

Mini-Micro Systems

A CAHNERS PUBLICATION

NOVEMBER 1984

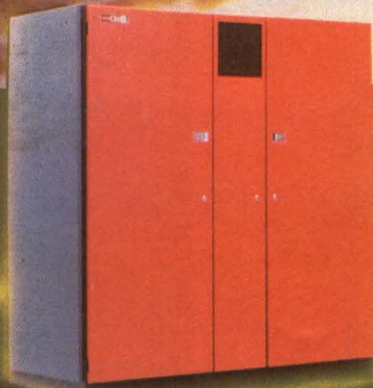

**Rolm connects
to IBM with micro,
board and PBX**

**Emulation software:
Turning micros
into mainframes**

**Multiprocessor system
achieves supermini
performance**

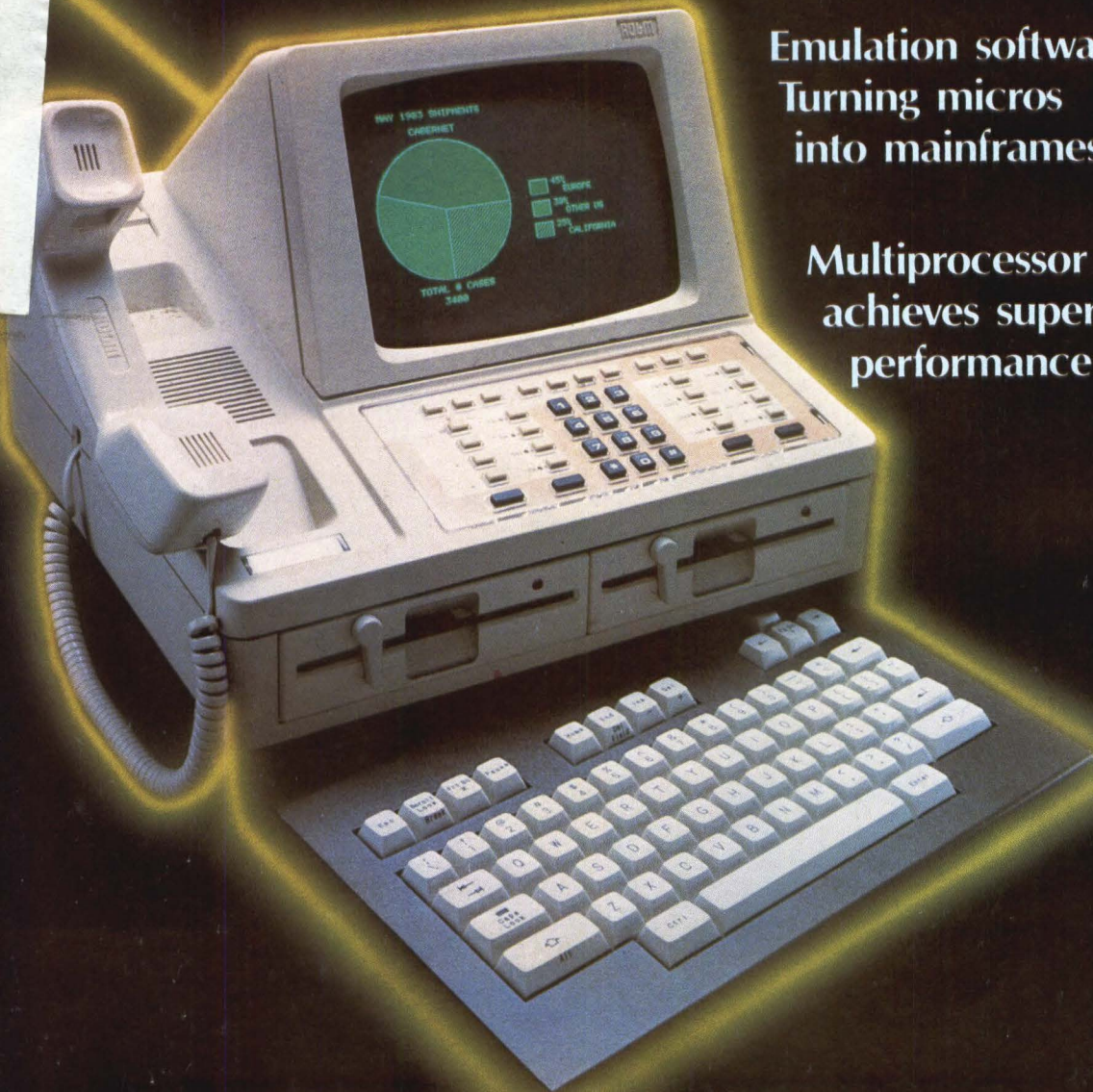

Model 6470 Cartridge Recorder — the latest distinguished member of a

PIONEER FAMILY

Kennedy didn't just pioneer the 1/4" cartridge field — it started it, with the first practical recorder using the new 1/4" 3M cartridge.

Model 6470 continues the tradition with the usual package of new features, such as:

- High Capacity — Model 6470 can store up to 54 MBYTES of formatted data on one cartridge.
- Start/Stop with data streamings at 37.5 ips.
- Full Command Repertoire, utilizing either the Pico Bus or Pertec interface.

- Automatic Read Thresholds — during read retry three different thresholds are automatically selected, a feature usually found only on large 9 track tape transports.
- Backward Compatibility — Model 6470 will read tapes written by Model 6455.

These are but a few of Model 6470's many features. Write or give us a call today for the complete story of the newest member of this oldest family.

KENNEDY

An Allegheny International Company

1600 Shamrock Ave., Monrovia, CA 91016

(918) 357-8831 • ITT TELEX 472-0116 KENNEDY

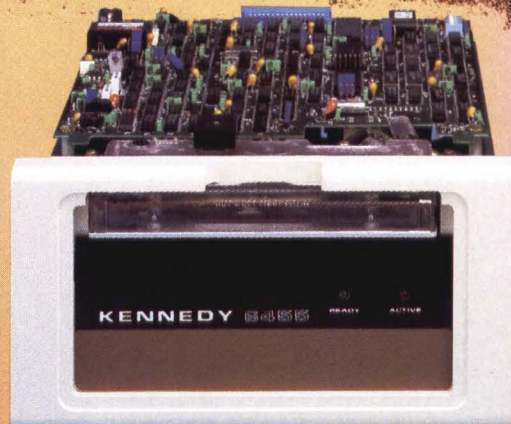

KENNEDY • QUALITY • COUNT ON IT

CIRCLE NO. 1 ON INQUIRY CARD



**If you have one of these,
Infotron can have you
communicating data
in just 48 hours.**

**Modems and stat
muxes, to go.**

Infotron offers a complete line. And now, with our unique distributor warehousing program, we can have any of them on your doorstep within 48 hours of your call. 48 hours, max. Just say the word.

Full system flexibility.

Infotron modems combine advanced features and inherent reliability.



Our statistical multiplexers handle from 4 to 32 channels in a range of models — with full provision for expansion.

All with the same high quality that earns us top marks in performance and reliability from our present users.

Add competitive pricing, and we start making real sense.

Then add our 48-hour delivery, and we're awfully hard to beat.

**To find out more.
Your Infotron distributor.**

There are Infotron distributors nationwide, ready to give you more information, provide equipment and offer expert advice on the best way to meet your needs. For the name of the distributor near you, dial toll-free 1-800-345-4636 and ask for ISO. Or write Infotron Independent Sales Organization, 9 North Olney Avenue, Cherry Hill, NJ 08003.

**Infotron. First in
performance and reliability.**

1-800-345-4636

CIRCLE NO. 2 ON INQUIRY CARD

 **INFOTRON** SYSTEMS

Mini-Micro Systems



p. 31 . . . Rolm bolsters its PBX network with the Cedar micro and the Juniper add-in board. Art direction and design by Bricker Associates. Courtesy of Rolm Corp.



p. 34 Window on the software world

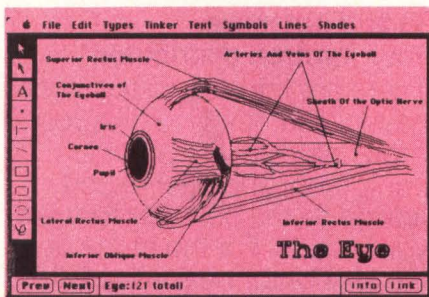

p. 45 Focusing on Apple software

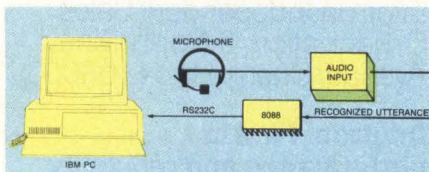

p. 56 Verbex amplifies IBM PC

MINI-MICRO WORLD News

- 31 Rolm integrates IBM PC compatibility into its proprietary PBX network
- 34 TopView begins IBM's shift to proprietary software
- 37 Oracle reduces size of relational DBMS for microcomputers
- 43 Heard on the Hill: High technology receives low priority in presidential campaign
- 45 Apple slices Macintosh software projections
- 46 Unibus-compatible controller combines 16 communications channels, dual emulation
- 51 Macrolink enters market for Perkin-Elmer disk controllers
- 54 Expandable Stride Micro family supports 22 users
- 56 Verbex voice-recognition terminal talks to IBM PC
- 62 Pathway Design steps into UNIX territory with micro-mainframe link
- 65 Megavault's high-capacity 8-inch Winchester access data in 18 msec
- 68 Daisy wheel printer prices must drop to slow advances of competing technologies

Corporate and Financial

- 75 Visicorp sells Visi^{On} technology to CDC, stresses marketing
- 77 Market Barometer: Sony's 3½-inch disk triumphs in micro market
- 77 Corporate and financial briefs

International

- 83 Britain's Torus Systems employs icons to help IBM PC users on local networks
- 86 Britain's Psion joins heated integrated-software market

*European News: E1 Ada activity increases despite low funding

E2 Explosion of products to market Data Recording's independence

E4 Fast-developing X.400 gains on Telex in popularity

E5 Pacific Perspective: Tangible results rally support for Japan's Fifth Generation computer project

*Appearing in the European edition only

INTERPRETER

- 103 Fiber-optic technology sheds light on local area networks
- 119 Superminicomputers climb to new levels of performance

INTEGRATOR

- 137 Publishing system streamlines document production

FEATURES

- 149 **Feature Highlights**
- 150 **Multiprocessor-based computer acts like super-mini . . .** tightly coupled multithread architecture and multiple buses serve high-speed information-management applications
- 165 **Low-cost terminals: More power for less . . .** faced with increased competition and falling prices, terminal manufacturers are cutting costs and looking ahead to automation and new market opportunities
- 183 **Terminal emulation software links micros to mainframes . . .** a variety of products convert micros into terminals that can access mainframe databases
- 199 **Software-transparent front-end processor links hosts, terminals to Ethernet . . .** Bridge Communications Inc.'s CS/1-X.25 communications server reduces computer-room cable maze, increases file-transfer speed
- 209 **COMDEX/Fall '84 preview . . .** spotlight is on multifunction products
- 219 **Color workstation offers winning combination of hardware and software . . .** Convergent Technologies' AWS scores high points with ergonomic design and powerful processor; loses a few for its BASIC compiler, linker
- 233 **Law column: Court restricts right to duplicate ROM software**

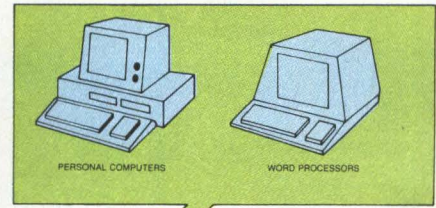

p. 137 Streamlining with CAP



p. 165 More power for less

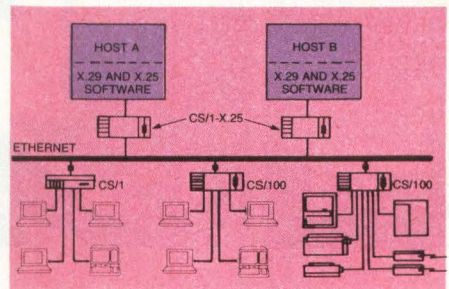

p. 199 Bridging the gap to Ethernet

DEPARTMENTS

- 4 Editorial Staff
- 11 Editorial
- 15 Breakpoints
- 242 New Products
- 270 Calendar
- 271 Classified Advertising
- 273 Career Opportunities
- 279 Index to Advertisers
- 280 Mini-Micro Marketplace

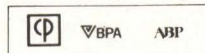

MINI-MICRO SYSTEMS (ISSN 0364-9342) is published monthly (with additional issues in spring, summer and fall) by Cahners Publishing Company, Division of Reed Holdings, Inc., 221 Columbus Avenue, Boston, MA 02116. Norman L. Cahners, Chairman; Saul Goldweitz, President and Chief Executive Officer; Ronald G. Segel, Executive Vice President and Chief Operating Officer. MINI-MICRO SYSTEMS is published by the Cahners Magazine Division: J. A. Sheehan, President; William Platt, Executive Vice President. Circulation records are maintained at Cahners Publishing Co., 270 St. Paul St., Denver, CO 80206. Second class postage paid at Denver, CO 80202 and additional mailing offices. Postmaster: Send address changes to MINI-MICRO SYSTEMS, 270 St. Paul St., Denver, CO 80206. MINI-MICRO SYSTEMS is circulated without charge by name and title to U.S. and Western Europe based corporate and technical management, systems engineers, and other personnel who meet qualification procedures. Available to others at the rate of \$55.00 per year in the U.S.; \$60.00 in Canada and Mexico; \$75 surface mail in all other countries; \$120 foreign air mail (16 issues). Special DIGEST issues, \$15.00. Single issues \$4.00 in the U.S.; \$5.00 in Canada and Mexico; \$6.00 in all other countries.

© 1984 by Cahners Publishing Company, Division of Reed Holdings, Inc. All rights reserved.

We've Built Unix Into More Micros Than Anyone Else...

and that's standard at UniSoft.

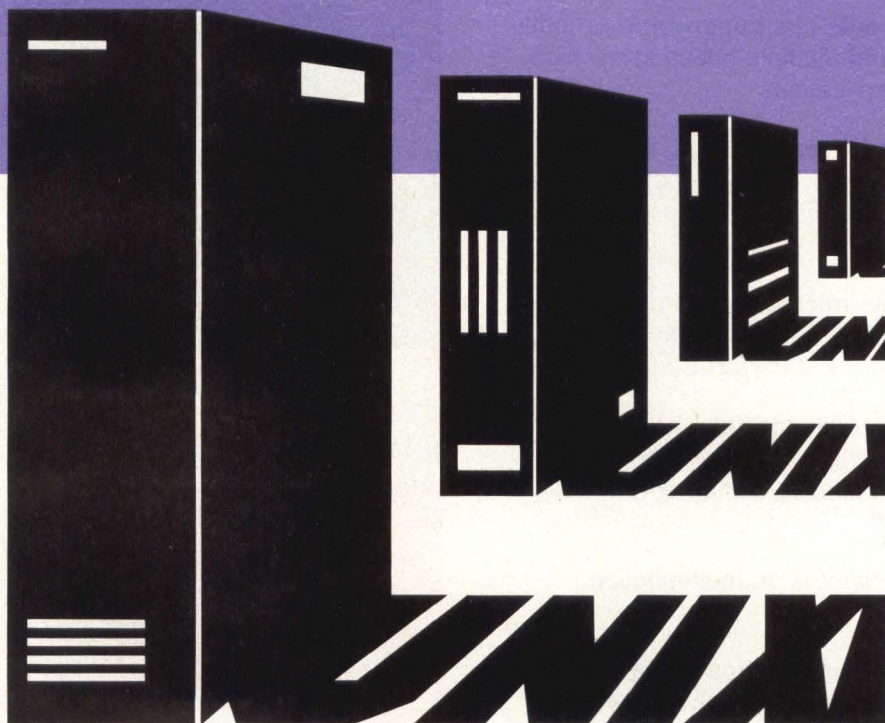

UniSoft has built Unix™ into 90 microcomputers (and the list is growing) from 60 manufacturers. That's more Unix porting and supporting than anyone else. And more manufacturers who have saved time and money, because of our experience. UniSoft can typically do the job for one fifth of the in-house time and expense. When the port is over, we don't vanish. Our standard family of services includes on-line updates, maintenance, software checks on our mainframe, and documentation (the clear, understandable kind). We also offer application and communications software.

Doing more. Being faster. Offering complete support. We know that this is exceptional behavior from a systems software house. But the exceptional is standard at UniSoft. (415) 644-1230, 739 Allston Way, Berkeley, CA. 94710. *Building System V now. Call or write for Your Building Plan.*

UniSoft

CIRCLE NO. 3 ON INQUIRY CARD

Unix is a trademark of Bell Laboratories.

STAFF

Vice President/Publisher
S. Henry Sacks

Editor-in-Chief
George V. Kotely

Managing Editor
James F. Donohue

Assistant Managing Editor
Bruce J. MacDonald

Senior Western Editor: **Jerry Borrell**
San Jose, (408) 296-0868
Senior Editor: **Lori Valigra**
Senior Projects Editor: **Rick Dalrymple**

Western Editor: **Carl Warren**,
Los Angeles, (213) 826-5818
Associate Editor: **Frances T. Granville**
Associate Editor: **Lynn Haber**
Associate Editor/Research: **Frances C. Michalski**
Associate Editor: **Tom Moran**,
San Jose, (408) 296-0868
Associate Editor: **David Simpson**
Associate Editor: **Marjorie Stenzler-Centonze**,
New York, (516) 595-2737
Associate Editor: **Michael Tucker**
Associate Editor: **Jesse Victor**
Assistant Editor: **David Bright**
Assistant Editor/New Products: **Eileen Milauskas**
Assistant Editor/Research: **Pamela Gorski**
Assistant Editor/Research: **Megan Nields**

Contributing Editors:

London: **Keith Jones**, (011-441-661-3040)
Data Communications: **Walter A. Levy**
Computer Architecture: **Efrem Mallach**
Office Automation: **John Murphy**
Frankfurt: **Maureen O'Gara**
Artificial Intelligence: **Steven Roberts**
Washington, D.C.: **Stephen J. Shaw**,
(202) 387-8666

Editorial Production

Senior Copy Editor: **Arsene C. Davignon**
Production Editor: **Mary Anne Weeks**
Copy Editor: **Gregory Solman**
Word Processing: **Kathleen Ewing**
Administrative Assistant: **Nancy Norton**

Editorial Services

Sharon Hassell, Terri Gellegos

Assistant to the Publisher: **Linda L. Lovett**

Executive Editor,
Cahners Computer Publications:
Alan R. Kaplan

Art Staff

Art Director: **Vicki Blake**
Assistant Art Director: **Cynthia McManus**
Artist: **Anne Tregay**

Director of Art Dept.: **Norm Graf**

Production Staff

VP Production: **Wayne Hultizky**
Supervisor: **William Tomaselli**
Production Manager: **Lisa Sisterhenm**
Composition: **Diane Malone**

Editorial Offices

Boston: 221 Columbus Ave., Boston, MA 02116. (617) 536-7780. **Irvine:** 2041 Business Center Dr., Suite 109, Irvine, CA 92715. **Los Angeles:** 12233 W. Olympic Blvd., Los Angeles, CA 90064. **San Jose:** 3031 Tisch Way, San Jose, CA 95128. **New York:** 33 Arcadia Dr., Dix Hills, NY 11746. **London:** Business Press International, Quadrant House, The Quadrant, Sutton, Surrey, SM2 5AS, England.

Reprints of Mini-Micro Systems articles are available on a custom printing basis at reasonable prices in quantities of 500 or more. For an exact quote, contact Art Lehmann, Cahners Reprint Service, Cahners Plaza, 1350 E. Touhy Ave., Box 5080, Des Plaines, IL 60018. Phone (312) 635-8800.

The Firebreathers from Gould blast the competition into oblivion.

With blazing performance.

Great leaps in raw performance are rare in the computer world. Usually, changes occur in increments of half-a-MIP or so. Now real Firebreathers roar into the arena, quadrupling the best the competition has to offer.

With scorching speed.

These creatures don't run a little faster. Running real production code supplied by VAX™ users, our PowerNode™ 9000 benchmarks at 4.5 times faster than the VAX 11/780... at a comparable price! Even our second-in-line

PowerNode 6000 runs 1.5 times faster. But with all this power and speed, the PN6000 has a dainty footprint... 60% less than the VAX 11/780.

With sizzling simplicity.

Even the hottest firebreather won't fly if it's hard to run. Ours are UNIX*-based, so ease of use and compatibility become part of the power. Plus we offer the "Compatibility Suite", application software packages which are consistent across our entire Gould PowerSeries™ product line... the widest range of UNIX-based systems in the world.

More than a myth.

We know these claims sound outrageous. Make us prove them. Give us your benchmarks and production code. We'll show you

numbers that surpass all expectations. Call 305-797-5459 for a test flight on the Firebreathers. Main-frame performance disguised as a supermini. The scorching performance you expect from Gould.

Gould Inc.,

Computer Systems Division
Distributed Systems Operation
6901 West Sunrise Boulevard
Ft. Lauderdale, FL 33313

* UNIX is a trademark of AT&T Bell Laboratories

™ PowerNode and PowerSeries are trademarks of Gould Inc.

™ VAX is a trademark of Digital Equipment Corp.



CIRCLE NO. 4 ON INQUIRY CARD



GOULD
Electronics

OUR DRIVES ARE MORE RELIABLE BECAUSE WE ONLY USE PARTS FROM RELIABLE COMPANIES.

Reliability. It's one of those attributes that takes years to earn.

And it's one of the strongest elements you'll find in everything Tandon does. Whether it's parts or delivery or the way we handle our business.

Take our vertical integration story, for instance. That's always set us apart from other OEM suppliers. About 80% of the cost of our drives is made up of parts we manufacture ourselves. From the button heads to printed circuit boards to the plated media in our Winchesters.

Consequently, we have unyielding quality control. Tighter specs. An independence from outside suppliers so we get what we want when we need it, right from our own factories.

That's how we've become the most cost-

effective company in one of the most competitive markets around.

And because we're well aware of the investment you make in a drive, we've set our standards high. So high, in fact, you're absolutely assured of superior performance from every Tandon drive. And, naturally, at the lowest possible price.

Our floppy and Winchester manufacturing divisions are structured to be the highest quality, lowest cost producers.

Each one gives special attention to the demands of its customers. And each has the stable corporate background that gave us the ability to go from a garage start-up to the industry leader.

All in all, no one makes better disk drives than Tandon. Because reliability is the best part we've put in them.

Tandon

THE DRIVING FORCE BEHIND THE SMALL COMPUTER INDUSTRY.

Tandon Corporation, 20320 Prairie, Chatsworth, CA 91311. (818) 993-6644, TWX: 910-494-1721, Telex: 194794. Regional Sales Offices: Boston (603) 888-8612 • New York (201) 851-2322 • Atlanta (404) 934-0620 • Chicago (312) 530-7401 • Dallas (214) 423-6260 • Irvine (714) 669-9622 • Santa Clara (408) 727-4545 • Kelsterback/Frankfurt, West Germany 6107-2091, Telex: 411547 • Reading/London, England (0734) 664-676, Telex: 848411. Distributors: Hall-Mark, Kierulff, Schweber.

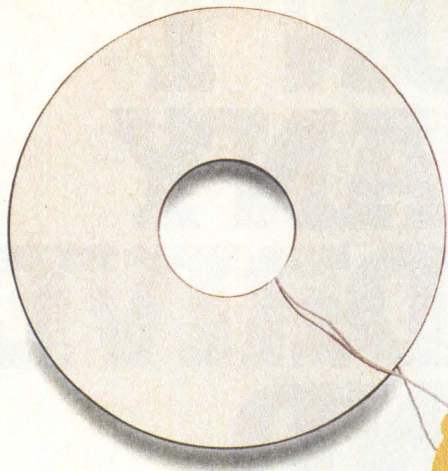

Made by
Tandon

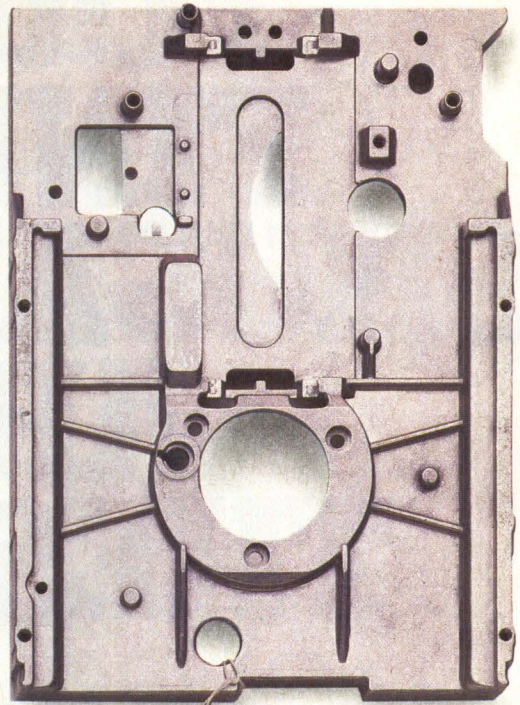

Made by
Tandon

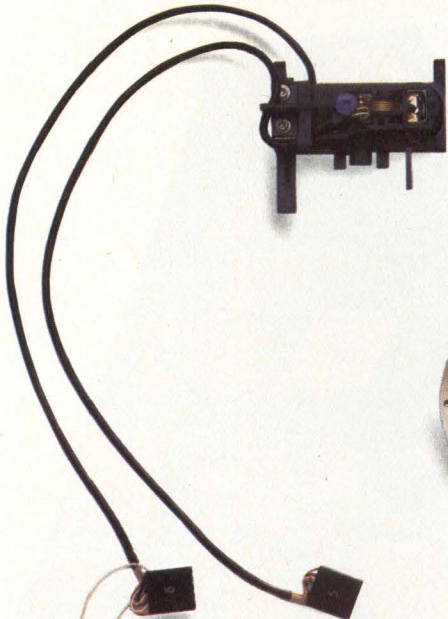

Made by
Tandon

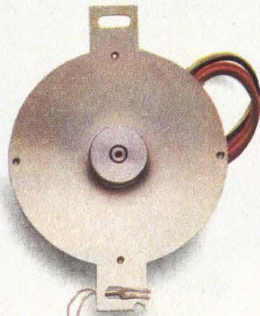

Made by
Tandon



Made by
Tandon

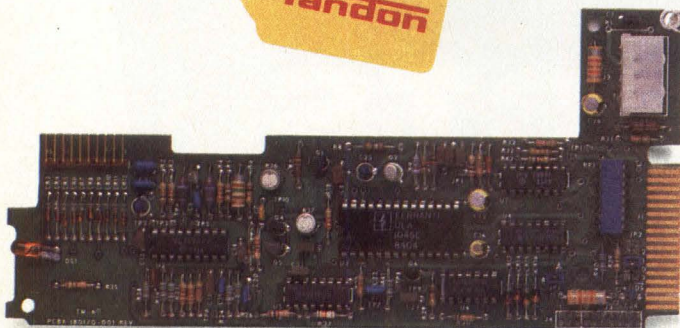

Made by
Tandon

CIRCLE NO. 5 ON INQUIRY CARD

**YOU WON'T
FIND MANY
SHUGART DRIVES
AROUND
THESE PARTS.**



You find Shugart new generation drives where they were built to be. In all kinds of systems. Under all kinds of conditions. Running. And running and running.

Setting a world standard for quality. A standard that doesn't allow room for failure. Because you don't.

To insure the reliability of your system, we begin with our suppliers. They go through a lot. Learning and qualifying, even building drives themselves.

We also involve our manufacturing engineers. And our quality control experts. From the very beginning. The design stage.

With their full collaboration, every new drive is designed for top quality. Unbeatable reliability. And ease of assembly. Using the fewest number of parts possible.

In other words, the same un-

compromising quality you design into your system is designed and built into every new Shugart drive. Right from the start. So you can count on consistent reliability. For example, 20,000 hours MTBF for new generation Winchesters.

Of course, every Shugart drive is subject to the most stringent testing and inspection at every stage. But inspection doesn't insure quality. At Shugart, we believe there's only one way to insure a reliable product. By eliminating the cause of failure from the product design.

At Shugart, quality is designed in. Not inspected in.

Let us prove it. Call Doug Daetz, our Director of Corporate Quality at (408) 737-3009 for details.

Shugart

Right from the start.

See us at Comdex between aisles 2700 and 2800

50,000 DRIVES DELIVERED

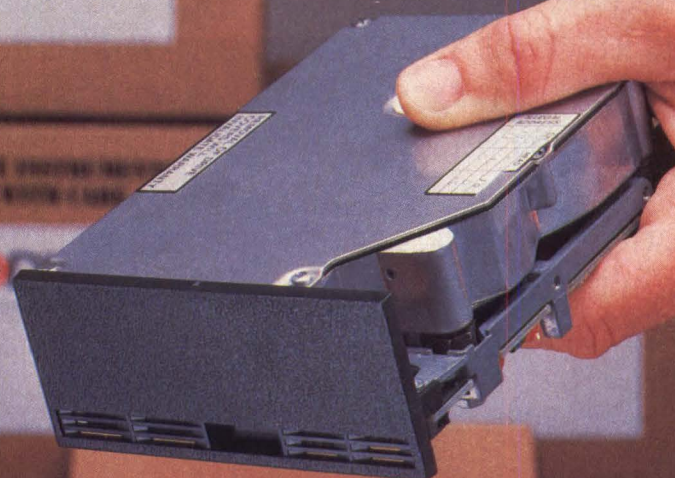

WE'VE BEEN DELIVERING 3 1/2" WINCHESTER DISK DRIVES FOR OVER A YEAR.

Rodime has been setting a new standard in Winchester disk drive storage for more than a year. Its 3 1/2" drive with 5 and 10 megabytes of formatted storage has become the industry leader for sub 4" Winchester disk drives. Rodime has now delivered tens of thousands!

The proven compact drive and proven quantity supplier

With thousands of its 3 1/2" Winchester drives in operation today Rodime has further demonstrated its reputation for reliability, a major design consideration for its 3 1/2" drive, and quality. It has a rugged design with high resistance to shock, an important consideration for portability and for vibration prone environments. Using advanced large-scale integration, the entire electronics for the drive are on a single compact board and there are no adjustments or select-on-test components.

New design horizons

The compact size of Rodime's drive suddenly puts large-scale storage into areas never considered before. The 350 series is one-fourth the volume of a 5 1/4" Winchester drive. And the 250 series, which includes



mounting brackets and a face plate, fits into the same space as a half-height 5 1/4" Winchester offering even further shock and vibration isolation. Now, system designers have a new level of flexibility. One area that has received attention is use with portable computers. Several major portable computer manufacturers have already incorporated Rodime 3 1/2" Winchester disk drives into

their products. There are other equally exciting areas such as desk top computer systems, intelligent terminals, point-of-sale terminals, industrial controllers, telecommunications systems, navigation and guidance systems, and portable instrumentation. In fact, the list of potential uses is only limited by the imagination of the system designer.

A tradition of excellence

In a few short years, Rodime has established itself as a major force within the Winchester disk drive industry. Rodime is one of the few manufacturers that are delivering 5 1/4" Winchester drives with a broad range of capabilities up to 54 megabytes. And is the only manufacturer delivering high-performance 3 1/2" Winchester drives in production quantities.

For the compact 3 1/2" Winchester disk or other 5 1/4" Winchester requirements, look to Rodime. Rodime delivers.

Boca Raton, Florida: 901 Broken Sound Parkway N.W., Boca Raton, FL 33431

Tel: (305) 994-6200 Tlx: 529566

Glenrothes, Scotland: Rothesay Place, Glenrothes, Fife, KY7 6PW, Scotland

Tel: 0592 757441 Tlx: 728239

Western U.S. Sales Office: 25801 Obrero—Suite 6, Mission Viejo, CA 92691

Tel: (714) 770-3085 Tlx: 683466

Eastern U.S. Sales Office: 6448 Highway 290 East, Suite E 100, Austin, TX 78723

Tel: (512) 453-5135 Tlx: 767139

©1984 Rodime, Inc.

RODIME

See us at Booth #H7258

COMDEX™/Fall '84

CIRCLE NO. 6 ON INQUIRY CARD

Value-added resellers escalate vertical markets



Because software packages are becoming extremely complex, and highly competitive hardware retail marketing is strangling profit margins, computer hardware and software manufacturers have turned to value-added resellers (VARs) to penetrate new and more profitable markets.

In fact, according to a major industry study conducted by *Mini-Micro Systems*—the trade journal of the value-added marketplace—sales of minicomputers and microcomputers in 1984 through the value-added marketing channel will exceed \$50 billion. Another recent study by Digital Equipment Corp. estimates a \$111 billion market among first-time users in vertical markets alone over the next five years.

But who are these VARs? By *Mini-Micro Systems'* definition, VARs are system houses, consultants (who configure systems), computer distributors/dealers (who configure systems) and third-party system integrators. They all share a common purpose: They provide hardware and software system solutions, not just products. To accomplish this goal, VARs buy computer hardware from manufacturers, add on hardware and/or software (the added value concept) and resell the complete system to end users. Equally important, VARs also provide system support, training and service.

In this manner, VARs help customize products that aim at meeting specific applications needs. In turn, these products infiltrate untapped vertical markets. Although the VARs' approach has been around for several years, it has recently emerged as a significant marketing channel for many companies mired in stagnant sales growth. In fact, most of the computer industry is now emphasizing vertical marketing channels instead of horizontal ones.

For example, on the software side, Lotus Development Corp. has recently made software tools available to software development VARs. These tools enable VARs to structure specialized packages that augment Lotus 1-2-3 software. Likewise, MicroPro International Corp. is licensing several run-time versions of its products to VARs for integration into tailored packages.

Other microcomputer software companies that have opted for the VARs' approach include Ashton-Tate, American Business Systems Inc., RealWorld Corp. and Digital Research Inc.

On the hardware side, IBM Corp., Apple Computer Inc. and Tandy Corp. pioneered the development of personal computer system-integration sales channels. In addition, over the past two years, Digital Equipment Corp., Data General Corp., Wang Laboratories Inc., Texas Instruments Inc. and Hewlett-Packard Co. have introduced personal computer products and programs geared toward VARs.

And still more companies appear poised to enter the VARs marketing channel. Informal surveys made by *Mini-Micro Systems'* staffers reveal a dramatic movement of various software packages into vertical markets, such as medical, legal, industrial, financial and engineering. These markets open up extra sales opportunities that would otherwise be difficult or even impossible to reach. Furthermore, customized systems translate into accessibility to more end users. Whether computer products are designed for general or special-purpose use, skilled VARs can still add value and therefore increase market availability.

On the debit side, though, vertical markets call for unique solutions to unique problems at satisfactory costs. To achieve those solutions, computer systems must be changed, modified, tailored or customized to a particularly narrow need—not a trivial task. Equipment manufacturers cannot meet this need because they can't anticipate all requirements for all users. Knowledgeable VARs do meet this need, however, by integrating add-on hardware/software into a capable product. In addition, by not reinventing the wheel, VARs get cost-effective products to market in short turnaround times.

VARs will play a key role in overcoming the presently soft sales period and reduced growth rate in the computer industry. What's more, for some computer, peripheral and software companies, the VARs' approach means sheer survival; for others, a potentially lucrative market growth.

A handwritten signature in cursive script that reads "George V. Kotlley".

George V. Kotlley
Editor in Chief

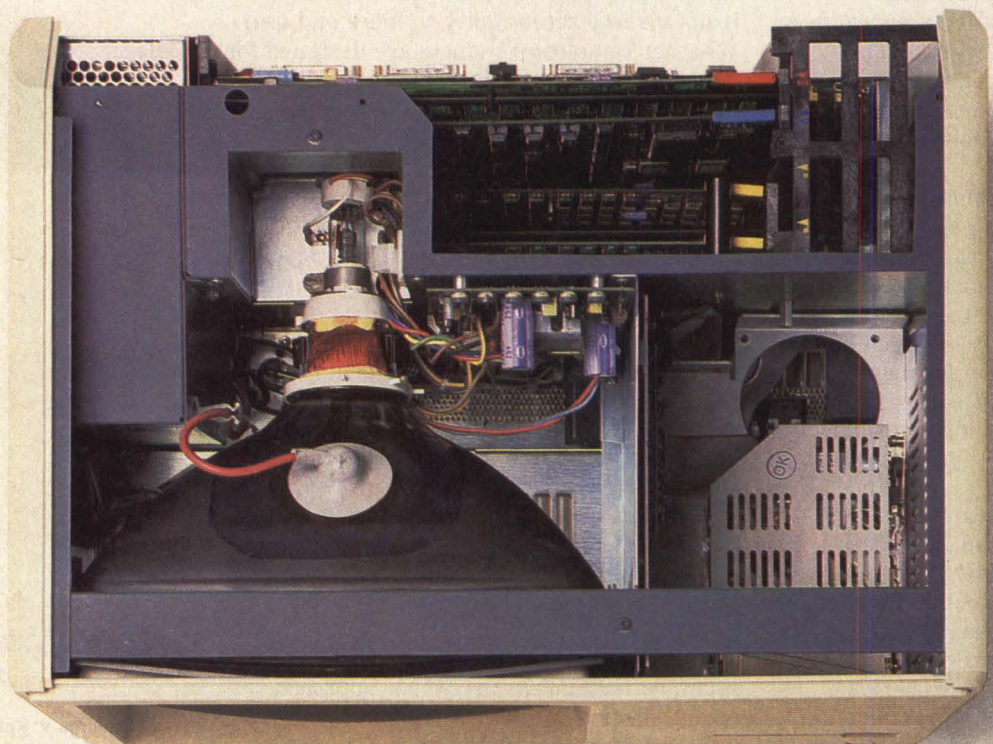
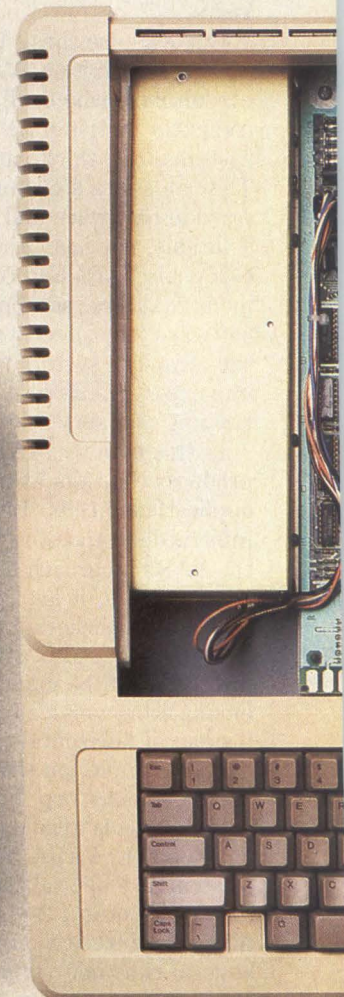
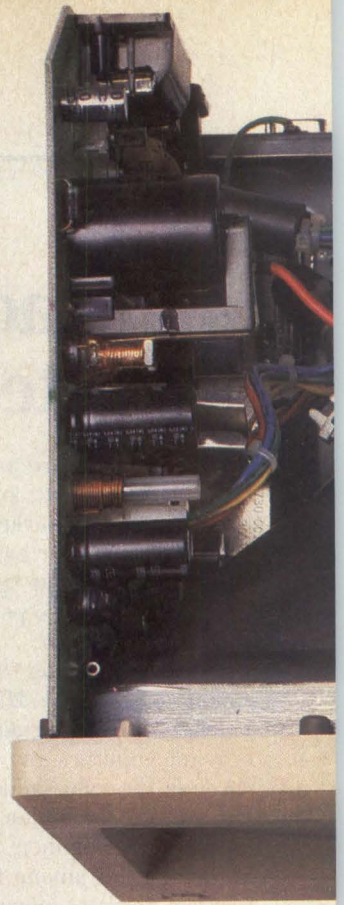
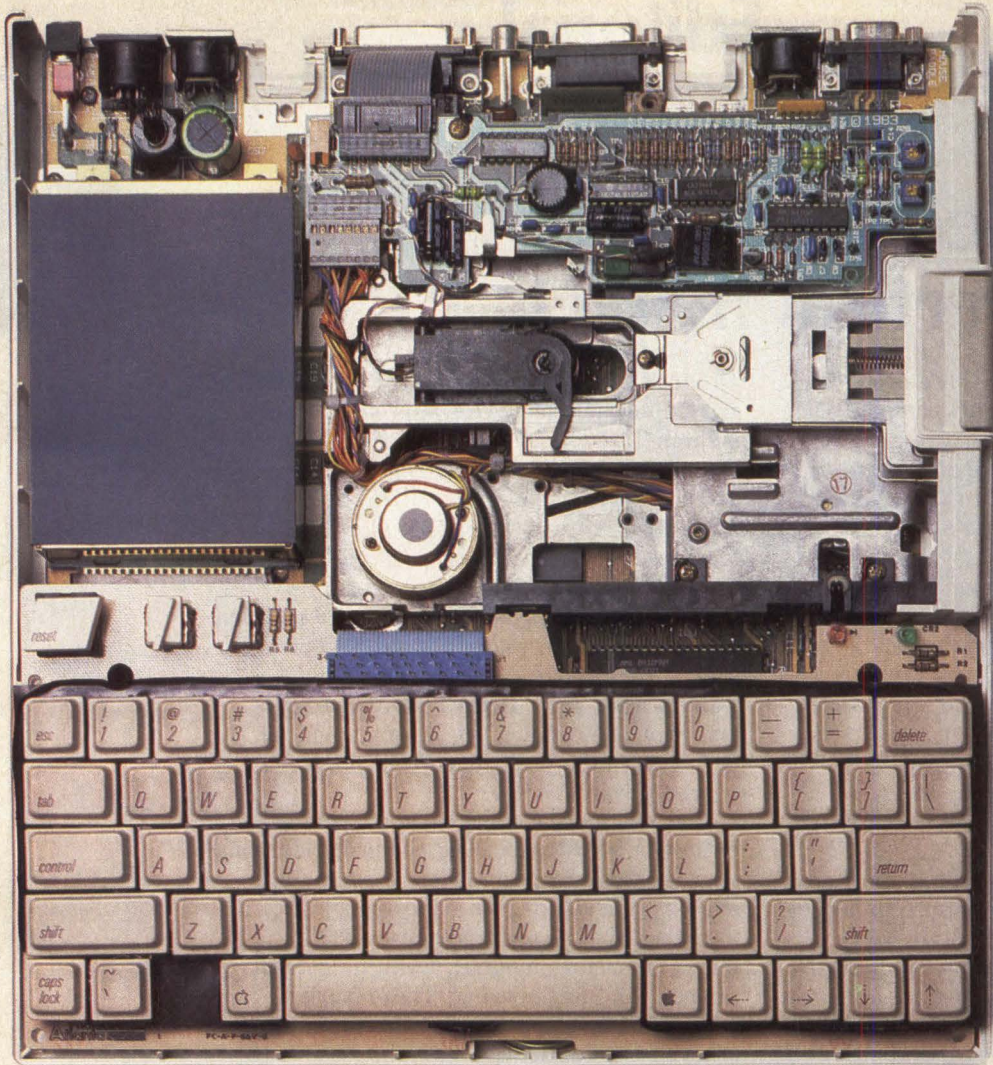

Pick our brains.

When you pick the technology you'll be building your name on, we not-so-humbly suggest you pick the technology we built our name on.

Apple technology.

Not, mind you, because we're the only ones who can offer VARs the technological versatility of the Apple® II family and the wizardry of Macintosh™ and Lisa®.

But because no matter which Apple you pick, you get all the brain power behind the machines that made the company. And the company that made the machines.

A complete VAR program that not only includes the standard technical documentation and programmer's tool kits, but financial, marketing, service and technical support. Plus VAR representatives to help you work out little details. Like how to merchandise your product. How to package it. How to develop it. How to pay for it. Even how to lease.

Just call 800-445-8277* and ask for the VAR sales representative nearest you.

Because picking our brains is as easy as picking up the phone.



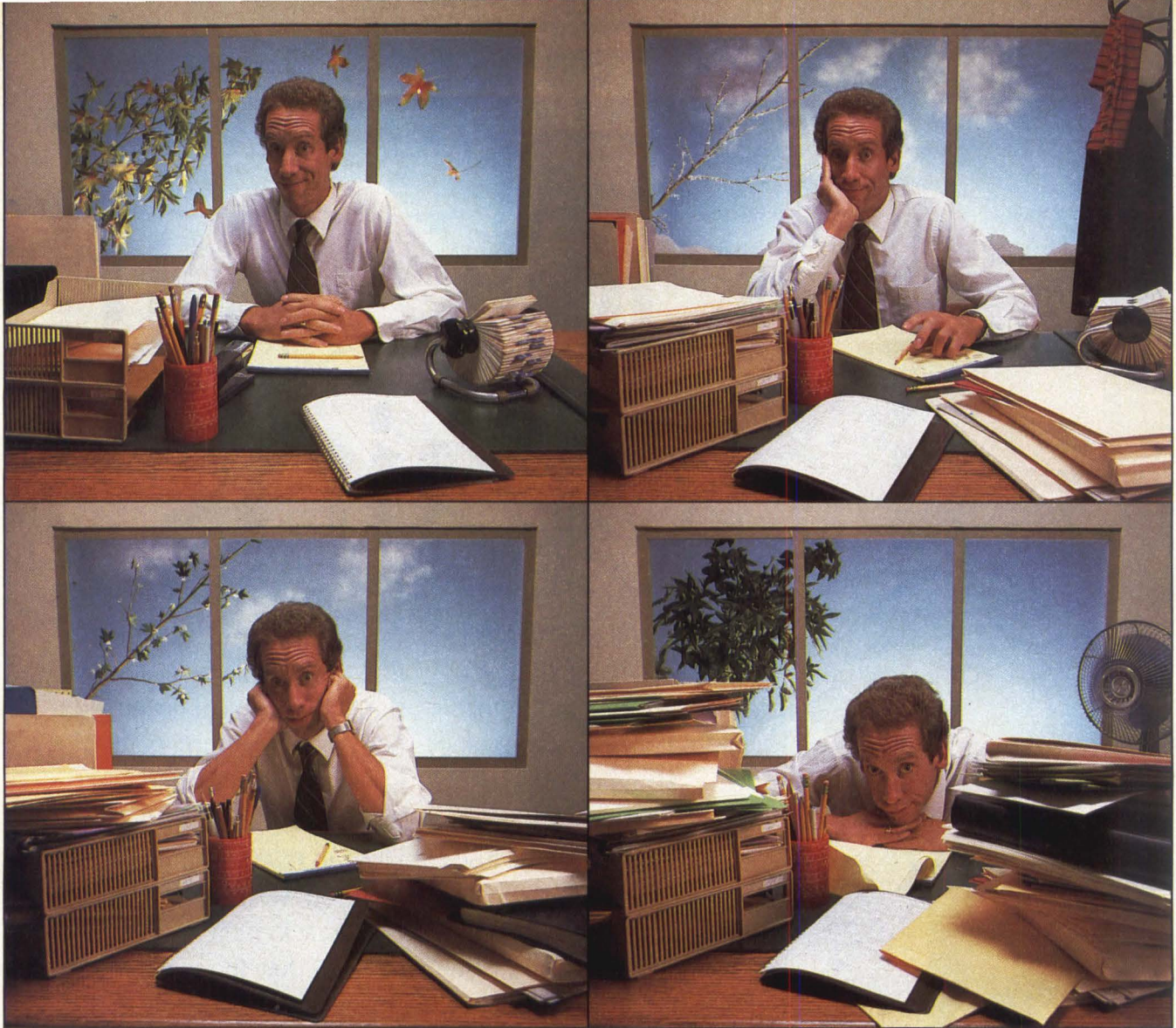

The DEC[®] VT220 you've waited for still isn't here.

**But the No. 1
alternative is.**



pluses over a DEC. Yet, it costs less.

The pluses:

Four additional enhanced menus. Display. General. Auxiliary Port. And Keyboard.

A convenient front-mounted on/off switch, not rear mounted like DEC's. A keyboard jack near the front, providing more cable length. And a 3-position keyboard elevating mechanism.

Plus, two more LED's than you'll find on the DEC keyboard. One for online, the other for shift lock.

See us at Comdex, Booth #s 1730 & 1736

CIRCLE NO. 8 ON INQUIRY CARD

What DEC announces, CIE Terminals delivers. Faster. Better. And more economically.

The new CIT220+ is available right now.

It has at least a dozen

A bi-directional Auxiliary Port, not just uni-directional like DEC's. So you can add either a printer or second host.

Plus, variable speed smooth scroll for fast or slow review.

And the pluses go on, including even more built-in reliability. So it stumps us why anyone would go on waiting for a DEC when you can get the 220 with all the pluses right now.

For immediate information, call (714) 660-1421 or phone toll free 1-800-854-3322. Ask for our Information Desk. Or write CIE Terminals, 2505 McCabe Way, Irvine, CA 92714.

CIE TERMINALS
A CITECH ELECTRONICS COMPANY

® DEC is a Registered Trademark of Digital Equipment Corp.
© 1984 CIE Terminals.

Breakpoints

SEAGATE TO INTRODUCE THREE DISK DRIVES, INCLUDING 3 1/2-INCH WINCHESTER

Seagate Technology, Scotts Valley, Calif., scheduled three disk drives for introduction at the recent Comdex show in Las Vegas, including the ST112, a 12.76M-byte (unformatted), 3½-inch Winchester drive supporting the ST412 interface. The company plans to ship the \$495 (for 1,000-unit purchases) drive this month. Seagate chairman Alan F. Shugart says the drive eventually will store 20M bytes (formatted) of information, but will require new media to achieve that density. The two other newcomers are the ST225, a half-height 25.52M-byte (unformatted), 5¼-inch Winchester, and the ST451, a 51M-byte (unformatted) Winchester disk drive. In a related development, Seagate plans to build all of its own stepper and spindle motors, beginning with the ST112 and ST225 drives.—L. Valigra

DRI ANNOUNCES MACINTOSH-LIKE INTERFACE FOR MS-DOS

Digital Research Inc., Pacific Grove, Calif., early this month planned to announce an Apple Computer Inc. Macintosh-like user interface for MS-DOS machines. Code-named "Crystal," the single-tasking Graphics Environment Manager (GEM) runs on IBM Corp. and AT&T Co. personal computers, as well as on IBM PC-compatibles with 256K bytes of RAM, two floppy disk drives, a bit-mapped graphics display and a mouse. GEM, which is an addition to the MS-DOS operating system, features overlapping windows and replaces operating system commands with icons and pull-down menus. DRI plans to work closely with OEMs to develop the screen drivers necessary for porting GEM from machine to machine. Availability for GEM, related presentation-graphics applications and a programmer's toolkit is scheduled for the first quarter.—D. Bright

RESHAPED OSBORNE COMPUTER CORP. BRINGS OUT ITS FIRST PRODUCT

Osborne Computer Corp., Fremont, Calif., is introducing the Vixen transportable microcomputer, its first hardware product for the U.S. market since the company reorganized under Chapter 11 bankruptcy protection earlier this year. The \$1,298, 22-pound Vixen comes with a Z80A processor, 64K bytes of RAM, a 7-inch amber display, two 390K-byte 5¼-inch floppy drives, a parallel port and an RS232 serial port. Bundled software includes CP/M 2.2, WordStar 3.3, MailMerge, SuperCalc 2, and MBASIC. Osborne also offers the Osboard electronic drawing board and the Media Master software that allows data disk transfers between PC-DOS, MS-DOS and CP/M machines.—T. Moran

MORROW DESIGN DEBUTS BOOK OF QUOTATIONS FROM ITS OUTSPOKEN CHAIRMAN

"The Quotations of Chairman Morrow," a red-bound book listing the more notable quotations of Morrow Design (San Leandro, Calif.) founder and chairman George Morrow, was expected to make its debut in Las Vegas at COMDEX. Morrow's colorful comments, which began when the former short-order cook started his computer company, include, "If George Lucas designed a lunch pail for Darth Vader, it would look like a Kaypro," and "I believe in standards. Everyone should have one."—L. Valigra

Breakpoints

THEYSYS BOOSTS IBM PC AND XT MEMORY CAPABILITY

Startup company Thesys Memory Products Corp., Scottsdale, Ariz., has developed some add-in cards that enhance the memory capabilities of the IBM PC/XT and compatible microcomputers. The Fastcard main memory extension, which should be shipped this month, is priced at \$495. It expands memory by 400K bytes, with 18K bytes used as a disk cache. A company spokesman says the memory expansion can exceed 640K bytes by using bank switching. To enhance storage capability, the Fastfile, which also uses 256K-bit dynamic RAMs, is designed to serve as a fast Winchester, ranging in size from 1M byte to 5M bytes. The Fastfile allows 1M-byte-per-second data transfers and has an access time of 250 microseconds for a 512K-byte block of data. The price for 1½M bytes is \$1,795; 3M bytes is \$2,795; and 5M bytes is \$3,495.—C. Warren.

CORTEX' CAD/CAM-LIKE SOFTWARE AIDS BUSINESS PROGRAM DEVELOPMENT ON VAXs

The first in a series of programs incorporating CAD/CAM-like diagramming techniques to automate business software development should be introduced by Cortex Corp., Wellesley, Mass., early next month. Called the Cortex Action Diagrammer, the program gives a graphical representation of very high-level program code that lets software writers add sophisticated program logic to generated code more easily. The product is for use on Digital Equipment Corp.'s VAX minicomputers.—L. Valigra

CITIZEN AMERICA AIMS AT DOT-MATRIX PRINTER AND 3½-INCH DISK MARKETS

Japan's Citizen America Corp., which recently opened its U.S. offices in Santa Monica, Calif., announced plans to move into the volatile dot-matrix printer market with a series of low-profile and low-cost printers. The model MSP-10, 80-column unit sells for \$549, and the model MSP-15, 136-column printer sells for \$799. Both operate at 160 characters per second. In addition to printers, the company plans to begin shipping half-height 3½-inch, Sony-compatible flexible drives. The 1M-byte drives are one inch high, and can operate on battery power for portable computer applications.—C. Warren

CHIP BRIDGES GAP BETWEEN 8- AND 16-BIT IBM PC AND PC-COMPATIBLE MACHINES

Add-in board manufacturers who want to make IBM Corp.'s large base of installed 8-bit Personal Computers compatible with the company's new 16-bit PC-AT computers can incorporate on their boards an application-specific converter chip from Edsun Laboratories Inc., Wayland, Mass. The EL-286-88 VLSI circuit converts 80286 signals to the equivalent signals of an 8088, and solves the problem of driving slow, 8-bit 8088 peripherals with a fast 80286 processor. The chip is priced at \$48 in quantities of 10,000. The company planned to demonstrate the chips at the COMDEX show in Las Vegas.—L. Valigra

MINISCRIBE BOOSTS 5¼-INCH WINCHESTER CAPACITY TO 86M BYTES

Miniscribe Corp., Longmont, Colo., expected to show its model 6086, 86M-byte (unformatted) 5¼-inch Winchester drive at the COMDEX show in Las Vegas. The new drive has a 30-msec average access time and is ST506/412

OUR MULTIBUS CONTROLLERS ALREADY SPEAK YOUR LANGUAGE.

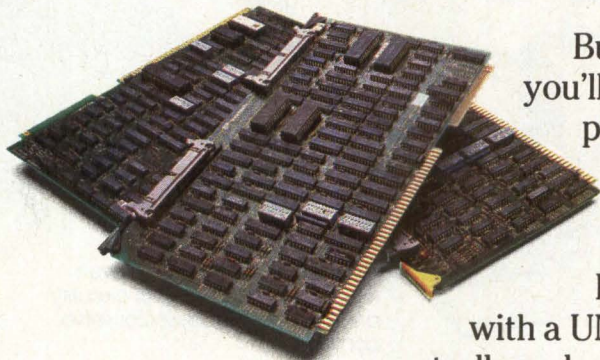

Buy anybody else's multibus* controllers and you'll probably spend a lot of time and money programming them to communicate with your system.

Buy ours and you can start talking right away.

Every Systech multibus controller comes with a UNIX Device Driver.** And because our controllers also contain a self-test program, you can install and check them out without CPU support or software development.

Systech engineers have considerable experience with the Motorola 68000 microprocessor, various hardware technologies and the UNIX operating system. This experience plus our software support ensures easy integration of our controllers into your systems.

We also ensure quality and reliability by subjecting our finished products to extreme variations of temperature and voltage in our environmental test chambers.

And we back our products with extensive technical documentation, a 12-month warranty and the best customer service program in the industry.

Applications of our multibus controllers include printer controllers, tape controllers and multi-channel communication controllers for multibus-based computer systems. For details, please send in the attached card. Or contact Systech Corporation, 6465 Nancy Ridge Drive, San Diego, CA 92121; (619) 453-8970.

You'll find that we speak your language, too.

ST **systech**™

*Multibus is a trademark of Intel Corp.

**UNIX is a trademark of Bell Labs. Available to licensed users.

RSD—THE DISK DRIVE WITH REMOVABLE MEDIA GIVES YOUR CUSTOMERS A SENSE OF SECURITY.

TOLL FREE
HOTLINE

1-800-828-8001

EXT. 82

IN MINNESOTA
(612) 921-4400

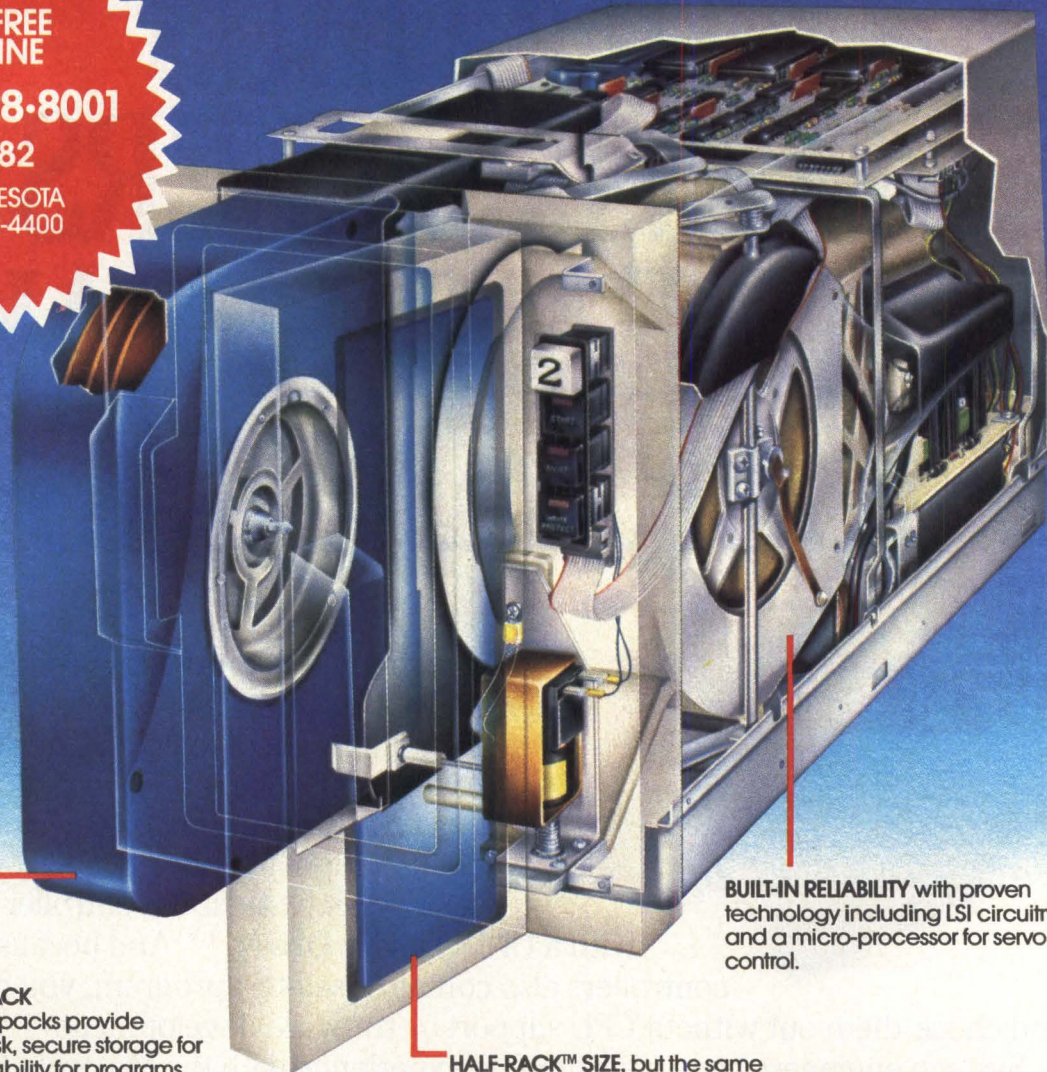

REMOVABLE DATA PACK

80 megabyte data packs provide backup for fixed disk, secure storage for vital data and portability for programs and data.

BUILT-IN RELIABILITY with proven technology including LSI circuitry and a micro-processor for servo control.

HALF-RACK™ SIZE, but the same capacity, speed and performance as the CDC® Storage Module Drive (SMD) in a unit half the size.

T H E R S D

The model 9710-80 disk drive is rapidly becoming a standard in removable data storage. Not only because it's a companion to our very successful FSD but because systems often need the advantages of removable media.

For information call your local Control Data OEM sales representative; call the toll-free number shown above or write: OEM Product Sales, HQW08X, Control Data Corporation, P.O. Box 0, Minneapolis, MN 55440. Also available through your Arrow or Kierulff Distributor.

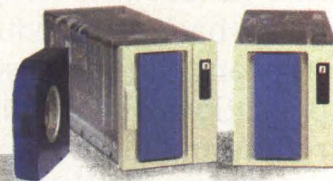

GD CONTROL DATA

Breakpoints

interface-compatible. Pricing hasn't been set, but a company spokesman said it would be less than \$2,000. Evaluation models should be available this quarter.—C. Warren

IBM PC USERS CAN ACCESS MAINFRAMES WITH DOS COMMANDS

Forte Data Systems, San Jose, Calif., is expected to make available in January its Off-Net micro-to-mainframe communications software and boards to OEMs and system integrators. Off-Net is designed to act as a DOS environment around a mainframe, enabling IBM PC, PC/XT or PC-AT users to access the mainframe with the same DOS commands used to access locally stored data. Pricing has not been set.—M. Stenzler-Centonze

PLEXUS LAYS THE FLOOR IN ITS MC68000 SYSTEM LINE

To broaden the product range which its OEMs and value-added resellers offer, Plexus Computers Inc., San Jose, Calif., plans to add the P/15 low-end system to its line of MC68000-based UNIX microcomputers by mid-November. The P/15 accommodates one to eight users, and includes two MC68010 processors and the virtual memory implementation of Motorola Inc.'s MC68000. With the P/15, Plexus marks its first use of 256K-bit RAMs. An entry-level system with ½M bytes of memory, a 10M-byte Winchester disk drive and a floppy disk drive sells for \$11,000 to \$15,000. The previous low-end system was priced at \$19,000. Plexus' top-end model supports as many as 40 users.—L. Valigra

LIBERTY EXPANDS TERMINAL LINE

Liberty Electronics USA, San Francisco, planned a COMDEX introduction of two graphics terminals. The new products are the \$1,395 Freedom 240, a DEC VT240-compatible monochrome graphics terminal, and the \$1,295 Freedom 210, an ASCII graphics terminal. Both have 665- by 288-dot resolution displays and are compatible with Tektronix Inc. 4010/4014 graphics software.—T. Moran

PRIAM PACKS 70M BYTES IN HALF-HEIGHT 5¼-INCH WINCHESTER

Developed for multitasking microcomputer systems, the model 201 5¼-inch half-height Winchester from Priam Corp., San Jose, Calif., sports an unformatted capacity of 70M bytes and an average access time of 25 msec. The four-platter model uses sputtered media, and has an ST412 compatible interface. The drive is planned for formal introduction in February, 1985. Evaluation units should be ready by the third quarter of next year and production units by the year end.—C. Warren

LAN FOR MACINTOSH INCLUDES DBMS

Lutzky-Baird Associates, Los Angeles, has designed a local area network that links as many as 40 Apple Computer Inc. Macintosh personal computers. The Ultra Office series centers on UNIX System V-based cluster processors that host the Macintoshes over a baseband cable. Supermicrocomputers, such as Charles River Data Systems' Universe 68 and Zilog Inc.'s new Z8000 Series Two, are used as cluster processors. The software includes a UNIFY

Breakpoints

database management system with a Macintosh shell on top for direct queries. By linking the cluster processors, as many as 1,500 Macintoshes can be supported. Pricing has not been set.—D. Bright

TECH FILES: A QUICK LOOK AT INDUSTRY DEVELOPMENTS

SOFTWARE FILES: IBM Corp. has endorsed graphics standards-based software with the latest introductions of graphic display boards and professional graphics series software for the Personal Computer. The graphics encompass the Graphical Kernel System (GKS), Virtual Device Interface (VDI) and Virtual Device Metafile (VDM), all of which are being considered by ANSI standards committees.—C. Warren

Communications Solutions Inc., San Jose, Calif., has adapted its Access/SNA software to work with systems running UNIX. The product enables UNIX users to access IBM mainframes through IBM's Systems Network Architecture protocols. Access/SNA can be used with UNIX System III, System V and XENIX operating systems. Licensing fees range from \$75,000 to \$100,000.—M. Stenzler-Centonze

Peachtree Software, Atlanta, Ga., is joining the software companies now providing programs on Sony Corp.'s 3½-inch floppy diskette. Peachtree's PeachText 5000 office productivity series, Back to Basics accounting, and Calendar Management programs are available for the recently announced Data General/One portable computer, which incorporates either one or two Sony drives.—M. Stenzler-Centonze

MINI FILES: Burroughs Corp. has introduced its first UNIX product: the XE-550 minicomputer, which is built around Convergent Technologies Inc.'s MC68010-based MegaFrame. The XE-550 simultaneously runs a version of Burroughs' proprietary BTOS operating system as well as Convergent's CENTIX implementation of UNIX System V. CENTIX includes Berkeley 4.2 enhancements such as virtual memory support. System prices begin at \$43,000.—D. Bright

Also joining in the increasing support for UNIX, **Stratus Computer Inc.**, Marlboro, Mass., has added System V capabilities to its fault tolerant computer systems. The operating system shares a common kernel with Stratus' proprietary VOS operating system. VOS already incorporates UNIX functions, a feature that helped Stratus merge the two operating systems, Stratus officials say. Most competitors, such as Auragen Systems Corp. and Sequoia Systems Inc. offer UNIX on their fault-tolerant systems, although market leader Tandem Computers Inc. does not. Yet another company developing a UNIX-based fault-tolerant system is startup EnMasse Computer Corp., Acton, Mass.—D. Bright

RANDOM DISK FILES: CPT Corp., Minneapolis, Minn., should introduce a high-capacity 3½-inch flexible drive early in the first quarter of 1985. The drive, obtained



You won't get over what this 350 CPS printer does for under \$2,000.



When you see what the CI-3500 Serial Printer can do, you might not believe it's priced under \$2,000. Besides giving you data processing printing at 350 CPS, the CI-3500 delivers letter quality printing at a rapid 87 CPS—more than twice the speed of most daisy wheel printers.

And you also get the capability for high resolution graphics, up to 240 X 144 DPI.

The office friendly CI-3500 is as flexible as it is versatile, especially for a table top, workstation printer. For example, a convenient interface cartridge system allows you to change your printer interface simply by changing cartridges.

A DEC-LA100® compatible cartridge is standard, but additional cartridges are available for interfacing with other systems, such as the IBM PC.

A similar font cartridge system accommodates multiple fonts and character sets, so you can avoid costly PROM installations.

The CI-3500 Serial Printer for under \$2,000. Whatever you need in a printer, you won't get over what it will do for you. To find out more, just write or call CIE Terminals, 2505 McCabe Way, Irvine, Ca. 92714-6297. (714) 660-1421. Or call toll-free 1-800-854-5959. In California, call 1-800-432-3687.

CIE TERMINALS
A CITICORP ELECTRONICS COMPANY

® DEC LA100 is a Registered Trademark of Digital Equipment Corp.
© CIE TERMINALS, INC. 1984

CIRCLE NO. 11 ON INQUIRY CARD

See us at Comdex, Booth #s 1730 & 1736

They Called It Impossible.



We Call It MicroNet.™

Imagine IBM PCs, intelligent workstations and S-100 BUS multiuser systems all on the same local area network.

Impossible?

Not with MicroNet, Intercontinental Micro's networking solution.

The key is a unique hardware and software approach to local area networks.

You get the flexibility of 8-bit and 16-bit processors on the same network, the cost savings of shared peripherals, and expandability to over 4000 users.

You simply organize the network the way you want, mixing IBM PCs, S-100 BUS multi-user systems, S-100 BUS file servers, and workstations.

Intercontinental's sophisticated single board computers, 8-bit and 16-bit slaves, memory and interface boards make your job even easier. MicroNet will work with almost any S-100 BUS system including IMS, Teletek, and any other S-100 master featuring phantom deselection or extended addressing capability.

The ability to run PC-DOS, MS-DOS, CP/M, MP/M, and other applications programs means whatever the future holds, MicroNet is ready.

And so is Intercontinental Micro.

You see, our S-100 BUS products revolutionized an industry. Intercontinental's slaves, masters and memory boards introduced advanced features like Direct Memory Access and Memory Management to micro environments. MicroNet™ The new net-



working solution from the company that's been building networking solutions for years.

Still think MicroNet's impossible?

Then call, write or circle the bingo number below—we'll send you complete information on MicroNet and descriptions of all our products, including the most complete S-100 BUS product line in the business.

OUR COMPLETE MICRONET AND S-100 BUS PRODUCT LINE

CPS4800X-SINGLE BOARD COMPUTER.

4 or 6 MHz processor (Z80A/B), onboard floppy disk controller, 64K RAM, 4 channel DMA controller, 24 line parallel I/O port, two serial I/O channels, real time clock. Memory mapped or I/O mapped capability.

CPS-16X—16-BIT 8086 SLAVE PROCESSOR.

256K, 512K or 1MB RAM, bank selectable, memory mapped, two serial ports, 24 line parallel I/O port, 8 MHz.

CPS-BMX/MX—Z80 SLAVE PROCESSORS

4 to 6 MHz processors, 64K RAM or 128K bank selectable memory, two serial ports, 24 line parallel I/O port.

256KMB—MEMORY BOARD.

Hard disk cache, linear addressable to two megabytes, bank selectable in 16K increments, configures for phantom deselection, parity error detection.

LAN100—MICRONET FOR S-100 BUS SYSTEMS

ARCNET controller meets 696.2/D2S-100 spec, coax cable interface, 255 nodes per network segment, 2.5 megabit/sec. data rate.

LANPC MICRONET FOR THE IBMPC

Plug-in expansion board with custom software drivers integrates IBMPC into MicroNet networks. 64K or 256K RAM options available.

WS80X-DISKLESS WORKSTATION

Converts almost any dumb terminal into intelligent workstation with networking capability. Floppy and hard disk options available.

PERSONALITY BOARDS—

SASI, Centronix, PRIAM, Clock/Calendar, RS232, Modem, RS422, long distance serial communications (up to 4000 Ft.)



4015 Leaverton Ct., Anaheim, CA 92807, (714) 630-0964, TELEX: 821375 SUPPORT UD

TurboDOS is a Trademark of Software 2,000, Inc. ARCnet is a Trademark of Datapoint. CP/M, CP/M 86, MP/M, MP/M 86, CP/M PLUS, Concurrent CP/M 86 are Trademarks of Digital Research. PC-DOS, IBM-PC are Trademarks of International Business Machines. MS-DOS is a Trademark of Microsoft. TurboLAN, MicroNET are Trademarks of Intercontinental Micro Systems.

See us at Comdex Riviera, Booth #8224/6.

See our future advertising in Mini-Micro Systems.

CIRCLE NO. 12 ON INQUIRY CARD

Breakpoints

from Toshiba Corp., should offer as much as 6M bytes of unformatted data storage by using vertical recording methods.—C. Warren

Archive Corp., Costa Mesa, Calif., and **Convergent Technologies Inc.**, Santa Clara, Calif., reportedly have inked a three-year, \$40 million pact, under which Archive will supply the supermicrocomputer manufacturer with 45M-byte, ¼-inch Scorpion streaming tape drives. Although neither company would comment on the agreement, industry observers say the deal gives Archive and the quarter-inch streaming tape drive market a much-needed boost.—C. Warren

Indicative of the vogue of 3½-inch disk formats, **Cambrian Consultants Inc.**, Calabasas, Calif., has both 10M-byte and 21M-byte models. Both units are compatible with the Seagate ST506/412 and the Rodime 350 interfaces. The company is looking for shared licensing on a non-exclusive basis.—C. Warren

Startup company **Lancore Technologies Inc.**, Westlake Village, Calif., is readying its first product for introduction at the COMDEX show in Las Vegas, November 14 to 18: a 5¼-inch, intelligent disk drive subsystem with an average access time of 30 msec. The drive, priced at \$5,995, features tape backup, an Intel Corp. 80186 processor, 128K bytes of dynamic RAM, an SCSI interface and an optional internal modem. It performs caching and allows concurrent multiuser access and simultaneous operation of both the disk and the tape drives.—D. Bright

MICRO FILES: Tandem Computers Inc. has developed what it calls the Dynamite workstation to supply corporate customers with MS-DOS compatibility. The modular workstation operates in three modes: Tandem terminal emulation, IBM Corp. 3270 terminal emulation and as an MS-DOS workstation. Users can extract files from Tandem's Encompass database management software running on its fault-tolerant computers, and have Dynamite's software format the files for integration with popular personal computer software such as Lotus Development Corp.'s 1-2-3. Prices start at \$2,995. Tandem stresses that it is not entering the personal computer retail market.—D. Bright

Sydis Inc., San Jose, Calif., plans to ship in December and February a number of enhancements to its VoiceStation office information system. Scheduled for December are multiple file servers, Wang-compatible word processing software, a GKS graphics library, and directory enhancements. February additions are said to comprise production shipments of Sydis' integrated voice/data workstation, a communications server subsystem, data communications software, networking software, business graphics and support for Hewlett-Packard Co.'s LaserJet printer and six-pen plotter.—T. Moran

PRINTER FILES: Fujitsu America Inc. is implementing a new retail channel strategy. As a start, its Peripheral Products division, San Jose, Calif. has begun to move its DotMax 9 and DotMax 24 wire impact printers through Fujitsu's own

Breakpoints

distributor/dealer network. Fujitsu had been selling almost all its products through OEM channels. The network presently includes 19 U.S distributors and more than 350 dealers, to be expanded to 1,200.—T. Moran

NOTES FROM OVERSEAS: IBM Corp. has hammered out its first technical collaboration pact in Europe by teaming up with Italian manufacturer Elsag SpA, an industrial controls subsidiary of the highly influential, state-controlled, telecommunications combine, STET. The pair will launch a joint venture to design and produce factory automation software. Observers note that it is the only major joint venture outside Satellite Business Systems in which IBM has settled for a 49 percent interest. The liaison may prove a stepping stone to the real prize, a coveted multimillion-dollar alliance with STET itself to provide Italy's high-technology companies with much-needed packet-switching gear in addition to database services, value added networks and perhaps the manufacture of a PABX.—M. O'Gara

ITT Corp. is starting to look serious about playing in the European computer theater. First it bought a 37 percent interest in a leading Continental software house, Holland Automation BV. Then it opened up negotiations to acquire the choice parts of newly bankrupt Danish data-communications CPU company, Christian Rovsing. And now, via its German subsidiary, giant Standard Elektrik Lorenz AG, it has picked up 49 percent of German minicomputer maker Computertechnik Mueller GmbH (CTM). CTM's fame is based on the 9032, the first German-designed, German-built 32-bit minicomputer, a conventional AMD 2901 bit-slice product. The \$75-million-a-year firm had intended bringing the 9032 to the United States, but ITT may short-circuit that strategy and use CTM products as a launching pad into heavy-duty office automation market in Europe.—M. O'Gara

Britain's premier computer maker, **ICL Plc.**, wants to be the top office systems supplier to Europe's very largest firms, vying with IBM Corp. for the business of companies with sales of \$125 million a year and up. To do so it has formed an Office Business Center to develop systems integrating data, text, image and speech. Its newly published statement of direction poohpoohs PABX-based office systems as immature and indicates it will use its Oslan version of Ethernet as a substitute central product for those systems. Another ploy in the strategy will be the Clan, Datamedia Corp.'s MC68000-based Pick/UNIX machine, which ICL currently sells only in Australia and South Africa. Other plans will see UNIX System V offered on the ICL DRS workstations and UNIX under VMS supported on its 2900 mainframes. Above all, ICL promises to make its proprietary protocols interface with anybody else's office wares—most particularly IBM's and Wang Laboratories Inc.'s.—M. O'Gara



BUILT FOR SPEED

CompuPro has now dramatically increased your micro-computing power and speed.

With our System 816/F™ supermicro with CPU 286/287™ board. The computer that gives you results. Fast.

Built to provide sophisticated computer users with the fastest 16-bit system available, the System 816/F is a multi-user computer so powerful it virtually has no supermicro peer.

The reason for such a strong statement? We configure the system around the **80286**—among the most powerful 16-bit processors available anywhere and one that's built for speed. The 286/287 board lets you run anything from the 8086/8088 family and includes the 80287 math processor and as much as 16 Kb of EPROM on-board.

But this board is only part of the story. CompuPro has included a long list of features that enhance this exclusive system even more. Like 1.5 Mb of our

MDRIVE®/H—a solid-state disk with the capacity to dramatically increase the speed of the 286 processor even more . . . 512 Kb of 16-bit main memory expandable to 16 Mb . . . 1.2 Mb floppy disk and up to 80 Mb of hard disk storage . . . 12 serial ports . . . and much more.

And even though our System 816/F has set some industry standards, we still designed it to conform to the IEEE 696/S-100 bus standard. And virtually no one else can say that.

The time you save with CompuPro will save you money, too. Our System 816/F speeds up software development. So the quality and capacity of your programs is enhanced, and the value, maximized.

The CompuPro System 816/F. It's the essential system for OEMs and system integrators who want all the power and speed they can get. And best of all, we've shipped hundreds of them already.

See us at Comdex Booth #H7366



The Essential Computer™

CompuPro®

A GODBOUT COMPANY

3506 Breakwater Court, Hayward, CA 94545
(415) 786-0909

MDRIVE is a registered trademark and System 816/F, CPU 286/287 and The Essential Computer are trademarks of CompuPro. Front panel shown is available from Full Service CompuPro System Centers only.
©1984 CompuPro.



Finding ESP 6110, the first \$495 terminal with a 14" screen, is an amazing stroke of luck.

Never before! A 14" display under \$500. Until now, you paid for low cost terminals with eye strain. Not anymore. The ESP 6110 gives you a big, high resolution, non-glare screen with sharp, 7 x 11-dot matrix characters.

5 user-friendly emulations. Looking for flexibility? The ESP 6110 is compatible with the Pick™ operating system. And it comes with resident emulators for ADDS Viewpoint® and Regent 25,® Esprit II, Hazeltine 1500 and ADM3A.® With menu-driven selection so you just type in the mode you need.

Quality look. Quality feel. This is no stripped-down, bare bones terminal. You get tilt & swivel. Low profile, DIN-standard, sculptured keyboard with a separate numeric keypad. An amber display is optional; our famous reliability isn't.

For more information, call Esprit (Es-pree) toll-free at 800-645-4508. In NY State 516-293-5600. And why not do it now? After all, finding a 14" screen for under \$500 makes this your lucky day.

®Registered trademarks: Viewpoint and Regent, Applied Digital Data Systems. The ADM3A, Lear Siegler, Inc.



Esprit
Systems, Inc.

PEACE OF MIND TECHNOLOGY
CIRCLE NO. 14 ON INQUIRY CARD

COMDEX WINTER HAS SOFTWARE FOR THE IT HARDWARE ...HARDWARE ALL FOR THE SOFTWARE.



COMDEX brings you
the whole computer industry under one roof
—hardware, software and everything else you need
to improve the profitability
of your business.

COMDEX™ WINTER '85

March 21 - 24, 1985
Anaheim Convention Center
Anaheim, California



Presented by THE INTERFACE GROUP, Inc., world's leading producer of computer conferences and expositions including The Nationwide COMPUTER SHOWCASE EXPOS, COMDEX/Winter, COMDEX/Spring, COMDEX/Fall, COMDEX/Europe, COMDEX in JAPAN, INTERFACE, FEDERAL DP EXPO & CONFERENCE and THE BYTE COMPUTER SHOWS.
300 First Avenue, Needham, MA 02194 • (617) 449-6600

World's largest
local distributor
with 50 locations
stocking the finest
lines of electronic
components and
computer products

- ALABAMA**
Huntsville (205) 837-7210
- ARIZONA**
Phoenix (602) 231-5100
- CALIFORNIA**
Avnet, L.A. (213) 558-2345
Avnet, S.F.V. (818) 700-2600
Avnet, O.C. (714) 754-6111
Hamilton, L.A. (213) 558-2121
Hamilton, S.F.V. (818) 700-6500
Hamilton, O.C. (714) 641-4100
Sacramento (916) 925-2216
San Diego (619) 571-7510
San Francisco (408) 743-3355
San Gabriel (714) 989-4602
- COLORADO**
Denver (303) 779-9998
- CONNECTICUT**
Danbury (203) 797-2800
- FLORIDA**
St. Petersburg (813) 576-3830
Miami (305) 971-2900
Orlando (305) 628-3888
Melbourne (305) 725-2700
- GEORGIA**
Atlanta (404) 447-7507
- ILLINOIS**
Champaign/Urbana (800) 625-8654
Chicago (312) 860-7700
- INDIANA**
Indianapolis (317) 844-9333
- IOWA**
Cedar Rapids (319) 362-4757
- KANSAS**
Kansas City (913) 888-8900
Wichita (800) 532-6720
- KENTUCKY**
Louisville (800) 428-6012
Lexington (800) 543-4783
- MARYLAND**
Baltimore (301) 995-3500
- MASSACHUSETTS**
Boston (617) 273-7500
- MICHIGAN**
Detroit (313) 522-4700
Grand Rapids (616) 243-8805
- MINNESOTA**
Minneapolis (612) 932-0600
- MISSOURI**
St. Louis (314) 344-1200
- NEBRASKA**
Lincoln/Omaha (800) 255-6702
- NEW JERSEY**
Fairfield (201) 575-3390
Cherry Hill (609) 424-0100
- NEW MEXICO**
Albuquerque (505) 765-1500
- NEW YORK**
Long Island (516) 231-9800
Syracuse (315) 437-2641
Rochester (716) 475-9130
- NORTH CAROLINA**
Raleigh (919) 878-0810
- OHIO**
Cleveland (216) 831-3500
Columbus (614) 882-7004
Dayton (513) 433-0610
- OREGON**
Portland (503) 635-8831
- PENNSYLVANIA**
Philadelphia (215) 831-1300
Pittsburgh (800) 321-6890
- SOUTH CAROLINA**
Columbia (800) 334-1597
- TEXAS**
Dallas (214) 659-4111
Houston (713) 780-1771
Austin (512) 837-8911
- UTAH**
Salt Lake City (801) 972-2800
- WASHINGTON**
Seattle (206) 453-5844
- WEST VIRGINIA**
Charleston (800) 543-4783
Huntington (800) 543-4783
- WISCONSIN**
Milwaukee (414) 784-4510
- INTERNATIONAL EXPORT**
Los Angeles (213) 558-2441
New York (516) 997-6868
Telex 66-4329
- CANADA**
Toronto (416) 677-7432
Montreal (514) 335-1000
Ottawa (613) 226-1700
Calgary (403) 230-3586
Vancouver (604) 272-4242

TO PERFECT YOUR PERFORMANCE: EMULEX SUBSYSTEMS

As champion Peter Vidmar can tell you, you must strive for perfection to succeed. Now for those of you striving for perfection in computer system performance: there's Emulex products from Hamilton/Avnet. The product line includes a winning selection of packaged subsystems, offered by Hamilton/Avnet with the option of complete integration support.

QBUS,* UNIBUS,* MULTIBUS, IBM† SUPPORT.** Emulex has the host adapters to interface with all these popular buses, and with the IBM PC† family.

A CHOICE OF HIGH CAPACITIES. Emulex subsystems: **SABRE ‡**, offering from 31.2 to 110 MB (formatted) on a 5 1/4" Winchester along with 10.4 MB of backup on an 8" removable cartridge disk. **Javelin ‡**, offering your choice of up to two 5 1/4"

peripherals for up to 220 MB of storage. Decathlon ‡ offers your choice of three 5 1/4" peripherals. For QBus and Unibus systems, you have even more choices: Vault ‡, for 70 MB on a 1/4" cartridge tape streamer, and Medley ‡, for 36, 67, or 110 MB of Winchester storage (formatted) with a 70 MB streaming tape backup (DEC TS-11 compatible). **ALL FROM ONE EXPERT SOURCE.** To help you match the Emulex products to the computer system you need, then put it all together for you, we have a complete staff of hardware and software engineers and technicians. Call our Computer Product Specialists for complete information on Emulex products and the popular computer systems they enhance... you'll see what makes us a champion champion team.

Hamilton Avnet
ELECTRONICS AN AVNET COMPANY
A commitment to stock and serve your local market!



Peter Vidmar
1984 Olympic
Gold and Silver
Medalist

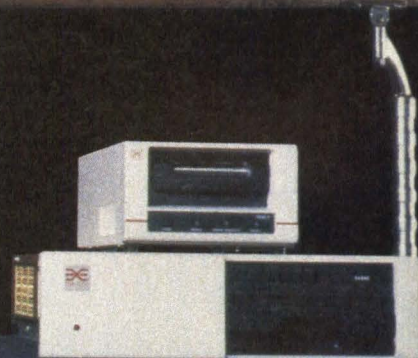
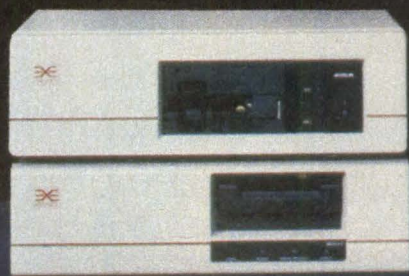
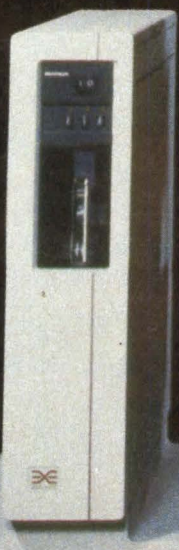

CIRCLE NO. 16 ON INQUIRY CARD

EMULEX from HAMILTON/AVNET

*Trademark Digital Equipment Corporation **Trademark Intel Corporation †Trademark International Business Machines ‡Trademark Emulex Corporation



Ada's First Family

Compiler	In Production Use	Validated
MC68000/ROS TeleSoft Labtek (Wicat)	✓ ✓	✓ ✓
MC68000/Unix System V Berkley 4.2bsd Unisoft Unix	✓ ✓ ✓ ✓	In Process In Process In Process In Process
VAX/VMS VAX/Unix	✓ ✓	In Process In Process
IBM 370/VM/CMS IBM 370/MVS	✓ ✓	In Process In Process
IBM PC Additional Implementations	✓ ✓	In Process In Process

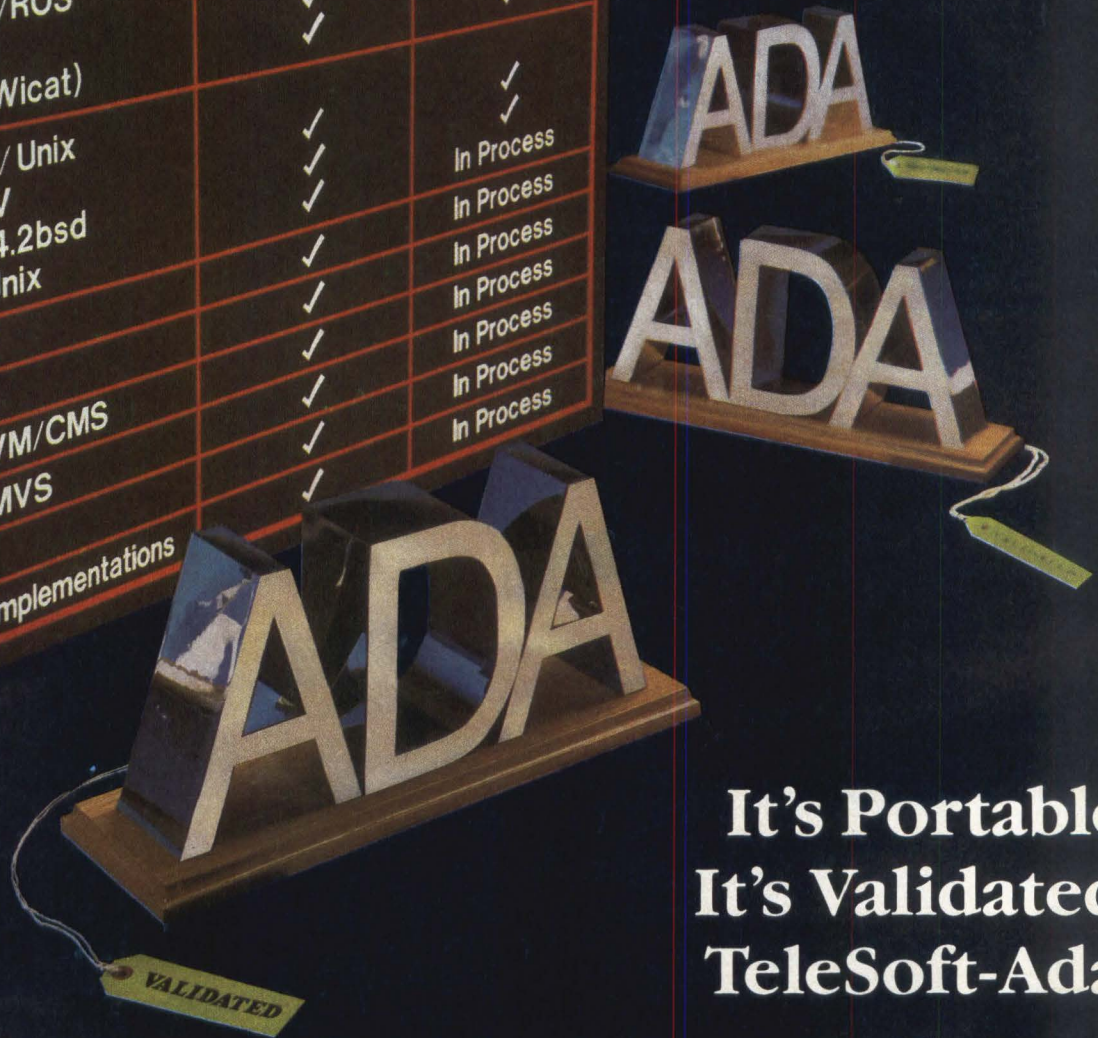

**It's Portable.
It's Validated.
TeleSoft-Ada.**

A growing company in San Diego has taken a giant step in bringing Ada to the software development world.

TeleSoft, the company that fielded the first Ada compiler and leads the market in user experience with over 450 installed, has validated the first in its family of portable Ada compilers.

TeleSoft's Ada compiler family is portable across most of today's popular host systems and development environments: MC68000/Unix, MC68000/ROS, Digital's VAX/VMS and VAX/Unix, IBM 370 VM/CMS and MVS. And development is well underway on Ada compilers for nearly a dozen other systems.

These compilers are all that Ada was intended to be: Truly portable, with complete support environments, and a clear growth path to exceptional compilation and execution speeds. TeleSoft has done this by developing technology

which minimizes machine-dependent software and allows fast adaptation to new environments.

TeleSoft's announcement is the first big step towards a new era in the software industry—based on components, true software portability, and Ada standardization.

TeleSoft™

10639 Roselle Street · San Diego, Ca. 92121 · (619) 457-2700

Ada is a trademark of the Department of Defense; VAX and VMS are trademarks of Digital Equipment Corporation; UNIX is a trademark of Bell Laboratories; IBM 370, IBM PC, CMS and MVS are trademarks of IBM Corporation. MC68000 is a trademark of Motorola Corporation. TeleSoft-Ada is a trademark of TeleSoft. Copyright 1983, TeleSoft.

CIRCLE NO. 17 ON INQUIRY CARD

Mini-Micro World

NEWS

Rolm integrates IBM PC compatibility into its proprietary PBX network

Tom Moran, Associate Editor

Rolm Corp., Santa Clara, Calif., this month bolstered its proprietary, digital private branch exchange (PBX) network by embracing IBM PC compatibility in two new products. They are the Cedar microcomputer and the Juniper add-in board that links IBM PCs into Rolm's PBX, called the CBX. Both products have a telephone handset and office automation and telephony software closely integrated with the CBX. The Cedar computer is one of the first PC-compatible products to integrate office automation and advanced telephony features coordinated by a PBX.

Depending on whether Rolm plays its trump card—a marketing agreement with IBM Corp., which recently boosted its 23-percent stake in Rolm to complete ownership—the company could have an advantage over companies like Datapoint Corp., which recently opened its proprietary attached resource computer local area network (ARCNET) to connect both IBM PCs and its own MS-DOS Vista-PC (MMS, August, Page 48). IBM paid \$1.25 billion in securities to merge with Rolm, the giant's first acquisition in more than 20 years. Rolm will become an independent subsidiary of IBM, retaining its name and top managers. The coupling is subject to approval by Rolm's stockholders and federal antitrust representatives.

A Rolm spokeswoman would not comment about IBM possibly selling Rolm products in Europe. But it is the opinion of Bill Frank, senior vice president of InfoCorp, Cupertino, Calif., that the relationship between

Rolm's Cedar personal-communications computer offers IBM PC compatibility and integrates a telephone and a keyboard that can be slipped under the system unit when not in use.



The Juniper add-in board from Rolm splices an IBM PC, PC/XT or PC-compatible with a full-featured digital telephone and Rolm's proprietary CBX private branch exchange.

Mini-Micro World

NEWS

Rolm and IBM will broaden to other products. "[The IBM connection is] pivotal [for Rolm] because to establish a relationship with the IBM world is a strategic decision that will affect what Rolm will be in the future....It should open up a lot more markets. Together, IBM and Rolm will end up stronger."

Norm DeWitt, associate director of personal computer programs for Dataquest Inc., San Jose, Calif., agrees. "[They're] very likely to increase [cooperation] further. Rolm brings expertise in the PBX area to IBM."

The June, 1983 marketing agreement with IBM to enhance interconnectability of Rolm and IBM products produced an IBM message center product that works with Rolm's CBX and is due out now. Different versions of that product are to be marketed by each party.

The Rolm spokeswoman emphasizes that both new PC-compatible products must be used with Rolm's CBX. "We have not been contacting IBM value-added resellers because our system doesn't work without the CBX. We have our own sales and service organization in the

United States, which accounts for about 80 percent of U.S. sales. The rest [of the sales] are through exclusive, independent distributors," says Janice Carnes, director of corporate marketing at Rolm.

Closely integrated with the PBX

Cedar and Juniper are tailored to take advantage of the proprietary aspects of Rolm's CBX systems, resulting in greater integration of total system functions. Software with the board-based Juniper works to link the IBM PC, PC/XT, and PC-compatibles with the CBX.

Stacking up Rolm PC-compatibles against the competition

With its IBM PC-compatible Cedar microcomputer and Juniper add-in board for the IBM PC, Rolm Corp., will face increasing competition with integrated voice, telephone and data communications products.

The desktop office-automation market for such products has been broken into three categories by the Gartner Group, Stamford, Conn.: PBX-proprietary devices like Cedar and Juniper; standalone workstations with analog data communications like Zaisan Inc.'s ES.1 or ES.3; and proprietary or non-proprietary add-ons to the IBM PC, such as Cygnet Technology Inc.'s CoSystem and Northern Telecom Inc.'s Displayphone.

Rolm group product manager Carol Wingard says the sales potential for the Cedar and Juniper products is between 100,000 and 200,000 Rolm units, based on her estimates of an installed base of more than 3 million telephone lines in its CBX private branch exchange system.

The 8088-based Cedar comes with MS-DOS 2.11, GW-BASIC, two 360K-byte 5¼-inch floppy disk drives, and 512K bytes of RAM, 384K bytes of which can be accessed by the user. The system measures 13.5 inches wide by 14.6 inches long by 11.5 inches high. The 9-inch diagonal screen displays 80 characters by 24 lines in alphanumeric mode, and has medium and high resolution graphics modes. A status line at the top of the

screen informs the user of incoming calls and messages.

Other Cedar and Juniper features include one-touch terminal configuration, one-touch logon/logoff for mainframes, minicomputers and databases, the terminal emulations, an auto-dial directory that holds around 200 names and numbers, 11 repertory dial keys for different dialing functions, a five-function calculator, data communication at speeds up to 19.2K bits per second, and simultaneous voice and data transmission.

With the simultaneous voice and data capability, a user can send memos or spreadsheets while discussing their content on a telephone with the person receiving them. Time-division multiplexing allows one physical line to provide several voice channels, and data and CBX-control channels. The CBX acts as a system controller, automatically routing long-distance calls and informing each workstation of incoming calls, voice messages and the status of other workstations. As a digital system, it avoids the limitation of some personal computers and workstations using low-speed analog modems to communicate with PBXs.

One company targeting the same base of installed IBM PCs as Rolm is Cygnet, Sunnyvale, Calif. Cygnet's CoSystem is an add-on voice and data telephony system for the IBM PC. The Cygnet device is not closely

integrated with a PBX. The CoSystem includes a 300-bits-per-second (bps) modem, and a 1,200-bps modem is optional.

Zaisan, Houston, Texas, introduced its ES.3 professional workstation this summer, touting it as the first IBM PC-compatible microcomputer with an integrated telephone. The \$2,595 ES.3 has an internal 300-bps modem with a 1,200-bps option, and is designed to be used with PBXs in general.

Frank Dyer, director of marketing operations for the advanced communications terminals division of Northern Telecom, Nashville, Tenn., declines to comment on whether Northern Telecom is planning to add personal-computing capability to its product line. Northern Telecom offers the \$1,295 Displayphone terminal and the \$1,595 Displayphone Plus, a recent upgrade which adds full VT100 emulation and an internal 1,200-bps modem instead of the external modem of the earlier Displayphone. The Displayphone Plus also uses amber instead of white phosphor in its display.

The Displayphones can be set up to work with standard PBXs, which means they target a wider total market than Cedar and Juniper, but lack the full features that result from closer integration with a specific PBX. Northern Telecom expected to begin shipping the Displayphone Plus last month.

Cedar is a personal-computer version of Rolm's personal communications terminal, the Cypress, which the company began shipping in June. Besides attaining IBM PC compatibility by using an 8088 processor and MS-DOS, the Cedar offers simultaneous high-speed voice and data communications, a host of message and dialing features and IBM 3270 and DEC VT100 terminal emulations. Rolm did not include any expansion slots in the Cedar because of the product's full features, a company spokesman says. For those desiring expansion slots, Rolm recommends the Juniper with IBM equipment.

The Juniper comprises an IBM PC-standard long add-in board, software on diskette and a Rolm-phone digital phone with a cable to connect it to the add-in board. The Juniper requires a minimum of 256K bytes of system RAM, but Rolm recommends having at least 384K bytes.

Success seen for Juniper

Christine Hughes, vice president for office systems for the Gartner Group, a Stamford, Conn., strategic planning concern, says the Juniper will be the more successful of the two new products. "It's probably the least expensive way for an existing IBM PC user to capitalize on the phone features that Rolm has to offer, so it's a very good marriage between an existing Rolm CBX and an existing installed base of IBM PCs." Most of Rolm's installed systems are in Fortune 500 or 1000 companies.

Laura Lundquist, an analyst with Future Computing Inc., Dallas, Texas, projects that IBM PCs and fully compatible personal computers will account for 65 percent of shipments of microcomputers to Fortune 2000 companies in 1984 and 81 percent by 1989. She says the over-

all penetration of personal computers into Fortune 2000 companies was 10 percent in 1984. She adds that it's difficult to sell a machine that is not fully IBM-compatible into these IBM shops.

Shape of things to come

According to Robert R. Maxfield, Rolm executive vice president and co-founder, Rolm assumes that the major PBX makers will follow the trend of combining telephones, personal computers and PBXs with office automation software. "We're convinced that the integration of voice and data and personalized communications services [results] in very strong productivity-enhancing products for desktop workers," he says. "So we really believe that this is the shape of things to come, and that the market success of these products will force our competitors to offer similar functionality."

Maxfield says Rolm has no present plans to offer similar products

for non-Rolm PBXs. "Our prime thrust is to provide CBX customers with solutions, and to differentiate Rolm as a total communications system supplier." Maxfield declined to say whether Rolm would offer Juniper-like products for the IBM PC-AT or any non-IBM microcomputer that is not PC-compatible. "What we have said very strongly is that we intend to provide maximum connectability and integration with IBM products, and so it's logical to assume that we will be looking very hard at other IBM desktop products," he says.

The Cedar will be priced at \$4,995 for one unit, and \$4,245 each for 100 units, with further discounts possible. The Juniper's single-unit price will be \$1,495, and \$1,360 each in quantities of 100. Both products include the Rolmphone and should be available 60 days after their planned introduction early this month. The price of the CBX system ranges between \$700 and \$900 per line. □

SYDIS, ITALTEL SIGN \$8 MILLION OEM PACT

Sydis Inc., San Jose, Calif., has signed an OEM contract to supply \$8-million worth of its VoiceStation system workstations over a three-year period to Italtel Telematica—Italy's largest telecommunications manufacturer. Italtel will combine the workstations, which integrate data, voice, text and graphics processing, under its own name with its private-automatic-branch exchanges. Recently, Sydis also sealed a \$142-million deal with GTE Business Communications Systems for the VoiceStation.

PC WORD-PROCESSING MARKET BOOMS

Sales of personal-computer word-processing applications will boom through 1988, while standalone word processor sales will fall off, according to a report from New York market research firm Frost & Sullivan Inc. The word-processing-application sales should increase 23 percent from \$8.7 billion in 1983 to \$10.7 billion in 1988. During the same period, sales of standalone word processors will decline from \$897 million to \$183 million. But the greatest word-processing growth rate will be in the electronic-typewriter market, where sales are expected to rise 40 percent, from \$3 billion in 1983 to \$4.2 billion in 1988.

TopView begins IBM's shift to proprietary software

Marjorie Stenzler-Centonze
Associate Editor

IBM Corp.'s recently introduced personal computer windowing environment, TopView, may be part of a major move by the company to shift toward more proprietary software with direct hooks to IBM hardware, analysts say. The TopView announcement was followed by IBM's introduction of 31 software packages developed internally for its PCs.

An issue of control

Kenneth Lim, an analyst with the research company Dataquest Inc., San Jose, Calif., sees IBM's decision to keep TopView products in-house as part of the company's underlying philosophy to move its hardware and software toward more proprietary systems. "IBM wants to maintain more control over the quality of the product, the usage of it and compatibility between various products," Lim says, "and at the same time get a little bit more of the end-user dollar."

Jean Yates, president of Yates Ventures, Palo Alto, Calif., says there is a growing faction inside IBM that questions the advisability of third-party dominance in the market for generic software applications like spreadsheets and word processors. "There will," Yates says, "undoubtedly be a shift by IBM toward more proprietary software in these areas, while the company pushes for the development of third-party vertical market applications." The three new programs include a series of five accounting packages.

TopView offers multitasking and windowing for single-user applications. It runs with PC-DOS ver-



IBM's TopView provides a multitasking and windowing environment for IBM applications. The program runs on the PC, PC/XT, PC-AT, Portable Personal Computer and 3270-PC.

A glance at TopView

TopView provides a single-user operating environment and runs with DOS 2.0, 2.1 or 3.0. Its facilities allow applications to have one or more windows. Additional features include:

- Multitasking
- Cut and paste
- Keyboard or mouse support
- Ability to run text and graphics applications
- Ability to run on monochrome or color displays
- Support of frequently used DOS functions

The TopView program gives graphics applications control of the full screen when they are in a foreground task. Medium resolution color (320-by-200 four-color pixels) and high resolution black and white video modes can be used for graphics applications.

In the future, IBM expects to have TopView capabilities available in productivity environments such as 3270 emulation and the IBM PC Network.

sions 2.0, 2.1 or 3.0, and can be used with the IBM PC, PC/XT, PC-AT, the Portable Personal Computer, and the 3270-PC. It requires a minimum of 256K bytes of RAM and two double-sided, double-density disk drives or one double-sided drive and

a fixed disk. TopView can be used with either a keyboard or a mouse pointing device. The \$149 program will be sold through IBM Product Centers, authorized dealers, and the company's national accounts branches.

PC-compatible makers wait

Since IBM did not design TopView with portability in mind, PC-compatible microcomputer makers are anxiously waiting to test the product, industry sources say. According to one beta test user, who wished to remain unnamed, the program in its current form runs without modification on Compaq Computer Corp. machines. A spokesman for Compaq notes that things could change significantly when the final version of TopView hits the market in the first quarter of 1985. Some analysts speculate that TopView will be sold in a form that ties it to parts of IBM hardware.

TopView works with applications programs for the IBM PC such as the Assistant Series, DisplayWrite 1 and 2, Multiplan, VisiCalc and several programming languages. IBM is encouraging third-party development of applications that use TopView's features. IBM will not spell out what other major companies' software runs with TopView. A spokesman for IBM says third-party software companies are still reviewing the program and "it's up to them to certify compatibility." Lotus Development Corp., Cambridge, Mass., would not comment on the compatibility of its products with TopView.

IBM is making available a TopView programmer's Toolkit for \$395. The kit advises on how to access TopView's functions from applications programs using a mouse and manipulating windows.

Robert M. Lefkowitz, director of microcomputer system software re-

Microsoft's Windows vs. IBM's TopView

One of the most significant differences between IBM Corp.'s TopView product and Microsoft Corp.'s Windows is that TopView is designed specifically to run on an IBM machine.

The goal of Windows is portability. Close to 30 different manufacturers already support the windowing environment, says Leo Nikora, group manager of product marketing at Microsoft, Bellevue, Wash.

Another big difference between the two products, according to Jean Yates, president of Yates Ventures, Palo Alto, Calif., is that TopView is character-oriented, while Windows is bit-mapped. TopView uses the screen as an array of characters and sup-

ports character operations. Windows places icons on the screen.

In addition, Yates says, TopView is designed to allow IBM's proprietary applications to run within its windows, while Microsoft's product is designed to allow generic applications to run.

In examining the windowing products announced so far, analyst Kenneth Lim of Dataquest Inc., San Jose, Calif., says TopView will come closer in functionality to Visi^{On}. "While Microsoft's Windows is basically an extension of the operating system, Visi^{On} is an operating environment separate from any operating system, and sits between the operating system and the applications packages."

search at InfoCorp, Cupertino, Calif., says companies who don't make a concerted effort to live with TopView's standards are going to make a big mistake in the long run. He expects companies like Lotus and Ashton-Tate to react to TopView shortly. "It will be interesting to see if they go back and recode their routines and, in the long run, potentially sacrifice speed of execution to [create] well-behaved software products that work within the TopView parameters and standards," Lefkowitz says. "Then again, they might thumb their noses at TopView because they feel they can do it better and put users in the position where they would have to run Lotus in the foreground on a TopView machine."

Some IBM watchers question the overall wisdom of developing a windowing program in house, instead of going with a third-party product such as Visi^{On} or Microsoft Corp.'s Windows. Visi^{On} was recently acquired from VisiCorp by Control Data Corp. Up to now, 27 companies have announced their support of Windows. While TopView differs from Windows in functionality, technical differences between the

two products may not have been IBM's only reason in deciding to develop the program in house. Its close relationship with Microsoft was likely to have been behind that decision as well. Microsoft and IBM cooperated closely in developing the PC's PC-DOS operating system.

InfoCorp's Lefkowitz says he believes IBM is concerned with burdening the comparatively small Microsoft with too much work. He says: "With all Microsoft's work in the operating system area, I think IBM was concerned about the company's resources to do a windowing product as well. As we have already seen with third-party suppliers on the hardware side, IBM does not

like to put all its eggs in one basket," in case the smaller company cannot pull together the resources to produce a major product in time.

Dataquest's Lim believes the MS-DOS 8088 world has gotten too big for IBM's comfort. "Although the company will continue to support MS-DOS, a year or two down the line they will begin to move farther from it," he says. Lim says IBM has under development three operating systems code-named Nina, Pinta and Santa Maria. They are expected to be proprietary, multiuser, multitasking systems that will allow MS-DOS or CP/M-86 to run as tasks underneath them. "That would give IBM the proprietary angle they are looking for and at the same time allow the coexistence of the existing standards," Lim says. He expects IBM to announce the first of these operating systems in the next 12 to 18 months. And he thinks there are likely to be proprietary hooks in TopView that pertain to such future uses.

Also significant to TopView's introduction, according to InfoCorp's Lefkowitz, is that IBM has finally endorsed a windowing product. "That means windows will become a de facto standard and all the IBM-compatibles will have to go out and scramble for a version of a windowing product, and it obviously can't be TopView, which is IBM-proprietary," he remarks. □

INTERFACE CONNECTS APPLE TO EPSON PRINTERS

Hanzon Data Inc., Woodinville, Wash., has introduced an intelligent serial interface card that connects Epson America Inc. printers to the Apple Computer Inc. Iie, Iic, Macintosh and Lisa personal computers. With the Model 12319 universal card installed, Epson RX and FX dot-matrix printers can be used as direct replacements for Apple Image Writer printers. Baud rates can be set from 300 to 19,200 bits per second with either 7- or 8-bit data. An on-board 2K-byte memory buffer is expandable to 16K bytes. Retail price is \$129.50.

BYTCOM MODEMS

Offering a wide range of features,
highest reliability, an exceptional
warranty and economical pricing.

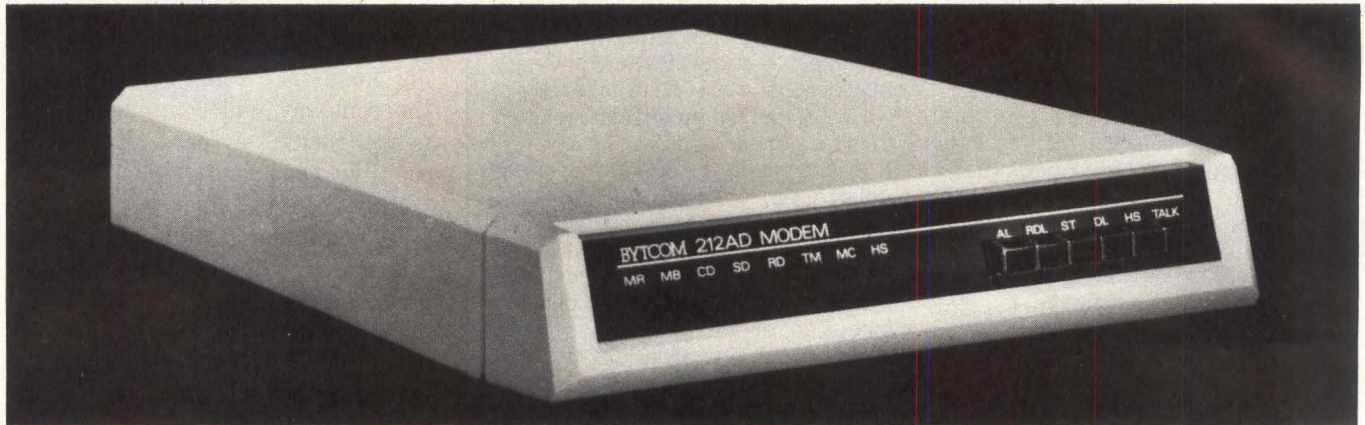

The Bytcom 212AD Modem gives you an advanced array of intelligent features for your PCs or Data Terminals. In addition, Bytcom offers the best warranty on the market, *free* SUPERSCOOT communications software for file transfer, with access to such databases as COMPUSERVE, DIALOG, NEWSNET and WESTERN UNION'S EASYLINK, and compatibility with most of the popular communications programs available today. All of this, including the following features, at a very economical price.

- Full Bell 212A compatibility (0-300, 1200 baud) with remote digital loopback and internal self test.
- 16 character security password.
- Designed for use with either "dumb" terminals or PCs.
- Synchronous and Asynchronous transmission modes.
- Auto-answer and Auto-dial capability.
- Internal storage of nine names and numbers to forty characters in length.
- Unique ability to "Reboot" your micro-computer via the modem.
- User-friendly help menu.
- Rack mountable version available.

A VERY BROAD WARRANTY. . .

The Bytcom 212AD Modem has proven its reliability over a period of years in some of the world's largest High Tech and Industrial Corporations. With this extensive experience, Bytcom is able to provide its customers with a unique, *Immediate Unit Replacement Warranty* within the first two years of ownership. Details on request.

Contact Bytcom for additional information and name of your nearest distributor.



Software Supplied By
BUSINESS COMPUTER NETWORK
SUPERSCOOT

BYTCOM



2169 Francisco Blvd. Suite H. San Rafael, CA 94901
(415) 485-0700 (800) 227-3254 (outside CA).

CIRCLE NO. 18 ON INQUIRY CARD

Mini-Micro World

NEWS

Oracle reduces size of relational DBMS for microcomputers

Tom Moran, Associate Editor

The Oracle Corp. claims it has adapted its Oracle large-computer database-management system (DBMS) to run on most major microcomputers by reducing its code by half. Company spokesmen maintain that the new PC Oracle retains all the relational DBMS features the original software offered on the larger minicomputers and mainframes. The company also has introduced Oracle Link, a complementary networking package for PC Oracle owners.

Oracle reduced the size of the software's code from 1M byte to less than 512K bytes, the company says. But the Menlo Park, Calif., manufacturer maintains that the same applications programs can be run without alteration on microcomputers such as IBM PCs, minicomputers and mainframes. PC Oracle includes a report writer, a networking system, an integrated data dictionary and an application generator and is compatible with IBM's SQL/DS and DB2 database software.

PC Oracle is available for IBM's PC/XT and PC-AT, Compaq Computer Corp.'s Compaq Plus, Eagle Computer Inc.'s Spirit XL, Durango Systems Inc.'s Poppy, Texas Instrument Inc.'s Professional, Digital Equipment Corp.'s Rainbow, Apollo Computer Inc.'s Domain, Fortune Systems Corp.'s 32:16 and Stratus Computer Inc.'s fault-tolerant systems. Oracle expects to produce a version for AT&T's 3B2 computer this month and plans ports to several other systems.

To run PC Oracle on IBM microcomputers requires 512K bytes of

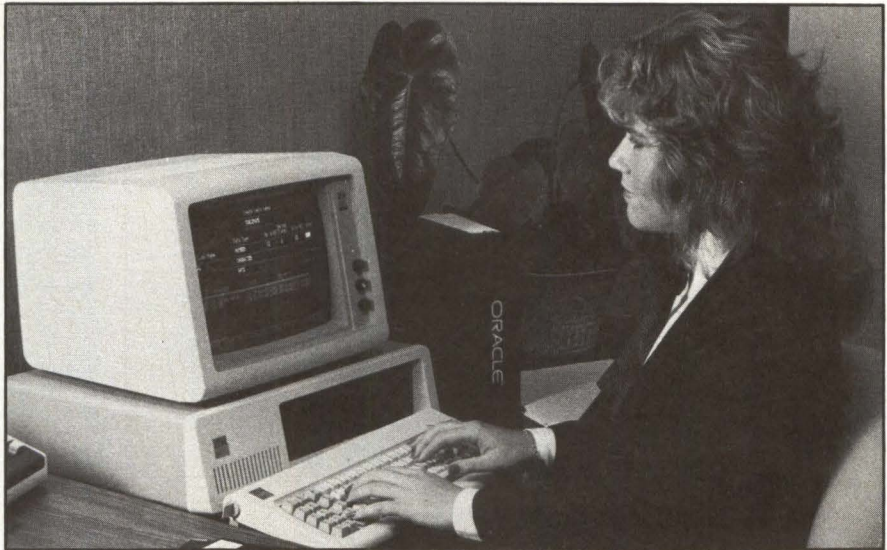

The PC Oracle relational database-management system runs on microcomputers such as IBM Corp.'s PC as a complete, but reduced-code, version of Oracle Corp.'s Oracle system for mainframes and minicomputers.

RAM, DOS 2.0 or 2.1, a 10M-byte Winchester disk drive with at least 3M bytes of free space, and one floppy-disk drive. PC Oracle runs on DEC VAXs with VMS and UNIX, DEC PDP-11s with RSX-11/M+, the IBM 30XX series, and Data General Corp. and Harris Computer Corp. computers.

According to Oracle president Larry Ellison, to compress Oracle for microcomputers the company had to create new compilers, a linkage editor and a debugging system. The process took almost two years.

Link supports communications

Oracle's new Oracle Link networking package communicates with versions of Oracle for DEC VAX superminicomputers and IBM mainframes. Oracle Link permits the exchange of shared database information to and from the large computer and PC Oracle on the microcomputer. PC Oracle's price, in-

cluding Oracle Link, is \$1,000 per system with a minimum order of six packages.

Robert M. Lefkowitz, director of microsystems software research for InfoCorp, a Cupertino, Calif., research company, says growing companies may choose to start out by buying an upscale high-end PC like the IBM PC-AT to run PC Oracle. Then, as they expand their databases, they could upgrade to larger machines without having to worry about converting software.

Jim Renalds, manager of the small computer industry service for Dataquest Inc., San Jose, Calif., disagrees with Lefkowitz. "I don't see it as that much of an advantage to run the exact same software on the micro as on the mainframe. [In what application] would you use a microcomputer in the same way that you use a mainframe? There's a [storage] capacity problem in that the database on the mainframe typi-

Mini-Micro World

NEWS

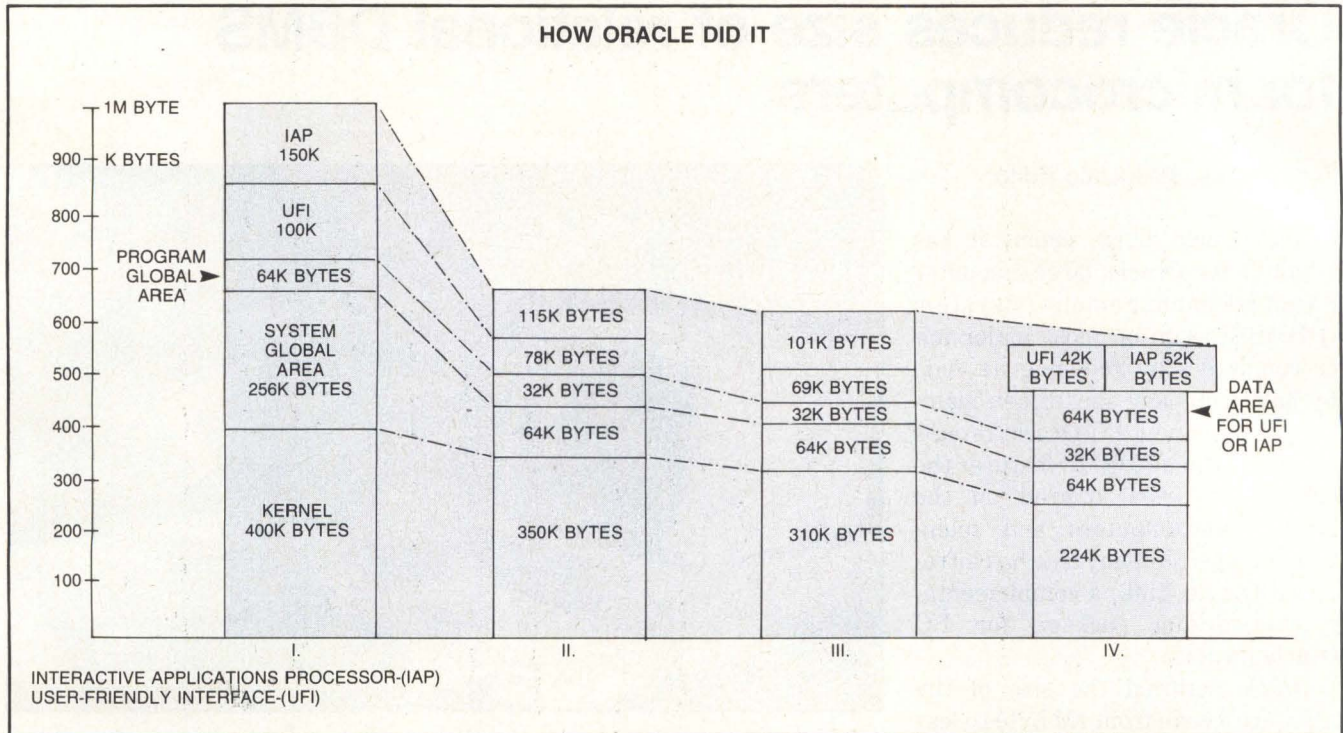

Bar I represents the original Oracle relational database-management system. In **Bar II**, the object code has been reduced by the instruction set architecture of the 8088 chip and by eliminating multiuser capability. Reductions in **Bar III** result from optimized pointer-refer-

ence handling and intermediate-results handling. The C compiler and reduction of the longest data pointer to 16 bits account for the final compression shown in **Bar IV**.

cally accesses a fairly complicated and large [amount of data]." Renalds maintains that, if a company needs that complex a database, the company would use dumb terminals or PCs acting as dumb terminals. But the task of extracting a subset from the main data remains. "The real question is, will users be willing to put up with the offloading time and slower execution of the micro, versus just [accessing data] on the mainframe?"

Renalds feels PC Oracle is an attempt to slice into the predominant market share of Ashton-Tate, Culver City, Calif., Microrim, Bellevue, Wash., and Software Publishing, Mountain View, Calif. "The reason those three [companies'] products, among others, have been so successful is that they run on the IBM PC," he says.

Dataquest estimates that Ashton-Tate has installed 280,000 units of

dBASE II and Software Publishing has in place more than 300,000 units of PFS:File. But Renalds concludes that Oracle is not entering the microcomputer market too late. "Da-

tabases are increasingly in demand by the small business user, so Oracle is still in the window for significant market share and sales," he says. □

PRINTED-CIRCUIT BOARD INDUSTRY GROWING UP

Until recently, the printed-circuit-board (PCB) manufacturing industry borrowed heavily from photographic, metal finishing and laminating production methods. But the advent of increasingly sophisticated microprocessors has forced PCB vendors to begin developing a native technology to efficiently produce the much denser patterns of conductive lines and insulation spaces required by microprocessors and other VLSI semiconductor devices. The cost of such retooling will be high, leading to a shakeout among the more than 800 industry participants, according to a Frost & Sullivan Inc. report. In the study, the New York market research firm predicts that, despite the high cost of industrial change, the PCB market will grow from \$3.5 billion in 1983 to \$13.7 billion in 1993. Double-sided boards will lead the market with a 49 percent share, followed by multi-layer boards with a 41 percent share.

A Picture's Worth:

U.S. SHIPMENTS (\$ BILLIONS)

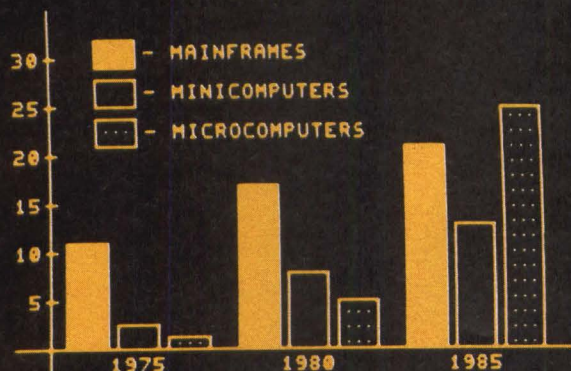

** GRAPHICS CAPABILITIES **

- ◆ HIGH PERFORMANCE GRAPHICS
- ◆ TEKTRONIX 4010 COMPATIBILITY
- ◆ AUTOMATIC SCALING (1023x1023) WITH 250x512 RESOLUTION
- ◆ ALPHA MODE (35 LINES x 73 COLS)
- ◆ OPTIONAL JOYSTICK
- ◆ CONNECTION TO LOW COST PRINTER FOR GRAPHICS HARDCOPY
- ◆ ASCII AND APL CHARACTER SETS
- ◆ BLOCK FILL, DOTTED/DASHED LINES

** DISPLAY TERMINAL CAPABILITIES **

- ◆ ANSI STANDARD CONFORMANCE
- ◆ DEC SOFTWARE COMPATIBILITY
- ◆ 80/132 COLUMNS, WINDOWING
- ◆ 4 PAGES OF MEMORY STANDARD (UP TO 8)
- ◆ 46 PROGRAMMABLE FUNCTIONS
- ◆ ASCII AND APL MODELS
- ◆ COMPACT ULTRA-THIN KEYBOARD
- ◆ HIGH BRIGHTNESS AMBER PHOSPHOR



High performance graphics at a new low price!

\$1190*

CONCEPT GVT+™ Graphics Display Terminal

*Small quantity price

human designed systems, inc.

Whether used in video display mode or in its high-performance graphics mode, Human Designed Systems' GVT+™ Graphics Display Terminal offers more user friendliness, more design features, and more advanced functionality to optimize productivity — and encourage creativity — for the terminal operator, interactive user, and applications developer than any other terminal available today.

Atlanta — (404) 391-9763; Boston — (617) 449-6446; Chicago — (312) 825-2960; Dallas — (214) 437-1888; Delaware — Infocon: (302) 239-2942; Denver — (303) 469-1953; Detroit — (313) 471-2807; Hawaii — Gray Associates: (808) 261-3751; Houston — (713) 952-1403; Los Angeles — (213) 410-9454; Northern New Jersey — Infocon: (201) 624-1372; New York City Area — Infocon: (212) 689-8833; New York State — Naco Electronics: Rochester: (716) 223-4490; Syracuse: (315) 699-2651; San Francisco — (415) 692-4184; Washington, DC — International Systems Marketing: (301) 279-5775; Argentina — Itron SA: (01) 774-9369; Australia — Computer Clarity Pty. Ltd.: (02) 241 3385; Belgium — BELCOMP: 091-31.52.22; Canada — CALL Systems: Toronto: (416) 362-1063; Denmark — ADCOM Data Aps: 1-19 44 66; Finland — Valtamatic Oy: 0-742 011; France — Walton: (1) 226.06.90; Japan — Ampere: 03 (365) 0825; Portugal — Soc. Com. Crocker, Dellatorce Co. Ltd.: 1-6801 41; Singapore — DTS Singapore: 33-88-566; South Africa — Psitac (Pty.) Ltd.: (11) 836-9181; Switzerland — Mittek ag: 01/461 22 52; United Kingdom — Shandell Systems Ltd.: 2407-2027; Venezuela — H. Blohm SA: 2 541.21.22; West Germany — COMKO Computersystemges. mbH: 221-48 30 51. INTERNATIONAL DISTRIBUTORSHIP INQUIRIES INVITED.

CIRCLE NO. 19 ON INQUIRY CARD

FIND THE TAPE MAKE A CON



If you need tape controllers and couplers for VAX, Unibus and QBus systems, you've come to the right ad. Emulex offers one of the industry's most complete selections.

FOR VAX SYSTEMS.

Our new TC7000 is a good example of the kind of performance you get with Emulex. This single-board controller lets you move up to the higher densities and transfer rates of state-of-the-art GCR transports. One TC7000 can handle up to four STC-type transports or eight reel-to-reel units with Pertec-type interfaces. And you can choose from three tape

densities: 800-bpi NRZI, 1600-bpi PE or 6250-bpi GCR.

FOR UNIBUS SYSTEMS.

Our TC11 emulates the basic DEC TM11 controller. It works with up to four industry-standard tape drives with densities to 1600 bpi and speeds up to 125 ips.

Unibus users will also appreciate the TC12. This single-board TS11-compatible coupler handles industry-standard formatted Pertec-type $\frac{1}{2}$ " tape transport, including conventional NRZI/PE start/stop and 800/1600/3200-bpi streaming tape drives.

The new TC15 is another

TS11-compatible tape coupler that allows you to interface the CDC Sentinel $\frac{1}{4}$ " streaming tape drive. And it features software transparency and standard operating system support on your Unibus system.

Last, but not least, is the TC13. This universal tape coupler works across the Unibus of PDP-11 and VAX-11 CPUs. It handles industry-standard $\frac{1}{2}$ " tape transports, including conventional start/stop, streaming, and the new generation of GCR units.

FOR QBUS SYSTEMS.

The TC02 has long been an Emulex favorite. This TS11-

EMULEX DOESN'T TROLLER FOR.

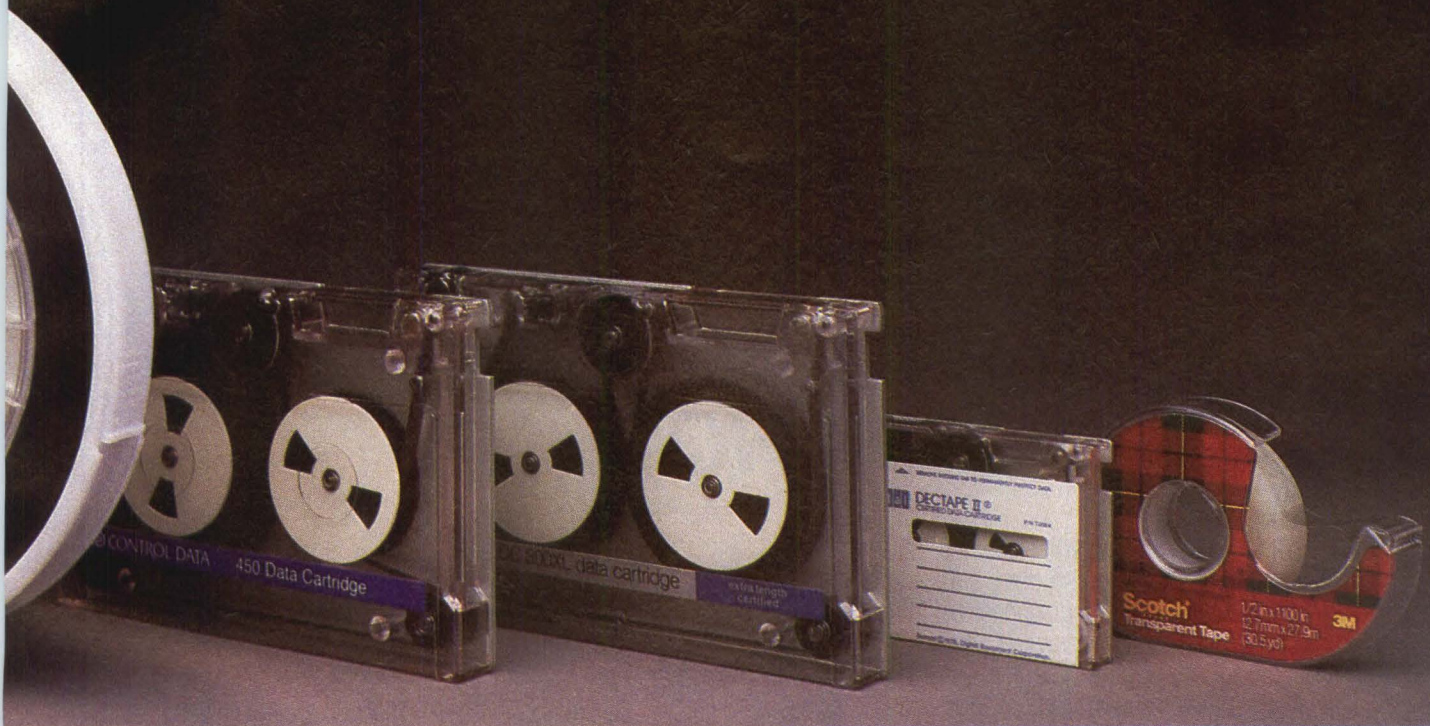

compatible tape coupler works with all 800/1600/3200-bpi formatters at speeds from 12.5 to 125 ips.

Another TS11-compatible coupler is our new TC05. It allows you to interface CDC Sentinel 1/4" streaming tape

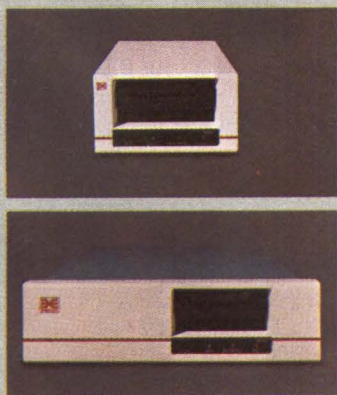

drives without using special streaming software.

And don't overlook the TC01. TU10/TM11-compatible, it handles as many as four dual-density 800/1600-bpi 1/2" transports at up to 75 ips.

NEW PACKAGED SUBSYSTEMS.

Also available for QBus and Unibus users are two packaged subsystems.

Vault™ is a 1/4" streaming tape that gives you up to 70 MBytes of storage.

Medley™ is a packaged subsystem that includes either a 35 or 110-MByte formatted 5 1/4" Winchester disk drive and a 1/4" streaming tape drive with

70 MBytes of backup storage capacity.

GET YOUR TAPE PROBLEMS UNDER CONTROL.

Stick with Emulex. Call us toll-free at (800) 854-7112. In California, (714) 662-5600. Or write Emulex Corporation, 3545 Harbor Blvd., P.O. Box 6725, Costa Mesa, CA 92626.



The genuine alternative.

THE SERIES 1000

The Only UNIX-Based, PC/IX-Compatible Multi-User, Multi-Tasking Microcomputer System Is Now Available From One Of The World's Largest Computer Products Manufacturers.

WHO?

SCI Systems, of Huntsville, Alabama, that's who. We've been so busy supporting the world's leading suppliers of microcomputers that we haven't taken the time to talk about ourselves.

We've delivered hundreds of thousands of 16-bit microcomputers - more than Convergent Technologies, Altos, Corvus Systems, Televideo and others combined - so we have quite a bit of successful experience to share with those who also want to be leaders.

Our new Series 1000 is worth a long hard look by any OEM or reseller who wants to build his business with a unique microcomputer system.

The Series 1000 is the only UNIX™-based, PC/IX™ compatible, multi-user, high performance, large capacity microsystem ready to be shipped.

A list of its features is impressive. Such as the 8 MHz 80186 microprocessor, over 100 MB of Winchester disk storage, up to one MB

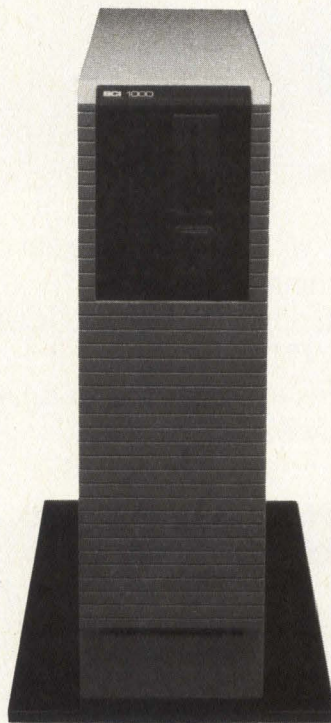

RAM, from two to eight users, networking, memory management, workstation peripheral, and many others that you can learn about by writing or calling us.

SCI has well earned its outstanding reputation for product reliability. We had to, for our customers are extremely demanding. Like NASA, the military, government agencies, and many of the largest companies in the world who always insist on the best.

SCI Systems. We've made more than a million computers for others. We're ready to make one for you.

COMPARE PRICE, COMPARE VALUE

\$8990. That's the cost for a basic four-user system, with 43 MB of Winchester disk storage, the lowest per-user cost of any comparable system.



PC/IX is a trademark of International Business Machines Corp.
UNIX is a trademark of American Telephone & Telegraph

SCI SYSTEMS, INC.
5000 TECHNOLOGY DR.
HUNTSVILLE, AL 35807
205-882-4304
See us at Comdex Hilton 8822

Stock, Boston/Bohdan Hrynewych



HEARD ON THE HILL

High technology receives low priority in presidential campaign

Stephen J. Shaw
Washington Editor

Regardless of the outcome of this month's presidential election, both Ronald Reagan's and Walter Mondale's campaigns have proved to be disappointments to the U.S. computer industry. During the long months of campaigning, both men consistently and repeatedly failed to address issues critical to the continued development of high-technology industries in this country.

This is not to say that the candidates paid no political lip service to high-technology industries. Reagan called for "high tech, not taxes," in one of his speeches. And Mondale pointed out that the basic industries of the 1990s will differ significantly from those of the 1970s. But aside from the most banal and soporific utterances, there was no significant national discussion concerning the future of those industries which both men agree represent the future of this country.

In preparing this column, we contacted both parties' national campaign headquarters and asked them to send position papers, speeches and any background material that would shed light on the candidates' points of view on the development of the U.S. computer industry and other high-technology industries. The response from both camps was astonishing: "We really don't have anything directly relating to high tech." No position papers (normally churned out in volumes by campaign staffs, and read by a scant handful of voters), no speeches, no compilation of legisla-

tive records. Nothing.

The issues branch of the Reagan campaign said that they had no high-tech specialist as they did for military spending, overall economic policy and social issues. In the words of Bob Dawson, Reagan's campaign manager in Massachusetts, "Reagan's philosophy is, what's good for business in general is going to be good for the high-tech industrial segment." He added that, "Since the president doesn't support a planned industrial policy, the campaign has concentrated on his development of investment incentives such as accelerated cost recovery schedules and tax cuts." Coincidentally, Dawson works at Wang Laboratories Inc.

The Mondale campaign staff in Washington referred us to the Democratic platform (non-binding on the candidate), and a document released in January by the National Democratic Caucus that outlined a blueprint for the country's future as seen by the Democratic members of the House of Representatives. (Again, the plan does not obligate Mondale.) Both documents contain some references to the need to address U.S. high-tech industrial development and related concerns, but only in the most vague terms. As political documents, they fall far short of providing any basis for the national discussion that is needed on this country's future economic mainstays, of which high tech is one.

Many issues deserve a national debate because they are so crucial to the computer industry and are therefore of national importance. Export administration, increased research

and development expenditures, increased access to foreign markets, protection of domestic markets and the trend toward offshore manufacturing are issues that received short shrift from both candidates when it came to relating party philosophies to concrete proposals.

The reason for this, according to a computer industry association executive, is the campaign's broad focus. "This campaign did not get down to many industry-specific issues," commented Ted Heydinger, vice president for government relations with the Computer and Business Equipment Manufacturers Association. The industries that did attract national attention—automobile, steel and agriculture—generated campaign discussions that were split along party lines. High-tech issues have not attracted such partisan support or opposition. Campaigns outline differences, notes another political observer, so since both Mondale and Reagan essentially agree on the importance of the computer industry and other high-technology industries to the future of the United States, what would be the point of getting bogged down in details?

The danger in such a superficial analysis is that differences between the two candidates were not likely to surface until after the election. While agreeing to the importance of high technology to this country's future, Mondale and Reagan assumed, and failed to live up to, the responsibility of formulating and communicating specific policy positions. It's a failure for which the winner of this month's election should be called to account.

THE SOURCE OF TELETEX SOURCE.

CCITT TELETEX SOURCE:

MicroTeletex software conforms to CCITT recommendations S.60, S.61, S.62, S.70 and F.200.

NETWORKS:

MicroTeletex is available for all three different types of networks; CSDN (X.21), PSDN (X.25), and PSTN (V.22bis/V.25bis).

MODULAR:

MicroTeletex is designed according to the OSI reference model and consists of layers 1 to 6. Each layer is a task running under a real-time executive.

PORTABLE AND FLEXIBLE:

MicroTeletex source is written in the language "C" and is portable to a wide range of operating systems. It may run stand-alone on a dedicated communication processor.

IMPLEMENTATION AIDS:

Testtools for teletex emulating and on-line monitoring are included to ease system integration and field diagnosing.

HIGH QUALITY DOCUMENTATION:

Complete specification and design documentation are available for all internal interfaces and layers.

ASSISTANCE:

Assistance for product design, porting, implementation and certification is available. We also offer maintenance.

AVAILABLE TO OEMs:

MicroTeletex source and documentation are available to system integrators and hardware manufacturers of WPs, PCs, LANs, advanced workstations, gateways and general micro/minicomputers. MicroTeletex has already been

delivered to several European and US manufacturers.

BOOST YOUR DEVELOPMENT:

MicroTeletex is the result of 30 man-years of development. This may save your company valuable time and money. You can use your technical resources for the development of local functions which make your product special.

For further information, please contact:

Software Support International, Inc.
1300 Conwed Tower, 444 Cedar Street, St. Paul MN 55101
Telephone (612) 291-7013, FAX (612) 291-0977, Telex 297438

or our headquarters located near Oslo airport:

A.S COMPUTAS COMMUNICATION
Veritasveien 1, PO Box 310, 1322 Høevik, Norway
Telephone (47-2) 47 79 31, FAX (47-2) 47 98 71, Telex 76192



MicroTeletex® - Registered trademark of A.S COMPUTAS.



Apple slices Macintosh software projections

Marjorie Stenzler-Centonze
Associate Editor

Apple Computer Inc., Cupertino, Calif., has revised its lofty projections about how many applications packages will be available for its Macintosh microcomputer by year's end. Apple had announced in January that more than 500 software packages would be available. But with only 75 applications shipped as of September, Apple officials have now reduced their estimate to a maximum of 150 software packages by the end of 1984. Even that may be overly optimistic because of the longer-than-expected learning curve for programmers, say some industry observers.

Apple is counting on third-party software developers for more than 90 percent of Macintosh software products, but applications development has been slower than anticipated. "We were overly optimistic in our initial forecast," states Guy Kawasaki, who heads the third-party software development effort at Apple. The first time programmers write a Macintosh application, they find it to be quite a challenging environment, Kawasaki explains. "The richness of our ROMs and the user interface have made Macintosh programs typically a six- to nine-month development process."

Once a third-party software developer comes out with its first Macintosh software product, subsequent packages will require less effort. But it is still a task to write for the Macintosh: Macintosh applications are not well-suited to porting from an IBM PC or Apple IIe, because the machines' features are so different. "Developers have to think about how to use scroll bars, windows, icons and a mouse-based system. [In] taking a program from

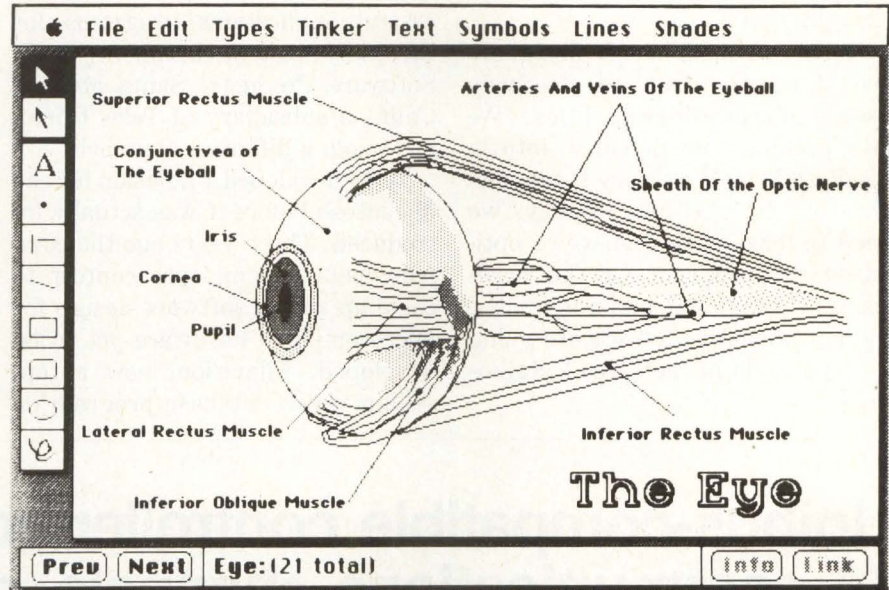

Telos Software's Filevision program for Apple's Macintosh computer combines filling with an object-oriented drawing system so that technical illustrations such as the one above can be created, stored and retrieved by the mouse cursor controller.

the PC to the IIe, no one had any of those considerations," Kawasaki states.

"The Macintosh environment is so different from the Apple [IIe] or IBM world that it essentially requires a rewrite to move existing software onto the machine," concurs Valorie Cook, group product manager at Software Publishing Corp., Mountain View, Calif., which has released two products for the Macintosh—File and Report.

Spreadsheets are needed

The important products for Apple to add to its stable of Macintosh products for business users are spreadsheets, according to Kenneth G. Bosomworth, president of the research company International Resource Development, Norwalk, Conn. During the first quarter of next year, Lotus Development Corp., Cambridge, Mass., plans to ship the Macintosh version of its 1-2-3 integrated spreadsheet. Ap-

ple's Kawasaki expects 1-2-3 to quickly climb to the top of the Macintosh best-seller list.

Although software packages are not as plentiful as Apple would have liked, most developers working on Macintosh applications agree that the programs that have come to market so far make good use of Macintosh features. "People aren't compromising on product design just to shove software out the door for Macintosh," says Jeff Raikes, director of applications marketing at Microsoft Corp., Bellevue, Wash. "They are really taking advantage of what Macintosh has to offer, including the high-speed processor, high-resolution bit-mapped graphics and the mouse pointing device," Raikes says.

Microsoft has released Multiplan, Microsoft Basic and Microsoft Chart for the Macintosh and expects to ship its Word and File programs by the end of this month. "We are pretty much on target with the pro-

grams we are bringing to market," Raikes says, "although the timing took a bit longer than we had thought."

Raikes says Microsoft designers are taking great pains to effectively use the Macintosh capabilities. "We are packing functionality into a small 128K-byte memory space, and once we get the functionality, we need to make sure that we've optimized the program for the hardware. I think we underestimated the amount of work we were going to have to do in that area," Raikes says.

Writing for theoretical machines

While many of the major software houses are rewriting already successful applications programs for the Macintosh environment, Telos Software Products, Santa Monica, Calif., a subsidiary of Telos Corp., has taken a different approach.

Telos developed Filevision for the Macintosh before it was actually introduced. Three years ago the company held an employee contest to come up with a software design for microcomputer hardware yet to be developed. Filevision, now a top-selling visual database program on

the Macintosh, was the winning product.

Telos, which had previously specialized in mainframe and minicomputer software, committed resources to the microcomputer market for the first time. "We were waiting for the right computer to come along," says Robert Foster, vice president of marketing for Telos Software. "We were different from other companies in that we knew just what we were going to do and only had to worry about implementing it on the right computer." □

Unibus-compatible controller combines 16 communications channels, dual emulation

Carl Warren, Western Editor

Distributed Logic Corp. has developed a multifunction, 16-channel asynchronous communications controller to help system integrators and end users extend communications on Digital Equipment Corp. VAX minicomputers using Unibus.

The Anaheim, Calif., company's new controller features full power-up diagnostics and user-selectable emulation of DEC's own DH11 and DMF32 asynchronous controllers on one Unibus-compatible board. Called the CU160, it also permits up to 38.4K baud on all channels. Each channel can be fully configured using onboard DIP (Dual In-line Package) switches. Therefore, all lines for each channel can be set up for either a modem/null-modem-transmit with receive lines switched, or high-speed, 600-line-per-minute printers.

Extending the word

The CU160 also supports multiword (4-bit to 16-bit words) on

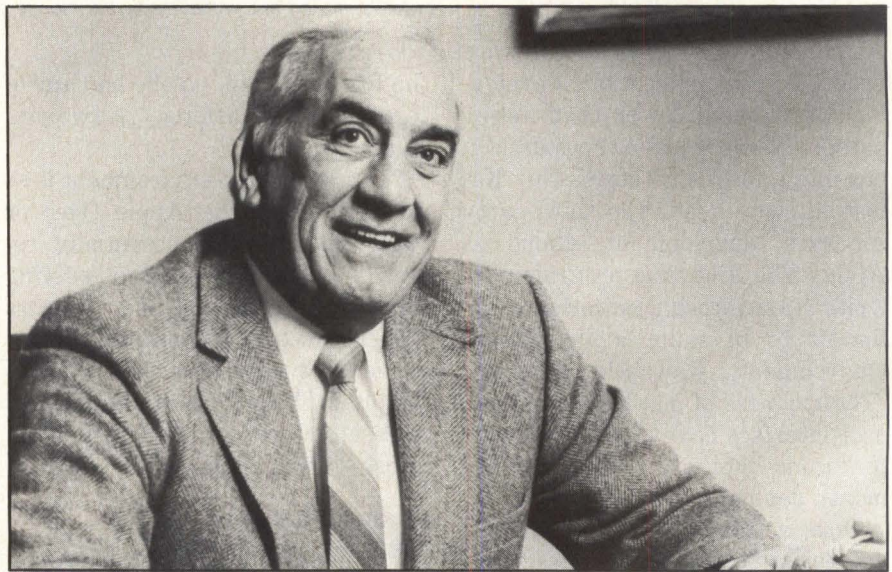

Distributed Logic's Raymond Ball explains that the CU160 Unibus-compatible controller emulates both DMF32 and DH11 asynchronous controllers, but at no extra cost for the dual capability.

single direct-memory-access (DMA) transfers. Therefore, according to Raymond Ball, corporate vice president of marketing at Distributed Logic, "The CU160 doesn't clobber the Unibus with multiple

transfers" each time a bus is strobed with a signal that data are correct on the bus. To achieve the fast DMA transfers without impacting the controller, host bus or other communications lines, a 64-character

COLOR!

It's spectacular

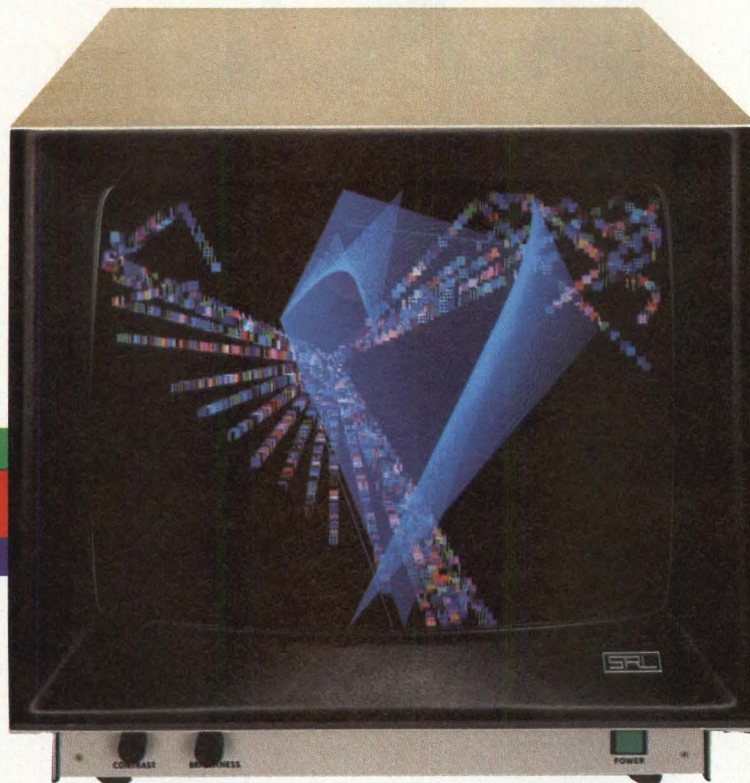

on an SRL 60 Hz noninterlaced display.

Our new 60 Hz noninterlaced Model 2110 display offers you one of the highest line rate, highest resolution color monitors available today. And at an economical price.

This state-of-the-art 1280 x 1024 format display features a 100 MHz ultra-high video bandwidth and a 64 kHz horizontal line rate for flicker-free performance. You get consistent brightness of narrow horizontal and vertical grid lines—and 1000 line resolution images at a 60 Hz noninterlaced frame rate.

There's no need to buy several monitors or to make circuit changes to meet your multiple line/frame needs. Simply select a range from 26.8 to 66.2 kHz with the Model 2110's unique *Select-a-Rate*.

CIRCLE NO. 23 ON INQUIRY CARD

And the SRL Model 2110 features even more benefits at no extra cost: differential video inputs...separate horizontal and vertical drive inputs...an adjustable bezel that allows you to insert anti-glare filters, and factory convergence that never deteriorates. Optional mechanical designs to meet specific packaging needs and custom engineering services are available.

The Model 2110 is the result of clean, precise engineering. No fans or baffles...no massive heat sinks or power supplies. Just the components necessary to give you spectacular color images.

So when you need better convergence, linearity and pure color fidelity across the screen and from edge to edge, contact us to find out more about our new 60 Hz Model 2110 color display.

Screen graphic courtesy of Metheus Corp.

SRL Quality Displays...for pure brilliance and crisp images.

SRL Visual & Training Systems

Systems Research Laboratories, Inc.
2800 Indian Ripple Road • Dayton, Ohio 45440-3639
(513) 426-6000 TWX 810-450-2621

IT WILL GROW ON YOU.

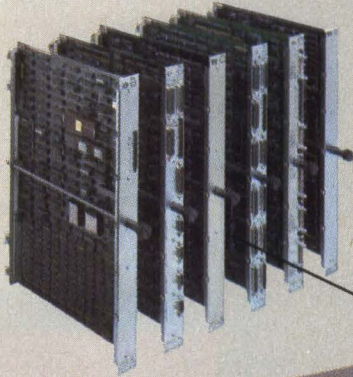

CONFIGURABLE ACCORDING TO USER NEEDS. As many as six processors can be installed in each enclosure. CPU-intensive jobs utilize multiple Applications Processors. Systems with heavy disk usage can distribute this load among several File Processors. The number of user ports can be increased by adding more I/O Processors.

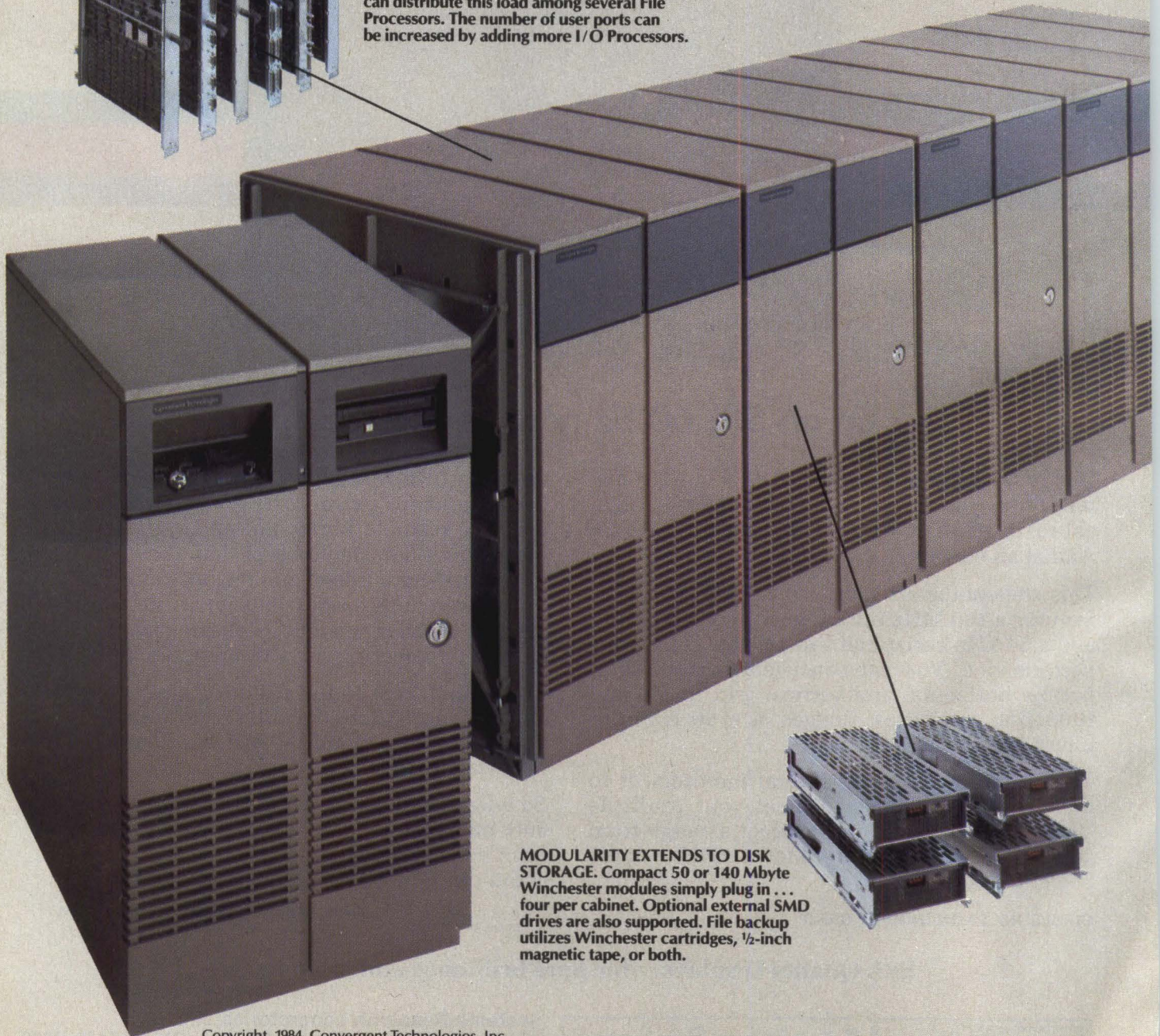

MODULARITY EXTENDS TO DISK STORAGE. Compact 50 or 140 Mbyte Winchester modules simply plug in . . . four per cabinet. Optional external SMD drives are also supported. File backup utilizes Winchester cartridges, 1/2-inch magnetic tape, or both.

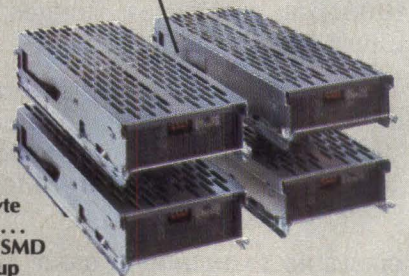

MegaFrame™. Now OEMs can offer a high-performance UNIX™-based system that can't run out of performance.

OEMs can now deal cost-effectively with the problems encountered when user applications produce computing demands that outstrip the capabilities of conventional systems.

Convergent Technologies' MegaFrame is a revolutionary new UNIX-based super-minicomputer—so innovative in its architecture that it represents the ultimate in multiuser systems design. It grows exponentially from a system offering minicomputer-level performance to an enormously powerful engine serving as many as 128 users with 36 parallel processors, 24 megabytes of RAM and gigabytes of disk storage.

No other system can match the MegaFrame's potential for field expansion. It enables manufacturers and systems builders to keep pace with today's requirements for more and more computing services... but *not* at the cost of discarding hardware or performing expensive CPU upgrades.

MegaFrame's architectural breakthrough. Dependence on traditional single-CPU shared-logic architecture is the root of systems bottlenecks.

Convergent's response: a novel system utilizing *multiple* specialized processors to distribute workloads for optimum performance—even if user needs are unpredictable or subject to rapid change.

MegaFrame's virtual memory Applications Processors each have a 32-bit CPU, up to 4 Mbytes of RAM and run a demand-paged version of UNIX System V. Up to 16 of them can operate in parallel.

The File Processors effectively function as back-end machines providing DBMS, ISAM and other disk-related services. Up to six File Processors each with four disks can operate in parallel.

Terminal and Cluster Processors can also be added—the latter serving front-end communications needs. They off-load communications from the other processors by running protocols such as SNA and X25 networks.

MegaFrame's daisy-chained cabinets offer total expansion potential of up to 36 slots. OEMs configure the system needed for specific applications simply by adding the correct number/combination of processors.

Flexibility in applications development. Inclusion of one or more Applications Processors allows running UNIX System V. All standard UNIX tools are provided, along with COBOL, FORTRAN-77, BASIC interpreter and compiler, plus Pascal.

The "least-cost solution" to serving a wide range of UNIX-systems needs, MegaFrame has won acceptance from OEMs in the U.S. and abroad. The uniqueness of its modular design, its versatility in providing upgrade-path options and its price/performance advantages give it market-share potential of outstanding dimensions.

The system that will grow on you starts at a very attractive price: about \$20,000 for a system that effectively supports 16 users. Send now for a comprehensive Information Package including reprints of magazine articles. It explains how MegaFrame's growth potential can impact favorably on your plans for growth in the UNIX market.

Convergent Technologies, Data Systems Division, 3055 Patrick Henry Drive, Santa Clara, CA 95050. Phone: 408/980-0850. Telex: 176-825.



Convergent Technologies

Where great ideas come together

MiniFrame™: the entry-level multiuser UNIX system.

Starting at under \$5,000 for a single-user system, Convergent's MiniFrame offers outstanding capabilities for small to medium sized organizations running large UNIX-based applications. Utilizing an MC68010 microprocessor operating at 10Mhz, with no wait states, it provides impressive CPU speed—comparable to VAX™-11/750 running the AIM™ Benchmark. MiniFrame features virtual memory management, with demand-paged implementation of UNIX System V. It runs as many as eight terminals, with up to 50 Mbytes of integral mass storage. MiniFrame and MegaFrame are object-code compatible, allowing OEMs to offer a *complete family* of systems unrivaled in price/performance characteristics.



MiniFrame and MegaFrame are trademarks of Convergent Technologies, Inc. UNIX is a trademark of Bell Telephone Laboratories, Inc., VAX is a trademark of Digital Equipment Corp.

Go from port to port without ever leaving the terminal.



The ATTACH system from ABLE Computer helps the data processing manager avoid a mutiny among users by enhancing processor efficiency. A multi-host terminal network system, ATTACH supports DEC UNIBUS VAX and PDP computers... and with its Softswitch feature that supports port selection, makes for smooth sailing through your network.

Ports-Of-Call, The User's Choice

With ATTACH, users select their network destination. The data processing manager assigns user class definitions for various host computers. Then users can initiate switching between any VAX and PDP-II UNIBUS computer ports in the system. Access to specific data files and applications in the appropriate host computer is readily available.

Navigate The Network Efficiently

With port selection, users match themselves to the application port required — no

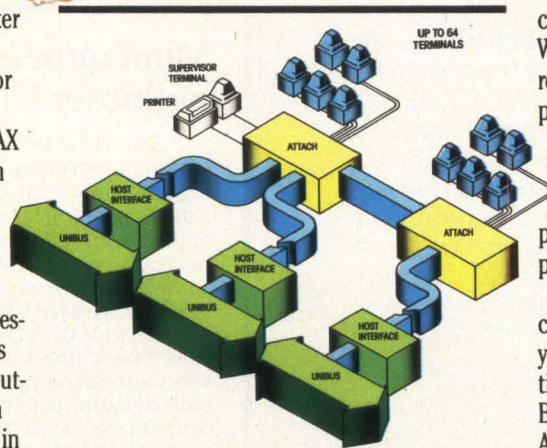

more wasted user time, or wasted support resources. And no host computer is sitting idle while others are overloaded.

Secure A Safe Passage

The ATTACH system assures the data pro-

cessing manager of security in the network. With user class definition the supervisor restricts access to any specified host computer, set of computers or subset — this safeguards critical data files. Plus, with ATTACH, the supervisor is free to allocate a particular host computer to high priority users who demand instant access and processing time.

Chart the right course through your communications network. Book passage with ABLE's ATTACH.

Contact an ABLE representative near you, or call us toll free at 800-332-2253.

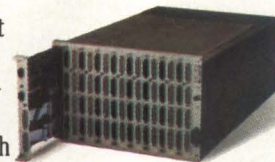

ABLE
COMPUTER

The Communications Specialists

ABLE Computer, 3080 Airway Avenue, Costa Mesa, California 92626. In the Costa Mesa area: (714) 979-7030. Or, TWX: 910-595-1729.

ATTACH is Patent Pending. DEC, PDP, UNIBUS and VAX are trademarks of Digital Equipment Corporation.

CIRCLE NO. 25 ON INQUIRY CARD

first-in-first-out buffer is provided for each line. That allows the 4-word [64-bit] DMA transfers when the bus is strobed.

Joel Jaworski, president of Peripheral Concepts Inc., Irvine, Calif., a marketing research firm specializing in controllers, points out that reducing bus traffic is an important feature for communications controllers. However, Jaworski points out that multiple emulation may be a more important factor. "Offering multiple emulation [DH11 and DMF32 on one product] reduces the manufacturing cost, the end-user cost and level of [product] complexity. Controller manufacturers are being forced to create more flexible devices [because of user demand]," he explains.

Emulex Corp., Costa Mesa, Calif., offers similar capability with the CS21 series of 16-channel controllers. Like Distributed Logic, Emulex provides multiple emulations for DMF32 and DH11. The Emulex emulation method, however, requires new programmable read only memories (PROMs) for each emulation, all at additional cost. Ball explains that the dual emulation capability on the CU160 is free. "A user can use or ignore the extra one," he says.

Packs in more

Distributed Logic provides extensions on the CU160 such as flow control. This lets users turn data streams off or on in accordance with the requirements of the attached

device, or of the host. "Typically on DEC equipment, this is a one-way street. We added bidirectional flow control, thus either the host or attached device can signal a go or no-go condition," claims Ball.

Distributed Logic also extends the available space and power of Unibus systems via the CU300 series of add-ons. The CU300 provides four additional Unibus slots, has an internal 20A power supply, can support either full-size or half-size boards and can accommodate up to 128 communications channels.

The model CU160 with DH11 and DMF32 emulation, 16-channels, multiword DMA, and bidirectional flow control is priced at \$3,000. The CU300 add-on is priced at \$7,500. □

Macrolink enters market for Perkin-Elmer disk controllers

Carl Warren, Western Editor

Tape controller maker Macrolink Inc., Anaheim, Calif., is invading the market for Perkin-Elmer Corp. computer disk controllers with the Macro 3 storage module device (SMD). The board is for use with high-performance Perkin-Elmer 3205 minicomputers.

By developing the Macro 3, Macrolink challenges a substantial number of competitors in the Perkin-Elmer niche, particularly Spectra Logic Corp. of Sunnyvale, Calif., which has more than 65 percent of the Perkin-Elmer disk controller market. According to Vipul Mehta, vice president of Peripheral Concepts Inc., an Irvine, Calif., re-

search firm specializing in controllers, the Macrolink board competes directly with Spectra Logic's Spectra 14. "The Spectra 14 is currently the most used controller. Typically, you find Spectra Logic disk controllers and Macrolink tape controllers on Perkin-Elmer machines," says Mehta.

Both the Macro 3 and Spectra 14 are capable of supporting extended SMD functions by special interleaving or staggering of the sectors, thus allowing for the 1.9M-byte-per-second transfer rate expected when using high-capacity disk drives such as the Fujitsu Eagle. However, Macrolink claims that the Macro 3 provides a strong upgrade path for Perkin-Elmer users. Macrolink president, R. David Vednor, explains: "Older Perkin-Elmer machines used the Mass Storage Module. The newer machines migrated

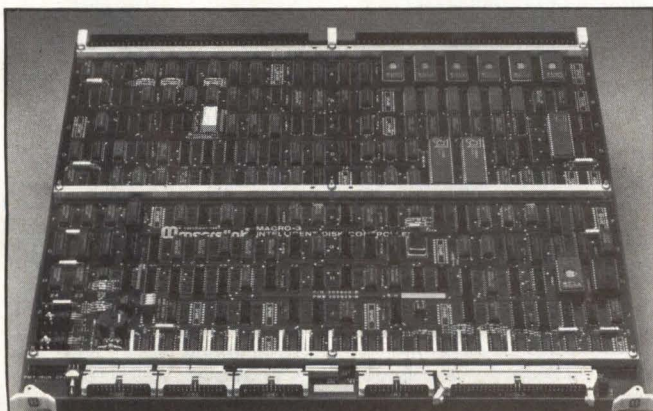

Macrolink's Macro 3 disk controller for Perkin-Elmer minicomputers uses a single DIP switch to set the device address, while all other functions are established via soft menus.

In 1985 There's Only One Softcon.

Sunday, March 31—Wednesday, April 3, 1985 Georgia World Conference Center, Atlanta

If you buy, sell, or develop software, you can't afford to miss Softcon, the International Conference and Trade Fair for Software merchandisers, publishers, users.

In only two years, Softcon has become the 15th largest trade show in America. Proof that software is the fastest growing product in the world. And that Softcon is the premier industry event.

Softcon has 850 exhibiting companies. That's 600 more software companies than the largest hardware and electronics shows. Softcon's 3000 booths will showcase more than 20,000 software products for professional, home, educational, entertainment, office, business, industrial and vertical market applications. Softcon features software for micros, minis and main frames.

Nearly 250 of the world's most respected software authorities will participate in this year's conference program. There will be three separate conferences—one for merchandisers and distributors, one for corporate and institutional users, and one for software industry technical personnel. Each conference will comprise 75 seminars, panel discussions, forums and workshops.

Softcon is a registered trademark of Northeast Expositions, Inc.

To register, just send your check for \$195 for four days of conferences and exhibits, or \$35 for exhibits-only to the address below. Please include your name and address and make checks payable to Softcon.

For a free Softcon brochure, call or write Softcon, c/o Northeast Expositions, 822 Boylston Street, Chestnut Hill, MA 02167. 617-739-2000. Please specify whether you are interested in attending or exhibiting.



The International Conference
and Trade Fair for Software
Publishers, Merchandisers,
and Business Users

Dataram does more with memory

digital

for system builders

...and system managers too.

Dataram does more with memory so you can do more with your minicomputer system. No matter whose it is — DEC, Data General, Perkin-Elmer, VERSAbus, or others.

You can do more because Dataram ADD-IN memory provides more — more capacity, more capability, and more reliability. And that adds up to more performance per square inch than anyone else can deliver. More from Dataram also means more savings on power, space...and cost! All backed by a responsive spares program, a liberal warranty, and dial-up technical support.

Key to it all is Dataram experience. Gained from years of supplying memory to today's leading mini manufacturers...from supplying more memory units than any other company...and by a nearly 20-year commitment to memory technology.

Whether you're a system manager or a system builder, you should talk to Dataram before you make your next memory decision. Learn why we can provide everything you want in memory...and more.

Dataram Corporation □ Princeton Road □ Cranbury, NJ 08512 □ (609) 799-0071 □ TWX: 510-685-2542
CIRCLE NO. 27 ON INQUIRY CARD

DATARAM

to the Intelligent Device concept. This means that older disk packs can't be read—so upgrading was tough. We solved the problem [in our controller] by reading both simultaneously." Vednor notes that pricing is part of the marketing strategy. The Macro 3 is priced at \$3,475, which contrasts to \$4,500 for the Spectra 14.

Soft menu helps users

The Macro has a soft menu whereby the user can establish the characteristics of the system by following the menu items. To set the functions of the controller, a writable control store is provided, as are erasable programmable read only memories (EPROMs) that can be used for coding special functions. A single DIP (Dual In-Line Package) switch sets the device address. Company vice president William Goodale says the writable control store and EPROM allow for more control over functions. The use of 256K bytes of cache RAM with built-in Error Correction Code means that virtually all errors can be corrected. "This is something Perkin-Elmer doesn't have," claims Goodale.

The Macro 3 is available now with complete compatibility to all Perkin-Elmer disk formats. The cost is \$3,475 per unit, or \$2,155 in orders of 100. □

LOOKING AHEAD IN MMS

The Interpreter section of Mini-Micro Systems' December issue focuses on office-automation systems.

OA systems have the potential to move mountains of paperwork and boost worker productivity. Yet, year after year, the promise is not quite realized. Buyer perceptions of machines as not user-friendly could be one reason. This article examines what's being done to improve OA's image.

Expandable Stride Micro family supports 22 users

Tom Moran, Associate Editor

Stride Micro, Reno, Nevada, formerly Sage Computer, has introduced a family of MC68000-based, expandable multiuser supermicro-computers with prices ranging from \$2,900 to \$58,500.

The three members of the Stride 400 series are the first systems to run Softech Microsystems Inc.'s Liaison operating system, which is a p-System superset that includes networking capability. The models 420, 440 and 460 use the VMEbus and sport the same CPU board, with a 10-MHz MC68000, 256K bytes of RAM, a 640K-byte floppy disk drive, a Centronics-compatible printer port and a battery-backed real-time clock. Also standard is a Corvus Omninet local area network interface. Operating system options include UNIX System V, CP/M-68K and RM-COS. The Stride sys-

tems support a total of 30 compilers and languages.

System building blocks

Bill Delaney, Stride's vice president of marketing, says that because all the Stride 400s run the same CPU and have LAN capability, "The same software that runs on a \$2,900 machine also runs on a \$60,000 computer. The idea is that you can use these three as building blocks in much larger systems."

In the United States, Stride distributes its systems mainly through 145 third-party dealers and value-added resellers, with a small percentage going through OEMs. A Stride spokesman says that up to 40 percent of the company's sales are to the international market, through 35 distributors in 43 countries.

As Sage, Stride had 4,000 installed units, with a recent installa-



The Stride 400 series from Stride Micro, Reno, Nevada, all contain an identical CPU board with a 10-MHz MC68000 processor. A Corvus Omninet local area network interface is standard.

***dBASE users
will have only
one thing to say
when they hear
about Clipper,
the compiler
that lets them
run dBASE up to
20x faster.***

"It's about time"



Introduce dBASE users to the time of their life.

Now you can sell a million dBASE users their most valuable commodity, Time.

Time to indulge themselves. Or, more time to utilize their computer to its fullest.

Announcing Clipper, the industry's hottest entre into the tremendous existing user base of the world's most popular database management system.

Clipper, the first true compiler for dBASE III gives your customers the gift of time by making their dBASE run up to 20x faster than with the standard dBASE interpreter.

A dBASE interpreter painstakingly checks and executes one line of source code at a time every time a program runs. With Clipper, once source code is debugged, it's compiled into more efficient machine code. Subsequently, the program runs without the time-consuming overhead of redundant translation.

And since it's impossible to translate from machine code back to source code, developers will appreciate the security as well as the speed. Clipper compiles your customers' existing dBASE III programs and any they'll use or write in the future.

So call us today and ask for details on becoming a Clipper dealer or distributor.

Because time is money.



Nantucket
20456 Pacific Coast Hwy.
Malibu, Ca. 90265/(213) 456-7315

CIRCLE NO. 28 ON INQUIRY CARD

tion-rate of 250 systems per month. Approximately 50 percent of its systems go to software developers; vertical markets account for about 30 percent of sales; the remaining 20 percent is split among educational, scientific, engineering, and process-control applications and OEMs. Stride reported revenues of \$10 million in the fiscal year ending March 31, representing a 420 percent increase over fiscal year 1982.

Norm DeWitt, associate director of personal computer programs for the market research group Dataquest Inc., San Jose, Calif., comments, "It sounds like they have a lot of horsepower for the dollar. They appear on the surface to be priced down in the area of the [IBM] PC-AT, which also offers multiuser capability, but not as much as Stride is offering."

System prices begin at \$2,900 for the 420, \$5,900 for the 440 with a 10M-byte Winchester disk drive, and \$8,900 for the 460 with a 15M-byte Winchester disk drive. A 460 configuration, with four 112M-byte Winchester disk drives and 3M bytes of RAM, is \$49,000.

Other options for the Series 400 include a 12-MHz MC68000 (for \$500) and a second floppy disk drive (also \$500). The standard 420 comes with its maximum four serial ports; the 440 and 460 models come with 10 serial ports. The 440 can be expanded to 16 ports and the 460's maximum is 22 serial ports; under certain operating systems, every serial port can support a user. The 420 can be expanded to 512K bytes of RAM for \$500; the 440, to 2M bytes for \$2,800, including six additional serial ports; and the 460, to 3M bytes and the optimum 22 serial ports for \$5,600.

Although Stride's former products, the Sage II and Sage IV, are being phased out, Delaney says the company will fulfill present contracts and continue support. □

Verbex voice-recognition terminal talks to IBM PC

David Bright, Assistant Editor

After selling fewer than 100 of its \$25,000, Verbex 3000 continuous-voice-recognition terminals, Verbex Corp. has scaled down the system to a \$4,900 unit called the Verbex 4000 that attaches to the IBM Corp. PC.

Officials at the Bedford, Mass., company and Verbex's parent, Exxon Enterprises, are betting that the more attractive price and its identification with the IBM PC will lead to much greater success for the product. Near-term plans also call for the unit to connect to a variety of other machines, including Digital Equipment Corp. (DEC) VAX superminicomputers and Hewlett-Packard Co. 1000 and 3000 minicomputers, says Dr. Michael McCallig, director of engineering.

While the Verbex 3000, which the

company continues to carry, is the size of a small washing machine, the new 4000 is smaller than an IBM PC system unit, measuring 17 by 4 by 12 inches. The reduction was achieved by trimming the 360-word, speaker-dependent user vocabulary to 100 words, and by making the new peripheral less intelligent. (Although it contains processors and memory, the unit functions like a dumb terminal and requires attachment to a host computer.) As a result, the 4000 needs one board, while the 3000 contains four. Compared to its predecessor, the 4000 uses a CMOS RAM cartridge for storing user voice templates, rather than a floppy disk drive, does not include a voice response (or "echo") feature for verifying speakers' input and doesn't perform chores such as error checking and data formatting.



The Verbex 4000 voice-recognition terminal, with a claimed accuracy rate of 98 percent against background noise of 85 dB, is designed for industrial data-entry applications. Not shown is the host IBM PC.

How to make your PC-XT multiply.



If you think that's no big deal, we'd like to introduce you to a multiplication table you've never seen before.

One PC-XT plus two terminals times one Pick System™ equals a three-user business system.

Net result: a savings of about 50% over the cost of three separate PC-XTs (which can't share data like we can, anyway).

To explain in slightly greater detail, the Pick System transforms

a single-user PC-XT personal computer into a complete business computer system.

If that's not enough—and for us it isn't—the Pick System also offers a built-in relational data base, a simple command language that uses everyday English words, and runs on hardware from micros to mainframes, from IBM® to Hewlett-Packard, and many more.

Which shows you just three more examples of Pick Power, and how our 20 years of business experience is ready to work for you.

If you'd like to add to your awareness of the Pick System, contact any authorized Pick dealer. Ask him how the Pick System can make your PC-XT multiply, and he'll give you his undivided attention.

The Pick System.

Computer Ease, Not Computerese.

For more information, call us toll-free at 1-800-FOR PICK. In California, call 714-261-7425. Dealer inquiries welcome.

Pick System is a trademark of Pick Systems. © 1984 Pick Systems.

INFORMIX AND File-it!

THE FIRST DATABASE SOFTWARE FAMILY
FOR UNIX AND MS-DOS.

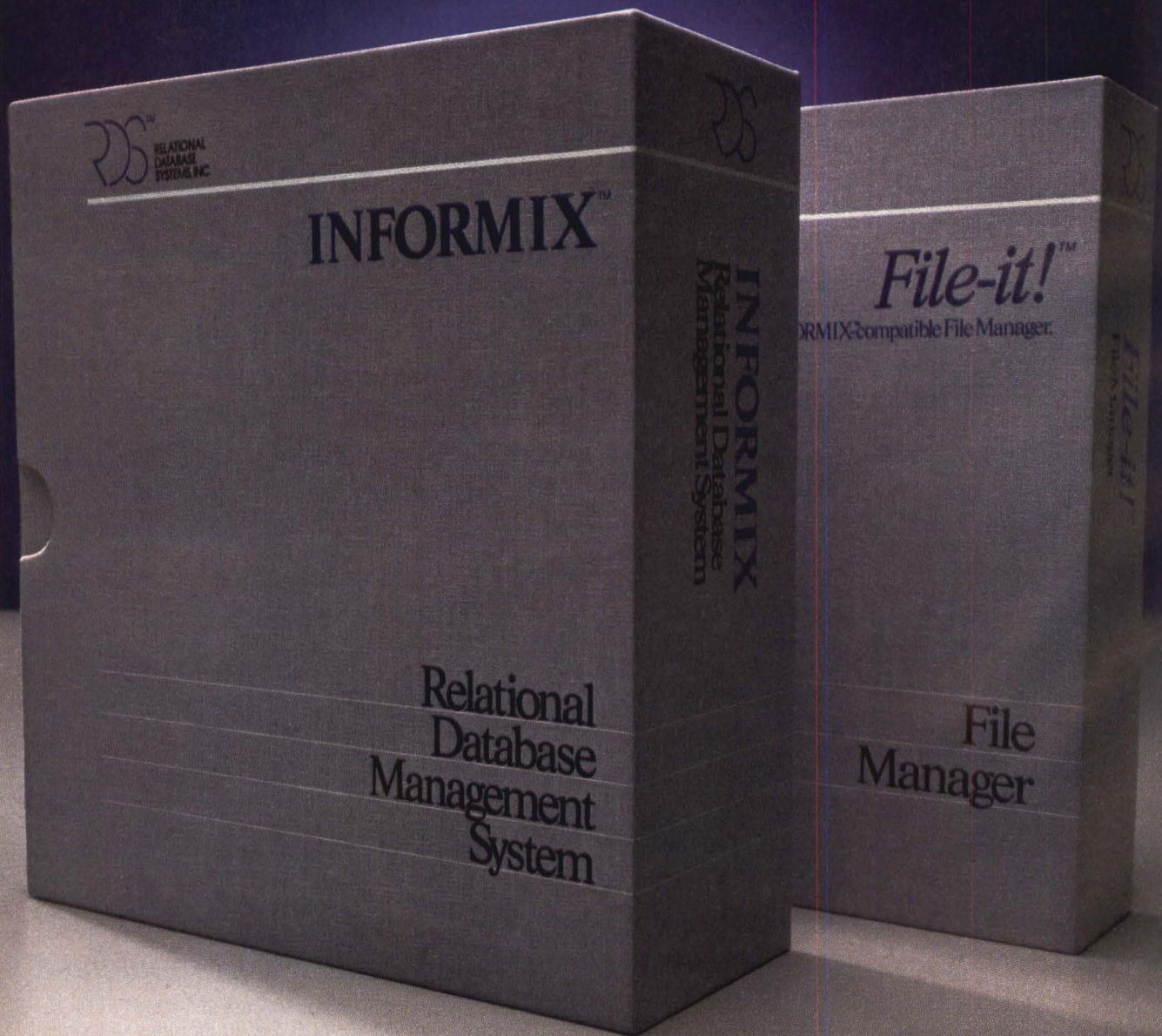

Now OEMs and systems integrators can sleep better at night. Because one company has taken the worry out of buying the right software.

RDS.

The company that produces a family of database software designed to take on the future.

Incompatibility is a thing of the past.

INFORMIX[®] and File-it![™] are compatible with UNIX[™], MS[™]-DOS, PC-DOS[™], and PC/IX systems (over 60 micros and minis* at last count).

INFORMIX is a true relational database system designed to take full advantage of the power of UNIX. It includes the most widely used report writer on the market.

Then there's File-it! The first easy-to-use UNIX file manager. Together, they have the flexibility to accommodate novices and experts alike.

INFORMIX and File-it! are fully integrated. Users can upgrade from File-it! to INFORMIX or access data from one program or the other without re-entering data, retraining employees or reprogramming.

Applications can also be moved from MS-DOS to UNIX and vice versa without having to rewrite the application.

Simplify program development.

RDS offers C-ISAM[™], the de facto standard ISAM for UNIX. It's a library of C subroutines with a B⁺-Tree based access method that stores, retrieves and modifies data from indexed files. It's embedded in INFORMIX and File-it! Or is available as a standalone product.

Software good enough for AT&T.

AT&T, inventor of UNIX, has co-labeled INFORMIX, File-it! and C-ISAM to run on their full AT&T 3B Computer line (from micros to minis).

Hewlett-Packard, Altos, Zilog, Siemens, Cromemco, Perkin-Elmer, Sydis and General Automation have selected RDS as well.

In fact, INFORMIX has an installed base of over 6,000 copies. And RDS has sold over 35,000 licenses for all their products to date.

But before you make up your mind, check the facts one more time.

There's only one database software family that's UNIX-, PC-DOS-, MS-DOS- and PC/IX-based. It runs on more than 60 systems. And it's ideal for both novice and expert.

Now it doesn't matter where the future's headed. You're already there.

*RDS products are available for the following systems:

Altos 586, 986, 8600, 68000	Hewlett Packard 150, 9000
Apollo DN300	Series 200, 9000 Series 500
AT&T 3B2, 3B5, 3B20,	IBM PC, PC-AT, PC-XT
AT&T Personal Computer	Intel System 86/380, 286/310
BBN C machine (all models)	Masscomp NC 500
Bunker Ramo Aladdin 20	Momentum Hawk 32
Charles River Data Systems	NCR Tower
Universe 68	Onyx C8002, C8002A
Convergent Technologies	Pacific Micro Systems PM200
Miniframe and Megaframe	Perkin-Elmer 32 Series, 7350
Corvus Systems Uniplex	Pixel 100/AP, 80 Supermicro
Cromemco System 1	Plexus P/25, P/35, P/40, P/60
DEC 11/23, 11/34, 11/44,	Pyramid Technology 90X
11/60, 11/70, VAX 11/730,	Radio Shack Model 16
11/750, 11/780	SCI Systems IN/ix
Dual Systems System 83	Silicon Graphics IRIS 1400
Fortune 32:16	Visual Technology 2000
Forward Technology 320	Wicat Systems
General Automation Zebra	Zilog System 8000
(all models)	(all models)

Demos of INFORMIX and File-it! are available. Demonstration software and complete manuals included.



**RELATIONAL
DATABASE
SYSTEMS, INC.**

2471 East Bayshore Road, Suite 600, Palo Alto, California 94303
(415) 424-1300 TELEX 467687

INFORMIX is a registered trademark of Relational Database Systems, Inc. RDS, File-it! and C-ISAM are trademarks of Relational Database Systems, Inc. UNIX is a trademark of AT&T Bell Laboratories. MS is a trademark of Microsoft and PC-DOS is a trademark of International Business Machines.

See us at Comdex

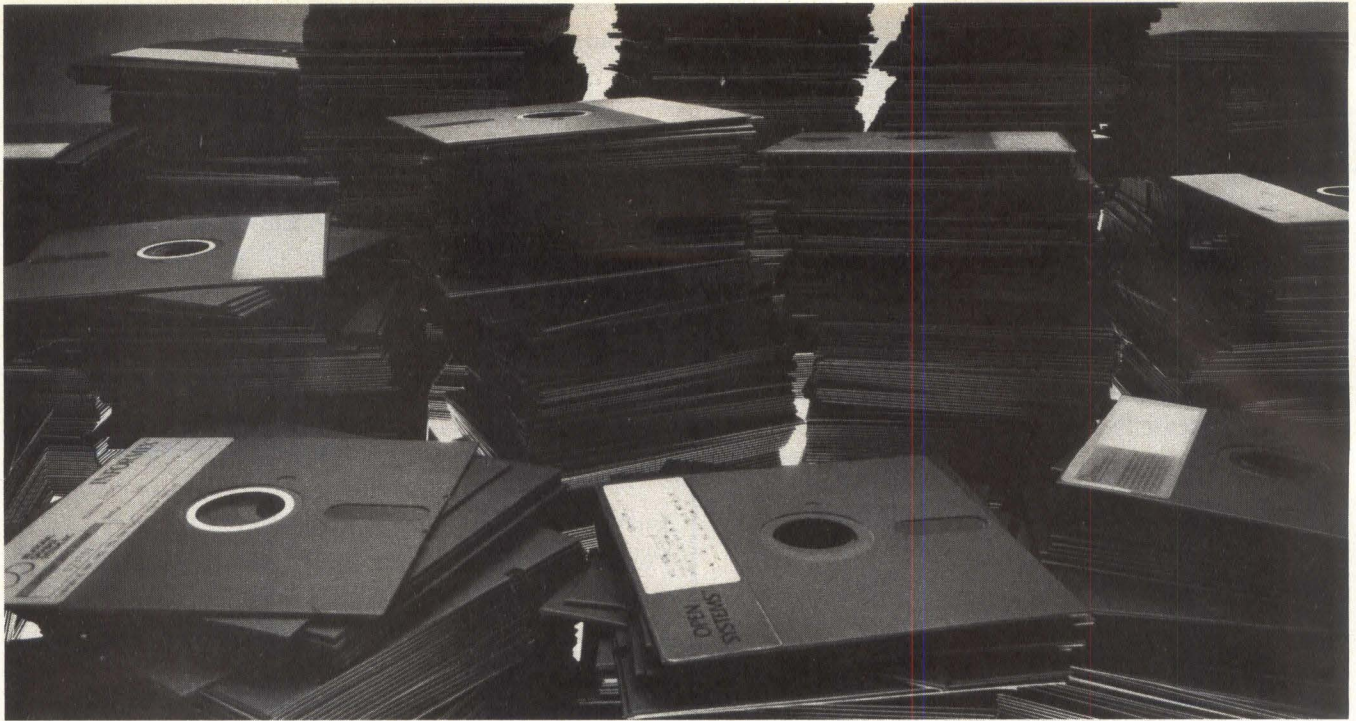

WE'RE WILLING TO LIVE WITH THE CONSEQUENCES OF HAVING XENIX ON OUR 286/310.

We're delighted to see the future catching up with our past. When we designed our Xenix* 286/310 multiuser, multitasking supermicro system, we felt confident that the industry standards would fall neatly in step with our own standards.

Like they just did.

So now dozens of independent software vendors will be publishing stacks of new software for machines using Xenix on the 286. Machines like ours.

But because our supermicro was introduced last year, we can already offer OEMs a choice of our own and ISV software that's here now and ready to run.

There are applications programs like spreadsheets, inventory, accounting, manufacturing and mainframe to micro connections. There

are productivity tools like forms and menus. And high level languages like COBOL, C and BASIC.

The Xenix 286/310 is designed for use by 4-12 people. And whatever tasks those people give it, the 286/310 races through them all at minicomputer speed.

It's perfect for OEMs who need to get to market fast. Not only because it has an existing software base, but also because it's an open system.

From chips to board to box, it's built on industry standards. Like Xenix, the 286 microprocessor and MULTIBUS*. That means, like all Intel systems, the 286/310 is easy to configure and easy to upgrade.

So you'll be able to adjust to the future's changing

markets as fast as you can adjust to this one.

For all its openness, multitasking, multiuser capabilities, and software, you can still get the 286/310 at a microcomputer price.

To find out how to take advantage

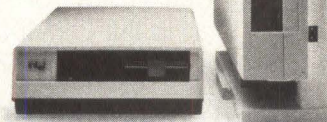

of this changing market today, call us toll free at (800) 538-1876. In California, call (800) 672-1833.

Or write: Intel, Lit. Dept. S-13, 3065 Bowers Avenue, Santa Clara, CA 95051.

And be prepared to live with the consequences.

intel[®]

© 1984 Intel Corporation
*Xenix is a registered trademark of Microsoft, Inc.

Mini-Micro World

NEWS

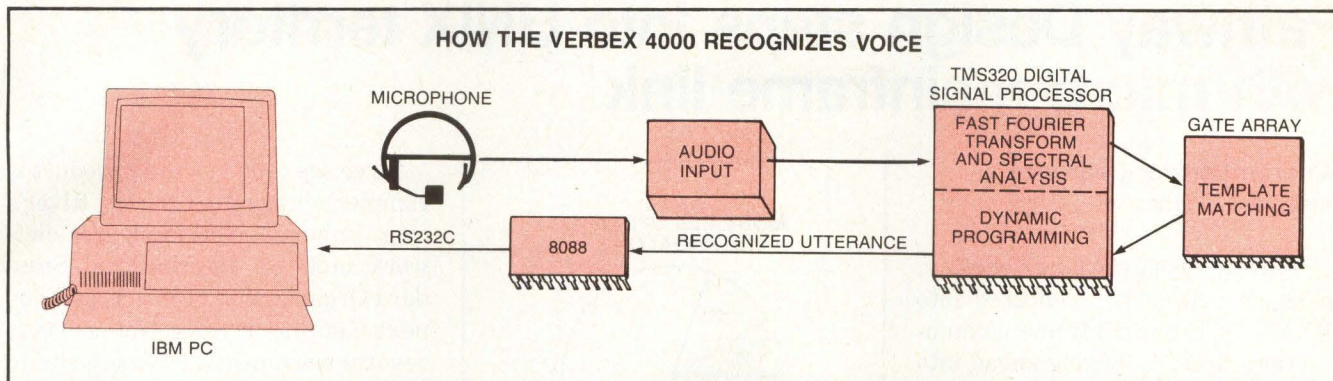

The TMS320 digital signal processor converts analog voice waves to digital form, and a gate array compares each voice pattern with the original. Dynamic programming algorithms then organize the voice patterns and send the recognized utterance to the host.

As voice-recognition technology advances, products will eventually make their way into the office, but for now, the 4000, like the 3000, is targeted mainly for industries where a worker needs the use of both hands while entering data. A typical application is an automobile assembly line, where a quality control inspector can walk around a vehicle and instantly report his observations by uttering strings of words like: "solder splatter left windshield post," and, when done, "end of car, end of car."

Other applications include entering data for product shipments from the warehouse floor, or baggage handling at airports. General Electric uses a model 3000 for inventory control at its New Concord, Ohio, parts distribution center. And at United Airlines' baggage-handling operation, at Stapleton International Airport, Denver, use of Verbex 3000 systems reportedly increased sorting capacity from 12 to 30 bags per minute. Most applications of this nature require fewer than 100 commands and descriptors—used for defining a particular item—so the 3000's maximum vocabulary of 360 words is usually unnecessary, explains marketing vice president Kenneth Backer. He cites an integrated circuit inspection program, for instance, which calls for only 79 words.

Gate array compares voices

The 4000's board contains an Intel Corp. 8088 microprocessor, a Texas Instruments Inc. TMS320 digital signal processing chip, a custom gate array chip with 5,000 gates, RAM and ROM totaling 160K bytes, and three standard 25-pin RS232C ports with 9,600-bits-per-second capacity. (Two of the RS232C interfaces can be used simultaneously.) Initial power-up diagnostics take 30 seconds; to operate the 4000, the user inserts an application vocabulary cartridge containing his or her speech patterns, and the system loads those patterns into the host within two seconds. When the user speaks into the microphone, the voice waves travel to the TMS320 digital signal processing chip, where they are converted from analog to digital by fast Fourier transform and spectral analysis algorithms. The custom gate array then compares the digitized voice with templates of the original from the cartridge. That comparison, or template matching, takes place at the sub-phoneme level. (A phoneme is the most basic unit of human speech. Verbex breaks each phoneme down to four or five acoustic kernels for an even finer comparison.) The TMS320 then uses dynamic programming algorithms to logically piece the parts of speech back together and sends the recognized

utterance through the 8088, and an RS232C port, to the host. (Besides handling the RS232C ports, the 8088's other functions are cartridge reading and writing.)

An ASCII terminal is required for the speech training. The user connects the terminal to the 4000 via an RS232C port and inserts the training cartridge created by the optional Voice Planner software. Following the menu-driven prompts displayed on the terminal's screen, the user repeats each word or phrase into the microphone headset and the speech patterns are put onto the cartridge. An ASCII terminal can also be used to display the echo of each utterance; or, a voice synthesizer such as DEC's DECTalk can provide voice response. Recognition response time is less than 300 milliseconds, and the stated accuracy level is at least 98 percent with background noise as high as 85 dB.

In addition to marketing the 4000 to OEMs and end users, Backer says the company plans to become a value added dealer of IBM PCs, reselling the PC, the 4000 and specialized applications software in vertical markets. Verbex also provides assistance in application development. The basic unit comprises three RS232C ports, a cartridge, a headset microphone and a switching power supply. The Voice Planner software is \$500. □

Pathway Design steps into UNIX territory with micro-mainframe link

Majorie Stenzler-Centonze
Associate Editor

Pathway Design Inc., Wellesley, Mass., which earlier ventured into the MS-DOS-to-mainframe communications area, is forging ahead into UNIX territory with the release this month of UniPATH gateway products.

UniPATH software products operate on 32-bit supermicrocomputers running under UNIX System III and V. With UniPATH, as many as 32 asynchronous terminals and printers can communicate with a variety of IBM Corp. hosts in SNA/SDLC and BSC networking environments. The software occupies 256K bytes of memory and offers concurrent emulation of 3270, 3280 and 2780 devices. A package including the software, a communications adapter and cabling lists for \$940.

"UniPATH represents a significant step toward enhancing our line with multiuser, multitasking capabilities as the market moves in the direction of UNIX," states Robert Broggi, president of Pathway. Broggi says Pathway expects the UNIX products to account for close to half of the company's revenue over the next couple of years. During that period, the company projects that revenues will jump from \$5 million to \$15 million.

Sales of UniPATH products will be handled by Pathway's direct sales force and through OEM contracts. The company expects approximately half its sales to be made through OEM channels.

Major OEM deal signed

Pathway has been directly developing its software on Charles Riv-

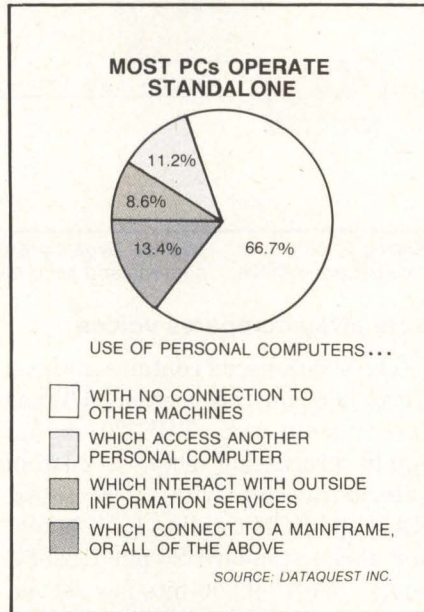

The market for micro-to-mainframe communications products is just beginning to take hold. Currently, more than half of all personal computers are being used as standalone units.

er's hardware. Users who purchase the Universe 68 will not have to spend any money on additional hardware for the IBM connection, says Dick Swee, manager of networking and operating system development at Charles River. According to him: "A lot of people offer the IBM connection through a third party by having a board-level solution. The user then has to spend \$1,500 to \$3,000 for the board, plus buy the software—and then it's not well-integrated into the system."

Swee says the Pathway product is complementary to Charles River's own Universe Net local area network built on International Standard Organization protocols and due next month. Universe Net connects several machines at a remote site to do local processing across the network, while the Pathway software ties the remote locations to the IBM host.

Pathway will manufacture and package UniPATH, but the contract gives Charles River the option to manufacture and package products under its own name and make royalty payments to Pathway.

Pathway has also signed an approximately \$1-million OEM agreement with Visual Technology Inc., Tewksbury, Mass., Broggi says. The company plans to use the gateway products in its System 2000 supermicrocomputer that operates under the UNIX-compatible XENIX operating system. Shipments are scheduled to begin in December.

Pathway is also developing a UniPATH package that will permit IBM communications to hosts for 32 logical units, including IBM PC or intelligent terminals in SNA/SDLC and BSC environments. The second release will place presentation components of the software in individual workstations while maintaining the SNA communications gateway on the supermicrocomputer. □

LOOKING AHEAD IN MMS

Mini-Micro System's December issue is our third annual overview of those leading edge technologies impacting our value-added market readership. A long-lasting sourcebook for technology and market data, the report presents past, present and future perspectives on key areas.

GD CONTROL DATA

YOU'VE BEEN WAITING FOR US!

Faced with growing storage requirements that your present system can't handle? Or a need for more sophisticated applications that can't be done with your OEM's limited selection of hardware? Your growth and success should reward you, not clean out your bank account. And rewards are in store for you at California Computer Group.

Take a look at our economical fixed drive and backup systems that offer you more freedom and greater potential than you ever thought possible with your present system, whether it's a DEC, DG, PE, TI, or multi-bus computer.

JUST THE RIGHT MATCH FOR YOUR MINI.

Control Data 9715
Fixed Storage Drive
9710 Removable
Storage Drive

CDC's 9715 provides up to 516 Mbytes of storage in a 9-inch fixed drive, with data transfer rates as fast as 1.8 Mbytes/sec. — all packed into a rack-mountable, sealed module. Or, mount two 9715s side by side for a total of more than one gigabyte of memory, accessible in just 20 ms.

You can back it all up with CDC's amazing 9710 front-loading removable storage drive, which gives you over 80 Mbytes of unformatted storage in a convenient removable data pack. Control Data's 9715/9710 drives for your minicomputer — a winning combination!

MORE POWER TO YOU — AND YOUR DATABASE.

Control Data XMD 9771 Fixed Drive

The XMD 9771's extensive use of thin film head technology brings up to 825 Mbytes of rugged, reliable fixed-disk storage to your data-intensive applications. The rack-mountable 9771 is fast, too, with an average access time of only 16 ms and data

DEC, DG, HP, TI, PE are registered trademarks of Minicomputer Manufacturers.
CDC, 9715, XMD 9771 and the Control Data logo are trademarks of Control Data Corporation.



transfer rates to 1.8 Mbytes/sec. Whether it's a DEC, DG, TI, PE, HP or multibus computer, we'll provide the interface for your system.

AFFORDABLE STREAMING TAPE DRIVES? YES!

Keystone 92185/
92180/92181
Tape Transports.

California Computer Group brings you the new Keystone high-performance

streamers at up to 70% savings over comparable subsystems! The Keystone 92185 reads and writes in both the phase-encoded (PE) and group coded recording (GCR) formats. With it, you can store up to 180 Mbytes on a single reel of tape and back up your fixed drive storage five times faster than conventional streaming tape drives. Easy to thread and gentle on tape, the entire family of low-cost Keystone streamers are compatible with a wide range of mini computers.

WAIT NO LONGER.

Let our configuration experts show you how to make a good system even better. We'll help you get the most from your minicom-

puter — with peripherals and subsystems that are both affordable and 100% compatible with the equipment you're using now. And we'll be there every step of the way, with assistance in installation, maintenance and continuing first-rate service.

Now — Are you ready for the best your money can buy?



California Computer Group
Making A Good System Better
3303 Harbor Blvd., Suite G-10
Costa Mesa, CA 92626
(800) 854-7488 ... Nationwide
(800) 232-1661 ... California
(714) 966-1661 ... Corporate

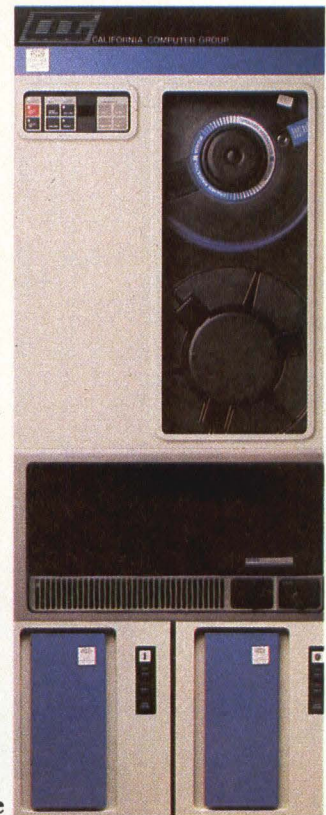

The Connectables™

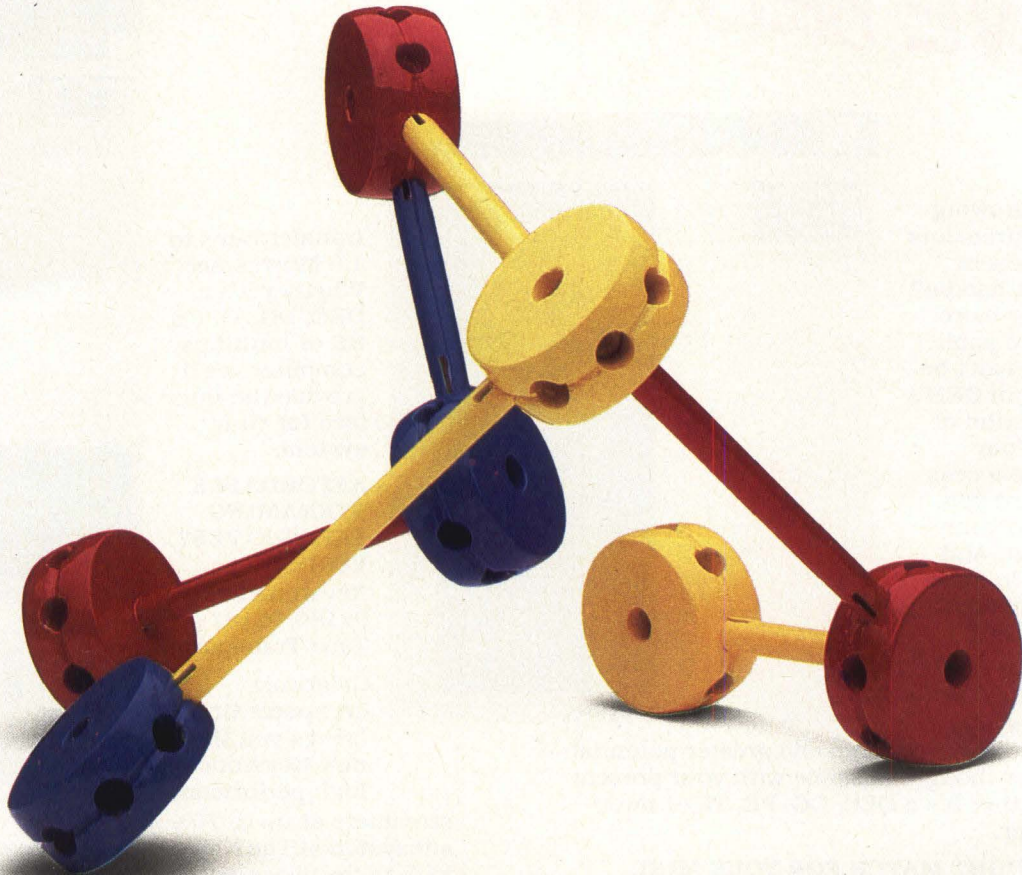

Networking Software So Simple To Use, It's Child's Play.

What do you think of when someone says "network"? Hardware? Complexity? Money? At TouchStone, we think networks should be simple. So we developed The Connectables™, a set of software packages that make networks easy to put together. The Connectables software — PCworks™, MacLink™, and UniHost™ — lets you build a network out of a collection of computers. Without special hardware, unnecessary complexity, or a lot of money.

UNIX+PC+Macintosh

Three great computers with different processors, different operating systems, and different data formats. The Connectables software lets you connect these systems together in whatever way you'd like to use them. Share electronic mail, exchange all types of files, run a program on

another system, or use a remote computer's disk or printer. The only hardware you'll need is a standard cable or telephone line and a serial data channel.

It's So Easy.

The Connectables software will take care of all the details — dial the right numbers, ask you what you want to do, and figure out the rest. Move a spreadsheet from your PC to

a UNIX system, or transfer a text file from the UNIX system to your Macintosh for editing. Print the file later on either system, or use another computer to backup your data. With The Connectables software, things that should be easy to do, are easy to do.

The Connectables Software from TouchStone.

The Connectables family of communication software packages from TouchStone offers a simple solution to networking problems. Look for MacLink, the newest member of the family, which provides connections to PCworks and UniHost for Macintosh™ computers.

TouchStone

Software Corporation

909 Electric Avenue, Suite 207, Seal Beach,
California 90740, 213/598-7746



THE CONNECTABLES™:
FAMILY OF COMMUNICATION SOFTWARE PACKAGES.

PCworks, UniHost, MacLink, and The Connectables are trademarks of TouchStone Software Corporation. UNIX is a trademark of AT&T Bell Laboratories. MS-DOS, Xenix, are trademarks of Microsoft Corporation. Macintosh is a trademark of Apple Computer Inc. Tinkertoy® symbols are a registered trademark of CBS, Inc., and are used under exclusive license. Copyright © 1984 TouchStone Software Corporation.

Megavault's high-capacity 8-inch Winchester access data in 18 msec

Carl Warren, Western Editor

Megavault Corp., Woodland, Hills, Calif., has added two 8-inch Winchester disk drives to its line: the 331.8M-byte (unformatted) MV-330 and the 660.4M-byte (unformatted) MV-660. Both drives feature an average access time of 18 msec, making the seven-platter drives some of the fastest on the market.

The drives are designed for integration into large systems using the industry standard Storage Module Device (SMD) interface. Megavault officials concede to maintaining a fairly conservative approach with the MV-330, which uses modified-frequency-modulation (MFM). "We didn't have to go to a group coding," says company president Clyde F. Czernek. "We built in lots of margin." In contrast, the MV-660, which is essentially the same drive as the MV-330, uses run-length-limited 2/7 code to boost the number of flux-changes-per-inch. Moreover, both the drives offer dual-porting capability which allows the attachment of more than one host.

Megavault is also preparing a parallel interface option to speed data transfers, and eventually will use dual drive heads to allow parallel data transfer. "These drives are for very large data bases in multiuser systems," elaborates Czernek. "The designers want to get the data quickly and with the least amount of difficulty."

In the past three years, 8-inch Winchesters haven't received as much attention as 5¼-inch Winchesters. But James Porter, publisher of *Disk/Trend Report*, Los Altos, Calif., says the market is growing

By using seven platters, Megavault's 8-inch Winchester disk drives offer 18-msec access time and capacities of 331.8M and 660.4M bytes.

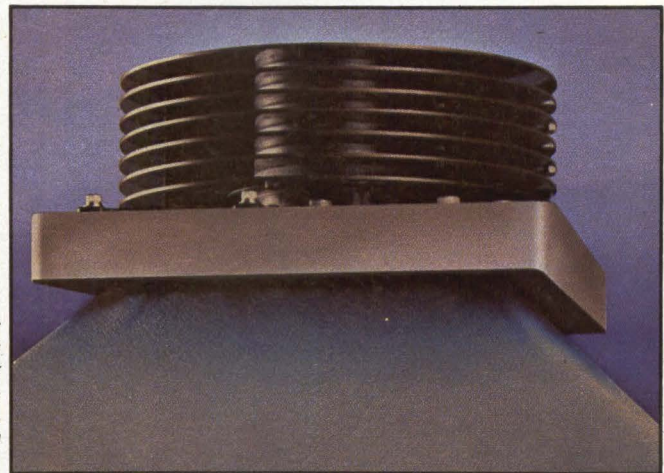

and forecasts that in 1986, 8-inch drives in the 100M- to 300M-byte range will account for about 15 percent of the units shipped worldwide, as compared to 11 percent in 1984. The share of larger 8-inch Winchesters should slip from 7.9 percent to 5.7 percent, however. Porter explains that the higher capacity 8-inch drives will contribute more to industry revenues than will smaller diameter drives, even though the total number of units is less.

Technology over packaging

Czernek claims that the continued market growth for 8-inch drives is really based on the technological limitations of smaller drives. "It's a function of areal density—how many bits you can get per square inch. With smaller drives you end up with a situation where the small drive can be more expensive than a drive with a larger form factor. The small drives offer nice packaging, but there are impracticalities to contend with."

Since drives with capacities above 50M bytes are normally used with

multiuser systems and local area networks rather than with desktop systems, compact size becomes less of a consideration, says Czernek.

Not everyone agrees with him, however. For example, Applied Information Memories (AIM), Milpitas, Calif., with its 250M-byte Dart, is currently one of the only 5¼-inch manufacturers clearly aiming a product at the 8-inch SMD market. According to vice president of engineering, William Glover, "Everything 8-inch SMD drives are can be put into smaller form-factors. It's a packaging job. The costs are about the same and eventually will be less. It is market dependent." But Glover does admit that squeezing the SMD requirements into the 5¼-inch form-factor takes some innovative VLSI and is an expensive undertaking.

Megavault plans to begin shipping the MV-330 in volume this November at just under \$3,000, with MV-660 shipments set for the second quarter of 1985 at just under \$6,000. Both drives should be shown at this month's COMDEX show in Las Vegas. □



UNIX™ HORSEPOWER!

There are a lot of UNIX based systems on the market today claiming to be "SUPERMICROS". But do they really have what it takes to run multi-user UNIX well? The IBC ENSIGN™ does and here's why:

FAST MEMORY: No computer running at **any** clock speed can run faster than it's overall memory design. The ENSIGN has up to 8MB of 120nsec memory with dual bit error correction. With IBC's proprietary memory management, **all** of this memory runs with no wait states as fast as the 68000 CPU will go. Compare this to other systems running only small cache memories at full speed. Other multiple user systems cannot load all their programs into a small cache memory. Their systems slow down considerably under a heavy multi-user load.

INTELLIGENT SERIAL I/O CONTROLLER: Even the fastest CPU will slow down when it's trying to handle interruptions from multiple on-line users. The ENSIGN provides slave serial I/O CPU's **and** FIFO buffering for both input and output. The result is the ENSIGN's ability to support up to 32 users, with heavy serial I/O demand, while leaving the main 68000 CPU free to run with little serial I/O overhead.

INTELLIGENT DISK CONTROLLER AND HIGH PERFORMANCE DISK DRIVES: The ENSIGN has a slave CPU to handle all disk operations, **plus** 16K of disk buffering. IBC's proprietary disk DMA allows high speed data transfer to main memory without slowing down the main CPU. Further, the ENSIGN

supports SMD type 8" hard disks with much faster seek times and transfer rates than 5¼" hard disks usually found in personal desk top computers.

THE RESULTS: The IBC ENSIGN runs multi-user UNIX at performance levels not attainable by other supermicros.

Call IBC and get a copy of IBC's multi-user benchmarks—benchmarks that test 8 users running large CPU programs, with heavy disk I/O **and** heavy serial I/O simultaneously. You'll find that nothing can compare to the ENSIGN.



If you want to run multi-user UNIX on a high performance system with up to 32 users, 8MB memory, and over 1,000MB disk storage, see the IBC ENSIGN.

IBC / Integrated Business Computers

21621 Nordhoff Street
Chatsworth, CA 91311
(818) 882-9007
Telex No. 215349

See us at Comdex Booth #2572

UNIX is a trademark of Bell Laboratories



WHERE TO MEET THE MOST OEM'S AND SYSTEMS INTEGRATORS FACE TO FACE TO FACE TO FACE...

Meet them at a Mini/Micro.

It's the one computer trade event that focuses entirely on computer design needs. That means you, as an exhibitor, can deal face to face with a prime concentration of OEM's, designers, systems integrators and software developers. On your own turf, but in their backyard; Mini/Micros are held regularly in the prime markets.

What's more, many Mini/Micros run concurrently with high-tech electronics shows like Electro, Midcon, Southcon and Northcon. That means extra value for you, because attendance statistics show that 27% of these attendees go to Mini/Micro as well.

So if you're after OEM's and systems integrators, be at a Mini/Micro. For complete information, call toll-free: 800-421-6816. In California, 800-262-4208.

Meet OEM's and systems integrators where they live.

Feb. 5-7 1985	Mini/Micro West	Anaheim
Mar. 5-7 1985	Mini/Micro Southeast Southcon	Atlanta Atlanta
Apr. 23-25 1985	Mini/Micro Northeast Electro	New York New York
Sept. 10-12 1985	Mini/Micro Midwest Midcon	Chicago Chicago
Oct. 22-24 1985	Mini/Micro Northwest Northcon	Portland Portland



Mini/Micro
FOCUSING ON THE OEM

Sponsored by regional chapters of IEEE and the Electronic Representatives Association

CIRCLE NO. 34 ON INQUIRY CARD

Daisy-wheel-printer prices must drop to slow advances of competing technologies

David Bright, Assistant Editor

Are high-end daisy wheel printers losing their popularity? Although they currently remain the standard for letter-quality output, they are caught in a price/performance squeeze by several competing technologies that produce faster, quieter printers with better graphics capabilities at an equivalent price. Analysts and vendors say that since daisy wheel printers are nearing their technological limits, the best way for their producers to fight back is through price reductions.

Larry Barber, product marketing manager at Qume Corp. tersely sums up the general marketing strategy: "Get the price down!"

The San Jose, Calif., company makes the \$2,800 Sprint 11/90 PLUS, which at 90 characters per second (cps), is one of the industry's fastest daisy wheel printers.

One notable threat to daisy-wheel technology is Hewlett-Packard

Co.'s recently introduced eight-page-per-minute (ppm) LaserJet laser printer that provides 300-dot-by-300-dot-per-inch (dpi) text-resolution output. The unit is based on Canon USA Inc.'s LBP-CX print engine. At \$3,495, the LaserJet competes in price with high-end daisy wheel printers, with print quality almost as good. Daisy wheel printers in this price range include the \$3,495 Diablo Systems Inc. 80-IF and the \$2,950 Fujitsu America Inc. SP830. Both run at 80 cps—much less than half the speed of the HP LaserJet. More low-priced units incorporating Canon's LBP-CX are expected to appear shortly from other vendors.

Also coming on strong, and comparatively priced, are other non-impact technologies, including ink-jet and thermal-transfer printers. One example is the new SQ-2000 drop-on-demand ink-jet printer from Epson America Inc.'s OEM products division. With a quantity price of less than \$2,500, the non-

clogging SQ-2000 produces 88 cps in letter-quality mode.

Daisy wheel printers also face competition from impact dot-matrix printers. Near-letter-quality models from several vendors, including Dataproducts Corp., Fujitsu, and soon, NEC Information Systems Inc., rival daisy-wheel-printer performance, often at lower prices.

Low growth means layoffs

Citing lower-than-expected growth in its daisy wheel printer shipments, caused partly by increased competition, Diablo, a Xerox Corp. subsidiary, recently laid off 284 workers—a third of its production force at Fremont, Calif. The pressure comes from two fronts: impact dot-matrix printers and Japanese daisy wheel printers on the low end of the price scale, and laser printers on the high end. In a reorganization following the layoffs, Xerox separated Diablo's impact and non-impact printer responsibilities and consolidated its electronic-typewriter operations with impact-printer operations. Because many Xerox typewriters and Diablo impact printers use the same parts, the company reasons that economies of scale will help reduce manufacturing costs.

But manufacturing costs, and ultimately prices, are not the only factors daisy-wheel-printer manufacturers must consider. Major drawbacks plaguing daisy wheel printers include limited speed, high noise level and limited graphics capability—the latter an increasingly important factor as more graphics packages and integrated software packages are introduced.

On the plus side, daisy wheel printers, unlike non-impact techno-

drop-on-demand

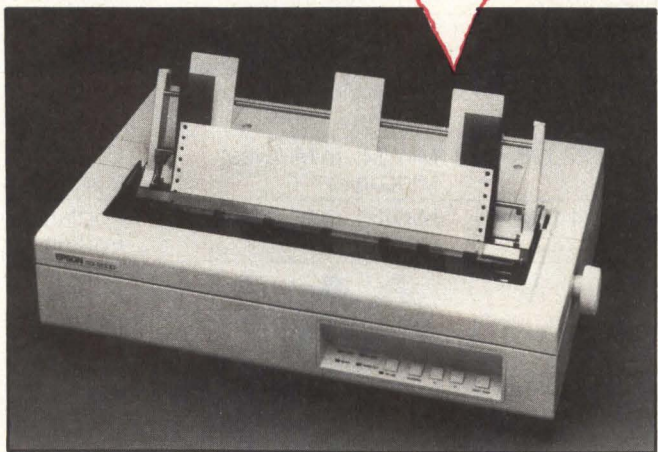

The output quality of non-impact printers—like the new 88-cps SQ-2000, drop-on-demand, ink-jet printer from Epson—makes them competitive with daisy wheel printers.

While others are simply making promises about high-capacity storage peripherals, we're actually making deliveries.

Being able to promise OEM's a 234MB, 8-inch Winchester Disk or a 100MB, 1/4-inch Tape Drive is one thing. Being able to deliver on that promise has always been something else.

Now, we can do both. Send us your order, and we can send you our Mercury* 234MB Disk Drive that features embedded servo technology, a choice of SMD or SCSI interfaces, and average access times as low as 20 ms. Our disk drive also offers microprocessor control, assuring you of fail-safe operation.

Or tell us you want the highest capacity 1/4-inch streamer available and we'll ship you the Flashback* 100MB Tape Drive. It has QIC-2 interface and QIC-24 or 11 interchangeability.

With either drive, you get the same outstanding reputation for design simplicity, data integrity and reliability that comes with Memory Systems' 16 years of design and manufacturing experience. But maybe most importantly, you'll get the drives themselves. For more information, or to order an evaluation unit, call 1-800-521-3278, Telex #810-223-6011.



234 MB

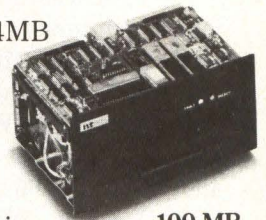

100 MB

nt northern
telecom

See the only 234MB Disk Drives and 100MB Tape Drives available today at the Comdex show, Northern Telecom Booth #2448, on Nov. 14-18.

*Trademark of Northern Telecom Limited

CIRCLE NO. 35 ON INQUIRY CARD

© Northern Telecom 1984

Mini-Micro World

NEWS

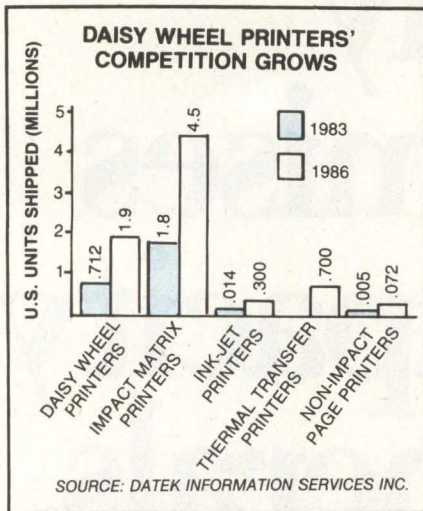

logies, can print multiple forms, which is an important issue in an office setting. Most daisy wheel printers offer interchangeable fonts. And many are workhorses, consistently churning out sharp, letter-quality print, with long intervals between failures. Moreover, maintenance on the new non-impact printers is generally not as straightforward as the simple ribbon cartridge change required by daisy wheel printers.

Nevertheless, the heyday of daisy wheel printers is nearly over, according to Jonathan Dower, vice president of Datek Information Services Inc., Waltham, Mass. Datek researches the printer field and publishes the industry newsletter, *Printout*. "People think the writing is on the wall [for high-end daisy wheel printers]," says Dower. He gives the high-end daisy-wheel-printer market about two more years of rapid growth. Datek predicts that daisy-wheel-printer unit shipments will rise from 712,000 in 1983 to 1.9 million in 1986, while non-impact page printer shipments will spurt from 5,200 to 72,000 in the same interval, a growth rate nearly five times as fast. A big reason Dower says, is that competitive laser printers emerged "a lot sooner than people expected." He

looks for more LBP-CX-based introductions in the near future.

Thermal transfer technology is not mature enough to be a major threat for a while, says Dower. Most are slow (under 120 cps) and have high upkeep costs. In fact, there's currently only one domestic supplier of thermal transfer ribbons. Datek does predict 1986 thermal-transfer printer shipments of at least 700,000, but most of those should be very low-end models, Dower says.

Customers want 'tried and true'

Susan Hayes, product manager for NEC Information Systems Inc.'s popular Spinwriter 3500 series of daisy wheel-like thimble printers, concurs with Dower's assessment. By late 1986 or early 1987, laser printers "will give us some trouble," she says. But she stresses laser printers' difficulty with multiple forms and heat-sensitive labels. And she suggests that customers may initially be reluctant to switch technologies: "They'd rather stick with the tried and true." But Hayes also points out that NEC produces a broad range of printers at its Boxborough, Mass., plant so it is prepared to use its product line as leverage to meet customer demands.

Hayes expects NEC to drop Spinwriter prices as much as 15 percent by next summer. In addition, NEC is working to increase the units' speed and reduce their noise level from the current 60 dBA to less than 55 dBA. Use of new platen materials could eliminate noise rather than merely mask it.

Other vendors state similar goals of increasing speed while lowering both noise and price. Dataproducts Corp., Woodland Hills, Calif., intends to cut the noise level of its daisy wheel printer models to at least 50 dBA, says distribution marketing manager Todd Hunter.

"There's a good three years of growth left in the daisy-wheel-printer market," but Dataproducts will eventually drop the line, he says. In the meantime, another potential life-prolonging enhancement will be the addition of a keyboard and extra features to a daisy wheel printer, enabling it to function as both a terminal and a printer. Late this year Dataproducts plans to introduce a 20-cps model that sells for under \$1,000 with a keyboard, Hunter adds.

Dataproducts' fastest unit, the DP-55, prints 55 cps. Although Hunter feels that 80 cps is the fastest that daisy wheel printers can print at high quality, Anthony Mauro, president of Primages Inc., Bohemia, N.Y., is confident of pushing his company's machines to speeds of 100 cps. Dataproducts employs a servo motor to move the printhead, but Primages uses a less complicated open-loop stepper motor in its 45-cps Primage I, which retails for \$1,695. With the stepper, costs are also saved because it doesn't require a special, regulating power supply or a complicated encoder. The simple position encoder used on the Primage I is one-tenth the cost of the more complex position-and-velocity encoder needed for printhead tracking with a servo motor, Mauro says.

Diablo recently announced its Series 80-IF, 80-cps daisy wheel printer. Paul Shapiro, Xerox printing system division marketing manager, says speed alone is not the key: Vendors have to do more than just offer "a vanilla-flavored 80-cps daisy wheel printer." Diablo's high-end strategy, he says, is to offer extra functions that attract local area network users and other vertical sector users. Some of those functions include the ability for a remote operator to change parameters, the use of double hammers to eliminate shifting, and a graphics wheel. □

Your IBM PC Deserves Davong MultiLink

You can do a lot with an IBM® PC, but think how much more you could do with access to the pooled resources of IBM PC users throughout your organization. You could share information and programs. Communicate with other users.

Make use of larger data storage. And all at a lower cost per user.

With the Davong MultiLink™ local area network, up to 255 IBM PC and PC-XT computers can share hard disk resources.

Anyone in the network can access hard disks attached to specified "File Server" computers. Although a user can operate a File Server computer as if it were a stand-alone unit, others in the network can access the File Server's hard disk storage, subject to network control and security.

It's fast, too—2.5 megabit with node-to-node token passing taking only 28 microseconds. You'll hardly realize you're running on a network instead of your own hard disk.

Davong makes networking practical. A large network (200 users or more) costs less than \$700 per workstation. Ask about our OEM and quantity discounts. Available through more than 800 computer dealers. Don't you and your computer deserve Davong MultiLink?

See us at Comdex, Las Vegas,
November 14-18, Booth H8606

™ Trademark ® Registered trademark
*Suggested Retail Price



Davong Systems, Inc. □ 217 Humboldt Court □ Sunnyvale, California 94086
Telephone: (408) 734-4900

CIRCLE NO. 36 ON INQUIRY CARD

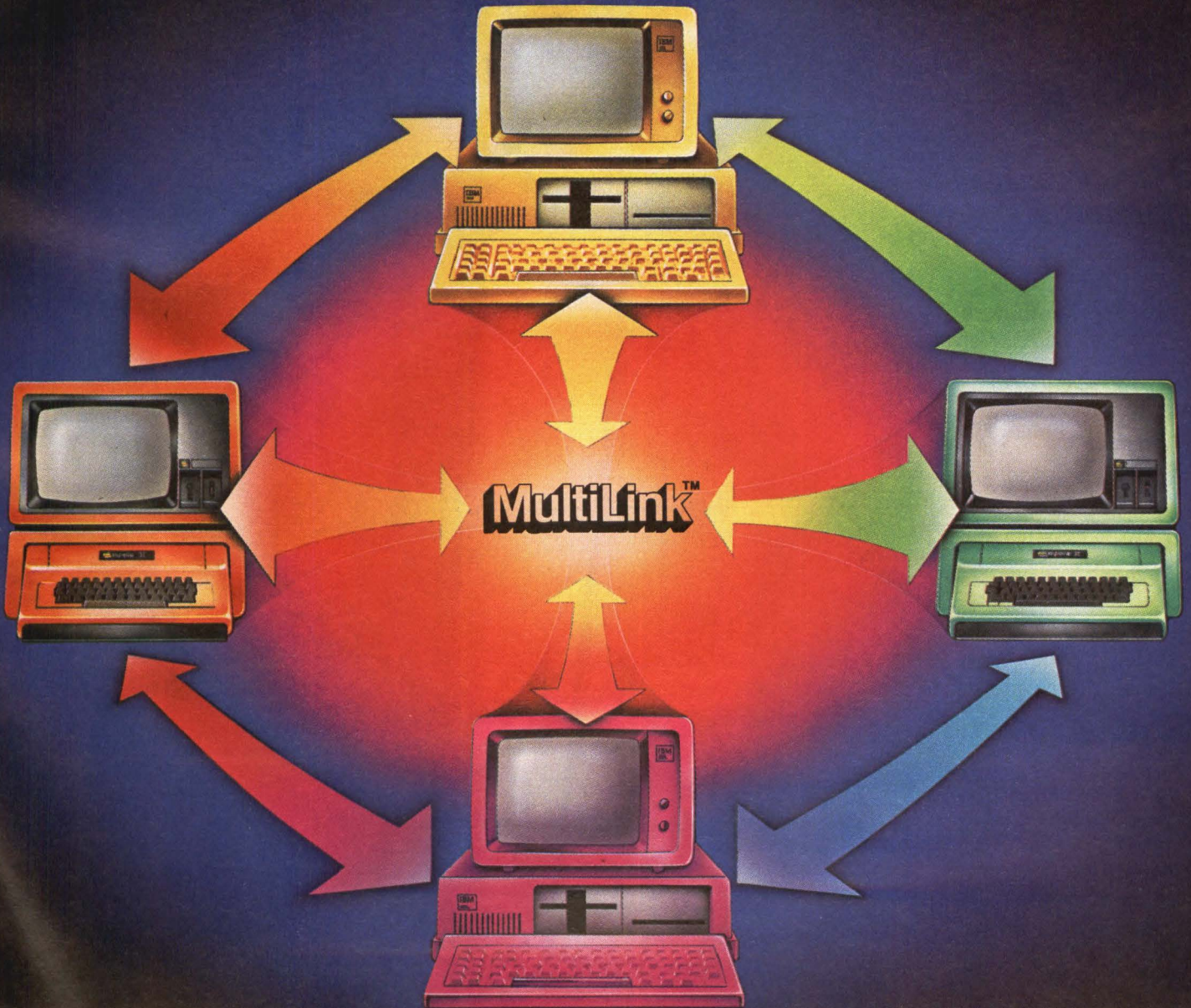

NO LIMITS

Expansion Slots

36 MB Disk

CPU Display



OEMs/Distributors

Come to COMDEX and see Dansk Data Elektronik demonstrate its SUPERMAX, closely-coupled, multi-cpu Super Micro family.

A unique design, with 32 bit architecture, gives easy expansion in the UNIX* environment. Of course there are limits to growth, but these limits are distant with SUPERMAX. SUPERMAX grows from:

- 1-8 MC68000 CPUs
- 2-8 I/O coprocessors offload main CPUs
- 1-128 Users
- 1/2-128 MB Memory
- 20 MB-10 GB disk

**ALMOST**

SUPERMAX Vertical
1 CPU, 8 users
1 MB Memory
36 MB Disk



TO GROWTH

Expansion Modules

Expansion Slot

36 MB Disks

CPU Displays



Easy, cost-effective Expansion

Expansion is simple and cost-effective: place more modules in the same SUPERMAX cabinet to increase number of users, memory, storage, and most important, POWER.

UNIX software remains the same regardless of expansion level. It supports, in a real-time environment, Bell-Licensed UNIX System III and tools with Berkeley enhancements. C, COBOL, Fortran, Pascal, SMC Basic, RDBMS, and a wide variety of communications protocols, including 3270 BSC and SNA are running and available.

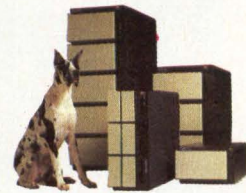

Meet the SUPERMAX family of great Danes at COMDEX Las Vegas, stand W1055-W1064, 14-18. Nov.

SUPERMAX Vertical
Same cabinet with
3 CPUs, 24 Users
3 MB Memory
72 MB Disk
and
2 HDLC/SDLC Ports



Dansk Data Elektronik A/S
199, Herlev Hovedgade
DK 2730 Herlev, Denmark
Telephone: int. +45 2 84 50 11
Telex 35258 dde dk

UNIX is a trademark of Bell Laboratories

CIRCLE NO. 37 ON INQUIRY CARD

Only FARADAY

Anyone can be compatible.
gives you packaging flexibility with
integrated IBM® PC BUS single board
computers and VLSI circuits

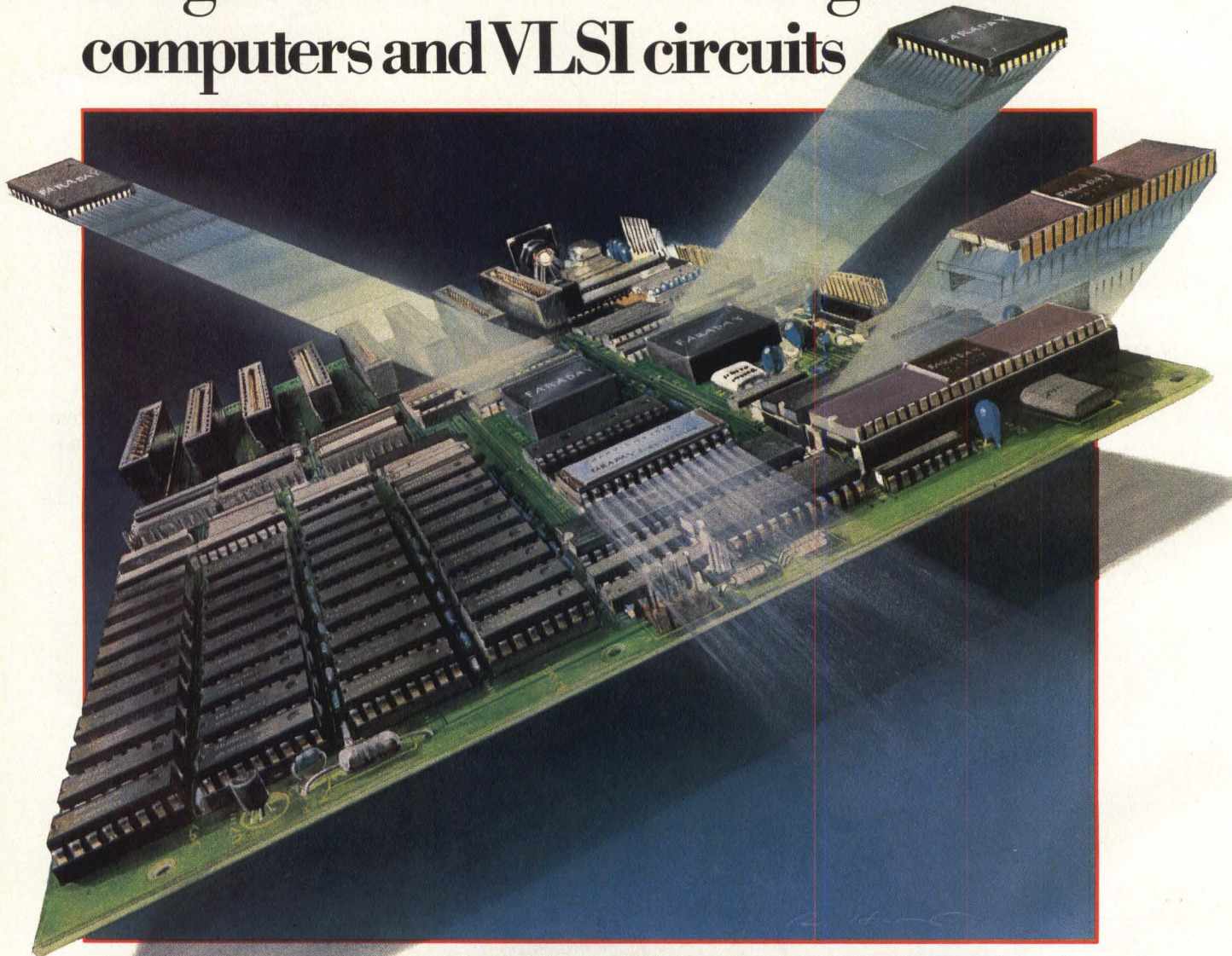

With Faraday state-of-the-art single board computers and CMOS VLSI circuits, you can implement PC-DOS compatibility in various system configurations. At lower cost. And with a shorter time to market.

Faraday single board computers are available with various combinations of integrated disk, video display and CPU controller functions. These and other functions are also available on Faraday adapter cards.

The single board computers include the Faraday BIOS in EPROM and support Faraday PC-DOS (enhanced MS™-DOS). Faraday provides MS-DOS and GW™-BASIC under license from Microsoft.

Using Faraday integrated circuits, you can integrate disk, monochrome display and CPU controller functions. These devices replace more than 75 integrated circuits.

To take advantage of the powerful cost, packaging and time advantages you'll get with this and future levels of integration, simply contact Ron Mazza, Director of Marketing, Faraday Electronics, 743 Pastoria Avenue, Sunnyvale, California 94086, (408) 749-1900.

MS and GW are trademarks of Microsoft Corporation.
IBM is a registered trademark of International Business Machines.



FARADAY

The OEM PC Compatible Company.

Mini-Micro World

CORPORATE AND FINANCIAL

VisiCorp sells Visi^{On} technology to CDC, stresses marketing

Marjorie Stenzler-Centonze
Associate Editor

VisiCorp has sold all Visi^{On} technology rights to Control Data Corp.(CDC). The San Jose, Calif., software company's enormously popular VisiCalc spreadsheet program helped spark the personal computer boom and its Visi^{On} windowing environment was expected to set yet another standard.

But Visi^{On}, which was announced nearly a year before shipments began, never took off as planned. VisiCorp has lately been under severe financial strain and has laid off more than 100 employees since May, making it even harder for the company to push development of Visi^{On} and the accompanying applications software. "We have been developing Visi^{On} for quite some time, but not at the pace we felt it really needed," acknowledges Michele Niven, product marketing programs manager at VisiCorp. "We did not have the resources to accelerate that pace at all. CDC has been involved with Visi^{On} as an independent software developer, using the open-ended features of Visi^{On} to do the customization for themselves," she explains.

CDC has purchased the Visi^{On} applications manager along with Visi^{On} Word, Visi^{On} Calc, Visi^{On} Graph and several other unfinished packages. CDC will also employ the eight-person Visi^{On} development team; the group already operates from CDC's Campbell, Calif., facility.

CDC plans to use the applications manager and user interface for portions of its own management applications systems, which run on personal computers, and for its remote

East					
	A	B	C	D	E
1		Eastern	Region	Sales	
2					
3					
4					
5					
6					
7					

West					
	A	B	C	D	E
1		Western	Region	Sales	
2					
3					
4					
5					
6					
7					

Total					
	A	B	C	D	E
1		TOTAL	NET	SALES	
2					
3					
4		Jan.	Feb.	Mar.	QTR # 1
5	East				0.00
6	West	1060.00	974.00	1672.00	3706.00
7	TOTAL	1060.00	974.00	1672.00	3706.00

Visi^{On}, which displays applications in overlapping windows, spawned a windowing craze in the personal-computer software market. But its developer, VisiCorp, recently sold the Visi^{On} technology to Control Data Corp.

computer services users. CDC will market the products to major account customers through its Business Information Services division. VisiCorp retains exclusive retail marketing rights and will continue to sell the applications manager, software and any enhancements through its retail distribution channels.

Industry observers say VisiCorp's problems stem from a number of causes, the most noteworthy being the premature announcement of Visi^{On}. But all in all, analysts believe the product shows good promise and that CDC is likely to be its salvation. "Despite the fact that VisiCorp had trouble making a go of it, Visi^{On} still remains a good product and is probably the only thing that is competitive with Lisa or Macintosh software in the IBM marketplace," states Kenneth R. Churilla, vice president and manager of the microcomputer industry

research group at Creative Strategies International, San Jose, Calif.

Back to 'startup mode'

While VisiCorp will not detail just what the CDC deal will net the company, Niven says expenses are matching income, and the recent infusion of cash from CDC and investors has stabilized the company.

Creative Strategies' Churilla estimates the VisiCorp-CDC agreement at \$2.5 million, and says those funds, combined with the venture capital VisiCorp has received, are likely to help VisiCorp establish a new operating strategy. "[VisiCorp is] basically heading back to where [its] roots are, and that is to be a publisher, rather than a developer, of software," he says. It was as the publisher of VisiCalc that VisiCorp made its mark. VisiCorp bought the rights to market VisiCalc from the product's developer—Software Arts Inc., Wellesley, Mass. □

FOUR WAYS TO IMPROVE YOUR MEMORY.

Teac's family of memory systems offers a complete array of floppy disk drives, Winchester drives and tape drives to fit your design requirements.

For example, our FD-55 Series has set the industry standard for half-high, half-power 5¼-inch floppy disk drives.

Our FD-35 Mini-Disk Series includes special Power Saver models that run on a mere 1.72 watts with a standby power of only 27 milliwatts.

Our SD-510 Winchester drive units are known for Teac's traditional high reliability, which means low cost of ownership.

Our MT-2ST Digital Cassette Series takes advantage of Teac's over 30 year history in tape transport technology to provide high speed and high capacity along with high dependability.

Teac's experience as a leader in the production of rotating memory systems is backed by proven field performance and cost competitiveness.

East (617) 475-7311 South (214) 221-8714 Midwest (312) 351-9124 Rocky Mountain (602) 242-4025 (303) 337-6329 (801) 532-2111
Northwest (408) 727-1424 Southern California (213) 726-0303

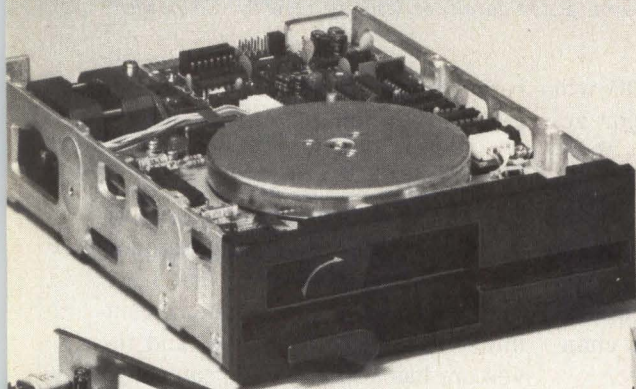

FD-55 Series
5¼-Inch Half-High Floppy Disk Drives
Capacities from 250 KB—1.6 MB.
2 new LSI's, 4.9 watts operating power.
Brushless DC Direct Drive Motor.

SD-510
Half-High 5¼-Inch Winchester Disk Drive
12.76 MB unformatted, 10 MB formatted storage cap.
5 MB per sec. transfer rate.
Industry standard ST-506 interface.

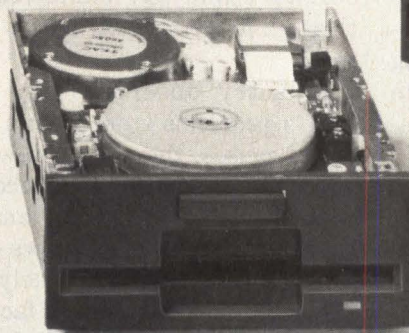

FD-35 Series
3.5-Inch Micro Floppy Disk Drives
Capacities from 250 KB—1 MB.
Interface Compatible with 5¼" Floppy Disk Drives.
Power Saver Version: 1.72 watts Read/Write, 2.9 watts Seek, 27 milliwatts Waiting.

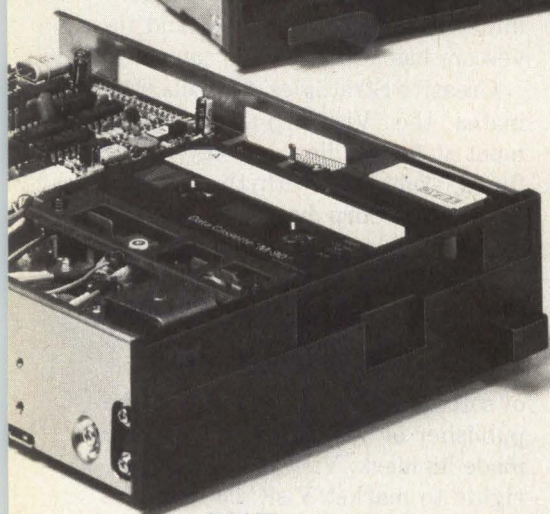

MT-2ST
Half-High Digital Cassette Streaming Tape Drive
Backs-up 20 MB in 4 min.
Industry standard QIC (02) interface.
Low cost media.

TEAC[®]

Instrumentation and Computer Products Division.

COPYRIGHT 1984, TEAC CORPORATION OF AMERICA. 7733 TELEGRAPH ROAD, MONTEBELLO, CA 90640

CIRCLE NO. 39 ON INQUIRY CARD

Mini-Micro World

CORPORATE AND FINANCIAL

Financings

Graphic Communications Inc., the Waltham, Mass., developer of Graphwriter business graphics software, has secured \$1.5 million in new venture capital financing. Firms included in the investment are Abingworth Plc., London, and Transatlantic Investment Corp.

Graphic Communications also provides device drivers for the Microsoft Corp. Windows operating environment.

The software networking vendor **Linkware Corp.**, Waltham, Mass., has received \$2.2 million in venture financing, bringing total investment in the startup to \$4.2 million. The

investment was led by networking pioneer Ungermann-Bass Inc. Linkware produces information servers for sharing information among microcomputers, minicomputers and mainframes.

Pyramid Technology Corp., the first company to market a computer system based on reduced instruc-

MARKET BAROMETER

Sony's 3½-inch disk triumphs in micro market

David L. Bunzel
Santa Clara Consulting Group

Since its introduction in 1982, the microdisk's format and value have been subjects of controversy. But strong sales of personal computers that use the Sony Corp. 3½-inch disk have made it evident since 1983 that this size microdisk would become the de facto format standard. Acceptance of this standard by companies such as Hewlett-Packard Co., Apple Computer Inc. and ACT Plc. of Birmingham, England, has virtually eliminated wide acceptance of other formats produced by companies such as Hitachi-Maxell (3 inches), IBM Corp. (4 inches), and Tabor Corp. (3¼ inches).

With the format issue decreasing in significance, the question of how, and in what market segment, microdisks will be used in the future remains. Of particular concern to hardware and media manufacturers is competition from the 8-inch and 5¼-inch disk market, and the influence of IBM on this market.

For now, microdisk-based systems are confined to use in individual productivity systems, which include portables. Innovations such as half-height 3½-inch drives, double-sided 3½-inch drives and the "Fat Mac" (an Apple MacIntosh using 256K chips) may make microdisk systems serious contenders in the office automation

market as well.

Although this enhanced technology will allow more sophisticated software applications for these systems, it will also result in a much higher disk consumption per disk drive, thus inducing market growth. A 1984 esti-

mate by the Santa Clara Consulting Group illustrates this: microdisk drives use an average of 15 disks per year compared to 19 per year for the 5¼-inch disk drives. By 1988, a reversal is expected, with microdisk drives consuming 17 disks per annum and 5¼-inch drives consuming 14.

The microdisk market would be dramatically affected were IBM to begin offering them. That appears unlikely at present, with IBM reluctant to adopt the 3½-inch microdisk standard. Microdisks are incompatible with all of the IBM's microprocessor-based systems. And the microdisk does not offer a significant advantage over 5¼-inch disk technology; the microdisk drive form factor and performance criteria are almost the same as that of the half-height 5¼-inch disk drive.

In any case, the microdisk has excellent growth prospects. The Macintosh alone represents an installed base of 100,000 machines in the United States, with Apple expecting this to grow sevenfold by the end of 1985. The Santa Clara Consulting Group expects sales of microdisks in this market to grow from 1.5 million units to 267 million units between 1983 and 1988, a compound annual growth rate of 183 percent. And, during the same time, microdisks will increase their share of the disk market from less than one percent to 27 percent.

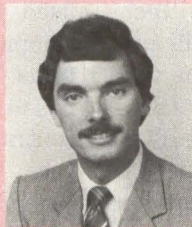

David L. Bunzel is the director of the Santa Clara Consulting Group, a San Jose, Calif., company specializing in market trends in the data-recording media industry.

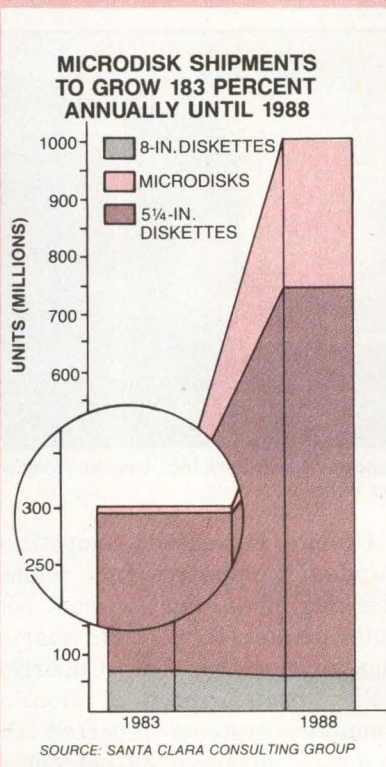

Mini-Micro World

CORPORATE AND FINANCIAL

tion set architecture—the 32-bit, 90X, UNIX superminicomputer—has received \$11 million in new financing. The funds come from a \$6 million, private stock placement and a \$5 million line of credit extended by the Bank of America.

Wet ink

Under a two-year, \$20 million private label agreement, **Wyse Technology**, San Jose, Calif., will provide Altos Computer Systems with customized, low-cost terminals....**Delphax Systems**, Westwood, Mass., has secured an \$8 million OEM contract with Hamilton GmbH for Delphax's S6000 60-page-per-minute, non-impact printer. Under the three-year agreement, Hamilton will sell the ion deposition printer in West Germany and the Netherlands under the



Numerix Corp.'s MARS 432 array processor will be sold with **Digicon Geophysical Corp.'s** seismic data processing equipment.

Hamilton label....**Numerix Corp.**, Newton, Mass., will deliver \$3.5 million worth of its MARS 432 array processors to **Digicon Geophysical Corp.** The Mars 432 will form part of **Digicon's DISCO** seismic data-processing system used for oil and gas exploration....**Pathway Design Inc.**, Wellesley, Mass., plans to supply **Visual Technology Inc.** with software gateways for microcom-

puter-to-IBM-mainframe communication. The three-year deal is for \$1 million worth of gateways....**Rodime Plc.**, the Scottish company that supplies 3¼-inch Winchester disk drives for the **Compaq Plus** portable computer, has signed a \$5.5 million contract with **Convergent Technologies**. **Rodime's** 20M-byte 5¼-inch Winchester will be used in **Convergent's MiniFrame** computer system....**Sun Microsystems Inc.**, Mountainview, Calif., has won the bidding for a \$15 million contract to supply **VIA Systems Inc.**, with workstations for **VIA's WorkSystem** graphics and design nodes. Under another contract, the **Sun** workstations will be distributed in Australia by the **Lionel Singer Group's** new company, **Sun Computer Australia**....**Tandon Corp.**, Chatsworth, Calif., has begun shipping disk drives and subsystems to **Atari Inc.** as part of an agreement potentially worth \$130.5 million.

The deliveries are scheduled to continue through the first half of 1985.

Quarterly reports

Compaq Computer Corp.'s growth rate has slowed. **Compaq**, which is currently the leading vendor of IBM PC-compatible computers, recorded sales of \$65.9 million in the second quarter of 1984 and \$62.9 million in the first quarter. The **Houston** company's 1983 second-quarter sales were \$18.1 million. Unit shipments for the second quarter of this year totaled 33,000, compared to 27,500 in the first quarter. Net income in the second quarter of 1984 reached \$892,000, or a gain of 3 cents per share, compared with a loss of \$1.2 million, or 33 cents per share, in the same period a year earlier. **Compaq's** new **Deskpro** desktop computer has not yet had an impact on sales and earnings, since **Deskpro** shipments began late in the second quarter.

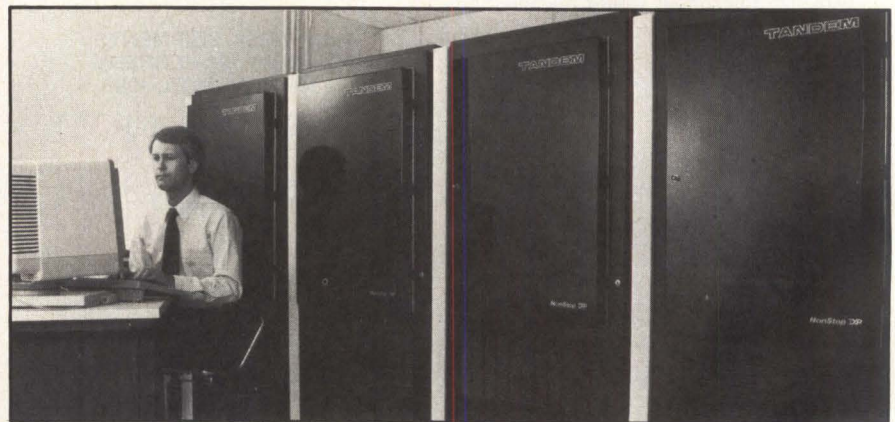

Tandem Computers Inc., with fault tolerant computer systems like the **NonStop TXP**, remains the leader in its field.

Despite increased competition, **Tandem Computers Inc.** remains the king of the fault tolerant computer market. For its third quarter, ended June 30, the **Cupertino, Calif.**, manufacturer of **NonStop** computer systems reported that revenues advanced 29 percent, to \$142 million, compared to \$110 mil-

lion in the same quarter a year earlier. Net income also increased—to \$9.3 million, or 23 cents per share, from \$8.4 million, or 21 cents.

Year-to-date revenues reached \$379.5 million, as opposed to \$300.4 million for the preceding year. Net income, however, declined to \$21.3 million from \$22 million.

NOW ON
DEC PROFESSIONAL
RAINBOW
IBM PC

Test your word processing I.Q.

PDP-11, VAX,
68000, 8088

And discover how the advanced features of LEX-11™ can increase your w-p capabilities.

THE CHALLENGE:

Almost any word processing software package will have such features as menus, editing, spelling error detection, list processing, cut and paste, automatic word wrap and automatic pagination. . .

. . . But can you tell the difference between run-of-the-mill software and a system that is really special?

EEC SYSTEMS offers you this challenge! Test your word processing I.Q.

THE QUESTIONS:

1 EDITING

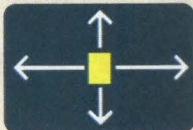

Which kind of editing operation is quickest to execute and easiest on the eyes of the word processing user?

- Full screen editing allowing for easy cursor movement around the screen?
- Moving the cursor around by doing a line count?
- Editing on the bottom line of text only?

2 DOCUMENT LAYOUT



Whatever document format you choose. . . you want to see what the finished article will look like. Should you. . .

- View it on the screen as it would come out of the printer?
- Run it through a pre-processor to see what it looks like and then if you like it, print it?

3 KEYSTROKES



Using a well designed w-p system, how many keystrokes should it take to execute the most often used w-p functions?

- One easy stroke with no codes?
- Two or more with complex w-p codes?
- Three or more?

4 FLEXIBILITY



As the business manager of your company, you would like to find w-p software that you can tailor to your company's specific needs. Should you. . .

- Look for w-p software that allows you to change and add menus, and change function keys?
- Write your own custom software?

5 RETRIEVAL

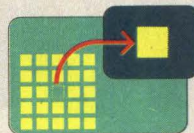

If you want to retrieve information quickly from a large database, which w-p software should you choose?

- One that can access a particular record by going to it directly?
- One that searches through all the records on the database sequentially until it finds the right one?

6 COMPATIBILITY



As a manager of MIS, you want a w-p system that can be integrated with other application software. Should you choose w-p software with. . .

- ASCII formatted files?
- Software which requires non-printing characters in it's file system?

7 MATH



Your company has a number of financial applications and is looking for a w-p package with math capabilities. Should you choose. . .

- On screen calculating allowing for editing, storing and recall of equations, calculations integrated with your word processing applications?
- Software where the math capabilities are tied to the list processing module?
- A separate math package?

THE ANSWERS:

If you answered "a" to all of the questions above, go to the top of the class. Chances are that you already use LEX-11 or are about to buy it. You know that LEX-11 is the ONLY word processing software that combines these advanced features. . . and more. . . in one software package.

PUT OUR SOFTWARE TO THE TEST

Call for a demonstration by modem in your office today.

(617) 443-5106

(617) 443-6376



EEC SYSTEMS INC.
Millbrook Park
327/E Boston Post Rd
Sudbury, MA 01776

LEX-11, LEX-68 and LEX-88 are available under the following operating systems: CP/M, MS-DOS, RT-11, TSX-Plus, RSX-11M, P/OS, RSTS/E, IAS, UNIX, (68000, 8088, PDP-11* and VAX*), IDRIS, VMS* . . . and it works in exactly the same way, with the same features for all operating systems, with your existing peripheral equipment.

EEC SYSTEMS INC. IS THE SOLE U.S. PUBLISHER OF LEX-11.
*LEX-11, LEX-68, 88 are the registered trademarks of ACE Microsystems Ltd.
LEX-88, 88 was ported by Softeq Inc.
** TSX is the registered trademark of S&H Systems Inc.
*** IDRIS is the registered trademark of Whitesmith Ltd.
† UNIX is the registered trademark of Bell Labs.
• DEC, LSI-11, PDP-11, VAX, VMS, RSX, RSTS/E, IAS, P/OS are the registered trademarks of Digital Equipment Corp.
• 68000 is the registered trademark of Motorola Inc.
†† 8088 is the registered trademark of Intel Corp.
■ CP/M is a registered trademark of Digital Research.
• MS-DOS is a registered trademark of Microsoft.

CIRCLE NO. 40 ON INQUIRY CARD

DIGITAL'S SUPERMICRO FAMILY GIVES YOU THE COMPETITIVE ADVANTAGE: GROWTH.

To give your OEM business the maximum opportunity for growth, you can't focus on just one thing. Such as I/O speed at the expense of peripheral support. Or expansion capacity without software flexibility. You need to consider everything: processor speed, system expansion, economy, reliability, software and networking capabilities.

The decision is really very simple. If you want systems that can support your growth, choose Digital's supermicro family. You'll have the high performance 16- and 32-bit systems you need today. Plus



INTRODUCING THE MICRO PDP-11/73.

the ability to grow your systems and add functionality when your needs expand tomorrow. And you'll have Digital's world-wide support network behind you every step of the way. Whether you're an OEM or an end user, you simply can't find a better solution for your success.

**MICRO PDP-11/73,
THE 16-BIT SYSTEM
WITH A 15 MHZ CHIP.**

Our MicroPDP-11/73™ system is based on our 15-megahertz J-11™ chip.

On-chip floating point and instruction pre-fetch increase

system throughput. An 8 Kbyte cache keeps frequently used instructions resident for fast access. And the system's Q-bus™ speeds data between peripherals and processor at a 3.2 million byte per second block transfer rate.

The MicroPDP-11/73 system provides the expansion capacity you need for your OEM solutions. It supports a 31 million byte internal Winchester disk and can support as many as 13 terminals or devices. Memory is expandable to 4 million bytes. Storage options include a 26 million byte fixed/26 million byte removable disk drive, dual 400 Kbyte diskette drive and 60 million byte streaming tape cartridge for disk backup.

Like all Digital's supermicros, the MicroPDP-11/73 system is designed to fit on a desk. Under it. Or in a computer cabinet.

**MICROPDP-11/23,
THE LOW COST,
HIGH RELIABILITY
SOLUTION.**

For proven performance and a low cost entry to our supermicro family, you can choose the MicroPDP-11/23™ system. It's completely software compatible with the MicroPDP-11/73 system, and can support up to six terminals or devices. Memory and storage options, as well as packaging, networking options and peripheral support are the same. This lets you expand the range of your OEM product offerings without extra development effort.

**MICROVAX,
YOUR BRIDGE TO
32-BIT CAPACITY.**

When you need the address capacity and functionality of a virtual memory 32-bit system, our supermicro family can take you there. Our

32-bit MicroVAX™ systems maintain compatibility with our 16-bit MicroPDP-11/23 and MicroPDP-11/73 systems in bus structure, peripheral support, languages (FORTRAN, DIBOL™, BASIC and Pascal), communications options and packaging. This makes the transition between 16- and 32-bit functionality logical and straightforward, because you can keep all the peripherals you've already configured in your OEM products.

And once you've made the switch to MicroVAX systems, you can keep on growing throughout our popular VAX™ family of systems. Our Micro VMS™ operating system is our powerful VMS™ operating system for MicroVAX systems.

**RICH SOFTWARE
ENVIRONMENTS MEAN
FASTER DEVELOPMENT.**

When you choose Digital's supermicro family for your OEM products, you'll have the tools you need to get to market faster. MicroPDP-11/23 and MicroPDP-11/73 systems offer a choice of seven different

operating environments (including Digital's enhanced UNIX™ software). For realtime and multiuser applications. And you'll have the entire heritage of PDP-11™ software at your disposal—including tools for development in advanced languages such as C and Pascal. So you'll have numerous high level languages. Powerful

development and debugging tools. File, screen and peripheral management utilities. And a choice of over 2,000 applications.

Or you can use your VAX systems to develop dedicated Pascal-based realtime applications that you can download to distributed MicroVAX or MicroPDP-11 target systems. MicroVAX systems provide dedicated Pascal execution through VAXELN™ software; MicroPDP-11/23 and MicroPDP-11/73 systems provide this capability through MicroPower/Pascal™ software. And you can download your developed applications through PROMs, disks or communications links. Your options are never limited with Digital

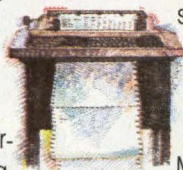

as your OEM partner.

**DECNET SOFTWARE
LETS YOU GO
WHERE YOUR CLIENTS
NEED YOU.**

Our supermicros are engineered for superior standalone performance. But their value extends far beyond standalone applications because all our systems can participate in local and wide area networks through DECnet™ software. You can share files and processing resources with other computers from Digital over Ethernet, leased lines or packet switched wide area networks. You can communicate with other vendors' systems, too, via standard or SNA™ protocols. With our networking capabilities, there are no boundaries to your computing growth.

**BEST ENGINEERED
MEANS ENGINEERED
TO A PLAN.**

Digital's MicroPDP-11/23, MicroPDP-11/73 and MicroVAX systems, like all Digital hardware and software products, are engineered to conform to an overall computing strategy. This means our systems are engineered to work together easily and expand economically. Only Digital provides you with a single, integrated computing strategy, from chips to 32-bit VAX systems, and direct from desktop to data center.

If you believe that your company could benefit from our very growth-oriented supermicro family, contact your nearest Digital sales office. Or call us toll free by dialing: 1-800-DIGITAL and ask for extension 230.

**THE BEST ENGINEERED
COMPUTERS
IN THE WORLD.**

ULTRIX, DIGITAL'S ENHANCED UNIX FOR 16 AND 32 BIT SYSTEMS.

You can develop UNIX-based applications with our supermicro family because all our systems support ULTRIX™ software, our implementation of the UNIX operating system. 16-bit ULTRIX-11 software is an enhanced superset of Version 7 of the UNIX operating system, with the Berkeley 3.7 full screen editor, large program user overlay scheme and a file system debugger. A C compiler as well as Assembler and FORTRAN languages are supported.

Best of all, the applications you develop with ULTRIX software can be applied to our entire line of 16- and 32-bit hardware. Including all our supermicros. And all our 32-bit VAX computers. This means that you can expand your reach from a single MicroPDP-11/23 system to large VAX systems supporting many users and massive databases.





No need
to look any
further.

Announcing
the finest port
of UNIX™ System V,
from Perkin-Elmer.

Unprecedented system responsiveness makes our XELOS™ operating system the finest port of UNIX System 5.2 worth considering.

We've optimized the kernel to take full advantage of our unique, register-rich 32-bit architecture. Giving you high job throughput on our Series 3200 supermini-computers. With data I/O throughput up to 40 MB/second.

XELOS runs on a full range of compatible, high-performance hardware. With a friendly, simplified user interface called the MenuMaker™. And a strong family of application software for office automation, decision support and data processing. All adding up to a highly productive programming and multiuser environment.

So if you're serious about the UNIX system standard, why not go for the finest: XELOS, from Perkin-Elmer.

To find out more, call us toll-free. Or write to The Perkin-Elmer Corporation, Two Crescent Place, Oceanport, N.J. 07757. In N.J. call (201) 870-4712.

800-631-2154

UNIX is a trademark of AT&T Bell Laboratories.
XELOS and MenuMaker are trademarks of The Perkin-Elmer Corporation.

PERKIN-ELMER

CIRCLE NO. 42 ON INQUIRY CARD

Mini-Micro World

INTERNATIONAL

Britain's Torus Systems employs icons to help IBM PC users on local networks

Keith Jones, European Editor

Torus Systems Ltd., Cambridge, England, is applying easy-to-use icon symbols, similar to those employed in Apple Computer Inc.'s Macintosh microcomputer, to help users become acclimated to local area networks (LANs) for IBM Corp. Personal Computers. Called the Torus Icon, the combination hardware and software product can connect up to 100 PCs over a one-kilometer Ethernet LAN. Icon permits each PC workstation to access networked facilities, including electronic mail and file managers; to tap into a variety of external communications methods; and to share programs, files and printers. The PC still can be operated as a standalone device.

"Systems software features like these are already available from U.S. vendors," notes Dr. John Hemphill, head of the technology group at Future Computing Inc., Richardson, Texas. But Torus marketing director Bernard Allenstein says Icon offers more user facilities than packages currently available. For example, Icon replaces often-obscure instructions with icon images that can be selected using a cursor or a mouse. Icon also has 450 "help" messages in English.

Applications make networks

Future's Hemphill insists that sophisticated systems software is not enough to make networking successful. "Applications software is now the key feature for networked machines. Network vendors in the United States are working with software houses to modify packages for a multi-user environment."

Torus' Allenstein agrees with

Hemphill's assessment. He explains that Torus is working with the British company that represents Ashton-Tate, Culver City, Calif., to modify a multi-user version of Ashton-Tate's dBase II database-management software to run with Icon. He notes that Ashton-Tate's product is already available on equipment from 3Com Corp., Mountain View, Calif. Allenstein also says that Icon can be easily changed to run applications developed for other popular network products. Icon, for instance, supports semaphores used in network products from 3Com and Orchid Technology Inc., Fremont, Calif. "The semaphores mean that applications developed for these networks can easily be modified for Icon," claims Allenstein.

Network access via a floppy

A PC user can access shared application programs and other Icon facilities by inserting a floppy disk into a workstation. When the disk is inserted, the user's workstation software notifies a designated network workstation manager that the user is on the network. In addition to sharing applications, authorized users can access network management functions. These functions enable PC operators to add users and file or printer server stations, or to rearrange files, discard mail messages, open and close the print queue and maintain the software library. This library contains both applications and systems software and can be stored on one or more stations on the network.

Systems software in the library includes the code needed to make a workstation act as a file, printer or communications server. The role of any of these three server types can

Sension links VAX with LANs

Integration of Digital Equipment Corp. VAX superminicomputers with Ethernet local area networks may be facilitated using a family of products from Sension Scientific Ltd., Northwich, England. Sales manager Richard White says Sension is seeking distributors and OEM customers in the United States.

The product line includes transceivers, coaxial and fiber-optic repeaters and an interface unit that enables as many as 16 asynchronous terminals to share one Ethernet node. As many as 48 asynchronous terminals can communicate over Ethernet with the VAX. The VAX requires only one DR11 parallel interface board. The VAX interface should be available this month for about \$7,000 to \$10,000, including DR11 driver software written by Sension to run under the VAX VMS operating system.

be assigned to one or more workstations on the network by the network manager workstation, which transfers the relevant software from the library to each selected station.

Access to files on a file server is protected on several levels. The level least controlled allows anyone to read and write information in files. The most restricted level allows only one person access and that person can only read files. The Icon system uses icon images to represent and manipulate files as though they were drawers in a filing cabinet. This is similar to Xerox Corp.'s Star workstation, one of the earliest devices to use icon technology.

Managers use Winchesters

The network manager and the stations acting as servers must be PC/XT models with Winchester

Mini-Micro World

INTERNATIONAL

disk storage. Torus provides a multitasking software kernel enabling such a station to run its special software concurrent with the software used in other workstations on an Icon network. Winchester stor-

age is not essential on other network workstations, but each one must have at least 256K bytes of random access memory. A mixture of color and monochrome PCs can be supported by the same Icon net-

work.

Allenstein quotes a price of around \$600 for the software shared by the network. The main expense is the hardware and software for each PC workstation, about \$1,500

British file server duo seeks U.S. distributors

Quorum Computers Ltd. and Micromite Plc., two Southampton, England manufacturers of file server systems, are seeking U.S. distributors. They're addressing a market that could have an installed base of 650,000 file servers by the end of 1989, says Bill Ablondi, vice president of the office group at Future Computing Inc., Richardson, Texas.

Quorum manufactures QuorumNet, a server offered on an OEM basis to builders of multiple workstation systems running under the CP/M-86 operating system. It provides as much as 280M bytes of disk storage, and can support as many as 64 stations over a one kilometer local area network (LAN).

Micromite builds a file server, called Micromite, which enables a mixture of microcomputer workstations, some running under CP/M-86 and others under MS-DOS or PC-DOS, to share the same data files. The server has up to 40M bytes of disk storage and can support up to 254 stations; 12 to 15 is the average number.

Both systems use proprietary LAN technologies to communicate with workstations. Quorum marketing director Martin Willard explains that QuorumNet employs a general poll technique: all the stations are polled in succession starting with the one nearest the server. Requests requiring data from these stations are stored and serviced in a batch, priority being determined simply by the location of the disk read/write heads. With Micromite, request priority assignments depend on the identity of the workstation. Both LANs have coaxial cable as the physical medium, support communication at 625,000 bits per second and use protocols based on IBM Corp.'s Synchronous Data Link Control.

Micromite sales manager Brian Goodall reveals that his company is negotiating a joint venture in the

United States to manufacture its product under license.

John Budden, OEM sales manager at Quorum, explains that his company is seeking U.S. distributors that can provide hardware backup, such as the integration of Winchester disk drives. He points to Quorum's existing OEM agreements in Europe with microcomputer suppliers that include Olympia Business Machines Ltd., London, and the British operations of two Japanese manufacturers, NEC Business Systems (Europe) Ltd., London, and Canon (UK) Ltd., Croydon, England.

Goodall quotes a price range of about \$9,000 to \$10,000 for servers providing 10M, 20M or 40M bytes of

storage, and each package includes a 20M-byte streaming tape drive for backup. Budden at Quorum quotes roughly \$9,000 for the smallest QuorumNet, providing 20M bytes of storage, and up to \$25,000 for a 280M-byte system with two 140M-byte drives. A 20M-byte cartridge backup unit adds an extra \$4,000.

Quorum's Willard says that his company is also offering U.S. dealers a complete networked system called Q-LAN, which employs QuorumNet technology. It also provides workstations built by Quorum, each configured around the Intel Corp. 80186 microprocessor. Each station is priced at \$2,500, not including a CRT.

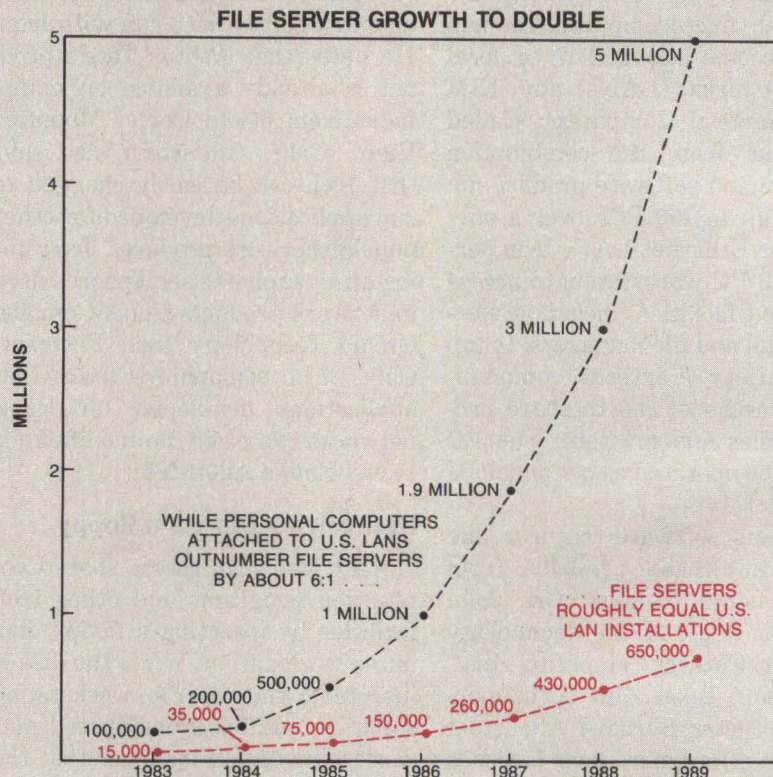

HAS THE HIGH COST OF MODEMS LEFT YOUR COMPUTER SPEECHLESS?

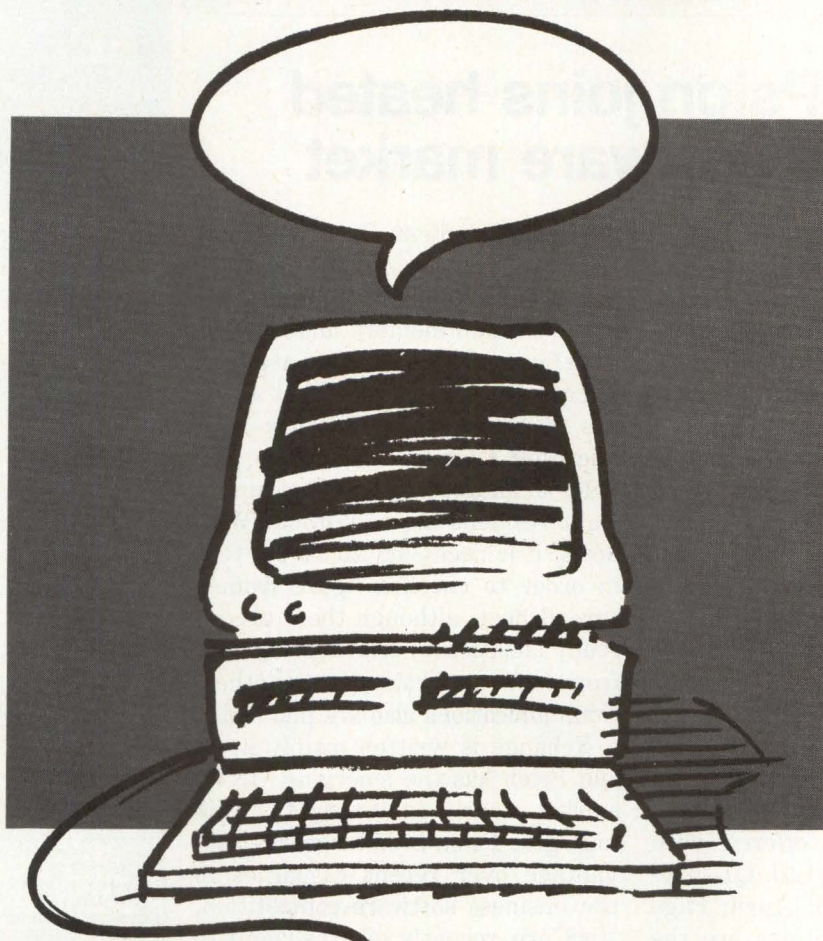

Introducing the SIGNALMAN EXPRESS. The modem that gives your computer a voice of its own—at a price that has the others talking to themselves.

Anchor Automation has a story to tell. About the Signalman Express, the 300/1200 baud modem that gives you all the features that others do at about half the price. Fully Hayes compatible, auto dial/auto answer, 10-number onboard storage, 8 modem configuration switches, 16 programmable software set registers, self-test capability and more. Manufactured by one of the world's leading independent modem makers—

Anchor Automation.

See the Signalman Express at your local computer store. Compare the features. Compare the price. Then listen to all the nice things your computer will say to you. Anchor Automation, 6913 Valjean Avenue, Van Nuys, California 91406. (818) 997-6493.

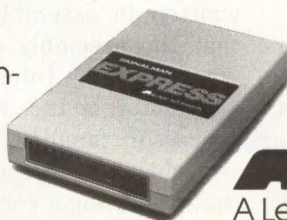

**SMART MODEM,
SMART PRICE.**

ANCHOR AUTOMATION
A Leader in Modem Technology

Visit us at Comdex

Mini-Micro World

INTERNATIONAL

for each. This includes an Ethernet interface board, originally from 3Com but now built by Torus.

Possible U.S. marketing outlets being explored by Allenstein include Ethernet hardware vendors, manufacturers of IBM PC-compati-

ble personal computers and retailers of IBM PCs and compatible machines. He names banking giant Citicorp's International Technology Group, Parsippany, N.J., as one of the first U.S. users to evaluate Icon. □

Britain's Psion joins heated integrated software market

Tim Palmer
European Correspondent

Psion Ltd., until recently a computer hobbyist company, is jumping into the hotly competitive integrated business software market.

The four-year-old London company has completed beta testing of its Xchange suite of integrated applications, which were released in September.

Unlike many integrated packages, Xchange is designed to work with future UNIX-based systems and with IBM Corp., Apple Computer Inc. and other microcomputers now. Xchange arose from Psion's successful creation of the bundled applications offered with the Sinclair Research Ltd. QL business computer (MMS, April, Page 83). The four applications are the Quill word processor, Archive database manager, Abacus spreadsheet and Easel business graphics package. The four elements can be purchased together for \$650. Separately, Archive is \$250 and the others are \$175 each.

Xchange partners

The first version of Xchange is for the IBM PC and Applied Computer Techniques Plc.'s Sirius, Apricot and xi. A version for the Apple Macintosh running under MAC-DOS is due out now, as is one for the

Digital Equipment Corp. Rainbow 100.

Xchange minimally requires 256K bytes of main memory and a 320K-byte floppy disk drive. It is not yet a full windowing package, but Psion has plans to marry Xchange with Microsoft Corp.'s Windows to provide simultaneous views of up to eight resident tasks. Without Windows, it is necessary to save a text in order to check a figure from a spreadsheet, although there are already facilities for transferring data from one application to another. Communications also are planned.

Xchange is written mainly in C, and Psion has the emerging UNIX market clearly in its sights. This may give Psion broader market advantage over recent casualties in the business software competition. VisiCorp, recently sold the rights to Visi^{on} to Control Data Corp., and Business Solutions Inc. has ceased operations completely.

Psion has developed a compression tool, the Psion Table Language, which it claims can reduce 10K bytes of C code to just 2K bytes. Other parts of Xchange are written in assembly language, so that the assembly code is already written for the Intel Corp. iAPX-86 and Motorola Inc. MC68000 microprocessor families. Psion founder and chairman David Potter claims that producing a version of Xchange



BUSINESS PRODUCTS
AUTHORIZED DISTRIBUTOR

**YOUR
"SPECIAL OFFER"
DISTRIBUTOR**

CALIFORNIA
Northridge, CPX • 818/341-3783
Orange, Data Bits Inc. • 714/633-6650
Sacramento, Quest Media & Supplies • 916/488-3310
San Diego, Computer Media Products • 619/565-7802
San Francisco, Force 4 • 415/397-1446
San Jose, Gaan Computer Supplies • 408/252-4210
San Rafael, Kalleen's Inc. • 415/459-1010
Sunnyvale, Idea • 408/745-1911
Tustin, Magnetic Disc Services • 714/832-4016

COLORADO
Denver, Greenbar Corp. • 303/373-8510

FLORIDA
Miami, Data Research Associates • 305/274-7855
Miami Lakes, Kar Computer Supplies • 305/557-4782
Tampa, National Data Products • 1-800/237-3875

IDAHO
Idaho Falls, R&L Data Systems, Inc. • 208/529-3785

ILLINOIS
Chicago, Computers Midwest Inc. • 312/964-4625
Chicago, Data Research Associates • 312/885-0200
Lombard, Dartek Computer Supplies • 312/963-9136
Schaumburg, Force 4 • 312/397-8444
West Chicago, Midwest Computer Supply • 312/231-1112
Wheaton, American Computer Equip. • 312/653-7444

INDIANA
Indianapolis, National Data Products • 317/241-8217
South Bend, Kelley World Co • 219/255-4926

IOWA
Des Moines, Nics Computer Supplies • 515/225-2526

LOUISIANA
New Orleans, Copper Business Forms • 504/581-7611

MASSACHUSETTS
Boston, Data Research Associates • 617/938-0425
Norwood, NRI • 617/769-7550
Norwood, Timebrokers of New England • 617/769-4060

MICHIGAN
Detroit, Transaction Storage Systems • 1-800/FLOPPYS
Southfield, Comtel Instruments • 1-313/358-2505
Warren, Design Business Systems • 1-313/759-5200

MINNESOTA
Minneapolis, Minnesota Computer Supplies • 612/881-5507

MISSOURI
Livonia, Eczel • 313/261-7510
St. Louis, Computime Inc. • 314/991-2991

N. CAROLINA
Charlotte, Dataprint Inc. • 704/535-0296

NEBRASKA
Omaha, Nebraska/Iowa Computer Supply • 402/551-1288

NEW JERSEY
Englewood, Data Research Associates • 201/569-2620
South Plainfield, CPX East • 201/756-8040

NEW MEXICO
Albuquerque, Del Sol Computer Supply Shop • 505/883-9127

NEW YORK
Deer Park, Macade Inc. • 516/667-6565
Rochester, Datron Computer Products • 716/328-8390
Plainview, Global Computer Supply • 516/292-3400
Staten Island, Compu Media Supplies • 1-800/248-2418

OHIO
Cleveland, DAK Supply • 216/238-0102
Cleveland, Comtel • 216/442-8080
Independence, Eczel • 216/661-7707
Columbus, ABCO Distribution Inc. • 614/457-6955

OREGON
Portland, Force 4 • 503/620-8888

PENNSYLVANIA
Philadelphia, Data Research Associates • 215/659-2360
Philadelphia, Teck-Mate Ltd • 215/245-4545
Pittsburgh, Data Research Associates • 412/429-1330

TEXAS
Dallas, CPX South • 214/248-2880
Dallas, Philbo Enterprises • 214/358-1200
Houston, Data Systems Supply • 713/680-9353
Houston, National Data Products • 713/988-4008
San Antonio, Tejas Business Services • 512/654-7969

UTAH
Salt Lake City, Force 4 • 801/973-9111
Salt Lake City, Rebel Enterprises • 801/261-3300

VIRGINIA
Fairfax, Data Research Associates • 703/385-3414

WASHINGTON
Bellevue, Force 4 • 206/682-9330
Seattle, Advanced Computer Products • 206/527-4300

WISCONSIN
Milwaukee, Media Management & Magnetics • 414/783-5423

SPECIAL OFFER!

TWO FREE

StorageMaster™

flexible diskettes
with every box of ten.

Buy the specially-marked boxes of Control Data's new StorageMaster brand 5¼-in. double sided, double density diskettes and get 2 extra floppies free during our special limited time offer. That's 12 disks—20% more—in every box, while supplies last.

So plan to stock-up now on StorageMaster brand diskettes. Ask for them at your local computer store or call your local authorized Control Data Business Products distributor.



StorageMaster™
Media
Premium Series
5.25-inch Flexible Disks
100% Certified
5-Year Warranty

**Get 12
Control Data
Flexible Disks
20% More In This Box.**

2 FREE DISKS

Give him a call...or call toll-free and we'll help you find the nearest source.
1-800/328-6207 (In Minnesota call 1-612/835-8065).



**So
how many
years
would you
like to take
off?**

Before you waste any more time, you may want to read about this.

VRTX[®]. That being the real-time operating system packaged in silicon. From Hunter & Ready.

It's a versatile kernel, efficient I/O system and flexible file manager.

Or to put it another way, it's everything you'd want in a multi-tasking operating system.

But not in the usual all-or-nothing sense of the word.

Fact is, you can use as much — or as little — as you like. And yes, then take as many years off as you like.

A good place to start is the VRTX kernel. Because with it, you can subtract two years from a lengthy design cycle.

Think of it as task management, real-time clock support, dynamic memory allocation, basic I/O, interrupt handling and fast pinpoint timing — all rolled into a neat 4K of memory.

OK, sounds like a lot, but not quite two years? You're right. That doesn't just come from design time. But from what makes VRTX as reliable as a quartz watch.

100,000 manhours of debugging and testing. The stuff nights and weekends can be made of.

Still you'll be happy to know, for all VRTX takes off, there's not much to give up.

Unlike other operating systems, it doesn't lock you into one processor

for life. Or tie you to one type of I/O and file management forever. VRTX is compatible with all major processor families and all standard types of file management and I/O.

And with that choice, we're back to the count.

Meaning if you don't want to spend time on I/O, take off another two years. Since our IOX component works with VRTX to take care of all block, disk and character I/O.

And right along with that goes our FMX file manager. And another two years off. Besides which, FMX includes all the things you'd want in a hierarchical file system. Concurrent file access. Random and sequential access. And compatibility with standard file systems, including none other than PC-DOS.

We could go on. But it's now time for our final summation.

A total of six years if you want it all off (VRTX, IOX and FMX). Two or four years if you'd like a real-time

head start.

Or if you'd like to know more before you decide,

write Hunter & Ready, 445 Sherman Avenue, Palo Alto, CA 94306. Or call (415) 326-2950.

There should always be more than one way to buy time.

HUNTER ♦ READY

We've taken the hard part out of operating systems.

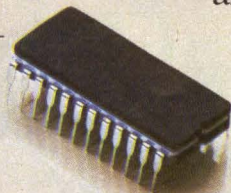

2 Years

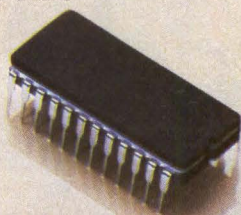

4 Years



6 Years

"IF IT WAS ANY MORE USER-FRIENDLY, IT WOULD JUMP UP AND KISS YOU."

— George Heffley, Intel Corp., Phoenix, AZ

EQUINOX

Presents

DATA PBX

A user-friendly
Port Selector



"Stunning performance and unrivalled dependability."

— Dr. Harold Koplou, Modular Computer Systems, Fort Lauderdale, FL (Equinox's first user)

"Surprisingly compact for its dazzling array of features."

— Charles Bairos, Polaroid Corp., Needham, MA

"Powerful switching with elegant simplicity."

— Arthur Fasciani, Computervision Corp., Bedford, MA

"The greatest thing since sliced bread in datacomm."

— Glenn Bryans, Hall Real Estate, Dallas, TX

"Obsoletes Goliath Port Selectors."

— Ralph Glasgal, Glasgal Communications, Inc., New York, NY

SMASH HIT
AT INTERFACE '84

CALL 1-800-DATA PBX*
Ask for an on-site demonstration

FEATURING

- USER CONTROLLED TERMINAL SWITCHING BETWEEN COMPUTERS
- EXPANDIBILITY FROM 24 TO 1320 TERMINALS AND PORTS
- HIGH THROUGHPUT • 660 SIMULTANEOUS 9600 BPS CONNECTIONS
- MAXIMUM RELIABILITY • ON-LINE BACKUP FOR NON-STOP OPERATION
- DO-IT-YOURSELF INSTALLATION WITH REGULAR TELEPHONE CABLE
- MENU-DRIVEN CONFIGURATION, DIAGNOSTICS, AND STATISTICS

G GENERAL AUDIENCES
even a child can operate it

NOW SHOWING AT THESE LOCATIONS



©1984 Equinox Systems, Inc.
All Rights Reserved

EQ 1600

ARIZONA Four Corners Technology (602) 998-4440	CALIFORNIA (South) Da/Com Inc. (213) 908-9804	CALIFORNIA (North) Western Data Group (415) 938-9582	COLORADO Four Corners Technology (303) 430-0133	FLORIDA Networks, Inc. (305) 822-6750	GEORGIA Xpoint Corp. (800) 241-4719	KANSAS System Technology (913) 492-7184
MARYLAND Commart, Inc. (301) 261-4344	MASSACHUSETTS Delta Data Comm Inc. (617) 935-8366	MICHIGAN W.C. Koepf Associates (313) 360-0626	MINNESOTA System Technology (612) 647-6902	MISSOURI System Technology (314) 225-4296	NEW JERSEY (North) Consolidated Data Systems Ltd. (201) 599-0380	NEW JERSEY (South) The Datastore (609) 779-0200
NEW MEXICO Four Corners Technology (505) 345-5651	NEW YORK (State) Annese & Associates, Inc. (315) 866-2213	NEW YORK (City) Glasgal Communications, Inc. (201) 768-8082	NORTH CAROLINA Xpoint Corp. (800) 241-4719	OHIO Data Processing Sciences (216) 582-0700	OHIO W.C. Koepf Associates (513) 885-2705	OKLAHOMA System Technology (918) 665-6340
OREGON Data World (503) 292-2679	PENNSYLVANIA The Datastore (609) 779-0200	TEXAS (Dallas) Technical Concepts (214) 783-9330	TEXAS (Houston) System Technology (713) 440-8340	UTAH Four Corners Technology (801) 485-7215	VIRGINIA/WASH., D.C. Commart Inc. (301) 261-4344	WASHINGTON Datacc (206) 575-1470

Equinox Systems Inc., 12041 SW 144th Street, Miami, Florida 33186 Telephone 1-800-DATA-PBX *In Florida (305) 255-3500
Regional Offices: Atlanta, Chicago, Dallas, Los Angeles, New York

CIRCLE NO. 46 ON INQUIRY CARD

MINI-MICRO SYSTEMS/November 1984

Mini-Micro World

INTERNATIONAL

for a new microprocessor—National Semiconductor Corp.'s series 32000, for example—and a new operating system would take a couple of months.

Virtual memory speeds access

A key feature of Xchange's software architecture is a virtual memory structure that quickly accesses the next required and the most recently used instructions and data from a 40K-byte space set up in main memory. As that space becomes filled, the least-recently used items are first buffered to another part of main memory, and eventually buffered back to disk. According to the company, it takes no longer to jump from page 1 to page 295 of a text than it does to jump from page 1 to page 2. Users should never get an "out of memory" error message no matter how large the Abacus spreadsheet is.

Psion has a wholly owned U.S. subsidiary, Psion Inc., Fairfield, Conn., that reportedly has signed OEM agreements with major international computer manufacturers. □

LOOKING AHEAD IN MMS

Mini-Micro System's December issue is our third annual overview of those leading edge technologies impacting our value-added market readership. A long-lasting sourcebook for technology and market data, the report presents past, present and future perspectives on key areas including:

- local area networks
- natural language translation
- operating systems
- non-impact printing
- relational database systems

8 in.
+ 660 MB
+ 18ms

= 2580 (booth#)

**MEGAVULT
MEMORIES
AT COMDEX**

CIRCLE NO. 47 ON INQUIRY CARD

*Computer not feeling well?
Down for the count?*

*Rx ... Take 1 MinTaur™ and get
peace of computer operation!*

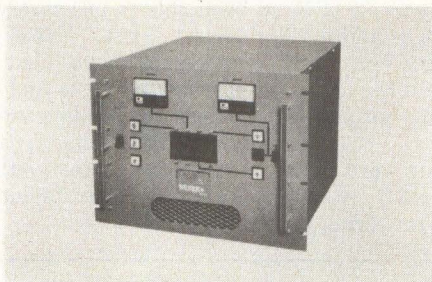

*From
Stock*

*\$5335
Delivered Price
until Dec. 30, 1984*

MinTaur the 3KVA Uninterruptible Power System with proven design and performance during the past 8 years. **MinTaur**...eliminates ^{all} power-related problems.

So...if your computer has a problem caused by local power, don't call the computer doctor...don't take a pill...Call Nova! Your remedy is in stock!

Other systems to 50KVA 1Ø and 3Ø

Nova Electric Mfg. Co. 263 Hillside Ave., Nutley, NJ
(201) 661-3434 Telex 219077

CIRCLE NO. 48 ON INQUIRY CARD

PACIFIC PERSPECTIVE

Databases to bloom in Japan

Ichiro Kakehashi,
Tokyo Correspondent

The word database is a relatively new one to most Japanese, partly because there haven't been many databases around and not many ways to get at those that are.

Two factors are sparking interest. The first is anticipated competition for so-called value-added networks, or VANs, expected to arise from the deregulation next April of the Nippon Telegraph and Telephone Public Corp. (NTT), Japan's government-supervised, telecommunications monopoly.

The second factor is an expected improvement in domestic hardware that will let Japanese businesses obtain and manipulate data. Although the use of computers to improve office productivity has been slow to emerge in Japan, interest is soaring. The announcement of products like IBM's PC-AT and the accompanying network that can link up to 72 IBM personal computers to share information, programs, messages, printers and storage devices whets the appetites of computer-hunting corporate purchasing officers.

They are encouraged by word that IBM Japan Ltd., the wholly owned subsidiary of IBM, is preparing a

year-end introduction of a new business personal computer that would be a somewhat lower-level relative of the popular 5550, an office personal computer that was introduced in June, 1983 in Japan. IBM has no comment on the new product, but the Matsushita Electric Industrial Co., which builds the 5550 under an OEM agreement, is tooling now for production at its Kadoma plant in Osaka, which has a capacity for 2,000 to 3,000 units a month.

The smaller machine is expected to be based on the same Intel 8086 that drives the 5550, providing general software compatibility. The expectation of Japanese analysts is that IBM Japan will follow a strategy similar to that used by its parent company: It will move nearer the home market by providing a machine for small, cost-conscious offices and businesses—that can be used for work at home.

IBM has been less circumspect about its intention to get into a VAN market—a market that no one has been able to measure yet, because it doesn't exist. Even though many companies have filed with Japan's Ministry of Posts and Telecommunications to offer data services, the race is quickly shaping up to a formidable three-way contest pitting IBM and AT&T's International Division against NTT.

The NTT software developers are already at work on a large-scale network for operation as early as next year. The communications utility started tests in September on its fiber-optic, cable-based, high-speed data network, the Information Network System (INS).

Software has been one of the most important areas of the VAN market research done so far by companies preparing to offer VAN services. One of the reasons AT&T has been seeking a Japanese partner is to obtain software. Another reason for AT&T's desire to align itself with a Japanese company is that the proposed VAN legislation restricts foreign capital participation to less than 50 percent.

The Diet, Japan's parliament, is expected to resume debate on the VAN bills and the closely allied NTT deregulation bills when its next session begins in December. Passage of NTT's deregulation is virtually assured.

One of the most recent examples of domestic databases was introduced late in August by IBM Japan Ltd., and Teikoku Data Bank Ltd. It is a corporate background file with information on the size and nature of companies and their financial condition. The service can be drawn upon by users of the IBM 5550 computer and the IBM 3278-52 Kanji display equipment. Information moves at 2,400 bits per second on the public telecommunications network. IBM will provide remote computing services.

LOOKING AHEAD IN MMS

The Interpreter section of Mini-Micro Systems' December issue focuses on office-automation systems.

OA systems have the potential to move mountains of paperwork and boost worker productivity. Yet, year after year, the promise is not quite realized. Buyer perceptions of machines as not user-friendly could be one reason. This article examines what's being done to improve OA's image.

Mini-Micro System's December issue is our third annual overview of those leading edge technologies impacting our value-added market readership. A long-lasting sourcebook for technology and market data, the report presents past, present and future perspectives on key areas.

The TARTAN C Compiler for VAX/UNIX. It's better than free.

TARTAN's C out-performs the portable C compiler you get free with UNIX™. With TARTAN C, you'll see: Faster execution speed, smaller-size object code, unsurpassed error diagnostics, and complete plug-compatibility with portable C. TARTAN C Compilers are part of a new generation of compilers that improve application performance and make programmers more productive.

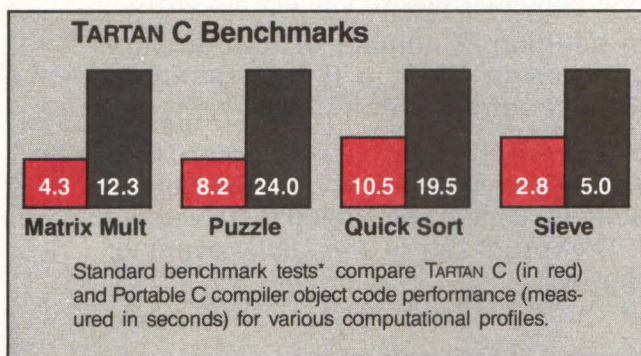

Get More Performance Into Your Applications.

TARTAN compilers make your programs more competitive. With TARTAN C, you'll see:

- Optimized object code that makes your programs run up to three times faster
- Object code that's up to 55% smaller

Get More Productivity Out of Your Programmers.

TARTAN's object code is optimized by the compiler, not the programmer. Our advanced diagnostics catch errors the first time—in context and with complete, concise messages. With TARTAN C, you'll see:

- No more hand optimizing
- Fewer recompilations
- Error-free code before you know it
- Optional runtime array bounds checking

There's More.

With TARTAN C, you'll see responsive product support and detailed documentation. We also include a copy of the brand new *C: A Reference Manual* by TARTAN's Sam Harbison and Guy Steele Jr.

Call Today.

Order The C Compiler That's Better Than Free.

TARTAN C Compilers for VAX™ systems running Berkeley UNIX have successfully completed customer-site testing and are ready for immediate delivery. To place your order, call our Sales Department at 412-621-2212, or write us at the address below.

The world's best-known C compiler is free. The world's best-performing C compiler isn't, but it's worth a lot more. The TARTAN C Compiler for VAX/UNIX.

We want to be your favorite software company.



TARTAN

TARTAN Laboratories
Incorporated
477 Melwood Avenue
Pittsburgh, PA 15213

TARTAN C Error Messages

C Program with Syntax Errors:

```
1 bubble(a) int a[100]; {int tmp, last, i;
2   for (last=100; last >= 2; last--)
3     {for (i=1; i <= (last-1); i++)
4       if (a[i] > a[i+1])
5         {tmp=a[i] a[i]=a[i+1];
6           a[i+1]=tmp;};
7     }
8 }
```

Portable C Compiler Error Messages:

```
"bubble.c", line 3: syntax error
"bubble.c", line 3: syntax error
"bubble.c", line 8: syntax error
```

TARTAN C accurately pinpoints errors and recovers:

```
2| for (last=100; last >= 2; last--)
3|   {for (i=1; i <= (last-1); i++)
4|     if (a[i] > a[i+1])
5|       {tmp=a[i] a[i]=a[i+1];
6|         a[i+1]=tmp;};
*** 1 Error 101: Parse error; token ")" inserted.
*** 1 Error 101: Parse error; token ";" inserted.
```

*A complete report on these and other benchmarks is available on request.
UNIX is a trademark of AT&T Bell Laboratories
VAX is a trademark of Digital Equipment Corporation.
©1984 TARTAN Laboratories Incorporated

Experience The Worlds of UNIX* at



UniForum™

The International Conference of UNIX Users

January 21-25, 1985 • INFOMART • Dallas, Texas

UniForum '85 is your passport to the fascinating "Worlds of UNIX." You'll examine the growing impact of UNIX in Office Systems, Personal Computers, Technical (Engineering/Programming), and Market Trends at UniForum '85, the largest UNIX event ever held.

More than 200 major vendors, in 850 booths, will display and demonstrate all that's new in UNIX products and applications.

An extensive conference and tutorial program will expand your UNIX database.

This program, organized by /usr/group, will include 15 all-day tutorials on user-specific aspects of UNIX...48 in-depth and informative conference sessions... four nationally-known plenary speakers.

In addition, a number of introductory courses in UNIX will be presented throughout the event.

UniForum '85 will be your total UNIX experience. Whether you're just getting started...or are a seasoned UNIX veteran ...UniForum '85 is *the* UNIX event of the year.

*For Complete Information, Call: 1-800-323-5155
(In Illinois, 1-312-299-3131).
Or Mail This Coupon Today!*

YES! I need to know more about UniForum '85. Please send complete details.

Name

Title

Company

Address

City

State Zip

Telephone (Area Code)

Electronic Mail Address (one only): _____

Mail To: UniForum
Suite 205, 2400 E. Devon Ave.
Des Plaines, IL 60018 USA

Sponsored by



*UNIX is a registered trademark of AT&T Bell Laboratories.

Save millions of dollars with Six-Shooters™

Last year 430 million business slides were made at a cost of \$3.2 billion. Most of these slides were manually generated.*

These slides could have been made on Sweet-P® Six-Shooter Personal Plotters™. Faster and better. With savings of millions of \$!

Save Money and Manage Better.

Use your office computer and Six-Shooter Personal Plotter to create and plot finished charts in 6 colors in 5 to 15 minutes. Save \$5.00 to \$100.00 per chart.

Save more money. Use your charts to:

- Reduce meeting times 28%**
- Get fast favorable decisions**
- Get your report read. "One Sweet-P picture is worth a thousand print-outs"

Don't settle for old-fashioned, slow plotters. With office costs running \$10.00 to \$20.00/hr., Six-Shooter performance saves a bundle. Best of all, Six-Shooter

performance and quality costs less—up to 45% less than other plotters in its class

The Sweet-P Six-Shooter is a high quality American made precision machine. It's fast. It plots 14 inches per second. It's beautiful for office and technical work. Plot perfect A-size slides for business presentations. Or big B-size block diagrams. Every office, every Quality and Production Manager and every Engineer should have one.

Over 100 graphics software packages drive the Six-Shooter—world famous packages like Lotus 1-2-3™ and ISSCO™, Tel-A-Graf™ and Disspla™

The Six-Shooter holds six pens. Pens are changed automatically. Pens are capped automatically when not in use, so that pens last longer and start quicker.

The Six-Shooter easily connects to almost any computer. It has RS-232



serial and Centronics parallel connectors. And it has two standard graphics languages—Sweet-P Graphics Language (SPGL™) and Hewlett-Packard Graphics Language (HPGL™).

The Six-Shooter plots on almost any media. Make brilliant overhead transparencies. Plot on film, and on plain and coated papers.

Save on wiring costs too. The Six-Shooter will "eavesdrop" on the RS-232 cables that connect your terminals now. (This makes it easy for Six-Shooters to join local and long distance networks.)

What about support? Six-Shooter customers get fast professional help with software, hardware and interface questions. And warranty and service support is quick. If we ever have to fix your plotter, we'll repair it in less than a week (usually 2 or 3 days).

Don't wait, order an evaluation plotter today. If you can't possibly use a plotter now, at least call or write and we'll send you more information and a sample plot. You'll love this great machine.

Our toll-free telephone numbers are: 800/227-4375
In California Call: 800/227-4371

Enter Computer, Inc.
6867 Nancy Ridge Drive
San Diego, CA 92121



Sweet-P, Six-Shooter, Personal Plotter and SPGL are trademarks of Enter Computer, Inc. Lotus 1-2-3 is a trademark of Lotus Development, Inc. Tel-A-Graf, Disspla and ISSCO are trademarks of Integrated Software System Corporation. HPGL is a trademark of Hewlett-Packard, Inc.

CIRCLE NO. 51 ON INQUIRY CARD

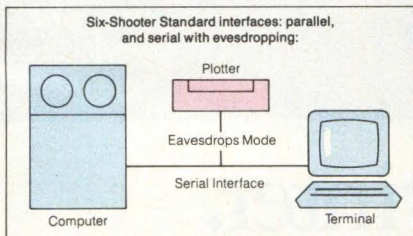

Source notes: **Yankee Group, The Technical Office, Vol. III 1983
**Wharton School Study, September 1981

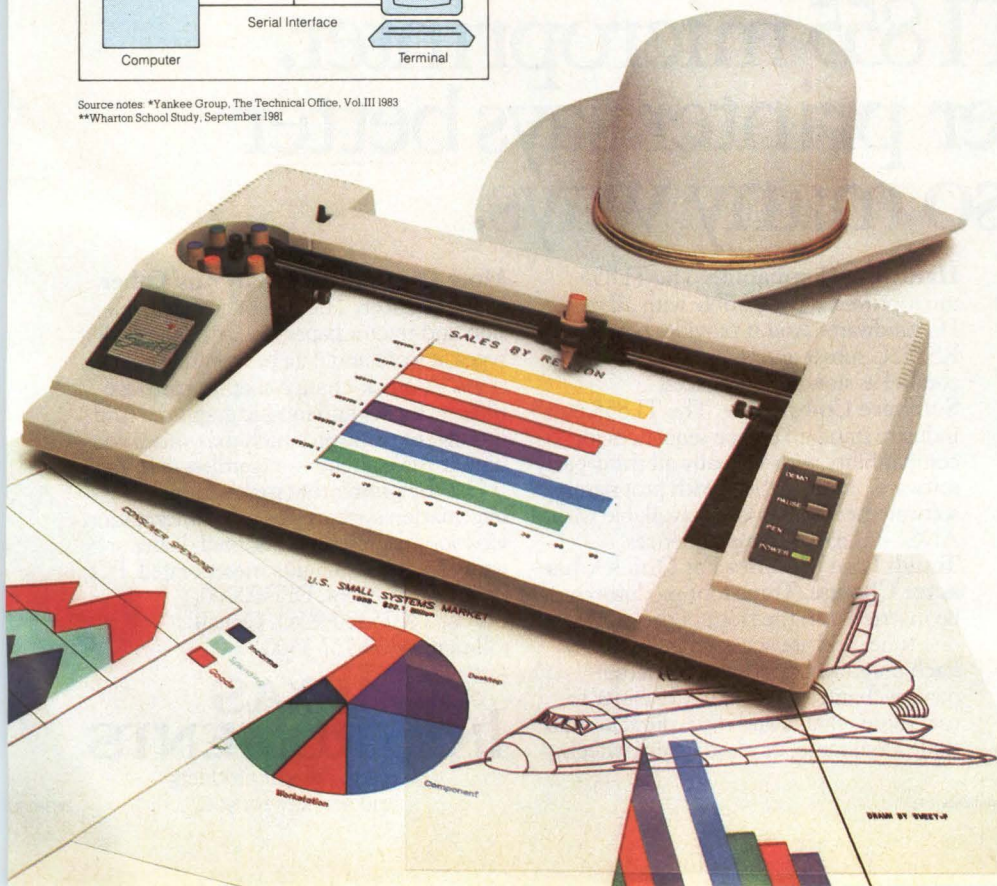

Both letter-quality and draft hard copy

Fastest document throughput in its class

Both friction and tractor paper feed

Industry standard serial and parallel interfaces.

Better, more versatile operator controls

TI reliability

Compatibility with third-party and proprietary software

Better, more durable easy-access font modules

The TI 855 microprinter. No other printer says better so many ways.

Feature for feature, no other microprinter can match the versatility, compatibility, reliability and productivity of the OMNI 800* Model 855 microprinter. Here's why.

Two Printers In One. With the TI 855 you get the speed of dot matrix draft copy. Plus the precise clarity of the most advanced matrix technology for letter-quality print. It's two printers in one — at one low price.

A Great Family Name. Texas Instruments is known for providing the world with the industry standard for printers — the TI 810. TI builds the same reliability into every 800 series microprinter. Both the 855 and the data processing Model 850 are part of the expanding TI line of high-performance, low-cost microprinters.

Hardware Compatible. The TI 855 microprinter is compatible with all major PC hardware. And it provides both serial RS232C subset and "Centronics-type" parallel as standard interfaces.

Software Compatible. The TI 855 uses industry standard escape sequences for compatibility with virtually all third-party software. And for those with proprietary software needs, a model is available with ANSI standard escape sequences.

Tough Font Modules For Quick Character Change. Three font modules can be inserted into the front of the printer at one time, and are accessed individually. Each contains both draft- and letter-quality character sets. They're easier to use, more reliable and more durable than traditional metal or plastic daisy wheels.

More Productivity Than Any Other Microprinter. The 855 offers both friction and tractor paper feed, to handle all types of word and data processing applications. A quick-change snap-in cartridge ribbon. Raster and mosaic graphics. And intelligent printing which maximizes document throughput — regardless of format.

Get the printer that makes for better information systems. For more information visit your nearest TI authorized dealer or write Texas Instruments Incorporated, P.O. Box 809063, Dept. DPF-00000, Dallas, TX 75380-9063. Or call toll-free: 1-800-527-3500.



TEXAS INSTRUMENTS

Creating useful products and services for you.

The hits just keep on coming
from Western Digital!



THE HOSTS

THE DRIVES

PC

ST506

SCSI

ESDI

SASI

QIC-36

Custom

SMD

General Purpose

SA450/SA850

Introducing the disk and tape

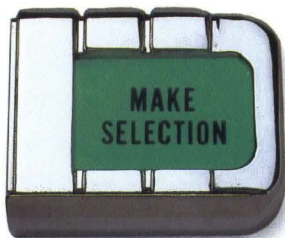

We're first with the most and latest with the greatest. And we've got a Jukebox full of new selections to speed and simplify your system design.



WD2010



WD277X

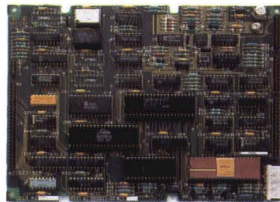

WD1003-SCS

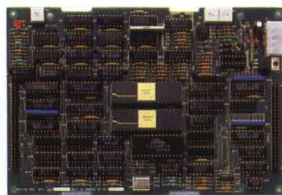

WD1036-SHD

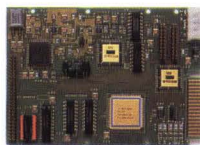

WD1002S-SHD

Introducing WD2010, a new VLSI Winchester controller with ECC, auto correction and 2048-cylinder addressability.

Introducing WD1003-SCS, first of a new generation of high-performance board-level controllers. Based on the WD2010. And featuring a full SCSI interface for your multi-user systems.

Introducing WD1002S-SHD. VLSI, surface mount technology and special gate arrays have enabled us to pack a SASI:ST506 controller into a 3½" form factor.

Introducing WD10C20, a VLSI self-adjusting data separator in CMOS.

Introducing WD1036-SHD, a new SASI:QIC-36 tape controller. Based on our new WD2400 chip set. Sure to help make ¼" streaming tape a chart-buster.

Introducing WD277X, the newest generation floppy disk VLSI controller, with on-board analog data separation.

Hits on silicon.

We've been at the top of the charts since we introduced the world's first floppy disk controller on a chip in 1976.



Select one of our off-the-shelf controllers. Or have us customize one for you.



#1 hit parade of controllers.

Proprietary VLSI is still our most powerful advantage. It gives us the edge by enabling us to control the technology, cost and future of our products.

Today we're developing new VLSI at a rapid rate, achieving higher levels of integration, migrating into CMOS and shrinking into SMT packaging.

We're playing your song.

If our new product introductions don't give you precisely the *host:drive* combination you need, check our other selections.

Take our WD1002-WX2 board for example. PC compatible.

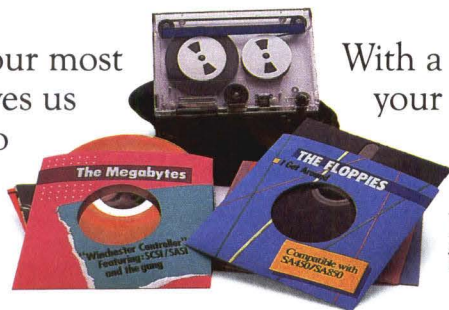

Floppy, Winchester and 1/4" tape — we've got controllers for all your storage needs.

With a menu of options to match your system's personality. Plus room on board to add extra memory, data privacy or other unique features.

Or we can design and build a board just for you. Our CAD capability

enables us to quickly adapt standard products to your custom needs. Our automated manufacturing capability gets you product in a hurry. Our worldwide Technology Centers and field engineering team speed system integration. And make you feel like dancing.

Punch our number.

Call our Hit Parade Hotline, 714/863-7827, and we'll rush you details on all of our new floppy, Winchester and tape controllers. Better yet, drop by our booth #658 at COMDEX and see each of these important new products.

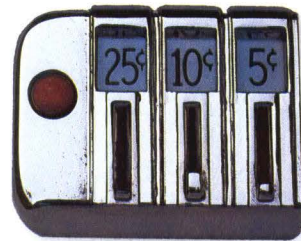

We deliver cost-effective, applications-driven solutions with just the right set of features.

WESTERN DIGITAL
C O R P O R A T I O N

A FEW OF OUR STORAGE MANAGEMENT PRODUCTS

	Part Number	Technical Information	Power Requirements	Package Size	Product Description
FLOPPY DISK CONTROLLER DEVICES	WD177X	Single chip	+5V	28 pins	FD179X functionality with built-in digital data separator and write precompensation.
	FD179X	Single chip	+5V, +12V	40 pins	Single/double density, IBM compatible.
	WD277X	Improved data separation	+5V	40 pins	WD279X with improved data separator.
	WD279X	Integrated data separator	+5V	40 pins	FD179X with built-in analog data separator and write precompensation, single/double density, and internal clock divide.
WINCHESTER DISK CONTROLLER DEVICES	WD1010	5MHz	+5V	40 pins	5.25" and 8" Winchester controller chip.
	WD1050	Single chip	+5V	68 pins	SMD controller.
	WD2010	5MHz	+5V	40 pins	WD1010 with ECC.
WINCHESTER DISK SUPPORT DEVICES	WD10C20	CMOS	+5V	28 pins	Data separator, and write precompensation device compatible with the WD1010 and WD2010.
	WD1015	Single chip	+5V	40 pins	Winchester buffer manager control processor.
	WD11C00-13	Single chip	+5V	20 pins	ECC support device compatible with the WD1010.
WINCHESTER BOARD PRODUCTS	WD1002-05/HDO	Board	+5V	5.75"X8"	5.25" Winchester/floppy controller board with ECC. HDO Winchester only.
	WD1002-SAS	Board	+5V	5.75"X8"	WD1002 Winchester/floppy with SASI interface.
	WD1002-SHD	Board	+5V	5.75"X8"	WD1002-SASI interface – Winchester only.
	WD1002S-SHD	Board	+5V	5.75"X4"	3.5" form factor of 1002A-SHD.
	WD1002-WX2	Board	+5V, -12V, +12V	3.85"X13"	WD1002 with IBM PC compatible interface – Winchester only.
	WD1003-SCS	Board	+5V	5.75"X8"	5.25" Winchester controller board with SCSI interface.
TAPE DRIVE CONTROLLER PRODUCTS	WD2401	Single chip	+5V	40 pins	Motion control & buffer manager
	WD24C02	Single chip	+5V	40 pins	Read/write formatter
	WD1036-SHD	Board	+5V, +12V	5.5"X8"	¼" tape controller (SASI:QIC-36)
	WD1036-WX2	Board	+5V, +12V	3.85"X13"	¼" tape controller (IBM PC/XT:QIC-36)

SALES OFFICES

Northeastern United States/ Eastern Canada

70 Atlantic Avenue
Marblehead, MA 01945
(617) 631-6466
TWX 710 347 1060

72 Summit Avenue
Montvale, NJ 07645
(201) 930-0700
TWX 710 991 8360

Southern United States

1015 Semoran Blvd.
Summit Plaza II, Suite D
Casselberry, FL 32707
(305) 331-4434
TWX 810 853 0297

4950 Westgrove Drive
Suite 115
Dallas, TX 75248
(214) 248-6785
TWX 910 997 0509

Wrightsville Building
2300 W. Meadowview Road
Suite 209
Greensboro, NC 27407
(919) 299-6733
TWX 510 922 7309

Northcentral United States

3600 West 80th Street
Suite 620
Bloomington, MN 55431
(612) 835-1003
TWX 910 576 2417

1827 Walden Office Square
Suite 308
Schaumburg, IL 60195
(312) 397-3111
TWX 910 997 0902

Western United States/ Western Canada

1151 Dove Street
Suite 170
Newport Beach, CA 92660
(714) 851-1221
TWX 910 595 2430

5743 Corsa Avenue
Suite 201
Westlake Village, CA 91361
(818) 991-2556
TWX 910 336 1441

201 San Antonio Circle
Building E, Suite 172
Mountain View, CA 94040
(415) 941-0216
TWX 910 379 5038

Europe

12 Rue Auber
75009 Paris
France

International Sales Subsidiaries

Western Digital (UK) LTD
55 East Street
Epsom, Surrey KT17 1BP
United Kingdom
3727 42955
TELEX: 851 925796

Western Digital Japan LTD
8th Floor, Dai 44, Kowa Bldg.
1-2-7 Higashiyama, Meguro-Ku
Tokyo 153, Japan
(81) 03 791 2001
TELEX: 781-34345

Western Digital Deutschland GmbH
Prinzregentenstrasse 120
D-8000 Muenchen 80
Federal Republic of Germany
011-49-89-470-7021
TELEX: 841 521 4568



The hits just keep on coming!

WESTERN DIGITAL
C O R P O R A T I O N

Stop tying up 90% of your time solving 10% of the problem.

Where does the time go in creating a technical document or manual?

In a word — art. It occupies about 10% of the finished product. But it consumes 90% of the effort.

Introducing the Qubix WorkSurface™

Now there's a better way. The Qubix WorkSurface.

Using the latest in CAD technology, the WorkSurface lets you interactively and simultaneously create both art and text on screen. Using the actual type styles. In their actual point size — from 4.5 point. The comprehensive batch and interactive composition and pagination software produces completed pages.

So what you see on screen is exactly what you'll see in print.

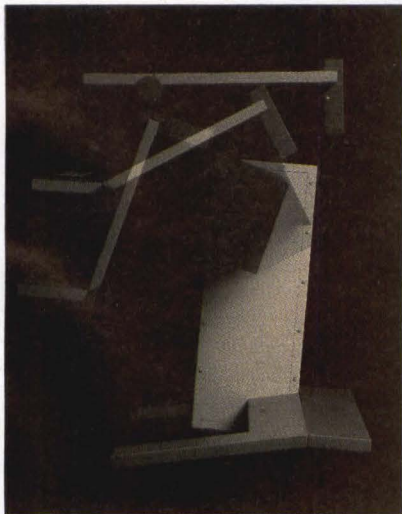

Up, down, all around. The WorkSurface electronically adjusts to how you like to work.

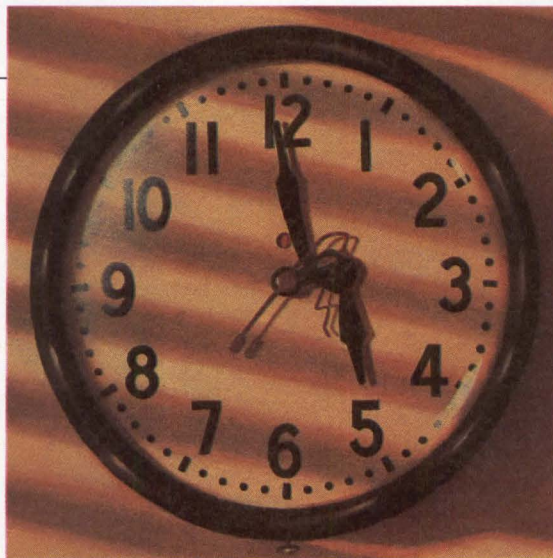

With the WorkSurface, it takes seconds. Simply display the appropriate page. Then, using the digitizing pen, draw the changes directly on the screen. That's all.

You can create illustrations from scratch in 1/4th the time. And make revisions in 1/10th the time. In fact, in little over a year, you'll save enough in time to pay for the system.

Now, once is always enough.

Any art elements you create can be stored in the system's memory. So commonly used elements need only be drawn once — and then recalled for use whenever and wherever needed. In any size you choose. And in combination with any other elements.

It uses a language you already know. English.

For all its sophistication, the WorkSurface is very easy to use.

Menus, in plain English, are displayed on the screen at all times. Select a command. And the system responds.

Making changes won't put you through changes.

With any document, there are always changes. And changing art has always been the most difficult. It might take hours. It might take days.

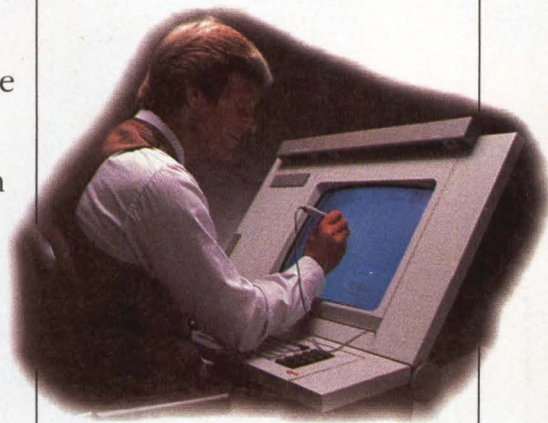

Draw your conclusions. Instantly. Redesign a page and evaluate several different layouts in seconds. Not hours.

For complete details and to arrange a demonstration, call us now at (408) 292-4000.

We'll show you how to do in a minute what used to take ten.

QUBIX
1255 Parkmoor Ave.
San Jose, CA 95126
(408) 292-4000

BEAT OUR BENCHMARK.

GET THIS WATCH.

Take the Plexus Challenge.

Everybody in the UNIX-based supermicro business talks performance.

Only Plexus dares to prove it... with the Plexus Challenge:

Show us a UNIX-based supermicro that can beat Plexus — running any recognized benchmark (or even your own application code*) — and we'll present you with this elegant Heuer chronograph valued at \$485.00.

How do we dare make this offer?

Simple: our multiprocessor architecture and highly-tuned version of UNIX leave the single-CPU competition in the dust. Multibus architecture and intelligent I/O processors let you expand modularly from

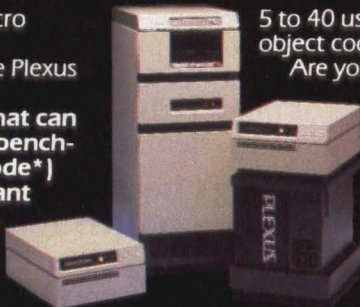

5 to 40 users — without changing a single byte of object code.

Are you thinking "Fine, but I really don't need all that performance"? Well, some of our customers tried other hardware first. They used to think the same thing.

Challenge details: This offer is extended to bona fide OEM's, value-added resellers, and volume end-users in the multiuser commercial UNIX systems market. Limit one award per company. Offer expires Jan. 31, 1985 unless withdrawn earlier. For complete rules and participation information, call (800) 556-1234 Ext. 560 (in Calif. (800) 441-2345 Ext. 560)

PLEXUS

Supermicros built for speed.

Plexus Computers Inc., 3833 North First Street, San Jose, CA 95134

*Subject to prior approval © 1984. UNIX is a trademark of AT&T Bell Laboratories. Multibus is a trademark of Intel Corp.

The Interpreter

Fiber-optic technology sheds light on local area networks

System integrators choose fiber-optic links for certain LAN applications

Lynn Haber, Associate Editor

The increasing use of microcomputers and intelligent workstations in the workplace has laid the groundwork for local area networks (LANs) which can satisfy the need for reliable, high-speed data communication. Currently considered a diamond in the rough by LAN experts, fiber-optic (lightwave) technology may soon become a polished gem for networking.

Boasting properties such as high bandwidth, light weight, immunity to electromagnetic interference and resistance to tapping, optical fiber is an attractive medium for LAN implementation. Though fiber-optic LAN technology remains in its adolescence, system integrators can opt for fiber-optic links within LANs in certain environments. These might include a campus where several LANs in separate buildings must be connected, a factory floor where machinery causes electromechanical interference and in applications that require a high level of data security.

According to Strategic Inc., a San Jose, Calif.-based research and consulting firm, by 1988, there will be 4,000 fiber installations out of an installed base of more than 124,000 LANs. In contrast, Strategic reported only 20 fiber LANs out of nearly 20,000 in 1983, with prototype installations existing exclusively in factories, universities and the military. Translated into dollars, Strategic estimates 1988 revenue from fiber LANs will amount to \$640 million, compared to almost \$500 million for broadband coaxial systems and approximately \$12 million for baseband coaxial systems.

Popular as a long-haul transmission medium, fiber optics will not be fully embraced as a LAN medium until designers can overcome technological obstacles. These include difficulties in tapping a signal from the fiber, connecting fibers to other LAN components and finding suitable network architecture for the physical and logical LAN design.

Fiber-optic technology utilizes light energy as opposed to electrical energy. In an optical link, information is transmitted as pulses of highly focused light

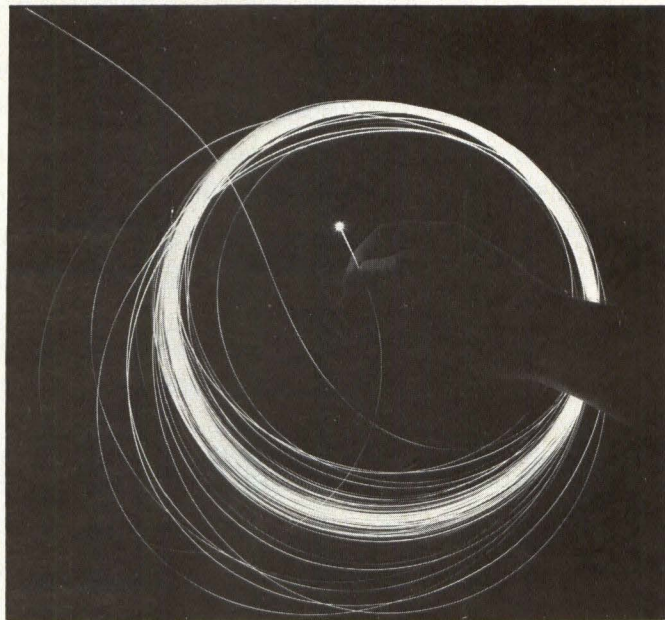

Hair-thin fiber-optic cable offers benefits such as light weight, high transmission speeds and immunity to electromagnetic interference and security.

emitted from a light source (transmitter), either a light-emitting diode (LED) or injection-laser diode. The light energy is carried over hair-thin fibers of glass (lightguides) enclosed in cable to a light detector (receiver), which converts the light pulses to electrical impulses.

In a LAN, the foremost benefit of fiber is its ability to carry vast amounts of information faster and over longer distances than can the more commonly used twisted pair, or coaxial cables. Fiber's high bandwidth—the range of frequencies that can pass over a circuit—allows the transfer of data along with other forms of communications such as voice, video and graphics. Today, fiber's capacity is 250 times that of copper, according to a spokesman from AT&T Bell Laboratories, Allentown, Pa. In the near future, that figure is expected to double, as technology improves.

S1 HIGHLIGHTS

The World's First 4th Generation Operating System.

The S1™ Operating System is an OEM's answer to product differentiation, a System House's answer to continuity and a programmer's dream come true. No other operating system in the world even comes close to the features and functionality of S1™. Some of the highlights are:

PORTABLE: The S1™ Operating System, All Languages supported, and All Applications running on S1™ can be ported to a newly announced chip architecture (even 32 bit) and running at full compiled speed within five (5) months. This is possible since the system and language compilers are written in a single common language called SL™. S1™ and All Languages supported are machine independent.

FILE SYSTEM COMPATIBILITY: S1™ can read and write files to and from: CP/M®, MP/M II™, MS-DOS™, UNIX®, XENIX®, p-System®, FLEX™, IBM 3741, DEC™ Files 11 and others.

MULTIUSER—MULTITASKING: Complete support: even multitasking per user.

MULTIPROCESSING: Up to **256 processors simultaneously** supported with any task running on any CPU.

NETWORKING: Remote Logon, Distributed File System, Intermachine Communications

EXTENSIVE GRAPHIC SUPPORT—FULL SCREEN MANAGEMENT—WINDOWING—BIT MAPPED DISPLAYS

FULL BIT MAPPED PRINTER & PLOTTER & TERMINAL SUPPORT—FULL SCREEN EDITING

EXTENSIVE UTILITIES: Assembler—relocating loader—linkage editor—high level assembly & language debuggers—sort—extensive O.S. managed error recovery—operating system debugging tools—desk calculator.

SUPPORTS ALL FORMS OF MEMORY MANAGEMENT, INCLUDING VIRTUAL MEMORY—BUT NOT REQUIRED

MODULAR: Unneeded system components can be omitted saving memory and load time such that the system can be configured for: REAL TIME—DATA ENTRY—PROFESSIONAL WORK STATION—PERSONAL—BUSINESS—MULTIUSER/MULTITASKING—DISTRIBUTED NETWORK—DEVELOPMENT.

UNIX® USER PROGRAM SOURCE COMPATIBILITY—RECORD LOCKING—EVEN BYTE LEVEL LOCKING

USER COMPATIBILITY: All configured versions of S1™ “Look” and “Respond” the same to all users, regardless of which chip or configuration is used.

VERY USER FRIENDLY: Menu driven, command driven, or prompting command processors.

PRESENTLY RUNNING ON: 68000, Z80®, 8080 and 8085. By Dec. 84: 8086/88—Jan. 85: 80186—March 85: 80286—June 85: 32016

LANGUAGES AVAILABLE: Pascal (ISO compatible) + Extensions, C (Kernighan + Ritchie) + Extensions; by Jan. 85: FORTRAN 77 + Extensions, BASIC (ANSI) + Extensions; by April 85: COBOL 74 + Extensions, Modula 2 + Extensions; by Sept. 85: PL/I + Extensions, Ada + Extensions, LISP + Extensions, SNOBOL + Extensions. All our languages are extended to provide many of the advantages of the S1™ Operating System (i.e.; 64 character file names) and are supersets of most popular language compilers, and can be made compatible with these languages using our available converters.

HIERARCHICAL DIRECTORIES & KEYED FILES (ISAM & VSAM & B-Tree)

ELECTRONIC MAIL & FILE TRANSFER

SEMAPHORES AND LOCKS—REAL TIME SUPPORT

UP TO 65,000 USER DEFINABLE SYMBOLS PER FONT

UNLIMITED NUMBER OF FONTS

*Registered trademarks: CP/M of Digital Research; UNIX of Bell Laboratories; UCSD p-System of Regents of University of California; XENIX of Microsoft, Inc.; Z80 of Zilog, Inc.

Trademarks: MS-DOS of Microsoft, Inc.; FLEX of Technical System Consultants; Pick of Pick and Associates; MP/M II and PASCAL/MT + of Digital Research; S1 and SL of Multi Solutions, Inc. HP of Hewlett Packard; DEC™ of Digital Equipment Corporation; BASIC PLUS of Digital Equipment Corporation

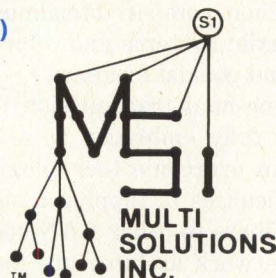

COMDEX/Fall
Booth 0739

Suite 207, 123 Franklin Corner Rd.
Lawrenceville, N.J. 08648
609-896-4100 Telex 821073

S1-The only operating system that does it all

CIRCLE NO. 54 ON INQUIRY CARD

The Interpreter

Additional advantages of optical fiber over metallic conductors include immunity to electromagnetic interference, because these lightguides do not conduct electricity; light weight, which makes installation easy; and security. Unlike copper cable, fiber-optic cable is very difficult to tap, unless physically broken.

Pioneers produce fiber LANs and components

Despite the youth of the fiber-optic industry, pioneers are making fiber LANs and their components available today. Among them are Ungermann-Bass Inc., a supplier of general-purpose LANs, and a handful of companies—such as Codenoll Technology Corp., Proteon Associates Inc., American Photonics Inc., Fibronic International Inc., and Seicor Fiberlan—that manufacture fiber-optic equipment.

In announcing a fiber version of the company's Net/One product earlier this year, Ungermann-Bass, Santa Clara, Calif., made one of the first fiber-optic LANs commercially available. Net/One is also available in its original coaxial cable versions.

The Net/One Optical Fiber LAN has a 10M-bits-per-second (bps) data-transfer rate, is Ethernet-compatible and employs carrier sense multiple access with collision detection (CSMA/CD), a scheme by which stations in a network compete for access. System components include fiber-optic cable, fiber-optic star couplers and the star wiring center.

"One of the founding commitments of the company,"

says Anthony Russo, director of product marketing for Ungermann-Bass, "was that we be a media-independent company and support all emerging standards. Fiber is another technology in which we need to have expertise." According to Russo, the company has installed four fiber systems, the largest for a Fortune 500 company at the cost of \$1.1 million.

Although fiber links are more expensive than copper ones, the cost gap between copper and fiber is narrowing. A typical fiber-optic Net/One with 200 device interface ports sells for \$135,000, according to a company spokesman. The same system in a baseband coaxial version sells for \$110,000, and an equivalent broadband coaxial system sells for \$115,000 (the cost of the cable is not included in these prices). Depending on a variety of cable characteristics, prices range from \$1 per foot for baseband coaxial cable; \$1 to \$7 per foot for broadband coaxial cable; and \$2 to \$15 per foot for optical fiber cable.

Although Codenoll, Yonkers, New York, and Proteon, Waltham, Mass., classify their respective products—proNet and Codenet—as LANs, Ungermann-Bass claims the Net/One fiber LAN distinguishes itself from these other products by its network interface unit (NIU), which reportedly functions as the intelligent interface between the LAN and other information processing equipment. "Other companies don't have an NIU. Their products only allow a certain subset of equipment to be hooked up in the network," explains

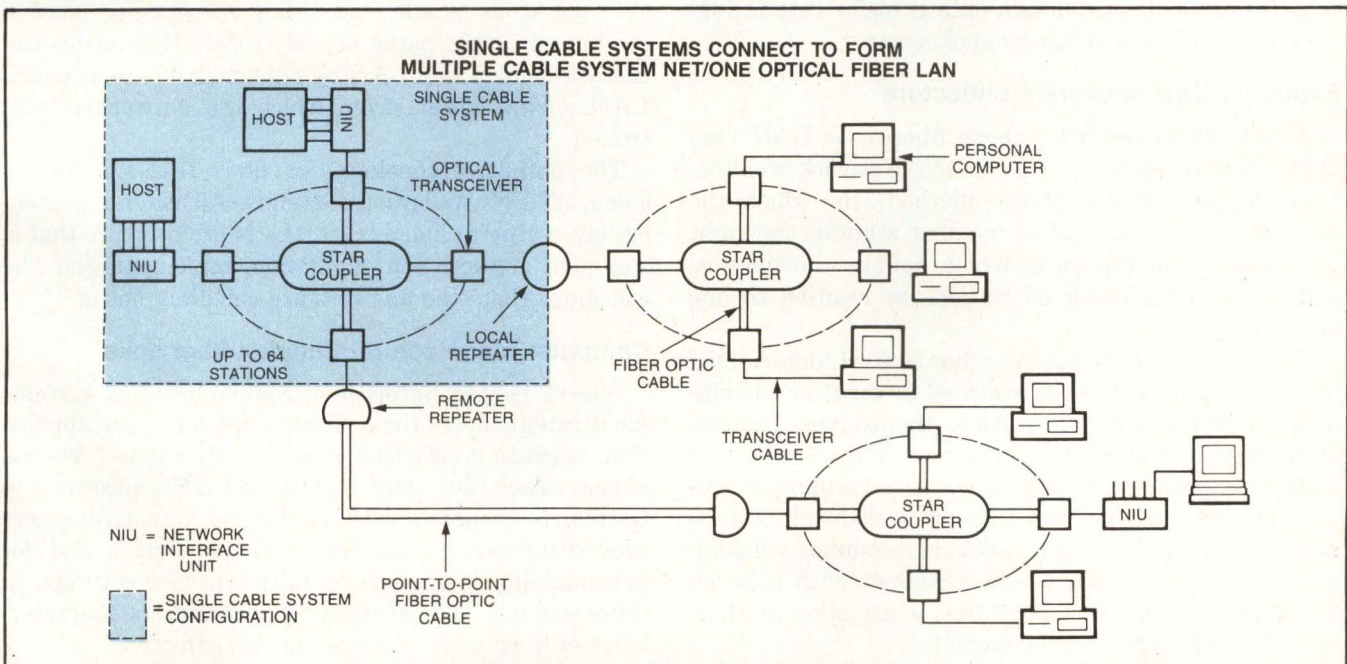

Multiple cable system configuration for Ungermann-Bass Inc.'s Net/One optical fiber LAN. System components include fiber-optic cable, fiber-optic star coupler, network interface unit (NIU) and optical transceiver.

The Interpreter

Russo. Without software to translate data files from a form used by one type of equipment to a form other equipment can understand, the network can't include equipment from a variety of vendors, he says.

Michael Coden, president of Codenoll, claims that by providing software and equipment interfaces, the Ungerma-Bass product is a turnkey system. In contrast, Codenoll sells fiber-optic network components. "We provide the interconnect technology. The software and computer interfaces are left up to the user," he says.

Researchers are trying to find a better LAN architecture that is 'uniquely attractive in a lightwave implementation...the answers are certainly not in.'

Codenoll, founded four years ago to develop fiber-optic communications equipment, makes Codenet, a fiber-optic, Ethernet-compatible LAN with a 10M-bps data transfer rate. Since the product became commercially available 18 months ago, the company has installed hundreds of systems which are either all-fiber or implement some fiber technology, Coden says.

Also Ethernet-compatible is the proNet network made by Proteon which can use fiber, coaxial or other types of cable. Its maximum data transfer rate is 10M bps, according to a company spokesman.

Exploring LAN network architecture

A precarious arena for these fiber-optic LAN vendors is that of network architecture. Network architecture consists of the access method, by which the network distributes among member stations the right to transmit and topology, which defines the physical and logical positioning of stations in relation to one another.

The access method can be either central, determined by a controller that polls stations in turn, or distributed, determined by the stations themselves. Distributed access methods can be either random, allowing any station to transmit at any time, or deterministic, requiring that stations wait in turn to transmit. Carrier sense multiple access (CSMA) is a common random-access method. CSMA is often refined with collision detection (CSMA/CD) capabilities, which allow stations to detect collisions and retransmit.

Among the three most common LAN topologies—bus (or tree), ring and star—the bus is the most popular

in the United States, according to Lawrence K. Anderson, director of electrical components and subsystems for AT&T Bell Laboratories. It is also the most difficult in which to implement fiber-optic technology, because so much tapping is required.

Most prototype fiber LANs utilize ring or star topologies. According to Ungerma-Bass' Russo, the fiber optic Net/One physically utilizes a star configuration, but is logically arranged as a bus. "The bus is ideal, but difficult to do physically," he explained. "The star is inexpensive and makes it easy to reconfigure the network [because] you splice at the star."

In a star topology, the system utilizes what is called a star coupler, made by criss-crossing optical fibers and melting them where the fibers intersect, according to Coden. Whatever light (digital information) is inputted on one side of the coupler, after passing through the melted point, divides itself equally among all of the other fibers and travels on to the network nodes.

As opposed to coaxial cable, which typically runs down a corridor with a tap branching off for every office, the star arrangement requires that a cable run from each office to a central point called a wiring closet. In this arrangement there are never more than four connections—a transmitter and a receiver at the computer, and one each at the wiring closet. Whereas any tap causes a large power loss, the star topology minimizes the number of taps.

Since most utility power grids in office buildings are also wired as a star, according to Coden, suitable conduits or cable paths already exist. New nodes can easily be added to a LAN by running cable to a central LAN wiring closet, from which the network is controlled.

The definitive topology for fiber LANs is yet to come, AT&T's Anderson contends. Although researchers are trying to find a better LAN architecture that is "uniquely attractive in a lightwave implementation," he concludes that "the answers are certainly not in."

Computer manufacturers market fiber links

Sherry Gettes, director of communications systems for Strategic notes that, "fiber is not for every application, because it just isn't economically viable." We can expect to see fiber implemented in LANs, according to Gettes, to dispense with vulnerable signal repeaters over distances, to provide wide bandwidth and for dependability in environmentally sensitive settings. In these settings, the necessity for the inherent characteristics of fiber make the system cost effective.

Computer manufacturers that sell LANs to connect their own equipment have been testing the waters of

Introducing the PC alternatives for the office and the factory.



For Office Control: ISI's 5160.



For Factory Control: ISI's 6160.

More flexible. More functional. More cost effective.

ISI International (formerly Intersil Systems) introduces two new IBM-compatible systems, one for the office and one for the factory.

Each is PC and XT-compatible in both hardware and software. But both offer significant advantages in flexibility, expandability and cost effectiveness.

Office Control: ISI's 5160.

The ISI 5160 office system looks like, and works like, the PC/XT, and it will run the software its more expensive counterpart will run. So you are assured of broad software availability.

But ISI designed the 5160 to be especially flexible in meeting the needs of different sized offices, with differing (and changing) processing requirements.

Expanding all the way from a single floppy to a fully loaded Winchester system is far easier with the ISI system. In fact, over 60 MB of on-line storage capacity is available. Half-height floppies, 10, 20 and 30 MB Winchester drives, cartridge tape backup, and a 130-watt power supply supports expansion.

The first step was to put all the CPU essentials onto the baseboard, leaving more open expansion slots and greater provision to meet users' changing needs. The standard 5160 system includes all these essential features on the baseboard: 8088 CPU and optional 8087 coprocessor; 128K memory (expandable to 640K); calendar/real-time clock with battery backup; two RS-232C ports; parallel printer port; floppy disk controller and SASI interface.

So for an office system that truly offers room to grow, choose ISI International's 5160 office system.

Factory Control: ISI's 6160.

The ISI 6160 is essentially the same easily expandable processor as the 5160, featuring the same PC and XT-compatibility, but with important additional features that make this the ideal system for factory applications.

For example, it's 19" rack-mountable RETMA enclosure is ruggedly designed and manufactured, and features fan cooling with positive airflow to eliminate hot spots; changeable filters for extra protection from contamination; and a key-lockable cover for limited access to power and reset switches, as well as to the shock-mounted disk drives.

Both the 5160 and the 6160 offer MS-DOS* and GW-Basic,* in addition, the 6160 factory system offers VRTX†; a multitasking kernel that permits you to run real-time, interrupt-driven control applications.

For operation in a more office-like setting, the 6160 can be dressed up in its own "office" style cabinet, just like the 5160. But underneath, it will still be the most versatile, expandable, functional computer available to run factory control applications.

For more information on either the ISI 5160 office system or the ISI 6160 factory system, call us in the West at (408) 743-4442, in the East at (201) 272-3920, or in the Midwest at (513) 890-6450.

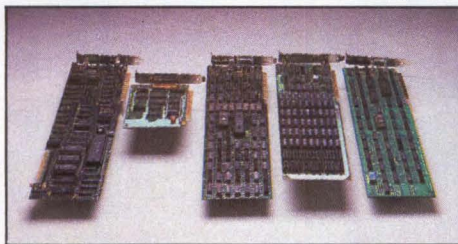

ISI International also offers an expanding array of adapter cards for use with ISI International systems, as well as IBM and other PC-compatible systems.



INTERNATIONAL
1275 Hammerwood Avenue
Sunnyvale, California 94089, (408) 743-4442
European headquarters, Paris (1) 878.42.25.

*MS-DOS and GW are trademarks of Microsoft Corporation.
†VRTX is a registered trademark of Hunter & Ready, Inc.

A DECLAR DATA INDE



When In The Course Of Business Events . . .

OEMs designing systems for today's businesses face two realities. One, data processing is rapidly becoming more decentralized. It is pushing outwards into individualized work units, defined more by job function and applications, performed by more people in

more places, demanding more data flexibility—more data independence.

Which brings OEMs face to face with a second reality. Winchester. Because the prevailing mass storage technology—in the form of large storage units used for access or downloading, or smaller, high capacity desk-top mechanisms—continues to head in

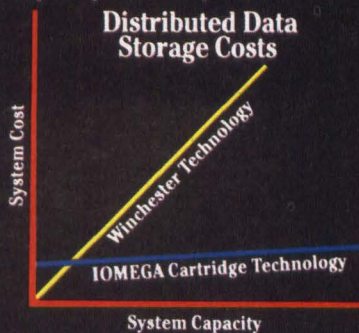

the opposite direction. Rather than freeing users to operate effectively in the new environments of distributed data processing, Winchester keep them device-dependent, keep them tied to a shared system of storage.

Slavery By Any Name . . .

There are lessons here. That the central issue isn't more data, but more data dynamics. And that Winchester are hardly data dynamic at all.

Consider the aggravations of "wait your turn" access, or the need for lots of "system savvy" on the user's part. Consider the time consumed in backing up and restoring data. And consider the ever-present risk of a system going down or files lost to expensive head crashes.

Now consider the alternative.



IOMEGA HAS REMOVED CAPACIT

ATION OF PENDENCE.

IOMEGA's Distributed Data Storage: Freedom Of Information.

The IOMEGA family of data management/storage systems effectively matches today's distributed data processing reality with a new reality: *distributed data storage*. Because IOMEGA's reliability and performance specs often exceed Winchester's, particularly in access times and transfer rates. And they deliver cost-per-megabyte figures that Winchester's cannot figure at all.

	IOMEGA BETA 5	IOMEGA ALPHA 10/10H	TYPICAL WINCHESTER
Formatted Capacity	5.0 Mbytes per cartridge	10.0 Mbytes per cartridge	10.0 Mbytes fixed
Data Transfer Rate	5.0 Mbits/Sec	9.0 Mbits/Sec	5.0 Mbits/Sec
Average Access Time	39 msec includes settling	35 msec includes settling	85 msec
Form Factor	5.25"	8"/8" Half Height	5.25"

The key is "in/out" simple—the IOMEGA cartridge. Think about downloading data and software to a single 5- or 10-megabyte cartridge, then manipulating, updating, and uploading with maximum convenience and cost efficiency. And think about a total enterprise solution, about storing individual applications, complex software programs, or data sets—all of which can be passed along to others without expensive networking resources. And when you need more storage, you use more cartridges, not more hardware.

Accept No Other Alternatives.

IOMEGA's distributed data storage solutions—in full- and half-height 8-inch 10-megabyte solutions, and a 5-megabyte, 5¼-inch version as well—give OEMs Winchester performance and reliability, and floppy convenience and cost efficiency. They are proven, risk-free solutions. And of the few cartridge opportunities on the market today, IOMEGA's—besides being available—are the only ones that are rugged, absolutely interchangeable, and inexpensive. As such, they give OEMs the most precious commodity of all: *the freedom of designed-in freedom*. The freedom your customers require.

Take The Liberty.

Get in touch with an IOMEGA representative today. One is conveniently located in an area near you.

IOMEGA™ THE FUTURE IN DISTRIBUTED DATA STORAGE

IOMEGA CORPORATION
1821 West 4000 South
Roy, Utah 84067
(801) 776-7330

See us at Comdex Fall Booth #4958

Y AS THE MASS STORAGE ISSUE.

WESTERN (714) 855-1211, (408) 263-4476; NORTHEAST (617) 933-2000; MIDWEST (312) 397-4234; EASTERN (203) 359-9858.

CIRCLE NO. 56 ON INQUIRY CARD

The Interpreter

The fiber-optic Extension (FOX) from Tandem Computers Inc. allows up to 14 of the company's NonStop II systems to form a high-speed information network. Fiber-optic cable is directly connected to a FOX controller board in the NonStop II system.

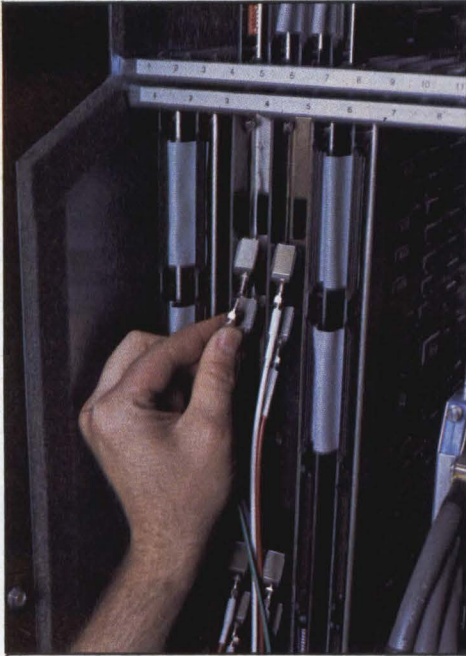

fiber technology, rather than taking the plunge. Companies such as Wang Laboratories Inc., Digital Equipment Corp. (DEC) and Tandem Computers Inc. have already introduced fiber-optic products, although none is a complete LAN and most are only links that expand the distance capacity of a system.

Tandem, a Cupertino, Calif., maker of network-oriented minicomputer systems based on parallel processing architecture, uses optical fiber in the company's Fiber Optic Extension (FOX) product. According to a company spokesman, FOX is a high-speed interface that enables users to expand their processing power beyond the maximum of 16 processors in a single Tandem system. A system-to-system link, FOX allows users to connect two to 14 of the company's NonStop II systems over distances as great as one kilometer. "We decided to use fiber because we saw a need for a high-speed interconnect between systems," the spokesman says. "Our users are large organizations, such as banks, the stock exchange and manufacturers who require strong communications capabilities."

Other companies say full implementation of fiber-optic technology is three to five years away. "We're looking at all types of LAN technologies," says a spokesman for Data General Corp. of Westboro, Mass. "Our position is to be compatible with all the standards, but we think it's premature now for our participation in the market. I'm sure we'll support fiber in the future." The company markets two LANs. One is a proprietary network bus system that uses baseband coaxial cable,

In a LAN, the foremost benefit of fiber is its ability to carry vast amounts of information faster and over longer distances than can the more commonly used twisted pair, or coaxial cables.

can support 32 nodes and has a data-transfer rate of 2M bps; the other is based on the Ethernet standard.

While Stratus Computer Inc., a Natick, Mass. maker of continuous processing equipment, doesn't presently support fiber-optics in their Stratanet network, it is a technology that the company eventually will support. "We don't see the requirement to have fiber today," states William Foster, company president. "Clearly, it is a new technology and one that you'll see more of in communications systems."

With standards for fiber-optic LAN technology still to come, many vendors are waiting to see in what direction the industry leaders will move. IBM Corp. virtually gave fiber its stamp of approval with an announcement earlier this year of the company's cabling system. One of four types of transmission cable being marketed by IBM is optical fiber. The cabling system is reportedly one piece of the proposed token-ring LAN that IBM is expected to make available within the next couple of years.

Closely following suit, AT&T Information Systems, Morristown, N.J., introduced the Information Systems Network (ISN), a local area network that combines fiber optics and existing copper wire to link workstations, terminals, personal computers, minicomputers and communications processors into one system. The network reportedly supports data transfer rates of up to 8.6M bps, and supports a multiplexed fiber interface for selected host computers.

Fiber makes ideal spine for hybrid LANs

The most successful networking application for fiber in the near term, according to industry experts, is as the backbone (spine or trunk) for one or more LANs. In this capacity, the fiber acts as a transparent high-speed data highway. With other media connected to the fiber trunk, the LAN becomes a multimedia or hybrid LAN.

At the Massachusetts Institute of Technology (MIT) in Cambridge, a five-year experimental project in the use of computers in education, called Project Athena, began in May, 1983. It will utilize a distributed network of 3,000 terminals and computers including DEC's VAX 11/750 and VAX 11/730 minicomputers, VS100 workstations and Professional microcomputers, and IBM

HOW TO GET ALONG WITH IBM.

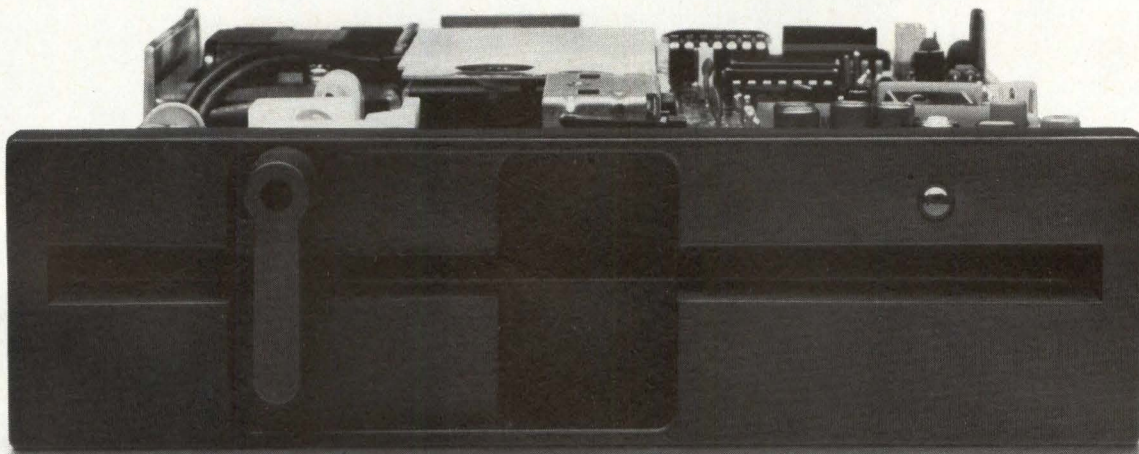

At 1.2 MB formatted, the Shugart 475 offers true 8" performance in a 5.25" package.

It's easy. Design your multiuser PC/AT* compatible system with Shugart's 1.6 MB half-height Minifloppy™ disk drive. The Shugart 475.

At 96 tpi, it's plug compatible with the IBM PC/AT drive. And comes equipped with a dual speed motor.

Which means backward compatibility to read 48 tpi diskettes. And that means you need only one drive to build your PC/AT compatible system.

With the Shugart 475, your compatible system design can be less expensive, simpler and more functional. While getting along just fine.

In addition, the Shugart 475 offers a true-ready command buffering feature to speed controller functions in multiuser applications. Thereby increasing system throughput.

See us at Comdex between aisles 2700 and 2800

There's even a latch-ready disk change option to alert the system without starting the drive when a disk is removed or changed. As a result, operators on the network can't interfere with other users' data.

Best of all, the Shugart 475 is available in production quantities now.

For true 8" performance in a 5.25" package, be the first to call Shugart at (408) 737-7900.

Learn how easy it really is to get along with IBM.

Shugart

Right from the start.

Milpitas, CA (408) 263-2600, Costa Mesa, CA (714) 979-1935, Thousand Oaks, CA (805) 496-5388, Rochester, NY (716) 235-7190, Minneapolis, MN (612) 546-4411, Richardson, TX (214) 234-3568, Framingham, MA (617) 879-1700, Saddle Brook, NJ (201) 368-8445, Smyrna, GA (404) 436-0953, Markham, ONT (416) 475-2655, Paris, France (3) 946-42-66, Munich, West Germany (089) 786-021, London, U.K. (44) 4862-27272, Wanchai, Hong Kong (852) 5-733307 Hamilton/Avnet, authorized distributor © 1984 Shugart Corporation.

*IBM PC/AT is a trademark of International Business Machine Corporation.

CIRCLE NO. 57 ON INQUIRY CARD



Not long ago, *PC Magazine* called MDBS III "The most complete and flexible data base management system available for microcomputers." That's a powerful statement. But then, MDBS III is an amazingly powerful software package. So powerful, in fact, that it lets you build mainframe-quality application systems on your micro or mini. MDBS III is not for beginners. It's for application developers with large data bases or complex data interrelationships who want to define data base structures in the most natural way—without resorting to redundancy or artificial constructs. It's for professionals who can appreciate its extensive data security and integrity features, transaction logging, ad hoc query and report writing capability and its ability to serve multiple simultaneous users. And if you want the power and the glory that only the world's most advanced data management system can provide, MDBS III is for you. For information on MDBS III and our professional consulting services, write or call Micro Data Base Systems, Inc., MDBS/Application Development Products, 85 West Algonquin Road, Suite 400, Arlington Heights, IL 60005. (800) 323-3629, or (312) 981-9200. **MDBS III. ABSOLUTE POWER.**

CIRCLE NO. 58 ON INQUIRY CARD

WE'LL GIVE YOU THE POWER.

YOU TAKE THE GLORY.

The Interpreter

4341 computers and PC/XTs dispersed across the approximately one-mile-by-two-mile campus. The project is funded by DEC, IBM and MIT.

According to Doug Wilson, manager of system development and operations for the project, the personal computers will be organized into Ethernet clusters, each with about 50 machines and one or more file servers. The Ethernet clusters will then be interconnected via a campus-wide fiber backbone network. "The philosophy behind our connection is to make the topology of the spine be transparent to any of the applications that would use the spine," Wilson explains.

The first fiber prototype will use four kilometers of cable in a ring topology. The project planners decided to install a dual redundant ring, making the total length of fiber used eight kilometers. The network will serve the entire campus. "We expect fiber to be the dominant technology," said Wilson.

According to AT&T's Anderson, advances in fiber-optic technology will eventually extend fiber right to the workstation via various star and ring networks. He also foresees interfaces between fiber-optic LANs and

The most successful networking application for fiber in the near term, according to industry experts, is as the backbone (spine or trunk) for one or more LANs.

the switched telecommunications network. "The main thrust here is to integrate various services and various technologies."

According to Codenoll's Coden, whose customers include NASA, the National Bureau of Standards, Pacific Telesis and Westinghouse Electric Corp., for those who previously used coaxial cable, then moved on to fiber, there's no turning back. "There's no sense going back to that old, antiquated, heavy stuff." □

Interest Quotient (Circle One)
High 834 Medium 835 Low 836

More things will change in the next 3 years than in the last 300 years.

Thorn EMI is recognized worldwide for being leagues ahead of its competitors in the computer industry—the recognized leader in technology and quality control ■ Thorn EMI has earned an international reputation for delivering on its promises, rather than promising on its deliveries. From the data recording systems that have served NASA's Spacelab program from the very beginning, to the world's best designed series of 1/2-inch streaming tape drives, Thorn EMI is the recognized leader in technology and quality. ■ Thorn EMI offers a choice of 3 models of 9-track, 1/2-inch tape drives, all IBM/ANSI compatible. The 8900, 9800 and 9900 models all offer the highest reliability combined with low cost of ownership. ■ All are uniquely designed with interchangeable components, providing simplified maintenance and training and minimal spares holding. All provide a total solution to the problems of Winchester disk backup. Thorn EMI's model 9800 is the world's smallest 1/2-inch streaming tape drive—again demonstrating that Thorn EMI is leagues ahead in technology.

■ Thorn EMI. Providing For The Future, Today.



**Thorn EMI—
Leagues Ahead In Technology**



**THORN EMI
Technology Inc.**

Computer Products

8601 Dunwoody Place • Atlanta, Georgia 30338
404-587-0017 • 800-243-2572

**THE QUALITY
OF OUR
THIN FILM
DISCS
IS AS GOOD
AS GOLD.**

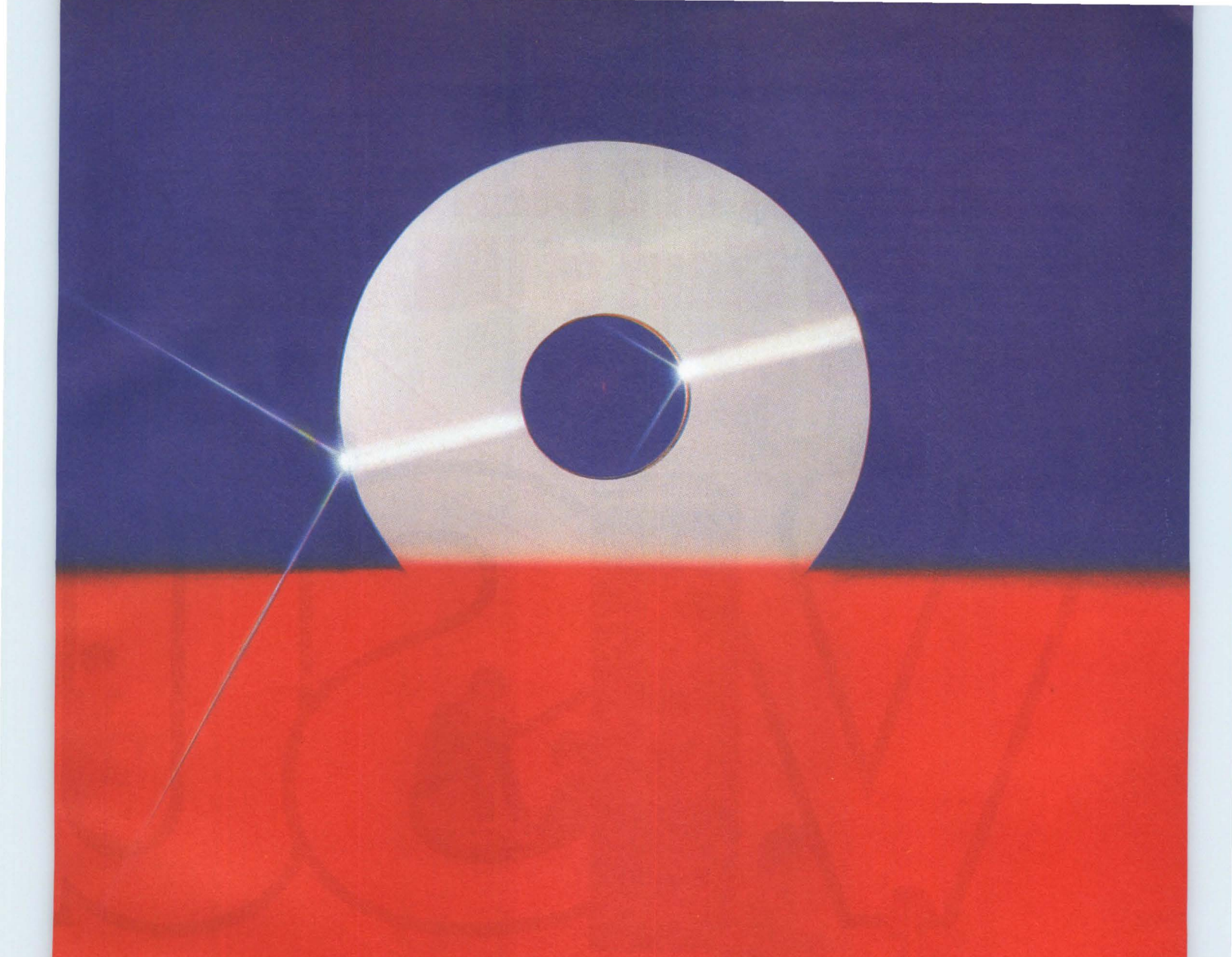

Our Gold Standards. Superior discs. In resolution. In signal to noise ratio. In amplitude and modulation. In overwrite and missing/extra pulses. Discs by which we measure all other discs. At Ampex, we develop a Gold Standard and thorough test plan for every customer's disc-head combination. An ALAR® thin film disc that doesn't meet our Gold Standard of quality isn't shipped. No ifs. No ands. No buts.

In fact, every disc we ship has survived a quality assurance program so stringent it's unparalleled in the industry. With ten major process control checks during manufacturing. We test and retest. From substrate to finished product. Then we test our tests. So you don't have to.

It takes experience to make quality thin film discs. We have more. Today, with over one million discs working in over 300,000 systems. And a \$30 million commitment to produce the volume to meet tomorrow's demand. So ride on our shoulders. We've made a name in magnetic media that's as good as gold. Ampex. Disc Media Operations, 960 Rincon Circle, San Jose CA 95131 (408) 945-5600 Telex 348464.

AMPEX

Ampex Corporation • One of The Signal Companies 

WE'RE THE HEAVYWEIGHTS IN THIN FILM MEDIA.

The Power of a Mini, The Cost of a Micro, The Clout of UNIX.

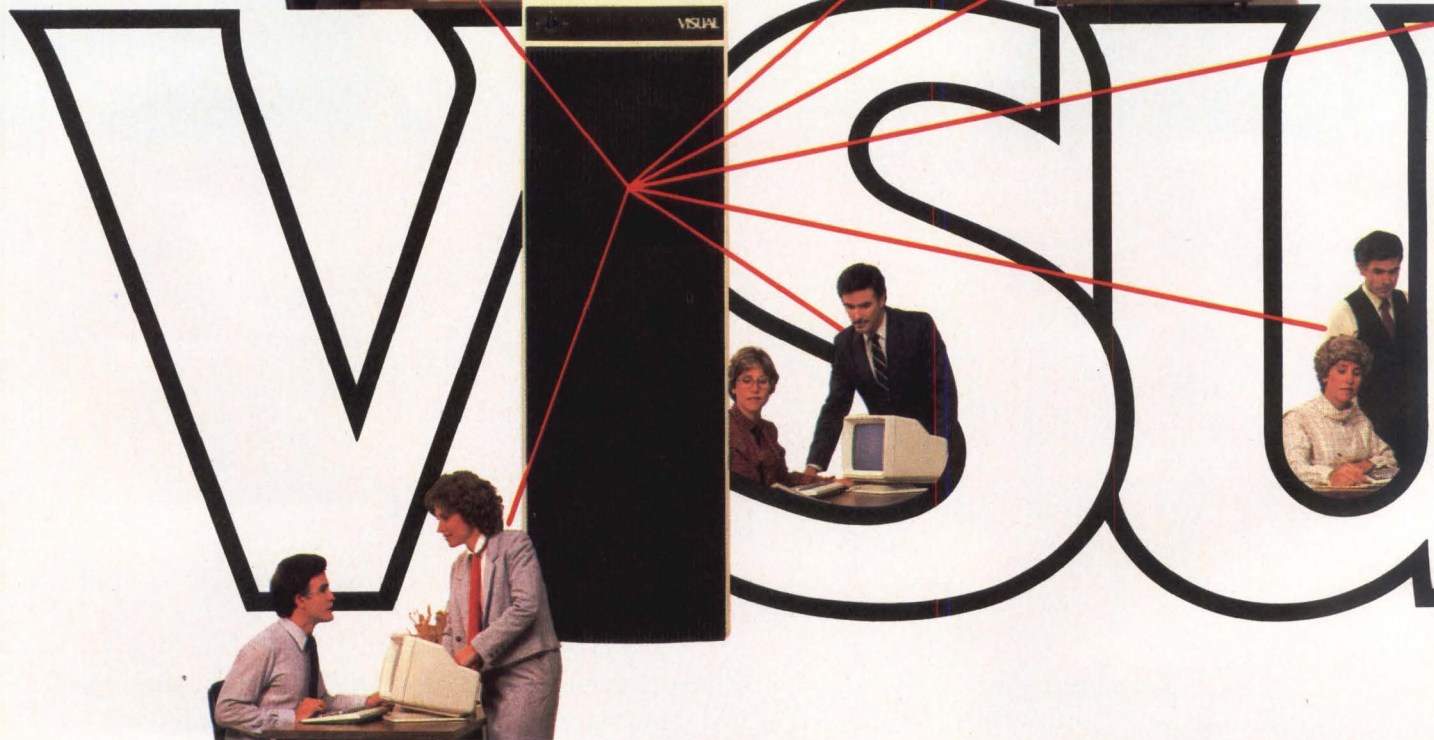

Introducing The Perfect System Builder

With the VISUAL 2000, we've designed the perfect tool for system builders and integrators. A multi-user computer system that supports more terminals, offers more expandability, and gives you more configuration flexibility than any other system in its price range. Truth is, it outperforms a lot of higher priced systems as well.

What that means for you is an important competitive edge in delivering integrated business solutions. An edge that comes not just from the VISUAL 2000's surprisingly low price. But from its higher technology. Technology that gives you . . .

Power to support more on-line users in demanding applications—up to 16 independent terminals or workstations.

Flexibility to accommodate a remarkable variety of application requirements, thanks to an open architecture, compatibility with mainstream industry standards, and a full spectrum of configuration options.

Expandability that can take you further than any other system in its class—an unrivaled upgrade path to protect your system investment.

Put the Full Power of Intel's 286 in Your Systems

The Intel 286 is today's chip of choice for UNIX-based systems. Only the 286 gives you: on-chip memory management; an instruction set optimized for multi-tasking; pipelined architecture; and an optional 287 numeric coprocessor which can speed up floating point by a factor of 10. What do these features mean to the end user? Faster response time, more users supported, and lower system cost.

A "Mainframe" on a Single Board

The VISUAL 2000's single-board base-level design is the key to higher performance, greater reliability and lower cost. A single high-density board includes the 286 CPU; 512KB-2MB of RAM; controllers

for Winchester, floppy and streaming tape; an intelligent communications processor; six RS-232 ports; and a parallel printer port. There's even a real-time clock with battery backup. A few short years ago a system with these features might have been called a mainframe.

From a Multi-User System to a Multi-System Network

With the VISUAL 2000 you never pay for more system than you need, and never have to settle for less. Up to 6 megabytes of RAM. 4 Winchester disk drives. Floppy. Streaming tape backup. And mainframe communications. All in a small stand-up enclosure which looks right at home next to a desk.

Use it as a central processor for inexpensive video terminals, or as a database manager for a cluster of intelligent workstations or personal computers, including VISUAL's own IBM®-compatible COMMUTER™.

And if a fully expanded VISUAL 2000

See us at Comdex, Booth #1836



VISUAL 2000

isn't enough, you can connect up to 254 systems in an ARCNET® local area network.

In all configurations, the VISUAL 2000 achieves an exceptional ratio of price/performance.

Software: A Complete System Builder's Tool Kit

Ultimately, the strength of a system is the strength of its software. And there too, the VISUAL 2000 really shines. Start with XENIX™, Microsoft's enhanced version of UNIX™, which gives you everything you expect from UNIX *plus* greater speed, reliability and ease of use in business applications. Then add all the tools you need to deliver end-user applications quickly and easily. Languages such as C, SMC BASIC, RM/COBOL™, TOM BASIC™, SOFTBOL™, and MicroFocus Level II COBOL™ to give you instant compatibility with hundreds of proven business applications. Plus sophisticated system foundations such as INFORMIX™ database

management and RealWorld™ modular accounting. And professional productivity software such as 20/20™ spreadsheet modelling and XED™ word processing.

The Bottom Line

High performance. Superior flexibility. Extensive software. And low cost... VISUAL 2000 systems start at under \$10,000, suggested list. No one gives you more in a UNIX-based multi-user system.

And when you consider that VISUAL has long been a leader in video terminals, and can supply a full range of compatible terminals and workstations, we think you'll agree that VISUAL is the system builder's system supplier.

The VISUAL 2000.

It began with a better design. And it's available *now* to help you build better systems. But don't take our word for it.

See for yourself. Call VISUAL today.

VISUAL

 See for yourself®

Visual Technology Incorporated
540 Main Street, Tewksbury, MA 01876
Telephone (617) 851-5000. Telex 951-539.

REGIONAL OFFICES:

Northwest:	(415) 490-1482
Southwest:	(213) 534-0200
North Central:	(513) 435-7044
South Central:	(214) 255-8535
Northeast:	(201) 528-8633
Southeast:	(301) 924-5330

ARCNET® trademark The Datapoint Corp./UNIX trademark AT&T Bell Labs/XENIX trademark Microsoft/IBM® trademark International Business Machines/COMMUTER trademark Visual Technology Incorporated/RM/COBOL trademark Ryan-MacFarland/TOM BASIC trademark The Office Manager/SOFTBOL trademark Omtool Corp./MicroFocus Level II COBOL trademark MicroFocus/INFORMIX trademark Relational Database Systems/RealWorld trademark RealWorld Corp./20/20 trademark Access Technology/XED trademark Computer Concepts Ltd.





Revolution.

Revelation.

It's a more enlightened approach that combines powerful storage with your compact processing needs.

The Micro VIP[®] (Virtual Information Processor) is a MICRO/PDP-11/23*, 11/73*, or MicroVAX* based system with a Q-bus* backplane—plus a whole lot more.

You get 120 megabytes of formatted hard disk storage with an easy-to-use 100 megabyte tape backup.

And best of all, the Micro VIP gives you the fastest mass storage system in the industry (effective access times under 10 ms. with 512K cache) inspired by U.S. Design's exclusive cache controller technology.

Now you don't have to build your own high performance DEC system. As a tower, or rack-mounted as a disk/tape subsystem the Micro VIP can do the job — at a price that's a revelation too.

So call us for fast access to all the details at 800-368-2811.

*Trademarks of Digital Equipment Corporation.

 **U.S. DESIGN**

5100 Philadelphia Way,
Lanham, Maryland 20706 (301) 577-2880
(800) 368-2811 • TWX 710-826-0417

See us at COMDEX Booth 520 and DEXPO Booth 2406.

CIRCLE NO. 61 ON INQUIRY CARD

The Interpreter

Superminicomputers climb to new levels of performance

DEC's anticipated high-end Venus will expand superminicomputer boundaries, forcing countermoves from competitors

Geoff Lewis, Contributing Correspondent

Since its introduction in 1977, Digital Equipment Corp.'s (DEC) VAX has dominated the superminicomputer market. With an installed base of more than 25,000 systems, VAX actually defines the market. Almost every competitor measures its products by the VAX yardstick, claiming similar performance at a lower price, or some other price/performance advantage.

Soon, however, DEC will provide a new yardstick with its long-anticipated and much-delayed high-end system—Venus. How Venus will alter those measurements and whether it will enable DEC to maintain market mastery are the essential questions for participants in the superminicomputer industry.

To some extent, both Data General Corp. (DG) and Prime Computer Inc. have recovered market share with high-end products that extend their capabilities beyond those of current VAXs. For companies such as Gould Inc.'s Computer Systems division and Perkin-Elmer Corp.'s (P-E) Data Systems group, which concentrate on niches within the superminicomputer market, Venus may represent a fresh threat. For the industry as a whole, bound to follow DEC wherever it leads, Venus represents an extension of boundaries more deeply into traditional mainframe-computer turf.

Venus symbolizes move toward mainframes

At this point, Venus' true identity remains shrouded in mystery. However, DEC president Kenneth Olsen has promised that Venus will be introduced by the year-end. Other DEC officials confirm that the system is being built around emitter-coupled-logic (ECL) circuitry, the difficulty of which reportedly has contributed to Venus' delays. DEC indicates that Venus will deliver performance in the 3- to 5-million instructions per second (MIPS) range. Most observers predict that the machine will sell for approximately \$100,000 per MIPS.

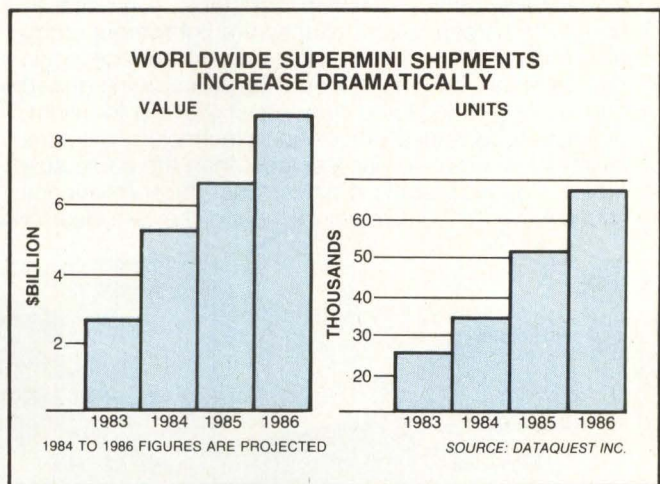

Analysts project the value of worldwide superminicomputer shipments to exceed \$8 billion by 1986.

None of these statistics are particularly threatening to DEC's traditional superminicomputer competitors, many of which already have delivered more powerful or price-competitive systems. Instead, Venus will be a symbol of the changing structure of the superminicomputer business.

The emergence of "this whole 3- to 5-MIPS class is a very important development," says Hambrecht & Quist securities analyst Marc Schulman. "It is going to change the product-line structure of these companies. Their current products have become more and more commodity-like as standard microprocessor designs move up in power. But at three to five MIPS, they will be out of the commodity range and will be able to charge higher prices and get better margins," he explains.

As superminicomputers escalate in processing power to the range of small mainframes, Schulman observes, "there is one humongous price umbrella under the IBM 3083 for them." The 3083, IBM Corp.'s entry-level mainframe, operates at about 4.4 MIPS and is priced at

SONIC DIGITIZING...

MORE VERSATILE EASIER TO USE LOWEST COST

Only sonic digitizers give you the freedom to digitize on virtually any surface—desktop, light table, even directly on a CRT screen. Because they are lightweight, compact and not restricted to a specific work surface, sonic digitizers can be placed where you want or integrated into a workstation, and they never leave a footprint. Science Accessories' unique sonic technology provides large active areas for far less cost than the same size tablet. Because sonic digitizers use high frequency sound waves to locate a point in space, they are ideal for

3-D applications including robotics and motion studies.

Every sonic digitizer comes complete with stylus or cursor, power supply and resolution of .005. All feature RS-232 as standard output (parallel and 2-way communications for enhanced user-friendliness optional). All SAC sonic digitizers are compatible with any CPU using RS-232-C or parallel. "Easy Digit" start-up software is available.

To learn more about the unique advantages of sonic digitizers, call Skip Cleveland (203) 255-1526.



GP-7 Grafbar

- \$950—(18" x 24")
- 3 times more active area than "the pads"
- 5 function menu standard
- Compact assembly incorporates 2 point microphone sensors
- OEM versions available

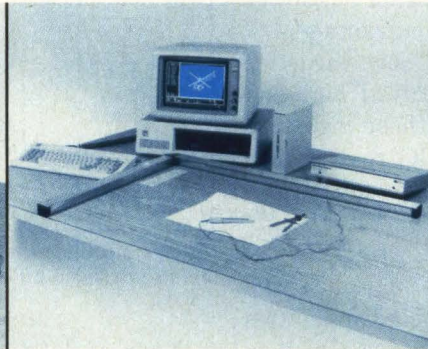

GP-8

- \$2590—(60" x 72")
- Large active areas for one-third the cost of tablets
- 2 linear microphone sensors in lightweight L-frame assembly
- 5 function menu standard
- Optional 59 character ASCII menu

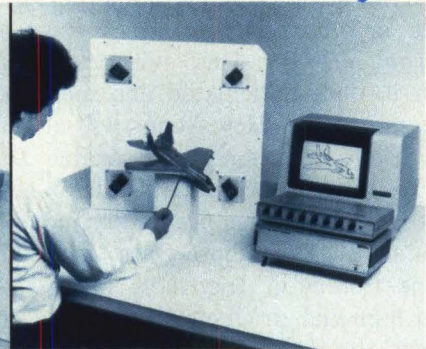

GP-8-3D-P

- \$7500—(9' x 9' x 9')
- Active volumes user adjustable
- "Free" stylus—no linkages, arms or other restrictive devices
- Digitize any material, including ferrous substances
- Use up to 16 locators sequentially (with optional multiplexor) for robotics, motion studies, etc.
- Consult with factory about offset digitizing

SAC® SCIENCE ACCESSORIES CORPORATION

970 King's Highway West, Southport, CT 06490
(203) 255-1526 Telex 964300

The Interpreter

approximately \$275,000 per MIPS, compared to as little as \$60,000 per MIPS for superminicomputers. IBM's own superminicomputers, the 4300 series, are priced as low as \$150,000 per MIPS, but market observers do not expect IBM to carry that pricing into a Venus-class product in the near future for fear that such a move would shift sales from high-profit mainframes to lower-margin 4300s. James Renalds of the San Jose, Calif., research firm Dataquest Inc. expects the average price of a superminicomputer to decline from \$180,000 in 1983 to \$120,000 in 1986.

Jack Hart, an IBM analyst with International Data Corp. (IDC), says that there is already some overlap between IBM's 2.7-MIPS 4381 and its 3083 in some applications. But he adds that IBM has kept most mainframe customers tied to its more profitable 308X family by not providing a clear upgrade path from the 4300s.

IBM may refrain from using muscle

"So in a sense," Schulman continues, "high-end superminis play into a part of the market where it is not necessarily in IBM's interest to compete." David Chanoux, VAX group product manager, agrees. "IBM has certain revenue and product-cycle expectations. It has a business in that space [where superminis run into IBM mainframes], so even though we expect IBM to drop prices, it may not be too aggressive in order to protect that business," he says.

George Weiss of Quantum Science Corp., New York City, predicts that Venus and other high-end superminicomputers will capture a sizable share of the late-1980s mainframe market as large-scale system applications change. Almost 85 percent of mainframe applications still are commercially oriented and use batch-processing methods. Weiss predicts, however, that by 1989, the figure will drop to 65 percent and that most commercial mainframes for batch-processing applications will be upgrades for the current installed base. The remaining 35 percent will be scientific applications and interactive processes such as computer-aided design, manufacturing and engineering (CAD/CAM/CAE), expert systems and other artificial intelligence applications, he says.

"Supermini suppliers really will be selling mainframes, but doing the highly interactive transaction-processing functions that IBM mainframe operating systems aren't suited to," Weiss adds. IDC's Hart, however, cautions that before that happens, there will emerge a new generation of IBM systems in the 4- to 8-MIPS range that match or improve on current prices for the company's 4300 systems.

At The Gartner Group research outfit in Greenwich,

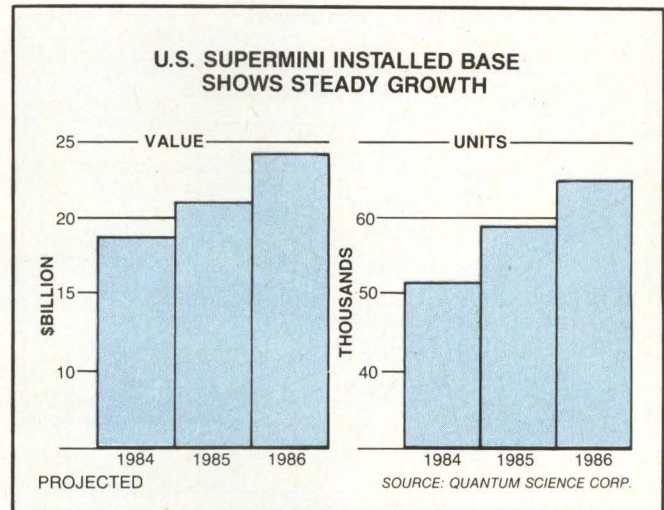

The U.S. superminicomputer installed base is expected to exceed 60,000 units by 1986, representing a value of almost \$25 billion.

Conn., analyst William Rosser adds, "In the past, as the lines between hardware categories blurred, there was still specialization by applications; but now functions overlap, too." Functional overlap leads to increased demand for networking capabilities and for software that allows data interchange among different-sized hardware performing similar tasks. "The resource requirements for these integrated systems puts the emphasis on the larger players," Rosser points out.

In the meantime, VAX group product manager David Chanoux says DEC is concentrating much of its competitive energies on IBM, which is becoming a more frequent rival. "With the 4361 and 4381 [introduced in late 1983], we see IBM calling on more and more of our accounts and pitching our kinds of applications. If we are going to respond to any competitor, we'll respond to IBM. From where I sit, IBM is the main competition by virtue of its size, its assets and its general business smartness," Chanoux says. He adds, "Of course, I don't want to turn my back on my neighbors at Data General and Prime, but IBM is my main concern."

Within its own base, Chanoux says, DEC is satisfying some demand for higher processing capabilities with its recently introduced 11/785 machine and the VAXcluster, a high-speed networking system that ties VAXs together. The latter solution alleviates system-access problems caused by connecting large numbers of terminals, but it does not increase computing power, he notes.

Data General prices MIPS aggressively

Schulman estimates that DG, DEC's long-time mini-computer-market rival from Westboro, Mass., has used increased CPU power to broaden its 32-bit supermini-

The Interpreter

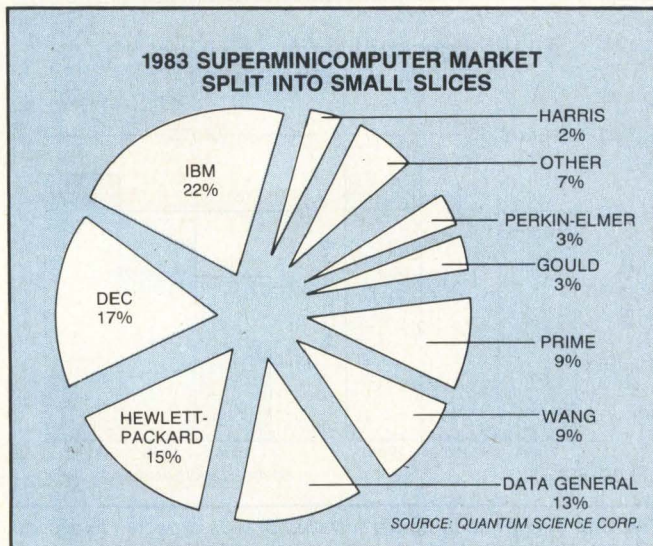

IBM Corp., Digital Equipment Corp. and Hewlett-Packard Co. captured more than 50 percent of the superminicomputer market in 1983.

computer business by 80 percent, for the fiscal year ended in September. Much of that gain—which helped the company expand revenue to a record \$745 million in the first three quarters of this year—came from sales of the high-end MV10000, a 2½-MIPS machine priced aggressively at \$70,000 per MIPS.

Donald McDougall, vice president and general manager of DG's Technical Products division, says that the addition of a high-end product that performs well above DEC's current VAX maximum of 1.7 MIPS has helped DG increase its presence in the *Fortune* 500 large-account business. "On the technical side, you need the CPU power to run computer-intensive [application] packages such as solids modeling. On the commercial side, we can fulfill the demand to add more and more users. On both sides, we can handle larger databases, an increasingly important requirement," he says.

McDougall says that the prospect of a 3- or 4-MIPS Venus does not threaten his company. "I don't think a 3½ MIPS or even a little faster Venus should panic us," he says. "When we came out with the MV8000 [DG's first 32-bit superminicomputer], we were three years late. With the MV10000 we were ahead. Now with Venus, we'll get back to the historical leap-frog we've played with DEC in product introductions."

However, McDougall is not convinced that DEC can retain its "stranglehold" on the superminicomputer market with Venus. "If it is readily accepted and is a real 'hummer' in the market, then DEC will maintain its position. If not, that image will be shattered. The concept of a DEC-defined market has not been shattered yet, but it has been cracked," he maintains.

Jan-Pieter Scheerder, DG's Technical Product division marketing director, points out that the move into mainframe-size applications is putting additional demands on superminicomputer makers. "The effect is to put a lot of pressure on system-software capabilities. It is not enough just to pump out high-end hardware. Gross profits may be higher on such systems, but the price of software support, customer support and a lengthy sales cycle are higher too," he points out.

In nearby Natick, Mass., Prime is using its longer experience selling into a traditionally mainframe market to propel sales of its new high-end products. Like DG, Prime expanded its superminicomputer line in 1983, adding the ECL-based 9950 at 2½ MIPS. Product marketing manager Steven Haley says that the company has retained its 22 percent share of the superminicomputer market and points out that Prime has competed with IBM for a long time.

"Our original mission was to bring the [Honeywell Inc.] Multics mainframe operating system into the minicomputer market. I think we know how to compete in the mainframe market already," he asserts. As to Venus itself, he says, "at 3 to 5 MIPS and \$100,000 per MIPS, we'll be competitive."

Haley also hints broadly that the 9950 may not be the top of Prime's line for long. "The next increment will be at least 4 MIPS. Possibly, we can deliver our high end prior to DEC's delivery schedule—if DEC is planning to ship in the spring, as we expect." For now, Prime is filling in below the 9950 with the 1.7-MIPS 9750, which replaces the earlier 750/850 series and the 9650, a system optimized for COBOL applications.

For the first six months of 1984, Prime has recorded sales of \$307 million, a 27 percent gain over last year's figures. At the same time, it improved net earnings by 35 percent, thanks to the more profitable 9950.

Beyond the 9950 and any Venus-class addition, Prime is looking toward an accelerated performance battle in the late 1980s. Recently, a Prime official declared that any superminicomputer competitor that does not have plans for an 8-MIPS machine by 1988 is not "with it."

But IDC's Hart points out that such a route could raise problems for manufacturers. "There seems to be a practical limitation for air-cooled uniprocessor architectures [of] around 8 MIPS, and I don't know if minicomputer manufacturers are ready to take on water cooling," he explains. DEC's Chanoux says, "As a marketer, I'd love to have an 8-MIPS machine to sell, but you do need water cooling—even with the technology we expect from Trilogy." In the near term, he says, DEC will be able to address many anticipated large-system needs by including the Venus in VAXclusters.

PRESENTING THE NEWEST MEMBER OF THE TOWER FAMILY.

From the nit-picking reliability fanatics at NCR.

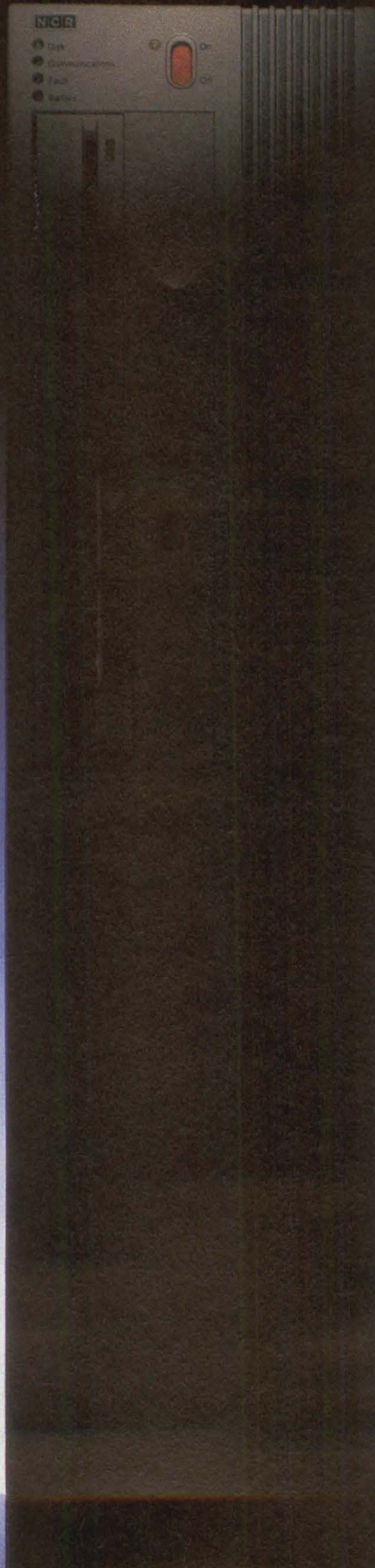

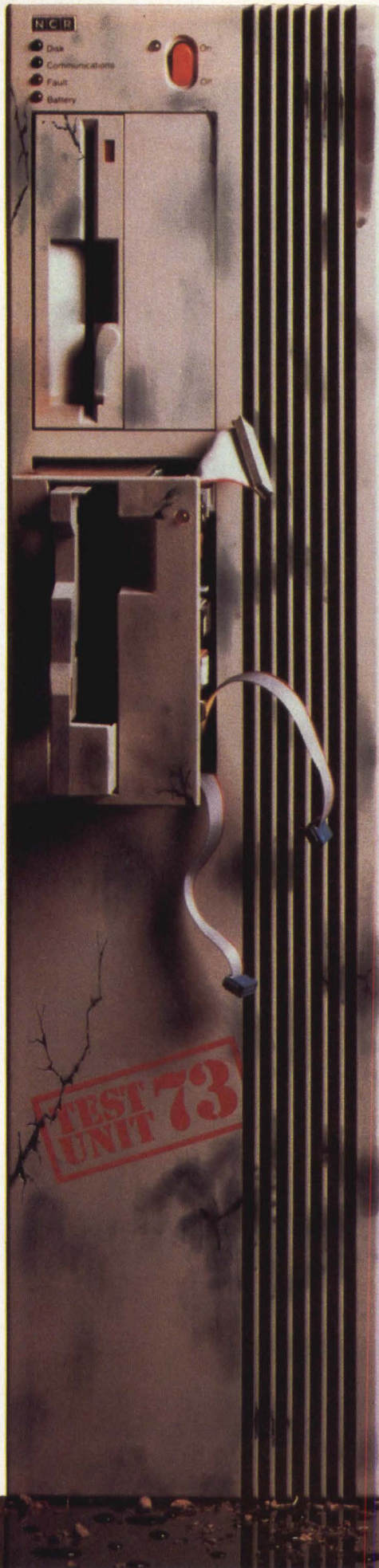

INTRODUCING TOWER XP. NOW THAT WE'RE THROUGH WITH IT, YOU CAN HAVE IT.

Reliability has been the hallmark of NCR products for over 100 years. But what began as a virtue has, quite frankly, become somewhat of an obsession.

Pick. Pick. Pick.

Before our reliability engineers allow our new Tower systems out the door, they do a little testing.

A little testing.

They burn in 100% of memories, processors and complex VLSI assemblies upon arrival. They burn in the assembled boards. Then, they give the finished unit an extensive burn-in over a wide range of temperatures.

They test the unit against NCR's rigid standards for electromagnetic interference (EMI), radio frequency interference (RFI) and electrostatic discharge (ESD).

And when they're finished performing more QA than any other manufacturer would dream of (an average of over 200 hours per unit), they start

testing features that other manufacturers *only* dream of:

Consistent error-logging.

Extensive in-service and remote diagnostics.

Automatic Power Failure Recovery.

A UNIX™ operating system that virtually never PANICs.

And more.

Tower XP gives your customers the power of a 68010-enhanced CPU, up to 260MB of mass storage, 45MB of 1/4" cartridge tape built into the CPU cabinet, industry-standard interfaces and a UNIX of truly commercial reliability.

Tower XP. Now that we're through with it, your customers will never have to settle for anything less.

**TOWER XP.
BUILT FOR SYSTEMS BUILDERS
BY NIT-PICKING FANATICS.**

NCR

OEM Systems Division

NCR Corporation, U.S. Data Processing Group, OEM Systems Division, CSP-1, Dayton, Ohio 45479. Nationwide (800) CALL-NCR. In Ohio (513) 445-2190. In Canada (800) 268-3966.

UNIX is a registered trademark of AT&T.

CIRCLE NO. 63 ON INQUIRY CARD

ColorTrend™

New from Intecolor

DEC* Compatible

ANSI X3.64 gives you DEC compatibility plus color and graphics.

A Colorful Background

Eight colors and graphics get the message across faster than ever before.

English spoken here

The set-up menu is written in a language you understand—English.

Automatic Color

Add color without modifying monochrome software. Now BLINK can be RED instead of annoying.

The Big Picture

An 80 x 24 high resolution screen that's 14" big. It's easy to read so productivity's increased.

Side by Side

A windowed display lets you view your 132 column reports.



A Custom Fit

Designed according to European standards, there's a low-profile keyboard and one-touch tilt display.

Keys to success

As many as two dozen keys programmable for up to 72 functions make short work of long commands.

\$1295

Small Wonder

The switch to color never looked so good.

Intecolor, the innovator in color terminals, introduces ColorTrend. It's the color terminal with all the features you need and all the comfort you've been waiting for.

Designed according to European ergonomic standards, ColorTrend is easy on the operator—any operator. One touch adjusts the angle of the display. Another puts the keyboard at just the right height. You can even put the keyboard in your lap, if that's more comfortable.

Everything from its small footprint to its legible 14" color display makes the ColorTrend easy to work with. And more work gets done thanks to ColorTrend's color display. Color and graphics relate more information faster. With ColorTrend's

Automatic Color feature, your existing software is automatically upgraded to color. A simple set-up menu choice turns a BLINK, UNDERLINE, BOLD, or REVERSE display code to any color you want.

Intecolor Quality.

Intecolor has been building color graphics terminals for the demanding industrial control market since 1973. ColorTrend has over 10 years of Intecolor knowhow, dependability and performance behind it.



Check the size, features and price. You won't find a color terminal that's got more going for it than ColorTrend. For the name of the distributor or representative nearest you, call our toll-free number: 1-800-241-7595 today.

Intecolor®
AN INTELLIGENT SYSTEMS COMPANY

225 Technology Park/Atlanta, • Norcross, Georgia 30092
404/449-5961 • TWX 810-766-1581

*DEC is a registered trademark of Digital Equipment Corporation.

The Interpreter

Unlike DG and Prime, which apparently are waiting for Venus before making any moves beyond 2½ MIPS, both Wang Laboratories Inc., Lowell, Mass., and Harris Corp.'s Computer Systems division of Ft. Lauderdale, Fla., have gone ahead with Venus-class products. The latter is best known as a supplier of products built around an unusual 48-bit architecture and oriented toward the market niche for real-time processing. However, according to product marketing director Rick Maule, the division has diversified into more general-purpose engineering applications including CAD and CAE, from which it derives half its annual revenues. Part of that move has been with the year-old H1000, a 5-MIPS system that starts at a very competitive \$250,000.

Maule says that Harris originally planned to introduce the ECL-based H1000 to coincide with DEC's Venus announcement. "We were going to announce in a comparable time frame and try to piggyback the publicity surrounding Venus," Maule recalls. However, in mid-1983 it became apparent that DEC would postpone introducing Venus for a year to reorient the product. "I believe DEC had a 3-MIPS machine in the works last year, having backed off from an original target of 4 to 5 MIPS. But the company realized that 3 MIPS would be too little too late, so they re-specified the design to 4 to 5 MIPS," Maule theorizes. In the meantime, Harris needed a product to counter new Gould models in the real-time processing market and brought out the H1000 last October.

The H1000, Maule says, is helping Harris' program to expand into more general-purpose systems. The company is selling H1000s against VAXs in general engineering, CAD and software-development applications. Harris sells another product, the 1-MIPS H60, as an alternative to the similarly powered VAX 11/780 in departmental applications—but at \$60,000 with peripherals. In the near future, Harris will be competing in yet another DEC market with machines running the UNIX operating system, sources close to the division predict.

Wang has announced a high-end VS300 system rated at 3.3 MIPS, with a price starting around \$170,000. Wang introduced the system last April, but will not ship units until spring. Company officials say that such an early introduction was necessary because of the system's magnitude. Some observers argue that Wang was anxious to assure major-account customers that it will deliver a high-end superminicomputer comparable to Venus and to the Data General MV10000. The MV10000, with DG's CEO software, has already made inroads into Wang's office-automation turf. By announcing a high-end minicomputer, Wang also quiets critics

that portray the company exclusively as an office-automation vendor.

But dangling new products in front of customers' eyes may also work to the advantage of Wang's competitors. Gartner's Rosser points out that DEC might have a better crack at the office-automation market with the introduction of Venus because its added power can more efficiently handle the performance-draining overhead built into DEC's ALL-in-1 office-automation system.

"One of the biggest impacts of Venus," DG's McDougall says, "is that it moves everybody up to the 2½- to 5-MIPS range. That takes away the reason people had to go with smaller players such as Gould and P-E because the majors can provide more languages, software packages and support."

But P-E and Gould have not been sitting still in their high-end niches. Both—along with Harris—traditionally have served the scientific and technical markets, which require intensive number-crunching capabilities for applications such as flight simulation and seismic research. In the past year, both P-E and Gould have made a pronounced effort to broaden their bases—specifically by embracing the UNIX operating system.

For the industry as a whole, bound to follow DEC wherever it leads, Venus represents an extension of boundaries more deeply into traditional mainframe-computer turf.

P-E, Gould meet demand for standards

James K. Sims, vice president and general manager of P-E's Data Systems group, predicts that this year the company will ship 2,000 systems, representing a substantial increase over 1983's 1,200 units. Sims contends this will give P-E the third-largest installed base in the market, behind only DEC and Prime. However, 1984 shipments include a 0.75-MIPS supermicrocomputer based on Motorola Inc.'s MC68000 microprocessor that sells for \$24,000, he notes.

"I have never considered DEC a competitor," Sims says. "With Venus, DEC will top out at 3 to 5 MIPS. Our supermini line goes from 3 MIPS to 21 MIPS. We compete with Gould, but [now that they have extended their product lines], I begin to worry about DEC and Data General," he adds.

Sims points out that, as Interdata (prior to its acquisition by P-E), the Data Systems group pioneered the 32-bit minicomputer market. "We have repositioned this company twice before, in the early 1970s with the

**TO DISCOVER
THE BEST OEM
PROGRAM IN PRINTERS,
FIRST
TRAVEL TO JAPAN...**



ON US.

Our program begins with the JDL-750, first in a new line of OA printers.

A high resolution serial impact dot matrix printer delivering letter quality and color graphics.

But the product is only half the story. Behind it are two companies with a comprehensive program that makes good sense for the OEM. The JDL-750 is manufactured by Japan Digital Laboratory, an acknowledged leader in OA technology since 1968. From design inception to our consistent manufacturing quality, we deliver value and reliability—on time. Japan Digital Laboratory backs up its commitment to the OEM with unqualified financial strength and a corporate tradition of customer support and service that directly involves 60% of the company's employees.

JDL, Inc. carries on the OEM commitment in the U.S.A. By providing local custom engineering, from proprietary interface and software, to your own logo and colors, we help you develop your OA workstation printer quickly and efficiently. Concurrent testing in the U.S.A. means that our procedures reflect your standards for quality in environmental and life testing, beta tests and agency approvals. And,

we carry on the corporate dedication to service and support in a way that assures you both satisfaction—and profit.

Skeptical? We don't blame you. That's why we want OEM's who meet our qualifications to join us in Japan, free. If you evaluate the JDL-750 and the resources behind it, we know we're going to be your new printer vendor.

So call us or use the coupon below. Then, start packing.



JDL
INCORPORATED

2801 Townsgate Rd. Suite 104
Westlake Village, CA 91361

(818) 889-1540 FAX (805) 495-3374

© 1984

MINI-MICRO SYSTEMS/November 1984

I'm an OEM looking for a better printer supplier. Tell me how I can qualify for your trip to Japan.

NAME _____

TITLE _____

COMPANY NAME _____

ADDRESS _____

CITY _____ STATE _____ ZIP _____

PHONE (_____) _____

MM 1184

CIRCLE NO. 65 ON INQUIRY CARD

129

The Interpreter

32-bit system and in the early 1980s by embracing standards," Sims says. P-E's strategy is almost antithetical to that of DEC or DG, which rely more and more on end-user sales of office-automation and engineering systems.

"End-user sales may be a good strategy for them, but we don't want to compete with our customers. Instead, we see a huge demand for 32-bit systems in systems houses that want standard operating systems and communications," Sims explains. He adds that the group intentionally has raised its reseller channel by 10 percentage points to account for 65 percent of current volume.

'We see a huge demand for 32-bit systems in systems houses that want standard operating systems and communications.'

Another company meeting the demand for standards is Gould, which uses the UNIX operating system for its new product line built around Gould superminicomputers and Convergent Technologies workstations and supermicrocomputers. Jerry Rodts, a former Prime and IBM marketing executive who was recently named Gould's vice president of sales and marketing, says, "Where I anticipate the impact of Venus is in the business we just are entering with the UNIX systems. In our real-time market Venus won't have any effect." In the UNIX market, Gould recently topped off its line with a virtual-memory version of its ECL-based 3297, giving it a UNIX family that extends all the way from an Intel Corp. 80186-based workstation to a 10-MIPS superminicomputer.

"DEC has a very loyal customer base, but we have cracked some accounts," Rodts says. "There is heavy demand for more performance, and DEC customers literally are running out of space using multiple VAX [clusters]."

Rodts says that demand for UNIX-based systems may increase sales in that segment by as much as 60 percent annually. He predicts that within three years, UNIX-based systems could account for half of the division's volume—even as the real-time portion continues to grow by as much as 20 percent annually. "I think we are a jump ahead with UNIX, and I see it as something that won't go away. Now everybody is committing to it," he says.

Indeed, even DEC itself is supporting a native-mode version of UNIX. Until recently, DEC supported only its VMS operating system, even though VAXs make up

the largest installed base of minicomputers running UNIX. However, Chanoux points out, UNIX may be somewhat irrelevant to the emerging high-end market. "At the low end, we see Ultrix 32 [DEC's superminicomputer UNIX package] shipping on as many as 20 percent of our systems. But on the high end, I don't think it will go out on more than 5 percent," he says.

Enter AT&T

AT&T, DEC's latest challenger in the superminicomputer market, naturally sees things differently. Thomas Arnold, AT&T Technologies Inc.'s computer systems marketing manager, argues that the compelling economics of transportable software—programs able to run unaltered on different computers—will make UNIX popular on machines of all sizes. "The question is no longer how fast a computer is. We view as much more important the question of how much it will cost to maintain software. You always can change the computer to fit your needs," he argues. "UNIX becomes the great leveler of the industry, putting all the difference on the computer itself, because the operating systems will be the same," he explains.

AT&T's initial hardware includes three superminicomputer-class products in the 3B20 series, machines that deliver power as high as 1.7 MIPS. However, Arnold says, use of intelligent input/output processors helps speed throughput to even higher performance levels. As for AT&T's plans for competing in the high-end-superminicomputer market, Arnold says only that the company is exploring several methods. These include advanced bipolar technology (such as ECL chips, which are used in limited numbers on the 3B20s), high-performance 32-bit microprocessors and distributed systems such as DEC's VAXclusters. He declines to say which path is most likely for AT&T.

"Our principle strategy is built around UNIX. It has been visible in the engineering community for a long time, and now we are seeing commercial resellers turning to it," Arnold says. Speaking of the eventual competition with mainframes, he adds, "In the applications-software area, there are an incredible amount [of packages] in the mainframe environment that are not available on minis and superminicomputers. But they are beginning to show up—especially under UNIX, and smaller, cost-conscious customers are beginning to buy these packages." □

Geoff Lewis is a senior editor for *Electronic Business*, in which this article originally appeared.

Interest Quotient (Circle One)
High 861 Medium 862 Low 863



A DEFENSE THAT HANGS TOUGH
PLAY AFTER PLAY AFTER PLAY.

THAT'S WHAT KEEPS ALL THE POINTS
ON YOUR SIDE.

All about defense. And winning. Designing information systems to compete for different business needs is a lot like putting together a winning sports team.

Each component has to offer you the maximum number of offensive and defensive advantages to assure success. Take computer printers.

The key advantage for the defense is reliability. Will the printers that have all the offensive capability going for them be able to hang tough inside your system?

How Okidata stacks up for you. Defensively, Okidata keeps piling up

the points on your side of the board. Their tank tough bodies can take the most punishing hits.

Their MTBF stats score up to 4,000 hours. Their printheads always go the distance, up to 200,000,000 characters. Their MTTR's are down to an impressive 15 minutes. There are no duty cycle limitations.

And their warranty claim rate record book says 99 1/2 out of every 100 Okidata printers are always in the game for you.

We'll help you win. In OEM system building, just like in Super Bowls, reliability is the name of the game.

If you're putting together a components team where defense counts, call us at 1-800-OKIDATA (609-235-2600 in NJ). Or write OKIDATA, Mt. Laurel, NJ 08054. We'd be more than happy to suit up for you. And help you win.

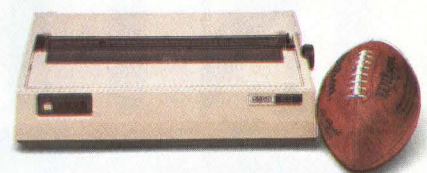

OKIDATA
an OKI AMERICA company

INTERFACE... FOR THOSE WHO SELL EQUIPMENT THAT MANAGES AND MOVES INFORMATION

*If you sell products for
data communications,
information systems integration
or communications,
INTERFACE '85 is the place to exhibit.
Here are 3 good reasons:*

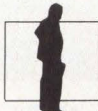

***The quality
of the attendee.***

High level decision-makers from Fortune 1000 companies, utilities, railroads, financial institutions, government, military, and other large multi-location users attend this premier show. These are the people who influence or control the purchase of the kind of equipment you make. Their presence at INTERFACE tells you they represent real business potential.



***INTERFACE
is cost-effective.***

Last year's attendance exceeded 12,000 and we're anticipating 15,000 in 1985. You'll meet real decision-makers — no tire kickers — because the people you meet at INTERFACE have the authority to specify and buy. You save time and expense by meeting with them at INTERFACE.



***The prestigious
INTERFACE conference.***

The INTERFACE Conference helps prepare attendees to discuss their problems with you on the exhibit floor. Conference sessions are conducted by some of the industry's leading experts who address the latest issues and technological advancements that face the information/office systems integration/communications professional.

INTERFACE® '85

Thirteenth Annual Conference & Exposition □ March 4-7, 1985, Atlanta, GA □ Co-sponsored by **BusinessWeek** and **Data Communications**

***To reserve exhibit space or for more information, call (617) 449-6600
or write INTERFACE '85, 300 First Avenue, Needham, MA 02194.***



Presented by **THE INTERFACE GROUP, Inc.**, world's leading producer of computer conferences and expositions including INTERFACE, FEDERAL DP EXPO & CONFERENCE, COMDEX/Winter, COMDEX/Spring, COMDEX/Fall, COMDEX/Europe, COMDEX in JAPAN, The Nationwide COMPUTER SHOWCASE EXPOs and THE BYTE COMPUTER SHOWS.

NOW
THE ONLY
DIAL ERROR
YOU CAN MAKE
IS TO STAY AT
1200 BPS.

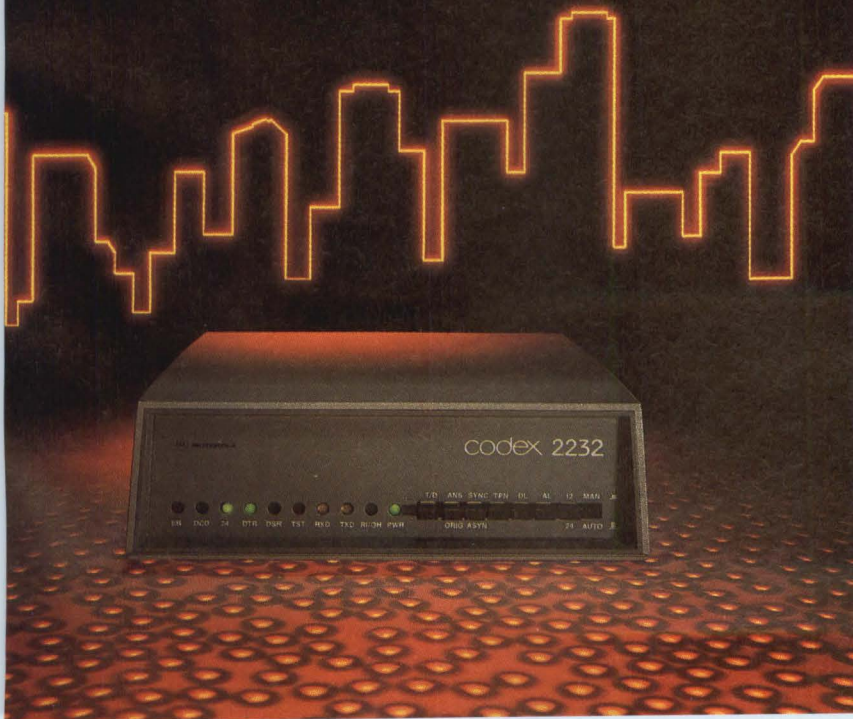

Announcing Codex's 2230 Series dial modems.

Now you can get 2400 bps productivity with the reliability you expect at 1200 bps.

Codex's 2230 Series full duplex modems accomplish this through the industry's only proven, second generation design. A design that combines powerful automatic and fixed equalization, delivering leased-line performance over any dial network.

The 2230 Series lets you operate at both 2400 bps and 1200 bps, allowing for faster screen fills and file transfers, reducing computer port needs, and drastically reducing line charges.

There's even a model with programmable auto call. So you can send data unattended at night when rates go down.

Each 2230 Series model is fully Bell 212 compatible. Each accommodates all communications protocols and meets the CCITT international 2400 bps dial standard. You can integrate Codex 2230's into your network gradually or all at once, without putting your system in turmoil.

Then, there's Codex's worldwide service and support organization, ready to answer any question or solve any problem.

Plus very attractive options to buy or lease.

To get the complete story on Codex's advanced 2230 Series dial modems, dial **1-800-821-7700**, ext. 881. Or write: Codex Corporation, Dept. 707-81, 20 Cabot Boulevard, Mansfield, MA 02048.

codex

 **MOTOROLA INC.**
Information Systems Group

MOTOROLA

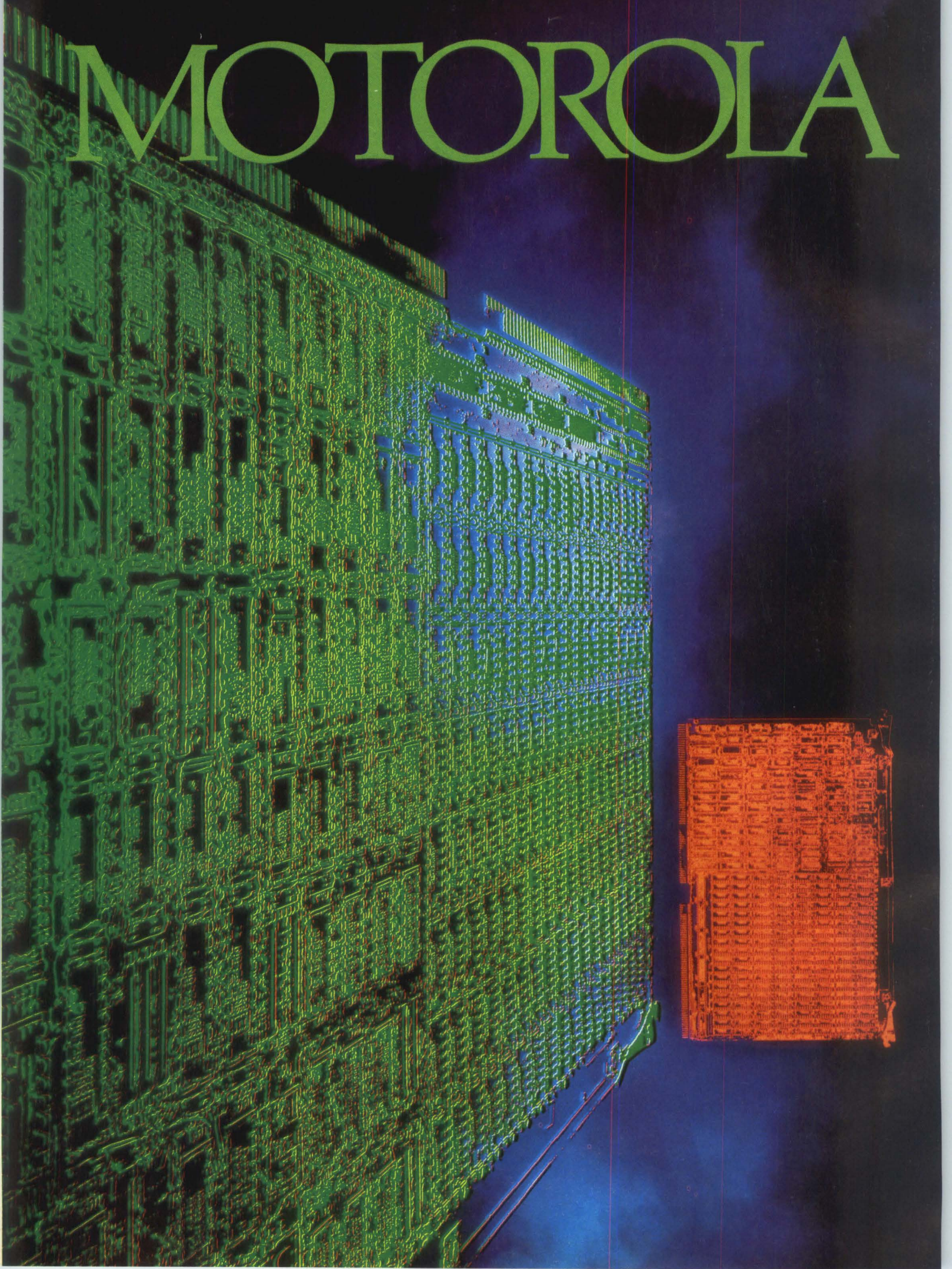

Challenge the mainframes.

VERSAmodule™ now run the MC68020, true 32-bit performance standard.

VERSAmodule microcomputer boards have already proven themselves in performance-demanding communication, industrial, laboratory and imaging applications. You knew these boards were powerful workhorses before, but hold on to your bootstraps, because Motorola's VERSAmodule line now ripples with even higher performance using the MC68020.

The VM04
VERSAmodule

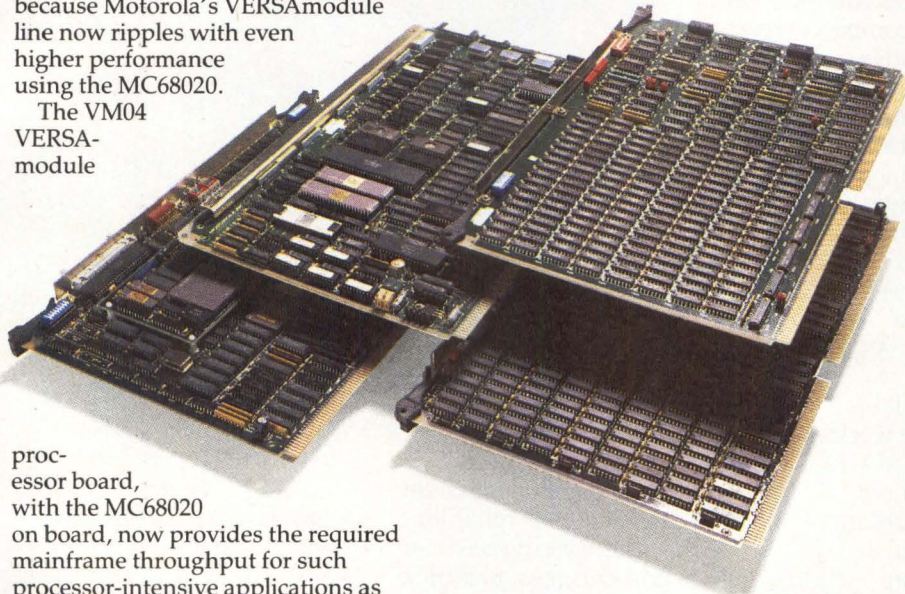

processor board, with the MC68020 on board, now provides the required mainframe throughput for such processor-intensive applications as bit-mapped graphics manipulators, scientific data acquisition systems and artificial intelligence machines. Applications that, before this, required mainframe machines.

Gaining speed, adding power, lowering overhead.

The new VERSAmodule VM04 processor board can access more than 4 billion bytes of data and manipulate or process 32 individual pieces of information every 180 billionths of a second (180 nanoseconds). Measured in millions of instructions per second (MIPS), the VM04 operates at a sustained rate of 2 to 3 MIPS, with burst rates exceeding eight MIPS, challenging the speed of some mainframe computers.

16K bytes of instruction/data cache on-board help reduce off-board memory accesses to ensure top performance. When off-board access is needed, the VM04 calls on the interface capabilities of Motorola's MC68020-specific RAMbus™ to eliminate most arbitration overhead and speed memory transfers.

The VM04 monoboard is the first MC68020 processor board to offer paged memory management hardware, plus an interface to support

the soon available MC68881 floating point math co-processor.

These new modules add to a broad offering of board-level products including processor, memory, controller and communication modules with complete evaluation and development systems.

the VM22 disk controller supports four SMD drives and four SA 400/800 floppy disk drives. Data transfer speeds up to 3 Mbytes/sec are maintained by the direct memory access feature of the disk controller.

A choice of real-time and whose-time-has-come operating systems.

The VERSAmodule Family is supported by both of Motorola's M68000 operating systems: the VERSAdos™ operating system for real-time applications, and the SYSTEM V/68™ operating system where a UNIX™ operating system environment is desired.

Full operating system support, including VERSAdos real-time device drivers, is available today for MC68000- and MC68010-based VERSAmodule monoboard. Porting is under way to assure their early availability on the VM04 monoboard.

Continued Motorola support.

Add to all this Motorola's expertise, proven products, training and service support and you can understand why VERSAmodule continue to be your best high-performance choice for board-level applications.

For more detailed information on VERSAmodule system components, mail in the coupon or call your local Motorola semiconductor sales office, authorized systems distributor or systems representative.

We're
on your
design-in
team.

Broad VERSAmodule line.

Two new high density memory boards have been added to the line to complement the MC68020-based monoboard.

The VM12 includes 1 or 4 Mbytes of RAM and supports the full 32-bit address width of the M68000 Family.

The VM13 dynamic RAM module provides 1 or 4 Mbytes of random access memory dual ported to both RAMbus™ and VERSAbus™.

A perfect system mate for the VM04 32-bit monoboard, the VM13 has error detection and diagnostic capability.

For system applications requiring high-capacity rotating mass storage,



MOTOROLA

VERSAmodule, VERSAbus, VERSAdos, SYSTEM V/68 and RAMbus are trademarks of Motorola Inc. UNIX is a trademark of AT&T Bell Laboratories.

To: Motorola Semiconductor Products, Inc., P.O. Box 20912, Phoenix, AZ 85036
Please send me more information on the VERSAmodule system.

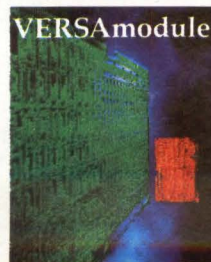

Name		
Title		
Company		
Address		
City	State	Zip
Call Me ()		

206MMS110084

More and more. For less and less.

Hewlett-Packard introduces the HP 2392A.

When you get this new HP display terminal, suddenly you'll be running applications

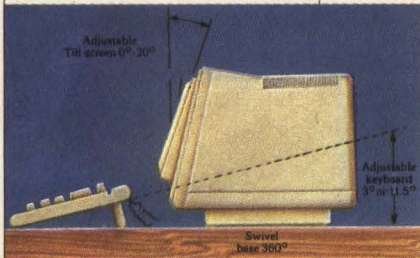

with less effort. In less space. For less money. And with more confidence, having HP's reliability and quality to count on.

Less effort.

The first thing that will impress you is how easily everything fits into place. Integral tilt and swivel make screen and keyboard adjustments easier. Power and brightness controls are right up front, at your fingertips.

Working becomes more pleasant, thanks to the non-glare, high-resolution screen and well defined, smooth scrolling characters. Up to four pages can be stored in display memory, with up to four more pages available as an option.

And all that happens on a 12-inch display that only takes up about one square foot of your desk.

More helpful.

With eight non-volatile, programmable function keys, it will take you less time to enter complex or repetitive commands. A handy terminal status line tells you what mode you're working in. And

17 national language keyboards are available to make work easier for everybody, just about everywhere.

You get more speed, too. You'll communicate

with your computer at up to 19,200 bps in block, line or character mode. So your information will get around in less time. It's also easy for you to get hard copy, since our terminal has an optional printer port you can install yourself.

If you're an ANSI user, you've also got more going for you. The HP 2392A has ANSI capabilities making it an ideal terminal for your DEC system.

More reliable.

HP engineered the HP 2392A using state-of-the-art VLSI



technology to minimize component count and increase reliability.

But, if you do need support services, just pick up the phone. A worldwide network of HP sales and service offices is staffed by qualified engineers ready to help you.

Less money.

With all these features, you'd expect to pay more than \$1,295* for our new display terminal. But that's all we're asking. So why settle for less?

To get more information, call your local HP sales office listed in the white pages. Or get in touch with Terry East-

ham, Hewlett-Packard, Dept. 008199, 8020 Foothills Blvd., Roseville, CA 95678. Phone (916) 786-8000. In Europe, contact

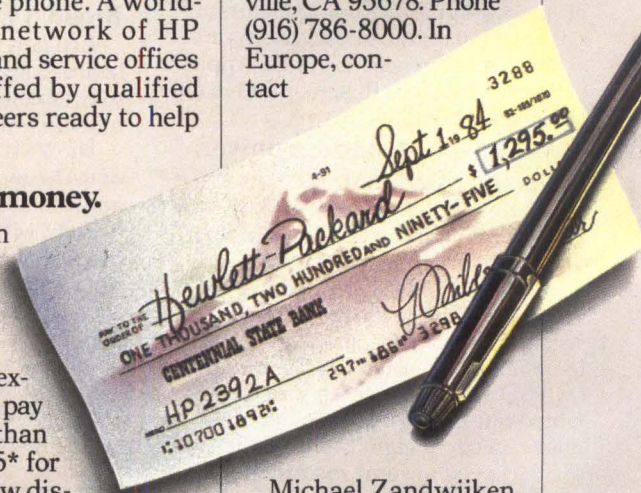

Michael Zandwijken, Hewlett-Packard, Dept. 008199, P.O. Box 529, 1180 AM Amstelveen, The Netherlands.

Productivity. Not promises.
**hp HEWLETT
PACKARD**

The Integrator

Publishing system streamlines document production

Microprocessor-based publishing system integrates a workstation, a laser printer and special software for high-quality on-site production

Mike Iannamico, Sun Microsystems Inc.

The use of computers for text processing began with crude line editors designed to aid programmers writing code. But it didn't take long for office workers to take note of—and to demand—the word-processing capabilities of these early line editors. These systems have now evolved, however, to the point where almost any office worker can use a word-processing system to write, edit and print a document for informal in-house distribution.

But typeset-quality documents intended for the public, such as financial publications, quarterly reports and technical manuals, must incorporate illustrations, diagrams and other artwork; therefore, most companies must hire typesetters and graphics artists to produce anything to be externally distributed. But, by allowing the creation and printing of typeset-quality documents with graphics, the OPS-2000 computer-aided publishing system from Interleaf Inc., Cambridge, Mass., extends the scope of traditional word processing by performing many of these costly and time-consuming steps.

The OPS-2000 combines the microprocessor-based UNIX SunStation workstation from Sun Microsystems Inc., Mountain View, Calif., Interleaf's text-processing software and the 8/300 laser printer from Imagen Corp., Santa Clara, Calif., to produce documents with multiple type fonts and integrated graphics. The OPS-2000 and the 8/300 take up only as much space as a personal computer and a desktop photocopier, respectively.

The 32-bit MC68010-based SunStation provides 16M bytes of virtual-memory addressing, a high-resolution, 19-inch monochrome monitor and bit-mapped graphics. It can be used in a high-speed local area network, enabling communications with other computers and peripherals.

The Imagen 8/300 laser printer uses an image-processing system with the LPB-CX print engine from Canon USA Inc., Lake Success, N.Y. The LPB-CX provides 300-dot-per-inch resolution and 8-page-per-minute (ppm) output, in contrast to the 1-ppm rate of

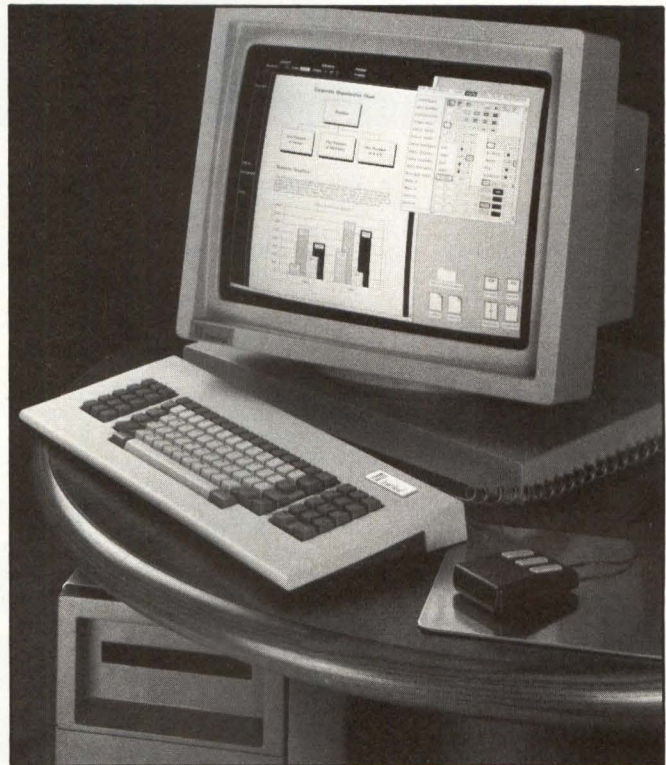

The Interleaf OPS-2000 computer-aided publishing system integrates advanced multiple-font word processing, business graphics diagramming and laser printing. The system uses Sun Microsystems' 32-bit SunStation, Interleaf's software and Imagen's laser printer. The user interface, which includes a mouse and a "what-you-see-is-what-you-get" display on a bit-mapped screen, makes it easy for those unfamiliar with computers to learn and use the system.

most daisy-wheel printers. In addition, it accommodates non-standard-sized paper, such as envelopes and business cards. The LPB-CX uses dry toner, encapsulated in a disposable cartridge, instead of often-messy liquid toner. The printer uses Imagen's Impress page-layout and -description language to define typesetting fonts and graphics. Imagen's software also supports several communications protocols, including Ethernet.

Unleash The True Potential Of The 68000/Unix Environment

PHILON FAST/Compilers are so fast, your concept of speed will never be the same. Compilers that unleash the ultimate power of the 68000 and drive UNIX* to its fullest potential. PHILON FAST/Compilers redefine performance in benchmarks — UP TO 47 TIMES FASTER (see benchmark chart).

FLEXIBILITY — it's built in. PHILON FAST/Compilers are specifically designed to free programmers from artificial constraints (such as 64K program size or data file limitations) and allow efficient development of highly-optimized application systems. You can even link program modules in the same or different languages.

DEBUGGING — it's a snap. The Phi-Analyzer high-powered debugger vastly increases programming productivity.

THOROUGH TESTING — RESPONSIVE SUPPORT

You demand reliable compilers; Philon's quality assurance commitment delivers.

ACCURATE, EASY-TO-UNDERSTAND DOCUMENTATION — it's part of The Philon Approach.™ Plus, you can become part of a comprehensive customer support program designed to keep productivity at its maximum. This is what you will come to expect from Philon.

*UNIX is a trademark of AT&T Bell Labs

**RM/COBOL is a trademark of Ryan-McFarland Corp.

†CBASIC is a trademark of Digital Research, Inc.

††MBASIC is a trademark of Microsoft, Inc.

RECOMPILE EXISTING APPLICATIONS FOR DRAMATIC RESULTS

Dramatic speed improvements can be achieved by simply recompiling with one of these corresponding PHILON FAST/Compilers.

RM/COBOL** **PHILON FAST/COBOL**
 CBASIC† **PHILON FAST/BASIC-C**
 MBASIC†† **PHILON FAST/BASIC-M**
 Any full implementation of K & R - "C" **PHILON FAST/C**

BYTE Magazine Sieve Benchmark



In a comparison of Ryan-McFarland COBOL 1.6A, Micro Focus COBOL 2.0 and PHILON FAST/COBOL 1.0 using the *BYTE* Magazine sieve benchmark the results are conclusive: PHILON FAST/COBOL executes the benchmark 24 times faster than Micro Focus and 47 times faster than RM/COBOL. (System configurations: 68000/UNIX/8mHz/1wait state.)

Unleash the true potential of your 68000/UNIX system, call Bob Gildenberg at (212) 807-0303 or write to Philon, Inc., 641 Avenue of the Americas, New York, NY 10011

PHILON™

The Integrator

Mouse and icons ease system use

The OPS-2000 makes extensive use of menus and icons, so illustrations, diagrams and charts appear on the screen as close as possible to how they will appear in print. Users employ a mouse pointing device to select from menus and icons and to manipulate, extract and merge text and graphics. The "what-you-see-is-what-you-get" approach makes it easy for users with little knowledge of computers to learn and become productive on the system. A multiwindowing feature allows users to view different pages of the same document or pages of different documents simultaneously; using the mouse, users can "cut-and-paste" text within the windows.

The OPS-2000's software features a desktop-management system that transforms the UNIX file and directory hierarchy into a collection of familiar symbols, or icons. Each user is assigned an account, or "desktop," in which to keep personal files and directories. Each document file is represented by an icon of a "manuscript," stored in a directory depicted by a "file folder," which is in turn stored in a "file cabinet." A "clipboard" denotes a directory for temporary files created as a preventive measure against mistaken deletions or system failures. To create, copy, move and delete files, or to assign codes that limit read and write access, the user merely points with the mouse to select these

Illustrations, diagrams and charts appear on the screen just as they will appear in print.

options from the appropriate menu.

In addition to letting users enter text with a keyboard, the OPS-2000 supports standard text-editing features, and also allows the selection of point size, spacing and style of type fonts. The type fonts produce 6- to 24-point classic or modern; 8- to 24-point bold or italic; and Greek, mathematics and logic symbols. The typewritten fixed-width options are limited to 8-, 10- or 12-point sizes. All of these fonts come standard.

Users of the OPS-2000 can employ its structured document-editing feature to specify a documents layout and the chosen character fonts. Each portion of a document, such as its headline, section headings, sub-headings and paragraphs has its own "field." Users can specifically define each field before entering any text, and can alter these attributes at any time.

Create illustrations on-screen

Besides processing text, the software allows users to create diagrams, graphs and freehand illustrations and

By integrating multiple-font text with business charts and diagrams on one page, the Interleaf OPS-2000 replaces the manual cut-and-paste process. The screen shows text, business graphics and line art (center). A user selects from a menu (top right) to select the design charts and from various fields that make up the document (left). The desktop-management system uses icons (lower right) to create and manipulate files.

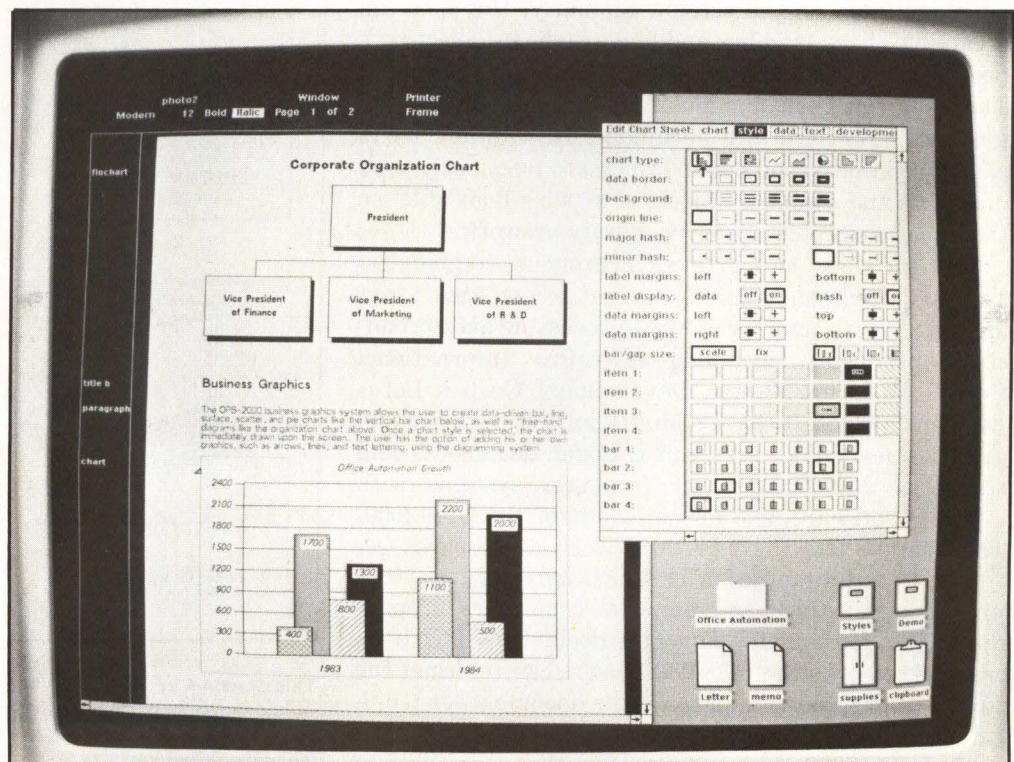

The Integrator

Examining the OPS-2000's hardware

Interleaf Inc.'s OPS-2000 computer-aided publishing system combines the MC68010-based SunStation microcomputer from Sun Microsystems Inc. and the 8/300 laser printer from Imagen Corp.

A Sun Microsystems memory-management unit (MMU) works with the virtual-memory capabilities of the 10-MHz MC68010 to provide memory allocation, address translation and data protection for as many as eight simultaneously active processes. The MMU also allows high-speed peripheral devices such as disk and tape drives to access virtual memory directly.

The SunStation's 19-inch monochrome monitor displays more than a million pixels in a 900-by-1,152 matrix. The non-interlaced, bit-mapped display is refreshed at 70 Hz and has exclusive access to 128K bytes of dual-ported, frame-buffer memory. One port performs video-refresh op-

erations, and the other updates the frame buffer. A customized very-large-scale-integration RasterOP chip provides hardware assistance for placing arbitrary bit patterns on the screen and performing complex manipulations of raster patterns.

The SunStation uses the Berkeley 4.2 version of the UNIX operating system, which includes more than 200 support utilities for preparing documents, writing programs and maintaining the system.

The other part of the OPS-2000, the 8/300 laser printer, uses Imagen's proprietary software to convert data transmitted from a host computer into page images. Canon USA Inc.'s LPB-CX print engine then converts the data into printed output.

To print an image with the LPB-CX, a semiconductor-diode laser beam passes repeatedly across the surface of a rotating cylindrical drum, leaving an electrostatically charged image

that is then coated with a toner and transferred to paper. To scan the drum efficiently, the laser is reflected from a polygonal mirror that, when rotated at high speeds, distributes the beam across the surface of the drum, which has been charged with an electric current. The laser beam is modulated as it scans back and forth, causing a dot-matrix image to be etched onto the drum. The charged areas of the drum not exposed by the laser attract the toner, which is then deposited on the paper to produce the printed page.

Imagen's Multibus-based image-processing hardware incorporates a 32-bit MC68000 microprocessor with 512K bytes of RAM, expandable to 1.5M bytes. The image processor translates data from a host computer into images and generally controls the functions of the print engine. It can accept serial data through an RS232C interface or parallel data through a Centronics interface.

to place them anywhere in a document. To create a diagram, a user selects a series of graphics components, such as lines and circles, from a menu and positions them on the screen. Similarly, the user can create pie charts and bar and line graphs by selecting a presentation style and entering the appropriate data. The user can then manipulate, size and position the graphics anywhere in a document. In addition, users can store information needed to create frequently used diagrams and graphics objects in a "wish book" file, so they need not re-create or re-specify artwork.

The software supports asynchronous communications and document conversions that accept ASCII text and data from a number of word-processing and spreadsheet programs, including MicroPro International Corp.'s WordStar, Lotus Development Corp.'s Lotus 1-2-3 and Microsoft Corp.'s MultiPlan. With editing and graphics features, users can transfer documents and statistical data from other computer systems with different software, and format them for the OPS-2000. This feature lets the OPS-2000 work as a shared resource in an organization in which inexpensive word-processing systems and personal computers prepare documents for transfer. Once the documents have been transferred onto the OPS-2000, users can reformat the text, add graphics and prepare the document for publication.

The OPS-2000 does not provide the versatility of

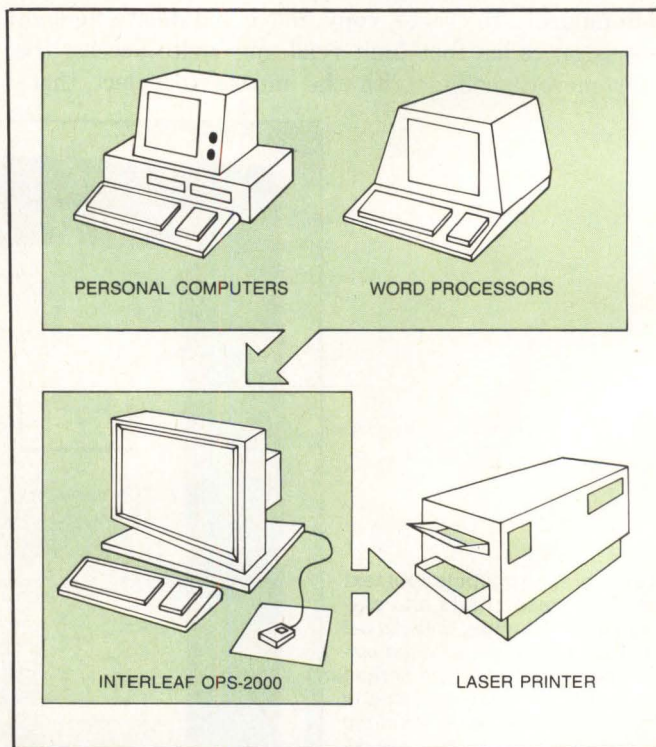

This drawing, created using the OPS-2000, shows how it works with word processors and personal computers. Users can transfer ASCII files composed on other systems to the OPS-2000, which interprets most popular word-processing and spreadsheet programs.



Our Low-Cost Voice Data Entry Peripheral Could Double Your Computer System's Productivity

Verbox voice data entry has improved the speed and accuracy of data entry operations for companies across the country. We're helping firms in material handling, inventory control, inspection, test and other applications save thousands of dollars in time and labor costs, often resulting in productivity gains of 100% and more. Now *you* can offer this proven technology in a new, low-cost voice data entry peripheral—the Verbox Series 4000 Voice Recognizer.

Integrating seamlessly with your own system, the Series 4000 Voice Recognizer adds simultaneous voice input to keyboard data entry for virtually any mainframe, mini, micro or personal computer. It loads voice patterns and applications vocabularies

directly from your host system, or from its own reusable CMOS voice cartridges. A user simply drops his own cartridge into the Series 4000 Voice Recognizer console and it instantly responds to verbal commands despite accent, dialect, or interference from loud background noise.

Simple software tools let you create custom vocabularies.

With our Series 4000 Voice Planner™ software, you can program vocabularies for any customer application. Voice Planner software runs on IBM® PC, PC compatible, and DEC VAX™ systems, and is readily adaptable to other computing environments.

True continuous speech recognition: the key to your success.

With Verbox, the user inputs data in a natural voice, so there's no risk of fatigue or irritation caused by the staccato diction that other products require. And while others may claim it, only Verbox's patented continuous speech recognition achieves this natural man/machine interface without sacrificing accuracy or vocabulary size.

For details on the Series 4000 or our OEM/VAR programs, call toll-free 1-800-343-4458. In Mass., call (617) 275-5160. Or write on company letterhead and ask for a free video tape of voice applications. Verbox, Two Oak Park, Bedford, MA 01730.

Verbox

A DIVISION OF EXON ENTERPRISES

Voice Planner is a trademark of Verbox. IBM is a registered trademark of International Business Machines Corp. VAX is a trademark of Digital Equipment Corp.

The Integrator

LMC's 32-Bit Virtual Memory MegaMicro Is The-State-Of-The-Art UNIX Microcomputer

LMC's 32-bit MegaMicro provides mainframe or super-minicomputer performance at prices competitive with today's far less powerful 8- and 16-bit microcomputers. This is made possible by use of the next generation of logic chips—the National Semiconductor 16000-series. LMC MegaMicros incorporate: the NS16032 central processing unit which has true 32-bit internal logic and internal data path configured on the IEEE 796 multibus; demand-paged virtual memory implemented in hardware; and hardware 64-bit double-precision floating-point arithmetic.

The LMC MegaMicro is supplied with HCR's UNITY* which is a full implementation of UNIX** and includes the Berkeley 4.1 enhancements to take advantage of demand-paged virtual memory. Also included are C and FORTRAN. Typical multi-user systems with 33 megs. of fast (30 ms. average access time) winchester disk storage, a half meg. of RAM, virtual memory, hardware floating-point arithmetic, UNIX, C, and FORTRAN 77 are available for \$20,000 (and even less with quantity or OEM discounts).

* UNITY is a Trademark of Human Computing Resources.

**UNIX is a Trademark of Bell Laboratories.

LMC MegaMicros The Logical Alternative™

LMC

The Logical MicroComputer Company

4200 W. Diversey, Chicago, IL 60639 (312) 282.9667



A member of The Marmon Group of companies

See us at Comdex Fall in Las Vegas

142

CIRCLE NO. 71 ON INQUIRY CARD

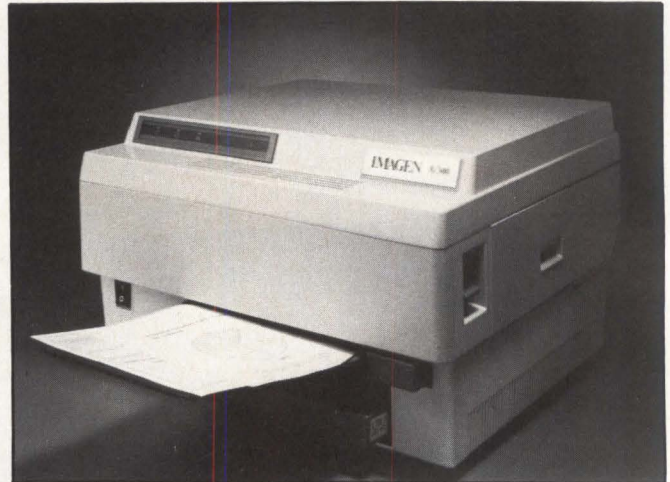

The OPS-2000 uses Imagen's 8/300 laser printer, which produces 8 pages per minute with a resolution of 300 dots per inch. The printer uses a dry toner encapsulated in a disposable cartridge.

typesetters and graphics artists, but it can prove more cost-effective in the long run than paying for these services. The OPS-2000, including a SunStation and all standard software, sells for \$37,500, and the Imagen 8/300 sells for \$14,500. For a total of \$52,000, the system can yield significant savings to organizations that need large quantities of high-quality documents for public distribution. □

Mike Iannamico is a technical writer for Sun Microsystems Inc., Mountain View, Calif.

Interest Quotient (Circle One)
High 837 Medium 838 Low 839

LOOKING AHEAD IN MMS

Mini-Micro System's December issue is our third annual overview of those leading edge technologies impacting our value-added market readership. A long-lasting sourcebook for technology and market data, the report presents past, present and future perspectives on key areas including:

- local area networks
- natural language translation
- operating systems
- non-impact printing
- relational database systems

HOW TO TAILOR YOUR COMPUTERS TO FIT ANY CUSTOMER.



MIX &

**Introducing OEMTEK.
First to put the
OEM first.**

Why don't OEM computer systems fit OEMs very well? Simple. They're "hand-me-downs." Designed for general applications. And sold to OEMs as an afterthought. Not at OEMTEK.

We're the first "OEM-compatible" computer company, tailoring computer systems just for OEMs.

With OEMTEK, you're never out of style.

We shun the latest fads and fancies — and use only proven, industry-standard technology. Like Intel's 8086 and 8088. And the soon-to-be-standard 80286.

And all our systems are truly IBM™ software compatible.

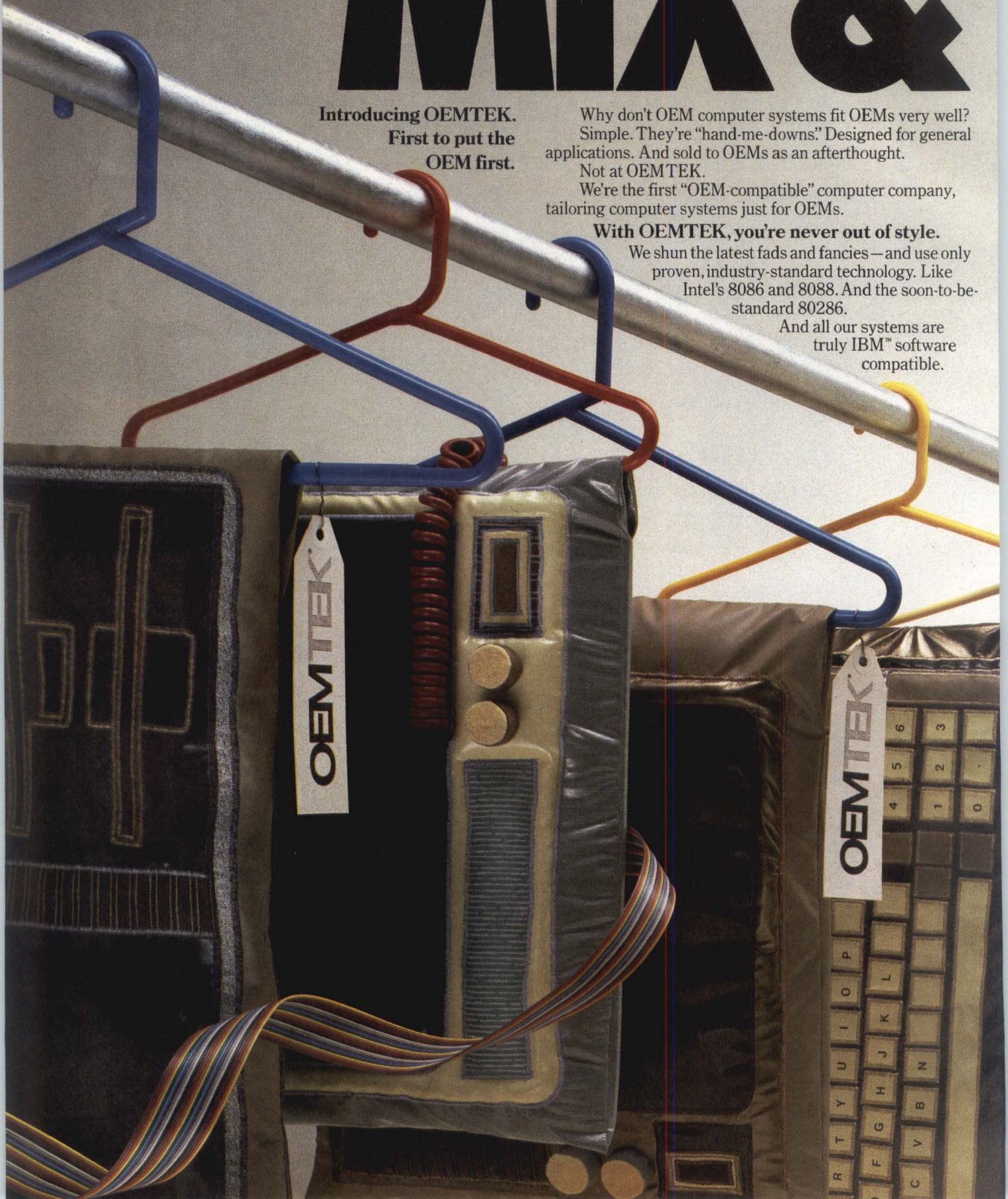

MATCH.

Which is about as "industry standard" as you can get.

So our systems work with standard PC and XT peripherals. And accommodate all industry standard interface cards.

But the crowning touch is that all our systems and components are interchangeable. You can literally take any off the rack. Arrange them any way you want. And create exactly the system you need.

Be a smooth operator no matter where you go.

With OEMTEK, you always operate in a comfortable environment. PC-DOS™ Concurrent CP/M™ And OEM Magix™, the most advanced yet easily maintained multi-user operating system.

And if you want to move data around, we've got all the right connections. Like the IBM PC™ bus and the MULTIBUS™.

We'll make you a screen star.

Naturally, the right CRT is essential to good looks. So we offer you both a vertical and horizontal 14-inch monochrome for word processing and standard applications. And a 13-inch color screen for graphics. Graphic proof that with OEMTEK, you get the exposure you need.

Outfit yourself a thousand different ways.

With all we give you to choose from, you can literally put together a system a thousand different ways.

Take keyboards. Having the right one is essential for sewing up the entire package. We give you a choice of three. A standard IBM-type. A standard IBM-type with 18 added function keys. And one with all of the preceding—plus an LCD panel.

In system and data storage modules, we'll outfit you nicely, too. With a standard module housing system board, eight expansion slots and two floppy or hard disk drives. And standard storage units holding up to two floppy and two hard disk drives. Want more? How about data base file servers handling up to 96 users.

But suppose even after looking over our incredible selection you still haven't found what you need?

Step over to our full custom department, please.

And let our expert design engineers customize a system to your exact specifications. Right down to packaging.

So if you want a 100 gigabyte file server, we'll tailor it for you. Or if you think a purple console with a green keyboard is your style, we'll make it for you.

Call for a fitting.

What's all this going to cost? Let's just say substantially less than the "industry standard." For details, get in touch with one of our regional managers by writing or calling OEMTEK, 3707 Williams Road, San Jose, CA 95117, (408) 247-1100.

And let us help you start dressing for success.

OEMTEK®

MULTIBUS is a trademark of Intel Corporation. Magix is a trademark of Science Dynamics Corporation. IBM PC and PC-DOS are registered trademarks of IBM Corporation. CP/M is a trademark of Digital Research Corp.
© 1984 OEMTEK, Inc.

CIRCLE NO. 72 ON INQUIRY CARD



OEMTEK

Pay less for more.



VP4801 APT, \$348*

Get RCA quality and performance.

OEM designers and systems integrators can now utilize the many performance features of RCA communication terminals, at most attractive prices.

The RCA APT (All-Purpose Terminal).

Professional quality RCA APT terminals are designed for remote data base timesharing and direct computer-connected applications. They feature a built-in 300 baud direct-connect modem, an RS232C interface for high speed modem and other accessories, and a parallel printer port for hard copy. Menu controlled operation and a "programmable personality" can match specific requirements for each data base.

VP4801 APT, \$348*

Full 60-key typewriter-style keyboard with 16-key calculator keypad. Auto-dial (tone or pulse) of up to 26 stored numbers for voice or data base calls. Programmable sequences initiated automatically after log-on. Two user keys for selection of printer or other operating modes; four programmable function keys, shiftable for a total of eight functions. APT can be programmed to match the communications requirements and control commands of many other (and more expensive) terminals. Briefcase size (17" x 7" x 2"), light weight (under 6 lbs.) and memory backup (minimum 48 hrs., without batteries) enhance portability. Many other user-friendly features.

VP3801 APT, \$348*.

Same features as VP4801, in rugged metal case with flexible membrane keypad, designed for dependable performance in hostile environments.

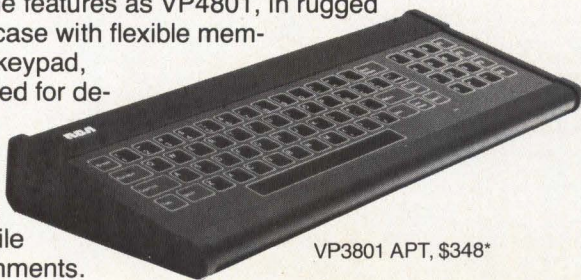

VP3801 APT, \$348*

VP3301 Interactive Data Terminal, \$307*.

58-key flexible membrane keyboard with finger positioning overlay includes two definable user keys. Full RS232C interface for direct modem and computer connection.

Six switch-selectable baud rates from 110 to 19.2 kilobaud. Full color graphics and reverse video. 40 character x 20 lines or 20 x 12 display formats. Video output for 525-line color or standard monochrome monitor. Size: 13.1" x 7" x 2". Weight: approx. 5 lbs.



VP3301 IDT, \$307*

To order, call toll-free 800-233-0094. (In PA, 717-295-6922.)

For more information, call 800-233-0187.

Or write: RCA Data Communications Products, P.O. Box 3140, Lancaster, PA 17604-3140.

*OEM quantity prices, 25 units.



VP4801 APT with optional display monitor.

RCA

Choose Precision Visuals graphics software and you're in the best company.

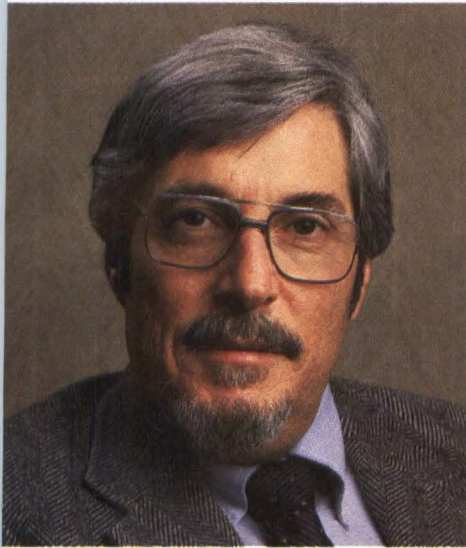

"DI-3000® graphics software will meet the needs of a total enterprise."

Phil Goss
Honeywell

Precision Visuals' graphics software tools are today's standard for over 800 organizations, large and small. Here's why. Graphics programmers are saving hundreds of hours by using the appropriate Precision Visuals software tools for the project. They choose from our integrated family of graphics packages based on the commercially acclaimed DI-3000® subroutine library or the GKS implementation, GK-2000.™ With full support for most computers—IBM, DEC, CDC, PRIME, Honeywell, Data General, Cray, Apollo, and many UNIX-based systems*—and over 80 popular graphics peripherals, their investment in our software is secure . . . today and tomorrow. Look into Precision Visuals and see why.

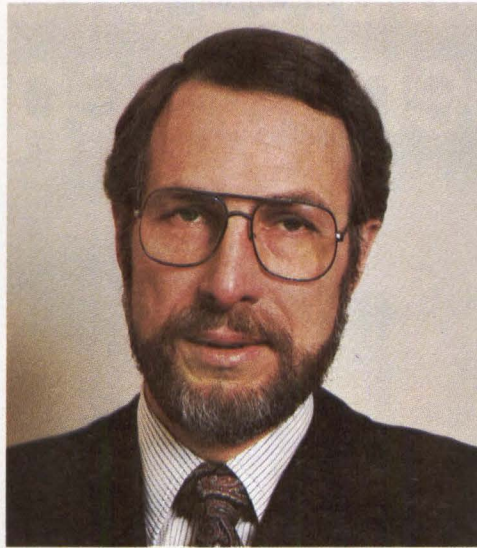

"Precision Visuals' documentation is a model for the industry."

Dr. James D. Foley, President
Computer Graphics Consultants, Inc.

Here's someone who knows how a good manual should look. Dr. Foley, Professor of Electrical Engineering and Computer Science at George Washington University, is co-author of *Fundamentals of Interactive Computer Graphics*. According to Dr. Foley, our DI-3000® manual is "ideal for people with little or no graphics experience." Our example-intensive documentation includes a quick reference guide for the experienced graphics programmer and step-by-step tutorials that quickly turn beginners into productive graphics programmers.

It's not surprising that many customers were sold on our graphics tools just by looking at our documentation. Ask to see a copy for yourself.

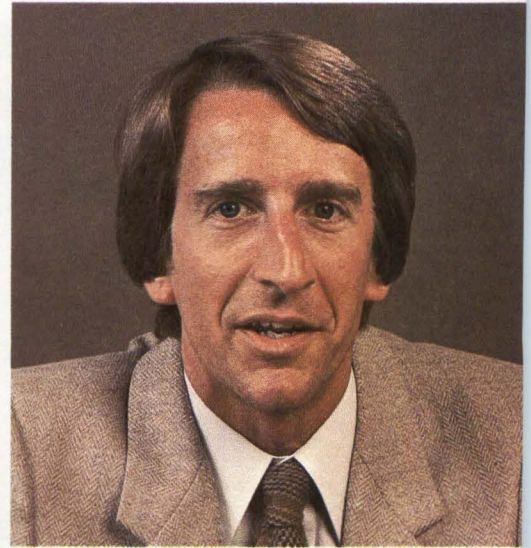

"It's not just the package that's important. It's the people behind it."

David Campbell
INCYTE, Fairchild/A Schlumberger Co.

What adds even more value to our versatile graphics tools is the support you get from our people at Precision Visuals. Graphics software specialists staff a Help Line for quick answers to keep you on schedule; national training programs, for the novice to the advanced graphics programmer, help get your applications operating on time and within budget; active international and regional user groups that exchange creative and productive ideas; plus thoroughly tested products and documentation designed to meet your needs today and in the future.

Don't you think it's time to choose Precision Visuals? Call us today at 303/530-9000.



Precision Visuals

6260 Lookout Road / Boulder, Colorado 80301
303/530-9000
TELEX 45-0364 / TWX 910-940-2500

Presentation Graphics

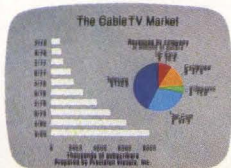

Enhanced Contouring

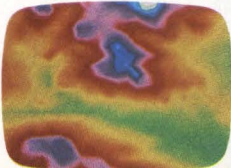

VLSI Design

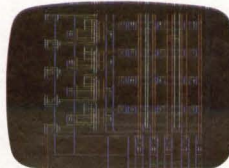

Solids Modeling

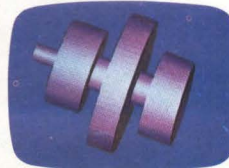

Process Control

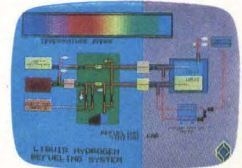

*UNIX is a trademark of BELL Laboratories, Inc.

Make your dumb terminal run circles around more expensive equipment

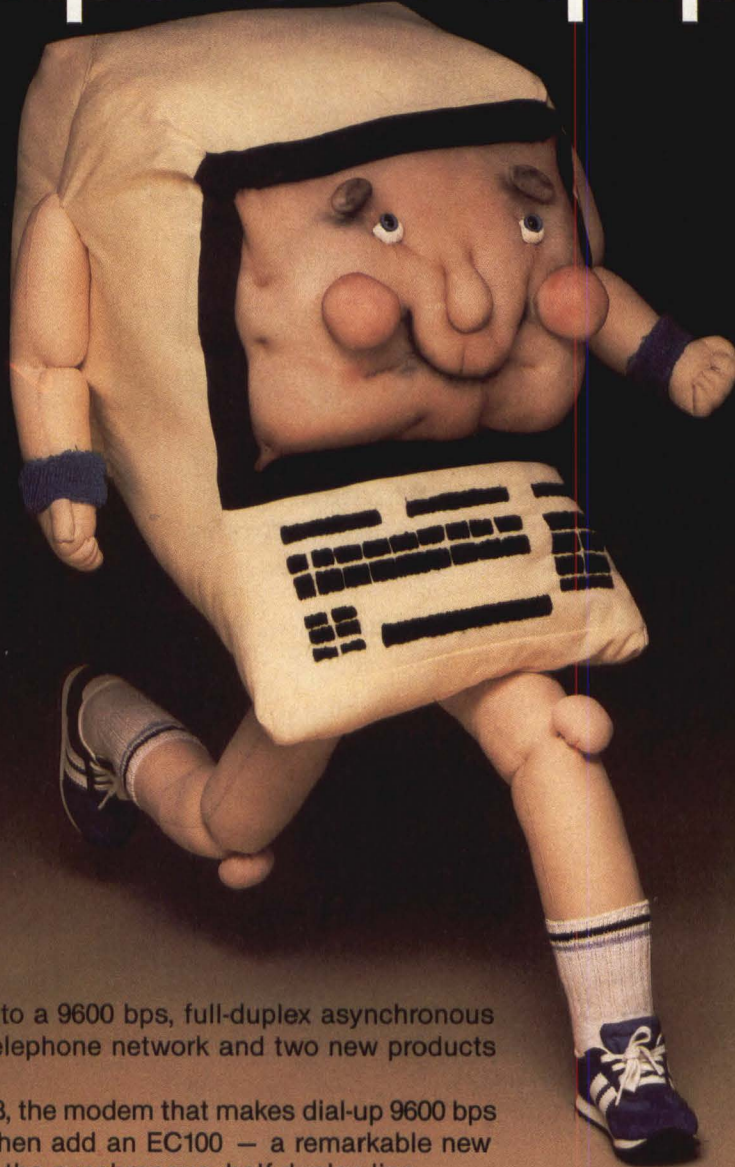

Turn your dumb terminal into a 9600 bps, full-duplex asynchronous genius, using the dial-up telephone network and two new products from UDS.

Start with a UDS 9600 A/B, the modem that makes dial-up 9600 bps communication a reality. Then add an EC100 — a remarkable new UDS product that converts the synchronous, half-duplex line signal to asynchronous full-duplex for presentation to your terminal. As a bonus, the EC100 also performs error correction for any synchronous modem, limiting message errors to one every several years.

Save on equipment investment and line charges by putting your terminals on a faster track. For details, phone 800/633-2252, ext. 356. Universal Data Systems, 5000 Bradford Drive, Huntsville, AL 35805. Telephone 205/837-8100; TWX 810-726-2100.

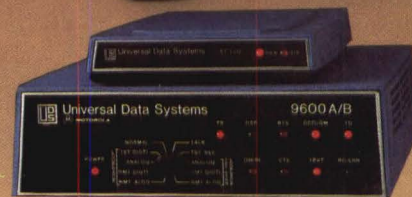

 Universal Data Systems



MOTOROLA INC.
Information Systems Group

UDS modems are offered nationally by leading distributors. Call the nearest UDS office for distributor listings in your area.
DISTRICT OFFICES: Atlanta, GA, 404/998-2715 • Aurora, CO, 303/368-9000 • Bellevue, WA, 206/455-4429 • Blue Bell, PA, 215/643-2336 • Boston, MA, 617/875-8868
Columbus, OH, 614/895-3025 • East Brunswick, NJ, 201/238-1515 • Glenview, IL, 312/998-8180 • Houston, TX, 713/988-5506 • Huntsville, AL, 205/837-8100
Mesa, AZ, 602/820-6611 • Minnetonka, MN, 612/938-9230 • Mountain View, CA, 415/969-3323 • Richardson, TX, 214/680-0002 • Silver Spring, MD, 301/942-8558
Tampa, FL, 813/684-0615 • Thousand Oaks, CA, 805/496-3777 • Tustin, CA, 714/669-8001 • Willowdale, Ont, Can, 416/495-0008 • Ypsilanti, MI, 313/483-2682

CIRCLE NO. 75 ON INQUIRY CARD

Created by Dayner/Hall, Inc., Winter Park, FL

FEATURE HIGHLIGHTS

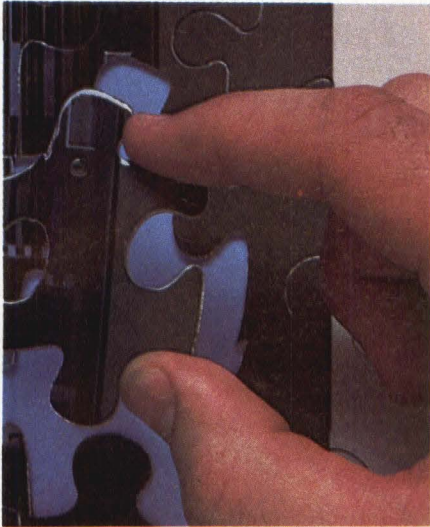

Multithread architecture

SYSTEMS: Until now, fault-tolerant minicomputers have been considered an expensive luxury, what with costly hardware duplication and large amounts of unused processing power. However, with tightly coupled multimicroprocessor architecture, multiple buses and a fault-resistant design, Arete Systems Corp.'s Arete 1200 enables OEMs to develop a cost-effective customized product. See **p. 151** for details.

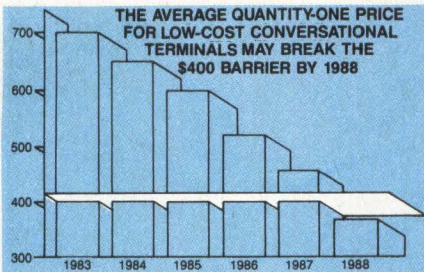

More power for less

TERMINALS: OEMs and system integrators looking for powerful terminals at low prices may find their answer in **alphanumeric terminals**. For a market analysis and a directory of manufacturers, see **p. 165**.

New micro-to-mainframe communications and **terminal emulation hardware and software** products make mainframe databases accessible to microcomputers. A look at what's available and a manufacturers listing begins on **p. 183**.

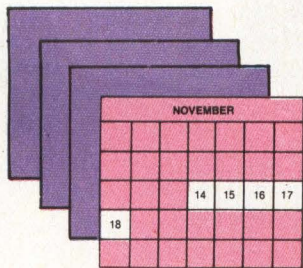

Multifaceted Las Vegas preview

Increased file-transfer speed and a reduction of the computer-room cable maze are just two advantages of the CS/1-X.25 **communications processor**. See **p. 199**.

COMDEX/FALL '84: A crowd of more than 83,000 is expected to convene November 14-18 in Las Vegas for COMDEX/Fall '84, a conference featuring 1,400 exhibitors, including manufacturers of small computer systems, software and accessories. The show will focus on multifunction products such as multiuser computer systems and multiapplication software packages. For more show information, see **p. 209**.

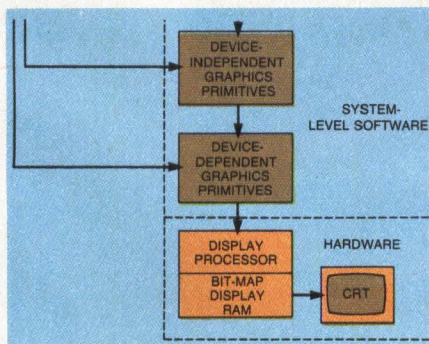

Workstation boasts powerful mix

PRODUCTION EVALUATION: Starting on **p. 219**, MMS presents an evaluation of a color graphics workstation from Convergent Technologies that features a powerful processor, a sophisticated operating system and an ergonomic design.

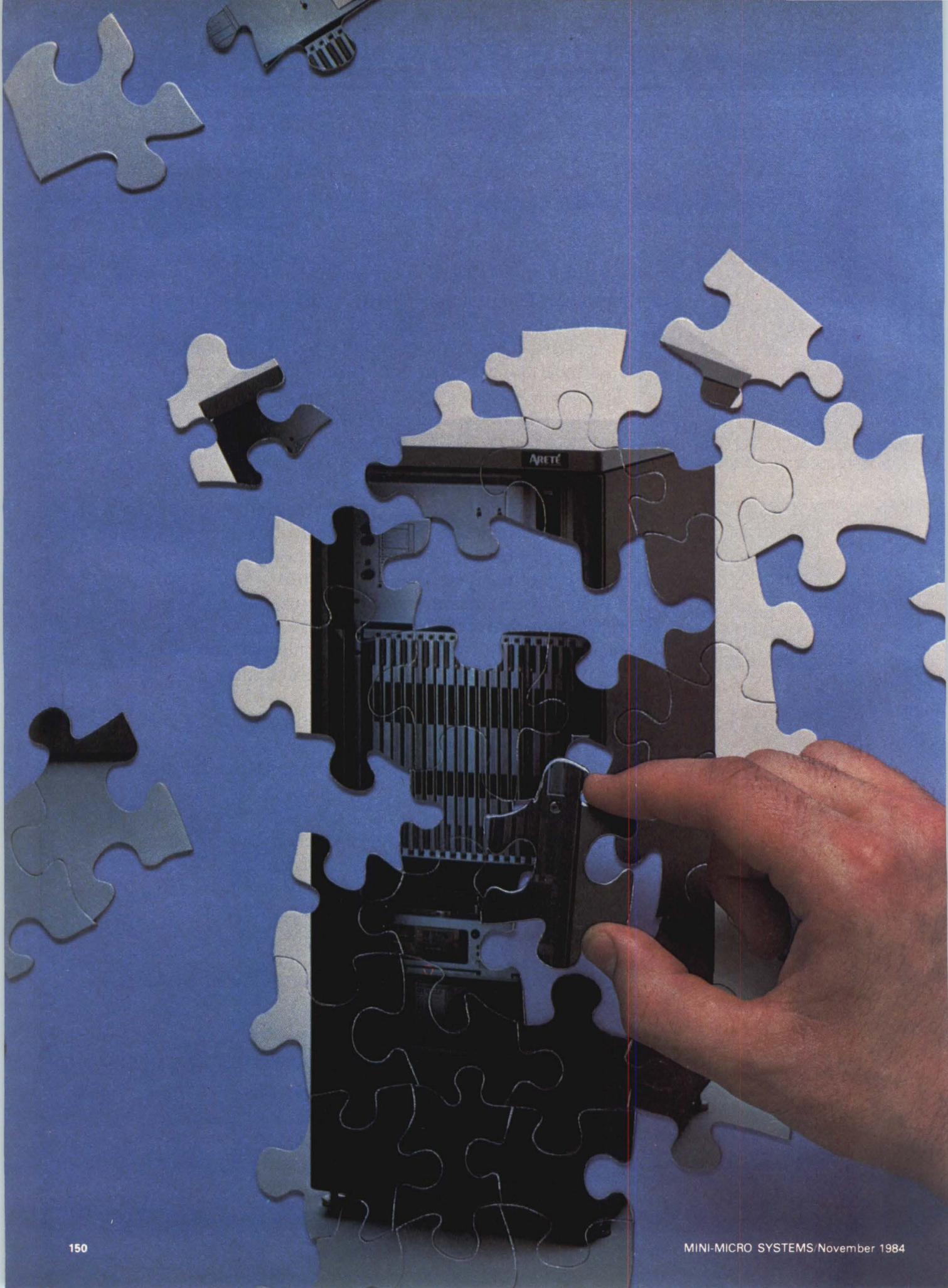

Fitting the pieces into a super-minicomputer

Multi-microprocessor-based computer combines tightly-coupled multithread architecture, multiple buses and semi-custom design into a system to serve high-speed information-management applications

John R. Vrolyk, Arete Systems Corp.

Fault-tolerant minicomputers designed for on-line transaction-processing applications can be expensive, requiring costly hardware duplication, although most of their processing power normally remains unused.

Arete Systems Corp's Arete 1200, in contrast, takes a different approach. It relies on tightly coupled multi-microprocessor architecture, multiple buses and fault-resistant design to provide cost-effective high-speed computing for a range of on-line information-management needs as well as traditional transaction-processing functions. OEMs can use the open architecture program to fine tune the Arete 1200 system to their application with semicustom or custom boards that afford easy entry into the computer's proprietary bus architecture.

Implements tightly coupled architecture

The Arete 1200 implements a tightly coupled multithread architecture that supports the UNIX System V operating system. With single-thread architecture, one CPU runs all user programs. Often, the CPU also performs all I/O processing, producing an architectural bottleneck that limits performance to the CPU's speed. In contrast, multithread architectures, such as the Arete 1200's, allow user programs to execute in any of four CPUs, thereby avoiding the design bottleneck of single-thread systems.

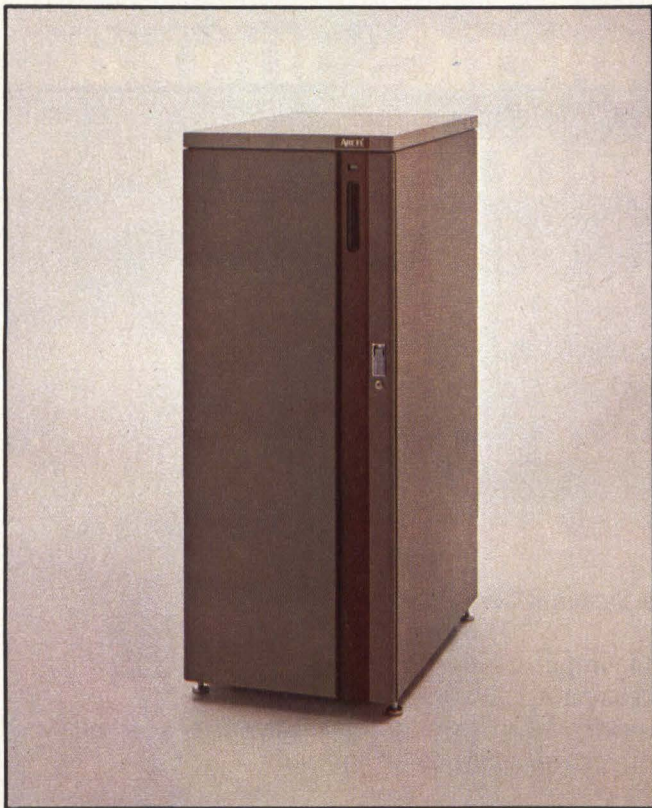

Multiple, 32-bit, tightly coupled microprocessors and a 33.3M-byte-per-second data-transfer bus help the Arete 1200 system achieve 2½-million-instruction-per-second performance.

There are two basic types of multithread computer systems: loosely and tightly coupled. An analogy to customers at a bank clarifies the differences between the two systems. Figuratively, in a loosely coupled bank (system), there is a line of customers (processing tasks) queued up in front of each teller (CPU). Because large differences exist in the time required for the tellers (CPUs) to complete different transactions, a wide disparity occurs in the time required to serve the separate queues.

In a tightly coupled system, such as the Arete 1200's, one large queue of tasks waits for processing. As tasks reach the head of the queue, they are handled by the next available CPU. Thus, with all CPUs operating at full capacity, each task meets with a nearly equal delay in receiving service regardless of the processor to which it is assigned. A tightly coupled architecture thus provides dynamic load leveling without operator or systems-software intervention, significantly increasing the computer system's ability to respond to changing system processing loads.

A traditional problem with tightly coupled computer architecture centers on the processing demands imposed on main-memory bandwidth. Because several CPUs can access main memory at the same time, it is busy much of the time, and one or more of the CPUs has to wait for memory access. The Arete 1200, however, eliminates this problem by using 4K-byte cache memo-

AVOIDING BOTTLENECKS: SINGLE-THREAD AND MULTITHREAD ARCHITECTURE

SINGLE-THREAD ARCHITECTURE

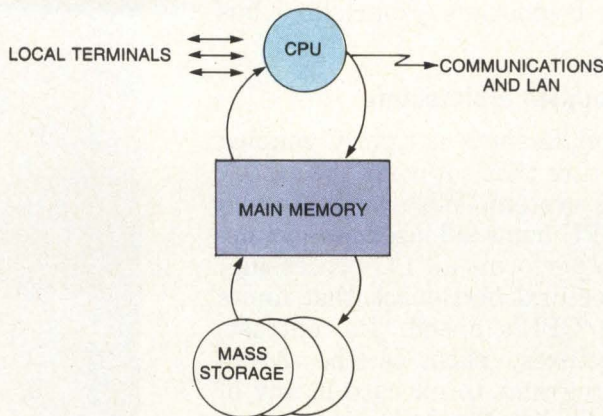

MULTITHREAD ARCHITECTURE

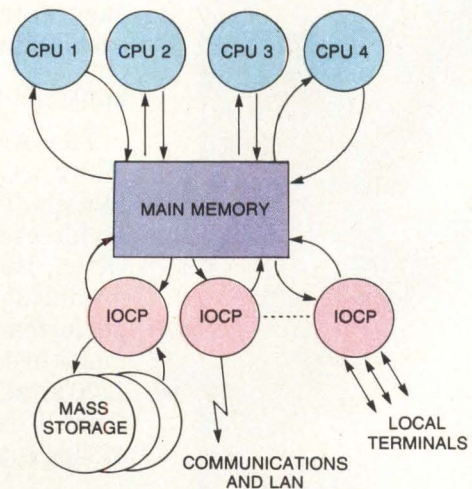

Computer systems with multithread architecture avoid the processing bottlenecks of single-thread designs in which one central CPU runs all end-user programs. I/O control processors (IOCPs) in the multithread architecture offload I/O handling tasks from the main CPUs.

STD BUS

PRICES CUT UP TO 34%

There's never been an easier way to implement a flexible Z80™ design than by using STD BUS boards and subsystems from Mostek.

And there's never been a better time to buy STD BUS products than now. Because through December, we're cutting the price on our STD BUS line of data processing, memory, I/O, and special function boards and systems by up to 34%.

What's more, Mostek is launching some exciting

new STD BUS products, like our MDX-ISIO intelligent serial I/O controller, with software programmable baud rates up to 1M baud. And our intelligent MDX-I488 module, which simplifies the implementation of IEEE 488 General Purpose Interface Bus standards at data rates up to 300K bytes/second. Then there's our MDX-ZRAM, a BYTEWYDE™ memory card with up to 16K bytes of our ZEROPOWER™ nonvolatile RAMs on board.

Part #	Designator	Description	Price	% Savings
MK77857	MDX-CPU3	Z80 CPU with 64K DRAM, 1-serial & 1-parallel port	\$300	30%
MK77761	MDX-DRAM32A	32K dynamic RAM	\$223	19%
MK77764	MDX-RAM64	64K dynamic RAM	\$300	26%
MK77765	MDX-RAM128	128 dynamic RAM	\$375	34%
MK77763	MDX-UMC2	Universal memory card	\$150	22%
MK77677	MDX-FLP2	Floppy disk controller	\$282	6%

Check the table for the savings on selected products, then contact your nearest Mostek sales office for

Northeast (203) 531-1146
Southeast (609) 596-9200

more information on this special offer, or for details of the new Mostek STD BUS products.

Central (214) 386-9141
Western (714) 250-0455



Z80 is a trademark of Zilog Corporation.
BYTEWYDE and ZEROPOWER are trademarks of Mostek Corporation.

ries on all of the CPUs. This setup permits the CPUs to get 92.5 percent to 96.3 percent of their memory accesses through the cache memories, requiring them to access main memory directly only 3.7 percent to 7.5 percent of the time. As a result, the four CPUs cumulatively load main memory directly only 14.8 percent to 30 percent of the time.

Multiple buses improve performance

The multithread architecture allows the multiple CPUs to generate several I/O requests per second, far more than a typical single-thread system. To optimize system performance in high-speed information-management operations, the computer uses four separate buses, each of which performs different functions.

The first bus, the processor memory bus (PMB), provides a 16M-byte-per-second channel between system main memory, the direct memory access (DMA) channels and the four CPUs. The PMB can transfer 32 bits of data on each cycle and supports 26-bit addressing, permitting a 64M-byte physical address space. Note that the PMB carries no I/O data; its sole function is to provide the CPUs' access to main memory.

Data transfers between the I/O control processors (IOCPs), or between an IOCP and main memory, are handled by the 32-bit-wide data transfer bus (DTB). It can speed data at 33.3M bytes per second, faster than the Multibus's 10M bytes per second or the VMEbus, which has a usable bandwidth of 10M to 15M bytes per second, although it affords burst rates of 40M bytes per second. The DTB allows IOCPs to send data directly to each other without using main memory or the PMB,

thus conserving valuable main-memory bandwidth.

This feature permits the Arete 1200 to handle as many as 88 on-line users while also functioning as a local area network (LAN) file server. Transfers from the disk IOCP to the LAN IOCP are handled by the DTB without impacting the main CPUs or main memory.

The interprocessor communications bus (ICB) handles data transfer synchronization and control within the system and provides the master CPU with a number of functions. For example, it allows the base address of memory boards to be set dynamically, and any board in the system to be withdrawn from active use (and diagnostics run on it). The master CPU also uses the ICB to inform the various IOCPs of pending I/O transfers. Because the system uses the ICB for control, synchronization, and communication functions, the bus conserves valuable CPU cycles as well as main-memory bandwidth.

The fourth bus in the system, the utility transfer bus (UTB), furnishes environmental status and control information to the master CPU from the power-control and supply subsystem. In this respect, the Arete 1200 comes with an external uninterruptible power supply (UPS) that keeps main memory and the disk and tape drives functioning whenever power fails or a "brown-out" occurs.

Providing complete on-line diagnostics, the power subsystem can change system logic voltages under diagnostic-software control. This capability allows the computer system to test itself under marginal operating conditions before it is forced to run programs under those conditions.

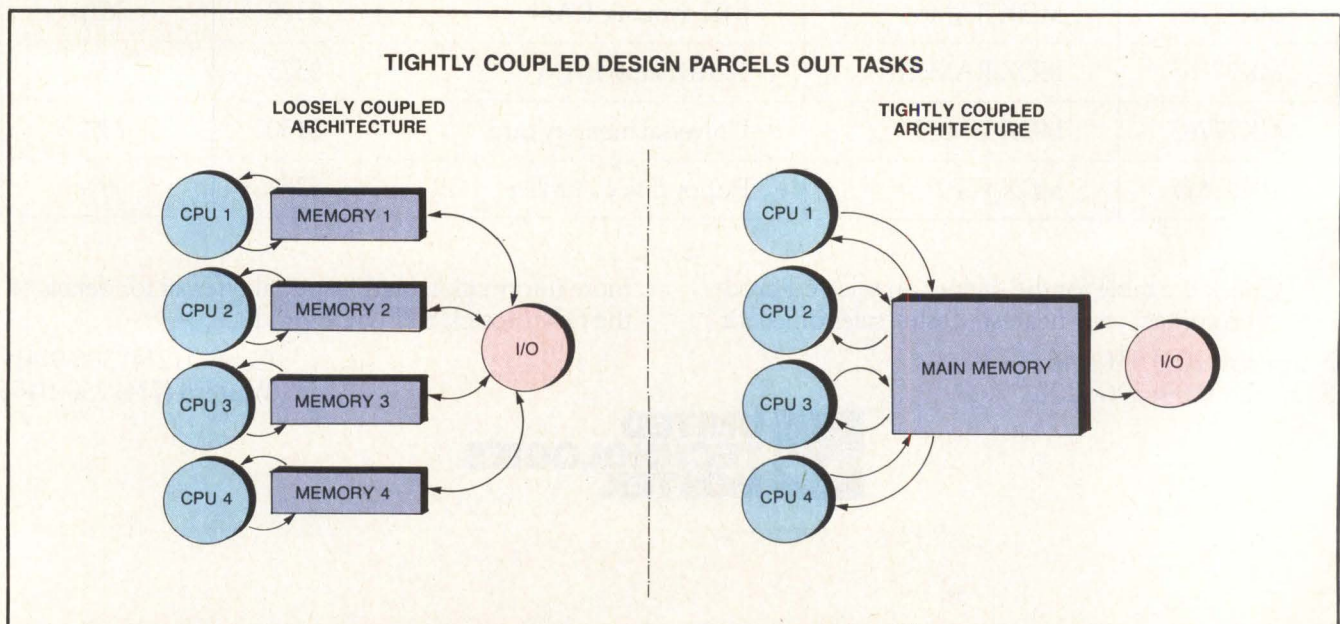

In tightly coupled computer systems, tasks queued in main memory are distributed to the next available CPU, avoiding the risk of slowdowns in loosely coupled architecture caused by disparities in the time required for processing each task.

VMEbus

VMEbus

PRICES CUT UP TO 24%

There's no better way to combine truly high performance with a compact board structure than to base your 16-bit design on the VMEbus system.

And there's no better time to do so than right now. Because through December, we're cutting the price of our VMEbus family of products by up to 24%.

What's more, Mostek is launching some exciting new VMEbus products, like the 1MB DRAM—the second generation of VMEbus-compatible DRAM boards. And our new, 10 MHz high-performance Matrix 68K™ family of VMEbus microcomputer systems.

Part #	Designator	Description	Price	% Savings
MK75801	VME-SIO	4-channel serial I/O board with 2 fixed RS-232 and 2 selectable RS-232 or RS-422	\$ 650	24%
MK75601	VME-SBC	MK68000 microprocessor (8 MHz), RS-232 serial I/O channel with 8 pre-configured BYTEWYDE™ memory sockets	\$1012	20%
MK75602	VME-MMCPU	Memory management CPU; MK68000 processor with MK68451 memory management unit	\$1700	20%
MK75701	VME-DRAM	256K dynamic RAM card; automatic refresh	\$1120	20%
MK75802	VME-SASI™	Hard disk controller interface; DMA can transfer up to 64K data blocks	\$ 805	20%
MK75803	VME-FDC	Floppy disk controller; word DMA or programmed byte transfer over VMEbus	\$ 820	20%
MK75605	VME-SYSCON	System controller card VMEbus slot 1 slave; control and check features and real-time clock (with battery backup)	\$ 921	6%

Check the table for the savings on selected products, then contact your nearest Mostek sales office for

Northeast (203) 531-1146
Southeast (609) 596-9200

more information on this special offer, or for details of the new Mostek VMEbus products.

Central (214) 386-9141
Western (714) 250-0455



BYTEWYDE is a trademark of Mostek Corporation.
SASI is a trademark of Shugart Associates, Inc.
Matrix 68K is a trademark of Mostek Corporation.

High I/O bandwidth speeds data

The key specification of an on-line information-management system is the speed at which it moves data through its I/O subsystem. In addition to the 33.3M-byte-per-second DTB, the Arete 1200's IOCPs also maximize data flow. Each intelligent device includes a 10-MHz 68000 processor, RAM memory dual ported onto the DTB, and peripheral device control logic.

The computer system distributes its I/O processing load across all the IOCPs. This distribution has two important effects. First, it frees the main CPUs from real-time I/O processing tasks, a significant advantage with an operating system such as UNIX, and helps preserve CPU cycles and main-memory bandwidth. Second, because each IOCP is intelligent, it can perform I/O transfers without the aid of the main CPU and operating system—an important benefit when dealing with real-time high-speed data communications over synchronous communications links and LANs.

Reduces the cost of data protection

Because on-line information-management systems are critical to the success of the businesses that they monitor and control, computer systems must address the possibility of system failure. Avoiding the costly redundant electronics and software overhead associated with fault-tolerant systems, the Arete 1200 system takes, instead, a fault-resistant approach. In furnishing a large measure of protection at a fraction of the cost of fully redundant systems, it follows the 80-20 rule: provide 80 percent of the function and performance of the system at 20 percent of the original equipment's cost. Consequently, those sections of the

computer that are prone to failure or are critical to the recovery of data in failure situations, have been reinforced, based on a careful analysis of expected computer system failures in the field.

In this regard, the parts of a computer system most likely to fail are the power supply, the disk drives, the tape drives and the fans, in that order. It is important to note that, aside from power problems, all these failures involve moving parts. To address these problems, the Arete 1200 provides a UPS, an optional transparently mirrored disk system and redundant fans. Because a tape failure does not bring the system down, tape drives have not been made redundant.

Although few problems in computer systems occur frequently enough to warrant complete hardware redundancy, a computer's main memory must be protected. To insure reliability of the 64K- and 256K-bit dynamic RAMS, all of the main-system memory locations are protected by error detection and correction (EDAC) circuitry. Because the EDAC circuitry resides on the DMA memory control board, it does not have to be duplicated as main memory capacity is increased, which reduces the cost of memory expansion.

Semi-custom boards fine-tune the system

The performance requirements of the on-line information-management computer marketplace mandate the use of proprietary buses. Without the PMB, DTB and ICB each handling their dedicated functions, the Arete 1200 could not have reached its price/performance goals. Standard buses, however, such as the VME or Multibus, have obvious advantages. Plug-compatible boards for these and other standard buses

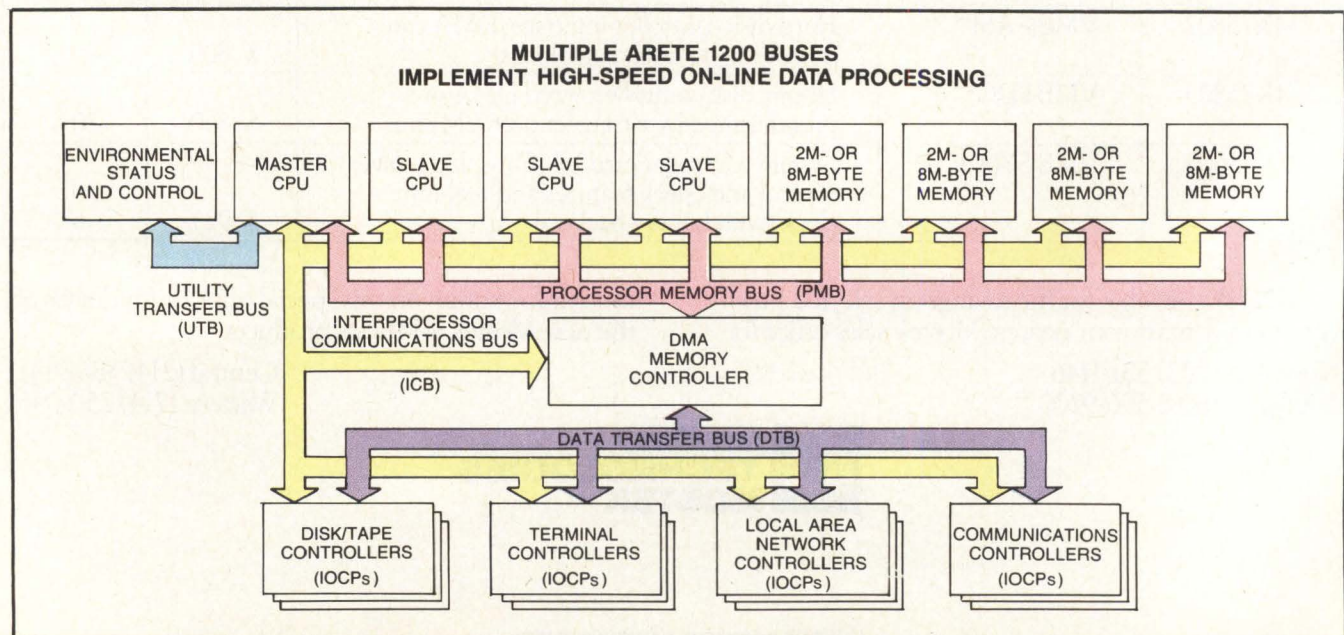

STANDARD PRICES CUT TILL THE MIDDLE OF DECEMBER WELCOME

Whether you're designing for the 8-bit or 16-bit world, Mostek has a system solution to get you there faster.

And if you act fast, you can take advantage of some substantial discounts on selected STD BUS and VMEbus products. You'll still get the high quality

and reliability you've come to expect from Mostek products, but at a savings of up to 34% from our regular prices.

This offer ends on December 15, 1984, so complete and return the coupon for full details today.

NAME _____
TITLE _____
COMPANY _____
ADDRESS _____
CITY _____ STATE _____ ZIP _____
TELEPHONE () _____

Mail to Mostek Corporation, 1215 W. Crosby Road, MS2205, Carrollton, Texas 75006 or call (214) 466-6000.

Northeast (203) 531-1146
Southeast (609) 596-9200

Central (214) 386-9141
Western (714) 250-0455



THERE'S NO COMPARISON.

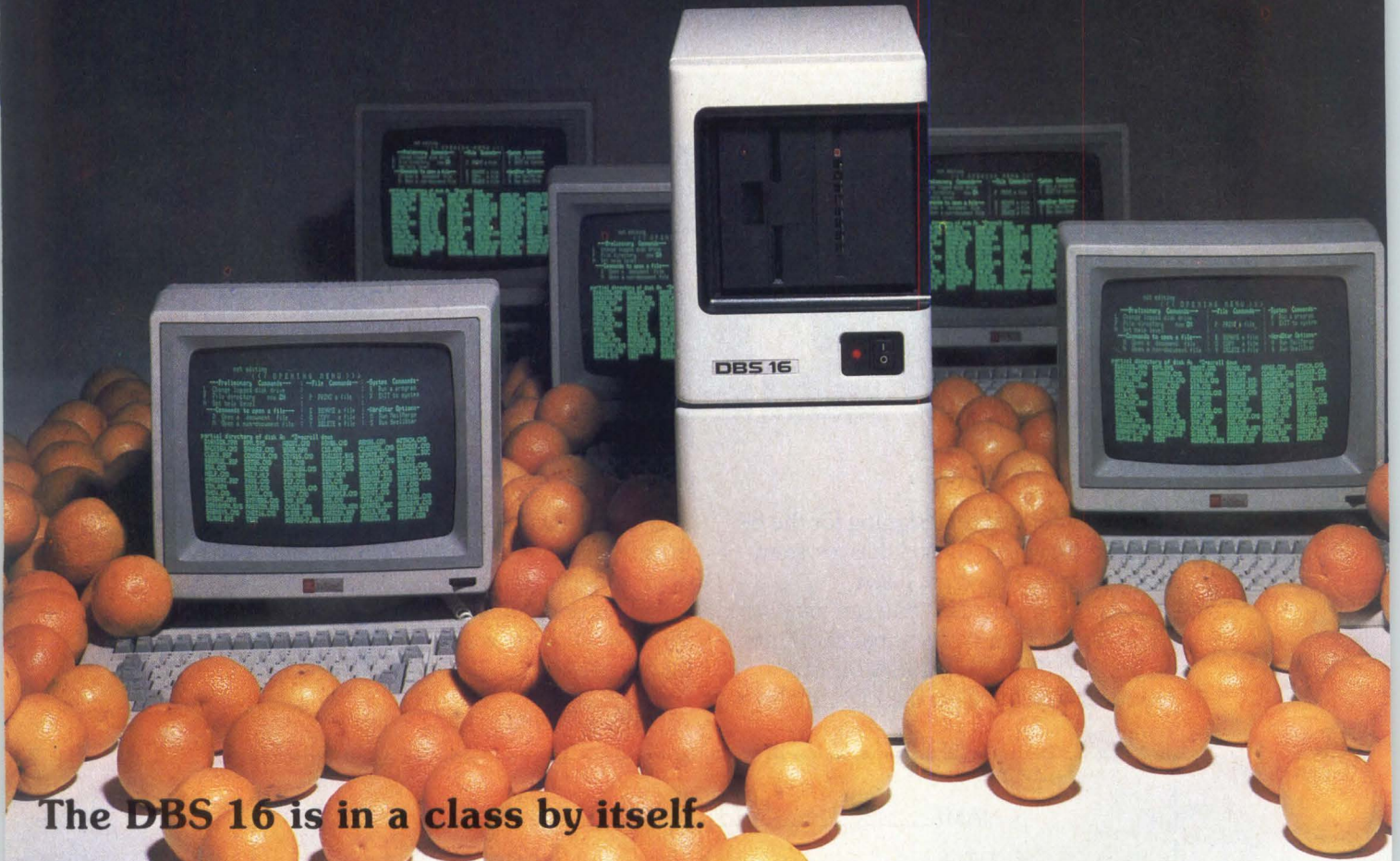

The DBS 16 is in a class by itself.

The minicomputers that rival it for features can't touch it for price. In fact, the DBS 16 with two or more terminals even costs less than the same number of personal microcomputers.

But personal computers – no matter how they're strung together – can't offer the features and performance of the DBS 16. Designed for business from the bottom line up, the DBS 16's networking capabilities are built in from the beginning. Sixteen bit processors and exceptional data-transfer techniques offer speed and power. So the system expands – from one to 28 terminals – with ease. Inexpensively.

Your customers become clients, returning time and again as their computing needs expand.

As time goes by, they – and you – will be glad they bought DBS 16's expandability. Other multi-user micros offer fewer bits, fewer bytes, less storage, and proprietary buses that limit their usage.

And they still cost more.

Face it. There isn't any (fair) comparison to the DBS 16.

ESPRIT DBS 16 SPECIFICATIONS

- 1 – 28 users via terminals
- 1 – 7 80186 16 bit microprocessors (8 MHz)
- Up to 3.58MB RAM (up to 512KB per 80186)
- From 720KB to 105MB of 5.25" disk storage
- 6 slot Multibus[®] expansion unit
- Optional tape subsystem
- Concurrent DOS and MP/M-86 multi-user operating systems

Esprit
Computer Products, Inc.

Peace of Mind Technology

For more information, call us at 1-800-ECP-4685. In Pennsylvania, call 215-628-4810. Or write to P.O. Box 425, Welsh Road & Park Drive, Montgomeryville, PA 18936. TLX 846419 DBS MMLL. **BOOTH 1748**

COMDEX/Fall '84
November 14-18, 1984
Las Vegas Convention Center

Concurrent DOS and MP/M-86 are products of Digital Research Inc. [®]Multibus is a registered trademark of Intel Corp.

EFFECTIVE PROCESSING SPEED RISES AS SYSTEM CPUs INCREASE IN NUMBER

Number of Arete 1200 main CPUs	Effective system processing speed relative to one CPU
1	1
2	1.84
3	2.64
4	3.0

OEM-DESIGNED CIRCUITRY CONFIGURES I/O CONTROL PROCESSOR (IOCP) BOARD TO END-USER APPLICATIONS

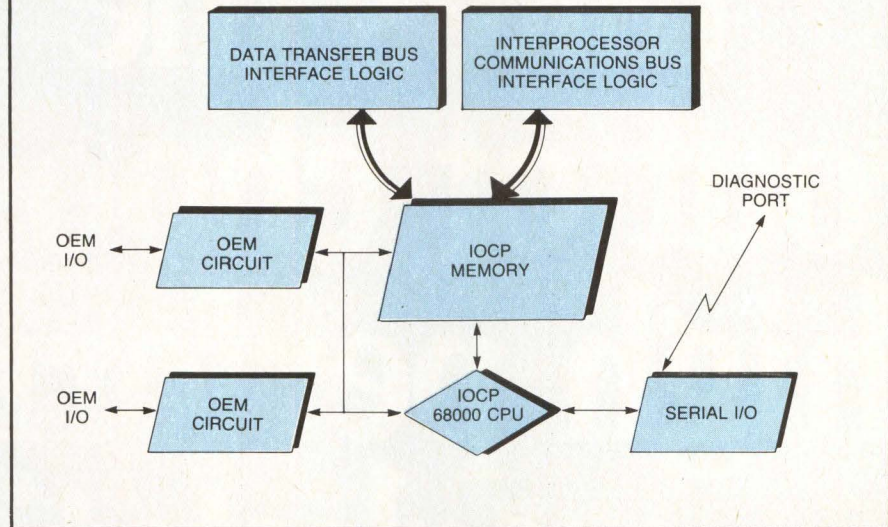

from many manufacturers make it easy for system integrators and OEMs to reconfigure a system to meet their needs.

Therefore Arete's open architecture (AOA) program allows OEMs and system integrators to take advantage of the Arete 1200's proprietary bus structure, without losing the flexibility afforded by standard computer buses. It provides a stable CAD system that OEMs can use to develop their own semi-custom hardware based

on the 1200 system. A set of library designs for board development is also furnished. The library includes bus-interface logic, CPU logic to provide the environment in which the IOCP's 10-MHz 68000s operate, and various memory-arbitration circuits used to dual-port the IOCP RAM memory onto the DTB.

Wire-wrapped boards can be generated within days of the completion of the schematic-capture phase of the design on the CAD system. After the design has been proven in wire-wrapped form, the database from the CAD system produces a printed-circuit board.

The AOA program's library elements, CAD schematic-capture capability and wire-wrapping, prototyping and PC-board services thus allow OEMs to fine-tune the Arete 1200 system to meet their application requirements and to develop and bring to market a custom product in just a few months. □

Spec summary

- **Product:** Arete 1200 computer system
- **Manufacturer:** Arete Systems Corp., San Jose, Calif. 95131
- **Central processors:** As many as four 12.5-MHz 68000 microprocessors, each with a 4K-byte cache memory
- **I/O controllers:** As many as 12 intelligent 68000-based I/O control processors (IOCPs)
- **Main memory:** To 16M bytes
- **Internal disk drive storage capacity:** To 320M bytes
- **External disk drives supported:** As many as 44 with as much as 8.8G-byte storage
- **RS232 ports:** Eight to 88
- **Operating systems:** UNIX System V, RM/COS
- **Languages supported:** C, RM/COBOL, RM/FORTRAN, AVL, MUMPS, SVS/Pascal, SVS/FORTRAN, SVS/X-BASIC, Ada, APL
- **Price:** \$75,000 for typical system with two central processors and as much as 320M bytes disk storage supporting as many as 66 users

John R. Vrolyk is president and founder of Arete Systems Corp., San Jose, Calif. Previously, Vrolyk was vice president of marketing for Codata Systems Corp., Sunnyvale, Calif., where he managed development of UNIX-based 68000 systems with Multibus architecture. Prior to joining Codata, he served as director of sales for International Memories Inc., Cupertino, Calif., and as software development supervisor at Zilog Inc., Campbell, Calif. Vrolyk holds a B.A. degree from California State University, Northridge, and studied at Stanford University's Graduate School of Electrical Engineering.

Interest Quotient (Circle One)
High 840 Medium 841 Low 842

Masscomp takes the risk out of choosing a high performance workstation.

How do you know the engineering workstation you choose is really going to work for you?

Considering the number of vendors in the market, and the baffling collection of workstations they offer, the choice is a tough one. With a sizable amount of capital at risk.

Masscomp is a computer company that not only builds workstations, but uses them every day. We've learned from hands-on experience that the heart of a good workstation is an extremely fast computer that delivers exceptional performance. Knowing this, we built our own very fast, high performance system: the WorkStation-500™.

The WorkStation-500 is designed with Masscomp's Performance Architecture™,

which uses floating point and array processors of our own design and can deliver over one-half million Whetstones. This architecture provides real-time computational and graphics power in a multi-tasking standalone workstation for technical and scientific users.

In applications like solids modeling, VLSI design, simulation, numerical analysis, and other CAE applications, the system is unsurpassed.

WorkStation-500 has a dual bus architecture and supports a virtual memory, real-time UNIX™ operating system, and provides a choice of many peripherals, graphic subsystems, Ethernet™, and mass storage devices.

We believe you can't find a better price/performance system. But before you commit to the purchase of any workstation, your decision should be an informed one.

That's why we're making available a free booklet, "A Guide to the Selection of High Performance Workstations." It tells you what you need to know about the important issues involved in selecting the right workstation. Reading it will help you choose the right productivity tool, and will greatly reduce the risk of buying a workstation that doesn't perform up to your expectations.

If you'd like a free booklet, or if you'd like to speak directly to one of our sales representatives, call 1-800-451-1824;

in Massachusetts, (617) 692-6200. Or write

Masscomp, One Technology Park, Westford, MA 01886.

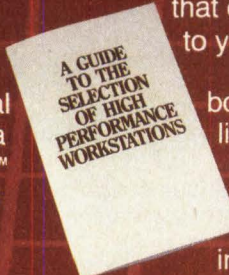

A GUIDE
TO THE
SELECTION
OF HIGH
PERFORMANCE
WORKSTATIONS

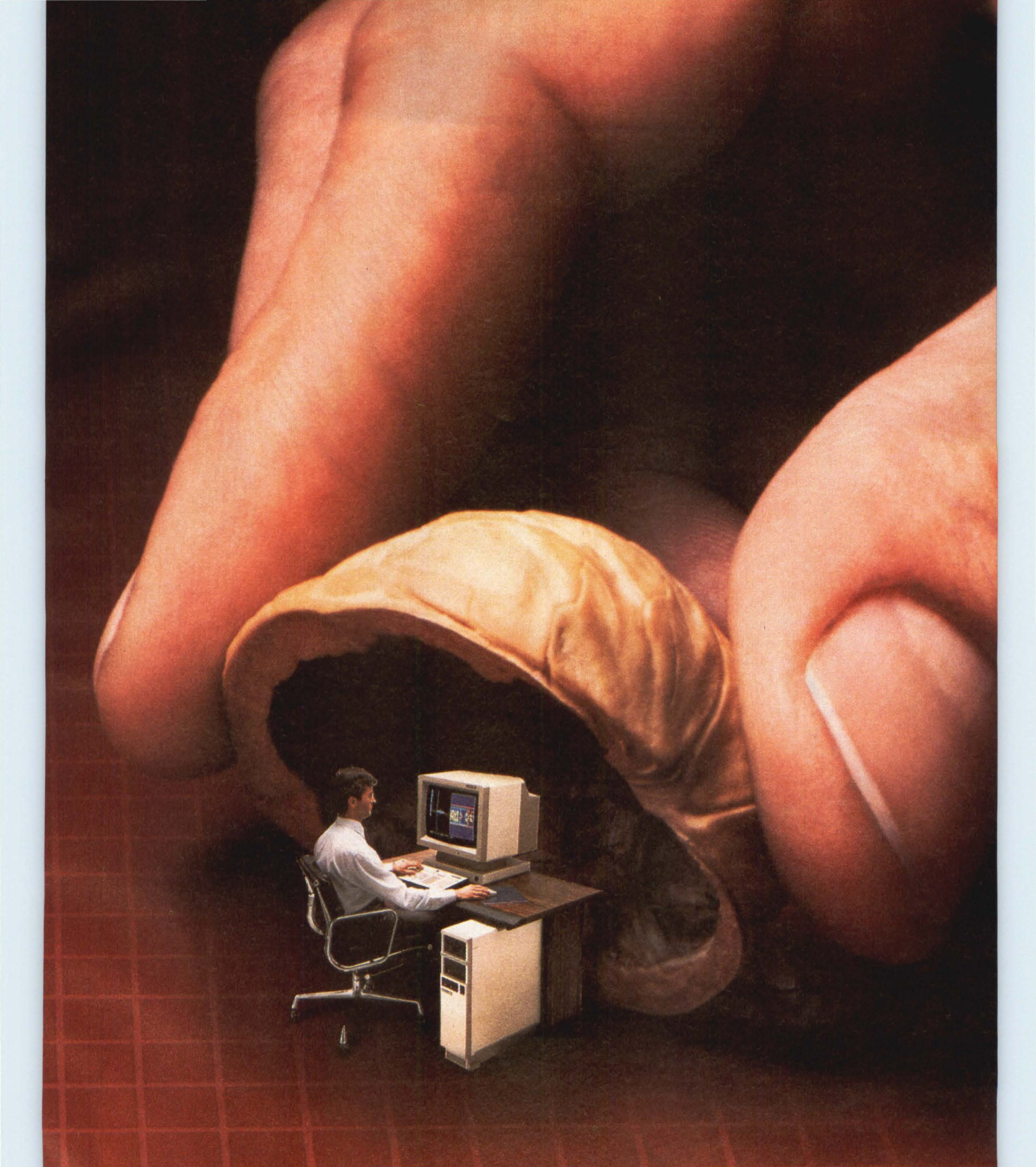

Performance Architecture and WorkStation-500 are trademarks of the Massachusetts Computer Corporation. UNIX is a trademark of AT&T Bell Laboratories. Ethernet is a trademark of the Xerox Corp.



MASSCOMP

CIRCLE NO. 80 ON INQUIRY CARD

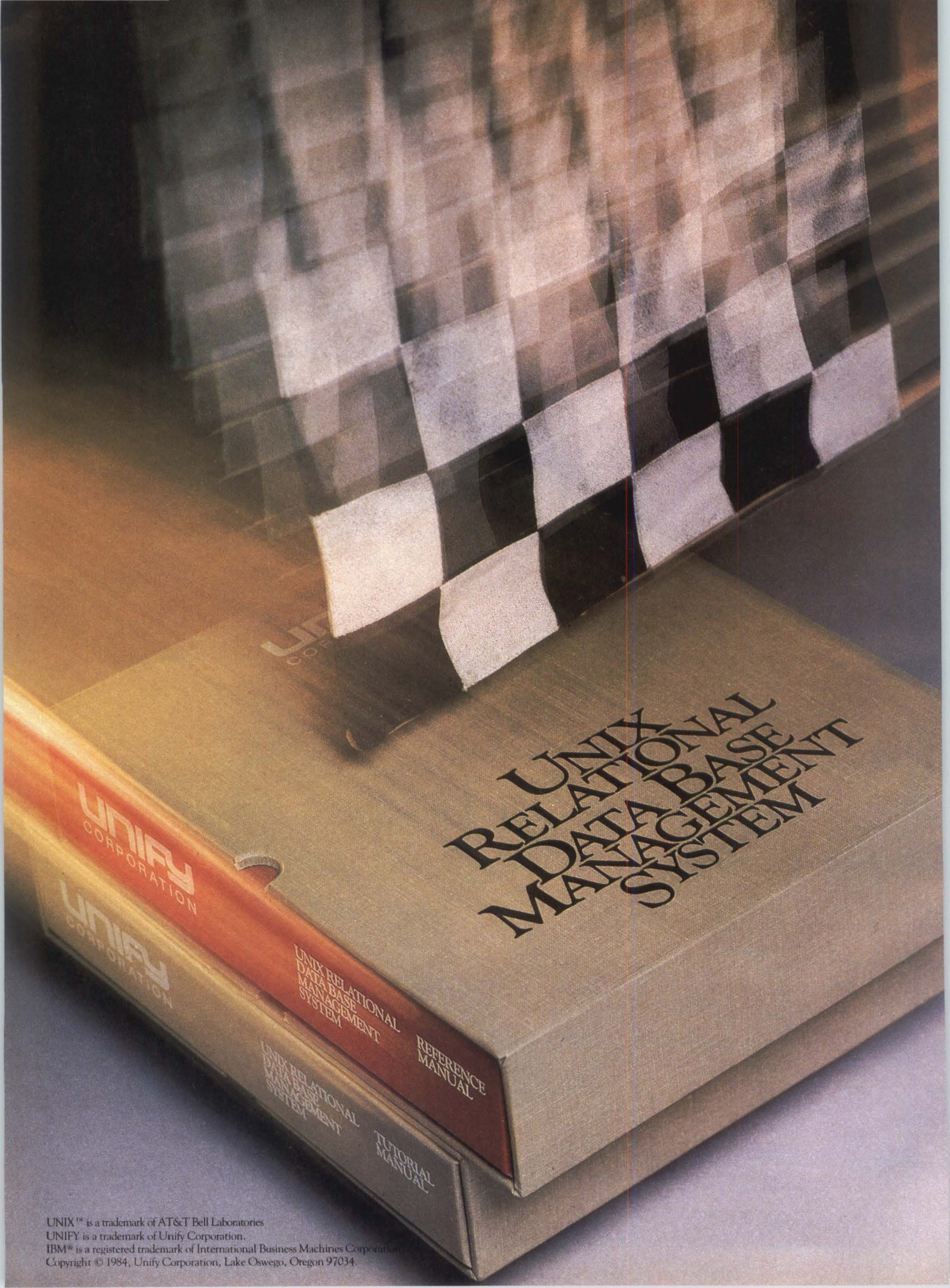

UNIX RELATIONAL DATA BASE MANAGEMENT SYSTEM

UNIFY
CORPORATION

UNIFY
CORPORATION

UNIX RELATIONAL
DATA BASE
MANAGEMENT
SYSTEM

REFERENCE
MANUAL

UNIX RELATIONAL
DATA BASE
MANAGEMENT
SYSTEM

TUTORIAL
MANUAL

UNIX™ is a trademark of AT&T Bell Laboratories
UNIFY is a trademark of Unify Corporation.
IBM® is a registered trademark of International Business Machines Corporation.
Copyright © 1984, Unify Corporation, Lake Oswego, Oregon 97034.



UNIFY FINISHES FIRST!

In one independent competition after another, UNIFY has proved itself the fastest UNIX data base management system. No wonder it's been selected by more computer manufacturers than all other UNIX data bases combined.

UNIFY speeds you through development and expedites program execution with some of the most powerful utilities of all, including:

Fully menu-driven design.

A powerful screen handling package that helps you format screens quickly, with no coding required.

Raw I/O, that lets you bypass the UNIX file system for up to 40% faster performance in large data bases.

Built-in optimizers that select the fastest of four data access methods.

Industry standard IBM SQL query language, plus our powerful report writer, for easy access by end-users.

Ninety subroutines for advanced program development... the most complete package of its kind.

UNIFY's integrated design links program modules like screens, query language and report writer to help you quickly create complete, friendly, easily expandable applications.

Horsepower for the long run. Unlike other data bases, UNIFY won't slow down under the weight of additional data or multiple users. It's built with the power to support new features later.

Judge for yourself. Send for our 300-page tutorial and 500-page reference manual—yours for only \$95—that show you how to build virtually any application. Contact UNIFY, Dept. MMS-11, 4000 Kruse Way Place, Bldg. Two, Suite #255, Lake Oswego, OR 97034, (503) 635-6265, TELEX 469220.

UNIFY[®]
THE PREFERRED DBMS.

CIRCLE NO. 81 ON INQUIRY CARD

Other terminals
will hide their screens in shame



See us at
DPMA, Booth 201
COMDEX, Booth 2113
DEXPO, Booth 4301

When you see TAB's new E-32 Display Terminal

The video qualities of this new Smart Ergonomic Terminal are the finest available. TAB's high resolution, non-glare, 15-inch green screen produces crisp, readable characters in both 80 and 132 column modes.

The E-32 has a display performance that makes your whole computer system look better. Plus it has built-in flexibility that allows TAB to quickly customize to OEM and System Integrator's specifications.

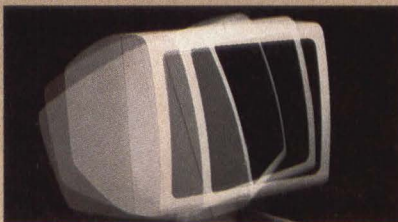

Ergonomics that make your customers comfortable. The E-32 screen tilts and swivels on its base for ideal viewing. A detached, lightweight keyboard features sculptured, stepped keys—and a low profile for hand, arm and back comfort.

Compatible with most computers in the industry. The E-32 is fully ANSI 3.64 compatible and communication compatible with DEC VT 52*, VT 100* and VT 132* terminals. Uniquely, it can memorize over 50 set-up parameters for each of three different computers, to be recalled at the touch of a key.

A terminal that adapts to your application. It was designed to be flexible for change. Keys can be added, moved or removed. In addition to a variety of character and line attributes, the E-32 has eight soft function keys that control more than 100 parameters of set-up and operation.

Room for expansion. Modular software design means the E-32 offers flexibility with a simple change of PROMs. The terminal housing can support an additional circuit board to add features such as internal modems.

Select the options your customers need. Options include amber or white CRT, memory expansion to 4 pages, serial and parallel print ports, internal modem and composite video.

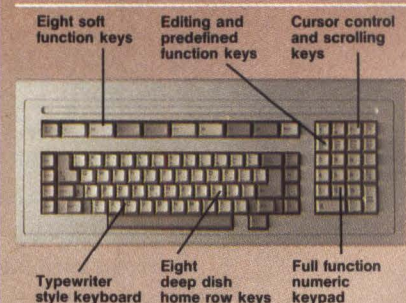

The E-32 is backed by 35 years experience in building and servicing quality products. See how it can enhance your systems capabilities by calling or writing 1400 Page Mill Road, Palo Alto, CA 94304. (415) 852-2400. (800) 672-3109 Outside California. In Canada, 550 McNicoll Avenue, Willowdale, Ontario M2H 2E1.

*Trademark of Digital Equipment Corporation.



TAB
PRODUCTS CO.

TECHNOLOGY
AND
BUSINESS

TERMINALS ■ COLOR-CODED FILING SYSTEMS ■ MOBILE SYSTEMS
FILING EQUIPMENT & SUPPLIES ■ FORMS PROCESSING EQUIPMENT
COMPUTER ACCESSORIES & SUPPORT FURNITURE ■ WORKCENTERS

CIRCLE NO. 82 ON INQUIRY CARD

Low-cost terminals: More power for less

Faced with increased competition and falling prices, terminal manufacturers are cutting costs, boosting capabilities, maintaining quality standards and looking ahead to automation and new market opportunities

Jesse Victor, Associate Editor

Competition is the name of the game in the low-cost terminal market and, to remain competitive, manufacturers are looking for ways to cut production costs, upgrade their products, maintain quality and protect profit margins. Low-end products are inching downward to a \$400 quantity-one price and commodity status. High-end alphanumeric terminals costing less than \$1,000 are, out of necessity, becoming indistinguishable from their microcomputer cousins.

A rapidly maturing market is slowing sales growth, pressuring profits and forcing terminal manufacturers to look ahead to new markets in office automation. Automated production lines are becoming a necessary and expensive requirement for boosting terminal-production efficiency. While this is a mixed message for the manufacturers, it is good news for OEMs and system integrators looking for increasingly powerful low-cost terminals at shrinking prices.

Will we see a \$300 or \$350 quantity-one price for an alphanumeric terminal in the next few years? Terminal vendors and industry analysts are divided on how far terminal prices will fall. "Manufacturers are continuing to drive prices down," observes George Chao, president of Liberty Electronics USA, San Francisco. "There is significant activity on the low end in terms of manufacturers trying to keep costs down and reduce the retail price. We are already at \$495 with our box [the Freedom 100]. As to whether it hits \$350 or not in the next few years, I think it eventually will."

Scott Kennedy, marketing specialist at RCA Microcomputer Products, Lancaster, Pa., foresees a \$350 to



Low in cost but not performance, the \$640 Fame III from Falco Data Products typifies the full-featured alphanumeric terminal with a quantity-one price less than \$1,000 available to system integrators and OEMs. ANSI X3.64-compatible, it furnishes a soft set-up screen, 12 function keys, three terminal modes, 80-column-by-24-line display and baud rates to 19.2K

\$400 price for terminals targeted at the general business market and even lower prices for other markets. "For home use, I can see terminals going down as low as \$100 for basic, dumb, interacting, conversational terminals," Kennedy says.

Will there be a floor on terminal prices?

Some manufacturers and industry analysts, however, expect distribution costs, marketing costs and squeezed profit margins to force a floor on terminal prices. "With practically everybody going offshore [to the Far East to manufacture their products], prices will fall," says Craig Lynar, director of marketing at TeleVideo Systems Inc., Sunnyvale, Calif., "but there will be a

What Lear Siegler Does Best We Also Do Special.



As standard products or OEM specials, Lear Siegler video display terminals convey the look and feel of quality your systems deserve.

With Lear Siegler terminals as your primary operator interface, your products will be more attractive, more reliable, easier to use, and more marketable than ever.

We will custom tailor Lear Siegler's superior performance, ergonomic design and exclusive High Touch™ style to meet your exact requirements—from simple logo changes to

completely unique terminal designs and proprietary firmware. Our dedicated OEM sales



Complete OEM design, engineering, assembly and testing are performed at Lear Siegler's Anaheim, CA. facility.
See us at Comdex Booth No. 2072/2076

and engineering groups are terminal experts who specialize in serving your needs. And they're backed by Lear Siegler's proven experience and reputation as an OEM supplier.

Call or write today for complete information on how Lear Siegler's OEM capabilities can work for you.



**LEAR SIEGLER, INC.
DATA PRODUCTS DIVISION**

901 E. Ball Road Anaheim, CA. 92803
(714) 778-3500

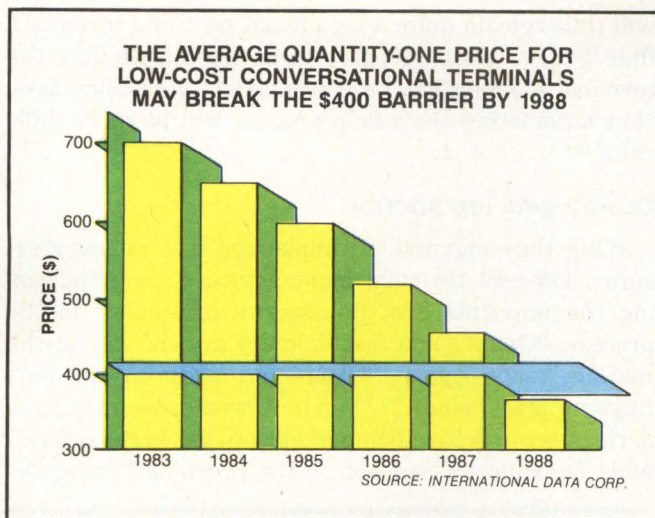

saturation point, if you want to call it that. Distributing and marketing the product in this country involves certain overhead costs, and they have to maintain a decent profit margin to support these functions."

Bob Sanekoff, vice president and director for display terminals at Dataquest Inc., San Jose, Calif., echoes this assessment: "The basic full-editing, block-mode terminal is getting pretty close to the lowest price possible. We might see \$499 or \$450 in the next 12 months [for this type of terminal]. That wouldn't shock me. But that is pushing the lower limit for a quantity-one list price. The main price erosion is in the 'sacred environments' of the IBM 3270- and Digital Equipment Corp. (DEC)-compatible markets." Along with price erosion, Sanekoff foresees continued migration of features down from higher end units. "The full-featured terminal that was once at the middle of the [low-cost] terminal market is now going to the low end."

John Kim, president of Kimtron Corp., Santa Clara, Calif., sees "the possibility of further price erosion based on current levels of quality for the keyboard and the CRT down to just under \$500 in the next 12 months." But Kim also expects a cost threshold, primarily involving these components, as making further price reductions difficult.

Falling terminal prices, though, are a mixed blessing. They could pose a threat to manufacturers in regard to maintaining quality standards and ensuring adequate profits in a maturing market, says Dr. John Hoper, vice president of the peripherals group at Future Computing, Dallas, Texas. "Terminal price points now are very appropriate for the market, if you want to avoid terminals significantly lower in quality," says Hoper. "Companies are trying to differentiate their products by features and functionality while trying to maintain a price point. If you drop from \$500 to \$350, you have to increase your market significantly to justify that. But

there is no great increase in market demand."

Indeed, the low-cost terminal market is rapidly maturing, and market growth is levelling off. Most market research firms classify the terminals market by product function rather than price and thus do not break out separate forecasts for low-cost terminals. International Data Corp. (IDC), Framingham, Mass., sees the installed base of conversational terminals, which occupy the low to middle segments of the low-cost terminal market, as growing at a compound annual rate of 17 percent through 1988. "We see stable, responsible, not dramatic growth," says Mary Lynn, project director for terminal studies and senior research analyst at IDC.

Maturing market puts squeeze on profits

The maturing market is forcing manufacturers to adopt one of two marketing strategies. They can drop their prices significantly in an effort to increase market share, accepting lower profit margins per unit, but maintaining overall profit levels by a corresponding boost in sales—a risky strategy in today's market. Or they can attempt to maintain profit margins and profit levels by emphasizing features and terminal capabilities, without banking on a strong rise in shipments. "You can continue disastrously to decrease your price," Future Computing's Hoper observes, "or you can be satisfied with the profit margins you have and go ahead

CONVERSATIONAL TERMINAL SHIPMENTS WILL GROW SLOWLY THROUGH THE END OF THE DECADE

(Units 000s)

	1984	1985	1986	1987	1988
Terminals shipped	461.1	507.2	536.0	627.7	693.6
Installed base	2,718.5	3,198.5	3,729.5	4,319.9	4,970.3

Source: International Data Corp.

to get money out of the business by doing features and maintaining price points."

Most low-cost terminal manufacturers have opted to follow the latter course, aggressively seeking manufacturing efficiencies that will enable them to remain competitive in a highly competitive market and pass on the cost savings to their customers without jeopardizing profit margins.

Surveying five terminal component areas—micro-processor development, keyboard, CRT monitor, power supply and case fabrication—Dataquest's Sanekoff sees few possibilities for major cost reduction. "There are possibilities for increased [manufacturing] efficiencies in keyboards," he notes, "but I don't see much reduction in monitor costs. Case manufacturing admits some increased efficiency, but power-supply

costs will probably remain stable." Sanekoff, recently returned from the Far East, added, "The people I talk to in Taiwan, Hong Kong and Japan tell me it's getting close to the bottom [in cost savings.] They just can't squeeze much more out."

"Fundamentally, cost savings are really derived from technological innovation," asserts Liberty Electronics' Chao. "They will be achieved from higher levels of integration in chips for memory and CRT functionality." Chao expects additional savings in component costs as suppliers' prices decline because of economies of scale from rising production volumes. RCA Micro-computer Products also focuses on terminal electronics for cost efficiencies. "You will see cost efficiencies coming in VLSI, in surface-mount technology and similar areas," says RCA's Kennedy. "You are getting more intelligent chips and components. Terminals are implementing more features in software and becoming less hardware intensive, lowering the component count."

Kimtron's Kim expects continuing cost reductions in terminal electronics, "and to some extent, in the keyboard," although "the CRT and power supply are still resistant [to cost reductions]." Additional cost savings will depend, says Kim, on component suppliers coming up with a one-chip logic module. But further progress will require reducing the labor involved in terminal manufacturing.

This assessment is echoed by TeleVideo's Lynar, who although he expects some cost savings in case manufacturing, notes that the most labor-intensive parts of a low-cost terminal are components that collectively constitute a good part of its final cost: the monitor, power supply and keyboard assembly. Labor, Lynar stresses,

will thus remain quite a significant part of a terminal's final cost. "Labor-intensive tasks like assembling the terminal modules can be mechanized," he emphasizes, "but automating the whole process will be more difficult."

Quality gets top priority

While they aggressively implement cost-cutting measures, low-cost terminal manufacturers are emphasizing the importance of not sacrificing quality in the process. "Quality and fast delivery are the key to the market," says Lynar. "OEMs and other buyers don't buy on price alone." "Vendors would be making a serious error in sacrificing quality to get lower prices," adds Dataquest's Sanekoff. "The [terminal] buyer de-

'Quality and fast delivery are the key to the market.'

mands and has every right to demand top quality. Terminals must continue to operate, like telephones, and be indestructible."

Is the trend toward overseas manufacturing compatible with high quality levels? Some market observers are doubtful. "The lowest priced terminals are now coming directly from offshore. The quality of these terminals is not something most OEMs would be willing to accept," contends Don Naples, vice president sales and marketing, at Falco Data Products Inc., Sunnyvale, Calif. "When you are dealing with offshore manufacturers, you have to make sure that they are shipping a high-quality product," asserts Lynar. "They can meet

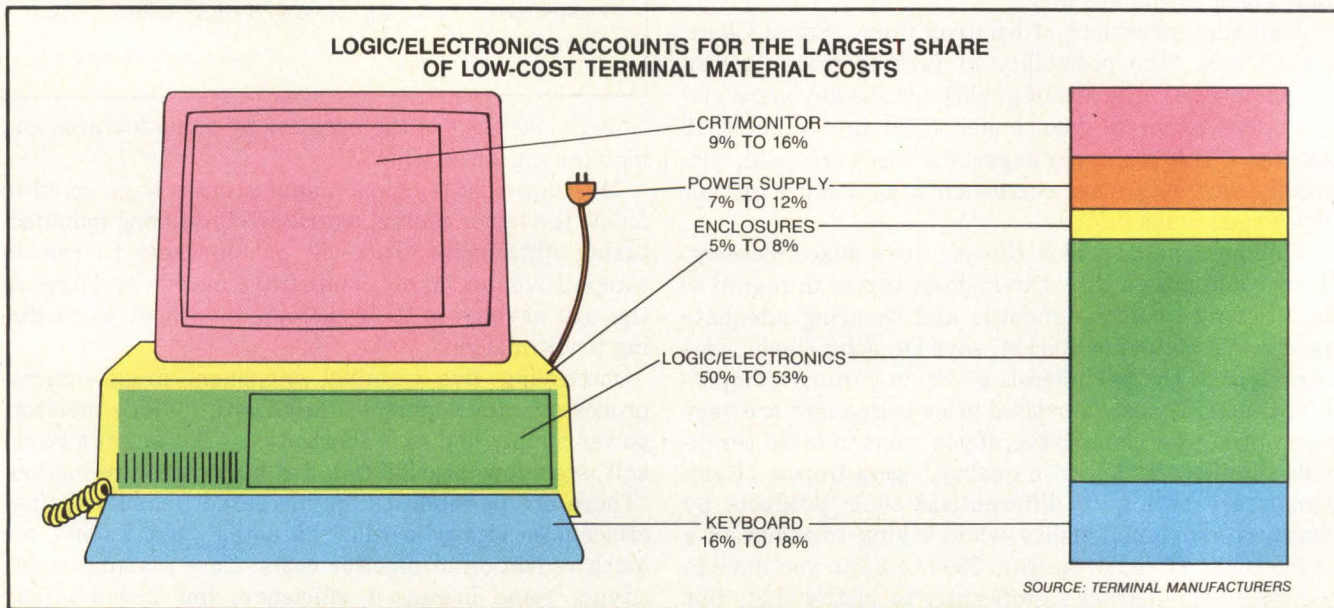

NEW FROM MICRO-TERM

ERGO[®] 301 FK *with* FUNCTION KEYS



Guaranteed VT 100-
Compatible **PLUS**

\$795

ERGO[®] 301 is still available
for just \$745 list.

Now, Micro-Term offers the unique ERGO 301 FK (function keys) terminal with total DEC VT 100 compatibility **PLUS** 20 function keys that are user-programmable, down-loadable and savable in non-volatile memory. The 20 function keys are switch-selectable to let you choose DEC VT 220 or Televideo 970 defaults. The ERGO 301 FK includes all of these standard features for just \$795 list.

STANDARD FEATURES:

- Advanced Video Standard
- Bidirectional Printer Port
- Two Pages of Memory
- Plain English Set-Ups
- 20 Function Keys (host-definable or user-programmable)
- Green Screen with Screen Saver
- Superior 132-Column Clarity
- Full one-year warranty.

OPTIONS:

- Plot-10 and ReGIS Graphics Board
- Amber Screen
- Current Loop

When you need TOTAL VT 100
COMPATIBILITY, choose a terminal
from MICRO-TERM.

Terminals are our only product, and we put more into them.
Call or Write: MICRO-TERM, INC., 512 Rudder Road, Fenton (St. Louis County), Missouri 63026
(314) 343-6515, TWX: 9107601662, MICROTERM, STL.
On-site service available at over 450 locations through Western Union

VT 52, Espirit II, ADDS Viewpoint, Televideo 925 and ADM 3A are Registered Trademarks.

delivery schedules, but have to be brought up to speed on quality standards set by people in the United States."

Most terminal vendors, however, acknowledge that overseas manufacturing is necessary to remain competitive in today's market. Making a virtue of necessity, they supervise closely the foreign part of their manufacturing process. Falco, for example, "keeps tight control over offshore operations to assure quality," says vice president Naples. "We have our own resident quality assurance people at the plant." Falco's custom

Falling prices...are a mixed blessing.

terminal facility, though, is in the United States, Naples adds.

Although TeleVideo has an overseas manufacturing facility, Lynar says, it does all terminal logic-board design, case design and final assembly in the United States, enabling the company to "maintain very good control over what is coming from offshore and what is going out to the customer."

Low quality sinks offshore terminal

Some market analysts—and manufacturers—are not so sanguine about overseas manufacturers' ability to meet the quality standards the market requires. One OEM considered buying terminals from an offshore vendor, says IDC's Lynn, but "they were too poorly made for them to add value. It was not worth doing." And a former low-cost terminal manufacturer's withdrawal from the market was due in large part to quality problems from a Far East manufacturer, asserts a high-level source at the company.

"It was a very good terminal with some unique features and very popular with OEMs" he says, "but its design and production was a step down from what we wanted. We had trouble with the terminal for months. When it came in from overseas, we had to open it up and practically rebuild the thing to add reliability to it—it was a little too Far East."

Offshore manufacturing, however, will only be a stop-gap measure for companies seeking to reduce production costs, maintains Dataquest's Sanekoff: "I can't imagine any manufacturer not automating or increasing its automation. It's necessary [in order] to remain competitive and improve production quality without significantly increasing manpower." Supporting this view, one manufacturer, Kimtron Electronics will continue to make terminals overseas to reduce labor costs, during the transition to automation. But, "Down the road," says Kim, "everything will be automated."

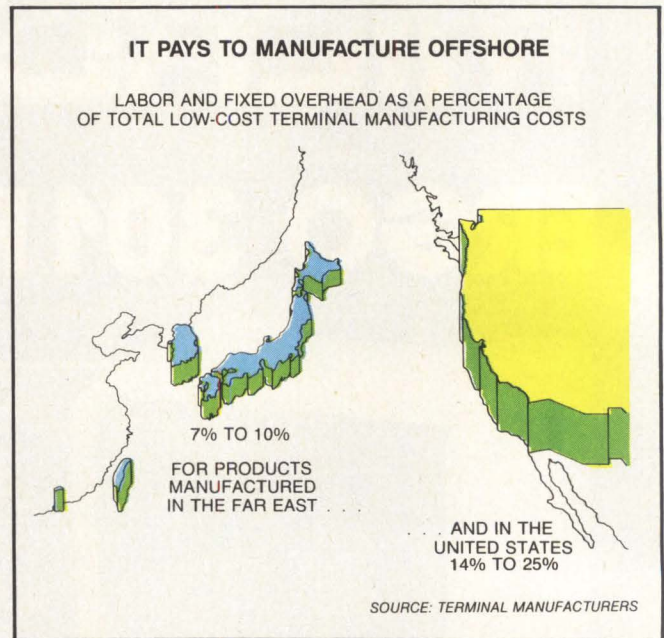

Kim, however, sees potential problems ahead for smaller terminal manufacturers. "Aside from the intensive investment required," he says, "automation requires large production volumes to justify it—approximately half a million units shipped a year."

One solution to insufficient production volume lies in integrating terminal production with other electronics products, a course followed by RCA in its year-and-a-half-old automated facility in Lancaster, Pa. And some overseas manufacturers are planning to follow suit, combining, for example, their TV and terminal production lines. Extremely fast board stuffing is one benefit of this technique, says Sanekoff. "The speed at which these devices work is unbelievable. A machine picks up as many as 30 different components and just flies in inserting them into the board."

However, when it comes to terminal production, Sanekoff says, "a tremendous amount of human intervention is still required, even though part of the line may be automated." Terminal production volumes are lower than those of TVs, and some terminal companies are not yet experienced with completely automated production. But in spite of these obstacles, offshore manufacturers are now ready to automate, Sanekoff stresses.

One terminal manufacturer, Zentec Corp., Santa Clara, Calif., is already deriving double benefits from automation, says Robert Angus, vice president for marketing and sales. In addition to terminal manufacturing, the company is using an automated system to conduct extensive burn-in and other tests of its terminal products, including computer-controlled testing of keyboards.

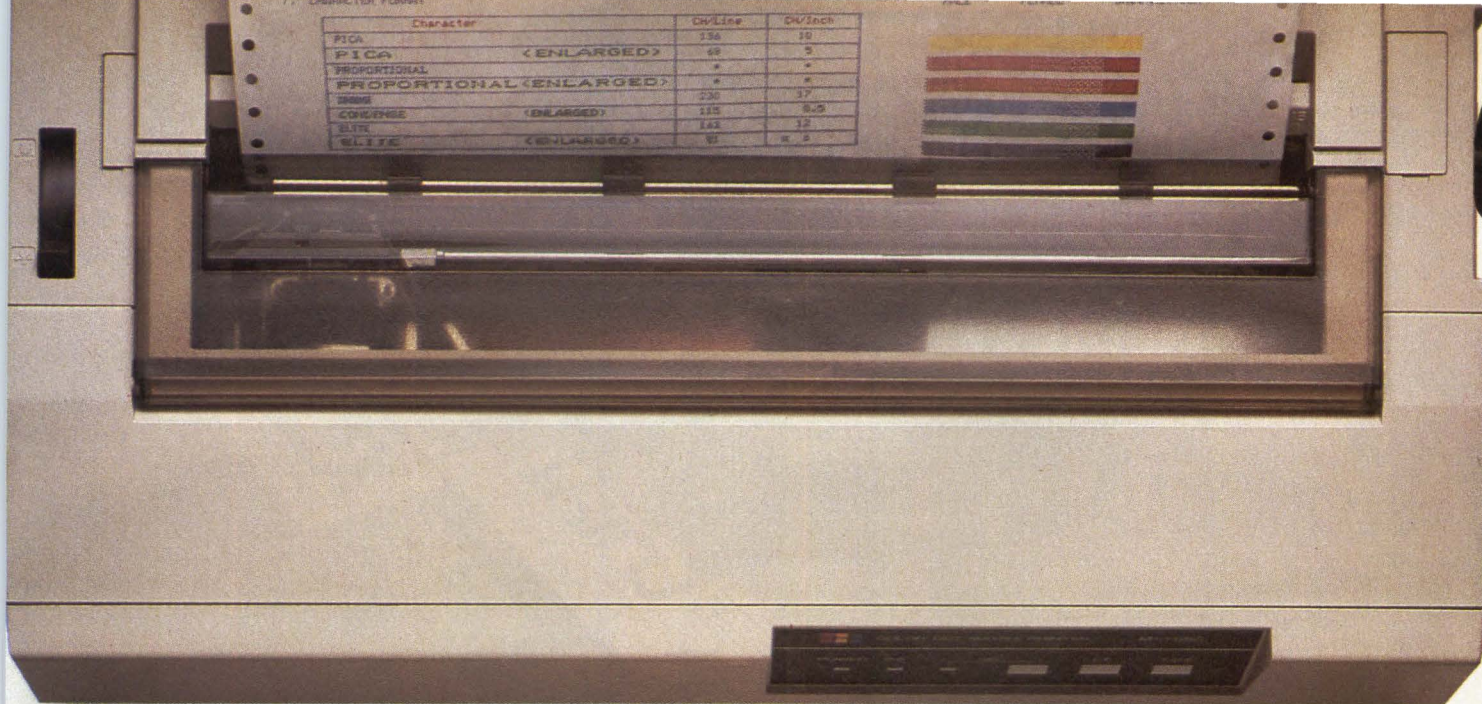

If you've only seen our fine print, you're missing some great lines.

When people try C.Itoh Electronics' high performance daisywheel or dot matrix printers, they're quite impressed. So impressed, in fact, that our line of printers just may be the most widely used in home and business—nationwide.

But our commitment to the electronics industry doesn't end there. You see, we also offer OEM's and end-users a wide variety of state-of-the-art electronic products. All with the same reliability and performance that has everyone talking about our printers.

For starters, there's our line of clearly superior Liquid Crystal Displays. Thin, lightweight and compact, they come in an almost endless array of modules to satisfy virtually any application.

Then there's our selection of Mini-floppy and Microfloppy Disk Drives. They offer exceptional reliability and easy-to-integrate high density storage.

We sell a full range of CRT monitors, too. And each delivers unprecedented levels of character clarity.

Finally, there's our CIE 2400/3600 plotters. Available in 24- and 36-inch models, they provide the fastest 400 DPI performance on the market today.

Of course, it takes more than a great product to make a sale. There's also that little intangible called

working with the customer. And work with you we will. To develop products that meet your specifications.

In addition to developing and marketing our own unique lines, we buy products from many U.S. and international manufacturers and sell them to the worldwide

market. So you can benefit from a world of experience and the latest developments.

We also recognize the importance of outstanding support to all of our customers—OEM's, Systems Integrators, Distributors, or End-Users. And don't forget the solid backing of C.Itoh, our \$60 billion parent company with 125 years of experience and offices worldwide.

So call or write C.Itoh Electronics for more information on our lines of high performance printers, LCDs, disk drives, CRTs, or plotters. And find out what you've been missing. C.Itoh Electronics, Inc., Headquarters, 5301 Beethoven St., Los Angeles, CA 90066, Tel (213) 306-6700, Telex 65-2451, TWX 910-343-7446, FAX (213) 390-1188.

C.Itoh Electronics, Inc.



Zilog now gives users of the System 8000 the kind of choice the big three cereal companies have given breakfast eaters for years.

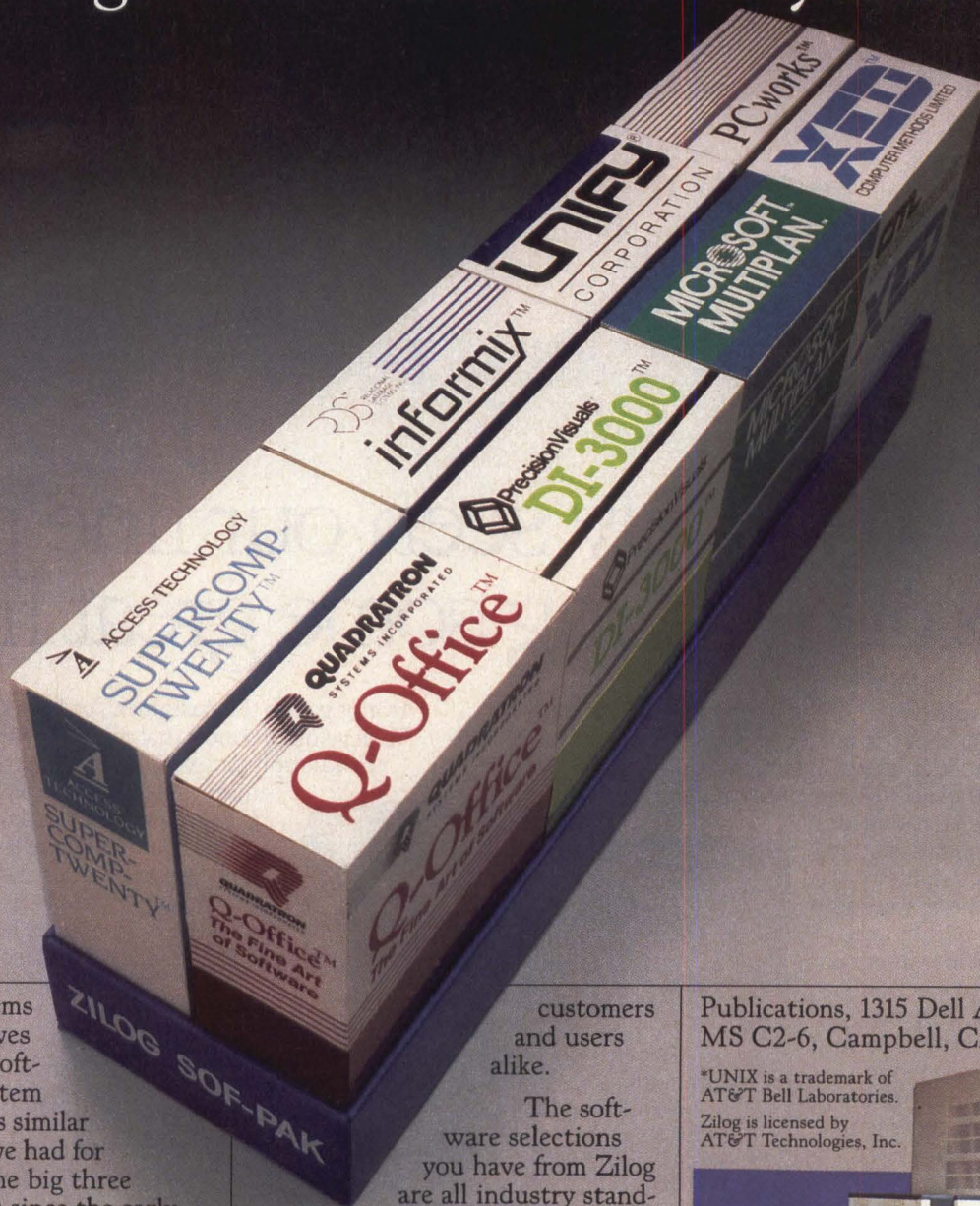

Zilog Systems Division now gives you a choice in software for the System 8000 supermicros similar to the kind you've had for breakfast from the big three cereal companies since the early 1960's. You get to select the software you need when you need it. It's an easy and practical way to satisfy individual tastes.

We give you a choice of the best software you can buy. All from a single source.

We give you a choice of the best software applications packages you can buy. All from a single source. It's efficient, convenient and it saves you money. While satisfying the individual needs of

customers and users alike.

The software selections you have from Zilog are all industry standard packages. Your customers will recognize them instantly. What's more, Zilog provides complete software support. So you don't waste energy seeking vendors for help if and when you need it.

Get a taste of what it's like to run the most satisfying menu of software on the best high-performance UNIX* multi-user supermicros ever built—the System 8000. Call Zilog Systems Division at (800) 841-2255. Or write: Zilog Systems Division, Corporate

Publications, 1315 Dell Avenue, MS C2-6, Campbell, CA 95008.

*UNIX is a trademark of AT&T Bell Laboratories. Zilog is licensed by AT&T Technologies, Inc.



Systems Division
Zilog

an affiliate of EXON Corporation

See us at Comdex, Booth #4118

CIRCLE NO. 86 ON INQUIRY CARD

ALPHANUMERIC TERMINALS

TRACKING PRICE/PERFORMANCE OF REPRESENTATIVE
LOW-END AND MID-RANGE TERMINALS

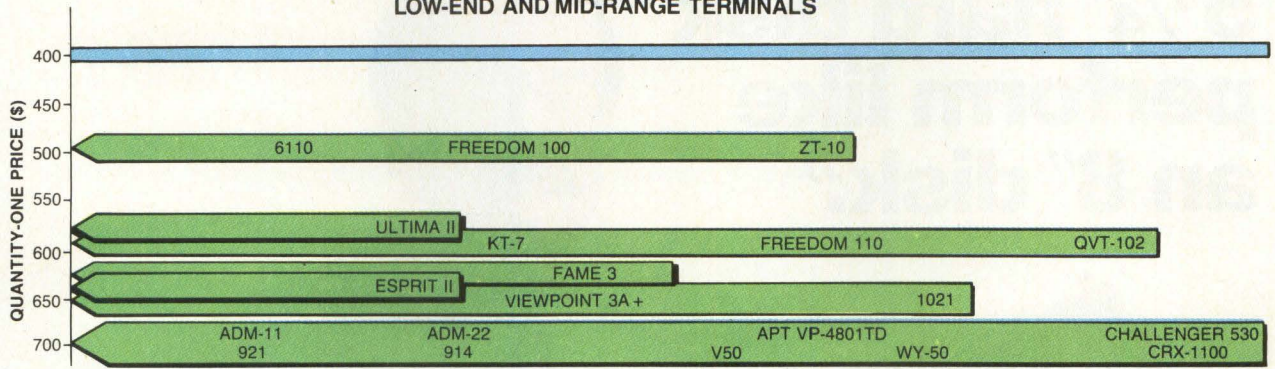

ALPHANUMERIC TERMINALS

Company Model	Display					Interfaces (protocols)					Function keys	Programmable function keys	Graphics	International character sets	ANSI X3.64	Soft set-up	Pages of memory	Non-volatile function(s)	Diagnostics	Integral modem
	12-inch	14-inch	Green	Amber	Screen format (col. X lines)	RS232C	Current loop	RS422	Printer port	(X-on/X-off)										
APPLIED DIGITAL DATA																				
Viewpoint/3A +	•		•	•	80X25	•	•													
ESPRIT SYSTEMS INC.																				
ESP 6110		•		•	80X24	•		•	•										•	
ESPRIT II	•		•		80X24	•	•										1		•	
FALCO DATA PRODUCTS INC.																				
Fame 3	•			•	80X25	•			•		12					•				
IMS INTERNATIONAL																				
Ultima II	•		•	•	80X25	•		•	•	•	72	•	•				2		•	
KIMTRON CORP.																				
KT-7	•		•	•	80X25	•					20	•	•	•					•	•
LEAR SIEGLER INC.																				
ADM-11	•	•	•	•	80X25	•	•	•	•	•	8	•	•						•	
ADM-22	•		•		80X25	•	•		•	•	7	•	•						•	
LIBERTY ELECTRONICS USA																				
Freedom 100	•				80X25	•	•		•	•	10	•	•							
Freedom 110	•		•	•	80X25	•	•		•	•	10	•	•		•				•	
QUME CORP.																				
QVT 102	•		•	•	80X24	•	•						•							
RCA MICROCOMPUTER PRODUCTS																				
APT VP-4801TD	•		•		80X24	•		•	•	•	4	•							•	•
SANYO BUSINESS SYSTEMS CORP.																				
CRX-1100	•		•		80X24	•	•		•	•	8	•					1		•	
SOROC TECHNOLOGY INC.																				
Challenger 530	•		•		80X24	•			•				•							•
TELEVIDEO SYSTEMS INC.																				
914	•	•	•	•	80X25	•	•	•	•	•	3	•					1	•	•	
921	•		•		80X25	•	•	•	•	•	16	•	•				1	•	•	
VISUAL TECHNOLOGY INC.																				
V50	•	•	•		80X25	•	•		•	•	3	•	•						•	
WYSE TECHNOLOGY																				
WY-50	•	•	•		132X26	•		•	•		16	•							•	
ZENITH DATA SYSTEMS																				
ZT-10	•		•		80X25	•			•				•						•	
ZENTEC CORP.																				
1021	•		•		80X25	•	•		•				•	•			1	•	•	

“With the Interphase Storager,TM I can make a 5 1/4” hard disk perform like an 8” disk.”

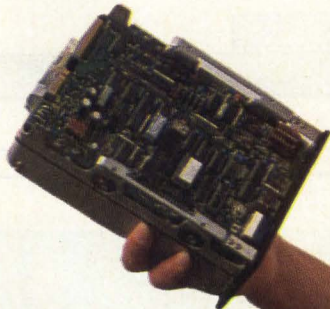

Frank Emser
Manager Hardware Development
Paradyne Corporation

The Interphase Storager MultibusTM controller can give a 5 1/4” Winchester disk capabilities never before possible. Storager not only gets more performance from existing ST506 drives, but also supports the new ESDI and ST412HP interfaces for more power and capacity than ever before. And since Storager can control two Winchester disks, four 1/4” tapes (QIC-02), and two 3 1/2”, 5 1/4” or 8” floppies, the same controller can be used for every storage need.

Storager features 1:1 interleave, with concurrent disk and tape transfers and simultaneous disk and bus transfers for speed and high performance. And Storager’s unique “virtual buffer” architecture with UNIXTM-optimized

intelligent caching can reduce or eliminate disk rotational latency and overcome data overrun/underrun problems of FIFO-based controllers. Plus,

line of high-performance

Multibus controllers. Interphase also offers Multibus controllers for SMD disks, local area networks and video monitors. Plus powerful disk controllers for the IBM[®] PC. They’re all backed by a great customer support team that works full time with Interphase customers to assure that our products work the way they should — in the system.

Find out how Storager can make a 5 1/4” disk perform like an 8” disk. Call Interphase today at

(214) 350-9000.

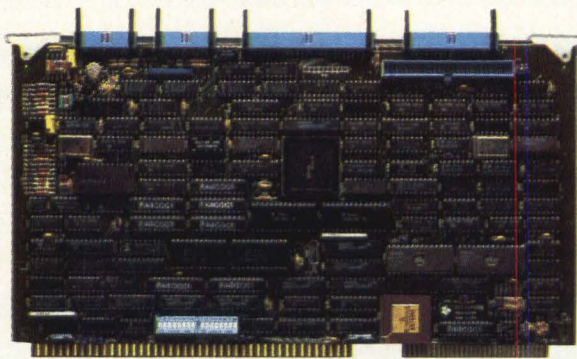

for the very first time on a controller, Storager has an *on-board* 68000 CPU.

The Storager controller is the latest product in Interphase’s

Storager is a trademark of Interphase Corporation
Multibus is a trademark of Intel Corporation
UNIX is a trademark of Bell Laboratories
IBM is a registered trademark of International Business Machines



2925 Merrell Rd. • Dallas, TX 75229

The capabilities of tomorrow's low-cost terminals will be, to a considerable extent, shaped by trends already discernible in today's market—ANSI X3.64 compatibility, continued migration of features downward from top-end units, the emergence of a "standard" low-cost terminal and a major thrust into office automation.

The market is forcing standardized code structure—what the terminal responds to or transmits, says Lynar. "For large systems especially, the ANSI X3.64 standard allows many peripherals to be installed with a minimum amount of software. The trend is reinforced by the influx of UNIX systems that use the ANSI standard. PBX manufacturers are also using it."

ANSI compatibility now appears only on the high end of TeleVideo's low-cost terminal line. The \$995 Model 922 is code compatible with the DEC VT220, VT100 and VT52. It offers a tilt and swivel, 12-inch green screen with 24-line-by-80-column or 12-column display; 15 programmable function keys; 10-key keypad; conversational, block, local monitor and self-test communications modes; and optional graphics upgrade board for Tektronix Corp. PLOT 10 software.

Other manufacturers offering low-cost ANSI-compatible terminals include Falco and Kimtron. Falco's \$640 Fame III provides a 12-inch, 80-column-by-24-line display, 12 function keys, three terminal modes, soft set-up screen and baud rates to 19.2K. With a 14-inch CRT, the \$795 Fame II furnishes an 80- or 132-column display, 50 nonvolatile programmable function keys with 900-character storage, block and monitor modes and business graphics. Available with optional ANSI compatibility, Kimtron's \$595 KT-7 features ergonomic design; nonvolatile hidden or embedded video attributes, 20 programmable function keys, menu set-up and answerback; line and block graphics and 20 special and mathematical symbols.

Low-cost terminals, particularly in the low- and middle-market segments, are increasingly exhibiting similar features and capabilities. Most have 12- or sometimes 14-inch CRTs, 80-column-by-24-line screen format (with 25th status line); RS232, current loop and X-on/X-off interface protocols; and function keys. Many have limited graphics and international character sets.

Tomorrow's terminals will accelerate this trend, con-

Manufacturers listing

APPLIED DIGITAL DATA SYSTEMS INC.
100 Marcus Blvd.
Hauppauge, N.Y. 11787
(516) 231-5400
Circle 785

ESPRIT SYSTEMS INC.
100 Marcus Drive
Melville, N.Y. 11747
(516) 293-5600
Circle 786

FALCO DATA PRODUCTS INC.
1286 Lawrence Station Road
Sunnyvale, Calif. 94089
(408) 745-7123
Circle 787

IMS INTERNATIONAL
2800 Lockheed Way
Carson City, Nev. 89701
(702) 883-7611
Circle 788

KIMTRON CORP.
2255 I Martin Ave.
Santa Clara, Calif. 95050
(408) 727-1510
Circle 789

LEAR SIEGLER INC. DATA PRODUCTS DIV.
901 E. Ball Road

Anaheim, Calif. 92805
(714) 774-1010
Circle 790

LIBERTY ELECTRONICS USA
625 Third St.
San Francisco, Calif. 94107
(415) 543-7000
Circle 791

QUME CORP.
2350 Qume Drive
San Jose, Calif. 95131
(408) 942-4000
Circle 792

RCA MICROCOMPUTER PRODUCTS
New Holland Ave.
Lancaster, Pa. 17604
(717) 397-7661
Circle 793

SANYO BUSINESS SYSTEMS CORP.
51 Joseph St.
Moonachie, N.J. 07074
(201) 440-9300
Circle 794

SOROC TECHNOLOGY INC.
165 Freedom Ave.

Anaheim, Calif. 92801
(714) 992-2860
Circle 795

TELEVIDEO SYSTEMS INC.
1170 Morse Ave., P.O. Box 3568
Sunnyvale, Calif. 94086
(800) 538-8725
Circle 796

VISUAL TECHNOLOGY INC.
540 Main St.
Tewksbury, Mass.
(617) 851-5000
Circle 797

WYSE TECHNOLOGY
3040 N. First St.
San Jose, Calif. 95134
(408) 946-3075
Circle 798

ZENITH DATA SYSTEMS
1000 Milwaukee Ave.
Glenview, Ill. 60025
(312) 391-8860
Circle 799

ZENTEC CORP.
2400 Walsh Ave.
Santa Clara, Calif. 95050
(408) 727-7662
Circle 800

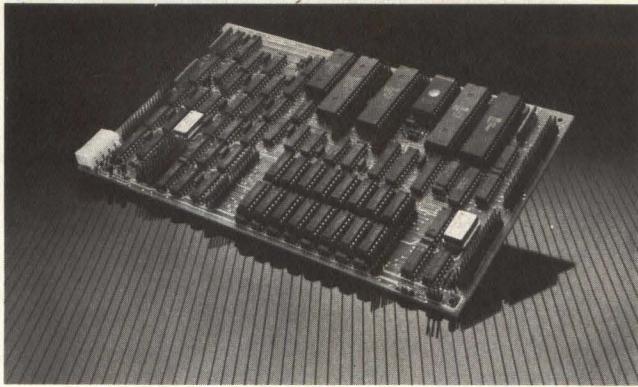

POWER THAT GOES ANYWHERE!

Single Board Computer

- FAST** — 6MHz Z80B* CPU
- POWERFUL** — 64K to 256K RAM, 2K to 64K ROM
— 5¼" and 8" Floppy Controller, SASI
— 2 RS-232, Centronics Port
- FLEXIBLE** — 50-pin I/O Expansion Bus.
- SMALL** — 5¾" x 10"

Davidge

DAVIDGE CORPORATION
292 East Highway 246
P.O. Box 1869
Buellton, CA 93427

(805) 688-9598

*Z80 is a registered trademark of Zilog

CIRCLE NO. 88 ON INQUIRY CARD

Add IBM Format-Compatible Magnetic Tape To Any RS-232 Port With The IBEX STC-100

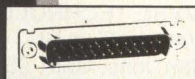

Plug-In ½" mag.
tape drives to any
mini or micro computer
Full read/write capability
Data logging
Call-detail recording

Write, phone or TWX
for information

IBEX

IBEX COMPUTER CORP.

20741 Marilla Street,
Chatsworth, CA 91311
(818) 709-8100
TWX 910-493-2071

ALPHANUMERIC TERMINALS

verging toward a "standard" terminal type with more or less standard features, asserts Lynar. The classification of terminals into dumb, smart or intelligent units is becoming blurred, as features migrate down from high-end products. "Features don't cost you anything anymore," he notes, "it's simply a matter of firmware. Terminal functions will [eventually] all be about the same. They may now have the same type of cursor addressing or different numbers of function keys. But that is all going to be coming together."

As low-cost terminals become more intelligent, says RCA's Kennedy, "they will come into direct competition with both personal computers and the telephone. They are all moving toward that corner of the desktop."

In the quest for new low-cost terminal markets, office automation (OA) will indeed loom large. "What we see now is a new emerging market: 'capturing the desk,'" asserts Dataquest's Sanekoff. "The new automated office environment is where you are going to see all the expansion of the display-terminal market. That is the market where you will see increasing growth and volume."

Sanekoff expects terminals to find use by a wide range of automated-office personnel—from secretaries to executives—and to hold their own against microcomputers. "Most executives need only simple data input and retrieval," he says. "They do not need word or data processing. They want to find out market status, inventory status, credit-line information and similar data. They want simple answers."

Low-cost terminals will merge into tomorrow's integrated office automation environment, including local area networks, tied to multiuser microcomputers, mini-computers or mainframes, says Sanekoff. "The key is the integration of information devices. Terminals fit into the business network and have their role in satisfying the information needs of many people in the office."

Other market observers look beyond the automated office for the development of new low-cost terminal markets. "[Tomorrow's] terminal market will depend on the computing power available to the average user," says Kim. "New applications such as videotex and electronic shopping will create new markets. The growth of multiuser computer systems will also be a big factor in creating demand. There will be a tremendous explosion of computing power."

Kim draws an analogy to the telephone in charting the future course of low-cost terminals. "When the telephone cost \$1,000, there were only a limited number of users. But when the cost of owning a phone dropped down to \$5, everyone could have one." □

Interest Quotient (Circle One)
High 843 Medium 844 Low 845

OEMs have the right questions

SMS has the right
answers

Introducing the SMS 1000 Model 40 DEC-Compatible Microcomputer System

SMS is listening: You want microcomputer systems that can meet your current needs and can be expanded to handle future requirements. Our new SMS 1000 Model 40 is designed to do just that!

Integrated Architecture

We knew what the end product had to do before we started, so we designed it based upon an integrated foundation module that optimizes performance and flexibility while minimizing complexity. The foundation module includes the Winchester, floppy and tape interfaces; serial communication ports; and the Q-bus interface. And we put it all on one board that doesn't require any backplane space!

Flexible Configurations

This system provides you with the widest choice of peripherals available in any microcomputer on the market. The options include 8 or 5¼ inch floppy drives, up to 140Mb of 5¼ inch Winchester and a streaming tape drive. All this in one 5¼ inch rack mount or floor stand enclosure.

Optimized Performance

The Model 40 allows non-interleaved disk transfers using an enhanced version of DEC's* MSCP storage architecture.

It is offered with fast access Winchesters and either LSI-11/23 or LSI-11/73 processors. So you can optimize your application's performance whether it runs on RT-11, RSX-11M*, RSX-11M-PLUS, RSTS/E*, or TSX-PLUS*.

High Reliability

Dependability is essential to your business. The SMS 1000 Model 40 is designed to provide your users the uptime both you and they dream about. And if things go wrong, the Support Monitor Subsystem is there to help you or your end users get back on the line quickly.

Family of Products

The SMS Model 40 is really a family of products, available in over 150 different configurations—today—with more to come in the near future.

If these are the answers to the questions you are asking, please contact us immediately for more information.

SMS Scientific Micro Systems, Inc.

339 N. Bernardo Avenue
Mountain View, CA 94043
(415) 964-5700 TWX: 910-379-6577

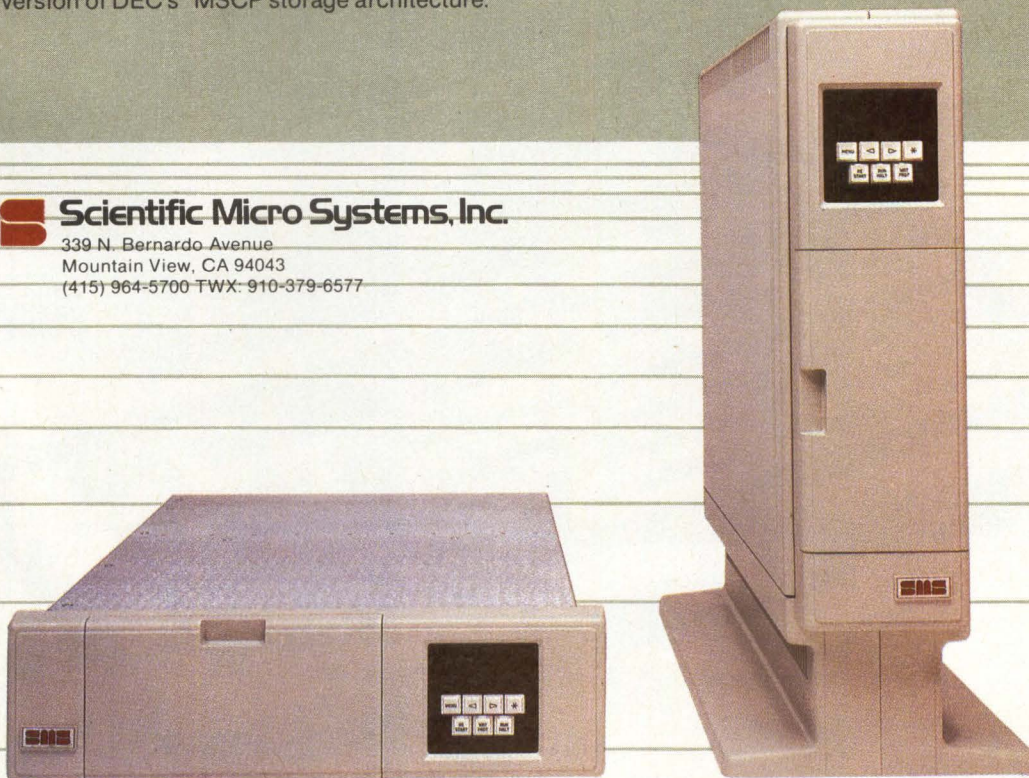

SMS SALES OFFICES: Seattle, WA (206) 883-8303; Boston, MA (617) 246-2540; Atlanta, GA (404) 296-2029; Morton Grove, IL (312) 966-2711; Melrose Park, IL (312) 345-5320; Arlington, TX (817) 429-8527; Philadelphia, PA (215) 860-8626; Greensboro, NC (919) 292-8072; Laguna Hills, CA (714) 643-8046; Mountain View, CA (415) 964-5700.
AUTHORIZED SMS DISTRIBUTORS FOR DEC PRODUCTS: Western—Pnambic Systems, Inc. (206) 282-0199; Quebec Province, Canada—Logicon, Inc. (514) 430-5960.

CIRCLE NO. 90 ON INQUIRY CARD

See us at Comdex Booth #111/113

*DEC, RSX and RSTS are trademarks of Digital Equipment Corporation. *TSX-PLUS is a trademark of S&H Computer.

A smart terminal smart on a desk.



should look

The WY-50 is one ASCII terminal that makes economic sense without offending your aesthetic sense. At \$695, it looks as smart to the people who pay for it as it does to the people who use it. No wonder it's now among the best-selling terminals in the world.

Like all our display products, the WY-50 combines an unusually small footprint with a very generous 14" diagonal display. The non-glare screen tilts, swivels, and displays a full 132-column format. The low-profile keyboard adjusts, too, for perfect fit and feel.

The WY-50 offers full software and hardware compatibility with most computer systems. And at \$695, its price/performance is unbeatable. More intelligence inside and out.

For more information about our complete line of products, write or call Wyse Technology, 3040 N. First Street, San Jose, CA 95134, (408) 946-3075. Outside of California 800-421-1058.

To find out where you can see the WY-50 demonstrated, call the regional office nearest you.

WYSE
| | | |

See us at Comdex Booth #378 East Hall

Regional Offices: Northeast (201) 725-5054; Southeast (305) 862-2221; Midwest (313) 471-1565; Southwest (818) 340-2013; Northwest (408) 559-5911.

CIRCLE NO. 91 ON INQUIRY CARD

FACIT



PRINTERS

There is a Facit Printer to satisfy virtually all printout requirements. From putting your Personal Computer on low cost printing terms, to the most professional heavy duty application with printers that put four-colour dots anywhere on paper.

Facit Matrix Printers, Daisy Wheel Printers and Graphic Flexhammer Printers offer intelligent solutions to any of your printing problems.

Just state your printing speed, print width, single sheet, fanfold or paper roll handling, letter quality, font and graphic print demands and Facit Printers will handle the rest.

So when comparing printers, think professionally.

Contact Facit – we'll introduce you to a whole family of Quality Printers.

FACIT

Head office: P.O. Box 54, S-172 22 Sundbyberg, Sweden. Phone: (8) 28 27 20.
USA: 235 Main Dunstable Road, P.O. Box 828, Nashua, N.H. 03061.
Phone: (603) 883-4157.

CIRCLE NO. 92 ON INQUIRY CARD

Our printers are the most widely recommended prescription for your paper problems.

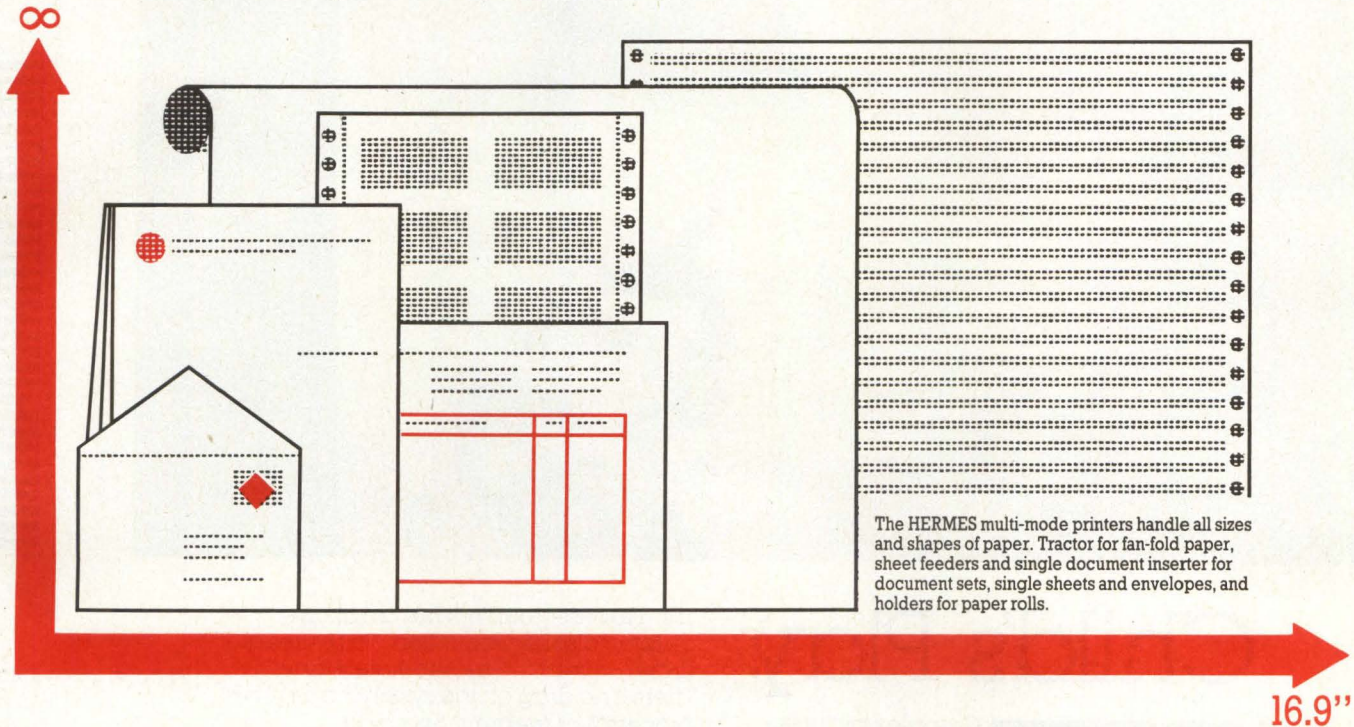

Troquet Advertteam

The HERMES multi-mode printers handle all sizes and shapes of paper. Tractor for fan-fold paper, sheet feeders and single document inserter for document sets, single sheets and envelopes, and holders for paper rolls.

Regardless of its shape and size, the paper used will reveal the impressive performance of the HERMES printers. Professionals who want only the best will also appreciate:

Their versatility. Wide range of attractive characters sets in 16 national versions, as well as math symbols, bar codes and teletex. Dual ports, parallel (CENTRONICS™/EPSON™ compatible) and serial (RS-232 C/RS-422) interfaces. DIABLO™ 630 emulation optional.

Their resolution. Finest print quality available on matrix printers. So good you can even print signatures. Bit mapping graphics in single and double density modes, 6 dots densities in each mode. A circle on the screen means a circle on the paper too!

Their quality. Swiss high quality construction. Quality that lasts – thanks to their exclusive «moving-ruby» head.

Their multicolored printing. Text and graphics printing in 8 colors on both models 615 and PC-Printer 2.



Manufactured in Switzerland by HERMES PRECISA INTERNATIONAL, CH-1401 Yverdon.

HERMES printers are distributed in Austria, Canada, Cyprus, Finland, France, Greece, Jordan, Kuwait, Lebanon, Saudi Arabia, South Africa, Spain, Sweden, Switzerland, United Kingdom, USA, West Germany.

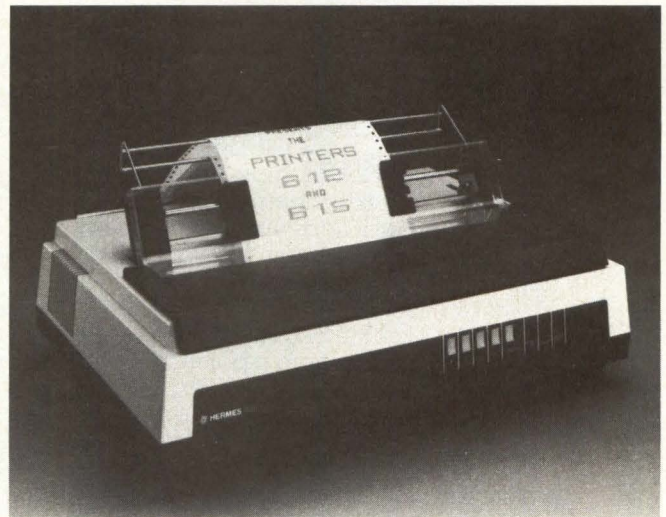

To receive a sample of the finest quality matrix print-out and additional information on the HERMES printers, please return the coupon below.

Please send me more documentation about your HERMES printers.

Name _____ Title _____

Company _____

Street _____ City _____

State _____ Zip _____ Phone () _____

Send to: HERMES PRODUCTS, Inc. – Printer Division
1900 Lower Road, LINDEN, NJ 07036, (201) 574 0300



Child's Play.



Complex pictures. Beautifully produced on screen. Easily controlled and manipulated.

For the D-SCAN GR-1104, it's child's play. Because this is the compact desktop terminal that thinks it costs twice what it does. And acts that way.

Picture this. A 60Hz non-interlaced 14" display. Bright. Stable. And flicker-free. With 1024 x 780 resolution!

But that's just the beginning. The 1104 lets you display 8 colors from a palette of 512 (not the usual 64). And lets you expand display list memory to a full 512K!

All of which means someone is going to be very happy. Visual cueing is better. And picture manipulation is localized. Which, of course, makes operators faster and more productive. And mainframes less burdened. Two cost-efficiencies every company can live with.

The 1104 will even support ANSI 3.64. And give you a VT100 keyboard (with 16 function keys). So there are no re-learning curves to finance.

What's more, the 1104 is Plot 10 compatible. Which means it can emulate the TEK 401X instruction set. And you can save a lot of time and money on software development.

Now for some impressive technology.

The 1104 uses four (not the usual one) graphic display controllers. So figures are drawn, filled and manipulated faster. There's no drag on the system caused by processor or memory overload.

Next, the video formatter is our own custom-LSI design. A gate array (2000 gates) that reduces power consumption and board space. And provides the video speed necessary for output to our high resolution display.

Which, we hasten to add, is beautiful. Especially with its .31mm pitch shadow mask. And contrast enhancement filter that eliminates screen glare and improves visual acuity.

You'll also be happy to note that the 1104 supports our Graphics Tablets (there are two) and Color Hard Copier (the one that's already taking the industry by storm).

One last item. Because we design, build, sell and service all of our products, you can count on getting the back-up you need. Direct service from 13 offices across the U.S.

So make life easy on yourself. Call today to get the full GR-1104 picture. It's easy. Just call your local Seiko Instruments sales person, or us at (408) 943-9100, or write 1623 Buckeye Drive, Milpitas, CA 95035.

You'll see that getting better resolution from a more user-friendly terminal, for a lot less money, really is child's play.

SEIKO
INSTRUMENTS

D-SCAN is a trademark of Seiko Instruments & Electronics, Ltd.
VT100 is a registered trademark of Digital Equipment Corp.
TEK and Plot 10 are registered trademarks of Tektronix, Inc.

© 1984 Seiko Instruments U.S.A., Inc., Graphics Devices & Systems Division.

Terminal emulation software links micros to mainframes

A variety of terminal emulation products convert microcomputers into terminals that can access mainframe databases

Paul Sniger, Senior Editor

Despite the proliferation of personal computers within American businesses, most of these computers function in standalone mode, exchanging but little information with each other and sharing centrally stored data even less. New micro-to-mainframe communications and terminal emulation hardware and software products, however, are improving this situation.

A terminal emulator reformats microcomputer-generated data into a format the mainframe recognizes. The emulation software and hardware permits any microcomputer to mimic another, typically IBM Corp. or Digital Equipment Corp. machines, so it, too, can communicate with a mainframe or microcomputer.

One of the more obvious reasons to install terminal emulation is economy. A typical IBM mainframe costs millions of dollars, contains as much as 12M bytes of RAM, and stores gigabytes of data. On the other hand, a typical IBM PC, PC-compatible, or equivalent microcomputer costs under \$3,000, contains only 256K bytes of RAM and stores megabytes of data. As to convenience, an IBM PC/XT or PC-AT fits on a desktop. By contrast, a typical mainframe computer, such as an IBM 370, measures 6 feet high, 4 feet wide and 15 feet long. It also requires support devices, a controlled room environment and specially trained operating personnel.

To access mainframe databases, information and processing power, IBM offers a family of 3270 terminals. (In practice, most mainframe users employ the basic IBM 3270s or equivalent terminals as their only means to access and control mainframes.)

The ability of intelligent microcomputers to emulate these mainframe terminals permits users to not only access the mainframe, but also to upload or download information and then locally process it. An advantage,

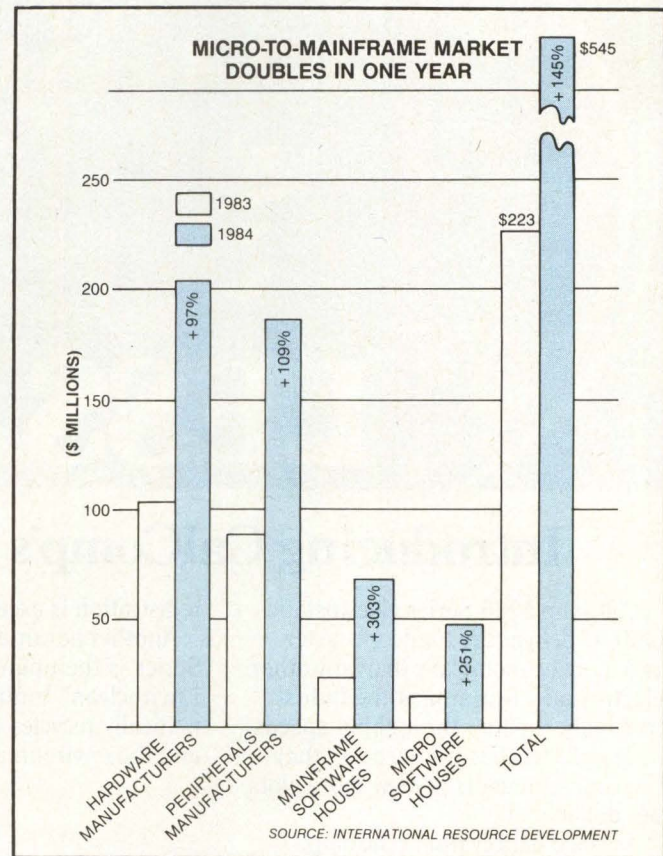

besides lower cost and smaller desktop footprints, is multiple-personality terminals that can function as microcomputers or in an emulation mode. And, since microcomputers exist in such profusion in business and engineering already, it makes economic sense to convert them into terminals that can access the mainframes.



MORE WORK.



LESS COST.

Introducing CalComp's new electrostatic plotters.

CalComp 5700 Series electrostatic plotters deliver dry hardcopy faster and more economically than any other electrostatic. Running at the industry's highest paper throughput speeds—up to 2.0 inches per second—they turn out more plots per day, more plots per dollar.

As you'd expect from CalComp, you get the best price/performance possible. For less than you'd expect, you get plots with 400 or 200-dpi resolution. And when it comes to accuracy, the 5700 Series can't be beat. With 0.1% vertical and horizontal accuracy, you can count on your drawings to be exactly right. Overlay

registration is excellent.

Another advantage of the 5700 Series is the unique CalComp Enviroclean™ toning system. It automatically recycles toner to keep plots and the environment clean. You save

on supplies since there's no waste.

With CalComp 5700 Series electrostatic plotters, there's no need to compromise productivity, image quality, or your budget. And a choice of four models assures a precise match with your needs.

Discover how CalComp's electrostatic plotters can do more work and cost you less. Call toll-free today, 1-800-CALCOMP, ext. 156, or write CalComp, 2411 W. La Palma Ave., P.O. Box 3250, Anaheim, CA 92803.

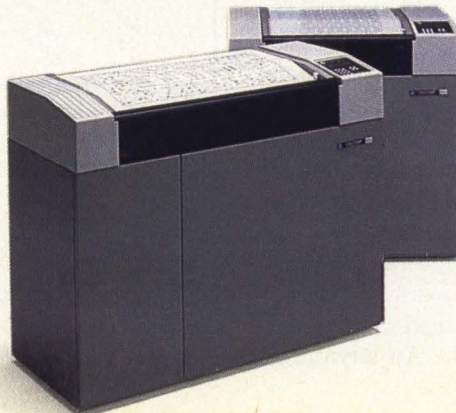

CALCOMP
25
1959 1984
CALCOMP
A Sanders Company

CIRCLE NO. 95 ON INQUIRY CARD

Operating a microcomputer terminal on a mainframe network requires some form of micro-to-mainframe communications software and some hardware, such as a card in the computer's expansion slot or in an external box. The communications products translate the two different protocols of the microcomputer and the mainframe. Generally, the concern centers on the data-link-control level; this level establishes and terminates a connection between two devices, performs error checking and places the data into a suitable transmission format. This level may also include character-code conversion, if different codes like ASCII and EBCDIC (Extended Binary Coded Decimal Interchange Code) are used.

But to communicate with a mainframe, a personal computer must behave like, or emulate, the terminal that normally communicates with the mainframe. This is where the terminal emulator comes in.

Terminal emulation market takes off

Although in the minicomputer world, most micro-to-minicomputer emulation products emulate VT50 or VT100 terminals for DEC minicomputers, in the mainframe world, most micro-to-mainframe emulation products emulate IBM 3270 terminals. Maureen Fleming, software products analyst at International Resource Development Inc. (IRD), Norwalk, Conn., says, "The 3270 is basically the standard for emulation. IBM has 70 percent of the mainframe market and it dominates the 3270 market and the PC market." IRD research has determined that the 1982 micro-to-mainframe market was \$50 million, more than \$220 million in 1983 and might exceed \$500 million in 1984.

Other market research companies share this optimism. Research firm Input Inc., Palo Alto, Calif., in a recent study projected that by 1988 almost a quarter of

all computer operations in larger corporations will involve micro-to-mainframe links. The report states that three-quarters of all corporations use PC or PC-compatibles today, and predicts that usage will reach 87 percent by 1986.

Another research company, Strategic Inc., reports that 31 percent of surveyed microcomputer operators used them mainly as a terminal, whether a 3270, VT100 or other type, and that another 24 percent used them as both a PC and a terminal. This dual usage is wasteful because it essentially converts a \$3,000 PC into a below-\$1,000, alphanumeric dumb terminal.

Commenting on this cost-effective aspect, Corley Phillips, marketing director of Grafpoint, Cupertino, Calif., says: "We are seeing a large level of installation of alphanumeric-only terminal emulation on personal computers. We feel that terminal emulation will divide into two basic categories. The first is terminals provided by Qume Corp., TeleVideo Systems Inc. and other products that are generally monochrome, low-cost and emulate terminals like the VT100 or even dumb graphics terminals such as the Tektronix Inc. 4014. The second is personal computers running both alphanumeric and graphic terminal emulation software."

Phillips feels that in the case of alphanumeric emulation, the buying choice is made because, for the price of a software package, the PC can also be used as a terminal. "In the case of color graphics," points out Phillips, "the PC, does and will continue to, cost less than a standalone color graphics terminal."

Because they require comparable amounts of processor power and memory relative to a PC, graphics terminals are presently at a cost disadvantage and will have to provide features like faster speed, higher resolution, and larger color palettes to compete. Grafpoint was the first company to pioneer color graphics terminal emulation in a market where the terminal costs more than the PC capable of replacing it.

Steven B. Weissman of the IRD research staff predicts that because the U.S. government is no longer closely scrutinizing IBM's every move, IBM will grow increasingly aggressive in lowering its product prices, such as for the 3270 family. Weissman also agrees with the generally held view that the industry is about to see a continuing flurry of new IBM product introductions. "We certainly are not alone in believing that IBM's settlement of its anti-trust lawsuit has triggered the computer maker into extraordinary new-product introduction activity." Other experts predict that IBM will become aggressive in competing with most IBM-compatible makers, and will become increasingly agile in invading niches now occupied by IBM-compatible makers. Weissman feels that this development will have

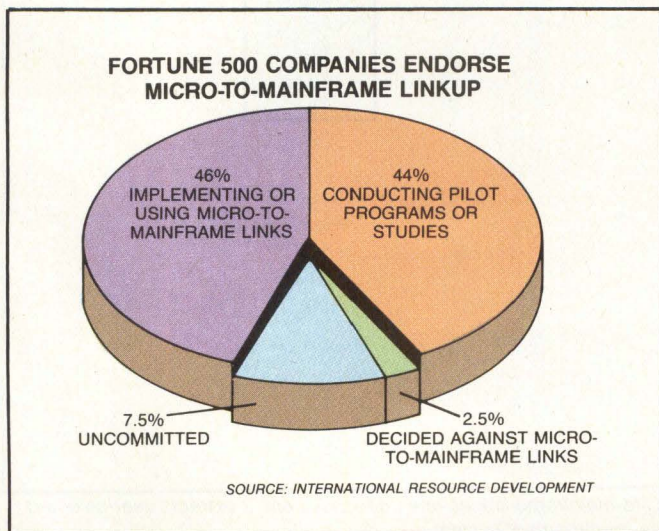

wide-reaching effects upon IBM-compatible product makers and the entire industry.

Emulation products follow a variety of approaches

But how do users select the best product for their particular application? Fortunately, terminal emulation and micro-to-mainframe communication products differ widely in their degree of emulation, their ability to link into a network and the enhancement they provide.

For example, modem-maker Hayes Microcomputer Products Inc., Norcross, Ga., recently introduced its Smartcom II 2.0. This upgraded communications software includes XMOdem protocol, batch commands and VT52, VT100 and VT102 terminal emulation. It provides enhancements such as password protection and off-line modem testing. "These enhancements ensure that this product will remain at the forefront [of the technology]," says director of marketing Garry Betty, after describing how "the VT52, VT100 and VT102 terminal emulations allow full-screen activity and other

capabilities when accessing mainframes." Enhancements also include a self-test macro and detailed error messages, self-test tests in both originate and answer mode, user-selectable configuration of black-and-white or color monitors and a selectable on-off disk-directory for a less cluttered screen.

Another emulation software package, PC Express, from Intelligent Technologies International Corp., Palo Alto, Calif., lets users handle inter-PC and PC-to-mainframe synchronous and asynchronous communications protocols, including SNA (327X emulation) and VT52 and VT100 emulations. A full-screen text editor and phone management software permits autodialing, autoanswering and a directory.

To meet the needs of today's office environments, IBM's Systems Network Architecture (SNA) is the basis for data communications. Because approximately 70 percent of large corporations have installed IBM computers, successful terminal emulation products must link into SNA and appear like or emulate IBM SNA

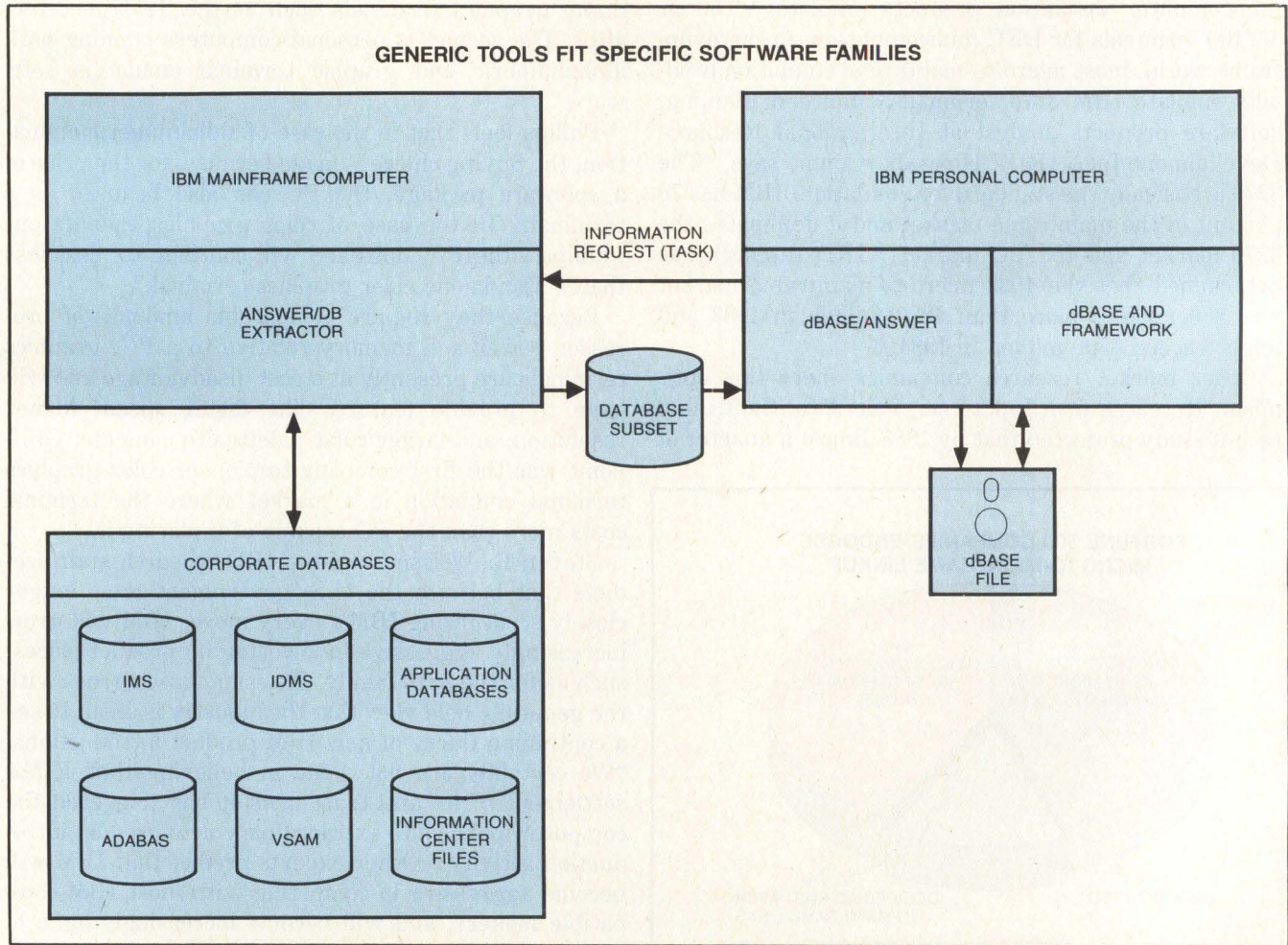

dBASE/Answers software from Ashton-Tate/Informatics treats the PC-to-mainframe link as one unified system. It extracts user-selected data on IBM or IBM-compatible mainframes from virtually any data-base-management system.

HOW TO CONTROL THE RISE AND FALL OF POWER.

Your small business computer can give you the power to raise your productivity. But first you have to control the power you give it. Because even the slightest dip or surge of electricity can result in a shocking surprise. An instant loss of important data or misinformation. Even worse, a total power line failure can create department devastation... a total system crash. You can't afford errors, delays and other problems. After all, you've invested in a computer to increase efficiency. But now there's a solution you can afford. The Sola SPS. This economical, UL listed Standby Power System is designed to protect personal, micro and mini computers from AC line disturb-

ances and failures. Sola SPS provides clean, regulated AC power to your computer when your power line experiences irregular voltage. Line dips or line surges are immediately converted to proper voltage. When the AC line is present, the SPS filters power to eliminate electrical noise. And when the AC line fails, the SPS goes into full action, providing precise AC power to the load from its internal battery. So the only noise you'll hear is the sound of performance. There's no maintenance. No installation. No kidding. Just plug it in and turn it on. Why let your productivity rise and fall with your power? The solution is as simple as SPS. The standby system that Sola stands behind.



CIRCLE NO. 96 ON INQUIRY CARD
Write for free literature. 1717 Busse Hwy., Elk Grove Village, IL 60007 (312) 439-2800

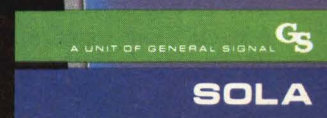

terminals. Non-IBM terminal emulation vendors are aided in producing compatible products by SNA's six-layered architecture and separation of functions. In fact, SNA permits non-IBM products to manage a subset of SNA functional capabilities, with the remainder handled by the applications programmer.

To gain access to SNA networks, an applications program running on a terminal emulation product must gain access to an application running on the host. To do this, a software-based interface provides device control.

SNA-compatibility is an easy host-access interface, as it involves only the SNA peripheral network. This permits a vendor to sell into the large existing SNA customer base with minimal research effort.

Alternatively, a software-based interface can access the IBM (or compatible) SNA mainframe, permitting the non-IBM microcomputer to access SNA host databases and application programs. One example of a software product that permits non-IBM users to access the host is the DG/SNA software package from Data General Corp. (DG), Westboro, Mass.

SNA-compatibility is an easy host-access interface, as it involves only the SNA peripheral network. This compatibility permits a vendor to sell into the large existing SNA customer base with minimal research effort. The degrees of emulation and compatibility differ, obviously, with the many different product offerings. To emulate an SNA unit, like a 3270 terminal, the terminal emulation product must address all SNA layers appropriate to the sessions being used. (Sessions are temporary logical connections established by network-addressable units to communicate with each other. Session parameters define the manner in which data interchange will occur through a handshaking protocol.)

As an example of the full SNA support, PC Express provides 3274 cluster controller emulation and operation in a 327X display terminal. The unit allows access to the SNA environment and to 3770 RJE emulation. Providing IBM PC compatibility, it can also emulate the DEC VT52 and VT100 terminals, provide full file-transfer capability, and access and store mainframe data for local processing. The keyboard emulates the VT100 keyboard with numeric keypad, function keys and special user keys.

Other terminal emulation products take a different approach. They use the IBM PC to emulate other

mainframe makers' terminals. For example, the integrated software family of asynchronous communications emulators from Insurance Technology Consultants (ITC), Orange, Calif., permits an IBM PC or PC-compatible to replace a Honeywell VIP7200, VIP7301 or VIP7303 terminal. This terminal emulation software requires no modification of existing host software and hardware, and uses the standard Honeywell terminal interface and functions. When combined with ITC's optional file-transmission facility FILE (Fast, Interactive, Logical Exchange), the PC becomes a powerful outboard processor in a Honeywell distributed processing network. FILE provides fast data file transfers between an IBM PC or PC compatible and a Honeywell GCOS 6 Mod 400 system. This development is only one of many that spell erosion for non-IBM mainframe terminal markets.

DEC and DG terminal emulation software is also beginning to enter this market. For example, Persoft Inc., Madison, Wis., offers SmarTerm. This software turns an IBM PC into a DG D100, D200 or D400 terminal, or provides DEC VT52, VT100 or VT102 terminal emulation. The package provides ASCII and binary file transfers, an error-free mode, full keyboard emulation, multiple setup configurations, smart soft-keys and command files, 75- to 9,600-baud operation, on-line help screens and full printer support. With the recent upgrade of IBM's PCjr, existing terminal emulation versions of SmarTerm for the PCjr, should improve terminal emulation capability.

Macintosh software emulates IBM, DEC terminals

Apple Computer's MacTerminal terminal emulation software for the Macintosh computer takes a different approach. In order to communicate with other computers, MacTerminal can emulate the DEC VT100 or IBM 3278 terminal by presenting icons, preset files, System folder, Empty Folder, and MacWrite or another word-processing program. By employing pull-down windows and dialog boxes to set up parameters, the user can set up the program to communicate with a remote host computer. By transmitting escape-code character sequences, the host can control the Macintosh screen and cursor.

For the MacTerminal software to emulate IBM and DEC terminals, Appleline hardware is required. Together, they permit the Macintosh to operate with an IBM 370 by emulating an IBM 3278 Model 2 terminal and working on-line only long enough to download data from the mainframe. From a real estate viewpoint, the Macintosh occupies half the footprint of a 3278. Unlike the 3278 with its demands made upon the mainframe, AppleLine and Macintosh are less vulnerable to response time slowdowns that can exceed half a minute

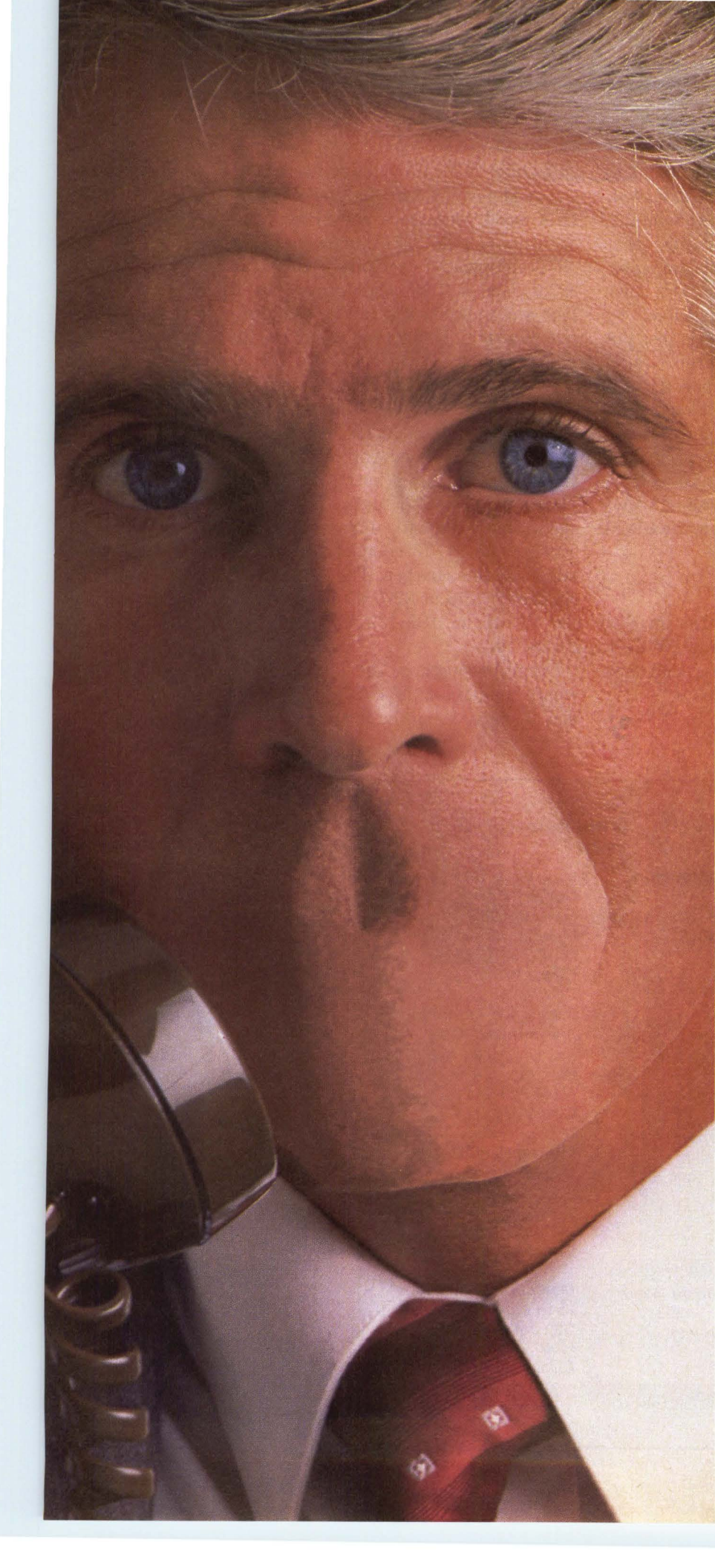

The most effective communications medium ever devised is still the human voice.

But now, technology makes voice go farther, faster, more efficiently—with the new VoiceServer™ from DSC.

VoiceServer is the low-cost OEM integration solution for digital voice processing and storage. From a stand-alone voice store and forward “mailbox” for any PBX—to applications like text-to-voice conversion and speaker/command recognition, VoiceServer handles them with plug-in hardware and UNIX-based software. DSC's Open System Architecture™ means many OEM opportunities for adding value, and long product life cycles.

VoiceServer's proprietary compression techniques yield high-quality digitized speech at only 8,000 bits per second. Use of standard peripheral interfaces and low-cost long-haul circuits simplifies the design of integrated voice/data systems.

So when you're thinking business communications, be sure to talk with the experts at Digital Sound.

We guarantee you won't be left speechless.

WHEN DESIGNING YOUR BUSINESS COMMUNICATIONS SYSTEM, DON'T FORGET THE MOST IMPORTANT PART.

I'm a (check one)

MM 11/84

- Telecommunications OEM or distributor
 Computer or OA manufacturer/reseller

Send me details on the VoiceServer.

Name _____

Title _____

Company _____

Division _____

Address _____

City _____

State _____ ZIP _____

Telephone(_____) _____

DSC Digital Sound Corporation

We speak the future.

2030 Alameda Padre Serra
Santa Barbara, CA 93103
(805) 569-0700

UNIX is a trademark of AT&T Bell Laboratories.
VoiceServer and Open System Architecture are trademarks of Digital Sound Corporation.

© 1984 Digital Sound Corp.

CIRCLE NO. 97 ON INQUIRY CARD

when many users are making demands upon the mainframe's resources. Once the information is downloaded, users can use the Macintosh to manipulate the data.

Upon power-up, AppleLine, a three-pound box that fits under the Macintosh, performs self-testing diagnostics. Once logged into the IBM mainframe, pull-down menu commands duplicate operations carried out by the 3278 functions keys. Desired information is then put into the Clipboard or Scrapbook and the user logs off and processes the information with his local software.

MacTerminal software, in a manner uncharacteristic of other emulation software, easily accounts for the different file structures used by different programs. While other software requires a separate conversion utility written for each application, MacTerminal's editing commands permit the user to reformat data without using a conversion program.

Product characteristics expand

The micro-to-mainframe terminal emulation market is embryonic, and many players are entering the field. As might be expected, their products offer a diverse and homogeneous mix of characteristics.

For example, TRU/BLU from Timeplex Inc., Wood-

cliff Lake, N.J., provides full-screen IBM 3178 emulation, and permits users to function just as they would on IBM word processors and IBM PCs. The IBM 3278 connects to IBM 3274 standalone controllers and IBM 3276's integrated controller (which can support seven 3278s), and is IBM's main product in this line. It offers four screen sizes, and can be configured in one screen size at a time. Other products in the line emulate other IBM terminals.

AST Research Inc., Irvine, Calif., provides a range of integrated hardware/software products capable of emulating IBM terminals or creating PC-based local area networks. They permit the IBM PC to function like a terminal for a host system or as a standalone computer for smaller tasks, thus not bogging down the mainframe host with unnecessary small jobs. It also permits the PC to complete local computing without telephone line charges. The AST-PCOX allows a PC to emulate a 3278 or 3279 display terminal, and connects the PC to an IBM 3274/3276 cluster controller via coaxial cable.

Other products in the line include the AST-SNA, which emulates a 3274/3276 controller and a 3279 display terminal using the Synchronous Data Link Control

Directory of manufacturers

Apple Computer Inc.
20525 Mariani Ave.
Cupertino, Calif. 95014
(408) 996-1010
Circle 767

Ashton-Tate
10150 West Jefferson Blvd.
Culver City, Calif. 90230
(213) 204-5570
Circle 768

AST Research Inc.
2121 Alton Ave.
Irvine, Calif. 92714
(714) 863-1333
Circle 769

Data General Corp.
4400 Computer Drive
Westboro, Mass. 01581
(617) 366-8911
Circle 770

Grapoint
866 Lily Ave.
Cupertino, Calif. 95014
(408) 446-3925
Circle 771

Hayes Microcomputer Products Inc.
5923 Peachtree Industrial Blvd.
Norcross, Ga. 30092
(404) 449-8791
Circle 772

Hewlett-Packard Co.
3000 Hanover St.
Palo Alto, Calif. 94304
(415) 857-1501
Circle 773

Informatics General Corp.
21031 Ventura Blvd.
Woodland Hills, Calif. 91364
(213) 887-9040
Circle 774

Input Inc.
Suite 600
2471 East Bayshore Road
Palo Alto, Calif. 94303
(415) 960-3690
Circle 775

Insurance Technology Consultants
P.O. Box 6610
Fullerton, Calif. 92634-6610
(714) 773-1754
Circle 776

Intelligent Technologies International Corp.
151 University Ave.
Palo Alto, Calif. 94301
(415) 328-2411
Circle 777

International Resource Development Inc.
30 High St.
Norwalk, Conn. 06851
(203) 866-7800
Circle 778

Molecular Computer
251 River Oaks Parkway
San Jose, Calif. 95134
(408) 262-2122
Circle 779

Motorola/Four-Phase Systems Inc.
10700 North DeAnza Blvd.
Cupertino, Calif. 95014
(408) 255-0900
Circle 780

Persoft Inc.
2740 Ski Lane
Madison, Wisc. 73713
(608) 233-1000
Circle 781

Strategic Inc.
Box 2150
Cupertino, Calif. 95015-215
(408) 243-8121
Circle 782

Timeplex Inc.
400 Chestnut Ridge Road
Woodcliff Lake, N.J. 07675
(201) 930-4600
Circle 783

(SDLC) protocol. SDLC is the bit-oriented protocol used in an SNA network to transmit data in frames over a communications link.

AST-BSC emulates 2770 batch RJE (Remote Job Entry) and remote 3270 terminals using the 3270 bisync protocol. (The bisync or BSC protocol is short for "bisynchronous synchronous protocol." It marks the start and end of text, headers and transmission blocks, and checks for transmission errors.) RJE facilitates batch job submission to a host from remote sites over communications links. This AST-BSC and equivalent emulation products enable various terminals, including the PC, to emulate transmission terminals.

'The 3270 is basically the standard for emulation. IBM has 70 percent of the mainframe market and it dominates the 3270 market and the PC market.'

Hewlett-Packard Co. (HP), Palo Alto, Calif., has also developed products to emulate various 3270 display terminals. Its group of interactive products, the DSN/3270 Display Station Emulation for Series 100 or 200 enables the HP 150 or Series 200 computer to emulate a 3270 display terminal. Other emulation products enable the HP 150 to emulate an IBM 3278 display terminal. The Series 200 line includes several models. Those with display enhancements support the 3270 emulator.

Motorola/Four-Phase Systems Inc., Cupertino, Calif., targets its software terminal emulation product Vision-Line toward the distributed data processing marketplace. Vision-Line enables Four-Phase's Vision system to emulate the host in a 3270 bisynchronous network. Vision, an advanced, transaction-oriented distributed processing system, combines source data entry, on-line inquiry and retrieval, standalone processing and batch communications. Vision provides a balance between local and central processing and data bases, with both batch and inquiry communications to the host mainframe.

The ability to perform like the host in a 3270 environment permits Vision to communicate with 3270 control units and give these control units interactive access to Vision applications and the Vision database. Vision-Line provides 3270 communications without having a mainframe.

"The systems that will support the 3270 Vision-Line emulator," states Howard Trailkill, president of Four-Phase Systems, "are any mapped machine from our Series 4000 or 5000. Terminal emulation fits in with the Four-Phase product family, which includes processors, operator workstations, communication facilities, vari-

ous peripherals and extensive software." The series 4000 systems support as many as 32 operator stations and can store video images in RAM, permitting users to manipulate data without actually transferring it to the local terminal. This setup permits those systems using the terminal emulation and 4000 capabilities to improve system productivity and increase the speed of interaction with the system. The series 4000 disk storage ranges from 2½M bytes to 574½M bytes. Series 5000 supports as many as 64 workstations and offers 6M bytes of RAM and 150M bytes to 2.2G bytes of disk capacity.

Vision-Line conforms to IBM standard 3270 bisynchronous EBDIC protocol in communications with 3271/3274-1C control units. Asynchronous terminals are interfaced to Vision-Line systems with protocol converters to change BISYN EBCDIC from Vision to ASCII ASYNCH for the terminals.

Taking another approach, Molecular Computer Inc., San Jose, Calif., offers IBM 3270 and 3780 emulation communications software, CLEO-3270 and CLEO-3780, that make the firm's multiuser business systems compatible with IBM mainframes. "Both packages function as IBM 3276/2 cluster controllers for ASCII terminals," says Harvey Hartman, senior vice president of marketing. Molecular's installed base exceeds 4,000 multiuser system supporting over 15,000 users. Hartman adds that, "In the past, most of our systems were sold to smaller companies. Offering CLEO emulation software now gives us the capability to attract larger corporate end users."

CLEO-3270 emulates an IBM 3276/2 display controller and supports as many as eight 3278 interactive display terminals or 3287 Remote Batch Workstations for high speed transmission and reception of files over telephone lines. "Users will be able to run multiple applications in a cost-effective manner, without investing in an IBM 3270," says Hartman. "Users can alternate between data processing and using WordStar locally on their Molecular system, thus making it a double-duty system."

Hartman admits that in the past it was impossible to transfer files between two Molecular systems except with an asynchronous modem that communicated at a much slower speed than the 9,600-baud transmission rate both packages support. Like many firms, Molecular is positioning its products to invade the larger corporations.

Joined forces create synergistic strength

Another significant trend is the joining of forces between different companies, with each bringing its own strengths to bear upon the micro-to-mainframe battlefield. Ashton-Tate, Culver City, Calif., creator of

TERMINALS FROM TRANSNET

PURCHASE PLAN • 12-24 MONTH FULL OWNERSHIP PLAN • 36 MONTH LEASE PLAN

Authorized Distributors — Carry the COMPLETE lines of:			MONTHLY RATES			OR Purchase
DEC			FULL Ownership 12 mo.	Lease 24 mo.	Lease 36 mo.	
digital	LA50	Personal Printer	\$ 62.	\$ 35.	N/A	CALL FOR DETAILS
	LA120KSR	DECwriter III	220.	122.	83.	
	VT101	CRT Terminal	115.	64.	43.	
	VT102	CRT Terminal	137.	76.	51.	
	VT220	CRT Terminal	115.	65.	45.	
	VT240	CRT Terminal	130.	75.	50.	
TI	VT241	CRT Terminal	190.	109.	73.	
	TI707	Portable Terminal	62.	35.	N/A	
	TI820KSR	Terminal Pkg.	211.	117.	80.	
	TI850	Printer w/Tractor	57.	32.	N/A	
TELE-VIDEO	TI855	Dual Mode Printer	86.	48.	32.	
	TV914	Tilt/Swivel CRT	62.	35.	N/A	
	TV950	CRT Terminal	103.	57.	39.	
NORTHERN TELECOM	TV970	Tilt CRT Terminal	115.	67.	43.	
	NT6K00	Displayphone	124.	69.	47.	
C.ITOH	NT6K55	Modem 212/A	47.	26.	N/A	
	CIT101	VideoTerminal	105.	58.	39.	
	CIT414A	Graphics Terminal	134.	74.	50.	
	CIT500	W/P Terminal	191.	106.	72.	
	CIT600	Line Printer	537.	298.	201.	

ON-SITE TECHNICAL SUPPORT & SERVICE

PERSONAL COMPUTER SYSTEMS

Visit our computer stores in Union and Ocean, NJ
AUTHORIZED RETAIL DEALER

APPLE® IIe, IIc, MAC, III and LISA — DEC RAINBOW — TI PROFESSIONAL

SUPPLIES — FREE CATALOG — CALL

DEC is a registered trademark of the Digital Equipment Corporation. APPLE is a registered trademark of Apple Computer Inc.



TRANSNET CORPORATION

1945 ROUTE 22 — UNION, NJ 07083

In NJ (201) 688-7800 • (800) 526-4965 • TWX 710-985-5485

CIRCLE NO. 98 ON INQUIRY CARD

9600bps MODEM \$97.*

The MADZAR Z9600® series of short haul modems are a cost effective way to get your asynchronous data down the hall or down the street at rates from 75 to 9600 bps. The MADZAR Z9600® series out performs any other brand in its price range and it's available in a rack mount version that packs 16 short haul modems in only 5-1/4 inches of rack space.

Try a pair of our MADZAR Z9600® series short haul modems for 30 days on credit approval. Then decide. Be particular. Buy the best and join the ranks of our growing list of customers like General Electric, NASA, Aerojet Strategic and General Dynamics to name just a few.

Want more information? Call or write us now for a brochure and complete pricing. (We have generous discounts for quantity buyers).



37490 Glenmoor Drive
Fremont, CA 94536-9990
415/794-7400

*100 Unit Price

CIRCLE NO. 99 ON INQUIRY CARD

EMULATION SOFTWARE

the relational database-management dBase II and III programs, recently entered into a joint venture with Informatics General Corp., Woodland Hills, Calif., resulting in the creation of a micro-to-mainframe system called dBase/Answer. The package permits IBM PC users to access virtually any IBM mainframe file or database-management system, and makes it possible to manipulate this data on their PCs. By transferring information directly from mainframe to microcomputer, the software eliminates time-consuming rekeying. Mainframe security is maintained, as the management-information-system and data-processing departments can specify portions of the database that are accessible to each microcomputer user. Users can then only download or upload and manipulate only the data specified.

The dBase/Answer system requires 256K of RAM in the IBM PC (or XT) and two disk drives. Although the price tag is only \$500, users require a modem and circuit cards inserted into the IBM PC slots to use the dBase/Answer software.

After selectively extracting data from the mainframe database, information is provided to the PC in a format usable for dBase II/III, Friday and Framework. States Merritt Lutz, software products group vice president of Informatics, "We positioned dBase/Answer as the next step toward total micro-to-mainframe integration. This software extends the power of dBase II/III, Friday and Framework to virtually any corporate database."

Informatics is a leader in software universal data extraction technology for corporate DP organizations, and Ashton-Tate is a front-runner in microcomputer database systems and applications. The two firms will market the software products to their respective customers. The synergistic combination of this approach has the potential for setting a trend in this field. □

Interest Quotient (Circle One)
High 846 Medium 847 Low 848

LOOKING AHEAD IN MMS

The Interpreter section of Mini-Micro Systems' December issue focuses on office-automation systems.

OA systems have the potential to move mountains of paperwork and boost worker productivity. Yet, year after year, the promise is not quite realized. Buyer perceptions of machines as not user-friendly could be one reason. This article examines what's being done to improve OA's image.

Silent Scribe®

Go Quietly.



In these modern times, you have to go all out to stay ahead of the competition. And going with our up-to-date Silent/Scribe printers can help keep you there; because Silent/Scribe quietly goes about your business reports, letters, charts and graphs, while you quietly go about your business.

Unruffled. Undisturbed. And assured that the letter you signed on the first day of the month and the final monthly report will both have

the same crisp high-quality look.

All Silent/Scribe printers feature snap-in long life ribbon cartridges, easy-to-use controls, and Logic/Card® interfacing to fit virtually any computer.

And they come in a variety of models to fit your specific needs and budget.

Call us today and discover how going quietly can quickly get you ahead.

Outside California: (800) 4-ANADEx
In California: (800) 792-9992

© Copyright 1984 Anadex, Inc.



Anadex ... When you know printers.

ANADEx, INC. • 1001 Flynn Road • Camarillo, CA 93010 • Tel: (805) 987-9660 • TWX: 910-494-2761
ANADEx, LTD. • Weaver House, Station Road • Hook, Basingstoke, Hants RG27 9JY, England • Tel: Hook (025672) 3401 • Telex: 858762 ANADEx G

CIRCLE NO. 100 ON INQUIRY CARD

How can you develop one system and offer your customers a choice of three?

Simple. Develop it around HP's new three-in-one microsystem. That way, you don't have to redesign your system to offer your customers a range of performance. Because the entire power range of HP's new A-Series computers fits into the same small, convenient package. At a slimmed-down starting price of \$6110*

So you can offer 1 MIPS performance. Or floating point hardware and microprogramming in either a 1 MIPS or 3 MIPS computer. Whichever one your customer chooses, you can fit it easily into the same space in your system.

Identical software keeps it simple.

When you change processors, you don't have to go back to the drawing board with your programs. Because, in addition to compatible hardware, these computers run identical software. That's the best kind of compatibility you can buy.

Our A-Series family consists of the Micro 26, Micro 27 and

Micro 29. The Micro 26 comes with integrated 14.6 Mb mini-Winchester disc and microfloppy. And it has 8 I/O slots, giving you plenty of room for our wide selection of I/O cards for instruments, measurement and control, and data-comm, to name a few.

The Micro 27 adds floating point hardware and microprogramming. And, for jobs needing up to three times the power, our 3 MIPS Micro 29 has got what it takes.

Our brand new operating system really performs.

That's one secret of our success. The new, full-function RTE-A real-time operating system provides the performance you need for your real-time automation applications. Ranging from dedicated machine control to monitoring instruments to supervising a network of computers.

This power, speed and I/O capacity also make our

A-Series systems ideal for multi-user, multi-tasking environments.

Of course, these compact new computers are part of our newly expanded OEM program. This includes higher discounts and credits, extended warranties and free training. So you'll make more when you get to market. And you'll also get there faster with our new operating system and newly packaged microsystems.

If you'd like micro, mini or maxi performance in one micro package, call your local HP sales office listed in the white pages of your phone book. Ask for a technical computer representative. Or write for more information to: Hewlett-Packard, Attn. Greg Gillen, Dept. 08171, 11000 Wolfe Road, Cupertino, CA 95014. In Europe, write to Henk van Lammeren, Hewlett-Packard, Dept. 08171, P.O. Box 529, 1180 AM Amstelveen, The Netherlands.

*A600+ microsystem component, 128Kb memory, box, Winchester disc.

Prices are U.S.A. list in OEM quantities of 100 and include integrated peripherals, one interface card, RTE-A and 512Kb of memory for Micro 26 and Micro 27. Micro 29 includes 768Kb of memory.

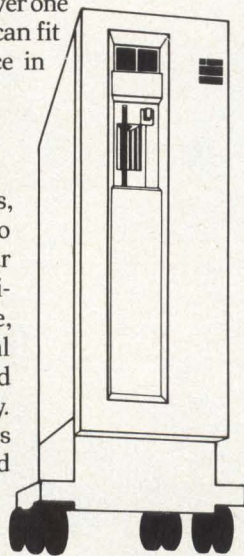

Our new microsystems also come in this floor-mount or bench-top models.

 **HEWLETT
PACKARD**

Micro:

1 MIPS for
\$7445

Maxi:

3 MIPS, plus floating
point hardware and
microprogramming, for
\$16,650

Mini:

1 MIPS, plus floating
point hardware and
microprogramming, for
\$13,140



Whatever the level of performance you pick, it fits in this little 7" x 19" x 25.5" package.

POWERFUL

COMPUTERS - **UNIX** SYSTEM V - AT&T 3B COMPUTERS - **UN**

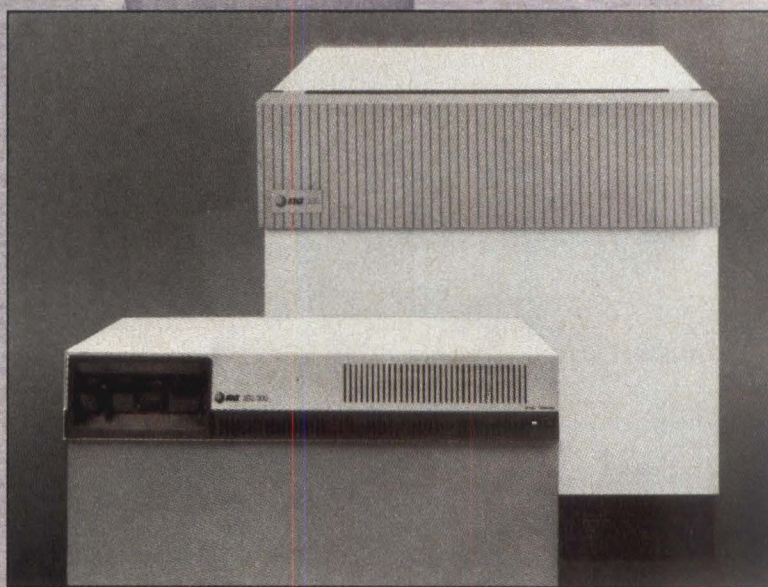

VERSATILITY

SYSTEM V - AT&T 3B COMPUTERS - UNIX SYSTEM V

More options. More power.
More sales.

That's what you can count on from the 3B family of business computers from AT&T.

Their special ability to run UNIX™ System V at maximum efficiency makes the AT&T 3B2/300 and the AT&T 3B5/100 and 200 the ideal machines for the growing multi-user and multi-tasking markets.

In fact, the benefits that AT&T builds into its UNIX System V are built into the hardware, too. WE® 32000 microprocessor. Software portability. Compatibility with other 3B computers. Reliability. Flexibility. Communications capability.

They'll open your customers' eyes to a better, more cost-efficient way of meeting their computing

needs. And open the door to more sales for you.

THE 3B2/300—A MIGHTY SUPER-MICRO COMPUTER

The 3B2/300 can support up to 18 users at individual workstations—making it an excellent machine for offices where a number of people require desk-top computing.

Because they share peripherals and data, the cost-per-user is far lower than if you achieved the same end with a network of PCs. The 3B2/300 works as a powerful single-user machine as well.

The 3B2/300 comes with a set of simplified UNIX System utilities that first-time users will find particularly helpful.

The four standard configurations allow for easy growth for

your customers; continuing business opportunities for you.

THE 3B5/100 AND 3B5/200

Up to sixty users at one time can work on these general-purpose super minicomputers. And with no sacrifice in response time.

The 3B5 computers, which run UNIX System V, can be custom-configured to handle any specific business application—with a wide variety of I/O, peripheral, memory and communications options.

For all members of the 3B family of computers, AT&T pledges a full program of service and support. Including a comprehensive, flexible program for resellers.

To find out more about our 3B family and our programs, call 1-800-833-9333, or use the international telex number (210-209).

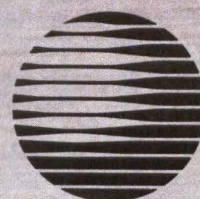

AT&T

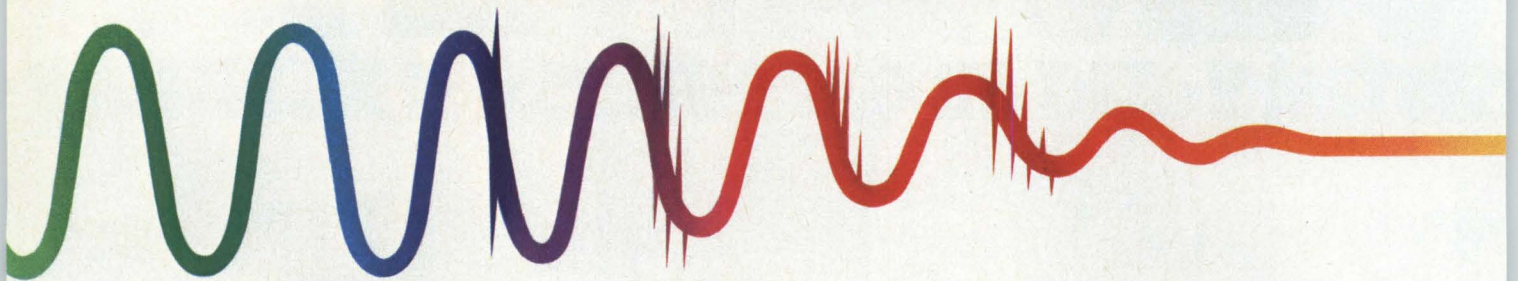

If your power is critical, finding your power problems is even more critical.

Today's computer systems, delicate instruments, and communications systems demand clean, pure power to perform accurately.

Unfortunately, that kind of power isn't always there.

Today's blackouts, brown-outs, and power surges can quickly destroy or alter precious data and delicate circuits.

The Liebert 3600A Power Line Disturbance Monitor® (PLDM®) won't stop these problems, but it will help pinpoint them.

It detects disturbances that exceed sensitive thresholds and classifies them by type, magnitude, and duration. The printout tells you when the problem occurred so you can compare the information with load equipment errors, problems, and failures.

Easy to Use

The fully programmable Liebert 3600A is extremely easy to set up and use.

Instructions are located on the inside of the unit's lid and on the operating face plate. Even if you use the 3600A only



once a month or less, you won't have to wade through an entire manual to make certain you set it up correctly.

Simply key in your threshold

CIRCLE NO. 102 ON INQUIRY CARD

parameters and clock settings. An easy-to-read LED display will verify all of the settings. And the 3600A's self-test diagnostics ensure everything

is operating properly.

When your tests are completed, simply close the lid and take the 3600A to the next test site . . . across the building, across town, or across the country.

UL-Listed

The Liebert 3600A is UL-Listed so you're assured that it meets the same rigid requirements as the equipment and systems it is designed to monitor.

Whether you specify, install, test, or use sensitive electronic systems, make certain you can count on the power you use.

Find out more about the Liebert 3600A PLDM.

Call or write us today.



Liebert
Programmed Power Division

48133 Warm Springs Blvd.
Fremont, CA 94539 (800) 538-1770.
In CA (415) 659-1400

PLDM is a registered trademark of Liebert Corporation.

MINI-MICRO SYSTEMS/November 1984

Software-transparent front-end processor links hosts, terminals to Ethernet

Communications processor reduces computer-room cable maze and increases file-transfer speed by multiplexing as many as 48 X.25 virtual circuits over one line

Judith Estrin and J. Patrick Malone,
Bridge Communications Inc.

The CS/1-X.25 communications server is a front-end processor that connects host computer systems supporting standard X.25 software and hardware interfaces to an Ethernet local-area network (LAN). With support for as many as 48 multiplexed virtual circuits over a single X.25 line, the CS/1-X.25 reduces the computer-room cable maze and increases file-transfer speed to 64K bits per second (bps). Bridge Communications Inc.'s CS/1-X.25 does not require modification to the software of hosts that support an X.25 Data Terminal Equipment (DTE) software package.

There are two prevalent ways to connect a host computer to a LAN. The most common is to attach the host's RS232 terminal or modem ports to ports on a

Fig. 1. Terminal-to-host communications can take place over a public data network (PDN) (top) or over a LAN (bottom). In a PDN, terminals access a local packet assembler/disassembler (PAD) on switched lines at low speed. In a Bridge X.25/Ethernet network, communications servers, such as the CS/1, CS/100 and CS/1-X.25, link various systems and devices to the Ethernet cable. The communications servers act like PADs, performing multiplexing and packet handling. The CS/1-X.25 acts like a host interface to a PDN, enabling the host to support terminals as if they were connected over an X.25 network.

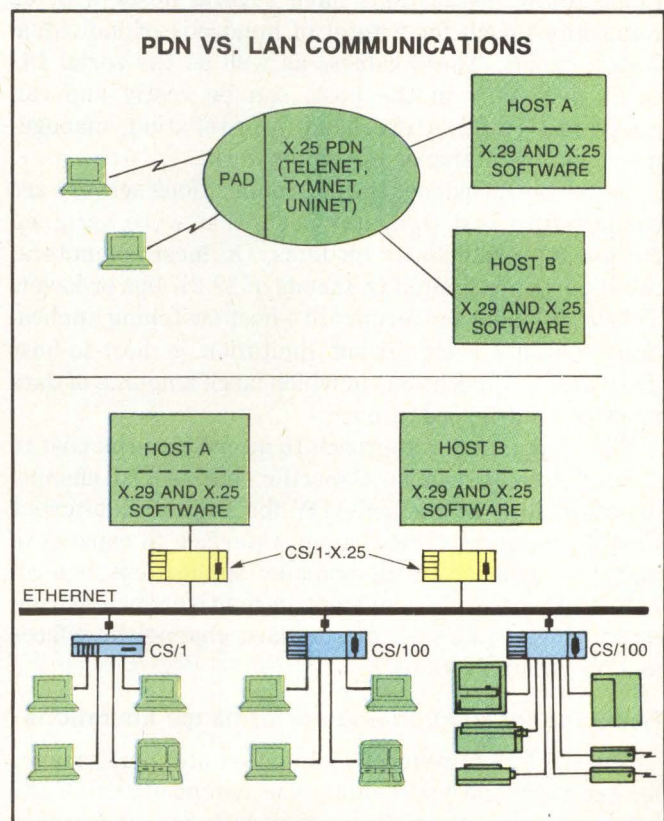

communications server. The communications server manages the LAN interface, high-level protocol processing and multiplexing and demultiplexing of terminal traffic to the host. The communications servers collectively form a physically distributed data switch capable of interconnecting multiple host computers and hundreds of RS232-based devices.

Using RS232 ports provides transparent connection for terminal-to-host communications. However, two limitations remain—one related to physical installation; the other, to performance.

Using RS232-based communications servers in a terminal-switching application eliminates the need for

The CS/1-X.25 makes the LAN environment look like a PDN to the host.

much of the long-distance, point-to-point cabling required with centralized switches. However, it doesn't reduce the need for running short RS232 cables between the communications servers and the computer's ports. Although the overall cable maze is reduced considerably, it is still a major problem in the computer room. Many installations have several hosts with 32 connections each for a total of hundreds of individual RS232 cables. These cables, as well as the serial I/O cards necessary in the host, can be costly and can generate significant overhead in installation, management and maintenance of the network.

As for performance, the communications servers are connected to host computer ports that were designed for use by terminals or modems. On most computers, these ports are limited to speeds of 19.2K bps or lower. This is sufficient for terminal-to-host switching applications, but it's a significant limitation in host-to-host file-transfer applications in which large amounts of data must be transferred at once.

The second major approach to interfacing the host to a LAN is to use a host-specific, high-speed channel interface such as the DR-11W for Digital Equipment Corp. computers. The channel interface is capable of high performance in file-transfer applications but requires extensive development in multivendor environments due to the lack of standard channel interfaces and operating systems.

Reducing installation and performance limitations

The CS/1-X.25 reduces installation and performance limitations while maintaining the independence of the host computer's operating-system software. It provides

a host interface for terminal switching and host-to-host file-transfer applications and minimizes cabling and installation requirements.

The X.25 protocol is an accepted standard for multiplexing data streams over a single interface. Most minicomputers and mainframes support X.25 interfaces for connection to an X.25-based Public Data Network (PDN) such as Telenet or Tymnet. These interfaces operate as fast as 64K bps. Many computer vendors also provide file-transfer packages, built onto the X.25 protocols, that facilitate file interchange between remote computers over a PDN. Such packages can be used without modification to transfer information be-

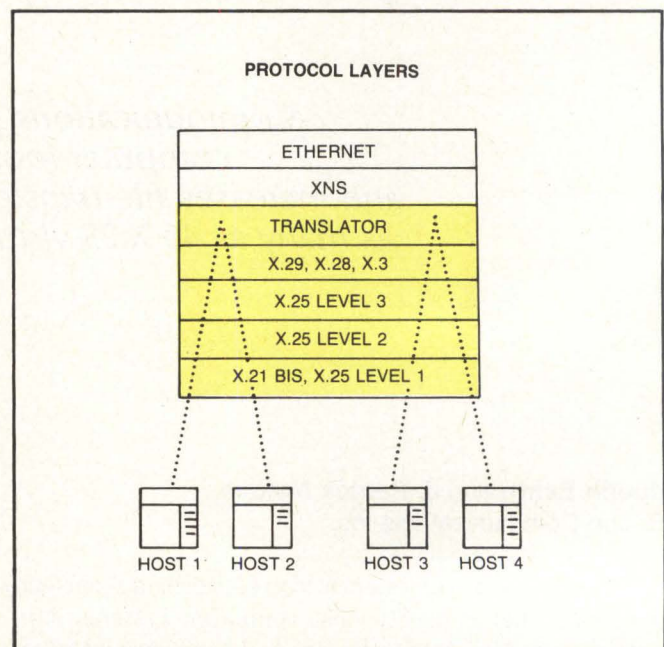

Fig. 2. The CS/1-X.25 supports as many as four hosts. In standalone host-to-host file-transfer applications, the CS/1-X.25 does not process packets through the Xerox network system (XNS) or Ethernet protocol layers.

tween hosts on a LAN via the CS/1-X.25.

Users can select an X.25 packet in sizes from 128 to 1,024 bytes, allowing users to trade off throughput vs. the number of sessions. File-transfer applications, for example, benefit from larger packets to achieve higher throughput. Terminal-oriented applications benefit from using the maximum number of terminal-to-host sessions with medium to low duty-cycle demands.

For terminal-switching applications, the CS/1-X.25 uses the X.3/X.28/X.29 protocol standards above X.25. These standard device protocols are typically used for teletypewriter-like terminal-to-host interaction across a PDN. In a CS/1-X.25 Ethernet network, a terminal or microcomputer connected to the Ethernet LAN via a Bridge CS/1 or CS/100 communications server can access a host computer attached to a CS/1-X.25. The

**SUDDENLY
THE TAPE
CONTROLLER
IS
OBSOLETE.**

SPECTRA LOGIC

terminal traffic appears to the host as if it were coming from a packet assembler-disassembler (PAD) on the PDN. Thus, the CS/1-X.25 makes the LAN environment look like a PDN to the host (Fig. 1).

The CS/1-X.25 multiplexes as many as 48 connections over an X.25 serial line to the host computer, thus replacing as many as 48 RS232 cables. In the case of heavy duty-cycle sessions in which the X.25 link speed might cause a bottleneck, the CS/1-X.25 can support as many as four lines for an aggregate throughput of 150K bps in full-duplex mode.

A multiline CS/1-X.25 can also be used as a standalone X.25 link switch for file-transfer applications between as many as four hosts. In standalone mode, host-to-host connections do not go over the Ethernet cable. Thus, data need not be processed through Xerox Corp.'s Xerox network system (XNS) and Ethernet protocol layers (Fig. 2).

Fig. 4. Host-to-host communications begin with a call request from Host 1 to an attached CS/1-X.25. The translator processes the request and receives the Xerox network system (XNS) address for Host 2's CS/1-X.25, establishing a connection between translators. The address mapper in Host 2's CS/1-X.25 then identifies the X.25 address of Host 2 and establishes the connection.

CS/1-X.25 employs one cable

The CS/1-X.25 attaches to the host computer via a single cable, over which X.25 virtual circuits are multiplexed. It can accommodate the three standard interfaces used for connection to a PDN: X.21bis (RS232) for speeds as high as 9,600 bps and RS422/449 or V.35 for speeds as high as 64K bps. The computer I/O port that would ordinarily be connected to the PDN modem is instead connected directly to the CS/1-X.25.

After the CS/1-X.25 is installed in front of the host, any terminal linked to a CS/1 or CS/100 communications

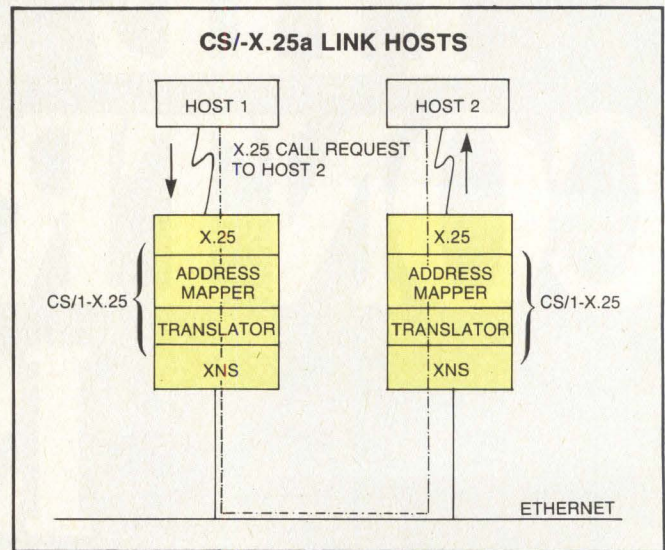
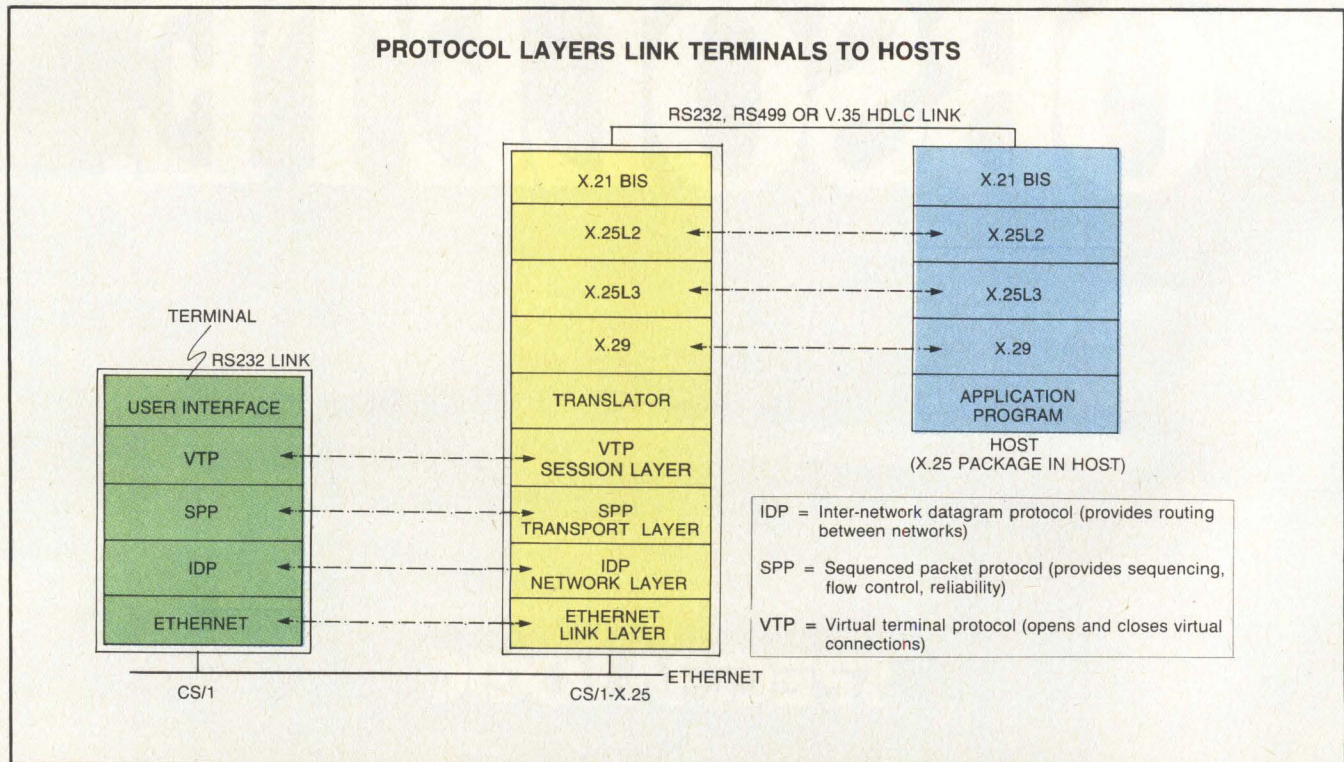

Fig. 3. Establishing and maintaining a virtual circuit between a terminal attached to a CS/1 and a host computer attached to a CS/1-X.25 requires the use of 19 protocol layers.



HOW TO DOUBLE YOUR CONTROL WITHOUT DOUBLING YOUR CONTROLLER.

If your plans for controlling disk and tape drives call for two boards and two CPU slots, you can now cut your plans in half.

And use the SPECTRA 25 LSI-11 emulating multifunction controller instead. You'll get all the control of separate disk and tape boards in just half the space. Half the slots. Half the spares. While using less power.

SPECTRA 25 is the smarter way to handle SMD/Winchester and 1/2-inch tape drives, and it's the first and only multifunction controller designed for DEC Q-BUS® computers.

Its block-mode data transfer capability can increase your throughput by up to 50%. And it performs Error Correction Code (ECC) independently of the operating system. All 32 bits worth.

SPECTRA 25 fully emulates DEC's RM02/5 and RM80 disk subsystems, and TS11 tape subsystem. It can run two SMD disk drives and four tape drives, in any combination. Plus an E²PROM lets you easily reconfigure while the controller is in your system.

But SPECTRA 25 puts something else in your system, too: proven reliability. Because you're working with half as many parts and pre-tested ICs.

You're also working with excellent documentation that's regularly updated. And the most comprehensive one year warranty in the industry. All backed by responsive nationwide service.



SPECTRA 25 is the multifunction controller that doubles your control. And your advantage on the competition.

Before you look at Emulex or Dilog, consider the SPECTRA 25 from Spectra Logic.

It could be all the controller you'll ever need. For further information on our expanding family of controllers for DEC Q-BUS and UNIBUS® computers, call or write us today.

	SPECTRA 15*/ SPECTRA 25	SPECTRA 111*/ SPECTRA 121	SPECTRA 12*/ SPECTRA 21
BUS	Q-BUS (Block-mode)	UNIBUS	UNIBUS
Disk Emulation	RM02/05, RM80, RP06 (2 drives)	RM02/05, RM80, RP06 (4 drives)	RK06/07 (4 drives)
Tape Emulation	TS11 (4 drives)	TS11 (4 drives)	TS11, TM11 (4, 8 drives)
Disk Transfer Rate (SMD)	2.0MB/sec	2.0MB/sec	2.0MB/sec
Configurable On-Line	Yes	Yes	No
*Single function disk controller			

Spectra Logic Corporation, 1227 Innsbruck Drive, Sunnyvale, CA 94089, (408) 744-0930, TWX 910-339-9566, TELEX 172524 SPL SUVL. International Sales Office: The Netherlands (31) 23 273744, TELEX 71080 SPECL. Distributor inquiries invited

See us at Comdex, Booth #1676

SPECTRA LOGIC

The Multifunction Controller Company.

CIRCLE NO. 104 ON INQUIRY CARD

©1984 Spectra Logic Corporation

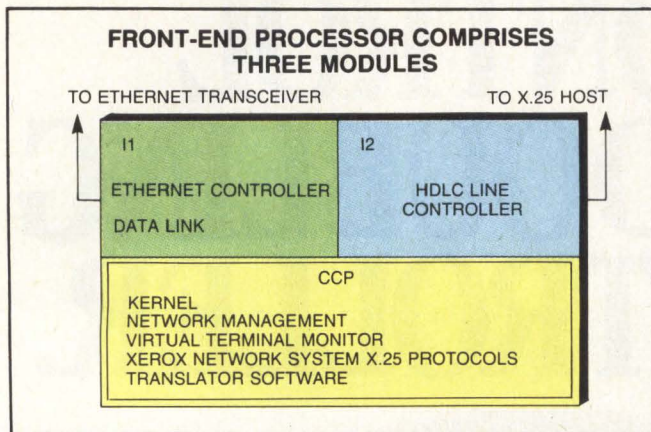

Fig. 5. The CS/1-X.25 consists of three modules: the central communications processor (CCP), which manages the network, supports virtual circuits and performs Ethernet-to-X.25 translation; the Interface 1 (I1) module, which connects to the Ethernet; and the I2 module, which supports high-level data-link control (HDLC) and connects to the host.

server in the network can gain access to the host by establishing virtual connections. A user accesses the host via a preassigned logical name contained in the "clearinghouse," which resembles a telephone directory.

To transmit information from a terminal attached to a CS/1 to a host computer attached to a CS/1-X.25, the user issues a connect command to the host. The CS/1 finds the name and the host destination address in the clearinghouse and issues a connect request to the host's CS/1-X.25. This involves the Bridge virtual terminal

The CS/1-X.25 multiplexes as many as 48 connections over a single serial line to the host computer.

protocol (VTP) and the XNS sequenced packet protocol (SPP) and inter-network datagram protocol (IDP) on both the CS/1 and the CS/1-X.25 (Fig. 3).

On receipt of the connection request, the CS/1-X.25 translator notifies the host of an incoming call. The X.25 software (levels 1, 2 and 3) is involved on both the CS/1-X.25 and the host. When the host accepts the call, the CS/1-X.25 accepts the connection from the CS/1 and the user is notified of the successful connection.

The CS/1 maps any modified terminal parameters into the proper X.3 port parameters and communicates them to the host via the X.29 protocol. The host also can modify terminal parameters using the X.29 protocol. The translator then maps these parameters and passes them on to the CS/1 via the VTP protocol. The

X.29 protocol is not used for host-to-host applications.

In the case of host-to-host communications, an address-mapper module performs the mapping from an X.25 host address to a complete LAN address on a CS/1-X.25. Host 1 issues an X.25 call request to the CS/1-X.25, using Host 2's X.25 address as a destination address. The CS/1-X.25 translator receives the call request. The address mapper supplies the LAN address corresponding to Host 2's X.25 address. The translator establishes an XNS connection to the translator residing in the CS/1-X.25 connected to Host 2. Thus, the XNS connection is extended via the translator through an X.25 virtual circuit to Host 2 (Fig. 4).

The CS/1-X.25 incorporates multiple 68000 microprocessors and a Multibus backplane with four free slots for host connection. The system consists of three logical modules: the central communications processor (CCP) module and two external interface modules (I1 and I2) (Fig. 5).

The CCP module includes the main CPU (MCP) board, which contains a 10-MHz 68000 microprocessor and 384K bytes of local memory. This memory is used as code and local data space, so that opcode fetch operations do not require Multibus access. The kernel, communications protocols and X.25 levels II and III software execute on the MCP.

The I1 module contains an Ethernet (or IEEE 802) interface, a 68000 for execution of the Ethernet data-link code and a 128K-byte shared buffer that is used as a packet buffer area for the various protocol layers. The shared memory also provides the common address space used for inter-processor communication. The Ethernet interface contains a sophisticated chaining direct memory access (DMA) capable of performing scatter/gather operations on incoming or outgoing Ethernet frames. This function, combined with the features of the kernel buffer manager, eliminates the need for copying packet buffers as they are passed through the protocol layers because the packet is never moved from shared memory. The CCP and I2 modules process the packets directly.

The I2 module consists of a dual-port, intelligent high-level data-link control (HDLC) serial interface and a serial I/O driver based on another 68000. It transfers data at rates up to 64K bps. □

Judith Estrin is vice president of engineering, and **J. Patrick Malone** is product marketing manager at Bridge Communications Inc., Mountain View, Calif.

Interest Quotient (Circle One)
High 849 Medium 850 Low 851

ONE BOARD GIVES YOU CONTROL FROM BOTH ENDS.

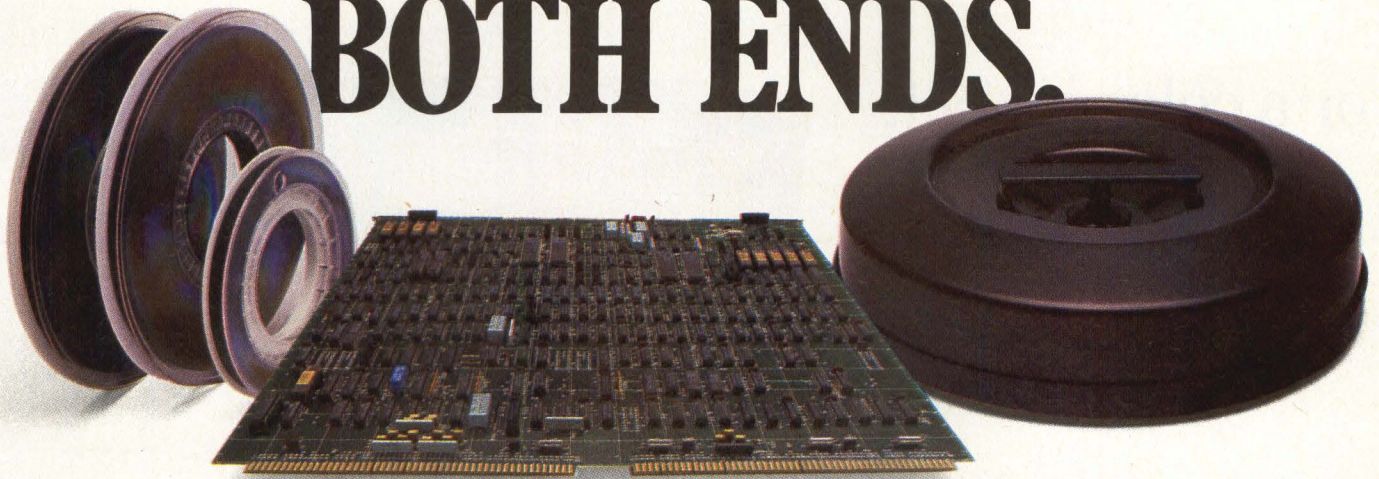

Looking at disk and tape control for Data General? You're probably looking at two separate controller boards. Which is one too many.

Spectra Logic multifunction controllers offer all the control you need, on just a single board. They're the smarter way to handle SMD/Winchester and 1/2-inch tape drives, because they've got you covered from both ends. But they do it in half the space and half the slots. Using half the power. And you're stocking half the spares.

So now buying separate boards for disk and tape makes no more sense than buying separate radios for AM and FM.

Our expanding family of Data General controllers offers you the performance you're looking for. We'll give you both ends for DG's NOVA® and ECLIPSE®/MV computers. And emulate DG's series of 6060 or 6160 disks and 6020 tape subsystems under RDOS, AOS, IRIS®, and BLIS/COBOL® without modifying your operating system.

But we'll also give you something extra: proven reliability. Because you're working with half as many parts and pre-tested ICs. Plus total FCC compliance and compatibility with DG's new hardened chassis.

You're also working with excellent documentation that's regularly updated. And the most comprehensive one year warranty in the industry. All backed by responsive nationwide service.

Spectra Logic. Our multifunction controllers double your control. And give you an advantage on the competition.

Look into Spectra Logic multifunction controllers for Data General computers. They could be all the control you'll ever need.

For further information, including complete technical specifications, call or write us today.

	SPECTRA 17*/ SPECTRA 27	SPECTRA 110*/ SPECTRA 120	SPECTRA 10*/ SPECTRA 20
BUS (Disk)	Burst Multiplexor Channel	Data Channel	Data Channel
Disk Emulation	606X, 6122, 6160, 6161 (4 drives)	606X, 6122, 6160, 6061 (4 drives)	606X (4 drives)
Tape Emulation (Data Channel)	6021	6021	6021
Operating Systems (without OS patches)	RDOS, AOS/VS	RDOS, AOS	RDOS
Disk Transfer Rate (SMD)	2.0MB/sec	2.0MB/sec	2.0MB/sec
Supports FCC Chassis	Yes	Yes	No
*Single function disk controller			

Spectra Logic Corporation, 1227 Innsbruck Drive, Sunnyvale, CA 94089, (408) 744-0930, TWX 910-339-9566, TELEX 172524 SPL SUVL. International Sales Office: The Netherlands (31) 23 273744, TELEX 71080 SPECL. Distributor inquiries invited

SPECTRA LOGIC See us at Comdex, Booth #1676

The Multifunction Controller Company.

©1984 Spectra Logic Corporation

CIRCLE NO. 105 ON INQUIRY CARD

At IBM, you're not limited to
a daisy wheel printer,



or an ink jet,

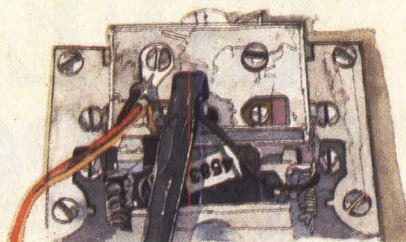

or a color ink jet,

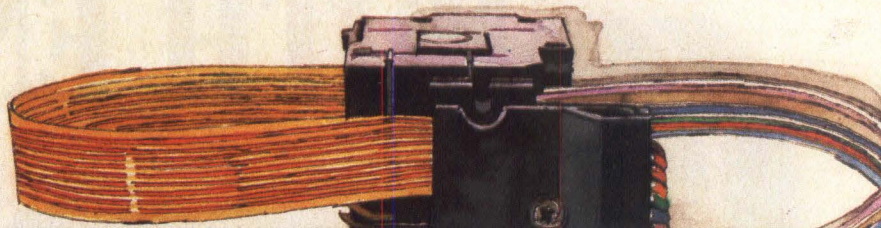

or a thermal,

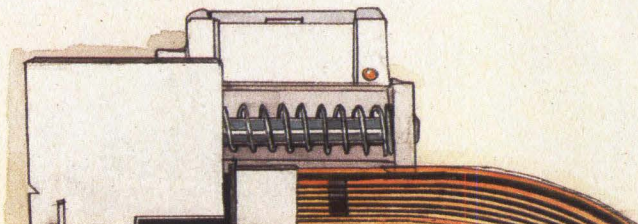

or a laser,

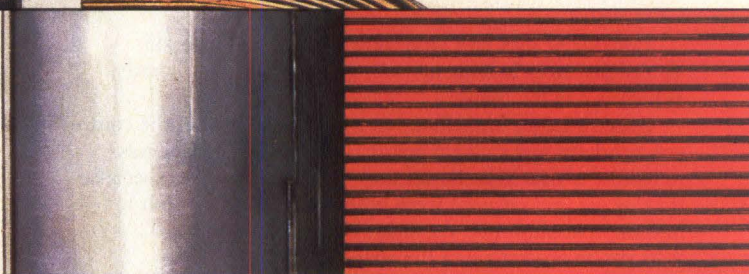

or a Selectric[®],



or a band,

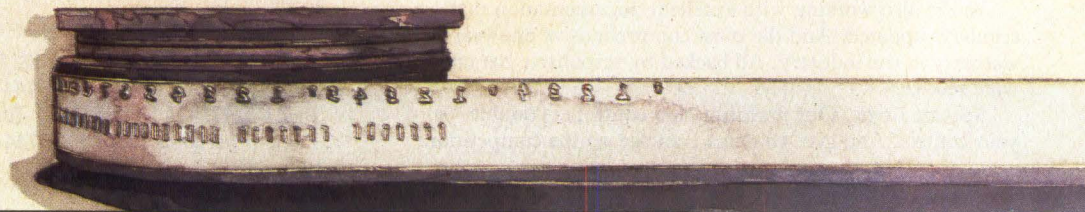

or an electro-erosion,

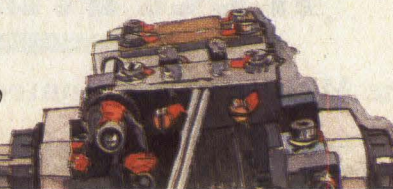

or a dot matrix,

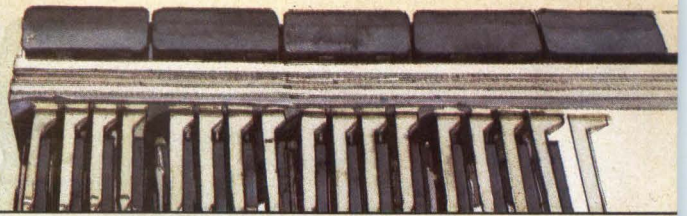

or a color dot matrix,

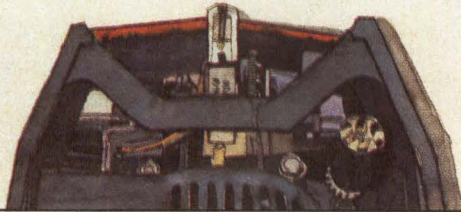

or a train printer,

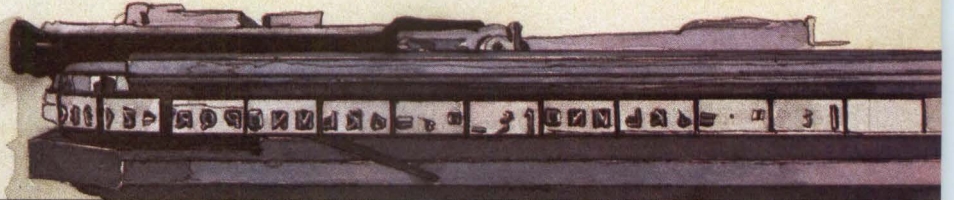

or even a plotter. Because we alone give you the choice of all of them.



What does this mean for you? Simply that our range of choices lets you choose the printer that best suits your needs.

IBM makes more than 70 different printer models, from personal computer printers to printers for our large computers.

We offer you an infinite choice of printing styles. From data printouts to IBM letter-quality printing. Color. Graphics. Electronic forms. And illustrations.

You can have print so perfect it's almost indistinguishable from offset printing.

There's also a choice of speeds —from desk-top printers measured in characters per second to printers fast enough to count in pages per second.

When computers first were joined with printers, IBM was

there. We built the first chain printers, train printers and laser printers. And in the process, IBM developed something else: a reputation for reliability.

At IBM, our range of print technologies and printers, our reliability and our service all serve a single purpose: To make your printing as effective as your processing. To give your work the finishing touch.

For free literature on our printers, call 1 800 IBM-2468, Ext. 96/3N.



IBM PRINTERS

The Finishing Touch

CIRCLE NO. 106 ON INQUIRY CARD

A Hard Driving Success Story.

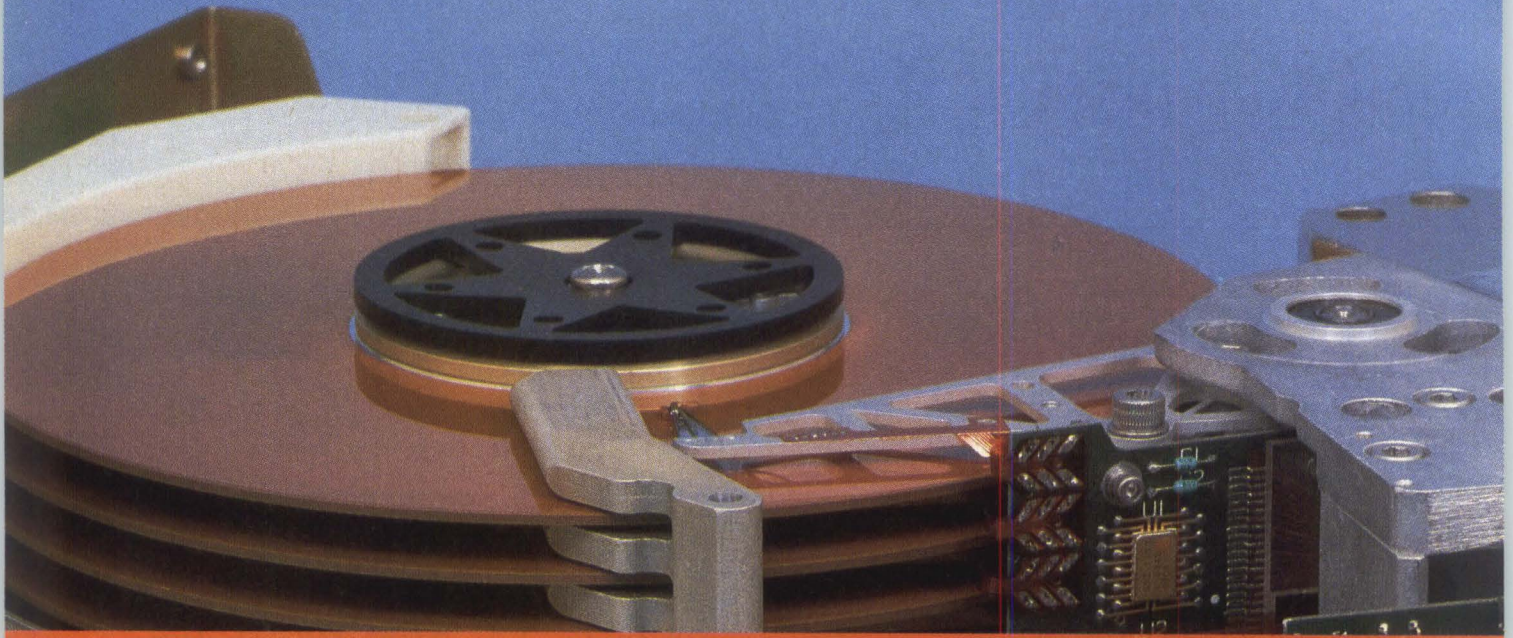

Innovative engineering in mechanical design and electronics with proven heads and media technology have been combined by PPC to create the DX Series 8-inch Winchester Disk Drives. Newly released, yet already well received by OEMs, the DX Series offers high performance, high capacity disk storage.

Sized to fit an 8-inch floppy drive envelope, the DX Series meets the growing demands of multi-user, multi-access systems for increased data base, fast throughput and uncompromised reliability.

- Capacities of 180, 240 and 300 megabytes
- ANSI and SMD interfaces
- Advanced-design rotary voice coil actuator
- Proven oxide disks and reliable composite heads

Look into our fast-rising star, and you'll know what hard-driving performance is all about.

Write or call for complete technical data and fast, firm delivery dates.

See us at COMDEX, Booth No. 3324



**PERTEC
PERIPHERALS
CORPORATION**

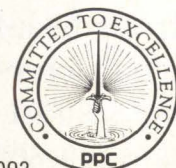

9600 Irondale Ave., Chatsworth, CA 91311 (818) 882-0030 TWX: (910) 494-2093
Toll Free Numbers: (800) 821-4126 (in California) (800) 443-9577 (outside California)

CIRCLE NO. 107 ON INQUIRY CARD

COMDEX/Fall '84 Preview

Exhibitors and speakers spotlight multifunction products: multiuser systems and multiapplications software packages

Lynn Haber, Associate Editor

Attendance figures are expected to swell above last year's 83,000 mark as visitors convene November 14-18 in Las Vegas for the 6th National Fall Conference and Exposition (COMDEX/Fall '84) for independent sales organizations (ISOs).

Conferees will peruse the wares of approximately 1,400 exhibitors, which include manufacturers of small computer systems, related peripherals, software, accessories and providers of services and supplies.

Of particular interest at this season's show are multifunction products, like multiuser computer systems and multiapplications software packages.

Almost single-handedly responsible for the multiuser market imperative was IBM's August announcement of the Personal Computer AT. Based on Intel

Corp.'s 80286 microprocessor, and running under the PC XENIX operating system, the PC-AT can operate as either a multiuser system or a standalone computer. Multiuser systems allow people working at computers or terminals to perform tasks simultaneously, as opposed to the single-user approach of the personal computer.

Other multiuser system manufacturers and exhibitors at COMDEX/Fall include Digital Equipment Corp., Data General Corp., and smaller companies such as Fortune Systems Corp., Altos Computer Systems and Durango Systems Inc.

An important issue in this year's marketplace is the conflict between dealer and direct sales forces. Several sessions will examine the issues and possible solutions to this problem.

Forty-five sessions will explore topics pertaining to



Amy Wohl, president of **Advanced Office Concepts**, will conduct a session on the future of small systems.

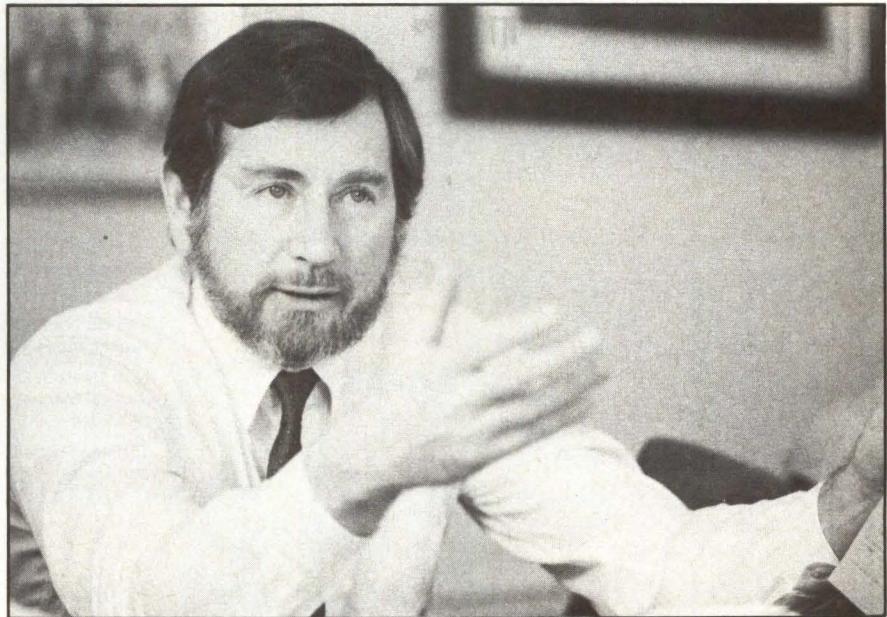

"These [portable] systems are worth buying, but people don't know that," says **Gene R. Talsky**, president of **Professional Market Management**.

HERE ARE THE FOUR DAYS OF THE CONFERENCE

	Wednesday	Thursday	Friday	Saturday
9				
10	Keynote	ISOs vs. Mass Merchandisers		
11			Government's Hand In ISO Success	Automating the Small Office: A Role for Resellers? The Education Market: Finding your Niche International Distribution Strategies Software Demo Dynamos Managing Your Sales Team
12		The Software Shake-up Local Ads and Promo for Lead Generation "New and Improved" Prospecting Techniques Add-Ons to the Rescue Financing ISO Growth		
1	Small Systems Forecast Shuffling Shelf Space for Increased Profits Microprocessor Companion-Chips		Living With Cross-Channel Conflicts Direct Response Tools and Techniques	
2	Integrated Packages: Power vs. Functionality Stay an Independent, Go Chain or Franchise?	Computers in the Home: Redefining the Market Software Distribution: Changes and Challenges Strategies for Retail Specialization: What's Right for You? Strategic Selling for Lucrative Results Multi-User Systems: Issues and Impacts	Closings You'll Never Forget Preview of New Storage Alternatives LANs, Links and Lettuce	The 1990 Resellers Market
3	Retail Sales Forecast Portables and Transportables UNIX and the Multi-User Opportunity Educational Software: All Ages Can Learn!		Telemarketing Strategies for Computer ISOs The Corporate Sell: Who Profits and How? New Deals in Database Dollars Vertical Markets: The 1985 Overview	
4	ISO Contractual Protection	ISO/Vendor Roundtable	Training Products for Resellers and Users	
5				

the business of designing, manufacturing, marketing, selling and supporting small computers. Seminars will cover such topics as the microcomputer marketplace, directions in distribution, one-on-one marketing, retail success routes, systems sales training, the software market and business strategies for ISOs.

A few new sessions incorporated in this fall's line up include "ISOs vs. Mass Merchandisers," "Government's Hand in ISO Success," "The Software Shake-Up," and "Living with Cross-Channel Conflicts." Other, more familiar, topics will be presented from a new perspective.

Speakers focus on small systems

Chairing a Wednesday (Nov. 14) talk entitled "Small Systems Forecast," Amy Wohl, president of Advanced Office Concepts Corp., Bala Cynwyd, Pa., will focus on small-business systems as used by small businesses or small groups within a company. According to Wohl, these systems will be viewed from two perspectives—physically small systems used by large companies and small systems used by small companies.

Past COMDEX coverage on this topic emphasized operating system software. Wohl says this year's discussion will attempt to balance coverage of hardware, operating system software and applications software. "We'll try to spend more time on the small-business system, rather than on the computer that happens to be small," she says. "We'll also look at what kind of hardware is coming into this market, the types of operating systems that are going to be seen in that hardware, what kind of application software is available now and what's going to come along."

Wohl plans an equally significant focus on the IBM PC-AT, with particular attention placed on the multi-user (PC) XENIX operating system and the company's PC local area network. "We're going to say, 'Hey, the market has changed.' It's the three-year anniversary of the birth of a piece of this industry and we're now going to try to recalibrate based on that change," asserts Wohl. "We have lots to talk about."

Later that afternoon, Gene R. Talsky, president of Professional Market Management Inc., an Old Lyme, Conn.-based consulting firm, will look at the portable and transportable computer market. As session organizer, Talsky will present an overview of applications and market strategy. He'll examine more closely what he terms the "false hopes" and projections for this industry segment. "Dealers are selling capability rather than a device," he says. If the portable market is to gain momentum, dealers and manufacturers must change the public's perception of these machines, according to Talsky. "These systems are worth buying, but people don't know that," he says.

International marketing differs from U.S. marketing both legally and culturally, remarks Barry E. Wagman, president of International Software Export.



Also speaking will be Thomas Kinch, president of MicroOffice Systems Technology Inc., Fairfield, Conn. The firm markets the Roadrunner, a five-pound, CP/M, Z80-based portable computer. Lisa Williams, president of STM Electronics, Menlo Park, Calif., will center on the transportable computer market and on the transportable as a desktop computer.

Speaking at a Thursday afternoon session, "Software Distribution: Changes and Challenges," Egil Juliussen, chairman of the board and senior vice president of research at Future Computing Inc., a Texas-based company, will examine the trends in software stores, the direct sales method of software distribution and electronic distribution.

Distribution conflicts and strategies

Deborah de Peyster, editor of *Micro-Market World*, will chair a Friday afternoon session entitled "Living with Cross-Channel Conflicts." Discussion will focus on the problem between dealers who complain that there are too many channels of distribution, and manufacturers, who dealers feel set up these avenues. According to de Peyster, the result of this situation is too many distributors competing with one another to sell the product. "This is an historic problem," she states. "Each channel feels it can handle the whole market. So, you have to start drawing lines denoting territory."

The speaker will outline some of these cross-channel conflicts, and then look for possible answers or ways of eliminating the problems to find effective distribution solutions.

For those companies preparing to enter the interna-

PROGRAMMABLE COMMUNICATIONS TRANSLATOR



MSI's PCT-100 IS A CONFIGURABLE IN-LINE RS-232 PROTOCOL AND DATA TRANSLATOR WHICH CAN PROVIDE:

- * TERMINAL OR PRINTER EMULATION
- * DEC OR IBM SYSTEM COMPATIBILITY
- * MACRO-FUNCTION KEYS
- * "TYPE-AHEAD" AND DATA BUFFERING
- * BAUD RATE CONVERSION
- * HANDSHAKE PROTOCOL TRANSLATION (E.G. CTS/RTS, XON/XOFF)

THE PCT-100 CONFIGURATION IS EASILY ENTERED AND MODIFIED USING A BUILT-IN EDITOR, COMPILER, AND DEBUGGER. CODING TRANSLATION ALGORITHMS IS SIMILAR TO PROGRAMMING A CALCULATOR.

WITH POWER SUPPLY AND CASE, THE PCT-100 IS \$495 FOR SINGLE UNIT QUANTITIES.

Method Systems Incorporated
3511 LOST NATION ROAD SUITE 202
WILLOUGHBY, OHIO 44094
(216) 942-2100

CIRCLE NO. 108 ON INQUIRY CARD

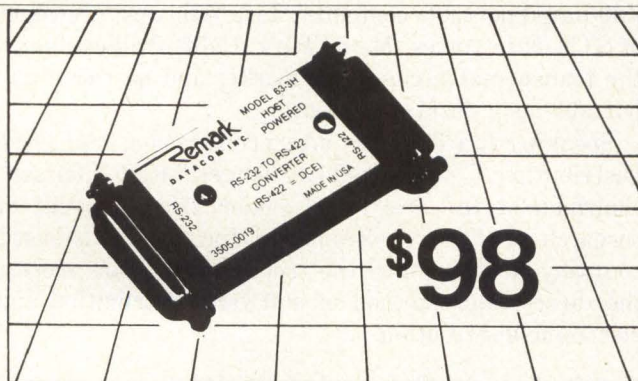

RS-422 CONVERTER TO/FROM RS-232

- Up to 100 kilobaud at 4000 feet
- Up to 3 miles at 1200 baud
- Supports eight signals
- Doubles as a high speed short haul modem
- All handshake signals and clock
- Write or call to order or for more information

TELEBYTE

A PUBLIC COMPANY

Remark Datacom Division • Telebyte Technology, Inc.
148 New York Ave., Halesite, NY 11743 • (516) 423-3232

CIRCLE NO. 109 ON INQUIRY CARD

tional marketplace, or for those already operating overseas, a session entitled "International Distribution Strategies" will examine how to approach the international marketplace, what to do once you're there and what is unique about that marketplace.

According to the session organizer, Barry E. Wagman, president of International Software Export Corp., Los Angeles, Calif., international marketing differs from U.S. marketing both legally and culturally.

If the portable market is to gain momentum, dealers and manufacturers must change the public's perception of these machines.

In approaching the marketplace, the speaker will examine what vehicles are available to the entrepreneur and the ramifications of each of those vehicles. Also to be discussed will be the pros and cons of overseas distribution outlets, using export and trading companies, getting consultation and distributing your own products.

Once you go international, how do you go about becoming profitable, what facilities and structures must be in place to succeed and what type of market strategy is needed for growth and survival in this marketplace? "These questions are more directed towards those already a part of the international marketplace, but [who] may not be profitable yet, or [those who] aren't satisfied with their strategy or are looking to expand," explains Wagman.

Alan Platt, vice president of international marketing for TeleVideo Systems Inc., and representatives from both ITT Europe (Brussels), and the Nippon Electric Corp. (NEC), Tokyo also will speak at this session. □

Interest Quotient (Circle One)
High 852 Medium 853 Low 854

LOOKING AHEAD IN MMS

Mini-Micro System's December issue is our third annual overview of those leading edge technologies impacting our value-added market readership. A long-lasting sourcebook for technology and market data, the report presents past, present and future perspectives on key areas including:

- local area networks
- natural language translation
- operating systems
- non-impact printing
- relational database systems

WHY BUY A DATABASE SYSTEM?

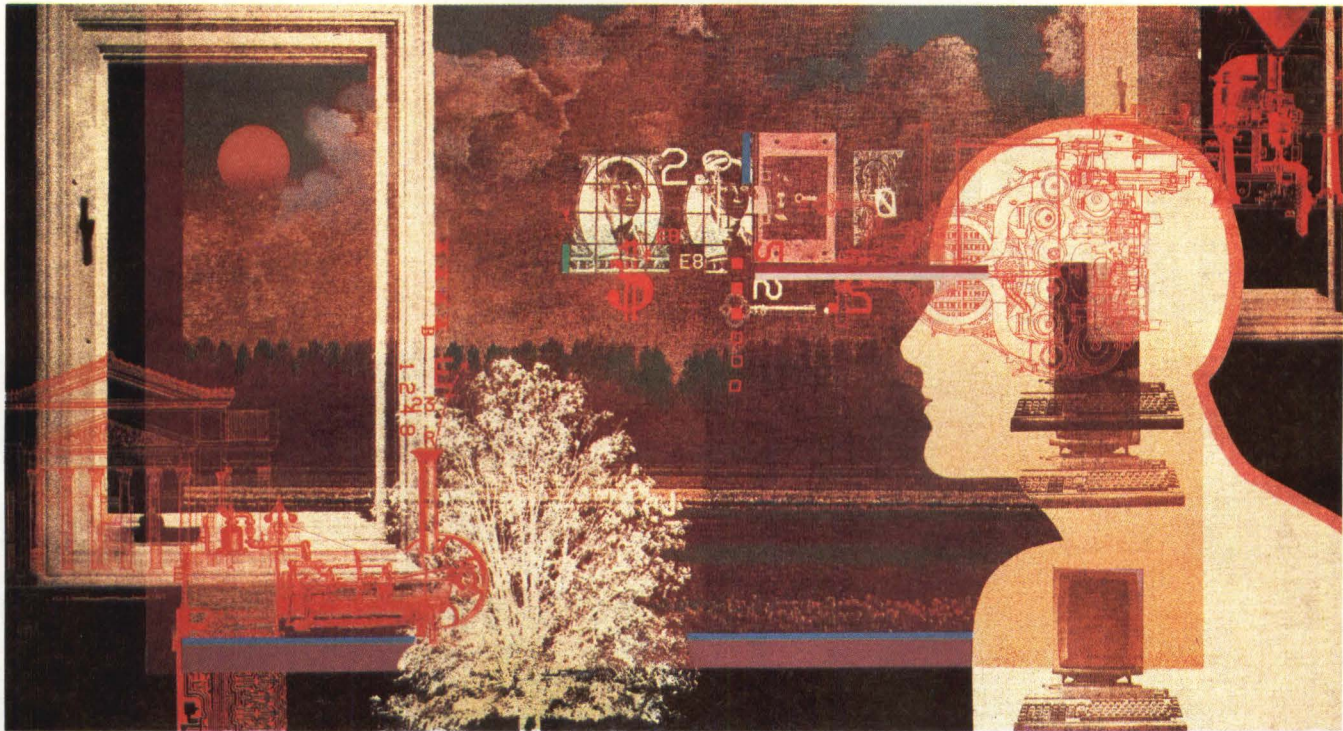

TO BUILD APPLICATIONS!

PROGRESS™ is the high-performance database system and fourth-generation application development language for multi-user microcomputers.

PROGRESS gives you all the flexibility and control of structured programming languages, but uses plain English syntax for simplicity and ease of customization. You and your staff will learn to use PROGRESS quickly and benefit immediately from its state-of-the-art features.

Why build business applications in C, BASIC, or COBOL when PROGRESS will increase your productivity 10 to 40 times? PROGRESS makes this possible by integrating these powerful features:

- English-like application language
- Flexible relational DBMS
- Integrated data dictionary
- Automatic screen and report formatter
- Full-screen syntax-checking editor with on-line help

Once your application is built, PROGRESS offers:

- High performance
- Comprehensive multi-user capabilities
- Automatic database recovery
- Easy modification and customization
- Ad hoc query and report-writing capability
- Portability to a wide range of machines

PROGRESS is available today on major UNIX™-based super-microcomputers.

Power. Performance. Ease of Use . . . Now, that's PROGRESS! You can't afford to build applications without it.



DATA LANGUAGE CORPORATION
5 Andover Road, Billerica, Ma. 01821
617-663-5000

PROGRESS

A NEW APPLICATION ENVIRONMENT

See us at Comdex Booth #H 7721, and make some PROGRESS for yourself.

Want to make PROGRESS in a hurry?
Call Area Code 617-663-5000 today.

Or just fill out and return the coupon below.

DATA LANGUAGE CORPORATION
5 Andover Road, Billerica, MA 01821
(617) 663-5000

- Yes! Please send me a demonstration disk and documentation for PROGRESS. I enclose \$295.
- Please send more information about PROGRESS.
- I am interested in PROGRESS seminars.
- I am interested in becoming a PROGRESS dealer.

Name _____ Title _____

Company _____

Address _____

City _____ State _____ Zip _____

Telephone (_____) _____

MM N

PROGRESS is a trademark of Data Language Corporation, developers of advanced software technology for business and industry.
UNIX is a trademark of AT&T Bell Laboratories.

HOW TO STRETCH A PC TO CREATE NEW MARKETS.

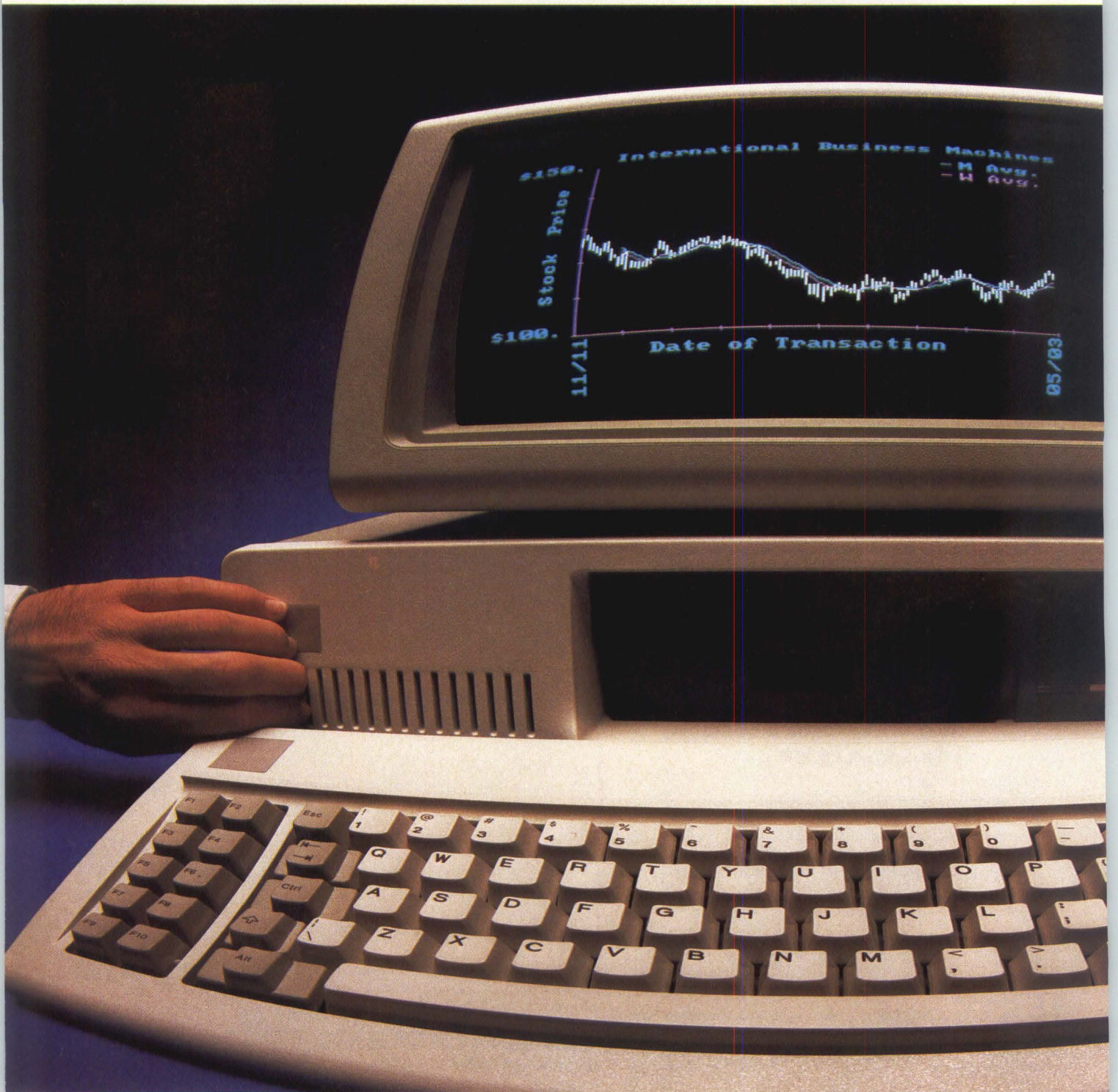

OR EXPAND EXISTING ONES.

When is a PC not a PC? When you turn it into a personal data base cruncher. Or a personal graphics workstation. A personal image processor. Even a personal signal processor.

You can do all that and more with the Marinc board pictured below. It's your key to unlocking new opportunities and new markets.

Power to the PC.

We've put array processor technology to work to supercharge the PC. Suddenly a spectrum of applications that were beyond that PC's capabilities are wide-open possibilities.

If your strength is software, the Marinc array processor gives you incredible performance improvements. Even the most complex spreadsheets can ripple faster than you can say 1-2-3. Enormous data bases can search, sort and report in the blink of a cursor. And high speed arithmetic calculations which slow a standard PC down to a crawl are performed in split seconds.

If you're a systems integrator, VAR or OEM looking for a competitive advantage, a PC with a Marinc array processor is a natural line extension, enabling you to offer a cost-effective "personal" version of your best-selling product.

The Race Is to the Swift.

The Marinc array processor is especially flexible and easy to program. So you can get to market quickly. Which, after all, is the name of the game.

We could fill pages with pertinent performance specs on our PC-compatible array processor. So we did. We've put together an 8-page brochure that will stretch your imagination. And just might open a world of opportunity. Write for a copy. Marinc Computer Products, a Helionetics company, 3878 Ruffin Rd., San Diego, CA 92123. Or call 1-800-421-4807, in CA (619) 268-4814.

Marinc array processors include a 24-bit floating point board with optional IEEE-754 compatibility and a 16-bit integer-only board for maximum price/performance.



MARINCO

CIRCLE NO. 111 ON INQUIRY CARD

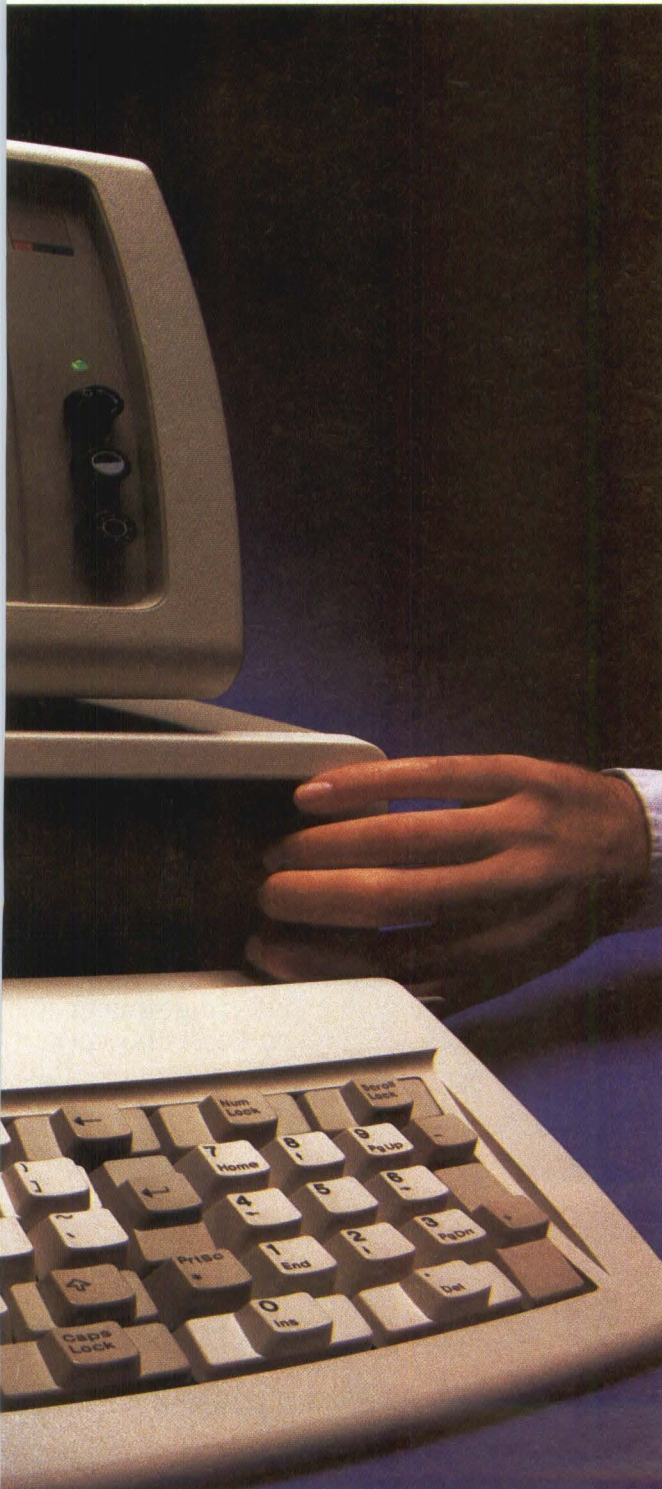

Xebec's New Owl Reduced Storage To

Then.

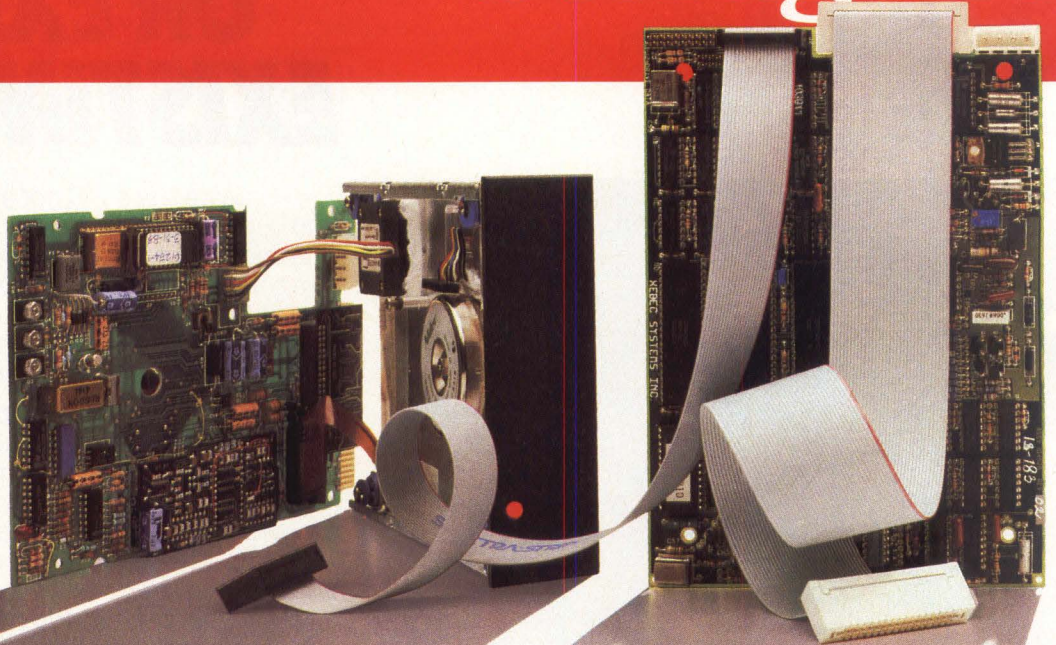

Microcomputer storage history has progressed by a series of small "next logical steps." A replacement of a component here, a refinement of technology there. But now Xebec has taken a giant step, with its Owl intelligent disk file.

On the surface, the Owl might look like other 10-megabyte, 5¼" half-high Winchester. Underneath, however, it's an example of superior technology. The integration of controller logic and drive electronics on a single board means not just one less PCB, but the elimination of expensive connectors and cabling, low power consumption (15 watts typical) and enhanced data integrity.

We've put data separation in the HDA for precise control of data windowing and the elimination of background noise. We've provided a diagnostics channel to the host that delivers meaningful error messages.

Just as our superiority in minicomputer controllers led the way to a similar superiority in micro controllers, and our tested pairs solutions evolved from our considerable sub-system and testing experience, so too the Owl

reflects our "top-down" engineering strategy—creating both technological and cost-of-owner-

Single-board drive and controller electronics insure higher reliability

Integrated data separation within disk drive delivers higher data integrity

Ruggedized design includes head landing zone

Comprehensive diagnostics eliminate "What's wrong?" guesswork

Compatible with industry-standard Xebec SASI bus for faster system integration

CORPORATE HEADQUARTERS
2055 Gateway Place, Suite 600
San Jose, California 95110 U.S.A.
(408) 287-2700

es Microcomputer Disk Two Words.

Now.

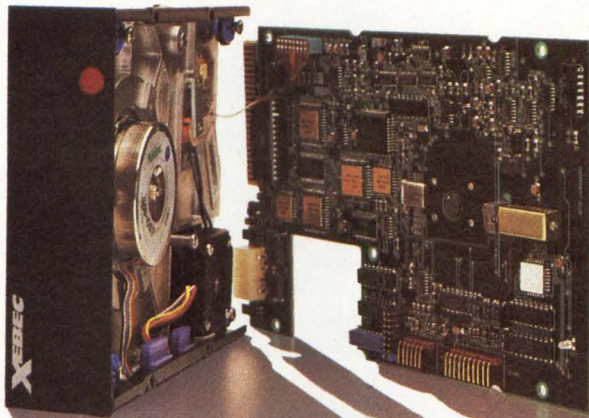

ship breakthroughs by designing sophisticated high performance, multi-user features into small-system, single-user environments.

The System-Engineered Solution.™

As a major user of drives, and a major testing resource for other drive manufacturers, we are concerned about drive reliability. And we've learned that it's not just a question of improving a component or consolidating some board real estate. The answer lies in careful consideration of overall system integration requirements.

The Owl epitomizes what we call the Xebec System-Engineered Solution. The focus is two-fold: on today and on tomorrow. Compatible now with industry-standard Xebec SASI, the Owl—by eliminating the ST506 interface—is

upwardly compatible for future higher densities, capacities and performance.

In broader perspective, Xebec's approach to OEM satisfaction rests on our proven experience, our vertical integration strengths—which now include production of heads and plated media—and our commitment to zero defect quality, by way of computer-aided design and robotics manufacturing.

Call Xebec today. Let us tell you more about the Owl. And how we can deliver the difference between then and now. Now.

See us at Comdex Fall

CIRCLE NO. 112 ON INQUIRY CARD

SALES, INTERNATIONAL,

Belgium
32-02-762-9494
England
44-734-693511
Italy
39-6-350201

SALES, U.S.A.

Sunnyvale, CA (408) 732-7330
Irvine, CA (714) 851-1457
Atlanta, GA (404) 457-9872
Boston, MA (617) 740-1707
Dallas, TX (214) 361-0687
Baltimore, MD (301) 992-7377
Federal (301) 621-3010
Chicago, IL (312) 931-1420

U.S.A. AND CANADA DISTRIBUTORS

Kierulff
Hamilton-Avnet
Avnet Electronics
Hamilton Electro Sales

XEBEC

The Quality Investment

SCSI.

Four letters that let you hook any host...

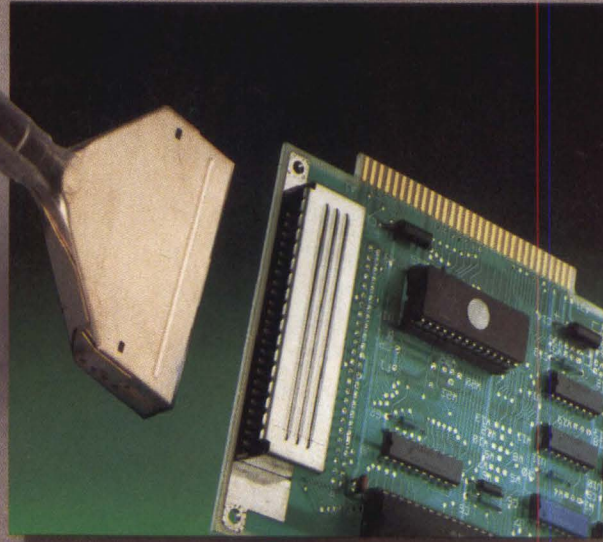

to any peripheral.

Presenting SCSI. Small Computer Systems Interface. An interface standard that lets you connect small computers with virtually any peripheral device — even those still on the drawing board. Without overhauling your hardware and software. So the best can go with the best, period — not the best of what's compatible.

SCSI works by masking the internal structure of the peripherals from the host. It uses an eight-port bus which can accommodate either single- or multiple-host systems. Its impressive transfer rate of 1.5 Mbytes per second allows direct copying between devices, too. Freeing the host for more important work. And giving it lots of power for lots of I/O activity.

In developing SCSI as a truly versatile standard interface, the American National Standards Institute (ANSI) enlisted some of the best minds in the industry — including more than a few from NCR-Wichita.

NCR is the undisputed leader, too, in designing and manufacturing SCSI components. We offer a complete line, from host adapters for Multibus and

IBM PC architecture to ST-506 and SMDO disk controllers to PERTEC and QIC-02 tape controllers. We've also made numerous advancements in reducing the size of the components — and in reducing their price.

And this same quality of expertise in applications engineering is available to our OEM customers, as well.

SCSI is changing the face of system integration. And NCR has been there all the way. With capacity and technology second to none... and a century of quality behind us.

If you want to know more about what SCSI can do for you, call NCR at 1-800-325-SCSI.

SCSI products from...



Engineering & Manufacturing / Wichita, KS 67226

Color workstation offers winning combination of hardware and software

Convergent Technologies' AWS scores high for its ergonomic design, powerful processor and sophisticated operating system. It loses a few points for its BASIC compiler and linker



A 15-inch color CRT on a rotating and swiveling socket, and a mainframe enclosure share the AWS workstation's 27-by-9-inch base. The distinctive enclosure contains circuit boards, power supply, a 5M- to 16M-byte Winchester disk and a 5¼-inch floppy-disk drive with as much as 640K of storage.

Marilyn Harper, Classic Systems Inc.

Convergent Technologies' 16-bit AWS color graphics workstation boasts an extremely powerful mix of hardware and software for system integrators and software developers and an impressive ergonomic design. Its drawbacks are primarily software-related, and except for one instance, relatively minor. They include the difficulty of learning to use its operating system and problems encountered with Convergent Technologies' implementation of BASIC.

My evaluation of the AWS' hardware and system

software is based on first-hand experience gained during a conversion project here at Classic Systems. We converted about 30 large programs, written for Microsoft Corp.'s BASCOM BASIC compiler, to run on the 16-bit AWS workstation. During the six months of this project, I observed "from the trenches" the workstation's hardware, operating system and system software.

The Convergent workstation uses a 16-bit Intel 8086 CPU running at 8 MHz. The hardware comprises a vertical mainframe enclosure and an adjustable CRT mounted side by side on a low, flat base, with a

detached keyboard. The workstation comes with 128K, 384K or 512K bytes of RAM.

Although the workstation's footprint is somewhat large (27 inches by 9 inches), it has a good ergonomic design. The 15-inch CRT enclosure rests in a rotating socket, which allows it to tilt and swivel to almost any position. The screen has an attractive non-glare surface, but it shows fingerprints distinctly—a minor inconvenience. The boxy mainframe enclosure on the CRT's right contains power supply, circuit boards and mass storage, which includes a 5¼-inch Winchester disk drive (5M to 16M bytes formatted), and a 5¼-inch floppy drive with about 600K capacity. The floppy drive configuration is unusual; it's mounted on top of the enclosure in "pop-up toaster" fashion. However, with the drive in this location it can be difficult—especially for short people—to see inside it.

An additional problem is that the side "O" read/write head for the floppy disk is on the far side of the drive. This means that the disk must be inserted with the maker's label facing away from you. Affixing your own label on the backs of the disks can remind you of this idiosyncrasy. If you use only the AWS workstation, you could quickly become accustomed to the nonstandard routine. But if you also have other micros around, with more common drive orientations, the AWS is hard to get used to. And none of its file-transfer utilities allow you to recover from drive errors caused by inserting two disks, inserting a floppy the wrong way or leaving a drive door open.

The detached keyboard plugs into a notch in the front of the base. Having the short, coiled cord in the front is more convenient than snaking it around to plug into the back of the computer. The well-laid-out keyboard provides 98 keys, including a numeric keypad and cursor-arrow keys to the right of the main key cluster. Function keys, labelled "1" through "10," sit in a row at the top. Fourteen other keys are labeled for special functions—particularly useful during editing. Eight keys—shift lock, overtype mode toggle, and six of the numbered function keys—have red LEDs that indicate when they are engaged, which is a useful feature.

Because the workstation has two display controllers, the CRT can operate in two modes. An Intel 8275 CRT controller chip and character-generator ROM on the CPU card handle alphanumeric mode. An NEC 7330 Graphics Display Controller, piggy-backed on the CPU card, implements a bit-mapped graphics mode.

The workstation's alphanumeric screen can show either a monochrome (green) or a color display of 80 columns by 28 rows. The character font of 256 symbols includes foreign language marks and other special characters; a set of 64 graphics characters for stick-figure type drawings is included and can be invoked

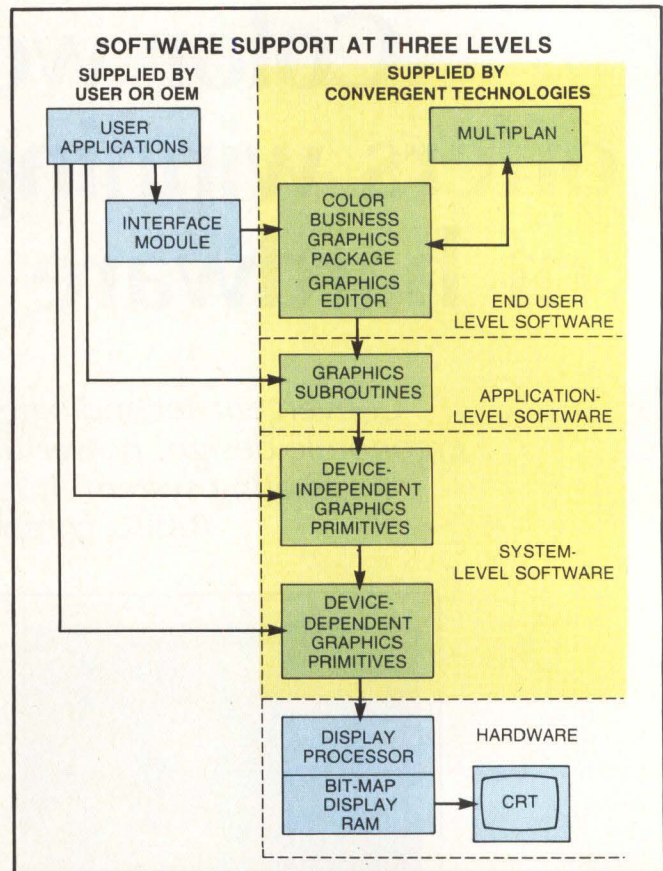

The AWS Color Graphics Workstation provides three different levels of graphics software support, including the high-level Color Business Graphics plotting package, application-level graphics plotting package, application-level graphics subroutines and system-level device-independent and device-dependent graphics primitives.

with the keyboard. This feature, however, is not particularly well implemented. Little effort was made to logically group the keys. I found it impossible to remember the graphics character set without a written prompt.

The 28 rows of the alphanumeric screen can be treated as either a whole or split screen display. In the latter case, the top two rows are used as a status area, the third row is a line dividing the frames and the bottom 25 rows make up the application screen. Operating system commands utilize this 25-row application frame. User-written programs can be compiled and linked so as to devote all 28 rows to a single application frame.

One problem with the alphanumeric screen is that it can accommodate only 16 video attributes in any one row. Mixing text and character graphics can easily exceed this limit. It takes one video attribute to "toggle" up to the alternate font (characters 128 to 255) and another to get back to the normal ASCII range characters (0 to 127). Other attributes include reverse video,

FIVE AGAINST ONE

It Hardly Seems Fair

Five against one is just as unfair in a business environment as it is on a basketball court. IBC's Multi-Star I,TM five user business computer—priced as low as a single user personal computer with all of the attributes of a true multi-user system has the full court advantage.

The Multi-Star isn't just another single user personal computer that can be "Networked" to pretend you have multi-user capabilities. It is a true multi-user business system like the high priced multi-user mini-computers of old. And, a low cost "Dumb" CRT terminal is all that you need for each user.

Sophisticated multi-user software with big system features such as record locking, user accounting, privilege levels, and system security provide capabilities well beyond those available on any personal computer.



There are hundreds of multi-user business accounting software applications available right now as well as word processing, spread sheet, and data base software.

The Multi-Star I is the smallest member of the IBC multi-user family. Software compatible systems with up to 16 users and 167 megabytes of hard disk storage are also available.

IBC has been manufacturing high-performance, multi-user micro-computers since 1979.

Their reputation has been built on quality, performance, and reliability. To find out more about the multi-user business systems that is priced like a single user personal computer, please call or write:

IBC

Integrated Business Computers
21621 Nordhoff Street
Chatsworth, CA 91311
(818) 882-9007
Telex No. 215349

See us at Comdex Booth #2572

CIRCLE NO. 114 ON INQUIRY CARD

Never Again Choose Between Price and Quality.

The competition says you must sacrifice one for the other. What they're really saying is they can't give you both. Introducing the TeleVideo® 921. Proof that low price and high quality do go together.

But don't let its low price fool you. The 921 is years ahead with features taken from our most expensive terminals. Like selectable embedded or nonembedded field attributes. 32 nonvolatile function keys. 6 fast edit keys. And something we're famous for: indepth support. Including technical assistance, service training and award winning documentation.

One glance at its nonglare green screen with true tilt and swivel. One pass over its low profile, sculptured keyboard. And you know this terminal is built right. In fact, the 921 is built to the highest quality standards in the industry — our own. We use modular subassemblies. All components are pretested and prestressed. Boards are mounted vertically to run cooler, last longer. There's even room to plug in upgrade options. Like our low cost, Tektronix® compatible graphics board.

The point is this. Don't sacrifice either price or quality. Get both. Get the new TeleVideo 921.

Call toll free, (800)
538-8725. In California,
call (408) 745-7760.

Regional Sales Offices: California/Santa Ana (714) 476-0244, California/Sunnyvale (408) 745-7760, Georgia/Atlanta (404) 447-1231, Illinois/Chicago (312) 397-5400, Massachusetts/Boston (617) 890-3282, New York/New York (516) 496-4777, Texas/Dallas (214) 258-6776

The TeleVideo 921



Terminals
TeleVideo Systems, Inc.

Tektronix is a registered trademark of Tektronix, Inc.

half intensity and blinking characters. If the attribute limit is exceeded, the results can be unpredictable; an entire row can suddenly go blank or parts of the row can drop out.

The workstation has two libraries of graphics routines. One contains the usual vector and circle-drawing procedures. The other—the business graphics package—serves data plotting and graphing. Both libraries are easily accessed from application programs by function calls.

Operating system furnishes high-end features

The AWS uses its maker's own CTOS multi-tasking and multiuser proprietary operating system. The CTOS screen prompt consists of the word "Command" followed by a row of half-intensity reverse-video blanks, onto which you type the name of a command or file-name. Some commands require parameters, others don't. If no parameters are needed, typing the command name and pressing "Go" will start execution.

The operating system provides many sophisticated features, including 16-level password protection, file locking, path selection for alternate directories and simulated menu-driven operation via the "Help" key. Most of these features can be bypassed. In a software-development environment, passwords, for example, are frills that just slow you down. But for a multiuser-application environment, CTOS is rich in high-end minicomputer-type system features.

The 50-character file names possible with CTOS are a welcome feature. To maintain convention, the BASIC programs we converted were still called FILE-NAME.BAS, but they could just as well have been renamed, "ProgramtoPrintCrossReferences.from-CTBASIC".

CTOS maintains an alphabetized list of programs, called up by using the "Help" key. Utilities called "NewCommand" and "RemoveCommand" allow you to add or delete programs from this list. Adding user-written programs to the command list results in a disk menu of programs.

CTOS provides a software clock—a helpful feature if used with care. For the clock to be useful, though, you must set the date and time whenever the system is powered up; the clock reading on power-up is the time recorded when the power was last shut off.

Many of the system utilities, including the editor, put a date-mark on the files they access, permitting users to determine when a file was last modified. There are several flaws to this system. Users must scrupulously keep the software clock set correctly. The editor will date-stamp a file, even if you abort without actually editing it. And, if you move a file from one disk to another, it will be date-stamped by the transfer utility,

overwriting the date the file was actually last modified.

Convergent Technologies' operating system comes with a large number of system utilities, invoked by entering the utility name and then filling in the command form, if required—a procedure very close to being truly menu-driven. In many cases, defaults are presented for some of the parameters, which you can accept without bothering to fill in the entire screen.

The size-reporting utilities don't measure in the "kilobytes" to which many microcomputer users have become accustomed. For example, the Volume Status reports space remaining on the disk in free pages. But, because a page is 512 bytes, you must divide pages by two to get kilobytes. To determine file size, you use the directory command "Files" and press "Return" to get its parameter screen.

File-moving utilities don't automatically overwrite an existing file on a destination disk with the same name as the one being moved—a nice safety feature. You can thus decide to overwrite on a file-by-file basis, confirming or denying each overwrite.

Some of the CTOS utilities that send output to a printer use a parallel printer port or a system print spooler. If you use a serial printer, you'll have to do a little tinkering to be able to talk to your printer. All serial I/O is controlled by a configuration file, which can be created or modified with the system utility, "CreateConfigurationFile."

Directory scheme consumes disk space

The Convergent workstation uses double-sided, double-density mini-floppies claimed by the manufacturer to have 640K maximum formatted capacity, but this figure is somewhat misleading. The complicated directory scheme on the disk takes up a significant amount of space, reducing the storage capacity available to the user. I was thus never able to get more than 605.5K of usable disk space, no matter how leanly I configured a disk.

A floppy-disk copy utility writes the contents of a source floppy onto the workstation's Winchester, then prompts for insertion of a destination floppy. The destination disk is formatted (whether it needs it or not), and then is written on from the hard disk, floppy-image file. This process is remarkably slow—taking about 7 minutes. Additional copies from the same source take about 4 minutes each.

Convergent Technologies provides an excellent communications program, the Asynchronous Terminal Emulator (ATE). We use it to transmit ASCII BASIC source code directly from an 8-bit CP/M computer, over a wire to one of the serial ports on the workstation, where it is received by the ATE program. ATE can receive at 9600 baud, and only needs a file name to save

what it gets. On the CP/M side, "PIP TTY: =FILENAME. EXT" is a sufficient sending mechanism.

An MBASIC program needs minor cosmetic surgery when it has been transmitted to the workstation. CTOS uses only Line Feeds (ASCII 10) for its Newline character. The Carriage Returns (ASCII 13) should be stripped from a transmitted MBASIC program. And embedded Line Feeds in MBASIC source code should be changed to ASCII 2's in the Convergent Technologies format.

With a little effort, users can also transmit random data files from CP/M to CTOS. The random file should first be converted to Intel hex format. It can then be sent over the wire to ATE like any other ASCII file. Users will need a simple program to read this sequential file, convert it to binary in record-sized chunks and write it to a random file under CTOS.

An outstanding text editor

The Convergent text editor is the finest programming editor I've yet used. With only 14 commands, it's very easy to learn. Most commands are invoked by holding down the "Code" key and pressing the first letter of the command name, for example, "Code F" for find.

The workstation's special labeled keys, such as "Next Page" and "Previous Page," aid in large-scale movement through a file. There are no "Word-forward" type of commands, but because all keys are auto-repeat when held down, motion by cursor arrow is generally fast enough. The editor comes up in insert mode, which can be turned off by pressing the "Overtime" key. The LED on the key reminds you that you are in the overwriting mode, until you press that key again.

The AWS workstation's block commands are superb, with blocks highlighted in reverse video. Special keys ("Move" and "Copy") operate on marked blocks. Mass deletions are implemented by marking the block to be deleted, then pressing "Code Delete." An excellent feature is the monitor-mode toggle, which Convergent calls the "visible" command. This shows all of the normally unprintable control keys, such as "Tab" and "Newline," as graphic symbols on the screen.

The Convergent editor creates an automatic back-up file for saving your work. As a safety feature, the current file is written on the disk periodically as a temporary file called Editor.ts. In the event of a power failure, you can restore some or all of the text you last edited by renaming that file.

The Convergent workstation supports a BASIC interpreter and compiler, COBOL, FORTRAN, and Pascal. IBM Corp. and Texas Instruments Inc. obtained their 16-bit BASIC languages by hiring Microsoft Corp. to provide them. Convergent, on the other hand,

bought the rights to Microsoft BASIC and used it to write their 16-bit CT-BASIC themselves. The difference shows.

Although most of the new 16-bit BASICs provide a full-screen editor, the CT-BASIC editor version 7.0 is still line-oriented. It uses all of the old commands, such as C for "Change" that BASIC-80 had. A few 8-bit MBasic features are missing from CT-BASIC, including the "Files" command and the "Inkey\$" function.

Several new pointer functions are provided to replace "Usr" and "Varptr." The new function, "Ptr," can be used to pass parameters, allowing you to call assembly language procedures such as those in the graphics library, even from interpreted programs. "Peek" and

Spec summary

- **Product:** AWS Color Graphics Workstation
- **Manufacturer:** Convergent Technologies Inc., 2500 Augustine Dr., Santa Clara, Calif. 95051, (408) 727-8830
- **System configuration:** standalone unit or clustered workstation
- **Main processor:** 16-bit Intel 8-MHz 8086
- **Main system RAM:** 128K to 512K bytes
- **Graphics processor:** NEC μ PD7220
- **Display:** 15-inch color screen, any eight colors for graphics and any eight for alphanumerics of 64 available colors, 28 rows by 80 columns of text
- **Screen resolution:** 432 by 319 pixel viewport
- **Display RAM:** 512 by 512 by 3-bit plane
- **Disk storage:** one 640K-byte minifloppy plus one 5M-, 10M- or 16M-byte Winchester
- **Communications protocols:** IBM Corp. 3270, 2780/3780 and X.25
- **High-level languages supported:** BASIC, FORTRAN, COBOL, Pascal
- **Operating system:** CTOS; real-time, multitasking
- **Cost:** from \$12,190 with 5M-byte Winchester and 640K-byte minifloppy to \$17,190 with 16M-byte Winchester and 640K-byte minifloppy

"Poke" have new formats to accommodate the extended addressing range of the 8086 processor.

You can invoke the interpreter directly with BASIC ("Go"), or you may fill out its forms screen. There is a bizarre bug, however, involving random record size. If you run a program with a record size of anything other than 128, it is not safe to save the program from the interpreter. The saved file is likely to acquire thousands of bytes of garbage, interspersed with the original program.

Overcoming compiler array variable problems

CT-BASIC version 7.0 currently suffers from a high degree of interpreter-compiler differences. Many of the latter, however, appear to arise from bugs which have not yet been fixed.

World's largest local distributor with 50 locations stocking the finest lines of electronic components and computer products

- ALABAMA**
Montgomery (205) 837-7210
- ARIZONA**
Phoenix (602) 231-5100
- CALIFORNIA**
Alhambra (916) 558-2345
Alhambra, S.F.V. (818) 700-2600
Alhambra, O.C. (714) 754-6111
Alhambra, L.A. (213) 558-2121
Alhambra, S.F.V. (818) 700-6500
Alhambra, O.C. (714) 641-4100
Sacramento (916) 925-2216
San Diego (619) 571-7510
San Francisco (408) 743-3355
San Gabriel (714) 989-4602
- COLORADO**
Denver (303) 779-9988
- CONNECTICUT**
Hartford (203) 797-2800
- FLORIDA**
St. Petersburg (813) 576-3930
Miami (305) 971-2900
Orlando (305) 628-3888
Deltona (305) 725-2700
- GEORGIA**
Atlanta (404) 447-7507
- ILLINOIS**
Springfield (217) 223-2216
Urbana (800) 625-8654
Chicago (312) 860-7700
- INDIANA**
Indianapolis (317) 844-9333
- IOWA**
Des Moines (515) 281-4444
Iowa Rapids (319) 362-4757
- KANSAS**
Kansas City (913) 888-8900
Topeka (800) 532-6720
- KENTUCKY**
Louisville (800) 428-6012
Lexington (800) 543-4783
- MARYLAND**
Baltimore (301) 995-3500
- MASSACHUSETTS**
Boston (617) 273-7500
- MICHIGAN**
Detroit (313) 522-4700
Grand Rapids (616) 243-8805
- MINNESOTA**
Minneapolis (612) 932-0600
- MISSOURI**
St. Louis (314) 344-1200
- NEBRASKA**
Lincoln/Omaha (800) 255-6702
- NEW JERSEY**
Fairfield (201) 575-3390
Herron Hill (609) 424-0100
- NEW MEXICO**
Albuquerque (505) 765-1500
- NEW YORK**
Long Island (516) 231-9800
Syracuse (315) 437-2641
Rochester (716) 475-9130
- NORTH CAROLINA**
Raleigh (919) 878-0810
- OHIO**
Cleveland (216) 831-3500
Columbus (614) 882-7004
Dayton (513) 433-0610
- OREGON**
Portland (503) 635-8831
- PENNSYLVANIA**
Philadelphia (215) 831-1300
Pittsburgh (800) 321-6890
- SOUTH CAROLINA**
Columbia (800) 334-1597
- TEXAS**
Dallas (214) 659-4111
Houston (713) 780-1771
Austin (512) 837-8911
- UTAH**
Salt Lake City (801) 972-2800
- WASHINGTON**
Seattle (206) 453-5844
- WEST VIRGINIA**
Charleston (800) 543-4783
Martinsburg (800) 543-4783
- WISCONSIN**
Milwaukee (414) 784-4510
- INTERNATIONAL EXPORT**
Los Angeles (213) 558-2441
New York (516) 997-6868
Telex 66-4329
- CANADA**
Toronto (416) 677-7432
Montreal (514) 335-1000
Ottawa (613) 226-1700
Winnipeg (403) 290-3586
Vancouver (604) 272-4242

THE COMPUTER GIANT NOW FITS UNDER YOUR DESK!

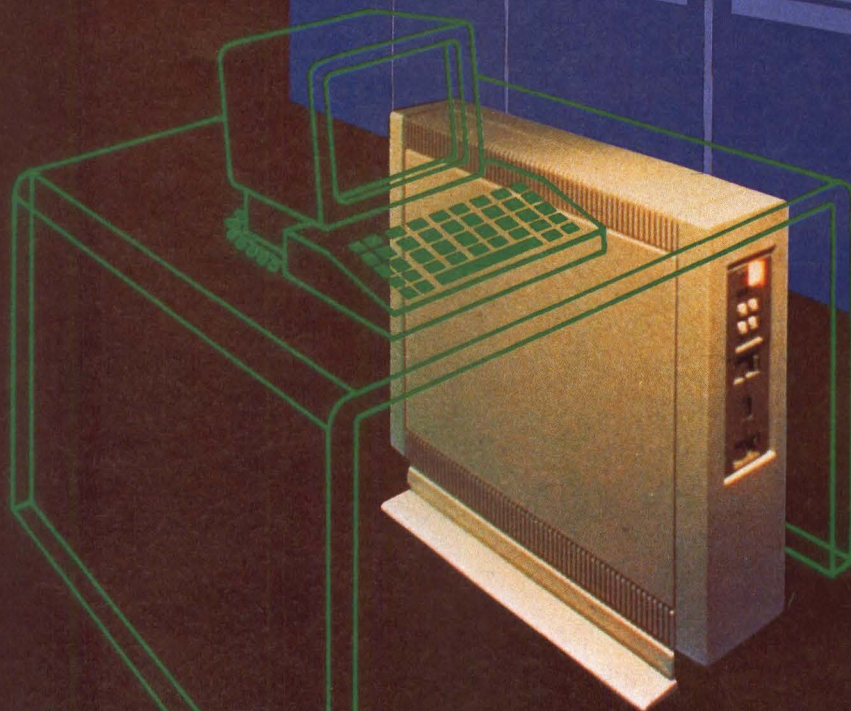

DIGITAL from HAMILTON/AVNET

Digital Equipment Corporation's VAX architecture in a 32-bit micro? Yes! Digital Equipment Corporation has taken the VAX power that fills a mainframe the size of four refrigerators and put it into a single unit you can slide under a desk! It's called the MicroVAX-1,* and it's available through Hamilton/Avnet. SUPPORTS 24 USERS. MicroVAX-1 is the first 32-bit micro with VAX performance and capability. That makes it the first 32-bit micro with the power to work for multiple users in time-critical applications. It supports as many as 24 concurrent users. And its compatibility

makes it easy for users to transport applications to larger VAX systems as growth requires it. EXPAND UP TO 10 MB. With 12 slots for expansion on its UNIBUS,* the MicroVAX-1 allows addition of memory up to 10 MB of 64K RAMs. A floating-point processor and additional intelligent controllers may also be added. CALL OUR SPECIALISTS. Our factory-certified Computer Product Specialists can assist you in the configuration of a system using the MicroVAX-1. Call them for complete information, and be sure to ask about our flexible leasing plans.

*Trademark of Digital Equipment Corporation.

CIRCLE NO. 116 ON INQUIRY CARD



Hamilton/Avnet
ELECTRONICS AN AVNET COMPANY

A commitment to stock and serve your local market!

This publication
is available in microform.

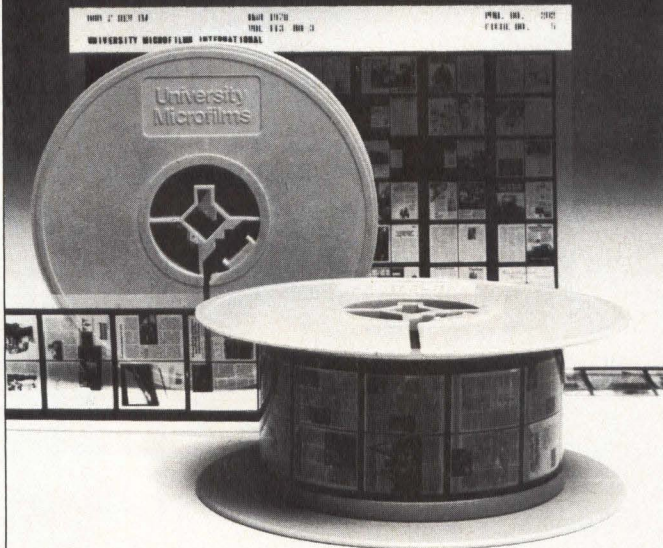

University Microfilms International

Please send additional information
for Mini-Micro Systems

Name _____
(name of publication)

Institution _____

Street _____

City _____

State _____ Zip _____

300 North Zeeb Road
Dept. P.R.
Ann Arbor, Mi. 48106
U.S.A.

30-32 Mortimer Street
Dept. P.R.
London W1N 7RA
England

CIRCLE NO. 117 ON INQUIRY CARD

PRODUCT EVALUATION

Most of the problems we encountered with the compiler were related to array variables. For example, "Swap A\$, B\$" works, but "Swap, B\$(I), B\$(J)" doesn't. The array "Swap" is not an unsupported feature—it doesn't trigger a compiler error—it's just a bug that may eventually be fixed. Until it is, it causes a run-time system crash.

The compiler won't allow the use of "A\$(n)" and "A\$," or "B(n)" and "B" in the same program. Microsoft's BASCOM had no problem with conflicting array and scalar variable names like these. Again, considerable conversion effort was expended in renaming variables.

Convergent's BASIC compiler has a drastic overreaction to encountering a misused reserved word in the source code: It shuts down with an error message instructing you to call Convergent for technical assistance. We first encountered this when the new function, "Ptr," inadvertently conflicted with an old 8-bit variable of that name.

The Convergent Linker (Version 8.0) is fairly slow and creates huge executable object files. A 1-statement BASIC program, consisting of "10 End", takes 1½ minutes to link. The object code takes up 47K bytes of disk space.

Speed aside, the linker is quite sophisticated. It is designed to allow easy creation of program overlays. One program—say, a menu—is compiled as the main module; the other components of the overlay system are compiled as subordinate modules. Then, all of the object-file modules are linked together, along with a CTOS module called "Brswp." The latter handles the automatic loading of the appropriate program modules during run-time operation. The main advantage of the overlay system is that it allows common variables used by the various component programs to remain in memory.

The main output of the linker is a ".Run" object file. The program is executed by invoking the system utility called "Run," and entering the name of the ".Run" file. To make the program somewhat more directly executable, the utility called "New Command" adds the program to the list of file names displayed by the "Help" command. The program can then be loaded and runs automatically, by typing its name and pressing the "Go" key.

Marilyn Harper is a senior analyst with Classic Systems Inc., a Houston-based company specializing in programmable controllers for industrial automation. She holds a bachelor's and master's degree in science from the University of Texas.

Interest Quotient (Circle One)
High 855 Medium 856 Low 857

The first thing ISI International put on this new Multibus® card was 2 megabytes...

**And that was just
the beginning.**

Squeezing 2 megabytes of memory onto a single Multibus® card is quite an accomplishment in itself. But we believe it takes more than just memory to meet the increasing needs of today's systems. That's why our new MCB-2X Multibus card is designed with a number of significant special features. And why ISI International is truly a leader in Multibus memory products.

Superior Dynamic Memory Relocation.

The new MCB-2X can relocate up to eight 64K or 256K blocks independently — making it a very powerful tool for "RAM disk," graphics display or multiple table look-up applications.

Expanded Error Correction Logic.

All single bit errors are automatically scrubbed during refresh cycles without system interruption. And thanks to the automatic memory initialization feature, software doesn't have to be pre-conditioned.

On-board ECC detects

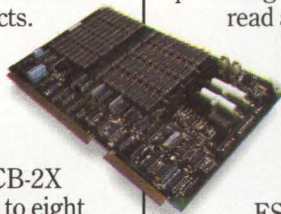

MCB-364

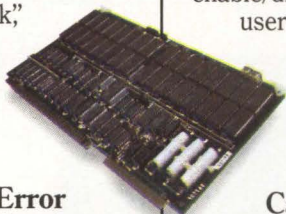

MCB-332

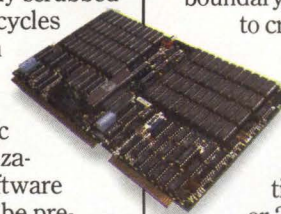

MCB-512

all single and double bit errors, while providing 370ns read access

through standard 64K or 256K RAMs. Plus, the MCB-2X has CSR and ESR interrogation capability and software control of ECC enable/disable, allowing users to provide comprehensive system-level diagnostics.

Flexible Addressing Capabilities.

Board addresses starting on any 4K boundary can be mapped to cross 1 and 4 megabyte boundaries. The MCB-2X can also occupy a continuous 512K or 2048K memory space within its 16 megabyte range.

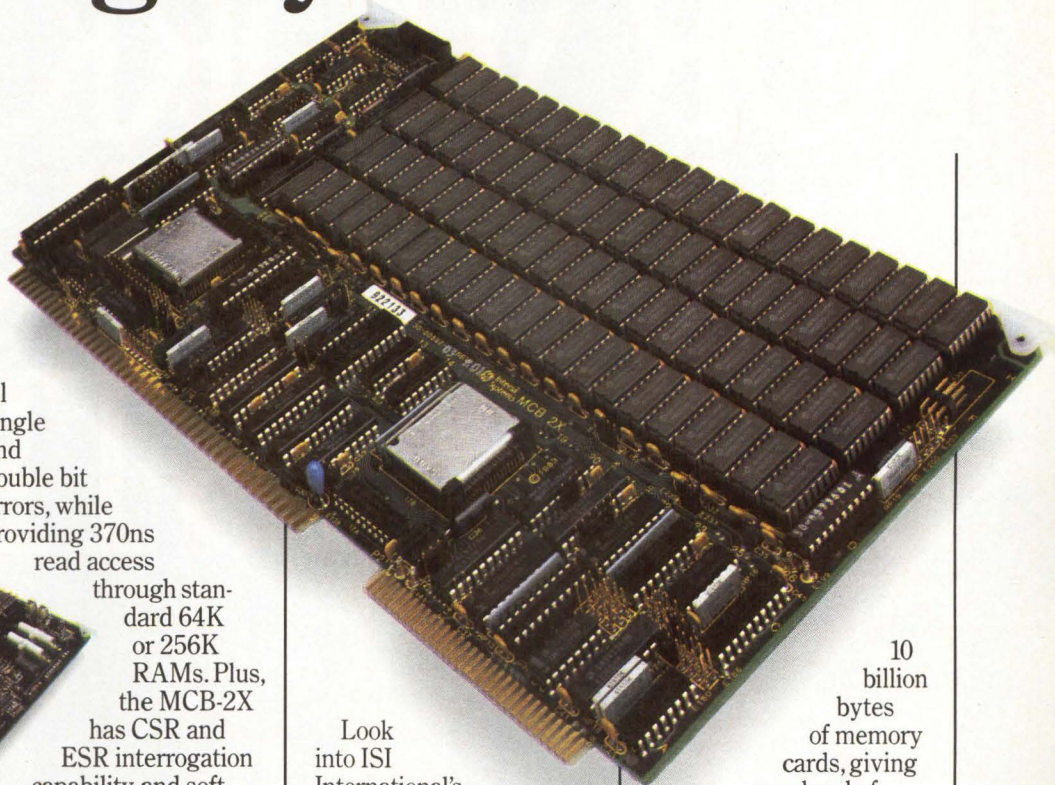

Look into ISI International's new MCB-2X. You'll find all the features you need... plus up to 2 megabytes of memory for the largest capacity available on a single card. Or, for non-volatile CMOS requirements, see our MCB-364 and MCB-332 modules. For simpler dynamic requirements, investigate our MCB-512.

Since 1970, ISI International has shipped over

10 billion bytes of memory cards, giving us a level of experience that's hard to match. Put it to work for you. For systems needs just call us in the West at (408) 743-4442, in the East (201) 272-3920, or in the Midwest call (513) 890-6450. For off-the-shelf products, contact your nearest ISI International distributor: Alliance, Anthem, Arrow, Future Electronics, R.A.E., Quality Components or Schweber.

*Multibus is a Trademark of Intel Corp.



INTERNATIONAL Formerly Intersil Systems

ISI International Corporation

1275 Hammerwood Avenue, Sunnyvale, CA 94089 • (408) 743-4443

CITIZENS
FOR WORKING
WITHIN
THE SYSTEM.

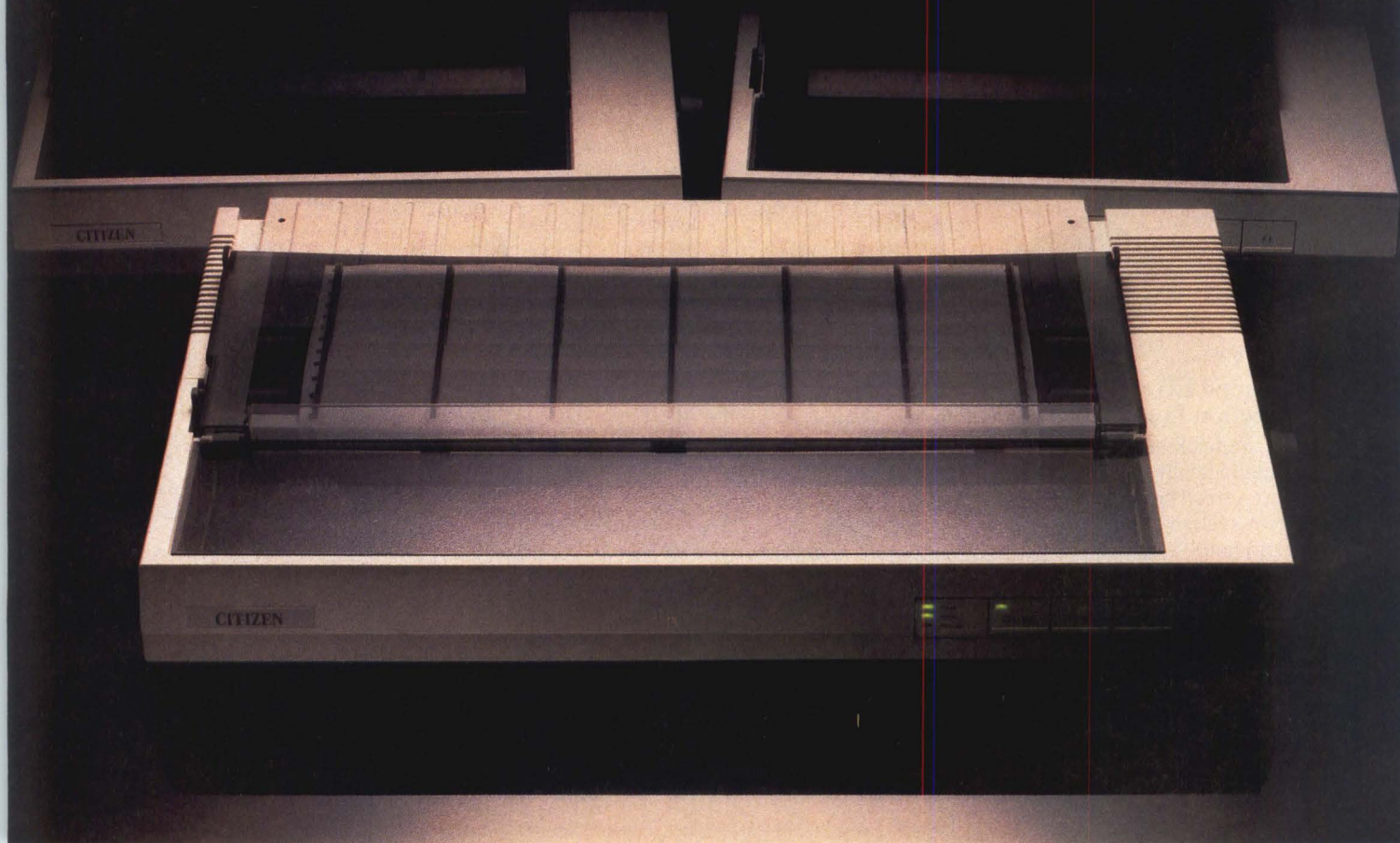

The last thing you need when you're putting together a hardware package is a printer that bucks the system.

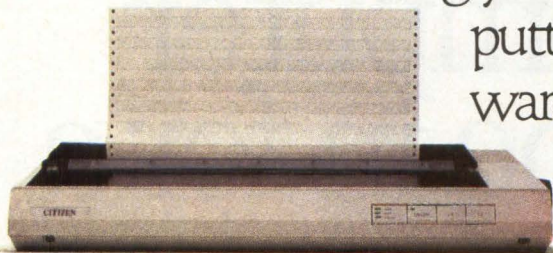

Introducing the Citizens. A whole new line of economical dot matrix printers.

Citizens know how to work within the system. They're rugged, reliable, and fully IBM® or Epson®-compatible. They deliver output speeds of 160 cps, or 40 cps correspondence-quality. Quietly and accurately. Just what you'd expect from a company famous for precision-engineered watches. Plus, our unique push-feed paper loading system makes loading easy. And customers happy.

Citizen™ printers. Because every system works better when there's at least one responsible Citizen.

For more information, call 1-800-556-1234, Ext. 34. In California, 1-800-441-2345, Ext. 34.

Or write Citizen America Corporation, 2425 Colorado Avenue, Santa Monica, CA 90404.

© 1984 Citizen America Corporation. Citizen is a trademark of Citizen America Corporation. IBM is a registered trademark of International Business Machines Corporation. Epson is a registered trademark of Epson Corporation.



CITIZEN

HOW TO CHOOSE A DISK DRIVE, PART I:

Your new computer system may be in for a cool reception.



Here's a cold, hard fact that should influence your selection of a disk drive for multi-user computer systems or local area networks: In today's energy-conscious offices, temperatures can vary enough during the

day to affect the performance of a disk drive. We made the operating range of ATASI drives up to 25% greater than most competitive drives because poor performance under thermal stress can result

in system downtime and even lost data. Here's how it happens.

In most drives, the bottom of the bowl serves as the base-plate where the carriage and spindle assemblies are

THERMAL STRESS

mounted. There is no thermal isolation. Heat from the motor, PC boards or a power supply can result in differential expansion of the baseplate, so that it temporarily warps. This can change the alignment of the carriage and spindle, which in turn affects the drive's ability to find data reliably.

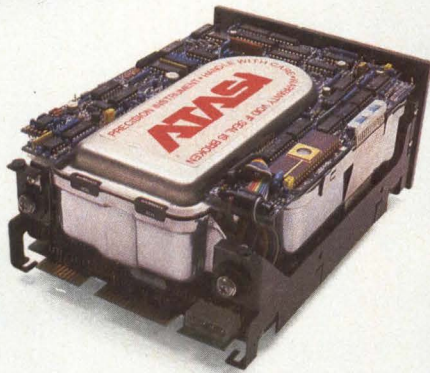

ATASI's 46 Mbyte, 5 1/4-inch Winchester disk drives are available in production quantities immediately.

Alignment problems

In high-performance, closed-loop drives, servo information carried on the bottom surface of the disk stack is used to position the data heads on all other surfaces. Assume that data is recorded when the drive is "cold." If the carriage and spindle go out of alignment when the drive gets "hot," the servo system cannot properly position the read/write heads to recover the data. This may mean that data written in the morning won't be accessible the same afternoon!

Thermal isolation

To prevent this from happening with ATASI's 5 1/4-inch Winchester disk drives, the ATASI design incorporates a baseplate which is separate and thermally isolated from

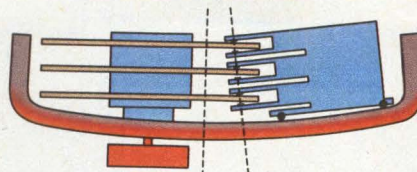

Heat can temporarily warp a drive's baseplate, causing alignment problems between carriage and spindle.

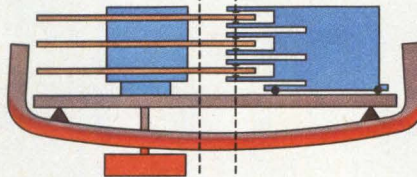

Thermal isolation in ATASI's proprietary design eliminates the problem.

the lower half of the bowl. The baseplate is therefore protected from external sources of localized heat. Even if the drive heats up, it does so uniformly, with no resultant deformation of the baseplate, and no alignment problems.

Extra margins

Thermally isolating key mechanical components is one way we improve the performance of ATASI drives, but not the only one. Everywhere in the design there are margins of safety other drives don't offer. For example, our proprietary spindle motor design provides substantially

greater dissipation of heat away from the disk module than competitive drives.

The ATASI White Paper

At ATASI, we are proud of the quality we build into every drive we make, and we encourage clients to test our products rigorously. To help, we have prepared a White Paper on thermal testing which discusses test methods and interpretation of test data in detail.

If you are a systems integrator, contact ATASI Corporation now to receive your ATASI White Paper. Corporate headquarters: 2075 Zanker Road, San Jose, CA 95131, (408) 995-0335; Eastern region: (617) 890-3890; Southwest region: (714) 432-0757.

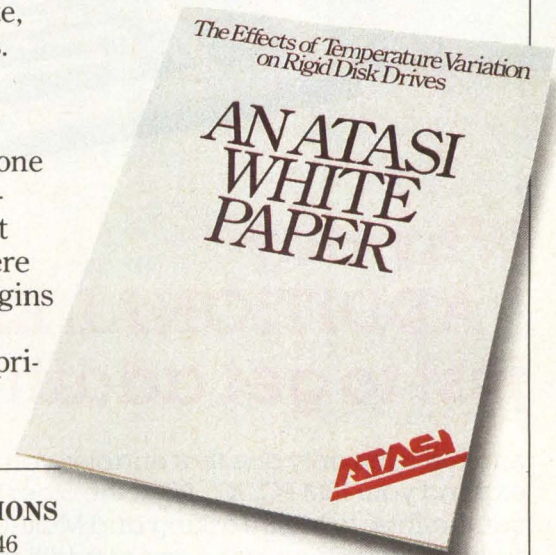

PERFORMANCE SPECIFICATIONS

MODEL NO.	3033	3046
CAPACITY	33 MB	46 MB
ACCESS TIME (AVG.)	30 ms	30 ms
DATA RATE	5 Mbits	5 Mbits
INTERFACE	ST 506	ST 506

Available in high volume today.

MODEL NO.	3065	3075
CAPACITY	65 MB	75 MB
ACCESS TIME (AVG.)	24 ms	24 ms
DATA RATE	5 Mbits	5 Mbits
INTERFACE	ST 506	ST 506

Available second half, 1984.

See us at Comdex Booth #6222



Think BEFORE YOUR NEXT PC!

Your PC to Time Sharing System

KT-7/PC

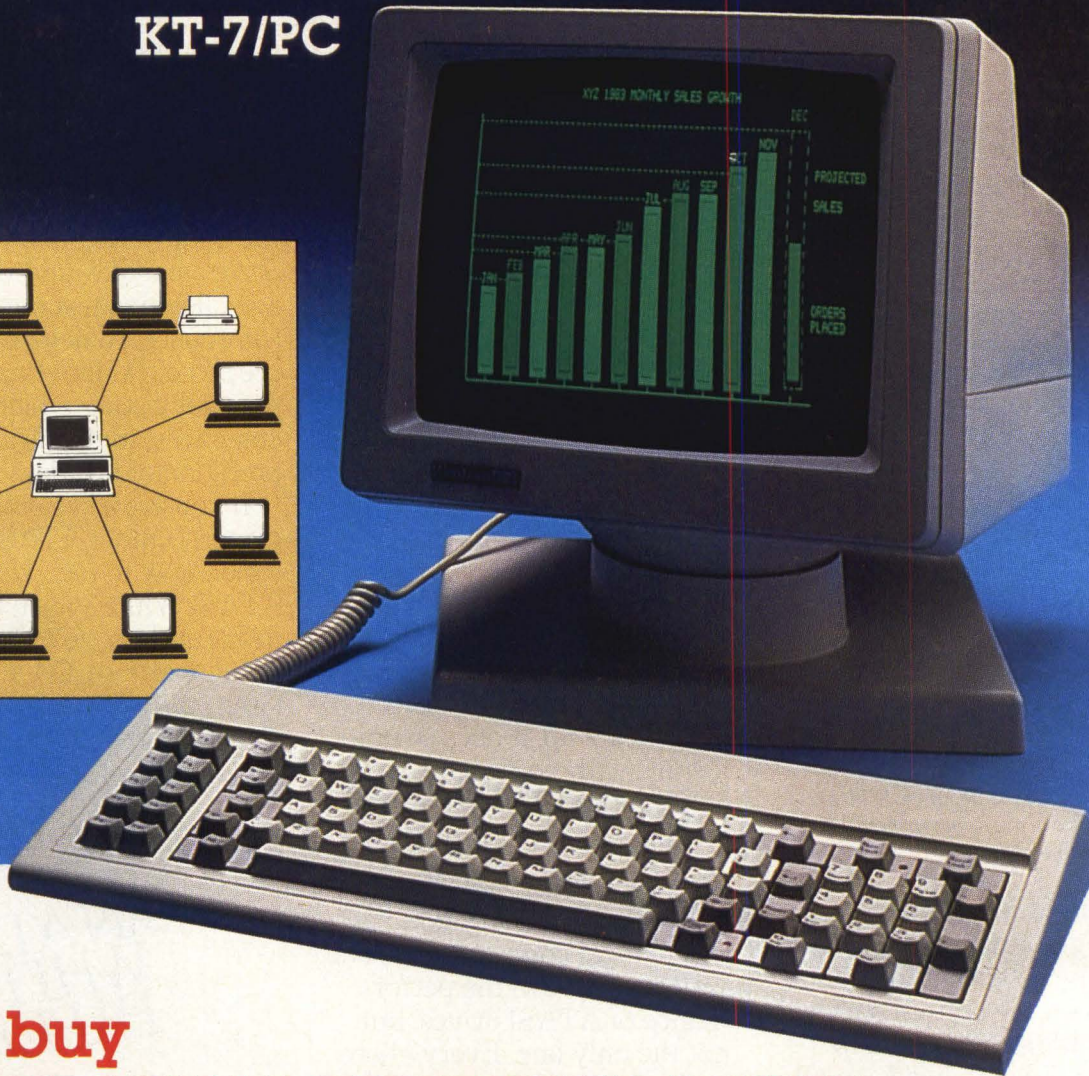
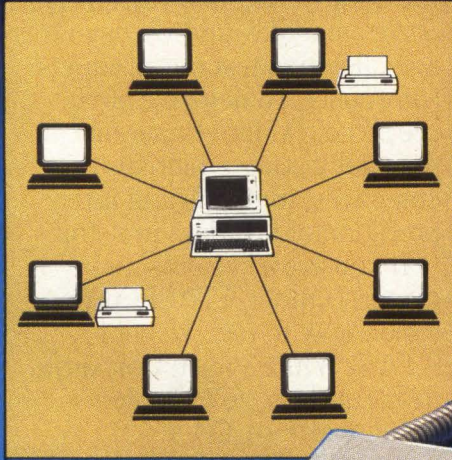

Why buy "ADDITIONAL EXPENSIVE PC'S" just to get additional users!

Kimtron is the only one that enables you to expand your IBM PC, XT, AT or the other PC compatibles to Multi-Tasking and Multi-User system at a fraction of the cost of additional PC's. Only Kimtron can display the screen exactly as your PC monochrome monitor, even for software like Lotus 1-2-3 or Word Star. Plus only Kimtron provides an IBM PC keyboard look-alike.

Operators will not only think and feel the KT-7/PC as if they're using IBM PC, but the KT-7/PC

Kimtron, a 5-year technology leader - we're going places and want you to join the Kimtron family of satisfied users. For more information about our KT-7/PC and your other terminal needs, call the Kimtron Corporation.

(408) 727-1510

NOTE: IBM PC, XT, and AT, Lotus 1-2-3, and Word Star are trade marks of IBM Corporation, Lotus Development Corp., and MicroPro International Corp.

See us at Comdex Booth #93

provides many more useful features such as tilt, swivel and height adjustment of monitor, optional amber screen, a dedicated serial printer port for each user at no extra cost, and optional 14 inch screen.

In addition, the KT-7/PC is designed for flexibility so that it can also be used as an industry compatible ASCII terminal.

 2225 - I Martin Avenue
Santa Clara, CA 95050
408-727-1510 TWX: 910-338-0237

Kimtron

CIRCLE NO. 120 ON INQUIRY CARD

Court restricts right to duplicate ROM software

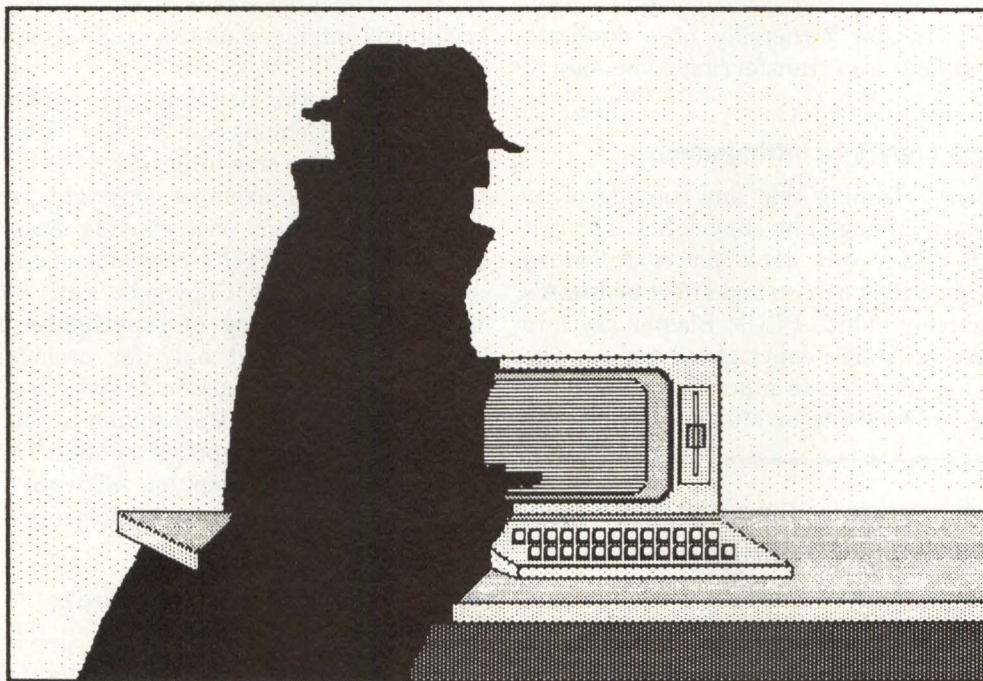

Precedent-setting ruling offers software developers increased protection against unauthorized program copying

L.J. Kutten, Attorney at Law

Piracy is a growing problem for software developers. Unauthorized copying of computer programs deprives them of their rightful share of the market and the profits necessary for continued growth. Because programs on floppy disks are relatively easy to copy, developers are increasingly putting programs in ROM. A precedent-setting decision last December by a U.S. district court restricting the right to duplicate software in ROM should provide a greater measure of protection, if upheld on appeal.

The U.S. District Court for the Northern District of Illinois ruled on a suit by Atari Inc. against JS&A Inc. JS&A, an Illinois-based retailer of electronic products, began marketing its PROM Blaster in the fall of 1983. The \$119 machine duplicated video-game cartridges, containing programs in ROM, compatible with the Atari 2600 home computer.

The PROM Blaster had two slots. According to JS&A's advertisement, "You simply plug in your Atari

or Activision cartridge in one slot and a blank cartridge in another, press a button and three minutes later you've created an exact duplicate." JS&A sold blank cartridges for \$10. The advertisement went on to say that the PROM Blaster was a quick way to protect a software buyer's investment in video game cartridges, "which can easily be ruined." JS&A also granted purchasers of the PROM Blaster the right to copy its own nine Atari 2600-compatible video games and even to sell the copies without restrictions.

The advertisement anticipated legal problems from duplicating the copyrighted software. It claimed that the PROM Blaster did not violate any laws because Congress had given explicit authority in Section 117 of the Copyright Act (under the 1980 amendments) to the owner of a computer program copy to make archival copies for backup purposes. Section 117 states: "[Despite] . . . the provisions of Section 106 of the Act [which give the copyright owner the exclusive right to reproduce the copyrighted work], it is not an infringement for the owner of a copy of a computer program to

make or authorize the making of any other copy or adaptation of that computer program provided . . . that any such new copy or adaptation is for archival purposes only . . .”

JS&A's advertisement warned, however, that a PROM Blaster cartridge owner could not give away, sell or otherwise transfer ownership of a duplicate game cartridge without also transferring ownership of the original.

Atari suit charges copyright infringement

Atari sued JS&A, claiming that any copying of its video-game software infringed its copyrights. The suit also claimed that JS&A was liable for *contributory* infringement because the purpose and effect of JS&A's actions was to actively induce PROM Blaster users to make illegal copies of Atari's copyrighted games. The company asked the court for an injunction to prevent JS&A from using, advertising or offering for sale the

Atari's suit also claimed that JS&A was liable for contributory infringement of Atari's copyrights.

PROM Blaster and the blank cartridges offered with it.

JS&A denied Atari's allegations and asserted that the copying of other manufacturers' video-game cartridges is perfectly legal. However, even if this were not a legal practice, JS&A said, the fact that JS&A sold its own games and granted buyers permission to duplicate them gave the PROM Blaster a legal use.

Court prohibits archival copying of ROM programs

In the case of Atari vs. JS&A, the U.S. District Court issued the first ruling on the archival copying provision of the Copyright Act. The court found that the PROM Blaster could fulfill only two functions: to copy JS&A's nine video games and to copy video games from other manufacturers.

The court discounted the PROM Blaster's ability to copy JS&A's games. It was highly unlikely, the court said, that anyone would buy the device only to duplicate JS&A's games because they went on the market only with the PROM Blaster. "It strains credulity," the court maintained, "to assert that consumers would spend that much for a machine that could only copy JS&A's games." Therefore JS&A's liability as a contributory infringer depended on the legality of the PROM Blaster's primary use: the duplication of other manufacturers' video-game software, the court said.

Because Section 106 of the Copyright Act gives the copyright owner the exclusive right to make copies of

the copyrighted work, JS&A had to prove that the PROM Blaster created an exception to Section 106, in order to win its case.

The court, however, decided that the programs in ROM could not be duplicated. It ruled that a machine capable of making copies of video-game software contributorily infringed on the original copyright holder's copyright.

In reaching this decision, the court referred to the work of the Commission on New Technological Uses (CONTU), which was ordered by the U.S. Congress in the late 1970s to examine copyright problems arising from computers and photocopying machines. Congress incorporated CONTU's recommendations in its 1980 amendments to the Copyright Law. CONTU recommended that copying of copyrighted computer programs be permitted only for archival purposes to "guard against destruction or damages by mechanical or electrical failure." Responding to this language, the district court felt compelled to limit the right to make archival copies of computer software to "where and only where a medium may be destroyed by mechanical or electrical failure."

Are ROMs susceptible to failure?

Atari claimed that its ROM cartridges were not susceptible to destruction or damage through mechanical or electrical failure and thus did not fit into the exception created by the 1980 amendments. JS&A countered that the ROMs could be destroyed through "a wire becoming disconnected, liquid spillage, crushing, etc."

The court decided that the danger to programs in ROM cited by JS&A were not of the nature to justify copying such programs under the exceptions to the prohibition against copying granted under Section 117 of the Copyright Act. It felt the dangers cited were physical in nature "not unlike the risk that a handwritten computer program will be shredded accidentally." It said, "Every copyrighted work, whether it be a book, phonograph record, or videotape, faces that kind of risk."

The court emphasized that Congress did not, in fact, enact a general rule making backup copies of copyrighted works non-infringing. Instead, Congress granted an exception to enable preservation of computer programs that are susceptible to damage by electrical or mechanical failure. Because JS&A did not show that the PROM Blaster's copying of copyrighted programs fell within the Copyright Law's exception for archival copying, the court granted Atari's request for the injunction.

Atari vs. JS&A has important implications for micro-computer software. If upheld on appeal, it will prevent the unauthorized copying of software in ROM and the

TWO TERMINALS IN ONE

(for only \$795.00)

ANSI x3.64

In ANSI mode Fame II gives you Dec VT 100* and VT102* compatability.

ASCII

In ASCII mode Fame II gives you Televideo 925* compatability with 2 pages of memory.

You can get full information on all the unique features of the Fame II or other great terminals from Falco Data Products by calling 800 835-8765 or 800 538-5383 in California.

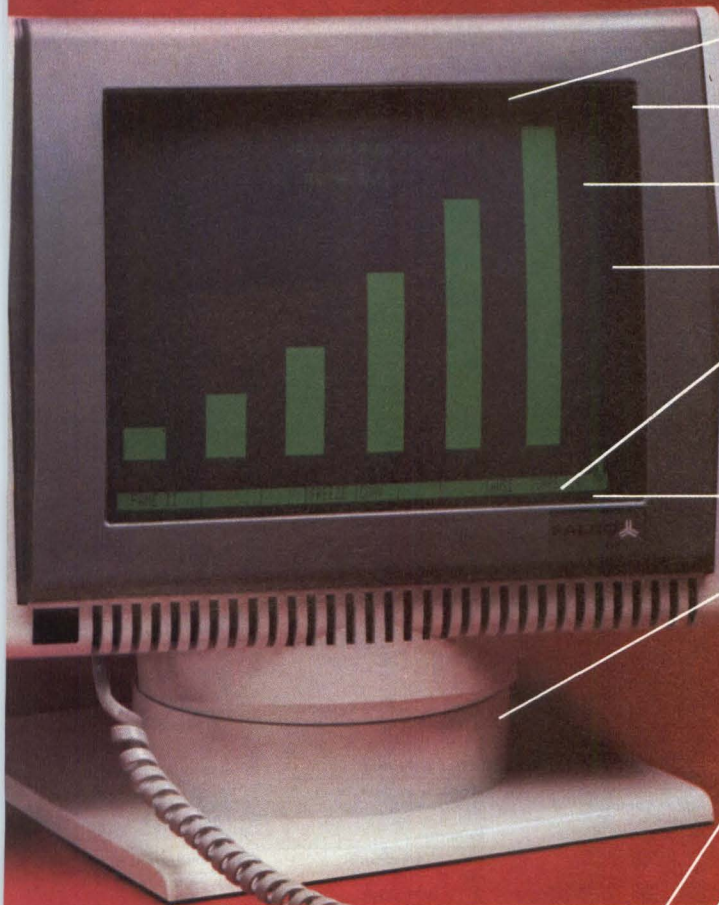

Hidden Video Attributes

High Contrast Non-Glare Green Screen

14 Inch Screen

80/132 Characters per Line

24 or 25 Line Display Status Line or User Line

Two Bi-Directional RS232 Ports

Screen Saver

Tilt and Swivel Housing

Keypad and Edit Mode

User Programmable Function Keys

Low Profile Keyboard

Lock Mode

IBM Style Correction Key

Dec VT 100/VT 102 is a Trademark of Digital Equipment Corp.

FALCO DATA PRODUCTS

1286 Lawrence Station Road • Sunnyvale, CA 94089 • (408) 745-7123

CIRCLE NO. 121 ON INQUIRY CARD

By granting an exception to computer programs and thus considering archival copies as not infringing the original copyrights, Congress wanted to protect those programs that are susceptible to damage.

selling of ROM duplicating machinery. And it will accelerate the trend toward putting programs in ROM instead of on easily duplicated flexible disks. Software piracy should decrease for the following reasons:

- It will no longer be possible for casual computer users to duplicate software easily (no more typing "BACKUP:0 to :1").

- Most microcomputer users do not have the technical skill necessary to build a device similar to the PROM Blaster.

- If someone builds this type of hardware, he cannot advertise it for sale or offer duplication services without risking a suit for copyright infringement.

- No trade-press publication, or any other reputable magazine, will take an advertisement for a product whose sole use will violate a copyright.

Better protection for computer software can benefit all system integrators and computer users by decreasing overall software prices. Once software developers/manufacturers have a secure method of protecting their products, they can lower prices knowing that they can sell to the widest possible market and that total distribution represents true sales and not someone passing a copy of a computer program to a friend. □

©1984 by L. J. Kutten

Edited by J. Victor

L.J. Kutten received the Juris Doctor degree from Washington University, St. Louis. A member of the Missouri and Illinois bar associations, he is in private practice, specializing in computer and high-technology law. Kutten is the author of *Computer Buyer's Protection Guide*, published by Prentice-Hall Inc.

Interest Quotient (Circle One)
High 858 Medium 859 Low 860

Let us prove how Cromemco systems can increase your satisfaction with UNIX System V.

Call, or visit, one of our Official System Centers today:

USA	In Massachusetts:	Bay Tech of Wisconsin, Inc. 414 / 846-3038 Computer World 414 / 499-9983
In Arizona:	Kierulff/Boston 617 / 667-8331 Cromemco, Inc. 617 / 938-7010	INTERNATIONAL In Australia
Artemis Computer 602 / 957-0469 Systems Solutions, Inc. 602 / 224-0026 Professional Data Systems, Inc. 602 / 265-6656	In Michigan:	Minicomp Software & Education 61-1 / 957-6800 Insystems P/L 61-3 / 690-2899
In California:	United Microsystems Corporation 313 / 668-6806 Jepsan Group, Inc. 616 / 698-8700 Automated Business Consultants 313 / 478-0557	In Canada:
Quintec 213 / 889-4819 American Computer & Communications 415 / 849-0177 MCM Enterprises 415 / 327-8080 American Computer & Engineers 213 / 477-6751 Kierulff Electronics 213 / 725-0325 Accountability Systems 714 / 639-4570 Excalibur 916 / 972-9252 Kierulff Electronics 714 / 278-2112 Kierulff Electronics 408 / 971-2600 Cromemco, Inc. 818 / 346-6690	In New Jersey:	Cro-Corp Holdings, Inc. 403 / 286-8459 Future Electronics 610 / 421-3251
In Connecticut:	Kierulff Electronics 201 / 575-6750	In Costa Rica:
Datacraft, Inc. 203 / 673-6952	In New Mexico:	Control Electronica 506 / 23-50-17 / 24-44-44
In Florida:	South West Computer Stores, Inc. 505 / 292-6568	In England:
Automated Computer Systems 305 / 594-3819 Computer Centre 813 / 484-1028 Royal Data, Inc. 305 / 267-1960	In New York:	Jarogate Ltd. 44-1 / 671-6321 Cromemco, Ltd. 44-1 / 785-9822
In Georgia:	C.C.S., Inc. 212 / 986-7520 Computer Clotser 914 / 268-5161	In Greece:
Cromemco, Inc. 404 / 391-9433 Systems Atlanta 404 / 928-0240 Kierulff Electronics 404 / 447-5252	In Ohio:	Algorithm Ltd. 30-1 / 933-8463
In Illinois:	Lucas Office Equipment & Service, Inc. 513 / 433-8484 Odyssey Systems, Inc. 216 / 526-9933	In Hong Kong:
Schauers Office Services 312 / 755-2100 Kierulff/Chicago 312 / 640-0200 Commercial Data Systems 309 / 797-9401 Alpine Computer Center, Inc. 815 / 229-0200 Cromemco, Inc. 312 / 934-0650 Alternate Computer Services 312 / 893-1992	(ISIS) Innovative Systems/Integrated Software 419 / 531-0220	Vanda Computer & Equipment 8529 348702-5
In Indiana:	In Pennsylvania:	In Italy:
K.I.D. Enterprises 312 / 891-1064 Harbourtown Sales 317 / 877-4900 Microcomputer Specialists, Inc. 219 / 762-8541	Modular System Design 412 / 521-6700	C.N.I.A. 39-51 / 375009 / 359406
In Kansas:	In Texas:	In Japan:
Tradewind Systems 316 / 624-8111 Armstrong Microcomputers 316 / 223-2939	Kierulff Electronics 214 / 343-2400 Gunn Enterprises 713 / 781-6911 Procomp dba Integrated Computer Systems 713 / 226-3648 Computer Crossroads of America 214 / 231-6108	Asahi Glass 81-3 / 218-5848
In Louisiana:	In Virginia:	In Israel:
Muse Data Technologies 504 / 293-0320 Standard Systems, Inc. 318 / 625-8613	SMS Data Products 703 / 827-0640 Business Communications Systems 703 / 344-5563 VCA Corporation 703 / 281-4666	Information Systems Ltd. 03-775111
In Maryland:	In Washington:	In Mexico:
Dynamic Data Processing 301 / 589-8950	Kierulff/Seattle 206 / 575-4420	Micromex, S.A./DE C.V. 905 / 687-8886 / 8913 / 905 / 536-5503
	In West Virginia:	In Mid-East:
	Systems Support 304 / 766-7762	Multi Media Video, Inc., CA USA 408 / 727-1733 National Computer System Karachi 4, Pakistan Computer System Marketing System Jeddah 21431, Saudi Arabia
	In Wisconsin:	In The Netherlands:
	Computer World 414 / 733-9547	Rocomp B.V. 31-40 / 524055



CROMEMCO COMPUTERS: DESIGNED TO MAKE UNIX SYSTEM V EVEN BETTER...

UNIX System V, the new standard in multiuser microcomputer operating systems, gives you high performance features along with the portability and flexibility of a standard.

Cromemco computers can make UNIX System V even better. Because our systems are designed with UNIX in mind. First of all, we offer UNIX System V with Berkeley enhancements. Then, our hardware uses advanced features like 64K of on-board cache memory and our high speed STDC controller to speed up disk operations—very important with UNIX.

More capability and expandability

We have a high-speed, 68000-based CPU that runs at 10 MHz, coupled with a memory manager that uses demand-paging and scatter loading to work *with* UNIX, not for it.

We provide room for expanding RAM to 16 megabytes—with error detection and correction—for running even the most sophisticated and advanced microcomputer programs. And the power to accommodate up to 16 users—all with plenty of memory.

But we give you even more.

A complete solution

We give you a choice in systems: the System 100 series, expandable up to 4 megabytes of RAM, and the System 300 series, expandable to 16 megabytes. A high speed 50 megabyte hard disk drive is standard on the systems. And you can expand the hard disk capacity up to 1200 megabytes using standard SMD drives. You can add floating point processing. High resolution graphics. Video digitizing and imaging. Communications through standard

protocols. Mainframe interface.

And software support is here to meet your needs. We offer major programming languages, database management systems, communications software, including SNA architecture, X.25 protocol, and Ethernet; even a program to interface to an IBM PC if you need to. And, of course, access to the broad range of standard UNIX applications programs that is growing dramatically every day.

Easy to use.

We also make our systems easier to use, because we install the operating system before we ship your computer. No complicated installation procedures. And the Berkeley enhancements give you the standard UNIX System V operating system, but with the added convenience of these widely acclaimed improvements.

Cromemco's System 100 and System 300 computers: designed to be the highest performance UNIX systems available anywhere.

Just call or visit one of our UNIX System V Official System Centers to see for yourself. They'll also give you a copy of our new publication, "What you should know before you buy a UNIX system." Or contact us directly.

We'll be glad to show you how to get a better UNIX system.

Corporate Headquarters: Cromemco, Inc., 280 Bernardo Avenue, P.O. Box 7400, Mountain View, CA 94039. (415) 969-4710. In Europe: Cromemco GmbH, 6236 Eschborn 1, Frankfurter Str. 33-35, P.O. 5267, Frankfurt

Main, West Germany, or Cromemco, Ltd., The Cambridge House, 178-182 Upper Richmond Rd., Putney, London SW15, England.



UNIX is a trademark of Bell Laboratories.
IBM is a trademark of International Business Machines Corp.

Cromemco®

CIRCLE NO. 122 ON INQUIRY CARD

Introducing
the only true
general purpose
multicomputer.

Flex/32™

A True MultiComputing Environment.

All computers are not created equal. Especially when it comes to their ability to tolerate change. In fact, most computers have a hard time trying to adapt when you need to expand or modify their capabilities.

The Flex/32,™ on the other hand, is a scaleable, general purpose multicomputer. That means it can be configured and reconfigured as often as needed at different levels of capacity and performance. All the way up. And down again.

True scaleability.

Each Flex/32 MultiComputer cabinet can contain up to twenty 32-bit CPU's, each operating in excess of one million instructions per second with 1 megabyte of RAM each. That's more power and memory than some of the largest mainframes available today. The Flex/32 is easy to maintain with automatic and continuous self diagnostics built in.

With an entry level system, you get two 32-bit computers with 2 megabytes of local memory, 128 kilobytes of common memory, and 2 VME bus I/O interfaces all located inside one card cage. Its card cage can accept another 18 cards allowing up to 18 more computers or another 152 megabytes of memory. As you expand your multicomputer, additional computers, memories and interfaces are merely slipped into slots.

As powerful as the entry level system is, Flex/32 can go much, much further. Your ability to expand the system is literally without limits.

True concurrency.

Because Flex/32 is a multicomputer, it can provide

true concurrency in processing. Which means it can run many processors at exactly the same instant in time. And since it provides direct programmer control over the use of concurrency, Flex/32 can be tuned to your application needs.

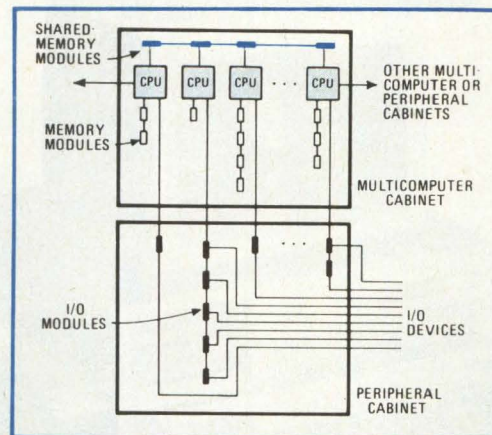

True programming freedom.

Just as the Flex/32 hardware gives you freedom from restrictions of growth, its software will set you free, too. Free from vendor dependence. Because it uses the universal UNIX™ System V operating system, and languages like C, FORTRAN 77, RATFOR, Flexible's own Concurrent C™, for real time and concurrent programming, and a selftest capability. And for enhanced performance, Flex/32 supports the

ISA extensions to FORTRAN 77.

It even contains a concurrency simulator and optimization procedures to improve run time performance—to enable you to tune your application.

True cost efficiency.

Given that a basic Flex/32 can outperform two superminis, it still only costs about the same as a single VAX™ 750. And since Flex/32 is scaleable, the economies continue throughout its growth path.

When you add it all up, the Flex/32 has few equals in terms of its performance and value in the supermini computer world. And you can't take away from that.

For more information, call (214) 869-1234, or write to us at 1801 Royal Lane, Suite 810, Dallas, Texas 75229.

Flexible
Computer Corporation

UNIX is a trademark of Bell Laboratories.
Flex/32 and Concurrent C are trademarks of Flexible Computer Corporation.
VAX is a trademark of Digital Equipment Corporation.

©1984 Flexible Computer Corporation

Up Your AT™

■ Emerald System's new 60MByte 1/4" cartridge tape subsystem is the perfect answer to faster processing of your PC AT's larger, more numerous data files.

Forget about keeping track of expensive floppies. Because this internal upgraded kit has everything you need, including BRU™, Emerald's unique Backup and Restore Utility™.

BRU works as your personal librarian, helping you to retire and track files for archival storage and enabling you to safely and easily transfer files between your Emerald or IBM hard disk and floppies and Emerald's 1/4" tape cartridge.

MORE RELIABLE

Our BRU-equipped tape drive protects your valuable data and helps assure timely access. All data written to tape is checked, and all write errors are corrected automatically.

Even if your AT floppy or disk drive is non-operational, you can still load files directly from tape. Media interchangeability with other machines also running BRU assures you easy access to your valuable data even if your machine is not operating. And our cartridges also allow you to distribute data files that don't fit on floppies.

MORE CONVENIENT

Do multiple volume backup from your IBM or Emerald hard disk or floppies on one data cartridge. And with a utility such as ProKey™, your backup procedure can be fully automated. BRU options invoked from the DOS command line or from a convenient menu gives you these choices:

- Backup an entire physical disk.
- Backup a logical volume.
- Backup entire DOS directories.
- Backup files by name (wild card allowed).
- Backup files by DOS date and time stamp.

■ And you can forget about file sizes. Emerald's BRU automatically breaks up files that are longer than the tape. Restoring files from tape involves options essentially the reverse of backup.

MORE ECONOMICAL

Emerald's 60 MByte tape cartridge gives you 50 times more storage capacity, yet costs less than 1/5 that of new high-capacity floppies. And for as little as \$65 per MByte you can install our hard disk kit in your PC/AT chassis. Emerald Systems' internal 40, 65, 140, 280 MByte hard disk AT upgrade kit is also 30% faster than IBM's.

And our hard disk cache feature makes retrieval speed of selective files 100 times faster. This hard disk caching feature keeps often-used files available in memory at microspeed access time. And you can partition our disks into 1 to 24 volumes, with up to 240 MBytes per volume.

You may not need 280 MBytes today. But if you need to share disk storage in your LAN or expand your database without being limited by DOS to 32 MBytes, you need Emerald Systems' technology today.

SUPPORTS ALL MAJOR OPERATING SYSTEMS & LANS

Emerald's subsystems support DOS 2.0/2.1/3.0, QNX, PC/IX, UCSDp System, and XENIX (when available). Also, all fully compatible LAN's including 3 COM, PC-NET, X-NET, NOVELL, and IBM's version of SYTEK's LAN (when available).

4901 Morena Blvd.
San Diego, CA 92117
(619) 270-1994

EMERALD

SYSTEMS CORPORATION

Mainframe Storage for Micros

A COMPREHENSIVE SOLUTION — AVAILABLE NOW!

Emerald Systems Corporation. The complete hard disk and tape backup solution for builders of desktop computer systems.

So up your AT, your XT, your PC, or your PC compatible system . . . with Emerald Systems' mainframe storage for micros. **Call (619) 270-1994 for more information and the name of the dealer nearest you.**

CIRCLE NO. 125 ON INQUIRY CARD



We seek VARs that have a mighty future.

IBM is looking for companies with real potential, those with a solid foundation for growth.

We want firms that have first-class application solutions that run on IBM products. Companies that hope to become IBM Value Added Remarketers.

It isn't easy to qualify; but if you do, IBM has much to offer.

For starters, IBM VARs can apply for some of our most competitive products: IBM 4300 systems, System/36, Series/1, System/38, the IBM Personal Computer and the System 9000 family.

Then IBM can add strength to your marketing efforts. We can, for instance, help with product literature, direct mail and business show support. IBM also has a wide range of professional classes for VARs. And thanks to an online referencing system used by IBM's own sales force, we can refer prospects with special needs to VARs with unique solutions.

For more information on qualifying as an IBM VAR, simply send in the coupon below or call 1 800 IBM-VARS, Ext. 96.

If you think you're destined for greater things, plant the first seed now.



Larry Humphreys
IBM Distribution Channels
P.O. Box 76477
Atlanta, GA 30358

96/11-84

Please send me your free booklet, "Looking for Leaders."

Name _____ Title _____

Company _____

Address _____

City _____ State _____ Zip _____

Phone _____ Product Interest _____

New Products

SYSTEMS

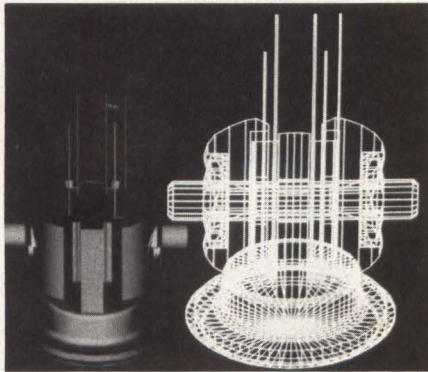

Graphics systems employ bit-slice technology

- 600-nsec-per-pixel writing speed
- processes read/write, arithmetic instructions concurrently

The two-member LEX 900 family of graphics systems features the System Control Module (SCM) controller. Based on 56-bit word microprocessor, the SCM achieves vector writing speeds of 600 nsec per pixel in any direction and pro-

cesses multiple read/write and arithmetic instructions concurrently. The LEX 90 software architecture is based on the Extended Graphics Operating System. The LEX 90/35 Model 2 graphics system features two software-selectable resolutions. SimulRes functionality allows simultaneous display of both a 640-by-512-by-8 image and a 1,280-by-1,024-by-4 overlay. The LEX 90/35 Model 3 supports eight planes of 1,280-by-1,024 display memory. Model 2 starts at \$13,925; Model 3, \$19,850. Delivery for Model 2, 90 days ARO; delivery for Model 3, 120 days ARO. **Lexidata Corp.**, 755 Middlesex Turnpike, Billerica, Mass. 01865, (617) 663-8550.

Circle No 300

UNIX systems support 16 users

- 768K bytes of RAM
- 64K bytes of EPROM
- two programmable RS232 interfaces

Featuring 768K bytes of RAM and the

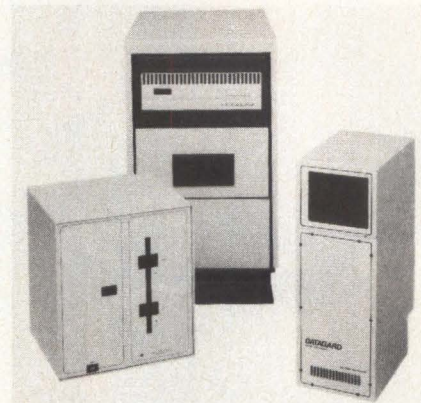

UniPlus operating system, two new 8300 VIX one- to 16-user, MC68000-based systems are modular and can be upgraded. Both VIX variations supply a nine-slot Multibus card cage. Two 5¼-inch floppy disk drives with a storage capacity of 1.4M bytes are combined with a 5¼-inch, 20M-byte Winchester disk drive on Model I. Model II furnishes disk storage to 300M bytes and



**See us at Comdex
November 14-18
Booth number M 138
MGM Grand Hotel**

Howdy, Podners. Name's Tatung.

Tatung high quality terminals and color monitors are compatible with most of the good guys.

So dealers who sell us, now have some interesting alternatives to offer customers. Sales clinchers! Now they can suggest Tatung color monitors with Apple,

Commodore and IBM personal computers. And high performance Tatung terminals for owners of DEC systems, and many other systems, looking for low cost, high performance alternatives, or for upgrading. And the TPC 2000, highly reliable, low cost small business system.

Another thing. Tatung has been riding the electronic range a l-o-o-ng time. Has 20,000 employees and over \$500 million in sales. We're sitting tall.

For prices call toll free 1-800-421-2929. In California call (213) 979-7055. **TATUNG CO. OF AMERICA, INC.**, 2850 El Presidio, Long Beach, CA 90810.



CIRCLE NO. 126 ON INQUIRY CARD



When your
ANSI needs
are multiplying,
we'll be there.

Qume's QVT 103™ ANSI* terminal lets you expand your system without the usual growing pains. You get full compatibility with Digital's VT 100** series, for a lot less money. You can be sure of high reliability, thanks to Qume's advanced engineering and stringent quality control. And with our nationwide service network, support is always just a short hop away.

Best of all, there's Qume's experience and stability as a member of the ITT family. As your needs grow in the years ahead, we'll be there.

For complete details on the QVT 103 and our full line of alphanumeric and graphics terminals, call (800) 223-2479. Or write Qume Corporation, 2350 Qume Drive, San Jose, CA 95131.



*Designed to American National Standards Institute, Inc., ANSI X 3.64 - 1979 guidelines.
**Full emulation of the VT 131, VT 100 and VT 52. Digital and Digital VT 131, VT 100 and VT 52 are registered trademarks of Digital Equipment Corporation.

© 1984 Qume Corporation.

CIRCLE NO. 127 ON INQUIRY CARD

Qume[®]
A Subsidiary of **ITT**

New Products

SYSTEMS

streaming tape backup. The main peripheral module contains two serial, programmable RS232 interfaces, 64K bytes of EPROM and an internal timer. Languages supported include C, COBOL 74, FORTRAN 77, Pascal, BASIC Plus, SMC BASIC, Macro Assembler and Simple Assembler. Com-

munications protocols provided are asynchronous, bisynchronous and SNA.SDLC. A Dataguard configuration of the Model I offers EMI and RFI suppression. Model I, \$10,000; Model II, \$23,000. **Megadata Corp.**, 35 Orville Drive, Bohemia, N.Y. 11716, (516) 589-6800. **Circle No 301**

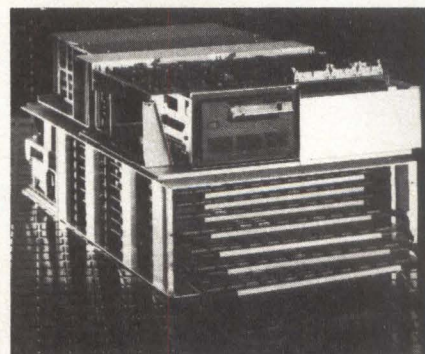

Workstation draws at 1M pixels per second

- 19-inch color display
- detachable keyboard
- 68010 processor

Accommodating the diverse packaging requirements of the value-added supplier, the RM550 color graphics workstation consists of an eight-slot processor module, a low-profile detachable keyboard and a 19-inch color display featuring 1,024-pixel-by-800-pixel resolution. The processor module contains a Motorola 68010 processor, a dedicated, bit-slice graphics subsystem, 3M bytes of main memory, 1M byte of display memory and a Domain network interface. The workstation provides 1M-pixel-per-second vector draws and 25M- to 35M-pixel-per-second area fills and bit-block transfers. The subsystem furnishes circle, arc and spline generation and user-definable area fills and vector patterns. Software support includes the proprietary operating system, AEGIS, and an implementation of Bell Labs' UNIX system III software with Berkeley extensions. \$30,000. Delivery is 180 days ARO. **Apollo Computer Inc.**, 330 Billerica Road, Chelmsford, Mass. 01824, (617) 256-6600.

Circle No 302

Microcomputer features 3½-inch Winchester

- 5M- or 10M-byte capacity
- 256K bytes of main memory
- three operating systems

The Apricot xi microcomputer combines the 3½-inch, 5M- or 10M-byte Winchester disk drive and an intelligent disk controller that supports multiple directories and subdirectories, permitting the disk to be partitioned for multiple users. Based on a 8086 processor,

BELL LABS FINDS 87% OF POWER DISTURBANCES AT COMPUTER SITES ARE VOLTAGE SAGS!

Sags. Not Spikes. Not Surges. Voltage Sags!

Bell Telephone Laboratories monitored commercial electric power at 24 computer sites of Bell Operating Companies, Western Electric, and the AT&T Long Lines Department. Utility-supplied power was monitored for up to 22 months, with an average per site of more than 11 months and total observation time of 270 months. Here is what Bell found:

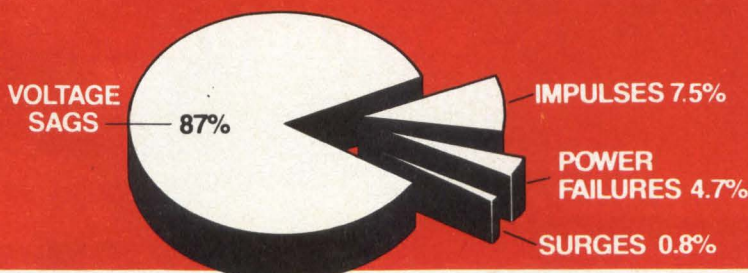

Sags Outnumbered Spikes Even During Storms!

Surprising, indeed! Even to the Bell Systems engineers who conducted the study:

Your Power Is Probably Like Ma Bell's

Chances are your computer is exposed to the same kind of power line sags, impulses and occasional failures. Nasty, costly events that can cause data loss, faulty computations, disk-head crashes and sudden shutoffs.

With Sags The Key Culprit, Why Zero In On Surges?

Is it wise to lay out money for surge

suppressors and spike clippers that give no protection against voltage sags? And leave your computer open to the most frequent power disturbances? Think about it!

Do The Job Right — With ISOREG

ISOREG power modules **block sags, spikes, and surges** and deliver good clean power to computers even when line voltages drop to 60% of normal — for minutes.

Don't Risk Computer Errors Due To Power Line Disturbances

Get full information, *free*. Use the Reader Service Card, or call (toll-free) **1-800-225-5078**. In Massachusetts, (617) 486-9483. TWX 710-347-6974 ISOREG LTTN.

ISOREG CORPORATION

410 Great Road, Littleton, MA 01460 USA

*"The Quality of U.S. Commercial AC Power," Goldstein, M.; and Speranza, P.D.; IEEE April 1982.

ISOREG®: Registered Trademark

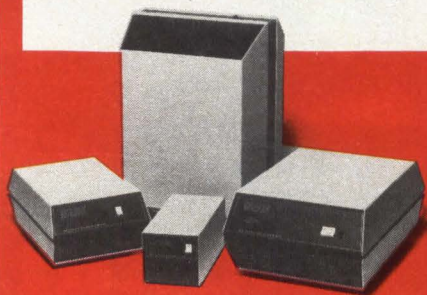

SIEMENS

See us at
Comdex Booth 2320

The Finishing Touch!

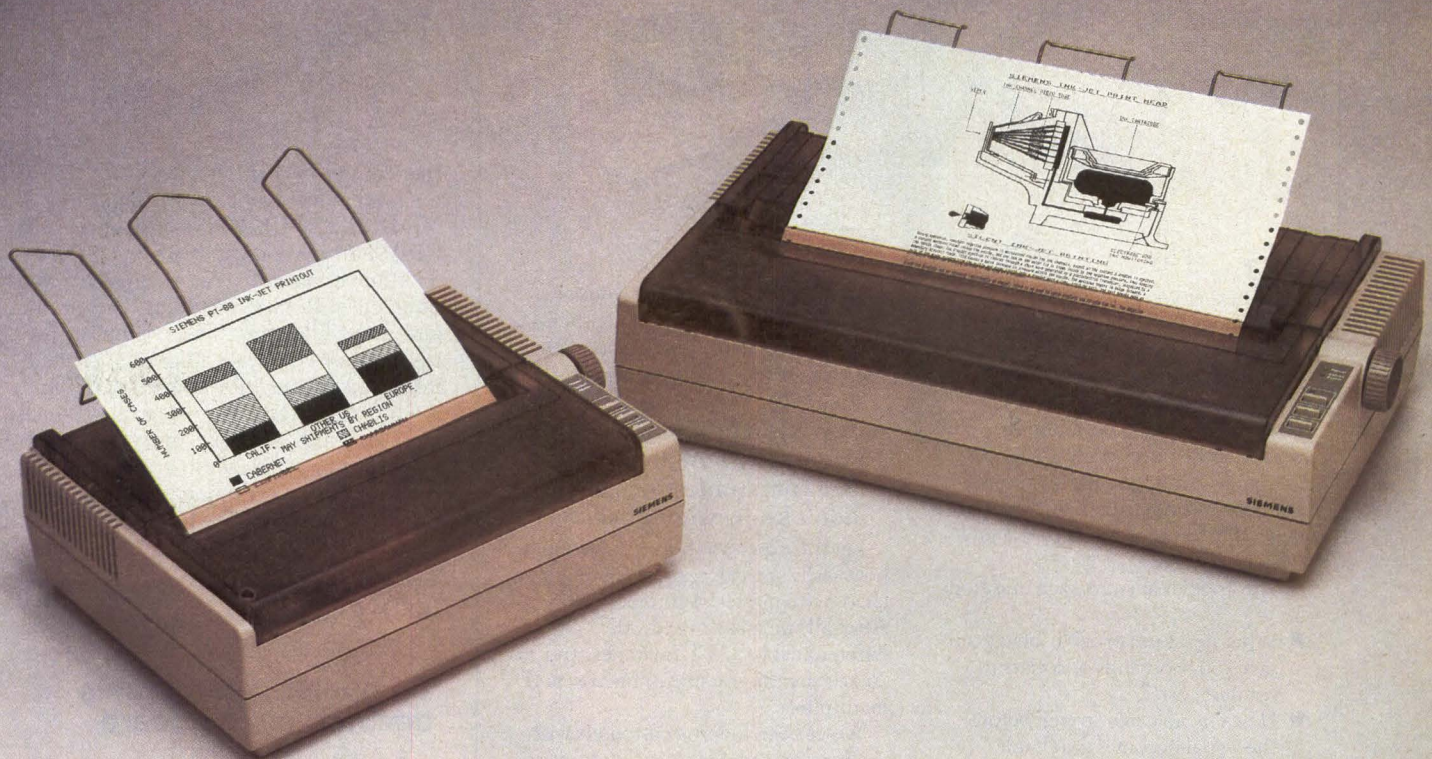

A golden opportunity to include Siemens PT-88/89 printers in your OEM system.

In today's "look-alike, sound-alike" PC systems market, the printer you select for OEM system integration reflects the importance you place on superior performance and long-term reliability. In fact, anything less than a quality printer not only compromises your system's total performance...it undermines customer perception of your system in a highly competitive marketplace.

That's why you owe it to yourself, and the success of your system, to make our incomparable PT-88 ink-jet printer...or the wide-carriage PT-89, part of your OEM system package. Just look at these unique features designed to enhance your system's performance...and give it the all-important "competitive edge":

- Ultra-silent operation (≤ 45 dBa)
- Exceptionally high reliability... the print head is rated in excess of 10 billion characters!
- High speed (150 cps bi-directional) performance
- "Drop-on demand" ink-jet quality printing...crisp, clean, consistent
- IBM-PC, EPSON, and other compatibilities available
- Full graphics capability
- Multiple interfaces
- Friction/traction or roll paper capabilities
- Downloadable character generator
- Siemens quality at no extra cost.

And here's more good news! Siemens PT-88/89 ink-jet printers offer OEMs the cost pricing benefits of high value-added reseller (VAR) margins. And of course, PT-88/89 printers are fully warranted and backed by one of the world's largest technical service/support organizations.

Take advantage of this golden opportunity. Fill out the attached postcard for our detailed information package on the PT-88/89 ink-jet printers. Siemens Communication Systems, Inc., Office Systems Group, 5500 Broken Sound Blvd., Boca Raton, FL 33431 (305) 994-8800 Extension 7608.

Silence is golden...the quiet ink-jet printers from Siemens.

Untangle your Data Communications Snarl with FREE Booklet from Inmac.

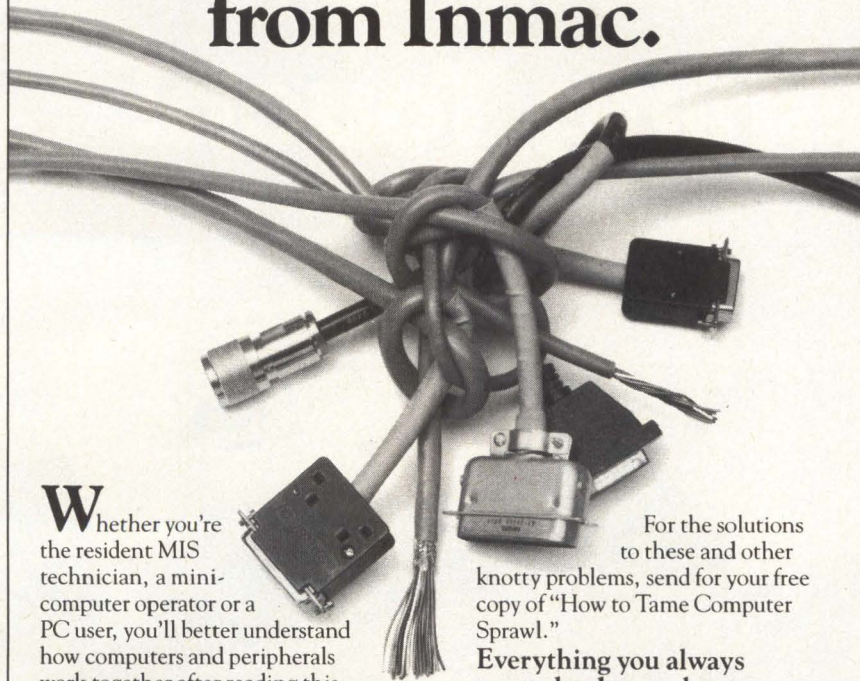

Whether you're the resident MIS technician, a mini-computer operator or a PC user, you'll better understand how computers and peripherals work together after reading this free guide. Photographs, diagrams, and easy-to-understand descriptions make this complex subject clear and manageable.

The booklet answers such questions as:

- What new kind of cable jacket can save you thousands of dollars in conduit costs?
- How far can cable stretch before the signal becomes unreliable? Why is this?
- What's the difference between a RS-232 interface and a parallel interface, and why is this important?
- Do your cables meet the new FCC requirements to keep data in and noise out?

For the solutions to these and other knotty problems, send for your free copy of "How to Tame Computer Sprawl."

Everything you always wanted to know about data communications but didn't know who to ask.

Let the experts at Inmac show you how easily you can control computer chaos with masterful connections. After all, we make over 2,000 different cables, 25 T-Switches, and 250 connectors for minis, micros, and mainframes.

We've been helping customers with products and advice since '76. Link up with the experts today and send for your free booklet. Or call toll-free 800-547-5444 (In California, 800-547-5447.) And manage your data communications like a pro.

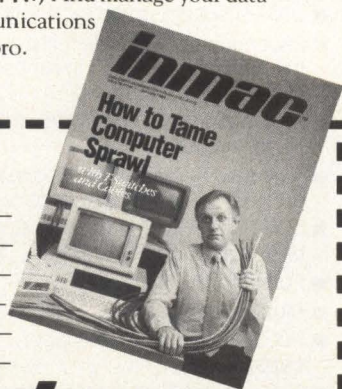

inmac™
2465 Augustine Drive,
Santa Clara, CA 95054

144134

Yes! Rush me the free Inmac booklet "How to Tame Computer Sprawl."

Name _____
Title _____
Company _____
Address _____
City _____ State _____ Zip _____
Phone No. _____

When you request this booklet, you'll also receive a free Inmac catalog.

- Check here if you already receive the Inmac catalog.

CIRCLE NO. 130 ON INQUIRY CARD

Products

SYSTEMS



the computer contains 256K bytes of main memory; three operating systems: MS-DOS 2.0, CP/M-86 and Concurrent CP/M-86; a 3½-inch, 315K-byte floppy disk drive; an integral calculator; and bundled software including SuperCalc and SuperPlanner. The computer features an 80-character MicroScreen built into the keyboard for operation without a CRT monitor. The separate 9-inch monitor tilts, swivels and slides. 5M-byte version with monitor, \$4,295; 10M-byte version with monitor, \$4,795. **Applied Computer Technologies Inc.**, Suite 342, 3375 Scott Blvd., Santa Clara, Calif. 95051, (408) 727-8090.

Circle No 303

Computer incorporates adaptor, motherboard

- 512K bytes of RAM
- two 360K-byte floppy disk drives

The model PB400 single-user, desktop computer incorporates a graphics adaptor on the motherboard, leaving an extra expansion slot for adding optional devices. It features software-selectable screen resolution of 640-by-400 pixels or 640-by-200 pixels, and runs graphics software written for the IBM PC. This 8088 microprocessor-based machine includes two 360K-byte, half-height, 5¼-inch floppy disk drives; one 10M-byte Winchester disk drive; 512K bytes of RAM; a 12-inch green monitor; an 83-key detachable keyboard; one RS-232C port and four expansion slots (one dedicated to the hard disk controller). MS-DOS 2.0, GWBASIC 1.0, MultiMate word-processing and PC Tutor software are provided. \$5,995. **Corona Data Systems Inc.**, 275 Hillcrest Drive, Thousand Oaks, Calif. 91360, (805) 495-5800.

Circle No 304

When you want the ASCII terminal that leads the field in performance, we'll be there.

Now there's an affordable all-purpose editing terminal that's ahead of the pace in quality, performance, and reliability: Qume's new QVT 109™. It comes to you with a full *one-year* warranty. Though that's twice the warranty of most other ASCII terminals, over 98% of our customers never need it. Qume quality control is *that* good.

The QVT 109 also leads the pack in performance, with 19 programmable function keys (38 functions) that can perform a sequence of tasks at a keystroke. There's a capacitive keyboard that combines the responsive touch of a typewriter with ruggedness that stands up to heavy-duty, all-day use. What's more, you're backed by our nationwide service network, as well as our vast resources and solid experience as an ITT company. You can depend on Qume to keep pace with your needs in the years ahead.

For more information about Qume's new QVT 109, our other alphanumeric and graphics terminals, or our full line of daisywheel printers and disk drives, call (800) 223-2479. Or write Qume Corporation, 2350 Qume Drive, San Jose, CA 95131.

Qume[®]
A Subsidiary of ITT

CIRCLE NO. 131 ON INQUIRY CARD

QVT
109™

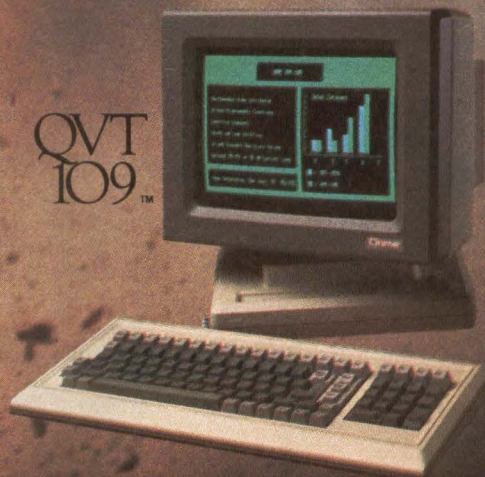

New Products

DISK/TAPE

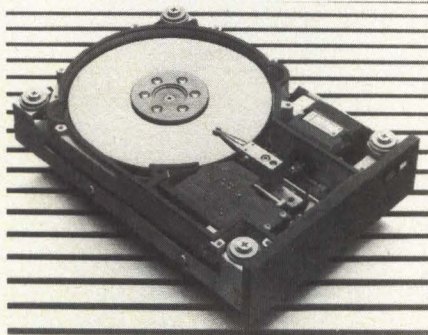

Half-height drive holds 20M bytes

- 5¼-inch format
- 5M-bps data-transfer rate
- 80-msec average access time

The model HH-725 half-height 5¼-inch Winchester disk drive provides 20M bytes of storage and uses an ST506/412 interface. It features a closed-loop servo-positioning system and a thermally isolated stepper motor, with four read/write heads. The drive features self-test when turned on, self-diagnostics, write fault detection and interface control designations and status production. A buffered seek feature allows an access time of 80 msec. The drive uses thin-film media and has a recording density of 9,680 bpi and a track density of 648 tpi. Data transfer rate is 5M bps. The 1.6-inch-by-5.75-inch-by-8-inch drive weighs 3¼ pounds and suits portable applications. Approximately \$900. **Microscience International**, 575 E. Middlefield Road, Mountain View, Calif. 94043, (415) 961-2212.

Circle No 305

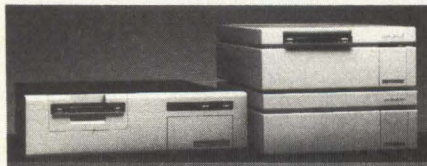

Storage subsystems work with DEC Q-bus computers

- 30-msec average access time
- ¼-inch cartridge tape backup
- 36M to 120M bytes of formatted capacity

The Cyclone series features 5¼-inch Winchester disk storage and ¼-inch tape cartridge backup. Both subsystems work with DEC Q-bus computer systems such as the PDP-11/23, PDP-11/73, MICRO/PDP-11 and MicroVax.

They are fully compatible with DEC's Digital Storage Architecture, which supports system software modifications and logical partitioning of disk drives. The subsystem stores 36M bytes to 120M bytes (formatted). Average access time is 30 msec. The ¼-inch tape cartridge stores 20M bytes of backup and features Kennedy 6455 start/stop tape drives that provide file-oriented transfer capability. The 8250 controller/interface enables simultaneous Winchester and tape drive operation on a Q-bus-compatible board: Starts at \$8,990. **Data Systems Design**, 2241 Lundy Ave., San Jose, Calif. 95131, (408) 946-5800.

Circle No 306

Tape drive employs IPI, Level 3 interface

- 160K-bps data-transfer rate
- 1,600/3,200 bpi

The Model 1880 Microstreamer combines a ½-inch streaming tape drive with the high-level Intelligent Peripheral Interface (IPI), Level 3. It supports high bus speeds with interface transfer rates to 6M bps in non-interlock mode, made possible by dual 1K integrated buffers. The IPI interface allows multiple block operations with one command, requiring 175 µsec., and tape and disk to share common I/O channel. The tape drive provides a 160K-bps data-transfer rate at 100 ips for streaming at 1,600 bpi; 50 ips for streaming at 3,200 bpi. In start/stop applications, it maintains 25 ips at 1,600 bpi. At 1,600 bpi, the drive can store 46M bytes of data; at 3,200 bpi, 92M bytes. \$3,000. **Cipher Data Products, Inc.**, 10225 Willow Creek Road, P.O. Box 85170, San Diego, Calif. 92138, (619) 578-9100.

Circle No 307

Winchesters work through ESDI interface

- 85M- to 170M-byte capacities
- 5¼-inch drive
- 28-msec average access time

The 1350 series of 5¼-inch Winchester disk drives works with the Enhanced Small Device Interface (ESDI) and offers formatted capacities of 85M, 127M and 170M bytes. The series implements the serial mode of the ESDI interface at a 10M-bps transfer rate. The serial mode permits drives to report configuration and status informa-

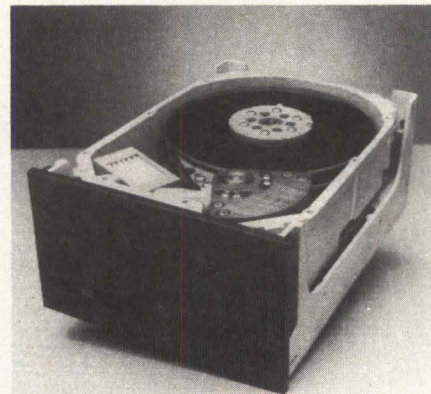

tion. Using four to eight read/write heads, all three series drives have an average access time of 28 msec. Track density is 1000 tpi. Other features include dual-chassis construction and balanced rotary voice-coil positioner. A spindle-motor brake minimizes friction and protects heads and media. \$1,469 to \$1,837, OEM quantities. **Micropolis Corp.**, 21329 Nordhoff St., Chatsworth, Calif. 91311, (213) 709-3300.

Circle No 308

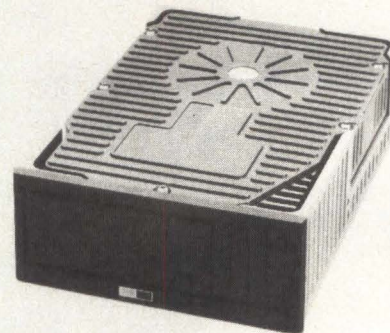

Small Winchesters store 5M, 10M bytes

- 80-msec average access time
- ST412/506 interface

The Ranger 3521 and 3522 3½-inch Winchester disk drives offer formatted capacities of 5M and 10M bytes, respectively. Equipped with the industry-standard ST412/506 interface, the drives' average access time is 80 msec. They operate reliably from 40 degrees to 122 degrees Fahrenheit. Acoustic noise is limited to less than 54 dBa. \$595, OEM quantities. **LaPine Technology**, 1111 Space Park Drive, Santa Clara, Calif. 95050, (408) 986-8676.

Circle No 309

8 INCH DISK MEMORIES



Quality Performers

Century Data Systems now introduces its new C-Series, a line of higher capacity, 8-inch disk memories. These memories are available in a variety of models to offer OEMs the versatility they want, along with the quality and reliability they have come to expect.

This new family of high performance, 8-inch disk memories uses advanced technology and provides compact, reliable mass storage. For example, our new 8-inch Winchester, the C2476, is the ideal choice for computer systems utilizing disk memories in multi-user and multi-task environments which require fast access to large files of data. The C2476 stores 476 megabytes in significantly less cabinet space than previously available models and has an average positioning time of 15 milliseconds.

The C2075, our initial C-Series offering, is an 8-inch fixed/removable disk memory containing 80.2 megabytes of storage. Continuing this line of disk memories is the C2120, our new 122.9 megabyte fixed/removable disk. Both of these disk memories provide OEMs with powerful new sales tools. The fixed Winchester disk portion of the device provides high-capacity, reliable, on-line storage while the removable cartridge extends the on-line storage and provides faster, more convenient backup than tape.

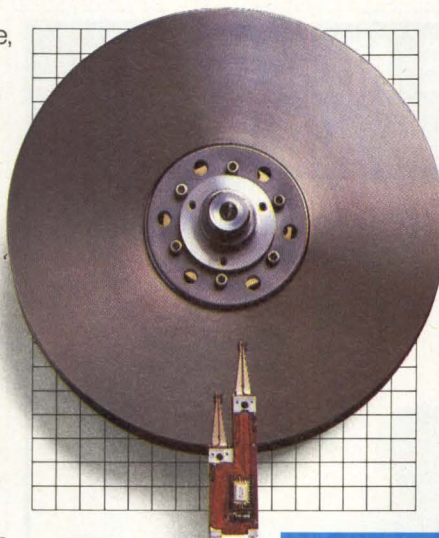

These compact, fixed/removable 8-inch disk memories are the perfect match with large personal computers, microcomputer systems or transaction-oriented systems.

All C-Series products fit in our new, standard 8.5-inch wide package. OEMs using large disk memories can now standardize on one compact package for installation in computer cabinets, equipment pedestals, or on desktops.

Like all our disk memories, the new 8-inch product line is reasonably priced, easy to install, and includes the quality and performance OEM systems require. We invite your inquiries. Write or call: Century Data Systems, Product Marketing, 1270 N. Kraemer Blvd., Anaheim, CA 92806 (714) 632-7500.

Specifications	C2075	C2120	C2476
Storage capacity, fixed disks	53.5 megabytes	87.8 megabytes	475.9 megabytes
Storage capacity, removable cartridge	26.7 megabytes	35.1 megabytes	—
Positioning time, average	32 milliseconds	32 milliseconds	15 milliseconds
Interface	SMD/LMD	SMD/LMD	ESMD
Transfer rate	1209 kilobytes/sec	1209 kilobytes/sec	1859 kilobytes/sec

New products

 **Century Data Systems**
A Xerox Company

See these new products at COMDEX, Booth 2758.
CIRCLE NO. 132 ON INQUIRY CARD

New Products

DISK/TAPE

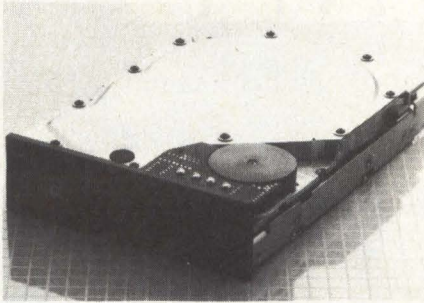

Two-disk drive accepts 25.52M bytes

- 690-tpi density
- 85-msec average access time

The model CM3426 half-height 5¼-inch drive uses two disks and stores 25.52M bytes of data. It features closed-loop servo positioning and a track density of 690 tpi. The drive uses a crystal-controlled spindle drive and an embedded track-zero concept. The drive employs a swing-arm actuator with closed-loop stepper motor control. The system achieves an average access time

of 85 msec. Track-to-track access time is 18 msec. The interchangeable drives weigh three pounds. \$525, OEM quantities, **Computer Memories Inc.**, 9216 Eton Ave., Chatsworth, Calif. 91311, (818) 709-6445. **Circle No 310**

IBM-compatible subsystem packs 75M bytes of data

- 25M bytes removable storage
- SMD PC-80 controller

The RDS 375 75M-byte disk subsystem uses the Century Data Systems C2075 8-inch SMD disk drive and stores 50M bytes fixed and 25M bytes removable. It suits IBM PCs and PC-compatibles that maintain large databases. The Maverick SMD PC-80 controller permits three times the speed of 5¼-inch Winchester drives in PC-net, Ethernet and Netware local area networks. Packaged in a table-top enclosure with storage for three spare cartridges, the unit comes with disk drive, fan, power sup-

ply, controller, cables and software for MS-DOS 2.0 or QNX. Average access time is 30 msec. \$9,495. **Interphase Corp.**, 2925 Merrell Road, Dallas, Texas 75229, (214) 350-9000.

Circle No 311

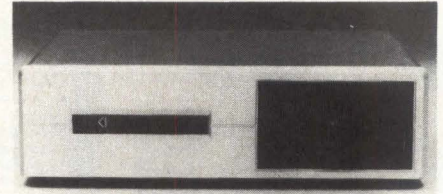

Disk/tape subsystem suits IBM PC, XT

- 10M- to 40M-byte storage capacities
- 40-msec average access time

The Datasystem combines either a 10M-, 21M-, 32M- or 40M-byte hard disk drive and a 24M-byte tape backup into one unit. Compatible with IBM PC and XT microcomputers, the subsystem features compressed or full-volume backup, file-by-file or full-volume restore and automatic flaw mapping that ensures media interchangeability. Average access time is 40 msec. The number of read/write heads on the fixed disk is two to eight and the data transfer rate is 62.5K bps. The six-track tape contains six read/write heads and moves at 78 ips. Housed in a 4½-inch-by-14-inch cabinet, the unit weighs 22 lbs. \$3,295. **Davong Systems Inc.** 217 Humboldt Court, Sunnyvale, Calif. 94089, (408) 734-4900. **Circle No 312**

UNFORGETTABLE MEMORIES MULTIBUS — QBUS

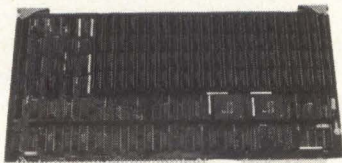

MULTIBUS MEMORY 512KB TO 2MB EDC

- Error Detecting and Correcting (EDC)
- Faster Access Times

	SINGLE QTY. PRICE	
	Without/EDC	W/EDC
512KB	895.00	1495.00
2MB	3595.00	4595.00

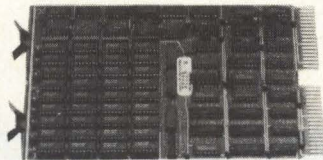

Q-BUS MEMORY 256KB TO 4MB

- Battery Backup Mode
- Block Mode DMA, ECC or Parity
- Works with LSI-11, J-11, MicroVAX

SINGLE QTY. PRICE

1MB	1695.00
256KB	525.00



"OFFERING QUALITY WITH AFFORDABLE PRICING"



Chrislin Industries, Inc.

31352 Via Colinas • Westlake Village, CA 91362 • 818-991-2254
TWX 910-494-1253 (CHRISLIN WKVG)

J-11, LSI-11, MicroVAX, Q-BUS are trademarks of Digital Equipment Corporation. MULTIBUS is a trademark of Intel Corporation.

Cartridge tape drive stores 67M bytes

- 60-ips read/write speed
- 16-track recording

The HP 9144A ¼-inch cartridge tape drive stores 67M bytes of data using a density of 10,000 bpi and a 16-track recording format. Operating in streaming mode, it provides 2M-byte-per-minute backup performance. A 12K-byte buffer aids data-transfer speeds. Read-after-write capability protects data. Exclusive OR- error correction and a media monitor ensure data reliability. Search speed is 9 ips; read/write speed, 60 ips. \$3,500. **Hewlett-Packard Co.**, 1820 Embarcadero Road, Palo Alto, Calif. 94303. (800) 547-3400.

Circle No 313

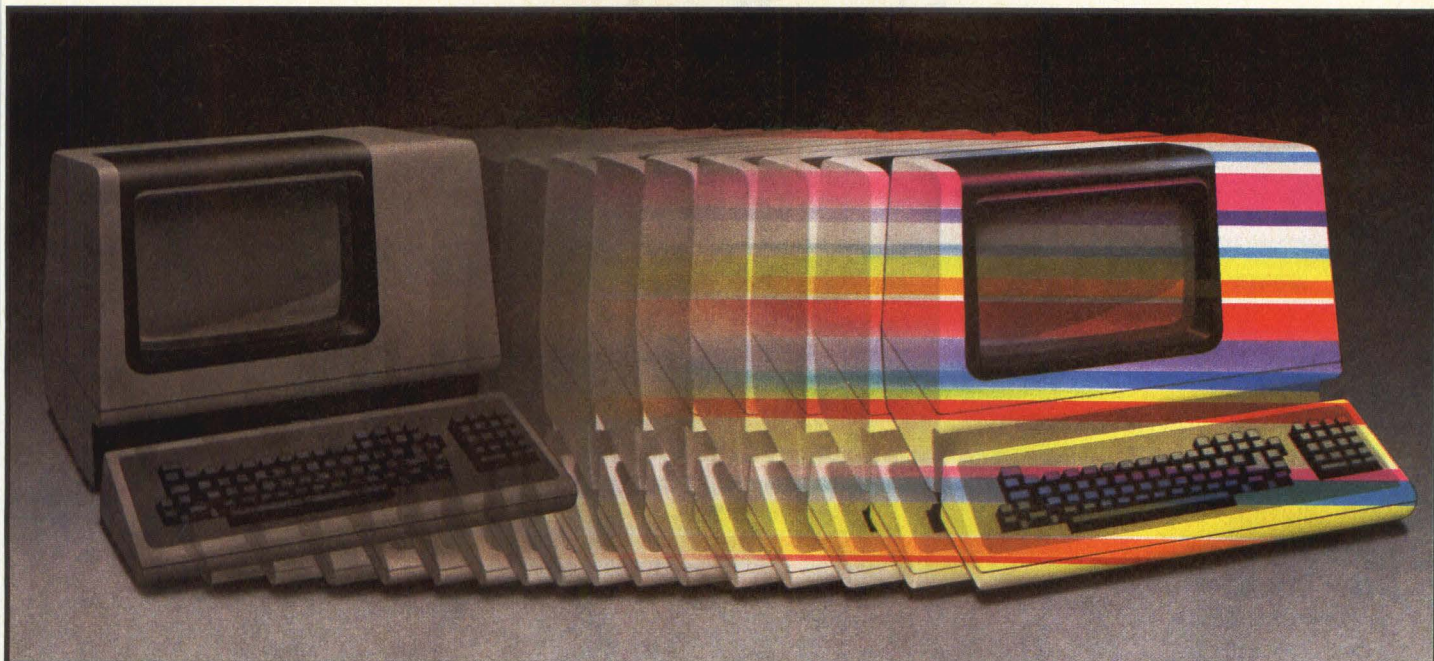

Turn your terminals... into IBM PC's.

The Solaris 1000™ gives your terminals total IBM PC capability.

Now you can turn all the terminals on your computer network into fully functional, IBM PC compatible work stations.

Not only that, but the Solaris 1000 gives you a simultaneous split screen window absolutely no other equipment has. It displays and processes IBM PC software in one window while simultaneously displaying and processing host computer data in the other window. Information can even be transferred back and forth between your "new PC terminals" and your host computer (File Transfer).

The Solaris 1000 is far less costly than replacing your existing equipment. And

there is no system disruption. The Solaris 1000 takes about two minutes to install. You simply connect a cable. No modifications are necessary.

For the OEM we offer the Solaris 1000 with complete function and modularity options. For the distributor it represents a unique selling opportunity. And for the end user it means the ability to greatly enhance your existing system.

For more information call (408) 943-1818 or write to Solaris Computer Corporation. If you haven't upgraded your terminals to total PC capability, you're missing the advantage of micro-mainframe technology.



Solaris 1000 running Lotus 123 on a VT-100 type terminal.

SOLARIS

COMPUTER CORPORATION

1994 Tarob Court, Milpitas, CA 95035
(408) 943-1818

TELEX: (ITT) 4994597

See us at Comdex - Booth H7244

Trademark/Owners: IBM PC/International Business Machines; Lotus 123/Lotus Development Corp.; VT-100/Digital Equipment Corp.

New Products

PRINTERS

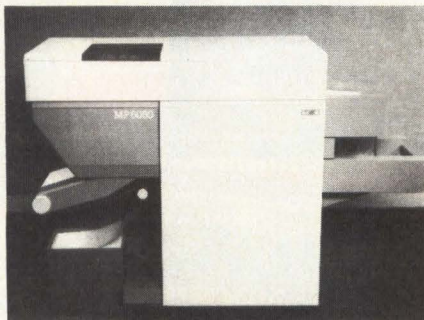

Non-impact printer achieves 50 ppm

- 240 by 240 dpi
- Handles multiple forms
- 10, 12, 13.3 and 15 cpi

The MP 6050 non-impact magnetic printer achieves a resolution of 240 by 240 dpi at a speed of 50 pages per minute. The 45.3- by 22.6- by 67.4-inch unit handles forms from 8½ to 9½ inches wide and 5½ to 12 inches high. Standard features include a video interface, a power stacker, operator or host-selected densities of 10, 12, 13.3 and 15 cpi and vertical densities of 6, 8, 10 and 12 lpi. Character sets come in four sets of 96, and are either operator- or host-selectable; page rotation occurs at zero and 90 degrees. \$15,000, OEM quantities. **Cynthia Peripheral Corp.**, 766 San Aleso Ave., Sunnyvale, Calif. 94086, (408) 745-0855.

Circle No 314

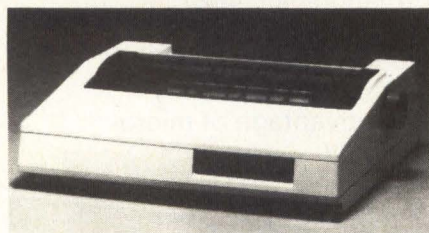

Dot-matrix printers offer IBM PC compatibility

- Single or multiple colors
- 105- to 180-cps print speeds
- 80 or 136 columns

Model 7500E of a series of IBM PC-compatible dot-matrix printers produces 80 columns at a 105-cps print speed and a 45-lpm throughput. It employs a 9-dot-by-9-dot matrix for alphanumeric and an 8-dot-by-8-dot matrix for dot-addressable graphics. The model 8510/1550SCE printers provide correspondence-print quality and seven-color business graphics at 120 cps and rough-

draft printouts at 180 cps. They use a 9-dot-by-9-dot matrix and a 144-dpi-by-160-dpi resolution. A 4K-byte serial or a 2K-byte parallel buffer, 13 switch- or software-selectable character sets and a 256-byte overrun buffer are standard. The model 8510SCE printer prints 80 columns on 4½- to 10-inch-wide forms; Model 1550SCE prints 136 columns on 4½- to 15½-inch-wide forms. Parallel and RS232C interfaces are available. Model 7500E, \$450; model 8510SCE, \$940; model 1550SCE, \$1,270. **C. Itoh Electronics Inc.**, 5301 Beethoven St., Los Angeles, Calif. 90066, (213) 306-6700. Circle No 315

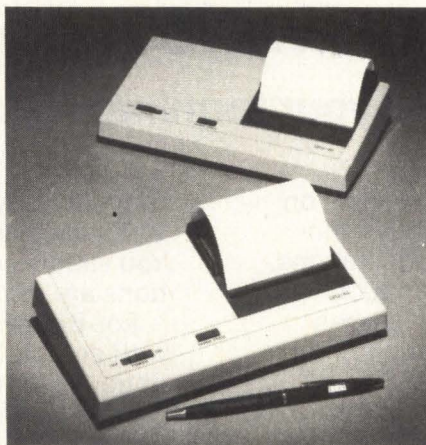

Thermal printer offers low cost, compactness

- Small size, low weight
- 5-dot-by-7-dot matrix
- 40 columns

The DPU-40 thermal printer measures 210mm long by 117mm wide by 53mm high and weighs 400 grams. The unit prints 40 columns of characters in a 5-dot-by-7-dot matrix format at approximately 0.6 lines per second. Characters are 2.4mm high by 1.1mm wide. An on-board character generator produces a 96-character ASCII set. The printer uses heat-sensitive, 80-mm paper accommodating a 40mm diameter roll of paper. The printing mechanism consists of a thermal print head, one DC drive motor, a tacho-generator and a home switch. Mean-time-between-failure is 500,000 lines. An 8-bit parallel port employs Centronics handshaking. \$86.25. **Seiko Instruments U.S.A. Inc.**, 2990 West Lomita Blvd., Torrance, Calif. 90505, (213) 530-8777.

Circle No 316

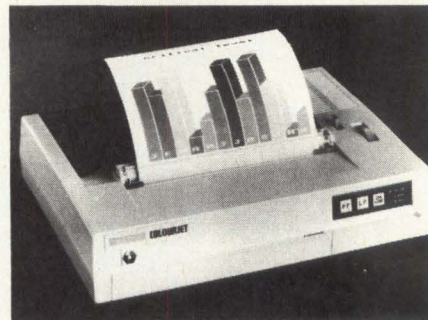

Ink-jet printer furnishes 36 colors

- IBM PC-compatible
- 252 dpi
- 80 and 132 columns

The Colourjet 132 ink-jet printer produces 36 colors with a 252-dpi resolution. It prints 132 columns compressed and 80 columns normal. Using a screen-dump disk, the unit is compatible with the IBM PC. Features include double-width, double-height and double-size printing, underlining, italics and programmable foreground and background colors. The unit can print in videotex format from a Centronics parallel input. \$795. **Integrex Inc.**, 233 North Juniper St., Philadelphia, Pa. 19107, (215) 568-9681. Circle No 317

Dot-matrix printers run at 160 cps

- 60 to 240 dpi
- 80 or 136 columns
- Parallel interface

The CTM series dot-matrix printers operate at 160 cps, providing 11 print functions. Character sets encompass 96 ASCII characters, nine international sets and 96 italic characters. Special printer effects include proportional spacing, superscript/subscript modes, ninth-pin underlining, printer select and deselect by software and graphics functions with variable densities from 60 to 240 dpi horizontal and up to 216 dpi vertical resolution. Model 80 prints 80 columns on 9½-inch-wide paper and Model 100 prints 136 columns on 16-inch-wide paper. A Centronics-style, 8-bit parallel interface, a multifont interface and a word-processing card come standard. CTM 80, \$370 (1,000 units); CTM 100, \$500 (1,000 units). **Epson OEM Products Division**, 3415 Kashiwa St., Torrance, Calif. 90505, (213) 533-8277.

Circle No 318

Technical Bulletin

No.1 in a series.



Subject: Engineering for maximum performance.

Quantum Software Systems Ltd. bring you QNX — The Ultimate Operating System. The design of QNX allows you to take advantage of an IBM-PC or similar micro-computers in ways that are only possible on large mini and mainframe computers.

Unlike other UNIX™ type systems QNX was engineered for the 8086/8088 architecture. All of QNX's features were designed into the operating system right from the beginning. As a Real-Time Multi-Tasking O/S, QNX will support up to 48 tasks executing simultaneously. It is also a Multi-User O/S with a Time-Sharing environment supporting up to 17 users, with a security conscious Message-Passing Protocol ideally suited for Local Area Networks. We will shortly be announcing a true (not just a file server) Distributed Local Area Network version of QNX.

To minimize memory requirements we allow Shared Code and Shared Libraries. Disk access is accelerated by Disk Caching. To improve productivity we give you Multiple Windows. For those of you who wish to add new devices, you simply mount a Device Driver. Our operating system is compact (64K).

Of course QNX is fast; benchmarked to be 20 times faster than other popular UNIX™ systems. On a 5 Mhz 8088, task switching is done within 1.3 msec. Interrupt latency is under 1 msec and kernel call overhead is under 350 usec.

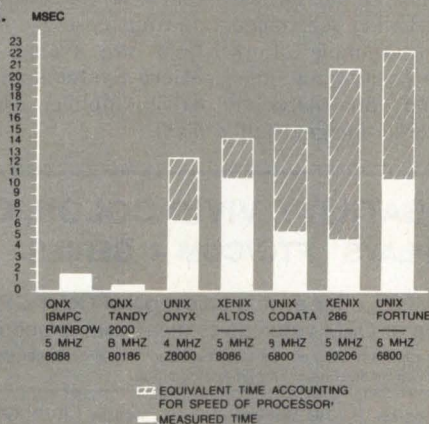

The QNX file system is highly optimized with minimum floppy disk access and is tolerant of power failure. It is a Hierarchical Directory System with 16 character file/directory names. There are NO limits to the number of files, or number of directories. The file system has a

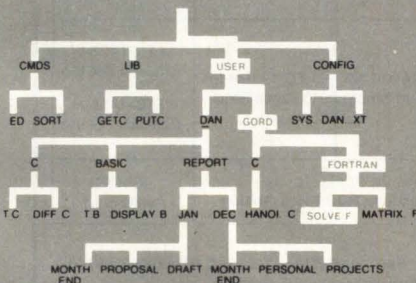

minimum File Allocation Unit of 512 bytes regardless of disk size with a directory overhead of less than 2%. Up to 40 files can be opened simultaneously. The QNX Multi-User file security includes read/write/append/execute/modify file permissions, and read/create/

block/modify directory permissions. 256 Groups of up to 256 users in each group are possible. QNX files can grow automatically and need not be contiguous.

The Intertask communications include message passing, non-blocking signals, and asynchronous exceptions. Messages are passed at the rate of 3 usec/

byte on a 5 Mhz 8088 and may consist of up to 64K bytes. Partial I/O of messages is permitted and message forwarding is supported. Priority task scheduling will allow up to 16 priorities and 48 simultaneous tasks. Messages may be sent between tasks on different nodes in the local area network version of QNX.

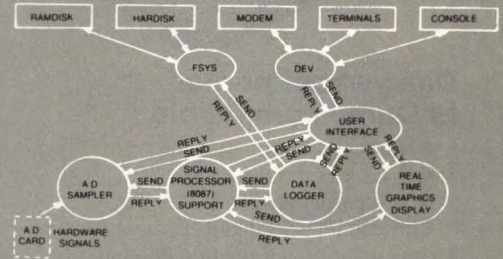

Asynchronous Communications are completely interrupt driven with up to 16 serial (RS232) devices supported. Input/output Flow Control is supported for XON/XOFF and DTR/CTS hardware. Loss of carrier can generate a High Level Exception. Line Editing is a programmable option on any terminal and terminal independence is made simple with a "TERMCAP" type database.

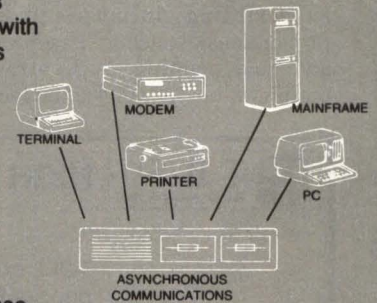

Other Quantum Software product development tools include a "C" Compiler, a Full Screen Editor, an 8086 Assembler, a Fortran Compiler, a Basic Compiler, a Qbol (Dibol) Compiler, and Graphics and Math libraries with complete 8087 support.

Minimum hardware required is an IBM-PC or compatible with 128K RAM, single 320K floppy drive, and display/keyboard (or terminal). Maximum requirements are 880K RAM, 8087 math co-processor, 8 disk drives (floppy, hard or ramdisk), 2 parallel printers and 16 RS232 devices (terminals, modems, printers).

QUANTUM SOFTWARE SYSTEMS LTD.
 Moodie Drive, HiTech Park
 215 Stafford Rd., Unit 104
 Ottawa, Canada K2H 9C1
 (613) 726-1893



PRICE LIST

QNX 1.20 WITH "C" COMPILER \$650
 QNX 2.00 WITH "C" COMPILER (2 NODES) .. \$850
 BASIC COMPILER \$300
 "C" COMPILER \$300

QBOL COMPILER \$595
 QMENU \$150
 BTREE \$150
 QSPELL \$199
 QDOC \$300
 TED/TERMCAP \$ 50

AUTHORIZED DISTRIBUTORS

CANADA:
 QUANTUM SOFTWARE SYSTEMS (613) 726-1893
 PERIPHERALS PLUS INC. (514) 364-5554
 KANATEK MICRO (613) 726-1907

USA:
 MICRO MANAGERS OF TEXAS INC. (512) 341-9544

EUROPE:
 XMIT A G (SWITZERLAND) (41) 57-311125

SOUTH AMERICA:
 ANALYSIS SISTEMAS
 PLANEJAMENTO
 E ORGANIZAC (BRAZIL) (11) 280-5930

New Products

PRINTERS



Daisywheel printer is Qume-compatible

- 120 columns in 10 pitch
- 8-bit parallel interface
- 18-cps print speed

The model 418 printer furnishes an 18-cps print speed using a 96-character, Qume-compatible, 10-, 12- or 15-pitch daisywheel. The printer accommodates 13-inch wide paper printing 120 columns in 10 pitch. It prints an original and four copies with a four-level impression control. Features include superscripting, subscripting, automatic underlining, proportional spacing, shadow printing and bold printing. A Centronics-compatible 8-bit parallel interface comes

standard; an RS232C interface is optional. \$545. **Teal Industries Inc.**, 1741 Lomita Blvd., Lomita, Calif. 90717, (213) 539-7244. **Circle No 319**

Laser printer includes graphics controller

- 24 ppm
- 90,000-dpi resolution
- 12 resident fonts

Printing 24 ppm, the intelligent Lasergrafix 2400 laser printer includes a graphics controller with 2M-byte RAM and 512K-byte EPROM. With a resolution of 90,000 dpi, the MC68000 processor-based printer suits distributed graphics and text-processing applications. The unit bit-maps an 8½-inch-by-14-inch page. Graphics capabilities include 12 resident fonts and font downloading and line and daisywheel simulation. The QMS Utility for Image Creation (QUIC) programming offers absolute and relative positioning, line/form drawing commands, line/character spacing control, reverse image, half-

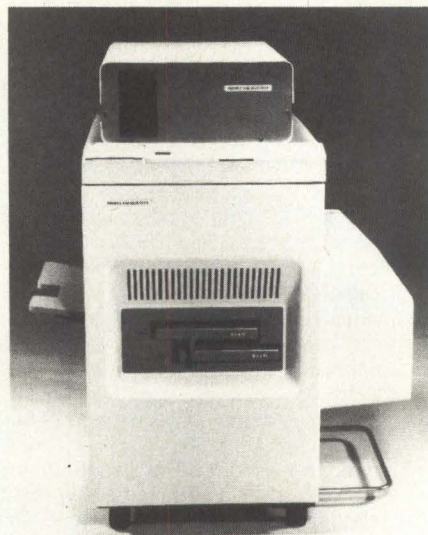

tone, vector graphics, pixel graphics and business graphics. Interface selections are available. \$35,000. **Quality Micro Systems Inc. (QMS)**, P.O. Box 81250, Mobile, Ala. 36689, (205) 633-4300. **Circle No 320**



HIGH PERFORMANCE, VERSATILITY, VIVID COLOR, CRISP IMAGE TOEI COLOR DISPLAYS FTC/CDM - SERIES.

TOEI, experienced Display Monitor specialists, offer a wide selection of Color CRT Displays. You can choose from our versatile standard models or OEM versions to meet your exacting requirements.

- Housed in lightweight, impact-resistant Cabinet. •Hi-Contrast (Black Face), Hi-Brightness CRT displays a crisp, sharp image. •Limitless colors can be displayed through Analog Input.

FTC Series

Versions CRT Size	RGB Version	NTSC Version	PAL Version	NTSC & RGB Version	PAL&RGB Version	IBM PC Compatible only	
12" (CRT Pitch)	FTC-1201-R (0.47mm Stripe)	FTC-1200-N (0.64mm Stripe)	FTC-1200-P (0.64mm Stripe)	FTC-1201-NR (0.47mm Stripe)	FTC-1201-PR (0.47mm Stripe)	FTC-1203-H (0.38mm Dot trio)	
	FTC-1203-R (0.38mm Dot trio)						FTC-1201-N (0.47mm Stripe)
	FTC-1208-R (0.28mm Dot trio)						
14" (CRT Pitch)	FTC-1423H-R (0.42mm Stripe)	FTC-1410H-N (0.52mm Stripe)	FTC-1410H-P (0.52mm Stripe)	FTC-1410H-NR (0.52mm Stripe)	FTC-1410H-PR (0.52mm Stripe)	FTC-1428-H (0.39mm Dot trio)	
	FTC-1428H-R (0.39mm Dot trio)						FTC-1416-N (0.64mm Stripe)
	FTC-1455H-R (0.31mm Dot trio)						
Applications	IBM PC Apple IIc, Apple IIe* RGB TTL & Analog	Commodore, Apple IIc, IIe		IBM PC Jr, Apple IIc-IIe Commodore, RGB TTL & Analog		IBM PC with card	

FTC-12" Series

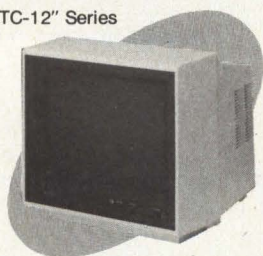

CDM-14" Series

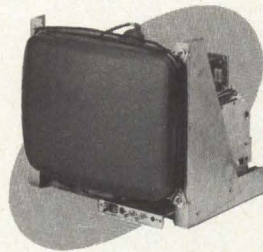

*through Compatible Interface-Module

FTC-1203-R, FTC-1203-I: Non-Glare

CDM Series (Unit for OEM)

Model	CRT Size	CRT Pitch
CDM-1208-R	12"	0.28mm Dot trio
CDM-1203-R	12"	0.38mm Dot trio
CDM-1201-R	12"	0.47mm Stripe
CDM-1455H-R	14"	0.31mm Dot trio
CDM-1428H-R	14"	0.39mm Dot trio
CDM-1423H-R	14"	0.42mm Stripe
CDM-1410H-R	14"	0.52mm Stripe

- Green/Orange CRT Displays are also available. (Included IBM Compatible.) CRT size: 9" or 12". Horizontal frequency: 15.75-64kHz.
- Special made products: Select Horizontal Frequency within 31-64kHz (Color), 24-64kHz (Monochrome). Display providing with more than 640x400-dot-resolution are also available.
- We are looking for reliable and established distributor worldwide.

TOEI ELECTRONICS (MFG) CO., LTD.

Kanda Cent Bldg., 2-4, Yushima 1-chome Bunkyo-ku, 113 Tokyo JAPAN
Tel. (03) 257-1131 Telex. 0222-2555 TOEICO J FAX (03) 258-3560

IBM PC is a Trademark of IBM Corp. Apple IIc, IIe are Trademarks of Apple Computer Inc.
Commodore is a Trademark of Commodore Business Machine Inc.

CIRCLE NO. 135 ON INQUIRY CARD

The new Canon TX-50 desktop computer.

It fits any customer's business as well as his desk.



No matter how specialized your customers' business needs, Canon's new compact desktop computer is uniquely designed to accommodate them.

Because the TX-50 is a self-contained computer that can be customized for a wide range of specific business applications.

Its all-in-one design includes:

- A high-performance 16-bit microprocessor with MS-DOS[†] operating system. Standard 128KB memory is expandable to 256KB.
- Seven-inch high-resolution monochrome CRT display.
- Fifty-function LED keyboard plus separate ten-key calculator pad and cursor control keys.
- Three-inch compact floppy disk drive with 150 K-bytes memory capacity per side.
- Optional RS-232C serial interface and Centronics-type parallel interface available.
- Wire dot impact printer that gives a

sharp 5X7 dot matrix and has a maximum 30 characters per line. One original plus two copies can be made on plain paper in either black or red.

With such impressive, self-contained flexibility, the TX-50 is ideal in areas such as customer operations and counter service. Especially since the TX-50 provides such a huge range of varied functions, yet takes up so little space.

Businesses such as gasoline stations, banks, mail rooms, real estate brokers and numerous others will find the TX-50 particularly useful for sales, credit, loan or general customer calculations.

So if you're dealing with business, whether large or small, and you feel they need a rather special computer, consider the new Canon® TX-50 desktop computer.

There isn't a desk it won't fit.

For more information:

Call 1-800-323-1717, Ext. 302.

(In Illinois call 1-800-942-8881, Ext. 302.)

Or write Canon U.S.A., Inc.

Systems Division/TX-Series

P.O. Box CN 11250, Trenton, N.J. 08650

Canon Systems Division

© 1984 Canon U.S.A., Inc.
†MS-DOS is a trademark of MICRO SOFT.

CIRCLE NO. 136 ON INQUIRY CARD

New Products

DATACOMM

Auto-dial modem offers two-level security

- 0-300 and 1,200 bps
- Bell 103- and 212A-compatible
- 16 telephone numbers

The AJ 1212-AD2 synchronous/asynchronous modem operates at speeds of 0-300 or 1,200 bps and is compatible with Bell 212A and Bell 103/113 modems

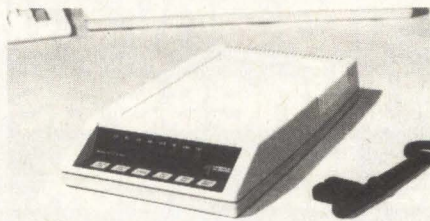

in switched telephone network operation. It automatically dials a computer via a code name and refuses commands unaccompanied by a password. A second-level password restricts access to the modem's memory. The modem stores 16 telephone numbers of 37 digits each for automatic or touch-tone dialing. A prefix of 19 digits may be added for speed-dialing from internal memory to carrier networks. The modem is approved for direct connection to the telephone line via RJ11 modular jack or RJ41 and RJ45 data jacks. \$695. **Anderson Jacobson**, 521 Charcot Ave., San Jose, Calif. 95131, (408) 945-9030.

Circle No 321

Advanced Tools for Artificial Intelligence

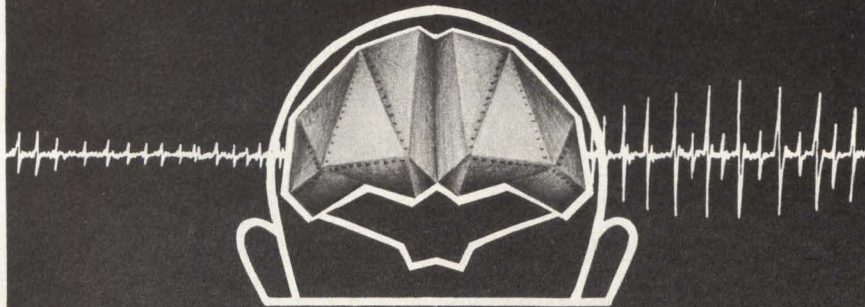

SRL's software for Artificial Intelligence applications are advanced tools for serious investigators. These tools permit integrating Lisp written algorithms into FORTRAN or Ada[®] developed systems.

FORTRAN LISP is a machine independent implementation of the list processing language Lisp, programmed in ASA Fortran.

ADA LISP is a machine independent implementation of the list processing language Lisp, programmed in Ada MIL-STD-1815A.

Both SRL's FORTRAN LISP and ADA LISP feature:

- Lisp data structures
- Recursion
- Garbage collection
- Portable from CPU to CPU
- Designed for AI systems integration

Translate Lisp written algorithms into FORTRAN or Ada through our:

LISP TO FORTRAN TRANSLATOR

or our

LISP TO ADA TRANSLATOR.

SRL's DEXPERT[™] software package is a portable expert system that features:

- User definable rules
- Probabilistic decision making
- A building block for integration into other applications, including Fortran and Ada

For full details about SRL's software tools for implementing such AI applications as expert systems, intelligent data base interfaces, and other scientific uses, contact:

Systems Research Laboratories, Inc.
Computer Systems Division
2800 Indian Ripple Road
Dayton, Ohio 45440-3639
(513) 426-6000

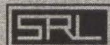

*Ada[®] is a registered trademark of the U.S. Government, Ada Joint Program Office.

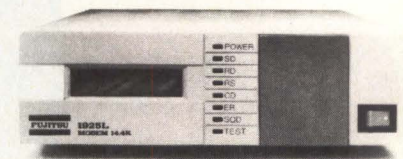

Standalone modem operates at 14,400 bps

- Six-channel multiplexer
- 32-character LCD

The model 1925L standalone modem provides 14,400-bps synchronous data transmission over unconditioned lines. It features an automatic adaptive equalizer and fallback speeds of 9,600, 7,200 and 4,800 bps. A 32-character liquid-crystal display monitors operation, checks signal quality, performs local and remote loopback tests and changes local and remote strap settings. A six-channel, time division multiplexer comes built in. \$6,500. **Fujitsu America Inc.**, 1945 Gallows Road, Vienna, Va. 22180, (703) 356-5758. Circle No 322

Server links 14 devices to Ethernet LAN

- MC68000 microprocessor
- Supports Xerox network protocols

The Communications Server/100-14 links an Ethernet LAN to as many as 14 devices equipped with RS232C interfaces. It contains multiple MC68000 microprocessors and supports industry-standard Xerox Network System high-level network protocols. Connection between devices is executed through user command interface software. \$5,400. **Bridge Communications Inc.**, 10440 Bubb Road, Cupertino, Calif. 95014, (408) 446-2981. Circle No 323

How does a new, letter-quality, thermal transfer printer made by Canon sound? Very quiet.

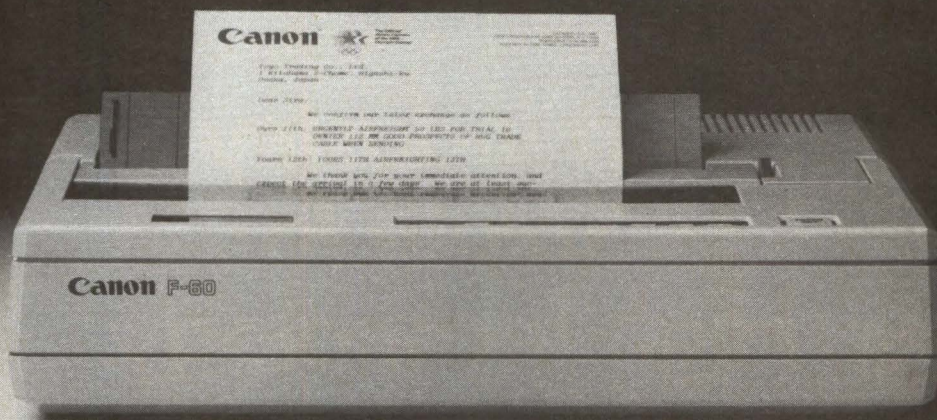

Canon's advanced non-impact printing technology heralds yet another achievement—The F-60: a flexible, high-quality thermal transfer printer with Graphic Image capability.

Its letter-quality printing is good enough to use with a word processor, yet quiet enough to be seen and not heard. The F-60 operates at a dramatically low 45db, so it's perfect for even the most noise-conscious office.

Extreme flexibility gives access to three attractive printing modes. Printing speeds range from Graphic Image at a rapid 80cps, through Draft and Near-Letter-Quality to Letter-Quality at a smooth 20cps and an impressive high-resolution 36X24 dot matrix.

But its flexibility doesn't stop there. A simple system of interchangeable typestyle cartridges gives an incredible choice of eight different fonts.

© 1984 Canon U.S.A., Inc.

The F-60 is also highly versatile. It handles not only thermal paper and overhead projection film, but also plain paper in single sheets, rolls or fan folded. Its self loading mechanism automatically inserts and advances the paper. It's even compatible with most leading personal computers.

Plus it prints in a choice of four bold colors.

And it does it very quietly, and at a very competitive price.

For upgraded performance, optional accessories include pin feed, tractors, roll paper holders and a serial interface card.

The new F-60 thermal transfer printer from Canon. You have to admit it sounds very good.

For more information:
Call 1-800-323-1717, Ext. 300.
(In Illinois call 1-800-942-8881, Ext. 300.)
Or write Canon U.S.A., Inc.,
Printer Division, P.O. Box CN 11250,
Trenton, N.J. 08650

Canon Printer Division

CIRCLE NO. 138 ON INQUIRY CARD

New Products

DATACOMM

Controller board supports multiple protocols

- 150- to 9,600-bps data rates
- Asynchronous and synchronous protocols

The Multiple Protocol Communicator controller board allows IBM PC and

IBM PC-compatible computers to support asynchronous and synchronous communications protocols. Using a Zilog 8530-SCC serial communications chip, it offers full-duplex data rates from 150 to 9,600 bps. Standard features include an on-board Intel 8253 counter/timer and an RS232 interface with support for 208

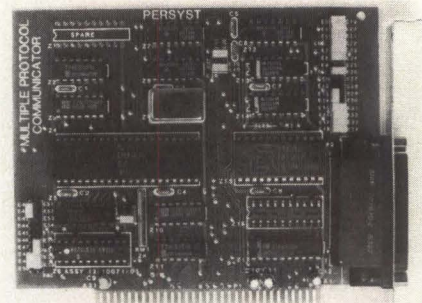

AB standard synchronous modems and asynchronous devices such as the Hayes modem. The board supports the company's 3270 bisynchronous terminal emulation software packages. \$150 (100 units). **Personal Systems Technology Inc.**, 17862 Fitch, P.O. Box 19615, Irvine, Calif. 92714, (714) 660-1010.

Circle No 324

NORM DE NARDI PRESENTS:

An Industry Salute To High Technology.

THE CALIFORNIA COMPUTER SHOW

At The Palo Alto Hyatt Hotel

The Longest Running Regional Computer Show

 A unique, one day computer showcase highlighting industry trends and product introductions.

 An opportunity to reach a base of qualified customers while simultaneously keeping abreast of the competition.

 An ideal environment for OEMs, dealers and distributors to meet with industry leaders.

 See the latest in computers, CAD workstations, graphic systems, peripherals, communication equipment, UNIX and other software development tools.

 Norm De Nardi's computer industry expertise has made the California Computer Show a most effective marketing tool.

 An extensive promotional effort including trade journal ads, direct mailings and show publicity insures industry awareness and participation.



289 S. San Antonio Rd., Suite 204, Los Altos, CA 94022 (415) 941-8440

The Palo Alto Hyatt Hotel • December 6, 1984 • 12 P.M. - 6 P.M.

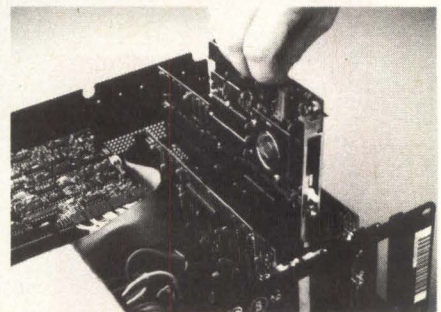

Board modems carry extra RAM

- 300- and 1,200-baud rates
- Auto-dial/auto-answer
- 64K or 256K bytes of built-in RAM

Available in three models, the Personal Communicator modem provides data-transmission capabilities at baud rates of 300 and 1,200. Two models add 64K or 256K bytes of usable RAM, a real-time clock and a parallel interface to the host computer; the basic model contains no RAM. Each version includes the company's Telpac communications software package and slides into an available slot in an IBM PC, IBM PC/XT or IBM PC-compatible machine. These asynchronous modems feature automatic speed detect, audio phone line monitor, volume control, programmable commands, two RJ11C jacks, telephone cord and a user's manual. Basic version, \$499; 64K-byte version, \$699; 256K-byte version, \$999. **U.S. Robotics Inc.**, 1123 W. Washington Blvd., Chicago, Ill. 60607, (312) 733-0497. Circle No 325

CIRCLE NO. 139 ON INQUIRY CARD

What's more incredible about Canon's color ink-jet printer? The quality... or the price?

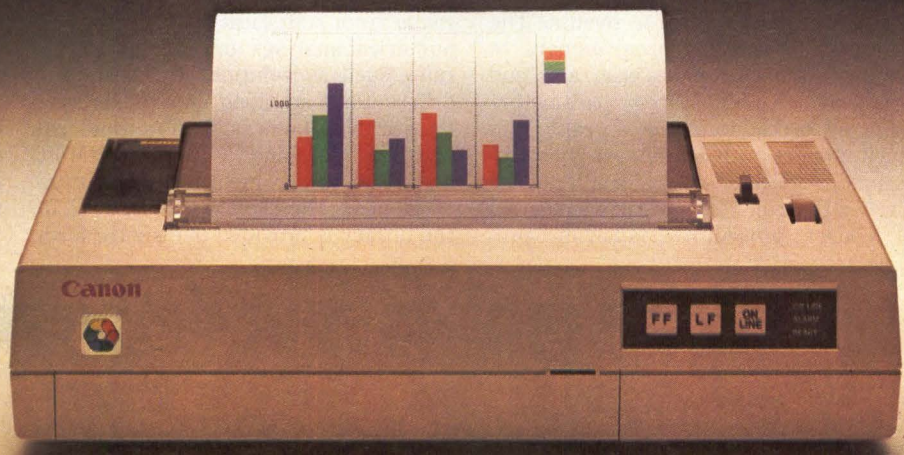

Take a look at the beautiful clarity of the Canon®PJ-1080A's color ink-jet printing. Then discover that Canon's color printer actually costs well under a thousand dollars. You'll be hard-pressed to decide which is more amazing.

What makes the quality so incredible? Features like:

- The advanced drop-on-demand printing system. Canon's patented ink-jet technology gives a sharp 640 dot-per-line scan mode, for dazzling high-resolution color and exceptionally clean, crisp printouts.
- Whisper-quiet operation of less than 50dB and an impressive speed of 37 c.p.s.
- A choice of seven bold colors for bright, imaginative graphics.
- A special dual-ink cartridge system that gives cleaner

resolution on blacks and saves you money, because when black is used up only the black cartridge need be replaced.

- The ability to print high-fidelity characters and images on transparencies for overhead projection.
- Compatibility with most computers you can buy.

And how much does all this cost? Far less than a thousand dollars.

So what's more incredible about the PJ-1080A color ink-jet printer? There's only one way you'll really be able to find out.

And that's to buy one and decide for yourself.

For more information:
Call 1-800-323-1717, Ext. 300.
(In Illinois call 1-800-942-8881, Ext. 300.)
Or Write Canon U.S.A., Inc.,
Printer Division, P.O. Box CN 11250,
Trenton, N.J. 08638.

© 1984 Canon U.S.A., Inc.

CIRCLE NO. 140 ON INQUIRY CARD

Canon Printer Division

New Products

SOFTWARE

Tools help users build C programs

- High-level interface
- Supports graphics devices

The Csharp Realtime Toolkit comprises five real-time, multitasking C programmer tools distributed as source code. The Csr tool accesses machine-level features such as processor priority control and device interrupts. It contains procedures written in assembly language and C and supports the DEC PDP-11 processor family and the Intel 8086/8088 processors. The Cevent tool interfaces to external events such as switch closures and button presses, and can count and time these events. The Cgraph tool enables programmers to write portable graphics programs and configure graphic system parameters using C procedure calls. Cgraph routines support graphics devices with programmer-specified device handlers. The Csched tool controls real-time execution of C-user procedures, allowing pro-

grammers to schedule, cancel and synchronize their tasks. The Cstate tool structures process control using state-system notation. \$600. **The Systems Guild Inc.**, P.O. Box 1085, Kendall Square Station, Cambridge, Mass. 02142, (617) 451-8479.

Circle No 326

FORTRAN library has 114 subroutines

- Runs under MS-DOS, PC-DOS
- 450 pages

This FORTRAN 77 library contains 114 classic scientific subroutines. They range from statistical analyses through numerical analyses and encompass routines such as solutions to third-order differential equations and to M equations in N unknowns. The routines run under MS-DOS and PC-DOS on IBM PC and IBM PC-compatible computers. Written in Microsoft FORTRAN 3.13, the library is provided in diskette form,

both as a linkable library and in source format. Each subroutine has an accompanying test program. The 450-page manual provides hardcopy of each subroutine, its test program, the test results and the mathematical method used. \$149.95. **Peerless Engineering Service**, 5819 Soquel Drive, Soquel, Calif. 95073, (408) 462-0330.

Circle No 327

Package downloads in real-time environment

- Works with IBM PC
- Summarizes, reformats and transmits files

The pcMAINFRAME data-transfer system allows users to download and upload files in a real-time environment between an IBM PC or IBM PC plug-compatible computer and a host IBM mainframe computer running the CICS teleprocessing monitor. The system provides capabilities to selectively extract,

Delta makes your deliveries DASH.



Delta DASH® delivers the same day to over 90 cities across the U.S. and abroad, covering 10,000 communities. Why get that small package delivered tomorrow when you can DASH it today? DASH (Delta Air Lines Special Handling) delivers packages up to 70 lbs. . . . to over 10,000 communities. So give us a ring at the Delta Marketing Office in the

city nearest you. Or call DASH at (800) 638-7333 for pick up or delivery.

For top priority shipments over 70 lbs., use Delta Air Express. It guarantees your shipment gets on the flight specified. For full details, call your nearest Delta Marketing Office.

DELTA AIR CARGO. READY ALL-AROUND.
CIRCLE NO. 141 ON INQUIRY CARD

Now you don't have to sacrifice print quality for speed.

The Canon® Impact Matrix Series Printers.

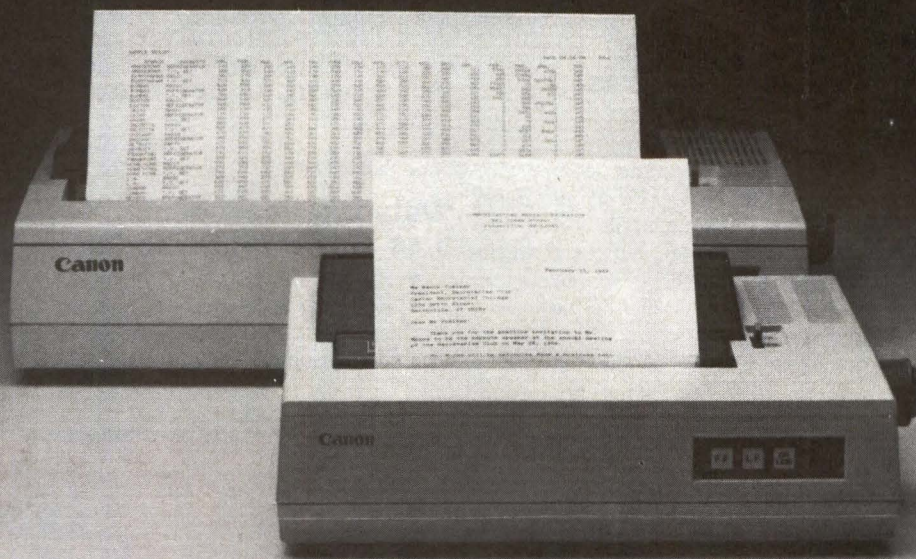

High speed and high quality in one functional, compact unit. That's what Canon's Impact Matrix Printers offer you.

They print hard copy at a rapid 160 characters per second. While in the double pass mode you get an impressive, high-density 23 X18 dot matrix that gives near letter quality printing suitable for word processing.

Canon's unique technology has also dramatically reduced bothersome clatter down to a muted noise level of less than 60dB.

Even at high speed.

And that, unlike many other impact matrix printers, makes them a pleasure to work with.

Plus there's limitless flexibility with the optional down-loading function that lets you print

whatever character fonts your host computer can create. As well as a choice of four different character styles (all printable on the same line) that you can enlarge or condense.

The Impact Matrix Series Printers give you a convenient choice of special paper widths—the PW-1080A for 80-character column printout and the PW-1156A for 156-character column.

Exceptional quality and high speed.

The Canon® Impact Matrix Series Printers give you the best of both worlds.

For more information:
Call 1-800-323-1717, Ext. 300.
(In Illinois call 1-800-942-8881, Ext. 300.)
Or Write Canon U.S.A., Inc.,
Printer Division, P.O. Box CN 11250,
Trenton, N.J. 08638.

Canon Printer Division

CIRCLE NO. 142 ON INQUIRY CARD

New Products

SOFTWARE

average, summarize, reformat and transmit records and fields from mainframe files for use on the personal computer. Security is provided on the system, user and data levels. The price is \$9,000 for the DOS version and \$12,000 for the OS version, which includes support for eight personal computers. **Oxford Software Corp.**, 174 Blvd., Hasbrouck Heights, N.J. 07604, (201) 288-1515.

Circle No 329

Package prepares customized systems

- Includes menu utilities
- Runs under MS-DOS 2.0

The LOIS development system, for the IBM PC and IBM PC compatibles, assembles standalone applications into customized integrated software workstations. LOIS's routing facility transfers selected data between applications, automatically performing file format conversions. The facility manager iden-

tifies files in a directory and command-free file operations such as create, delete, move, copy, display, print and rename. Each LOIS is tailored to the application. The development system includes menu (screen, action, information and help) utilities, create/edit utilities, routing script create/edit utilities, a file format conversion filter library, the run-time package and documentation. Minimum system requirements are DOS 2.0 or higher, 256K bytes of RAM and hard disk. \$995. **ModTech International Inc.**, 5250 S. Green St., Suite 100, Salt Lake City, Utah 84123, (801) 264-2050.

Circle No 330

Database manager has six separate modules

- Pick-based
- Requires 320K bytes

Based on the Pick operating system, the Revelation relational database man-

agement system and applications environment for IBM PCs and IBM PC workalikes uses a variable-length data structure. The only logical limits to Revelation's files are 65,535 characters per field and 65,535 fields per record. The maximum number of records per database is defined by the user's disk space. Revelation consists of six separate modules: R/Design, a fourth-generation application and program generator for defining files and building menus; R/List, a dictionary-driven report generator; R/File for creating and manipulating data files; R/Copy to convert MS-DOS or PC-DOS files for use with Revelation; R/Edit, an interactive line editor; and R/BASIC, a hybrid procedural language for advanced applications and structured programming. The program requires 320K bytes of memory. \$950. **Cosmos Inc.**, 19530 Pacific Highway S., Suite 102, Seattle, Wash. 98188, (206) 824-9942.

Circle No 331

Your low-cost direct line to the value-added market

Mini-Micro Systems DIRECT RESPONSE INFORMATION CARDS

- Sell products and services directly
- Introduce new products
- Distribute catalogs and literature
- Investigate new applications
- Develop quality sales leads

1984 Postcard Schedule

Materials

Closing

Date: 2/7 4/13 8/10 10/8

Mailing

Date: March May Sept. Nov.

Format

Loose Card Deck / Card

Size—3½" × 5½", Live

Copy—3⅞" × 5⅞"

Mechanical Requirements

Negatives—right reading emulsion side down. Camera ready mechanicals—110 line screen

Rates

	Advertisers	Non-advertisers
1 card	1350	1600
2 cards	1300	1550
3 or more cards	1250	1500

Contact:

Carol Anderson, Sales Manager

Mini-Micro Systems

Direct Response Postcards

221 Columbus Avenue, Boston, MA 02116
(617)536-7780

The new Canon[®] Handy Terminal makes any computer system go farther.



The new Canon[®] Handy Terminal 5000 is the portable unit that lets you gather and process information out of the office.

With a maximum 32K internal user RAM plus up to 64K optional file memory, it's perfect for jobs like retail audits, warehouse inventories, order-taking anywhere in the field or any one of hundreds of business applications.

It can be programmed to perform almost any task, adopting BASIC and Assembler languages.

And can even relay information to your computer via phone hookup.

Portability is also the key word of the 5000, because Canon's Handy Terminal was especially designed for traveling light.

At a weight of less than 2 lbs., it can operate on a rechargeable battery and can be carried by neck strap or in an attache case. Yet it's highly durable, water resistant and shock resistant. Which means it can take its fair share

of hard knocks.

Also available is the 5000P (shown above) which has a built-in thermal dot printer that can print one original and a copy.

And both terminals can incorporate an optional bar code reader.

So why not widen your computer horizons with Canon's new Handy Terminal. It lets you go as far as you like.

For more information:
Call 1-800-323-1717, Ext. 302.
(In Illinois call 1-800-942-8881, Ext. 302.)
Or Write Canon U.S.A., Inc.,
Systems Division/Handy Terminal,
P.O. Box CN 11250, Trenton, N.J. 08638.

© 1984 Canon U.S.A., Inc.

CIRCLE NO. 144 ON INQUIRY CARD

Canon Systems Division

One billion byte supermicro. Just think of the possibilities.

Introducing the new, expandable Dual 83/500. A UNIX*-based, 68000-driven supermicro so capable, you'd swear it was a mainframe.

The system already comes with 500 megabytes of Winchester storage. And our patent-pending high-speed SMD disk controller for fast access to data.

But you can increase memory to a massive one billion bytes just by adding a twin drive.

Or take an already sizeable two megabytes of RAM and expand it to six.

Or even double user capacity from 8 to 16. The hardware is already in place.

When it comes to value, no supermicro system offers you more than the 83/500. Because along with the computer, you get a 9-track, 1600 BPI phase-encod-



ed tape drive for reliable disk backup and quick file transfers to other systems.

There's a convenient one megabyte double-sided/double-density floppy disk drive that protects individual files.

And the industry standard UniPlus+™ implementation of AT&T's UNIX System V with

Berkeley enhancements. Plus a multi-user license.

All at no extra cost.

And while you're speedily going about processing your data, we're protecting your investment. For free. With a comprehensive 12-month warranty. And a nationwide service network that protects your system whether it's in or out of warranty.

See the system that's redefining the supermicro. The value-packed Dual 83/500. Call or write Dual Systems Corporation, 2530 San Pablo Avenue, Berkeley, CA 94702, (415) 549-3854

At just \$65,940 base price, its possibilities are endless.

*UNIX is a trademark of AT&T Bell Labs.
™UniPlus+ is a trademark of UniSoft Corp.

There's only one **DUAL**

New Products

SOFTWARE

DATABUS compiler runs on MS-DOS computers

- Supports ISAM files
- Compiles into absolute machine code

SUNDB86M, a 16-bit implementation of the DATABUS language for Intel 8086-/8088-based microcomputers running MS-DOS 2.0 or PC-DOS 2.0, has many of the features found in DATABUS language with the exception of hardware-dependent instructions. The software supports sequential and random files, including read and write tabbing, and ISAM files with minor changes in the OPEN and PREP statements. It compiles into absolute machine code, poses no limit on user data area within overall program size, works with most terminals and supports print spooling. \$495. **Sunbelt Computer Systems Inc.**, Suite 111, 5525 E. 51st St., Tulsa, Okla. 74135, (800) 331-9163 or (918) 660-0670.

Circle No 332

Spreadsheet offers computer compatibility

- HP 150 or IBM PC operation
- HP 3000 or DEC VAX II operation
- 24 individual or global formats

The Optical electronic spreadsheet offers compatible operation between microcomputers and minicomputers. It transfers entire spreadsheets directly, requiring no intermediate formats or rekeying. Data capacity per sheet is limited only by available memory. Optical permits a wide variety of data-input methods, entry of 190-step formulas, more than 130 built-in functions, 24 individual or global formats, independent display and print windows, sorting, editing and formula debugging. On a mini-computer, the package produces batch-mode operation. \$495. **John McLean & Associates**, P.O. Box 270507, Houston, Texas 77277, (713) 871-9134.

Circle No 333

Drafting software produces keyboard drawings

- Digital logic diagrams
- Printed-circuit board layouts
- Project schedules

The MGI/Schematic Drafter produces non-dimensional symbolic drawings such as electronic circuit diagrams, digital logic diagrams, printed-circuit board layouts and project schedules.

Using a template guide, users enter letter-designated symbols from the IBM PC or IBM PC-lookalike computer keyboard into a series of cells on the screen. Individual symbols can be rotated or mirrored to change the symbol's orientation within a cell. Overstrike places multiple symbols into one

cell. Text can be added and dragged or rotated into position. Entire blocks of an existing schematic can be saved or quickly moved for revisions. \$3,900. **Microcomputer Graphics Inc.**, 13468 Washington Blvd., Marina del Rey, Calif. 90292, (213) 822-5258.

Circle No 334

TIME AFTER TIME. REPEATABILITY.

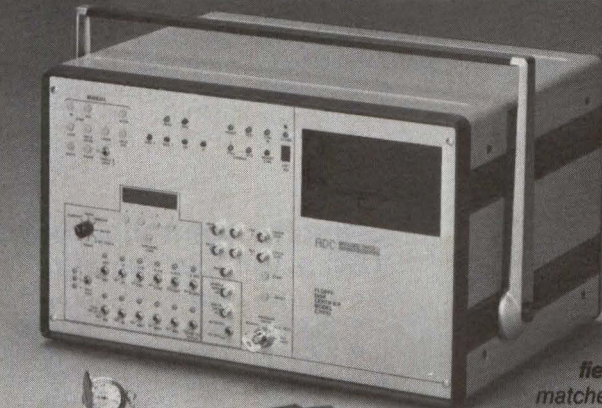

There isn't another **Media Certifier** available that matches the precision and versatility of the **C-7000**.

At ADC we've engineered a high-accuracy, high-repeatability media tester that meets engineering criteria AND full volume production demands.

All test routines and test parameters are user-programmable, either from the certifier control panel, or downloaded from a host computer.

Used in automatic mode with ADC's Robotic Disk Handler (RDH), it achieves high throughput and virtually eliminates susceptibility to operator error.

That versatility wasn't achieved at the expense of performance. Repeatability is our goal, low noise analog and 10 bit digital conversion is a fact. Amplitude, dropout/ dropin, resolution and modulation — **C-7000** does it all! Full track/half track stepping, programmable spindle speed, selectable write current — **C-7000** has it all!

Call **Today** for more information on the diskette certifier and the full range of high performance products from Applied Data Communications, 14272 Chambers Road, Tustin, CA 92680, (714) 731-9000.

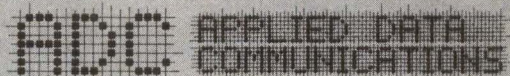

CIRCLE NO. 146 ON INQUIRY CARD

New Products

SUBASSEMBLIES

Unit connects devices to IEEE-488 bus

- Joins parallel inputs/outputs
- 52 or 104 data lines
- Accepts BCD/hex data

The model 4833 programmable interface unit connects devices having parallel input and/or output interfaces to the IEEE-488 bus. As a bus talker, the unit converts BCD/hex or binary data from a parallel-output instrument into the proper format for bus transmission. As a listener, the unit converts data from the bus controller into parallel words, for use by a parallel-input device. The product comes in a single-channel model with 52 data lines and in a dual-channel model with 104 data lines. Through program commands, users can mix data lines as talker and listener lines. Single-channel version: \$850, dual-channel version: \$1,050. **ICS Electronics Corp.**, 2185 Old Oakland Road, San Jose, Calif. 95131, (408) 263-4844.

Circle No 335

Disk controller features cache memory

- 64K bytes of RAM
- 8K bytes of ROM
- Stores data in four 10K-byte buffers

The Multibus-compatible model STDC disk controller supports two ST506 Winchester disk drives. It stores data read from the disk in four separate 10K-byte cache memory buffers. After four disk accesses, the controller purges one cache on a "least-recently used" basis. The product contains a Z80A processor, 64K bytes of RAM and 8K bytes of ROM. A DMA peripheral channel transfers data between the disk, host processor and local memory in five different modes. Other features include clock recovery via an on-board phase locked loop, and write data precompensation. \$795. **Cromemco Inc.**, 280 Bernardo Ave., P.O. Box 7400, Mountain View, Calif. 94039, (415) 964-6988.

Circle No 336

Interface links Versabus computers to Ethernet

- 32K-byte block of dual-ported memory
 - Plugs into Versabus backplane
- The Versabus/Ethernet interface unit

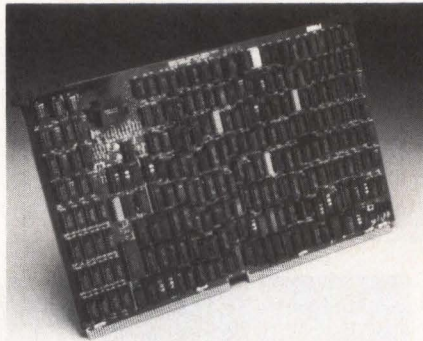

(V/EIU) provides controller logic and performs physical and data-link layer protocol functions, in accordance with Ethernet and IEEE 802.3 requirements. Consisting of one printed circuit board that plugs into the Versabus host's backplane, the unit appears as a set of memory-mapped I/O ports with a 32K-byte block of dual-ported memory. Setup and initialization is controlled by the host, but all other access takes place through dual-ported memory. \$3,000. **Advanced Computer Communications**, 720 Santa Barbara St., Santa Barbara, Calif. 93101, (805) 963-9431.

Circle No 337

Graphics controller draws 12M pixels per second

- Bit-slice drawing processor
- 16 colors from palette of 4,096
- 256 colors from palette of 16 million

Available for Multibus and Q-bus microcomputers, the Parallax 600 series board-level raster graphics controllers feature a proprietary bit-slice processor that draws 12M pixels per second. The controllers provide 16 colors from a palette of 4,096 in the 4-bit-per-pixel version; 256 colors from a 16-million color palette in the 8-bit-per-pixel version. Their instruction set furnishes single-instruction polygon, box, circle- and vector-drawing commands, and solid fill, outline, stipple, cut-and-paste and opaque/transparent modes. The controllers feature dual-ported video memory, RS-170 video compatibility with genlock, two frame buffers, zoom, smooth pan and scroll. The double-buffered controllers display 640 by 480 pixels out of a 1024-pixel-by-512-pixel memory with four bit planes. \$5,000. Delivery is 30 to 60 days ARO. **Parallax Graphics Inc.**, Suite 215, 1095 E. Duane Ave., Sunnyvale, Calif. 94086, (408) 720-1600.

Circle No 338

Host adapter brings mass storage to IBM PCs

- 2K bytes of RAM
- 6K bytes of ROM

The IB01 host adapter links SCSI-based 5¼-inch Winchester and ¼-inch cartridge tape drives to IBM PCs. Packaged on one printed-circuit board, the adapter plugs into an IBM Corp. PC, PC/XT or IBM PC-compatible com-

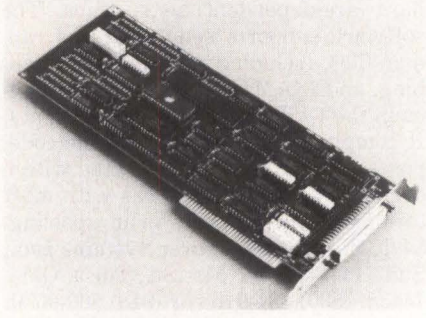

puter. The adapter implements the full SCSI protocol. It features 6K bytes of ROM and 2K bytes of RAM, which are used for storing initialization routines, for configuring the SCSI subsystem, for bootstrapping the loader routine and for handling SCSI operations. The unit aids hard-disk memory expansion to 1M byte and accommodates seven SCSI-compatible disk controllers. \$345, OEM version. **Emulex Corp.**, 3545 Harbor Blvd., P.O. Box 6725, Costa Mesa, Calif. 92626, (714) 662-5600.

Circle No 339

Prime-compatible controller supports 32 lines

- 16 standard baud rates
- Provides DMQ and DMT transfer modes

The model 5258 communications interface for Prime computers supports 32 asynchronous channels on one card. It operates under Prime's DMQ and DMT transfer modes. Other features include 16 standard baud rates, to 19,200 bps for each channel, as well as the option to program baud rates for special applications. The card comes with a connector panel that uses standard RS232C connectors so that devices can be added without special Prime cabling. \$6,500. **EMC Corp.**, 12 Mercer Road, Natick, Mass. 01760, (800) 222-3622.

Circle No 340

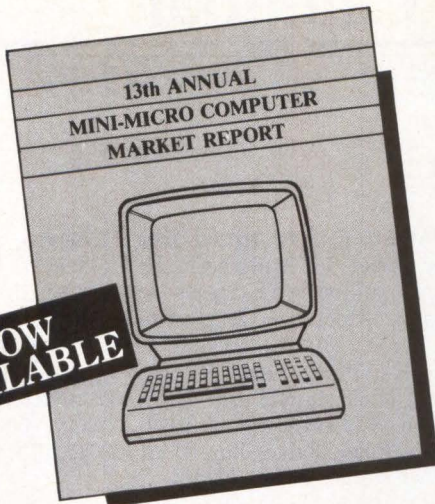

Key in on Your Hot Prospects

with Mini-MicroSystems 13th Annual Mini-Micro Computer Market Report

This year Mini-Micro Systems readers will spend \$50 billion on minicomputers, microcomputers, peripherals, software and supplies. The 13th annual Mini-Micro Computer Market Report outlines 8,511 sites (buying centers) representative of the explosive value-added market. Data is available in the following formats:

MAGNETIC TAPE OF COMPLETE DATABASE

For those marketers who wish to receive all the information and be able to generate their own analysis, the complete database is available on magnetic tape. Data includes:

- 1983 Expenditures for minicomputers, microcomputers, peripherals, and software.
- 1984 Estimated Expenditures for minicomputers, microcomputers, peripherals, and software.
- Geographical Regions
- Type of Organization
- Minicomputers/Microcomputers purchased in 1983 and those installed in prior years:
 - Vendor name and model number
 - Units acquired
 - Major applications
- Minicomputers/Microcomputers planned 1984 purchases:
 - Vendor name and model number
 - Units planned to be acquired
 - Major applications
 - Sites planning to change major vendor
 - Fail-safe computer operations
 - Electronic office functions

- Boston (617) 536-7780
- Chicago (312) 635-8800
- Dallas (214) 980-0318
- Denver (303) 388-4511
- Los Angeles (213) 826-5818
- Mid-Atlantic (215) 293-1212
- in New York (212) 724-1790
- Orange County (714) 851-9422
- Northern California & Northwest (408) 243-8838
- Southeast (404) 955-6500

CP Cahners Publishing: Publishers of 33 specialized magazines in Building & Construction, Electronics & Computers, Foodservice, Manufacturing, Healthcare

Mini-MicroSystems

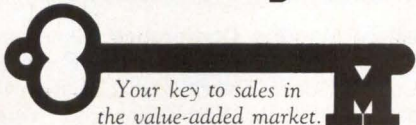

PRESELECTED LISTS AND MAILING LABELS

All selections are available as a listing or as cheshire or pressure sensitive labels. Cross tabulations of categories are also available.

Site Selection	Site Count
■ Total sites surveyed.....	8,511
■ Sites by planned 1984 expenditure levels	
\$50,000-99,999.....	4,829
\$100,000-249,999.....	3,582
\$250,000-499,999.....	2,218
\$500,000 or more.....	1,403
■ Sites planning to install integrated electronic office functions in 1984.....	1,642
■ HOT PROSPECTS... Sites planning to change major vendors in 1984.....	1,085
■ Value-added OEMs and third parties.....	3,110
■ Value-added user sites.....	4,813

13th ANNUAL MINI-MICRO COMPUTER MARKET REPORT

All data is available in a 200-plus page bound report for \$495. In addition to an executive summary, the report's tables include:

- 1983 Unit expenditures
- Type of Organization
- Geographical Regions
- Current Computer Vendors
- 1984 plans for:
 - switching vendors
 - unit expenditures
 - fail-safe computer operations
 - electronic office functions

For more information on prices, list selections, and the MINI-MICRO SYSTEMS Market Report, fill out and send the coupon below.

Mini-MicroSystems

Please send _____ copies of the 13th Annual MINI-MICRO COMPUTER MARKET REPORT to the address below. (Please make checks payable to Mini-Micro Systems. \$495.00/report.)

Please send more information on...

_____ The complete Mini-Micro Computer Market Database _____ Preselected lists and mailing labels

_____ The 13th Annual Mini-Micro Computer Market Database

Name _____

Title _____

Company _____

Address _____

City _____ State _____ Zip _____

Telephone (____) _____

MINI-MICRO SYSTEMS COMPUTER MARKET REPORT, 221 Columbus Avenue, Boston, MA 02116

CIRCLE NO. 147 ON INQUIRY CARD

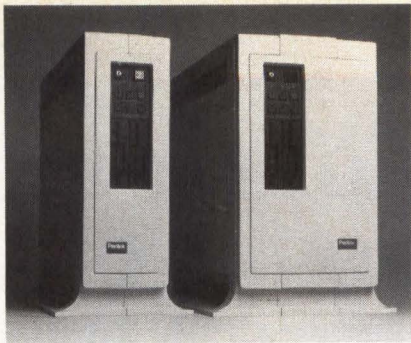

Finally! A computer graphics system defies obsolescence.

- Open Architecture.
- Customize or expand by selecting modules.
- Accepts modules from us and many others.
- Color or monochrome.

Our new Perigraf 1 is built around a standard Q-bus with slots for many extra cards to expand or customize your system.

Peritek offers cards for color or monochrome, for dot graphics or alpha- numerics, for low to high resolution, and for one or more display channels.

You can choose a single unified bus or a bus split for two microprocessors. Choose a standard single-wide enclosure or a double-wide enclosure for super micros.

You get a hard disk and two floppies on a single plug-in module that you can replace in one minute.

You can link up to six Perigraf's for parallel data transfer by DMA at 250,000 bytes/sec.—or link any number for local area networking by Ethernet.

Complete development software is included. Image editor. Vector de-jagging. System diagnostics. GKS-compatible software. All supported by popular operating systems.

Basic \$14,500 price includes 11/73 CPU, 512 Kb RAM, 2 RX50 type floppies, 36 Mb hard disk, 4 port serial I/O, RT clock, and graphics interface.

Contact Peritek Corporation, 5550 Redwood Road, Oakland, CA 94619 (415) 531-6500. Eastern Regional Sales Office (516) 931-4664. TWX 910-366-2029.

Peritek

CIRCLE NO. 148 ON INQUIRY CARD

Calendar

NOVEMBER

- 13-15 INTERFACE I**, Conrad Hilton Hotel, Chicago, sponsored by Society of Manufacturing Engineers, Computer and Automated Systems Association (CASA/SME) and American Production and Inventory Control Society (APICS). Contact: Society of Manufacturing Engineers, One SME Drive, P.O. Box 930, Dearborn, Mich. 48121, (313) 271-1500, or American Production & Inventory Control Society, 500 W. Annandale Road, Falls Church, Va. 22046, (703) 237-8344.
- 13-15 Buffalo Computer and Industrial Technology Show**, Buffalo Convention Center, Buffalo, N.Y., sponsored by Buffalo Area Chamber of Commerce. Contact: Sandy Zweig, Exhibit Sales, Buffalo Computer and Industrial Technology Show, 527 Statler Bldg., Buffalo, N.Y. 14202, (716) 852-2006.
- 13-15 CAM-I's 13th Annual Meeting and Technical Conference**, Sheraton Sand Key Hotel, Clearwater Beach, Fla., sponsored by Computer Aided Manufacturing-International Inc. Contact: Rhonda Gerganess, Computer Aided Manufacturing-International Inc., Suite 1107, 611 Ryan Plaza Drive, Arlington, Texas 76011, (817) 265-5328.
- 14-16 "Data Communications: Network Design, Integration and Applications" course**, Ramada O'Hare, Chicago, sponsored by Software Institute of America Inc. Contact: Kristin Kittle Lynch, Operations Coordinator, Digital Consulting Associates Inc., 6 Windsor St., Andover, Mass. 01810, (617) 470-3870.
- 14-18 COMDEX/Fall**, Las Vegas Convention Center, Las Vegas Hilton, Riviera, Sahara, MGM Grand and Caesar's Palace Hotels, organized by The Interface Group Inc. Contact: Peter B. Young, Linda M. Yogel, or Lori Robak, The Interface Group Inc., 300 First Ave., Needham, Mass. 02194, (617) 449-6600 or (800) 325-3330.
- 19-22 Canadian Computer Show & Conference**, Toronto International Centre of Commerce, Toronto, Ontario, Canada, co-sponsored by Canadian Information Processing Society. Contact: James K. Mahon, Group Show Manager, Industrial Trade Shows, 20 Butterick Road, Toronto, Ontario, M8W 3Z8, Canada, (416) 252-7791.
- 26-28 "Computer Graphics for Business" seminar**, Hyatt on Union Square, San Francisco, offered by Technology Transfer Institute. Contact: Lee Clayton, 741 10th St., Santa Monica, Calif. 90402, (213) 394-8305.
- 28-30 UNIX Application Forum**, Century Plaza Hotel, Los Angeles, sponsored by Yates Ventures. Contact: Meg Rustad or Janet L. Taylor, Yates Ventures, Suite 111, 4962 El Camino Real, Los Altos, Calif. 94022, (415) 964-0130 or (617) 965-5171.
- 28-29 Computer Vertical Markets Conference**, Sheraton Harbor Isle Hotel, San Diego, sponsored by Frost & Sullivan Inc. Contact: Carol Every, Industry Representative, Frost & Sullivan, 106 Fulton St., New York, N.Y. 10038, (212) 233-1080.

Classified Ads

hardware

**HEWLETT
PACKARD**
Desktop CAD/CAM
Computer
Systems 

**SAVINGS ON ALL
SERIES 200/500
WORK STATIONS**

9836S 9000 Non-HP memory
9020S 9826A and peripherals
CALL OR WRITE FOR DISCOUNT PRICES

**graphic
systems center**

Box 23051 Portland, OR 97223 USA
503-246-0202
International Sales Telex 360-143

CIRCLE NO. 225 ON INQUIRY CARD

software

MicroPERT®
Project Management
for Tektronix, IBM PC, XT
For information, call or write
SHEPPARD SOFTWARE COMPANY
4750 Clough Creek Rd.
Redding, CA 96002
(916) 222-1553

CIRCLE NO. 226 ON INQUIRY CARD

DISKIM
DISK I/O CACHE for 11-M
D-M-DRIVER
DISK in MEMORY for 11-M
Call 415-420-9579

Proto Systems 1238 Josephine St.
Berkeley, California
94703

CIRCLE NO. 227 ON INQUIRY CARD

software

IBM-PC - PLOT-10
PC-PLOT-III is an intelligent emulation of the Tektronix Model 4010 graphics terminal which runs on the IBM-PC. The program allows display and creation of picture files when connected to a host computer running PLOT-10 (tm) or compatible software. The user may save picture data files on a local diskette as they are received from the host. The program also includes local printer control, and a serial line debug mode. Utility programs included allow the drawing of a local picture data file on the screen, plotting it on a HP Model 7470A pen plotter, printing on a local printer, and scaling. VISA, MasterCard, checks, PO's accepted. \$95.00

MicroPlot Systems Co.
2151 East Dublin-Granville Rd.
Suite 205
Columbus, OH 43229
614-882-4786

CIRCLE NO. 228 ON INQUIRY CARD

software

INTEGRATED ACCOUNTING
System for
CP/M Microcomputers
GL, AP, AR, & Payroll
Total \$300.00!
Source Code Included
BASIC BUSINESS SYSTEMS
P.O. Box 3453,
Reston, VA 22090

CIRCLE NO. 229 ON INQUIRY CARD
inventions wanted

**Inventors, Entrepreneurs,
Product Promoters**
wanted to display concepts at
national technology trade show
Call: 1-800-528-6050 X831

CIRCLE NO. 230 ON INQUIRY CARD

Copy Deadline:

Space reservations and
advertising copy must

be received by the 10th
of the month preceding
the issue date. Camera-
ready mechanicals
must be received by the
15th of the month pre-

ceding the issue date.
For example, to appear
in the February issue,
copy must be received
by January 10; mechan-
icals by January 15.

Small ads do
attract attention.
Next time, why not read
your ad here?

Call 617/536-7780

CLASSIFIED ADVERTISING ORDER FORM

Mini-Micro Systems classifieds reach more mini-micro people

Rates: \$80.00 per column inch (non-commissionable)
6x program earns 5% discount; 12x program earns 10% discount.

There is no charge for typesetting classified listings. Plan approximately 50 average words to a column inch, 8 lines of approximately 38 characters per line (3 inch maximum). Please send clean typewritten (double-spaced) copy.

Category: The following categories are available; be sure to specify the category you wish to be listed under: Business Opportunities, New Literature, Selling, Buying, Trading, Seminars, Services, Software, Supplies & Accessories. (Other categories may be employed at our discretion.)

Run this ad in _____ (number issues) Reader Inquiry No. YES NO
Ad size 1 col. wide by _____ inches deep Under _____ (category)
Check enclosed for \$ _____ (Pre-paid orders only)

Signature _____

Name _____ Title _____

Company _____ Telephone No. _____

Address _____

City _____ State _____ Zip _____

**MAIL TO: Linda L. Lovett, Classified Advertising, Mini-Micro Systems,
221 Columbus Ave., Boston, MA 02116**

BOSTON

Robert K. Singer
National Sales Manager
Norma E. Lindahl
Assistant To The National
Sales Manager

John J. Fahey
Regional Manager
Katie Kress
Sales Coordinator
221 Columbus Ave.
Boston, MA 02116
(617) 536-7780

PHILADELPHIA

Stephen B. Donohue
Regional Manager
1837 Route 70, Suite 302
Cherry Hill, NJ 08003
(609) 751-0170

ATLANTA

Larry Pullman
Regional Manager
6445 Powers Ferry Rd.,
Ste. 140
Atlanta, GA 30339
(404) 955-6500

CHICAGO

Robert D. Wentz
Regional Manager
Marianne Majerus
Sales Coordinator
Cahners Plaza
1350 E. Touhy Ave.
P.O. Box 5080
Des Plaines, IL 60018
(312) 635-8800

DALLAS

Don Ward, Regional Manager
13740 Midway Suite 515
Dallas, TX 75234
(214) 980-0318

DENVER

John Huff
Regional Manager
270 St. Paul St.
Denver, CO 80206
(303) 388-4511

LOS ANGELES

Len Ganz
Regional Manager
12233 West Olympic Blvd.
Los Angeles, CA 90064
(213) 826-5818

ORANGE COUNTY

Debra Huisken
Regional Manager
2041 Business Center Dr.
Suite 109
Irvine, CA 92715
(714) 851-9422

SAN FRANCISCO

Frank Barbagallo
Regional Manager
Rick Jamison
Regional Manager
Janet Ryan
Regional Manager
Laura Obradovic
Sales Coordinator
Sherman Building, Suite 1000
3031 Tisch Way
San Jose, CA 95128
(408) 243-8838

AUSTRIA

Elan Marketing Group
Neutor g. 2
P.O. Box 84
1010 Vienna, Austria
Tel: 43-222-663012 or -638461

BENELUX

Elan Marketing Group
Boschdijk 199B
5612 HB Eindhoven
The Netherlands
Tel: 32-40-455724

ISRAEL

Elan Marketing Group
13 Haifa St., P.O. Box 33439
Tel Aviv, Israel
Tel: 972-3-252967 or -268020
Telex: 341667

JAPAN

Tomoyuki Inatsuki
General Manager
Trade Media Japan Inc.
R. 212 Azabu Heights
1-5-10 Roppongi Minato-ku,
106, Japan
Tel: (03) 587-0581

TAIWAN

Mr. Donald H. Shapiro
Trade Winds, 2nd Floor
132 Hsin Yi Road, Sec. 2
Taipei, Taiwan

UNITED KINGDOM

Elan Marketing Group
5th Floor, Suite 10
Chesham House
136 Regent St.
London W1R 5FA
Tel: 437-6900
Telex: 267653

SWEDEN

Elan Marketing Group
Humlegardsgatan Nr. 5
11446 Stockholm, Sweden
Tel: 46-8-677243 or -676243

WEST GERMANY

Elan Marketing Group
Sudring 53
7240 Norb/Neckar, West Germany
Tel: 49-7451-7828

Mini-Micro Marketplace

Norma Lindahl
221 Columbus Ave.
Boston, MA 02116
(617) 536-7780

Direct-Response Postcards

Carol Anderson
221 Columbus Ave.
Boston, MA 02116
(617) 536-7780

Career Opportunities

Peggy Gordon
Recruitment Advertising Manager
P.O. Box 10277
8 Stamford Forum
Stamford, CT 06904
(203) 328-2550

Cahners Magazine Division

J.A. Sheehan, President
William Platt
Executive Vice President
Tom Dellamaria, VP/Production
Ira Siegel, VP/Research

Promotion Staff

Susan Rapaport
Marketing Communications Director
Mary Gregory
Promotion Coordinator
Liz Phillips
Promotion Assistant

Circulation

Denver, CO:
(303) 388-4511
Sherri Gronli
Group Manager

Calendar

DECEMBER

- 5-7 Software Connection Exposition**, New York Coliseum, New York, produced by Conference Management Corp. (CMC). Contact: Carol Sturgeon, Barmmer/Elliott Inc., 15 West 39th St., New York, N.Y. 10018, (203) 852-0500 or (212) 944-0655.
- 6 California Computer Show**, Hyatt Hotel, Palo Alto, Calif. Contact: Norm De Nardi Enterprises, 289 S. San Antonio Road, Suite 204, Los Altos, Calif. 94022, (415) 941-8440.
- 10-13 1984/1985 Strategic Issues Conference**, Americana Canyon Hotel, Palm Springs, Calif., sponsored by Infocorp. Contact: Corky Holden, 10833 Stevens Creek Blvd., Cupertino, Calif. 95014-2107, (408) 973-1010.
- 11-13 Automotive Computer Graphics '84 (ACG '84)**, Hyatt Regency, Dearborn, Mich., sponsored by the Engineering Society of Detroit and the University Center for Science and Technology. Contact: ESD, Automotive Computer Graphics '84, 100 Farmsworth, Detroit, Mich. 48202, (313) 832-5400.
- 11-14 DEXPO/West '84**, Disneyland Hotel, Anaheim, Calif., organized by Expoconsul International Inc. Contact: Natalie Kaye, Project Manager, Expoconsul International Inc., 55 Princeton-Hightstown Road, Princeton Junction, N.J. 08550, (609) 799-1661.
- 17-19 "Carl Machover on CAD/CAM" seminar**, Cathedral Hill Hotel, San Francisco, Calif., sponsored by Frost & Sullivan Inc. Contact: Carol Every, Industry Representative, Frost & Sullivan, 106 Fulton St., New York, N.Y. 10038, (212) 233-1080.

JANUARY

- 2-4 Eighteenth Annual Hawaii International Conference on System Sciences**, Honolulu, Hawaii, sponsored by University of Hawaii and University of Southwestern Louisiana. Contact: Nem B. Lau, HICSS-18 Conference Coordinator, Center for Executive Development, College of Business Administration, University of Hawaii, 2404 Maile Way, C-202, Honolulu, Hawaii 96822, (808) 948-7396.
- 14-18 International Software Update**, Kahala Hilton Hotel, Oahu, Hawaii, sponsored by Raging Bear Productions. Contact: Philip J. Russell, Raging Bear Productions Inc., Suite 175, 21 Tamal Vista Drive, Corte Madera, Calif. 94925, (415) 924-1194 or (800) 732-2300.
- 29-31 Communication Networks Conference & Exposition**, Washington D.C. Convention Center, organized by Hajar Associates. Contact: Judie McDaid, CN National Sales Director, Box 880, Cochituate Road, Framingham, Mass. 01701 (617) 879-0700 or (800) 225-4698.

Get results with

Mini-Micro Systems

CAREER OPPORTUNITY SECTION...

When you advertise in **Mini-Micro Systems**, you can be sure of reaching only the people you are trying to recruit. Every reader is a potential employee. We reach the highest percentage of all significant personnel in our industry. You'll find us not only effective, but a more economical magazine.

for space reservation
contact:

Peggy Gordon
203-964-0664

Career Opportunities/Recruitment Advertising

Rates

	Page	3/4	1/2	1/3	1/4	Col. Inch
1x	\$3,990	\$3,140	\$2,145	\$1,605	\$1,075	\$110
3x	3,885	3,025	2,060	1,550	1,015	100
6x	3,765	2,935	1,995	1,490	985	95
9x	3,655	2,845	1,935	1,445	955	90
12x	3,530	2,755	1,880	1,430	930	85
15x	3,425	2,675	1,820	1,385	900	80
18x	3,295	2,565	1,750	1,370	870	75
24x	3,235	2,520	1,720	1,310	850	70

Circulation

Over 122,000 technically sophisticated professionals in computer operations/systems management, data communications, engineering management, systems engineering/integrators, educators and systems programming specialists.

Recruitment
Hot Line

(203) 328-2550

Call your ad in—
we'll set the type
at no charge.

Mail Film to:

Peggy Gordon
Recruitment Manager

CAHNERS PUBLISHING CO.
8 Stamford Forum
P.O. Box 10277
Stamford, CT 06904

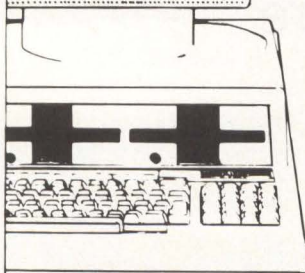
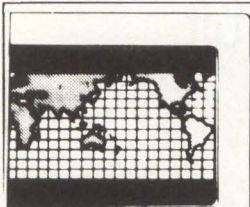

You Don't Need a Computer to Figure Out Why We're World Leader.

HARDWARE DEVELOPMENT MANAGER

But we need you to help us stay there! For years now, Olivetti's talented people have listened to business' problems and tackled them on a worldwide basis. From a personal computer to a highly intelligent workstation offering true 16-bit technology, access to local area network and a wide range of software, our \$2.4 billion company has provided

the answers. Today, our Advanced Technology Center in Cupertino seeks more talented professionals to continue to provide microcomputer innovation to the world.

We are looking for an experienced Hardware Development Manager to oversee a newly established group of 10 engineers involved with one of our most recently developed microcomputer systems. Your position will involve project management responsibility—from conceptualization/specification of the design, integration and release through to production. Your groups' activities will include

the development of new PC boards based on custom VLSI logic, as well as new mechanical structure and power supply definition. To qualify, you will need 4 to 6 years experience managing the design of computer systems. You must also possess complete knowledge of personal computer systems, including power supplies, structure and peripherals. Some understanding of firmware/software is requisite, as is a familiarity with custom components. A knowledge of Intel components such as 8086/8088 is necessary, and knowledge of 80286 is preferred. We require that you have an MSEE/BSEE for this integral position, which involves both domestic and international travel.

Join us at our Advanced Technology Center—you'll be making an excellent move! Along with the opportunity to work with some of today's hottest systems, we'll offer you a very competitive salary and a benefits package that includes 4 weeks paid time off. To apply, please send your resume to Professional Employment, Dept. 45, Olivetti ATC, 10430 South De Anza Blvd., Cupertino, CA 95014. EOE

olivetti

CAREER OPPORTUNITIES...

Spokane, Washington

ISC Systems Corporation, the leader in microprocessor-based terminal systems for the financial industry, has outstanding opportunities for **HARDWARE AND SOFTWARE PROFESSIONALS** to join our expanding Spokane operation.

We are seeking:

RELIABILITY ENGINEERS - 5+ years in micro design analysis, MTBF calculations and failure analysis.

COMPONENTS ENGINEERS - 3-5 years components engineering experience in state-of-the-art microprocessor technology.

VENDOR LIAISON ENGINEER - 3-5 years in computer industry selecting, qualifying and coordinating electronic and mechanical vendors for a high volume production environment.

MANAGER - QUALIFICATION TEST - 5-10 years experience managing a qualification test organization in the computer industry.

TEST ENGINEER - 5+ years experience in product design and qualification testing.

DIAGNOSTICS TEST ENGINEER - 3-5 years experience writing diagnostic software for microprocessor-based products.

SENIOR DIGITAL DESIGN ENGINEERS - 5-7 years designing with microprocessors for a high volume production environment. Must have project management experience.

GURU - OPERATING SYSTEMS DEVELOPMENT - define and develop a structured multi-tasking O/S with open-ended migration path in a micro networking environment.

SOFTWARE DEVELOPMENT SPECIALISTS - 5-7 years microprocessor experience on operating systems, networks, data communications, languages and file-server applications.

BANKING APPLICATIONS SPECIALISTS - 4+ years software design experience on credit systems and commercial lending systems.

INTERNATIONAL SOFTWARE SPECIALISTS - 4-5 years of software design experience, preferably using Z-80 assembler on financial applications. Commercial banking and data communications experience a plus.

SOFTWARE SUPPORT ENGINEERS - 2-4 years microprocessor experience preferably in Z-80 assembler language.

ISC offers an excellent salary, extensive fringe benefits and plenty of room for advancement. To explore these unparalleled opportunities, please send your resume to: **Bill Baumann, ISC Systems Corporation, P.O. Box TAF C-8, Spokane, WA 99220.** ISC is an equal opportunity employer.

WE'RE CHANGING THE PACE OF BANKING!



ELECTRONICS TECHNICIAN LOS ALAMOS NATIONAL LABORATORY

The **Chemical Process Development Group** at the Laboratory is seeking an Electronics Technician to provide computer/data acquisition system support to chemical process, laser isotope separation and laser development programs. This work requires a close working relationship with both experimentalists and software development personnel. Other job responsibilities include hardware configuration, design and set up, as well as diagnostic troubleshooting and repair of data acquisition hardware such as CAMAC modules, computer peripherals, follow and hold amplifiers and various computer interfaces.

Qualifications include graduation from a technical institute, successful completion of college-level courses in engineering or a combination of education and relevant work experience; substantial experience working with computer/CAMAC (Data General) based data acquisition systems and a good working knowledge of digital circuit design. Familiarity with machine level, device driver computer software is preferred. An active or reinstatable DOE Q Clearance is required.

The **Laboratory**, one of the nation's leading multi-faceted research and development organizations, is operated by the University of California for the United States Department of Energy. We offer competitive salaries and a comprehensive benefits package, including 24 days of vacation a year. Our beautiful mountain location in northern New Mexico provides exceptional recreational activities and a casual, unpressured lifestyle.

To apply, send your resume in confidence to:

Sandy Harding
Personnel Administration Division
DIV. 85-G
Los Alamos National Laboratory
Los Alamos, New Mexico 87545

University of California U.S. Citizenship Required.

LOS ALAMOS

An Affirmative Action/Equal Opportunity Employer.

CIRCLE NO. 242

PROGRAMMER ANALYST FOR PHARMACY SYSTEM

Position available

Position: Programmer analyst for Pharmacy system

Salary: \$2,370.00 per month

Education Required: BS in Pharmacy, MS in Medical Biophysics and computing

Licenses Required: Utah State Pharmacy License

Experience Required: 1 year on Tandem 16 Computer System

Description: This company provides software for hospital information systems. The job to be performed requires that the HELP system (Health Evaluation through Logic Processing) be integrated into their pharmacy section. The job also requires the development of a portable terminal system for nurses to record medication administration and thereafter to integrate that information into the HELP system. Thereafter this information will be used for pharmacy and nursing management purposes.

The applicant must have 1 year experience on the Tandem 16 computer system which is the computer system which the employer operates.

Excellent working conditions.

Applicants should send resumes to **Job Service, 1234 South Main, Salt Lake City, Utah, (801) 533-2400, Job # 76799.** An Equal opportunity employer. Ad paid for by employer.

CIRCLE NO. 243

SENIOR PROGRAMMER ANALYST. Will develop, implement, operate and refine programs for financial accounting data base (FRS); personnel data base (PER/PAS); and student record system, employing image resource inquiry and view. To use the following: HP3000 mini-computer (SERIES 68) and VIEW 3000 and IMAGE 3000 software. Required: BS degree in Comp Sci or Comp Info Syst. plus 2 yrs. experience; or MS degree in Comp Sci or Comp Info Syst. Knowledge of COBOL and FORTRAN. Knowledge of management information systems, data analysis and design of data base systems. \$24,390/yr., 40-hour week. Apply at the **Texas Employment Commission, El Paso, Texas**, or send resume to the **Texas Employment Commission, TEC Building, Austin, Texas 78778, J.O. #3650 879.** Ad Paid by an Equal Employment Opportunity Employer.

CIRCLE NO. 244

ELECTRONIC ENGINEERS SOUTHEAST

Openings for design engineers of circuits, computers, logic, signal, communications, testing, ATE, systems, and controls. Professional confidential service. Fee paid by employer. Send resume to:

Ted McCulloch
McCulloch & Co.
P.O. 10211
Greenville, SC 29603

CIRCLE NO. 245

Associate Engineer: 40 hours per week; no overtime; 8:00 a.m. — 4:30 p.m.; \$26,021.00 per year; Computer software design; specifically design of computer control systems for flexible manufacturing systems; M.S. Computer Science required plus one year experience in job offered or one year experience as industrial designer; Education and or experience to include: knowledge of C programming language. Send resumes to **Illinois Job Service, 910 S. Michigan Avenue, Room 400, Chicago, IL 60605; Attention S. Chalem; Reference #3630-S; An Employer Paid Ad.**

CIRCLE NO. 246

Computer Consultants Corner

TKC

• THE KEENAN CORPORATION

FCC 15J WE WROTE THE BOOK

"Digital Design for Interference Specifications"

• FCC/VDE & Static Retrofit and Testing
• "Front End" Design Guidance

R. Kenneth Keenan, Ph.D.

8609 66th Street North Pinellas Park, FL 33565
(813) 544-2594

CIRCLE NO. 247

UNIX System V Consultants

A professional team, with specialties in

- Applications in the C Programming Language
- UNIX Internals and Device Drivers
- Telecommunications

Contact: Marty Poulsen

PROTOCON INCORPORATED
140 Statesir Place
Red Bank, New Jersey 07701
(201) 747-8974

6800/68000 Experts

- Microprocessor hardware and software design
- Industrial control specialists
- Hierarchical software design methodology
- Complete prototype facilities

CLIENTS INCLUDE: Sohio • Elgar • Schlumberger • Motorola • Gulf Oil • Carborundum • Renal Systems

CSN

Computer System Associates
7564 Trade St., San Diego, CA 92121 (619) 566-3911

Career Opportunities/Recruitment Advertising

RESUME FORWARDING SERVICE

To have your resume forwarded on to the company of your choice, simply write in the box at the right the name of the company that interests you.

Forward my brief resume to:

(Never more than 3 companies, please)

Complete the following brief resume and mail to: Peggy Gordon
MINI-MICRO SYSTEMS
P.O. Box 10277
8 Stamford Forum
Stamford, CT 06904

(Please type, or print using all caps in dark ink.)

1.

Last Name _____ First _____ Middle Initial _____

Home Address (Street, City, State, Zip) _____

Home Phone (Area Code) _____ Other (Area Code) _____

2. *EDUCATION INFORMATION: Schools Attended*

Name _____ Location: _____ Degree: _____

Name _____ Location: _____ Degree: _____

3. *EMPLOYMENT INFORMATION:*

Name & Address of Present Employer (Will not be contacted) _____

Position (Please give brief description of your title and current job assignment)

Length of time with current employer _____

4. Are you willing to relocate? _____

What are your geographical preferences? _____

5. Please Check One:

U.S. Citizen _____ Permanent Resident _____ Student Visa _____

6. Foreign Language

Read _____ Write _____ Speak _____

7. Please indicate current salary _____

*Please Sign Here

Date

*Your signature will authorize us to forward the above information on to the company of your choice, in the strictest confidence. Your current employer will not be contacted.

11-84

Mini-Micro Systems

Most Useful Publication

An independent survey across the readership of 25 publications shows **Mini-Micro Systems** to be the most useful publication for information about data communications systems and equipment.

On June 15, 1983, Universal Data Systems, a division of Motorola, Inc., asked 25 publications, including those listed below, to provide 200 subscribers' names for a media preference study. UDS combined these names with 300 UDS customers and 2000 UDS distributors to create the sample audience of over 7000.

QUESTION: Of the publications listed, which do you find most useful for information about data communications systems and equipment?

RESPONSE:

Publication	% of Total
MINI-MICRO SYSTEMS	9.75%
Data Communications	9.55
Datamation	8.12
Computerworld	7.93
EDN	6.89
Computer Design	6.82
Electronic Design	6.76
Electronics	5.72
Electronic Engineering Times	4.68
MIS Week	4.61
Computer Decisions	4.03
Digital Design	4.03
Communications News	3.64
Electronic News	3.25
Business Computer Systems	3.12
Systems & Software	2.99
Information Systems News	2.60
Telephony	2.14
Computer Systems News	2.01
TE&M	1.17

For copies of the complete study, contact your regional sales manager.
Listing includes only those publications with greater than 1% response.

Mini-Micro Systems



Cahners Publishing Company

221 Columbus Avenue, Boston, MA 02116
(617)536-7780

Publishers of 30 specialized business magazines in Building and Construction
 Electronics and Computers Food Service Manufacturing Health Care

Regional Sales Offices: Boston—(617)536-7780; Chicago—(312)635-8800; Dallas—(214)980-0318; Denver—(303)388-4511; Los Angeles—(213)826-5818; Mid-Atlantic/Southeast—(215)293-1212; Orange County—(714)851-9422; San Francisco—(408)243-8838

Advertisers Index

Able Computer	50	Hewlett-Packard	136, 194-195	Pick Operating Systems	57
Ampex Corp., Disk Media Operation	114-115	Human Designed Systems Inc. (HDS)	39	Plexus Computers	102
Anadex Inc.	193	Hunter & Ready	88-89	Precision Visual	147
Anchor Automation	85	IBC/Integrated Business Computers	66, 221	Quantum Software	225
Apple Computer Inc.	12-13	Ibex Computers Corp.	176	Qubix	101
Applied Data Communications	267	IBM Corp.	206-207, 241	Qume	243, 249
Atasi Corp.	230-231	Infotron Systems Corp.	1	RCA	146
AT&T Technologies, Inc.	196-197	Inmac	248	RDS-Relational Database Systems	58-59
Bytcom	36	Intecolor Corp., an Intelligent Systems Co.	126	Rodime	10
C. Itoh Electronics	171, E10	Intel Corp.	60	SCI Corp.	42
CalComp	184	Intercontinental Micro	22	Science Accessories	120
California Computer Group	63	Interface Group	28, 132	Scientific Micro Systems	177
Canon U.S.A.	257, 259, 261, 263, 265	Interphase Corp.	174	Seiko Instruments USA	182
Century Data Systems (a Xerox Co.)	251	Iomega Corp.	108-109	Shugart Corp.	8-9, 111
Chrislin Industries, Inc.	252	ISI International	107, 227	Siemens Corp.	245-247
CIE Terminals	14, 21	Isoreg corp.	244	Softcon	52
Citizen America	228-229	JDL Inc.	128-129	Sola Electric	187
Codex Corp.	133	Kennedy Co.	C2	Solaris Computer Corp.	253
CompuPro	25	Kimtron	232	Spectra Logic	201, 203, 205
Computas	44	Lear Siegler Inc.	166	Systech	17
Control Data Corp.—Business Prod. Group	86-87	Liebert Programmed Power	198	Systems Research Laboratories Inc.	47, 258
Control Data Corp.—OEM	18	Logical Microcomputer	142	Tab Products	164
Convergent Technologies	48-49	Madzar Corp.	192	Tandon Corp.	6-7
Cromemco Inc.	236-237	Marinco Computer Products	214-215	Tartan Labs	93
Danish Data Electronics	72-73	Masscomp	160-161	Tatung Co.	242
Data Language Corp.	213	Megavault	91	TEAC Corp. of America	76
Dataram	53	Method Systems Inc.	212	Telebyte Technology	212
Davidge Corp.	176	Micom Systems Inc.	C4	Telesoft	30
Davong Systems	71	Micro Data Base Systems Inc.	112	TeleVideo Systems Inc.	222
Delta Airlines	262	Micro-Term	169	Texas Instruments Inc.	96
Digital Equipment Corp.	80-81	Mini-Micro Systems	226, 264, 269, 273, 278, E4, E12	Thorn EMI	113
Digital Sound Corp.	189	Mostek Corp.	153, 155, 157	Toei Electronics	256
Dual Systems	266	Motorola Semiconductor Products	134-135	TouchStone Software	64
EEC Systems	79	Multi Solutions	104	TransNet Corp.	192
Electronic Conventions	67	Nantucket	55	Uniforum	94
Emerald Systems Corp.	240	NCR Corp.	123-125	Unify Corp.	162-163
Emulex Corp.	40-41	NCR Boardlevel Products	218	Unisoft Systems	4
Enter Computer Inc.	95	NEC	E5	Uniras	E6
Epson America, Inc.	C3	Norm DeNardi Enterprises	260	Universal Data Systems Inc.	148
Equinox Systems	90	Northern Telecom	69	U.S. Design Corp.	118
Esprit Computer Products	158	Nova Electric Manufacturing	91	Verbex	141
Esprit Systems Inc.	26-27	OEMTek	143-145	Visual Technology Inc.	116-117
Facit Inc.	180	Okidata Corp.	131	West Computer	E3
Falco Data Products	235	Olivetti	E9	Western Digital	97-100
Faraday Electronics	74	Peritek Corp.	270	Wyse Technology	178-179
Flexible Computer	238-239	Perkin-Elmer Corp.	82	Xebec	216-217
Gould Inc., Distributed Systems Div.	5	Pertec Peripherals Corp.	208	Zilog Inc.	172
Hamilton/Avnet Electronics	29, 225	Philon Inc.	138		
Hermes Precisa Int'l	181				

See P. 271 for Classified Advertising
 See P. 274-277 for Career Opportunity Advertisers
 See P. 280-282 for Mini-Micro Marketplace

This index is provided as an additional service. The publisher does not assume any liability for errors or omissions.

Mini-Micro MARKETPLACE

Products and services for the value-added market.

READERS: Please circle reader service numbers for additional information.

ENCLOSURE PRODUCTS

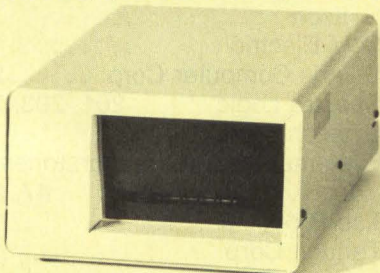

- Floppy and Hard Disk Drive Enclosures for all Major Micros.
- Xebec Controllers Optional
- Custom Design Available
- Class 'B' Certification Support Can Be Provided
- Call For Pricing and Catalog

Microware, Inc.

41711 Joy Road • Canton, MI 48187
(313) 459-3557

CIRCLE NO. 200 ON INQUIRY CARD

SAM...Prevents Computer MELTDOWN



SAM, The Smart Ambient Temperature Monitor/Power Controller, measures computer room temperature and lets your computer know too! Automatic power-down is a simple task if your mini-computer gets too hot for comfort. There's no threat of computer damage or loss of data with SAM watching over your system.

Features:

- Utilizes a powerful single-chip micro
- Dual Solid State Temperature Sensors
- Controls Popular Mini-Computer Power Distribution Panels
- Standard RS-232 Interface
- Built-in Audible Warning Alarm
- Switch Selectable Band Rates: 300, 1200, 4800, and 9600
- Auto Hi/Low Temperature Storage
- Compact Size: 2 1/2" x 5 1/2" x 7"
- Metal Case
- One Year Warranty

101 W. 31 ST., N.Y., N.Y. 10001 (212) 947-5533

CIRCLE NO. 201 ON INQUIRY CARD

If you are a serious software developer, shopping for software development tools, call or write today for more information. **800-551-5554** in CA call **(408) 733-2919**

TARGET MICROPROCESSORS

8086/80186, 8096, 8080/8085, 8051, 8048, and others.

HOST MINI'S

DEC VAX, PDP-11, DG MV-Series Eclipse, Apollo, UNIX Systems, and others.

HOST PC'S

IBM PC, Data General/ONE, HP 150, COMPAQ, Columbia, DEC Rainbow, and other Compatibles.

SOFTWARE TOOLS

C Compilers, Pascal Compilers, Assemblers, Simulators, Linking Loaders, Librarians, Conversion/Download, Communications, and VT-100 Emulator.

for Serious Software Developers

**MICROTEC
RESEARCH**

3930 Freedom Circle, Suite 101, Santa Clara, CA 95054
Mailing Address: P.O. Box 60337, Sunnyvale, CA 95088
(408) 733-2919 Telex (ITT) 4990808

CIRCLE NO. 202 ON INQUIRY CARD

PortaPac™

PortaPac is a portable, solid state, non volatile data transfer and retention device.

- Two RS232C Serial ports
- software and hardware handshake
- CMOS SRAM
- 1 year warranty
- 16, 32, 64, 128, 192 K byte capacity

AI **Cryptronics, Inc.**
11711 Coley River Circle, Suite 7
Fountain Valley, CA 92708
Phone: (714) 540-1174

CIRCLE NO. 203 ON INQUIRY CARD

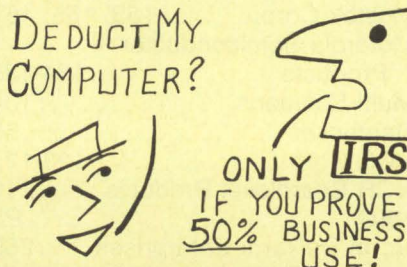

DEDUCT YOUR COMPUTER?

New tax laws require proof of 50% business use. The *PYD* (Prove Your Deduction) program records and reports use on most CP/M and MS-DOS computers.

Only \$24.95
Call BCD = COMPUTERS
(800) 223-5369 EXT 242

CIRCLE NO. 204 ON INQUIRY CARD

Promote New Literature

at a **LOW
COST**

If you've got catalogs or literature, distribute them at a low cost in the **MINI-MICRO MARKETPLACE.**

Call Norma Lindahl
(617)536-7780

CIRCLE NO. 205 ON INQUIRY CARD

Z80 MADE E—Z

EZT, the most POWERFUL Z80* software debug tool available today for CP/M* systems features:

- Assembly Language Input.
- Disassembler.
- Direct Instruction Execution.
- Trace with Traps.
- Up to Seven Breakpoints.
- Search Mode.
- On Line Calculator.
- Binary, Octal, Decimal, Hex, ASCII.

\$44.95 includes complete 100 kbyte source program on diskette. Visa, MC, P.O. or personal checks accepted.

TAYLOR MICRO TECHNOLOGY
1800 Mariposa Lane
Fullerton, CA 92633
(714) 773-4882

* registered trademarks of Zilog and Digital Research.

CIRCLE NO. 206 ON INQUIRY CARD

Promote New Literature

at a LOW COST

If you've got catalogs or literature, distribute them at a low cost in the **MINI-MICRO MARKETPLACE.**

Call Norma Lindahl
(617)536-7780

CIRCLE NO. 207 ON INQUIRY CARD

NEW FROM OMEGA! WB-40 Interfacing Micro-Computer

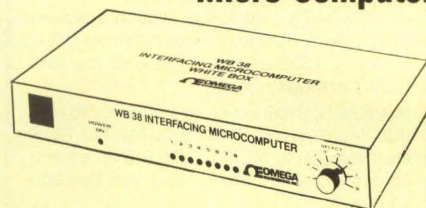

The White Box™ 40 stands alone or converts up to 8 analog signals to RS-232C format for full two-way communications with any compatible computer.

OMEGA
ENGINEERING, INC.

One Omega Drive, Box 4047, Stamford, CT 06907 U.S.A.
Telex 996404, Cable OMEGA, FAX (203) 359-7700

(203) 359-RUSH

CIRCLE NO. 208 ON INQUIRY CARD

MINI Z80B

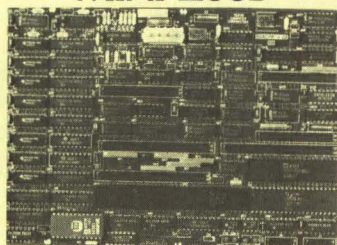

SERVO 8 Single Board Computer

- 5.75" by 8", same as a minifloppy
- Fast, 6 megahertz with no wait states
- Controls both 5.25" and 8" floppy drives
- SASI bus controls 10 megabyte Winchester
- 64K RAM and 2K EPROM, both expandable
- 2 RS232 serial ports and Centronics port
- Runs CP/M and OASIS operating systems
- Special introductory price, only \$495.
- In stock, 5 day delivery - VISA M/C COD

SERVO

SERVO COMPUTER CORPORATION
3608 N. ELLENSBURG ST. BOX 566
GOLD BEACH, OREGON 97444
(503) 247-2021

CIRCLE NO. 209 ON INQUIRY CARD

MicroMate

"the terminal converter"

128K
with
Bundled
Software

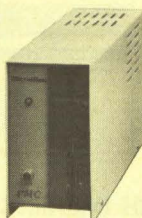

Lowest
priced
Business
Computer

You already have half of your next personal computer if you own a terminal. Just add our MicroMate to run thousands of CP/M software programs and still keep the same mainframe connection.

Personal Micro Computers, Inc.

275 Santa Ana Court, Sunnyvale, CA 94086
(408) 737-8444

CIRCLE NO. 210 ON INQUIRY CARD

ZX-5000™ EXTENDED RANGE™ SURGE SUPPRESSORS

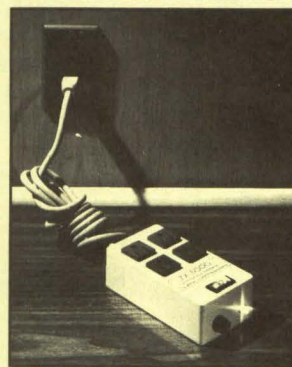

SUTTON DESIGNS INC.

111 S. Cayuga, Suite 200, Ithaca, NY 14850-607/2774301

CIRCLE NO. 211 ON INQUIRY CARD

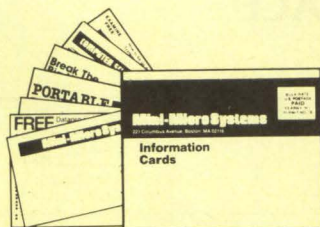

HIGH INQUIRIES LOW COST

- Sell products and services directly
- Introduce new products
- Investigate new applications
- Develop new sales leads

MINI-MICRO SYSTEMS DIRECT RESPONSE POSTCARDS

CIRCLE NO. 212 ON INQUIRY CARD



SWITCH BOXES CAN ADD TO THE VERSATILITY OF YOUR HARDWARE. Data Set Cable provides ABC & ABCDE boxes in a wide variety with all kinds of connectors. Avoid need to change cables manually. Economical, too - ultra-compact ABC Single Coax box only \$55. In addition, Data Set has the biggest selection of interface cables, test equipment and other essentials to support your DP department. Send for catalog to **Data Set Cable Co.**, 722 Danbury Road, Ridgefield, CT 06877 - (203) 438-9684 or Las Vegas - (702) 382-6777.

CIRCLE NO. 213 ON INQUIRY CARD

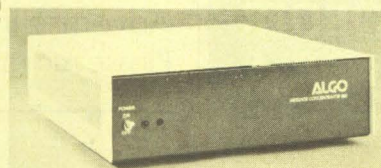

ALGO Message Concentrator 600

An easy, inexpensive way to network IBM-PCs or compatibles with existing mini/micro computers without the use of special bus cards or communications software. The 600 can save on telephone line costs.

- Local/Remote Networking for any group of computer systems using only one RS-232-C Port/system.
- Obeys simple command strings from your applications program.
- 6 Asynchronous RS-232 Ports.
- No special PC-Bus Cards or System Software Needed.
- Automatic, Easily Modified Message Routing.
- Complete Error Control.

Six Ported Message Concentrator priced at 1545.00

ALGO, INC.
9198-C Red Branch Rd.
Columbia, MD 21045
301-730-7442

CIRCLE NO. 214 ON INQUIRY CARD

The Solution To Your Data Incompatibility Problems - CROSSDATA®

CROSSDATA is the low-cost utility software that converts data/text file formats from CP/M to MS/PC-DOS and back again on any IBM PC/XT or clone.

It is a self-contained program, ready to run, that reads/writes CP/M and MS/PC DOS Diskettes using MS/PC-DOS 2.0 or 2.1 and comes with 27 formats - plus you can add your own!

Solve your computer incompatibility problems fast with CROSSDATA, the proven conversion package, by ordering one today.

Price \$99.00



AWARD SOFTWARE, INC.

236 North Santa Cruz Ave., Los Gatos, CA 95030
(408) 395-2773

CIRCLE NO. 215 ON INQUIRY CARD

The Little Board™ ...\$199*
The world's simplest and least expensive CP/M computer

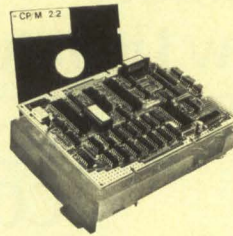

- 4 MHz Z80A CPU, 64K RAM, Z80A CTC, 8732 Boot ROM
- Mini/Micro Floppy controller (1-4 Drives, Single/Double Density, 1-2 sided, 40/80 track)
- Only 5.75 x 7.75 inches, mounts directly to a 5 1/4" floppy drive
- 2 RS232C Serial Ports (75-9600 baud & 75-38,400 baud), 1 Centronics Printer Port
- Power Requirement: -5VDC at .75A; -15VDC at .05A/On-board -15V converter
- CP/M 2.2 BDO5 • ZCP83 CCP • Enhanced AMPRO BIOS
- AMPRO Utilities Included:
 - read/write to more than 2 dozen other formats (Kaypro, Teletype, IBM CP/MS6....)
 - format disks for more than a dozen other computers
 - format/copy/verify all in one
 - menu-based system customisation
- SCSI OPTION • BIOS and Utilities Source Code Available
- Custom Versions: Contact Factory • OEM enclosure available

AMPRO COMPUTERS INCORPORATED
67 East Evelyn Ave. • Mountain View, CA 94041 • (415) 962-0930 • TELEX 4940302

CIRCLE NO. 216 ON INQUIRY CARD

PIN GRID ARRAY & DIP SOCKETS

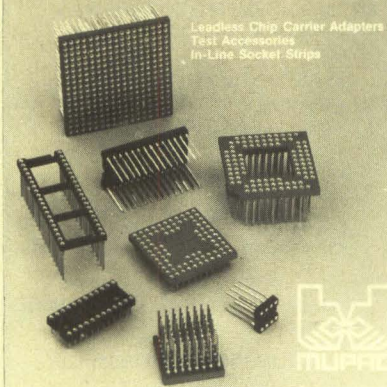

10 Mupac Drive, Brockton, MA 02401
Tel (617) 588-6110 TWX (710) 345-8458

CIRCLE NO. 217 ON INQUIRY CARD



THE RSX/VMS SPECIALISTS

THE LSI-11/73 BASED CM-300/Q22 COMPUTER SYSTEMS WITH RSX-11M+ SUPPORTING SUPERVISOR-MODE LIBRARIES AND SEPARATE I AND D SPACE

THE MICRO-VAX I BRINGS VAX POWER AND HIGH PERFORMANCE TO THE Q-BUS

CM-300/Q22 computer systems are configured with DEC's NEW LSI-11/73 CPU, giving these systems 11/70 PERFORMANCE AT LSI-11 PRICES. CM-300/Q22 systems can be configured with up to 1200MB of fixed Winchester disk, up to 4MB of main memory and up to 64 terminals. System back-up is provided by an industry standard 9 track 1/2" 1600 BPI tape drive. Optional software packages include accounting software, mailing list, FORTRAN 77, FMS-11, BASIC +2 and DATARETIVE. An LSI-11/73 based 300MB system including RSX-11M+ license, media and documentation, with a VT220 terminal may be purchased for under \$23,000.

MICRO VAX I computer systems can be configured with up to 4MB of main memory, up to 31MB of fixed disk and up to 5 terminals. Prices start at \$13,730.

Call A.C.S. and let us configure a hardware/software solution for your specific problems.

ADVANCED COMPUTER SYSTEMS, Inc. 250 Prospect Street
Waltham, Massachusetts 02154
617-894-3278

CIRCLE NO. 218 ON INQUIRY CARD

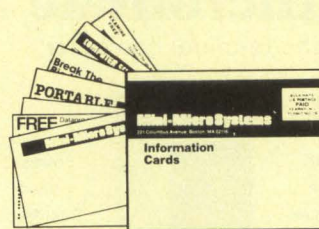

**HIGH INQUIRIES
LOW COST**

- Sell products and services directly
- Introduce new products
- Investigate new applications
- Develop new sales leads

**MINI-MICRO SYSTEMS
DIRECT RESPONSE POSTCARDS**

CIRCLE NO. 219 ON INQUIRY CARD

DON'T BLAME THE SOFTWARE!

Complete Hi-Tech Equipment Protection: Write for Free Catalog!

- Power line isolators
- Spike/surge suppressors
- Power line filter/suppressors
- Twist type socket protection
- Line voltage regulators
- Line conditioners
- Modem protectors



Electronic Specialists

171 S. Main, Natick, MA 01760 (617) 655-1532
Toll Free Order Desk 1-800-225-4876

CIRCLE NO. 220 ON INQUIRY CARD

ORDER FORM

Advertise in the **MINI-MICRO MARKETPLACE**

Please run my advertisement in the following issues

EFFECTIVE JANUARY 1985

1x	3x	6x	12x	18x
\$660	\$595	\$575	\$560	\$545
	24x	48x		
	\$525	\$505		

MATERIALS

- Glossy photo with 50-75 words.
We will typeset your ad at no charge.
- Camera ready artwork.
- Film negatives: right reading emulsion side down.

AD SIZE: 2 1/4" x 3 1/16"

COMPANY _____

ADDRESS _____

CITY _____ STATE _____ ZIP _____

TELEPHONE _____

SIGNATURE _____

Space reservation by the first week of the month proceeding issue date.

- Materials enclosed Materials to come Please send information

Send to: Norma Lindahl, **MINI-MICRO SYSTEMS**
221 Columbus Ave.
Boston, MA 02116

15% Agency commission to accredited agencies. Please specify agency.

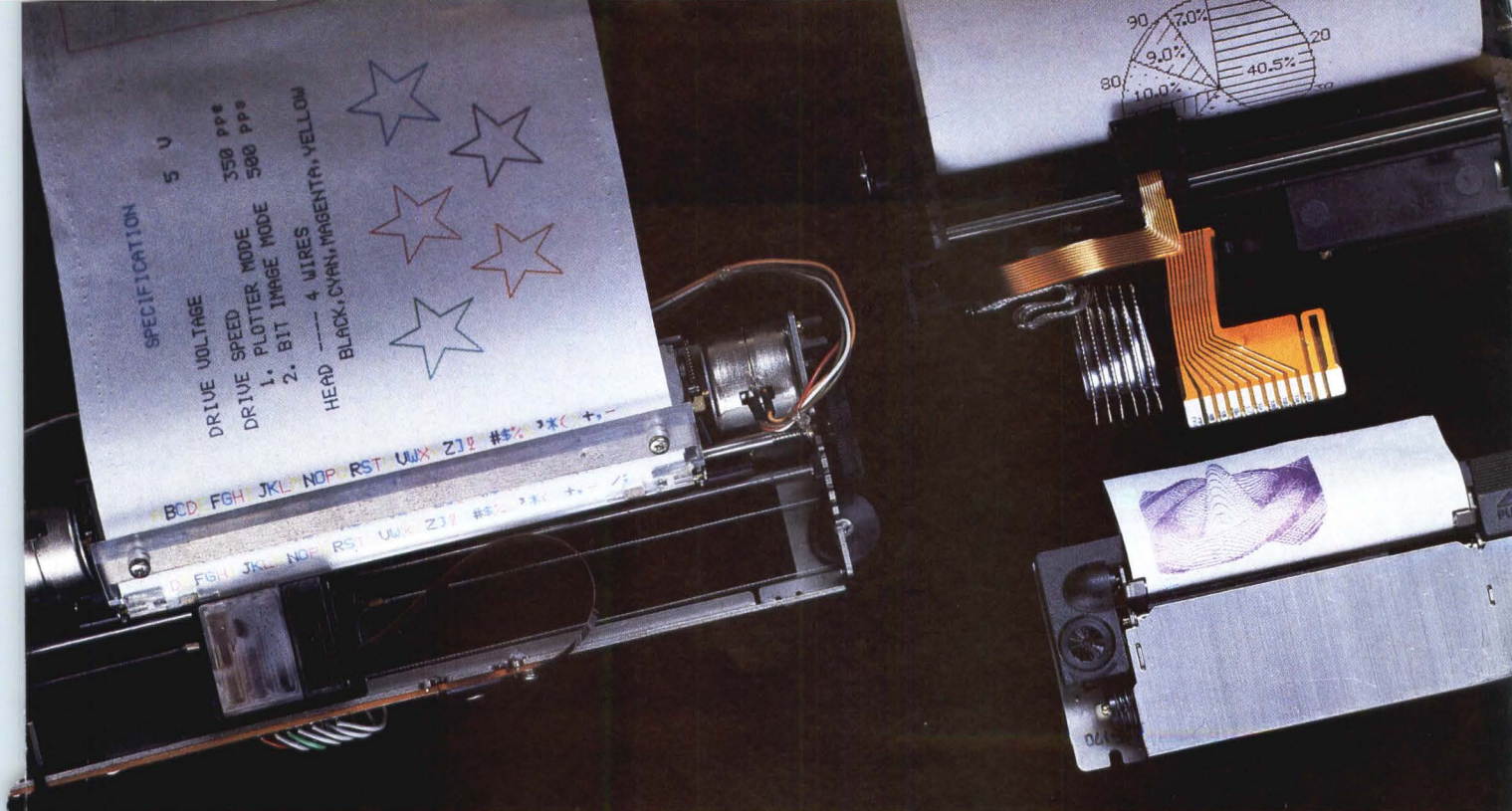

There's an Epsonomic answer to your instrumentation hard copy needs.

Our new ink dot OEM printers are part of it.

Epsonomics means more than product leadership. Though the technology involved in our new ribbonless color impact (ink dot) printer mechanism is a giant stride ahead of the field.

Epsonomics means more than leadership in product quality. Though Epson's mastery of production engineering and precision manufacturing has given our printers and printer mechanisms the lowest out-of-box failure rate in the industry.

Epsonomics means even more than quality in quantity. Though Epson has shipped more micro and mini printer mechanisms than all other manufacturers combined. And our thermal and mini dot matrix printers are ideal for battery operated and portable data logging operations.

But Epsonomics means more. It means designed-in reliability to extend your product's life expectancy and lower after-sale service costs. It means scheduled deliveries to help you minimize inventory costs. It gives you a way to grow profitably, so we can grow, too.

Find out how Epsonomics can help you keep ahead of your competition. Call or write us today.

EPSON[®]
OEM

EPSON AMERICA, INC.
OEM Products Division
Peripherals Group
23600 Telo Avenue, Torrance,
CA 90505 (213) 534-4500
TELEX: 664277



*The top lines for
your bottom line*

Please see us at Comdex Booth #s 4761 & 4864

SW Region (714) 768-7046 • NW Region (408) 970-9977 • SE Region (404) 956-1934 • NE Region (617) 245-8007 • Central Region (815) 338-5810
© Registered trademark of the Epson Corporation.

CIRCLE NO. 149 ON INQUIRY CARD

Our IBM Protocol Converter is not the same under the skin.

MICOM's new Micro7400 is very, very different. It not only provides a Gateway for dumb asynchronous terminals to access IBM mainframe applications, but goes far beyond the basic capabilities of IBM 3270s and other protocol converters. *It's even easy to use.*

Since MICOM is the world's largest volume manufacturer of data concentrators, it's only natural that MICOM's protocol converter should include the same features that made the concentrators so popular. And fortunately for asynchronous terminal users wishing they could connect to IBM mainframes, and for mainframe DP managers looking for less expensive terminals, the combination makes a very effective hybrid.

All Standard IBM 3270 Features

Functioning as an IBM 3274 Model 51C Cluster Controller using either Bisync or SNA/SDLC protocol, the Micro7400 allows ASCII terminals (or personal computers emulating terminals) to perform as 3270s. Display terminals emulate IBM 3278s; printers emulate IBM 3287s. And special software allows printer terminals to interact with full-screen programs originally developed for crt's.

Plus Extra Functions

The Micro7400 also offers features not available in the IBM 3270 line, including dial-up access to the protocol con-

verter, terminal-controlled diagnostics, and do-it-yourself channel configuration for setting terminal-related parameters like parity.

Support for IBM Personal Computers

IBM PCs connected to the Micro7400 can emulate IBM 3270 terminals, too, for communicating with mainframes. Diskette-based MICOM software makes it easy.

Switching Between Multiple Hosts

Users can switch between two IBM hosts, or between an IBM host and asynchronous ports on one or more mini-computers—completely under terminal control.

Command Port

Unique among protocol converters, the Micro7400's Command Port allows a network manager to dynamically alter operating parameters like priority assignment, as well as providing monitoring, diagnostic, and control facilities.

As Low As \$400 Per Channel

Even the pricing is more like a concentrator—as low as \$400 per channel in standard models, plus there's a budget-minded 2-channel "LTD" version too.

Call today for a 12-page color brochure, technical specifications, and a price list.



MICOM Systems, Inc. • 20151 Nordhoff Street • Chatsworth, CA 91311 • Telephone (805) 583-8600 • TWX 910/494-4910
Regional Sales/Service • Atlanta, GA • (404) 435-2999 • Boston, MA • (617) 527-4010 • Chicago, IL • (312) 964-0551
Dallas, TX • (214) 258-0774 • San Francisco • (415) 327-0890 • St. Louis, MO • (314) 576-7626 • Teaneck, NJ • (201) 836-4000
MICOM-Borer Ltd. • Reading RG20JT, England • (0734) 866801 • Micom Europe • Newbury RG13JU, England • (0635) 832441

For literature please call: (800) "MICOM U.S."

AVAILABLE NOW FROM THESE STOCKING REPS. . . AK: Anchorage (907) 561-1776 / Juneau (907) 789-4101 • AL: (800) 327-6600 • AR: (214) 620-1551 • AZ: (602) 994-5400
CA: Anaheim (714) 635-7600 / Lodi (209) 334-1961 / San Diego (619) 565-1557 / San Jose (408) 298-7290 • CO: Denver (303) 777-8070 • CT: (617) 235-5520 • DE: (609) 779-0200
FL: (800) 432-4480 • GA: (800) 327-6600 • HI: (808) 537-9758 • IA: (402) 895-5850 • ID: (801) 466-6522 • IL: (312) 255-4820 • IN: (317) 846-2591 • KS: (816) 252-3700
KY: (502) 228-5401 • LA: (800) 327-6600 • MA: (617) 235-5520 • MD: (301) 340-0600 • ME: (617) 235-5520 • MI: (313) 588-2300 • MN: (612) 425-4455
MO: Independence (816) 252-3700 / St. Louis (314) 721-0401 • MS: (800) 327-6600 • MT: (801) 466-6522 • NC: (800) 327-6600 • ND: (612) 425-4455 • NE: (402) 895-5850
NH: (617) 235-5520 • NJ: North (201) 569-2353 / South (609) 779-0200 • NM: Albuquerque (505) 292-1212 / Las Cruces (505) 524-9693 • NV: (714) 635-7600
NY: Albany (518) 459-5891 / Buffalo (716) 662-4568 / New York City (201) 569-2353 / Rochester (716) 424-7492 / Syracuse (315) 455-5841 • OH: Cleveland (216) 524-5930 /
Dayton (513) 434-7500 • OK: (405) 478-5000 • OR: (503) 224-3145 • PA: East (609) 779-0200 / West (412) 892-2953 • RI: (617) 235-5520 • SC: (800) 327-6600
SD: (612) 425-4455 • TN: (800) 327-6600 • TX: Dallas (214) 620-1551 / Austin (512) 327-8600 / El Paso (915) 542-1762 / Houston (713) 353-7728 • UT: (801) 466-6522
VA: North (301) 340-0600 / South (800) 327-6600 • VT: (617) 235-5520 • WA: (206) 454-2383 • WI: (414) 784-9379 • WV: East (301) 340-0600 / West (412) 892-2953
WY: (303) 777-8070 • Washington, DC: (301) 340-0600 • Puerto Rico: (809) 753-1771 MD003

CIRCLE NO. 150 ON INQUIRY CARD