

# Mini-MicroSystems

THE MAGAZINE FOR COMPUTER SYSTEMS INTEGRATION

A CAHNERS PUBLICATION

## Xerox, Ventura campaign to press would-be publishers

### SPECIAL REPORTS:

- UNIX
- Desktop publishing
- Ink-jet and thermal printers

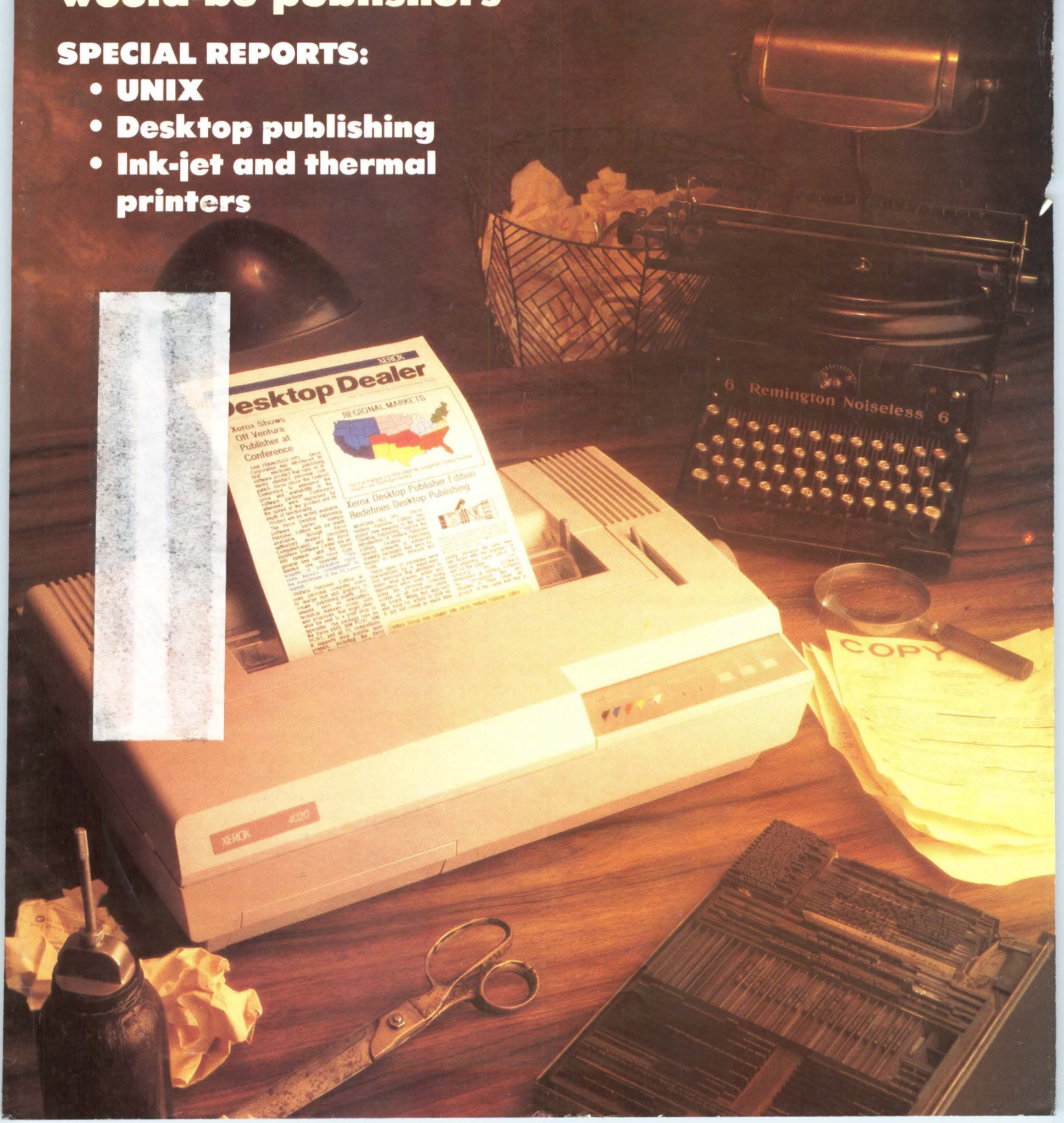



**FREE!**  
LaserControl™  
TRANSLATOR SOFTWARE\* UNTIL 3/31/87.  
\$150 VALUE

# It's an Okidata!



## The Okidata Laserline™ 6 printer from Hall-Mark.

Now everyone can afford advanced laser technology for fast, high-quality printing with the Laserline 6, available now from Hall-Mark.

The Laserline 6 is a feature-rich alternative to models costing twice as much. First-time users will find it easy to set up and operate, and veterans of laser technology will appreciate its high performance.

### 15 resident fonts

The Laserline 6 comes standard with 15 built-in typeset-quality fonts, using true boldface and italic for exceptional quality.

### Compatible

The Laserline 6 is compatible with a wide variety of software, including Hewlett-Packard's LaserJet and LaserJet Plus.

### Easy to use

All replaceable supplies feature snap-in installation and require no tools. The toner cartridge takes less than two minutes to change.

### Outstanding paper handling

Up to 150 pages at a time can be stacked, and the pages are printed face down in proper order. Operators do not have to shuffle documents to get them out of reverse order after printing.

Call Hall-Mark today for a demonstration and more information on the Okidata Laserline 6 or any Okidata product. For outstanding service and delivery, Hall-Mark is the one.

\* Provides Diablo® 630 API, EPSON® MX, IBM® Graphics Printer, NEC® 3550 and Qume® Sprint XI Emulations

#### Alabama

Huntsville (205) 837-8700

#### Arizona

Phoenix (602) 437-4200

#### California

San Area (408) 946-0900  
Orange County (714) 669-4700  
Sacramento (916) 722-8600  
San Diego (619) 268-1201  
San Fernando Valley (818) 765-7300  
West Los Angeles (213) 27-8400

#### Colorado

Denver (303) 790-6662

#### Connecticut

Connecticut (203) 269-0100

#### Florida

FT. Lauderdale (305) 971-9280  
Orlando (305) 855-4030  
Tampa Bay (813) 530-4543

#### Georgia

Atlanta (404) 447-8000

#### Illinois

Chicago (312) 860-3800

#### Indiana

Indianapolis (317) 872-8875

#### Kansas

Kansas City (913) 888-4747

#### Maryland

Baltimore (301) 988-9800

#### Massachusetts

Boston (617) 935-9777

#### Minnesota

Minneapolis (612) 941-2600

#### Missouri

St. Louis (314) 291-5350

#### New Jersey

Fairfield (201) 575-4415

#### New York

Long Island (516) 737-0600

#### North Carolina

Raleigh (919) 872-0712

#### Ohio

Cleveland (216) 349-4632

Southern Ohio (614) 888-3313

#### Oklahoma

Tulsa (800) 234-0253

#### Pennsylvania

Philadelphia (215) 355-7300

#### Texas

Austin (512) 258-8848

Dallas (214) 553-4300

Houston (713) 781-6100

#### Utah

Salt Lake City (801) 972-1008

#### Wisconsin

Milwaukee (414) 797-7844





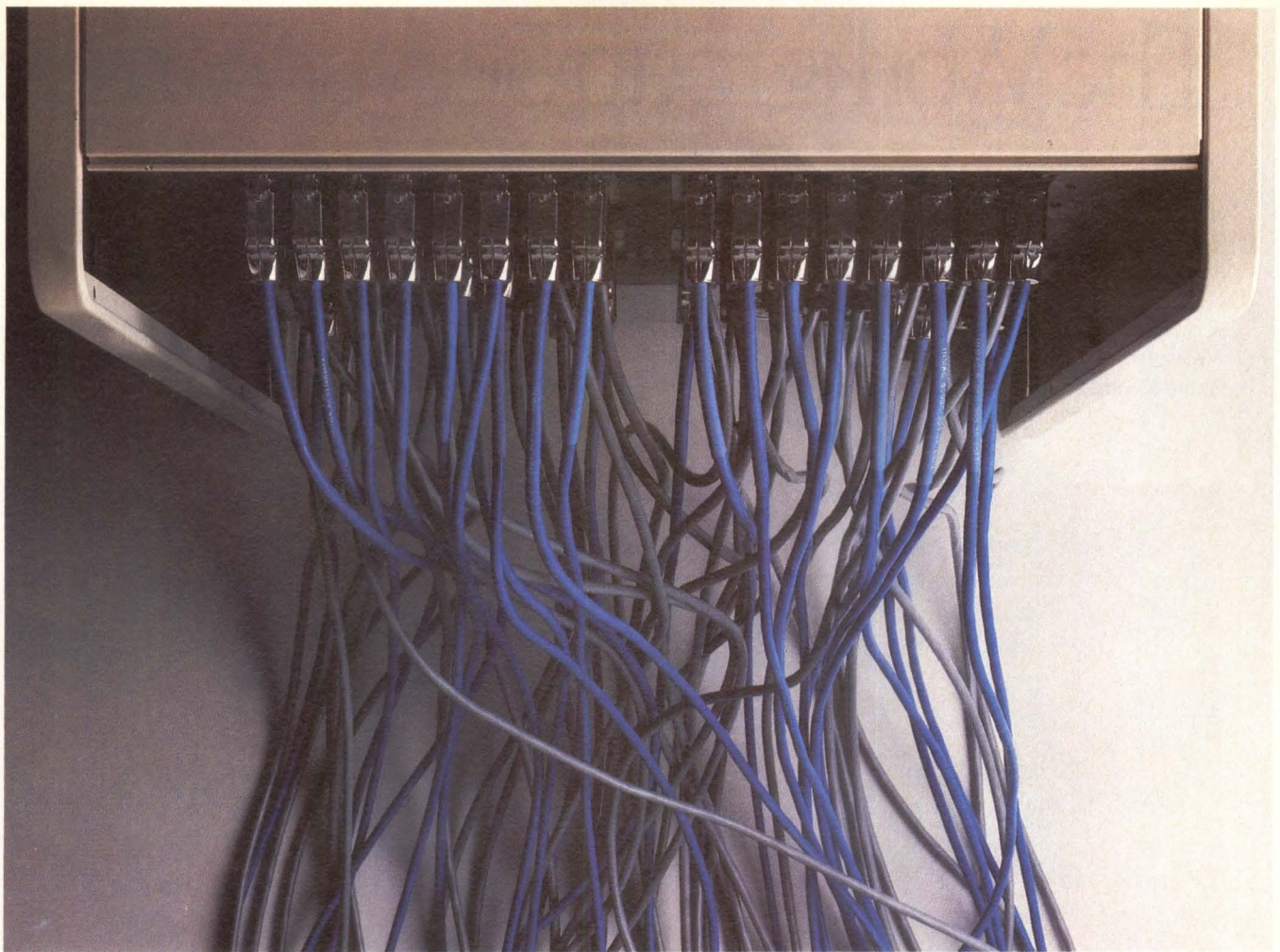

## How many more reasons do you need to Unplug your computer?

Until now, connecting 128 terminals to your computer meant one thing. A myriad of cards taking up precious space on the backplane. And accomplishing nothing but communications. All of which could frustrate almost any self-respecting system designer into hanging up his calculator.

Well, at Systech, we understand the serial communications problems of a multi-user system. So we developed The Unplug™ asynchronous distributed multiplexer that can be used with any Multibus®, VMEbus or Multibus® II system.

The Unplug can take those 128 connections off the back of the computer and turn them into just one. And presto, you've got all the expansion slots you need for more important things. Like disks. Streaming tapes. More CPU power. A synchronous communications processor. And your imagination.

You see, what we did was move part of the computer's operating system—the part devoted to managing traffic to and from the terminals—out of the computer and into The Unplug. Giving the host computer the freedom to concentrate on more important tasks.

We know it sounds simple. And the truth is, it is. In fact, you might wonder why no one thought of it before. Then again, no one else has our commitment to make your job easier. And a lot more gratifying.

Just give us a call at Systech to hook up with The Unplug. Then you can start figuring out what you want to add on next.

Instead of trying to figure out how to untangle all those wires.

Systech Corporation, 6465 Nancy Ridge Drive, San Diego, CA 92121, (619) 453-8970.

**CIRCLE NO. 2 ON INQUIRY CARD**

# The Unplug.

An outlet for your frustrations.

When you're ready to expand, you simply run one cable from the last Unplug to the next. And you've hooked up 8 new users, without ever opening the computer cabinet.

The Unplug is a trademark of Systech Corporation. Multibus is a registered trademark of Intel Corporation.

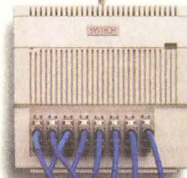
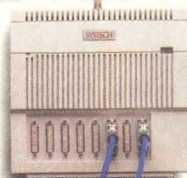

See us at Uniforum Booth #2132

**SYSTECH**

© 1986 Systech Corporation.  
The Unplug patent pending.



# The Workgroup Server™ Family:

There are only three primary colors. But by mixing and matching these three colors, an artist can create any color in the rainbow. This is the principle we've used in developing our computer solutions.

Standards. Enhancements. Connectivity.

Convergent has put them all together in a family of Workgroup Servers that give resellers the leverage to solve a wide variety of specific problems.

We started with industry standards for hardware, operating systems, networking and software. Things like UNIX\* System V, Motorola's 68000 microprocessor family, and VME and SCSI buses. The standards.

Then we enhanced these standards to give your customers increased performance and productivity. The simple windowing interface to UNIX is one example. Our fully integrated office automation package is another.

And finally, we went one more step and connected our Workgroup Servers to a wide range of computers



#### *The S/320:*

*A 32-user system with optional VME expansion.*

*Third party packages like Ultra-Office from Lutzky-Baird enable you to connect Apple Macintoshes and IBM PCs to your Workgroup Servers.*

*With our PC Exchange™ software, Workgroup Servers connect heterogeneous LANs to share mail, file servers, print servers and common relational databases.*

#### *The S/640:*

*At 25 MHz, the S/640 is a processing powerhouse, supporting up to 64 users.*

*IBM PCs gain access to our UNIX databases through Multiplex,\* a PC-UNIX interconnect.*

Workgroup Server is a trademark and Convergent is a registered trademark of Convergent Technologies, Inc. UNIX is a trademark of AT&T. IBM is a registered trademark of International Business Machines Corporation. Apple and Macintosh are registered trademarks of Apple Computer Corporation.

See us at Uniforum Booth #1061

**CIRCLE NO. 3 ON INQUIRY CARD**



# Where great systems converge.

from other vendors. Including IBM\* PCs and compatibles, Apple\* Macintoshes,\* other UNIX-based systems and IBM minis and mainframes.

Sound interesting? There's one more thing.

Convergent offers a comprehensive VAR program to complement this strong product offering. Featuring the margins and support services you'd expect from a company exclusively dedicated to resellers.

With no cross-channel conflict.

Standards, enhancements, connectivity and a great VAR program. To find out more about these areas of opportunity, call us today at 1-800-832-2255, ext. 296. In Europe, ring 44-3444-11707. Or write us: Convergent Technologies, 2700 North First Street, San Jose, CA 95150-6685, Mail Stop 10-015.

We'll help you find the end of the rainbow.

## The S/1280:

The most expandable system in the Workgroup Server Family, it uses multiple processors to support up to 128 users.

Our fully integrated WGS/Office™ automation software includes a windowing interface, word processor, spreadsheet, calendar and electronic mail.

## The S/220:

68020 performance for up to 22 users in a small package.

## The S/50:

A "personal" UNIX system that doubles as a server for up to five users.

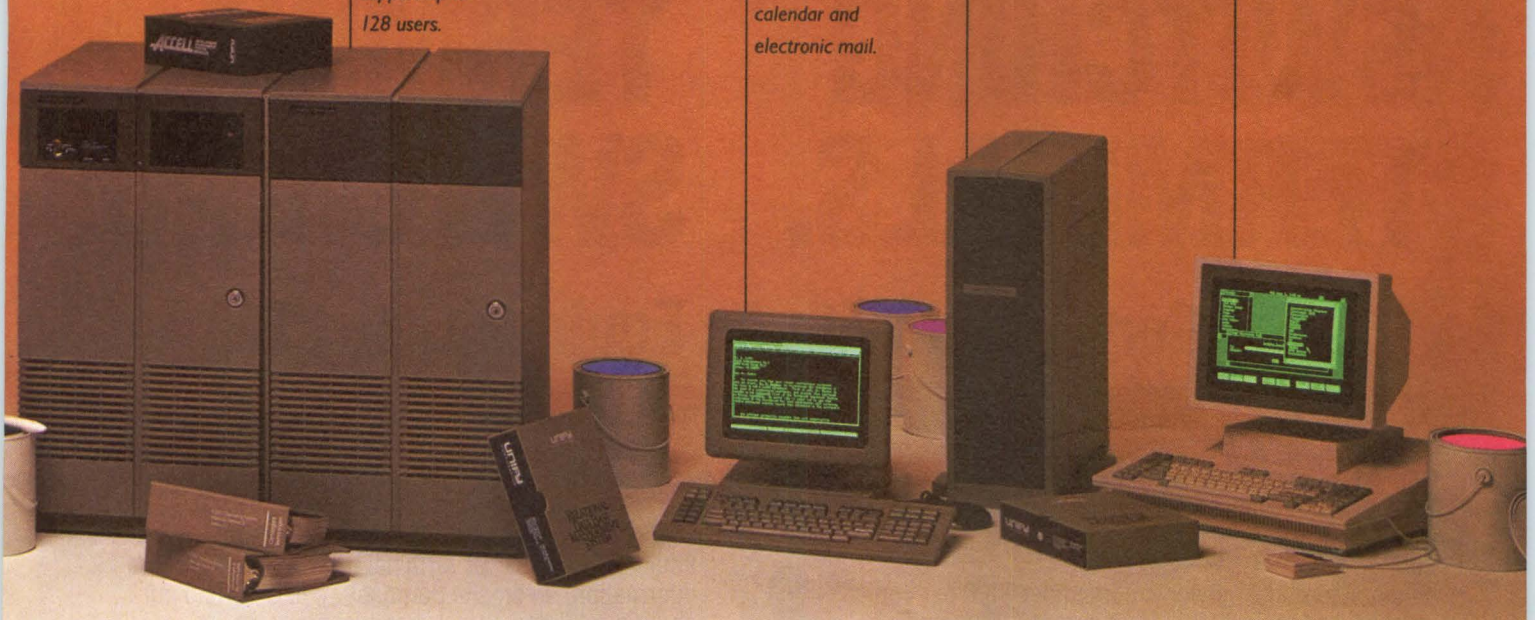

## THE WORKGROUP SERVER FAMILY

	S/50™	S/120™	S/220™	S/320™	S/640™	S/1280™
Max Users	5	12	22	32	64	128
Max RAM	2 MB	5 MB	5 MB	16 MB	64 MB	24+ MB
Max Disk Storage*	80 MB	140 MB	280 MB	4.0 GB	4.0 GB	6 GB
Technology	10 MHz 68010 CPU	12.5 MHz 68020 CPU	12.5 MHz 68020 CPU	12.5 MHz 68020 CPU	25 MHz 68020 CPU	4x16.67 MHz 68020 CPU
MIPS	.75	2.0	2.0	2.0	4.25	8.8

\*storage listed in unformatted capacities

# Convergent

When great ideas converge, great products emerge.





# SWITCHING TERMINALS.

# TERMINAL SWITCHING.

## Get Connected With An Equinox Data PBX.

An Equinox Terminal Network lets you connect your terminal to any async RS-232 computer, modem or printer with a few keystrokes. No more cable swapping, A-B switches or moving between terminals.

### Low-Cost, Easy Installation.

Equinox terminal networks cost under \$100 per connection and are protocol transparent. "Plug and play" wiring accessories, menu-driven configuration and on-line "HELP" make installation a snap.

### Network Growth With Compatible Products.

Whether you have a few terminals or thousands, we have a Data PBX to create the right size Terminal

Network for your needs. And all of our Data PBXs are fully compatible, so they can be expanded and networked to accommodate growth and protect your investment.

Find out why thousands of terminal users rely on an Equinox Data PBX for terminal networking. For more information, an on-site demonstration or to find out about our 30-day no-risk free trial program,

### Call 1-800-DATA-PBX.

In Florida call (305)255-3500.

Equinox Systems Inc.  
12041 S.W. 144th Street  
Miami, FL 33186-6108.

Equinox is a registered trademark of Equinox Systems Inc.

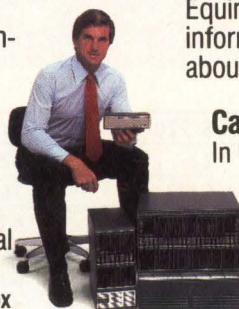

MDX  
8-16 Lines

DS-5  
24-960 Lines

DS-15  
24-1320 Lines

# EQUINOX

## Smart Connections For Dumb Terminals.

CIRCLE NO. 4 ON INQUIRY CARD



# Mini-Micro Systems

A CAHNERS PUBLICATION

VOL XX NO.1  
JANUARY 1987

## EXCLUSIVE

### COVER STORY

**Xerox Ventura campaign to press would-be publishers . . . . . 17**  
Xerox desktop publishing series brings ease-of-use to IBM PCs

## INTERPRETER

### MINICOMPUTERS

**IBM, Digital square off to capture "work-sharing" market . . . . . 24**  
Tale of the tape for IBM's mid-range contender

### DATA STORAGE

**High-capacity flexible disk drives invade low-end storage arena . . . . . 34**  
Alternative storage solutions for system integrators

## FEATURES

**Government, IEEE favor POSIX interface . . . . . 45**  
Software-transportability benefits of interface standard outweigh UNIX operating system shortcomings and pave way for POSIX acceptance

**Desktop publishing: Sifting type from hype . . . . . 57**  
Macintosh users have enjoyed desktop publishing benefits for more than a year. Now, powerful IBM PC packages have arrived. The big question is, "What can they really do?"

**Scanners present maze of options . . . . . 71**  
Driven by desktop publishing requirements, scanners are rapidly overcoming previous limitations, but the pathway to the right equipment still demands careful navigation

**Improved color enhances nonimpacts . . . . . 85**  
Color output joins better resolution and quiet operation to make ink-jet and thermal printers formidable contenders for high-quality, low-cost printing

**Product table . . . Plotters . . . . . 97**

## DEPARTMENTS

Editorial Staff . . . . .	6
Letters . . . . .	9
Breakpoints . . . . .	11
New Products . . . . .	103
Index to Advertisers . . . . .	108
Mini-Micro Marketplace . . . . .	111

Cahners Publishing Company • A Division of Reed Publishing USA • Specialized Business Magazines for Building and Construction • Computer/Technology • Electronics • Food/Packaging • Manufacturing Industries • Medical, Design & Publishing  
MINI-MICRO SYSTEMS (ISSN 0364-9342) is published monthly with additional issues in February, May and November by Cahners Publishing Company, A Division of Reed Publishing USA, 275 Washington St., Newton, MA 02158. William M. Platt, President; Terrence M. McDermott, Executive Vice President; Jerry D. Neth, Vice President of Publishing Operations; J.J. Walsh, Financial Vice President/Magazine Division; Thomas J. Dellamaria, Vice President Production and Manufacturing; Edwin V. Burkholder, Group Vice President. Copyright 1987 by Reed Publishing USA, a division of Reed Holdings Inc., Saul Goldweitz, Chairman; Ronald G. Segel, President and Chief Executive Officer. Circulation records are maintained at Cahners Publishing Co., 270 St. Paul St., Denver, CO 80206. Second class postage paid at Denver, CO 80202 and additional mailing offices. Postmaster: Send address changes to MINI-MICRO SYSTEMS, 270 St. Paul St., Denver, CO 80206. MINI-MICRO SYSTEMS is circulated without charge by name and title to U.S. and Western European-based corporate and technical management, systems engineers and other personnel who meet qualification procedures. Available to others at the rate of \$65 per year in the United States; \$80 in Canada and Mexico; \$105 surface mail in all other countries; air mail surcharge, \$45 (16 issues) Special HAND-BOOK issues, \$15. Single issues, \$6 in the United States; \$8 in Canada and Mexico; \$10 in all other countries.

1987 by Cahners Publishing Company, Division of Reed Publishing USA. All rights reserved.

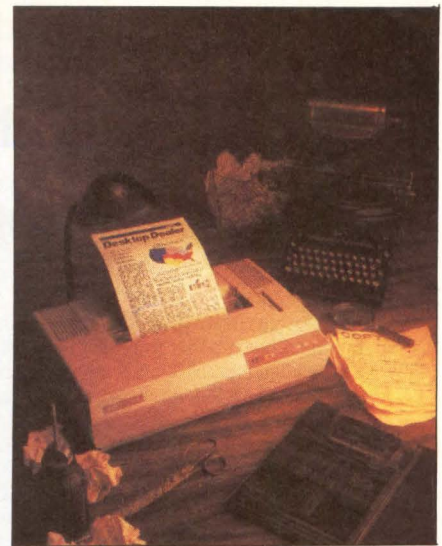

p. 17 . . . Bringing ease-of-use to IBM PCs. Courtesy of Xerox Corp.

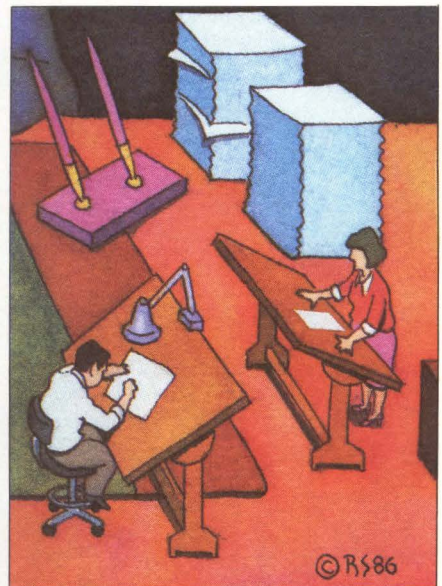

p. 57 . . . . . Desktop publishing



p. 85 . . . . . Printers









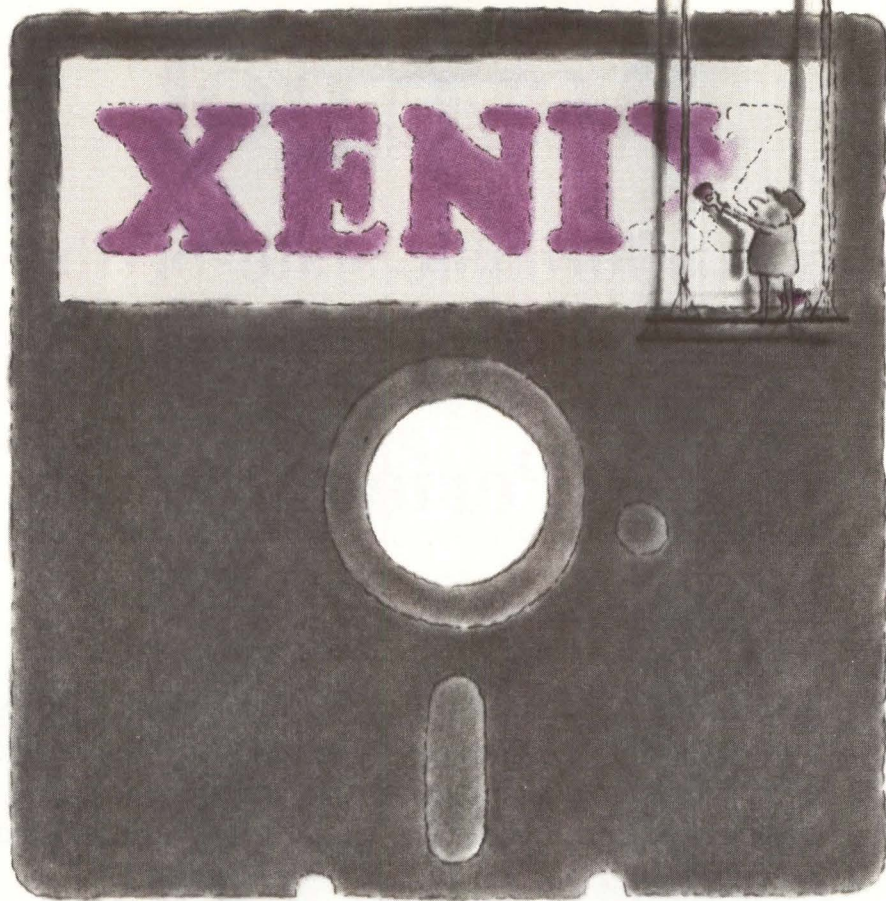

*"It's UNIX SYSTEM V,  
only better."*

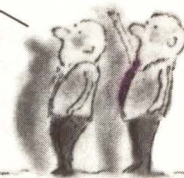

It's time to spread the news: XENIX<sup>®</sup> is the better choice. XENIX is full UNIX<sup>®</sup> System V, with improvements by Microsoft<sup>®</sup>. Enhancements like speed—XENIX System V/286 is the fastest version of UNIX available for the Intel architecture.

XENIX wins the software race as well. Over 160,000 XENIX sites are supported by a huge array of applications. From word processing and relational data bases to business packages for stock brokers and hotels—XENIX System V has more available software than any other version of UNIX.

Microsoft and XENIX are registered trademarks of Microsoft Corporation. UNIX is a registered trademark of AT&T. IBM is a registered trademark of International Business Machines Corporation. COMPAQ and DESKPRO 386 are registered trademarks of COMPAQ Computer Corporation.

And now we've made 386 software development faster as well. Our new XENIX System V/386 Toolkit—available for only \$395—lets you develop and run 386 programs on advanced machines like the COMPAQ<sup>®</sup> DESKPRO 386<sup>®</sup>.

For more information on the XENIX Toolkit, call (800) 227-4679.

**Microsoft<sup>®</sup> XENIX<sup>®</sup>**  
The High Performance Software.

The Microsoft XENIX System V/386 Toolkit requires either an IBM<sup>®</sup> PC AT with IBM PC XENIX Release 2.0 or SCO XENIX System V or a COMPAQ DESKPRO 286 or DESKPRO 386 with COMPAQ XENIX System V/286. Price shown is Microsoft's suggested retail price, and is subject to change without notice.

**CIRCLE NO. 6 ON INQUIRY CARD**



# We've got

## the most affordable, state-of-the-art data PBX you can buy.

### Period.

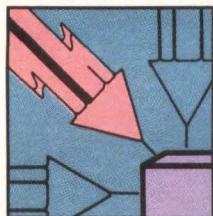

Sequel's SDC family is the first series of intelligent data switches to offer you all large network management features, whether you need a few or hundreds. Features like single sign-on, time-of-day clock, toggling, redundant power and logic, security call-back, and more.

#### **Think Small. Then Grow Big.**

You can start out with as few as six local ports and expand to as many as 1,536, worldwide. □ Sequel's SDC family links together terminals, I/O ports, printers, modems, and any device that sends or receives data up to 19.2K bit/s. Without line drivers or multiplexers. Even at maximum usage, the 19.2K bit/s rate persists.

#### **Meet The Three.**

The SDC 660 gives you a range of six to 60 ports. □ If you outgrow it, keep all the cards and buy the SDC 6192 chassis. Now you can grow to 192 ports. □ If you need to expand further, the SDC 6192 Network is the answer. Plug Sequel's local networking card into as many as 8 chassis and expand up to 1,536 lines.

#### **Break The \$100-Per-Port Barrier.**

With all this to offer and more, our switch costs less than any other. The low \$100-per-port price begins at 30 ports.

#### **Find Out For Yourself.**

Call today and we'll demonstrate to you why Sequel's SDC family is so fast, flexible, and affordable. And why Sequel means "We're What's Next."

#### **Standard Features Sampling**

- **Port contention by name, number, or class**
- **Help menus**
- **Simultaneous toggling**
- **Priority queing**
- **Auto baud**
- **Network status display**
- **Password-controlled protection**
- **Alternate destination routing**
- **Time-of-day reconfiguration**
- **Single sign-on**



# SEQUEL

Sequel Data Communications, Inc.  
5246 Greens Dairy Road Raleigh, NC 27604  
(919) 790-0300 Telex 5106002826

CIRCLE NO. 7 ON INQUIRY CARD



# LETTERS

## MORE FROM MAXTOR

To the editor:

The November issue of *Mini-Micro Systems* incorrectly stated in the Breakpoints section that large quantities of the 760M-byte model XT-8760E from Maxtor Corp. would not be available until 1988. Evaluation units of the product are available immediately, and production volume units will be shipped during the first quarter of 1987. Also, the article incorrectly identified Censtor Corp. as a supplier of vertical recording heads and media for the product. The XT-8760E achieves its capacity gains through longitudinal recording techniques.

**Skip Kilsdonk**  
Director of Marketing  
Maxtor Corp.  
San Jose, Calif. 95134

## MORE ON SINGLES

To the editor:

Your August product listing of single-board microcomputers was, as always, a comprehensive and highly useful reference guide. However, I would like to make a correction that may be of interest to your readers.

Our add-in board that contains a microprocessor, memory and other features for adding terminals to a multi-user system is listed under the product name PC-PLUS. Actually the \$985 add-in board is called PC-SLAVE/16.

**Nigel Spicer**  
Senior Vice President  
Sales and Marketing  
Alloy Computer Products Inc.  
Framingham, Mass. 01701

## HIGH INTEREST

To the editor:

The October issue (New Products) detailed Miltope's 3801 non-impact line printer. Thank you for including our product.

Unfortunately, the article listed a unit price of \$4,000 rather than the catalog price of \$84,000. Needless to say, it generated considerable interest!

**Robert J. Ceonzo**  
Director of Marketing  
Miltope Business Products Inc.  
Melville, N.Y. 11747

Bus Specific Networks

# IN HALF A SLOT

Interconnect Novell, Vianet, TurboDOS, and other ARCnet networks with our new half-size LANPC card.

Only from InterContinental Microsystems, now in a new half-slot size card, you can convert hard-working PCs to even harder-working LAN Intelligent Workstations, Diskless Workstations and File Processors. You get IBM PC bus-standard compliance, built-in complete controller for ARCnet modified token passing networks. And you can have a fiber-optic option. All with FCC approval. So you can have ARCnet capabilities in less space than ever before — in only half a PC slot. Just imagine the things you can do with the other half.

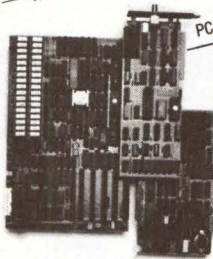

PC, ARCNET, AND S-100 APPLICATIONS.



**ICM**  
TOMORROW'S BREAKTHROUGHS TODAY  
InterContinental Microsystems  
4015 Leaverton Ct., Anaheim, CA 92807  
Phone: (714) 630-0964  
Telex: 821375 SUPPORT UD  
Easylink 62562040 BBS (714) 632-8750

CIRCLE NO. 8 ON INQUIRY CARD

## Stay Informed

Turn to the Inmac catalog for helpful hints and problem solving advice from our engineers. And for over 2,400

computer supplies and accessories displayed and described in detail. All have our exclusive 45-day trial and minimum 1-year guarantee.

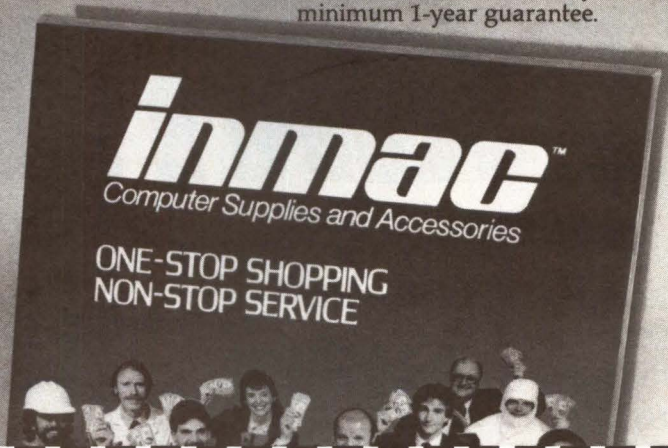

# FREE!

Call or write today. Yes...  
rush me your catalog  
today.

**800-547-5444**

**inmac™**

Name \_\_\_\_\_

Company \_\_\_\_\_

Address \_\_\_\_\_

City \_\_\_\_\_ State \_\_\_\_\_ Zip \_\_\_\_\_

Phone ( ) \_\_\_\_\_

2465 Augustine Drive, Santa Clara, Ca. 95054

CIRCLE NO. 9 ON INQUIRY CARD



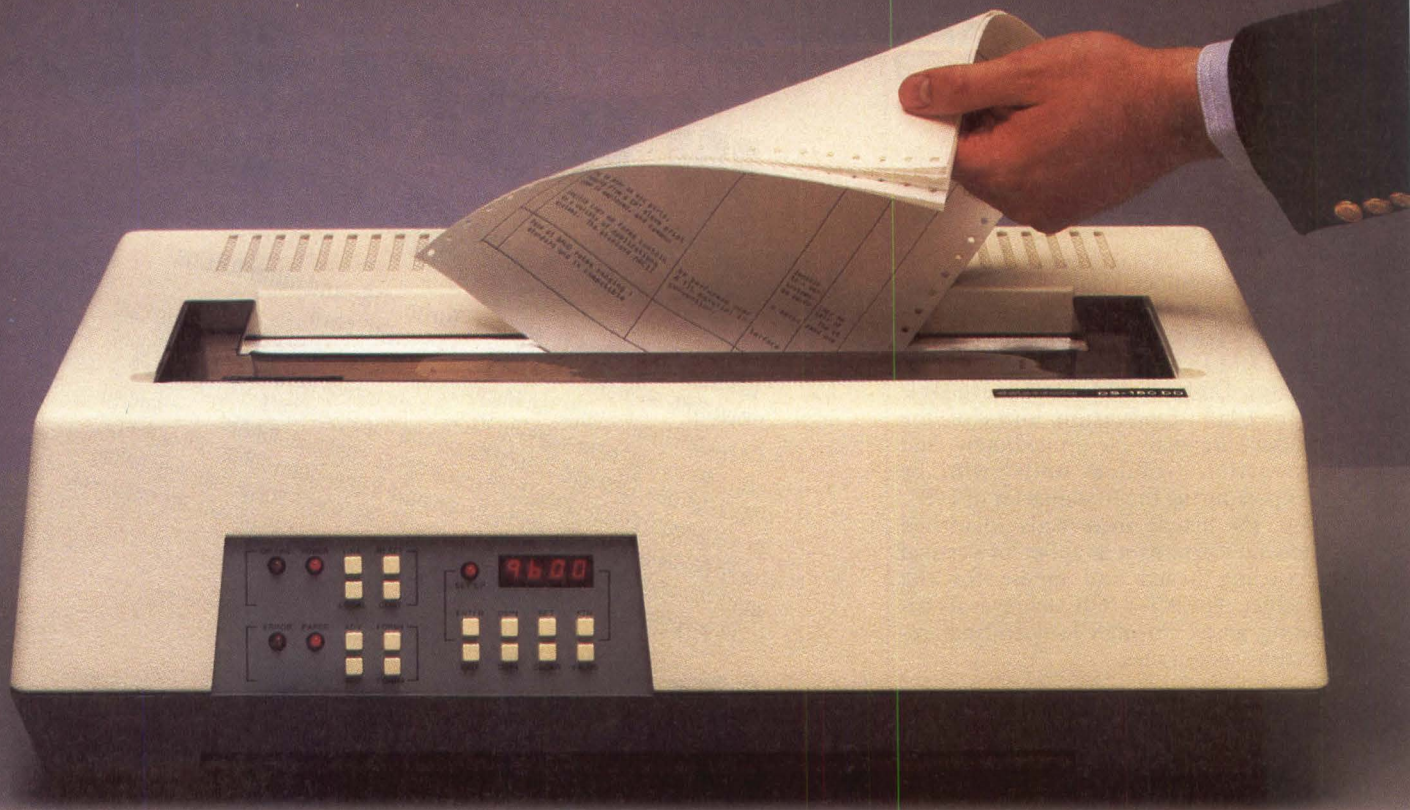

# RIP OFF THIS PRINTER.

Rip off hotel bills, airline tickets, invoices or any other type of form, up to six copies thick. Datasouth Demand Document printers put them out day and night, and let you rip them off without losing the next form.

Datasouth Demand Document printers feature bidirectional dot matrix printing at 180 cps. You can print to within 1/2 inch of the tear-off bar, without affecting the next form. The push-button front panel and LED readout make

our printers exceptionally easy to use.

There's a Datasouth Demand Document printer for almost any communications environment. The DS 180 DD has standard Serial and Centronics-type parallel interfaces. The TX 5180 DD emulates the IBM 5256, 5224 and 5225 printers in System 34/36/38 environments. And the CX 3180 DD emulates the IBM 3287 in 3270 environments.

No matter what kind of form you're printing, there's a Datasouth printer that could be doing it better. So call us at 1-800-222-4528, and ask about our Demand Document printers.

When you consider all the money-saving advantages, it's really quite a steal.



**Datasouth**  
AMERICA'S HIGH PERFORMANCE  
PRINTER COMPANY

P.O. Box 240947, Charlotte, NC 28224, (704) 523-8500, Tlx: 6843018, DASO U.W. SALES: 1-800-222-4528, SERVICE: 1-800-438-5050; West Coast Office: 415-940-9828.

IBM is a registered trademark of International Business Machines Corporation

**CIRCLE NO. 10 ON INQUIRY CARD**



# BREAKPOINTS

## **DEC REELS OUT BUNDLE OF REAL-TIME PRODUCTS**

Digital Equipment Corp. heightens its drive into such real-time processing areas as factory automation, assembly-line robotics, simulation and laboratory control when it introduces this month a group of board-level and system products based on its VAXELN application-development software. Upcoming: a single-board MicroVAX II computer, the KA620; repackaged 8000 series 32-bit minicomputers optimized for real-time; a variation of VAXLAB I/O software to allow data-input devices to exploit the VAXBI high-speed architecture; and a VAXBI version of the VAXELN MicroVAX board, as an alternative to the Q-bus board. The Maynard, Mass., company says it wants to be the first to offer higher performance throughout the VAX line and to provide a full set of VAXELN-based real-time software-development tools.—*Tim Scannell*

## **BIG OPPORTUNITIES SEEN IN SMALL BUSINESSES**

Resellers and OEMs looking for new business avenues might have better luck pursuing small businesses rather than Fortune 500-type companies. The National Federation of Independent Business, Washington, released findings some time ago that showed that the average small concern spends from \$25,000 to \$36,000 for computer equipment and about \$11,000 for software—for a total investment of about \$33 million, or up to eight percent of total annual sales in the industry. In addition, large corporations may not even be the best place to peddle multiuser systems and software. Bonnie Digrius, director of software market analysis for INPUT, a research company in Mountain View, Calif., says that multiuser systems are “really geared for individual companies and small businesses” —*Tim Scannell*

## **MICROTEK TIES SCANNERS INTO PC-TO-FAX LINK**

Look for February shipments of an add-in board from Microtek Lab Inc. that allows scanners, in conjunction with personal computers, to transmit documents to CCITT Group 3 facsimile machines. The Gardena, Calif., manufacturer plans to sell its MFAX card and software for \$995. The MFAX has a standard J11 jack to connect the IBM Corp. PC and compatibles to phone lines and can automatically dial up to 10,000 numbers. When used without a scanner, the MFAX can send multipage documents stored on a PC to a number of locations. Users can also enter a document into the personal computer via a Microtek scanner and transmit it to fax machines.—*Mike Seither*

## **ISDN TESTS START IN EARNEST; FIRST SERVICES EXPECTED NEXT YEAR**

Expect 1987 to be the year for intense testing of integrated services digital network (ISDN) products and technologies by the seven regional Bell holding companies. The first holding company to test ISDN at a user site, US West Inc., Denver, says it plans to have six tests under way by March. The first commercial ISDN service is expected in March 1988, offered by BellSouth Corp. in Atlanta (at the regional office of Prime Computer Inc. and at the Trust Company Bank of Georgia). How much for ISDN? A spokesman for BellSouth says the company will ask for rates 1.5



to 1.75 times higher than those for existing services. ISDN provides for simultaneous transmission of voice, data and video over twisted-pair wires.—*Jim Donohue*

### **HEWLETT-PACKARD HIGH-END WORKSTATIONS BOAST LOW PRICE TAG**

Look this month for a high-end workstation in six configurations from Hewlett-Packard Co., Palo Alto, Calif. The company claims its HP 9000 Series model 350 is the industry's lowest priced entry into the CAE/CAD market. It utilizes the 25-MHz Motorola Inc. MC68020 microprocessor, supplemented by a 20-MHz Motorola 68881 floating-point coprocessor. Standard features include 8M bytes of RAM and HP-IB and RS232C interfaces. Prices range from \$21,999 to \$54,900.—*Megan Nields*

### **FORCE BEGINS SAMPLING 80386 CPU BOARD FOR VMEBUS**

VMEbus board manufacturer Force Computers Inc., Los Gatos, Calif., a staunch supporter of the Motorola Inc. MC68000 line of processors, is now developing loyalties to Intel Corp.'s 80386. This month Force plans to ship small quantities of its CPU-386. The sample double-height VME boards come with 2M bytes of pipeline memory. Price: \$5,775. The CPU-386 features four sockets to connect up to 512K bytes of EPROM, as well as a socket for Intel's pending 80387 math co-processor chip. Within the next few weeks, Force says, the real-time '386 VRTX kernel, file and I/O management software from Hunter and Ready Inc. will be available for the board.—*Mike Seither*

### **DEC'S TIGHT LID ON VAXBI**

Peripherals manufacturers who feel left out by Digital Equipment Corp.'s unwillingness to open up its VAXBI high-speed bus architecture, which prevents connecting non-DEC disk drives, get no sympathy from the Maynard, Mass., company. According to Kenneth Olsen, president and CEO, VAXBI will remain proprietary, despite efforts by such subsystem makers as Emulex Corp. and System Industries to provide alternatives. Nor will VAXBI evolve to replace DEC's more popular Q-bus or UNibus architectures. Olsen offered this rationale for VAXBI's technological aloofness: "It's expensive, and almost nobody needs it."—*Tim Scannell*

### **SOFTGUARD GOES VIRTUAL WITH NEW '386 TOOLKIT**

Softguard Systems Inc., Santa Clara, Calif., the company that earned its spurs developing software-protection schemes for such notables as Ashton-Tate and Lotus Development Corp., has developed a VM 386 toolkit that allows developers to fully utilize the power of the Intel Corp. 80386 microprocessor by breaking the 640K-byte memory barrier. Members of the engineering staff of The Technical Assessment Group Inc. (TAGI), Saratoga, Calif., liken the tool kit to the IBM Corp. compiler/simulator development tool kit, SUPPAK 360.—*Carl Warren*

### **ADIC PLANS LOW-COST QUARTER-INCH TAPE SUBSYSTEM**

Expect Advanced Digital Information Corp., Redmond, Wash., to introduce a 40M-byte quarter-inch tape subsystem for under \$800. According to a company spokesman, the unnamed product will plug directly into the flexible disk controller on an IBM Corp. PC and will not require any modifications to the operating system.—*Carl Warren*



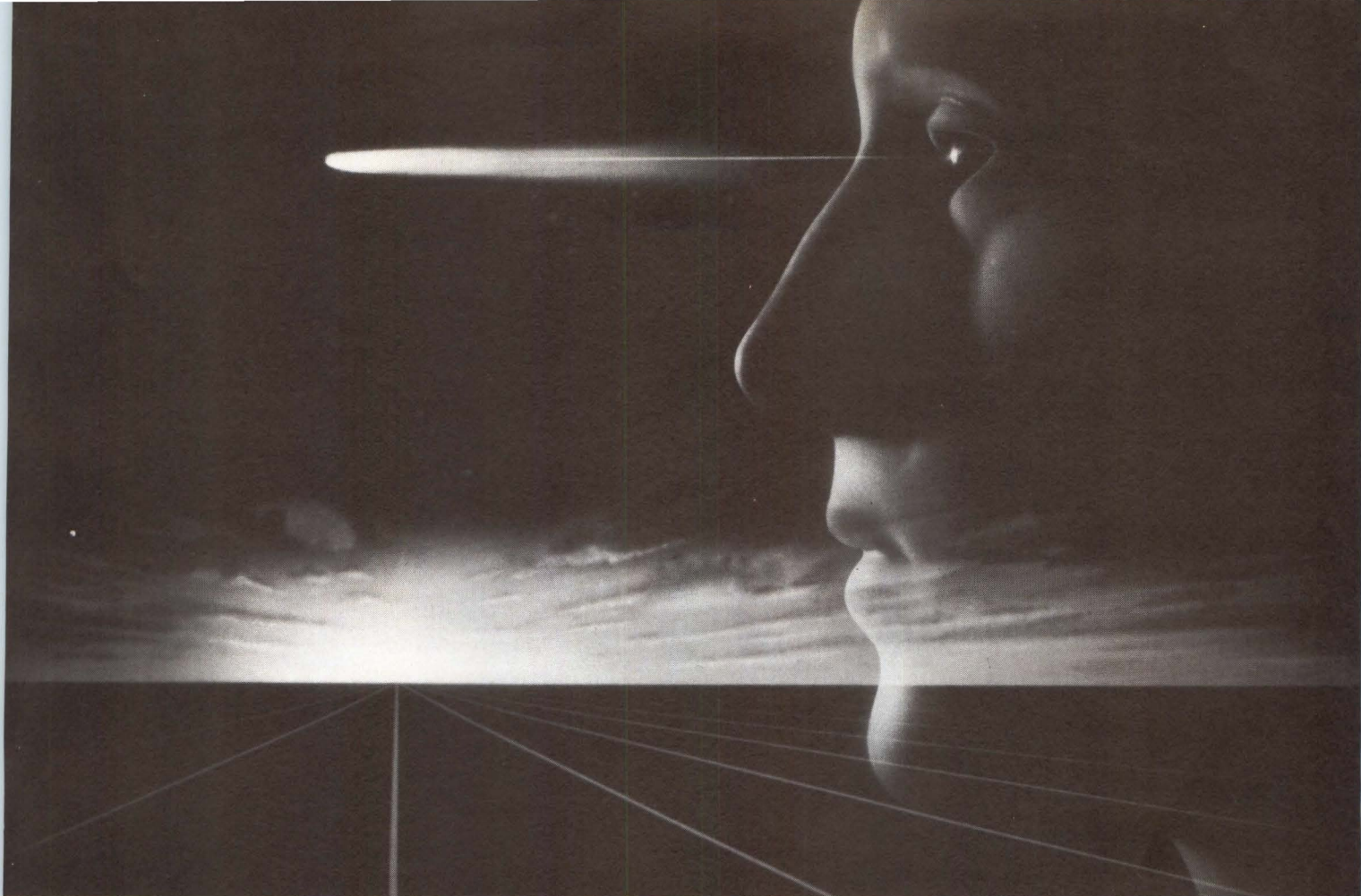

## YOU'RE FACING THE PROBLEMS.

### **INTERFACE '87** The force behind commu- nications and information networking solutions.

INTERFACE '87 unites you with the latest innovations in communications equipment and services. Networking products. LANs. Peripherals. Fiber optic systems. Software. Cabling systems. Office automation equipment and systems. Satellites. Earth stations. The solutions at the core of greater productivity.

To help you understand and implement the solutions you need, the INTERFACE '87 Conference reveals and explains the most pressing

## NOW COME FACE-TO-FACE WITH THE SOLUTIONS.

technical, applications, and management issues. Industry experts explore such topics as Virtual Connectivity, Voice/Data Integration, Network Implementation, and LANs. You'll examine case studies that reveal how others have solved problems you're facing. Learn new methods of meeting the increasing challenges your people and systems face. And equip yourself with new skills for coping with and conquering the age of technology.

And with such highlights as the gala Awards Banquet and the Executive Briefing, the show gleams with excitement and innovation.

INTERFACE '87 turns technological promises into solutions. Register now.

## **INTERFACE '87**

March 30–April 2, 1987  
Las Vegas Convention Center

### **I WANT SOLUTIONS NOW!**

- Send me complete attendee information.
- Send me information on exhibiting.

Name \_\_\_\_\_

Title \_\_\_\_\_

Company \_\_\_\_\_

Address \_\_\_\_\_

City \_\_\_\_\_

State \_\_\_\_\_ Zip \_\_\_\_\_

Return to: Mr. Irwin Stern  
The Interface Group, Inc.,  
300 First Avenue, Needham, MA 02194.

MMS/87

Produced by

☐ THE INTERFACE GROUP, Inc..

Co-sponsored by

**Data Communications** and **BusinessWeek**

CIRCLE NO. 53 ON INQUIRY CARD

© The Interface Group, Inc.



# The people who make Seagate





the first name in disc drives:

# Ron

The man who kept the moon clean now makes sure that Seagate drives are spotless.

Ron Hite, Seagate's Contamination Control Manager, was one of the pioneers of federal microcontamination standards as a "dust hunter" for many of America's space programs. He helped create the procedures that kept rocket interiors immaculate and the lunar surface free of contamination from the spacecraft.

Ron brings the same meticulous attention to detail to Seagate's clean rooms and other manufacturing facilities. In disc drives, like rockets, even the smallest speck of dust can interfere with the precise operations. Ron's expertise ensures the data integrity of our drives by keeping them free of microscopic contaminants.

OEMs have come to expect this kind of relentless emphasis on quality from Seagate. That's one reason they've bought more than 4 million of our 5¼" hard disc drives.

Seagate's reputation is built by its people. If you think your drives should be made by dedicated experts like Ron, call us.

800-468-DISC. In California, 800-468-DISK.



The first name in disc drives.

CIRCLE NO. 12 ON INQUIRY CARD



# DataFlex does windows!

The best DBMS just got better! Pop up help screens and pull down menus are now easy to accomplish in your DataFlex applications. Revision 2.2 gives you full and easily-programmed control over the size, color and location of every screen page and allows each to be displayed without disturbing other on-screen data. A new DataFlex command even allows you to temporarily suspend

execution of your DataFlex application, run any other program or DOS command, and then return to DataFlex at the point you left it! But best of all, DataFlex applications can run flawlessly on over 30 single user, multi-user and LAN operating systems! See your nearest DataFlex dealer today or write us and ask for your free DataFlex demo kit.

**GUARANTEED**  
to run as specified on over  
200 single-user and multi-user  
systems including IBM TOKEN  
RING NETWORK.

**DATA FLEX**  
Single-User • Multi-User • LANS • XENIX • UNIX V • VAX/VMS

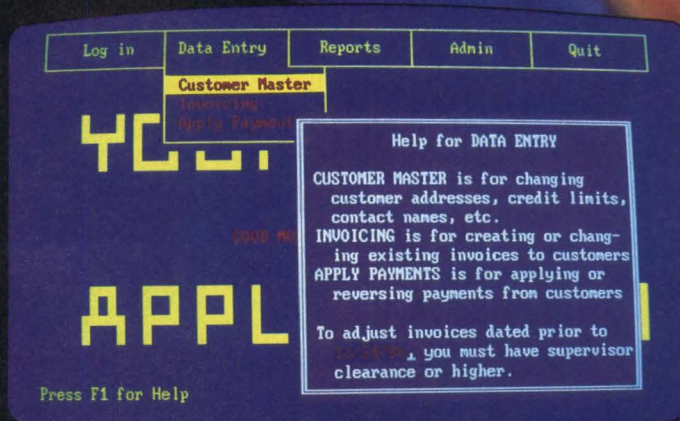

**Data Access Corporation**  
8525 S.W. 129 Terrace  
Miami, Florida 33156  
(305) 238-0012

DataFlex is a Registered Trademark of Data Access Corporation.  
XENIX is a trademark of Micro Soft.  
UNIX V is a trademark of AT&T.  
VAX/VMS are trademarks of Digital Equipment Corp.

CIRCLE NO. 81 ON INQUIRY CARD



# MINI-MICRO SYSTEMS

## EXCLUSIVE

### Xerox, Ventura campaign to press would-be publishers

**Mike Seither**  
Associate Western Editor

It goes by the somewhat unwieldy handle of Xerox Desktop Publishing Series: Ventura Publisher Edition. Some industry pundits are calling it the darling of desktop publishing software for the IBM Corp. PC, PC/XT, PC/AT and compatibles. Ventura Publisher, they say, for the first time brings to the PC the ease of use of page-composition software written for Apple Computer Inc.'s Macintosh — most notably Pagemaker from Aldus Corp.

For its part, Xerox Corp., which last year scooped up worldwide marketing rights for the program from its developer, Ventura Software Inc. of Morgan Hill, Calif., believes it has a winner. Its marketing plans for Ventura Publisher are anything but modest. In fact, industry insiders claim that Xerox, headquartered in Rochester, N.Y., has a \$10 million promotion budget in place to push desktop publishing systems. Although Xerox officials won't disclose specific spending plans, it's clear that the company is writing some sizable checks for advertising. Witness the recent spate of prime-time Xerox television spots.

"We want Ventura to do for desktop publishing what [Lotus Development Corp.'s] 1-2-3 did for spreadsheets," declares Larry Spellhaug, product business manager for Xerox's desktop publishing operation. "To do that, we are making the program as broadly usable as possible."

Although Xerox has been selling the first commercial release of Ventura Publisher—it lists for \$895—for

## USA Daily News

SPECIAL EDITION THURSDAY, OCTOBER 2, 1986 SEPTEMBER, 1986

### Xerox Shows Off Xerox Desktop Publisher at Conference

SAN FRANCISCO (VP) — Xerox Corporation has introduced its first electronic publishing software product that runs on industry standard personal computers. Xerox chose the Seybold Conference to announce the price and availability of the software package. Conference attendees were impressed by the speed of the product and its depth of functionality.

Product will be widely available. The Xerox Desktop Publishing Software Series: Ventura Publisher Edition will be made available through Xerox authorized dealers (including ComputerLand), and the Xerox Business Software Center via an 800 number, and the Xerox

### ELECTRONICS IMPORTS

Year	Japan	Korea	Taiwan	Singapore
1965	~100	~50	~20	~10
1975	~250	~150	~80	~40
1985	~550	~350	~180	~90

### Xerox Desktop Publisher Edition Redefines Desktop Publishing

MORGAN HILL (VP) — Xerox Desktop Publisher Edition has added new meaning to the term "Desktop Publishing." Before the introduction of Xerox Desktop Publisher Edition, Desktop Publishing was primarily for drawing packages that had to be handled by hand-drawn packages that were used to doing graphic artists and were used to doing personal computer in electronic paste. While this approach of artists to pick up, result in much time saving because the user was still faced with the drudgery of hand-adjusting each piece of text on the page. Fortunately, the software developers at Ventura Software Inc. recognized this and

Complex page with many fonts being used in with a large amount of graphics. Many printers will fully print a page this complex.

Mini-Micro Systems

Ventura Publisher Edition, marketed by Xerox, was used to integrate the text and AutoCAD graphics in this document, which was produced on a Xerox 4020 ink-jet printer.

only two months, a new version is scheduled to be in the distribution pipeline this quarter, says Spellhaug.

Version 1.1 of Ventura Publisher will feature three key enhancements: operation with all the major page-de-



# UNIX Users

## Connect Your VAX, NCR Tower and Others to Ethernet with TCP/IP

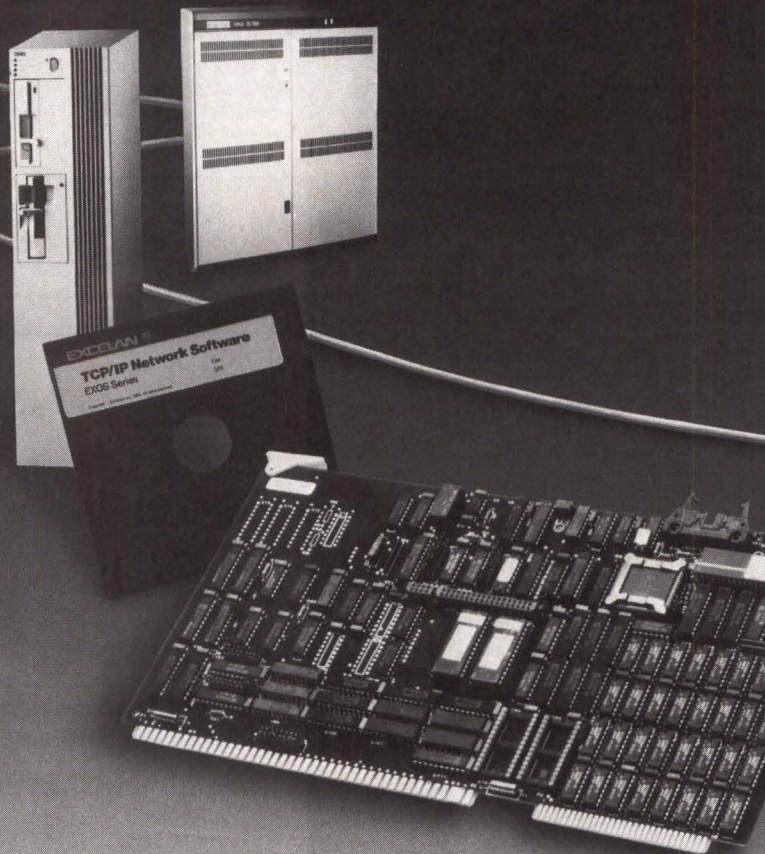

- Complete solution
- Applications: Mail (*uucp*), FTP, TELNET, R-Utilities
- Hardware: On board TCP/IP and TELNET Server with 512K RAM
- Development library:
  - A socket programming interface
- 1 year warranty on hardware
- Field proven, thousands of installations
- Unbeatable price performance

For all the details to suit your individual needs,  
Call 800-EXCELAN or 800-521-3526 in Calif.

**EXCELAN**

2180 Fortune Drive, San Jose, California 95131 Fax 408-434-2310 Telex 176610

scription languages (PDLs), support of more word processing programs and the addition of foreign-language editions.

With version 1.1, Ventura Publisher will offer support for two more page-description languages—DDL (Document Description Language) from Imagen Corp. and Interpress from Xerox. These languages sit between the page-composition program and the printer (or typesetter) and translate font and graphical information into raster images, which the printer reproduces. In addition, they control such printing functions as colating pages and determining the number of documents produced. The original Ventura Publisher works only with the PostScript PDL, which is licensed to manufacturers of laser printers and typesetters by Adobe Systems. PostScript was instrumental in making Apple's LaserWriter printer and other manufacturers' printers hits with desktop publishing fans.

Because of Xerox's efforts to promote its own Interpress language, the company's support of DDL and PostScript has baffled many analysts. "It's confusing to me," admits Ajit Kapoor, director of the electronic publishing industry service for Dataquest Inc., the San Jose, Calif., market-research concern. "How can a company go out and ask for one standard [Interpress], then support two others [DDL and PostScript]?"

To date, Interpress has only been available on the high-end Xerox 3700 and 9700 laser printers, which produce from 20 to 120 pages per minute. Whether Xerox will offer the language on its low-end laser printers, like the 4045 (or on newer ones), is still unclear.

Other observers claim that Xerox had no choice but to bite the bullet and support languages other than its own. "Xerox realized early in the game that Ventura [Publisher] would die, if it didn't support PostScript," says industry watcher Tony Bove, co-publisher of *Desktop Publishing*, a Woodside, Calif., newsletter. "Now Xerox realizes the same is true of DDL."



One possible reason? Late last year Hewlett-Packard Co. announced that its best-selling Laserjet printers would support DDL. Not long after HP got behind DDL, Cordata Technologies Inc. also announced that its laser printers would operate with Imagen's PDL.

Insofar as Ventura Publisher is concerned, the company line at Xerox now is to support any emerging standards. "Obviously, our primary support is for Interpress," says Spellhaug. "By the same token we feel very strongly about Ventura, and we don't want it locked out of a segment of the market because it can't address DDL. It's still to be seen how the market will react to HP's support of DDL, though a vendor of [HP's] caliber certainly has to be respected."

The additional word processing programs version 1.1 will support are IBM's DisplayWrite and XyQuest Inc.'s XyWrite. The new release will also support IBM's Document Content Architecture (DCA) files. The program currently accepts formatted text from, and stores it back to, Xerox's Writer, MicroPro International Inc.'s WordStar, Microsoft Corp.'s Word and Windows Write, MultiMate International Corp.'s MultiMate and Satellite Software International's WordPerfect, as well as word processors that generate standard ASCII files.

While the program now supports a full international character set, version 1.1 will feature user interfaces in U.K. English, French, German, Italian and Spanish, as well as hyphenation algorithms for each. "Our ultimate goal is to support a dozen languages," says Ventura president John Meyer.

#### All channels are open

Xerox's marketing strategy for Ventura Publisher is to get the package into all the major distribution channels. The first effort has been through direct sales to Xerox's existing base of corporate accounts. Xerox can now offer those customers a turn-key desktop publishing system by bundling Ventura Publisher with its

# VMS Users Connect Your VAX or MicroVAX to Ethernet with TCP/IP

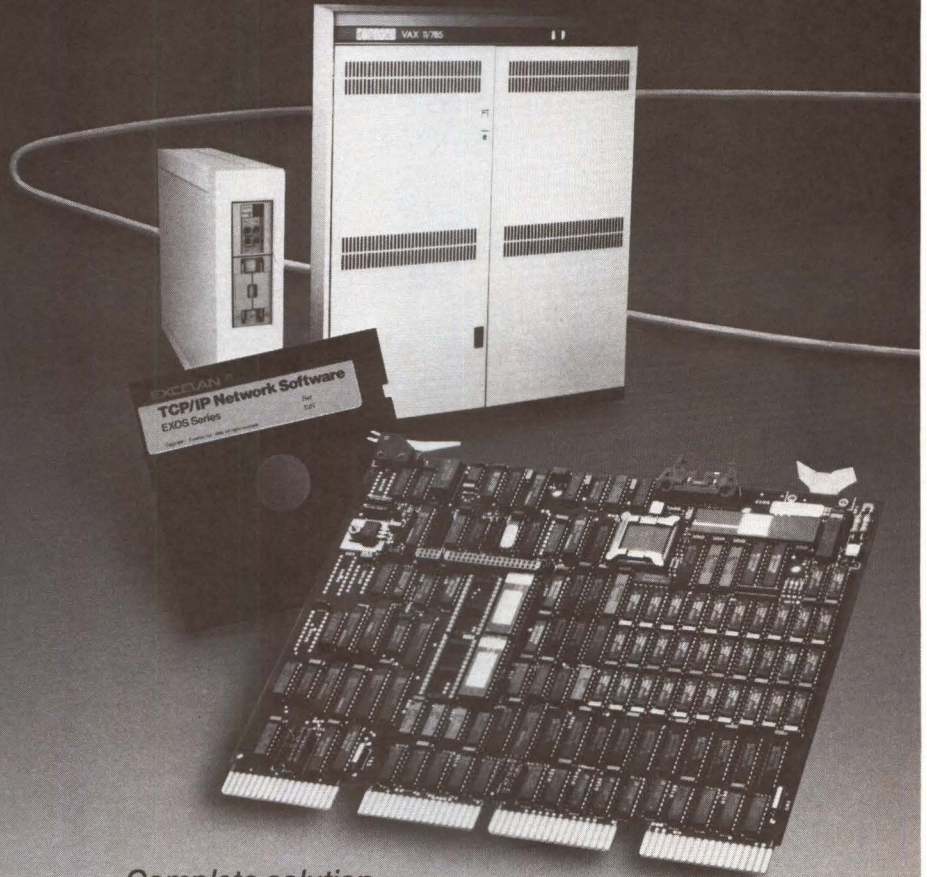

- Complete solution
- Applications: Mail (SMTP), FTP, TELNET
- Hardware: On board TCP/IP and TELNET Server with 512K RAM
- Development library:
  - A QIO programming interface
- 1 year warranty on hardware
- Field proven, hundreds of VAX customers
- Unbeatable price performance

For all the details to suit your individual needs,  
Call 800-EXCELAN or 800-521-3526 in Calif.

**EXCELAN**

2180 Fortune Drive, San Jose, California 95131 Fax 408-434-2310 Telex 176610





# GOOD LOOKS. GREAT PERSONALITY.

We've got more than just good looks. At \$599 the Freedom<sup>®</sup> ONE Turbo terminal has more horsepower than

DEC's VT220 and WYSE's WY-50 combined. The Turbo is loaded with emulations of the most popular ANSI and ASCII terminals plus the extra personality of a PC terminal that allows you to use it as an added workstation in a Personal Computer AT<sup>™</sup> multi-user application. These versatile operating modes, ultra-sleek styling and display clarity second to none, make the Freedom ONE Turbo a pretty, smart alternative.

Built by the same people who manufacture Princeton Graphic monitors and workstation products for Harris Lanier, the Freedom ONE Turbo is backed by a "no worry" **three year limited warranty** and a nationwide network of Authorized Service Centers.

To get a good look at the great personality of the Freedom ONE Turbo, call us today at (415) 742-7000.

 **Liberty**  
*We make terminals.*

DEC, VT220, VT100, and VT52 are registered trademarks of Digital Equipment Corporation. Personal Computer AT is a registered trademark of IBM Corporation. Princeton is a registered trademark of Princeton Graphic Systems. WYSE is a registered trademark. WY-50 is a trademark of Wyse Technology. Freedom is a registered trademark of Liberty Electronics, U.S.A.

CIRCLE NO. 17 ON INQUIRY CARD



6065 personal computer and 4045 laser printer.

Second, Xerox has stepped up its emphasis on OEM deals. Among the first to sign on were Univation Inc., Milpitas, Calif., and Tall Tree Systems, Palo Alto, Calif. Univation sells Ventura Publisher with its \$1,400 Turbo Publisher add-in board for the IBM PC. Tall Tree combines Ventura Publisher with its Jlaser PC boards, which can be used in conjunction with any printer built with the Canon U.S.A. Inc. laser engine. The Jlaser board occupies a PC expansion slot and uses a high-speed video connection that bypasses the printer's serial-port controller.

Bob Ford, manager of Xerox's OEM marketing program in Dallas, claims that about 50 OEMs are now evaluating Ventura Publisher. They run the gamut from minicomputer

vendors established in the office-automation market to manufacturers of personal computers and laser printers, who would package the page-composition software with their products.

For customers who order more than 200 packages a year, Ford says that Xerox will consider writing conversion programs (on a bid basis) to allow Ventura Publisher to accept additional application packages like those for word processing and graphics. Besides its announced support for more than half a dozen word processors, Ventura Publisher also can integrate graphics from Lotus 1-2-3, Autodesk Inc.'s AutoCAD, Digital Research Inc.'s GEM Draw and GEM Graph, and Zsoft Corp.'s PC Paintbrush. It also integrates DXF files created by computer aided design programs.

**PC OVERTAKES MAC**

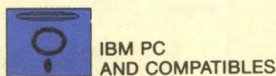
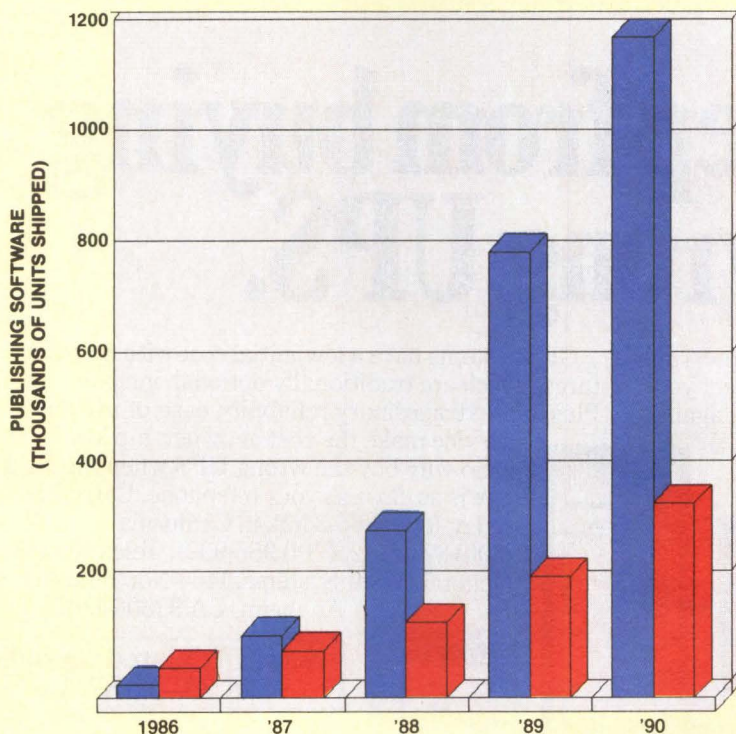

SOURCE: DATAQUEST INC.

# VME

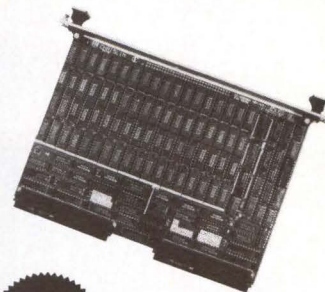

# 16MB

**4MB, 8MB or 16MB  
in one VMEbus slot.**

Chrislin has produced a product that surpasses the performance characteristics that were once regarded as the standard on the VMEbus.

The CI-VMemory is capable of handling a full 16 MEGA-BYTES ON ONE CARD (also available with 4MB or 8MB). The memory supports 32 or 24 bit addressing. The CI-VMemory has an unprecedented average access time as low as 180ns on reads and 60ns on writes. The 4MB or 8MB are easily field upgradeable to 16MB.

**CALL TODAY FOR  
MORE DETAILS  
(818) 991-2254**

*Over a decade  
of leadership.*

**Chrislin  
Industries**

31352 Via Colinas  
Westlake Village, CA 91362  
Phone: (818) 991-2254  
TWX 910-494-1253  
(CHRISLIN WKVG)

CIRCLE NO. 18 ON INQUIRY CARD





Too big.



Too noisy.

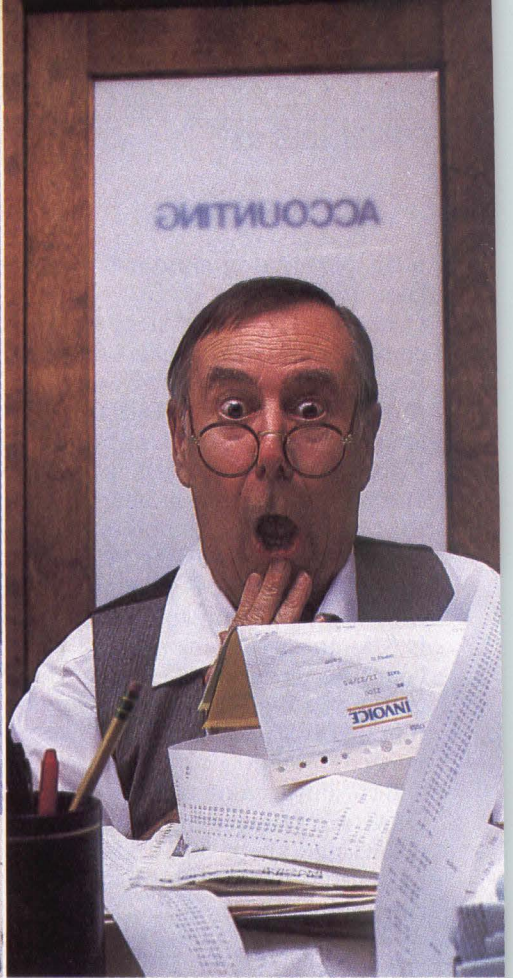

Too much.

# How to keep from buying the wrong UPS.

If you've been told a big, noisy, expensive uninterruptible power supply is the only way to really protect your power-based system from error or disaster, look again.

Yes, you do need a UPS.

But a UPS doesn't have to hog half your computer room, or put your staff—or your treasurer—into shock. Not when the UPS is from General Power Systems.

GPS is the pioneer in transistor-based UPSs with all the benefits that implies—small, quiet, cool, reliable, efficient. In fact, a GPS system is often half the size of another supply of comparable power. And because GPS manufactures the most complete line of UPSs on the market, we have what you need—on-line models from 500VA to 50KVA, and exceptionally small standby systems from 200VA to 2000VA with transition times as low as 2ms.

GPS systems have a low initial cost with many features, which are traditionally optional, included free. Plus, our extraordinary reliability, ease of use and service make the cost of ownership low.

So why buy the wrong UPS when the right one is as close as your telephone. Call GPS today. (800) 854-3469, in California (800) 824-8912, (714) 956-9321, Telex 182283. General Power Systems, 1400 North Baxter St., Anaheim, CA 92806-1201.

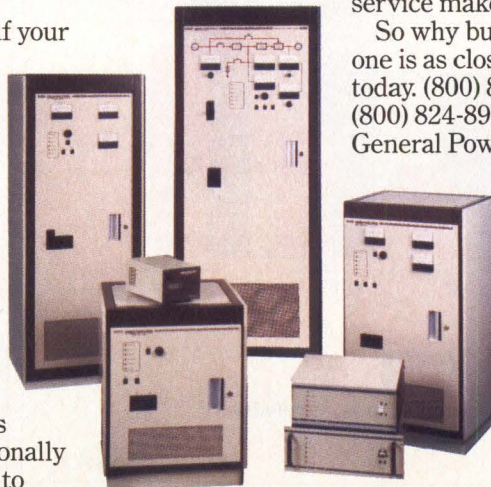

Now, UL Listed models  
1KVA-10KVA.

## GENERAL POWER SYSTEMS

A Division of ALS Corporation

CIRCLE NO. 19 ON INQUIRY CARD



In the OEM world Xerox is also attracting the attention of monitor manufacturers, a number of whom showed Ventura Publisher running on high-resolution devices at Comdex/Fall. For example, Sigma Designs Inc., San Jose, Calif., introduced its LaserVue system, which consists of a driver for Ventura Publisher, an adapter board for the IBM PC, PC/XT or PC/AT and a choice of 15-inch or 19-inch monitors with resolutions of 1,664 by 1,200 pixels.

Conographic Corp., Irvine, Calif., also showed its Conovision 2800 operating with a Ventura Publisher driver. The system includes a raster image processor and adapter cards for the PC, plus a display with a resolution of 1,440 by 1,024 pixels.

And Verticom Inc., Sunnyvale, Calif., displayed its Desktop 480, an IBM PC video-display adapter card that operates multisynchronous monitors at 640 by 480 pixels.

Ventura president Meyer says that, with monitor vendors offering their support for PC publishing software, users are able to get performance previously available only with more expensive workstations from companies like Sun Microsystems Inc. With a monitor like Sigma Design's LaserView Display System, it's possible to display two full pages and work on both at the same time. Although Ventura Publisher supports most major graphics standards now available for the PC, such as IBM's enhanced graphics adapter and Hercules Computer Technology's monochrome adapter, they fall far short of the capabilities of high-resolution monitors.

#### Dealer's choice

It should be noted that monitor vendors are supporting not just Ventura Publisher, but the growing number of page-composition programs now coming on the market for the IBM PC and clones (see "Desktop publishing: sifting type from hype," Page 57). These include Pagemaker from Aldus Corp. and Harvard Professional Publisher by Software Publishing Corp.

Besides moving Ventura Publisher

#### FACT FILE

Xerox Ventura Publisher Edition

##### Xerox Corp.

101 Continental Blvd.  
El Segundo, Calif. 90245  
(800) 822-8221

Circle 473

\*Desktop publishing software for IBM Corp. PC, PC/XT, PC/AT and compatibles.

\*Produces documents on printers that support the three major page-description languages: PostScript, DDL and Interpress. Native-mode drivers include IBM Proprinter, Epson America Inc. MX-80 and FX-80 and laser printers from Xerox, AST Research Inc., Cordata Technologies Inc. and Hewlett-Packard Co.

\*Allows integration of text and illustrations generated by most popular word processing and graphics programs, as well as scanners, including WordStar, Multimate, WordPerfect, GEM Draw, Lotus 1-2-3, AutoCAD, Dest and Microtek.

\*Formats up to eight columns (same or different widths) per page. Text flows automatically from page to page. Produces documents up to 5,000 pages in length.

through OEM and direct-sales channels, Xerox also hopes to attract dealers. Xerox recently announced distribution agreements for Ventura Publisher with two major computer retailers: ComputerLand Corp. and MicroAge Computer Stores Inc. Combined, these two companies have about 700 retail stores. In addition, they sell to large corporations. But it is in the dealer channel—which Xerox says it will strongly support—where the company is expected to meet its strongest challenge. The main contender will be Aldus, which has sold more than 30,000 copies of the Macintosh version of Pagemaker over the last year and a half. Most of the Pagemaker packages have gone out through dealers.

"Aldus has built up dealer awareness of Pagemaker," says industry observer Bove. "Since the PC version is identical to the Mac version, dealers will be able to sell it more easily than Ventura."

However, Bove adds that, while Ventura Publisher may have a better feature mix than Pagemaker, Xerox has still to prove that it can sell personal computer software in volume to dealers. □

## Florida Data offers the world's fastest serial matrix printers

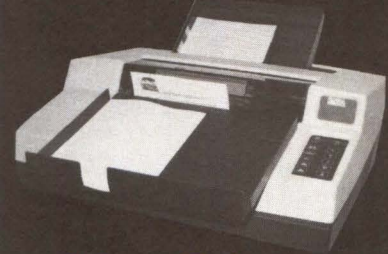

Line Printer performance at half the cost!

Up to 300 LPM at 600 CPS

#### Standard Features

- 8 Resident Fonts
- Speeds: 75 CPS LQ – 600 CPS DP
- Tractors and Cut-Sheet Feeder
- 1 Billion Character Life Head
- Dual Interface: RS232 & Centronics
- Multi-Part Forms Handling
- Exclusive Preprinted Forms Aligner
- 20 Function Control Panel
- Heavy-Duty Modular Construction

#### Optional Features:

- Over 200 Fonts Including: Bar Codes, Languages, Signature, OCR, Large Characters, Custom
- Downloadable Fonts on PC Disks
- Graphics of 360H X 384V DPI
- Mainframe Interfaces
- NCR On-Site Nationwide Service

Call or Write Today for Literature and Print Samples

**FLORIDA DATA**

600D John Rodes Blvd.  
Melbourne, FL 32935  
(305) 259-4700  
Telex: 56210 FDC MELB

CIRCLE NO. 20 ON INQUIRY CARD



# INTERPRETER

## MINICOMPUTERS

# IBM, Digital square off to capture 'work-sharing' market

Tim Scannell, Senior Editor

At Digital Equipment Corp.'s recent annual meeting, company president and chief executive officer Ken Olsen spent a lot of time talking about the past.

As he addressed both stockholders and analysts, he cited such events as the unveiling of the first modem, the origin and evolution of networks and even the development of the first VAX minicomputer some 12 years ago. His audience listened patiently, not because they had not heard these things before, but because they knew Digital—having recently reported a 153 percent increase in profits and a 26 percent jump in sales—was on

financially solid ground and could afford to take time out to look back.

IBM Corp., on the other hand, is not in a position to dwell on the past. Company employees are so concerned with the problems IBM is experiencing now, they can't afford to be anything but deadly serious about operations and directions.

For example, at a recent press conference in New York, IBM introduced a series of machines aimed directly at the DEC marketplace. IBM called upon a cadre of its vice presidents to explain how its new machines—unofficially dubbed "VAXBusters"—were designed for connectivity and departmental computing and how they would extend the company's 370

mainframe architecture downward. Also, for the first time, IBM used satellites and closed-circuit television to broadcast the introduction of the 9370 superminicomputer series to 15 locations and more than 3,000 customers.

These are tough times for IBM, and getting the word out about offerings is as crucial as coming out with the right products; particularly if it wants to make a dent in the U.S. VAX population—currently numbering about 41,500 sites, according to Computer Intelligence, a La Jolla, Calif., market-research company.

### Which way did they go?

But whether or not IBM's new strategy to port 370 applications down and distribute system capabilities over physically different locations will be successful is the subject of much debate. Even DEC's Olsen, usually silent when asked about the competition, admits to some confusion over IBM's new direction.

"The 9370 seems to imply they are going after our [systems]. But there are so many changes taking place in that 'other world' that I can't keep up with them," Olsen said at DEC's annual meeting. "At least it doesn't make sense to me."

IBM's chief corporate target is not the only one confused. Although the idea of porting 370 applications to mid-range processors is a good one, present and future users of IBM systems may raise questions about the 9370's positioning and the company's strategy for new entrants.

For example, although the systems are designed to attack DEC's "work-sharing" architectures—which allow small groups of users to share a common database and files—field testing and early support of the 9370 systems will not start until sometime next month. Volume shipments, of several

### THE BUILDING BLOCKS OF IBM 9370s

Model	Memory (M bytes)	No. of internal I/O buses	No. of I/O card slots	Min./max. attachable storage (M bytes)
9373-20	4/16	1	7	368/6,592
9375-40	8/16	4	17	368/13,184
9375-60	8/16	4	17	368/13,184
9377-90	8/16	2/6	10/54	368/39,552

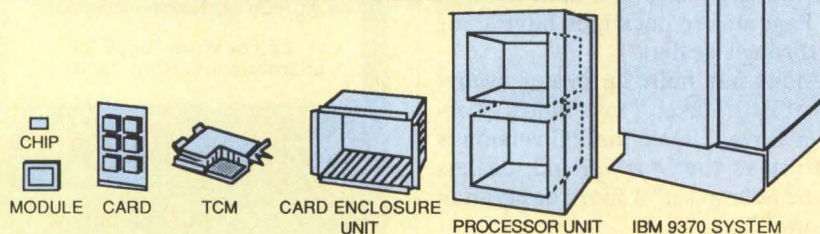

SOURCE: COMMUNICATION SOLUTIONS INC.

In the 9370 model 90, logic chips are mounted on substrate housed in an air-cooled thermal-conduction module (TCM).



# With the right connections, you'll open new windows of opportunity.

Your opportunities depend directly on your ability to react to a changing marketplace. And each step you save in R&D helps you get your products to the market faster — *before they're obsolete.*

At KMW, we've got the connections to help you achieve that goal. So while your designers concentrate on what they do best, we supply data conversion and communications products ready to integrate with them.

For almost a decade, KMW has pioneered integrated answers to imaging and data conversion problems.

Our Auscom division is the industry leader in reliable high-speed channel interfaces for IBM® mainframes.

Fourth generation

KMW protocol converters allow local or remote attachment for serial and parallel asynchronous devices to IBM systems. And our graphic element processors offer a complete graphic subsystem for connecting monochrome or color raster hard copy devices.

So the technology that you need probably already exists at KMW. And if it doesn't, we'll design a custom solution.

By taking advantage of our connections, you can concentrate on your particular technology. R&D time and expenses are reduced, as is the need for support staff to service products for connectivity. You're free to capitalize on new opportunities.

If you're still not familiar with the total resources of KMW, join the growing number of Fortune 500 companies who are. Call 1-800/531-5167 (in Texas, 512/288-1453) or write KMW Systems Corporation, 8307 Highway 71 West, Austin, Texas 78735.



**KMW  
SYSTEMS  
CORPORATION**

*For the right connections*

Auscom is now a division of KMW Systems Corp.

IBM® is a registered trademark of International Business Machines Corp.

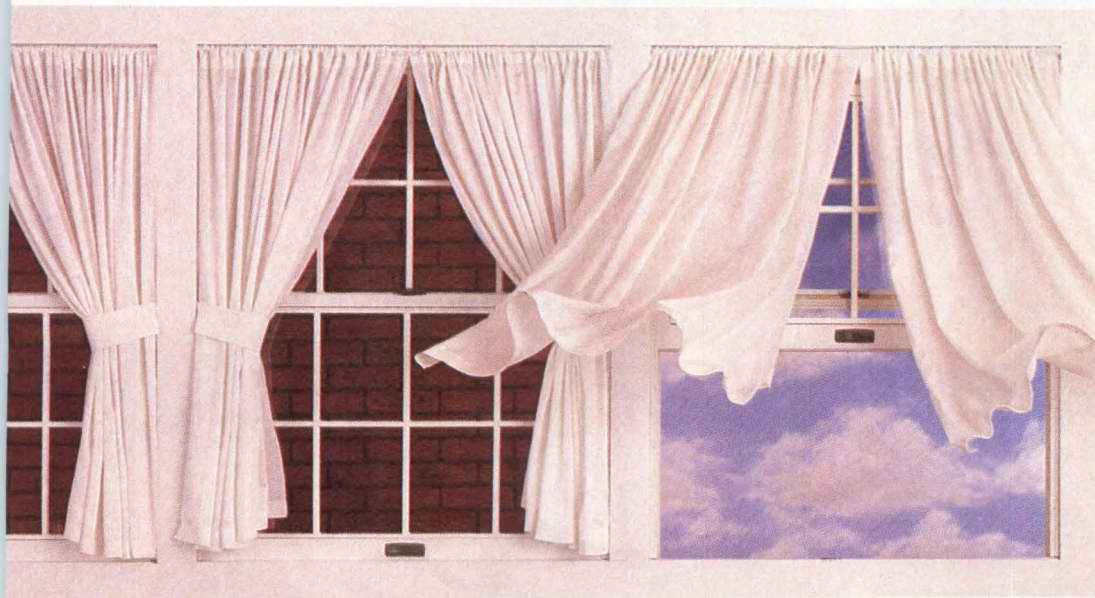



NEC WOULD LIKE TO WISH ALL  
ITS DISK DRIVE COMPETITORS  
MANY HAPPY RETURNS.





**NEC guarantees a DOA rate of less than 1%.**

A high DOA rate can take a big chunk out of your bottom line.

After all it takes 15 to 20 minutes to test one drive. And if the drive doesn't work you have to spend even more time repacking it and sending it back. Then you have to sit and wait for a replacement.

NEC can make your life much happier. Just ask and we'll guarantee the lowest DOA rate in the industry—less than 1%. In writing. What you'll likely get from our competitors is 5-10%.

A low DOA rate is just the icing on the cake. NEC disk drives are also more reliable over the long run. In fact, in the average lifetime of any NEC drive, 9 out of 10 will never fail.

NEC has been designing and improving disk drives for over 25 years. Way back in 1959, we were one of the first to create magnetic recording devices. NEC has grown up to be a 13 billion dollar worldwide company. So you can expect continuing products and support.

If other disk drive suppliers keep sending you surprises instead of drives that work right out of the box, call in NEC. You can reach us at 1-800-343-4418. (In Massachusetts call 617-264-8635.) Or write NEC Information Systems, Inc., 1414 Massachusetts Avenue, Department 1610, Boxborough, MA 01719.

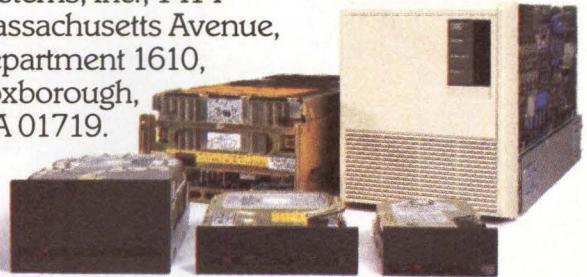

**NEC DISK DRIVES.  
RELIABILITY RUNS IN THE FAMILY.**

**NEC**

NEC Information Systems, Inc.



# HI-TECH NOISE KILLER

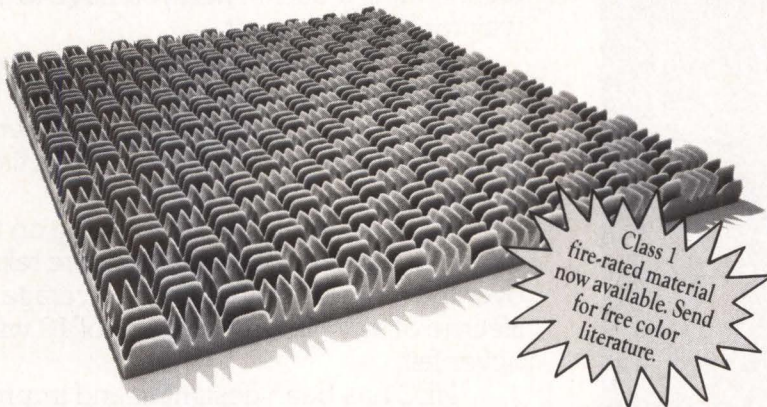

Class 1  
fire-rated material  
now available. Send  
for free color  
literature.

SONEX acoustic foam is deadly to annoying computer room noise. And it'll look great in your hi-tech environment. Simply hang sheets of this patented, professional foam to quiet the combined clatter of fans, motors and printers. Call or write for complete facts and a free brochure: 3800 Washington Ave. North, Minneapolis, MN 55412. (612) 521-3555.

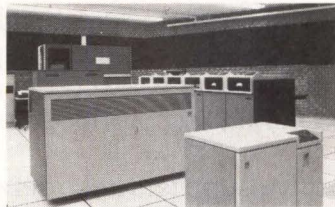

**illbruck**

CIRCLE NO. 22 ON INQUIRY CARD

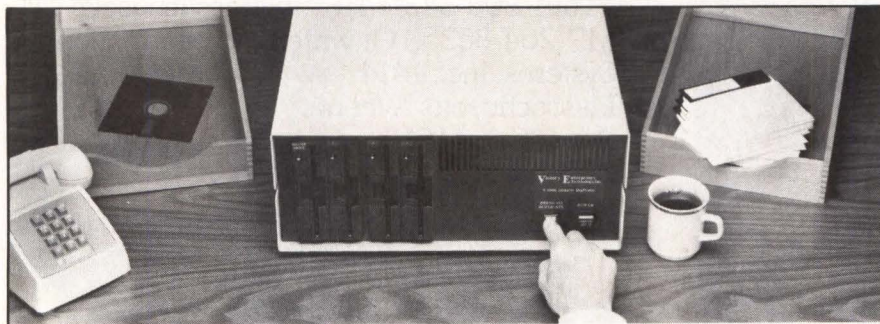

## Copying diskettes will never be easier than pushing one button.

While your computer is busy doing other things, your Victory Duplicator can be making as many as eight copies of a diskette at once—producing up to 400 copies in an hour. DualMaster™ models can even make multiple copies of two different diskettes simultaneously. Just insert the diskettes and press one button.

### Copy different formats, flawlessly.

An automatic format analysis program makes it possible for the Victory Duplicator to

copy virtually any 5¼, 3½ or 8-inch diskette. The system tests for quality and accuracy at every stage of the process.

### It practically services itself.

Each drive has a separate controller to maximize up-time. Simple diagnostics to verify drive alignment and industry standard drives allow you to maintain your system without waiting for outside service.

### All at an attractive price.

Victory Duplicators offer fast copying, serialization,

copy protection, a communications port, a four-month warranty and much more—all for one low price.

### Call 1-800-421-0103.

Call today for more information. (In Texas, call 512-450-0801.)



**VICTORY  
ENTERPRISES**  
Technology, Inc.

8910 Research Blvd., Suite B2  
Austin, Texas 78758

©1986 Victory Enterprises Technology, Inc.

CIRCLE NO. 23 ON INQUIRY CARD

## INTERPRETER

thousand processors or more, will not start until the second half of the year. In fact, some local area network and enhanced ASCII features will not be available until the fourth quarter, according to an IBM spokesman.

Also, while the 9370 computers open a pathway for 370 mainframe users to distribute computing power and applications, they further splinter IBM's systems line. They create yet another incompatible tier of computing. For example, the top 9370 system, the 9377-90, overlaps IBM's 4381 model 11 and offers from 10 percent to 15 percent more performance, according to Michael J. Quinlan, president of IBM's North Central Marketing Division in White Plains, N.Y. The low-end 9373 model 20 performs at a ratio of 1-to-5 compared with the 4361 model 3. The 9373 model 20 offers 25 percent more performance and roughly twice the price/performance ratio, Quinlan says.

### They went disarray

Although the 9370 is presented as a small-systems solution to 370-architecture applications, present customers—especially those already using IBM System/36 and System/38 computers—may be confused as to which system is the right choice. All three compete in the same market.

Not to worry, says IBM Southwest Marketing Division president Robert E. Dies in Atlanta. The 9370 is specifically aimed at new users who want to distribute 370 capabilities and not at System/36 or /38 customers who already use those systems for distributed processing. In fact, at the time of the 9370 series unveiling, IBM announced a new link-protocol converter that reportedly lets users switch easily among 370 and System/36 and /38 applications.

"Many customers have extensive System/36 and System/38 applications code, and we would anticipate they will continue expanding their networks and using these systems, either one at a time or as part of a network."

The 9370 Information Systems family consists of four processors: the 9373 model 20, the 9375-40, the 9375-60, and the 9377-90. The lineup



# COST SAVING CONNECTIONS

RS232 INTERFACE PROBLEM SOLVERS...FROM WESTERN TELEMATIC INC.

## END DATA SWITCHING PROBLEMS



Is switching data cables becoming a pain in the ASCII? Automatically switch between computers, printers, instruments—just about any RS232 device.

Economically expand computer ports, access multiple computers or remote peripherals.

From simple AB switches to intelligent 196 port code activated switching systems, our reliable, easy to use, interface switches will help end your interconnect problems.

## EFFICIENT PRINTER SHARING

It's time to make more efficient use of your expensive printers. Share up to two plotters, daisy wheel, dot matrix or laser printers with up to 8 computers, word processors or CAD systems. Ideal for the automated office, school or engineering lab.

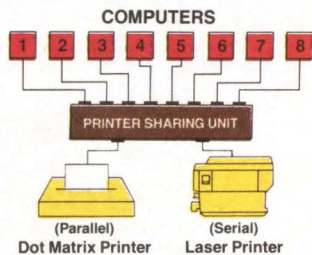

Our 4 or 8 port Printer Sharing Units work automatically with up to 256K buffering. No cable switching or knobs to turn. Software changes are usually unnecessary since they use standard Ready/Busy or XON/XOFF handshaking.

## AFFORDABLE RS232 NETWORKING

Create your own local network with our Any-port to Any-port Smart Switches. Available in either 8 or 16 port versions, the Smart Switch is ideal for computer port expansion, computer sharing, engineering work clusters and much more.

Each port has its own spooling buffer. So any baud rate can communicate with any other baud rate and parity anywhere in the system.

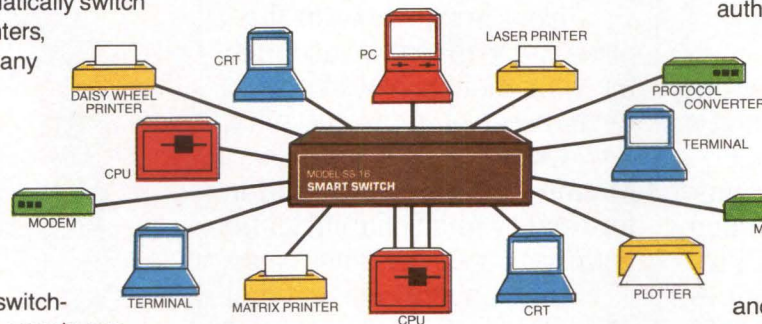

A special supervisory port lets you monitor activity on any other port, connect ports together, broadcast messages or designate the supervisory power to other ports.

The Smart Switch is easy to use. User friendly commands allow you to select ports, disconnect and display port activity. A push button defines each port for either DCE or DTE. So if you need an intelligent, affordable way to link your RS232 system, you're ready for the Smart Switch.

## CONCERNED ABOUT DATA SECURITY?



Prevent unauthorized access to your computer system. Our Dial-back Security Unit prevents outsiders from peeking at, destroying or tampering with your data. Only users entering authorized passwords and dial-back numbers stored in the 200 number battery backed directory will be allowed access.

An auxiliary command port is used to set-up the directory and security levels as well as log each password attempt and duration of each call.

Simply connect the DSU between your computer and modem and feel secure about who's using your data.

## QUALITY PRODUCTS

Every WTI product is designed and manufactured with quality and reliability as a major requirement. We're so confident you'll like our products that we offer a 30 day return policy. Compare our features, quality, customer support and prices with any other manufacturer and you'll know why WTI is a recognized leader in the Data Communications industry.

## IT'S ALL IN THE BOOK...IT'S FREE

Descriptions, diagrams, specifications and prices for the above products, plus many more, are in our colorful new catalog. It's your cost saving connection...just ask for it!

Call toll free: **1-800-854-7226**  
(in California 714/979-0363)

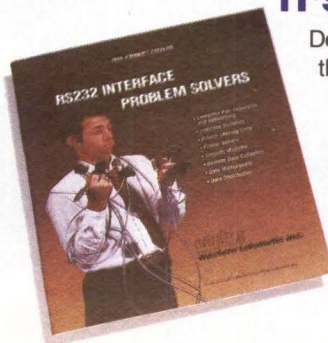

**wti** western telematic inc.

2435 S. Anne St., Santa Ana, CA 92704 • Telex 467741

CIRCLE NO. 24 ON INQUIRY CARD



# INCREASE YOUR AT THE SPEED

With the new MT 910sl laser printer, you can do more without paying more. And you can do it laser fast.

The MT 910sl zips out crisp, clean copies at 10 pages per minute.

That's fast.

But the real story is performance.

You'll have dual paper bins with a 500 page total capacity.

A short, simple paper path with fewer obstructions to virtually eliminate jamming.

A special paper path to allow single feeds of envelopes, labels and transparencies without changing bins.

Five emulation modes — Diablo 630, Epson FX, IBM ProPrinter, LaserJet Plus, Qume II — to meet existing software needs.

Front panel programming to prompt an operator through easy operation without dip switches, without numeric codes.

Two resident fonts that allow bold, italic, enlarged or condensed type in both portrait and landscape mode.

And a laser engine designed to print 300,000 pages before servicing. Which is 5,000 pages a month for five full years.

Your options?

Two font cartridges, a one megabyte memory expansion (allowing, with the

resident 512K, a total of 1.4 megabytes user-accessible RAM), a 5-bin output sorter and a shared interface that allows access from up to four separate stations.

And the price lists at just \$3,695.

No other printer in the price range gives you as much for your money. Not in performance. Not in productivity.

Combine that with the Mannesmann Tally reputation for quality and reliability, and your next step becomes clear.

Pick up a phone and dial (206) 251-5524.

And at the speed of sound, you can order an MT910sl

for your own competitive evaluations.

When the results are on the table, we think you'll be suitably impressed.

And why not?

Our goal isn't just to produce copies at the speed of light. But to do the same for your sales.

\*Diablo, Epson, IBM, Hewlett-Packard, & Qume.

**MANNESMANN**  
**TALLY**

*THE NEW MT 910sl  
LASER PRINTER*

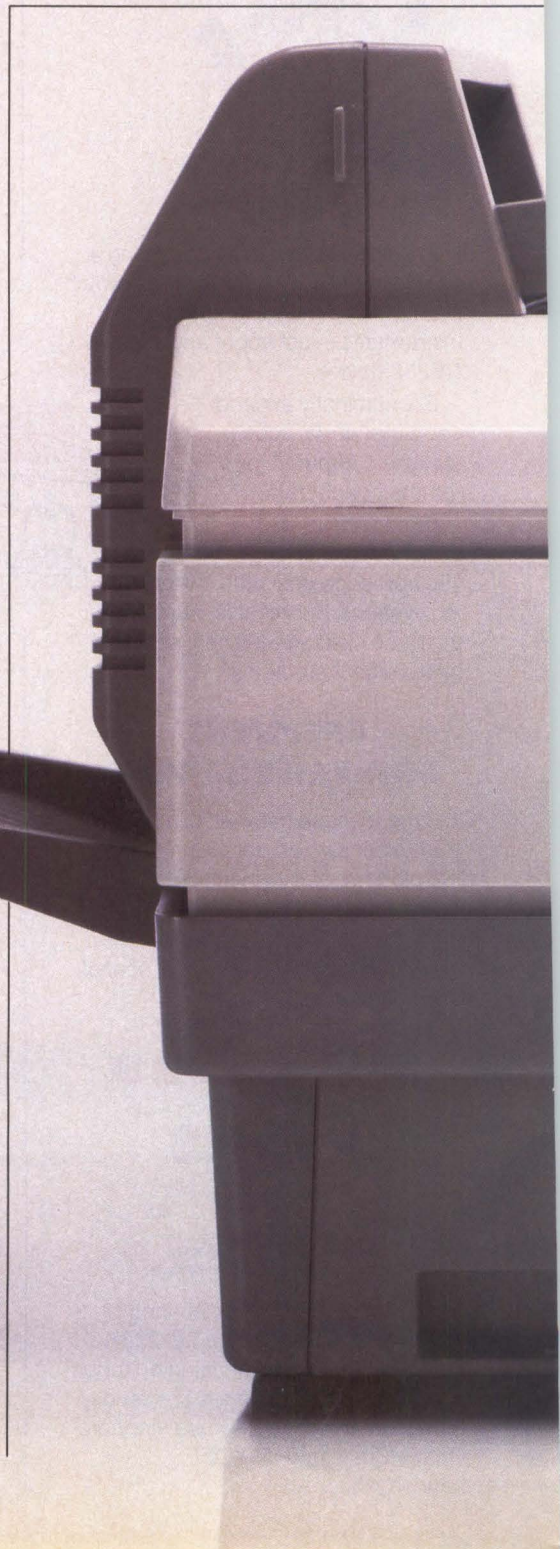



# PERFORMANCE OF LIGHT.

---



CIRCLE NO. 25 ON INQUIRY CARD

MMS0100701



## **UNIX SYSTEMS ADMINISTRATION AND DATA PROTECTION**

**UBACKUP**  
BACKUP, RESTORE, AND  
MEDIA MANAGEMENT

.....

**USECURE**  
SYSTEM SECURITY  
MANAGEMENT

.....

**SPR**  
**SUPER SPOOLER**  
PRINT SPOOLING AND  
BATCH JOB SCHEDULING

.....

**UCONTROL**  
COMPLETE SYSTEM  
ADMINISTRATION. ONE  
INSTALL. LESS MONEY.

.....

For more information,  
call or write  
(703) 860-3000

.....

1800 ALEXANDER BELL DR.,  
SUITE 101  
RESTON, VA 22091  
TELEX 197817 UNITEC UT

**Visit us at**  
**UNIFORM**  
**Booth No. 1906**

UNIX is a registered trademark of  
AT&T Bell Laboratories.

**UNITECH**<sup>TM</sup>  
SOFTWARE INC.

CIRCLE NO. 26 ON INQUIRY CARD

## INTERPRETER

offers varying amounts of memory, internal I/O buses, card slots and disk-storage capacities. For example, the entry-level 9373 model 20 can be equipped with from 4M to 16M bytes of memory and models 40, 60 and 90 with 8M to 16M bytes of memory. The model 20 also has a maximum of seven I/O slots and a single internal I/O bus. Models 40 and 60 each have 17 slots and four I/O buses. Finally, while users can upgrade from a model 40 to a higher level system, the entry-level machine cannot be upgraded, due to its limited bus and I/O structures, according to an IBM spokesman.

Prices for the 9370 systems range from \$31,000, for a basic 9373 model 20, to \$210,000, for a 9377 model 90 with the maximum memory.

All of the 9370 systems are equipped with new releases of IBM's VM/Integrated System and VSE/System Product operating environments, which are said to be completely compatible with 370-developed software and to "offer the power of a System/370 without the complexity."

The systems boast a variety of technological innovations ranging from IBM's first use of its 1M-bit 7,500-circuit chips; more extensive use of rack-mounted components, which offers some incentive to value-added resellers and integrators; and even a newly developed thermal-conduction module (TCM) on the high-end model 90. The TCM houses the processor logic, cache memory and control storage to cool the densely packed logic and array chips.

### **Service and support shoot-out**

Since the 9370 does target the DEC VAX marketplace—in fact, during the New York press conference IBM continually stressed the scientific performance capabilities of the new systems—IBM wrapped a number of announcements concerning software and maintenance pricing and applications around the 9370 introduction.

For example, IBM announced maintenance discounts of from 16 percent to 24 percent for minicomputer and personal computer users who agree to absorb some of the tasks related to keeping a computer fit. Customers who demonstrate they can

"manage their own problems and facilities" by passing an inspection by IBM service personnel will receive the discounts. The company also unveiled software "SolutionPacs" that tailor software and support to specific vertical applications, such as banking, plant automation and LAN implementations.

Perhaps the most significant software-related announcement, however, was IBM's revelation that it will begin offering graduated one-time charges for more than 90 of its System/370 VM/VSE software programs. What the graduated program boils down to is this: the smaller the processor, the lower the one-time charge for software—a fact that may upset users of high-end IBM systems. IBM apparently realizes this but prefers to offer pricing incentives in a market where there is more competition.

"Clearly the benefits of graduated charges improve more with a small processor," observes IBM's Quinlan. "We weren't trying to address the cost of software in the high-end so much as to take that software and make it more affordable for smaller processors."

Recently, DEC extended its VAX-cluster networking software downward to run on MicroVAX II and VAXstation II systems operating within localized "work groups." The software reportedly allows users to share systems and resources easily via Ethernet while eliminating the need for a dedicated computer acting as a resource manager. This elimination of a middle-man computer is basic to IBM's 9370 series strategy.

DEC also announced that it will offer volume discounts of up to 40 percent for users of its MicroVAX II and VAXstation II systems—a departure for DEC and the company's first venture into high-volume software discounts, according to a spokesman.

However, DEC's Olsen insists that his local area VAXcluster and related announcements—unveiled little more than a week after the 9370—are not a direct response to IBM's systems assault. "It's presumptuous of us to compare ourselves to IBM," Olsen said at DEC's annual meeting. "But it's dangerous not to take them seriously." □



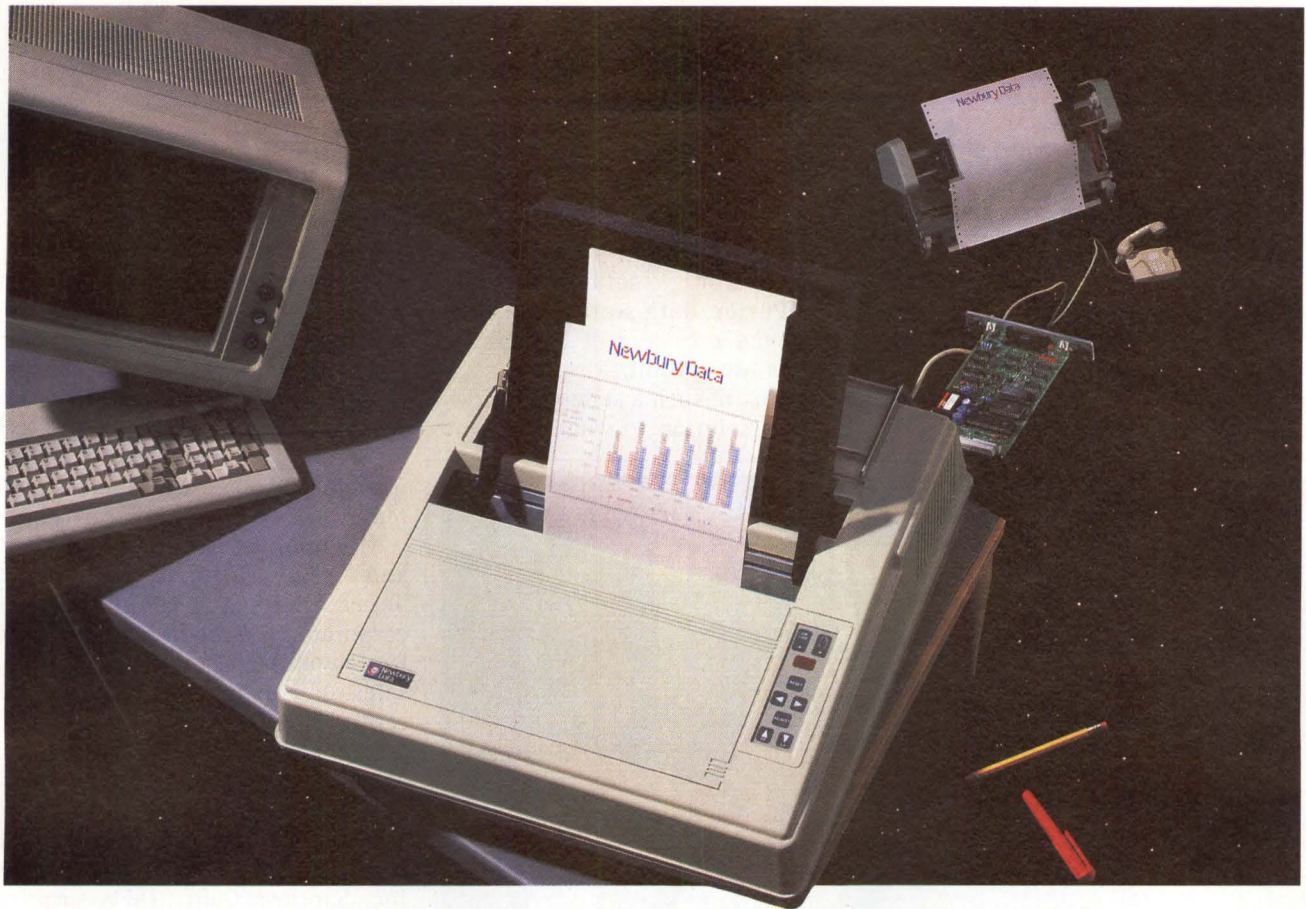

# Newbury's solution to The Great American Printer Hang-up.

**We've taken all the wrinkles out of paper handling.**

Now you can have reliable paper handling for more high-speed, dot matrix printing time. Newbury Office Systems Printers (OSP) are designed to more than match the capabilities of your Personal Computer—whether your application is word processing or financial modeling, using shared resources or local area networks.

**Set-ups and change-overs have never been easier with our 3-way paper handling.**

In addition to speedy printing, Newbury gives you a new standard in 3-mode convenience and flexibility. We've integrated a unique, automatic paper-feed mechanism that is fast and reliable. It features self-registration auto-load for single sheets. Simply snap in an interlocking paper cassette for faster automatic sheet-feeder applications. Or, snap in the interlocking tractor option with single belt and gear for true alignment of continuous forms.

**Newbury offers more things for more offices.**

Even at speeds of 200 cps, noise levels are quieted to less than 50 dBA. For print quality that is truly outstanding Newbury offers 9, 12 or 18-wire OSP models. All feature high-speed printing thru-put with Newbury's exclusive 3-line look-ahead logic, low-mass, high-efficiency printheads, and fast-line advance. And when you're ready for color, you have it by just inserting a clip-in color ribbon cartridge.

**CIRCLE NO. 27 ON INQUIRY CARD**

Document after document, Newbury delivers faster thru-put rates and a total-feature-package that just makes more sense for more offices.

**Get more details immediately.**

**Newbury Data**  
A member of the DRI Group

Europe's Leading Peripherals Manufacturer

**Newbury Data, Inc. U.S. Headquarters**

2200 Pacific Coast Hwy., Suite 208

Hermosa Beach, CA 90254

Phone: **So. West** 213/372-3775, **No. West** 415/254-8350,

**No. East** 617/273-2161, **So. East** 512/477-1221

MMS1/87

**For OEMs and Distributors Only.**

- Rush details on Newbury's OSP Printers.
- Send info on Newbury's 8850 300 lpm serial dot matrix printer.
- Send info on Newbury's model 8933 240 cps Text Processing Printer.
- Send data on Newbury's 3.5" /50MB and 5.25" /65 to 380MB high-performance Disk Drives.

Name \_\_\_\_\_ Title \_\_\_\_\_  
 Company \_\_\_\_\_ Phone \_\_\_\_\_  
 Address \_\_\_\_\_  
 City \_\_\_\_\_ State \_\_\_\_\_ Zip \_\_\_\_\_



DATA STORAGE

# High-capacity flexible disk drives invade low-end storage arena

Carl Warren, Senior Editor

The newest flexible disk drives, with capacities as high as 20M bytes, "provide system integrators with al-

ternative storage solutions," says James Porter, data-storage industry analyst and president of Disk/Trend Inc., Los Altos, Calif.

The crux of such a statement, however, is a solution to what? In some

cases, high-capacity flexible disk drives will replace tape storage, suggests Mountain Computer Inc.'s director of engineering, Eric Swartz. His company is bundling into its subsystem Iomega Corp.'s 20M-byte model Beta-20, a half-height 5¼-inch flexible version of the popular 8-inch, removable Bernoulli box cartridge.

Mountain of Scotts Valley, Calif., and Tandy Corp. of Fort Worth, Texas, are the first companies to incorporate the Beta-20 from Iomega of Roy, Utah, and both anticipate large sales. For example, Tandy's 3,000 captive stores expect to sell at least 100,000 Beta-20 systems this year.

Mountain, on the other hand, has to rely on retail distribution but will do equally well, says Phil Devin, senior data storage analyst for Dataquest Inc., San Jose, Calif. "I'd be surprised if they sell less than 5,000 units per month," he said.

Mountain's Bernoulli 9000 series is designed to match a user's system requirements. For example, its \$3,995 subsystem contains a 40M-byte Winchester drive and the 20M-byte Beta-20 cartridge drive. "Essentially, we provide backup to the 40M-byte Winchester with the removable Bernoulli cartridge," says Swartz.

Iomega has elected to provide the Beta-20 only as an OEM product. "We have to create an established standard in the OEM world," says Michael Joseph, director of Iomega's product marketing. Early on, Iomega met with difficulty by trying to reach the OEM market with a single-sourced, non-standard product. Then, the company took the 8-inch Bernoulli box to the retail market via distribution and met with success. "We didn't have the burden of dual sources, compatibility and all the things OEMs demand. We did provide end-users with a solution to extensible storage—as you need more, you just add another cartridge," explains Joseph.

The Beta-20 uses a common-command-set (CCS) compatible small computer systems interface (SCSI)

## Custom Keypads in Just 10 Days!

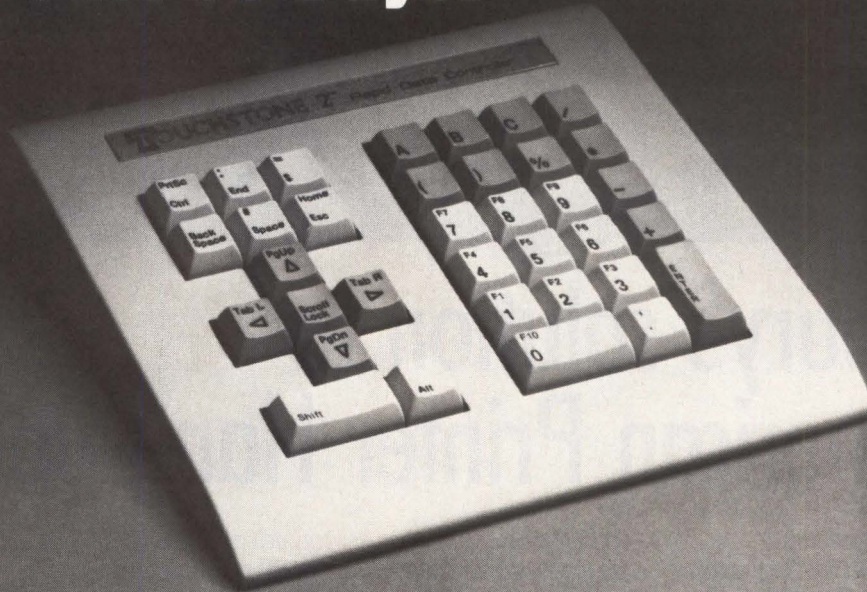

### Touchstone Keypads

The choice of thousands of serious PC users, the TOUCHSTONE 2 keypad is the premier auxiliary keypad for the IBM PC, XT, AT and many compatibles. Its solid construction, careful design and software transparency make it well worth its \$200.00 retail price.

### 8-inch Square Footprint

The compact design of the Touchstone keypad makes it ideal for applications where workspace is limited. However, this size makes it impossible to include every key, so we did the next best thing. We designed it for quick and economical reconfiguration.

### Use Your Imagination

Specialized applications of the Touchstone keypad are unlimited: Public access systems, control systems, point-of-sale; wherever you need controlled access, simplified entry, space savings, or other custom features.

### Fully Supported

Custom keypads from Touchstone have a one-year warranty. They can have macros or other multi-key combinations embedded; even high-quality custom keycaps within two weeks of order.

### Call for our Designer's Kit

Find out how easy it can be to get Touchstone keypads custom configured to your exact requirements. Write or call today, with no obligation.

**Call Toll Free**  
**1-800-828-6968**

In New York: 1-800-462-4891  
International calls: 1-716-235-8358



**TOUCHSTONE**  
TECHNOLOGY INC.  
955 Buffalo Road  
Rochester, NY 14624



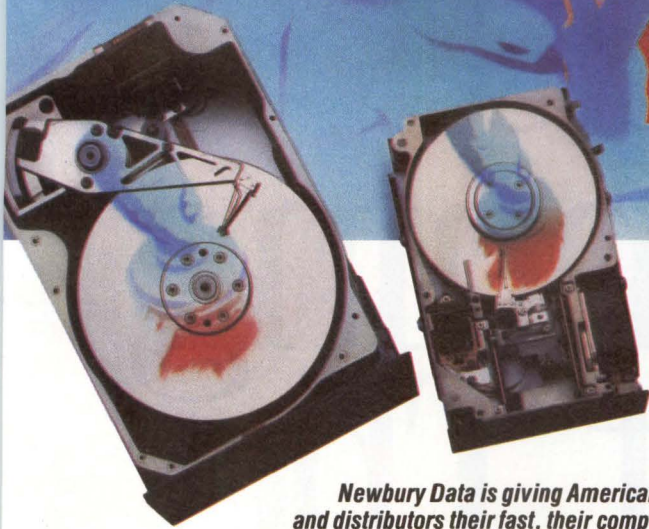
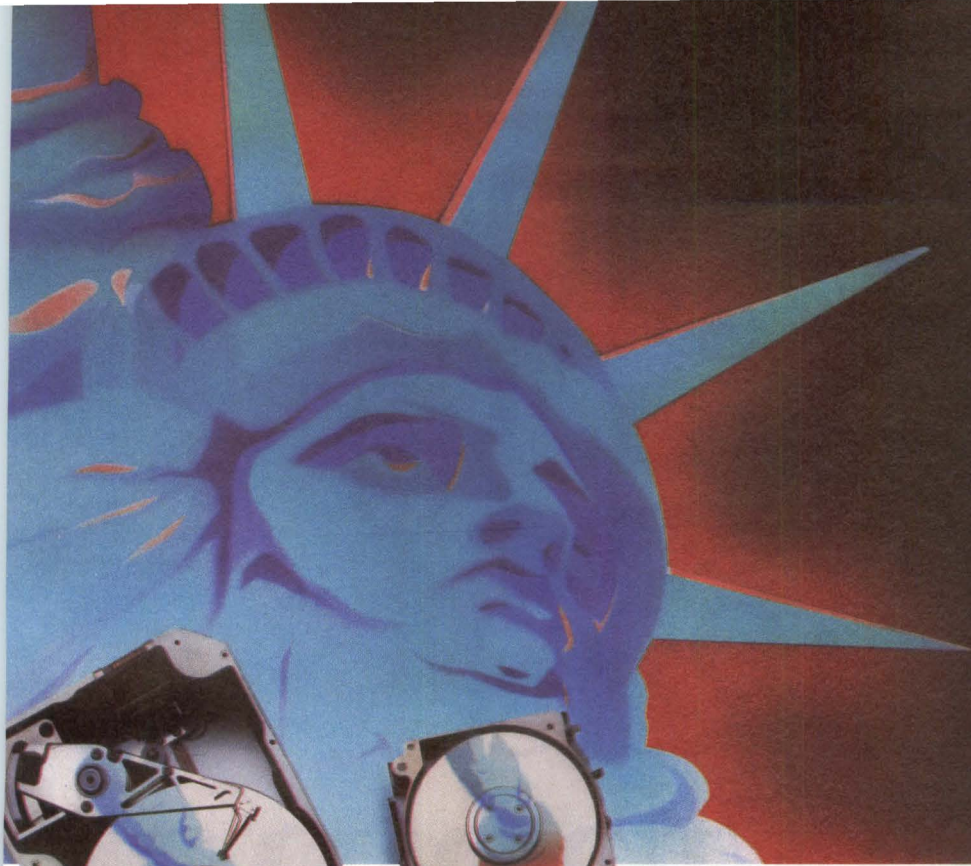

# Newbury brings its European winners to America!

**Newbury Data is giving American OEMs and distributors their fast, their compact, their efficient, their reliable, their proven world-class disk drives.**

Newbury Data now brings two high-capacity disk drive series to this side of the Atlantic—the 65 MB to 380 MB 5.25" and 50 MB 3.5" Winchester—both proven leaders throughout Europe. Newbury's world-class design, manufacturing and support capabilities are giving Americans a new freedom and opportunity to gain from competitive advantages that have long been recognized by Europe's leading advanced system developers. But then, this is the kind of total advantage you should expect from the company that is the leading independent peripherals manufacturer in Europe.

**Newbury Data's proven 5.25" Winchesters are in a world-class of their own.** This family of 5.25" disk drives delivers users a range of unformatted storage capacities from 65 to 380 MB. The 1000 (65, 85, 105, 140 MB) and 2000 (190 MB) series offer ST-506/412 interfaces and the 4000 (175, 380 MB) series offers an ESDI interface. Data access times have been reduced a full 15 percent, to as low as 25 ms.

**Newbury Data's brand new "Penny" 3.5" Winchester 50 MB has no world equal.** The new 3.5" "Penny" is now in full production, fully proven and fully tested—unequaled in its advanced combination of unformatted high capacity, fast data access under 40 ms, and compact size. Newbury Data's 50 MB "Penny" drive is especially tailored for data-

intensive microcomputer applications. The innovative use of surface-mounted devices and other advanced manufacturing techniques deliver major benefits including outstanding product durability and reliability.

Successful? Yes, Newbury Data disk drives are turning in world-class performances around the world.

## Newbury Data

A member of the DRI Group

Europe's Leading Independent Peripherals Manufacturer

### NEWBURY DATA, INC. North American Headquarters

2200 Pacific Coast Hwy., Suite 208

Hermosa Beach, CA 90254

Phone: (213) 372-3775

**Regional Sales Offices:** Austin (512) 834-7746, Boston (617) 273-2161, Los Angeles (213) 372-3775, San Francisco (415) 254-8350



**CIRCLE NO. 28 ON INQUIRY CARD**

### For American OEMs and Distributors Only.

- Rush details on Newbury's 5.25" fully family of world-class drives.
- Rush details on Newbury's 3.5" "Penny" for my microcomputer applications.
- Send data on Newbury's world-class printers, too—both Text-Processing and Multi-Function models.

Name \_\_\_\_\_ Title \_\_\_\_\_

Company \_\_\_\_\_ Phone \_\_\_\_\_

Address \_\_\_\_\_

City \_\_\_\_\_ State \_\_\_\_\_ Zip \_\_\_\_\_



# Imagine Going To Vegas And Winning 94% Of The Time.

**Micro-Term did.** And without anything up our sleeve. Several thousand people took Micro-Term's Screen Test at Comdex and 94% of them chose our new ForeSight Edition's letter quality screen as having the clearest, most readable display among the six terminals featured.

We won despite some pretty

amazing odds, since the choices included DEC, WYSE, CIE, Tele-Video and ADDS. But then our ForeSight Edition terminals are also pretty amazing. And you can see that for yourself just by giving us a call.

We'll arrange a personal Screen Test for you, through our nationwide network of distributors, featuring our new ForeSight

Edition's high speed Tektronix 4010/4014 graphics and DEC VT220 emulating terminals. Once you see The ForeSight Edition, with the best displays in the business, we think you'll know why winning 94% of the time in Vegas had nothing to do with luck.

**For A Personal Screen Test  
Call 1-800-325-9056**

## **MICRO-TERM**

Solutions You Can See.

From The Company To Watch.™

512 Rudder Road, Fenton, Missouri 63026, 314-343-6515  
TWX: 910 760 1662 FAX: 314-326-0052

**CIRCLE NO. 13 ON INQUIRY CARD**



# What made manual mechanical engineering drawing obsolete in Japan?

Hitachi HICAD GM-1000™ micro-CAD software.

Now, for \$1,950, you can use the design tool that's #1 in Japan.

It took thousands of hours of engineering drawing for Hitachi to become one of the world's five largest producers of electrical and electronic hardware. But, you don't design computers without learning how to use them to become more productive. That's why Hitachi also became Japan's largest supplier of innovative CAD/CAM software.

The HICAD GM-1000 software package brings full-function CAD system capability to your desk top, turning your IBM PC®, XT® AT®, or compatible into a CAD workstation.

HICAD GM-1000 gives you the features you need the way you need

them—easy to learn and use. HICAD GM-1000 provides prompts, error messages, and a help button to guide you.

Lines and basic figures can be drawn free hand or automatically constructed, then combined, moved, copied, rotated, or scaled to create complex geographic constructions. All entities are stored in a mathematical database that allows high-speed dynamic pan and zoom without interrupting another function. True ellipses and true splines are built-in commands.

User definable features include menus, keyboards, mouse, line styles, batches, and advanced macros. Dimensioning, leader lines, balloons, and fail-safe

ten-command storage are automatic. Drawings may be separated into as many as 255 layers and displayed independently or grouped.

HICAD GM-1000 is a package that will make manual drawing obsolete for you, too. Our demo will show you why. Send for details today.

## Hitachi America, Ltd.

Computer Division

950 Elm Avenue, San Bruno, CA 94066

Telephone: 1-800/842-9000 ext. 6672

In Canada: 1-800/843-9090 ext. 6672



CIRCLE NO. 30 ON INQUIRY CARD

IBM PC, XT, and AT are registered trademarks of International Business Machines Corporation.

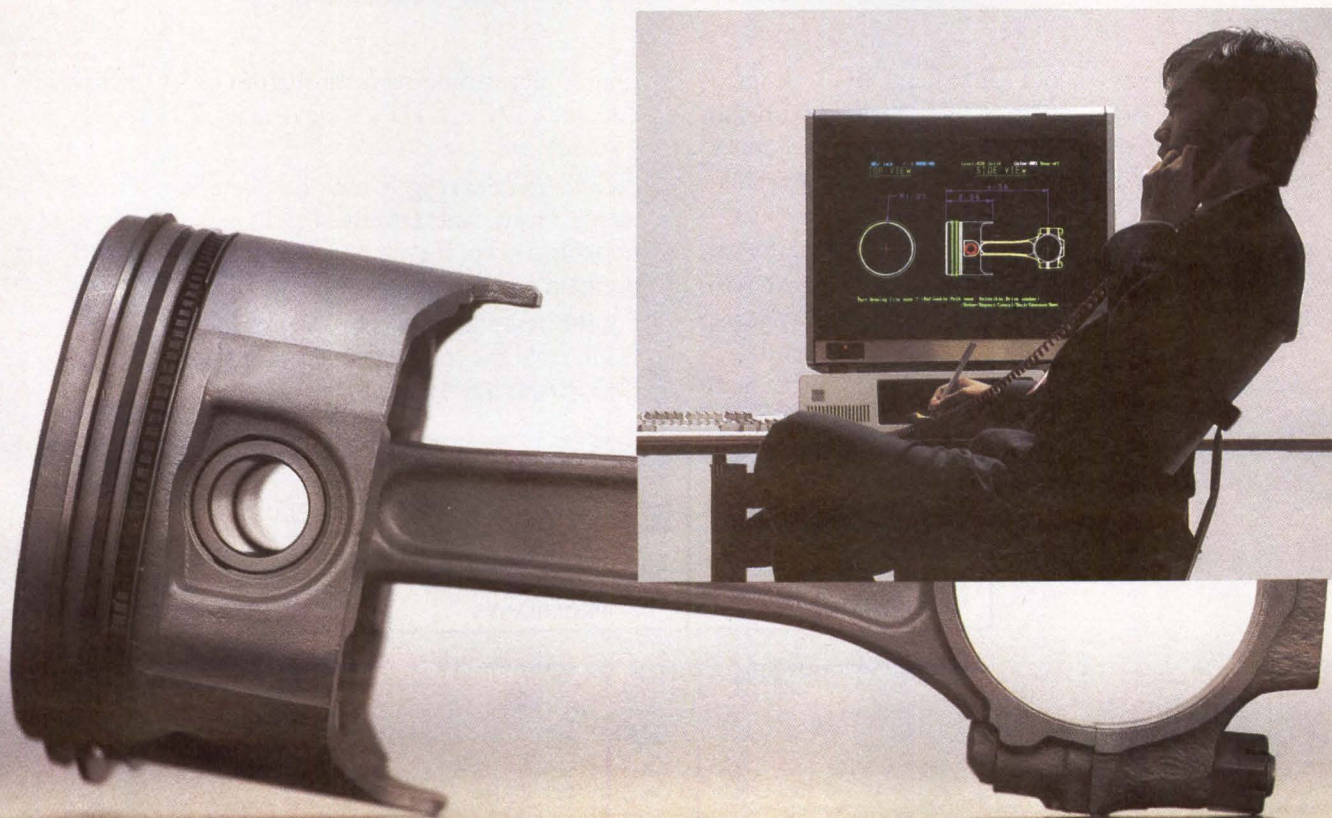



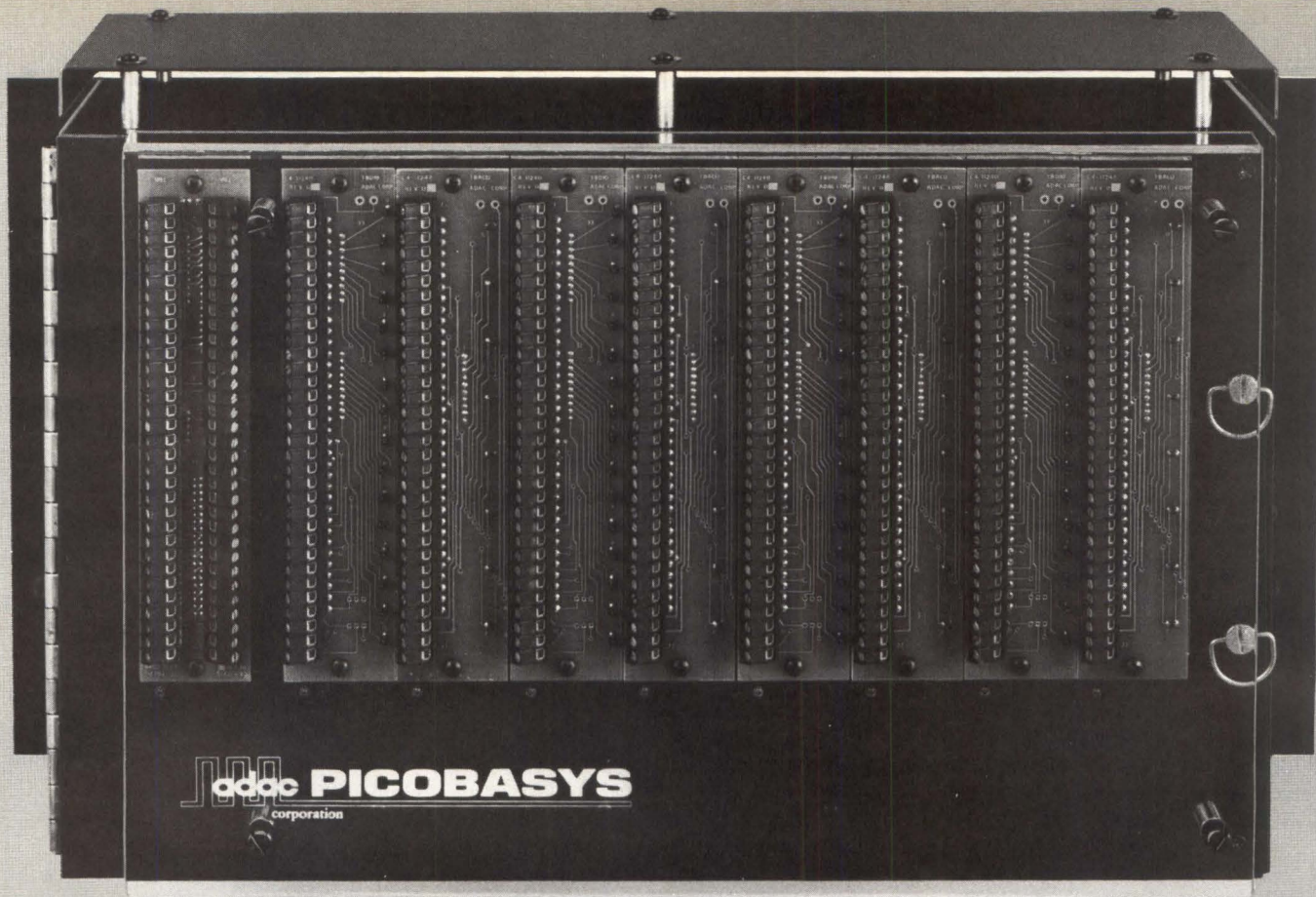

**Best solution for data acquisition systems designers:  
an IBM PC/XT/AT\* front-end that's both  
interactive and stand-alone...**

**yet starts at under \$3,000. PICOBASYS™**

PICOBASYS lets you put IBM PC's, DEC Vax and MicroVax II\*, and DEC mini's into real-time control without sacrificing use of the computer for other important activities. PICOBASYS handles all of the signal conditioning and has an on-board I/O processor to provide event-driven, stand-alone control when needed. You can upload data from and download programs to PICOBASYS in fast, easy-to-use I/OBASIC language. PICOBASYS has 8 convenient, in-the-door module slots for hundreds of channels of I/O. Select from more

than 30 plug-in modules for all manner of I/O including: AC, DC, T/C's, RTD's, strain gauges, TTL, mV, 4-20 mA, etc.

PICOBASYS is rugged, built for plant floor environments. Front panel terminal blocks make I/O wiring hook-up a snap. It even has 30-day, battery-backed program and data protection.

For the best and most cost-effective solution to using a PC in real-time control, design your system with PICOBASYS out front.

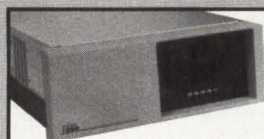

DISKBASYS

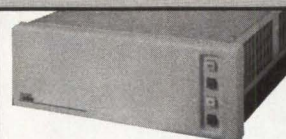

PROMBASYS

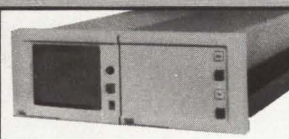

MICROBASYS



70 TOWER OFFICE PARK, WOBURN, MA 01801 (617) 935-6668 Telex 951802

Philadelphia (609) 596-4447 • Los Angeles (213) 476-6535 • Cupertino (408) 973-7829 • Chicago (312) 980-3191  
Dallas (214) 701-8008 • EUROPEAN HEADQUARTERS: SURREY, ENGLAND (Tel) 3727-42577 Telex 918179

\*Registered trademarks of IBM Corporation and Digital Equipment Corporation  
**CIRCLE NO. 32 ON INQUIRY CARD**



embedded on the master unit (\$540 quantity 5,000) and a proprietary 50-pin connection on the slave (\$360 quantity 5,000) unit. This combination, says Iomega's product manager for the Beta-20, Craig Brooksby, lets a user double the storage capacity by simply plugging in another unit.

### Other solutions in the wings

Although Iomega has the lion's share of the market (an estimated 150,000 to 200,000 units) with their 8-inch Bernoulli box and can be assured of similar numbers in 1987 for the Beta-20, other manufacturers, including Data Technology Corp., Santa Clara, Calif., and Konica Technology Inc., Sunnyvale, Calif., expect to "byte" a share of the market as well.

DTC's TakeTen—a 10M-byte, 5¼-inch, hard-shell cartridge drive—is aimed at the retail distribution market. The \$1,085 unit, for example, mounts directly into an IBM Corp. PC/XT. Alternatively, a \$1,995 model comes as a complete subsystem: "A plug-in and run approach," says Michael Sugihara, DTC's director of strategic planning.

The DTC TakeTen resulted from an OEM agreement with Eastman Kodak Co., Rochester, N.Y. Kodak has announced 6.6M-byte and 12M-byte versions of the drive but hasn't been aggressive in the marketplace. Sugihara, however, expects to be more aggressive with the current product and is already looking to the future. "We think that a 40M-byte version would be in great demand." No one, particularly industry analysts, disagrees with Sugihara. In fact, most predict that the 10M-byte version of the drive will be short-lived. Other factors may aid acceptance of the DTC drive: an encased media in a hard-cartridge shell, 333-tracks-per-inch (tpi) density and an embedded servo.

However, one retailer at Comdex/Fall complained, "I don't see any compatibility with anything." He felt, as did others, that Iomega had essentially established a standard with its 8-inch cartridge and that its new Beta-20, although not a retail product from Iomega, would establish a de

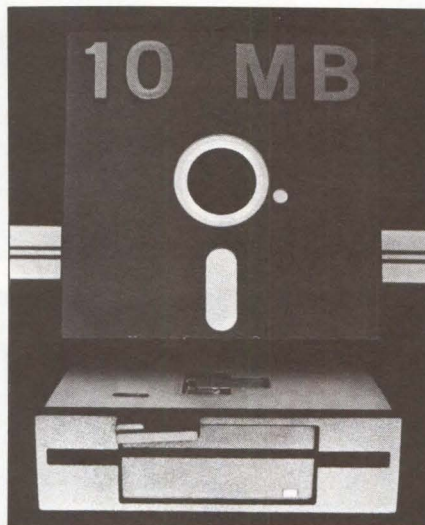

**The Konica KT-510** reads 360K-byte and 1.2M-byte standard disks and stores up to 10M bytes using 600-Oe medium.

facto standard for 5¼-inch flexible cartridge drives. Dataquest's Devin thinks that with both the DTC hard-shell approach and the Konica soft jacket route, an OEM partner is needed to guarantee success.

Undaunted DTC officials, however, expect to surpass sales projections of 75,000 units in 1988. "We think there are multiple ways, including adding software, that will make the TakeTen a compelling product for distribution," says a company spokesman. However, OEM buyers still recall defunct Amlyn Corp. and Drivetec Corp. and are leery of tackling high-capacity flexible disk drives. Amlyn and Drivetec were unable to develop an agreeable standard to build by, and media costs were well beyond acceptable limits. While they battled for limited market share, Iomega carefully mined the distribution/end-user market and established a base for follow-on products (such as the Beta-20), which would be acceptable to OEMs. Vendors of high-capacity flexible drives face similar marketing obstacles.

Konica, another company vying for OEM and distribution-market position, offers an under-\$400 (in quantities of 10,000), 10M-byte, 5¼-inch flexible disk drive. It uses a standard 600-oersted (Oe) medium in a soft

## REAL-TIME UNIX

**D-NIX is a real-time, System V compatible operating system for transaction handling and process control applications. It fulfills all the requirements defined in the Unix System V Interface Definition at Base System and Kernel Extension Level.**

### THE DIFFERENCE

What makes D-NIX different from other attempts at real-time UNIX is the handler concept. This extension of Unix allows application programs to access local and remote resources, such as databases and non-Unix file systems, but leaves the task of accessing local and remote resources to the handler.

### D-NIX IS A REAL-TIME OS

D-NIX was developed for the transaction handling and process control applications which need a real-time environment and want full Unix compatibility. This was achieved by writing a no-wait kernel from scratch. In practice, this means faster turn-around between different activities in the system. This demand page, virtual memory operating system achieves real-time response in an event driven environment.

### UNIX V.2 compatible Real-Time OS with many enhancements

- Guaranteed interrupt response time.
- Event-Queue and NO-WAIT system calls for simultaneous requests
- Contiguous files for fast disk I/O.
- Individual file buffer write for transaction checkpointing.
- Advanced color window handling option.
- Memory resident processes for faster response time.
- Extensive network support for TCP/IP.X.25, SNA/SDLC and others
- Secure bit-map file system.
- File handlers for Unix, MS-DOS, and CP/M running concurrently.
- User configurability of OS parameters.

D-NIX is available for M680XO and NS32000 family 32 bit CPU's.

**DIAB SYSTEMS INC.**

323 Vintage Park Dr  
Foster City, CA 94404  
(415) 571-8811  
TELEX 516020 DATABOARD  
TELEFAX (415) 573-7562

Unix is a trademark of AT&T. MS-DOS is Microsoft. CP/M is a trademark of Digital Research.

**CIRCLE NO. 33 ON INQUIRY CARD**



**“They’ll give us UNIX® V.2  
compatibility, POSIX conformance,  
and Real-Time capabilities.”**



If you're a hardware OEM or system integrator, you have to build a product that can win in the marketplace.

You need a computer supplier who can give you more than the same off-the-shelf package your competitors have.

Charles River is the only supermicro builder who offers a UNIX System V.2-based operating system, plus conformance to the new IEEE POSIX

trial-use standard, plus a compatible real-time kernel, UNOS™, that lets you tackle tough real-time jobs.

For more on how we can help you build a winner, from customizing to multi-vendor networking, contact Charles River Data Systems, 983 Concord St., Framingham, MA 01701, (617) 626-1000, Telex 681-7373 CRDS UW.



**We'll help you build a winner.**

**Charles  
River™**



UNIX is a registered trademark of AT&T. UNOS is a trademark of Charles River Data Systems.

**CIRCLE NO. 35 ON INQUIRY CARD**





**Packing up to 20M bytes** into a removable 5 1/4-inch cartridge, the *Omega Beta-20* contains an embedded SCSI interface on the master unit and a proprietary interface on the slave module.

jacket. "There is a big market out there using so-called AT-compatible flexible disks. Our model KT-510 can read data from the standard 360K-byte and 1.2M-byte disks currently used in the IBM PC, PC/XT and PC/AT. Consequently, users aren't going to be dealing with anything foreign, such as a new and expensive media," says Richard J. Freedland, Konica's director of business marketing.

Already, Konica is trying to establish strategic alliances with other companies, such as Citizen America Inc., Santa Monica, Calif., for manufacturing and possibly marketing purposes. "Right now it's a manufacturing agreement. We will work out other details later," says Freedland.

Kodak will probably have to make similar arrangements for distribution, possibly with another one of its companies, such as Verbatim Inc. "They will need to set up various distribu-

tion channels, and the Verbatim people already have distribution lines in place," suggests Disk/Trend's Porter.

To achieve high capacity, the KT-510 has 480 tpi: "We needed a multiple of 96 to maintain compatibility with 360K-byte and 1.2M-byte disks," says Freedland. One concern voiced by analysts and expected buyers has been the viability of the media. However, Freedland says that bit-resolution really isn't the problem, and that Konica isn't even pushing the maximum resolution of the media. "We are below 18,000 flux-changes per inch. DTC is at 22,000 and Iomega is at 21,000, and we all use 600-Oe media. There is very little difference in the media except how we use and package it," he claims.

Freedland says that the real problem is in the servo system. The KT-510 uses an adaptive servo system, but that limits the drive tilt to no more than 30 degrees. "Above 250

## ADVANCED BASIC FOR UNIX

**D-Basic V, a compiler-interpreter, brings the power and versatility of an interactive compiler to the Basic applications developer.**

### INTERACTIVE PROGRAM DEVELOPMENT

In contrast to other BASICs that interpret the source program at each execution, D-BASIC V checks and compiles a source program as it is entered. A syntax error will therefore result in an immediate error message on the screen. Your development time is reduced since there are fewer errors at execution.

**DATABASE HANDLING** D-BASIC V has special handling capabilities for ISAM which permits the user to work with one or more databases at the same time.

**INTER-PROGRAM COMMUNICATION** is easily accomplished with OPEN PIPE statements. Integrating Unix system calls into your application programs is easily performed with REQUEST statements.

### FROM BASIC TO C... WITH EASE

With **BasC, a D-Basic V to C language compiler**, convert your application programs to fast executing programs. BasC translates the D-basic program to C source code, and thereafter uses the system utilities for compilation and linking with the included BasC library. With BasC, applications achieve up to 15 times faster execution.

### Features common to D-BASIC V and BasC

- Long variable names.
- Multiline recursive functions and procedures with local variables.
- REPEAT . . . UNTIL and WHILE . . . WEND statements.
- Multiline IF . . . IFEND with ELIF
- Open Pipe statements for effective sub program handling
- REQUEST statement for access to all Unix system calls.
- IEEE standard floating point arithmetic with trigonometric functions
- 32 or 16 bit integers with automatic conversion to/from float for maximum execution speed
- 120 digit decimal string arithmetic
- Conforms to ANSI X3.60-78 with many extensions
- Date and time function
- PORTABLE-Written in C

AVAILABLE for: AT&T, DEC, NCR, PYRAMID, CONCURRENT, SPERRY, and many more.  
An MS-DOS version is also available.

**DIAB SYSTEMS INC.**

323 Vintage Park Dr.  
Foster City, CA 94404  
(415) 571-8811  
TELEX 516020 DATABOARD  
TELEFAX (415) 573-7562

Unix is a trademark of AT&T.

**CIRCLE NO. 34 ON INQUIRY CARD**



# The OTC TriMatrix™ Series



## **THE FASTEST SERIAL DOT MATRIX PRINTER IN THE WORLD!\***

★ **Made Proudly In The USA** ★

**700 characters per second / 200 lines per minute  
with reliability built in!**

### **The best Price/Performers in the Industry!**

At OTC, Price and Performance are inseparable. With our printers, high speed doesn't mean high price!

### **Round-the-clock printing for heavy-duty applications!**

- ★ Data Processing
- ★ Financial
- ★ Graphics
- ★ Spreadsheets
- ★ Bar Codes
- ★ Near-Letter-Quality

\*Based on 136 column draft printing at 10 cpi.  
Epson is a registered trademark of Epson Corporation  
IBM is a registered trademark of IBM Corporation  
DEC is a registered trademark of Digital Equipment Corporation

### **Flexible features to meet your needs!**

- ★ Serial, parallel, or IBM 34/36/38 twin-ax
- ★ Variable pitch printing
- ★ EPSON, DEC, or IBM 5224/5226/5256 emulations
- ★ Front panel menu programming (no DIP switches)
- ★ 8K data buffers
- ★ Front and bottom paper feed
- ★ International character sets . . . and more!

### **Output Technology Corporation . . .**

*The Price/Performance Leader!*

**1-800-468-8788**

(8am-5pm Pacific Standard Time)

**OTC** **OUTPUT  
TECHNOLOGY  
CORPORATION**

E. 9922 Montgomery, Suite #6, Spokane, WA 99206  
(509) 926-3855, Telex # 15-2269 OUTPUTSPOK  
800-4-OUTPUT (468-8788)



**ADVANCED DATA PRODUCTS, INC.**

GAITHERSBURG, MD  
(800) 732-7654 (Outside MD)  
(301) 424-9490

**CANAMICRO**

CANADA  
(800) 361-3185 (East)  
(800) 361-1210 (West)  
(514) 737-3631

**EASTERN MICRO, INC.**

BOSTON, MA  
(800) 443-4506 (Outside MA)  
(617) 480-0400

**ATLANTA, GA**

(800) 762-6652 (Outside GA)  
(404) 428-8400

**GENERAL BUSINESS COMPUTER**

CHERRY HILL, NJ  
(800) 222-0404 (Outside NJ)  
(609) 424-6500

**M-P SYSTEMS**

DALLAS, TX  
(800) 854-8885 (Outside TX)  
(214) 385-8885

**LAGUNA HILLS, CA**

(800) 624-1688 (Outside CA)  
(714) 770-6411

**OSSMAN COMPUTER  
TECHNOLOGIES**

SYRACUSE, NY  
(800) 537-5378 (Outside NY)  
(800) 628-4466 (Inside NY)

**DAYTON, OH**

(800) 824-5934 (Outside OH)  
(800) 824-9627 (Inside OH)

**PREMIER SOURCE**

IRVINE, CA  
(714) 261-2011  
(800) 227-7501 (S. CAL.)

**R SQUARED**

DENVER, CO  
(303) 799-9292

**SALT LAKE CITY, UT**

(801) 595-0631

**SMART DATA**

CHICAGO, IL  
(800) 336-6875 (Outside IL)  
(312) 966-2033

**SWENSON ASSOCIATES**

DAYTON, OH  
(513) 866-3233

**THE SUPER SOURCE**

ATLANTA, GA  
(800) 241-8579 (Outside GA)  
(404) 441-3451

**ORLANDO, FL**

(305) 857-6604  
(800) 824-0081 (Inside FL)

**WESTERN MICRO SYSTEMS**

MOUNTAIN VIEW, CA  
(800) 544-0020 (Outside CA)  
(800) 338-1600 (Inside CA)

**REDMOND, WA**

(800) 538-7596 (Outside WA)  
(800) 835-5513 (Inside WA)

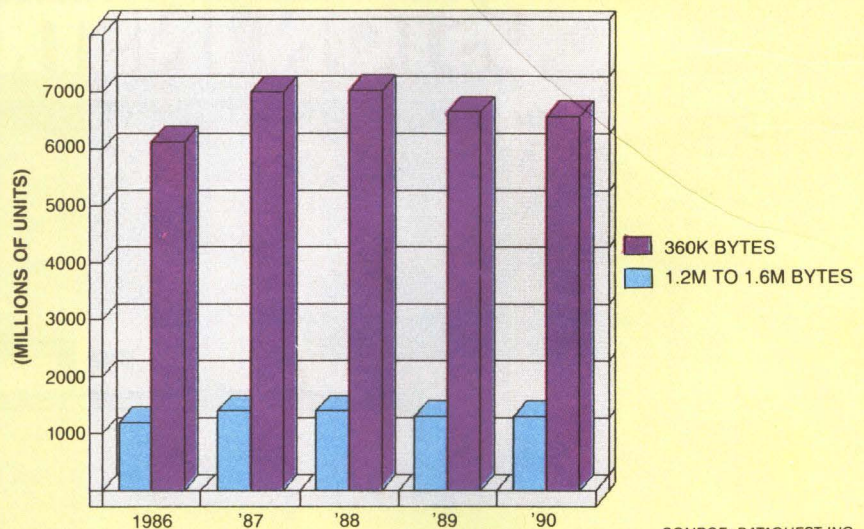
**INTERPRETER****5¼-INCH FLEXIBLE DISK MARKET**

tpi, you have to have a closed-loop servo. In flexible disk drives it has to be fairly sophisticated, simply because the media is subject to physical changes due to temperature, humidity and handling.”

Dataquest's Devin predicts that by 1988 everyone will win something. DTC's 10M-byte hard-jacketed drive is projected to sell around 75,000 units by 1988 with a rapid fall off in 1989. The Konica soft-jacketed approach is expected to follow a similar path. “There will be initial demand, but the 3½-inch, high-capacity drive will start eating into the 5¼-inch market quickly,” says Devin.

NEC Corp., Tokyo, has developed a 6M-byte, 3½-inch flexible disk drive that reads and uses existing 1M-byte and 2M-byte, 3½-inch media and a servo sampling method. The drive formats down to 4M bytes, but even at that offers a significant capacity increase over existing 3½-inch, 720K-byte drives.

Another Japanese company expecting to garner some share of a yet undetermined market is Toshiba America Inc. with its 3½-inch, 4M-byte drive. The Toshiba drive uses barium ferrite medium, but it can read conventional 1M-byte disks as well.

The market impact seems clear. At

least for the next 24 months, 5¼-inch solutions (in the 10M- to 20M-byte range) will most likely rule the roost. However, over the long term, the 10M-byte versions are at most risk because the demand is for greater capacity at lower cost. “Drives like the Iomega Beta-20 are in the \$15- to \$20-per-megabyte range, and we'd like them down around \$5 per megabyte. But that can take some time until the volumes build up,” says Mountain's Swartz.

**Applications broaden market**

With the strategic maneuvering by the various players in the high-capacity flexible disk market, users will end up the overall winners. Iomega is seeing much interest in using the Beta-20 as an interim cache between compact disk ROMs and the system and as a tape replacement. DTC and Konica claim (since neither is shipping) that potential buyers are eyeing the drives as ideal solutions for shipping large databases and managing images and copy in desktop publishing.

IBM may soon get into the high-capacity removable flexible drive business as well. There are reports that its Tucson, Ariz., division, primarily responsible for tape units, is seeking information on who buys Iomega-type drives and why. □



# THE SECRET BEHIND THE PLOT: HOUSTON INSTRUMENT.

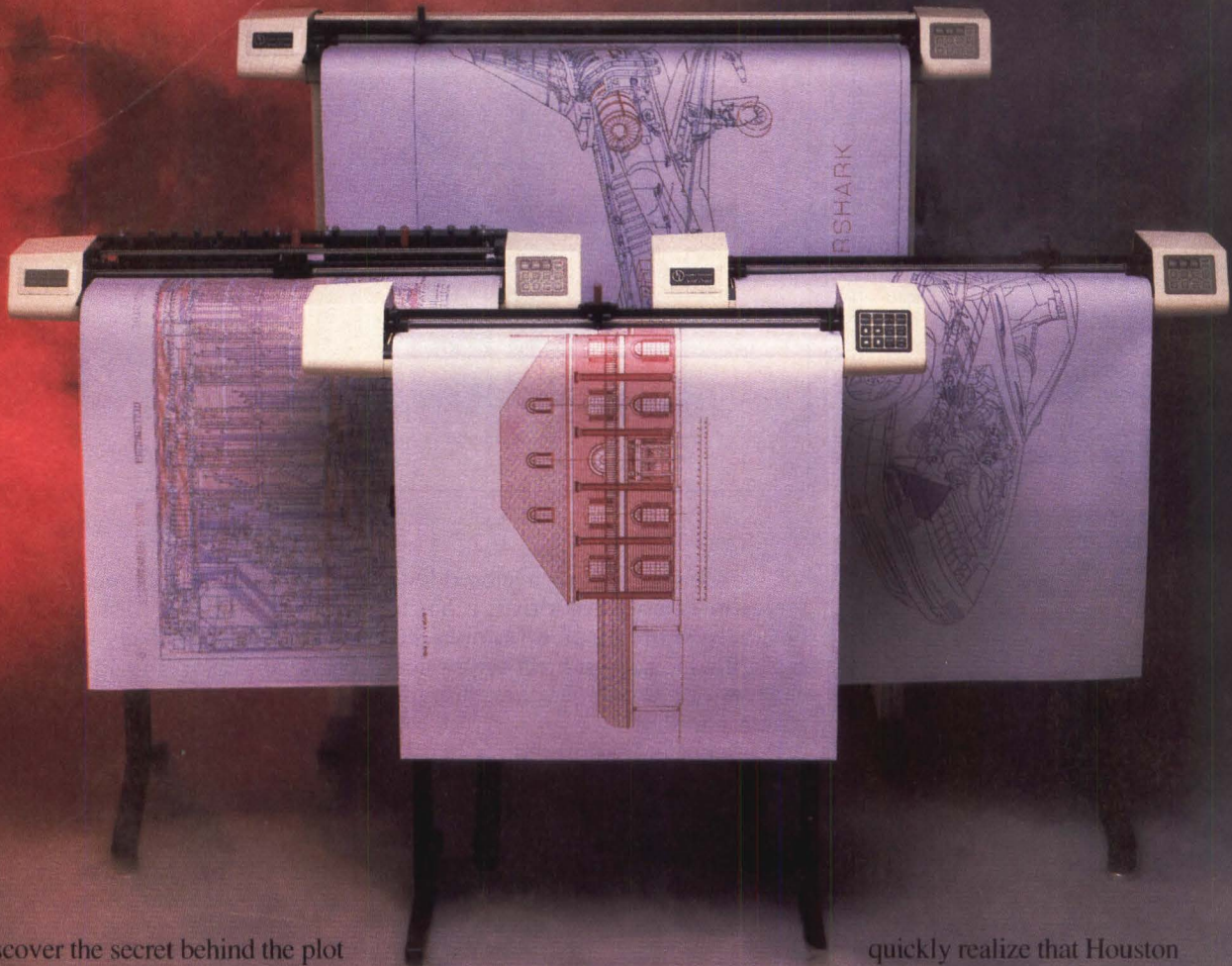

**D**iscover the secret behind the plot with Houston Instrument's line of low cost, high performance plotters.

Within HI's impressive line, you'll find a full range of models suited for virtually any CAD application.

#### Secrets in flexibility and quality.

Define your requirements. You'll find a plotter that's uniquely suited to your CAD system in HI's lineup.

Choose from models with one, four, six, eight, even 14 pens. Select the types of pens and plotting media you need. Decide on format sizes—from A through E. Whichever model you choose, your HI plotter will create accurate, crisp, colorful drawings.

#### Secrets in performance and price.

With high MTBF ratings, your HI plotter excels in reliability. And,

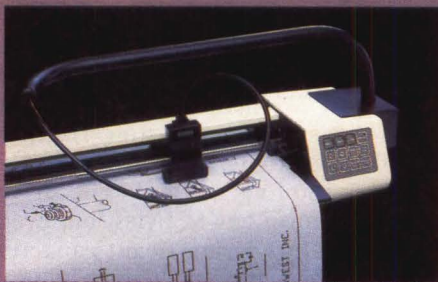

*Accessory to the plot: HI's exclusive SCAN-CAD™ option turns your DMP-50 series plotter into an automatic scanner.*

depending on the model you select, you'll experience plotting speeds up to 22 inches per second and resolutions ranging from .005 to .001 inch.

As you examine features, performance, and especially price, you'll

quickly realize that Houston Instrument™ offers outstanding performance at an affordable price.

Regardless of the model you pick, you'll find hundreds of compatible software packages. And, by using HI's popular DM/PL™ language, you can create your own custom software and be assured of upward compatibility with HI's entire line of plotters.

Discover more about the secret behind the plot. Also examine HI's full line of TRUE GRID™ digitizers. Call 1-800-531-5205 (512-835-0900 if in Texas) or write Houston Instrument, 8500 Cameron Road, Austin, Texas 78753.

**CIRCLE NO. 37 ON INQUIRY CARD**

**houston  
instrument** **AMETEK**  
DIVISION



# GOVERNMENT, IEEE FAVOR POSIX INTERFACE

Software-transportability benefits of interface standard outweigh UNIX operating system shortcomings and pave way for POSIX acceptance

**Wendy Rauch-Hindin**  
Special Features Editor

Companies have noted for some time that four out of five government RFQs (requests for quotations) for computer systems have specified UNIX. And the National Bureau of Standards made it official in August 1986. It published in the *Federal Register* an announcement of intent to adopt the IEEE UNIX-interface standard called POSIX (for Portable Operating Systems—IX) as the Federal Information Processing Standard should, as appears certain, POSIX become a “full-use standard.”

Let there be no confusion about a UNIX standard, though. Most major organizations intend to adhere to a UNIX interface standard rather than to some particular version of the UNIX operating system. The closest thing to a commercial UNIX interface standard today happens to be AT&T Co.’s System V Interface Definition (SVID). In March 1986, however, the IEEE P1003 committee approved POSIX—also based on System V—as a trial-use standard.

“Trial use” means that controversial items are relegated to the appendix rather than placed in the main document. In July, the IEEE will vote on making POSIX a full-use standard. At that time, the items in the appendix will be re-evaluated based on feedback during the trial-use period, and many of them will be incorporated into the full-use standard.

POSIX defines the interface between applications and the UNIX operating system. It does not define UNIX. Its goal is to support source-level portability of application programs across diverse machines that run P1003-conformant versions of UNIX.

UNIX was chosen by default as the multiuser operating system on which to standardize. It is the only operating system that is widely supported by major vendors on different types and levels of machines. MS-DOS, which is the de facto standard on microcomputers, was not

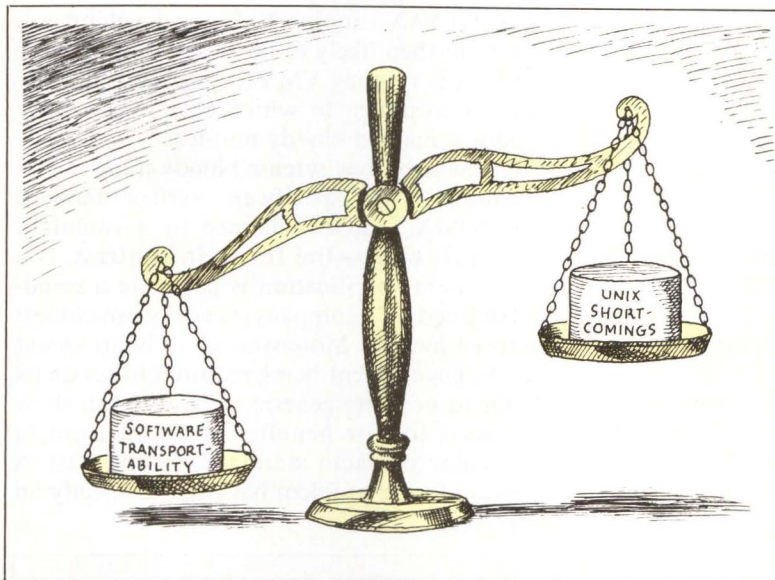

considered to be a suitable standard for application transportability, because it’s a single-user operating system and is deemed to be constrained to certain classes of hardware (see “Why not standardize on MS-DOS?” Page 46.)

## Necessity is the mother of migration

Application transportability, conservation of programmer skills and the resulting decrease in software costs are the driving forces behind the government’s shift toward standardization. And UNIX fits in well with the way the government does business.

For example, government policy dictates competitive procurements for purchases above a certain price. If UNIX is specified as the baseline operating system, it is possible to design software and acquire hardware in parallel. In contrast, in the pre-UNIX days, it was necessary to first have the hardware and then either put out an RFQ for software or develop the software internally.

Needless to say, a UNIX-based interface



standard reduces the time required to get systems into the field. In addition, having a standard also allows a maximum number of companies to bid on government contracts and forces them to be competitive. And, if the hardware is replaced at a later date, users can, for the most part, reuse the same software in the new operating environment.

There is also a fairness aspect to competitive bidding based on a UNIX specification. Bidding based on functionality alone was nice for the company that was awarded the contract. But, as Robert Borochoff, research computer scientist at the Federal Judicial Center and a member of the board of Unicorn (a federal UNIX user group) points out, "Suppose you bought a VAX running VMS for development. You were then likely to be locked in to supplying VAXes running VMS for perhaps 200 production systems, in which case every other vendor screamed bloody murder."

It's because they scream bloody murder that it is imperative to specify an interface standard like POSIX, which is defined by a voluntary standards body—the IEEE. In contrast, if a government specification is based on a standard defined by a company, vendors can contest contract awards. Moreover, there is precedent for the government being required to revise its RFQs to be more generic, even if it can show the need for, or benefits obtained from, a particular de facto standard. In the past, a solution to the problem has been to specify an interface.

**Fig. 1. The P1003.2 shell and utilities application interface standard defines an interface to the UNIX shell, its command language, utilities and tools.**

Such is the case with POSIX. With the approval of POSIX as a trial-use standard, P1003 formed several working groups. For example, the P1003.2 working group is chartered to produce a standard interface to a shell, its command language and tools-level UNIX facilities. This standard is not intended to specify interfaces that are user-friendly, such as visual shells, desktop metaphors, command recall and mice. However, such programs will be expected to use the programmatic interfaces defined by the standard (Fig. 1).

Another working group, P1003.3, is defining the test-method specifications for testing conformance of a product to the standards. From these test-method specifications, the National Bureau of Standards intends to build a reference implementation for a test suite with which to check product conformance. But the Bureau will not certify a product. Instead, it will develop the test suite and then release it into the public domain.

Other IEEE subcommittees are working with the UNIX /usr/group technical committees to resolve issues of UNIX-based networking, security, graphics, database, internationalization, performance and real-time extension (MMS, September 1986, Page 61).

**Procurement has significant impact**

Meanwhile, the first government specification requiring POSIX has been released by the Bureau of Census. It calls for delivery of a full-use POSIX implementation, once that interface standard is approved. It is a large procurement, requiring the POSIX implementation on what are often called "IBM-class" machines.

This procurement will force many large-scale vendors to make known their POSIX or UNIX intentions. Some have started. IBM Corp., for example, has become active in the IEEE and /usr/group UNIX-interface committees to the extent of volunteering to sponsor the IEEE POSIX meeting in Toronto in April. It also put on quite a show at last October's UNIX Expo in New York City with its UNIX-based RT PC and its VM-based UNIX blanketing almost every possible application.

Hewlett-Packard Co. also has positioned itself for the UNIX marketplace, offering both general-purpose and real-time versions of UNIX System V. The company is firmly committed to maintaining compatibility with the IEEE and SVID standards. Moreover, it offers a migration path from its proprietary operating system to UNIX, without the need to rewrite existing code. Amdahl Corp., Burroughs Corp., Concurrent Computer Corp., Data General Corp., Gould Inc., Honeywell Inc., Intel Corp., Motorola Inc. and Texas Instruments, as well as

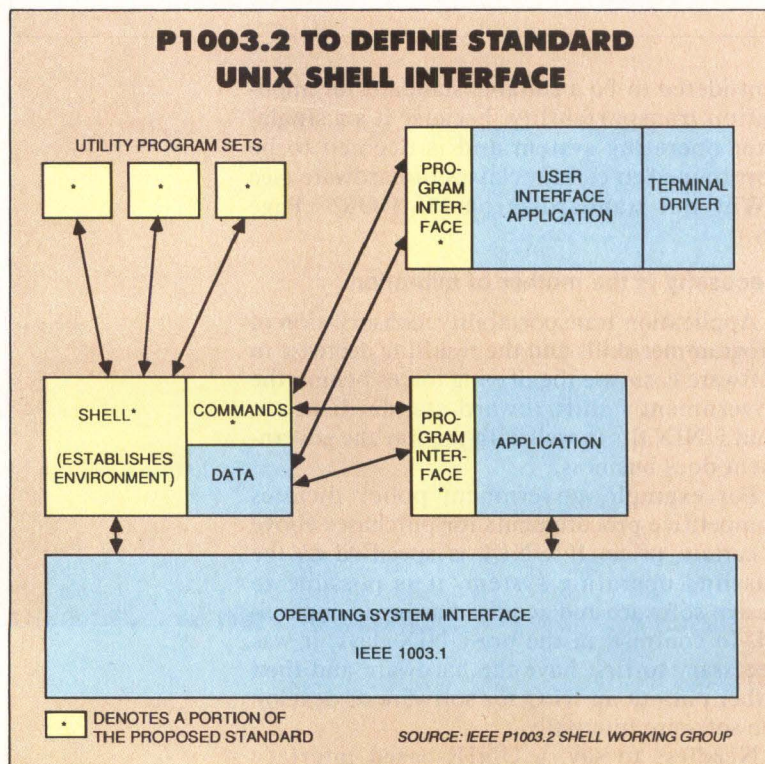



# Gould: One-stop UNIX® shopping.

Everything you need, from the company that ties it all together. Gould offers the most complete range of UNIX-based systems in the world:

- Secure (C2) UNIX systems
- AT&T System V and BSD 4.x
- Integrated information systems

- Desktop-to-mainframe hardware

For more information on Gould's one-stop shopping, contact Gould Inc., Information Systems Computer Systems Division, 6901 West Sunrise Boulevard, Fort Lauderdale, Florida 33313 1-800-327-9716.

**High Performance Solutions in Factory Automation, Computers, Instrumentation, Defense, and Semiconductors.**



CIRCLE NO. 38 ON INQUIRY CARD

A black and white photograph of a person's hand holding a shopping list card in a wire shopping cart. The card lists various computer systems and services. The background shows the metal mesh of the shopping cart and a hand on the handle.

Secure (C2) UNIX® systems  
Diskless Workstation Support  
Network File System (NFS®)  
AT&T System V and BSD 4.x  
Integrated information systems  
Desktop-to-mainframe hardware  
Languages  
C, FORTRAN, Ada, Pascal, ACECOBOL™,  
Common Lisp...  
Database Management Systems  
INGRES™, UNIFY®, EMPRESS/32™, INFORMIX®...  
Communications  
Ethernet™, (TCP/IP and XNS™)  
IBM 2780/3180, 3170, BSC and SNA  
Public Data Networks (X.25)  
Defense Data Network (DDN)

Trademarks: ACECOBOL — Austec, Inc.;  
INGRES — Relational Technology, Inc.;  
EMPRESS/32 — Rhodnius, Inc.;  
Ethernet and XNS — Xerox Corporation.

Registered Trademarks: UNIX — AT&T  
Bell Labs; NFS — Sun Microsystems, Inc.;  
UNIFY — Unify Corporation; INFORMIX —  
Relational Database Systems, Inc.



Jon Garman, Director of Product Engineering  
Workstation Division,  
Sun Microsystems, Inc.



## XYLOGICS SUPPORTS THE POWER OF THE SUN.

When Sun Microsystems began looking at Multibus disk and tape controllers for their high performance engineering workstations, they demanded a lot.

*"We needed a fast Multibus SMD disk controller, one that could read fast drives, like the Fujitsu Eagle, at full speed,"* says Sun Director Jon Garman. *"The boards we were evaluating simply couldn't measure up."*

That's when Sun discovered Xylogics.

*"Getting Xylogics' 440 controllers operational with Sun's workstations was a positive experience,"* Garman remembers. *"What the manual said, the Xylogics boards did, and the software interface was simple to use."*

*"We had our first Xylogics board up and running with UNIX in just four hours. It was quite phenomenal,"* he says.

Next, Sun integrated the Xylogics 450 in its second-generation family of workstations because it was the fastest, most reliable Multibus board they could find.

*"From the start, our number one concern has been performance,"* says Garman. *"But just*

*as important is the support Xylogics gives us. They've always been very responsive.*

*They listen. And take us seriously. We have a close working relationship: engineering to engineering and management to management. They've always delivered on their promises."*

Xylogics' newest product, the 751 VME controller, is now being integrated into Sun's third generation of workstations, The Sun-3 Series.

Little wonder that Xylogics is the secret behind virtually every supermicro and workstation company. Or that nearly half of all high performance Multibus disk and tape controllers in use today are Xylogics.

Find out how Xylogics performance, reliability and support can be part of *your* success story. Call or write for information about our complete line of Multibus and VME bus products.

**THE SECRET'S OUT.**



**Xylogics®**

Your Partner For Performance

144 Middlesex Turnpike  
Burlington, Massachusetts 01803  
(617) 272-8140

Kevin Gonor, Xylogics and Jon Garman,  
Sun Microsystems, with Sun-3/160 C  
Color Workstation

CIRCLE NO. 39 ON INQUIRY CARD

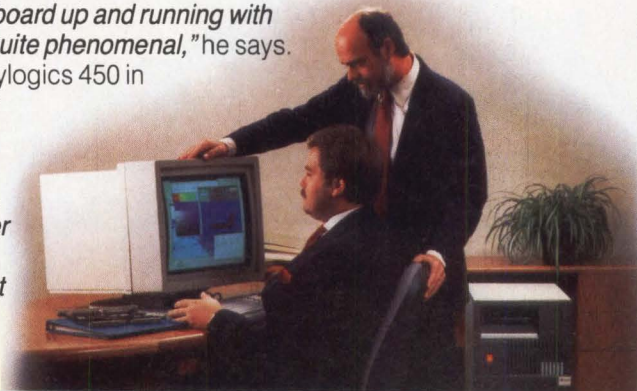



Apollo Computer Inc. and Sun Microsystems Inc. are other major computer manufacturers committed to System V.

Digital Equipment Corp. supports UNIX too. However, DEC supports (even if it does not push) its own ULTRIX, which is based on Berkeley UNIX Version 4.2. As its white paper on UNIX indicates, DEC is lukewarm to the System V SVID and says it prefers POSIX, if its customers want it.

If the government and the manufacturing community moves indicate public attitude, DEC's customers do want it. Although based on System V, POSIX does have some Berkeley features. The National Bureau of Standards and several vendors expect that, once POSIX becomes a full-use standard, ULTRIX will begin to resemble POSIX. The user base appears to be moving in the direction of POSIX and it is unlikely that DEC will let that customer base slip through its fingers. What is more likely is that DEC is resisting UNIX because DEC stands to lose more than any other computer manufacturer by adopting UNIX. The VMS operating system, along with DECnet, are major features differentiating DEC from other companies, and both VMS and DECnet have been under attack in the interest of standardization and compatibility.

### Supersets abound

One way that computer vendors are dealing with the differentiation problem is by adding features to a basic SVID UNIX or POSIX to make it special. If the story ended there, such construction of UNIX supersets would allow system integrators to port basic UNIX applications to their environments but not from their environments to anyone else's. As a result, manufacturers are still able to maintain a captive installed base.

This practice could backfire, however. With the government's and other major users' emphasis on compatibility, it is conceivable that something less than 10 percent of a manufacturer's loyal followers could become dependent on these features. The manufacturer would then be stuck with having to support its special version, practically forever.

Fortunately for compatibility, most third-party vendors and software developers are refusing to use these superset features. For third-party vendors and software developers, a single, standard operating system ensures that their applications will run on the maximum number of machines with the least amount of rewriting. Consequently, major UNIX database vendors—such as Informix Software Inc., Oracle Corp., Relational Technology Inc. and Unify Corp.—are writing only for the standard operating system features. Other features that

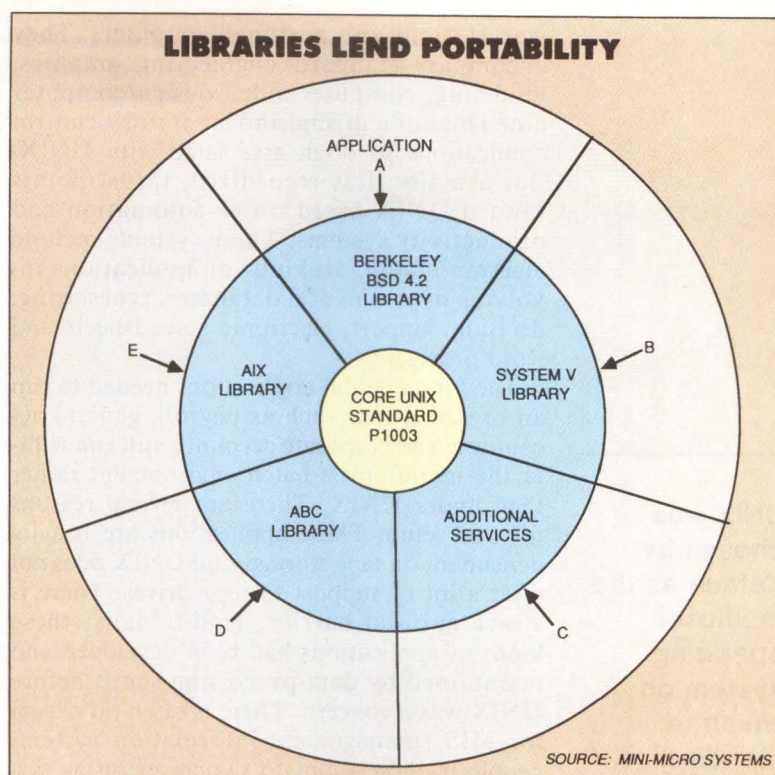

would be nice to have are either written by the database companies themselves or by the application developers.

Application developers have also adopted strategies that permit them to create a single application for various machines running different supersets of UNIX. For instance, many of them have indicated that they will provide for UNIX extensions in library routines. These library routines will interface to the core standard (P1003 or SVID) on one side. The other side will interface to the application (Fig. 2).

The system calls for any particular service will appear the same to each UNIX system's library. Portability results for the following reasons. The system calls that the application makes directly to the core standard UNIX do not affect portability because the core is standard. If a feature does not exist in the core standard, but does exist in a certain UNIX superset, the application will make a system-call request to that superset's system library, which will perform the service in its own way. In the case of a UNIX system (call it the ABC UNIX) that does not provide the feature at all, the identical system call will go to the ABC library, which will contain a vendor-written service routine able to perform the function.

The federal government hopes to use this library scheme to run its numerous applications, both in the Department of Defense and in civilian agencies, on different UNIX-based computers, with few modifications. These applications run on mainframes, minicomputers,

**Fig. 2. To create applications that are portable across different UNIX supersets, developers provide the UNIX extensions via library routines rather than by using the UNIX supersets directly.**



workstations and personal computers. They encompass standard engineering graphics, modeling, computer aided design/computer aided manufacturing, and laboratory-control applications so often associated with UNIX. But a major, less recognized, thrust points toward UNIX-based office automation and productivity systems. These systems include electronic mail, all kinds of applications involving departmental databases, typesetting, decision support, electronic spreadsheets and word processing.

The fundamental applications needed to run an organization, such as payroll, general accounting and corporate accounts, still run within the mainframe's batch environment rather than under UNIX. There are several reasons for this setup. These applications are heavily dependent on tape storage, and UNIX does not offer a lot of support to tape drives. There is also a cultural barrier. Traditionally, these kinds of applications had been developed and maintained by data-processing shops before UNIX was a concern. There is often no reason for MIS (management-information system) people in these shops to switch operating systems. Moreover, MIS people tend to deal with high-level data structures and security while UNIX and the C programming language have been oriented toward lower level objects.

However, UNIX's strength in office automation should not be surprising. UNIX originally

was a text manipulator. This orientation underlies its strength as a software-development system—a computer program is really composed of structured text. In fact one of the early major UNIX vendors—Fortune Systems Corp.—made its claim to fame by emulating the Wang Laboratories Inc. word processor. This was a relatively easy product to develop because of all the text handling utilities in UNIX.

UNIX's other technical strength—its ability to handle low-level objects such as registers, program counters and memory locations—makes it attractive to system programmers developing communications applications. This capability, in conjunction with economic factors, also makes UNIX attractive for distributed-processing applications.

### Great expectations

Nothing is perfect, and UNIX has its shortcomings. Some of them are intrinsic weaknesses; others are really the lack of features that users expect in production environments.

Among weaknesses that users cite are lack of database-application development tools, ANSI tape tools and standardized system-administration tools; poor error-handling capabilities, flimsy file systems, poor security and subpar handling of flexible disks. Users also feel that UNIX, like production operating systems, should provide for writing the data to disk immediately upon request, instead of holding

---

**UNIX was chosen by default as the multiuser operating system on which to standardize.**

---

## Why not standardize

MS-DOS, ubiquitous in the microcomputer world, is, for several reasons, not considered to be a suitable operating system to provide software transportability across multitasking, multiuser mainframes and minicomputers. Principally, although it recently received multitasking capabilities, MS-DOS is not a multiuser operating system. In addition, it does not have software-protection facilities to supervise and coordinate the machine resources that a program can access, and it is written in assembly language.

Multitasking, software protection and multiuser capabilities are related but not mutually dependent. For example, DOS 4.0 is multitasking, but it is not necessarily protected. Consequently, even on a single-user multitasking DOS 4.0 system, a background process could run rampant and clobber other processes. The Intel Corp. 80286 version of DOS 4.0 provides protection, because it is designed to take advantage of the 80286's memory-management hardware. But most existing applications written for DOS will not run in DOS 3.0, DOS 4.0 and the 80286 DOS 4.0 environments, because they violate the programming rules for protection. Applications behave differently in

protected and unprotected environments.

For example, most existing applications deal directly with the hardware in some way, whether it be to write directly to graphics memory, read directly from the basic input/output system, write directly to various parts of memory, or read or write to the disk without going through DOS. But, even if the applications were rewritten to deal only with the operating system, porting MS-DOS to multiple-class computers would require rewriting the entire operating system because MS-DOS is written in Intel Assembler rather than in the C language. Microsoft Corp. admits that such a rewrite is a lengthy and impractical task.

Even if all these problems were miraculously solved, DOS would still not be suitable as a generic operating system for personal computers and large multiuser computers because DOS is single-user oriented, claims Mark Ursino, manager of strategic accounts at Microsoft. Multiuser implies a number of capabilities with regard to understanding different users, such as different user privileges and different scheduling techniques. MS-DOS doesn't support these multiuser capabilities and, Ursino says



the data in a buffer until the buffer is full.

Both third-party vendors and the IEEE have been working to alleviate these and other concerns. The IEEE is even sponsoring a contest to find the worst problems in POSIX.

Differences between POSIX and the SVID are also being resolved. It is not generally realized, but it is now possible to have an operating system implementation that conforms to POSIX and also passes the test for

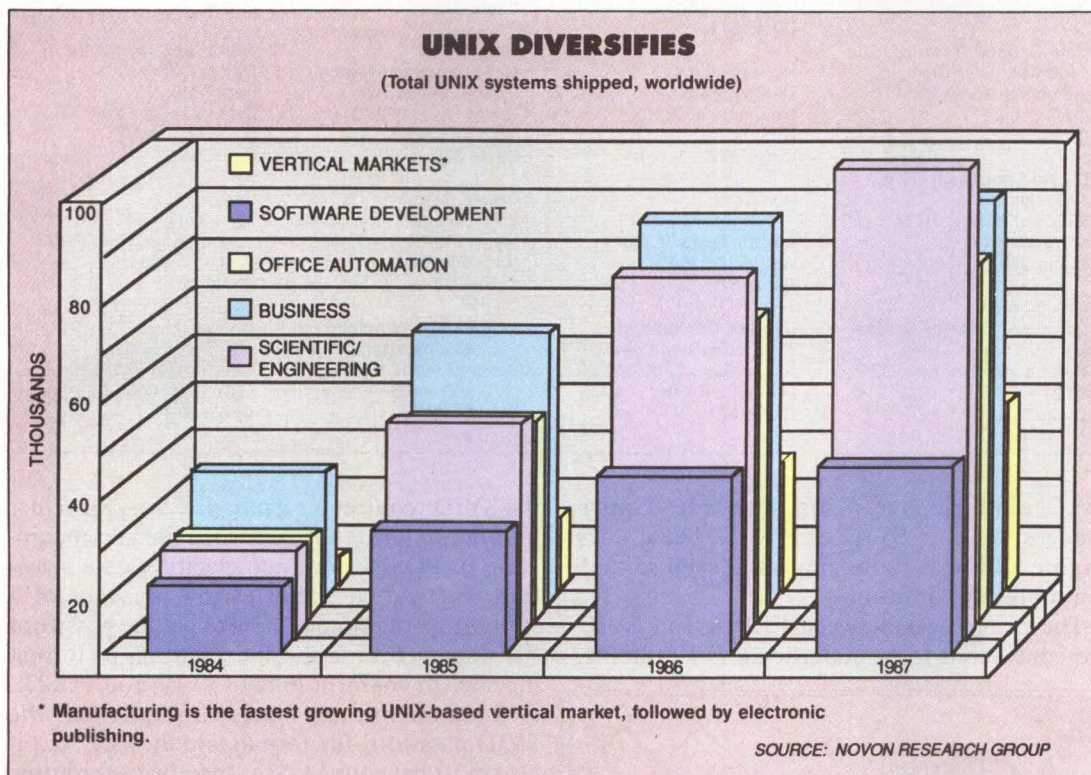

Figures indicate that, although scientific and engineering applications have been one of UNIX's largest growth areas, UNIX has found its greatest use in office automation and business applications.

## on MS-DOS?

emphatically, "Microsoft has no plans to make MS-DOS multiuser. XENIX is our multiuser operating system."

It turns out that time-sharing UNIX, with its round-robin scheduling and fairness principles, rather than privileges, doesn't have many of these capabilities either. For this reason, Ursino believes that UNIX is not the optimal portable operating system for multiple-class machines and applications. Applications that make use of the scheduler won't work, if they are transported across workstations and different-purpose time-sharing machines all running the same operating system but with different schedulers.

AT&T Co., the IEEE and the UNIX /usr/group are all working to design a version of UNIX with the priority-scheduling capabilities needed for applications such as real-time and transaction processing. But as far as making MS-DOS multiuser, Ursino views such an idea as "a cruel joke, because it will not provide users with the capabilities they think they would be getting."

There are several problems. One is that most DOS applications do not support multiuser requirements

such as record- and file-locking. An even bigger problem is that most DOS applications are graphics-based. Currently, nobody builds anything that even approaches a cost-effective multiuser computer that offers each user full graphics capability. As a result, whether users hang dumb terminals off their multiuser MS-DOS systems, or run MS-DOS as a task under UNIX, they would quickly discover that applications like Lotus Development Corp.'s 1-2-3 or window-based applications would not run. These applications could run on the main system console or on an intelligent terminal that emulated the DOS graphics environment. But that only buys an expensive DOS machine.

There is yet another problem. "Multiuser" implies a single processor supporting a number of terminals. In that configuration, supporting multiple graphics terminals is not cost-effective.

This is as true for multiuser UNIX as it is for MS-DOS. Consequently, the highly graphical UNIX systems used in engineering design are usually operated as single-user workstations. Information in these environments is then shared via closely coupled networks.



## Companies mentioned in this article

**Amdahl Corp.**  
1250 E. Arques Ave.  
P.O. Box 3470  
Sunnyvale, Calif. 94088  
(408) 746-6000  
**Circle 363**

**Apollo Computer Inc.**  
330 Billerica Road  
Chelmsford, Mass. 01824  
(617) 256-6600  
**Circle 364**

**AT&T Co.**  
295 N. Maple Ave.  
Basking Ridge, N.J. 07920  
(201) 221-8851  
**Circle 365**

**Concurrent Computer Corp.**  
197 Hance Ave.  
Tinton Falls, N.J. 07724  
(201) 758-7420  
**Circle 367**

**Data General Corp.**  
4400 Computer Drive  
Westboro, Mass. 01580  
(617) 366-8911  
**Circle 368**

**Digital Equipment Corp.**  
146 Main St.  
Maynard, Mass. 01754  
(617) 897-5111  
**Circle 369**

**Gould Inc.**  
Computer Systems Division  
6901 W. Sunrise Blvd.  
Fort Lauderdale, Fla. 33313  
(305) 587-2900  
**Circle 370**

**Hewlett-Packard Co.**  
Inquiries Manager  
1820 Embarcadero Road  
Palo Alto, Calif. 94303  
(800) 367-4772  
**Circle 371**

**Honeywell Inc.**  
7900 W. Park Drive MS-1006  
McLean, Va. 22102  
(703) 827-3718  
**Circle 372**

**IBM Corp.**  
11400 Burnet Road  
Austin, Texas 78758  
(512) 838-3300  
**Circle 373**

**Informix Software Inc.**  
4100 Bohannon Drive  
Menlo Park, Calif. 94025  
(415) 322-4100  
**Circle 374**

**Intel Corp.**  
3065 Bowers Ave.  
Santa Clara, Calif. 95051  
(408) 987-8080  
**Circle 375**

**Motorola Inc.**  
Microcomputer Division  
2900 S. Diablo Way  
Tempe, Ariz. 85282  
(602) 438-3501  
**Circle 376**

**Oracle Corp.**  
3000 Sand Hill Road 3-180  
Menlo Park, Calif. 94025  
(415) 598-8000  
**Circle 377**

**Relational Technology Inc.**  
1080 Marina Village Parkway  
Alameda, Calif. 94501  
(415) 769-1400  
**Circle 378**

**Sun Microsystems Inc.**  
2550 Garcia Ave.  
Mountain View, Calif. 94043  
(415) 960-7310  
**Circle 379**

**Texas Instruments Inc.**  
P.O. 809063  
Dept. Unix  
Dallas, Texas 75380  
(800) 527-3500  
**Circle 380**

**Unify Corp.**  
4000 Kruse Way Place  
Lake Oswego, Ore. 97034  
(503) 635-6265  
**Circle 381**

**Unisys Corp.**  
1 Burroughs Place  
Detroit, Mich. 48232  
(313) 972-7000  
**Circle 386**

SVID conformance. This does not require changes to either SVID or POSIX, but it does require adding certain features to each so they can mutually conform.

The differences between POSIX and SVID are considered to be superficial. For example,

the SVID requires a certain directory structure in order to locate the password file and manipulate it. POSIX does not specify such a structure. Instead, it specifies the presence of a subroutine that knows how to get the password file wherever it may be and whatever its format may be. To conform to both SVID and POSIX, an implementation needs to implement the SVID password-file format and location, but it also must have the POSIX-specified subroutine for accessing the same information.

Many of the issues surrounding items in the appendix of the trial-use standard, such as "locking," have also been resolved. The locking controversy centered on "advisory locking" vs. "mandatory locking." Mandatory locking sounds like something that must be necessary to ensure data integrity. Yet the agreement favored advisory locking for two reasons. First, it was realized that mandatory locking had some problems. In particular, if the accounting file is locked, no one can log on to the system, and all processes stop running because they can't log their accounting data. A second reason was that, in the aftermath of such realizations, no one was able to come up with any example where mandatory locking would be required.

As it now stands, an International Standards Organization effort has already been initiated, and approval of POSIX 1003.1 as a work item is expected this month. The IEEE hopes to get and incorporate feedback from ISO before its own, full-use, document is voted on in July.

### The Real World Runs on Real Time.



Modern intelligent systems require real time response and high efficiency. That's why OS-9/68000 has been the designer's choice in thousands of the most demanding real-life applications.

OS-9 is very compact, highly adaptable, and fully ROMable. It's C source code compatible with Unix, and it's supported by a wide range of outstanding software tools, including graphics and networking options.

Many leading suppliers of 68000 and 68020 based systems offer ready-to-run OS-9 packages for their products. Or you can use a Microware PortPak to install OS-9 on your own custom hardware.

When microseconds count, you can count on OS-9.

**OS-9/68000™ — The Emerging Standard.**

*microware*

Microware Systems Corporation  
1866 N.W. 114th Street • Des Moines, Iowa 50322  
Phone 515-224-1929 • Telex 910-520-2535

CIRCLE NO. 40 ON INQUIRY CARD

Interest Quotient (Circle One)  
High 483 Medium 484 Low 485





Don't miss the SCSI bus.

**F**ujitsu's line of compatible SCSI data storage products will help you drive your system to its full performance potential.

If you want cartridge tape drives, optical disk drives, 5¼-inch, 8-inch, and 10½-inch Winchester drives — or any combination thereof — on your SCSI bus, you'll never miss with Fujitsu America.

Our SCSI storage systems and products can keep up with the most sophisticated multi-host, multi-tasking SCSI-based system you can design. You can take full advantage of the extended performance features of SCSI — with products that set performance standards of their own.

Our Intelligent Disk Controller (IDC) can be configured with up to four drives on a single node, for a storage capacity that can exceed 2.7 Gigabytes. Choose our 8-inch, 337 and 690 MB drives or our 10½-inch Eagle XP, 689 MB drives. The SCSI IDC offers either single-ended or differential drivers and Common Command Set support for easy integration into any SCSI environment.

For 5¼-inch drives, our 172 MB drive, with its embedded SCSI controller, offers you large capacity and high performance in a compact package.

And Fujitsu's SCSI family also meets your need for cost-effective back-up devices. Our 130 MB, ½-inch cartridge tape drive or our new 600 MB, 5¼-inch optical disk drive provide unique solutions to meet your SCSI requirements.

If you'd like to put your SCSI system into high gear — stop! And find out more about Fujitsu's compatible data storage products. Call (408) 946-8777. Or write Fujitsu America, Inc., Storage Products Division, 3055 Orchard Drive, San Jose, CA 95134-2017.

Put Fujitsu drives on your SCSI bus. And give superior system performance the green light.

**WE'RE DEVELOPING TECHNOLOGY FOR YOU.**



**FUJITSU AMERICA**  
Storage Products Division

**CIRCLE NO. 41 ON INQUIRY CARD**





One of the most significant developments in IBM ASCII terminals is the one you may never use.



**Announcing an IBM first:  
the three-year ASCII  
terminal warranty.**

Here's how it works.

Should you have a problem with any of the three elements\* of an IBM ASCII terminal purchased after June 15, 1986, just take the problem element to any

IBM Service Exchange Center or IBM authorized remarketer.

They'll exchange the non-working element for one that works. So you'll be on your way with a minimum of downtime.

How will you know which element isn't working properly? Our built-in diagnostics let you know quickly.

Of course, all this may well be academic. For given the reliability that's built into every IBM ASCII terminal, the three-year limited warranty is one feature you'll probably never need.



IBM's unique plug-in emulation cartridges.

Emulation	3161	3162	3163	3164
ADDS Viewpoint	X	X		
DEC VT220/100/52		X		
DEC VT100/52			X	
DEC VT220 w/Hot Key/3708		X		
Hazeltine 1500	X	X		
Lear Siegler ADM-3A	X	X		
Lear Siegler ADM-5	X	X		
TeleVideo 910, 910+, 912, 920, 925, 925E	X	X		
TeleVideo 950			X	
WYSE 50/50+		X		
IBM 3101	X	X	X	X
Enhanced IBM 3708 Attachment	X			

**Introducing the 132-column  
IBM 3162.**

But our three year warranty isn't the only significant development in IBM ASCII terminals.

There's our new full-function 3162.

It features a crisp, clear, readable 9 x 15 character cell.\*\*

And it's available with our new amber-gold 14-inch screen. Or our new green 14-inch screen. Your choice.

What's more, not only is the IBM 3162 switchable between 132 and 80 columns, it shows 28 rows of data. Which enables it to display even more information.

The 3162 comes with a compact, yet fully-functional, 102-key keyboard. Or a space-saving 84-key keyboard.

But, of course, size isn't everything. Read on.

**New developments  
in emulation.**

Our exclusive plug-in Emulation Cartridges allow all our ASCII terminals to operate in the most widely-used data streams. (Including the DEC VT 220 and WYSE 50+.) So that instead of changing terminals, you merely change cartridges.

And, in addition to their changeable personalities, all IBM ASCII terminals share another trait. The ability to operate in their own function-rich native mode.

**What isn't new.**

Our superb ergonomics, for one thing. And our quantity discounts, for another.

Neither is the availability of financing from IBM Credit Corporation. Or the quality and support you'd expect from IBM.

For more information, contact IBM or your marketing representative. Or call 1 800 IBM-2468, Ext. CM/96 for the IBM authorized supplier nearest you.

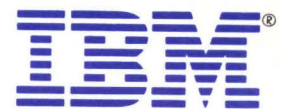

This limited warranty applies only to ASCII terminal models 3161, 3162, 3163 and 3164 purchased in the U.S. and Puerto Rico.

\*Keyboard, display and base. \*\*9 x 15 character cell in 25-line mode only.



# THE ONLY DESKTOP PRINTER / PLOTTER FROM A TO C-SIZE



## Introducing the **JDL-850 EWS™** Engineering Workstation Printer/Plotter

The JDL-850 EWS brings a new level of convenience and capability to workstation output. High quality drawings from A to C-size can be produced in 14 colors with line quality and accuracy exceeding most pen plotters. For continuous plot production, an optional automated media feeder accepts A through C-size papers and vellum. And, with the 850 EWS you never have to worry about changing pens, having the right pen color, or running out of ink. You spend more time on productive output and less time on set-up and maintenance.

The HP-GL™ compatible GL Processor™ option frees the host computer from the CPU-time consuming task of vector to raster conversion. Optimizing the 850 EWS performance, the GL Processor produces faster plot times and significantly increased system productivity. In micro to mainframe applications the 850 EWS/GL Processor provides high resolution plotting with CAE/CAD/AEC and graphics software that supports HP-GL.

For added workstation functionality the 850 EWS emulates the Diablo 630, IBM 5182 Color Printer, and Epson printers for text and graphics compatibility with word processing, spreadsheet and business graphics programs.

Speed, output versatility, desktop size, unattended operation and low cost media and supplies make the 850 EWS Printer/Plotter so convenient and affordable, every CAD workstation can have one.

### The JDL-850 EWS family:

- 850 EWS with GL Processor Controller for maximum performance and features.
- 850 EWS/GLP - internal card for HP-GL compatibility.
- 850 EWS Printer/Plotter.

For specifications and a plot sample call (805) 495-3451.  
In the eastern half of the U.S. call (704) 541-6352.



2801 Townsgate Road, Suite #104  
Westlake Village, CA 91361

Plot sample produced on the 850 EWS printer/plotter with AutoCAD software.  
AutoCAD is a registered trademark of Autodesk Inc. IBM is a registered trademark of International Business Machines Corp. Diablo is a registered trademark of Xerox Corp. Epson is a registered trademark of Epson America. HP-GL is a registered trademark of Hewlett-Packard Corp.

CIRCLE NO. 43 ON INQUIRY CARD



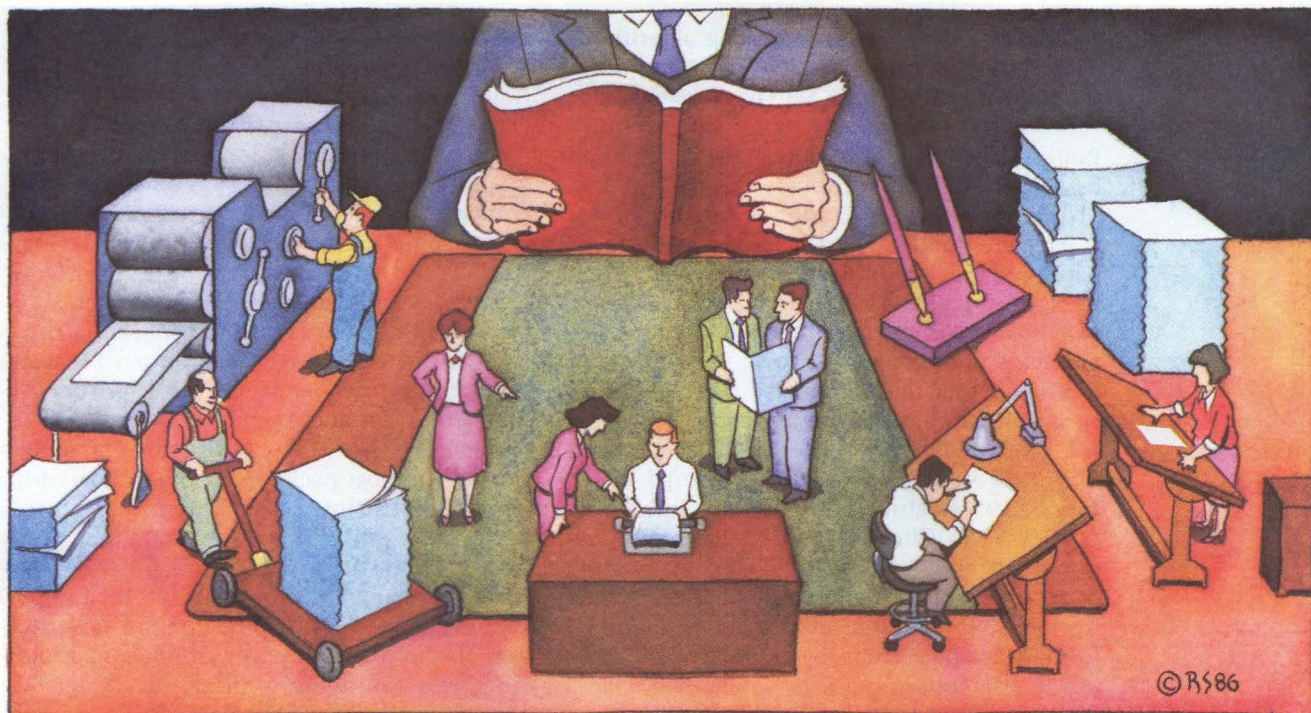

# DESKTOP PUBLISHING: SIFTING TYPE FROM HYPE

Macintosh users have enjoyed desktop publishing benefits for more than a year. Now, powerful IBM PC packages have arrived. The big question is, "What can they really do?"

**David Simpson**, Senior Editor

Desktop publishing seems to be an ideal profit vehicle for value-added resellers and system integrators. Few end users are capable of hooking up the disparate components that these systems require, which often include scanners, personal computers, high-resolution monitors, device drivers, disk drives, laser printers and page-composition software. But so much hype has been lavished on desktop publishing that it's difficult to understand just what the systems can and cannot do.

At the heart of a desktop publishing system is the page-composition program, also called a page-makeup or page-layout program. These packages were preceded by simpler printer-control programs and souped-up word processing programs. At first glance, all the packages appear identical in functionality, but by closely evaluating them, differences between product

brochure and product performance become as evident as differences between product A and product B.

For example, most packages claim to be "what you see is what you get," or WYSIWYG: what appears on the screen is exactly what will appear on the hard copy. However, even with high-resolution monitors, you can often confuse different typefaces on IBM Corp. PCs.

Buyers should also be aware that with many packages, they can't edit entire pages in WYSIWYG mode—they can only "preview" the screen on demand. In other words, the programs don't have true interactive WYSIWYG capabilities.

A fundamental feature of page-composition programs is the ability to hyphenate and justify. But be sure to find out whether hyphenation is automatic or manual. And, if it's automatic, whether it performs hyphenation by referring to a dictionary—the size of which varies widely



---

**Another key consideration is whether or not a package can accept formatted text.**

---

among the packages—or by using algorithms. The latter method is used by Manhattan Graphics Corp.'s Ready,Set,Go, Version 3, for the Macintosh, and Xerox Corp.'s Ventura Publisher for the PC. Ideally, a package should be able to use both techniques.

Another key consideration is whether or not a package can accept formatted text. Most packages can import unformatted ASCII text files, but page-composition packages vary widely in acceptance of formatted files from popular word-processing packages. Also be sure to ask whether those imported files will retain type styles and formatting codes.

Less expensive packages, such as Letraset USA's \$199 MacPublisher II, Orange Micro Inc.'s \$395 Ragtime and Software Publishing Corp.'s \$185 ClickArt Personal Publisher do not maintain the type style and formatting codes of imported files. In contrast, Xerox Corp.'s \$895 Ventura Publisher does retain the formatting codes from five popular word-processing programs.

Other packages are essentially word-processing programs with added page-composition capabilities. They include Spellbinder Desktop Publisher, based on the Spellbinder word-processing program, Orange Micro's Ragtime, incorporating a MacWrite-like word-processing program, and International Microcomputer Software Inc.'s PagePerfect. Such packages give you full word-processing functions within the page-composition environment, thus eliminat-

ing the need for outside text editors.

Most desktop publishing applications require mixing text and graphics. One way to get graphics on-screen is with an image scanner. Another method is to import images from a graphics program. Many PC-compatible page-composition packages accept images from popular graphics packages such as Autodesk Inc.'s AutoCAD, Digital Research Inc.'s GEM Draw, Lotus Development Corp.'s 1-2-3, Media Cybernetics Inc.'s Dr. Halo and Microsoft Corp.'s PC Paintbrush. Macintosh-compatible packages usually accept images directly from Apple's MacPaint and MacDraw.

There are two levels of graphics manipulation. With most packages, you have to exit the page-composition environment and go to a separate graphics program (or to a separate module of the page-composition program), perform the sizing and cropping, and then import the image back to the page-composition package. In the higher level of graphics manipulation, you can actually draw, or change, the images on the page while in the page composition-environment. Examples of this type of package are Megahaus Corp.'s First Impression and White Sciences Inc.'s Pagebuilder package.

Also important is how long a document the package can handle, which is related to how you get the various elements on the page. This can be done either in batch mode or interactively; in other words, does the program perform automatic pagination or does it require

## What you want is what

**Edward Teja**, vice president of Freehold Corp., Santa Cruz, Calif., on Xerox Corp.'s Ventura Publisher:

"Overall, I'm impressed with it, it's very powerful. What I don't find good about it is that the difference between the reduced page layout [which displays the full page on the screen] and the normal page layout is too drastic. In the reduced page layout, you often can't tell what things look like, you can't see the words . . . it's just to see if the full page is attractive. If I had a zoom where I could go in gradually, it would resolve some of these problems.

"Another minor inconvenience is that, when you're doing text editing, let's suppose you turn off the sidebar because you want to see the whole page, or the full width of the page, and you see something you want to boldface. You block it off—no problem—but now you have to pop the sidebar back on in order to tell it to boldface. You can't just go through and mark everything you want boldfaced and then do it at the end, because if you move the highlighting, it forgets where it was before . . .

"When you install Ventura, it reconfigures [Digital Research Inc.'s] GEM. I had GEM configured for

enhanced graphics, but I configured Ventura for [IBM Corp.'s] CGA and now GEM is configured for CGA . . . In fact, installing Ventura is a long and tedious process, so you better make sure you've got it the way you want it. The documentation is not bad, and most things you can figure out by just banging around on the system."

**Jose Ramos**, publisher of the WYS/WYG newsletter, Redwood City, Calif.,—which focuses on the electronic publishing industry—on Ventura Publisher:

"The key thing about Ventura is that it was designed for the XT, and they wanted it to be fast. So they wrote the screen drivers in 8088 assembler language. They also selected a geometric model that is denominated in integer arithmetic. What that means is that you don't need a floating-point co-processor chip. With other packages, you have to go out and buy a co-processor chip and plug it into the motherboard of the PC.

"It was a very clever decision. They wound up with a very fast package on the XT and then by luck they found themselves well-positioned for the Compaq 386 because the Compaq doesn't yet have the



manual page makeup? For example, with Studio Software's Corp.'s FrontPage, the operator uses cut-and-paste techniques to manually create pages one at a time. Software Publishing's ClickArt is another example of a manual page-makeup program.

Xerox's Ventura Publisher allows you to create documents interactively as well as in batch mode. In batch mode, you select a style sheet, identify the text and graphics by simply pointing a mouse and clicking and then tell the program to make the page(s). Ventura Publisher automatically "pours" text and graphics onto the screen in the proper format. In addition, the program automatically updates the source file when changes are made and reflows and repaginates pages when images or text are added.

Bestinfo Inc.'s high-end (\$7,000) multiuser Superpage II is another package that combines batch and interactive capabilities. Similarly, Software Publishing's Harvard Professional Publisher, which is based on the original Superpage, can handle long documents in batch-layout mode. In general, interactive mode is slower than batch mode.

Other functions to look for in a desktop publishing package include automatic reflowing of text to different page formats, spelling checkers, automatic image scaling, repagination, table of contents generation, vertical justification, text runaround (text flowing around an image) and availability of predefined

style sheets or page templates. Armed with such a checklist, buyers can quickly eliminate certain packages but, as with most software, the only way to decide on a package is to test-drive a few.

The list of typographic functions to look for in a desktop publishing system is bewilderingly long, notes CAP International Inc.'s Arlene Karsh. But, Karsh, director of the Marshfield, Mass., computer publishing systems market-requirements service, adds, "The key to future, widespread adoption of desktop publishing and all levels of computer publishing, is not in platforms or features, batch vs. interactive, codes vs. WYSIWYG, or whether one should scan, paint or draw and at what resolution, at what output speed and via which page-description language. Rather, the real issue is integration."

#### Vendors target VARs

Some vendors of desktop publishing software specifically target VARs. For example, White Sciences' Pagebuilder sports a programmable user interface that can be tailored for vertical-market applications. Alternatively, buyers can choose from three vendor-supplied interfaces: beginner, intermediate or advanced, depending on whether the targeted users are novices or have graphic-design experience.

Studio Software offers an advanced version of FrontPage that the company sells only to VARs. Called FrontPage Plus, the \$1,295 pack-

---

**'The real issue is integration.'**

---

## you wait for: users speak

floating-point co-processor. The raw speed of the Compaq makes Ventura even faster.

"We did a benchmark comparison between the Ventura package and an Interleaf Version 2.0 package [Interleaf has since released Version 3.0] running on a Sun [Microsystems Inc.] workstation. There was little difference in functionality.

"I don't see PageMaker in the same category as Ventura. PageMaker is just a page-layout package whereas Ventura offers you much more than that. I see PageMaker as the first generation and Ventura as the second.

"The biggest statement that I can make for Ventura is that it is probably the king package right now if it runs on a Compaq. But those statements are moving targets because now that everyone sees what Ventura has, they'll all rush to put bells and whistles into their packages and we have this leap-frogging effect."

**Larry Graff**, managing editor of Marketing News, published by the American Marketing Assoc., on Bestinfo Inc.'s Superpage II:

"It's really nice. It makes things much more

interactive [than the original Superpage]. We put out tabloids. We didn't really look hard at Xerox's or Aldus [Corp.] packages because they just don't give the look and . . . the professional typeset quality that we wanted.

"We're also installing a network and there's some problems. One of the main problems that we've had is that they haven't yet written the proper driver for our typesetter. We telecommunicate to a commercial type house. We want to go directly to a Mergenthaler 202 and they haven't finished writing the program for that. They also had to write software to support the [MicroDisplay Systems Inc.] Genius monitor . . .

"All this stuff was supposed to come out in the spring [of 1986] . . . they showed a prototype version in April, then they said it's coming out in June, and then July, then September, then October 15 . . . and then they started installing it on the 30th and the guy told me we couldn't telecommunicate yet, that we'd have to send disks over to the typesetter. Right now, we're just waiting."



**Incorporating its own word processing program, IMSI's PagePerfect allows users to lay out a complete document in advance and then enter text directly into the layout. The package also features nine zoom levels.**

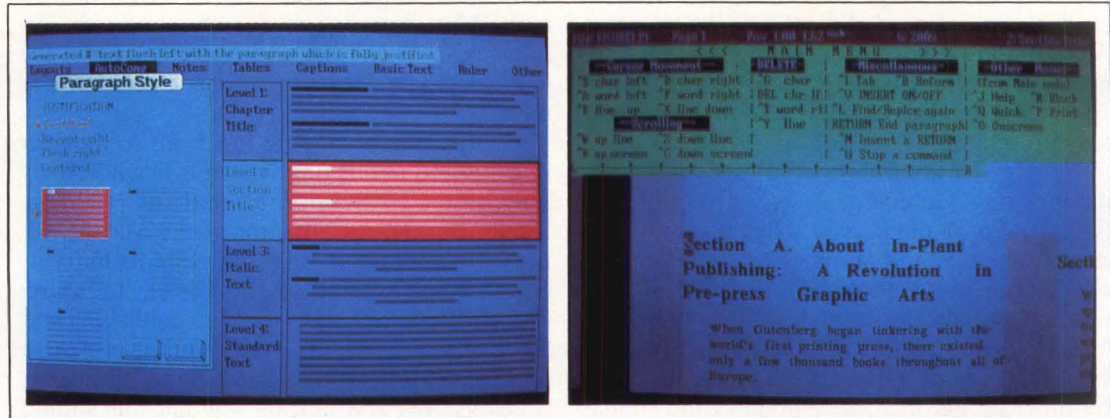

age is aimed at professionals who need additional drivers and interfaces to link systems to wide arrays of output devices, including photo-composition systems. VARs can add a variety of options to the Plus version, including kits for alternate laser printers, typesetters, scanners and high-resolution monitors. FrontPage Plus is available only through Studio Software VARs, called "Certified Desktop Publishing Specialists."

"You've got so many competing pieces of software and hardware that the consultant-VAR-system integrator is likely to be king," says Univation Inc. consultant Lewis Perdue. Univation has an OEM agreement with Xerox to bundle Xerox's Ventura Publisher with Univation's Turbo Publisher board. "I think you'll see a bigger rise in VARs in this field than in almost any other," adds Perdue. "They'll act as a combination of distributor and system integrator."

One of the most eagerly awaited desktop

publishing packages was Xerox's Ventura Publisher, formally titled "Xerox Desktop Publishing Series: Ventura Publisher Edition" (see "Xerox, Ventura campaign to press would-be publishers," Page 17). Xerox acquired exclusive marketing rights to the package from Ventura Software last April and started shipping the product last November.

The package has received almost universal approval. Aside from the considerable clout of Xerox, the Ventura package stands a good chance of success because of a rich set of features, some of which are not found on similarly priced packages. Ventura Publisher runs on a 640K-byte PC/XT or a Xerox 6065, but you can also use it on a 512K system, if you can tolerate limited performance.

Ventura Publisher runs under Digital Research's GEM operating environment; the package's prime competitor—Aldus Corp.'s PC version of PageMaker—runs under Microsoft Windows. "Running under GEM or Win-

**SELECTED MACINTOSH-COMPATIBLE DESKTOP PUBLISHING PACKAGES**

Company Package	Price (\$)	Memory requirements	Import characteristics		Printer support	Notes
			Formatted text	Graphics		
<b>Aldus</b> Pagemaker Version 2.0	495	512K, plus rigid disk	MacWrite, Microsoft Word, Microsoft Works	MacDraw, MacPaint, MacDraft, Full Paint, others	Postscript (inc. typesetters), ImageWriter	scheduled shipments late '86/early '87
<b>FTL Systems</b> MacTeX	750	512K, plus rigid disk	MacWrite, Microsoft Word	MacDraw, MacPaint	Postscript (inc. Linotron 300 typesetter)	typesetting program that combines TeX and Postscript
<b>Letraset</b> MacPublisher II	199	128K, rigid disk recommended	MacWrite, Microsoft Word	MacDraw, MacPaint	Postscript, ImageWriter	doesn't maintain formatting, type styles of imported text; package developed by Boston Software
LetraPage	599	512K	MacWrite, Microsoft Word	MacDraw, MacPaint, scanned images	Postscript, ImageWriter	maintains formatting, type styles of imported text; 93,000-word dictionary
<b>Manhattan Graphics</b> Ready, Set, Go, Version 3	295	512K	MacWrite, Microsoft Word	MacDraw, MacPaint	Postscript (inc. Linotron 100 and 300), ImageWriter	60,000-word spelling checker; direct Postscript programming
<b>Orange Micro</b> Ragtime	395	512K, plus 800K disk	no	MacDraw, MacPaint	Postscript, ImageWriter	integrated MacWrite-like word processor, spreadsheet, forms processor and page-layout program



# A Complete Desktop Publishing System From Quadram® and scLASERplus™

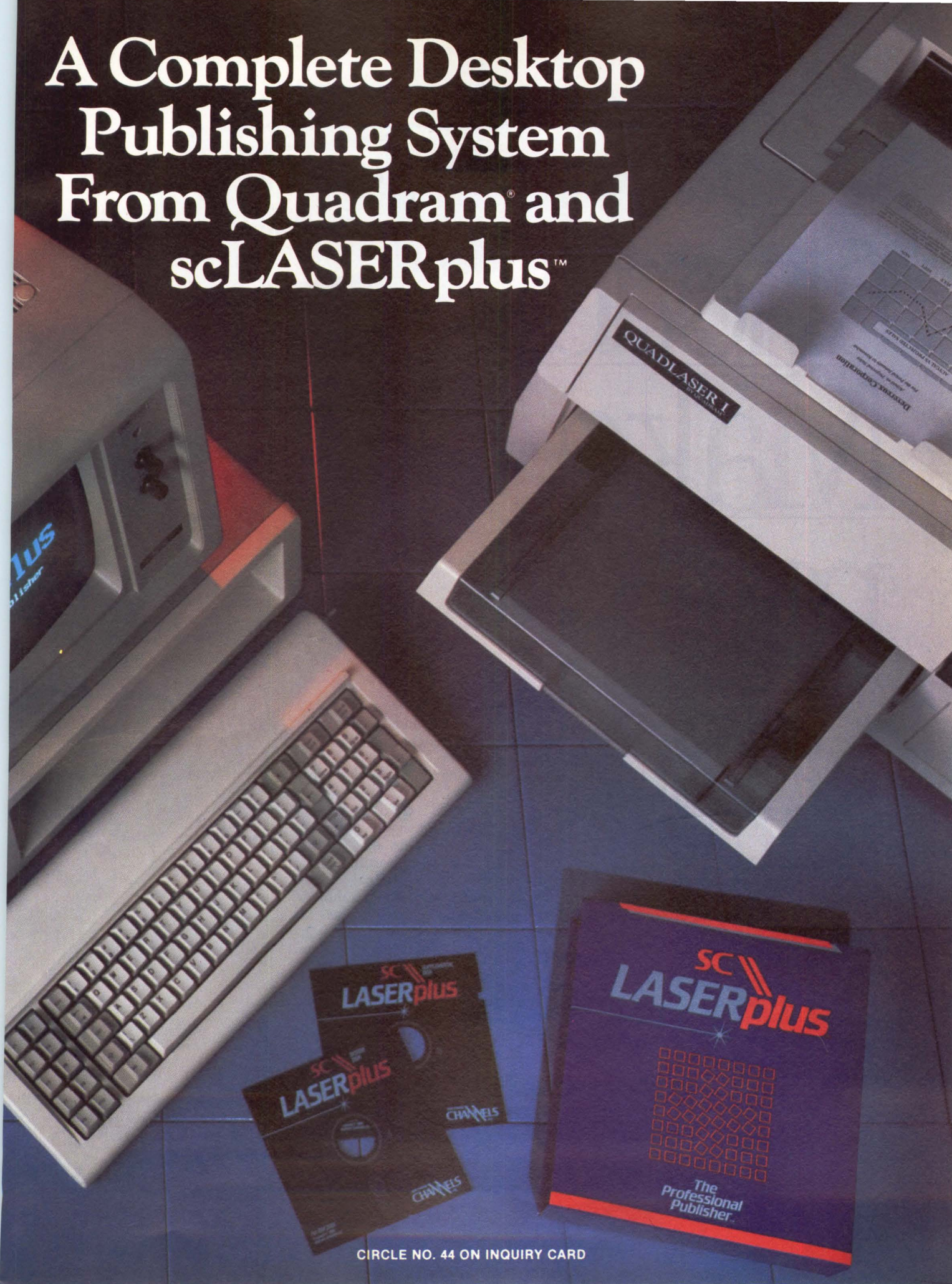

CIRCLE NO. 44 ON INQUIRY CARD



# Go ahead. Make my page.



That's the challenge. And it's coming from thousands of people in business, government, and education. People who want an integrated, working solution in desktop publishing.

Intellipress™ is Cordata's response. A fully-integrated, turn-key system with pre-installed software. Optimized for ease of learning,

ease of use, and high performance. Producing near-typeset quality, professional-looking documents, with integrated text and graphics, on an IBM-compatible personal computer.

With Intellipress, an ultra-resolution display ensures that "what you see is what you get". A selection of type fonts and (optional) image scanner makes sure that what you get is what you want. And a powerful 80286 processor provides the high performance that desktop publishing demands.

Intellipress is backed by Cordata's product development and dealer support organization, and the manufacturing and financial muscle of Daewoo Corporation, a multi-billion dollar conglomerate.

Go ahead.  
Find out about becoming an Intellipress dealer by calling Cordata at (800) 233-3602 (in CA: 800-524-2671). And make your day.

## Plug 'n play Desktop Publishing.

**intellipress**



275 E. Hillcrest Drive, Thousand Oaks, CA 91360.  
TELEX: 650-2696270. TEL: (805) 495-5800.  
In Europe: Holland 31-324-018111.

IBM is a trademark of International Business Machines Corp.

**CIRCLE NO. 45 ON INQUIRY CARD**



dows," explains Woodrow Vandever, executive vice president of InterConsult, a Cambridge, Mass., market-research and consulting firm, "allows third-party vendors to get up and running more quickly. Secondly, [GEM and Windows] provide the interfaces that isolate you from the specifics of printers or scanners." Another key advantage of the GEM and Win-

dows environments for desktop publishing are their graphical interfaces. "What they all want to do is emulate MacPaint and MacDraw," adds Vandever.

Perhaps the most important advantage of Ventura Publisher, relative to other desktop publishing packages, is that the program can handle large documents. Each chapter of a

### SELECTED PC-COMPATIBLE DESKTOP PUBLISHING PACKAGES

Company Package	Price (\$)	Memory requirements	Import characteristics			Notes
			Formatted text	Graphics	Printer support	
<b>Aldus</b> PC version of PageMaker	695	min.: AT with 512K plus 10M-byte rigid disk; recommended: 640K plus 20M-byte rigid disk	Microsoft Word, Windows Write, WordStar, Multimate, XyWrite 3, WordPerfect, DisplayWrite 3, Samna Word, DCA	Windows Paint, Windows Draw!, In*a*Vision, PC Paint, PC Paintbrush, Publishers Paintbrush, Lotus 1-2-3, Symphony, AutoCAD, others	Postscript, Laserjet, Turbolaser, PagePrinter 3812, DDL early '87	file compatibility between Macintosh and PC versions; runs under Windows; requires EGA or Hercules graphics card
<b>Bestinfo</b> Superpage II	7,000	PC/XT or /AT with 640K, plus rigid disk	all major word processing files, including XyWrite	PC Paintbrush, Lotus 1-2-3, scanned images	over 55 devices, inc. over 47 typesetting systems	multiuser system; connects to Novell Network LAN; requires Hercules graphics card
<b>IMSI</b> PagePerfect	695	PC/AT with 640K, plus rigid disk	WordStar, Microsoft Word, MultiMate, WordPerfect, DisplayWrite, pfs:Write, Samna Word, XyWrite, others	scanned images, unannounced graphics programs	Postscript, Laserjet, HPGL	shipping scheduled early '87; includes nine zoom levels; automatic gray-scale averaging (seven levels); package developed by BeyondWords
<b>Laser Friendly</b> The Office Publisher, Plus	795, 1,495	512K, plus rigid disk	WordStar, WordPerfect, Samna Word 3, Multimate, Microsoft Word, DisplayWrite, XyWrite Plus, others	PC Paintbrush, scanned images	Laserjet, Xerox 4045 (Interpress), Postscript, Canon, Ricoh, Printware 720IQ, others	shipments scheduled December '86; Plus version allows users to build macros
<b>Lexisoft</b> Spellbinder Desktop Publisher	695	256K; recommended rigid disk	no	PC Paintbrush, 1-2-3, scanned images	Laserjet, OASYS LaserPro, others	combination word-processing, page-composition package; doesn't require outside text editor
<b>Megahaus</b> First Impression	695	640K, plus rigid disk	WordStar, Multimate, WordPerfect, others	Lotus 1-2-3, AutoCAD, Symphony, scanned images	Postscript, Laserjet, PagePrinter, Interpress	scheduled for January '87 release, DDL support early '87; users can create graphics on-screen
<b>SofTest</b> Softype	1,000; 1,500	varies	WordStar, WordPerfect, Microsoft Word, Multimate, Samna Word, DCA, DisplayWrite 3, others	scanned images	Postscript, Laserjet, Quadram, Xerox 4045 and 2700, Canon, Imagen	single-user version: \$1,000; multiuser: \$1,500; runs on MS-DOS, UNIX or XENIX machines
<b>Software Publishing</b> ClickArt Personal Publisher	185	512K, plus two flexible drives	no	no	Laserjet, Postscript, dot-matrix printers	package developed by T/Maker; laser printer drivers available for \$150
<b>Harvard Professional Publisher</b>	695	PC/XT or /AT with 640K, plus rigid disk	DCA	Harvard Presentation Graphics, Lotus 1-2-3, PC Paintbrush, Dr. Halo, MS Windows Paint, PC Paint Plus, scanned images	Laserjet, Postscript, scanned images	based on Bestinfo's Superpage; uses interactive and batch pagination
<b>Studio Software</b> FrontPage	695	512K, plus rigid disk; 640K recommended	most popular word-processing packages	Lotus 1-2-3, Freelance, AutoCAD, ChartMaster, HPGL	Laserjet, Postscript, DDL	drives phototypesetters in native language; requires math coprocessor chip; replaces DO-IT page-layout program
<b>White Sciences</b> PageBuilder	495	PC/XT or /AT with 384K, plus rigid disk	no	Lotus 1-2-3, DIF, AutoCAD, scanned images	all Canon-based, most Ricoh-based	fully programmable user interface; supports on-screen drawing; drives Canon printers directly via Tall Tree J Laser controller card
<b>Xerox</b> Ventura Publisher	895	PC/XT or /AT with 512K, plus rigid disk	WordStar, Multimate, WordPerfect, Microsoft Word, others	Lotus 1-2-3, AutoCAD, GEM Draw, GEM Graph, PC Paintbrush, Mentor Graphics PC CAD, others	Laserjet, Postscript, Xerox 4045 (Interpress), Epson dot matrix, ProPrinter, Xerox 4020 color ink jet	price includes printer driver, font package, 20 predefined style sheets; runs under GEM; interactive or batch pagination



**Last October, the formidable triumvirate of Aldus, HP and Microsoft announced plans to jointly offer complete desktop publishing solutions.**

document can be 100 pages, and users can string chapters together to create documents as large as 5,000 pages.

However, Xerox isn't the only giant hoping to cash in on the desktop publishing craze. Last October, the formidable triumvirate of Aldus, Microsoft and Hewlett-Packard Co. announced plans to jointly offer complete desktop publishing solutions. The alliance's first offering includes Aldus' PC-compatible version of PageMaker (\$695); Microsoft's Windows and Microsoft Word; and HP's Laserjet printers, Vectra AT computers and Laserjet Publisher kit—an under-\$2,500 PC board that enhances the capabilities of Laserjet printers with Imagen Corp.'s document description language (DDL).

Shipments of the Laserjet Publisher kit are scheduled for this quarter. The kit includes a Motorola Inc. MC68000 processor with 2M bytes of RAM and 16 built-in fonts that can be scaled and transformed. In addition, the board incorporates algorithmic character generation, which allows users to vary point sizes.

Arguably, Aldus kicked off the desktop publishing rage about one and a half years ago when it introduced PageMaker for the Macintosh, which is still the leading page-makeup program for the Apple environment, followed by Manhattan Graphics' Ready,Set,Go. Shipments of the PC version of PageMaker were scheduled for last month. The recommended configuration includes an IBM PC/AT or compatible, at least 512K bytes of RAM and a

10M-byte rigid disk, an IBM EGA (enhanced graphics adapter) or Hercules Computer Technology graphics card and a Windows-compatible mouse.

At least in the early market, the battle for the lion's share of the desktop publishing market will likely be waged by two companies. "Unfortunately, people will go where the publicity is, and that's with two companies [Aldus and Xerox]," says InterConsult's Vandever.

If page-composition packages are the heart of desktop publishing systems, page-description languages provide the muscle. PDLs link the application program and the laser printer. Although you can't squeeze phototypesetting quality (1,200 dots per inch) out of your laser printer, you can maximize its capabilities by using powerful PDLs.

There are currently three major PDLs: Adobe Systems' Postscript, Imagen's DDL and Interpress from Xerox. Just when the industry was about to adopt Postscript as the sole standard, HP last September threw a wrench into the works by announcing adoption of DDL. The relative merits of the three competing languages are hotly contested; the real job for system integrators is to match the power of a particular language to the requirements of the application while, of course, meeting cost requirements.

With the recent flurry of page-composition packages, and the arrival of heavyweights such as Xerox, HP and Microsoft, more and more packages are sure to follow. To get an idea of

## Companies mentioned in this article

**Adobe Systems Inc.**  
1870 Embarcadero Road  
Palo Alto, Calif. 94303  
(415) 852-0271  
Circle 320

**Aldus Corp.**  
411 1st Ave. S.  
Seattle, Wash. 98104  
(206) 622-5500  
Circle 321

**Apple Computer Inc.**  
20525 Mariani Ave.  
Cupertino, Calif. 95014  
(408) 996-1010  
Circle 322

**Bestinfo Inc.**  
130 S. State Road  
Springfield, Pa. 19064  
(215) 328-2900  
Circle 323

**FTL Systems Inc.**  
234 Eglinton Ave. E.  
Toronto, Ontario  
M4P 1K5, Canada  
(416) 487-2142  
Circle 324

**Hewlett-Packard Co.**  
11311 Chinden Blvd.  
Boise, Idaho 83714  
(208) 323-3869  
Circle 325

**IBM Corp.**  
900 King St.  
Rye Brook, N.Y. 10573  
(914) 934-4822  
Circle 326

**Imagen Corp.**  
2650 San Tomas Expressway  
Santa Clara, Calif. 95051  
(408) 986-9400  
Circle 327

**Interleaf Inc.**  
10 Canal Park  
Cambridge, Mass. 02141  
(617) 577-9800  
Circle 328

**International Microcomputer Software Inc. (IMSI)**  
1299 Fourth St.  
San Rafael, Calif. 94901  
(415) 454-7101  
Circle 329

**Laser Friendly Inc.**  
453 Ravendale Drive  
Mountain View, Calif. 94043  
(415) 964-0395  
Circle 330

**Letraset USA**  
40 Eisenhower Drive  
Paramus, N.J. 07653  
(201) 845-6100  
Circle 331

**Lexisoft Inc.**  
P.O. Box 1950  
Davis, Calif. 95617  
(916) 758-3630  
Circle 332

**Manhattan Graphics**  
10 Columbus Ave.  
Valhalla, N.Y. 10595  
(914) 769-2800  
Circle 333

**Megahaus Corp.**  
5703 Oberlin Drive  
San Diego, Calif. 92121  
(619) 450-1230  
Circle 334

**Microsoft Corp.**  
16011 N.E. 36th Way  
Redmond, Wash. 98073  
(206) 882-8080  
Circle 335

**Orange Micro Inc.**  
1400 N. Lakeview Ave.  
Anaheim, Calif. 92807  
(714) 779-2772  
Circle 336

**Softest Inc.**  
555 Goffle Road  
Ridgewood, N.J. 07450  
(201) 447-3901  
Circle 337

**Software Publishing Corp.**  
1901 Landings Drive  
Mountain View, Calif. 94039  
(415) 962-8910  
Circle 338

**Studio Software Corp.**  
3001 Red Hill  
Costa Mesa, Calif. 92626  
(714) 957-0458  
Circle 339

**Univation Inc.**  
1231 California Circle  
Milpitas, Calif. 95035  
(408) 263-1200  
Circle 340

**White Sciences Inc.**  
P.O. Box 24756  
Tempe, Ariz. 85282  
(602) 967-8257  
Circle 341

**Xerox Corp.**  
101 Continental Blvd.  
El Segundo, Calif. 90245  
(800) 822-8221  
Circle 342



# Anatomy of a true WYSIWYG\* monitor

## Full Page Display—

15" portrait mounted screen for true "What You See Is What You Get" performance.

## High Resolution Images—

Superb detail enhanced with four shades of gray—ideal for newsletters, manual updates, etc.

## Flickerless Display—

Non-interlaced 74.63 KHZ scanning frequency for comfortable viewing.

## Princeton Reliability, IBM Compatibility—

Operates with IBM XT/AT and compatibles (free cable included), with traditional Princeton dependability.

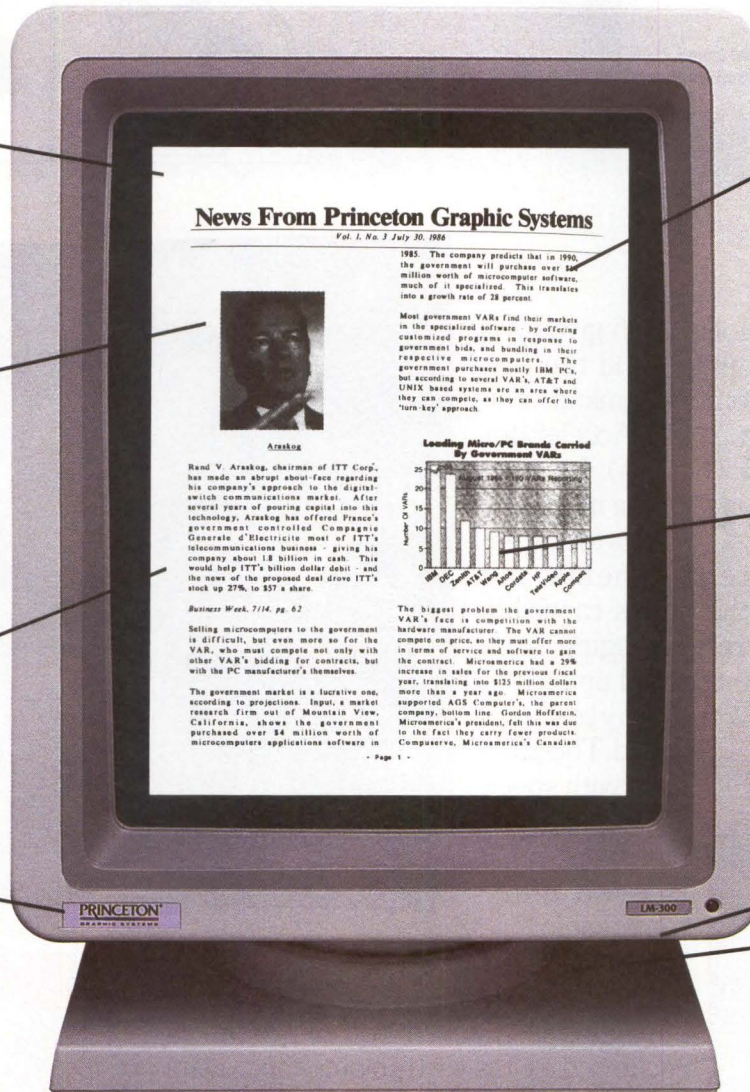

## Crisp, Clear Text—

Superior high resolution and four shades of gray emulate 300 dots per inch (dpi). Fonts designed for 300 dpi. Laser printers can be displayed in actual size.

## Well Defined Graphics—

1220 x 1664 pixel resolution at 160 MHz video bandwidth produces sharp clear graphics. Images scanned with a 300 dpi scanner can be displayed actual size.

## Ergonomic Design—

Built-in tilt and swivel base, easy to reach front mounted controls plus eye pleasing design complements its IBM styling.

## Introducing the Princeton LM-300 Monitor

The new Princeton LM-300 Monitor extends your PC's productivity into desktop publishing, CAE/CAD/CAM, full page text processing and other applications. It's a "What You See Is What You Get" (WYSIWYG) monitor with a true full page display which allows you to view an entire page without scrolling. Now you can view your working documents in final form, BEFORE you print. When utilized with the LM-300A controller and software interface, you can perform cut and paste functions, image reduction and enlargement, image rotation up to 360 degrees and a whole lot more. And its built to last—each LM-300 is backed by a full one year warranty.

For more information about the LM-300 Monitor, call or write: Princeton Graphic Systems 800-221-1490 (Ext. 76), 609-683-1660 (NJ only), Telex: 821402 PGS PRIN. 601 Ewing Street, Bldg. A, Princeton, NJ 08540.

\*What You See Is What You Get

# PRINCETON®

GRAPHIC SYSTEMS  
AN INTELLIGENT SYSTEMS COMPANY

CIRCLE NO. 46 ON INQUIRY CARD

IBM is a registered trademark of International Business Machines Corp.



Storage Technology's  
New 2925  
Tape Accelerator.

*It goes with unsurpassed speed.  
It comes with unsurpassed features.*

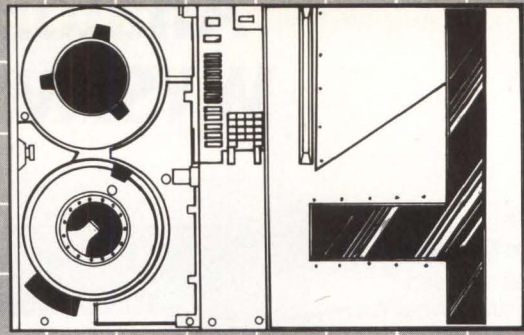

StorageTek's Model 2925 gives you the speed you need, and the features your customers demand. The **TAKE THE PERFORMANCE DRIVE.** 2925's Accelerator (Cache) feature dynamically adapts to system requirements and the host's capability ... at transfer rates ranging from 100 kilobytes per second up to 1.25 megabytes per second. The 2925 goes with speed indeed; but what it *comes with* is even more remarkable.

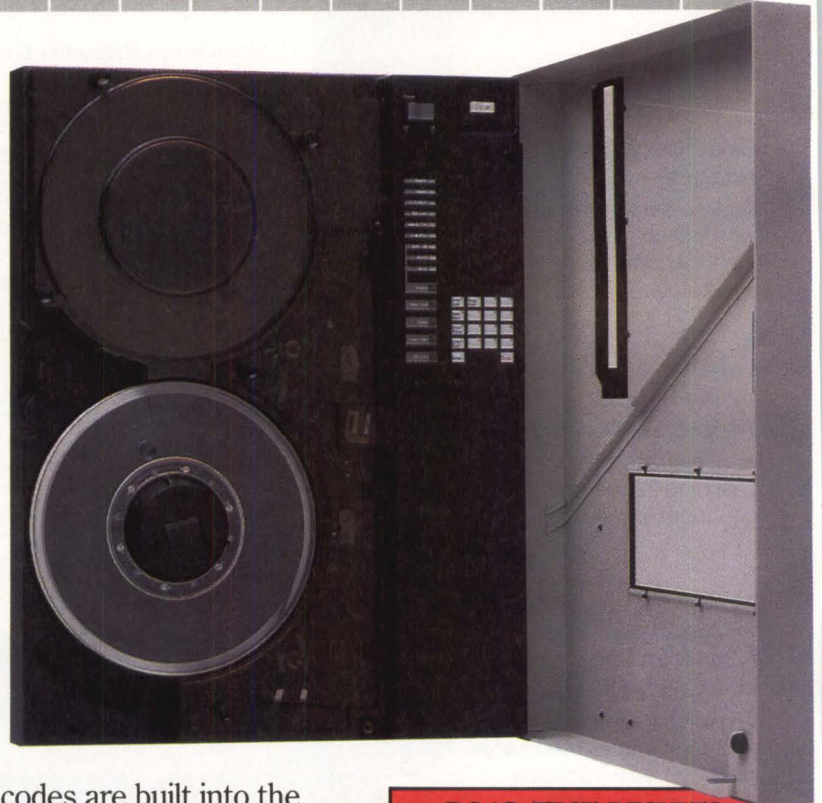

**AT A GLANCE**

**Series Standard Features**

Dual-speed 50 ips Start/Stop and 100 ips Streaming with Buffered or Synchronous mode

ANSI Standard 1600 bpi/6250 bpi formats

Convenient Auto-Threading

Integrated Formatter/Controller

Service Panel with Alpha/Numeric Display

Resident Diagnostics

Host-optimized Data Transfer Rates

Error correction codes are built into the cache's 256k of multi-record memory; so your data is checked both as it enters cache and as it is written onto tape. Data can be retrieved directly from cache—should defective media be encountered. The 2925 allows OEM systems integrators to attach ANSI-compatible 1600/6250 bpi capability to systems ranging from micros to minis... without software modification. For ease of integration, the 2925 is available with either

StorageTek- or Pertec-compatible interfaces.

That's still only the beginning—be sure to read the accompanying list of features. You'll understand at a glance that 2925 performance is not only *speed... but reliability, flexibility and ease of operation.* StorageTek's experience with GCR 6250 bpi technology includes a full 11 years of pioneering, proving and perfecting. Our 2920 Series includes the 2921 (50 ips start/stop), the 2922 (50 ips start/stop with 100 ips streaming) in addition to the 2925 subsystem.

Take a drive in our 2920 Series...

and experience performance you'll be proud to call your own.

**ROAD TEST RESULTS**

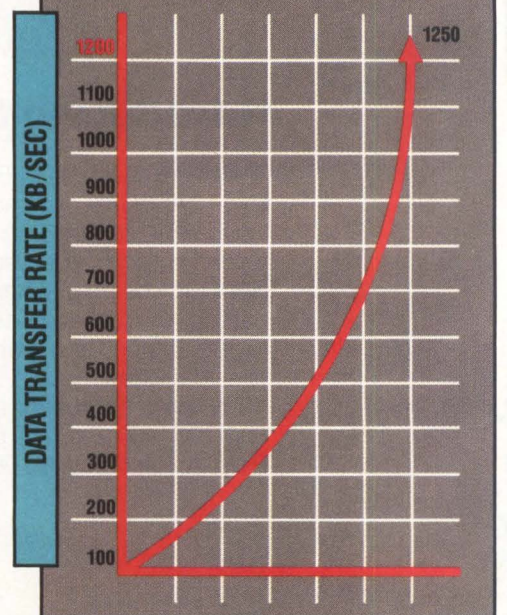

**StorageTek**

Storage Technology. It's More Than Our Name... It's Our Commitment.

CIRCLE NO. 47 ON INQUIRY CARD

OEM MARKETING/3N, Louisville, Colorado 80028-0001 USA (303) 673-4066



the importance of desktop publishing, it's more revealing to look at recent moves into the market by influential companies, rather than relying on the staggering, somewhat suspect, market projections. For example, IBM last July formed a Publishing Systems Business Unit, presaging a strong entry into the electronic publishing market. Big Blue announced that it would bundle third-party software with its hardware, and analysts expect products for PC-level machines, as well as for larger machines such as the System/36 and possibly mainframes.

IBM last October announced a desktop publishing application program for its RT PC. Developed by Interleaf Inc., the leading supplier of workstation-level publishing systems, the package includes all the functions you would expect from a desktop publishing program, as well as sophisticated graphics capabilities. And, true to its newfound charter of trying to provide connectivity between its various levels of processors, IBM's publishing package allows users to size, rotate and annotate computer aided design drawings created on the RT PC and on larger IBM hosts. In addition, the system accepts text from programs such as IBM's DisplayWrite 3, as well as Document

Composition Facility (DCF) and Document Content Architecture (DCA) files and a variety of other standard word-processing packages. However, IBM charges a hefty \$8,200 one-time license fee for the program.

Regardless of what the major players do, desktop publishing is an ideal application for system integrators and VARs. Dataquest Inc., a San Jose, Calif., market-research company, expects desktop publishing sales—including those for personal computers, composition software, scanners and laser printer—to surge from \$147 million in 1985 to almost \$5 billion in 1990.

However, optimistic market projections tend to obscure some fundamental shortcomings in desktop publishing, such as the fact that none of the systems—with the possible exception of Bestinfo's Superpage II—can even approach the quality of true typeset printing. And, voicing an often overlooked point, Gene Talsky, president of Professional Marketing Management Inc., Old Lyme, Conn., adds that, "All the software in the world won't make you a graphics designer." □

Interest Quotient (Circle One)  
High 486 Medium 487 Low 488

**'Unfortunately, people will go where the publicity is, and that's with two companies.'**

**TO:**  
OEM Systems  
Integrators of  
Computer Peripherals

**SUBJECT:**

**SYSCON: The Sub-Systems Conference & Exposition**

**FEATURING:**

A concentrated, technical conference, with focused papers and seminars on Storage Devices, Disk and Tape Drives, File Servers, Modems, Printers, Plotters, Keyboards, Industrial I/O Drives, Power Conditioning/UPS Systems, and Systems Software . . .

**PLUS:**

Relevant tutorial exhibits displaying and demonstrating these peripherals . . .

**PLUS:**

New techniques, products, applications, selection and evaluation criteria, performance features, and other technical information to help systems integrators decide which sub-systems and peripherals to use in OEM computer systems.

**LOS ANGELES AIRPORT HILTON HOTEL**  
JANUARY 20 and 21, 1987  
(To be held in conjunction with BUSCON/87 West, the Bus/Board Users' Conference at the same location)



For complete program, and registration details call Edward Grazda at (213) 402-1610, or write SYSCON, 17100 Norwalk Blvd., #116 Cerritos, CA 90701-2750



# WIN WITH THE WORLD'S FASTEST 300 PPI THERMAL PLOTTER ...VERSATEC VERSACOLOR.

The winning thermal color plotter, Versatec Versacolor, gives you better hard copy faster. You get 300 point-per-inch resolution A-size color plots in 45 seconds; B-size in 60 seconds. International users can plot on A3 or A4 media.

Simplify operation with exclusive donor cartridge and cut sheet media. Plot on paper or clear film. Versatec Versacolor is the easiest to use thermal plotter available.

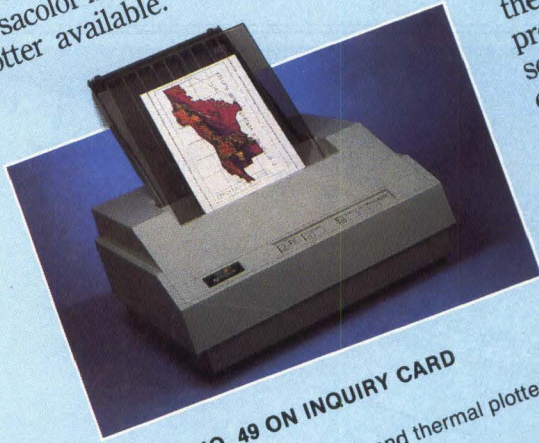

**CIRCLE NO. 49 ON INQUIRY CARD**

See Versatec electrostatic and thermal plotters at NCGA.

Save space. Just 21" wide, 19.7" deep and 9.5" high, the typewriter-size Versatec Versacolor is the perfect desktop companion for your computer, workstation, or display.

Plot sooner. Capture data directly from the CRT screen with Versatec's low-cost video controller. Or simplify plot processing with Versatec's low-cost rasterizer controllers. Plug right into standard Versatec hardware interfaces.

Gain higher resolution, more speed, and exclusive convenience features. All at a price that meets or beats other thermal color plotter competitors. And protect that investment with single-source service and supplies for both electrostatic and thermal plotting.

To learn more about the Versatec Versacolor thermal plotter, circle the readers' service number, call toll-free 800/538-6477\*, or visit your nearby Versatec sales office.

**VERSATEC**  
A XEROX COMPANY

2710 Walsh Avenue  
Santa Clara, California 95051  
Telephone: (408) 988-2800  
TWX: 910-338-0243  
Telex: 334421

Versatec and Versacolor are trademarks of Versatec, Inc. Xerox is a trademark of Xerox Corporation.

\*In California, call toll-free 800/341-6060.

Plot data courtesy of Zeh Engineering.  
Car courtesy of Allfire Equipment.

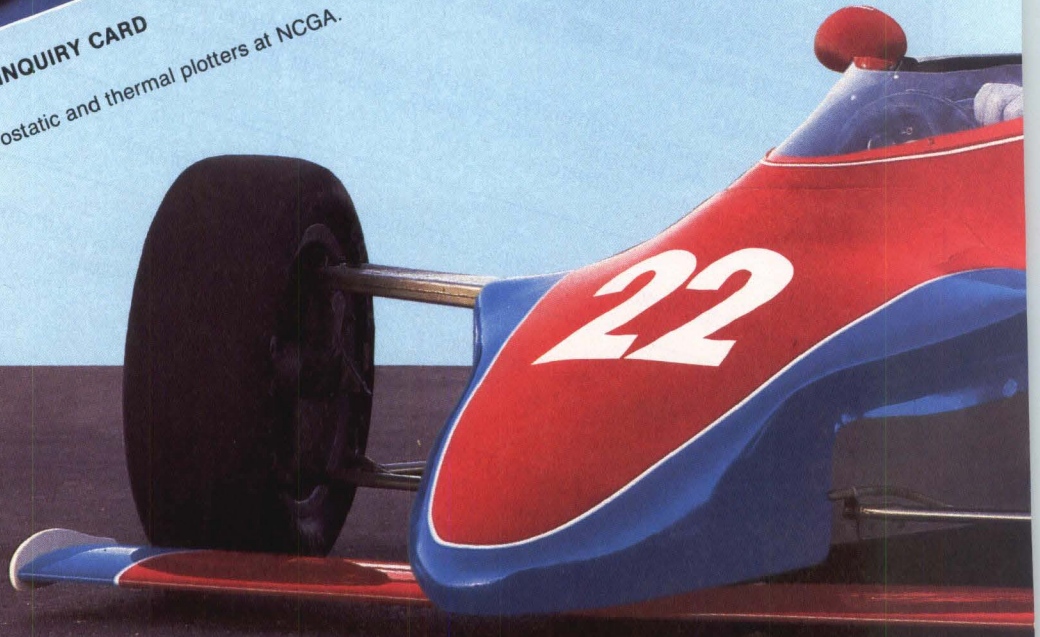



# WIN WITH THE WORLD'S MOST VERSATILE PLOTTER/PRINTER

## ...VERSATEC SPECTRUM.

The winning electrostatic plotter/printer, Versatec Spectrum, plots, prints, and makes color hard copy direct from display (with optional video controller). Choose from 200 or 400 point-per-inch resolution. Get A-size plots in 58 to 75 seconds; B-size in 90 seconds. International users can plot A3 and A4 drawings.

Enjoy the lowest cost per copy of any technology. An A-size color copy costs as little as seven cents. Gain unmatched versatility. Only Versatec Spectrum automatically handles any mix of A- and B-size, color and monochrome, graphics and text—all without operator intervention. Get output on paper or clear

film. Use unattended—run from 200 to 700 pages without changing paper. Plug in. Versatec interfaces and software are available for most popular computers. Low-cost video and rasterizer interfaces support electrostatic and thermal plotting.

Achieve more versatility, the highest image quality, and lowest cost per color copy. With uptime assured by Versatec worldwide service and supplies. For more information about the Versatec Spectrum electrostatic plotter/printer, circle the readers' service number, call toll-free 800/538-6477\* or visit your nearby Versatec sales office.



2710 Walsh Avenue  
Santa Clara, California 95051  
Telephone: (408) 988-2800  
TWX: 910-338-0243  
Telex: 334421

Versatec and Spectrum are trademarks of Versatec, Inc. Xerox is a trademark of Xerox Corporation.

\*In California, call toll-free 800/341-6060.

Plot data courtesy of Valid Logic.  
Car courtesy of Allrite Equipment.



**CIRCLE NO. 50 ON INQUIRY CARD**

See Versatec electrostatic and thermal plotters at NCGA.





# STOP SINKING IN ASCII TERMINAL QUICKSAND



## RISE UP TO THE FALCO 5500. \$495.

It's a jungle out there in the ASCII terminal market. Don't get stuck in the quagmire of ordinary video display terminals. Wise up to Falco, and stay on top, with the FALCO 5500 video display terminal.

The FALCO 5500 is the newest member of the FALCO 500 Family of Computer Terminals. The same industry leading features that have made Falco a leader in the ANSI terminal market are now available to the ASCII terminal market.

Screen display features like a 10 x 16 character cell; 40 lines of data by 132 columns; green, white or amber phosphor at no additional cost; and a flat profile, non-glare CRT make the 5500 a guiding light through the terminal jungle.

There is no reason to get bogged down in terminal decisions, as the FALCO 5500 meets all your terminal requirements: compatible with ASCII protocols, a choice of keyboards (ASCII or PC/AT layout), Falco's Multi-Host Windowing, dual Online communication ports, 40 lines by 132 columns of data, two pages of memory, and 5000 bytes of programmable memory.

And there's no sinking feeling when you see the price for this terminal either. Call now for more information, and the name of your local Falco Distributor.



1294 Hammerwood Ave., Sunnyvale, CA 94089 • In California: (800) 538-5383 • Outside California: (800) 835-8765

CIRCLE NO. 75 ON INQUIRY CARD



# SCANNERS PRESENT MAZE OF OPTIONS

Driven by desktop publishing requirements, scanners are rapidly overcoming previous limitations, but the pathway to the right equipment still demands careful navigation

**Linda Helgerson**

Diversified Data Resources Inc.

Acquiring text and graphics electronically; storing, accessing and manipulating it; and then producing a document defines the process of desktop publishing. As such, complete desktop publishing requires scanners, personal computers, page-composition packages, high-resolution monitors, disk drives and laser printers. Obviously, integrating these disparate components can become a nightmare.

Desktop publishing is a desirable and necessary application, but getting there is far from automatic. Just finding the right device drivers for an integrated, operable system is sometimes difficult, sometimes impossible.

Including the scanning function in an integrated system compounds the problems. The difficulty no longer centers on whether scanners can meet the rigorous demands of desktop publishing applications. They can. Within the last year, data-capture products and software have surfaced that provide increased functionality. Furthermore, new scanners are smaller, sturdier, cheaper and easier to install and use.

The problem is that no single scanner can perform all possible functions or work within all systems. Although options abound, the goal is to determine what is required, and that can be difficult. Users do not necessarily consider system-integration problems, and those who know about configuring peripherals are probably not the ones who will be using the system.

The range of scanning options fall essentially into five categories: optical character recognition (OCR) machines, image scanners, image scanners with text-conversion software, generic software that performs image editing and/or text conversion and, most recently, scanners in fully configured desktop publishing systems.

Integrators configuring systems with scanning capabilities must keep two things in mind: what is required of the scanning mechanism and secondly, which scanner will work within



an existing or planned system.

Text converters, or OCR scanners, detect an alphanumeric character, recognize it and convert the character to machine-readable form (see "How OCR works," Page 72).

If the requirement for the scanner is to capture only text, there are many products available in different price ranges and with different capabilities. Determining which system to purchase involves knowing what types of documents will be typically scanned plus the capabilities of other peripherals within the system. Analysis should begin with the source documents.

- **Paper:** Some roll-feed scanners will only accept bond paper. Onion skin, glossy paper, or paper of varying thicknesses may be rejected or get jammed in the roll-feed mechanism. If the source documents vary in weight and consistency, then a flat-bed scanner is recommended. No single OCR device offers both options.

- **Microform:** If the source materials are microfilm or aperture cards, OCR technology is not yet able to digitize negative images (white characters on a dark field). A black-on-white paper copy of each film image must be made

## **Incorporating the TurboScan**

*optical page scanner, AST Research's Premium Publisher is a complete desktop publishing system. The 300-dpi scanner merges text and graphics and allows for data compression and DMA transfer.*



for use with an OCR scanner. The alternative is to scan the image with an image scanner and convert the characters to ASCII with software.

- Document size: Scanners vary in the size of source documents they accept. All accept 8½ by 11 inches; most also accept 8½ by 14 inches as well. Smaller source documents may dictate scanner selection.

- Double-sided documents: To date, unlike high-end photocopying equipment, there are no scanners that automatically scan both sides of a page. Users must feed in a sheet, flip it and feed it in again. If the application requires a large number of copies, the user should photocopy one of the two sides and place both sides in a feeding mechanism. However, not all scanners have large-capacity feeder mechanisms.

- Volume to be scanned: The quantity of source documents limits the OCR scanner selected. If the application calls for batch conver-

sion on a fairly regular basis, an appropriate feeder mechanism is desirable. In addition, different scanners use different techniques and options for error correction. If there is a consistent volume of source documents, then the option of automatic error highlighting or correcting using dictionaries and context checkers may be critical. If the scanner requires operator intervention with each detected error or each page scanned, the device would be inappropriate for high-volume situations, even with a large-capacity feeder mechanism.

- Books and magazines: Documents other than single flat sheets of paper require particular attention. A flat-bed scanner is one alternative, but there are also a few specialized scanners that are configured specifically for books as source documents.

- Images: If it's necessary to scan images—such as line art and halftones—as well as text,

## How OCR

(Derived from National Archives and Records Service information.)

Optical character recognition (OCR) converts typed or printed alphanumeric characters into machine-readable form by measuring the differences in reflectivity between ink and paper and then using this information to identify a character through one of two methods: matrix-matching or feature analysis. The logic of the character-recognition process used in many OCR systems is illustrated in Fig. A.

Fig. A

### OPTICAL CHARACTER RECOGNITION PROCESS

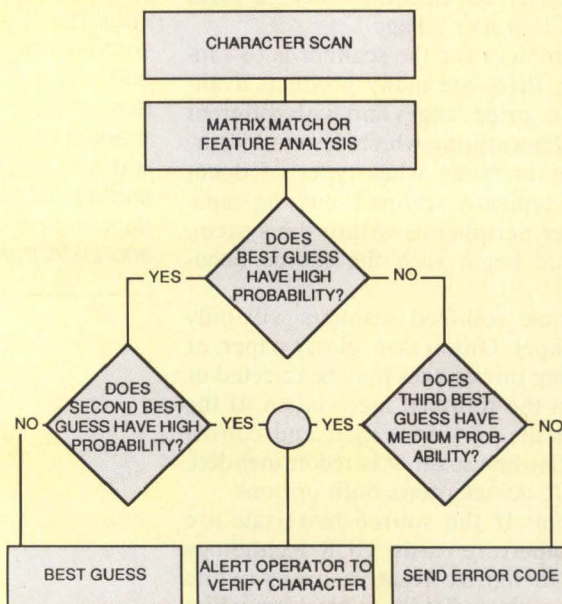

SOURCE: NATIONAL ARCHIVES AND RECORDS SERVICE

Matrix matching consists of converting an alphanumeric character into digital signals that are compared with digital signals of a standard alphanumeric character set. This is accomplished by dividing each character location into a matrix of pixels, or picture elements. If ink is detected at various points in this matrix, the pixels corresponding to these points are turned "on" in the matrix. Generally, a pixel in an "off" state is white (binary 0); a pixel in an "on" state is black (binary 1). This digitized image is then compared with digitized images of a standard alphanumeric character set. Because no paper, typewriter or typist is perfect, it is not likely that there will be a perfect pixel match

Fig. B

### MATRIX MATCHING

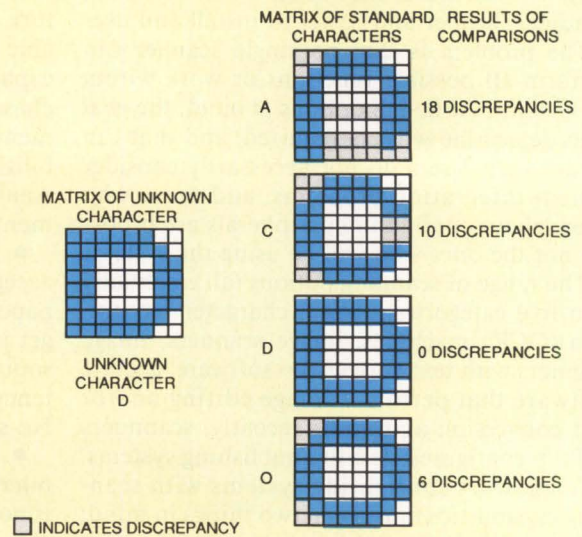

SOURCE: NATIONAL ARCHIVES AND RECORDS SERVICE



then an OCR scanner is inappropriate. Such jobs require image scanners with text-conversion software.

- **Output resolution:** Although character resolution may not seem to be as important for OCR scanners as with image scanners, it becomes essential in fully integrated systems. If the scanned data is to be transmitted via a facsimile device at some later time, then the CCITT Group 3 standard calls for 300 dots per inch (dpi). Most laser printers output 300 dpi, but not all. Converting 300-dpi input resolution from a scanner to a different output resolution for another peripheral, such as a dot-matrix or laser printer, is sometimes impossible. The display device may also require a certain scanning resolution. In short, resolution becomes a key factor in system integration.

- **Use of the scanned text:** The ultimate use

of the converted textual information is most important. The data may be needed as a resource only. The ASCII data can be stored and accessed by full-text retrieval software or database management software later. Or, the text may require direct formatting in a word-processing program for editing and manipulation prior to printing. OCR scanners have different capabilities, which should be analyzed thoroughly based on system requirements. Only a few OCR machines, for example, will scan forms, extracting and converting data from certain preprinted areas.

- **Fonts and font sizes:** Possibly the most discussed consideration—and most severe limitation of OCR devices—is the type and size of recognizable fonts. Some text converters handle only designated typewritten fonts. The difficulty here is one font may have the same name but vary in appearance between brands. Recogn-

## works

between the two digital signals. Consequently, the assignment of a character is made on the basis of a previously determined level of matching. Typically, this level of matching, which is known as a confidence level, is set by the software developer.

Note that Fig. A identifies a step in the process in which questionable characters are highlighted for verification, and unrecognizable characters are highlighted for correction. The "best guess," which really is an unambiguous recognition, occurs when the match meets the previously determined high-probability level. A low-probability response, however, leads to a "second best guess" option in which a previously determined high-probability level

can result in alerting the operator to verify the character or send an error code.

The logic of matrix matching can be seen in identifying the character "D" as shown in Fig. B. In this example, the pixel matrix for character "D" is compared with pixel matrices for character "A," "C," "D," and "O," which are stored in the OCR software. The character for a particular type font with the least number of discrepancies is selected. In this instance, the character "D" has no discrepancies and therefore a match is identified. It should be noted that this example is greatly simplified because OCR systems generally would use many more pixels in a matrix match.

The second method used in conventional OCR is called feature analysis. Although this technique utilizes the same pixel pattern that matrix matching employs, there is, nevertheless, a substantial difference between the two. In feature analysis the black pixels in a pixel matrix are analyzed in terms of vertical, horizontal and diagonal lines, loops and ending lines. Feature analysis, therefore, focuses upon discrete dimensions of an "unknown" character by breaking it down into a set of distinctive strokes or lines and comparing the strokes or lines in this matrix with the stroke or line image matrices of a character set for a particular type font. Again, because of the imperfections of paper, typewriters and typists, the assignment of a character to a given set of strokes or lines is not always a perfect match. Fig. C illustrates how feature analysis works in identifying an "unknown" character as a "D." Note that there are no discrepancies between the number of vertical lines and loops in the "D" line image matrix and the "unknown" character. It is on this basis, therefore, that the "unknown" character is read as a "D."

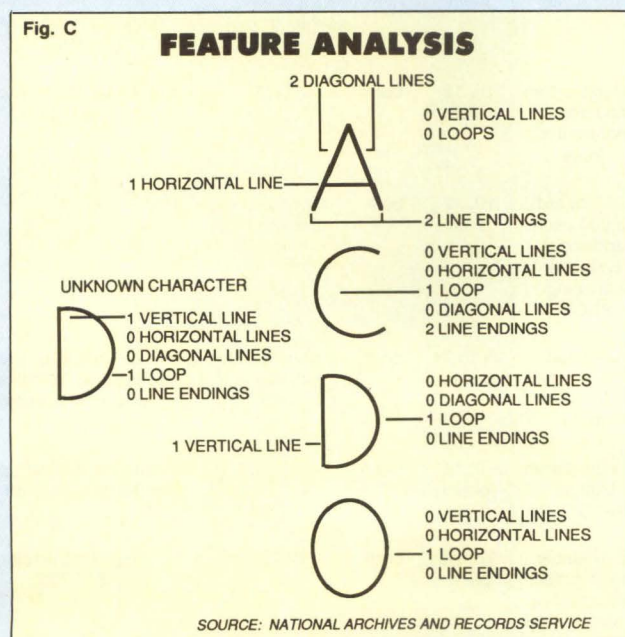



nition of proportionally spaced letters, a later enhancement with word-processing systems, is not possible with all OCR machines. For scanners that utilize the matrix-matching technique, system memory may limit the number of recognizable fonts. Generally, only the higher priced systems can recognize an unlimited number of fonts, various printer outputs, proportional spacing and highly stylized characters. Some vendors sell add-on font packages. Some accompanying scanner software enables an operator to "train" the system to recognize additional fonts. Both options increase either the cost of the system or operation time. Although some OCR devices are claimed to be able to recognize handwriting, these scanners utilize context and feature analysis as well as additional spelling checkers, all of which increase the processing requirements and the purchase price.

- **Time:** The purpose of scanning text to machine-readable data is to cut the time required to key in the alphanumeric. Correcting questionable or unrecognizable characters, formatting the data once converted, and feeding in source documents one sheet at a time, can all be time-consuming. There may also be hidden

costs in the initial set-up phase. Some OCR scanners have no or limited conversion programs. Training the scanner to recognize each new font can also increase time requirements.

On the surface, converting stacks of manuscripts to machine-readable form via an OCR device seems to be an easy task. However, without considerable analysis of requirements, product specifications and actual operation, the task becomes almost impossible. There are many excellent OCR systems available, but matching them to applications is complex.

**Image scanners capture graphics**

Image scanners, also called raster or bit-mapped scanners, convert an image, such as a photograph, map or line art—or a complete document—to an array of picture elements, or pixels. First, the image is detected and converted to electronic form. Next, the raw data is converted to a simple bit array, where each pixel is characterized as either black or white; as an array of gray-scale values, in which each pixel is characterized as having one of several shades of gray; or to full-color raster with each pixel defined in terms of its intensity of three primary colors. All image scanners conduct the

**REPRESENTATIVE OCR SCANNERS**

Company Model	Price (\$)	Flat-bed/ sheet-fed	Automatic document feeder	Document size (inches)	Scan time (seconds per page)	Font characteristics			Interface	Notes
						Type(s) recognized	Size(s) recognized	Mono/ pro- portional spacing		
CompuScan PCS 220; 230; 235	6,495; 5,695; 3,150	sheet-fed	50 sheets	5×3 to 8.5×14: text 8.5×11: image	25: text <30: image	cartridge, 20 type styles	10, 12 pitch	both	RS232 serial or parallel; asynch or bisynch	312K min., 640K recommended; model 235 compatible with IBM PC only
DEST PC Scan	2,785	sheet-fed	no	3.5×3.5 to 8.5×14	30 to 45	20 typewritten and some dot-matrix fonts	10, 12 pitch	both	SCSI	opt. DMA interface card: \$195
Hendrix TR100	10,500	sheet-fed	100 sheets		250 cps	six fonts std., \$5,000 each additional typeface matching PROM	10, 12 pitch	both	asynch serial, bisynch opt.	
Kurzweil 4000 Intelli- gent Scan- ning System	36,000 base	flat-bed	opt. 50 sheets	3.5×5 to 8.5×14	25 to 55 cps	unlimited typewritten and typeset fonts	six to 24 points	both	interfaces to virtually any system	two-day operator training required; handles magazines, books
Oberon OMNI- READER	199	flat-bed	manual only	7.2×11.8	33 to 160 cps	Courier; Letter Gothic; Prestige Elite	10, 12 pitch	mono	RS232C	data handshake opt.; RTS, X-on/X-off
Totec TO-5000B	7,461	sheet-fed	75 sheets	8.5×4 to 9×14	15 to 20	15 available; one included; may install up to six PROMS	10, 12 pitch	both	RS232C	tempered version: \$17,705



# The Tandy® 3000 HD Has What It Takes to Give VARs The Competitive Edge.



The powerful Tandy 3000 HD computer is the affordable alternative to the IBM® PC/AT. It features an Intel 80286 microprocessor operating at 8MHz clock speed, 640K RAM, expandable to 1 megabyte on the main board, 10 expansion slots, enhanced keyboard and a built-in 40 megabyte hard drive with an average access speed of 28 ms.

The 3000 HD's power makes it ideal in a networking or multiuser environment. As the hub of our

ViaNet Local Area Network (LAN), the 3000 HD establishes a standard of fast throughput. Or, with XENIX® System V, our multiuser solution, up to six users can access programs and data on the 3000 HD at the same time using low-cost display terminals.

### Best of all . . .

The 3000 HD is available through the Tandy VAR Program. A program that features one-contract coverage for all products, special

discounts for development systems, strong technical support and fast service through more than 150 Tandy-owned facilities nationwide. There's even a "turnkey" leasing program\* available exclusively to Tandy VARs. To learn more about Tandy's VAR Program, give us a call or return the coupon today!



**Tandy Corporation**

**Value-Added Resale**

Telephone (817) 390-3099

\*Tandy VAR Leasing Program administered by Dana Commercial Credit. IBM/Registered TM International Business Machines Corp. XENIX/Registered TM Microsoft Corp.

**CIRCLE NO. 51 ON INQUIRY CARD**

Send information on the  
Tandy VAR Program and Products.

Dept. 87-A-776, 300 One Tandy Center  
Fort Worth, Texas 76102

Name

Company

Address

City

State  ZIP

Phone





# Here's the best resolution to your terminal needs.

## The Wyse WY-60.

It's everything we know you want in a terminal, and then some.

Higher resolution. Hidden attributes. Multiple personalities, including ASCII, ANSI, and PC Terminal emulation. Multiple display formats, with up to 132 columns and 44 lines of information on one screen. And soft fonts, so it can be crisp, clean and easily readable in any



language. And we've added WYSEWORKS, a nifty clock/calendar/calculator combination for extra productivity.

You choose the screen color, and the keyboard layout that suits your application: Wyse WY-60 ASCII; WY-60 ANSI; IBM PC AT; IBM ENHANCED PC; or IBM 316X. The

adjustable arm option lets you choose the perfect height and screen position. You can even choose the service

plan that works best for you.

When it comes to terminals, we ship more than anybody but IBM.\* So it's natural we'd come up with a terminal with a lot of years of wisdom behind its good looks.

Call toll-free today, for more information.

**Call 1-800-GET-WYSE**

# WYSE

YOU NEVER REGRET A WYSE DECISION.

WYSE is a registered trademark of Wyse Technology. WY-60 and the "V" shaped design are trademarks of Wyse Technology. IBM PC AT and IBM 3161 are trademarks of International Business Machines Corporation. © 1986 Wyse Technology. 3571 N. First Street, San Jose, CA 95134. \*Dataquest 1985 terminal shipment update.

**CIRCLE NO. 52 ON INQUIRY CARD**



first step, but capabilities vary widely in converting images to pixels that are other than just black or white.

There is further differentiation among image scanners. They may have limited, extensive or no image-enhancement capabilities. Enhancements may occur automatically or require operator intervention. The capability may be included in the firmware or require additional software at an additional price. Because manipulations, such as removing extraneous marks and filling lines or dark areas, are critical to the finished publication, image enhancement is an important consideration.

Another difference among image scanners deals with compression. Compression ratios vary as does the degree of sophistication among raster scanners. Compressing raster data into a more compact form is necessary in the micro-computer environment. Raster data requires large amounts of storage and, therefore, processing capabilities.

Because of the important differences among image scanners on the market, selection should consider system and user requirements as well as integration concerns.

• Resolution: The desired resolution of the scanned image is dependent upon how the

### REPRESENTATIVE IMAGE SCANNERS WITH OCR CONVERSION SOFTWARE

Company Model	Price (\$)	Flat-bed/ sheet-fed	Automatic document feeder	Document size (inches)	Scan time (seconds per Page)	Resolution (dpi)	Font characteristics			Gray scale	Interface	Notes
							Type(s) recognized	Sizes(s) recognized	Mono/ pro- portional spacing			
Canon U.S.A. IX-12	1,190	sheet-fed	5 sheets	3×5 to 10×24	30 at 200 dpi	75, 150, 200, 300	8 fonts	8-20 points	both	32 shades	serial, high-speed video	OCR software: \$595
CompuScan PCS 240; PCS 245	5,995; 3,995	sheet-fed	50 sheets	5×3 to 8.5×11	25: text <30: image	100, 150, 200	20	10, 12 pitch	both	no	RS232 serial or parallel	min. 312K, 640K recommended; model 245 compatible with PC, /AT, /XT only
Datacopy JetReader; JetReader Plus	2,950; 3,250	sheet-fed	10 sheets	5.8×4.1 to 8.5×14	43 at 300 dpi; 28 at 200 dpi	200, 300	12 typewritten fonts	10, 12 pitch	mono	two halftone patterns	IBM PC	requires 640K RAM, dual flexibles or hard disk; compatible with Apple Mac
DEST PC Scan Plus	2,495	sheet-fed	no	3.5×3.5 to 8.5×14	nine max.	200, 240, 300	typewriter, impact or laser printer fonts	10, 12 pitch	both	32 shades, dithering	DMA, SCSI, opt. IBM PC	includes 750K; Mac Plus version available; supports TIFF (Tag Image File Format)
Intelligent Optics IOC Reader	4,295	sheet-fed	30 sheets	5×5 to 8.5×14	18: text or 150 cps	200 to 400	up to 60 fonts can be stored on disk; included in price	10, 12 pitch	both	64 shades	RS232C asynch or bisynch	automatic thresholding for paper color and density
Microtek Smart- Reader	1,795	sheet-fed	opt. (\$295), 50 sheets	8.5×24: text 8.5×11: image	20	200	type styles and text from nine WP programs		both	52 shades	parallel (TTL compatible), serial (RS232C)	includes OCR System Inc. software
Palantir CDP (Com- pound Document Processor)	39,500	sheet-fed	50 sheets	3×5 to 8.5×14	20	300	all typewritten, typeset, daisywheel or dot matrix	six to 28 points	both	line art, graphics	RS232 serial; 1.2K to 19.2K TTL	up to 256 user-definable zones per page; includes graphics tablet, automatic thresholding; five MC68000s on board
Tecmar eSCAN	2,495	drum	no	8.5×14	60	100, 200, 240, 300	six typewritten styles	10, 12 pitch	mono	no	DMA, IBM PC, /XT, /AT	requires 10M-byte hard disk



image will be used. If data is for normal CRT display, resolutions up to 200 dpi are sufficient. High-resolution monitors and graphics plotters could require up to 1,000 dpi. For most laser printers accompanying most desktop publishing systems, 300 dpi is sufficient. Generally, the price of the scanner is directly proportionate to image resolution.

- **Storage:** The higher the resolution, the greater the storage requirements. The higher the storage requirements, the greater the system's processing requirements. Gray scale, halftones and, particularly, color images increase storage requirements considerably, even with the most sophisticated compression techniques. The price of capturing and converting high-resolution images is increased storage and processing requirements. Adding an image scanner to an existing configuration may require enhancements to the system as well, which costs.

- **Speed:** Given deadlines, speed may be important. The faster the scanner, the higher the cost, but saving dollars may increase time con-

sumption beyond the cost effectiveness of initial savings.

- **Image enhancement:** Improving the image, such as by blackening gray areas, adding hatch lines, completing lines and modifying the gray-scale or color shades is certainly available, but the options among scanners vary. Some systems provide it all for a price; some have software with different enhancements. Some capabilities are in the firmware, some in the software, but all are system-dependent. Integration can be backwards—installing the scanner to fit the system—or forwards by adding more memory, resident software, new drivers.

- **Output devices:** Laser printers usually require 300 dpi. Plotter requirements vary widely. Digital transmission of images requires 300 dpi. As with OCR scanners, the resolution required for the output device may dictate the resolution of the scanned image.

Raster scanners differ in photodetection technologies, document-handling systems and interfaces. And again, integration concerns arise. The advantages of adding graphics to a

## Vendors of scanning equipment and software

### OCR SCANNERS

#### DEST Corp.

1201 Cadillac Court  
Milpitas, Calif. 95035  
(408) 946-7100

Circle 382

#### Hendrix Technologies Inc.

670 N. Commercial St.  
Manchester, N.H. 03101  
(603) 669-9050

Circle 383

#### Kurzweil Computer Products Inc.

185 Albany St.  
Cambridge, Mass. 02139  
(617) 864-4700

Circle 384

#### Oberon International

Cleveland Road  
Hemel Hempstead  
Hertshire, HP2 4SE, England  
(0442) 3803

Circle 385

#### Totec Co. Ltd.

9205 Alabama Ave.  
Chatsworth, Calif. 91311  
(818) 718-0055

Circle 386

### IMAGE SCANNERS

#### Abaton Technology Corp.

1526 Cloverfield Blvd.  
Santa Monica, Calif. 90404  
(818) 905-9399

Circle 387

#### AST Research Inc.

2121 Alton Ave.  
Irvine, Calif. 92714  
(714) 863-1333

Circle 388

#### AT&T Information Systems

1776 On The Green  
Morristown, N.J. 07960  
(201) 898-6561

Circle 389

#### Electronic Information Technology Inc.

373 Rte. 46 W.  
Fairfield, N.J. 07006  
(201) 227-1447

Circle 390

#### IBM Corp.

900 King St.  
Rye, N.Y. 10573  
(800) 426-2468

Circle 391

#### Itek Graphix Corp.

34 Cellu Drive  
Nashua, N.H. 03063  
(603) 889-1400

Circle 392

#### NEC Home Electronics (U.S.A.) Inc.

1401 Estes Ave.  
Elk Grove Village, Ill. 60007  
(312) 228-5900

Circle 393

#### Panasonic Industrial Co.

1 Panasonic Way  
Secaucus, N.J. 07094  
(201) 348-7000

Circle 394

#### Printing and Graphics Enhancement

150 Mount Bethel Road  
Warren, N.J. 07060  
(201) 647-3678

Circle 395

#### SpectraFAX Corp.

2000 Palm St. S.  
Naples, Fla. 33962  
(813) 775-2737

Circle 396

#### Thunderware Inc.

21 Orinda Way  
Orinda, Calif. 94563  
(415) 254-6581

Circle 397

### IMAGE/OCR SCANNERS

#### Advanced Vision Research

1943 Hartog Drive  
San Jose, Calif. 95131  
(408) 436-5566

Circle 398

#### Canon U.S.A. Inc.

1 Canon Plaza  
Lake Success, N.Y. 11042  
(516) 488-6700

Circle 399

#### CompuScan Inc.

81 Two Bridges Road  
Fairfield, N.J. 07006  
(201) 575-0500

Circle 400

#### DataCopy Corp.

1215 Terra Bella Ave.  
Mountain View, Calif. 94043  
(415) 965-7900

Circle 401

#### Intelligent Optics Corp.

238 Main St.  
Hackensack, N.J. 07601  
(203) 669-3650

Circle 402

#### Microtek Inc.

S. Western Ave.  
16901 Gardena, Calif. 90247  
(213) 321-2121

Circle 403

#### The Palantir Corp.

2500 Augustine Drive  
Santa Clara, Calif. 95054  
(408) 986-8006

Circle 404

#### Ricoh Corp.

5 Dedrick Place  
West Caldwell, N.J. 07006  
(201) 882-2000

Circle 405

#### Tecmar Inc.

6225 Cochran Road  
Solon, Ohio 44139  
(216) 349-0600

Circle 406

#### Truvel Corp.

2808 Oregon Court  
Torrance, Calif. 90503  
(213) 533-4971

Circle 407

### SCANNING SOFTWARE

#### DataChange Inc.

6075 Atlantic Blvd.  
Norcross, Ga. 30071  
(800) 631-9841

Circle 408

#### Elan Computer Group

260 Alta Vista Ave.  
Los Altos, Calif. 94022  
(415) 948-8193

Circle 409

#### Media Cybernetics Inc.

8484 Georgia Ave.  
Silver Springs, Md. 20910  
(301) 495-3305

Circle 410

#### OCR Data Systems Inc.

250 Clearbrook Road  
Elmsford, N.Y. 10523  
(914) 592-5510

Circle 411

#### Solution Technology Inc.

21301 Powerline Road  
Boca Raton, Fla. 33443  
(305) 487-1880

Circle 412



**AVAILABLE NOW**  
30 megabyte PCA-30s

PCA-40  
40 Megabytes

\$3,395



PCA-30  
30 Megabytes

\$2,995



PCA-20  
20 Megabytes

\$2,495

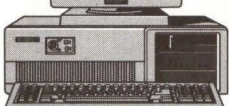

PCA-1  
1.2 Megabytes

\$2,195

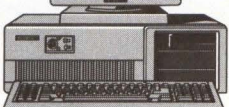

PCX-20  
20 Megabytes

\$1,595

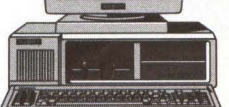

PCX-10  
10 Megabytes

\$1,295



PCX-2  
720 KBytes

\$1,195



PCX-1  
360 KBytes

\$1,155



# MORE MEGABYTES. NOT MEGABUCKS.

In a business climate this competitive, you've got to look for every advantage you can. That's why before you buy an XT or AT compatible, Tandon suggests you screen us against the competition.

From top to bottom, our full line of compatible systems give you precisely what you're looking for in a business computer. And something you've never seen before. Prices that average around 40% less than comparable models from IBM®

But that's where all comparisons end. Because in the most significant areas Tandon comes out on top. For sheer storage capacity and fast access time few measure up to our PCA™-40, a 40 megabyte AT®-compatible micro. And our monitor is bigger, by a wide margin.

And because our selection is one of the

most complete in the industry, we can meet the needs of your business, large or small.

All of which proves that for the personal computer line that combines reliability, compatibility and affordability, no one stacks up to Tandon.

To find the name of a dealer near you call us toll free now on:

**800/556-1234** Ext. 171

In California:

**800/441-2345** Ext. 171

**Tandon**  
Less money. More micros.

405 Science Drive,  
Moorpark, CA 93021 805/378-6081

PCX™ and PCA™ are trademarks of Tandon Corporation. IBM® and IBM PC AT® are registered trademarks; IBM PC XT™ is a registered trademark of International Business Machines Corporation. Prices displayed are manufacturer's suggested prices and do not include monitor.

**CIRCLE NO. 11 ON INQUIRY CARD**



# 27mW and you're ready to roll.

27 milliwatts. That's all it takes for standby mode on our FD-35 Series 3.5 inch floppy disk drives with the Power Saver option. And, in operation, they consume a mere 1.72 watts average at read/write, and 2.90 watts average at seek. These just happen to be the lowest numbers for any 3.5 inch drive.

This remarkable feat is made possible by the use of new custom LSI chips with CMOS technology for more efficient control over all the drive functions.

For added reliability and accuracy we shortened the gap between the band actuator and the head and included a more precise head position mechanism. This means stable reading and writing, even at high track densities.

And, as if all that weren't enough, we've thrown in special aluminum RF shielding to keep out noise pollution.

With the growing need for more portable systems, 27 milliwatts is a load anybody can carry.

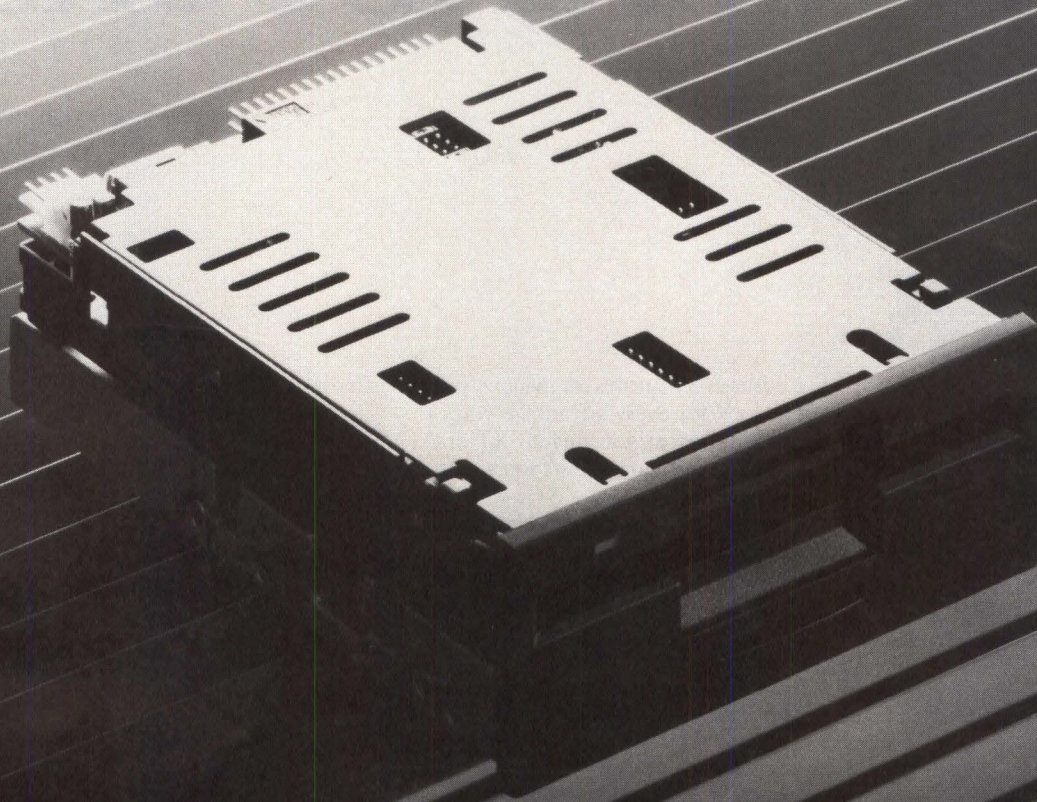

Built To Fanatical Standards. **TEAC**<sup>®</sup>

INSTRUMENTATION AND COMPUTER PRODUCTS DIVISION, 7733 TELEGRAPH ROAD, MONTEBELLO, CA 90640

East (617) 475-7311 South/Midwest (312) 351-9124 Rocky Mountain (602) 242-4025 (303) 337-6329 (801) 532-2111  
Northwest (408) 727-1427 Southern California (213) 726-0303

© 1985

CIRCLE NO. 54 ON INQUIRY CARD



report, combined with the decrease in time or skill necessary to create the graphic, justifies confronting the maze in figuring out what scanner is both useful and workable.

### Combine text and graphics

Scanners that convert both text and images simultaneously are recent arrivals on the market in response to typical desktop publishing requirements. These scanners are a combination of the two types discussed so far. Essentially, they are image or raster scanners with additional software for differentiating between text and images on a single page and then converting one to raster data and the other to ASCII.

Although the combination offers a much broader range of options for desktop publishers, there are obvious costs. Typically, the unit is larger and contains its own storage and processing capabilities. Many considerations mentioned before for OCR and image scanners still apply here. The units are priced far higher than units with separate capabilities, but, in most instances, the increased capabilities and flexibility are worth the added expense.

Image scanners with text-conversion software are useful in specialized publishing environments. In technical publishing, for instance, it is desirable to take an existing page of text with graphics and revise a drawing or add text revisions. Given the large storage capacities now able to be distributed widely at relatively low cost, such as with compact disk ROM technology, some industries are combining photographs with supporting documentation.

Another recent arrival on the market is software for use with many different OCR or image scanners that perform many functions that follow the scanning process, such as character recognition or image enhancement. Some editing programs go further, to include page-composition capabilities. Again, the functions vary, the integration with various operating systems differs, and few are directly comparable to one another.

Application-software packages that integrate the scanner with page-composition functions are relatively new. Some are sold for image enhancement, cutting and pasting, etc. Others are bundled with desktop publishing systems or coupled with a specific scanner. The more expensive packages also provide for text conversion and the merging of text and images in a document.

Although the packages vary, all allow for immediate operation of the scanner, some for image enhancement and a few for text conversion. Other possible functions include compression of raster data, formatting of textual data into word-processing programs and incor-

poration of page-composition protocols.

### Put it all together

Given the wide range of peripherals, the need for fully integrated systems becomes paramount. Estimating the range of uses for a scanning device and the myriad integration concerns is indeed confusing. Many users forego the headache and purchase an integrated, off-the-shelf system. This is fine, but the user can get only what is available, not necessarily what is wanted.

Desktop publishing, when first introduced, was considered principally for small publication operations. Now, the concept is moving away from that environment toward others, and as new application requirements surface, new capabilities are needed. Scanners are no exception. Prior to 1986, no one considered scanning technology marketable enough to create supportive application programs. Now, even some operating systems include scanning functions.

---

**Linda Helgerson**  
is president of  
Diversified Data  
Resources Inc.,  
Falls Church, Va.

---



---

Interest Quotient (Circle One)  
High 489 Medium 490 Low 491

---

## FOUL-WEATHER FRIEND.

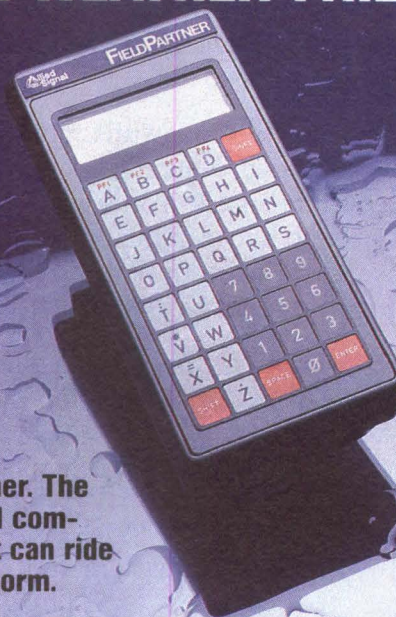

**FieldPartner. The hand-held computer that can ride out the storm.**

The FieldPartner is made to perform in foul weather. It weighs less than a pound, but has a big memory and an amazing range of keyboard options.

The FieldPartner. Man's best foul-weather friend.



**Immediate Business Systems**  
2100 Riverchase Center  
Birmingham, Alabama 35244  
205-985-0208



CIRCLE NO. 55 ON INQUIRY CARD



# Peace of Mind

## Compliments of Hitachi's 1500 Disk Drive Design Engineers.

That's right. . . Hitachi has 1500 design engineers who work on nothing but disk drives. We design, build, and qualify all key components ourselves, to our famous ultra-high specifications. We don't simply assemble stock items. Since we build our own motors, heads, microprocessors and custom LSI, we subject these parts to the most stringent Quality Assurance program in the industry.

This may seem like an awful lot of work, but during the 15 years of producing disk drives, we've learned that this is the only way to make drives good enough to use in our own systems. . . the only way to get the peace of mind that comes from knowing that the drives work.

Your peace of mind can come easy too. Use the most reliable disk drives available: Hitachi disk drives.

*A serious, historic commitment to the disk drive business.*

Hitachi's involvement with memory peripherals goes back to the earliest days of mag tape. We still produce mag tape equipment. And, today we have one of the broadest lines of disk drives you'll ever find—including 3.5", 5.25",

8", and 8.8" Winchesters. We've even made the enormous R & D expenditures necessary to be one of the pioneers in optical storage technology.

You don't make these kinds of commitments to a product line unless you're serious about its long-term success. Hitachi is serious. Very serious. We believe in forging long-lasting relationships supported by highly reliable products that can stand the test of time.

When you decide to use Hitachi disk products, you'll have a business partner who will be here to work with you, today and tomorrow. . . helping you to satisfy your customers. . . giving you peace of mind.

***Fast Action:***

To obtain product literature immediately, CALL TOLL FREE, 1-800/842-9000, Ext. 6901. Ask for literature number PB-001.





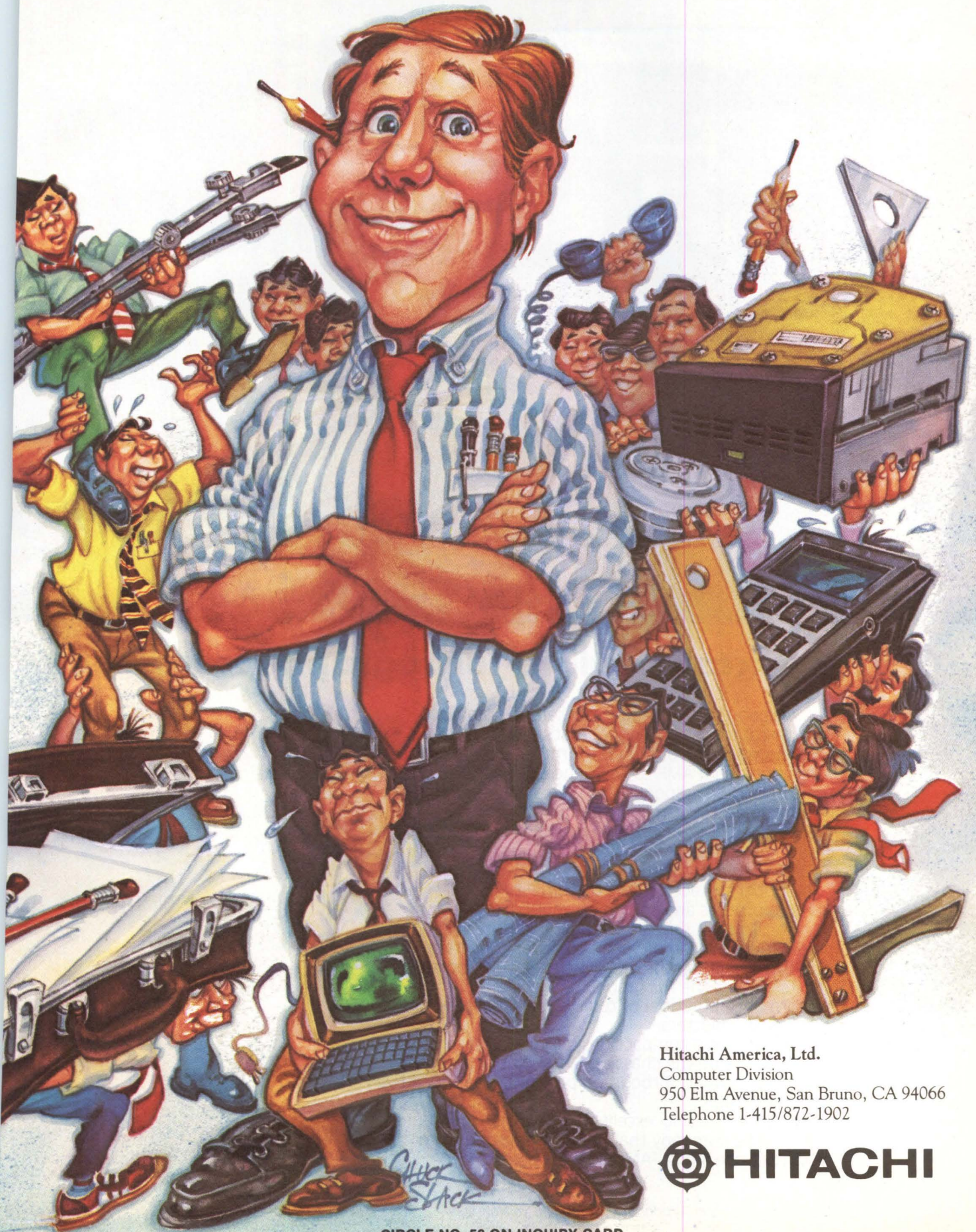

Hitachi America, Ltd.  
Computer Division  
950 Elm Avenue, San Bruno, CA 94066  
Telephone 1-415/872-1902



CIRCLE NO. 56 ON INQUIRY CARD



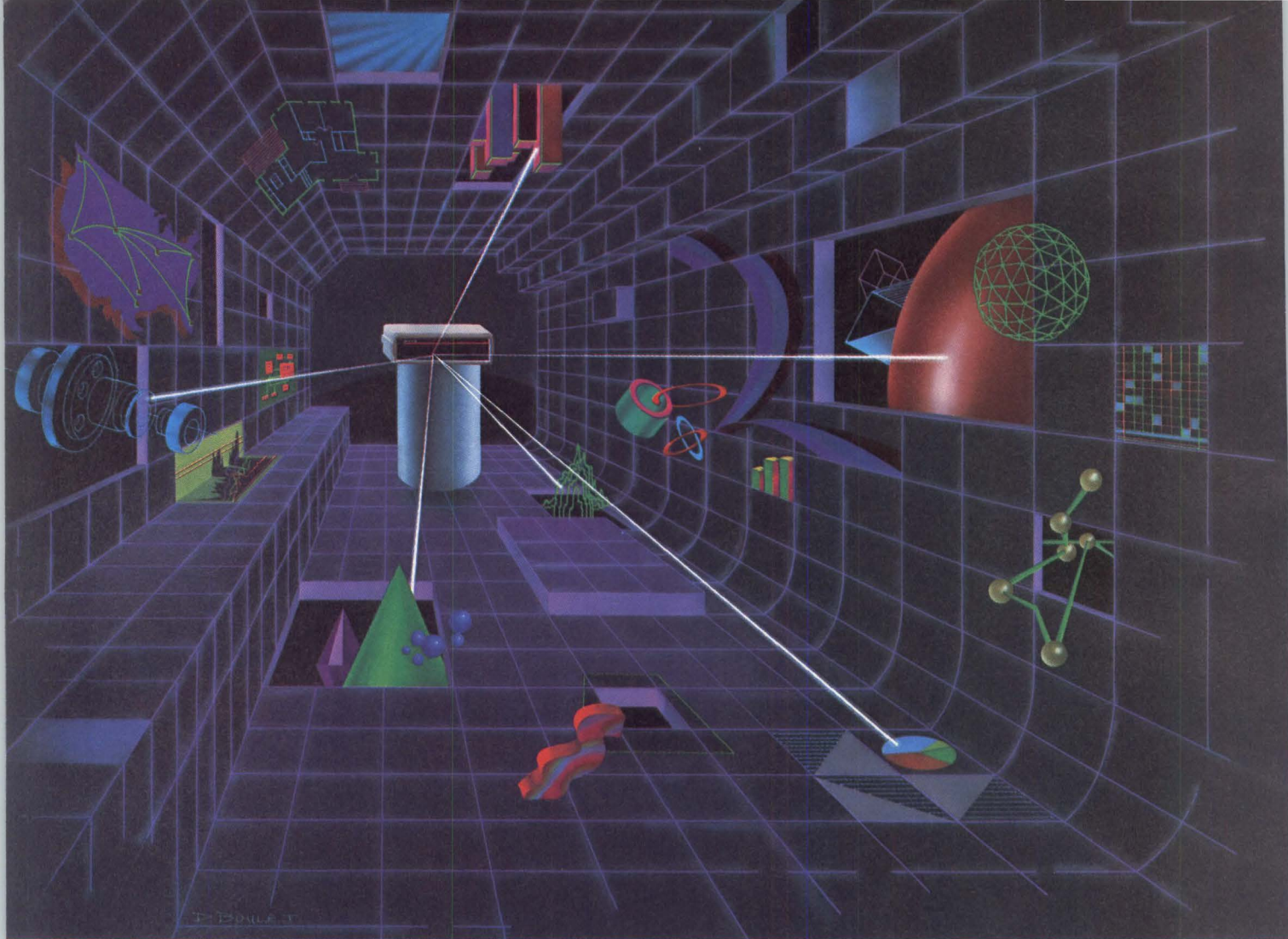

## Graphic excelleration. Turbograph™ processors.

Accelerated performance. Excellent graphics. At an exceptionally low price. That's Turbograph—the innovative line of high performance graphics processors from AMF Logic Sciences.

Turbograph responds to the soaring demand for improving and streamlining computer-generated graphics in all sectors of the market. From IBM PCs creating business graphics to VAX-type systems in CAD/CAM environments.

Turbograph accelerates the time it normally takes to process and convert graphics from vector to raster form. It relieves the host computer from the costly overhead of vector-to-raster conversion. And by eliminating the VRC bottleneck, Turbograph also unleashes the full graphics capabilities and performance potential of today's sophisticated printers and plotters.

Available in a compact desktop unit or as a board which fits inside the chassis of your plotter, printer, or host computer, Turbograph processors are priced as low as \$1995.\*

Discover graphic "excelleration" with Turbograph. Contact the company that has specialized in raster graphics since 1972—AMF Logic Sciences.

**AMF**  
LOGIC SCIENCES, INC.

10808 Fallstone Road  
Houston, TX 77099  
713/879-0536; telex 706691

*\*US. list price for one Turbograph 300, IBM PC version; OEM discounts available.*

**CIRCLE NO. 57 ON INQUIRY CARD**



# IMPROVED COLOR ENHANCES NONIMPACTS

Color output joins better resolution and quiet operation to make ink-jet and thermal printers formidable contenders for high-quality, low-cost printing

**Jesse Victor**, Associate Editor

Color has come of age for ink-jet and thermal printers. Low-end machines give business users the fill-in colors needed for highlighting increasingly complex charts and graphs. Better resolution, combined with near-letter-quality (NLQ)—and in some cases, letter-quality—text, produces the high-quality color output required for presentations on transparencies or paper approaching bond quality. High-end color ink-jet printers serve demanding color proofing and computer aided design/computer aided engineering applications. And advances in ink technology and color registration are resulting in hard copy that can rival offset-printing quality.

Four computer-industry and office-automation trends are fueling demand for color ink-jet and thermal printers. For one, color monitors are gaining market share from monochrome units, and users want a hard-copy version of their screen displays. Computer-industry researcher CAP International Inc., Marshfield, Mass., sees color monitor sales of more than \$10 million by 1990, topping monochrome shipments by more than \$4 million.

## Better quality mandated

In addition, more personal computer application packages are appearing that can utilize ink-jet and thermal printers' color capability. And the increasingly modular, open design of today's work environments necessitates quieter peripherals that sit on a desk next to a personal computer without disturbing a whole office. Nonimpact printers can be as quiet as 45 dB(a), a far cry from the clatter of impact units' 55 dB(a) or higher.

Finally, the proliferation of desktop publishing systems and internally generated hard copy is mandating better quality printing. Business users are demanding copy that approaches as near as possible offset printing, with fully formed characters and more persuasive and

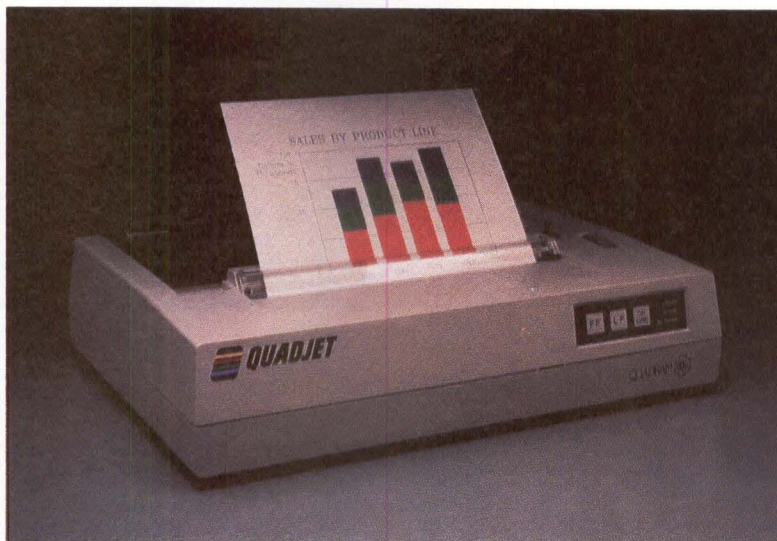

vivid combinations of text and graphics.

All these factors mean healthy growth for nonimpact printers. Users will increasingly turn to ink-jet and thermal technology, if they want to upgrade from older dot-matrix technology and combine color, text and graphics without incurring the higher cost of laser printers. Indeed, CAP International foresees nonimpact printers taking a widening bite out of total electronic printer sales, compared to impact devices. From approximately 12 percent of U.S. end-user placements in 1985, nonimpact units (including laser and electrostatic printers) will capture approximately 28 percent in 1990, according to CAP. In terms of estimated value, nonimpact printers will gain approximately 55 percent of the same market by 1990.

## Color thermals need three passes

Thermal printers utilize one of two different print mechanisms. The older, direct thermal types form characters and images by burning a special, chemically impregnated heat-sensitive paper with heated pins. Thermal-transfer printers, on the other hand, employ thin-film or thick-film printheads to melt and deposit on

**The Quadjet ink-jet printer** from Quadram delivers 640 dots per 80-character line plus bit-mapped graphics in up to seven colors at 40 cps.



**Supplying a built-in rasterizer, CalComp's ColorMaster thermal printer combines with Zenographics' Mirage color-graphics software to generate a 203-by-200-dpi graphic of Fleischer Studios' cartoon characters. (Copyright: Fleischer Studios Inc.; Courtesy: Zenographics Corp.)**



paper a wax-based ink contained on a mylar ribbon. (IBM's Quietwriter printer uses resistive elements in its ribbon to place ink on the paper.)

Color thermal printers divide the thermal-transfer ribbon into the three process-ink colors: yellow, magenta and cyan. Three separate passes of the printhead are required to register color output. Most printers can overprint the three colors to produce at least three secondary colors—green, orange and purple.

The TPX-80 from C. Itoh Electronics Inc. is typical of low-end color thermal printers. Connecting to IBM Corp. PCs and compatibles with a Centronics parallel interface, it prints 80-column, 12-by-15-dot-matrix draft output at 80 characters per second (cps) and 24-by-15-dot-matrix NLQ output at 50 cps. Supporting the IBM and Epson America Inc. character and graphics sets, the 24-element head has a resolution of 144 dots per inch (dpi) for graphics. The 12-pound, 15.3-by-11.4-by-3.4-inch unit uses friction feed for cut-sheet paper and optional tractor feed for fanfold paper. Noise is rated at below 50 dB(a).

The TPX-80, like many color thermal printers, handles only 8-1/2-by-11-inch, A size (or 297-by-210-mm A4) paper. If you want to print a spreadsheet or CAD/CAM (computer aided manufacturing) output, you might need the B size (A3) or the 11-by-17-inch capability of Mitsubishi Electronics America Inc.'s G650. Producing seven colors (yellow, cyan, magenta,

green, blue, red and black) on cut-sheet paper or transparency film, it provides 300-by-300-dpi resolution in four display formats: 1 by 1, 2 by 2, 3 by 3 or 2 by 4 dots, for dot-density variation. The G650 can churn out B size pages in 60 seconds; A size, in 30 seconds.

Four-color or three-color ink film cassettes produce 125 B size or 210 A size images per cassette. The standard Centronics interface can be expanded by custom interface circuits that fit into three empty slots on the printer.

Mitsubishi's 240-dpi G500 color thermal printer-plotter affords A size output, emulates Hewlett-Packard Co. and Houston Instrument plotters and is supported by over 100 IBM PC-compatible graphics software packages including Autodesk Inc.'s AutoCAD and Lotus Development Corp.'s 1-2-3.

Versatec's Versacolor thermal-transfer plotter produces B/A3 size or A/A4 size, high-resolution, 300-dpi four-color output on cut sheets and transparencies in 80 or 60 seconds, respectively. With the Versatec parallel interface, color data protocol and Versaplot software, it can reproduce over 2 million colors. A Centronics interface is optional for OEMs. Fast FORTRAN callable subroutines are compatible with basic pen-plotter routines.

Used with the company's Model 250 red-green-blue (RGB) video controller, the unit can take a fast screen dump directly from a personal computer or workstation to reproduce the CRT's output.



# FIRST WE INVENTED MATRIX LINE PRINTING.

Our original P-Series printers became the best selling matrix line printers in the world. With the best print quality. Outstanding reliability. And the lowest cost of ownership in the industry.

## YOU THINK WE'D LEAVE WELL ENOUGH ALONE.

### Introducing the P6000 Series Printers.

Our new P6000's are tough as always. And faster than ever, with speeds up to 800 lines per minute. Add our Intelligent Graphics Processor\* (IGP) option, and you'll raise your printing capabilities to an art. Create forms, logos, bar codes, even custom typefaces.

You'll get superior print quality in three modes: high speed, data processing, and letter quality. Print up to 12 six-part forms per minute, at less than a penny per page. And mix type styles and character sizes on the same line for dynamic, expressive business communications.

The 32-character plain-English message display provides status, selection and diagnostics for easy operation. And the built-in Epson® protocol makes it the logical choice for networking your PC's.

Find out why our newest line is destined to become a legend in its own time.

\*IGP option available with QMS® or Printronix compatibility.

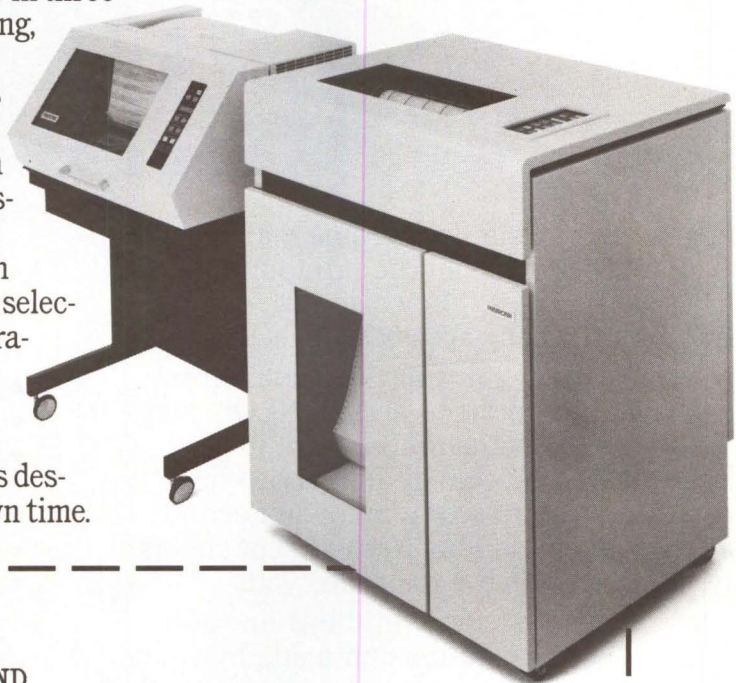

**CALL NOW: 1-800-826-3874**

**IN CALIFORNIA, 1-800-826-7559**

**I'D LIKE TO LIVE WITH A LEGEND.**

Send me more information on the new P6000 Series.

Name \_\_\_\_\_

Company \_\_\_\_\_

City/State/Zip \_\_\_\_\_ Phone \_\_\_\_\_

Printronix is a registered trademark of Printronix, Inc. QMS is a registered trademark of Quality Micro Systems, Inc. Epson is a registered trademark of Epson America.

Corporate/USA Headquarters: Printronix Inc. P.O. Box 19559, 17500 Cartwright Rd., Irvine, CA 92713, Telephone (714) 863-1900, Telex: 910-595-2535 European Headquarters: Printronix Europe S.A., Brussels, Belgium, Telephone: (32) 2-660-2904, Telex: 20643 PRINTR B. Far East Headquarters: Printronix A.G., Singapore, Telephone: (65) 242-3833, Telex: RS 55884 PRTNIX. ©1986, Printronix, Inc.

# PRINTRONIX®

MMS



# THE NEW FACE FOR YOUR PC

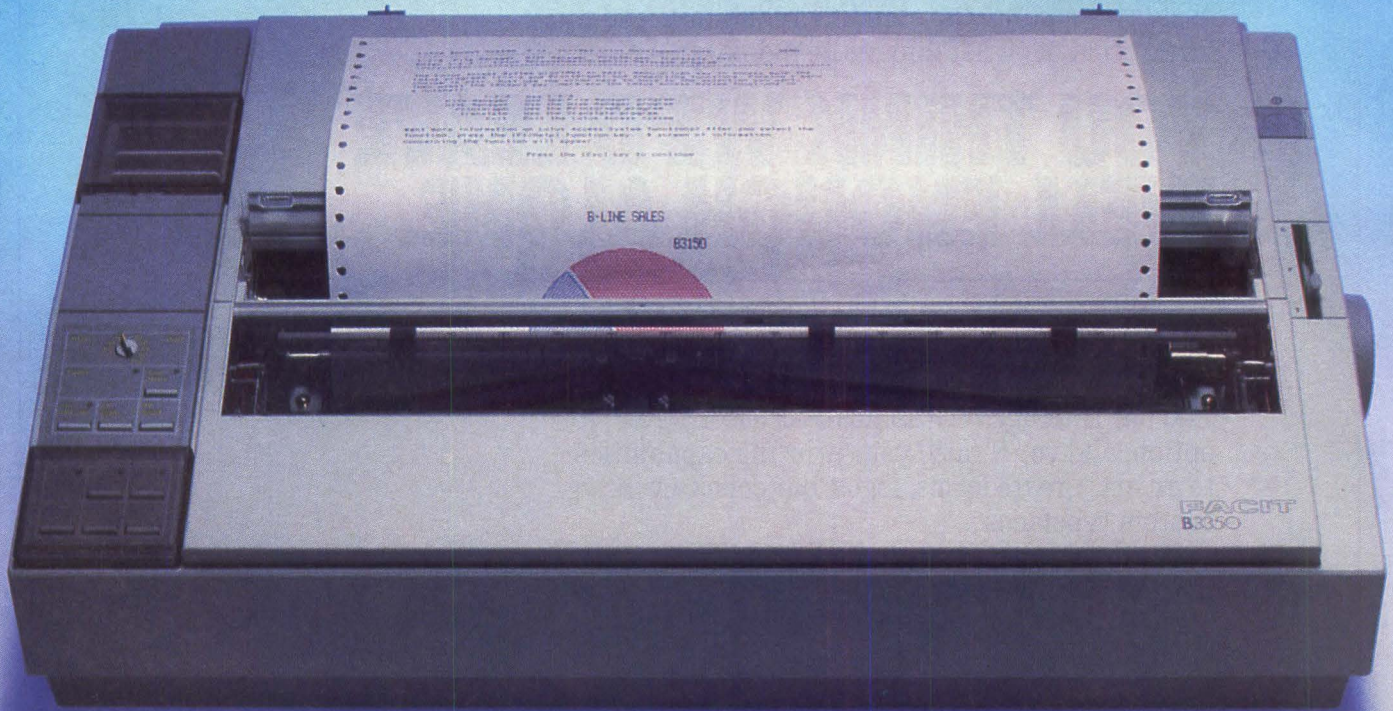

The new generation Facit B-line matrix printers not only provide all the printout options your office requires. They also give you extraordinarily easy access to these features.

Such as when you want to change from high throughput draft to perfect NLQ – just flick the rotary switch on the front panel. When you want to change font style – just plug in a new font card. When you need to change from continuous forms to cut sheets – the printer loads the paper for you.

And while the beauty of the B-line concept improves the impression made by your PC, the attractive design and low noise level make the printers perfect for every office environment, too.

## FACIT

Head Office: *Facit AB, S-172 91 Sundbyberg, Sweden. Phone: 46 8 764 30 00.*  
USA: *Facit Inc. P.O. Box 334, Merrimack, NH 03054. Phone: (603) 424-8000*

Check out the facts below and go for a test drive at your nearest Facit representative.

- *B3100: 80 columns, 128 lines/minute\* (250 cps)*
  - *B3150: 136 columns, 128 lines/minute\* (250 cps)*
  - *B3350: 136 columns, 109 lines/minute\* (200 cps), 18-needle printhead for 100 cps NLQ*
  - *Rotary switch for fast print quality selection*
  - *Easy operation with soft set-up in national language*
  - *Extensive paper handling – push/pull tractor, tear-off, automatic loading of single sheets. Optional single or double bin sheetfeeder*
  - *Low noise key*
  - *Facit, IBM Proprinter and Epson FX/JX emulations*
  - *Parallel and serial interfaces*
  - *4-color option*
  - *Extra fonts by means of plug-in card*
- \* 80 col. 10 cpi.

*IBM and Epson are reg. trademarks*

AUSTRALIA: EAI Electronics Associates Pty Ltd., 427-3322. AUSTRIA: Ericsson Information Systems GmbH, 0222-613 641. BELGIUM: Ericsson S.A., 02-243 82 11. CANADA: Facit Canada Inc., 416-825-8712. CYPRUS: LBM (Lillytos) Ltd 516 46 34. DENMARK: Facit A/S, 02-63 33 11. FINLAND: OY Facit, 90-420 21. FRANCE: Facit S.A., 1-4780 7117. GREAT BRITAIN: Facit 0634-40 20 80. GREECE: Computer Application Co. Ltd., 01-67197 22. HONGKONG: Gilman & Co. Ltd., 5-893 00 22. ICELAND: Gisli J. Johnsen HE 354-64 12 22. INDIA: Forbes Forbes Campbell & Co. Ltd., 22-20 48 081. IRELAND: Ericsson Information Systems Ltd., 75 30 93. ITALY: Facit Data Products S.p.A., 039-63 63 31. JAPAN: Electroflux (Japan) Ltd., 03-479-7570. KOREA: True Trading Co. Ltd., 2-783-3855-7. THE NETHERLANDS: Facit B.V., 3480-21784. NEW ZEELAND: Northrop Instruments and Systems, 501-801, 501-219. NORWAY: Ericsson Information Systems A/S, 02-35 58 20. PORTUGAL: Regisconta Sarl, 1-56 00 91. SINGAPORE: Far East Office Eqpts Pte Ltd., 745 82 88. SPAIN: Perifericos S.A., 4-57 90 81. SWEDEN: Ericsson Information Systems Sverige AB, 08-28 28 60. SWITZERLAND: Ericsson Information Systems AG, 01-821 59 21. USA: Facit Inc., (603) 424-8000. WEST GERMANY: Ericsson Information Systems GmbH, 0211-61 090.

**CIRCLE NO. 251 ON INQUIRY CARD**



Color thermal printers are raster devices and require conversion of application packages' vectors and primitives to a bit-map format. Having the host computer perform this operation trades off the savings from dispensing with a standalone rasterizing computer for slower output. However, the rasterizer allows you to interface minicomputer-mainframe graphics packages, such as Integrated Software Systems Corp.'s (ISSCO) TELL-A-GRAF and DISPLA, as well as share the printer in IBM SNA-SDLC (Systems Network Architecture-synchronous data link control) environments.

For example, if you want to generate graphics on the G500 at its full speed of less than 3 minutes per page (at 240 dpi), you can utilize Lasergraphics Inc.'s UI-100M24 rasterizing microcomputer. It accepts high-level graphics commands from the host computer over an RS232 serial ASCII line in Lasergraphics Language (LL) and/or HP Graphics Language (HPGL). Multiple copies can be produced without further host intervention, and six software-selectable fonts are standard. Rasterizers are also available for the Seiko Instruments U.S.A. Inc. CH-5301 and CH-5312 color thermal-transfer printers as well as color ink-jet printers.

If you want C size (17 by 22 inches) or larger output, you'll have to go to high-end flatbed plotters or Panatech Semiconductor, which supplies both thermal heads and printer mod-

ules on an OEM basis.

"Most heads supplied by Japanese vendors stop at about 10¼ inches, which is not quite B size," asserts Richard Bartlett, Panatech's thermal-printhead marketing manager. "We can make heads from 1 inch to 20 inches wide. We are supplying an oil industry client now with one 20 inches wide for seismic-analysis applications."

Thermal printers can integrate high-quality text and color graphics with the quiet operation required for today's open business environments. Disadvantages for color printing center on the slower speed required by the three passes of the printhead, the high accuracy needed for proper registration of the colored dots and the relatively high cost of the ribbons and the smooth, somewhat glossy paper required for high-quality images.

Hitachi America Ltd. claims to overcome the latter problem with its new PT-10E color thermal-transfer printer. Accommodating paper up to 10 inches wide (cut sheets and fanfold), it affords 180-by-180-dpi graphics on paper closer to photocopier quality than traditional thermal stock. A half-shift mode overlaps dot placement for better quality color. A wide carriage version, PT-12E, prints a line of 96 characters and handles 12-inch-wide paper. Both have Centronics parallel interfaces.

A host of color ink-jet printers can produce integrated text and graphics with quality (and

---

**Solid-ink ink-jet printers promise a 'quantum jump' advance in freedom from clogging and print quality.**

---

## Ink-jet pioneer looks ahead

Dr. C. Hellmuth Hertz, who for the past 20 years has pioneered in the development of electrically controlled continuous-stream ink jets as well as the use of ultrasound in medical diagnosis, is not resting on his laurels. Chairman of the Department of Electrical Measurements at Lund University, Lund, Sweden, he is now tackling two problems that have, so far, stumped ink-jet technology: full-color printing competitive with photographs and color printing on textiles.

"Half-tones obtained by random dither," the conventional technique for color ink jets, Hertz explains, "have a grainy appearance to the eye. It is far from a photographic image." His solution is to vary, by a factor of 30, the number of dots allocated to each pixel, with the smallest dot measuring 30 microns. Hertz expects to license the technique some time this year.

Hertz's device for large-array printing of textiles or wallpaper is now in prototype form. The problem, says Hertz, is that the "pigmented inks required for such printing will not pass through the very fine nozzles on conventional ink jets."

Hertz's solution? A "compound" continuous ink jet

that utilizes a cylinder of pigmented ink surrounding a 10-micron-diameter nozzle a short distance below the ink's surface. When a liquid, like water, is shot from the nozzle at high velocity, it picks up a sheath of ink, which breaks up into the fine ink droplets required for color printing.

Hertz emphasizes the problems entailed by the development of high-resolution (500 or 600 dots per inch) ink jets. "You'll need much smaller nozzles, say, 5 micron, rather than the 10 micron we use." But the main problem for color printing, he stresses, is not higher resolution but better control of such factors as low-intensity variations between two similar colors.

Although Hertz cautions that, "Engineering is a major barrier to the future development of ink jets," he predicts wider applications of the technology and the appearance of more "ink-jet enthusiasts."

Ink-jet enthusiasts are easily recognized, Hertz notes. "They have messy fingers and look continually at the bottom of beer cans to check the ink-jet printing. God has exempted them from Murphy's Law. They will try to convince you that ink-jet technology is simple. But be sure one is a good engineer before you take his advice."





**Full-color graphics** with 240-by-240- or 240-by-480-dpi resolution and an embossed feel are provided by Howtek's Pixel-master solid-ink ink-jet printer. (Source: Howtek)

low noise level) comparable to thermal units. For example, Quadram Corp.'s Quadjet delivers 640 dots per 80-character line as well as bit-mapped graphics in up to seven colors at 40 cps. It's bundled with software for the IBM PC (which requires a parallel interface card) and a color graphics tablet for the Apple Computer Inc. II or IIe.

"It's very effective to see full-color presentations on paper or transparencies. For the presentation market today you need color," says Quadram's general manager for graphics and storage, James Rush. "But I don't think the typical user needs more than seven colors. Most screens have CGA (color graphics adapter) type graphics. The Quadjet produces good fill colors and it's easy to use."

Rush claims that the clogging problems that have plagued some ink jets is a thing of the past. "For the most part, clogging problems are history. We have not had significant problems with our device," he says. "The biggest problem we have had is with distributors who test the unit and then forget to lock the cap that protects the nozzles."

Other color ink-jet printers are available from HP, IBM, Canon U.S.A. Inc., Tektronix Inc. and other vendors. HP's QuietJet, for example, offers 19-by-32-dot NLQ printing and up to 192-by-192-dpi graphics in seven colors at 40 cps (10 characters per inch) or 48 cps. It supports eight international character sets and operates at less than 48 dB(a). The company's new version of its battery-powered ThinkJet ink-jet printer connects to portable computers via a Centronics parallel interface.

CalComp's ColorMaster prints at 1 minute per A size color page and furnishes a horizontal

resolution of 203 dpi, vertical resolution of 200 dpi and a built-in rasterizer with 512K buffer that can store up to 100 pages of text. Compatible with popular graphics packages such as Zenographics Corp.'s Mirage and Autumn and Decision Resources Chart-Master, plus Lotus 1-2-3 and Symphony, the printer incorporates a native implementation of the Graphic Software Systems Inc.'s (GSS) virtual device interface (VDI) driver. An EGA screen-dump facility is also available.

Software packages with advanced color capability can produce output on a color thermal printer that far surpasses what basic seven-color capacity would indicate. For example, Zenographics' Version 5.0 of Mirage and Autumn color-graphics software allows users to choose from a 98-color palette, a superset of Genigraphics Corp.'s slide-making systems' color palette. Additional colors can be "mixed" from a range of 360 million values, with hue values ranging from zero to 360, lightness from zero (black) to 1,000 (white) and saturation from zero to 1,000.

#### **Moving up to top-quality output**

Most of the excitement in nonimpact technology focuses on mid-range and high-end color ink-jet printers that can produce full-color output with quality that rivals offset printing.

For example, Advanced Color Technology Inc.'s Chromajet 4000 uses an 18-by-36-dot matrix to handle 1,000-color printing and bit-mapped graphics up to 240 dpi. It operates at 27 cps in letter-quality mode, interfaces via RS232C or a Centronics parallel line, prints a 115-character line and can size images on the page.

Xerox Corp.'s 4020 color ink-jet printer employs 20 nozzles and drop-on-demand technology to combine seven colors into approximately 4,000 shades. In addition to a 120-by-120-dpi mode, it uses an enhanced 120-by-240-dpi mode to create denser graphic images and more-filled-in characters. A Centronics interface is standard, RS232C optional.

The 4020 has several features to prevent clogging. An automatic purge system cleans the nozzles. A removable cartridge furnishes the "maintenance" fluid in which the nozzles rest when not in use.

Ink-jet printers with new solid-ink technology from Dataproducts Corp. and Howtek Inc. promise a "quantum jump" advance in freedom from clogging and in print quality that rivals the "embossed" look of lithography.

Dataproducts' SI 480 heats the solid ink pellet, which melts down into a heated reservoir, from which it is taken up into a compres-



# Get the Courier HST™ 9600-bps modem. Then watch the rest of the world play catch-up.

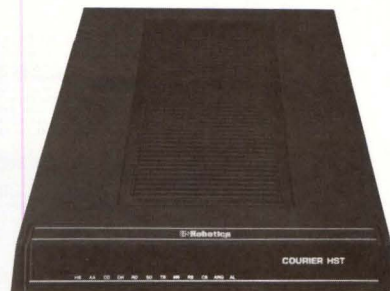

**USRobotics new high speed technology delivers over 1,000 characters/second on more dial-up phone lines. For less than \$1,000.**

The new Courier HST (High Speed Technology) dial-up modem combines four great ideas that add up to a new standard for personal computer data communications.

**It's full-duplex**, with high speed (9600-bps) and low speed (300-bps) channels—automatically assigning the high speed channel direction. This asymmetrical solution avoids the problems of echo-cancelling technology or inefficient half-duplex schemes.

**The most powerful data signalling technique**—Trellis Encoded Modulation—lets Courier HST achieve maximum speed over a much wider range of phone line conditions than other 9600-bps modems.

**A unique error- and flow-control method** allows Courier HST to send up to 1,100 characters a second over long distance phone connections.

**It's familiar** as any 2400- and 1200-bps modem. Same features, commands and, in most cases, the same software. In fact, Courier HST automatically falls back to 2400, 1200 and 300-bps, connecting you with nearly all modems.

High speed. High accuracy. High value. And a two-year parts and service warranty. Get the USRobotics Courier HST, priced under \$1,000. And watch the rest of the world play catch-up.

**CALL 1-800-DIAL-USR  
In Illinois (312) 982-5001**

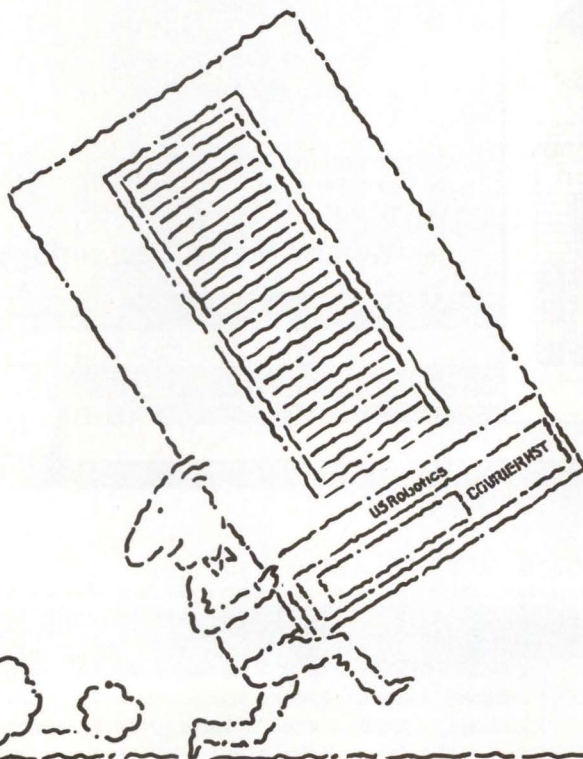

Yes, please send me your FREE 8-page book explaining the new Courier HST and today's new high speed technology.

Name \_\_\_\_\_

Title \_\_\_\_\_

Company \_\_\_\_\_

Address \_\_\_\_\_

City \_\_\_\_\_ State \_\_\_\_\_ Zip \_\_\_\_\_

Business Phone ( ) \_\_\_\_\_

1/87-MM-HST

**USRobotics™**

The Intelligent Choice in Data Communications.  
8100 McCormick Blvd., Skokie, Illinois 60076.

CIRCLE NO. 59 ON INQUIRY CARD





## All-In-One AMT Office Printer™

### FONTS AND PRINT MODES

The AMT Office Printer can store up to eight resident fonts. You can print these fonts in Letter, Memo, or Draft mode. Letter mode produces true letter-quality characters at 45 cps. Memo mode produces characters that are near-letter-quality at 100 cps. Draft mode produces draft-quality characters at 250 cps. Here are some examples:

Courier 72, one of the most popular business typefaces, prints 10 characters to the inch.

Letter Gothic 12, another widely-used typeface, prints 12 characters to the inch.

Setex 17, a font that is perfect for printing spreadsheets, prints 17.1 characters per inch.

Trend 75, a proportionally-spaced typeface, comes in handy when typing formal documentation.

Scientific 10:

$$\frac{1}{x} = \sum_{n=1}^{\infty} dx \left( \frac{\sin x^2}{\cot x^2} \right)$$

$$\sum_{k=1}^{n-1} \frac{1}{k} = \sum_{k=1}^n \frac{1}{k} - \frac{1}{n} = \sum_{k=1}^n \frac{1}{k} - \frac{1}{n}$$

### PRINTER COMPATIBILITY

The AMT Office Printer can contain multiple resident emulations. This feature lets you turn the AMT Office Printer into a variety of other popular printers. For example, if you're using a program that supports only the Epson 38-80 printer and not the AMT, just press a single button and the AMT is instantly compatible.

### Color Graphics on the AMT Office Printer

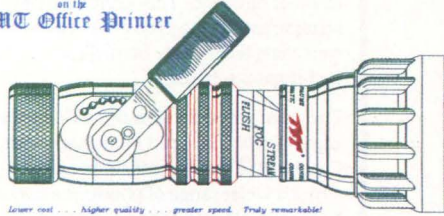

Lower cost... higher quality... greater speed. Truly remarkable!

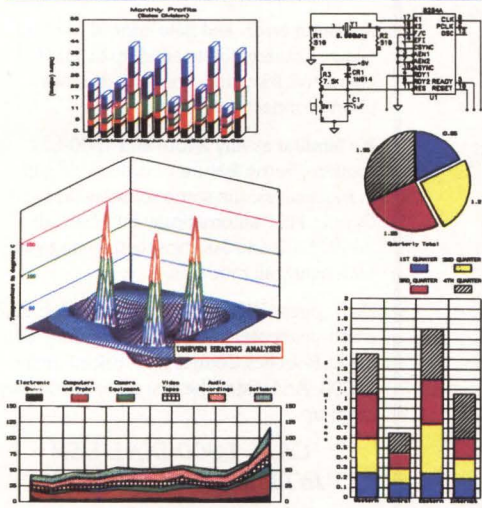

1157 Tourmaline Drive, Newbury Park, CA 91320, U.S.A.  
Telephone USA (805) 499-8741 FAX USA (805) 499-1547 Telex 280805

The All-In-One Printing Solution

# AMT Office Printer™

Tired of juggling three or more separate devices to meet your printing needs? Confused about which technology—daisywheel, dot-matrix, plotter, ink-jet, thermal or laser—is right for you?

The all-in-one AMT Office Printer does the job of all these devices with superb print quality, speed, and the ability to mix text with multicolor high-resolution graphics. In fact, this exciting printer has set a new standard in functional versatility.

How can one printer do so much? With an ingenious print mechanism, unrivaled font, graphic and color flexibility, multiple resident emulations, plus widespread hardware and software compatibility.

The AMT Office Printer is applications-oriented. For word processing, there is better-than-letter and near-letter-quality text, a font library with both fixed and proportionally-spaced fonts, scientific and technical character sets, and built-in features that italicize, color, bold, shadow, super/subscript, underscore, expand, center, and justify text. For data processing, there is high-speed, draft-quality text with up to 264 characters per line. For business graphics, CAD/CAM/CAE plots, and other precision graphic applications, there are full-color graphic modes providing resolutions up to 240V x 480H dots per inch. And for technical applications, there is custom font generation, font download, plotter emulation, and many other printing utilities.

Most importantly, the AMT Office Printer is fully compatible with software that drives the Diablo 630™, Qume Sprint 11™, NEC Model 3550 Spinwriter™, Diablo C-150 Ink-Jet Printer™, IBM Model 5182 Color Printer™, and Epson JX-80™. So just plug the printer into your computer's serial or parallel port, load your favorite software, and begin printing.

Isn't it about time to solve all your printing problems? The all-in-one AMT Office Printer!

1157 Tourmaline Drive  
Newbury Park, CA 91320 (805) 499-8741  
European sales office UK (0) 7356-71464

Advanced Matrix Technology, Inc.



CIRCLE NO. 60 ON INQUIRY CARD

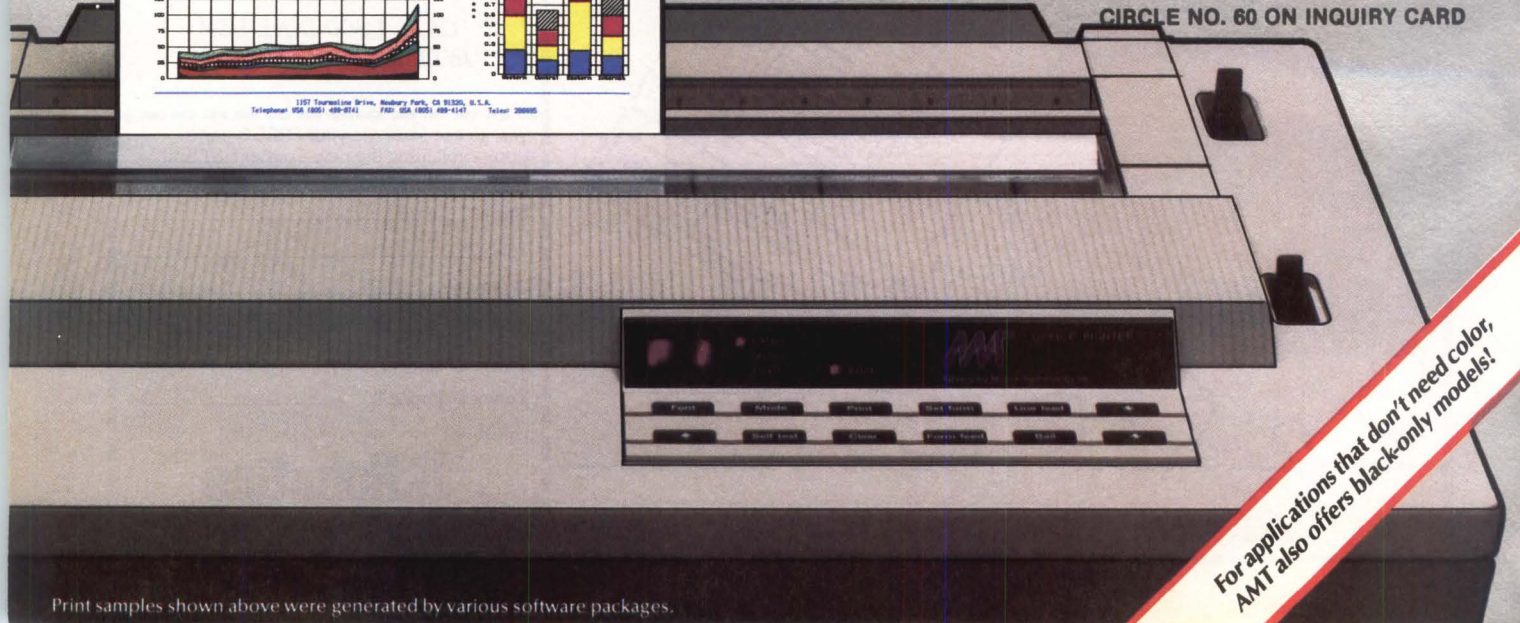

Print samples shown above were generated by various software packages.

For applications that don't need color, AMT also offers black-only models!



sion chamber. A print signal activates the piezoelectric, drop-on-demand transducer that fires the ink droplets through 2-mil orifices onto paper or transparencies.

Fitz Turner, Dataproducts director of marketing, claims several benefits from solid-ink technology, including dark, sharp-edged print quality and elimination of clogging.

"With water-based inks, if you don't print for a while, the water evaporates and the ink crusts in the orifice and blocks the holes," Turner explains. "Also, with very high-quality, high-rag-content paper, the ink wicks into the paper and spreads out, causing the characters to look rough edged."

Turner continues: "Solid ink is a major breakthrough in terms of higher reliability and print capacity. Because it has no aqueous base, it does not evaporate and cause nozzles to clog. Because it 'freezes' and does not evaporate on the page, it does not wick into the paper. The SI-480 offers executive-quality printing and is totally insensitive to paper."

The SI-480 furnishes up to 240-by-480-dpi graphics at 20 inches per second and offers high-quality printing on paper from tissue through card stock and even, claims Turner, to sandpaper "for the abrasive letters we all want to write." Two fonts (Courier like and Gothic like) come standard and others can be downloaded under software or front-panel control via a 64K buffer. The printer also offers a wide range of emulation, formatting and pitch modes and an MTBF of 24 months at a 25 percent duty cycle. An optional programmable power pedestal offers two 500-sheet bin feeders or one bin feeder and a 70-envelope feeder.

Howtek's Pixelmaster color ink-jet printer provides "embossed" quality, full-color graphics with 240-by-240-dpi resolution and "raised" text on virtually any office paper, claims Ray Roque, vice president of marketing. It can half-step horizontally for 240 by 480 dpi. The nonfriction vertical paper feed lifts the paper past the rotating printhead, which deposits the solid plastic, melted ink. Full color pages print in 3 to 4 minutes.

The unique print mechanism contributes to the unit's 20,000 page mean output between failures, says Roque. Sixteen different fonts in plug-in ROM cartridges can reside in memory at one time.

SCSI, RS232C, Ethernet and Centronics interfaces are standard as are GSS Grafstation and HP Laserjet emulation; HPGL emulation also will be offered.

Iris Graphics Inc.'s 2044 large-format (E size, 34 by 44 inches) and 2024 medium-format (24 by 24 inches) color ink-jet printers aim at

## SOLID-INK TECHNOLOGY TAKES AIM AT CLOGGING

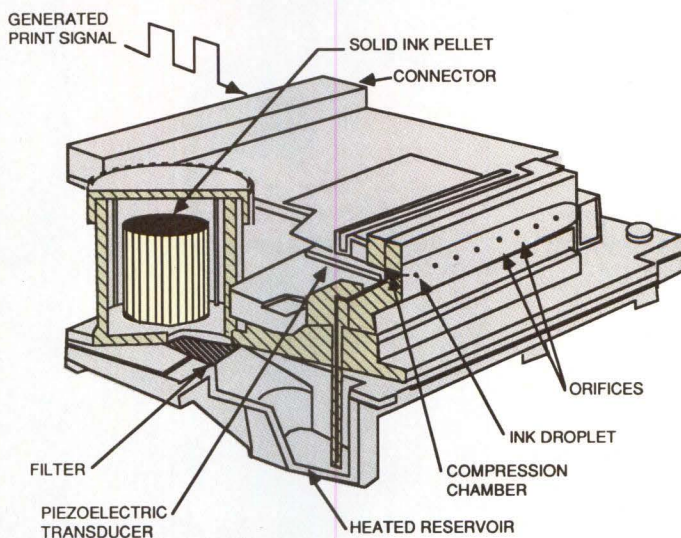

nonphotographic, color prepress proofing and CAD/CAM applications. Based on continuous-stream technology developed by Dr. C. Hellmuth Hertz, the 2024 produces 1 million 15-micron droplets per second for 240-by-240-dpi resolution "on anything you can mount on the drum," contends Tad Thompson, director of communications at Iris.

Under control of an Intel Corp. 8085 processor, the printer can step, repeat and rotate images over a page, merge and delete image files and integrate text and line art in over 250,000 colors.

"Film-based color proofs can be expensive, and labor intensive," explains Thompson. "A typical 12-by-18-inch DuPont Corp. Cromalin or other photographic color proof can cost \$35 or more. We can supply a color hard-copy alternative for about 35 cents. The 2044 can turn out a 16-page signature in 30 minutes; the 2024, two double-page-spread magazine proofs in 12 minutes. In addition, computer-equipment vendors are using the machines to produce low-cost posters of their ads for their retail outlets or distributors."

Color thermal and ink-jet printers will continue to refine their technologies. The color thermal printers' relatively high cost per printed page of 25 to 50 cents will come down over the next few years to 15 to 30 cents, says Greg Porell, senior consultant at CAP International.

Rohm Corp. will introduce 300-dpi heads

**A solid-ink pellet in Dataproducts' SI 480 ink-jet printer melts into a heated reservoir and is taken up by an intake channel into a compression chamber. A drop-on-demand transducer fires the ink droplets through 2-mil orifices onto paper or transparencies.**



early this year and eventually 400-dpi units, says Bob Peckham, marketing manager for thermal-LED (light-emitting diode) printheads. But the latter may not be easy to implement. "You need a very smooth print surface and an

extremely thin transfer ribbon," Peckham cautions.

However, resolution for most units will probably not get much beyond 200 dpi, contends Dave Collier, electrical projects manager at General Scanning Inc., which makes a full line of thermal recorders.

"The thermal-printhead market is driven by the facsimile market, which uses 200-dpi heads. You can get 400-dpi heads, but they probably won't appear on thermal printers, because you can get higher resolution with laser printers."

The reliability, paper-handling features and high-quality text and images afforded by solid-ink technology will migrate down to mid- and low-end units as more color graphics packages appear that can take advantage of the precision and range of colors these units can produce.

Nonimpact technologies will not cause the complete and sudden demise of serial-impact and daisywheel units. Users who want full-letter-quality output will only gradually migrate to nonimpact printers as the price/performance, and print quality, of these units continues to improve.

However, rapidly maturing laser printers cast a big shadow over the nonimpact printer market, offering intense competition for the higher end ink-jet and thermal printers. But until the much heralded color laser printer becomes a commercial reality, nonimpact color printers will remain the only game in town for system integrators who want full color graphics and integrated text. □

**For color pre-press proofing or CAD/CAM applications, Iris Graphics' 2024 color ink-jet printer prints 24-by-24-inch, 240-by-240-dpi digitized images.** (Source: Iris Graphics Inc.)

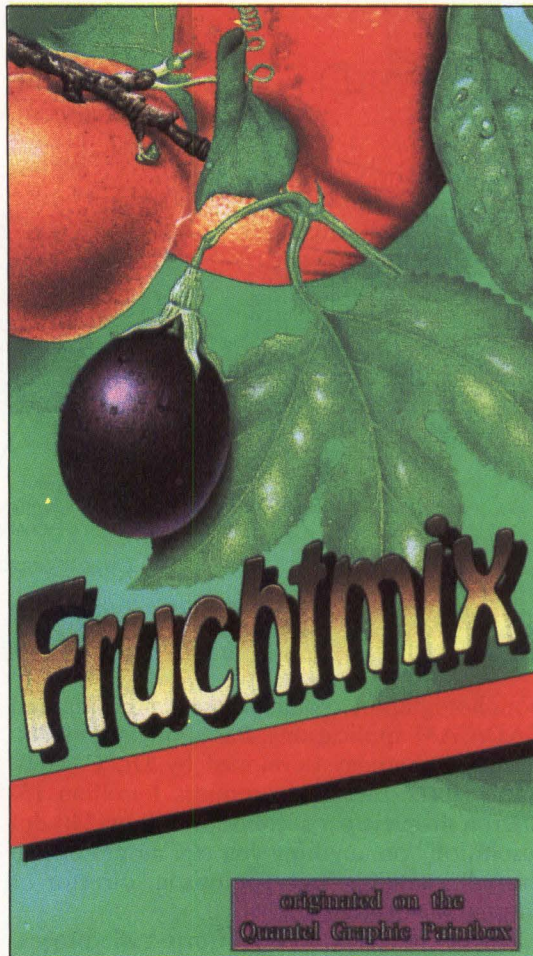

Interest Quotient (Circle One)  
High 492 Medium 493 Low 494

## Companies mentioned in this article

**Advanced Color Technology Inc.**  
21 Alpha Road  
Chelmsford, Mass. 01824  
(617) 256-1222  
Circle 343

**C. Itoh Electronics Inc.**  
5301 Beethoven St.  
Los Angeles, Calif. 90066  
(213) 306-6700  
Circle 344

**CalComp**  
2411 W. LaPalma Ave.  
Box 3250  
Anaheim, Calif. 92801  
(714) 821-2000  
Circle 345

**Canon U.S.A. Inc.**  
1 Canon Plaza  
Lake Success, N.Y. 11042  
(516) 488-6700  
Circle 346

**Dataproducts Corp.**  
6200 Canoga Ave.  
Woodland Hills, Calif. 91365  
(818) 888-4014  
Circle 347

**General Scanning Inc.**  
500 Arsenal St.  
Watertown, Mass. 02172  
(617) 924-1010  
Circle 348

**Hewlett-Packard Co.**  
300 Hanover St.  
Palo Alto, Calif. 94304  
(415) 857-1501  
Circle 349

**Hitachi America Ltd.**  
Office Automation  
Systems Div.  
59 Route 17 S  
Allendale, N.J. 07401  
(201) 825-8000  
Circle 350

**Howtek Inc.**  
21 Park Ave.  
Hudson, N.H. 03051  
(603) 882-5200  
Circle 351

**IBM Corp.**  
900 King St.  
Rye Brook, N.Y. 10573  
(914) 934-4000  
Circle 352

**Iris Graphics Inc.**  
41 Elm St.  
P.O. Box 508  
Stoneham, Mass. 02180  
(617) 438-1500  
Circle 353

**Lasergraphics Inc.**  
17871 Cowan Ave.  
Irvine, Calif. 92714  
(714) 660-9497  
Circle 354

**Mitsubishi Electronics America Inc.**  
Computer Peripherals Div.  
991 Knox St.  
Torrance, Calif.  
(213) 515-3993  
Circle 355

**Panatech Semiconductor**  
3375 Scott Blvd.  
Santa Clara, Calif. 95054  
(408) 727-8144  
Circle 356

**Quadram Corp.**  
1 Meca Way  
Norcross, Ga. 30093  
(404) 923-6666  
Circle 357

**Rohm Corp.**  
P.O. Box 19515  
Irvine, Calif. 92718  
(714) 855-1669  
Circle 358

**Seiko Instruments U.S.A. Inc.**  
Graphics Devices  
and Systems Div.  
1623 Buckeye Drive  
Milpitas, Calif. 95035  
(408) 943-9100  
Circle 359

**Tektronix Inc.**  
P.O. Box 500  
Station Y3-314  
Beaverton, Ore. 97077  
(503) 627-7111  
Circle 360

**Versatec**  
2710 Walsh Ave.  
Santa Clara, Calif. 95051  
(408) 988-2800  
Circle 361

**Xerox Corp.**  
101 Continental Blvd.  
El Segundo, Calif. 90245  
(213) 857-1501  
Circle 362



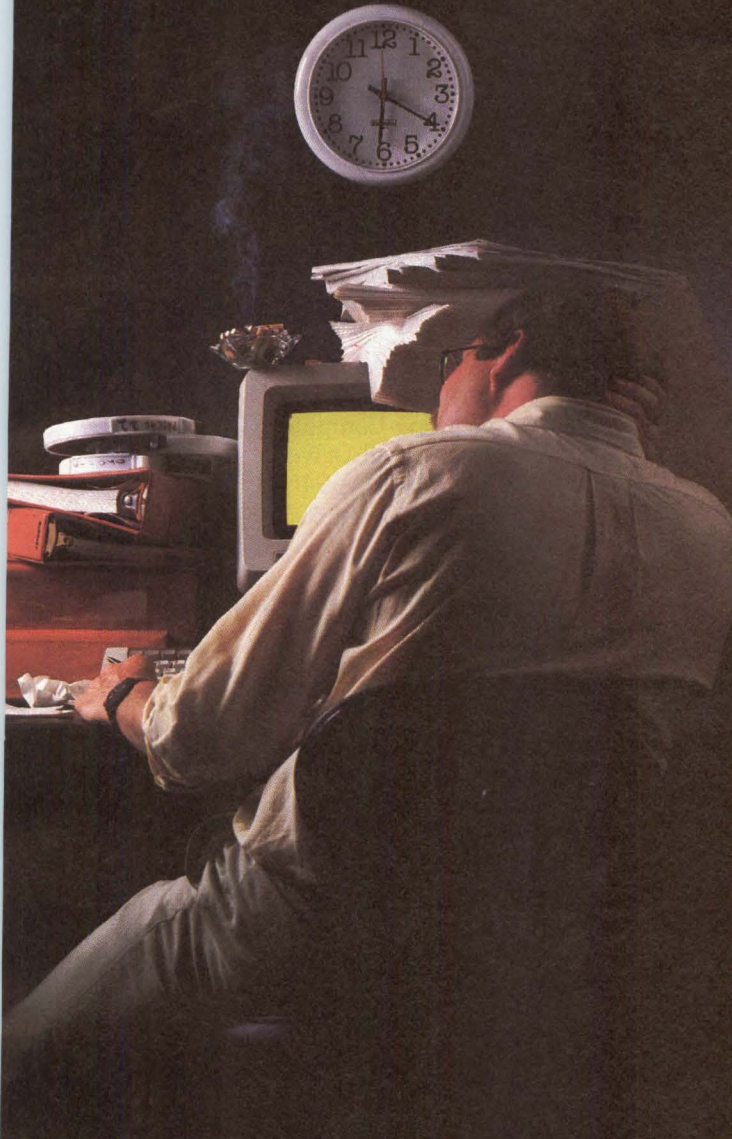

## 4:30 PM–6:30 PM

Joe Jones adds and modifies 27 user accounts, rebuilds a corrupted queue file, and schedules a complete system backup.

**SystemMaster**, from Strategic Information, automates major system-management tasks at VAX/VMS sites. Easily. Securely. Profitably.

If you're a system manager, this means freedom. Freedom from tedious, repetitive tasks like queue management, process management, system backup and restore. Freedom to concentrate on challenging, productive tasks like programming, tuning, . . .

SystemMaster provides a secure, controlled environment for distributing system management. You can selectively delegate system-management responsibility and control the assigned tasks.

VAX/VMS are trademarks of Digital Equipment Corporation.



## 4:30 PM–5:00 PM

Mary Smith does the same thing.  
With SystemMaster.

And because SystemMaster is menu driven with on-line help, it simplifies system-management. Minimal training, few operating manuals, and little system knowledge are required.

SystemMaster. For system managers, it's powerful automation. To learn more about it, call us today. Put time and profit on your side.



### Strategic Information

80 Blanchard Road, Burlington, MA 01803  
(617) 273-5500 (800) 227-1209

**CIRCLE NO. 61 ON INQUIRY CARD**



Until now, you expected to get what you paid for. Bruning's new ZETADRAF 900 E-size, single sheet plotter gives you *more*.

How? We've designed and engineered a totally new E-size plotter to the point where it outperforms every other plotter of its type.

And at the same time, we reduced the price!

The drawing quality is superb. And, when you consider 6 g's acceleration, 45 ips chart speed and 8-pen color capability, it's unmatched.

Of course our faster plot speed means your output is higher than ever. ZETADRAF 900 could cut the plot time for your most dense design in half.

ZETADRAF 900 supports all major CAD software packages and

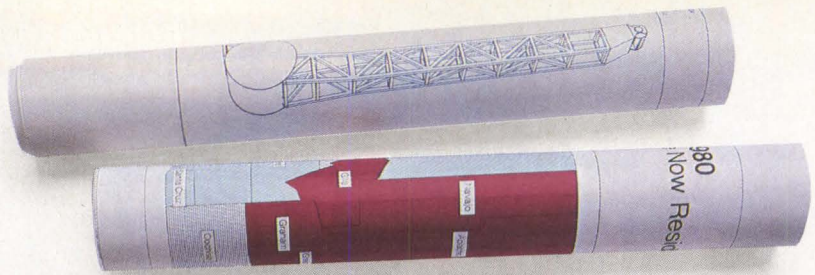

is compatible with most computers. Interfaces include RS232, IEEE-488, GML and HPGL.

No prior plotter experience is required, even for liquid ink. ZETADRAF 900 has two levels of operation—novice and advanced. But *everyone* appreciates features such as the angled, LCD control panel and the ability of the plotter to store even complex user-designed configurations.

Sorry CalComp and HP. We just didn't realize when we started out that we could produce so much plotter for so little money. But we did. Get all the facts about ZETADRAF 900 or our other ZETA drafting plotters by calling (415) 372-PLOT or write:

Bruning Computer Graphics  
777 Arnold Drive  
Martinez, CA 94533  
TWX 910-481-5951



CIRCLE NO. 62 ON INQUIRY CARD

**BRUNING**

Introducing the  
ZETADRAF 900  
for \$7,950.

We just raised the  
performance level  
for single sheet,  
E-size plotters.



We also lowered  
the price!



# PLOTTERS

Company Model	Plotter type	Pen type	Number of colors	Plotting speed (ips)	Media type	Paper size (inches)	Number of character sets	Mechanical resolution (inches)	Repeatability (inches)	Compatible software	Hardware interface	Unit price (\$)
<b>ALPHA MERICS CORP.</b>												
8031 Remmet Ave., Canoga Park, CA 91304, (818) 999-5580												
Alphaplot II	flatbed, pen plotter	ballpoint, fiber tip, wet ink	6	8.5	all media	24×34 (A-D)	0.001	0.00125		HPGL	RS232C	5,990
Customline	flatbed, pen plotter	all	6	15	all media	48×96 (A-E)	0.002				RS232C	
<b>ARISTO GRAPHICS CORP.</b>												
5 Emery Ave., Randolph, NJ 07869, (201) 366-7000												
Aristomat 100	flatbed, cutting	ballpoint, felt tip, ink		2.8	mylar, paper, rubylith, scribefilm	48×60	1	0.0002	0.0004	Hewlett-Packard	RS232C	55,000-75,000
Aristomat 200	flatbed, cutting	ballpoint, felt tip, ink		15	mylar, paper, rubylith, scribefilm, vinyl	48×67	3	0.0002	0.0018		RS232C	65,000-92,000
<b>BENSON INC.</b>												
385 Ravendale Dr., P.O. Box 7169, Mountain View, CA 94039-7169, (415) 964-7900												
CES-3036	electrostatic		512	0.3	film, paper	36 roll (E)	1	254 dpi		CAD/CAM, CAE, IC design application	IBM channel	85,000
CTP-XX	thermal transfer		7	40-180 sec. per copy	film; plain, clay-coated paper	11 roll (A, B)	1	300 dpi		HPGL	Centronics, IBM PC bus, RS232C, RS343	8,950-11,900
<b>CALCOMP</b>												
2411 W. LaPalma Ave., Anaheim, CA 92801, (714) 821-2000												
1043GT	pen plotter	ballpoint, fiber tip, liquid ink, plastic tip	8	24	paper, polyester film, vellum	36.7×47 (A-E)	10	0.0005	0.005	AutoCAD, CADVANCE, VersaCAD	RS232C, IEEE 488	8,905
5735	electrostatic		1	0.5	clear, matte film; standard, translucent paper	36 roll	11	400 dpi		AutoCAD, CADVANCE, VersaCAD	Centronics, Dataproducts, RS232C	54,455
<b>ENTER COMPUTER INC.</b>												
6867 Nancy Ridge Dr., San Diego, CA 92121, (619) 450-0601												
SP600	pen plotter	fiber tip	10	14	bond, transparency, vellum	8½×11, 11×17 (A, B)	18	0.004	0.008	HPGL	Centronics, RS232C	1,095
SP1000	pen plotter	fiber tip, liquid ink, roller ball	10	31	bond, transparency, vellum	all (A-D)	18	0.00025	0.004	HPGL	RS232C	3,995
<b>FACIT INC.</b>												
9 Executive Park Dr., P.O. Box 334, Merrimack, NH 03054-0334, (603) 424-8000												
4550	pen plotter	ballpoint, ceramic tip, fiber tip	8-12	6	paper, glossy paper, transparency	8½×11 (A)	16	0.004	0.008	HPGL	Centronics, RS232C	795
4551	pen plotter	ballpoint, ceramic tip, fiber tip	8-12	8	paper, glossy paper, transparency	11×17 (A, B)	16	0.004	0.008	HPGL	Centronics, RS232C	995
<b>GULTON INDUSTRIES INC. (GRAPHIC INSTRUMENTS DIV.)</b>												
Gulton Industrial Park, East Greenwich, RI 02818, (401) 884-6800												
Superplot-80	thermal printer/plotter	dot matrix	1		thermal paper	8½×11, 8½ roll	1	100 dpi			Centronics, IEEE 488, OEM bit parallel, RS232C	2,050
<b>HARRIS CORP. (COMPUTER SYSTEMS DIV.)</b>												
2101 Cypress Creek Rd., Fort Lauderdale, FL 33309, (305) 974-1700												
Harris 4765	electrostatic printer/plotter	dot matrix	1	1	electrographic paper	11 roll, fan fold (A-E)		200 dpi		Versaplot	Harris VLLI, parallel, DMA controller	12,500
Harris 4770	electrostatic printer/plotter	dot matrix	1	1.5	electrographic paper	34 roll (A-E)		200 dpi		Versaplot	Harris VLLIC, parallel, DMA controller	49,000



# PLOTTERS

Company Model	Plotter type	Pen type	Number of colors	Plotting speed (ips)	Media type	Paper size (inches)	Number of character sets	Mechanical resolution (inches)	Repeatability (inches)	Compatible software	Hardware interface	Unit price (\$)
<b>HEWLETT-PACKARD CO. (SAN DIEGO DIV.)</b>												
16399 W. Bernardo Dr., San Diego, CA 92127, (619) 487-4100												
7550A	pen plotter	fiber tip, liquid ink, roller ball	10	31.5	paper, polyester film, transparency, vellum	11×17 (A, B)	20	0.001	0.004	major business, technical and CAD packages	IEEE 488, RS232C	3,900
Color Pro	pen plotter	fiber tip	10	15.7	paper, transparency	8½×11 (A)	5	0.001	0.004	major business, technical and CAD packages	IEEE 488, RS232C	1,295
<b>HOUSTON INSTRUMENT (DIV. OF AMETEK INC.)</b>												
8500 Cameron Rd., Austin, TX 78753, (512) 835-0900												
DMP-51/52 MP	pen plotter	stainless steel, tungsten tip drafting; water-based hard nib	14	22	matte film, paper, vellum	(C, D)		0.001	0.002	350 CAD, business graphics packages	RS232C	5,295
DMP-56A	pen plotter	stainless steel, tungsten tip drafting; water-based hard nib	1	22	matte film, paper, vellum	8½×11 to 36×48 (A-E)		0.001	0.004	350 CAD, business graphics packages	RS232C	5,995
<b>IBM CORP.</b>												
Old Orchard Rd., Armonk, NY 10504, (800) 426-2468												
6180 Model 1	pen plotter	fiber tip	8	20	paper, transparency film	8½×11 (A)	19	0.001	0.004	ChartMaster, Lotus, SlideWrite	IEEE 488, RS232C	1,285
7372	pen plotter	fiber tip	6	15	paper, transparency film	11×17 (A, B)	20	0.001	0.004	ChartMaster, Lotus, SlideWrite	IEEE 488, RS232C	1,900
<b>IOLINE CORP.</b>												
19417 36th Ave. West, Suite D-1, Lynnwood, WA 98036, (206) 775-7861												
LP3700	pen plotter	fiber tip, liquid ink, roller ball	1-20	14	film, mylar, paper, vellum	up to 37½×81 (A-E)	2	0.0025	0.0025	DM/PL	RS232C	4,495
LP4000	pen plotter	fiber tip, liquid ink, roller ball	1-20	28	film, mylar, paper, vellum	up to 37½×81 (A-E)	2	0.001	0.0025	DM/PL	RS232C	5,995
<b>NCR CORP. (MICROGRAPHIC SYSTEMS DIV.)</b>												
520 Logue Ave., Mountain View, CA 94043, (415) 965-3700												
4300	raster plotter	laser imaging	1	3 min. per card	aperture card	35mm		200 dpi			Versatec processor	38,000-45,000
<b>PRINTRONIX INC.</b>												
17500 Cartwright Rd., Irvine, CA 92714, (714) 863-1900												
4160	printer/plotter	dot matrix	1	13.6	mylar, paper, vellum	3½-16 roll, fan fold	2	160×168 dpi	0.003	Versaplot	Centronics, Versatec	5,380
<b>ROLAND DG</b>												
7200 Dominion Circle, Los Angeles, CA 90040, (213) 685-5141												
DPX-2000	flatbed, pen plotter	ballpoint, ceramic tip, fiber tip, liquid ink, oil-based	8	16	up to ¼ inch thick	23.3×17 (A-C)	16	0.00049	0.001	Hewlett-Packard	Centronics, RS232C	5,495
DXY-980	flatbed, pen plotter	ballpoint, ceramic tip, fiber tip, liquid ink, oil-based	8	9.8	up to ¼ inch thick	14.9×10.6 (A, B)	16	0.0019	0.01	Hewlett-Packard	Centronics, RS232C	1,695
<b>SEIKO INSTRUMENTS USA INC.</b>												
1130 Ringwood Court, San Jose, CA 95131, (408) 943-9100												
CH-5301	thermal transfer	dot matrix	4,912	45 sec. per copy	paper, transparency film	8½×11 (A)		152 dpi			parallel, video	from 5,995
CH-5312	thermal transfer	dot matrix	4,912	65-115 sec. per copy	paper, transparency film	8½×11, 11×17 (A, B)		203 dpi			parallel, video	from 9,995

Circle 309

Circle 310

Circle 311

Circle 312

Circle 313

Circle 314

Circle 315

Circle 316



# INTERPHASE PULLS A FAST ONE

## V/SMD 4200

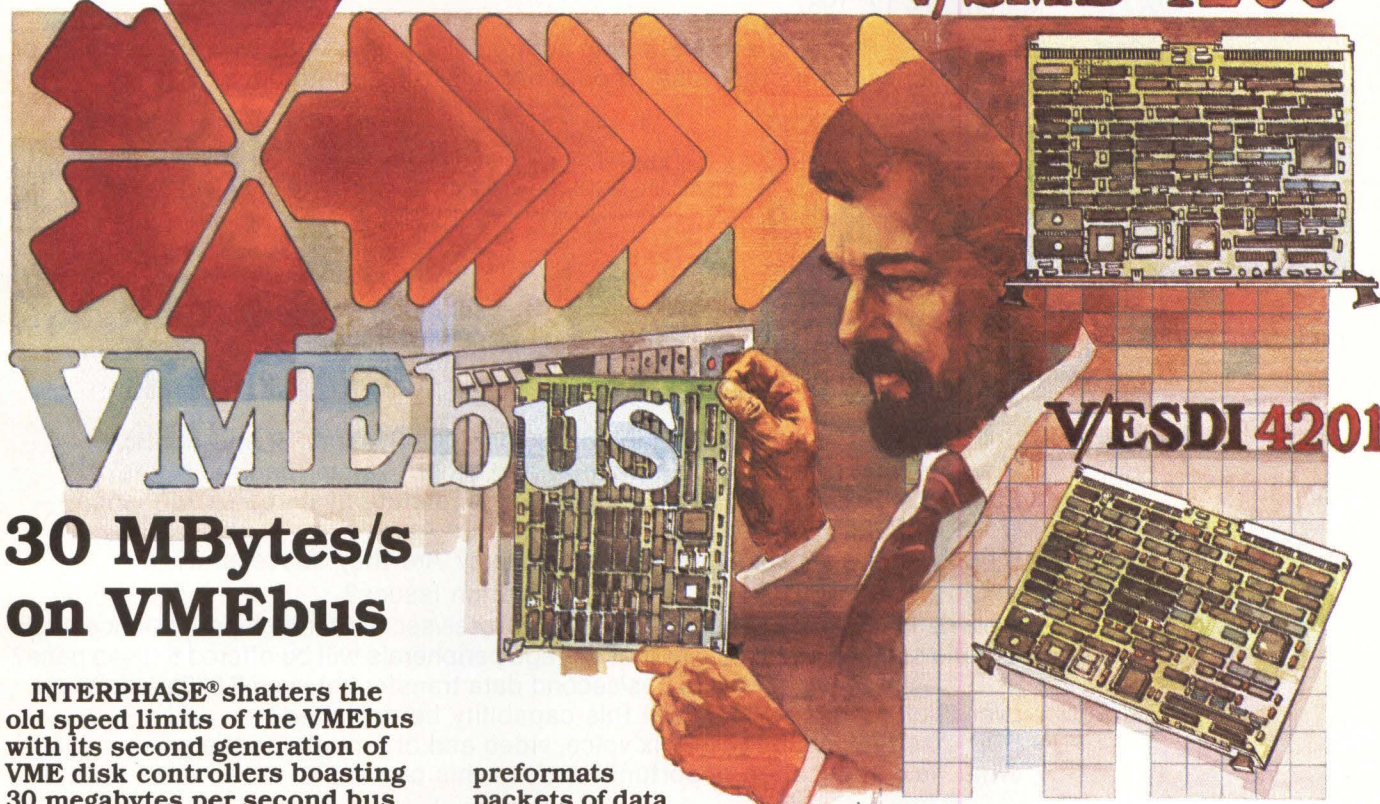

## 30 MBytes/s on VMEbus

INTERPHASE® shatters the old speed limits of the VMEbus with its second generation of VME disk controllers boasting 30 megabytes per second bus speeds and above. Using a new INTERPHASE technology breakthrough called the BUSpacket Interface<sup>SM</sup> ... the new V/SMD 4200 Cheetah and V/ESDI 4201 Panther triple existing VMEbus speeds and approach the VMEbus theoretical bandwidth of 40 megabytes per second!

### **SIMPLY THE FASTEST**

The combination of the BUSpacket Interface and a large (128 KBytes) cache memory provide the V/SMD 4200 and V/ESDI 4201 with unequalled speed, and make them the fastest SMD and ESDI controllers by a factor of three. No one even comes close!

In simple terms, the new INTERPHASE technology

preformats packets of data to go across the bus before acquiring it. The INTERPHASE BUSpacket approach unharnesses the VMEbus from slow devices through deep, high-speed bus FIFOs and an asynchronous delay line-based state machine, which controls bus transfers. Data is emptied onto the bus in packets at speeds 30 megabytes per second and above.

### **STICK WITH THE WINNERS**

The V/SMD 4200 and V/ESDI 4201 also incorporate the proven INTERPHASE features of the multitasking Virtual Buffer Architecture<sup>SM</sup>, Intelligent Caching, and zero latency operation found on other popular INTERPHASE

products. The four drive V/ESDI 4201 Panther even adds an integral SCSI port for easy addition of back up devices.

Both products complement INTERPHASE's high-performance V/Tape 3209 1/2" tape controller, and are **PLUG & PLAY** software compatible with the industry's most successful SMD and ESDI controllers, our V/SMD 3200 and V/ESDI 3201.

### **THEY'RE GOING FAST**

To learn more about the fastest SMD, ESDI and 1/2" tape controllers around, call or write today ... but you better move fast ... INTERPHASE certainly is.

(214) 350-9000



**INTERPHASE**  
corporation

2925 Merrell Road • Dallas, Texas 75229 • Telex: 9109976245 NASDAQ-NMS:INPH

Interphase International

93a New Street, Aylesbury, Bucks. HP20 2NY, England (0296)35661 Telex: 826715 AERO G

Interphase is a registered trademark of Interphase Corporation. BUSpacket Interface and Virtual Buffer Architecture, are service marks of Interphase Corporation.

**CIRCLE NO. 63 ON INQUIRY CARD**



# IPI/FDDI FORUM / SAN JOSE '87

A technical conference on the **Intelligent Peripheral Interface (IPI)**, with complementary sessions on the **Fiber Distributed Data Interface (FDDI)**.

**WHERE** The San Jose Hyatt on 1740 North First Street in San Jose, California

**WHEN** March 10-12, 1987

**WHO** Engineering, Planning and Marketing personnel of companies who are using IPI or FDDI, or considering their use, should not miss this conference.

## FEATURED SPEAKERS

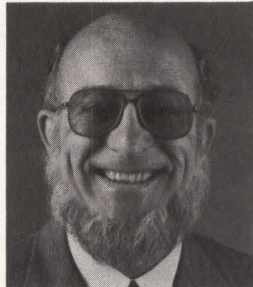

**I. Dal Allan**  
President, ENDL Consulting



**Bill Almon**  
Vice President,  
Storage Products  
IBM

## ISSUES

- IBM uses IPI-3 for disk and tape on System/36, System/38, and the 9370 — How will this affect the OEM market and other system manufacturers?
- Storage subsystems, not processor speeds, dictate systems performance — How does IPI minimize response time?
- IPI products are here — Who's using them? Are they successful?
- What are the SMD and SCSI to IPI migration issues?
- IPI is defining bandwidths above 100 Megabytes/second for high-performance applications such as graphics — What storage peripherals will be offered to keep pace?
- FDDI can support 10 Megabytes/second data transfer between 2,000 stations over 2 kilometers — How will this capability be exploited?
- FDDI has the capability to mix voice, video and other data on the same cable — What new application opportunities does this present?

## IPI/FDDI TECHNICAL PROGRAM MARCH 11-12

For the first time, the complementary high-performance IPI and FDDI Interfaces will be the subject of one conference:

- Industry Status and Activities
- IPI Market Trends and Issues
- IPI-3 Device Generic Applications
- IPI-2 Device Specific Applications
- IPI Chip Sets Update
- FDDI-1 Data Applications
- FDDI-2 Voice and Data Applications

## IPI/FDDI TUTORIAL

Principles and Concepts will be covered on March 10 — IPI in the morning and FDDI in the afternoon.

## IPI/FDDI EXHIBITORS PROGRAM

Exhibitors Workshops will be held on March 10-11. On the evening of March 11, an Exhibitors Reception will provide delegates with the opportunity to see IPI and FDDI products.

## SPONSORS

- AT&T Lightguide
- Control Data Corporation
- ENDL Consulting
- Fujitsu America Inc.
- Gould CSD
- Hitachi America, Ltd.
- Mini-Micro Systems
- NEC Information Systems
- Prime Computer Inc.
- Siemens AG, Data
- Sun Microsystems
- Technology Forums
- Xylogics, Inc.

Please register me for the  entire 3-Day Program for \$995;  2-Day IPI/FDDI Technical Program for \$795;  1-Day IPI/FDDI Tutorial for \$395. I have printed the following information as I want it to appear on my name tag and the list of delegates.

**NAME** \_\_\_\_\_

**TITLE** \_\_\_\_\_

**PHONE** (\_\_\_\_) \_\_\_\_\_

**COMPANY** \_\_\_\_\_

**ADDRESS** \_\_\_\_\_

IPI Forum registrations cannot be accepted without full payment. Please make checks payable to **IPI FORUM** and mail with this registration form to:

**Technology Forums** • 3425 Pomona Boulevard, Suite F • Pomona, CA 91768 • (714) 861-7300

**CIRCLE NO. 64 ON INQUIRY CARD**



## PLOTTERS

Company Model	Plotter type	Pen type	Number of colors	Plotting speed (ips)	Media type	Paper size (inches)	Number of character sets	Mechanical resolution (inches)	Repeatability (inches)	Compatible software	Hardware interface	Unit price (\$)
<b>SHARP ELECTRONICS CORP.</b> Sharp Plaza, Box C, Mahwah, NJ 07430, (201) 529-9500 <span style="float: right;">Circle 317</span>												
JX-720	ink jet printer/plotter	dot matrix	7	2.2 min. per 1024x1024	paper, clay-coated paper, transparency	8½ roll	1	120 dpi	120 dpi	IBM Business Graphics, image, scientific; Apple applications	Centronics	1,395
<b>SOLTEC CORP.</b> Sol Vista Park, San Fernando, CA 91340, (818) 767-0044 <span style="float: right;">Circle 318</span>												
RY-5200	drum pen plotter	ballpoint, ceramic tip, fiber tip, drafting	8	20	film, mylar, paper, vellum	63x22 roll (A-D)	12	0.01	0.008	Hewlett-Packard, HPGL, IBM	Centronics, IEEE 488, RS232C	6,495
SPL-430	pen plotter	ballpoint, ceramic tip, fiber tip, drafting	6	22.2	film, paper	11x17 (A, B)	19	0.001	0.008	HPGL, Lotus, dBASE III	Centronics, RS232C	1,595
<b>VERSATEC (XEROX CO.)</b> 2710 Walsh Ave., Santa Clara, CA 95051, (408) 988-2800 <span style="float: right;">Circle 319</span>												
Spectrum	electrostatic printer/plotter	dot matrix	512	2.5	clear polyester film, matte film, opaque paper	8½x11, 11x17 roll	8	200, 400 dpi			Differential, parallel, TTL	11,950-14,950
Versacolor	thermal transfer		up to 100,000	45-60 sec. per copy	paper, transparency film	8½x11, 11x17		300 dpi			parallel	8,950



**BUS**  
**THE RACE**  
**IS ON!**

## BUSCON/87-West

The Bus/Board Users Show & Conference

**January 19-21, 1987**

Los Angeles Airport Hilton Hotel  
Los Angeles, California

### **DISCOVER:**

- Which vendors are winning the race
- What products are available
- New ways to solve your technical needs
- How to keep you and your company up-to-date in this rapidly changing field
- All about new—and special—Bus architectures

**SEE:** Hands-on exhibits with new Bus/Board products

**LEARN:** Through tutorial seminars and technical sessions on Emerging Bus Technologies and Features, plus new applications ideas for your current projects

For more information, write Bill Weber  
BUSCON, 17100 Norwalk Blvd., Ste. 116,  
Cerritos, CA 90701-2750  
or call Bill at (213) 402-1610



# COPY CAD.

In fact, copy anything. Faster. With higher quality. And more flexibility. For a lot less money.

That's what you get with the CH-5300 Color Hardcopier. And you get it with next to no effort at all.

Because we've already qualified over one hundred video sources. Which means no software drivers are required. And there's no host down-time during installation.

Plus, you can turn your hardcopier into a shared resource with our Multiplexor. Up to four different sources can be connected so the cost per user becomes astonishingly low.

In the

end, you get beautifully sharp color copies of everything on your screen. And you get them fast. Data is downloaded into the hardcopier instantly (there's no processing to slow things down). A-size copies and presentation quality transparencies are produced in under 40 seconds. And B-size copies are delivered in moments.

So copy our phone number. Then call. We'll show you how to save money, save time and save your image with the Seiko CH-5300 Color Hardcopier.

Call Martin Nelson at  
(408) 943-9100 today.

**SEIKO**  
INSTRUMENTS



© 1986 Seiko Instruments U.S.A., Inc.





# QUALIFIED VIDEO SOURCES FOR THE SEIKO COLOR HARDCOPIER.

Over one hundred models from more than fifty manufacturers. It's a long list and it's growing every day. Give us a call to make sure your hardware is a qualified source.

## Qualified Manufacturers

Advanced Electronics Design  
 Applicon  
 Apollo  
 Aries  
 AT&T  
 Autotrol  
 Aydin  
 CalComp  
 Computer Aided Engineering  
 Calma  
 Chromatics  
 CGX  
 Computervision  
 Computer Sciences Corp.  
 Conographics  
 Control Systems  
 Data General  
 EDS (General Motors)  
 Genisco  
 Harris  
 Hughes  
 Hewlett-Packard  
 IBM  
 Ironics  
 Lexidata  
 Masscomp  
 Matrox  
 Megatek  
 Metheus  
 Moore Products  
 Number Nine  
 Omnicomp  
 Ramtek  
 Raster Technology  
 Raytheon  
 Scion  
 Seiko  
 Silicon Graphics  
 Sun Micro Systems  
 Symbolics  
 Tektronix  
 Vectrix  
 Vermont Micro  
 Verticom  
 VG Systems  
 Wang



© 1986 Seiko Instrument U.S.A., Inc.

**CIRCLE NO. 66 ON INQUIRY CARD**

MINI-MICRO SYSTEMS/January 1987

# NEW PRODUCTS SYSTEMS

**Megan Nields**, Assistant Editor

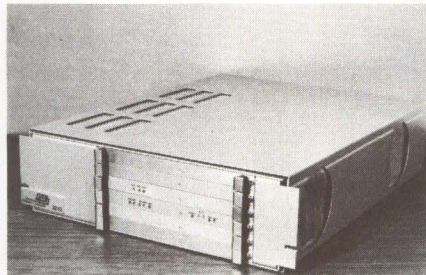

## Supermini supports up to 64 users

- 16M bytes of memory
- Eight communications ports
- 200G bytes of disk storage

The Series 3200 superminicomputer addresses up to 16M bytes of memory and over 200G bytes of disk storage. A basic configuration consists of 4M bytes of memory, eight communications ports, a line-printer interface and 1M byte of cache memory. An OEM version is available. \$42,000 and higher. **Concurrent Computer Corp.**, 197 Hance Ave., Tinton Falls, N.J. 07724, (201) 758-7000.

Circle 413



## Personal computer runs at 9.54 MHz

- 640K byte of RAM
- Two serial ports
- Built-in graphics adapter

Operating at 9.54 MHz via an IBM PC-compatible 8088-1 processor, the WYSEpc+ runs two times faster than the IBM PC. The unit includes a built-in monochrome or color graphics adapter, 256K bytes of RAM expandable to 640K bytes, two serial ports and one parallel port. It can be configured

with a single flexible disk drive, a dual flexible disk drive or a 20M-byte rigid disk. \$1,265 to \$1,995. **Wyse Technology Inc.**, 3571 N. First St., San Jose, Calif. 95134, (408) 433-1000.

Circle 414

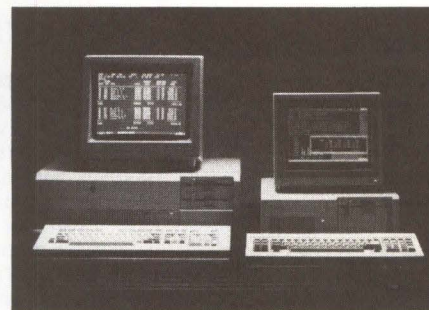

## Personal computer uses 80286 processor

- Two configurations
- 3.5M bytes of memory
- 20M-byte disk drive

Available in two configurations, the PC/microIT or PC/uIT is based on the 80286 processor. The first unit offers 512K bytes of memory expandable to 1.5M byte without an expansion slot, or 3.5M bytes via a single card. The second model supplies a 1.2M-byte flexible disk drive and a 20M-byte rigid disk drive. Features include an RS232C port, five full-expansion slots and MS-DOS 3.1. \$2,345, PC/microIT; \$3,590, PC/uIT. **Sperry Corp.**, P.O. Box 500, Blue Bell, Pa. (215) 542-2240.

Circle 415

## Hand-held computer packs 320K bytes

- RS232C port
- Built-in modem
- 46 keys

The MLS II hand-held computer employs 128K bytes of memory expandable to 320K bytes. It contains a built-in modem with baud rates of 300 or 1,200. Features include an 8-by-32-character LCD window, 46 keys and a bar-code reader option. An RS232C port is standard. \$2,495. **Michell-Lane Inc.**, Suite 2, 2721 Van Marter Drive, Spokane, Wash. 99206, (509) 922-2233.

Circle 416





DIGILOG 300  
**PROTOCOL ANALYZER**  
 SETS THE NEW STANDARD

**\$3,995**

INCLUDES 800K BYTE DISK

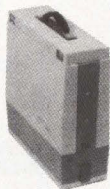

Digilog 300 sets the new standard for performance in network service applications. It sets up fast . . . automatically. Built-in tests and decodes speed you to a fast fix . . . so service engineers don't

need to know all the protocol details to be effective. Think of the training savings.

**Expanded use with library of applications**

Digilog ready-to-use software does the job when your needs go beyond protocol monitoring, trapping, and recording. Easy-to-run analysis, test, and emulation packages are available for SNA, SDLC, X.25, and the other protocols. They're easy to load, run, and understand.

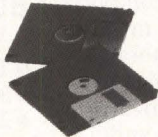

**Performance you want**

- Full remotely -controlled operation
- 800K byte diskette storage
- Built-in automatic protocol decoding for SDLC/SNA, HDLC/X.25, Bisync, etc.
- Real-time graphic display
- Six menu selectable BERTS
- RS-232 Interface Lead Breakout
- Logging printer control port
- Extensive trap/trigger facilities
- Library of test/emulation programs

**3-Year Warranty**

Unmatched Digilog warranty protects you.

**FREE 20-page color brochure**

Get full details on the Digilog 300 and all the other protocol analyzers in the Digilog family.



Digilog Inc.  
 1370 Welsh Road  
 Montgomeryville, PA 18936

Call toll free 1-800-233-3151  
 in Pennsylvania, call 1-215-628-4530

**DIGILOG**

*Leading in Data Communications Test and Control*

CIRCLE NO. 67 ON INQUIRY CARD

# If your disk doesn't cut it, the MegaRam Disk Emulator does

If your disk cannot access information fast enough to keep your CPU operating efficiently...

The MegaRam eliminates all delays associated with mechanical motion and can allow the system to run more than five times faster than with conventional disk drives.

**If downtime caused by disk failures is catastrophic...**

The MegaRam, with no moving parts, can provide many years of trouble free operation requiring virtually no maintenance.

**If your system is subjected to hostile environments...**

The all solid-state MegaRam construction allows error free operation to continue even in the presence of dust, dirt, shock and vibration.

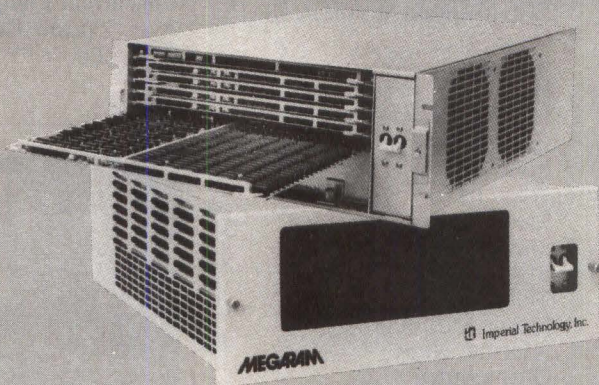

**Designed for the following computers:**

DEC, Data General, Sperry Univac (V77 Series), Modcomp, Hewlett Packard, SEL, CDC (System 17).

**Features:**

- Capacities from 2 megabytes to 40 megabytes in 2 megabyte increments.
- Up to 40 megabytes in a 7" chassis.
- Battery back-up.
- Streaming drive back-up.



**Imperial Technology, Inc.**

831 S. Douglas Street • El Segundo, California 90245 • Phone: (213) 536-0018

CIRCLE NO. 68 ON INQUIRY CARD



NEW PRODUCTS  
DISK/TAPE

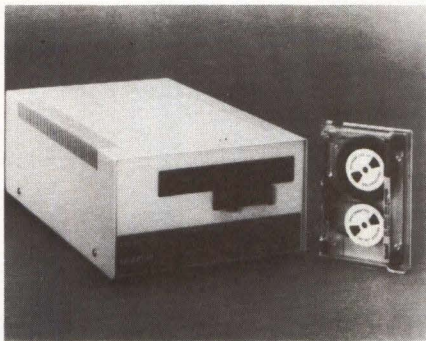

**Tape drive handles 67M bytes**

- Quarter-inch unit
- 57.6K bytes per second
- 67M-byte storage

The Packetape quarter-inch tape cartridge drive provides up to 67M bytes of formatted data storage. The device allows data capture for logging or archival applications from RS232C asynchronous data source without software protocol. It accepts data transfer rates of up to 57.6K bytes per second. \$2,990. **Telebyte Technology Inc.**, 270 E. Pulaski Road, Greenlawn, N.Y. 11740, (516) 423-3232.

Circle 417



**Flexible subsystem offers 100-msec access**

- 3 1/2-inch unit
- IBM PC compatible
- 100-msec access time

A 3 1/2-inch flexible disk drive subsystem, the MD13 is compatible with the IBM PC, PC/XT and PC/AT. The internal device furnishes a 720K-byte storage capacity, a 100-msec average access time and proprietary software. It supplies 80 tracks and two heads. MBTF is 10,000 hours. \$355. **Manzana Micro-Systems Inc.**, P.O. Box 2117, Goleta, Calif. 93118, (805) 968-1387.

Circle 418

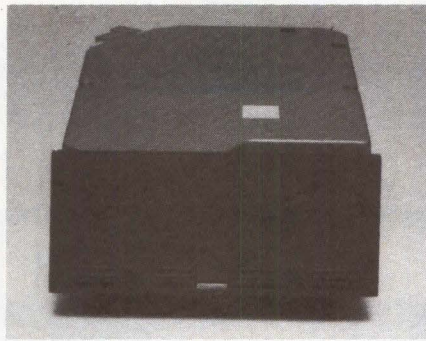

**Winchester stores 51M bytes**

- 3 1/2-inch unit
- 40-msec access time
- 12,500 bpi

Achieving a 51M-byte storage capacity, the model M2227D is a 3 1/2-inch Winchester disk drive. The unit provides a 40-msec average positioning time and a 625K-byte-per-second transfer rate. Data is recorded at 12,500 bpi and MBTF is 30,000 hours. \$695, OEM quantity 100 pricing. **Fujitsu America Inc.**, 3055 Orchard Drive, San Jose, Calif. 95134, (408) 946-8777.

Circle 419

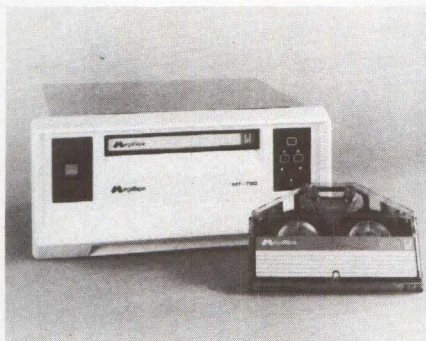

**Half-inch tape drive stores 630M bytes**

- 120 ips
- 16,000 bpi
- 240K bytes per second

The MT-500C half-inch tape cartridge streamer offers a 630M-byte storage capacity and a 128M-byte cache with error detection. It supplies 16,000 bpi and a 240K-byte-per-second transfer rate. Tape speed is 120 ips. The unit uses a 24-track serpentine format and GCR encoding techniques. \$15,500. **MegaTape Corp.**, 1041 Hamilton Road, P.O. Box 317, Duarte, Calif. 91010-0317, (818) 357-9921.

Circle 420

**Clearpoint**  
High Density System  
and  
VMEbus Peripheral  
Local Memory

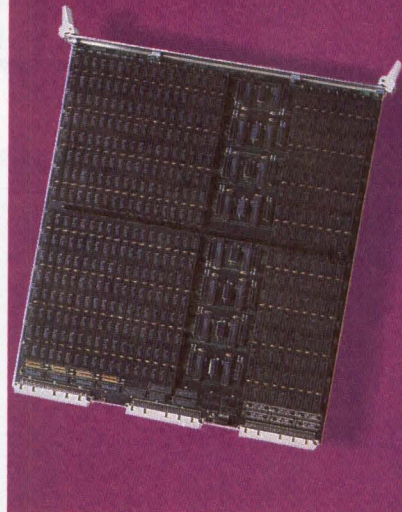

■ **The Sun 3-Series**

The SNXRAM is the first 12 MB Sun 3-compatible memory card that delivers the full 16 MB address space using a single slot. Replacing up to 3 Sun memory cards, it frees two VMEbus slots for expansion.

- Available in 2, 4, 8, or 12 MB capacities.
- No Dip Switches, it comes factory configured for correct starting address and memory sizing.
- Using the 32-bit wide private memory bus, the SNXRAM frees the system bus from processor-memory transfers.

The VMERAM provides 4 MB of local memory for the VMEbus. This highly reliable EDC memory can be used to support peripherals such as array processors operating in parallel with the main processor.

*Write or call for our new designer literature packages.*

Sun is a trademark of Sun Microsystems



**CLEARPOINT INC.**

99 South Street • Hopkinton, MA 01748

U.S.A. 1-800-CLEARPT  
Telex: 298281 CLEARPOINT UR  
Massachusetts 617-435-5395/435-2301  
Europe Steptrade, Ltd. (Netherlands)  
Telex: 71080 ACT H NL Tel: (31) 23-256073

**CIRCLE NO. 69 ON INQUIRY CARD**



# Workaholics

## THE GENICOM 3000 SERIES

Printers that don't know  
when to quit

Business success demands hard work. That's why more and more businesses depend on the Genicom 3000 series. Six hardworking, reliable printers that make life easier.

**You name it.  
The 3000s can handle it.**

No matter what you need in a rugged business printer—3000's your number. Just look at these job qualifications. Data processing printing at a blazing 400 cps. Letter quality at an unmatched 180 cps. And reliable paper handling for even the most demanding applications.



Need a trained specialist? The 3000s are ready. With extra quiet printers that

crank the work out at under 55 dBA. Printers with seven color capability for presentation quality business graphics. Even printers for bar codes.



Best of all, there's a 3000 series printer built specifically for your office. For dependable printing with everything from a single PC to a multi-terminal information system.

**Real team players.**

The 3000 series printers make fast friends with their co-workers. Because they're compatible with any computer worth mentioning. And software packages like Lotus 1-2-3<sup>®</sup>, Symphony<sup>®</sup> and WordStar<sup>®</sup>.

So, don't waste time with a clockwatching printer. Hire one of the workaholics. A Genicom 3000 series printer. For more information, contact your nearby Genicom dealer.

Or call 1-800-437-7468.  
In Virginia, call  
1-703-949-1170.

Lotus 1-2-3 and Symphony are registered trademarks of Lotus Development Corporation. WordStar is a registered trademark of MicroPro International.

# GENICOM

The Printers That Mean Business.

Genicom Drive, Waynesboro, VA 22980

CIRCLE NO. 76 ON INQUIRY CARD



NEW PRODUCTS  
PRINTERS



**Laser printer  
outputs 26 ppm**

- 1,500 lpm
- 60,000 pages per month
- Epson emulation

A letter quality laser printer, the LaserPRINT 2670 produces up to 26 ppm for about 1.8 cents per page. The unit runs up to 1,500 lpm and handles as many as to 60,000 pages per month. It emulates Calcomp, Diablo 630, Epson, NEC and Xerox 2700 printers. Features include a dual-imput feeder and a 300-dpi resolution. \$11,400. **Advanced Technologies International Inc.**, 2041 Mission College Blvd., Santa Clara, Calif. 95054, (408) 748-1688.

Circle 421

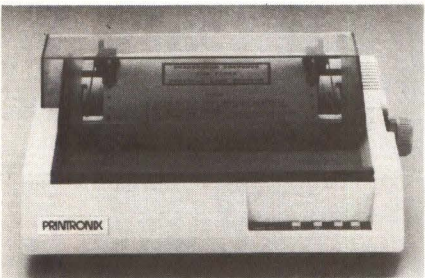

**Printer emulates  
Diablo, Epson, IBM**

- 47, 134 lpm
- Plug-in cartridges
- Bit-map graphics

The Personal Line Printer can emulate Diablo 630, Epson LQ-1500 and IBM Proprinter printers through plug-in cartridges. The desktop unit produces 47 lpm, letter quality and 134 lpm, draft. It supplies IBM software-emulation and block-graphics characters and bit-map graphics. \$795. **Printronix Inc.**, 17500 Cartwright Road, Irvine, Calif. 92714, (714) 863-1900.

Circle 422

**Plotter handles  
300 dpi**

- Thermal transfer unit
- Seven colors per dot
- Proprietary controller

A thermal transfer plotter, Versacolor achieves a 300-dot-per-inch resolution with seven colors per dot. The unit can be used as a hard-copy device with a proprietary RGB controller that captures data from a CRT screen in less than 1 second. Media support includes cut-sheet paper and polyester film transparencies. Paper size is changed via cartridges. \$8,950. **Versatec**, 2710 Walsh Ave., Santa Clara, Calif. 90501, (408) 988-2800.

Circle 423

**Printer offers  
50, 100, 200 cps**

- 18-wire unit
- 12, 15, 20 cpi
- Cut-sheet feeder

An 18-wire dot-matrix printer, the OSP runs at speeds of 50 cps, letter quality; 100 cps, near letter quality and 200 cps, draft mode. The device produces 12, 15 or 20 cpi on 8½-inch by 11-inch paper. Data is accepted via an RS232C or Centronics interface. Features include a cut-sheet feeder and an optional color ribbon cartridge. \$1,690. **Newbury Data Inc.**, Suite 208, 2200 Pacific Coast Highway, Hermosa Beach, Calif. 90254, (213) 372-3775.

Circle 424

**Printer produces  
8 ppm**

- 300 by 300 dpi
- 19 resident fonts
- 2.5M bytes of RAM

The QMS SmartWriter 80+ furnishes 2.5M bytes of RAM and 816K bytes of download font and print buffer memory. It produces 8 ppm and a 300-by-300-dpi resolution. The unit offers Diablo 630, Epson FX-80 and Qume Sprint II emulation modes. A dual Centronics and RS232C interfaces are standard. Features include dot-addressable graphics modes and 19 resident fonts. \$4,595. **QMS Inc.**, P.O. Box 81250, Mobile, Ala. 36689, (205) 633-4300.

Circle 425

**Clearpoint**

Single Slot  
2 MB Capacity Memory  
for Computer  
Workstations

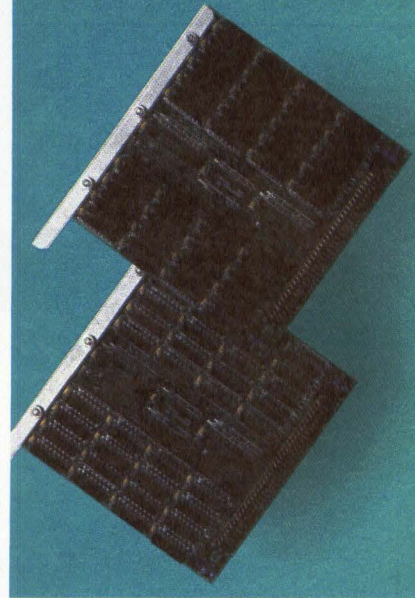

■ **Apollo DN3000**

The DN3000 memory offers 1 or 2 MB capacities on a single card. Completely hardware/software compatible with the Apollo DN3000 series of computer workstations, it supports the 32-bit data bus with byte, word, longword and unaligned transfers.

Access time is 120ns, achieving identical performance to the Apollo memory. However, by using zig-zag in-line packaged 256K dynamic RAMS (ZIP DRAMS), the board delivers twice the density per slot. The DN3000 is lifetime warranted\* and is supported by a 24 hour before repair/replacement policy.

*Write or call for our new designer literature packages.*

- Clearpoint's 80-page Designers Guide to Add-in Memory
- The 20-page Add-in Memory Catalog and Selection Guide

\*All Clearpoint memory products are warranted for life.



**CLEARPOINT INC.**

99 South Street • Hopkinton, MA 01748

U.S.A. 1-800-CLEARPT  
Telex: 298281 CLEARPOINT UR  
Massachusetts 617-435-5395/435-2301  
Europe Steptrade, Ltd. (Netherlands)  
Telex: 71080 ACT H NL Tel: (31) 23-256073  
Asia EPRO Ltd. (Hong Kong)  
Telex: 51853 JUNW1 HX Tel: 3-7213300

Apollo DN3000 is a trademark of Apollo Computer, Incorporated

CIRCLE NO. 70 ON INQUIRY CARD



# Contactless de-soldering and soldering

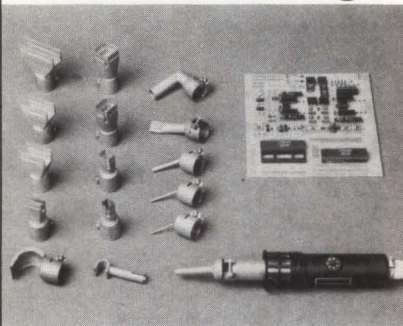

## with the Leister-Labor "S" Hot Air Tool

Electronic Temperature Adjustment from 20 to 600°C. Electrical Air Volume Adjustment from 1 to 150 litres per minute. For contactless de-soldering and soldering of SMD- and DIP-components in 2-4 seconds.

Ask for free brochure UA 20

AIR-TEMP, P.O. Box 148, Mohnton, PA 19540  
Tel. (215) 775-5177

CIRCLE NO. 252 ON INQUIRY CARD

## REGIONAL SALES OFFICES

### NEW ENGLAND

John J. Fahey  
Regional Manager  
Susan Rapaport  
Regional Manager  
275 Washington St.  
Newton, MA 02158  
(617) 964-3030

### NEW YORK/MID-ATLANTIC

Stephen B. Donohue  
Regional Manager  
1873 Route 70, Suite 302  
Cherry Hill, NJ 08003  
(609) 751-0170  
in N.Y.: (212) 972-0058

### SOUTHEAST

Larry Pullman  
Regional Manager  
6540 Powers Ferry Rd.,  
Suite 170  
Atlanta, GA 30339  
(404) 955-6500

### MIDWEST

Robert D. Wentz  
Regional Manager  
Lynne Graham  
Sales Coordinator  
Cahners Plaza  
1350 E. Touhy Ave.  
P.O. Box 5080  
Des Plaines, IL 60018  
(312) 635-8800

### SOUTHWEST

Don Ward, Regional Manager  
13740 Midway, Suite 515  
Dallas, TX 75234  
(214) 980-0318

### MOUNTAIN STATES

John Huff  
Regional Manager  
270 St. Paul St.  
Denver, CO 80206  
(303) 388-4511

### SOUTHERN CALIFORNIA/ NEVADA

Len Ganz  
Regional Manager  
18818 Teller Ave.  
Irvine, CA 92715  
(714) 851-9422

### NORTHERN CALIFORNIA/ NORTHWEST

Frank Barbagallo  
Northwestern Regional Sales  
Manager  
Rick Jamison  
Regional Manager  
Sherman Building, Suite 100  
3031 Tisch Way  
San Jose, CA 95128  
(408) 243-8838

### UK/BENELUX/SCANDINAVIA

Jan Dawson  
Cahners Publishing Co.  
c/o Computaprint  
39A Bowling Green Lane  
London, EC1R 0BJ, England  
011-44-278-2152  
Telex: 28339

### ISRAEL

Elan Marketing Group  
13 Haifa St., P.O. Box 33439  
Tel Aviv, Israel  
Tel: 972-3-252967  
Telex: 341667

### JAPAN

Kaoru Hara  
Dynaco International Inc.  
Suite 1003, Sun-Palace Shinjuku  
8-12-1 Nishishinjuku, Shinjuku-ku  
Tokyo, 160, Japan  
03-366-8301  
Telex: J2322609 DYNACO

### TAIWAN

Donald H. Shapiro  
Trade Winds, 2nd Floor  
132 Hsin Yi Road, Sec. 2  
Taipei, Taiwan  
Tel: 3932718  
Telex: 24177 FC Trade

### EUROPE, EXCEPT UK/ BENELUX/SCANDINAVIA

Elan Marketing Group  
Neutor g. 2  
P.O. Box 84  
1013 Vienna, Austria  
Tel. 43-222-663012

### Mini-Micro Marketplace

Carol Flanagan  
275 Washington St.  
Newton, MA 02158  
(617) 964-3030

### Direct-Response Postcards

Carol Flanagan  
275 Washington St.  
Newton, MA 02158  
(617) 964-3030

### Career Opportunities

Carol Flanagan  
Recruitment Advertising Manager  
275 Washington St.  
Newton, MA 02158  
(617) 964-3030

### Cahners Magazine Division

William Platt, President  
Tim Burkholder, Vice President  
Computer Group  
Tom Dellamaria, VP/Production

### Promotion Staff

Susan Rapaport  
Marketing Communications  
Director

Mary Gregory  
Promotion Manager  
Beth-Ann Legare  
Promotion Assistant

### Circulation

Denver, CO:  
(303) 388-4511  
Sherri Gronli  
Group Manager

## ADVERTISERS' INDEX

COMPANY	PAGE NO.	INQUIRY NO.	COMPANY	PAGE NO.	INQUIRY NO.
ADAC Corp.	38	32	JDL	56	43
Advanced Matrix Technology Inc.	92	60	Karl Leister	108	252
AMF Logic Sciences	84	57	KMW Systems Corp.	25	16
Analog & Digital Peripherals	112	207	Liberty Electronics USA	20	17
BP Microsystems	112	208	Mannesmann Tally	30-31	25
Bruning Computer Graphics	96	62	Melard	112	211
Charles River Data Systems	40	35	Method Systems Inc.	111	205
Chrislin Industries, Inc.	21	18	Microsoft	7	6
Clearpoint	105, 107	69, 70	Micro-Term	36	13
Clinton Digital	112	210	Microware	52	40
Communications Research Group	111	201	Moya Corp.	112	214
Convergent Technologies	2-3	3	Multi-Tech	Cov 3	73
Cordata	62	45	NEC Peripherals	26-27	21
Data Access	16	81	Newbury Data	33, 35	27, 28
Datasouth Computer Corp.	10	10	Output Technology	42-43	36
Davidge Corp.	112	215	Princeton Graphic Systems	65	46
Diab Systems Inc.	39, 41	33, 34	Printronic Inc.	87	58, 80
Digilog	104	67	Quadram Corp.	61	44
Electronic Specialists	111	203	Radio Shack (Tandy Corp.)	75	51
Equinox Systems	4	4	Seagate Technology	14-15	12
Excelan	18-19	14, 15	Seiko Instruments USA	102-103	66
Facit	88	251	Sequel Data	8	7
Falco Data Products	70	75	Sigma Designs	6	5
Florida Data	23	20	Softronics	112	209
Fujitsu America Inc. Storage Division	53	41	Storage Technology	66	47
General Electric Co.	111	206	Strategic Information	95	61
General Power Systems	22	19	Syscon	67, 101	48, 65
Genicom	106	76	Systech	1	2
Gould Inc., Computer Systems Div.	47	38	Tandon Corp.	79	11
Hall-Mark/Okidata	Cov 2	1	TEAC Corp.	80	54
Hitachi America Ltd.	37, 82-83	30, 56	Technology Forums	100	64
Houston Instrument Div. of Bausch & Lomb	44	37	TouchStone	34	29
IBM/Information Systems	54-55	42	Uniforum	109	73
IBS	81	55	Unitech	32	26
ICC	110	72	Universal Data Systems Inc.	Cov 4	74
Illbruck/USA	28	22	U.S. Robotics	91	59
Imperial Technology Inc.	104	68	Versatec Inc. (a Xerox Co.)	68-69	49, 50
INI Computer	112	213	Victory Enterprises	28	23
Inmac	9	9	Wall Street Computers	111	204
Intercontinental Micro	9	8	Western Telematic Inc.	29	24
Interface Group	13	53	Wyse Technology	76	52
Interphase Corp.	99	63	Xylogics Inc.	48	39
Ioline Corp.	111	202	See P. 111-112 for Mini-Micro Marketplace		

This index is provided as an additional service. The publisher does not assume any liability for errors or omissions.







# EIGHT COMPUTER GRAPHIC OPPORTUNITIES YOU CAN'T AFFORD TO MISS!

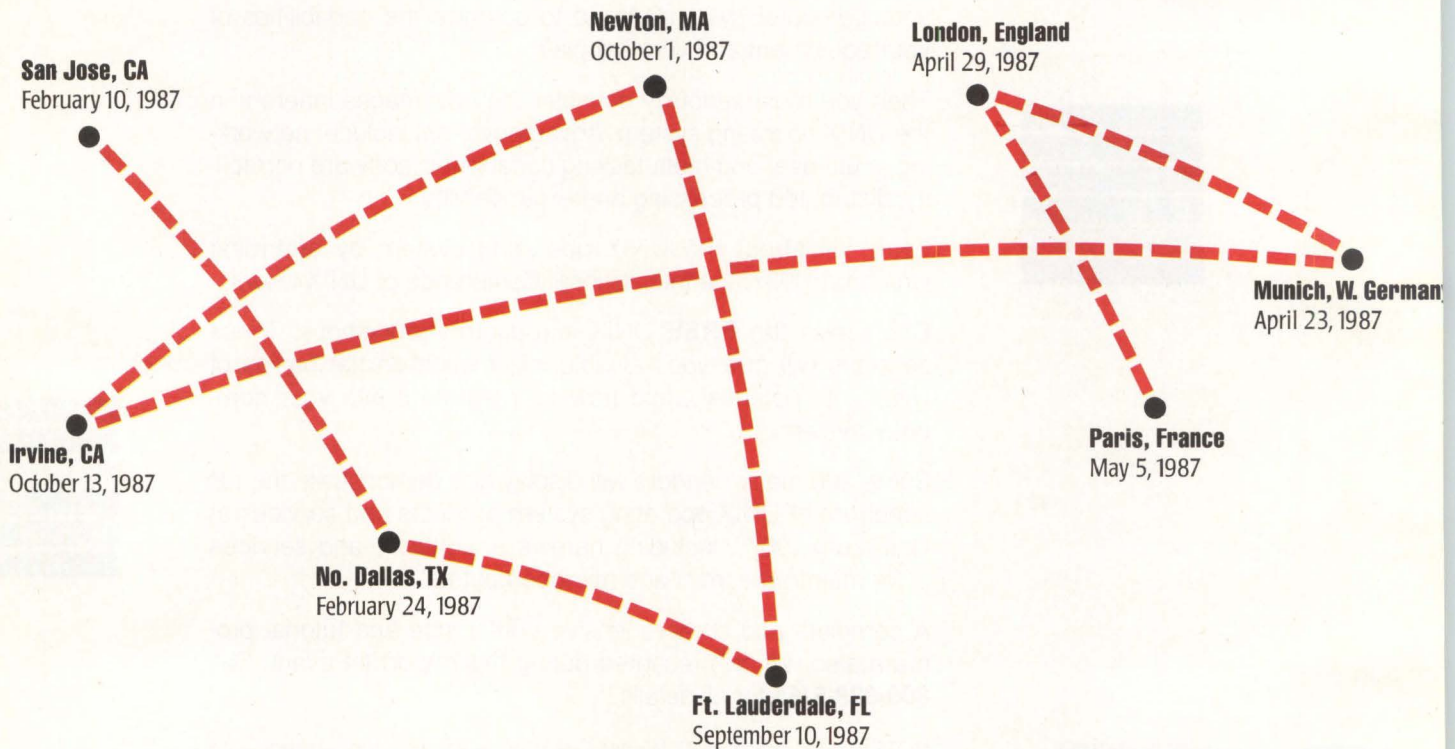

If you're a computer graphics manufacturer, you can't afford to miss the opportunity to bring your latest technical information and products to the attention of a targeted audience of OEMs, system integrators and large volume end users. And, if you're a volume buyer of computer graphic products, you won't want to miss the free technical seminars and product demonstrations coming to your area—close to where you live and work.

With the one day Computer Graphic ICCs, manufacturers can time and cost efficiently demonstrate their products throughout the U.S. and Europe. Unlike national shows, the table top product displays and business hospitality setting provide a simple, yet pleasant, working environment to conduct business one-on-one.

So don't miss this computer graphic opportunity! If you are a manufacturer of workstations, image processors, graphic software, graphic displays/terminals, printers/plotters or other associated computer graphic peripherals, call us today and reserve space. If you are a volume buyer, call your local computer graphic supplier, or our offices, for a Computer Graphic ICC invitation in your area.

In the U.S., contact B. J. Johnson & Associates, Inc., 3151 Airway Avenue #C-2, Costa Mesa, CA 92626, Phone (714) 957-0171, Telex 5101002189 BJ JOHN.

In Europe, contact C. J. Nicholl & Associates, Ltd., 37 Brompton Road, London SW3 1DE, England, Phone 01-581 2326/9, Telex 888068 CJNAD G.





# MINI-MICRO MARKETPLACE

**ATTENTION: BUYERS AND SELLERS OF PRODUCTS AND SERVICES IN THE COMPUTER SYSTEMS INTEGRATION MARKETPLACE:**

**READERS:** For additional information on the companies in this section, please circle reader service numbers on the Reader Inquiry card

## BLAST

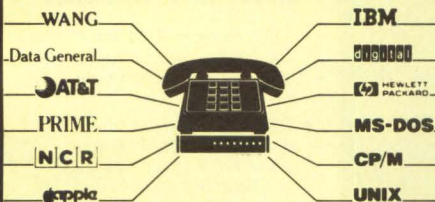

### PC to MINI to MAINFRAME COMMUNICATIONS SOFTWARE

The low cost solution for linking hundreds of PCs with central systems!

- An Asynchronous Connectivity Tool • No Boards – Uses standard RS-232 ports • Provides distributed data management • Sends binary or text data or commands • Sends spreadsheets, programs, etc • 100% error-free data transfer • Links different operating systems • Uses phone lines, LANs packet nets • Connects multiple sites, unattended • Uses any low-cost modems, any speed

• \$250 / Micros • \$495-895 / Minis • \$2995 up / Mainframes

### COMMUNICATIONS RESEARCH GROUP

5615 Corporate Blvd. Baton Rouge, LA 70808 (504) 923-0888

(800)-24-BLAST

**CIRCLE NO. 201 ON INQUIRY CARD**

### CREATE A BETTER IMAGE

Ioline Corporation introduces the LP3700 large format line plotter: the high performance, professional quality instrument that maximizes value...with a price that draws conclusions: **\$4,995.**

#### The LP3700 offers:

- **Versatility** – Lets you plot on any media at any size up through E (37½" x 81")
- **Precision** – .0025" Resolution & Repeatability
- **Buffering** – 14K to 512K
- **Speed** – Up to 10 ips (axial)
- **Reliability** – Rugged all metal frame – Endurance tested at over 60 million cycles

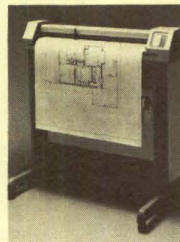

LP3700 Plotter

- **Value** – At \$4,995, the LP3700 is in a class all by itself.

19417 36th AVENUE WEST, SUITE D1  
LYNNWOOD, WA 98036  
(206) 775-7861

**IOLINE**  
CORPORATION

**CIRCLE NO. 202 ON INQUIRY CARD**

### AVOID COMPUTER DOWNTIME!

- **11-25 MINUTES BLACKOUT POWER**



- **FRONT PANEL TEST SWITCH**

FREE CATALOG

- **SineZUPS** – NATURAL SINE WAVE UPS
- CONTINUOUS ON-LINE OPERATION
- ELIMINATE:
  - BLACKOUT • SPIKE/SURGE
  - BROWNOUT DAMAGE
  - EMI/RFI INTERFERENCE
- EXCLUSIVE LITE UPS ILLUMINATE WORK AREA WHEN LIGHTS GO OUT
- SINE-UPS, BATTERIES & LITE UPS
  - SU-250 250 WATT \$1095.00
  - SU-500 500 WATT \$1495.00

**ESP Electronic Specialists, Inc.**  
171 SO. MAIN, NATICK, MA 01760  
617-655-1532 TOLL FREE 800-225-4876  
VISA, MASTERCARD, AMERICAN EXPRESS

**CIRCLE NO. 203 ON INQUIRY CARD**

Buy a Crey Micro XT and  
get our CAD Software FREE



Complete systems for only \$1186.45

- Turbo XT Motherboard
- 640k RAM
- Dual 360k Floppy Drives
- AT Style Keyboards
- Amber Graphics Monitor
- Graphics Display Adaptor
- PC XT Compatibility

Call 305-344-0097

Wall Street Computers, Corp.  
P.O. Box 8210  
Coral Springs, FL 33075-8210

**CIRCLE NO. 204 ON INQUIRY CARD**

## PROGRAMMABLE COMMUNICATIONS TRANSLATOR

The PCT-100 is an in-line, user-programmable RS-232 protocol and data translator. It can provide a simple, inexpensive solution to your communications and compatibility problems.

- Terminal & Printer Emulation
- Baud Rate Conversion (50 through 19.2 kbaud)
- Handshake Translations (XON/XOFF, CTS/RTS, ENQ/ACK)
- Code Conversions (ASCII, Modified ASCII, EBCDIC)
- Bidirectional Manipulation of Data Strings, Bytes, Bits
- User-Programmable
- User Programs are Easily Implemented
- Built-in Compiler, Editor and Debugger
- Programs via any RS-232 ASCII Device
- Only \$495 (single unit quantities)
- User's Technical Manual \$25



**Method Systems Incorporated**  
3511 Lost Nation Road  
Willoughby, Ohio 44094  
(216) 942-2100 or toll-free Sprint local  
number, then 666-0212

**CIRCLE NO. 205 ON INQUIRY CARD**

### Brushless DC and Digital Encoder Motors

GE has teamed up with one of the world's leading precision motor manufacturers to offer brushless DC and digital encoder motors. We supply custom engineered precision motors to many major Business Equipment manufacturers for spindles and head actuators for magnetic and optical drives, printers and plotters. We can also furnish brushless DC motors for air moving applications.

Call or write with specifications about your motor needs.

**Rod Everett, Market Specialist**  
General Electric Co.

Motor Venture Operation  
1635 Broadway, P.O. Box 2204  
Fort Wayne, IN 46801-2204  
(219) 428-3189

**GENERAL ELECTRIC**

**CIRCLE NO. 206 ON INQUIRY CARD**



**IBM PC COMPATIBLE RS232 EASI-DISK  
5 1/4" FLOPPY DATA STORAGE &  
TRANSFER SYSTEM**

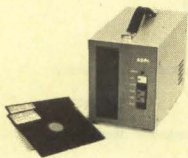

- Reads & Writes IBM PC DOS 5 1/4" Disks
- RS-232C I/O
- Rugged Portable Package
- Host and/or Manual Controls
- ASCII or Full Binary Operation
- Baud Rates 110 to 19.2 K Baud
- Automatic Data Verification
- Price \$1,095 in Singles - OEM Qtys. Less

28 other systems with storage from 100K to 35 megabytes  
ANALOG & DIGITAL PERIPHERALS INC



815 Diana Drive  
Troy, Ohio 45373  
513/339-2241  
TWX 810/450-2685

Branch Off Oklahoma City OK - Factory Yucca Valley CA

**CIRCLE NO. 207 ON INQUIRY CARD**

**EPROM  
PROGRAMMER  
\$349**

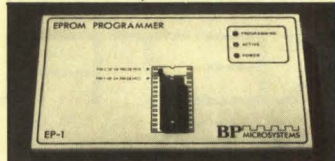

*The EP-1 is a great value, here's why:*

- IBM PC Software included or RS-232 to any computer
- ASCII Command driven operation; All intelligence in unit
- Reads, Programs, Copies over 150 types from 2716 to 27512
- Optional Intel microcontroller programming head
- Menu-driven Chip Selection; No Personality Modules
- Fast, Slow, Quick-Pulse Programming Algorithms
- Intel (8080 & 8086), Motorola, Tekhex, Straight Hex Files
- Splits Files by Base Address and Odd/Even (16 bit systems)
- Gold Textool ZIF IC socket
- Generate & Set Checksums
- Over-Current Protection
- 8 Baud Rates 300 to 38,400
- Full One-Year Warranty
- 5,12 5,21,25V Programming
- U.V. Erasers from \$34.95
- Same Day Shipment

**BP  
MICROSYSTEMS**

10681 Haddington, #190 / Houston, TX 77043  
(713) 461-9430 (800) 225-2102

**CIRCLE NO. 208 ON INQUIRY CARD**

**TERMINAL  
EMULATIONS**

**NEW RELEASE !  
SOFTERM PC 2.0**

- \* OVER 30 EXACT EMULATIONS
- \* KEYBOARD MACROS
- \* VIRTUAL DISK CAPABLE
- \* KEYBOARD TRANSLATE
- \* HOTKEY
- \* SCRIPT FILES
- \* MULTITASKING
- \* FILE TRANSFER WITH 7 PROTOCOLS  
(i.e. KERMIT-SERVER, HAYES, XMODEM, ETC.)
- \* CONCURRENT AND BACKGROUND COMMUNICATIONS

**SOFTRONICS**

THE LEADER IN EXACT EMULATIONS  
800/225-8590

303/593-9540

TELEX 450236

**CIRCLE NO. 209 ON INQUIRY CARD**

**We Buy & Sell**

NEW & USED

**DEC\***

EQUIPMENT

Call Today  
for Price & Delivery Quotes.



**CLINTON  
DIGITAL INC.**

770 WATER STREET  
FRAMINGHAM, MA 01701

TELEPHONE:  
(617) 877-9564

\*DEC is a registered trademark  
of Digital Equipment Corporation.



**CIRCLE NO. 210 ON INQUIRY CARD**



**ACCESS II.**  
The perfect portable  
for dozens of  
applications...  
including  
yours!

Displays  
eight full  
40 character  
lines.  
320K  
capacity.  
So portable,  
it fits in  
your pocket!  
Engineered to  
your specifications.

**MELARD TECHNOLOGIES, INC.**  
5 Westchester Plaza  
Elmsford, New York 10523

(914) 592-3044

**CONVENIENT FEATURES!**

- 320 K memory, RAM and ROM, allocated between interchangeable cartridge and onboard memory.
- Direct-connect, Hayes function, onboard modem; 1200 baud, auto dial/auto answer, voice and data. Bell and CCITT compatible.
- Programmable in C and Forth. Powerful data entry application generator.
- Acoustic modem cups, 300 baud.
- 2 serial ports, RS232/422.
- Flexible, interchangeable battery system to satisfy any requirement.
- Compact, portable printers.
- Bar code reader.
- Weighs from 24 oz.
- (8 1/2 x 3 3/4 x 2 1/2) in.

**CIRCLE NO. 211 ON INQUIRY CARD**



**INI-10/AT  
PC-AT EXPANSION CHASSIS**

- Full 16-bit PC-AT bus
- 10 slots
- 250W power supply
- Two fans
- Direct extension of PC-AT bus
- No software changes needed
- Inexpensive, simple, attractive

Dealer Inquiries Invited.  
List Price \$1,400.00

**INI Computer Products**  
6915 Hightech Drive  
Midvale, UT 84047

(801) 561-1100  
Contact Mark Jenkins

**CIRCLE NO. 213 ON INQUIRY CARD**

**Moya's Reliable Tape  
and  
Microcomputer  
Products**

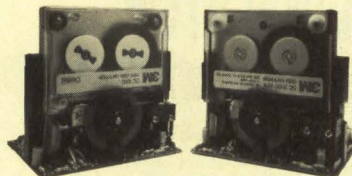

**OEM Devices to Complete Systems**

- DC1000 and DC2000 Tape Cartridge Transports
- Complete Tape Systems
- Smart Tape Interfaces
- STD Bus Modules



Moya Corporation  
9001 Oso St. Unit B  
Chatsworth, CA 91311  
818-700-1200

**CIRCLE NO. 214 ON INQUIRY CARD**

**PROCESS CONTROL  
STORE & FORWARD  
COMPUTER**

**Features:**

- Z80A CPU
- 4 RS-232 serial ports supported by DARTs
- Centronics parallel port
- 8 Byte-wide memory sockets accept any combination of static RAM, EPROM or EEPROM
- Integral power supply operates on 100, 120, 200 or 240 VAC
- LEDs indicate POWER ON and activity on serial lines

**Options:**

- Battery backed RAM
- Non-interrupting clock calendar
- Custom paint & silkscreen
- MTBASIC in ROM

**Davidge**

Davidge Corporation P.O. Box 1869 Buellton, California 93427 (805) 688-9598

**CIRCLE NO. 215 ON INQUIRY CARD**



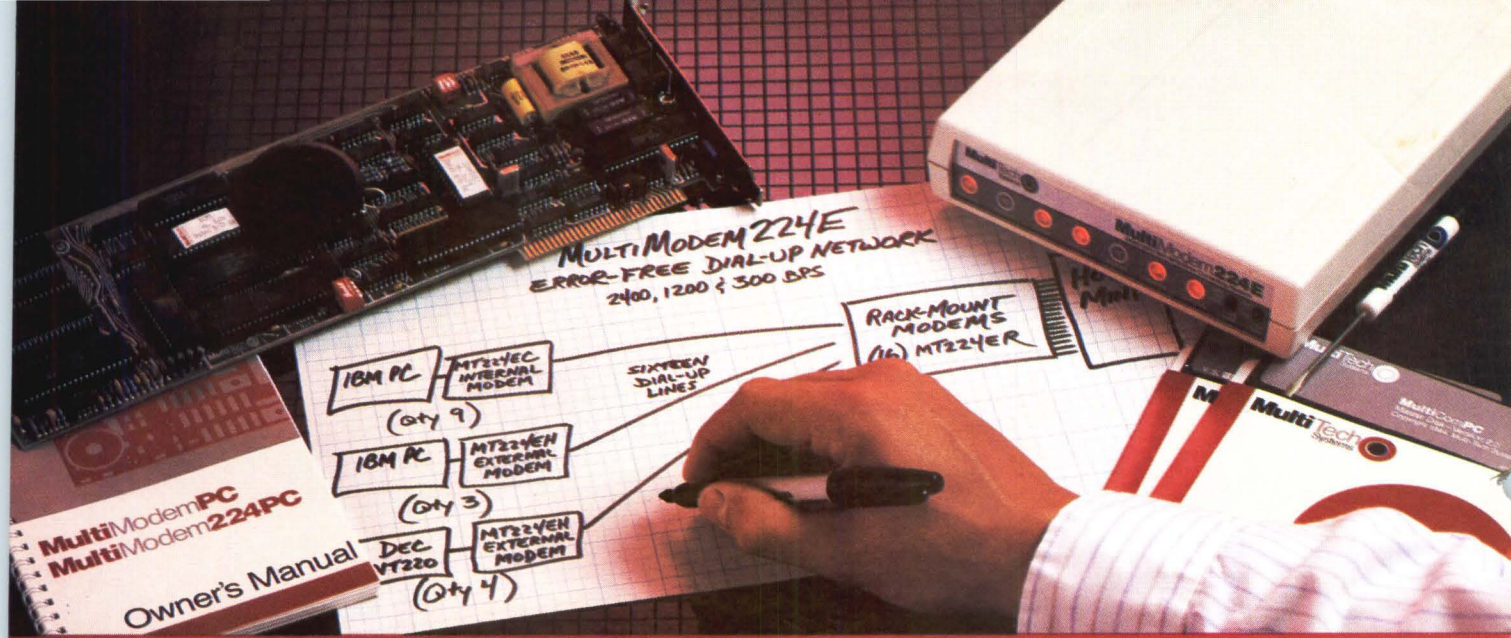

## Error-Correcting 2400 bps Modems from Multi-Tech Systems: When it has to be as good as it is fast

- Dial-up 2400 bps modems have arrived. More datacomm users are upgrading from 1200 to 2400 than ever before. But there can be a flip side to increased speed: more transmission errors.
- That's why our MultiModem224E™ offers MNP™ error correction. Available in our 2400 bps desktop, internal and rack-mounted modems, MNP gives you 100% error-free transmissions, no matter how bad the phone line. MNP does it without the speed degradation of less efficient, software-based protocols.
- Another important point: MNP Class 3 has emerged as an industry standard. It's now in the public domain, and has been implemented in virtually all 2400 bps modems that offer error-correction.

● So, why buy error-correcting modems from Multi-Tech? There are many good reasons, including:

1. Multi-Tech modems are 100% Hayes-compatible (more so than Hayes' own 2400 bps modems\*), and our MultiModem224E with error-correction costs less than a Hayes Smartmodem 2400™ without this feature.
2. Bonus features, like speed conversion, both synch and asynch operation, battery-backed option settings and phone number memory.
3. Versatility: the auto-dial/auto-answer Multi-Modem224E runs at 2400, 1200 or 300 bps, with or without error-correction, automatically!
4. Our two year warranty means something. Since Multi-Tech modems are designed and manufactured at our Minnesota headquarters (as they have been for the last sixteen years), you can be sure we'll be here when you need us.

● Please call us toll-free at **1-800-328-9717**, for additional information... get a modem that's as good as it is fast!

*\*InfoWorld-8/5/85-reprints available*

Trademarks: MultiModem and the Multi-Tech Systems logo:  
Multi-Tech Systems Inc. • MNP: Microcom Inc.  
Smartmodem: Hayes Microcomputer Products, Inc.

# MultiTech Systems

*The right answer every time.*

Multi-Tech Systems, Inc. • 82 Second Avenue S.E. • New Brighton, Minnesota 55112 U.S.A.  
1-800-328-9717 • 1-612-631-3550 • TWX 910-563-3610 (Domestic) • Telex 4998372 MLTTC (International)  
**CIRCLE NO. 73 ON INQUIRY CARD**







# Universal Data Systems



YES

NO

HOME

## Three Keys to Successful TDM or Statistical Multiplexing

Three keys! They're all you need to configure Universal Data Systems' new multiport V.33 modem/multiplexer combination. Separate versions offer either six-channel TDM or eight-channel statistical multiplexing capability.

In either configuration, the device is trellis coded at its basic 14.4 kbps operating speed and has alternate data rates of 12 or 9.6 kbps. If your system utilizes TDM, you may also choose between asynchronous and synchronous operation and you can have V.29 operation at 9.6 kbps.

The three-pushbutton/LCD control panel allows configuration choices (with different data rates for each channel if you desire), "soft strap" settings and easy review of both multiplexer and modem status.

The entire set-up and review process is menu-driven; the user need only answer a series of questions by pressing the appropriate YES or NO switch. When the process is complete, a

push on the HOME switch returns the device to the communications mode.

Diagnostics on both versions of the V.33 multiplexer/modem include local and remote digital loopback on each channel as well as local and remote analog loopback. All test features are compatible with CCITT V.52 and V.54 recommendations.

**YES**, you can now have TDM or stat mux capability in a single package with a 14.4 kbps trellis coded modem.

**NO**, these devices are not expensive to buy or difficult to apply.

**HOME** of the new V.33 multiplexer/modem is Universal Data Systems, 5000 Bradford Drive, Huntsville, AL 35805. Telephone 205/721-8000; Telex 752602 UDS HTV. Ask for detailed specs and quantity prices.

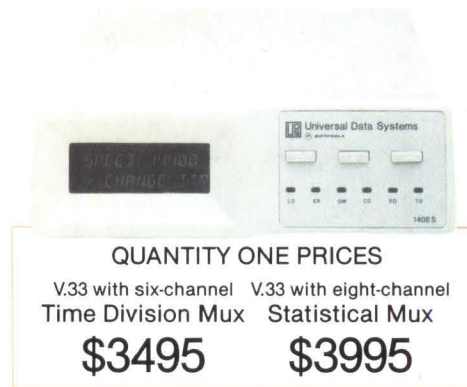

### QUANTITY ONE PRICES

V.33 with six-channel Time Division Mux    V.33 with eight-channel Statistical Mux

**\$3495**

**\$3995**

 Universal Data Systems

 **MOTOROLA INC.**  
Information Systems Group

UDS modems are offered nationally by leading distributors. Call the nearest UDS office for distributor listings in your area.  
DISTRICT OFFICES: Apple Valley, MN, 612/432-2344 • Atlanta, GA, 404/998-2715 • Aurora, CO, 303/368-9000 • Blue Bell, PA, 215/643-2336 • Boston, MA, 617/875-8868 • Columbus, OH, 614/895-3025 • East Brunswick, NJ, 201/238-1515 • Glenview, IL, 312/998-8180 • Houston, TX, 713/988-5506 • Huntsville, AL, 205/721-8000 • Issaquah, WA, 206/392-9600 • Livonia, MI, 313/522-4750 • Mesa, AZ, 602/820-6611 • Milwaukee, WI, 414/273-8743 • Mission Viejo, CA, 714/770-4555 • Mountain View, CA, 415/969-3323 • Richardson, TX, 214/680-0002 • St. Louis, MO, 314/434-4919 • Silver Spring, MD, 301/942-8558 • Tampa, FL, 813/684-0615 • Uniondale, NY, 516/222-0918 • Van Nuys, CA, 818/891-3282 • Willowdale, Ont, Can, 416/495-0008

CIRCLE NO. 74 ON INQUIRY CARD

Created by Dayner/Hall, Inc., Winter Park, Florida