

# modern data

MARCH 1976

LIBRARY  
STATE TECHNICAL INSTITUTE  
AT MEMPHIS

## PRODUCT PROFILE:

Alphanumeric Display Terminals, Part 2

DATRAN'S DATADIAL AND TELENET'S VAN SERVICES:  
A Cost Comparison

32-BIT MINIS: Tempest in a Teapot?

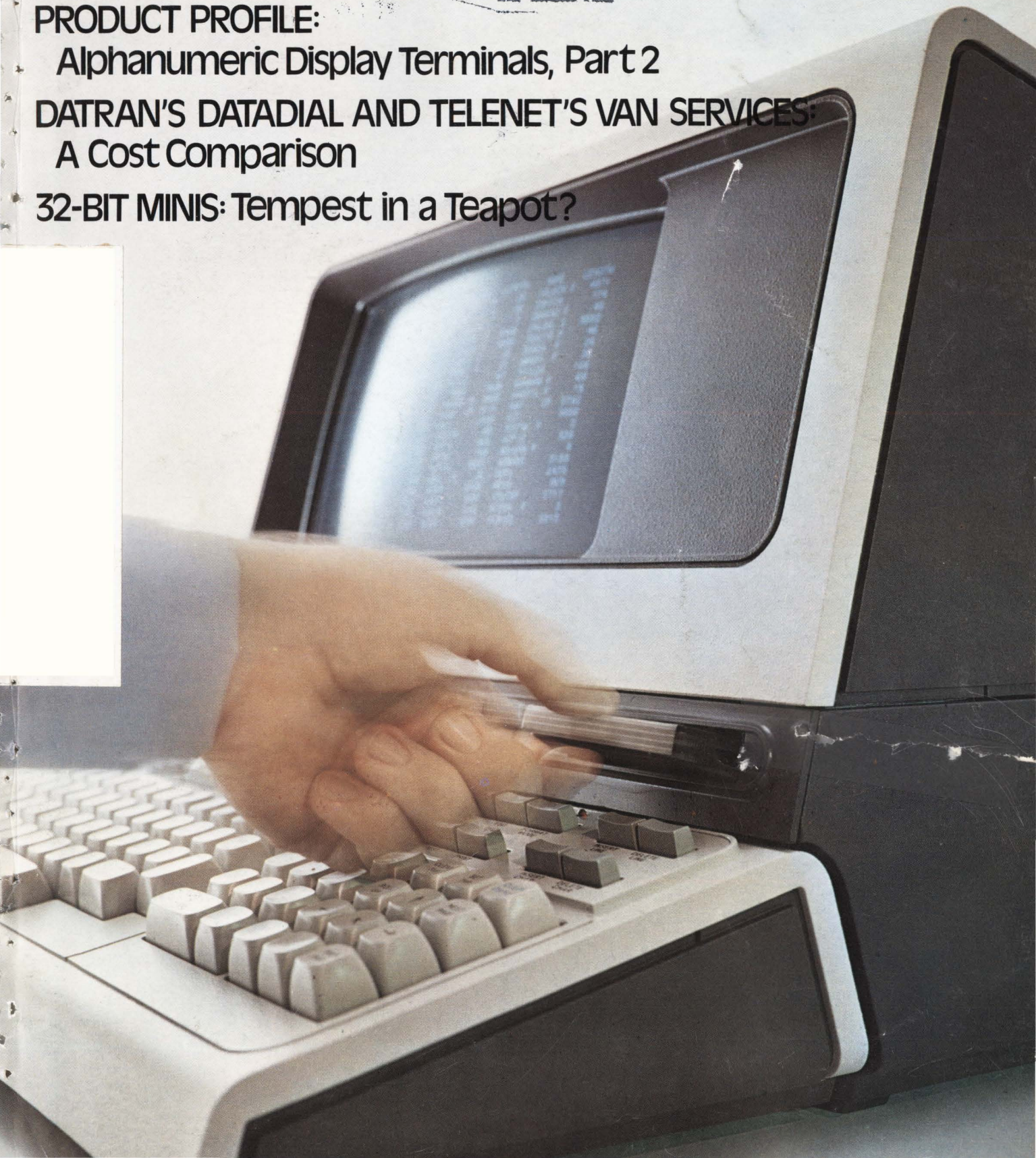

# Why Documation can sell you a 2250 line printer for the price of many 1200 line printers.

It's a simple, provable fact: Documation's DOC 2250 offers more output for less money than any other printer on the market. Here's why.

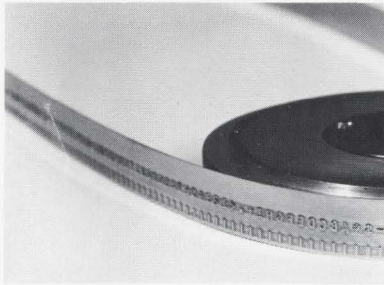

Control buffer that allows format control for pages up to 24 inches in length and establishes either 6 or 8 lines per inch. • A powered forms stacker accom-

modating forms 3 to 24 inches in length. • Acoustically-insulated powered cover that holds operating noise to 74 dba. • Resident micro-diagnostics and maintenance independent of host system. • Up to 6 part forms. • Paper slew up to 100 inches per second.

After we design and develop it, we build it. Documation's facility is an integrated

At Documation, "Research & Development" is a bit more than a name on the door to the engineering lab. Quite a bit more. Instead of sitting on their slide rules waiting for some genius to come up with a great new technical application, Documation's engineers constantly research ways to build more efficient equipment at a price advantage. One secret of the DOC 2250's cost efficiency is its integrated controller – a Documation-developed microprocessor. The controller communicates through its interface with the host system, decodes all commands, controls the printer hardware and reports various errors and status.

Other advances our design department made standard on the DOC 2250 are:

- Fully-buffered print line.
- Interchangeable character arrays.
- A Universal Character Set buffer that allows any character set to be used.
- 2250 LPM with a 48 character set.
- Vertical Forms

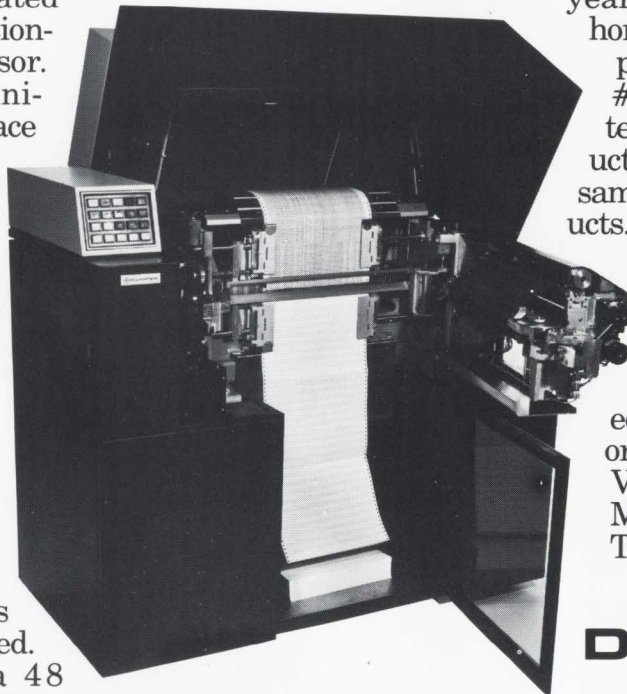

manufacturing plant not just an assembly line. Tour our plant and you'll see stacks of metal waiting to be turned into precision parts for our printers and card readers on our computer-controlled automatic milling machines, circuit boards being manufactured, and finally, painstaking assemblage and testing of all Documation equipment. What this means to you is that we don't get hung up on somebody else's production schedule or somebody else's price boost.

Frankly, DOC 2250 is our first entry in the highly competitive printer field. But, just as frankly, we know it's the best on the market. All we ask is the chance to prove it to you. A few years ago we were the dark horse candidate in the card processor field. Today we're #1 – because we built a better, more cost-efficient product. We intend to follow the same course in printer products. And if you'll compare our product, feature for feature with any other printer, you'll see how our printer can give your system a real competitive edge. For more details, call or write Mr. Roy Ostrander, Vice President, Box 1240, Melbourne, Florida 32901. Telephone (305) 724-1111.

**DOCUMATION**  
INCORPORATED

# We've got connections for an easy and smart printer buy

Easy to interface. Easy to cost justify. Easy to maintain. The line printer for the long run. The Tally Series 2000 is the easiest decision you can make.

Compatible controllers for DEC PDP-8 and PDP-11, Data General, Nova and Eclipse, Hewlett-Packard 2100, Data Point 2200 and Uniscope 100/200. Also a synchronous serial RS-232 and, of course, the standard Tally parallel interface. Or, if your present printer is too old, too slow, too fast, or too expensive, simply plug us in.

Upgrade your system with either a 125 or 200 line per minute printer that you can drive as hard as you want without fear of failure. With no duty cycle limitations. With no preventative maintenance except for routine cleaning. A truly low cost of ownership investment.

A data processing line printer. 132 columns. 2- or 8-channel vertical format unit. Multiple character sets and fonts. Adjustable forms handling. Tally's renowned straight line print registration.

With 47 interface selections to date, we've probably got your interface. Either off-the-shelf, or for special interface requirements, talk to our applications engineering staff. Call or write the Tally office nearest you.

Tally Corporation, 8301 S. 180th Street, Kent, WA 98031.  
Phone (206) 251-5524

## TALLY

CIRCLE NO. 1 ON INQUIRY CARD

### OEM Sales Offices:

New York (516) 694-8444,  
Boston (617) 742-9558,  
Chicago (312) 965-0690,  
Seattle (206) 251-6730,  
Los Angeles (213) 378-0805,  
San Francisco (408) 245-9224.

### Business Systems Sales Offices:

Eastern Region (201) 671-4636,  
Western Region (415) 254-8350.



# THIS OEM ASKED US TO GIVE HIM THE WORKS.

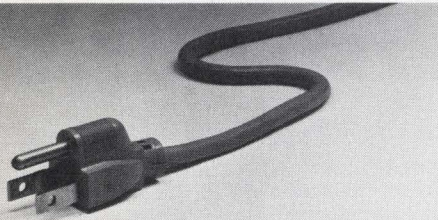

Brownout proof power supply.  
**No extra cost.**

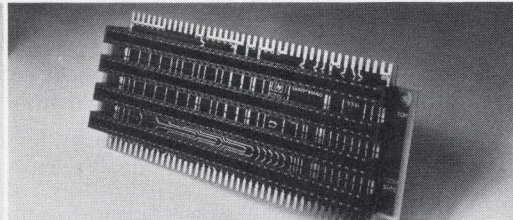

Extra memory and I/O capacity.  
**No extra cost.**

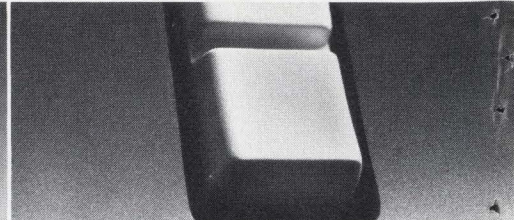

ROM bootstrap loader.  
**No extra cost.**

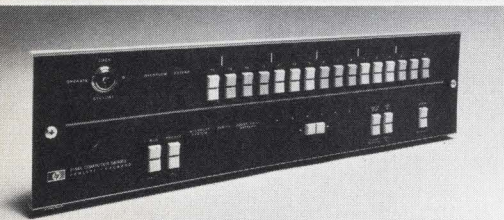

Display panel.  
**No extra cost.**

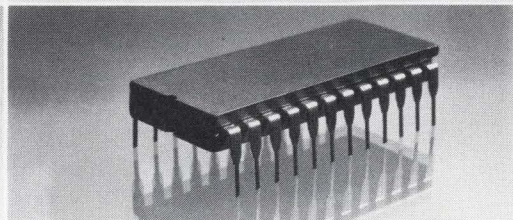

Parity, EAU, floating point.  
**No extra cost.**

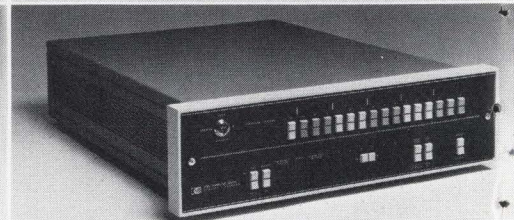

The Hewlett-Packard 21MX Minicomputer.  
**One low cost.**

**“Y**ou say it's a bargain at the price. But what do we get for our money?” Canadian Marconi asked. They were planning systems that would use 20 to 250 of our minicomputers each.

“A lot more than you'd expect,” we replied. Even the smallest Hewlett-Packard 21MX

minicomputer uses solid state 4K RAM memories. Then we include floating point and extended arithmetic as standard items. From other suppliers these are extras that might add \$1,000 to \$4,000 to your bill.

Next there's parity. It's standard too — not the usual surcharge of up to \$1,000 per memory module.

Or consider the brownout proof power supply — one of the best in the industry. Standard again. As is a ROM bootstrap loader. As is power-fail interrupt capability. Extra memory

slots. A full front panel that lets you display or change contents of data registers.

“Standard” too is low power consumption and compact size, allowing more equipment to be put in each rack.

Even our options are surprisingly low in

cost. Want to add memory for example? It's just \$1,500 per 8K words. Want better throughput? You can microprogram custom routines using a Writeable Control Store (\$1,000).

In fact, if you add up what it costs to bring a “bargain” mini up to our standard capability,

don't be surprised if it adds up to a lot more than the \$4,059\* you'll pay for the Hewlett-Packard 21MX.

So, if you need the works, call us. Canadian Marconi did.

\*DOMESTIC USA OEM QUANTITY 50 WITH 8K MEMORY.

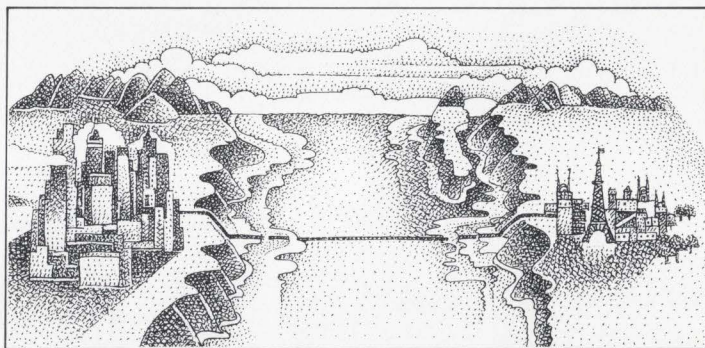

Canadian Marconi Company uses a minimum of 20 Hewlett-Packard 21MX minicomputers in each modular Telex switching system they build. These systems gather and switch Telex traffic for international transmission.

22607

## NOW WHAT CAN WE DO FOR YOU?

HEWLETT  PACKARD

Sales and service from 172 offices in 65 countries.  
1501 Page Mill Road, Palo Alto, California 94304

CIRCLE NO. 2 ON INQUIRY CARD

Publisher, Editorial Dir. . . . . S. Henry Sacks  
Assoc. Publisher . . . . . William A. Gannon  
Editor . . . . . Alan R. Kaplan  
Assoc. Editor . . . . . Barbara A. Reynolds  
Technical Editor . . . . . Dan M. Bowers

Washington Editor, Nan Meredith  
Internat'l Editor, Bohdan O. Szuprowicz

**CONSULTING & CONTRIBUTING EDITORS**

Boris Beizer                    Ivan Flores  
Ralph Berglund                James I. Leabman  
Maurits de Regt                Walter A. Levy  
Ken Falor                        Efrem Mallach  
L.A. Feidelman                 John A. Murphy

**ART/PRODUCTION DIRECTOR**  
John W. Kelley, Jr.

**PRODUCTION ASSISTANTS**

Sally Haskins                    Linda Ladd Lovett

**ADVERTISING PRODUCTION**

Manager . . . . . Bernard Greenside

**ASS'T TO PUBLISHER**

Pamela E. Page

**CIRCULATION DEPARTMENT**

Carol Grace, Mgr.

All correspondence regarding circulation, advertising, and editorial should be addressed to the publication offices at:

**MODERN DATA**  
5 Kane Industrial Drive  
Hudson, MA 01749  
(617)562-9305

**SALES OFFICES**

Sales Mgr. . . . . Robert J. Bandini  
Mktg. Services Mgr. . . . . Melvin L. Hayden

**NEW ENGLAND**

Melvin L. Hayden, 5 Kane Industrial Drive, Hudson, MA 01749 (617)562-9305

**NEW YORK**

Irwin L. Werfel, *E. Regional Sales Mgr.*, Robert J. Bandini, 18 East 48th St., N.Y., N.Y. 10017 (212)753-0375, (203)255-6293

**MIDWEST & SOUTHWEST**

Dick Powell, Jeff Edman, The Pattis Group, 4761 Touhy Ave., Lincolnwood, Ill. 60646 (312)679-1100

**WEST COAST**

David E. Pearson, 7135 W. Manchester Ave. Suite 3., Los Angeles, Cal. 90045 (213) 670-5651

Published monthly and copyrighted 1976 by Modern Data Services, Inc., 5 Kane Industrial Drive, Hudson, MA 01749. The contents of this publication (in excess of 500 words) may not be reproduced in whole or in part without written permission.

**SUBSCRIPTIONS:** Circulated without charge by name and title to U.S.-based corporate and technical management, systems engineers, systems analysts, EDP managers, software specialists, and other personnel who qualify under our qualification procedures. Available to others at the rate of \$18.00 per year; single issues \$1.75. Subscription rate for all foreign subscriptions is \$25.00 per year (12 issues). **POSTMASTER:** Send Form 3579 to: Circulation Dept., Modern Data, 5 Kane Industrial Drive, Hudson, MA 01749. Controlled Circulation postage paid at Long Prairie, MN. Back issues of MODERN DATA are available on microfilm. Contact University Microfilms, 300 North Zeeb Rd., Ann Arbor, Michigan 48106 for ordering information.



# modern data

**21 CORPORATE PROFILE**  
Tymshare, Inc.

**24 DATA COMMUNICATIONS**

**24 DATACOMM NEWS**

A summary of data communications products, services, and events.

**32 DATACOMM SCENE**

Datran's Datadial and Telenet's Van Services: A Cost Comparison

**37 MINI/MICRO SYSTEMS**

**37 MINI/MICRO NEWS**

A summary of recent minicomputer products, services, and events.

**41 MINI/MICRO FORUM**

**32-Bit Minis: Tempest in a Teapot?**

32 bits isn't everything.

**52 FEATURED PRODUCT**

**52 The HP 9825A Programmable Calculator**

Powerful interrupt/interfacing capabilities make it an instrument control system as well.

**54 How the HP Interface Bus Operates**

An explanation of what is now an industry standard.

**56 MINI/MICRO MARKETING**

**The Computer Store**

Something no neighborhood should be without.

**44 PRODUCT PROFILE**

**ALPHANUMERIC DISPLAY TERMINALS**

**Part 2 — Who's Who in CRTs and Where the Market Is Going**

A list of suppliers with CRTs they supply and coming alternatives to CRTs.

**COVER CREDIT:**

Hewlett-Packard's microprocessor-controlled 2644A Mini Data Station features the newly-developed miniature version of the 3M tape cartridge, providing 220,000 bytes of storage.

**DEPARTMENTS**

- 4 LETTERS
- 6 NEWS & COMMENT
- 10 INTERNATIONAL NEWS
- 14 BOOKSTORE
- 16 DC DATASCAN
- 22 CORPORATE & FINANCIAL
- 57 NEW PRODUCTS
- 64 NEW SOFTWARE & SERVICES
- 66 NEW LITERATURE
- 68 INDEX TO ADVERTISERS

SUBSCRIPTION CARD . . . . . OPPOSITE PAGE 1  
READER INQUIRY CARD . . . . . OPPOSITE PAGE 68  
BOOKSTORE ORDER CARD . . . . . OPPOSITE PAGE 68

**To the Editor:**

Your "Printer Technology Profile" in the November 1975 issue is both thorough and accurate. It is with a particular satisfaction that I watch the advance of Tally's line of dot matrix printers, for I was in on its birth.

In exception to ARK's answer to Mr. Malone of Tally, the lineage of the "Mogator" Comb that is the heart of the Tally printer stops in going back at Data Computing, Inc. The engineers involved, of which I was one, go back to General Electric, but not the concept. I can assure you that the idea originated and was developed entirely within Data Computing, later to be inherited and expanded at Tally.

**David L. Barnett, Consulting Engineer  
Engineering Design & Graphics  
Phoenix, AZ**

*We accept Mr. Barnett's explanation completely. Even aside from the "Mogator" mechanism, however, there are similarities between the Tally printers and General Electric's line of TermiNet printers that imply a common origin. Both, for example, use a novel Mobius-twisted ribbon cartridge.*

— ARK

**To the Editor:**

MODERN DATA's December issue contained a list of "Independent Mini-computer Peripheral Manufacturers." Unfortunately, it listed our *old* address. Our current address is:

10520 S.W. Cascade Blvd.  
Portland, Oregon 97223

**Sheridan F. Barre, Marketing  
Floating Point Systems, Inc.**

**To the Editor:**

In the November issue you published an article on value-added networks that totally ignored the only time-proven value-added network currently available for joint use. That network, TYMNET, currently shares its excess capacity with over 35 organizations utilizing nearly 60 hosts from every major main-frame manufacturer. TYMNET hosts can be accessed from over 65 domestic cities today, and the list of access cities is growing by 3 to 4 each month. TYMNET is available to both commercial and federal customers and is generally the most cost-effective way to solve a real telecommunications problem. We are happy to see your

interest in value-added networks and hope that the enclosed information will help you in the preparation of future articles.

**Larry H. Nebel  
Manager, Midwest Region  
Tymshare, Inc. El Segundo, CA**

*The article was not intended to include a complete listing of VAN carriers, but to describe several of the factors affecting the cost of packet services available from representative VANs. TYMNET provides excellent VAN services, but we did not consider that service representative. The services mentioned were those "Composite Data Carriers" which are permitted by the FCC to profit directly by joint use and enhancement of common carriage. TYMNET services are provided under the "excess usage" provision of Tariffs 260 and 263. Although we agree with TYMNET that, insofar as the TYMNET user is concerned, this may be a trivial distinction, it did influence our decision to exclude TYMNET. Other VANs considered non-representative and not mentioned in the article include the Defense Department's AUTODIN, and the Advanced Research Project Agency's ARPANET.*

— ARK



**the new  
DataPacer™  
magnetic  
tape system sets  
the pace on the  
bottom line.**

**for system  
buyers:**

Big 3M data cartridge capacity of 2.8 million bytes.

High speed read or write of 30 ips with transfer rate of 48,000 bps. Search at 90 ips.

Precise stop-and-go bidirectional operation cuts access time in search and retrieval.

Operational control comparable to half-inch drives with unit selection, on-line/local selection and off-line rewind.

Complete DEC-compatible software package.

**Performance far surpasses cassette standards, at a cassette price: from \$2980.**

**or system  
builders:**

Small, compact and modular, up to three data cartridges across a 19-inch rack.

Single cable, single card plug-in interfacing for PDP-8 or PDP-11 minicomputers.

Automatic CRC error detection, dual gap read-after-write recording head, phase encoding. Meets proposed ANSI standards.

Simple, reliable transport, field-proven on thousands of units.

Fast, easy installation and maintenance.

**Performance far surpasses cassette standards, at a cassette price: from \$2980.**

Write or call for complete information.

**TENNECOMP SYSTEMS INC.**

795 Oak Ridge Turnpike Oak Ridge, Tennessee 37830  
Telephone 615/482-3491

# The most significant concept in tape handling since the open reel EMERSON'S NEW TAPE PAC® SYSTEM

## Model 2005 Tape Drive

A small package with a big capability. You'll get an operating speed of 25 ips and a search speed of 240 ips. 7 or 9 track NRZI (200/556/800 bpi) or 9 track PE (1600 bpi) bi-directional recording. Or a special serial recording format at 3200 bpi.

No reel motors or servos. A dual differential capstan drive. No significant tension or stress variations are imposed on the tape as it's spooled.

Plug-to-plug compatibility with tape drives using industry-compatible NRZI or PE formatters. Easy installation, operation and maintenance.

And you'll get a price that makes the Model 2005 the most attractive tape drive on the market.

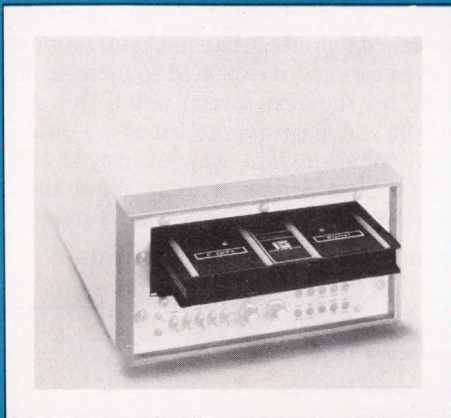

## Model 2004 Tape Pac®

The first pack to totally protect tape from the environment. A standard Tape Pac® has 600 feet of ½-inch, 1.0 mil magnetic tape. It's capable of handling 0.5 mil tape (1000 feet) with the same guaranteed reliability, increasing data capacity by more than 60%.

Spring-loaded "dust doors" close when the pack is removed from a drive, providing complete media protection. Integral tape guides completely eliminate oxide contact. And the tape is stored in a reel-to-reel configuration on flangeless reels mounted on bearings in the pack.

Add a simple design, controlled tape path and precise pack-to-head positioning.

## Result:

The most significant, innovative concept in tape handling since the open reel. All from Emerson... a quality name in tape technology.

For more about the Tape Pac® System, call Ron Carroll, Marketing Manager, (714) 545-5581. Or write Emerson Electric Co., ICD, 3300 S. Standard St., P.O. Box 1679, Santa Ana, Ca. 92702.

We've pioneered tape handling concepts for military and instrumentation applications for more than 15 years. Now we're applying our technology to the commercial tape market. For applications like source data entry, data communication terminal networks, and mini-computer or microprocessor systems.

Our 2000 Series Tape Pac® System features a tape drive that offers greater performance and reliability than open reel, cartridge and cassette drives. It's as small as a diskette drive but has 50 times more capacity. And our Tape Pac® uses ½-inch computer-compatible magnetic tape that can work in virtually any environment.

You'll find the new 2000 Series has the best cost/performance available... and design benefits you won't find anywhere else.

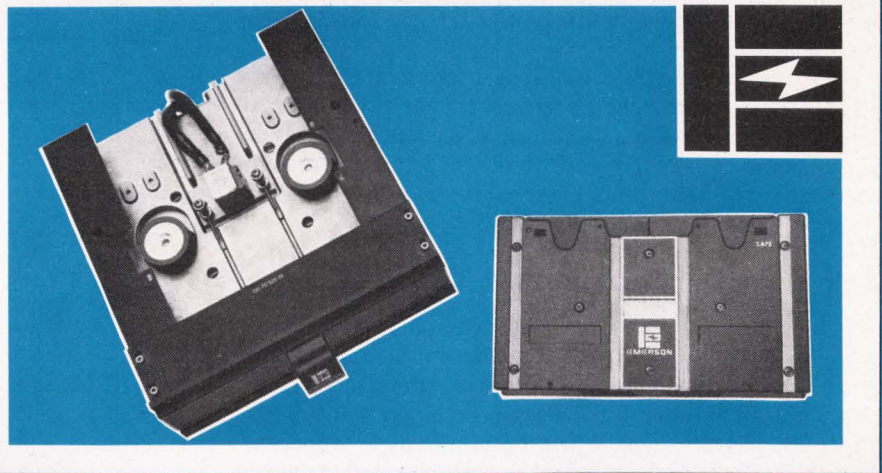

# EMERSON

CIRCLE NO. 3 ON INQUIRY CARD

## BULLS IN '76, BEARS BY '78

Most industry leaders expect things to pick up in 1976, but this optimism is colored by caution because capital goods spending is not keeping pace with the recovery. Lack of investment now could bring about goods shortages followed by credit shortages late in 1977, culminating in another recession by 1978. This is what *Gnostic Concepts* (Menlo Park, CA) projects for the next three years.

Evidence that 1976 should be a relatively good year was provided by a recent *International Data Corp.* (Waltham, MA) survey of spending plans of 128 users. Among the good signs are few expected budget cuts this year (3 percent vs. 11 percent last year), increased application development (majority plan increase vs. deferment last year), and more central processing unit upgrades (30 percent vs. 15 percent last year). Despite these plans, users' projected spending growth averages only 10.8 percent — 1 percent less than that of 1975, although much of it was absorbed by inflation. "Real" growth in hardware spending is projected to be 9 percent for 1976 compared to 7 percent for 1975; staff spending should increase 4 to 5 percent compared to 1 percent in 1975. IDC attributes the small budget increase of 1976 to large corporations' already complete teleprocessing plans and medium companies' reliance on pre-established networks.

*Gnostic Concepts* expects this election year will bring about expansionary fiscal policy that will further strengthen the military electronic sector. A decline in the inflation rate to 6 or 7 percent will convince businessmen by midyear that the recovery is real, so that capital spending should increase by year's end. Until then, however, lower capital spending plans will affect the communication, business equipment and computer sectors. Large systems will be especially vulnerable and the decline in their orders could be permanent, according to *Gnostic Concepts*. On the other hand, minicomputer orders will continue to increase through 1976. Third world electronic consumption will expand very rapidly in the next few years and the production of domestic equipment should return to the U.S. as foreign labor costs increase.

The first storm clouds will appear late in 1976 or early 1977, when government electronic expenditures begin to taper off, inflation starts its upturn, and goods shortages begin. A rush to stockpile will result in demand for credit exceeding its supply and a probable recession by 1978.

So as the bulls meander, live it up.

## TAX ANALYSES IN A BRIEFCASE

Not only can tax accountants let the computer do the work now, they don't have to be anywhere near a computer. Computone's (Atlanta, GA) *Keypact* briefcase terminal acts as the go-between for the tax accountant and Computone's 360-based system. When the tax preparer enters the taxpayer's data into the terminal and calls the Atlanta-based computer, the computer calculates the individual's taxes by all methods available. The computer tax for the most appropriate method comes back in voice response mode and the accountant transcribes the information on the applicable form. In addition to Form 1040, Schedules A, D, G and 4726 can be prepared by *Keypact*. Basic cost of the Model 411 *Keypact* terminal is \$975 in addition to a monthly computer connect time charge.

## NEW YORK'S ACH

Joining 14 other operating automated clearing houses across the country, New York's ACH will process consumer-based pre-authorized payments for the Second Federal Reserve District, consisting of New York State, New Jersey's northern half and Fairfield, CT. NYACH is operated by the New York Clearing House Association and becomes the second ACH to be operated independently of the Federal Reserve. Operating under a pilot project since July, 1975, NYACH had a sophisticated model to follow. The New York Clearing House Association's CHIPS operation was established in 1970 for single message, high value, money market transfers. It uses computer-to-computer transmission for its 3/4 million monthly transactions (that's more than any ACH). NYACH will use the CHIPS Burroughs 6700 computer for its transactions. Magnetic tapes received from commercial banks and thrift institutions in the afternoon will be sorted and available later the same afternoon or evening. For this turnaround time, computer-to-computer transmission will soon be necessary, according to NYACH.

## THE IMPACT OF NON-IMPACTS

The market for non-impact printers has increased almost tenfold in the past five years and is expected to increase 30 to 40 percent annually for the next several years. This was the finding of a recent 200-page report issued by International Resource Development, Inc., which surveyed 100 of the "Fortune 1000" large computer users about their future buying plans. The IRD researchers predicted greatest

NON-IMPACT PRINTER SHIPMENTS (WORLDWIDE)  
1975 - 1985

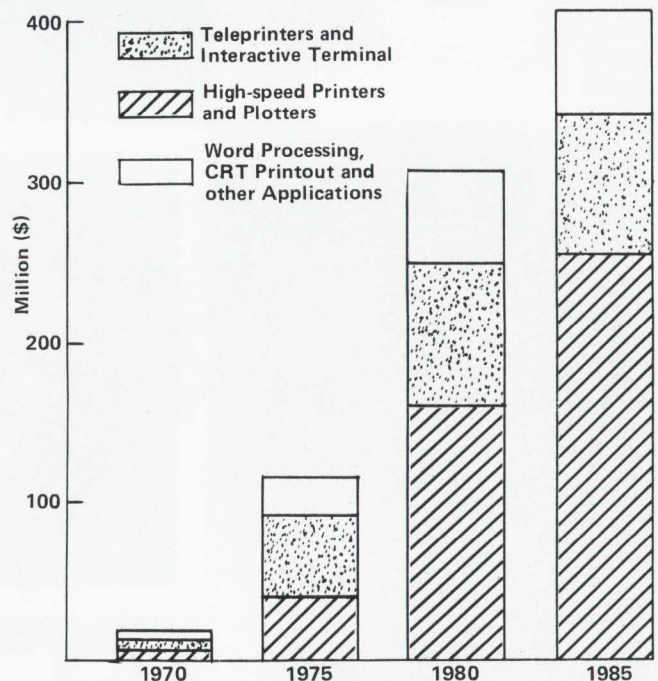

growth will be in the ultra high-speed printer market, such as Honeywell's Page Printing System and IBM's 3800. Also included in the report is a detailed market analysis with a financial profile of each non-impact printer vendor. The report is available from *International Resource Development, Inc.*, 46 Main St., New Canaan, CT 06840.



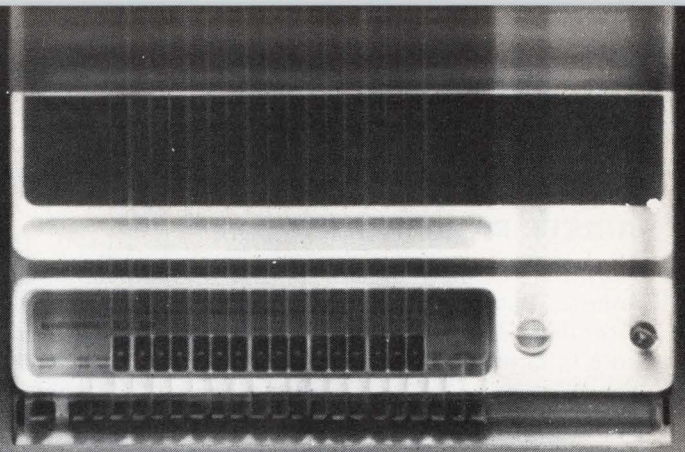
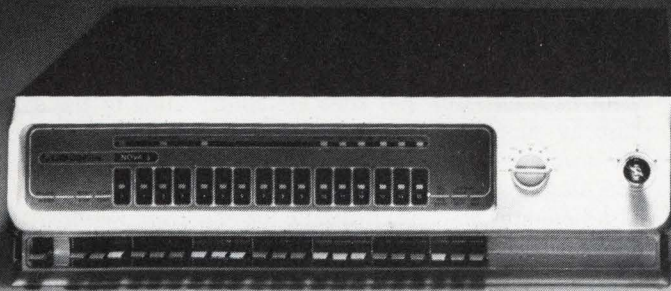

## The biggest thing to ever hit the OEM market, gets even bigger.

The four slot version of the Nova 3 gets pretty big. Up to 32K words of memory. But Nova 3 doesn't stop there. If you want to go further, consider the 12 slot Nova 3.

It can take on up to 128K words of memory. And our optional Memory Management Unit makes efficient use of all that memory, without a lot of systems overhead.

If you're going to need more I/O than the 12 slot Nova 3 can give you, there's an optional 12 slot expansion chassis.

And if one fully expanded Nova 3 still isn't big enough to handle the problem, you can add more Nova 3's and make multiprocessor systems. And they come with standard off-the-shelf software.

Why do we go to the trouble of offering such a wide range of configurations?

So you can meet any number of different systems requirements with the same processor. Without buying a lot of

different spares. Without training your people in a lot of different test and maintenance procedures.

And so you can take your smallest product and make it a lot bigger. Without systems redesign. Without rebuilding your interfaces. Without rewriting your software.

And, no matter how small a Nova 3 you start out with, you get big performance. Nova 3 executes instructions in only 700 nanoseconds. Or more than twice as fast as the computers you're apt to compare it with.

Yet for all its bigness, there is one small feature in the Nova 3. Price. You can get a 64K word MOS memory Nova 3 with Memory Management Unit, Automatic Program Load and Power Fail Protection for just \$16,800\* (Or a smaller Nova 3 for an even smaller price. A 4K MOS system for \$2,600\*.)

Write for the brochure.

You may discover that bigger is better.

\*Single unit price before OEM and quantity discounts get figured in.

## DataGeneral

Nova 3: The biggest thing to ever hit the OEM market.

•Data General, Dept. N10, Route 9, Southboro, Mass. 01772 (617) 485-9100. Data General (Canada) Ltd., Ontario. Data General Europe, 15 Rue Le Sueur, Paris 75116, France. Data General Australia, Melbourne (03) 82-1361/Sydney (02) 908-1366.

CIRCLE NO. 4 ON INQUIRY CARD

## BUNKER RAMO DESERTS POS

Shortly after Singer decided to give up the point-of-sale business, Bunker Ramo followed suit. The company will discontinue development and production of its Electronic Store Information System (ESIS) product line — one of the first POS systems for supermarkets. “The retarded development of the market for these terminals has increased substantially the anticipated startup costs, resulting in continuing operating losses,” said Bunker Ramo President George S. Trimble. The ESIS POS system was purchased by display terminal manufacturer Bunker Ramo in 1973 after its initial development by Nuclear Data and the Jewel Company of Chicago. Losses for the ESIS division amounted to about \$4 million in 1975, but the company is allowing \$7 million in write-off expenses. Existing installations will be maintained while a search for buyers of the POS line continues.

## USED COMPUTER PRICES

Even for those not trying to sell or buy a used computer, there could be a need to know a computer's value (e.g., IRS). Unlike used cars or wine, computer values neither decline nor increase proportionally with age. Rather, technological obsolescence is the major factor affecting used computer value, according to Adolf Monosson, president of American Used Computer (Boston, MA). As reported in the *Computer Law and Tax Report*, other factors include cost reductions in

## BITS & BYTES

Horny whooping cranes can be a problem, especially when there's hardly a mate to be found. But with the International Species Inventory System (ISIS) centered in the Minnesota Zoological Garden, whooping cranes should be a lot happier. Over 200 zoos are contributing to the data base by supplying species population statistics. So when one member of an endangered species needs another member, it's only a printout away.

The Common Market's Brussel's headquarters has to deal with a certain Doktor Hendrick Eldeman and a three-story computer. It seems der doktor has a plan to tattoo numbers on individuals using laser beams as a basis for a worldwide credit system. Denial is the Common Market's way of dealing with him, for he is (we hope) only a figment of the imagination of some fundamentalist Protestant sects in the U.S.

How to make a cold computer room warm is the problem confronted by a computer center design firm, Sumner and Granier Designs, Inc., of Los Angeles. Their techniques include operator-oriented layouts, warm colors and textures, and, above all, soundproofing.

Smokey the Bear will have a new friend in the Los Angeles area if bureaucratic tangles don't get in the way. To help the brush and forest fire-plagued city, a Firescope Computer System would store terrain data and an inventory of available fire fighting equipment. When a fire began and weather conditions were submitted, the computer would indicate where firefighters should build firebreaks. The computer could also predict the status of the firefighting units, what structures were threatened, etc. But alas, this could all be a dream. Six municipal, state and federal agencies have to agree before Firescope is a reality.

Almost totally computer-written books are the product of O'Neil Data Services, a stock market brokerage firm. Each Friday, 250 million pieces of stock information on computer tape are submitted to the computer, edited and formatted by the computer, and output from the computer as print-ready copy for a five-pound book found on money manager's desks each Monday morning.

Would you believe up to 33 kilobits per inch per track? This is what Bell & Howell says its new digital recording method, HI-D, can handle. Operating at up to 120 inches per second on one of B&H's Datatape recorders, HI-D is said to achieve bit error rates as low as 1 in  $10^7$  on 14-track systems.

When Univac acquired RCA installation base in 1972, the Spectra 70 product line was renamed Series 70 and became part of the Univac line. But the Series 70 Computer Users Association remained apart from the Univac Users Association. Recently they merged to become the 1400-member Americas Univac Users Association.

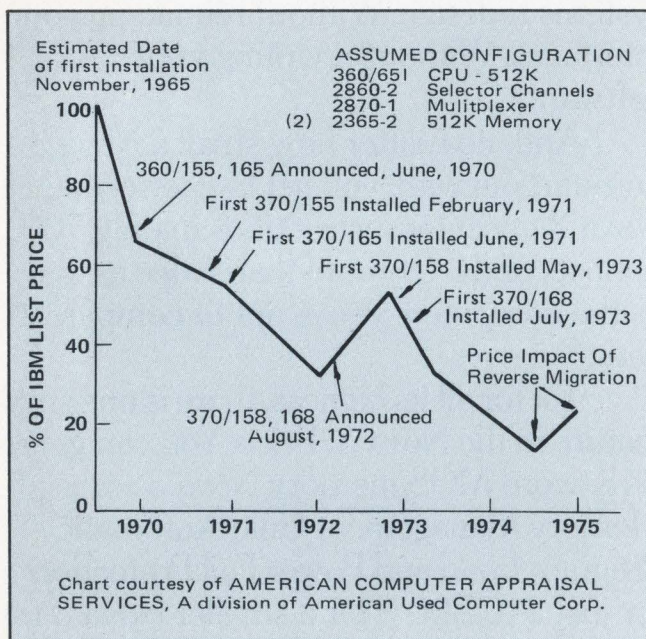

CPUs and memories, the supply and demand at a specific moment, services provided by the manufacturers toward installation, maintenance and software, and the effect of the economy (demand for used computers — and therefore value — increases with slowdowns in the economy). American Used Computer supplied a 360/65 configuration as an example. Starting with 100 percent valuation in 1965, the 360 dropped to 65 percent by 1970 with the announcement of the 360/155. By 1972, its value had dropped to 30 percent, but with the economic depression it increased to over 50 percent of its original value. (See chart).

**IF YOU HAVE A "NEED TO KNOW"  
 ABOUT COMPUTER SECURITY**

**see the ad on page 48.**

# Our 3270 replacement: It's more than you bargained for.

**A 45% cost saving** is a bargain. But Computer Optics offers more. The CO:77 display terminal is a totally compatible replacement for your IBM 3270. And it offers a range of design features that you can't get from IBM. At any price.

**Large 15-inch display** with a non-glare screen and a constant display of all system functions. It's designed to ensure viewing ease.

**Touch sensitive keyboard** lets operator feel each keystroke, and helps reduce errors.

**Fast 60-cycle refresh rate** for a sharper, steadier image and reduced operator fatigue.

**Moveable display** housing that tilts to the individual operator's best viewing angle. It means increased comfort for the operator and increased productivity for you.



**Computer Optics Inc.**  
Berkshire Industrial Park, Bethel, CT 06801

Toll free: 800-243-1314 In Connecticut call collect (203) 744-6720

CIRCLE NO. 5 ON INQUIRY CARD

## IBM ABROAD HELPS RESULTS

A surge in foreign outright sales helped IBM's fourth quarter results, according to *Drexel Burnham's* Harry Edelson. Foreign revenues and earnings increased over 20 percent and accounted for 50 and 56 percent of IBM's revenues and earnings, respectively. The 158 and 168 were hot foreign items, although domestic sales of these two models have slowed since 1974.

## A NEW MADAM IN FRENCH CUSTOMS

Sophia is her name and she's the first of her kind in Continental Europe. Starting next spring, Sophia will be stationed at three Paris airports — le Bourget, Orly, and Charles de Gaulle. As an online computer system, Sophia will help automate the process of clearing air cargo through customs. The only other comparable system is at London's Heathrow Airport. Sophia's software is by Computer Sciences Corp. (El Segundo, CA); her hardware is by Compagnie Internationale pour l'Informatique.

## DER KOMPUTERMARKT

Germany's market for computers is a reflection of the once booming German economy which began growing negatively in 1974 and 1975. The once open-ended and largest European market for data processing, which was based on the premise that too much was better than not enough, is becoming saturated. According to a recent U.S. Dept. of Commerce report, end-users started to become frugal near the end of 1974. Computer equipment is being used longer and leasing is supplanting purchasing. Replacement sales, especially in medium and large computers, is exceeding new sales. The exceptions to this trend are the small business systems, minis and terminals.

General-purpose mainframes in Germany numbered 20,860 for a total installed value of \$8.2 billion in 1974. *Diebold Statistics* estimates IBM's market share at 51.9 percent, Siemens' share at 21.3 percent and growing, Honeywell and Univac with less than 10 percent each. Siemens' installed systems for 1975 were up 13.6 percent over 1974, while IBM's systems had a 5.5 percent increase. IBM's control of this market can be explained by Germany's (and therefore Siemens') late entry into the data processing industry. Germany's electronics industry was restricted until 1955 as a result of World War II. As Germany's largest electrical concern, Siemens kept Germany's interest in the EDP market alive. In 1961, it introduced the 3003 business system. From this, Siemens went into process control with the 300 series of industrial minicomputers. RCA's Spectra 70 formed the basis for the 4004 system introduced in 1965. After acquiring Zuse KG, Siemens announced the Zuse-designed 404/3 disk processing system. Enhancements to the 4004, such as virtual memory features and semiconductor main memory, helped maintain Siemens' competitive position against IBM's System/

## KNOW-HOW NOT A MATTER OF SIZE

Expertise, not size, was the reason that Realizations Etudes Electroniques (R2E), a French microcomputer developer, selected International Marketing Services to represent them in the U.S. Their confidence in IMS has been justified many times over. First, the little Wellesley (MA) company mounted a very effective campaign to publicize R2E's "Micral," an 8080-based small business system. Next, the firm acted as R2E's U.S. office while simultaneously interviewing potential sales organizations and licensees. Settling on licensing as the proper vehicle for R2E, IMS selected COMSTAR as an attractive possibility. By the time negotiations started, COMSTAR was acquired by Warner & Swasey. But since IMS was looking for expertise in micros (COMSTAR) and financial strength (Warner & Swasey), the merger did nothing but enhance the prospect. The licensing agreement was concluded last year, and initial response to what is now a product of Warner & Swasey's Electronic Products Division (*nee* COMSTAR) has been excellent.

370. To further strengthen its position against IBM, Siemens joined with Philips of the Netherlands and CII of France to form Unidata in 1973. The Unidata 7700 Series was announced in 1974 to compete in the small and medium systems market, specifically against IBM. However joint product development was not enough to keep the partners together so by 1975 Siemens was on its own again. Siemens will continue to produce and market the Unidata product line and continue product development with Philips.



**GERMANY'S WUNDERKIND: NIXDORF.** Shown is the company's newest offering in the market where German's make their presence felt — small business systems. However, the 8870 is "foreign"-built. The processor comes from Digital Computer Controls, the CRT from Hazeltine, the printer from Dataproducts.

Although Siemens has been able to cut into IBM's share of the market, sizable losses in the EDP division in addition to declining mainframe shipments make it questionable whether Siemens will be able to maintain its growth. But then, data processing is only 6 percent of Siemens' business.

Germany's computer success story has been in the mini-based business and distributed processing area.

## QUICKLY AROUND THE WORLD

Bank Brussels Lambert (Belgium) has ordered a Burroughs B 7700 and B 6700. The dual-processor 7700 will be used for online data communications between 1,100 branch and district offices; the 6700, also a dual processor, will be used for batch processing applications such as payroll, mortgage loan and general accounting. Total value of the contract is \$15 million.

The Helsinki University Central Hospital has installed a Honeywell Model 66/20 and a 716 minicomputer valued at \$1.5 million. The 3,200-bed hospital will use the system for administrative applications such as bed scheduling.

Rumasa, a large Spanish holding company, has ordered a Univac 1100/21, valued at \$2.4 million, to be used for banking applications for its 300 member companies.

The Swedish Telecommunications Board has signed a \$1.2 million contract with Codex for 9600-bps modems to be used for end-user data communications applications as well as on international links terminating in Sweden.

And the main character has been Nixdorf. From a small OEM supplier of calculating devices in 1965, Nixdorf has grown to become Europe's leading small computer manufacturer, with sales of \$224 million in 1974. In this market, IBM and its small systems are not as overwhelming, so Nixdorf has plenty of room for growth. *Frost & Sullivan* expects this \$450 million market of 1975 to double by 1980. Nixdorf has maintained a 25 percent annual growth rate in revenues in recent years and has been able to establish a foothold in the U.S. The company sees its growth continuing as small and medium firms become more conservative in filling their needs and as large users decentralize with remote processing.

Nixdorf's early growth was based on the small applications-oriented 820 and 840 systems. In 1975, Nixdorf introduced a new line with the 8864 bank terminal and the 8870 Basic-language business system. Nixdorf emphasizes support by providing complete applications software for its systems. However, U.S. dominance can still be felt since the 8870 hardware is from U.S. OEM manufacturers.

Minicomputers are another U.S. stronghold with Digital Equipment leading the pack of 55 minicomputer manufacturers in Europe. Germany's Siemens and AEG-Telefunken have concentrated on process control systems and are just now starting to penetrate the OEM market. Germany's minicomputer market for 1975 was \$65 million and by 1980 is expected to reach \$200 million.

The Commerce Dept. expects the German economy to pick up in 1976. Areas reflecting the upturn will be small business systems and minicomputers. And the U.S. will certainly reap benefits as the trend toward increasing imports from the U.S. continues.

## IRANIAN CAPITAL, CDC TECHNOLOGY

Computer Terminals of Iran is a new company formed by Iran Electronics Industries and Control Data. The company will be 70 percent owned by the Iranian Government company and 30 percent by CDC. The company will focus on the development of low-cost computer terminals for high volume manufacturing. CDC with Iranian help, will do the initial product development in its Minneapolis facilities. The first product should appear in 1978.

## GERMAN MICROPROCESSORS AND AMERICAN LAWSUITS

General Instruments was designing and producing chips based on the CP3F microprocessor from the German firm, Olympia Werke, AG. Then the head of GI's microprocessor development program, Dr. David Chung, left to become head of Fairchild Camera and Instrument's F8 development. Since the F8 closely resembled the CP3F, General Instruments sued Fairchild for trade secret violations. GI would not settle with Fairchild out of court, so Fairchild settled with the original developer, Olympia. For a reported \$2 million in royalties over the next seven years, Fairchild has a license involving patents, patent applications and technology associated with Olympia's CP3F. Fairchild contends that this agreement includes a complete release of Olympia's information for any possible use in the F8 processor, and that GI has no standing in the matter now. GI does not agree.

## FOOTHOLDS ABROAD

There may be a global recession, but U.S. exports have the reputation of growing faster than most individual countries' domestic markets. So it's not surprising to see a number of new U.S.-foreign agreements.

**Data 100 (Minnetonka, MN)** is forming a new company, Sumisho Electronics Co., Ltd., in conjunction with two Japanese firms to market its products in Japan. Initially, Sumitomo Shoji Kaisha, Ltd. (Tokyo), a trading firm, and Japan Information Service, Ltd. (Tokyo), a computer service bureau, will provide financing. Data 100 has the option to acquire 45 percent of Sumisho.

**Identicon Corp. (Franklin, MA)** is joining forces with the Italian and West German arms of Data Logic to market its bar code scanning equipment. Data Logic, as a European manufacturer of photoelectric products, will market Identicon's Model 100 and 400 remote scanners, Model 600 multiplex system, and the PortaPen 2 portable data acquisition unit.

**Microdata Corp. (Irvine, CA)** will market its Reality business computer system through CMC Germany, which recently separated from its parent company, CMC of Los Angeles. The system will be called "Prisma" and the user language will be called "Deutsch" ("concise").

**Raytheon Data Systems (Norwood, MA)** is using a Japanese peripheral equipment company, Nissho Electronics Corp., to market its PTS-100 intelligent terminal. Nissho currently markets computer output microfilm, data entry and OCR equipment.

# FRONT ROW CENTER

ON THE WORLD OF DATA COMMUNICATIONS

MIAMI BEACH CONVENTION CENTER

REGISTER

ADMIT  
ONE

MIAMI BEACH - MARCH 29-31, 1976



## THE STAGE IS SET FOR INTERFACE 76

And you can be there—*front row center*—on all the excitement! This year, as in the past, INTERFACE 76 continues to be *the* Data Communications Conference and Exposition. Co-sponsored by DATAMATION Magazine, INTERFACE 76 combines thoroughly experienced conference management with this major source of editorial excellence to bring you the most comprehensive and productive data communications event ever held.

INTERFACE 76 has, as its goal, cost effective management on all levels through data communications. That goal is reached through complete management programs tailored to you. Regardless of your level of expertise in data communications, you can follow a comprehensive program at INTERFACE 76. Sessions are structured in contiguous groups to ensure that you receive thorough coverage of the subjects to meet your needs. (Attention—EDP, Datacomm and Communications Management—General and Financial Management, too . . . Shouldn't *your* organization benefit from this kind of comprehensive coverage?)

Co-sponsored by

**DATAMATION**  
Magazine

## HELD OVER—1975'S BIG HIT

The **Data Comm School** is just one of our show stoppers. Pupils in the Data Comm School study fundamentals of data communications with emphasis on management decision-making rather than technical details. There's lots of new material designed for novices, experienced staffers and management from other areas who want an introduction to and an overview of data communications.



With over 125 speakers to hear and *hundreds of exhibits* to see, you'll be front row center on the world of data communications.

## AN EXPANDED PROGRAM DESIGNED IN DEPTH

The INTERFACE 76 Conference Program is three full days, 41 different fact-filled sessions with over 125 speakers, designed to bring you the latest information on the world of data communications.

In *Methods Workshops*, you'll study latest methods and procedures needed to plan, implement and maintain a data communications system. Emphasis will be on the latest networking approaches.

Follow that up in our *Product Workshops* to thoroughly understand the role of specific products and services in data communications systems. These workshops also offer guidelines on equipment evaluation and selection.

Hear in-depth analyses of today's important topics. INTERFACE 76 *Highlight Sessions* are forums for the issues and answers that closely affect the User community.

Apply this input of information to your specific industry. It's sure to be included among the 14 major areas covered in the *Applications Sessions*. Here, four-member panels of experienced users will employ a case study approach in describing their use of data communications.

A complete listing of program titles and descriptions is contained in our brochure.

## INTERFACE 76—CLEARLY THE CRITICS CHOICE

A team of consultants and industry editors working in data communications have structured program content to be most logical, vital and productive for attendees.

### Program Committee

Ralph Berglund, Industry Consultant  
John Buckley, Pres., Telecommunications Mgmt. Corp.  
Richard L. Deal, Pres., Richard L. Deal & Assoc.  
Donald Dittberner, Pres., Dittberner Assoc., Inc.  
Dr. Dixon R. Doll, Pres., DMW Telecommunications Corp.  
Philip H. Dorn, Pres., Dorn Computer Consultants, Inc.  
Dr. Philip H. Enslow, Jr., Prof., Georgia Inst. of Tech.  
Phil Hirsch, Editor of Data Channels  
Richard A. Kuehn, Pres., RAK Associates  
Robert A. Lively, Pres., Lively Communications  
Einar Stefferud, Pres., Network Mgmt. Assoc.  
Bernard Strassburg, Communications Consultant & Former Chief, FCC Common Carrier Bureau

And here's our INTERFACE 76 *Industry*

### Editors Advisory Board

Ken Bourne, COMMUNICATIONS NEWS  
John Kirkley, DATAMATION  
Arnold Keller, INFOSYSTEMS  
Robert M. Patterson, MINICOMPUTER NEWS  
Alan Kaplan, MODERN DATA  
William R. Schulhof, THE OFFICE  
Jim Hughes, TELECOMMUNICATIONS  
Ray H. Smith, TELEPHONE ENGINEER AND MGMT.  
Leo Anderson, TELEPHONY

## APPEARING SOON IN OUR THEATER BY THE SEA

INTERFACE 76 will be staged in one of the finest convention sites in the country—the centrally located Miami Beach Convention Center. For attendee convenience, *free shuttle bus service* between the Convention Center and all convention hotels will be provided by INTERFACE 76 conference management.

Convention hotels include Miami Beach's most popular. Special conference rates range from \$21-\$47 for room accommodations.

Complete hotel registration information will be furnished upon receipt of Conference Registration Coupon, or call our INSTANT INFO number below.

To register for INTERFACE 76, simply fill out and mail coupon to:

INTERFACE 76  
160 Speen Street  
Framingham, Massachusetts 01701

Note the special "team rate" discounts when you register 3 or more from the *same location* of your organization.

REGISTRATION FEE	3 Full Days	One Day
1st and 2nd attendees	Each \$95	\$50
3rd and more attendees	Each \$50	\$25

Mail to:

INTERFACE 76  
160 Speen Street  
Framingham, Massachusetts 01701

Name \_\_\_\_\_ Title \_\_\_\_\_  
 Organization \_\_\_\_\_  
 Address \_\_\_\_\_  
 City \_\_\_\_\_ State \_\_\_\_\_ Zip \_\_\_\_\_  
 Telephone( ) \_\_\_\_\_  
 My check for registration payable to DataComm Interface, Inc. in amount of \$ \_\_\_\_\_ is enclosed.  
 Please bill me.  Please send brochure.

# FOR INSTANT/INFO CALL TOLL FREE (800) 225-4620

WITHIN MASSACHUSETTS, CALL COLLECT (617) 879-4502



# INTERFACE 76

## book reviews

**AUTOMATION AND LAW ENFORCEMENT**, by *Clyde L. Cronkhite, M.P.A., Charles C. Thomas, Publisher, Springfield, Illinois. 133 pages + bibliography and index. \$10.50 (cloth), \$6.95 (paper).*

This book is aimed at college students of police automation and computer classes of this specialized field of automation. The first chapter serves as a guide to computer technology for the student in law enforcement. Police automation systems are categorized as systems for field information, investigation, communication, and management and staff. As a part of this background, a listing of definitions of computer-related terms is provided. (It is unfortunate that the author did not make use of the ANSI Information Processing Vocabulary for his definitions.) These classifications influence most of the remainder of the book (Chapters II through V) in that the author then presents examples of Los Angeles Police Department automated systems which fall within these groups. Case history models and standards presented provide a basis for planning systems in these areas. Chapter VI summarizes the information presented in terms of organizing systems to meet police objectives by applying appropriate standards of design. Those planning police automation systems who have limited system design experience will find this book a broad but helpful introduction.

— Michael S. Keplinger

(*Mr. Keplinger, J.D., of the National Bureau of Standards is responsible for policy matters arising from the interaction of computer technology and the law.*)

**BENCHMARKING: COMPUTER EVALUATION AND MEASUREMENT** edited by *Nicholas Benwell. Halsted Press, New York. 160 pages + appendices, index and bibliography. \$20.00.*

The ongoing controversy over benchmarking is not settled by this book, but different sides of the story are presented. Consultants from Arthur Anderson and Software Services Limited, representatives from computer manufacturers Univac and ICL, researchers and others told of their benchmarking attempts at *Benchmarking '74* held at Churchill College in Cambridge, England. As editor, Nicholas Benwell, a lecturer in data processing at Cranfield Institute of Technology (England), compiled their papers. Topics included the role of benchmarking, manufacturer's attitudes, multi-access benchmark design, synthetic program design, and case studies of commercial and multi-access benchmarking applications. Determining how "well" a computer performs involves an infinite number of variables. Even speed, the most tangible thing to measure, depends on the individual application. And there the dilemma just begins. What is a typical instruction set? A typical job mix? How does benchmark performance relate to the user's varying production loads? How should human interface time be handled? How is performance of a CPU on a chip measured?

Although there's no consensus, the direction for measuring hardware and monitoring software seems to be away from the grandiose million dollar benchmarks for specific user applications and toward small synthetic programs consisting of a CPU loop and an I/O loop. But then, each manager has the problem of relating the performance to his workload. According to one conference member, the sense of the conference could be summed up in 11 letters — frustration. Nevertheless, this book can be a useful reference for examining benchmark results in perspective. — BAR

### 1. The Programmer's COBOL

By *Marjorie Berk*. Helps the COBOL programmer quickly find information to prepare a program for a computer. Features easy use and direct application of its comprehensive treatment of the COBOL computer language. 250 pp., \$22.50

### 2. Computer-Assisted Planning Systems

By *James B. Boulden*. A clear, thoroughly researched perspective on how computer-assisted planning systems can and should perform in operations ranging from strategic planning and budgeting to market forecasting and pricing and buying decisions. 228 pp., \$12.95



### 3. The Programmer's RPG

By *Rochelle Gershon*. Defines and discusses the RPG language, provides a highly detailed presentation of each language element, and presents many sample programs illustrating the definitions and rules. 443 pp., \$6.95

### 4. Management Information Systems Handbook

By *W. Hartman, H. Matthes, and A. Proeme*. A step-by-step approach to the preparation of a computerized data processing system for business organizations utilizing the ARDI approach (Analysis—Requirements Determination—Design and Development—Implementation and Evaluation). 750 pp., \$37.80

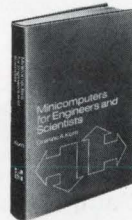

### 5. Minicomputers for Engineers and Scientists

By *Granino Korn*. This book will give anyone who is using or planning to use minicomputers a full understanding of the units now available and of how their possibilities may be more completely realized. Also covers peripherals, assembly language, etc. 352 pp., \$21.50

### 6. Managing the EDP Function

By *A. Ditri, J. Shaw, and W. Atkins*. Explains how EDP functions can be directed and controlled by any responsible executive—even those who have no technical knowledge of computers. An indispensable reference for planning, resource allocation, implementation, and control of computer operations within an organization. 228 pp., \$19.80

### 7. Materials Requirements Planning

By *Joseph Orlicky*. The new way of life in production and inventory management. Maps out fundamental concepts of the MRP system; describes the system elements and implementation alternatives, discusses input and use of outputs, applicability of techniques, and impact on theory and practice of production and inventory control. 292 pp., \$12.95



### 8. Condensed Computer Encyclopedia

By *P. Jordain*. Arranged alphabetically, this work explains the array of terms, items, technical details, interpretive languages, etc. connected with computers. Numerous examples, detailed essays, and precise, accurate explanations sweep away the mystery surrounding computers. 448 pp., \$17.50

### 9. A Guide for Software Documentation

By *Dorothy Walsh*. Clearly sets forth the steps and content for the preparation of documentation for a variety of computer situations—and shows just which topics should be covered. Documentation models included are product specification, operator's guide, internal logic manual, subprogram, program library, assembly language, etc. 158 pp., \$18.75



# FAMED BOOKS ON COMPUTERS...

## 10. Managing Computer System Projects

By *John Shaw and William Atkins*. Presents and describes—in working detail—a methodology for the planning, development, and implementation of computer-based systems. Emphasis is on the *practical*—what to do and why—using proven management techniques. 304 pp., \$21.00

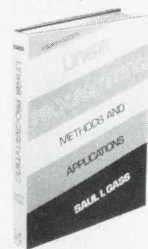

## 11. Linear Programming

Methods and Applications, Fourth Edition

By *Saul I. Gass*. This revised fourth edition retains the basic aims of teaching the reader to recognize potential problems, to formulate them as linear programming models, to use the proper computational techniques in solving them, and to understand the mathematical aspects that tie together these elements of linear programming. 358 pp., \$18.50

## 12. Principles of Data Communication

By *R. Lucky, J. Salz and E. Weldon*. A reference book of timely information on such matters as theoretical performance bounds, adaptive equalization, optimum pulse transmission systems, and error control. 198 pp., \$22.00

## 13. Microprocessors

Edited by *Laurence Altman*, *Electronics Book Series*. A general overview of the technology of microprocessors. Includes analyses of specific systems, design innovations, and practical applications in a collection of recent articles from *Electronics* magazine. Generously illustrated with diagrams, photographs, charts, and tables, it is a valuable reference for designers and engineers. 154 pp., \$13.50

## 14. The Art of Writing Effective Letters

By *Rosemary T. Fruehling and Sharon Bouchard*. Lively and conversational, this book explains the how-to of writing persuasive business and personal letters. Covers requests, acknowledgments, special replies, goodwill, sales, claim and adjustment, credit and collection, job application, reports—in short—the gamut of business correspondence. 258 pp., \$7.95

## 15. How to Sell Your Home Without A Real Estate Broker

By *Carl J. Kosnar*. A guide for selling all types of real estate—single-family home, condominium, cooperative apartment, commercial property, vacant land. Offers full professional guidance. Anticipates questions sellers ask about price, negotiating procedures, mortgage money, tax and legal matters. Includes forms, aids, sample contracts, payment tables, and glossary of terms. 224 pp., \$10.95

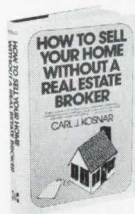

## 16. Management Systems for Profit and Growth

By *Richard F. Neuschel*. The entire focus of this book is on helping readers make certain that the systems they now use in a company are truly in tune with the times. The author alerts managers to the latest thinking and practice in key areas of strategic analysis, operational planning, work force management, and capital budgeting and control. This enables them to base pressing decisions on actual systems that have proved to be most effective. 367 pp., \$12.95

## 17. Boss Psychology: Help Your Boss Make You a Success

By *Charles C. Vance*. A book for anyone who works for someone. Designed to help employees work *with* rather than against management to further their own best interests. Full of practical suggestions for handling the boss and moving ahead. 200 pp., \$8.95

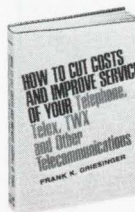

## 18. How to Cut Costs and Improve Service of Your Telephone, Telex, TWX and Other Telecommunications

By *Frank K. Griesinger*. A money-saving manual covering every conceivable technique for achieving better telecommunications at less cost. 288 pp., \$14.50

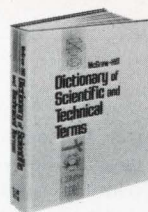

## 19. McGraw-Hill Dictionary of Scientific and Technical Terms

*Daniel N. Lapedes, Editor-in-Chief*. A definitive reference for scientists, engineers, technicians, educators. Contains 100,000 definitions drawn from 100 fields of science and technology, plus 2,800 illustrations. 1,600 pp., \$39.50

## 20. Microprocessor Applications Manual

By *Motorola Semiconductor Products, Inc.* An authoritative volume providing detailed applications information for a representative general purpose MPU. Assumes no prior MPU knowledge on the readers part, and covers all the systems phases, exploring architecture, the instruction set, addressing modes, interrupt structure, and other features. 698 pp., \$25.00

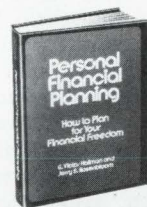

## 21. Personal Financial Planning

By *G. V. Hallman and Jerry S. Rosenbloom*. The first book to emphasize the all-important function of planning one's personal finances, Mindful of the economic belt-tightening everyone is currently going through, the authors approach the subject with a view towards helping the reader set realistic objectives. 416 pp., \$9.95

## 22. Nine Roads to Wealth

By *David L. Markstein*. A simple, easy-to-understand, *layman's* guide to "leverage"—the wealth-building technique behind just about every fortune being built today. Mr. Markstein explains what leverage is, and why leverage makes it possible to earn enormous profits on even a small investment. 224 pp., \$8.95

## 23. Technology Mathematics Handbook

By *Jan J. Tuma*. A convenient reference for all types of engineers and technologists. Offers definitions, formulas, tables, and examples of elementary and intermediate mathematics with emphasis on technological applications. Individual sections on arithmetic, algebra, geometry, trigonometry, analytic geometry, differential and integral calculus, series, vector and matrix algebra, and numerical procedures. 300 schematic drawings and illustrations. 352 pp., \$15.95

## 24. The Complete Bond Book

A Guide to All Types of Fixed-income Securities

By *David M. Darst*. For everyone who wants to make money and improve investment returns, here is clear, detailed information on how to analyze, purchase, and sell U.S. government and Federal Agency securities, corporate bonds and preferred stocks, tax-exempt securities, short-term money market instruments, and all other types of fixed-income securities. 336 pp., \$12.95

## 25. The Stock Options Manual

By *Gary L. Gastineau*. The first book to explain in easy-to-understand terms the characteristics and tax treatment of options as well as the principles that stand behind the rational evaluation of an option contract. Concentrates on the true key to the intelligent use of options. 262 pp., \$12.95



## 26. Digital Computer User's Handbook

By *M. Klerer and A. Korn*. A group of experts give guidance in subjects such as list processing, sorting and merging, interpolation and curve fitting, symbolic logic, linear and non-linear programming, commercial data processing, information retrieval, and scheduling and inventory control. 550 pp., \$32.95

To order any of these McGraw-Hill books, use the Special Order Card

## AIDS FOR COBOL-74

Programming aids for conversion to Cobol-74 have been compiled by the National Bureau of Standards. "Aids for Cobol Program Conversion" (FIPS PUB 43) contains a detailed listing of Cobol language additions and deletions along with a comparison of Cobol-68 and Cobol-74. Copies are available for \$1.10 prepaid from *Superintendent of Documents, U.S. Govt. Printing Office, Washington, DC 20402* (SD Catalog No. C13.52:43).

## LOGICON KEEPS TABS ON MINUTEMAN

Getting it off the ground is one thing, but making sure the Minuteman doesn't get off the ground unintentionally is another. So the Strategic Air Command uses a simulation program by Logicon (Torrance, CA) to test the initial launch program for the Minuteman III intercontinental ballistic missile system. One task tests the coding of a program to insure against unauthorized launch; another evaluates program efficiency.

## WILL THE PRIVACY ACT KEEP THINGS PRIVATE?

One of the Act's sponsors says it doesn't go far enough, Federal agencies are busy finding ways to circumvent it, and a lawyer for the business community hopes it never comes to the private sector. The Privacy Act of 1974 prohibits transfer of personal information between Federal agencies, grants individuals the right of access to their files, and establishes a Privacy Protection Study Commission to investigate privacy abuses in the private sector.

Rep. Barry M. Goldwater, Jr. (Republican-CA), a sponsor, is disappointed in compliance so far. He thinks *routine use* has been too broadly defined as "the use of such record for a purpose which is compatible with the purpose for which it was collected."

Federal agencies have been less than enthusiastic about complying with the act, according to the *Privacy Journal*. No Federal agency has publicized the act. The act prohibits interagency transfer, but HEW, which includes the Social Security Administration, student loan service and National Institute of Mental Health, has defined itself as *one* agency. So information transfers within the "agency" are almost unlimited. And of course the military has found a way of making it "inoperable." To obtain health care, personnel have to sign this statement: "The SSN (So-

cial Security Number) is necessary to identify the person and records... In the case of active military personnel, disclosure of requested (medical) information is mandatory. In the case of all other personnel... if the information is not furnished, optimal medical care may not be possible... I understand that the foregoing one-time Privacy Act Statement will apply to all requests for personal information made by medical treatment personnel or for medical treatment purposes."

"Applying these concepts (Privacy Act) and their logical extensions to *all* businesses and to *all* files would be extreme," said Washington, DC, attorney Francis Gregory in a recent speech before the National Chamber of Commerce Communications Committee. The Koch-Goldwater bill (HR 1984), which would do just that, Gregory labeled "antibusiness." He believes the American public does not realize that the costs of extending the Privacy Act would far outweigh the benefits. If the study commission focuses only on privacy abuses and ignores the costs and real benefits of extensive privacy restrictions for business, Gregory fears that the legislature could feel compelled to pass something like HR 1984. This would be consistent with the way Congress reacted to the public's outcry at Watergate abuses with the Privacy Act of 1974.

## SCAN-DATA RECEIVES \$4 MILLION FROM MARINE CORPS

Scan-Data Corp. announced that it has been advised of its selection to supply its 2250/2 Key Entry Systems and related services to the U.S. Marine Corps under an initial contract valued in excess of \$4 million. The award is principally for the purchase of standard system units, plus the purchase of special equipment and maintenance services over the estimated life of the contract. The Marine Corps has an option to order additional equipment and services up to approximately \$3.8 million.

## NEW ASCII IMPLEMENTATION INSTRUCTIONS

Instructions for implementing ASCII standards in Federal computer and telecommunication applications have been revised by the National Bureau of Standards. This means stricter enforcement of the common code and collating sequence. Under the provisions, a monitoring official must be appointed by every Federal agency to enforce the standard, all computer and telecommunication systems must be tested to ensure compliance with the standard, all data and programs authorized for interchange must be recorded using the codes, and the standards can be waived only if the agency head decides it would prohibit an agency from performing its mission. Complete copies of the standard, FIPS PUB 1-1, can be obtained by writing *NBS Office of ADP Standards Management, Washington, DC 20234*.

## ELECTRONIC MAIL

As part of its ongoing effort to disassociate itself from the motto, "less service for more money," the U.S. Postal Service is experimenting with an electronic mail program. Designed for long distance mail, the Pitney Bowes system incorporates the latest in data entry, communications and peripheral equipment. Letters are placed in cartridges to maintain confidentiality. They are then scanned, digitized, and then transmitted by satellite. At the receiving station, the system converts the digital message and prints it on 8-1/2" by 11" sheets. The letter is collated, folded and inserted into a machine-addressed envelope for local delivery. To fill the high-speed printing requirement, a Versatec electrostatic printer, which produces four pages per second, is used. However, with privacy on everyone's mind, how willing will the public be to reveal the contents of their mail, even to a computer?

**ADDENDUM.** The listing of mini/micro peripherals in the December issue of MODERN DATA omitted mention of that granddaddy of all magnetic media miniperipherals — Linc Tape. We were informed of this oversight by Computer Operations, Inc., 10774 Tucker St., Beltsville, MD 20705, which supplies Linc Tape, DECtape-compatible and Linc/Disk combination drives for Digital Equipment, Data General, Varian, Computer Automation, Hewlett-Packard and Interdata systems. Our apologies.

# TSP

**IT'S CONVINCING  
THE WORLD'S  
TOUGHEST  
COMPUTER BUYERS**

# MODCOMP

**TSP Computers.** Buying a computer to do what you need right now is one thing. But how about two years, five years from now? Or even a few months from now, when you maybe discover you're already outgrowing all that shiny new stuff you just bought. That's when a MODCOMP system proves your safest investment. Now and for the future. Because every one of our computers is fully upward compatible with all the others. From the smallest tabletop mini. To our largest 32-bit machine. So you can add on as you need to. Interchange processors or peripherals. Expand into a distributed processing network. Without expensive reprogramming or engineering changes. We're not called "Modular" for nothing.

**TSP Software.** Whoever said that manufacturers' software is all alike? MODCOMP users will tell you that our real-time multi-programming systems are the easiest they have ever used. But simplicity is only part of the story. When we design an operating system, our software team works hand-in-glove with our hardware experts. So that the software will get the most out of all the features we build into our hardware. And vice versa. The results can be seen in superfast execution times that commonly beat the best any comparable systems can offer.

**TSP Networks.** The switch is on. From big stand-alone computers to integrated distributed processing networks. Our MAXNET operating system was designed for just that purpose. And it's been out working in the field for almost two years. In measurement and control networks of all shapes and sizes. To find out how a network system might solve your own problem, talk to us. We know more about them than anybody.

**TSP Peripherals.** Buy from MODCOMP, and we supply all the system pieces you need. A complete selection of keyboard terminals, graphic displays and EDP peripherals. Including all types of disc storage, mag tape units, impact and electrostatic printers, card and paper tape equipment — you name it. Meaning that MODCOMP is your single source for Total Systems Performance — and total systems service.



\*TSP = Total

# MODCOMP TSP\*

MODCOMP Total Systems Performance has won the confidence of many of the largest (and choosiest) computer users. They know that MODCOMP TSP gives them a lot more for their money in many different ways.

Using standard systems products, a MODCOMP TSP system is up and running faster. Is easier to use. And requires far less

investment in software. Totally supported by MODCOMP, it offers greater reliability and security. And is the easiest to build on to as future needs expand.

For industrial and scientific process control. For high speed data communications and information processing systems.

MODCOMP TSP leads the way. Here are a few of the reasons why.

**TSP Data Communications.** Our specialized communications hardware and software tools offer the data communications specialist a wider range of systems capabilities than anyone else in the minicomputer industry can provide. Including processors with firmware macros for efficient data manipulation; direct memory interface to our versatile Universal Communications Subsystem; and MAXCOM, the operating system designed exclusively for communications use. Full details are in our 32-page communications brochure. Send for it.

**TSP Process Interfaces.** MODCOMP has designed and makes the most comprehensive line of process interfaces available from any computer company. For everything from laboratory instrumentation to aluminum pot line control. Standard analog and digital I/O products include capabilities for low/high-level, differential/single-ended, and high/low-speed sampling of process signals. And all are fully supported by our operating systems.

## Systems Performance.

CIRCLE 120 ON ENQUIRY CARD

**TSP Sales.** When you need a problem solved, you need someone who can help you solve it. Not a pencil-pushing order-taker. Our team of sales engineers and field analysts work with you right from the start. To configure a system to get your particular job done. In the best way. At the least cost. Most of the time from standard products right off the MODCOMP shelves. But if your need calls for special design, they'll help you with that, too. All part of our Total Systems Performance. It gives you a great feeling of security.

**TSP Training.** To keep your computer personnel up to snuff on the programming and operation of MODCOMP systems, our full time staff of instructors conduct regularly scheduled courses at our Training Center in Ft. Lauderdale, Florida. If you prefer, we will also arrange on-site instruction courses at your location.

**TSP Service.** Over 80 MODCOMP service centers provide on-the-spot service for every piece of MODCOMP-supplied equipment. Hardware. Software. Peripherals and process interfaces. The works. Meaning that just one phone call gets you the professional service you need. Fast. And our support engineers and programmers are always on call to help solve problems and assist with new hardware and software start-ups.



**TSP. The proof.** Let us show you proof-positive no other computer company can match. By actual demonstration on our own equipment at the MODCOMP Computer Center nearest you (they're located in major cities across the U.S. and Europe). No weeks of waiting for benchmark results from some far away factory. We show you what MODCOMP TSP can do. Here, and now.

To find out more about how Total Systems Performance can be put to work for you, send for the MODCOMP TSP brochure.

Modular Computer Systems, 1650 West McNab Road, Ft. Lauderdale, FL 33309. Phone (305) 974-1380. TWX: 510-955-9820.

European Headquarters: Export House, Woking, Surrey, England. Phone (04862) 71471. Telex: 859348.

# MODCOMP TSP\*

**\*TSP=Total Systems Performance.**

MODCOMP SALES OFFICES: ALBUQUERQUE, NM/ATLANTA, GA/BOSTON, MA/CHICAGO, IL/CINCINNATI, OH/DALLAS, TX/DENVER, CO/DETROIT, MI/ HOUSTON, TX/HUNTSVILLE, AL/INDIANAPOLIS, IN/KANSAS CITY, KS/LOS ANGELES, CA/MONTREAL, CN/NEW YORK, NY/ ORLANDO, FL/ PHILADELPHIA, PA/PITTSBURGH, PA/ROCHESTER, NY/SAN JOSE, CA/SEATTLE, WA/TORONTO, CN/WASHINGTON, DC/ INTERNATIONAL OFFICES OR REPRESENTATIVES IN ENGLAND/FRANCE/BELGIUM/WEST GERMANY/NORWAY/SWEDEN/JAPAN

CIRCLE 120 ON ENQUIRY CARD

PRINTED IN U.S.A.

## Tymshare, Inc.

**OFFICERS:** *T.J. O'Rourke*, President and Chairman. Vice Presidents: *Ronald W. Braniff*, Marketing; *Albert A. Eisenstat*, Administrative Services; *Edward J. Field*, Treasurer; *Bernard Goldstein*, Corporate Development; *Alden R. Heintz*, International and Corporate Operations; *Warren F. Prince*, Data Services; *Laszlo Rakoczi*, Technical Research and Development.

**BACKGROUND:** Computer time sharing was just beginning as a commercial service when Tymshare, Inc. was incorporated in January, 1966, by cofounders Thomas J. O'Rourke and David L. Schmidt, both formerly with GE's computer division. In 1970, the year of its first public stock offering, Tymshare began its own international data communications network, Tymnet, which now reaches about 80 cities in the U.S. and Western Europe from its operational center in Cupertino. The company added to its interactive time sharing and communications services in December, 1974, when it acquired United Data Centers, Inc., a commercial batch processing firm. In 1975 Tymshare acquired both Leasco Response and Quelex Data Systems, which it combined with its Valcomp equipment repair and parts supply organization. The company moved into the international sphere when it licensed CEGOS-Tymshare in France to market its services in Europe and formed Tymshare UK in conjunction with Unilever. Tymshare now employs about 1200 persons.

**FACILITIES:** Corporate headquarters and major administrative facilities occupy 60,000 ft<sup>2</sup> leased in Cupertino, CA. Other major facilities include computer centers at Cupertino and Palo Alto, CA; Houston, TX; and Valley Forge, PA. There are also 15 batch data centers located mostly in the eastern half of the country. Tymshare maintains sales offices serving more than 40 major U.S. cities. The company's Valcomp division is centered around division headquarters and laboratory and warehousing facilities at Westlake Village, CA. Headquarters for the company's batch data processing services through the Data Centers Division is at Wichita, KS, in conjunction with a major data center and the Dynatax service development center. Overseas facilities operated by affiliated companies include headquarters and equipment operations of Tymshare, U.K., in London; the CEGOS-Tymshare headquarters and computer center near Paris; and other CEGOS service offices in Brussels, The Hague, and Lausanne.

**PRODUCTS/SERVICES:** Tymshare provides a broad range of added-value computing and information services, all of which may make use of Tymshare's computers, communications network, information terminals, applications software packages and programming languages, and customer training and support personnel. One classification of Tymshare services focuses on the service modes: *Interactive* remote computing for information analysis and data management, *remote* batch data processing or remote job entry, *facilities* management, *local* batch data processing, and shared network use. Specialized information or applications systems development and programming is provided under contract by the TASC (Tymshare Applications Systems Consulting) group to customers who then run their systems on Tymshare facilities. The Tymnet data communications network presently consists of 140 communications processors connected to 60,000 miles of leased private telephone lines. Recent product introductions include an online

market research service called SURVEY, a securities information data base for investment counselors called TYM-QUOTE and a data base management system called MAGNUM. Other services are available for cash and project management, sales order tracking, inventory control and production planning, analyses and control, and data consolidation and reporting. Batch mode services include general ledger and payroll as well as specialized professional packages. Tymshare supports existing computer installations with complete maintenance, repair and refurbishment services for mainframe and peripheral equipment.

**CURRENT POSITION:** Tymshare considers itself to be the largest *independent* remote computing services firm. Interactive time sharing provides the major source of company revenue, with remote batch and remote job entry becoming increasingly significant. Tymshare has expanded from its engineering and scientific orientation to the extent that those customers now make up only 20 percent of the user base. The approximate 4000 organizations using Tymshare services today represent 40 different types of businesses and industries. Tymshare's typical customer is a medium to very large firm, representing \$2000 per month in revenue.

**OUTLOOK:** Computer services revenue for 1975 was estimated between \$3 and \$4 billion by Research-West, a California-based research firm. According to the firm's study, the industry growth rate has averaged 25 percent in recent years and is expected to ease to a 15 to 20 percent annual rate in the future. By 1980, computer service revenues should reach \$7 to \$8 billion. Local batch processing will give way to remote batch processing, which is expected to show a 30 percent annual growth rate between now and 1980. Tymshare has consistently bettered the industry growth rate and expects to continue this due to its breadth of service and broad customer base. The company has made several major acquisitions in recent years and will continue to make "compatible acquisitions" to complement internal growth.

**FINANCIAL SUMMARY:** The company made a public offering of 600,000 shares of its common stock on September 24, 1970, at \$6.00 per share. In addition, 205,317 shares were offered on behalf of certain shareholders on December 19, 1973, at \$7.125 per share. Approximately 3.7 million shares were outstanding at year-end 1974. Additional shares have been issued in connection with acquisition agreements. Cash position was approximately \$3.6 million at year-end 1974 including marketable securities. Long term debt stood at \$2.5 million a year-end 1974 and continues to decline. The years 1970 and 1971 now show as unprofitable due to the pooling of interests in connection with the United Data Centers acquisition. Shareholders' equity was \$15.3 million at year-end 1974. Cost of sales has remained relatively consistent at approximately 40 percent of revenues.

Period	Revenues	Earnings	Earnings per Share
FY 12/31/70	16,200,000	(600,000)	(.22)
FY 12/31/71	19,400,000	(700,000)	(.22)
FY 12/31/72	24,200,000	1,500,000	.42
FY 12/31/73	35,200,000	2,700,000	.71
FY 12/31/74	46,500,000	3,300,000	.89
9 mos. 9/30/74	34,352,716	2,426,214	.65
9 mos. 9/30/75	42,058,573	3,499,620	.91

## HARRIS NEGOTIATES WITH SINGER

Notwithstanding numerous second-hand reports of prospective buyers for all or parts of The Singer Company's POS and computer operations, at this writing only one has officially announced negotiations. The Harris Corp. said it reached preliminary agreement with Singer to acquire M&M Computer Industries, Inc. of Orange, CA, a Singer subsidiary that produces remote batch processing terminals. No buyer has yet been found for Singer's business machines facility in San Leandro, CA, where at least 300 Singer employees are currently scheduled for termination in mid-March.

## FAIRCHILD, CAMBRIDGE SETTLE LAWSUIT

Fairchild Camera & Instrument Corp. announced an agreement for settlement of a lawsuit brought by the company last August against Cambridge Memories, Inc. The suit had asked payment plus interest for semiconductor components delivered by Fairchild to Cambridge over the first six months of 1975. The claim was for more than \$1 million. The settlement calls for payment over the next 10 months of an amount less than that claimed, and includes an agreement reopening business relations between the two companies by providing for future purchases of Fairchild products by Cambridge.

## MERGERS AND ACQUISITIONS

**Centronics Data Computer Corp.** (Hudson, NH) has agreed in principle to acquire **Data Printer Corp.** (Cambridge, MA). The acquisition would put Centronics, currently the leading independent producer of serial impact printers, in the high-speed line printer market as well . . . . .  
**Data Technology Corp.** of Santa Ana, CA, and **Penril Corp.** of Rockville, MD, have consummated the previously announced purchase by Penril of DTC's **Data Instrument Division**. The Division manufactures digital panel meters, digital multimeters, chart recorders, A-to-D converters and a line of logic modules. . . . .  
**Tymshare, Inc.** of Cupertino, CA, has completed the acquisition of two firms, and called off merger discussions with

two others. The new acquisitions are **Quelex Data Systems, Inc.** of Northridge, CA, which will combine operations with Tymshare's Valcomp Division (equipment repair and parts supply); and the U.S. timesharing division of **Leaseco Response Inc.**, a subsidiary of Reliance. Discussions were terminated with **Major Computer Corp.** of Long Island, NY, and **AutEx, Inc.**, a

financial data service located near Boston, MA . . . . .  
**Xerox Corp.** has acquired **Versatec, Inc.** of Santa Clara, CA, a manufacturer of electrostatic printers and plotters. Cost of the acquisition to Xerox was approximately \$19 million in stock . . .  
**Universal Information Systems, Inc.**, a Paramas (NJ) based multi-service corporation, has acquired **Microfax, Inc.**,

## BOX SCORE OF EARNINGS

COMPANY	PERIOD	REVENUES	NET EARNINGS (Loss)	EARNINGS (Loss) PER SHARE
Anderson Jacobson	9 mos. 12/31/75	12,771,133	646,663	.26
	12/31/74	9,431,163	478,261	.19
Automatic Data Processing	6 mos. 12/31/75	86,317,000	7,914,000	1.13
	12/31/74	72,826,000	6,334,000	.91
Computer Automation	6 mos. 12/28/75	14,364,522	1,371,966	.73
	12/29/74	10,251,184	515,901	.31
Computer Communications	3 mos. 9/30/75	1,471,626	158,901	.06
	9/30/74	1,367,469	103,062	.04
Computer Sciences	39 wks. 12/26/75	158,000,000	5,105,000	.36
	12/27/74	128,076,000	2,379,000	.17
Comshare	6 mos. 12/31/75	6,675,093	404,280	.30
	12/31/74	5,640,059	788,011	.58
Control Data	12 mos. 12/31/75	1,246,369,000	41,476,000	2.44
	12/31/74	1,101,142,000	(1,226,000)	(.18)
Data General	12 wks. 12/20/75	29,023,000	3,501,000	.37
	12/20/74	24,119,000	2,816,000	.35
Datapoint	12 mos. 7/31/75	46,890,000	4,567,000	2.43
	7/31/74	34,063,000	3,401,000	1.84
Dataproducts	9 mos. 12/27/75	61,688,000	4,882,000	.72
	12/28/74	65,229,000	4,291,000	.63
Digital Computer Controls	9 mos. 11/30/75	7,849,506	382,306	.25
	11/30/74	7,666,547	167,174	.11
Graham Magnetics	6 mos. 12/31/75	8,174,610	600,563	.64
	12/31/74	8,248,293	662,982	.70
Honeywell	12 mos. 12/31/75	2,777,930,000	77,826,000	3.96
	12/31/74	2,621,576,000	67,131,000	3.48
Inforex	9 mos. 9/26/75	41,462,000	602,000	.21
	9/27/74	35,633,000	164,000	.06
Keydata	3 mos. 10/31/75	3,663,000	209,000	.08
	10/31/74	3,154,000	34,000	.01
Logicon	9 mos. 12/31/75	24,306,000	617,000	.72
	12/31/74	26,000,000	556,000	.65
Mathematica	3 mos. 9/30/75	3,868,400	187,800	.27
	9/30/74	3,486,500	222,900	.32
National Semiconductor	28 wks. 12/14/75	162,280,000	10,900,000	.83
	12/15/74	130,181,000	9,333,000	.77
Raytheon	12 mos. 12/31/75	2,245,445,000	70,973,000	4.69
	12/31/74	1,928,855,000	57,751,000	3.85
Recognition Equipment	12 mos. 10/31/75	59,254,000	3,375,000	.58
	10/31/74	42,913,000	2,087,000	.39
Scientific Atlanta	6 mos. 12/31/75	20,375,000	809,000	.59
	12/31/74	16,058,000	515,000	.40
Sykes Datatronics	9 mos. 11/30/75	2,313,635	95,134	.10
	11/30/74	2,435,446	102,973	.11
Wang Laboratories	6 mos. 12/31/75	42,248,000	2,161,000	.53
	12/31/74	33,896,000	1,615,000	.40
Wyle Laboratories	9 mos. 10/31/75	89,195,000	1,257,000	.38
	10/31/74	100,833,000	2,462,000	.72



a microfilm services corporation located in Hillsdale, NJ . . . . .  
**University Computing Co.** has discontinued negotiations for the sale of its banking division to Boeing Computer Services, Inc., a subsidiary of The Boeing Company. The two companies announced in November that an agreement in principle for the sale had been signed. Instead, UCC, a subsidiary of Wyly Corp., said an agreement in principle has now been signed to sell the banking division to **Optimum Systems, Inc.**, a computer services firm headquartered in Santa Clara, CA . . . . .  
**Western Peripherals** (Anaheim, CA) has agreed in principal to acquire the assets of **Kastle Industries**, an electro-mechanical assembly services firm also located in Anaheim.

**BUNKER RAMO SELLS NASDAQ**

Bunker Ramo Corp. has sold, for approximately \$10 million, the NASDAQ system for reporting over-the-counter securities to the National Association of Securities Dealers. Concurrent with the sale, the company signed a four-year agreement with the NASD to provide continued technical services, including maintenance of NASDAQ subscriber equipment. Bunker Ramo said it expected that revenues during the first year of the agreement would be approximately \$4 million.  
 The company designed, built, and for the past five years has been successfully operating the NASDAQ system.

**DG ABUILDING**

Speaking at Data General's annual meeting, President Edson de Castro told stockholders that 1976 "clearly appears to be a time of renewed growth and resource expansion." Clearly is right. Within the space of three weeks, the minicomputer firm made three separate announcements of expansions: a 74-acre land purchase and plans for a \$5 million corporate headquarters in Westboro, MA; the purchase and lease of facilities that will add 39,000 ft.<sup>2</sup> adjacent to DG's present headquarters in Southboro, MA, and another 55,000 ft.<sup>2</sup> in nearby Framingham; and an agreement to purchase 50 acres of land and a 105,000 ft.<sup>2</sup> building in Portsmouth, NH.

The company is only keeping pace. Last year Data General achieved \$108.2 million in sales, a 30 percent increase

over all of fiscal 1974. And the first 12 weeks of this fiscal year produced sales of \$29,023,000, a 20 percent increase over the same period a year earlier.

**BELL TO SPEND \$10 BILLION**

The Bell System will spend some \$10 billion in 1976 for growth and service improvements, up from \$9.5 billion this year. John D. deButts, American Telephone and Telegraph Company

board chairman, said that new money requirements are down to \$2.9 billion this year from \$4.1 billion in 1974. Mr. deButts attributed the decrease in part to the increased investment tax credit which will enable the company to generate approximately 70 percent of its capital requirements internally this year. This compares to 60 percent that was internally generated in 1974 and as little as 44 percent in 1970.

# DATA PROCESSING PAPER PROBLEMS?

- Conventional Size Computer Printout Difficult to Handle?
- Cost of Office and Storage Space Increasing?
- Paper Costs Soaring?

## Computer output is EXPENSIVE!

Want Xerox® photo-reduction copies without Xerox® cost?

Eliminate excessive paper costs and expensive post-printout copy reduction with

### Potter's LP7000 Printer with GRAND SLAM OPTION

Print 15 characters per inch (132 columns) on 8 1/2 x 11" size paper. Operates at 1500 Lines/Minute.

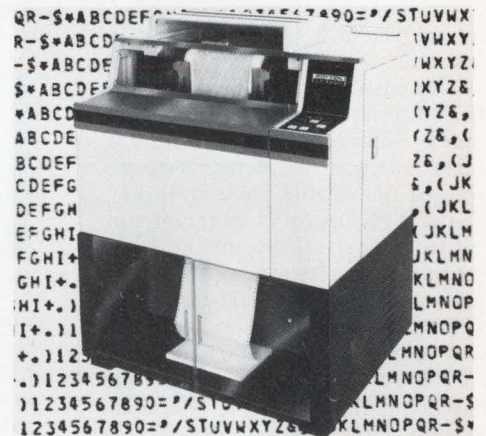

NATIONWIDE SERVICE ON INSTALLED BASE PROVIDED BY RAYTHEON SERVICE COMPANY

## Here is a unit that is OEM or IBM 1403 Plug-Compatible which PUTS YOU AHEAD FIVE WAYS

- 1 PAYS ITS OWN RENT – Saves 40% of your former paper costs
- 2 Provides easy to read, easy to handle output on 8 1/2" x 10 5/8" Paper WITHOUT XEROGRAPHIC REDUCTION
- 3 Prints Faster – Better than 1500 LPM
- 4 Print Quality Equal to IBM 1403 at 2/3 Size
- 5 Saves Floor Space – 7.7 Sq. Ft. Total Required



**POTTER  
 INSTRUMENT  
 COMPANY, INC.**

Contact: Sales Department

151 Sunnyside Boulevard • Plainview, N. Y.

516 Overbrook 1-3200

CIRCLE NO. 6 ON INQUIRY CARD

**CUSTOM-DESIGNED  
TERMINALS**

Megadata Computer and Communications Corporation (Bohemia, NY) has developed a new programmable intelligent terminal, System 700, which includes a full 12-bit minicomputer with up to 64K storage for program and data. According to John Hill, Megadata's VP of Sales, virtually every aspect of the terminal's operation is program-controlled, giving the user the versatility



to implement a system that is "application designed" to meet his specific needs and system requirements. In addition to a full 12-bit minicomputer, Megadata System 700 features include a 15-inch diagonal screen, detachable solid state keyboard with up to 71 program controlled function keys and 12 status indicators, software compatibility with existing CPUs, and user-specified communication conventions with speeds up to 38,400 baud serial and 20,000 characters per second parallel. Pricing of the Megadata System 700 is determined by the application requirements of an individual user.

Circle No. 86 on Inquiry Card

**WESTERN UNION EXPANDS  
HOT/LINE SERVICE**

Western Union announced an expansion of its popular Hot/Line point-to-point telephone service, with seven new cities and 61 new city pairs added to the existing Hot/Line network. The announcement was contained in a tariff revision filed with the FCC. The seven new Hot/Line cities are Austin, Baltimore, Buffalo, Syracuse, Wilmington, Cincinnati and Philadelphia. The nodial Hot/Line Service, in which the user lifts the handset to automatically ring his designated location, will link 92 city pairs in the U.S., and New York to Montreal and Toronto.

**UCC CHOSEN FOR RCA SATCOM**

University Computing Co. has been chosen to provide computing services for the orbital insertion of the RCA "Satcom" communications satellite. The Satcom launch is the first of two planned by RCA Astro-Electronics Division for RCA Globcom. RCA/AED built the communications satellite and is responsible for positioning it. Space Applications Corp. has contracted to develop the Univac 1108 software and the interface to the tracking computer in the operations control centers. UCC's responsibility includes providing "super express priority" for attitude and orbit determination runs during the transfer orbit phase of the mission.

**MODEM SHARER**

A modem for polled system users allows four or more terminals to share a single modem. Designated the SMS-1, it can be used with any terminal that can operate in a polled environment and is compatible with all synchronous data sets and modems. Each terminal



must be addressable and not raise its Request-to-Send (RTS) lead until it has been addressed. Once a terminal has requested service, all other terminals connected to the SMS-1 are "locked out." When a terminal begins transmission, the RTS lead initiates a timer. If the terminal does not relinquish the line before a customer-selected interval (usually 30 seconds), SMS-1 will automatically drop that terminal from the line and free the system for other users. If any terminal inadvertently short circuits any of the following leads to ground, it will only affect the operation of that terminal and allow the rest of the system to function normally. Each SMS-1 regenerates to RS-232 levels all critical signals between modem and terminal, eliminating any signal strength loss normally caused by cable length or number of modem sharers. SMS-1's may be connected in tandem to expand to any number of terminals served. There is no limit to the number of levels. SMS-1 configured to handle four terminals is priced at \$385. Contact *SKEI Corporation, Columbia, Missouri, 65201.*

**AT&T FILES RATE INCREASE**

As a regulated monopoly, AT&T is allowed to keep its earnings at certain levels. In January, the FCC told AT&T it could raise its interstate rate of return from 8.74 to 9.5 percent. So AT&T filed for rate increases with the FCC affecting most interstate private line services and about two-thirds of out-of-state long distance calls. Included are increases for WATS, MTS and short-haul private lines services (station terminal, channel terminal and interexchange mileage). According to the Center for Communications Management (Ramsey, NJ), this rate increase further restructures MTS and WATS by putting an increased burden on short-haul customers. Interstate mileage bands have been redefined and international mileage bands for Canada and Mexico have been modified.

**NEW DATASPEED 40  
STILL ON HOLD**

AT&T must still wait to market its latest model Dataspeed 40. The FCC Common Carrier Bureau is actively examining the requested tariff after objections were raised by IBM, the Computer and Business Equipment Manufacturers Association (CBEMA) and the Computer Industry Association (CIA). The IBM forces are seeking denial or suspension of the tariff on the basis that AT&T is entering the competitive data processing field under regulatory protection (see last month's MODERN DATA). AT&T, which planned to have the tariff effective in December, now has to wait another month - until March - while the FCC tries to determine where communications stop and data processing begins.

**AT&T MUST LET  
COURTS DECIDE**

AT&T's major defense against the anti-trust suit filed by the Justice Department in 1974 was that only the FCC, not the courts, had jurisdiction over AT&T as a regulated monopoly. However, the FCC has replied that the Justice Department can prosecute for anti-trust violations, but should stay away from areas such as determining who should be allowed to enter the communications industry, deciding on interconnection orders and approving tariffs. The FCC urged the court to take no action that would substantially change the industry structure without initial consideration by the FCC. In other words, the case can be heard by the courts, but the ultimate authority still rests with the FCC.

# DP Dialogue

Notes and observations from IBM that may prove of interest to data processing professionals.



*An integrated data base approach like AEIMS helps Martin Marietta design and produce the Titan III Space Launch Vehicle.*

## A New Data Base Concept for Engineers

High personnel costs . . . stringent reliability requirements . . . expanding documentation needs. They all make it increasingly important for engineering firms to assure that up-to-date, accurate information is readily available to every user within the organization.

Traditionally, many engineering and manufacturing companies have treated every department as a separate entity.

Each would have its own data base and computer programs. With that approach to information handling, however, data corrections or modifications made in one area might have taken a week or longer to reach other departments. The impact on the company's ability to respond to an urgent bid request, or to solve a production problem, could be critical.

To help improve the speed and accuracy of communication between departments, IBM has developed the Administrative Engineering Information Management System (AEIMS) concept. It is a terminal-oriented approach to storing and updating information in a central data base . . . from initial contract award to final product.

The AEIMS concept is designed to eliminate the need for redundant data files, enable many different users to share information when they need it, and help prevent the discrepancies that often crop up in separate data bases.

The Data Systems division of Martin Marietta's Aerospace Group in Denver has already established a system using a similar concept. Called the Technical Requirements Management System (TRMS), Martin Marietta's data base approach is made up of various subsystems corresponding to the functions of requirements identification, planning and scheduling, configuration verification, document status and parts data. The TRMS system uses IBM's Information Management System (IMS) which runs on Martin Marietta's System/370 Model 168 computer based in Orlando, Florida.

"Our greatest administrative problem used to be lack of crosstalk among departments," says David Lucero, chief of configurations management operations. "Now that data entry and corrections can be made directly at our IBM 3270 display terminals, we can operate with the assurance that all of us have exactly the same up-to-date information."

Another benefit is reduced paper generation. Instead of requesting extensive reports on a scheduled basis and then analyzing them manually, people in each department can now select the specific information they need, when they need it.

From an operational point of view, Don Edmunds, TRMS product manager for data systems, says: "Our data base system was developed in close consultation with users. As a result, it is flexible enough to be effective for everything — from our smallest to our most complex projects. Most importantly, the system costs are being recovered through productivity gains."

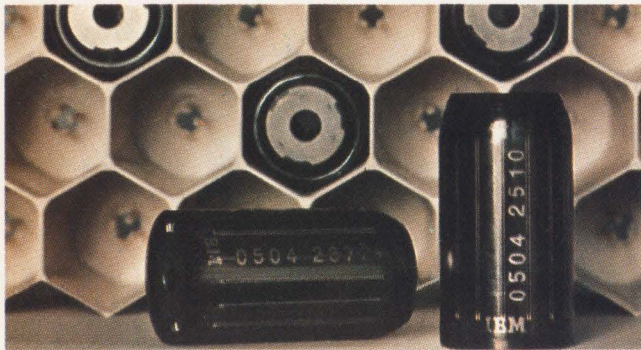

The 3850 Mass Storage System is a revolutionary new way to put vast amounts of data under system control, resulting in fewer errors and lowered operating costs.



The 3344 and the 3350 contain about twice as much data per square inch as the 3330 Model 11, while for most users the cost per megabyte is typically cut in half.

## Putting Storage Systems Under the Microscope

Because of the importance of storage to the entire data processing function, new developments in storage devices are causing users to take a fresh look at their overall storage systems. As part of such studies, IBM has been assisting with in-depth analyses of the performance of storage installations. The ultimate aim is to determine the optimum storage configuration for each installation.

These comprehensive storage system evaluations go far beyond the speed and cost of specific devices. They include factors such as supplies, labor and the cost of error recovery. They are based on comprehensive records of actual usage, generated in most cases by IBM Systems Management Facilities (SMF), an adjunct of the computer operating system that logs performance.

The evaluations answer questions such as: Which data sets are employed most frequently? What is the average data set size for tape and disk? Can high density recording increase system performance?

Results of such studies may be expressed in detailed reports accompanied by usage graphs. Taking into account the nature and objectives of the installation, the studies can lead to recommendations for achieving maximum storage efficiency through the best possible combination of devices.

The systems analysis and recommendation approach worked out quite successfully for the large installation at Trans World Airlines in Kansas City, Missouri. According to Richard D. Pearson, TWA staff vice president—commercial data processing, "We have already begun to achieve the efficiencies and cost savings anticipated in the original study."

be placed in a "virtual online mode" under direct system control with the MSS. That is the equivalent of 4,720 disk packs (3336 Model 1)—all accessible without manual intervention and at sharply reduced costs per megabyte transferred.

An important characteristic of both the 3344 and the 3350 is fixed-media technology—non-removable sealed head/disk assemblies. Since there are no disk packs or data modules to mount, efficiency and security are improved. And fewer mechanical parts and less restrictive tolerances are an aid to reliability.

### Where Fixed-Media Storage Fits In

IBM studies have shown that a growing number of users, particularly those with large installations, rarely if ever change many of their disk packs. For all practical purposes, once they mount a disk pack containing application data, it remains online for as long as they plan to use it.

It's in installations like these that the fixed-media 3344 and 3350 can take over important areas of disk storage and provide improved direct access storage performance at new low costs per megabyte. However, portable storage media—the 3330 and the 3340—will continue to be needed to meet special requirements.

In the IBM storage spectrum, each type of product has a function at which it excels. Together, in the right configuration, they can handle the complete range of storage requirements for any given installation. It is to make sure that each configuration represents the utmost in overall efficiency that IBM helps with comprehensive storage system evaluations. Information on them can be obtained through the IBM Data Processing Division branch office.

### Dramatic Advances In Storage Devices

Behind these analyses is a story of continuing progress in IBM storage. Particularly noteworthy are the 3850 Mass Storage System (MSS) and the 3344 and 3350 Direct Access Storage, which have made possible greatly improved price/performance levels for direct access storage.

The 3850 MSS can be thought of as providing "virtual" capability for direct access storage devices, much as virtual storage (VS) does for mainframe storage. Up to 472 billion bytes can

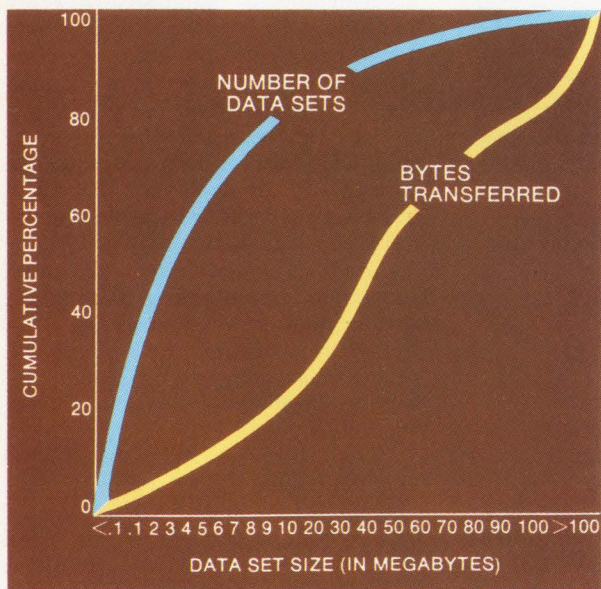

For a typical installation, this graph shows cumulative percentages in terms of number of data sets and bytes transferred. Note that the many small data sets contribute only a small part of the total data transferred.

## 24-Hour Banking Is a Hit in Baton Rouge

Pay day is Friday. But now pay day is different.

You get your pay check before lunch hour, as usual—but you no longer need rush to the bank before it closes.

Instead, you can deposit your check at any time you choose over the weekend and withdraw cash at the same time. How? With an online, full service teller machine called the IBM 3614 Consumer Transaction Facility.

In Baton Rouge, Louisiana, this kind of convenience is a reality for customers of the Fidelity National Bank. Fidelity's six 3614s stand ready to accept deposits to checking and savings accounts and dispense cash from them 24 hours a day, seven days a week.

"In fact, our 3614s can handle almost any teller transaction," says Frank S. Craig Jr., president of the Fidelity National Bank of Baton Rouge. "That includes transferring funds from one account to another, accepting installment loan payments and informing customers of their current account balances. You can even order a new supply of checks through them."

Five of Fidelity's machines are "through the wall" models located at branch banking offices, while the sixth



A 3614 automated teller machine in use around the clock at Fidelity National Bank at Baton Rouge, La.

is in the lobby of the main office. All it takes to operate them is a magnetically encoded plastic card, which the bank makes available to its customers, together with a personal identification number. The customer inserts the card

in a slot in the 3614 and keys in his personal ID number. Simple instructions for each step of a transaction appear on a display panel in the machine.

"The public reception of the 3614s  
(Continued on next page)

## Environmental Research Aided by TSO



Alive and well in Redondo Beach, this starfish lives in a mixture of ordinary and recycled sea water.

For snails, starfish and sea urchins who live in the King Harbor area of the California coast, life has never been better. At least that's what studies of the sea creatures seem to indicate to scientists at Southern California Edison.

According to Kevin A. Muench, chief marine research scientist and director of the utility's Redondo Beach laboratory, preliminary results of a novel research program show that growth of marine life is expanding, due to the warmer temperatures of water that has been used to cool power plant condensers and has then been returned to the harbor.

Key to the study is the interactive IBM Time Sharing Option (TSO), together with PL/1, a powerful IBM language. Using them, scientists can speed data to the central computer for analysis and return. Throughout Southern California Edison, some 250 people—including scientists and engineers involved with construction and power

supply, and financial and customer service personnel—can sit down at remote terminals and communicate directly with the computer whenever they need to.

Robert Umbaugh, Edison's data processing manager, reports, "By putting TSO on System/370 Model 168, we've eliminated outside timesharing charges of \$400,000 a year. TSO, PL/1 and VS BASIC have made the computer as much a part of the engineer's tools as a desk or pencil. With them we're getting a lot more for less."

While long active in marine monitoring, Southern California Edison began its specific research program at Redondo Beach over a year ago to assess any potential disruption of biological patterns caused by water which returns to the harbor several degrees warmer.

The long-range goal of the program is predictive biological modeling, which will help the utility plan and operate future power plants in ways that will maintain a balanced marine life.

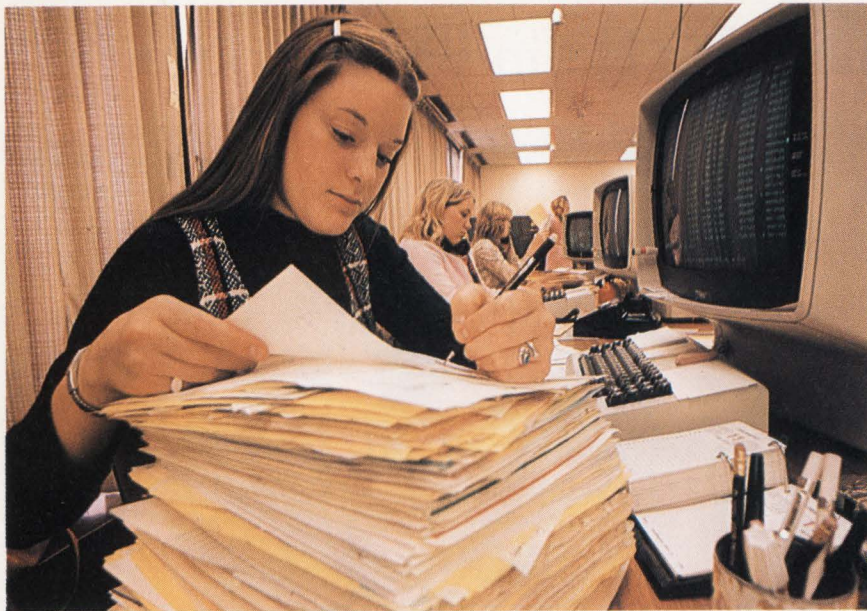

Using a new computerized mail tracking system, clerks enter information regarding incoming requests directly into IBM 3277 Display Stations at National Guardian Life Insurance Company.

## Computerized Mail System Tracks Customer Correspondence

Over 3,000 pieces of mail—many of which require immediate responses—arrive every morning at the National Guardian Life Insurance Company in Madison, Wisconsin. By noon, all the mail has been opened, sorted, logged, categorized according to request and distributed to the appropriate department.

“The key to our new control system is a computer program designed to keep track of all our correspondence through every stage of processing,” says Spencer Francis, director of systems and data processing. “Using the computer, we can locate a file immediately, simply by typing in the name of the policyholder at a terminal, with-

out making phone calls to five or six different departments.”

Before using the computer, all written requests were handled by jotting down a policy number and a brief description of the request on ordinary index cards. But as Francis comments, “Index cards have a way of getting lost. Besides, it took a great deal of time for our clerks to sort through all the cards to check on the status of a request.”

Under the new “Call-Up” program, every incoming letter is assigned a unique file number which includes a code indicating the nature of the request such as policy changes, accounting changes or general maintenance.

This number, along with the name of the policyholder or the agent who wrote the letter, is entered into the company’s IBM System/370 Model 135 via several 3277 Display Stations in the records department. The department to which the file is sent is also noted, so that any file can be located within seconds.

In the case of a request for a change of beneficiary, for example, the letter is routed to the policy change department which responds by sending out the correct forms. That information, along with a follow-up date to check on whether the completed forms have been received, is entered at a 3277 terminal handling policy changes. A daily list of files which have reached their follow-up dates is printed and sent to the relevant departments.

“With this system, we can find out the status of a request within seconds, simply by keying in a name at the terminal,” says Francis. “It has also been a tremendously effective tool to help us spot potential bottlenecks and keep an accurate record of the number of requests handled by each department.”

In addition to current status of change requests, information about more than 120,000 policy files can be accessed at the terminals. The company’s data base also includes files retained for five years after they become inactive, as well as new policy applications and information regarding National Guardian’s investment portfolio.

The Call-Up program took only a few months to write and test according to senior systems programmer Jim Hartman. “The 3277 terminals are particularly well suited to our operation—very fast and flexible. And our people were able to learn how to operate them within a few minutes,” he adds.

“Agents have been impressed with our faster response time,” says Francis. “We feel the system gives us a valuable competitive edge in providing a high level of service for our customers.”

## 24-Hour Banking...

(Continued from preceding page)

has been tremendous,” says Mr. Craig. “We haven’t been able to keep up with the demand from our customers for their cards. It seems that ‘anytime banking’, as we call it, meets a real need, especially on weekends. We’re particularly pleased that deposits through the 3614s have exceeded withdrawals.”

In recent months, the full-function 3614 has been installed at a number of

banks and financial institutions across the country. It is part of the IBM 3600 Finance Communication System, a family of terminals designed to speed and simplify banking operations.

At Fidelity, installation of the 3614s was preceded by the development of an integrated Customer Information File (CIF), through which information on every customer and type of account can be accessed both by the 3614s and by IBM display terminals. Fidelity is proceeding with plans for a complete online teller network as the next phase in implementing the 3600 system.

*DP Dialogue appears regularly in these pages. As its name suggests, we hope DP Dialogue will be a two-way medium for DP professionals. We'd like to hear from you. Just write: Editor, DP Dialogue, IBM Data Processing Division, White Plains, N.Y. 10604.*

**IBM**<sup>®</sup>

Data Processing Division

## COMMUNICATIONS INTERFACE

Data Works Instrumentation (Chatsworth, CA) is offering the RS-232 Interface Model 6600A that provides a means of adding an RS-232 communications interface to existing paper tape equipment. It is said to be a truly compatible controller for paper tape readers, magnetic tapes and floppy disks. The

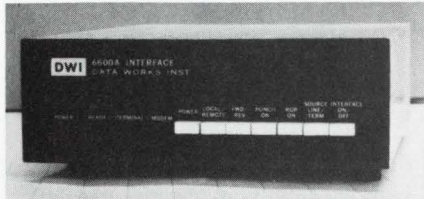

controller accepts remote commands over the RS-232 line, provides control signals to the paper tape equipment, and transfers data to/from the paper tape unit. For storing data on a floppy disk, the unit transfers data from the line and puts it onto the disk, and when required, reverses the process. Incremental magnetic tape recorders are handled in the same manner as paper tape punches. One of the principal features of the Model 6600A is that it accepts a two-character sequence for each remote command. The first character is fixed as the ASCII escape character and the user may select the second character. They are stored in a plug-in PROM and can be changed at any time.

## MONITOR/SIMULATOR

Digitech Data Industries (Ridgefield, CT) has introduced a portable data line monitor/simulator, called Pacer-103, which gives the user a first hand look at his data stream at the RS-232 interface. The results are displayed in a 32-



character alphanumeric window (and a two-character Hex display). The unit also analyzes communication problems by simulating DCE and DTE in a polling/response environment. This active capability is software based and, as such, is said to offer a great deal of versatility in the simulation of nearly all communication equipments now in place or planned.

## MODCOMP'S NEW REMOTE TERMINAL SYSTEMS

A new family of low-cost remote terminal systems, designed to combine the remote job entry capability of intelligent batch terminals with the local batch capability of medium-scale computer systems, has been introduced by Modular Computer Systems, Inc. (Fort Lauderdale, FL). Designated MODCOMP RTS, the new family, which consists of three systems of increasing capability, is said to provide for the first time, a complete remote terminal system at a price comparable to a less capable intelligent batch terminal. In addition to providing the same benefits as those offered by the typical intelligent terminals, i.e., the accommodation of additional manufacturers' protocols; more efficient protocols; additional peripherals and increased diagnostic capabilities, the MODCOMP RTS family enables much of the computing load currently being transmitted to a large central computer to be executed locally. Additional functions such as program/data preparation, local file maintenance, data validation and

preprocessing can be performed locally. "Previously the relatively high cost of a system to perform these functions forced many remote users to acquire hard-wired terminals and rely exclusively on the remote central computer and communications facilities to perform their computing functions," said Edward Marinaro, MODCOMP's head of marketing. "However, the downward price trend in small-to-medium scale computers, combined with MODCOMP's emphasis on providing superior operating systems, batch processors, libraries and utility processors has enabled the company to develop remote terminal systems that will satisfy the most demanding requirements," he explained. The MODCOMP RTS models offer the more popular terminal emulations, including the IBM 2780/3780, IBM HASP Workstation, CDC 200 UT and Univac 1004 as well as local batch processing capability. All systems include disk storage, card readers, line printers, CRTs and at least 64K bytes of core memory. Options include magnetic tape and faster card readers and line printers.

## Creative solutions to data display

There are plenty of companies that will sell you CRT display terminals. Ann Arbor is one of them. We manufacture a full line of CRTs. But where do you go if you have a tough application? One that requires engineering assistance, a customized keyboard, a unique character set, or a special mounting? That narrows the field considerably. At Ann Arbor, that's what we do best. And we can usually do it for less.

Of course, even if you don't have a problem, we'll be glad to talk to you about our broad line of standard products. We've designed our product line to let you buy at your own level. Whether

you need barebones board sets, our rugged Series 200 case for industrial applications or our Design III desktop terminal. Available in KSR and RO versions with a wide choice of options including graphics.

See our listing in the 75/76 EEM, Volume 1, Pages 134 through 140, or contact us direct.



**ANN ARBOR**  
TERMINALS, INC

6107 Jackson Road  
Ann Arbor, Michigan 48103  
(313) 769-0926 • TWX: 810-223-6033

**MILGO AND ITS MODEMS**

Armed with its recent patent suit victory over United Telecommunications, Milgo Electronic Corp. has now gone after the giant - AT&T - and a host of others. The original modem patent suit against United Business Communications, a United Telecommunications subsidiary, was filed in 1971 in the U.S. District Court of Kansas. Three patents for modems invented by employees of Milgo subsidiary, International Communications Corp. (ICC), were involved. One modem invented by Sang Whang used the narrow band concept of data transmission, which allows modems to transmit high-speed data over voice-grade telephone lines. The other two patents involved improvements in analog detectors. The Kansas District Court found, "No prior art modems or references ever taught the industry to use only a small narrow part of the line so that within that part all the lines look alike and dependable." Regarding the other two patents, the court found them "to represent significant and non-obvious improvements over the analog detectors." Although no damages were awarded, the court said Milgo's patents had been violated

and Milgo therefore had the right to sue and recover for past infringement.

Considering that many modems today seem to use this patented technology, Milgo had a number of potential victims to choose from. For starters, Milgo sought injunctions against Western Electric for manufacturing data set Models 208 and 209 (4800- and 9600-bps modems) and against AT&T and its subsidiary Southwestern Bell for distributing them. In the suit filed also in the Kansas District Court, Milgo cited two of the patents upheld in the first suit and two additional patents for direct distance dialed and modulated modems.

Milgo didn't stop there either. In a counteroffensive move, Milgo filed a declaratory relief suit against Codex in California. Codex had recently filed a suit against Milgo stating that ICC's 96 Multimode modem infringed on a recently issued Codex patent. Milgo wants the patent declared invalid and noninfringed.

In companion actions, Milgo then filed against two Kansas users of the disputed modems. Boeing Computer Services of Wichita uses Western Electric modems and Yellow Freight Systems

of Kansas City uses Codex modems. No specific amount of money was named in any of the lawsuits. However, victory for Milgo, especially in the first suit, could significantly change the looks of the modem market if Western Electric had to pay a royalty on every high-speed modem it manufactured.

**COMMUNICATION PRINTERS**

General Electric (Waynesboro, VA) has added to their TermiNet line with a new family of line printers offering print rates ranging from 340 lines per minute to 90 lines per minute. The TermiNet 310, 320, 330 and 340 line printers use the rotating belt technology used in the TermiNet 300 and 1200 printers. (More than 75,000 of these printers have been installed.) The print rate for TermiNet line printers varies with the number of printable characters per line and the size of ASCII subset used. The throughput rate for the 64-character ASCII subset is an average of 340 lines per minute when there are 90 or fewer characters printed on a line. Minimum throughput is 231.8 lines per minute when printing characters in all 132 columns. This includes one linefeed per line. Commonality of parts among all the TermiNet belt printer family makes the line printer series customer modifiable so that throughput can be increased quickly and at modest cost. The interchanging of two boards plus the addition of a hammer-bank fan will upgrade a 310, 320 or 330 to a 340 printer,



for instance. In all, 67 percent of parts are common among the entire belt printer family which includes the TermiNet 300 and 1200 keyboard printers and TermiNet 120 line printer. List prices for the TermiNet line printers range from \$3900 for the TermiNet 310 to \$5130 for the TermiNet 340 in quantity one.

**MAG TAPE SYSTEMS FOR MINICOMPUTERS**

Compatible with PDP-11, PDP-8, NOVA, and HP 2100.

Reliability backed by a full one-year warranty.

Prices from \$4,750 for a complete system which includes transport, controller cables and diagnostics.



**DIGI-DATA CORPORATION**

*Supplier of magnetic tape transports and systems.*

8580 Dorsey Run Road, Jessup, Md. 20794 (301) 498-0200  
 831 S. Douglas St., El Segundo CA 90245 (213) 640-2060  
 Fluestrasse 632, 5313 Klingnau, Switzerland TELEX: 845-58555

CIRCLE NO. 7 ON INQUIRY CARD



# SUPER BEE 3

## polling video display terminal



**“My new micro-programmable Super Bee 3 provides a Daisy Chain Port for POLLING yet requires NO CONTROLLER UNIT! A 4800 baud asynchronous/synchronous data transmission combines with the many other exceptional features and functions offered in my other Super Bee terminals to give you an unmatched price to performance ratio.”**

SUPER BEE

**p.s.**

*We can also custom program to your polling requirements. For example: Burroughs, ICL, Univac, IBM*



Another Quality Product from

**BEEHIVE TERMINALS**

BEEHIVE MEDICAL ELECTRONICS, Inc.

870 West 2600 South • Box 25668 • Salt Lake City • Utah 84125 • (801) 487-0741 • TWX 910-925-5623

CIRCLE NO. 9 ON INQUIRY CARD

# DATRAN'S DATADIAL AND TELENET'S VAN SERVICE: A Cost Comparison

Don't assume that because these carriers have similar tariff structures they are equally cost effective. They're not.

## EDITOR'S NOTE:

Since the 1971 FCC decision to permit specialized common carriers, numerous alternatives to AT&T have appeared. The specialized common carriers were given an added boost with the recent Office of Telecommunications policy requiring federal agencies to rely as much as possible on the private sector for their telecommunication requirements. As a followup to his article "Value-Added Networks" in the November issue of MODERN DATA, Peter Moulton compares the cost of the two most prominent non-dedicated line services: Telenet's VAN network and Datran's Datadial.

These two services share a common distinction in that many data transmission applications do not need dedicated line facilities due to the relatively small volume of data transmitted. VAN

or Datadial services, which charge only for transmission facilities actually used, have an advantage in these cases since the user does not have to pay the larger dedicated facility monthly charges.

Both services have synchronous, full-duplex lines (Datadial can also be asynchronous); both are responsive to user network troubleshooting and coordination; and both can relieve users of substantial design and development investment costs. VAN began operating in June 1975; Datadial began operating in January 1975. Telenet's VAN service presently connects 16 U.S. cities; Datadial services 18 cities. To find the most cost-effective service, three recurring variables must be considered — speed, volume and distance. However, other variables such as installation and technical operation costs also must be considered. Therefore, each application must be examined individually in its entirety.

Specialized common carriers tailor their services and tariffs for a specific data communications market segment. Generally, they charge either for full-period dedicated transmission facilities or for only those transmission facilities actually used. Two specialized common carrier services belonging to the latter category are Datran's Datadial service and Telenet Communications Corp.'s Value Added Network (VAN) service.

## SIMILAR ENDS, DIFFERENT MEANS

Both Datadial and VAN services have fixed monthly charges for interconnection to their data transmission networks, but they calculate the variable network usage charges differently. Datadial service is similar in operation to an ordinary business telephone. The customer with data to transmit uses a Datalink keypad to call the receiving station which is also connected to Datran's network. The call is answered, the data transferred, and the customer charged only for the transmission time actually consumed. Telenet's VAN service

requires that the sending and receiving station interconnection be performed and controlled by the data terminal or the network computers using predesignated assignments or information in the data stream. Customers are charged for "packets," i.e., units of 128 or less characters, sent over the network.

Since the service offered by each is transmission of digital data, and since the tariff structures are similar in that they both have fixed monthly interconnection charges and variable network usage charges, both appear to be equally cost effective in solving the same types of data transmission problems. This is not so.

In cases with higher line speeds, such as 600 and 1200 characters per second (4800 and 9600 bits per second), lower monthly data volumes, and shorter distances between sending and receiving stations, Datran's Datadial service will cost less than VAN service. Conversely, it is more cost effective to use Telenet's VAN service for lower (e.g., 150 cps) transmission speeds, larger data volumes, and greater transmission distances. These relationships are illustrated in Fig. 1, which was developed by comparing VAN and Datadial service charges for a 20-terminal, synchronous communications line protocol network. All sending and receiving sites are in Telenet and Datran central office cities and within 10 miles of central office facilities. A transmission efficiency of 60 percent was used in both cases to account for inefficiencies in transmission intrinsic in synchronous transmission protocols. The transmission efficiency was incorporated in the calculations in a manner consistent with the technical operation and variable cost structure of each vendor's service.



P.D. Moulton has designed and evaluated communications systems and networks for several federal government agencies. He participated in the design of the AFOS system at the National Weather Service and specialized in terminal and data communications processor development at Sanders Data Systems, Inc. Mr. Moulton received his B.S. degree in mathematics and M.S. degree in industrial management from Clarkson College of Technology.



*"It's economy, reliability and versatility! That's how Teletype sold 600,000 model 32 and model 33 data terminals."*

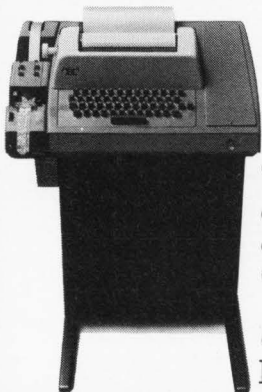

The Teletype® model 33 is the standard of the industry because it delivers outstanding economy, reliability and versatility in a wide range of applications. From message communications to computer input/output. On switched network as well as private-line systems.

For more information about the model 33, write or call: Teletype Corporation, Dept. 40Y, 5555 Touhy Ave., Skokie, Ill. 60076. Phone 312/982-2000.



Teletype is a trademark and service mark registered in the United States Patent and Trademark Office.

**CIRCLE NO. 10 ON INQUIRY CARD**

$$M = A_1 (1/LOAD) + A_2$$

**M** is the mileage where costs for VAN service are equivalent to costs for Datadial service.

**LOAD** is the monthly data transmission volume in millions of characters.

**A<sub>1</sub>** is a constant developed by dividing the difference in fixed charges, times the line speed, times 60 seconds, times the transmission efficiency by the Datadial variable cost rate for the line speed.

**A<sub>2</sub>** is derived by multiplying the VAN rate per kilo packet which has been divided by the transmission efficiency and then by 1000, by the line speed times 60 seconds, times the transmission efficiency which was also divided by the Datadial variable cost rate for the line speed.

Distance in Miles Between Remote Site and Host Computer

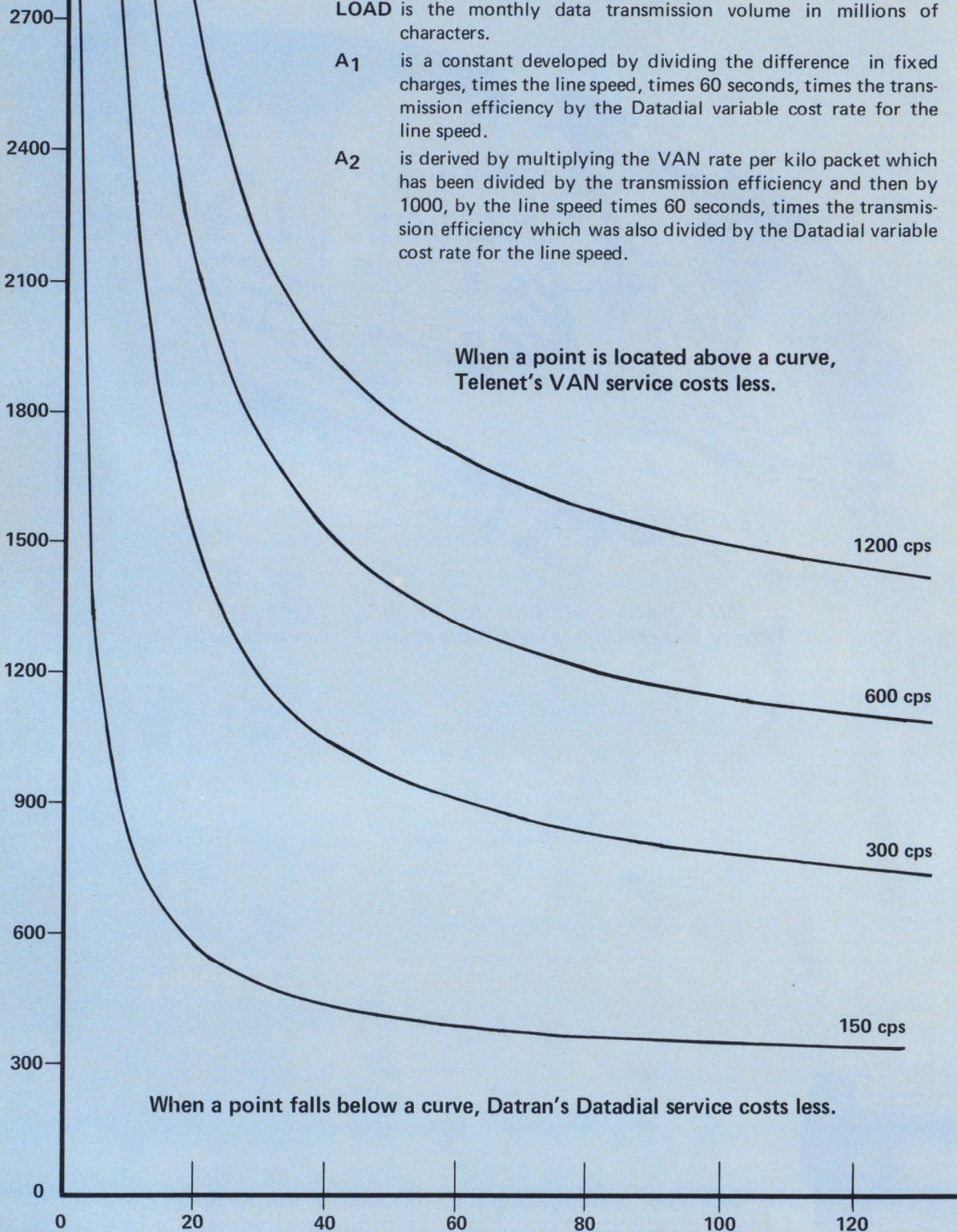

Monthly Data Load in Millions of Characters

Fig. 1 - Datran Datadial and Telenet VAN Services Cost Effectiveness Comparison

**Table 1 — Datran Datadial and Telenet VAN Service Cost Calculations**

*Distance Dallas to Washington, DC: 1180 miles  
Monthly Data Load: 40 million chars.*

**VAN Costs**

LINE SPEED	300/600 cps
<b>Fixed Charges</b>	
Dedicated leased line at Dallas with 10-mile local loop . . . . .	\$251/mo.
Dedicated leased line at Washington with a 10-mile local loop . . . . .	\$251/mo.
Multiple connect charge (\$200 X 1/20) . . . . .	\$ 10/mo.
<b>Variable Charges (Packet Costs)</b>	
Load ÷ (72 characters per packet X 1000) X \$.60 per kilopacket . . . . .	\$333/mo.
<b>Total Monthly Cost</b>	<u>\$845/mo.</u>

**DATADIAL Costs**

LINE SPEED	300 cps	600 cps
<b>Fixed Charges</b>		
Termination at Dallas. . . . .	\$130/mo.	\$140/mo.
Termination at Washington . . . . .	\$130/mo.	\$140/mo.
<b>Variable Charges</b>		
[Load ÷ (Speed X 60 secs X .6)] X Distance X Cost per mile per min. <sup>1</sup> . . . .	\$656/mo.	\$437/mo.
<b>Total monthly cost</b>	<u>\$916/mo.</u>	<u>\$717/mo.</u>

<sup>1</sup> Cost of 300-cps service per mile per minute is \$.00015; for 600-cps service, it is \$.0002.

**LOW-SPEED LINES**

If a remote terminal at Dallas, TX, had a monthly data load of 40 million characters to be transferred to Washington, DC, using a synchronous line protocol at 300 cps, it would cost less to use Telenet's VAN service than Datadial service, as shown in Fig. 1. The distance between Washington and Dallas is calculated to be 1180 miles using the FCC tariff V and H coordinates. Plotting 1180 miles and 40 million characters per month gives an intersection at a point above the 300-cps curve, which indicates VAN service will cost less. Table 1 contains cost calculations for each type of service, showing VAN service costs are lower for 300-cps transmission speeds.

**HIGH-SPEED LINES**

Suppose the Dallas site had already installed Datadial service based on a planned data load of 20 million characters per month, but once the site became operational, the data load jumped to 40 million characters per month. Should the customer change to VAN service because it will lower costs?

Figure 1 suggests an alternative. If the transmission speed were increased to 600 cps, the intersection of 40 million characters per month and 1180 miles would fall below the transmission speed curve, indicating the existing Datadial service would remain more cost effective. Table 1 also contains the monthly costs for 600-cps Datadial service to Dallas. Comparing these costs to 300-cps service, we see that the increased transmission speed makes the Datran Datadial total monthly cost less than the VAN service costs.

Datadial service is most cost effective for low volume, high speed and short distance applications, while Telenet's VAN service is tailored to low speed and long distance applications as well as higher volume non-dedicated line applications with its low cost per packet. This comparison shows the more significant variables affecting recurring monthly costs for Datadial and VAN services. It can be helpful in ballpark network planning, but more detailed implementation planning that considers technical implementation and one-time installation costs must be performed before a single type of data communications service can be recommended as a solution to a specific network problem. ■

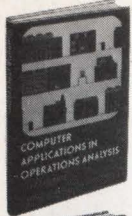

767/289  
**COMPUTER APPLICATIONS IN OPERATIONS ANALYSIS**  
 by B. P. Lientz  
 Pub. price, \$12.95  
 Club price, \$10.95

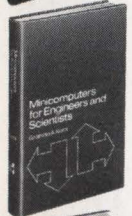

353/387  
**MINICOMPUTERS FOR ENGINEERS AND SCIENTISTS**  
 by G. A. Korn  
 Pub. price, \$21.50  
 Club price, \$13.95



394/555  
**OPERATING SYSTEMS**  
 by S. E. Madnick and J. J. Donovan  
 Pub. price, \$18.50  
 Club price, \$12.50

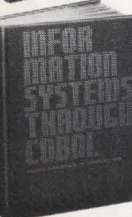

497/672  
**INFORMATION SYSTEMS THROUGH COBOL**  
 by A. S. Philippakis and L. J. Kazmier  
 Pub. price, \$12.95  
 Club price, \$9.95

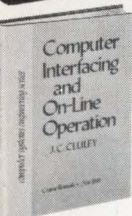

767/017  
**COMPUTER INTERFACING AND ON-LINE OPERATION**  
 by J. C. Cluley  
 Pub. price, \$14.50  
 Club price, \$12.35

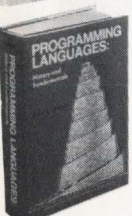

767/513  
**PROGRAMMING LANGUAGES**  
 by J. E. Sammett  
 Pub. price, \$21.00  
 Club price, \$17.50

## Introductory offer to new members of the COMPUTER PROFESSIONALS' BOOK CLUB

any one of these great professional books for only **\$1.00** values up to \$29.95

Special \$1.00 bonus book comes to you with your first club selection



770/271  
**BUCHSBAUM'S COMPLETE HANDBOOK OF PRACTICAL ELECTRONIC REFERENCE DATA**  
 by W. H. Buchsbaum  
 Pub. price, \$17.95  
 Club price, \$13.50



158/274  
**MANAGEMENT INFORMATION SYSTEMS: Conceptual Foundations, Structure, and Development**  
 by G. B. Davis  
 Pub. price, \$15.50  
 Club price, \$11.95



767/408  
**HANDBOOK OF COMPUTER MANAGEMENT**  
 by R. Yearsley and R. Graham  
 Pub. price, \$19.75  
 Club price, \$15.95



767/53X  
**PROGRAM STYLE, DESIGN, EFFICIENCY, DEBUGGING, AND TESTING**  
 by D. Van Tassel  
 Pub. price, \$12.00  
 Club price, \$9.95



767/920  
**COMPUTER TIME SHARING FOR MANAGERS**  
 by J. F. Odeneal  
 Pub. price, \$24.95  
 Club price, \$17.95



279/535  
**COMPUTER SYSTEM PERFORMANCE**  
 by H. Hellerman and T. F. Conroy  
 Pub. price, \$18.50  
 Club price, \$14.75



767/203  
**DATA PROCESSING MANAGEMENT**  
 by D. H. Brandon, A. D. Palley, and A. M. O'Reilly  
 Pub. price, \$29.95  
 Club price, \$21.50



767/246  
**A COMPUTER PERSPECTIVE**  
 by C. Eames and R. Eames  
 Pub. price, \$15.00  
 Club price, \$12.75

## save time and money by joining McGraw-Hill's new COMPUTER PROFESSIONALS' BOOK CLUB



**T**HIS new professional club is designed to meet your day-to-day on-the-job needs by providing practical books in your field on a regular basis at below publisher prices. If you're missing out on important technical literature—if today's high cost of reading curbs the growth of your library—here's the solution to your problem.

The Computer Professionals' Book Club was organized for you, to provide an economical reading program that cannot fail to be of value. Administered by the McGraw-Hill Book Company, all books are chosen by qualified editors and consultants. Their understanding of the standards and values of the literature in your field guarantees the appropriateness of the selections.

How the Club operates: Every month you receive free of charge *The Computer Professionals' Book Club Bulletin*. This announces and describes the Club's featured book of the month as well as alternate selections available at special members' prices. If you want to examine the Club's feature of the month, you do nothing. If you prefer one of the alternate selections—or if you want no book at all—you notify the Club by returning the card enclosed with each *Bulletin*.

As a Club Member, you agree only to the purchase of four books (including your first selection) over a two-year period. Considering the many books published annually, there will surely be at least four you would want to own anyway. By joining the club, you save both money and the trouble of searching for the best books.

### MAIL THIS COUPON TODAY

**COMPUTER PROFESSIONALS/Book Club**  
 P.O. Box 582 Princeton Road, Hightstown, New Jersey 08520

Please enroll me as a member of the Computer Professionals' Book Club and send me the two books indicated below. I am to receive the bonus book for just \$1, and my first selection at the special Club price. Actual postage, plus 25¢ handling charge will be added (sales tax, also, if applicable). These books are to be shipped on approval, and I may return them both without cost or further obligation. If I decide to keep the books, I agree to purchase as few as four additional books (including this first selection) during the next two years at special Club prices (guaranteed 15% discount often more).

Write Code # of \$1.00 bonus book selection here

Write Code # of first selection here



NAME \_\_\_\_\_

ADDRESS \_\_\_\_\_

CITY \_\_\_\_\_

STATE \_\_\_\_\_ ZIP \_\_\_\_\_

All prices subject to change without notice

**P39147**

## BOARDS AND BOXES

Information Control Corp. (Los Angeles) has entered the microcomputer market with the *Abacus Microsystem* and *Commander MDS*. Available in preassembled kit form for under \$1000 or as a fully assem-



The whole ball of wax from Information Control Corp.

bled and tested system, the modular Abacus Microsystem features micro-packaging on 2" by 3" PC boards, and Intel NMOS 8080A CPU. The development system (Commander MDS) features editor, monitor, and assembler software, audio tape cassette I/O, an alphanumeric display, and optional line printer.

Circle No. 81 on Inquiry Card

EBKA Industries of Oklahoma City offers the "Familiarizer," a complete microcomputer system with its own hexadecimal keyboard and display built into a single PC board, and requiring only a power supply for operation. The heart of the *Familiarizer* is a Mostek 6502 eight-bit processor that can address up to 65K bytes of memory. On-board memory consists of 1K bytes of RAM for user programs and two eight bit input and output ports. A 256 byte monitor program is supplied in one 1702A erasable PROM. The *Familiarizer* is available in both kit form, containing all parts, manuals and documentation for \$229, or completely assembled for \$285.

Circle No. 82 on Inquiry Card

National Semiconductor (Santa Clara, CA) is shipping production quantities of its 16-bit, single-chip "PACE" microprocessor for use in Hamilton/Avnet's new *Pacer* desktop microcomputer.

The *Pacer* kit, which was designed and developed entirely by Hamilton/Avnet Electronics, is a build-it-yourself computer, complete right down to the power cord, which the company claims can be assembled by a rank amateur and made to operate in about six hours. It costs \$675, or it can be purchased completely assembled for \$835.

Circle No. 80 on Inquiry Card

Electronic Memories and Magnetics Corp.'s (Hawthorne, CA) *System 80* microcomputer is compatible with the 8080 microprocessor and is available with a full range of core and semiconductor memories. It is said to offer up to four times the speed of typical 8080-based micros, and features an extended addressing capability of up to 1 megabyte. *System 80* consists of an asynchronous bipolar (hence the speed increase) MSI central processor, a minimum of 16Kx8 read/write memory, DMA, ROM bootstrap loader, RS-232C2 interface, operator panel, and a 5-slot, 5-1/4" chassis with integrated power supply. Basic system prices begin at \$4,150 for 16K bytes of core memory and \$4,500 for 32K bytes of semiconductor memory.

Circle No. 83 on Inquiry Card

MOS Technology Inc.'s (Norristown, PA) KIM-1 microcomputer system is *not*, we repeat, NOT, a kit. We stress that fact because it sells for only \$245 in onesies. For that price you get a board containing the firm's 6502 8-bit microchip; two 6530 arrays, each with 1024 ROM bytes (for the monitor), 64 RAM bytes, 15 I/O pins and an interval timer; a 1024-byte static RAM; 24-position keyboard; 6-digit LED display; TTY interface; and audio cassette interface. You also get a pile of manuals. Very nice.

Circle No. 84 on Inquiry Card

Intel (Santa Clara, CA) has introduced a complete system - CP, RAM, ROM, and I/O (both parallel and serial) - on a 6-3/4" by 12" board. And for under \$300 (Q = 100). The 8080-A based system,

which Intel calls the SBC (for Single Board Computer) 80/10, will be sold as a "super component." By that, Intel means to stress the SBC 80/10's ability to blend into many different equipments by

simply changing a few program instructions (Intel claims six or less) and plugging in appropriate line drivers and terminators. In other words, it is as much a component as, say, a power supply.

Circle No. 79 on Inquiry Card

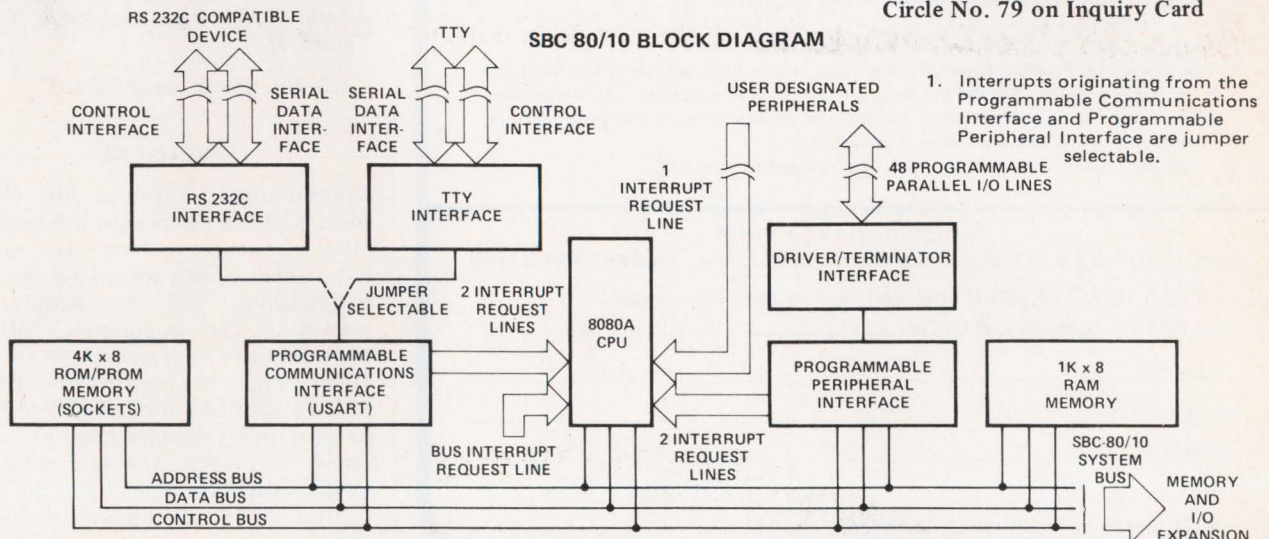

## MANUALS

Northeast Services, Inc. (34 Cooper Ave., Wallingford, CT 06492) has an 8080 design manual written specifically for the hardware designer. The \$24.95 manual covers 8080 signal definition, timing and state transition, memory configurations, control panel design, use of an 8080 prototyping board, and a standard control panel. Explanations of the 8080 instruction set, guidelines for program organiza-

tion, and a discussion of common programming pitfalls are also included . . . A manual for the MIKE 2 microcomputer offered by Martin Research consists of over 150 pages and contains circuit diagrams and theory of operation for this 8008-based computer. Included also are software listings for MONITOR 8, the computer's operating system. Price of the manual is \$25.00, which includes a certificate worth \$15.00 towards purchase of a system. It is avail-

able from Martin Research, 3336 Commercial Ave., Northbrook, IL 60062 . . . A features and concepts manual on the "Micos" minicomputer system is available on request from Mini-Computer Systems, Inc., 525 Executive Blvd., Elmsford, NY 10523. The manual serves as a brief introduction to this interactive business system.

## MINI GETS BIT PART

A Digital Equipment mini has a "12-bit part" in the film "Three Days of the Condor," a spy thriller that casts a PDP-8/E in the role of a system that scans and translates books in foreign languages. While the translating system, like the film, is entirely fictional, all the hardware used (apart from the "reader") is standard DEC equipment. Programs that simulated translation output were developed for the film by Stephen Kallis, a DEC publicist who has his own PDP-8.

## MINICOMPUTER FILM COURSE

Titled "Minicomputers: Cost Effective Computing Power," a videotape course with guidebook and coordinating guide is designed for managers involved in evaluating the potential use of minicomputers in an existing data processing environment. Material covers characteristics of equipment, distributed and centralized processing networks, and criteria for selecting a manufacturer. Case studies are provided to give the student the opportunity to design networks to solve particular problems. "Minicomputers" requires two-to-four hours to complete and is available on 1/2-inch reel-to-reel and 3/4-inch cassette videotapes. Other formats, including film, are available under special pricing arrangements. *Advanced Systems, Inc., Elk Grove Village, IL.*

Circle No. 85 on Inquiry Card

## OVERSEAS

Mini-Computer Systems, Inc. (Elmsford, NY) has established a subsidiary, MCS of France, in Paris. The subsidiary, which is 80% owned by the U.S. corporation, will concentrate on marketing the company's "Micos" minicomputer system . . . *Advanced Micro Devices* has licensed the SESCO-SEM Division of Thomson-CSF to build its proprietary bipolar microprocessor family in France. The agreement follows similar agreements for U.S. manufacture with Raytheon Semiconductor and Motorola.

## MORE PERCEPTIVE and MORE INFORMATIVE

the newest service to the newest  
Billion-Dollar Industry its name

## MINI/MICRO SYSTEMS

a fortnightly newsletter

MINIMICRO SYSTEMS is *Modern Data Services'* fortnightly hotline serving the users, vendors, and observers of minicomputers, microcomputers, microprocessors, small business computers, miniperipherals, minisoftware, intelligent and remote batch terminals, word processing systems, data entry systems, industrial automation systems, and all of the variety of products which make this the most exciting of all industries.

### NEWS / INTERPRETATION / ANALYSIS / FORECASTS

Flashing the news quickly to its readers  
is only one of the services of MINIMICRO SYSTEMS.

*Modern Data* magazine has always been ahead of the field in perceiving long-term trends, in addition to its major strength in organizing and classifying the products in our fast-changing industry. *Modern Data's* offspring, MINIMICRO SYSTEMS, reports and analyzes the up-to-the-minute news against the background of what we perceive to be the direction of the industry.

### ALL THIS AND CPC TOO

The Computer Product-Line Clearinghouse, a constant feature of MINIMICRO SYSTEMS, provides, for the first time *anywhere in any industry*, a free medium of exchange between potential buyers and sellers of rights to product-lines, inventions, subsidiaries, whole companies, etc.

In the boom years to come, you can't afford to miss CPC.

### Subscription Department

MINI/MICRO SYSTEMS / 5 Kane Industrial Drive / Hudson, MA 01749

- PAYMENT of \$65 is enclosed add 5% handling + postage  
 Bill my company. P.O. No. \_\_\_\_\_  Bill me later

NAME \_\_\_\_\_ TITLE \_\_\_\_\_

COMPANY \_\_\_\_\_

STREET \_\_\_\_\_

CITY \_\_\_\_\_ STATE \_\_\_\_\_ ZIP \_\_\_\_\_

NOTE: for air mail outside of US/Canada - add \$15



# Tired of debugging your PDP-11 the small system way?

The Program Debug Console from Formation will change all that. This powerful program debugging tool and systems maintenance aid performs a range of functions on the PDP-11 simply not possible with current software or hardware. Allowing you to stop or interrupt the system at any point, and then examine its various elements... and offering a unique "backward" look at the last 16 words that appeared on the UNIBUS, providing a valuable trace of the processor and I/O UNIBUS activity. It gives you, for the first time, a look at the PDP-11 under actual operating conditions, not a slowed-down, simulated environment. And the Program Debug Console electronics are packaged as a small peripheral controller (SPC), which means it's ready to go to work almost immediately.

Think big. Think about the Program Debug Console from Formation. One of the Maverick Systems. Offering the break in tradition their name reflects.

DEC, PDP, and UNIBUS are registered trademarks of Digital Equipment Corporation. © Formation, Inc.

Wake up the **MAVERICK** spirit inside you.

**formation** <sup>®</sup>  
823 East Gate Drive  
Mt. Laurel, NJ 08057  
609-234-5020

CIRCLE NO. 27 ON INQUIRY CARD

## MAINFRAMER'S SYSTEMS

NCR (Dayton, OH) has a new entry-level system, the NCR 499, to succeed its 399. A basic 499 system includes a 12K-byte mini, 75 cps matrix printer, cassette transport, forms handler and full A/N keyboard with separate numeric pad.

Circle No. 76 on Inquiry Card

Features of the \$17,900-and-up system include expansion to 9.8 million bytes of disk memory and 32K bytes of core, a variety of printers and readers, and the ability to serve as an intelligent terminal or RBT as well as a stand-alone processor.



NCR 499 with optional line printer and disk unit.

Interdata (Oceanport, NJ) has introduced two systems it calls "the most economical packaged computer systems available today." IPAC/16 costs \$33,500 and includes a 16-bit Interdata Model 6/16 with 64K bytes of memory, a 10M byte disk, card reader, line printer and Carousel 30 terminal in addition to the OS/16 MT2 operating system. The IPAC/32 system is priced at \$43,500 and includes a 32-bit Interdata Model 7/32 with 128K bytes of memory, the same peripherals and the OS/32MT operating system.

Circle No. 77 on Inquiry Card

Digital Equipment Corp. (Maynard, MA) has configured a PDP-11 specifically for fast FORTRAN number-crunching. Called the PDP-11T55, it incorporates a new PDP-11/55 processor, a new floating-point processor, and 16K or 32K words of bipolar memory. The PDP-11T55 operates under DEC's RSX-11M operating system in a twin disk-pack configuration, and employs FORTRAN IV-plus, an extended version of ANSI FORTRAN IV. Prices begin at \$61,000.

Circle No. 75 on Inquiry Card

IBM announced major enhancements for its lowest-priced general business computer, the System/32. IBM's General Systems Division (Atlanta, GA) also added a new model to its larger System/3 line and introduced an industrial data collection system.

The S/32 enhancements increase disk capacity from the present 5 million and 9.1 million byte systems to 13.7 million bytes, and add 80- and 96-column punched card capability to all S/32 models. New S/32 software consists of two new Industry Application Programs: one for lumber and building materials, and the other for operating on data entered via the simultaneously introduced 5230 Data Collection System.

The new S/3 Model 4 is a multitasker designed to control up to five CRT work stations in an online, interactive environment, while performing batch operations, such as sorting or printing, concurrently. A typical S/3 Model 4 will carry a purchase price of \$52,500.

Circle No. 78 on Inquiry Card

## MCP 1600 SECOND SOURCED

National Semiconductor will produce Western Digital's "MCP-1600" 16-bit microprocessor as well as Western's line of "ASTRO" data communication chips under a reciprocal agreement that permits Western to produce National's 4K-bit RAMs. Other manufacturers licensed to alternate-source National's 4K RAMs are Advanced Memory Systems, Monolithic Memories, and Synertek.

## COURSES AND CONFERENCES

"System Design," "Minicomputers" and "Microcomputers" are the subjects of three "Institutes" (seminars) to be presented the week of March 28-April 2 at the Pheasant Run Lodge, St. Charles, IL, by the National Engineering Consortium, Inc. The registration fee for each Institute is \$595. Write: *NEC Registrar, 1301 W. 22nd St., Oak Brook, IL*, or call (312)325-5700.

A Mini/Midi Symposium sponsored by DECUS, the Digital Equipment Computer Users Society, will take place at

the OMNI International Hotel in Atlanta, GA, May 25-28. Six parallel sessions on each of the four days will focus on 18-bit systems and on graphics and biomedical applications. For information, call: *Maryann Oskirko at (617) 897-5111 Ext. 2414*.

**The Trenton Computer Festival**, a convention of amateur computer hobbyists, will be held Sunday, May 2nd, at Trenton State College. The Festival is sponsored by the Amateur Computer Group of New Jersey and TSC. Contact: *Dr. Allen Katz, Trenton State College, Trenton, NJ 08625*.

**ELECTRO/76**, the international convention and exposition of the Institute of Electrical and Electronics Engineers, will be held May 11-14 in Hynes Memorial Auditorium, Sheraton-Boston (MA) Hotel. Six sessions will address various microprocessor subjects. Contact: *Raquel Howard at (213)381-2876*. **A Microcomputer Interfacing Workshop** will be offered at Virginia Polytechnic Institute and State University on five as-yet-unspecified days in May. Contact: *Dr. Norris H. Bell, CEC, Blacksburg, VA 24061*.

## SOFTWARE NOTES

TSOS-16, a multi-terminal, event-driven operating system for GA SPC/16 series computers, gives each of up to 64 terminals a batch-like capability. Private files can be established by, and made accessible only to the originating user. The operating system is available for \$3,000 from ADTECH, 8550 West Bryn Mawr Ave., Chicago, IL 60631... Fortran IV-equipped Data General computers can now use the company's hardware floating point processor. The multi-accumulator floating point processor operates in parallel with the central processor to perform high-speed single and double-precision arithmetic, but until now it was supported only by DG's Fortran 5... Microtec (P.O. Box 337, Sunnyvale, CA 94088) has added to its line of microprocessor support products a set of macro-assemblers and simulators for the Motorola 6800, Fairchild F8, and the Signetics 2650. The programs are written in ANSI standard Fortran IV and are said to operate on any computer that has a 16-bit word length and 16K words of main memory. The programs are priced at \$800.

# The Complete Microcomputer Series 70

• ECONOMICAL • MODULAR • EXPANDABLE • PERIPHERAL SUPPORT • SOFTWARE OPTION



Model 70-100 CPU and Model 70-131 front panel console

### Standard Features

- Intel 8080
- 1K bytes ROM
- 4K bytes RAM
- Async controller
- DMA
- Floppy Disk Controller

### Applications

- Communications Systems
- Office Systems
- Small Business Systems
- Word Processing Systems
- Process Control Systems
- Text Editor Systems
- Source Data Entry
- Media Conversions
- Interactive Software Development
- Firmware Development
- Hardware/Interface Development

### Options

- Add-on memory to 64K
- Add-in memory PROM to 4K, RAM to 16K
- Front panel console
- Enclosures
- IBM floppy disk
- 3M tape cartridge
- Programmable communication
- PROM programmer
- Line printer controller
- 9 Track tape controller
- Programmable clock
- General purpose I/O controller

### Software

- ADC $\mu$  Executive for development
- ADC extended BASIC/DOS
- RS232 Firmware

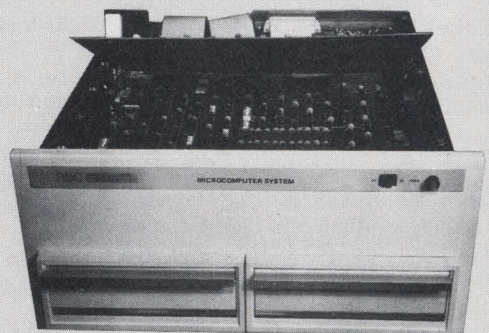

Model 70-132 CPU, Dual Disk

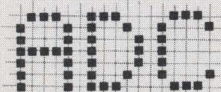

APPLIED DATA COMMUNICATIONS

1509 East McFadden Avenue  
Santa Ana, California 92705  
Telephone: (714) 547-6954

Also Add-on Mini Peripherals for DEC PDP-11, Data General DEC PDP-8

# 32-bit minis: tempest in a teapot?

---

---

## EDITOR'S NOTE:

As you might've guessed, the author of this article has elected to remain anonymous for a very good reason: He is employed by a manufacturer of 32-bit machines. As a primary designer of 16-bit machines as well (no more clues), we suggested that he was a perfect candidate to provide us with a "non-vanilla" tutorial on the subject of 32-bit minis. We were, however, somewhat surprised to receive the article which follows. Our second thought was that it might be just the thing to provoke some stimulating replies. So c'mon you 32-biters, get mad! Let's hear from those of you who believe these heresies should not be allowed to stand.

— ARK

---

---

There has been a lot of publicity in the past year about "32-bit minis." The Interdata 8/32 and SEL 32 are frequently mentioned, with the DEC PDP-11/70 also said to have some 32-bit aspects. Is this publicity deserved? Are 32-bit minis as revolutionary as their proponents claim? Is there, for that matter, such a thing as a 32-bit mini?

The answers to these questions are respectively "not really," "no," and "sort of." In the next few paragraphs, we'll see that 32-bit minis are members of the same breed as any other mini, and that their disproportionate publicity has created (or has resulted from) some common misconceptions.

First, let's differentiate between two aspects of computer architecture: programmer visibility and internal hardware implementation. The programmer visibility of a computer is the collection of registers, data types, instructions and so on with which the programmer deals. The internal hardware implementation, on the other hand, is the set of logic units, data paths and storage areas from which the computer is constructed. Both the programmer visibility and the hardware implementation have one or more "preferred" data lengths. However, the preferred lengths for the programmer do not have to be those of the hardware. Normally, they will be related — one will be a multiple of the other, for instance — but they need not be identical. To see this, just look at the IBM System/360. While it behaves to programmers as if it processes character strings one byte (8 bits) at a time, the hardware may operate on eight bytes (64 bits) in parallel. Conversely, while it appears to process long floating point data in 64-bit units, the hardware may deal with 8-bit units only.

This brings us to a key point: *a minicomputer may have 32-bit programmer visibility without 32-bit hardware implementation, and vice versa.* It can also have both, or neither. Which combination it will have depends on its designers' view of its market and on cost-performance tradeoffs.

## SEARCHING FOR A CRITERION

The reasons for 32-bit programmer visibility relate primarily to ease of programming. The reasons for 32-bit hardware implementation relate entirely to performance. It would be absurd to say that all easy-to-program machines must be fast and all slow machines must be hard to program. We must therefore address the two aspects of a 32-bit architecture separately.

A 32-bit programmer visibility has three advantages over 16 bits. These are in designing the instruction set, in addressing large memories, and in manipulating high-precision numeric data.

These advantages are real. For example, you can define a more comprehensive instruction set with 32 bits to work with than you can with 16. But why restrict yourself to one length? Some things are done quite well (and more efficiently) with a 16-bit instruction. Data General's ECLIPSE designers found this to be so; that system has both 16-bit and 32-bit instructions. The architects of Control Data's supercomputers reached a similar conclusion: the CDC 6600 and its Cyber successors have instructions of 15 and 30 bits. There is no need to stop with two lengths: such disparate systems as the DEC PDP-11 and the IBM System/370 have instructions of 16, 32 and 48 bits. What is their word length? We can't tell from their instruction formats. Instruction length by itself, then, does not make a 32-bit mini. A machine of almost any word length can have instructions of almost any length by piecing words together (PDP-11) or splitting them (CDC 6600). We will have to look elsewhere if we want to find a real criterion of "32-bitness."

If we want to address large memories, we need an address longer than the usual 16-bit minicomputer word. Various schemes can be used to achieve this. "Memory management," "memory mapping" and "paging" (all of which mean roughly the same) are currently popular. None of these expand the *instantaneous* addressing range beyond the limit of a computer without such a feature, however.

# The '76 NCC Landmarks June 7-10

This is the year of landmarks at the National Computer Conference, June 7-10 in New York. The '76 NCC . . . during our Nation's Bicentennial . . . will explore the latest trends in computer science and technology, systems and applications, societal concerns, EDP management, and professional issues. And that's only the beginning. Other landmarks include the largest exhibit program ever held at an NCC, plus the 25th anniversaries of both the first Joint Computer Conference and the first commercially available electronic digital computer.

Register now for the world's most comprehensive computer conference. More than 100 information-packed sessions will cover 12 major areas including complex systems, architecture and hardware, software, computer communications and networking, applications, and education. And more than 275 organizations will display their latest computer products and services on three floors of the New York Coliseum.

Heading five plenary sessions will be a keynote address by J. Paul Lyet, Chairman and Chief Executive Officer of Sperry Rand Corporation. In addition, the NCC will feature a variety of special events and activities, including a unique networking demonstration and a Pioneer Day Program pay-

ing tribute to individuals from the Moore School of Electrical Engineering. And for an added fee, program registrants may also choose among a number of Professional Development Seminars.

Apply now for the *NCC Bicentennial Card* covering all four days of the conference, including exhibits. You'll save \$15 on full-conference registration. Just fill in the coupon for advance registration, or to get all the facts on the '76 NCC.

'76 NCC, c/o AFIPS, 210 Summit Avenue,  
Montvale, New Jersey 07645

MD

Please send me my *NCC Bicentennial Card* covering advance registration; my \$60 fee is enclosed.

Please send me all the facts on '76 NCC.

Name \_\_\_\_\_

Company \_\_\_\_\_

Street \_\_\_\_\_

City \_\_\_\_\_ State \_\_\_\_\_ Zip \_\_\_\_\_



'76 NCC  
Landmarks  
in Data Processing

This limit is typically 32K words. The page tables or memory maps let a user scatter this space around a much larger memory (up to perhaps a million words), but don't let him expand it. To address an item outside this space, the tables or maps must be changed. This normally means a time-consuming call to the operating system.

Expanding the instantaneous addressing range means direct or indirect addresses more than 16 bits long. One way of doing this is by a sufficiently long address field in a 32-bit instruction, such as the 20-bit address field of the Interdata 8/32. Another is by using base registers, which can be longer than a word if necessary. Still another is to use a multiple-word address extension to the instruction where such systems as the ECLIPSE and PDP-11 use single words. All these are feasible. All give a machine some 32-bit aspects. Are they — is any of them — enough to create a "32-bit mini?" That's a matter of opinion.

Now for data precision. Clearly, 32-bit data will be more accurate than 16-bit data. Instructions which process 32-bit data are easier to use, as well as somewhat faster, than programmed double precision. But do they make a "32-bit mini"? Honeywell's Series 16 and System/700, which trace their roots back to 1963, have had 32-bit arithmetic for years, yet nobody calls them 32-bit minis. Minis with floating-point capability usually process 32-bit and 64-bit operands, but this does not seem to have made them into 32-bit minis. We must keep looking — but we have exhausted the places to look in the area of programmer visibility. We will now look at performance.

#### STILL SEARCHING

There are many ways designers of a typical mini can go beyond the performance limits of conventional technology and 16-bit data paths. There are high-speed semiconductor technologies available for those willing to pay the price. Circuits using many components can perform a function (such as shifting) faster than a simpler, less expensive design. Multiple, parallel internal operations can be performed at the cost of additional control logic. And wide data paths and functional units (maybe 32 bits wide) can be employed to process more than 16 bits at a time.

At what point do 32-bit data paths become part of the performance enhancement package? This question has no simple answer. The answer changes from one month to the next, as the available technologies evolve. The answer depends on a particular designer's skill with the available tools. The answer also depends, we must admit, on the degree to which the computer has 32-bit programmer visibility. The more it does, the more common 32-bit operands are, the sooner 32-bit data paths will pay off. But this is a matter of degree. The extent of 32-bit programmer visibility can only move the decision point for a 32-bit hardware implementation up or down the scale. It cannot change the nature of this point or of the tradeoffs it implies.

So — what is a "32-bit mini"? Just like the cliché "luxury car," it is a combination of many things. Give an ordinary mini (or car) one of them, and you have a mini (or car) with a 32-bit (or luxury) feature. Give it another, and you approach the concept more closely. Give it all you can think of, and people will agree you have reached your goal. But you have reached it one step at a time. Neither a full 32-bit mini nor a Mercedes-Benz 280 differ very much from the next step down.

Just as astute car buyers look past the "luxury" label, look past the "32-bit" label — and buy the most cost effective mini for your job. ■

## THE ON-LINE BANKING EQUIPMENT AND SERVICES MARKET

In the ten years ending 1985, more than \$2.9 billion of on-line terminal equipment will be shipped to U.S. banks. The advent of electronic funds transfer has been a catalyst for changing bankers' attitudes about their business and functions. The banking industry is now aware that technology can be exploited not only to improve and economize on existing operations but also to create wholly new products, services and delivery vehicles which can fundamentally change the interface between banks and their customers.

Frost & Sullivan has completed a report analyzing and forecasting the on-line banking equipment market, with specific forecasts to 1985 for thrift industry (mutual savings banks, savings and loans and credit unions) teller terminals, commercial bank teller terminals, unattended automated tellers, in-branch automated tellers and displays. The outlook for voice response units is given. Future banking industry trends, product descriptions and pricing are discussed, and an applications analysis is made. Configuration changes and requirements are identified by type of banking institution. A questionnaire survey of end users furnished information on their future equipment usage needs, satisfaction or dissatisfaction, equipment features desired, plans to sell services and preferred manufacturers.

**Price \$600.** Send your check or we will bill you. For free descriptive literature plus a detailed table of contents contact:

**FROST & SULLIVAN, INC.**  
106 Fulton Street  
New York, New York 10038  
(212) 233-1080

# UPS\* your computer's memory

... so you don't lose it, BIT-BY-BIT.

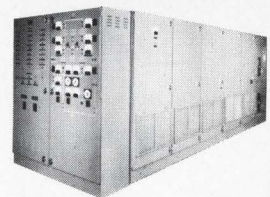

**ACCUPOWER®**, the Uninterruptible Power System\* protects against outages . . . provides complete voltage, frequency and transient control. It's backed by Emerson Electric and features all solid-state design.

Get the full information. Call or write

**EMERSON** INDUSTRIAL CONTROLS DIVISION  
3300 S. Standard St., Santa Ana, CA 92702 • (714) 545-5581  
Elgin Dr., Swindon, Wiltshire SN2 6DX England • 0793-24121

CIRCLE NO. 15 ON INQUIRY CARD

# ALPHANUMERIC DISPLAY TERMINALS

## Part 2 — Who's Who in CRTs and Where the Market is Going

*This second part of a two-part profile lists CRT suppliers and their products, and projects what the alphanumeric display terminal market will look like by 1980.*

What began as an experimental vacuum tube prototype about 15 years ago has grown into a \$400 million industry for 1974 and is expected to be a \$500 million industry by 1980. Naturally there are plenty of participants. The following pages contain a list of market participants showing what market they're in: TTY-33/35, 2260- or 3270-compatible. Whether the supplier has stand-alone or clustered systems, and whether the terminal is user programmable is also indicated. Complete details on the specifications of these terminals can be obtained from the supplier.

This profile is based largely on a study (*Alphanumeric and Graphic CRT Terminals*) recently prepared by Venture Development Corp., a nationally recognized marketing research and technology assessment firm. Only a few of the many market breakdowns and projections contained in the 203-page study are mentioned in this article. For more information, write *Venture Development Corp., One Washington St., Wellesley, MA 02181.*

### MARKET BIG SHOTS

IBM has over 30 percent of the entire CRT market, according to *Venture Development Corp.* study. And there are close to 75 other suppliers to fight it out for the remaining market share. Two percent of the market can make you a leader. Within the CRT market, *Venture Development* compiled these statistics on the individual markets and their leaders (see Fig. 1).

**IBM 3270 and Compatibles.** Since its introduction in 1972, IBM's 3270 has become the largest and most profitable terminal line. It holds over 75 percent of the 3270 market. Independent manufacturers making the replacement market are neither great in numbers nor great in market share. Not one has more than 5 percent. However, IBM-compatible replacements are growing as a percentage of the IBM 3270 market due to their lower prices and increased flexibility.

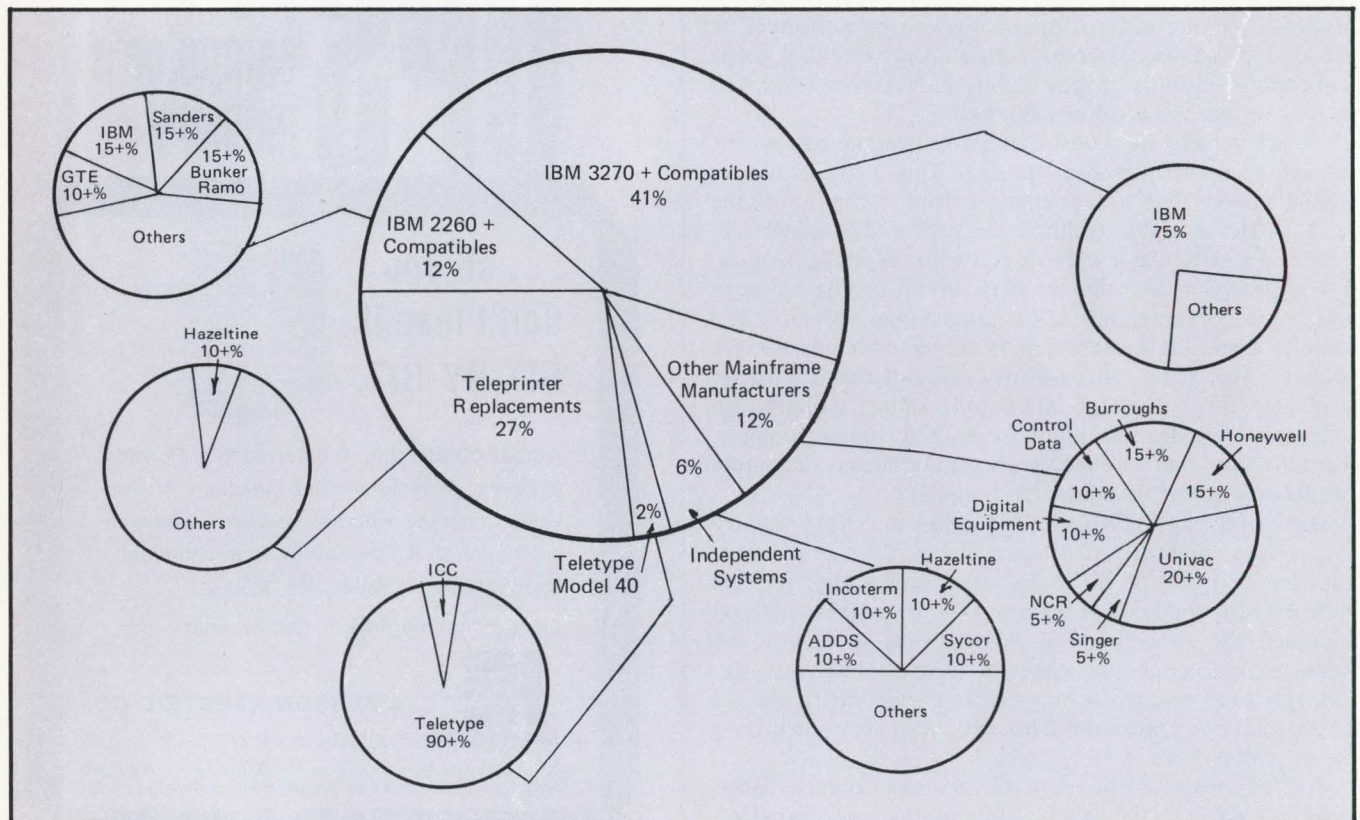

Fig. 1 — Alphanumeric CRT Terminal Installed Base in Number of Units. (Data supplied by Venture Development Corp.)

# Little Moe.

## Codex launches the mightiest modem series yet.

There's nothing like it for bringing data into a port.

Little Moe. The new Codex LSI family of high speed data modems that combines LSI technology with proven Codex operational performance, to produce a fleet of third generation modems unmatched for versatility, dependability, reliability and performance.

Choose from eight mighty little modems: the Codex LSI 9600, LSI 7200 and LSI 4800 for point-to-point, full-duplex circuits with all the options and diagnostics you expect from the high speed modem leader...

The revolutionary LSI 96FP, LSI 72FP and LSI 48FP "Fast Poll" multipoint series mates outbound speeds of 9600, 7200 and 4800 bps with a speedy 9 msec RTS/CTS delay at 4800 bps inbound, to produce the optimum in multipoint system response time and throughput...

The LSI 48I CCITT V.27 compatible units let you go full speed ahead when you operate

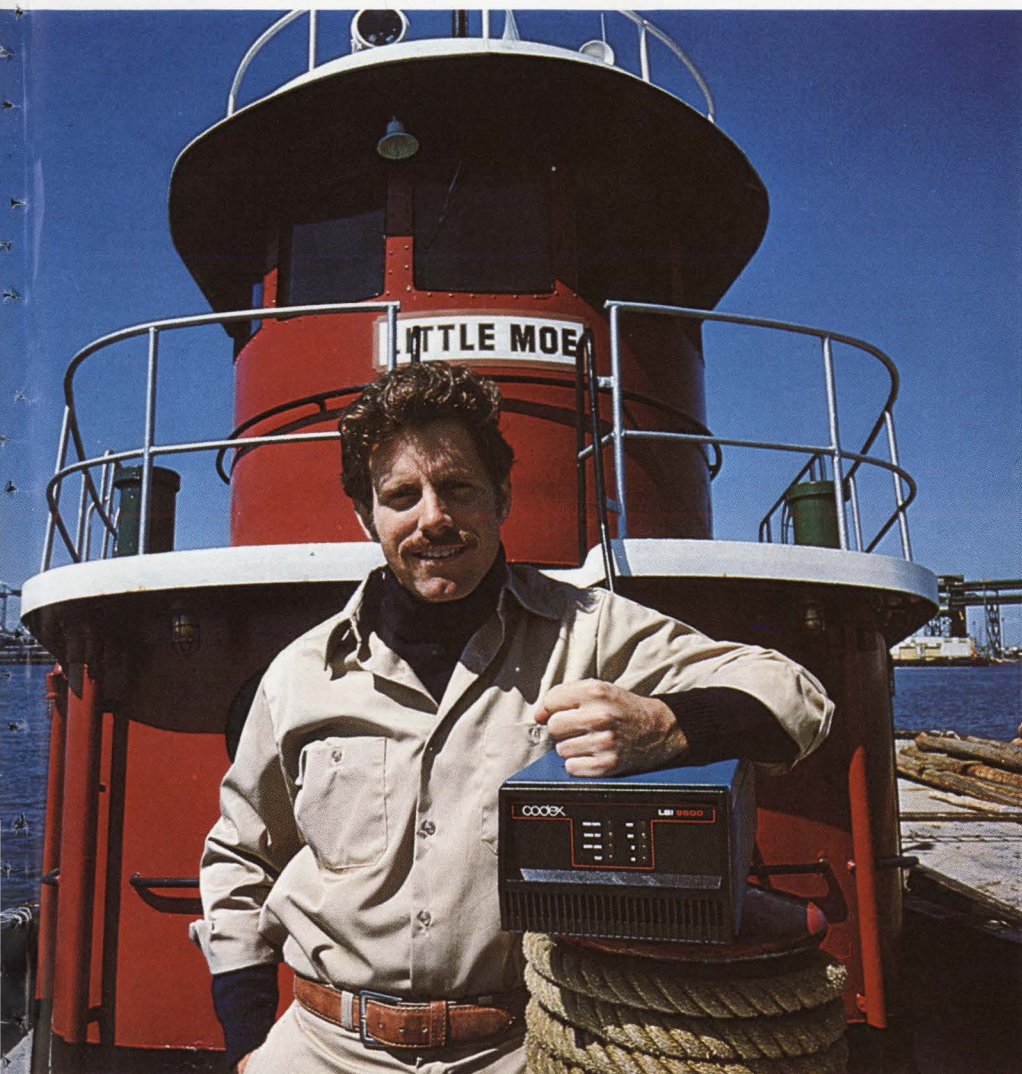

point-to-point or multipoint in international waters... the LSI 48D gets you reliably past the shoals when you navigate on the DDD network.

Little Moe is supported with a new wave of optional network diagnostics. The Circuit Quality Monitoring System (CQMS) combines five standard test and diagnostic functions into a single package for complete central site control. The Multipoint Network Control System (MNCS) provides monitoring, test and restoral functions for the ultimate in multipoint network performance.

Drop Codex a line. Find out how Little Moe can pilot your data communications network safely, reliably and economically.



**codex**  
We'll get you through

member of  
**IDCMA**

Codex Corporation, 15 Riverdale Avenue, Newton, Massachusetts 02195, (617) 969-0600, Telex: 92-2443

Codex Europe S.A., Bte 7/Av. de Tervuren 412, B-1150 Brussels, Belgium, Tel: 762.23.51/762.24.21, Telex: 26542

CIRCLE NO. 17 ON INQUIRY CARD

# The Private Eye.

It solves the mystery of data communications networks.

The new Codex 6000 Series Intelligent Network Processor.

The Codex 6000 has a unique, multiple-micro-processor system architecture that combines the best features of time division multiplexers and computer-based concentrators.

The Codex 6000 slips into your network without a clue: it's completely transparent to network protocol, terminal mix, system configuration or existing control facilities. Yet no customized programming is necessary.

Line costs are reduced because the Codex 6000 combines statistical bandwidth alloca-

tion and data compression — outperforms traditional TDM's by factors as high as four to one, with less node-to-node delay. Error-free data is assured by a full-duplex internal ARQ protocol.

The 6000 checks out all the facts. From a central-site communications and control console it surveys your network, collects such statistical data as terminal error rates, trunk and node performance, data compression efficiency, line utilization. Then computes and reports the information.

Assign pre-set performance thresholds to the Codex 6000 Series Intelligent Network Processor, and it lets you know when they're exceeded.

It's the Private Eye from Codex, sweetheart.

A great case to work on for better network planning, growth and management.

**codex**  
We'll get you through

member of  
**IDCMA**

Codex Corporation, 15 Riverdale Avenue, Newton, Massachusetts 02195, (617) 969-0600, Telex: 92-2443

Codex Europe S.A., Bte 7/Av. de Tervuren 412, B-1150 Brussels, Belgium, Tel: 762.23.51/762.24.21, Telex: 26542

CIRCLE NO. 18 ON INQUIRY CARD



**IBM 2260 and Compatibles.** The market leader in the IBM 2260 segment is still IBM, although the industry giant does not actively support this product and would prefer to switch its customer base to IBM 3270 terminals. The current lawsuits between IBM and Sanders over interface standards are indicative of the IBM competitive strategy to "encourage" its customers to update their equipment. Other large suppliers are shown in the figure.

**Teletypewriter Replacements.** This market is the most competitive CRT segment. Manufacturers compete on the basis of price, product quality and corporate reputation. Only one firm has over a 10 percent market share, while over 20 firms have a 1 percent or better market share, and close to 50 firms offer teletypewriter replacements.



**FOR THOSE ON THE MOVE.** Digi-Log's portable teletypewriter-replacement type CRT weighs only 23 pounds.

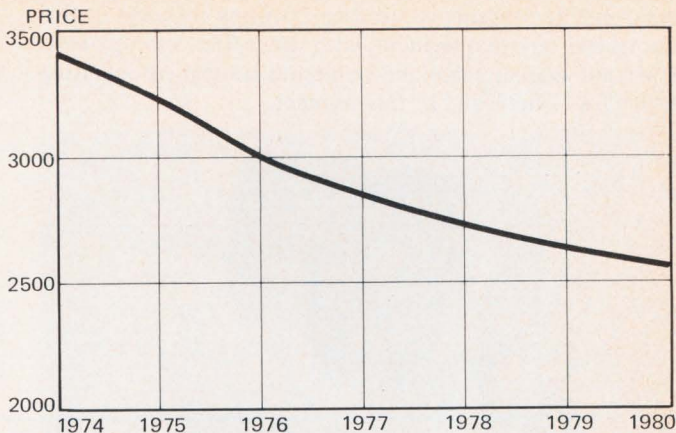

**Fig. 2 — Average Alphanumeric CRT Prices.** (Data supplied by Venture Development Corp.)

**Teletype Model 40 and Compatibles.** As might be expected, Teletype commands the major share of this market (90 percent); however, ICC offers a terminal that has the potential of being a lucrative replacement for Teletype's CRT.

**Other Mainframe Manufacturers.** After IBM, the *Venture Development* study found seven other mainframe manufacturers contributed 12 percent of the total installed base for CRTs. Of the seven (now six, with the departure of Singer), only Univac had as much of 20 percent of that 12 percent market slice, although none had less than 5 percent. Honeywell and NCR purchase their terminals on an OEM basis from Datapoint and ADDS, respectively. Digital Equipment has the fastest growing segment among mainframe manufacturers with an inexpensive terminal and a large minicomputer customer base.

# Data bank output on large TV screens



The ever growing use of data processing is providing an important planning and analysis resource for executives in a broad spectrum of business: from bankers, to bakers, to candlestick makers.

The computer's expanding involvement with daily operations produces a wealth of information that often requires frequent presentation to groups of six, sixty, or six hundred or more people.

### Illustrate your data bank

The most valued and versatile component in your information system could be the large screen color television projector . . . the incomparable General Electric PJ5000. Coupled to your computer facilities through suitable interface equipment, it can project Alphanumeric data, graphic displays and computer generated images, in real time, for instant review and analysis. In addition, it can project information from all standard video sources.

Just visualize a 2 to 20 foot wide TV screen with fast breaking investment data, or sales information for immediate discussion and decision, being presented in color. Or corporate strategy ideas being immediately fed to the computer and their likely consequences projected as "war game" conclusions in TV graphs and charts.

All the advantages of utilizing computer data bank information as a decision making resource are greatly magnified by the use of large screen TV projection. The GE PJ5000 is designed to deliver a dependable professional performance with ease of operation. The GE exclusive single gun, single optical path system projects bright, natural color pictures with inherent color registration, on large screens for front or rear projection.

The PJ5000 is easily transportable and ready to move from your board room, to any other location, and it operates from standard 120v/20 amp appliance outlets. Its compact, self-contained Control unit can be removed from the projector, for remote set-up and operating control, with the addition of an accessory control cable.

The PJ5000 solid-state, high brightness, color video projector is engineered for excellent picture quality and power efficiency, with ease of operation, maintenance and service.

To find out more on how to present your data in a dynamic new light, call (315) 456-2562 or 456-2533 today, or write to:

Video Display Equipment Operation  
General Electric Company  
Electronics Park, 6-206  
Syracuse, New York 13201

**The GE large screen color TV projector... PJ5000**

GENERAL  ELECTRIC

CIRCLE NO. 19 ON INQUIRY CARD

**Independent Systems.** More than 20 firms compete in this specialized terminal segment, with seven firms having over a 5 percent market share and numerous companies operating in the low volume end of this segment.



**TELETYPE MODEL 40'S MAIN COMPETITOR.** *International Communications Corp. is expected to move in on Teletype Corp.'s 90 percent market share.*

**PRICES: DECLINES NOT PLUNGES**

Prices can range from \$1000 to \$12,000 depending on features. For around \$1000, there are asynchronous teleprinter-replacement CRTs with 960-character display, typewriter keyboard, cursor and character repeat features. For another \$11,000, you can get a synchronous user-programmable CRT with printer, dual cassettes, 1920-character screen, controller and every imaginable editing feature. Price competition is stiffest at the lower end where prices are ap-

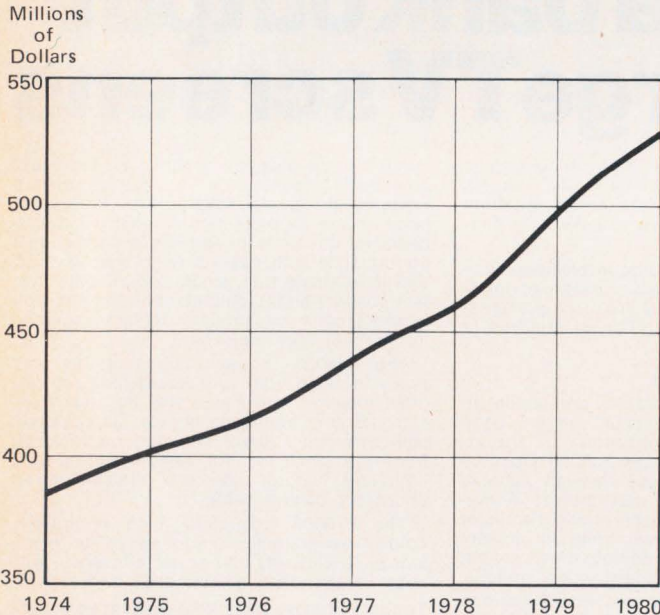

**Fig. 3 - Dollar Volume of Alphanumeric CRT Shipments.** (Data supplied by Venture Development Corp.)

proaching those of the Teletype. According to *Venture Development*, the average price of an alphanumeric CRT was \$3400 in 1974 and is expected to be \$2580 by 1980, an average price decline of 4 to 5 percent per year (see Fig. 2). Price declines will depend on two factors in the next five years: wage levels and integrated circuit prices. Wages will of course rise, but integrated circuit prices – the more dom-

inant factor – will drop substantially to enable the overall price decline. Higher volumes and more competition will also keep prices down.

**MARKET GROWTH: LINEAR NOT EXPONENTIAL**

The most important factors influencing market growth in the next five years are the volume of computer, minicomputer and time sharing system shipments; CRT price trends; AT&T's policies regarding line usage; and the timing of the next generation to replace IBM's 3270. Taking these factors into account, *Venture Development* projects over \$500 million in annual shipments of CRTs by 1980 (see Fig. 3). Growth is expected in the markets for teleprinter and Teletype Model 40 replacements, for other mainframe supplied displays and for independent (or specialized) systems. The 2260 will likely be phased out completely by 1980, and the 3270's growth will level off (see Fig. 4). IBM will probably have started a new generation (and another market) of terminals by then, possibly incorporating plasma displays and definitely microprocessors.

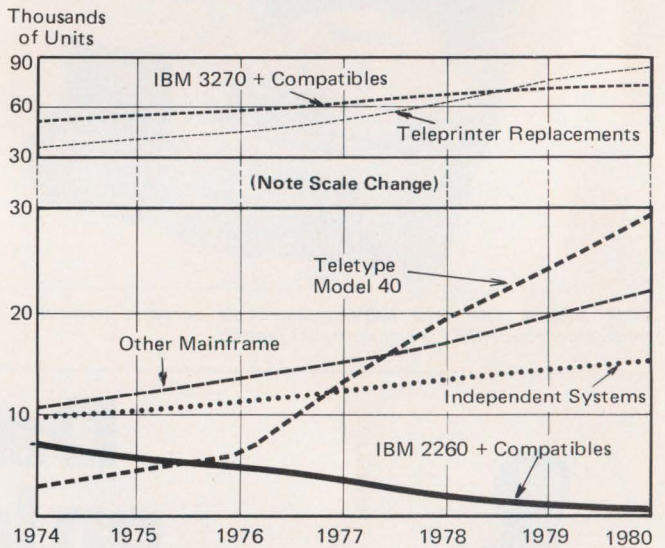

**Fig. 4 - Alphanumeric CRT Shipments by Number of Units.** (Data supplied by Venture Development Corp.)



**ALL SIZES AND SHAPES.** From the most common version pictured in the foreground, CRTs have diversified to fit new applications as evidenced by Applied Digital Data Systems' (ADDS) product line.

TABLE 1 — ALPHANUMERIC DISPLAY TERMINAL SUPPLIERS

SUPPLIER	Configuration		Compatibility					User Programmable
	Stand-Alone	Cluster	TTY 33/35	TTY 40	IBM 2260/65	IBM 3270	Other	
ANN ARBOR TERMINALS, INC. 6107 Jackson Road, Ann Arbor, MI 48103	●		●					
APPLIED DIGITAL DATA SYSTEMS, INC. 100 Marcus Boulevard, Hauppauge, NY 11787	●		●			●	●	
BEEHIVE TERMINALS 870 West 2600 South, P.O.Box 19244, Salt Lake City, UT 84119	●		●				●	●
BUNKER RAMO CORP. Trumbull Industrial Park, Trumbull, CT 06609		●			●			
BURROUGHS CORP. Room 2A38, Burroughs Place, Detroit, MI 48232	●				●	●	●	
CALIFORNIA COMPUTER PRODUCTS, INC. 2411 W. LaPalma Ave., Anaheim, CA 92801		●				●		●
COMPU TEK, INC. 143 Albany St., Cambridge, MA 02139	●	●	●		●	●		●
COMPUTER COMMUNICATIONS, INC. 2610 Columbia St., Torrance, CA 90503	●	●			●			
COMPUTER OPTICS, INC. Berkshire Industrial Park, Bethel, CT 06801	●	●			●	●		
CONRAC CORP. 600 N. Rimsdale Ave., Covina, CA 91722	●	●	●			●		●
CONTROL DATA CORP. 8100 34th Ave. South, Minneapolis, MN 55420	●	●	●				●	
COURIER TERMINAL SYSTEMS, INC. 2202 E. University Drive, Phoenix, AZ 85034	●	●			●	●		
DATA 100 CORP. 7725 Washington Ave. South, Minneapolis, MN 55435	●		●					
DATA DISC 686 W. Maude Ave., Sunnyvale, CA 94086		●			●			
DATA GENERAL CORP. Route 9, Southboro, MA 01770	●		●					
DATAMEDIA CORP. 7300 N. Crescent Boulevard, Pennsauken, NJ 08110	●		●					
DATAPPOINT CORP. 9725 Datapoint Drive, San Antonio, TX 78284	●		●		●	●	●	
DELTA DATA SYSTEMS CORP. Woodhaven Industrial Park, Cornwells Hgts, PA 19020	●	●	●		●			●
DIGI-LOG SYSTEMS, INC. Babylon Road, Horsham, PA 19044	●		●		●	●		●
DIGITAL EQUIPMENT CORP. 146 Main St., Maynard, MA 01754	●		●					
FOUR-PHASE SYSTEMS, INC. 19333 Vallco Parkway, Cupertino, CA 95014		●	●		●	●		●
GENESIS ONE COMPUTER CORP. 300 East 44th St., New York, NY 10017		●				●		
GTE INFORMATION SYSTEMS, INC. One Stamford Forum, Stamford, CT 06904	●	●			●	●		
HAZELTINE CORP. Greenlawn, NY 11740	●	●	●				●	
HENDRIX ELECTRONICS, INC. 645 Harvey Road, Manchester, NH 03103	●	●	●				●	●
HEWLETT-PACKARD 1501 Page Mill Road, Palo Alto, CA 94304	●		●					
HONEYWELL INFORMATION SYSTEMS, INC. 200 Smith St., Waltham, MA 02154	●	●	●				●	●
INCOTERM CORP. 6 Strathmore Road, Natick, MA 01760	●	●			●	●	●	●
INFORMER INC. 2218 Cotner Ave., Los Angeles, CA 90064	●	●	●					

# Computer Security Institute Introduces The "Unbundled" Membership Program

## An alternative to full service membership.

### BIMONTHLY NEWSLETTER

Every other month (six times each year) you will receive *Computer Security: The Newsletter for Computer Professionals*...your direct line to the most significant news in the field. This comprehensive, tightly knit letter is "one-of-a-kind" — the only letter that you can count on to keep current on all aspects of computer security. It is edited by Belden Menkus, a nationally recognized management consultant. Each issue delivers clear-cut and useful computer security information.

General topics include:

- ★ News on security equipment and services including new product announcements and software packages.
- ★ Discussion and analysis of members' specific computer security problems.
- ★ Special commentaries by experts in areas of current interest, e.g., privacy legislation, disaster recovery, encryption, risk analysis, fire protection, UPS, and physical access control systems.
- ★ A summary of new literature, who's who in computer security, important legal opinions, article summaries and up-coming events.
- ★ Case histories. Robert V. Jacobson, a nationally known authority, contributes two case histories for each issue. Taken directly from the recent news, they provide valuable insight, expert analysis, and solid recommendations.

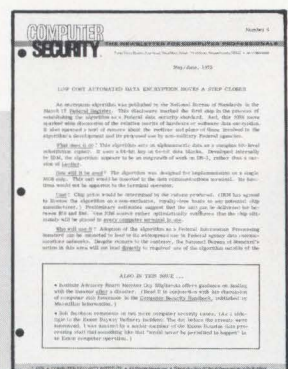

Circulation of *Computer Security* is restricted to Institute members.

### COMPUTER SECURITY MANUAL

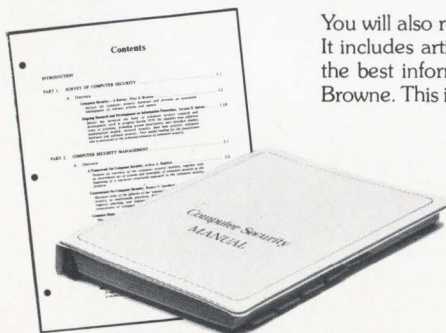

You will also receive a 375 page manual which is available only to Computer Security Institute members. It includes articles and presentations carefully chosen by the Institute's Advisory Board—a distillation of the best information currently available on the subject. It is edited by Advisory Board member Peter S. Browne. This invaluable, time-saving tool is logically organized into six major categories:

- Survey of Computer Security
- Computer Security Management
- Physical Security
- Hardware/Software Control
- Audit: Measurement & Review
- Privacy & Computer Abuse

The emphasis is on the practical, "how-to"...a reference source designed to be USED...not studied. Included for the serious practitioner is a highly selective bibliography of 133 articles and papers...35 of which appear in the manual. The manual can also serve as a convenient repository for your *Computer Security* newsletters.

### DISCOUNT PRIVILEGES

A major benefit of the "unbundled" option is the 15% discount which can be applied to other Institute services:

- Seminars
- Research Reports
- Buyer's Guide

For example, if you attend the three day Annual Conference, you would realize a savings of \$66.75...the non-member registration fee being \$445.

### HOT LINE SERVICE



This special service alone can be worth the price of membership. Our staff is *on call*—available to you on an informal basis. Use this two-way communications channel to seek answers to your computer security problems. This service is available only to Institute members.

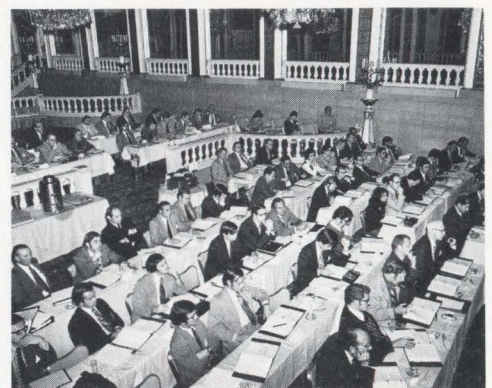

Annual Conference • New York City

## Full Service Membership



### INSTITUTE SPONSORED RESEARCH

Each year you will receive two major Research Reports. Current Special Reports are:

*Computer Security Risk Management Handbook* co-authored by Institute Advisory Board members Robert V. Jacobson and Peter S. Browne. It is a practical "how-to-do-it" guide designed to help you systematically identify, organize, analyze, and prioritize your D.P. risk exposures. Complete with step-by-step fill-in forms, reference sources, and case histories. Topics include:

- Preparing for risk analysis
- Threats & vulnerabilities
- Probabilities of occurrence
- Cost/benefit analysis

The non-member price is \$95.

*Decision Guide to Physical Access Control Systems* is a guide to help you understand and evaluate a wide variety of physical access control systems. A practical approach with tables, checklists, diagrams and recommendations. Detailed comparison charts describe system attributes, and include pricing data.

Major areas examined include:

- Basic principles of access control systems
- Stored-code, portable key & physical attribute systems
- Cost/benefit analysis
- Index to manufacturers

### COMPUTER SECURITY COMPLIANCE TEST PROGRAM

Once a year you will have an opportunity to find out how well your organization's computer security program is doing, and at the same time determine how the security of your D.P. facility compares with others around the country. The Institute will send you a self-administered test. Your responses will be tabulated and you will be notified of the results. The test is designed to allow you to determine how *important* each test item is with respect to your own installation, and how well you are *implementing* it. This innovative exercise will assist you in pointing out to senior management your facility's strengths and weaknesses.

### COMPUTER SECURITY BUYER'S GUIDE

Published annually, the *Computer Security Buyer's Guide* is a comprehensive survey of security equipment and services. This useful guide is cross referenced by product and manufacturer. It is the *only* compilation of its kind...a convenient one-stop reference source. Listings include site access control systems, air conditioning equipment, automatic fire protection systems, uninterruptible power supplies, software packages, consulting services.

**PLUS...THE NEWSLETTER, COMPUTER SECURITY MANUAL & HOT LINE SERVICE.  
ALSO...DISCOUNT PRIVILEGE OF 33% ON ALL SEMINARS.**

### SEMINARS

A nationwide schedule of seminars offers you an excellent opportunity to broaden your computer security skills. Each Institute sponsored seminar is something special. The intensive programs are directed by Advisory Board members and offer the very latest techniques which can be applied immediately to your own security problems.

And each seminar has something "extra" built in. A previous program included a tour of the McDonnell Douglas (MCAUTO) facilities in St. Louis; another provided the opportunity to consult with speakers on a prearranged basis. Workshops are now included in each program. Questionnaire input from the attendees prior to the seminar determines which topics will be discussed.

These "interactive" seminars are either two or three day programs. The non-member registration fee is \$350 for two days, and \$445 for the three day program.

#### COMPUTER SECURITY INSTITUTE

43 Boston Post Road · Northboro · Massachusetts · 01532 · (617) 393-3666

- I would like to take advantage of the "unbundled" option and become a member of the Computer Security Institute at the annual rate of \$75 per year (\$90 overseas).
- I would like to take advantage of the Full Service Option and become a member of the Computer Security Institute at the annual rate of \$245 per year (\$275 overseas).
- Please send me more information on Computer Security Institute membership.

- Check enclosed payable to "Computer Security Institute".
- Please bill me.  Please bill my organization.

Please print:

Name \_\_\_\_\_ Title \_\_\_\_\_  
Organization \_\_\_\_\_ Phone ( ) \_\_\_\_\_  
Address \_\_\_\_\_  
City \_\_\_\_\_ State \_\_\_\_\_ Zip \_\_\_\_\_

TABLE 1 — ALPHANUMERIC DISPLAY TERMINAL SUPPLIERS / continued

SUPPLIER	Configuration		Compatibility					User Programmable
	Stand-Alone	Cluster	TTY 33/35	TTY 40	IBM 2260/65	IBM 3270	Other	
INFOTON, INC. Second Ave., Burlington, MA 01803	●		●					●
INTELLIGENT SYSTEMS CORP. 2405 Pine Forrest Dr., Norcross, GA 30071	●						●	●
INTERFACE TECHNOLOGY, INC. St. Louis, MO 63132	●		●					
INTERNATIONAL BUSINESS MACHINES CORP. 1133 Westchester Ave., White Plains, NY 10604	●	●			●	●		
INTERNATIONAL COMMUNICATIONS CORP. 8600 N.W. 41st St., Miami, FL 33166	●			●				
INTERNATIONAL TELEPHONE & TELEGRAPH CORP. East Union Ave., East Rutherford, NJ 07073	●	●	●		●			
I.P. SHARP ASSOCIATES, LTD. P.O. Box 1900, Karleton Place, Ontario	●						●	
JACQUARD SYSTEMS 1505 11th St., Santa Monica, CA 90404	●	●	●			●		●
KUSTOM ELECTRONICS INC. 1010 West Chestnut, Chanute, KS 66720	●						●	
LEAR SIEGLER, INC. 714 North Brookhurst St., Anaheim, CA 92803	●		●					
LOCKHEED ELECTRONICS CO. 6201 E. Randolph St., Los Angeles, CA 90022	●		●					
MEGADATA COMPUTER AND COMMUNICATIONS CORP. 10 Evergreen Place, Deer Park, NY 11729	●	●					●	●
MICRODATA 17481 Red Hill, Irvine, CA 92705	●		●					
MICROTECH DATA SYSTEMS, INC. 1141 East Janis St., Carson, CA 90746	●	●	●				●	●
NCR CORP. Bldg. 23, 3rd Floor, Main & K Sts., Dayton, OH 45409	●		●					
OLIVETTI CORP. OF AMERICA 500 Park Ave., New York, NY 10022	●	●	●		●	●		●
OMRON SYSTEMS, INC. 432 Toyama Drive, Sunnyvale, CA 94086	●		●					●
ONTEL CORP. 3 Fairchild Court, Plainview, NY 11803	●	●	●				●	●
PERTEC BUSINESS SYSTEMS 17112 Armstrong Ave., Santa Ana, CA 92705	●		●					
PLANTRONICS, INC. 385 Reed St., Santa Clara, CA 95050	●		●					
QUOTRON SYSTEMS, INC. 5454 Beethoven St., Los Angeles, CA 90066		●			●		●	
RANDAL DATA SYSTEMS 2807 Oregon Court, Torrance, CA 90503	●		●					
RAYTHEON DATA SYSTEMS COMPANY 1415 Boston-Providence Turnpike, Norwood, MA 02162	●	●	●			●	●	●
RESEARCH, INC. P.O. Box 24064, Minneapolis, MN 55424	●		●					
SANDERS DATA SYSTEMS, INC. Daniel Webster Highway, Nashua, NH 03060	●	●			●	●	●	●
SCIENTIFIC MEASUREMENT SYSTEMS, INC. 26 Olney Ave., Cherry Hill, NJ 08003	●		●					
SELECTERM, INC. 59 Union Square, Somerville, MA 02143	●		●					
SYCOR, INC. 100 Phoenix Drive, Ann Arbor, MI 48104	●	●				●	●	●
SYS COMPUTER CORP. 17-25 DiCarolus Court, Hackensack, NJ 07601	●		●					

TABLE 1 – ALPHANUMERIC DISPLAY TERMINAL SUPPLIERS / continued

SUPPLIER	Configuration		Compatibility					User Programmable
	Stand-Alone	Cluster	TTY 33/35	TTY 40	IBM 2260/65	IBM 3270	Other	
<b>TEC, INC.</b> 9800 North Oracle Road, Tuscon, AZ 85704	●		●				●	●
<b>TEKTRONIX, INC.</b> P.O. Box 500, Beaverton, OR 97005	●		●					
<b>TELERAM COMMUNICATIONS CORP.</b> 1032 Mamaroneck Ave., Mamaroneck, NY 10543	●		●					
<b>TELETYPE CORP.</b> 5555 Touhy Ave., Skokie, IL 60076	●	●		●				
<b>TERMIFLEX CORP.</b> 17 Airport Road, P.O.Box 1123, Nashua, NH 03060	●		●					
<b>TERMINAL COMMUNICATIONS, INC.</b> 3301 Terminal Drive, Raleigh, NC 27611	●	●				●		
<b>TEXAS INSTRUMENTS, INC.</b> P.O. Box 2909, Austin, TX 78767	●		●					
<b>TEXAS SCIENTIFIC CORP.</b> 8000 Harwin Drive, Houston, TX 77036		●				●		
<b>TRIVEX, INC.</b> 3180 Red Hill Ave., Costa Mesa, CA 92626	●	●			●	●		
<b>UNIVAC DIVISION, SPERRY RAND CORP.</b> P.O. Box 500, Blue Bell, PA 19422	●						●	
<b>VIDEO DATA SYSTEMS</b> 657 Old Willets Path, Hauppauge, NY 11787	●		●					
<b>WANG LABORATORIES, INC.</b> 836 North St., Tewksbury, MA 01876	●		●					●
<b>WESTINGHOUSE CANADA, LTD.</b> Box 510, Hamilton, Ontario, Canada L8N 3K2	●	●	●		●		●	●
<b>WILTEK, INC.</b> Glover Ave., Norwalk, CT 06850	●	●	●					
<b>WINTEK CORP.</b> 902 N. 9th St., Lafayette, IN 47904	●		●					
<b>WYLE COMPUTER PRODUCTS</b> 3200 Magruder Boulevard, Hampton, VA 23666	●	●			●	●		●
<b>ZENTEC CORP.</b> 2368-C Walsh Ave., Santa Clara, CA 95050	●						●	●

**READY FOR A NEW TECHNOLOGY?**

High power consumption, excessive heat generation, high voltage requirements, video distortion – these are some of the problems associated with CRT display terminals. So naturally many have predicted the eventual demise of the CRT. But what about a replacement? At least 10 firms are already marketing other types of display terminals. It's just a question of which will catch on. Alternate technologies include light emitting diodes (LEDs), liquid crystals (LCDs) and gas panel displays. LEDs, which are used in most pocket calculators, are limited in the number of possible character configurations they permit. This restriction similarly applies to LCDs, which also form characters by selective activation of a relatively few (generally 7) line segments rather than the 35 or more dots available to form each CRT character. Additionally, character generation circuitry is more complex for large arrays of LED- or LCD-produced characters.

The most likely CRT replacement is the gas panel (plasma) display, which is already being used on a small scale in products manufactured by IBM, Burroughs, Owens-Illinois, and others. These include the:

- **IBM 3760/3790 Terminal.** IBM's approval of gas displays came as part of a key-to-disk data entry system introduced in 1975. A small 236-character plasma display was included in the system.
- **Burroughs Self-Scan Panel Display.** Already used in the TD700 alphanumeric terminal, this display is available in various sizes, but maximum is 256 characters, formatted into eight rows.
- **Owens-Illinois Digivue Plasma Panel.** Available in two sizes with a display capacity of over 2000 characters, the Digivue has the added feature of not requiring a refresh memory. This relaxes the timing constraints on the display and allows the screen to be updated at a slower rate than a corresponding CRT. At \$2300, the Digivue display is expensive, but prices should decline with increasing volume.

The new technology is there, but for it to catch on, it will have to come down in cost, engineers will have to get used to it, and customers will have to be willing to change from something reliable and proven. And to make engineers feel comfortable and customers feel secure, IBM will have to adopt it in its next generation of alphanumeric display terminals. ■

# The HP 9825A

Hewlett-Packard calls it a "programmable calculator."  
We would not.

Hewlett-Packard's new 9825A is described with typical HP conservatism as a "desk-top programmable calculator." That it is, but the label is nonetheless unfortunate because it immediately invites comparisons with such other desk-top programmables as the new IBM, Tektronix and Wang offerings. Insofar as the 9825A is an exceptionally powerful calculating instrument, it does indeed compete with those systems. But the 9825A does a lot more than calculate; it controls as well. For that reason we believe bench-top programmable calculator/controller would be a more apt string of appositives. It would at least call attention to the system's unique multi-function capabilities in a laboratory (bench-top) rather than office (desk-top) environment.

Like other models in the 9800 line, particularly the 9821A, which it will phase out, the 9825A uses a high-level, Fortran-like algebraic language, contains a thermal printer, tape cartridge and one-line LED display, and accepts a variety of special-purpose plug-in ROMs and interface modules. With all these similarities, however, the 9825A differs sharply from its predecessor.



HP's new 9825A comes with 8K bytes of internal read/write memory and can be expanded in optional 8K increments to a total of 32K bytes. Other options include four plug-in ROMs (for string processing, plotter control and formatting, general I/O, and extended I/O), and three interface cards — a 16-bit parallel card for general-purpose interfacing, a BCD card, and an HP-IB card for instruments that conform to IEEE Standard 488-1975. All options are usable together.

To begin, the 9825A is much faster. Most of the increase results from use of the new tape cartridge first seen a few months ago on the 9815. Compared to the cartridge used in the 9821A and 9830A, the 9825A cartridge gets more than 3-1/2 times as much information on less than half as much tape (see box). We ran essentially the same tapebound pro-

gram on both machines and the answers appeared on the 32-character display of the 9825A some 12 to 20 times faster than on the 16-character display of the 9821A.

Other significant features of the 9825A are its interrupt/priority logic and "live" keyboard. Together, these allow the user to perform calculations, examine and change program variables, and list programs while the 9825A is performing other operations. The system apportion operations on a priority basis, making it appear that everything is happening at once. A related benefit is that if runs are interrupted in mid-program, either under operator control or because of power failure, the contents of all registers are written to tape. Reloading the tape automatically resets the data and status registers, and continues whatever program(s) had been running.

By themselves, these are impressive features. But it is only after they are considered as part of the system's interface that the real power of the 9825 becomes apparent. How and why this total interfacing capability evolved is a story worth telling.

## A STANDARD INTERFACE . . .

Even before HP produced its first computer, it was searching for efficient ways of using computers to monitor and control HP instruments. This research led to the development of proprietary computer interface techniques that have been incorporated in HP systems since the Sixties. Naturally, HP was also interested in alternative approaches used by other instrument makers, by users, and by other computer manufacturers.

By the early Seventies it was obvious that a standard interface — one that would permit the instrumentation products of different manufacturers to communicate with each other — would be forthcoming. Several German companies were already pooling efforts in this direction. HP's efforts at designing its own standard digital interface had resulted in an interface bus (IB) and protocols that enabled one HP control unit to handle communications among up to 14 HP devices.

## . . . AND AN INTERFACE STANDARD

In mid-1972, HP began to participate in various national and international standardization bodies. The U.S. Advisory Committee, composed of diverse interests represented by both users and manufacturers, first established initial goals, — and then adopted the interface concept utilized by the HP Interface Bus as an appropriate starting point. A draft document was subsequently written and evaluated by members of the Committee, and then submitted as the U.S. proposal to an IEC (International Electrotechnical Commission) Working Group in the autumn of 1972. The proposed standard was subsequently redefined slightly to accommodate various needs at the international level.



# DELTA 4500

USER  
PROGRAMMABLE  
VIDEO DISPLAY  
TERMINAL



## INTRODUCTION

The DELTA 4500 is a standalone, user-programmable video display terminal designed for interactive and off-line "intelligent" data processing operations. The terminal is available with up to 16 kilobytes of memory in any combination of Read Only Memory, Programmable Read Only Memory and Random Access Memory, depending upon requirements. Up to 25 lines of 80 upper/lower case characters may be displayed on the terminal's 14-inch diagonal screen. Communications speeds (full or half duplex) up to 9600 bps are possible with the DELTA 4500; and the terminal may also be used in clustered environments.

User programmability is provided by the terminal's integral resident assembler, debug package and text editor, or downstream loader. The downstream loader permits the central system—or peripheral devices—to load programs in any or all terminals, as applications change.

## SPECIAL FEATURES/ADVANTAGES

On-the-job programmability provides a number of significant advantages towards lowering costs, improving productivity and enhancing overall system efficiency. The DELTA 4500 is immediately adaptable to meeting new terminal applications as the needs arise; it may be used to emulate other terminals in an existing system; and the terminal will perform many functions now being processed by a computer. Typical of these functions would be local error checking, text editing, formatting and many other off-line processing operations. These capabilities help to significantly reduce operator, computer and communications line time along with associated costs.

Other features provided by the DELTA 4500, and the advantages they offer include:

### PACKED DISPLAY MEMORY—

Useful where many lines of display are needed, this feature helps lower communications time.

### PRINTER ON LINE MODE—

Allows the printer to operate from the communications line simultaneously with keyboard input functions to the display.

### SIMPLE, EASY-TO-USE KEYBOARD,

plus the availability of special symbols and character generators reduce operator intervention, minimize error possibilities and eliminate fatigue while helping to speed operations.

### USER-PROGRAMMABLE COMMUNICATIONS INTERFACE—

Helps prevent terminal obsolescence by allowing special communications devices and peripherals to be added onto the system for future applications.

### EXCLUSIVE PAGING FEATURE—

permits display of all the characters in memory—regardless of the number of lines—in any format, without computer memory or regard to the number of lines of information transmitted. PAGING permits the user to recover information that has been rolled off the screen—top and bottom—by the push of a button.

### PROTECTED FORMAT CONTROL—

transmits variable information only, thus reducing transmission time; also eliminates the need to re-enter forms which further reduces transmission time and job time; permits rapid modifications and editing of variable data.

### FOUR DISPLAY MODES—

include normal, reverse, blink, reverse with blink—highlight important fixed or variable data; allow display of information in chart form.

## Typical applications

- Reservations systems
- Word processing
- Message switching
- Medical information systems
- Order entry
- Law enforcement
- Data retrieval
- Accounting systems
- Inventory control systems

Plus many other applications for industries and organizations of all kinds such as banks, security firms, hospitals, transportation, Government agencies at all levels, utilities, municipalities, insurance industries—practically everywhere intelligent display terminals are needed in a computer or data communications system environment.



**DELTA terminals  
are reliable . . .  
they're built for  
years of depend-  
able, trouble-free  
performance!**



# DELTA 4500 Specifications

CHARACTERISTICS	DESCRIPTION
<b>PROGRAMMABILITY</b>	User-programmable Terminal—Up to 16 Kilobytes of RAM or ROM
<b>CRT</b>	
Type	T.V. Monitor
Size	14 Inches (Diagonal)
Phosphor	P31 (Green)
<b>DISPLAY</b>	
Refresh Rate	60 Hz (50 Hz optional)
Characters Per Line	80
Lines Per Display	25
Video	Standard, Blinking, Reversed, and Blinking Reversed
<b>CHARACTER GENERATION</b>	
Type	MOS ROM
Size	5x7 Dot Matrix
<b>CHARACTER CODE</b>	USASCII
<b>CHARACTER SET</b>	224 Displayable Characters as follows: 64 Upper-Case; 32 Lower-Case; 32 Control Codes; 96 Escape-sequence Codes
<b>CURSOR TYPE</b>	Non-destructive blinking underline or blinking full block
<hr/>	
<b>STANDARD PROGRAM (DELTA 4000 EMULATION)</b>	
<b>DISPLAY MEMORY</b>	
Size	2048 Characters
Overflow	Paging Variable Buffer Memory
<b>AUTOMATIC PAGE-UP</b>	Last line scroll
<b>ERASE CAPABILITY</b>	Clear Memory, Clear Line, Clear to End of Memory
<b>PAGING</b>	Next Page, Previous Page, Page-Up, Page-Down
<b>EDITING</b>	Insert Character, Delete Character, Insert Line, Delete Line, Page Edit
<b>TAB</b>	Tab Set, Tab Clear, Tab Forward, Tab Backward
<b>CURSOR CONTROL</b>	Home, Cursor Up, Cursor Down, Cursor Right, Cursor Left, Tab, Back Tab
<b>CURSOR POSITION ENTER</b>	Write Cursor Address
<b>CURSOR POSITION TRANSMIT</b>	Read Cursor Address
<b>BELL</b>	Control "G" sounds audible alarm
<b>MARGIN (Fixed)</b>	Keyboard entry at character position 73 sounds audible alarm
<b>I/O COMMUNICATIONS</b>	
I/O Port	EIA Standard RS-232-C, CCITT V, 24
Printer Port	EIA Standard RS-232-C, CCITT V, 24
<b>DATA TRANSMISSION</b>	
Line Characteristics	Half Duplex or Echo
Data Formats	Asynchronous 10 or 11-bit code; Synchronous 8-bit code
TTY Mode	Character-by-Character, Memory-Transmit or Message-Transmit
TYPE Mode	Memory-Transmit or Message-Transmit
Code	7-Bit USASCII
Parity	Odd, Even, or None (switch selectable)
Timing	Switch-selectable baud rates of 110, 150, 300, 600, 1200, 2400, 4800, or 9600 EXT (External) clock position provided
Memory-Transmit	Transmit contents of memory up to first ETX
Message-Transmit	Transmit data delimited by two (2) ETX's
<b>DATA COMPRESSION</b>	Inhibit transmission of selected characters occurring to the right of a delete-code on a line
<b>PRINT MODE (Optional)</b>	ON LINE or OFF LINE LOCAL/ON LINE
<hr/>	
<b>KEYBOARD</b>	
Type	Upper/Lower case
Function Pad	Numeric
Key Repeatability	Variable between 13 and 80 characters per second
Program Function Keys	8-Program Function Keys
Security Lock (Optional)	Inhibits keyboard entries only
<b>SELECTABLE FEATURES</b>	Transmit Program-Function Code; Transmit Escape-Sequence Code; Memory-Transmit / Message-Transmit; Transmit-Pending
<b>FIRMWARE</b>	DELTA 4000 Function Program (see above); Demon Debug Monitor; Bootstrap Loader (optional)
<b>SOFTWARE</b>	Text Editor—Resident; Assembler—Resident; Cross Assembler
<b>DIMENSIONS</b>	Width: 18½ inches (460.4 mm); Height: 15¾ inches (400 mm); Depth: 27 inches (685.8 mm)
<b>WEIGHT</b>	75 pounds (34.02 kg) approx.
<b>LINE VOLTAGE</b>	115 Volts A.C., 60 Hz; 220 Volts A.C., 50 Hz
<b>POWER CONSUMPTION</b>	170 Watts
<b>OPERATING TEMPERATURE</b>	10°C to 40°C

For additional information, applications assistance or demonstration, write or call:



Woodhaven Industrial Park  
Cornwells Heights, PA 19020  
(215) 639-9400

DELTA DATA SYSTEMS, LTD.  
London: 01-580-7621

Service in 42 locations in the U.S., and 13 European countries and Canada.

CIRCLE NO. 21 ON INQUIRY CARD

In September 1974, the parent technical committee, IEC TC66, approved the main interface draft document for a formal ballot among the member nations of the IEC. Although final ballot results are not expected until the end of 1976, the present definition of the HP-IB is compatible with the current and approved IEC draft document.

### LESS TAPE, MORE POWER, SAME PACKAGE

The 3M tape cartridge used in the 9825A looks identical to the one used in the 9821A and 9830A. There the similarity ends.

	9821A-9830A	9825A
Tape capacity	70,000 bytes	250,000 bytes
Length	300'	140'
Density	30 bytes/in.*	136 bytes/in./track
Number Tracks	1	2
Search speed	29 in./sec.*	90 in./sec.
Read/write speed	10 in./sec.*	22 in./sec.
Total rewind time	125 sec.	19 sec.
Average search time	42 sec.	6 sec.
Transfer rate	300 bytes/sec.	2750 bytes/sec.
Access rate**	560 bytes/sec.	14,300 bytes/sec.

\*Average

\*\*Including gaps

Meanwhile, the IEEE Standards Board has approved IEEE Standard 488-1975, "Digital Interface for Programmable Instrumentation," as published in April 1975. The IEEE standard is based on work initiated by the IEC, and follows the general concepts of the draft standard document now under consideration by IEC member nations. The HP Interface Bus is Hewlett-Packard's implementation of IEEE Standard 488-1975.

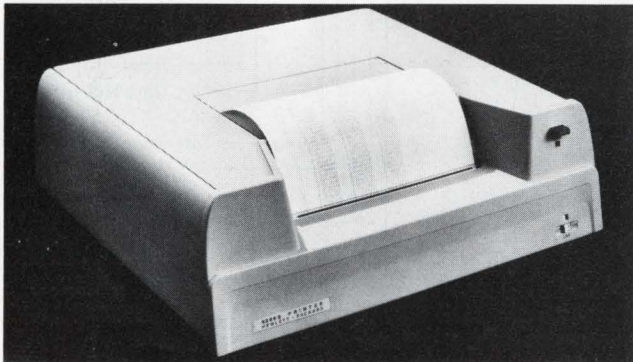

The 9866B Printer was announced simultaneously with the 9825A for attachment to all HP 9800 Series calculators. It contains a 95-character ASCII set, with characters and symbols reproduced by a 5x7 thermal dot matrix in full page width. It can print up to 80 characters per line at a speed of 240 lines per minute and, under calculator control, plot graphs and bar charts with a resolution of .017 inches, at a speed of 900 rows of dots per minute. The HP 9866B printer is priced at \$3200.

### PUTTING IT ALL TOGETHER

Thus the 9825A is hardly just a "desk-top programmable calculator." Because its interface adheres to an industry standard, it is a true "general-purpose" controller as well. In what passes for real time, it can: 1) control an almost unlimited range of instruments; 2) collect data from those instruments; 3) perform calculations on the collected data; 4) present the results graphically on a plotter; and 5) perform offline calculations. All from one 26-lb. package that starts at \$5900!

# DID YOU KNOW PARADYNE

- Has over 2500 **9600** bps LSI Modems installed throughout the world.
- Has been shipping **4800, 7200, & 9600** bps LSI Modems since 1974.
- Has a **9600** bps LSI Modem that **DOES NOT** require line conditioning.
- Has an **LSI FAMILY** of modems with the lowest purchase prices in the industry.
- Offers **100%** rental and purchase credit **ANYTIME** the user upgrades LSI Modem speeds.
- Can rack mount **18** LSI Modems in a single standard 19 inch rack.
- Has LSI Modems with an MTBF significantly longer than the Bell 209 or the Codex 9600 C.
- Maintains customer service centers in all major cities throughout the U.S.

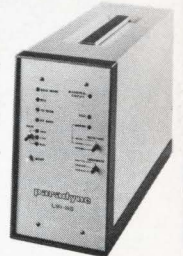

## paradyne

Paradyne Corporation

8550 Ulmerton Road Largo, Florida 33540  
813-536-4771 TWX 810-866-0432

#### Sales Offices:

Boston (617) 965-4850  
Chicago (312) 858-6310  
Dallas (214) 661-0242  
Detroit (313) 559-5360  
Los Angeles (213) 822-1530  
New York (212) 661-5790  
Philadelphia (215) 293-0940  
San Francisco (415) 574-0902  
Tampa (813) 536-4771  
Washington, D.C. (703) 548-4453

#### International Sales Offices:

Canada, Europe, Japan

CIRCLE NO. 23 ON INQUIRY CARD

# How the HP Interface Bus Operates

All active interface circuitry is contained within the various HP-IB devices, and the interconnecting cable (containing 16 signal lines) is entirely passive. The cable's role is limited to that of interconnecting all devices together in parallel, whereby any one device may transfer data to one or more other participating devices.

Every participating device (instrument, controller, accessory module) must be able to perform at least one of the roles of TALKER, LISTENER or CONTROLLER. A TALKER can transmit data to other devices via the bus, and a LISTENER can receive data from other devices via the bus. Some devices can perform both roles (e.g., a programmable instrument can LISTEN to receive its control instructions and TALK to send its measurement).

A CONTROLLER manages the operation of the bus system primarily by designating which devices are to send and receive data, and it may also command specific actions within other devices.

A minimum HP-IB system configuration consists of one TALKER and one LISTENER, but without a CONTROLLER. In this configuration, data transfer is limited to direct transfer between one device manually set to "talk only" and one or more devices manually set to "listen only" (e.g., a measuring instrument talking to a printer, for semi-automatic data logging).

The full flexibility and power of the HP-IB become more apparent, however, when one device which can serve as CONTROLLER/TALKER/LISTENER (e.g., calculator or computer) is interconnected with other devices which may be either TALKERS or LISTENERS, or both (e.g., frequency synthesizers, counters, power meters, relay actuators, displays, printers, etc.) depending on the application.

## HP-IB connections and structure

The 16 signal lines within the passive interconnecting HP-IB cable are grouped into three sets, according to their function.

Eight DATA lines carry coded messages in bit-parallel, byte-serial form to and from devices, with each byte being transferred from one TALKER to one or more LISTENERS. Data flow is bidirectional in that the same lines are used both to input program data and to output measurement data from an individual device. Data is exchanged asynchronously, enabling compatibility among a wide variety of devices. All interface messages (to set up, maintain, and terminate an orderly flow of device-dependent messages) are 7-bit coded. Device-dependent messages may be from 1 to 8 bits; however, the codes containing printable characters of the ASCII (American Standard Code for Information Interchange) code set are most commonly used, and messages containing numbers are typically presented in scientific notation (Fortran-type) format.

Three DATA BYTE TRANSFER CONTROL (handshake) lines are used to effect the transfer of each byte of coded data on the eight DATA lines.

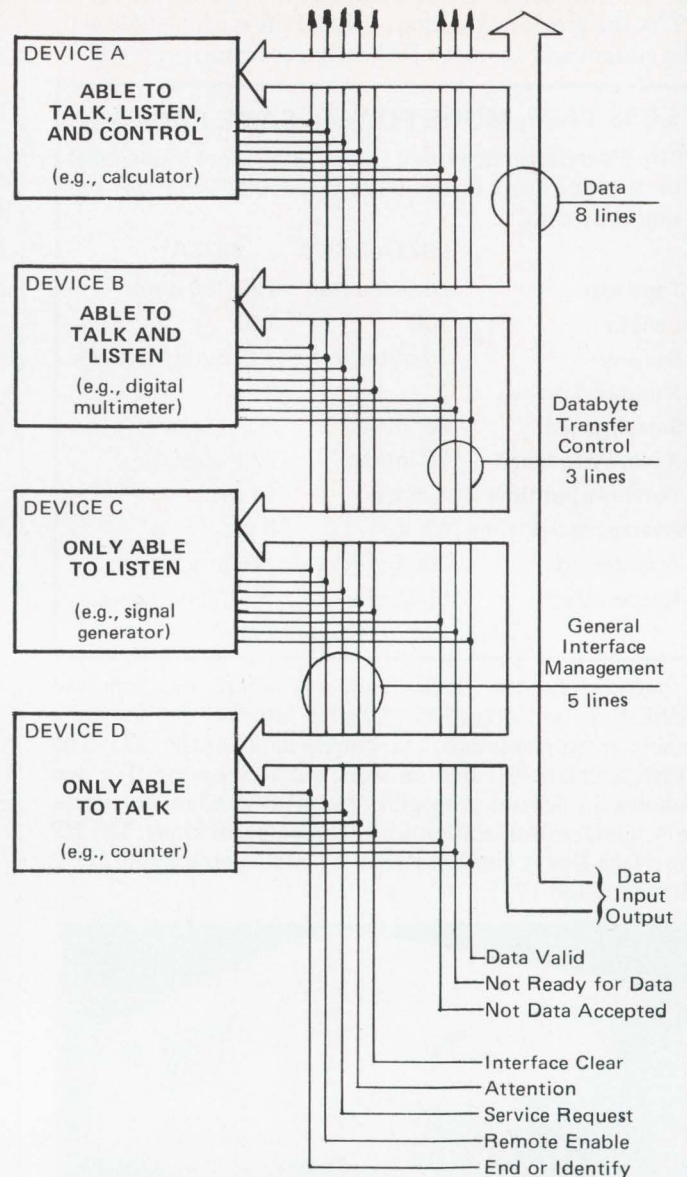

## INTERFACE CONNECTIONS AND BUS STRUCTURE

The five remaining GENERAL INTERFACE MANAGEMENT lines ensure an orderly flow of information within the HP-IB system. One of these is called "ATTENTION" line.

The controller dictates the role of each of the other devices by setting the ATTENTION line low (true) and sending talk or listen addresses on the DATA lines. (Addresses are manually set into each device at the time of system configuration, either by switches built into the device or by jumpers on a PC board.) When the ATTENTION line is low, all devices must listen to the DATA lines. When the ATTENTION line is high (false), only those devices that have been addressed will actively send or receive data, while all others ignore the DATA lines.

Several listeners can be active simultaneously, but only one talker can be active at a time. Whenever a talk address is put on the DATA lines (while ATTENTION is low), all other talkers are automatically unaddressed.

# If you punch cards, read cards or do anything else with cards, we want to talk to you.

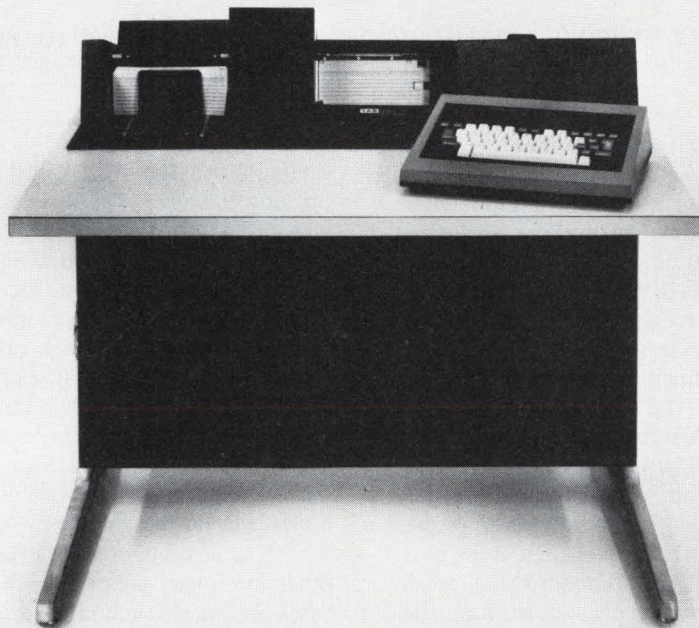

## We want to talk to you about the Tab 501 Data Entry Microprocessor.

About the unique versatility and operating capabilities resulting from its built-in microprocessor, RS-232C interface and unmatched performance characteristics:

- Minicomputer card input or output.
- Data transmission via modem or cable for terminal applications.
- Interfacing to virtually any type of data entry or processing system.
- On-line or off-line versatility.
- Reading, punching, printing, verifying and interpreting capabilities.
- Attractive purchase or lease plans.

## We want to tell you about our standard features.

- Constants from memory—up to 220 columns.
- Up to 28 program levels with automatic sequencing.
- Instant verification.
- Completely automatic error correction.
- High speed character duplication.
- Exceptionally quiet.
- Unparalleled operator acceptance of over 2,000 installed units.
- Easy to learn—easy to operate.

**Let's talk about "specials!"** We want your specials. Special applications. Special operating characteristics. Special interfaces. Special keyboard requirements. Because the Tab 501 Data Entry Microprocessor has this unique flexibility, we can give you what you want—easily and inexpensively. It's worth talking about.

### Gentlemen: Let's talk.

Name \_\_\_\_\_

Company \_\_\_\_\_

Address \_\_\_\_\_

City \_\_\_\_\_ State \_\_\_\_\_ Zip \_\_\_\_\_

Telephone \_\_\_\_\_

### Let's talk:

Interfaces.

Terminal applications.

Special requirements.

Send more information.

**TAB**  
PRODUCTS CO

2690 Hanover Street  
Palo Alto, California 94304

# THE COMPUTER STORE

A revolutionary technology, a revolutionary concept and a revolutionary location come together in this Bicentennial Year.

A visitor to Burlington, Massachusetts, is likely to pass through the historic towns of Concord and Lexington, where he would find literally hundreds of little shops and stores dealing in the artifacts of revolutionary America. Burlington also has its stores that specialize in revolutionary American artifacts. Among them is one called The Computer Store, and between it and the little shops in Concord and Lexington is a distance of some two miles and two hundred years.

What is revolutionary about The Computer Store is that it sells the world's most revolutionary products over the counter. Its founders, Dick Brown and Sid Halligan, are technological entrepreneurs who declared their independence from Digital Equipment and Prime Computer, respectively, to do their own thing with the things they know best: mini- and microcomputers. Appropriately, the location they selected to do it at is only a short distance from another convergence of Yankee independence and technology: the intersection of Militia Way, where stands the memorial to the revolutionary Minuteman, and Route 128, Boston's "Miracle Mile."

Beginning in mid-March, one will be able to purchase at The Computer Store just about anything associated with small computers. The store will feature the MITS line of Altair 8800 and 680 kits and fully-assembled systems, but equipment from such commercial vendors as Digital Equipment and Data General will be available as well. Also for sale will be tools and instruments; books and manuals; logic, memory and processor chips and boards; components such as keyboards, power supplies and T.V. monitors; and software. A blueprint library and copying services will be provided to stimulate what Sid Halligan calls "technology transfer at the hobbyist level." (He assures us, however, that proprietary software rights will be respected.) Experimenters with problems will be able to receive assistance from a technical staff with access to a library of diagnostic and development software, and equipped with ROM burners and a full complement of test equipment. Regular patrons will be invited to attend educational film showings and vendor presentations held evenings in a meeting room at the rear of the store that will also be available during the day for informal lectures and *cafe klatches*.

The Computer Store concept did not originate with Brown or Halligan. Another store with that name is already

operating on the West Coast, and more are planned for opening this year. The Brown-Halligan operation, however, will differ from those others in that it will eventually offer a range of products and services that extends far beyond those intended only for recreational use by hobbyists. Thus, besides the products already mentioned, Brown and Halligan will also act as a distributor of commercial terminals and products, and will stock such general computer supplies as printer paper and ribbons, hard and floppy disks, paper tape and cards, and magnetic cartridges and cassettes. The Computer Store is already a distributor for the Information Terminals line of floppy and cassette drives, and for the 3M line of magnetic media.

This is in keeping with Halligan's observation that computers no longer present a public image of mysterious electronic brains that require the care of an elite group of specialists. Instead, Halligan sees computers as increasingly ubiquitous tools that before the end of this decade will be as accepted — and almost as pervasive — as office typewriters or copiers. To support this view, he cites the rapid "price evaporation of silicon" and the increasing realization by product developers that inexpensive four- and eight-bit processors can replace 16-bit minis in many applications. Even today, one can purchase at The Computer Store a disk-oriented BASIC system for under \$2500. So with processing power becoming available to everyone, Halligan believes it only natural that retail computer outlets will begin to supplant commercial distributors and manufacturers' technical reps as sources of computer supplies and equipment.

Brown and Halligan do not expect this to take place overnight. That it *will* happen, however, they have no doubt. They are committed not only to *The Computer Store*, but to a business plan that involves establishing similar stores throughout the northeastern and mid-Atlantic states. For the present, however, their primary missions will be to serve hobbyists and experimenters, and, in general, to "stimulate awareness."

Certainly a more stimulating location than Boston's Route 128 would be hard to find. As Halligan points out, the typical Route 128 manager constantly hears about microprocessors, and The Computer Store offers him or her an inexpensive and painless way to learn about them. Says Halligan: "At this location we offer job security as well as fun." ■

# new products

## KEY-DISPLAY SYSTEM

The Model 2409-2/3 Key-Display Systems are designed for large installations keying high volumes in multiple shifts. The 2409-2 system has a disk capacity of 90,000 125-character records; the 2409-3 has a 150,000 125-character record capacity. The large disk of the 2409-2 and 2409-3 allows cumulative storage of data collected only weekly or monthly, eliminating the need to separate infrequently-run jobs into smaller batches. The extra capacity is also useful for holding a disk-resident library of user programs. A typical 16-keystation 2409-3 configuration averages approximately \$135 a month per keystation (maintenance included) on a three-year lease. *Mohawk Data Sciences, Parsippany, NJ.*

Circle No. 137 on Inquiry Card

## SPEECH PLUS DATA SYSTEM

The RF 8500 Speech Plus Data System provides a dedicated full-duplex speech channel and up to four low speed FDM channels in one equipment enclosure. Additional data channels can be accommodated by interconnecting a standard FDM equipment shelf to the system. Various configurations allow the user to select the number of data channels, speech cutoff frequency and voice system interface. The system will interface to any PBX, central office or telephone instrument for dial repeating, ringdown or hotline operation. All line signaling, ringing, two-to-four wire conversion, amplification and control is provided within the system. *Harris Corp., Melbourne, FL.*

Circle No. 141 on Inquiry Card

## TOUCHSCREEN TERMINAL

When a point on the display screen of the SiR-1000/TS Touch Screen terminal is pressed, it is inverted or intensified as an indication to the user that data has been entered. This is accomplished by a process called *display surface wave reflection*. Two rows of piezo-electric transducers are pulsed to propagate a wavefront in the x and y directions across a special CRT faceplate. When a finger touches the faceplate, a reflected wave is created by the disturbance of the wavefront. A 12-bit MOS LSI/MSI processor is included in the terminal. Fields of application include education, voter registration and bank customer service. *Mega-data Computer and Communications Corp., Bohemia, NY.*

Circle No. 142 on Inquiry Card

## FLOPPY DISK

The Model 76 is offered in standard or double density with up to 6.4 million bits, a 250K-bps transfer rate and a 6-millisecond track-to-track access time. Features include a door close and open interlock that eliminates operator error, and a self-centering "lotus petal" clutch that eases the diskette into registration position. Price in OEM quantities is \$528. *Orbis Systems, Inc., Tustin, CA.*

Circle No. 134 on Inquiry Card

## PRINTER CONTROLLER

The MDB line printer controller is completely software compatible and transparent to Interdata minicomputers and most printers. The single printed circuit half-board fits into any Interdata 15-inch chassis. The board comes with a ribbon cable and mating connectors to the line printer. The interface board is priced at \$750. *MDB Systems, Inc., Orange, CA.*

Circle No. 150 on Inquiry Card

# Strike it rich with Roytype's new gold computer ribbons.



When it comes to fill-in letter writing and scanning, Roytype Gold Scanoptik™ computer ribbons can't be beat. Their write is jet black, clear, nonsmearing, character after character.

They'll save you money two ways. First, you'll get up to one million lines per ribbon. Second, the writing quality of Gold Scanoptik ribbons is so good that major utilities and other commercial customers have reported rejection rates as low as ½ of 1%.

Gold Scanoptik ribbons are work savers, too. They incorporate a special cohesive ink formulation that doesn't "dust" on impact. Downtime and maintenance are held to a minimum.

Your Roytype salesman can tell you about Gold Scanoptik or other multipass film ribbons for computers, typewriters and accounting machines. Give him a call or mail the coupon.

For more information contact your Roytype representative or write J. T. Dessureau, Roytype Division of Litton Industries, 1031 New Britain Avenue, West Hartford, CT 06110.



**ROYTYPE**

Impression and Imaging Products

CIRCLE NO. 25 ON INQUIRY CARD

## PORTABLE TELEPRINTERS

An addition to TI's Silent 700 data terminals, the Model 745 weighs only 13 pounds. It is designed for use in remote sales order entry, inventory control, real estate services, insurance policy planning, and financial analysis. Another model, the 743 KSR, is designed for time sharing and I/O console applications. Both models include a TI micro-



processor that replaces previous discrete components. Also featured are ANSI standard keyboards with a calculator-style numeric keypad, and either half- or full-duplex operating modes, standard parity options, automatic paper loading, and 30-character per second thermal printing. The Model 743 KSR interfaces via TTY, EIA or optional

integral modem; the Model 745 portable has a built-in acoustic coupler with adjustable muffs and optional auxiliary EIA interface capability. The 743 is priced at \$1395; the 745 at \$1995 in single quantities. *Texas Instruments, Inc., Houston, TX.*

Circle No. 135 on Inquiry Card

## SMALL BUSINESS SYSTEM

The Model 400 computer system sells for \$16,000 with CRT display, light pen, ASCII keyboard, modem, realtime clock, 1.2 Mbyte disk drive and 125ns 16-bit processor with floating point and virtual memory. The system operates from a battery which is constantly charged from the line, and will operate for 20 minutes during power outages. Up to 8 processors can be connected together for high processing rate applications. Its 500ns MOS memory can be expanded to 16 partitions and one million bytes. The basic disk can be expanded to 50 Mbytes. Software includes an assembler, Fortran IV compiler, text editor and file management programs. The operating system allows 8 users to share each memory partition at the same time. Additional software

is available for Interactive graphics, electrical engineering, sign designing, mail-lists, automatic testing and business applications. *Computer Talk, Inc., Idledale, CO.*

Circle No. 125 on Inquiry Card

## UNINTERRUPTIBLE POWER SYSTEM

The Model 5264A solid-state 15-kva three-phase input/output uninterruptible power system is available in non-redundant and redundant configurations. An LED indicator panel gives system status. Self-contained modules include heat sinks with power devices,

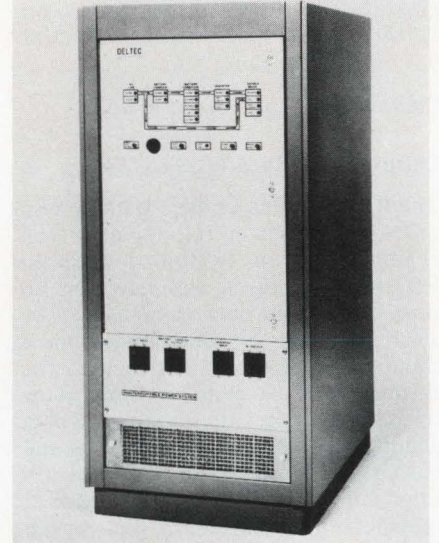

PC boards, and all circuitry for each of the three major elements of the system: inverter, battery/charger and transfer switch. *Deltec Corp., San Diego, CA.*

Circle No. 129 on Inquiry Card

## INTERFACE MODULE

General-purpose interface module for Data General Nova and Eclipse minis, and DCC look-alikes, accommodates up to 216 socket positions (24, 28, 40 and 80-pin sockets). The epoxy glass boards are intended for wire-wrap breadboarding and permanent one-of-a-kind interface applications. The N100 module has 204 14/16-pin low-profile socket positions plus one universal row with 130 socket mounting holes. Versions are available with wire-wrap pins only or with pins, sockets and capacitors. (Decoupling capacitors mounted at each chip socket location, and filter capacitors mounted adjacent to the flat cable connectors on the universal row. Prices for individual boards start at \$375. *Interconnection Technology, Inc., Hudson, NH.*

Circle No. 126 on Inquiry Card

# CPC

## Computer Product-Line Clearinghouse

Free listings are available for companies and people seeking to sell or buy or license mini/micro computer-related product-lines and/or inventions. All listings are given a key number so that the identity of the offerors remain confidential.

**POTENTIAL SELLERS** are individual inventors, companies with developed products which they do not care to exploit, companies looking to divest themselves of product lines or subsidiaries, companies seeking acquirors.

**POTENTIAL BUYERS** are computer companies looking for new products, entrepreneurs and investors looking for the product base for a new company, companies seeking entry into the minicomputer field.

Send your listing (approx. 30 words) to:

**CPC Editor**  
**MINIMICRO SYSTEMS**  
5 Kane Industrial Drive  
Hudson, MA 01749

### COMPUTER PRODUCT-LINE CLEARINGHOUSE

is a regular feature of *Modern Data's* fortnightly newsletter "MINIMICRO SYSTEMS."

For subscription information, write to address above.



# new products

## MEMORY ACCESS MULTIPLEXER

The Memory Access Multiplexer (MAM) for Interdata 32-bit minis can increase system throughput from 30,000 to 195,000 characters per second in byte transfer mode. It uses high-speed Schottky logic in its table driven control store and high-speed list processing sections. While each selector channel could previously accommodate only one device at a time with data flow in one direction, the MAM accommodates up to 63 devices and data transmission is possible in either direction. The MAM performs special communication character recognition, automatic buffer switching and interrupt handling. Each MAM plugs into one Interdata I/O slot and up to seven are permitted. Price is \$4500. *Interdata, Oceanport, NJ.*

Circle No. 132 on Inquiry Card

## INTELLIGENT FLOPPY

The Series 62 Intelligent Floppy Disk has serial RS-232 ROM programs to enable it to operate as a terminal page storage system or as online disk storage system. The disk is IBM-compatible with 77 tracks and 26 sectors of 128 bytes each. Average access time is less than 1/2 second to any sector or page. The online RS-232 program accommodates up to eight disk drives by specific address — while the terminal-oriented program accommodates up to eight disk drives by added page numbers. Page capacities are customer-selectable in multiples of 128 characters. Price for a single-drive system \$4,250. *Applied Data Communications, Santa Ana, CA.*

Circle No. 127 on Inquiry Card

## VOICE GENERATOR

The Model 200 Voice Generator provides an analog of the human voice with a synthesizer circuit driven by highly compressed digital codes stored in ROM. The compressed digital codes are prepared offline by computer analysis of real speech. Stored vocabularies may include separate words or continuous phrases in either male or female voice. Codes are transmitted from memory to the synthesizer in short bursts so many synthesizers can be operated independently from a single vocabulary memory. Evaluation units with a 48-word vocabulary are priced at \$2500. *Speech Technology Corp., Santa Monica, CA.*

Circle No. 151 on Inquiry Card

## REEL-TO-REEL TAPE DRIVES

The Model 9300 125-ips tape transport features side-by-side vacuum columns. Air bearings support the tape at all convex bends in the tape path; physical contact with the tape is two ceramic guides and the read-after-write head. Head life is said to be at least 4000 hours. Data density on the 7-track unit is 200/556 cpi or 556/800 cpi; 800 cpi, 1600 cpi or 800/1600 cpi on the 9-track unit. Prices start at \$5700. *Kennedy Co., Altadena, CA.*

Circle No. 143 on Inquiry Card

## FLOPPY CONTROLLER

The Model 121 "Naked" floppy disk controller is compatible with DMA channels as well as programmed I/O channels. It interfaces with most minis and micros, and is expandable to control up to four disks. The 121 generates a 16-bit cyclic redundancy check code, appends it to each sector written, and then checks the CRC code contained in each sector to verify reading. Price in OEM quantities is \$772. *Dicom Industries, Inc., Sunnyvale, CA.*

Circle No. 156 on Inquiry Card

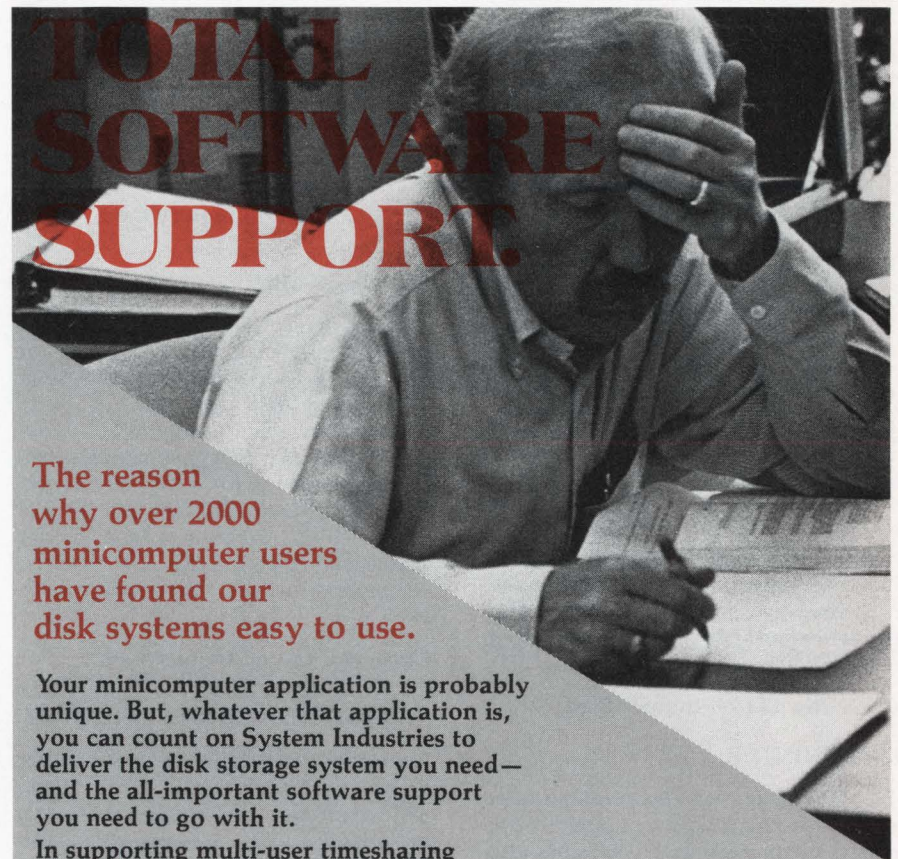

**The reason why over 2000 minicomputer users have found our disk systems easy to use.**

Your minicomputer application is probably unique. But, whatever that application is, you can count on System Industries to deliver the disk storage system you need — and the all-important software support you need to go with it.

In supporting multi-user timesharing systems, for example, powerful software packages featuring the BASIC language are available. For the PDP-11, several of DEC's operating systems (DOS, RSX, RT) can be implemented on our high-performance hardware. Our IRIS package is also ideal for NOVA applications. Software such as this accompanies our standard disk storage products — 2.5- to 10-Mbyte systems (2400 rpm, under 35-ms average access), as well as an 80-Mbyte unit (3600 rpm, under 30-ms average access) which transfers data at 1 Mbyte/second. For multi-user timesharing applications, this all adds up to easy implementation and high throughput — plus large storage capacity (1 billion bytes).

Our total capability in disk storage starts with 30-day delivery. That's the beginning. If you need special software help or other applications assistance, just let us know.

Software is only part of the story. For further details on the unmatched price/performance our disk systems can provide, call Phyllis at (408) 732-1650.

**System Industries**

535 Del Rey Avenue  
Sunnyvale, California 94086

An equal opportunity employer.

CIRCLE NO. 26 ON INQUIRY CARD

# new products

## MAGNETIC CARD/ TAPE CONVERTER

The MDRS-9 terminal and MC II coupler option interface with IBM's Mag Card II typewriters for data exchange between magnetic cards and magnetic tape. Fifty magnetic cards can be stacked in the Mag Card II console at one time for processing. Conversion in either direction is automatic and continues through the last card in a deck. In read mode, data throughput including card handling overhead ranges from 140 to 230 cps. Each output record is



written in EBCDIC code on magnetic tape and is 200 characters long. In record mode, the system transfers information written on magnetic tape to magnetic cards. Text punctuation, line identifier and page end codes are included. Monthly rental for the system is \$600. *Mitron Systems, Beltsville, MD.*

Circle No. 131 on Inquiry Card

## MINI PRINTER

This desktop or pedestal-mounted printer produces 132 columns of 5x7 matrix characters at 125 lines per minute or 265 characters per second continuously. A new print head uses 22 pin drivers instead of the usual seven or nine. The printer is available with OEM parallel and RS-232 serial interfaces, and can be used with minis, small business systems and terminals. It sells for under \$1700 in quantities of 100. *Okidata Corp., Morrestown, NJ.*

Circle No. 139 on Inquiry Card

## CRT TERMINAL

The Consul 520 is a Teletype-compatible CRT priced at \$1595 in single units. Screen size is 1920 characters. Five transmission rates are available with either RS-232 or current loop interfaces. *Applied Digital Data Systems, Inc., Hauppauge, NY.*

Circle No. 152 on Inquiry Card

## REMOTE DATA ENTRY

The System 180 includes a processor with a 48K-byte memory, communications controller, a 2.4M-byte disk pack, and up to 4 Data/Scope keystations (either local or remote). Keyboards can be either typewriter or 029 keypunch style. Additionally, the system can support various printers with line speeds to 600 lines per minute and a 300-card per minute card reader. The system features Entrex's data entry and preprocessing operating system and Data/Comm software, and a generalized binary synchronous communications package that permits emulation of multiple terminal types. A single-keystation System 180 is priced at \$575 per month on a three-year lease. *Entrex, Inc., Burlington, MA.*

Circle No. 128 on Inquiry Card

## TURNKEY MINI

The C/P Based Mini-System provides a single user with a manufacturing - or distribution - oriented turnkey system including a CRT terminal, 16K-byte CP, removable and floppy disk, 50-lpm printer, and inventory management application system for \$900 per month. The C/P Based Mini-System uses a DEC PDP-11. Multi-user systems are also available with 2780 RJE support. *Computer Covenant Corp., West Simsbury, CT.*

Circle No. 144 on Inquiry Card

## CALCULATOR CASSETTE SYSTEM

Interfaced with Monroe's 1800 series programmable calculators, the Model 392 read/write tape cassette system provides flexibility and expanded stor-

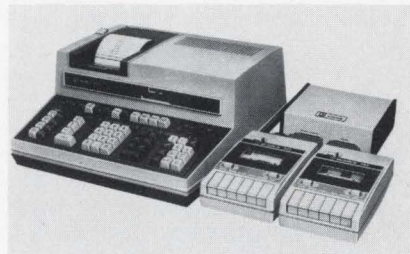

age capability for engineering, medical, payroll and general business applications. Tape drives can be operated manually from the 1800 keyboard or the 1800 can be programmed to operate the drives automatically. Preconditioning divides the tapes into the number of blocks specified by the operator. Price for a single drive is \$695. *Litton Industries, Monroe Division, Morristown, NJ.*

Circle No. 146 on Inquiry Card

## RUGGED HPT DRUM

Pretested ceramic ICs, JANTX diodes and transistors in the VRC 3020 head-per-track drum ensure approximately 15,000 hours MTBF. A freedom-of-movement mounting system provides resistance to operating shock and vibration for shipboard or van-mounted applications. The 3020 is sealed and pressurized with nitrogen to isolate the

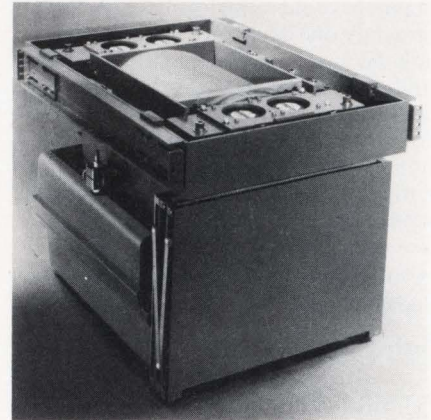

head/media system from contamination. This eliminates the need for a sustaining gas supply typical of helium filled systems. Capacities range up to 37.9 million bits. *Vermont Research Corp., North Springfield, VT.*

Circle No. 130 on Inquiry Card

## FLOPPY FOR MICROS

A floppy disk drive in kit form with operating system is available for the Altair 8800 and other micros. The stand-alone controller requires one card slot. Included in the controller are a 256-byte read/write buffer for programmed I/O and a two-byte cyclic redundancy check character for reliability. The controller can operate one of two floppies. A program generation system is also provided. *CDI, Westlake Village, CA.*

Circle No. 136 on Inquiry Card

## MULTIPOINT MODEM

The 48/Multi data modem can operate at 4800 bps with unconditioned lines in either full-duplex or half-duplex over four-wire networks, or half-duplex over two-wire networks. The eight-phase differentially coherent 48/Multi offers single-station equalization that requires no operator intervention at the distant station. Built-in diagnostics include analog/digital loopback, remote test, integral signal quality meter, and self-test. Price is \$2395. *Penril Corp., Rockville, MD.*

Circle No. 133 on Inquiry Card

# new products

## TIME SHARING SYSTEM

The 4000 Series Datashare business time sharing systems are based on Datapoint 2200 and 5500 processors. Each system also contains 5M to 50M bytes of disk storage, a maximum of 16 terminals, printer, multiport communications adapter and operating software. All systems use the Databus high level language for application programs. Basic system prices start at \$833 per month for a two-year lease. *Datapoint Corp., San Antonio, TX.*

Circle No. 138 on Inquiry Card

## TELEPRINTERS

The 7300 Series data communications terminals are available in receive/only, send/receive, and automatic send/receive models. All are solid-state and modular for reliable operation and are equipped with switch-selectable speeds of 50, 75, 100, 110, and 150, 200 and 300 baud. An acoustic cover suppresses noise for quieter operation. Optional features include: 80-column width, character counter, form feed, vertical tab, horizontal tab, selective call. *SCM Kleinschmidt, Deerfield, IL.*

Circle No. 158 on Inquiry Card

## NON-IMPACT PRINTERS

The Model 8210 is a 2400-line per minute printer that sells for \$3000 and prints 80 columns wide on 8-1/2-inch paper. Also available is the Model 8230 with 132-column output on 14-7/8-inch paper. It sells for \$3785. Features include full print line buffer memory, automatic top of form advance, 400-inch per minute paper advance speeds, and the ability to use both roll and fanfold paper interchangeably. The paper drive uses a high-speed stepper drive without gears, light wheels, or complex servo loops. *Houston Instrument, Austin, TX.*

Circle No. 157 on Inquiry Card

## CALCULATOR LINE PRINTER

The Hewlett-Packard 9866B printer is designed to be used with all HP 9800 Series desktop programmable calculators. It contains a 95-character ASCII set, with upper- and lowercase alphabet and symbols reproduced by a 5x7 dot matrix. It prints up to 80 characters per line at a speed of 240 lines per minute. It also plots graphs and bar charts with a resolution of .017 inches, at a speed of 900 rows of dots per minute. Price is \$3350. *Hewlett-Packard, Palo Alto, CA.*

Circle No. 147 on Inquiry Card

## WORD PROCESSING SYSTEM

The Wordstream III multiterminal word processing system was designed to replace stand-alone video text-editors and mag card units. It features display terminals and dual diskette mag storage. Each display screen provides a page of 4500 characters. Each diskette holds 77 full pages of text on each side (154 pages total for two sided diskettes). Text can be printed out on Selectric typewriters or line printers simultaneously with the operation of the editing terminals. All terminals and all output devices timeshare the central computer. *Avionic Products Engineering Corp., Denville, NJ.*

Circle No. 154 on Inquiry Card

## MULTIPROCESSING SYSTEM

Galaxy/5 is a medium-sized multiprocessing system for use in teleprocessing, time sharing, data base management and similar interactive applications. Memory sizes range from 32K to 1M bytes and each system includes from one to four central processors. Input/output is handled by up to four DMA controllers. A programmable communication interface permits asynchronous speeds up to 9600 baud and synchronous speeds up to 56,000 baud. Peripherals include 32M to 240M-byte disk drives, 100 to 400-lpm printers and CRTs. A minimum configuration including one CPU, 32K memory, 32-MB drive, 100-lpm printer, and CRT is priced at \$42,150. *Digital Systems Corp., Frederick, MD.*

Circle No. 153 on Inquiry Card

## 500-LPM PRINTER

Printing on the Model LP6351 Line Printer is accomplished with only two different moving parts: hammers and the platen. There are 22 hammers set in a single accessible bank for minimum maintenance. Microprocessor logic provides character generation and print control. The printer operates at 500 132-column lines per minute delivering 1120 characters per second or 69,300 characters per minute. Reduced size print is also available within the same unit to provide 13.3 characters per inch spacing or 176 columns per line. The standard 96-character font provides upper- and lowercase printout in a 9x9 matrix pattern. Optional switch-selectable custom fonts are achieved via EPROM logic. *Potter Instrument Co., Inc., Plainview, NY.*

Circle No. 145 on Inquiry Card

## PROGRAM DEVELOPMENT STATION

The Datatester Model 8010 permits interactive program development without auxiliary computer equipment or software. Features include cassette tape; online, high-speed memory; full keyboard facilities for program entry, modification and unit control; and complete parity check on all data trans-



missions. The Model 8010 provides standard 1K x 16-bit memory, and is expandable to 4K words for larger memory requirements. Internal logic will accept data from serial or parallel input devices. When used as a test program memory, such as with the Datatester 400 Automatic Test Processor, test data rates are achieved up to 1 MHz. Price for the 8010 is \$5545. *Data Test Corp., Concord, CA.*

Circle No. 159 on Inquiry Card

## BEEMAK TABCARD HOLDERS

FOR SYSTEM 3—80 COL.—51 COL.  
RACKS — TRAYS — ACCESSORIES

BP100 80 col.

BP200 80 col.

BP500

BP900 96 col.

51 col. BP300

Holders with magnets or adhesive strip. Spring clips for attaching to shelves.

R100-18

Racks made with any holder in any design or size.

Vinyl envelopes available with adhesive back or magnets.

BP950 for System 3. Unbreakable carrier protects cards traveling thru plant. Visible, accessible.

## BEEMAK PLASTICS

7424 Santa Monica Blvd., Los Angeles, Calif. 90046  
Phone: (213) 876-1770

CIRCLE NO. 12 ON INQUIRY CARD

# UNDERSTANDING SDLC

A 12-page reprint collects and *updates* the series of five articles on IBM's Synchronous Data Link Control (SDLC) line protocol which appeared in MODERN DATA between February and September, 1975. *Not included in the published series but contained in the reprint* are several pages on the derivations of the equations used in the articles. Taken together, the series provides a comprehensive, independent explanation and appraisal of this most important line protocol, *written in the working language of computer-communications users*. SDLC subjects covered include:

1. General Concepts and Structure
2. The Control Field
3. Supervisory and Non-Sequenced Control Field Formats
4. Throughput Calculations
5. An Analysis of Response Time Performance
6. Derivations of Equations Used.

**PRICE — \$2.95**

Use handy coupon below — only pre-paid orders accepted.

**PRE-PAID  
ORDERS ONLY**

MODERN DATA REPRINT DEPT.  
5 Kane Industrial Drive  
Hudson, MA 01749

Enclosed is my check for \_\_\_\_\_ for \_\_\_\_\_ copy(ies) of "Understanding SDLC" at \$2.95 per copy.

Send reprint to:

Name \_\_\_\_\_  
Company \_\_\_\_\_  
Address \_\_\_\_\_  
City \_\_\_\_\_  
State \_\_\_\_\_

## new products

### DATA TRANSMISSION TEST SET

The Digitech Model 2056 can provide field or inplant analysis of data transmission equipment, including applications such as modem checkout, teleprinter ranging and addressing video

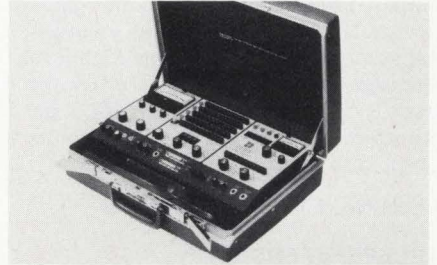

terminals. Combined in the 2056 are a selected character and test sentence generator in ASCII, EBCDIC, BCD/EBCD and BAUDOT languages, controlled distortion generator, character error rate tester, analyzer, DB meter, test tone generator, and a VOM. The unit operates at up to 9600 bps. It is priced at \$2750. *Digitech Data Industries, Inc., Ridgefield, CT.*

Circle No. 155 on Inquiry Card

### COMMUNICATIONS CONTROLLER

The Intelligent Communications Control Unit supports both local and remote cluster requirements of AT&T's Dataspeed 40 synchronous or asynchronous CRT. Options include store and forward and format selection. Typical systems are configured to control 16 local devices (a mix of video displays and hard copy printers) along with 16 lines and associated terminals. *Northfield Electronics, Norwalk, CT.*

Circle No. 140 on Inquiry Card

### DIRECT ENTRY PHOTOTYPESETTER

The Comp/Set 510 direct entry phototypesetter composes type in sizes ranging from 5-1/2 to 74 points in 70 size gradations. Seventy sizes can be set in four fonts of 112 characters each from a single type disk with self-contained character width programming. Unrestricted mixing of the four type styles and 70 sizes can be produced at any time by the operator from keyboard commands. Other features include: 45-pica line length; hyphenless justification with fail/safe overset control, manual and automatic mortise control, and automatic leader insertion and leading. Foreign language versions are also available. Price is \$12,950. *Addressograph Multigraph Corp., Cleveland, OH.*

Circle No. 148 on Inquiry Card

seminars  
**ADP  
procurement  
in the  
federal  
government**

GOVERNMENT SALES CONSULTANTS, INC. is pleased to announce the expanded availability of their successful seminar designed for all people engaged in either buying or selling ADP equipment and related software, maintenance and consulting services in the Federal Government.

This course is available monthly in the Washington, D.C. area for a fee of \$350 (Cancellations less than a week prior to class are subject to a \$25 cancellation fee.) including extensive handout documentation. Quantity discounts are available. Total attendance for the course has now topped 500 people from over 20 agencies of the government and over 50 companies. An abbreviated outline is shown below.

- I. *General Federal Market Overview*
- II. *Role of the General Services Administration*
- III. *General Contracting Factors*
- IV. *ADP Procurement in Other Federal Agencies*
- V. *Pricing and Bidding Strategies*
- VI. *Proposal Evaluation and Contract Award*
- VII. *Relationships Between Different ADP Functions*
- VIII. *Government Funding of ADP*
- IX. *Policy Issues*
- X. *Summary and Workshop*

**THE NEXT COURSES WILL BE HELD AS FOLLOWS:**

**April 19-21   May 10-12   June 14-16   July 19-21   Aug 9-11   Sept 13-15**

*Mail the coupon below for the full outline, hotel information, dates and quantity discount schedule.*



**GOVERNMENT SALES CONSULTANTS, INC.**  
Suite 205  
7023 Little River Turnpike  
Annandale, VA 22003

Name \_\_\_\_\_

Agency/Company \_\_\_\_\_

Address \_\_\_\_\_

City, State, Zip \_\_\_\_\_

# new software & services

## INVESTMENT SECURITIES SERVICE

TYMQUOTE is a timeshared computer data base containing current and historical trading statistics for more than 23,000 securities. It contains 12 million days of history with 50 million items of information, and has no data base fee or per-access fee. The data base consists of three components: the master directory, which contains descriptive and status information; the price data base, which contains an extensive history of daily volume, high, low and closing prices, or bid-asked prices; and the dividend data base, which has complete dividend, split, and stock distribution statistics for equity issues, and bond interest payment data for debt issues. *Tymshare, Cupertino, CA.*

Circle No. 236 on Inquiry Card

## TAPE LIBRARIAN

This system catalogs, compiles and maintains programs and data files on magnetic tape rather than disk. Called LIBRARY, it is available in object deck form on a license basis for a fee of \$995. A data security routine for the system may be added on an optional basis for an additional \$200. LIBRARY maintains Cobol, RPG, Fortran, PL/1 and BAL programs, job control streams, source statement books, relocatable modules, object decks, and card image data files. An audit trail is provided for program decks, indicating the most recent file maintenance on both the LIBRARY printout and the compiler listings. A directory indicating the name of each "BOOK" in the LIBRARY, its descriptive title and the date of last maintenance, can be printed at any time. *GMA Software, Chicago, IL.*

Circle No. 221 on Inquiry Card

## ON-LINE, FILE MAINTENANCE SYSTEM

SCRIBE is an on-line set of programs for the creation and maintenance of files. Once created, records can be added, changed, inserted and deleted in the files. Password control is provided for inquiry and/or update, browse function allows forward and backward stepping by line or page. Record sizes can be variable up to one half of the screen size. Up to 62 fields may be set up per record. The system runs under 360/370 CICS for DOS or OS, real or virtual. The most popular uses of SCRIBE are documentation, data entry and terminal job entry. *Intech Inc., Minneapolis, MN.*

Circle No. 224 on Inquiry Card

## GRAPHICS LANGUAGE

GSS-3 (Graphic Support Software) enables the Fortran user to create and manipulate simple or complex graphic images on Sanders SA 500 interactive graphic display systems. With GSS-3, the programmer can organize display information into independent pages. There is a Teletype simulator at each operator station for keyboard input, and a *mark* within pages so the programmer can perform random access updates to displayed information. Price is \$1000. *Sanders Associates, Inc., Nashua, NH.*

Circle No. 227 on Inquiry Card

## PDP-8 PAGING MACRO ASSEMBLER

PAGE8 is an automatic paging macro assembler that runs under PDP-8's OS/8 operating system. PAGE8 handles full address arithmetic by automatically adjusting offset references when necessary. The macro facility incorporates backwards and forwards assembly branches, nesting, symbolic concatenation, defaulted arguments and character string processing. External symbol directories, annotated cross reference listings and total syntactic error detection facilitate the development and maintenance of PDP-8 programs. A permanent license is available for \$580. *Dewar Information Systems Corp., River Forest, IL.*

Circle No. 206 on Inquiry Card

## SALESTAX DIRECTORY

SALESTAX is a magnetic tape version of the Vertex National Sales Tax Rate Directory. Over 13,000 records contain tax rates for all sales and rental tax jurisdictions in the U.S. The data base is updated monthly. Price for initial one-year subscription is \$165 per month. *Vertex Systems, Inc., King of Prussia, Pennsylvania.*

Circle No. 225 on Inquiry Card

## ENTREX COMMUNICATIONS

DATA/COMM is a parameterized communications option allowing the Entrex System to communicate with a wide range of binary synchronous devices, including the IBM 3780, 2780, 2770, 3741, 3747 and 2968. Other enhancements include spooling, unattended operation, expanded buffer/record size, transparency, data compression, and multipoint support. *Entrex, Burlington, MA.*

Circle No. 212 on Inquiry Card

## SCHOOL ADMINISTRATION

The Student Online Administration/Registration System (SOARS) is available for Basic Timesharing Model 4000 Series Interactive Timesharing Systems. It is divided into two major segments: school administration and business accounting. Functions encompassed by school administration include: admissions, registration, class lists, class scheduling, grade reports and transcripts, and student billing, all related to a common student information data base. Business accounting covers accounts payable, general ledger, payroll, inventory control, and income management. SOARS is available under a perpetual license for a one-time charge of \$12,500. *Basic Timesharing, Sunnyvale, CA.*

Circle No. 234 on Inquiry Card

## TIME SHARED DATA BASE

XDMS data management system users enter data from remote terminals to Interactive Data's IBM System/370 Model 168 computer at Waltham, MA, where all information is checked to ensure conformity with the data base definition. Multiple data bases can be accessed simultaneously and multiple reports can be produced from a single pass through a data base. The time sharing environment enables easy changes in data base definitions and integration to other systems. XDMS is accessed by an English command language and can also be accessed from other languages, such as Fortran, Cobol and PL/1. *Interactive Data Corp., Waltham, MA.*

Circle No. 226 on Inquiry Card

## SOFTWARE MONITORING

SLACMON, operating as a systems task or job, is designed to monitor hardware and software performance over a given period of time. A series of reports is produced to help identify areas of low utilization as well as performance bottlenecks. Monitoring is performed by counting various events and by sampling others. Output from SLACMON consists of a series of reports (up to 12) followed by a page summarizing both these reports and the run itself. Certain summary data may appear on the console device, if desired. It is written in assembler language (f, G, or H levels), and runs on IBM System/360 under OS/360 MVT or MFT with subtasking. *Cosmic, University of Georgia, Athens, GA.*

Circle No. 235 on Inquiry Card

# new software & services

## MINI I/O

TRIO-1 (Teletype Real Time Input/Output System for Minicomputers) is a Fortran-callable buffered TTY system which allows real-time programs to generate input and output, to and from, the TTY without degrading the real-time process. TRIO-1 sends "output buffer full" and "input buffer empty" messages to the calling program and consists of four subroutines: **Start read** sets up the user's input buffer and its pointers. **Start write** sets up the output buffer and the output buffers' pointers. **Get** returns data to the calling program from the input buffer. **Put** accepts output data from the calling program and places it in the output buffer. System price is \$3300 for the Computer Automation Model, and \$2875 for the Data General model. Prices upon request for other models. *Cyber Associates, Inc., Pittsburgh, PA.*

Circle No. 237 on Inquiry Card

## COM MANAGEMENT SOFTWARE

FAME (Fiche Advanced Microformatting Editor) will insert variable titling characters — either positive or negative — within the body of the fiche, through user initiated control. Capabilities include variable character sizes and number of lines for fiche title (heading) frames, 64 or 86 lines per page, data page characters per line ranging 96 (8-1/2 x 11 page format) to 160 (11 x 14 page format), variable microfiche formats (rows and columns) for accommodating COM reduction ratios of 24X, 42X and 48X, and NMA standard microfiche index frame. *Bell & Howell, Newport Beach, California.*

Circle No. 217 on Inquiry Card

## PROCESS CONTROL COURSE

Audio tape course on process control concepts describes the basic components common to any computer, whether used for data processing or process control. Also covered are the communications devices that enable the computer to interface to the process being controlled, as well as the instruments that measure and control process performance. Course materials consist of a 100-page illustrated workbook and four tape cassettes. Ten quizzes with answers provide a self-check. Listening time is about 2-3/4 hours. The course is priced at \$125. *Honeywell, Phoenix, AZ.*

Circle No. 214 on Inquiry Card

## SECURITY SYSTEM

The Data Access Security system protects against destruction of, or unauthorized access to, sensitive and valuable data, operates on all versions of the operating system including HASP, TSO, MVT and MFT. The job control statements or TSO procedures are used to determine authorized use of data sets. It records attempts and failures through the SMF facility and includes a reporting system that provides historical and analytical reporting. Price is \$6500. *Tesseract Corp., San Francisco, CA.*

Circle No. 232 on Inquiry Card

## INTEL CROSS ASSEMBLERS

Written in ANSI standard Fortran IV, the Mycro-Tek 8080 cross-assembler will execute on any 16-bit word computer that supports Fortran IV. The program generates an assembled program listing and a hexadecimal object tape compatible with Intel's MCS-80. The program requires 8K to 10K of memory but no disk access is required. Price is \$300. *Northeast Services, Inc., Wallingford, CT.*

Circle No. 205 on Inquiry Card

Designed for Nova users, this Intel cross-assembler includes a simulator for program debugging. The assembler accepts user programs written in 8008/8080 assembly language and provides octal or hex listings plus hex paper object tape output, printer, or direct-line transmission for loading RAM. The assembler runs in 16K to 32K without disk. Price in paper-tape or auto-load magnetic tape version is \$450. *Information Processing Techniques, Corp., Palo Alto, CA.*

Circle No. 207 on Inquiry Card

DEVELOP-80 is a package for developing assembly language programs for 8080 type microprocessors on DECsystem 10 time sharing computers. The package consists of a macro assembler, an 8080 simulator, a modified version of the DDT debugging package, and various support programs. Special features include cross reference assembly listings, a high speed simulator, symbolic debugging, and execution profiles for speed optimization. Price is \$750. *MITS Creative Electronics, Albuquerque, NM.*

Circle No. 204 on Inquiry Card

## DATA MANAGEMENT SYSTEM

DATAMANAGER uses a "data dictionary" to centralize, standardize and control the relationships between the various elements of a data base system. It is also used to produce reports for system and program documentation and to provide inquiry/retrieval capabilities. Additional facilities include the production of data descriptions in Cobol, PL/1 and Assembler Language Code ready for immediate compilation, as well as appropriate data descriptions for use by Database Management Systems (DBMS) software (current developments include TOTAL, ADABAS and IMS; future developments may include IDMS and System 2000); and the extraction of appropriate information (from existing Cobol and PL/1 libraries) to set up the dictionary. DATAMANAGER is available on IBM 360/370 computers. It requires a minimum partition of 55K bytes under os; 60K bytes under DOS when overlaid. *Management Systems & Programming, Ltd., London, England.*

Circle No. 203 on Inquiry Card

## RESEARCH STUDY

### NON-IMPACT PRINTERS

- 200 pages, 46 exhibits, 10-year world-wide market projections
- Examination of more than ten key non-impact printing technologies, including description and illustration of operation, advantages/disadvantages, trends, developments, available equipment.
- Market segmentation into nine different functional market segments, with value of equipment shipped, number of units shipped, etc. by manufacturer. Includes markets for teleprinter communications, computer printout, word processing.
- Estimate of present and future markets for specialty papers required by non-impact printers, and effect on markets for manifold business forms, carbonizing tissue and envelopes.
- Discussion of activities, market position, and possible plans of more than 20 suppliers of non-impact printers.
- Results of market survey of leading EDP equipment users.

Published January 1976.

For free descriptive literature and detailed table of contents contact:

#### INTERNATIONAL RESOURCE DEVELOPMENT INC.

46 Main Street  
New Canaan, Connecticut 06840 U.S.A.  
Phone: (203) 966 5615



CIRCLE NO. 28 ON INQUIRY CARD

## CALCULATOR/TERMINAL

The use of the Hewlett-Packard 9830 desktop programmable calculator as a computer time sharing terminal is discussed in this 4-page application summary. The addition of certain ROM/data communication packages enable the HP 9830 to act as an intelligent computer terminal. Included in the summary are discussions of setting-up operations of the time sharing terminal, commands for the sending and receiving of programs and data, and the selection of the proper modem. *Hewlett-Packard, Palo Alto, CA.*

Circle No. 260 on Inquiry Card

## DESKTOP PRINTER

This 6-page folder uses photographs, drawings and charts to illustrate the design features of Okidata's 110-character-per-second printer. The folder pinpoints one dozen important engineering features of the printer, and provides detailed specifications about its parallel buffered interface and RS-232 communications interface that permits direct connection to a wide range of modems, CRTs and minicomputers. *Okidata Corp., Moorestown, NJ.*

Circle No. 261 on Inquiry Card

## MODEM FAILURES

This 4-page brochure explains how to keep your data network up and running when a modem fails at a remote communication site. Intertel's "hot spare" modem is described and diagrammed. *Intertel, Burlington, MA.*

Circle No. 264 on Inquiry Card

## MODEM DIGEST

Envelope-delay distortion and its effects on high-speed data transmission is the topic of the second issue of *Modem Digest*, a quarterly publication describing common technical and operational problems in data communications. Two common theories of equalization in high-speed modems — zero forcing and mean-square error — are discussed in this issue. The comparison of convergence quality between the two algorithms is given, and Tele-Dynamics' Model 7208, a 4800 bps modem is described. Forthcoming issues will discuss such topics as self-diagnostic modems, moving to higher-speed transmission, multiplexing, etc. *Tele-Dynamics, Fort Washington, PA.*

Circle No. 269 on Inquiry Card

## SMALL SYSTEM APPLICATIONS

This 2-page black and white brochure describes applications for Wang computers and word processing systems in business, science and engineering. *Wang Laboratories, Tewksbury, MA.*

Circle No. 268 on Inquiry Card

## ANALOG WALL CHART

This 34-x22-inch technical wall chart contains data, graphs, circuits and formulas used by analog circuitry engineers. Application circuits include a single quadrant sine generator, a noise measurement analysis system, and an isolated bridge amplifier. Tables and curves show thermal noise in resistors, Fourier spectra, crest factors of common waveforms and a variety of other data. *Intronics, Newton, MA.*

Circle No. 263 on Inquiry Card

## SOFTWARE CONSULTANTS

*An Introduction to Software and Consultants* provides information on the selection and use of software consultants. Included in the 8-page booklet are sections discussing standardized software, customized software, the advantages of independent consultants, locating a consultant, what to look for in the consultant's background, requesting a proposal, and monitoring development. Also included is a glossary of terms. *Hewlett-Packard, Palo Alto, CA.*

Circle No. 265 on Inquiry Card

## INSTRUMENTATION PROCESSOR

The CP70A digital data processor is described in this 8-page brochure. In-depth discussion is provided of the system's options and the standard programs available. Typical applications for some of the equations are shown in block diagram form. A timing cycle drawing is also given for those intending use of the device in a system configuration. *Aiken Industries, San Diego, CA.*

Circle No. 266 on Inquiry Card

## UNINTERRUPTIBLE POWER

How three-phase uninterruptible power systems work and which machine is right for a particular application is discussed in this 21-page booklet. Included are rectifier, static inverter and static switch technologies. *International Power Machines Corp., Mesquite, TX.*

Circle No. 270 on Inquiry Card

## DATA ACQUISITION

Digitem's expanded data acquisition capabilities including collecting, processing and recording vital data from local sources or remote unattended locations is described in non-technical language in this 6-page brochure. The Digitem central telemetry terminals can use dial-up telephone lines to relay data to a processor-based control station. *FX Systems Corp., Kingston, NY.*

Circle No. 267 on Inquiry Card

## HPT DISK

This 4-page illustrated brochure describes General Instrument's Series 700 head-per-track disk drive. The unit is offered in increments of 32 tracks up to 256 tracks. Access time is 8.5 milliseconds and the data rate is 4.5 mHz. *General Instruments Corp., Hawthorne, CA.*

Circle No. 262 on Inquiry Card

## PERIPHERAL CATALOG

This 6-page short form catalog describes the MFE computer peripheral product line. Included are strip chart recorders, digital printers, X-Y recorders, potentiometric recorders, digital cassette tape transports, buffered data terminals, miniature recorders, Teletype projectors and graphic translators. *MFE Corp., Salem, NH.*

Circle No. 251 on Inquiry Card

## 2400-BPS MODEMS

ICC's Modem 24 LSI is compared with AT&T's Dataphone 2400 data set. The 16-page booklet includes a comparison of pricing policies, line turnaround time, and features such as reverse and secondary channels and diagnostics. Numerous charts, photos and diagrams illustrate the features under comparison. *International Communications Corp., Miami, FL.*

Circle No. 258 on Inquiry Card

## MODULAR MICROS

This 16-page catalog describes the Martin Research line of modular microcomputers, which are programmed with a calculator-style keyboard, and include a monitor program in a PROM to support basic programming functions. The bus structure is compatible with the 8080, 8008 and other eight-bit CPUs. *Martin Research, Northbrook, IL.*

Circle No. 259 on Inquiry Card



## ASSEMBLY LANGUAGE REFERENCE

Two 6-page assembly language reference cards enable the programmer to compare machine codes against assembly language for Control Logic's M and L Series modular micros. Machine codes are listed in numerical (octal) sequence with assembly language instructions in adjacent columns. *Control Logic, Inc., Natick, MA.*

Circle No. 253 on Inquiry Card

## SCPC COMMUNICATIONS

Single Channel Per Carrier (SCPC) terminals for INTELSAT applications are described in this 4-page brochure. The SCPC technique allows each telephone channel to be transmitted from any earth station using its own radio carrier, without multiplexing with other channels. SCPC operates using pre-assigned radio frequencies. Additional circuits may be added between any participating earth stations. Precise information on SCPC systems, terminal features, and applications are included in the brochure. *Digital Communications Corp., Gaithersburg, MD.*

Circle No. 252 on Inquiry Card

## MICRO EDUCATIONAL PACKAGE

Use of this firm's microprocessor system is covered in this brochure for those who want to learn digital electronics. Described in detail is E & L Electronic's Micro-Designer. Also covered are the company's series of *Bug-books*, which present step-by-step instructions for completing experiments or circuits in digital electronics. *E & L Instruments, Inc., Derby, CT.*

Circle No. 255 on Inquiry Card

## CUSTOM DISPLAY PANELS

Detailed information and photographs of a variety of custom designed display panels for computers, process control and traffic control systems are included in this 4-page brochure. Illustrations depict various data display methods available in "on" and "off" indication modes. A cutaway drawing shows construction features and ease of lamp replacement. Details and illustrations are also provided on bezel options and mounting techniques. System interface capabilities are outlined and illustrated. *Data Panel, Inc., Edina, MN.*

Circle No. 254 on Inquiry Card

# Microprocessors and Microcomputers

## A TECHNOLOGY PROFILE

Comprised of material which appeared in the January and February, 1975, issues of MODERN DATA, this 24-page Technology Profile is the most thoughtful and comprehensive effort to date to organize and summarize the complex, confusing, and fast-moving world of micro systems. This booklet will serve, for years to come, as a primer to the newcomer and a review guide for the more experienced.

Written by practicing experts:

Scott McPhillips — *Microcomputer Technique*  
Jerry Ogdin — *Microcomputer Technique*  
Doug Cassell — *Control Logic*  
Mike Tenner — *Technology Service Corp.*  
Bill Liles — *Technology Service Corp.*  
Eric Garen — *Integrated Computer Systems*  
Dan Bowers — *MODERN DATA*

Price: \$3.95  
per copy, prepaid, to MODERN DATA

Prepaid Orders Only

MODERN DATA REPRINT DEPT.  
5 Kane Industrial Drive  
Hudson, MA 01749

Enclosed is my check for \_\_\_ copy(ies) of your 24-page Technology Profile report, "Microprocessors and Microcomputers" at \$3.95 per copy.

Send to:

Name \_\_\_\_\_

Company \_\_\_\_\_

Address \_\_\_\_\_

City \_\_\_\_\_

State \_\_\_\_\_ Zip Code \_\_\_\_\_

# DATASCOPE

a new diagnostic tool for  
data communications systems

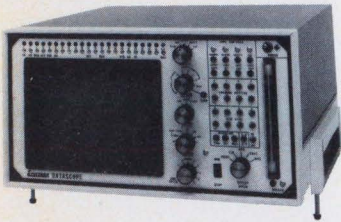

**Operates on-line to:**  
**MINIMIZE DOWNTIME**  
**PINPOINT SYSTEM**  
**FAILURES**  
**DEBUG SOFTWARE**

- Provides CRT display of every data link character, sent or received
- Simultaneous full duplex data stream tape recording
- Accepts all codes, line disciplines and speeds up to 9600 bps
- Switch selectable alphanumeric or hexadecimal display
- Monitors full and half duplex circuits
- Printed record available on standard teletype printer
- Designed for operating personnel, programmers and engineers
- Compatible with EIA Interface RS-232
- Lamp display of all EIA Interface signals
- Complete electrical isolation from monitored channel
- Lightweight portability . . . single compact unit
- Simple, straight forward connection



CHURCH ROAD & ROLAND AVENUE  
MOORESTOWN, N. J. 08057  
609 - 234 - 5700

CIRCLE NO. 29 ON INQUIRY CARD

## index to advertisers

AFIPS . . . . .	42
ANN ARBOR TERMINALS, INC . . . . .	29
APPLIED DATA COMMUNICATIONS . . . . .	40
BEEHIVE TERMINALS . . . . .	31
BEEMAK PLASTICS . . . . .	61
CODEX CORP . . . . .	44A, 44B*
COMPUTER OPTICS INC. . . . .	9
COMPUTER PROFESSIONALS' BOOK CLUB . . . . .	36
	Insert Card between 36 and 37
COMPUTER SECURITY INSTITUTE . . . . .	48, 49
DATA GENERAL . . . . .	7
DELTA DATA SYSTEMS CORP. . . . .	52A, 52B*
DIABLO SYSTEMS, INC. A XEROX CO . . . . .	Cover 4
DIGI-DATA CORP . . . . .	30
DOCUMATION, INC. . . . .	Cover 2
EMERSON ELECTRIC CO. INDUSTRIAL CONTROLS DIV. . . . .	.5, 43
FORMATION . . . . .	39
FROST & SULLIVAN, INC. . . . .	43
GENERAL ELECTRIC CO. VIDEO DISPLAY EQUIPMENT OPERATION . . . . .	45
GOVERNMENT SALES CONSULTANTS, INC . . . . .	63
HEWLETT-PACKARD . . . . .	2
IBM CORP. . . . .	25, 26, 27, 28
INTERFACE 76 . . . . .	12, 13
INTERNATIONAL RESOURCE DEVELOPMENT INC. . . . .	65
MCGRAW-HILL . . . . .	14, 15, Tab Card Between Cover 3 and Page 68
MODERN DATA . . . . .	38, 58, 62, 67
MODULAR COMPUTER SYSTEMS . . . . .	17, 18, 19, 20
PARADYNE CORP. . . . .	53
POTTER INSTRUMENT CO., INC. . . . .	23
ROYTYPE DIV. OF LITTON INDUSTRIES . . . . .	57
SPECTRON CORP . . . . .	68
SYSTEM INDUSTRIES . . . . .	59
TAB PRODUCTS CO. . . . .	55
TALLY CORP. . . . .	1
TELETYPE CORP . . . . .	33
TENNECOMP SYSTEMS INC. . . . .	4
WESTERN UNION DATA SERVICES CO . . . . .	Cover 3

\*In Demographic issues only