

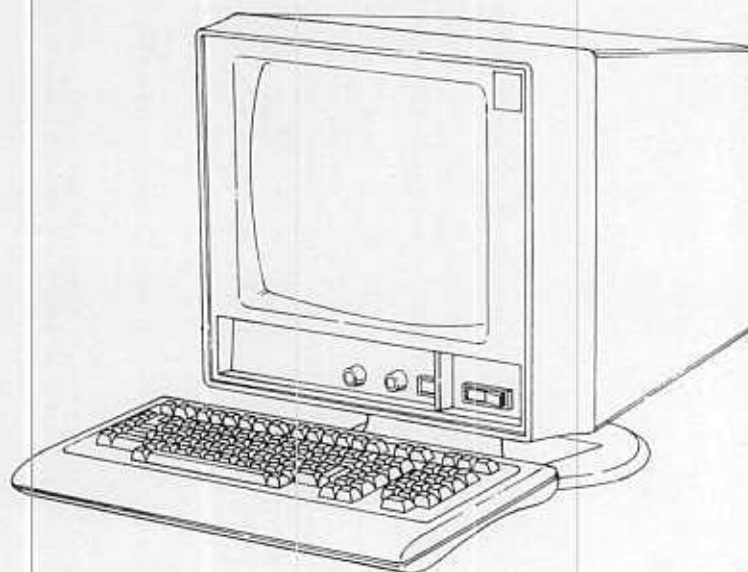

CDC[®] 721
DISPLAY TERMINAL



OPERATOR'S GUIDE/INSTALLATION INSTRUCTIONS

TITLE: 721 Display Terminal
Operator's Guide/
Installation Instructions
PUBLICATION NO. 62940019
REVISION E

CONTROL DATA CORPORATION
TECHNICAL PUBLICATIONS DEPARTMENT
2401 NORTH FAIRVIEW AVENUE
ST. PAUL, MINNESOTA 55113

REASON FOR CHANGE:

DATE: 01-25-84

To incorporate the following:

- o 1200/1200 Baud internal modem made available for installation in terminal.
- o Touchpanel adjustment procedure changed to permit adjusting touchpanels when all grid lines are not visible.
- o To correct technical errors



WARNING

This equipment has been certified to comply with the limits for a Class B computing device pursuant to Subpart J of Part 15 of the FCC rules. Only peripherals (computer input/output devices, printers, etc.) certified to comply with the Class B limits may be attached to this display terminal. Operation with non-certified peripherals is likely to result in interference to radio and TV reception.

This equipment generates and uses radio frequency energy and if not installed and used properly, that is, in strict accordance with the manufacturer's instructions, may cause interference to radio and television reception. It has been type tested and found to comply with the limits for a Class B computing device in accordance with the specifications in Subpart J of Part 15 of FCC Rules, which are designed to provide reasonable protection against such interference in a residential installation. However, there is no guarantee that interference will not occur in a particular installation. If this equipment does cause interference to radio or television reception, which can be determined by turning the equipment off and on, the user is encouraged to try to correct the interference by one or more of the following measures:

- reorient the receiving antenna
- relocate the display terminal with respect to the receiver
- move the display terminal away from the receiver
- plug the display terminal into a different outlet so that the terminal and receiver are on different branch circuits.

If necessary, the user should consult the dealer or an experienced radio/television technician for additional suggestions. The user may find the following booklet prepared by the Federal Communications Commission helpful:

"How to Identify and Resolve Radio-TV Interference Problems".

This booklet is available from the
US Government Printing Office,
Washington, DC 20402, Stock No.
004-000-00345-4.

NOTE

The following statement is required by the Canadian Department of Communications for data terminals having an internal modem installed. Refer to Appendix B of this manual to determine if such a modem is installed in this terminal.

NOTICE: The Canadian Department of Communications label identifies certified equipment. This certification means that the equipment meets certain telecommunication network protective, operational and safety requirements. The Department does not guarantee the equipment will operate to the user's satisfaction.

Before installing this equipment, users should ensure that it is permissible to be connected to the facilities of the local telecommunications company. The equipment must also be installed using an approved method of connection. In some cases, the company's inside wiring associated with a single line individual service may be extended by means of a certified jack-plug-cord ensemble (telephone extension cord). The customer should be aware that compliance with the above conditions may not prevent degradation of service in some situations. Existing telecommunications company requirements do not permit their equipment to be connected to customer-provided jacks except where specified by individual telecommunications company tariffs.

Repairs to certified equipment should be made by an authorized Canadian maintenance facility designated by the supplier. Any repairs or alterations made by the user to this equipment, or equipment malfunctions, may give the telecommunications company cause to request the user to disconnect the equipment.

Users should ensure for their own protection that the electrical ground connections of the power utility, telephone lines and internal metallic water pipe system, if present, are connected together. This precaution may be particularly important in rural areas.

Caution: Users should not attempt to make such connections themselves, but should contact the appropriate electric inspection authority, or electrician, as appropriate.

Notice: This terminal uses an eight-conductor cable with an eight-position miniature plug for connecting the terminal keyboard to the terminal display-unit housing. This plug must never be plugged into a telecommunications line (telephone line) jack. Such a connection would seriously damage the keyboard and might possibly render the telecommunications line inoperable.

NOTE

The following statements are required by the United States Federal Communications Commission (FCC) for data terminals using modems to connect to common carrier telephone lines. Refer to Appendix B of this manual to determine if such a modem is installed in this terminal.

FCC REQUIREMENTS

1. The Federal Communications Commission (FCC) has established Rules which permit the model XA360-A data modem to be directly connected to the telephone network. A jack is provided by the telephone company; jacks for this type of customer provided equipment will not be provided on party lines or coin lines.
2. If the modem is malfunctioning, it may also be causing harm to the telephone network. The modem should be disconnected until the source of the problem can be determined and until repair has been made. If this is not done, the telephone company may temporarily disconnect service.
3. The telephone company may make changes in its technical operations and procedures; if such changes affect the compatibility or use of the modem, the telephone company is required to give adequate notice of the changes.

COMPANY NOTIFICATION

4. Before connecting the model XA360-A data modem to the telephone network, the telephone company must be provided with the following information:
 - a. Your telephone number
 - b. The FCC registration number
 - c. The ringer equivalence number
 - d. The USOC jack required

Please note that items b, c, and d are included on the equipment label. Refer to Appendix B of this manual.

SERVICE REQUIREMENTS

5. In the event of equipment malfunction, all repairs will be performed by Control Data Corporation or an authorized agent of Control Data Corporation.



CDC[®] 721
DISPLAY TERMINAL

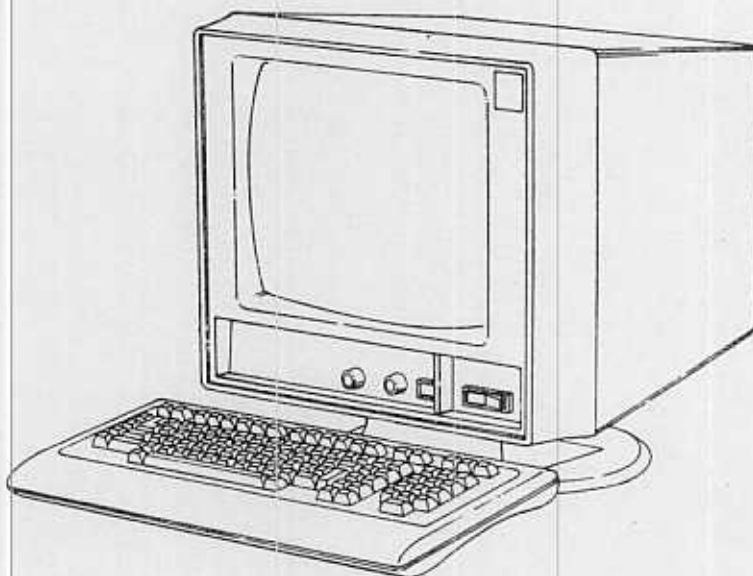

OPERATOR'S GUIDE/INSTALLATION INSTRUCTIONS

REVISION RECORD

REVISION	DESCRIPTION
01 (04-15-82)	Preliminary edition.
A (05-14-82)	Manual released. Includes information from manual verification and product testing. This edition obsoletes all previous editions.
B (07-30-82)	Manual revised to incorporate ECO/FCO 15337 and ECO 15346. Also includes additional information from manual verification and product testing. This edition obsoletes all previous editions.
C (08-18-82)	Manual revised to correct technical errors.
D (10-19-82)	Manual revised to incorporate ECOs 15012, 15371, and 15478.
E (01-25-84)	Manual revised to include information on internal 1200/1200 bit-per-second modem, to incorporate new touchpanel adjustment procedure, and to correct technical errors. This edition obsoletes all previous editions.

Publication No.

62940019

Address comments concerning this manual to:

Control Data Corporation
 Publications and Graphics Div.
 2401 North Fairview Avenue
 St. Paul, Minnesota 55113

REVISION LETTERS I, O, Q AND X ARE NOT USED

©1981, 1982, 1983, 1984

by Control Data Corporation
 Printed in the United States of America

or use Comment Sheet in
 the back of this manual.

LIST OF EFFECTIVE PAGES

New features, as well as changes, deletions, and additions to information in this manual are indicated by bars in the margins or by a dot near the page number if the entire page is affected. A bar by the page number indicates pagination rather than content has changed.

PAGE	REV	PAGE	REV	PAGE	REV
Cover	-	A-9	E		
a thru c	-	A-10	D		
Title Page	-	A-11	B		
ii thru iv	E	A-12	E		
v/vi	D	A-13 thru A-15	B		
vii thru x	E	A-16 thru A-18	E		
xi	E	A-19	B		
xii	E	A-20	C		
xiii	B	A-21	B		
xiv	E	A-22	C		
xv/xvi	E	A-23 thru A-25	E		
1-1 thru 1-3	A	A-26	D		
1-4	E	A-27	E		
1-5/1-6	A	A-28	B		
2-1/2-2	A	A-29	A		
2-3	B	A-30/A-31	E		
2-4	A	A-32	B		
2-5 thru 2-7	D	A-33 thru A-37	E		
2-8/2-9	A	B-1 thru B-17	E		
2-10	D	Comment Sheet	E		
3-1/3-2	B	Mailer	-		
3-3 thru 3-9	E	Back Cover	-		
3-10	B				
3-11/3-12	D				
4-1/4-2	B				
4-3/4-4	E				
4-5 thru 4-12	B				
4-13	C				
4-14 thru 4-17	B				
5-1	A				
6-1	D				
6-2	B				
6-3	D				
6-4/6-5	E				
6-6	E				
6-7 thru 6-12	A				
6-13	B				
6-14 thru 6-21	A				
6-22	B				
A-1/A-2	E				
A-3	D				
A-4/A-5	E				
A-6/A-7	A				
A-8	D				

PREFACE

This manual contains operating and installation information for the CDC® 721 Display Terminal. This information is for the operator of the terminal and the person who installs it.

The operating information provided specifically covers how to operate the terminal in CYBER mode. That mode is for operations with computer systems of the CDC CYBER 120 or 170 series. This is accompanied with general information such as:

- A general description of the terminal
- A description of operator controls and indicators
- How to start up the terminal and run its self tests
- Instructions on cleaning the terminal
- Error recovery and fault isolation procedures and information on how to turn in terminal components to a CDC repair service center

This general information is to supplement manuals which cover the operation of the terminal in other than CYBER mode.

The installation information covers the procedure for installing the terminal and checking it out for operation.

Other associated manuals include the:

<u>Title</u>	<u>Publication Number</u>
721 Display Terminal Unpacking/Packing Instructions	62940038
721 Display Terminal Reference Manual	62940020

All manuals may be ordered from:

Control Data Corporation
Literature and Distribution Services
308 North Dale Street
St. Paul, Minnesota 55103

CONF

This sheet is for keeping a label installed in your display to refer to the Equipment Identification panel of the terminal. These not all may apply and be on

THIS HALF OF LABEL CONTAINS THE EQUIPMENT AND SERIAL NUMBERS OF THE TERMINAL

THIS HALF OF LABEL LISTS THE EQUIPMENT AND SERIAL NUMBERS OF EACH SERVICE-CENTER INSTALLED FEATURE AND OF USER-INSTALLED KEYCAP AND POWER CONVERSION KITS



Serial number of the terminal is (check the one that is applicable)

- CC634-A, which has no touchpanel installed
- CC638-A, which has optional touchpanel installed

Service-center installed features include

- XA358-A optional graphics
- XA360-A optional 1200 dpi printer

User-installed features include

- YR101-A dual asynchronous terminal
- YR102-A parallel-terminal
- YA274-A United Kingdom keycap
- YA274-B Spanish keycap
- YA274-C German keycap
- YA274-D French keycap
- YA274-E Swedish/Finnish keycap
- YA274-F Danish/Norwegian keycap
- YA275-A power conversion kit

meter entries in case reentry becomes
 e person who installs the terminal. This is
 nt of a parameter entry field are factory

F	L I D	F	P O R T A	F	P O R T B	F	i n s t l
7	- - - - -	8	- - - - -	9	- - - - -	10	m o d e n
	<u>0 0 0 0 0</u>		<u>0 6</u>		<u>A 6</u>		
	<u>0 0 0 0 0</u>		<u>0 6</u>		<u>A 6</u>		

DF	F	A - D I A L	F	A - D I A L	F	DF T R	F	A C C E S S
-	7	- - - - -	8	- - - - -	9	-- - -	10	- - - -
<u>4</u>		<u>0 0 0 0 0 0</u>		<u>0 0 0 0 0 0</u>		<u>00 6 6</u>		<u>0 0 0 0</u>

DF	F	A - D I A L	F	A - D I A L	F	DF T R	F	A C C E S S
-	7	- - - - -	8	- - - - -	9	-- - -	10	- - - -
<u>4</u>		<u>0 0 0 0 0 0</u>		<u>0 0 0 0 0 0</u>		<u>08 6 6</u>		<u>0 0 0 0</u>

DF	F	A - D I A L	F	A - D I A L	F	DF T R	F	A C C E S S
-	7	- - - - -	8	- - - - -	9	-- - -	10	- - - -
<u>5</u>		<u>0 0 0 0 0 0</u>		<u>0 0 0 0 0 0</u>		<u>00 6 6</u>		<u>0 0 0 0</u>

DF	F	A - D I A L	F	A - D I A L	F	DF T R	F	A C C E S S
-	7	- - - - -	8	- - - - -	9	-- - -	10	- - - -
<u>4</u>		<u>0 0 0 0 0 0</u>		<u>0 0 0 0 0 0</u>		<u>00 6 6</u>		<u>0 0 0 0</u>

DF	F	A - D I A L	F	A - D I A L	F	DF T R	F	A C C E S S
-	7	- - - - -	8	- - - - -	9	-- - -	10	- - - -
<u>7</u>		<u>0 0 0 0 0 0</u>		<u>0 0 0 0 0 0</u>		<u>00 9 9</u>		<u>0 0 0 0</u>

DF	F	A - D I A L	F	A - D I A L	F	DF T R	F	A C C E S S
-	7	- - - - -	8	- - - - -	9	-- - -	10	- - - -

NOTE

The following information is repeated later in this text in English.

BETRIEBSANLEITUNG: CDC 721 DISPLAY TERMINAL

Das " Display Terminal " ist für eine Betriebsspannung von

120 V	50/60 Hz; 1.3 A	und
220/240 V	50/60 Hz; 0.71 A	

konstruiert.

Die erforderliche Netzumschaltung wird an der Rückseite nach Lösen der Schraube am Netzumschalter vorgenommen.

Das Netzanschlußkabel ist mit einem Schutzkontaktstecker versehen.

Auf richtige Netzspannung ist zu achten, da im anderen Falle das Gerät zerstört wird.

Die Netzwandsteckdose ist unmittelbar und leicht zugänglich, in der Nähe des Gerätes zu montieren.

Netzschalter:

Der Netzschalter befindet sich an der Frontseite.

Stellung gedrückt - O - AUS
Stellung gedrückt - I - AN

Der Gerätesicherungsautomat an der Rückseite, ist durch Eindrücken zu betätigen.

Weitere Bedienungseinrichtungen für

Reset
Kontrast
Helligkeit

befinden sich an der Frontseite.

Nach Einschalten der Netzspannung dauert es ca. 15 Sekunden bis der Bildschirm aktiviert ist.

Das Öffnen des Gerätes ist nur von qualifiziertem Fachpersonal nach Abschalten der Stromzufuhr zum Gerät, vorzunehmen. Beachten Sie die Wartungs- und Garantiebestimmungen.

Umgebungstemperatur:

10°C bis 40°C

Temperaturwechsel:

10°C innerhalb 1 Stunde

Relative Feuchtigkeit:

20% bis 80%

Gewicht:

inkl. Keyboard - 21.8 kg

Weitere Informationen entnehmen Sie dem Geräte - Manual CDC Nr:
62 94 00 19

CONTENTS

1.	GENERAL DESCRIPTION AND OPERATOR SUPPLIES	
	Overview	1-1
	Standard Features	1-2
	Optional Features	1-4
	Specifications	1-4
	Electrical Specifications	1-5
	Environmental Specifications	1-5
	Physical Specifications	1-5
	Operator Supplies	1-6
2.	OPERATOR CONTROLS AND INDICATORS	
	Controls	2-1
	Indicators	2-2
	Alarm	2-4
	Keyboard	2-5
	Keycap Configurations	2-5
	Keyboard Operating Characteristics	2-8
	Optional Touchpanel	2-9
	Positioning Adjustments	2-9
3.	STARTUP AND SELF TESTS	
	Starting Up Terminal	3-1
	Running Self Tests	3-6
	Operator-Intervention Test	3-6
	Cyber-Mode Test	3-10
	Host Initiated CYBER-Mode Test	3-10
	Locally Initiated CYBER-Mode Test	3-10
	Installing Memory Module	3-10
	Replacing Battery	3-11
4.	OPERATING IN CYBER MODE	
	Operator Parameters	4-1
	Protected Screen Positions	4-5
	Character/Block-Transmit Modes	4-5
	Character-Transmit Mode	4-5
	Block-Transmit Mode	4-5
	Keyboard Functions	4-6
	Altering Keyboard Entries	4-7
	Shift Keys	4-7
	Lock Key	4-8
	CTRL Key	4-8
	Entering Special Symbols	4-8

Moving Cursor	4-12
Tabbing	4-13
Editing	4-14
Controlling Communications and Printing	4-16
Host Controlled Functions	4-17

5. CLEANING TERMINAL

Cleaning Keyboard	5-1
Cleaning Cabinet and Screen	5-1

6. ERROR RECOVERY/FAULT ISOLATION

Loss of Installation Parameters	6-1
Error Recovery/Fault Isolation	6-1
Turning in Components to a Repair Service Center	6-18
Preparing Basic Terminal Unit for Turn In	6-18
Preparing Keyboard for Turn In	6-21
Preparing User-Installed Boards for Turn In	6-21
Accompanying Information	6-22

APPENDIX

A. INSTALLATION AND CHECKOUT

Installation Considerations	A-1
Required Tools and Supplies	A-2
Terminal Preparation	A-2
Printed-Circuit Board Installation	A-4
Cable Installation	A-5
Initial Power On	A-8
Parameter Entries	A-9
Checkout	A-26
CRT Realignment without Touchpanel Installed	A-30
CRT Realignment with Touchpanel Installed	A-33

B. 1200/1200 B/S INTERNAL MODEM

General Description	B-1
Operation	B-3
Entering a Telephone Number on the Terminal Keyboard	B-3
Monitoring a Telephone Call on the Terminal Display Screen	B-5
Manually Dialing a Telephone Call	B-8
Installation	B-9
Connecting Modem-Equipped Terminal to Telephone Line	B-9
Installation Parameter Modification	B-13

FIGURES

1.	GENERAL DESCRIPTION AND OPERATOR SUPPLIES	
1-1	Terminal	1-1
1-2	Terminal Dimensions	1-6
2.	OPERATOR CONTROLS AND INDICATORS	
2-1	Terminal Controls	2-1
2-2	Terminal Indicators	2-3
2-3	Keyboard with Standard English Keycaps	2-5
2-4	Keyboard with United Kingdom Keycap Options	2-6
2-5	Keyboard with French Keycap Option	2-6
2-6	Keyboard with German Keycap Option	2-6
2-7	Keyboard with Swedish/Finnish Keycap Option	2-7
2-8	Keyboard with Danish/Norwegian Keycap Option	2-7
2-9	Keyboard with Spanish Keycap Option	2-7
2-10	Optional Touchpanel	2-9
2-11	Positioning Adjustments	2-10
3.	STARTUP AND SELF TESTS	
3-1	Checking TEST Switches	3-2
3-2	Failure Messages for Power-On Test	3-3
3-3	Mode Menu	3-4
3-4	Operator-Intervention Test Display	3-7
3-5	Key Values Shown During Test	3-8
3-6	Installing a Memory Module	3-11
3-7	Replacing Battery	3-12
4.	OPERATING IN CYBER MODE	
4-1	First Set of Operator Parameters for CYBER Mode	4-2
4-2	Second Set of Operator Parameters for CYBER Mode	4-4
4-3	Function/Special Keys that Start Block Transmission	4-6
4-4	Keys Whose Functions May Change	4-7

6. ERROR RECOVERY/FAULT ISOLATION

6-1 Removing Optional User-Installed Printed-Circuit Boards 6-19
6-2 Packing Basic Terminal Unit 6-20
6-3 Packing Keyboard 6-21

A. INSTALLATION AND CHECKOUT

A-1 Connecting Keyboard Cable A-3
A-2 Installation of Optional Printed-Circuit Boards A-5
A-3 Host Communications Via External Modem A-6
A-4 Host Communications Via Direct Cable A-7
A-5 Associated Asynchronous-Communication Peripheral A-7
A-6 Associated Graphics Printer A-8
A-7 Terminal Installation Parameters (5 Sheets) A-11
A-8 Mode Installation Parameters (9 Sheets) A-17
A-9 Estimating Required Realignment A-31
A-10 Realignment Entries A-32
A-11 Display Screen Touchpanel Video Alignment A-37

B. 1200/1200 B/S INTERNAL MODEM

B-1 View of Terminal Showing I/F-4 Slot B-1
B-2 Auto-dialing Display Messages B-6
B-3 Telephone-line Extension Cord
with Duplex-jack Plug B-9
B-4 Installing a Modem-equipped Terminal B-11
B-5 Completed Installation of
Modem-equipped Terminal B-12
B-6 Operator Controls on Front and Rear of Terminal B-14

TABLES

2. OPERATOR CONTROLS AND INDICATORS

2-1 Function of Controls 2-2
2-2 Meaning of Indicators 2-3

4. OPERATING IN CYBER MODE

4-1 Operator Parameters for CYBER Mode 4-2
4-2 Correlation Between Conventional Characters and
Line-Drawing Symbols 4-9

4-3	Correlation Between Conventional Characters and Special Symbols	4-10
4-4	Moving Cursor	4-12
4-5	Tabbing Functions	4-13
4-6	Editing Functions	4-14
4-7	Controlling Communications and Printing	4-16

6. ERROR RECOVERY/FAULT ISOLATION

6-1	Power Problems	6-2
6-2	Power-On Test Problems	6-3
6-3	Host Loading Problems	6-4
6-4	Memory-Module Loading Problems	6-6
6-5	Operator-Intervention Test Problems	6-6
6-6	Display Problems	6-10
6-7	Keyboard and Touchpanel Problems	6-13
6-8	Printing Problems	6-16

A. INSTALLATION AND CHECKOUT

A-1	Problems Possibly Caused by Improper Parameters	A-27
-----	-----------------------------------------------------------	------

This section gives an overview of the terminal, summarizes its standard and optional features, and lists its specifications and operator supplies.

OVERVIEW

The terminal (figure 1-1) is a versatile input/output device that may be configured in a communications network, be connected via telephone line to a remote computer, or be cabled directly to a local computer. The terminal may also be locally configured with a character printer or graphics printer. The data displayed by the terminal can be in the form of alphanumeric characters (domestic or foreign) and/or graphic symbols or drawings.

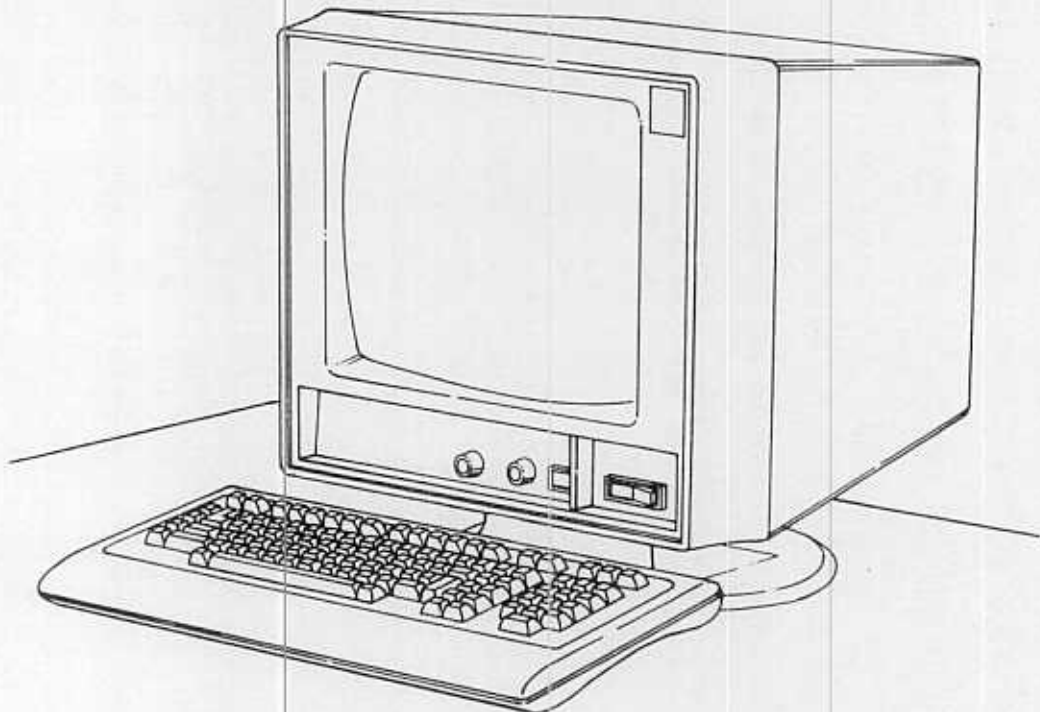

Figure 1-1. Terminal

The versatility of the terminal results from the available optional features and the capability of loading operating-mode programs into terminal memory. Such programs can be loaded from the host computer or from a memory module (read-only memory pack) plugged in the back of the terminal. These capabilities are also supplemented by a permanently stored (resident) program that enables operations in CYBER mode. CYBER mode is for operating with computer systems of the CDC CYBER 120 or 170 series.

Many operating characteristics of the terminal are determined by selectable parameters. Parameters are initially selected during installation and are stored in nonvolatile memory.* These parameters condition the terminal for the operating modes to be used and the communication facilities at the site.

The parameters stored in nonvolatile memory can be changed if necessary, but only by qualified personnel (such as the personnel who install the terminal). Certain parameters, however, can be temporarily changed without making changes to nonvolatile memory. These temporary changes may be made by either the operator or the host after the terminal has been placed in the operating mode.

STANDARD FEATURES

The standard features of the terminal include:

- Tiltable display with a 380-mm (15-in) cathode-ray tube (crt) and low-glare faceplate
- Programmable display set of 256 symbols including 95 domestic alphanumeric characters, 32 control-code symbols, 1 special parity-error symbol, 32 line-drawing symbols, 32 foreign language characters, and 64 special symbols or 64 host-loaded symbols

*Nonvolatile memory provides permanent storage. The memory for parameter storage is nonvolatile because it receives power from a battery when terminal power is off.

- Display format of 80 or 132 characters per line with 24 or 30 display lines
- Display cursor that may be an underline or a block and may blink or be steadily illuminated
- Page or roll display
- Programmable character positions that may be blanked, dimmed, underlined, protected, or shown blinking or in inverse video (dark characters on light background)
- Detached keyboard that can be placed in a flat or tilted position
- Resident programs for operating in CYBER mode, for self-test diagnostics, and for loading other operating-mode programs. The loading of other operating-mode programs may occur from a memory module or from a host that uses ASCII* communications such as the Control Data Shared Network
- 64K of random-access memory (RAM) for loading and operating memory
- Parameter selection made via keyboard with parameter storage in nonvolatile memory
- Asynchronous RS-232-C/CCITT V.24** host interface with selectable receive/transmit speeds up to 19 200 bps
- 120-V ac, 60-Hz operation

*ASCII is an abbreviation of American Standard Code for Information Interchange, which is the type of coding used by the Data Services network.

**RS-232-C is the Electronic Industries Association standard for signal interchange between data terminal equipment and data communication equipment. CCITT V.24 is a comparable European standard.

OPTIONAL FEATURES

Optional features of the terminal include:

- Full-vector graphic displays plus a touchpanel
- Internal 1200/1200 bit-per-second modem with auto-dial capabilities Refer to Appendix B for more detailed information on the internal modem.
- Parallel interface for attaching a graphics printer
- Dual serial interface with asynchronous RS-232-C/CCITT V.24 ports for attaching serial-communication devices (for example, a character printer)
- Power conversion kit for 220/240-V ac, 50-Hz operation
- Keycap kits for operating in British, German, French, Spanish, Swedish/Finnish, or Danish/Norwegian.

The last four features listed are user installed (their installation is covered jointly by instructions included with the items and by appendix A of this manual).

SPECIFICATIONS

The next paragraphs describe the electrical, environmental, and physical specifications for the terminal.

ELECTRICAL SPECIFICATIONS

The electrical specifications for the terminal are:

- 120 V ac, 60 Hz, single phase, at 1.3 A maximum
- With power conversion kit installed - 220/240 V ac, 50 Hz, single phase, at 0.71 A maximum

ENVIRONMENTAL SPECIFICATIONS

The environmental requirements of the terminal are:

- Operating:

Temperature: 10°C to 40°C (50°F to 104°F)
Temperature Change: 10°C (18°F) per hour
Relative Humidity: 20% to 80%
Humidity Change: 10% per hour
Maximum Altitude Above Sea Level: 3000 m (9850 ft)
Heat Dissipation: 416 Btu per hour

- Nonoperating

Temperature: -40°C to 60°C (-40°F to 140°F)
Temperature Change: 20°C (36°F) per hour
Relative Humidity: 5% to 100%
Humidity Change: 10% per hour
Maximum Altitude Above Sea Level: 3000 m (9850 ft)

PHYSICAL SPECIFICATIONS

The overall dimensions of the terminal and keyboard are shown in figure 1-2. The terminal weighs 19.5 kg (43 lb) and the keyboard weighs 2.3 kg (5 lb).

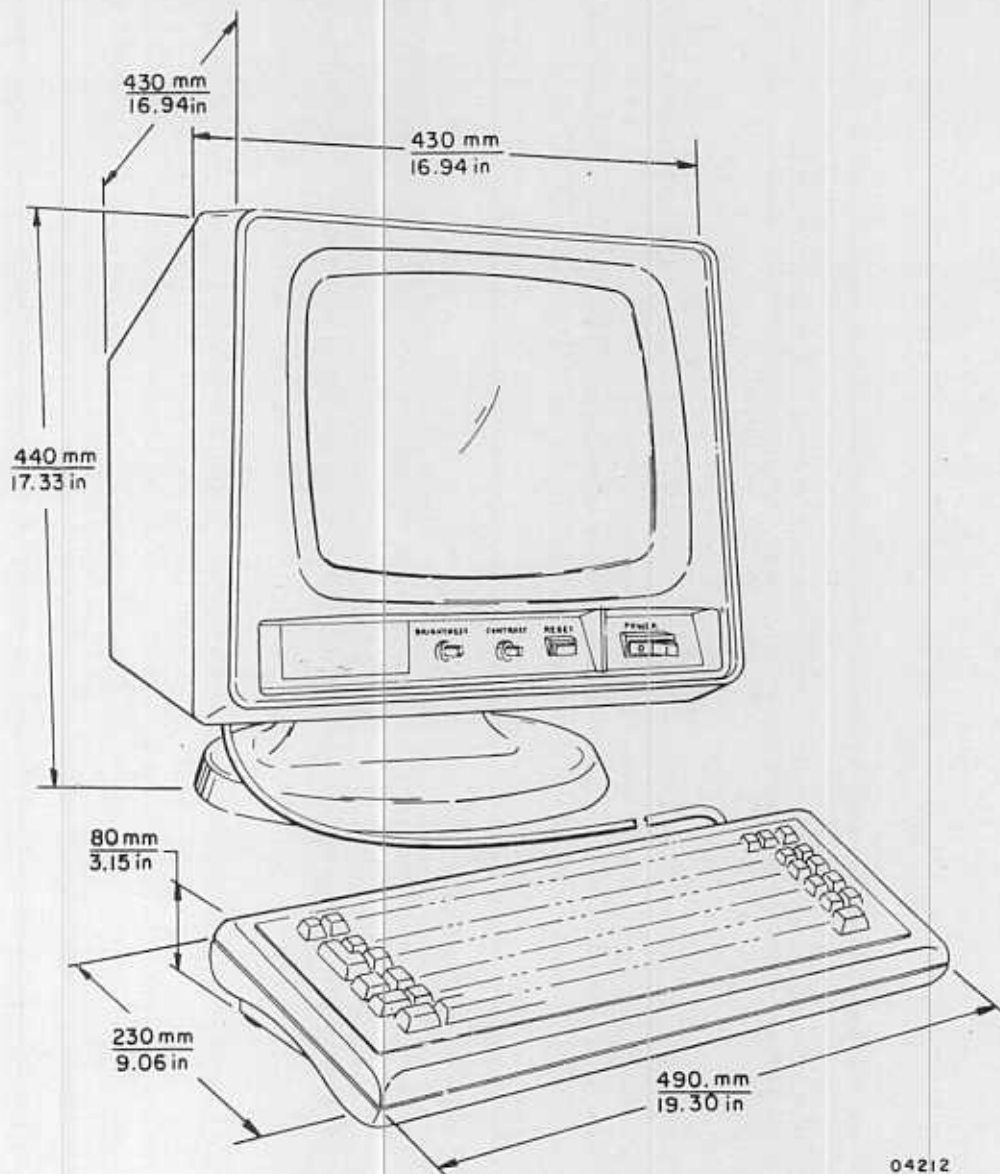

04212

Figure 1-2. Terminal Dimensions

OPERATOR SUPPLIES

The only operator-supply item required is a replacement for the terminal battery. When the terminal is turned off, this battery keeps installation parameters stored in memory. The terminal automatically checks the voltage of the battery following each power on or reset and displays a message when battery voltage is getting low. When this occurs, the battery needs to be replaced (section 3 contains instructions).

The battery to be used is an Eveready* Number 522 or equivalent. This is a 9-V alkaline-type battery that is readily available at most stores. A battery normally lasts about a year.

*A registered tradename of Union Carbide Corporation.

This section describes the controls, indicators, and input devices of the terminal and its positioning adjustments. The order of this information is as follows:

- Controls
- Indicators
- Alarm
- Keyboard
- Touchpanel option
- Positioning adjustments

CONTROLS

Figure 2-1 shows the location of the terminal controls and table 2-1 defines their function.

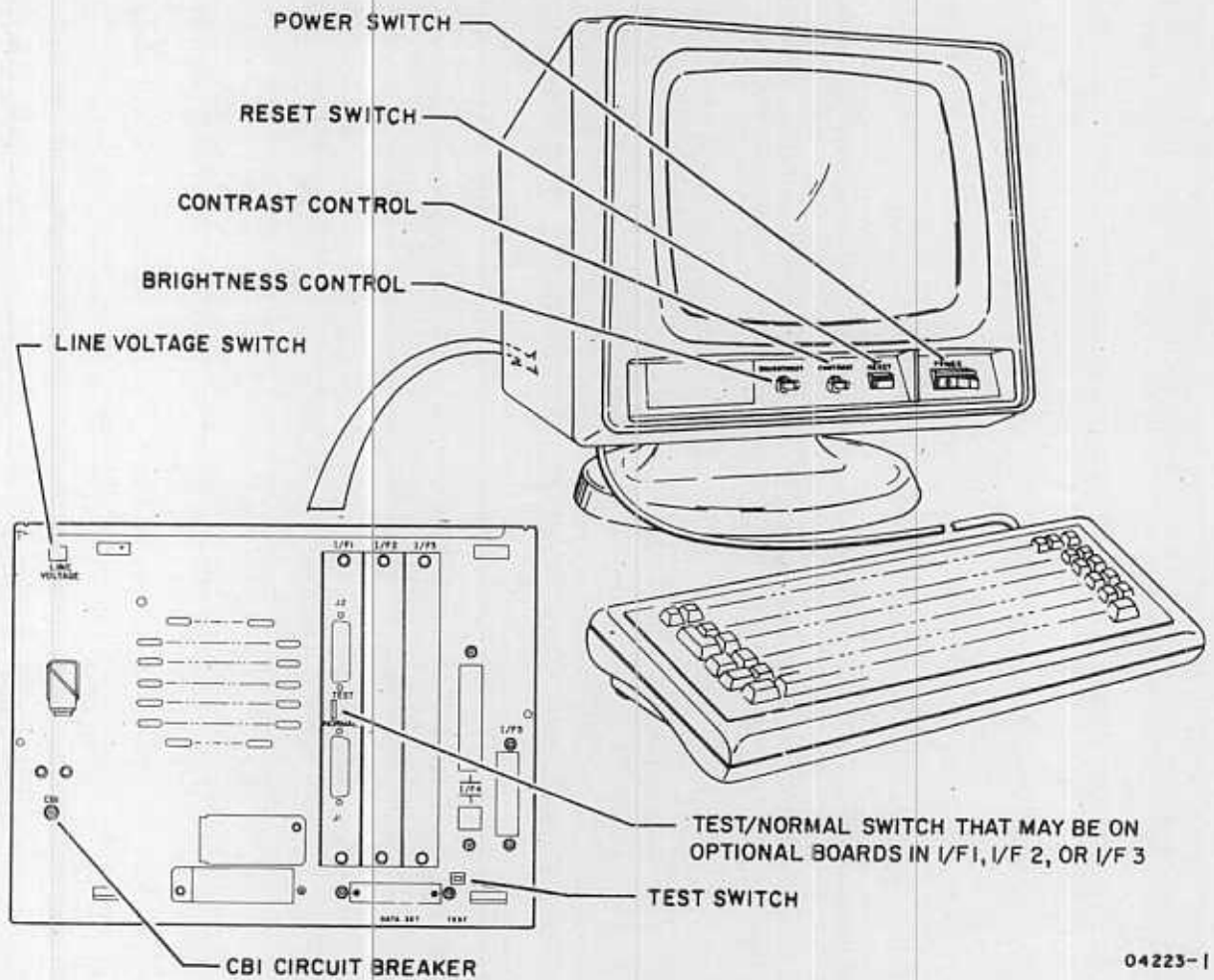

04223-1

Figure 2-1. Terminal Controls

TABLE 2-1. FUNCTION OF CONTROLS

CONTROL	FUNCTION
POWER Switch	Controls power to terminal. Pressing side of switch marked with the 1 turns power on and initiates startup process outlined in section 3. Pressing side of switch marked with the 0 turns power off.
RESET Switch	Pressing this switch clears the terminal and reinitiates startup process.
CONTRAST Control	Controls contrast between data and background on screen. Rotating control clockwise increases contrast; counterclockwise decreases contrast.
BRIGHTNESS Control	Controls brightness of lit areas on screen. Rotating control clockwise increases brightness; counterclockwise decreases brightness.
TEST Switch	Allows communication and keyboard-support circuits to be tested offline. This is described under Operator-Intervention Test in section 3. For normal operation, switch must be pushed in.
TEST/NORMAL Switch (may be on optional boards in I/F 1, I/F 2, or I/F 3)	Used with above described TEST switch to check communication circuits in operator-intervention test.
LINE VOLTAGE* Switch	Conditions terminal for voltage at site. Is set at factory for 120-V ac, 60-Hz operation. That setting is only changed when power conversion kit is installed for 220/240-V ac, 50-Hz operation.
CB1 Circuit Breaker	Provides overcurrent protection for terminal. If breaker trips, wait 15 to 20 seconds and press breaker in to reset it.
<u>CAUTION</u>	
*	If LINE VOLTAGE switch is not set correctly, damage to terminal may result.

INDICATORS

Figure 2-2 shows the indicators on the terminal and table 2-2 defines their meaning.

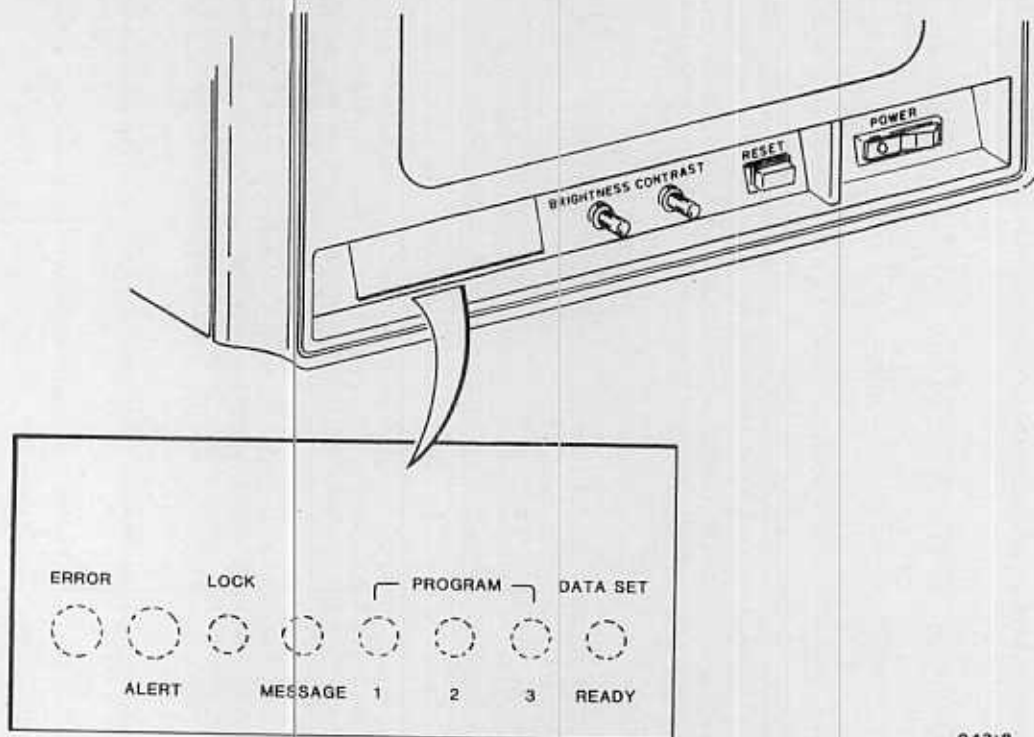

04218

Figure 2-2. Terminal Indicators

TABLE 2-2. MEANING OF INDICATORS

INDICATOR	MEANING WHEN LIT
ERROR	An error has occurred in terminal self tests or in the loading of the operating-mode program (corrective actions are described in section 6).
ALERT	Dependent on host.
LOCK	Keyboard is locked to prevent input. This occurs when: <ul style="list-style-type: none"> ● A page-print operation is done in CYBER mode ● A block of data is being transmitted in CYBER mode ● Host commands that keyboard be locked ● Terminal is unable to transmit data because modem is not ready

TABLE 2-2. MEANING OF INDICATORS (CONTD)

INDICATOR	MEANING WHEN LIT
MESSAGE	Dependent on program being run.
PROGRAM 1, 2, 3	Dependent on program being run.
DATA SET READY	Data Set Ready signal is being received from modem.

ALARM

The terminal has a two-level (loud/soft) audible alarm that sounds for the following conditions:

- At completion of the self test that follows a power on or reset. This sounding of the alarm alternates soft, loud, then soft
- If a keyboard entry in a protected position is attempted
- If a keyboard entry is attempted while the keyboard is locked
- If an improper keyboard entry is attempted during parameter selection or during startup
- When instructed by host
- If enabled by parameters*, when keyboard entries advance the cursor to the eighth position from end of line or advance the cursor into the last line

Whether the alarm sounds loud or soft depends upon parameter selection*. The only exception to this is when the alarm alternately sounds soft and loud for the first listed condition.

*In CYBER mode, the parameters for these features may be temporarily changed by the operator. This is covered under Operator Parameters in section 4.

KEYBOARD

The next paragraphs describe the various keycap configurations of the keyboard and its operating characteristics.

KEYCAP CONFIGURATIONS

Figures 2-3 through 2-9 show the variety of keycap configurations that may be used with the terminal. These include the:

- Keyboard with standard English keycaps (figure 2-3)
- Keyboard with United Kingdom keycap option (figure 2-4)
- Keyboard with French keycap option (figure 2-5)
- Keyboard with German keycap option (figure 2-6)
- Keyboard with Swedish/Finnish keycap option (figure 2-7)
- Keyboard with Danish/Norwegian keycap option (figure 2-8)
- Keyboard with Spanish keycap option (figure 2-9)

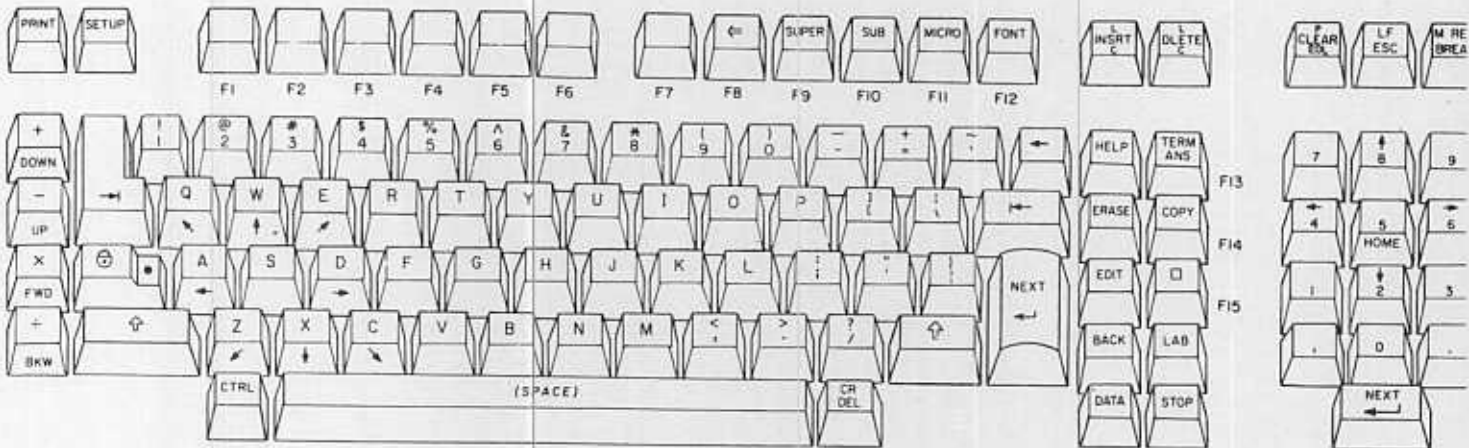
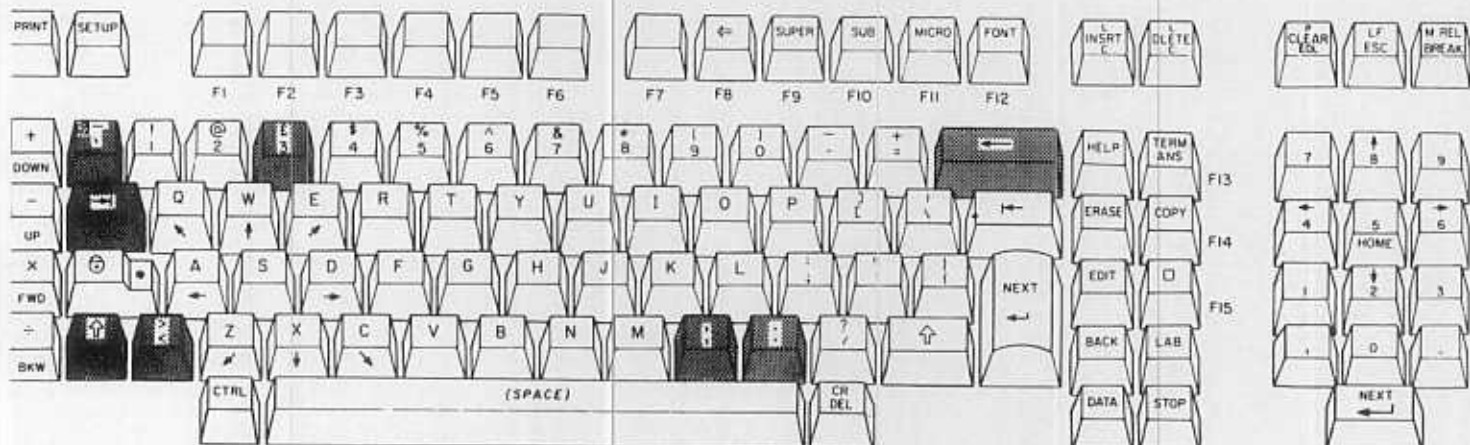

Figure 2-3. Keyboard with Standard English Keycaps



NOTES:
OPTIONAL KEYCAPS ARE SHADED FOR ILLUSTRATING PURPOSES

03942-19

Figure 2-4. Keyboard with United Kingdom Keycap Option

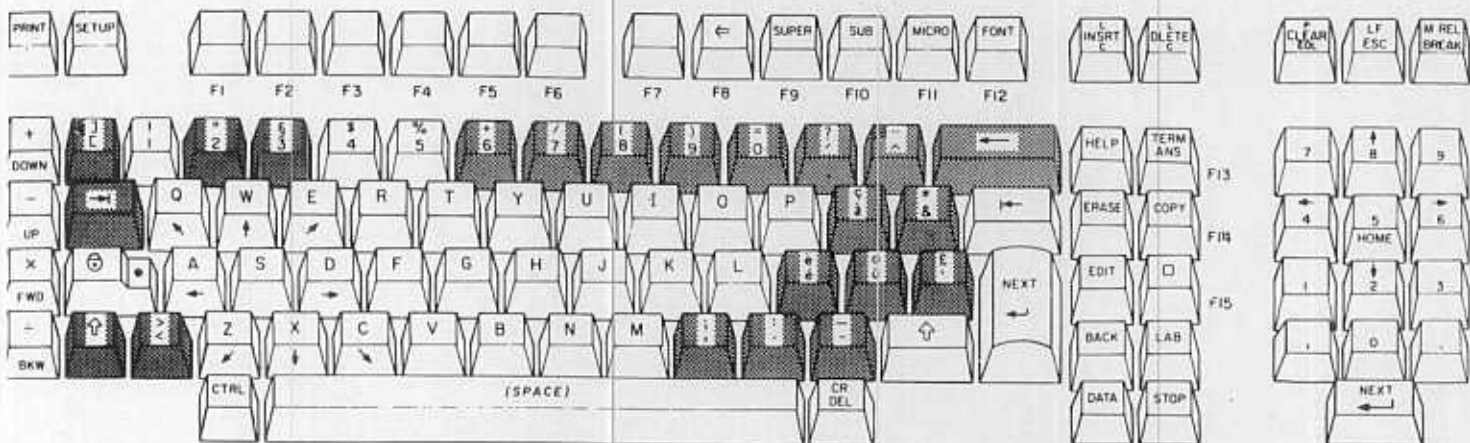

NOTES:
OPTIONAL KEYCAPS ARE SHADED FOR ILLUSTRATING PURPOSES

03942-18

Figure 2-5. Keyboard with French Keycap Option

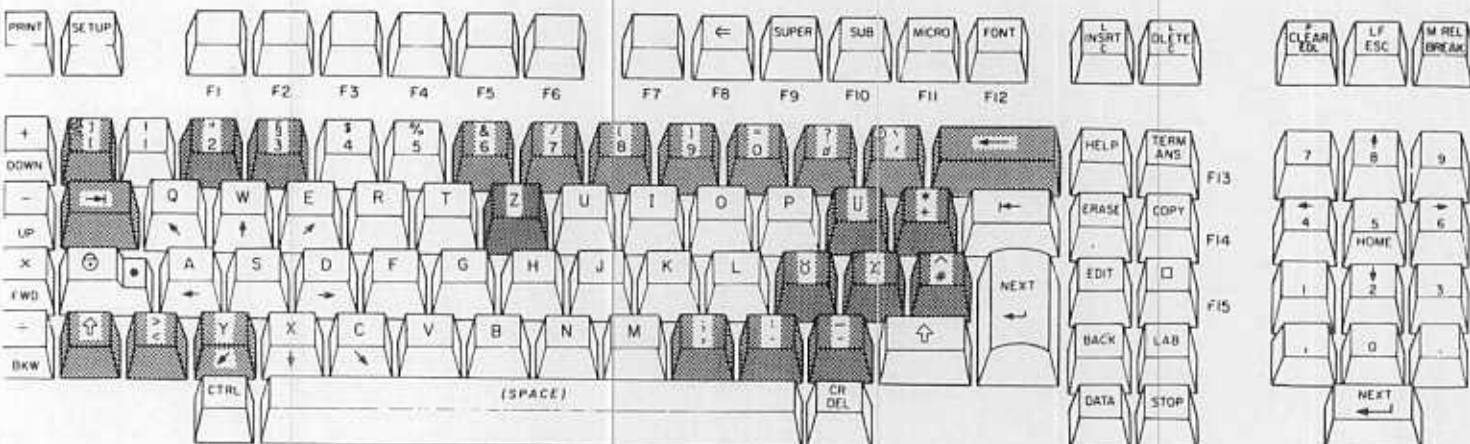

NOTES:
OPTIONAL KEYCAPS ARE SHADED FOR ILLUSTRATING PURPOSES

03942-27

Figure 2-6. Keyboard with German Keycap Option

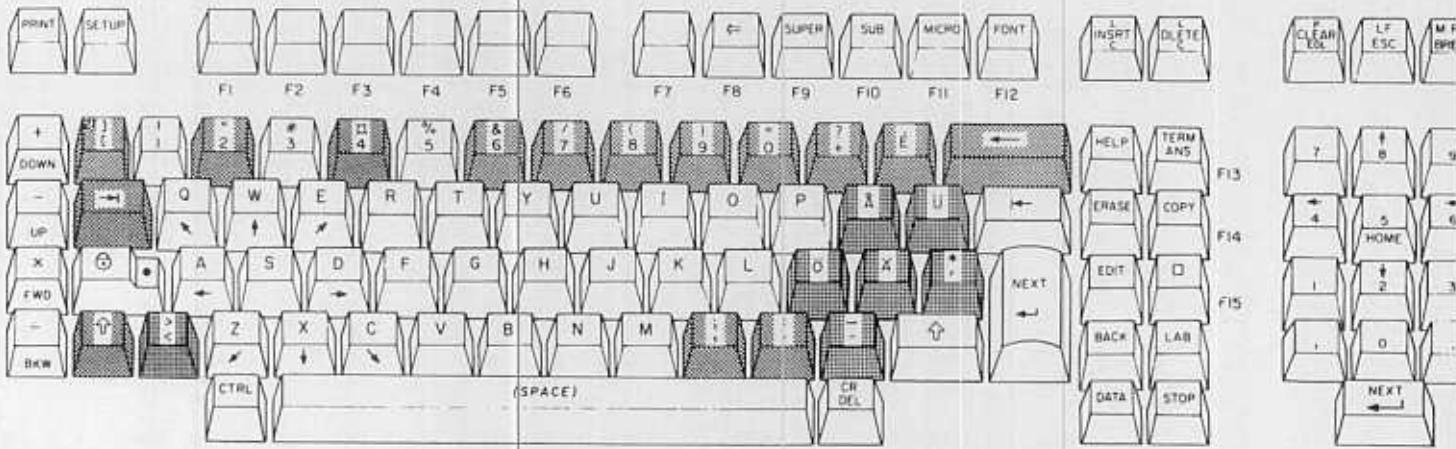

NOTES:
OPTIONAL KEYCAPS ARE SHADED FOR ILLUSTRATING PURPOSES

03942

Figure 2-7. Keyboard with Swedish/Finnish Keycap Option

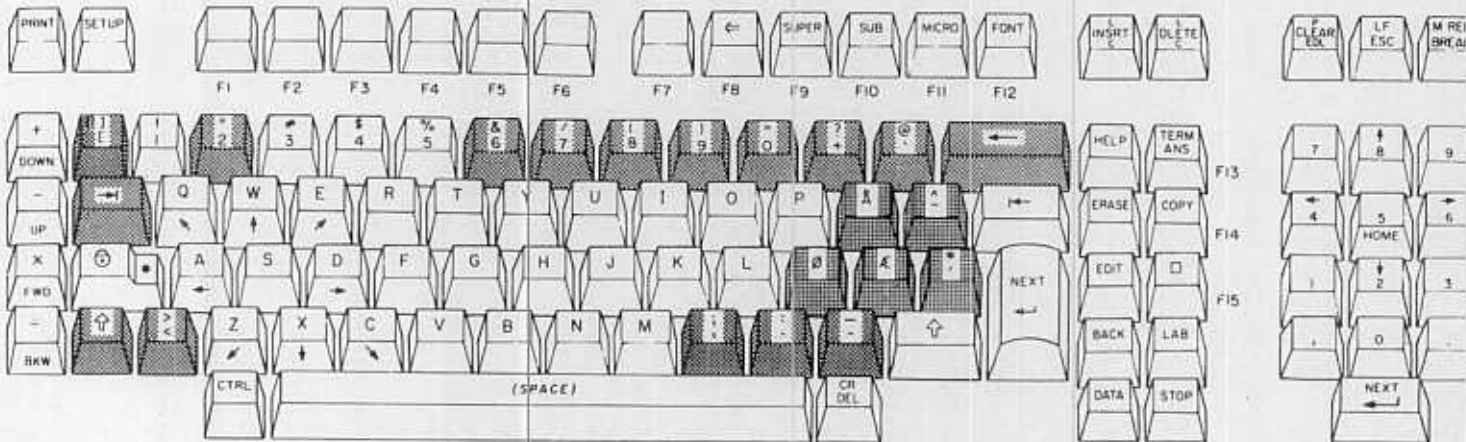

NOTES:
OPTIONAL KEYCAPS ARE SHADED FOR ILLUSTRATING PURPOSES

03942-

Figure 2-8. Keyboard with Danish/Norwegian Keycap Option

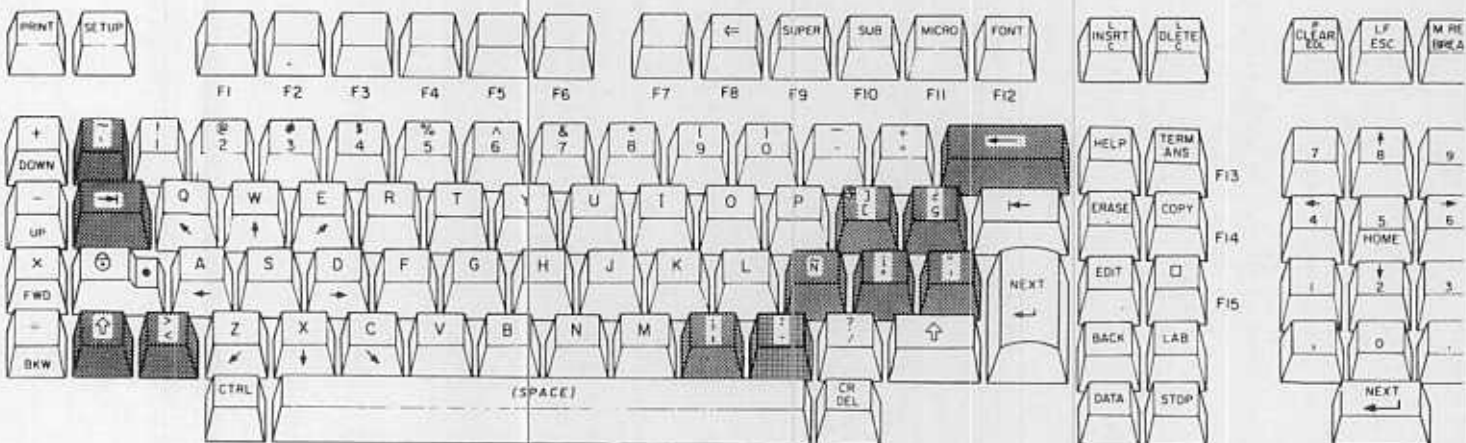

NOTES:
OPTIONAL KEYCAPS ARE SHADED FOR ILLUSTRATING PURPOSES

05383

Figure 2-9. Keyboard with Spanish Keycap Option

KEYBOARD OPERATING CHARACTERISTICS

The keyboard has the following basic operating characteristics. Details on the use of the keyboard when operating in CYBER mode are given in section 4.

- The keyboard has three categories of keys:
 - Data-entry keys for alphanumeric characters, symbols, and punctuation marks
 - Control keys for editing data and controlling the display cursor
 - Special keys that perform functions that vary with the operating mode and/or host
- Keys in the data-entry and control categories may be made typamatic through the parameters established during installation. If they are, they start repeating when pressed for longer than a second. The repeat rate is 15 characters per second.
- In operating modes that use control codes and command sequences, the CTRL (Control) key is used in conjunction with other keys to modify their function and code output.
- There are two Shift (⇧) keys, one on each side of the main key cluster.
- The Lock (Ⓔ) key/indicator can be conditioned through parameters* to function as a normal shift lock or to limit only alphabetical characters to uppercase. With either function, the indicator lights until the Lock key is pressed a second time to release the lock.
- The 13 keys in the numeric pad group on right side of keyboard can be conditioned through parameters* to operate in both lowercase and uppercase or uppercase only.

*In CYBER mode, the parameter for this feature may be temporarily changed by the operator. This is covered under Operator Parameters in section 4.

OPTIONAL TOUCHPANEL

The optional touchpanel (figure 2-10) is an auxiliary input device that has 256 square areas overlaid on the display screen. In modes supporting touchpanel input, these square areas are touch sensitive. A common use of the touchpanel is the input of an item chosen from a number of items appearing on the screen. This is done by touching the area where the chosen item appears.

MATRIX LINES IN TOUCHPANEL
ARE NEARLY INVISIBLE AND
ARE EXAGGERATED HERE FOR
ILLUSTRATING PURPOSES

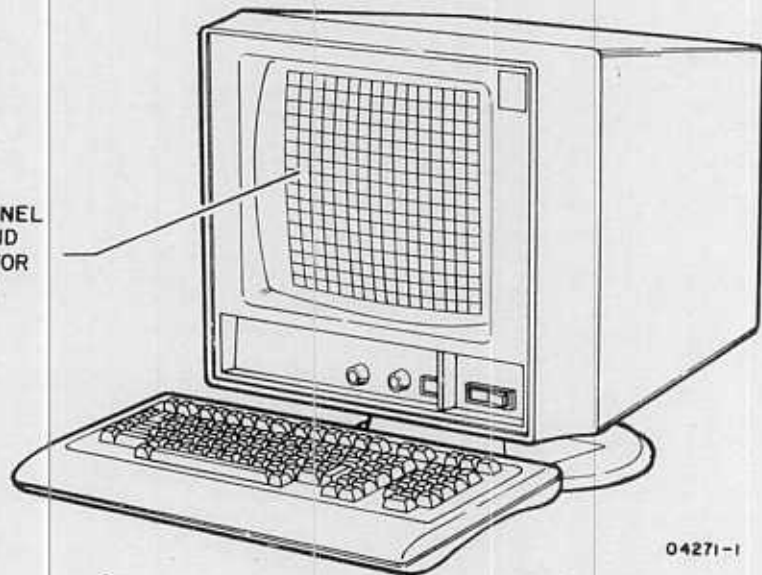

04271-1

Figure 2-10. Optional Touchpanel

POSITIONING ADJUSTMENTS

Figure 2-11 shows the positioning adjustments available on the terminal and keyboard.

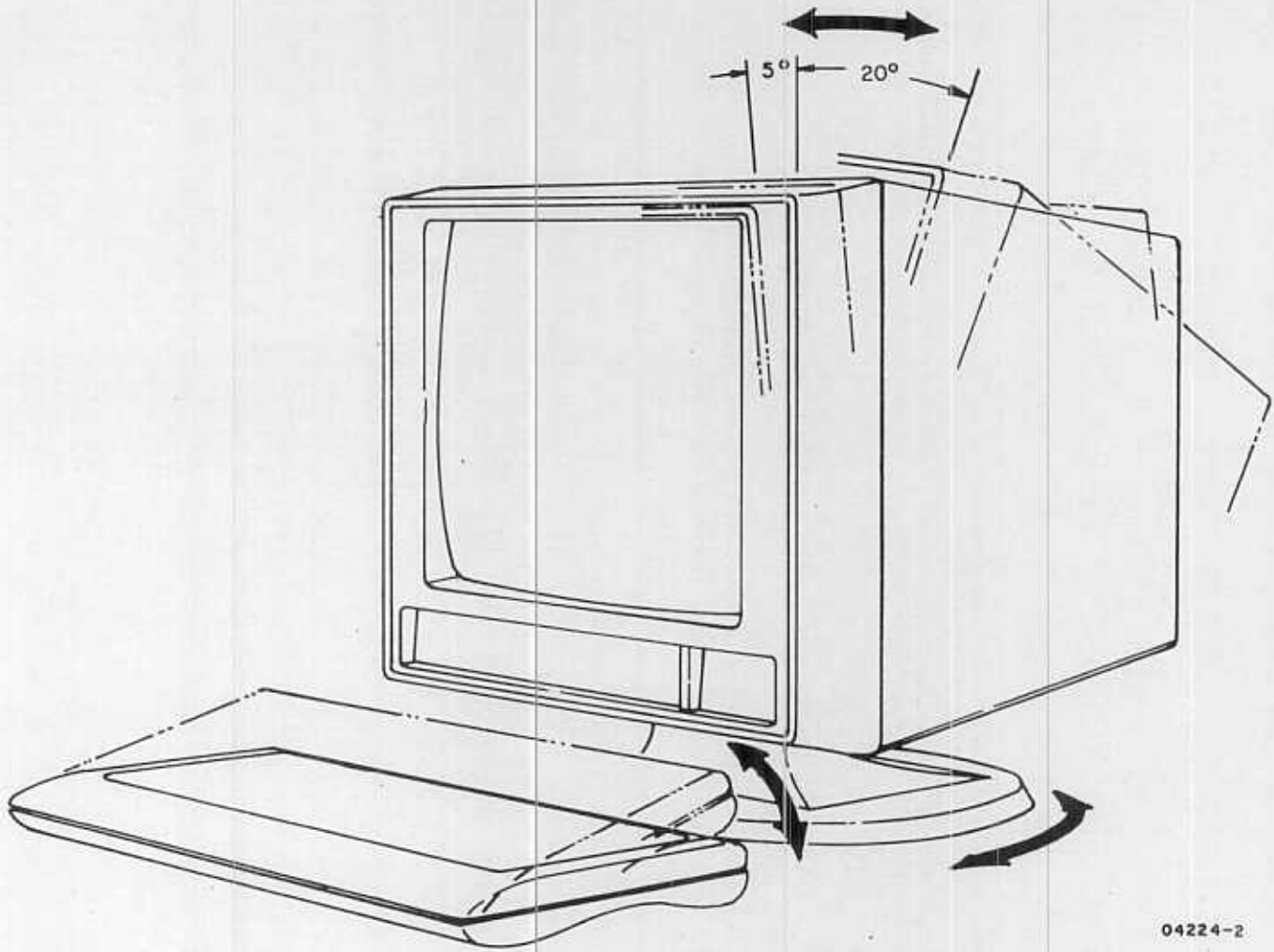

04224-2

Figure 2-11. Positioning Adjustments

This section contains instructions on:

- Starting up terminal for operation
- Running terminal self tests
- Installing a memory module
- Replacing battery

STARTING UP TERMINAL

To start up the terminal, do as follows:

NOTE

The startup process for the terminal varies with parameters established during installation. For the first startup, have your supervisor go through the process with you.

1. Check that:

- All cables between terminal and other equipment are securely connected
- Power cords for equipment are plugged into proper electrical outlets
- TEST switches shown in figure 3-1 are set for normal operation

2. If program loading is required from a memory module that has not been installed yet, install module per instructions near end of this section. (This is not applicable for CYBER mode.)

CAUTION

Never install a memory module while terminal power is on. Doing so may damage the terminal and/or the memory module.

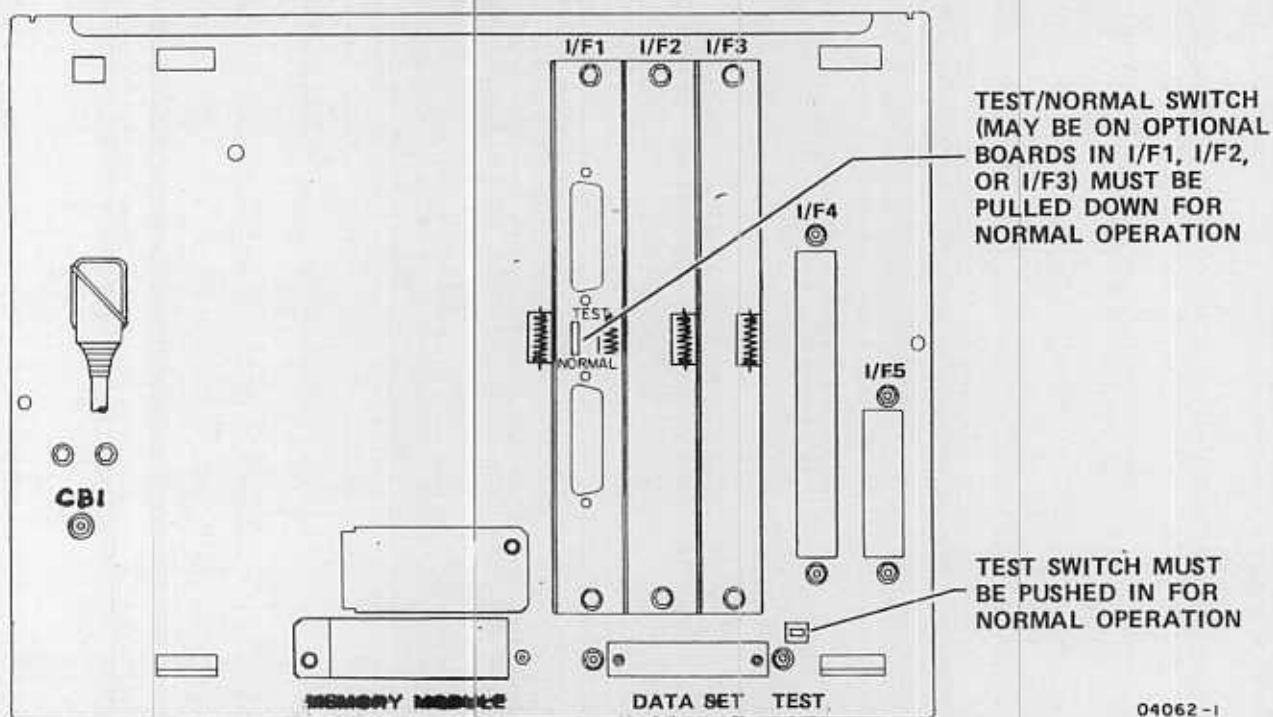

Figure 3-1. Checking TEST Switches

NOTE

If terminal is cabled directly to a computer, the power-on sequence in the next step has to be done in conjunction with the power-on sequence for the computer.

3. Turn on peripherals connected to terminal. Then turn on terminal and any connected communications equipment (for terminal, press the side of POWER switch marked with the 1).

With power applied, the terminal automatically does a power-on self test. This test checks the major elements of the terminal. Test execution takes a few seconds and the audible alarm sounds in a soft/loud/soft sequence when the test ends.

NOTE

The crt warms up within 10 to 15 seconds after the test. If the screen is completely dark, the BRIGHTNESS or CONTRAST control may be set too far counterclockwise.

If the test detects a fault, the ERROR indicator lights and the item(s) that failed are listed on the screen. Figure 3-2 shows the various possible listings and notes the appropriate action should they appear.

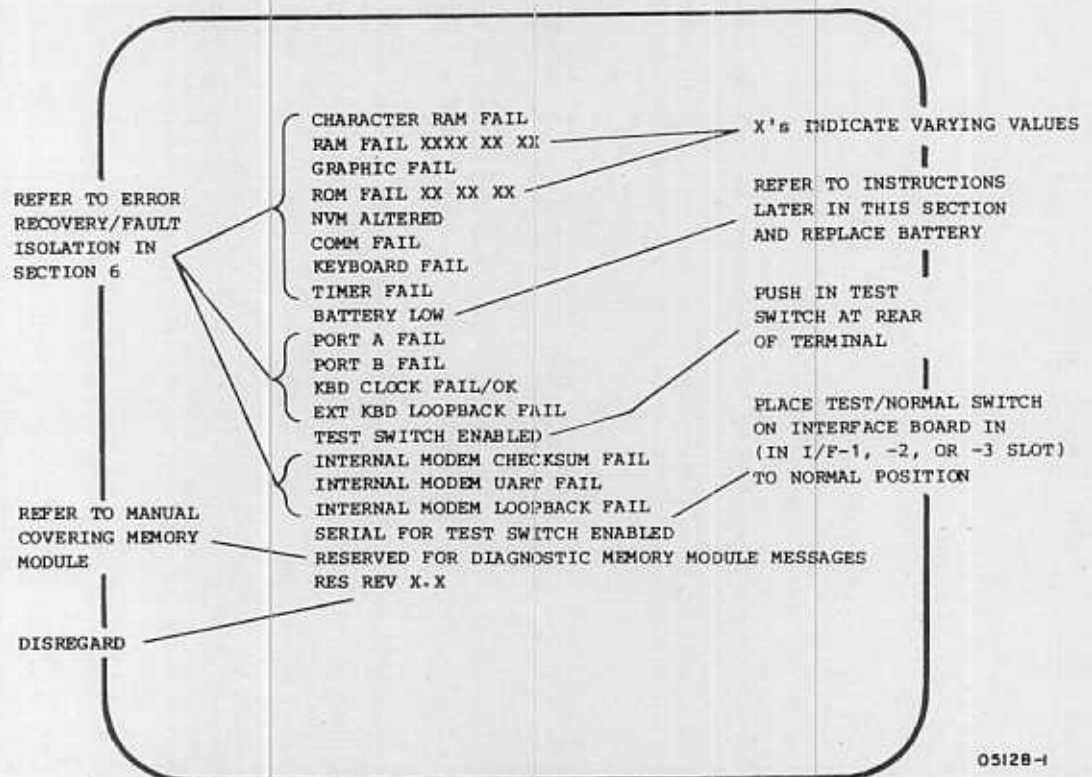
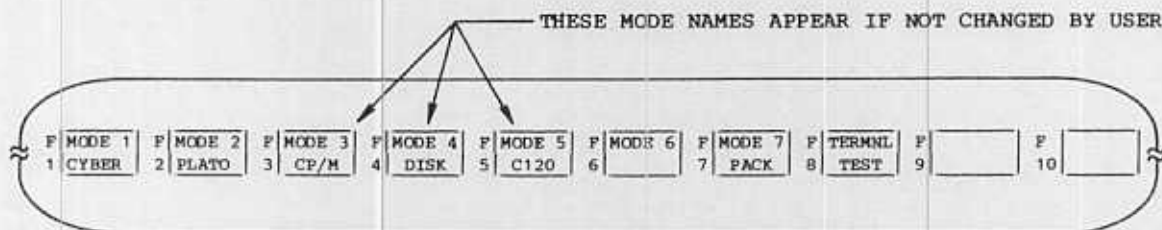

Figure 3-2. Failure Messages for Power-On Test

4. If the mode menu in figure 3-3 appears, do the following:
 - a. Determine the mode to be used from selection on screen:
 - MODE 1/CYBER - Represents resident CYBER mode
 - MODE 2/PLATO - Represents PLATO mode, which only exists if a load source is available
 - MODE 3/CP/M, MODE 4/DISK, and MODE 5/C120 represent preassigned modes for commonly used applications. Each such mode may be replaced with a user assigned mode having a different name.

- MODE 6 - Reserved for mode that was user assigned during installation
- MODE 7/PACK - Reserved for modes stored in a memory module
- TERMNL TEST - Runs operator-intervention self test (instructions for running test are given later in this section)



NOTE: IF TERMINAL IS SET UP FOR AUTOMATIC MODE SELECTION, PULLING TEST SWITCH OUT AND PRESSING RESET SWITCH WILL SHOW MODE MENU AND AN ASTERISK (*) WILL BE DISPLAYED IN THE BLOCK FOR THE AUTO SELECT MODE.

05332

Figure 3-3. Mode Menu

- b. Indicate chosen mode by pressing the numbered function key that appears adjacent to the mode listing in the menu. (For example, for CYBER mode, press the F1 key.)
 - c. If alarm sounds and FAILURE LOADING MODE appears, the mode chosen is either invalid or disabled or a loading problem has occurred. Find out the correct mode and repeat step b.
 - d. If ENTER ACCESS CODE appears, enter the assigned four-digit code through keyboard. As each digit is entered, an X replaces one of the four segments in the inverse-video block that follows the prompt. If code is entered wrong, SORRY is displayed and step b must be repeated.
5. If SELECT LOAD SOURCE > DISK HOST ROM appears, the source for the program load must be indicated by either:
 - Pressing the NEXT key. This automatically selects the default load source that was assigned during installation.
 - Pressing the D key for disk, the H key for host, or the R key for ROM pack (memory module).
 6. If ENTER PHONE NUMBER or SELECT FILE NO. appears, use the following applicable method to enter the phone number to be dialed or the program file number to be loaded.

- If the default phone or file number (assigned during installation) is the number to be dialed or the file to be loaded, simply press the NEXT key. The default phone number then automatically dials or the default file loads. Telephone-call or file-load status information appears on the terminal display screen as either of these load methods progress.
 - If the default phone or file number is not desired, key in the desired phone (0₁₆ to F₁₆, see Appendix B for more details) or file number (two digits between 00₁₆ and 3F₁₆), and press the NEXT key after the entry is complete. Correct typing errors using the ERASE key and re-key number. Call or file status information appears on the display screen as described above.
7. If HOST NOT CONNECTED appears, terminal is ready to load from host, but does not detect any communications activity. For a terminal connected to communications equipment having a telephone, this may be a normal condition that requires the following actions:
- a. Dial phone number of host manually (for terminals using external modems only; refer to appendix B for manual dial procedure using an internal modem).
 - b. When answer tone is heard, switch telephone line to terminal. (Depending on the arrangement, this may be accomplished by pulling up an exclusion key on the phone, pressing a DATA button on the phone, placing the phone handset on an acoustic coupler.)
8. Entry into CYBER mode or successful loading is indicated by the following:
- Entry into CYBER mode - Screen clears and cursor resets to home position (lower- or upper-left corner of screen). For information on operating in CYBER mode, refer to section 4.
 - Successful load from host - Typical load takes about 3 to 4 minutes. During this time, hexadecimal numbers representing the file and block being loaded appear on the screen. When loading is done, this is replaced with a message such as TERMINAL READY.
 - Successful load from memory module - Takes less than a second and the display shown on the screen depends on the program.

If loading fails, press RESET switch and retry. If that attempt fails, refer to section 6 for corrective action.

RUNNING SELF TESTS

The self tests of the terminal include the automatic power-on test (described earlier under Starting Up Terminal), an operator-intervention test, and a CYBER-mode test. The next paragraphs cover the latter two tests.

OPERATOR-INTERVENTION TEST

This offline test checks items that require operator intervention. These items include symbol and highlight display features, the front-panel indicators, the keyboard, the optional touchpanel, and sending and receiving circuits. In addition, the test shows a border on the screen for checking display alignment. The test relies on the operator to verify that results are correct. If any item does not perform correctly, refer to section 6 for corrective action.

To run the test, do as follows:

1. Make mode menu appear (figure 3-3) by doing the applicable actions that follow:
 - If operating in CYBER mode, press SETUP key, then F10 key twice. If keyboard locks, press Shift () and M REL/BREAK keys to unlock keyboard and retry.
 - If not in CYBER mode and terminal is conditioned for manual selection of operating mode, press RESET switch (menu appears after power-on test).
 - If not in CYBER mode and terminal is conditioned for automatic selection of operating mode, pull out TEST switch at rear of terminal, then press RESET switch. This shows a TEST SWITCH ENABLED message with menu. Disregard message and push TEST switch back in.
2. Press F8 key to select TERMINAL TEST mode from menu. This initiates the following:
 - If optional graphics feature is installed, a display of vertical lines appear with the lines alternately going on and off near the bottom of the screen. To progress on, press any key. This brings the next described display on the screen.
 - A display with seven lines of different symbols within an alignment border (figure 3-4). Following the symbols is a line with the words BLINK, DIM, UNDERSCORE, and INVERSE. Each of these words are displayed with corresponding highlighting; that is,

- c. Release the key and refer to figure 3-5 for the correct value when key is up. This should be the code now being displayed.
 - d. Repeat steps a through c for each key to be checked.
 4. If present, a touchpanel may be checked by touching the effective area* of the panel when the screen shows TOUCHPANEL ENABLED. This moves the cursor to where the touch was made. This can be repeated as often as desired.
 5. To check sending and receiving circuits, do the following:
 - a. If a graphics printer is connected to the terminal, verify printer is powered on and its PRINT switch is lit.
 - b. If a board containing a TEST/NORMAL switch is in I/F-1 through I/F-3 slots at rear of terminal place switch in TEST position.
 - c. Pull out TEST switch at rear of terminal. This disables keyboard input and begins internal cycling of test data. If applicable, this is accompanied by a communications exchange with the connected graphics printer. The results of these activities appear on the screen as follows:
 - KBD CLOCK OK (FAIL if error occurs)
 - If a graphics printer is included in testing - PARALLEL PORT OK (FAIL if error occurs)
 - COMM RUNNING (FAIL if error occurs)
 - KBD RUNNING (FAIL if error occurs)
 - If a TEST/NORMAL switch has been set to TEST - PORT A RUNNING and PORT B RUNNING (FAIL if error occurs)
 - d. When end of testing is desired, push TEST switch in and place TEST/NORMAL switch to NORMAL if present.
 6. Exit from test by pressing RESET switch.

*The effective (touch sensitive) area of the touchpanel is smaller than the screen. The area is approximately 203 mm (8 in) square and in the middle of the screen.

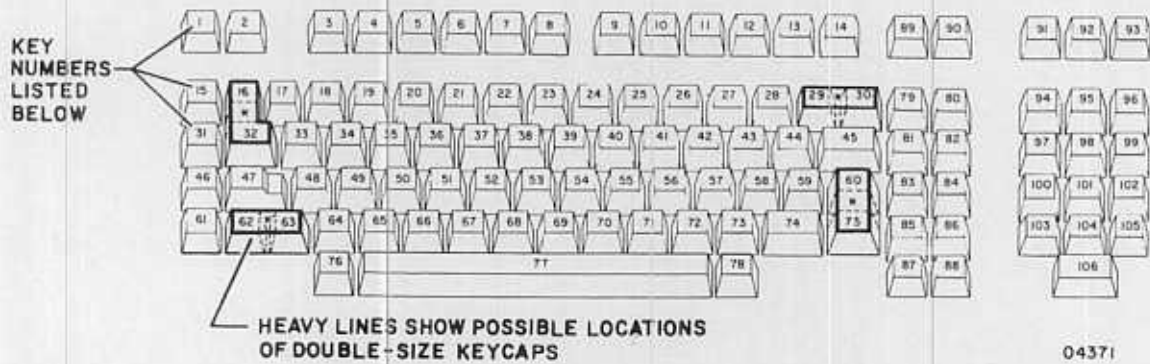

04371

KEY NUMBER	DISPLAYED CODE**		KEY NUMBER	DISPLAYED CODE**		KEY NUMBER	DISPLAYED CODE**	
	DOWN	UP		DOWN	UP		DOWN	UP
1	10	90	41	63	E3	76	25	A5
2	18	98	42	6B	EB	77	2D	AD
3	20	A0	43	73	F3	78	35	B5
4	28	A8	44	7B	FB	79	6E	EE
5	30	B0	45	7F	FF	80	36	B6
6	38	B8	46	12	92	81	77	F7
7	40	C0	47	1A	9A	82	6F	EF
8	48	C8	48	22	A2	83	5F	DF
9	50	D0	49	2A	AA	84	55	D5
10	58	D8	50	32	B2	85	5D	DD
11	60	E0	51	3A	BA	86	56	D6
12	68	E8	52	42	C2	87	45	C5
13	70	F0	53	4A	CA	88	4D	CD
14	78	F8	54	52	D2	89	7D	FD
15	11	91	55	5A	DA	90	75	F5
16*	19	99	56	62	E2	91	6D	ED
17	21	A1	57	6A	EA	92	37	B7
18	29	A9	58	72	F2	93	1D	9D
19	31	B1	59	7A	FA	94	16	96
20	39	B9	60*	67	E7	95	1E	9E
21	41	C1	61	14	94	96	26	A6
22	49	C9	62*	1C	9C	97	17	97
23	51	D1	63*	24	A4	98	1F	9F
24	59	D9	64	2C	AC	99	27	A7
25	61	E1	65	34	B4	100	4F	CF
26	69	E9	66	3C	BC	101	47	C7
27	71	F1	67	44	C4	102	3F	BF
28	79	F9	68	4C	CC	103	4E	CE
29*	7E	FE	69	54	D4	104	46	C6
30*	76	F6	70	5C	DC	105	3E	BE
31	13	93	71	64	E4	106	3D	BD
32*	1B	9B	72	6C	EC			
33	23	A3	73	74	F4			
34	2B	AB	74	7C	FC			
35	33	B3	75*	66	E6			
36	3B	BB						
37	43	C3						
38	4B	CB						
39	53	D3						
40	5B	DB						

*These keys may be covered with double-size keycaps. Pressing a double-size keycap randomly displays the code of either key under that keycap.

**Keycodes displayed during test are used internally and are not the same codes transmitted when online.

Figure 3-5. Key Values Shown During Test

CYBER-MODE TEST

This test can only be run when the terminal is in CYBER mode. The test is basically the same as the power-on test, except that it runs differently and can be initiated by the host or be initiated locally via the keyboard.

Host Initiated CYBER-Mode Test

Upon receiving an initiate-test command from the host, the terminal reruns its power-on self test. The terminal returns a response to the host indicating whether the test ran with or without a detected fault. No error message appears if a fault occurred. The screen clears after the test is completed.

Locally Initiated CYBER-Mode Test

Pressing the CTRL (Control), =, and V keys while offline in CYBER mode causes the terminal to continuously run its power-on self test until a fault is detected or the RESET switch is pressed. If a fault is detected, the terminal halts the test and displays the error message for the fault (error messages for power-on test are described earlier in this section under Starting Up Terminal). This method of test execution may be of use in detecting an intermittent fault.

INSTALLING MEMORY MODULE

To install a memory module, refer to figure 3-6 and do as follows:

CAUTION

Never install or remove a memory module while terminal power is on. Doing so may damage the terminal and/or the memory module.

1. Press terminal POWER switch to the 0 position.
2. Use a screwdriver and remove screw securing memory-module cover.

3. Remove memory-module cover.
4. A memory module can only be inserted one way. Carefully insert module in exposed connector.
5. Replace memory-module cover and secure with screw.

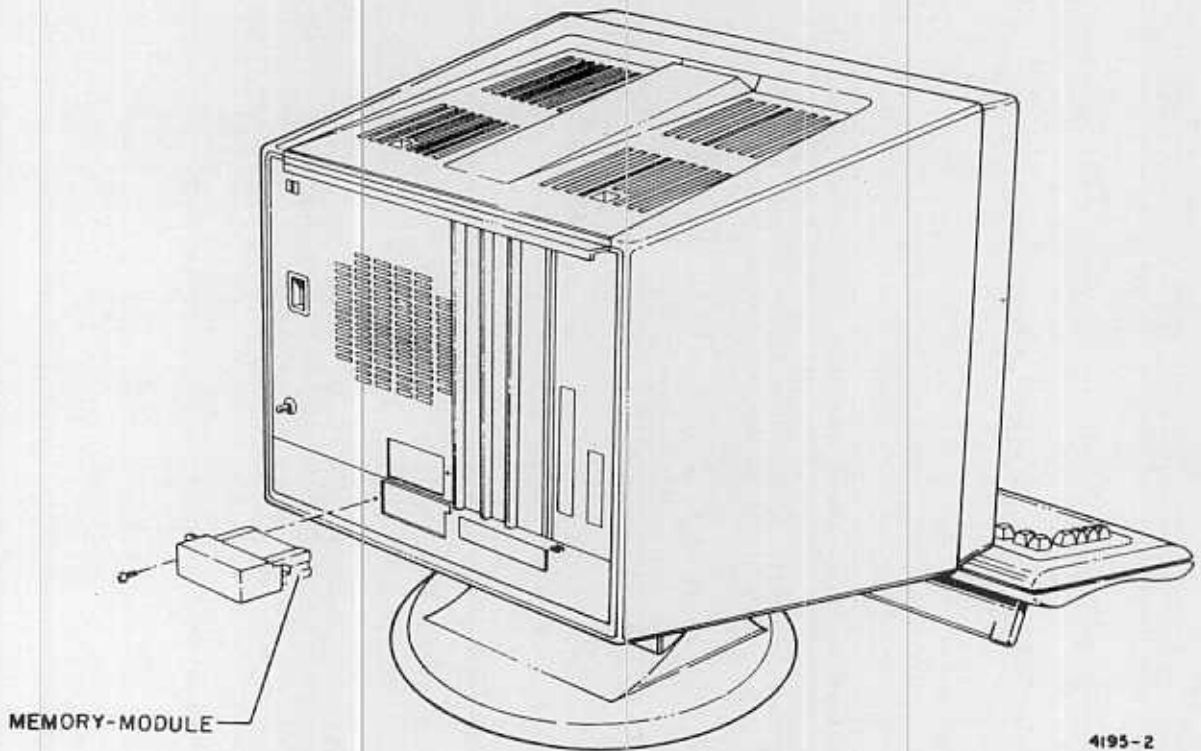

Figure 3-6. Installing a Memory Module

REPLACING BATTERY

The battery in the terminal must be replaced when the power-on test detects that battery power is getting low (BATTERY LOW displayed). The battery keeps parameter data stored in nonvolatile memory when terminal power is off. The terminal cannot function without this data. Information on the type battery required is in section 1 under Operator Supplies.

To replace the battery, refer to figure 3-7 and do as follows:

CAUTION

Always leave terminal power on while removing and replacing the battery. Otherwise, stored parameter data will be lost when the old battery is removed and NVM FAIL will display following the power-on test. Should this occur, refer to Loss of Installation Parameters in section 6.

1. Keep terminal power on and use a screwdriver to remove screw securing battery cover.
2. Remove battery cover.
3. Pull battery out from compartment and pull cap off battery terminals.
4. Cap can only go on terminals of battery one way. Snap cap on new battery and place battery in compartment. Make sure cap wires are inside compartment.
5. Replace battery cover and secure with screw.

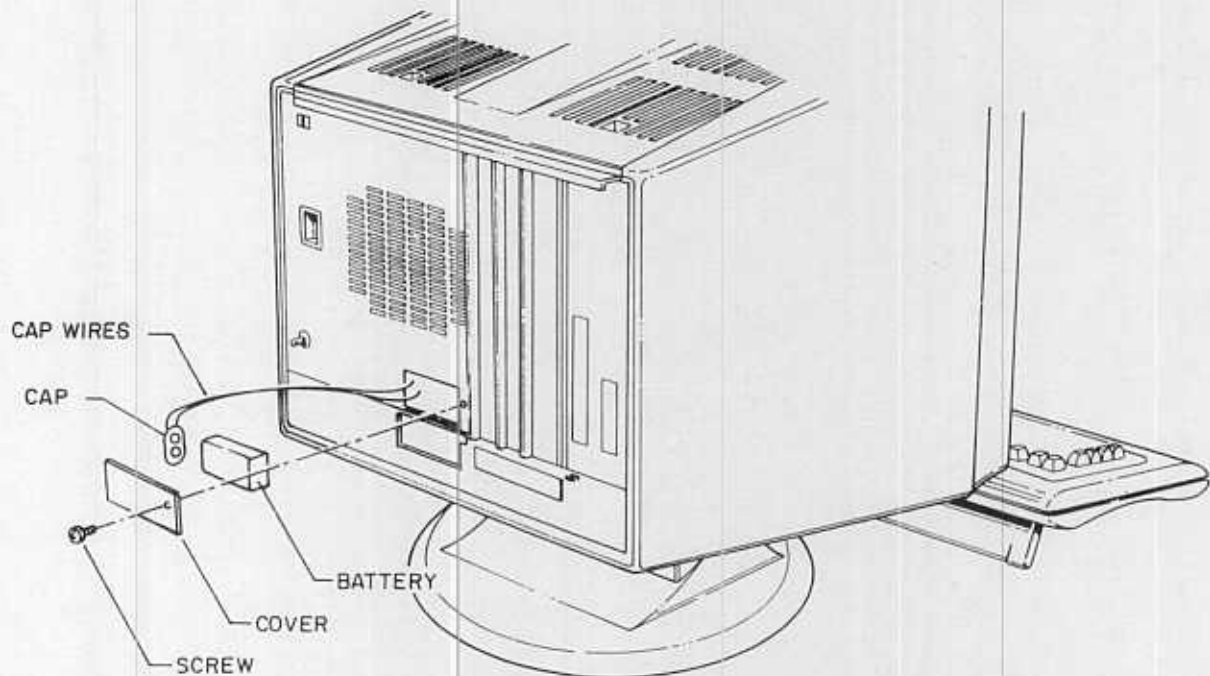

04195-3

Figure 3-7. Replacing Battery

This section describes the operation of the terminal in CYBER mode. Contents include:

- Operator parameters
- Protected screen positions
- Character/block-transmit modes
- Keyboard functions
- Host controlled functions

OPERATOR PARAMETERS

Operator parameters in CYBER mode allow the operator or host to temporarily change certain operating characteristics. These changes override corresponding parameters in nonvolatile memory until the RESET switch is pressed or power is turned off.

Table 4-1 defines the operator parameters, and the following steps cover how changes are made.

NOTE

All operator parameters except characters per line (CHR/LN) or lines per display (LINES) can be changed without losing any displayed data. Changing the CHR/LN parameter or LINES parameter causes all data on screen to clear.

NOTE

Incorrect parameter selections can cause errors. If you are not sure about a parameter selection, check with your supervisor.

1. Press SETUP key while in CYBER mode. This temporarily replaces any data on last two lines of screen with first set of operator parameters (figure 4-1) and disables all but the F1 through F10 function keys.

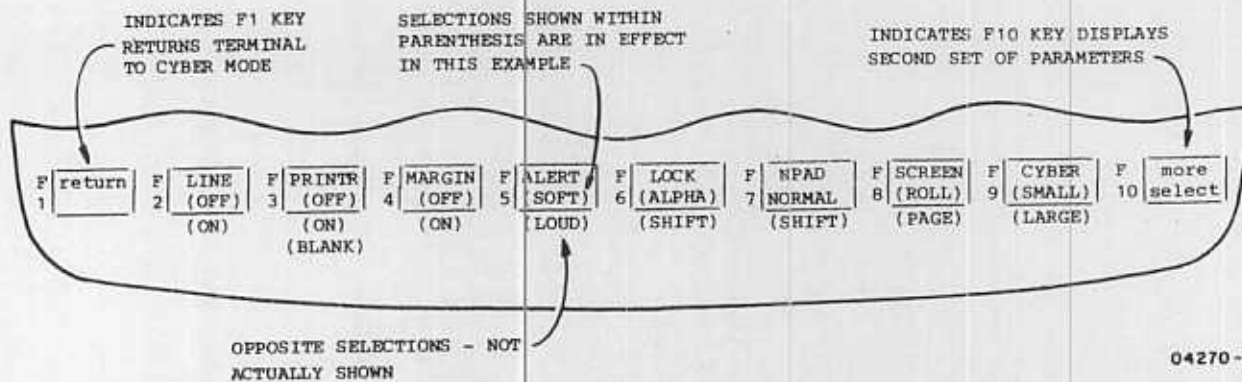

Figure 4-1. First Set of Operator Parameters for CYBER Mode

TABLE 4-1. OPERATOR PARAMETERS FOR CYBER MODE

PARAMETER LISTED ON SCREEN*	DEFINITION
LINE (OFF or ON)	Determines whether operations are online (ON) with host or offline (OFF) to do printing or testing. With offline operation, transmission to host is disabled.
PRINTR (OFF, ON, or blank)	Determines whether printing is enabled (ON) or disabled (OFF). If no printer has been assigned, this field will remain blank and no changes can be made to it.
MARGIN (OFF or ON)	With MARGIN ON, alarm sounds when keyboard entries advance display cursor to either eighth position from end of line or to last line. With MARGIN OFF, alarm does not sound for these conditions.
ALERT (SOFT or LOUD)	Determines if alarm sounds LOUD or SOFT.
LOCK (ALPHA or SHIFT)	Governs operation of the Lock key (Ⓢ). With SHIFT selected, Lock key functions as a normal shift lock. With ALPHA selected, Lock key limits only alphabetical characters to uppercase.
N PAD (NORMAL or SHIFT)	Governs operation of the 13 keys of the numeric pad group, which are on the right side of the keyboard. With NORMAL selected, these keys operate in lowercase or uppercase as applicable. With SHIFT selected, the keys only do uppercase functions as if a Shift (⇧) key is in use.
SCREEN (ROLL or PAGE)	Determines whether cursor movement beyond last line causes display to ROLL up one line or causes cursor to reset to home position (PAGE).

TABLE 4-1. OPERATOR PARAMETERS FOR CYBER MODE (CONTD)

PARAMETER LISTED ON SCREEN*	DEFINITION
CYBER (SMALL or LARGE)	SMALL selection is for operating with CYBER 120 series systems, while LARGE selection is for operating with CYBER 170 series systems.
more select	Indicates pressing F10 key displays second set of operator parameters.
BACKGD (DARK or LIGHT)	Determines whether screen shows light characters on DARK background or dark characters on LIGHT background.
CURSOR (LINE or BLOCK)	Determines whether cursor appears in the form an underline (LINE) or a BLOCK.
CURSOR (BLINK or SOLID)	Determines whether cursor is shown blinking (BLINK) or steadily illuminated (SOLID).
BAUD (75 through 19.2)	Governs the transmit and receive rate used in host communications. Each operation of the F5 key steps the transmit/receive rate to the next higher value between 75 and 19.2K bps. Operation of this key when the rate is set to 19.2 selects the slowest rate (75 bps). Set this value to 1200 for terminals using the internal 1200/1200 b/s modem for communications.
DUPLEX (HALF or FULL)	Governs routing of keyboard data within terminal. With HALF selection, keyboard data is displayed simultaneously as it is transmitted. With FULL selection, keyboard data must be echoed back by host before being displayed.
CHR/LN (80 or 132)	Determines whether 80 or 132 maximum characters are displayed per line. <u>When optional graphics feature is used, CHR/LN must be set for 80.</u>
LINES (24 or 30)	Determines whether screen uses 24 or 30 lines for displaying characters.

TABLE 4-1. OPERATOR PARAMETERS FOR CYBER MODE (CONTD)

PARAMETER LISTED ON SCREEN*	DEFINITION
XPARNT (OFF or ON)	Governs a test feature that causes received and keyboard-entered control codes to be displayed for monitoring instead of the control functions being performed. With ON selection, this feature is enabled; with OFF selection, operation is normal.
mode select	Indicates that pressing F10 key causes mode menu to display.

*Parameters are divided in two sets that appear separately on screen.

- Parameter selections in effect appear within blocks on screen. If a change is to be made, press the numbered function key that appears adjacent to the block. This places the opposite selection in effect. For example, if second block shows LINE (OFF), pressing the F2 key will change the parameter to LINE (ON). Transmissions to host will then be enabled when terminal is returned to CYBER mode in step 5.
- To display second set of parameters, press the F10 key.
- If a parameter in second set is to be changed (figure 4-2), make change per step 2.
- Press F1 key to return to CYBER mode. This clears parameters from screen.

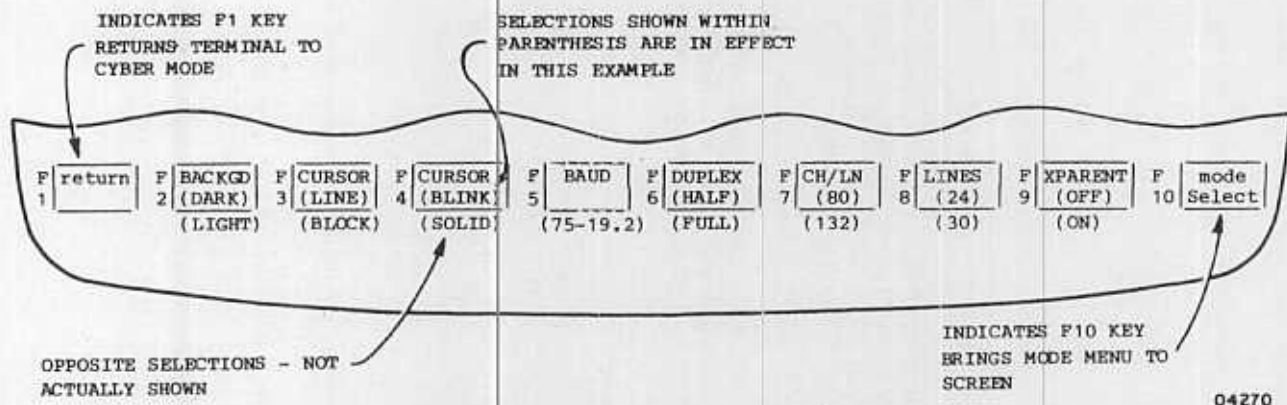

Figure 4-2. Second Set of Operator Parameters for CYBER Mode

PROTECTED SCREEN POSITIONS

The host may designate any character position on the screen as protected. The contents of protected positions can only be changed by the host. Any attempt to clear, move, or enter data in a protected position with the keyboard results in no action except sounding the alarm.

Normally, protected positions are identified by their characters being highlighted. The type of highlighting used is determined by the host. The highlighting may be characters that are dimmed, underlined, blinking, or be characters shown in inverse video (dark characters on light background).

CHARACTER/BLOCK-TRANSMIT MODES

In CYBER mode, data may be transmitted to the host either character by character (character-transmit mode) or by block (block-transmit mode).

CHARACTER-TRANSMIT MODE

This mode of transmission is in effect unless the host sends a command to enter the block-transmit mode. In character-transmit mode, the code for a pressed key is transmitted immediately. That is if operations are online and the cursor was in an unprotected position on the screen. In addition, the character for the pressed key displays immediately if half-duplex routing is being used, or with full-duplex routing, displays when the corresponding code is echoed back by the host.

BLOCK-TRANSMIT MODE

Block-transmit mode can only be entered or terminated by commands from the host. In this transmit mode, keyboard entries display immediately (regardless of half/full-duplex routing) and are stored for subsequent transmission. This storage is done on a page basis, which allows the screen to be filled and edited before transmission occurs. The only exceptions to this are:

- When the L INSRT C (Insert-Line/Insert-Character) key is used with a Shift key. This causes an immediate transmission of the codes for an insert-line function, and the function is not performed until the codes are echoed or sent back by the host.
- When the L DELETE C (Delete-Line/Delete-Character) key is used with a Shift key. This causes the same type action for the delete-line function.

When entries and editing are done, pressing anyone of the keys shown in figure 4-3 will start transmission of all unprotected data on the screen. However, the significance of the codes from these keys varies with the host and application. Check with supervisory personnel as to which key is to be used for this purpose.

During a block transmission, the keyboard locks (LOCK indicator lights) and the cursor moves through the displayed data as it is being transmitted. After all unprotected data is transmitted, the cursor returns to the position it occupied before transmission and the keyboard unlocks.

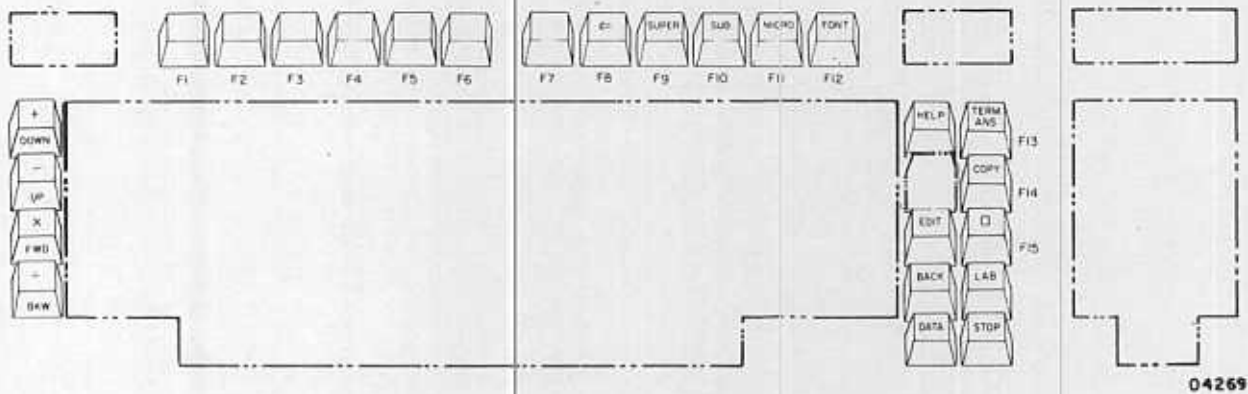
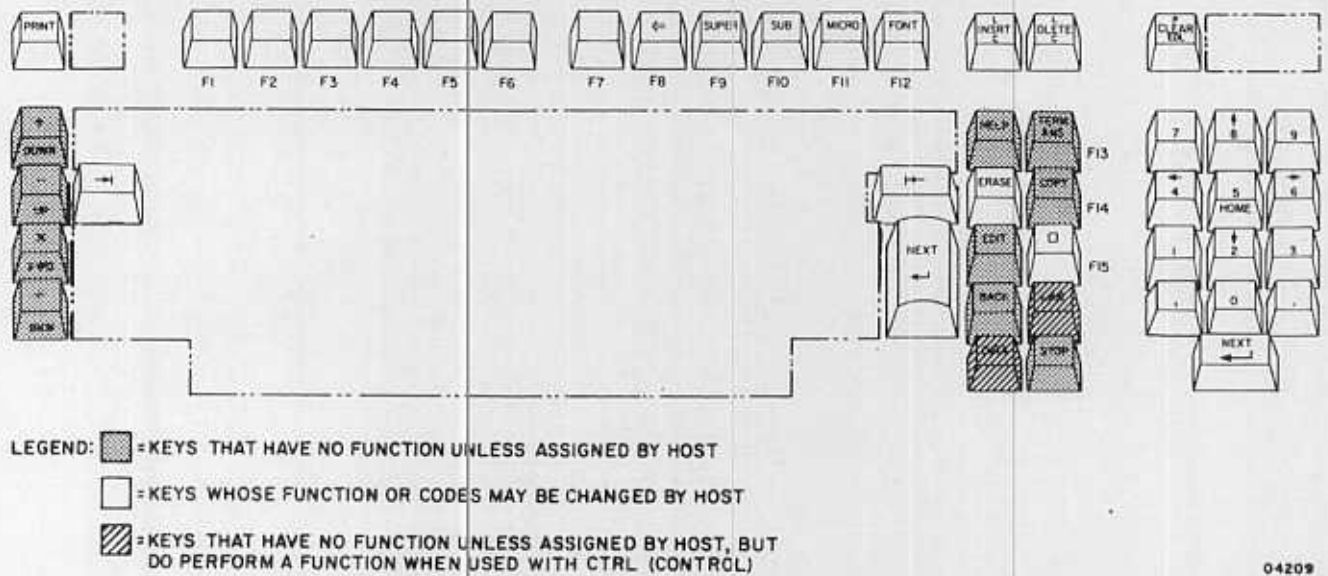

Figure 4-3. Function/Special Keys that Start Block Transmission

KEYBOARD FUNCTIONS

This portion of the section describes keyboard functions as they apply to CYBER mode. In CYBER mode, the host may assign special functions or codes to the keys identified in figure 4-4. These keys function as described here unless changed by the host.



04209

Figure 4-4. Keys Whose Functions May Change

Keyboard functions are divided into the following categories:

- Altering keyboard entries
- Entering special symbols
- Moving cursor
- Tabbing
- Editing
- Controlling communications and printing

ALTERING KEYBOARD ENTRIES

Keyboard entries are altered by the Shift keys, the Lock key, and the CTRL key.

Shift Keys

Pressing one of the Shift keys (⇧) and a alphanumeric key generates the uppercase character or control function for the alphanumeric key. When two symbols share a key, the upper symbol or control function is active while either Shift key is actuated.

Lock Key

The Lock key (⊕) can be conditioned through operator parameters to function as a normal shift lock or to limit only alphabetical characters to uppercase. First pressing of the Lock key initiates the conditioned function and lights the indicator in the key. Second pressing of the key halts the function and extinguishes the indicator.

CTRL Key

The CTRL (Control) key is used with other keys to generate special code sequences. The use of special code sequences depends on the host and the application.

ENTERING SPECIAL SYMBOLS

In CYBER mode, the host can direct the terminal to display different groups of special symbols in place of the characters on the keycaps. This does not change keycodes, but does cause certain keys to display special symbols. The special symbols made effective may be:

- Line-drawing symbols that display in place of the punctuation and numeric characters listed in table 4-2.
- Special symbols that display in place of the lowercase/uppercase alphabetical characters. This correlation is listed in table 4-3.
- Host-loaded symbols that display in place of alphabetical characters in a manner similar to the special symbols, but which are undefined. This is because each host-loaded symbol consists of a specific pattern that is loaded into terminal memory prior to normal operations.

TABLE 4-2. CORRELATION BETWEEN CONVENTIONAL CHARACTERS AND LINE-DRAWING SYMBOLS

COLUMN A CONVENTIONAL ENTRY FOR ALL KEYCAP SETS UNLESS OTHERWISE NOTED		COLUMN B CORRESPONDING LINE-DRAWING SYMBOL	
A	B	A	B
(Space)	—	0	⌋
!		1	⌋
"	┌	2	⌋
£ (British or Spanish or French keycaps)	}	3	⌋
# (Other keycap sets)		4	⌋
\$	}	5	⌋
Å (Swedish/Finnish keycaps)		6	
§	└	7	
&	┘	8	└
' (Apostrophe)	└	9	└
(┘	: (Colon)	└
)	┘	; (Semicolon)	└
*	+	<	■
+ (Plus)	=	=	■
, (Comma)		>	(Space)
- (Minus)	┌	?	■
. (Decimal Point)	┌		
/	┌		

TABLE 4-3. CORRELATION BETWEEN CONVENTIONAL CHARACTERS AND SPECIAL SYMBOLS

COLUMN A CONVENTIONAL ENTRY FOR ALL KEYCAP SETS UNLESS OTHERWISE NOTED		COLUMN B CORRESPONDING SPECIAL SYMBOL	
A	B	A	B
à (French keycaps)	} (Space)	T	μ
É (Swedish/Finnish keycaps)		U	π
§ (Spanish or German keycaps)		V	ρ
@ (Other keycap sets)		W	σ
A	/	X	ω
B	≡	Y	<
C	~	Z	>
D	↩	° (French keycaps)	} θ
E	≠	Å (Swedish/Finnish or German keycaps)	
F	↑	í (Spanish keycaps)	
G	→	Æ (Danish/Norwegian keycaps)	
H	↓	[(Other keycap sets)	
I	→	§ (French keycaps)	} (Space)
J	×	Ö (Swedish/Finnish or German keycaps)	
K	∑	Ñ (Spanish keycaps)	
L	Δ	Ø (Danish/Norwegian keycaps)	
M	∪	/ (Other keycap sets)	
N	∩	§ (French keycaps)	} °
O	÷	Å (Swedish/Finnish or Danish/Norwegian keycaps)	
P	α	° (Spanish keycaps)	
Q	β	ü (German keycaps)	
R	δ] (Other keycap sets)	
S	λ		

TABLE 4-3. CORRELATION BETWEEN CONVENTIONAL CHARACTERS AND SPECIAL SYMBOLS (CONTD)

COLUMN A CONVENTIONAL ENTRY FOR ALL KEYCAP SETS UNLESS OTHERWISE NOTED		COLUMN B CORRESPONDING SPECIAL SYMBOL	
A	B	A	B
ÿ (Swedish/Finnish keycaps)	(Space)	o	(Space)
^ (Other keycap sets)		p	\
_ (Underline)	›	q	/
é (Swedish/Finnish keycaps)	} ¯	r	/
' (Grave accent on other keycap sets)		t	-
a	..	u	-
b	□	v	
c	o	w	
d	◆	x	▨
e	x	y	▨
f	'	z	=
g	'	e' (French keycaps)	} = ----- ----- -----
h	v	ä (Swedish/Finnish or German keycaps)	
i	↕	æ (Danish/Norwegian keycaps)	
j		ç (Spanish keycaps)	
k	<	{ (Other keycap sets)	
l	>		
m	} (Space)		
n			

TABLE 4-3. CORRELATION BETWEEN CONVENTIONAL CHARACTERS AND SPECIAL SYMBOLS (CONTD)

COLUMN A CONVENTIONAL ENTRY FOR ALL KEYCAP SETS UNLESS OTHERWISE NOTED		COLUMN B CORRESPONDING SPECIAL SYMBOL	
A	B	A	B
ù (French keycaps)	}	¨ (French keycaps)	}
ö (Swedish/Finnish or German keycaps)		ü (Swedish/Finnish keycaps)	
ñ (Spanish keycaps)		— (Overbar on British or Danish/Norwegian keycaps)	
ø (Danish/Norwegian keycaps)		β (German keycaps)	
(Other keycap sets)		~ (Other keycap sets)	
ë (French keycaps)	}	DEL (Delete)	}
ä (Swedish/Finnish or Danish/Norwegian keycaps)			
ç (Spanish keycaps)			
ü (German keycaps)			
} (Other keycap sets)			

MOVING CURSOR

The functions listed in table 4-4 allow the cursor to be moved without affecting displayed data.

TABLE 4-4. MOVING CURSOR















CURSOR MOVEMENT*	PRESS KEY(S)
Left one character position (backspace)	 or  + 
Right one character position	Space bar or  + 
Up one line in same column	 + 
Down one line in same column	 + 

TABLE 4-4. MOVING CURSOR (CONTD)

CURSOR MOVEMENT*	PRESS KEY(S)
To first character position of present line	 +  if terminal is not conditioned for automatic line feed**
To first character position in next line	 for small CYBER operations*** or large CYBER operations*** if terminal is conditioned for automatic line feed**
To home position designated in operator parameters	 + 
<p>*With full-duplex routing, cursor movement does not occur until codes for keys are echoed back by host.</p> <p>**Automatic line feed is a mode installation parameter.</p> <p>***Small or large CYBER operation is selectable via operator parameters.</p>	

TABBING

The tabbing functions available through the keyboard are listed in table 4-5. These functions are similar to the tab set function on a typewriter.

TABLE 4-5. TABBING FUNCTIONS







TAB FUNCTION*	PRESS KEY(S)
Set column that cursor is in as a tab stop**	 + 
Clear column that cursor is in as a tab stop**	 + 
Tab forward. This automatically advances cursor as follows:	

TABLE 4-5. TABBING FUNCTIONS (CONTD)

TAB FUNCTION*	PRESS KEY(S)
<ul style="list-style-type: none"> ● With no protected positions on screen, to position immediately following next field of dimmed characters or to next tab stop, whichever comes first. If neither is present, cursor advances to home position. ● With protected positions on screen, to beginning of next unprotected field or next tab stop. If neither is present, cursor advances to home position. <p>Tab backward. This automatically moves cursor backward until a position is reached that meets the criteria described for tab forward.</p>	
<p>*With full-duplex routing, tab functions do not occur until codes for keys are echoed back by host.</p> <p>**These functions cannot be performed if cursor is in a protected position.</p>	

EDITING

Table 4-6 lists the editing functions available in CYBER mode.

TABLE 4-6. EDITING FUNCTIONS











EDITING FUNCTION*	PRESS KEY(S)
<p>Clear data from present cursor position forward to end of line or until a protected position is encountered, whichever comes first.</p> <p>Clear all unprotected positions on screen and move cursor to home position.</p>	  + 









TABLE 4-6. EDITING FUNCTIONS (CONTD)

EDITING FUNCTION*	PRESS KEY(S)
<p>In small CYBER operations, clears present line forward and backward to end of unprotected field or to beginning or end of line, whichever comes first. In conjunction with this, cursor moves back to where backward clearing stopped (beginning of unprotected field or beginning of line).</p> <p>In large CYBER operations, cursor is backspaced and, if the new position is unprotected, the position is cleared.</p> <p>If cursor is in a protected position, use of the ERASE key results in the alarm sounding. No other action will be taken.</p>	
<p>Delete character at present cursor position and shift characters right of cursor one position left. If protected positions are right of cursor, shifting stops at those positions.</p>	
<p>Delete present line of characters and shift lower lines up one line. This shifting continues until a line with protected positions is encountered or until bottom line has been shifted.**</p>	 + 
<p>Shift character at present cursor position right and insert a space in that position. This shifting continues to end of line or until a protected position is encountered, whichever comes first.</p>	
<p>Shift present line down and insert a line of spaces. Shifting of lines progresses down screen until a line with protected positions is encountered or until bottom line rolls off screen.**</p>	 + 
<p>*With full-duplex routing, editing functions do not occur until codes for keys are echoed back by host.</p> <p>**In block-transmit mode, these functions do not occur until codes for keys are echoed or sent back by host.</p>	

CONTROLLING COMMUNICATIONS AND PRINTING

The keyboard functions that control communications and printing in CYBER mode are listed in table 4-7.

TABLE 4-7. CONTROLLING COMMUNICATIONS AND PRINTING

FUNCTION	PRESS KEY(S)
Do a manual release. This aborts all host communications and print transfers, and if keyboard is locked, unlocks the keyboard.	 + 
Start a block-mode transmission	Refer to description of Block-Transmit Mode earlier in this section.
Transfer to printer all displayed data from present line to end of page. In this transfer, control and command codes are replaced with spaces and a carriage return and line feed are inserted at the beginning of transfer and at end of each line. During transfer, keyboard locks (LOCK indicator lights) and received data is temporarily ignored.	
Same type print transfer just described except dimmed data is replaced with space codes.	 + 
Transmit a break signal.*	
Transmit a delete code.	
Transmit an escape code.	
<p>*With full-duplex routing, the break signal being echoed back from host results in the display of a parity-error symbol (■) with the alarm sounding. This is to be disregarded.</p>	

HOST CONTROLLED FUNCTIONS

In CYBER mode, the host can direct the terminal to:

- Load a program from host
- Load up to 64 separate symbol patterns from host
- Perform special functions and/or generate special codes for designated keys
- Make changes to operator parameters
- Protect designated screen positions from keyboard entries
- Highlight designated positions by showing characters dimmed, underlined, blinking, or in inverse video
- Display line-drawing symbols, special symbols, or host loaded symbols in place of correspondingly coded alphanumeric characters
- Enable/disable touchpanel use
- Enable/disable transmission to host
- Perform a self test similar to power-on test and notify host whether a failure occurred or not
- Light ALERT indicator, MESSAGE indicator, or PROGRAM indicators
- Transfer data to printer or stop transfer to printer
- Switch from CYBER mode to a new designated operating mode (mode 3 through 7)

This section contains instructions on cleaning the keyboard and the cabinet and screen.

CLEANING KEYBOARD

1. Turn off terminal by pressing side of POWER switch marked with the 0.

CAUTION

Do not use solvents to clean keyboard. Solvents can cause defective key operation and damage keycaps.

2. Dust keyboard with soft-bristled brush.

CLEANING CABINET AND SCREEN

1. Turn off terminal by pressing side of POWER switch marked with the 0.
2. Wipe exterior of terminal cabinet using a soft, damp, lint-free cloth.
3. Clean screen or touchpanel using a soft, lint-free cloth dampened with a mild soap and water solution. Do not allow cleaning solution to run down screen or enter keyboard.

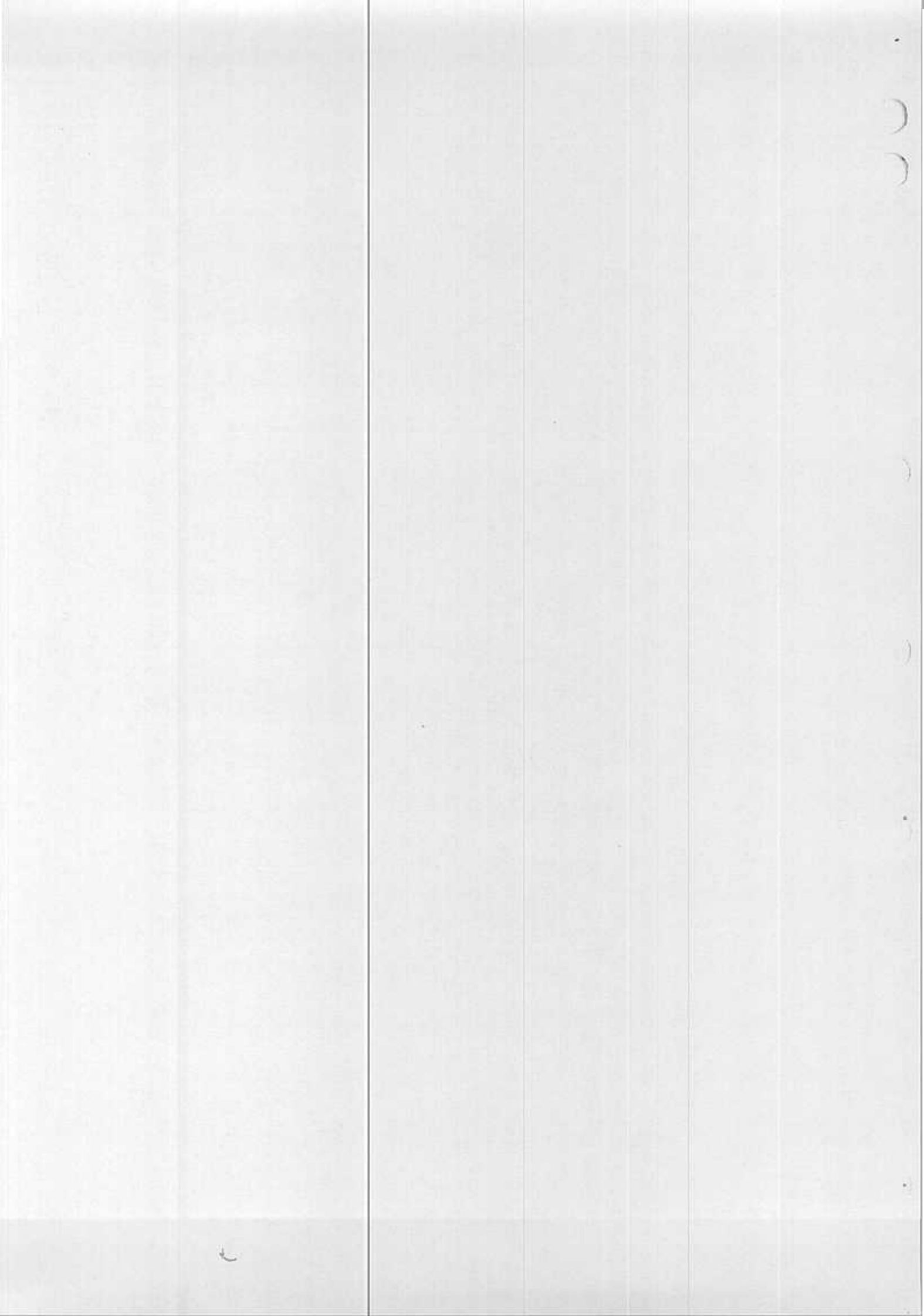

This section describes the actions to take should installation parameters be lost, contains error-recovery/fault-isolation information, and covers how terminal components are turned into a repair service center.

NOTE

If you have changed an operator parameter, make sure that is not the cause of problem before proceeding.

If you are not sure about a parameter selection, check with your supervisor. To revert all operator parameters back to their original selections, press the RESET switch or change them with the keyboard as described under Operator Parameters in section 4.

LOSS OF INSTALLATION PARAMETERS

Loss of installation parameters from nonvolatile memory occurs if the battery is replaced while terminal power is off. When power is turned on, the terminal will display NVM FAIL (nonvolatile memory fail) following the power-on test. This will require supervisory personnel to reenter all installation parameters that had been previously stored (refer to Entering Parameters in appendix A and to parameter entries recorded on the foldout Configuration Sheet near front of manual).

ERROR RECOVERY/FAULT ISOLATION

This portion of the section describes the actions to take when a problem is encountered in operating the terminal. This is done with tables that list various symptoms with recommended corrective actions. Some actions may require assistance from supervisory personnel.

The type problems covered are listed below with their corresponding table number. The tables assume that the terminal has been installed and checked out per appendix A and that the terminal battery has kept installation parameters stored in nonvolatile memory (loss of installation parameters is described above). If the problem experienced is not covered in the tables, confer with supervisory personnel and if necessary, call the hotline number recorded on the Repair Service tag.

<u>Type of Problem</u>	<u>Table No.</u>
Power problems	6-1
Power-on test problems	6-2
Host loading problems	6-3
Memory-module loading problems	6-4
Operator-intervention test problems	6-5
Display problems	6-6
Keyboard and touchpanel problems	6-7
Printing problems	6-8

TABLE 6-1. POWER PROBLEMS

SYMPTOM	ACTIONS TO BE DONE UNTIL PROBLEM IS CORRECTED OR RESOLVED
Terminal does not come on when side of POWER switch marked 1 is pressed in	<ol style="list-style-type: none"> 1. Check that BRIGHTNESS and CONTRAST controls are not turned too far counterclockwise. 2. Verify that power cord is not pulled loose from terminal or from power outlet. 3. Wait at least 15 to 20 seconds after trying POWER switch, then press in CBI circuit breaker at rear of terminal and retry POWER switch. 4. Check outlet for power by connecting a different device to outlet. If that device does not operate either, notify building electrician. If device operates OK, basic terminal unit and power cord need maintenance attention.*
CBI circuit breaker on terminal has tripped more than once	<ol style="list-style-type: none"> 1. If 50-Hz power is being used, verify that LINE VOLTAGE switch at rear of terminal is set for 220/240 V.** 2. Basic terminal unit needs maintenance attention.*
<p>*If items requiring maintenance attention are to be turned in to a CDC repair service center, refer to the latter portion of this section for instructions.</p>	
<p>**</p> <p style="text-align: center;"><u>CAUTION</u></p> <p style="text-align: center;">If LINE VOLTAGE switch is set for incorrect voltage, damage to terminal may result.</p>	

TABLE 6-2. POWER-ON TEST PROBLEMS

FAILURE MESSAGE	PROBLEM/CORRECTIVE ACTION
None - power-on test never completed (alarm never sounded) or test did complete, but with an improper display instead of mode menu	Check that terminal has power (for power problems, refer to table 6-1). If it has power, do the corrective actions listed in table 6-6 for meaningless-or-no-data-displays symptom.
<p>CHARACTER RAM FAIL</p> <p>RAM FAIL XXXX XX XX (Note: Xs above represent hexadecimal digits in message)</p> <p>GRAPHIC FAIL XXXX XX XX (Note: Xs above represent hexadecimal digits in message)</p> <p>GRAPHIC FAIL</p> <p>ROM FAIL XX XX XX (Note: Xs above represents hexadecimal digits in message)</p>	<p>Basic terminal unit >needs maintenance attention.*</p>
<p>NVM FAIL</p> <p>COMM FAIL</p>	<p>Have your supervisor re-enter all installation parameters in nonvolatile memory (refer to Entering Parameters in appendix A and to parameter entries recorded on foldout Configuration Sheet near front of manual). Then press RESET switch to rerun power-on test. If NVM FAIL displays again, basic terminal unit needs maintenance attention.*</p>
<p>KEYBOARD FAIL</p> <p>TIMER FAIL</p> <p>KBD CLOCK FAIL</p> <p>EXT KBD LOOPBACK FAIL</p>	<p>Basic terminal unit >needs maintenance attention.*</p>

TABLE 6-2. POWER-ON TEST PROBLEMS (CONTD)

FAILURE MESSAGE	PROBLEM/CORRECTIVE ACTION
BATTERY LOW	Battery needs to be replaced. Instructions are in section 3.
PORT A FAIL PORT B FAIL	<div style="border-left: 1px solid black; border-right: 1px solid black; padding: 0 10px;"> Dual asynchronous- >interface board installed in I/F 1, I/F 2, or I/F 3 at rear of terminal needs maintenance attention.* </div>
TEST SWITCH ENABLED	TEST switch at rear of terminal is pulled out for testing. Push TEST switch in for normal operation.
INTERNAL MODEM CHECKSUM, UART, or LOOPBACK FAIL (3 messages)	Basic terminal unit needs maintenance attention.*
SERIAL PORT TEST SWITCH ENABLED	TEST/NORMAL switch on dual asynchronous interface board in I/F 1 through I/F 3 is in the TEST position. Set switch to the NORMAL position for normal operation.
*If items requiring maintenance attention are to be turned in to a CDC repair service center, refer to the latter portion of this section for instructions.	

TABLE 6-3. HOST LOADING PROBLEMS

SYMPTOM	ACTIONS TO BE DONE UNTIL PROBLEM IS CORRECTED OR RESOLVED*
HOST NOT CONNECTED shows on screen and communications with host are over telephone lines	1. If terminal DATA SET READY indicator is lit, go to number 2; if not lit, check that modem/terminal power is on and that all cable connections are secure. If DSR remains unlit, modem is probably at fault. If another external modem cable is available, this may be further tested by replacing cable between terminal and modem and retrying load.

TABLE 6-3. HOST LOADING PROBLEMS (CONTD)

SYMPTOM	ACTIONS TO BE DONE UNTIL PROBLEM IS CORRECTED OR RESOLVED*
	<ol style="list-style-type: none"> 2. If internal modem, have supervisor check for correct parameter entries (refer to Appendixes A and B). 3. If external modem, verify that phone line has been switched to terminal. 4. Check that host computer, network equipment, and local phone equipment are operational (manual dial and listen). 5. Basic terminal unit needs maintenance attention.**
<p>NO REPLY shows on screen and ERROR indicator lights</p>	<ol style="list-style-type: none"> 1. If screen shows block 0 loading and then NO REPLY appears, verify that a valid file number is being entered. 2. Verify that host computer and communications network are operational. 3. Enter operator-intervention test and check transmit and receive circuits using TEST/NORMAL and TEST switches (section 3 states how and table later in this section lists error fixes). 4. Notify network personnel of problem.
<p>HOST LOADING FAILURE momentarily shows on screen and ERROR indicator lights</p>	<ol style="list-style-type: none"> 1. Verify that host computer and network are operational. 2. Enter operator-intervention test and check transmit and receive circuits using TEST/NORMAL and TEST switches (section 3 states how and table later in this section lists error fixes). 3. Notify network personnel of problem.
<p>*Actions assume that instructions under Starting Up Terminal in section 3 have been followed and that no fault was detected by power-on test.</p>	
<p>**If items requiring maintenance attention are to be turned in to a CDC repair service center, refer to the latter portion of this section for instructions.</p>	

TABLE 6-4. MEMORY-MODULE LOADING PROBLEMS

SYMPTOM	ACTIONS TO BE DONE UNTIL PROBLEM IS CORRECTED OR RESOLVED*
Attempting to load from a memory module and FAILURE LOADING MODE shows on screen and alarm sounds	<ol style="list-style-type: none"> 1. Verify that memory module is installed in terminal. Section 3 contains installation instructions. 2. Verify that loading from memory module is correct procedure for mode to be run. 3. Replace memory module.**
<p>*Actions assume that Starting Up Terminal procedure in section 3 was followed and that no fault occurred in power-on test. **Order from CDC Marketing; not from Customer Engineering.</p>	

TABLE 6-5. OPERATOR-INTERVENTION TEST PROBLEMS

SYMPTOM	PROBLEM/CORRECTIVE ACTION*
Power-on test ran OK but operator-intervention test cannot be initiated	
Vertical lines displayed by graphics feature appear incorrectly or pressing a key does not clear lines from screen	
Not all specified symbols appear in display	>Basic terminal unit needs maintenance attention.**
Symbols are randomly displayed on screen	
Words BLINK, DIM, UNDERSCORE, and INVERSE are not displayed with corresponding highlighting or the word BLANK appears	
Alignment border is not in line with notches in bezel	Have your supervisor realign crt per appendix A.

TABLE 6-5. OPERATOR-INTERVENTION TEST PROBLEMS (CONTD)

SYMPTOM	PROBLEM/CORRECTIVE ACTION*
Wrong code appears for a key or code does not change when key is released	Pull out TEST switch at rear of terminal. If KBD FAIL or KBD CLOCK FAIL is displayed, basic terminal unit needs maintenance attention; otherwise, keyboard needs maintenance attention.**
One or more indicators on front of terminal do not light during test	
Touching touchpanel when TOUCHPANEL ENABLED is displayed does not move cursor to touched position	>Basic terminal unit needs maintenance attention.**
TEST switch pulled out and KBD CLOCK FAIL is displayed	
TEST switch pulled out and either COM FAIL or KBD FAIL is displayed	Basic terminal unit needs maintenance attention.**
TEST switch pulled out and either PORT A FAIL or PORT B FAIL is displayed	Verify that TEST/NORMAL switch on dual asynchronous-interface board in rear slot I/F 1 through I/F 3 is in TEST position. If not, place that switch in TEST position and rerun test by pushing TEST switch in and then pulling it back out. If TEST/NORMAL switch was in TEST position, dual asynchronous-interface board needs maintenance attention.**
Test halted when TEST switch was pulled out	Basic terminal unit plus any boards in I/F-1 through I/F-3 slots need maintenance attention.**

TABLE 6-5. OPERATOR-INTERVENTION TEST PROBLEMS (CONTD)

SYMPTOM	PROBLEM/CORRECTIVE ACTION*
<p>TEST switch pulled out, PARALLEL PORT FAIL is displayed, and a graphics printer is connected to PARALLEL connector of terminal</p>	<p>Do the following actions until problem is corrected or resolved. Recheck test results after each action by momentarily pushing TEST switch in and then pulling it back out. This reruns test and if problem is corrected, PARALLEL PORT OK displays.</p> <ol style="list-style-type: none"> 1. Check that PRINT indicator/switch on printer is lit. If not, press PRINT switch to light indicator. 2. Check that FT116-A terminator is secure in rear connector of printer. Also check that cable(s) connecting devices are secure. 3. Press PRINT indicator/switch on printer to extinguish indicator and use printer TEST switch to do a test print (refer to printer operator's guide/reference manual, preface lists publication number). If print-out cannot be done, graphics printer needs maintenance attention. 4. If equipment is covered by an on-call maintenance agreement, call for maintenance service; otherwise, proceed to next step. 5. If another graphics printer is available as a substitute, do the following: <ol style="list-style-type: none"> a. Power off current printer and terminal. b. Connect substitute printer and cable (if available) in place of original printer and cable.

TABLE 6-5. OPERATOR-INTERVENTION TEST PROBLEMS (CONTD)

SYMPTOM	PROBLEM/CORRECTIVE ACTION*
	<p>c. If substitute printer does not have a terminator, install terminator from original unit.</p> <p>d. Press in TEST switch on terminal, then power on printer and terminal.</p> <p>e. Press PRINT indicator/switch on printer to light indicator.</p> <p>f. Refer to section 3 and reenter operator-intervention test.</p> <p>g. Pull out TEST switch. If PARALLEL PORT OK appears, original printer and cable need maintenance attention. If PARALLEL PORT FAIL still appears, parallel-interface board (board with PARALLEL connector) needs maintenance attention.**</p> <p>6. Call hotline number for assistance.</p>
<p>*Actions assume that instructions under Operator-Intervention Test in section 3 have been followed.</p>	
<p>**If items requiring maintenance attention are to be turned in to a CDC repair service center, refer to the latter portion of this section for instructions.</p>	

TABLE 6-6. DISPLAY PROBLEMS

SYMPTOM	PROBLEM/CORRECTIVE ACTION
Display went completely black	<p>Check that terminal has power (for power problems, refer to table 6-1). If terminal has power, verify that BRIGHTNESS or CONTRAST control did not accidentally get turned too far counterclockwise. If that is not the problem, basic terminal unit or board in rear slot I/F 1 through I/F 3 needs maintenance attention. If terminal is covered by a carry-in maintenance agreement, determine which is faulty as follows:</p> <ul style="list-style-type: none"> ● If no board is installed in slots I/F 1 through I/F 3, basic terminal unit needs maintenance attention.* ● If one or more boards are installed in I/F 1 through I/F 3, do the following: <ul style="list-style-type: none"> a. Turn off power to terminal and all devices connected to terminal. b. Remove two screws securing cover plates of boards in I/F-1 through I/F-3 slots and pull boards from slots (reference figure 6-1 later in this section). c. Power on terminal to see whether display now operates correctly. Note if a dual asynchronous-interface board was removed, a PORT A FAIL and PORT B FAIL message will appear if display is operating properly. This is because the board is removed.

TABLE 6-6. DISPLAY PROBLEMS (CONTD)

SYMPTOM	PROBLEM/CORRECTIVE ACTION
Wrong language character set is displayed	<p>d. If display still does not operate correctly, the basic terminal unit needs maintenance attention; otherwise, the board(s) removed in step b needs maintenance attention.*</p> <p>Have your supervisor verify that correct language is selected in terminal installation parameters. If that is not the problem, basic terminal unit needs maintenance attention.*</p>
No display of keyboard entries or data displayed is meaningless.	<p>Press RESET switch. If problem is still present, basic terminal unit or board in rear slot I/F 1 through I/F 3 needs maintenance attention. If terminal is covered by a carry-in maintenance agreement, determine which is faulty as follows:</p> <ul style="list-style-type: none"> ● If no board is installed in slots I/F 1 through I/F 3, basic terminal unit needs maintenance attention.* ● If one or more boards are installed in I/F 1 through I/F 3, do the following: <ol style="list-style-type: none"> a. Turn off power to terminal and all devices connected to terminal. b. Remove two screws securing cover plates of boards in I/F-1 through I/F-3 slots and pull boards from slots (reference figure 6-1 later in this section).

TABLE 6-6. DISPLAY PROBLEMS (CONTD)

SYMPTOM	PROBLEM/CORRECTIVE ACTION
	<p>c. Power on terminal to see whether display now operates correctly. Note if a dual asynchronous-interface board was removed, a PORT A FAIL and PORT B FAIL message will appear if display is operating properly. This is because the board is removed.</p> <p>d. If display still does not operate correctly, the basic terminal unit needs maintenance attention; otherwise, the board(s) removed in step b needs maintenance attention.*</p>
<p>Display not stable BRIGHTNESS or CONTRAST control have little affect</p>	<p>>Basic terminal unit needs maintenance attention.*</p>
<p>Display too bright</p>	<p>Check that BRIGHTNESS and CONTRAST controls are not turned too far clockwise. If that is not the problem, basic terminal unit needs maintenance attention.*</p>
<p>Background of display is opposite than expected</p>	<p>Enter CYBER mode (refer to Starting Up Terminal in section 3) and display second set of operator parameters by pressing SETUP key, then F10 key (parameters displayed are described in section 4 under Operator Parameters). Press F2 key several times to verify that display background alternately goes light to dark. If no change occurs, basic terminal unit needs maintenance attention.*</p>
<p>Display resolution poor</p>	<p>Check that BRIGHTNESS control is not too far clockwise. If that is not the problem, basic terminal unit needs maintenance attention.*</p>

TABLE 6-6. DISPLAY PROBLEMS (CONTD)

SYMPTOM		PROBLEM/CORRECTIVE ACTION
Data in left margin seems too close or too far from side of screen		Enter operator-intervention test (section 3 contains instructions). Check whether alignment border in test is
Data in first line seems too close or too far from top of screen		in line with notches in bezel. If border is not in line, have your supervisor realign crt per appendix A. If that does not correct problem, basic terminal unit needs maintenance attention.*
Unit does not hold tilted position		Basic terminal unit needs maintenance attention.*
*If items requiring maintenance attention are to be turned in to a CDC repair service center, refer to the latter portion of this section for instructions.		

TABLE 6-7. KEYBOARD AND TOUCHPANEL PROBLEMS

SYMPTOM		PROBLEM/CORRECTIVE ACTION*
No response when any key is pressed	key is	<p>Make sure that:</p> <ul style="list-style-type: none"> ● Keyboard cable is connected to terminal ● TEST switch at rear of terminal is pushed in ● Communications with host have not been cut off ● If a board with a TEST/NORMAL switch is in I/F 1 through I/F 3 at rear of terminal, that switch is set to NORMAL

TABLE 6-7. KEYBOARD AND TOUCHPANEL PROBLEMS (CONTD)

SYMPTOM	PROBLEM/CORRECTIVE ACTION*
	<p>If none of these are cause of problem, do as follows:</p> <ol style="list-style-type: none"> 1. Pull out TEST switch at rear of terminal. 2. Press RESET switch to rerun power-on test. 3. If KBD CLOCK FAIL or EXT KBD LOOPBACK FAIL appears on screen, basic terminal unit needs maintenance attention; otherwise, keyboard needs maintenance attention.**
<p>Not the expected response when a particular key is pressed</p>	<p>Enter operator-intervention test and check whether correct code appears when key is pressed (section 3 contains instructions). If correct code appears, problem is likely not with keyboard or terminal but with operating program or host. If incorrect code appears, keyboard needs maintenance attention.**</p>
<p>Lock key indicator does not light when that key is in use</p>	<p>Check whether indicator lights while in CYBER mode (instructions for entering CYBER mode are in section 3 under Starting Up Terminal). If indicator lights in CYBER mode, operating-mode program being used is not instructing indicator to light. If indicator does not light in CYBER mode, do as follows:</p> <ol style="list-style-type: none"> 1. Refer to instructions in section 3 and enter operator-intervention test. 2. If a board with a TEST/NORMAL switch is in I/F 1 through I/F 3 at rear of terminal, place switch in TEST position.

TABLE 6-7. KEYBOARD AND TOUCHPANEL PROBLEMS (CONTD)

SYMPTOM	PROBLEM/CORRECTIVE ACTION*
Keyboard unexpectedly locked (LOCK indicator lit on front panel)	<p>3. Pull out TEST switch at rear of terminal. If KBD FAIL is displayed, basic terminal unit needs maintenance attention; otherwise, keyboard needs maintenance attention.**</p> <p>If operating online with host, check that connected modem is operational and that DATA SET READY indicator is lit on terminal. If that is not the problem, unlock keyboard by pressing RESET switch. If condition reoccurs, call hotline number for assistance.</p>
No response to attempted touchpanel input	<p>Enter operator-intervention test and check whether touchpanel operates correctly in test (section 3 contains instructions). If it does, touchpanel input was probably not enabled when attempted or there is a problem with operating program or host. If touchpanel does not operate correctly in test, basic terminal unit needs maintenance attention.**</p>
<p>*Actions assume that instructions under Starting Up Terminal in section 3 have been followed and that no fault was detected by power-on test.</p>	
<p>**If items requiring maintenance attention are to be turned in to a CDC repair service center, refer to the latter portion of this section for instructions.</p>	

TABLE 6-8. PRINTING PROBLEMS

SYMPTOM	ACTIONS TO BE DONE UNTIL PROBLEM IS CORRECTED OR RESOLVED
<p>No printing occurs in CYBER mode when PRINT key is pressed</p>	<ol style="list-style-type: none"> 1. Check that: <ul style="list-style-type: none"> ● Printer is ready and online with terminal (if necessary, refer to printer operator's guide for instructions on placing printer online) ● Cable connections at terminal and printer are secure ● TEST switch at rear of terminal is pressed in, and if a TEST/NORMAL switch is present at rear in I/F-1 through I/F-3, that switch is in NORMAL position 2. Check whether printer can do a test print or self test successfully (refer to printer operator's guide for applicable procedure). If it cannot, printer needs maintenance attention. 3. If printer has been reconnected and is a character printer, verify it is connected to the correct connector at terminal. Connector J1 is for port-A operations and connector J2 is for port-B operations. Which port is correct depends on the parameters established during installation. 4. Enter operator-intervention test and check that PRINT key displays correct code and use TEST/NORMAL and TEST switches to check sending and receiving circuits (section 3 contains instructions and a table earlier in this section lists corrective actions if an error occurs in test). 5. Call hotline number for assistance.

TABLE 6-8. PRINTING PROBLEMS (CONTD)

SYMPTOM	ACTIONS TO BE DONE UNTIL PROBLEM IS CORRECTED OR RESOLVED
Character printer prints meaningless data when terminal is turned on	<ol style="list-style-type: none"> 1. Power off terminal and run printer self test (refer to printer operator's guide for procedure). If printer self test does not run successfully, printer needs maintenance attention; otherwise, basic terminal unit and dual asynchronous-interface board need maintenance attention.*
Meaningless or missing data in printout	<ol style="list-style-type: none"> 1. If this problem is occurring with a character printer in its initial use, check that printer and terminal port are using same data rate, parity, and number of stop bits. These characteristics on terminal port are determined by installation parameters. Correlation between port and terminal connector is that connector J1 is for port-A operations and connector J2 is for port-B operations. 2. If this problem is occurring with a graphics printer, check that FT116-A terminator is secure in rear connector of printer. 3. Check whether printer can do a test print or self test successfully (refer to printer operator's guide for applicable procedure). If it cannot, printer needs maintenance attention. 4. Enter operator-intervention test and use TEST/NORMAL and TEST switches to check sending and receiving circuits (section 3 contains instructions and a table earlier in this section lists corrective actions if an error occurs in test). 5. Call hotline number for assistance.
<p>*If items requiring maintenance attention are to be turned in to a CDC repair service center, refer to the latter portion of this section for instructions.</p>	

TURNING IN COMPONENTS TO A REPAIR SERVICE CENTER

The information in this portion of the section is for supervisory personnel. This information covers the procedure for turning in terminal components to a CDC repair service center when maintenance attention is required. Such maintenance service is available to users having a carry-in maintenance agreement with CDC. To acquire this type of agreement, contact your nearest CDC sales representative. The representative will inform you of the nearest available repair service center. Always check with the representative before shipping an item because the location of repair service centers occasionally change and a newly opened center may be closer.

All items turned in (either by person or by shipment) must be packed in CDC approved materials. If original packing materials were not saved, approved materials may be obtained through your CDC representative. Indicate that the packing material required is CDC part number 90538400. You will be charged for packing material.

The following terminal components are assigned as turn-in items:

- Basic terminal unit - includes all but the keyboard, equipment-interconnecting cables, optional user-installed printed-circuit boards, and any memory module that may be installed
- Keyboard with attached cable
- Optional user-installed printed-circuit boards that are housed in slots I/F 1 through I/F 3 at rear of terminal. These include the parallel-interface board and the dual asynchronous-interface board.

The next paragraphs describe how to prepare the above mentioned items for turn in. After that is a listing of information that must accompany turned-in items.

PREPARING BASIC TERMINAL UNIT FOR TURN IN

Parts removed from the basic terminal unit in the following steps are to be saved for later installation and not turned in with the unit. To prepare the unit, do as follows:

1. In case the memory containing installation parameters inadvertently gets cleared during maintenance, make sure current installation parameters are recorded on the Configuration Sheet near front of manual. Instructions in appendix A tell how to display the current parameters.
2. Turn off power to terminal and to all devices connected to terminal.
3. Disconnect the following:
 - Terminal power cord at both ends
 - Keyboard cable from terminal
 - All device-interconnecting cables from terminal (it maybe desirable to tag these cables to facilitate reconnection later)
4. If any printed-circuit boards are in the I/F-1 through I/F-3 slots at rear of terminal (figure 6-1), they may be removed before turning in terminal. If that is desired, remove two screws securing cover plates of boards to rear

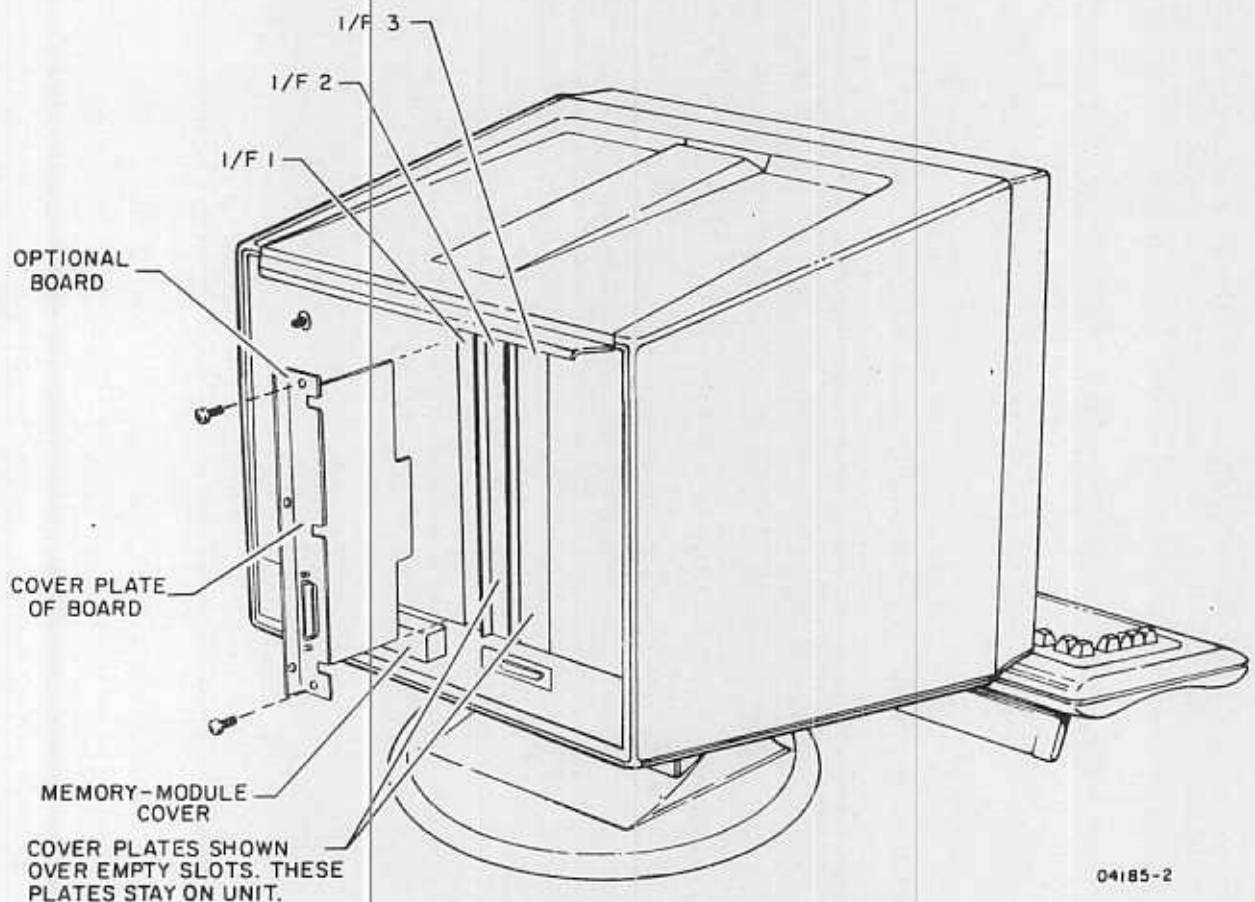

Figure 6-1. Removing Optional User-Installed Printed-Circuit Boards

of terminal and pull boards from slots. Then use same screws and cover empty slots with original cover plates. If boards are left in terminal, record their serial numbers on the Configuration Sheet near front of manual.

5. If a memory module is installed, remove screw securing memory-module cover, remove cover, and carefully pull memory module out.
6. Coil up terminal power cord and place in a polyethylene bag.
7. Refer to figure 6-2 and pack basic terminal unit using original packing materials or approved, replaced materials.
8. Place bag with coiled power cord on top of terminal unit and tape to inside of carton.
9. Seal basic terminal carton with 3-inch box-sealing tape.
10. Proceed to instructions on Accompanying Information.

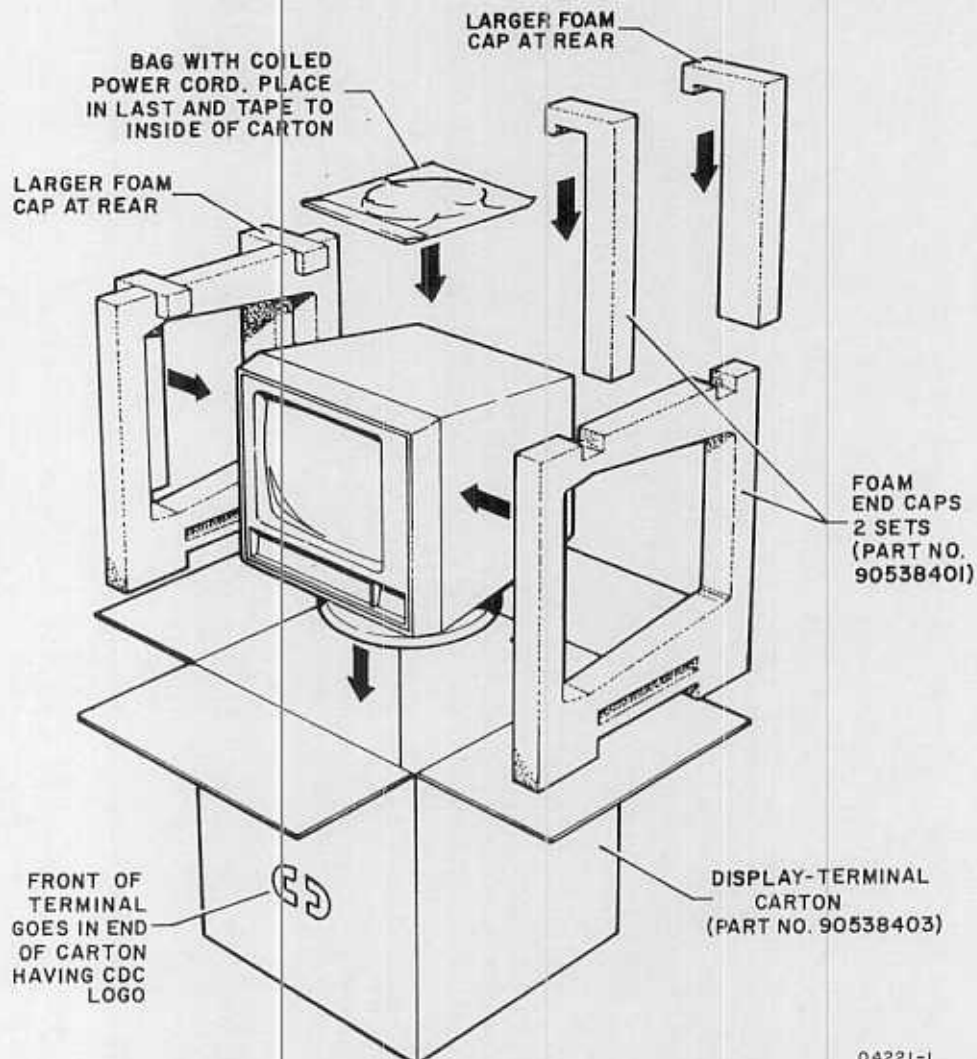
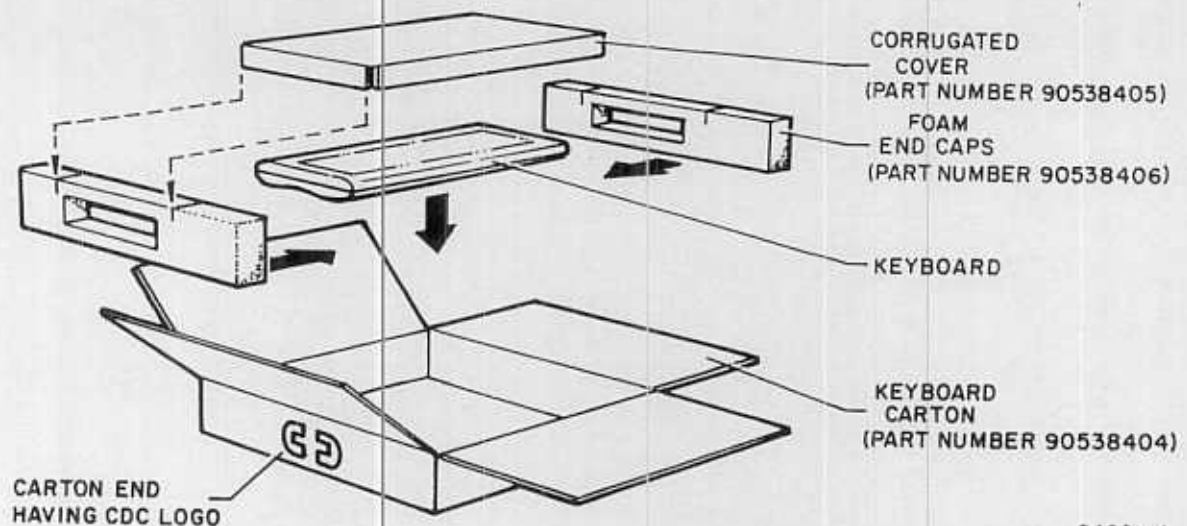

Figure 6-2. Packing Basic Terminal Unit

04221-1



04221-4

Figure 6-3. Packing Keyboard

PREPARING KEYBOARD FOR TURN IN

To prepare the keyboard for turn in, do as follows:

1. Turn off power to terminal.
2. Disconnect keyboard cable from terminal.
3. Refer to figure 6-3 and pack keyboard using original packing materials or approved, replaced materials. Seal keyboard carton with 3-inch box-sealing tape.
4. Proceed to instructions on Accompanying Information.

PREPARING USER-INSTALLED BOARDS FOR TURN IN

To prepare an optional user-installed board for turn in, do as follows:

1. Turn off power to terminal and to all devices that are connected to bad board.
2. Disconnect device cable(s) from connector(s) on cover plate of bad board.

3. Remove two screws securing cover plate of bad board to rear of terminal and pull board from slot (figure 6-1). Keep screws for later installation of board.
4. Pack bad board in original packing container or a replacement container and fill space between board and container with cushioning material.
5. Proceed to instructions on Accompanying Information.

ACCOMPANYING INFORMATION

The following information must accompany the turned-in item:

- The company name and address of the user
- The name and telephone number of the person to be contacted if any questions arise
- The failure that occurred
- The contract number or account number of the maintenance agreement
- The eight-digit part number on the item being returned

The information in this appendix is for personnel who have a technical background and an understanding of the system to which the terminal is to be connected. This information includes:

- Installation considerations
- Required tools and supplies
- Terminal preparation
- Printed-circuit board installation
- Cable installation*
- Initial power on
- Parameter entries*
- Checkout*
- CRT realignment

INSTALLATION CONSIDERATIONS

For proper installation, the following items must be taken into consideration.

- Check that enough cable slack is provided to allow moving the terminal approximately 1 m (3 ft) to permit servicing.
- Avoid direct sunlight on display screen.
- Allow a 102-mm (4-in) minimum space at top and sides of terminal for adequate cooling.
- Avoid installing the terminal in areas of high electromagnetic interference. Such areas usually exist near radio-transmitting antennas, radar, induction heaters, arc welders, insulation testers, time clocks, certain electrical heating systems, and high-energy power lines.
- Avoid installing the terminal where particulate, liquid, and gaseous atmospheric contaminants exist, such as those found in some process industries. Such environments can cause corrosion of copper and other metals that may result in terminal failures.

* Appendix B has additional installation, operation, and checkout information for terminals using the internal 1200/1200 b/s modem.

- Separate I/O cables from electrical-power wiring by a minimum of 51 mm (2 in). Unshielded, high-energy power wiring (above 220/240 V ac) requires a larger separation.
- Support I/O cables, both horizontally and vertically, every 3 m (10 ft).
- Ensure that the electrical power circuit for the terminal has adequate overload protection to limit maximum current flow to 20 amperes. Also, the installation location must allow easy access to the power outlet.

REQUIRED TOOLS AND SUPPLIES

The tools and supplies required for installation include the following:

- Medium sized Phillips screwdriver
- Medium sized slot-head screwdriver
- Cable for host communications using DATA SET connector at rear of terminal. The recommended cable is CDC 799-10 (equipment number YA255-A), which is 3 meters (10 feet) long and meets RS-232-C requirements.* See Appendix B if using internal modem.

TERMINAL PREPARATION

These instructions assume that the terminal, the keyboard, and optional items have been unpacked per the instruction sheet that was included with shipping papers. With that done, do as follows:

1. Place terminal where it is to be used. This must be a flat surface and a 102 mm (4 in) clearance must exist at top and sides of terminal for ventilation.
2. Place keyboard in front of terminal and connect keyboard cable to terminal (figure A-1). Be sure clip on cable connector is to the front and that clip locks when making connection.
3. If keyboard is to be in a tilted position, flip down leg on bottom of keyboard.

*RS-232-C is the Electronic Industries Association standard for signal interchange between data terminal equipment and data communication equipment.

4. If terminal is to load from a memory module during operations, refer to instructions in section 3 and install memory module.
5. If a keycap kit or power conversion kit is to be installed, install per the instructions that came with the kit.
6. If a separate printed-circuit board came with the terminal, proceed to Printed-Circuit Board Installation instructions; otherwise, proceed to Cable Installation instructions.

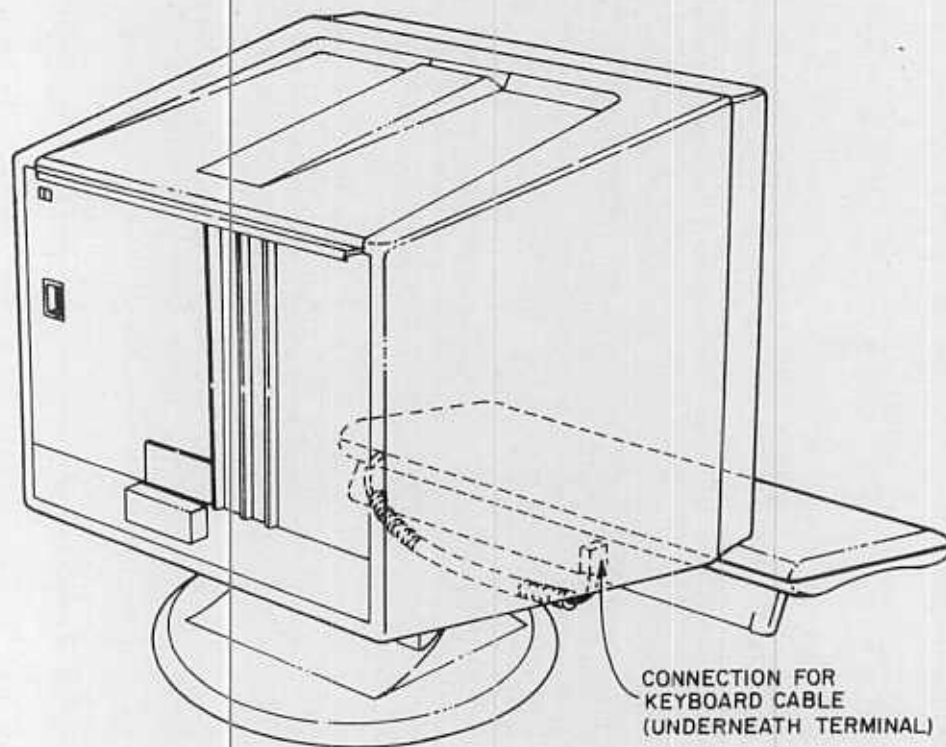

Figure A-1. Connecting Keyboard Cable

PRINTED-CIRCUIT BOARD INSTALLATION

These installation instructions apply to the following optional printed-circuit boards:

- The YR101 asynchronous-interface board
- The YR102 parallel-interface board

To install one of these boards, refer to figure A-2 and do as follows:

1. Remove two screws securing cover plate on rear of terminal at I/F-1.
2. Remove cover plate. This exposes the I/F-1 board slot. Save cover plate for remounting if basic terminal is shipped to a service center.

CAUTION

Be sure board is aligned with slot connector before pushing on board during next step.

3. Insert optional board in I/F-1 slot as shown in figure A-2.
4. Use the two screws removed in step 1 and secure cover plate of board to rear of terminal.
5. If a TEST/NORMAL switch is on cover plate of board, check that switch is in NORMAL position.
6. If more than one board is being installed, repeat previous steps and install in I/F-2 or I/F-3 slot.
7. Proceed to Cable Installation instructions.

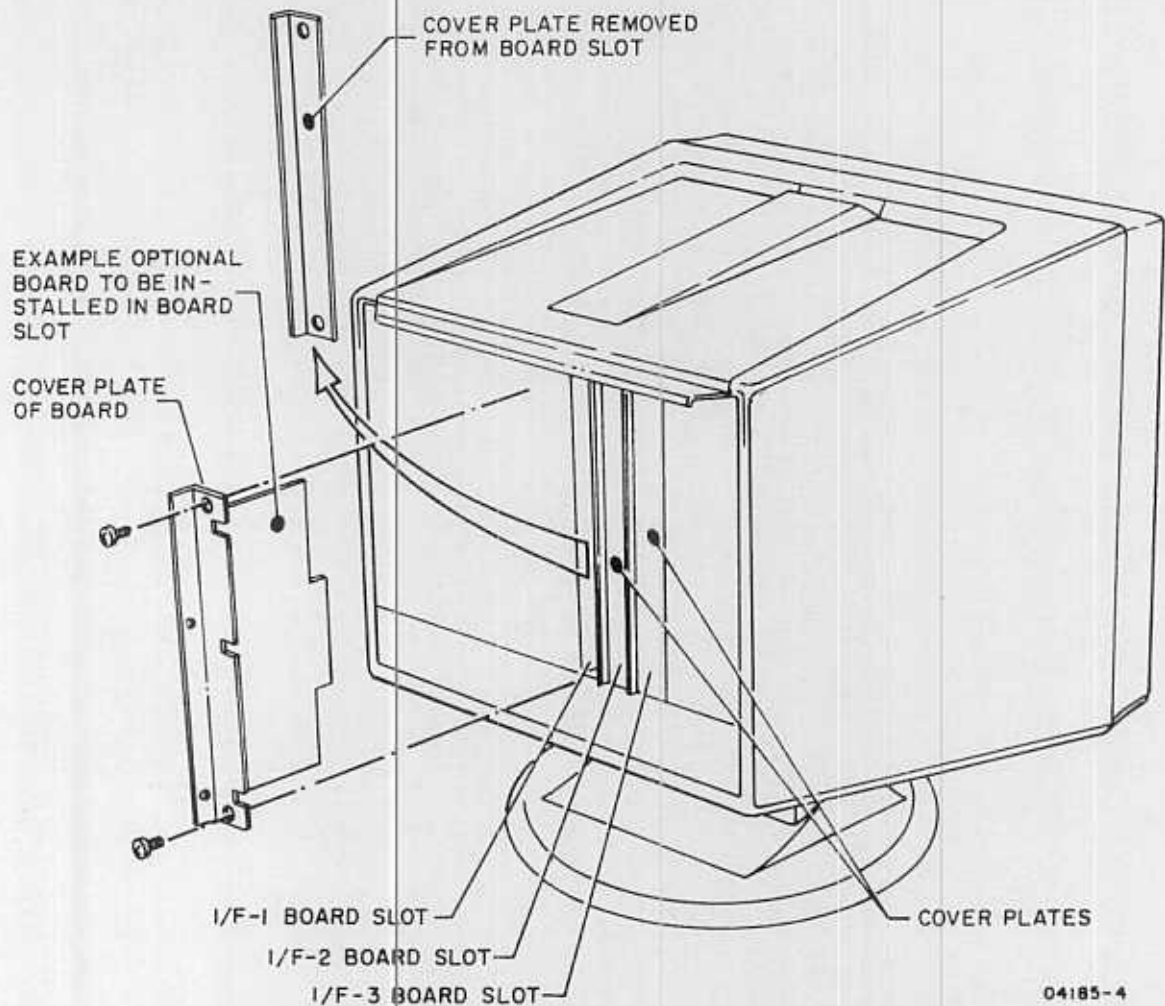
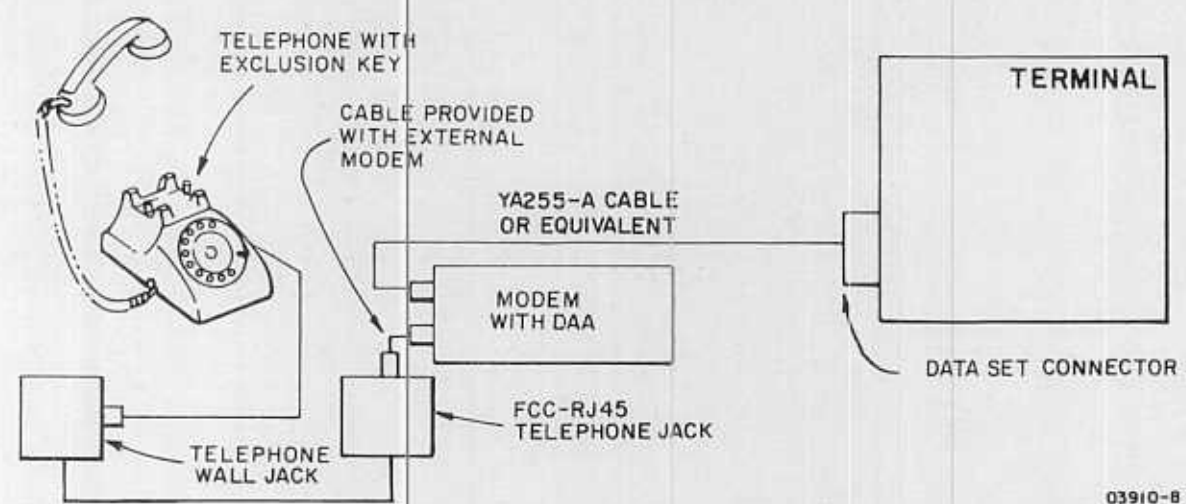

Figure A-2. Installation of Optional Printed-Circuit Boards

CABLE INSTALLATION

This portion of the section shows the cable connections for the equipment arrangements listed below (refer to Appendix B for installing a terminal using an internal modem). Refer to the appropriate figure(s) and be sure to tighten screws when connecting cables with connector retainers.

<u>Equipment Arrangement</u>	<u>Figure No.</u>
Host communications via external modem	A-3
Host communications via direct cable	A-4
Associated asynchronous-communication peripheral	A-5
Associated graphics printer	A-6



MODEM

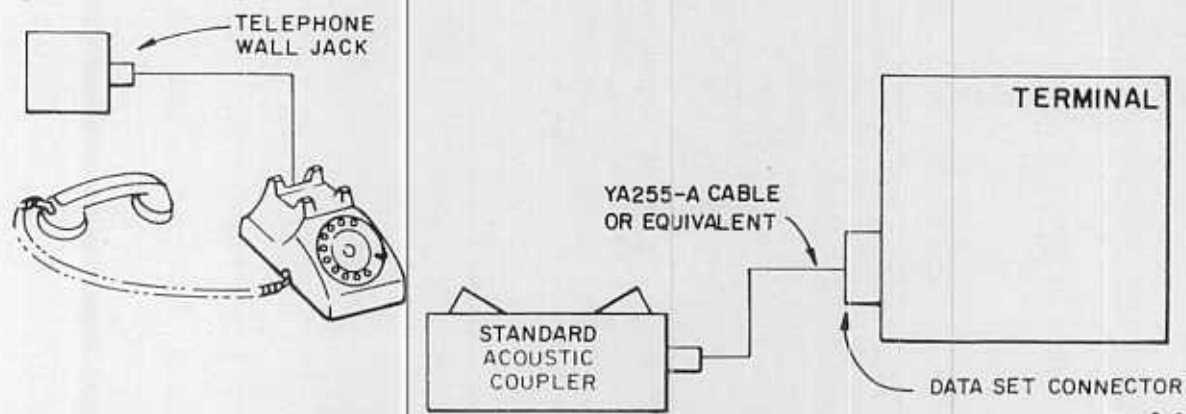

STANDARD ACOUSTIC COUPLER

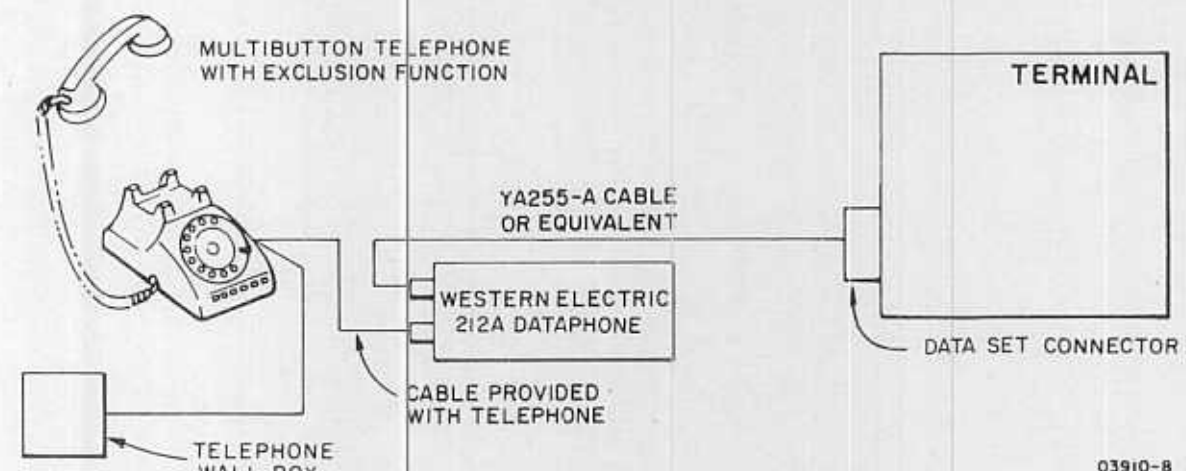

DATAPHONE

Figure A-3. Host Communications Via External Modem

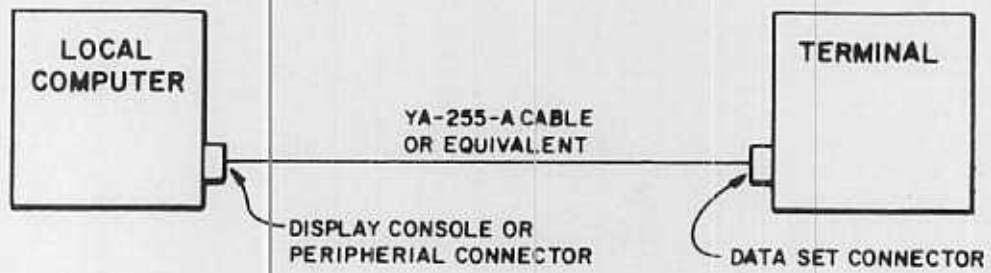
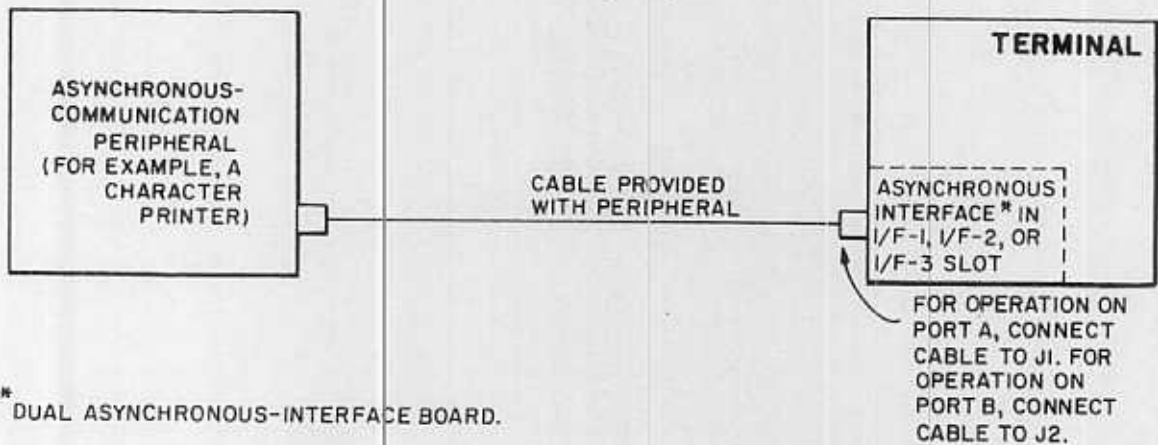

Figure A-4. Host Communications Via Direct Cable



* DUAL ASYNCHRONOUS-INTERFACE BOARD.

03910-12

Figure A-5. Associated Asynchronous-Communication Peripheral

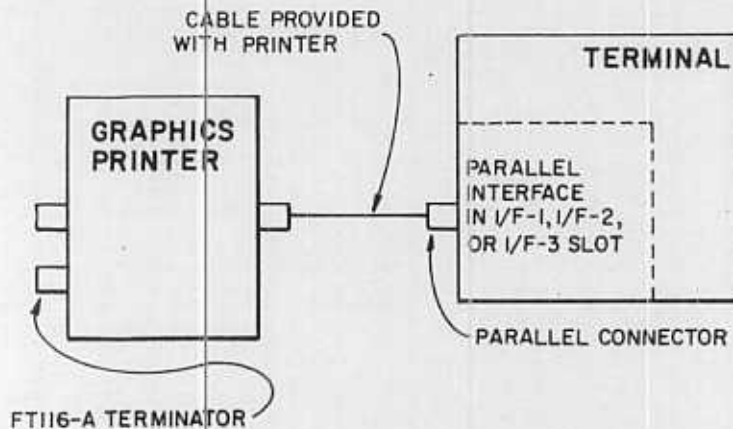

Figure A-6. Associated Graphics Printer

INITIAL POWER ON

With the preceding installation instructions completed, power on the terminal as follows:

1. Check that side of POWER switch marked with a 0 is pressed in.
2. Connect power cord to receptacle at rear of terminal and to site power outlet. Secure cord to receptacle with locking clip.

CAUTION

The next step assumes that the terminal is conditioned for existing power voltage. The terminal comes from the factory conditioned for 120-V ac, 60-Hz operation. For 50-Hz operation at 220/240 V ac, the YA275-A power conversion kit must be installed or damage to the terminal may result.

3. Apply power to terminal by pressing side of POWER switch marked with the 1. With power applied, the terminal automatically does a power-on self test. Test execution takes a few seconds and the audible alarm sounds when the test ends. A mode menu then appears, consisting of a row of blocks displayed in inverse video (dark characters on

light background). If the mode menu is not visible, the BRIGHTNESS or CONTRAST control is probably turned too far counterclockwise.

4. Proceed to Parameter Entries.

PARAMETER ENTRIES

The following instructions cover the process of entering installation parameters into nonvolatile memory using the keyboard. A full complement of installation parameters includes a set of terminal installation parameters and up to six sets of mode installation parameters, one set for each mode that the terminal is to operate in. The terminal installation parameters and five sets of mode installation parameters are factory set for a typically configured terminal and for the most commonly used operating modes. Changes may be required for installed options or for certain applications; such changes will be noted in the option or application documentation. The instructions here cover all parameters in detail so that future changes may be made easily. Refer to Appendix B for parameters specifically related to the internal 1200/1200 b/s modem option.

The values of the factory-set parameters are listed below. A factory-installed battery in the back of the terminal has kept these values stored in nonvolatile memory (Replacing Battery instructions are in section 3). If the battery is replaced incorrectly (terminal power off when battery is replaced), the parameter values in nonvolatile memory will be lost and the factory-set values will be displayed for rewriting into nonvolatile memory. This rewriting is done with the COPY key as described in the following instructions.

Preset Terminal Installation Parameters

<u>Block</u>	<u>CC634-A Terminals</u>	<u>CC638-A Terminals</u>
F2	000000	010000
F3	000000	001000
F4	000000	000000
F5	000000	000000
F6	0 0 0	0 0 0
F7	0 0000	0 0000
F8	0 6	0 6
F9	A 6	A 6

Preset Mode Names and Installation Parameters

<u>Block</u>	-----M O D E S-----				
	<u>CYBER</u>	<u>PLATO</u>	<u>CP/M</u>	<u>Disk</u>	<u>C120</u>
F2	100000	100100	100110	100110	100000
F3	000110	000110	000100	000110	001010

F4	000000	000001	000000	000001	000000
F5	010000	000000	000000	000000	000000
F6	4C04	6C24	6C25	6C24	4421
F7	000000	000000	000000	000000	000000
F8	000000	000000	000000	000000	000000
F9	00 6 6	08 6 6	00 6 6	00 6 6	00 9 9
F10	0000	0000	0000	0000	0000

To make the initial entries, do as follows:

1. If terminal has just been installed, fill out front of Configuration Sheet (foldout) near front of manual. That portion of sheet is to be referred to for parameters that deal with the configuration of the terminal.

NOTE

The next step assumes that the mode menu is on the screen after Initial Power-On instructions have been done. If existing parameters are being accessed, mode menu is displayed by doing as follows:

- If operating in CYBER mode, press SETUP key, then F10 key twice.
 - If not in CYBER mode and terminal is conditioned for manual selection of operating mode, press RESET switch (menu appears after power-on test).
 - If not in CYBER mode and terminal is conditioned for automatic selection of operating mode, pull out TEST switch at rear of terminal, then press RESET switch. This shows a TEST SWITCH ENABLED message with menu. Disregard message and push TEST switch back in.
2. With mode menu on screen, press CTRL (Control) and SETUP keys. This displays menu of terminal installation parameters (figure A-7).

NOTE

Only certain keys are enabled while entering parameters. These keys are referred to where applicable in the procedure. Pressing a disabled key sounds the alarm.

3. Square cursor in F2 block of menu indicates where first entry is. Each succeeding block through F9 contains further entries. Refer to figure A-7 and follow instructions on figure.

INDICATES THAT F1 KEY
RETURNS MODE MENU TO
SCREEN

INDICATES THAT F10 KEY IS USED
WHEN PROGRESSING TO MODE INSTAL-
LATION PARAMETERS

```

F1 r e t u r n  F2 C O N F I G  F3 C O N F I G  F4 C O N F I G  F5 C O N F I G  F6 A S X Y  F7 L I D  F8 P O R T A  F9 P O R T B  F10 i n s t l
1 2 0 X 0 0 0 0  3 0 0 X 0 0 0  4 0 0 0 0 0 0  5 0 0 0 0 0 0  6 0 0 0  7 0 0 0 0  8 0 0 0  9 A 0 1 0 m o d e n
  
```

STEP A. ANSWER THE FOLLOWING QUESTIONS AND COMPARE ANSWER VALUES WITH THE PRESET VALUES ON SCREEN TO DETERMINE WHETHER ANY CHANGES ARE REQUIRED. SPACE IS PROVIDED TO MARK ANSWERS.

STEP B. IF A CHANGE IS REQUIRED, PRESS THE F2 THROUGH F9 KEY THAT CORRESPONDS WITH THE NUMBERED BLOCK WHERE CHANGE IS TO BE MADE. THIS MOVES CURSOR WITHIN THAT BLOCK. USE SPACE BAR TO GO FORWARD OR BACKSPACE KEY (←) TO GO BACKWARD AND MOVE CURSOR TO DIGIT OF WRONG VALUE. THEN KEY IN NEW DIGIT.

```

F C O N F I G
2 0 X 0 0 0 0
  
```

Touchpanel installed?

Not used _____

Yes _____ Enter 1

No _____ Enter 0

Dual asynchronous-interface board installed?

Yes _____ Enter 1

No _____ Enter 0

Graphic printer installed?

Yes _____ Enter 1

No _____ Enter 0

Flexible disk drive installed?

Yes _____ Enter 1

No _____ Enter 0

Not used _____

Figure A-7. Terminal Installation Parameters (Sheet 1)

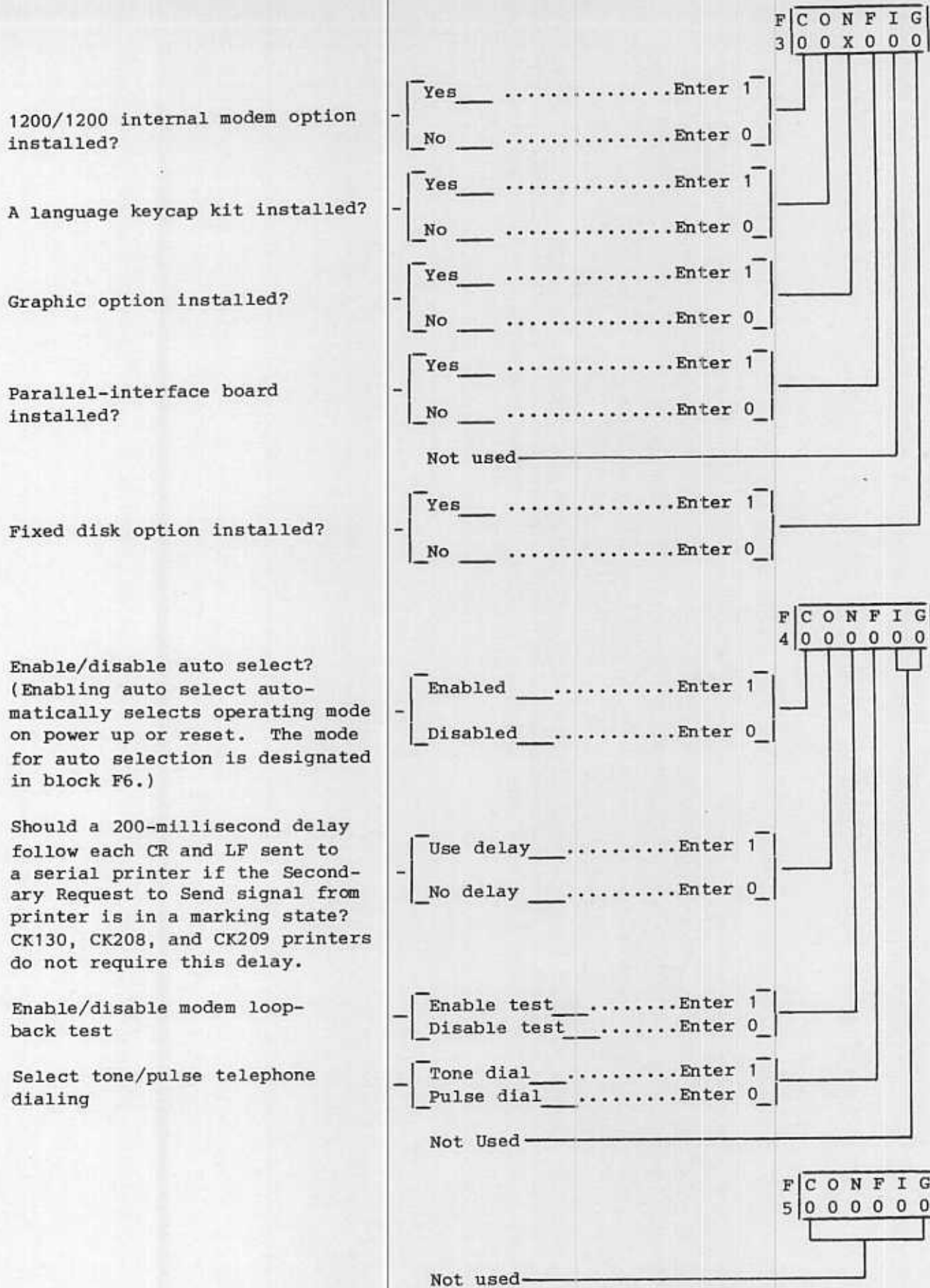

Figure A-7. Terminal Installation Parameters (Sheet 2)

Which one of these is to be designated as the auto-select mode? If auto-select parameter in block F4 is enabled, the designated mode is automatically selected upon a power on or reset. If auto-select parameter is disabled, no entry is required.

- CYBER mode.....Enter 0 or 1
- PLATO mode.....Enter 2
- Mode 3*.....Enter 3
- Mode 4*.....Enter 4
- Mode 5*.....Enter 5
- Mode 6*.....Enter 6
- Mode in memory module (ROM pack).....Enter 7

F	AS	X	Y
6	0	0	0

Leave as is. Entries are only made here when crt needs realignment (instructions are given later in this appendix under CRT Realignment).

Characters displayed are to be in:-

- English.....Enter 0 or 1
- French.....Enter 2
- German.....Enter 3
- Swedish/Finnish...Enter 4
- British.....Enter 5
- Spanish.....Enter 6
- Danish/Norwegian..Enter 7

F	L	I	D
7	0	0	0

If host uses identification (ID) codes, fill in the four hexadecimal digits for the terminal code in the space below.

Terminal ID code _____Enter code if any

*Modes 3, 4, and 5 are preassigned as CP/M, disk, and C120 modes respectively. Mode 6 is for a user assigned mode. If desired, modes 3 through 5 may be changed for additional user assigned modes. Modes are assigned later when mode parameters are entered.

Figure A-7. Terminal Installation Parameters (Sheet 3)

If dual asynchronous-interface board is not installed, disregard the following.

The peripheral connected to connector J1 (port A) of the interface board is a:

Bidirectional device/ no printer.....=1 } -2³.....
 Receive-only printer.....=0

Parity on port A is to be:

Disabled.....=1 } -2².....
 Enabled.....=0

If parity is enabled on port A, parity is to be:

Even.....=1 } -2¹.....
 Odd.....=0

If parity is disabled on port A, eighth-code bit is to be a:

Mark.....=1 } -2⁰.....
 Space.....=0

Number of stop bits to be transmitted with each code is:*

Two.....=1 } -2⁰.....
 One.....=0

Data rate on port A is to be:

- 75 bps.....Enter 0
- 110 bps.....Enter 1
- 150 bps.....Enter 2
- 200 bps.....Enter 3
- 300 bps.....Enter 4
- 600 bps.....Enter 5
- 1200 bps.....Enter 6
- 1800 bps.....Enter 7
- 2400 bps.....Enter 8
- 4800 bps.....Enter 9
- 9600 bps.....Enter A
- 19 200 bps.,.....Enter B

Refer to following conversion table and enter appropriate hexadecimal digit

2³ 2² 2¹ 2⁰ = Hex

0	0	0	0	=	0
0	0	0	1	=	1
0	0	1	0	=	2
0	0	1	1	=	3
0	1	0	0	=	4
0	1	0	1	=	5
0	1	1	0	=	6
0	1	1	1	=	7
1	0	0	0	=	8
1	0	0	1	=	9
1	0	1	0	=	A
1	0	1	1	=	B
1	1	0	0	=	C
1	1	0	1	=	D
1	1	1	0	=	E
1	1	1	1	=	F

PORT A
8 0 6

*Codes received by the terminal may have either one or two stop bits regardless of this selection.

Figure A-7. Terminal Installation Parameters (Sheet 4)

If dual asynchronous-interface board is not installed, disregard the following.

The peripheral connected to connector J2 (port B) of the interface board is a:

Bidirectional device/ no printer.....=1
 Receive-only printer.....=0

Refer to following conversion table and enter appropriate hexadecimal digit

Parity on port B is to be:

Disabled.....=1
 Enabled.....=0

If parity is enabled on port B, parity is to be:

Even.....=1
 Odd.....=0

If parity is disabled on port B, eighth-code bit is to be a:

Mark.....=1
 Space.....=0

Number of stop bits to be transmitted with each code is:*

Two.....=1
 One.....=0

2 ³	2 ²	2 ¹	2 ⁰	= Hex
0	0	0	0	= 0
0	0	0	1	= 1
0	0	1	0	= 2
0	0	1	1	= 3
0	1	0	0	= 4
0	1	0	1	= 5
0	1	1	0	= 6
0	1	1	1	= 7
1	0	0	0	= 8
1	0	0	1	= 9
1	0	1	0	= A
1	0	1	1	= B
1	1	0	0	= C
1	1	0	1	= D
1	1	1	0	= E
1	1	1	1	= F

Data rate on port B is to be:

- 75 bps.....Enter 0
- 110 bps.....Enter 1
- 150 bps.....Enter 2
- 200 bps.....Enter 3
- 300 bps.....Enter 4
- 600 bps.....Enter 5
- 1200 bps.....Enter 6
- 1800 bps.....Enter 7
- 2400 bps.....Enter 8
- 4800 bps.....Enter 9
- 9600 bps.....Enter A
- 19 200 bps.....Enter B

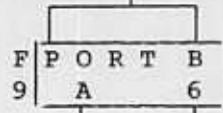

*Codes received by the terminal may have either one or two stop bits regardless of this selection.

Figure A-7. Terminal Installation Parameters (Sheet 5)

4. If any entries were made, check that they are correct. Then press COPY key. This writes entries into nonvolatile memory (also applies if factory-set values have been cleared and are being rewritten).
5. If changes were made to the factory-set terminal installation parameters, record the entries on screen on back of Configuration Sheet. This is to facilitate reentry if it becomes necessary in the future.
6. Press F10 key. This displays:

ENTER MODE n

7. The terminal uses 1 through 7 as identifying numbers for operating modes. Mode 1 is the resident CYBER mode; mode 2 is for PLATO mode; modes 3 through 5 are preassigned as CP/M, disk, and C120 modes respectively, but may be changed through mode parameters for user assigned modes; mode 6 is for a user assigned mode; and mode 7 is reserved for modes stored in a memory module. Except for mode 7, each mode to be used requires a separate set of mode parameters. Parameters for modes 1 through 5 have been preset.

Enter number for mode that terminal is to operate in. If operations are to occur in more than one mode, enter number of lowest number mode. If number entered is 3, 4, 5, or 6, ENTER MODE NAME appears on screen; if number entered is 1 or 2, menu of mode installation parameters appears (figure A-8). With modes 3 through 5, the name of the preassigned mode appears adjacent to ENTER MODE NAME.

8. If ENTER MODE NAME is displayed and a mode name already exists that is not to be changed, press either of the NEXT keys. Otherwise, with ENTER MODE NAME displayed, enter four alphanumeric characters to serve as an identifying code name for mode whose number was entered. After parameters are established, terminal will show this name along with the mode number when displaying mode menu.

Upon pressing a NEXT key or entering the four characters, menu of mode installation parameters appears (figure A-8).

9. The menu of mode installation parameters on screen is for the mode whose number was entered in step 7. Refer to figure A-8 and make entries as required.

INDICATES THAT F1 KEY
RETURNS MODE MENU TO
SCREEN

F1	return	F2	CONFIG	F3	CONFIG	F4	CONFIG	F5	CONFIG	F6	OPR DF	F7	A-DIAL	F8	A-DIAL	F9	DF T	R	F10	ACCESS
1		2	100XX0	3	00XXX0	4	00000X	5	0X0000	6	XXXX	7	000000	8	000000	9	0X X X	X	10	0000

STEP A. ANSWER THE FOLLOWING QUESTIONS AND COMPARE ANSWER VALUES WITH VALUES ON SCREEN.

STEP B. IF A CHANGE IS REQUIRED, MOVE CURSOR AND MAKE ENTRY AS DESCRIBED IN PREVIOUS FIGURE COVERING TERMINAL INSTALLATION PARAMETERS. IF A NEW MODE IS BEING ASSIGNED, ENTER THE ANSWER VALUES FOR THE MODE IN BLOCK F2 THROUGH F10. CURSOR ADVANCES WITH EACH ENTRY.

F	C	O	N	F	I	G
2	1	0	0	X	X	0

Mode execution to be enabled or disabled? If disabled, mode cannot be run until this parameter is changed.

Enabled..... Enter 1
 Disabled..... Enter 0

Is it to be required that an access code be entered before operations can take place? If so, only persons who know the designated access code can operate mode.

Yes..... Enter 1
 No..... Enter 0

Are phone number, source, and file for program loading selected by operator or automatically selected (default values selected from parameter entries)?

Manually..... Enter 1
 Automatically.. Enter 0
 Not applicable for CYBER Mode... Enter 0

Are operations to be in CYBER mode or mode loaded from a memory module (run internal) or is mode to be loaded from host or disk (load external)?

Load external.. Enter 1
 Run internal... Enter 0

If load external was chosen above, is loading to be from host or disk?

Load from disk. Enter 1
 Load from host. Enter 0
 Not applicable for CYBER Mode.... Enter 0

Figure A-8. Mode Installation Parameters (Sheet 1)

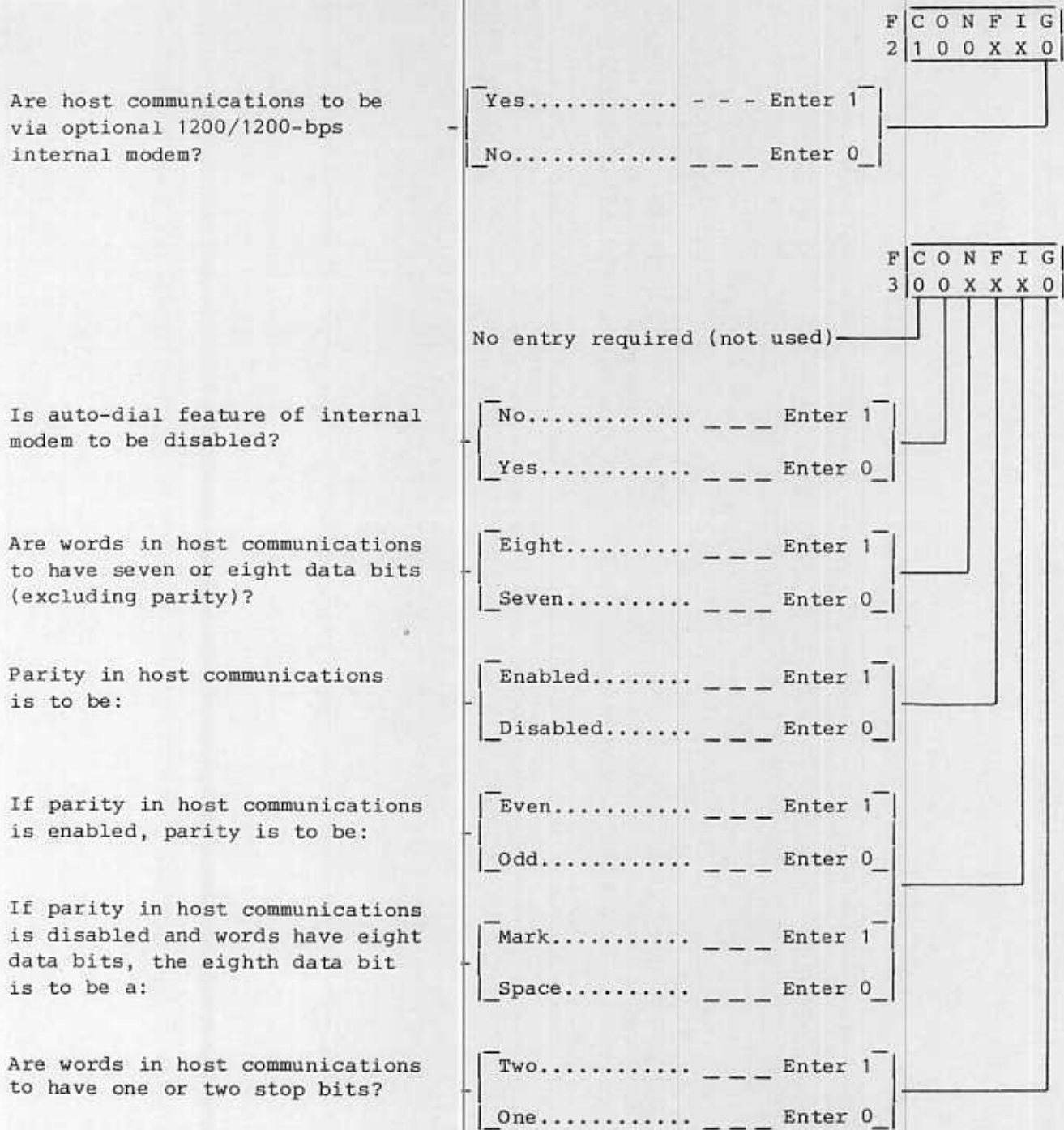

Figure A-8. Mode Installation Parameters (Sheet 2)

F C O N F I G
4 0 0 0 0 0 X

If host communications are via an external modem, is Data Terminal Ready (DTR) signal to modem to be on constantly or be switched off during local operations?

- [Switched..... _ _ _ _ Enter 1]
- [Constant..... _ _ _ _ Enter 0]
- [Not applicable. _ _ _ _ Enter 0]

If host communications are via an external modem, is Request to Send (RTS) signal to modem to be on constantly except when DTR or Data Set Ready (DSR) signals drop or is RTS signal to be switched on/off per the following?

- If full-duplex routing is used (half/full-duplex parameters are selected in F6 block), a switched RTS drops during local operations.
- If half-duplex routing is used, a switched RTS goes on with the first keyboard entry and drops:

- Upon receipt of a break (a received word containing a space in the stop-bit position)
- During local operations
- Following the transmission of a CR (0D₁₆), LF (0A₁₆), ACK (06₁₆), or NAK (15₁₆) code

- [_ _ _ Switched RTS.....Enter 1]
- [_ _ _ Constant RTS.....Enter 0]
- [_ _ _ Not applicable...Enter 0]

Are data-entry and control keys to be typamatic (start repeating after being pressed for longer than a second)?

- [No..... _ _ _ _ Enter 1]
- [Yes..... _ _ _ _ Enter 0]

Are modem control signals to be ignored while sending/receiving host communications (data only on) or is terminal to monitor DSR and Clear to Send when sending and DSR and Carrier Detect when receiving (data only off)?

- [Data only on.. _ _ _ _ Enter 1]
- [Data only off. _ _ _ _ Enter 0]

Figure A-8. Mode Installation Parameters (Sheet 3)

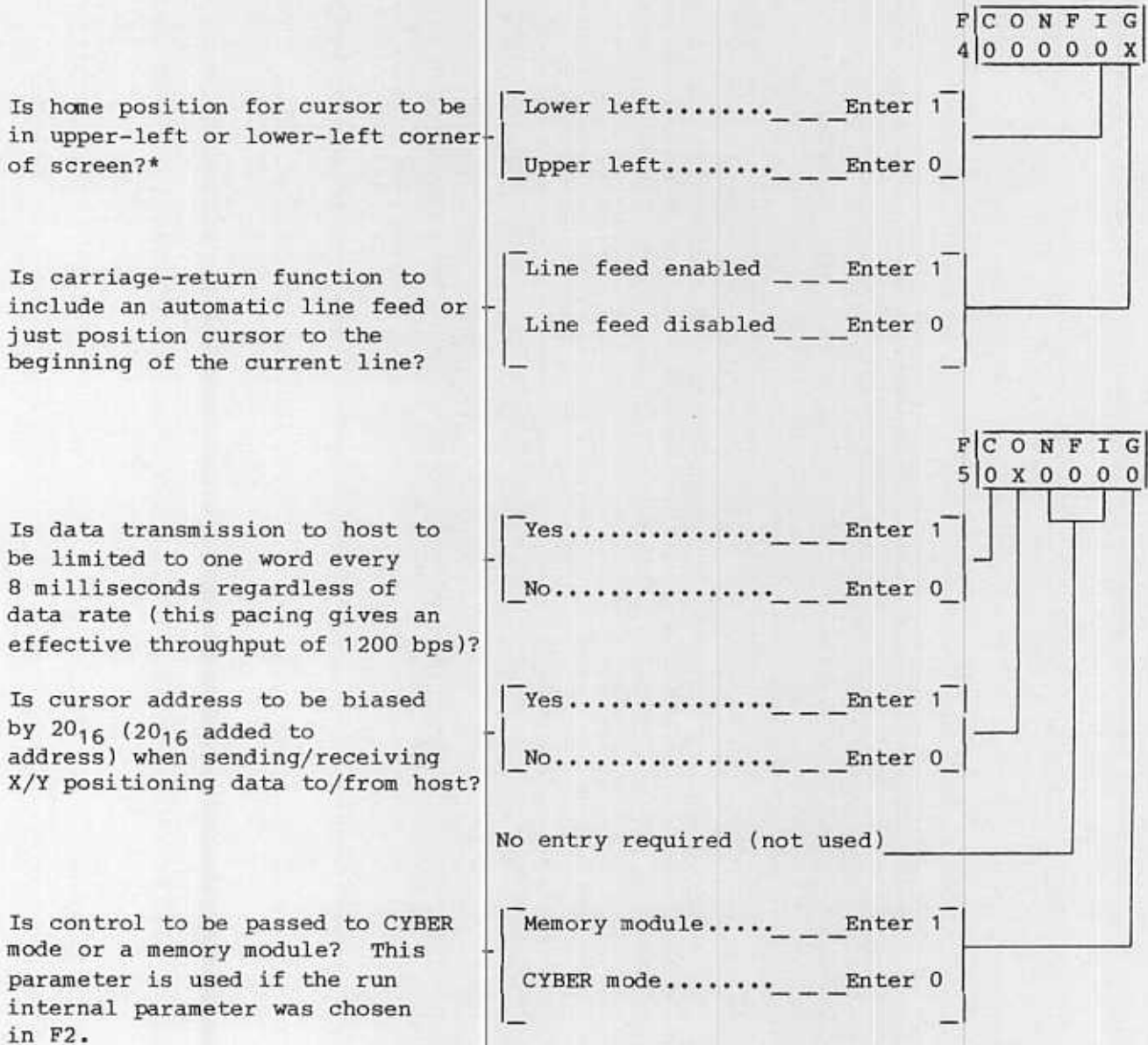

*Upper-left selection is applicable in CYBER mode if compatibility with CDC 722-10 (CC628-A) TTY Display Terminal is desired.

Figure A-8. Mode Installation Parameters (Sheet 4)

NOTE

THE PARAMETERS OF BLOCK F6 REPRESENT DEFAULT PARAMETERS THAT ARE EFFECTIVE DURING A MODE EXCEPT WHEN TEMPORARILY CHANGED BY OPERATOR OR HOST (SUCH CHANGES ARE MADE THROUGH THE OPERATOR PARAMETERS COVERED IN SECTION 4). THESE DEFAULT PARAMETERS APPLY SPECIFICALLY TO THE RESIDENT CYBER MODE. FOR A MODE OTHER THAN CYBER, USE OF THE DEFAULT PARAMETERS IS PROGRAM DEPENDENT AND SOME PARAMETERS MAY BE IGNORED.

Is audible alarm to be loud or soft?

--- Loud=1
 --- Soft=0

Is audible alarm to signal operator when keyboard entries advance cursor to either eighth position from end of line or to last line?

--- Yes=1
 --- No=0

If a printer is connected, is printing of received and transmitted data to be initially enabled when mode is entered?

--- Yes=1
 --- No or not applicable..=0

Is terminal to assume a local or online state after mode is entered (local state disables transmission to host)?

--- Local=1
 --- Online=0

Refer to following conversion table and enter appropriate hexadecimal digit

2 ³	2 ²	2 ¹	2 ⁰	= Hex
0	0	0	0	= 0
0	0	0	1	= 1
0	0	1	0	= 2
0	0	1	1	= 3
0	1	0	0	= 4
0	1	0	1	= 5
0	1	1	0	= 6
0	1	1	1	= 7
1	0	0	0	= 8
1	0	0	1	= 9
1	0	1	0	= A
1	0	1	1	= B
1	1	0	0	= C
1	1	0	1	= D
1	1	1	0	= E
1	1	1	1	= F

F O P R D F
 6 X X X X

Figure A-8. Mode Installation Parameters (Sheet 5)

Is coding in CYBER mode to be for a CYBER 120 series system or a CYBER 170 series system?

--- CYBER 170.....=1
 --- CYBER 120 or
 --- Not applicable.....=0

.....
 -2³.....

Refer to following conversion table and enter appropriate hexadecimal digit

Is display screen to operate in a roll or page manner (this is independent of the cursor home position selected in block F4)?*

--- Roll.....=1
 --- Page.....=0

-2².....

2 ³	2 ²	2 ¹	2 ⁰	Hex
0	0	0	0	= 0
0	0	0	1	= 1
0	0	1	0	= 2
0	0	1	1	= 3
0	1	0	0	= 4
0	1	0	1	= 5
0	1	1	0	= 6
0	1	1	1	= 7
1	0	0	0	= 8
1	0	0	1	= 9
1	0	1	0	= A
1	0	1	1	= B
1	1	0	0	= C
1	1	0	1	= D
1	1	1	0	= E
1	1	1	1	= F

Are the 13 keys in the numeric pad group on right side of keyboard to operate in both lowercase and uppercase or only uppercase?

--- Uppercase only.....=1
 --- Both lowercase and
 --- uppercase.....=0

-2¹.....

Is Lock (⊕) key to function as a normal shift lock or is it to limit only alphabetical characters to uppercase?

--- Shift lock.....=1
 --- Only alphabetical.....=0

-2⁰.....

Refer to following conversion table and enter appropriate hexadecimal digit

Not used.....=0

-2³.....

Is cursor to be steadily illuminated or blink?

--- Steady.....=1
 --- Blink.....=0

-2².....

Is cursor to be in the form of an underline or a block?

--- Block.....=1
 --- Underline.....=0

-2¹.....

Is display screen to show light characters on dark background or dark characters on light background (inverse video)?

--- Light background.....=1
 --- Dark background.....=0

-2⁰.....

2 ³	2 ²	2 ¹	2 ⁰	Hex
0	0	0	0	= 0
0	0	0	1	= 1
0	0	1	0	= 2
0	0	1	1	= 3
0	1	0	0	= 4
0	1	0	1	= 5
0	1	1	0	= 6
0	1	1	1	= 7
1	0	0	0	= 8
1	0	0	1	= 9
1	0	1	0	= A
1	0	1	1	= B
1	1	0	0	= C
1	1	0	1	= D
1	1	1	0	= E
1	1	1	1	= F

*Roll selection is applicable in CYBER mode if compatibility with CDC 722-10 (CC628-A) TTY Display Terminal is desired.

Figure A-8. Mode Installation Parameters (Sheet 6)

In CYBER mode, this selection governs a test feature that makes received and keyboard-entered control codes transparent to terminal. This means that symbols for control codes are displayed for monitoring instead of control functions being performed.

F	O	P	R	D	F
6	X	X	X	X	

--- Transparent feature on...=1
 --- Normal operation.....=0

Refer to following conversion table and enter appropriate hexadecimal digit

Is screen to use 24 or 30 lines for displaying characters?

--- 30 lines.....=1
 --- 24 lines.....=0

2³ 2² 2¹ 2⁰ = Hex

0	0	0	0	=	0
0	0	0	1	=	1
0	0	1	0	=	2
0	0	1	1	=	3
0	1	0	0	=	4
0	1	0	1	=	5
0	1	1	0	=	6
0	1	1	1	=	7
1	0	0	0	=	8
1	0	0	1	=	9
1	0	1	0	=	A
1	0	1	1	=	B
1	1	0	0	=	C
1	1	0	1	=	D
1	1	1	0	=	E
1	1	1	1	=	F

Are there to be 80 or 132 maximum characters displayed per line? When graphics option is used, 80 characters must be selected.

--- 132 characters.....=1
 --- 80 characters.....=0

This selection governs the routing of keyboard data within the terminal. Is keyboard data to be displayed simultaneously as it is transmitted (half-duplex routing) or is it to be echoed back by host before being displayed (full-duplex routing)?

--- Full duplex.....=1
 --- Half duplex.....=0

F	A	-	D	I	A	L
7	0	0	0	0	0	0

Default auto-dial phone number for use with internal modem. Allowable entries are 0 to F₁₆: where 0 to 9 are numeric entries, A is not used, B is tone dial *, C is tone dial #, D pauses till a tone is detected on the line, E delays dialing sequence till no tone is detected for 3 seconds, and F terminates a phone number entry that does not fill entire 12-digit F7/F8 field.

Figure A-8. Mode Installation Parameters (Sheet 7)

F	A - D I A L
8	0 0 0 0 0 0

Refer to description for preceding F7 field entry.

If program loading is to be done from host, fill in file number for program in space below (number must be two hexadecimal digits not exceeding 7F₁₆). If file selection is to be made automatically (determined in block F2), terminal will always load this number file from host. If file selection is to be made manually, the number filled in below should represent the normal file for the mode. This permits manual selection of that file by just pressing the NEXT key.

F	DF	T	R
9	OX	X	X

File _____Enter number |
 Not applicable.....Enter 00 |

NOTE

THE TRANSMIT AND RECEIVE RATE SELECTIONS THAT FOLLOW ARE DEFAULT RATES THAT CAN BE TEMPORARILY CHANGED THROUGH OPERATOR PARAMETERS. THESE DEFAULT RATES MAY BE SET TO DIFFERENT VALUES FOR RECEIVING AND TRANSMITTING. IF A RATE CHANGE IS MADE IN OPERATOR PARAMETERS, BOTH THE TRANSMIT AND RECEIVE RATES WILL BE TEMPORARILY FORCED TO THE SAME VALUE.

Data is to be transmitted to host at:

_____	75 bps.....	Enter 0
_____	110 bps.....	Enter 1
_____	150 bps.....	Enter 2
_____	200 bps.....	Enter 3
_____	300 bps.....	Enter 4
_____	600 bps.....	Enter 5
_____	1200 bps.....	Enter 6
_____	1800 bps.....	Enter 7
_____	2400 bps.....	Enter 8
_____	4800 bps.....	Enter 9
_____	9600 bps.....	Enter A
_____	19 200 bps.....	Enter B

Note that entry of 6 is necessary for using internal modem

Figure A-8. Mode Installation Parameters (Sheet 8)

Data is to be received from host at:

- ___ 75 bps.....Enter 0
- ___ 110 bps.....Enter 1
- ___ 150 bps.....Enter 2
- ___ 200 bps.....Enter 3
- ___ 300 bps.....Enter 4
- ___ 600 bps.....Enter 5
- ___ 1200 bps.....Enter 6
- ___ 1800 bps.....Enter 7
- ___ 2400 bps.....Enter 8
- ___ 4800 bps.....Enter 9
- ___ 9600 bps.....Enter A
- ___ 19 200 bps.....Enter B

Note that entry of 6 is necessary for using internal modem

F	DF	T	R
9	OX	X	X

If access-code parameter in block F2 was not selected, disregard the following and do not make any entries.

Fill in access code for mode in space below, or if desired, record elsewhere for future reference. This assigned code is to consist of four digits that may be any hexadecimal value. Once parameters are established, operations in a mode will only be allowed after the assigned access code has been entered.

Access code _____.....Enter code

F	A	C	C	E	S	S
10	0	0	0	0		

Figure A-8. Mode Installation Parameters (Sheet 9)

10. If any entries were made, check that they are correct and press COPY key to write entries into nonvolatile memory (also applies if factory-set values have been cleared and are being rewritten).
11. If changes were made to factory-set mode parameters or a new mode established, record the entries on screen on back of Configuration Sheet.
12. If operations are to occur in more than one mode, press F1 key, then CTRL and SETUP keys. This returns operations back to where step 6 is the next action to be taken. Repeat steps 6 through 11 for each mode that terminal is to operate in.
13. Proceed to Checkout instructions.

CHECKOUT

Do the following to check out the terminal. If a problem is encountered, refer to table A-1 and verify that the problem is not due to an improper installation parameter. If an improper parameter has been selected, update the Configuration Sheet after making correct entry. Parameters may be observed and changed by repeating the Parameter Entry instructions. If an improper parameter is not the cause of the problem, refer to Error Recovery/Fault Isolation information in section 6.

1. Attach the yellow and black Repair Service tag you received in the keyboard carton where it is handy for reference. The numbers on this tag are Control Data hotline numbers which you may call if you have equipment problems that you cannot solve. In the blank box on the tag, enter the phone number of the repair center in your area. You can find the number in the pamphlet that came with the tag.
2. Power on peripheral and communications equipment connected to terminal.
3. Press RESET switch on terminal to rerun power-on test. With TEST switch at rear of terminal pulled out, a message appears with mode menu and ERROR indicator lights. If no fault is detected, message only states TEST SWITCH ENABLED along with the words RES REV, which are to be disregarded.
4. Push in TEST switch.
5. Refer to instructions in section 3 and run operator-intervention test. Check each key for correct code and if present, check that touchpanel operates correctly.
6. Refer to Startup instructions in section 3 and check operation of terminal and connected peripheral equipment online with host.

TABLE A-1. PROBLEMS POSSIBLY CAUSED BY IMPROPER PARAMETERS*

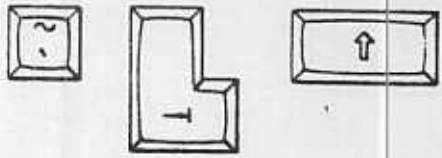
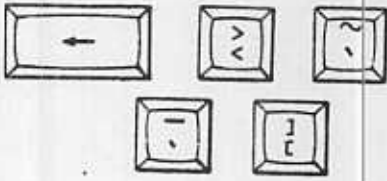
SYMPTOM	POSSIBLE CAUSE
<p>Power-on test shows message of GRAPHICS FAIL 8000 XX 55 (Note: XX are random hex digits)</p>	<p>Optional graphics feature not present but recorded in terminal installation parameters as being installed.</p>
<p>Power-on test shows message of PORT A FAIL and PORT B FAIL</p>	<p>Dual asynchronous-interface board not present but recorded in terminal installation parameters as being installed.</p>
<p>Terminal has standard keycaps and incorrect codes appear for one of the following keys in operator-intervention test:</p>	<p>Optional keycaps inadvertently recorded in terminal installation parameters.</p>
	
<p>Optional keycap kit installed and incorrect codes appear for one of the following keys in operator-intervention test:</p>	<p>Optional keycaps not recorded in terminal installation parameters.</p>
	
<p>No reaction when touchpanel is touched in operator-intervention test</p>	<p>Presence of touchpanel not recorded in terminal installation parameters.</p>
<p>TEST switch pulled out in operator-intervention test and PARALLEL PORT FAIL appears</p>	<p>Optional parallel-interface board not present but recorded in terminal installation parameters as being installed.</p>

*Appendix B covers parameter-entry problems for internal modem.

TABLE A-1. PROBLEMS POSSIBLY CAUSED BY IMPROPER PARAMETERS (CONTD)

SYMPTOM	POSSIBLE CAUSE
TEST switch pulled out in operator-intervention test and no PORT A or PORT B RUNNING displays and dual asynchronous-interface board is installed.	Optional dual asynchronous-interface board is not recorded in terminal installation parameters as being installed.
Trying to load from host and NO REPLY shows on screen and ERROR indicator lights	Receive/transmit rate for host communications entered in mode installation parameters is incorrect.
Trying to load from host, screen shows block 0 loading, then NO REPLY shows and ERROR indicator lights	Invalid file number recorded in mode installation parameters.
Automatic mode selection in effect and FAILURE LOADING MODE shows on screen instead of mode being entered or loading occurring	<p>Any of the following:</p> <ul style="list-style-type: none"> ● Number of auto-select mode entered in terminal installation parameters does not match the number of the mode for which mode installation parameters have been established (invalid mode being selected). ● Specified auto-select mode is inadvertently disabled in mode installation parameters. ● No memory module installed but is assigned as load source for auto-select mode in mode installation parameters.
Online but cannot establish communications with host	<p>Any of the following:</p> <ul style="list-style-type: none"> ● Invalid word format or wrong parity specified in mode installation parameters for host communications. ● Receive/transmit rate for host communications entered in mode installation parameters is incorrect.

TABLE A-1. PROBLEMS POSSIBLY CAUSED BY IMPROPER PARAMETERS (CONTD)

SYMPTOM	POSSIBLE CAUSE
<p>Communications with host have parity errors (■ shown on screen)</p>	<p>Any of the following:</p> <ul style="list-style-type: none"> ● Invalid word format or wrong parity specified in mode installation parameters for host communications. ● Receive/transmit rate for host communications entered in mode installation parameters is incorrect.
<p>No keyed-in characters display when online</p>	<p>Host does not echo data back and full-duplex internal routing is designated in mode installation parameters.</p>
<p>Two characters display for each keyboard entry when online</p>	<p>Host does echo data back and half-duplex internal routing is designated in mode installation parameters.</p>
<p>Cursor positioning done by host is erratic</p>	<p>Selection regarding biasing of cursor address is incorrect in mode installation parameters.</p>
<p>Displayed data from host seems restricted to a single line</p>	<p>If in CYBER mode, coding selected in mode installation parameters is for CYBER 120 (small) series systems instead of for CYBER 170 (large) series systems.</p> <p>If not in CYBER mode, automatic line feed is disabled in mode installation parameters, but should not be.</p>
<p>Alternate lines of displayed data from host are blank</p>	<p>If in CYBER mode, coding selected in mode installation parameters is for CYBER 170 (large) series systems instead of for CYBER 120 (small) series systems.</p> <p>If not in CYBER mode, automatic line feed is enabled in mode installation parameters, but should not be.</p>

TABLE A-1. PROBLEMS POSSIBLY CAUSED BY IMPROPER PARAMETERS (CONTD)

SYMPTOM	POSSIBLE CAUSE
Character printer connected to dual asynchronous-interface board does not respond when PRINT key is pressed in CYBER mode	Port having printer connected (port A/connector J1 or port B/connector J2) is conditioned in mode installation parameters for a bidirectional device instead of a receive-only printer.

CRT REALIGNMENT WITHOUT TOUCHPANEL INSTALLED

The following instructions apply if the displayable area of the screen has drifted off center. This is a normal condition that may gradually occur as the crt ages. If realignment does not correct this condition, the basic terminal unit needs maintenance attention.*

To realign the crt, do as follows:

1. If the display for the operator-intervention test is currently on the screen (figure A-9), disregard this step and step 2; otherwise, make the mode menu appear by doing the applicable actions that follow:
 - If operating in CYBER mode, press SETUP key, then F10 key twice.
 - If not in CYBER mode and terminal is conditioned for manual selection of operating mode, press RESET switch (menu appears after power-on test).
 - If not in CYBER mode and terminal is conditioned for automatic selection of operating mode, pull out TEST switch at rear of terminal, then press RESET switch. This shows a DIAGNOSTIC FAILURE message with menu. Disregard FAILURE message.

*Instructions for turning in the basic terminal unit into a CDC service center are provided in section 6.

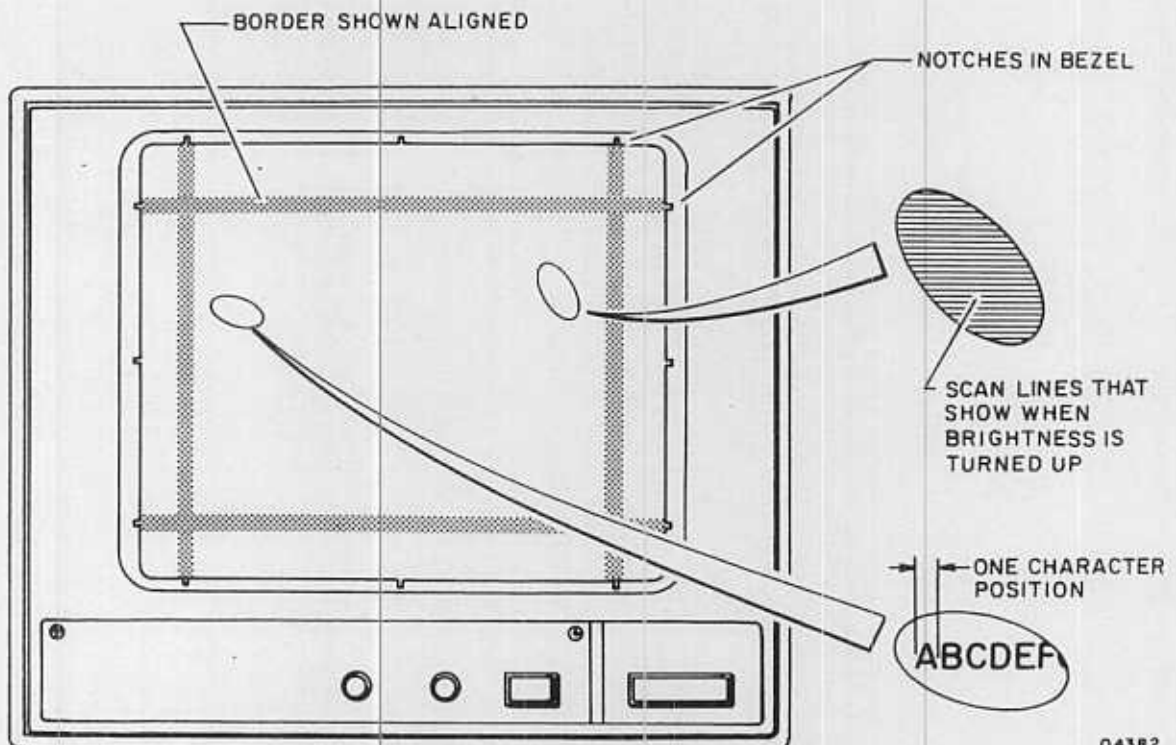

04382

Figure A-9. Estimating Required Realignment

2. Press F8 key to select `TERMINAL TEST` mode from menu. This shows the display for the operator-intervention test on the screen (figure A-9).
3. The notches in the corners of the screen bezel indicate where the middle of border lines should be displayed on the screen (figure A-9). Use those as a guide and estimate the distance to be corrected as follows:
 - If border is off center horizontally, estimate how many character positions right or left that the border must move.
 - If border is off center vertically, estimate how many scan lines up or down that the border must move. To see the scan lines on the screen, momentarily turn the `BRIGHTNESS` control nearly all the way clockwise.
4. Make mode menu appear per step 1.
5. With mode menu on screen, press `CTRL` (Control) and `SETUP` keys. This displays menu of terminal installation parameters (figure A-10).

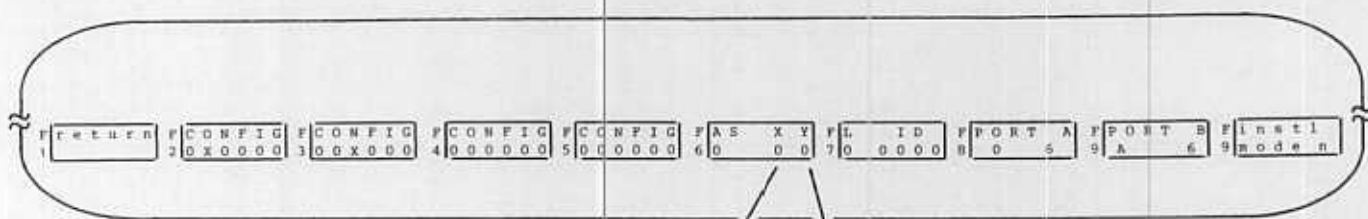

FOLLOWING LISTED ENTRIES
REALIGN CRT HORIZONTALLY:

FOLLOWING LISTED ENTRIES
REALIGN CRT VERTICALLY:

ENTRY	DIRECTION	NUMBER OF CHARACTER POSITIONS
0	-	NONE
1	RIGHT	1
2	RIGHT	2
3	RIGHT	3
4	-	NONE
5	LEFT	1
6	LEFT	2
7	LEFT	3

ENTRY	DIRECTION	NUMBER OF SCAN LINES
0	-	NONE
1	UP	1
2	UP	2
3	UP	3
4	UP	4
5	UP	5
6	UP	6
7	UP	7
8	-	NONE
9	DOWN	1
A	DOWN	2
B	DOWN	3
C	DOWN	4
D	DOWN	5
E	DOWN	6
F	DOWN	7

Figure A-10. Realignment Entries

- Press F6 key to advance cursor into block F6. Then use Space bar to advance cursor under X if horizontal realignment is required, or under Y if vertical realignment is required. If cursor is advanced too far, backspace cursor with Backspace (←) key.
- Refer to figure A-10 and make applicable keyboard entry. If a mistake is made, overwrite the erroneous entry with the correct entry. If horizontal plus vertical realignment is necessary, make each entry.
- Press COPY key. This writes entry into nonvolatile memory and changes alignment.

9. Press F1 key to return to mode menu, then press F8 key to return to operator-intervention test. If optional graphics feature is installed, follow this by pressing any key.
10. Check alignment of border with notches in bezel. If further correction is needed, repeat the process starting with step 3.

CRT REALIGNMENT WITH TOUCHPANEL INSTALLED

This procedure is also used to realign the display area of the crt if it has drifted off center. This procedure, however, is for use with terminals that have the touchpanel and graphics option installed.

To realign the screen in this instance, do the following:

NOTE

Before determining if the adjustment is necessary, allow the terminal to warmup for approximately 10 minutes.

1. Use one of the following methods to get the mode selection menu appearing on the terminal display screen:
 - If operating in CYBER mode, press SETUP key, then F10 key twice.
 - If not in CYBER mode, and terminal is conditioned for manual selection of operating mode, press RESET switch (menu appears after power-on test).
 - If not in CYBER mode and terminal is conditioned for automatic selection of operating mode, pull out TEST switch at rear of terminal, then press RESET switch. This shows a DIAGNOSTIC FAILURE message along with the mode selection menu. Disregard the failure message and press the TEST switch at the rear of the terminal back in.
2. Select CYBER mode by pressing the F1 key.
3. Press the SETUP key to obtain the first display of operator-selectable parameters near the bottom of the screen.

4. Select the following conditions on the operator parameter selection display:
 - LINE (OFF) - use the F2 key to select offline operation of the terminal
 - SCREEN (PAGE) - use the F8 key to select page-mode operation of the terminal display screen
 - MORE SELECT - use the F10 key to advance to the second display of operator-selectable parameters
 - BACKGD (LIGHT) - use the F2 key to select inverse video function of the display screen so that dark characters appear on a light background
 - CURSOR (BLOCK) - use the F3 key to select the block type of cursor
 - CURSOR (SOLID) - use the F4 key to select the nonblinking type of cursor
 - CHR/LN (80) - use the F7 key to select 80 characters per display line
 - LINES (30) - use the F8 key to select 30 lines per display page.
5. Press the F1 key to return to CYBER mode of terminal operation.
6. Enable the terminal touchpanel by pressing:

CTRL, SHIFT and + keys (3 keys) all at the same time
CTRL, SHIFT and R keys (3 keys) all at the same time
SHIFT and R keys (2 keys) at the same time
7. Turn the brightness and contrast controls to maximum to determine if the touchpanel has both vertical and horizontal grid lines visible. Having both grid lines available for reference simplifies things a little, but the procedure is essentially the same whether both are visible or not.
8. Simultaneously press the shift key ($\hat{\uparrow}$) on the main keyboard and the HOME key on the numeric keypad to the move the cursor to the upper left corner of the display screen.
9. Use the numeric keyboard to key in 1234567890 on the first line of the display screen.

10. Simultaneously press the shift key (\uparrow) on the main keyboard and the HOME key on the numeric keypad to the move the cursor to the upper left corner of the display screen.
11. Simultaneously press the shift key (\uparrow) on the main keyboard and the cursor-up key (\uparrow) on the numeric keypad to the move the cursor to the lower left corner of the display screen.
12. Use the numeric keyboard to key in 1234567890 on the 30th line of the display screen.
13. Simultaneously press the shift key (\uparrow) on the main keyboard and the HOME key on the numeric keypad to the move the cursor to the upper left corner of the display screen.
14. Hold the the shift key (\uparrow) on the main keyboard down and press the cursor-down key (\downarrow) on the numeric keypad 14 times to move the cursor to the vertical center of the display screen.
15. Use the numeric keyboard to key in 1234567890 four times across the center of the display screen.
16. Verify that the entries made in the preceding steps leave the terminal display screen appearing as shown in figure A-11.
17. Check the vertical relationship of the touchpanel to the display raster as follows. The first row of characters (10) should appear to rest just above the first horizontal grid line on the touchpanel. The second row of characters (40) should appear to rest just above the eighth horizontal grid line on the touchpanel. The third row of characters (10) should appear to hang just below the last horizontal grid line on the touchpanel. If all three lines of characters are uniformly too high or too low, use the keyboard input technique described in the preceding procedure to correct the problem. If proper adjustment is not possible using this method, request a service call by terminal maintenance personnel to rectify the problem.
18. Check the horizontal relationship of the touchpanel to the display raster as follows. Place the edge of a piece of paper or another straight edge between the top and bottom alignment notches toward the left side of the screen bezel (refer to figure A-11). The edge of the paper should just cover the 5 column in all three test display rows, leaving the 1234 columns of all three rows visible to the left of the straight edge. Moving the straight edge over to the middle upper and lower alignment notches in the bezel should leave the last 0 character in the middle row of the

test display just visible to the left of the straight edge. If these two checks reveal that the display columns are uniformly too far left or too far right, use the keyboard input technique described in the preceding procedure to correct the problem. If proper adjustment is not possible using this method, request a service call by terminal maintenance personnel to rectify the problem.

19. Using a soft blunt instrument, such as the eraser on a pencil or your pinky, touch the rightmost 8 and 9 numbers in the center line of characters on the screen. The cursor should position itself over the number 9. If the cursor is off by more than one character position left or right, it requires adjustment. Attempt to adjust the cursor position using the keyboard input technique described in the preceding procedure. If proper adjustment is not possible using this method, request a service call by terminal maintenance personnel to rectify the problem.
20. If both horizontal and vertical grid lines of the touchpanel are visible, the following checks may also be performed. Check that four H characters fit between any two adjacent vertical grid lines on the touchpanel, and check that two H characters placed one immediately above the other fit between any two adjacent horizontal grid lines on the touchpanel. If proper adjustment of displayed H's is not possible using the preceding keyboard-input adjustment procedure, request a service call by terminal maintenance personnel to rectify the problem.

16 X 16 TOUCHPANEL GRID, VISIBLE WHEN IN INVERSE VIDEO

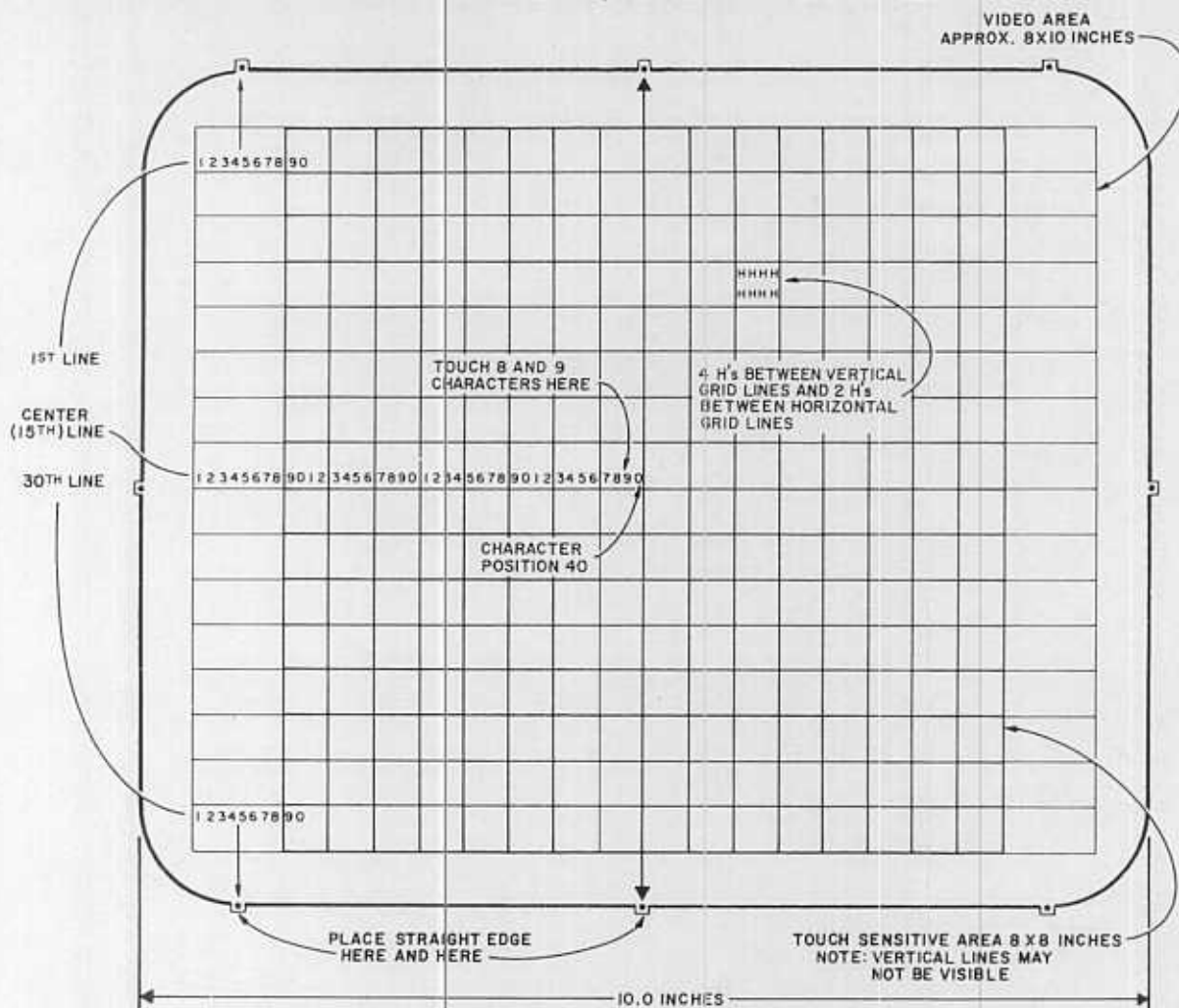

Figure A-11. Display Screen Touchpanel Video Alignment

This appendix provides information about the internal 1200/1200 bit-per-second (b/s) modem that can be installed as an option in the terminal. Included in the appendix are a general description of the modem and its operating characteristics. Also included is information regarding the operation and installation of a terminal containing an internal modem.

GENERAL DESCRIPTION

The equipment number of the modem is XA360-A, and it is installed in large option-board location I/F-4 (refer to figure B-1). The presence of this modem in the terminal is most easily established by checking the I/F-4 location at the rear of the terminal. The rear of the modem with its Canadian Department of Communications and FCC certification label is prominently visible through a slot in the rear of the terminal at the I/F-4 location. The modem is a factory/service-center installed option; it is not installable by the user because installation requires access to the inside of the terminal.

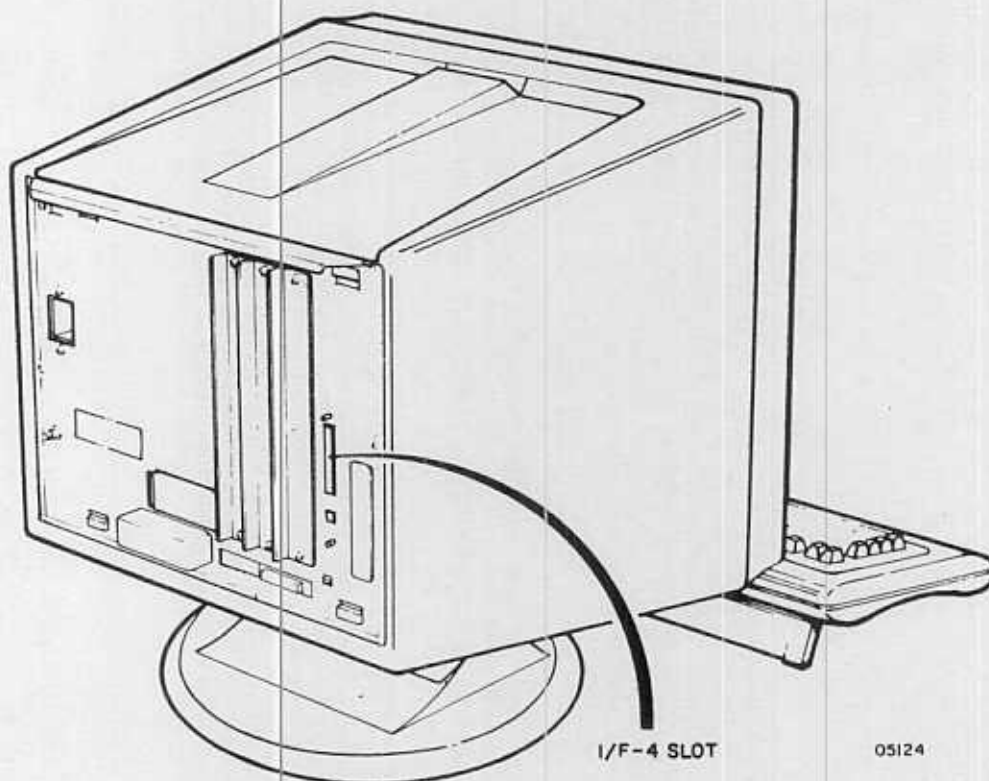

Figure B-1. View of Terminal Showing I/F-4 Slot

The 1200/1200 b/s modem provides the Viking X terminal with a telephone line interface capable of data reception and transmission at a rate of 1200 bits per second (approximately 120 characters per second). The modem is compatible with Bell 212A data communication equipment requirements and is capable of either full- or half-duplex 1200 b/s data transfers on standard telephone transmission lines. The modem has been designed and manufactured for conformance to most of the commonly recognized industry, national, and international standards.* Some of the more notable features and capabilities of the modem are listed below:

- Bell 212A compatibility for 1200 b/s data exchange rates
- Capable of full-duplex transmissions on 2-wire, switched-network local or long-distance telephone lines without special conditioning
- Automatic dual-tone multi-frequency dialing (touch-tone)
- Automatic pulse dialing (standard dial-phone dialing)
- Operation in either call originate or call answer mode
- Operation in both digital and analog loopback test mode
- A firmware-resident self-test feature
- Standard telephone line interface: 1) a RJ11C modular phone-jack connector accessible at rear of terminal, and 2) a 4.3 metre (14 foot) cable with a RJ11 plug at one end and a RJ11 duplex (T) connector at the other end for connecting both the terminal and a telephone to the same line
- A 4k read-only memory

The principal use of the internal modem is to permit its host terminal to communicate over the telephone lines with a host computer system or with other terminals using a compatible interface to the same telecommunications network. The automatic features of the modem permit its use either for automatically downloading an operating mode from the host computer of the system, or for use in communicating with the host computer or other network terminals during typical system operations.

*Specific standards with which the modem is in conformance include: industry standards UL STD 478, FCC Part 15 (Subpart J), and FCC Part 68; national standards ANSI X3.4, ANSI X3.15, and ANSI X3.16; and international standards CITT V.24k-1968, CSA STD C22.2-143, VDE 0871, VDE 0730, VDE 875, IEC 380, and TAPS.

The modem incorporates self-test features that greatly facilitate troubleshooting. A ROM checksum test of the modem firmware runs whenever the terminal tests are run. If the terminal is offline, a loopback test is also run on the UART circuit of the modem. These two tests therefore normally run during a terminal power up or reset operation. In addition, terminal installation parameter F4, position 3, can be set to enable a loopback routine that checks the modem interface itself. This last test also only runs when the terminal is off line. Following is a listing of the messages associated with the modem self tests. If any one of these messages appear on the display screen following the terminal self tests, the terminal requires maintenance service.

- INTERNAL MODEM CHECKSUM FAIL
- INTERNAL MODEM UART FAIL
- INTERNAL MODEM LOOPBACK FAIL

OPERATION

This portion of the appendix describes operations and operator actions related to a terminal with an internal modem installed. It does not discuss the temporary modification of operator parameters associated with the 1200/1200 b/s modem; such information is discussed in Section 4 of this manual. The following text includes operations associated with the 1200/1200 b/s modem to which the terminal operator responds or reacts. These operations include entering a telephone number on the terminal keyboard, monitoring phone-call status on the terminal display screen, and manually dialing a telephone call.

ENTERING A TELEPHONE NUMBER ON THE TERMINAL KEYBOARD

The following description assumes that the terminal has had its mode installation parameters previously set up to select the auto-dial function of the internal modem but not to use the default-value parameter entries for automatic selection of the phone number, load source, and load files. It also assumes that the terminal has been powered on, all of the power-up self tests have run successfully, and the mode-selection menu has appeared on the lower portion of the terminal display screen (refer to section 3 in main body of this text if required). At this point, the operator does the following:

1. Presses function key associated with the desired operating mode of the terminal. (In accordance with the previous assumptions, the mode selected must be one that uses the internal modem.) As a result of this action, the following message appears on the terminal display screen:

ENTER PHONE NUMBER

2. Keys in the desired phone number on the terminal keyboard. The following characters are permissible for making phone number entries on the terminal keyboard; the terminal does not accept key entries other than those listed below.
 - 0 to 9 these digits are used to make standard telephone number entries.
 - A this alpha character entry is acceptable. However, it is reserved for future use and is not currently used in making phone-number entries.
 - B this alpha character entry is used as a substitute for the * character on tone-dial telephones. It should not be used on pulse-dial lines.
 - C this alpha character entry is used as a substitute for the # character on tone-dial telephones. It should not be used on pulse-dial lines.
 - D this alpha character entry causes an auto-dialing sequence to pause until a tone is detected. For example, it delays the dialing sequence to wait for a dial tone after dialing for an outside line)
 - E this alpha character entry causes an auto-dialing sequence to pause until no tone is detected on the line for 3 seconds. It is used, for example, to insert a 3 second delay between a direct-dial access number and an area-code number sequence, or between the area-code number sequence and the actual telephone number.
 - F this alpha character entry is acceptable. However, it is reserved for future use and is not currently used in making phone-number entries.
3. Presses the NEXT key on the terminal keyboard once the operator has made the proper entries and the desired telephone number is appearing on the display screen.

At this point, the auto-dial function of the internal modem takes over and all that the operator can do now is monitor the progress of the call on the terminal display screen.

MONITORING A TELEPHONE CALL ON THE TERMINAL DISPLAY SCREEN

Figure B-2 depicts the sequence of display messages possible during an auto-dial operation of the terminal modem in which the operator makes the phone number entry. The sequence that automatically enters a phone number and selects the load source and file is very similar except that the boxed-in display messages do not appear (operator only monitors call status and is not required to make entries). The following text describes the all of the steps depicted in figure B-2 in more detail.

- ENTER PHONE NUMBER - this is the initial message that appears on the display screen during an auto-dial sequence in which the terminal operator enters the desired telephone number on the terminal keyboard. The operator's response to this message has been previously described under the heading Entering a Telephone Number on the Terminal Keyboard.
- NO DIAL TONE/DIALING PHONE NUMBER - either one of these two messages can occur as the first response after the operator has keyed in the telephone number and pressed the NEXT key on the terminal keyboard. Regardless of which message occurs, it only appears on the display screen for a short time. The no-dial-tone message provides an no-connection pathway to the SELECT LOAD SOURCE, etc. message. The connection-possible path, of course, is via the dialing-phone-number message, and this path can lead to either of the two following messages.
- ILLEGAL DIGIT/WAITING FOR ANSWER - the first message only appears if, as the modem is dialing the phone number, it detects a character that is not usable as a phone number character on the type of line being used. For example, this message would appear if a B character (tone-dial equivalent of *) had been entered for use on a pulse-dial telephone line. Note that pulse dialing can be used on a tone-dial network, but that the reverse is not true. That is, tone-dialing cannot be used on a pulse-dial network. As is the case with the first possible no-connection response, this one also leads to the SELECT LOAD SOURCE, etc. message. The connection-possible message (waiting-for-answer) appears on the display screen during the brief interval that the modem is awaiting a response after having completed the dialing sequence. This connection-possible pathway then leads to one of the following three messages.

Operator-action/Comments

Operator selects an operating mode that uses internal modem, but does not use default source/file/phone-number values stored in mode parameter entries; F2, for example.

Operator keys in phone number and presses NEXT key. See text for allowable entries.

The next messages appear one at time in sequence. Where more than one message possibility is available, only the message that reflects the actual condition of the phone line appears.

Operator keys in desired load source (H), or default value can be used.

Operator keys in desired file number (00 to 3F₁₆ range), or default value can be used.

This message reflects loading of file specified by operator (or default value).

The YY₁₆ portion of this message increments as each block of the selected file loads.

The last message (HOST NOT CONNECTED) only appears if the source-select message is entered via the no-dial-tone, illegal-digit, dialing-error, busy, or no-answer route. About 40 seconds after this last message appears, a loading failure message appears along with the redisplay of the mode-selection menu. At this time the operator can retry the load, but should first verify proper terminal and mode installation parameter settings. Operator should also double check for correct procedures.

Possible Display Messages

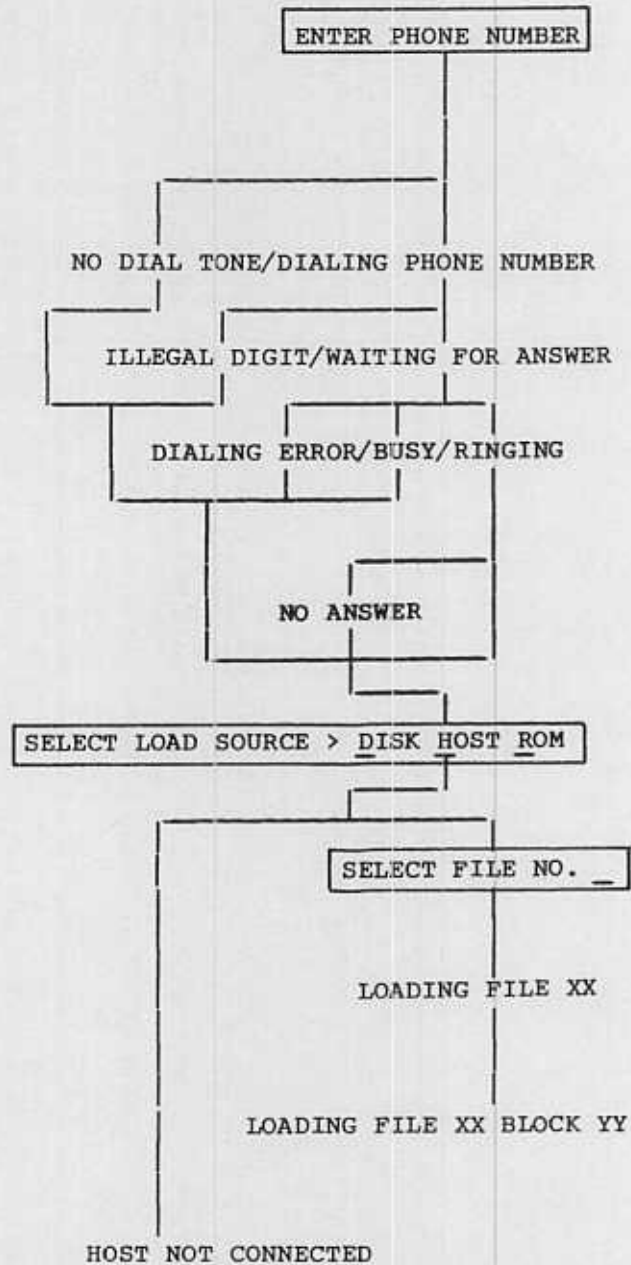

Figure B-2. Auto-dialing Display Messages

- DIALING ERROR/BUSY/RINGING - the first two of these messages are fairly self explanatory and indicate that the phone call cannot properly be completed. They therefore follow the no-connection path to the SELECT LOAD SOURCE, etc. message. The last of the three possible messages (ringing) indicates that the number dialed has been reached and that the dialed device is ringing. This message can still lead to one last possible no-connection message, or it can take a connection-completed path.
- NO ANSWER - this is the last of the no-connection messages. It indicates that the dialed phone has rung a specified number of times and has not answered the call. This is the last of the no-connection pathways to the SELECT LOAD SOURCE, etc. message.
- SELECT LOAD SOURCE > DISK HOST ROM - Notice that this display screen message may be arrived at by way of either a no-connection or a connection-completed pathway. If this message appears on the display screen due to a no-connection condition, the operator may either try again later to make connection, or he may use a telephone handset to manually dial the desired phone number and verify cause of the no-connection condition. If the SELECT LOAD SOURCE, etc. message results from a connection-completed condition, the operator's response should be to key an H on the terminal keyboard and press the NEXT key. This latter action causes the following message to appear.
- SELECT FILE NO. _ - In response to this message, the terminal operator is to key in the file number that corresponds to the desired load file and press the NEXT key. Permissible numeric entries for selecting the load file include hexadecimal numbers between 00₁₆ and 3F₁₆. This last operator entry results in the following two display messages:
 - LOADING FILE XX - this message displays to verify that the file selected by the operator is the one being loaded.
 - LOADING FILE XX BLOCK YY - this message is similar to the preceding one but provides additional information. The YY portion of the message is a hexadecimal number that indicates which block of the selected file is currently loading and increments as each successive block of the file loads. When loading is complete, a Terminal Ready message appears on the display screen to inform the operator that applications operations of the terminal may now begin.

Three other display messages may appear on the terminal display screen as the result of an attempt to download information over the telephone lines using the internal modem. These messages occur only if the terminal has not made a proper telephone-line connection with the host computer. In such an instance, a HOST NOT CONNECTED message appears a short time after the terminal operator presses the H and NEXT keys of the terminal to initiate the download operation. If the terminal has not established a communications line connection within 40 seconds after the HOST NOT CONNECTED message appears, the download operation aborts and both HOST LOAD FAILURE and FAILURE LOADING MODE messages appear on the terminal display screen. Along with these last two messages, a redisplay of the mode selection menu occurs.

MANUALLY DIALING A TELEPHONE CALL

The following method of manually making a telephone line connection between the terminal and a host computer using the internal modem assumes that both the modem and a telephone handset are connected to the same telephone line via a telephone jack T adapter. It also assumes that the mode installation parameters of the terminal have been set up not to use the auto-dial feature of the modem. In such a case, the operator begins a manual-dial call with the mode selection menu appearing on the terminal display screen. Completing the operation requires that the operator take the following steps:

1. Dial the desired telephone number on a hand set. Wait for the phone to be answered and to hear the answer tone.
2. Select the desired operating mode by pressing the appropriate function key. Assuming the F2 (PLATO mode) is selected, the following message appears on the terminal display screen:

```
SELECT LOAD SOURCE > DISK HOST ROM
```

A short time later the answer tone is replaced by a rushing sound. This indicates the connection has been made, and you may now hang up the telephone hand piece.

3. Press the H key on the terminal keyboard to select a load-from-host operation.
4. A SELECT FILE NO. _ message appears on the display screen, and the system awaits the entry of the file number that is to be loaded. Entering the desired file number and pressing NEXT causes the file download to begin.

With the exception that different messages appear on the terminal display screen, selections other than PLATO mode react in a similar manner during a manual dial operation to connect the host computer.

INSTALLATION

This portion of the appendix describes how a terminal with a 1200/1200 b/s modem installed is connected to the telephone line. It also describes how to modify certain installation parameters that are associated with the internal modem. For information regarding installation of the terminal itself, refer to Appendix A in this same manual.

CONNECTING MODEM-EQUIPPED TERMINAL TO TELEPHONE LINE

To connect a terminal to the telephone line in the manner described below, the following items are necessary:

- A Viking X terminal with an internal 1200/1200 b/s modem (equipment number XA360-A) installed in it
- A 4.3 metre (14 foot) telephone-line extension cord (CDC part number 61409590), having a single, modular RJ11 plug on one end and a duplex-jack RJ11 plug on the other end (refer to figure B-3)
- Additionally, a RJ11 modular jack that is connected to the building telecommunications lines must be available within 4.3 metres (14 feet) of the terminal installation site

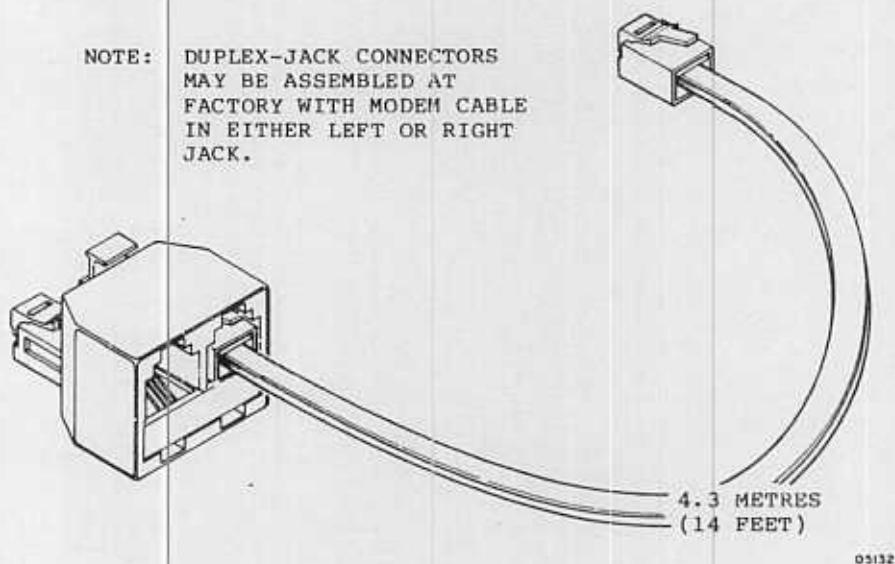

Figure B-3. Telephone-line Extension Cord with Duplex-Jack Plug

To connect the terminal to the telecommunications lines, refer to figure B-4 and perform the following operations.

NOTE

Canadian Department of Communications guidelines require that a tool is necessary to disconnect communications cords or cables from their associated communications devices. To conform to Canadian requirements, the terminal-device ends of all extension cords furnished with internal-modem-equipped terminals have had the retaining clips of their RJ11 plugs shortened slightly so that a tool is necessary to remove them from their mating jacks.

1. Remove the telephone cord from the wall jack to which the terminal is to be connected by squeezing the retaining clip of the RJ11 plug and withdrawing the plug from the jack (refer to figure B-4a).
2. Insert the plug on the duplex-jack end of the furnished extension cord (CDC part number 61409590) into the wall jack from which the telephone cord was just removed (refer to figure B-4b).
3. Insert the free end (single plug end) of the furnished extension cord (CDC part number 61409590) into the RJ11C connector at the rear of the terminal (refer to figure B-4c).
4. Insert free end of the telephone cord removed in step 1 into the second jack (only open one) of the duplex-jack connector plugged into the wall jack (refer to figure B-4d).
5. Check that completed installation appears as shown in figure B-5.

NOTE

The installation must appear as shown in the figure B-5. The installation will not function properly with the duplex-jack plug of the furnished extension cord connected to the rear of the terminal, or to the body or hand piece of the telephone.

SQUEEZE TAB AND
WITHDRAW PHONE
CORD FROM WALL
JACK

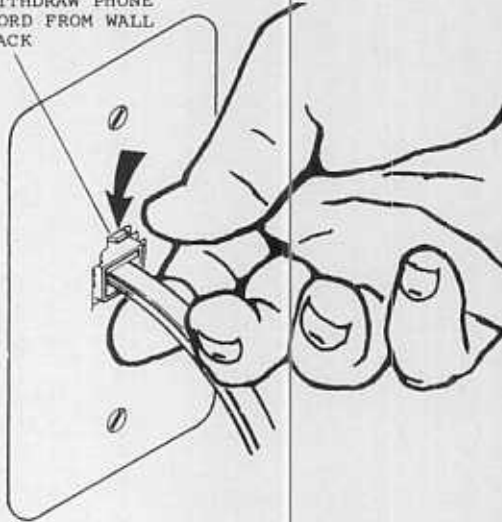

a)

INSERT DUPLEX
ADAPTER INTO
WALL JACK

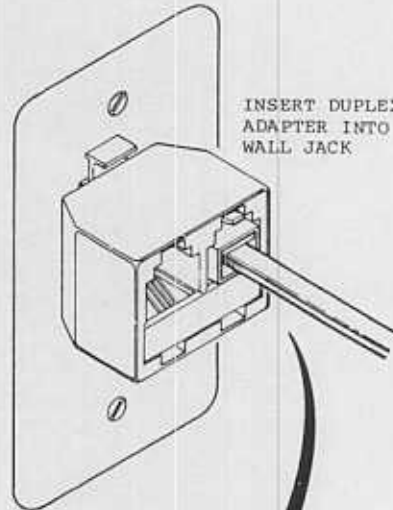

b)

NOTE: DUPLEX-JACK CONNECTORS
MAY BE ASSEMBLED AT
FACTORY WITH MODEM CABLE
IN EITHER LEFT OR RIGHT
JACK.

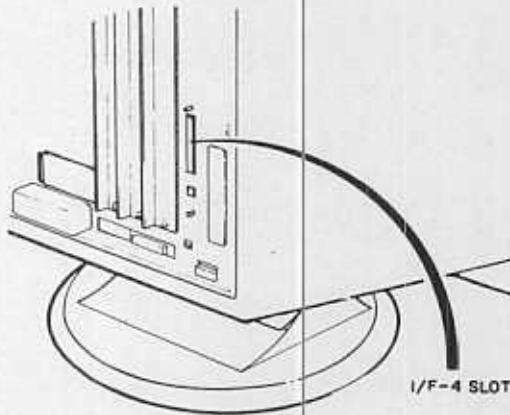

INSERT FREE END
OF MODEM PHONE
CORD INTO MODEM
c) AT REAR OF TERMINAL

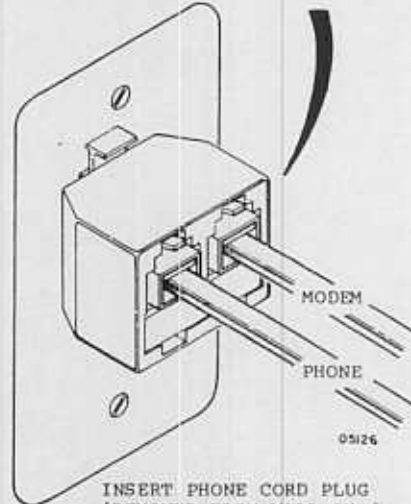

d)

INSERT PHONE CORD PLUG
(REMOVED FROM WALL IN 6a
INTO OPEN JACK OF DUPLEX
PLUG

Figure B-4. Installing a Modem-equipped Terminal

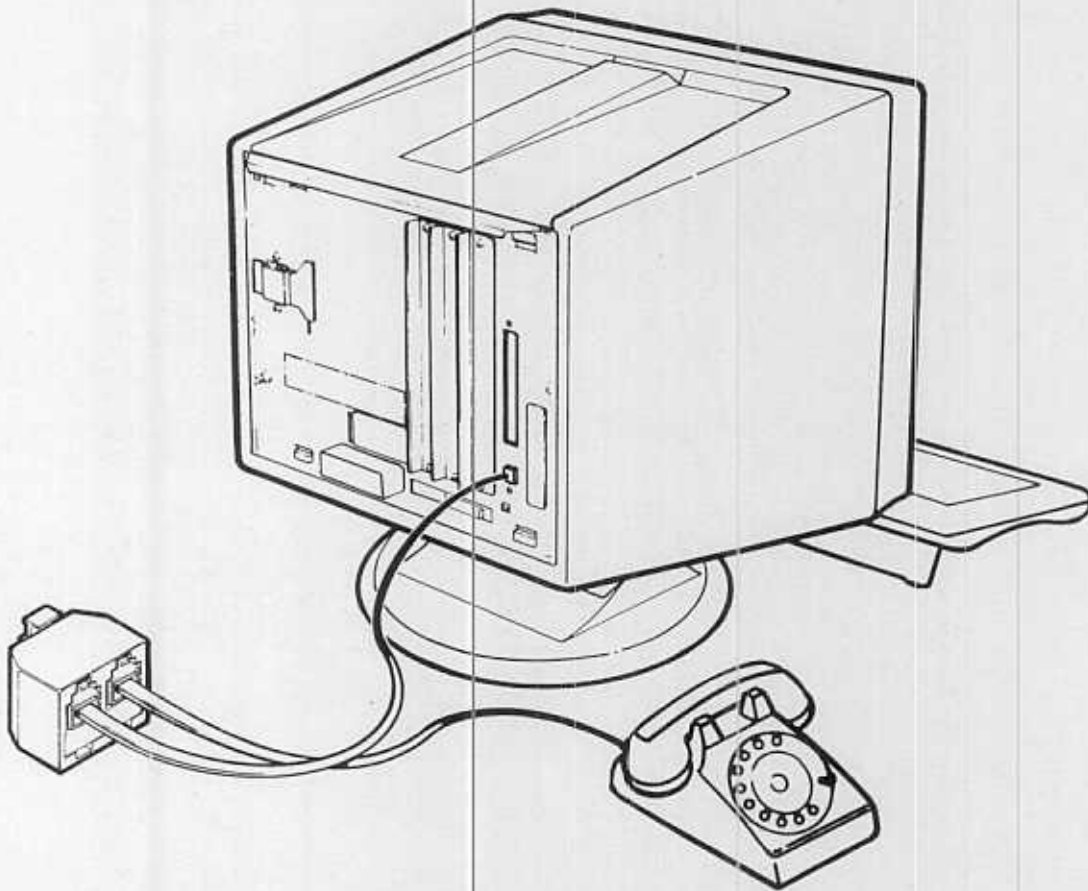

05/25-2

Figure B-5. Completed Installation of Modem-equipped Terminal

INSTALLATION PARAMETER MODIFICATION

This portion of the appendix is for use by service or supervisory personnel in modifying default installation parameters of the terminal that are related to the internal 1200/1200 b/s modem.

To set the Terminal Installation and Mode Installation parameters relating to an internal 1200/1200 b/s modem (XA360-A), do the following:

1. Obtain a Mode Selection Menu (Display) by pressing 1 side of 0/1 (on/off) switch at lower left front of terminal to turn terminal power on. One of two things occurs at this point.
 - a. Mode Selection Menu appears at bottom of display screen as illustrated below. If this occurs, skip to step 2; if not, continue with step 1b.

F	MODE 1	F	MODE 2	F	MODE 3	F	MODE 4	F	MODE 5	F	MODE 6	F	MODE 7	F	TERMINL	F		F	
1	CYBER	2	PLATO	3	CP/M	4	DISK	5	C120	6	XXIX	7	PACK	8	TEST	9		10	

Mode Selection Menu

- b. The terminal automatically enters one of its available operating modes because certain parameters have been preset to cause this action to occur. If this latter action occurs, forcing an error condition causes both an error message and the mode selection menu to display. An error condition may be forced by:
 - 1) Pulling out the TEST switch located at the left rear of the terminal (refer to figure B-8).
 - 2) Pressing the RESET pushbutton located towards the right front of the terminal.
 - 3) Pushing the TEST switch at the rear of the terminal back in as soon as the Mode Selection Menu appears near the bottom of the display screen.

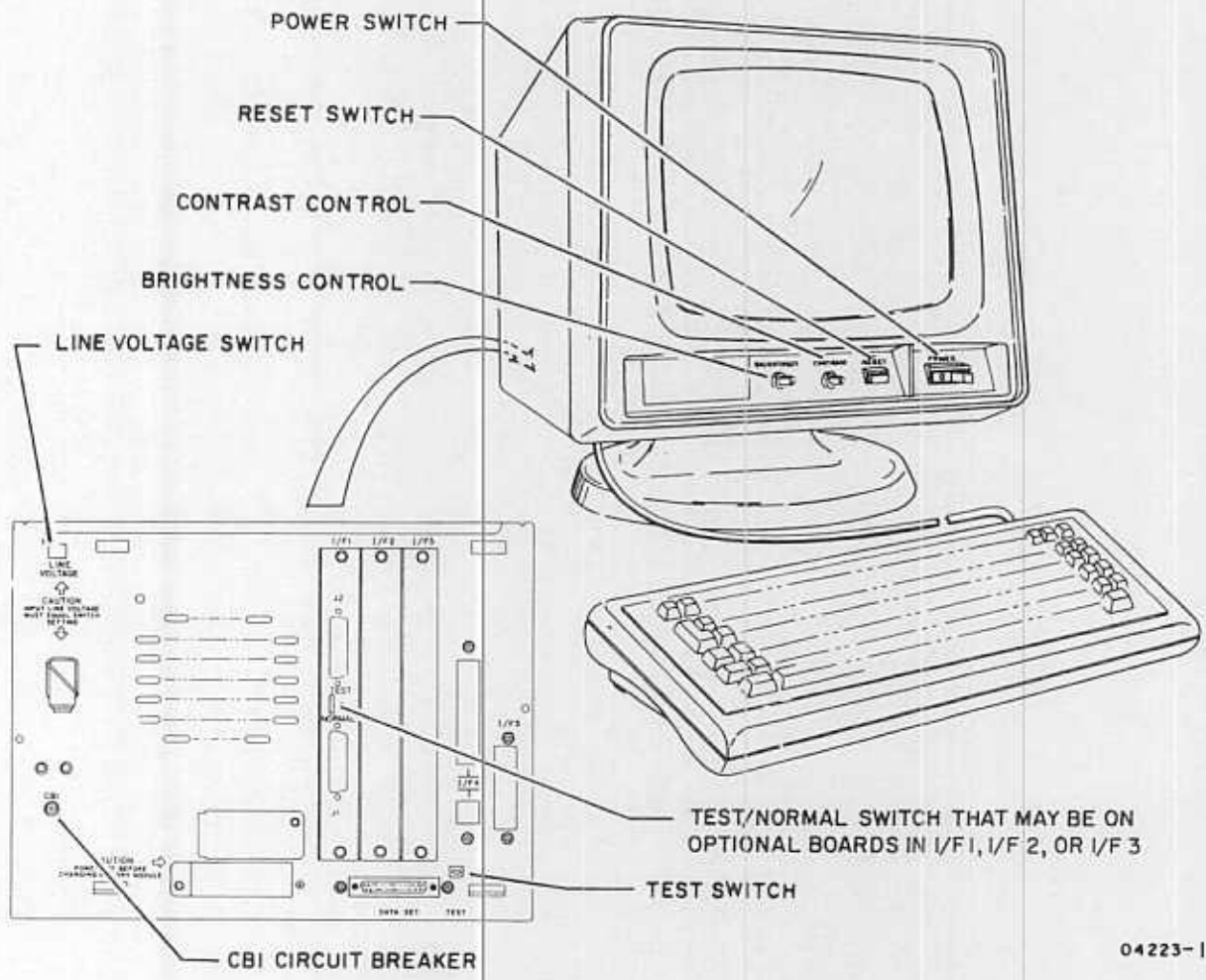

04223-1

Figure B-6. Operator Controls on Front and Rear of Terminal

2. Press the CNTL key and hold it down while pressing the SETUP key; then release both keys. The Terminal-Installation Parameters Menu replaces the Mode Selection Menu at the bottom of the display screen. The Terminal Installation Parameters Menu looks like this:

```

F |return| F |CONFIG| F |CONFIG| F |CONFIG| F |CONFIG| F |AS X Y| F |L ID| F |PORT A| F |PORT B| F |instl|
1 |      | 2 |123456| 3 |123456| 4 |123456| 5 |123456| 6 |O O H| 7 |O HHH| 8 |H H| 9 |H H| 10|mode n|

```

Terminal Installation Parameters Menu

3. Three Terminal-Installation Parameters relate directly to the 1200/1200 b/s modem. The first parameter is the first entry position of the F3 field. A 1 is to be entered in this position if the 1200/1200 b/s modem is installed in the terminal; a 0 is entered if the modem is not installed. The second parameter is the third position of the F4 field (F4P3) and the third parameter is the fourth position of the F4 field (F4P4). Setting F4P3 to a 1 enables the UART and modem loopback tests; setting F4P3 to a 0 disables these tests. Setting F4P4 to a 1 conditions the modem for use on a tone-dial phone line; setting F4P4 to a 0 conditions the modem for a pulse-dial phone line.
4. Assuming the entry related to the 1200/1200 b/s modem must be changed, press the F3 key to move the entry cursor to the first entry position of the F3 field. The entry cursor may also be moved forward by using the Space bar on the keyboard and backward using the backspace (←) key.
5. Make the appropriate 1 (modem installed) or 0 (modem not installed) entry in the first position of the F3 field.
6. Make desired changes to the F4 field or any other necessary changes to the Terminal-Installation Parameter entries in the same manner as described above.
7. Press the COPY key on the terminal keyboard to complete the entry of the Terminal Installation Parameters.
8. Press the F10 key on the terminal keyboard. An ENTER MODE n (1-6) prompt appears on the display screen. Pressing 1 or 2 and NEXT keys in response to this last prompt immediately causes the mode installation parameters menu to appear. Pressing a 3 through 6 key and the NEXT key, however, causes an ENTER MODE NAME prompt to appear on the display screen. If the ENTER MODE NAME prompt appears, either entering a four-character mode name or pressing the NEXT key causes the Mode-Installation Parameters Menu to appear just below the prompt.

F	return	F	CONFIG	F	CONFIG	F	CONFIG	F	CONFIG	F	OPR DF	F	A-DIAL	F	A-DIAL	F	DF T R	F	ACCESS
1		2	123456	3	123456	4	123456	5	123456	6	HHHH	7	HHHHHH	8	HHHHHH	9	OH H H	10	HHHH

Mode-Installation Parameters Menu

Parameter entry positions 3 and 6 of the F2 field and position 2 of the F3 field are related to the 1200/1200 b/s modem. The F7, F8, and F9 fields also contain entries relating to the 1200/1200 b/s modem.

9. Use the keyboard Space bar to move the entry cursor to position 3 of the F2 field and make the desired entry. A 1 in this position permits the terminal operator to enter a telephone number via the keyboard; a 0 in this position causes the terminal to use the phone number stored in the F7 and F8 Mode-Installation Parameter fields later in this procedure.
10. Use the keyboard Space bar to move the entry cursor to position 6 of the F2 field and make the desired entry. A 1 in this position causes the terminal to use the 1200/1200 b/s modem to load its operating program; a 0 in this position causes the terminal to use the host interface to load its operating program.
11. Use the keyboard Space bar to move the entry cursor to position 2 of the F3 field and make the desired entry. A 1 in this position enables the auto-dial feature of the 1200/1200 b/s modem; a 0 in this position disables the auto-dial feature.
12. Press the F7 key to move the entry cursor to the first entry position of the F7 field of the Mode-Installation Parameters Menu.

The F7 and F8 fields allow the entry of up to 12 characters of information related to the default telephone number (refer to position 3 entry of F2 field). Allowable character entries for the F7 and F8 fields are the hexadecimal digits 0 through F. The 0 through 9 digits are used to enter the digits of the telephone number. The A character is not currently used and is reserved for future use. The B and the C alpha characters represent the tonal symbols * and #, respectively. The D and the E alpha characters are both used for inserting pauses in the number dialing sequence. The D character inserts a pause in the dialing sequence until a tone is received, and the E character inserts a 3 second pause in a dialing sequence and then recommences dialing provided no tone is received.

The F character is used to indicate the end of a telephone-number dialing sequence that does not fill the 12 available spaces of the combined F7 and F8 fields. An example of a telephone call made from an inhouse switching network might be as follows:

9D855E1155F

13. Make the desired default telephone number entry in the F7 and F8 fields.
14. Press the F9 function key on the terminal to move the entry cursor to the beginning of the F9 field.
15. Use the space to move the entry cursor directly under the T area of the F9 field, and then enter a 6 on the keyboard to correspond to a 1200 b/s transmit rate for the terminal. The cursor automatically advances to directly under the R area of the F9 field. Key in another 6 to correspond to a 1200 b/s receive rate for the terminal.
16. Make any other required mode-installation parameter entries. Use the backspace key, the spacebar, and the appropriate function keys (F2 through F10) to move the cursor to the proper locations for making the required entries.
17. Press the COPY key on the terminal keyboard to complete the entry of the Mode Installation Parameters.
18. Press the F1 key on the terminal keyboard to return to the main Mode Selection Menu.

COMMENT SHEET

MANUAL TITLE: 721 Display Terminal Operator's Guide/
Installation Instructions

PUBLICATION NO.: 62940019

REVISION: E

NAME: _____

COMPANY: _____

STREET ADDRESS: _____

CITY: _____ STATE: _____ ZIP CODE: _____

This form is not intended to be used as an order blank. Control Data Corporation welcomes your evaluation of this manual. Please indicate any errors, suggested additions or deletions, or general comments below (please include page number references).

NO POSTAGE STAMP NECESSARY IF MAILED IN U.S.A.

STAPLE

FOLD

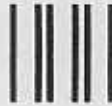

NO POSTAGE
NECESSARY
IF MAILED
IN THE
UNITED STATES

BUSINESS REPLY MAIL

FIRST CLASS

PERMIT NO. 8241

MINNEAPOLIS, MINN.

POSTAGE WILL BE PAID BY

CONTROL DATA CORPORATION

Technical Publications Department

2401 North Fairview Avenue

St. Paul, Minnesota 55113



CUT ALONG LINE

FOLD

03377

CORPORATE HEADQUARTERS, P.O. BOX 0, MINNEAPOLIS, MINN. 55440
SALES OFFICES AND SERVICE CENTERS IN MAJOR CITIES THROUGHOUT THE WORLD

LITHO IN U.S.A.



CONTROL DATA CORPORATION