

RIMFIRE 45 Product Specification

**Copyright Computer Products Corporation
March 1982
Revision A 3-22-82
Publication Number 21010045**

REVISION INFORMATION

Revision Record

Revision	Date	Comments
01	3-1-82	Initial Release
A	3-22-82	Production Release

REFERENCE DOCUMENTS

The following documents are applicable to the CPC RIMFIRE 45 and will be of interest to the user:

1. ANSI Specification XT39/1226
2. User's Manual for applicable disk drive
3. User's Manual for applicable tape drive
4. The 8086 Family User's Manual--Intel
5. RIMFIRE 45 Application Note,
CPC Publication 21020045
6. Multibus Specification,
INTEL Publication 9800683

TABLE OF CONTENTS

1.0	INTRODUCTION
1.1	GENERAL DESCRIPTION
1.2	FEATURES
2.0	DEFINITION OF TERMS
2.1	CHANNEL ATTENTION
2.2	GATE
2.3	POINTER
2.4	PARAMETER BLOCK
3.0	DISK ORGANIZATION
3.1	TRACK
3.2	CYLINDER
3.3	HEAD
3.4	SECTOR
3.5	DISK FORMAT
4.0	FUNCTIONAL DESCRIPTION
4.1	INITIALIZATION
4.1.1	RESET
4.1.2	SYSTEM CONFIGURATION POINTER
4.1.3	SYSTEM CONFIGURATION BLOCK
4.1.4	CHANNEL CONTROL BLOCK
4.2	COMMAND EXECUTION
4.3	INTERRUPTS
4.3.1	NON-VECTORED INTERRUPTS
4.3.2	MAILBOX INTERRUPTS
4.4	PAGING
4.5	USER 8089 PROGRAMS
5.0	DISK COMMAND EXECUTION
5.1	DISK PARAMETER BLOCK
5.1.1	COMMAND
5.1.2	HEAD SELECT
5.1.3	PAGE ADDRESS
5.1.4	CONTROL
5.1.5	CYLINDER
5.1.6	SECTOR
5.1.7	RECORDS
5.1.8	SOURCE/DESTINATION
5.1.9	DRIVE STATUS
5.1.10	COMMAND STATUS
5.1.11	INTERRUPT/LINK
5.2	COMPLETION
6.0	TAPE COMMAND EXECUTION
6.1	TAPE PARAMETER BLOCK
6.1.1	COMMAND
6.1.2	RESERVED
6.1.3	PAGE ADDRESS
6.1.4	CONTROL
6.1.5	RETURN COUNT
6.1.6	BUFFER SIZE

TABLE OF CONTENTS

6.1.7	RECORDS
6.1.8	SOURCE/DESTINATION
6.1.9	DRIVE STATUS
6.1.10	COMMAND STATUS
6.1.11	INTERRUPT/LINK
6.2	COMPLETION
7.0	BLOCK MOVE EXECUTION
7.1	BLOCK MOVE PARAMETER BLOCK
7.1.1	COMMAND
7.1.2	RESERVED
7.1.3	PAGE ADDRESS
7.1.4	CONTROL
7.1.5	BYTE COUNT
7.1.6	SOURCE
7.1.7	DESTINATION
7.1.8	SEARCH BYTE
7.1.9	MASK/COMMAND STATUS
7.1.10	INTERRUPT
7.1.11	TABLE
7.1.12	THROTTLE
7.2	COMPLETION
8.0	DUMP/RESTORE EXECUTION
8.1	DUMP/RESTORE PARAMETER BLOCK
8.1.1	COMMAND
8.1.2	HEAD SELECT
8.1.3	PAGE ADDRESS
8.1.4	CONTROL
8.1.5	CYLINDER
8.1.6	SECTOR
8.1.7	RECORDS
8.1.8	SOURCE/DESTINATION
8.1.9	DRIVE STATUS
8.1.10	COMMAND STATUS
8.1.11	INTERRUPT/LINK
8.1.12	END HEAD
8.1.13	END CYLINDER
8.1.14	END SECTOR
8.2	COMPLETION
9.0	RIMFIRE 45 COMMANDS
9.1	DISK DRIVE CONTROL
9.1.1	CONFIGURE
9.1.2	DISK DRIVE STATUS
9.1.3	LOAD
9.1.4	UNLOAD
9.1.5	DISK RESET
9.1.6	SEEK
9.1.7	READ ID
9.1.8	INTERROGATE
9.1.9	TEST DISK I/F
9.1.10	READ/WRITE PERMIT
9.1.11	DISK MICRO
9.1.12	REZERO

TABLE OF CONTENTS

9.2	TAPE DRIVE CONTROL
9.2.1	TAPE DRIVE STATUS
9.2.2	REWIND
9.2.3	OFFLINE/UNLOAD
9.2.4	WRITE FILEMARK
9.2.5	SEARCH FILEMARK
9.2.6	SPACE
9.2.7	ERASE
9.2.8	ERASE TAPE
9.2.9	SPACE FILEMARK
9.2.10	DRIVE RESET
9.2.11	SEARCH MULTIPLE FILEMARK
9.3	DISK DATA TRANSFER
9.3.1	DISK READ
9.3.2	DISK WRITE
9.3.3	FORMAT
9.3.4	MAP DEFECT
9.4	TAPE DATA TRANSFER COMMANDS
9.4.1	TAPE READ
9.4.2	TAPE WRITE
9.4.3	TAPE EDIT
9.5	COMBINATION COMMANDS
9.5.1	DUMP
9.5.2	RESTORE
9.6	SPECIALS
9.6.1	NOP/ID
9.6.2	DIAGNOSTIC
9.6.3	BLOCK MOVE
9.6.4	CLEAR INTERRUPT

APPENDICES

A.	SPECIFICATIONS
B.	CABLES
C.	ERROR CODES
D.	JUMPERS
E.	CONNECTOR PIN-OUTS
F.	COMMAND CODES
G.	DISK DRIVE TYPES

1.0 INTRODUCTION

This document describes the operation of the CPC RIMFIRE 45 ANSI Disk/ $\frac{1}{2}$ -inch Magnetic Tape Drive Controller. It provides the information necessary for the user to incorporate the RIMFIRE 45 into a Multibus-based system.

- 1.1 This section contains a generalized overview of the operation of the RIMFIRE 45. Detailed information is contained in later sections.

The CPC RIMFIRE 45 is an intelligent, Multibus-compatible controller, capable of handling up to eight Winchester disk drives conforming to ANSI proposal X3T9, and up to four $\frac{1}{2}$ -inch formatted start/stop or streaming tape drives. The controller is fully Multibus-compatible, and functions in 8 or 16 bit systems, with 16, 20 or 24 bit addressing, single or multi-processor.

Disk and tape operations are controlled through Parameter Blocks placed in system memory by processors requiring use of the controller. The location of the Parameter Block is programmable for each operation, i.e., the location is passed to the RIMFIRE 45 at the start of each command or chain of commands. Once an operation has begun, no further system intervention is necessary. The RIMFIRE 45 will complete the task or tasks as assigned, and then become available for the next command.

In addition to disk and tape operations, the RIMFIRE 45 can perform several powerful data move and diagnostic functions, and may be used as a general purpose DMA controller. It will also execute user-written 8089 programs. Refer to later sections for details.

1.2 FEATURES

- * Controls up to eight ANSI-compatible Winchester disks and four $\frac{1}{2}$ -inch formatted start/stop or streaming tape drives.
- * Automatic Dump and Restore commands.
- * Programmable for 8 or 16 bit systems.
- * DMA operation with 24 bit addressing.
- * Many programmable options including Bus Lock, Linked Commands, Interrupts and Retry Disable.
- * Flexible Format capability with Auto-interleave option.
- * Defect mapping with transparent alternate track selection.
- * Single or Multimaster environments.
- * Powerful Block Move capability with Search and Translate options.
- * Executes user-written 8089 programs.
- * Single 5VDC operation.

2.0 DEFINITION OF TERMS

This section defines the terms used during the detailed description of RIMFIRE 45 operation.

2.1 CHANNEL ATTENTION

A Channel Attention is an I/O Write to the Multibus address of the RIMFIRE 45 which is in the system I/O space. It is issued by the system CPU to initiate each RIMFIRE 45 activity. The I/O address may be set by the user via DIP switches on the board. Also selected is the width of the I/O address—8 bits for 8080, Z80 or similar systems, or 16 bits for 8086-type systems. A Channel Attention must never be issued while the RIMFIRE 45 is busy (i.e., Gate closed).

Since the least significant bit of the I/O address is not selectable, the RIMFIRE 45 occupies two addresses. The Channel Attention is defined as the even address. The odd I/O address is defined as the Software Reset. A write to this address resets the RIMFIRE 45 CPU (see sec. 4.1.1).

2.2 GATE

The Gate is a byte of data in the Channel Control Block in system memory. It controls all access to the use of the RIMFIRE 45 by system processors. It is opened (set to 00H) by the RIMFIRE 45 when it is not busy, and closed (set to FFH) by a processor using the RIMFIRE 45. A processor may only close the Gate when it has found the Gate open. In multiprocessing systems, the Gate should only be closed with a test-and-set type instruction.

2.3 POINTER

All system memory addresses passed to the RIMFIRE 45 through a Parameter Block must be in the form of a Pointer. Following the Intel 8086 convention, a Pointer consists of two 16 bit words which are combined by the RIMFIRE 45 to form a 20 bit system memory address. The word at the higher address, or Base, is left-shifted by four bits and added to the lower addressed word, or Offset, to obtain the 20-bit result. Refer to the Intel 8086 Family User's Manual for a more detailed discussion of Pointers.

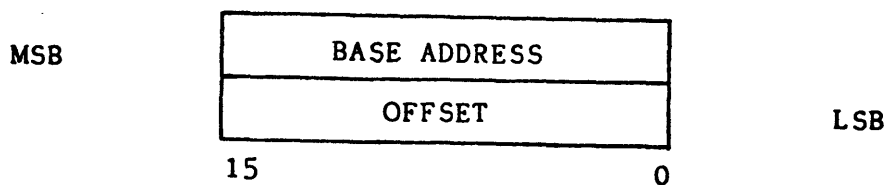

Figure 2-1. Pointer Value

To accommodate 24-bit addressing, the user may select one of 16 1 Mbyte pages. Refer to sec. 4.4 for details.

2.4 PARAMETER BLOCK

A Parameter Block is a short block of consecutively addressed data placed in system memory by a processor in preparation for command execution. The Parameter Block contains information the RIMFIRE 45 requires to perform the desired operation. The RIMFIRE 45 command always occupies the first byte of the Parameter Block, which is at the lowest-addressed location.

The Parameter Block is read by the RIMFIRE 45 into local memory when it begins execution, and is rewritten to system memory with appropriate updates just prior to opening the Gate.

3.0 DISK ORGANIZATION

Data is written on the disk in addressable blocks called Sectors. Each sector address is made up to three components which define a unique position on the disk: Cylinder, Head and Sector. Refer to Fig. 3-1.

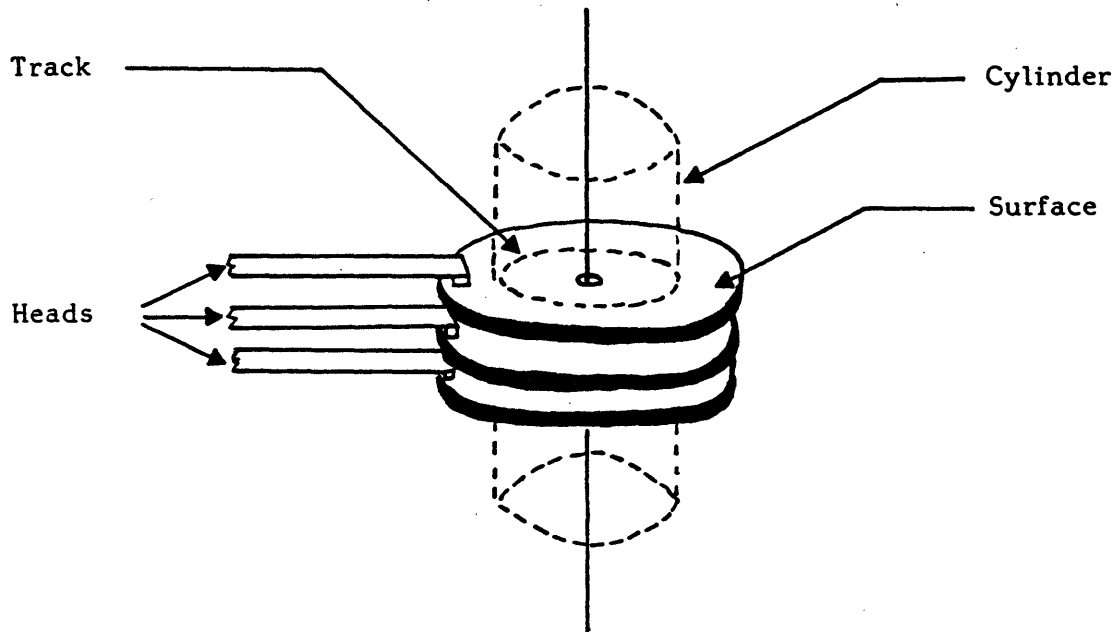

Fig. 3-1. Disk Organization

3.1 TRACK

A Track is one of a number of concentric data paths on a disk surface. If a disk surface has N tracks, they are numbered from 0 to N-1, with track 0 being that circular data path with the largest diameter, i.e., furthest from the center. A track is defined by a given cylinder number and head number.

3.2 CYLINDER

A cylinder is the set of all tracks with the same diameter, located on parallel surfaces. Cylinders are numbered in the same manner as tracks.

3.3 HEAD

The Head identifies which surface is to be addressed on a multiple surface disk, i.e., which track in a given cylinder. Heads are numbered starting with 0.

3.4 SECTOR

Sectors are addressable blocks of data on the disk. Sectors are numbered logically starting from 1 to N on each track. The first logical sector (sector 1) is always the first physical sector, identified by the occurrence of the Index pulse.

3.5 DISK FORMAT

The Disk Format used by the RIMFIRE 45 is shown in Fig. 3-2.

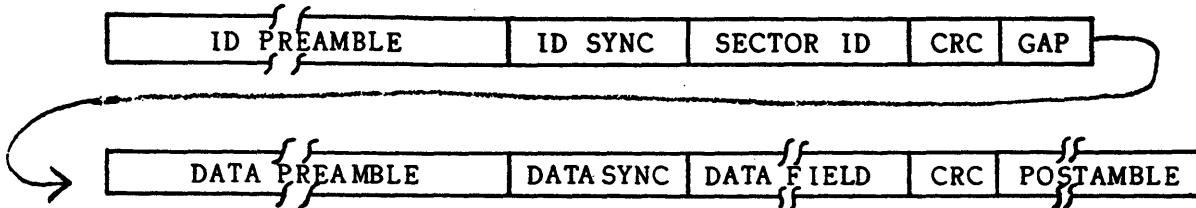

Fig. 3-2. Disk Format

The fields have the following lengths in bytes. Some of the fields vary depending on the drive used. Refer to Appendix G for information regarding specific disk drives.

<u>Field</u>	<u>Length</u>
ID Preamble	- Drive dependent
ID Sync Code (F9H)	- 1 byte
Sector ID	- 6 bytes
Cylinder Upper	
Cylinder Lower	
Sector Upper	
Sector Lower	
Track type	
Head	
CRC	- 2 bytes
Gap	- 2 bytes
Data Preamble	- Drive dependent
Data Sync Code (FDH)	- 1 byte
Data Field	- User selectable
Data CRC	- 2 bytes
Postamble	- Drive dependent

The Track Type byte in the sector ID may be one of three hex values.

- AA - Normal track
- C3 - Defective track
- 3C - Assigned alternate

4.0 FUNCTIONAL DESCRIPTION

This section contains a detailed description of the operation of the RIMFIRE 45.

Operation may be separated into 2 parts: Initialization and Command Execution. All operations are initiated with the issuance of a Channel Attention to the RIMFIRE 45.

4.1 INITIALIZATION

Initialization is the procedure through which the RIMFIRE 45 receives the definition of the system environment from the host. The RIMFIRE 45 always executes the Initialization procedure when it receives the first Channel Attention after a board reset (sec. 4.1.1).

After the Channel Attention, the RIMFIRE 45 initializes itself by reading information from three control blocks located in system memory. It is the responsibility of the system to correctly set up these control blocks prior to issuing the first Channel Attention.

The three control blocks are the System Configuration Pointer, the System Configuration Block and the Channel Control Block. The Initialization process is outlined in Fig. 4-1.

4.1.1 BOARD RESET

The RIMFIRE 45 board-level Reset may be executed through a system reset or software reset. A system reset occurs when the INIT/ line on the Multibus is activated (low) according to bus convention. A software reset occurs when a write to the higher (odd) I/O address of the RIMFIRE 45 is executed by a system processor. The two signals are logically "OR'd" together on the board.

4.1.2 SYSTEM CONFIGURATION POINTER

The 6-byte System Configuration Pointer may begin at any system memory address in the lower 1 Mbyte. The only restriction is that the least significant nibble of the address must be 6H (SCP address = 0XXXX6H). The remaining address bits are set via jumpers on the board.

After the first Channel Attention, the RIMFIRE 45 reads the first byte of the System Configuration Pointer (SYSBUS) to determine the width of the system bus (initially assumed to be 8 bits). A 00H indicates an 8-bit system bus, 01H a 16-bit bus. Byte 2 is not used. Bytes 3-6 comprise a Pointer to the next block, the System Configuration Block. Note that the bus width selected by SYSBUS is the width of the RIMFIRE 45-to-memory bus, and is independent from the system processor type. Most current memory modules will support 16-bit transfers, which would be the most efficient.

After adjusting for physical size, the RIMFIRE 45 continues to the System Configuration Block and reads that information.

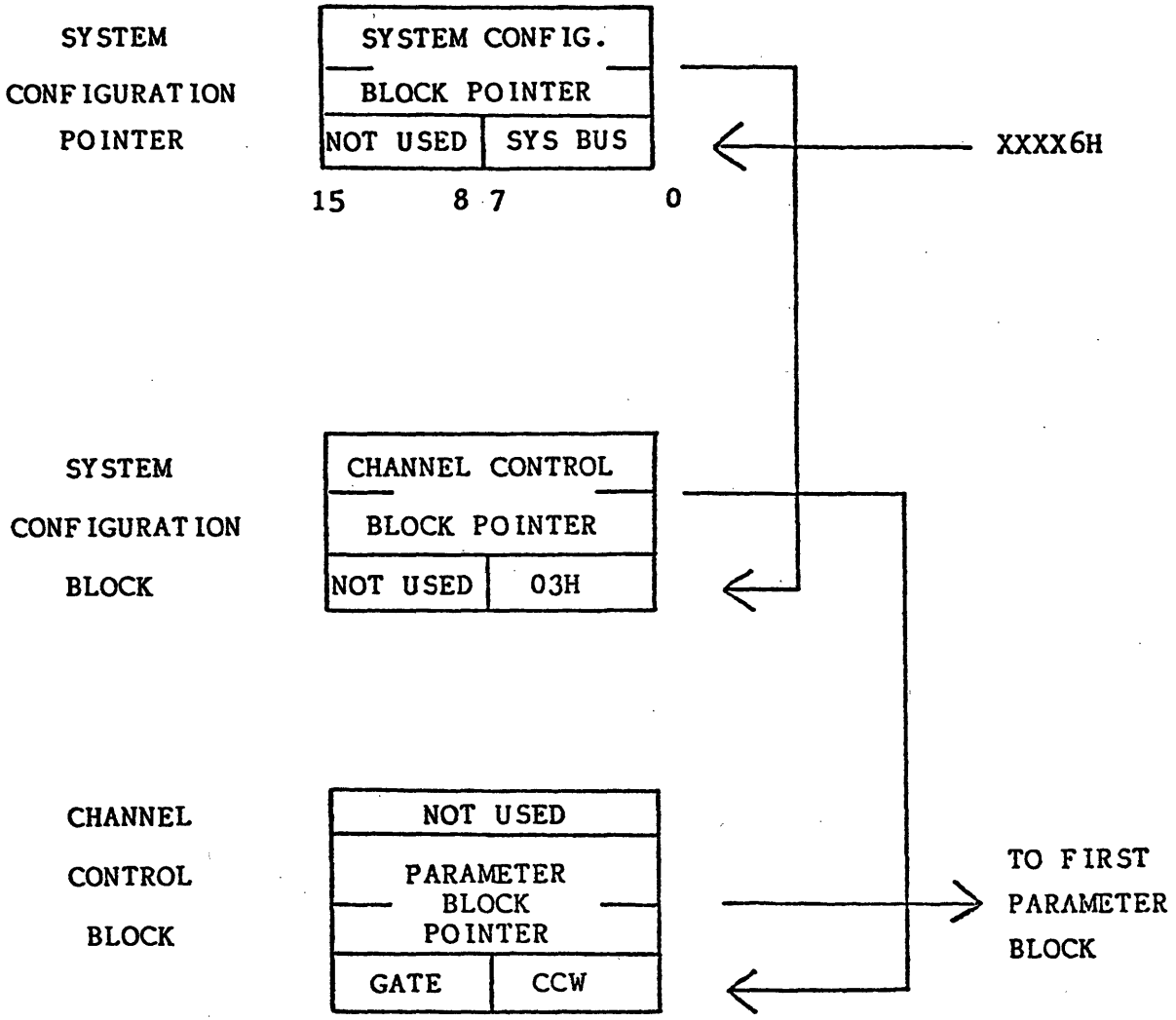

Fig. 4-1. Initialization Sequence

4.1.3 SYSTEM CONFIGURATION BLOCK

The 6 byte System Configuration Block contains one byte whose value is fixed, (03H), an unused byte, and a 4 byte pointer to the last Initialization Block, the Channel Control Block.

After picking up the pointer in this block, the RIMFIRE 45 continues to the last block.

4.1.4 CHANNEL CONTROL BLOCK

The Channel Control Block contains six bytes around which all RIMFIRE 45 operations revolve. Byte 1 is the Channel Control Word (CCW). For all RIMFIRE 45 commands, it must contain either 11H, for normal operation, or 09H, to clear an active non-vectored Multibus interrupt. The CCW may contain other values when executing user-written 8089 programs. Refer to section 4.3 and 4.5 for additional information on the CCW.

Byte 2 is the Gate, which the RIMFIRE 45 uses to signal its readiness to execute a command. Bytes 3-6 (Parameter Block Pointer) form a pointer to the location of the LSB of the first Parameter Block.

During the Initialization process, the only byte used in the Channel Control Block is the Gate. It must be set closed (set to FFH) prior to the Initialization process. When the Initialization process has been completed, the RIMFIRE 45 will open the Gate (set to 00H), indicating it is now ready to execute commands. The locations used for the System Configuration Pointer and System Configuration Block, if they are RAM-based, may now be re-used as required.

4.2 COMMAND EXECUTION

After the completion of the Initialization process, the RIMFIRE 45 is ready to accept commands, as it now "knows" the programmable locations of the Gate, and of the Parameter Block Pointer. A system processor wishing to execute a command may now do so through the following procedure:

- A. Set up the Parameter Block or Blocks in memory.
- B. Read the Gate location to determine when the RIMFIRE 45 is not busy. When the Gate is open (00), the system processor may take control by setting it closed (FFH). (NOTE: In a multi-processor system, a Test-and-Set type instruction must be used to close the Gate. This is necessary to prevent one processor from reading the Gate between the read and write of the Gate from a second processor).
- C. After closing the Gate, the user sets the pointer in the Channel Control Block to point at its first Parameter Block. It must also set the Channel Control Word, as required.
- D. Issue a Channel Attention to the RIMFIRE 45.

The RIMFIRE 45 will then execute the selected command with no additional system intervention. Upon completion of each command, the RIMFIRE 45 may go on to another Parameter Block, or halt with or without interrupt, depending upon options selected. When it halts, it will open the Gate to signal its readiness to accept another command.

4.3 INTERRUPTS

The RIMFIRE 45 may be programmed, through the CONTROL entry in the Parameter Block, to generate an interrupt at the completion of a command (last command only in a linked chain) or if an unrecoverable error occurs. (If such an error occurs during the execution of an intermediate command in a linked chain, the RIMFIRE 45 will search through the chain and act on the interrupt options of the last command).

Interrupts may be of two types--Non-vectorized Multibus, or Mailbox interrupts.

4.3.1 NON-VECTORED INTERRUPTS

Non-vectorized interrupts occur when the RIMFIRE 45 activates one of the eight Multibus interrupt lines. The interrupt will be asserted at the completion of the command or chain of commands for which an interrupt was enabled immediately prior to the opening of the Gate. The interrupt line will remain active (low level on the Multibus) until cleared.

The interrupt line may be cleared by setting the CCW to 09H and executing another RIMFIRE 45 command. The RIMFIRE 45 will clear the interrupt before it reads the Parameter Block. The Clear Interrupt command may be used here to avoid the time required for a normal Parameter Block sequence, since it requires only a 2-byte command code and halts immediately after clearing the interrupt.

4.3.2 MAILBOX INTERRUPTS

A Mailbox Interrupt occurs when the RIMFIRE 45 sets the contents of a memory location (mailbox) to FFH. The location of the mailbox is stored as a 4-byte pointer in the Interrupt/Link field in the Parameter Block.

4.4 PAGING

The RIMFIRE 45 supports 24 bit addressing through a paging technique. When data is to be transferred to or from system memory, the upper four Multibus address bits (ADB 20-23) are set in the Page register on the RIMFIRE 45 board. Thereafter all data operations of that command will take place within the selected 1 Mbyte page. These address bits are selected in the Page entry in the Parameter Block.

All Parameter Blocks and Initialization Blocks must reside in the lower 1 Mbyte.

4.5 USER 8089 PROGRAMS

The RIMFIRE 45 will execute user-written 8089 object code, either from system memory or from on-board RAM.

If execution is to begin in system memory, the starting system memory location should be placed as a 4-byte pointer, in place of the first four bytes of the Parameter Block. The remainder of the Parameter Block is not used. The CCW in the Channel Control Block must be set to 13H. A Channel Attention will begin execution.

If the user program is to be executed from on-board RAM, the Block Move should be used to move the code from system memory to RIMFIRE 45 RAM. This RAM occupies local addresses C000H to C800H. The starting local address of the user program should be placed in the first 2 bytes of the Parameter Block. The remainder of the Parameter Block is not used. The CCW should be set to 11H. A Channel Attention will begin execution.

5.0 DISK COMMAND EXECUTION

When a disk command is executed, the RIMFIRE 45 obtains the information it requires from the Parameter Block. Disk Read and Write commands, for example, require a starting disk address (cylinder, head and sector), a sector count and a starting system memory location. Some fields may or may not be used depending on the command.

5.1 DISK PARAMETER BLOCK

The Disk Parameter Block (Fig. 5-1) contains 22 bytes, divided into 11 fields. The Parameter Block Pointer must point to the least significant byte of the Parameter Block, i.e., byte 1 of the command field.

The various fields are described in the following sections. Also indicated is whether the field contains information required by the RIMFIRE 45 (Input), status return information from the RIMFIRE 45 (Output) or both (Input/Output). Not all fields are used by all commands.

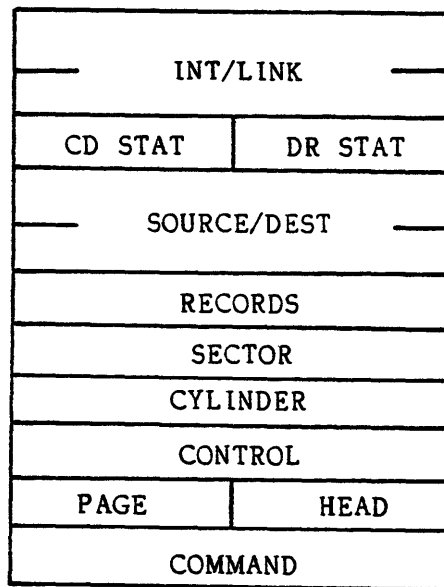

Fig. 5-1. Disk Parameter Block

5.1.1 COMMAND (Input)

The Command field contains 2 bytes. Refer to section 9 for the command list.

5.1.2 HEAD SELECT (Input/Output)

This field contains the starting head select for disk access commands. The RIMFIRE 45 will accommodate up to 256 heads.

5.1.3 PAGE ADDRESS (Input)

The lower nibble of this byte selects the 1 Mbyte page in which this command is to transfer data (ADB 20-23).

5.1.4 CONTROL (Input)

The CONTROL field (Fig. 5-2) contains various information used by the RIMFIRE 45 during the execution of disk commands.



Fig. 5-2. Disk Control Word

- DS - (Disk Select) selects one of eight possible drives.
- RD - (Retry Disable) disables all automatic retries when set to 1.
- M - (Mailbox Interrupt) selects non-vectored interrupts (0) or Mailbox interrupts (1) if the I bit is set.
- I - (Interrupt) causes the RIMFIRE 45 to interrupt on completion of a command or chain of commands.
- L - (Link) informs the RIMFIRE 45 that another Parameter Block follows. The Link and Interrupt options are mutually exclusive, since each uses the Source/Destination field. The Link option takes priority.
- BL - (Bus Lock) causes the RIMFIRE 45 to lock the system bus (1) during DMA transfers to or from system memory.
- A - (Auto-interleave) is used only during a Format or Map Defect command. When set, the RIMFIRE 45 will calculate the logical sector numbering order. Otherwise the user must provide the logical sector order. This bit is also used in conjunction with the Interleave Table bit (see below).

IT - (Interleave Table) is used only during a Format command in combination with the Auto-interleave option. It allows the user to examine the calculated sector numbering table without actually formatting. The A and IT bits have the following significance during Format:

<u>IT</u>	<u>A</u>	<u>Result during Format</u>
X	0	Format disk, user supplies sector numbering order starting at the S/D address.
0	1	Format disk, RIMFIRE 45 calculates sector numbering order based on Interleave value in Records field.
1	1	Bypass Format, but return the calculated sector numbering table, starting at the Source/Destination address.

P - (Protect) may be used to override the automatic alternate track selection feature of the RIMFIRE 45. When set(1), a Disk Read from or Write to a track which has been mapped out as defective will be allowed. No access to the alternate track will be made. This bit also allows a direct access to a track which has been assigned as an alternate, which would otherwise result in an error.

W - (Width) selects the logical width of the system bus. "1" indicates 16 bits, "0" indicates 8 bits. Normally this bit would match the bus width selected during Initialization (SYSBUS). However, it may be used to force byte transfers on a 16-bit bus. A logical width of 16 bits may not be selected if the physical width is 8 bits.

5.1.5 CYLINDER (Input/Output)

This field specifies the starting cylinder for disk access commands.

5.1.6 SECTOR (Input/Output)

This field specifies the starting logical sector number for disk access commands, where applicable.

5.1.7 RECORDS (Input/Output)

This field specifies the number of sectors to be transferred for a disk Read or Write command. It will also return Sense Byte 1 and 2 for a Disk Status command. See section 5.2 for an explanation of these bits.

5.1.8 SOURCE/DESTINATION (Input)

This 4-byte pointer specifies the starting system memory address for data transfer commands.

5.1.9 DISK DRIVE STATUS (Output)

The disk drive General Status byte is returned in this field at the completion of the command (Fig. 5-3). Refer to the appropriate disk user's manual for a detailed explanation of these bits.

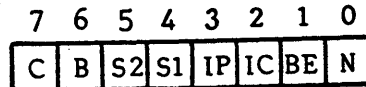

Fig. 5-3. Disk Drive General Status

- N - Not Ready
- BE - Control Bus Error
- IC - Illegal Command
- IP - Illegal Parameter
- S1 - Sense Byte 1 Active
- S2 - Sense Byte 2 Active
- B - Busy
- C - Normal Completion

5.1.10 COMMAND STATUS (Output)

These bits reflect the status of the command. (Fig. 5-4).

- E - (Entered) The Parameter Block has been entered by the RIMFIRE 45 and execution has begun.
- C - (Complete) The RIMFIRE 45 has successfully completed the command as outlined in this Parameter Block.
- ERROR - This 6-bit field specifies an error code when a non-recoverable error is encountered. Error codes are listed in Appendix C.

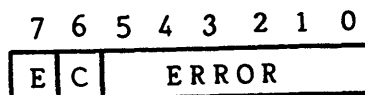

Fig. 5-4. Command Status Field

5.1.11 INTERRUPT/LINK (Input)

The Interrupt/Link field is a 4-byte pointer which points to the next Parameter Block if the Link is set, or the Mailbox Interrupt location if the Interrupt and Mailbox bits are set. Otherwise it is ignored.

5.2 COMPLETION STATUS

When a disk command has completed, the RIMFIRE 45 will update the Parameter Block as required. If the command was a Read or Write, the disk address (cylinder, head and sector) will represent the last sector successfully transferred, plus 1. This facilitates reusing the Parameter Block for sequential operations.

The Records field will be updated for Read and Write commands to reflect the number of sectors which have not yet been transferred. This value will be 0 if the command terminates properly. If a non-recoverable error occurs, this field will help determine the location of the error. This field will return the two Sense Status bytes for a Disk Status command. (Fig. 5-5). Refer to the appropriate disk drive user's manual for a detailed explanation of these bits.

The Command Status and General Status bits will be updated for all disk commands.

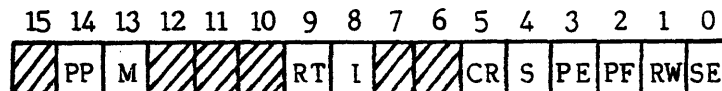

Fig. 5-5. Disk Sense Bytes

- SE - Seek Error
- RW - Read/Write Fault
- PF - Power Fault
- PE - Read/Write Permit Error
- S - Speed Error
- CR - Command Reject
- I - Initial State
- RT - Ready Transition
- M - Attribute Table Modified
- PP - Positioned within Write Protected area

6.0 TAPE COMMAND EXECUTION

Tape commands generally begin a tape operation at the current location of the tape with respect to the read/write head of the drive. An Erase Tape command, for example, will erase the tape from the current location to the EOT marker.

The RIMFIRE 45 will assure that the tape is located in one of three places depending on the tape command: Load Point, EOT or (most commonly) in the inter-record gap (IRG) between records.

6.1 TAPE PARAMETER BLOCK

The Tape Parameter Block (Fig. 6-1) contains 22 bytes, divided into 11 fields.

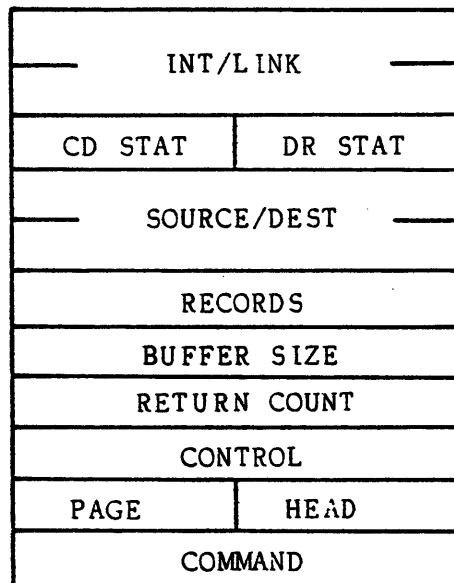

Fig. 6-1. Tape Parameter Block

6.1.1 COMMAND (Input)

The Command field contains 2 bytes. Refer to section 8 for the command list.

6.1.2 RESERVED

This field is not used for tape operation.

6.1.3 PAGE ADDRESS (Input)

The lower nibble of this byte selects the 1 Mbyte page in which this command is to transfer data (ADB 20-23).

6.1.4 CONTROL (Input)

The Control field (Fig. 6-2) contains various information used by the RIMFIRE 45 during operation.

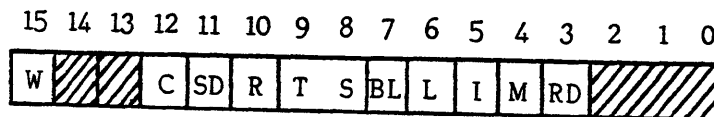

Fig. 6-2. Control Word

- RD - (Retry Disable) disables all automatic retries when set to 1.
- M - (Mailbox Interrupts) selects non-vectored interrupts (0) or Mailbox interrupts (1), if the I bit is set.
- I - (Interrupts) causes the RIMFIRE 45 to interrupt on completion (1).
- L - (Link) informs the RIMFIRE 45 that another Parameter Block follows. The Link and Interrupt options are mutually exclusive, since each uses the Source/Destination field. The Link option takes priority.
- BL - (Bus Lock) locks the system bus (1) during DMA transfers.
- TS - (Tape Select) selects one of four tape drives.
- R - (Reverse) indicates the operation should proceed in the reverse direction, where applicable.
- SD - (Speed/Density) selects high speed (1) or low speed on dual speed drives such as the Cipher Microstreamer. On remote-selectable dual density drives, this bit selects low density (1) or high density (0).

C - (Continuous) causes the tape to be left moving after a write operation (if the drive supports this feature), effectively extending the acceptable reinstruct window.

W - (Width) selects the logical width of the system bus. "1" indicates 16 bits, "0" indicates 8 bits. This bit may be used to force byte transfers on a 16-bit bus. The logical width must not exceed the physical width selected during Initialization.

6.1.5 RETURN COUNT (Output)

The RIMFIRE 45 uses this field to return the number of bytes actually transferred during a read, write or edit operation. If the command terminates successfully, this field will be the same as the Buffer Size field.

6.1.6 BUFFER SIZE (Input)

This field indicates the block size of the tape block to be read or written. Maximum block size is 65K bytes (FFFFH).

6.1.7 RECORDS (Input)

This field is used as input for commands which require a record count, such as the Space command. Otherwise it is not used.

6.1.8 SOURCE/DESTINATION (Input)

This 4-byte pointer specifies the starting system memory address for transfer operations.

6.1.9 DRIVE STATUS (Output)

These bits reflect the status of the drive at the completion of the command (Fig. 6-3).

- P - (Write Protect) The tape does not have a write enable ring.
- FB - (Formatter Busy) The Formatter is busy.
- R - (Ready) The selected drive is ready.
- EOT - (End of Tape) The EOT marker was detected.
- LP - (Load Point) The tape is at load point.
- OL - (On Line) The drive is On Line.
- FM - (Filemark) A Filemark was detected on this operation.

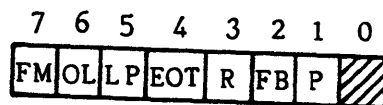

Fig. 6-3. Tape Drive Status

6.1.10 COMMAND STATUS (Output)

These bits reflect the status of the command. (Fig. 6-4).

- E - (Entered) The Parameter Block has been entered by the RIMFIRE 45 and execution has begun.
- C - (Complete) The RIMFIRE 45 has successfully completed the command as outlined in this Parameter Block.
- ERROR - This 6-bit field specifies an error code when a non-recoverable error is encountered. Error codes are listed in Appendix C.

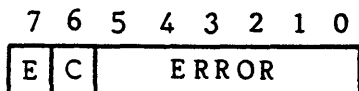

Fig. 6-4. Command Status Field

6.1.11 INTERRUPT/LINK (Input)

The Interrupt/Link field is a 4-byte pointer which points to the next Parameter Block if the Link is set, or the Mailbox Interrupt location if the Interrupt and Mailbox bits are set. Otherwise it is ignored.

6.2 COMPLETION STATUS

The Return Count and Records fields will be updated at the completion of a tape command. Tape Status and Command Status will also be reported. Tape Status represents the condition of the drive immediately at the completion of the command.

7.0 BLOCK MOVE EXECUTION

The RIMFIRE 45 can execute a Block Move, or memory-to-memory DMA operation, with many powerful options. The Parameter Block supplies the Source Address and Destination Address, either or both of which may be Local (on the RIMFIRE 45 board) or system memory. The byte count and options are also selected in the Parameter Block.

7.1 BLOCK MOVE PARAMETER BLOCK

The Block Move Parameter Block (Fig. 7-1) contains 26 bytes, divided into 8 fields.

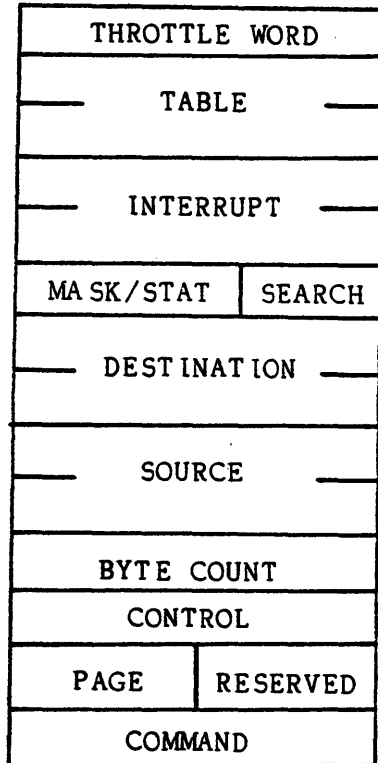

Fig. 7-1. Block Move Parameter Block

7.1.1 COMMAND (Input)

The Command field contains the Block Move command, 80H.

7.1.2 RESERVED

This field is not used for the Block Move command.

7.1.2 PAGE ADDRESS (Input)

The lower nibble of this byte selects the 1 Mbyte page in which data is to be transferred (ADB 20-23). This applies to system memory addresses only.

7.1.4 CONTROL (Input)

The Control field (Fig. 7-2) contains various information used by the RIMFIRE 45 during a Block Move.

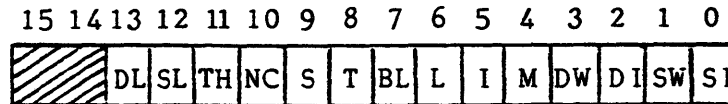

Fig. 7-2.

- SI - (Source I/O) specifies that the source address of the Block Move increments after each transaction (0) or remain constant (1).
- SW - (Source Width) specifies the logical width of the source as 8 bits (0) or 16 bits (1). The logical bus width cannot exceed the physical bus width as specified during Initialization.
- DI - (Destination I/O) same as SI for the destination address.
- DW - (Destination Width) same as SW for the destination address.
- M, I, L and BL are the same as for the tape or disk.
- T - (Translate) selects (1) the translate option. This causes each byte from the source to be translated from a look-up table before being moved to the destination. When this option is selected, all transfers must be 8 bits.
- S - (Search) causes (1) the RIMFIRE 45 to check each byte against a Search Byte during transfer, and stop on a compare (or non-compare). Before the compare is made, each byte is first masked with a Mask Byte, so that only desired bits are checked. When this option is selected, all transfers must be 8 bits.

NC - (Non-Compare) causes (1) a Search operation to stop when a non-compare is encountered. If it is not set, a Search operation will stop on compare.

TH - (Throttle) causes (1) the RIMFIRE 45 to inject a delay between each byte or word transferred. The length of the delay is specified in the Parameter Block. This option is used to prevent the RIMFIRE 45 from monopolizing the bus during a non-critical operation.

SL - (Source Local) indicates (1) that the source is a 16 bit Local address, i.e., on the RIMFIRE 45 board, or a 20 bit system memory address (0) specified as a 4-byte pointer.

DL - (Destination Local) indicates (1) that the destination address is a 16 bit Local address, i.e., on the RIMFIRE 45 board, or a 20 bit system memory address (0) specified as a 4-byte pointer.

7.1.5 BYTE COUNT (Input/Output)

This field specifies the number of bytes to be transferred. If a Search is active, the Block Move will terminate on a compare, if that occurs before all bytes have been transferred. This field will contain the number of bytes remaining at the completion of the command, normally zero.

7.1.6 SOURCE (Input)

This field contains a 4-byte pointer to the starting local or system location from which data is to be moved (2 bytes only if the Source cal).

7.1.7 DESTINATION (Input)

This field contains a 4-byte pointer to the starting local or system memory location to which data is to be moved (2 bytes only if the destination is local).

7.1.8 SEARCH (Input)

This field contains the compare byte used during Search operations.

7.1.9 MASK/STAT (Input/Output)

This field serves a dual purpose. At the start of the command it contains an 8-bit value to which each byte is masked before being compared, during a Search operation. After completion of the command, this byte contains status information as shown in Fig. 7-3.

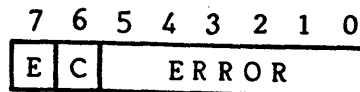

Fig. 7-3. Block Move Status

The E, C and ERROR fields are the same as for the tape or disk except that a code of 20H indicates that a match was found during a Search.

7.1.10 INTERRUPT (Input)

The Interrupt field specifies the location of the Mailbox Interrupt, if enabled.

7.1.11 TABLE (Input)

This 4-byte pointer specifies the starting system memory address of a 256-byte look-up table. If the Translate option is selected during a Block Move, each source byte is used as an index into this table. The entry at that location is then moved to the destination.

7.1.12 THROTTLE WORD (Input)

If the Throttle bit is set in the Control Word, the RIMFIRE 45 uses this entry to determine the length of delay between each byte or word transferred. This 16-bit number is counted down to 0000 before each transfer, at the rate of about 100 micro-seconds per count.

7.2 COMPLETION STATUS

Besides the Mask/Status field, the only other field to be updated is the Byte Count field. At the end of the command, this field will contain the number of bytes to be transferred. After a successful command completion, this field will be 0.

8.0 DUMP/RESTORE EXECUTION

The Dump and Restore commands obtain a starting and ending disk address (cylinder, head and sector) from the Parameter Block, and transfer data between the disk and tape until all sectors have been moved. The data is divided into blocks of selectable size, and system memory is used to buffer each block.

8.1 DUMP/RESTORE PARAMETER BLOCK

The Dump and Restore Parameter Blocks are identical except for the Command field, and contain 30 bytes in 13 fields (Fig. 8-1).

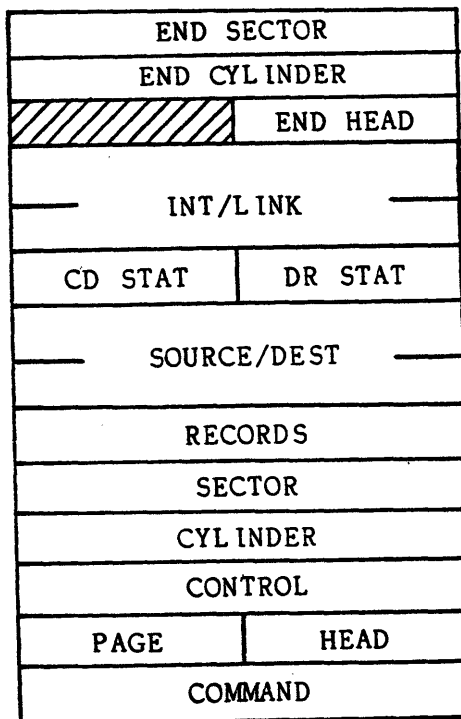

Fig. 8-1. Dump/Restore Parameter Block

8.1.1 COMMAND (Input)

This field contains either the Dump (54H) or Restore (58H) command code.

8.1.2 HEAD SELECT (Input/Output)

This field contains the head select at which the Dump or Restore is to begin.

8.1.3 PAGE ADDRESS (Input)

The lower nibble of this byte selects the 1 Mbyte page in which the system memory buffer is located.

8.1.4 CONTROL (Input)

The Control field (Fig. 8-2) contains various information used by the RIM-FIRE 45 during the execution of Dump and Restore commands.

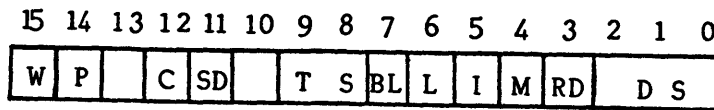

Fig. 8-2. Dump/Restore Control Word

- DS - (Disk Select) selects one of eight disk drives.
- RD - (Retry Disable) disables all automatic tape and disk retries when set to 1.
- M - (Mailbox Interrupts) selects non-vectorized interrupts (0) or Mailbox interrupts (1) if the I bit is set.
- I - (Interrupt) causes the RIMFIRE 45 to interrupt on completion of a command or chain of commands.
- L - (Link) informs the RIMFIRE 45 that another Parameter Block follows. The Link and Interrupt options are mutually exclusive, since each uses the Source/Destination field. The Link option takes priority.
- BL - (Bus Lock) causes the RIMFIRE 45 to lock the system bus (1) during DMA transfers to or from system memory.
- TS - (Tape Select) selects one of four tape drives.
- SD - (Speed/Density) select high speed (1) or low speed on dual speed drives such as the Cipher Microstreamer. On remote-selectable dual density drives, this bit selects low density (1) or high density (0).
- C - (Continuous) causes the tape to be left moving after a write operation (if the drive supports this feature), effectively extending the acceptable reinstruct window.
- P - (Protect) overrides the automatic alternate track selection feature of the RIMFIRE 45. When set (1), a disk access to a track which has been mapped out as defective will attempt to access that track. No seek will be made to an alternate track.
- W - (Width) selects the logical width of the system bus. "1" indicates 16 bits, "0" indicates 8 bits. This bit may be used to force byte transfers on a 16-bit bus. The logical width must not exceed the physical width selected during Initialization.

8.1.5 CYLINDER (Input/Output)

This field specifies the starting cylinder at which the Dump or Restore is to begin.

8.1.6 SECTOR (Input/Output)

This field specifies the starting logical sector number at which the Dump or Restore is to begin.

8.1.7 RECORDS (Input/Output)

This field specifies the system memory buffer size, in sectors, to be used for the Dump or Restore. The block size in bytes that is written to or read from the tape is this number multiplied by the bytes per sector. This byte count cannot exceed 65K (FFFFH).

8.1.8 SOURCE/DESTINATION (Input)

This 4-byte pointer specifies the starting address of the system memory buffer.

8.1.9 DRIVE STATUS (Output)

At the completion of the Dump or Restore, this field will contain the disk drive status (Sec. 5.1.9) if the command terminates successfully, or if a disk error occurs. If a tape error occurs, this field will return the tape drive status (Sec. 6.1.9).

8.1.10 COMMAND STATUS (Output)

These bits reflect the status of the command. (Fig. 8-4).

- E - (Entered) The Parameter Block has been entered by the RIMFIRE 45 and execution has begun.
- C - (Complete) The RIMFIRE 45 has successfully completed the command as outlined in this Parameter Block.
- ERROR - This 6-bit field specifies an error code when a non-recoverable error is encountered. Error codes are listed in Appendix C.

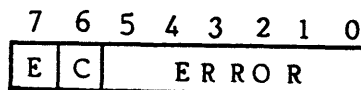

Fig. 8-4. Command Status Field

8.1.11 INTERRUPT/LINK (Input)

The Interrupt/Link field is a 4-byte pointer which points to the next Parameter Block if the Link is set, or the Mailbox Interrupt location if the Interrupt and Mailbox bits are set. Otherwise it is ignored.

8.1.12 END HEAD (Input)

This field specifies the head select of the last logical sector to be transferred.

8.1.13 END CYLINDER (Input)

This field specifies the cylinder number of the last logical sector to be transferred.

8.1.14 END SECTOR (Input)

This field specifies the number of the last logical sector to be transferred.

8.2 COMPLETION

The Dump/Restore Parameter Block will be updated at the completion of the command to contain the disk address (cylinder, head and sector) of the last logical sector to have been transferred successfully, plus 1.

9.0 RIMFIRE 45 COMMANDS

The RIMFIRE 45 executes 31 commands in six categories. Refer to sections 5,6 and 7 for a description of the contents and significance of the Parameter Block fields. The Command Code (in hex) follows each command. The Configure command (00H) must be the first command executed, or an error will result.

9.1 DISK DRIVE CONTROL

These commands transfer control and status information between the RIMFIRE 45 and the disk drives, and perform other non-data functions such as positioning or status.

9.1.1 CONFIGURE (00)

This command initializes the RIMFIRE 45 and allows it to process all other commands. In addition, the controller executes a short on-board diagnostic. A 64-byte Disk Record, whose location is specified by the Source/Destination pointer, is read from system memory during this command. The form of the Disk Record is shown in Fig. 9-1.

The Disk Record entries are hex numbers and have the following significance:

- Heads/Cylinder - The highest numbered head select, starting with 0. An entry of 02H indicates 3 heads per cylinder.
- Drive Type - This byte indicates the disk drive type. Refer to Appendix G for a listing of drive types.
- Sectors/Track - The highest numbered sector on a track, starting with 1. An entry of 0042H indicates 42H sectors per track (66 decimal).
- Cylinders/Disk - The highest numbered cylinder. An entry of 022FH indicates 230H cylinders per disk (560 decimal).
- Bytes/Sector - The number of data bytes in one sector. An entry of 0100H indicates 256 (decimal) bytes per sector.

The user must form the Disk Record prior to the execution of the Configure command. The Disk Record allows for 8 disks, each disk requiring 8 bytes. The entire Disk Record must occupy real memory locations, although only those entries which correspond to physical drives need contain meaningful data.

The Disk Record is stored by the RIMFIRE 45 in its own memory. Whenever a subsequent disk command is executed, the RIMFIRE 45 examines the Disk Select bits in the Parameter Block of that command, and selects the corresponding disk parameters from its copy of the Disk Record. In this way the RIMFIRE 45 can support up to 8 disks with completely different characteristics and formatting.

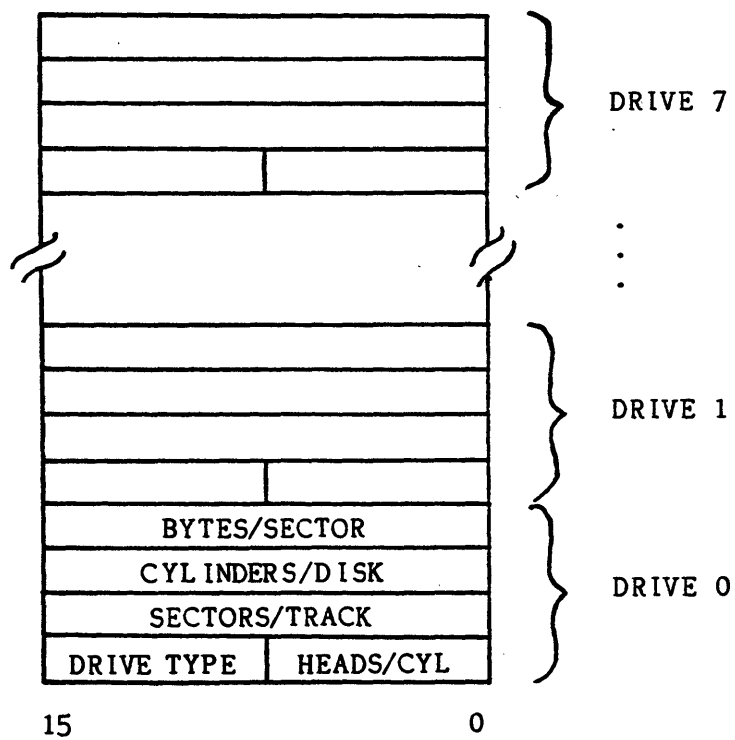

Fig. 9-1. Disk Record

9.1.2 DISK DRIVE STATUS (04)

This command returns three bytes of disk status information. The first byte, returned with all disk commands, is the General Status byte as described in section of 5.1.9. Sense Byte 1 is returned in the lower byte of the Records field, and Sense Byte 2 is returned in the upper byte. These bytes are shown in Fig. 5-5.

9.1.3 LOAD (18)

This command issues a "Spin-up" directive to the drive if required to start rotation.

9.1.4 UNLOAD (1C)

This command issues a seek to track 0 and a "Spin-down" directive if required to stop rotation.

9.1.5 DISK RESET (6C)

This command issues a Reset directive to the disk drive.

9.1.6 SEEK (78)

This command selects the head specified in the Parameter Block, and then initiates a Seek operation to the specified track. This command is used to overlap Seek operations.

9.1.7 READ ID (7C)

This command reads the 6-byte ID of the first sector encountered on the current head and cylinder. Note that no Seek is implied, and the head and cylinder entries in the Parameter Block are ignored.

9.1.8 INTERROGATE (88)

This command is used to read a portion or all of the Attribute Table of the disk drive. The RIMFIRE 45 will read attributes from the specified starting to ending attribute number. The command will terminate when all desired attributes are read, or if the drive does not support the attribute requested. In such cases the RIMFIRE 45 will return an "Illegal Command" error code.

The attributes read by the RIMFIRE 45 are placed in system memory starting at the Source/Destination address. Starting and ending attribute numbers are specified in the Records field as shown in Fig. 9-2.

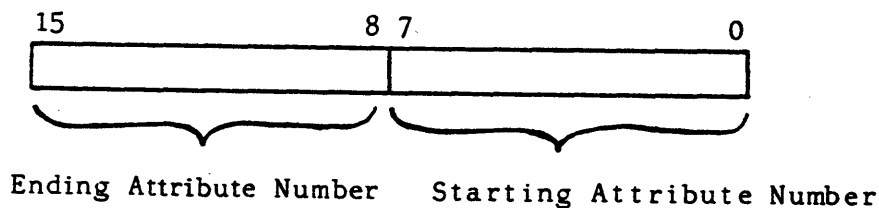

Fig. 9-2. Records Field for Interrogate Command.

9.1.9 TEST DISK I/F (8C)

This command tests the RIMFIRE 45-to-disk interface, by writing a byte to the drive and then reading it back. The user selects the byte to be written by placing it in the lower byte of the Records field. The RIMFIRE 45 will return the byte read in the upper byte of the Records field. The user may then compare the two bytes.

9.1.10 READ/WRITE PERMIT (98)

This command will examine the Records field bit by bit starting with bit 0 and executes the function corresponding to the first bit set for the designated drive.

<u>Bit</u>	<u>Function</u>
0	Write enable the drive.
1	Write disable the drive.
2	Load write permit.
3	Load read permit.
4	Report Write permit.
5	Report Read permit.

The cylinder address for loading and reporting read and write permit will be passed in the cylinder location in the Parameter Block.

9.1.11 DISK MICRO (A4)

This command may be used to execute any current or future ANSI disk command. The desired command code is specified in the lower byte of the Records field. If the command requires a parameter to be sent, it is specified in the upper byte of the Records field. If the command returns a parameter, it will be returned in this location.

9.1.12 REZERO (AB)

This command issues a Seek to track 0.

9.2 TAPE DRIVE CONTROL

These commands transfer control and status information between the RIM-FIRE 45 and the tape drives and perform other non-data functions such as positioning or status.

9.2.1 TAPE STATUS (28)

The status of the selected drive is returned in the Drive Status byte.

9.2.2 REWIND (34)

The tape is rewound to load point.

9.2.3 OFFLINE/UNLOAD (38)

This command causes the drive to go offline. For the Cipher Data Microstreamer, it also causes the tape to be rewound and unloaded.

9.2.4 WRITE FILEMARK (40)

A filemark and gap are written on the tape.

9.2.5 SEARCH FILEMARK (44)

This command searches, forward or reverse, until a filemark is found. Search Filemark also terminates with an EOT (forward) or Load Point (reverse).

9.2.6 SPACE (48)

This command spaces, forward or reverse, a specified number of data records. A filemark is counted as a record. The desired number of records is specified in the Records field.

9.2.7 ERASE (4C)

A fixed length (approximately 3.5 inches) is erased for each record specified in the Records field.

9.2.8 ERASE TAPE (50)

This command erases the entire tape from current position to several feet beyond the EOT.

9.2.9 SPACE FILEMARK (70)

This command is similar to Space except that it terminates early if a filemark is encountered before all the records are spaced over.

9.2.10 DRIVE RESET (90)

This command resets the Formatter Enable. It may be used to abort a runaway tape condition.

9.2.11 SEARCH MULTIPLE FILEMARK (94)

This command is similar to a Search Filemark except that it proceeds until a specified number of consecutively written filemarks are located. This command is very useful when using double or triple filemarks as file separators. The number of filemarks, up to 255, is specified in the Records field LSB.

9.3 DISK DATA TRANSFER

These commands transfer data between system memory and the selected disk.

9.3.1 DISK READ (10)

This command transfers one or more sectors of data from the disk to system memory. The first sector transferred is the logical sector specified by the Cylinder, Head and Sector entries in the Parameter Block. Thereafter sectors are transferred in logical order, with ascending sector number, head select and cylinder respectively. A multiple sector transfer may cross head and cylinder boundaries. The number of sectors to be transferred is specified in the Records entry. The starting system memory location is specified as a pointer in the Source/Destination field.

9.3.2 DISK WRITE (14)

This command transfers one or more sectors of data from system memory to the disk. The first sector transferred is the logical sector specified by the Cylinder, Head and Sector entries in the Parameter Block. thereafter sectors are transferred in logical order, with ascending sector number, head select and cylinder respectively. A multiple sector transfer may cross head and cylinder boundaries. The number of sectors to be transferred is specified in the Records entry. The starting system memory location is specified as a pointer in the Source/Destination field.

9.3.3 FORMAT (24)

This command formats the disk. The format variables (i.e., bytes/sector, cylinders/disk) are supplied during a previously executed Configure command. The Format starts at the track and head as specified in the Parameter Block, and continues to the programmable end of the disk. Note that the programmable end of the disk is defined by the Configure command, and need not be the physical end. This allows portions of the disk to be formatted with different sector sizes if desired.

The RIMFIRE 45 requires that the user select the type of inter-leaving, i.e., the order in which the physical sectors are assigned logical numbers. One of two interleave options may be chosen, Auto-interleave or user-supplied. If the Auto-interleave bit in the Control Word is set during the Format, the RIMFIRE 45 will assign the logical sector numbers based on the selected interleave schedule. This interleave number must be entered in the Records field. This option is limited to disks having 255 sectors or less per track.

If the Auto-interleave bit is not set, the RIMFIRE 45 will read the sector numbering table from system memory, starting at the address specified in the Source/Destination field. The user must create this table, and insure that it contains an entry for each sector and that no numbers are skipped. Each entry in the sector numbering table is a byte for disks with 255 or less sectors per track, and a word (16 bits) for those disks with 256 sectors per track or more.

The Format command may also be used to examine the interleave table created by the RIMFIRE 45 without actually formatting any tracks. See section 5.1.4 for details.

Refer to the RIMFIRE 45 Application Note for Format examples.

9.3.4 MAP DEFECT (84)

This command is used to inform the RIMFIRE 45 that the track specified in the Parameter Block has a defect and should be mapped out. The RIMFIRE 45 will mark the track as defective by reformatting the track with the Defective Track ID (sec. 3.5). An alternate track is assigned from the end of the disk, i.e., the highest numbered cylinder and head combination which has not been used as an alternate. This track is also reformatted with the Alternate Track ID (sec. 3.5).

When a defective track is accessed during normal operation, the RIMFIRE 45 will automatically access the alternate track, transparent to the user. The cylinder and head of the alternate track are contained in all ID's of the defective track.

Alternate track selection may be overridden by setting the "P" bit in the Control Word for Disk Read or Write commands.

9.4 TAPE DATA TRANSFER COMMANDS

Tape Data Transfer commands transfer data from the tape to system memory (read) or from system memory to the tape (write, edit). The desired block size, in bytes, is contained in the Buffer Size entry. The starting system memory address is contained in the Source/Destination entry.

When the RIMFIRE 45 has completed the operation, the number of bytes actually transferred is returned in Return Count. For successful operations, this will match the Buffer Size.

9.4.1 TAPE READ (2C)

This commands transfers a single data block from the tape to system memory. The system must accept data at an average rate equal to or greater than that of the drive. Maximum block size is 65K bytes.

9.4.2 TAPE WRITE (30)

This command transfers a single block from system memory to the tape. The system must supply data at an average rate equal to or greater than that of the drive. Maximum block size is 65K bytes.

9.4.3 TAPE EDIT (3C)

This command edits the record immediately preceeding the current position of the read/write head. Maximum block size is 65K bytes.

9.5 COMBINATION COMMANDS

These two commands transfer data between the disk and the tape, using system memory as a buffer.

9.5.1 DUMP (54)

This command transfers sectors of data from the disk to the tape, using the starting and ending disk locations in the Parameter Block. The transfer is accomplished in a series of two-step procedures. First, the specified number of sectors are read from the disk and stored in system memory starting at the Source/Destination location. Next, this data is written to the tape as a single block, which cannot exceed 65K bytes. These steps are repeated until the ending sector has been transferred, or until an unrecoverable error is detected. If an EOT is encountered, the tape will be rewound to Load Point, and the Parameter Block updated to point to the next sector to be read. This allows the Dump procedure to be continued when a new tape has been loaded, simply by issuing a Channel Attention.

When a non-recoverable error occurs, the Parameter Block will always contain the disk address (cylinder, head and sector) of the last sector successfully transferred plus 1. This allows the dump operation to continue from the correct point when the error is eliminated.

9.5.2 RESTORE (58)

This command transfers data from the tape to the disk, using the starting and ending disk locations in the Parameter Block. The transfer is accomplished in the reverse process as the Dump. A data block is read from the tape to system memory, then divided into sectors and written to the disk. These steps are repeated until the ending sector has been transferred, or until a non-recoverable error occurs.

The Restore must use the same parameters and disk format as did the associated Dump command. Interleaving need not be the same.

9.6 SPECIALS

These commands do not involve the tape or disk, any may be executed with the drives unconnected.

9.6.1 NOP/ID (20)

This command executes the mechanics of normal Parameter Block operation, and returns the RIMFIRE 45 Board ID (30H) in place of the General Status byte in the Parameter Block.

9.6.2 DIAGNOSTIC (5C)

This command executes a controller diagnostic.

9.6.3 BLOCK MOVE (80)

This command moves data, up to 65K bytes, between two memory locations. Either location may be local (on the RIMFIRE 45 board) or system memory, and may be constant or incrementing.

Several operations may be performed on the data during the move, as outlined in Sec. 7.1.4.

The Block Move provides a powerful tool for any Multibus system. Some example usages are:

- * Extended Memory--Since the RIMFIRE 45 can address 16M bytes (24 address bits), it can be used in conjunction with a compatible memory board to provide access to memory not normally accessible to system processors.
- * User 8089 programs--The Block Move may be used to download a user-written 8089 program from system memory to RIMFIRE 45 RAM for execution. (See Sec. 3.6).

9.6.4 CLEAR INT (9C)

This command requires no Parameter Block except for the 2-byte command field. It will immediately halt after clearing an active interrupt, if the CCW Word in the Channel Control Block has been set to 09H. This command is a useful tool to quickly remove an active interrupt without the time involved in a full Parameter Block command.

APPENDICES

APPENDIX A - SPECIFICATIONS

Physical: Height 6.75 in.
Length 12.00 in.

Electrical: Voltage +5v +5%
Current

		<u>Typ</u>	<u>Max</u>
	RIMFIRE 45	2.5	3.5
	RIMFIRE 45D	2.0	3.0

Capacity: 8 disk drives
4 tape drives

Transfer Rate: Tape - Tape speed to 675 Kbps (8 bit system)
1.25 Mbps (16bit system)

Disk - Disk interface to 1.25 Mbps
Multibus interface to 675 Kbps (8 bit system)
to 1.25 Mbps (16 bit system)

Environmental: 0° - 55° ambient

Bus interface: Fully Intel Multibus compatible

Mating Connectors: J1, J2, J3, -3M No. 3425 or equivalent
P1 -Viking No. 2VH43/1AV5 or equivalent

APPENDIX B - CABLES

The RIMFIRE 45 requires two 50-pin flat cables to the tape drive, and one 50-pin flat cable to the disk drive. Standard cable length is 10 feet. Daisy-chain cables are available on a custom-order basis.

CPC	P/N	Function
	81011001	RIMFIRE 45 J3 to disk drive
	81011011	RIMFIRE 45 J2 to tape drive P2
	81011021	RIMFIRE 45 J1 to tape drive P1

Some tape drive formatters utilize a single 100-pin board-edge connector instead of two 50-pin connectors. In such cases an adaptor board should be obtained from the drive manufacturer or from Computer Products Corporation.

APPENDIX C - ERROR CODES

This section lists the codes for unrecoverable errors detected by the RIMFIRE 45 during the execution of a command. The code is returned in the Command Status byte, bits 0-5.

Code	Description
00	This command executed successfully with no unrecoverable error and no retries
01	This command executed successfully with no unrecoverable error, but required at least one retry during the execution.
02	A data CRC error occurred during a disk read.
03	An ID CRC error occurred.
04	A seek error occurred, because of a Seek Error status from the disk, or because the target track was beyond the logical or physical end of the disk.
05	A verify error occurred when the RIMFIRE 45 read an ID after a seek. To correctly verify, the track and head of the first ID encountered after a seek must match the target head and track.
06	The disk was not ready when a disk command was begun.
07	The desired logical sector number could not be located on this track.
08	The RIMFIRE 45 could not locate an ID sync mark between sector pulses during a read or write, or the data sync mark between sector pulses during a write.
09	An unexpected End-of-Tape mark was encountered during a tape operation.
0A	A data error was detected during a tape read, or during an automatic read-after-write.
0B	An overflow occurred during a tape read, or an underflow occurred during a tape write. This error indicates that the 64-byte tape data FIFO was empty when the drive requested a byte of data during a write, or full when the drive sent a byte of data during a read. The usual reason for this error is that the RIMFIRE 45 has been kept off the Multibus for too long.
0C	A tape command was attempted on a RIMFIRE 45D disk-only controller.
0D	A diagnostic command was attempted with the diagnostic mode jumper not installed.
0E	A checksum error in the PROM-resident firmware was detected during a Configure command.
0F	A tape time-out error occurred during a tape read or write because the tape drive failed to supply an expected read or write strobe. This may result from a damaged tape. It also will occur during a tape read operation if the block size requested is larger than that on the tape.
10	The tape drive was not ready when a tape command was begun.
11	The disk or tape was write protected when a write operation was begun.
12	Not used.

- 13 The parameters for a Dump/Restore command were incorrect. This could occur if the ending disk address is not greater than the starting disk address, or if a zero buffer size was selected.
- 14 Not used.
- 15 A filemark was encountered during a tape read command.
- 16 A direct access was attempted to a track on the disk which has been assigned as an alternate.
- 17 Not used.
- 18 Not used.
- 19 An illegal parameter was specified. Possible error conditions include:
- Zero record count for disk read or write.
 - Zero byte count for tape read or write.
 - Auto-interleave selected during a disk format with greater than 255 sectors per track.
- 1A Not used.
- 1B Not used.
- 1C The disk is busy executing a command.
- 1D The disk is busy executing a command issued by the RIMFIRE 45.
- 1E An illegal disk parameter, selected through a previously executed Configure command, was detected during a disk command.
- 1F The selected disk drive is down, inoperable or not connected.
- 20 A match was found during a Block Move command using the Search option.
- 21 An expected Data Busy false from the tape drive did not occur.
- 22 An expected combination of Data Busy false, Formatter Busy false and Ready true from the tape drive did not occur.
- 23 An expected Ready false from the tape drive did not occur.
- 24 An expected Ready true from the tape drive did not occur.
- 25 An expected Data Busy true from the tape drive did not occur.
- 26 A system memory time-out occurred.
- 27 A blank tape was encountered when data was expected from the tape.
- 28 A failure occurred during the execution of the micro-diagnostic.
- 29 An attempt was made to link to a Block Move command.
- 2A An unexpected offline condition was detected from the tape drive.
- 2B An unidentifiable hardware error occurred.
- 2C A RIMFIRE 45 command other than the Configure was attempted before the Configure command was executed.
- 2D The RIMFIRE 45 was unable to write a disk ID during a Format or Map Defect command.
- 2E-3F Not used.

APPENDIX D - JUMPERS

This section describes the setting of jumpers and DIP switches on the RIMFIRE 45 board. Factory settings are indicated with an asterisk

1. Jumpers 1-10 (Read Gate Delay Counter)

These jumpers are factory set and are used by the RIMFIRE 45 sequencer.

2. Jumpers 11, 12 (Diagnostic Mode)

This jumper allows the execution of RIMFIRE 45 diagnostic commands.

Jumper 11-12	Diagnostic enabled.
* No jumper	Diagnostic disabled.

3. Jumpers 13, 14 (Bus time-out)

These jumpers enable or disable the system bus time-out.

Jumper 13-14	Time-out enabled.
* No jumper	Time-out disabled.

4. Jumpers 15-17 (I/O Address Bus Width)

These jumpers select the width of the I/O address Bus.

* 8-bit width	- jumper 15-16
16-bit width	- jumper 15-17

5. Jumpers 18-22 (Maintenance)

These jumpers are used at the factory to allow the insertion of the CPC 8089 Emulator into the CPU socket.

Maintenance Mode	- Jumper 19-21, 20-22
* Normal Mode	- Jumper 18-19, 20-21

6. Jumpers 23,26 (BPRO/)

These jumpers are set according to the type of bus priority used on the Multibus.

* Serial priority	- Jumper 23-26
Paralell priority	- No jumper

7. Jumpers 24, 25, 27-30 (Bus Arbitration)

These jumpers control the conditions under which the RIMFIRE 45 surrenders control of the Multibus during a transfer sequence. Jumpers 24, 25, 27 allow CBRQ/ to be jumpered low (24-25) or to the Multibus (24-27). Jumpers 28-30 allow the ANYQRST input on the 8289 Bus Arbitrator to be jumpered high (28-29) or low (29-30). Four configurations are possible.

Mode	Jumper	Description
1	(24-27) (29-30)	The RIMFIRE 45 will surrender the bus to a higher priority master, when that master activates CBRQ/.
2	(24-27) (28-29)	The RIMFIRE 45 will surrender the bus to a higher or lower priority master, when that master activates CRBQ/.
* 3	(24-25) (28-29)	The RIMFIRE 45 will surrender the bus after each transfer cycle.
4	(24-25) (29-30)	The RIMFIRE 45 will surrender the bus to a higher priority master after every cycle.

8. Jumpers 31-50 (Initialization Address)

These jumpers allow the user to select the upper 16 bits of the 20-bit System Configuration Pointer address (see sec. 3.1.2). This address is normally set once to the optimum location for a particular system and not changed thereafter.

The address is set in two groups of eight bits. Each group is set in a similar fashion. Each group contains 10 pins - 8 pins corresponding to address bits, one pin to a pull-up, and one to ground. Those address bits which are to be active are daisy chained to the pull-up, and those which are to be inactive are daisy-chained to the ground.

The pins have the following significance.

31 - Ground	41 - Ground
32 - A4	42 - A12
33 - A5	43 - A13
34 - A6	44 - A14
35 - A7	45 - A15
36 - A8	46 - A16
37 - A9	47 - A17
38 - A10	48 - A18
39 - A11	49 - A19
40 - Pull-up	50 - Pull-up

As an example, Fig. D-1 indicates the connections necessary to set the address to 0AAAA6H. (The lowest nibble is not selectable and must be 6H).

* Factory setting is 00FFF6H, unless requested otherwise.

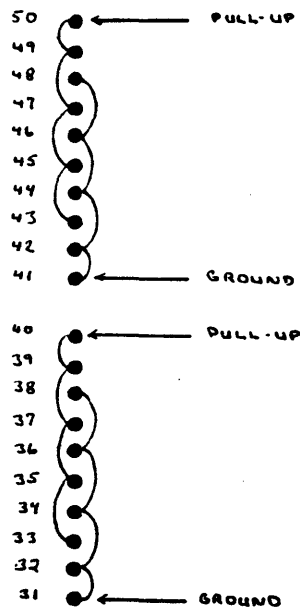

Fig. D-1. Initialization Address

9. DIP switch (Channel Attention, Bus Width)

The two DIP switches are used to select the Channel Attention address (15 bits), and the width of the system data bus (8 or 16 bits). A bit will be decoded as a "1" (active) if the corresponding switch is set to the closed position.

As an example, Fig. D-2 shows the switch settings for a Channel Attention Address of AAAAH-AAAABH, using a 16-bit data bus. (The RIMFIRE 45 occupies two I/O addresses, since A0 is not decoded).

* Factory setting is AAH, 8-bit I/O address and 16-bit data bus, unless requested otherwise.

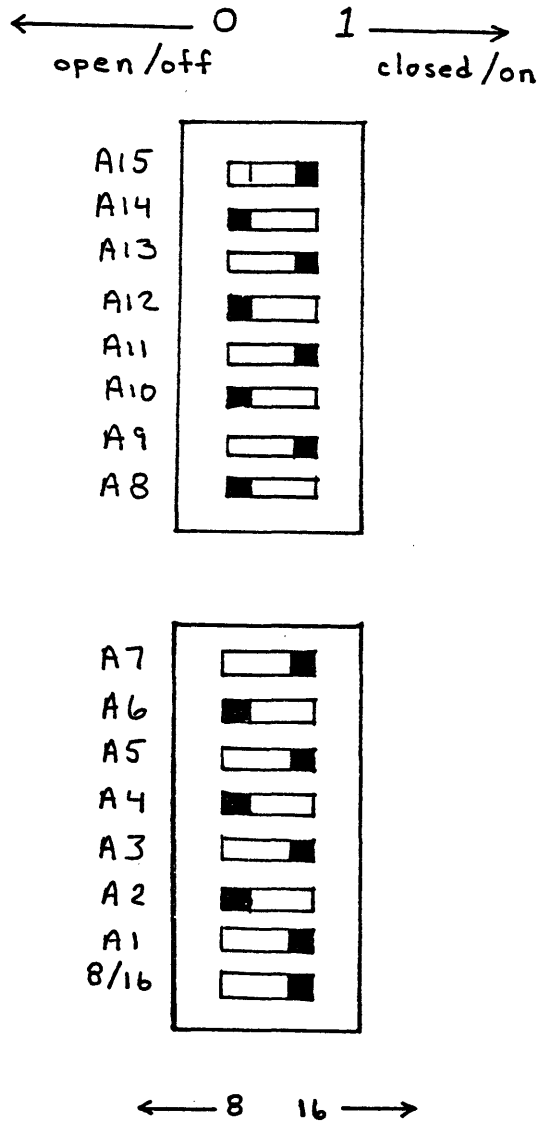

Fig. D-2. Channel Attention Address AAAAH.

10. Jumper INT, I0-17 (Interrupts)

These jumpers select the non-vectored interrupt priority level by connecting the INT pin to the appropriate level (I0 = Interrupt 0, I7 = Interrupt 7).

* Factory setting is Interrupt level 7.

APPENDIX E CONNECTOR PIN-OUTS

J1

J2

Pin	Signal Description	Pin	Signal Description
1	Ground	1	Read Parity
2	Formatter Busy	2	Read Data 0
3	Ground	3	Read Data 1
4	Last Word	4	Load Point
5	Ground	5	Ground
6	Write Data 4	6	Read Data 4
7	Ground	7	Ground
8	Initiate Command	8	Read Data 7
9	Ground	9	Ground
10	Write Data 0	10	Read Data 6
11	Ground	11	Ground
12	Write Data 1	12	Hard Error
13	Ground	13	Ground
14	Not Used	14	Filemark
15	Ground	15	Ground
16	Not Used	16	CCG/IDENT
17	Ground	17	Ground
18	Reverse	18	Formatter Enable
19	Ground	19	Ground
20	Rewind	20	Read Data 5
21	Ground	21	Ground
22	Write Parity	22	End of Tape
23	Ground	23	Ground
24	Write Data 7	24	Offline/Unload
25	Ground	25	Ground
26	Write Data 3	26	Not Used
27	Ground	27	Ground
28	Write Data 6	28	Ready
29	Ground	29	Ground
30	Write Data 2	30	Not Used
31	Ground	31	Ground
32	Write Data 5	32	File Protect
33	Ground	33	Ground
34	Write	34	Read Strobe
35	Ground	35	Ground
36	Read Threshold 2	36	Write Strobe
37	Ground	37	Ground
38	Edit	38	Data Busy
39	Ground	39	Ground
40	Erase	40	Not Used
41	Ground	41	Ground
42	Write Filemark	42	Corrected Error
43	Ground	43	Ground
44	Not Used	44	On Line
45	Ground	45	Ground
46	Transport Address 0	46	Transport Address 0
47	Ground	47	Ground
48	Read Data 2	48	Formatter Address
49	Ground	49	Ground
50	Read Data 3	50	Speed/Density

J3

Signal Pin	Ground Pin	Signal Name
1	10	Ground
		Control Bus
2	10	Bit 0, Select/Attn. Device 0
3	10	Bit 1, Select/Attn. Device 1
4	10	Bit 2, Select/Attn. Device 2
5	10	Bit 3, Select/Attn. Device 3
6	10	Bit 4, Select/Attn. Device 4
7	10	Bit 5, Select/Attn. Device 5
8	10	Bit 6, Select/Attn. Device 6
9	10	Bit 7, Select/Attn. Device 7
11	12	Not Used
13	14	Select Out/Attn. In Strobe
15	16	Command Request
17	18	Parameter Request
19	20	Bus Direction Out
21	22	Port Enable
23	24	Address Mark Control
25	26	Read Gate
27	28	Write Gate
29	30	Bus Acknowledge
31	32	Index
33	34	Sector/Address Mark Detected
35	36	Attention
37	36	Busy
39	38	Read Data+
40	38	Read Data-
42	41	Read/Reference Clock+
43	41	Read/Reference Clock-
45	44	Write Clock+
46	44	Write Clock-
48	47	Write Data+
49	47	Write Data-
	50	Ground

APPENDIX F - COMMAND CODES

This section lists the hex codes for all RIMFIRE 45 commands.

Group I. Disk Drive Control

- 00 - Configure
- 04 - Disk Drive Status
- 18 - Load
- 1C - Unload
- 6C - Disk Drive Reset
- 78 - Seek
- 7C - Read ID
- 88 - Interrogate
- 8C - Test Disk I/F
- 98 - Read/Write Permit
- A4 - Disk Micro
- A8 - Rezero

Group II. Tape Drive Control

- 28 - Tape Drive Status
- 34 - Rewind
- 38 - Offline/Unload
- 40 - Write Filemark
- 44 - Search Filemark
- 48 - Space
- 4C - Erase
- 50 - Erase Tape
- 70 - Space Filemark
- 90 - Tape drive Reset
- 94 - Search Multiple Filemark

Group III. Disk Data Transfer

- 10 - Disk Read
- 14 - Disk Write
- 24 - Format
- 84 - Map Defect

Group IV. Tape Data Transfer Commands

- 2C - Tape Read
- 30 - Tape Write
- 3C - Tape Edit

Group V. Combination

- 54 - Dump
- 58 - Restore

Group VI. Specials

- 20 - NOP/ID
- 5C - Diagnostic
- 80 - Block Move
- 9C - Clear Interrupt

APPENDIX G - DISK DRIVE TYPES

<u>Type</u>	<u>Overhead Bytes</u>	<u>Manufacturer</u>	<u>Model/Series</u>
00	46	3M	8500
		SLI	CHEYENNE
		KENNEDY (BASF)	6170
		PRIAM	ALL
01	110	3M	8400
02	80	IMI	7700

REVISION RECORD	
REV	ZONE
A	RELEASE
B	AA-00004-A
C	AA-00068-A

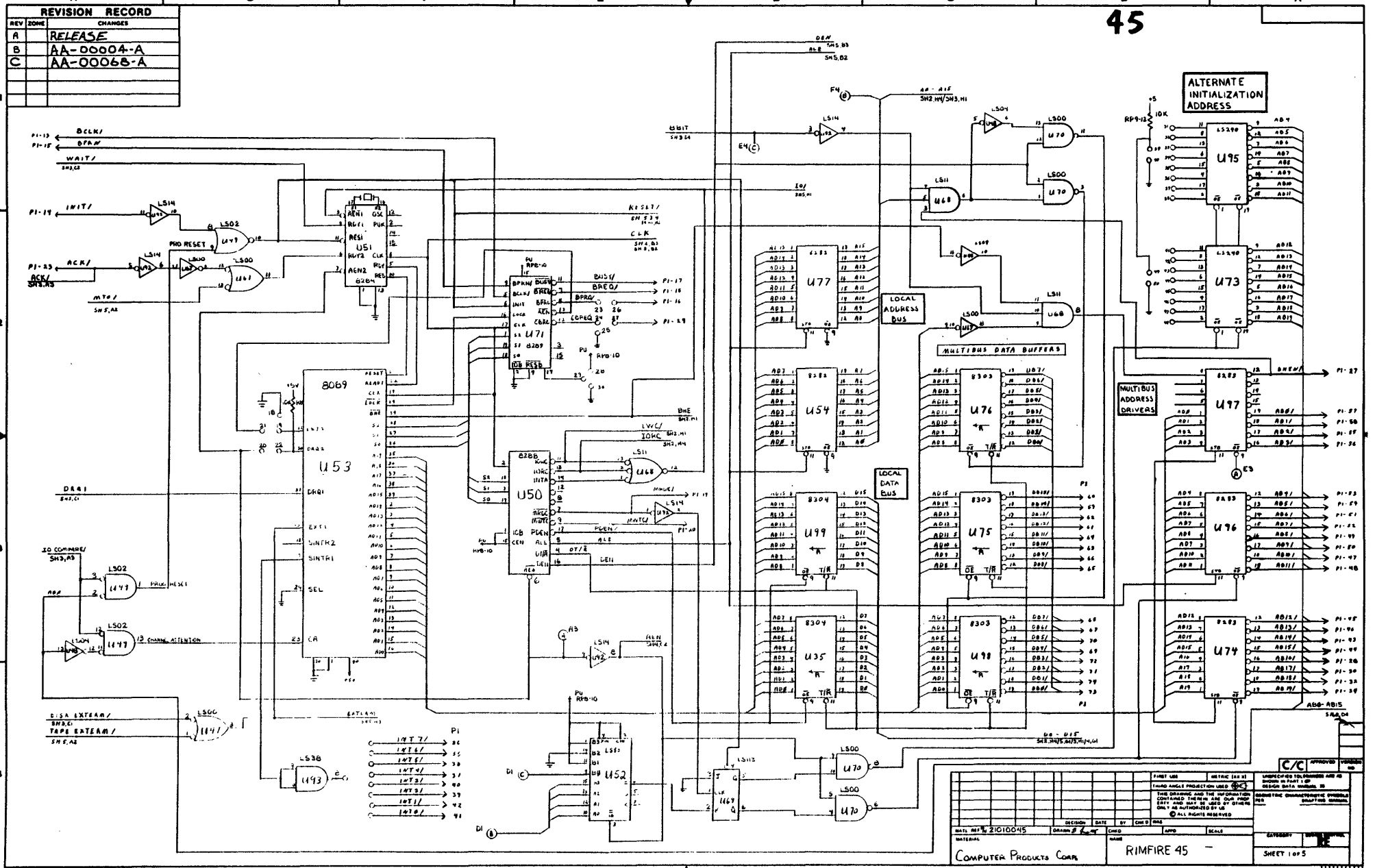

MAIL REF: 21010045		DESIGN: 2	DATE: 11/74	BY: CWD	NAME: []	SCALE: []	EXTENT: []	DATE: []	BY: []	NAME: []	
COMPUTER PRODUCTS CORP		RIMFIRE 45		SHEET 1 of 5		C/C		APPROVED		ISSUED	

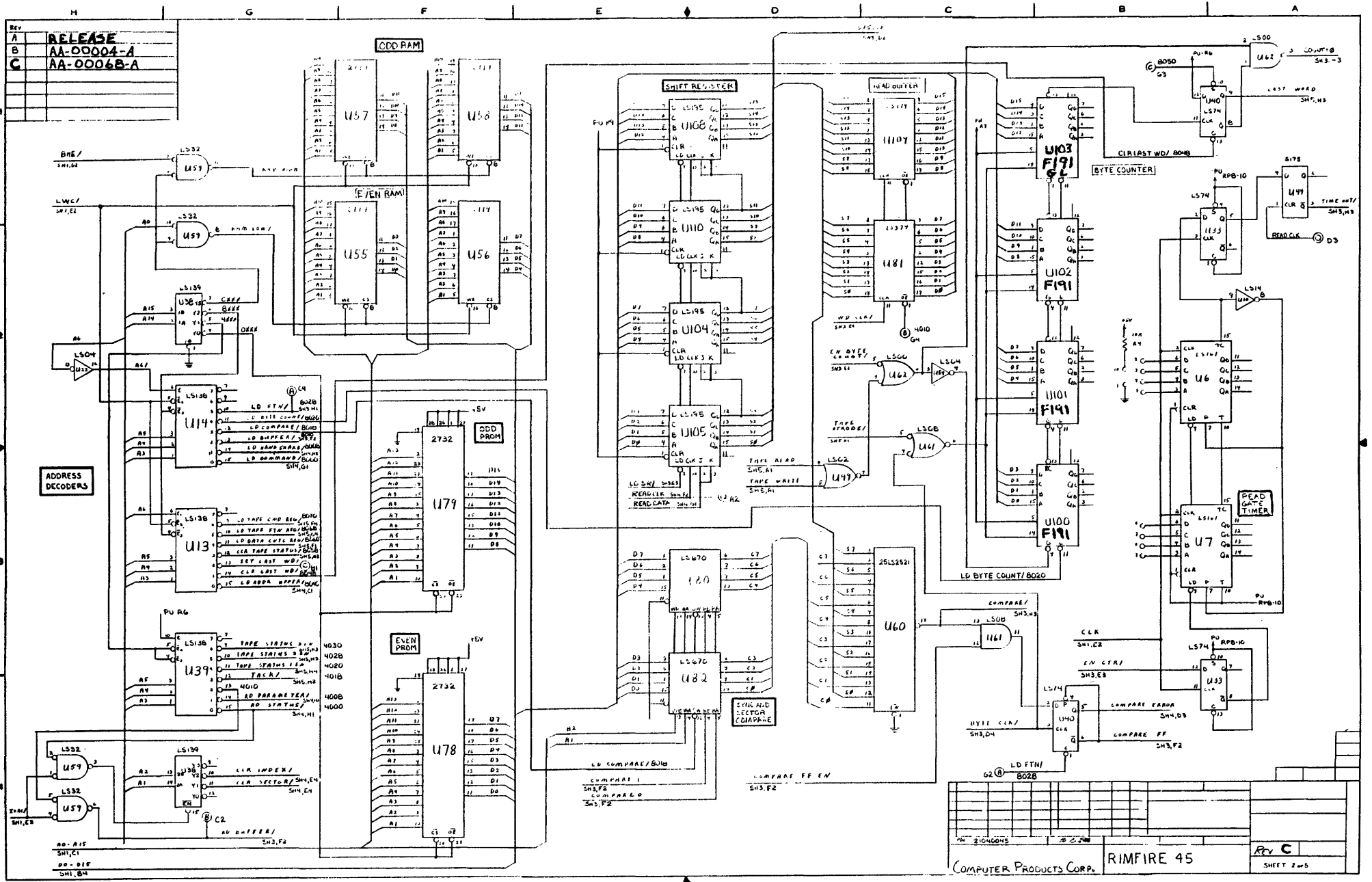

REV	A	RELEASE
	B	AA-00004-A
	C	AA-00068-A

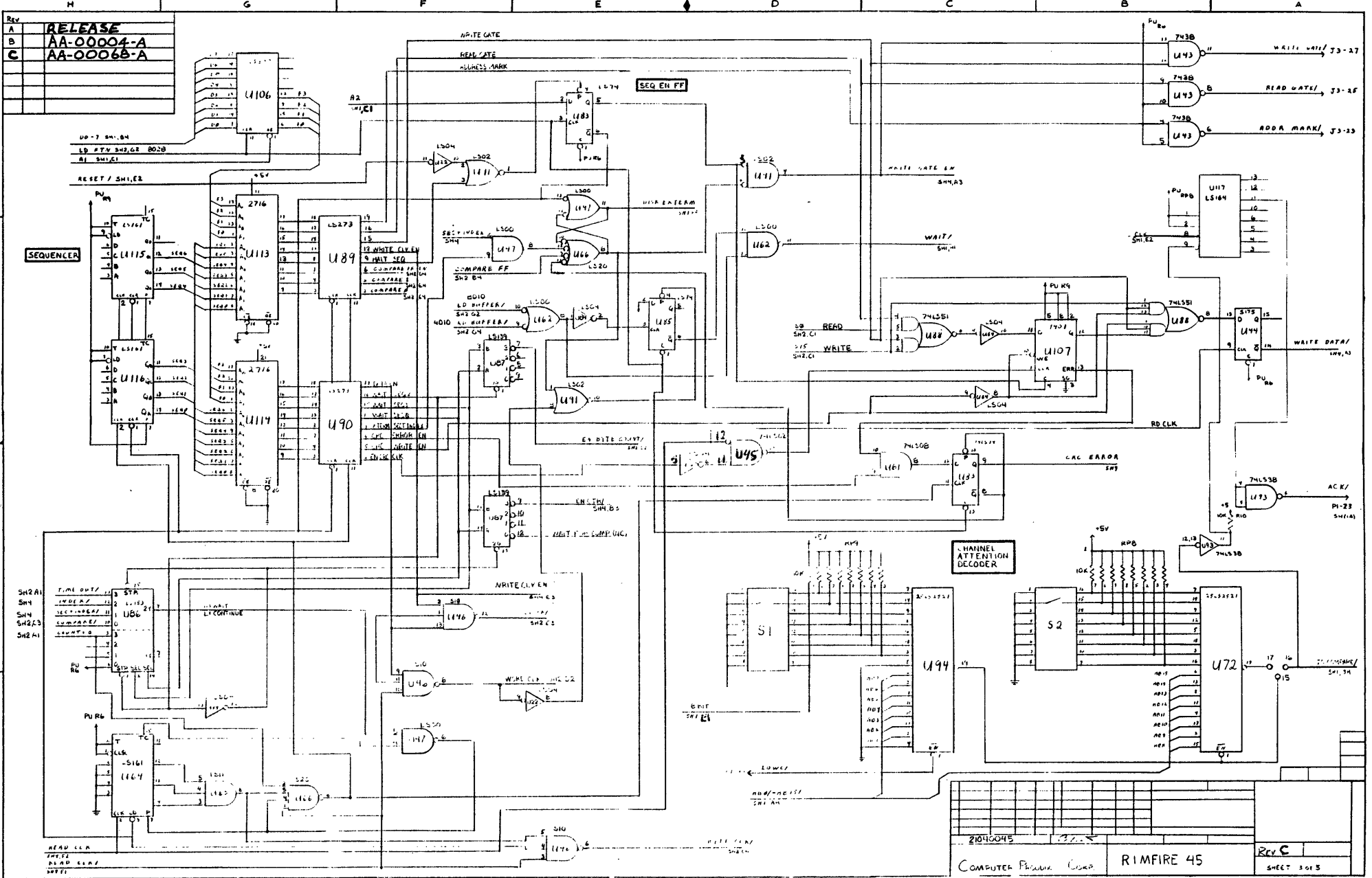

Rev A	RELEASE
Rev B	AA-0004-A
Rev C	AA-0006B-A

00-7 SW. B4
 LP #TY SW. G2 B02B
 #1 SW. C1
 RESET / SW. E2

SEQUENCER

CHANNEL ATTENTION DECODER

SH2A1 TIME OUT
 SW1 IMDEA
 SW4 SEC. INDEA
 SW2C3 COMPARER
 SW2A1 COUNT + 0

READ CLK
 #TY CLK
 READ CLK
 SW. F1

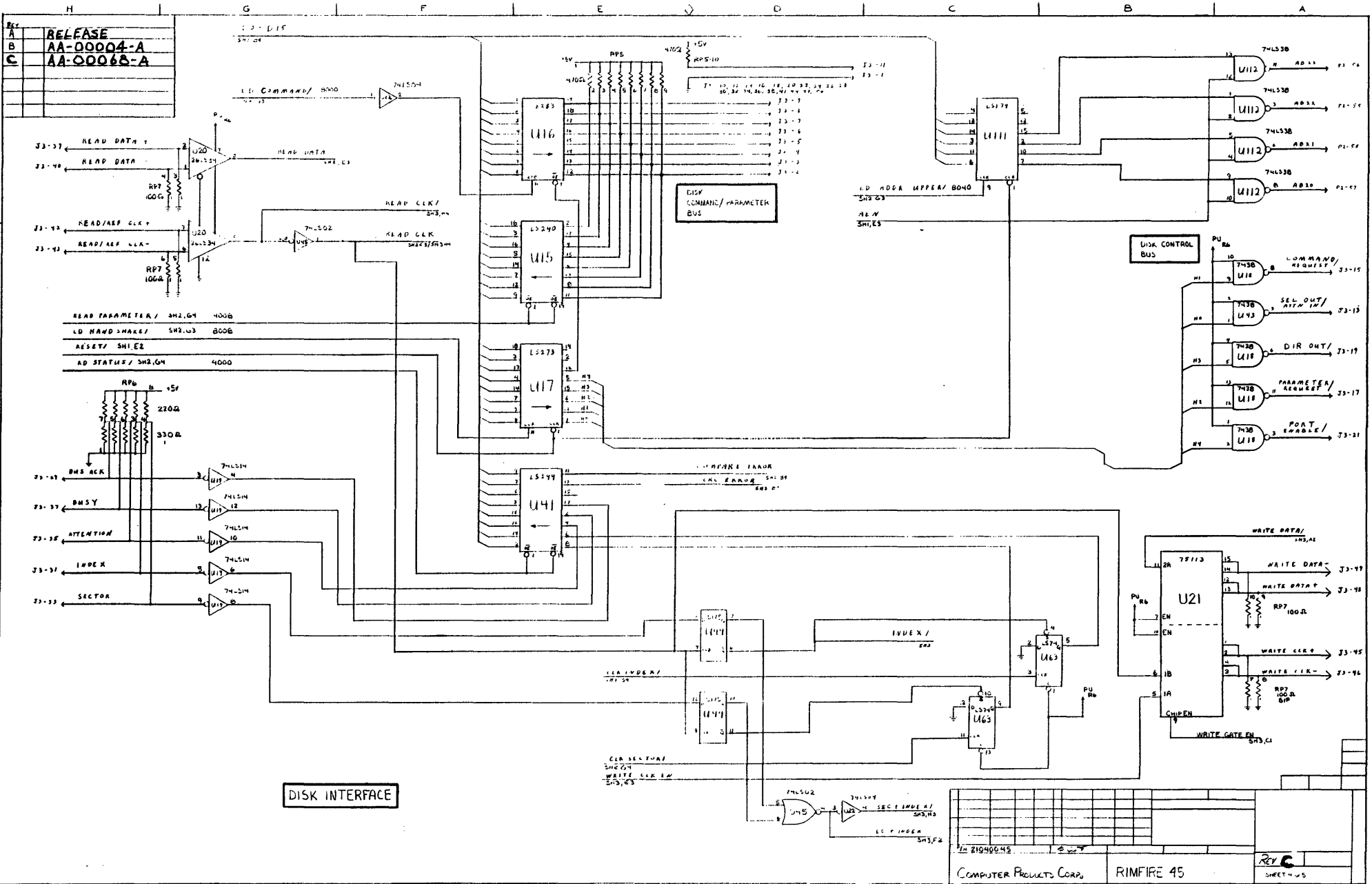

REV	
A	RELEASE
B	AA-00004-A
C	AA-00068-A

DISK INTERFACE

REV	
A	RELEASE
D	AA-00004-A
C	AA-00068-A

