

COMPUTER DESIGN

THE MAGAZINE OF COMPUTER BASED SYSTEMS

SPECIAL REPORT ON MICROSYSTEMS

**EMERGING 32-BIT
MICROPROCESSORS**

**LOCAL AREA NETWORK
ADAPTS DYNAMICALLY**

**CHIPS ARE THE KEY
TO LOW COST VIDEOTEX**

**CUSTOM LSI ENHANCES
DOT-MATRIX PRINTING**

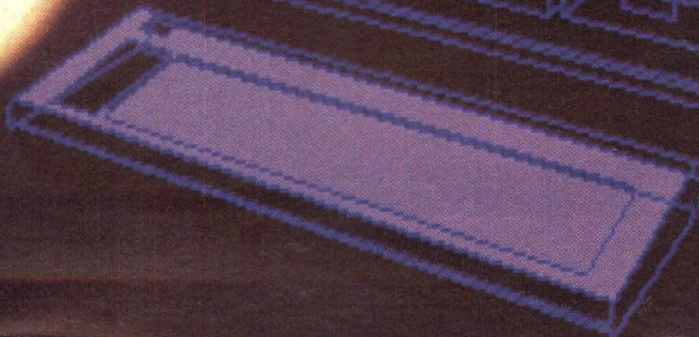
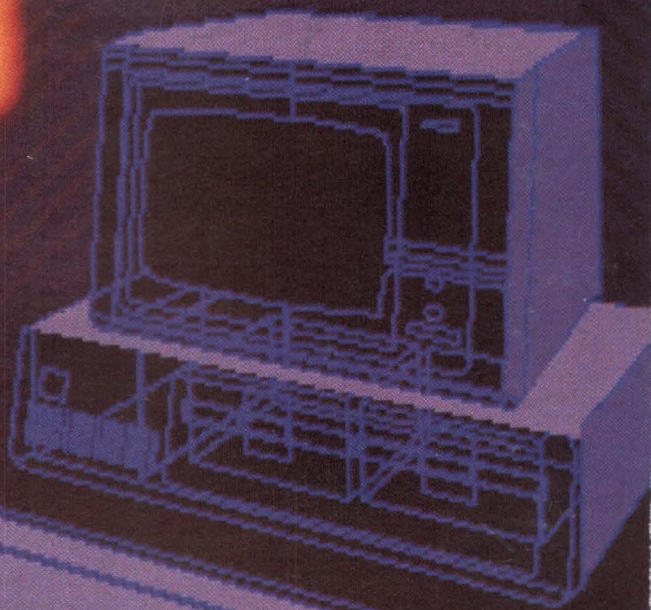
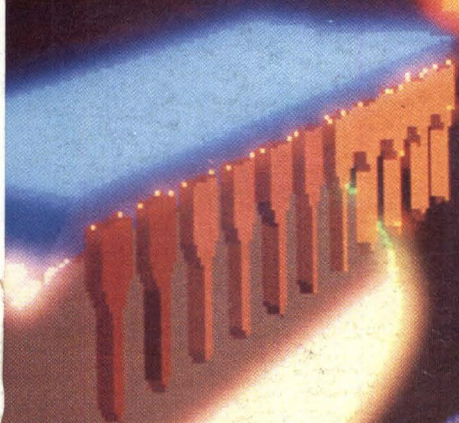

AS BRIGHT AS YOU ARE?

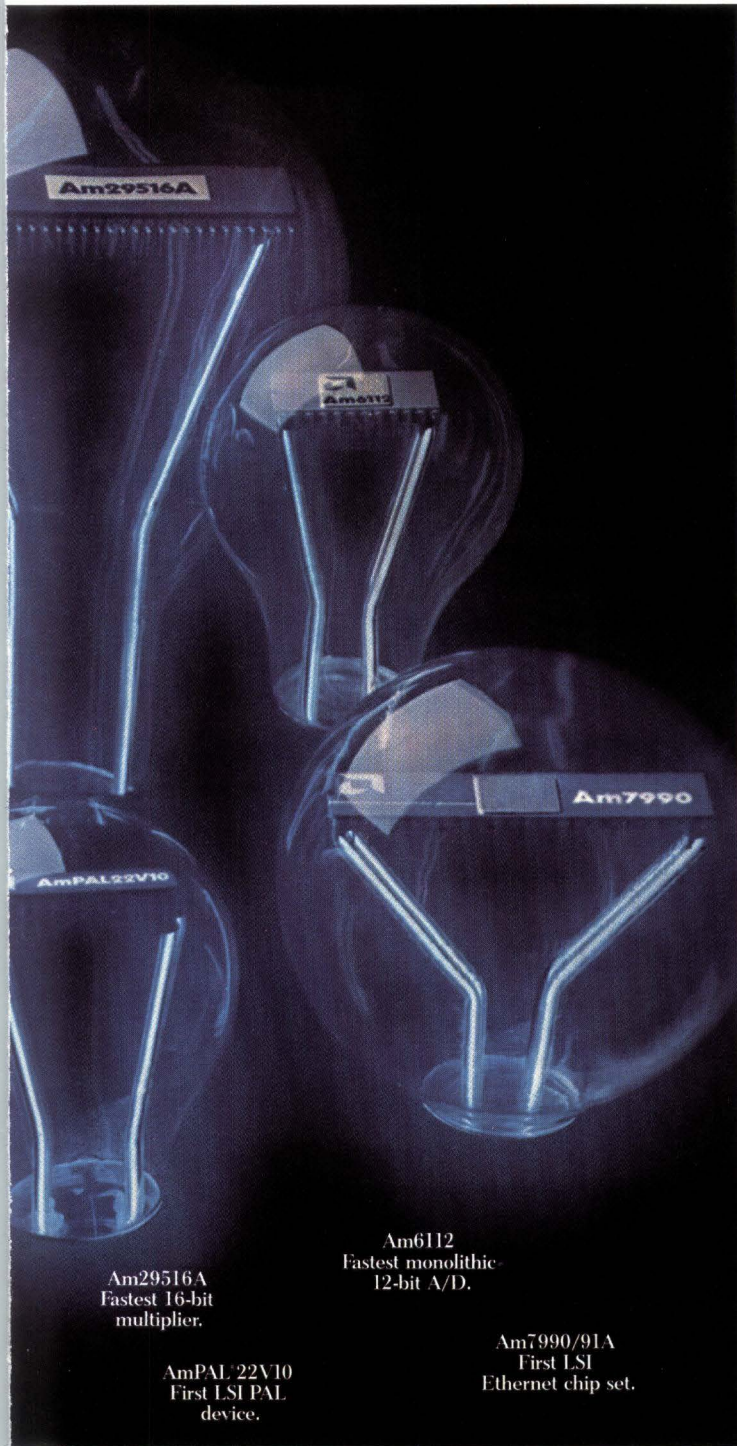

Am29516A
Fastest 16-bit
multiplier.

Am6112
Fastest monolithic
12-bit A/D.

AmPAL 22V10
First LSI PAL
device.

Am7990/91A
First LSI
Ethernet chip set.

You're doing everything you can to stay ahead of the competition. Shouldn't your IC company do the same?

We think so.

In 1983 we spent a record-breaking 18.7% of sales on research and development. That's more than any other major IC company.

And that's why 40% of our total sales come from products that were invented here.

Our Am8052 CRT controller lets you squeeze every last drop of performance out of a video tube.

And our Am7910 is the only modem you can program for any major telephone system anywhere in the world.

We make the first perfectly matched VLSI Ethernet chip set and the only complete kit solution to super high speed digital signal processing.

We make the world's first 512K EPROM and the world's fastest microprocessor.

We're even an innovator when it comes to quality.

While other guarantees run on and on,

The International Standard of Quality guarantees a 0.1% AQL on all electrical parameters, AC and DC, over the entire operating range.

INT-SID-1000

ours is short and sweet.

So, if you've got a product you want to really shine, call us. We can put you as far ahead of the competition as we are.

Advanced Micro Devices

901 Thompson Place, P. O. Box 3453, Sunnyvale, CA 90488
(408) 749-5000, outside California, call toll free (800) 538-8450, ext. 5000.

THE PERIPHERAL DESERT

Many tri and tri again — but never make it.

Model 9400 GCR tape system—the latest in a long and honored line of Kennedy products. Products that have always been first in innovation, design, and performance. Model 9400 carries on this tradition of 'first across the line'. For complete details on the industry's premier tri-density, hi-performance tape system, write or call today.

KENNEDY

An Allegheny International Company

1600 Shamrock Ave., Monrovia, CA 91016

(818) 357-8831 • ITT TELEX 472-0116 KENNEDY

TWX 310-472-0116 KENNEDY



KENNEDY • QUALITY • COUNT ON IT

CIRCLE 1

System technology

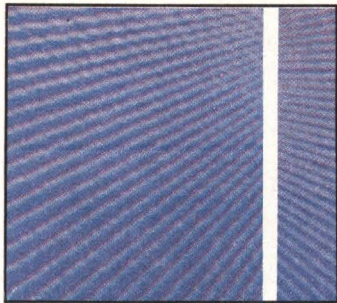

Page 36

- 27 **Computers:**
Superminis assert superiority through superior numbers
- 29 **Data communications:**
Simpler clusters emerge as local area network alternative
- 36 **Peripherals:**
Partial pixel addressing increases effective display resolution
- 45 **Software:**
Multistage compilers move from mainframes to micros
- 48 **Integrated circuits:**
As densities increase, EEPROMs grope toward standards

System design



Page 87

- 61 **Data communications: Local network responds to changing system needs**
by Ashraf M. Dahod—A local area network that dynamically adjusts to changes in the nature and volume of system traffic ensures that devices can obtain timely network access.
- 75 **Computers: Tagged architecture supports symbolic processing**
by Abraham Hirsch—Even though the Lisp programming language enables artificial intelligence functions on large computers, efficient processing necessitates a different architecture.
- 87 **Integrated circuits: IC decoder paves the way for videotex revolution**
by Gregg Ledford—Cost is key in public acceptance of videotex information systems. With a presentation-level standard ensuring transmission uniformity, attention turns to development of reasonably priced hardware.
- 105 **Peripherals: Shift register maneuvers data to add print features**
by Philip Gordon—Using custom LSI techniques, a special type of shift register allows dot-matrix line printers to offer upgraded print and data-formatting features.



NCC '84



- 55 The National Computer Conference, like its predecessors, offers a varied menu of technical sessions and seminars. Of particular interest to computer-based system designers are sessions such as those on hardware and architecture, computer communications, office automation, and artificial intelligence. Concurrently in the schedule, typical professional development seminars of interest include artificial intelligence, software engineering, computer graphics, supercomputers, and local networks.

Special report on microprocessors/microcomputers—Part I

- 121** The deluge of 32-bit micros is beginning with a trickle. However, by 1985 these wonder chips will be available in quantity to power the next generation of superminis and low end mainframes. Many will be implemented in CMOS, the technology of choice for the next generation of micros. A few will have unique architectures, but all will be designed to run the type of software expected on larger, higher performance computer systems.



This month's cover was created and designed by Mark Lindquist on the Digital Effects Video Palette III and D-48 high resolution camera system. Data bases were constructed by Joe Pasquale and Anezka Sebek.

System components

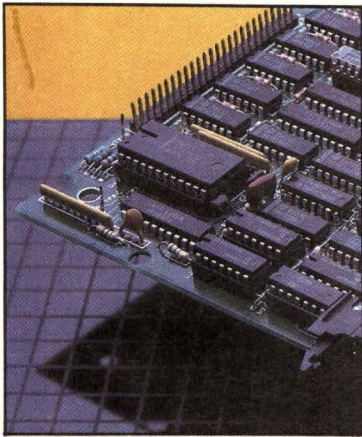

Page 201

- 201 Interface:**
Controller joins host adapters to step up performance
- 202 Memory systems:**
Memory bubbles packaged to ride high on the Multibus
- 202 Software:**
Source control tools help manage large software projects
- 204 Integrated circuits:**
Smart disk controller locates and searches strings
- 204 Microprocessors/microcomputers:**
Board counts on CMOS for low power CPU processing
- 206 Peripherals:**
Interactive CAD digitizer enters the third dimension

Departments

- | | | | |
|------------|------------------------------|------------|-------------------------------|
| 5 | Up front | 256 | System showcase |
| 13 | Editorial | 257 | Advertisers' index |
| 20 | Letters to the editor | 260 | Recruitment |
| 253 | Literature | 267 | Reader inquiry card |
| 254 | Calendar | 267 | Change of address card |
| 255 | Designer's bookcase | | |

COMPUTER DESIGN©1984 (ISSN-0010-4566) is published monthly, with a thirteenth and fourteenth issue respectively in June and October by PennWell Publishing Company, Advanced Technology Group, 119 Russell Street, Littleton, MA 01460. Second-class postage paid at Littleton, MA 01460 and additional mailing offices. COMPUTER DESIGN is distributed without charge to U.S. and W. Europe-based engineers and engineering managers responsible for computer-based equipment and systems design. Subscription rate for others is \$50 in U.S.A. and \$75 elsewhere. Single copy price is \$5.00 in U.S.A. and \$7.50 elsewhere. Microfilm copies of COMPUTER DESIGN are available and may be purchased from University Microfilms, a Xerox Company, 300 North Zeeb Road, Ann Arbor, Michigan 48106. POSTMASTER: CHANGE OF ADDRESS-FORM 3579 to be sent to COMPUTER DESIGN, Circulation Department, P.O. Box 593, Littleton, MA 01460 (USPS 127-340).

Officers of PennWell Publishing Company, 1421 S. Sheridan, Tulsa, OK 74101: P. C. Lauinger, Chairman; Philip C. Lauinger, Jr., President; Joseph A. Wolking, Senior Vice President; H. Mason Fackert, Group Vice President; Carl J. Lawrence, Group Vice President; V. John Maney, Vice President/Finance; L. John Ford, Vice President.

V BPA **★ ABP**

® COMPUTER DESIGN is a registered trademark. All rights reserved. No materials may be reprinted without permission. Phone (617) 486-9501.

Chairman of the boards

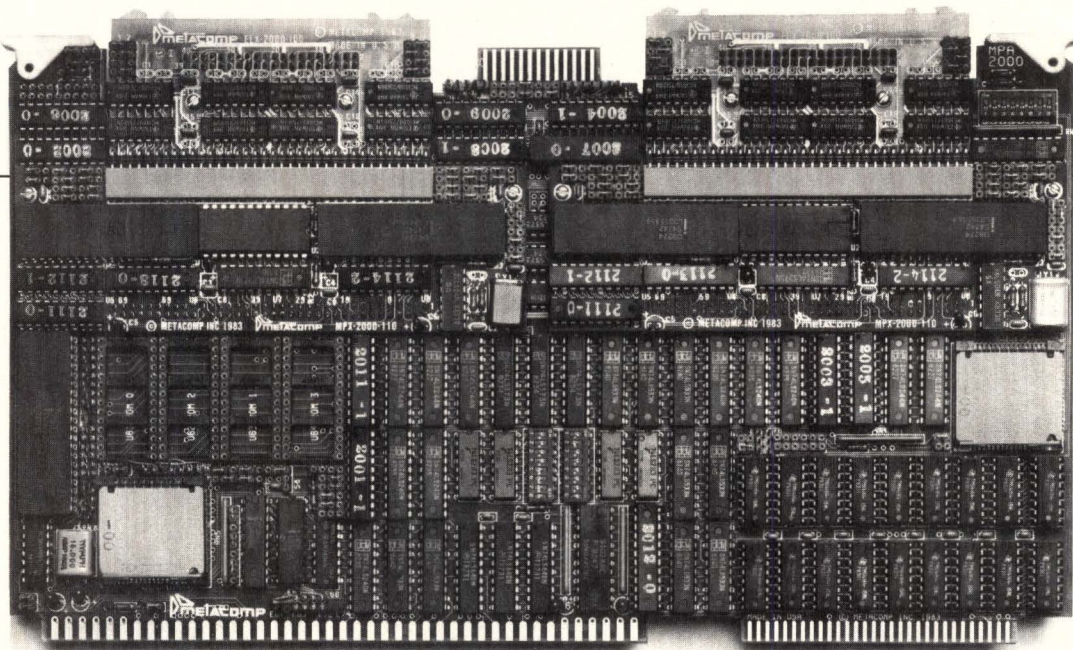

The first true Multibus single-board computer

The MPA-2000 is highly qualified for the top slot. It's the first to offer the iAPX-186 CPU. The first to offer 512KB of dynamic RAM. And, the first with architecture that allows plug-in modules with multiple DMA channel support.

That makes it the first CPU and I/O processor that combines: data processing, data communications, local area networking, disk I/O and similar peripheral functions. Standard data communications packages available include; CCITT-1980 X.25, IBM-3270 SNA (LU 1, 2 & 3), SDLC, HDLC (LAPB) and IBM-3270 BISYNC. Operating system portations include; PC-DOS, iRMX-86, VRTX/86 and MTOS-86. In all, it has the performance and capability to replace 2, 3 or 4 board members in most applications.

With that outstanding resume, it's easy to see how the MPA-2000 became the unchallenged Chairman of the Boards.

For complete specifications and ordering information, call or write METACOMP, Inc., 9466 Black Mountain Road, San Diego, California 92126, (619) 578-9840. TWX 910-335-1736 METACOMP SDG.

Ask for the resume of the Chairman of the Boards.

METACOMP™

The MPA-2000 is a trademark of METACOMP, Inc., Multibus, and iRMX-86 are trademarks of Intel Corp., PC-DOS is a trademark of IBM Corp., MTOS-86 is a trademark of Industrial Programming, Inc. VRTX/86 is a trademark of Hunter and Ready, Inc.
© Copyright 1984 METACOMP, Inc. All rights reserved.

THE MULTIBUS BREAKTHROUGH PEOPLE

UP FRONT

Superminicomputer features a realtime Unix operating system

The fact that AT&T's just out-of-the-closet 3B20D superminicomputer is suitable for a lot more than just telephony applications—the firm uses it for switching and database control—is clear to savvy computer system designers. They are already looking for it to compete with DEC and Data General's traditional offerings. What is not so well known is that the 3B20D's RTR operating system provides a realtime environment. To do this, the 32-bit processor-based (24-bit virtual and physical addressing) machine's Unix, in contrast to standard Unix, sports three partitions—process, kernel, and kernel process. The extra kernel process partition provides the realtime capabilities while the process partition supports the Unix Version v, Release 2 environment with up to 128 segments of 128 Kbytes each. The kernel process is equivalent to taking the device drivers out of standard Unix and giving each its own address space. Each kernel process can also have 128 of the 128-Kbyte segments but will not handle swapping. Realtime control is provided by 16 execution levels with a preemptive priority structure. Computer designers interested in RTR alone will have to wait to see if it will be unbundled from the 3B20D.—*H.H.*

Texas Instruments to produce National Semiconductor's 32-bit micro family

In a move to accelerate design-ins of the NS32000 family of microprocessors and peripheral chips, National Semiconductor (Santa Clara, Calif) has signed an agreement with Texas Instruments (Dallas, Tex) for TI to produce currently designed chips and to coordinate future designs in the NS32000 family of chips. The long-term agreement culminates in the development of the NS32C432, a CMOS 32-bit microprocessor that will run 7 million instructions/s compared to 1 MIPS for the currently available NS32032. All new collaborative designs will use CMOS processing, and TI plans to include all new designs in the company's extensive cell library of computer aided design tools. According to J. Fred Bucy, TI's president, the NS32000, which has now been relabeled the Series 32000, is the only commercially available true 32-bit microprocessor with a minicomputer VAX-like architecture that runs Unix and offers demand-paged virtual memory. These factors are essential for designing high performance products such as engineering workstations, some of which already incorporate the National part.—*N.M.*

Cell library creates 32-bit CMOS microprocessors

Using a semicustom CMOS library of 60 logic and memory cells, Sperry Corp (St. Paul, Minn) has designed an externally microprogrammable 32-bit microprocessor called Proteus. As presented in the Rochester, NY Custom Integrated Circuits Conference, the chip has nearly 42,000 transistors implemented in 1.2-micron double-level metal CMOS. Although originally designed to demonstrate the CMOS cell library, Proteus has the practical potential of emulating other processors. The chip has a specified cycle time of 120 to 200 ns, dependent on the set of microcode used and the access time of the external RAM or ROM that stores it. A major goal of the project was to show that semicustom design methodology permits fast low cost design. With less than four man-years of development time, Proteus has demonstrated to system designers the possibility of "rolling their own" microprocessors from standard cell libraries.—*J.B.*

UP FRONT

The VMEbus rolls as agreement is forged

A salvo of Motorola VMEbus product introductions has been reinforced by a multiple-source agreement with Signetics/Philips. Motorola Semiconductor Products Inc (Phoenix, Ariz) will become a second source for Signetics (Sunnyvale, Calif) VME boards, such as the System Controller Board (SMVME1500) and the Intelligent Multiple Disk Controller Board (SMVME4300). Signetics will in turn produce a version of the Motorola designed 68010 microprocessor. At the same time, Motorola has added nine new VME modules to its line. These include an Ethernet controller that connects VMEbus nodes to Ethernet, and a monoboard microcomputer based on the 68010.—*J.V.*

ISO computer communication protocols to replace proprietary standards

Practical application of the International Standards Organization (ISO) software protocols for computer communications is no longer a gleam in the standards maker's eye. For example, stimulated in part by the predicted success of next month's National Bureau of Standards sponsored ISO protocol demonstration at the National Computer Conference in Las Vegas, Data General will replace the proprietary network and transport protocols in its Zodiac networking package with the ISO Internet and Class 4 Transport protocols. Not to be left behind in what is becoming a race to "go ISO," Burroughs Corp will make the ISO protocols an integral part of the Burroughs Network Architecture. And, Tektronix says it will implement ISO software to allow its terminals, instrumentation controllers, and development systems to be ISO compatible. All of these conversions mean that computer system designers will be able to hook up more and more disparate computer-based gear regardless of manufacturer—without expensive protocol converters.—*H.H.*

System design lags, VLSI advances

Setting the tone for the Custom Integrated Circuits Conference in Rochester, NY, General Electric (Triangle Park, NC) vice president James E. Dykes in his keynote address pointed out the growing gap between VLSI designers and system designers. He called for the establishment of standards for design systems VLSI and CAD tools as a first step toward bringing the two disciplines together. He also noted the need for better CAD systems to allow direct translation of systems to the chip level. Finally, Dykes proposed greatly expanded training for system designers to increase the number of engineers from the few thousand currently involved in the VLSI design to the hundreds of thousands needed to make VLSI system design meet its promise.—*J.B.*

Motorola adds a chip to the 256-Kbit pot

Introduction of Motorola's 256-Kbit dynamic RAM chip at this year's Electro conference is one more signal that U.S. manufacturers are finally responding to Japanese incursions. With substantial numbers of 256-Kbit RAMs from Japanese producers (including Fujitsu, Toshiba, Mitsubishi, NEC, and Hitachi) already on the market, stateside companies have to overcome a long lead. Samples of Motorola's chip will be available in the second half of 1984, with quantity production beginning late in the year. Mostek already has samples of a 32-K x 8-bit RAM in the field and will introduce a 256-K x 1 device next year. And, a few customers of both Texas Instruments and Intel have received some 256-Kbit chips for sampling.—*J.V./S.F.S.*

Like DEC's.

\$8,845 system price*

256 KB minimum...
up to 4 MB!

Media and software
compatibility with
DEC's RX02 8" floppy
(vs. Micro/PDP-11's
non-compatible 5 1/4" floppy)

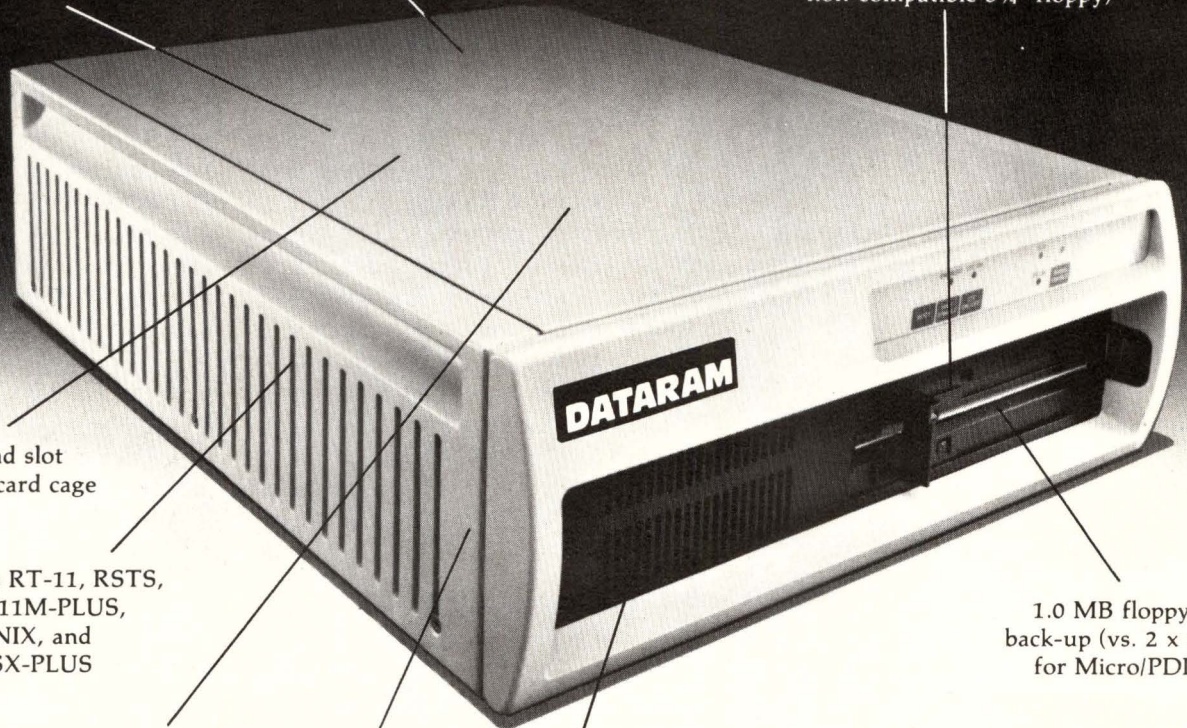

8-quad slot
Q-BUS card cage

Supports RT-11, RSTS,
RSX-11M-PLUS,
UNIX, and
TSX-PLUS

Two fans in card cage
area (vs. one in
Micro/PDP-11)

1.0 MB floppy disk
back-up (vs. 2 x 400 KB
for Micro/PDP-11)

RL02-compatible
5 1/4" Winchester disk;
10 MB, 20 MB, or
40 MB capability

Cartridge tape
capability

Only better.

You can buy DEC's Micro/PDP-11 with its impressive array of features...or you can get Dataram's A22—an LSI-11/23 based minicomputer that gives you a whole lot more...for a lot less dollars! Like an 8" RX02-compatible floppy. 40 MB 5 1/4" Winchester and 1/4" cartridge tape capability. And two fans that provide push-pull air flow in the card cage area. For more information, forward this coupon to us, or, for faster response, call (609) 799-0071.

Send information. Contact me immediately.

Name _____

Company _____

Address _____

City _____ State _____ Zip _____ Phone _____

Dataram Corporation, Princeton Road, Cranbury, NJ 08512

CD684

*\$8,845 is single-quantity domestic price for A22 with LSI-11/23, 256 KB, 10 MB Winchester and RX02-compatible 8" floppy.

DEC, LSI-11, Micro/PDP, PDP, RSTS, RSX, and RT-11 are trademarks of Digital Equipment Corporation. TSX-PLUS is a trademark of s&h computer systems, inc. UNIX is a trademark of Bell Laboratories.

CIRCLE 3

DATARAM

Dataram Corporation □ Princeton Road □ Cranbury, New Jersey 08512 □ Tel: 609-799-0071 □ TWX: 510-685-2542

UP FRONT

Algorithms to be developed to match new parallel computer speeds

Pipelining, data flow, multiple processors, and other parallel hardware architectures for tomorrow's faster computers show much promise. However, it's a poorly kept secret that the classic algorithms used to solve design problems are made for serial machines and just don't work well in parallel architectures. But, parallel hardware designers need not despair; the Air Force Office of Scientific Research at Bolling Air Force Base in Washington, DC is starting what it calls a Fast Algorithms Initiative. The program will address (and support) good algorithm ideas for large scale computation that are also suitable for emerging parallel hardware architectures. Both hardware and software designers will need to keep track of what this project turns out and may even want to submit some ideas themselves.—*H.H.*

Versatec enters the world of CAE

A well-known manufacturer of high end plotters, Versatec Corp (Santa Clara, Calif), is in the process of transforming itself into a computer aided engineering company. The company, owned by Xerox, is adapting schematic capture, place-and-route, and logic simulation software to the Xerox Star system, known in the office automation world for its window management in an Ethernet-based environment. Versatec is still in the process of getting a full suite of design software running on the Star system, but intends to incorporate the Star's flexible user environment along with such engineering packages to generate test vectors for ATE equipment. In addition, the company will call upon the existing software (eg, word processing and data management) already available on Star office systems to use as a competitive edge.—*T.W.*

"Safe" ROM BIOS for IBM PC-compatible computers

Designers developing personal computers to be "100 percent" compatible with the IBM PC do not have to spend tedious hours writing the Basic I/O System (BIOS) code and risk infringing upon IBM's copyright any longer. They can instead buy a PC-compatible BIOS package for \$100,000, embed it in ROM, and be assured via a \$2-million insurance policy against a copyright infringement suit that their newly designed PC-compatible computer does not infringe on IBM's BIOS. Phoenix Software (Norwood, Mass) went through meticulous procedures that company president Neil Colvin says was "a technologically unchallenging effort but an overwhelmingly difficult legal hurdle to overcome." Part of the procedure was to develop a functional specification for the IBM PC BIOS from IBM's reference manual and hand this specification to an independent software developer who knew nothing of the BIOS. Phoenix became the single interface point between the developer and the test group that was geographically distant from the developer and that developed the test procedures to ensure that the new BIOS was compatible with the PC. Only written communications describing problems were transmitted between test group and developer. Phoenix followed all these steps at the advice of legal counsel after numerous PC-compatible manufacturers were challenged in court by IBM with the claim that the BIOS written by their engineers infringed upon IBM's copyright.—*N.M.*

Networking Your System?

Change a 12 Month Design Cycle to 12 Days.

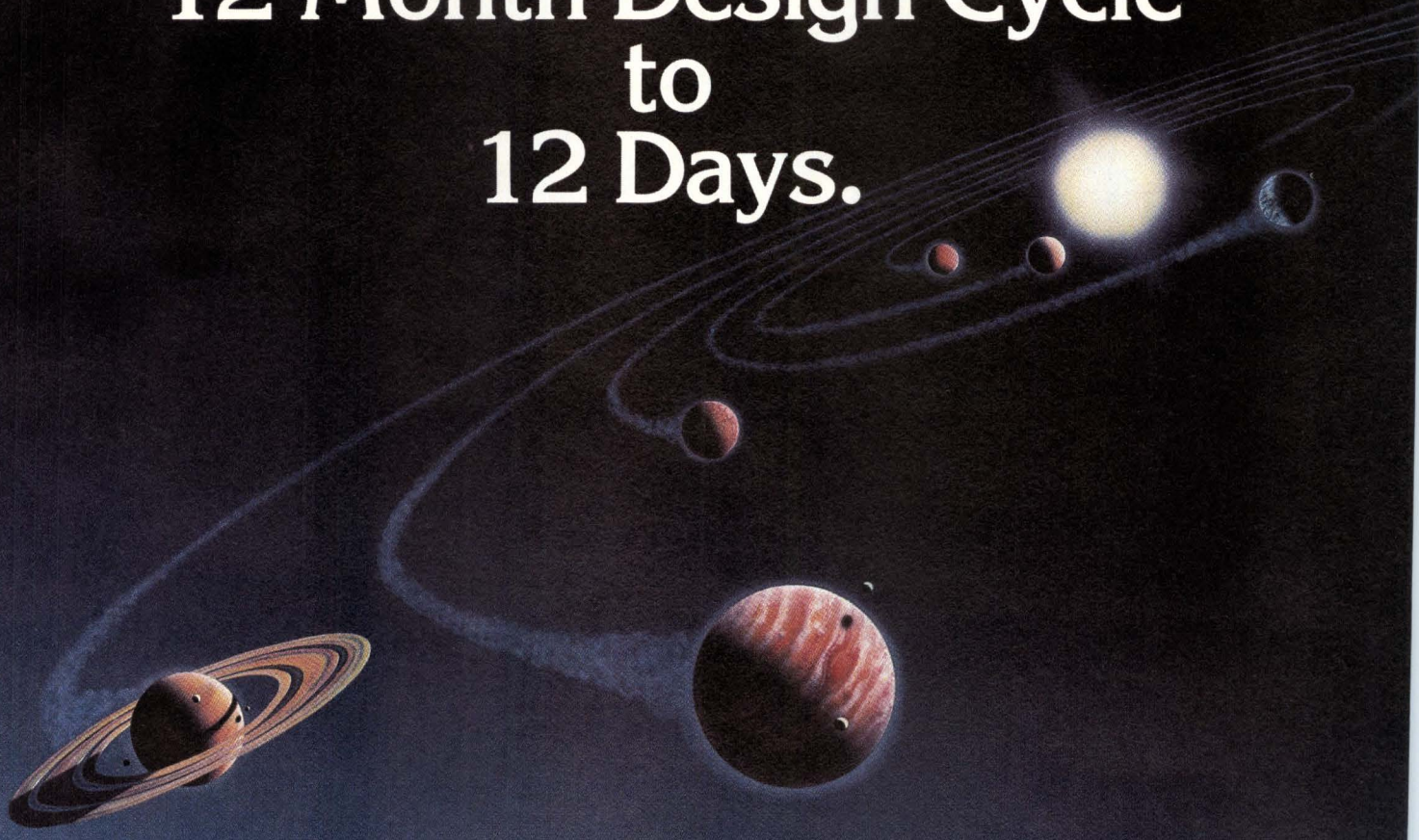

Time. Development time.
Time to market.

If you're building your new computer system around a LAN, you're in a race against time.

Ethernet* gives you a fast start, but the protocol software and system integration efforts can take as much as a year — even longer.

But now you can shorten that design cycle. With EXOS™, from Excelan. EXOS technology gives you a complete LAN capability, hardware and software, that simply plugs into your computer system's backplane. Integration takes next to no time.

With EXOS, you can be up and running in as little as 12 days — even sooner.

EXOS, or EXcelan Open Systems, is a family of Ethernet front-end processor boards, standard high-level protocol software which runs on the front-end processor, and network application software which runs on the host computer.

EXCELAN

"Excellence in Local Network Technology"

2180 Fortune Drive
San Jose, California 95131
(408) 945-9526 TELEX 176610

EXOS technology includes front-end processors for all Multi-bus,* VME bus, Unibus* and Q-Bus based computers and software supporting the standard TCP/IP high-level protocol. And if your host system supports any variety of UNIX,* then half a dozen network applications are provided as well.

EXOS. It gives your computer system a complete LAN capability with the ease of plug-in integration. That can change your design cycle from 12 months to 12 days. And get your product to market before your competition.

* Ethernet is a trademark of Xerox Corporation. Multibus is a trademark of Intel Corporation. Unibus is a trademark of Digital Equipment Corporation. Q-Bus is a trademark of Digital Equipment Corporation. UNIX is a trademark of AT&T Bell Laboratories. EXOS is a trademark of Excelan, Inc. Copyright © Excelan, Inc., 1984. All rights Reserved.

**TAKE
A SHORT
20,000-HOUR
DRIVE.**

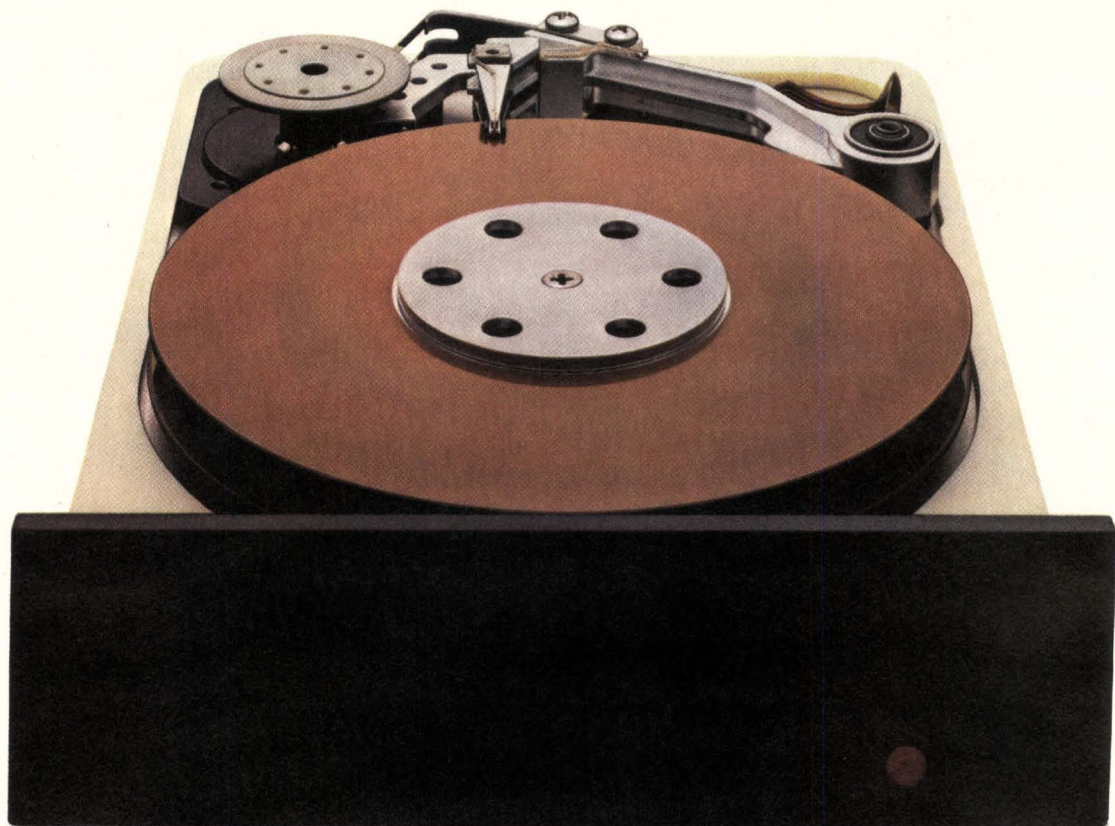

And wave goodbye to the competition.

Presenting the Shugart 712. Our new 5.25" half-height 10 Mbyte Winchester.

It's a high performance compact that redefines reliability. So much so, it outdistances all other half-height Winchesters.

For starters, it runs at an MTBF of 20,000 power-on hours. That's 60% longer than other drives.

And it's roomy. With 10 Mbytes of formatted storage.

Plus four-point shock and vibration mountings, for a very smooth ride. And rugged enough to withstand up to 40 G's.

The 712 is based on 3370 flexure technology, bringing mainframe horsepower down to size.

And our new, low-mass head design complete with pre-amp is standard equipment, too. This makes flying height more uniform. And data integrity a given.

All this was made possible by our venture group approach. A specially chartered engineering and

manufacturing team that makes sure the bugs are out the first time out.

And we make sure they have everything they need. Like the \$40 million investment we made in capital equipment.

Which includes more progressive assembly lines. Class 100 clean tunnels. Even a more advanced spindle motor.

In short, everything you need for single-user personal computers. Intelligent workstations. And, down the road, multi-tasking software.

You won't have to reinvent the wheel every time you want to redesign, either. Thanks to our 1600 controller with built-in SCSI. Plus the drive level interface standard.

So test drive the 712 today. Or its 5 Mbyte version, the 706.

Just call your local Shugart sales office. Or, contact Hamilton/Avnet, our authorized distributor.

And find out how a little drive can take you a lot further.

Shugart

Right from the start.

 **HITACHI**

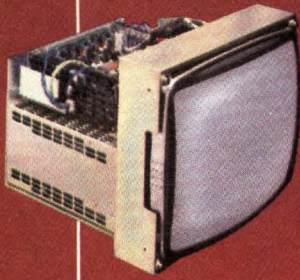

- 1280 × 1024 Resolution
- 60Hz, Non-interlace
- 100 MHz Bandwidth
- Compact, modular design

HM 4619

 **HITACHI**



- 1280 × 1024 Resolution
- 30Hz, interlaced
- 45MHz Bandwidth
- 0.1/0.3 mm convergence

HM 3619A

 **HITACHI**



- 1024 × 1024 Resolution
- 40 MHz Bandwidth
- Compact

NEW

HM 3719

 **HITACHI**

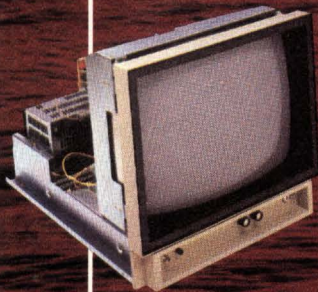

- 640 × 512 Resolution
- 25 MHz Bandwidth

HM 2719

HITACHI

Bridges The Gap In OEM RGB Color Monitors

The world of computer graphics is moving at incredible speed. Software advances dictate hardware advances; new applications demand new engineering specifications. "Limited standards" don't always fit the need.

Hitachi is the totally integrated OEM source. Our complete range of RGB Color Monitors provide a very wide selection of power, resolution, size and price. More important, we can and do modify specifications to meet highly specialized individual OEM requirements.

Best of all, our "standard" monitors and our "not so standard" monitors all reflect clearly the world renowned Hitachi technology and our dedication to design excellence.

HITACHI.....the image speaks for itself.

 **HITACHI**

The Image Speaks For Itself.

Hitachi America, Ltd.
59 Route 17S, Allendale, NJ 07401
(201) 825-8000

Hitachi America, Ltd.
3540 Arden Road, Hayward, CA 94545
(415) 783-8400

Hitachi Europe, Ltd., Lee House (10th Floor)
London Wall, London EC245AS
(01) 606-7831

Hitachi Denshi Canada, Ltd. 65 Melford Drive
Scarborough Ontario, Canada M1B 2G6
(416) 299-5900

CIRCLE 6

WHAT'S A COMPUTER JOURNALIST?

One unfortunate by-product of the Watergate crisis was the emergence of a new generation of journalists who saw the profession as a shortcut to fame and fortune. Of course, journalism no more provides an automatic ticket to success than does engineering or any other profession. But, the new journalists are a determined crowd. In search of big bucks, the post-Watergate kids have swarmed to each and every new fad—most recently, personal computers.

Because objectivity, detachment, and humility don't carry much weight in their lexicon, the new journalists find ample opportunity to promote themselves and each other ("you mention me in your column and I'll mention you in mine"). In addition, to co-opt the glamour of the industry they claim to cover, they call themselves "computer journalists." A few weeks ago, for example, the *Boston Globe* ran an article in which the writer raved about a young woman who had taken over a successful newsletter and turned it into a slightly less successful one by renaming it and shifting its emphasis from semiconductors to personal computers. The *Globe* writer characterized the woman as the "doyenne of computer journalism."

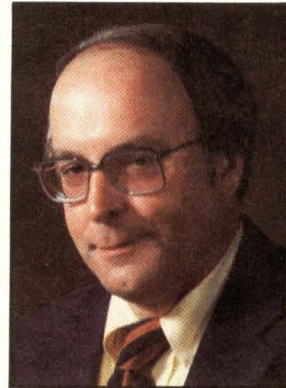

This could all be dismissed as just another passing fad, except that one of the "computer journalists" has reached a new level of arrogance by choosing to question the ethics of the technical trade press—the magazines that have been covering the technology while the "computer journalists" were writing their gossip columns. In his "Periscope" column in the *San Francisco Sunday Examiner and Chronicle*, John Dvorak launched his offensive with the headline: "The sorry state of high-technology journalism." After crediting himself with having written the most thorough analysis of Apple's Macintosh, he continued as follows: "Most of the specialized journals are written primarily by public relations firms for their clients. When you see an article in *Byte* or *Electronics*, for example, and it is supposedly written by some engineer or corporate president, you are being fooled. With few exceptions, the article was ghost-written by one of the many Silicon Valley hi-tech PR firms and put into the magazine because the company advertises a lot... Even most of the so-called news items are simply rewritten (if that) press releases. The public relations firms grind them out, and the "journalists" lightly edit them." Since Dvorak's column appeared on April Fools' Day, it is just possible that the joke is on me. However, the friend who sent me the clipping didn't think it was a joke—and I doubt if the editors of *Byte* and *Electronics* did either.

Unfortunately, there is just enough truth in what Dvorak says to trap the unwary reader into believing all of it. It is true that not all engineers write the articles that carry their bylines—just as not all celebrities write their own memoirs. Some do not have the time, and some do not have the ability. In *Computer Design*, for example, I would estimate that 20 percent of the contributed articles are initially ghost-written. But, the articles are then heavily rewritten by our editors and checked for accuracy by the bylined authors. Of course, if the manuscript is too commercial, it is not accepted. Articles are solicited, accepted, and edited solely to inform readers and fulfill our editorial plans—not "because the company advertises a lot."

The main reason magazines do a lot of editing, research, and original writing (and scrupulously avoid pandering to advertisers) is simple. It is known as competition. A magazine must serve its readers and maintain a high readership or it will soon die. The only publications that can get away with running unedited press releases are newspapers. By the time a monthly magazine appears, its readers already know the basic facts—they need in-depth and technically knowledgeable news analysis. Of course, Dvorak doesn't have to worry about competition because he works for a monopoly newspaper.

Furthermore, magazines such as *Computer Design* are able to do a better job because they hire engineers as editors. We have six graduate engineers on the editorial staff, and most of them worked as design engineers before switching to journalism. For example, John Bond—who wrote the staff report in this issue—is an engineering graduate of the U.S. Naval Academy. He has worked as an engineer for General Dynamics, the Air Force, and Texas Instruments. He also worked for two competing magazines and for Digital Equipment Corp, before joining our magazine. His report on 32-bit microprocessors certainly doesn't follow a script handed out by PR people of the companies advertising in *Computer Design*. In fact, less than half of the companies mentioned in Bond's report advertise in our magazine. And, their PR people don't send out press releases saying they are having trouble making 32-bit processors or that they won't be introducing them until next year. That sort of information has to be dug out the hard way.

So, if anyone can claim to be a computer journalist, I would think that a professional like John Bond should take precedence over a gossip columnist like John Dvorak. In fact, he may even be a doyen.

Michael Elphick
Editor in Chief

We don't design this.



You do.

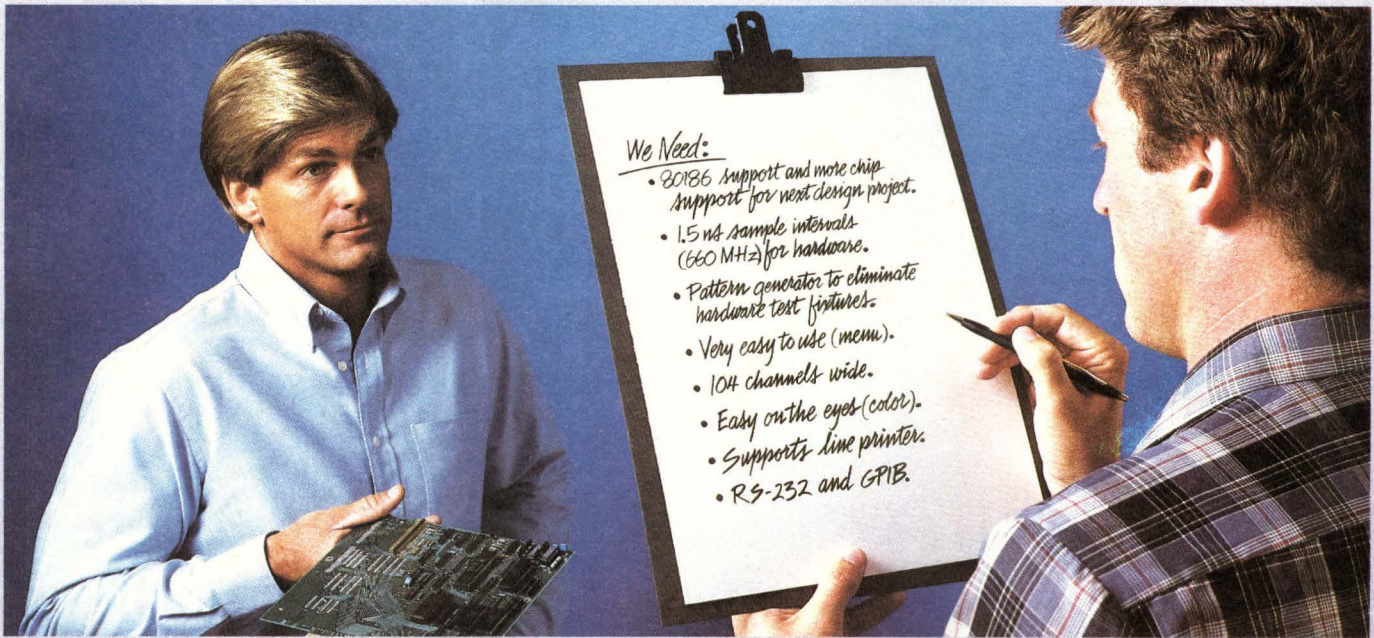

We Need:

- 80186 support and more chip support for next design project.
- 1.5 ns sample intervals (660 MHz) for hardware.
- Pattern generator to eliminate hardware test fixtures.
- Very easy to use (menu).
- 104 channels wide.
- Easy on the eyes (color).
- Supports line printer.
- RS-232 and GPIB.

The DAS gives you a choice.

Who needs limits — on your capability to solve a problem, or on the value of your investment? That's why we built the DAS. You configure it. You upgrade it. So you fit the solution to the problem. Without the limits imposed by monolithic instruments.



Configure your own.

Choose from six different data acquisition modules and two pattern generator modules. You can combine up to six modules to design your own analysis system.

You decide — 96 channels for software analysis. General purpose 25 MHz software and hardware analysis. 100 MHz hardware analysis. High-speed hardware analysis — 330 MHz or 660 MHz. Pattern generation. And add GPIB, RS-232, tape drive, line printer and hard copy support if you want.

Microprocessor support? None better.

The best in the business. You can design your own custom disassembly, using our Extended Define Mnemonics firmware, or choose from our support packages:

8080	6800	68000	65C02
8031	6801	68008	1802
8039	6802	Z80	1805
8085	6803	Z8001	NSC800
8086	6805	Z8002	F9450
8088	6808	Z8003	1750A
80186	6809	Z8004	UNIBUS
80188	68121	6502	Q-BUS
GPIB	ASCII	EBCDIC	

We've got color.

Nobody else does. Color makes the DAS the easiest design tool on the market to view, to use, to understand. You work faster because you spot hardware and software errors faster.

Time to talk about your design.

Call your Tektronix sales engineer and talk about your applications. We'll help you design your DAS.

TEKTRONIX LOGIC ANALYZERS

Talk to us.

For further information, contact:

U.S.A., Asia, Australia, Central & South America, Japan Tektronix, Inc., P.O. Box 1700, Beaverton, OR 97075. For additional literature, or the address and phone number of the Tektronix Sales Office nearest you, contact: Phone: 800/547-1512, Oregon only 800/452-1877. TWX: 910-467-8708, TLX: 15-1754, Cable: TEKTRONIX
Europe, Africa, Middle East Tektronix Europe B.V. European Headquarters, Postbox 827, 1180 AV Amstelveen, The Netherlands. Phone: (20) 471146, Telex: 18312-18328
Canada, Tektronix Canada Inc., P.O. Box 6500, Barrie, Ontario L4M 4V3, Phone: 705/737-2700

Thinking LAN*? Call the MAN from COMPUTROL

Ask him about MEGALINK for LOCAL AREA NETWORKS. Because only these LAN systems from Computrol are specifically designed for industrial real-time applications — from CAD/CAM to process control and factory automation.

Megalink Systems include both hardware and software and interface to virtually any processor you have on line:

- PDP-11 Series
- LSI-11 Series
- VAX Series
- DEC PRO/350
- All Multibus systems

So call the specialists in "network communications for industry." Call the man from Computrol.

Ask him to explain how modular Megalink solves networking problems by providing custom solutions that are as economical as they are innovative.

Call Ken Still. At (203) 544-9371. If his line is busy, talk to Don Babbitt. Or to one of our systems engineers.

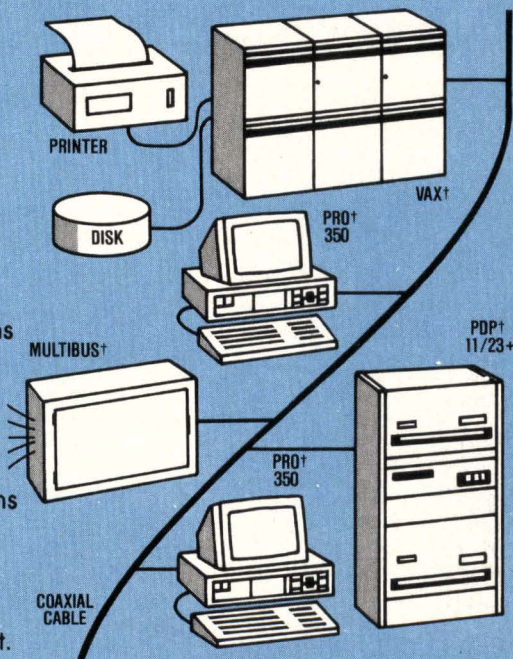

†PDP, LSI, VAX and PRO/350 are trademarks of Digital Equipment Corp. Multibus is a trademark of Intel Corp.

*LAN = local area network

COMPUTROL Network Communications for Industry
DIVISION OF KIDDE AUTOMATED SYSTEMS, INC.
KIDDE

15 Ethan Allen Highway • Ridgefield, Connecticut 06877 • (203) 544-9371

16 COMPUTER DESIGN, June 1, 1984

CIRCLE 8

COMPUTER DESIGN

The PennWell Building,
Littleton, MA 01460. Tel (617) 486-9501
Editorial/Executive Offices

Editor in Chief, Michael Elphick
Managing Editor, Sydney F. Shapiro
Senior Editors, John Bond, Peg Killmon
Special Features Editor, James W. Hughes
Senior Associate Editors,
Malinda E. Banash, Deb Highberger
Associate Editor, Jack Vaughan
Copy Editors,
Leslie Ann Wheeler (*Chief*),
Helen McElwee, Jane E. Shattuck,
Lauren A. Stickler

Editorial Assistants, Julia E. Cote,
Cynthia L. Podesta

Editorial Field Offices:
New York, NY (212) 986-4310
Senior Editor, Nicolas Mokhoff
Special Features Editor, Harvey J. Hindin

Sunnyvale, CA (408) 745-0715
West Coast Managing Editor,
Tom Williams

Editorial Assistant, Robin Mock
San Francisco, CA (415) 398-7151
Field Editor, Sam Bassett

Long Beach, CA (213) 426-1172
Field Editor, Joseph A. Aseo

Publisher, Frederic H. Landmann

Marketing Director, Robert A. Billhimer
Circulation Director,
Robert P. Dromgoole
Promotion Director, Steve Fedor
Marketing Services/PR Manager,
Linda G. Clark

Publishing Director, Gene Pritchard

Production Director, Linda M. Wright
Production Manager, Philip Korn
Art Director, Lou Ann Morin
Ad Traffic Coordinator, Debra Friberg
Printing Services, Padraic Wagoner

PennWell
PUBLISHING COMPANY

Advanced Technology Group
119 Russell St, Littleton, MA 01460
Tel (617) 486-9501

H. Mason Fackert, *Group Vice President*
Saul B. Dinman, *Editorial Director*
David C. Ciommo, *Controller*
John M. Abernathy, *MIS/DP Director*
Patricia M. Armstrong,
Administrative Services Manager



Now you can watch the entire Whizzard® family in 3D.

Because the industry's widest range of high performance graphics systems now has a whole new dimension.

A third dimension.

Which means now you can buy 3D Megateknology starting for *under* \$12,000. For instance, the Whizzard 1600 desktop design terminals with color or monochrome capabilities, very high resolution and VT-100™ compatibility.

Or our Whizzard 3355, which holds the speed record for its price range—400,000 vectors per second—thanks to our one-of-a-kind Graphics Engine.™

Then there's the ultimate computer graphics system: the Whizzard 7200. It guarantees remarkable speed and flexibility, modular architecture that supports high resolution and real-time dynamic color raster displays, and unmatched interactive graphics capabilities.

Plus, with every one of our products you get Megateknology—our longstanding trademark of innovative design, quality and high reliability.

There's a whole new dimension to our Whizzard family, thanks to the latest in 3D Megateknology.

Watch it add more dimension to your creativity.

See us at SIGGRAPH,
Booth 606, July 24-26.

 **MEGATEK
CORPORATION**
A UNITED TELECOM COMPANY
Making History out of State-of-the-Art

That's Megateknology.™

World Headquarters • 9605 Scranton Road • San Diego, California 92121 • 619/455-5590 • TWX: 910-337-1270
European Headquarters • 34, avenue du Tribunal-Fédéral • CH-1005 Lausanne, Switzerland • Telephone: 41/21/20 70 55 • Telex: 25 037 mega ch
VT-100 is a trademark of Digital Equipment Corporation

CIRCLE 9

HARRIS SPE

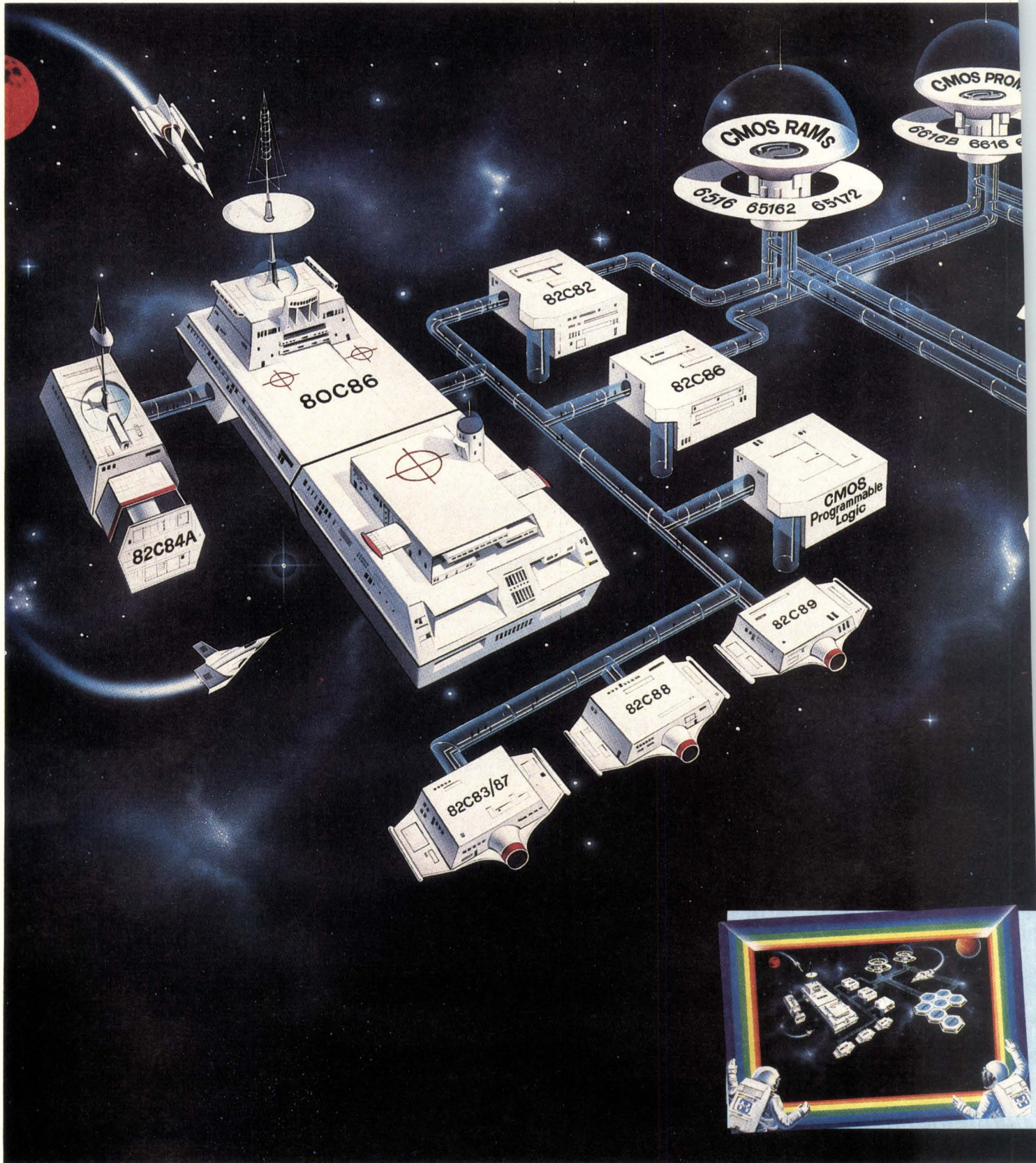

CTRUM

Harris. Exploring new frontiers in CMOS.

Taking CMOS to greater dimensions.
Harris has your total CMOS system solution.

No one comes close to Harris when it comes to CMOS.

Since the very beginning, Harris has been your competitive edge in low-power CMOS ICs. Making more technical breakthroughs than anyone—including the first 4K CMOS RAM, first 256K RAM module, first 16K CMOS PROM, and most recently, the world's first 16-bit CMOS microprocessor—the 80C86.

Right now, Harris offers a complete line of CMOS products. All available in commercial, industrial and military temperature ranges, in a variety of package options. Ready to give you that low-power CMOS edge in your new system designs and upgrades.

80C86 16-Bit CMOS CPU and Peripheral Family

All the performance of NMOS circuits but only 10% of the power required. It's yours with the Harris 80C86 series. Full DC to 5 MHz frequency range with low operating (10 mA/MHz) and standby (500 μ A) current requirements. Static design and low-power SAJI CMOS combine for outstanding performance characteristics with complete 8086 hardware/software compatibility.

Synchronous and Asynchronous CMOS RAMs

Low power or high speed, Harris has the CMOS RAM solution for you. Six-transistor cell construction assures you of data stability and low standby power operation. With access times as low as 70 ns.

CMOS Fuse-Link PROMs

Nothing beats Harris CMOS fuse-link PROMs for long-term data stability. And with 15 mA/MHz operating current (50 μ A standby) and 120/90 ns access times, your competitive edge in system design is guaranteed.

At Harris, CMOS isn't slow anymore.

Isn't it time you put the total CMOS system solution to work for you? Contact your local Harris sales office, representative or distributor to find out more about the full spectrum of Harris CMOS microprocessor and memory products.

Harris Semiconductor Digital Products Division,
P.O. Box 883, MS 53-035, Melbourne, Florida 32902-0883.

Harris Semiconductor Sector: Analog-Bipolar Digital
CMOS Digital-Gallium Arsenide-Semicustom-Custom

Harris Technology... Your Competitive Edge



HARRIS

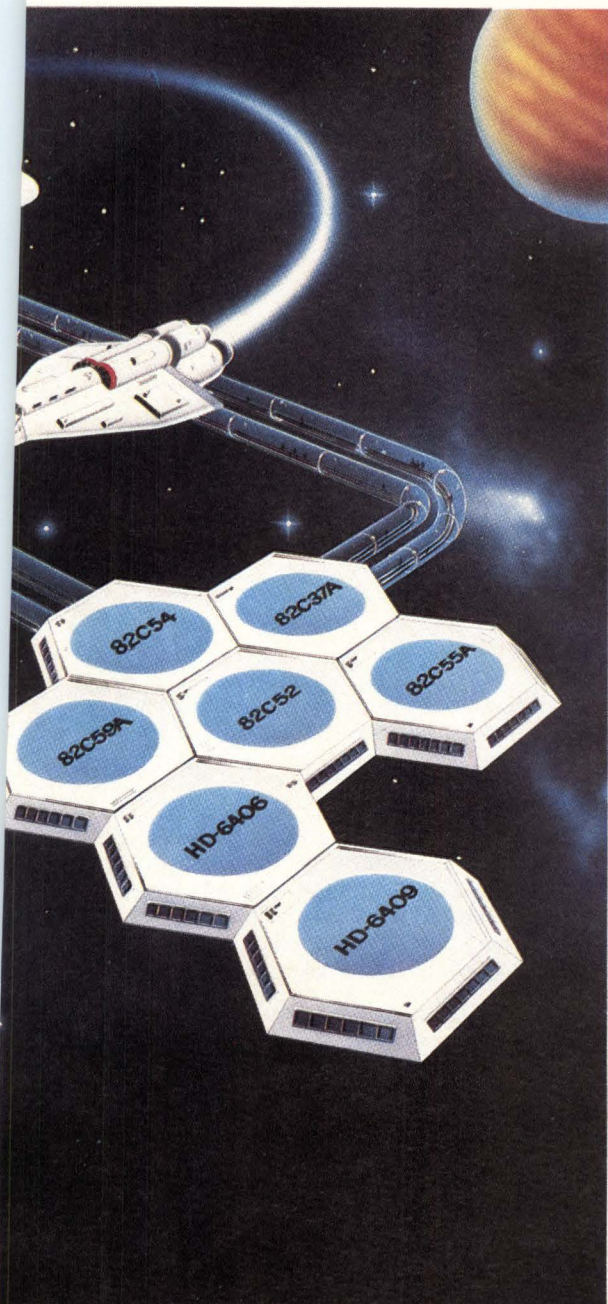

Free poster

Colorful 29" x 21" wall poster shows the Harris family of CMOS circuits from a dramatic new viewpoint. It's out of this world! To obtain your free copy, send letterhead request or your business card to:

Harris Semiconductor
Digital Products Division, P.O.
Box 883, MS 53-035, Melbourne,
Florida 32902-0883.

Predicting microprocessor reliability

I read with interest Carl P. Oppenheimer's article, "Reliable Designs Begin with the Basics" (Aug 1983, p 93). The article treats microprocessor reliability predictions as a lost cause because design flaws can cause erratic operation. However, one of the basic rules of any reliability prediction is that the design be in accordance with generally accepted practices. Then a prediction can be made based on the reliability of the individual components.

This prediction can be quite realistic, since it is based on data that has been accumulated for over 20 years. In fact, many manufacturers are now using predicted MTBF as a part of their specifications. These predictions are also used to determine service and spare parts requirements.

Since it is relatively easy to predict microprocessor system reliability with the data base that is available today, one wonders why it is not used more as a sales tool. I have noticed it advertised heavily for many Japanese digital products. Could it be that they are about to beat us in this area too?

Michael Hordeski
Siltran Digital
2250 Monterey Rd
Atascadero, CA 93422

Educating the public

The February 1984 editorial, "The Computer Illiteracy Threat," is very much to the point. But it is not just excessive hype that is ruining the bright future for the industry. Just about everyone is ignoring that the public has been offered a tool that it does not know how to use.

Graphics capabilities are not only useless, they are a threat to a public that has been left untutored in the meanings of visual communication. Willful color manipulation because it is available and technically possible, is worthless for most. One must know how to channel, what the subliminal metaphor is that has been triggered, and what the human factors of the psychological response are.

Indeed, by creating this magic tool, and pushing it on the public, it is the responsibility of the industry (made up of those who have often detested the humanities)

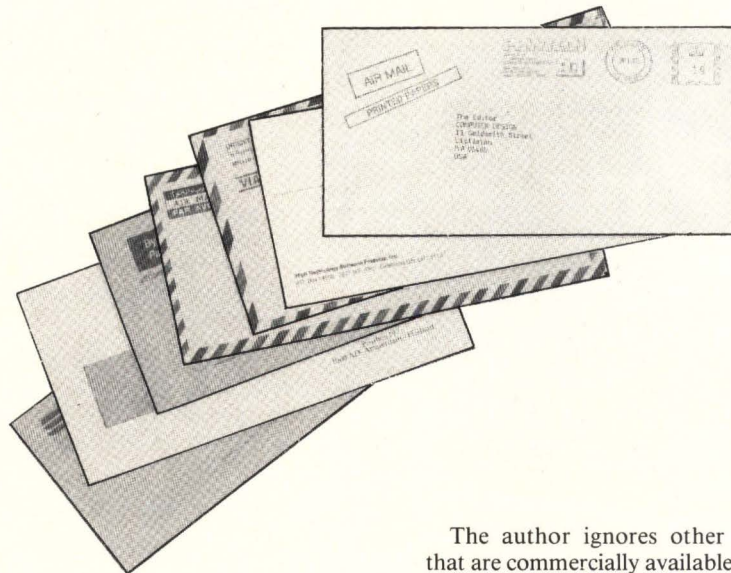

to explain and relate, to equate and simplify. And, if the members of the industry cannot do this, then they should hire someone who can.

Odeda Rosenthal
East Hampton, New York

Industry teams up with academia

The increasingly common alliances between industry and academia (Apr 1984, p 6) portend further economic hardships for working engineers. Too much of the work previously assigned to industry's engineers is now diverted to the campus, where it is performed, in the guise of "research," by greedy professors and grossly underpaid graduate students.

It is a trend that must be resisted.

Irwin Feerst
Committee of Concerned EEs
PO Box 19
Massapequa Park, NY 11762

There's more than one DSP chip

I have just finished reading Surendar Magar's article "Signal Processing Chips Invite Design Comparisons" (Apr 1984, p 179). I was very disappointed to discover that *Computer Design* would print an article that appears to contain technical information, but turns out to be nothing more than a slanted opinion or an advertisement for a particular system.

The author ignores other DSP chips that are commercially available and which may be superior to the TMS32010. However, because of his choice of chips, the TMS32010 appears to be the best DSP chip available. That is far from reality.

For example, the Fujitsu MB8764 DSP, which is currently available, was not mentioned. Furthermore, the author completely neglected to mention the AT&T Bell Labs DSP chip which, although it may not be commercially available to anyone outside of AT&T, was the first DSP chip developed. In fact, recent generations of the chip continue to lead in the area. Also, any customers within AT&T would be comparing any other chip to the Bell Labs DSP chip.

My disappointment is that I expected that at least an editor of the article would catch the omissions.

Salomi T. Charalambous
AT&T Information Systems
307 Middletown-Lincroft Rd
Lincroft, NJ 07738

Letters to the Editor should be addressed:

Editor in Chief
Computer Design
119 Russell St.
Littleton, MA 01460

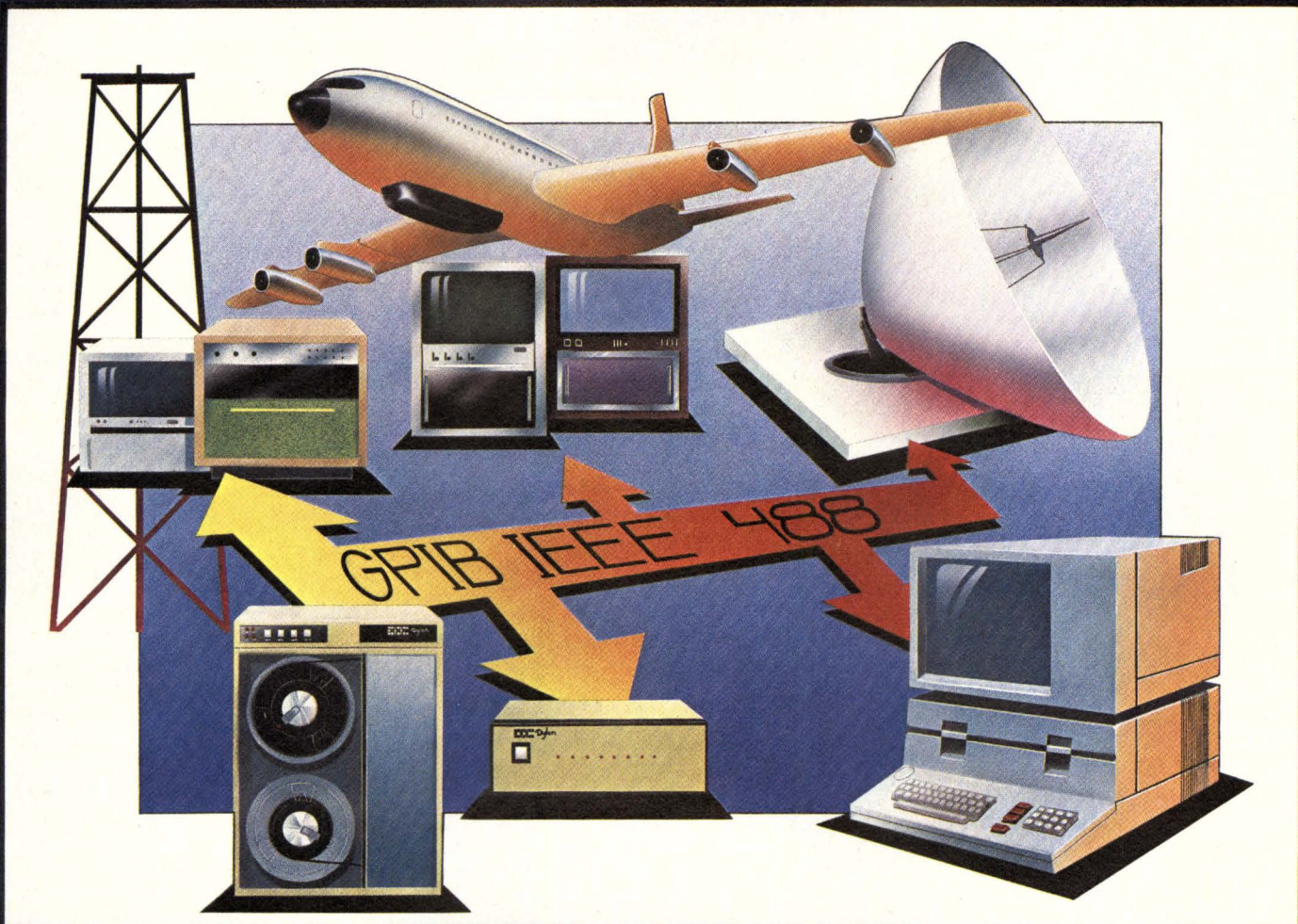

The Ultimate in IEEE-488 Data Storage

So It's Always There When You Need It

Dylon, the world leader in magnetic tape systems and controllers for GPIB (IEEE-488) users, offers the ultimate in data recording and storage. Whether your bus controller system is Hewlett Packard, Tektronix, Fluke, DEC or the IBM Personal Computer, you keep the data you need at a cost you can afford.

Built for reliability. Dylon magnetic tape controllers and systems give you field-proven dependability in such demanding applications as military aircraft, shipboard or other mobile installations throughout the world.

And our product range fits your data collection needs. Not the other way around; all products provide industry standard formats for information interchange, with 1/2" tape speeds from 12.5 to 75 inches per second and recording densities of 800 cpi, 1600 cpi and 6250 cpi. One quarter inch cartridge systems at 1600 or 6400 cpi are also available.

All that capability plus total support. Dylon application engineers are available to assist you, and our products carry a 12-month warranty. For extra security a low-cost annual fee extends your warranty indefinitely, saving you money and keeping your network running. Whatever tasks your IEEE-488 instruments perform, Dylon makes it possible for you to store the data safely, conveniently and in the most cost effective manner possible.

Discover Dylon - the PERFORMANCE ALTERNATIVE

Call (619) 292-5584 or return this coupon for more information. Distributor and OEM inquiries invited.

Name _____ Title _____
 Company _____
 Address _____
 City/State/Zip _____
 IEEE-488 System Type _____
 Application _____



Dylon
Data
Corporation

9561 Ridgehaven Court San Diego, CA 92123

CIRCLE 12

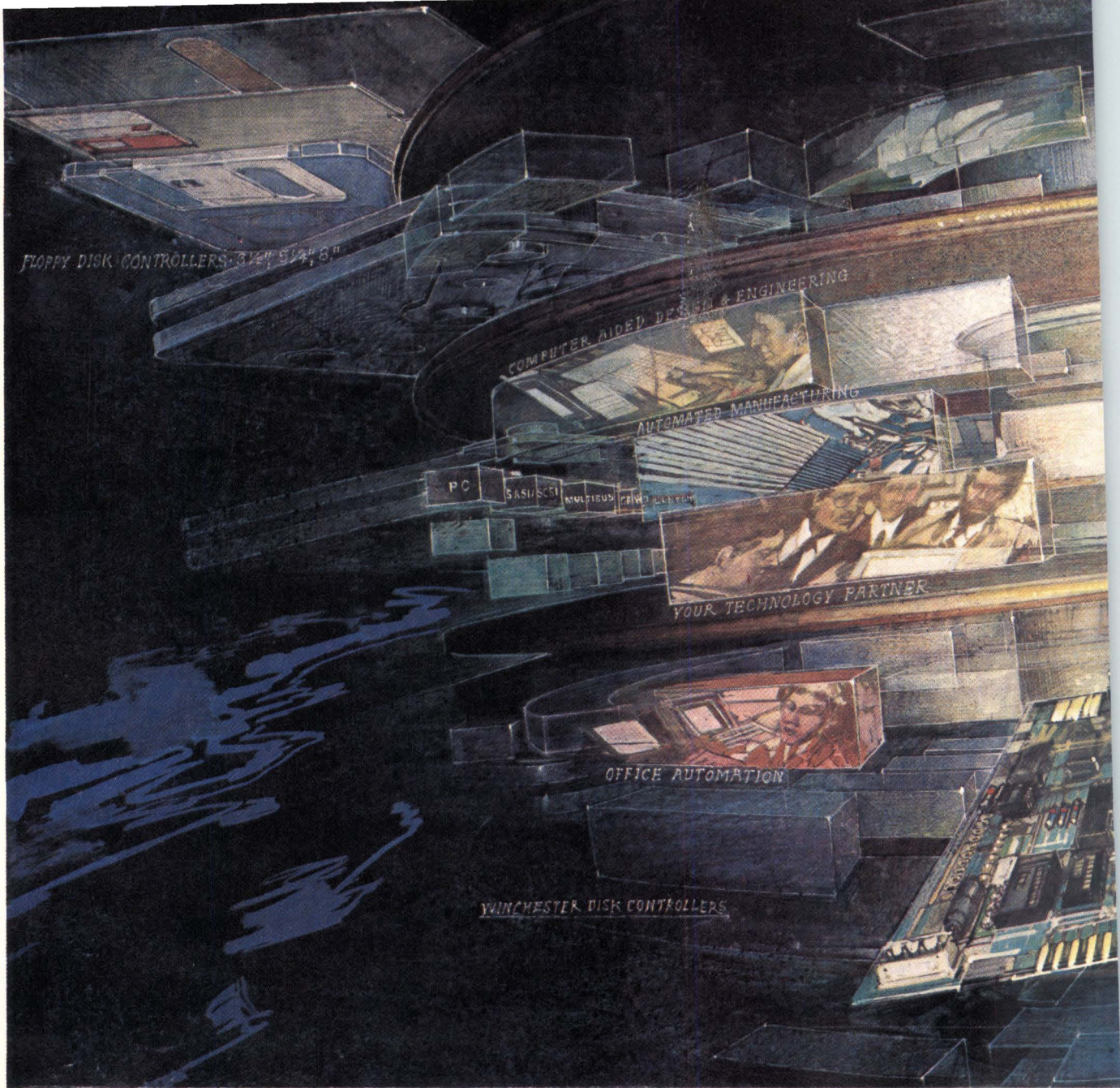

WHAT'S IN STORE FOR DISK STORAGE? THE FUTURE...

Your future is ensured when you make Western Digital your partner in storage management technology. We've led the way with non-stop innovation, from the first single chip floppy disk controller nearly a decade ago to the broadest offering of chip and board-level floppy, Winchester and tape controllers today.

Systems in Silicon.

What makes us unique are our extensive VLSI capabilities. Designing and manufacturing our own proprietary chips enables us to 1) pack more performance into our controllers than is possible using general purpose LSI, 2) continuously integrate more and more functionality into fewer and fewer devices, 3) and provide you with an unending path to lower cost and higher performance as we ride the experience curve.

Chip-to-board synergy.

Solutions are what we offer systems builders. Having us build you a board-level disk controller

TWENTY-FIVE YEARS AGO CALCOMP PIONEERED THE M



Back in 1959 when computer graphics was barely a concept, CalComp pioneered the first computer-driven plotter. Since then we've had one successful product after another, and the momentum has never been greater than it is now.

Versatile DUAL-MODE™ pen plotters fill out the line.
To offer you the broadest line of

plotters in the industry, we've introduced a new generation of intelligent, micro-processor-based DUAL-MODE™ pen plotters. They give you the versatility to run unattended, continuous roll batch jobs, as well as drawings on cut-sheet or pre-printed forms.

The fastest electrostatic plotters in the industry.
CalComp offers a complete line of electrostatic plotters. With the fastest paper travel speeds in the

industry, you get fast finished-quality plots at an affordable price.

An unmatched choice in precision digitizers.

Known for accuracy and reliability, CalComp digitizers range from a small 11-inch (2794mm) square to tablets as large as 44 x 60 inches (11176 x 1524mm), with

THE MOMENTUM

MOVEMENT TOWARDS INNOVATIVE GRAPHICS PRODUCTS.



advanced features such as rear projection and microprocessor control.

Powerful new CAD systems.

The new CalComp System 25 interactive CAD system is designed to meet your most demanding design and drafting needs. Configured as a small stand-alone system or a large multi-station network, System 25 delivers the most complete

solutions quickly and cost-effectively.

Displays draw on local intelligence.

We've also enhanced our display family with a valuable option that lets you use the intelligence of your terminal for developing customized graphic applications.

Move forward with the leader.

CalComp will introduce a wide array of state-of-the-art products this year. Our 25th anniversary year. That's the kind of momentum that has made CalComp the leading supplier of computer

graphics equipment, with the most complete product line in the industry.

You'll find CalComp plotters, displays, digitizers and CAD systems in every corner of the world, supported by a comprehensive sales and service network.

As you can see, the momentum is growing every day.

CALCOMP, 2411 West La Palma Avenue, P.O. Box 3250, Anaheim, CA 92803.

In continental U.S., except California, call (800) 556-1234, ext. 156. In California call (800) 441-2345, ext. 156.

CALCOMP
A Sanders Company

M IS GROWING

Because You need to run FORTRAN programs 10X to 100X faster...

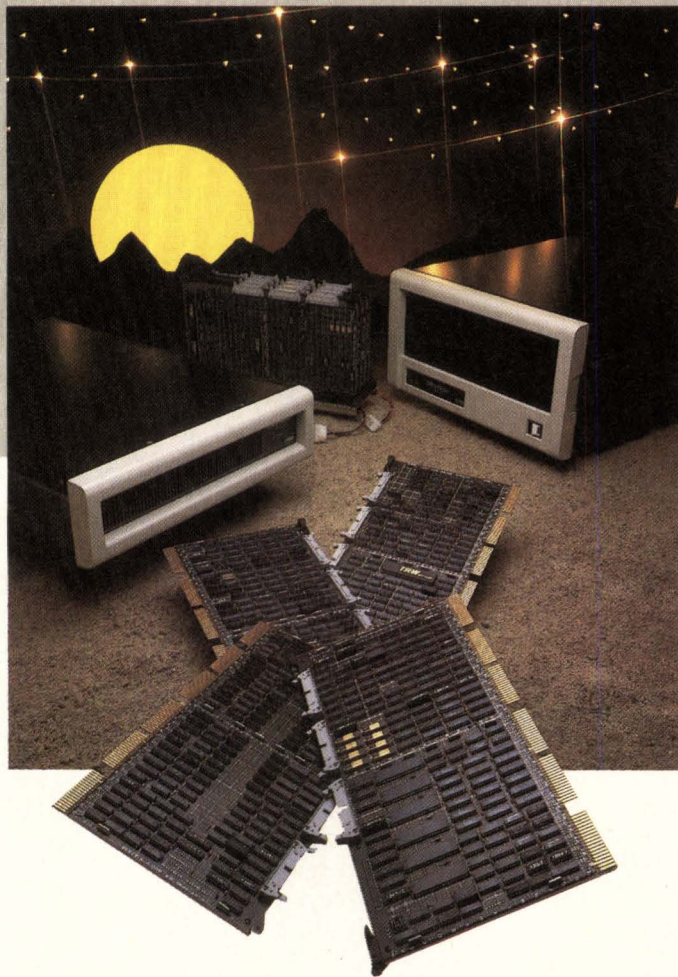

Mini-MAP makes it practical to apply array processing to general-purpose scientific and engineering computing.

Practical in terms of use: Mini-MAP's compiler allows you to program the array processor directly in FORTRAN. An assembler, a linker, and a debugger are also part of the package. Plus you can use our library of over 250 highly optimized scientific subroutines.

Practical in terms of throughput: Because it is an array processor, Mini-MAP increases the computing speed of a mini or super-mini computer as much as 10 to 100 times. Where it takes a typical minicomputer minutes to perform tasks such as image rotation, Mini-MAP reduces interactive response times to seconds. Your computer may require hours to perform each step of a trial-and-error-process such as simulation, but Mini-MAP can zip through in mere minutes.

DEC, PDP-11, LSI-11, and VAX-11 are trademarks of Digital Equipment Corp. Mini-MAP is a trademark of CSPI.

Practical in terms of cost: Mini-MAP is available as an economical, four-board set or as a packaged system. Now, with Mini-MAP, OEMs can offer their customers a better product at lower costs. Mini-MAP's low power demands, small size, and high reliability make the package extremely attractive. And end users will find our FORTRAN compiler and other software tools minimize program development costs.

We built Mini-MAP.™

Some practical things to know about Mini-MAP:

32-bit DEC™ floating point format Interfaces to DEC PDP-11, LSI-11, and VAX-11 series Up to 16 MBytes of data memory 1024 x 1024 2-D FFT in 8.8 seconds Extensive software tools plus dedicated applications assistance including training, convenient parts depots, and field service staff support our worldwide installations. To find out how Mini-MAP can work for you, call toll free 1 800 325-3110.

CSPI
THE ARRAY PROCESSORS

40 Linnell Circle, Billerica, Massachusetts 01821 • 617/272-6020 • TWX 710-347 0176

Superminis assert superiority through superior numbers

The flurry of recently released 32-bit minicomputers dampens rumors that micros have taken over the minicomputer world. Some say this renewed vitality stems from recognition of the need for an intermediary in the micro-to-mainframe link. Others maintain that minicomputers have always occupied a special niche because of their superior price/performance ratios, and interactive natures.

Heading for top ranking in the supermini field, Gould extends its Concept 32 family with the addition of the 32/97xx, and Digital Equipment Corp puts together a machine that supplies more raw power than the familiar VAX 11/780. Meanwhile, Harris Corp extends its 48-bit line with the entry level H60, and Modular Computer Systems Inc joins the 32-bit ranks with its Classic 32/85. In addition, AT&T launches its long-awaited line of mini and supermini machines.

Even more diverse than the companies promoting them, these machines fit every conceivable need. Common to all is a smaller sized package. This is made possible by increased use of VLSI to replace discrete IC packages, and the heavy use of 256-Kbit RAM in main memory. In addition, most support Unix, and remain compatible with other family members by running proprietary operating systems.

Cutting down on package size

Harris Corp's (Computer Systems Division, 2101 W Cypress Creek Rd, Fort Lauderdale, FL 33309) H60 has a 48-bit CPU, which is contained on only two boards. The 256-Kbit RAM allows 6 Mbytes of memory to reside on a single board, while retaining all standard error detection, error correction, and diagnostic features. An example of this is the optional single board integrated scientific arithmetic unit (ISAU) hardware processor that supplies a 50 percent increase in floating point performance over equivalent software routines. The ISAU contains 900 fewer ICs than the previ-

ous 5-board implementation, a reduction achieved through heavy use of VLSI and custom gate arrays containing more than 8000 gates.

Inside this 30- x 19- x 30.5-in. (76.2- x 48.3- x 77.5-cm) cabinet is a CPU, an 80-Mbyte, 8-in. Winchester disk drive, a 23-Mbyte cartridge tape drive, and a communication controller. The unit can support up to 32 interactive users, and its performance is rated at 80 to 110 percent of that provided by a VAX 11/780.

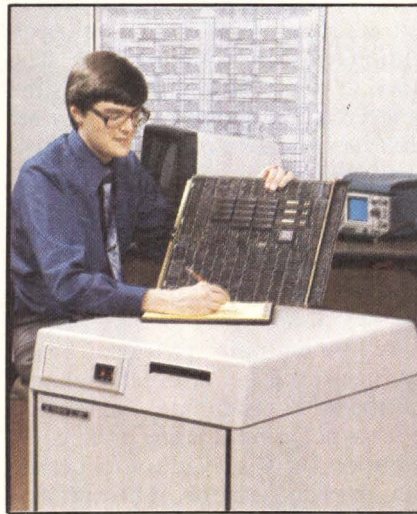

Operating at nearly 1 MIPS, the Harris 60 uses VLSI/LSI circuits, custom gate arrays with over 8000 gates, and a 256-Kbit RAM to decrease bulk. Performance enhancements such as the integrated scientific arithmetic unit (ISAU) increase reliability.

To supply this performance level, the CPU includes a 6-Kbyte cache memory formed of 150-ns bipolar RAM—half storing instructions, half operands. The unit currently runs the proprietary virtual memory operating system (VOS) to maintain software compatibility with more powerful family members. Unix support should appear by the end of the year.

Aiming for a similar sized box, Gould (Computer Systems Division, 6901 W Sunrise Blvd, Fort Lauderdale, FL 33313) fielded the PowerNode 6000 series. Composed initially of PowerNode 6030, 6050, and 6080, the series' performance is rated from

1.5 to 3 times that of the 11/780. The entry level 6030 packages 2 Mbytes of main memory with an 80-Mbyte Winchester drive and 60 Mbytes of cartridge tape in a 30- x 29- x 30-in. (76.2- x 73.6- x 76.2-cm) cabinet. It is based on a 3-board, 32-bit CPU.

The supermini architecture of the high speed TTL CPU accommodates a 32-Kbyte, 2-way set associative cache memory. This memory provides 150-ns effective access time. Virtual addressing for up to 16 Mbytes, in conjunction with demand-paged hardware memory management, allows handling of large programs.

A second processor in a tightly coupled configuration raises the computational power of the 6080 by as much as 80 percent. As in the Concept series, this internal processing unit handles computation-bound tasks for the CPU. The UTX/32 operating system for the series is based on the Berkeley 4.2 BSD Unix, with features from Unix System v. This operating system supports virtual memory management, as well as the tightly coupled dual processors used in the 6080.

The Classic 32/85 marks Modular Computer's (Modcomp, 1650 W McNab Rd, Fort Lauderdale, FL 33310) first venture into the high performance 32-bit world. With the CPU's effective cycle time of 100-ns and extended microinstruction word length that allows parallel internal operation, Modcomp leaves its traditional 16-bit realm. Aimed at answering needs for realtime response, this machine provides rapid movement between priority based tasks with extremely fast context switching.

The 32/85's instruction set processor is a complete ALU that consists of a functional microprogrammable processor with hardware multiply and floating point arithmetic. Its context file is a high speed RAM containing 128 sets of 15 general purpose registers. Operating under the control of independent status words, the vectored interrupt system is able to switch up to 16 mapping caches (each 128 registers) and up to 128 sets of
(continued on page 28)

Superminis assert superiority

(continued from page 27)

15 registers (each 32 bits wide) within a few microseconds. This arrangement eliminates the need to save and restore environments under software control, and allows the machine to handle fast changes when performing in realtime environments.

The system's multiported memory enables concurrent parallel transfers through up to six ports. Multiported memory also allows shared memory and multiprocessor configurations to be built. Such units fill needs for high performance applications by providing load sharing and high availability. This memory is overlapped, not interleaved as in other systems. Thus, failures are confined to a single memory module, rather than allowed to spread throughout multiple modules. In addition, the system uses cache memory to speed effective memory access time. This 64-Kbyte, 4-way set associative memory is broken into 16 Kbytes per set. A least

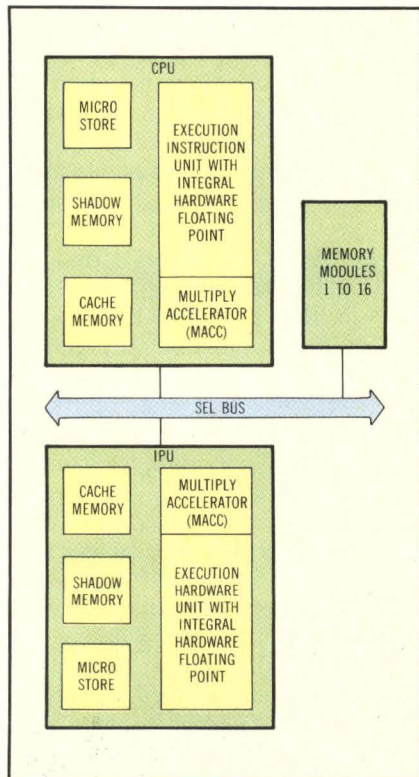

Functional units within the central and internal processing units that form the Concept 32/9780 are connected by internal buses that have 75-ns cycle times. During each 75-ns cycle, 4 macroinstructions are in various phases of execution, increasing the effective throughput of the system.

recently used algorithm is used to maintain a record of the least recently used set for each group of four 32-bit words in the cache.

Raising the stakes

Gould's high end contribution to superminicomputer class machines supplies all the performance of previous Concept 32 systems, plus 16-Mbyte task addressing capability and modular performance enhancements. Moreover, in its basic configuration (with CPU, 4 Mbytes of main memory, and 32 Kbytes of cache memory), the 32/9705 provides performance rated at up to 4.67 million instructions per second (MIPS).

Low end machines in this family are based on an instruction unit/execution unit CPU architecture. The 10-K ECL CPU has a 75-ns cycle time bolstered by the use of a 4-way set associative cache memory and a 4-stage instruction pipeline. Optional performance enhancements—ie, multiply accelerator, additional cache, shadow memory, and dual processor—raise CPU performance to the 10-MIPS level.

A floating point processor based on high speed ECL is an integral part of the CPU. Handling single- and double-precision floating point computation, its 64-bit wide buses permit high speed operation. The optional plug-in multiply accelerator (MACC) adds 1 MIPS to the CPU's computational power by computing products for nine integer and floating point instructions. Comparable to a two-board plug-in VAX, but transparent to the software, the MACC makes its presence known only by the speed with which multiply computations are executed.

Main memory's 300-ns read, 150-ns write cycle is reduced still further by the use of cache memory that resides between main memory and the processor. The optional 32-Kbyte cache, structured with 4 banks of 8 Kbytes each, provides a double word to the CPU in 75 ns. Another option, user-controllable cache or shadow memory, consists of from 128 to 256 Kbytes of high speed RAM. Used in conjunction with the cache controller, shadow memory (like cache) can be accessed within a 75-ns cycle time.

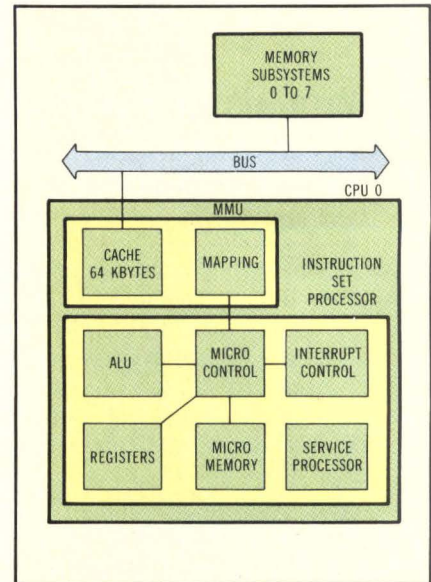

The CPU in Modcomp's 32/85 executes two instruction sets; one compatible with the 16-bit Classic II/75, the other providing 32-bit addressability. The instruction set processor is a complete ALU consisting of a functional microprogrammable processor with hardware multiply and floating point arithmetic. Microinstructions are contained in a writable control store.

However, whereas addresses contained in cache are a function of recent processor utilization, shadow memory always contains the same set of addresses. This can raise the hit rate from the approximately 95 percent attained with a large cache to 100 percent, thus guaranteeing a certain level of performance in time-critical applications.

The long-awaited arrival of AT&T's (Computer Systems Division, 222 Broadway, New York, NY 10038) promised contributions to the superminicomputer world let established vendors breathe a sigh of relief. While extensions to the family promise significantly increased performance, the three mini level systems, the 3B20S, the 3B20A, and the 3B20D use readily available technology.

These systems use bit-slice bipolar technology and 64-Kbit RAM. The 3B20S architecture relies on programmable micro store with capacity for 8 Kbytes of 64-bit long instructions as well as cache memory, to attain speeds of 1 MIPS. With 8 Kbytes of cache enabled, the CPU can access its maximum 12-Mbyte memory in a 400-ns

effective access time. The single processor 3B20S machine that supports up to 100 users and performs at a rate of roughly 1 MIPS grows into a 3B20A attached processor system that nearly doubles performance. Rated at 1.8 MIPS, the 3B20A uses parallel processing, with both processors performing operating system calls independently. The unit supports 50 to 180 users and costs only 30 percent more than the 3B20S.

The 3B20D is a dual processor unit that provides fault tolerant performance. To supply high reliability (minimum downtime), one processor acts as a hot standby for use only when the other malfunctions. This unit runs the Unix realtime reliable (RTR) operating system to provide its fault tolerant features in a realtime environment. These reliability features are supplied by a fully duplexed architecture. Redundant self-checking logic allows automatic fault detection. All peripherals are dual ported and the operating system provides for automatic reconfiguration after failure. A crashproof file system and mirrored disk volumes ensure data integrity.

To stay competitive, DEC (146 Main St, Maynard, MA 01754) has introduced a new VAX, not the anticipated "Venus," but an adequate extension to the line. Along with this extension come promises that further additions will be made later this year. The new VAX 11/785 provides performance 50 to 70 percent greater than the 11/780, bringing it up to the 1.7-MIPS range. Improved circuit technology and internal performance enhancements in the traditional VAX architecture provide increased power. Improvements include implementation of the CPU from high speed advanced Schottky circuits, larger cache memory, new floating point accelerators, and writable control store for microprogram instructions.

CPU cycle time has been shortened to 133 ns to match the switching capability of the advanced Schottky logic. This accelerated cycle time allows operations to occur 50 percent faster. Synchronization circuitry allows the system to use unmodified /780 synchronous backplane interconnect interfaces, controllers, and peripherals.

Injection of a 32-Kbyte cache into the CPU reduces bus traffic by in-

creasing the probability that data will be in cache. This reduces data transfers from main memory and improves I/O performance. Using the same technology and timing as the CPU, the FP785 floating point accelerator can improve floating point performance 47 percent.

Another change is the storage of microcode in RAM, instead of in ROM as in the /780. This provides enhanced CPU performance and facilitates microcode updates. All in all, this system can support 50 workstations or 100 interactive terminals, while maintaining compatibility with existing software and peripherals.

In spite of all this activity, the performance improvements displayed by these machines are marked more by evolution than revolution, and may disappoint those looking for great strides forward. However, recognizing that these incremental achievements were enabled through simple circuit tweaking makes speculation about future advances even more exciting.

—Peg Killmon, Senior Editor

DATA COMMUNICATIONS

Simpler clusters emerge as local area network alternative

Monolithic local area networks may give way to a cluster concept. Based on multiple clusters, each operating within narrow geographical and organizational boundaries, the concept simplifies peripheral sharing and cuts connect costs. Simplicity results from tying fewer terminals together. The cost per connection is reduced because less data travels shorter distances at slower speeds.

This cost reduction is the goal of vendors such as AST Research with PCNet, Network Development Corp with its Device Network Architecture, and IBM with PC Cluster. These offerings serve fewer users (typically no more than 32) and run shorter distances than high speed networks such

as Ethernet. However, they guarantee access to network resources with lower system overhead.

Developing alternative networks

Meanwhile, a related development focuses on cheaper implementations of the IEEE 802.3 baseband (read: Ethernet) specifications. National Semiconductor (Santa Clara, Calif) hopes that its upcoming network controller chip set will find its way into "Cheapernet" systems using inexpensive RG58AU coaxial cable rather than the more costly RG50AU cable Ethernet requires. Advanced Micro Devices and Seeq Technology, Inc (both in Sunnyvale, Calif) may also support this alternative, which lowers

cost while retaining the 10-Mbit/s data transfer rate of its cousin.

Rather than competing directly with their more expensive counterparts, cluster nets actually increase high speed network effectiveness. By focusing on natural work settings (eg, groups of offices or a department), they concentrate resources where needed. Up to 95 percent of communication traffic involves accesses to local data bases or local peripherals, according to Albert Wong, vice president of AST Research (2121 Alton Ave, Irvine, CA 92714). Clustering reduces the amount of traffic over high speed networks. Network traffic consists only of requests to central

(continued on page 30)

Simpler clusters emerge

(continued from page 29)

Comparison of Clustered Networks				
	Cheapernet	PCNet II	PC Cluster	Device Network Architecture
Transmit speed	10 Mbits/s	800 kbits/s	375 kbits/s	800 kbits/s
Topology	bus	bus	bus	bus
Access method	CSMA/CA*	CSMA/CA**	CSMA/CD	polling
Transmission medium	coaxial cable	twisted-pair wire	coaxial cable	coaxial cable
Maximum no. of connections	512	160	64	64

*Carrier sense multiple access/collision detection
**Carrier sense multiple access/collision avoidance

data bases and access to peripherals too expensive to dedicate to one cluster (eg, laser printers and SNA gateways).

Many local networks encourage contention among users since all users must contend for a single resource—the bus. Fairly inexpensive resources (eg, dot-matrix printers, 5¼-in. rigid disk drives) are connected to the same link as the expensive resources. As a result, it takes as much time to submit a print job to a \$600 printer as it would to a \$60,000 one.

Cost—the big issue

Clusters promote efficiency by attacking connection costs that approach \$1000 per node for typical network implementations. Factors affecting these costs include the number of nodes on the network, network topology, access control method, overall distances that the network must cover, and the transmission speeds needed to support many nodes over extended distances. Faster speeds are needed to shorten delay times between nodes.

Of these considerations, distance and the number of nodes have the most impact. Long distances require extensive transmission medium shielding so that spurious noise from the environment does not disrupt transmission.

This is the major reason that the RG50AU cable used for Ethernet is

much more expensive than the RG58AU cable used in Cheapernet. The more expensive version allows packets to be sent as far as 5000 cable-ft. RG58AU, however, limits transmissions to 2000 cable-ft maximum. The less expensive cable cannot be used in noisy environments, such as wiring conduits and ventilation shafts.

Total distance also impacts the number of nodes supported because a minimum gap between nodes (eg, the 36 in. required in Ethernet) is needed for sufficient delay between transmissions. Distance affects transmission speeds in a similar manner by determining the amount of delay incurred in sending a message from one node to the other. Higher transmission speeds (such as the 10 Mbits/s dictated by Ethernet) are needed to support a large number of nodes in geographically dispersed locations.

Network controllers must be more sophisticated (and hence more expensive) when many nodes are interconnected. This is because the probability of collisions rises. Access control surfaces as an issue with more nodes contending for overtaxed bus bandwidth. Prevalent schemes used to handle this challenge—collision detection and token passing—incur significant overhead that may be bypassed if there is a decrease in the number of nodes.

(continued on page 32)

What is "The Alps Advantage", and why is it important to you, our customers?

Essentially, The Alps Advantage encompasses a whole series of customer benefits, brought together to help give you a competitive edge in your marketplace.

Welcome To The Alps Advantage For design engineers, it means a vast array of electro-mechanical components and system products—particularly noteworthy for their innovative technology, state-of-the-art performance, high degree of miniaturization, built-in quality and long-life reliability. It also means a never-ending flow of new product introductions and helpful application engineering assistance from our Technical Product Managers.

For purchasing and production people, The Alps Advantage takes on other meanings—competitive pricing, automated manufacturing facilities and on-time deliveries. Equally important, it means a special kind of philosophy based on a spirit of teamwork and cooperative customer relations.

The Alps Advantage is everything you need to improve your products and enhance your competitive position—and everything you'd expect from a world-class supplier. Since its founding in 1948, Alps Electric Co., Ltd. has experienced steady, stable growth—to a level of world-wide sales now up to \$1-billion per year!

We look forward to the opportunity of putting The Alps Advantage to work for you—to get started, please contact the Alps Sales Rep nearest you:

AL	Huntsville (Jack Harvey & Assocs.)	(205) 536-4414
AZ	Phoenix (Eltron)	(602) 266-2164
CA	San Diego (Harvey King, Inc.)	(619) 566-5252
CA	Santa Clara (Nova-Tronix, Inc.)	(408) 727-9530
CA	Garden Grove (West Electronic Sales)	(714) 898-0120
CO	Englewood (Nelligan Co.)	(303) 761-2121
CT	Yalesville (Technology Sales, Inc.)	(203) 269-8853
FL	Clearwater (Jack Harvey & Assocs.)	(813) 725-1841
FL	Ft. Lauderdale (Jack Harvey & Assocs.)	(305) 763-1945
GA	Norcross (Jack Harvey & Assocs.)	(404) 449-4643
IL	Arlington Heights (Micro Sales, Inc.)	(312) 956-1000
IN	Indianapolis (Jack Harvey & Assocs.)	(317) 872-1031
IN	Kokomo (Jack Harvey & Assocs.)	(317) 453-4260
KS	Kansas City (BC Electronic Sales, Inc.)	(913) 342-1211
KS	Wichita (BC Electronic Sales, Inc.)	(316) 942-9840
KY	Prospect (Jack Harvey & Assocs.)	(502) 228-4100
MD	Baltimore (Burgin-Kreh Assocs., Inc.)	(301) 265-8500
MA	Waltham (Technology Sales, Inc.)	(617) 647-5700
MI	Oak Park (A. Blumenberg Assocs., Inc.)	(313) 968-3230
MN	Minneapolis (P.S.I.)	(612) 944-8545
MO	St. Louis (BC Electronic Sales, Inc.)	(314) 291-1101
NC	Greensboro (Wallace Electronic Sales)	(919) 996-2742
NJ	Boonton (PAF Assocs.)	(201) 335-0680
NY	Smithtown (PAF Assocs.)	(516) 360-0940
NY	Albany (Reagan/Compar)	(518) 489-4777
NY	Endwell (Reagan/Compar)	(607) 723-8743
NY	Fairport (Reagan/Compar)	(716) 271-2230
NY	New Hartford (Reagan/Compar)	(315) 732-3775
OH	Rocky River (Norman Case Assocs.)	(216) 333-0400
OK	Tulsa (Norcom, Inc.)	(918) 832-7747
OR	Aloha (Venture Electronics)	(503) 642-9090
PA	Willow Grove (Harry Nash Assocs.)	(215) 657-2213
TN	Knoxville (Jack Harvey & Assocs.)	(615) 524-7057
TX	Dallas (Norcom, Inc.)	(214) 386-4888
TX	Austin (Norcom, Inc.)	(512) 451-2757
TX	Houston (Norcom, Inc.)	(713) 778-0392
UT	Salt Lake City (Nelligan Co.)	(802) 261-1121
VA	Lynchburg (Burgin-Kreh Assocs., Inc.)	(804) 239-2626
WA	Bellevue (Venture Electronics)	(206) 454-4594
WI	Milwaukee (Micro Sales, Inc.)	(414) 782-1171
CANADA:	St. Laurent (Vitel Electronics)	(514) 331-7393
CANADA:	Mississauga (Vitel Electronics)	(416) 676-9720
CANADA:	Kanata (Vitel Electronics)	(613) 592-0090

The Alps Advantage in keyboards:

Keyboards for modern product design. When you bring your keyboard requirement to Alps, you'll find yourself in good company, alongside many of the most prestigious OEM industry names in the world. From single key switches to complete keyboard units including matrix and encoder circuits, you'll discover the quality, reliability and customer service that have become such important parts of The Alps Advantage, together with everything you need to sharpen the competitive edge of your products:

Full-travel keyboard units. Standard or customized designs, mechanical or conductive rubber contacts, soft-push or tactile feedback with "snap" or "click" feeling.

KFL low profile keyboard. Meets the latest world-wide standards of ergonomic design, including European DIN requirements for reduced keyboard height. The KFL is only 15.2mm from PC board to keytop.

Mem-Tact panel keyboards. Ultra-low profile units, custom-designed to your requirements for arrangement, feeling, component mounting, dust and water-proof construction, etc. Two basic styles: sheet type enclosed and keytop type.

Wide choice of keytops. Sloped, stepped or stepped-sculptured. 10 standard colors. Double-shot molded legends. An almost infinite variety of combinations!

Custom design and application assistance. Our Engineering Product Managers are highly skilled, experienced keyboard specialists. You are invited to consult with them during your earliest design planning. They can probably help you save time, effort and money. Write or call today, and let the world's largest keyboard supplier put The Alps Advantage to work for you.



ALPS ELECTRIC (USA), INC.

100 N. Centre Ave., Rockville Centre, NY 11570
Phone 516-766-3636 • Telex (WU)14-4508

A complete choice of standard and customized keyboard units, including our new full-travel low profile Series KFL, the 15-millimeter keyboard.



Advanced Multibus Products

**Powerful 68000
SBC, Graphics
Complete Software
Development Tools**

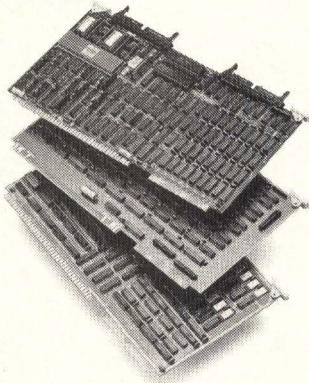

Featuring a 10MHz 68000 processor, a high performance Multibus™ graphics controller and add-on memory. The board level products of Forward Technology combine low price to keep your systems cost down, and high performance to keep your customer satisfied.

Single Board Computer ... FT-68X

- 10MHz MC68000
- 2 level MMU
- 256 KB No Wait State Memory
- Dual Port DMA
- 8 MB Addressability

Fast, High-resolution Graphics ... FT-1024

- 1024 by 1024 by 1 frame buffer
- Bit-map organized in (X,Y) coordinates
- Simultaneous access to 4 different graphical objects
- On-board "raster OP" implementation
- One 16-bit update executed each microsecond

Large-capacity Add-on Memory ... FT-768

- Add-on memory for FT-68X
- Single board
- 768 KB of no wait state RAM
- Supported by FT-68X DMA

XENIX™ Operating System

- FORTRAN 77, C, PASCAL, APL and BASIC language support for multiple users.

Forward Technology products for forward looking OEMS. Send today for full information. 2175 Martin Ave., Santa Clara, CA 95050. (408) 988-2378

™Multibus is a registered trademark of Intel Corp
™XENIX is a registered trademark of MicroSoft Corp.



CIRCLE 17

Simpler clusters emerge

(continued from page 30)

Fewer nodes also mean shorter cable lengths and slower transmission speeds. Shielding becomes less important since the chance of collision decreases due to shorter distances traveled. Furthermore, terminals and personal computers can also be connected more closely together. Vendors such as AST Research, IBM, and Network Development Corp use these benefits to their advantage and lower connection costs to as little as \$200 per node.

Much of this cost reduction comes from the use of cheaper transmission medium (cable TV-type coaxial and twisted-pair wire) and connectors. Simpler controllers can handle the slower transmission speeds (typically 1 Mbit/s) and simplified access control schemes.

Using predefined time slots

Instead of relying on probabilistic schemes that determine access by generating random numbers (eg, Ethernet back-off), the aforementioned vendors allocate predefined time slots to each user. The most popular schemes use the carrier sense multiple access (CSMA) method popularized by Ethernet. But they also employ collision avoidance techniques rather than collision detection.

With collision detection, more than one user can transmit a message concurrently. Errors are detected when collisions create a large voltage on the bus. Collision avoidance schemes, on the other hand, require that a user transmit a message request before actually sending the message. If the message returns without collision, then the user has sole control of the bus for transmission. To prevent one user from hogging the network, both AST Research and IBM Entry Systems Division (PO Box 2989, Delray Beach, FL 33444) implement priority schemes so that time slots are reallocated periodically.

National Semiconductor claims that collision avoidance schemes incur an overhead penalty not justified by traffic conditions. Design manager, R.V. Balakrishnan, says that collision avoidance schemes work best in net-

works where transmissions tend to be "bursty" rather than sustained, and peripheral services are seldom required. He notes that servicing multiple requests on collision avoidance networks requires that the peripheral wait for its turn, as determined by the priority scheme. Here, collision detection networks are better suited since requests can be serviced as often as each peripheral can transmit a message.

Network Development Corp implements a polling scheme whereby a master station periodically checks each satellite for requests. Multiple transmissions are avoided by allowing variable-sized packets (as large as 4 Kbytes) that fully utilize the timeslots allocated to each satellite.

Clusters can increase high speed network efficiency by handling the bulk of local processing, as well as by packaging individual packets into larger messages. As a result, traffic going across the high speed network would consist of intercluster messages, requests destined for central data bases, or services rendered on expensive peripherals. Thus, clusters and networks can work hand in hand to better serve the user.

—Joseph Aseo, Field Editor

SYSTEM TECHNOLOGY
(continued on page 36)

Like to write?
The editors invite you to write technical articles for *Computer Design*. For a free copy of our *Author's Guide*, circle 503 on the *Reader Inquiry Card*.

MULTIBEST™

RIGHT STUFF

Make your Multibus® product launch successful.

Wespergroup's new Multibest™ tape and disk controllers have the right stuff to successfully perform on Multibus systems. The Multibus MB-SMD disk controller is software compatible with the Intel iSBC 220 disk controller while supporting up to 2 megabyte/sec. disk transfer rate, 4 SMD type disk drives and improving throughput.

The Multibest MB-506/1000 disk controls up to three (3) ST506 or SA1000 disk drives and four (4) SA400 type floppy disk drives. The MB-506/1000



also supports mixed capacity drives and overlapped seeks.

The Multibest MB-QIC-2 tape coupler controls up to four (4) ¼" cartridge tape drives with industry standard QIC-2 interfaces.

The MB-506/1000, QIC-2 and Multibest Companion Link—the winning combination that allows image backup and restores disks to tape *without host intervention*.

Call or write today for the complete Wespergroup catalog. WESPERGROUP, div. of WESPERCORP (USA), 14511 New Myford Road, Tustin, CA 92680, Tel: (714) 730-6250, Cable WESPER, TWX 910-595-1775, Telex 4720629. (Germany) GmbH, Tel: 089 982420. (U.K.) Tel: (44) 0276-20934.

Multibus is a registered trademark of Intel Corp.
TM—Multibest is a trademark of Wespercorp

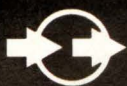

WESPERGROUP

Division of WESPERCORP

CIRCLE 18

11,000 GATES

NEVER HAS SO LITTLE MEANT SO MUCH.

In the last decade, we've opened more technological gates than anyone.

In both CMOS and bipolar.

Our 11,000 gate 2 micron CMOS array is just part of the story. We also offer TTL up to 2,000 gates. ECL to 3,000 gates. And 400 to 11,000 gate CMOS arrays. Not to mention our 100K- and 10KH-compatible ECL arrays.

Of course, a gate array is only as good as the people behind it. And at NEC, we have some of the best support engineers. Ready to help you take your design from start to finish.

With easy-to-use CAD tools. And sophisticated software capable of simulating up to 20,000 gates. All available at our 18 customer design centers, worldwide.

As for quality, we offer 100% burn-in, standard. At no extra cost. And you won't have to wait long to get it. Our turnaround is as quick as 8 weeks.

So next time you need a gate array, weigh your alternatives. Then call NEC.

WE'RE TAKING ON THE FUTURE.

For the fastest response to your questions or for more detailed information, call us TOLL FREE at 1-800-556-1234, ext. 188. In California, call 1-800-441-2345, ext. 188.

NEC national sales offices: Woburn, MA (617) 935-6339 · Melville, NY (516) 423-2500 · Poughkeepsie, NY (914) 452-4747 · Ft. Lauderdale, FL (305) 776-0682 · Norcross, GA (404) 447-4409 · Columbia, MD (301) 730-8600 · Arlington Heights, IL (312) 577-9090 · Southfield, MI (313) 559-4242 · Bloomington, MN (612) 854-4443 · Austin, TX (512) 346-9280 · Dallas, TX (214) 931-0641 · Orange, CA (714) 937-5244 · Cupertino, CA (408) 446-0650

© 1984, NEC Electronics Inc.

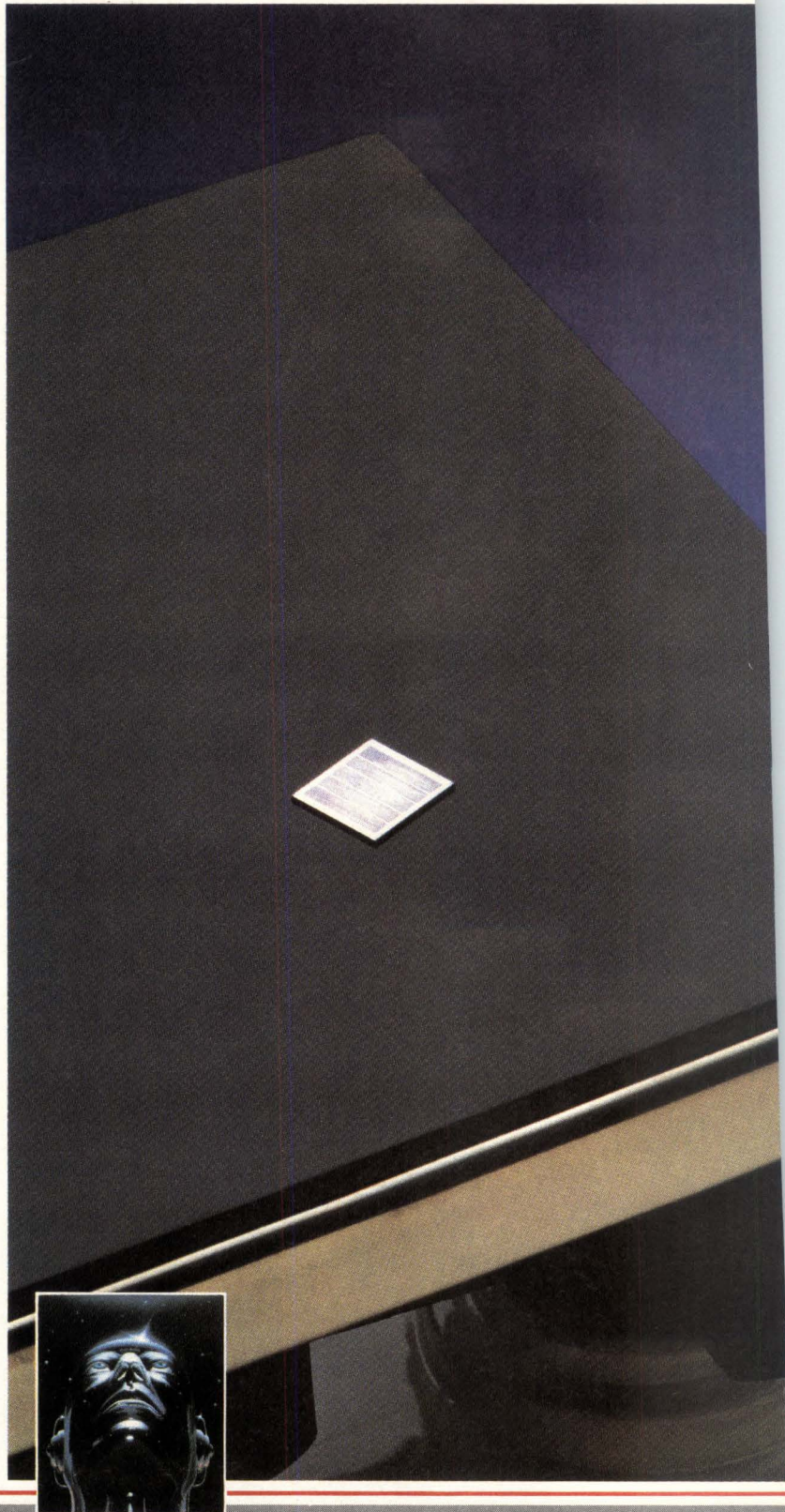

PER GRAM.

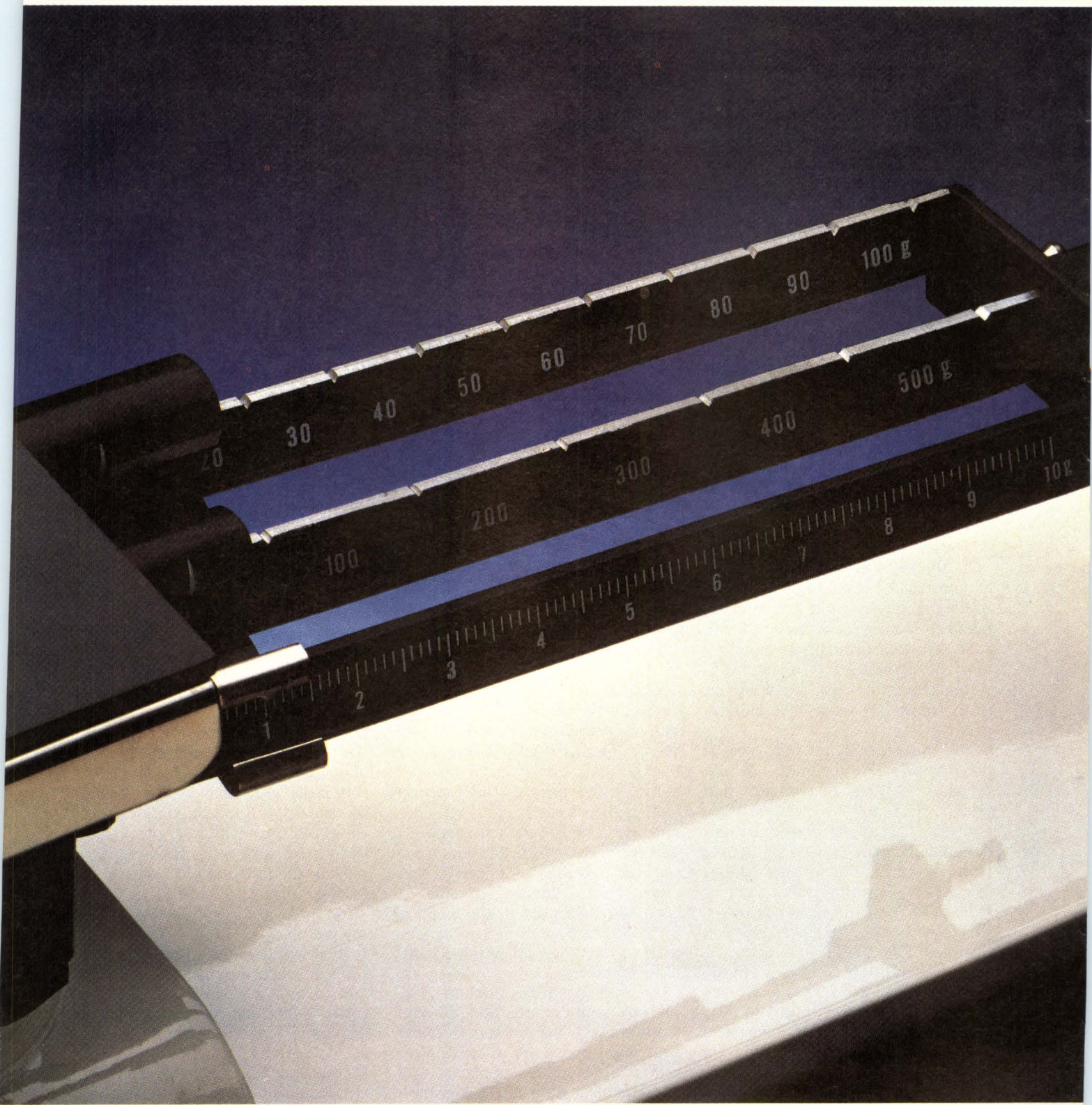

NEC
NEC Electronics

CIRCLE 19

Partial pixel addressing increases effective display resolution

Using a proprietary technique called pixel phasing, a graphics display can provide a significantly clearer image than conventional raster monitors and at little added cost. The technique allows portions of pixels to be addressed in order to smooth jagged lines. Pixel phasing thus overcomes the major disadvantage of raster-scan displays compared to vector drawn displays—aliasing.

Aliasing describes the stepped or jagged lines that occur for oblique lines, typically less than 20 degrees from the horizontal or vertical axis. Since pixel coordinates are locked into fixed locations within the raster plane memory, they cannot deviate from the locations of idealized pixels that lie along the line displayed.

Aliasing solutions versus pixel phasing

The conventional solution to aliasing calls for increasing the vertical and horizontal resolution (ie, number of lines scanned, or number of pixels per line). However, this incurs greater cost because raster plane memory must also increase. In addition, system throughput suffers because it takes longer to draw lines and fill in areas.

On the other hand, the partial pixel addressing technique within Megatek's (9605 Scranton Rd, San Diego, CA 92121) Merlin 9200 addresses the problem without attendant handicaps. Like its namesake from Arthurian legend, the Merlin graphics workstation uses sleight of hand to increase the effective resolution of its 1024- x 1024-pixel physical display to 3072 x 2304 points.

A less conventional method, favored by Advanced Electronics Design (440 Potrero Ave, Sunnyvale, CA 94086) for its AED767 color terminal, optically smooths the lines by blending vector slopes with the background. Firmware resident in the terminal (see *Computer Design*, May 1982, p 24) uses a process called ramping. This process involves a transition from one color to another so that both blend together. The

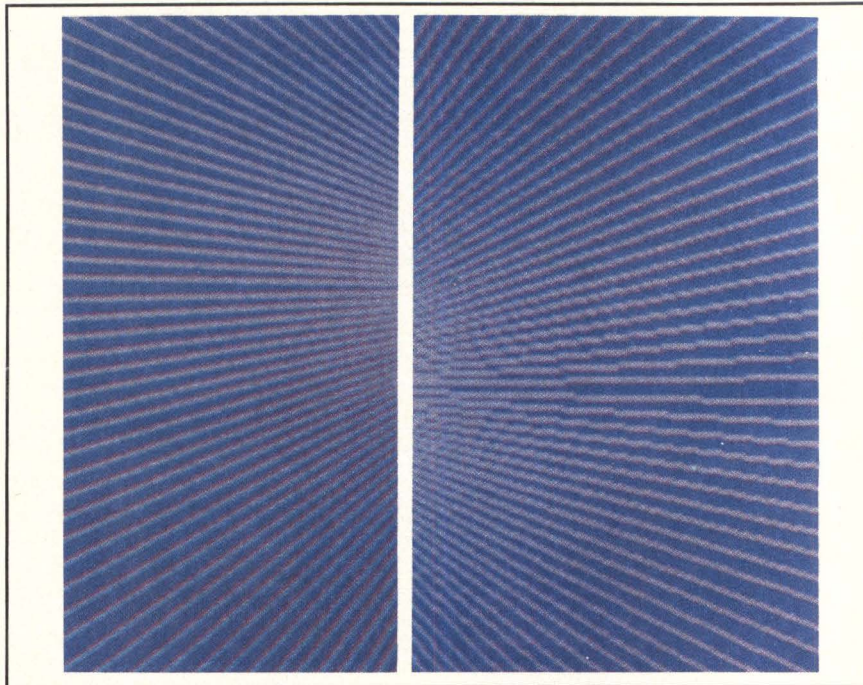

With pixel phasing, a graphics workstation can address portions of individual pixels and eliminate jagged lines. For example, the Merlin 9200 offers an effective resolution equivalent to 3072 x 2304 pixels (left). Using conventional techniques results in vectors as shown on right.

vector slope determines the adjacent pixels to be blended, as well as the individual intensity. As a result, the vector color gradually fades into the background color (usually black).

Major drawbacks to this approach include the fuzziness of altered lines, and the restriction on user-defined colors. Only 8 of the 256 simultaneously displayable colors can be anti-aliased because 16 intensity values for each color are used in the blending process. Furthermore, the gray scale used to blend the color table is not user alterable.

In contrast to this method, pixel phasing handles antialiasing through a process known as micropositioning. Individual pixels are divided into a grid of 16 smaller subpixels, each addressable within a 4 x 4 grid. In addition, the grid boundaries can be shifted from one-quarter to three-quarters of its width or height.

Consequently, the shape of each pixel can be altered by shrinking or

stretching. The pixel can also be shifted to better approximate the slope of the line. Microdeflection of the CRT beam within the monitor alters the vertical displacement of subpixels. This corrects lines within 45 degrees of the horizontal plane. Likewise, lines within 45 degrees of the vertical axis are drawn by displacing the left or right boundaries between pixels.

The real thing

Real-world objects replace visual trickery when it comes to modeling and displaying three-dimensional solids. Unlike many three-dimensional display systems that portray objects as collections of endpoints, the Merlin 9200 stores in its data bases representations that have such attributes as topology, surface texture, and depth. The amount of attribute information associated with the objects is so extensive that shading and hidden

(continued on page 38)

You won't find this PC in an office.

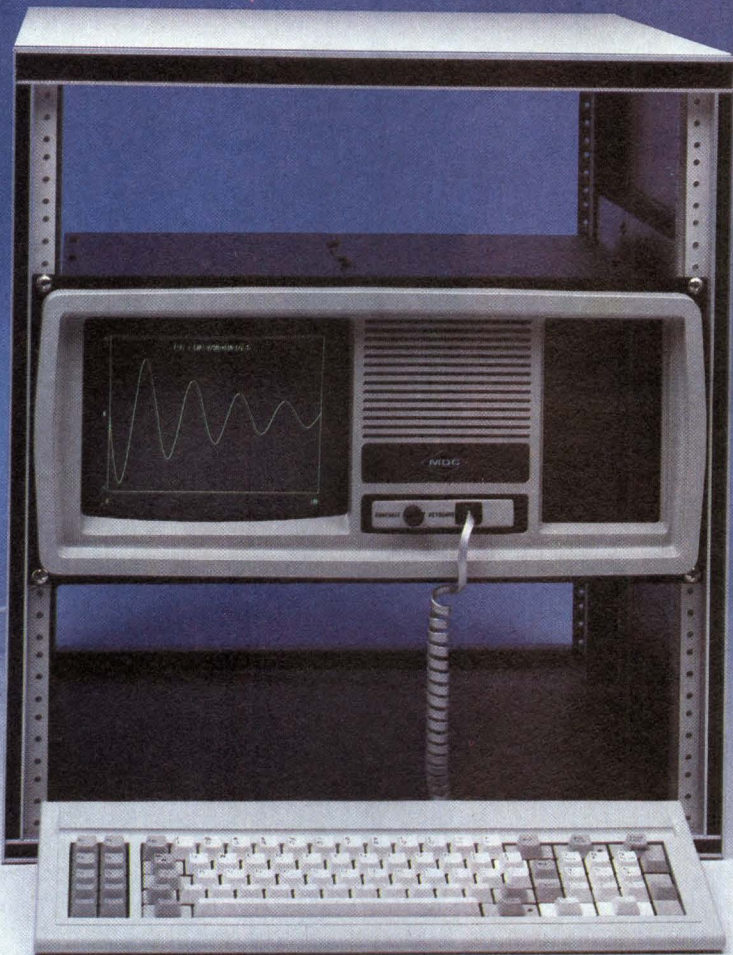

Compatibility:
IBM® PC

RAM on main board:
256 KB standard
512 KB optional

Storage:
Two 320 KB floppies
Optional 10 MB Winchester
RAM-disk built in

Ports:
1 parallel, 1 serial

Expandability:
4 available slots
110 W power supply

Display:
High-contrast, non-glare
16x13 character font
640x325 graphics built in

Software:
MS™-DOS, GW-BASIC™,
assembler

The MDC RM-1600™ Rackmount IBM PC-Compatible Computer

At last, an IBM PC-compatible computer for industrial and scientific use. The RM-1600 makes available thousands of IBM PC-compatible software and add-on hardware products. It also offers the modularity of a rackmount housing.

And the RM-1600 provides four available expansion slots and a high capacity 110 W power supply that let you really mix and match all those add-ons.

For additional storage and speed, an optional 10 MB Winchester replaces a diskette drive. Or for speed enhancement alone, try the built-in RAM disk, using the 512 KB on-board RAM capacity. In numerical applications, you can add an 8087 co-processor for greater speed.

So whether the application is laboratory instrumentation, test and measurement, R&D, numerical control, process control, or OEM systems, the RM-1600 lets you construct your equipment as you want it.

MDC has been building process control equipment for over 13 years. We first created the RM-1600 for our own use, and now offer our advantage to you. Take the advantage; give us a call and arrange for a closer look.

RM-1600 is a trademark of Materials Development Corporation.
IBM is a registered trademark of International Business Machines Corporation.
MS and GW-BASIC are trademarks of Microsoft Corporation.
Product features subject to change without notice.



Materials Development Corporation

21541 Nordhoff Street • Chatsworth, CA 91311 • (818) 700-8290 • Telex: 662438

MODEMS AT THE SPEED OF LIGHT



Optelecom's family of fiber optic modems provides high speed, high quality data transmission between terminals or modems. These modems offer you optical communications advantages with low error rate operation, convenient mounting and simple connection.

Optelecom's unique status lights, standard on each model, ensure fast and accurate system checkout.

Each modem converts standard asynchronous RS232 data signals into optical pulses for noise-free transmission over one kilometer fiber optic cables and back to RS232.

Take the enlightened path to data communications... the family of Optelecom modems include:

- **Model 4110**—Cable mounted RS232 or MIL-STD-188 versions. Eliminate optical connectors.
- **Model 4121**—SMA Style Optical Ports—switch for terminal/modem capability. RS232 only.
- **Model 4122**—SFR AMP Ports—switch for terminal/modem capability. RS232 only.

Optelecom—high performance quality fiber optic communications. For more information, please contact us at:

optelecom
The Optical Communications Company

15940 Luanne Drive
Gaithersburg, MD 20877
(301) 840-2121

CIRCLE 21

Partial pixel addressing

(continued from page 36)

surface removal occur automatically in hardware as objects are rotated or moved.

Typical graphics data bases, as illustrated by the company's own Template package (see *Computer Design*, July 1983, p 66) define real-world objects around a 3-axis coordinate system (ie, length, width, and depth) and as a unique entity (eg, three connected line segments form a triangle). Raster coordinates or vector endpoints generate an image of this object after absolute coordinates (independent of view orientation) are used to describe the image. This display list is what the user actually sees onscreen. Any changes the user makes to the screen do not alter the underlying mathematical model. In other words, raster coordinates are changed, not the mathematical model's coordinates.

This approach's primary weakness is that users must consciously define visible features to remove hidden features. Working with the display list, users must first describe the order in which polygon faces are defined (clockwise or counterclockwise). Users can then calculate normal vectors to each face, enabling all or a part of the polygon faces to be erased as they point into the screen.

Increased memory requirements

Defining hidden features for many views results in having to store multiple display lists. In addition, changes made directly to the underlying mathematical model require that new display lists be generated and displayed on the user's screen. Memory requirements further increase, because the three-dimensional model itself must be saved at the end of the session.

In contrast, the graphics data base found on the Merlin 9200 more closely resembles that used in the Anvil 4000 (see *Computer Design*, July 1983, p 66) from Manufacturing Consultants and Services (Irvine, Calif). In this case, the three-dimensional model also contains the graphical attributes. Thus, three-dimensional coordinates replace the two-dimensional coordinates that display lists typically use. This means that the

physical characteristics (ie, height, width, and depth), geometrical relationships (eg, one face is perpendicular to another), and textual information (eg, parts lists) are all retained.

Even with an underlying three-dimensional mathematical model, implementations such as Template lose attribute information when display lists are generated. On the other hand, users can create classes of objects within the Merlin data base and then produce different versions. They accomplish this by merely altering the display list or the model itself (eg, defining a rectangle and then creating squares). Rather than work with polygon faces that only approximate the object (like Template), users manipulate that object's mathematical definition.

Associating graphics information with the three-dimensional model lets polygon faces hide all or a portion of other polygons without computations. The graphics data base recognizes each view to be displayed. Changes in one view, therefore, do not affect the display of other views.

In fact, the Merlin has a Z-buffer that features depth information on each displayed object. This buffer contains the Z-value (depth) closest to the front of the terminal for each X, Y coordinate. Where there is an overlap, the polygon point closest to the viewer is stored. Consequently, automatic hidden feature removal occurs as objects are translated or rotated to appear in front of each other. The system can also display translucent objects to allow background objects to show through.

Fitting the pieces

The Merlin 9200 distributes processing across several boards linked by a proprietary 32-bit bus. The 80186-based local task processor handles local communications with all external interfaces (RS-232 serial ports, Centronics parallel port, floppy disk, and Multibus for memory or I/O expansion) and provides local task execution. An 80286-based database processor manages the local graphics data base, any symbolic references to named entities within the data base,

(continued on page 40)

You choose from all the best technologies at

KEYBOARD HEADQUARTERS

DIN compatibility in the most advanced keyboard technologies.
Only from Cherry: Where we are ready today to meet 1985 ergonomic standards.
Only from Cherry: Where we make all the most cost-effective technologies for your application.

Only from Cherry: Your Keyboard Headquarters. Worldwide.

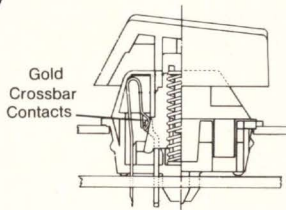

Full Travel Hard Contact

Gold crossbar contact configuration relied on in millions of applications worldwide. A first from Cherry more than a decade ago. Now proven and improved to meet the low-profile challenges of the 80's.

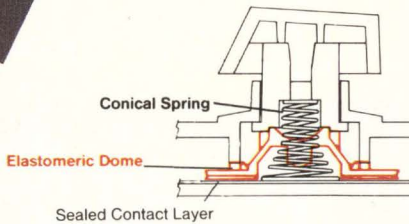

Full Travel Sealed Contact

NEW: A next generation keyboard that combines full travel with the quality and reliability of sealed silver contacts for long life, low cost. **Conical steel spring action** with linear feel... **or elastomeric action** with tactile feel.

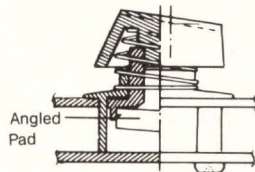

Full Travel Capacitive

Pad capacitive in a uniquely simple design requiring only five parts and a snap-in angled pad. Another keyboard technology alternative from Cherry... the folks with the *most* logical alternatives.

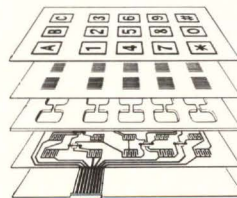

Flat Panel Membrane

Unlimited design options thanks to our state-of-the-art production techniques and in-house fabrication. Thin, lightweight, reliable, low cost. All this and sealed contacts, too!

SEND FOR COMPLETE DATA



KEYBOARD HEADQUARTERS

CHERRY ELECTRICAL PRODUCTS CORP.

3614 Sunset Avenue, Waukegan, IL 60087 • 1-312-578-3500

CIRCLE 22

Wireless Keyboards too! Call me at 1-312-578-3524 Bob Terwall

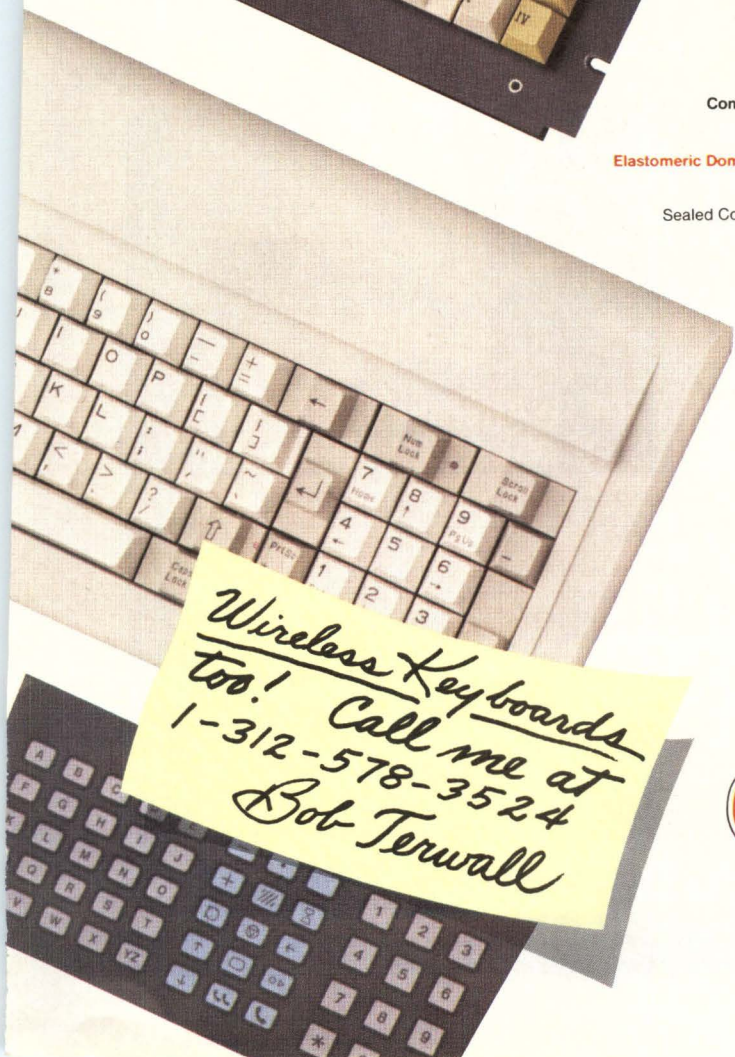

Partial pixel addressing
(continued from page 38)

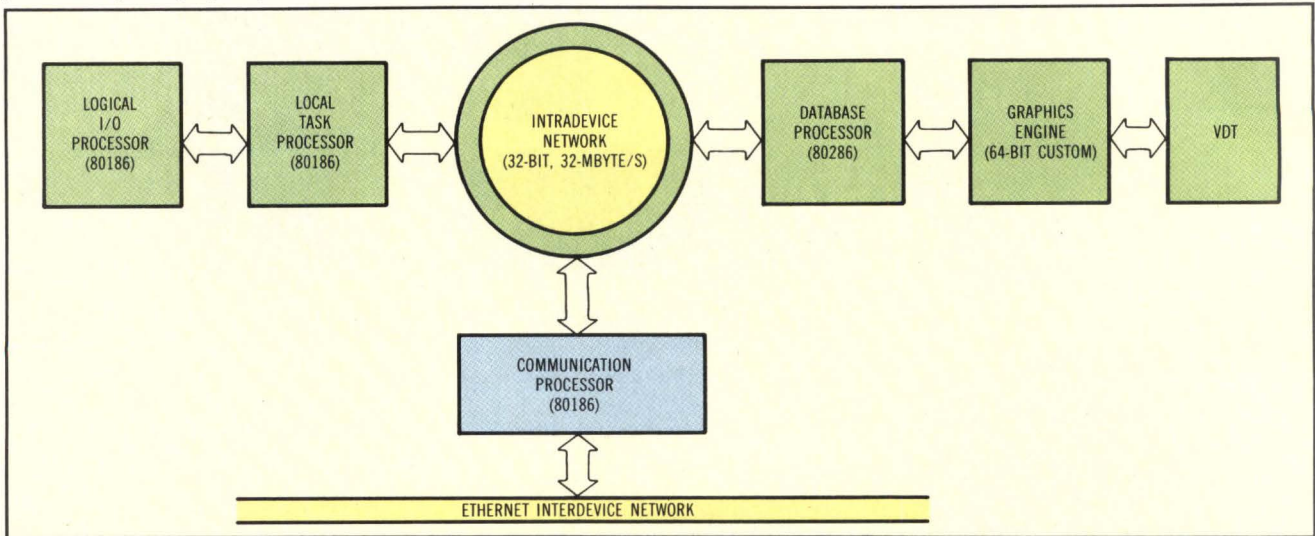

Distributing functions among several processors, the Merlin 9200 increases parallel processing. A 32-bit backplane serves as the network for interprocessor communications.

as well as graphics editing and text formatting. It also manages the routing of display instructions and data to the raster-display processor.

This processor actually interprets and executes the graphics instructions by first breaking them into absolute

vector or discrete pixel data. It then ships the information to the digital vector generator. There, three-dimensional vector information is converted into pixel representations. The result is then stored in frame buffer memory. Each frame buffer

supports 1280 x 960 pixels with two planes per board. As many as 256 colors can be displayed when four of these boards are connected together.

—Joseph Aseo, Field Editor
SYSTEM TECHNOLOGY
(continued on page 45)

EXTEND THE CAPABILITY OF YOUR PC

RTCS ADVANCED OPERATING SYSTEMS AND SOFTWARE DEVELOPMENT TOOLS CAN TAKE YOUR PC TO THE LIMITS OF YOUR IMAGINATION

RTCS/UDI - UNIVERSAL DEVELOPMENT INTERFACE

- Runs Intel Series III software on a PC, XT or any MS-DOS computer.
 - PC / Series III file transfer software included.
 - 100% software compatible with Series III.
 - PCSBC - Upload, download & debug target system (Option).
 - UDEBUG - Onboard debugging tool (Option).
 - Over 800 licensed RTCS/UDI's in use.
- PRICE \$500

PC/IRMX - REAL-TIME MULTIUSER MULTITASKING OPERATING SYSTEM FOR IBM PC

- More versatile than Intel's System 86/330.
 - Intel Utilities, Edit, Link, Locate, Librarian & ASM included.
 - Intel Pascal 86, Fortran 86, PL/M 86 and C 86 Languages optional.
 - Ethernet, GPIB and Hard Disk options.
 - Available for COMPAQ, TI Professional and DEC Rainbow
- PRICE \$2,250

FORCON - BRING DOWN MAIN FRAME FORTRAN PROGRAMS TO RUN ON THE PC

- Pascal, PL/M, Fortran 77/66 and C compatible compilers.
 - Superior object code optimization and in-line 8087 code.
 - Support large arrays (over 64K).
 - Overlay loading.
 - Object modules run on IBM PC and XT.
 - Special large program utilities option.
 - Available for COMPAQ, TI Professional and DEC Rainbow.
- PRICE \$4,850

SOFT SCOPE - HIGH LEVEL SOFTWARE DEBUGGER

- Source code interface.
 - High level Trace, Single Step and Breakpoints.
 - Access to Symbols and Line Numbers.
 - Machine disassembly and Floating Point support.
 - Goes beyond Intel's Pscope.
- PRICE \$995

All RTCS Software products support the 8087 Numeric Data Processor. Soft-Scope is a trademark of Concurrent Sciences, Inc. MS-DOS is a trademark of Microsoft Corp. IRMX is a trademark of Intel Corporation.

RTCS

Distributed in Japan by SYSCON CORP., Tokyo

REAL-TIME COMPUTER SCIENCE CORP. SOFTWARE DEVELOPMENT TOOLS
ADVANCED OPERATING SYSTEMS
P.O. BOX 3000-886, CAMARILLO, CALIFORNIA 93011 • PHONE NO. (805) 482-0333 • TELEX 467897

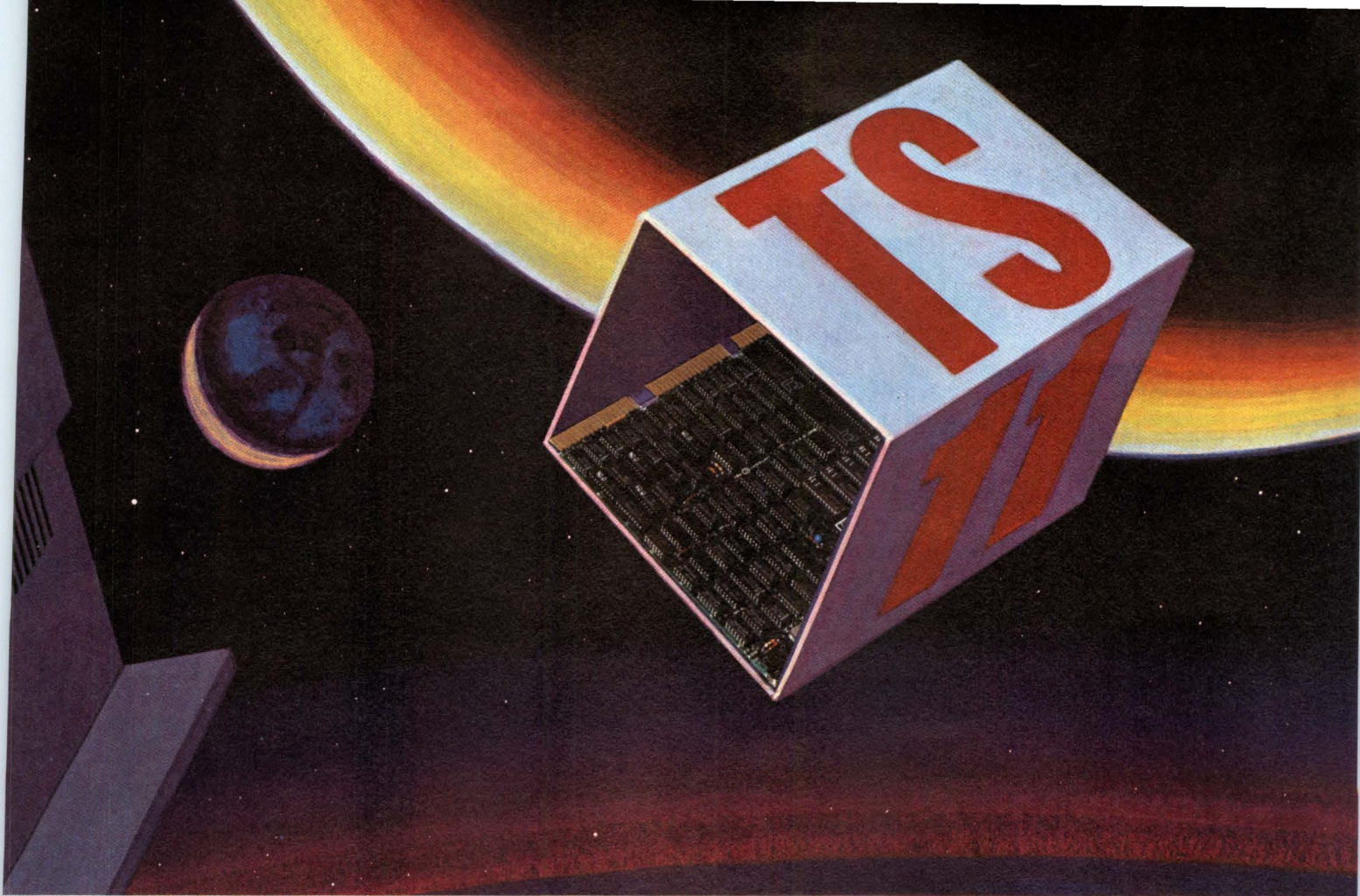

TS11 Tape Controller...

Because the world is changing

We're on this journey together. We have been since MDB first enhanced DEC systems with our interfaces to the PDP-11 in 1972.

This dynamic new world requires that we anticipate what system designers will need to take advantage of the new micro architecture. Today and tomorrow.

And this is just the beginning. The MLSI TS11/TSV05 has the capability tape controllers of the future must offer. It interfaces the Q-bus* family of processors to the new generation of tape drives with embedded formatter. And it allows up to eight different magnetic

tape drives with data densities of 800, 1600, 3200 or 6250 BPI to be connected to a single quad board.

Its out of this world capability includes 16K byte buffer for streaming tape drive connection and software configurable operating modes that can be changed at the operator's console.

We've made a commitment to the future. The immediate future. One that will see us introduce several compatible products that are interchangeable. They not only keep pace with the new micro system architecture advances...but lead the way.

Just watch this space.

*TM Digital Equipment Corp

MDB
SYSTEMS INC.

Corporate Headquarters
1995 N. Batavia Street, Box 5508
Orange, CA 92667-0508
Tel. 714-998-6900 TWX: 910-593-1339
FAX: 714-637-4060

MDB Systems Europe, Inc. Geneva, Tel. 41 22 439410
MDB Systems U.K., Ltd. Berkshire, Tel. 44 06286 67377
MDB Systems Germany Munich, Tel. 49 89 9101272
MDB Systems Australia Neutral Bay, Tel. 612 929-6526

In the western states MDB products are also distributed by

WYLE
LABORATORIES

ELECTRONICS MARKETING GROUP

CIRCLE 24

See us at NCC Booth A1808-A1814

THE BEST PLACE TO BOARD THE BUS.

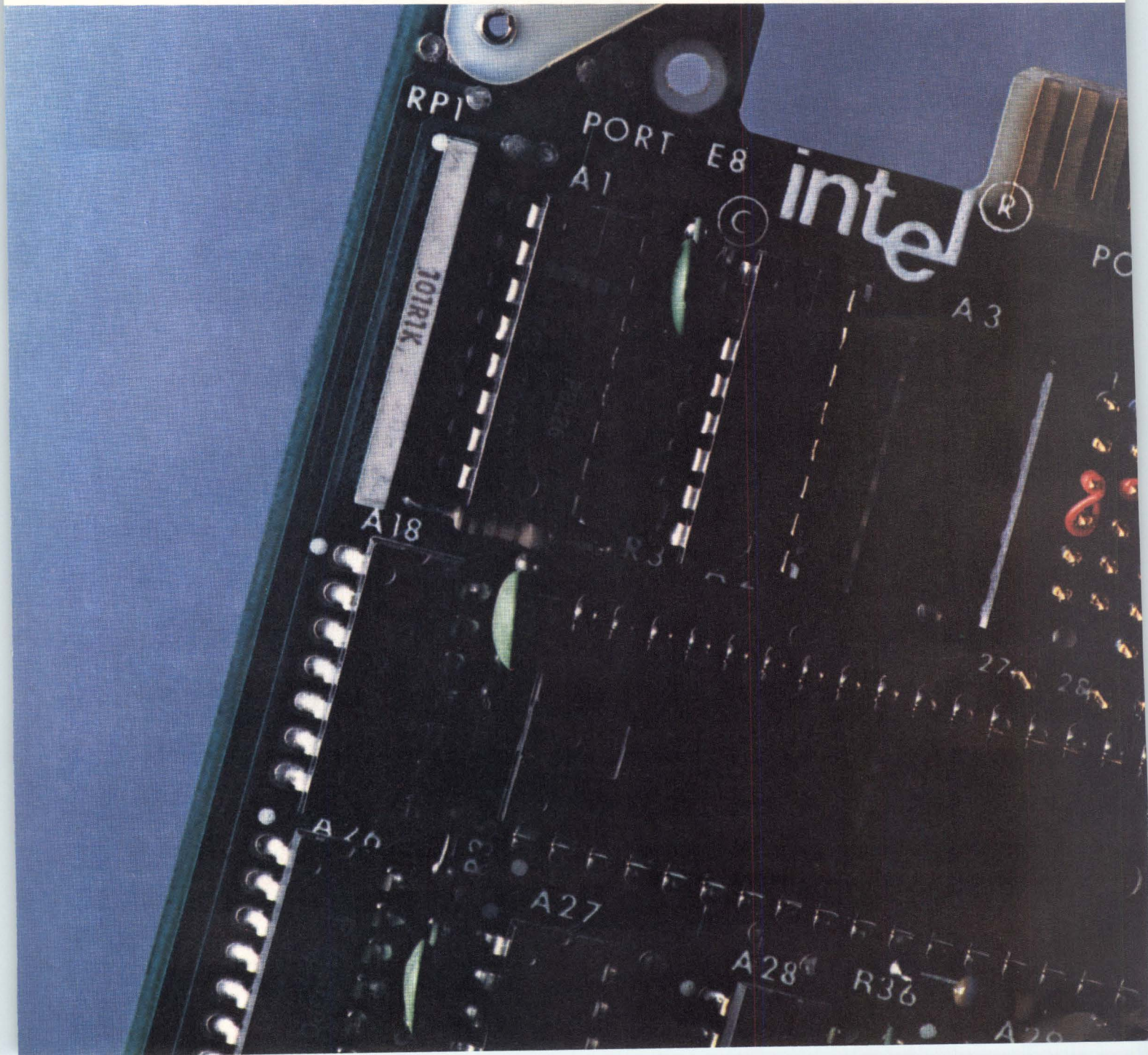

Of course, we're talking about the MULTIBUS® architecture. The most widely accepted, best supported bus architecture in the world.

But since you've already made the wise decision to use MULTIBUS as your road to riches, we're now going to show you the best place to start your journey.

Right here. Because as you might suspect, we know just about all there is to know about MULTIBUS. After all, we invented it. And we have the largest selection of MULTIBUS products to be found. Anywhere.

For starters, there are our boards. We've produced over a million since 1976. Which should give you an indication of the experience we have in manufacturing quality boards. Quality that's not easily achieved.

Our boards are scrutinized at every level of integration. From chip through system level. And each board is tested to make sure it does its job in every one of its configurations. We even pull finished product from our warehouse for retesting and inspection. Just to make certain nothing slips by.

You can count on the road being smooth for a long time to come, too. Reliability is assured from start to finish. We continually monitor each board throughout its entire production life. Even going so far as lot sampling older boards and putting them through 5000-hour life test studies.

Then there's the selection. A big one.

Over 115 different

board-level products. Supporting 15 CPUs (from our 8080 to 80286). So you won't get stuck into one or even two design approaches. A tranquil thought when you consider how fast things change in the marketplace.

What's more, you can count on getting everything you need. From peripheral controllers to memory expansion, data communications and graphic boards. Plus card cages and software (including iRMX 86™, the most popular real-time operating system in the MULTIBUS world).

One more fact about our MULTIBUS products. You can get fast service anywhere along the road. We've got one of the largest field engineering forces in the world. Over 600 factory-direct people. Not to mention localized support from our worldwide network of trained distributors.

So don't miss the bus. Travel safely. And arrive sooner. Call toll-free (800) 538-1876. In California, (800) 672-1833. Or write Intel, Lit. Dept. C-20, 3065 Bowers Ave., Santa Clara, CA 95051.

We'll be happy to welcome you aboard.

intel®

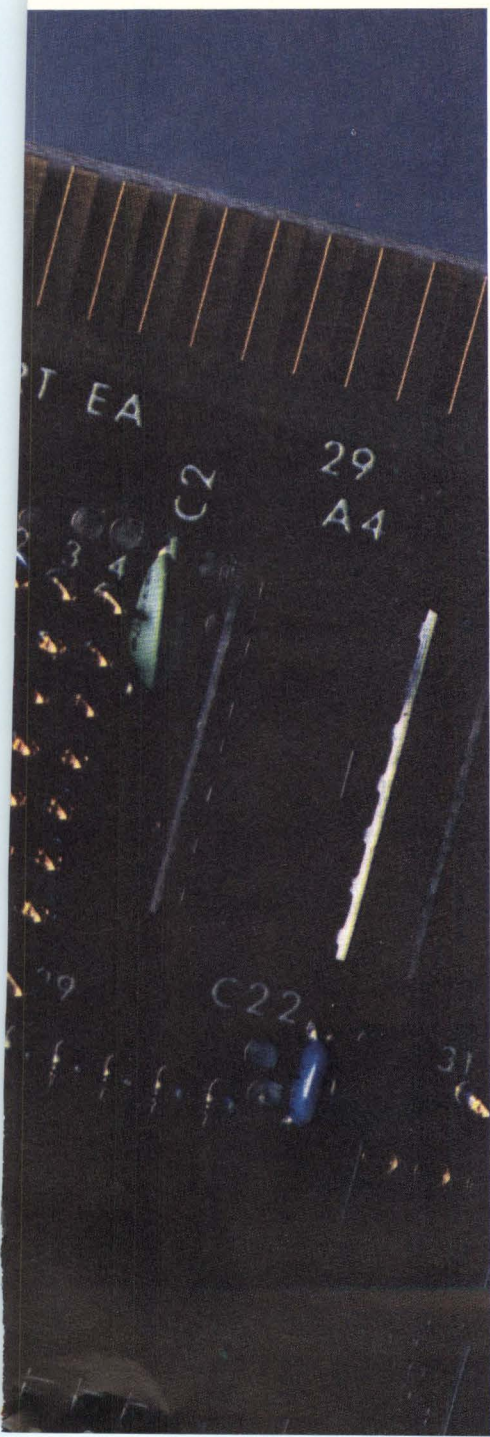

68000

16000

8086/88

Z8000

SOFTWARE DEVELOPMENT TOOLS "One-Stop Shopping"

OASYS provides a "One-Stop Shopping" service for software developers and managers in need of proven, cost effective, cross- and native- development tools.

OASYS can save you time, energy and money! We understand what it means to be a developer. Over the past 3 years, we've built over 1MB of working code.

We not only develop our own tools, but also specialize in evaluating, selecting and distributing the best complementary tools from other suppliers.

Our tools are currently in use in over 1,000 installations worldwide on micro-, mini-, and mainframe computers for a variety of 8-, 16- and 32- bit UNIX (and non-UNIX) systems.

Most likely, we have what you're looking for (even if it doesn't appear in the tables shown). But, if we don't, we'll be glad to tell you who does.

So, call or write today for more information and start shopping the smart way, the fast way, the economical way.

"The One-Stop Shopping Way."



60 ABERDEEN AVENUE
CAMBRIDGE, MA 02138
(617) 491-4180

CROSS TOOLS

PRODUCTS ⁽¹⁾	HOST ⁽²⁾	TARGET ⁽³⁾
C COMPILERS	VAX, PRIME	68000 16000 8086/88
PASCAL COMPILERS	VAX PDP-11, LSI-11 PRIME	68000 16000 8086/88
FORTRAN COMPILERS	VAX PDP-11, LSI-11	68000 16000 8086/88
ASSEMBLERS ⁽⁴⁾	VAX, PDP-11, LSI-11, PRIME, IBM/PC, IBM 370	68000, 16000, 8086/88, Z8000, 680X, 808X, Z80
SIMULATORS	VAX, PDP-11 LSI-11, PRIME, IBM/PC, IBM 370	68000, 8086/88 808X, Z80

- (1) WE DISTRIBUTE PRODUCTS FOR: GREEN HILLS SOFTWARE, VIRTUAL SYSTEMS, COMPLETE SOFTWARE, PACER SOFTWARE, SOFTWARE MANUFACTURERS
 (2) HOST OPERATING SYSTEMS INCLUDE: VMS, RSX, RT-11, PRIMOS, UNIX V7, III, V, BSD 4.1, 4.2, UNOS, IDRIS, XENIX, MS/DOS, VM/CMS, CPM 68K
 (3) OTHER TARGETS ARE: M6801-6803, 6805, 6809, 8080, 85, 28, 35, 48, 51; Z-80
 (4) ALL ASSEMBLERS INCLUDE LINKER, LIBRARIAN AND CROSS-REFERENCE FACILITY
 (5) AVAILABLE ON: CALLAN, OMNIBYTE, CHARLES RIVER DATA, PLEXUS, SAGE, FORTUNE, WICAT . . . to name a few.

C/UNIX NATIVE TOOLS

- NATIVE ASSEMBLERS FOR 68000s^(4, 5)
- SYMBOLIC C SOURCE CODE DEBUGGER
- C-TIME PERFORMANCE UTILITY
- UP/DOWN LINE LOAD UTILITIES
- COMMUNICATION UTILITIES
- C-BASED FLOATING POINT MATH PACKAGE
- BASIC-TO-C TRANSLATOR . . . AND MORE

TRADEMARKS: UNIX IS A TRADEMARK OF BELL LABORATORIES, XENIX AND MS/DOS ARE MICROSOFT CORP'S; IBM/PC, VM/CMS, AND IBM 370 ARE INT'L BUSINESS MACHINES; VAX, PDP-11, LSI-11, VMS, RSX, AND RT-11 ARE TRADEMARKS OF DIGITAL EQUIPMENT CORP; CPM 68K IS DIGITAL RESEARCH'S; PRIMOS IS PRIME'S; UNOS IS CHARLES RIVER DATA'S; IDRIS IS WHITESMITH'S LTD.

Multistage compilers move from mainframes to micros

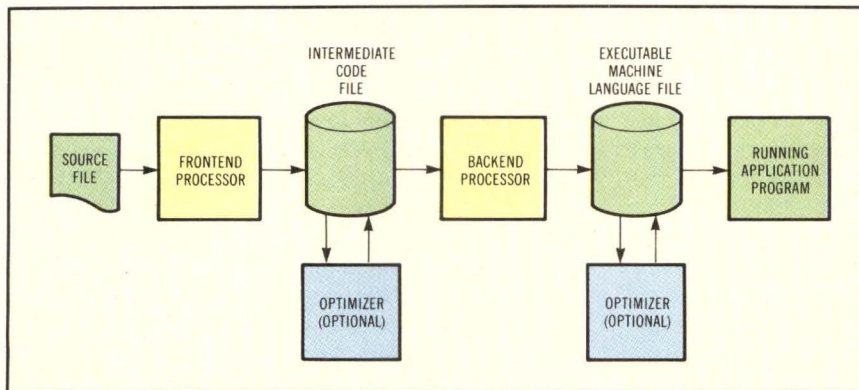

Multistage compilers first process source-language (text) files to produce intermediate code files. These files can be further processed for efficiency by an optimizer. The intermediate code file is then processed by a "back end" that generates and (optionally) optimizes executable machine code files.

Although multistage optimizing compilers have been available on mainframe computers for a number of years, they have only recently become available for micros. A recent announcement from Language Processors, Inc, and forthcoming announcements from TeleSoft and Digital Research, Inc serve to illustrate this trend.

There are several advantages to multistage compilers. A multipass compiler creates intermediate code files, which describe the program as written for a simple abstract machine, rather than going directly to machine code for a particular microprocessor. This additional step allows the compiler writer to optimize the program's logic and storage use. Common intermediate code files also let the programmer "mix and match" routines from different languages to produce a given program. An example given by Language Processors includes writing the main logic of a program in Pascal, and including a Cobol routine for handling files.

Writing compilers for many languages also becomes easier. The architecture of the abstract machine, though simple, can be made powerful enough to handle all high level language constructs while still mapping easily onto a given microprocessor's instruction set. Furthermore, for a given microprocessor (eg, the 68000), only one machine language-generating "back end" needs to be written.

Frontend compilers for transforming source files to intermediate code files can thus be given more time and attention.

Single-stage compilers generally handle functions including processing

the source-code file, optimizing code, and generating machine code. Including these and other functions makes compilers large, complex, and difficult to program and debug. A multistage approach breaks the various functions into separate programs, making the programming effort much more manageable. Such modules are smaller and easier to understand, and more effort can be devoted to making them powerful and efficient.

Global versus peephole optimization

There are two different approaches to optimization—global and local (or peephole). Global optimizers look at the whole program structure, identify and eliminate sections of code that will never be executed, optimize register usage, and generally streamline the logic. Peephole optimizers, on the other hand, generally

(continued on page 46)

Learn FAST.



If you're looking for high speed and low power in drivers, receivers, multiplexers, ALUs, latches and registers, think FAST™ Fairchild Advanced Schottky TTL.

Come to think of it, contact your nearest sales office and ask to see our FAST circuits and applications videotape seminar. Fairchild Digital Products Division, 333 Western Avenue, South Portland, Maine 04106.

FAIRCHILD
A Schlumberger Company

FAST is a trademark of Fairchild Camera and Instrument Corporation for Digital Products. Fairchild Camera and Instrument Corporation.

Multistage compilers

(continued from page 45)

look at only a few instructions at a time. These optimizers move constant expressions out of loops and find more efficient machine instructions to perform a given function. In general, global optimizers are more suitable for processing intermediate code files, while peephole optimizers polish and accelerate machine language implementation.

Optimizing causes trade-offs

As with any technique, there are trade-offs in optimizing. The optimizer can be designed to produce fast code (reducing runtime) or compact code (decreasing storage requirements). A balance point exists between the two, and choosing depends on the experience and judgment of the compiler writer or designer. There are trade-offs in the degree of optimization too—the more detailed and thorough the optimization, the more time that compilation will take. Alternately, a fast compiler with an un-

sophisticated optimizer will produce less than optimal code.

Language Processors, Inc (400-1 Totten Pond Rd, Waltham, MA 02154) has announced compilers that run on 68000-based Unix systems for Cobol, RPG-II, Pascal, and C, with PL/I and Basic to follow soon. All use what the company calls its "component architecture," a modular architecture with five standard subsystems: a front end, an optimizer, a code (machine language) generator, a runtime library, and a high level debugger. The programs all use the same indexed sequential access method (ISAM) to handle data files. Thus, programs written in one language can address and use files written in another.

Common intermediate code files allow integration of routines written in different languages and simplify creation of runtime libraries. A multi-language debugger recognizes the language in which a particular routine is

written, and lets the programmer correct errors at the source level, rather than in the machine code.

The compilers are being offered to hardware manufacturers at \$50,000 plus royalties, based on the size of the system on which they are used. Single copies with runtime distribution licenses are also available.

TeleSoft (San Diego, Calif) has made multistage compilers part of its Ada development effort from the start. Since Ada is such a large and complex language, the sheer magnitude involved in developing a compiler for it almost mandates a stage by stage approach.

Building on experience gained with the UCSD p-System, the company developed a proprietary operating system, called ROS. It has since moved on to produce compilers that run under Unix, IBM mainframe operating systems, on the VAX, as well as on the IBM PC and its clones. All of these implementations are presently in beta testing with Department of Defense validation expected very soon.

Digital Research, Inc (Pacific Grove, Calif) has announced its adherence to the philosophy of multistage compilers, and the firm is expected to introduce a C compiler early this summer. The compiler will run under the company's CP/M-86 and, presumably, CP/M-68K operating systems. With the ability of CP/M-86 to emulate MS-DOS, these C compilers should become widespread and affordable.

The company has announced that all of its languages will henceforth have multistage compilers, and be able to exchange object modules. It is also working on the Intel 80286 processor Unix implementation for AT&T, and has announced language and application support for Unix systems. Thus, a great many interesting developments can be expected in the next 18 months.

—Sam Bassett, Field Editor

MORE STORAGE FOR LESS

**DEC
USERS**

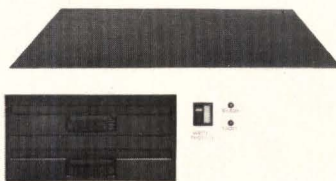

**LSI-11
COMPATIBLE**

EMULATION RK06/RK07	EMULATION RL02
42MB Winchester/Floppy (8") ... \$6995.00	10MB Winchester/Floppy (8")..... \$4495.00
70MB Winchester/Floppy (8") ... \$7195.00	20MB Winchester/Floppy (8")..... \$4995.00
140MB Winchester/Floppy (8") ... \$8195.00	40MB Winchester/Floppy (8")..... \$5995.00

ALL SYSTEMS CONTAIN 2MB OF FLOPPY BACKUP
CALL FOR DETAILS ON RM02 EMULATION AND/OR TAPE BACKUP

★ NEW ★ MORE MEMORY ON A SINGLE CARD THEN ANY OTHER MANUFACTURER ★ NEW ★
512KB TO 2MB QBUS ERROR DETECTING AND CORRECTING MEMORY

CALL FOR MORE DETAILS!
See us at NCC '84 Booth Nos. D3530 & D3532

"OFFERING QUALITY WITH AFFORDABLE PRICING"



Chrislin Industries, Inc.

31352 Via Colinas • Westlake Village, CA 91362 • 213-991-2254
TWX 910-494-1253 (CHRISLIN WKVG)

RK06, RK07, RL02, QBUS, DEC, LSI-11 are trademarks of Digital Equipment Corporation.

SYSTEM TECHNOLOGY
(continued on page 48)

GET THIS.

FROM THIS.

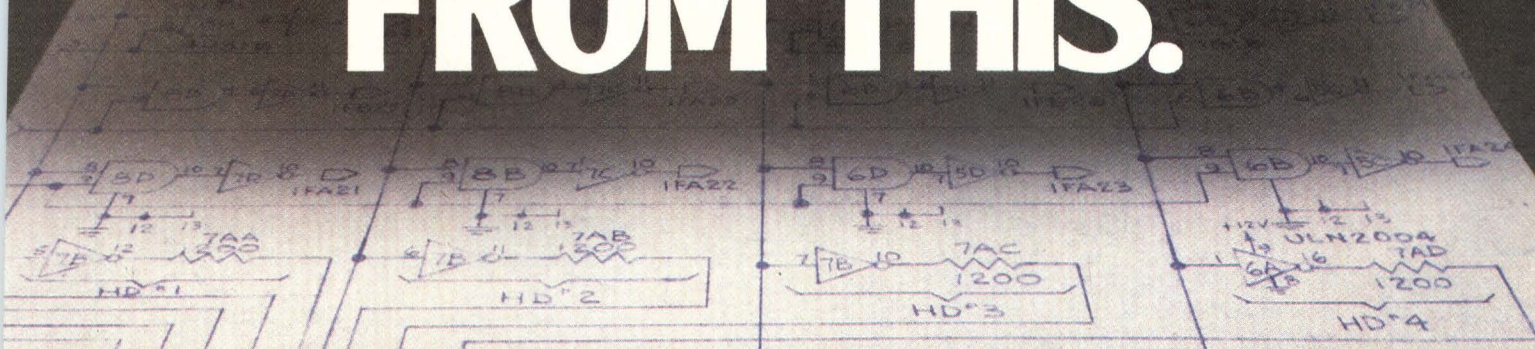

MULTIWIRE[®] DESIGN CENTERS PROVIDE SCHEMATIC REDUCTION.

Working with a sophisticated CAD system, your Multiwire Design Center can shorten your design cycle by weeks, saving you thousands of dollars.

We offer a variety of design services, depending upon your needs. Your boards are designed from as little input as a logic diagram or net list, along with board geometry and special parameters.

Multiwire designs and fabricates finished boards to meet both your routine and accelerated delivery requirements. In fact, you can receive a finished board from schematic in as little as four to six weeks,

including design time.

And when you need to make changes, they will be simple and fast. That's because Multiwire boards only use artwork to distribute the power and ground potentials. So a logic change is simply keyed into the computer, creating new floppies for wiring and drilling, and the circuitry is rerouted for your next board.

When it comes to moving a project from paper to prototype to production, nobody does it faster or more economically than Multiwire. To learn more, return the coupon, or circle the reader service number.

MULTIWIRE	
10 Andrews Rd., Hicksville, NY 11801	
<input type="checkbox"/> Please send me your 8-page sales brochure.	
<input type="checkbox"/> Please have a salesman call.	
Name _____	
Title _____	
Company _____	
Address _____	
City/State/Zip _____	
Telephone _____	C.D.

 **MULTIWIRE[®]**
DIVISION
KOLLMORGEN CORPORATION

MULTIWIRE/NEW YORK-31 Sea Cliff Ave., Glen Cove, NY 11542 (516) 448-1428; MULTIWIRE/NEW ENGLAND-41 Simon St., Nashua, NH 03060 (603) 889-0083
MULTIWIRE/WEST 3901 East La Palma Ave., Anaheim, California 92807 (714) 632-7770; MULTIWIRE/ADVANCED MANUFACTURING GROUP 10 Andrews Rd., Hicksville, NY 11801 (516) 938-2000
Multiwire is a U.S. registered trademark of the Kollmorgen Corporation.

As densities increase, EEPROMs grope toward standards

Electrically erasable PROMs have evolved dramatically in recent years. From relatively simple parts that needed a lot of peripheral support circuits, they have progressed to very dense (now reaching 64 Kbits) devices with most necessary functions contained on a single chip. On the way, a serious lack of function and pin assignment standards led to extensive incompatibility. With the advent of the 64-Kbit EEPROM, however, manufacturers appear to be reaching tacit agreement on most points. Thus, designers may soon be able to select chips based upon the presence or absence of certain features but remain relatively unconcerned with hardware compatibility.

Major issues affecting EEPROMs as they approach higher densities include protecting the device against false writes during power-up and power-down, providing a means of quickly writing the memory, and defining pin 1 in the 28-pin Joint Electron Device Engineering Council (JEDEC) standard package. The issue of pin 1 appears to be the most easily resolved. Some early 64-Kbit announcements define pin 1 as a ready/busy signal for sending an interrupt to the microprocessor when the write cycle is complete, but this may change. Although ready/busy was popular in 16-Kbit versions using a 24-pin package, the 64-Kbit designs tend to preserve their 28-pin site for anticipated 256-Kbit versions. A different method of signaling the microprocessor is used, reserving pin 1 for an address pin (A14) in 256-Kbit designs.

Determining the write cycle complete

Xicor Corp (851 Buckeye Ct, Milpitas, CA 93035) has introduced DATA polling, a software method for determining if a write cycle is complete. A polling method of some sort has become necessary in EEPROMs as density has increased. Given the 10-ms typical write time per byte, microprocessors would be idling for far too long unless they performed other tasks while writing. DATA

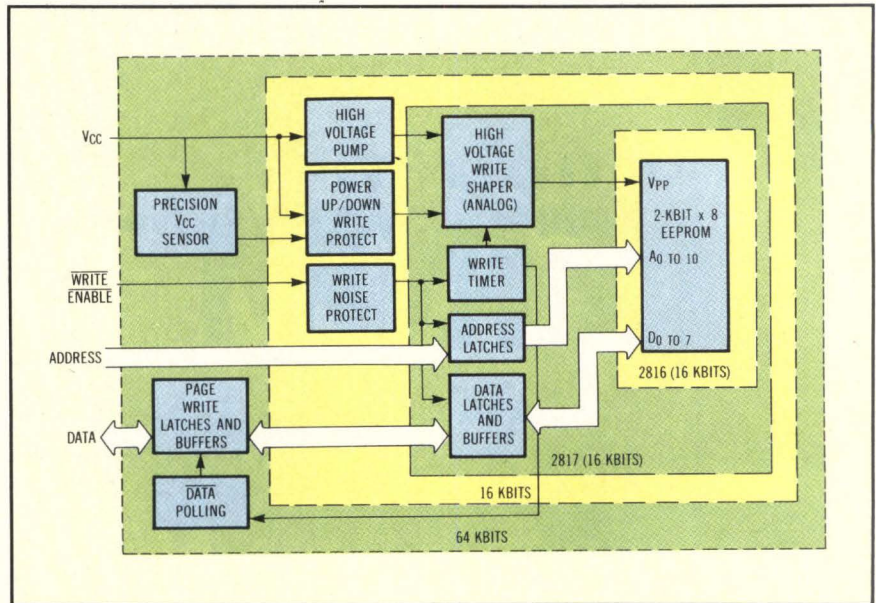

As EEPROM densities have increased, peripheral circuits and features incorporated onchip have grown. Features at the 16-Kbit level evolved through several stages. The 64-Kbit level has demanded even more. (Source: Xicor Corp)

polling allows the processor to look at the data being written. If a write is still in progress, the buffers return the 2's complement of the data that is being written.

This offers two advantages. First, it frees the processor to perform other tasks during the write cycle. Second, it lets the system optimize the actual time consumed by write operations. Since systems may incorporate relatively large numbers of dense EEPROMs, the savings may be considerable.

EEPROMs are specified at a given time to perform a write, typically 10 ms for a byte, or in the newer parts, for a page of data. Since the devices are self-timed, however, the actual time needed to perform a write may vary over a range of shorter times. This depends on differences in temperature and manufacturing. DATA polling allows the processor to determine when a write cycle is complete without taking up an extra pin for a ready/busy signal.

Some manufacturers (eg, Intel) have assigned pin 1 as a ready/busy pin in their 64-Kbit, 28-pin designs. They apparently expect designs in the

256-Kbit range to use 16-bit word widths. This would require a different package altogether—possibly a 40-pin type.

Cutting write cycle time

The increased densities of EEPROMs have made their use conceivable in an ever-expanding range of applications. However, the time needed to program a single byte has become a major hindrance. At 10 ms per byte, the time it takes to program an entire 64-Kbit part exceeds 81 s. Where smaller devices latched single bytes to free the processor, the newer devices buffer and latch groups of bytes and write each group *en masse* while the processor is busy elsewhere. The method is called page mode.

There is a trade-off to consider here. Most applications do not require that the entire EEPROM be rewritten very often. Each time a group of bytes is changed to alter one byte, the erase/write endurance for the whole group is diminished. Although endurance typically reach 10,000 erase/write cycles per byte, not all designers feel entirely comfortable with that

(continued on page 50)

If you've been waiting for a supermicro with UNIX* System V on a 68010-based processor, stop.

Introducing the Callan Unistar™ 300. It's the single best supermicro you can buy. For a couple of reasons:

One, the 10MHz 68010 CPU. It's the newest, fastest, best. It crunches numbers in a snap. And works beautifully with the new UNIX.

Two, the new UNIX System V. It's faster than UNIX System III. On the Unistar 300, it supports a host of languages. And when it comes to portability, flexibility and system support, nothing comes close.

There's more. The Unistar 300 allows for expansion to 172M bytes of high-speed disk storage with integral tape backup—all within one enclosure that easily fits under a desk.

Its convenient 12-slot Multibus* chassis lets you easily add options like networking, communications, floating point array processors and more. Up to 2M bytes of main memory provide real power for every user. And nationwide service is available through ITT/Courier.

Unistar 300. Finally a supermicro with super everything. Available today from Callan. For more information contact Callan Data Systems, 2645 Townsgate Road, Westlake Village, CA 91361. (800) 235-7055. In California (805) 497-6837. TELEX 910 336 1685.

Callan Unistar

*Callan and Unistar are trademarks of Callan Data Systems. UNIX is a trademark of Bell Labs. Multibus is a trademark of Intel Corporation.



SUPER. MICRO.

EEPROMs grope toward standards

(continued from page 48)

figure. This is especially true in the newer application areas that are opening up for the larger capacities.

The page mode approach is thus a compromise between the desire to gain speed in writing data to the EEPROM and the reluctance to use up a given byte's erase/write cycle allotment. The balance seems tilted in favor of speed in writing data. Page sizes for Intel's projected 64-Kbit device and Xicor's 2864A are 16 bytes. The Inmos 48C64, on the other hand, and the Advanced Micro Devices AMD 2864 will have 32-byte buffers. A 64-Kbit part from Inmos, the 3630, sports a 64-byte page size.

Time savings for write operations using page mode can be dramatic. Xicor, for example, specifies a write cycle time of 5 ms. By latching and writing data 16 bytes simultaneously, the time to completely write 64-Kbits is cut to 2.5 s. EEPROMs with 32-byte pages would, of course, require half that time.

One manufacturer, Exel Microelectronics (2150 Commerce Dr, San Jose, CA 95131) has opted to dedicate its pin 1 to a special status word (\overline{SW}) function. This locks its 28-pin package out of the 256-Kbit arena, but gives it extra software features to support page mode in its 64-Kbit XL48C64. A set of onchip registers can be read or written by the microprocessor when \overline{SW} pin 1 is low. This allows the chip to supply ready/busy status information to the processor when it reads a register during \overline{SW} active. The processor can also write commands into the XL48C64 to set it for page, fast write, or chip erase mode.

Banning unwanted writes

Protecting an EEPROM against inadvertent writes during power-up and power-down calls for a combination of voltage threshold sensors, noise filters, and timeouts. In addition to disabling write functions until

the memory reaches V_{CC} , it is necessary to keep the write disabled for a certain amount of time thereafter to allow V_{CC} to settle. Intel and AMD for example, disallow writes if V_{CC} is below 4 and 3 V, respectively. Xicor has implemented a precision V_{CC} sensor that the user can use to set the threshold voltage by writing and locking an EE cell.

These companies also include a typical power-up timeout of 100 ms on initial power-up before the chip can be written. Thus, V_{CC} can become stable and noise does not initiate an unwanted write. Exel makes use of its status word pin by requiring that a pattern be written into a register that enables the charge pump to provide the 21-V programming voltage from the 5-V supply before a write can take place. An inadvertent write on power-up cannot take place because the registers are static, but the chip must be initialized.

It appears that, although higher density EEPROMs are inducing agreement about onchip features, there are several areas of choice among hardware-compatible parts, and areas of noncompatibility still exist. Users of the 28-pin JEDEC packages can be reasonably sure of hardware compatibility at the 64-Kbit level. There will, however, be software considerations in the use of Xicor's DATA polling and Exel's status word. As densities move to the 256-Kbit level, two distinct approaches are emerging. One will retain the 28-pin device using pin 1 for an address line, while those manufacturers who have already played their pin 1 card will pursue a different packaging arrangement.

—Tom Williams,
West Coast Managing Editor

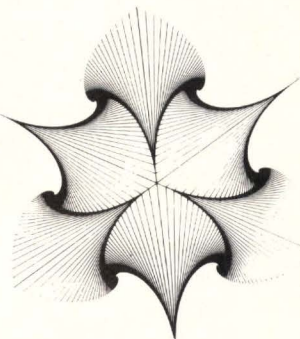

**V-GRAPH
TEKTRONIX 4010
GRAPHIC EMULATOR
FOR YOUR
PERSONAL
COMPUTER**

V-GRAPH is your link into the world of powerful, high-resolution graphics. Now your personal computer can act as a Tektronix 4010 terminal. Not just an emulator, V-GRAPH can even save graphics and text on disk and replay or print it later without reconnecting to the host computer.

V-GRAPH provides an equivalent for every function found on the Tektronix, including the cross-hair cursor used for graphic input. Plus, control and function keys may be programmed to emit commonly used character strings.

V-GRAPH supports the highest resolution possible, and is currently available for the IBM PC, Zenith Z-100 and Victor 9000. Requires MS-DOS & 64K. \$120

CompuView
PRODUCTS, INC.

1955 Pauline, Ann Arbor, MI 48103 • (313) 996-1299

Get your own

If you're reading someone else's copy of *Computer Design*, why not get your own? To receive a subscription-application form, circle 504 on the Reader Inquiry Card.

Special Report From adac

New Dual Height Function Cards For Q-Bus Boost Density And Performance For Data Acquisition And Control.

ADAC continues to expand the industry's widest line of function cards for Q-Bus (LSI-11 and MicroVAX compatible). The most recent additions represent significant advancements for high speed data acquisition, both in terms of improved performance and lower system costs.

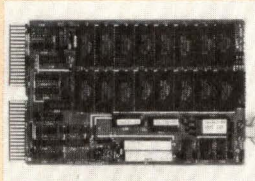

Battery-Backed 22-Bit Address CMOS RAM Improves Density 4 Times. PROM Board Added.

In its maximum configuration of 128K bytes, Model 1822CMOS provides 4 times the density previously available. Model variations from 32K to 128K bytes are offered.

Compatible with 16, 18 and 22-bit addressing, Model 1822CMOS features on-board batteries and power loss protection for 30 days or more. Batteries have a minimum 3 year life.

Model 1822PROM, another new high density memory board (to 512K bytes), is compatible with 16, 18 and 22-bit addressing backplanes. Sixteen sockets accept EPROMs or ROMs of 2K x 8, 4K x 8, 16K x 8, and 32K x 8 configurations. Ideal for non-volatile program storage, 1822PROM can be used to configure unattended systems on automatic re-start after power interruption.

Both boards can be selected for addressing at any 4K boundary by switches on the edge of the board, that are accessible even when the board is in the backplane. For volume buyers, combinations of battery-backed CMOS RAM and PROM are available on a single board. CIRCLE 32

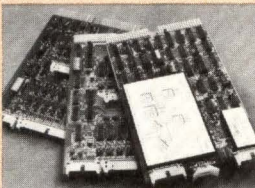

Most Flexible Wide Range A/D Allows Software To Configure Inputs... Provides 250 Volt Common Mode Protection.

With sampling rates of 200 per second, ADAC's new Model 1114AD is both the most flexible and fastest wide range...10 millivolts full scale to 10 volts full scale...A/D converter on the market. Multiplexer modules 1114SX and 1114VX permit system expansion to 128 channels with up to 250 volt common mode isolation.

The 1114 12-bit A/D system is so flexible that it allows unrestricted mixing of high and low level analog input signals and 7 different thermocouple types simultaneously. Direct connections of RTDs and strain gauges, as well as thermocouples, are possible.

Inputs can be unipolar or bipolar with 8 software programmable gain settings and software selection of thermocouple cold junction compensation. CIRCLE 33

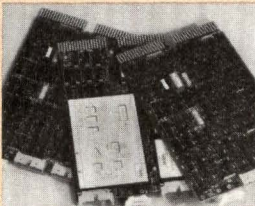

SILO A/D Provides Continuous Performance At 100 kHz.

A new ADAC three-board subsystem provides continuous data sampling to memory, for up to 16 input channels, with 12-bit resolution, at up to 100 kHz aggregate throughput. The 1023S consists of a high-speed, high-level A/D converter card with 64-word SILO buffer, coupled to two 1622 direct memory access controllers. A set of RT-11 installable software drivers is included.

The SILO buffer permits continuous conversion independent of CPU activity. The use of the two DMA controllers eliminates the latency induced by single controller initialization at the end of a buffer completion cycle. While one controller administers data transfers from the A/D over the system bus to memory, the other 1622DMA is available to be set up for the next buffer interval.

The A/D converter board features software gain selection of 1, 2, 4, and 8. An optional board allows expansion to 64 input channels.

Unique in its 22-bit addressing capability, the 1622DMA is available separately and in support of other ADAC A/D and parallel TTL interfaces. CIRCLE 34

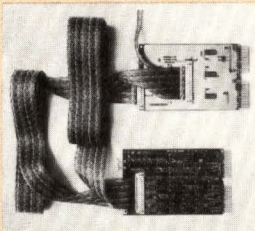

Bus Repeater Is First To Support 22-Bit Addressing, 4 Interrupt Levels And Block Mode DMA.

ADAC's powerful new bus repeater repowers bus signals in both directions for high performance Q-Bus backplane expansion. Model 1953 provides completely transparent multi-backplane Q-bus operation for up to 21 slave units and up to 462 dual-heights cards without the need for expensive interprocessor linking software and multi-processor topography.

Supporting 16, 18 and 22-bit addressing, four levels of interrupts and block mode DMA, cards and/or peripherals in a typical star-configuration system operate as if adjacent to the CPU. Model 1953 also features unique backplane co-ordinated power sequencing circuitry that assures proper "booting" and orderly shutdown on power turn-off or loss.

With high noise immunity, controlled rise times and on-board arbitration for both DMA and levels of interrupts, the 1953 offers plug-in ease of bus expansion. CIRCLE 35

U.S.A. Headquarters: 70 Tower Office Park • Woburn, MA 01801
Tel. (617) 935-6668 • Tlx. 951802

U.K. Headquarters: P.O. Box 42 • Epsom KT18 7SP • Surrey, England
Tel. 3727-42577 • Tlx. 918179

adac
corporation

IF IT WEREN'T FOR UNIX WE NEVER COULD HAVE BUILT THE PYRAMIDS

Ordinary computers, yes. But not a Pyramid Technology 90x.

After all, here's a supermini not just capable of running UNIX,[™] but born to run it. And run it up to four times faster than

the most popular UNIX host. For a lot less money.

The secrets of this Pyramid are a thorough understanding of UNIX, a few fundamentals of RISC (Reduced Instruction Set

Computer) theory, more registers than 30 VAXs, and a 32-bit proprietary architecture that outperforms a roomful of micros.

All combined to speed up UNIX just where it likes to slow down.

For example, gone are 85% of performance-robbing memory references. The endless parameter shuffling of yesterday's technology has been replaced with a hardware register win-



dow. Even context switching takes less than one percent of the CPU's time.

It's amazing what hardware architects can do, given the chance. It's almost as startling as what our software wizards did.

They crafted OSx, a dual port of Berkeley's 4.2 BSD and Bell's System V. Because you can switch environments at will, no UNIX port offers more capabilities. With absolutely no loss

of compatibility.

Well, almost.

We do admit to one feature not compatible with other UNIX systems. Our single-source support.

One telephone number instantly connects you to both hardware and software experts. In-house pros, who spend their energy pointing you towards solutions. Not pointing fingers at each other.

So no matter how you see your requirements shaping up, contact Pyramid Technology, 1295 Charleston Road, Mountain View, California 94043. Or call (415) 965-7200.

Because when it comes to running UNIX, a Pyramid looks good from any angle.



THE EVOLUTION SOLUTION

WINCHESTER DRIVE PROBLEMS:

Size — Weight — Heat
Power — Shock.

THE SOLUTION:

The 3.5"
Winchester.

WHY?

The evolution of this 3.5" model has greatly reduced drive size, weight, mass, power requirements and heat generation, while increasing shock resistance. The problems of larger Winchesters are virtually eliminated by these inherent advantages of this miniaturized model.

MMI offers the same 3.5" Winchester in different package sizes to make the advantages of the smaller model immediately available to systems now using the 5.25" drive, either full size or half height, without design changes.

Capacity: 6 or 12 MB
Interfaces: ST506, ST412
Dimensions: 1.625" x 4.0" x 5.75"
Weight: 2.2 Pounds

To take advantage of the EVOLUTION SOLUTION please contact



**MICROCOMPUTER
MEMORIES, INC.**

7449 Valjean Avenue, Van Nuys, CA 91406 • (818) 782-2222



1984 NATIONAL COMPUTER CONFERENCE

Las Vegas Convention Center and Hilton Hotel Las Vegas, Nevada
July 9 to 12, 1984

State-of-the-art...new developments...impact of technology...Such buzzwords and phrases abound in the little preconference information available on the NCC '84 technical program. As usual, the program seems to be a mixed bag, covering a wide range of interest areas.

There are a number of tracks of particular interest to the computer-based system designer. For example, among the program tracks included are Hardware and Architecture, Computer Communications, The Automated Office, and Artificial Intelligence. According to conference chairman Russell K. Brown, all sessions are chaired by "leading professionals" and "each will address contemporary issues critical to the industry." A sampling of both session organizers and topics confirms this. Certainly, the session titles and available abstracts promise that many sessions in at least the four program tracks mentioned above could be worthwhile for the system designer.

The exhibit portion of NCC '84 is a far different and far more promising matter. More than 650 companies have contracted for exhibit floor space. Unless NCC '84 differs entirely from previous NCCs, this area will be one of the most important for system designers.

Many U.S. (and a number of foreign) companies choose NCC each year as the site to introduce their latest products. Each year, somewhere on the exhibit floor—with appropriate fanfare—or quietly at private suites in nearby hotels, at least two or three truly notable new products are introduced. In addition, exhibitors display hundreds of important, but not necessarily revolutionary, products. Usually, the exhibit floor products are at or near production stage, while most of the suite introductions are of prototypes and may be shown only to a limited number of special viewers.

A sampling of the information on "to be introduced at NCC '84" products indicates that this NCC will follow the trends of previous ones regarding new products. A special section in the June 15 issue of *Computer Design* will describe most of these products—at least those that companies will discuss prior to the conference.

Of course, many other products will not be announced until the conference begins, but they

will be on exhibit at the respective booths. Unfortunately, attendees will have to locate them on their own. As for the private showings, attendees will need to check out the perpetual rumors to determine which are real, and then find a way to view the actual products.

The technical program in brief

Concentration within the Hardware and Architecture program track will be varied. Yet, the one subject that will appear most noticeably is the 32-bit microprocessor. In particular, the architecture of both existing and near-future chip sets will be discussed. For example, one session (on Tuesday morning) will compare the architectures of five chip sets: two from Hewlett-Packard and Western Electric that are available only for proprietary products, one from National that is now in production, and two from Zilog and Motorola that will be available late this year or in 1985. (For a thorough discussion of 32-bit microprocessors, see the article "Architectural advances spur 32-bit micros," by John Bond, Senior Editor, on p 125 of this issue. The next session in this track on Tuesday morning concentrates on proposed standard P754, Draft 10.0, which is accepted by at least three of the now commercially available or near-future 32-bit microprocessors.

This program track will not ignore supercomputer systems and the "fifth generation." On Wednesday, discussions will include the parallel characteristics involved in operational supercomputers and the necessary upward compatibility of future systems. That will be followed by a review and update of the predictions made at NCC '83 on fifth-generation computers.

Computer Communications will address several key phases of that segment of the industry. Dominant in the discussion areas will be networks—local area, multi-vendor, and the necessary integration. But, much emphasis will also be on protocols involved and computer integrated automation with personal computers. As an example, a two-part session will concentrate on the need for manufacturers to coordinate their product designs to alleviate the problems of multi-vendor networks. These sessions will be tied to exhibit floor

(continued on page 56)

(continued from page 55)

demonstrations sponsored by the National Bureau of Standards, Boeing Computer Systems (with 13 vendors), and General Motors (with 7).

Office automation is another important subject for system designers. For example, as was discussed thoroughly in *Computer Design's* Special Edition on "Office Systems Design" (Fall 1983), the automated office involves system designers at almost all levels. Included as elements (ie, products) are the many systems and subsystems common to all computer-based systems: computers, disk drives, printers, terminals, and so on. System designers must be aware of both direct and associated technologies. For instance, designers must include considerations such as ergonomics and artificial intelligence either directly or indirectly into any office system design. It is impossible to ignore either the human element or the hardware/software aspects.

In line with this, participants in the program track on The Automated Office will concentrate their discussions on the design of office systems—in particular, the influence of the microprocessor on such systems. Voice technology (ie, voice messaging, voice synthesis, and voice recognition) and the future impact of such expected advances, will therefore be a key session (on Tuesday afternoon).

A focus on artificial intelligence

At least since the World War II era, and the crushing need to develop automatic cryptographic deciphering techniques and devices, artificial intelligence has been almost as cryptic a term as its initial application. Now, however, at least some phases of AI are attaining various levels of feasibility. Some could even be considered to be practical.

This phase of computer science, which enables some degree of symbolic reasoning and problem solving ability to be attained by mechanical/electronic devices (eg, robots) must be considered in any attempt to design equipment for the present as well as future systems. Closely tied to AI, however, is computer or machine vision. In many applications both must be included in the system design considerations.

The NCC '84 program track on Artificial Intelligence will include discussions of both AI, *per se*, and computer vision. In particular, a Monday afternoon session on AI techniques for signal interpretation is scheduled. Additionally, a Wednesday morning session will present applications of AI to the field of "expert systems." This session will evaluate several representative expert systems along with examples of their usage. Further discussions will encompass natural languages and interfaces to software systems. One session, for

instance, will emphasize the importance of a computer's ability to respond to commands and questions in English. Still other sessions in this AI program track will discuss tools for commercial AI systems, software engineering techniques, and the impact of AI on fifth-generation systems.

Professional development seminars

Concurrent with the series of conference technical program sessions will be a series of 18 full-day professional development seminars. As with the program tracks, several of the seminars will be of value to the system designer. For example, the Monday seminar on Artificial Intelligence will cover language, expert systems, and fifth-generation computers in the morning; computer vision, brain, and robotics in the afternoon.

Wednesday seminars of interest include one on Software Engineering with Ada, and another on Introduction to Computer Graphics. The Ada seminar will cover both the language and its applications as they relate to the principles of modern software engineering. A full range of computer graphics aspects will be discussed in the second seminar, which focuses on the making and managing of pictures with computers. (As an example, see the front cover of this and previous issues of *Computer Design* of the past few years.) Portions of this seminar will tackle important developments in the field: data representation graphics, graphic arts, computer aided design and drafting, decision support systems, and system design.

Two other seminars, on Thursday, show promise. The first is on Super Computers: Why They Are Needed and Where Are They Useful, and the second on Local Networks. The Super Computer seminar first will provide an overview of the history and evolution of fifth-generation computers and will define just what a supercomputer is—from several different viewpoints. Then the attendees will learn of future trends, architectures, hardware, software, and applications, as well as the advantages and disadvantages of special purpose versus general purpose computers. In the Local Networks seminar, speakers will cover both equipment and system developments. The scope will include introductions to concepts, and illustrations of how those concepts can be implemented, as well as trends in both the technology and available products.—S.F.S.

NCC is sponsored by the American Federation of Information Processing Societies, the Association for Computing Machinery, the Data Processing Management Association, the IEEE Computer Society, and the Society for Computer Simulation. For further information, contact AFIPS, 1899 Preston White Dr, Reston, VA 22091. Tel: 703/620-8952.

AT LAST!... 'Snap-able' IDC Strips

Cut board and pin costs

Keep a one-part inventory

Unique breakaway feature lets you snap SAMTEC connector strips to any number of positions. Just snap to the desired position. Or you can get them pre-snapped to your exact requirements ... with or without cable assembled.

1 to 72 positions... mate with .025" square posts.

1 to 36 positions with single row strip... 2 to 72 positions with double row strip. Both mate with the popular .025" square posts. And you stock only one size.

PLUS...SAMTEC SUDDEN SERVICE... delivery you can count on.

IT'S A SNAP!

Reliable gas tight connection.
Cable-conductor-to-contact.

Probing holes
in cover or cap.

Unique contact design
eliminates need for
side lock on cap and base.
Pat. applied for.

Low profile.
Slim line design.
Only .390" max high.

Single row end stackable...
Side stackable in less than
36 or 72 positions.

Actual Size

Selectively plated
Beryllium Copper contacts.

OPTIONAL
Locking Clip

Locks cable connector
to mating square
post header.

OPTIONAL
Polarization Key

Single row uses
standard .100" center cable...
double row uses
standard .050" center cable.

Assemblies 100% tested
when factory supplied.

UL (94V-0) material.

Simultaneous
termination technique.

Let me send you a sample... You can bet I'll make it snappy!

We can handle your order. Big or small. On time... in time.
With Samtec Sudden Service. I personally guarantee it.

Sam & Shine
Prop.



© 1983 Samtec, Inc.

samtec

ELECTRONIC HARDWARE

810 PROGRESS BOULEVARD, NEW ALBANY, INDIANA 47150 (812) 944-6733

CIRCLE 37

EMULEX A SOME PLUSES TO ITS Q

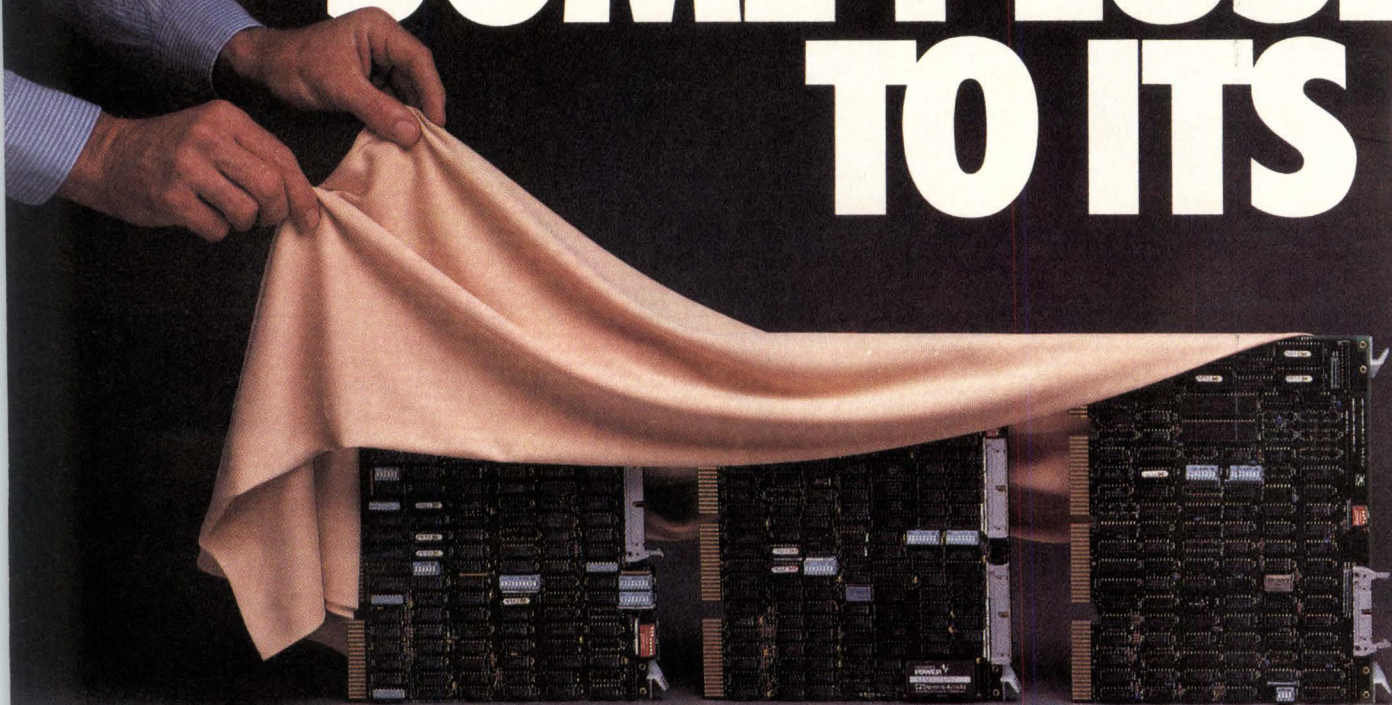

New UC02 emulating host adapter using Mass Storage Control Protocol (MSCP).

New CS02 multiplexer for LSI-11 through 11/23 PLUS and MICRO/PDP-11 computers.

New TC05 tape coupler for CDC Sentinel 1/4" streaming tape drives emulates DEC TS11.

Once again, Emulex gives you more, while charging you less. We're introducing three new controllers for QBus users, and reducing prices on four of our most popular products.

FIRST, THE NEW INTRODUCTIONS.

Our CS02 is a high-performance asynchronous multiplexer for LSI-11 through 11/23 PLUS and MICRO/PDP-11 computers. Both versions can handle 16 lines—eight lines more than DEC's DHV11—yet they fit into existing space within the DEC system.

Also available is our TC05

tape coupler featuring DEC TS11 software transparency and standard operating system support on your QBus. It allows you to interface CDC Sentinel 1/4" streaming tape drives without using special streaming software.

Last, but not least, is the UC02 emulating host adapter, with unique features like automatic drive sizing, command stacking, seek ordering and error control.

By using the Mass Storage Control Protocol (MSCP), the UC02 allows the operating system to utilize the precise characteristics of the Winchester disk drive without

patches or modifications to the operating system. The UC02 plugs into any single quad width QBus slot and provides you the versatility of using the Small Computer System Interface (SCSI) bus.

NOW, THE PRICE REDUCTIONS.

First, we've slashed 33% off the price of our TC02 TS11-compatible tape coupler.

Likewise, we've cut 33% off the price of our SC02 SMD-interface disk controller.

Our UC01 emulating host adapter for SCSI interface has been reduced 21%.

NINOUNCES AND MINUSES BUS LINE.

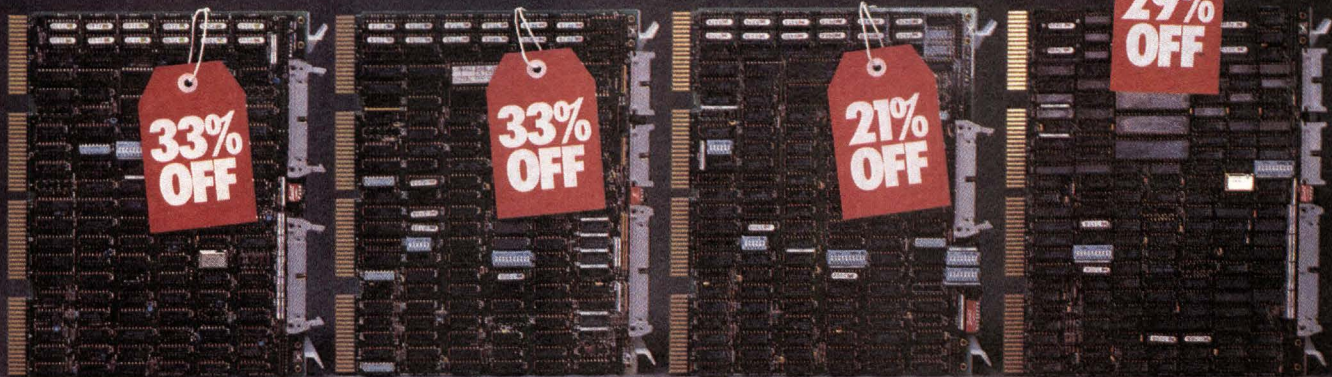

TC02 TS11-compatible tape coupler.

SC02 small/medium disk controller for DEC's QBus.

UC01 emulating host adapter emulates DEC's RL01/RL02.

SC03 large disk controller handles the new 1.8 MByte/second drives - like the Fujitsu "Eagle."

And we've shaved 29% off our SC03 SMD-interface disk controller.

NEW PACKAGED SUBSYSTEMS, TOO.

Also available for QBus users are two storage subsystems.

Vault is a 1/4" streaming tape that gives you up to 70 MBytes of storage at maximum block size.

SABRE™ combines a 31.2 MByte 5 1/4" Winchester with a 10.4 MByte removable 8" cartridge disk. It gives you an

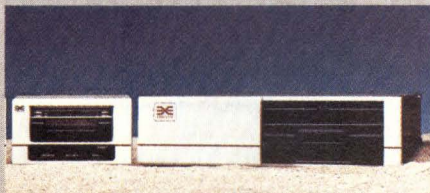

overall capacity equivalent to four (4) DEC RL02s.

HIGH QUALITY WITHOUT HIGH PRICES.

Over the years, Emulex has earned a reputation for performance. For example, our TC01 disk controller has a calculated MTBF of 41,000

hours. But field operations have proven that its actual MTBF is a whopping 164,930 hours.

That's not bad, considering Emulex products are so very reasonably priced. And our

quantity discounts can lower your costs even further.

Isn't it time you added Emulex to your system? Call toll-free: (800) 854-7112. In California: (714) 662-5600. Or write: Emulex Corporation, 3545 Harbor Blvd., P.O. Box 6725, Costa Mesa, CA 92626.



The genuine alternative.

A photograph of the Space Shuttle Columbia during launch, showing the orbiter and external tank with the word "USA" on the side. The shuttle is ascending vertically, with large plumes of fire and white smoke from the engines.

HORSEPOWER

Packing greater performance into a more efficient package.

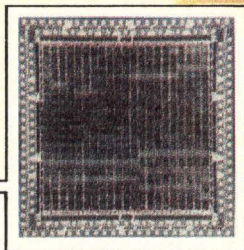

In the semiconductor industry, horsepower translates into *gate array density*. And just as the space shuttle engines shown above have won a reputation by putting more pure power into the most compact and reliable package possible, so have computer components assembled with Honeywell custom and semi-custom hardware.

For instance, the Honeywell HT5000 gate array packs *five thousand* logic gates on a single chip. Twice that of other bipolar arrays.

Speed figures in, too. With a 0.6nS gate delay speed, that same HT5000 operates about *five times faster* than typical ALSTTL chips.

It took over three decades to build the know-how necessary to consistently design and manufacture this kind of performance. And Honeywell puts it into every chip we make.

For more information on the most powerful digital signal processors, semi-custom gate arrays, radiation-hardened IC's, and VHSIC IC's, talk to the company that has been in this industry since before it was an industry.

The Honeywell Digital Product Center, 1150 East Cheyenne Mountain Blvd., Colorado Springs, Colorado 80906.

1-800-328-5111,
extension #3402.
(In Minnesota, call
1-612-870-2142,
extension #3402.)

Together, we can find the answers.

Honeywell

LOCAL NETWORK RESPONDS TO CHANGING SYSTEM NEEDS

A local area network that dynamically adjusts to changes in the nature and volume of system traffic ensures that devices can obtain timely network access.

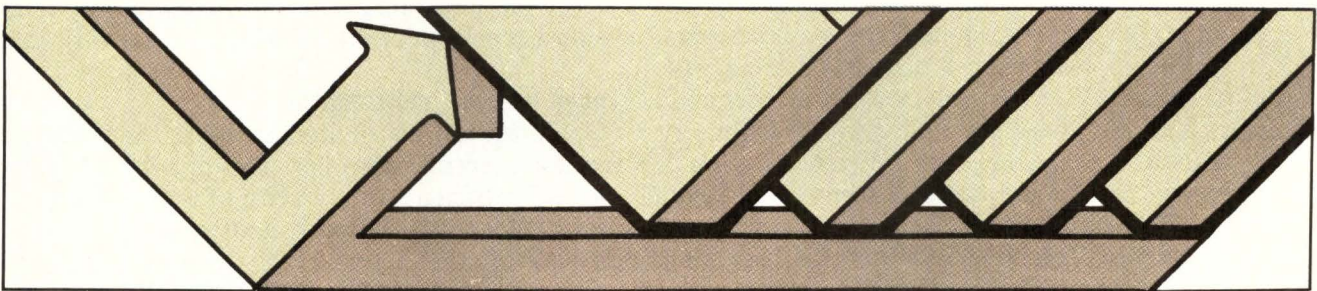

by Ashraf M. Dahod

Today's local area networks must often work with a variety of device types and handle a wide range of data traffic capacities. Unfortunately, most local networks are optimized to handle a narrow range of network conditions and prove to be inefficient in many commonly encountered operating situations. One local area network, however, dynamically adjusts to changes in the nature and volume of system traffic to maximize efficiency.

Before examining the details of this network, note that most commercial local area networks (LANs) are developed to serve specific types of user devices and data traffic. For example, devices that must perform highly time-critical, synchronized operations need a network that ensures access at preset, specific times. On the other hand, nonintelligent terminals typically generate short, burst-like data streams. Such devices require low access delays but do not need a LAN that provides time-specific

Ashraf M. Dahod is chairman of Applitek Corp, 107 Audubon Rd, Wakefield, MA 01880. He holds a BS in electrical engineering from the University of Michigan, a BS in physics and mathematics from the University of Bombay, an MBA from Harvard, an MS in engineering management from Northeastern University, and an MS in electrical engineering from Stanford University.

access. Stressing the importance of yet another network characteristic, devices that must pass large static data files back and forth are best served by networks that do not devote undue resources to bus contention issues.

Unfortunately, the devices found on a single network might include dumb terminals, graphics systems, printers, common files, intelligent workstations, and mainframes. Each of these could benefit from different and often mutually exclusive network characteristics. The wide range of data traffic capacities further complicates the situation. Appropriate network operation at 20 percent of the maximum traffic capacity may be wasteful at 85 percent. Moreover, a single network device may be used in different ways, each requiring a different type of network access. A personal computer, for example, might transfer files at one time and then emulate a host computer terminal at another.

Methods for network access

Overcoming the drawbacks of LANs that provide optimal service only within a limited range of network conditions, Applitek's UniLAN incorporates the firm's UniLINK universal access method, which offers the benefits of three commonly used access methods: carrier sense multiple access with collision detection (CSMA/CD), token passing, and slotted-time division multiple access (STDMA). A brief look at these techniques can illustrate the

benefits and drawbacks of each and provides background for considering UniLINK's operation.

CSMA/CD, a distributed technique, provides immediate access and permits variable message length under low network loads. CSMA/CD is efficient for networking devices (such as nonintelligent terminals) that infrequently send messages. To avoid data collisions, CSMA/CD requires that each device listen to the network. When a device is ready to transmit, it proceeds with its message only if it does not hear another device transmitting. If, while transmitting, it hears another device transmitting, both devices stop and wait for a random amount of time before trying to transmit again. This random back-off time ensures that one device will subsequently gain access.

With CSMA/CD, devices can obtain immediate network access if the traffic load stays low. However, the probability of collisions increases as more devices are added, or as the message frequency increases. Ten years ago, when most network devices were nonintelligent terminals, CSMA/CD was adequate, but as networks began handling file transfers or synchronous devices, network efficiency declined.

Another distributed access technique—token passing—provides each device with a guaranteed network access. Token passing involves circulating a unique bit sequence (the token) among the network nodes in a specific order. Only the node that holds the token has network access. Because a node wishing to transmit must wait for the token

before it can transmit, the method's efficiency drops when the traffic load is light. Furthermore, the explicit passing of the token makes the technique complex to implement and limits the maximum number of devices on a single network.

The third technique, STDMA, is a centralized access method that suits applications involving highly synchronized operations and those covering long distances. STDMA breaks the available network time into slots of equal duration and assigns these slots to specific devices. A device can send messages only for the duration of the time slot; if a message requires more than one slot, it must be broken up, transmitted in several slots, and reassembled at its destination. If a message requires less than one time slot, the remaining time in the slot is wasted. STDMA requires a central synchronizer, which allows all the devices on the network to detect the beginning and end of each slot. If the central synchronizer fails, the entire network fails.

Token passing and CSMA/CD

UniLINK is a distributed technique and does not require a central controller. This distributed control makes it efficient for a variety of network sizes. In accordance with network load and the types of devices on the network, UniLINK automatically adjusts to perform like CSMA/CD, token passing, or a combination of the two techniques. It supports variable- or fixed-length message packets, as does the STDMA technique. Thus, UniLINK can support the longer distances associated with STDMA.

UniLINK requires that user devices follow a set of rules on the network. Time is divided into message blocks, as shown in Fig 1(a). All messages—defined here as the times during which packets can be transmitted—are implicitly numbered and allocated (via a process called automatic message number allocation) to the network interface units. These units connect user devices to the network and keep track of the current message numbers. A device can transmit a fixed- or variable-length data packet only during the message whose number has been assigned to its network interface.

A technique known as pacing, which any network interface can perform, allows each interface to keep track of current message numbers. An interface becomes a pacer when, on power-up, it hears no activity and sends a block synchronization message that returns with no collision and no error. The pacer then sends out a block synchronization message within each message block. This allows each interface to keep an accurate count of message numbers. When the count value equals a certain interface unit's allocated message number, that interface is in pace and can transmit.

Messages are assigned on a dedicated or contention basis [see Fig 1(b)]. Assigning a message number to only one interface unit results in a

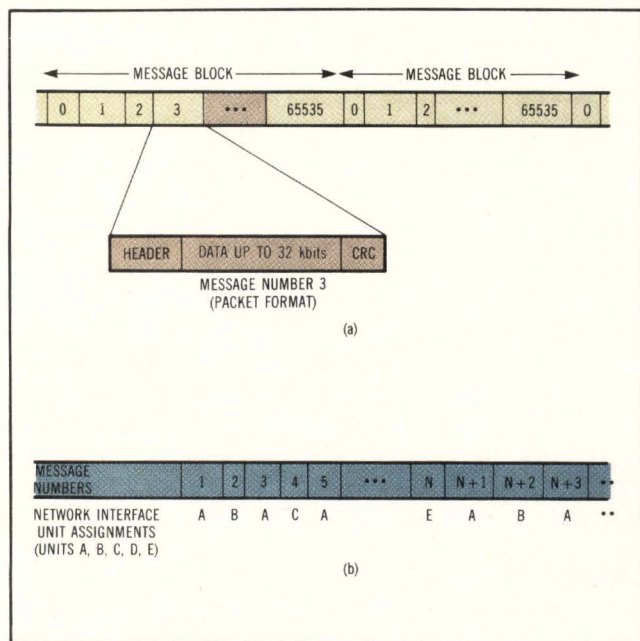

Fig 1 The UniLINK scheme divides time into numbered message blocks allocated to specific network interfaces. Each message includes a header, data, and cyclic redundancy check (CRC), as shown in (a). UniLINK operates on either a contention or dedicated basis. In the latter type (b), assigning more message numbers to certain interfaces gives these interfaces priority, thus improving on typical CSMA/CD schemes.

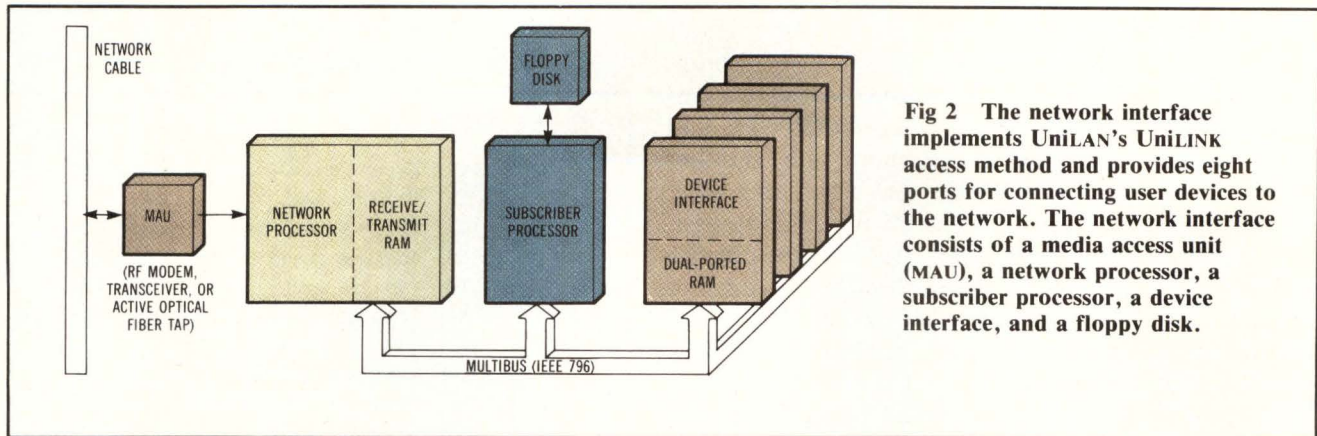

Fig 2 The network interface implements UniLAN's UniLINK access method and provides eight ports for connecting user devices to the network. The network interface consists of a media access unit (MAU), a network processor, a subscriber processor, a device interface, and a floppy disk.

dedicated message because only that unit can use the corresponding message to send information over the network. In contrast, a contention message number is assigned to more than one interface unit. Those units must contend for that message's use. Moreover, each interface unit can have multiple numbers assigned to it.

As in CSMA/CD, when an interface unit detects a collision, it stops sending and waits a random length of time before trying to send again. If a dedicated message number assigned to that interface comes up before the random wait period ends, the interface will use the dedicated message to transmit.

In contrast to the CSMA/CD technique, UniLINK's ability to assign dedicated message numbers significantly reduces delays caused by collisions and random waiting. Simply assigning more message numbers to certain interfaces gives those interfaces priority, as Fig 2 illustrates.

A network manager or a distributed automatic allocation algorithm embedded in each interface can perform the message number allocation function. Interfaces use the common (or contention) channel message numbers located within each message block to request message allocation. In a large network, message number allocation and other network management functions can be automatically performed by a network monitor unit.

Adapting to traffic conditions

When network traffic is light and the active devices primarily asynchronous (eg, nonintelligent terminals sending short, burst-like messages), UniLINK provides immediate network access, as would CSMA/CD under similar conditions. When synchronous devices or computers transmitting regular, frequent traffic are added to the network, UniLINK dynamically adapts to provide guaranteed token-passing type access (with bounded transmission delays) for those added devices and computers. If increased collisions persist, then all devices receive guaranteed access.

Network interfaces implement UniLAN's UniLINK access method. UniLAN supports several

thousand network interfaces, depending on the cable chosen. Each network interface (Fig 2), which consists of a media access unit (MAU), network processor, subscriber processor, and a device interface, can perform all the functions necessary to keep the network operating.

The MAU connects the network interface to the network cable. Any IEEE 802 baseband transceiver for a baseband coaxial cable can serve as the MAU. To connect network interfaces to broadband coaxial cable, Applitek developed a radio frequency modem that provides 10-Mbit/s operation in one 6-MHz TV channel. This modem follows proposed IEEE 802 guidelines. Another MAU choice, the optical-fiber tap, connects the network interface to optical fiber cable.

The network processor employs an 8-bit processor as well as firmware to implement UniLINK. The receive/transmit buffer has 12 Kbytes of RAM to store packets to be received and transmitted. This buffer features resettable first in, first out memory for increased data throughput. For baseband and optical-fiber networks, the network processor furnishes Manchester data encoding/decoding. Moreover, a Motorola 68000 microprocessor and a 3½-in. microfloppy disk allow the subscriber processor to connect to as many as four device interfaces via an IEEE 796 bus (Intel Corp's Multibus). The disk stores programs and configuration parameters.

The device interfaces, each of which can support up to eight RS-232/449 asynchronous, bisynchronous, and synchronous data-link control (SDLC) devices, include 68000 processors as well as 32 Kbytes of dual-ported RAM. This RAM stores inbound and outbound message packets. When one packet is being assembled, another can be transmitted. Every 8-bit segment of RAM within the network interface has an odd-parity, error checking function. Network interface software generates a checksum to perform error checking on all packets in the system.

Software commands allow each interface, or port, to be configured individually in order to handle certain Electronics Industries Association (EIA)

RS-232 signals (specifically, RTS, DSR, CTS, DCD, and RI) in different ways. Table 1 lists the RS-232 signals defined by EIA as well as some signals not found in the definition. For each interface, software commands can separately set such functions and parameters as transmit mode, baud rate, number of stop bits, character-code selection, and local echo. Because of the hardware's modular design, UniLAN's software divides between the device interface boards and the subscriber processor board. Also, each device interface and subscriber processor has an independent onchip copy of the pSOS-68K operating system kernel, from Software Components Group, Inc (Santa Clara, Calif).

Splitting software into two process groups

The software further divides into two groups of processes (Fig 3). The operating system on the subscriber processor supports one group, which includes the session layer functions. Meanwhile, the operating system on each device interface supports the other group, which includes transport, presentation, and application layer functions.

The subscriber processor and device interface pass data and commands to each other through the dual-ported RAM that resides on the device interface. Both the subscriber processor and device interface have access to this RAM. Data intended for network transmission is transferred to the transmitter RAM

Pin No.	Signal	Function	Circuit	
			EIA	CCITT*
1	PG	Protection ground	AA	101
2	TD	Transmit data	BA	103
3	RD	Receive data	BB	104
4	RTS	Request to send	CA	105
5	CTS	Clear to send	CB	106
6	DSR	Data set ready	CC	107
7	SG	Signal ground	AB	102
8	DCD	Data carrier detect	CF	109
11	—	Spare input A	—	—
15	TC	Transmit clock	DB	114
17	RC	Receiver clock	DD	115
18	—	Spare input B	—	—
19	—	Spare input C	—	—
20	DTR	Data terminal ready	CD	108.2
21	—	Ext. transmitter clock	—	—
22	RI	Ring indicator	CE	125
24	ETC	Ext. transmitter clock	DA	113
25	MB	Make busy	—	—

*International Consultative Committee for Telephone and Telegraph

on the network processor board. Data coming from the network intended for the subscriber processor or a user device is removed from the network processor's receiver RAM by the subscriber processor.

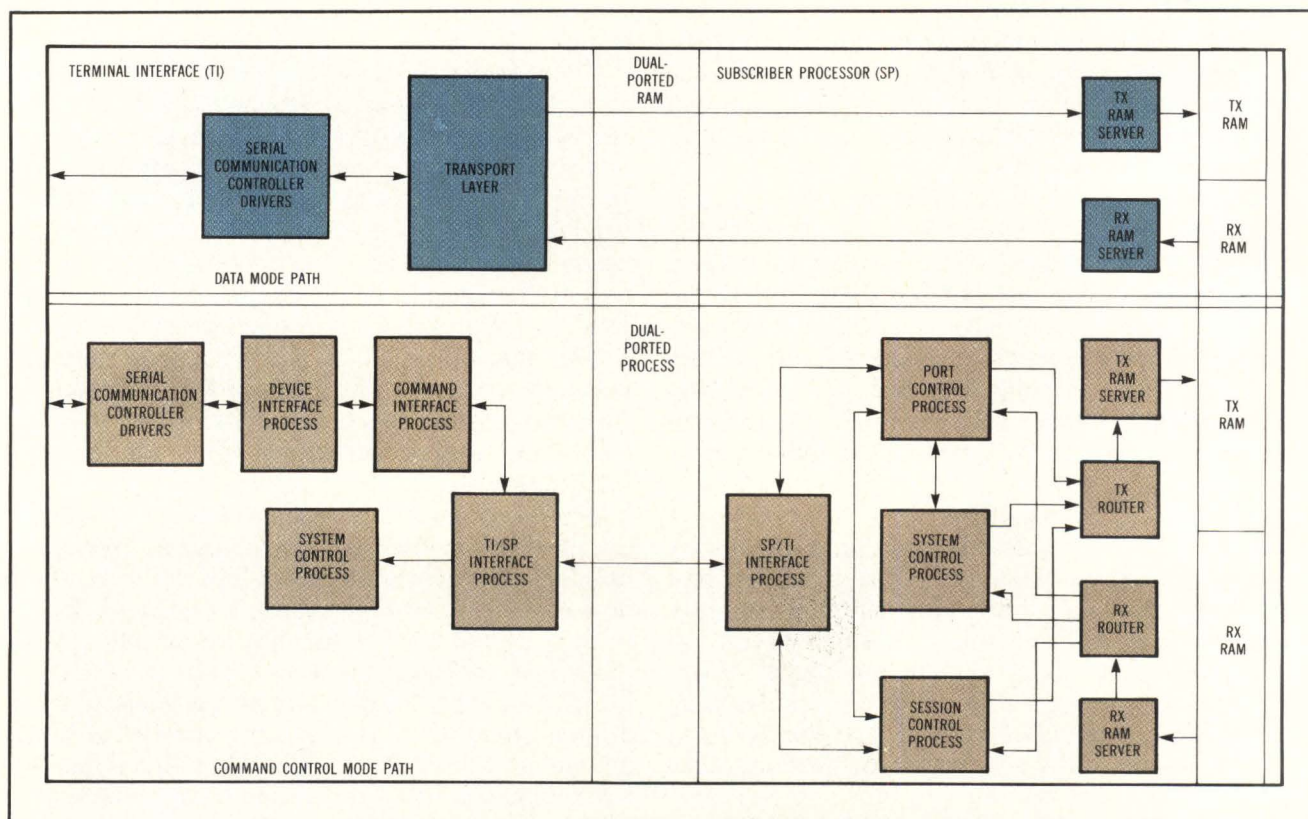

Fig 3 This modular software design follows the layering scheme promulgated by the International Standards Organization in its Open System Interconnection model. Software residing in the subscriber processor supports session layer functions while software on each device interface supports transport, presentation, and application layer functions. Transmit (TX) and receive (RX) RAM resides on the device interface.

High Performance Ethernet Solutions. It's written all over our board.

Presenting the ENP™-10 Ethernet Node Processor. It's a VMEbus interface that's one in a series of bus-based high performance Ethernet LAN solutions from Communication Machinery Corporation.

Clearly evident on all our ENPs is the CMC commitment to setting the pace in LAN technology.

It's written into the innovative design of the LANCE emulator originally built by CMC as a template for the evolution of the LANCE chip set. Taking supervisory functions from a 16 bit 68000 processor, the LANCE chip set gives you maximum network intelligence with minimal board real estate.

The CMC commitment can be seen in the built-in advantages of industry standard protocols (XNS and TCP) for inter-operability; all ENP boards conform to IEEE 802.3 specifications.

You can read it in our performance. The ENP series offers Ethernet Host-to-Host transfer rates in excess of sustained 1.6 Mbit/Sec and increases Host computer performance by over 30%. You can achieve this speed all

the way across the ENP family which includes VERSAbus™, MULTIBUS™, and UNIBUS™ interfaces.

Software flexibility. We've embedded it right into our boards with our K1 Kernel communications executive that manages memory resources, supervises transmission/reception of messages, and performs sophisticated diagnostics. We can also provide you with application software as part of our complete Ethernet capabilities.

OEMs, write the highest performance Ethernet solutions into your networking plans. For delivery of the ENP Series, call CMC today. **(805) 963-9471**



Communication Machinery Corporation
1421 State Street
Santa Barbara, CA 93101
TWX 910 334-3508

The ENP-10. Only from CMC.



ROM

- ◆ Protocols XNS or TCP
- ◆ Power up diagnostics
- ◆ K1 Kernel communications executive
- ◆ All software is high bandwidth

LANCE

- ◆ Designed exclusively for Ethernet
- ◆ VLSI AM7990/91
- ◆ Performs Levels 1 & 2 of ISO model

MPU

- ◆ 10 MHz 68000
- ◆ Performs Levels 3 & 4 of ISO model
- ◆ Diagnostics & network statistics

RAM

- ◆ 128 Kilobytes
- ◆ No wait states
- ◆ Parity checking
- ◆ Dual ported

BUS INTERFACE

- ◆ DMA transactions to/from Host memory
- ◆ 24 bit address
- ◆ Master or slave operation
- ◆ 16 bit data

ENP is a trademark of CMC. VERSAbus is a trademark of the Motorola Corporation. MULTIBUS is a trademark of Intel Corporation. UNIBUS is a trademark of Digital Equipment Corporation.

TABLE 2
Software-Alterable Port Configuration Parameters

Parameters	Options	Parameters	Options
Transmit mode:	Full duplex Half duplex	Data mode session:	No predefined session Permanent predefined session
Baud rate:	50 to 19,200 bits/s		EIA signal controlled predefined session
Stop bits:	1.1.5.2		RTS-ignored, valid TD indicator
Parity:	Odd, even, none	EIA control signal options (NI as DCE):	DSR-on, off, follows DTR CTS-on, off, follows RTS DCD-on, off, valid RD indicator
Character code:	ASCII, EBCDIC, none (transparent)		RI-on, off, indicates connect request received, on during session, off during session
Local echo:	Echo or no echo		DTR-indicates DTE power-on, ignored
End of packet Condition:	Normal packet size (selectable) and end of message character (selectable) Normal packet size (selectable) and timer (selectable) Echoplex	EIA control signal options (NI as DTE):	DTR-on, off RTS-on, off, valid TD indicator DSR-ignored, indicates DCE power-on DCD-ignored, valid RD indicator CTS-ignored, enables NI transmitter (selectable)
XOFF threshold:	16 to 4,000 characters (selectable)		(control mode only)
Broadcast group name:	(Control mode only)	Enable disable:	
Flow control:	X-ON X-OFF (selectable), DSR, CTS	User access to configuration options:	
Port type:	Asynchronous, Bisynchronous, SDLC, HDLC, DDCMP		
Rotary port name:	(selectable) (control mode only)		
Terminal mode:	Data mode only Data and command mode		

To make UniLAN easy to use, the software uses a command structure similar to the English language. This is presented in menu form. A help facility provides online support. Software creates virtual circuits, called sessions, for passing data between devices on the network. By using simple software commands, users can connect or disconnect sessions, configure port parameters, and send broadcast messages (or datagrams) to other users on the network.

Software sets parameters

After a session is connected, data passes between devices in packets. The packet size for each port is one of the port-configuration parameters that software sets. Error detection and error control procedures ensure data integrity. Other password-protected functions are available only to the network manager, who can reconfigure any port on the network, reinitialize the network, connect or disconnect users anywhere on the network, change port buffer sizes, get status information on any device or session, and perform various diagnostic activities.

Three modes of operation—command, control, and data—provide different types of user services. Separate paths handle the flow of data mode data

and command and control mode data through network interface software to ensure high throughput and quick response times.

The command mode allows users to connect or disconnect sessions, use a network directory, configure port parameters, and send messages to other users on the network. Password protected, the control mode provides remote session control, network control, and diagnostic functions for the support staff. Diagnostic functions include access to an error history log, which the system automatically maintains, and the ability to put ports into a loopback mode, thereby helping to pinpoint the location of problems. Control mode also allows third-party connection and disconnection of sessions as well as remote port configuration and renaming.

Once a session has been established, data mode expedites the actual passing of data between devices. For devices that communicate solely with one destination, predefined sessions can be established for that device's port. This procedure keeps the device connected to that port in data mode, making network operation transparent to the user.

On system initialization, software loads from the network interface local floppy disk, which serves as each network interface's original source of software

This New Fiber Optic Modem will Extend a DCE Interface to Any Point in Your Local Area Network.

Plus a whole lot more.

- Can also be used for standard modem applications
- Automatically accepts or supplies DCE/DTE clocks
- Fully supports all EIA handshaking signals
- Provides secondary data channel

In short, you can use our new fiber optic modem between *any* two plug compatible units in your local area network. And it won't require any jury-rigging or looping clock and interface signals. That's because, from an operating standpoint, our fiber optic modem looks just like an EIA cable; whether you're going from a long-haul

modem to a remote terminal or from a CPU port to a printer. And it's just about as easy to install as a cable — we even provide two separate connectors (DTE and DCE) on each modem. YOU determine how our modem will function simply by selecting which connector you use!

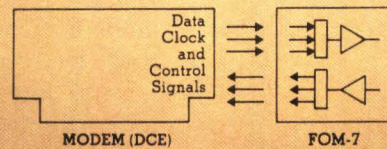

Once our fiber optic modem is installed and operating it'll really begin to shine. You'll benefit not only

from the advantages inherent with fiber optics (traffic security plus noise immunity) but also from the exceptional operating performance. Our very low error

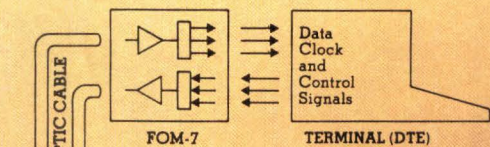

rate and continual signal quality monitoring means that you'll operate with a higher throughput and less downtime than ever before.

Versitron manufactures a complete line of fiber optic products for Local Area Networks. Our 20 years' experience in fiber optic is reflected in the performance capabilities of our products.

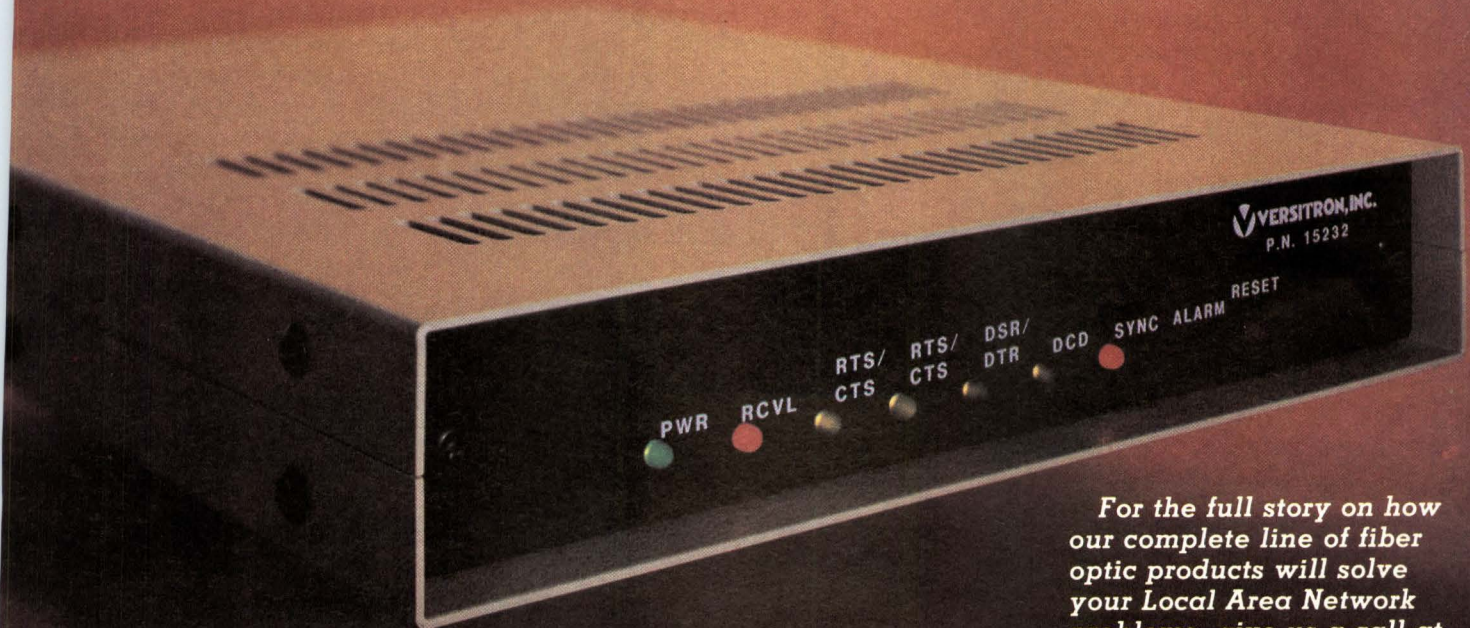

For the full story on how our complete line of fiber optic products will solve your Local Area Network problems, give us a call at (202) 882-8464. Or write:

VERSITRON, INC.

6310 Chillum Place, N.W., Washington, D.C. 20011. TWX: 710-822-1179
CIRCLE 41

NOBODY KNOWS MORE ABOUT HOW TO DISTRIBUTE POWER

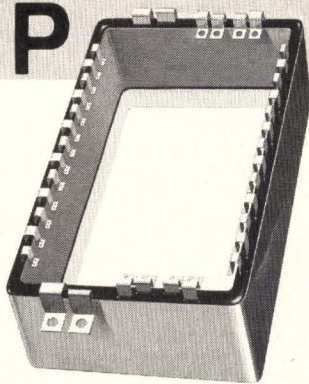

Innovative bussing solutions. Rogers pioneered the first laminar bus bars. Today, our power distribution solutions

range from MINI/BUS® PCB bus bars to QUIK/BUS® do-it-yourself laminar busses.

Fully customized designs. We engineer bus bars in a variety of materials and configurations for production runs. And of course, provide complete prototyping.

The perfect power distribution package. Rogers laminar bus bars provide higher reliability than bulky wiring harnesses. They fit space requirements exactly. And feature low inductance, high distributed capacitance, and low characteristic impedance.

Worldwide service. Facilities in the U.S., Japan, France and Belgium offer customers around the world the best value in the industry.

Free design/value analysis. Nobody knows more about power distribution than a Rogers Design Engineer. Why not consult him or our Product Manager today at (602) 830-3370.



ROGERS

Rogers Corporation
Bus Products Division
5750 East McKellips Road, Mesa, AZ 85205
602 830-3370

code as well as configuration parameters. Software revisions can be downloaded onto the floppy disks from other floppy disks, facilitating software updates. The floppy disk also holds help files, the local network directory and the field-support error log file. During network operation, these files are accessed when a user requests help with a command or wants to see or alter the network directory, and when the system logs an error.

Most environments today require a LAN to connect dissimilar devices that have different communication needs.

Each port has several characteristics or parameters that are configurable to let the port handle variations in devices and session requirements. The floppy disk retains the port parameters, allowing reinitialization of a port with previously selected parameters. When port parameters are changed, the floppy disk is automatically updated.

All ports can be reconfigured with software commands, either remotely by the network manager, or locally by the user. Table 2 provides a list of parameters that software commands can alter. In control mode, the network manager can select the control parameters that users can change in command mode.

To facilitate field diagnostics, a standard diagnostic port configuration is stored permanently on floppy disk. The disk similarly holds a default port configuration. In control mode, the change port configuration command allows selection of these standard configurations.

Most environments today require a LAN to connect dissimilar devices that have different communication needs. Thus, a large organization must interconnect many synchronous and asynchronous devices as well as intelligent and dumb terminals on a single cable. Network traffic generated by these devices will range from light to heavy at various times. Such applications require a network that can adapt to varying network conditions to provide the fastest possible response.

Please rate the value of this article to you by circling the appropriate number in the "Editorial Score Box" on the Inquiry Card.

High 701

Average 702

Low 703



ABLE's ATTACH customers enjoy their spaghetti in the dining room, not the computer room.

ABLE's ATTACH, the breakthrough multi-host terminal switching system for DEC UNIBUS computers that eliminates the spaghetti-like mess of cables in your computer room.

One ATTACH host board and a *single* cable replaces 16 DEC interfaces, and their associated "spaghetti." And it still supports up to 128 terminals on your system without the endless tangle of cables that tie-up your computer room.

One ATTACH host board does the work of many multiplexers. The immediate advantage is a dramatic reduction in mounting space and expansion cabinetry, resulting in significant cost savings. And ATTACH can be located up to a kilometer away from your computer room.

Cook up a system to meet your present data communication requirements with ATTACH. At the touch of a keyboard, terminals can be dynamically *switched* among any combination of VAX and PDP-11 UNIBUS systems. And,

ATTACH is compatible with RSX, RSTS/E, VMS and UNIX operating systems.

Expanding your capabilities, or adding terminals is easy with ATTACH. As your requirements grow, simply add modular ATTACH units to your system.

Whether you have 28, or 128 or more terminals, ATTACH has the right recipe for cost-effective connectivity. ABLE Computer's ATTACH is the most efficient terminal interconnection system on the table.

Contact the ABLE representative near you, or call ABLE toll-free at 800-332-2253.



The communication specialists

CIRCLE 43

1732 Reynolds Avenue, Irvine, California 92714. In the Irvine area: (714) 979-7030. Or, TWX: 910-595-1729.

DEC, PDP, RSTS, RSX, UNIBUS, VAX and VMS are trademarks of Digital Equipment Corporation. UNIX is a trademark of Bell Laboratories. ATTACH is patent pending.

WE MAKE OUR 5¼" HALF-SATISFY THE TOUGHEST

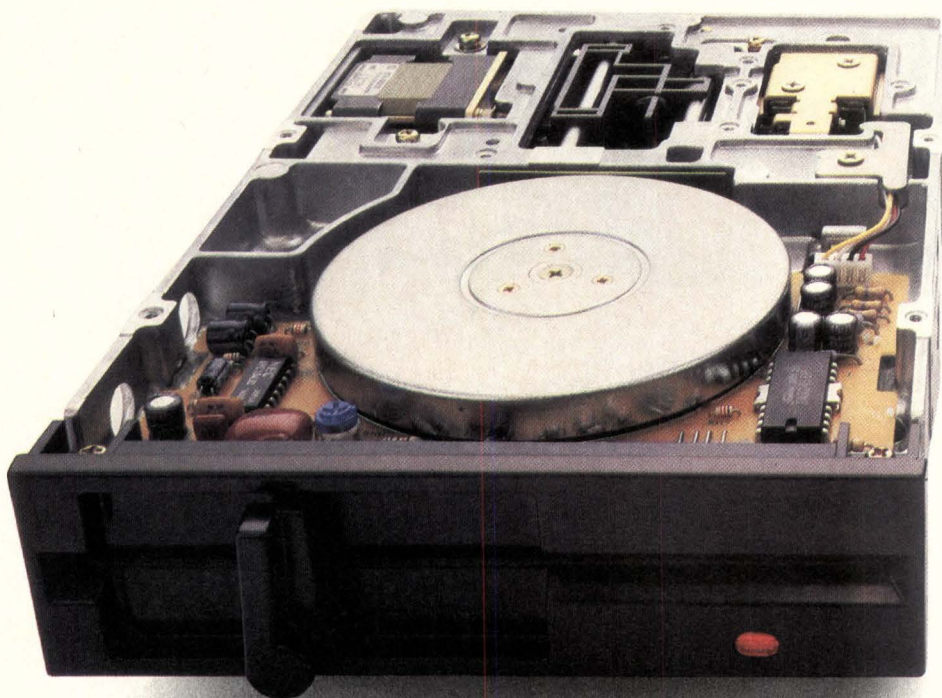

Specifications

	FD1053	FD1055	D5124
Capacity (MB)	.5	1.0	12.9
Avg. Access (ms)	95	95	85
Power (watts)	4.8	4.8	26
MTBF	12,000	12,000	12,000
Head Load Time (ms)	35	35	15
Form Factor	1.625" x 5.75" x 8.00"		
Positioner	Stepper Motor—Band		

Ourselves.

NEC manufactures some of the most advanced computer systems in the world today. And inside every one of them, you'll find some of the most advanced disk drives.

All designed and made by NEC.

You'll also find the same NEC drives in a lot of other well-known computer systems. Because system builders know every NEC drive is made by

people who look at drives the same way they do.

One reliable source for 5¼" drives.

The latest additions to the NEC disk drive line are 5¼" half-height Winchester and flexible drives. The Winchester is available now with 12.91 MB of storage; flexibles with 1.0 MB. Even larger capacities will be introduced in the near future.

If you use both drives in your systems, now you can count on one reliable source for all your needs.

20 years in the driver's seat.

NEC was one of the first to develop magnetic recording devices, back in 1959. But NEC has been pioneering advance-

12.9 MB of storage is available in Winchester drives (Model D5124). .5 and 1.0 MB is available in flexible drives (Model FD1053 and FD1055).

HEIGHT DISK DRIVES TO OEM IN THE BUSINESS.

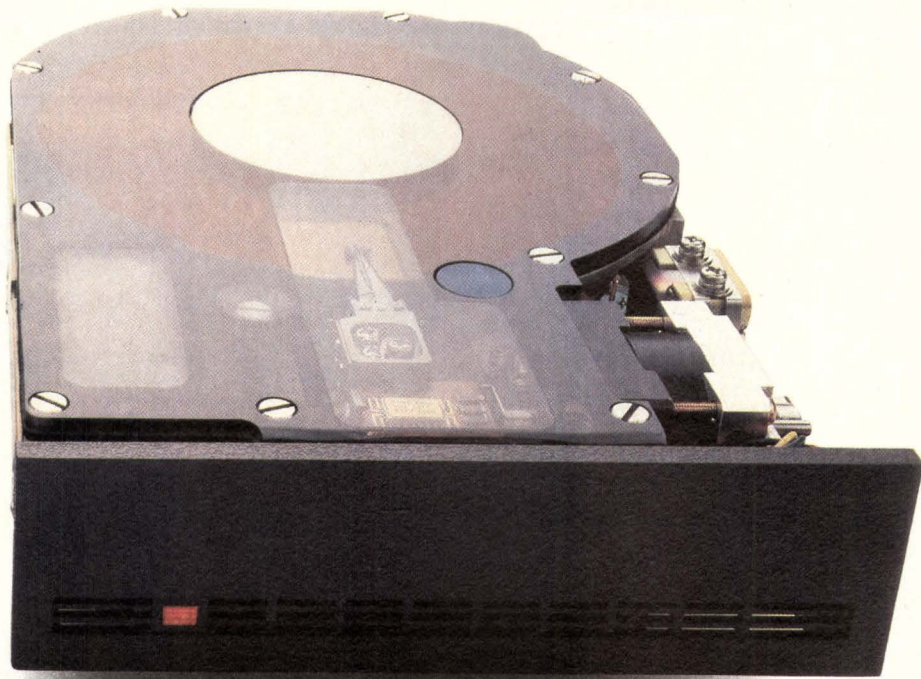

ments in electronics for almost 85 years. Today, we're a world-wide company with over \$6 billion a year in sales.

NEC is one of the few who make a full range of disk drives: 8-inch and 5 1/4" Winchester and flexible drives, along with a new high capacity 9" Winchester. Some drives incorporate such advanced techno-

logies as NEC manufactured plated media and thin-film heads. Clearly NEC is at the leading edge of disk technology.

For more information on 5 1/4" drives or other sizes, or product literature, call 1-800-343-4418. (In Massachusetts, call 617-264-8635.) You'll discover why more and more systems builders are saying, "NEC and me."

NEC AND ME



Please send me more information on:

___ 5 1/4" Half-height Winchester disk drive ___ 8" Winchester drive
 ___ 5 1/4" Half-height floppy drive ___ 9" Disk drive 520 MB

Name _____

Title _____

Company _____

Address _____

City _____ State _____ Zip _____ Tel. (____) _____

NEC Information Systems, Inc.
 1414 Massachusetts Avenue
 Boxborough, MA 01719

CD684

Now, with 8051 emulation ... the gives you more microcomputer

With the introduction of the HP 64264S Emulator, you can now take full advantage of the versatile Intel 8051/31 microcomputer. At the same time, if you have opted for the Motorola 6801/03/05 you will find the HP 64256S or HP 64192S Emulators to be powerful allies when developing your microcomputer-based systems. Now more than ever you can appreciate the flexibility of the Hewlett-Packard 64000 Logic Development System approach to universal emulation.

Only from HP... the most detailed 8051/31 emulation available.

Our HP 64264S Emulator gives you a complete picture of internal 8051 operation showing you more than ever before available. You can monitor all activity across the internal data bus, including data memory accesses (not just what's in ROM). You get real-time, nonintrusive tracing of all Special Function Registers. Plus, the HP 64264S lets you trace activity on all four of the 8051's I/O ports.

Our solution is the only one that lets you map the entire 128K bytes of the 8051's addressable memory. Plus you can resolve activity in blocks of only 256 bytes. You get the best of both: a significantly refined diagnostic vision over a greatly expanded field of view.

Trace:	address	opcode	operand	control	count	time
010	0111	02	INC 27H	5BH	1	0.00
005	0112	27			read	1.00
005	0113	15	DEC B	5BH	1	0.00
007	0114	F8			read	0.00
006	0115	E5	MOV A, B	5BH	1	0.00
005	0116	F8			read	1.00
004	0117	84	CINE A, 85H, 011H		read	1.00
003	0118	58			read	1.00
002	0119	F7			read	1.00
001	011A	F8			read	1.00
000	011B	F8	MOVX @SPTR, A		read	1.00
001	011B	45			ext data write	1.00
002	0115	58			read	1.00
003	011B	45	DPH: A, 27H	5BH	1	0.00
004	011C	27			read	1.00
005	011D	85	MOV 36H, DPL	15H	1	0.00

STATUS: 16051--Running Trace Complete 15:35
 modify external data memory BUFF_START thru BUFF_END to 0
 run scale stop display modify break end --E1000

Trace photo of internal data bus is example of how the HP 64264S Emulator shows you more of the 8051 internal operation than ever before.



HP 64000 options than ever.

A complete family of emulators.

Our HP 64000 Logic Development System features optional emulation modules for all the most popular microcomputers and microprocessors as the table shows. Plus our universal emulation package can give you an early start on future microprocessor offerings.

Microcomputers	8-Bit Microprocessors	16-Bit Microprocessors
6801/03	Z80	68000
6805	6800	68010
8048	6802	Z8001
8051/31 (NEW)	6809	Z8002
	6809E	80186 (NEW)
	8080	80188 (NEW)
	8085	8086
	NSC 800	8088

Dedicated vs. universal development systems.

Until now, if you wanted to design with the 8051 and wanted emulation, you had to buy a dedicated development/emulation system as well. But what if you don't want to get locked into a single vendor's microprocessor line? What if you want the freedom of choosing the best microprocessor for your application, no matter who makes it? That's where the HP universal solution comes in.

Call us today at 1-800-4HP-DATA.

We're ready to help, with the product and service support that has made HP famous. If you already own an HP 64000 system you can move up to 8051/31 or 6801/03 emulation for as little as \$6,000*. A complete development system, with 8051/31 emulation built in, costs approximately \$25,000*. To help you decide if our solution is right for you, outside Colorado,



call toll free 1-800-4HP-DATA. In Colorado, call 1-590-3340. We'll send you a technical data sheet on the new HP 64264S Emulator for 8051 processors and a brochure that explains our comprehensive processor support program. Or, call your local HP sales office listed in the telephone directory white pages. Ask for the electronic instruments department.

*U.S.A. price only.



**HEWLETT
PACKARD**

A Symbolic Computer and much, much more

There are two high-performance LISP machines on the market today. And one clear choice.

Both the LMI Lambda™ and the Symbolics™ 3600 are based on LISP machine technology originally developed at MIT, one of the foremost AI research centers in the world. Both machines feature versions of the ZETALISP software originally licensed from MIT, widely recognized as an extremely powerful and productive programming environment. Both machines offer a large address space and special architecture and microcode for the efficient execution of LISP, giving users the symbolic computing power needed to deal with applications where program size and complexity overwhelm conventional programming techniques.

But today's users need more than just a LISP machine, more than just a symbolic computer. Today's users need and demand a LISP machine that protects them against obsolescence; one that allows them to take advantage of the wide range of peripheral products offered by hundreds of third-party manufacturers; one that allows them to run applications in optimal, concurrent, independent processors, rather than forcing the translation of existing non-LISP programs to LISP architectures. Most of all, they need a LISP machine with a flexible design that offers an **evolutionary** path to the increased productivity offered by intelligent computing.

As a careful comparison will reveal, what today's users need is the LMI Lambda — a symbolic computer and much, much more.

- **Multiprocessor bus architecture** — optimal environments for applications: LISP + LISP or LISP + 68000/68010/UNIX. Processors execute concurrently and independently.
- **Extended-STREAMS interface** — for interprocessor communications at the full speed of the NuBus (37.5 megabytes/second)
- **Integral MULTIBUS™**, gives you access to hundreds of third-party peripherals and board level accessories for ease of configuration.
- **Virtual control store and microcompiler**. Enables you to tailor the Lambda's architecture to suit the needs of your specific application, without the difficulty associated with traditional microcode delivery. Makes the application run fast, **not just the environment**.
- **ZETALISP-PLUS™ software**, an enhanced version of the famous MIT ZETALISP environment.
- **Easy conversion of programs from Symbolics 3600 to LMI Lambda**.
On-site assistance available at our cost if needed.

LMI LISP Machine Inc.

Suite 900, 6033 West Century Blvd.,
Los Angeles, California 90045
(213) 642-1116 TELEX 66-4608

**Creative Tools for
Applied Intelligence.™**

Features ¹	LMI Lambda™	Symbolics™ 3600
HIGH-SPEED MULTIPROCESSOR BUS ARCHITECTURE	YES	NO
UPGRADE TO FULL-PERFORMANCE 2-USER LISP SYSTEM	AVAILABLE JULY	NO
68000 CO-PROCESSOR W/UNIX™ Version 7 (SWAPPING)	AVAILABLE NOW	NO
68010 CO-PROCESSOR W/UNIX™ System V (PAGING)	AVAILABLE AUGUST	NO
EXTENDED-STREAMS INTERFACE	YES	NO
USER-PROGRAMMABLE VIRTUAL CONTROL STORE IN LISP CPU	YES - 64K X 64 BIT	NO ²
LISP MICROCOMPILER FOR EASY MICROCODE DELIVERY	YES	NO
BUS SPEED	37.5 MEGABYTES/SEC	20 MEGABYTES/SEC
MULTIBUS™	STANDARD, INTEGRAL	OPTIONAL
IN MAINFRAME	YES	NO, ADD-ON CABINET REQUIRED
OTHER LANGUAGES AVAILABLE:		
CommonLISP	AVAILABLE MAY	?
PROLOG	YES/MICROCODED	? ³
FORTRAN-77	IN 68000/68010/UNIX	ON LISP HARDWARE
C	IN 68000/68010/UNIX	ON LISP HARDWARE
PASCAL	IN 68000/68010/UNIX ⁴	ON LISP HARDWARE
OPTIONAL 1/2-INCH STREAMING TAPE DRIVE	YES	YES
IN MAINFRAME	YES	NO, ADD-ON CABINET REQUIRED
OPTIONAL 1/4-INCH TAPE DRIVE	YES	YES
HIGH-RESOLUTION B&W DISPLAY	YES	YES
MEDIUM-RESOLUTION COLOR WITH FRAME GRABBER	AVAILABLE APRIL	NO
HIGH-RESOLUTION COLOR	AVAILABLE AUGUST	YES
WINCHESTER DISK DRIVE(S) — CAPACITY	UP TO 1.8 GIGABYTES	UP TO 1.8 GIGABYTES
LISP PROCESSOR	32-BIT	36-BIT
TAGGED ARCHITECTURE	YES	YES
FULL ZETALISP DIALECT, INCLUDING:		
FLAVORS OBJECT-ORIENTED PROGRAMMING	YES	YES
WINDOW SYSTEM, INSPECTOR, ZMACS, WINDOW DEBUGGER ...	YES	YES
ETHERNET-II™ NETWORKING	YES	YES
VAX™ VMS™ & UNIX™ INTERFACES	YES	YES

(1) Some of the features detailed may not apply to certain Lambda configurations. The LMI Lambda system offers many advanced resources not listed here, and a detailed technical summary and software overview are available on request. This table is based on data available from Symbolics published data sheets and advertisements, and may not reflect changes or improvements made by Symbolics concurrent with or subsequent to the release of this comparison.

(2) The Symbolics 3600 has an 8K X 112-bit control memory. User microprogrammability is not encouraged.

(3) A non-microcode-optimized PROLOG version is available for the Symbolics 3600 from LISP Machine Inc.

(4) Available August

ETHERNET-II is a trademark of the Xerox Corp.

LMI Lambda is a trademark of LISP Machine Inc.

MULTIBUS is a trademark of the Intel Corp.

NuBus is a trademark of Texas Instruments.

SYMBOLICS 3600 is a trademark of Symbolics Inc.

UNIX is a trademark of Bell Laboratories

VAX and VMS are trademarks of Digital Equipment Corporation.

ZETALISP-PLUS is a trademark of LISP Machine Inc.



TAGGED ARCHITECTURE SUPPORTS SYMBOLIC PROCESSING

Even though the Lisp programming language enables artificial intelligence functions on large computers, efficient processing necessitates a different architecture.

by Abraham Hirsch

Lisp has capabilities lacking in other computer languages in that it permits manipulation of complex structures and symbolic information. Because of its ability to manipulate symbols, it is used for expert systems, visual recognition, and other sub-categories of artificial intelligence. Its major drawback, however, is that its large size and flexibility can easily swamp a conventional mainframe. This flaw is more a result of conventional computer architecture than of any shortcomings of the Lisp language itself. Efficient Lisp processing thus requires a new type of computer architecture.

Complex knowledge and data are described by physical or abstract symbols in natural language (eg, words and numbers) with lists of properties to describe them. The properties consist of a variety of data types, such as text and numbers, that form a long itemized list attached to each symbol. This is different from most computer languages where variables have only one numerical value, because of computer limitations. The closest analogue to symbols are records in a data base. However, database records are full of fixed-length fields that are difficult to manipulate. Symbols take the database concept several steps further. Fields are totally arbitrary in terms of data type, length, and order, with no fixed structure among symbols, as in data records.

As noted, symbols are defined by lists of properties that can be processed dynamically, unlike those

in a normal data base—ie, they can be broken apart or combined to form new symbols. Also, because the symbols are processed dynamically at run time, there are certain memory allocation/deallocation problems that do not occur with conventional programming languages.

Most computer languages define variable and fixed arrays, and allocate memory space at compile time. If the computer needs more space than is allocated during compile time, and it is unavailable, the program will abort. Symbolic processing, however, is so dynamic that the operating system does not know at compile time how big the data structures are going to be, or what they will look like when the program executes.

Lisp, a mnemonic for list processing language, deals efficiently with these lists and data structures, but it can bog down the performance of a conventional mainframe and use up all its memory trying to process symbols dynamically. Despite such difficulties, large conventional computers were originally used to develop Lisp and prove its viability as a symbolic computer language.

Lisp advantages

Given the problems that Lisp presents for traditional computer architecture, it is only natural to ask whether it is worth all the trouble. The characteristics of the language as it has developed to support symbolic processing provide an answer to the question.

Lisp, a computer programming language that originated as a tool to facilitate artificial intelligence (AI) research, was invented in the 1950s by Professor John McCarthy of the Massachusetts Institute of Technology (MIT), who is now of Stanford University. Since intelligence involves thinking about objects, how they relate to each other, and their

Abraham Hirsch is manager of product management at Symbolics, Inc, 4 Cambridge Center, Cambridge, MA 02142. He holds a BS in electrical engineering and an MEng from Cornell University.

Examples of Generic Operations

Conventional computers	Symbolics 3600
A minimum of three add instructions in hardware are required:	A single add instruction in hardware for all data types
- Add two fixed point numbers	Ability to mix data types
- Add two single precision floating point numbers	Fewer instructions
- Add two double precision floating point numbers	Simple software
Unable to mix integers with floating point	Higher throughput

properties and uses, Lisp represents arbitrary objects and the relationships among them. Lisp also allows the modeling of procedural knowledge (ie, "how to do something" as opposed to "what something is"). Procedural knowledge is expressed by functions—computational entities that know how to perform some specific action or computation upon supplied objects.

The language imposes no penalty for dividing a program into dozens or hundreds of functions, each one the expert in some specific task. Thus, Lisp promotes "modularity"—the clean division of a program into unique areas of responsibility—with well-defined interaction. Lisp also features extensible syntax or notation. This means that language constructs are not limited to those supplied, but can include new constructs. Defining new language constructs does not involve modification of the supplied software, or expertise in its internal details, because it is a standard feature.

Lisp also frees programmers from the detailed management of memory in the computer. Although it is possible to construct fixed-size arrays, Lisp excels in providing facilities to represent arbitrary-size objects, sets of unlimited numbers of elements, and objects in which the number of details or parameters is totally unknown.

New computers designed specifically for Lisp provide an interactive environment in which both data and functions coexist and can be inspected or modified easily. Functions can be tested as they are written, and problems found quickly. These features have made Lisp the preferred tool of AI researchers. If Lisp and computer interactions seem flawed, the fault lies within the architectural rigidity and limitations of conventional computers.

Lists of properties contain different data types. As they are processed, the computer must be able to identify which can be added to, subtracted from, or combined. This involves an enormous amount of data-type checking, which requires the use of long strings of instructions at compile and run time. Conventional machines cannot do this in hardware.

Another deficiency of conventional computer architecture involves the dynamic nature of property

lists. To use Lisp, a process must be created to reclaim user memory at run time. In a normal computer, this is a very memory-expensive process; all of the list structures in memory must be periodically checked to see if they are still in use so memory can be reclaimed. Every structure in virtual memory must be read. Doing this requires a large program called a "garbage collection" algorithm.

A third flaw of most computers is the size of the virtual memory space available. Programs used in AI applications are often large and complex, and their data sets are even larger. Examples of these are satellite images, speech, and sensor input. As a result, the total memory requirements of Lisp programs are enormous, outstripping the memories of even the largest computers.

Developing an architecture

To solve these problems, researchers at MIT's AI laboratory began the Lisp machine project in 1974. Initially, a simulator was written on a time-shared computer to permit software development to proceed while the hardware was under development. CONS was the first machine designed, in 1976. It was superseded in 1978 by a second-generation Lisp machine, the CADR. This machine was a model for the first commercially available Lisp machines, including the Symbolics LM2.

The third generation, represented by the 3600, is based on a completely new architecture. Like the LM2, it runs the Zetalisp dialect for software compatibility. Zetalisp is a Lisp dialect, developed for the Lisp machine project that adds many features and improvements. Foremost is the Flavors system for object-oriented programming with message passing. A full range of data types, modern control constructs, flexible function calling, multiple value returns, and stream-oriented I/O add to basic Lisp features. Additional improvements include macros to permit syntax extension, multiple name spaces, and predefined functions to support such operations as sorts, hash tables, linear equations, and matrix operations.

As the Symbolics first Lisp machine, the LM2 had microprogrammed Zetalisp instructions so that it was the assembly language on the system. This addressed the question of how to build a new environment using Lisp. It also allowed Lisp to deal with itself as a data structure by taking advantage of its power to deal with symbols. In addition, it made it very easy to build incremental compilers, whereby each function may be compiled as it is entered or modified. That makes debugging and recompilation faster, more interactive, and allows more powerful test and debug tools.

The LM2, like its MIT prototypes, solved many problems with its 32-bit microprogrammed virtual memory architecture. However, because it was found that a great deal of processor bandwidth was

expended on data typing and dynamic memory allocation and deallocation, a better way was needed to deal with these functions. Tagged memory architecture was the method used to solve these remaining problems. It proved to be a simple, elegant, and very powerful concept that resulted in a new machine, the Symbolics 3600 Lisp processor.

Lisp normally stores data in a complex data format. An extra word attached to each data word identifies the nature of the data. This can be fixed or floating point, a rational or complex number, an object known to Lisp, an array, a string, or compiled object code or source code. Normally, numerous data types are tagged in software so that there are as many words in memory identifying the data type as there are words of data. This is not very efficient, however, since a great amount of computer time is spent just reading and checking these "tags." It is done throughout memory on virtually every piece of data and code structure in the system.

The tagged architecture concept, as implemented in the 3600 processor, performs this function in hardware. Simply by adding 4 extra bits to the end of the 32-bit word as "memory tags," the same data that previously was put into memory serially can be placed in memory in parallel, and in the same location. Therefore, the 3600 was built with some unique features—ie, 36-bit architecture (register and memory) and hardware to handle the memory tags. The processor can detect those tags and perform the proper operations in hardware and firmware. As a result, all the overhead of extra instructions disappears, and there is nearly an order of magnitude increase in performance. This increase in speed is accomplished by performing data-type checking in parallel with instruction execution.

Data tagging

Data-type checking occurs at run time because compile-time, data-type checking is not compatible with Lisp's flexibility. Runtime-type checking is supported by the tag field appended to every word processed by the processor.

All macroinstructions are generic. (See the Table.) One add instruction, for example, handles all appropriate data types: fixed point, floating point, double precision, etc. The behavior of a specific instruction is determined by the operand type read in the tag fields. Because data-type checking is performed in parallel with the instruction, there is no performance penalty. Thus, one macroinstruction, by using generic instructions and tag fields, can do as much as several instructions on a conventional computer. The result is a compact storage of compiled programs and fast execution of those programs.

The 3600 processor's 36-bit word has two formats (Fig 1). The one most often used is called a tagged pointer format and consists of a 6-bit tag, 2-bit contents of data register (CDR) code, and 28 bits of

an address pointing to a data structure. The other, an immediate number format, has a 2-bit tag, a 2-bit CDR code, and 32 bits of immediate numerical data. In main memory, each word is supplemented with an additional 7 bits for error correction code and a spare bit to make a 44-bit word.

In Lisp, the first element of a list is called the contents of address register (CAR) and the remainder of the list is called the CDR. The amount of storage needed to hold the list is reduced by coding CDR into 2 bits. Values of the CDR code indicate whether it is a conventional CAR and CDR pointer list element pair or represents a more efficient vector in memory (Fig 2). The new vector format takes only half as much memory as usual, and therefore only half as many memory fetches. Thus, the performance doubles over conventional Lisp implementations.

Because of the recursive nature of Lisp applications, efficient processing requires a stack-oriented machine. Although not a pure stack machine, the 3600 is stack oriented and designed to make function calls and returns as fast as possible. Most instructions, but not all, use the stack to get operands and store results. The processor contains multiple stacks and buffers used for fast storage of temporary data. Stacks are used to pass arguments. The processor controls the stack pointers and buffer manipulation (which takes only one machine cycle). A given computation is associated with a particular stack group.

Each stack group contains three stacks for control, binding, and data. The control stack, containing the control environment, local environment, and caller list, is formatted into frames that correspond to function calls. A frame consists of a fixed header followed by arguments and local variable slots. Binding is the process by which a variable is temporarily given a value (a special variable). The binding stack contains special variables and previous values of those variables to be restored later. The data stack,

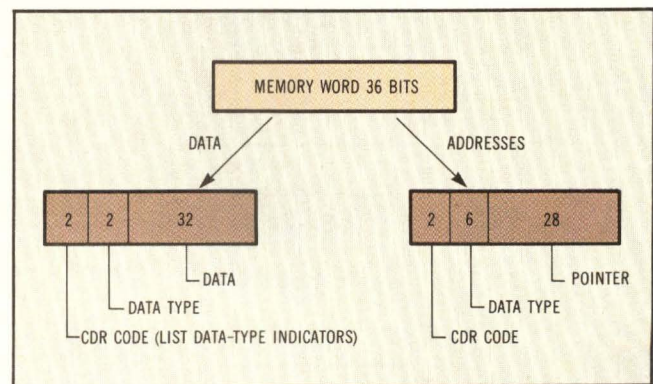

Fig 1 There are two basic formats for 36-bit words. The immediate number format consists of a 2-bit tag, a 2-bit contents of data register (CDR) code and 32 bits of immediate numerical data. The tagged pointer format consists of a 6-bit tag, 2-bit CDR code, and 28-bit data structure address.

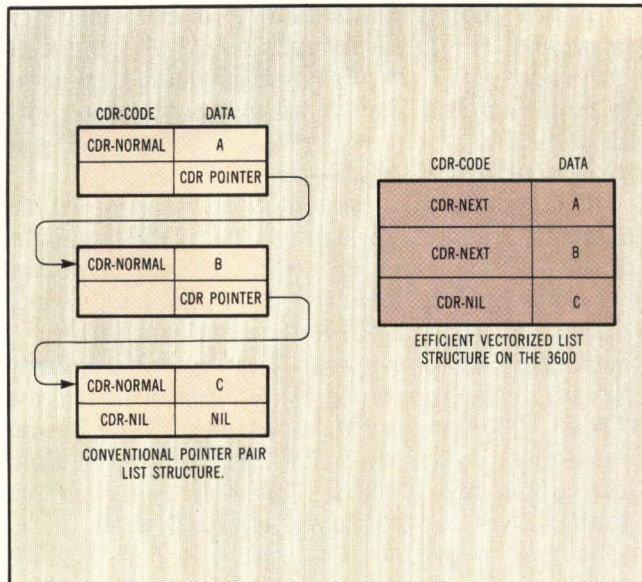

Fig 2 An analysis of Lisp CDR coding, comparing conventional computer architecture Lisp implementations (a) to tagged architecture (b), is shown.

which helps reduce garbage-collection overhead, contains dynamic Lisp objects, such as temporary arrays and lists.

There are two major Lisp variations: Maclisp from MIT; and Interlisp, developed at Bolt, Beranek & Newman (BBN) and used extensively at Stanford. Zetalisp, derived from Maclisp, was influenced by others as well. Xerox Corp's learning research group (Palo Alto, Calif) has done extensive work with children to investigate natural ways of communicating

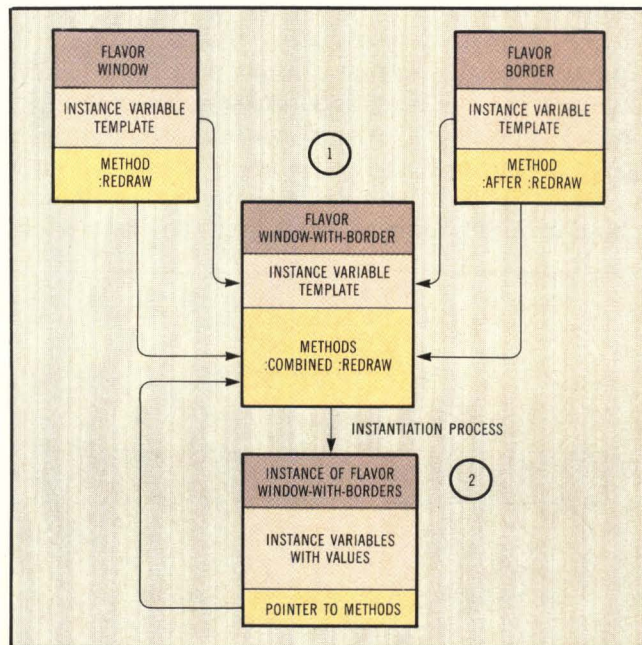

Fig 3 The Flavors system (abstract type) can be combined to form new flavors (see No. 1). When generic flavors are provided with specific variables, flavor instances (objects) that can be manipulated by sending messages (requests for specific operations) are produced, as shown in No. 2.

with computers. Out of this research came the object oriented programming language, Smalltalk, that was developed in 1972 and has since undergone numerous iterations. Smalltalk, recognized as a simple but powerful concept, is more limited in scope than Lisp. At MIT, the concept was altered and extended to become the Flavors system.

Surveying system characteristics

Although this system contains many Smalltalk constructs, it also permits multiple inheritance, a characteristic that earlier versions of Smalltalk did not have. Multiple inheritance is the ability to inherit characteristics from classes (similar objects) that are hierarchically unrelated. Another major difference is that Flavors is a fully-integrated extension of Lisp. Consequently, the Zetalisp dialect used on the 3600 incorporates the features of both Lisp and Flavors.

Flavors represents generic objects. For example, a generic "ship" with its description could be a flavor. An aircraft carrier with the addition of its unique (nongeneric) descriptors would be an instance of the flavor "ship." (The process of going from the generic to the specific is called instantiation.) Such instantiated flavors are manipulated by sending messages that request specific operations. Since the procedures are already contained within the object, it responds by performing the operation requested. Complex-dependent relationships can be declared among flavors and can be modified as needed (Fig 3).

The 3600 machine instruction set corresponds closely to Zetalisp. No programming is done directly in the instruction set and no assembler is supplied. Programmers may encounter the Lisp-like instruction set when using the inspector or disassembler, but programming will normally be done in Zetalisp. Although the Lisp dialect is an extension of Maclisp and has numerous enhancements, it is compatible with the other dialect of Lisp through the use of the Interlisp compatibility package. Other languages supported by the system are Fortran and Pascal. Hardware ties it together.

The 3600 CPU, designed to support Lisp and provide very close coupling with the software, is built around a 36-bit memory tagged architecture, with 32-bit external data paths (Fig 4). The tagged architecture permits runtime data-type checking with no overhead. The machine is stack oriented with high speed buffering of the top stack frames. The instruction prefetch is overlapped with normal execution to permit many opcodes to execute in as little as 200 ns. Runtime checking is assisted by hardware to find data-type mismatches, uninitialized variables, and array bound errors. Fast array indexing and IEEE standard floating point operations are additional processor features.

Memory efficiency is enhanced by another processor feature—hardware-assigned garbage collection.

The first GCR with high performance and low cost, in a small-sized package.

As the leader in 1/2" streaming tape drives, Cipher has been at the forefront of progress, first with Microstreamer®, then CacheTape™, and now GCR CacheTape™.

Available in two models, the M990 and M991, GCR CacheTape provides unbeatable performance features, with both start/stop functions and streaming operation. And all at an unprecedented low cost and small size.

Call or write us today for a free product brochure and GCR CacheTape specifications. We have the tape drive that meets your needs.

Low
Cost of
Ownership
IBM-Compatible
1600/3200/6250BPI
Autoload/thread

180MB
Storage

Easy to
Integrate

Start/Stop & Streaming

Improved Data Reliability

Cipher Error-Free Interface

Advanced Self-Test Diagnostics

395/790KBS Transfer Rates
High-Capacity
Backup



cipher®
data products, inc.

10225 Willow Creek Road, P.O. Box 85170
San Diego, California 92138
Telephone (619) 578-9100, TWX: 910-335-1251

European subsidiaries in:
United Kingdom (phone: 0276-682912),
West Germany (phone: 089-807001/02),
France (phone: 1-668-87-87)

See us at NCC Booth C-4118

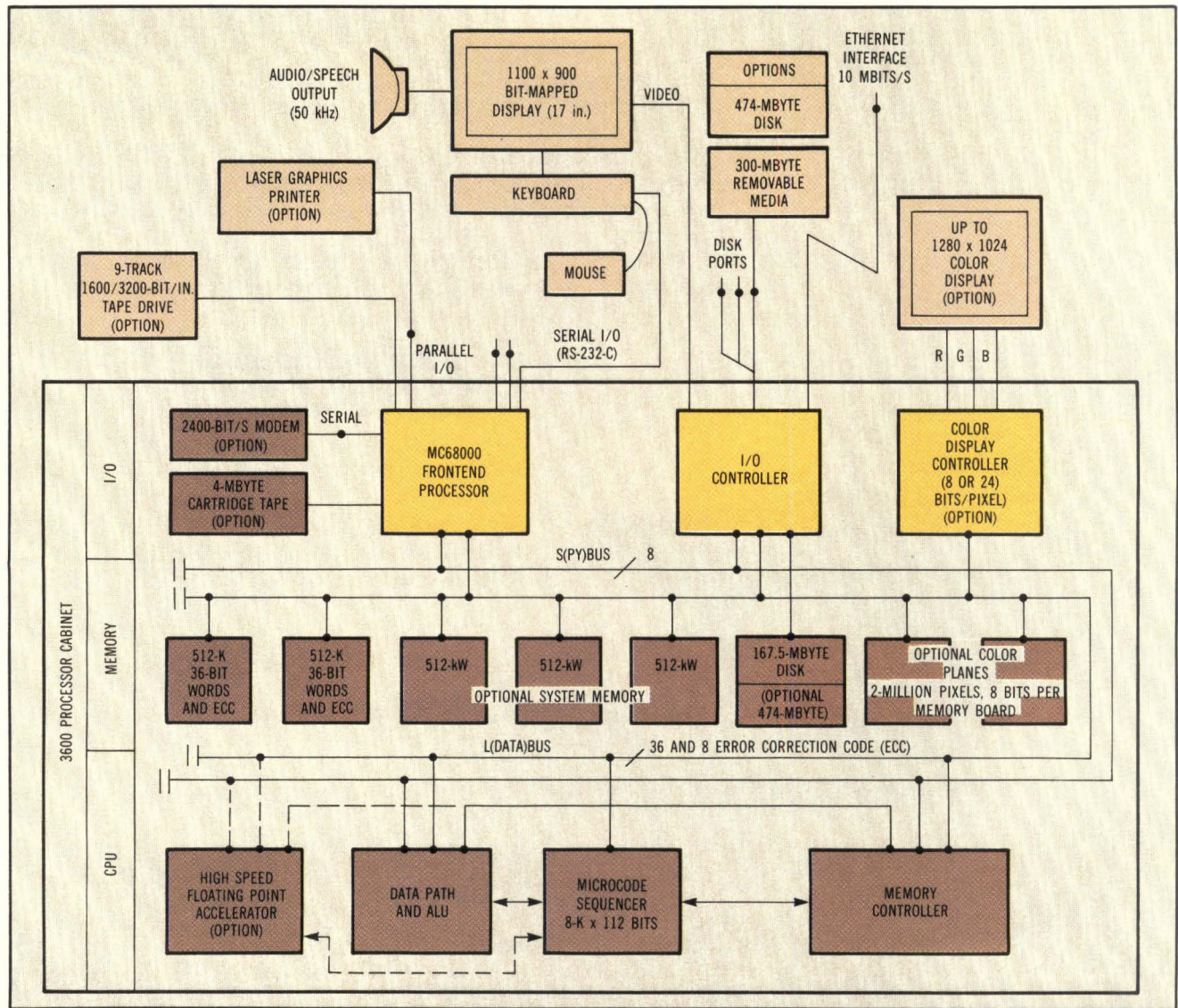

Fig 4 Like all computers, the 3600 symbol processor consists of three sections: CPU, memory, and I/O. However, the stack-oriented CPU and memory tagging provide an organization specifically designed for Lisp processing.

Given the requirements of Lisp processing and the size of the demand-paged memory, it is needed. Up to 256 million, 36-bit words (1 Gbyte) can be directly addressed. Also, up to 7.5 million words (30 Mbytes) of error-corrected physical memory can be configured in a system.

For I/O, the 3600 also includes a 68000-based front-end processor that controls low and medium speed I/O devices and is used for system diagnosis. But for higher performance, the 3600 has an I/O board that handles 10-Mbit/s Ethernet, disks, and the high performance graphics console.

Symbolic processing allows computers to deal with complex knowledge and data in such a way that it appears to mimic human intelligence. The Lisp computer language evolved to handle the constructs of symbolic processing. It now enables computers to be easily programmed to represent objects and the relationships among them. The high overhead costs resulted in a new, stack-oriented, tagged memory

architecture designed around Lisp. Complex AI techniques are now out of the laboratory and have become commercially and economically practical. For this reason, the future will see many new applications for Lisp machines as AI techniques are applied to whole new classes of non-numerical problems that, up to now, have been unsuitable for traditional computer methods.

Please rate the value of this article to you by circling the appropriate number in the "Editorial Score Box" on the Inquiry Card.

High 704

Average 705

Low 706

VIEWING PARAMETERS

ZV = 103
XF = 296
YF = 269
MX = 30065
MN = 15.3

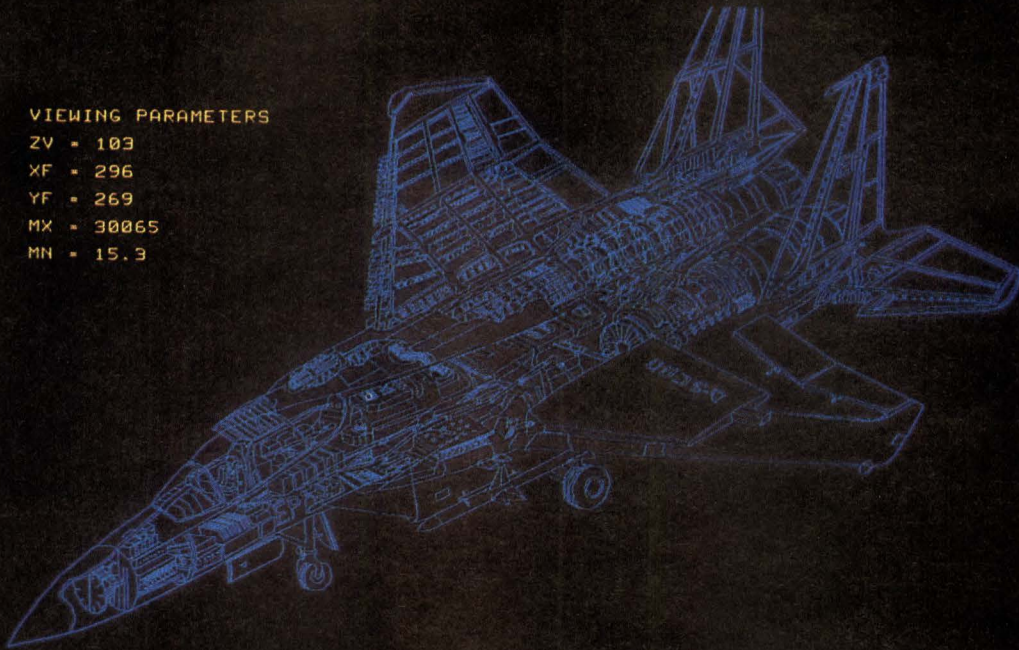

D-SCAN

High Speed Craft.



No, not the fighter. The craft we're talking about is yours. Because with the D-SCAN GR-2414, you'll experience something you've probably never felt before. High speed response.

Gone are the days when you had to sit around waiting for the host computer to answer your commands.

Quickly, here's the story. Speed. Efficiency. Power. Extraordinary visual acuity. And local control!

We're not done yet, either. You can display up to 1024 colors (not the usual 256). Read them flawlessly on our 1280 x 1024 display (with 60Hz non-interlaced refresh rate!). And expand the 4 bit planes to 10.

The 2414 also gives you display list storage that's simply unmatched in its price class. Starting with 256K and field-expandable to over 1Mbyte! That's two, three, sometimes even four times more storage than you can find in so-called competitive terminals.

Then, to make sure you get the picture you want, the 2414 gives you local picture manipulation. Local transformations. And local graphics tablet support. Which means you'll have true local interactive support. You won't get bogged down while the host spews out accounting reports. And you get instant visual response every time you need it.

There's more to those pictures, too. More complexity. More detail. More information on the 20" screen at any one time. Plus, the handy ability to manipulate the image in more ways. And display alphanumeric with beautiful precision.

A very pretty picture indeed. What's more, you get easy interface to our color hardcopier. Programmable function keys. A user-definable look-up table. And user-definable hardware anti-aliasing.

But hardware technology notwithstanding, you also get a powerful software story with the 2414. For instance, it's compatible with the TEK 401X instruction set and Plot 10 package. So you can save a lot of time and aggravation implementing graphics software. Upgrade quite painlessly. And eliminate costly re-learning curves.

There's something heavyweight to remember, too. Our service. We design, build, sell and service all of our equipment. So you never have to wander around wondering who to call for help. And waits are lifted because you get direct service from 13 offices across the U.S.

So call today to learn more about the GR-2414. We'll get back to you with utmost speed. Just call your local Seiko Instruments sales person, or us at (408) 943-9100. Write 1623 Buckeye Drive, Milpitas, CA 95035.

You'll find there's a new high speed craft that's drawing a lot of attention. Yours.

SEIKO
INSTRUMENTS

D-SCAN is a trademark of Seiko Instruments & Electronics Ltd.
TEK and Plot 10 are registered trademarks of Tektronix, Inc.
© 1984 Seiko Instruments U.S.A., Inc., Graphics Devices & Systems Division.

OUR COMPETITORS CAN TALK PLATED MEDIA, BUT THEY CAN'T DISH IT OUT.



Everyone's talking about plated media. How it's more reliable than oxide media. More durable. More everything.

We couldn't agree more. Unfortunately, our competitors' talk is just that: long on puff and short on product.

Because, puffery aside, the Tandon Winchester Company is the only major hard disk drive manufacturer with plated media in true high volume production.

How we got there is an instructive story. One that clearly shows the difference between Tandon and our competitors.

Six months ago, when our competitors were dragging their feet on plated media, we were building a factory to do what they claimed was

impossible: to produce and ship high performance plated media drives in high volume at prices lower than most vendors charge for oxide media.

Now that we've proved it's possible, everyone's jumping on the plated media bandwagon.

But all their talk can't match what we're delivering. Our factory is in full production. Which means that all our drives up to 50 MB can offer all the advantages of plated media. Today, not someday. In high volume, not in premium production runs.

And while our competitors have been talking louder and louder, we've been turning up the volume on our plated media production even higher. Future Tandon Winchester drives are coming soon. All will use plated media exclusively.

Which means we'll be in the interesting position of delivering even more products our competitors will still only be talking about.

TANDON WINCHESTER COMPANY.

Tandon

THE DRIVING FORCE BEHIND THE SMALL COMPUTER INDUSTRY.

Tandon Corporation, 20320 Prairie, Chatsworth, CA 91311. (213) 993-6644, TWX: 910-494-1721, Telex: 194794. Regional Sales Offices: Boston (617) 938-1916 • New York (201) 851-2322 • Atlanta (404) 934-0620 • Chicago (312) 530-7401 • Dallas (214) 423-6260 • Irvine (714) 669-9622 • Santa Clara (408) 727-4545 • Frankfurt, West Germany 6107-2091, Telex: 411547 • London, England (0734) 664-676, Telex: 848411. Distributors: Hall-Mark, Kierulff, Schweber.

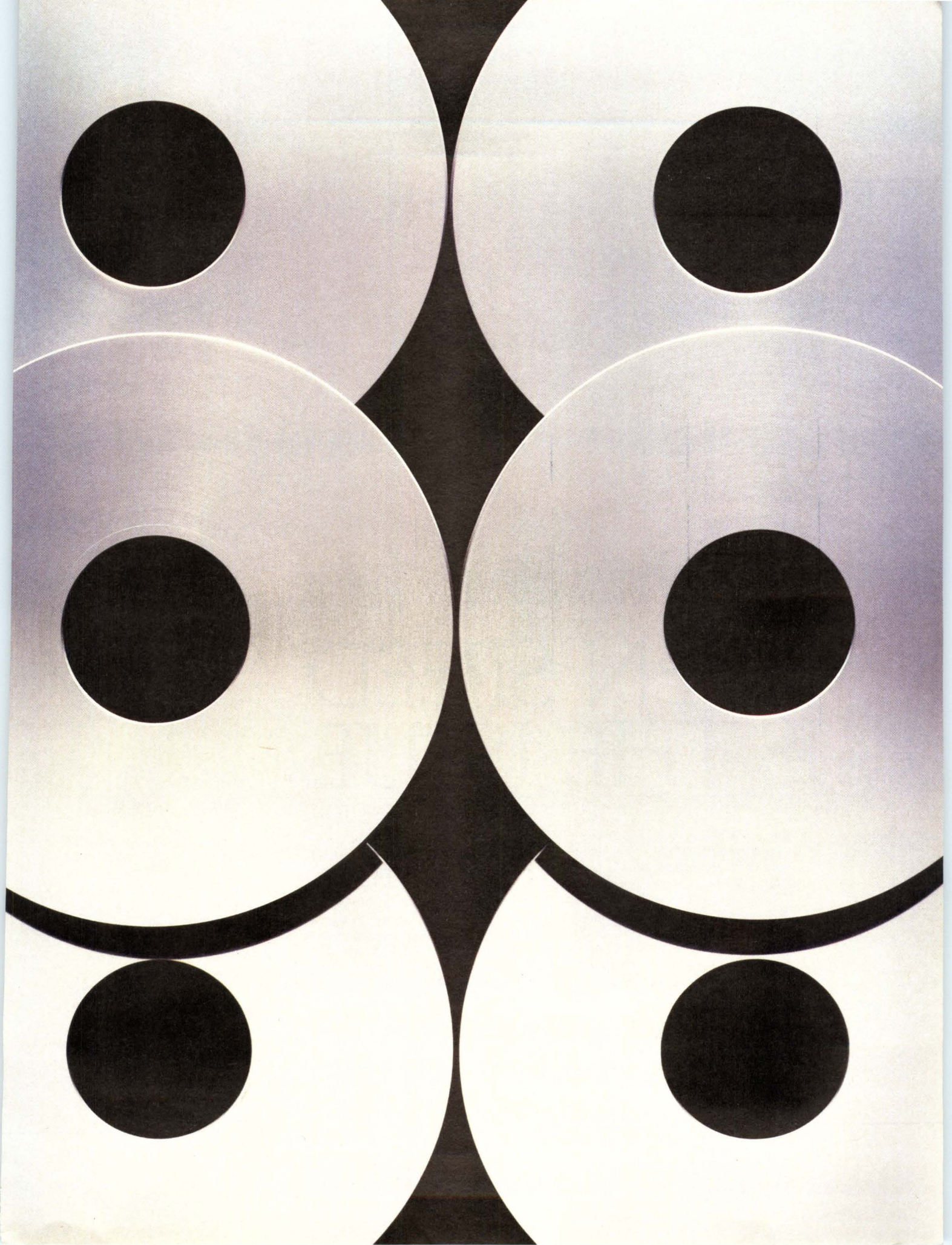

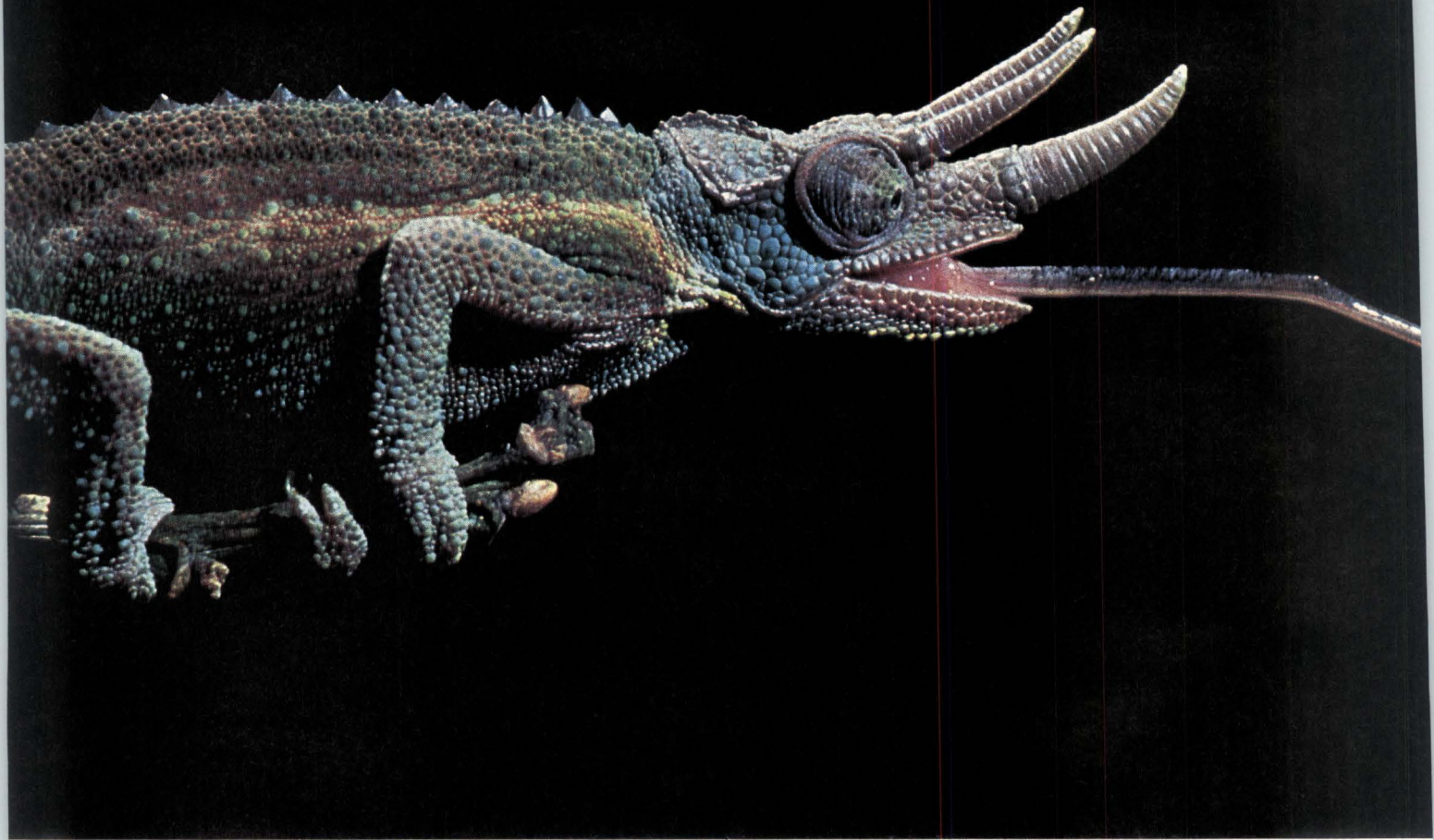

WHEN SPEED IS THE ISSUE

GaAs ICs FROM HARRIS MICROWAVE SEMICONDUCTOR

The Three-horned Chameleon (chamaeleo jacksonii) depends on speed to stay alive. With a tongue faster than a small-caliber rifle bullet, it can strike a fly in flight at six inches. With clock rates 5 times as fast as silicon ECL, Harris Microwave Semiconductor's new Gallium Arsenide ICs give you design freedom never before possible with digital technology.

OUTPERFORMS ALL AVAILABLE DEVICES

A universal Shift Register operating at up to 1.4 GHz clock speed, and

a Binary Counter running at data rates up to 2.0 GHz outperform all known products in applications requiring subnanosecond system response times and reliable operation. At last, designers of EW signal processing systems, supercomputers, instrumentation, and high-speed data communications systems have the speed and bandwidth necessary to realize the full potential of their designs.

ECL/GaAs COMPATIBLE

Harris' Shift Register and Counter (the first two in a family of GaAs SSI & MSI products), are compatible

with ECL, and with other GaAs devices, to provide significant speed improvements and design flexibility for a broad range of high-speed digital applications.

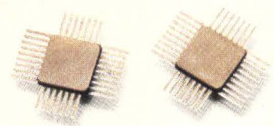

Hermetic package to minimize parasitic and cross-talk performance degradation.

Harris' HMD-11141-1 universal 4-bit Shift Register is housed in a hermetic package suitable for microstrip, stripline, and co-planar circuit design media. Features include:

- 1.4 GHz clock speed
- Shift right or shift left, parallel entry and hold operations
- Flatpack packaging provides optimum performance for GHz signal transmissions
- Reliable Ti/Pt/Au metallization system

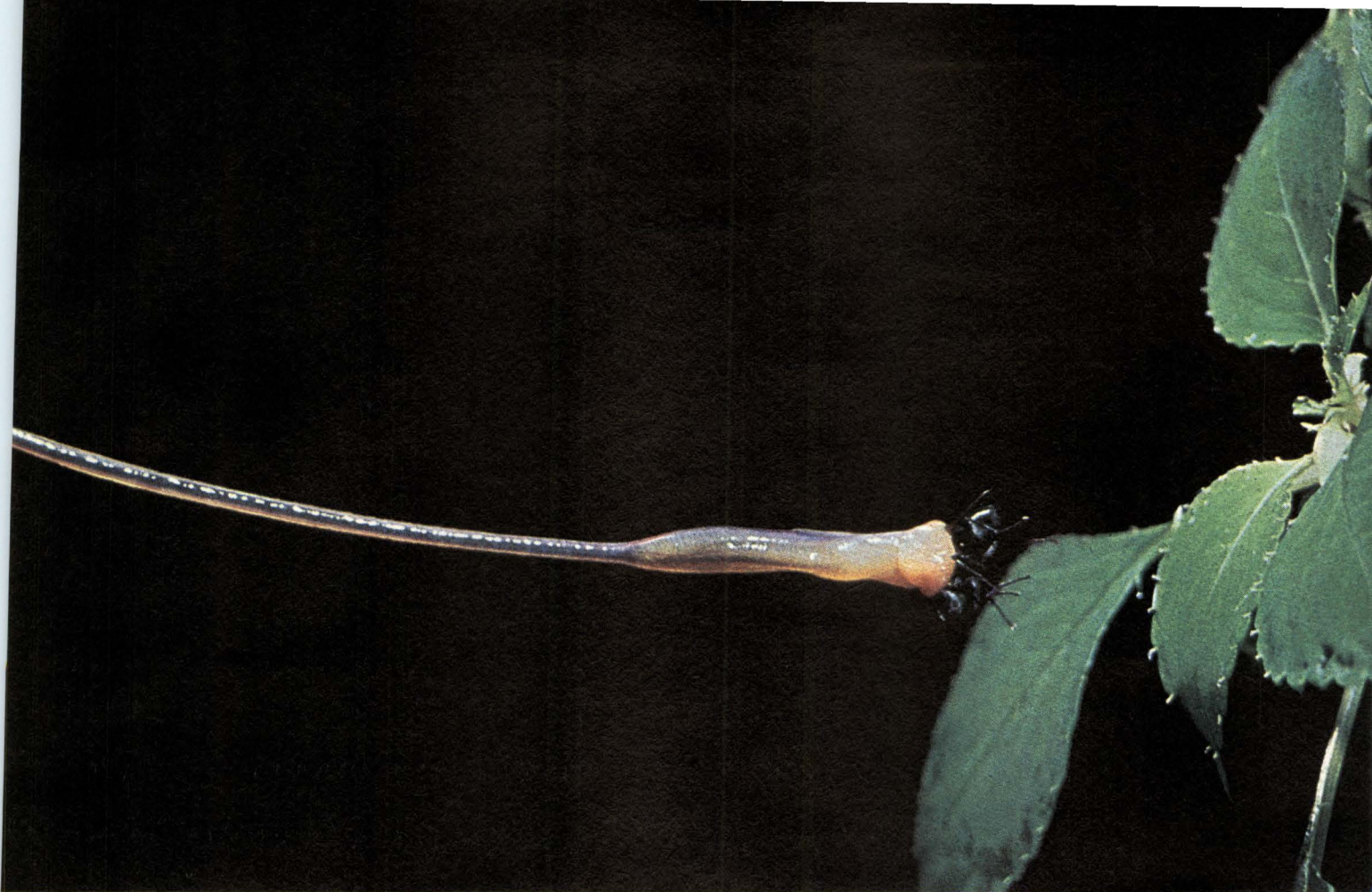

The Harris HMD-11016-1 Binary Counter divides by 2, 4 and 8, and supplies these three outputs simultaneously to facilitate bit-steering. Features include:

- DC to 2.0 GHz input data rates
- Asynchronous master clear and clock enable
- 50 ohm drive capability
- ECL and GaAs compatible

**VERTICAL INTEGRATION—
THE KEY TO HIGH VOLUME
PRODUCTION AND RELIABILITY**

Harris Microwave Semiconductor has refined Gallium Arsenide technology to accomplish production reliability goals in the finished product. The manufacture of its own Gallium Arsenide materials and substrates makes possible the rigorous control necessary for superior quality in these high complexity devices.

AND MORE TO COME

In the next few months, Harris Microwave Semiconductor will

introduce a potent array of flipflops, diff amps, NAND, OR, NOR and Exclusive OR gates for data rates up to 4 GHz. More GaAs IC's for EW, computer, instrumentation, and high-speed data communications are soon to follow.

So, when speed is the issue in your designs, contact the people who are writing the Gallium Arsenide book at Harris Microwave Semiconductor, 1530 McCarthy Boulevard, Milpitas, CA 95035. Call (408) 262-2222, or TWX 910 338 2247.

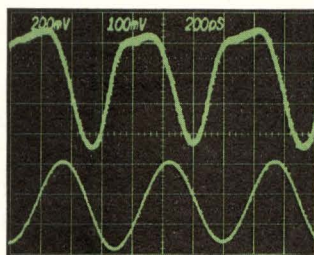

High toggle rate HMD-11141-1 Shift Register showing clock (lower trace) and output functions.

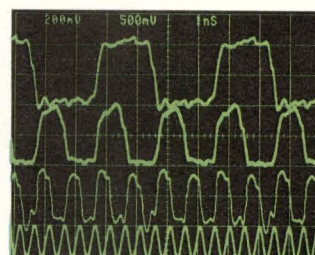

HMD-11016-1 Binary Counter's 2, 4 & 8 synchronous division with 2.0 GHz input. (Input & output data attenuated for presentation purposes.)

Harris Microwave Semiconductor. To do it right, we start from scratch.



“There’s no magic to using your personal computer for data acquisition.”

Fred Molinari, President

There’s no trick to it.

It’s as easy as calling Data Translation.

So take your choice of our new single board plug-ins and bring complete analog and digital I/O capabilities to your personal computer.

Whether you’re working in laboratory research or industrial process control, our single boards can give you measurement and control capabilities without having to spend big bucks.

And who knows that better than the leading supplier of low cost data acquisition boards, systems, and software?

Our boards include multi-channel A/D with programmable gain, D/A, digital I/O, a programmable clock and many have direct memory access capabilities. With power and performance to match your PC, our analog interfaces provide 12, 14, or 16-bit A/D resolution and direct connection for high or low level signal inputs.

And these boards are easy to use. They plug into the PC’s backplane. No messy external boxes or cables. User input connections are simple with our compatible line of screw terminal panels for all of the I/O capabilities.

And comprehensive user manuals with



DATA ACQUISITION FOR PC'S					
	12-BIT A/D	12-BIT D/A	DIGITAL I/O	PROG. CLOCK	SOFTWARE LIBRARY
IBM PC™	X	X	X	X	X
APPLE II™	X			X	
TI PROFESSIONAL™	X	X	X	X	X
DEC RAINBOW™	X	X	X	X	X
COMPAQ™ Portable	X	X	X	X	X



many programming examples get you up and running fast.

These easy to use, and easy to program boards are highly reliable at a very low cost, and of course fully backed by Data Translation’s service and support team.

So why look any further? No other analog I/O systems can offer PC users such quality, power and performance for such a reasonable price.

But you probably expected that. After all, making data acquisition easy is what we’re all about.

And that’s no illusion.

Call (617) 481-3700.

Data Translation is the leading supplier of personal computer hardware and software for data acquisition and control.



See our 192 pg. new product supplement in Gold Book 1984, Vol. III, and our 336 pg. catalog/handbook in Gold Book 1983.

DATA TRANSLATION

World Headquarters: Data Translation, Inc., 100 Locke Dr., Marlboro, MA 01752 (617) 481-3700 Tlx 951-646.

European Headquarters: Data Translation, Ltd., 430 Bath Rd., Slough, Berkshire SL1 6BB England (06286) 3412 Tlx 849-862.

IBM PC is a registered trademark of IBM. Apple II is a registered trademark of Apple Computer Corp. TI Professional is a registered trademark of Texas Instruments, Inc. DEC Rainbow is a registered trademark of Digital Equipment Corp. COMPAQ is a registered trademark of COMPAQ Computer Corp.

CIRCLE 51

IC DECODER PAVES THE WAY FOR VIDEOTEX REVOLUTION

Cost is key in public acceptance of videotex information systems. With a presentation-level standard ensuring transmission uniformity, attention turns to development of reasonably priced hardware.

by Gregg Ledford

For the last several years, videotex/teletext services have but hinted at their potential capabilities. Soon, however, they will offer the United States a wide array of information services. The public, already familiar with the power brought to personal computing by the microprocessor, is prepared for real application of processing power in what it sees as the most important job—facilitating important day-to-day exchange of information. The introduction of interactive data systems, complete with vivid graphics, promises a reshaping of the way an individual will read, write, and communicate with the rest of the world.

Although Europe pioneered the way, the joint cooperation of U.S. and Canadian interests cemented a standard for the interactive transmission of data and spurred interest on this side of the Atlantic. The North American Presentation Level Protocol Syntax (NAPLPS) standard gives engineers a starting point for the design of home videotex or teletext decoders. But, because the standard is so well-defined, currently available off-the-shelf hardware gives end-equipment designers NAPLPS compatibility in a minimal amount of time and at minimum cost.

Videotex has been available in the United Kingdom since 1979 through Viewdata, a service based on the

Gregg Ledford is a systems and software design engineer at Texas Instruments, Inc, 9901 S Wilcrest Dr, Houston, TX 77099, where he is responsible for the definition and prototyping implementation of videotex systems and software based on the NAPLPS standard. Mr Ledford holds a BS in electrical engineering from Louisiana State University.

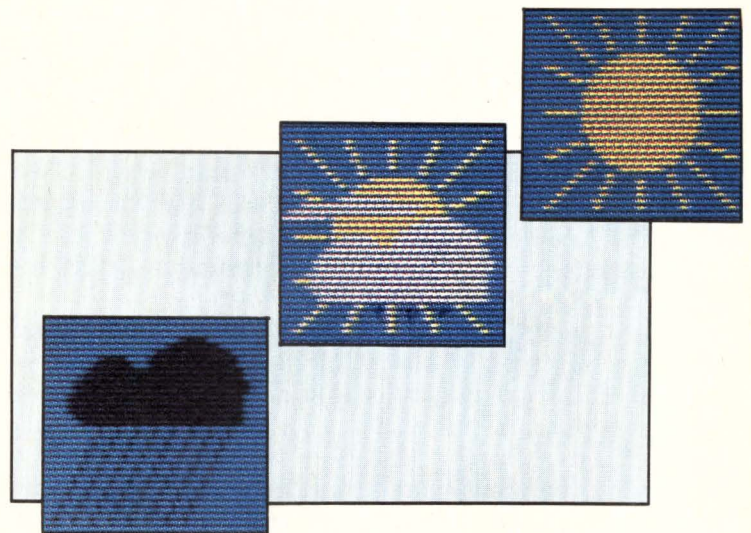

Prestel coding scheme. It provides customers with alphamosaic graphics—pictures built from characterized blocks. Like Britain, France's telecommunications agency recognized the potential future of videotex services and developed its own system, called Antiope. In addition to alphamosaics, the French service uses semigraphics characters as well. Unlike the British system, which uses serial coding for mosaics, Antiope uses parallel coding.

The Antiope system produces better graphics than its British counterpart. However, the Conference of European Posts and Telecommunications has endorsed the British technique, causing similar systems in other parts of Europe to be derived from it.

The Canadian Department of Communications, after watching developments in Europe with interest, came up with its own system, called Telidon. Here, graphics elements are defined by points connected by picture description instructions (PDIS). The instructions include such art elements as points, lines, rectangles, arcs, and polygons. After points on the screen are identified, a drawing instruction is used to connect them with the appropriate art element. In that manner, detailed images can be produced.

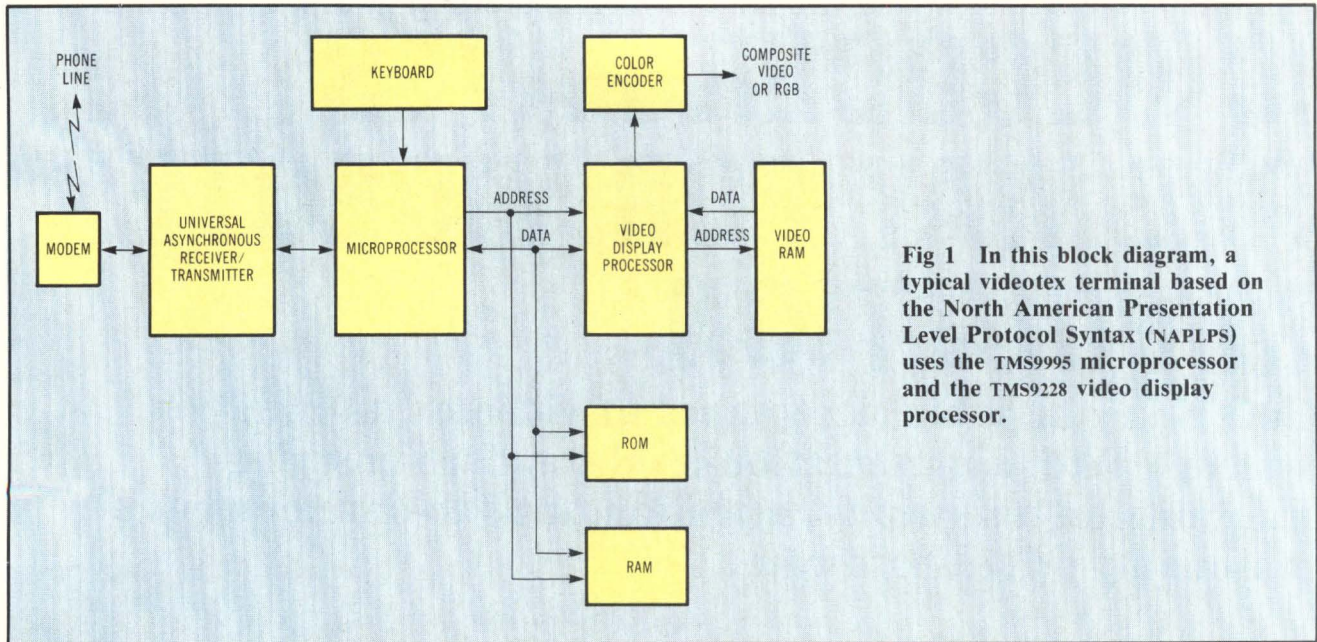

Fig 1 In this block diagram, a typical videotex terminal based on the North American Presentation Level Protocol Syntax (NAPLPS) uses the TMS9995 microprocessor and the TMS9228 video display processor.

In 1981, U.S.-based AT&T published a Presentation Level Protocol (PLP) to help standardize the manner in which videotex data would be sent. Two years later, the Canadian Standards Association and the American National Standards Institute jointly issued the Videotex/Teletext Presentation Level Protocol Syntax, also called the NAPLPS.

A videotex system allows the user to tap into a vast reservoir of data. Color text and graphics give it an appealing quality that not only helps sell the service to the public, but also makes it an extremely effective tool for education. News, business, shopping, banking, and a host of family services all extend to and from the subscriber's own home via existing cable television or telephone installations.

But, for those who must design the hardware that accomplishes all that, the "elegance" of a simple chip set is beyond compare. A typical chip set (Fig 1) to implement a NAPLPS decoder includes a microprocessor with ROM and RAM, a video display processor to handle the text and graphics, and a modem to handle the communications. The NAPLPS standard, because it specifies the precise manner in which both text and graphics information must be sent, eliminates any vagaries about what will be demanded of the end product's performance.

Rules to use in design

Videotex is a two-way transmission and reception service primarily associated with, but not limited to, phone lines. A subscriber to a videotex system can tap into such interactive services as home banking, shopping, or news. Teletext, on the other hand, is a one-way service from the provider to the subscriber. Its data, usually broadcast over the air, carries such services as news and similar features.

The NAPLPS establishes the rules, formats, and coding schemes that facilitate the interchange of text

and graphics information without regard to specific hardware. That is, a picture coded according to the NAPLPS standard will appear the same on different CRT terminals, even if their resolutions differ. The only requirement is that they all decode NAPLPS data in accordance with the standard.

Implementing a videotex system allows the user to tap into a vast reservoir of data.

The designers of NAPLPS had the advantage of hindsight, since several coding schemes had already been written—the previously mentioned Telidon system and the PLP coding scheme. Although the end product carries some traces of the British Prestel standard and France's Antiope system, it is unique. It incorporates data-compression techniques that save time and money in transmitting pictures. It also has a rich assortment of text, graphics, and control functions that should please a technically savvy and discriminating public.

Videotex is interactive in that it accepts information from data bases for transmission to the user. But, it can also accept user information for transmission back to the service provider. Teletext is a one-way service that can only display information sent from the source. The latter is less expensive since its data can be sent on such traditional one-way media as broadcasting stations. The vertical blanking intervals between successive frames on a TV picture are ideal slots into which teletext information can be fit. Videotex, on the other hand, requires a two-way path for which the dial-up telephone network or cable television lines are most immediately practical but which can also include dedicated lines.

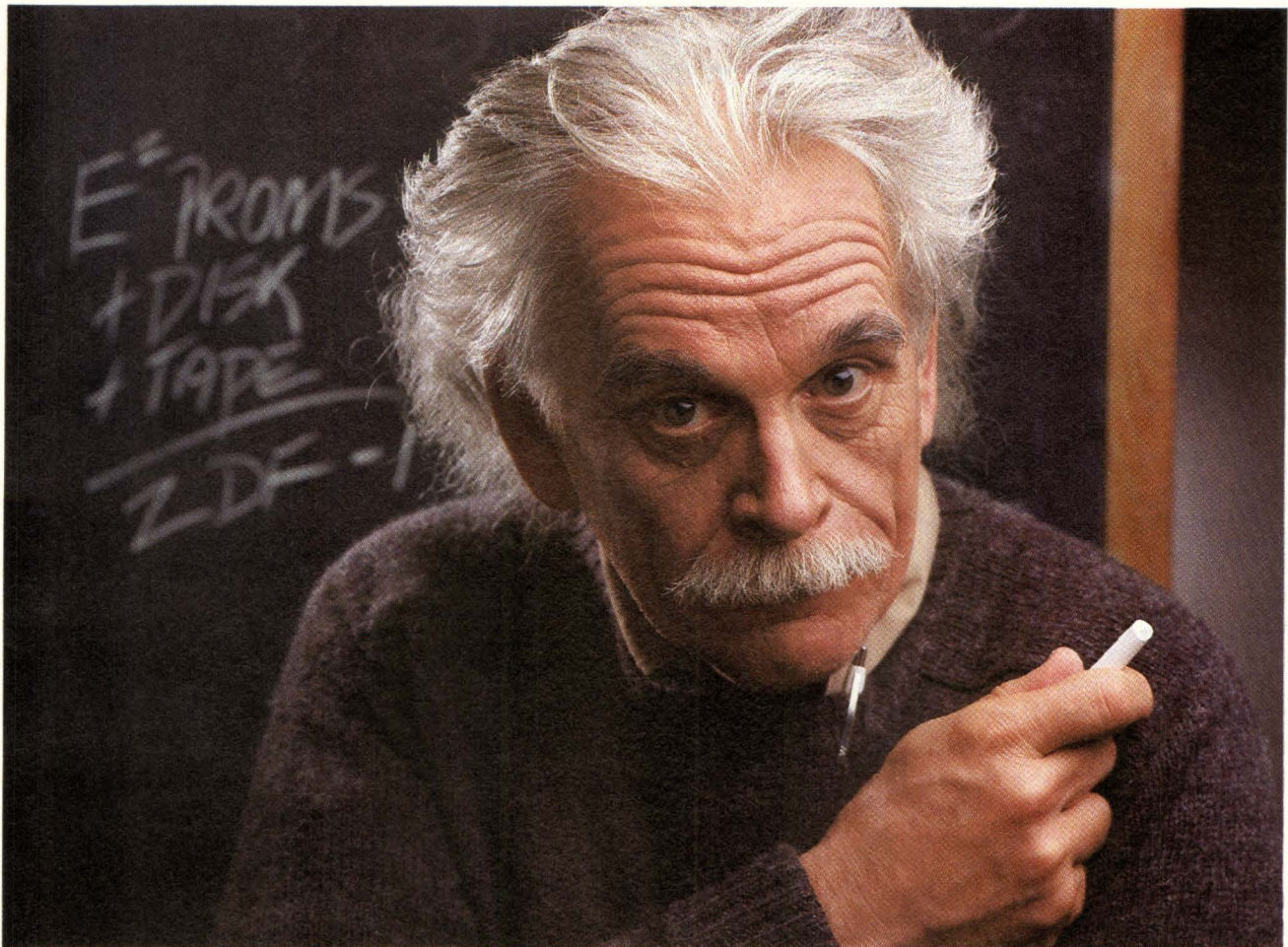

Zetaco's newest Slot-Saver^{T.M.} uses a touch of genius to control both disk and tape.

The ZDF-1 dual function board has dedicated microprocessors to control disk and tape drives for DG's Nova/Eclipse series.

Now there is a dual function controller you can trust. Zetaco's ZDF-1 combines two well-proven products and more: our Model 295 Disk Controller and our Model 133 Magnetic Tape Coupler. Two complete controllers on a single board, with full emulation of DG's 60XX and 61XX series disk sub-systems and 6021 and 6125 tape systems, enhanced to provide higher transfer rates and maximum use of your storage capacity.

There's more. On-board ECC and the ability to run unmodified RDOS/AOS. E²PROM technology

eliminates on-board switches, making each drive configurable from your keyboard. ZDF-1 has true "plug-and-go" compatibility: it needs no software patches, and backplane cabling is compatible with DG's new FCC-compliant chassis.

Zetaco designed the ZDF-1 as a controller to grow with. As technology

advances to higher transfer rates, beyond 600 MB Winchester, beyond 150 ips GCR tape drives, you'll find the genius of ZDF-1 is ready. Now, and in the future.

Get the full ZDF-1 story from Zetaco, 6850 Shady Oak Road, Eden Prairie, MN 55344, (612)941-9480. Telex 290975. European Headquarters: 9 High Street, Tring, Hertfordshire, HP23 5AB, England. (044282) 7011. Telex 827557. ZETACO G.

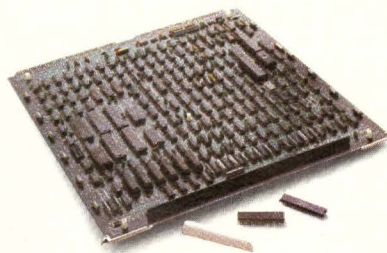

ZETACO

Controller Division, Custom Systems Inc.

CIRCLE 52

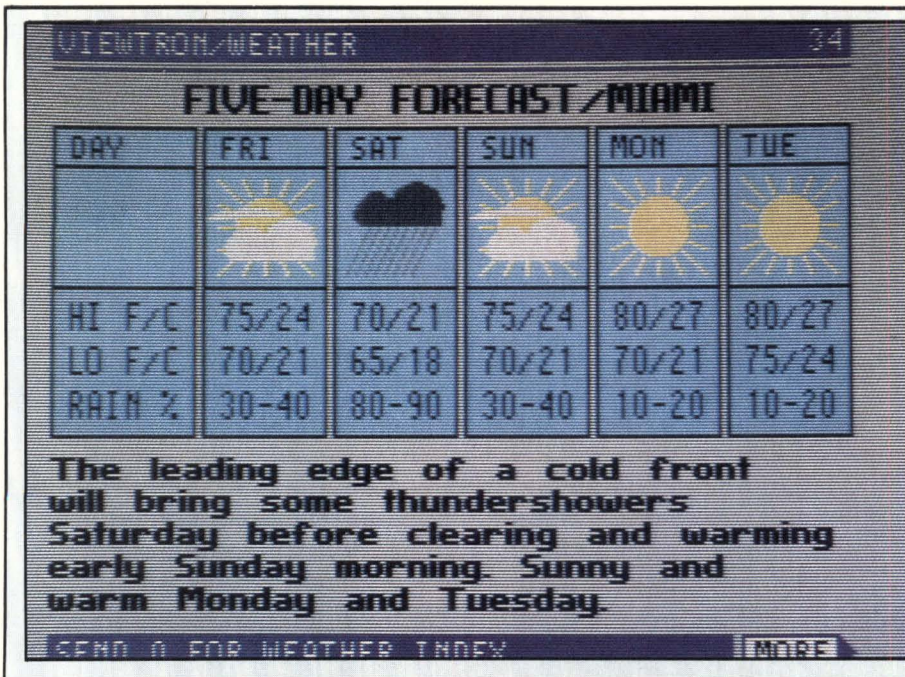

Fig 2 Shown is a sample picture from the Viewtron videotex service currently operating in the south Florida area. This videotex service is based on the NAPLPS standard.

To implement a videotex system, the user needs a terminal; a modem that converts digital to analog; a decoder; and, of course, the transmission lines. The service on a videotex system is usually presented in menu form with the user advancing from a main menu to increasingly more specific offerings. The

desired information might be delivered as alphanumeric text, graphics, or a combination of the two (Fig 2).

Fundamental to NAPLPS is the layered architecture that facilitates the Open System Interconnection model (Fig 3). Basically, data can be easily exchanged between participating systems. The architecture is an assembly of interrelated protocols, which define the entire communication system. Each layer addresses a unique aspect of the system, allowing other protocols to be substituted at various layers. In this way, the data exchange can be accomplished over different transmission media.

Common to videotex and teletext is the presentation layer, which provides a way to represent information in a coding format so that it retains its meaning. There are, however, seven layers that can be portioned into two major groups. Layers 1 to 4 deal with how data is transferred; layers 5 to 7 concern the data itself and how it is processed and used.

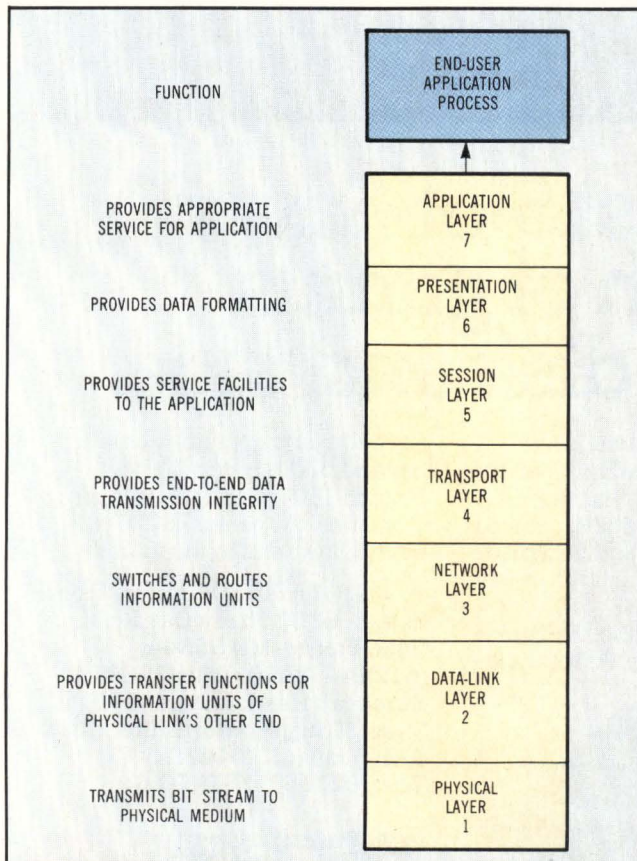

Fig 3 The Open System Interconnection (OSI) model is based on seven functional layers. The NAPLPS standard corresponds to OSI level 6, the presentation level.

The functional layers and what they do

Layer 1 describes the mechanical, electrical and procedural functions that help establish, maintain, and release physical connections. Following that physical layer is the data-link layer, which determines the data-transmission link across one or more physical connections. Included here are error correction, sequencing, and flow control to help maintain data integrity.

The third layer serves the fourth by providing routing, switching, and network access. The succeeding layer, or transport layer, is thus unburdened with how underlying transmission resources are used. It is concerned only with the end-to-end, transparent, virtual data circuit that crosses over one or more tandem network transmission facilities.

Service facilities are provided by the session layer. Here, the procedures for establishing a session connection and supporting the orderly exchange of data and related control functions are detailed. Following the sixth, or presentation layer, are the applications. These protocols provide the actual service sought by the end user. In the seventh layer, for example, information retrieval service commands might be found.

Making use of device independence

Because the entire standard is based on the concept of an abstract Cartesian coordinate system, the NAPLPS is device independent. This system defines all pictorial, textual, and incremental drawing operations. For two-dimensional drawings, the plane consists of a square area called the unit screen. Its points along the X and Y axes range from 0,0 inclusive in the lower left corner to 1,1 exclusive in the upper right corner (Fig 4). In three dimensions, the drawing space is a cube with a Z axis that defines 0 as the furthest point from the viewer.

Since most TVs and monitors have an aspect ratio of 4:3, the entire unit screen will not fit into the active display area. Thus, the unit screen mapped to those devices would range from 0,0 to 1,0.75. Although terminals with different resolutions map the unit screen to their device coordinates differently, the pictures are the same as long as the NAPLPS data is properly decoded.

Coordinate data is transmitted as signed 2's complement binary fractions representing fractions of the unit screen. Because the fractions are written in the abstract terms of the unit drawing area, they may not be represented exactly in the receiving terminal's internal arithmetic. Thus, some approximation is implemented by eliminating unrepresentable LSBs via a truncation process, if necessary.

Data in a NAPLPS system is read from an input stream 1 byte at a time (ie, a byte-oriented protocol). Each byte is interpreted with the aid of a decoding table, the size of which is dependent on the coding scheme. For example, in a 7-bit format, the MSB is not used. That allows a table of 128 entries. On the other hand, an 8-bit format gives a table of 256 entries. The decision to use either format is established by prior agreement of the information provider and the user. It can also be accomplished by commands issued at another appropriate protocol layer.

The decoding mechanism in a NAPLPS system consists of two groups of control functions called C-sets (containing 32 entries each), and four groups of text and graphics functions called G-sets (containing 94 or 96 entries), depending on whether two character codes have previously been assigned the meanings for space and delete. In a 7-bit format, the decoding table will contain one C-set and one G-set at any given time (Fig 5). However, in an 8-bit environment, the table contains two C-sets and two G-sets at any instant (Fig 6).

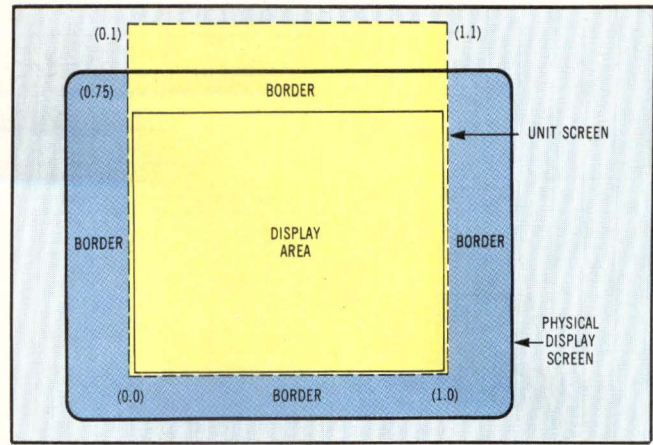

Fig 4 The NAPLPS standard adheres to the unit screen concept. This means that all coordinate data is transmitted as fractions of the unit screen, thus making the NAPLPS standard resolution independent.

The control sets are called C0 and C1 and each has a function. The C0 set contains commands to position a cursor, clear the screen, change the contents of the decoding table, and initiate escape control sequences. The C1 set expands the control-function capabilities of the NAPLPS. It provides commands to turn the cursor on or off, start and stop a blinking function, set the text size, and define operations.

D7	0	0	0	0	1	1	1	1
D6	0	0	1	1	0	0	1	1
D5	0	1	0	1	0	1	0	1
COLUMN	2	3	4	5	6	7	6	7
ROW	D4	D3	D2	D1				
0	0	0	0	0				
0	0	0	1	1				
0	0	1	0	2				
0	0	1	1	3				
0	1	0	0	4				
0	1	0	1	5				
0	1	1	0	6				
0	1	1	1	7				
1	0	0	0	8				
1	0	0	1	9				
1	0	1	0	10				
1	0	1	1	11				
1	1	0	0	12				
1	1	0	1	13				
1	1	1	0	14				
1	1	1	1	15				

CO SET

G SET

DEL

Fig 5 In a 7-bit code environment, the in-use decoding table consists of 128 entries. Here, the table can hold one C-set and one G-set concurrently.

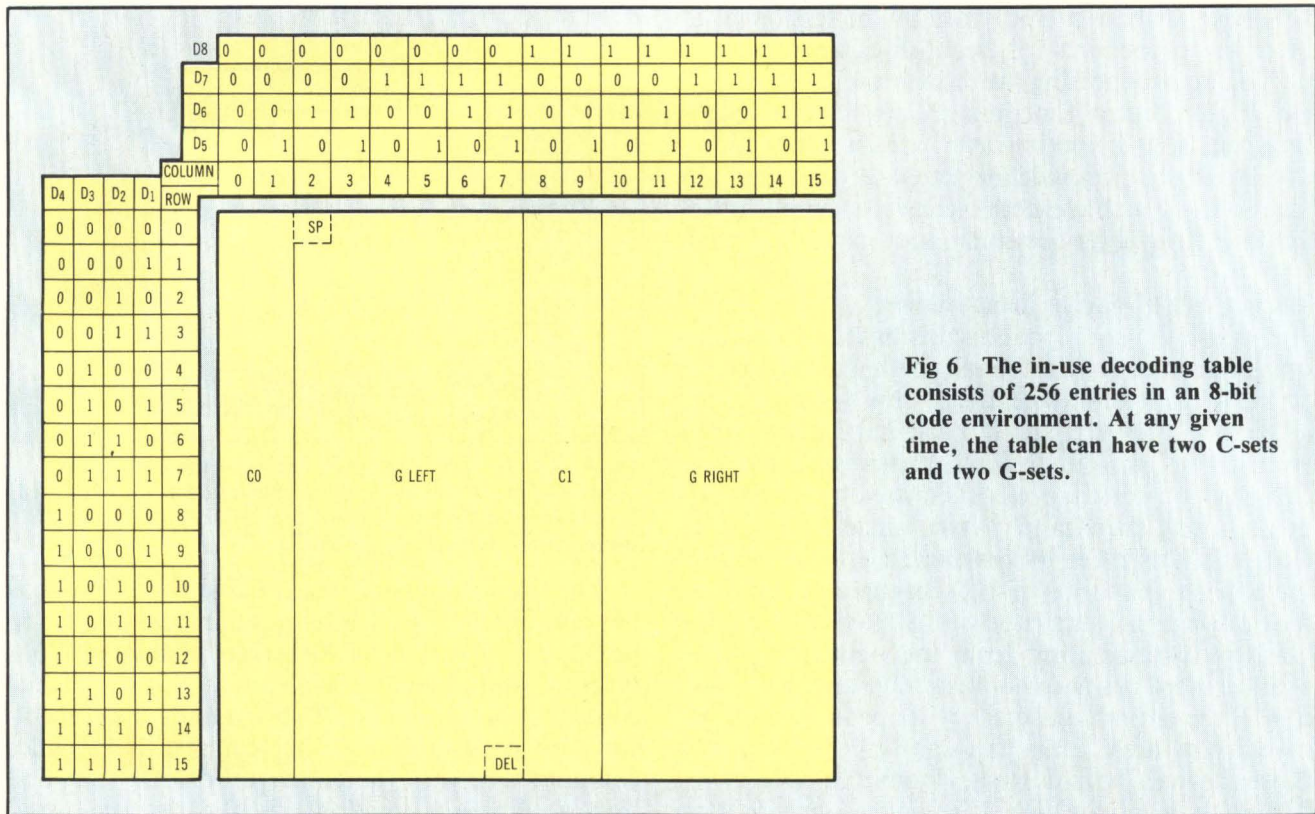

Fig 6 The in-use decoding table consists of 256 entries in an 8-bit code environment. At any given time, the table can have two C-sets and two G-sets.

Each of the four G-sets, G0 to G3, can be designated as one of the following: the primary character set, the supplementary character set, the mosaic set, the dynamically redefinable character set (DRCS), the PDI, and the macro set. Escape control sequences map one of those six sets to a G-set. The default G-set designations are the primary character set for G0, the PDI set for G1, the supplementary character set for G2, and the mosaic set for G3.

Once designated either by default assignment or by escape control sequences, G-sets can be brought into the decoding table. For example, if G1 is designated as the PDI set and invoked into the 7-bit decoding table, the byte Hex31, if received, would be decoded as a PDI command (Fig 7). However, the same byte would be decoded as the text character "1" if the G1 is designated as the primary character set and invoked into the decoding table.

Text and graphics

The primary character set consists of all uppercase and lowercase characters, digits, punctuation marks, and other symbols. The particular character fonts used for those characters depend on the terminal manufacturer. Those fonts will be stored in the NAPLPS decoder's ROM.

In addition to the font, other attributes that affect the display of the text include the text character field size, the foreground and background colors, the color mode, rotation, character-path movement, intercharacter and interrow spacing, word wrapping, scrolling, and underlining. All are set by using either a PDI control command or a C1 command.

The supplementary set expands the number of characters available and includes accent marks and special characters. Some are nonspacing, so the accent marks can be placed on top of characters. More flexibility is added by the mosaic set, which generates course-resolution graphics. Here, each character cell is divided into six blocks, any of which can be turned on or off. The character code associated with each mosaic determines the representation of the character. Thus, the character fonts need not be stored in ROM. Instead, they can be dynamically generated as the mosaic character codes are received.

To cover all bases, the NAPLPS standard includes a DRCS. This allows the host system to define a special set of characters and use them for generating a display image. These DRCS characters can be defined by implementing any of the various NAPLPS commands.

The picture description set can be divided into three major groups of commands—control commands, geometric drawing primitives, and incremental primitives. The first consists of eight commands that perform such functions as resetting, selecting a drawing color, or choosing a particular line texture.

There are 20 geometric drawing primitives that allow the host system to draw points, lines, rectangles, arcs, and polygons. All are implemented with attributes that have been defined by previous NAPLPS commands. The four incremental drawing primitives permit transmission of pixel maps and allow groups of lines or filled polygons to be represented in a compressed manner.

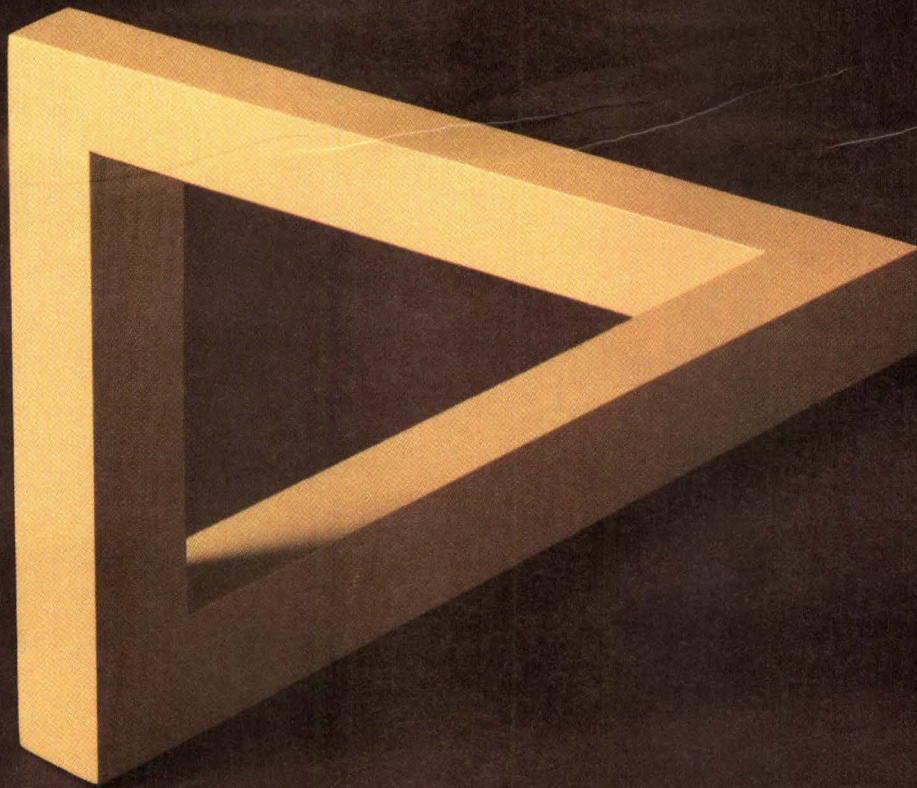

**A Complex Concept
Simply Defined:
The Strategic Supplier
Is A Partner In
Creating Opportunities.**

In today's innovation-oriented marketplace, the role of the materials supplier must shift from passive vendor to active contributor in product advances.

The strategic supplier looks beyond today's sale to perceive changing needs and be ready with solutions. The strategic supplier is willing to commit major investment in technology to integrate thoroughly with your programs. The strategic supplier has the ability to deliver global resources and tangible support with every product.

The strategic supplier doesn't just seize opportunities but helps create them in a partnership. GE Plastics is the strategic supplier.



LEXAN[®]
sheet/film/foam/resin
ULTEM[®]
foam/resin

NORYL[®]
foam/resin
XENOY[®]
resin

VALOX[®]
film/foam/resin

We bring good things to life.

GENERAL  **ELECTRIC**

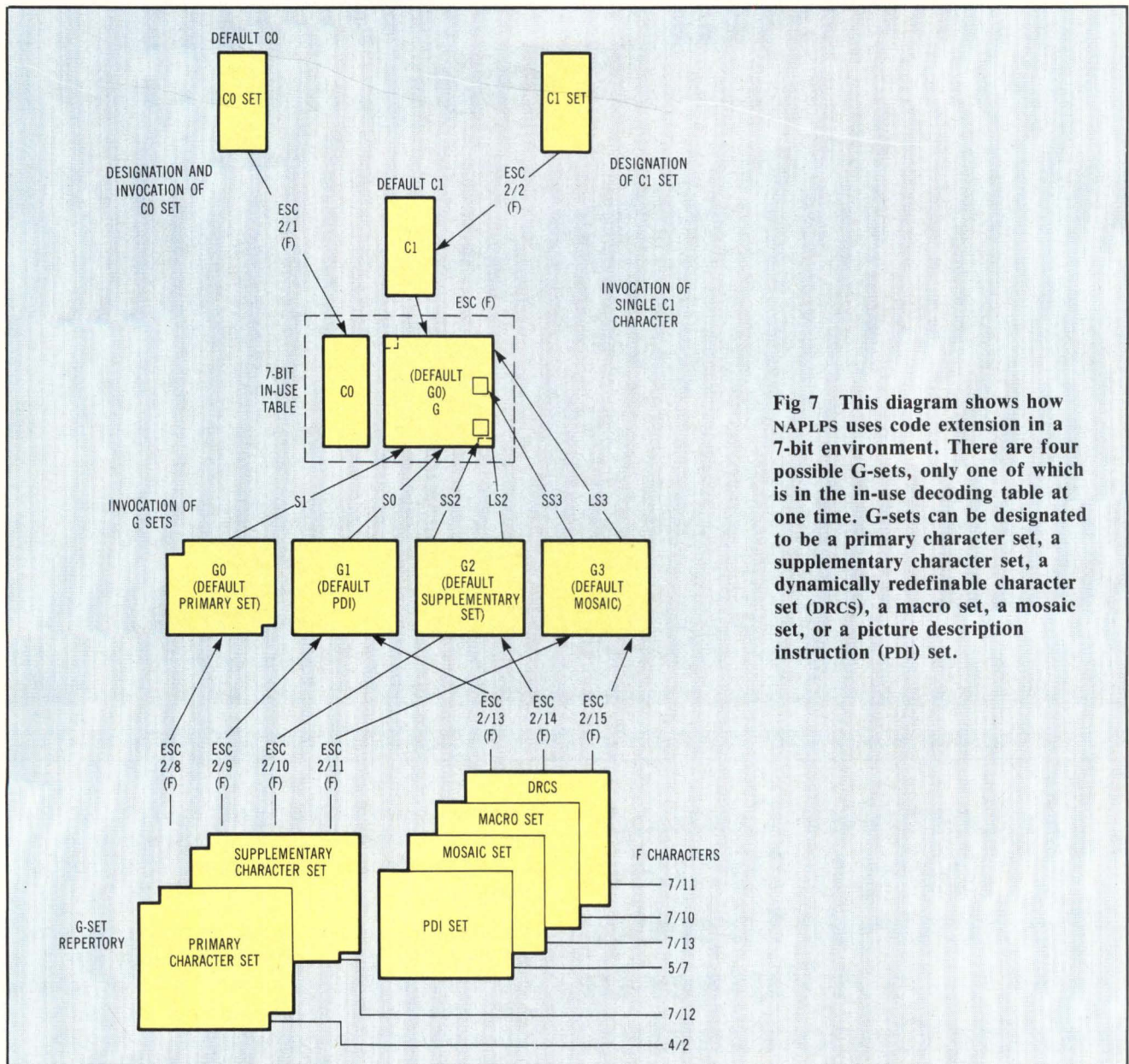

Fig 7 This diagram shows how NAPLPS uses code extension in a 7-bit environment. There are four possible G-sets, only one of which is in the in-use decoding table at one time. G-sets can be designated to be a primary character set, a supplementary character set, a dynamically redefinable character set (DRCS), a macro set, a mosaic set, or a picture description instruction (PDI) set.

Coordinate data for graphics representation is transmitted as signed, 2's complement binary fractions with from 1 to 8 bytes used to specify a coordinate pair. To distinguish a PDI command from coordinate data, the former have bit 7 equal to 0 and the latter equal to 1.

In a two-dimensional system, X, Y coordinate values are coded. Each byte represents 3 bits of X data and 3 bits of Y data. The first byte specifies the sign bit, followed by the MSB to the right of the decimal point. Each byte that follows specifies more data with each bit of lower significance.

In a three-dimensional system, the X, Y, and Z coordinate values are encoded. Each byte represents 2 bits of data for determining the X axis, 2 more for the Y axis, and 2 bits for the Z axis.

The eight PDI control commands help determine the specific attributes of the displayed graphics and text. Reset selectively reinitializes control parameters

and attributes to their default values. The screen can be cleared and the screen border color reset. The color mode can also be reset with or without changing the drawing color. Attributes set by other PDI control commands, such as text, domain, and texture, can be reset to default values, as can blinking, unprotected fields, macros, and DRCS character definitions.

The domain command sets the length of both single-value and multiple-value operands. These operands signify the length of byte strings for the numeric data fields of the PDI command, which specifies control, attribute or coordinate parameters required by the commands. It also determines dimensionality and the size of the logical pel—a geometric construct whose size determines the stroke width and height used in drawing the graphics primitives. The NAPLPS document advises that although the terms pel and pixel are often synonymous, for the purposes

TOMORROW'S DISTRIBUTED SWITCHED DATA NETWORK TODAY.

RIXON'S Data Concentration Exchange (DCX) is a revolutionary concept in data communications equipment by combining distributed switching, statistical multiplexing, concentration, contention, and network processing functions.

DISTRIBUTED SWITCHING allows a terminal user direct connection to a local CPU or remote CPU without having data transmitted to a central switch and back over the same line. It will also save you the expense for multiplexer hardware, excess cables, computer parts, communication links, and the modems required when using a central data switch.

CENTRALIZED MANAGEMENT AND CONTROL is established by making one node the master over all other DCX switches and multiplexers. Faults can be localized to individual ports and/or network links as everything can be managed from one node.

RESOURCE SHARING capabilities of the DCX line of products gives you

your own digital PABX system. This allows interconnect to as many as 15 other DCX switches and as many as 63 in a single network. Access levels restricting certain computer facilities for security reasons are easily assigned with the DCX products.

With a DCX at your local or remote cluster, you can minimize your hardware investments by having everything needed in one box. You eliminate your central switching device, multiplexers to serve each remote cluster, and excessive cabling between data switch ports and the multiplexer ports. The cost of the DCX is application dependent, but will be less because you are purchasing a complete system in one cabinet from one company.

Call Dave Shaffer so he can explain to you in detail how you can benefit from RIXON'S family of statistical multiplexers at (301)622-2121, ext. 471, or write to RIXON at 2120 Industrial Parkway, Silver Spring, Maryland, 20904

See us at NCC Booth #H-948

3048 © RIXON INC., 1983

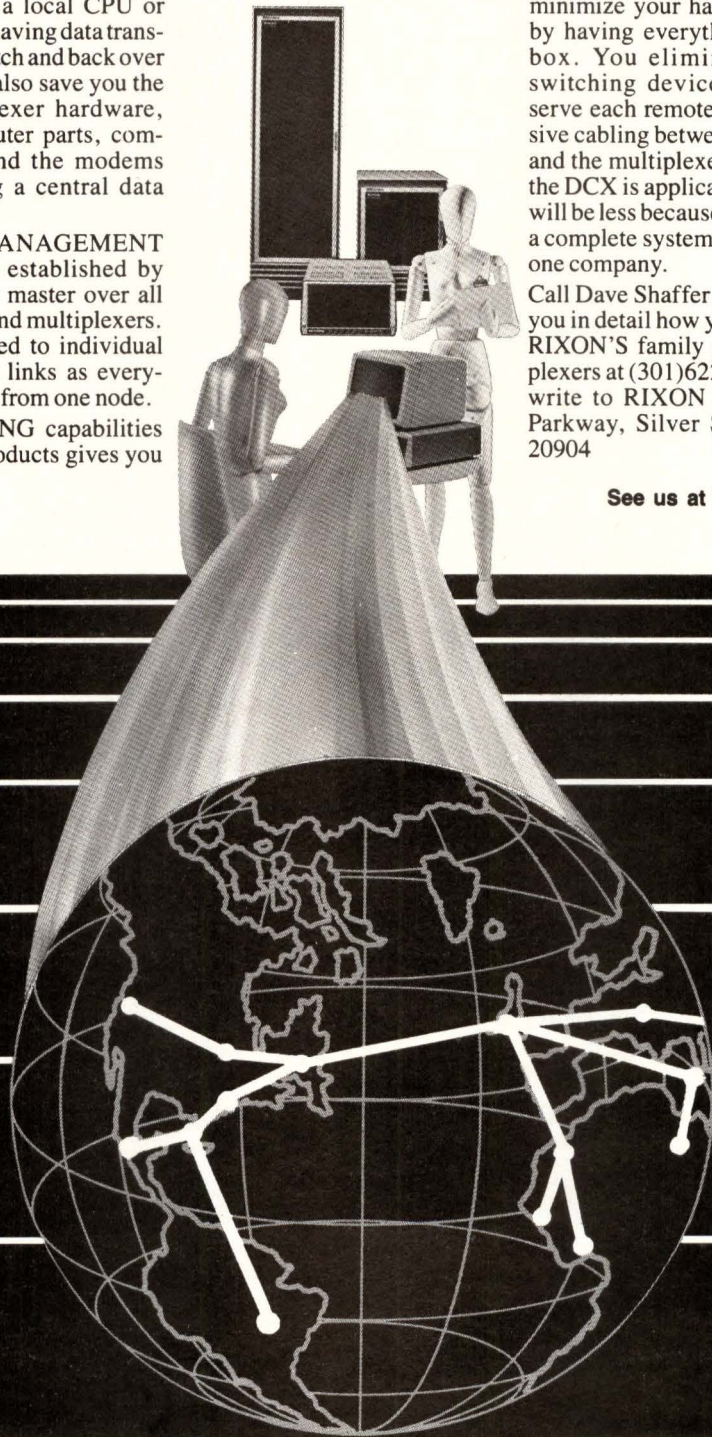

RIXON INC.

CIRCLE 54

of the document, pel is a logical picture element, but pixel refers only to a physical picture element. Thus, the logical pel can map onto several pixels.

A single-value operand can range in length from 1 to 4 bytes and can specify color indexes and the timing value of a blinking function. On the other hand, multiple-value operands can be up to 8 bytes long and can determine coordinate data and the values of color maps. Dimensionality can specify either two- or three-dimensional graphics construction. At present, the latter is not considered, but the NAPLPS does provide mechanisms for future standardization.

Moving text

The content of the text command determines the movement of characters across a videotex screen. Such attributes as rotation, character path, inter-character and interrow spacing, move parameters, cursor style, and character field dimensions come into play. The versatility of the standard allows text to be rotated 0, 90, 180, or 270 degrees. Characters can also be automatically moved to the right, left, up, or down as the character string is displayed.

The spacing between characters determines how much the cursor will move each time a new character is displayed. A choice allows movement in 1, 5/4, or 3/2 multiples of the character field size. In addition, characters can be proportionally spaced. The precise intercharacter distance is determined solely by the character being displayed. A choice is also available for interrow spacing, which can be 1, 5/4, 3/2, or 2 times the character field size.

The cursor is used to position text and the drawing of point position graphics. Both are repositioned with regard to each other by use of the move parameters. Both can move together, independently, or with either leading. Plus, four cursor styles are provided: an underscore, a block cursor, a cross-hair, and a custom cursor. Finally, the character-field dimensions determine the size of the displayed text characters. A default character field size is 1/40 by 5/128 of the unit screen.

Line textures can be varied for different effects. For example, they can be solid, dotted, dashed, or a combination of the latter two. Highlighting can also be turned on or off for perimeters of filled arcs, rectangles, and polygons. Textures for filled areas can be solid, vertical, horizontal, or cross-hatched. The thickness of the hatch is determined by the logical pel size. Also permitted are four host-defined texture masks.

The NAPLPS specifies three color modes: one direct and two indirect. Direct color mode 0 specifies a color that is written directly into the graphics bit-mapped memory whenever it is the color currently being used. Indirect modes 1 and 2 apply when color paletting or mapping is used. Color index values are written into the graphics memory, which

in turn will address the color palette to provide the required color information. Color mode 1 handles foreground color paletting; mode 2, both foreground and background. In modes 1 and 2, the set color command sets the values in the palette.

Set color operands can range in length from 1 to 8 bytes for a total of 48 bits of information (6 bits of color information to a byte). On the other hand, select color operands can be from 1 to 4 bytes long—a total of 24 bits of information.

The service reference model (SRM) for NAPLPS is a set of guidelines specifying a conformance level to the standard. Although the videotex/teletext SRM specifies 16 simultaneous colors from a palette of 512, the full NAPLPS provides the capability for up to 16 million (2^{24}) simultaneous colors from a palette of 281 trillion (2^{48}).

*To implement a videotex system,
the user needs a terminal, a modem,
a decoder, and transmission lines.*

Other commands include wait, which puts delays into the execution of NAPLPS data. The exact time is specified in intervals of 0.1 s. The blink command causes an entry in the color map to blink between two colors. The process first specifies the color to which the current color should change, and sets the on and off intervals as well as the start delay. Here too, all intervals are in 0.1-s units.

Filling in the blanks

The point command positions the drawing point but may or may not display a point itself. Coordinate data following the point can be interpreted as either absolute or relative. That gives four types of commands: absolute/invisible, relative/invisible, absolute/visible, and relative/visible. The visible point is drawn with the dimensions of the logical pel.

There are four line commands as well: line absolute, line relative, set-line absolute, and set-line relative. The first two use the current drawing point position as the first point of the line. The set-line commands specify both end points of a line. Absolute coordinates give the position of the end point directly. Relative coordinates, on the other hand, add to the current position of the drawing point to generate an end point position.

Unlike the line, three points are needed to draw an arc: the starting point, an intermediate point on the arc, and the end point. Arc-outlined and arc-filled commands use the current position of the drawing point as the starting point of the arc. Set-arc commands give the starting point in absolute coordinates.

Arcs can be either outlined or filled. When filled, the area between the arc and the chord connecting

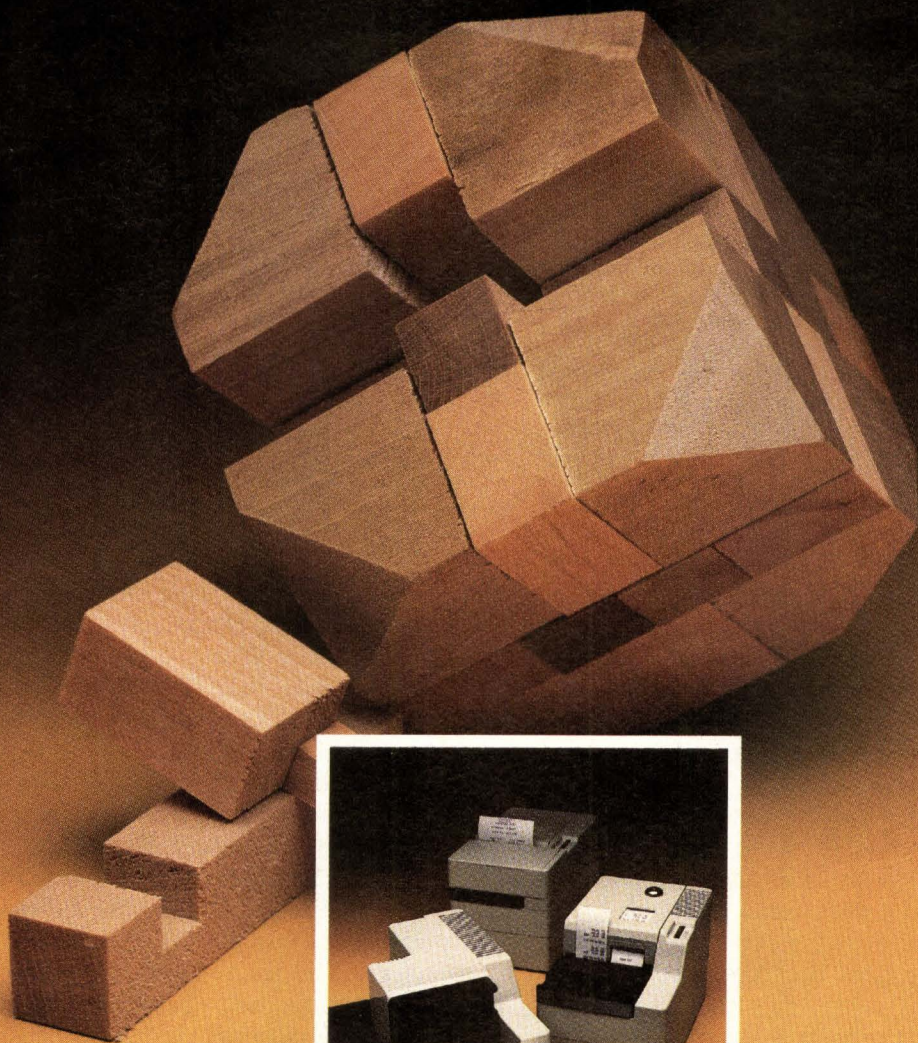

COMPATIBILITY

NCR 40-column printers... fit in perfectly with your design. NCR's highly compatible printers are easily adaptable to slip printing, data logging, or receipt or journal printing. It's the only family of printers, standalone and basic mechanisms, guaranteed to meet the various needs of the OEM marketplace. Compact, easily installed and highly reliable, NCR printers continue to prove their worth with over one million units in use throughout the world. Getting more information is no puzzle. You just call (800) 222-1235. In Ohio, call (513) 445-2380.

NCR
OEM MARKETING DIVISION

NCR 40-column printers... designed for demanding applications.

CIRCLE 55

An advanced video display processor

The TMS9228 video display processor is an upgraded version of the TMS9918A family of video display processors found in the TI-99/4A home computer, ColecoVision, Coleco Adam home computer, and the Japanese MSX standard. The software-compatible processor implements the same 40-char/line text mode, graphics I mode, and graphics II mode as its predecessor. In addition to these modes, the unit has an 80-char/line multicolored text mode, and graphics modes III, IV, and V. Graphics modes I to IV are pattern graphics modes, while the graphics mode V is fully bit mapped.

The graphics V mode of the TMS9228 is designed primarily to cost-effectively implement the requirements of the NAPLPS service reference model (SRM). The SRM has a set of guidelines defining a minimum conformance level of the NAPLPS standard that both data providers and terminal manufacturers should follow. This mode is a full bit-mapped graphics mode

with a 256 x 210 resolution with 4 bits/pixel. There are 16 simultaneous colors selectable from a color palette of 512. The onchip color palette replaces a large amount of external circuitry found in other graphics systems.

Other major features include 32 multicolored sprites with up to 10 sprites on one line. A block move command relieves the CPU from having to move large amounts of data in the video RAM. A programmable interrupt signals the CPU on completion of any specified horizontal scan line.

An onchip sound generator is compatible with the TI SN76489. Video outputs include color difference signals, or RGB. There is the ability for the CPU to perform DMA operations into the video display processor's video RAM. The external video interface allows the cascading of multiple video display processors or the ability to synchronize an external video signal for graphics overlay capability.

the two end points is filled. Circles are drawn simply by making the arc's starting point equal to its end point. Alternatively, circles can be drawn by defining an arc command with just two points that specify the diameter of the circle. If more than three points define the arc command, a curvilinear spline is drawn.

Like arcs, rectangles can be outlined or filled. The set-rectangle command gives the beginning point in absolute coordinates and the diagonal point in relative coordinates. Conventional rectangle commands use the current drawing point as the beginning point and then give the diagonal point in relative coordinates.

Polygon commands process a list of coordinate data that is interpreted as vertices. Polygon edges should not cross each other and the number of vertices supported should be at least 256.

More drawing primitives

Several incremental drawing commands enhance a display. For example, the field command defines a rectangular region in the unit screen, while the default field is the entire screen. The field, once defined, can be used for columnating text—specifying areas of the screen that are protected and unprotected, as well as an area of the screen used by the incremental point command. That command helps download a bit-mapped graphics image into a previously defined field on the screen. Of the two operands that follow the command, the first is a packing counter that determines how to group bits of the bit stream to form the color information for each point. The second operand is the data bit stream.

If the packing counter is 4, every 4 bits from the bit stream will be grouped together. The incremental point is executed by taking color information from the bit stream and placing it in the graphics bit-

mapped memory corresponding to the position of the drawing point. That point is automatically moved to its next position, depending on the dimensions of the logical pel. The point size also depends on the logical pel. The entire process is repeated until the end of the bit stream.

Complex line drawings, such as personalized signatures, can be drawn using the incremental line command. This command presents such drawings in a compact and compressed form and, like the incremental point command, is followed by two operands. The first gives the dx and dy step size parameters. The second is a series of bytes that supplies the move and draw instructions.

The step size parameters determine the distance, in the dx and dy directions, that will be used by the move instructions that follow. Every 2 bits, excluding the 2 MSBs, are grouped together to indicate a line drawing instruction. That yields three move instructions per byte.

The incremental polygon command is very similar to the incremental line command with the exception that the draw-flag indication is always on. If a modifying parameter is received that attempts to change the draw flag, it is treated as a null.

Finally, the macroinstruction set provides mechanisms for data compression as well as for creating pictures with structure. A macroinstruction is a string of locally buffered NAPLPS commands. These commands are stored in a decoding terminal's RAM. Once a macro is defined, it can be executed by sending a single byte of information—the macro name. That requires the macro to be part of the 96 commands that are designated to a G-set and are in the currently used decoding table.

Implementing a NAPLPS decoder

Most NAPLPS-based videotex decoders built today are designed using CRT controllers and many MSI

and SSI components to achieve the functionality required by the NAPLPS SRM. As a result, these videotex decoders are not very cost effective. Widespread commercial videotex is on the horizon and has been for some time. In order for videotex to become a nationwide commercial reality, the cost of the NAPLPS videotex decoders must be reduced to a price acceptable for the consumer. When this happens, the long-awaited videotex explosion will occur.

There are many problems that relate to cost in designing a NAPLPS-based videotex terminal. In order to conform to the NAPLPS SRM, the resolution should be on the order of 256 x 200 pixels with 16 simultaneous colors. This is usually implemented with 4 planes of bit-mapped graphics memory, yielding 4 bits/pixel. In addition, a 512-color palette is necessary to provide the color shading and flexibility demanded by videotex advertisers and graphics artists. The color palette, in most designs to date, has been implemented external to the CRT or video display processor controlling the graphics memory. This amount of external circuitry is one of the reasons NAPLPS videotex decoders are so expensive today.

Texas Instruments has developed a video display processor, the TMS9228, which was designed in parallel with the NAPLPS standardization efforts (see Panel, "An advanced video display processor"). Now, a NAPLPS-based videotex terminal can be

designed to completely conform to the NAPLPS SRM at a low cost. The graphics v mode of the video display processor is a full bit-mapped graphics mode with 4 bits/pixel with a 256 x 210 resolution. There are 16 simultaneous colors available selectable from a color palette of 512. The onchip color palette reduces the chip count and overall system cost considerably.

This video display processor can also be used in applications besides videotex. Its powerful animation capabilities, such as multicolor sprites, are used in videogames. Also, its 80-char text mode can be used in personal computing applications such as word processing, accounting, and spreadsheet analysis.

Ultimately, there will be the home information system. The functional characteristics of personal and home computers, videotex, videogames, education, and many other features will merge together into one unified system. The TMS9228 video display processor is one graphics device that can serve all of these needs.

Please rate the value of this article to you by circling the appropriate number in the "Editorial Score Box" on the Inquiry Card.

High 707

Average 708

Low 709

Fujitsu believes an OEM deserves lots of fast talk.

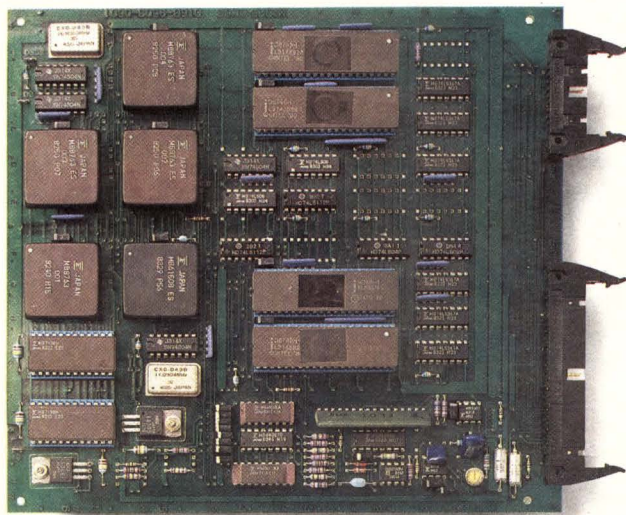

The world's first 14.4 kilobit modem card; superior reliability in a compact package. 9,600, 4,800 & 2,400 bps core modems and stand-alone modems also available.

That's why Fujitsu now offers the world's first 14,400 bit per second modem card, along with companion 9,600 bps, 4,800 bps and 2,400 bps core modems. All three single PC boards employ custom digital signal processors. And from a standpoint of versatility, the units are compatible with any type of equipment.

By offering your customers the fastest, most reliable, and economical modem, you're not only offering state-of-the-art technology, but a product that is backed by a world leader in the telecommunications and computer industry.

We also realize that diversity sells your products and increases your profits. So, Fujitsu not only offers core modems, but also offers a full line of stand-alone modems.

Fujitsu modems meet the future head on. And that's the kind of fast talk you deserve.

FUJITSU

Fujitsu America, Inc. ♦ Data Communications Division ♦ 1945 Gallows Road ♦ Vienna, Virginia 22180 ♦ (703) 356-5758

THE CASE F

It measures 5.00"x 6.62"x 14.75". And it fits smartly beside many of today's popular microcomputers. But the case in point, Xebec's new 10-megabyte 9710 Universal Storage Subsystem, has more to do with the components inside—specifically, the controller and the disk drive—than with the dimensions and the aesthetics outside.

Actually, the most important thing on the outside of the case is the name. Xebec. A company whose 5.25" hard disk controllers are found in more business micros—including those of IBM, Hewlett Packard, TI and Eagle—than any other, anywhere. What put us there was—and remains—our ability to *engineer in* more features and *manufacture in* more quality—zero defect quality, delivered on time and in quantity.

What puts us here, in the subsystem business, is at once a derivative and encompassing quality issue. The fact is that the more sophisticated we make our controllers, the more obvious become the deficiencies of the disk drives they control—the very drives found in all of the subsystems for small business computers being sold today. And all the more obvious becomes the need for someone to create a new standard for bringing these critical components together.

The Xebec 9710 is that new standard. First, it houses the industry's best selling 5.25" hard disk controller, the Xebec S1410, with its patented architecture, state-of-the-art feature set and VLSI design. But the real key is the incorporation of a disk drive that is "quality matched" to that controller, not just "component compatible." A drive that goes through the most rigorous testing possible before it goes into a 9710.

The results are directed at the serious end users and system integrators of microcomputer mass storage. Superbly matched components that deliver unmatched performance and reliability, right down to a complete range of host adaptors—for the IBM PC, Apple IIe, S-100, Multibus and Q-bus—that give the Xebec 9710 its impressive "universality."

And lest you think that our case for quality is made at the expense of other important considerations—like price and availability—consider this. The 9710 is founded on a commitment to the processes that optimize all of these factors—computer-aided design, manufacturing and test. A commitment most recently demonstrated by our \$20 million investment in advanced robotics equipment.

The case we are making is not, then, an empty one—no high-minded cliché thrown into the promotional fray. It is solid and smart.

It is, bottom line, an open and shut case for quality.

OR QUALITY.

Xerox



INTERNATIONAL
Xebec International
2 Blvd. De la Woluwe
1200 Brussels, Belgium
Telephone: 32-(02)-762-9494
TWX: 65054 Xebec B

SALES OFFICES
U.S.A.
Sunnyvale, CA (408) 733-4200
Irvine, CA (714) 851-1437
Atlanta, GA (404) 457-9872
Boston, MA (617) 740-1707
Dallas, TX (214) 361-0687

NORTH AMERICAN DISTRIBUTORS
Kierulff
Hamilton-Avnet

XEBEC
*The Zero Defect
Company*

See us at the NCC show in Las Vegas, Booth #A2134

CIRCLE 57

**NOBODY
DELIVERS
HALF-HEIGHT
WINCHESTERS
LIKE
SEAGATE.**

HALF-HEIGHT 5 1/4" DRIVES IN VOLUME

Everybody promises you half-height drives, but you can't ship promises.

Only Seagate™ ships zero-defect 10MB (formatted) half-height Winchester in production volumes for the lowest total system cost.

Designed for survival in the real world of portable and down-sized desktop systems, the ST212 can withstand a 40G drop. It features a reliable single platter design, proven risk-free technology, controller compatibility with the ST412 standard height drive, and lower power consumption.

Why gamble when you don't have to? Seagate assures you the most dependable half-height Winchester you can buy, product in volume to meet your needs, and the industry's largest Winchester support team. All of which translates into 5 1/4" Winchester disc drives with a total system cost that no other supplier

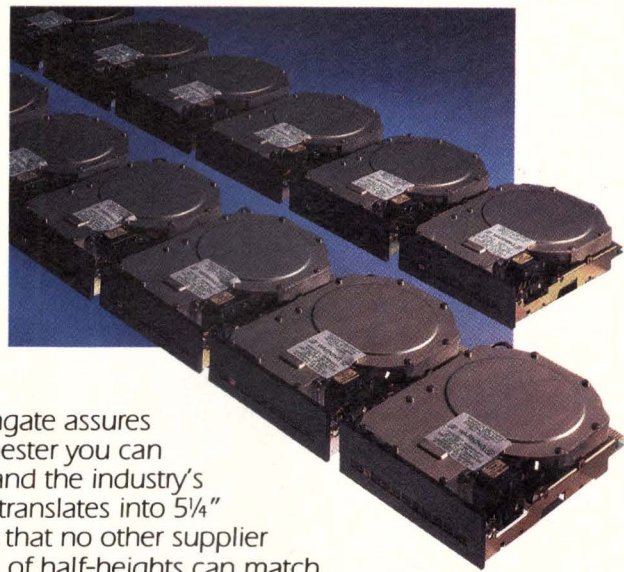

of half-heights can match.

Make us prove it. We want your business. Call Seagate.

Unformatted capacity (MB)	12.76
Formatted capacity (MB)	10
Average access time (ms)	65

Seagate

NOBODY DELIVERS QUALITY IN VOLUME LIKE SEAGATE.

920 Disc Drive,
Scotts Valley, California 95066
Telephone (408) 438-6550,
TELEX 176455SEAGATESCVL

Regional Sales Offices:
Newport Beach, California, (714) 851-9964;
San Jose, California, (408) 286-7580;
Woodland Hills, California, (213) 884-2699;
St. Petersburg, Florida, (813) 577-1199;
Littleton, Massachusetts, (617) 486-9711,
Dallas, Texas, (214) 783-6711.



Authorized U.S. Distributors:
Arrow Electronics, Pioneer Electronics and
Wyle Laboratories

Canada:
Scmad,
(416) 475-3922, TWX 6104924455
European Sales Office:
49 89 177017, TELEX 524275 SEAG D

Seagate is a trademark of Seagate Technology.
©1984 Seagate Technology.

CIRCLE 58



Brighten up your dumb terminal— add a UDS 212 A/D

A little outside intelligence can turn your dumb terminal into a data communications genius. And the intelligence you need is built into UDS' new 212 A/D, a smart 300/1200 bps modem with an integral automatic calling unit.

With the 212 A/D you can dial from keyboard or, with a single keystroke, from memory. Five 30-digit numbers in memory are battery backed for 3-5 year retention after shutdown. Built-in test functions allow fast, reliable verification of system operation.

Before you invest in more microcomputers, check the advantages of add-on intelligence. Contact Universal Data Systems, 5000 Bradford Drive, Huntsville, AL 35805. Telephone 205/837-8100; TWX 810-726-2100.

★ **NCC '84**
Booth #B-3258



 **Universal Data Systems**

 **MOTOROLA INC.**
Information Systems Group

UDS modems are offered nationally by leading distributors. Call the nearest UDS office for distributor listings in your area.
DISTRICT OFFICES: Atlanta, GA, 404/998-2715 • Bellevue, WA 206/455-4429 • Blue Bell, PA 215/643-2336 • Boston, MA, 617/875-8868 • Columbus, OH, 614/895-3025 • Englewood, CO, 303/694-8043 • Glenview, IL, 312/998-8180 • Houston, TX, 713/988-5506 • Huntsville, AL, 205/837-8100 • Mountain View, CA, 415/969-3323 • Old Bridge, NJ, 201/251-9090 • Richardson, TX, 214/680-0002 • Silver Spring, MD, 301/587-0166 • Tampa, FL, 813/684-0615 • Tustin, CA, 714/669-8001

CIRCLE 59

Created by Dayner/Hall, Inc., Winter Park, Florida

SHIFT REGISTER MANEUVERS DATA TO ADD PRINT FEATURES

Using custom LSI techniques, a special type of shift register allows dot-matrix line printers to offer upgraded print and data-formatting features.

by Philip Gordon

With today's increasingly sophisticated data processing applications, users of dot-matrix impact line printers often require flexible document formatting and other advanced features. When printers were simpler, the physical structure of the print mechanism posed few interfacing problems for designers of printer controllers. However, earlier dot-matrix printers offered limited features compared with today's models. Thus, because of the growing complexity of printers, a new electronic design technique is recommended to format and sequence the dots that drive the print-mechanism hammers.

Sequencing problems would be eliminated if the impact printer mechanism could accept direct raster-scan type data. For example, the printer's control electronics, called dot-generation logic (DGL), would be quite simple if designers used a single, large shift register loaded with an entire print row's bit image during the nonprinting print-bar turnaround time. Such a shift register has one storage cell for each dot that can be placed across the print row during a single pass of the bar. The shift register also has taps spaced evenly over its length—one tap for each hammer in the printer. Each tap, therefore, drives a single hammer. This basic shift-register concept yields such advanced printer features as mixed character-set pitches and proportional line spacing.

Until a few years ago, implementing a large shift register of the type described was a technological

Philip Gordon is a development engineer at Hewlett-Packard's Boise Division, 11311 Chinden Blvd, Boise, ID 83707, where he is responsible for digital system design for printer controllers. He holds a BSEE from the University of California at Berkeley and an MSEE from Stanford University.

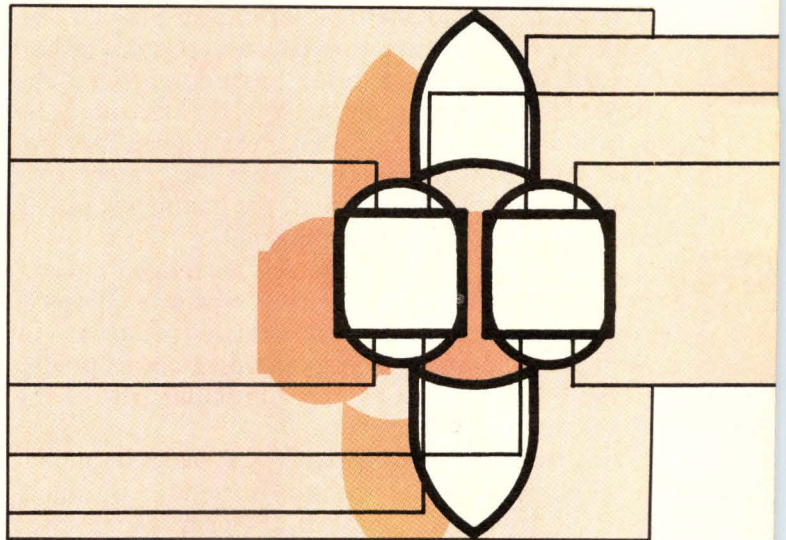

disaster. Large static shift registers—512 to 2048 bits—are unsuitable since they are accessed serially (no taps are provided). A TTL shift register can be built from standard MSI devices, but this approach is prohibitively expensive. However, an economical and viable alternative for a controller designer capitalizes on advances in custom LSI technology. A custom LSI component using standard MOS processing costs just a few dollars. Design expenses and risks are also minimized because the chip layout is a repetitive series of shift-register partitions.

This strategy has been adopted by Hewlett-Packard for its two recent dot-matrix line printers, the 300-line/min model 2563A and the 900-line/min 2566A. With improved DGL circuitry, character text is printed at several fixed pitches, and proportional spacing is planned.

At the heart of the 2563A and 2566A DGL models is a Hewlett-Packard designed and fabricated MOS LSI shift register. The device contains a 2772-bit, single-direction main shift register having 132 output taps stationed every 21 bits. It also includes an

132-bit bidirectional parallel-to-serial output shift register. The main register is cleared and filled in 2 ms, well within the 4-ms print-bar turnaround and paper advance time of the faster 2566A printer. When the shift register is used in the 33-hammer 2563A printer, an external divide-by-four circuit loads every fourth bit from the output shift register into a 33-bit hammer-driving shift register. Proper synchronization guarantees that 99 of the 132 output bits are discarded and not externally stored. This effectively programs the LSI device as a 2772-bit main shift register with 33 useful taps 84 bits apart, and a 33-bit output shift register.

Covering the dot-matrix basics

The basic dot-matrix impact printing operation involves the electromagnetic release of a spring-steel tine called a hammer. In a captured-hammer design, the hammer tips are drawn away from the paper by a small permanent magnet. When the electromagnet overcomes the field of the permanent magnet, the hammer flies forward and a hardened stylus or ball welded near its tip impresses the ribbon between the paper and platen to print the dot. The electromagnet is then disabled and the permanent magnet captures the hammer as it rebounds from the platen. In a noncaptured-hammer design, the hammer is pulled and released by an electromagnet.

All hammers and magnets are arranged linearly along a print-bar mechanism. To print a complete row of characters, a motor shuttles the print bar horizontally to multiple dot positions. Dots are printed in the proper locations of a particular row of the character dot matrices.

Any combination of hammers can be fired simultaneously, depending on the information to be printed. When a dot row is complete, the print bar reverses direction while a stepper motor advances the paper the distance of a vertical dot row; the next row of dots for the characters is then printed on the line.

A full-width line printer must print text at a density of 10 chars/in. (10-pitch) across at least 13.2 in. of the paper. Most dot-matrix printers use 132, 66, 44, 33, or 17 hammers spaced evenly along the print bar at intervals of 0.1, 0.2, 0.3, 0.4, or 0.8 in., respectively. Theoretically, if both the print-bar direction reverse (turnaround) and paper-step advance times are 0, a printer with 132 hammers moving approximately 0.1 in. will print twice as fast as a similar printer having just 66 hammers that must travel 0.2 in. Both times are significant considerations in printer design, so the ultimate speed is not merely a linear function of the number of hammers. Still, high speed printers usually have more hammers than their slower speed and lower cost counterparts.

A dot-matrix impact line printer's control electronics can be organized for convenience into I/O, control-microprocessor, and DGL sections. Data must pass through the I/O system, be parsed for control information and nonprintable characters, and be formatted by the microprocessor. Finally, it must be converted into dots and passed to the print mechanism in the proper order by the DGL.

The DGL usually includes a buffer memory for all active characters to be printed on a line; either a microprocessor or algorithmic state machine with arithmetic and programmable dot-extraction capability; various character-set, dot-image ROMs; and frequently, a dot-image buffer. Fig 1 shows the organization of these elements. The dot-position detector at the bottom generates print strobes each time the print bar passes a printable dot location. The hammer-driving electronics comprise a series of identical latches and high voltage current-switching circuits for the electromagnets.

While conversion of ASCII-coded information into the proper dot images is not difficult, the DGL's formatting and sequencing of the dots to the hammers can be troublesome. Although a dot-matrix printer appears to print a single dot row at a time,

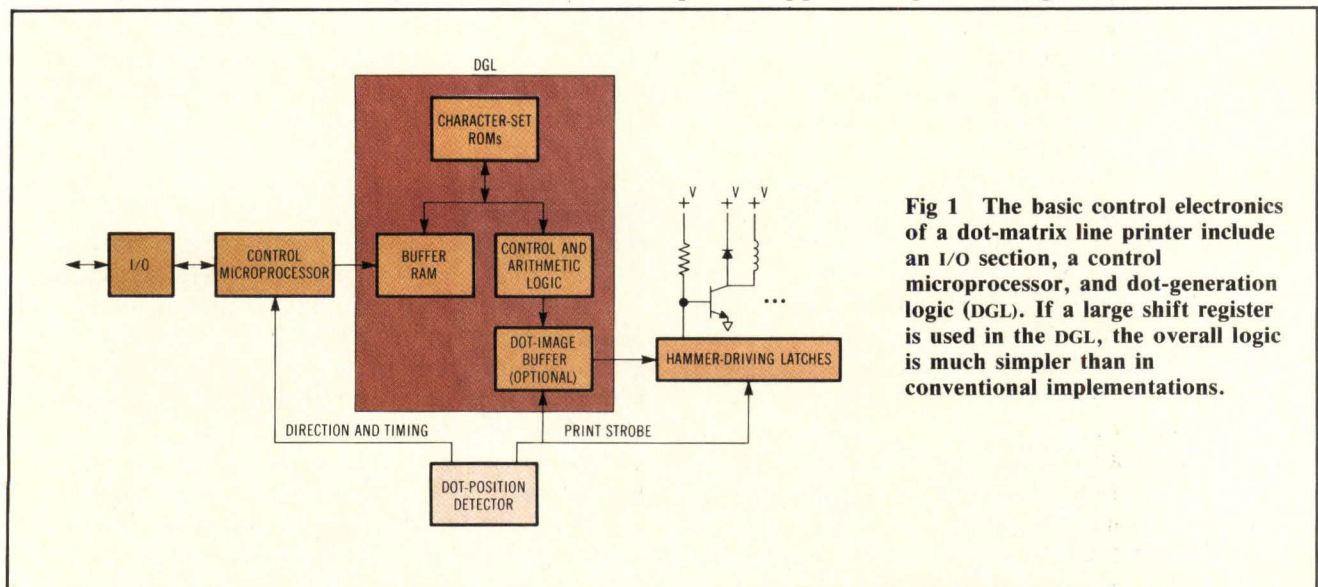

Fig 1 The basic control electronics of a dot-matrix line printer include an I/O section, a control microprocessor, and dot-generation logic (DGL). If a large shift register is used in the DGL, the overall logic is much simpler than in conventional implementations.

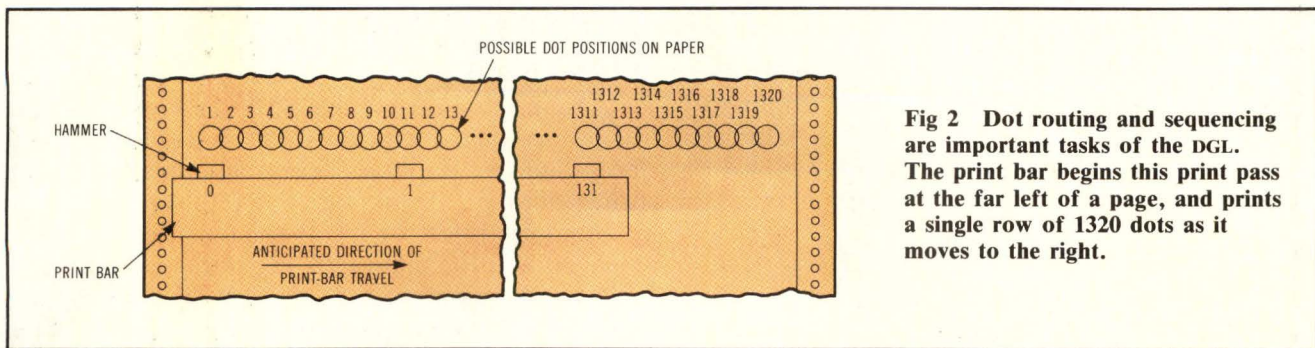

Fig 2 Dot routing and sequencing are important tasks of the DGL. The print bar begins this print pass at the far left of a page, and prints a single row of 1320 dots as it moves to the right.

the hammer-driving circuits cannot collectively accept simple raster-scan dot data like a video display unit. For example, as the print bar on a 132-hammer line printer moves from one extreme position to the other, each hammer passes across its exclusive 0.1-in. print area. Each hammer prints as a 0.1-in. mini-raster scan, but the print bar, viewed as a unit, appears as a conglomeration of 132 disjointed raster scans.

Dot-image data must be ordered to compensate for the print mechanism's physical geometry. If the print bar mentioned above covers 13.2 in. of paper at a dot density of 100 dots/in., the first 132 dots printed simultaneously as the bar passes across the first printable position are those numbered 1, 11, 21, ..., 1311. The next 132 dots printed simultaneously are numbered 2, 12, 22, ..., 1312. The final group of 132 dots will be numbered 10, 20, 30, ..., 1320. Fig 2 illustrates the printer mechanism and the various dot positions that can be printed.

The importance of hammer spacing

Spacing between print hammers on simple dot-matrix line printers is an exact or integral multiple of the printable horizontal character width. This lets the DGL be quite simple, and characters are not divided between adjacent hammers. Division between hammers can accentuate any alignment inconsistencies. In a simple printer, the ASCII-to-dot conversion and dot-sequencing algorithm are uncomplicated. No matter where the print bar is during a pass, all hammers print the same dot column of the characters at the same time. Each printable character is mapped through its dot-image ROM, yielding 8 bits. Then, based on the column being printed, 1 bit is extracted and passed to the hammer-driving electronics. All printers can easily print standard 10-pitch characters. It also follows that DGL could print 15-pitch characters if its hammers were spaced 0.2, 0.4, or 0.8 in. apart. It could print 13.3- or 16.7-pitch characters if its hammers were 0.3 in. apart.

An enhanced DGL is required to print character text at a density that does not explicitly fit the hammer spacing. In addition, dots from characters that are printed simultaneously can originate from different columns within the characters. Modulo arithmetic can supplement the logic required for the most simple case above. That would allow for processing

and simultaneous printing of, for example, the first column of the first character, the third column of the second character, the fifth column of the third character, and so forth.

Logic of greater complexity is required if the instantaneous character pitch is permitted to change within a print row. Although rare in existing line printers, this is required for printing proportionally spaced text, and for performing character kerning and a more efficient right-margin justification.

Proportional spacing requires variable-width characters. For example, the letter I is narrower than a W. Kerning goes a step further by selectively narrowing letter widths if adjacent characters can be squeezed close together. Right-margin justification adds blank characters between words on the print line. Variable-width blank characters can eliminate visibly irregular interword spaces by making all spaces appear equal. These features require either a dedicated microprocessor or more substantial arithmetic logic to track changing character widths and dot positions, and to send the dots in proper order to the print hammers.

The ASCII-to-dot conversion process is inefficient in DGL subsystems that do not include buffering for the entire dot-image row. Each byte-wide, dot-image ROM location can be accessed up to 8 times—1 bit at a time—along a print row. In the highest speed and/or highest dot-density printers, this can limit performance since the time between print strobes (hence the dot-image generation time) is relatively short. A RAM buffer that stores an entire line of dots is included sometimes to allow storage of the 8 useful bits from each ROM access. The RAM's logic can be complex because the number of hammers on a bar, the range of dots for each hammer, the character width, and the printer's horizontal dot density are rarely exponents of 2, which is preferred.

A raster-scan system for printing

If an impact printer mechanism could accept raster-scan data, the DGL would be very simple. A large shift register with a storage cell for every dot and a tap to drive every hammer has this capability. The shift register can be clocked on each hammer activation, bringing the next printable set of dots to the taps in preparation for the next hammer sequence.

The shift register acts as an ideal and complete line buffer that complements the geometry of the print bar exactly. The DGL builds the row of dot-image print all at once, so no duplicate accesses of the character-set ROMs are required. With progressive LSI technology, such a shift register, fabricated in low cost MOS, is easily built.

To hold down system cost, the shift register should be as small and inexpensive as possible.

In operation, the DGL's algorithmic state machine fills the shift register with the exact data image to be printed during the next pass of the print bar. Either a single-direction or bidirectional register can be used. A single-direction register, however, must be filled differently for each direction the bar travels. Both types require a tap multiplexer or tap gathering bidirectional output shift register to compensate for the direction of bar travel.

To hold down system cost, the shift register should be as small and inexpensive as possible. By folding a large, but less complex, single-direction main shift register together with a small, but more complex, bidirectional shift register into a custom LSI design, the number of package pins can be limited to 14.

Multiple 8-bit TTL single-direction shift registers adapt well to the LSI device's serial output and can be used to control the hammer-driving electronics, as shown in Fig 3.

Assume that the 12 characters in Fig 4(a) are to be printed on the left side of the paper. The text will be printed at 10-pitch if each character is 15 dots wide and the print rate is 150 dots/in. If a 33-hammer print bar prints the next dot row from right to left, the main shift register (Fig 3) must be filled and the output shift register shifted as shown in Fig 4(a). The hammers begin the pass just to the right of D, H, and L, as shown. If the bar prints from left to right, the main shift register must be filled in reverse, and the output shift register shifted with the hammers beginning the pass just to the left of A, E, and I, illustrated in Fig 4(b).

DGL processing begins with the information held in its buffer RAM. Assume that the left-most character on the print row is always stored at address 0 and character ordering follows upward (higher addresses). Assume further that the ROMs hold the character-set dot images. Since each character image can be up to 15 dots wide, 2 bytes representing one dot row are packed, one after the other, in the ROMs. Byte 0 stores the right-most bits (dots) and byte 1, the left-most bits. The general ASCII-to-dot conversion algorithm that yields the results in Fig 4 can be summarized by the following examples.

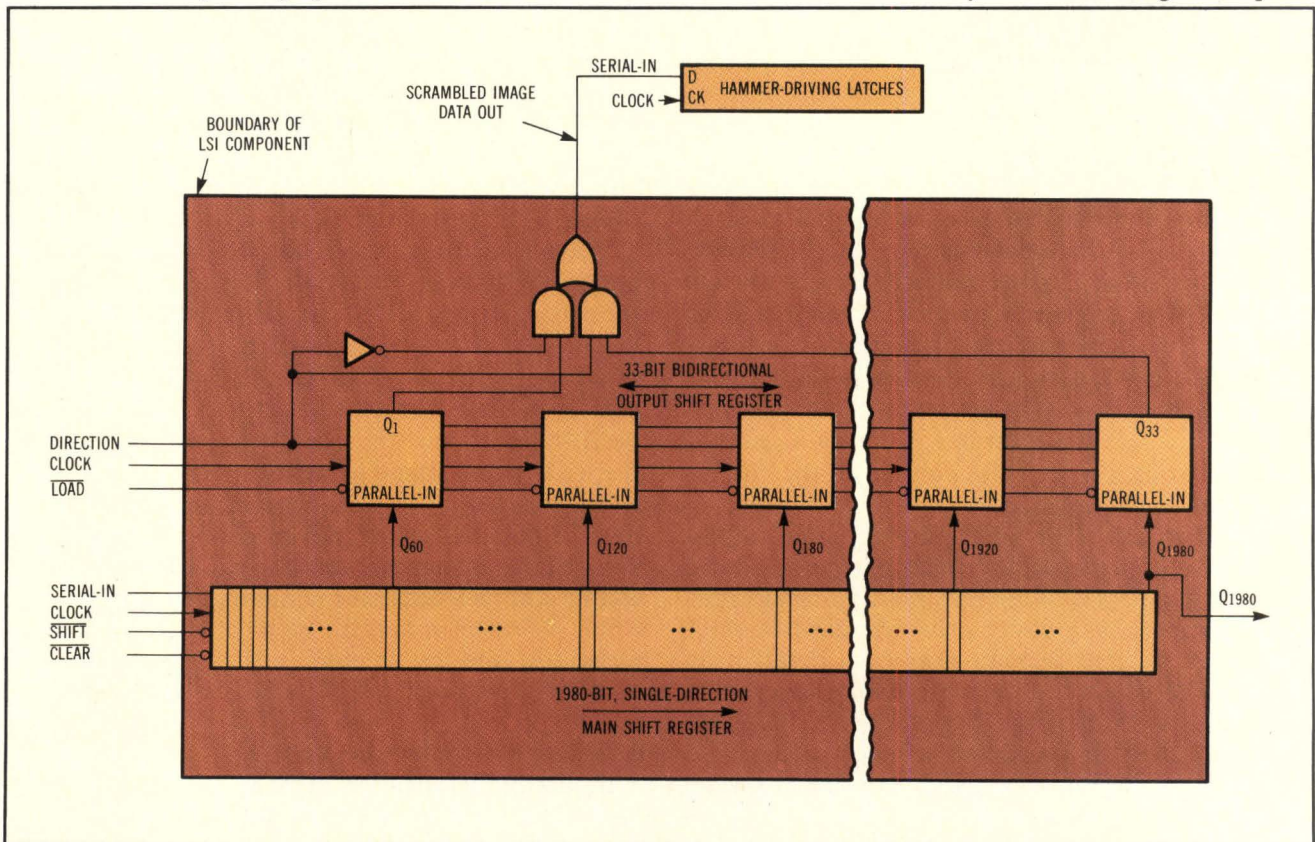

Fig 3 This 1980-bit LSI shift-register component supports a 33-hammer line printer at 150 dots/in. The hammers, 0.4 in. apart, can reach and print 60 dots. A 33-bit bidirectional shift register supports the main register and compensates for the print-bar direction.



D-Subminiatures

Connectors – Contacts – Backshells – Hardware – Applicators
Maximum EMI/RFI Shielding – Minimum Noise

Malco offers you the latest technology in high quality D-connectors and shielded cable components. A complete family of metal shell D-subminiature connectors, contacts, backshells, hardware and applicators is available for applications requiring effective EMI/RFI shielding. The Malco connector system is ideal for telecommunications, computer/peripheral, industrial and datacom applications.

Malco's contacts are stamped and formed, crimp type, available in loose piece and reeled form, selectively plated, in two contact configurations for #24-28 and #20-24 gauge wire applications. The family of backshells include plastic, die cast, metal insulated, and metal backshells, and provide the latest in shielding technology. The Malco family of 'D' hardware consists of the highest quality industry standard posts, slide locks and jackscrews. Malco offers you a full line of application equipment, including a State-of-the-Art semi-automatic stripper-crimper, heavy duty and economy hand tools, and insertion/extraction tools.

Interfacing with industry standards is easy with Malco's D-subminiature product family because they have been designed to intermate with all existing D-subminiature connectors. Both the connectors and contacts are designed to be intermateable, intermountable and interchangeable with the AMP HDP-20 series. Malco products meet all applicable industry standards and are UL listed. The 376-series D-

subminiatures are designed to comply with RS-232C, RS-449, IEEE Project 802 and other Industry & Networking Standards.

For maximum shielding with minimum noise, Malco's (patent applied for) metal and metal insulated backshell systems offer you the best EMI/RFI/ESD isolation at the lowest applied cost. This unique, highly reliable system has been designed to exceed the requirements of FCC Docket 20780, VDE, and Tempest for most applications. This single-piece easy to install approach offers you a streamlined, aesthetically pleasing, worry free shielding system. Malco's crimp applied, grounded/shielded approach is unique and is tailored to work with your shielded cables in any size from .190 to .650 inch OD.

Additionally, Malco's metal port shields are available to cover both plugs and receptacles and offer you unprecedented shielding and protection.

Every component you need to make a cable assembly is available from Malco, including connectors, contacts, backshells, hardware and applicators. Malco's vertically integrated manufacturing facilities assure you of a product built to the highest quality standards available with on-time delivery. For additional information, literature, samples or a demonstration, call or write your local sales representative, distributor, or Malco, 12 Progress Drive, Montgomeryville, PA 18936. TWX 510-661-8206, (215) 699-5373.



A Division of
Microdot Connector
Group

Malco is dedicated to quality

CIRCLE 60

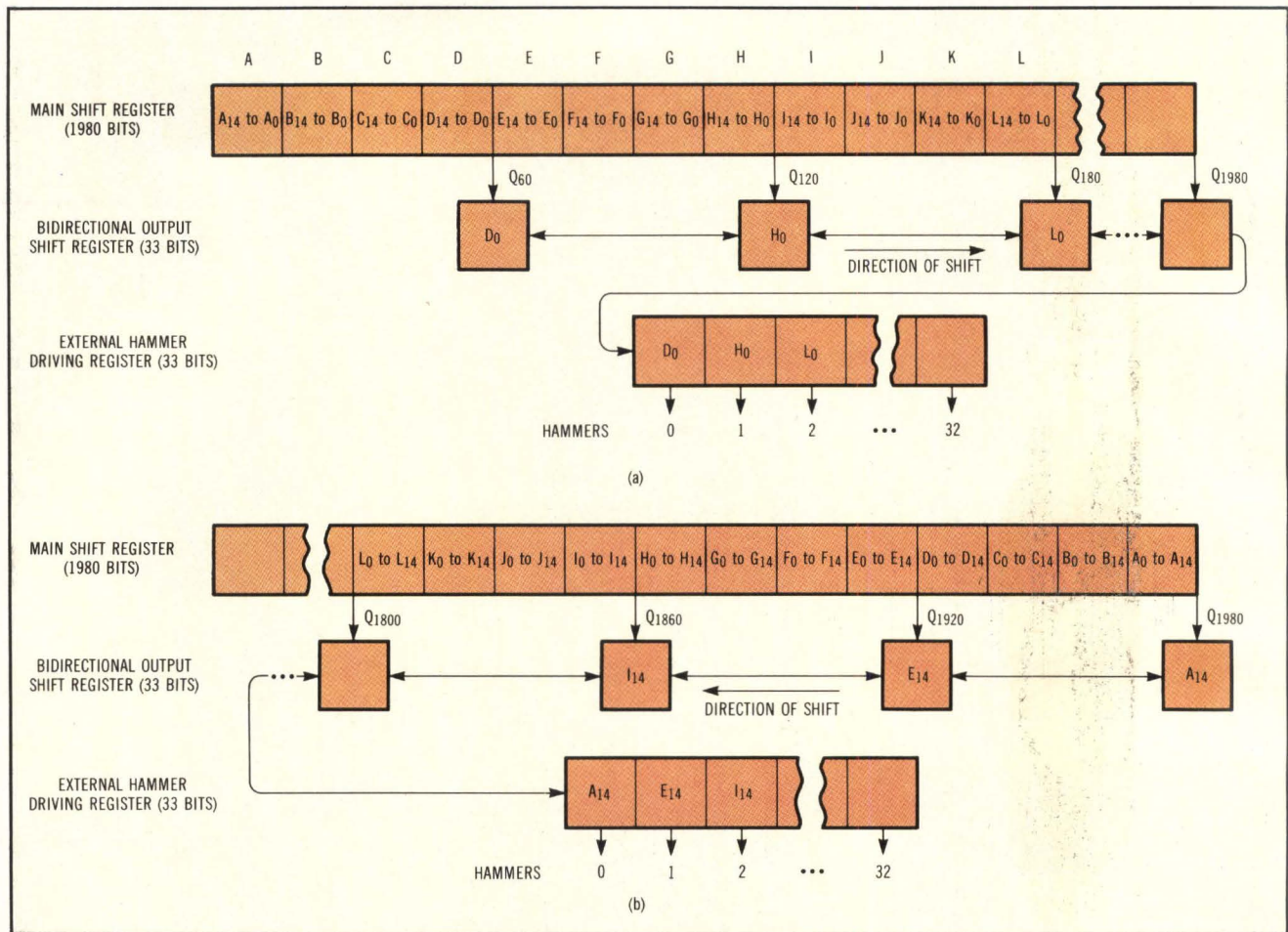

Fig 4 Each of the 12 characters above (a) is 15 dots wide and the printer prints at 150 dots/in. If the print bar prints from right to left, the hammers begin the pass just to the right of the D, H, and L. When the main register is filled, the output register is shifted (b). If the print bar moves from left to right (hammers begin the pass just to the right of A, E, and D), the main shift register must be filled in the reverse order, and the output shift register is shifted.

If the print bar prints from right to left, characters in buffer RAM are addressed from the highest possible address down to 0. Dot-image bytes in the character-set ROMs are then accessed in order—0 to 1—while first shifting in the LSB (ultimately, the right-most dot on the paper) of each byte. This continues for all characters until the last character (left-most on the paper) at RAM address 0 is completely processed.

If the print bar prints from left to right, with the main shift register clear, a dummy 1 bit is injected as a termination flag. Characters in the buffer RAM are addressed from 0 upward. Dot-image bytes in the character ROMs are accessed from 1 to 0, shifting the MSB (left-most on the paper) of each byte first. This continues for all characters until the termination flag leaves the end of the register. If the buffer RAM is filled with variable-width characters, the termination flag provides the easiest way to know when the bits of the first character reach the precise end of the main register.

Using a more complex bidirectional main shift register, the algorithm would operate as though the print bar always traveled right to left, except that

the register would be filled from its other end in the true left-to-right direction. Other algorithm changes include the absence of a termination flag, but the end result would be the same as in Fig 4.

After the main register is loaded and the turnaround interval complete, each print strobe generated by the dot-position detector should parallel-load the output shift register and then shift the main register by 1 bit. The next 33 clocks to the output register should pass the register's contents to the external hammer-driving shift register. These bits represent the dots to be printed on this strobe.

Implementing a fill algorithm

Fairly elementary DGL can support a full-featured 150-dot/in. printer. It can offer popular fixed-character pitches such as 10 (width = 15), 15 (width = 10), and 16.7 (width = 9). With intelligent computer or control-microprocessor firmware, features such as proportionally spaced characters, kerning, and a more smooth right-margin justification can be completed.

Assume the buffer RAM holds 512 bytes, divided into 256 character text entries, each 2 bytes. The

**SUDDENLY
THE TAPE
CONTROLLER
IS
OBSOLETE.**

SPECTRA LOGIC

first byte is the 7-bit ASCII code; the second byte is the character-set ROM number in the upper 4 bits and the character width in the lower 4 bits. This allows for 16 selectable character sets and character widths up to 15 bits (dots) wide. ASCII blanks can fill much of the buffer. Fig 5 illustrates a logic system that implements such DGL. The shift register fill algorithm for the system is shown in Fig 6. Each of the seven states in Fig 6 operates in the following manner.

Fairly elementary dot-generation logic can support a full-featured 150-dot/in. printer.

State 0, for example, is the normal nonprocessing state. At the start of the print-bar turnaround period, the control microprocessor updates the dot-row number and passes other relevant data to the DGL. Then, it commands the DGL to convert the characters from buffer RAM into dots for the main shiftregister. Inserting the termination flag into the main register is state 1, if the print bar is to travel from left to right. State 2 draws byte 1 from RAM and stores the character-set number into its register, the width into counter 0 and, depending on the bar

direction and how the dot-image bytes are to be serialized, either the width itself or 0s into counter 1.

In addition, state 3 draws byte 0 from RAM and stores it into the ASCII character latch. Counter 0 is decremented to set it up properly for state 5. Moreover, state 4 prepares counter 1 to be the correct value to drive the parallel-to-serial multiplexer, while state 5 is the workhorse state that passes a dot into the main register. The latter is executed successively as many times as the character is wide. This is indicated by the character-width counter reaching 0. Row processing is complete if the termination flag appears.

Finally, state 6 checks for a terminal value of the RAM addressing counter. This is 0 or FF, depending on the print-bar direction. This is an alternative way to indicate completion of a dot row. The addressing counter is either incremented or decremented, depending on bar direction, to address the next character in the buffer.

Higher density and multiple-pass character text can be processed with this procedure. Direct raster-graphics processing requires that dot-image graphics data in buffer RAM be passed directly to the parallel-to-serial multiplexer and not through a character-set ROM.

Variable dot-density capability can be added to the DGL. This accommodates the applications in which a dot density less than the maximum

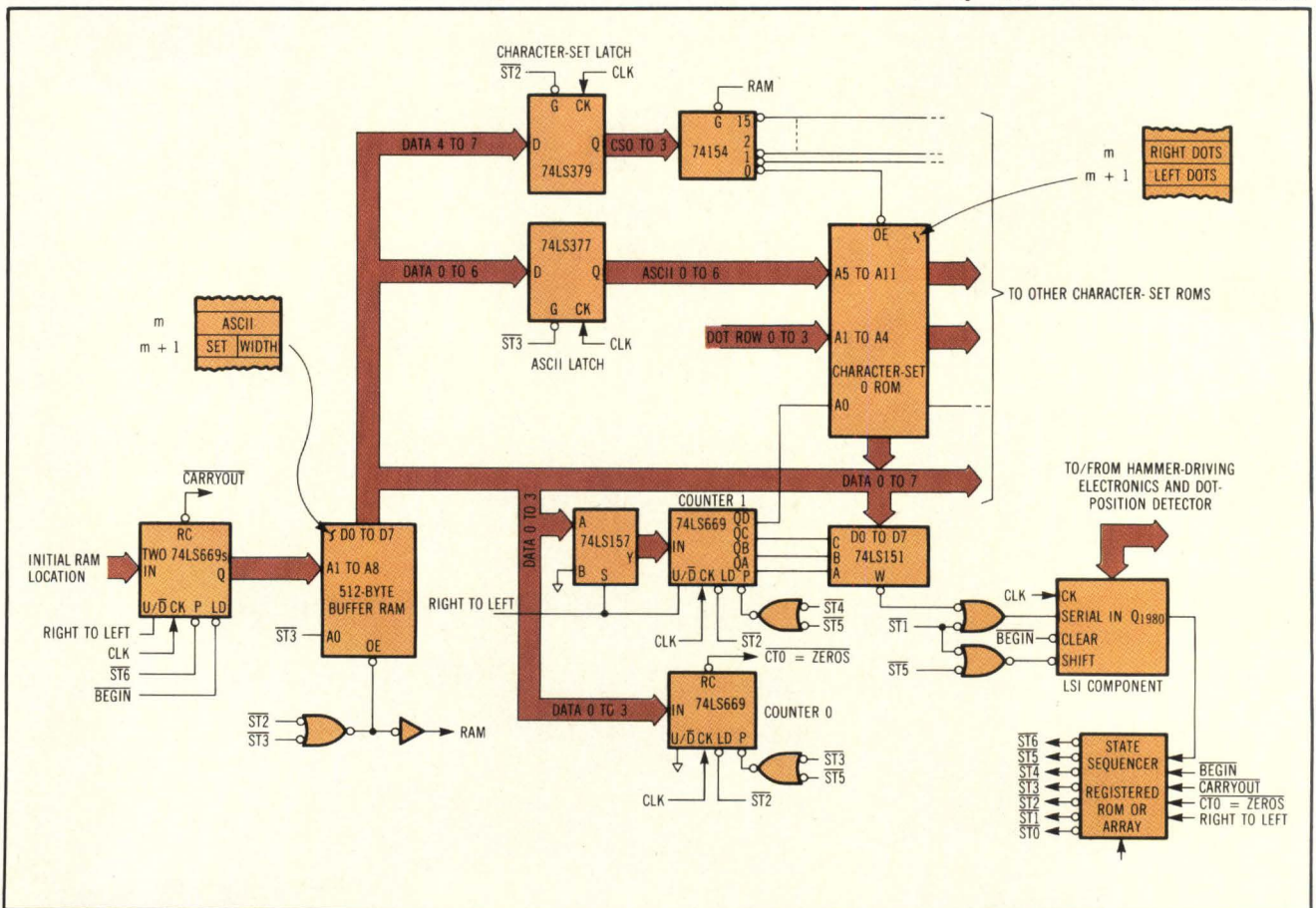

Fig 5 A simplified DGL schematic excludes circuitry needed by the control microprocessor to load the buffer RAM and other support circuitry. However, implementing a full-featured DGL for an impact line printer may require only a handful of common TTL devices.

HOW TO DOUBLE YOUR CONTROL WITHOUT DOUBLING YOUR CONTROLLER.

If your plans for controlling disk and tape drives call for two boards and two CPU slots, you can now cut your plans in half.

And use the SPECTRA 25 LSI-11 emulating multifunction controller instead. You'll get all the control of separate disk and tape boards in just half the space. Half the slots. Half the spares. While using less power.

SPECTRA 25 is the smarter way to handle SMD/Winchester and 1/2-inch tape drives, and it's the first and only multifunction controller designed for DEC Q-BUS® computers.

Its block-mode data transfer capability can increase your throughput by up to 50%. And it performs Error Correction Code (ECC) independently of the operating system. All 32 bits worth.

SPECTRA 25 fully emulates DEC's RM02/5 and RM80 disk subsystems, and TS11 tape subsystem. It can run two SMD disk drives and four tape drives, in any combination. Plus an E²PROM lets you easily reconfigure while the controller is in your system.

But SPECTRA 25 puts something else in your system, too: proven reliability. Because you're working with half as many parts and pre-tested ICs.

You're also working with excellent documentation that's regularly updated. And the most comprehensive one year warranty in the industry. All backed by responsive nationwide service.



SPECTRA 25 is the multifunction controller that doubles your control. And your advantage on the competition.

Before you look at Emulex or Dilog, consider the SPECTRA 25 from Spectra Logic.

It could be all the controller you'll ever need. For further information on our expanding family of controllers for DEC Q-BUS and UNIBUS® computers, call or write us today.

	SPECTRA 15*/ SPECTRA 25	SPECTRA 111*/ SPECTRA 121	SPECTRA 12*/ SPECTRA 21
BUS	Q-BUS (Block-mode)	UNIBUS	UNIBUS
Disk Emulation	RM02/05, RM80, RP06 (2 drives)	RM02/05, RM80, RP06 (4 drives)	RK06/07 (4 drives)
Tape Emulation	TS11 (4 drives)	TS11 (4 drives)	TS11, TM11 (4, 8 drives)
Disk Transfer Rate (SMD)	2.0MB/sec	2.0MB/sec	2.0MB/sec
Configurable On-Line	Yes	Yes	No
*Single function disk controller			

Spectra Logic Corporation, 1227 Innsbruck Drive, Sunnyvale, CA 94089, (408) 744-0930, TWX 910-339-9566, TELEX 172524 SPL SUVL. International Sales Office: Belgium (32) (2) 5134892.

SPECTRA LOGIC

The Multifunction Controller Company.

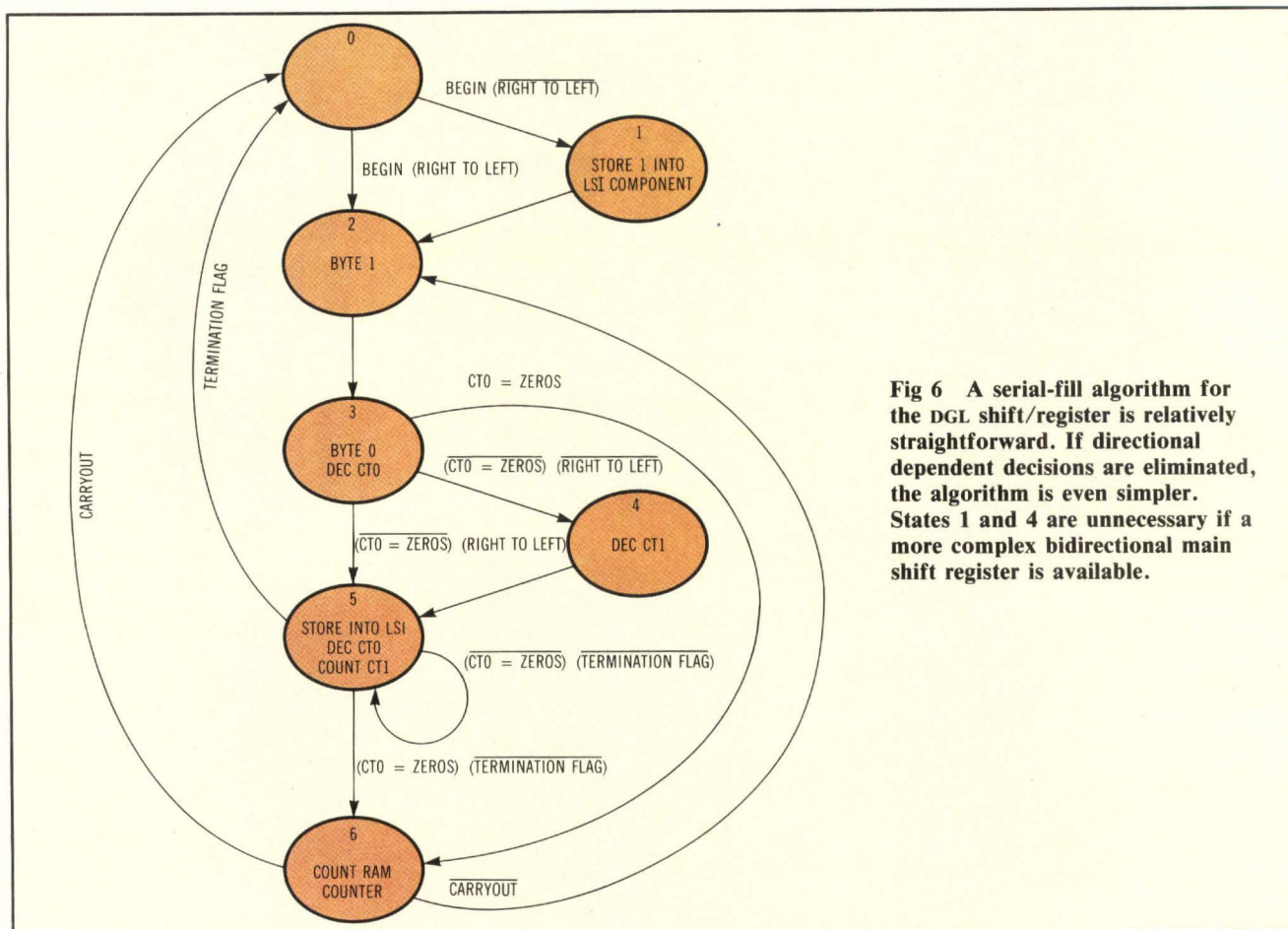

Fig 6 A serial-fill algorithm for the DGL shift/register is relatively straightforward. If directional dependent decisions are eliminated, the algorithm is even simpler. States 1 and 4 are unnecessary if a more complex bidirectional main shift register is available.

established by the design of the main register is desired. But, this requires additional logic and a supplementary counter programmed with a value that can interrupt the fill algorithm of Fig 6 after the programmed number of printable dots passed into the main shift register.

Assuming a hammer spacing that is an integral multiple of 0.1 in. permits the printer to operate under program control at any multiple of 10 dot density (eg, 70 dots/in.) on a line-by-line basis. Dummy fill bits, whose number is simply the difference between the programmable value and the number of dots per hammer at maximum density, can be injected periodically to pad the main shift register. For example, if the maximum dot density is 150 dots/in. in a 33-hammer printer, and a 70-dot/in. density is desired, the new programmed counter will be 28 (ie, 28 dots in 0.4 in.).

For every 28 printable dots passed to the main register, 32 dummy bits follow, resynchronizing the printable dots to a 60-bit (0.4-in. when printed) intertap boundary. This padding process ensures that at the completion of main-register filling, the valid printable bits are directly beneath the taps in the main register. The dot-position detector generates the properly timed number of strobes equal to the programmed value in the new counter.

The 2772-bit LSI shift register used in the 2563A and 2566A printers packs the machines with enhanced

features. Both printers have programmable dot densities. The highest density—210 dots/in.—is used for common 10-pitch text (with a 21-dot wide character) and for the planned additional feature of proportionally spaced text. Compressed 16.7-pitch text is being adopted by users who need 132 characters printed in less than 8.5 in. of paper. Since there is no character width that exactly yields this pitch at 210 dots/in., the dot density is changed to 200 dots/in. Thus, a width of 12 dots forms a character of the proper size.

Graphics printing is performed at 70 and 140 dots/in. The readability of optically scanned bar codes is very sensitive to the difference between the narrow or wide and light or dark bars. Dot size and dot density affect the regularity. For the expected nominal dot size of these printers, special bar-code dot densities of 100 and 110 dots/in. are used to meet military standard specifications.

Please rate the value of this article to you by circling the appropriate number in the "Editorial Score Box" on the Inquiry Card.

High 710

Average 711

Low 712

ONE BOARD GIVES YOU CONTROL FROM BOTH ENDS.

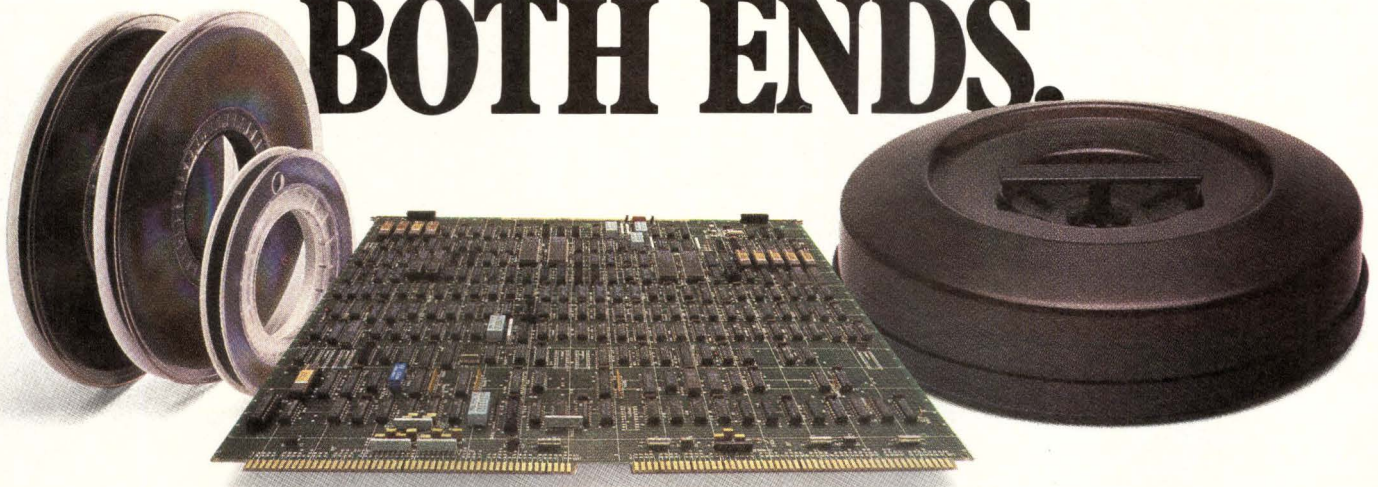

Looking at disk and tape control for Data General? You're probably looking at two separate controller boards. Which is one too many.

Spectra Logic multifunction controllers offer all the control you need, on just a single board. They're the smarter way to handle SMD/Winchester and 1/2-inch tape drives, because they've got you covered from both ends. But they do it in half the space and half the slots. Using half the power. And you're stocking half the spares.

So now buying separate boards for disk and tape makes no more sense than buying separate radios for AM and FM.

Our expanding family of Data General controllers offers you the performance you're looking for. We'll give you both ends for DG's NOVA® and ECLIPSE®/MV computers. And emulate DG's series of 6060 or 6160 disks and 6020 tape subsystems under RDOS, AOS, IRIS®, and BLIS/COBOL® without modifying your operating system.

But we'll also give you something extra: proven reliability. Because you're working with half as many parts and pre-tested ICs. Plus total FCC compliance and compatibility with DG's new hardened chassis.

You're also working with excellent documentation that's regularly updated. And the most comprehensive one year warranty in the industry. All backed by responsive nationwide service.

Spectra Logic. Our multifunction controllers double your control. And give you an advantage on the competition.

Look into Spectra Logic multifunction controllers for Data General computers. They could be all the control you'll ever need.

For further information, including complete technical specifications, call or write us today.

	SPECTRA 17*/ SPECTRA 27	SPECTRA 110*/ SPECTRA 120	SPECTRA 10*/ SPECTRA 20
BUS (Disk)	Burst Multiplexor Channel	Data Channel	Data Channel
Disk Emulation	606X, 6122, 6160, 6161 (4 drives)	606X, 6122, 6160, 6061 (4 drives)	606X (4 drives)
Tape Emulation (Data Channel)	6021	6021	6021
Operating Systems (without OS patches)	RDOS, AOS/V5	RDOS, AOS	RDOS
Disk Transfer Rate (SMD)	2.0MB/sec	2.0MB/sec	2.0MB/sec
Supports FCC Chassis	Yes	Yes	No
*Single function disk controller			

Spectra Logic Corporation, 1227 Innsbruck Drive, Sunnyvale, CA 94089, (408) 744-0930, TWX 910-339-9566, TELEX 172524 SPL SUVL. International Sales Office: Belgium (32) (2) 5134892.

SPECTRA LOGIC

The Multifunction Controller Company.

©1984 Spectra Logic Corporation

See us at NCC, Booth No. 2122

CIRCLE 62

High Voltage Low Anxiety

© 1983 Quantum Corporation

me.
ety.

The only surprises you'll get with Quantum disk drives are pleasant ones.

Consistently excellent performance.

Quality and reliability you can count on to keep systems up, anxiety down.

Low Cost.

And the best surprise of all: we can deliver all the medium-capacity Winchester drives you need. Now. 8" drives, from 10 to 85 megabytes. 5¼" drives, from 20 to 40 megabytes.

Quantum Corporation,
1804 McCarthy Boulevard,
Milpitas, CA 95035. Eastern
Regional Sales Office: Salem,
NH, (603) 893-2672. Western
Regional Sales Office: Santa
Clara, CA, (408) 980-8555.
International Sales Office:
Milpitas, CA, (408) 262-1100.
TXW: 910 338-2203.

QUANTUM

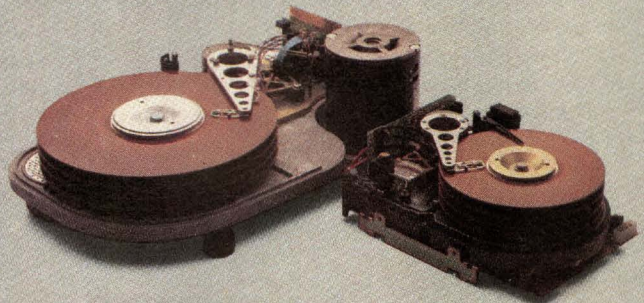

How can you develop one system and offer your customers a choice of three?

Simple. Develop it around HP's new three-in-one microsystem. That way, you don't have to redesign your system to offer your customers a range of performance. Because the entire power range of HP's new A-Series computers fits into the same small, convenient package. At a slimmed-down starting price of \$6110*

So you can offer 1 MIPS performance. Or floating point hardware and microprogramming in either a 1 MIPS or 3 MIPS computer. Whichever one your customer chooses, you can fit it easily into the same space in your system.

Identical software keeps it simple.

When you change processors, you don't have to go back to the drawing board with your programs. Because, in addition to compatible hardware, these computers run identical software. That's the best kind of compatibility you can buy.

Our A-Series family consists of the Micro 26, Micro 27 and

Micro 29. The Micro 26 comes with integrated 14.6 Mb mini-Winchester disc and microfloppy. And it has 8 I/O slots, giving you plenty of room for our wide selection of I/O cards for instruments, measurement and control, and data-comm, to name a few.

The Micro 27 adds floating point hardware and microprogramming. And, for jobs needing up to three times the power, our 3 MIPS Micro 29 has got what it takes.

Our brand new operating system really performs.

That's one secret of our success. The new, full-function RTE-A real-time operating system provides the performance you need for your real-time automation applications. Ranging from dedicated machine control to monitoring instruments to supervising a network of computers.

This power, speed and I/O capacity also make our

A-Series systems ideal for multi-user, multi-tasking environments.

Of course, these compact new computers are part of our newly expanded OEM program. This includes higher discounts and credits, extended warranties and free training. So you'll make more when you get to market. And you'll also get there faster with our new operating system and newly packaged microsystems.

If you'd like micro, mini or maxi performance in one micro package, call your local HP sales office listed in the white pages of your phone book. Ask for a technical computer representative. Or write for more information to: Hewlett-Packard, Attn. Greg Gillen, Dept. 11171, 11000 Wolfe Road, Cupertino, CA 95014. In Europe, write to Henk van Lammeren, Hewlett-Packard, Dept. 11171, P.O. Box 529, 1180 AM Amstelveen, The Netherlands.

*A600+ microsystem component, 128Kb memory, box, Winchester disc.

Prices are U.S.A. list in OEM quantities of 100 and include integrated peripherals, one interface card, RTE-A and 512Kb of memory for Micro 26 and Micro 27. Micro 29 includes 768Kb of memory.

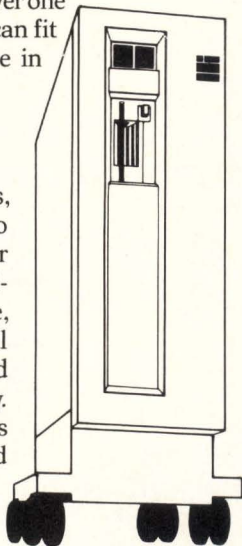

Our new microsystems also come in this floor-mount or bench-top models.

 **HEWLETT
PACKARD**

Micro:

1 MIPS for
\$7445

Maxi:

3 MIPS, plus floating
point hardware and
microprogramming, for
\$16,650

Mini:

1 MIPS, plus floating
point hardware and
microprogramming, for
\$13,140



Whatever the level of performance you pick, it fits in this little 7" x 19" x 25.5" package.

Quality 8 Inch Drives

From FUJITSU

Look no further. Because anywhere you look, Fujitsu America covers your needs for quality, high reliability disk drives.

Broad selection—choose from four different drives with capacities ranging from 24 to 168 megabytes.

Rotary voice coil or Stepper actuator—whether you need high performance or economical drives, Fujitsu can provide either.

Fujitsu's rotary voice coil drives offer you high capacity, fast head positioning, and SMD transfer rates. Fujitsu's stepper motor drives offer you medium capacities and economy.

Unsurpassed quality—a Fujitsu hallmark. From design to final burn-in, every Fujitsu drive earns its 10,000 MTBF rating.

Field service support—access to Fujitsu America engineers and product specialists is as close as your telephone.

For more information on the Fujitsu line of 8-Inch Quality Drives, contact the sales office nearest you. Northwest: (408) 946-8777, Central: (612) 835-7025, East Coast: (617) 229-6310, Southwest: (714) 476-0852, Europe: 441/493-1138.



	STANDARD	HIGH PERFORMANCE	
CAPACITY (M Bytes)	24/48	84	168
AVG. POSITIONING TIME (ms)	70	20	20
TRANSFER RATE (M Bytes/s)	1.2	1.22	1.22
INTERFACE	SA4000	SMD	SMD
POSITIONING METHOD	Buffered Stepper	Rotary Voice Coil	Rotary Voice Coil

STORAGE PRODUCTS DIVISION

Quality Lives



CIRCLE 65

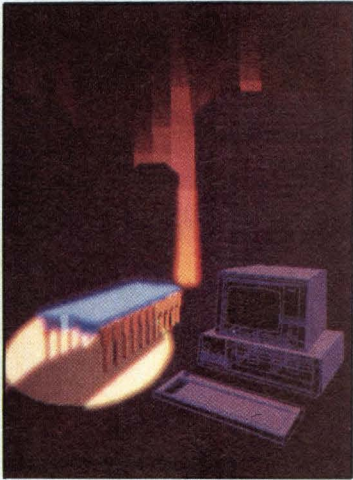

Special report on microprocessors/microcomputers—Part I

123 Introduction

125 Architectural advances spur 32-bit micros

by John Bond—With promised advances that vary from evolutionary to revolutionary, most of the long-awaited 32-bit microprocessors remain long awaited. Only two are actually available for designers.

143 Thirty-two bit micro supports multiprocessing

by Pete Wilson—Combining processor, memory, and I/O in a 32-bit RISC-like, single-chip architecture allows multiple microprocessors to work in parallel.

157 CMOS micros enter the mainstream

by Walter J. Niewierski—The technology of choice for future 32-bit microprocessors is CMOS. In fact, current 8- and 16-bit CMOS microprocessors already offer features that are unavailable in NMOS.

173 How to port Unix to a new microprocessor

by Nai-Ting Hsu, Glenn Skinner, and Jay Zelitzky—CPU architecture has a significant effect on the process. Compromises must be made between the capabilities of the chip and the purity of Unix.

187 Microprocessor design supports multitasking

by Paul Wells—Hardware segmentation corresponds to modular software, easing design of current applications.

A BIG CHANGE THAT HASN'T CHANGED OUR PRODUCTS IS OUR NEW NAME.

GENICOM



Normally, you might not trust a product with a new name. But while all of our products have a new name, they also have a proven history of quality and reliability.

That's because Genicom was formerly the Data Communication Products Department of General Electric. Now an independently owned company, Genicom will continue the same product line we established with GE...only the name has changed.

Our Genicom 3000 family, for instance, still offers the same performance features already preferred by users and the design flexibility so important to OEM's, distributors, retailers and dealers. Speeds from 40 to 400 cps. Single or dual mode printing. Type quality from EDP to NLQ. Multi-color printing. Graphics. Selectable type fonts, American craftsmanship and more.

Of course, we'll also offer Genicom 2000 tele-

printers and the soon to be introduced 4000 shuttle matrix printers. You'll find we have the same complete product line that we had with GE. We have the same corps of experienced employees, the same facilities, and the same nationwide service network.

But above all, we have a new commitment to excellence. Which means, while we continue to serve existing customers with established products like our 3000 family, we plan to introduce more products to meet growing needs.

At Genicom, we've changed our name and we're planning to change the future with more innovations, and more of the quality you've come to expect from us under any name.

Genicom Corporation, One General Electric Drive, Dept. M321, Waynesboro, VA 22980. In Virginia, call 1-703-949-1170.

GENICOM

For the solution to your printing needs call
TOLL FREE 1-800-437-7468

See us at NCC Booth #3308

CIRCLE 66

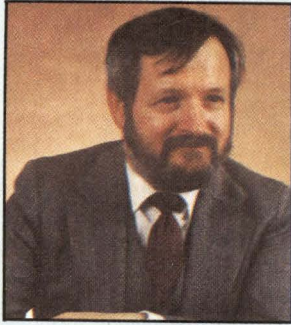

SPECIAL REPORT ON **MICROPROCESSORS/ MICROCOMPUTERS—PART I**

The ubiquitous microprocessor has changed the entire electronics industry. In particular, its effect on computer systems has been amazing. The CPUs of mainframes and superminis have, so far, seemed immune to the micro invasion—but the introduction of 32-bit microprocessors is about to change that. Two such microprocessors are already here, and more are scheduled for late '84 and early '85 introductions.

The new generation of microprocessors is heavily influenced by the architectures of existing mainframes and superminis. This is because they are aimed at the same jobs. Thus, the micros support large physical memory, virtual addressing, high level languages, hardware floating point operations, and large operating systems. They offer most of the software advantages of larger computer systems.

At least one of the new micros can emulate the instruction sets of midrange mainframe computers through its external microprogrammability. Another has a unique architecture that allows multiprocessing. A more common approach is the evolutionary extension of existing 16-bit chip architectures. This evolution includes 32-bit instructions, data types, addressing modes, registers, and data paths. In some instances the process has been made easier because the original 16-bit chips were designed from the outset with 32-bit features or with the extension to 32 bits in mind.

Meanwhile, CMOS has become the technology of choice for this new microprocessor generation. Not only does CMOS offer the lower power consumption that paves the way for the needed chip density, it also permits features unobtainable in NMOS. As proof, many of these unique features are already available in 8- and 16-bit CMOS designs.

Software, of course, is a major issue for micros. The hardware has been designed to support multitasking, to permit easy compiler development, and to allow Unix and other complex operating systems to be easily ported to the new chips.

John Bond

John Bond
Senior Editor

ROCKWELL SEMICONDUCTOR TECHNOLOGY BREAKS THE CMOS SPEED BARRIER.

Led by the R65C02 microprocessor, Rockwell's R65C21, R65C24, R65C51 and R23C64 are the latest members of our high-speed, low-power CMOS family.

500 ns instruction time is our CMOS microprocessors' record-breaking speed—two times faster than NMOS—with power consumption of only 80mW. And now Rockwell International offers peripheral devices such as the R65C21 (PIA), R65C24 (PIAT) and the R65C51 (ACIA) for your system design.

Our low-power, high-speed combination is not all you get from Rockwell's CMOS; you also get latch-up immunity, a bit manipulation and byte operation instruction set, power and temperature variance toleration, low noise generation, high noise immunity and a small die size. All these features combine to save you design time, lower your costs and improve system performance.

If all that doesn't convince you, write on your letterhead for a free sample of our R65C02 CPU.

(It's pin- and bus-compatible with the popular R6502). Using is believing.

For your high-speed CMOS storage, we're accepting codes now for our R23C64 CMOS Static ROM. This 64K ROM has an access time of 150 ns and consumes only 10mW active, 50 μ W passive. With 24-hour code approval and competitive lead times, too, you won't find CMOS any faster.

Find out how our breakthrough CMOS family can perform for you. Contact your local Rockwell distributor or sales representative today.

Rockwell Semiconductor Products Division

Rockwell International, P.O. Box C,
MS 501-300, Newport Beach,
CA 92660. Call Toll Free
(800) 854-8099. In California,
(800) 422-4230.



Rockwell International

...where science gets down to business

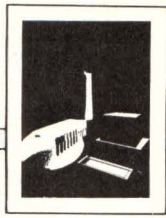

ARCHITECTURAL ADVANCES SPUR 32-BIT MICROS

With promised advances that vary from evolutionary to revolutionary, most of the long-awaited 32-bit microprocessors remain long awaited. Only two are actually available for designers.

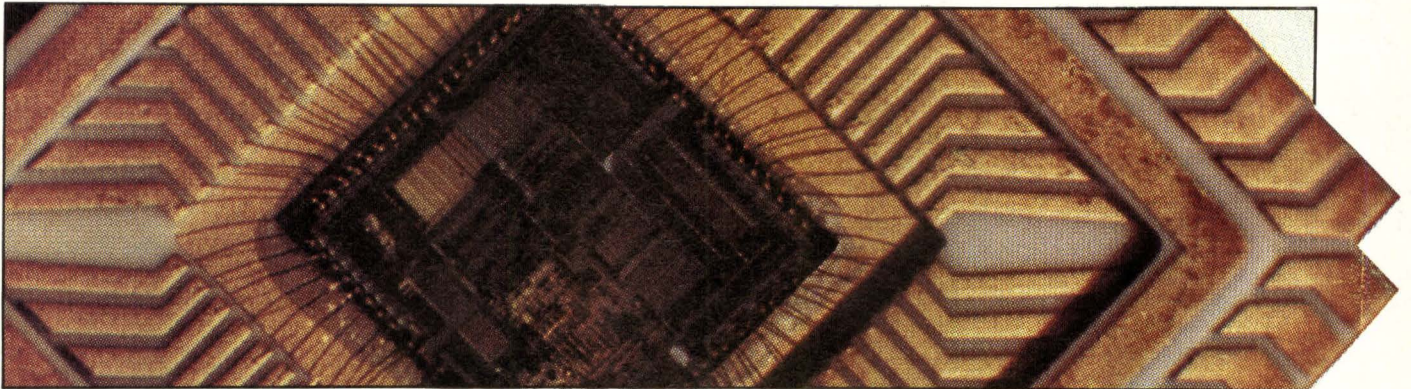

by **John Bond,**
Senior Editor

The stampede of 32-bit microprocessors, promised for 1984, has slowed to a walk. Despite promises in the trade press, most of these 32-bit chips will not be available before the end of the year and it will be 1985 before the industry sees production quantities. The complex architectures and advanced process technology that make such chips possible have also conspired against manufacturers' schedules. Not only must chip designers deal with a new, more complex chip design but, in some instances, a change in process from NMOS to high speed CMOS. Often, the design must proceed concurrently with the design of floating point or other coprocessor chips. The result is an enormous drain on manpower and sophisticated computer aided design tools, leading to missed schedules. Despite that, successful designs

have been completed, and at least two of these are currently available on the market. Those not yet ready may be worth waiting for because of their sophisticated architectures or because of software compatibility with existing microprocessor families.

Some promise, some deliver

At present, there are only two 32-bit microprocessors actually available on the market. They are the NS32032 from National Semiconductor Corp (Santa Clara, Calif) and the NCR/32 chip set from NCR Corp (Colorado Springs, Colo). The National chip is the newest member of the NS16000 family of 8-, 16-, and 32-bit data bus chips. Each has an internal 32-bit architecture and implementation, but only the NS32032 has a 32-bit data path to memory.

The NCR micro exhibits one of the most unique features of any chip or chip set either in production or promised. This micro consists of a set of four VLSI chips and two LSI chips, which together form a very powerful CPU. It is unique in its use of

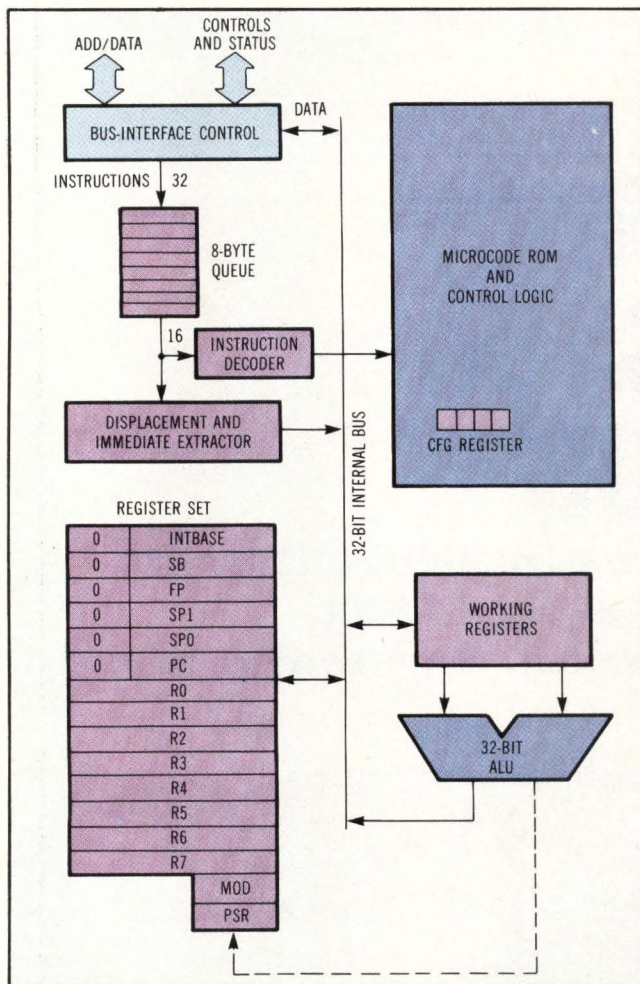

Fig 1 The NS32032 bus interface control unit makes 4-byte instruction transfers into an 8-byte queue. From there, instructions are decoded and passed to the execution unit. An intermediate preprocessor selects and runs microcode for address computation, operand fetching, execution, and result storage.

externally programmable microcode that enables the NCR/32 to emulate other computers.

There are at least two other 32-bit processors in production but they are not commercially available. One of these, Hewlett Packard's (Palo Alto, Calif) Focus, fabricated in 1- μ m NMOS, is probably the most advanced processor yet manufactured. It is used in the HP 9000 computer. The other chip is the AT&T Technologies Inc (New York, NY) WE32000, which was formerly the Bellmac-32. This 2.5- μ m CMOS chip is used in several AT&T products.

The second generation of that processor, the WE32100, was recently announced. Fabricated in 1.75- μ m CMOS, the new chip offers a threefold performance improvement over its predecessor. The chip uses a 64-word instruction cache and a new I/O controller that supports both multiprocessor and coprocessor architectures. Microcode is extensively changed to improve instruction cycle efficiency and take advantage of the separate address and data ports. A companion circuit, the WE32101 memory

management unit (MMU) is twice as fast as the original MMU. Both processor and MMU operate at 14 MHz and are packaged in 132-pin packages.

It once seemed likely that AT&T would offer the WE32000 commercially, but now the official line from the company is that they will not. Therefore, 32-bit system designers have only two choices at the present time—National and NCR. The microprogrammable NCR/32 is considered by NCR to compete primarily with bipolar bit-slice processors such as the AMD 2901. And that leaves the NS32032 out there alone as the only mainstream 32-bit microprocessor available in the merchant semiconductor market. It is helpful to compare its architecture and implementation with presently available 16-bit devices that have some 32-bit features.

Instruction sets influenced by VAX

While most 16-bit microprocessors were heavily influenced by PDP-11 architecture, National's NS16000 family was influenced by VAX. Initially conceived as a 32-bit architecture, it was first introduced in a 16-bit external bus version, the NS16032. Shortly thereafter, the NS32032 was brought out. It was essentially the same chip except for a 32-bit bus. Although the NS32032 could be claimed as the first full 32-bit implementation, earlier processors have had numerous 32-bit features. The Motorola 68000, for example, has 32-bit registers even though it is externally a 16-bit chip. Intel's 432 is another example of an innovative 32-bit architecture, although it has a 16-bit data path to memory.

Instruction sets have evolved in a similar way. Again, most 16-bit instructions were influenced by the PDP-11. The Zilog (Campbell, Calif) Z8000 also had some IBM influence with IBM-style string moving instructions. The VAX influence is most apparent in the NS32032 instruction set and addressing modes that provide high level language support. The chip's designers felt that in the future there would be much greater emphasis on high level languages, an approach common to all the new 32-bit designs. In addition to eight general-purpose 32-bit registers in the NS32032, several special-purpose registers support high level language addressing modes (Fig 1). For example, a stack pointer register handles temporary storage of intermediate results, a frame pointer allows access to parameters and local variables on the stack, and a static base pointer is used for global variables. Support of stack-based addressing simplifies implementation of reentrant procedures and is especially useful for block-structured languages such as Pascal.

Addressing is divided into four modes that are standard for microprocessors, and an additional five modes (Fig 2) that are used for high level languages. Addressing is uniform rather than segmented. All registers, and therefore all addressing modes, use the

same style of addressing. The advantage to this is that a compiler writer does not need a different type of code generation for static variables, local variables, or stack variables.

A major objective of the NS32032 design is to achieve good code using mediocre compilers. Since compilers take time to mature, programmers must often work with immature compilers, which generate mediocre code. To demonstrate this advantage, National engineers performed high level language benchmarks, using a new version of the company's own Pascal compiler. This was benchmarked against a 68000, running a Motorola (Phoenix, Ariz) Pascal that had been refined for years. The National Pascal ran about 47 percent faster. This occurred, not just because the National chip is better, but because it produces superior code from National's own, admittedly less mature, compiler.

National's 32-bit chip performs floating point operations in a slave processor (NS16081) that differs slightly from a coprocessor. The CPU stops when it sends an instruction (and possibly data) to the floating point processor (FPP) that performs the instruction. The FPP then sends back a response (and data, if required) and the CPU continues processing. The Intel 8087 and 80287 coprocessors work only with their appropriate Intel processors because, unlike the NS16081, they are more closely coupled to their processor chips. The National FPP will work with

other processors and, in fact, it is used in a number of 68000 applications. Because Intel has matched the pipelines of processors and coprocessors it makes for an efficient combination. But, it prevents the coprocessor from being effectively used with non-Intel processors. Using a slave processor also makes it easier to bring that function onchip when process advances permit it.

The NS16082 MMU is also a slave processor. The entire mapping of the logical address space is described by tables in memory and the MMU has automatic, direct access to those tables. The MMU maintains an internal cache of the 32 most recent translations. It updates the cache automatically when it gets a request for a page that is not in cache. It simply holds the processor, accesses the table in memory, gets the new translation, and continues. The whole process takes 2 μ s.

Because the NS16082 MMU is designed for demand-paged virtual memory and the NS16081 is available to support IEEE standard floating point operations, an entire system can reside on one board. This is an important consideration when designing low cost systems. The NS16000 series does not have onchip cache but does provide an instruction prefetch. Because the instruction set is designed with variable instruction size, however, instruction alignment is necessary. This does not slow the system because an instruction is always ready for execution in the 8-byte

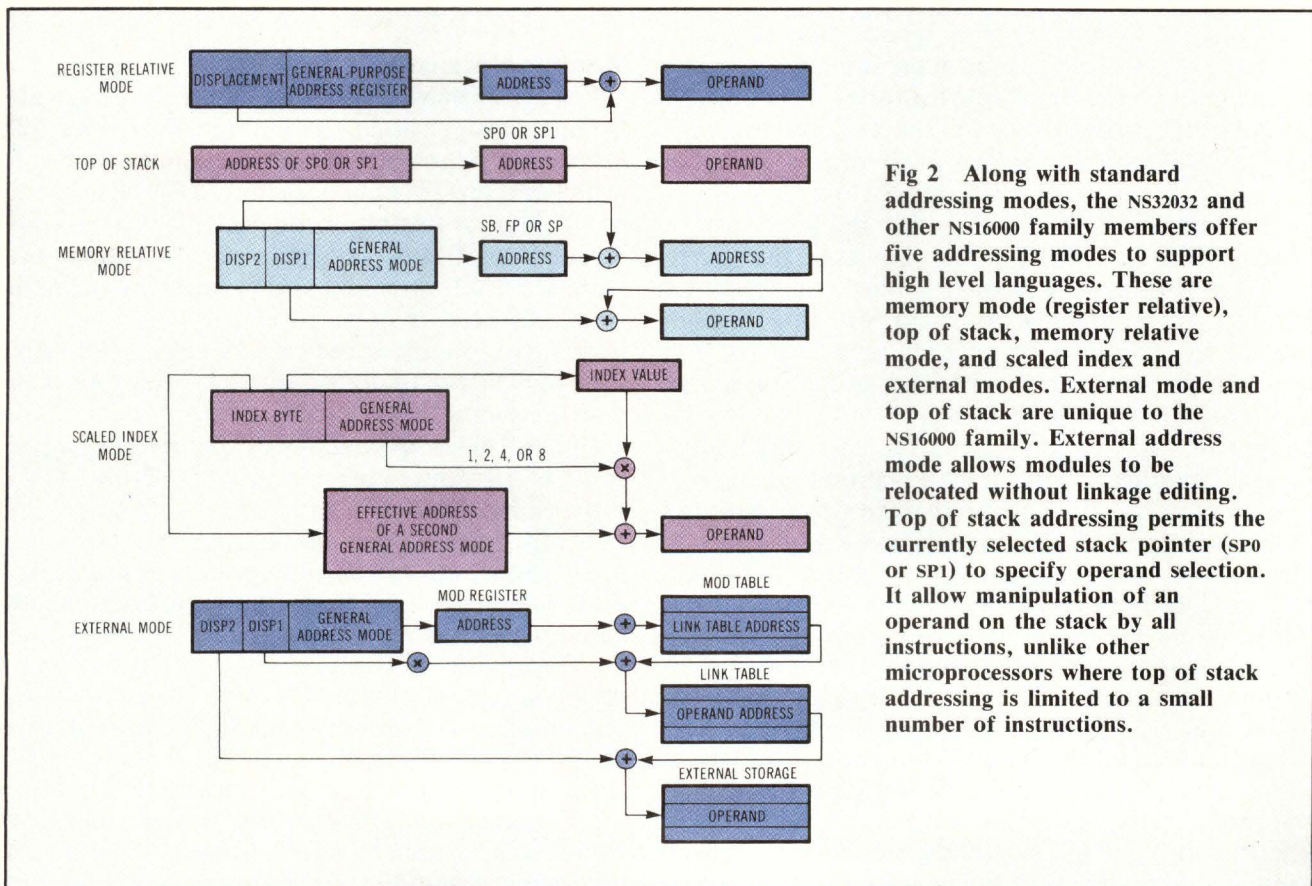

Fig 2 Along with standard addressing modes, the NS32032 and other NS16000 family members offer five addressing modes to support high level languages. These are memory mode (register relative), top of stack, memory relative mode, and scaled index and external modes. External mode and top of stack are unique to the NS16000 family. External address mode allows modules to be relocated without linkage editing. Top of stack addressing permits the currently selected stack pointer (SP0 or SP1) to specify operand selection. It allow manipulation of an operand on the stack by all instructions, unlike other microprocessors where top of stack addressing is limited to a small number of instructions.

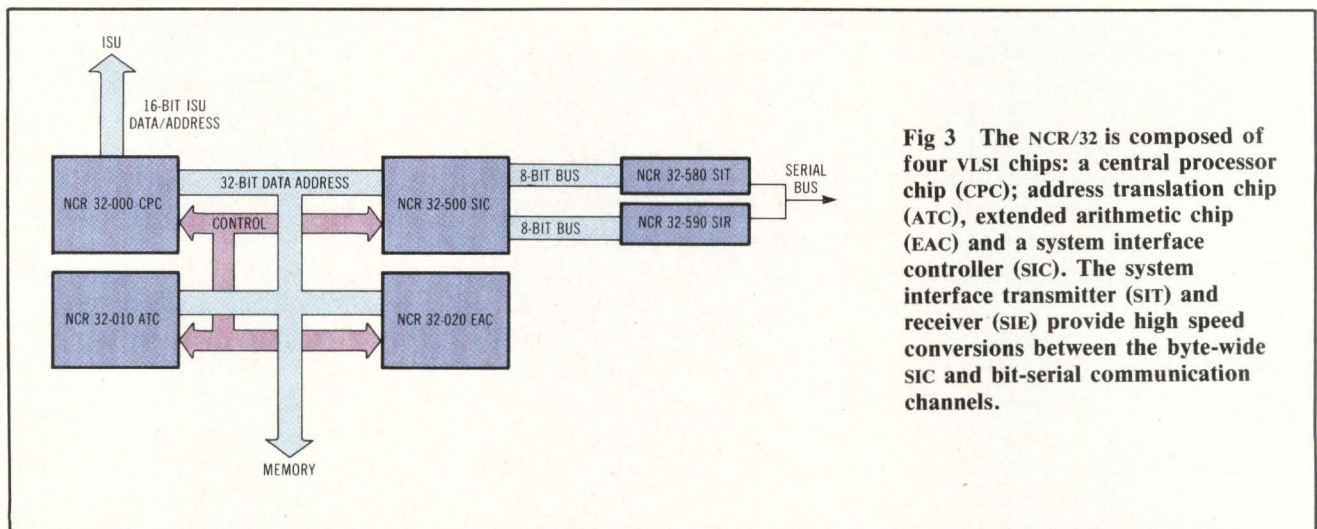

Fig 3 The NCR/32 is composed of four VLSI chips: a central processor chip (CPC); address translation chip (ATC), extended arithmetic chip (EAC) and a system interface controller (SIC). The system interface transmitter (SIT) and receiver (SIR) provide high speed conversions between the byte-wide SIC and bit-serial communication channels.

prefetch queue that is loaded with aligned transfers. The CPU fetches 4 bytes at a time from the instruction stream. Whenever the bus is free, it reads another instruction.

On the other end of that queue is a unit that decodes instructions while functioning as the interface between the execution unit and the instruction stream. In most cases, the instruction is already decoded and ready to execute in what is essentially a three-stage instruction pipeline. One stage performs the fetch and decode while the next stage executes.

Although the NS32032 does not have a data cache, a future version of the chip will use a bus protocol designed to support a high speed external cache. National elected this approach because the size cache that can be put on a chip with today's technology is not very large (typically, about 256 bytes whereas an optimal computer system cache would probably be about 2 Kwords). Also, an onchip cache locks the system designer into the chip designer's cache policy. If the cache is external, however, the system designer can choose a cache policy that provides answers to several questions: Do you write through the cache, continually updating memory? Do you save changes and only write back to main memory with an update when necessary? What do you do about multiple processors on the same bus? How is DMA handled? According to National, if cache is on the chip, it is difficult to give the system designer the flexibility needed to configure a high end system. Nonetheless, there are several chip manufacturers who disagree with National's position and are building caches into their chips.

National beat the other semiconductor manufacturers to market with a 32-bit chip because the company was very conservative from a process standpoint. The family was brought out in 3.5- μm NMOS, which is not National's most advanced technology. The company has a 2- μm CMOS process in gate arrays and will eventually migrate the NS16000 family into that technology or some other advanced

process. But for this iteration, the designers avoided complications by bringing out microprocessors in a technology that they fully understood.

The chip is currently available in a 6-MHz version, but a 10-MHz chip will be in production in the third quarter of '84. When the die is shrunk, the whole family will be upgraded to a 15-MHz clock. So, while the present NS32032 uses current technology, competitors have had to slip introductions because of more complex architectures or processes they have pursued. National, however, expects to bring out advanced versions of the chip by the time more advanced, competing chips are in production.

Mainframe emulator

For designers who want to emulate existing mainframes or superminis, or to implement their own instruction set to take advantage of an existing software base, there is only one choice. The NCR/32 chip set allows that flexibility and is available. For those inclined to dismiss the chip set as a computer manufacturer's attempt to do in four chips what the semiconductor manufacturer's do in one, it is instructive to look at the chip functions. The division of labor is really no different than what the semiconductor houses offer—except that all the peripheral chips are actually available. The chip set consists of four VLSI circuits: a 32-bit central processor chip (CPC), an address translation chip (ATC) for memory management, an extended arithmetic chip (EAC) for floating point arithmetic, and a system interface controller (SIC) that controls slow speed peripheral I/O. Two LSI chips work with the SIC to provide local area network or synchronous data-link control communications. These are the system interface transmitter (SIT) and system interface receiver (SIR). Fig 3 illustrates these chips.

In addition to these chips, a 128-Kbyte external memory called the instruction storage unit (ISU) contains the external microinstruction program that tailors the system to the user's needs. It is accessed

MAGSTRIPE™

READERS/ENCODERS/INTERFACES for magnetic stripe cards, passbooks and badges.

STATE-OF-THE-ART TECHNOLOGY for reading and encoding magnetic stripes. Choose from a large selection of standard products: wipe-through, building-block, and stand-alone. Need a special model? We can design and develop the optimum reader for your OEM application. Our

unique, patented technology eliminates virtually all but media or operator induced error, extends life... and upgrades your total system performance. Whatever your magnetic stripe reading and encoding need, contact **American Magnetics**.

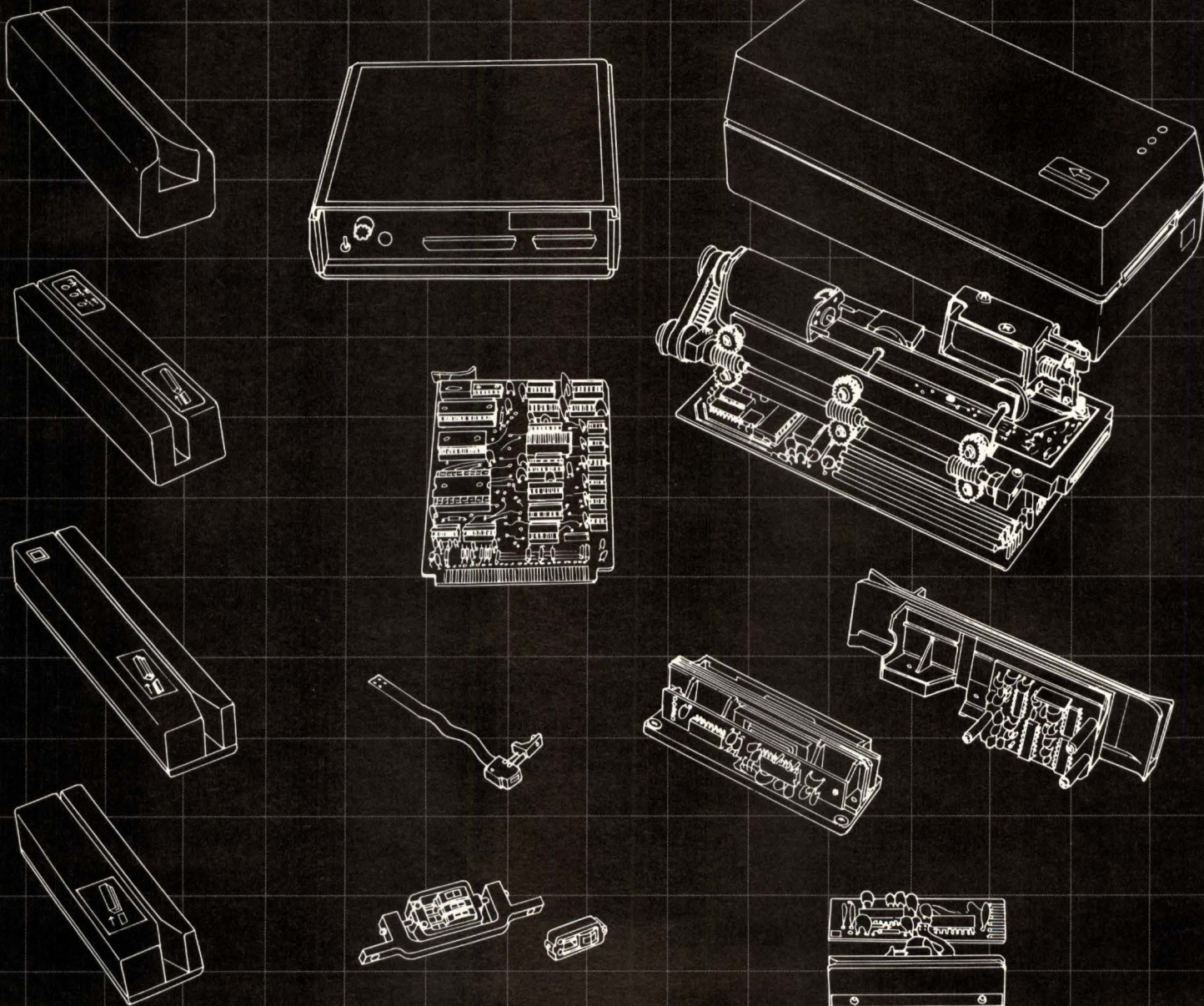

CIRCLE 68

American Magnetics

740 Watsoncenter Road, Carson, CA 90745
(213) 775-8651, TWX 910-345-6258

Products of unequalled reliability since 1971

by the CPC over the 16-bit multiplexed ISU bus. The main bus, however, for interchip as well as offchip system communication is the processor memory bus. This is a 32-bit multiplexed data/address bus with associated control lines capable of transfer rates in excess of 50 Mbytes/s.

The CPC contains a set of 179 primitive instructions in onchip ROM. These microinstructions are designed to execute in one clock cycle of 150 ns. This is similar to the single-cycle instruction execution found in Reduced Instruction Set Computer (RISC) applications. It is responsible for the speed advantage of the chip's native-mode instructions.

To emulate existing mainframes or superminis, there is only one choice.

In emulation mode, a virtual machine's instructions can be emulated to permit the use of existing software. Since the external ISU must be used for this, emulation mode runs more slowly than native mode. The simplified microinstructions, resident on the CPC, free up silicon that would normally be needed for control functions. This is put to good use to provide a RISC-like, register-rich architecture.

A three-stage instruction pipeline (fetch, interpret, and execute) and 13.3-MHz clock add to the performance of the chip set. But, program execution speed varies according to whether the chip is used in native or emulation mode or what type or processor is emulated. For example, setup registers for virtual machine emulation are tailored for the IBM 370 instruction set. Also, the EAC supports IBM-compatible floating point. So it is not surprising that the NCR/32 can run IBM MVS at about the same speed as an IBM 4331. When emulating Digital Equipment Corp's (Maynard, Mass) VMS, however, it runs three to five times slower than a VAX 11/780. By comparison, when each runs the same task in its own native code, the NCR/32 will run two to three times faster than a VAX. NCR uses the chip set in the NCR 9300 system and Honeywell has announced plans to use it in a new small-to-medium mainframe family.

Not available yet

The big three of microprocessors—Intel (Santa Clara, Calif), Motorola, and Zilog—have not yet introduced their 32-bit offerings to the world. Of these, the Motorola 68020 is probably the closest to production. Originally scheduled for the end of the first quarter 1984, introduction has slipped to the summer of 1984 and some industry sources indicate the chip may not appear until nearly the end of the year. Since Motorola's long awaited floating point

coprocessor will not be produced until after the 68020, users are in for a still longer wait for that part. Motorola has recently taken a closed-mouth approach to officially releasing information about the 68020 to the press. However, Motorola personnel have presented papers at conferences that detail many of the features of the new microprocessor.

Intel has said even less about its entry, the iAPX 386, except that it is an extension of the 8086/286 family architecture. Since the introduction data is in the first half of 1985, Intel spokesmen obviously do not want to discuss a design that may still be somewhat fluid. However, a clear picture of the company's direction may be obtained by looking at the existing family and extrapolating that to the 32-bit world.

Zilog's position regarding the Z80,000 has been much more open. The product has been announced in considerable detail, including trade magazine articles. Unfortunately, the project has not kept pace with promotion and has been dogged with delays. Zilog now estimates the sampling data as mid-February 1985, some six months after the company sees first silicon on the part.

A step beyond

The 68020 uses the basic 68000 instruction set but adds new instructions and addressing modes. Six instructions are extended to larger data types. Sixteen new instructions are added for additional data types and seven more new instructions provide support for coprocessors.

Since the 68020 will be the first 68000 family member to possess a full 32-bit ALU, several

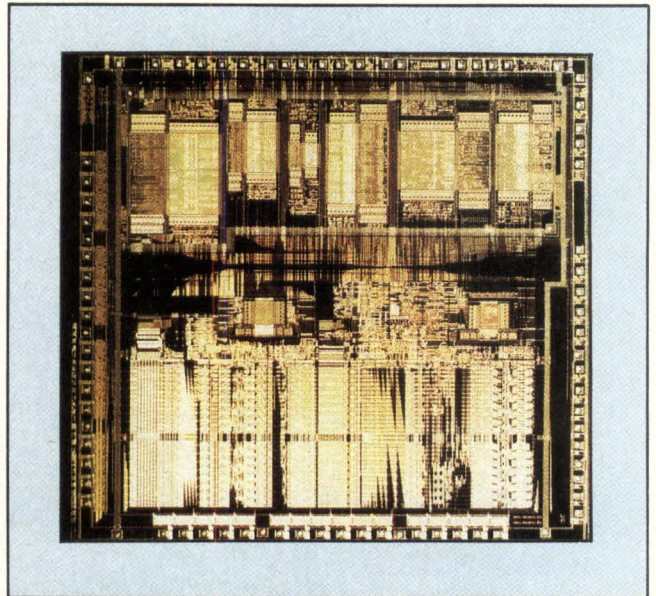

The WE32000 32-bit microprocessor has been available within AT&T for some time. A more advanced version, the WE32100, was recently introduced. However, there are no plans to make either chip available outside AT&T.

Avoid being called for interference.



Oak's FTM[®] keyboard. Fully shielded against RFI/EMI to meet the FCC Article 15, Class A&B deadline and VDE requirements. Right now. At the right price.

The Oak FTM (Full Travel Membrane) keyboard has an inherent design that offers an optional shielding system which can be easily designed right in. You don't have to re-design your equipment with cumbersome shielding or wait for other types of keyboards that have added shielding with substantial added expense.

Find out how FTM keyboards block out interference. And they're available now for a surprisingly low cost.

You can't afford not to call Oak.
Phone 815/459-5000,
TWX 910-634-3353, Telex 72-2447

OAK Switch Systems Inc.

P.O. Box 517 • Crystal Lake, Illinois 60014

For Information Only Circle 69

For Sales Call Circle 153

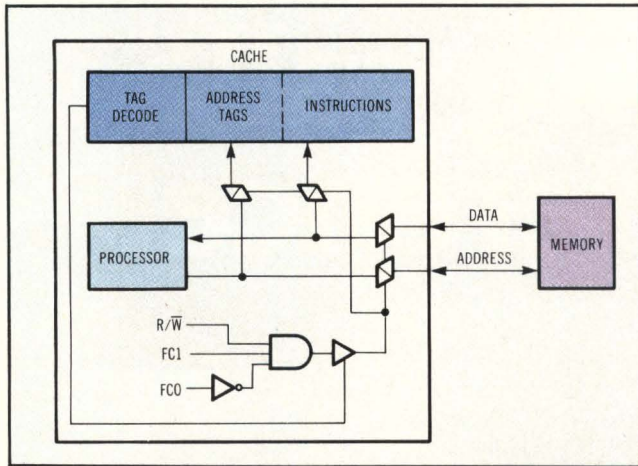

Fig 4 Because of the pipelined internal architecture of the Motorola MC68020, the ALU can execute instructions faster than they can be fetched from external memory. To permit the chip to run at full speed, an instruction cache is built into the chip. This cache is used only for instructions, not for data.

instructions had to be enhanced to support 32- and 64-bit data. Other new instructions provide aid for multiprocessing and compiler writing. Additional addressing modes include scaled indexing and memory indirection.

Memory management will be supported by an instruction continuation mechanism as it is in the 68010. Demand-paged virtual memory requires this feature because the CPU must be able to suspend an instruction at any point and continue it later. The 68020 extends that ability and adds new registers and instructions to support a virtual memory environment.

A coprocessor interface to support the MC68881 floating point coprocessor is an important addition, or at least it will be when that chip becomes available. Adding to the speed of the chip, the pipelined architecture can execute instructions faster than they can be fetched from offchip memory. To prevent slower, external memory from limiting the speed of the device, an onchip instruction cache was included to allow faster instruction fetches (Fig 4). For programs that fit within the cache, the 68020 will run six times faster than the 68000. Most programs will actually run four times faster on the 68020. This chip will be fabricated in a combination CMOS/NMOS process that offers high speed and low power consumption.

Evolutionary developments

Given the current development schedules in the industry, Intel could be the last one out with a 32-bit microprocessor. But don't count on it—Intel may be the only company with a realistic schedule. In any event, there should be no great surprises. The iAPX 386 is an evolutionary extension of the basic 86 architecture. It is bit compatible and allows migration of existing software to a 32-bit environment (Fig 5).

Like the iAPX 286, the 386 will have a four-level protection mechanism implemented in the microcode. Software can be assigned to any of four priority levels and access controlled between levels. The 386 will be fundamentally the same in other ways, as well. The primary difference will be that the 386 will have 32 bit addresses, registers, and data paths. Moreover, the 386 will be implemented in CMOS, unlike the NMOS 286.

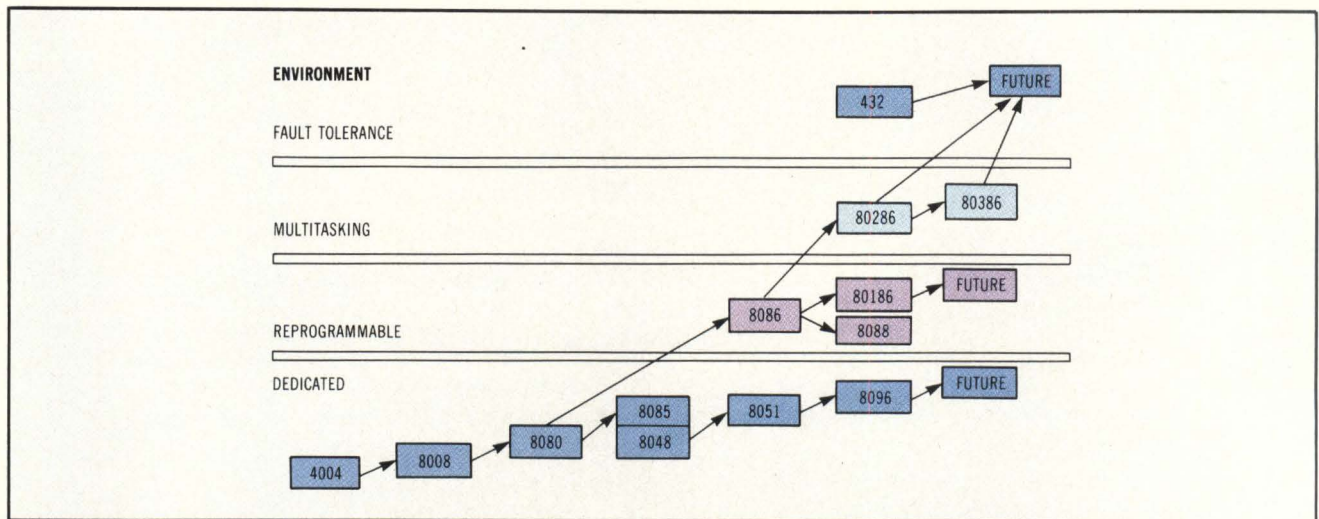
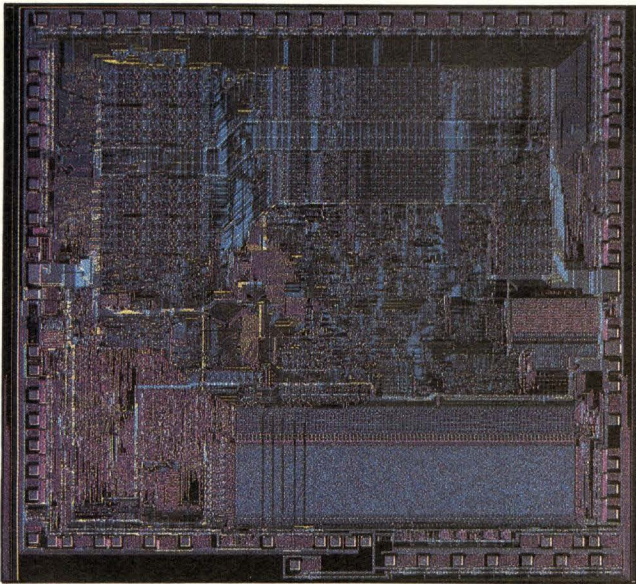

Fig 5 Intel's approach to microprocessor family evolution is best understood in terms of the environment for which each is intended. The basic 8-bit processors (and one 4-bit) are aimed at dedicated applications such as controllers. The reprogrammable processors are aimed at the first level of computer applications. Starting with the 8086, the basic CPU evolved into the 8-bit external, 16-bit internal 8088 and 80186. The latter brought many of the support functions onchip to lower system costs. The next level is capable of multitasking. It includes higher performance processors like the 16-bit 80286 and the 32-bit 80386. These CPU's can handle extensive physical and virtual memory. They are designed for high level language support. Finally, for fault tolerant processing, the 432 is unrelated to the rest of the 86 family but some, as yet unspecified, future chip may pull it all together.



National Semiconductor's NS32032 is the first 32-bit chip available from a mainline semiconductor supplier. Like other members of the NS16000 family of microprocessors, it is organized to optimize support for high level language.

A major consideration at Intel is software compatibility across a family of products. Intel has made the entire 86 family instruction set compatible with extensions, as appropriate. For example, the 286 has (and the 386 will have) extensions for a memory management protection mechanism similar to the Motorola 68010. But according to Intel, the 386 will exhibit tighter coding and a more byte-efficient instruction set than the 68010. Memory space and performance are improved because the fewer bytes required for an application reduce bandwidth requirements. Features of the family instruction set include coprocessor escape mechanism (to support coprocessors) and string instruction (operating string primitives) to develop instruction loops for higher level instructions (almost like macros with very few bytes). As an example, the move operation is a single byte. A contiguous move operation that transfers an entire block of memory from one space to another takes only 2 bytes. Therefore, something that would require substantial looping capabilities in a traditional instruction set can now be done in 2 bytes.

The 8086 has a 1-Mbyte address space. The 286 provides a 16-Mbyte physical address space and 32-Gbyte virtual address space (each of 32 users have 1 Gbyte). The 386 will support even larger physical and virtual address spaces. Both support virtual memory and swapping.

In the 8086, the user views address space as a set of segments. These can be linked to support large data structures or treated individually. The 286 and 386 retain the same addressability but treat it as virtual memory. Consequently, total available address space grows from 1 Mbyte to the gigabyte range.

It is consistent from the programmer's point of view because it treats addresses alike whether they are physical or virtual. So, software is portable from

a low cost processor such as the 8088 up to the higher cost 286 and 386.

To programmers familiar with PDP-11s, memory segmentation, as implemented on the Intel chip may be an unfamiliar concept. But those used to programming IBM or Burroughs equipment will find the concept not only familiar but will appreciate the benefits it confers. Among software designers, segmentation is much more readily understood and appreciated. Visi Corp, for example, has used segmentation to implement VisiOn software packages. Windows are controlled on a segment basis.

The memory management chips from Zilog and Motorola also use a segmented concept, but their processors have a linear address space. Intel chose to build segmentation into the processor chip as a fundamental concept. The Intel chips have fewer registers than Motorola's, however, the register set in the family is more oriented toward, and optimized for, high level languages. Because these registers are useful for high level languages, they allow for compactness of instruction set and relative efficiency in register utilization.

Addressing, register sets, and instruction sets are attributes that remain consistent from member to member of the family including the 386. This is because they are the attributes visible to the programmer. But, there will be new instructions for vectors and bit fields and to support 32-bit data types.

The family is basically organized with a 16-bit ALU. The 386 takes that to 32 bits. The 386 is also very fast, with a high degree of pipelining. Fetch, queue, decode, and address calculations are all done in parallel. Thus, at any point there are three instructions undergoing execution. (The 8086 used prefetching as a first step toward some degree of parallelism.) Intel's approach with the 286 and 386 is that virtual addressability is totally independent of the I/O pins. By bringing it onchip, Intel has allowed virtual address space to be totally independent of the number of physical pins.

The 386, along with other family members, offers onchip memory management. It also has an onchip instruction queue but not a true cache for both instructions and data. The new instructions, a bus that supports fault tolerance, and a much faster floating point coprocessor round out the evolutionary advances in the product line.

A revolution in silicon

Though well publicized and billed as a "mainframe on a chip," the Zilog Z80,000 development program has been delayed and the company has not yet produced first silicon. This may be due to the complexity of the design, since the performance claimed for the chip is extraordinary. Zilog is attempting nothing less than to leapfrog the entire industry and produce the highest performance 32-bit microprocessor (see the Table).

Comparison of 32-bit Microprocessor Features

Features	Zilog Z80,000	Motorola 68020	National NS32032	Intel 80386
MMU onchip	yes	no	no	yes
Instruction cache onchip	yes	yes	no	yes
Data cache onchip	yes	no	no	no
Pipeline	yes	no	no	yes
Burst memory transfer	yes	no	no	no
Bus scaling	yes	no	no	no
Addressing (linear/segmented)	both	linear only	linear only	segmented only
Orthogonality	no	no	yes	no
Floating point support	yes	yes	yes	yes
General-purpose registers	16	16	8	6-segment 8-data

Source: Zilog, Inc

It is all part of a plan to orient the company's product lines toward two distinct function areas—control and computation. Zilog realized that although the Z80 architecture was well suited for control applications, computation-oriented tasks required a different architecture, a different register model, and a different instruction set. So, the company developed a new 16/32-bit computational family.

Since chip densities at the time would not allow the implementation of a 32-bit processor, the 16-bit Z8000 was first built as a downward-compatible member of the Z80,000 family. Thus, the Z80,000 has its foundation in the Z8000, although the 16-bit chip was hardwired and the Z80,000 will be microcoded.

Zilog has chosen to implement the Z80,000 in NMOS. The 2- μ m design-rule process used permits four different transistor types. This allows the designer to optimize the speed and power needs of each individual logic element. High value polysilicon resistors permit large, fast onchip static RAMs for cache memory. Multiple interconnect levels allow higher packing density of logic elements. The power dissipation of this NMOS process approaches that of CMOS.

Although initial versions of the chip will run at 10 MHz, the process will enable speeds up to 25 MHz. A Z80,000 at 25 MHz will have a peak instruction execution rate of 12.5 million instructions per second (MIPS), and a sustained rate of 6.75 MIPS. The sustained instruction rate takes into account 32-bit instructions, the full instruction set, cache misses, and pipeline interlocks, making the Z80,000 almost four times as fast as the VAX 11/780. Since the chip does not yet exist, such performance estimates are based on Zilog's simulations and may not reflect the real-world characteristics of the chip.

To facilitate execution of complex 32-bit instructions, particularly those requiring extensive operand address arithmetic, the chip uses a multistage instruction pipeline with both an execution stage ALU and an address calculation ALU. The Z80,000 breaks instructions into six phases: fetch, decode,

operand address calculation, operand fetch, execution, and operand store. This pipeline improves execution speed significantly. To keep the pipeline full, the Z80,000 has a 256-byte fully associative cache memory. The cache always contains the most recently used instructions and data. It may contain instructions only, data only, instructions and data together, or be used as a fixed memory as needed by the user.

To maximize bus bandwidth without requiring faster memories, the Z80,000 uses a burst mode that permits memory transactions to use the nibble mode or page mode feature of some RAMs. This mode allows multiple data transactions to follow an address transaction without intervening address transactions. Thus, memory bus bandwidth is effectively doubled.

The onchip demand-paged memory management unit maps the pages of logical memory into the frames of physical memory. To implement this scheme, a translation look-aside buffer (TLB) is incorporated onto the chip. This buffer contains the 16 most recent maps between logical and physical memory. The Z80,000 automatically checks the TLB for the proper map. If there is a match, the corresponding physical frame address is read and a memory access made. If there is no match, the Z80,000 automatically accesses translation tables in main memory to obtain the proper map. This new map is then loaded into the TLB in place of the oldest entry. As in the case of the cache, the least recently used algorithm is used to ensure that the TLB always contains the most recent entries.

Other voices, other chips

For all the talk of VAX-like 32-bit architecture heard from the micro makers, there can be no doubt that the most "VAX-like" chips were those described in three DEC papers given at the International Solid State Circuits Conference (ISSCC) earlier this year. The presentations covered a four-chip VLSI VAX CPU implementation with 1,220,550 transistors, an interface chip for a new 32-bit bus with

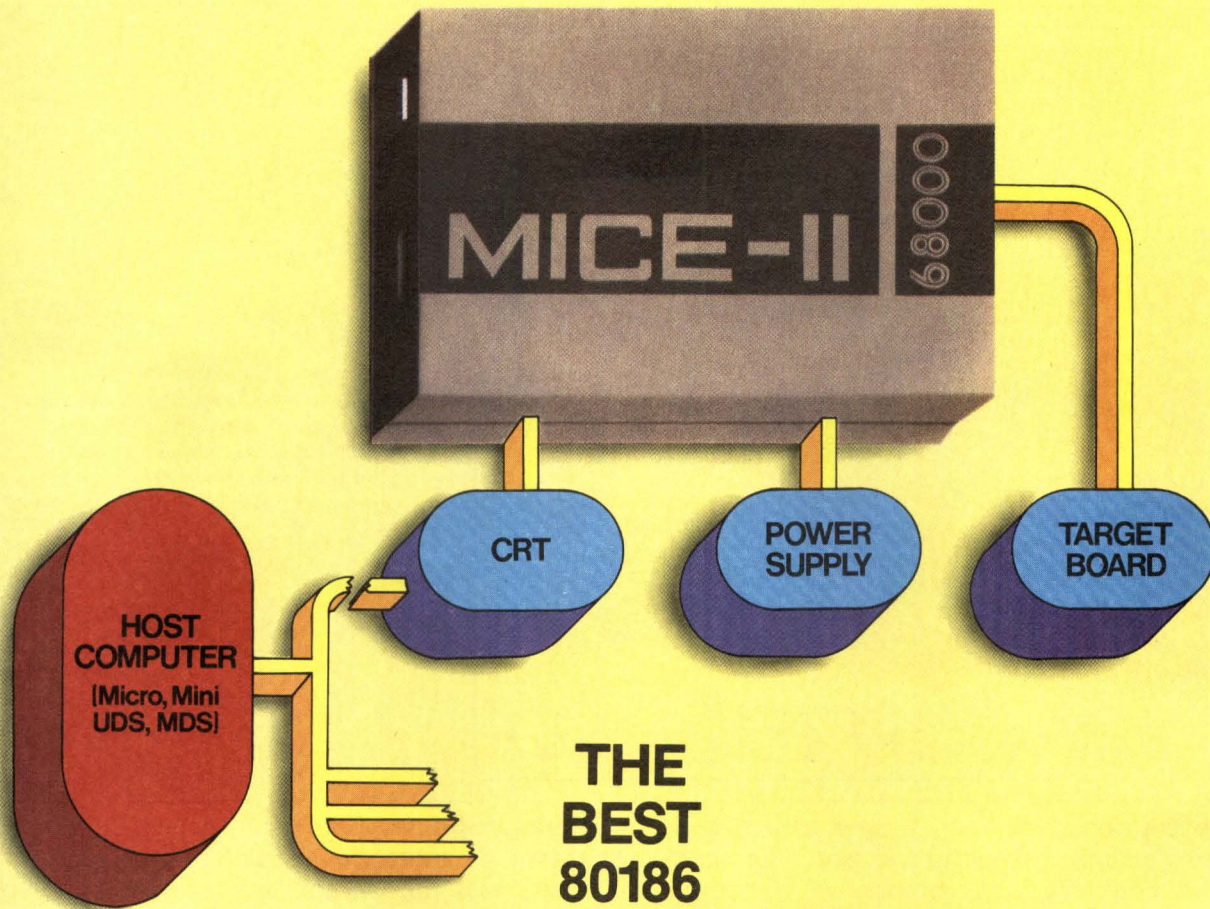

THE BEST 80186 DEVELOPMENT/ DEBUGGING

It's powerful, portable, configurable. Use it to turn your mini/micro computer into a cost-effective full-scale universal development system.

Use it to expand your full-scale development system into a multi-workstation system.

Use it with MULTIMICE to debug hardware/software in a multi processor environment.

Use it to evaluate different micro-processors at a minimum change-over cost.

It's easy to use. MICE I/O drivers are available for Apple II, IBM-PC, PDP-11, VAX, MDS, iPDS, TI Professional and all CP/M systems. And symbolic debugging is available for some models.

MICROTEK INTERNATIONAL, INC.
2-1 Science Road 1
Science-Based Industrial Park
Hsinchu, Taiwan, 300, R.O.C.
Telephone: (035) 772155
Telex: 32169 MICROTEK

**TOOL
YOU
CAN
BUY
FOR
\$4,200**

It gives you all these features. Real-time emulation with no wait state • Retain full memory and I/O space • Resident assembler/disassembler • Real-time forward/backward trace up to 2048 cycles • Instruction step, cycle step through program • Two hardware breakpoints • Interchangeable personality module • Up to 128K emulation memory.

It supports all these microprocessors. 8048 • 8085 • 8086/88 (MAX) • 8086/88 (MIN) • 80186/80188 • 6809/6809E • 68000 • 68008 • 68010 • 6502 • 65SCXX Series • 65SC1XX Series • Z80R • NSC 800.

And it's programmer supported. GP-256 micro based, system/gang EPROM programmer for JEDEC pinouts. MICE I/O driver or master loading.



MICROTEK LAB, INC.
17221 South Western Ave.
Gardena, CA 90247
(213) 538-5369

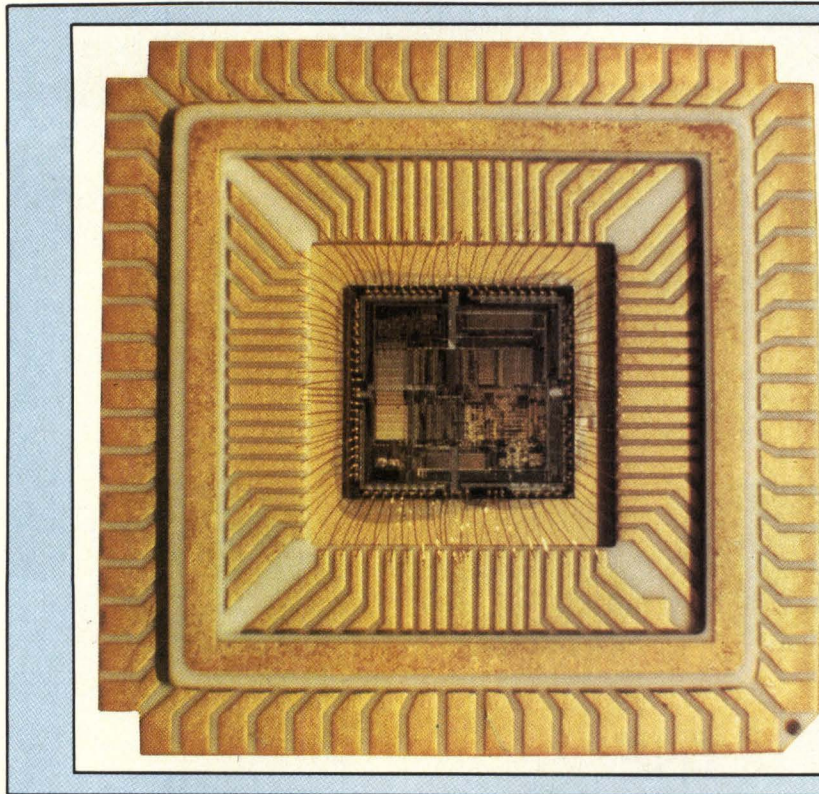

The NCR/32 VLSI processor family contains the only micros designed to emulate existing midrange mainframes. Shown here is the NCR 32-000 central processor chip, the heart of the chip set. This externally microprogrammable VLSI system is currently available.

13.2 Mbytes/s bandwidth, and—most interesting of all—a single-chip VAX microprocessor. The single-chip VAX could be very competitive with other 32-bit processors on the market, if DEC should offer it for sale. The company's present position is that a decision has not been made whether to sell the chip (or the chip set). Both will undoubtedly appear in future VAXes, but whether the single-chip VAX will be offered generally shall be decided on the basis of yields and marketing considerations. However, since DEC does offer LSI-11 processor chips to their OEM customers, it is likely that VAX chips will eventually be offered as well.

The firm's 20-MHz device places 125,000 transistors on an 8.5- x 8-mm die. It is a full 32-bit chip that executes the instruction set and demand-paged virtual memory management of the VAX-11/780. Implemented in NMOS, the chip, which is packaged in a 68-pin chip carrier, has a worst-case power dissipation of 3 W. The design features overlapped instruction prefetching and parallel instruction decoding. Of the VAX's 304 instructions, the most commonly used 175 instructions are microcoded onchip, 70 are in a separate FPP chip, 27 are in microcode-assisted macrocode, and 32 are entirely in macrocode. Dynamic RAMs can be interfaced without wait states and the chip has an internal clock generator. Physical address space is 1 Gbyte and virtual memory is 4 Gbytes. The chip contains 16 general registers, 20 microcode scratch registers, 32-bit ALU, and a barrel shifter.

A discussion of 32-bit microprocessors would not be complete without a mention of the most architecturally unique chip yet announced—the Inmos

(Colorado Springs, Colo) transputer. This 32-bit RISC-type computer, aimed at multiple processor systems, uses the Occam language (see series of articles in *Computer Design*, Nov '83 to Jan '84). It includes processor, memory, and communications on the same 250,000 transistor CMOS chip. Like so many of its 32-bit cousins, it is not expected before 1985. In the meantime, another article in this special report section (see pp 143, "Thirty-two Bit Micro Supports Multiprocessing" by Pete Wilson) provides details about this unusual and controversial chip architecture.

Two of the new 32-bit microprocessors are already here. By mid-1985, or sooner, more will be available to help change the way we build computer systems. The system designer need only look at computers in current use to foresee the 32-bit microprocessor future. This is because architecture, instruction sets, and addressing modes have less to do with 8, 16, or 32 bits than they do with the passage of time and the state-of-the-art in computer science. Ideas that appear first in mainframes and superminis, eventually show up in silicon. This generation of 32-bit chips will be oriented toward high level languages—much like the computer systems in use for some time now.

Please rate the value of this article to you by circling the appropriate number in the "Editorial Score Box" on the Inquiry Card.

High 713

Average 714

Low 715



VME

PLESSEY JUST GAVE VMEbus WHAT IT NEEDS MOST. PLESSEY.

Introducing a full line of board level hardware, software and technical support for all your VMEbus systems.

Take a bus as powerful, versatile, reliable and future compatible as VME. Add a company as powerful, versatile, reliable and future compatible as Plessey and you have everything it takes to board the VMEbus with complete confidence.

Introducing Plessey VME. Plessey has a full range of VME board level hardware, software and technical support services. We'll give you the languages, operating systems, the drivers, complete technical assistance and, of course, that famed Plessey guarantee with worldwide backup. All to support our superior VMEbus products including . . .

VMEbus Single Board Computers.

Build your systems around any of our four new single board computers with features that include up to:

- 10 MHz 68000, 512 Kbytes of memory and 128 Kbytes EPROM
- 512 Kbytes of dual ported memory
- Memory management, DMA controllers, virtual memory processors
- 3 serial ports, multi protocol serial I/O
- 24-bit bidirectional parallel I/O
- Floppy disk controller, real time clock with battery backup
- And a lot more.

VMEbus Memories. Enhance your system with add-in memories including:

- Parity boards up to 4 Mbytes capacity with 270 ns access time

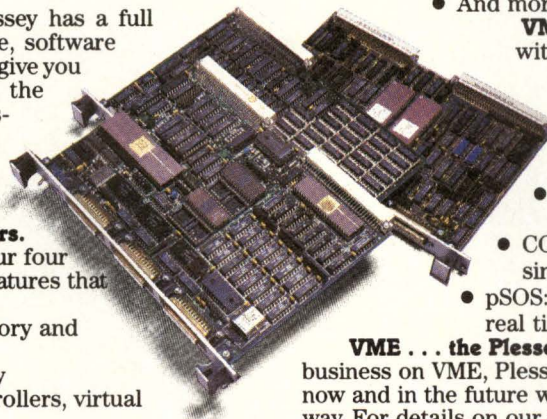

- ECC boards up to 3 Mbytes capacity with 300 ns access time.
- Static RAM/EPROM boards with up to 256 Kbytes of both RAM and EPROM in 16 JEDEC standard sockets
- And up to 128 Kbytes high speed static RAM boards with 140 ns access time and on-board battery backup.

VMEbus Controllers, Graphics and I/O Boards.

Plessey VME also includes:

- Winchester / floppy disk controllers
- Intelligent SASI controllers
- 16-color graphics boards
 - 6-channel serial I/O boards
- And more coming.

VME Software. Support your system with our wide range of firmware and software products:

- Monitor: EPROM resident monitor/debugger
- Ideal: EPROM resident assembler/editor
- Basic and Forth language compiler/interpreters
- COHERENT*: UNIX[†] V7 compatible single/multi-user operating system
- pSOS: EPROM resident multi-tasking real time executive.

VME . . . the Plessey Way. If you are building your business on VME, Plessey VME means business. Right now and in the future with new VME products on the way. For details on our comprehensive VMEbus products and capabilities, call or write Plessey Microsystems, One Blue Hill Plaza, Pearl River, NY 10965. (914) 735-4661 or toll-free (800) 368-2738. Or use the coupon below.

*COHERENT is a trademark of the Mark Williams Corp.
†UNIX is a trademark of Bell Laboratories



PLESSEY MICROSYSTEMS

CIRCLE 71

For additional information, clip and mail to
Plessey Microsystems, One Blue Hill Plaza,
Pearl River, NY 10965.

Name _____ Title _____
 Company _____
 Address _____
 City _____ State _____
 Phone _____ Zip _____

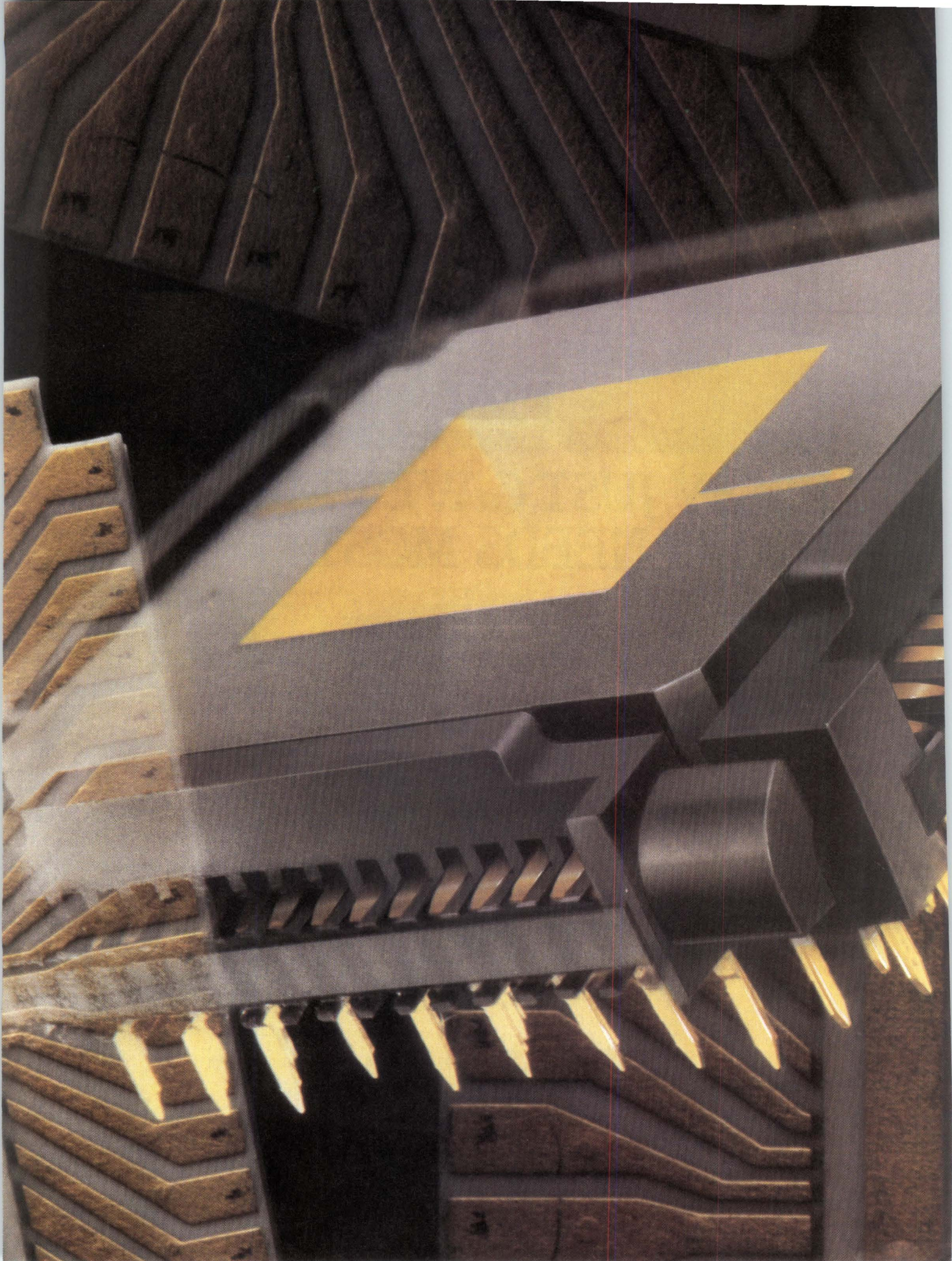



AMP low-profile chip carrier sockets make technology more affordable across the board.

If you've been waiting for leadless chip carrier technology to reach a more practical stage, it has.

The world's lowest-profile chip carrier sockets are available at a surprisingly low-profile cost. From AMP.

In standard JEDEC sizes from 44 through 100 positions. In surface-mount or through-hole versions, with optional snap-on heat sinks.

And they're available immediately, so you can take advantage of today's design work. And move it into production economically.

Our sockets are designed to provide easy board insertion. Fast and positive substrate registration. Easy-access probing after chip carrier installation.

Made, in essence, to make you more productive. So technology gets more affordable.

Find out more. Give us a call.

For more information, call the AMP Chip Carrier Socket Desk at (717) 780-4400. AMP Incorporated, Harrisburg, PA 17105.

AMP means productivity.

CIRCLE
NUMBER
10

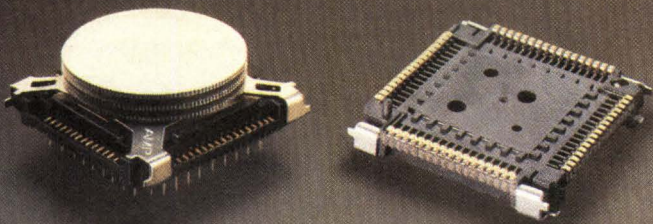

AMP Low-Height Chip Carrier Sockets: Duplex plated contacts eliminate solder-bath contamination. Surface-mount or through-hole versions, overall installed height 0.275" for 44-84 positions, 0.350" for 100 positions, to allow 0.500" pc board spacing.

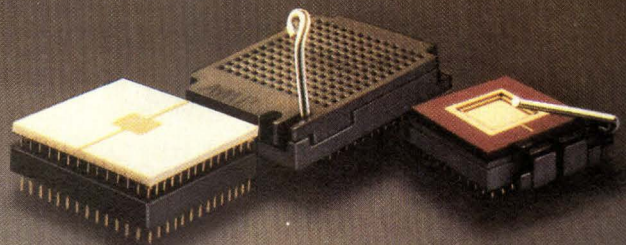

AMP Pin-Grid Array Sockets: Up to 324 positions in 18 x 18 array. Zero- and low-insertion force production versions, plus a zero-insertion force test socket.

Introducing TI's Climb on the 32-

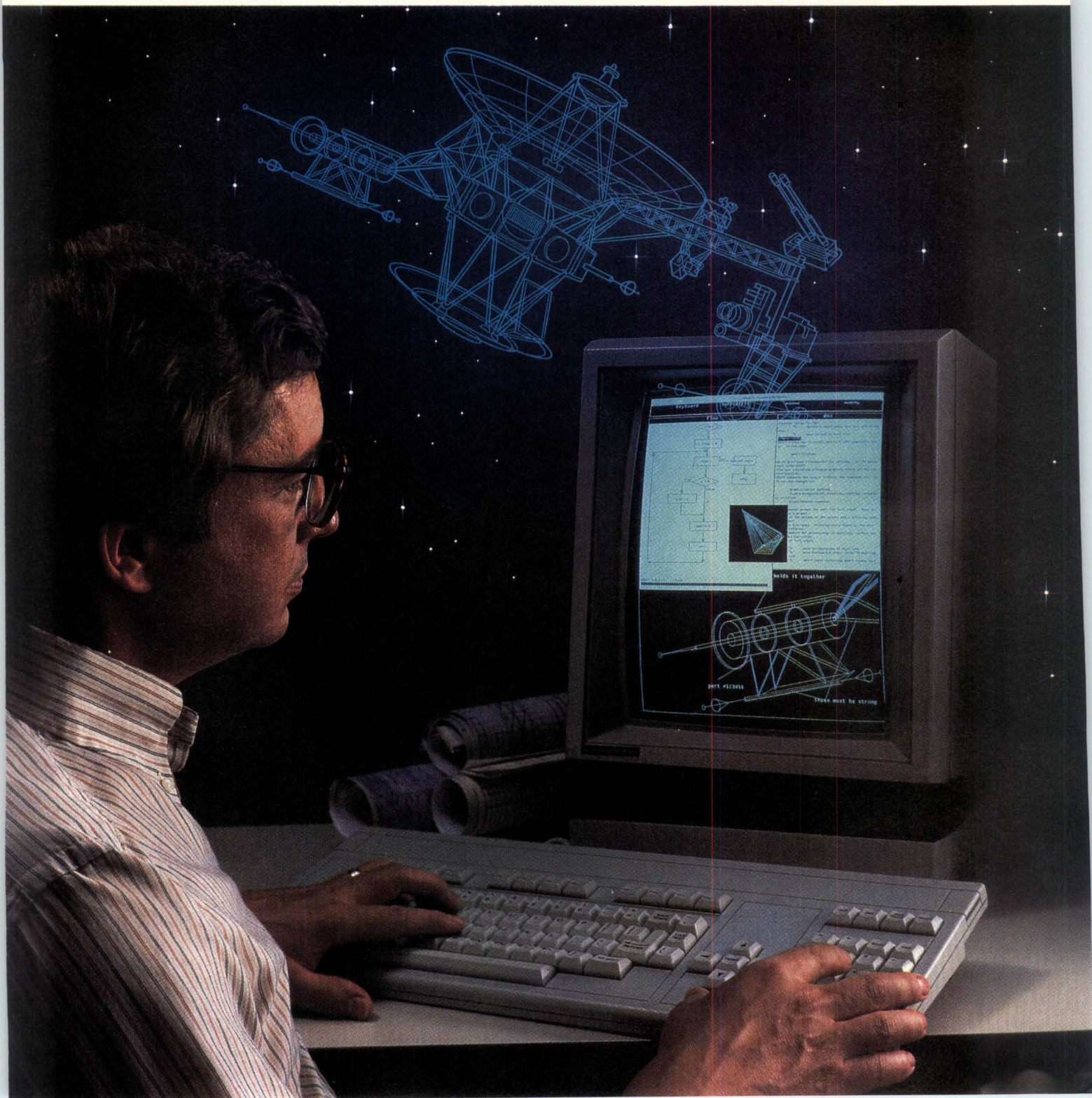

Nu Machine. bit NuBus now.

The Nu Machine™ Computer. The first system in the Texas Instruments Nu Generation Computer family. The only system now available built on a modern 32-bit bus. The processor-independent NuBus™ architecture helps meet your advanced-technology design requirements today. And tomorrow.

First high-performance 32-bit bus

The NuBus technology, designed at M.I.T., is optimized for 32-bit data and address transfers. Its 37.5-Mbyte/sec bandwidth combines with an elegant arbitration scheme to ensure fast and fair data flow.

Innovative, flexible architecture

The NuBus design was developed to support sophisticated system architectures and eliminates the

built-in obsolescence of processor-dependent systems. It lets you concentrate on developing applications, not architecture. Your significant investments are protected as new technologies develop.

The Nu Machine's open architecture solves your make vs. buy dilemma. Multiple-processor configuration support combines with the NuBus high bandwidth, high-resolution graphic displays, cache memory, and high-speed disks to make the Nu Machine system attractive to sophisticated end-users, systems integrators, and OEMs in the engineering and scientific marketplace.

Anticipating industry trends, the power and expandability of TI's Nu Machine allow it to accept 32-bit processors of the future.

Open system supporting industry standards

TI's Nu Machine system is currently available with a

10-MHz 68010 processor supporting a UNIX™-based operating system with enhancements for windowing and high-resolution displays.

Those who want to design their own system processors and controllers can now license the NuBus design from Texas Instruments.

Also, a NuBus-to-Multibus™ converter allows the use of existing interface cards and peripherals from third parties.

The system you can build on from now on

Because its high performance and flexibility are designed for the long run, TI's Nu Machine can be updated when other systems are outdated.

And, Nu Machine computers are backed by TI's service and customer-support network and by TI's commitment to quality and reliability.

To climb on the NuBus bandwagon, call toll-free: 1-800-527-3500. Or write Texas Instruments Incorporated, P.O. Box 402430, Dept. DNA2030S, Dallas, Texas 75240.

Nu Machine and NuBus are trademarks of Texas Instruments Incorporated
Multibus is a trademark of Intel Corporation
System V/68 is a trademark of Motorola, Inc.
UNIX is a trademark of Bell Laboratories

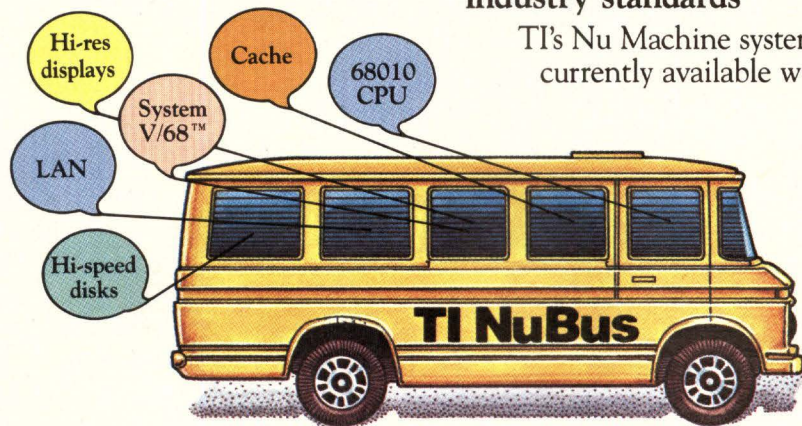

Combining innovative NuBus architecture with advanced graphics, powerful peripherals, and UNIX-based software, TI's Nu Machine provides the outstanding performance and flexibility required by scientific and engineering systems designers.

27-7379
© 1984 TI

**TEXAS
INSTRUMENTS**

Creating useful products
and services for you.

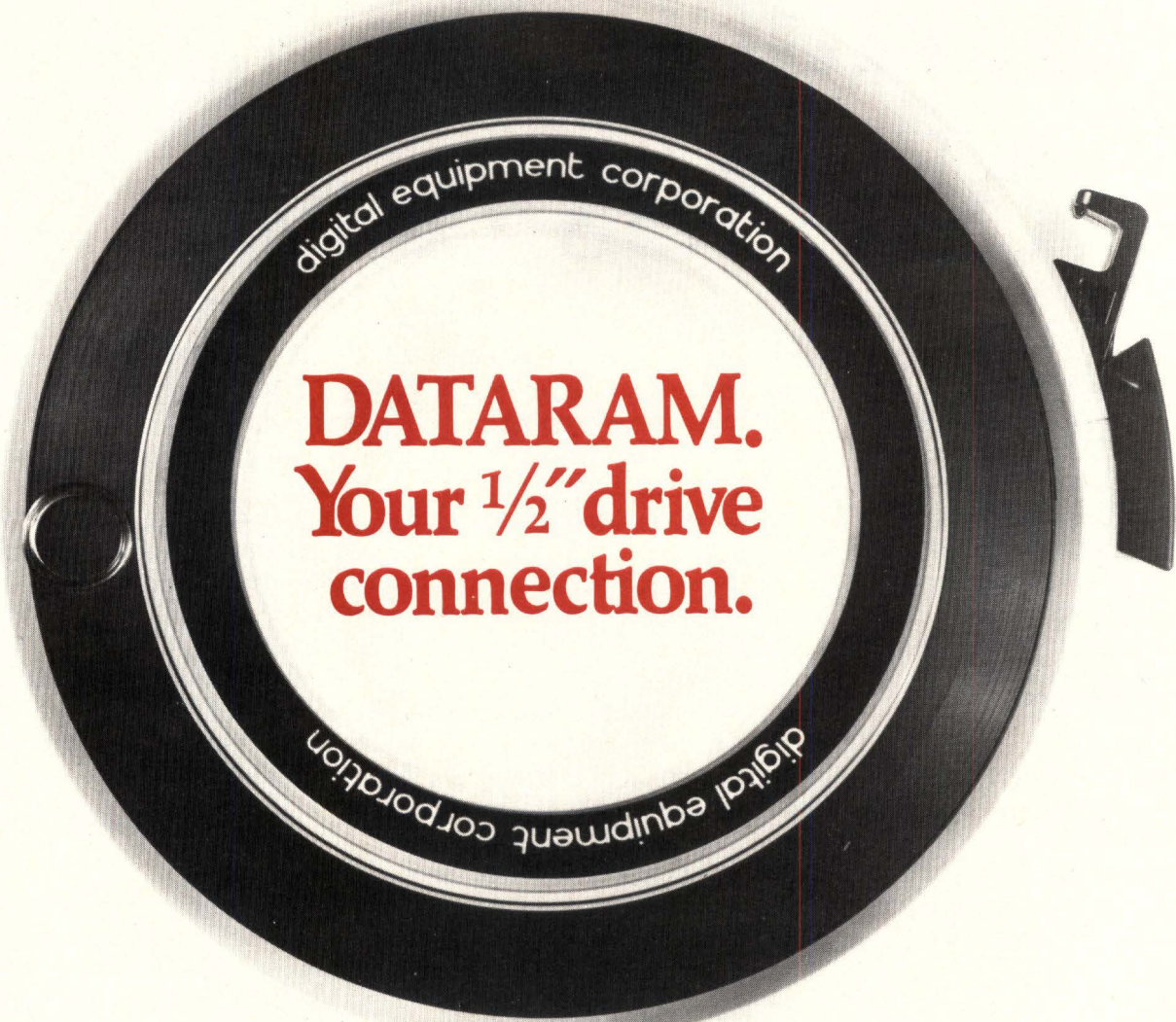

It's easy to interface your 1/2" drive to a DEC computer. When you have connections.

Dataram provides tape drive connections to your host LSI-11, PDP-11, or VAX computer, with a family of couplers/controllers that operate in NRZI, PE, or GCR modes. Dataram's couplers/controllers operate with 1/2" tape drives from all major manufacturers. As slow as 25 ips — or as fast as 125 ips. 200 BPI to 6250 BPI. With TM11 and TS11 emulations.

Start-stop or streaming. Efficient streaming is supported by a unique RSX-11M utility, FASTSAVE-11M, which provides optional backup and save capability for Dataram's streamer coupler. A full one-year warranty is standard.

For more information about 1/2" drive connections, call (609) 799-0071. We'll help you make the connection you need!

STANDARD AND STREAMER		GCR
AMPEX	KENNEDY	STC
CIPHER	PERTEC	TELEX
CDC	S. E. LABS	
DATUM	TANDBERG	
DIGI-DATA	TDX	

Dataram Corporation. Princeton Road.
Cranbury, NJ 08512. (609) 799-0071.

LSI-11, PDP and VAX are registered trademarks of Digital Equipment Corporation.
FASTSAVE is a trademark of Computer Systems Advisors.

DATARAM

CIRCLE 73

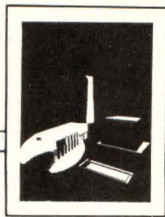

THIRTY-TWO BIT MICRO SUPPORTS MULTIPROCESSING

Combining processor, memory, and I/O in a 32-bit RISC-like, single-chip architecture allows multiple microprocessors to work in parallel.

by Pete Wilson

With the 16/32-bit microprocessor arena already crowded, introducing yet another family is no trivial task. It requires that the new machines offer something beyond what is currently available. Inmos's transputer family meets this challenge by providing a major performance increase over current micros. The family's first product, the 32-bit IMS T424, executes programs about 10 times faster than a 10-MHz 68000. Since simply outperforming the competition does not guarantee the future, the transputer family is designed with an innovative architecture able to deal with future advances in process technology and wafer-scale products.

Just deciding to be innovative is inadequate. To understand the final decisions made for the transputer family, the 1980 microprocessor marketplace must first be reexamined. Fig 1 gives an accurate picture of repeated attempts to put the processing engine of a decent modern minicomputer onto a single chip. In the attempts, two things are clear: all machines have the same system architecture (a single processor with a single bus issuing from it to which many slave devices are attached), and each new attempt has more transistors in it than the previous one. However, the performance of these designs rarely reflects the effort put into them. Compare, for example, the Z8000 with a 432.

Pete Wilson is microcomputer applications manager at Inmos Corp, PO Box 16000, Colorado Springs, CO 80935. He holds a BS in physics and mathematics from Sheffield University, England.

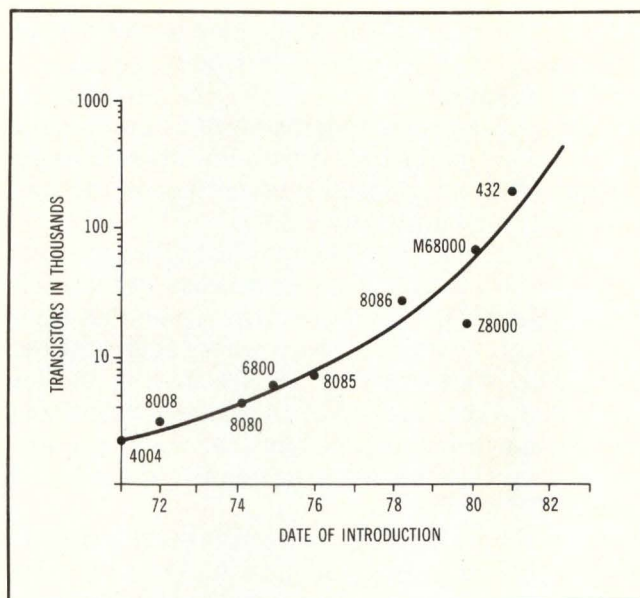

Fig 1 A microprocessor development curve shows the growth of transistor density, over time, in the attempt to wring more performance from what is essentially the same architecture.

Choosing such a complex design does not make good use of the technology. Simply consider what can be built today on a single 4-in. wafer. Approximately 40 million transistors can be put on the wafer and connected to form either memory or processors. They can make around 2 Mbytes of dynamic RAM. Thus, the technology's own costs show that a processor is worth around 4 Kbytes of memory. If current machines reflected this in their architectures, it would be as easy to build a 128-Kbyte, 32-processor system as it is to build a 256-Kbyte, one-processor system. However, this is not the case.

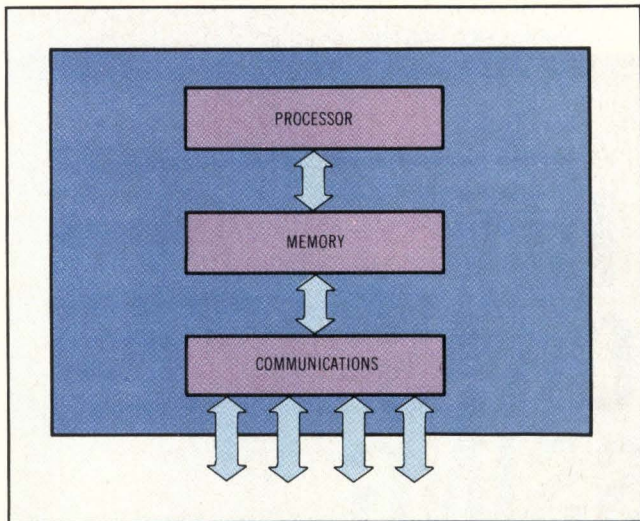

Fig 2 An architectural view of the transputer shows processor, memory, and communications on a single chip.

Nonetheless, the ability to build multiprocessor systems is key to more powerful systems. Redesigning a 1-million instruction per second (MIPS) processor to create a 10-MIPS processor is difficult, but not impossible. However, changing a 10-MIPS processor into a 100-MIPS machine is impractical. Generally, multiple processors are required to achieve these performances. By the time performance reaches supercomputer levels of hundreds or thousands of million floating point operations per second (MFLOPS), parallel processing is the only available implementation choice.

Further in the future, the so-called fifth-generation machines will call for highly concurrent systems. The 1990 targets of the Japanese Fifth-Generation Computer Project call for systems whose aggregate performance is estimated at 10,000 MIPS at the low end. (Naturally, the top of the range machines are not as sluggish.) Such systems can only be implemented with the use of a large number of connected, cooperating processors.

From these arguments, a microprocessor product that could be engineered into highly concurrent systems would be in demand. Current machines simply could not compete effectively. Naturally, it is vital that the concurrency capability does not compromise the microcomputer's abilities in single processor systems. For obvious commercial reasons, the device should outperform traditional microprocessors on their own ground, at the same or lower cost.

With the established aim of a high performance microprocessor well-suited to highly concurrent systems, it is necessary to reexamine the technology to decide on the product's internal architecture. It is accepted, more or less without question, that transistors are getting smaller each year. As transistors shrink, the number of devices per die goes up. This is instantly reflected in design time. The problems of design time explosions and the resul-

tant uncontrollable designs are well-known. The software industry has had consistent difficulties in creating stable operating systems.

As the devices shrink they operate faster, because they need to switch smaller amounts of energy. Regrettably, this speed improvement is lost the moment the signals have to go offchip. The interchip world is still locked in the protocols of TTL, switching relatively large amounts of energy. Interfacing involves a long chain of buffer amplifiers in steadily increasing size and delay, which throws away the speed advantage. This problem, like the design time explosion, will merely get worse while the technology improves. Curing both design time and performance problems while ensuring suitability for use as a parallel system building block are the goals of the transputer.

A transputer is a single-chip product combining processor, memory, and communications (Fig 2). Each chip has multiple high speed communication channels, allowing the device to be connected to other transputers without extra interfacing logic. Each transputer has at least four full-duplex links that allow multi-transputer systems of arbitrary size to be built. Each link has a bandwidth, approximating normal microprocessor bus rates. Topologies are restricted only by the number of links per part.

A transputer can execute programs from its on-chip memory, thus avoiding the performance bottleneck of having to go offchip for each instruction and data access. Since the processor is physically small—a 32-bit version contains about as many transistors as an 8086—it was a manageable design problem. Nearly half of the die area is occupied by the memory, which is (on the first products) 4 Kbytes of static RAM. Redundancy techniques are used, ensuring yield control.

High speed approach yields denser code

The processor's instruction set reflects the design philosophy of the new generation of Reduced Instruction Set Computer (RISC) machines, although the design owes nothing to extant RISC designs. The RISC philosophy implements complex operations as a sequence of simple, very tightly encoded, high speed instructions. This is in stark contrast to the traditional microprocessor/computer approach, which provides a complete repertoire of complex instructions, including all combinations of address modes. This results in physically large (ie, multibyte), and relatively slow instructions. A RISC machine, by careful instruction set and encoding, can produce significantly denser code than a traditional design. Also, a compiler may easily achieve code densities very close to the machine's capabilities. Thus, the transputer is programmable in high level languages without losing efficiency.

Just providing hardware suitable for high performance, highly concurrent systems is insufficient. A

LOW COST HOUSING DEVELOPMENT



HOSTYREN™ VO Polystyrenes can help you build important savings and high performance properties into your enclosures.

It's easy to see why more and more designers and processors are switching to American Hoechst's versatile line of HOSTYREN VO polystyrenes for many kinds of electronic enclosures.

Unlike competitive materials, these easy-to-process VO resins give you all the high performance characteristics you need—*without costly over-engineering!*

As a cost-effective alternative to traditional materials, they have a lot to offer: proven color stability, excellent heat and impact resistance, good finish properties and dependable product consistency, resulting from total "in-house" production control.

The complete HOSTYREN polystyrene family is also the *only* line of polystyrenes that offers a choice of custom and standard colors on *less-than-truckload* orders.

Add the fact that American Hoechst's experienced

and fast-growing technical sales and service team offers prompt, hands-on solutions to on-site problems and you can see why HOSTYREN polystyrene resins are such a popular choice. Mail the coupon now for technical details and cost comparison data. We're the Plastics Fanatics.

Please send technical information and cost comparison data sheets on your HOSTYREN VO polystyrene resins.

Name _____ Title _____

Company _____

Address _____

City _____ State _____ Zip _____

Telephone _____

Send to: Mr. Larry Vallon,
American Hoechst Corporation
289 North Main Street
Leominster, MA 01453 Phone (617) 534-2627

CD-6

Hoechst 

*The name and logo Hoechst are registered trademarks of Hoechst AG.

CIRCLE 74

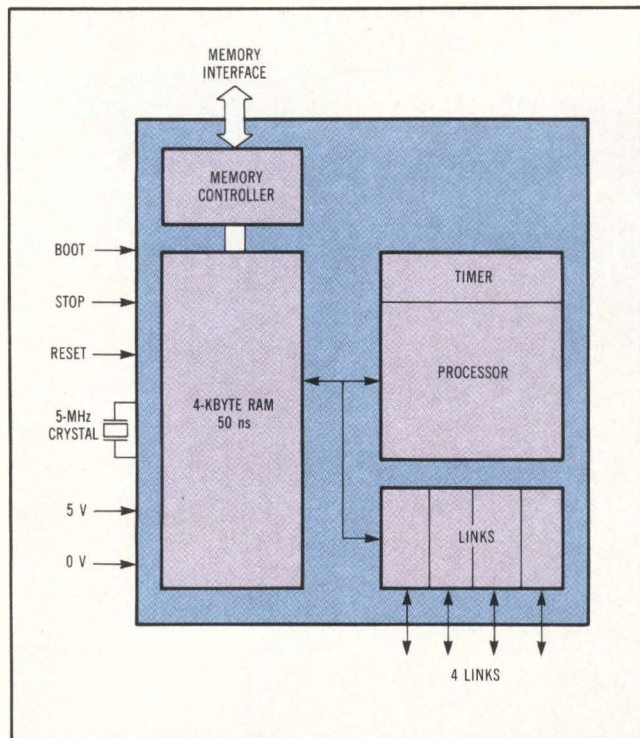

Fig 3 The IMS T424, 32-bit transputer contains a 10-MIPS processor, 4 Kbytes of 50-ns RAM, and four 1.5 Mbyte/s full-duplex communication links. It addresses 4 Gbytes of memory and has an external memory bandwidth of 25 Mbytes/s. Implemented in a 2- μ m CMOS process, the chip contains 250,000 devices.

design technology allowing systems to be designed, sized, and programmed is also needed. No traditional programming language is sufficient for programming collections of thousands of connected computers. Those that might (eg, Lisp or Prolog) assume that some other language has arranged the coordination of the machines and the partitioning of the work. These are application languages, not system languages. More modern languages like Modula 2 and Ada capture a degree of concurrency, but assume systems with relatively small numbers of processors—generally below 100—that are normally connected by a bus or shared store. In addition, they

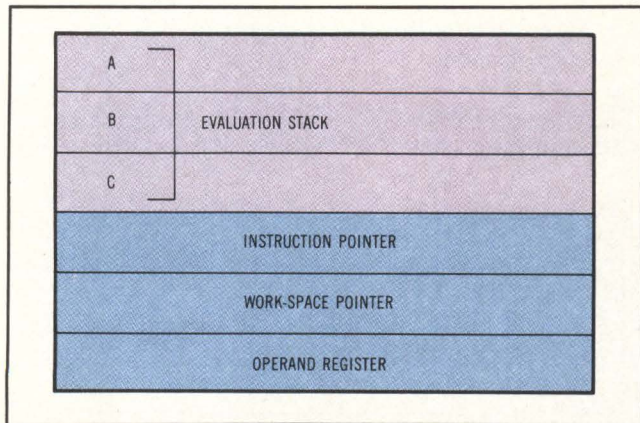

Fig 4 The register set consists of a small set of function specific registers to minimize process swap time and simplify compiler design.

make assumptions about system application requirements that may be entirely inappropriate for upcoming novel architectures.

Thus, Inmos has developed Occam, a language suitable to the task. Covered in a series of articles in *Computer Design* from November 1983 to January 1984, Occam takes the same building-block view of the world as the transputer. It considers the world to be constructed from independent, concurrent processes with their own local concerns. These processes can occasionally interact by sending or receiving messages.

The Occam communication model is simple and universal, involving minimum overhead and allowing very efficient hardware implementations. An Occam program can be written independently of the transputer on which it will eventually be executed. When there are more processes than processors, a transputer will time-share itself between the processes requiring attention. The transputer's instruction set includes facilities to directly support the Occam process and communication model. The result is that process communication is no more expensive than multiplication.

The first transputer product is the IMS T424 32-bit transputer. Fig 3 gives an overview of the machine. It contains a true 32-bit processor, 4-Kbyte onchip static RAM, 4 Inmos links, and a parallel interface for the connection of extra offchip memory and traditional device controller chips. The numbering scheme chosen for Inmos transputers provides a short-form definition of each part; the first "4" in T424 indicates 4-byte internal working, the "2" is the n in 2^n , indicating 4-Kbyte onchip memory, while the last "4" denotes a 4-byte wide data path to external memory. Future transputer family members will implement a variety of the obvious possible combinations; the second transputer is a T222.

The device is clocked by a 5-MHz signal. This can be either a directly connected crystal, or a signal from a separate clock. The machine itself, in standard form, operates with a 50-ns minor cycle, and obtains this by multiplying up the 5-MHz external clock to provide the required internal clock.

Registers and functional units are regular bit-slice designs with data buses flowing through them. Control signals are generated from a microcode ROM, optimized to match both the size and control line pitching of the data path.

The register set is shown in Fig 4. Rather than keeping variables in general purpose registers, the T424 keeps them in store, copying their values to and from registers attached to the ALU for computation. This has a number of benefits. First, context switching is very efficient since variables do not need saving and restoring. Second, in conjunction with the instruction set, compilers may be very simply designed to generate dense code without the

problems of register optimization. Third, there is no arbitrary limit set on the number of local variables, as there would be if a fixed number of registers were used to hold the values of variables.

The work-space register points at the address of the first variable in store. On a procedure call, the pointer value changes to point at the first variable of the called procedure. This allows simple and efficient implementation of normal high level languages.

The A, B, and C registers form an evaluation stack that is the source and destination for most arithmetic and logical operations. Loading a value into the stack pushes B into C, and A into B, before loading A. Storing a value from A, pops B into A, and C into B. A stack size of three was chosen as the minimum that was practicable. Three words are needed for operations like multiply and divide, although in evaluating complex expressions, a compiler may need to create some temporary variables for partial results. However, simulations showed that a significantly greater stack size would be necessary to improve substantially on the three. This would have used extra silicon area with a concomitant slowing of the processor.

Direct functions

There is just one instruction format—each instruction is 1-byte long, and is divided into two 4-bit parts. The 4 MSBs of the byte are a function code, and the 4 LSBs are a data value (Fig 5). The representation provides for 16 functions, each with a data value ranging from 0 to 15. The 16 functions are split into three groups to provide direct functions (one-address instructions, generally pushing data to, or popping data from, the evaluation stack); indirect functions (zero-address instructions manipulating values held in the evaluation stack); and operand extension instructions (work with the operand register to allow data values larger than 4 bits to be constructed).

Thirteen of the direct instructions provide a general purpose set of functions listed in the Table. The most common operations performed by a program are loading and storing one of a small number of variables, and loading small literal values. The load constant instruction enables values between 0 and 15 to be loaded with a single-byte instruction.

The load-local, store-local, and load-local pointer instructions all access locations in memory relative to the work-space pointer. The load and store non-local and load nonlocal pointer instructions behave similarly—except that they access locations in memory relative to the A register. Compact sequences of these instructions allow efficient access to data structures, and provide simple implementation of the static links or displays used to implement block-structured programming languages.

One direct function causes its data value to be interpreted as an operation on the values held in the

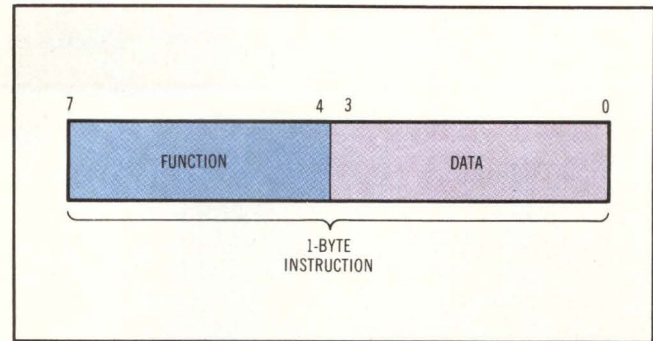

Fig 5 In the instruction set, all instructions are 1 byte long. The 4 MSBs represent a function code and the 4 LSBs are data.

evaluation stack. These zero-address instructions are also listed in the Table. This allows up to 16 operations to be encoded in a single instruction. The operand extension instructions access many more operations via instruction sequences. In choosing which functions to encode in the base, single-instruction operations (the results of an investigation into programs compiled for the transputer) were used. The most frequently used operations were chosen to be encoded into single instructions. These include add, subtract, multiply, and divide.

Measurements show that about 80 percent of the executed instructions are encoded in a single instruction.

Three further instructions provide comparisons and conditional behavior. The equal-zero instruction loads the A register with a truth value; true if A is initially zero, false otherwise. Similarly, the greater than instruction loads the A register with true if $B > A$, false otherwise. True and false are represented by 1 and 0, respectively. Consequently, the conditional jump instruction also serves as jump if true. True and false can be loaded with single-byte load constant instructions. All conditional testing and branching can be compactly implemented using the instructions equal-zero, greater than, difference, and conditional jump.

In addition, further instructions provide addressing capability with both byte and word subscripting provided. These instructions treat A as holding a base address and B as the subscript.

Measuring performance

Measurements show that about 80 percent of the executed instructions are encoded in a single instruction. Many of these instructions, such as load-local and add, require just one 50-ns processor cycle.

The T424 addresses its memory one word at a time, thus providing four instructions for each memory access. The processor has an instruction buffer and a prefetch buffer, allowing four instructions to be worked on while the prefetch is getting

Transputer Instruction Set

One-address instructions

load local
store local
load constant
add constant
add to memory
load local pointer
load nonlocal
store nonlocal
load nonlocal pointer
jump
conditional jump
call
adjust workspace

Zero-address instructions

arithmetic:
add, subtract, multiply, divide remainder, normalize
long add, long subtract, long multiply, long divide
multiply, long divide

logical:
and, or, xor, shift left, shift right

comparison:
difference, greater than, equal zero

general:
load byte, store byte, byte count, word count, byte subscript, word subscript, check subscript, extend to word, check partword, extend to double, check word, reverse, return, minimum integer, initialize

concurrency and communications:
move message, input message, output message, start process, end process, start, enable channel, enable timer, disable channel, disable timer, ALT wait, read timer.

the next four. This pipelining is effective because while the processor rarely has to wait for an instruction, the pipeline is short enough for jumps to cause only a minimal time penalty when prefetched instructions need to be discarded.

Because of the direct mapping of most high level languages into the transputer instruction set, it is possible to provide a lookup table to estimate program size and execution time. The lookup table gives the execution time and object-code size of program fragments (eg, the name of a variable, or an addition). Total program size and execution time are the sum of the values of its fragments. The lookup table provides average values, including the effects of the compiler creating temporary variables and operand extension instructions. Generally, the lookup table will give results accurate to around 10 percent for medium-sized and larger programs.

To put the T424's performance in perspective, a simple benchmark, the sieve of Eratosthenes, is run against an 8-MHz 68000. The T424's performance is estimated under the worst conditions of onchip execution and offchip data access. The conditions are considered the worst because instruction pipelining cannot conceal the relative slowness of offchip memory. Moreover, although the sieve is a small program, the performance table is used to estimate speed. This means that figures for variable access are those appropriate for a bigger program. Finally, the comparison is of a compiled high level language program (ie, Occam) against a handcrafted 68000 assembler. Nonetheless, the T424 performs nearly four times as well as an 8-MHz 68000, and requires a significantly smaller code size.

Most microprocessor applications call for more than a 4-Kbyte memory. The parallel interface provides the ability to connect a large amount of external memory to the T424. Both static RAM and

dynamic RAM are supported. For DRAM, the interface can provide a 9-bit refresh address as well as explicit column address strobe (CAS) and row address strobe (RAS) signals.

The interface is configurable. Up to sixteen popular "programs" built in to the interface are available. They are selectable by connection of a configuration pin. If other configurations are desired, they can be selected from an external ROM at power-up time. The configuration includes the ability to set the following times: access, cycle, address-setup, address-hold, precharge, write-data setup, write-data hold, and the timing of each of these nonspecific strobe lines individually to within a 25-ns tolerance within a cycle.

The processor perceives the external memory to be a linear extension of onchip memory. As with all transputers, the internal width of the machine defines the address space, so the T424 can address up to 4 Gbytes of memory. Both program and data can be freely positioned anywhere in the address space. The only difference between on- and offchip memory, as far as the processor is concerned, is that offchip memory will generally be slower.

Replacing traditional microprocessors

The description thus far is of a high performance microprocessor that happens to have some very fast local RAM onchip. As such, the T424 can be looked upon as a straight replacement for traditional microprocessors (eg, the 68000, 8086 family, or Z8000). Any system designed around these machines can be simply reimplemented, without significant redesign, using a T424. The changes will be limited to aspects such as different PC board layout to reflect the simpler interfacing. Porting the software should be no problem either. Not only does Inmos provide compilers for C, Fortran, Pascal, and Occam (with

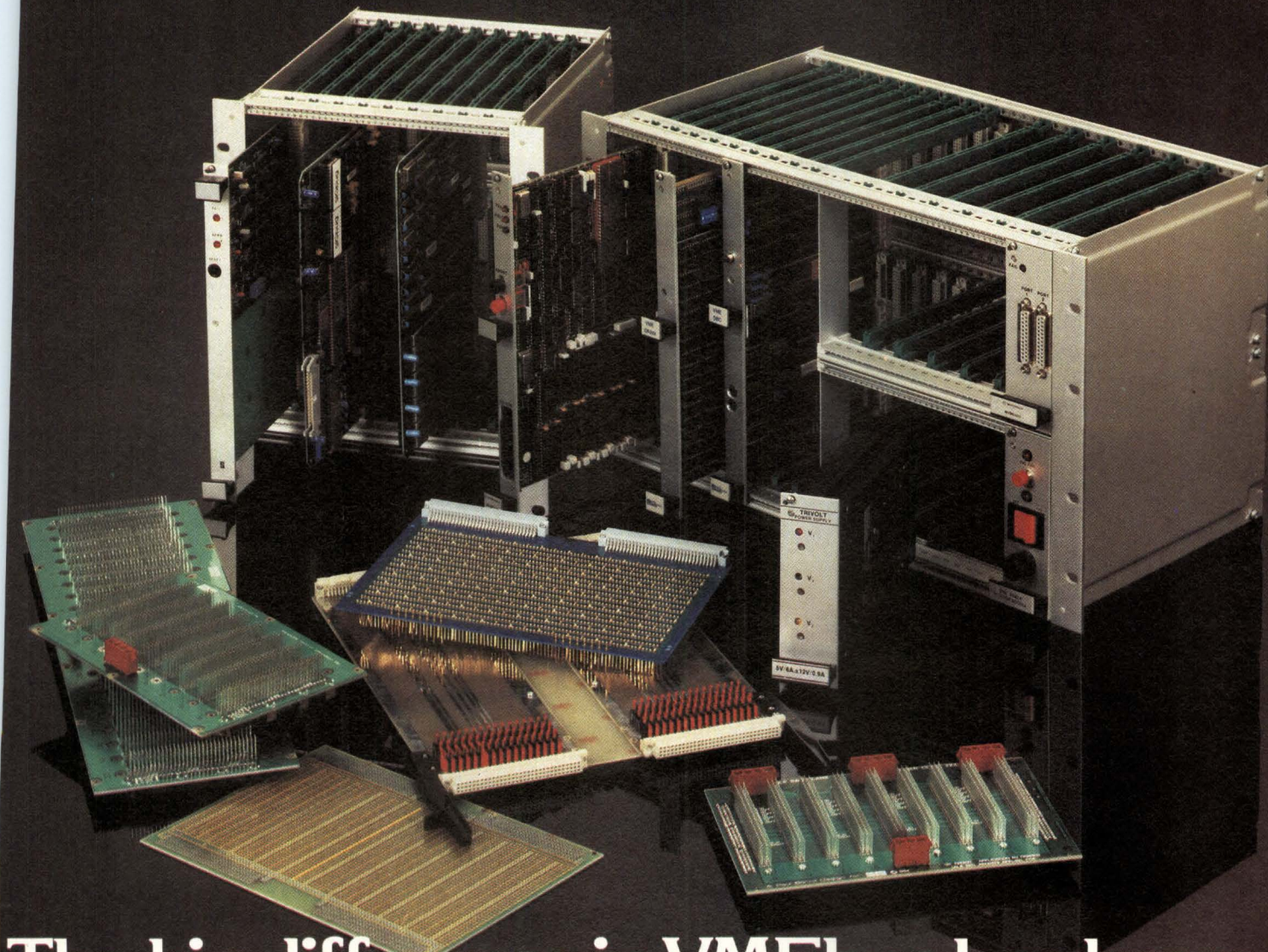

The big difference in VMEbus hardware from one company to another is the company.

The VMEbus is making a tremendous impact internationally. Through our involvement, we've learned that all VMEbus products appear to be pretty much alike, but there are important differences.

Take it from us, when you're buying VMEbus equipment you're really buying the manufacturer. His services, standards, prices and promises.

Products can be virtually the same.

It's the company that makes the biggest difference. And that's why BICC-Vero hardware is recognized by international companies for its remarkable performance, reliability, precision, and compatibility.

Our extensive inventory and efficiency guarantees you immediate delivery on all VMEbus products. Orders are handled by our world-wide network of subsidiaries and distributors to ensure prompt service and customer satisfaction.

BICC-Vero offers these VMEbus products from stock right now: IEC connectors, prototype boards, backplanes, extender cards, power supply with power monitor module, card frames and front panels.

When you need VMEbus equipment, turn to us.

Our hardware is as fine as anybody's. It's the company that's better.

**BICC-VERO
ELECTRONICS INC.**

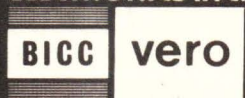

A BICC Company

171 Bridge Road
Hauppauge, NY 11788
(516) 234-0400
TWX: (510) 227-8890

4001 Leaverton Court
Anaheim, CA 92807
(714)630-2030
Telex: 277732

TELEPHONE: UNITED KINGDOM (04215) 66300 • FRANCE (4) 402.46.74
• WEST GERMANY (0421) 8 28 18 • SOUTH AFRICA 53-7846/7 • CANADA (613) 384-1142

VME boards supplied courtesy of Mostek, Motorola & Signetics

CIRCLE 75

mixed language capabilities), it actively encourages third-party software vendors to retarget their compilers and operating systems to the transputer family. The most obvious results of the change to a T424 include smaller PC boards, a three- to tenfold improvement in performance, and perhaps a 20- to 40-percent reduction in program memory requirements. However, the T424, designed to act both as a traditional microprocessor and as a computing component in a highly concurrent system, includes many features to make such systems very efficient.

First, the designer of a highly concurrent system generally wants to create software that is not tied to a specific number of machines. It is more convenient to trade cost and performance by varying a system's transputer count. Using Occam to design and implement the software makes this fairly straightforward. However, when running software aimed at thousands of connected transputers on fewer machines, those machines must be multiplexed so that they behave to the software in the same way that a larger number of machines would.

Constructing multiprocessor systems requires some form of interprocessor communication.

Processor multiplexing is implemented in the T424's instruction set. Both interprocess communication and the sharing out of the processor are done by special instructions. Each process is represented in the machine by a work space. The work space contains both the local variables of the process and necessary red tape for the processor to housekeep the communications and multiplexing. The processor executes just one active process at a time. The work space pointer points at the current process, while the remainder are held in a queue. They are looked after by a pair of registers indicating the first and last entries.

In practice, the scheduler provides two priority levels; normal and priority. Priority processes can perform tasks commonly accomplished with interrupt routines. If a normal process is being executed, and a message arrives for a priority process, the processor typically starts to execute the priority process within 650 ns (ie, the average 50 ns for the current instruction to complete, plus a 600-ns switch time). Multiplication and division take approximately 2 μ s, slowing the switch. Block move operations are interruptible. Normal processes resume execution only when no priority processes can proceed.

The current process will cease being executed if it attempts communication with a process that is not yet ready; the processor suspends the process and chooses the next process from the front of the active queues. When the partner process eventually attempts

communication itself, the processor transfers data, places the suspended process on the back of the appropriate queue, and continues execution of the partner. This communication-driven scheduling is frequent enough in concurrency-oriented programs intended for multiprocessor applications to share processor time fairly. However, some sequential programs may, if left to themselves, unfairly hog processor time. So, mechanisms to implement time-slicing are also provided.

Constructing multiprocessor systems requires some form of interprocessor communication. Rather than shared-store or bus-oriented schemes, the T424 provides four links, each of which implements a pair of Occam channels (one in each direction). The links work full duplex at rates up to 20 Mbits/s in each direction simultaneously, and look to the processor just like channels. The hardware distinguishes between channels connecting multiplexed processes (which are implemented as a single word of memory), and link channels by address. Thus, by appropriate parameterization, processes can be written to communicate with other processes without knowing whether their partners are on the same chip or on a different one. The compiler produces the same instruction sequence for either.

Each link has two pins, so that a transputer is connected to another by two one-directional signal lines. Each signal line is used to carry data and control information.

Links are primarily intended for use on a single PC board, or between boards on the same backplane. They are straightforward to use. The only requirements are that the maximum capacitance specification is not exceeded, and that the input clock frequencies of two interconnected transputers are within 100 ppm. Because the input and output pins of the link are TTL compatible, the range of a link can be extended by inserting standard (eg, RS-422/423) line drivers and receivers in each of the two signal lines.

The instruction-set architecture chosen for the transputer has one very important side effect. It is no longer necessary to consider programming in assembler, since compilers can do as good a job of code generation as the best assembler hacker. Indeed, Inmos has no intention of providing an assembler for the transputer family, although the details necessary to write compilers will, of course, be available.

Please rate the value of this article to you by circling the appropriate number in the "Editorial Score Box" on the Inquiry Card.

High 716

Average 717

Low 718

**INTRODUCING
THE IBEX PCT-1000[®]**



THE LEAN MACHINE

The IBEX PCT-1000 is a revolutionary new IBM format compatible 1/2-inch tri-density streaming tape drive that slims and trims your space and budget requirements in one easy installation.

At less than 40 lbs., this mighty mite *weighs over 60% less, costs 25% less and occupies 25% less space* than any other 9-track tape drive available.

The PCT-1000 is IBM and ANSI compatible. It can accommodate standard 1/2-inch, 9-track tape reels from 7 to 10-1/5 inches in diameter, yet it fits into dual 8-inch Winchester or floppy drive footprint.

There's more. Much more. The IBEX PCT-1000 gives you:

- Storage of up to 136M bytes per reel
- Transfer rates of 20K to 160K bytes/second
- 800 bpi NRZI, 1600 and 3200 bpi PE format operation
- Plug compatible with standard Cipher/Pertec interface
- Internal diagnostics
- Mounting options: 5-1/2" high top-loading drawer mount or 14" high front-loading conventional rack mount

No matter what your application — disk backup, data interchange, or access to archives — the PCT-1000 is your most cost-effective, load-lightening answer.

PCT-1000. The lean machine that out-muscles the competition.

Call, TWX or write today for complete technical data.

IBEX

Right for the times

IBEX COMPUTER CORPORATION
20741 Marilla Street, Chatsworth, CA 91311
(818) 709-8100 - TWX 910-493-2071

Please see us at NCC Booth #A2225

**SEE
YOUR CIRCUIT
IN A
FLASH...**

**...OF
COLOR.**

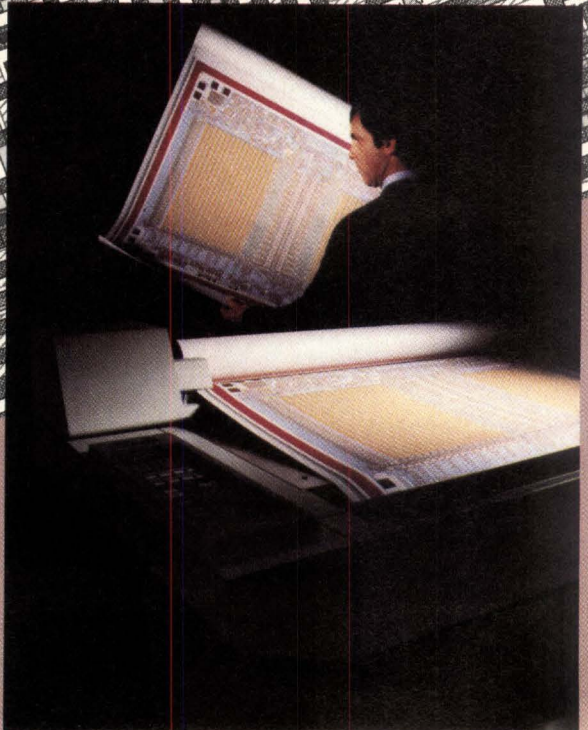

XEROX® is a trademark of XEROX CORPORATION.
Versatec is a trademark of Versatec.

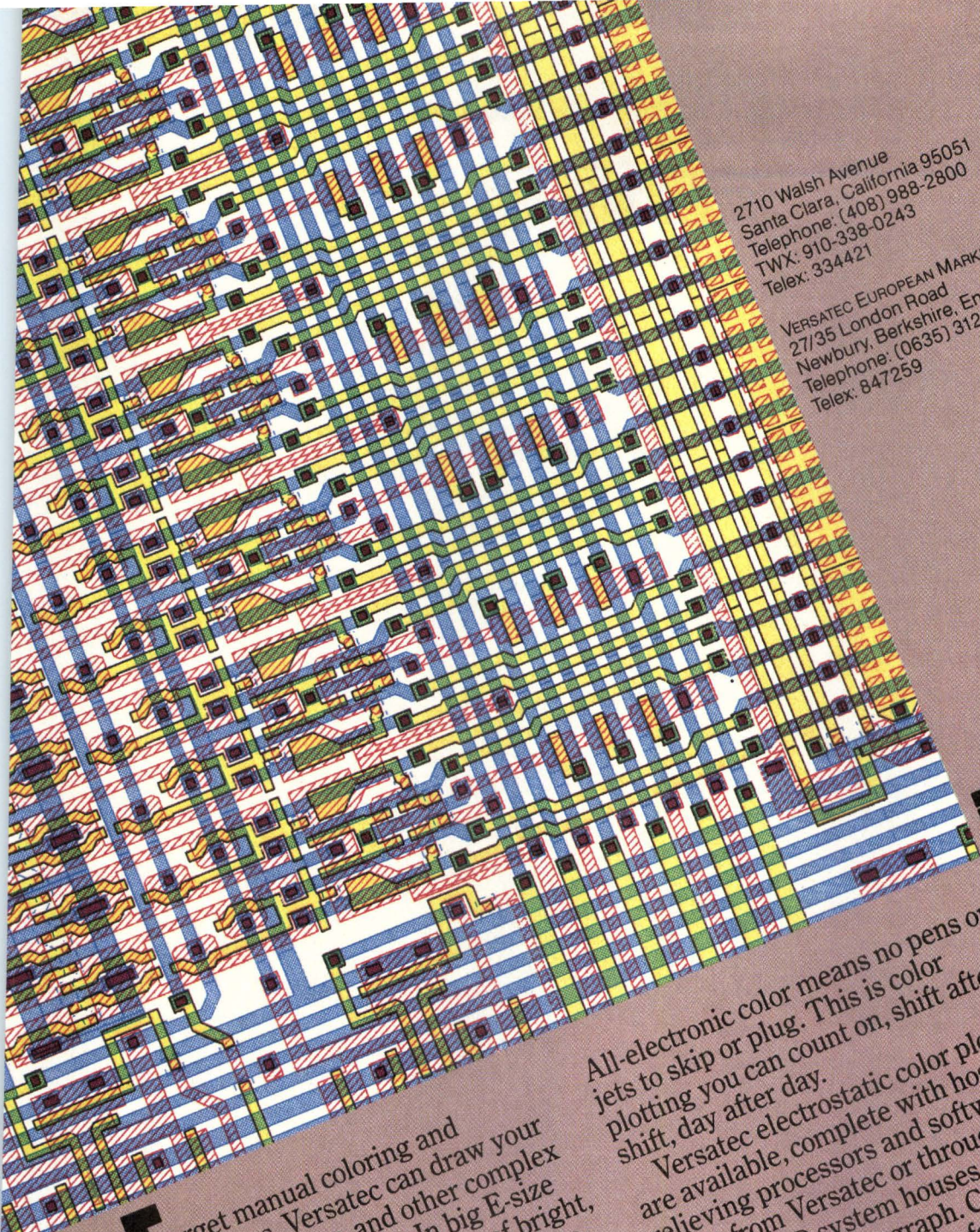

2710 Walsh Avenue
Santa Clara, California 95051
Telephone: (408) 988-2800
TWX: 910-338-0243
Telex: 334421

VERSATEC EUROPEAN MARKETING
27/35 London Road
Newbury, Berkshire, England
Telephone: (0635) 31221
Telex: 847259

VERSATEC
A XEROX COMPANY

Forget manual coloring and overlays. Versatec can draw your VLSI, gate arrays, and other complex IC designs. In minutes. In big E-size formats. And with hundreds of bright, vibrant shading colors to define data-paths, junctions, and layers.

Only Versatec electrostatic plotters draw with so much speed, color, and reliability. Faster color gives you quicker turnaround and more throughput for a faster product design cycle. Discriminating color enables faster analysis of complex circuit designs.

All-electronic color means no pens or jets to skip or plug. This is color plotting you can count on, shift after shift, day after day.

Versatec electrostatic color plotters are available, complete with host-relieving processors and software, direct from Versatec or through leading CAD system houses, such as Calma and Intergraph. Circle the readers' service number for our free brochure — "15 ways to use electrostatic color plotting."

THE FASTEST WAY TO COLOR.



VERSATEC.

THE BETTER CONTROLLERS

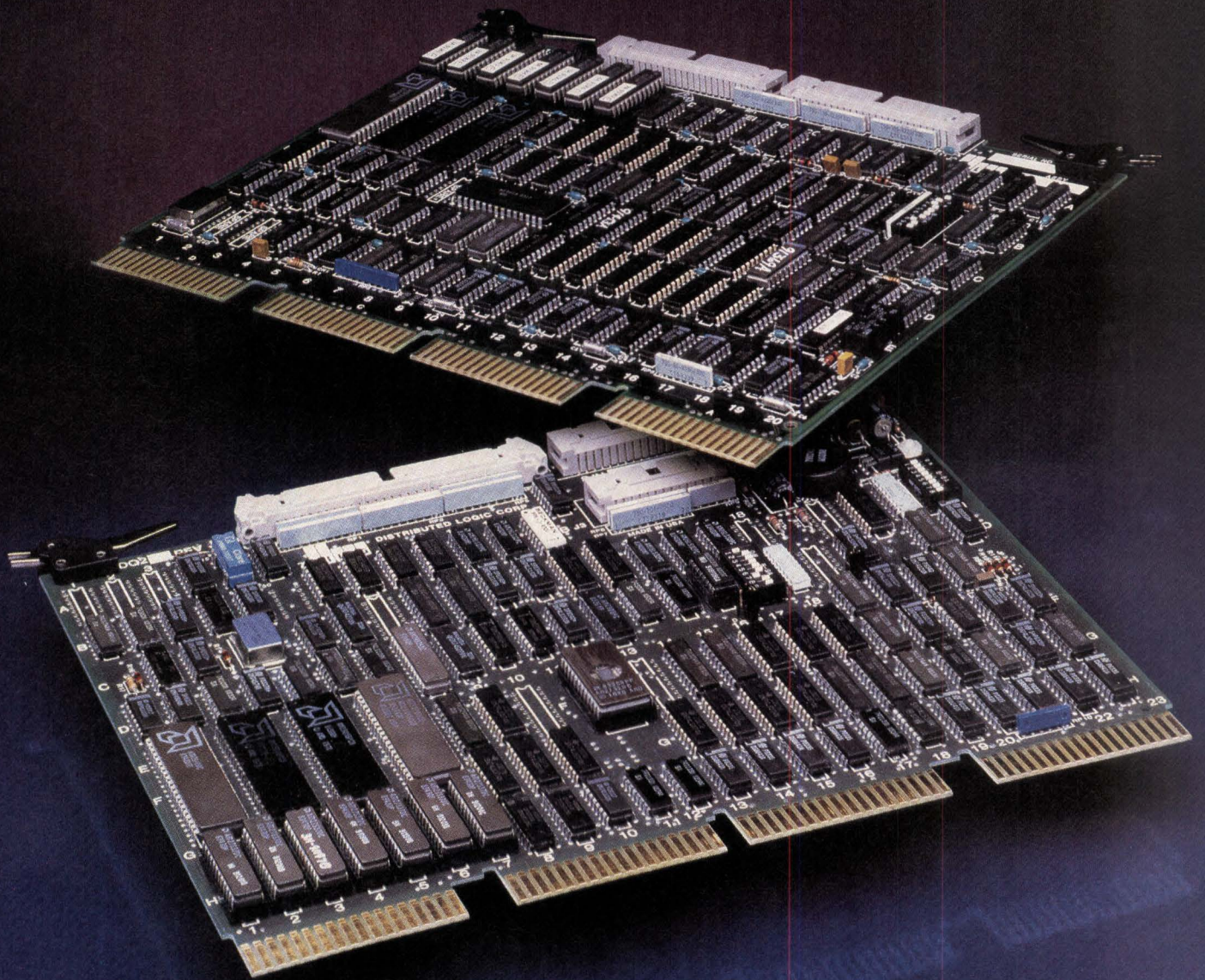

AND FOR GOOD REASONS.

NO OTHER SMD OR 1/2" TAPE CONTROLLERS MATCH THEM.

First, they're an economical, high performance pair you can "rack and stack yourself." Or you can get them from your nearby DILOG distributor in a completely supported subsystem package. In either case, they let you interface the RM02/RM05/RM80 emulating 8" and 14" Winchester drive(s) and back up with the TS-11/TSV05/TU-80 emulating 1/2" tape drive(s) of your choice.

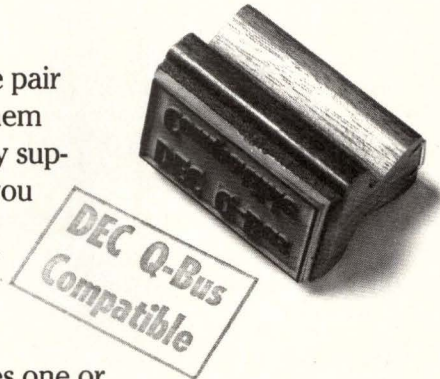

The hard disk controller, Model DQ228, handles one or two 8" or 14" SMD I/O drives. And because it has DILOG's exclusive Universal Formatting™ you can mix or match drives, so long as they have the same I/O. Simply unplug one and plug in another. You get a choice of RSX-11 or RSTS operating systems. The controller also includes 56-bit ECC for accurate error detection, 22-bit addressing for speedy 4-MB access of memory and time saving 2-MB transfer rate.

The Model DQ132, is a 1/2" Magnetic Tape Coupler offering you interface of up to four formatted industry standard I/O (Pertec formatted) or streamer/"CacheTape" transports. You get a choice of RT-11, RSX-11 and RSTS. It likewise offers 22-bit addressing for 4-megabyte access of memory and is GCR compatible supporting 600 KB transfer rate.

For complete data on these better controllers, contact the factory or the distributors listed below.



DISTRIBUTED LOGIC CORPORATION

12800 Garden Grove Blvd. ■ Garden Grove, CA 92643 ■ (714) 534-8950 ■ TLX 681399
64-A White Street ■ Red Bank, NJ 07701 ■ (201) 530-0044
12 Temple Square ■ Aylesbury, Buckinghamshire, England HP 20 2QL ■ 44 (0296) 84101 ■ TLX 837038

MASSACHUSETTS, Norwood
Storex Corp.
Phone: (617) 769-3400

NEW YORK, Rochester
Cameron Computers, Inc.
Phone: (716) 473-4590

NEW JERSEY, Edison
Total Tec Systems, Inc.
Phone: (201) 572-3722

PENNSYLVANIA, Philadelphia
Rohr Associates, Inc.
Phone: (215) 836-2200

MARYLAND, Lanham
Data Systems Marketing
Phone: (301) 577-3700

NEW MEXICO, Albuquerque
ASR
Phone: (602) 949-8293

WASHINGTON, Seattle
Pnambic Systems, Inc.
Phone: (206) 282-0199

CALIFORNIA, Sunnyvale
Computer Marketing Assoc.
Phone (408) 734-9870

CALIFORNIA, Orange
Gemini Associates
Phone: (714) 891-1507

LOW POWER, CMOS 8086 SINGLE BOARD COMPUTER

Replace Your iSBC* 86/05 and get the Benefits of CMOS Technology Without Redesign

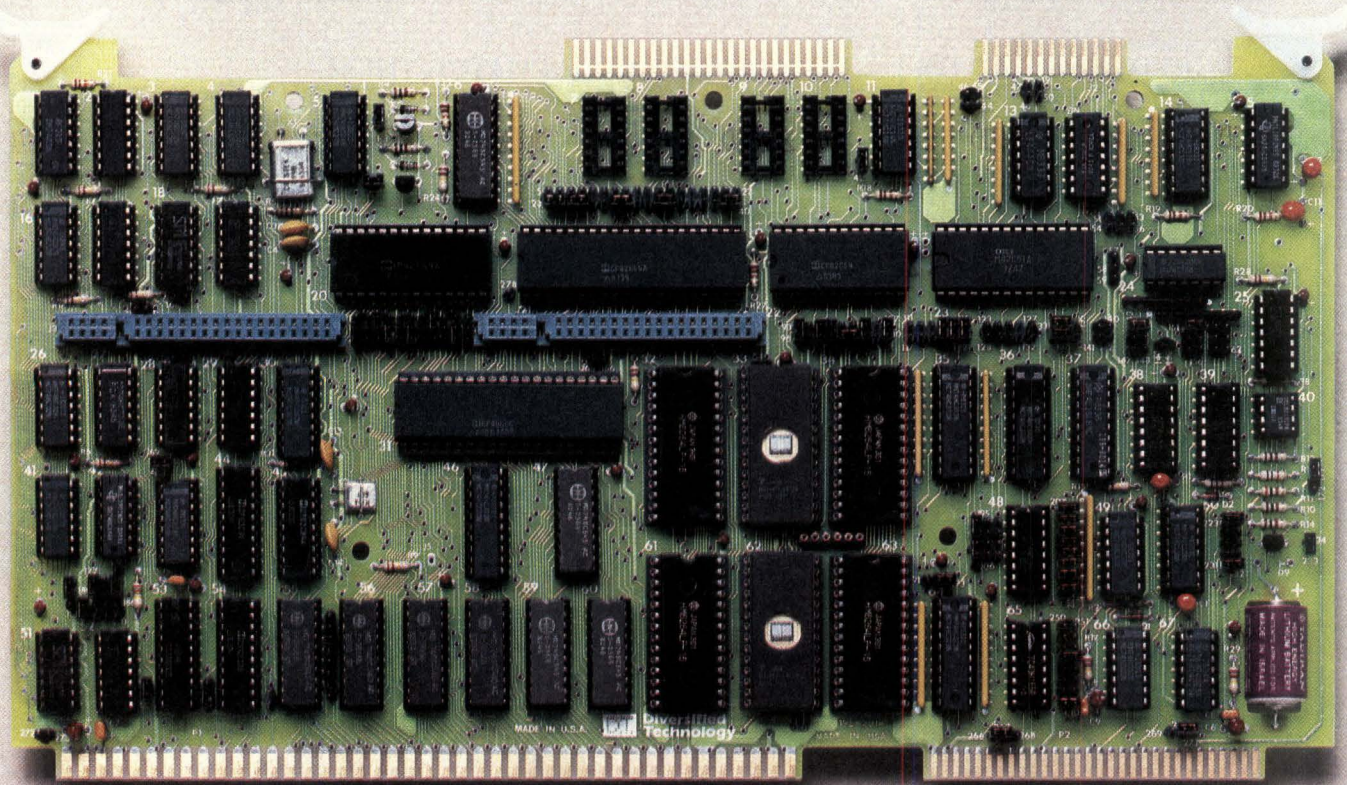

Compare these Key Features:

	INTEL iSBC* 86/05	DIVERSIFIED TECHNOLOGY CBC 86C/05
Bus Type	MULTIBUS*	MULTIBUS*
CPU	8086	80C86
5V Operating Current	4.7 amps max.	200 milliamps max.
Operating Temperature	0°C to 55°C	0°C to 70°C
Supplied RAM (Bytes)	8K	16K
RAM Battery Back-Up On Board	No	Yes (2.5 yrs. data retention)

Whether your application is an existing system upgrade or a low-power CMOS system design, DTI's CBC 86C/05 will make your job easier. Full hardware and software compatibility with the iSBC* 86/05 allows you to gain the low power advan-

tages of CMOS without sacrificing system performance or your development investment. You even get fast nonvolatile memory on-board, and a full-spec MULTIBUS* interface to maintain compatibility with existing systems.

For more information regarding the CBC 86C/05 CPU board, or any of our other all-CMOS MULTIBUS* boards, contact Bill Long, CBC Product Manager at **(601) 856-4121**.

Diversified Technology
An Ergon Co.

P. O. Box 748, Ridgeland, MS 39157
Telex 585326

ASK ABOUT OUR NONVOLATILE CMOS RAM FOR MULTIBUS AND LSI-11 TOO!
Above specifications taken from manufacturers' current published data.
*MULTIBUS and iSBC are trademarks of Intel Corp.



CMOS MICROS ENTER THE MAINSTREAM

The technology of choice for future 32-bit microprocessors is CMOS. In fact, current 8- and 16-bit CMOS microprocessors already offer features that are unavailable in NMOS.

by **Walter J. Niewierski**

Trends in CMOS microprocessors follow two paths. Major architecture developers dedicate new designs directly to CMOS while CMOS manufacturers, with no foothold in architecture development, convert existing NMOS designs to CMOS. Regardless of the approach taken, however, special attention is given to enhancing the inherent benefits of CMOS in low power systems. Thus, each CMOS CPU has specific features that offer advantages over comparable NMOS products. These include static design, extended instruction set, power-down instructions, and internal architecture enhancements (see the Panel, "An overview of CMOS microprocessors").

Mainstream microprocessor architectures implemented in CMOS, with additional low power features to enhance the already low power CMOS, provide the most popular route. This path offers low power benefits and takes advantage of the established base of hardware and software designs that exist for the NMOS processors. This method not only provides a path for CMOS microprocessor product development in those companies that are not architecture trend-setters, but it also extends the life of existing NMOS

Walter J. Niewierski is currently a technical marketing engineer at Harris Corp, Semiconductor Digital Products Division, PO Box 883, MS54-130, Melbourne, FL 32901. He is responsible for technical support of the CMOS 80C86 microprocessor family. He holds a BS in electrical engineering from the University of Michigan.

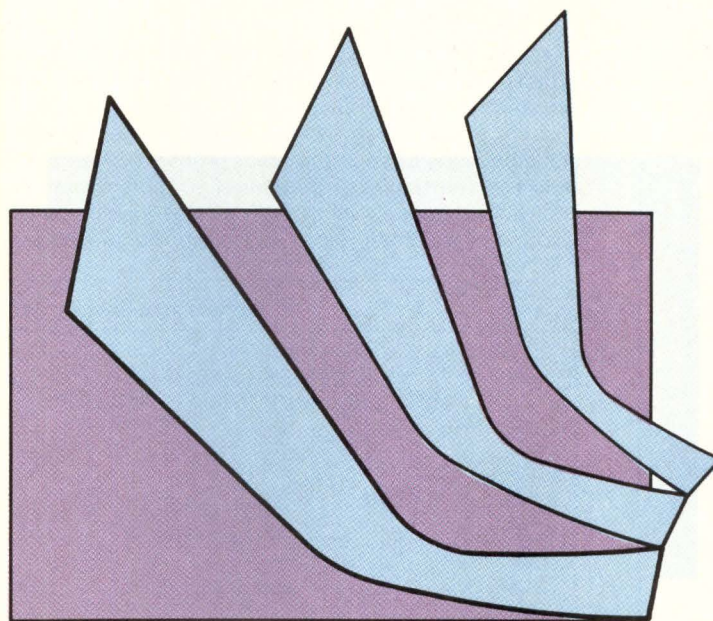

architectures by opening new low power system design possibilities.

The major architectures that have been implemented in CMOS are the familiar Intel (Santa Clara, Calif) 8085, 8086, and 8088; Zilog (Campbell, Calif) Z80; and the Commodore (Norristown, Pa) 6502. A smaller portion of the CMOS microprocessor market (in terms of device type available, but not in quantity shipped) has featured those processors with architectures or pin definitions that are unique when compared to NMOS products. The microprocessors comprising this portion are the Harris (Melbourne, Fla) 6120, National Semiconductor (Santa Clara, Calif) NSC800, and the RCA (Somerville, NJ) 1802.

Of these, the RCA 1802 is the only one that has a truly original architecture. The rest borrow from other areas, whether it be NMOS microprocessors or minicomputer architectures; hardware or software. The NSC800 from National Semiconductor is derived

from both the Z80 and the 8085. The Harris 6120 is designed to be software compatible with the Digital Equipment Corp (Maynard, Mass) PDP-8E.

In this context, microprocessors create an entirely new ball game when compared to logic or memories. Support is the key in the microprocessor market. Extensive support in terms of development systems, hardware designs, software operating systems, and people is needed to generate significant levels of design-ins. This makes the existing-architecture con-

version to CMOS the simplest route for both the manufacturer and the designer.

Another reason why many manufacturers have changed to CMOS is the power barrier into which NMOS is running. Exemplified in Fig 1, second-generation NMOS 16-bit microprocessors are hitting the upper limits of package power dissipation capabilities. Dissipation levels of 2 to 3 W per package are becoming commonplace in high complexity NMOS processors.

An overview of CMOS microprocessors

In considering the CMOS microprocessors available, 8-bit microprocessors are still the most common (see Table). For example, OKI Semiconductor (Santa Clara, Calif), has announced the 80C85. This device is compatible with the NMOS 8085 and is supported by several CMOS peripheral products. The OKI design of the 80C85 is not static and requires a constant clock with a minimum frequency of 500 kHz to refresh internal dynamic registers.

Meanwhile, Rockwell (Anaheim, Calif), GTE (Tempe, Ariz), and Synertek (Santa Clara, Calif) are shipping CMOS versions of the popular 6500 microprocessor family. Several pinout variations are available. Software and internal architecture enhancements have been included in the CMOS products. Also available is a full family of peripheral support circuits.

Toshiba (Tustin, Calif), with a CMOS version of the Zilog Z80, is scheduled to introduce the Z84C00 this

year. The model is static in design with TTL-compatible inputs over the industrial temperature range. Although no version is completely compatible with the NMOS product, several other versions of the Z80 exist in CMOS. The National Semiconductor NSC800 will execute the instruction set of the Z80, although it is not pin compatible.

For controller applications in severe environment situations, and for portable battery-operated systems, RCA has developed the 1802. It has been augmented by several processors of varying architectures, all designed to focus on specific applications. Complete 1802 peripheral and memory circuit support is available along with several development systems and higher level languages. The 1802 is static in design.

The NSC800 has also coupled the internal architecture and instruction set of the Z80 with a unique pinout resembling the external bus structure of the

Performance Characteristics of CMOS Microprocessors

	Operating frequency		Operating current at maximum frequency	Standby	Guaranteed V _{CC} range	Temperature range guaranteed*	Sources
	Minimum	Maximum					
<u>8-bit</u>							
80C85	500 MHz	3 MHz	22 mA	NA	5V ± 5 percent	I	OKI
65SC02	dc	4 MHz	16 mA	10 μA	5V ± 10 percent	C,I,M	GTE, Synertek, Rockwell
NSC800	32 kHz	4 MHz	—	NA	5V ± 10 percent	C,I	National Semiconductor
1802	dc	5 MHz	6 mA maximum	200 μA maximum	4 to 6.5 V 4 to 10.9 V	I,M	RCA, Hughes
6120	dc	5 MHz	10 mA maximum	500 μA maximum	5V ± 5 percent	I,M	Harris
Z84C00	dc	2.5 MHz	15 mA maximum	10 μA maximum	5V ± 10 percent	I	Toshiba
<u>8/16-bit</u>							
80C88	dc	5 MHz	50 mA maximum	500 μA maximum	5V ± 10 percent	C,I,M	Harris
65SC802	dc	4 MHz	20 mA maximum	—	5V ± 10 percent	I	Western Design Center, GTE
<u>16-bit</u>							
80C86	dc	5 MHz	50 mA maximum	500 μA maximum	5V ± 10 percent	C,I,M	Harris
J-11	—	15 MHz	200 mA typical	—	5V ± 5 percent	C	DEC

* C = Commercial (0 to 70 °C)
 I = Industrial (-40 to 85 °C)
 M = Military (-55 to 125 °C)

To overcome this power problem, many new third-generation 16- and 32-bit processor families are being initially developed in CMOS. This represents a major shift in philosophy for NMOS houses. CMOS is no longer merely a nice little low power technology for special applications; it is the technology that will allow microprocessor architecture developers to create advanced generations of their devices.

The most significant benefit of CMOS microprocessors is the power they save compared to NMOS

and bipolar devices. In systems where direct replacement is possible, an immediate (but not optimum) reduction in power is achieved. Although a power supply reduction may not occur, reduced power usage will. Direct replacement of ICs for lower power is a relatively simple matter, but redesign of existing systems to reduce power supplies, fans, and other cooling equipment may not be economically feasible. In order to take full advantage of the low power characteristics of CMOS, systems need to be designed for low power from conception.

Designing low power CMOS systems

The best approach is to do initial CMOS system design with low power systems in mind. Designers must consider the global implications of reducing operating power by more than 90 percent—ie, what can be reduced, replaced, or eliminated when power and heat are significantly reduced. The biggest reduction will initially be in size and weight. Large, bulky power supplies can be eliminated and replaced with small converters or batteries. Even if a standard power supply is necessary, it will be much smaller as long as CMOS plays a dominant role in the system design. The system should include not only the processor, but also peripheral support circuits, logic RAM, and nonvolatile memory.

With the lower operating temperatures of CMOS, heat-related hardware such as fans, heat sinks, and dissipation panels can often be eliminated. Without the need for cooling equipment and airflow, sealed enclosures become possible. Sealed enclosures reduce electromagnetic interference (emi) and lead to higher device and system reliability. Less weight leads to true portability for instrumentation and personal computers. Moreover, lower power and lower heat dissipation allow high density system packaging in space-critical designs. This would not be possible with NMOS and bipolar components.

All aspects of low power system design are manifested in lower system cost. In the application shown in Fig 2, a typical NMOS/bipolar system is redesigned for CMOS and low power. The system cost is broken down into three areas: semiconductors, power supply, and cooling equipment/fans/enclosures.

Costs for CMOS semiconductors are somewhat higher than those for NMOS and bipolar devices. Most CMOS microprocessors are relatively new, low volume products. As products mature, CMOS manufacturing costs decrease, driving prices lower due to higher volume. Also, the extra cost of processing CMOS can be recouped if system design is truly low power, because expensive cooling equipment and power supplies are eliminated. A reduction in from 25 W (5 V, 5 A) to 1 W (5 V, 200 mA) can result in a power supply cost reduction of approximately \$50 to \$100, depending on the type of power source. The use of batteries makes it even less expensive.

8085. The NCS800 has three operating frequencies: 1, 2.5, and 4 MHz. Several peripheral combination chips are also available in CMOS. The NSC800 is not static and requires a minimum clock frequency of 32 kHz.

From Harris, the 6120, developed for Digital Equipment Corp, provides a CMOS processor that is software compatible to the DEC PDP/8E. The HD-6120 is actually a 12-bit machine and emulates the instruction set of the DEC PDP/8E. Completely static design allows operation from dc to 5 MHz. Simplified I/O and memory control signals make the 6120 easy to use with standard memories and peripherals.

Microprocessors with 8/16-bit CMOS are also available. The 80C88, introduced by Harris in May 1984, is directly pin-for-pin, hardware and software compatible with the NMOS 8088. With an operating frequency range of dc to 5 MHz, the 80C88 is static in design. Power supply current specifications are the same as the 80C86 with a standby current of 500 μ A maximum, and an operating current of 10 mA/MHz. Intel is a licensed alternate source for the 80C88. A complete family of peripheral and bus circuits to support system design is available.

Western Design Center (Mesa, Ariz) has announced a CMOS 16-bit upgrade of the 6502, 8-bit processor. Two versions will be available: the 65SC802 (completely 6502 hardware and software compatible with an 8-bit external bus, an expanded instruction set, and internal 16-bit architecture), and the 65SC816 (8-bit data bus with expanded addressing to 16 Mbytes of memory). GTE will also produce the part.

Harris is currently in production with the 80C86, a CMOS 16-bit microprocessor that is hardware and software compatible with the industry standard NMOS 8086. The completely static CMOS design has an operating frequency range of dc to 5 MHz. Stopping the CPU clock yields a standby current of 500 μ A maximum while the operating current is 10 mA/MHz. Intel is a licensed alternate source for the 80C86.

The J-11 from DEC is a CMOS microprocessor chip set that emulates the DEC PDP-11. Designed and manufactured by the Harris Semiconductor CMOS Digital Products Division, the J-11 is a two-chip CMOS processor. Each device is packaged in an 84-pad leadless chip carrier (LCC) and both are mounted on a 60-pin dual-inline ceramic substrate. Completely static in design, the Micro J-11 will execute the PDP-11 instruction set and has many advanced hardware features such as complete PDP-11-70 equivalent on-chip memory management, a 32-bit internal data path, and 4-Mbyte addressing capability. Operating frequencies from dc to 15 MHz are possible with the static design of the two chips.

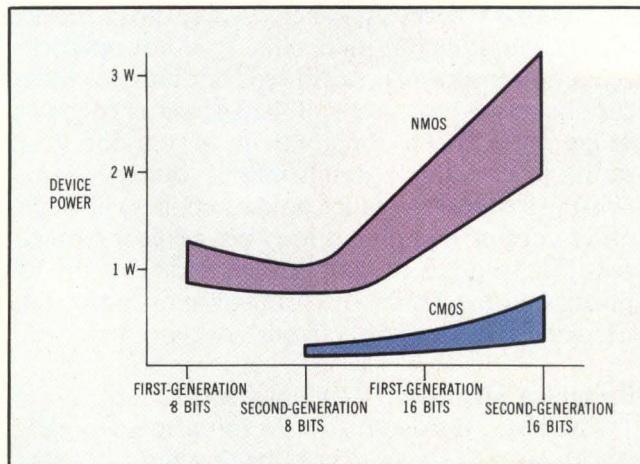

Fig 1 As shown, the power dissipation of complex 16-bit NMOS microprocessors is reaching a limit. This is causing a move to CMOS.

Although there is a rise in overall semiconductor cost from 26 to 33 percent, the 15-percent cost reduction in power supplies and the 11-percent reduction in cooling costs result in an overall system cost reduction of 19 percent. Designing for low system power also allows products to have value added features: portability, battery operation, desirable ergonomic features (eg, quiet operation, reduced maintenance, and greater in-field reliability). All of these features make premium system pricing possible.

One reduction leads to another in CMOS design. This is especially true when system concepts begin with the idea of low power system development completely done in CMOS.

Circuit design to minimize power

Many CMOS microprocessors have design features that can be used to enhance low power operation. Static circuit design, input termination circuits, and power-down capabilities significantly reduce the operating and standby power requirements of CMOS microprocessor systems.

Several CMOS microprocessor features offer significant advantages in power savings if properly used in system designs. Software and hardware

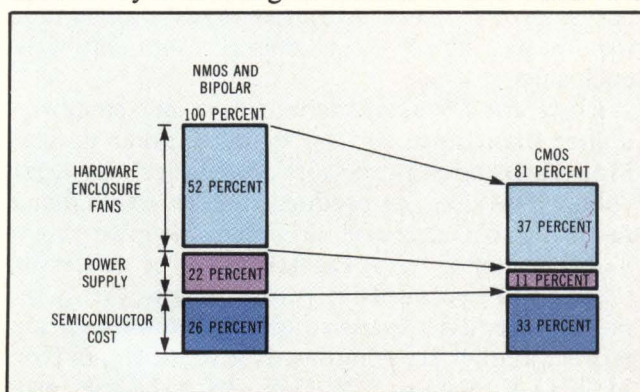

Fig 2 Despite higher semiconductor costs, CMOS reduces overall system costs by decreasing both cooling and power supply equipment.

power-down capabilities allow manipulation of system frequency for absolute control of system power. This type of control is not possible, however, unless the CPU is static in design. Therefore, static design is critical. Finally, floating inputs, which can severely impact power requirements, are important in designing absolute low power systems.

A CMOS 80C86 system shows the advantages of CMOS and the circuit design techniques necessary for optimizing the low power and high performance benefits of CMOS. This prototype system (Fig 3) is developed to show the effect that high speed CMOS can have on system power and performance. The key features of the prototype all-CMOS system include a CMOS 80C86 static 16-bit microprocessor, completely static design with a dc to 5-MHz operation, and a parallel interface using the 82C55A programmable peripheral interface. The serial port for terminal interface uses an HD-6406 universal asynchronous receiver/transmitter/bit-rate generator (UART/BRG) and the local area network (LAN) (1-Mbaud data rate) uses an 82C52 UART/BRG and HD-6409 Manchester encoder/decoder. The 82C59A interrupt controller provides eight-level interrupt capability, while the 82C54 interval timer supplies the three independent timers. The 44 Kbytes of CMOS memory are made up of 36 Kbytes of static CMOS RAM (an HM-6516 2-K x 8 CMOS RAM and an HM-92560 CMOS RAM module) and 8 Kbytes of CMOS fuse-link PROM (HM-6616 synchronous PROM).

The power comparison chart (see the Table) details the current requirements for the CMOS 80C86 system and its NMOS/bipolar equivalents. These numbers are worst-case operating currents seen over the full operating temperature device range. There is a 90-percent decrease in power when doing a straight replacement of NMOS/bipolar with CMOS. An even greater savings can occur when CMOS design techniques are used to their full advantage.

The CMOS system discussed here (Fig 3) has a room temperature of 25°C, typical current of 95 mA, and has been powered by four AA batteries for more than 10 hours. System-clock frequency is 5 MHz and the system regularly transmits message information to a terminal during this period. Power supply current figures are for 25°C, 5-V operation.

Hardware power-down capability is added at two levels: stop-clock and stop-oscillator. By stopping the clock to the CPU, 95 percent of the devices are put into a standby mode. The 82C84A clock generator continues to run and provides a clock to the HD-6406 in order to receive incoming serial data and to the 82C54 in order to continue any ongoing timing functions.

When the clock to the 80C86 is stopped, the system power supply current drops from 95 mA (full operation) to approximately 30 mA. Execution of software begins again immediately after the control line for stop-clock operation becomes inactive.

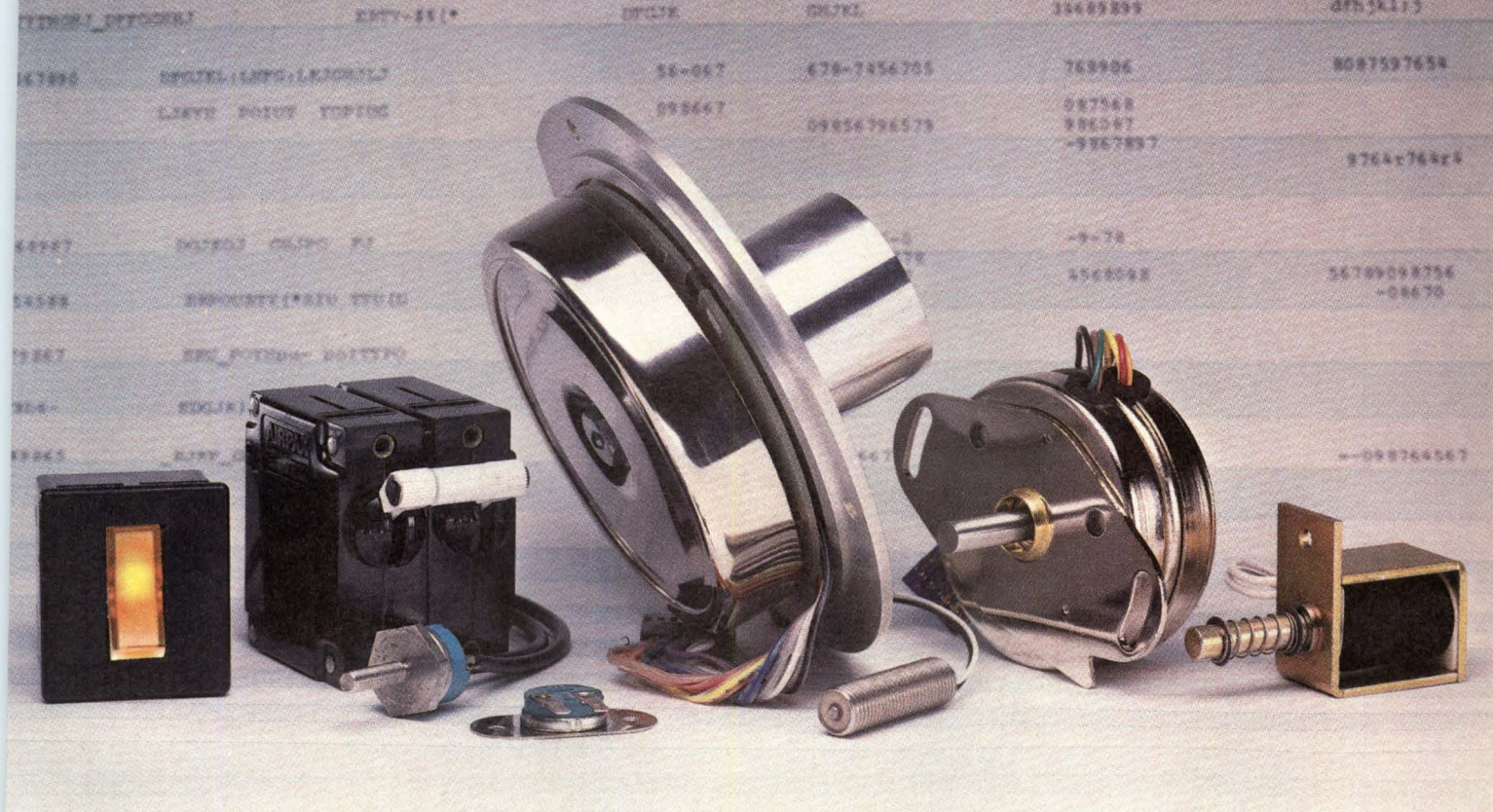

**We have the
components that
make your disc
drive drive, your
printer print,
etc., etc.**

We have the electromechanical components you need for your computers and peripherals. And the responsiveness you need to keep your production rolling.

For memory units, we supply solenoids and a complete line of brushless DC motors designed for 5¼" to 18" disc drives. And linear actuators that position read/write heads in precise digital steps.

For printers, we make rotary steppers and subfractional HP motors, and magnetic pick-ups.

For microcomputers, minis and mainframes, Airpax magnetic circuit breakers assure positive protection. They're unaffected by ambient temperature, and serve the dual function of power switch and overload protection.

And Airpax thermostats monitor cabinet temperatures, and shut down systems instantly when overheat threatens sensitive circuits.

You can select from our thousands of standard models. Or we'll create a custom model for you, and produce a few dozen for prototypes, or millions for a production run.

Ask us for engineering data. Airpax Corporation, a North American Philips Company, W. Johnson Ave., Box A, Cheshire, CT 06410. (203) 272-0301.

AIRPAX®
We give you control.

CIRCLE 80

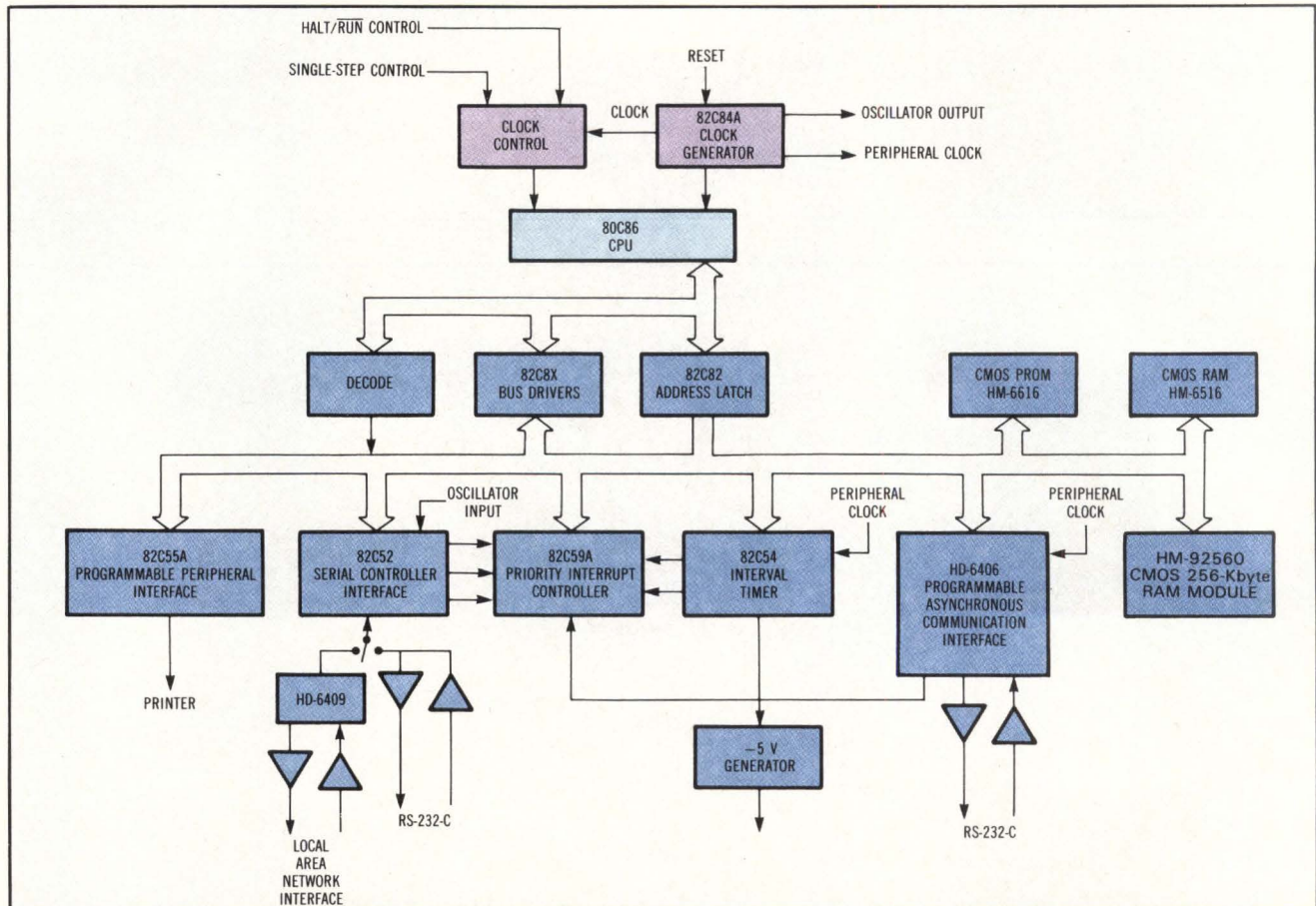

Fig 3 The CPU input board built around the 80C86 processor chip shows a CMOS approach to building a 16-bit processor. This prototype system also features a completely static design and a parallel interface using the 82C55A programmable peripheral interface.

Stopping the 82C84A oscillator results in an even greater power reduction with the system power supply current (I_{CC}) falling to less than 2 mA. This standby current includes a bias current for a negative voltage generator in the system for the RS-232 interface. Actual CMOS system standby current is less than 1 mA for room temperature (25°C) typical operation.

Using the Harris 80C86 CMOS 5-MHz, 16-bit CPU, along with CMOS peripheral and memory products, this design operates at less than 100 mA (5 V, 25°C). This power reduction of over 95 percent, when compared to the equivalent NMOS/bipolar system, is achieved with no sacrifice in performance. In addition, trade-offs that will minimize power dissipation can occur in a CMOS system. Evaluation of speed/power requirements for a system should take place early in a project so that long term power goals can be met.

One of the biggest advantages of CMOS microprocessor systems is the ability to stop circuit operation, either through a software command or hardware control. Two types of software power-down functions are now in use. The first type stops only the clock to the internal registers and CPU logic. This will result in approximately 50- to 70-percent power savings for the CPU and the clock

driver circuit. This type of software power-down capability is available on the NSC800.

Stopping only the clock to internal circuitry allows an immediate restart from the power-down situation. Since the oscillator is left running, there is no

Worst-case Power Comparisons between CMOS and NMOS/Bipolar			
PART TYPE	CMOS I_{CC}^*	NMOS I_{CC}^*	
80C86	50 mA	340 mA	5-MHz operating frequency
82C52	16 mA	120 mA	for NMOS 8251 current and BRG current
82C54	10 mA	140 mA	at 8-MHz count frequency on all timers
82C55A	1 mA	120 mA	—
82C59A	1 mA	85 mA	—
82C8X	14 mA	1120 mA	Seven 82C8x latches and transceivers
82C84A	25 mA	162 mA	15-MHz crystal frequency (5-MHz system)
PROM	60 mA	250 mA	8 Kbytes of PROM
RAM	110 mA	770 mA	44 Kbytes of RAM
	287 mA	3107 mA	

*Specification maximums over full temperature and voltage ranges, where available. Worst-case estimates are used in other cases.

Introducing Xycom's VMEbus Product Line. A Better Mousetrap.

Our "better mousetrap" offers you some attractive bait: increased productivity through use of state-of-the-art VMEbus hardware for data acquisition and control. The fact is, our new VMEbus modules are loaded with

extra value: in systems architecture, in product reliability, and in customer support before and after the sale. All enhanced by fifteen years of intensive, industrial microcomputer experience—with thousands

of successful installations worldwide.

So go ahead. Beat a path to our door today and ask for our new VMEbus brochure. After all, everybody deserves a better mousetrap, don't they?



The image shows a VMEbus circuit board with a mouse trap mechanism. The board is blue and populated with various integrated circuits and components. A coiled metal spring is attached to the board, forming a trap. A small mouse is positioned to the left of the board, with its tail coiled. The background is a dark grid pattern with a red and purple glow at the top.

xycom

Look Closer. We Deliver Added Value.

750 North Maple Rd., Saline, Michigan 48176 Phone in MI: (313) 429-4971, Toll-Free: 1-800-367-7300
Regional Offices: San Francisco (415) 785-1294 • Chicago (312) 963-7272
Philadelphia (215) 687-0186 • Boston (617) 246-2544 • Cleveland (216) 499-2555

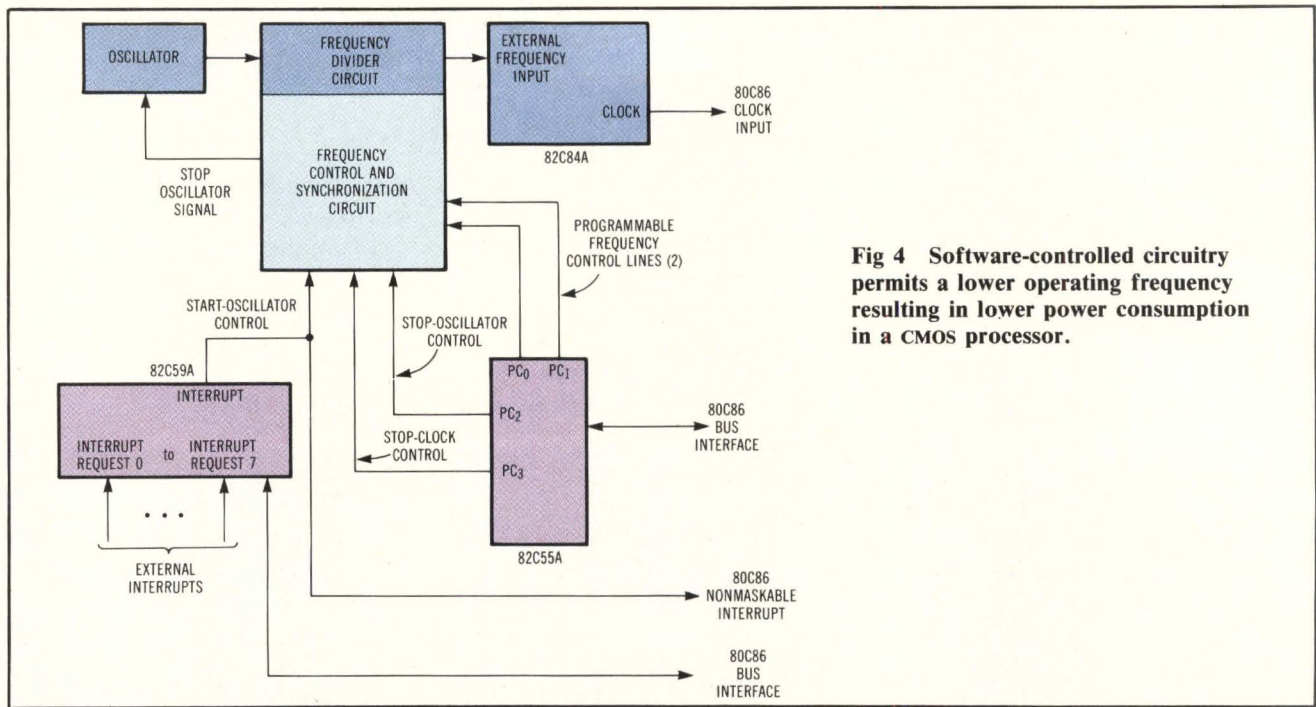

Fig 4 Software-controlled circuitry permits a lower operating frequency resulting in lower power consumption in a CMOS processor.

oscillator startup time needed. Because of the continuing oscillator operation, however, the CPU and associated clock circuit, whether internal or external, will still dissipate power. In addition, the 30 to 50 percent of the original power required is in the 10- to 45-mA range.

A second option is becoming popular on some single-chip processors. This power-down command stops the oscillator and brings the entire system power down to the standby levels. All clocks and oscillators are stopped and the entire system is put into a standby or quiescent state. Standby current totals for all-CMOS systems can be in the range of 1 to 3 mA, depending on system size and complexity. The 146805 single-chip microcomputer from Motorola has this power-down command. This can be accomplished on existing general-purpose, static CMOS microprocessors (including the 80C86) with the use of external circuitry.

Surveying static operation

All devices in the 80C86 family are designed with fully static circuitry. This allows device operation from dc to the individual maximum rated frequencies. Since operating power is critical in low power applications, this parameter can be controlled by the user, based upon system operating frequencies. CMOS operating power is directly related to frequency; the lower the frequency, the lower the operating power dissipation. At a dc frequency, device standby currents are typically less than 10 μ A.

Under normal, full-power operating conditions, an 80C86 system runs at a standard 5-MHz operating frequency and keeps full operating power to a minimum. If, however, the microsystem power fails independently of the main power, operation can be

maintained. With a backup battery power supply, the system can transfer from main power operation to battery supply. With system power levels approximately 10 percent that of equivalent NMOS/bipolar circuits, full 5-MHz operation is still possible.

A major advantage of CMOS micro systems is the ability to stop circuit operation via a software command or hardware control.

As primary power is diminished (battery discharging) or removed (power interruption or battery-backup operation) in portable or remote battery-powered applications, the need to run at a lower frequency to conserve power may become important. Operating power is critical in low power applications and CMOS operating power is directly related to frequency. With the static design of the 80C86 family, power requirements can be controlled by the user; reduced operating frequency lowers power. Static design allows this reduced operating frequency without the fear of causing data loss or invalid operation.

One method of low frequency operation is shown in Fig 4. The system clock is divided by software-controlled external circuitry to provide a lower operating frequency—eg, 100 kHz. The system power consumption is significantly reduced while complete computational powers remain available. The low frequency mode of operation is unavailable with some CMOS microprocessors and most NMOS processors, including the NMOS 8086. Dynamic register designs in the nonstatic CPUs need to be refreshed at a minimum rate and do not allow very low operating frequencies or stopped-clock standby operation.

PICTURE PERFECT PRODUCTIVITY

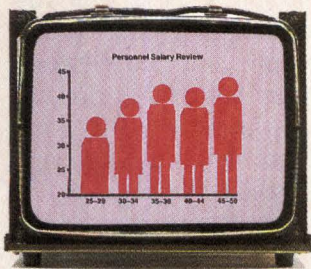

Administration



Order Entry

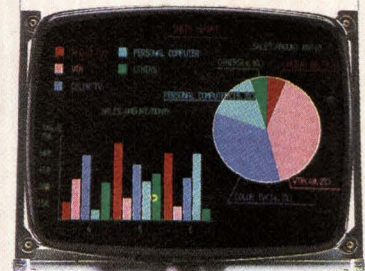

Marketing and Sales

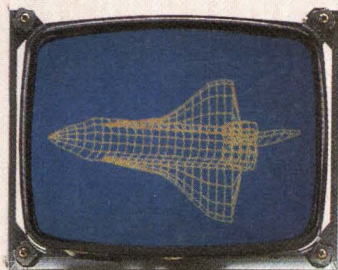

Engineering

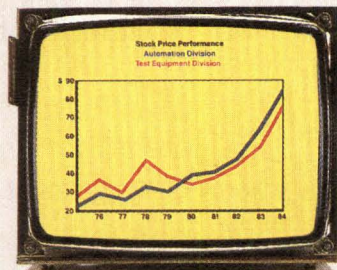

Finance

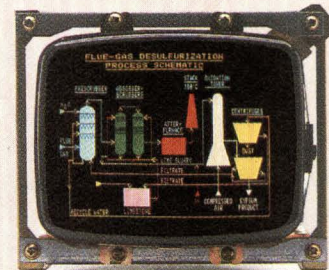

Q.A. and Statistics

MIS Monitors from Mitsubishi

Mitsubishi monitors take excellent care of business at every level from clerical to top management. Our extensive product line includes both color and monochrome models, with high and medium resolution. In any size you need, with exceptional strength in 12", 14" and 16" models. Customs, too.

With all this selection, it's easy for you to performance-match our monitor to your MIS requirements. For superb business graphics, we'll deliver super-high contrast monitors with an extended range of true, vibrant colors and a very dense black. For number-crunching tasks, select a high-efficiency monitor with special anti-reflective coating, reducing operator fatigue even after extended periods of viewing. Choose economical monochrome units to staff up an entire order entry department. And use our precision, high fidelity monitors for demanding CAD/CAM applications.

VISIT OUR NEW MONITOR DISPLAY AT NCC, Booth # D3210

Just pick the features, then let us show you how Mitsubishi monitors can give your system a better image at the best possible price.

For complete technical specifications or MIS applications information, contact Mitsubishi today.

Write or call: Mitsubishi Electronics America, Inc., Industrial Electronics Division, 991 Knox St., Torrance, CA 90502. Telephone: (213) 515-3993. In the East, call (617) 938-1220; in the Central area, call (312) 298-9223.



**MITSUBISHI
ELECTRONICS**

ADVANCED AND EVER ADVANCING
CIRCLE 82

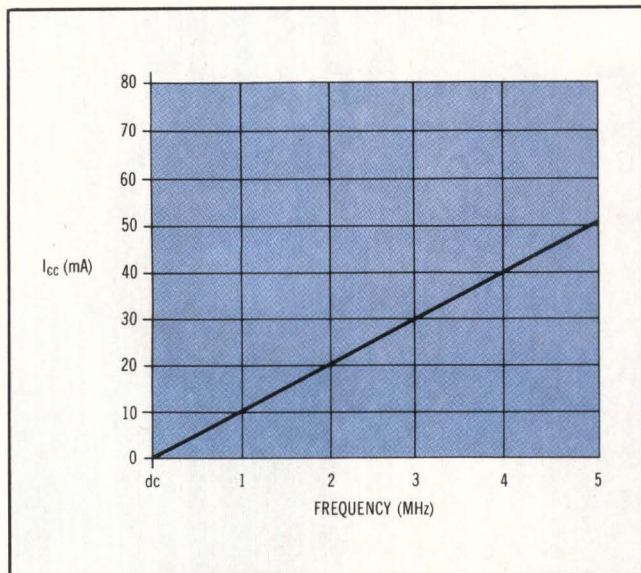

Fig 5 Power supply current of the 80C86 (and other CMOS micros) is linearly related to the operating frequency.

Worst-case operating current for the 80C86 CPU at 5 MHz is 50 mA, derated linearly as frequency is reduced (Fig 5). This means that the operating power supply current for the 80C86 CPU is approximately 1 mA at 100 kHz. Similar deratings are valid for the power dissipations of the peripheral, support, and memory circuits.

Finally, given a power critical situation where power is diminished to the point where even continuous, low frequency operation is not desirable, the 80C86 static internal circuits allow the clock to be

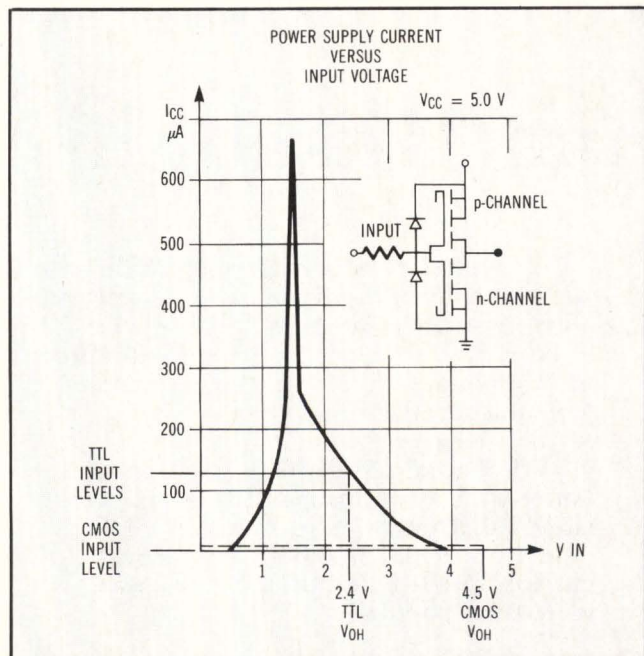

Fig 6 CMOS input circuit transfer characteristics show the danger of allowing the input voltage to float within the active region of the device. The floating inputs will settle at the threshold voltage where current flow is greatest. Consequently, unused inputs must be tied to either V_{CC} or ground.

stopped. This eliminates the power dissipation associated with switching and reduces device currents to standby levels. At standby, individual 80C86 peripheral device currents are guaranteed to be less than $10 \mu A$ with the 80C86 CPU less than $500 \mu A$.

In order to meet minimum 80C86 clock timing requirements, the clock frequency reduction must be timed properly. Therefore, synchronization is required between the system clock and the low frequency/stop-clock control signals. Cases of asynchronous timing errors caused by irregular clocks outside the CPU specification limits must be avoided. Additional circuitry allows control of this power-down mode using a bit from the 82C55A for stopping the clock. The output from the 82C59A priority interrupt controller is used to restart the clock to the CPU upon demand from an external source.

Another advantage to static design is the ability to stop and single step the system clock during system prototyping. This valuable method of debug allows the designer to inspect the system bus and look at specific operations in the system. The real-time complications of 5/8-MHz bus transfers are eliminated and system debug is significantly simpler.

Static design debug eliminates the realtime complications of 5/8-MHz bus transfers and simplifies system debug.

Undefined input voltage levels are forbidden in CMOS system design. Undefined input states allow the input circuitry to "float" within the active device region. Unfortunately, floating CMOS inputs tend to settle at the threshold voltage, where current flow is the greatest. This will increase I_{CC} in most CMOS devices and can thus cause irregular or incorrect operation.

Fig 6 shows the CMOS input circuit transfer characteristic. As input voltage moves away from either power supply rail, both the n-channel and p-channel are turned on and current increases. Therefore, all CMOS inputs, if unused, must be tied to V_{CC} or ground by one means or another. This will avoid high I_{CC} conditions and oscillation.

If non-CMOS input voltages exist in a mixed technology system (TTL, NMOS, etc), system power can be increased again. Since these other technologies can have less than ideal output voltages, both the p-channel and n-channel input transistors can operate in their linear region. This defeats the complementary function of CMOS, which yields its low power.

Pull-up/pull-down resistors offer the most common method of defining CMOS inputs when no driving source is present. This technique has several disadvantages. First, additional components (resistors) that increase production costs and board real estate are necessary. Second, more power dissipation

can actually occur when using pull-up/pull-down resistors. Since the driving output must supply extra current when switched to the opposite state of the pull-up/pull-down resistor, a significant increase over normal CMOS leakage currents can occur.

The role of bus-hold circuitry

To eliminate external resistors along with the high power effects of "floating" inputs, the 80C86 CPU uses onchip "bus-hold" circuitry to provide valid input voltages when there is no driving source (ie, a no-connect or a driving input that goes to a high impedance state). The bus-hold circuits maintain these pins, internally and externally, as the last valid logic level until they are overdriven by another source. A driver must supply 400 μ A of sink or source current at valid input voltage levels to overdrive the bus-hold circuits. Since this circuitry is active, and not a passive resistive-type element, 80C86 standby current is kept to a minimum.

System needs and overall compatibility dictate the placing of bus-hold circuits on the CPU. The 80C86 CPU has bus-hold devices on selected pins (AD0 to AD15, A_X/S_X, S0 to S3, and control lines on pins 29 to 32 and 34) that are common to the local bus. This eliminates the summing of overdrive current, which would occur if all 80C86 family members had bus-hold circuits on common pins.

The 82C82/83/86/87 octal latches and transceivers have specialized input circuits that minimize I_{CC} transients occurring due to switching and undefined inputs. These circuits also help eliminate the need for external resistors. Inputs are gated off on the 82C82 by the falling edge of the strobe input, while input inverters are isolated from V_{CC} by turning off the upper p-channel and lower n-channel. Thus, there is no current path, other than leakage, between V_{CC} and ground during input transitions once data is latched into the 82C82. Internal circuitry is also isolated by gated inputs. Invalid logic states from floating inputs will not be transmitted to succeeding stages when the inputs are gated off. Pull-up resistors can be removed.

Please rate the value of this article to you by circling the appropriate number in the "Editorial Score Box" on the Inquiry Card.

High 719

Average 720

Low 721

TURN YOUR IBM PC INTO A 21.4 MBYTE SUPERSYSTEM!

READY-TO-USE FIXED/REMOVABLE DISK MEMORY FOR THE PC AND XT

The Vermont Research Corporation 81 PC, a fixed/removable hard disk subsystem, turns your IBM PC or PCXT into a 21.4 Mbyte supersystem. With 10.7 Mbytes on a fixed hard disk and 10.7 Mbytes on a cartridge disk, the 81 PC streamlines **data backup** and gives you all the **portability and security** advantages of removability. The 81 PC copies 6 times faster than a Winchester/floppy combination.

*IBM is a registered trademark of International Business Machines.

Yet for all its versatility, the VRC 81 PC still offers **Winchester Performance and reliability and 0 to 55° C operating temperature range**. And the VRC 81 PC is **ready-to-use under PC DOS 2.0**. The subsystem comes complete with the fixed / removable drive, a power supply, SASI controller, a cable and a PC host adapter that plugs into a standard expansion slot.

The VRC 81 PC is manufactured by a company with 24 years experience supporting OEMs and system integrators.

Vermont Research Corp.
Precision Park
North Springfield, VT 05150
Tel: (802) 886-2256
TWX 710/363-6533

VRC[®]

**Memory Products for Systems
That Can't Stand Failure**

SEE US AT
COMDEX AND NCC.



TOSHIBA. A LEA OF CMOS AND GET

A brand new perspective on filling your IC Microcomputer and Microprocessor needs.

Here's news for every design and purchasing department: Toshiba has developed one of the world's most comprehensive line-ups of CMOS and NMOS Microcomputers available today.

In fact, we're the world's second largest manufacturer of 4-bit CMOS and NMOS Microcom-

puters. Our 8-bit devices—including the CMOS and NMOS 8048 and 8049 as well as the CMOS Z80 family—are meeting wide approval because they're tops in quality and are in high volume production now. And our 16-bit processors are on the way.

Throughout our entire product line, we have the experience, technology, quality, price, performance and availability to surprise you in a lot of pleasant ways.

AREA SALES OFFICES: WESTERN AREA, Toshiba America, Inc., (714) 752-0373; CENTRAL AREA, Toshiba America, Inc., (612) 831-2566; EASTERN AREA, Toshiba America, Inc., (617) 272-4352; NORTHWESTERN AREA, Toshiba America, Inc., (408) 720-8570; REPRESENTATIVE OFFICES: ALABAMA, Glen White Associates, (205) 883-7938; ARIZONA, Semper Fi Sales Company, (602) 991-4601; ARKANSAS, Technology Sales Company, (214) 380-0200; CALIFORNIA (Northern), Elrepc, Inc., (415) 962-0660; CALIFORNIA (Southern), Bager Electronics, Inc., (714) 957-3367; COLORADO, Duffy Associates, (303) 595-4244; CONNECTICUT, Datcom, Inc., (203) 288-7005; DELAWARE, Vantage Sales, (609) 663-6660; FLORIDA, Donato & Associates, (305) 522-2200, (305) 352-0727, (813) 785-3327; GEORGIA, Glen White Associates, (404) 441-1447; IDAHO, Components West, (206) 271-5252; ILLINOIS, L-TEC, (312) 593-7200; INDIANA, Leslie M. DeVoe Company, (317) 842-3245; IOWA, J.R. Sales Engineering, (319) 393-2232; KANSAS, R.R. Burton & Associates, (816) 763-5385; KENTUCKY, Leslie M. DeVoe Company, (317) 842-3245; LOUISIANA, Technology Sales Company, (214) 380-0200; MARYLAND, Glen White Associates, (301) 252-6360; MASSACHUSETTS, Datcom, Inc., (617) 891-4600; MICHIGAN, R.C. Nordstrom & Company, (313) 559-7373; MINNESOTA, Quantum Sales, Inc.,

GETTING CLOSE TO THE SOURCE OF NMOS MICROCOMPUTERS.

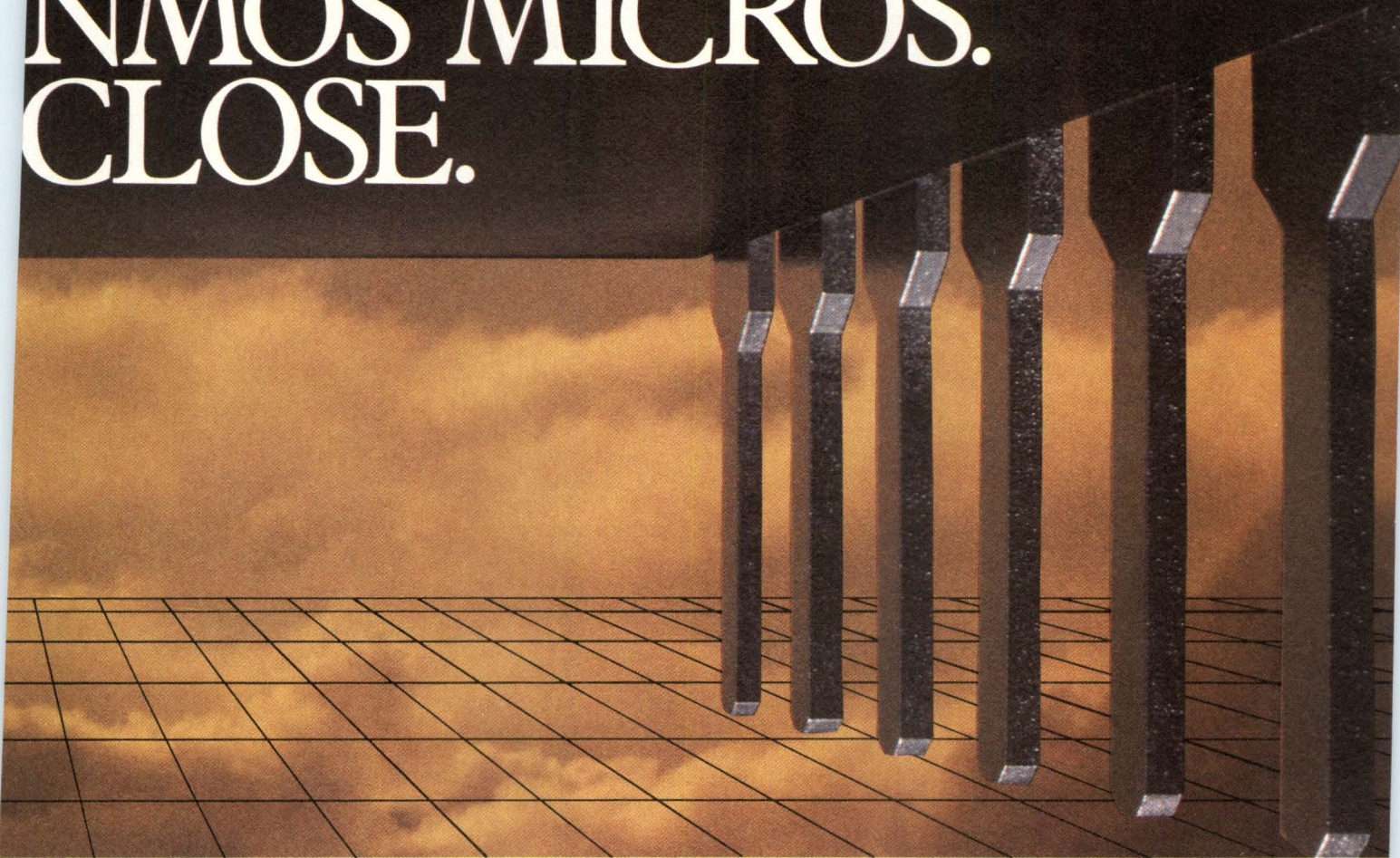

Get close to the world's most respected name in MOS technology and make us your new source of CMOS and NMOS Microcomputers and Microprocessors.

Toshiba. This new perspective will do you a world of good.

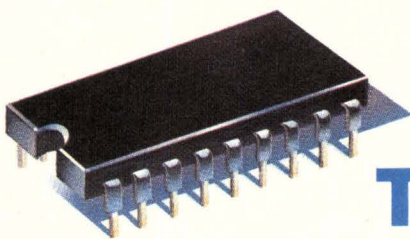

8-BIT SINGLE CHIP MICROCOMPUTERS—8048/8049 FAMILY						
Device	Technology	ROM (Bytes)	RAM (Bytes)	Speed	Operating Current (Max)	Standby Current
TMP8048	NMOS	1K	64	6MHz	135mA	15mA
TMP80C48	CMOS	1K	64	6MHz	10mA	10µA
TMP8049	NMOS	2K	128	6MHz/11MHz	170mA	50mA
TMP80C49	CMOS	2K	128	6MHz	10mA	10µA
TMP80C50	CMOS	4K	256	6MHz	15mA	10µA

8-BIT MICROPROCESSOR—CMOS Z80A FAMILY				
Device	Description	Technology	Operating Current	Power-Down Current
TMPZ84C00	4MHz Z80A CPU	CMOS	15mA (@ 4MHz)	10µA

Also available are the popular Z80 peripherals in CMOS including P I/O, CTC, CLOCK, DMA & S I/O.

8-BIT MICROPROCESSOR—8085A FAMILY				
TMP8085A	NMOS	8085A	3MHz CPU plus many of the popular 8-bit peripherals.	

4-BIT SINGLE CHIP MICROCOMPUTERS—TLCS-47 FAMILY	
The TLCS-47 Includes Many Powerful Features Including:	
• 90 Instruction, Instruction Set	• 12-Bit Timer/Counter
• Serial I/O Capability	• 6 Interrupts
Available Device Types:	• Devices With LCD Drive
• CMOS Devices	• Devices With V.F. Drive
• NMOS Devices	• Many ROM/RAM, I/O Versions

TOSHIBA AMERICA, INC.

A WORLD STANDARD IN MOS.

(612) 884-4700: **MISSISSIPPI**, Glen White Associates, (804) 237-6291; **MISSOURI**, R. R. Burton & Associates, (816) 763-5385; **MONTANA**, Components West, (206) 271-5252; **NEBRASKA**, R. R. Burton & Associates, (816) 763-5385; **NEVADA**, Elreco, Inc., (415) 962-0660; **NEW JERSEY**, Necco 1, (201) 461-2789; Vantage Sales, (609) 663-6660; **NEW MEXICO**, Semper Fi Sales Company, (602) 991-4601; **NEW YORK**, Necco 1, (201) 461-2789; PI-tronics, (315) 455-7346; **NORTH/SOUTH CAROLINA**, Glen White Associates, (919) 787-7016, (919) 787-7023; **NORTH/SOUTH DAKOTA**, Quantum Sales, Inc., (612) 884-4700; **OHIO**, Del Steffen & Associates, (216) 461-8333; (419) 884-2313, (513) 293-3145; **OKLAHOMA**, Engineering Sales Company, (918) 493-1927; Technology Sales Company, (214) 380-0200; **OREGON**, Components West, (503) 643-5588; **PENNSYLVANIA**, Del Steffen & Associates, (412) 276-7366, Vantage Sales, (609) 663-6660; **TENNESSEE**, Glen White Associates, (615) 477-8850; **TEXAS**, Technology Sales Company, (214) 380-0200, (512) 476-9874; **UTAH**, Duffy Associates, (303) 595-4244; **VIRGINIA/WEST VIRGINIA**, Glen White Associates, (804) 237-6291, (804) 295-0435, (804) 224-7764, (804) 224-0404; **WASHINGTON**, Components West, (206) 885-5880; **WISCONSIN**, L-TEC, (414) 774-1000; **WYOMING**, Duffy Associates, (303) 595-4244; **CANADA**, Source Electronics, Ltd., (416) 675-6235

The Hitachi CMOS 6300 Family— 8-Bit, Single-Chip Microcomputers

The Real Performance Leader

The 63B01 offers you a powerful CPU and high-speed operation for systems requiring complex and fast data processing. Here's how it compares with the 80C51.

Benchmark Study

	Execution Time (μ s)		Code Efficiency	
	63B01	8051/ 80C51	63B01	8051/ 80C51
XTAL (MHz)	8	12	8	12
Instruction Cycle Time (μ s)	0.5	1	0.5	1
TASK				
Binary Multiply	39	42	37	43
Bit Manipulation	6.5	6	8	8
Logical Operations (AND/OR)	7	3	11	6
Nibble Comparison	11	12	29	29
Interrupt Processing	11.5	21	1	19
TOTALS	75	84	86	105

Execution time for the 6301 ranges from 0.5 μ s (2 MHz) to 1 μ s (1 MHz) depending on the model, at a wide range of operation: $V_{CC} = 3V$ to 6V. And an error-detecting function prevents illegal op-code and illegal addresses.

Other enhancements of the 6300 Family include upward source and object code compatibility with the HD6800 and bus compatibility with the MC6800 Family.

All the Support You Need

Hitachi's comprehensive development support includes evaluation kits, emulators, prototyping devices, and cross-software packages running under

CP/M on personal computers and under ISIS-II on Intel development systems.

The 63P01 offers piggyback flexibility, which lets you "fine tune" programming before committing to a final ROM code. All this development support is available now for you to start your design.

Enviably Track Record

The 6301 has been in mass production for more than two years. Five million units are now the brains behind hand-held terminals, briefcase computers, printers, digital switches, phones, modems, and automotive spark control computers.

Available in Quantity

If you need them now...in production quantities...you're in luck. The Hitachi 6300 Family offers immediate availability of the finest selection of single-chip microcomputers on the market today.

Why wait when you can have the finest 8-bit, single-chip microcomputers immediately. For complete design solutions, you can combine Hitachi's 6301 with our CMOS peripheral LSIs, CMOS ROMs, and CMOS RAMs for a total CMOS system.

So when you want deliveries, not just promises, call Hitachi. Ask your local Hitachi Representative or Distributor Sales Office about the CMOS Family of 8-bit, single-chip microcomputers.

HD63B01

4K Bytes of ROM, 128 Bytes of RAM
29 Parallel Input/Output Lines
Stop-Start Serial Communication Interface
16-Bit Timer
8 x 8 Multiply Instruction
Low Power Consumption Mode (60mW)
Sleep Mode (10mW), Standby Mode (10 μ W)
Instruction Cycle Time: 0.5 μ s
40-Pin Package

Part No.

Architecture

HD6301, 63A01, 63B01	Mask Programmable ROM On-Chip
HD6303	External ROM
HD63P01	Piggyback EPROM

FAST ACTION

To obtain product literature immediately,

CALL TOLL FREE

1-800-842-9000, Ext. 6809.
Ask for literature number 705.



Hitachi America, Ltd.
Semiconductor and IC Sales
and Service Division
1800 Bering Drive
San Jose, CA 95112

6301 \geq 80C51

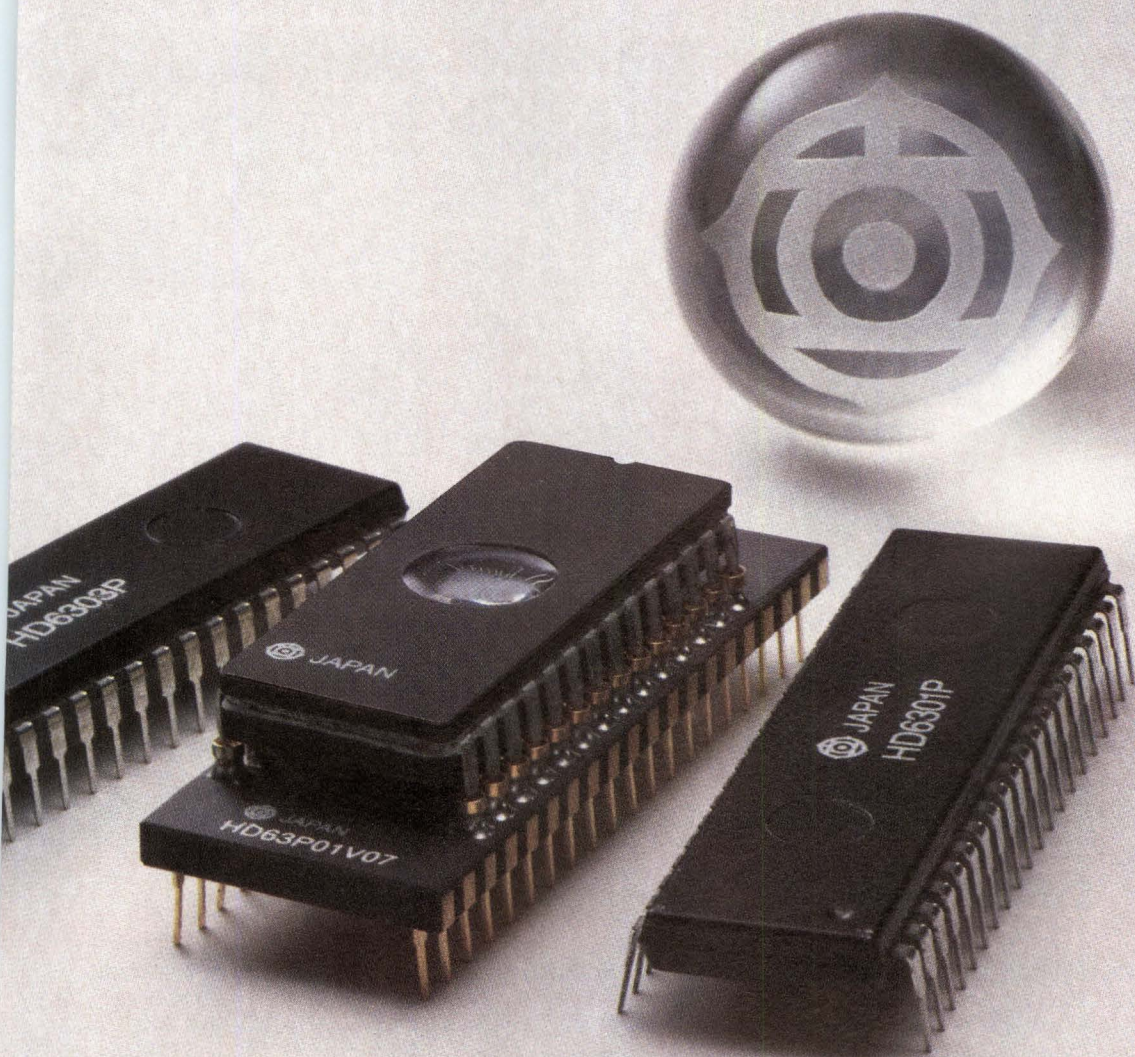

 **HITACHI**
A World Leader in Technology

WITH OUR REAL-TIME OPERATING SYSTEM AND YOUR IBM® PC, YOU COULD CONTROL THE WORLD.

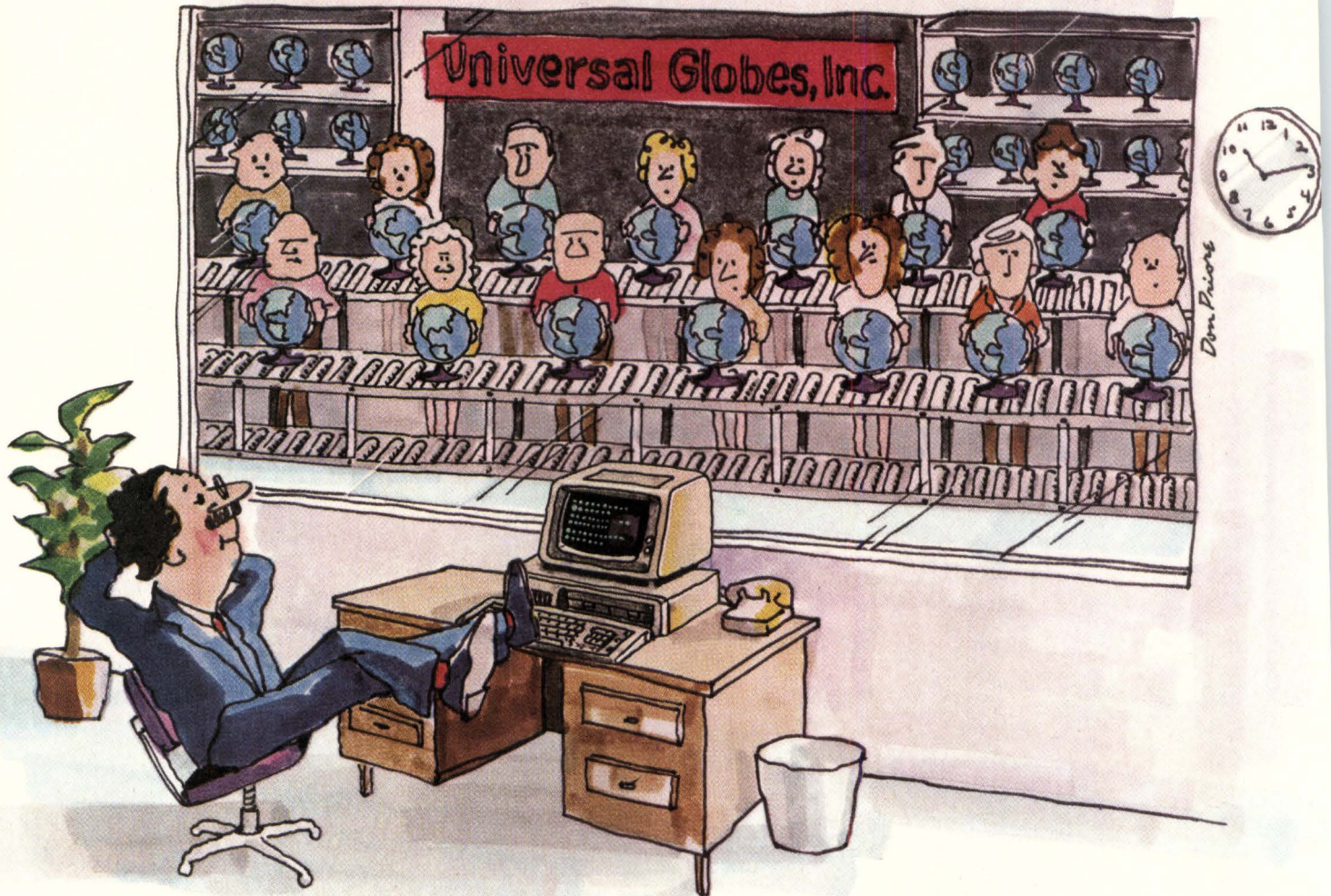

Factory automation is just one of the many control and data acquisition applications you can run with our MTOS-86/PC operating system and your IBM® PC (or equivalent). Chemical process control is another. Alarm reporting systems are a third. The list is virtually endless.

MTOS-86/PC is the newest member of our MTOS-86 family of real-time multi-tasking operating systems. The fastest, most efficient O/S software on the market today.

Within your IBM PC, MTOS-86/PC fully controls the PC and its peripherals, including keyboard, disk drives, timer, interrupt controller and process input/output systems. It allows custom drivers to be attached for special hardware and can easily be configured for your application.

MTOS-86/PC comes on diskette in the PC format. It includes executive, console driver, debugger, high-speed file system, a run-time interface for the Intel® C compiler and a test/demonstration program.

Price for a single copy, including user manuals, is \$495. Inexpensive technical support is available, too.

For more information, contact Industrial Programming Inc., 100 Jericho Quadrangle, Jericho, NY 11753. (516) 938-6600. Telex: 429808 (ITT).

ipi Industrial Programming Inc.

The standard-setter in operating system software

IBM is a registered trademark of International Business Machines Corporation.
Intel is a registered trademark of Intel Corporation.

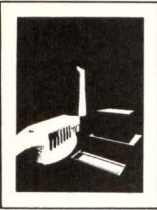

HOW TO PORT UNIX TO A NEW MICROPROCESSOR

CPU architecture has a significant effect on the process. Compromises must be made between the capabilities of the chip and the purity of Unix.

**by Nai-Ting Hsu,
Glenn Skinner, and
Jay Zelitzky**

Without a doubt, Unix is moving out of the laboratory and university and into the commercial marketplace. During this year, the availability of Unix System V on the National Semiconductor 16032, Motorola 68000, Intel 286, and Zilog Z8000 microprocessors will help bring Unix solidly into the world of microcomputers. Small microprocessor-based machines running Unix will be able to provide many of the powerful functions of larger computer systems, but at a lower cost.

Nai-Ting Hsu is currently senior engineering manager at National Semiconductor Corp, 2900 Semiconductor Dr, Santa Clara, CA 95051. He holds an MS and a PhD in computer science from the University of Wisconsin—Madison.

Glenn Skinner is engineering section head at National Semiconductor Corp. He holds a BA and an MS from Cornell University.

Jay Zelitzky is a systems programmer at National Semiconductor Corp. He has a BA in computer science from the University of California at Santa Cruz.

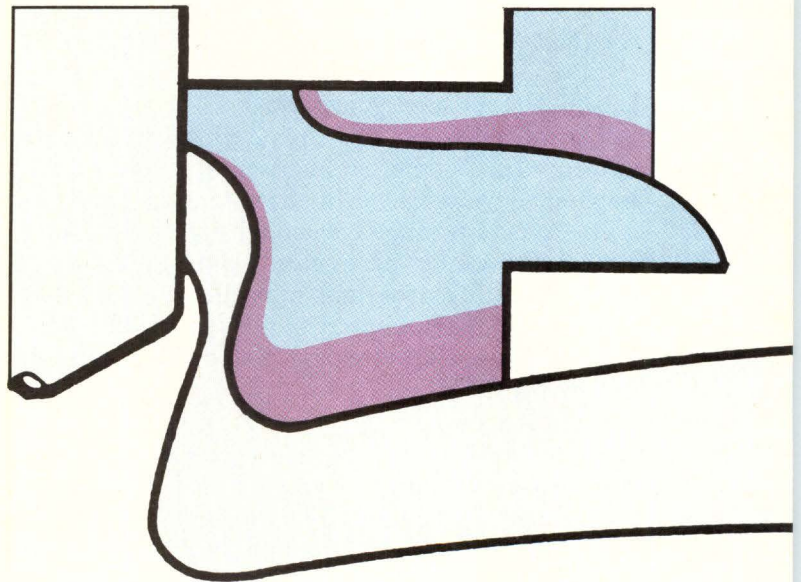

From a microprocessor manufacturer's standpoint, the task of taking existing, working Unix code and moving it to a new machine is not as difficult as starting from scratch with a proprietary operating system. Nor does it require as much manpower. Moving Unix to one of these advanced microprocessors, although easier than starting from scratch, can still be a challenging task. At National Semiconductor, the Berkeley 4.1 BSD version of Unix is ported to the NS16032. This product is called Genix.

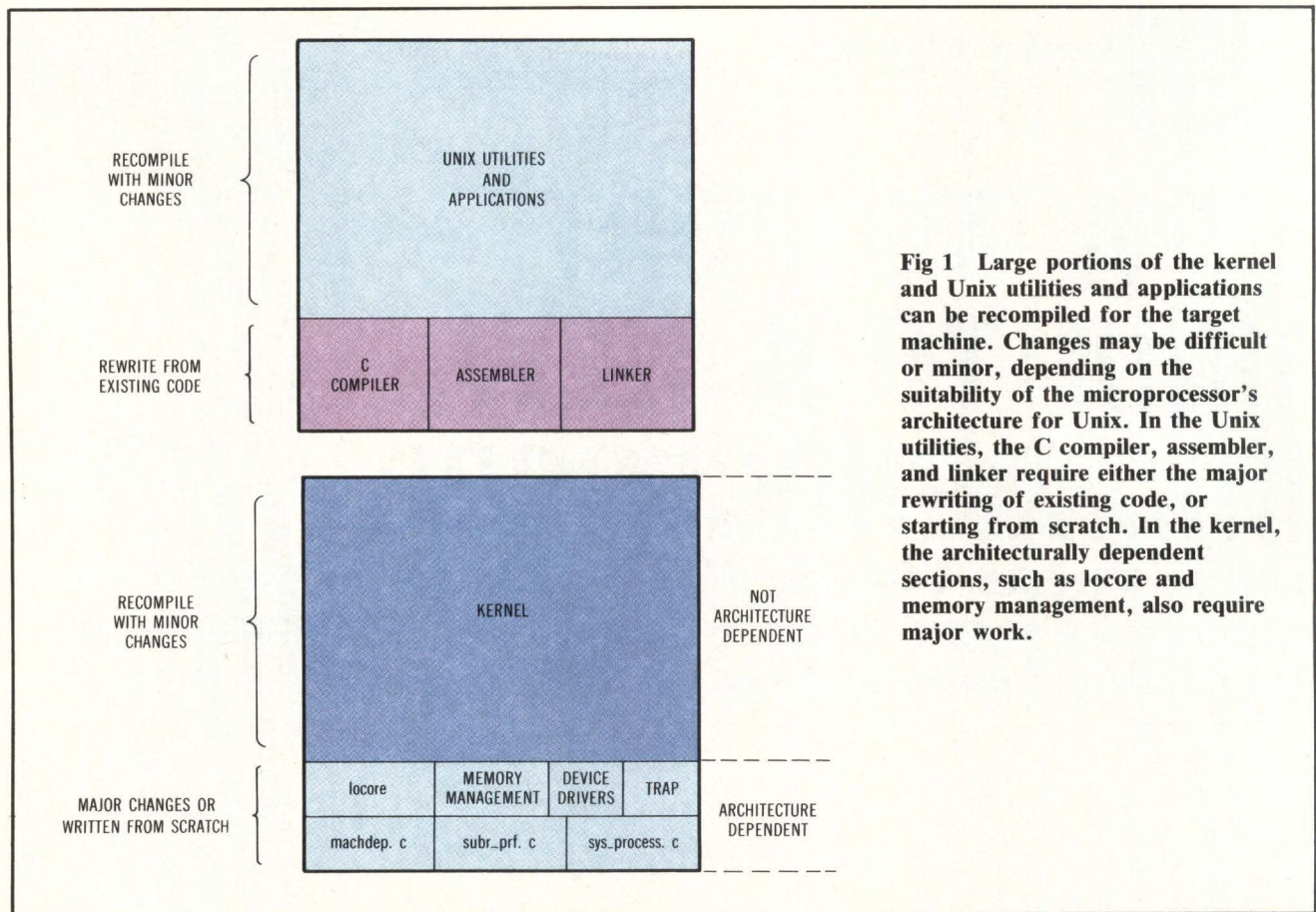

Fig 1 Large portions of the kernel and Unix utilities and applications can be recompiled for the target machine. Changes may be difficult or minor, depending on the suitability of the microprocessor's architecture for Unix. In the Unix utilities, the C compiler, assembler, and linker require either the major rewriting of existing code, or starting from scratch. In the kernel, the architecturally dependent sections, such as *locore* and memory management, also require major work.

With the experience of having successfully moved Unix to a new microprocessor, here is some advice for those faced with a similar task.

Establishing porting guidelines

The process of porting Unix begins with the development of a C compiler, an assembler, and a linker. In parallel, work can begin on the Unix system kernel itself. Assembly language code (roughly 2000 out of 40,000 lines) must be written from scratch. Then, the Unix utility programs must be recompiled for the target machine and modified if necessary. Debugging, software release, and quality assurance follow (Fig 1).

Before this work begins, porting guidelines should be established to keep the effort consistent. Guidelines should determine when it is acceptable to modify existing code, what the target kernel size should be, and what procedures should be used for software releases.

Depending on the needs of the porting team, the Unix porting process can bring competing goals face to face. On the one hand, because a new chip offers a range of features and capabilities, the operating system could be made to exploit these features, whether or not it was designed to do so. For example, if a microprocessor offers demand-paged virtual memory, users should be able to take advantage of it. On the other hand, changes in the operating system that would affect the compatibility of

application programs should be avoided. Compromises must be made.

Other porting teams may want their porting goals to include minimum changes in the existing code. If time is extremely short, this may be the best choice. National Semiconductor's accomplished goals allow existing code to be changed when chip features could be exploited. This is done while keeping the modifications inextensive and maintaining the basic Unix structure.

Regarding the kernel itself, keeping a microprocessor-based operating system as small and clean as possible ensures low overhead. To improve the system's efficiency, avoid introducing new bugs or unnecessary complications, and find and fix old bugs in existing code. Finally, adhering to a structured design approach will result in a finished product that is easy to understand and maintain.

Quality is a big issue in American industry, in software as well as in other products. In an effort as large as porting Unix to a new microprocessor, it is essential to build in quality from the beginning of the project. Software quality-assurance personnel should be involved from the earliest stages of the project to ensure that proper equipment and software are available when it comes time to test the system. Software modules should be coordinated while they are in the development process to maintain consistency between modules. Engineering managers should plan revision control.

tcc

it may become your favorite UNIX command.

TARTAN's C Compiler: compatibility across machines and highly optimized code—to save you resources. Superior error reporting, complete documentation, and responsive product support—to save you time.

tmc

it may become another favorite UNIX command.

TARTAN's Modula-2 Compiler: the language Pascal wishes it could be—structured syntax, separate compilation, concurrent processing support. With TARTAN's high quality performance, error handling, and support.

Your Favorite Compilers— Save You Time and Resources

- **Optimized Code:** Fits more application on your machine; lets it execute faster. You'll get more work done with your present machines.
- **Superior Compile-time Diagnostics:** Minimizes recompilations. Locates errors precisely. Reduce the hours needed to produce a correct program.
- **Compatibility:** Keep up with a changing world. Mix languages in an application. Add new machines, and compile your existing programs correctly. TARTAN's technology produces compatible compilers without sacrificing optimization. Start with TARTAN compilers and grow with them—compatibly.
- **Complete Documentation:** Answers to the questions that always arise. Complete explanations and suggested actions for every compiler message. Your people adapt to TARTAN compilers quickly, and save time every day.
- **Responsive Product Support:** Your time is important. Take your questions and problems to our support service team. You get the answers when you need them.

TARTAN's compilers for C and Modula-2 for VAX/UNIX, DEC-20, and both 16000 and 68000 series computers. Additional machines and languages, including Ada, are coming. Ask us today about compiler suites.

**TARTAN—
We're going to be your favorite software company.**

VAX is a trademark of the Digital Equipment Corporation.
UNIX is a trademark of Bell Laboratories.

CIRCLE 87



TARTAN

TARTAN Laboratories Inc.
477 Melwood Avenue
Pittsburgh, PA 15213
(412) 621-2210

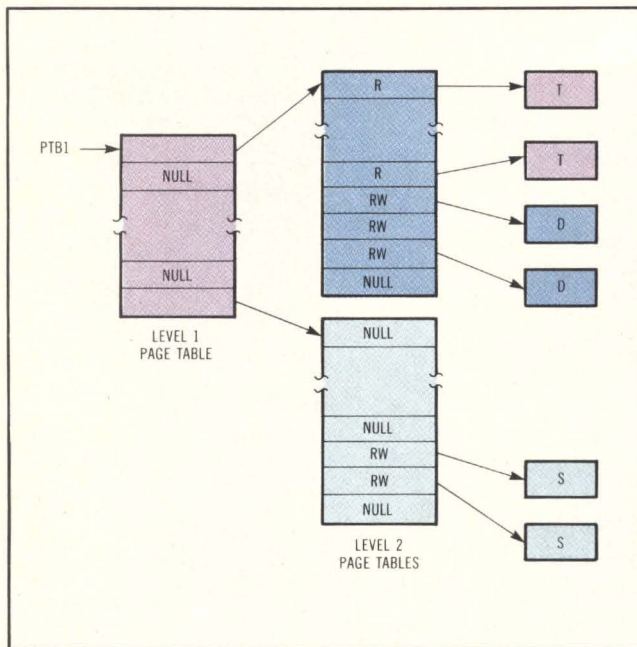

Fig 2 This user process map shows that in the NS16000 memory management scheme, the first-level page table entries point to second-level page table entries, which in turn point to the text (T), data (D), or stack (S) areas. Protection is provided in hardware. Text is read only (R), data is read/write (RW), and the stack is read/write.

In the case discussed here, the final software release is automated. The software recompiles the source code, loads it onto the SYS16 development system, and instructs the development system to perform a certain set of tests on the code. This minimizes human intervention in the release process.

Written in the high level C language, Unix is a highly portable operating system. It is not, however, entirely machine independent. Early in the porting effort, team personnel should (if they have not done so already) learn the requirements of the operating system, the architecture of the machine that the software is being ported from, and the capabilities of the target microprocessor. The porting effort's degree of difficulty is governed by how well the microprocessor's architecture can provide the features needed by the operating system.

Microprocessor architecture affects Unix port

Unix was not designed to accommodate a segmented architecture such as that of the 286, although it is a useful feature for some other operating systems. Rather, at the root of Unix structure is the need for a uniform, linear address space that can be divided into three regions: the text area, data area, and stack area (Fig 2). Unix assumes that, for an executing process, the lower section of the address space will contain the text, the data will follow the text, and the stack will begin at the highest address and grow downward. Since segmented architectures do not support this kind of layout, Unix will run on them only after considerable programming effort.

However, because the NS16032 has a uniform, 16-Mbyte address space, none of this was a problem.

For a single-user target system, virtual memory is not an issue. If the target microprocessor is intended to function in a multitasking environment, accomplishing virtual memory management can be a major benefit. As a multitasking operating system, Unix context switches between processes, diverting the CPU's attention from one to the other. Whenever the context is switched, the map for the old process must be saved and the virtual memory map for the current processes must be established. The means of mapping a process's virtual addresses to physical addresses is highly dependent on the available memory management architecture. The microprocessor should also provide protection. Thus, this architecture determines the success of the multitasking scheme.

Once the porting effort guidelines are established, the next key decision is choosing which C compiler to port. Ideally, the compiler should be highly reliable, with as few bugs as possible. In addition, consider the compiler's ability to produce compact code. The Berkeley 4.1 BSD portable C compiler was chosen, for example, because it was a well-debugged compiler that had been used extensively in the field.

A compiler goal should be adopted before porting is begun. The program aim (once a reliable, efficient compiler is chosen) should be to use as much existing code as possible and change only those elements that are directly affected by the microprocessor architecture. With minor revisions, this can shorten both development and debugging time. Attempts to optimize compiler performance should be done carefully. Be aware of what changes in the compiler can improve performance considerably, and what changes would result in little improvement. Consider debugging time when deciding on changes.

Once the porting effort guidelines are established, the next key decision is choosing which C compiler to port.

The target microprocessor's architecture affects how easily the C compiler can be ported. Because the NS16032 has a regular instruction set, it allows the use of any instruction on any register and in any addressing mode. With other microprocessors, there can be odd registers for special purposes, various rules for different instructions, and exceptions to the exceptions. These exceptions make the resulting code difficult to read, optimize, and debug. Programmers porting the compiler should always keep these exceptions in mind.

Assembler choice is a big decision and one that is not easily reversed. Before trying to develop an assembler, find out if there are already assemblers

Gould...Innovation and Quality in Superminicomputers

We've drawn the line on computer price/performance.

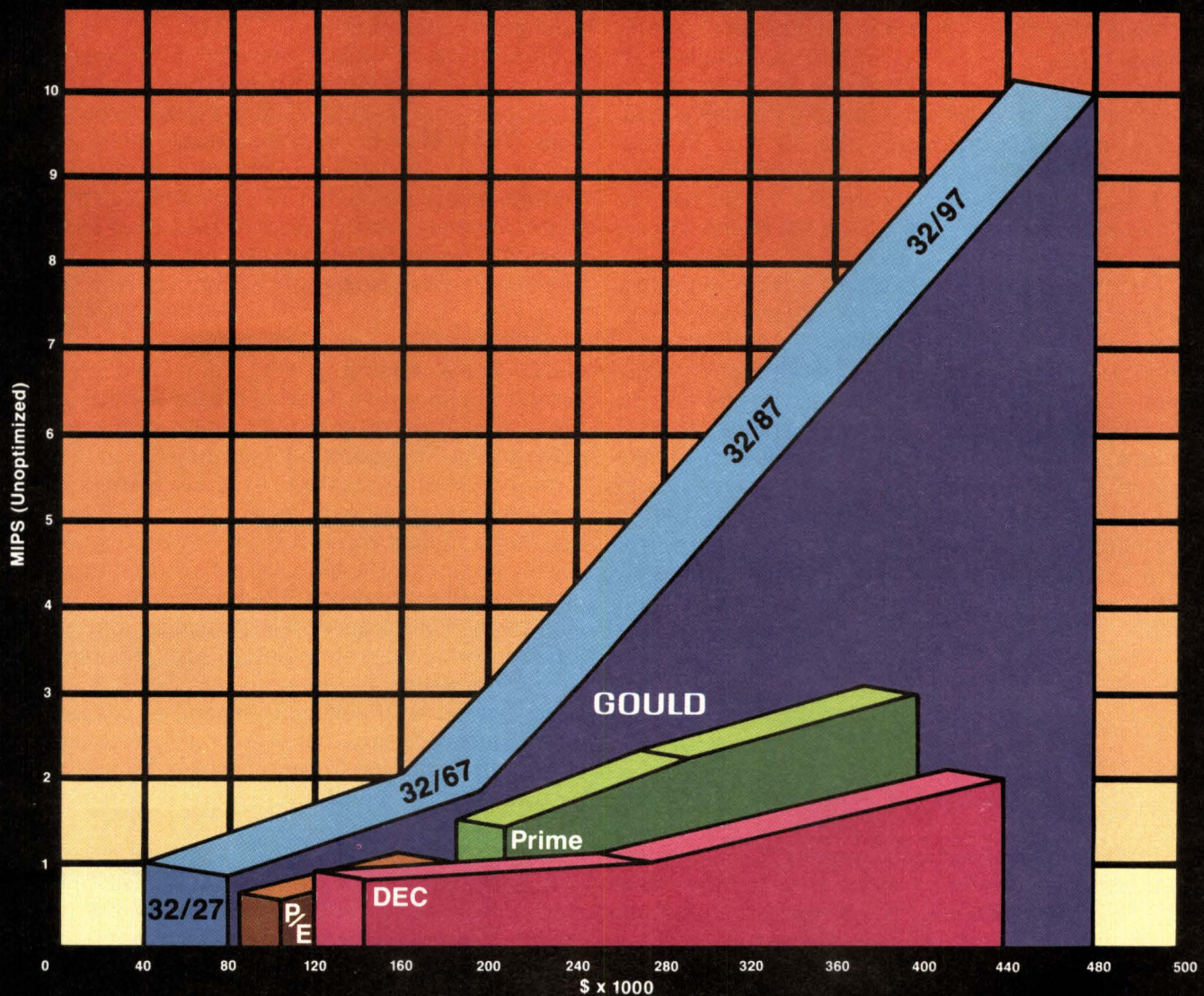

Gould has set new supermini-computer performance standards with its CONCEPT/32™ family of 32-bit machines. The cost-effective, wide-ranging capabilities of Gould minicomputers make Gould Computer Systems the dominant source for the compute power you need, at a price you can afford.

The competition just doesn't tow the line in either price or performance. Whatever the requirement. The Gould CONCEPT/32 family offers the widest range of superior performance while

keeping the price in line. Our low-end CONCEPT 32/27 incorporates high density packaging for lower cost. The mid-range 32/67 combines a minimal footprint and cost with superior computational power. For heavy duty scientific and engineering applications, the Gould CONCEPT 32/870 offers mainframe performance at a fraction of the cost. And if you're worried about where your application falls on the line, don't be. Upward compatibility and software transportability allow you to move up our line as far as you need to go.

Gould has drawn a new price/performance line. One that shows it takes more than 32-bits to make a supermini. A line the competition can't cross. Call or write for more information.

Gould Inc., Computer Systems Division

High Performance Systems Operation
6901 West Sunrise Boulevard
Ft. Lauderdale, Florida 33313
1-800-327-9716

All chart data from published competitive information.
™ CONCEPT/32 is a trademark of Gould Inc.



GOULD
Electronics

CIRCLE 88

available for the CPU that could be suitable for use with Unix. If none are available, consider moving an assembler from a different CPU. Compare these options to the effort involved in writing an assembler from scratch.

Pointer and integer sizes

Machine architecture affects the kinds of applications that a compiler can support. Although Unix ran originally on 16-bit machines, the restrictions imposed by this architecture limited the power and size of application programs that they could run. Just as the 32-bit VAX architecture supports applications that are too limited by the 16-bit PDP-11, microprocessors (eg, the NS16032) can handle larger, more complex applications.

Microprocessor architecture affects pointers, pointer sizes, and integer sizes. To support the C language, a CPU should be able to support pointers and integers that are the same size. If it cannot, many programs will be difficult to port to the new system. Moreover, it will sacrifice application software compatibility because most C programs mix pointers and integers. Some microprocessor manufacturers have tried to get around this problem by offering various versions of their C compiler, each with a different combination of pointer and integer sizes. Users have to hunt for compilers that will be compatible with their existing software.

Before trying to develop an assembler, find out if there are already assemblers available for the CPU that could be suitable for use with Unix.

Preferably, a CPU should support 32-bit pointers and integers in order to accommodate larger programs. No system could hope to support a program as large as a fully implemented version of "vi"—the most popular Unix text editor—without 32-bit pointers and integers, for example. Trying to support 32-bit integers and pointers when the CPU's natural pointer size is less than 32 bits, will result in having to pay the associated overhead costs. With an Intel 8086, 8088, or 286, several additional instructions must be included for every 32-bit pointer manipulation done within a program. Microprocessors such as the NS16032 have natural pointer and integer sizes of 32 bits.

Demand-paged virtual memory management is not essential but is very desirable for a multi-user Unix system. Conventional swapping suffices for some applications, but if users are running large programs, the system can end up spending most of its time swapping processes at context switching.

Even the VAX architecture (from which Berkeley 4.1 BSD was ported) has memory management restrictions. The page tables that contain the map

between virtual and physical memory are a fixed size, must reside in main memory, and must be located in contiguous memory locations. Transferring the 4.1 BSD memory management scheme would have been easier than writing code from scratch, but the resulting Unix kernel could not have taken advantage of the microprocessor's advanced memory management features.

Variable page table sizes, and provisions for second-level page tables to page out to memory, allow the whole 16-Mbyte address range to be used. Thus, a user program could conceivably fill the entire process space. Writing general virtual memory subroutines treats the kernel as just another address space, allowing certain pieces of the kernel itself to page out. A kernel that can page pieces of itself out to disk is convenient for running very large programs.

There are also a few added features not included on the 4.1 BSD version. A VSPY function allows the kernel to point a virtual address space at a particular physical address space. VLOCK locks memory into place so that programs can execute DMA into user memory. VMAP copies pages from one address space into another, allowing the PS and W programs to obtain the command arguments for any process easily.

This version of the Unix kernel's virtual memory management is not necessarily better than 4.1 BSD in all respects. For instance, 4.1 BSD includes some more efficient routines for swapping. Instead of swapping one page at a time, for example, it can swap 50 pages at a time. To keep paging as general as possible, it pages when necessary, but uses a read-ahead paging optimization routine to collect paging requests and perform them in bunches.

Debugging the chip set

Initially, every new microprocessor and its support chips will have bugs, regardless of the manufacturer. Waiting for another group to debug the chips and fix them would mean that a software team will have less trouble porting Unix or any other software to the chip. But by that time, the competition will be miles ahead. A better approach to developing software of any type for a new chip is to plan the effort to work with prototype hardware, thereby isolating hardware bugs from software bugs. Often, this means building software from a simple skeleton and substantiating it as bugs are found and fixed.

Developing the memory management section of the Genix kernel began by debugging the NS16032 CPU. Initially, the NS16032 main memory unit (MMU) was unavailable. Consequently, the kernel and a user process had to share the same address space, with the user process residing above the kernel. Because the CPU's modular table is limited to the first 64 Kbytes of the address space, a stripped-down kernel was built to fit into 56 Kbytes, reserving some of the modular table entries for the user process.

Announcing the WY-75.



Adding elegance to your DEC* computer never cost less. Just add the WY-75, VT-100* software-compatible terminal.

It's a lot more than just an accessory. The WY-75 has a compact, ergonomic design. With a finely sculpted, low-profile keyboard. And a swivel and tilt non-glare 14" screen, tailored with an 80/132 column format. A combination of features other VT-100 software-compatible terminals just don't offer.

The WY-75 lists for only \$795. A price that won't tie you down.

Contact Wyse Technology for more information and you'll see why we're so well-suited for your DEC.

**Dress up your DEC
for \$795.**

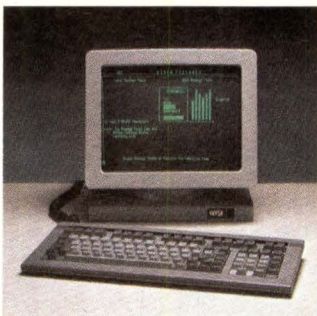

WYSE

Make the Wyse Decision.

Wyse Technology, 3040 N. First Street, San Jose, CA, 95134, 408/946-3075,
TLX 910-338-2251, Outside CA call toll free, 800/421-1058, in So. CA 213/340-2013.

*VT-100 and DEC are trademarks of Digital Equipment Corporation.

CIRCLE 89

Context switching was performed by moving all memory above the kernel to or from the swap space.

Next, MMU bugs were isolated by using the MMU chip with the CPU in a limited way. A static page map mapped the user addresses one to one (ie, virtual address 10,000 was mapped directly to physical address 10,000). At the same time, access was disallowed to the kernel's memory. The MMU was instructed to translate only user mode references, so that kernel mode references still went straight to physical memory. Taking precautions against user programs or MMU bugs affecting the kernel itself resulted in the isolation of those MMU bugs that did exist.

Expanding the kernel

Virtual addresses were shifted so that programs began at zero, but remained mapped to one contiguous section of memory above the kernel. Once this scheme worked, the next step was to expand the kernel above 56 Kbytes and start to change it into the standard 4.1 BSD kernel. Once convinced that the MMU was translating reliably, it was tested in supervisor mode, again with a one-to-one static map. Finally, kernel mode translations were used to context switch the user area.

A rudimentary paging system kept a very simple free page list, searching for the first available memory page to swap out when memory was full. Second-level page tables were never swapped and texts could not be shared. Swapping was synchronous, so that the kernel did nothing else while I/O was in progress. There was no virtual memory scheduler, but the software could take page faults from user mode and handle them.

As the MMU bugs were found and fixed, features were added to the kernel to make it more efficient. Using the reference and modify bits, swapping second-level page tables, and implementing asynchronous paging resulted in demand loading of text segments and prepaging. Swapping parts of the kernel enabled page faults to be taken from kernel mode. In addition, a virtual memory scheduler was added to swap out whole processes.

During this development process, several large bugs were found. For some time, the reference and modified bits worked improperly. Moreover, the MMU instruction to read or write the user data space from the kernel did not work, so the copy in/copy out subroutines were used instead. Early on, there could be no page fault in the user text or the process would fail. Therefore, temporary code was added to the kernel that would lock user text into memory while context switching. Beginning with a simple kernel and adding features one at a time, these bugs could be identified as hardware (not software) problems and worked around.

In every kernel there is a section of code that is written in assembly language. On the VAX, this sec-

tion, *locore.s*, consists of about 2000 lines. This particular section is not so much ported as it is rewritten from scratch. The first step is to understand precisely what the original code does. This requires expertise in the machine's assembly language from which Unix is ported. Next, code must be written in the target system's assembly language to duplicate the function of the original code.

Routines for other machine-dependent sections of Unix must also be developed in this manner, even if they are written in a high level language. The serial I/O drivers' code for the SYS16 system, for example, had to be written essentially from scratch. The serial I/O board resembled a hybrid between two DEC peripheral boards, therefore, very little of the original code for this routine remains.

Porting the Unix utilities can be easy if the target processor closely resembles the system from which Unix is ported. In this case, the NS16032 so closely resembled the VAX that porting the utility programs only meant recompiling existing VAX utilities with a compiler. A large fraction of the programs were ported with no modifications whatsoever (Fig 3).

Problems arise when the target architecture is dissimilar to that of the original machine. In the case of the 68000 processor, the integer formats differ from those used by the VAX. With integers, the VAX and 68000 store the bytes in the opposite order. However, 68000 character strings are stored in the same format as on the VAX. Consequently, programmers must know the actual layout of the data in question to switch sections where the formats must be reversed.

A good debugging environment helps a porting effort considerably. Unix is equipped with a standard

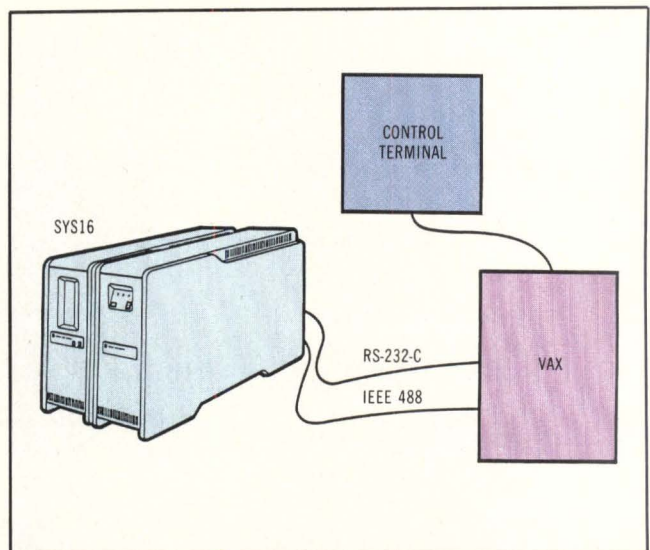

Fig 3 Developed on a VAX host, the Genix operating system is downline-loaded onto the NS16032-based SYS16 system. It accomplishes remote debugging by communication from a control terminal via the VAX and an RS-232-C line to a ROM monitor in the SYS16. The IEEE 488 bus provides fast file transfer.

source level debugger (SDB). The problem with SDB is that it contains quite a few bugs itself. Relying on it is risky. In addition, SDB can be utilized only to debug user programs under Unix and is useless for debugging a kernel. Consequently, instead of porting SDB to its system, the company developed its own debugging tools and had them ready at the time of the Unix port.

Porting the Unix utilities can be easy if the target processor closely resembles the system from which Unix is ported.

The company's debugger is structured in two pieces: one is a user interface and the other a ROM monitor. Resident on the target hardware, the ROM monitor supports a set of primitive debugging commands that make it possible to find what is stored in memory at a particular address, insert values at certain addresses, and set breakpoints, for example. By connecting the NS16000 hardware to the company's VAX host via a serial line, the company could run the frontend user interface on the VAX and still control the target system.

This debugging environment proves to be extremely useful in debugging the Unix kernel itself. Instead of having to scatter printouts strategically throughout the software, they were able to single-step through instructions in the kernel to see exactly how it was behaving. They were also able to substitute a native resident equivalent of the ROM monitor for native debugging. Debugging continued throughout the porting effort. Additional debugging was performed when the Unix modules were assembled and released.

The task of porting Unix to a new microprocessor can be challenging. However, a chip's architectural features can make the job easier, and thereby contribute to the commercialization of the Unix operating system.

Please rate the value of this article to you by circling the appropriate number in the "Editorial Score Box" on the Inquiry Card.

High 722

Average 723

Low 724

TAPE MATE

Add our Communicating Tape Controller to your mag tape system for lower datacomm costs and increased security.

Communicating Tape Controllers communicate off line tape-to-tape, on line tape-to-host — for low cost data communications, data logging and system input



- Selectable data rates to 56Kbps
- RS-232C bisynchronous (2780/3780) or asynchronous
- Dedicated or leased lines
- No software required
- Single or dual density tape

Request complete technical literature today.

GENERAL SYSTEMS CENTER, INC.

A data communications company

95 Centershore Road • Centerport, NY 11721
Telephone: (516) 754-9140

CIRCLE 90

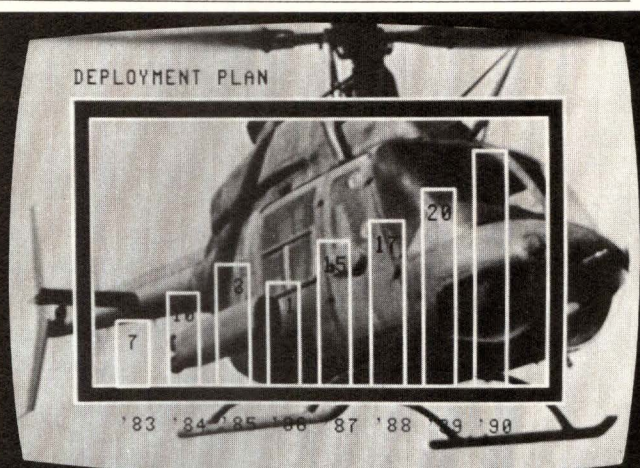

PUT SOME REALISM IN YOUR COMPUTER GRAPHICS

The GraphOver 9500 is a general purpose computer graphics generator that, in addition to its many other features, has the ability to overlay graphics on any videodisc, videotape or TV camera output. This creates a composite picture with a realistic background, displayable in either RGB or NTSC modes.

NEW MEDIA GRAPHICS CORPORATION
279 CAMBRIDGE ST.
BURLINGTON, MA 01803
617-272-8844



GraphOver 9500

CIRCLE 91

COMPUTER DESIGN/June 1, 1984 181

Introducing the newest member of The HP 1630G...65 channels and maximize 16-bit system

First came the HP 1630A and the HP 1630D. One, a low-cost general purpose logic analyzer suited to the needs of the full development cycle. The other, with 16 channels of timing analysis and 27 of state, an invaluable tool for the hardware design engineer. Now Hewlett-Packard introduces the HP 1630G. With up to 65 channels of state analysis, it is the new standard for software design engineers working on complex new 16-bit microprocessor-based products. Plus, the ability to configure 8 of those lines for 100 MHz timing analysis gives you a logic analyzer system with investigative power and versatility for virtually all your needs.

Three new software overview modes let you nonintrusively monitor software performance and hardware/software interactions in real time.

The HP 1630G significantly expands on the software performance capabilities already introduced in the HP 1630A/D family members. In addition to time histograms that show execution-time distribution, and label histograms that show address activity, the HP 1630G gives you three new modes: program flow, time positional, and linkage measurements. *Program flow measurement* lets you monitor program activity based strictly on opcode accesses. This can help resolve confusions which may occur when histogramming by address, especially

if the program generates inline code or if memory blocks are interspersed between sections of the program. *Time positional measurement* lets you measure the number of occurrences of an event per unit time. Use this to better understand the behavior of your system under a time-varying load. *Linkage measurement* measures the relative frequency of the activity between specific software modules. You'll find this mode invaluable when you want to monitor the transfer activity between a main program and a series of subroutines, for example. Take advantage of all these software performance analysis modes to rapidly



HP-IB: Not just IEEE-488, but the hardware, documentation and support that delivers the shortest path to a measurement system.



HP 1630A

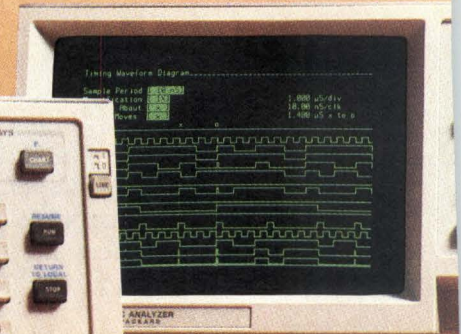

HP 1630D

HP's logic analyzer family.

advanced software analysis help you performance.

discover if your system is resource-limited or if, for example, poorly chosen program segmentation is causing too much time-consuming disc-to-memory swapping.

Time tagging gives you added insights into system functions.

In the state analysis mode, time tagging measures the time elapsed between each stored state. Make detailed absolute time measurements between states and known physical events. Or, use the mode to measure the total time from the trigger point to a particular state. Because time tagging is a single-pass activity, it is well suited to helping you identify inline sections of code that take longer to execute than anticipated.

Floppy disc interface and popular 16-bit microprocessor support.

On-board non-volatile memory keeps one instrument setup and your current disassembler instantly available at power-up. For even greater storage, the HP 1630G features direct compatibility with a number of HP disc drives such as the HP 9121S/D (the HP 9121D is illustrated). In one convenient 3 1/2" floppy you can now store data, state listings, timing diagrams, alternate disassemblers, and instrument setup configurations. For added flexibility, the HP 1630G supports all popular 8-bit, as well as the following 16-bit microprocessors: 68000, 8086, 8088, 80186, 80286, Z8001 and Z8002.

Our HP 1630G upgrade kit protects your previous HP investment.

If you've already invested in an HP 1630A or HP 1630D, but you feel you need the added capabilities of the HP 1630G, you'll be glad to know that an upgrade kit is available.

Compare the HP 1630G. At \$12,100* it's even HP-IB programmable for fully automated measurements. To find out more about the HP 1630G or its companions the HP 1630A/D, call your local HP sales office listed in the telephone directory white pages. Ask for the electronic instruments department.

* U.S.A. list price only.



HP 1630G



HEWLETT
PACKARD

0801403

ONLY ONE BUS LETS YOU CHOOSE YOUR OWN ROUTE.

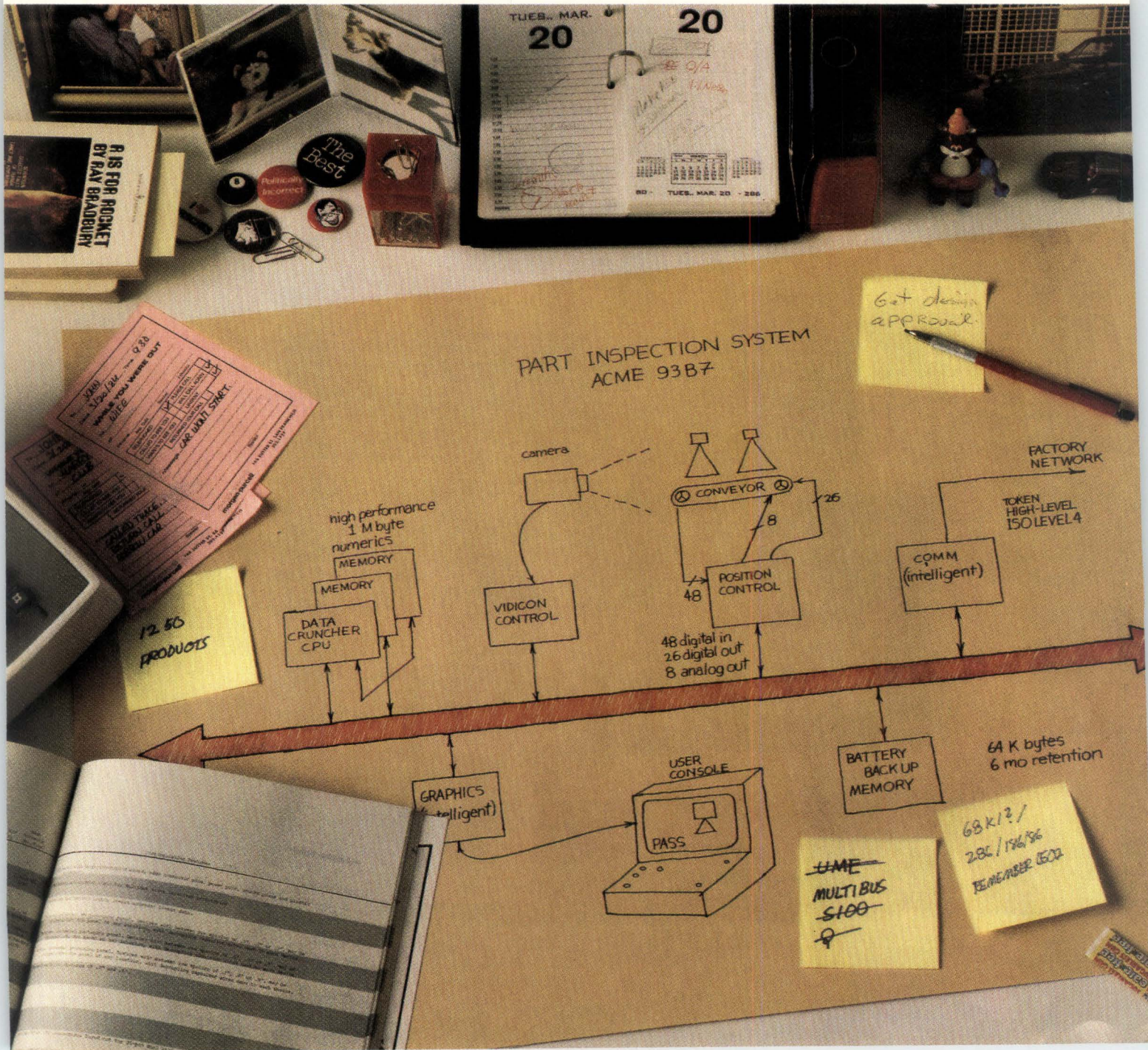

The MULTIBUS® architecture.

Because by making your bus architecture decision first, you can ease the pressures of taking a rather arduous journey. Reduce your risk. Get where you're going faster. And, to a large extent,

guarantee yourself a very smooth ride.

First, consider having a wide open road ahead. Only MULTIBUS supports more than 30 different operating systems. And all the major microprocessors. Seventeen, in fact. So you can drive your design right at the ultimate application. Even change your mind when the market changes its. And thoroughly profit from Intel's open systems approach.

It will also comfort you to know that MULTIBUS is the world's best supported architecture. Over 200* companies make and distribute MULTIBUS products. Giving you a selection of more than 1250* products.

And as if that weren't acceptance enough, MULTIBUS is an IEEE standard (IEEE 796). So you can count on your products fitting and working together. With no design breakdowns along the way.

Next, consider that MULTIBUS supports

all levels of integration. Chips. Boards. And boxes. From leading edge to commodity. So while you're custom-configuring your own product, you can count on getting exactly what you need. Hardware and software. And service along the way.

Finally, MULTIBUS keeps you fueled up for whatever's coming around the next bend. With a defined upgrade path to MULTIBUS II®. Which, by the way, is the most advanced bus architecture going. And which already has over 100 companies committed to its support.

So call us toll-free to begin your travels with MULTIBUS. (800) 538-1876. In California, (800) 672-1833. Or write Intel, Lit. Dept. C-19, 3065 Bowers Ave., Santa Clara, CA 95051.

Because there's no good reason why you should find yourself up the road without a paddle.

intel®

*Source: MULTIBUS Buyer's Guide, Winter 1984. © 1984 Intel Corporation

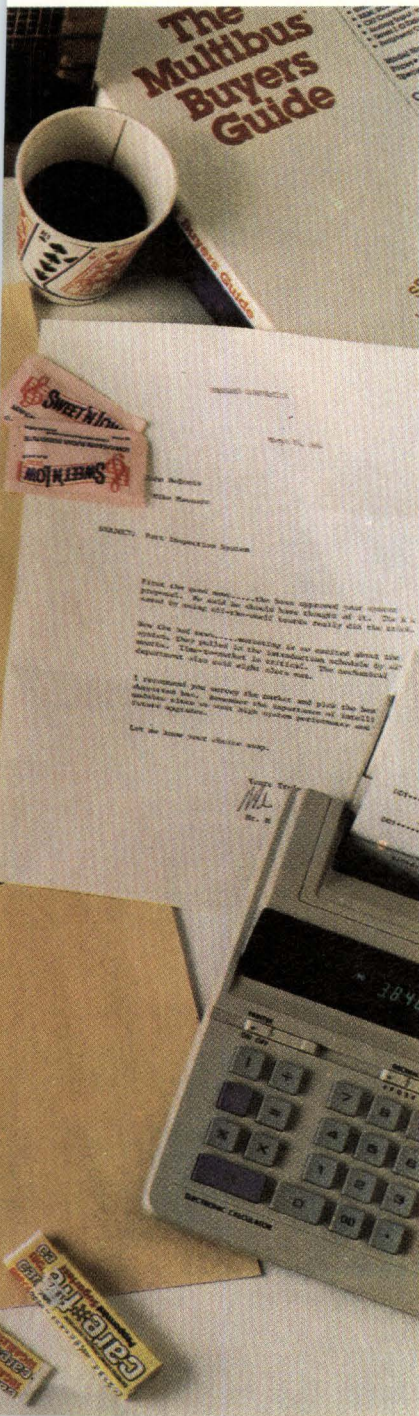

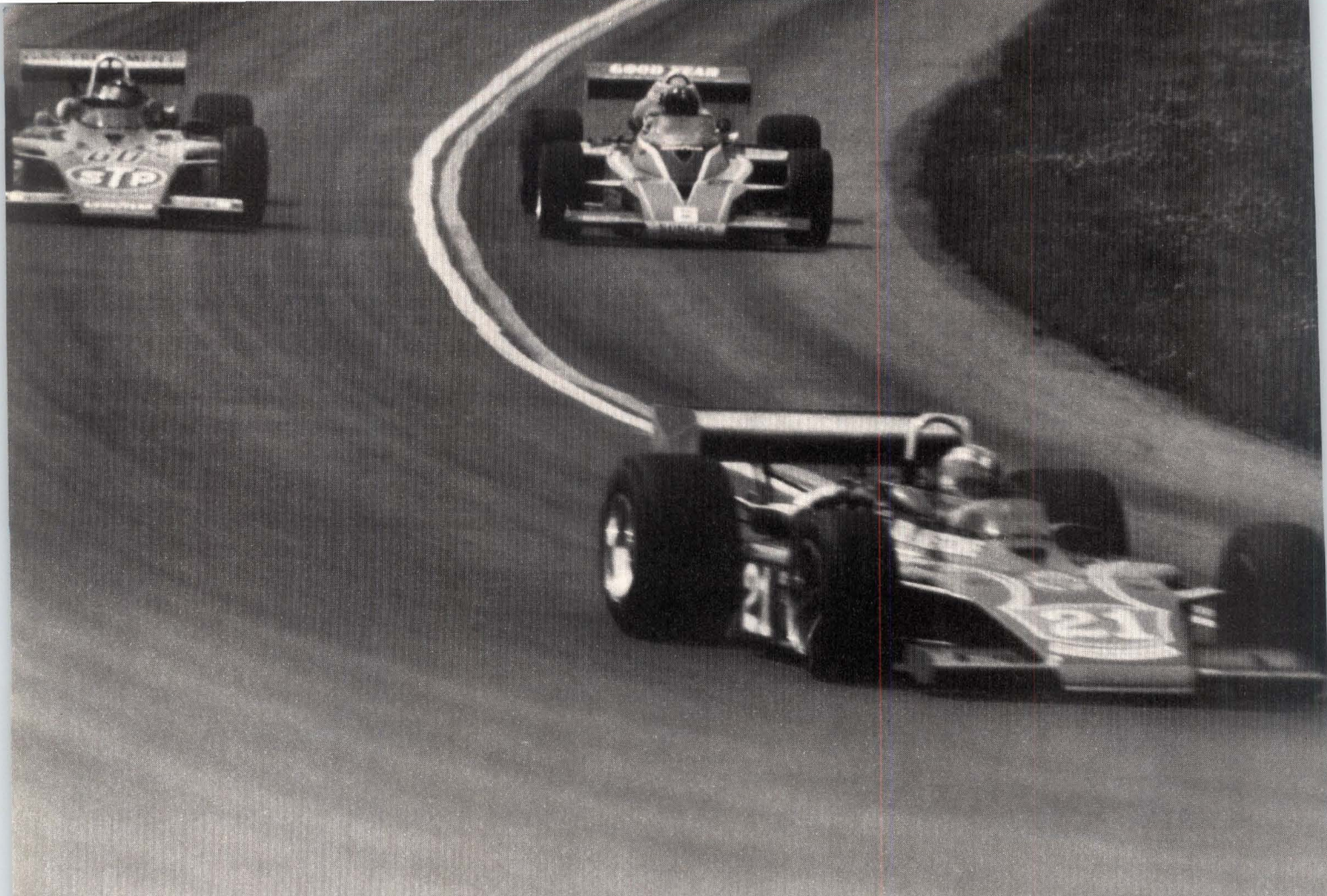

Put your computer system back on the fast track

IBIS puts your computer system on the fast track. If you are building systems that require large-scale data storage *and* don't want to wait for data input/output delays, IBIS has the answer. There's a new standard in disk drive technology. Especially if you are involved with image processing, super-mini systems, or other high performance computer requirements. IBIS gives you 1.4 gigabytes of data storage on a single 14-inch Winchester disk drive. The data transfer rate is 12 megabytes per second with a track-to-track access time of 2.5 milliseconds and an average access time of 16 milliseconds. IBIS gives you the fastest drive in the industry with throughput that puts your system on the fast track.

There's more to an IBIS disk drive system than large-scale storage and a high-speed transfer rate. Our "designed-in" reliability assures your system's performance. IBIS utilizes the latest technology in thin film plated media and advanced air filtration. IBIS disk drives also have self-diagnostics, dynamic error detection, and modular construction that promotes ease of maintenance and service. In fact, with the high reliability of the IBIS drive, preventive maintenance consists of merely changing the pre-air filter once a year.

To put your computer system on the fast track with a reliable, high-performance disk drive, contact IBIS Systems, Inc., 5775 Lindero Canyon, Westlake Village, CA 91362. Telephone (818) 706-2505.

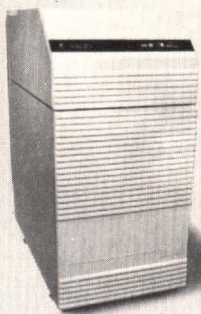

See us at NCC & at
Siggraph Booth #1319

ibis  TM
CIRCLE 94

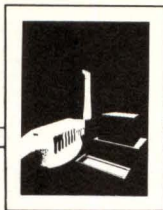

MICROPROCESSOR DESIGN SUPPORTS MULTITASKING

Hardware segmentation corresponds to modular software, easing design of current applications.

by Paul Wells

The spread of personal computers in the workplace has created a need for integrated software packages that juggle several tasks simultaneously. In the past, such facilities have been supported by multitasking operating systems running on larger computers. Bringing multitasking down to the level of microprocessor-based personal computer systems takes a high degree of cooperation between hardware and software. Some examples of this cooperation are Microsoft's Windows and VisiCorp's VisiOn. Both integrated software systems make good use of memory segmentation found in Intel microprocessors. Such segmentation is specifically designed to meet the heavy demands of a multitasking environment. Segmentation is further extended in the 80286 CPU through onchip implementation of key functions needed to support concurrency. Moreover, special coprocessors cooperate with this multitasking hardware to boost performance without imposing additional overhead.

As with its predecessors in the iAPX 86 family—the 8086/8088 and 80186/80188—the 80286 views its system memory as a collection of individual blocks (or segments) of data and executable code. This memory model, as a collection of individual segments, corresponds directly to the way software designers think of data and programs—as a set of

Paul Wells is a technical marketing manager at Intel Corp, 3065 Bowers Ave, Santa Clara, CA 95051. He received a BS from the University of Santa Clara.

individual modules. For example, in creating an integrated software package, programmers might place a software program for word processing in one or more segments, spreadsheet routines in others, and communication software in still other segments.

Segments serve as the fundamental units of all operations in the 80286. The processor deals with a segment through a consistent data structure (called a segment descriptor) for all multitasking support, memory management, or memory protection operations. Just as efficient programmers build pointers to manipulate a physical block of data or program code, the CPU handles descriptors that contain all the information needed to access a segment (Fig 1).

Code and data segment descriptors contain a 24-bit field that specifies the physical memory address of an associated segment, permitting a 16-Mbyte physical memory. A 16-bit field specifies segment size, allowing it to range between 1 byte and 64 Kbytes. Because the 80286 packs its pipelined architecture with dedicated onchip hardware registers for each class of descriptor associated with critical system operations, the CPU outraces even the VAX 11/780 in performance tests.

Memory management

Besides enhancing overall system performance, the onchip registers relieve programmers of low level details in implementing CPU-specific mechanisms. Furthermore, as in the 80286's virtual addressing mechanism, these onchip registers provide a path for migration of the large installed software base for the 8086/8088 and 80186/80188 to the next generation of personal workstations.

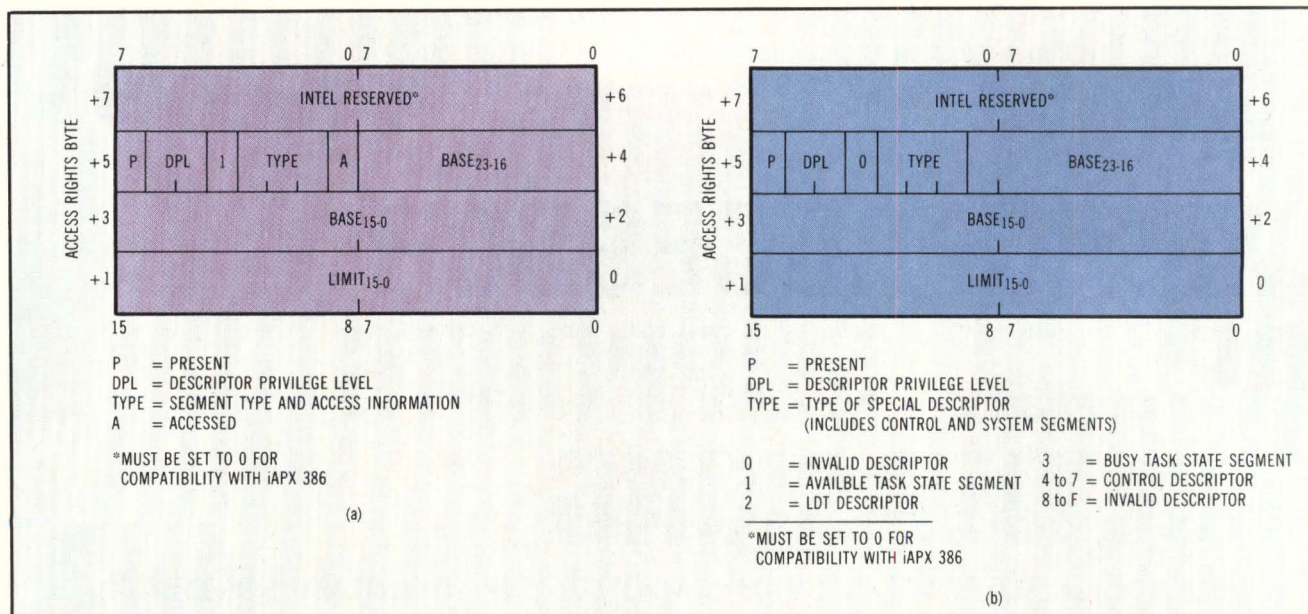

Fig 1 The 80286 segments all operations. To refer to these segments, the CPU uses one type of descriptor for code and data (a) and others for maintaining special structures like those used in multitasking (b).

Increasingly sophisticated user interfaces and large information bases will strain memory resources in future personal computers. Although the 80286 sports a 16-Mbyte physical address space, most desktop personal computers will not be fully packed with costly semiconductor memory. They will instead exploit the economic advantages of virtual memory management—a strategy that has proven effective in mainframes and minicomputers.

In a virtual memory environment, system memory is logically extended beyond the confines of available physical memory. The system accomplishes this by using mass storage to store data and code segments not needed by currently running tasks. The application software issues references to logical memory and relies on the operating system both to ensure that needed segments are in physical memory and to translate the logical reference into one that addresses data or code within the segment once it is in physical memory.

In order for the system to determine which segments to bring from disk and where to put them, the operating system uses flags associated with each segment. For example, an operating system can use the “present” and “accessed” bits in 80286 segment descriptors to check if a segment is present in physical memory and if the segment has been recently accessed. Once it loads a segment, the operating system updates tables that indicate where a logical segment is located in physical memory. Drawing from these tables, a memory management unit (MMU) sets up tables in its own internal cache, which it uses to convert a logical address supplied by the CPU into a physical address (Fig 2).

In traditional virtual memory systems, when an application program loads an address pointer with a value that is not in the MMU, operating system

routines must execute a cumbersome series of procedures to update the MMU. This includes loading the MMU with the translation information, verifying access rights to the missing segment, verifying that the segment actually exists in physical memory, and reconstructing the state of the CPU before the address fault. Traditional systems could easily waste a millisecond of precious CPU time to handle this form of virtual memory management. Thanks to the memory management capability built into the 80286 CPU, users enjoy the performance advantages of rapid address translation, while programmers gain an extended memory reach with little apparent effort.

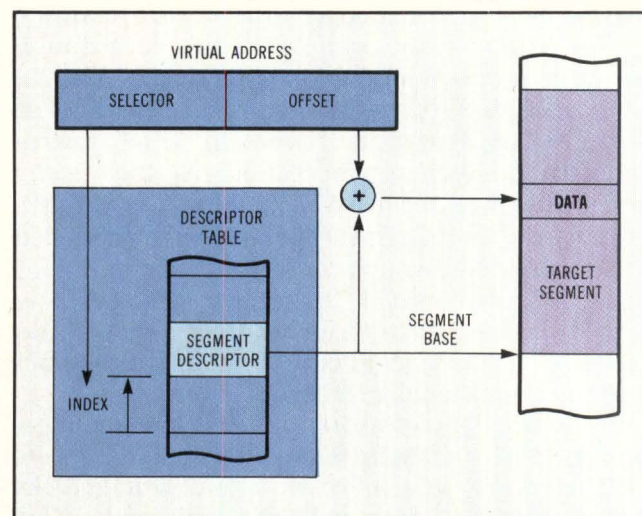
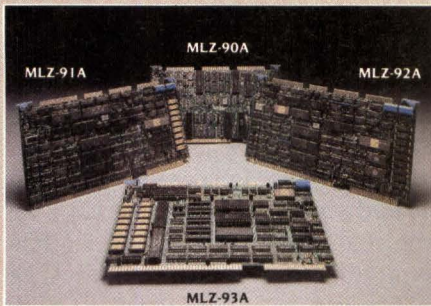

Fig 2 An address in the 80286 is comprised of an offset and a selector. In virtual addressing, the selector is used as an index into a table of descriptors for building the physical address. In real address mode, instead of the operation indicated in the shaded portion of the figure, the CPU multiplies the segment selector by 16 and adds the result to the offset to point to the desired location in memory.

THERE IS MORE THAN ONE GOOD REASON TO CALL HEURIKON

Make HEURIKON your source for Multibus microcomputers and system components.

Since 1972 Heurikon has been working hard to make life a little easier for those who "put it all together." Powerful Z-80™ and MC68000™ based Multibus™ microcomputers like MLZ-92A and HK68 have helped Heurikon customers find economical solutions for their problem applications.



MLZ-90A single board microcomputer with nine byte-wide memory sockets for use with RAM or ROM (AM9511 and floppy disk drive controller optional).

MLZ-91A single board CP/M™ system with on-card floppy disk drive controller, winchester interface, optional AM9511, streamer tape interface, two serial ports, one parallel port, 64K bytes RAM with parity, two EPROM sockets, and GPIB CONTROLLER.

MLZ-92A single board CP/M™ system with four serial ports on-card, floppy disk drive controller, winchester interface, optional AM9511, Centronics printer interface, 64K bytes of RAM with parity, and two EPROM sockets.

MLZ-93A single board CP/M™ system with 128K bytes of dual ported RAM, four EPROM sockets, floppy disk drive controller, optional AM9511 and powerful serial port features including SDLC and HDLC protocol support and modem controls.

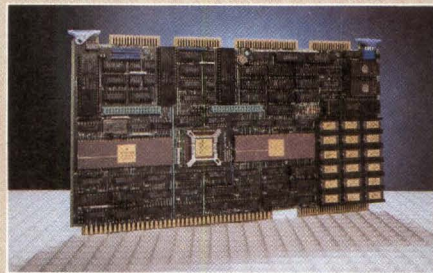

HK68™ powerful and versatile single board UNIX™ or CP/M-68K™ system with MC68000 CPU, MMU, quad channel DMA, four serial ports, 128K or 256K bytes of on-board RAM with parity (expandable to 1M byte on-board!), and two iSBX™ connectors for I/O expansion.

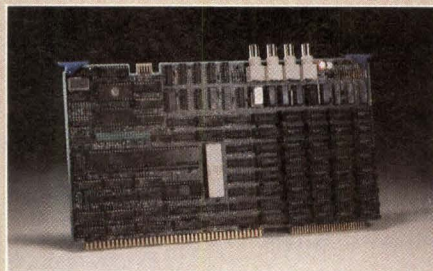

MLZ-VDC intelligent 640 x 480 x 4 color graphic controller based on the NEC 7220 controller chip with on-board Z-80 CPU, DMA controller, and user definable FIFO interface to Multibus™. Users may display up to 16 colors from a 4K palette. Up to 1024 x 1024 x 3 interlaced also available.

iSBX Expansion Models

Heurikon also stocks iSBX™ modules for I/O expansion on its HK68 and MLZ-VDC. These modules may be used on any other board

complying with Intel iSBX specifications.

Presently available are the SBX-FDIO floppy disk controller module and the SBX-SIO serial port expansion module.

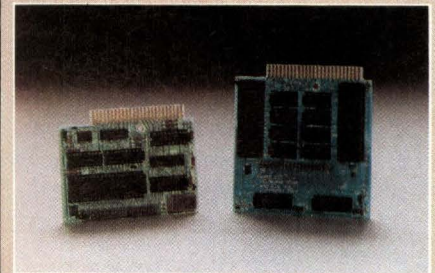

The SBX-FDIO can control up to four single or double sided, single or double density 5¼ inch or 8 inch floppy disk drives. A software toggle allows both 5¼ inch and 8 inch drives to be intermixed on the same cable!

The SBX-SIO is a quad serial port expansion module utilizing Zilog SCC controller chips with built in baud rate generators. The SBX-SIO is available in synchronous and asynchronous models.



Systems

Heurikon also supplies completely integrated systems with your choice of CP/M-80™, MP/M-80™, CP/M-68K™, and "Berkeley enhanced" Unix operating systems.

Systems are available with four, six, and fourteen slot enclosures with 5¼ inch or 8 inch dual floppy or floppy winchester drive combinations.

HEURIKON CORP

3001 Latham Dr. Madison, WI 53713 Telex 469532

CIRCLE 95

Call Heurikon Direct **1 800 356-9602** In Wisconsin 1 608 271-8700

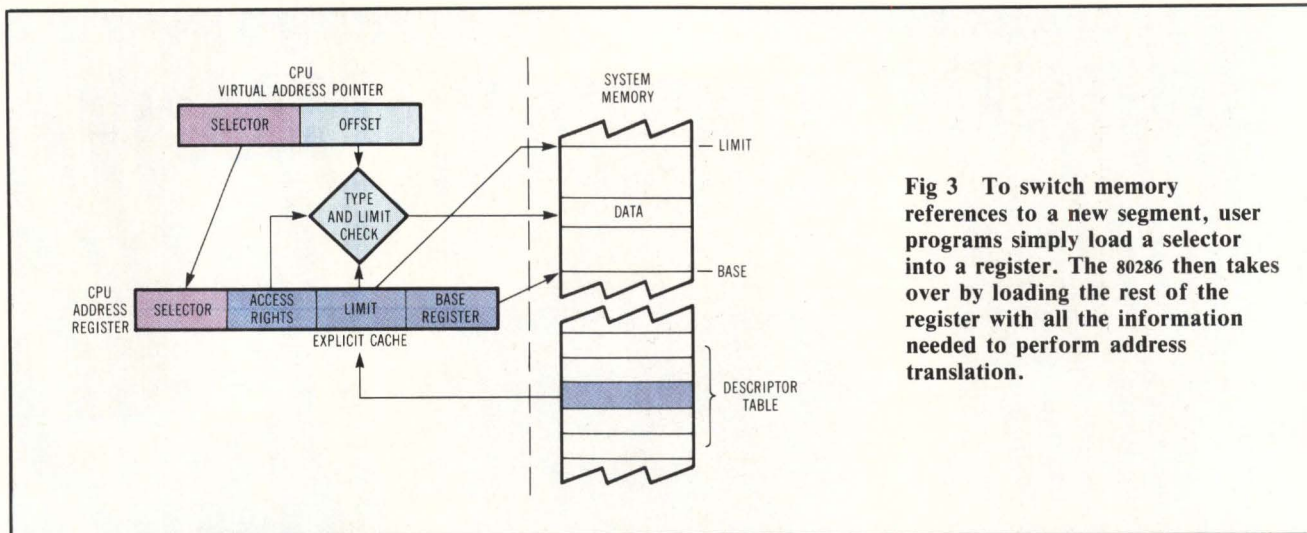

Fig 3 To switch memory references to a new segment, user programs simply load a selector into a register. The 80286 then takes over by loading the rest of the register with all the information needed to perform address translation.

As in the earlier members of the iAPX 86 family, an address in the 80286 is a 32-bit value, comprised of a 16-bit field that selects a particular segment and a 16-bit field that pinpoints a byte within the target segment. However, the 80286 treats the segment selector differently in its real address and virtual address modes.

In virtual address mode, the 80286 can complete a translation in a single clock cycle, using an onchip cache of registers that contain translation and access rights information drawn from the associated segment descriptor (Fig 3). When a program needs to change segments, software simply loads the selector to the associated descriptor. The 80286 automatically loads the needed memory management information into the onchip registers. Until a program specifies a new segment, the 80286 uses these registers to translate subsequent address references.

Programmer's helper

The 80286 chip further strengthens multitasking systems with direct hardware support for the critical mechanisms of multitasking. In a multitasking environment, system level software normally maintains minimal information for each task likely to be executed. When a user activates one of these tasks, such as pointing to a symbol with a mouse, system level software routines use this information to begin executing the corresponding programs. For example, a user might start transferring a document through electronic mail and then open both a spreadsheet and a document file to prepare a report. Thus, the CPU is forced to juggle a number of active tasks simultaneously.

System-level software maintains information on the state of each of these active tasks. This information typically includes data on both the physical status of the task, represented in the contents of the CPU registers, and its logical status—such as whether the task is waiting for another task or device to complete some action. When system software finds that a task has satisfied all the logical condi-

tions needed to enable its execution, the operating system then loads the physical information corresponding to the task so that the CPU can commence (or continue) its execution. The process is called a task switch.

This logical status information is closely connected to the particular design and implementation of a multitasking system. Consequently, a general purpose CPU cannot include special purpose hardware that ties the hands of software designers by requiring them to use a hardwired scheme for these system level algorithms. However, manipulating this physical information is an inescapable part of a multitasking system—and one that can result in severe system overhead. Consequently, 80286 hardware directly supports this physical aspect of a task switch.

Traditionally, software manages this task-related information. To effect a task switch in these systems, software must exercise a series of procedures, including copying the CPU registers and pointers into system memory. Several hundred milliseconds are usually required to complete this process. In an integrated software system intended to provide a reasonable electronic analogue to the physical environment, this delay is unacceptable.

Speedy switch

The 80286, on the other hand, needs only 21 μ s to effect a task switch because CPU hardware directly recognizes a special data structure, called a task-state segment, that is fundamental to task switch operation. The CPU keeps track of the current task with a dedicated register that contains the address of the task-state segment descriptor.

The system programmer is not concerned with the low level details of a task switch, but simply loads the task-state register with the selector to a task-state segment descriptor. Consequently, to the programmer, a task switch is just a JUMP instruction, rather than a set of special instructions. The 80286 saves the state of the currently executing task in the previous task-states segment and it then

Zilog's Z8[®] single-chip microcomputer gives you 30% more performance with 30% less code than the 8051.

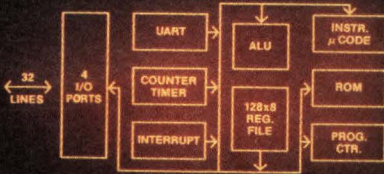

ZILOG'S Z8 MCU ELIMINATES THE ACCUMULATOR BOTTLE—NECK, providing the fastest processing capability available in a single-chip microcomputer. The Z8 MCU's general-purpose register architecture operates on data directly in registers or ports, eliminating the need to first move data to the accumulator. As shown, a simple addition in the Z8 MCU requires only one instruction and executes much faster than Intel's accumulator-oriented 8051. In most applications, the Z8 MCU operates at least 30% faster, with 30% less code!

This device has other advanced features, including 128 bytes of RAM and 4K bytes of ROM, hardware port handshake, a UART and two counter/timers.

ZILOG'S NEW ZSCAN-8™ EMULATOR MAKES CODE DEVELOPMENT A SNAP, TOO!

The ZSCAN-8 is a CRT-based, menu-driven, in-circuit emulator containing full trace memory and breakpoint capabilities. And it's host-independent, so it minimizes development costs by allowing you to work with your existing Zilog, Intel, or CP/M[®] development system.

There isn't a better, faster 8-bit computer-on-a-chip solution than Zilog's Z8 MCU. Ask anyone who uses them, or find out for yourself. Fill out the coupon and mail to: Zilog, Inc., Components Tech. Publications, 1315 Dell Avenue, MS C2-6 Campbell, CA 95008. Or call TOLL FREE 800-272-6560.

- Please send me a Z8 family technical overview.
- Please have a salesman contact me.

Name _____

Title _____

Company _____

Address _____

City _____

State _____ Zip _____

Phone _____ / _____
Z8

CD 6/1/84

Zilog

Pioneering the Microworld
 An affiliate of **EXON** Corporation

Z8 is a registered trademark of Zilog, Inc.
 ZSCAN is a trademark of Zilog, Inc.
 CP/M is a registered trademark of Digital Research Inc.

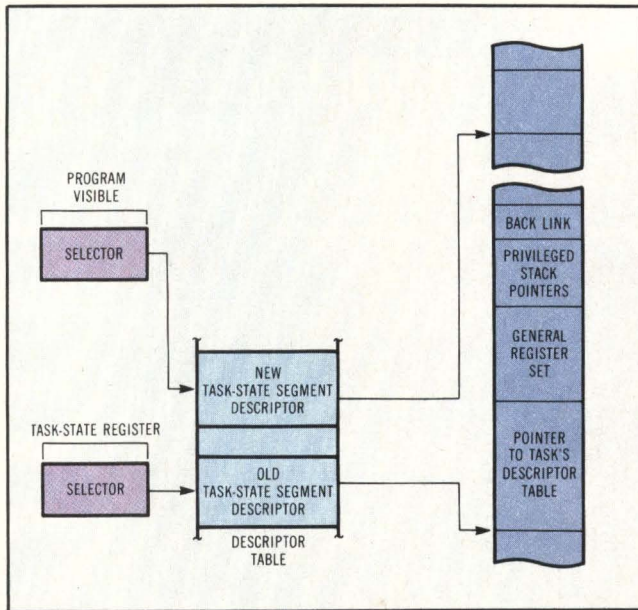

Fig 4 Just as with address translation, programmers are not bothered with the details of a task switch. Instead, after loading the task-state register with the selector to a new task-state segment's descriptor, they let the CPU bring in the information that specifies a task's state. This is contained in the task-state segment.

automatically loads the information contained in the new task-state segment (Fig 4).

Just as a typical business day is filled with a continuous series of interruptions, a typical multitasking operating environment is continually bombarded with a flood of hardware interrupts from keyboard and mouse interaction, disks, and peripheral devices such as printers and modems. To the 80286, these interrupts simply occasion a task switch.

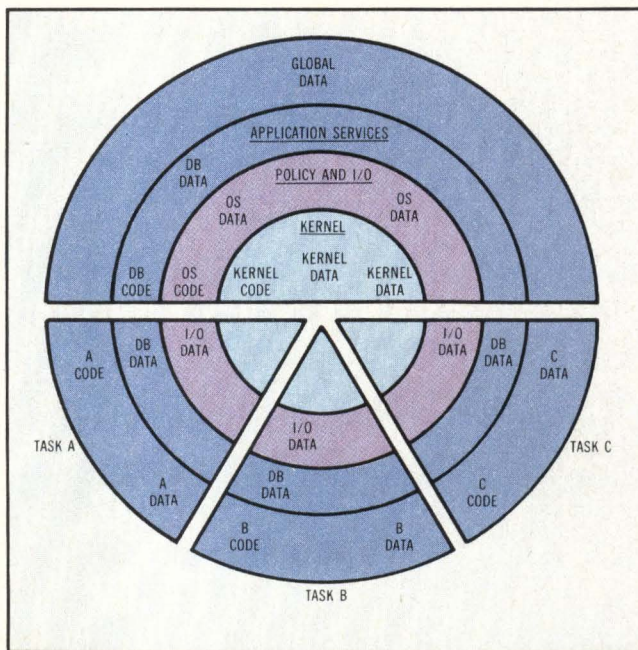

Fig 5 With four privilege levels, the 80286 can support a number of different protection policies. Typically, the most trusted inner ring holds code and data for the kernel—the most fundamental mechanisms of an operation system.

In fact, the task-state segment contains a special field that holds the address of the interrupted task-state segment. In a series of interrupts, the CPU uses this back-link pointer to maintain a record of interrupted tasks. The 80286 then unravels this chain of tasks and finally returns to the task that was running before the interrupts occurred.

In an iAPX 286 system, coprocessors like the 80287 numeric coprocessor, 82586 local communication controller, 82501 Ethernet serial interface, or 82730 text coprocessor impose no extra burden on the task switch mechanism. A CPU task switch does not change the coprocessor's own internal state. Instead, the 80286 simply sets an internal bit whenever it executes a task switch.

The next time an instruction specifies use of a coprocessor, this set bit causes the CPU to trap to a system handler that determines if the last task that used the coprocessor is the same task currently requesting its use. The trap handler needs to switch the coprocessor's internal state only if the current task is different. In this way, if a task that is using a coprocessor is interrupted, it may continue to use the coprocessor without necessarily executing a coprocessor context switch following the interrupt.

Segments anchor protection

The ability for individual systems to communicate across networks translates into a need for effective software protection. Systems must constrain access to programs and data. In addition to challenging illegal attempts to break into a system, protection also serves a more mundane function. It must ensure reliable system operation even when a software bug sends a program into space normally reserved for the operating system and related functions.

To control this situation, computers usually provide a simple pair of privilege levels—executive and user—in which a program may execute. But even user programs must be able to execute system level functions such as I/O. Consequently, truly secure systems extract user accessible system software and place it in its own level—requiring that the CPU support at least three different execution levels. Going one better, the 80286 provides four privilege levels, numbered 0 through 3. Programs executing at a given level may only access data (or programs) at a numerically greater (less trusted) level.

A typical system would normally apportion its services over a number of these levels. For example, a system might place the fundamental mechanisms, or kernel, of an operating system in the most trusted level (PL0), system services in the next level, library services in the lower level, and application programs in the least trusted level, which is PL3 (Fig 5).

In this type of multidomain operating environment, the protection mechanism must nevertheless leave a door open for less trusted tasks to access segments at the more trusted levels. In the 80286, these

STEP-27 SERIES

Bit-Slice
Microprogramming
ROM-Simulation
Support

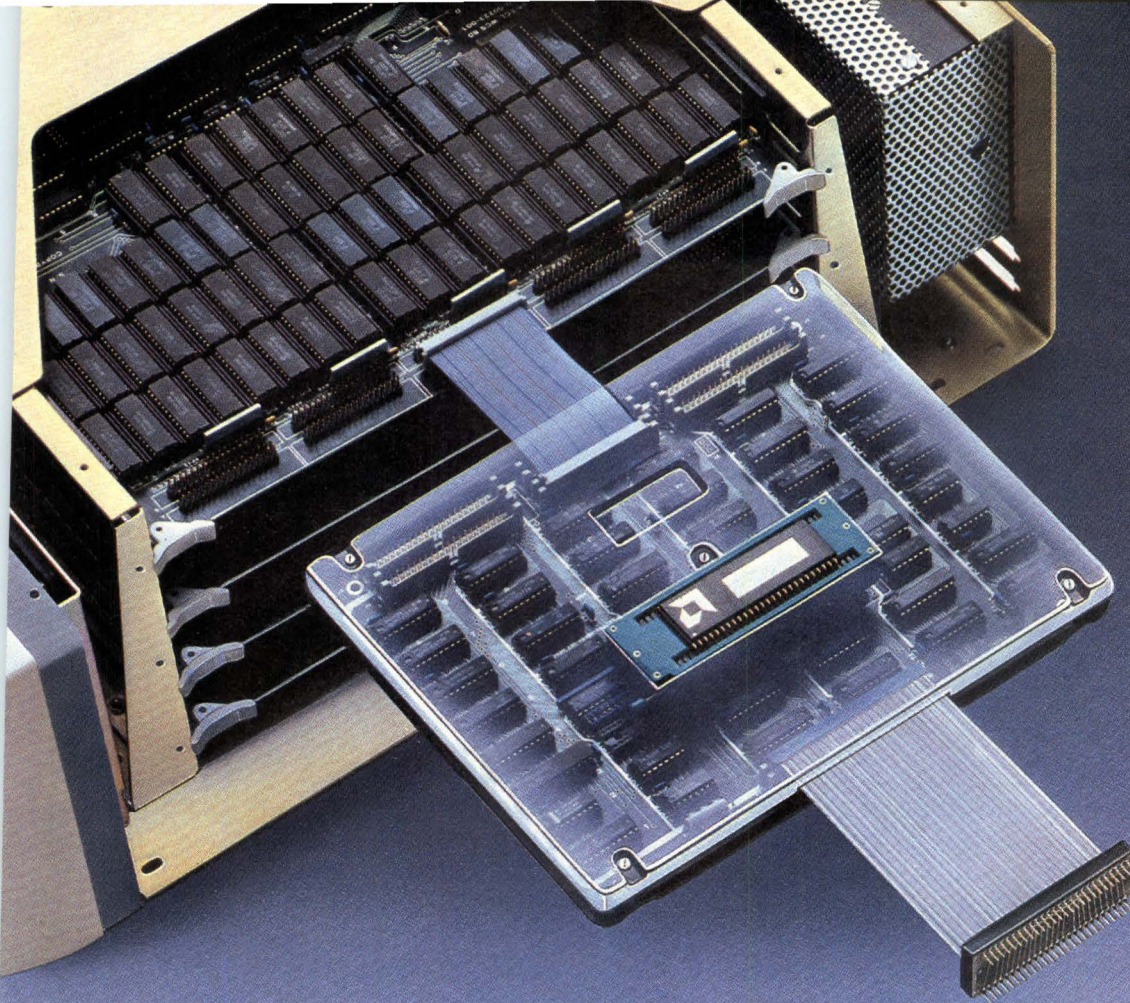

29116 & 2910 Emulation? Only from STEP!

Since STEP Engineering has always been a "Step Ahead" in quality high-speed processor development support, it's only natural to be the first with these emulators. The STEP-27, a complete development station, includes the following:

Disassembler? The First For the Microprogrammer! No need to convert ones and zeros into mnemonics. Poly-Meta-Symbolics (PMS)[™] does it for you. It even enters your patches symbolically.

Fast, Bug-Free Programs? Simple! STEP-27's powerful logic analyzer includes a 20-MHz, 16-level-state machine with five, 54-bit matchword/qualifiers for each level. The 4K buffer uses PMS to disassemble and display its contents in mnemonics.

Software? The Best! In addition to full software support for either a local or a remote host, STEP provides a general-purpose meta-assembler.

Poly-Meta-Symbolics (PMS) is a trademark of STEP Engineering.

Writable Control Store (WCS)? The Fastest! STEP's ten nanosecond WCS provides real-time execution of the most demanding high-speed designs. With any number of arrays (each up to 512-bits wide by 64K deep), the STEP-27 supports the largest micro-program requirements.



Communications? Of course! Using an RS232 linkup, the STEP-27, with a unique, general-purpose, menu-driven communication program, easily interfaces with the IBM[®] PC, VAX[®], PDP-11[®] or CP/M[®]-based and other operating systems.

PDP-11 & VAX are registered trademarks of Digital Equipment Corporation.

CPM is a registered trademark of Digital Research Inc.

Are We Interested In Your Questions? You Bet! Our sales engineers quickly respond to all inquiries. Mail coupon or call **Toll Free (800) 538-1750; in California (408) 733-7837.**

Please send more information. Please schedule STEP-27 demo ASAP.

Name _____

Title _____

Company _____ M.S. _____

Street _____

City _____ State _____ Zip _____

Phone _____



Post Office Box 61166 Sunnyvale, Ca. 94088

CIRCLE 97

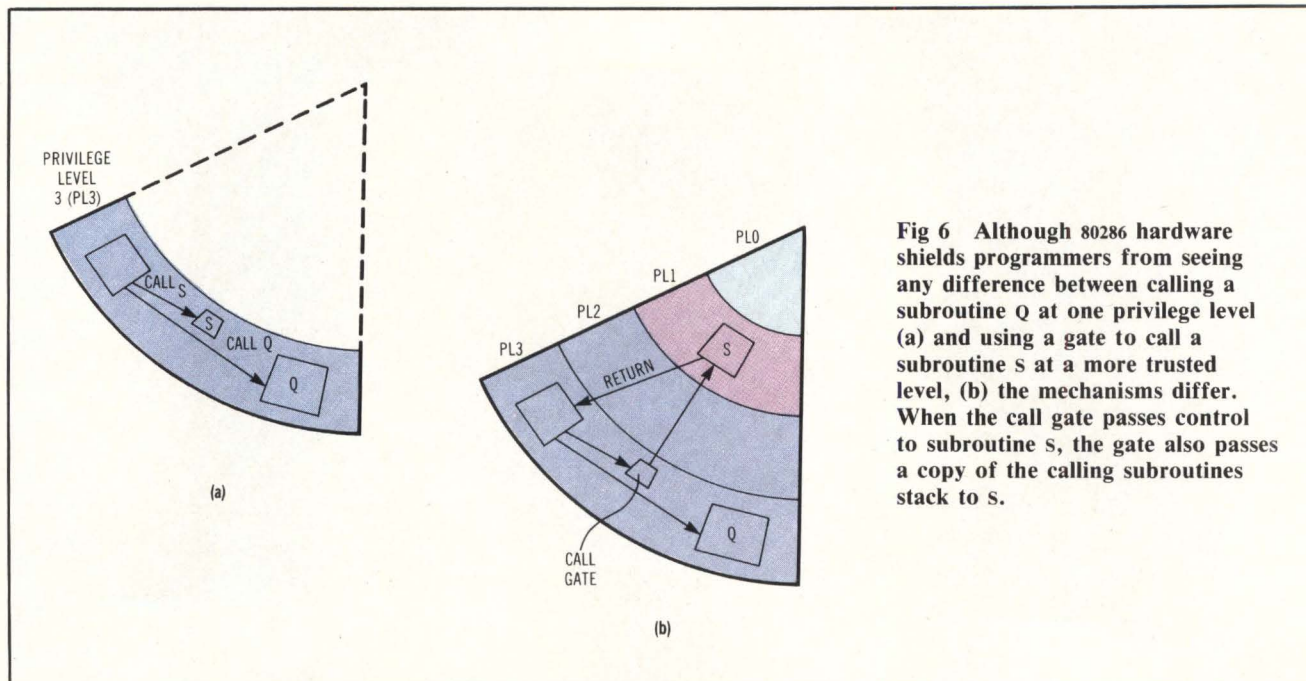

Fig 6 Although 80286 hardware shields programmers from seeing any difference between calling a subroutine Q at one privilege level (a) and using a gate to call a subroutine S at a more trusted level, (b) the mechanisms differ. When the call gate passes control to subroutine S, the gate also passes a copy of the calling subroutines stack to S.

portals between levels are special descriptors, called gates. The CPU permits a less trusted task to access the segment associated with a gate only if the gate descriptor is located at the same level or a less trusted level. From the programmer's point of view, access through gates to segments at a more trusted level looks just like a normal subroutine call (Fig 6).

However, when a task passes the access rights check, the underlying mechanism of passing control to the associated segment is much more complex than when a task accesses another segment through a normal descriptor. Tasks typically pass parameters to subroutines through the system stack. But in the interests of maintaining system security, the CPU must maintain separate stacks for a task at each privilege level.

Gates resolve both these requirements by copying a specified number of words from the calling task's stack to the corresponding stack at the target segment's privilege level. A special field in the gate descriptor permits up to 32 16-bit words to be passed in this manner.

Gate-mediated access also results in more streamlined calls to operating system routines. In traditional operating systems, the program executes a trap or software interrupt to a separate system handler when a program requests a system function. This software routine must first copy the parameters from the user stack to the system stack and then call the appropriate system subroutine. With this method, a typical system call takes 80 to 200 μ s. Because the 80286 permits application programs to execute a simple subroutine call to operating system services while handling the related housekeeping in hardware, a typical operating system call takes only about 12 μ s.

PRESTON QUALITY AT A NEW REMARKABLY LOW PRICE

Building Better Solutions With The New EM Series A-to-D Conversion Systems

Preston Scientific now brings you its new low-cost, high performance ADC Instrumentation Systems. The EM Series! Three models give you 13-bit resolution and the conversion rate you need for your most critical applications. Three models: 1MHZ, 500 kHz, 312 kHz. All with the same performance and quality that has made Preston world-famous.

The new EM Series provides: high quality, high resolution, and high speed. You buy only what you need and that saves you money. Best of all, the EM Series can be delivered quickly. 30 days ARO. Don't settle for less. For a better A-to-D solution, call or write today for details.

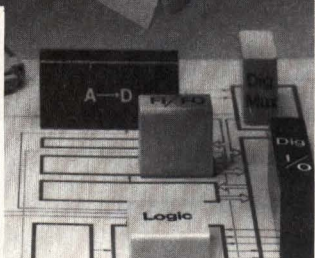
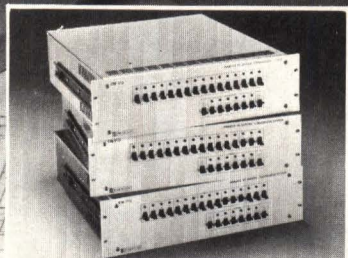

PRESTON PRESTON SCIENTIFIC
805 E. Cerritos Ave., Anaheim, CA 92805
Phone: (714) 776-6400

Please rate the value of this article to you by circling the appropriate number in the "Editorial Score Box" on the Inquiry Card.

High 725

Average 726

Low 727

COLORPLOT™ II

Color Hard Copy with Line Printer Performance



TRIOLOG's patented multicolor technology provides full color as well as conventional printing on plain fanfold paper at 100 dots per inch resolution.

COLORPLOT™ II provides CAD/CAM and/or business graphics hard copy in full color — quickly, reliably and accurately. With TRIOLOG'S TIP series of dot matrix line printers, there's no need to sacrifice anything. Available now are impact printers with all the quality, versatility and reliability that any mini/micro computer system needs.

With COLORPLOT™ II the extras are free:

- Full color hard copy output
- CAD/CAM graphics
- Business graphics
- Bar code generation
- Forms generation
- Data processing print @ 300 LPM
- Compressed print @ 220 LPM
- Letter quality print @ 75 LPM

And TRIOLOG puts it all into one printer with proven reliability from the pioneers of NON-STOP-PRINTING™.

COLORPLOT™ II is sold and supported through our worldwide distribution network.

For more information call or write today:

TRIOLOG, INC. 17391 MURPHY AVE., IRVINE, CA 92714
(714) 863-3033 TWX (910) 595-2798

TRIOLOG®

CIRCLE 99

IT WILL GROW ON YOU.

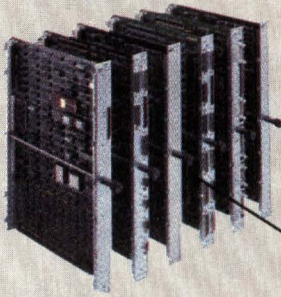

CONFIGURABLE ACCORDING TO USER NEEDS. As many as six processors can be installed in each enclosure. CPU-intensive jobs utilize multiple Applications Processors. Systems with heavy disk usage can distribute this load among several File Processors. The number of user ports can be increased by adding more I/O Processors.

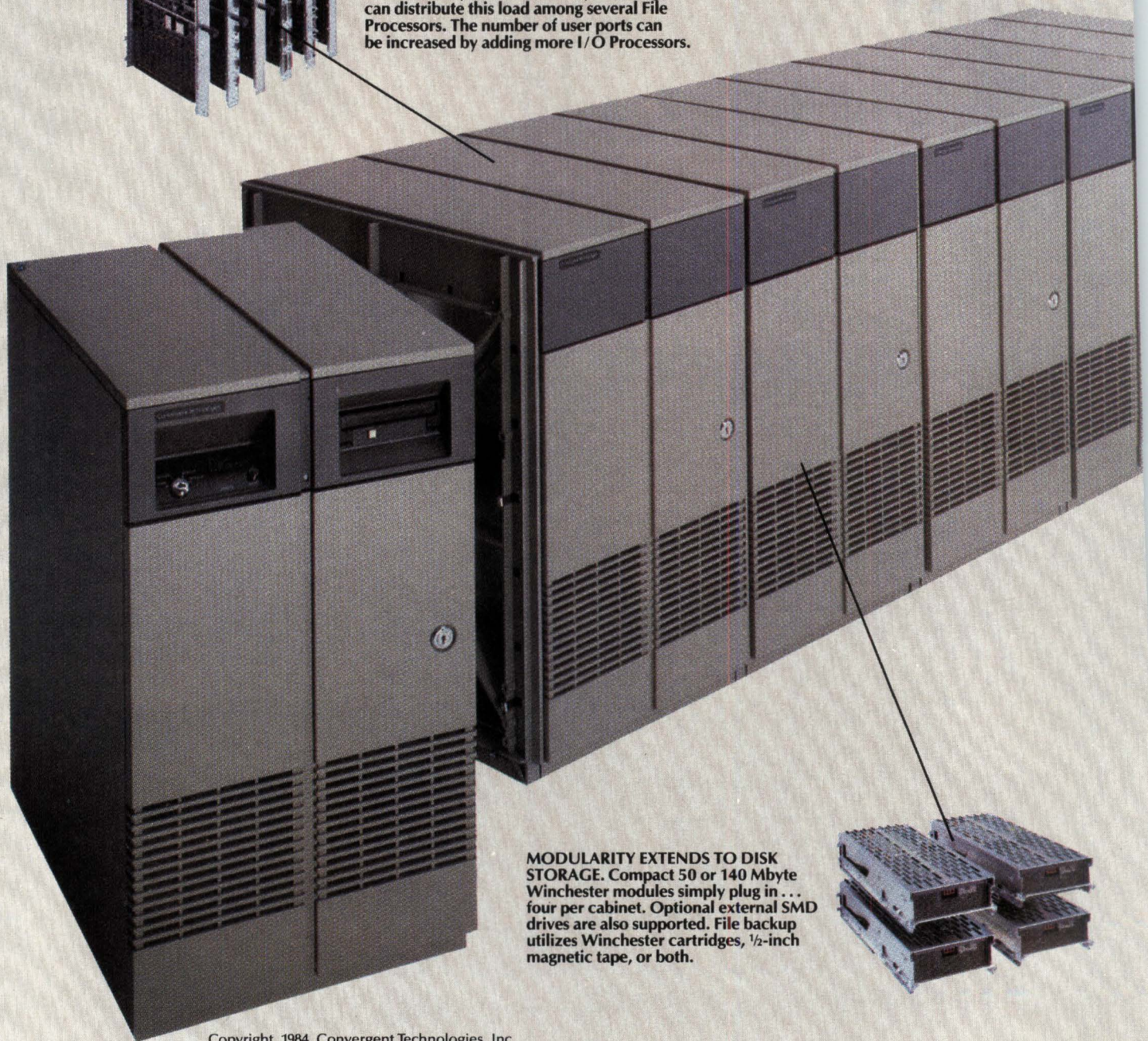

MODULARITY EXTENDS TO DISK STORAGE. Compact 50 or 140 Mbyte Winchester modules simply plug in . . . four per cabinet. Optional external SMD drives are also supported. File backup utilizes Winchester cartridges, 1/2-inch magnetic tape, or both.

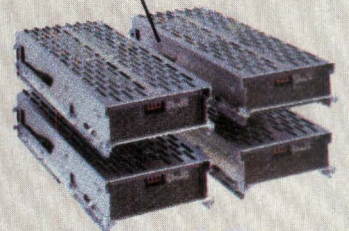

MegaFrame™. Now OEMs can offer a high-performance UNIX™-based system that can't run out of performance.

OEMs can now deal cost-effectively with the problems encountered when user applications produce computing demands that outstrip the capabilities of conventional systems.

Convergent Technologies' MegaFrame is a revolutionary new UNIX-based super-minicomputer—so innovative in its architecture that it represents the ultimate in multiuser systems design. It grows exponentially from a system offering minicomputer-level performance to an enormously powerful engine serving as many as 128 users with 36 parallel processors, 24 megabytes of RAM and gigabytes of disk storage.

No other system can match the MegaFrame's potential for field expansion. It enables manufacturers and systems builders to keep pace with today's requirements for more and more computing services... but *not* at the cost of discarding hardware or performing expensive CPU upgrades.

MegaFrame's architectural breakthrough. Dependence on traditional single-CPU shared-logic architecture is the root of systems bottlenecks.

Convergent's response: a novel system utilizing *multiple* specialized processors to distribute workloads for optimum performance—even if user needs are unpredictable or subject to rapid change.

MegaFrame's virtual memory Applications Processors each have a 32-bit CPU, up to 4 Mbytes of RAM and run a demand-paged version of UNIX System V. Up to 16 of them can operate in parallel.

The File Processors effectively function as back-end machines providing DBMS, ISAM and other disk-related services. Up to six File Processors each with four disks can operate in parallel.

Terminal and Cluster Processors can also be added—the latter serving front-end communications needs. They off-load communications from the other processors by running protocols such as SNA and X25 networks.

MegaFrame's daisy-chained cabinets offer total expansion potential of up to 36 slots. OEMs configure the system needed for specific applications simply by adding the correct number/combination of processors.

Flexibility in applications development. Inclusion of one or more Applications Processors allows running UNIX System V. All standard UNIX tools are provided, along with COBOL, FORTRAN-77, BASIC interpreter and compiler, plus Pascal.

The "least-cost solution" to serving a wide range of UNIX-systems needs, MegaFrame has won acceptance from OEMs in the U.S. and abroad. The uniqueness of its modular design, its versatility in providing upgrade-path options and its price/performance advantages give it marketshare potential of outstanding dimensions.

The system that will grow on you starts at a very attractive price: about \$20,000 for a system that effectively supports 16 users. Send now for a comprehensive Information Package including reprints of magazine articles. It explains how MegaFrame's growth potential can impact favorably on your plans for growth in the UNIX market.

Convergent Technologies, Data Systems Division, 3055 Patrick Henry Drive, Santa Clara, CA 95050. Phone: 408/980-0850. Telex: 176-825.



MiniFrame™: the entry-level multiuser UNIX system.

Starting at under \$5,000 for a single-user system, Convergent's MiniFrame offers outstanding capabilities for small to medium sized organizations running large UNIX-based applications. Utilizing an MC68010 microprocessor operating at 10Mhz, with no wait states, it provides impressive CPU speed—comparable to VAX™-11/750 running the AIM™ Benchmark. MiniFrame features virtual memory management, with demand-paged implementation of UNIX System V. It runs as many as eight terminals, with up to 50 Mbytes of integral mass storage. MiniFrame and MegaFrame are object-code compatible, allowing OEMs to offer a *complete family* of systems unrivaled in price/performance characteristics.



MiniFrame and MegaFrame are trademarks of Convergent Technologies, Inc. UNIX is a trademark of Bell Telephone Laboratories, Inc., VAX is a trademark of Digital Equipment Corp., and AIM is a trademark of Aim Technology.

Convergent Technologies

Where great ideas come together



- Disk
- Communications
- Fault
- Battery



On

Off

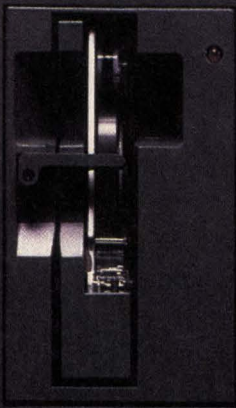

TOWER 1632. THE SHAPE'S THE SAME, BUT IT'S GOT AN ENTIRELY NEW DIMENSION.

The most memorable shape in the computer industry just became even more unforgettable.

You might think it would be hard to improve on the computer that took the OEM world by storm only a short year ago, but we've done just that.

First, we added two 46MB, 5 $\frac{1}{4}$ " Winchester to bring total storage capacity to 92MB (unformatted) in a single Tower unit.

Then we added a $\frac{1}{4}$ " streaming tape for faster, more convenient back-up. The tape's 45MB capacity allows you to dump the entire contents of a Winchester on one tape cartridge.

Of course, this enhanced Tower still offers the UNIX*-based Tower Operating System for maximum software compatibility and flexibility. And unsurpassed interfacing capacity. And the NCR name. Your guarantee of support. Now and in the future.

And it all still comes in that famous box. You know. The one that towers over the minicomputer.

Call us at 1-800-222-1235 to learn more about the Tower's exciting new dimension.

*UNIX is a trademark of Bell Laboratories.

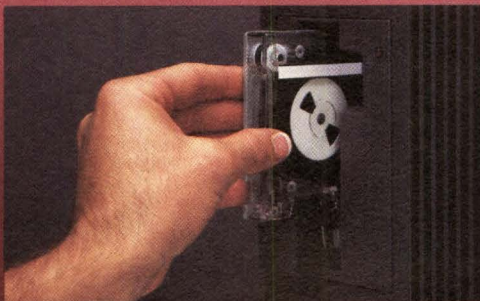

BUILT FOR SYSTEMS BUILDERS.
TOWER 1632.

NCR
OEM Systems Division

NCR Corporation, World Headquarters, OEM Systems Division, Dayton, Ohio 45479. Nationwide (800) 222-1235. In Ohio (513) 445-2380. In Canada (800) 268-3966.

CIRCLE 101

THE JETSTREAM™ 16 IS HERE

In excess of 100 megabytes

QIC-02/QIC-24 compatible

SCSI/QIC-24 compatible

16 or 9 tracks

Streaming on 9 or 16 tracks, the new high-density JETSTREAM™ 16 is fast, dependable, and big in capacity. Winchester back-up, data interchange, or archival storage are ideal applications for this exciting machine that packs in excess of 100 megabytes on a single data cartridge and takes no more space than an 8-inch floppy. OEM drives, as well as JETSTREAM™ systems are available. Contact us today for full details at North Atlantic Qantex, 60 Plant Avenue, Hauppauge, NY 11788 (516) 582-6060 (800) 645-5292

 north atlantic
Qantex

CIRCLE 102



JETSTREAM™ 16

Controller joins host adapters to step up performance

Addressing multi-user/multitasking systems that require high I/O subsystem performance, model ACB-5580 provides full support for the SASI/ANSI SCSI bus implementation. The rigid disk controller includes arbitration and disconnect/reconnect functions, and an SMD interface. At the controller's core is a 10-Mbit/s custom chip set, making it responsive to SMD drive performance requirements. The controllers can now handle disk memory capacities ranging from 5¼-in. Winchester to large SMD drives.

As part of the SCSI implementation, the boards have a straightforward bus structure that includes 8 data bits, 1 parity bit, and 9 control bits. An easy-to-use command set provides access to virtually all functions using only read, write, and format commands. Variable block sizes and multiple block transfers are allowed with a single read or write command. The I/O is fully buffered with a dual-ported FIFO. Buffer size ranges from 1024 bytes to 65 Kbytes.

Furthering the concept of maximized I/O performance, the board supports up to seven host CPUs through the SCSI bus and up to four SMD drives. It drives either 8- or 14-in., 9.6-Mbit/s SMD drives and includes all the features of the company's 5500 board for 5¼-in. Winchester. This includes disconnect/reconnect, file sharing, and noninterleaved operation.

The disconnect/reconnect feature of the bus allows a system to run concurrent tasks by handling multiple seeks and read/writes with the I/O bus disconnected. It reconnects only when a drive has data ready for the read/write operation. The controller, therefore, completes the tasks in the most efficient order, regardless of the order in which they were received. The result is increased speed and efficiency of I/O transfers. In addition, multiple drive access time is decreased, resulting in up to a five time increase in system I/O performance.

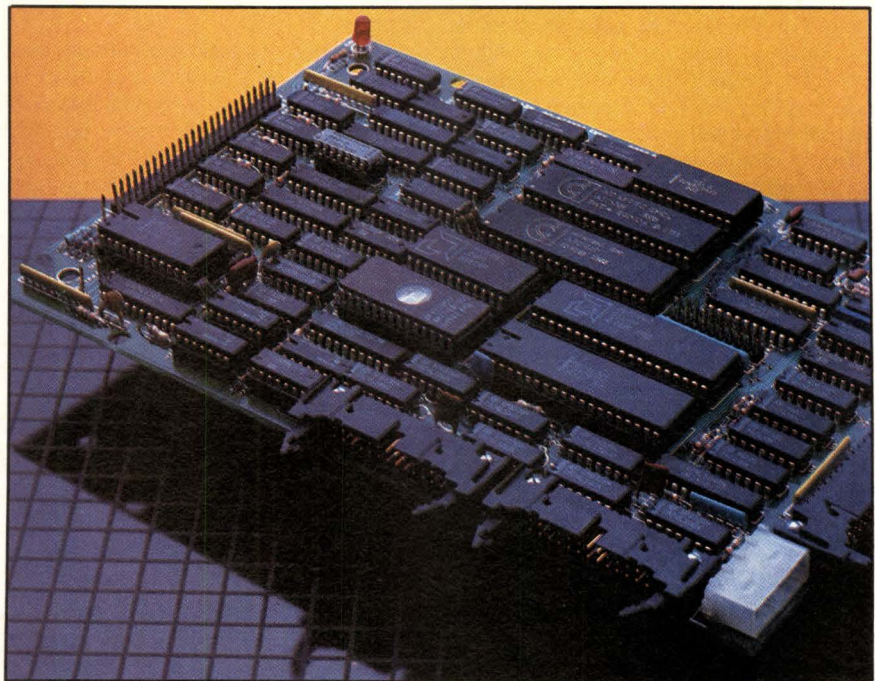

The board relieves the operating system of managing shared disk functions in a networked system through a reserve/release command. This command manages multiple access to files maintaining data integrity. Moving these functions to the disk controller increases operating system speed and improves file-sharing reliability by simplifying the operating system.

Data throughput increases by implementing noninterleaved operation. All information on one track of the disk is accessible in one rotation. Other controllers can require up to four or more rotations of the disk (in interleaved operation) to access all the information on a single track.

Complementing the board's multitasking operation capability, the AHA-1510 and the AHA-1530 are intelligent host adapters that support the S-100 host bus and the Multibus, respectively. They sit between

the host bus and the SCSI bus to improve system performance by functioning as I/O processors, working with the I/O supervisor of the operating system.

Both host adapters support high speed DMA at 1.5 Mbytes/s from the SCSI bus to the host's local memory. This support, together with monitoring bus handshake protocols and interrupts, maximizes hardware performance. Developed using IBM's concept of a block multiplexer channel, the adapters handle up to eight concurrent I/O requests. The operating system is then freed of its I/O management duties and can execute more application functions.

Price for the ACB-5580 is \$980 with production beginning in the third quarter of this year. The AHA-1510 is \$425, while the AHA-1530 is \$460. **Adaptec Inc**, 580 Cottonwood Dr, Milpitas, CA 95035. —M.B. Circle 260

Memory bubbles packaged to ride high on the Multibus

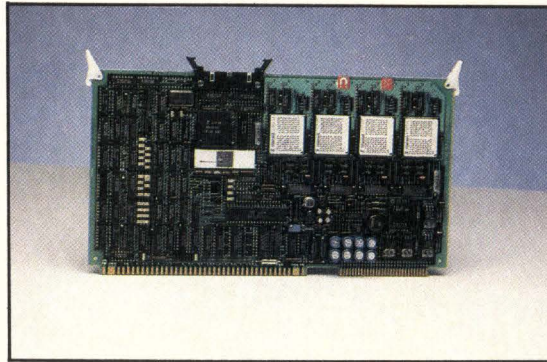

Offering built-in 1-Mbit bubble devices, the FBC504M4M series provides four different memory capacities—128, 256, 384, and 512 Kbytes. The card operates as memory-mapped I/O requiring only a 64-byte memory space. Advantages include a single 5-V power source, an internal power fail protection circuit, and data retention even without power.

All bubble memory operations are controlled by commands that are set by 5 separate bits in the command register. Several registers act as the interface between the host and the bubble device. A 4-byte FIFO data output register holds

data that is read from the bubble. When a data read command is set in the command register, data transfers from the bubble memory to the data output register at a 80- μ s/byte rate. Page changes increase this transfer time by 0.3 to 1.5 ms. As the data transfer begins, the number of pages (as specified by the host system) goes to the data output register at the same 80- μ s rate. Also a 4-byte FIFO register, the data input register functions in the same manner when the data write command is in the command register.

Other registers include a status register, which indicates the card's condition via flags. An error status register lists error contents; a page address register holds the starting address of a page; and a page count register keeps track of the number of pages that will be transferred. In addition, a DMA band select, write only register is accessed for DMA transfers.

The bubble device operates in various software-controlled modes. The read/write

command sets the interface registers to execute the read/write operation. It begins by sending the start page from the host to the page address register and the number of pages to be transferred to the page count register. The command register is then set with a command, allowing a sequence of operations to execute. First, bad loop data is automatically read from a boot loop. An error occurs if the bad loop data is invalid or if the data cannot be read. Next, the page indicated in the page address register is searched. Data is then written to the bubble via the data input register or read from the bubble via the data output register. During the transfer process, the controller continuously refers to the bad loop data storage so bad loops are skipped. When all the pages indicated by the page count register transfer without errors, a status register bit is set.

Other memory card features are 12.5-ms average access time, subpage read/write commands, and error correction. Prices range from \$620 to \$1410 in 100s. **Fujitsu America, Inc, Component Div**, 918 Sherwood Dr, Lake Bluff, IL 60044.—*M.B.* Circle 261

Source control tools help manage large software projects

A set of software tools designed to help manage and maintain large software projects currently runs on DEC's PDP-11 RSX and RSTS, as well as VAX/VMS environments. Called SourceTools, the package is a collection of version management, file building and file comparison programs that work with any computer language and allow programmers to use their favorite text editors and utilities.

SourceTools consists of three groups of programs that work together to create an integrated software development environment. The first of these is SOURCECON, a control package that handles the creation and modification of source files. User-defined information can be required via prompts, so that an accurate history of each module can be maintained.

SOURCECON also ensures a disciplined modification order for modules. If a programmer checks out a module for editing, other users may check the same module out for other purposes, such as reference, compiling, running, linking, documentation, etc., but may not alter it.

Only when users decide that their editing changes are to be included in the module do they invoke UPDSRC, which updates that module. The module remains locked to changes by other users

until the update is completed, thus ensuring integrity of modules. When a module is updated, it registers all changes, who made them, and when they were made. It also prompts the programmer to state and explain the most recent changes.

Such prompts painlessly create a history of each module that can be retrieved and printed using the PRSRC function. The history includes the reasons for updates, as well as a record of all changes. A file comparison utility lists all changes that have been made to a file.

A file builder program called MAKE keeps programs under development up to date as modules are changed. This avoids lengthy recompilations of the entire program at every change. The programmer supplies a description file that indicates which modules depend on others. MAKE then looks at the description file to decide which modules to compile and use to build the main program. In this way, the user may simply build different descrip-

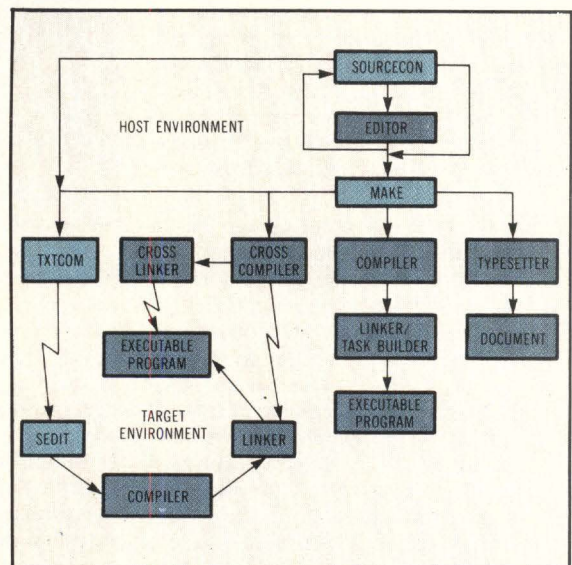

tion files to create different configurations of the same basic program.

The price of SourceTools is \$4500 for RSX and VMS in RSX compatibility, and \$3600 for the RSTS version. Prices include one year of customer support. **Oregon Software**, 2340 SW Canyon Rd, Portland, OR 97201.—*T.W.* Circle 262

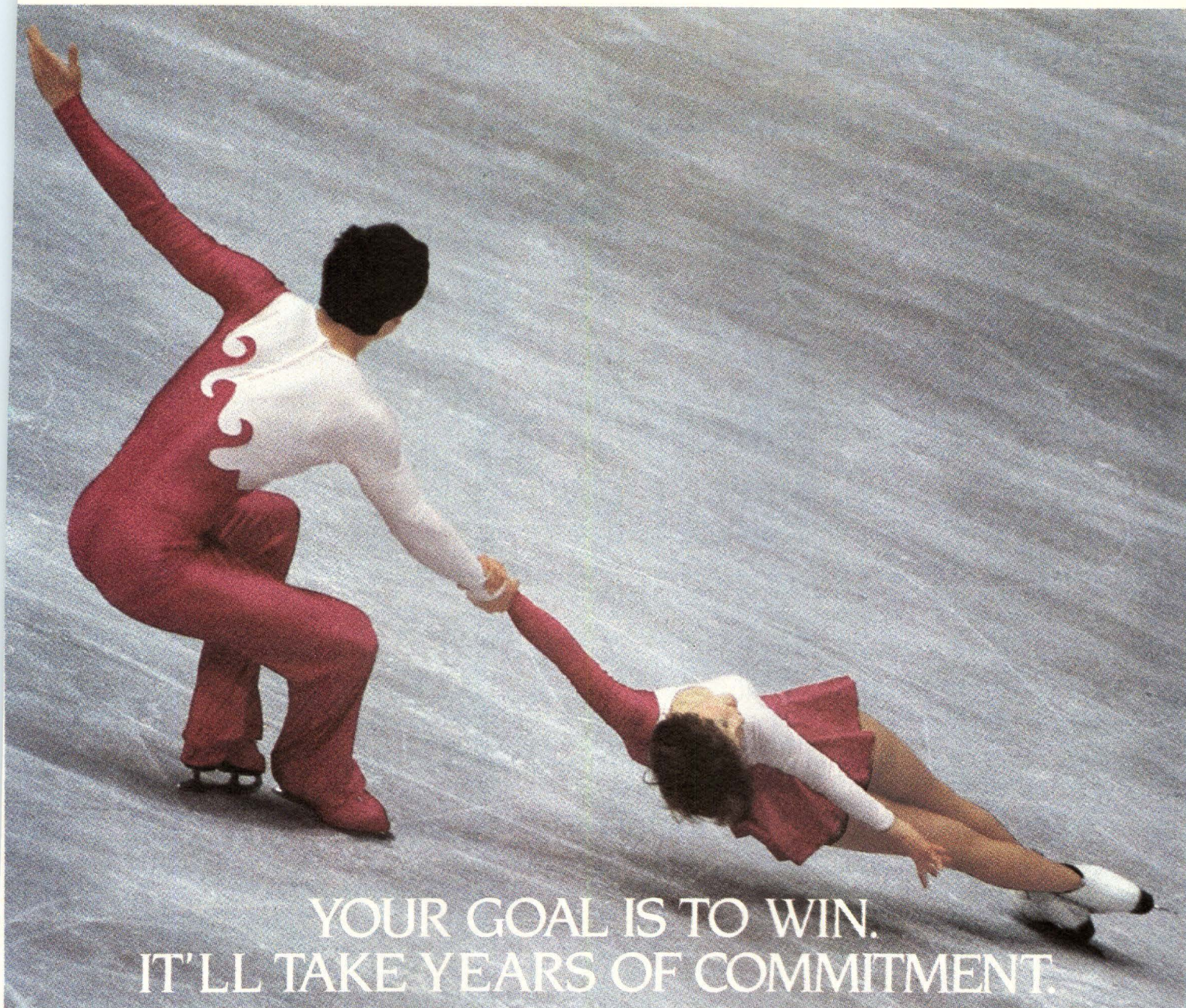

YOUR GOAL IS TO WIN.
IT'LL TAKE YEARS OF COMMITMENT.

YOU'LL NEED A PARTNER WHO CAN CUT IT.

How We Look At The Future. Designing information systems for the business office of the future is a lot like planning the flawless performance in ice skating.

Choosing the right printer partner can be critical.

Are the same strong goals for success shared? Is the necessary talent, commitment, and dedication to meeting and exceeding those goals present?

As a major designer and manufacturer of state-of-the-art printers, worldwide, Okidata knows the importance of goals and commitment. And living up to them.

What We're Doing Today. For Tomorrow. Right now, our dedicated

research and new product design teams are pushing and testing the limits of present technology to find better ways to build better printers.

Through an on-going and expensive commitment to robotic assembly, we're assuring smoother and faster-than-ever product flow.

And, elsewhere, we're streamlining our customization and modification turnaround times to respond even more quickly to your rapid startups.

We'll Be There When You Need Us. In OEM system building, just like in the Olympics, commitment is everything.

If your audience will be looking to you for more flawless performances in the future, we're the printer com-

pany who'd like to join you. In fact, we're already working on it. Call 1-800-OKIDATA. Or write OKIDATA, Mt. Laurel, NJ 08054.

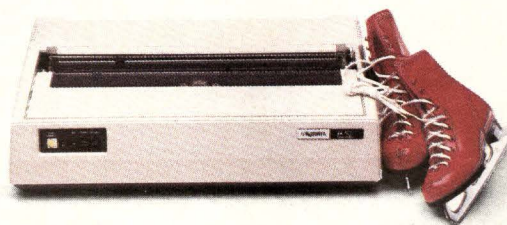

OKIDATA
an OKI AMERICA company

Smart disk controller locates and searches strings

The general trend in chip building is to put progressively more intelligence on silicon, and off-load control functions from the host CPU. The Intelligent Multiple Disk Controller (IMDC) SCN68454 does just that by offering the system designer a versatile programmable disk controller. In addition, it provides a sophisticated string matching function that can be used to create a disk-based database system.

Bus compatible with the Motorola 68000 microprocessor, the chip supports vectored interrupts, a 31-bit address counter, and either 8- or 16-bit data transfers. It supports up to four floppy or hard disks, and uses either SA1000 or ST506 protocols to control the drives.

Capable of handling serial data rates up to 10 Mbits/s, the IMDC has a range of commands that allow the programmer to specify disk parameters, and to read soft or hard sectored disks, as well as standard

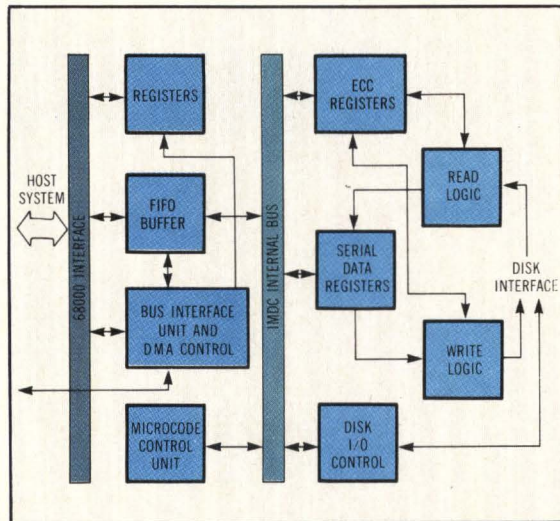

IBM floppy formats. The chip has a DMA controller, and a 128-char FIFO buffer onboard, handles bus arbitration automatically, and uses tables resident in the host's memory to get and send status and control information to and from the host.

Error-handling functions include automatic bad sector handling, 32- and 40-bit ECC, and support for host-generated ECC.

It handles FM and MFM data encoding, and can read or write multiple sectors automatically.

Using parameters supplied in a control block in system memory, the IMDC locates a specified string of characters within any logical data block on the recording media. It can then retrieve and store the contents of the block, use a pointer value to access data within the block, or locate all data blocks that contain a string that matches a given search string.

Both fixed- and variable-length records can be searched, and pointers can be used to search for key fields within the record. With fixed-length records, the index will be an integral number of bytes from the beginning of the record, but in variable-length records, it will be the "nth" field in the record. To support variable-length records, the IMDC lets the programmer specify a field delimiter. Using the separator as a marker, the IMDC simply counts fields, and retrieves the proper one for key processing. **Signetics Corp.**, 811 E Arques Ave, PO Box 409, Sunnyvale, CA 94086. —S.B.

Circle 263

Board counts on CMOS for low power CPU processing

Both hardware and software compatible with Intel's iSBK 86/05, the CBC 86C/05 captures the low power prize of CMOS without sacrificing system performance. Based on the Multibus, the board features an 80C86 CPU operating at 5 MHz, up to 48 Kbytes of a CMOS RAM/ROM mix, and onboard battery backup.

Standard ROM/EPROM memory capacity is 96 Kbytes maximum. With an optional

CMX 1600 expansion module, the maximum reaches 160 Kbytes. With a RAM/EPROM mix, standard onboard capacity is 48 Kbytes, expandable to 80 Kbytes with the CMX module.

The onboard lithium battery provides over 2.5 years of continuous data retention without system power. Voltage sensing logic ensures data integrity during both short- and long-term power outages.

An onboard 5-V power fail detection circuit can be used to protect RAM contents during power down and power up. An external memory protect signal can also be applied to disable RAM access.

In addition to the Multibus interface, the board uses a programmable peripheral interface that provides 24 parallel I/O lines. These lines are software configurable into any combination of uni- or bidirectional I/O ports. All Multibus and parallel I/O signals are TTL, or optionally, CMOS. A programmable synchronous/asynchronous RS-232-C serial interface results from a USART.

Asynchronous serial communication characteristics include 5- to 8-bit characters, 1, 1½, or 2 stop bits, framing, parity, and overrun error detection. Synchronous specs include 5- to 8-bit characters with internal character synchronization and automatic sync insertion. Asynchronous baud rates range from 75 to 9600, while synchronous baud rates range from 1760 to 38,400 baud.

The board also contains three 16-bit programmable counter/timers with various counting modes. A programmable interrupt controller handles nine maskable interrupts—eight with programmable cascading inputs for expansion to 64 interrupts.

The 80C86 CPU's word size for instructions is 8, 16, 24, or 32 bits and data word size is 8 or 16 bits. Memory addressing for ROMs and EPROMs in 2-, 4-, 8-, or 16-Kbyte devices is selectable on compatible address boundaries. With RAM, 8-K x 8 devices are selectable on 8-Kword boundaries.

Single-piece pricing is \$1395 for the 16-Kbyte RAM version with quantity discounts available. Delivery is from stock to six weeks. **Diversified Technology, Inc.**, PO Box 748, Ridgeland, MS 39157. —M.B.

Circle 264

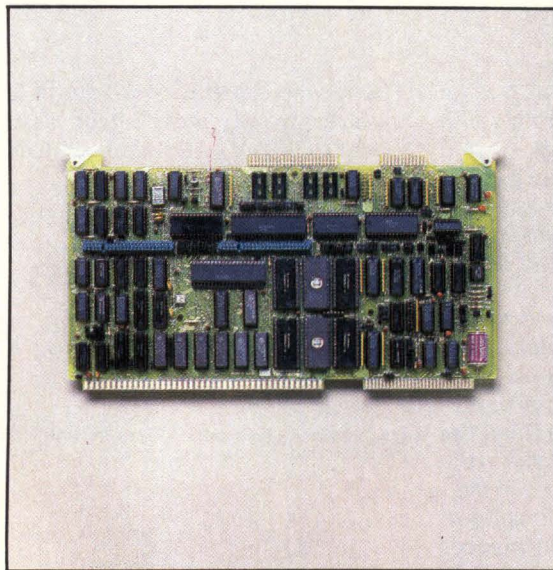

DATACHECK II

THE ULTIMATE

BREAKOUT BOX

We call it the ultimate breakout box because of all the features we pack into this pocket-size unit. Count them. 23 major features . . . all in an easy-to-use, reliable package. No wonder Datacheck II is the ultimate breakout box.

EASY TO USE

- Top to bottom functional panel layout.
- 25 individually numbered breakout switches.
- Four-state indication on all key signals (mark, space, clocking, undefined).
- LED's separated by signal source (DTE and DCE sides).
- Pocket-size, illustrated operators manual.
- 24-page instructional application notes.

RELIABLE

- Power off/reset button (conserves battery life).
- Molded ABS plastic case with metal hinge for durability.
- Two 9 volt batteries.
- Separate compartment for cable and jumpers.
- Gold-plated recessed pins.

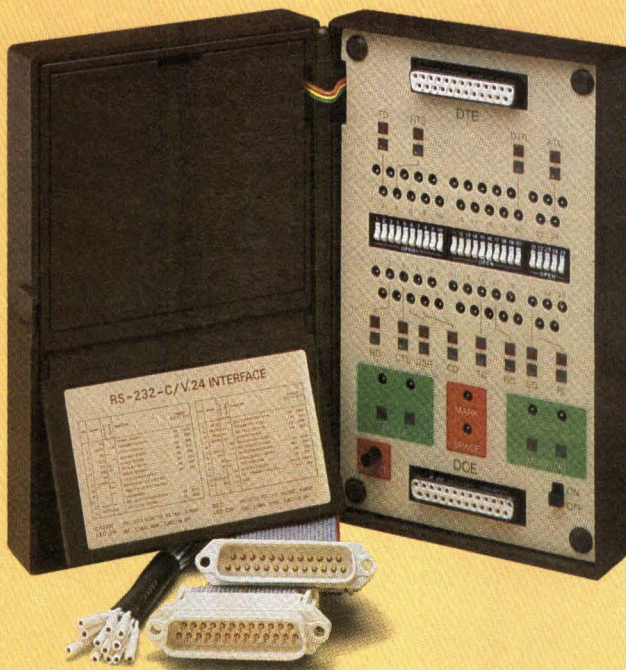

- Polycarbonate face (lettering can't wear off).
- Recessed LED's.

ADDED FUNCTION

- Detachable RS-232C ribbon cable (connection flexibility).
- Two-way and three-way jumper cables.
- Independent mark and space source pins.
- Dual tristate monitors for secondary signals.
- Power ON/OFF switch for extended interface reconfiguration.
- Dual pulse trap circuits (isolate intermittent signals).
- Optional Baud Rate Counter (measure transmission frequency).
- Optional Voice Frequency Monitor (listen to the condition of the phone line).
- Optional rechargeable batteries.
- Optional metal case.

ONLY \$239.

NAVTEL
FOR THE TESTING TIMES

TELEPHONE (416) 669-9918

A division of **Arelco**

Interactive CAD digitizer enters the third dimension

Dubbed an intelligent CAD peripheral that takes advantage of existing software, the Perceptor creates computer models of 3-D objects. Because its handheld pointer moves about the area to be digitized, an engineer can directly convey X, Y, and Z input coordinates—however irregular the physical reference.

Typical CAD workstations conform to 2-D design conventions and contain parts information in a special data base. For instance, X-Y coordinates are input using cursors, lightpens, or mice, and a digitizer tablet. Afterward, the Z coordinate is entered through the keyboard or constructed by software.

As an interactive, relatively low cost peripheral, the Perceptor can simplify desktop computer graphics and engineering tasks. Prospective applications include CAD, for creating and modifying 3-D designs under software control. Other applications include analyzing contours, tracing nested patterns, and modeling complex user-defined surfaces. Moreover,

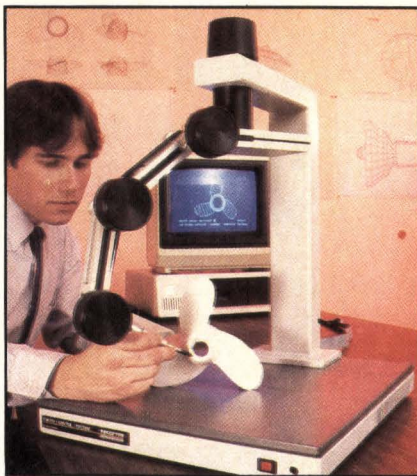

the unit maps fields when sensors for sound, temperature, and radiation replace the standard pointer tip.

Mounted on a ground aluminum reference plate, the digitizing arm captures up to nine X, Y, and Z coordinates per second at 9600 baud. The arm has five

standard joints; a sixth comes with an optional rotational platform. Embedded pots inside each joint convey the electrical information the system needs to calculate rotation angles. Maximum arm reach is about 42 cm.

A Z80A microprocessor board inside the 41- x 46- x 61-cm platform controls electrical data acquisition and converts analog readings from the pots. In turn, the digital signals can be sent over RS-232 interface to any computer that accepts serial input. The processor board also controls digitization modes and rates, baud rates, and calibration. Digitization modes are point, stream, delta distance, and delta time; baud rates are switch and/or software selectable at 300, 600, 1200, 2300, 4800, and 9600. Resolution is 0.018 to 0.025 cm.

Test units are scheduled to ship this month. Price will be under \$7000. **Micro Control Systems, Inc.**, 143 Tunnel Rd, Vernon, CT 06066. —D.H. Circle 265

DATA TERMINALS



The TransTerm® family of data terminals has the following common features:
 5x7 Dot Matrix A/N Icd Display (upper and lower case)
 Membrane A/N Keyboard with audible key-click
 Standard RS-232 Serial ASCII Communications
 25 pin RS-232 Female I/O Connector
 Eight Switch selectable Baud Rates (110, 150, 300, 600, 1200, 2400, 4800, 9600)
 Data Format: 1 Start Bit, 7 Data Bits, 1 Parity Bit, 1 Stop Bit
 Parity Bit Switch Selectable (even, odd, mark, space)
 Bell Code Annunciator
 Powered by Wall Plug-in Transformer (12 Vac) or external DC between 8-16 Volts.
 Low Power Consumption (less than 7.5 Watts)
 Add-on Options: 20 Ma current loop I/O, RS422 Compatible I/O

TRANSTERM 1
 Two Line 64 character display
 53 key Keyboard
 Three operating modes:
 TTY emulation
 Block Send
 Polled/Multidropped
 Unit Price \$449.

TRANSTERM 2
 24 Line Buffered Terminal
 Single Line 80 character display
 58 key Keyboard
 Optional 12K memory
 Unit Price \$549.

TRANSTERM 3
 NiCd Battery Powered
 Two Line 80 character display
 48 Line Buffer memory
 68 key Keyboard w/Edit Functions
 Soft Set-up from Keyboard
 Optional Printer/Plotter (3P)
 Optional 300 baud Modem/Coupler
 Optional Barcode Wand
 Unit Price \$499.

COMPUTERWISE, INC.

4006 E. 137th Terrace • Grandview, MO 64030 • (816) 765-3330 • TELEX 705337

Low Cost Subminiature Ball Slides

LOW FRICTION, LOW INERTIA, PRECISION BALL SLIDES—
 preloaded to eliminate backlash and side play in head carriages and other reciprocating mechanisms in disk drives, printers, plotters, and copiers.

Hardened stainless steel balls roll on hardened way rods for long life without added lubrication. Anodized aluminum bodies ground top and bottom. Stackable for XY positioning. Custom and special designs available.

Sizes start .23" high x .38" wide x .50" travel, capacity 1½ lb. Linear accuracy .0005 inch/inch. Repeatability .0002 inch.

COMPARE OUR PRICES—
 Popular sizes in stock.
 Call (203) 775-4041 for
 12 page catalog
 and price list,
 or see us in
THE M.C.A.T.



DelTron Precision, Inc.

934 Federal Road Route 7
 Brookfield, CT 06804
 (203) 775-4041

DATA GENERAL'S MV/10000. LESS MONEY THAN DEC'S VAX 11/780 AT TWICE THE SPEED.

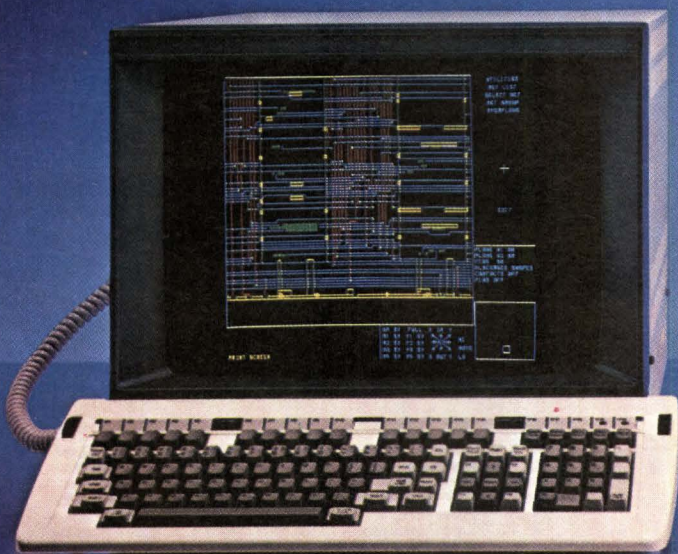

DATA GENERAL

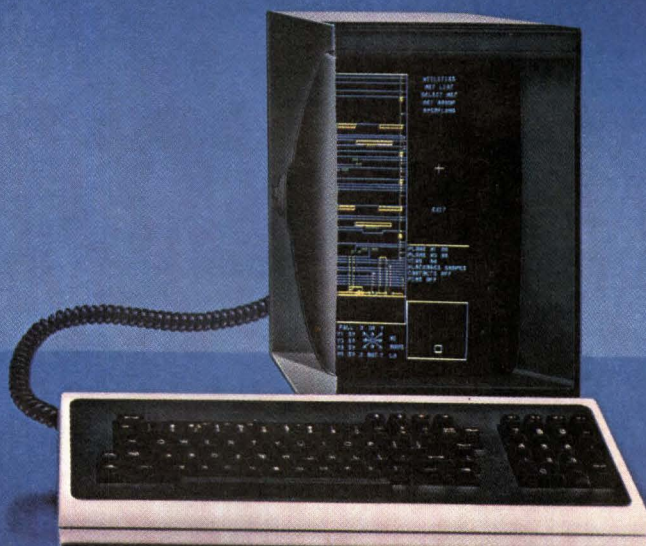

DEC

DATA GENERAL'S MV/FAMILY-TOP PERFORMANCE, NOT TOP DOLLAR

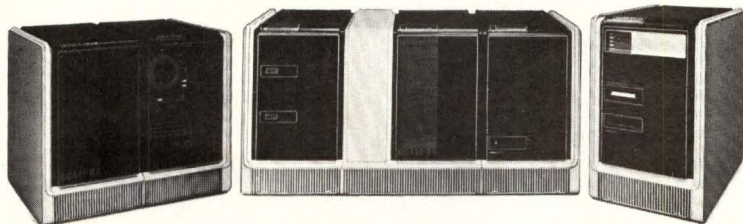

Forget VAX.™

Data General's ECLIPSE® MV/Family of 32-bit computers brings you the best price/performance available for engineering applications—while running some of the best electronics engineering software.

TWICE AS FAST AS VAX

Consider the price/performance graph shown below. On the basis of dollar-per-MIP,

Data General's MV/10000™ gives you twice the performance of the VAX 11/780—at a lower price.

Now compare the MV/8000®II to the VAX 11/780. Same performance. But the MV/8000II is half the price. The same holds true when you compare the MV/4000® to the VAX 11/750. And our recently announced OEM MV/8000 C offers almost twice the performance of the VAX 11/750. But it's the same price.

RUNS THE MOST WIDELY-USED SOFTWARE

You can run all of the best software on our ECLIPSE MV Series, including TEGAS™, NCA/DVS™, MicroSet-86®, ECAD's DRACULA, and Mentor's CADISYS®

And Data General keeps you a generation ahead by bringing you comprehensive service plans and industry standard software development environments.

CALL NOW

For more information on Data General's ECLIPSE MV/Family, call **1-800-554-4343** and ask for **Operator IOF**.

Copyright 1984 Data General Corporation, Westboro MA. ECLIPSE, ECLIPSE MV/4000 and ECLIPSE MV/8000 are registered trademarks, and ECLIPSE MV/10000 is a trademark of Data General. DEC and VAX are trademarks of Digital Equipment Corp. Prices based on Data General and DEC price lists and other publicly available information as of Jan. 1984. TEGAS is a trademark of Calma Co. MicroSet-86 is a registered trademark of First Systems Corp. CADISYS is a registered trademark of California Automatic Design.

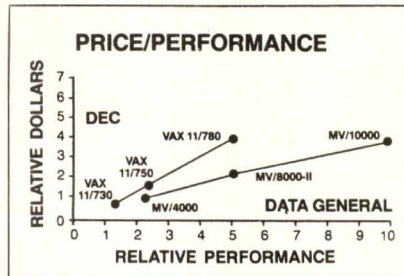

Data General
a Generation ahead.

212 MB

8" Winchester Drives

■ SMD INTERFACE

■ SCSI INTERFACE

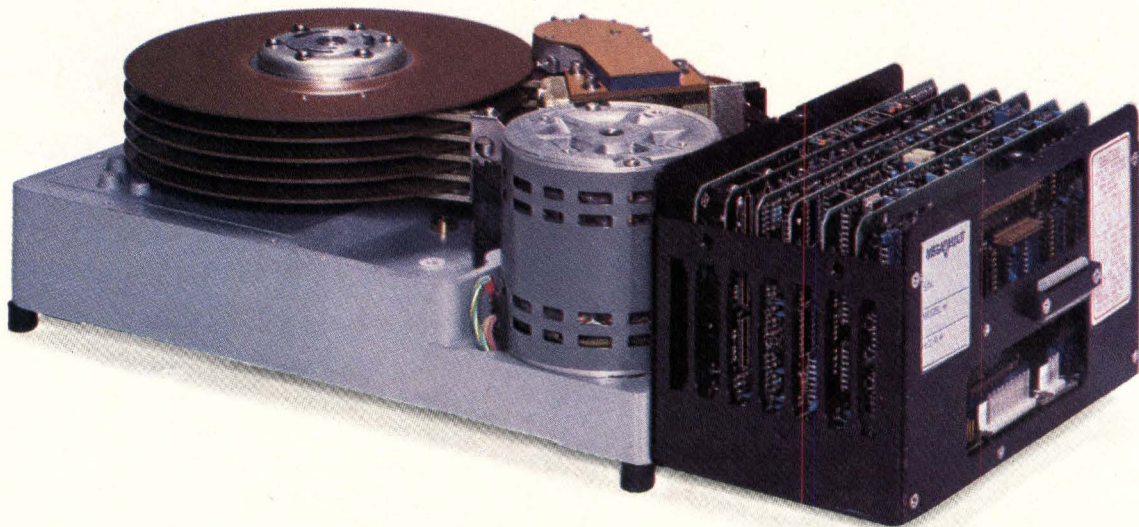

Yes! Our 212 MB, 8 inch Winchester drives are available in either SMD or SCSI interfaces immediately. Just send us your purchase order and we will ship your drives today. By the way, if 212 MB is just too large for your needs, we can ship 166 MB or 83 MB just as fast.

Call today:

MEGA V AULT
... a safe place for data

6431 Independence Avenue, Woodland Hills, CA 91367 (818) 884-7300 Outside California 1-800-MEGAULT

CIRCLE 108

Analzers feature automatic protocol analysis and interpretation



Intelligent about both character and bit-oriented protocols, the 200, 400, 600, and 800 analyzers can tell the operator what went wrong with the protocol and which device caused the problem. The 200 has a removable EEPROM pack, auto-setup, and full-protocol decodes. The 800 has a 10-Mbyte Winchester, color CRT, Sony microfloppy, and multilevel program operation. **Digilog Inc, Network Control Div**, 1370 Welsh Rd, Montgomeryville, PA 18936.

Circle 266

Network operating system pivots on message concept

The QNX operating system allows tasks to communicate with each other by sending messages. The tasks need not know the node on which another task is running in order to communicate with it. There are no restrictions upon the resources, which can be used by any task, nor are there any restrictions on the processor on which a task may execute. All workstation resources connected to the network are available for every task. **Quantum Software Systems Ltd**, PO Box 5318, Station F, Ottawa, Ontario, Canada K2C 3H5.

Circle 267

Networking device permits direct connection of host and RS-232

Microprocessor controlled, the Robin can network any four computers or terminals and a parallel device. Each unit carries its own control electronics based on a Z80 micro, 64 Kbytes of user memory (plus 2 Kbytes of nonvolatile memory), four RS-232 ports, one bidirectional parallel port, and configuration control. Auto-connect presets a port to a chosen destination. The network incorporates an adaptive time division multiplexing pro-

ocol. It is designed for round-robin scheduling and requires no collision detection or token passing. Signaling rate is 2 Mbits/s with a maximum aggregate user data rate of 1.8 Mbits/s. Cost is \$1950. **Metapath, Inc**, 73 Lincoln Centre Dr, Foster City, CA 94404.

Circle 268

Protocol converter interfaces ASCII devices to an IBM mainframe

With 4, 8, 12, or 16 ports, the PSA 300 converter supports interactive sessions through the 3276 protocol and batch sessions through the 3770 SLU protocol. The SNA/SDLC converter is a diskette-based unit allowing configuration and/or diagnostic control to be assumed by any terminal attached on either local or remote basis. It supports up to 31 different CRT or microcomputer terminal types. Prices range from \$4800 to \$13,500 per unit. **Perle GSD, Ltd**, 600 S Dearborn St, Chicago, IL 60605.

Circle 269

High speed modems use LSI technology for small size

Models HD9600FP (9600 bits/s) and HP4800FP (4800 bits/s) are point-to-point and multipoint fast polling modems using the maximum capability of the processor. Other models are general-purpose CCITT-type modems appropriate in both dial-up and leased-line networks, point-to-point, and multipoint. Modem dimensions are 8.3 x 11.8 x 2.0 in. (21.1 x 29.9 x 5.1 cm) and weight is 5 lb. Power consumption is 13 VA. All modems use signal processor and micros to perform scrambling/descrambling, modulation/demodulation, encoding/decoding, and filtering. **Hitachi Denshi America, Ltd**, 175 Crossways Park West, Woodbury, NY 11797.

Circle 270

July Preview
A Special Report on System Software

Modem communicates with microwave and satellite networks

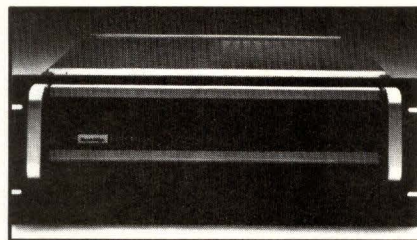

The Modem 112K operates full duplex and features manual sound speed switching. Line equalization and filtering methods eliminate both distortion and line noise often found in microwave/satellite networks. Diagnostics include analog loopback, DTE loopback, and data test. The modem offers a CCITT V.35-compatible interface. An integral multiplexing option permits two-port operation, each port having a 56-kbit/s data rate. Other options include elastic buffer and alarm relay. Price is \$16,500. **Racal-Milgo**, 8600 NW 41st St, Miami, FL 33166.

Circle 271

Data-switching capacity increases in large data network

The PACX IV SE data-switching system has a 100-percent increase in bandwidth. The switches serve as large centralized switches or as nodes in the Pacnet data communication network. With this 19.6-Mbit/s capacity, the system can handle up to 2048 attached devices. Microboard design enables units to provide up to 1024 data channels operating simultaneously at 9600 bits/s (asynchronous) and 19.2 kbits/s (synchronous). **Gandalf Data Inc**, 1019 S Noel, Wheeling, IL 60090.

Circle 272

Modem uses parallel interface to ease design configuration

The XCOM modem is Bell 212A compatible. With the parallel interface baud rate, it is independent and therefore requires no host intervention to adjust between different rates. This permits automatic selection of baud rates. Other versions are available for use with the Apple, TRS-80/2000, S-100-based systems, and the PCjr. **Delta Communication Products, Inc**, 3213 Ramos Cir, Sacramento, CA 95827.

Circle 273

The new Telex 9250 tape subsystem

Finally! Full-Performance GCR Made Affordable. Telex Shamrock ♻️

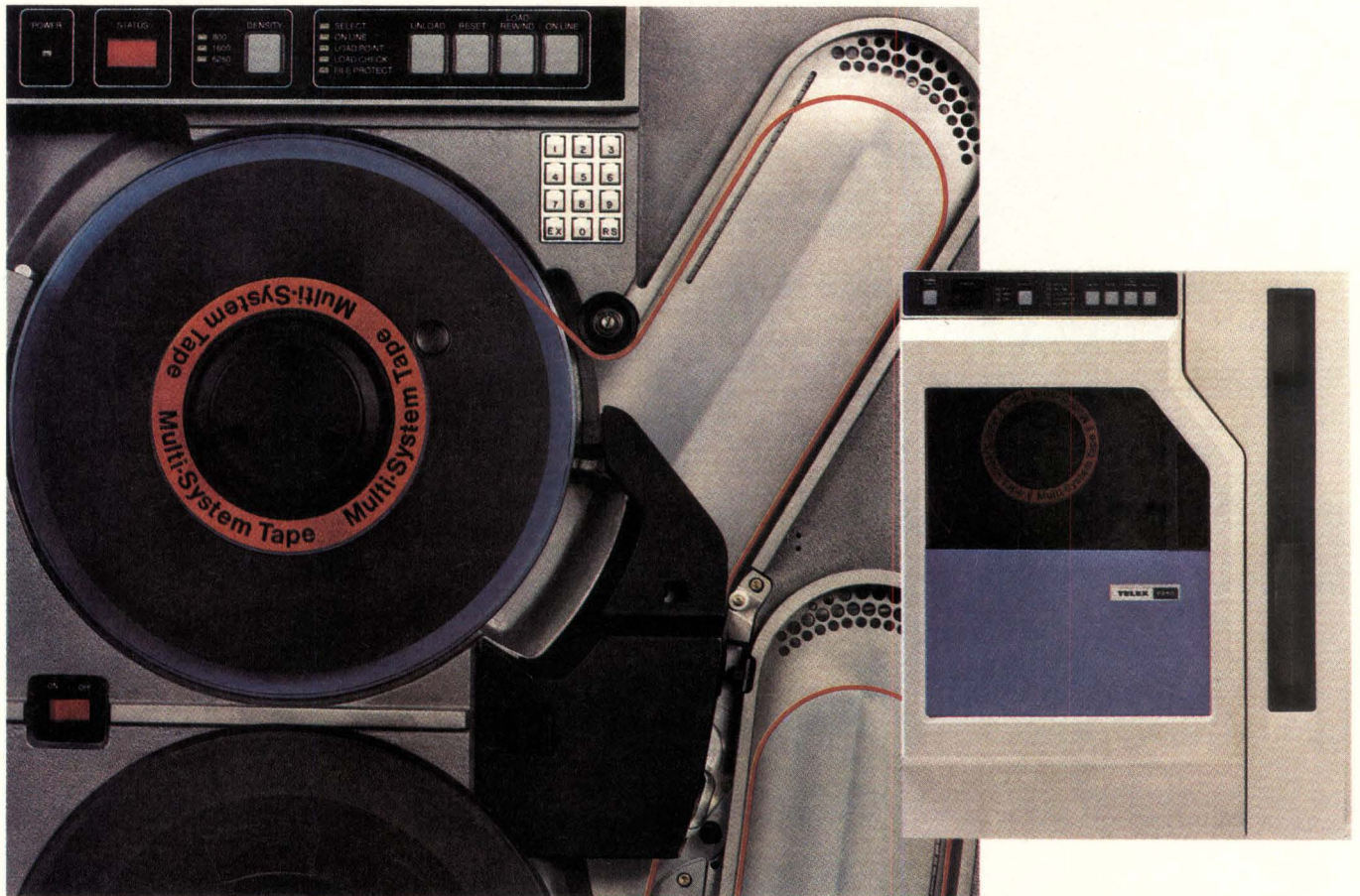

It took Telex to introduce a GCR subsystem with all the performance, all the reliability of larger subsystems — and make it affordable for minicomputer and mid-range mainframe manufacturers.

The Telex 9250 GCR tape drive is the first 50 ips unit to appreciably lower the cost of GCR without sacrificing performance. Advanced LSI gate array technology and vacuum column design offer advantages like low cost, low power and low noise

(before offered only on old tension arm systems) — plus all the performance that only vacuum column technology can deliver, including . . .

- ANSI standard (0.3") interblock gap
- Faster access time (0.3 millisecond write, 3.4 millisecond read)
- Higher data reliability
- Greater media integrity
- No adjustments
- Low maintenance

Other features include autoloader, autothread, 1x4 option, resident diagnostics and tri-density option to offer the most ingenious application of vacuum technology to date.

Performance *and* savings — it's what you've come to expect from Telex.

For more information, contact the nearest Telex OEM Sales Office listed or phone our OEM Marketing Department in Tulsa: (918) 627-1111.

TELEX® SHAMROCK ♻️

The Innovation continues . . .

Telex Computer Products, Inc.
Terminals/Peripherals/OEM Products
6422 East 41st/Tulsa, Oklahoma 74135
(918) 627-1111

Telex Regional Offices

- Amherst, NH (603) 673-9272
- Garden Grove, CA (714) 898-9833
- Houston, TX (713) 497-6770

International

Telex Computer Products, Inc.
P.O. Box 128/Addison, TX 75001
(214) 931-8511/telex: 730612 TLXINTL ADDI

Switcher has 16 channels for information display systems

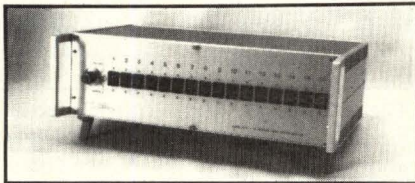

Designed for IBM 327X-type systems, the 9316 accepts inputs from display stations and either switches them in bulk to controller A or B, or switches them in a pre-programmed mix between two controllers. When in mix mode, individual channels can be switched. All channel connections to the display stations and controllers are made at the rear panel via male BNC coaxial two-stud lock connectors. Channel-to-channel isolation is maintained. Price is \$1050 as rackmount and \$1100 as desktop. **Electro Standards Laboratory, Inc.**, PO Box 9144, Providence, RI 02940.

Circle 274

Short-haul modem incorporates independent handshaking

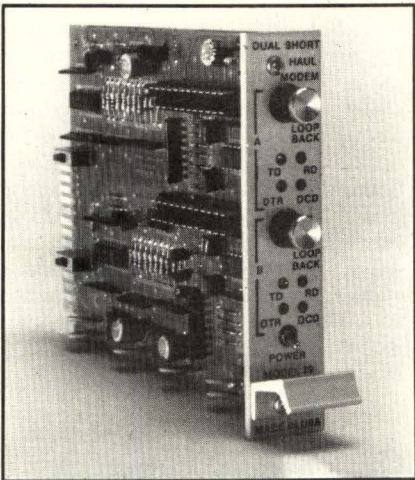

A high density package offering bidirectional handshake/control signals, the model 79 provides full-duplex operation at speeds to 19.2 kbaud. Distances are up to 10 mi over two twisted pairs. Designed for asynchronous operation, the network cabling must provide dc continuity and be of the nonloaded type. Handshake/control signal is implemented by the DTR and DCD pin. Transmission between models is via ± 12 mA current loop controlled by optocouplers. In quantities of 250, prices are \$180. **Remark Datacom, div of Telebyte Technology, Inc.**, 148 New York Ave, Halesite, NY 11743.

Circle 275

Full-duplex modem simultaneously handles voice and data

Enabling transmission of voice and data over one telephone line, the SPM-94B creates two data channels. One is in the forward direction, one in the reverse, all within a portion of the voice band. Data is transmitted at speeds to 300 bits/s. Five

front-panel LED indicators monitor the unit's operation for system diagnostics. Interface modules are available in standard protocols with special modules available on request. **Coherent Communication Systems Corp.**, 60 Commerce Dr, Hauppauge, NY 11788.

Circle 276

DO YOU OFTEN WISH THAT THE SMITH COMPANY WAS THE SMITH & SMITH & SMITH & SMITH COMPANY?



Business people often find themselves doing so many things that just one of them isn't enough.

So hire some of the needy and disadvantaged young people of America this summer to help you.

Hiring them can also help you in another very important way. Because a business that hires economically disadvantaged youth during the summer may get as much as an 85% tax credit on the first \$3,000 of wages you pay them. Write the National Alliance of Business at PO. Box 7207, Washington D.C. 20044. And support your local summer-jobs-for-youth programs.

You'll be doing something for yourself, for your business, for your community, and for the needy youth of America, too.

LET'S GET ALL OF AMERICA WORKING AGAIN.

A PUBLIC SERVICE
OF THIS PUBLICATION &
THE ADVERTISING COUNCIL **Ad Council**

Network performance monitoring merges with matrix switching

Identifying and correcting network problems and analyzing network performance, the Intelli-MAX runs on one CRT. Dynamic rotational monitoring checks critical portions of networks continuously while monitoring less crucial lines on a rotational basis at user-defined intervals. The device produces color graphics dis-

plays of up to seven layers of network activity. The system displays network activity minute by minute and in 5-min color trends. It will also verify normal operation after corrective action on the network has been taken. Fully configured systems start at \$61,400. **Data Switch Corp.**, 444 Westport Ave, Norwalk, CT 06851.

Circle 277

High speed modems use the 68000 as a controller

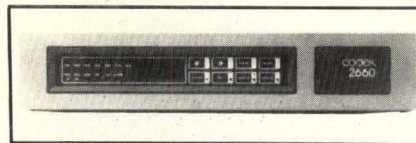

The 2600 series features trellis-coded modulation for improved performance above 9600 bits/s and reliable data transmission up to 16.8 kbits/s. Automatic speed adjustment to changing line conditions is designed for maximum throughput. Built-in network control monitors and tests lines and devices directly from the control panel or from a central site control system. The modems have integral dual-dial restore with auto-call/auto-answer capability for dial backup in case of leased line failure. The series consists of three models for transmissions, ranging from 4800 bits/s to 16.8 kbits/s. **Codex, sub of Motorola Inc, Information Systems Group**, 20 Cabot Blvd, Mansfield, MA 02048.

Circle 278

PUT Canon Precision IN YOUR PRODUCT

SUB-FRACTIONAL DC MOTORS

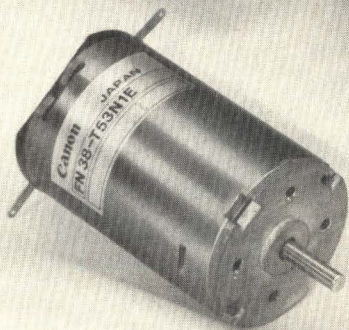

Canon Precision Inc., a wholly owned subsidiary of Canon Inc., is one of the world's largest manufacturers of DC micromotors. These motors are designed and built to the same standards of excellence as Canon's famous cameras, copiers, calculators, typewriters and other fine products.

We offer a complete line of over 100 sub-fractional HP DC motors and gearmotors ranging from 13mm diameter to 50mm diameter in conventional iron core motors and from 39mm to 52mm in brushless types. Electronics are available for the brushless motors. The motors are designed to meet UL, CSA and FCC requirements. Special modifications are available in OEM quantities.

If you need precision in your products...design it in...with Canon Precision.

Canon®

For a comprehensive catalog, call or write:

Canon U.S.A., Inc.
Electronic Components Division
One Canon Plaza
Lake Success, NY 11042

Tel: (516) 488-6700

Telex: 96-1333

Cable: CANON USA LAKS

Protocol converters network multiple hosts and mixed computer types

Tru/Blu converters perform switching functions, as well as conversions between synchronous EBCDIC and asynchronous ASCII, speeds, and coaxial cable and RS-232 interfaces. These functions allow one terminal or printer to work with two or more host computers of different types. Model 74 emulates a 3274 controller, 78 allows PC to provide full-screen emulation of 3278 terminal, 87 adapts an ASCII printer to coaxial cable, and 80 emulates 3780, 2780, 2770, and 3774 protocols. **Timeplex, Inc.**, 400 Chestnut Ridge Rd, Woodcliff, NJ 07675.

Circle 279

Cluster controller links multiple hosts, PCs, and terminals

The Netway 274 multidissimilar host controller supports up to 16 workstations and connects up to 5 multipoint and 16 point-to-point connections. It includes a floppy disk system for loading system software configuration information, a parallel printer port, and optional networking software. The controller supports 3270 BSC, SNA/SDLC, Burroughs poll/select, and asynchronous start/stop protocols. Prices start at \$9150 with a typical configuration at \$12,510. **Tri-Data**, 505 E Middlefield Rd, Mountain View, CA 94043.

Circle 280

Enclosures for your ideas

Off-the-Shelf...

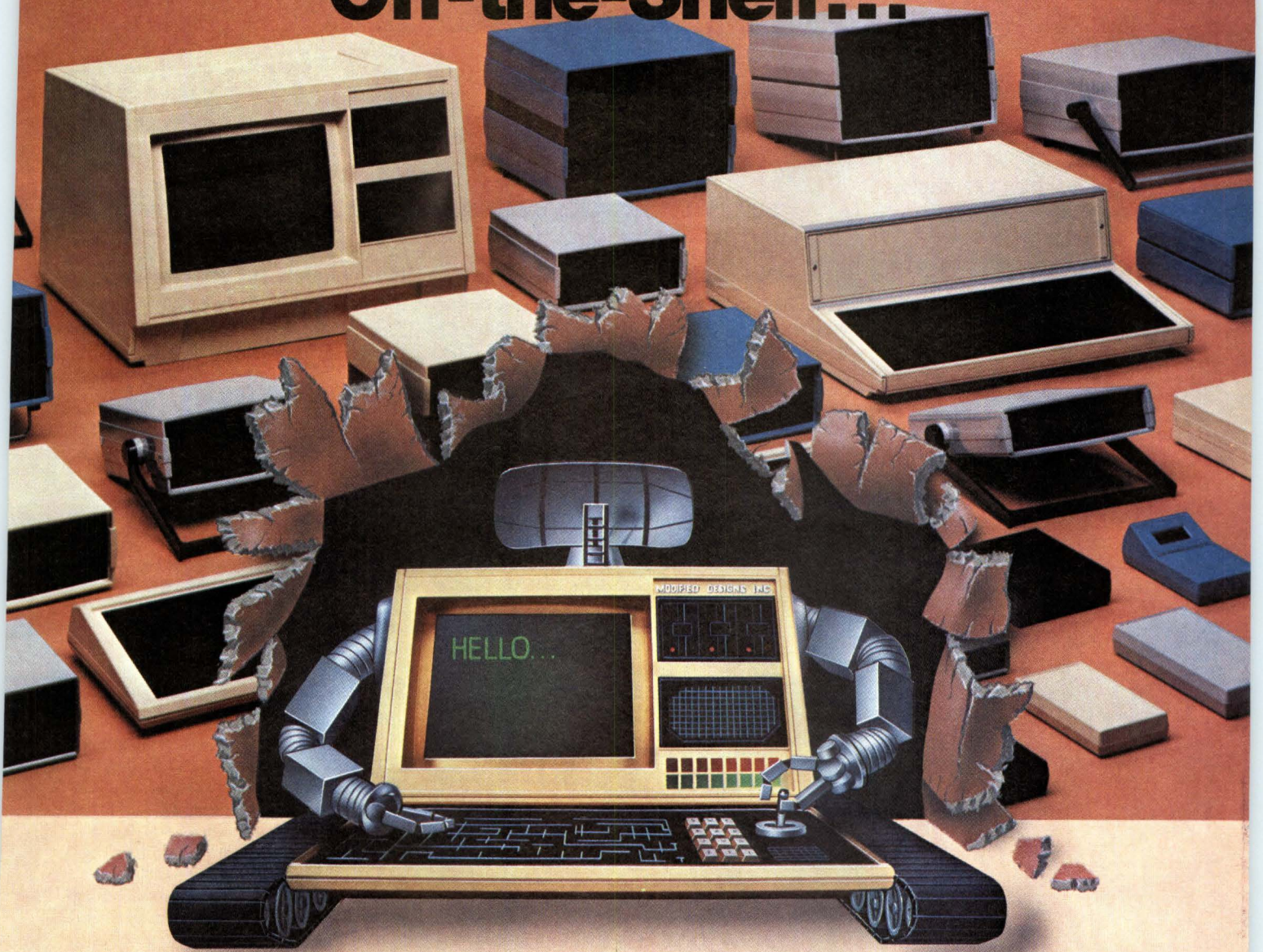

or Off-the-Wall.

Whether you buy standard stock or our "customized" models, your PacTec enclosure is engineered inside and out to look smart, last long, and cost less.

Because hundreds of PacTec enclosures are available from stock, it's likely we've already designed a package for your idea.

But if you have something in mind that's truly out of the ordinary, PacTec engineers, with years of packaging and design experience, will work with you to make your enclosure attractive, functional, and cost-effective—perhaps with just a simple modification to an existing PacTec package.

All PacTec enclosures offer you these benefits:

- Long-lasting, attractive appearance—molded-in colors in impact- and scratch-resistant ABS—flame-retardant and EMI/RFI shielded where necessary.
- Significantly less expensive than metal or molded enclosures.

- Host of standard accessories—handles, carrying straps, tilt stands, belt clips, and many more.
- Low-cost modifications—vents, louvers, and mounting flanges—plus, custom front and rear panels and special colors.

PacTec's standard enclosures do away with long lead times and secondary finishing, and save money in tooling and assembly.

So if you're looking for something off-the-shelf or off-the-wall, give us a call. We have all the in-house capabilities for design, production, and secondary operations to provide you with a single source for any enclosure you can imagine.

PAC TEC® Corp.

Subsidiary of LaFrance Corp.
Enterprise and Executives Aves., Philadelphia, PA 19153
(215) 365-8400

High resolution CRT displays over 8000 characters

The 15-in. M38-200 resolves the equivalent of 3000 TV lines (3.9 million pixels) in a scanning area of 7 $\frac{1}{8}$ x 10 $\frac{1}{8}$ in. It is available in standard P-4 (white) and P-31 (green) phosphors with approximately 46-ft-L brightness for use in high ambient light. A special deflection coil reduces distortion and deflection defocusing, and eliminates raster pincushion effects. The tube and deflection unit combination is designed for use in both vertical and horizontal screen formats. Price is \$575. **Ampere Electronic Corp, Slatersville Div**, Providence Pike, PO Box 278, Slatersville, RI 02876.

Circle 281

Wideband operational amplifier settles in 70 ns to 0.01 percent

The AM-1435 provides high open-loop gain (100 dB), flat frequency response beyond 10 kHz, and a 6-dB/octave roll-off beyond 100 MHz. Gain bandwidth product is typically 1 GHz and slew rate is 300 V/ μ s. DC characteristics include 1-M Ω input impedance, initial offset voltage of ± 2 mV, and input offset voltage drift of ± 5 μ V/ $^{\circ}$ C. Minimum common mode rejection ratio is better than 80 dB, and full power frequency is 8 MHz minimum. Prices in 100s range from \$68 to \$102. **Datel**, 11 Cabot Blvd, Mansfield, MA 02048.

Circle 282

Thin-film recording heads designed for Winchester drives

Developed specifically for 8-, 5 $\frac{1}{4}$ -, and sub-5-in. Winchester drives, the Cyber 100 series is based on advanced air bearing and suspension technology. It features an inductive read/write transducer, and is directly deposited on a ceramic slider via a proprietary semiconductor-like process. Units come as slider/suspension or head/arm assembly. The heads operate at track densities ranging from 345 to 1200 tracks/in. Resolution is in excess of 70 percent, at flux densities of 8000 to 15,000 flux changes per inch. In evaluation quantities, price is \$1000 for 10 heads. **Cybernex Corp**, 6580 Via Del Oro, San Jose, CA 95119.

Circle 283

SOFTWARE

Micro-mainframe link provides full file-transfer capabilities

Via software addition, the dual processor-based (Z80/8088) TC3278 terminal converter transforms an IBM 3278/3178 into an intelligent workstation. The software runs in the CMS, TSO, and CICS operating environments and under DOS/VS, OS/MVS, or VM/370 operating systems. IBM files are accessible to all TC3278 units as a shared data base. The link connects coaxially between the terminal and cluster controller for both a nonintrusive Line mode and a Local mode for file transfer, personal computing, and software terminal connection to host. One-time charge for the IBM host environment is \$500; \$200 for each terminal converter. **Avatar Technologies Inc**, 99 South St, Hopkinton, MA 01748.

Circle 284

Graphics software packages provide high performance

Designed for use with NEC's advanced personal computer, the Designer package is one of four in a series. Each graphics system contains a graphics board and 128 Kbytes of RAM. Autocad software for the system allows a user to zoom at the rate of a trillion to one. Input is via keyboard, mouse, or digitizer, and output is to a pen plotter. Other software packages include an integrated spreadsheet, an executive system for graphics presentations, and a presenter for screen- and plotter-oriented presentations. Prices range from \$1948 to \$2258. **NEC Information Systems, Inc**, 1414 Massachusetts Ave, Boxborough, MA 01719.

Circle 285

Get your own
If you're reading someone else's copy of Computer Design, why not get your own? To receive a subscription-application form, circle 504 on the Reader Inquiry Card.

Protocol analysis software fully interprets SNA protocol

The SNA Trace software is specifically designed for use on the Chameleon—a portable data communication protocol analyzer/simulator. The software allows user access to line header, transmission header, request response header, and request response unit. Display options view the link unit components in hex and/or EBCDIC characters. The user can select traffic on only one address or all addresses. In addition, if any frame components are not immediately needed, they can be suppressed for later review. Entire hardware/software system is priced at \$18,000. **Tekelec Inc**, 2932 Wilshire Blvd, Santa Monica, CA 90403.

Circle 286

Software package captures and lays out on single workstation

The Starline family consists of integrated, application-specific bundled software that runs on Apollo 32-bit workstations. Star-designer features design capture and MOS logic simulation modules; Stargate has gate array design, MOS logic simulation, and layout; and Starcell contains cell design, simulation, and layout. Other packages provide PC board design with behavioral and functional simulation, as well as switched capacitor circuit design. All packages run under the control of a database management nucleus. Prices start at \$41,000. **Silvar-Lisco**, 1080 Marsh Rd, Menlo Park, CA 94025.

Circle 287

Debugging tool works with Z8000, 68000, and 8086 CPUs

Designed to quickly and accurately aid in locating and correcting program bugs for microcomputer software, the debugger is aimed at realtime application software. Features are breakpoint control, symbolic debugging, register setting and display, symbol value listing, and single-step execution. In addition, it provides complete symbol management and a full expression analyzer. The debugger is available for use with the OS/RT realtime operating system, but will run under other operating systems. **The Destek Group**, 830 E Evelyn, Sunnyvale, CA 94086.

Circle 288

"Wow! Only \$189 for a data and control terminal with all these features!"

The fast and friendly TM27 Microterminal™. Rugged, compact, \$189 each, any quantity. Use it as a front panel control for machines—NC, medical equipment, test equipment, robotics. Or as a data entry terminal—remote, shop floor control, process control, inventory, energy management, work station reporting. You can multidrop up to 63 TM27's on a single host computer signal line for a fast, low cost, factory floor data collection system.

And the best thing about it—you don't have to spend costly engineering time to design and make your own. Not when ours is \$189 and on the shelf, ready when you are.

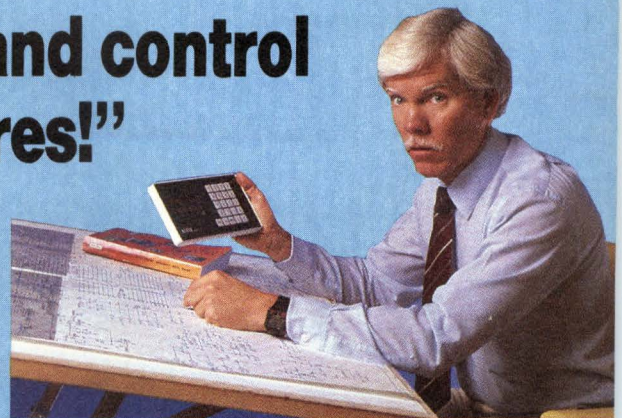

TM27 Microterminal™ Features

- Large, easy-to-read 8-character LED display
- 12-character input buffer
- 21 oversized keys reduce entry errors
- Water, dust resistant panel stands up to tough industrial environments
- Simple operation, no operator training needed
- 5 LED status indicators
- 6 user-programmable function keys simplify data entry and control operations
- 5 TTL digital outputs, 3 TTL digital inputs
- Compact size, 8.5" × 4.5" × 0.6", saves panel, mounting space
- Baud rates from 300 to 4800
- RS-422 or RS-232C communications interface, 7-bit ASCII code



A Full Microterminal™ Family

Need more features, more power? We've got them. 14 more models offer up to 40-character alpha and numeric displays, full 80-character I/O buffers, baud rates to 19,200, up to 14 programmable function keys, bar code and magnetic stripe readers, user EPROM's, polled and nonpolled operation, RS-232, RS-422, and 20mA current loop interface. All low cost,

friendly solutions for your control, data entry, and display applications.

Call or write us today, and we'll send you the complete specifications for all our Microterminals™. Or just order the TM27 and try it out yourself for \$189.

Data Acquisition and Control Systems Division
3631 E. 44th Street, Tucson, AZ 85713 • (602) 747-0711



Putting Technology To Work For You

(205) 882-0316, (206) 455-2611, (213) 991-8544, (214) 681-5781, (215) 657-5600, (216) 729-3588, (301) 628-1111, (301) 251-8990, (303) 663-4440, (305) 365-3283, (305) 395-6108, (312) 832-6520, (313) 474-6533, (314) 291-1101, (315) 699-2671, (315) 853-6438, (316) 942-9840, (317) 636-4153, (319) 393-0231, (404) 447-6992, (408) 559-8600, (412) 487-8777, (505) 883-3668, (602) 746-1111, (607) 785-3191, (612) 884-8291, (614) 764-9764, (617) 444-9020, (713) 988-6546, (714) 835-0712, (716) 544-7017, (716) 889-1429, (801) 467-2401, (805) 496-7581, (813) 885-7658, (913) 342-1211, (914) 964-5252, (919) 722-9445, **CANADA:** (403) 230-1341, (416) 678-1500, (514) 731-8564, (613) 722-7682

Fitness Plan for Overweight Displays

Introducing the *thin* alternative. New 2000-character PlasmaGraphics 120 display.

To meet the demand for ever-smaller footprints and more enticing product appearance, today's designers are increasingly turning to flat panel displays.

The new PlasmaGraphics™ 120 panel is perfect for applications that demand a more modern approach than bulky, overweight CRT's. There are a host of reasons why the PG 120 is the unsurpassed leader in flat panel technology.

- 120,000 addressable pixels (480 x 250).
- 25 lines; 80 characters/line.
- highly readable in low, high or normal ambient light.
- combines AC and DC technology for better-than-ever flat panel performance.
- compact 7" x 10" x 1½" (18 x 25 x 4 cm) package.
- cost effective design.

Find out more today. Use the bingo card number below or call for our "Thin-is-in" designer's information package.

PlasmaGraphics Corporation,
P.O. Box 4903, Mt. Bethel Road,
Warren, NJ 07060. Telex 83:3456.
Telephone (201) 757-5000.



PlasmaGraphics

Circle 114 for Future Reference
Circle 115 for Current Project
Circle 116 for Possible Project

Copyright 1984 PlasmaGraphics Corporation
PGC-3. Printed in U.S.A.



Unix port to IBM PC-XT adheres to standards

UNIX-II is an implementation of AT&T's Unix III with Berkeley 4.1 enhancements. It will be offered both in a bundled package and in unbundled form. The basic product includes the system III kernel, basic (Bourne) shell, and utilities. Hardware requirements include 320 Kbytes of memory and optional installation of an 8087 math coprocessor for enhanced performance. Optional utilities are PC-DOS shell and text processing utilities. Basic price is \$595. **International Data Services**, 122 Saratoga Ave, Santa Clara, CA 95050.

Circle 289

Standard-cell layout system automatically places and routes

Cadicell CAD software places cells within a design and interconnects them. The portable software runs on Mentor's workstations as well as the VAX, IBM, and Apollo systems. Cadicell's interactive placement

and routing tool is Cellgraph, which uses menus and automatic prompts. It offers interactive floor-plan generation and manipulation. Cells within the library can be created by text entry or graphics design. Users can enter cell information via keyboard or use a pointing device to draw cell characteristics onscreen. Available in the third quarter of 1984, price is \$60,000. **Mentor Graphics Corp**, 8500 SW Creekside Pl, Beaverton, OR 97005.

Circle 290

Software package runs CAD/CAM on 32-bit processors

Interactive graphics capability is the heart of the exclusive 32-bit Unigraphics II. It has an associative data base that permits the user to establish and manipulate links among various information for automation of design, drafting, and manufacturing. A macro capability captures a sequence of menus and increases process speed. Other features include Fortran-

based post processors, file management, drafting protocols, and multisurface machining. **McDonnell Douglas Corp**, 5552 Cerritos Ave, Cypress, CA 90630.

Circle 291

Software automatically converts PLAs to gate arrays

The Angop package accepts as input the logic equations defining a PLA design and produces as output a gate array net list. This net list is then processed on MDS's GateMark workstation. The workstation contains a library of structured cells and features 3- μ m CMOS technology. The resulting gate array parts reduce power consumption while offering improved speeds. The software offers PLA benefits while lowering development costs and cutting design cycle time. **Matra Design Systems**, 2840-100 San Tomas Expwy, Santa Clara, CA 95051.

Circle 292



**ABOVE ALL OTHERS
Magnetic Shielding by Eagle**

- CUSTOM SHIELDS
- SHEET
- FABRICATION
- FINISHING
- STANDARD SHIELD
- FOIL
- HEAT TREATING
- CONSULTING
- DESIGN ENGINEERING
- TESTING

PHOTOMULTIPLIER TUBE SHIELDS . . . CATHODE RAY TUBE SHIELDS . . . SHIELDS FOR MEDICAL INSTRUMENTS . . . TRANSFORMER SHIELDS

Eagle can help improve your product and lower costs, by designing the right shield for you. Take advantage of Eagle's vast background in shield design and production.

Choose from a wide selection of sheet and foil, so you can form your own shields. For helpful design and cost data, write or call. Offices worldwide.



P.O. BOX 24283 • INDIANAPOLIS, INDIANA, 46224 • PHONE (317)297-1030

CIRCLE 117

**STEPPING INTO THE FUTURE
...WITH MOLON MOTORS**



A Galaxy of Stepper Motors Ranging from 0.9° to 18° Step Angle



For more information write or call:

MOLON MOTOR & COIL CORP.
340 E. Main, Lake Zurich, IL 60047
(312) 438-4400
TWX 910-651-0028 Molon Lazh

CIRCLE 118

Single-board 68000-based computer runs on the STD bus

Running at 8 MHz, the 68008 processor provides a throughput of approximately 60 percent of the equivalent 8-MHz 68000. STD bus signals are buffered for easy expansion. The board features three 28-pin JEDEC sockets for a total of 32-Kbyte-wide onboard memory. An EPROM moni-

tor is optionally available. Full 1-Mbyte 68008 addressing is available. Nonmultiplexed offboard addressing is implemented by 1 of 8 decoder/drivers that selects additional memory boards via a front connector. Baud rates can be individually programmed for each port. **Peopleware Systems Inc**, 5190 W 76th St, Minneapolis, MN 55435. **Circle 293**

Single-board Unix system has half or whole megabyte

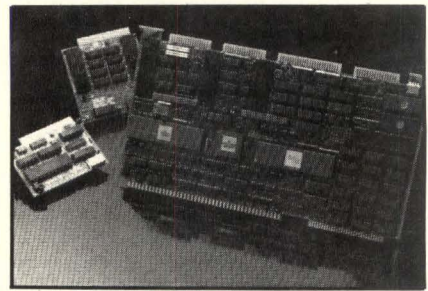

The HK68A includes Winchester and tape interface, four to eight serial ports, two ISBX I/O expansion plugs, one quad channel DMA, and MMU. Other features include 32 Kbytes of EPROM, user programmable LEDs, and three programmable 16-bit counter/timer channels. Currently supported are Unix System III and V with drivers for Ethernet, SDLC/HDLC, and floating point processors. Other operating systems include CP/M-86K, polyForth, and Regulus. **Heurikon Corp**, 3001 Latham Dr, Madison, WI 53713. **Circle 294**

Two high performance processors are Z8000 and 68000 based

An iLBX interface for the Multibus gives two processor boards a high speed memory path. The boards support a demand-paged virtual memory operating system, and each offers a control circuit tailored to high speed operation. The Z8000 board runs at a clock frequency of 10 MHz, while the 68000 board runs at 12.5 MHz. A state machine uses a PROM as the sequencer to control all cycles on the boards. Complete bus vectored interrupts are supported, as well as normal level/edge triggered interrupts. **Central Data Corp**, 1602 Newton Dr, Champaign, IL 61821. **Circle 295**

Virtual memory microcomputer is built on a single Multibus card

The 32-bit demand-paged GVC-16 is based on the NS16032 processor. It combines the complete NS16000 chip set with up to 2 Mbytes of RAM, Winchester disk interface, and peripherals for a multi-user system. Large onboard memory allows a 10-MHz CPU to run without wait states. Hardware floating point uses the 16018 FPU; up to 32-Kbyte EPROM is available. In a standard configuration, which includes 512 Kbytes of memory and the interrupt control unit, the price is \$3295. **GVC Inc**, 222 Third St, Cambridge, MA 02142. **Circle 296**

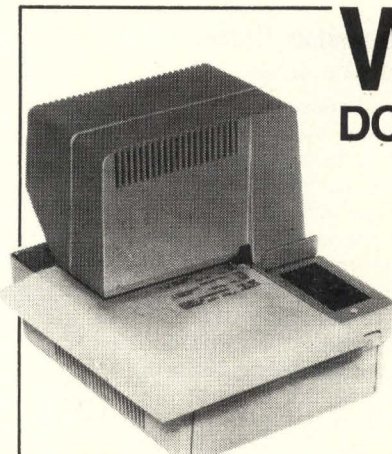

WESTREX DOT MATRIX PRINTERS

NEW! STAND-ALONE, 150 CPS SLIP/DOCUMENT PRINTERS

8000 SERIES

MODELS 8400/8410

Model 8400 and Model 8410 are new, packaged, stand-alone, alphanumeric, bi-directional, flat bed, Slip/Document

dot matrix printers. They print up to 40 columns at 12 characters per inch at 3 lines per second. Both models provide side or front form insertion; top and bottom-of-form sensors and adjustable Slip/Document Stop. The print head employs a 7-needle vertical array that permits selection of fonts and characters (5x7, double width, etc). The character set is fully alphanumeric under software control. The 100% duty cycle print head life is rated at 100 million characters.

Model 8400 and Model 8410 are complete with control and drive electronics. Serial RS-232C or TTY and parallel interfaces are available. Both units can provide multiple print lines and carbon or pressure sensitive copy.

Model 8410 additionally features a stepping motor paper drive system which permits variable and programmable forward/reverse line spacing for applications requiring line selection and/or unique form indexing.

QUANTITY DISCOUNTS AVAILABLE. NCC-BOOTH-A-1854



For full details, write or call us

WESTREX OEM PRODUCTS

51 Penn Street, Fall River, MA 02724, (617) 676-1016 TELEX: 1651490, Relay WNJV
 IN FRANCE — WESTREX OEM PRODUCTS, 103-105 Rue de Tocqueville, 750 Paris, France 01-766-322-70 TELEX: 610148
 IN SWEDEN — WESTREX OEM PRODUCTS, Box 3503, S-17203 Sundbyberg, Sweden 46/8 +981100 TELEX: 12129

Optically it's
tough to tell
the difference.

FREE
Fiber Optic Seminar
See details below.



Belden can help you make the best fiber optic cable choice.

When you only compare optical attenuation and bandwidth performance fiber optic cables may seem the same. But how they stand up under physical stress and environmental strain in your application is the real proof.

Since Belden developed the first CATV fiber optic cable to be installed in Manhattan, we've helped develop cables that have been pulled through crowded ducts beneath Houston, buried beneath Alaskan tundra to hook-up satellite antennas, deployed for radar links in the Sahara, and installed on transmission towers rising 1500 feet above California hills.

Belden® cable designs use fibers with core diameters from 50 to 300 microns. Cable jackets and strength members are designed to your spe-

cific requirements: direct burial, field deployable, aerial, all-dielectric, plenum or duct. But what's best for you?

Here's how we can help you decide.

We have a three-part seminar on fiber optics you won't want to miss. And one's coming to your area. Each seminar covers:

1. An Introduction to Fiber Optics
2. Fiber Optic Components and Link Analysis
3. Fiber Optic Cable Construction

Contact your regional Belden office listed for the place and date of the seminar nearest you, or call:

1-800-BELDEN-1 direct.

If you're looking for technical help right now, contact your Belden distributor and ask for our Fiber Optic cata-

log, Compatible Components Listing, and the Optical System Design Guide. For even quicker assistance, call 1-800-323-0864, and talk to a Belden fiber optic cable specialist. Belden, Fiber Optics, 2000 S. Batavia Avenue, Geneva, IL 60134

Regional Offices:

Belden West—Irvine, CA 714-833-7700

Belden Central—Richmond, IN
317-983-5200

Belden East—Framingham, MA
617-872-7846

FO-2-2C



BELDEN

IBM

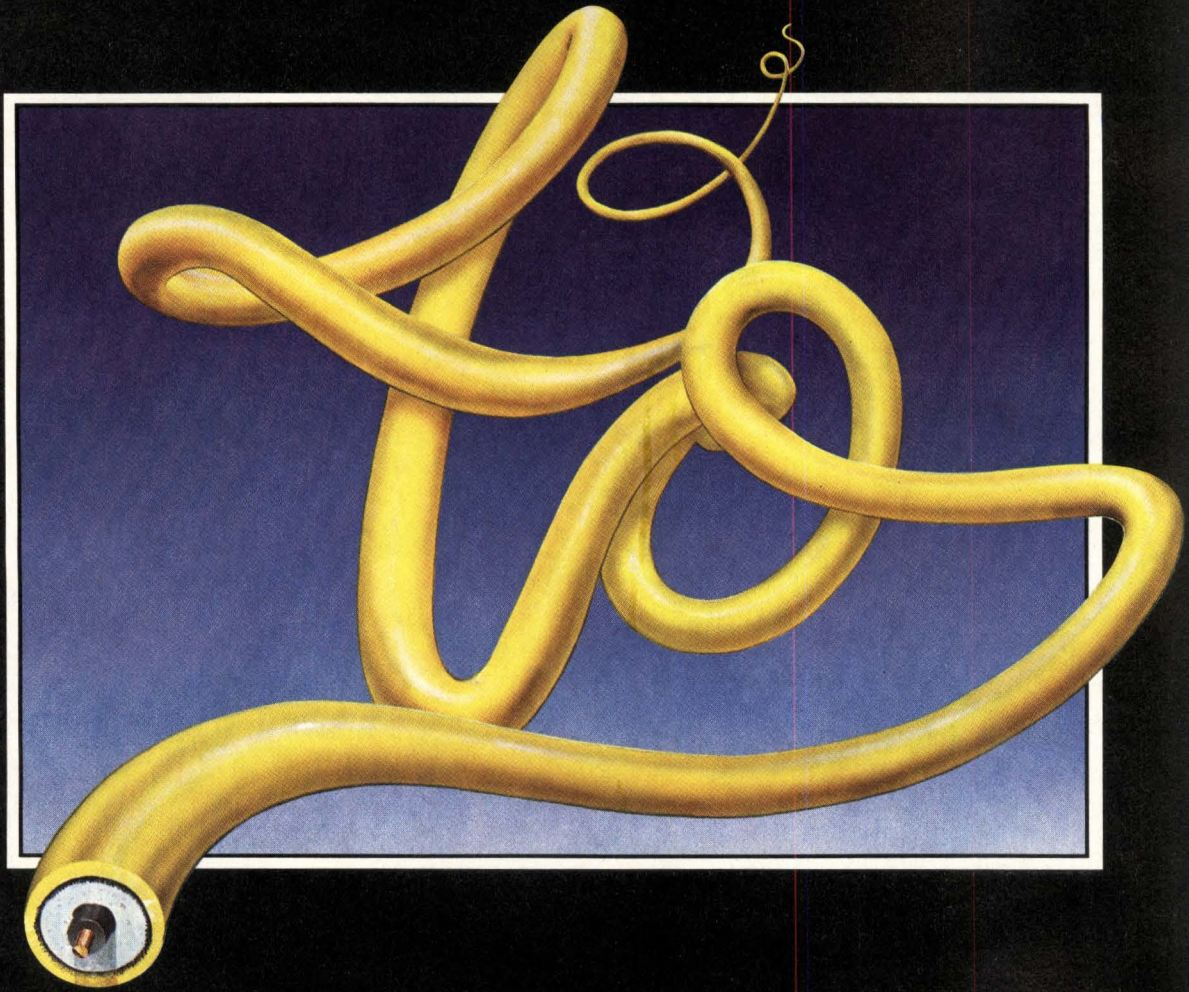

Ethernet

and other local area networks



AUSCOM introduces the proven solution for connecting your IBM mainframes to Local Area Networks. Using the 8911 Programmable Channel Interface, AUSCOM can connect your network directly to the channel and, through software, provide the necessary drivers to incorporate the LAN protocol of your choice. You select the LAN; AUSCOM will make the connection to your IBM!

by **AUSCOM, INC.**
the "IBM to Anything" people

2007 Kramer Lane • Austin, Texas 78758 • 512/836-8080

Ethernet is a trademark of Xerox.

©1984 AUSCOM, Inc.

Single-chip microcomputer implements 16-bit instruction set

Configured either as an embedded stand-alone controller or an intelligent peripheral controller, the MK68200 offers high speed execution and code space efficiency. The instruction set includes bit manipulation, extensive BCD arithmetic, and high speed multiply/divide operations. The micro provides full-duplex USART capable of data rates of up to 1.5 Mbits/s. Three 16-bit multimode timers are provided for interval timing, pulse-width generation/measurement, and baud rate generation. In 100s, price is \$75 each. **Mostek Corp., div of United Technologies Corp.**, 1215 W Crosby Rd, Carrollton, TX 75006. **Circle 297**

Telecom microcomputer comes on CMOS chip

The G65SC150 communication terminal unit is optimized for telephone line signaling and data transmission. The monolithic system integrates an 8-bit micro, 2 Kbytes of ROM, 64 bytes of RAM, a dual 26-step sine wave generator, 27 I/O lines, a timer, and two counters. Compatible with the 6500 and the 6800 bus structures, the product can operate as a standalone terminal or as an intelligent peripheral to another micro. Prototype units, without a programmed ROM, are available in 68-pin LCCs. In quantities of 100 or more, the unit price is \$38. **GTE Microcircuits Div**, 200 W 14th St, Tempe, AZ 85281.

Circle 298

Multibus-compatible computer board achieves 10-MHz operation

A plug-in replacement for and software-transparent to Intel's iSBC*86/05, the Am97/8605/010 features serial and parallel ports, three counter/timers, and 8 Kbytes of static RAM. In addition, it provides sockets for up to 64 Kbytes of EPROM, three ISBX connectors, and an interrupt controller. The 16-bit board's power requirements are 5 V at 2.8 A, 12 V at 40 mA, and -12 V at 40 mA. Connectors allow a variety of SBX modules to plug in to change the board's function. Price in quantities of 1 to 9 is \$1995. **Advanced Micro Devices Inc**, 901 Thompson Pl, Sunnyvale, CA 94086.

Circle 299

Single-board computer functions on the STD

The STD-145 8085A features a battery backed time-of-day, full-duplex serial USART port, 24-bit programmable parallel I/O and three programmable counter/timers. ROM/RAM implementations as small as 2 Kbytes or up to 64 Kbytes can be accommodated. Peripheral functions

are I/O mapped, and occupy 32 consecutive locations in the map. A write only control port takes care of memory sockets 1 and 2 on/off, bus on/off, and boot enabled/disabled. Baud rates are programmable to 19.2 kbaud. Price is \$325. **Micro-Link Corp.**, 14602 N U.S. Hwy, Carmel, IN 46032. **Circle 300**

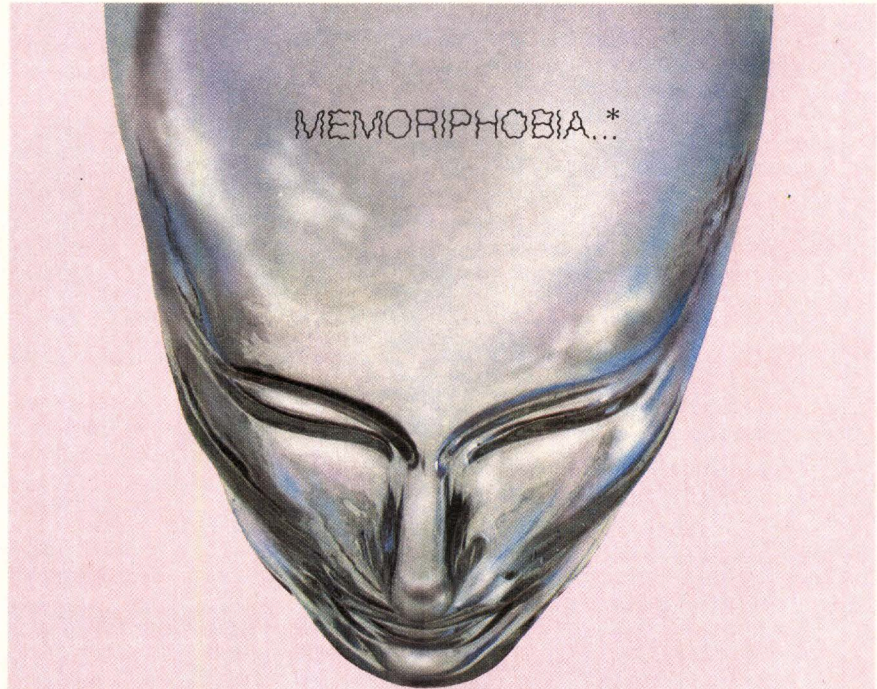

MPD Solves Computer Designers' Worst Fear.

(*Fear of Memory Loss)

Loss of memory caused by a power failure can be devastating! For example, where vital programs and procedures are stored on CMOS I.C.'s in a computer...

Fortunately, MPD is on guard. Memory Protection Devices' innovative line of state-of-the-art battery holders provide safe, economical and dependable memory back-up systems that can be integrated right into the circuit.

Choice of type is virtually limitless. MPD offers battery holders for low-profile coin cells, stacking coin cells and single or

multi-pack cylinder cells...sized to accept Lithium, Ni-Cad, Carbon-Zinc or Alkaline batteries. We even develop custom designs.

And nothing is left to chance. Coin cell and single holders are tough, warp-free Valox® with stainless steel nickel-plated contacts. For multi-cylinder cell holders, material is heavy-duty nylon with spring steel tin-plated contacts. All are designed for PC Board mounting, correct polarity and easy battery installation and removal.

So, if your electronic memory is priceless, remember MPD. Call or write today.

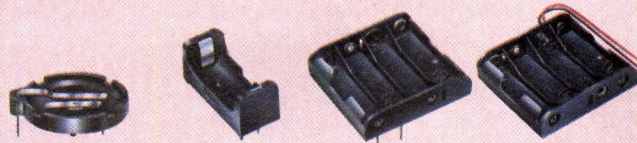

COIN CELLS

- For single Lithium batteries 20-24mm
- Spoon stacking holder for 6-volt operation, 23mm and 20-24mm

SINGLE HORIZONTAL

- For Lithium, Ni-Cad, Carbon-Zinc, Alkaline batteries
- PC, fast-on or hardwire connect
- 2/3A, 1/2AA, AA & C.

HORIZONTAL PACKS

- For AA and AAA standard Ni-Cad, Carbon, Carbon-Zinc Alkaline batteries
- 2, 3 & 4 cell series connect.

HORIZONTAL PACKS

- Other styles available, 6" lead wire for connection, male and female 9 volt snap-on terminal, PC terminals.

MPD
Creative Solutions
to Memory Problems

MEMORY PROTECTION DEVICES INC.
320 Broad Hollow Rd.,
Farmingdale, N.Y. 11735
(516) 454-0340

3¼-inch computing is ready when you are.

Media, drives, software. Everything you need is here now.

Dysan 3¼" Flex Diskettes™. Personal computing is getting more personal. Smaller, lighter, more portable. How small will it get? Frankly, we don't know. But we're confident that 3¼" is the next step on the way down.

Why?

Because everything you need to get the most out of 3¼" computing is here now. In spades.

The story starts with our 3¼" one megabyte Flex Diskettes. They're built on the same tried and true technology as the larger Dysan diskettes you use today. But with some very interesting innovations.

Like a durable metal hub that provides long-term read/write stability and accuracy.

A flexible combination of media and jacket, free from rigid metal shutters and fragile plastic parts.

And plastic carrying pouches that protect one to five diskettes. In your pocket. Or in the mail.

It all adds up to reliability. Dysan 3¼" Flex Diskettes are guaranteed to be 100% bit error-free. And durability. They're backed by a five-year limited warranty.

3¼" Floppy Drives.

Simply put, 3¼" floppy drives are 5¼" drives refined. And cut down to size.

They're generally ¼ the size and ½ the weight of 5¼" drives. And they use less than half the power.

Yet 3¼" drives plug right into today's personal computers. All that's required is less space.

Best-selling software in 3¼". There's just one last thing necessary to turn 3¼" diskettes and drives into 3¼" computing.

Software.

And Dysan Series Software™ has already solved that problem by licensing and converting scores of best-selling programs to 3¼". Programs from DRI, Microsoft, Sorcim, Peachtree, Pearlsort, ADS, ADI America and more.

It's where personal computing is going.

We'd be remiss if we didn't point out that 3¼" computing isn't just Dysan's good idea.

3¼" diskettes are being manufactured by several suppliers. So you're always assured of an abundant supply of quality media.

And 3¼" floppy drives are being built by a number of leading manufacturers. Including Tabor, Seikosha, MPI

and, soon, Seagate.

That's the 3¼" story. Quality diskettes, reliable drives and a great selection of software.

It's where personal computing is going.

And it's ready when you are.

Call Toll-Free (800) 551-9000 for complete information about 3¼" computing.



Dysan Corporation
5201 Patrick Henry Drive
Santa Clara, CA 95050
(408) 988-3472

Dysan is a registered trademark.
Flex Diskette and Dysan Series Software are
trademarks of Dysan Corporation.
Copyright 1984, Dysan Corporation.

SYSTEM COMPONENTS/ MICROPROCESSORS/MICROCOMPUTERS

Memory and CPU card set meshes with the VMEbus

The high performance 68000/68010-based VME-68K board allows up to 16 Mbytes of memory with no wait states at 12 MHz. This provides a 1.4-MIPS performance. Located on the CPU card are two programmable serial ports—one with modem control. The high speed memory management unit supports an 8-Mbyte logical process and up to 16 Mbytes of physical memory. Also available are an intelligent multifunction I/O card, an SCSI host adapter, a QIC-II tape host adapter, and a VME-compatible add-on memory card.

Integrated Solutions, Inc., 1350 Dell Ave, Campbell, CA 95008. Circle 301

Peripheral functions and PC compatibility reside on CPU

The FE 6410 series 2-layer boards offer 64 or 128 Kbytes of parity checked RAM, 32 Kbytes of EPROM space, and both serial and parallel ports. BIOS software supports PC-DOS, MS-DOS, CP/M-86, and concurrent CP/M. The boards have the option of a floppy disk controller and/or monochrome video display controller integrated on the CPU board. External dimensions of the boards are physically identical to the PC CPU. Prices for the series run as low as \$275 in quantity.

Faraday Electronics, 1029 Corporation Way, Palo Alto, CA 94303. Circle 302

COMPLEX MATH

for HP Series 200 DESKTOP COMPUTERS

Language enhancement adds complete complex math support to BASIC 2.0.

- Fully integrated into BASIC language
- Provides new math functions including hyperbolic functions
- Performs complex operations on entire numeric arrays
- Includes all complex functions of ANSI Standard Fortran

Ideal for electrical design and circuit analysis programs.

Price: \$975 (USA Domestic)

For complete information contact:

STRUCTURED SOFTWARE SYSTEMS, INC.

Box 1072 Irick Road
Mt. Holly, New Jersey 08060
609/267-1616 Telex 299 043
SSJA UR

CIRCLE 124

SYSTEM COMPONENTS/COMPUTERS

Array processor system takes on multiple users' multiple tasks

Mini-MAP Plus 4 consists of up to four 32-bit floating point array processors interfaced to one VAX-11/780, /750, or /730. Each processor can be accessed by a separate user with different task requirements. The VAX can then accommodate four separate computation-intensive tasks simultaneously, each with 5 MFLOPS of processing speed. Basic configuration includes four array processors with 64 Kbytes of data memory packaged in a single 10.5-in. chassis. Software development tools are also provided. Price is \$78,700. **CSP, Inc.**, 40 Linnell Cir, Billerica, MA 01821.

Circle 303

Desktop microcomputer internally processes 32 bits at a time



The 9002 can be used as a powerful desktop workstation for one user, or with its optional Xenix operating system as a host supporting up to three additional users through attached terminals. The processor is a 68000 with 32-bit registers and 16-bit data flow. Memory capacity is 128 Kbytes of RAM expandable to 5.2 Mbytes in 256-Kbyte increments, and 128 Kbytes of ROM. Four drives, either 5¼-in. 640-Kbyte or 8-in. 985-Kbyte type, can attach to the system. Computer is priced at \$6495. **IBM Corp., Information Systems Group**, 900 King St, Rye Brook, NY 10573. Circle 304

Supermicro implements Xenix on 80286 processor

The X-286 supports 5 users (expandable to 16) and incorporates the iAPX 286 processor, an 80-bit 80287 numeric co-processor, and 512 Kbytes of error detecting and correcting RAM. RAM is dual-ported between the Multibus and a private high speed local extension bus. The local bus allows access to offboard memory as if it were local. A micro-based terminal controller unburdens the host CPU by processing terminal interrupts, storing data in onboard, dual-ported buffers. The disk system includes a pipelined controller and either 65- or 140-Mbyte Winchester drives with 30-ms average access times. Prices start at \$15,900. **BDS, Inc.**, 1400 Shepard Dr, Sterling, VA 22170.

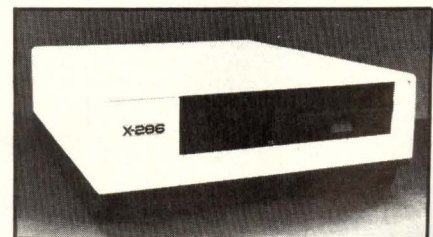

Circle 305

Talk to the editor

Have you written to the editor lately? We're waiting to hear from you.

Virtual processor works in network and standalone applications

The 32-bit, Unix-based PowerNode 6000 is available in three versions: the 6030, packaged in a 30-in. tall cabinet with an integrated disk and tape; the 6050, in a 71-in. tall cabinet with ample space for a variety of disks and tapes; and the 6080, with an internal processing unit that handles computation bound tasks for the CPU. The architecture for the series is centered around a high speed bus with a throughput of 26.67 Mbytes/s. A 32-Kbyte, two-way set associative cache increases performance. Prices start at \$80,000. **Gould Inc, SEL Computer Systems Div**, 6901 W Sunrise Blvd, PO Box 9148, Fort Lauderdale, FL 33310. Circle 360

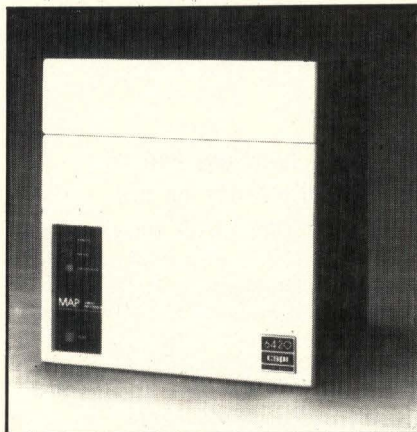

When interfaced to a host, it provides a programmable peripheral to offload numerical algorithms and execute them at greater speeds. The basic configuration has 4 Mbytes of memory and an independent control processor. Data memory is expandable to 64 Mbytes. The address space is 1 Gbyte. Floating point word size is 64 bits with 16 decimal digits of precision. **CSP Inc**, 40 Linnell Cir, Billerica, MA 01821. Circle 307

Microcomputer system supports multi-user and application software

The high performance MTX-11 includes either 15.9 or 32 Mbytes of hard disk storage, 1-Mbyte DEC/IBM-compatible floppy disk drive, 256 Kbytes of memory, and four serial 9600-baud ports. Built around the LSI-11/23 16-bit CPU, the system can use the large library of PDP-11 software. The operating system accommodates large programs in memory; when available memory runs out, the operating system uses a priority and time-slice scheduling system to determine which jobs to swap to the Winchester. Transparent spooling allows the user to print files without degrading terminal response and program performance. **Scientific Micro Systems, Inc**, 777 E Middlefield Rd, Mountain View, CA 94043. Circle 308

Array processor computes in double precision

Designed for scientific applications, the MAP-6420 floating point processor is based on a high performance parallel architecture with Fortran programming.

July Preview
A Special Report on System Software

NEW LITHIUM BATTERY HOLDERS FOR HORIZONTAL CYLINDER CELLS

CYLINDER HOLDER*
Standard PC version
See table



PC Board Terminals

CYLINDER HOLDER*
Tab version
See table



Fast-On Tab Terminals

Memory Protection was Never Easier.

Now, solder MPD's horizontal battery standard holder right on your PC board. Or use tab holder with fast-on or hardwire connect. Standard holder allows for 3/4" PC board stacking. Standard 3-volt Lithium cylinder cells for reliable memory back-up systems clip right in. Also accepts Ni-Cad, Carbon-Zinc and Alkaline horizontal cylinder cells.

• Sturdy, high-temp UL94V-O Valox® material • Stainless steel nickel plated contacts • Easy insertion and removal of batteries • Efficient, economical • Custom battery holders available on request.

*Patent Pending

SIZES	2/3A	1/2AA	AA	C
MODEL #	BH2/3A	BH1/2AA	BHAA	BH-C
FAST-ON-TAB	BH2/3AT	BH1/2AA-T	BH-AA-T	BH-C-T

For all the details, call or write today.

Memory Protection Devices Inc.
320 Broad Hollow Road, Farmingdale, NY 11735 • 516-454-0340

Fact:

Fighting heart disease and stroke is a life or death matter.

Your gift can make a difference.



American Heart Association

WE'RE FIGHTING FOR YOUR LIFE

The New WY1000 Microcomputer
**BUILDING
 BLOCKS**
 Powerful, Affordable, Expandable.

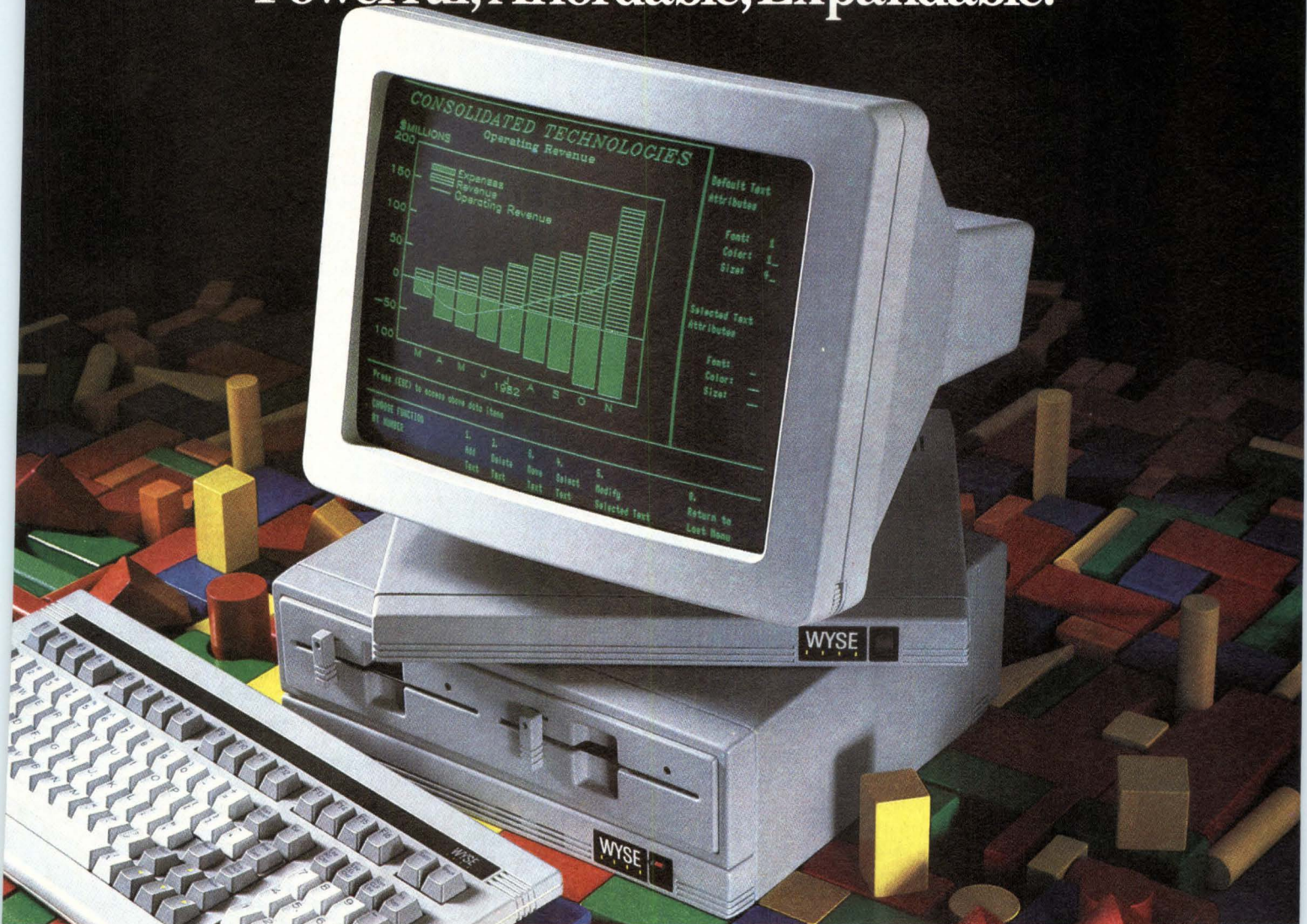

The WY1000 stacks up to be a lot of machine from a few simple pieces. By adding the WY1000 microcomputer to the good-looking, ergonomic WY50 display terminal, we created the most exciting concept in desktop workstations on the market today.

We also added sophisticated high resolution graphics, suitable for the most demanding applications.

Plus, we added color capability, when used with our color terminal.

And on top of that, we added a Winchester Disk Drive option providing an additional 10 megabytes of storage.

FEATURES:

- 80186 16 Bit 8 MHz Processor
- 128KB to 768KB RAM Memory
- Two Floppy Disk Drives (725 KB)
- Optional 10 MB Winchester Drive
- RS232 & RS422 Serial Ports
- Optional Graphics/Color Graphics
- Networking Capability
- CP/M™, MS-DOS™ Compatible
- Priced from only \$1995

Best of all, we priced the WY1000 from only \$1995. It all adds up to a system builder's dream.

For a complete brochure on the WY1000 contact Wyse Technology toll free at 800/421-1058.

WYSE

Make the Wyse Decision.

WYSE TECHNOLOGY 3040 N. First St., San Jose, CA 95134, 408/946-3075, TLX 910-338-2251, Outside CA call toll-free, 800/421-1058, in So. CA 213/340-2013.

CIRCLE 126

CP/M is a registered trademark of Digital Research Corporation. MS/DOS is a registered trademark of Microsoft Corporation.

Keyboard encoder family simplifies hardware/software requirements

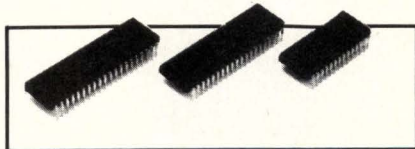

The KR9600 is an improved, single 5-V power supply version of the industry standard KR3600. The 9601 adds caps-lock and auto-repeat, while the 9602 is designed for detached keyboards and provides serial data output. The encoders automatically scan, debounce, and encode up to 90 single pull, single throw switches. They provide selectable n-key or two-key rollover. The 9600 and 9601 provide a parallel, TTL-compatible data output of up to 10 bits, as well as four operation modes in a 40-pin package. The 9602 comes in a 28-pin package. **Standard Microsystems Corp.**, 35 Marcus Blvd, Hauppauge, NY 11788. **Circle 309**

Fast FIFO saves power without losing speed

TTL compatible, 67L401 has a fall-through time of 4 μ s, yet consumes no more than 110 mA. The 5-MHz FIFO accommodates differing data rates, easing communications between computers and peripherals. The memory is organized as 64 words x 4 bits and can be cascaded to expand word and bit dimensions. Designed for asynchronous operation, it features structured pinouts, with outputs directly opposite inputs. The 16-pin chip, in 100s, is priced between \$15.50 and \$16.76 each. **Monolithic Memories, Inc.**, 2175 Mission College Blvd, Santa Clara, CA 95050. **Circle 310**

Semicustom gate array operates at high speed and low power

Combining current mode logic with ECL 10K/10KH I/O cells, the HE2000 array is suited for mini, supermini, peripheral, and test instrument applications. It offers the functional equivalent of 2000 logic gates on a chip and has typically demonstrated internal gate delays of 300 ps while consuming 3.1 W. The HE2000 consists of 539 cells: 399 CML internal cells, 96 ECL to CML receivers, and 64 CML to ECL drivers. Nonrecurring engineering costs

are approximately \$40,000, including 10 working prototypes. **Honeywell Digital Products Center**, 1150 E Cheyenne Mountain Blvd, Colorado Springs, CO 80906. **Circle 311**

Nonvolatile memory family expands with 5-V RAM

The NCR 52002 NVRAM is a byte-wide device that operates from a single 5-V power supply. The 2-Kbit chip consists of a 256 x 8 RAM array with duplicate EEPROM array for backup. Typical access time is less than 300 ns. Maximum access times for commercial and military use are 300 and 450 ns, respectively. Number of possible store cycles is guaranteed to be at least 10^4 with one-year data retention. Each store cycle takes only 10 ms. Price is \$18.70 each in quantities of 100. **NCR Corp, Microelectronics Div**, 8181 Byers Rd, Miamisburg, OH 45342. **Circle 312**

Small PROMs figure in random logic replacement

The 82S130A/131A are configured as 512 words of 4 bits and are function and pin compatible with industry standard 2-Kbyte PROMs. The 126A/129A are 256 words of 4 bits and carry 2 chip-enable inputs. The 23A and 123A have 32 words of 8 bits and carry 1 active-low chip-enable input. All parts have a 50-percent increased performance over their predecessors. Packaging options include plastic and ceramic DIPs. Prices range from \$1.25 to \$6.95 in quantities of 100. **Signetics Corp.**, 811 E Arques Ave, PO Box 409, Sunnyvale, CA 94086. **Circle 313**

It pays to communicate

You can further your career by writing technical articles about the advanced work you're doing. Also, we pay an honorarium for all manuscripts that we publish. For a free copy of our Author's Guide, circle 502 on the Reader Inquiry Card.

Circuit modem meets Bell 212A and CCITT specs

A 28-pin CMOS device forms the heart of a full-duplex, 1200-bit/s modem. The MP7223 requires a crystal-controlled clock, filters, and a line interface to emulate various modems. It uses phase shift keying modulation and digital demodulation. The chip is divided into three sections: demodulator, modulator, and timing control circuitry. A synchronized digital phase-locked loop maintains the basic timing and initiates all phase shift detection operations. Prices range from \$15 to \$27, depending on quantity. **Micro Power Systems, Inc.**, 3100 Alfred St, Santa Clara, CA 95050. **Circle 314**

Dynamic RAMs feature 100-ns and 250-ns access times

Organized in 65,536 single-bit words, the F4164 family of 64-Kbit devices operates on a single 5-V source. The chips have low capacitance, TTL-compatible inputs that employ overshoot and antistatic protection to ensure data and address input integrity. With an unlatched output at cycle end, the unit allows for page boundary extension and 2-D chip selection. Operation modes include random write or read, read/write, read/modify/write, and page cycles. In 100s, the prices range from \$11 to \$13. **Fairchild Camera and Instrument Corp, Microprocessor Div**, 450 National Ave, Mountain View, CA 94024. **Circle 315**

Logic circuits combine transceivers with latches

Two circuits—the ZX74HCT/LS646 for transmitting noninverted data and the 648 for inverted data—ease high speed multiplexed data transmission. Maximum propagation delay is 25 ns and 80 mA is the quiescent supply current. Both are fully TTL equivalent, providing a 12-mA drive current at 0.4 V and 24 mA at 0.5 V. Each chip features two D-type flipflop latches and offers six control inputs: output enable, direction, two clocks, and two data-source selections. Devices are priced at \$4.25 in 100-unit lots. **Zytrex Corp.**, 750 E Arques Ave, Sunnyvale, CA 94086. **Circle 316**

ITT Schadow's Power Switches

Multinational approval and high surge ratings are good reasons to use ITT Schadow Power switches in your computers and peripherals.

If you market your equipment overseas – and these days, who doesn't? – ITT Schadow's Pushbutton switches are worth specifying for their multinational approvals alone. And even if you never sell a piece of hardware beyond the borders of the U.S.A., you are bound to appreciate the ruggedness and high performance of these outstanding switches.

ITT Schadow's MSA has a dual rating of 10Amps at 125VAC and 4Amps at 250VAC, with an 80Amp surge in either instance. (Switches with a 64Amp surge rating are also available). A shutdown option lets a central location shut off terminals by remote control.

For details on ITT Schadow Power Switches – or for information on ITT Schadow's custom switchmaking and worldwide sourcing – mail the coupon below. Or contact your local Authorized ITT Schadow Switch Center.

FREE SAMPLES

- I buy or specify switches. Please have a rep call me about a free Power switch Schadow Box.
- I am not ready to talk with a rep yet, but please send a full-line switch catalog.

CD-6

Name _____

Title _____

Company _____

Address _____

City _____

State _____ Zip _____

Telephone (_____) _____

MAIL TO: ITT Schadow Inc., a subsidiary of ITT Corporation, 8081 Wallace Road, Eden Prairie, MN 55344 (612) 934-4400

Schadow **ITT**

Circle 130 for Catalog
Circle 131 for Sales Engineer Call/Samples

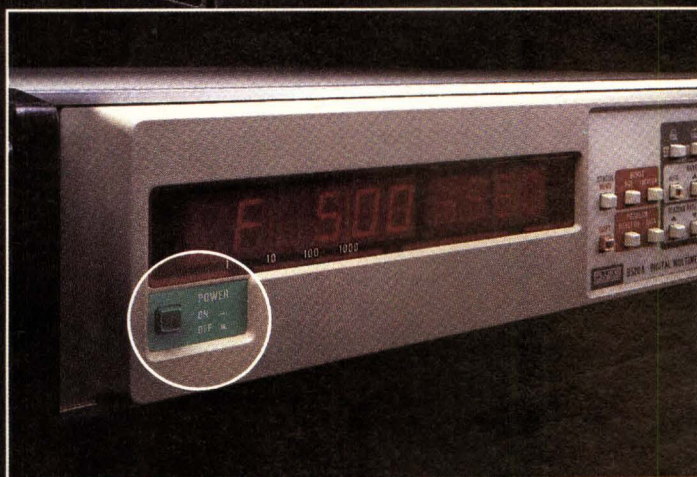
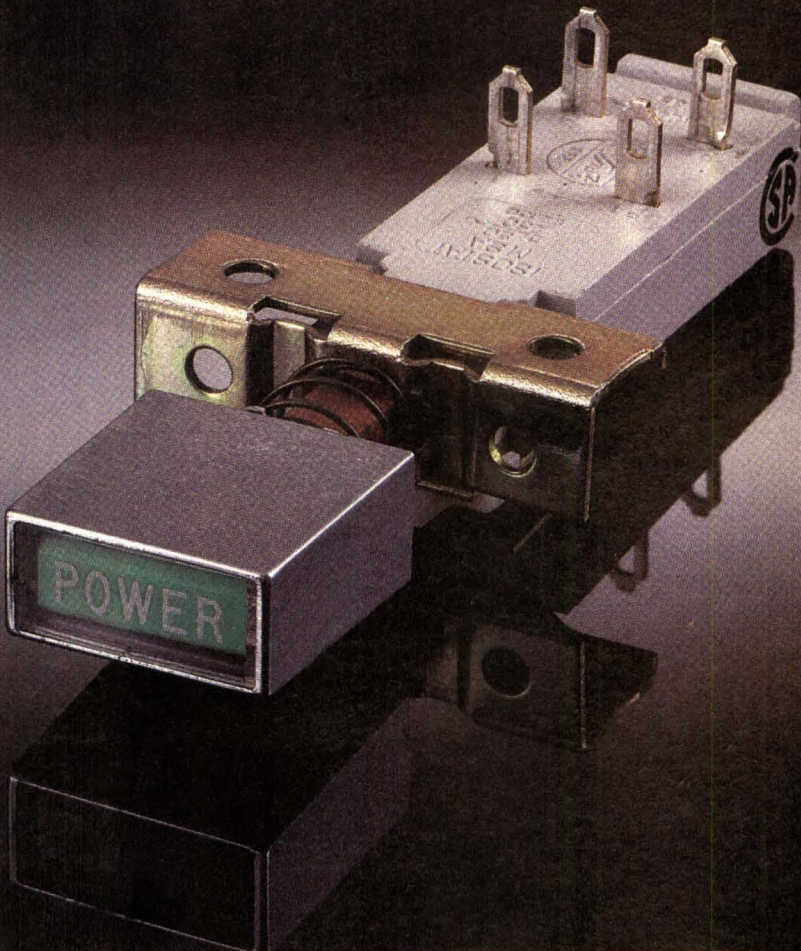

WE SOLVE PROBLEMS!

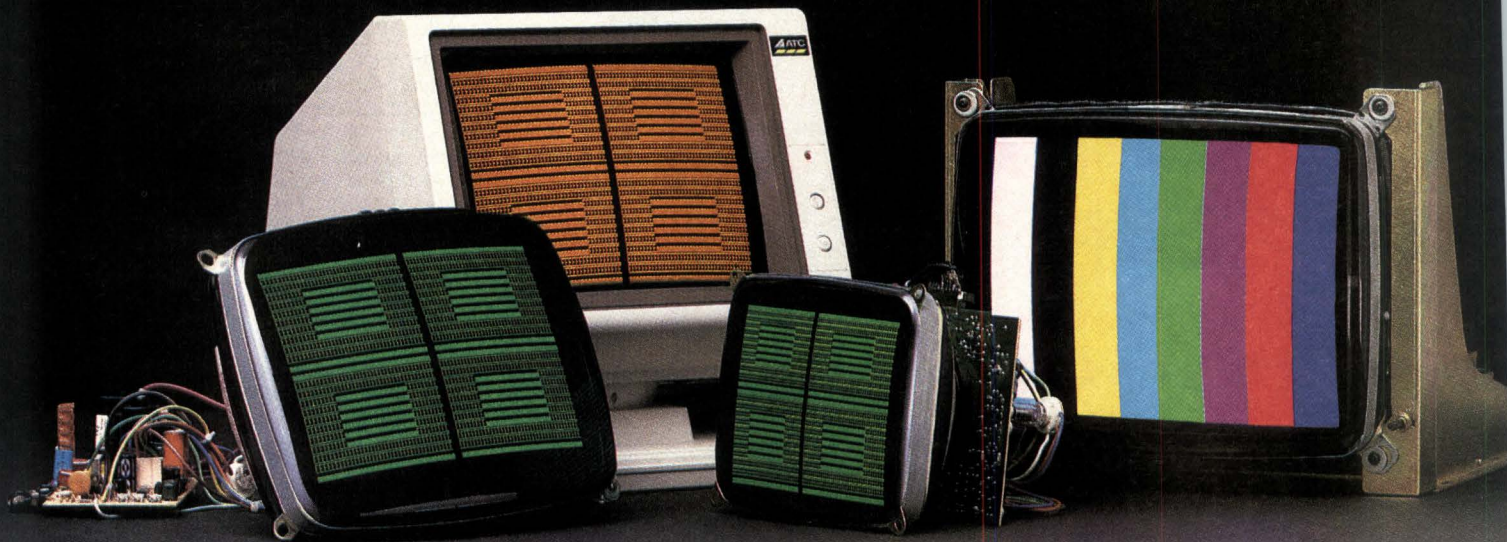

In all sizes, shapes, colors and configurations.

You need high performance, innovative design data displays. Contact Audiotronics. We have what you need. In 3", 5", 7", 9", 12", 14", 15", 23" and 5" x 9", monochrome and color, integrated (neck-mounted), chassis, kit or cabinet. And if we don't have what you need, we'll design it for you.

Using our basic displays, our engineers become your engineers. They custom design a display for your specific application, meeting your particular system design requirements.

Just give us your specifications and we'll solve all your display problems. And

we'll deliver on time, when you want them.

Audiotronics has been solving problems for almost 30 years, designing thousands of custom data displays for important customers like you, both large and small. Call us today. Turn our engineers loose with your display system problems.



North Hollywood
California 91605
(818) 781-6700

Static RAMs speed at 55 ns in address access specs

The HM6287 is a 64-Kbit device organized as 65,536 words by 1 bit. The TTL-compatible RAM runs from a single 5-V supply and consumes 300 mW in operation and 100 μ W in standby. The HM6267 is a 16-Kbit device that has an address access time of 35 ns. High speeds are attained via a 2- μ m design rule and Hi-CMOS technology. Also contributing to high speed is the provision of address-pulse transition detector circuitry. **Hitachi America, Ltd.**, 1800 Bering Dr, San Jose, CA 95112.
Circle 317

Dynamic RAM multiplexes address inputs for standard packaging

The MCM6664B/65B is a 64-Kbit device organized as 65,536 one-bit words. Complete address decoding is done on-chip with address latches incorporated. Both devices have RAS only on refresh mode. The 64B version has the automatic refresh control function available on pin 1, providing two additional modes of refresh, automatic and self-refresh. All inputs and outputs, including clocks, are TTL compatible. Data out is controlled by $\overline{\text{CAS}}$, allowing system flexibility. Prices range from \$7.80 to \$8.65 in 100s. **Motorola Inc, MOS Integrated Circuits Group**, 3501 Ed Bluestein Blvd, Austin, TX 78721.
Circle 318

Multiplying D-A converter contains onboard data latch

As a replacement for the AD7545, the MP7645 precision monolithic 12-bit DAC interfaces directly to most 12- and 16-bit bus systems. Its data latch is loaded by a single 12-bit wide word. Data loads into the input latch under the control $\overline{\text{CS}}$ and $\overline{\text{WR}}$ inputs. Gain error is 2 ppm/ $^{\circ}\text{C}$ maximum with output capacitance at 50 pF maximum. Amplifier offset sensitivity is 330 $\mu\text{V}/\text{mV}$. Typical applications are in data acquisition, process control, and industrial control. The chip is offered in 20-pin plastic or ceramic packages, with prices ranging from \$11.20 to \$38.10. **Micropower Systems, Inc.**, 3100 Alfred St, Santa Clara, CA 95050.
Circle 319

Worst-case access times are 250 ns in 256-Kbit ROMs

Made with proprietary Selectox silicon gate CMOS technology, the SMM6325 and 6326 use 1/5 the operating power and 1/10,000 the standby power of comparable NMOS parts. The devices are pin compatible with industry standard 61256 and 23256 types, respectively. Customer's EPROMs from breadboarding and system verifications are used to communicate programs. The data in the EPROMs is converted by computer into the metal mask patterns of the finished ROM. Both devices are \$10.65 at the 10,000-piece level. Mask charge per program is \$2800. **S MOS Systems, Inc.**, 50 W Brokaw Rd, San Jose, CA 95110.
Circle 320

Controllers place terminal functions on one circuit

Providing complete display and memory control, the CRT 9028 and 128 video terminal logic controllers interface directly to 8085, Z80, 8051, and 6500/6800 micros. Each features a video timing generator and controller, character generator, graphics generator, video attributes controller, video-shift register, and memory controller. The chips have 32-, 64-, and 80-col displays with up to 25 data rows. Display features include bidirectional smooth scroll, wide and thin graphics, and user-programmable character fonts. Prices in 100s are \$22.50. **Standard Microsystems Corp.**, 35 Marcus Blvd, Hauppauge, NY 11788.
Circle 321

Share your knowledge

Other system designers face the same problems you've already solved. You could help them by writing a technical article for Computer Design. For a free copy of our Author's Guide, circle 500 on the Reader Inquiry Card.

ATTENTION MULTIBUS USERS:

DCS INTRODUCES ITS DCS/SERVO MULTIBUS (IEEE796) MODULE FOR HIGH PRECISION DIGITAL MOTION CONTROL

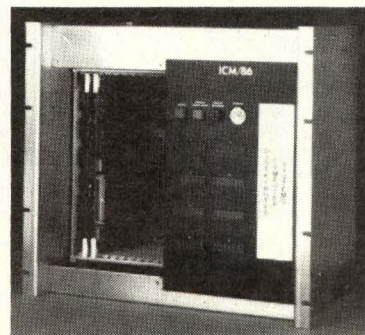

DCS/Servo is a dual-axis Digital position control module utilizing incremental encoder feedback, driving conventional servo-amplifiers and DC motor/tachs. Among the many features which make DCS high precision digital position control systems the most advanced in the motion control field are analog shaft locking and a high speed position loop to eliminate overshoot and jitter. The addition of an Industrial 8086/8087 based Multibus CPU module with 10 year battery back-up RAM and motion control software for up to 8 axes, provides the complete digital motion control system solution. All of this can be packaged in a variety of cardcages or rack mountable chassis and is supported by available software for real-time or development applications.

To place your order or for more information call (617) 890-8200

Multibus TM Intel

DCS Distributed Computer Systems
330 Bear Hill Road
Waltham, MA 02154

CIRCLE 129

COMPUTER DESIGN/June 1, 1984 229

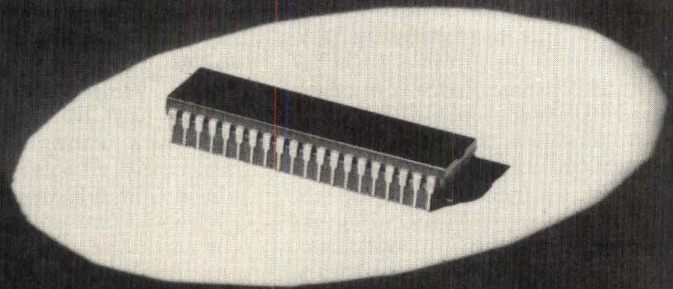

DEMAND PERFORMANCE

FROM YOUR MICROPROCESSOR DEVELOPMENT TOOLS

PERFORMING FOR OVER 10 YEARS.

In 1974, Boston Systems Office was established as one of the pioneers of Universal Microprocessor Development Systems. Today, BSO is still at the forefront of the industry, offering the fastest, most cost effective systems.

PERFORMANCE WITH PRODUCTIVITY.

BSO products can reduce your programming and debugging time by up to 80%. Combine that with a system that can be configured for one to one hundred users, and you've got exceptional performance and increased productivity.

SUPPORT PERFORMANCE.

BSO supports over forty micro-

processors including the Intel 80186, 8087, and 8051, Motorola 68000 and 6809, and the Zilog Z80 and Z8000. The BSO product line includes C compilers, Pascal compilers, symbolic high level debuggers, and assemblers.

JOIN THE CHORUS.

No wonder BSO products are being used by more than 1200 companies and 20,000 engineers in nearly thirty countries. Our affordable systems are working for more than 70% of the top 100 *Electronic Business* corporations. That's impressive. But not expensive. BSO products are affordable to both large and small companies.

BSO AND DEC, A NOTABLE DUET.

BSO microprocessor development systems are recommended and sold

by Digital Equipment Corporation. BSO products are designed to operate on popular DEC computers like the VAX, PDP-11, MicroPDP-11 and Professional 350.

Call us now for the specific benefits of BSO products. If you demand performance, you'll get it with BSO. Manuals are available at no charge.

**Boston Systems Office
469 Moody Street
Waltham, MA 02254 USA
(617) 894-7800
TWX: 710-324-0760**



DEC, VAX, PDP-11, MicroPDP-11 and Professional are trademarks of Digital Equipment Corporation.

High resolution CAD system offers two monitors

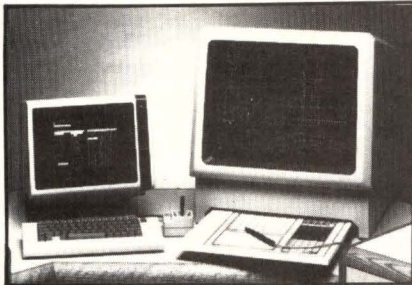

The Cascade X provides a standard 12-in. monochrome CRT as well as a 19-in. nonglare monitor with 1024 x 798 resolution. The dual monitors allow the user to view the menu on one screen and draw on the other. The system uses a 68000 microprocessor backed by 756 Kbytes of RAM for nearly instantaneous processing of graphics input. Up to eight workstations can be networked. The complete unit also includes keyboard, tablet, joystick, 5 Mbytes of hard disk storage, and a 5¼-in. floppy. **Cascade Graphics Development, Inc.**, 1000 S Grand Ave, Santa Ana, CA 92705.

Circle 322

Instrumentation mainframe solves logic problems with plug-in modules

The COLT 300 is a virtual instrument with a slot that accepts a single plug-in instrumentation module. Various modules allow state or timing, universal or micro-specific logic analysis, in-circuit emulation and digital pattern generation. The device's mainframe includes two 5¼-in. floppy drives that load a module's program, data files, and setups. Also included are two RS-232-C ports, parallel printer port, and IEEE 488 bus interface. Base cost is \$9500. **Dolch Logic Instrumentation, Inc.**, 3052 Orchard Dr, San Jose, CA 95134.



Circle 323

Software resolves CAD interface by simplified data sharing

The CAD-VANTAGE software runs on the HP 3065 and extracts data from CAD systems for use in the test area. Instead of depending on CAD-supplied postprocessors, this approach takes standard CAD outputs and reformats them in the test system. It adds terminal-emulator software routines for accessing CAD systems and supports nine-track mag tape interface. Once a data transfer process is complete, the in-circuit program generator can test a board in a fraction of the time required by many conventional test systems. Prices range from \$5000 to \$10,000, depending on configuration. **Hewlett-Packard Co.**, 1820 Embarcadero Rd, Palo Alto, CA 94303.

Circle 324

Mainframe graphics capability extends to IBM PC and XT

A combination software and board package, Forte-Graph allows a PC or XT to act as a full-function color graphics terminal linked to an IBM mainframe. It provides enhanced emulation of an IBM 3279 model S3G terminal with programmed symbols and seven colors. While online, individual text or graph screens can be captured for printing or storage. Hardware consists of program symbols option board, which mounts on an emulator adapter board called the Forte-PJ. Together the boards occupy one expansion slot. Forte-Graph is priced at \$2590. **Forte Data Systems, Inc.**, 1500 Norman Ave, Santa Clara, CA 95050.

Circle 325

Multiprocessor system links mainframe and graphics

The Lynxsystem 1000 series attaches to a Control Data Cyber 170 channel permitting the attachment of interactive graphics devices. System software dynamically downloads the micro at run time according to the application requirements. It is based on a high speed bus that has two to five single-board 68000s, each with 128 Kbytes of dual-ported memory, two serial ports, and an I/O expansion bus. The recommended minimum configuration is priced under \$25,000 including software. **Lynxys, Inc.**, PO Box E, West Lafayette, IN 47906.

Circle 326

Unix tools link to software development for range of microprocessors

With development for micros including 8086 and 68000 and operating systems including MS-DOS and CP/M, the Workshop allows programs to be developed on computers running under Unix, Xenix, or Berkeley 4.1 operating systems. Workshop operates by linking Unix tools to cross-development and host target communication software. All programs are developed under Workshop on the host and are tested on the target system. Source code can either be passed across as text or compiled code output by the cross-development tools on the host. **Logica**, 64 Newman St, London, England W1A 4SE.

Circle 327

Workstations provide fast interactive solids modeling

The PowerStation 3100 and 5100 systems include a minicomputer, high resolution color graphics terminal, and mechanical CAD/CAM software. The devices have numerical control capabilities so tool paths can be simulated on the solids representations, not just on the outline drawing. The 3100 is based on a 16/32-bit computer, while the 5100 is based on a 32-bit virtual processor. Both workstations are Unix based and use a mechanical CAD/CAM package. Prices start at \$69,900 with dual systems, while the 5100 ranges to \$152,500. **Gould Inc, Computer Systems Div.**, 6901 W Sunrise Blvd, PO Box 9148, Fort Lauderdale, FL 33310.

Circle 328

Printed circuit board for CAD/CAM system is priced low

Supporting up to 16 workstations, the series 300 network system allows simultaneous independent design tasks. It links to workstations over a fiber optic local area network. The system is configured around a system manager with associated 12-in. terminal and full ASCII keyboard. The processor is a 15-MHz DEC LSI-11/73 with 32-bit internal architecture. The unit can produce all design and fabrication PC board documents; all wire list/bill of material input is subject to comparison checking. Prices start at \$35,000. **Paragon Technology Corp.**, 2199 Norse Dr, Pleasant Hill, CA 94523.

Circle 329

Microcomputer is central to portable oscilloscope

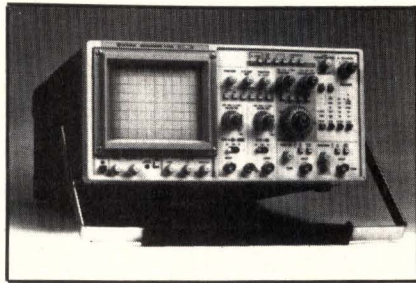

The V-1100 features CRT readout that displays frequency counter and DVM functions as well as constant ground level display. The 100-MHz unit shows the measurement of voltage value between ground level and reference cursor or two cursors and the time difference between two points. Additional features include quad channel with independent position controls, 8-trace with alternate sweep, maximum sweep time of 2 ns/division, and variable hold off. **Hitachi Denshi America, Ltd**, 175 Crossways West, Woodbury, NY 11797. **Circle 330**

Alignment disk supports 3.5-in. Sony standard

A single-sided disk compatible with both the 600-rpm Sony machine and the 300-rpm Shugart machine provides head alignment control for data interchange between flexible storage subsystems. The disk is available in quantity with a double-sided version coming soon. **Dymek Corp**, 1851 Zanker Rd, San Jose, CA 95112. **Circle 331**

Tell us what you like
Did you remember to rate the articles in this issue of Computer Design? A special editorial score box is provided on the Reader Inquiry Card.

Measurement plotting system enhances and simplifies lab graphics

Combining the benefits of digital plotters, waveform and X-Y recorders, and data acquisition systems, the 7090A provides 1 Kword x 12 bits of buffer as a waveform recorder. Also in this capacity it has a 30,000-sample/s A-D converter on each channel with sine response at 3 kHz. As an X-Y recorder, it offers three high-sensitivity CMRR inputs of X-Y or Y-T recording. The unit can also plot when connected to a controller or smart instrument. Six pens in 10 different colors and two line widths are available. Cost is \$4400. **Hewlett-Packard Co**, 1820 Embarcadero Rd, Palo Alto, CA 94303. **Circle 332**

Development station converts PC to engineering workstation

The PC7 closely links the Step-7 firmware integration test station with the IBM PC. It takes extensively used disk files and puts them onto RAM disk in the PC, reducing file access times. Using the PC as a host computer, it is possible to define bit-slice designs, assemble programs, format object code, and debug microcode. To provide 1-key operation, the 10 function keys on the PC keyboard now replace the most heavily used multi-character commands. Prices range from \$10,000 to \$25,000. **Step Engineering**, 757 Pastoria Ave, Sunnyvale, CA 94086. **Circle 333**

Computer prototyping board builds add-on interfaces

The ez board is a solderless experiment system. Features include a glass epoxy PC board mounted with a set of solderless breadboarding units for building circuits. Four separate distribution buses with 50 tie-points each can be used for power, ground, clock lines, and reset commands. The breadboarding area consists of 1460 tie-points with a capacity of sixteen 14-pin DIPS. Components with lead diameters up to 0.032 in. plug in and connect with ordinary solid hookup wire. Price is \$174.95 each. **S.E. Corp**, PO Box 1132, Yorba Linda, CA 92686. **Circle 334**

System for CAE/CAD designs custom integrated circuits

Generating both logic and layout for custom ICs, Chipgraph IC editor speeds up and simplifies VLSI design. It supports user-defined links between logic and layout hierarchies as well as top-down and bottom-up methodologies. The system's variable-screen windows provide simultaneous viewing of logic and layout. The system provides both symbolic and composite (mask-level) capture of layout information and automatically converts the symbolic designs to mask level. The layouts can be mixed on a cell-by-cell basis for optimal speed within chip requirements. Price is \$50,000, with availability in the third quarter of 1984. **Mentor Graphics Corp**, 8500 SW Creekside Pl, Beaverton, OR 97005. **Circle 335**

Data line monitor determines status of major RS-232 signals

The low cost model 42 Micropeeper provides a LED display to check the seven main signals and an eighth user-selectable signal. The device monitors transmit data, receive data, request to send, clear to send, data set ready, data carrier detect, and data terminal ready. The monitor is equipped with female and male type DB-25 connectors and is transparent to the operation of any standard interface since all 25 leads are passed through. In 100s, price is \$43 each. **Telebyte Technology, Inc**, Remark Datacom Div, 148 New York Ave, Halesite, NY 11743.

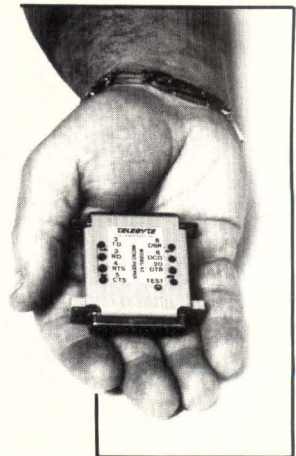

Circle 336

Introducing Lear Siegler's 3278 Keyboard Compatibles

Easy to Look at. Easier to Use.

Now you can combine Lear Siegler's exclusive High Touch™ style with the convenience of true IBM 3278 keyboard compatibility.

The ADM 1178 video display terminals offer superior performance and ergonomic design. With standard protocol converters, you can interface with virtually any IBM mainframe to achieve substantial savings in hardware and operator training expense.

The ADM 1178 terminals can handle computer transmissions up to 19,200 baud without handshaking. They feature five video attributes (underlining, blink, blank, bold and reverse video), the IBM extended character set, four cursor modes (block or underline, blinking or steady), and 24 Program Function (PF) keys and two Program Access (PA) keys.

For operator convenience, the ADM 1178 terminals come with a full tilt and swivel monitor that stops positively in any position, an easy-to-read non-glare screen, and a detached, low-profile DIN standard keyboard.

The ADM 1178s are available with a standard 12" green or amber screen and an RS-232C serial printer port. They can be easily modified for OEM applications and are available with such options as 14" green or amber screen, answerback memory, current loop or RS-422 interface, and international character sets.

These Lear Siegler High Touch terminals are made in America—designed, engineered, manufactured and shipped from Anaheim, California. With this total, on-shore capability, and a complete worldwide network of sales and service centers, OEMs as well as end users can be assured of the best local support available in the industry.

Call our ADM 1178 product specialists today for complete information on products and protocol converters.



Small footprint saves desk space.

Green or amber screens, 12" or 14".

Operator information area—separated by a horizontal line.

IBM extended character set.

True 3278 keyboard layout.

3 key rollover.

Adjustable keyboard tilt.

Hooded bezel reduces glare.

Five visual attributes: underlining, blink, blank, bold and reverse video.

Tilt and swivel for operator convenience.

On/off, contrast controls on front of unit.

24 Program Function (PF) keys.

Two Program Access (PA) keys.

Selectable Numeric or PF Keypad



LEAR SIEGLER, INC.
DATA PRODUCTS DIVISION

901 E. Ball Road, Anaheim, CA 92805 (714) 774-1010

IBM is a registered trademark of International Business Machines Corp.

©1984 Lear Siegler, Inc.

The first thing ISI International put on this new Multibus® card was 2 megabytes...

**And that was just
the beginning.**

Squeezing 2 megabytes of memory onto a single Multibus® card is quite an accomplishment in itself. But we believe it takes more than just memory to meet the increasing needs of today's systems. That's why our new MCB-2X Multibus card is designed with a number of significant special features. And why ISI International is truly a leader in Multibus memory products.

Superior Dynamic Memory Relocation.

The new MCB-2X can relocate up to eight 64K or 256K blocks independently — making it a very powerful tool for "RAM disk," graphics display or multiple table look-up applications.

Expanded Error Correction Logic.

All single bit errors are automatically scrubbed during refresh cycles without system interruption. And thanks to the automatic memory initialization feature, software doesn't have to be pre-conditioned.

On-board ECC detects

all single and double bit errors, while providing 370ns read access

through standard 64K or 256K RAMs. Plus, the MCB-2X has CSR and ESR interrogation capability and software control of ECC enable/disable, allowing users to provide comprehensive system-level diagnostics.

Flexible Addressing Capabilities.

Board addresses starting on any 4K boundary can be mapped to cross 1 and 4 megabyte boundaries. The MCB-2X can also occupy a continuous 512K or 2048K memory space within its 16 megabyte range.

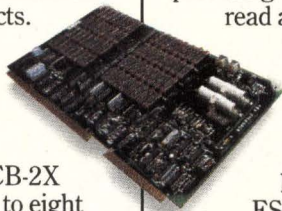

MCB-364

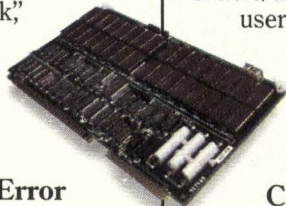

MCB-332

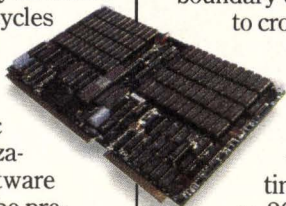

MCB-512

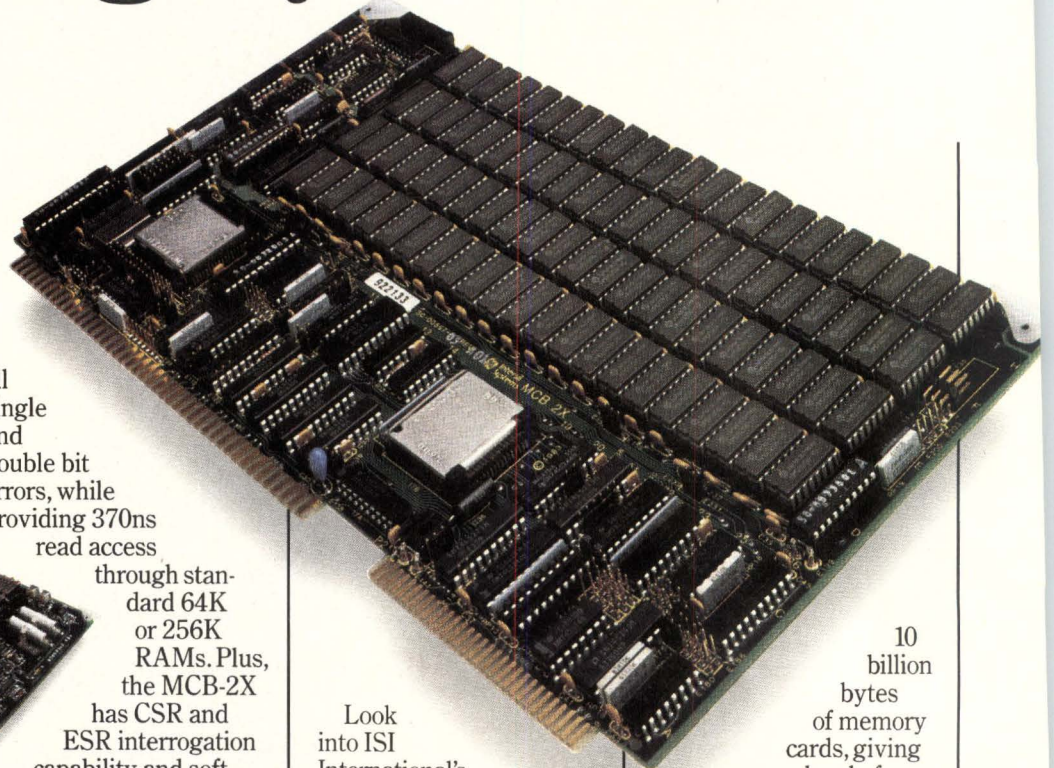

Look into ISI International's new MCB-2X. You'll find all the features you need... plus up to 2 megabytes of memory for the largest capacity available on a single card. Or, for non-volatile CMOS requirements, see our MCB-364 and MCB-332 modules. For simpler dynamic requirements, investigate our MCB-512.

Since 1970, ISI International has shipped over

10 billion bytes of memory cards, giving us a level of

experience that's hard to match. Put it to work for you. For systems needs just call us in the West at (408) 743-4442, in the East (201) 272-3920, or in the Midwest call (513) 890-6450. For off-the-shelf products, contact your nearest ISI International distributor: Alliance, Anthem, Arrow, Future Electronics, R.A.E., Quality Components or Schweber.

*Multibus is a Trademark of Intel Corp.



INTERNATIONAL Formerly Intersil Systems

ISI International Corporation

1275 Hammerwood Avenue, Sunnyvale, CA 94089 • (408) 743-4443

Nonvolatile VMEbus board provides calendar/clock

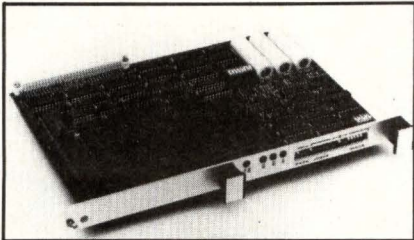

Providing 128, 64, or 32 Kbytes, the MM-6500C employs low power, 8-K x 8 or 2-K x 8 CMOS static RAMs. Three redundant, onboard, parallel, and separately fused backup batteries ensure reliable operation in the event of power failure. Both lithium and NiCad batteries are available. Rechargeable NiCads provide three-month data retention; nonrechargeable lithium batteries permit five-year retention. Realtime calendar/clock provides programmable, periodic, switch-

selectable interrupts that occupy 32 locations in the memory map. Other features include 24-bit addressing up to 16 Mbytes, cycle and address time of 220 ns, and variable delays. The 128-Kbyte version is \$1175. **Micro Memory, Inc.**, 9436 Irondale Ave, Chatsworth, CA 91311.

Circle 337

Removable cartridge Winchester are IBM-XT compatible

The Micro-Magnum 11/11 and 11R feature an 11-Mbyte cartridge. Track density has increased to 908 tracks/in. with 9254 bytes/in. Fully retracted heads never touch the disk surface, protecting the media and heads from damage and wear. The self-sealing drives prevent contaminants from entering critical areas of the head disk assembly. The cartridge is protected by a spring-loaded door, which covers the head access and air exit ports

when not in use. In 1000s, the 11/11 drive is priced at \$1525; the 11R is \$1190. **DMA Systems Corp.**, 601 Pine Ave, Goleta, CA 93117.

Circle 338

Hard disks and floppy backup combine in one storage module

The Discovery 1604 storage array accommodates up to four 5¼-in. Winchester and four minifloppies or superminifloppies. A power sequencer automatically powers up the Winchesters sequentially. Four independent access arms result in throughput greater than a single-arm drive. Initial release is of CP/M Plus and dpc/os 3.0 systems in limited configurations. The tabletop version is priced at \$3700, including one 22-Mbyte Winchester and a 40-Kbyte floppy. **Action Computer Enterprise, Inc.**, 430 N Halstead St, Pasadena, CA 91107.

Circle 339

PACKAGED POWER



150-WATT SWITCHERS

- MEET FCC & VDE RADIATION SPECS**
- Five Outputs ■ 75% Efficiency ■ Soft-Start Circuitry ■ 32 mSec Hold-Up Time ■ 1500 VDC Isolation ■ MOV Transient Protection ■ OVP & Short Circuit Protection ■ Input Line Filters ■ 115/230 VAC Jumper ■ UL & CSA Standards

See EEM, Gold Book, or Ask for Catalog

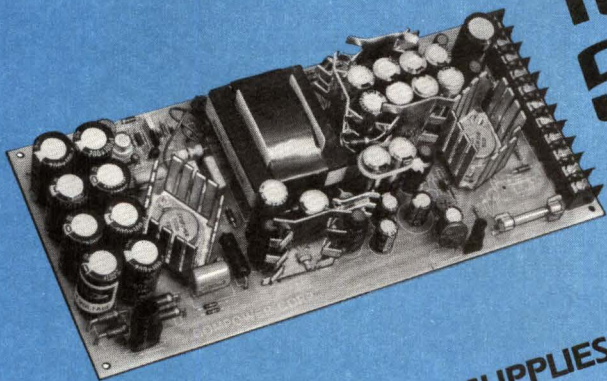

80008 SERIES POWER SUPPLIES

Custom Models:
Consult Factory

\$315 1-9 Piece Price \$220.50 100 Piece Price

TWO-YEAR WARRANTY



Compower Corp.

2220 LUNDY AVENUE • SAN JOSE • CA 95131 TELEPHONE (408) 942-1600 • TELEX: 172760

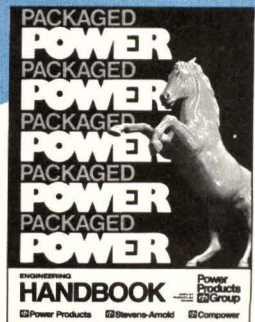

Power Products Group

COMPUTER PRODUCTS, INC. Companies

POWERING YOU THROUGH THE 80'S...AND BEYOND!

STRAIGHT.....

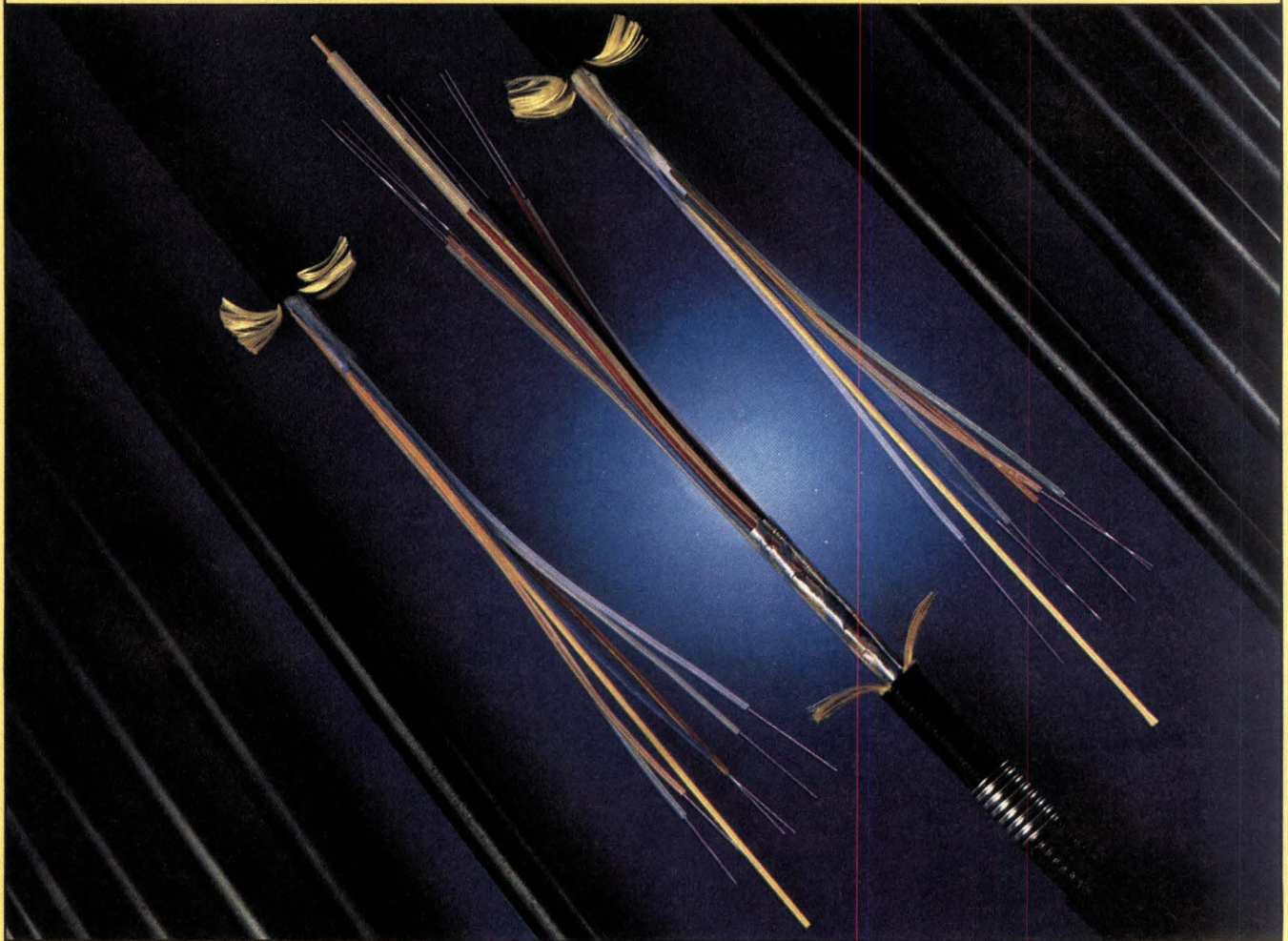

FROM GENERAL CABLE FIBER OPTICS

Cables for all installation environments, to meet your specific transmission requirements.

General Cable has been involved in fiber optics for over a decade. In 1976 we manufactured the cable used in the world's first fiber optic system for commercial telephone service.

Today, we provide fiber optic cables for all applications—from telephony to data communications.

GenGuide® SINGLE MODE CABLES

Provide system engineers with a readily expandable transmission network. Expandable, by simply upgrading terminal equipment. GenGuide Single Mode cables are available with a variety of protective sheaths for duct, aerial and direct buried installations.

GenGuide MULTIMODE CABLES

Available with fiber types to meet end-use attenuation, bandwidth and light source coupling requirements. Cable designs include those for intra-building use, patching terminal equipment and outside plant installation.

FIELD AND ENGINEERING SERVICES

Complement the GenGuide fiber optic cable line. Whether you want us to supervise your installation, provide training in splicing and measurement or recommend the proper ancillary equipment, General Cable has the experience and knowledge you need.

For more information about our line of GenGuide Optical Fiber Cable

write: **GENERAL CABLE COMPANY**
FIBER OPTICS DIVISION
160 Fieldcrest Avenue,
Edison, NJ 08818

or call: **(201) 225-4780**

General Cable  **FIBER OPTICS**
Company DIVISION

GenGuide® is a registered trademark of General Cable Company
A Unit of The Penn Central Corporation

Error detection and correction occurs on 1-Mbyte Multibus board

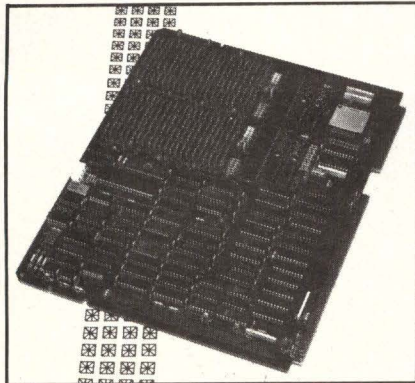

The EDMB series features dynamic memory boundary relocation, serial communication port, interleaving on bank level, and onboard processor. EDC can detect and correct single-bit, double-bit or multiple-bit errors. Configuration flexibility to the host CPU is through I/O commands. The

processor supports transparent memory scrubbing, distinguishes hard and soft errors, and does error stats. Both the 1/2-Mbyte and 1-Mbyte versions operate on 5 V with typical read access times of 250 ns and maximum write access times of 130 ns. The 1-Mbyte version is approximately \$4000. **Electronic Designs, Inc.**, 35 South St, Hopkinton, MA 01748. **Circle 340**

Data storage and backup subsystem saves space

The free-standing DataTower is a combined 8-in. disk drive, intelligent controller, and streaming tape drive. A main system component, the DS-101 intelligent controller handles most processing required to support data storage peripherals through five basic commands. The unit features a disk-drive defect manage-

ment system, plus the ability to perform concurrent backup during normal system use. The system uses a 45-Mbyte streamer and an 86-Mbyte drive. **Priam Corp.**, 20 W Montague Expwy, San Jose, CA 95134. **Circle 341**

It pays to communicate

You can further your career by writing technical articles about the advanced work you're doing. Also, we pay an honorarium for all manuscripts that we publish. For a free copy of our Author's Guide, circle 502 on the Reader Inquiry Card

PACKAGED POWER

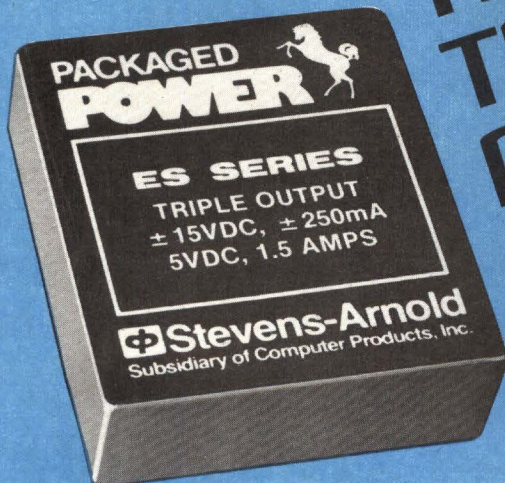

NEW! 15W TRIPLE OUTPUT DC/DC CONVERTERS

- Wide Input Range: 9V-18V, 18V-36V, 36V-72V ■ Efficiency to 82%
- +5V, ±12V, ±15V Outputs ■ 3.0 x 2.56 x .83 Inch Case
- 100 KHz Switching ■ 500VDC Isolation
- OVP & Short-Circuit Protection
- No Derating

See EEM, Gold Book, or Ask for Catalog

Custom Models:
Consult Factory

\$119 1-9 Piece Price \$83.30 100 Piece Price

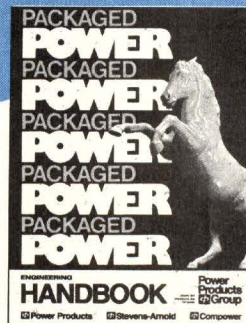

LOW COST

TWO-YEAR WARRANTY



Stevens-Arnold Inc.

Power Products Group

7 ELKINS ST • SOUTH BOSTON • MA 02127 (617) 268-1170 • TLX: 95-1465 • TWX 710-339-0855

COMPUTER PRODUCTS, INC. Companies

POWERING YOU THROUGH THE 80'S...AND BEYOND!

**IT'S ABSOLUTELY,
POSITIVELY, UNEQUIVOCALLY,
AND WITHOUT A DOUBT
EXACTLY LIKE RL01-02/RX02.**

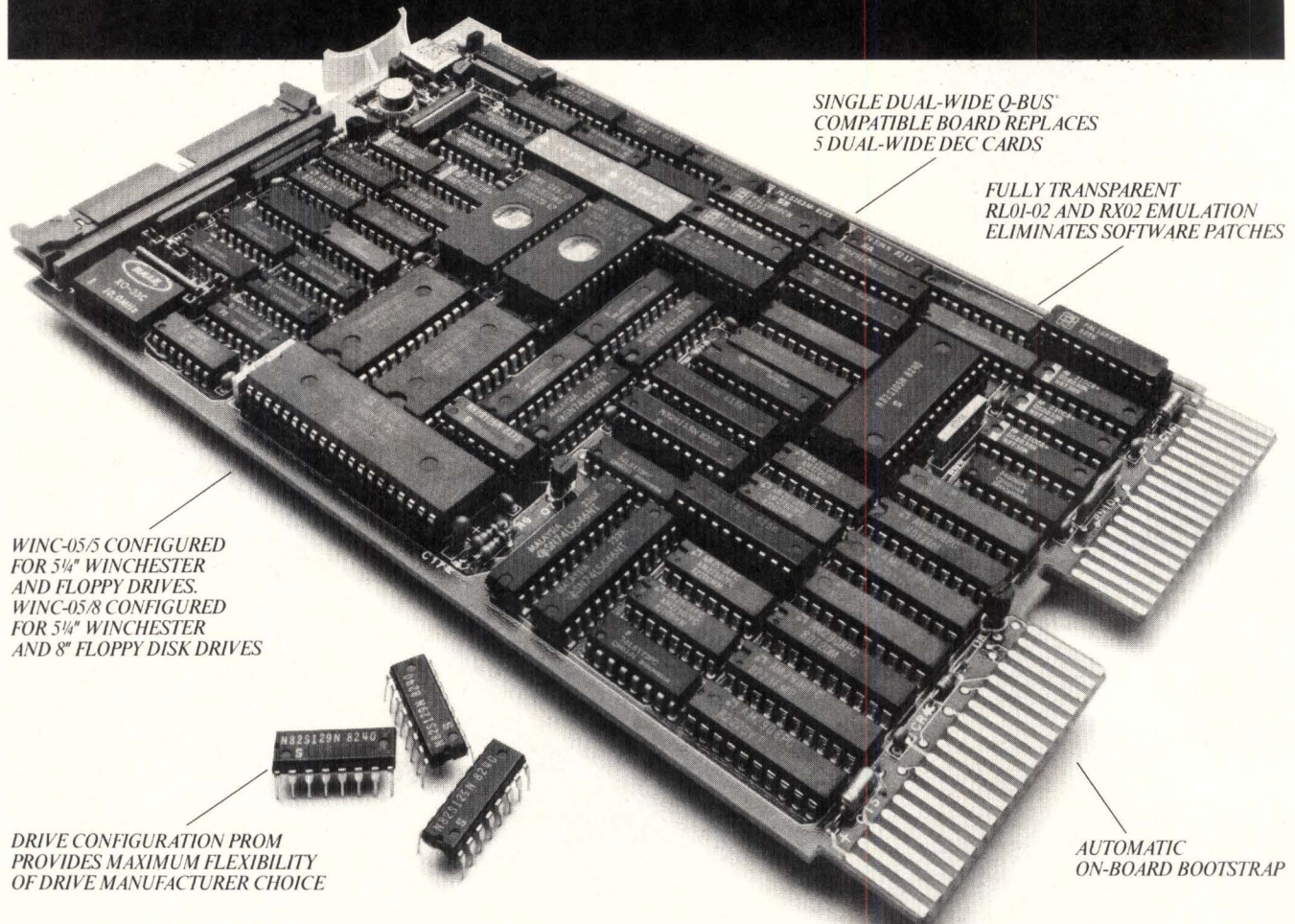

*SINGLE DUAL-WIDE Q-BUS™
COMPATIBLE BOARD REPLACES
5 DUAL-WIDE DEC CARDS*

*FULLY TRANSPARENT
RL01-02 AND RX02 EMULATION
ELIMINATES SOFTWARE PATCHES*

*WINC-05/5 CONFIGURED
FOR 5¼" WINCHESTER
AND FLOPPY DRIVES.
WINC-05/8 CONFIGURED
FOR 5¼" WINCHESTER
AND 8" FLOPPY DISK DRIVES*

*DRIVE CONFIGURATION PROM
PROVIDES MAXIMUM FLEXIBILITY
OF DRIVE MANUFACTURER CHOICE*

*AUTOMATIC
ON-BOARD BOOTSTRAP*

ONLY 5 TIMES BETTER.

Meet the family of WINC-05™ dual-wide Q-Bus controllers from AED. The WINC-05/5 and WINC-05/8.

They're absolutely transparent to your DEC system, so your software never has to know the difference.

Each controller positively replaces the 5 standard dual-wide DEC controller cards, freeing up valuable backplane slots.

Both unequivocally adapt to the specifications of most popular disk drives with the simple change of a single PROM.

And without a doubt, they give you

the most flexibility at a lower cost.

All from a field-proven product going into its second year of shipments. AED's WINC-05 family. Single controller boards with 5 ways to better the competition.

For prices and ordering information, call or write us at: 440 Potrero Avenue, Sunnyvale, CA 94086; (408) 733-3555 or (800) 538-1730 outside CA.

AED ADVANCED
ELECTRONICS
DESIGN, INC.

WINC-05 is a trademark of Advanced Electronics Design, Inc.. RL01-02, RX02 & Q-BUS are registered trademarks of Digital Equipment Corporation.

CIRCLE 137

Controller configures in simple PID or more complex fashion

The MOD 30 is a universal micro-based instrument that works as a simple controller with alarms, or as a controller with feedforward/feedback and adaptive reset. Software resides in 72 Kbytes of PROM. Eleven major function blocks contain all the parameters and conditions necessary for cooperation and control. Up to 500 entry parameters can be applied to a given control loop or function. The configuration data base allows the control strategies without PROM burning or rewiring. **Taylor Instrument, a div of Combustion Engineering, Inc.**, PO Box 110, Rochester, NY 14692.

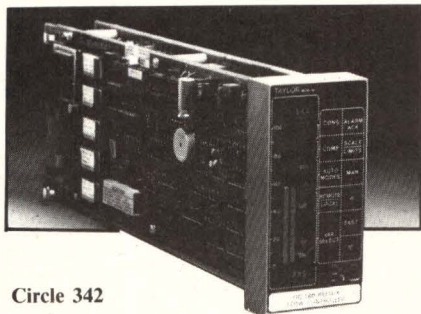

Circle 342

Hardware/software package provides industrial graphics



The Classicmate II can be paired with General Electric Series Six programmable controllers to provide a complete man/machine interface for process control. It integrates the 2200 terminal featuring bubble memory, with an easy-to-use graphics development package. It eliminates the need for user software programming to link the graphics to the PC. By keyboard and display, an operator can monitor and change variables in a process controlled by the PC. **Industrial Data Terminals Corp.**, 173 Heatherdown Dr, Westerville, OH 43081. Circle 343

Programmable controller expands memory size

Offering increased user logic storage, the 884A-200 contains from 2000 to 3500 nodes of relay ladder logic. It provides storage for over 1000 numerical registers and an additional 1024 on/off (discrete) variables for a total memory capacity of nearly 5000, 16-bit words. Features include battery backup for CMOS RAM with capacity for a minimum of 35 weeks without power. A memory-protect keyswitch prevents unauthorized program changes. Memory security option provides four-level pass-code system in which the pass-code levels start with monitoring functions and progress to configuration programming. Cost is less than \$2000. **Gould Inc, Programmable Controller Div.**, PO Box 3083, Andover, MA 01810. Circle 344

Talk to the editor

Have you written to the editor lately? We're waiting to hear from you.

PACKAGED POWER 

NEW! OPEN-FRAME LINEARS

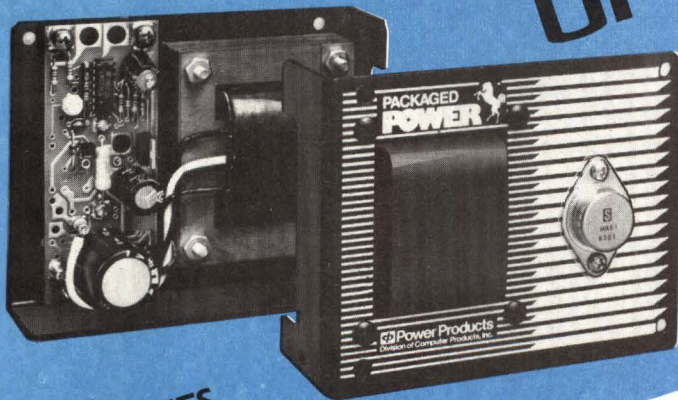

- 15 to 150 watts ■ 100/115/220/230/240 VAC Inputs ■ Single, Dual & Triple Outputs
 - Standard-Size Aluminum Frame ■ Designed to UL & CSA Standards
 - .05% Regulation ■ 3mV P-P Ripple & Noise ■ OVP & Short-Circuit Protection
- NEW CATALOG NOW AVAILABLE**

Custom Models:
Consult Factory

From \$34 to \$114.75
100 Piece Price

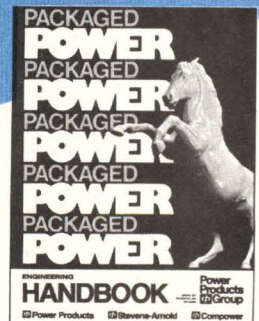

PL100 SERIES POWER SUPPLIES

TWO-YEAR WARRANTY

Power Products Div.  Power Products Group

2801 GATEWAY DR • POMPANO BEACH, FL 33060 TELEPHONE (305) 974-2442 • TWX 510-956-3098

COMPUTER PRODUCTS, INC. Companies

POWERING YOU THROUGH THE 80'S...AND BEYOND!

Finally, a 2,000 LPM band printer somewhere between unreliable and too much money.

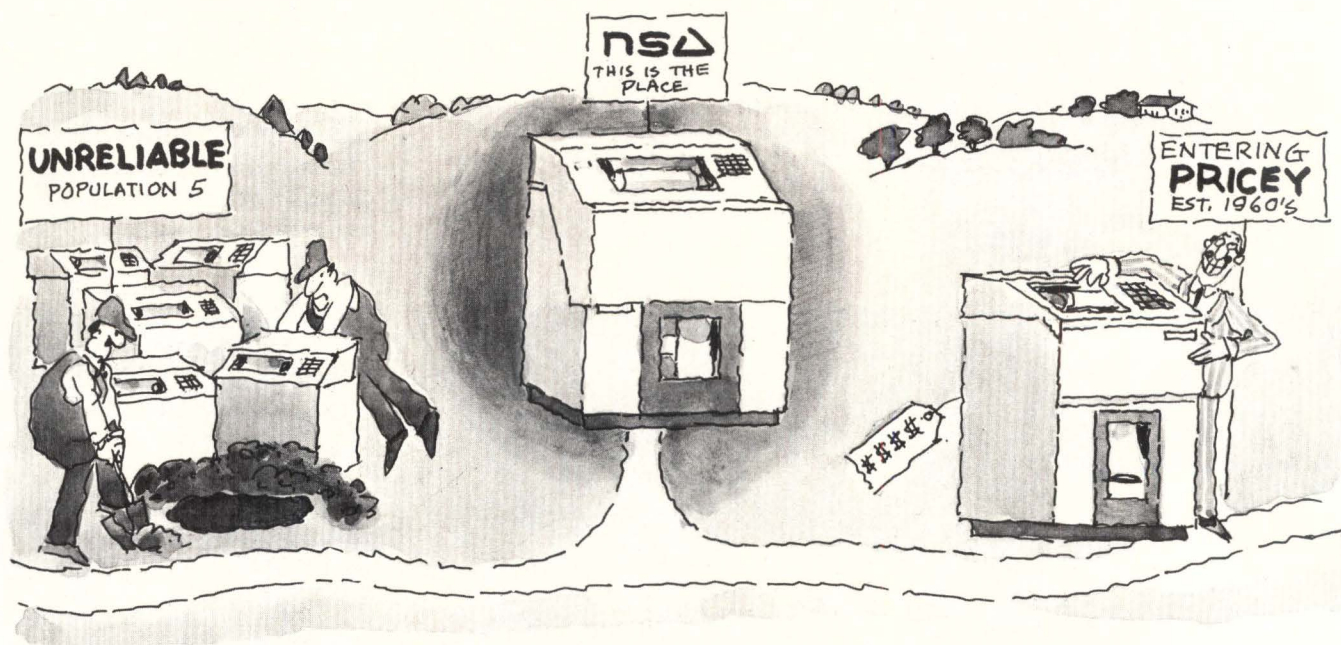

Twice the reliability.

Compare Hitachi Koki's FP-2000 against any low-priced 2,000 LPM band printer. The differences are immediately apparent. Instead of a light-duty souped-up machine, you'll find heavy-duty 3,000 LPM technology that has actually been slowed down for unprecedented reliability at 2,000 LPM. You'll find a printer that's suited for continuous operation — not just transaction printing. That delivers consistent OCR scannable print quality. And most significantly, that delivers an honest 1,200 hours MTBF.

Half the price.

Next compare the FP-2000 against the old industry standard for reliability. After evaluations, large OEMs have reported reliability every bit as good, print quality better, and the price almost half. They have also found comprehensive diagnostics, modular construction, IBM plug compatibility, and a quiet, compact design engineered for ease of use, ease of service and low-cost of ownership.

Call NSA today. The FP-2000 is part of a full family of band printers ranging from 300 to 2,000 LPM.

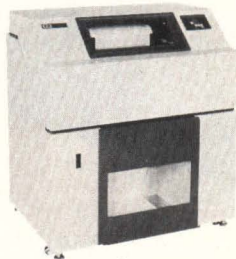

NSA

NISSEI SANGYO AMERICA, LTD.



HITACHI
Hitachi Koki Co., Ltd.

Boston: 40 Washington Street, Wellesley Hills, MA 02181, (617) 237-9643
San Francisco: 460 E. Middlefield Road, Mountain View, CA 94043, (415) 969-1100

Monitor interface addresses FCC emission test

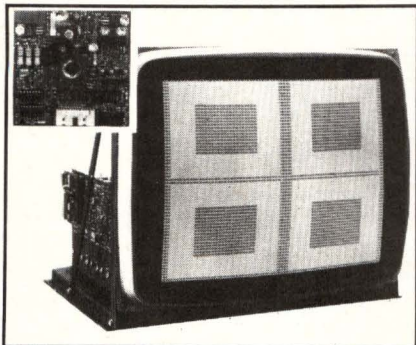

High resolution, VR-Series 20-in. monitors have a horizontal frequency of 31 to 68 kHz. The raster-scan device displays up to 1100 noninterlaced lines refreshed at 60 frames/s. The display runs at a pixel level of up to 100 MHz. At that point, the video has a rise/fall time of 40 ns using either ECL or TTL inputs. It provides 100 lines/in. at 60 Hz or 200 lines/in. in both vertical and horizontal dimensions. **Monitorm Corp**, 7160 Shady Oak Rd, Eden Prairie, MN 55344. **Circle 345**

Workstation is compatible with DEC computers

Full-featured display station WY-75 incorporates the ANSI X3.64 standard and is fully software compatible with the VT-100. The alphanumeric display station is a smart editing unit that features a 14-in. screen with nonglare green phosphor and user-selectable 80- or 132-col widths. The video module has a fully tilting and rotating display. Keyboard is detached and has 16 programmable function keys with 32 separate control codes. It also includes a nonvolatile memory that eliminates the usual DIP switches. Cost is \$795. **Wyse Technology**, 3040 N First St, San Jose, CA 95134. **Circle 346**

User-friendly voice entry improves 327X productivity

The VS1000 provides voice data entry, local user screen formatting, and help center facilities. It reduces data entry keyboard activity by allowing users to simultaneously enter/access data while performing other job functions. With total IBM

host transparency, no host programming changes are required. Specs include a vocabulary of up to 300 utterances for each local user screen, realtime word identification, and better than 99-percent accuracy for digit entry. It communicates with 3274/6 controllers via coaxial A and allows either 3278/9, 3178, IBM PC, or VT100 displays to be used. Price is \$7500. **Sphere Technology, Inc**, 222 Richmond St, Providence, RI 02903. **Circle 347**

Synthesizer module adds natural sounding speech to Multibus

The EV-8950 module is based on the TI 5220 voice synthesis processor, which places little demand on the host CPU. It also contains a standard voice synthesis memory chip. The chip is a 128-Kbit ROM featuring either the 206-word industrial vocabulary or optional vocabularies. The data is compressed by linear predictive coding techniques and drives the processor on a time-varying electron digital filter model of the human vocal tract. **Symbicon Assocs, Inc**, 89 Rte 101A, Amherst, NH 03031. **Circle 348**

RPM custom-designed clutches and brakes... The cost-effective alternative for your rotary motion problems

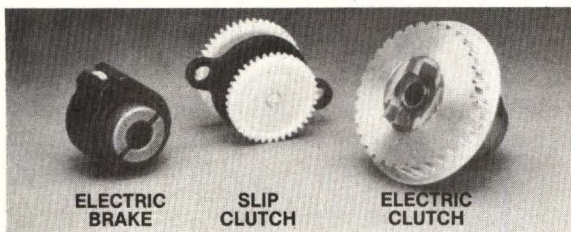

ELECTRIC BRAKE

SLIP CLUTCH

ELECTRIC CLUTCH

RPM clutches and brakes have solved many rotary motion problems for OEMs. That is our specialty. We design and manufacture our products to meet your special performance needs. Of course, we also offer standard units.

EXCELLENCE rpm
REELL PRECISION MANUFACTURING CORPORATION
 1259 Wolters Boulevard
 St. Paul, Minnesota 55110

CALL FOR FREE APPLICATION ANALYSIS (612) 484-2447
 RPM offers free analysis of your OEM clutch and brake applications requiring up to 50 lbs. of torque.

CIRCLE 140

ZEUS SUB-LITE-WALL™ HEAT-SHRINK TUBING



OF TEFLON* TFE

CAT WHISKER THIN WITH A HOLE IN IT!

THE WORLD'S SMALLEST TUBING FOR ADVANCED MICRO-TECHNOLOGY!

Inert! Highly dielectric. Slippery. Abrasion-proof. Permanent. Stands temps to 500°F. Uniform ID's down to .001"; thin-walls to 1.5 mils. Heat-shrinkable or permanently extruded around wires to AWG 44. Available expanded to heat-shrink ratios of 4 to 1 around irregular shapes, delicate equipment, to encapsulate against damage or corrosion. Special requirements welcome. IF YOU CAN USE IT, ZEUS MAKES IT!

SEND FOR FREE SAMPLES & BROCHURE

ZEUS INDUSTRIAL PRODUCTS, INC.

P.O. BOX 298, Raritan, NJ 08869
 800-526-3842 • 201-526-0800 • TWX 710-480-9346

* DuPont's registered trademark for its fluoropolymer resins.

CIRCLE 141

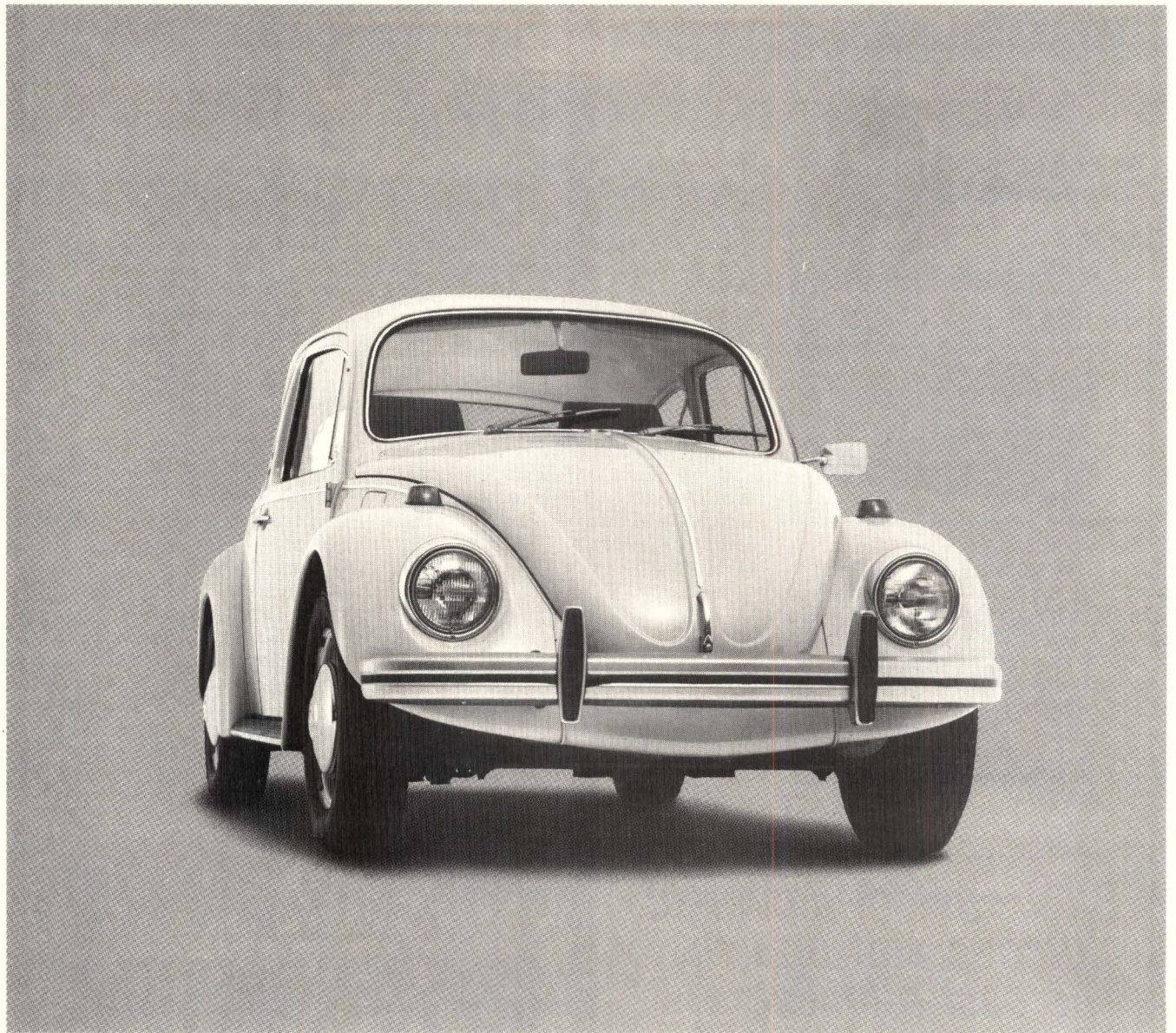

Get a bug if you find a bug.

Show us a bug in our VRTX® real-time operating system and we'll return the favor. With a bug of your own to show off in your driveway.

There's a catch, though.

Since VRTX is the only microprocessor operating system completely sealed in silicon, finding a bug won't be easy.

Because along with task management and communication, memory management, and character I/O, VRTX contains over 100,000 man-hours of design and testing.

And since it's delivered in 4K bytes of ROM, VRTX will perform for

you the way it's performing in hundreds of real-time applications from avionics to video games.

Bug free.

So, to save up to 12 months of development time, and maybe save a loveable little car from the junkyard, contact us. Call (415) 326-2950, or write Hunter & Ready, Inc., 445 Sherman Avenue, Palo Alto, California 94306.

Describe your application and the microprocessors you're using—Z8000, Z80, 68000, or 8086 family. We'll send you a VRTX evaluation package, including timings for system

calls and interrupts. And when you order a VRTX system for your application, we'll include instructions for reporting errors.*

But don't feel bad if in a year from now there isn't a bug in your driveway.

There isn't one in your operating system either.

HUNTER
◆ **READY** 
VRTX
Operating Systems in Silicon.

*Call or write for details. But, considering our taste in cars, you might want to accept our offer of \$1,000 cash instead. © 1983 Hunter & Ready, Inc.

Touch-interactive display develops 480 orange or green characters

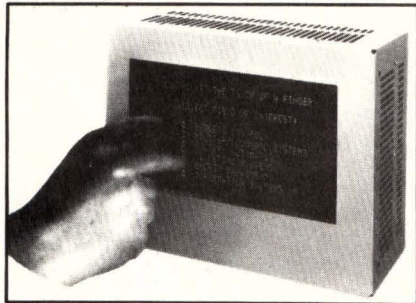

The VuePoint II has 12 lines x 40 chars and a 12-line x 20-col optical touch screen with up to 240 touch points. The gas plasma display has a standard three-page memory expandable to 7, 19, 35, or 51 pages. Smart features include multiple touch response formats, auto-scroll, protected fields, multiple blink rates, dual intensity, and random cursor positioning. Other features are menu setup of self-test, baud rate, and audible feedback. Regular single quantity price is \$2295. **General Digital Corp**, 700 Burnside Ave, East Hartford, CT 06108. Circle 349

Display stations feature IBM 3278/79 compatibility

The 3179 color and 3180 monochrome displays provide a modifiable keyboard with layouts that can be defined with a 3274 control unit. Standard workstation features include highlighting, reverse image, and tilt and swivel. The 14-in. terminal displays 1920 alphanumeric characters in either four or seven colors. The 3180's

display, when attached to a 3274 control unit, can be changed to accommodate four format options from 1920 to 3564 alphanumeric characters. Prices range from \$2195 to \$2295. **IBM Corp, Information Systems Group**, 900 King St, Rye Brook, NY 10573. Circle 350

Intelligent terminals offer high performance at low cost

Featuring soft setup using nonvolatile RAM, the Ovation 1041 and 1051 also provide firmware customization and expansion for custom logic. The 1051 has 256 graphics chars and 128 alphanumeric chars. Display formats are 80 or 132 cols. Standard 16 Kbytes of memory expands to 64 Kbytes. Based on the Z80A, the terminal off-loads functions from the CPU for faster response time. The 1041 is 8085A based and features 84 graphics chars and 8 function keys. The 1051 is \$1295, while the 1041 is \$1095. **Zentec Corp**, 2400 Walsh Ave, Santa Clara, CA 95050. Circle 351

Color graphics pen plotter works with VAX computers

The LVP16 draws on either plain paper or transparencies and offers a choice of 6 colors from a palette of 10 (for paper) or 7 (for transparencies). The plotter provides graphics with 0.001-in. accuracy, at a maximum speed of 15 in./s. It weighs 16 lb, and is designed for installation on desktop or stand. With a standard RS-232 interface, the unit can communicate with

systems that support the HP-GL protocol. Once pens are loaded, color selection is totally under software control. Price is \$1995. **Digital Equipment Corp**, 10 Main St, Maynard, MA 01754. Circle 352

Graphics terminal provides APL capability and text editing

In graphics mode, the 16GRF/APL is Tektronix 4010/4014 and PLOT 10 compatible, with a 240- x 640-bit mapped display resolution. A transparent printer port transmits data in LA102/LA34 format. APL mode can be accessed any time by entering the shift out code. The terminal has four resident character sets in addition to APL—line drawing, mosaic, superscript/subscript, and ASCII. Macro keys can be encoded with any alternate characters or sequences. The standard 12-in. model lists at \$2940. It is also available in 9- and 15-in. styles with amber, green, or white CRTs. **Teleray**, PO Box 24064, Minneapolis, MN 55424.



Circle 353

THE \$2395 DEVELOPMENT SYSTEM

Turns any personal computer into a complete micro-computer DEVELOPMENT SYSTEM. Our integrated control/display program runs under PC/MS-DOS, CP/M, or TRS-DOS, and controls the UDL via an RS-232 port.

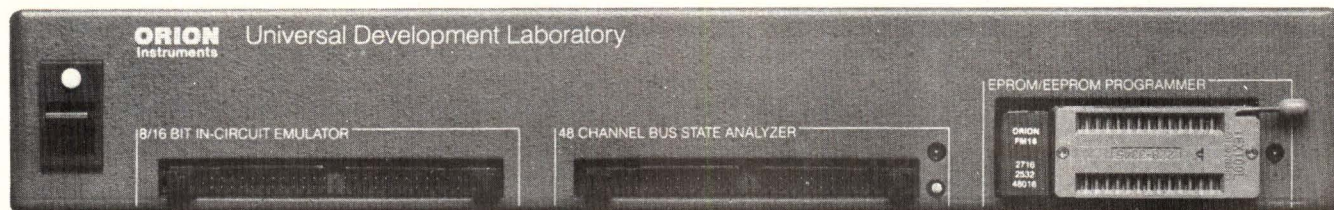

Up to 128K bytes of **ROM EMULATION** (8K standard) allows you to make program patches instantly. Since the target ROM socket connects data and address lines to both the analyzer and the emulator, no expensive adaptors or personality modules are needed.

The powerful **BUS STATE ANALYZER** features four-step sequential triggering, selective trace, and pass and delay counters. \$99 symbolic trace disassemblers are available for Z-80, 8048, 6500, 6800, 8031, 8085, 3870, Z-8, 1802, 8088, & 8086.

The **PROM PROGRAMMER** also doubles as a **STIMULUS GENERATOR**. For a brochure and list of cross assemblers call or write: **ORION Instruments**, 172 Otis Ave., Woodside, CA 94062 (415) 851-1172

Graphics/imaging systems display medium resolution

Expanding the 9460 and 9465 lines, the terminals offer 640- x 512-pixel resolution supporting high performance graphics processing with medium resolution. Through a context-switching feature, either system can share its graphics controller and have multiple workstations perform independent graphics and/or imaging operations from a single host interface. Features include local pan and zoom, arithmetic image combinations, logical image manipulation, and entity detection. Prices start at \$10,450. **Ramtek Corp.**, 2211 Lawson Ln, Santa Clara, CA 95050.

Circle 354

Touch-sensitive monitor targets small computer use

The Point-1 monitor allows users to select from menus, position the cursor, and create and manipulate graphics by touching the screen. Resolution is 1024 x 1024 touch points. It includes a 12-in.

monochrome CRT and an intelligent controller, as well as an RS-232-C port for communication. The screen technology incorporates a sandwich constructed of two transparent resistive sheets that detect touch by measuring voltage drops. Either green or amber phosphor displays are available. Price is under \$665. **Micro-Touch Systems, Inc.**, 400 West Cummings Park, Woburn, MA 01801.

Circle 355

Smart video display terminal enters at low end

The Freedom 110 features tilt and swivel styling, a detached 94-key DIN standard keyboard with numeric keypad, and a nonglare green phosphor display. Amber display is optional. Standard are a 24 x 80 display, 10 programmable function keys, 15 thin-line graphics characters, and 8 editing keys. It emulates the TeleVideo 910, ADDS Regent 25, ADM 3A/5, and Hazeltine 1420. Setup modes are either full page or line, and character attributes require

no display space. The terminal also provides built-in self-test. Prices range from \$535 to \$595, depending on quantity. **Liberty Electronics**, 625 Third St, San Francisco, CA 94107.

Circle 356

Terminal offers multifunctional data communications

The Sigma-Data 3200 provides three fully concurrent communication ports. Line protocols are Telex; TWX; DDD; and private wire protocols 81D1, 83B3, 85A1, and 8A1. The terminal combines a 14-in. amber CRT with dual 5¼-in. floppy disks storing 1.3 Mbytes. Features include preparation and editing of information for ongoing transmission, formatting of all messages, and verify with answer-back and auto-redial. Line speeds are up to 9600 bits/s. Word processing functions are multiformatted with split screen, and concurrent I/O. **Telecomet Inc.**, 820 Second Ave, New York, NY 10017.

Circle 357

SYSTEM COMPONENTS/INTERFACE

Speech inputs through universal interface with MS-DOS

Conversion of MS-DOS software packages to speech input occurs with the Oto-1* speech recognition system. The system consists of a single circuit board that plugs into any auxiliary slot in an IBM PC, PC-XT, or compatible. A proprietary firmware/software combination provides a transparent interface with the application program, allowing voice input to be used interactively with a keyboard or other data entry device. The system has a better than 98-percent word recognition accuracy and 16 Kbytes of RAM, expandable to 64 Kbytes. Single-quantity price is \$795. **Microphonics Technology Corp.**, PO Box 7411, Federal Way, WA 98003. Circle 358

Host interface unit adapts SCSI to S-100 specs

This IEEE 696 board allows a system to talk to drives employing the SCSI standard. The SCSI handshake status information is decoded to simple signals. User-controlled, software-readable switch changes host device; multiple host adapters expand control of multiple disk drives. The board

requires only 4 consecutive I/O mapped ports and has a 16-bit extended addressing mode. Interrupts are generated on read data or status from SCSI controller. Pricing in quantity is \$80. **Inner Access Corp.**, PO Box 888, Belmont, CA 94002. Circle 359

Network controller hooks up with the STD bus

Control module for S871 provides STD bus users with a simple interface to ARCNET local area networks. Individual modules provide users with transparent network operation, control, and protocol in the passing of data within the ARCNET system. ARCNET networks support up to 255 nodes and data rates up to 2.5 Mbits. **Contemporary Control Systems, Inc.**, 4949 Forrest Ave, Downers Grove, IL 60515. Circle 363

Converter takes binary angle and gives BCD equivalent

The SBD227 accepts up to a 22-bit binary digital input angle and converts it into a 26-line BCD output with a resolution of

0.0001 degrees and a full-scale reading of 359.9999 degrees. The 3-state output is available in 4 bytes, allowing it to be compatible with an 8-bit data bus. Timing and control signals are not required. Conversion time is limited only by the propagation delays of the components used. It supplies sufficient output to drive 5 TTL loads. Single-unit pricing starts at \$295. **Natel Engineering Co, Inc.**, 4550 Runway St, Simi Valley, CA 93063. Circle 361

Microprocessor-based printer buffer offers programmable functions

The EXS-PB module is EXORbus compatible and is connected between the computer printer port and the printer. The maximum character transfer rate is 10,000 chars/s, typical values are 1000 chars/s. Storage capacity is 131,000 chars. Programmable functions allow deletion and copying of files in the buffer, pause functions, and built-in self-diagnostics. In case of paper confusion, listing may be repeated from the beginning of the file. **Dataware**, Hamngatan 9, SF-22100 Mariehamn, Finland. Circle 362

READ. WRITE.

It is the highest performance, most reliable 5¼" cartridge disk drive in the industry.

It features more resistance to shock and vibration than any other disk drive, fixed or removable.

Its cartridge is the least expensive among formatted 5-megabyte cartridges on the market today.

Its cartridge interchangeability from drive to drive is absolute. Its start/stop time is the fastest available of any high-performance disk drive.

It is the Beta 5 Cartridge Disk Drive from IOMEGA. And it is, in a word, superlative.

IOMEGA Corporation
1821 West 4000 South
Roy, Utah 84067
Or call (801) 776-7330



IOMEGA™
High Performance Cartridge Disk Drives

REGIONAL AND DISTRICT SALES OFFICES: SOUTHEASTERN REGION, (305) 755-1060; SOUTH-CENTRAL REGION, (214) 458-2534; WESTERN REGION, (714) 855-1211, (408) 263-4476; NORTHEASTERN REGION, (617) 933-2000; MIDWEST REGION, (414) 782-5229; EASTERN OFFICE, (203) 359-9858.

See us at NCC in Las Vegas

CIRCLE 144

Gould... Innovation and Quality in Logic Analyzers

The K105-D analyzer with Trace Control™ helps you find faults quickly and easily.

For most engineers, the frustration is not in solving the problem. But in finding it.

Not anymore. Take the Gould K105-D logic analyzer. It can help you isolate errors and their causes quickly and easily. Because now you can capture and examine several possible cause areas with a single pass.

Advanced program tracking and data capture.

Flexibility is the key.

With 8 levels of Trace Control, you can follow every bend and turn in your program flow. No matter how complex. And capture widely-separated slices of code better than any other triggering method.

Although faults and their causes may be separated by thousands of lines of code, the K105-D records only what you want to see.

Once captured, the K105-D brings these windows of information directly to the screen for your analysis.

This selective recording conserves memory. While it helps you get at the problem — and solve it — in less time than ever before.

An analyzer that speaks your language.

The K105-D speaks simple assembly language, not complex object code. Quite fluently, we might add.

With our disassembly modules for the 68000, 8086, 8080, 8085A and Z80® B microprocessors, you need only one analyzer for debugging most popular processors.

Clear, concise pattern definitions.

With the K105-D, you can define all your event patterns with symbolic labels. These labels can represent address locations, data values, fetched instructions or any control signal you're monitoring.

And since you create them, they're easier to understand and remember.

What's more, Trace Control uses English-like commands which make for shorter set-ups. Quicker comprehension. And a more productive engineer.

To make debugging even easier, add the optional dual floppy disk drive. With it, you can store up to 35 set-ups and associated recordings on a single diskette for instant recall.

Now, capture up to 4 segments of complex program flow to pinpoint problems fast.

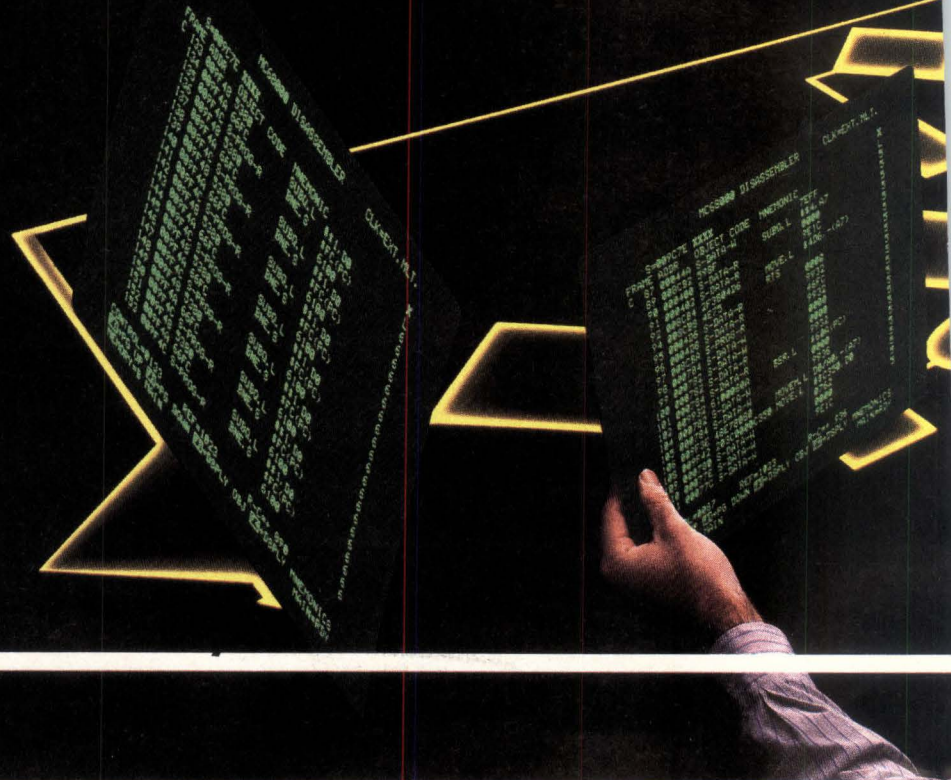

You won't get caught in a loop.

By using the K105-D's loop counter, you can follow a sequence of events for a specific number of iterations. Then stop at will.

It's a quick way for you to test the repeatability of a program function. And verify that your code is having the predicted effect.

Integration made easy.

For the hard part (hardware/software integration), now there's a simpler solution. The K105-D's 100 MHz high speed link.

It's an extremely precise way to see how timing affects software execution. And vice-versa.

Again, for this task, Trace Control can help you track down hard-to-find faults. So you end up with a program that flows smoothly. Error free. In a fraction of the time it used to take.

Performance above all the rest.

At Gould, we engineer every instrument to be clearly the best in its class.

So now with your insight and the K105-D analyzer, you can capture the problem. And solve it. Fast.

For the name and number of your nearest Gould sales representative or for a detailed brochure and application notes, call us toll-free at **(800) 538-9320**. In California, call **(800) 662-9231** or **(408) 988-6800**. Or write Gould Inc., Design & Test Systems Division, 4600 Old Ironsides Drive, Santa Clara, CA 95054-1279.

United Kingdom: Gould Inc., Design & Test Systems Division, Hainault Operation, Roebuck Road, Hainault, Essex IG6 3UE, United Kingdom. Phone: (44) (1) 500-1000.

West Germany: Gould Inc., Design & Test Systems Division, Dieselstrasse 5-7, D-6453 Seligenstadt 3, West Germany. Phone: 06182/801-1.

™ Trace Control is a trademark of Gould, Inc.
* Z80 is a registered trademark of Zilog, Inc.

HELP



The K105-D gives you two levels of HELP at the touch of a button. First, step-by-step operating instructions that appear along the bottom of the analyzer screen. Second, a menu that allows you to select more detailed "help" should you need it.

© 1984, Gould, Inc.

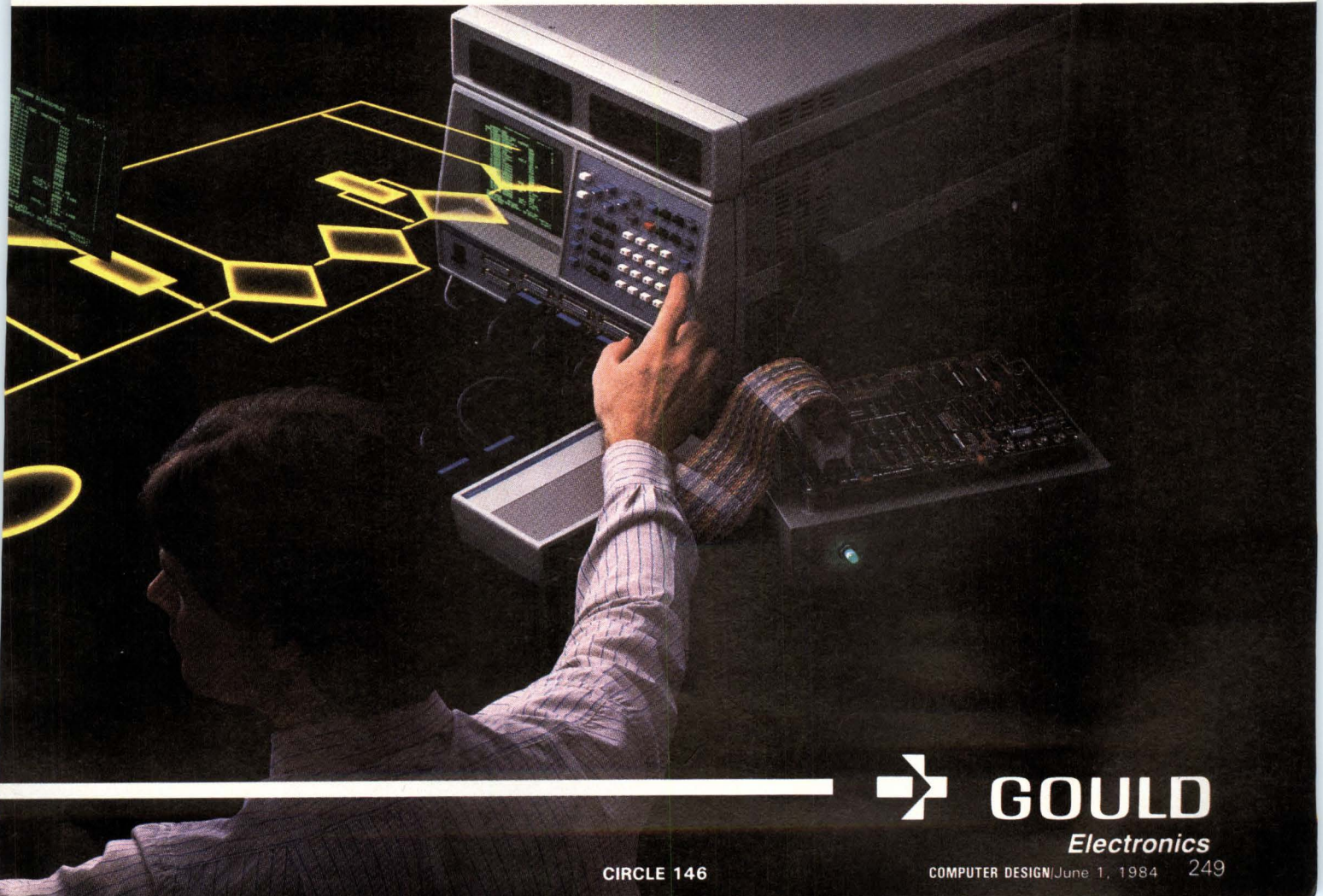

GOULD
Electronics

THE WRIGHT BROTHERS THEY WERE JUST THE

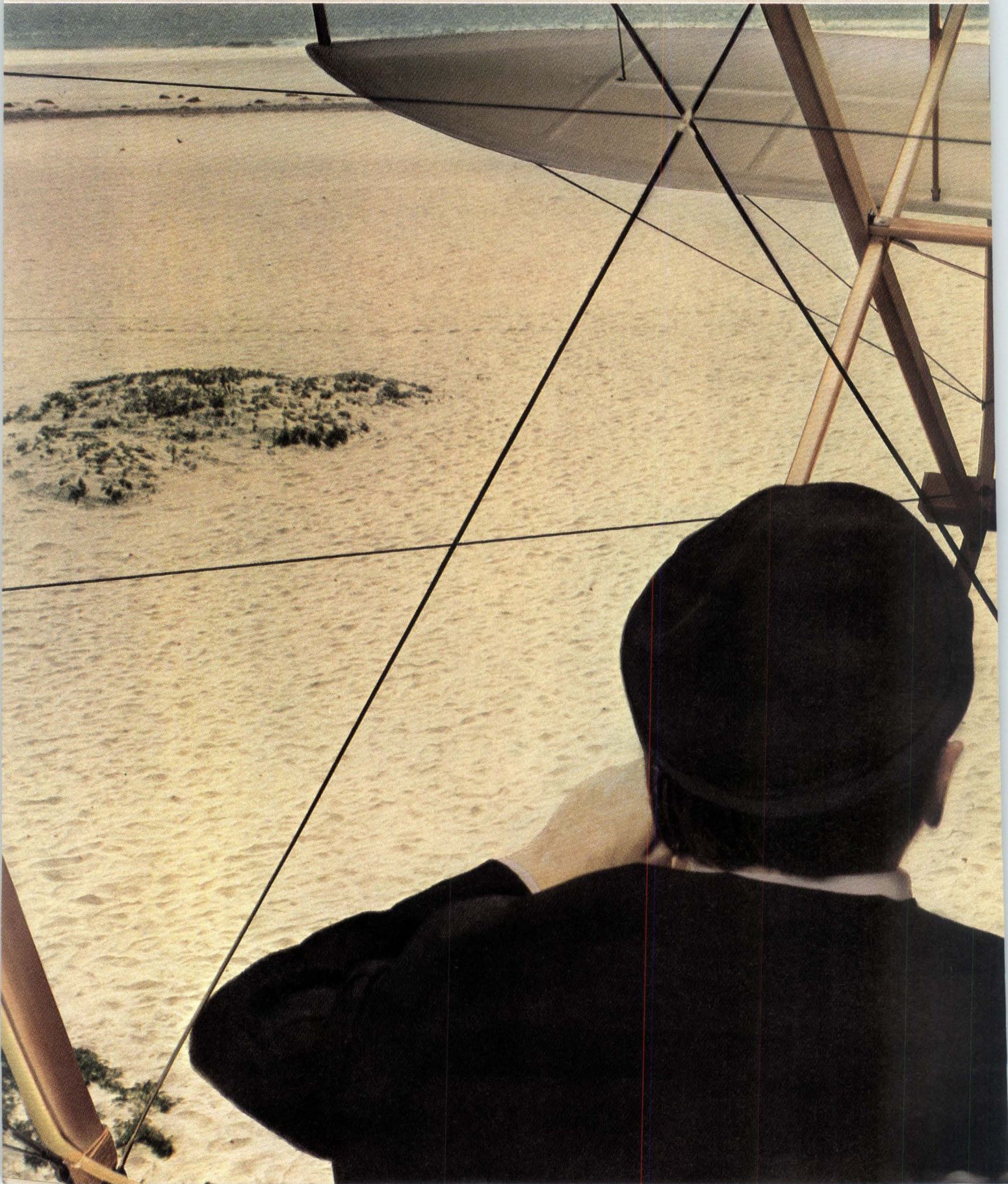

WEREN'T THE FIRST TO FLY. FIRST NOT TO CRASH.

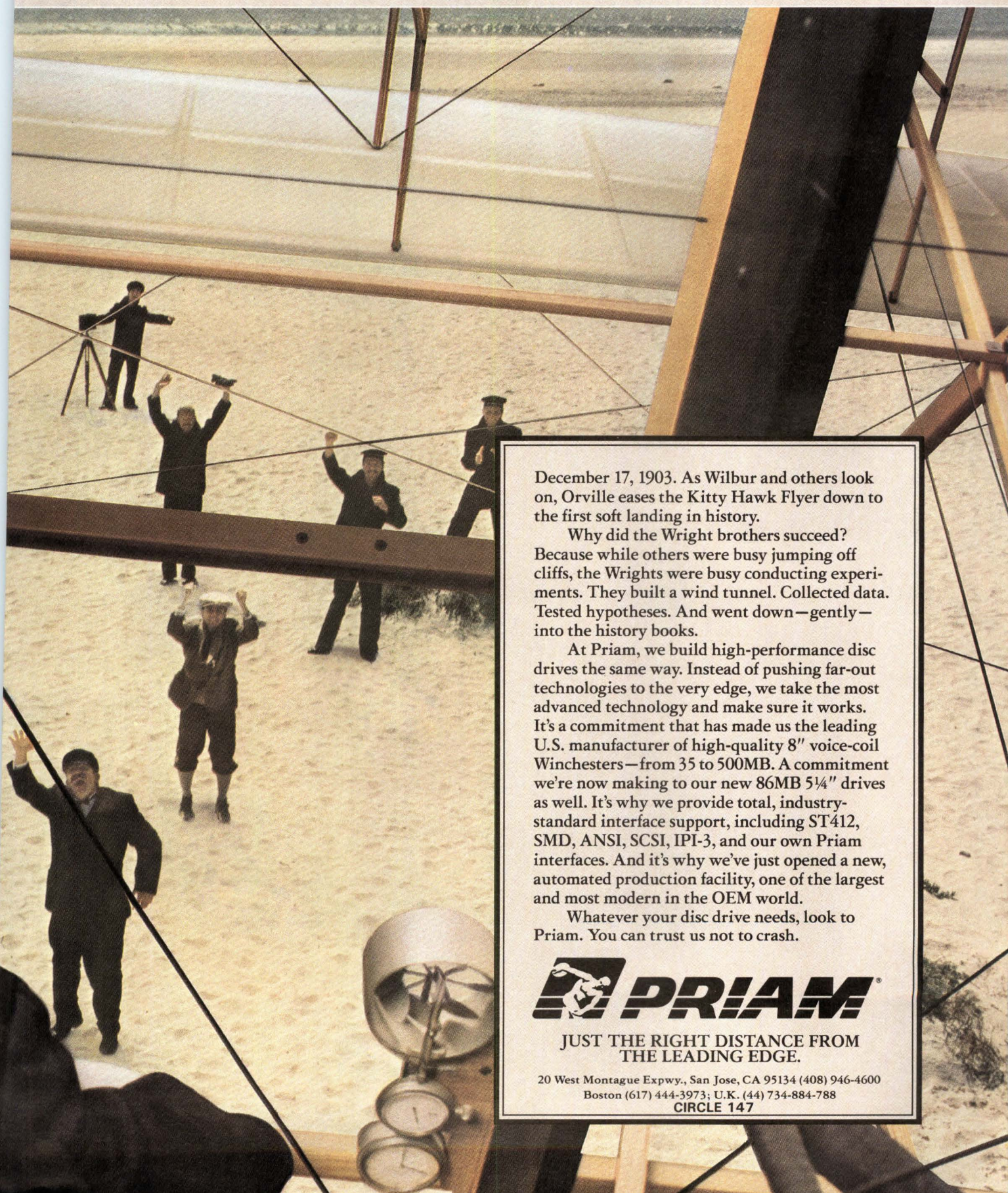

December 17, 1903. As Wilbur and others look on, Orville eases the Kitty Hawk Flyer down to the first soft landing in history.

Why did the Wright brothers succeed? Because while others were busy jumping off cliffs, the Wrights were busy conducting experiments. They built a wind tunnel. Collected data. Tested hypotheses. And went down—gently—into the history books.

At Priam, we build high-performance disc drives the same way. Instead of pushing far-out technologies to the very edge, we take the most advanced technology and make sure it works. It's a commitment that has made us the leading U.S. manufacturer of high-quality 8" voice-coil Winchester— from 35 to 500MB. A commitment we're now making to our new 86MB 5¼" drives as well. It's why we provide total, industry-standard interface support, including ST412, SMD, ANSI, SCSI, IPI-3, and our own Priam interfaces. And it's why we've just opened a new, automated production facility, one of the largest and most modern in the OEM world.

Whatever your disc drive needs, look to Priam. You can trust us not to crash.



JUST THE RIGHT DISTANCE FROM
THE LEADING EDGE.

20 West Montague Expwy., San Jose, CA 95134 (408) 946-4600
Boston (617) 444-3973; U.K. (44) 734-884-788
CIRCLE 147



SIGGRAPH '84

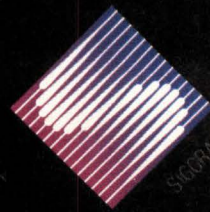

The
Premier
Computer Graphics Conference

July 23-27, 1984

Minneapolis, Minnesota USA

An unparalleled technically-oriented experience, SIGGRAPH '84 covers virtually every area of computer graphics—from an exhibition of the latest high-performance hardware and software to a full spectrum of technical sessions and courses.

SIGGRAPH '84—designed for computer graphics professionals concerned about function as well as form, about bottom-line applications as well as art. It's the *premier* computer graphics conference.

SIGGRAPH '84 is sponsored by the Association for Computing Machinery's Special Interest Group on Computer Graphics.

For an advance program, contact the SIGGRAPH '84 Conference Office
111 East Wacker Drive
Chicago, Illinois 60601 (312) 644-6610

CIRCLE 148

Measurement handbook



Full-color, 200-page reference guide contains technical and application guides for pressure and strain measurement/control applications; prices are included. **The Omega Group**, Stamford, Conn.

Circle 410

Seminar bulletin

A 29-page bulletin includes seminars about technology and management; overall, a variety of sessions runs through December 1984. Registration form and price included. **Worcester Polytechnic Institute**, Worcester, Mass.

Circle 411

Interfacing A-D

Six-page application note discusses techniques for interfacing A-D converters with microprocessors for different conversion data rates; seven figures illustrate interfaces, circuits, and software flow. **ILC Data Device Corp.**, Bohemia, NY.

Circle 412

Packaging system

Metric series packaging system offers stitch-wire, wire-wrapping, and insulation displacement pin wiring options to provide optimum-performance development on production system. **Interconnection Technology, Inc.**, Huntington Beach, Calif.

Circle 413

Fiber optics and optical communication

Selection guide for fiber optic and optical communication and systems provides specs, photos, and schematics for fiber optic LANS, links and systems, and line-of-sight beam links. **Codenoll Technology Corp.**, Yonkers, NY.

Circle 414

Bibliography of metric guides

The American National Metric Council (ANMAC) has published a metric practice guide listing 56 items for metric transition; copies are available for \$5, plus a large self-addressed envelope (37¢ postage). ANMAC, 5410 Grosvenor Ln, Bethesda, MD 20814.

Software for PDP-11

Two-volume PDP-11 sourcebook covers application and system software programs for PDP-11 minis and microcomputers; over 1500 applications in 33 categories are described. Prices, vendors, addresses, and phone numbers are listed. **Digital Equipment Corp.**, Northboro, Mass.

Circle 415

Applications for Domain

The second application catalog for the Domain system contains over 200 third-party software, hardware, and value-added supplier applications; the 256-page book covers 13 different areas. **Apollo Computer**, Chelmsford, Mass.

Circle 416

Systems for the STD bus

Brochure details wide range of STD bus board and system-level products; separated by function, general specs are provided for the entire product line. **Applied Micro Technology, Inc.**, Tucson, Ariz.

Circle 417

Consensus standards

Nine standard guides and one specification compile voluntary guidelines for computerized systems and services; the book covers project definition; functional requirements; functional design; implementation design; assembly, installation, and test; and evaluation for most system sizes and types. Price is \$15.20 for ASTM members; \$19 for nonmembers. **ASTM (formerly American Society for Testing and Materials)**, 1916 Race St, Philadelphia, PA 19103.

Multibus products

Catalog features Multibus-compatible horizontal and vertical, rackmountable card cages, universal pattern panels, and such accessories as connectors and fans; each description includes photos and drawings. **Augat Inc, Interconnection Systems Div**, Attleboro, Mass.

Circle 418

Microwave connectors

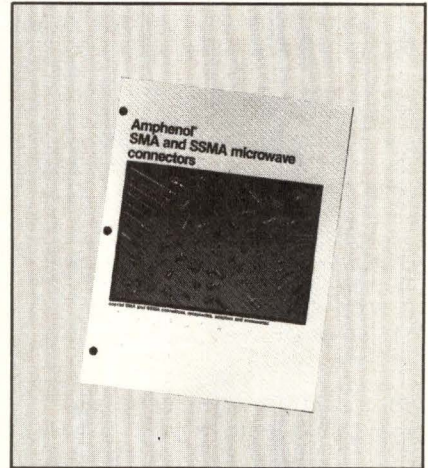

Illustrated, 104-page catalog details SMA and SSMA microwave connectors, receptacles, adapters, and accessories; quick-reference photos and functional selection charts are provided. **Amphenol Products**, Oak Brook, Ill.

Circle 419

Trimmer catalog

Catalog details trimmer models according to features, specs, and dimensions; sections on multiturn, single-turn, and MIL-spec versions, plus selection and designer guides, are included. **Bourns, Inc, Trimpot Div**, Riverside, Calif.

Circle 420

Binary to BCD converter

The SBD227 22-bit binary to BCD converter is described in two-color data sheet; the converter accepts binary digital representation of an angle and provides a scaled BCD equivalent angle. **Natel Engineering Co**, Simi Valley, Calif.

Circle 421

Filtering CRT video

Technical bulletins specify video/filter CRT anti-glare panels for many types of display terminals; applications and options are examined. **Panelgraphic Corp**, West Caldwell, NJ.

Circle 422

Power conditioning and monitoring

Catalog features complete line of power monitoring and conditioning equipment, covering computers, telecomm, word processors, and machine tool controls. **Registration Electric**, Linden, NJ.

Circle 423



CONFERENCES

JULY 9-12—NCC (National Computer Conf), Las Vegas Convention Ctr, Las Vegas, Nev. INFORMATION: IEEE Computer Society, PO Box 639, Silver Spring, MD 20901. Tel: 301/589-8142

JULY 23-25—Computer Simulation Conf, Copley Plaza Hotel, Boston, Mass. INFORMATION: Society for Computer Simulation, PO Box 2228, La Jolla, CA 92038. Tel: 800/225-7654

JULY 23-27—SIGGRAPH Conf on Computer Graphics and Interactive Techniques, Minneapolis, Minn. INFORMATION: Lynn Valastyan, 111 E Wacker Dr, Chicago, IL 60601. Tel: 312/644-6610

JULY 30-AUG 2—Internat'l Pattern Recognition Conf, Montreal, Canada. INFORMATION: ICPR Secretariat, 3450 University St, Montreal, Quebec, Canada H3A 2A7. Tel: 514/392-6744

AUG 2-6—Autofact Japan Conf and Expo (held conjointly with **Mechatronics**), Osaka, Japan. INFORMATION: Leslie Hossack, Society of Manufacturing Engineers, One SME Dr, PO Box 930, Dearborn, MI 48121. Tel: 313/271-0023

AUG 12-15—Computers in Engineering Conf and Exhibit, Las Vegas Hilton, Las Vegas, Nev. INFORMATION: Mary Benedict, American Society of Mechanical Engineers, 345 E 47th St, Suite 13M, New York, NY 10017. Tel: 212/705-7100

AUG 19-24—Technical Symposium on Optics and Electro-Optics and Instrument Display, Town & Country Hotel, San Diego, Calif. INFORMATION: Rich Donnelly, Information Services, SPIE, PO Box 10, Bellingham, WA 98225. Tel: 206/676-3290

AUG 21-24—Conf on Parallel Processing, Hilton Shanty Creek, Bellaire, Mich. INFORMATION: Tse-yun Feng, 1604 Stormy Ct, Xenia, OH 45385. Tel: 614/422-1408

AUG 30-SEPT 1—Conf on Solid State Devices and Materials, Kobe, Hyogo, Japan. INFORMATION: Susumu Namba, Osaka Univ, Faculty of Engineering Science, Toyonaka, Osaka, Japan 560.

SEPT 5-8—Conf on Digital Signal Processing, Florence, Italy. INFORMATION: A. G. Constantinides, Dept of Electrical Engineering, Imperial College of Science & Technology, Exhibition Rd, London SW7 2BT, England. Tel: 01/5895111

SEPT 10-13—Advanced Control Conf, Purdue Univ, West Lafayette, Ind. INFORMATION: Edward Kompass, Editor, *Control Engineering* magazine, 1301 S Grove Ave, PO Box 1030, Barrington, IL 60010. Tel: 312/381-1840

SEPT 11-13—Electronic Imaging, Westin Hotel, Boston, Mass. INFORMATION: Morgan-Grampian Expositions Group, 2 Park Ave, New York, NY 10016. Tel: 212/340-9780

SEPT 11-13—Midcon Electronics Exhibition and Convention, Dallas Convention Ctr, Dallas, Tex. INFORMATION: Kent Keller, Electronic Conventions, Inc, 8110 Airport Blvd, Los Angeles, CA 90045. Tel: 213/772-2965

SEPT 11-13—Mini/Micro-Southwest Computer Conf and Exhibition, Dallas Convention Ctr, Dallas, Tex. INFORMATION: Kent Keller, Electronic Conventions, Inc, 8110 Airport Blvd, Los Angeles, CA 90045. Tel: 213/772-2965

SEPT 11-13—Voice Input/Output System Applications Conf, Marriott Crystal Gateway Hotel, Arlington, Va. INFORMATION: Robert Burgess, Public Information Office, Lockheed Missiles & Space Co, Inc, Sunnyvale, CA 94086. Tel: 408/742-6688

SEPT 11-14—Unix Systems Expo, Los Angeles Convention Ctr, Los Angeles, Calif. INFORMATION: David Sudkin, Computer Faire, Inc, 181 Wells Ave, Newton, MA 02159. Tel: 617/965-8350

SEPT 16-20—Comcon Fall, Hyatt Regency Crystal City, Arlington, Va. INFORMATION: IEEE Computer Society, PO Box 639, Silver Spring, MD 20901. Tel: 301/589-8142

SEPT 17-21—FOC/LAN (Fiber Optic Communications and Local Area Networks) Exposition, MGM Grand Hotel, Las Vegas, Nev. INFORMATION: Michael O'Bryant, Information Gatekeepers, Inc, 138 Brighton Ave, Suite 212, Boston, MA 02134. Tel: 617/787-1776

SEPT 19-21—Connector and Interconnection Technology Symposium, Disneyland Hotel, Anaheim, Calif. INFORMATION: Electronic Connector Study Group, Inc, PO Box 167, Fort Washington, PA 19034. Tel: 215/279-7084

SEPT 26-28—Eurocon: Computers in Communications & Control, Brighton, England. INFORMATION: Brian Atkinson, IEE, Savoy Place, London, WC2R OBL England.

OCT 1-4—AUTOFACT 6 Conf & Exh, Anaheim Convention Center, Anaheim, Calif. INFORMATION: Soc of Manufacturing Engineers, 1 SME Dr, PO Box 930, Dearborn, MI 48121. Tel: 313/271-0777

OCT 2-4—Northcon Electronics Conf & Exh, Seattle Center Flag Pavilion, Seattle, Wash. INFORMATION: Nancy Hogan, Electronic Conventions, Inc, 8110 Airport Blvd, Los Angeles, CA 90045. Tel: 213/772-2965

OCT 2-4—Mini/Micro Northwest Conf & Exh, Seattle Center Flag Pavilion, Seattle, Wash. INFORMATION: Nancy Hogan, Electronic Conventions, Inc, 8110 Airport Blvd, Los Angeles, CA 90045. Tel: 213/772-2965

OCT 8-9—9th Conf on Local Area Networks, Minneapolis, Minn. INFORMATION: Harvey A. Freeman, Architectural Technology Corp, PO Box 24344, Minneapolis, MN 55424.

OCT 8-10—ACM Annual Conf: The Fifth Generation Challenge, San Francisco Hilton Hotel, San Francisco, Calif. INFORMATION: Karen Duncan, Chairman, ACM '84, 15 Parsons Way, Los Altos, CA 94022.

SHORT COURSES

AUG/NOV—Applications-Oriented Approach to Artificial Intelligence, Ottawa, Canada and Washington, DC. INFORMATION: George Harrison, The George Washington Univ, Washington, DC 20052. Tel: 800/424-9773

SEPT 10-14—Decision of Digital Control Systems, Washington, DC. INFORMATION: George Harrison, The George Washington Univ, Washington, DC 20052. Tel: 800/424-9773

SEPT/OCT/NOV—EMI Seminars, One and two days each, Boston, Philadelphia, Washington, and Chicago. INFORMATION: Trish Puhl, R & B Enterprises, 20 Clipper Rd, W Conshohocken, PA 19428. Tel: 215/825-1965

SEPT/OCT—World Conf on Ergonomics in Computer Systems, various U.S. and European cities. INFORMATION: Robert W. Bailey, Computer Psychology, Inc, 54 E Main St, PO Box 16, Mendham, NJ 07945. Tel: 201/543-9009

Designer's Bookcase

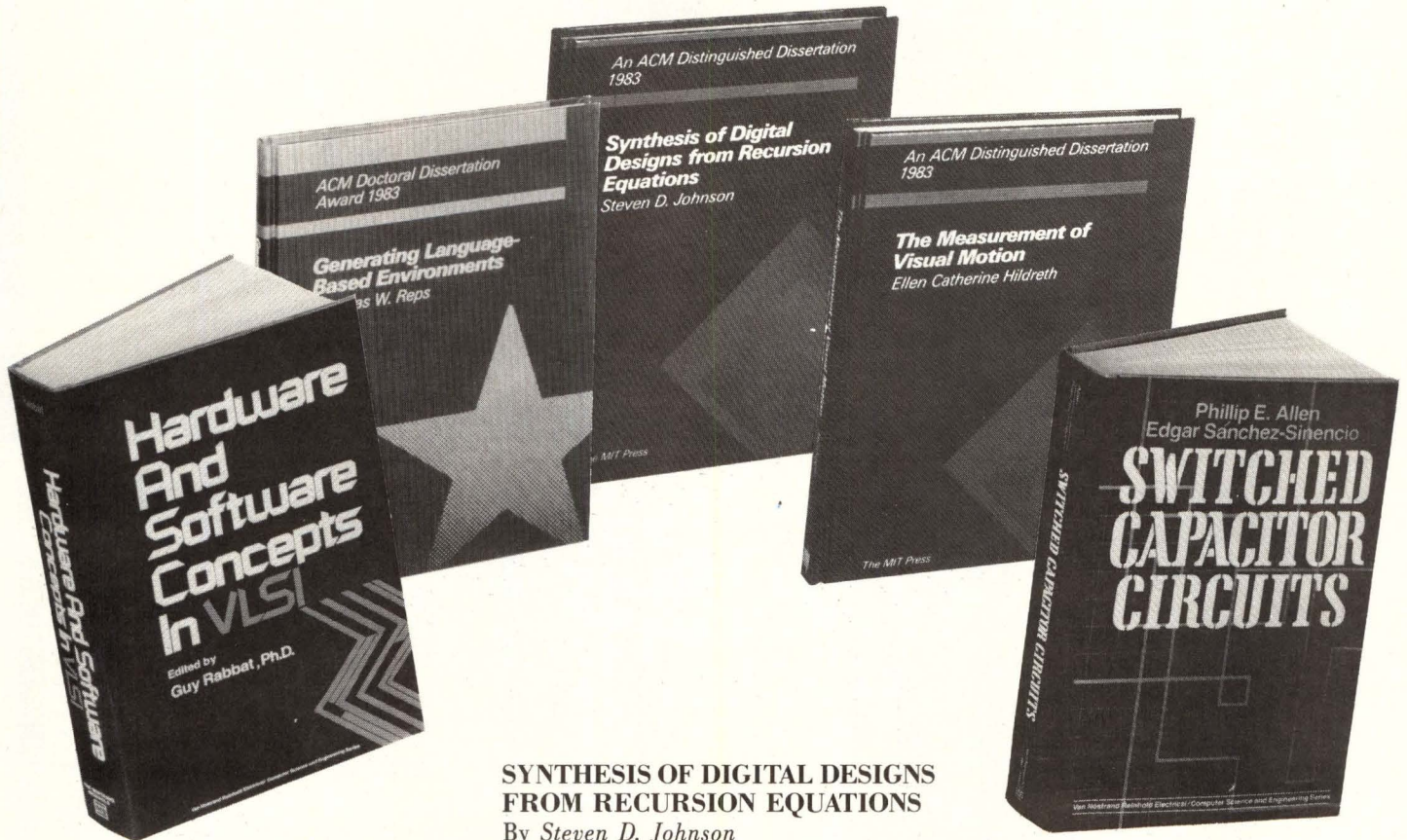

GENERATING LANGUAGE-BASED ENVIRONMENTS

By *Thomas W. Reps*

This book addresses a fundamental software engineering issue, applying formal techniques and rigorous analysis to a practical problem of great current interest: the incorporation of language-specific knowledge in interactive programming environments. It makes a basic contribution in this area by proposing an attribute-grammar framework for incremental semantic analysis and establishing its algorithmic foundations.

\$27.50

Circle 446

HARDWARE AND SOFTWARE CONCEPTS IN VLSI

By *Guy Rabbat*

Discover the most recent industrial advances in VLSI—very large-scale integration. This landmark guide is the first to provide detailed coverage of Josephson junction technology from the system, circuit, and device standpoints. Fully explored are key innovations such as masterslice bipolar design, computer-aided design, MOS technology, and electron-beam testing techniques.

\$42.50

Circle 445

SYNTHESIS OF DIGITAL DESIGNS FROM RECURSION EQUATIONS

By *Steven D. Johnson*

Defines a circuit description language that uses systems equations to state connectivity—systems that are, in fact, applicative programs that compute the logical behavior of the circuit described. An interpreter is then presented through which both specifications and target descriptions can be executed, allowing engineers to experiment directly with the design notation without having to translate into a simulation language or construct a physical prototype.

\$30.00

Circle 457

THE MEASUREMENT OF VISUAL MOTION

By *Ellen Catherine Hildreth*

The organization of movement in the changing image that reaches the eye provides our visual system with a valuable source of information for analyzing the structure of our surroundings. This book examines the measurement of this movement and the use of relative movement to locate the boundaries of physical objects in the environment. It investigates the nature of the computations that are necessary to perform this analysis by any vision system, biological or artificial.

\$30.00

Circle 458

SWITCHED CAPACITOR CIRCUITS

By *Phillip Edward Allen and Edgar Sánchez-Sinencio*

Find out how to design and use switched capacitor circuits for many applications. This one comprehensive source demonstrates the latest developments in circuit design, analysis, and implementation. It is the first dataguide to fully explain MOS analog integrated circuit design. Computer programs are included to help you design MOS devices.

\$56.50

Circle 459

HOW TO ORDER:
15-DAY FREE EXAMINATION
 (U.S. AND CANADA ONLY)
 Simply circle the appropriate number(s) on the Reader Inquiry Card at the back of this magazine.
 Your book will be sent to you for your **15-day free trial**. If you are satisfied, keep the book and an invoice will follow. Otherwise return the book by the end of the 15-day period, and owe nothing.

COMPUTER DESIGN'S

SYSTEM SHOWCASE

CIRCLE 475

for rates and information

CALL...

Shirley Lessard
(800)225-0556
in MA 486-9501



LIKE NEW PRODUCTS

For free catalog,
phone toll-free (800)225-1008
In Massachusetts (617)938-0900
GENSTAR REI SALES COMPANY
6307 DeSoto Ave, Suite J,
Woodland Hills, CA 91367.

CIRCLE 476

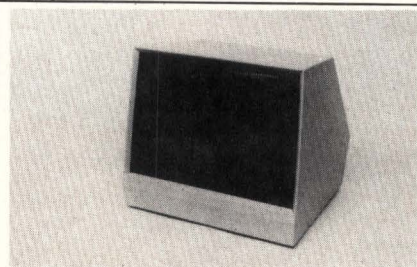

CUSTOM VIDEO TERMINALS

Our video terminal may be the solution to your custom video display requirement. They are available housed, in ASR, KSR, or RO form, or in configurations suitable for use in your system. Special data formats and protocols, multi-page display, graphics, and intelligent features are possible. We also have standard hardware to provide custom solutions for your non-display communications needs. Call today. **ENTERPRISE SYSTEMS CORP.**, Box 698, Dover, NH 03820. Tel: (603)742-7363.

CIRCLE 477

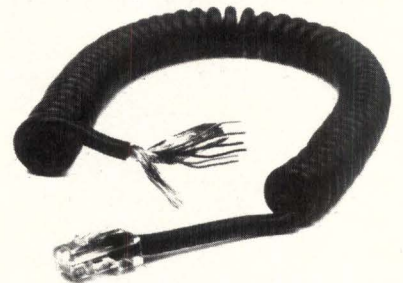

KEYBOARD/COMMUNICATION CABLES

Shielded cords for EMI/RFI Control Coil Cords, Line Cords, Flat or Round Modular Plug ended as you require • Single/Multiple twisted pairs • Aluminized mylar/drain wire • Served TinCu shield, Cond. nylon tapes • Multiple shielding combinations • Solderable pin and spade terminals • 4, 6, 8 position modular plugs. **MEYER WIRE CO, INC.**, 1072 Sherman Ave, Hamden, Conn 06514. Tel: (203) 281-0817. TWX 710-465-6390.

SHIELDED CORDS CIRCLE 478

6801 Test Bed & Programmer

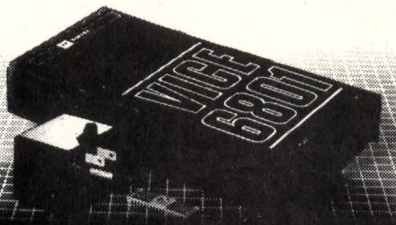

Virtual In-Circuit Emulator (VICE) develops single-chip microcomputer programs for the 6801/68701 and programs on-board EPROM. A cost and time effective way to program the 6801/68701 for \$695.

WINTEK
Wintek Corp.
1801 South Street
Lafayette, IN 47904
317-742-8428

CIRCLE 479



8048 IN-CIRCUIT EMULATOR

E232-48 emulates Intel compatible 8048, 8049, 8050 microcomputers and their ROMless and CMOS versions. It features:

- Real time emulation up to 11 Mhz.
- Hardware Breakpoints.
- RS-232 interface to host system.
- In-line Assembler and Disassembler.
- Complete debugging facilities.
- Software Drivers for IBM PC, CP/M-80, and CP/M-86 included at no extra cost.

E232-48 \$1795.00
Cross Assembler (8048 & others)
From 99.50

SIGNUM SYSTEMS, 726 Santa Monica Blvd, Santa Monica, CA 90401. Tel: (213) 451-5382

CIRCLE 480

COMPUTER DESIGN SUPER DECKS

- Now 90,000 circulation - 75,000 qualified Computer Design U.S. subscribers, plus 15,000 pass-along engineer inquirers
- Six mailings in '84 - January, March, May, July, September and November
- Less than a penny per card for 6 time users.
- Rates start at \$1195.00 and go down with frequency.
- Closing 21st of previous month of mailing.

Contact Shirley Lessard, Computer Design, 119 Russell St, Littleton, MA 01460. Tel: Toll Free (800)225-0556.

CIRCLE 481

AD INDEX

Able Computer.....	69
ADAC Corp.....	51
ACC.....	C4
Advanced Electronic Design.....	238
Advanced Micro Devices.....	C2
Airpax Corp.....	161
Alps Electric (USA).....	30, 31
American Hoechst Plastics.....	145
American Magnetics Corp.....	129
AMP.....	138, 139
Audiotronics.....	228
Auscom.....	220
Belden.....	219
BICC-Vero Electronics.....	149
Boston Systems Office.....	227
Burr-Brown Corp.....	215
Calcomp.....	24, 25
Callan Data Systems.....	49
Canon USA.....	212
Cherry Electrical Products.....	39
Chrislin Industries.....	46
Cipher Data Products.....	79
Communications Machinery Corp.....	65
Compower Corp.....	235
Computerwise.....	206
Computrol.....	16
CompuView Products.....	50
Convergent Technologies.....	196, 197
CSPI.....	26
Data General Corp.....	207
Dataram Corp.....	7, 142
Data Translation.....	86
Del-Tron Precision.....	206
Distributed Computer Systems.....	229
Distributed Logic Corp.....	154, 155
Diversified Technology.....	156
Dylon Data Corp.....	21
Dysan.....	222
Eagle Magnetic Co.....	217
Emulex.....	58, 59
Enterprise Systems Corp.....	256
Excelan.....	9
Fairchild Digital.....	45
Forward Technology.....	32
Foxfire Div, Intertec.....	259
Fujitsu America.....	99, 120
General Cable Co.....	236
General Dynamics, Data Systems Div.....	261
General Electric Plastics.....	93
General Systems Center.....	181
Genicom.....	122
Genstar REI Sales.....	256
Gould, Computer Systems Div.....	177

HOW TO SPEAK LOGIC FLUENTLY IN 3 LANGUAGES:



ABEL™ is the revolutionary new CAE software package from Data I/O that lets you design the way you think.

ABEL lets you specify logic designs for IFL, PROM, and PAL devices using any method or combination of state diagrams, Boolean equations, or truth tables.

So now, with ABEL, you can create logic designs in the language most natural for you...and fully realize the tremendous efficiencies and full potential of programmable logic.

ABEL. It's only logical. And it's ready to work with your IBM® PC (MS-DOS™ operating system) or Digital VAX® (using VMS® or UNIX®) right now.

Send for a tutorial disk.

See for yourself why ABEL is today's state-of-the-art CAE package. Send \$10 with this order form for an IBM PC-compatible ABEL tutorial disk. (Make checks payable to Data I/O.)

Name _____

Title _____

Company _____

Address _____

City _____ State _____ Zip _____

Telephone _____

Check here for ABEL spec sheets and application notes only.

10525 Willows Road NE/C-46
Redmond, WA 98052
Attn: ABEL Marketing

DATA I/O

ABEL is a trademark of Data I/O. The following trademarks are also acknowledged: IBM, International Business Machines; MS-DOS, Microsoft; VAX, VMS, Digital Equipment Corporation; & UNIX, Bell Laboratories.

AD INDEX

Gould, Design & Test Systems Div.....	248, 249	Plessey Microsystems.....	137
GTE Communication Systems.....	262	Power Products.....	239
Harris Microwave Semiconductor.....	84, 85	Preston Scientific.....	194
Harris Semiconductor/Digital Products.....	18, 19	Priam Corp.....	250, 251
Heurikon Corp.....	189	Pyramid Technology.....	52, 53
Hewlett Packard.....	72, 73, 118, 119, 182, 183	Qantex.....	200
Hitachi America, Ltd.....	12, 170, 171	Quantum.....	116, 117
Honeywell Digital Products Ctr.....	60	Real-Time Computer Science.....	40
Hunter & Ready.....	242	Rixon.....	95
Ibex.....	151	Rockwell International.....	124
Ibis Systems.....	186	Rogers Corp.....	68
Industrial Programming.....	172	RPM Corp.....	241
Intel Corp.....	42, 43, 184, 185	Samtec.....	57
Intel National Systems.....	263	Seagate Technology.....	102, 103
Iomega Corp.....	245	Seiko Instruments USA.....	81
ISI International.....	234	Shugart Corporation.....	10, 11
ITT Schadow.....	231	Signum Systems.....	256
Kennedy Co.....	1	Siggraph '84.....	252
Lear Siegler.....	233	Spectra Logic Corp.....	111, 113, 115
LISP Machine Inc.....	74	Step Engineering.....	193
Malco.....	109	Stevens-Arnold.....	237
Materials Development Corp.....	37	Structured Software Systems.....	223
MDB Systems.....	41	Tandon Corp.....	82, 83
Megatek.....	17	Tartan Laboratories.....	175
Megavault.....	208	Tektronix.....	14, 15
Memory Protection Devices.....	221, 224	Telex Computer Products.....	210
Meyer Wire Co.....	256	Texas Instruments.....	140, 141
Metacomp.....	4	Toshiba America.....	168, 169
Microcomputer Memories.....	54	Trilog.....	195
Microtek Lab.....	135	Universal Data Systems.....	104
Mitsubishi Electronics America.....	165	Vermont Research.....	167
Molex.....	264	Versatec, a Xerox Co.....	152, 153
Molon Motor & Coil Corp.....	217	Versitron.....	67
Multiwire.....	47	Western Digital.....	22, 23
National Semiconductor Corp.....	260	Wespergroup Div of Wespercorp.....	33
Navtel Ltd.....	205	Westrex OEM Products.....	218
NCR Corp.....	97	Wintek Corp.....	256
NCR Corp Tower.....	198, 199	Wyse Technology.....	179, 225
NEC Information Systems.....	70, 71	Xebec.....	100, 101
NEC Electronics USA.....	34, 35	Xycom.....	163
New Media Graphics.....	181	ZAX Corp.....	246, 247
Nissei Sangyo America, Ltd.....	240	Zetaco, division Custom Systems.....	89
Numerix.....	C3	Zeus Industrial Products.....	241
Oak Switch Systems.....	131	Zilog.....	191
Oasys.....	44		
Okidata.....	203		
Optelecom.....	38		
Orion Instruments.....	243		
PacTec.....	213		
Plasma Graphics Corp.....	216		

The AD INDEX is published as a service. The publisher does not assume any liability for errors or omission.

Home Office

119 Russell St., Littleton, MA 01460
(617) 486-9501

Marketing Director, Robert Billhimer
Ad Traffic Coordinator, Debra Friberg
Systems Showcase/Postcard Deck, Shirley Lessard
List Rental, Robert Dromgoole
Classified/Recruitment, Shirley Lessard

New England/Upstate New York

Barbara Arnold
119 Russell St., Littleton, MA 01460
(617) 486-9501

Mid-Atlantic/Southeast

Richard V. Busch
40 Stony Brook Lane, Princeton, N.J. 08540
(609) 921-7763
Eleanor Angone
74 Brookline Ave., E. Atlantic Beach, NY 11561
(516) 432-1955

Midwest & Colorado

Berry Conner
88 West Schiller St., Suite 2208, Chicago, IL 60610
(312) 266-0008

Southwest

Steve Lassiter
1200 S. Post Oak Blvd., Houston, TX 77056
(713) 621-9720

Southern California

Buckley/Boris Associates
Tom Boris, John Sabo
2082 SE Bristol, Suite 216, Santa Ana, CA 92707
(714) 957-2552

Northern California

Buckley/Boris Associates
Tom Boris, John Sly
920 Yorkshire Drive, Los Altos, CA 94022

Northwest

Buckley/Boris Associates
Tom Boris
2082 SE Bristol, Suite 216, Santa Ana, CA 92707
(714) 957-2552

International

International Sales Manager
Eric Jeter
1200 S. Post Oak Blvd., Houston, TX 77056
(713) 621-9720

U.K. and Scandinavia

David Betham-Rogers, David M. Levitt
tel: 222-0744
12 Caxton Street, Westminster, London SW1H 0QS

France, Belgium and S. Switzerland

Daniel R. Bernard—354-5535
Prominter, 247 rue Saint Jacques, 75005 Paris
telex: 250303 Public Paris
(Pour Prominter no. 9102)

Holland, Austria, W. Germany, Switzerland & Eastern Europe

Heinz Gorgens—0 21 53/89988, 89989
4054 Nettetal 1, West Germany, Krugerpfad 1

Japan

Sumio Oka & Shigeo Aoki—502-0656
International Media
Representatives Ltd.
2-29, Toranomom 1-chome
Minato-ku, Tokyo 105
telex: J22633

*(TM)

**“Let us be ready to take the field
whenever danger calls.”** JOHN HANCOCK

Training and readiness are vital for today's minute men too.
So is support from you, their employers. Write: Employer
Support of the Guard and Reserve, Arlington, VA 22209.
Protect their future while they protect yours.

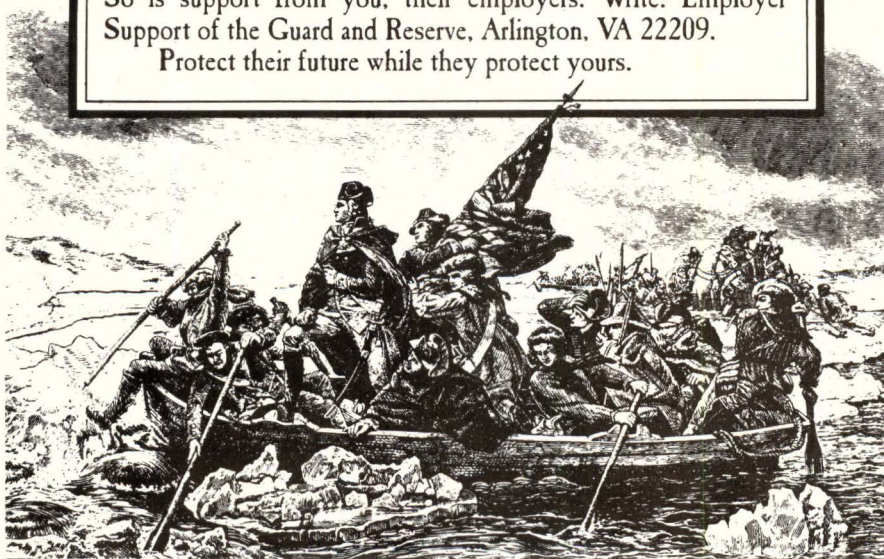

**EMPLOYER SUPPORT OF
THE GUARD & RESERVE**



A Public Service
Council of This Publication

**ELECTRONIC
PROFESSIONALS**

Our leading-edge R&D facility is enlarging its staff and is presently accepting resumes for several select positions. We urgently need Senior Level Micro-Programmers, Digital and Analog Engineers and have an immediate opening for a Firmware Programmer (Z80 and 8086 Assembly language-hardware experience a plus) and a Senior Micro-Processor Logic Designer (5-10 years of in-depth experience with Z80's, 8086's, etc., heavy emphasis on operating systems CP/M, MS-DOS). Also have openings for Analog and Digital Lab Technicians with a background in micro-processors-5 years of experience a minimum.

Our facility is located on the world famous resort of Hilton Head Island, South Carolina, and we offer one of the best compensation packages in the industry for individuals who can perform in a challenging R&D environment. RESPOND NOW! For prompt consideration submit a resume, including salary history and salary requirements, to:

**Support Services Manager
FoxFire
Development Center
P.O. Drawer 6628
Hilton Head Island, SC 29938**

All inquiries will be held in strictest confidence. We are an Equal Opportunity Employer.

The Series 32000™— The First Computer to Become a Chip.

National Brings Sophisticated Mainframe System Design Principles to Microprocessors.

The Series 32000* wasn't the first 16-bit microprocessor *per se*. But, unlike the competition, National designed the Series 32000 as one would design a computer — as a *system*.

This "top down" design approach enables us to lay claim to making the first computer that became a chip, instead of the other way around. And the reception by OEMs has been outstanding, to say the least.

What Does All This Mean to You?

The Series 32000 story should convince you that National is committed to developing and marketing the highest technology. If you share that commitment, consider these opportunities:

Product Engineering

Senior Microprocessor Applications Engineer

This is your opportunity to design systems based on the Series 32000, provide technical input to product planning and write application notes and articles. You should have a BSEE, or equivalent, plus at least 3 years' design experience.

Technical Marketing Specialist

In this challenging position, you will make detailed architectural and applications comparisons of the Series 32000 with other 32-bit microprocessors, write papers for trade press and conferences, and prepare and evaluate benchmark studies. Additionally, you will have the opportunity to work with engineering and with key customers in conceiving and introducing new products. A strong computer science background and some project management experience required, as well as good analytical, writing and speaking skills.

Section Head and Senior Engineers

You'll be directly involved with performance evaluation and improvement, characterization, chip-to-chip communication and new design evaluation for the Series 32000. Also involves intimate coordination with design, applications, systems integration and testing. Requires BS/MS/PhD in EE or CS, or equivalent, plus microprocessor experience, including testing and characterization. Packaging experience a plus.

Design Engineering

Senior Circuit Design Engineers

With design responsibility for National's Series 32000 circuits, this position provides the opportunity to work with advanced architectures and high-performance MOS technologies. You will be responsible for all phases of microprocessor circuit design, including logic and circuit design, project scheduling, circuit evaluation and resolution of testing issues. BS/MS/PhD in EE or CS, or equivalent, plus MOS/LSI design experience required, including experience in successfully transferring designs to production.

Get the Full Story.

The breadth of National's technologies, and the depth of our commitment to advancing those technologies, makes National the ideal place for you to pursue your career. Send your resume to National Semiconductor, Dept. MS, Professional Employment, P.O. Box 62499, Sunnyvale, CA 94088. We are an equal opportunity employer, m/f/h/v.

*Formerly NS16000 Family

*Together,
We'll Do Even
More.*

 **National Semiconductor**

SHAPE YOUR OWN FUTURE.



General Dynamics Data Systems Division helps shape the future of many significant programs at its major locations in San Diego, California; Fort Worth, Texas; and Norwich, Connecticut; as well as at satellite locations including Detroit, Michigan, and Pomona, California. We provide diverse support functions for such high-technology programs as the F-16 multimission fighter/attack aircraft, the M1 main battle tank, nuclear-powered submarines, and the entire family of cruise missiles. Throughout our division you'll find a variety of opportunities to apply your own scientific and engineering expertise

to create a more exciting future.

The Data Systems Division gives you the chance to join one of the most skilled teams in the industry today, and offers excellent salaries and benefits.

If you're interested in shaping your own future on our innovative support team, one of our opportunities listed below may be just right for you.

For immediate consideration, send your resume to the Vice President/Director at the Data Center of your choice.

PRODUCT SOFTWARE

- Bachelor's and/or Master's degree, and 3-8 years' experience.
- SKILLS: FORTRAN, JOVIAL, PASCAL, Ada, Assembly Languages, Applied Math, Data Bases, Operating Systems, Documentation (MIL Standards).
- APPLICATIONS: Command & Control Software (Guidance, Navigation, C³I, Display Systems, Executive & System Support Software), Mission Planning, Data Handling & Communication, Automatic Testing Equipment/Simulations, Image Processing, Estimation & Control Theory.
- Embedded Systems: Real-Time Software.

CAD/CAM

- Bachelor's and/or Master's degree, and 3-8 years' experience.
- SKILLS: FORTRAN, Ada, Assembly Languages, IBM, CDC & VAX Operating Systems, Computational Geometry, Information Modeling & Data Dictionaries.
- APPLICATIONS: Turn-key Graphic Systems, Solid Modeling, Robotics, CNC-DNC, Real-Time Processing Control, Group Technology.
- CADAM, CAT/A, Computervision, SC/CARDS, Model 204, Systems Engineering, Group Management.

ENGINEERING SYSTEMS

- Bachelor's and/or Master's degree, and 3-8 years' experience.
 - SKILLS: Simulation Languages, FORTRAN, COBOL & IBM Assembler, TSO, SPF, DISSPLA, RAMIS, Scientific Programming and Microcomputer experience.
 - APPLICATIONS: Simulation, SLAM, Manufacturing, Operations Research, Image Processing, Graphics Application Development, Sneak Circuit Analysis, Program Marketing.
- U.S. CITIZENSHIP REQUIRED
Equal Opportunity Employer, M/F

GENERAL DYNAMICS *Data Systems Division*

WESTERN CENTER
P.O. Box 85808, Drawer 002
San Diego, CA 92138

CENTRAL CENTER
P.O. Box 748, Drawer 002
Fort Worth, TX 76101

EASTERN CENTER
100 Winnenden Rd., Drawer 002
Norwich, CT 06360



...The Key To Our Success!

And a successful career begins here in Phoenix with GTE Communication Systems. A vast network of 31,130 acres of major lakes within an 80 mile radius of Phoenix affords the opportunity of sailing year round, water skiing, boating and fishing. Arizona also ranks #1 nationally per capita in boat ownership, and you can add your name to the list. All this...and GTE too!

We offer the latest in telecommunications technology plus the chance of becoming a contributing member of our team where professional advancement is limited only by your own initiative. If you're an engineering professional in Computer Science, Electrical Engineering or related field with three or more years of experience in telecommunications design and development and are interested in upgrading your career and your lifestyle, we invite your inquiry.

Please send your resume or letter of qualifications to:
GTE Communication Systems,
Manager Human Resources, Dept. 8915,
W. Utopia Road, Phoenix, Arizona 85027. An
equal opportunity employer m/f/h.

PEOPLE



**Communication
Systems**

Working Together To Be The Best

SOFTWARE & HARDWARE SYSTEMS CAREER OPPORTUNITIES

PROGRESS...The Only Constant In Leadership

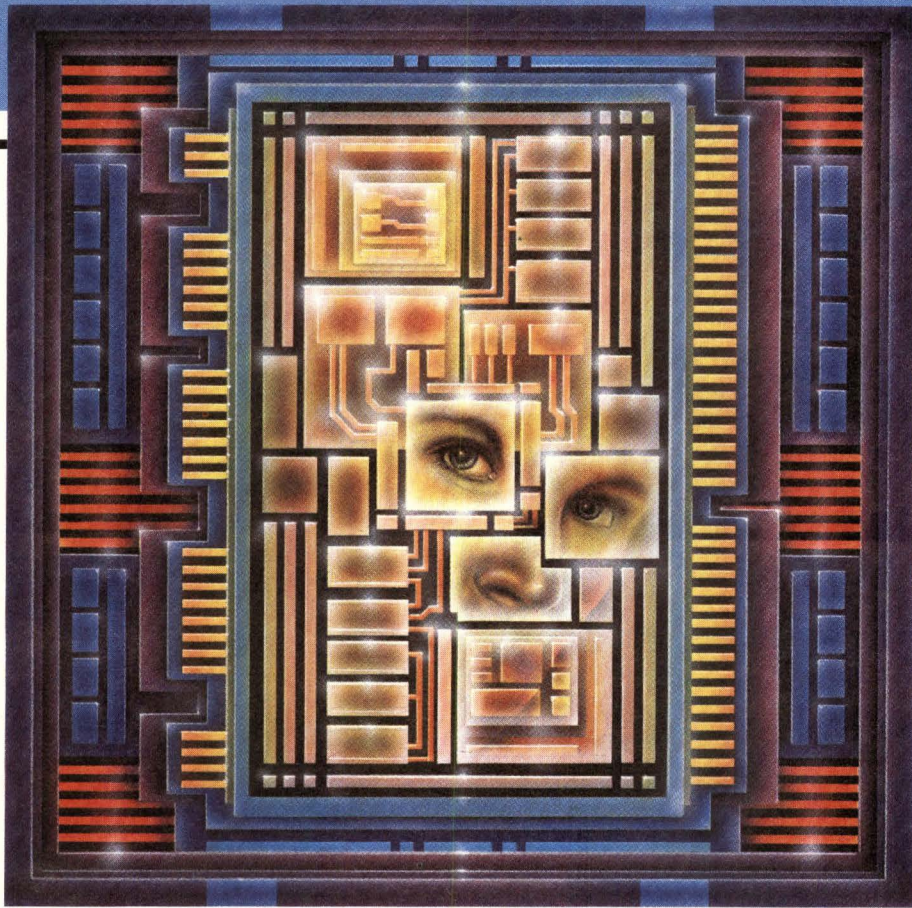

Progress, the by-product of innovation, is an Intel tradition. This leadership quality is well documented on the components side. Now, we're putting that same tradition to work in the area of systems with advancements such as our super-powerful, supermicro system for OEMs, the 286/310, to date the most powerful we've ever made. When it comes to systems integration, we're out in front with our iDIS Database Information System. Our iTAPS Transaction Processing System handles up to 16 users and allows for the development of individual application software 50% faster.

While we have grown in size, strength and technology, we have not lost sight of the qualities that put us out in front. You will still find a highly charged atmosphere of discovery and mutual respect. We still place a high premium on finding people who have inquiring minds, strong technical skills, and the ability to adapt quickly to

changing situations. If you're an engineer involved with **SOFTWARE EVALUATION, PRODUCT MARKETING, HARDWARE SYSTEMS, DIAGNOSTICS, CUSTOMER SERVICE, SYSTEMS SOFTWARE, CAD, PRODUCT EVALUATION, GRAPHICS, HIGH-LEVEL LANGUAGES, OPERATING SYSTEMS, COMPILER, RELIABILITY, TECHNICAL MARKETING, or DATABASE MANAGEMENT SYSTEMS**, and want to see your work integrated into sophisticated new systems, let's talk.

Intel offers competitive compensation, advancement based on achievement, and the chance to work with some of the best minds in American industry. For consideration at Intel sites in Phoenix, AZ; Santa Clara, CA; Portland, OR; and Austin, TX, please direct your response to: Mike Gore, Intel Corporation, Dept. 8828, 2402 W. Beardsley Rd., Phoenix, AZ 85027. All inquiries will be answered promptly and held in strict confidence. An Equal Opportunity Employer M/F/H.

intel[®]

C-Grid: the Molex .100" x .100" PCB interconnection system.

Shortest Leadtimes in the Industry

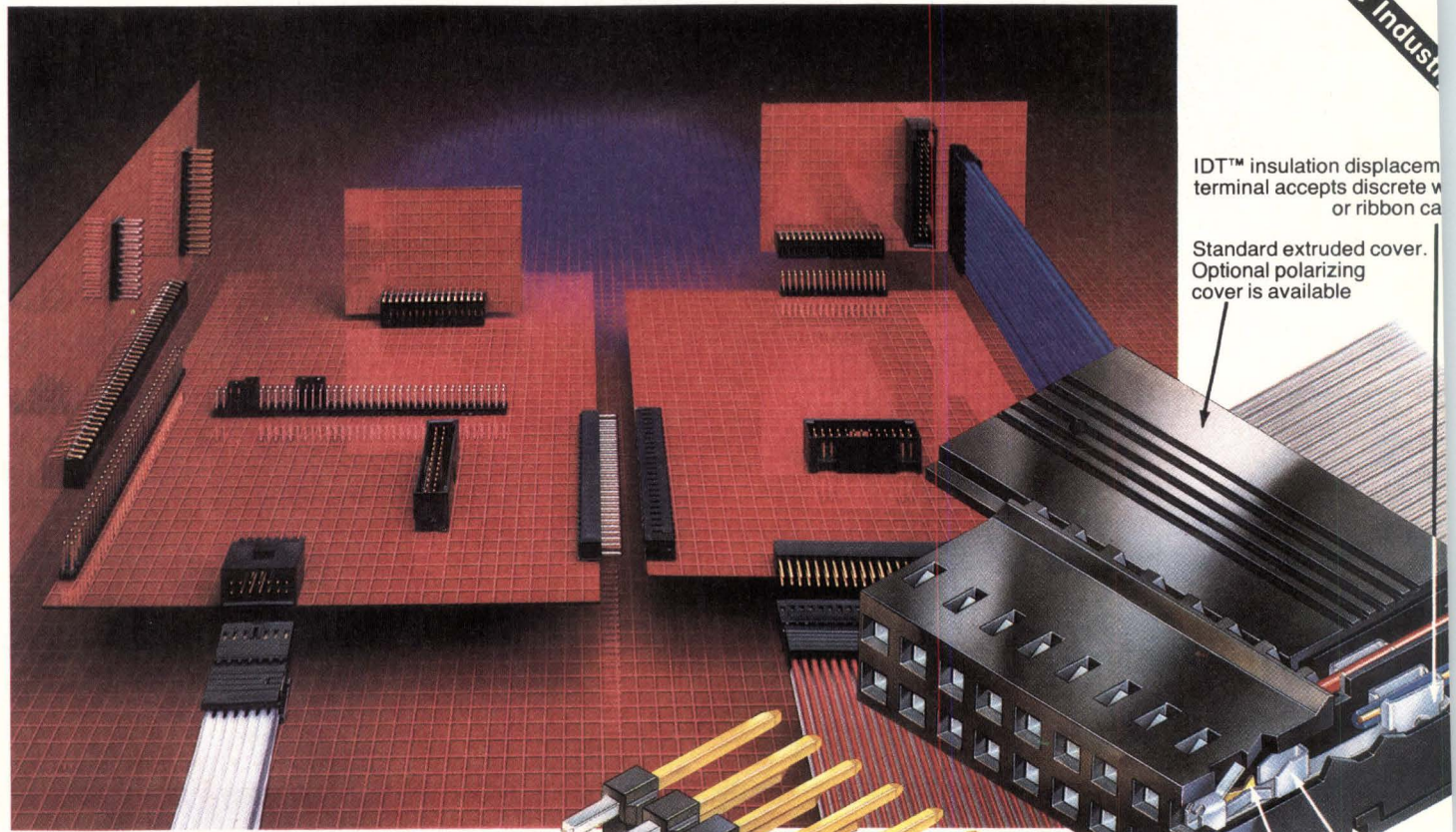

IDT™ insulation displacement terminal accepts discrete wire or ribbon cable

Standard extruded cover. Optional polarizing cover is available

Tin plated for improved solderability

Pin stop

Selective gold plating on contact area of dual beam contact terminal

.025" selectively gold plated-square wire pins

Segmented wafer body separates into smaller units

UL 94V-0 material

C-Grid is the most advanced high density interconnection system Molex has ever designed for board-to-board, wire-to-board and wire-to-wire applications. It features selective plating, for the highest performance at the lowest cost, and offers you a wide variety of companion products for convenient design flexibility and reliability.

The C-Grid system achieves its high density capability by using .025" (0,64mm) square pins for the male connector parts, set in a .100" x .100" (2,54 x 2,54mm) matrix. The pins can either be placed directly in the board or used in volume with wafer bodies.

To load loose pins into the PCB board, Molex offers a patented single- or Multi-Pinsetter® capable of up to 156,000 insertions per hour — the fastest on the market.

Shrouded and unshrouded headers are available in straight and right-angle wafer bodies.

The #8676 dual-row, insulation displacement connectors are stackable, end-to-end, and feature IDT™ terminals with mass termination application tooling available to help you achieve greater cost savings in your assembly operations.

Molex closed-or open-end shunts make it easier and less expensive to retrofit board circuitry by avoiding DIP switches.

Molex also offers a female connector (7990-series) to be soldered to one board and mated with the .025" (0,64mm) pins on another. Its features include low mating force, ease of insertion and improved solderability.

For more information on our C-Grid interconnection system, contact the Molex office nearest you.

First in Customer Service ...Worldwide

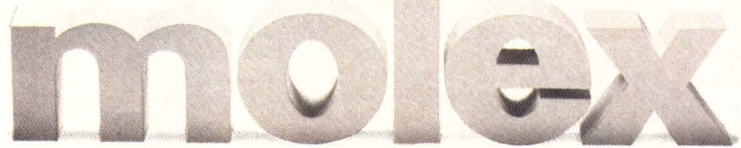

Corporate Headquarters: 2222 Wellington Court, Lisle, Illinois 60532 Phone: (312) 969-4550 Telex: 27-0072/25-4069
 European Headquarters: Molex House, Church Lane East, Aldershot, Hants, England GU11 3ST Phone: (0252) 318221 Telex: 851858988
 Far Eastern Headquarters: 5-4, 1-Chome Fukami-Higashi, Yamato-Shi, Kanagawa Pref., Japan Phone: (462) 614500 Telex: 781-03872486

The fastest...the largest memories... the easiest to program...

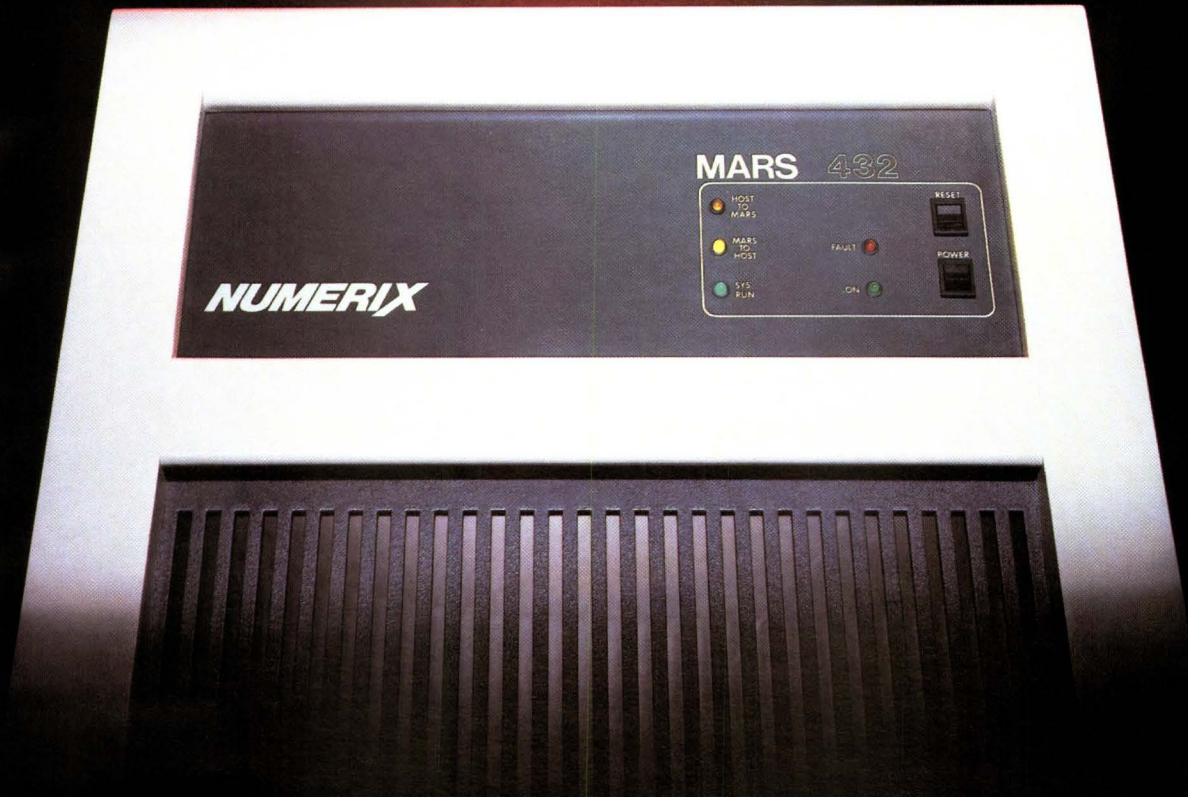

MARS-432 Array Processor Speed

A high-speed programmable arithmetic processor used as a peripheral to a general purpose computer.

The state of the art in 32-bit floating point array processors. Direct addressability of up to 16 million words (64 megabytes) of data memory and direct access to the high-speed internal data bus assure the user of highest throughput rates.

MARS-432 Array Processor Features Include:

- Add and multiply times of 100ns
- Computational power of 30 megaflops
- Computes a 1024-point complex FFT in 1.7ms
- DMA transfers at I/O bus rates of 20 megabytes/sec
- Data memory read or write in 100 ns
- Memory paging for uninterrupted processing during I/O transactions.

MARS-432 Array Processor Memories

Program and data memories compatible with programs written for today's array processor applications.

Program Memory

Virtual and physical address space of 4K words—standard. Expanded configuration uses a 4K cache memory to extend total memory to 64K words.

Data Memory

Data I/O is supported by DMA transfers into data memory with a physical address space of 16 million words. A data memory page-loading feature provides the option of zero overhead background loading of data during time critical program execution. No DMA cycle stealing overhead is incurred. Uninterrupted processing can occur simultaneously with high-speed I/O transfers.

MARS-432 Array Processor Software

An architecture specifically designed to support a FORTRAN compiler and other software development tools.

FORTRAN Development System (FDS)

FORTRAN compiler, linker, and trace/monitor provide high-level language access to the MARS-432.

Microcode Development System

Off-line development package includes macro-assembler, microcode diagnostics, and a unique utility for automatic microcode optimization.

AP Run Time Executive Support Package (AREX)

As the interface to the MARS-432 at run time, AREX provides processor initialization, I/O operations, and array function execution.

Applications Libraries

Extensive applications libraries include math, signal processing, and image processing.

NUMERIX

For additional information on the MARS family of high-speed Array Processors, write or call:
Numerix Corp., 320 Needham Street, Newton, MA 02161 Tel. 617-964-2500 TELEX 948032

**Network Designers—
Introducing the simplicity
of a Remote Procedure Call
...ACCES XNS.**

ACCES XNS is ACC's networking protocol package ready for use on popular minicomputers and work stations. It links applications and system level programs to data files and processing services in your distributed computer environment...through simple Remote Procedure Calls.

The ACCES XNS Protocol Package adheres to Xerox protocol standards: Courier, SPP, and IDP—making it compatible with other standard products, present and future.

Whether you are responsible for designing a communication environment around your company's product line, or interconnecting your company's computer resources, ACCES XNS meets your network design requirements.

To learn more about ACCES XNS, Courier, and Remote Procedure Calls, phone ACC at (805) 963-9431 and we'll gladly send you the ACCES XNS Brochure.

We Make Advanced Computers Communicate.



```
GET_FILE, TRUE, TIMEOUT);  
(STRING, "backup_file");  
& Trnld) == RETURN  
VGCARD, &FileSize);  
, &Count) != C_EOM)  
utfd, buffer, 512);  
fd, buffer, Count);
```

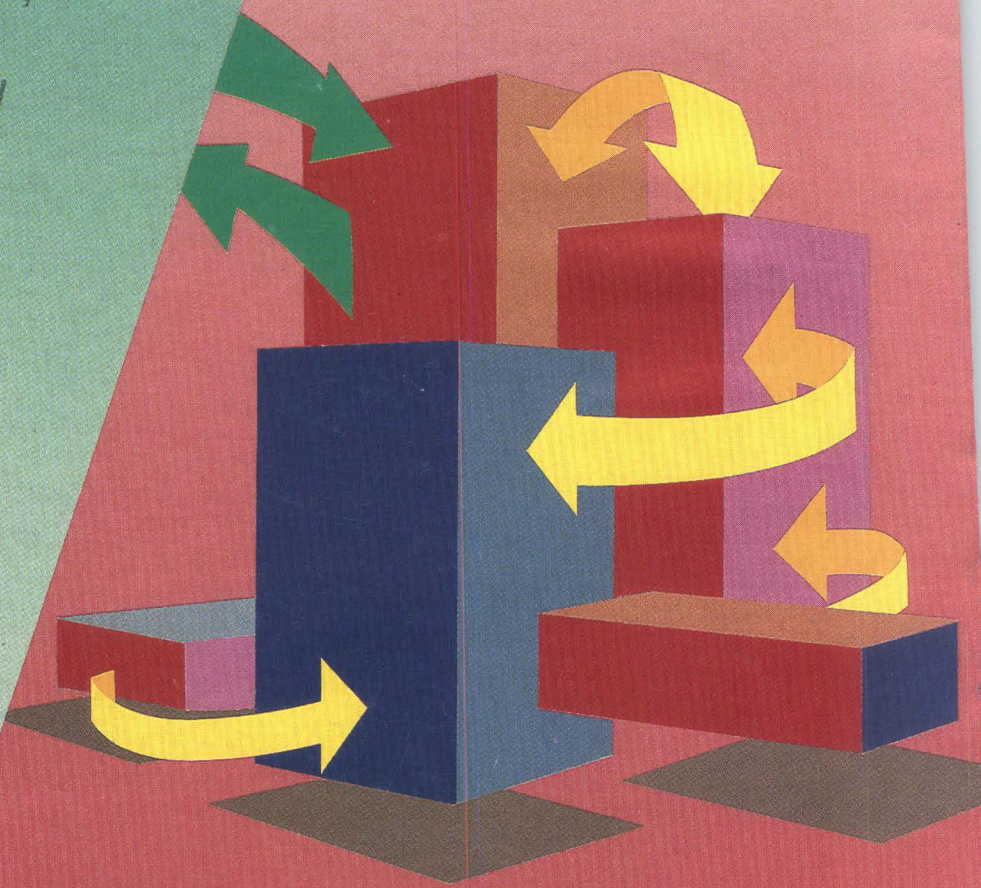

© ACC 1984
ACC is a trademark of Advanced Computer Communications.
Xerox is a trademark of Xerox Corporation.
ACCES is an acronym for Advanced Computer Communications Exchange System.



**Advanced Computer
Communications**

720 Santa Barbara Street
Santa Barbara, CA 93101
(805) 963-9431
TWX 910 334-4907