



Cii Honeywell Bull

PRODUCT SPECIFICATION

D 140 DISK DRIVE

OEM SALES

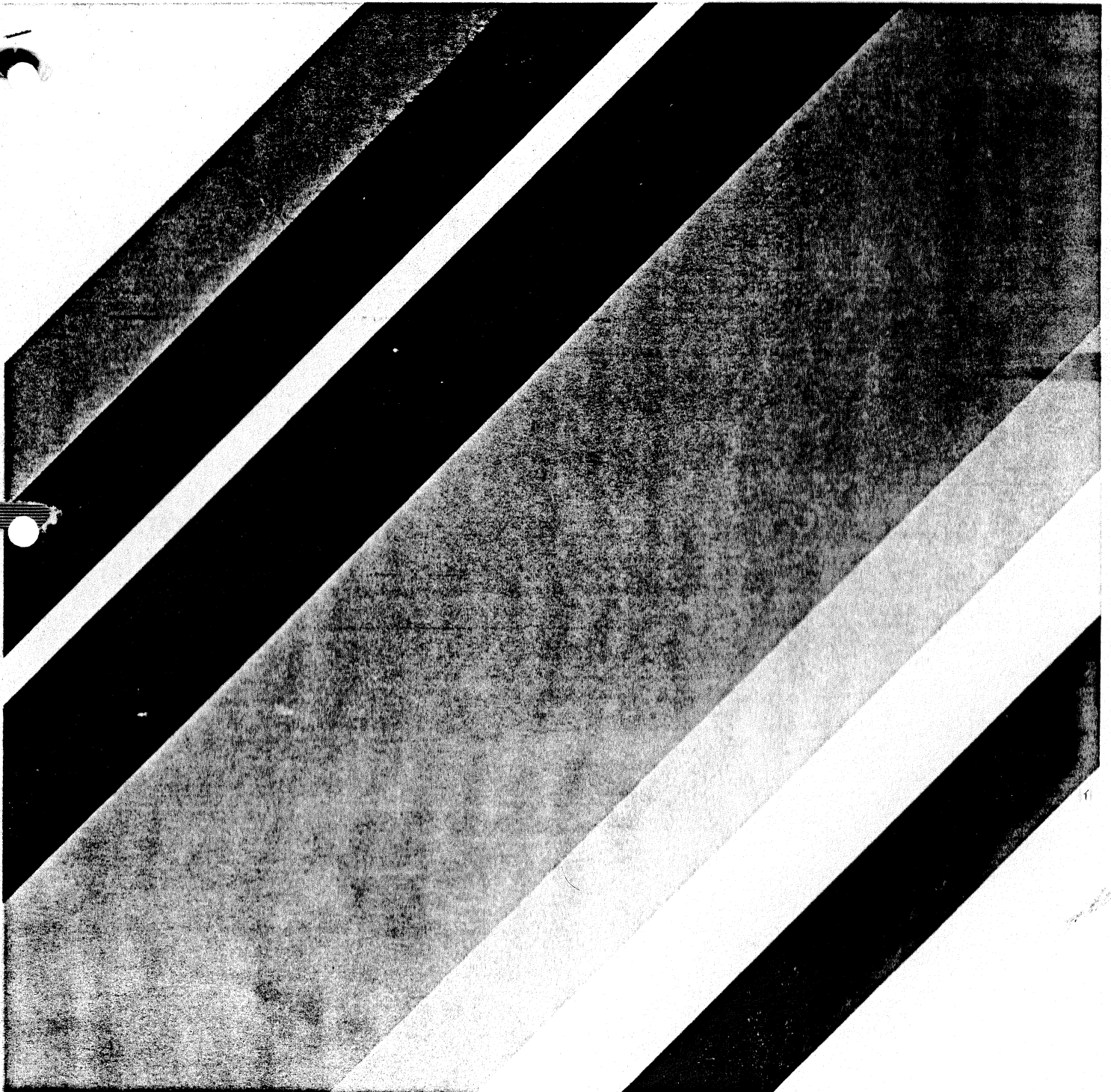

OEM PRODUCT SPECIFICATION
FOR THE D140 FIXED AND
REMOVABLE DISK DRIVE

document reference N° BEM 1208

issue A0, JUNE 1979

Cii Honeywell Bu11
OEM SALES
6, AV. DES USINES
90001 BELFORT/FRANCE

CE DOCUMENT DOIT ETRE CONSIDERE COMME ETANT D'USAGE
INTERNE A CII-HB. IL NE PEUT ETRE COMMUNIQUE A DES TIERS
SANS AUTORISATION EXPRESSE DE CELLE-CI



Cii Honeywell Bull

COMPAGNIE INTERNATIONALE POUR
L'INFORMATIQUE CII-HONEYWELL BULL

D140 OEM PRODUCT
SPECIFICATION

SPEC. NO.

BEM 1208

FOLIO

2

REV.

A0

LIST OF ILLUSTRATIONS

Figure	1	M 4120 Cartridge	9
	2	Track Format	11
	3	Sector Format	12
	4	Start Cycle	17
	5	Stop Cycle	18
	6	Interface Block Diagram	21
	7	Interface Lines Diagram	25
	8	Index/Sector Timing	31
	9	Address/Strobe Timing	32
	10	Read Enable Timing	33
	11	Write Enable Timing	33
	12	Data Clock Timing	34
	13	Valid sector/Address Timing	35
	14	Logic Cable Connector	37
	15	Power Connector	40
	16	Installation Mounting	44
	17	Connectors Location	45

LIST OF TABLES

Table	1	Address Lines and Strobes	23
	2	Logic Connector J04 Pin Assignment	38
	3	Logic Connector J01 Pin Assignment	38
	4	Drive Power Requirements	39
	5	Operating Environment Limits	42

CE DOCUMENT DOIT ETRE CONSIDERE COMME ETANT D'USAGE INTERNE A CII-HB. IL NE PEUT ETRE COMMUNIQUE A DES TIERS SANS AUTORISATION EXPRESSE DE CELLE-CI

TABLE OF CONTENTS

1. GENERAL DESCRIPTION	
1.1 Product Description	5
1.2 Standard Equipment	5
1.3 Optional Equipment	5
1.4 Accessories	5
2. PERFORMANCE	
2.1 Access Characteristics	6
2.2 Data Capacity	6
2.3 Data Transfer Rate	7
2.4 Recording Parameters	7
2.5 Disk	7
2.6 Head	7
2.7 Spindle	7
2.8 Start/Stop Times	7
2.9 Data Security	7
2.10 Error Rate	8
2.11 Device Fault	8
3. MEDIA	
3.1 Cartridge	9
3.2 Fixed Disk	10
3.3 Removable Disk	10
3.4 Cartridge Compatibility	10
4. DATA FORMAT	
4.1 General	11
4.2 Track Format	11
4.3 Sector Format	12
5. OPERATION	
5.1 General	14
5.2 Cartridge Loading	14
5.3 Start/Stop	14
5.4 Cartridge Unloading	14
5.5 Head Loading/Unloading	14
5.6 Initialization Seek	15
5.7 Seek Operation	15
5.8 Write Operation	15
5.9 Read Operation	15

CE DOCUMENT DOIT ETRE CONSIDERE COMME ETANT D'USAGE INTERNE A CII-HB. IL NE PEUT ETRE COMMUNIQUE A DES TIERS SANS AUTORISATION EXPRESSE DE CELLE-CI



Cii Honeywell Bull

COMPAGNIE INTERNATIONALE POUR L'INFORMATIQUE CII-HONEYWELL BULL

D140 OEM PRODUCT SPECIFICATION

SPEC. NO.

BEM 1208

FOLIO

4

REV.

A0

5.10	Index Mark	16
5.11	Sector Mark	16
5.12	Operator Controls	19
5.13	Write Protect Option	19
6.	<u>INTERFACE</u>	
6.1	Interface Definition	20
6.2	Input Signals to Drive	22
6.3	Output Signals from Drive	26
6.4	Interface Timing	34
6.5	Receivers/Drivers	36
6.6	Interface Cable	36
6.7	Logic Connector	36
7.	<u>ELECTRICAL REQUIREMENTS</u>	
7.1	Input Power Supplies	39
7.2	Input Power Connector	40
7.3	Grounding	41
7.4	Power Consumption	41
8.	<u>PHYSICAL CHARACTERISTICS</u>	
8.1	Dimensions	41
8.2	Weight	41
8.3	Finish Requirements	41
8.4	Nameplate	41
9.	<u>INSTALLATION</u>	
9.1	Environment Conditions	42
9.2	Installation	43
10.	<u>RELIABILITY</u>	
10.1	Mean Time Between Failures	44
10.2	Mean Time to Repair	46
10.3	Useful Life	46
11.	<u>MAINTENANCE</u>	
11.1	Preventive Maintenance	47
11.2	Maintenance Documentation	47
11.3	Special Tooling	47
11.4	Recommended Spare Parts	47
12.	<u>HANDLING, PACKING, TRANSPORTATION</u>	48

CE DOCUMENT DOIT ETRE CONSIDERE COMME ETANT D'USAGE INTERNE A CII-HB. IL NE PEUT ETRE COMMUNIQUE A DES TIERS SANS AUTORISATION EXPRESSE DE CELLE-CI



Cii Honeywell Bull

COMPAGNIE INTERNATIONALE POUR
L'INFORMATIQUE CII-HONEYWELL BULL

D140 OEM PRODUCT
SPECIFICATION

SPEC. NO.

BEM 1208

FOLIO

5

REV.

A0

1. GENERAL DESCRIPTION

1.1 PRODUCT DESCRIPTION

The D140 is a moving head with removable and fixed disks intended for small business systems, visible record computers, mini-computers, process control and terminal systems. It is available in table-top and standard 19 inch rack mounting versions.

1.2 STANDARD EQUIPMENT

The D140 in its standard form comprises the following components:

- Disk motor and drive mechanism
- Fixed disk
- Read/write heads, carriage and voice coil motor
- Head loading mechanism
- Cartridge loading mechanism
- Four printed circuit boards for :
 - logic + analogic and interface circuits
 - read/write amplifiers
 - voice coil control circuits
 - spindle motor power circuits
- Front loading door : comprising door + cover panel with viewing window to read cartridge edge label.

1.3 OPTIONAL EQUIPMENT

- Write protect function - fixed disk
- Write protect function - removable disk
- Controller.

1.4 ACCESSORIES

No cables nor connectors are supplied with the drive. They can be ordered separately as below:

- 1 - Logic cable assembly (maximum length : 3 m) comprising two edge connectors, type Cii HONEYWELL BULL and a flat cable. Two cable assemblies are required per drive.
- 2 - Power cable connector.
- 3 - Logic cable connector.



Cii Honeywell Bull

COMPAGNIE INTERNATIONALE POUR
L'INFORMATIQUE CII-HONEYWELL BULL

D140 OEM PRODUCT
SPECIFICATION

SPEC. NO.

BEM 1208

FOLIO

6

REV.

A0

2. PERFORMANCE

2.1 ACCESS CHARACTERISTICS

2.1.1 Positioning Times

All positioning times are measured from seek initialization to the on track condition.

The maximum single track positioning time is 15 ms. This is defined as the time to move the head between any pair of adjacent tracks.

The average positioning time is 75 msec. This is defined as the time taken to make all possible moves divided by the number of all possible moves.

2.1.2 Head to head switching time : 30 ms on the same disk.

: 47 ms max. with disk change.

2.1.3 Latency time

The average latency time is 8.33 msec, based on the nominal disk speed of 3600 rpm.

The maximum latency time is 17.20 msec, based on a disk speed of 3492 rpm (3600 - 3%). Latency time is defined as the time required to reach a particular sector location after positioning is complete.

2.2 DATA CAPACITY

The data capacity specified is based on the number of bytes that are recorded on a track, i.e., the useful or formatted capacity. This does not include the allowances for gaps, servo-track zone, data mark, data control and disk speed tolerance.

DATA CAPACITY - FORMATTED

	<u>Removable</u>	<u>Fixed</u>
Bytes/sector	: 256	256
Bytes/track	: 12,800	12,800
Bytes/surface	: 5 Megabytes	5 Megabytes
Bytes/disk	: 10 Megabytes	10 Megabytes
Total capacity :		20 Megabytes

CE DOCUMENT DOIT ETRE CONSIDERE COMME ETANT D'USAGE INTERNE A CII-HB. IL NE PEUT ETRE COMMUNIQUE A DES TIERS SANS AUTORISATION EXPRESSE DE CELLE-CI



Cii Honeywell Bull

COMPAGNIE INTERNATIONALE POUR
L'INFORMATIQUE CII-HONEYWELL BULL

D140 OEM PRODUCT
SPECIFICATION

SPEC. NO.

BEM 1208

FOLIO

7

REV.

A0

2.3 DATA TRANSFER RATE

Nominal bit rate : 7.35 MHz (919 kbytes/second)

2.4 RECORDING PARAMETERS

Mode : MFM
Density (inner track) : 4758 bpi nominal

2.5 DISKS

Disk type : Fixed + removable in dustproof cartridge
Recording surfaces : 4 (2 per disk)
Tracks per surface : 392
Disk diameter : 10.50 in.
Track spacing : 508 TPI (0.00197 in. nominal or 20 tracks per mm.)

2.6 HEADS

Recording heads : 4
Read/write function : no erase gap

2.7 SPINDLE

The spindle speed is 3600 rpm \pm 3% rpm.

2.8 START/STOP TIMES

Start time : The start time is 30 seconds max. This is the time between the start command (RUN at low level) from the controller and the READY TO SRW signal from the drive.

Stop time : Stop time is 30 seconds max. When power is present, it is the time between the dispatch of the control stop signal (RUN at HIGH level) and the drive response with CARTRIDGE ACCESS - i.e., the access door can be opened for cartridge changing.

2.9 DATA SECURITY

Data is protected by inhibiting the write current in all fault conditions (see § 6.36, write and seek circuit malfunctions). In the event of a low spindle speed the heads are unloaded; in the case of loss of power, the heads are unloaded, the motor is stopped and the write circuits are disabled.

 Cii Honeywell Bull COMPAGNIE INTERNATIONALE POUR L'INFORMATIQUE CII-HONEYWELL BULL	D140 OEM PRODUCT SPECIFICATION	SPEC. NO. BEM 1208	FOLIO 8	REV. A0
---	---	------------------------------	-------------------	-------------------

Internal interlocks prevent the operator from exchanging the cartridge before the disk is fully stopped.

2.10 READ ERROR RATE

2.10.1 Recoverable Read Errors

A recoverable read error is one which may be corrected in 3 or less attempts to read a record. The recoverable error rate is not more than one in 10^9 bits transferred.

2.10.2 Irrecoverable Read Errors

An irrecoverable read error is one which cannot be corrected after 3 attempts at reading a record. The irrecoverable error rate is not more than one in 10^{11} bits transferred.

2.10.3 Environmental Errors

When operation is at a low effective data transfer rate, i.e., random access of short single periods, the apparent error rate may be expected to exceed the above limits due to external environmental interference. The resulting recoverable read error rate will be less than one error in eight hours of operation.

2.11 DEVICE FAULT

A Device Fault is said to be recoverable when it can be corrected in one try after resetting the FAULT latch with a FAULT RESET or INITIALIZE signal. The recoverable Device Fault must not exceed one in 10^5 seeks.

2.12 NOTES

Read error rate calculations and Device Fault do not take into account error conditions due to:

- a controller malfunction
- the use of a damaged or non-certified cartridge

Any error exceeding the above stated Read Error rate of the Device Fault is considered as a device failure requiring repair action, or indicates that a defective cartridge has been used.

CE DOCUMENT DOIT ETRE CONSIDERE COMME ETANT D'USAGE INTERNE A CII-HB. IL NE PEUT ETRE COMMUNIQUE A DES TIERS SANS AUTORISATION EXPRESSE DE CELLE-CI



Cii Honeywell Bull

COMPAGNIE INTERNATIONALE POUR L'INFORMATIQUE CII-HONEYWELL BULL

D140 OEM PRODUCT SPECIFICATION

SPEC. NO.

BEM 1208

FOLIO

9

REV

A0

3. MEDIA

3.1 CARTRIDGE

The D140 disk drive uses a M 4120 cartridge (Cii Honeywell Bull reference) or any qualified cartridge allowing the same performance. The cartridge is 283 mm (11.1 in.) wide, 285 mm (11.2 in.) deep by 23 mm (0.9 in.) thick, and weighs 1.3 kg (2.8 lb).

For protection against dust and shocks, the cartridge, when stored, is completely closed and dustproof with the disk immobilized. The cartridge is front loading.

The cartridge can be stored on a shelf - book storage, or may be hooked on rails using the special notch provided. A depression in the cartridge is used when the write protect option is fitted - see paragraph 5.12.

The customer may affix his own labels using the special zones provided on the cartridge.

For further details of the cartridge, refer to M 4120 Cartridge Product Specification, document N° BEM 1176.

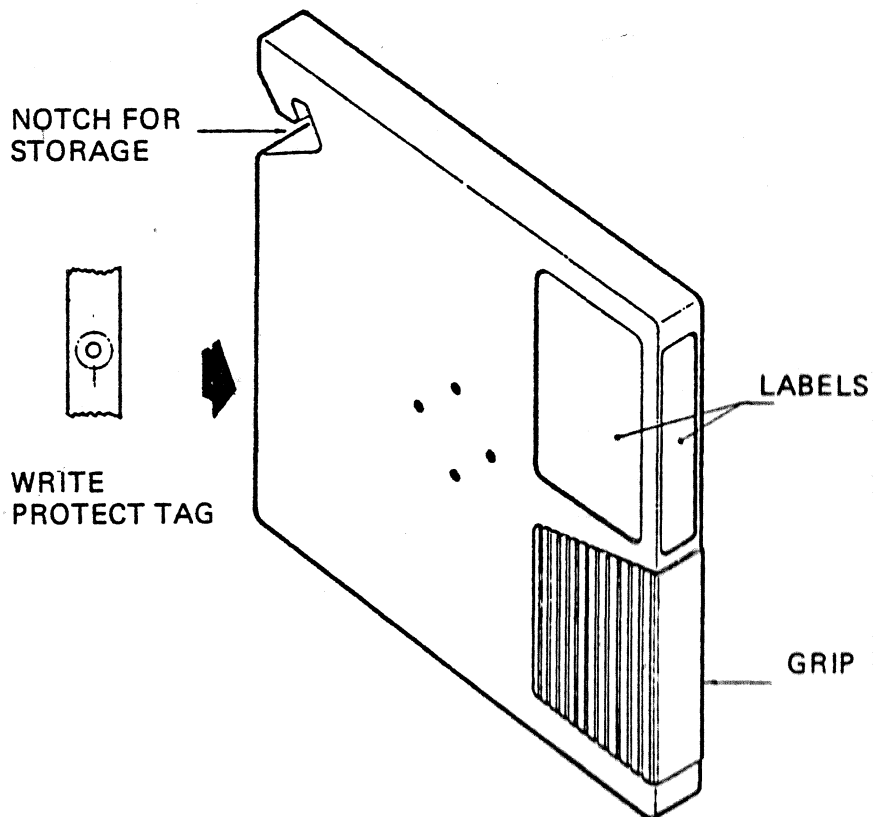

Figure 1 - M 4120 Cartridge

CE DOCUMENT DOIT ETRE CONSIDERE COMME ETANT D'USAGE INTERNE A CII-HB. IL NE PEUT ETRE COMMUNIQUE A DES TIERS SANS AUTORISATION EXPRESSE DE CELLE-CI



Cii Honeywell Bull

COMPAGNIE INTERNATIONALE POUR
L'INFORMATIQUE CII-HONEYWELL BULL

D140 OEM PRODUCT
SPECIFICATION

SPEC. NO.

BEM 1208

FOLIO

10

REV.

A0

3.2 FIXED DISK

The fixed disk is an industry standard disk of 10.5 in. diameter, oxide coated on both sides. The disk is pre-recorded with head servo data, track address, address parity and a defective sector flag and is supplied ready for use. See paragraph 4 for full details on data format.

3.3 REMOVABLE DISK

The removable disk contained in the cartridge has the same characteristics as the fixed disk (see paragraph 3.2).

3.4 CARTRIDGE COMPATIBILITY

Cartridges used on the D120 and D140 disk drives are interchangeable.

 Cii Honeywell Bull COMPAGNIE INTERNATIONALE POUR L'INFORMATIQUE CII-HONEYWELL BULL	D140 OEM PRODUCT SPECIFICATION	SPEC. NO.	FOLIO	REV.
		BEM 1208	11	A0

4. DATA FORMAT

4.1 GENERAL

The disks are pre-recorded with formatting and head servo information at the beginning of each sector. Thus, it is not necessary for the user to write header labels. This servo zone is described in paragraph 4.3.1.

The formatted disk contains 392 tracks per surface, each comprising 50 sectors of 256 useful data bytes; in addition, there are 2 bytes per sector allowed for CRC which has to be calculated by the controller. The beginning of each track is indicated by an Index Mark.

A reserve of 48 sectors on track zero or track 391 is provided on each surface (in addition to the 10 megabytes) for use in the case of defective sectors. Defective sectors are indicated by the VALID SECTOR information contained in the head servo zone - described in paragraph 6.3.9.

Should the user want to write the table of defective sectors of a surface, he can use sector 00 either on track 000 or 391. These sectors are guaranteed valid as per specification.

4.2 TRACK FORMAT

The track format has 50 sectors per track. Each sector contains a data block of 256 bytes maximum, preceded by a pre-data block, the beginning of which is not accessible to the user.

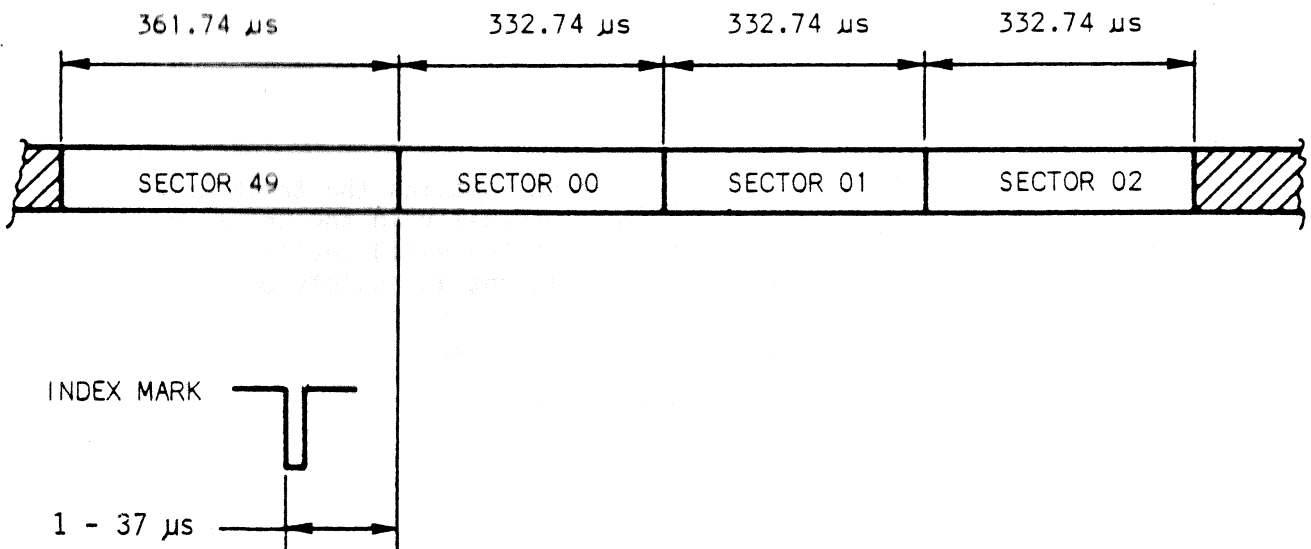



Figure 2 - Track Format

CE DOCUMENT DOIT ETRE CONSIDERE COMME ETANT D'USAGE INTERNE A CII-HB. IL NE PEUT ETRE COMMUNIQUE A DES TIERS SANS AUTORISATION EXPRESSE DE CELLE-CI

 Cii Honeywell Bull COMPAGNIE INTERNATIONALE POUR L'INFORMATIQUE CII-HONEYWELL BULL	D140 OEM PRODUCT SPECIFICATION	SPEC. NO. BEM 1208	FOLIO 12	REV. A0
---	---	-----------------------	-------------	------------

4.3 SECTOR FORMAT

The sector format is fixed. The data block can contain up to a maximum of 256 bytes.

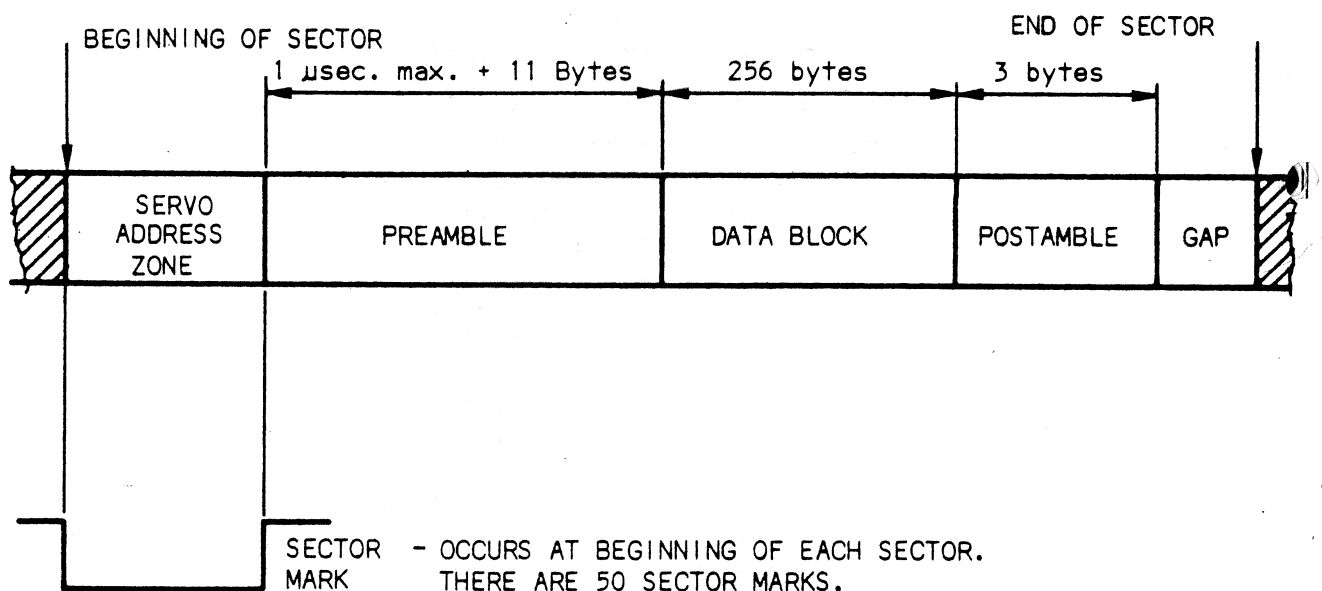



Figure 3 - Sector Format

4.3.1 Servo Address Zone

The Servo Address Zone contains the track address and the head servoing data used internally in the drive and also both the address parity bit and the valid sector bit which are sent over the interface. It is not accessible by the controller.

 Cii Honeywell Bull COMPAGNIE INTERNATIONALE POUR L'INFORMATIQUE CII-HONEYWELL BULL	D140 OEM PRODUCT SPECIFICATION	SPEC. NO.	FOLIO	REV.
		BEM 1208	13	A0

4.3.2 Preamble

This gap provides a window for controller response time to dispatch WRITE ENABLE or READ ENABLE, write switching-on time, VFO synchronisation and data mark.

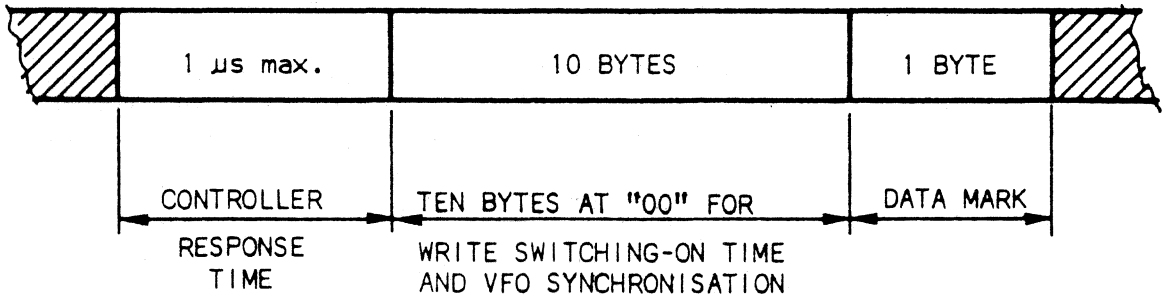

4.3.3 Postamble

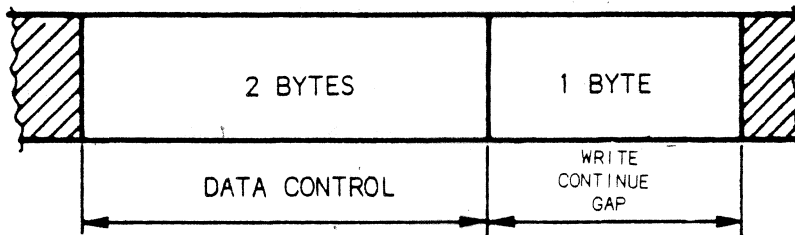

4.3.4 Gap

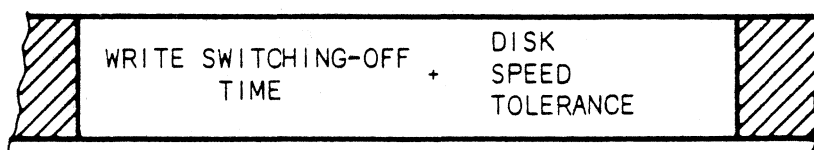



Cii Honeywell Bull

COMPAGNIE INTERNATIONALE POUR
L'INFORMATIQUE CII-HONEYWELL BULL

D140 OEM PRODUCT
SPECIFICATION

SPEC. NO.

BEM 120E

FOLIO

14

REV.

A0

5. OPERATION

5.1 GENERAL

All signals and timing concerning the operation described in the following paragraphs are given in Chapter 6, INTERFACE.

5.2 CARTRIDGE LOADING.

The cartridge is loaded into the drive through the hinged access door. A prerequisite condition for loading is the CARTRIDGE ACCESS signal at low level. During cartridge insertion, a device within the drive opens a window in the cartridge for head access.

5.3 START/STOP

A start command (signal RUN at low level) from the controller starts up the drive which, after completing the motor start-up phase and the first seek, replies with the READY TO SRW line going true. Signal RUN is significant only when the access door is closed, a cartridge is loaded, and all power supplies are present. See figures 4 and 5.

When the stop command (signal RUN at high level) is true and when the motor is completely stopped, a signal, CARTRIDGE ACCESS is dispatched to the interface to inform the operator that it is possible to open the access door.

5.4 CARTRIDGE UNLOADING

Internal interlocks within the drive prevent the operator from opening the access door for cartridge changing as long as the RUN signal is true and/or the motor is running. Note, in the event of a power off, the access door cannot be opened if a cartridge is present.

5.5 HEAD LOADING/UNLOADING

After the cartridge is loaded and during the closing of the access door, the head carriage is moved forward mechanically so that the heads are introduced into the cartridge and over the fixed disk in the unloaded position. The heads are loaded when the motor has attained the correct speed.



Head unloading is quickly performed in the event of:

- a stop command (signal RUN at high level)
- loss of speed
- a power failure

When the access door is opened, the head carriage is mechanically retracted and the heads withdrawn from the cartridge to allow a cartridge change.

5.6 INITIALIZATION SEEK

This operation starts automatically after head loading, and terminates with the dispatch of READY TO SRW at low level. At this time, head 0 on the removable disk is selected and positioned over track 000.

5.7 SEEK OPERATION

The Address lines 0 to 7 with signals STROBE 1 and STROBE 2 are used to select disk, head and track. The drive replies with READY TO SRW when the seek is completed - i.e., when the address read by the selected head is equal to the address received from the controller.

5.8 WRITE OPERATION

Signal WRITE ENABLE switches on the drive write circuits; the WRITE DATA line transfers the data in NRZ mode, synchronized by the DATA CLOCK sent by the drive. On the disk surface, the data are written in MFM mode.

5.9 READ OPERATION

Signal READ ENABLE switches on the VFO and the data recovery circuits. The drive replies with READ DATA in NRZ mode and the DATA CLOCK for use by the controller for synchronization of the received data. DATA STROBE EARLY or LATE may be used for data recovery.

CE DOCUMENT DOIT ETRE CONSIDERE COMME ETANT D'USAGE INTERNE A CII-HB. IL NE PEUT ETRE COMMUNIQUE A DES TIERS SANS AUTORISATION EXPRESSE DE CELLE-CI



Cii Honeywell Bull

COMPAGNIE INTERNATIONALE POUR
L'INFORMATIQUE CII-HONEYWELL BULL

D140 OEM PRODUCT
SPECIFICATION

SPEC. NO.

BEM 1208

FOLIO

16

REV.

A0

5.10 INDEX MARK

The angular origin of the selected disk (fixed or removable) is indicated by the INDEX MARK timing pulse. This pulse is obtained from a magnetic transducer which detects a notch on the disk hub (one per disk).

The angular relationship of the two notches is variable.

5.11 SECTOR MARK

This sector mark is generated at the beginning of each sector from the pre-recorded information in the servo zone on the disk.

CE DOCUMENT DOIT ETRE CONSIDERE COMME ETANT D'USAGE INTERNE A CII-HB. IL NE PEUT ETRE COMMUNIQUE A DES TIERS SANS AUTORISATION EXPRESSE DE CELLE-CI

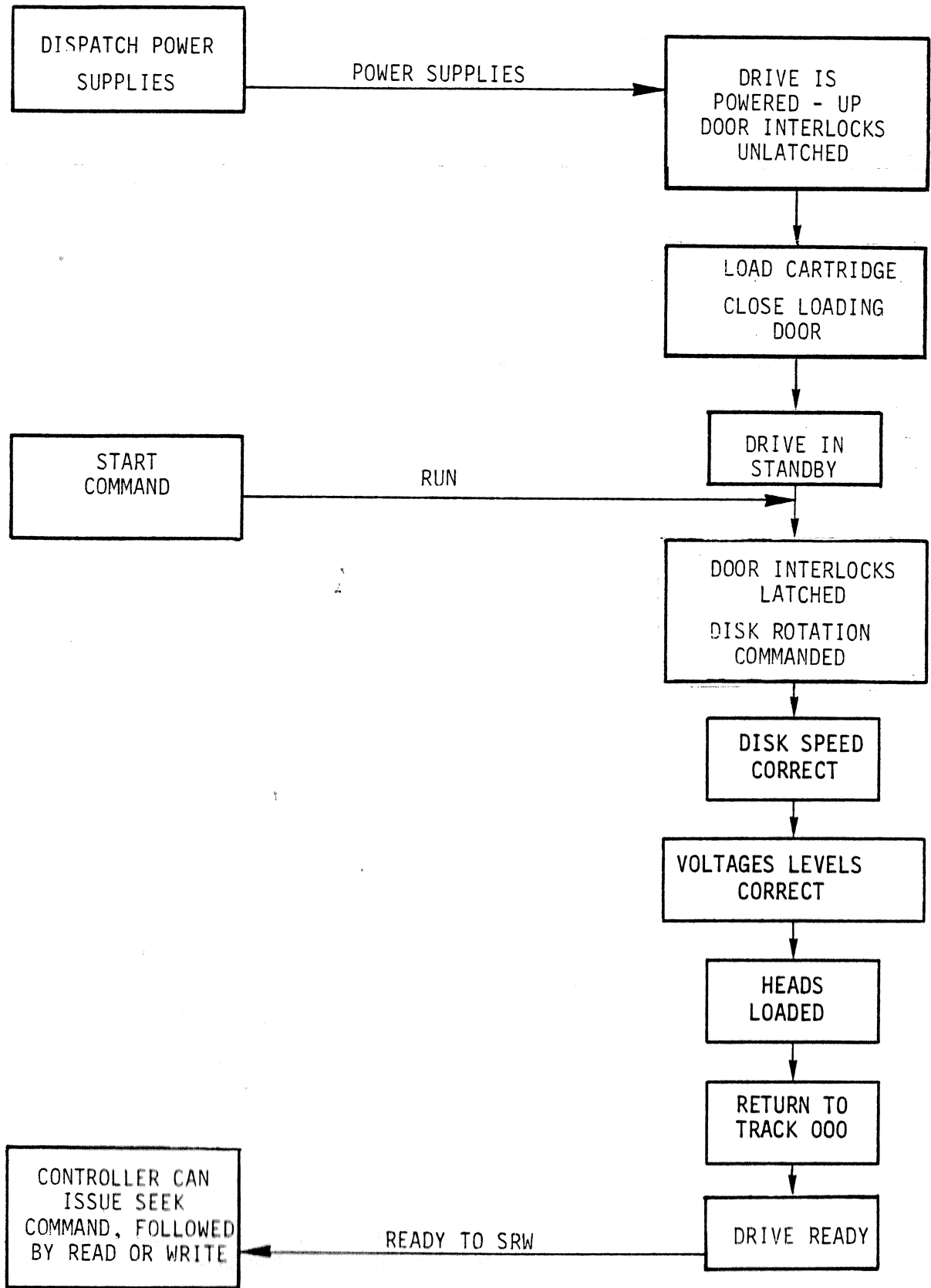

Figure 4 - Start Cycle

CE DOCUMENT DOIT ETRE CONSIDERE COMME ETANT D'USAGE INTERNE A CII-HB. IL NE PEUT ETRE COMMUNIQUE A DES TIERS SANS AUTORISATION EXPRESSE DE CELLE-CI



Cii Honeywell Bull

COMPAGNIE INTERNATIONALE POUR L'INFORMATIQUE CII-HONEYWELL BULL

D140 OEM PRODUCT SPECIFICATION

SPEC. NO.

BEM 1208

FOLIO

18

REV.

A0

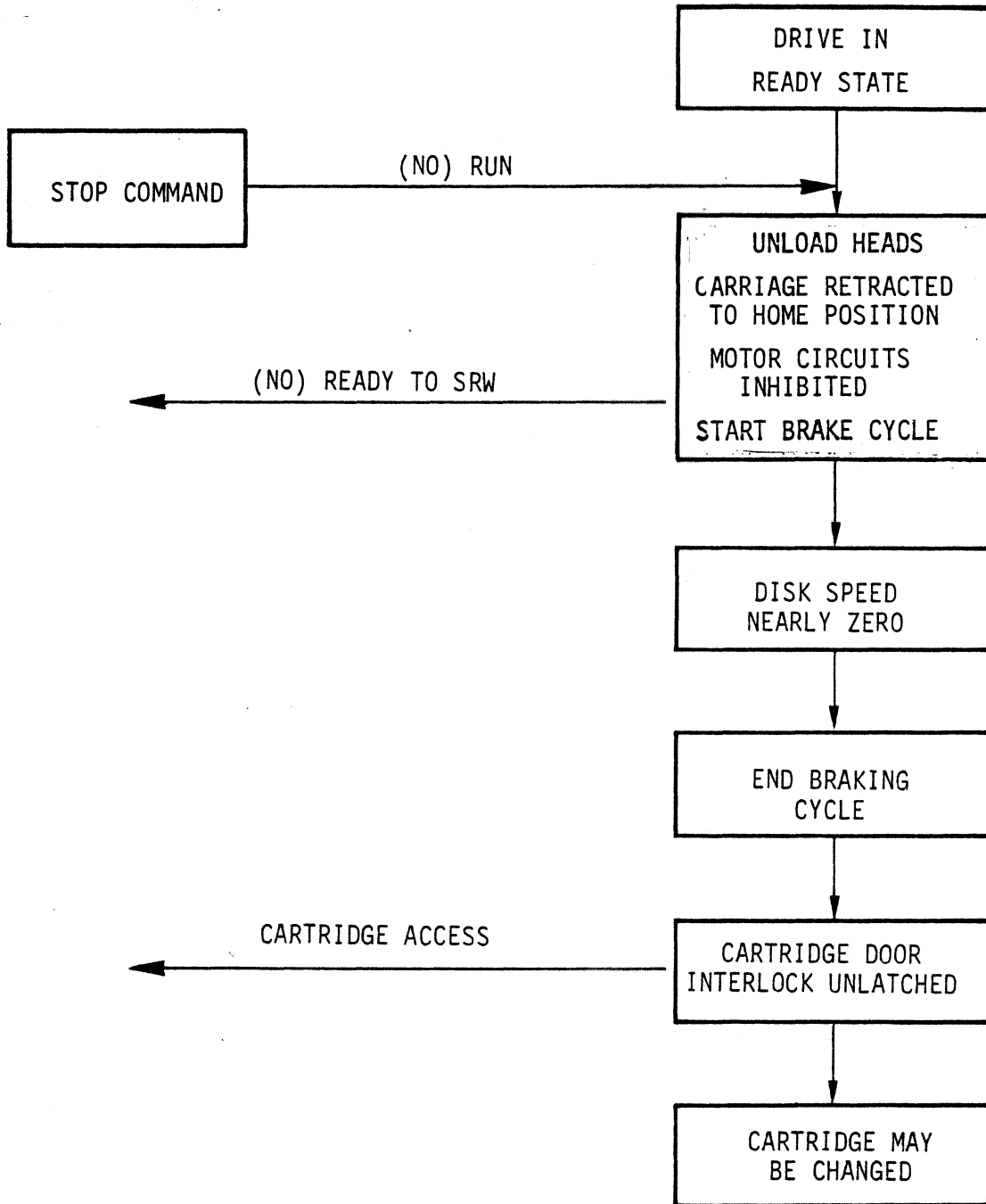

Figure 5 - Stop Cycle

POWER DOWN

No special procedure is required for power down, which is made when the controller cuts off the power supply.



Cii Honeywell Bull

COMPAGNIE INTERNATIONALE POUR
L'INFORMATIQUE CII-HONEYWELL BULL

D140 OEM PRODUCT
SPECIFICATION

SPEC. NO.

BEM 1208

FOLIO

19

REV.

A0

5.12 OPERATOR CONTROLS

No operator controls are provided on the drive (except the optional write protect switch for the fixed disk). All controls and indicators are to be provided by the user; these will be normally housed in the disk controller, system cabinet or console.

5.13 WRITE PROTECT OPTIONS

The write protect function is provided on option, and prevents any drive fitted with this option from writing on either protected cartridges or protected fixed disks or both.

A) REMOVABLE DISK WRITE PROTECT

When a cartridge is write-protected - i.e., the write-protect access hole in the cartridge is occluded, a sensor located inside the drive inhibits the write function and a WRITE PROTECT signal is dispatched to the interface at low level.

B) FIXED DISK WRITE PROTECT

The fixed disk write protect is operator selected by a switch located behind the front door. When a write-protected fixed disk is selected, the write function is inhibited and a WRITE PROTECT signal is dispatched to the interface at low level.



Cii Honeywell Bull

COMPAGNIE INTERNATIONALE POUR
L'INFORMATIQUE CII-HONEYWELL BULL

D140 OEM PRODUCT
SPECIFICATION

SPEC. NO.

BEM 1208

FOLIO

20

REV.

A0

6. INTERFACE

6.1 INTERFACE DEFINITION

The D140 drive is designed for star connection as standard. Signal levels are at TTL, using negative logic over the interface. Figure 6 shows the interface circuits block diagram.

Signal levels are defined below:

HIGH : 2.8 to 5.25 volts - corresponding to logic 0, or False

LOW : 0 to 0.4 volts - corresponding to logic 1, or True.

In the following descriptions of signals and timing diagrams, HIGH and LOW are used to define the signal level:

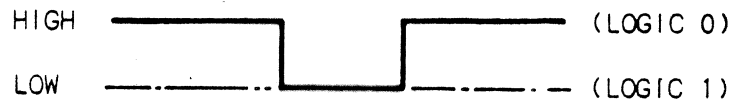

Note : In this section the significant edge for triggering is denoted by either low to high transition or high to low transition.

Signal names followed by an asterisk (*) indicate that the signal is significant at LOW level.

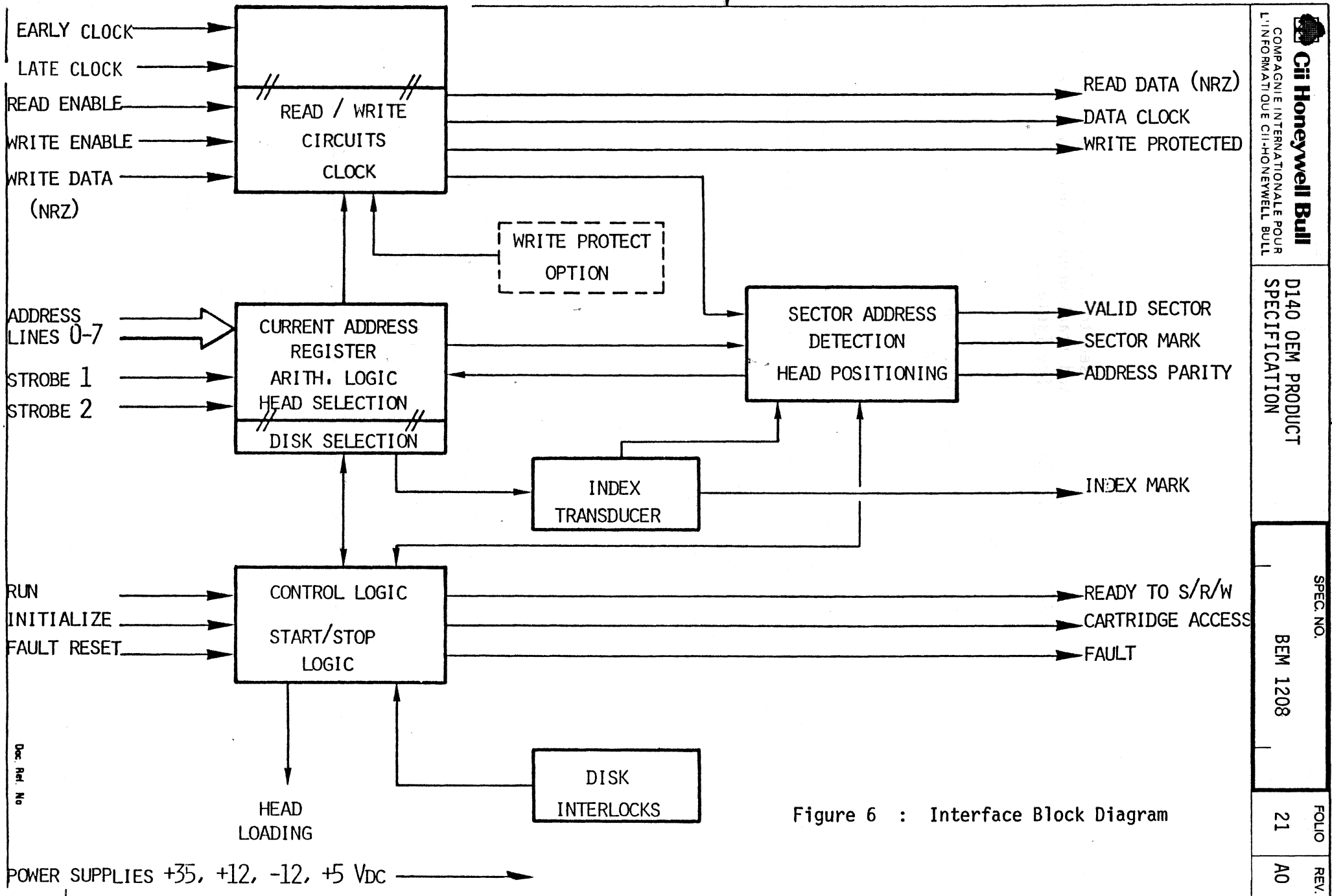

Cii Honeywell Bull
 COMPAGNIE INTERNATIONALE POUR L'INFORMATIQUE CII-HONEYWELL BULL
 D140 OEM PRODUCT SPECIFICATION
 SEC. NO. BEM 1208
 FOLIO 21
 REV. A0

Figure 6 : Interface Block Diagram

Doc. Ref. No

CE DOCUMENT DOIT ETRE CONSIDERE COMME ETANT D'USAGE INTERNE A CII-HB. IL NE PEUT ETRE COMMUNIQUE A DES TIERS SANS AUTORISATION EXPRESSE DE CELLE-CI

 Cii Honeywell Bull COMPAGNIE INTERNATIONALE POUR L'INFORMATIQUE CII-HONEYWELL BULL	D140 OEM PRODUCT SPECIFICATION	SPEC. NO.	FOLIO	REV.
		BEM 1208	22	A0

6.2 INPUT SIGNALS TO DRIVE

6.2.1 Address Lines 0-7

The address lines are used to select the fixed or removable disk, a disk surface and track when strobed by signals STROBE 1, STROBE 2. See Table 1.

6.2.2 Strobe 1 and Strobe 2

A pulse of 0.5 μ sec. min. When LOW, it is used to sample the 8 Address Lines. The Low to High transition is significant.

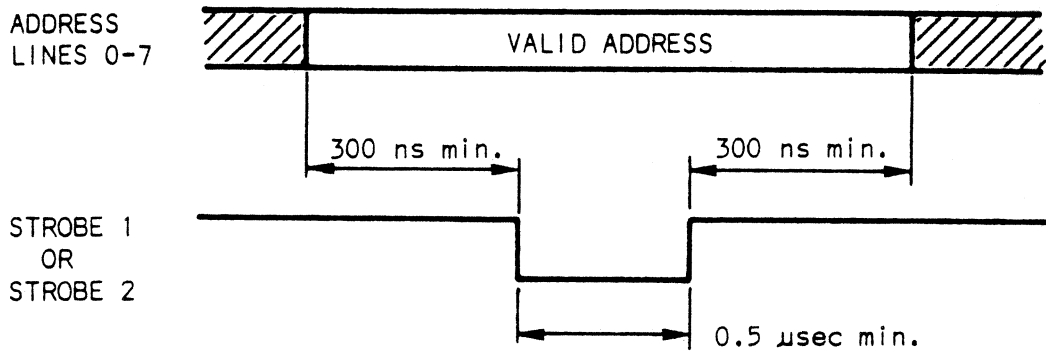

STROBE 2 must be preceded by STROBE 1. The Low to High transition is significant. See Table 1 and figure 9.

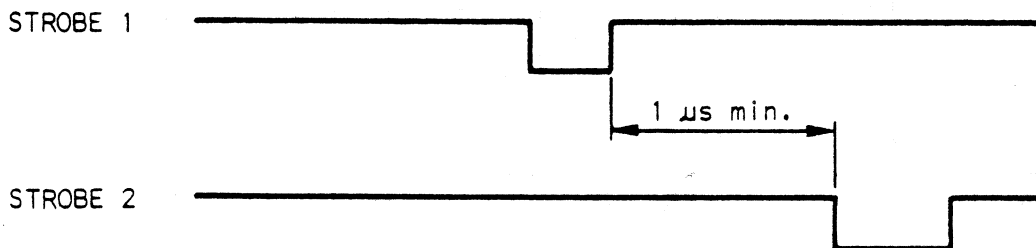

CE DOCUMENT DOIT ETRE CONSIDERE COMME ETANT D'USAGE INTERNE A CII-HB. IL NE PEUT ETRE COMMUNIQUE A DES TIERS SANS AUTORISATION EXPRESSE DE CELLE-CI

Table 1 : ADDRESS LINES AND STROBES

ADDRESS LINES 0-7	STROBE 1		STROBE 2	
	HIGH	LOW	HIGH	LOW
ADLIN 0	-	Track address position $2^8(256)$	-	Track address position $2^0(1)$
1	Select FACE 0	Select FACE 1	-	Track address position $2^1(2)$
2	RESERVED	RESERVED	-	Track address position $2^2(4)$
3	-	RESERVED	-	Track address position $2^3(8)$
4	-	RESERVED	-	Track address position $2^4(16)$
5	-	RESERVED	-	Track address position $2^5(32)$
6	Select removable disk	select fixed disk	-	Track address position $2^6(64)$
7	-	RESERVED	-	Track address position $2^7(128)$



6.2.3 Read Enable

Low signal from the controller to enable the output lines READ DATA and DATA CLOCK from the drive. READ ENABLE must go high after the last bit read. See Figure 10 for timing.

6.2.4 Early Clock/Late Clock

Low signal on one of these two lines during a read operation enables data recovery with an earlier or later clocking of marginal peak shifted read data from disk - CLOCK EARLY/LATE must be maintained in a steady level during all the read operation. These signals may be used for data recovery if required.

6.2.5 Write Enable

Signal at low level which enables the drive write circuits. It must go high after the last bit is written. For timing see Figure 11.

6.2.6 Write Data

The two states of the WRITE DATA signal in conjunction with DATA CLOCK determine the value of the data to be written. The high level corresponds to "0's" and low level to "1's" - (NRZ code). See also Figure 12.

6.2.7 Run

The low level of this line corresponds to Start and sets the disk rotating when all the drive start-up conditions are met. RUN at high level stops the disk to enable cartridge changing for example. Starting and stopping times are approximately 20 seconds.

6.2.8 Fault Reset

A pulse at low level used to reset the FAULT latch - see paragraph 6.3.6.

Minimum duration 0.5 μ sec., maximum duration 300 μ sec.
FAULT RESET must be high during drive start-up (RUN command).

CE DOCUMENT DOIT ETRE CONSIDERE COMME ETANT D'USAGE INTERNE A CII-HB. IL NE PEUT ETRE COMMUNIQUE A DES TIERS SANS AUTORISATION EXPRESSE DE CELLE-CI

6.2.9 Initialize

A pulse at low level used to reset the FAULT latch and to select the initialization address, Head 00, Track 000 on removable disk. Minimum duration 0.5 μ sec. Maximum duration 300 μ sec.

INPUT LINES TO DRIVE

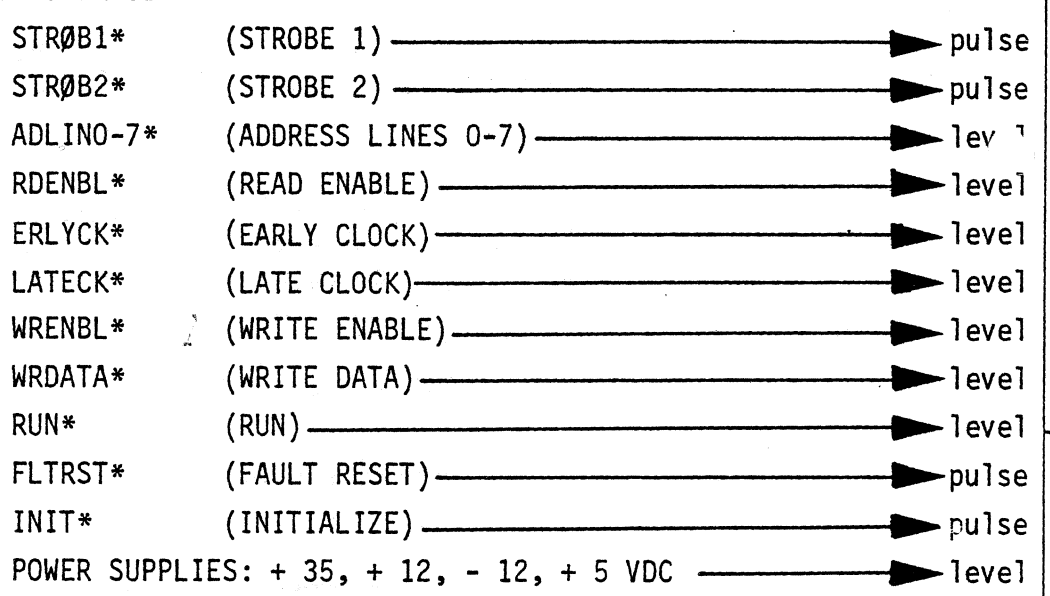

OUTPUT LINES FROM DRIVE

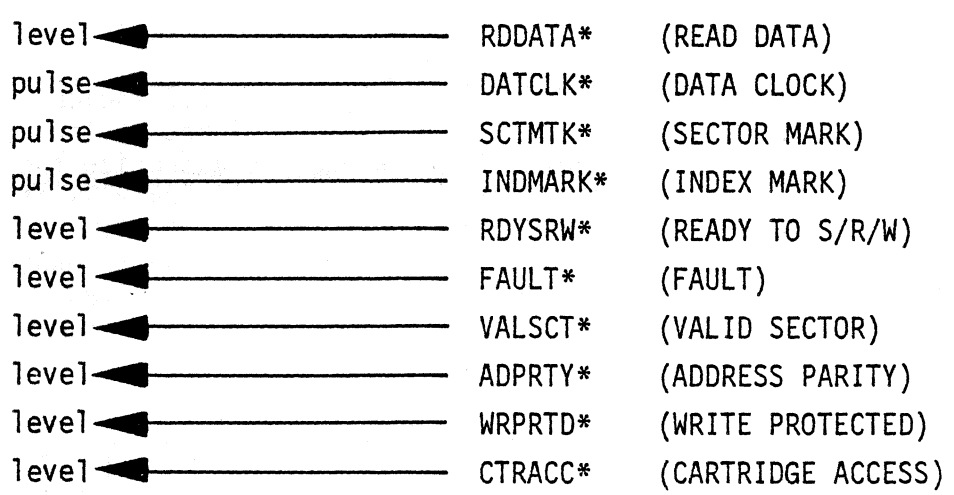

Figure 7 - Interface Lines Diagram



6.3 OUTPUT SIGNALS FROM DRIVE

6.3.1 Ready to SRW

This line at low level indicates to the controller that the drive is ready for a seek, read or write command. READY TO SRW goes low 30 seconds maximum after the start signal (RUN = low level); it goes HIGH following a stop command (RUN = high level), a seek command after STROBE 2 and during a seek operation. In the case of a seek to the same address, READY TO SRW goes low at the end of the following SECTOR MARK. See also Figure 9.

READY TO SRW remains high at the interface at the end of a seek operation in the case of a Seek fault or an illegal address.

6.3.2 Index Mark

A pulse delivered for each disk revolution, indicating the origin of the selected disk. It is significant on the transition from high to low level and has a duration of $10 \mu\text{sec} \pm 2$. The sector following the INDEX MARK is Sector N° 0 - i.e. the first sector. See timing diagram, Figure 8.

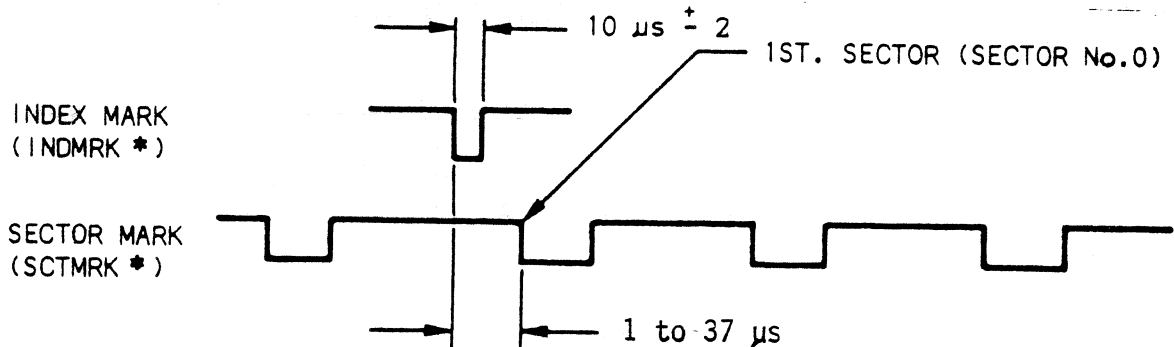

6.3.3 Sector Mark

A pulse of $22.2 \mu\text{sec} \pm 0.7$ indicating the beginning of each sector. It is significant at low level and the transition from low to high is used to authorize the dispatch of addressing, write commands. The SECTOR MARK is also used for sector counting in the controller. See timing diagram, Figure 8. Sector Marks are not present during a change in volume sequence. They reappear with the new valid Index Mark.

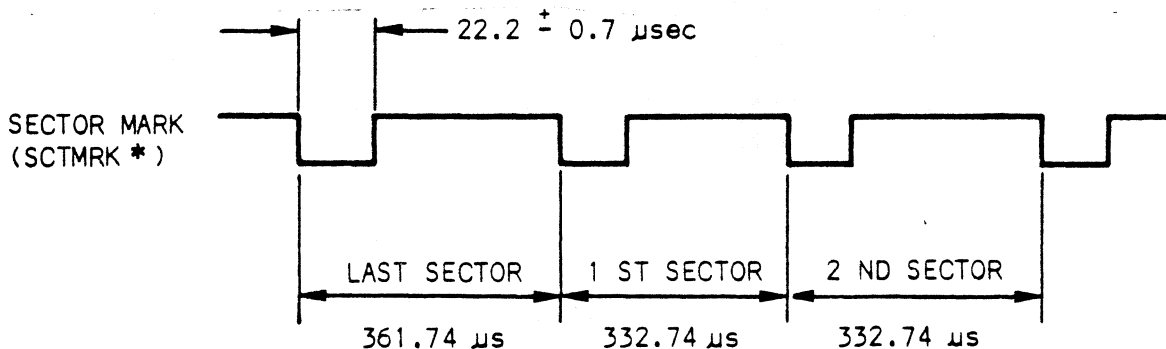



6.3.4 Read Data

The value of the data read is determined by this line in conjunction with DATA CLOCK. The level high corresponds to "0's" and low level corresponds to "1's" (NRZ code). This line is enabled by READ ENABLE. In the absence of a READ ENABLE command and during the VFO sync. time the READ DATA line is held at logic "0" - high level. See also Figures 10 and 12.

6.3.5 Data Clock

This line transmits square waveform clock pulses continuously at 7.35 MHz \pm 3%. When a READ ENABLE signal occurs, the DATA CLOCK is taken from a VFO to strobe the READ DATA, see Figure 10. On the other hand, when a WRITE ENABLE command occurs, the DATA CLOCK signals come from the oscillator for strobing the WRITE DATA. The transition from low to high is significant; see also Figure 12.

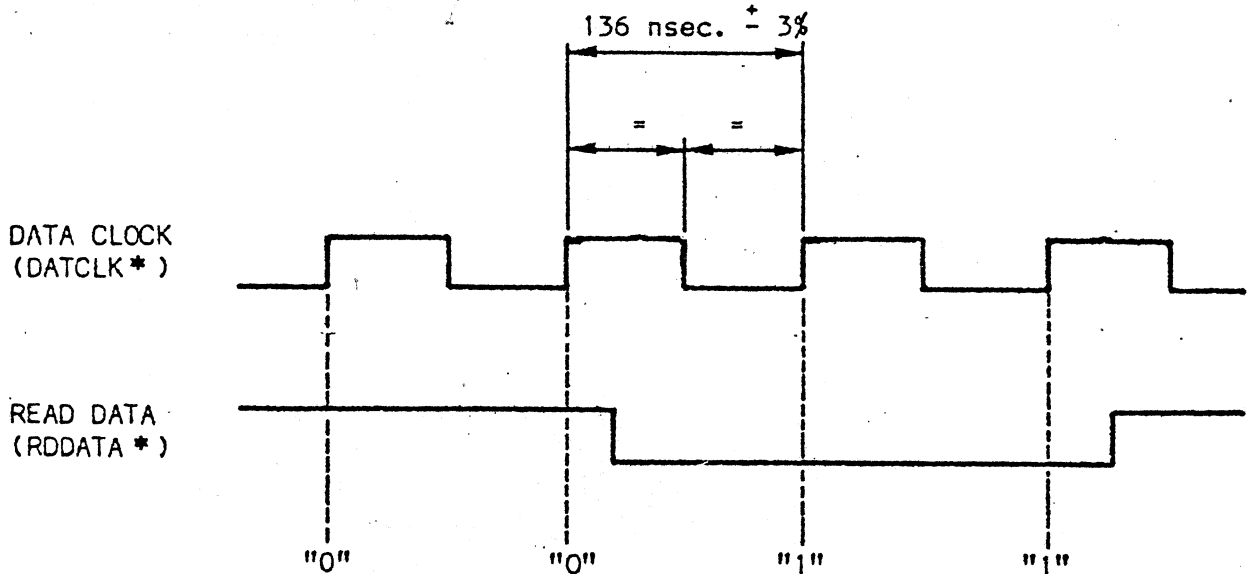

6.3.6 Fault

At high level, this line indicates that a fault has been detected in the drive. Faults can occur due to the conditions outlined below.

- a) Seek fault or illegal address : occurs after several internal automatic retries to locate the track address, or if positioning time is too long.
- b) Write fault : No NRZ Write Data change on the interface line during a write operation or no write transition in the read/write circuits after WRITE ENABLE command, or write current present without a WRITE ENABLE command.



6.3.6 Fault (continued)

c) Illegal Command

- 1 - dispatch of commands STROBE 1 or STROBE 2 when READY TO SRW is not validated or when a Sector Mark is present (in which case the command signal is ignored).
- 2 - when READ ENABLE and WRITE ENABLE are present at the same time.
- 3 - dispatch of a read or write command when the drive is not READY TO SRW.
- 4 - in the case where the write protect option is fitted, the presence of WRITE ENABLE with WRITE PROTECTED.

d) Device Malfunction

When a device malfunction affecting the servo zone recognition or accurate positioning has been internally detected.

- e) Power absent or voltage levels incorrect.
- f) When the FAULT line is broken

NOTE

When any one of the above incidents occurs, the FAULT is stored in a latch, maintaining the FAULT line at high level and inhibiting the write current. FAULT RESET or INITIALIZE is dispatched from the controller to restore the latch and to reset the FAULT line. If the fault is permanent, the FAULT RESET or INITIALIZE is not active.

6.3.7 Write Protected

A signal at low level indicating that the selected disk in the drive is write protected. When the disk is not protected, signal WRITE PROTECTED is at high level. When the write protect option is not fitted to the drive for the selected volume (disk) this signal is always high.

The change in status on this line occurs after receipt of STROBE 2. See timing diagram below.

No change in the protection status of a given volume is authorized while the drive is running.



Cii Honeywell Bull

COMPAGNIE INTERNATIONALE POUR L'INFORMATIQUE CII-HONEYWELL BULL

D140 OEM PRODUCT SPECIFICATION

SPEC. NO.

BEM 1208

FOLIO

29

REV.

A0

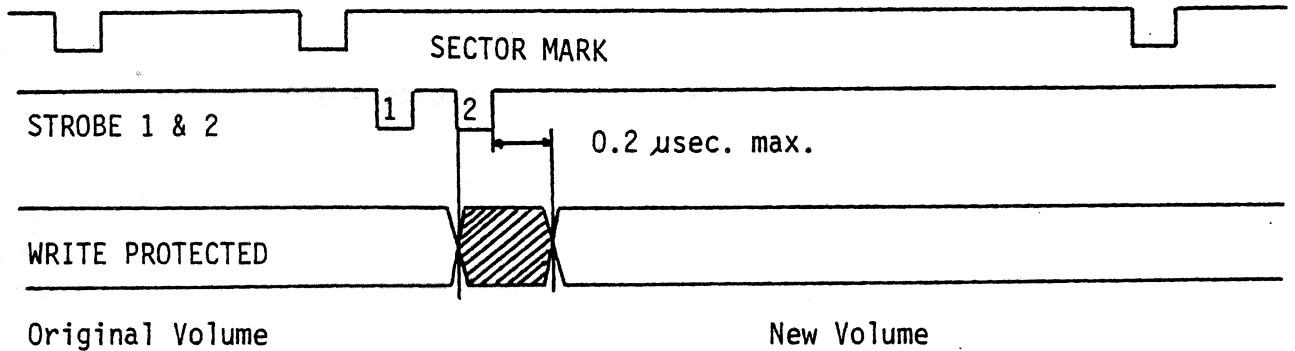

6.3.8 Cartridge Access

A signal at low level indicating that the operator can change the cartridge. This signal is at low level when all the following conditions are met : all voltages present, motor is stopped and front access door is unlocked.

6.3.9 Valid Sector

This line can change during the sector mark and is valid at the interface when the SECTOR MARK changes from low to high. VALID SECTOR at low level indicates that the sector which follows the next SECTOR MARK has no defect. A high level indicates this sector is defective and not to be used, in which case the sub-system can call up a reserved sector. For timing, see Figure 13.

6.3.10 Address Parity

This line can change during the sector mark and is valid at the interface when the SECTOR MARK changes from low to high. A low state indicates an even parity of the sector which follows the next occurring SECTOR MARK. The parity is calculated by adding the number of bits (binary "1's") of the disk address, the surface address, the track address, the sector address and the VALID SECTOR bit. See Figure 13 for timing.

CE DOCUMENT DOIT ETRE CONSIDERE COMME ETANT D'USAGE INTERNE A CII-HB. IL NE PEUT ETRE COMMUNIQUE A DES TIERS SANS AUTORISATION EXPRESSE DE CELLE-CI



Cii Honeywell Bull

COMPAGNIE INTERNATIONALE POUR L'INFORMATIQUE CII-HONEYWELL BULL

D140 OEM PRODUCT SPECIFICATION

SPEC. NO.

BEM 1208

FOLIO

30

REV.

A0

EXAMPLE:

	<u>Decimal</u>		<u>Binary</u>		
Disk address	00	-	000	}	
Surface address =	00	-	000		
Track address =	03	-	011		
Sector address =	07	-	111		
					= 5 bits = ODD
				}	
VALID SECTOR low level		-	1		
					= 1 bit = ODD
					= 6 bits = EVEN = which gives "1" on the ADDRESS PARITY line

SECTOR MARK (SCTMRK *)

VALID SECTOR (VALSCT *)

ADDRESS PARITY (ADPRTY *)

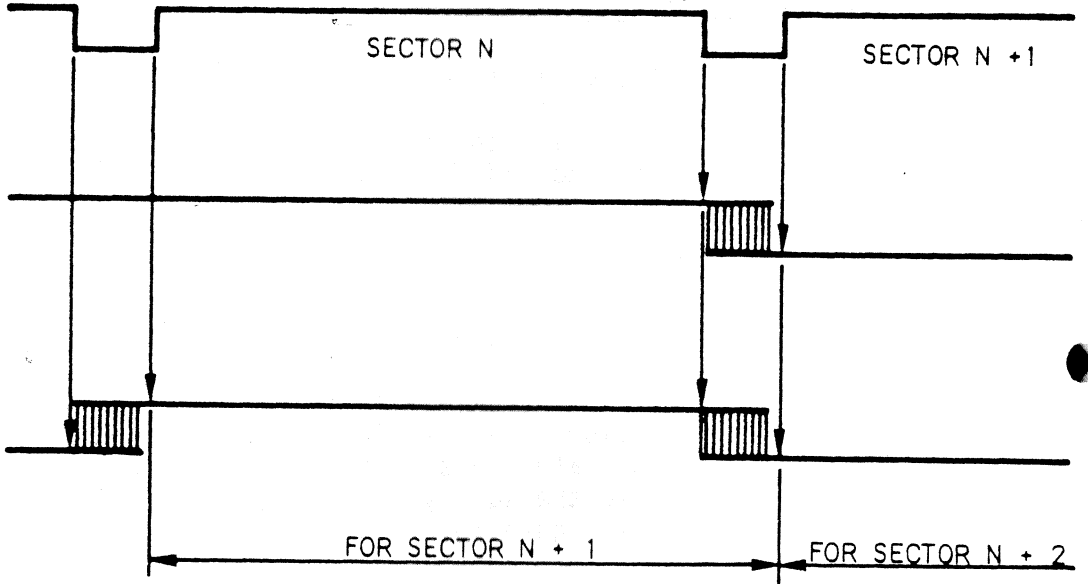

Cii Honeywell Bull
 COMPAGNIE INTERNATIONALE POUR
 L'INFORMATIQUE CII-HONEYWELL BULL

**D140 OEM PRODUCT
 SPECIFICATION**

SPEC. NO.
BEM 1208

FOLIO
31
 REV.
A0

6.4 INTERFACE TIMING

6.4.1 Index/Sector Timing

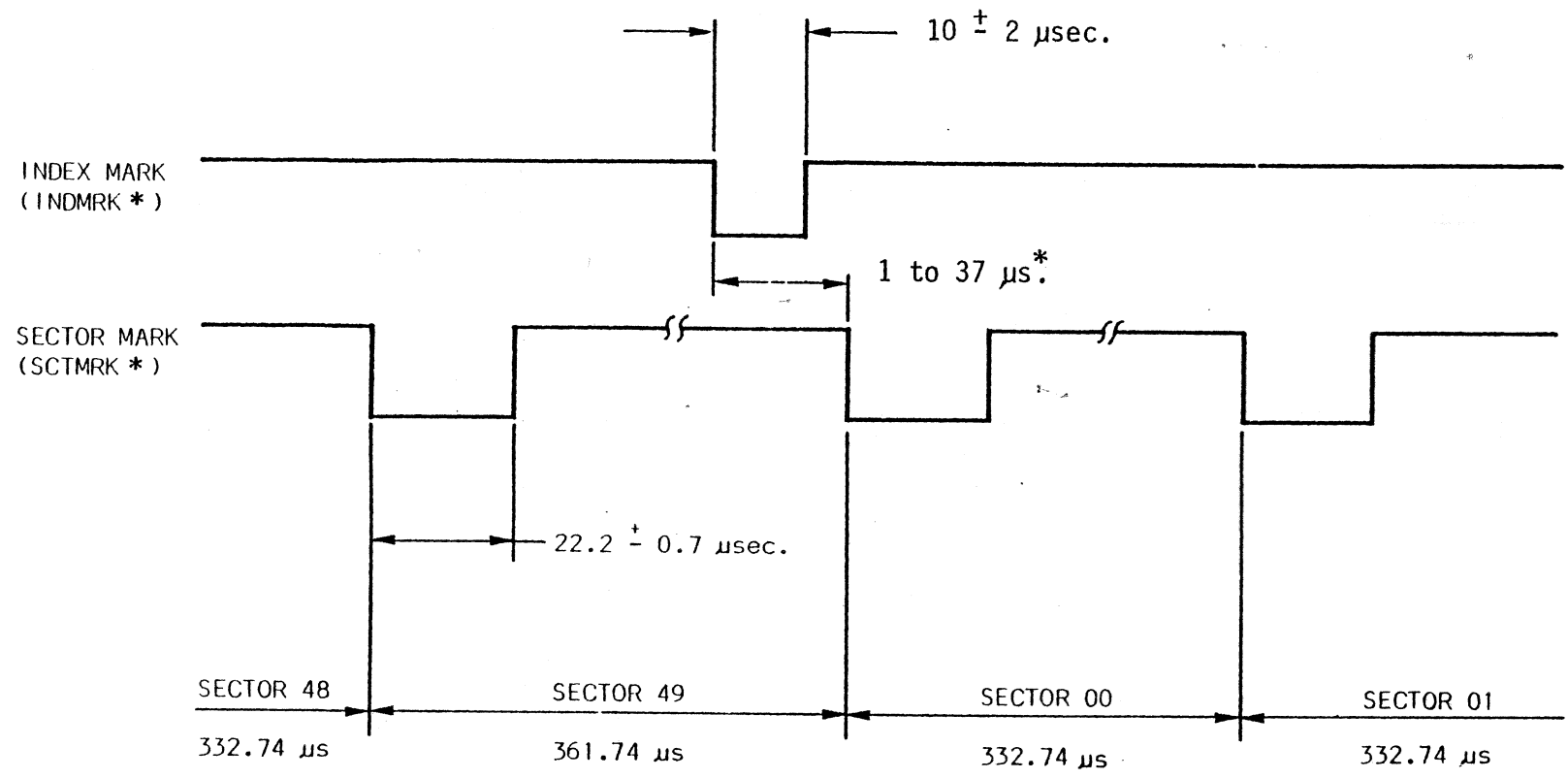

Tolerances are $\pm 3\%$ on the Sector Timing

Figure 8 - Index/Sector Timing

IMPRIME N° C 135

6.4.2 Addressing

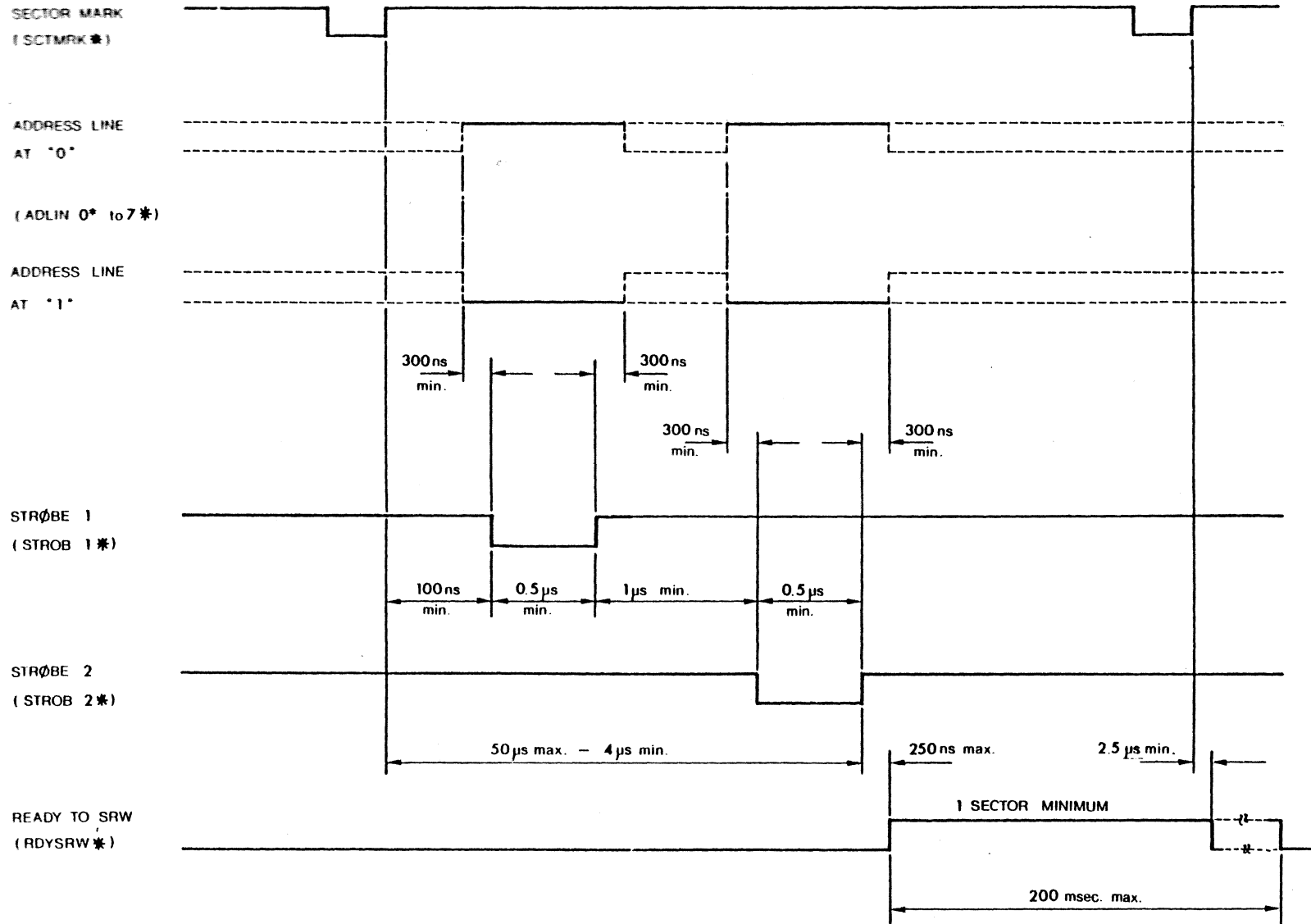

Figure 9 - Address / Strobe Timing

6.4.3 Read/Write Enable

IMPRIME N° C 135

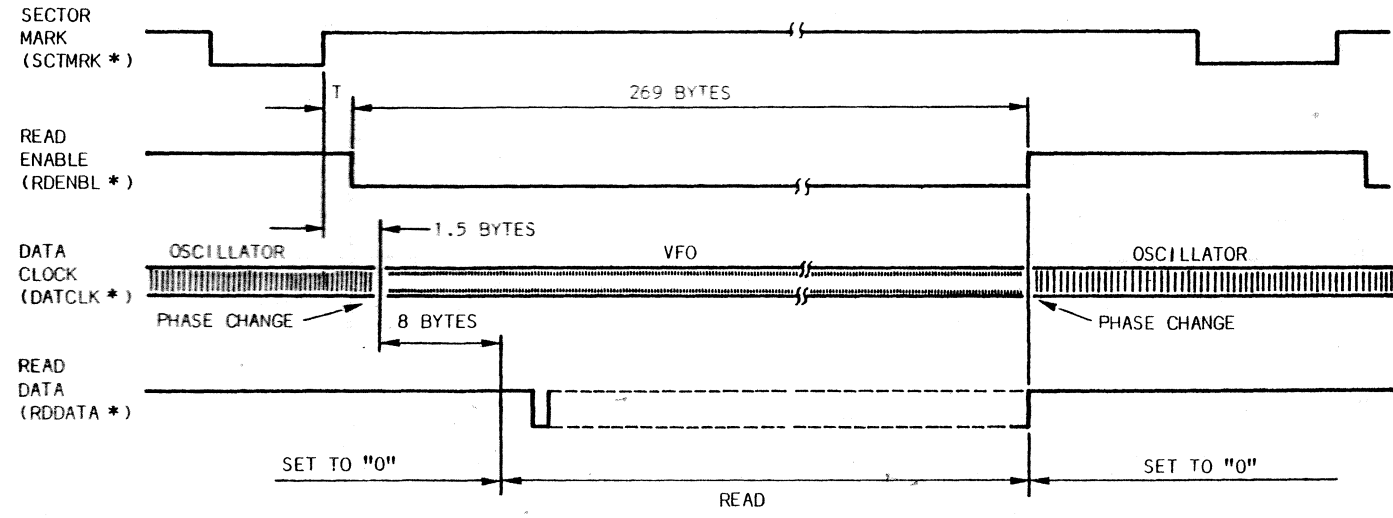
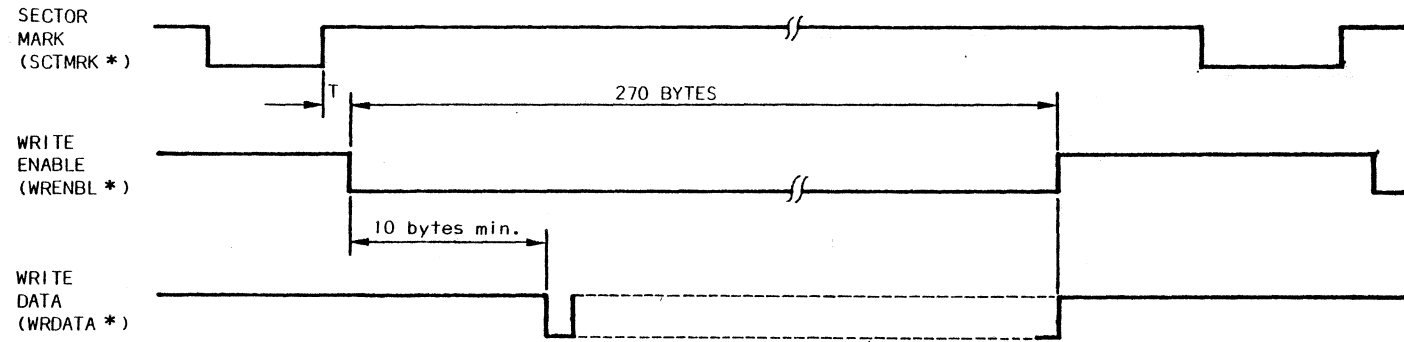

Figure 10 - READ ENABLE Timing diagram



T=CONTROLLER RESPONSE TIME +PROPAGATION TIME (DRIVE TO CONTROLLER +CONTROLLER TO DRIVE TIMES).
 T MUST NOT EXCEED 1 usec.

Figure 11 - WRITE ENABLE Timing diagram

IMPRIME N° C 135

6.4.4 Data Clock

Cii Honeywell Bull
 COMPAGNIE INTERNATIONALE POUR
 L'INFORMATIQUE CII-HONEYWELL BULL

D140 OEM PRODUCT
 SPECIFICATION

SPEC. NO.
 BEM 1208

FOLIO 34
 REV. A0

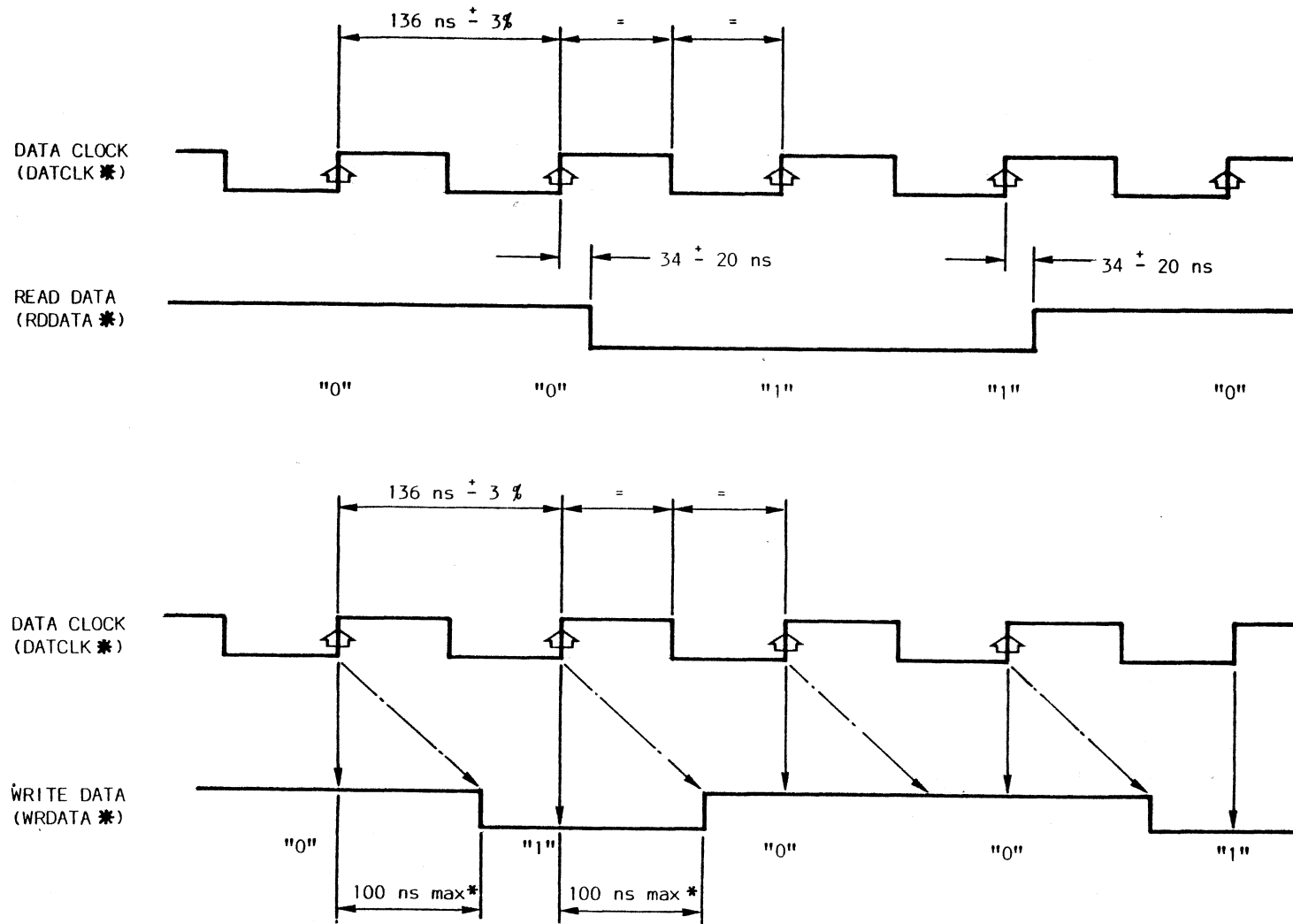

* INCLUDING PROPAGATION IN CABLE (DRIVE TO CONTROLLER + CONTROLLER TO DRIVE TIMES).

Figure 12 - DATA CLOCK timing

6.4.5 Valid Sector/Address Timing

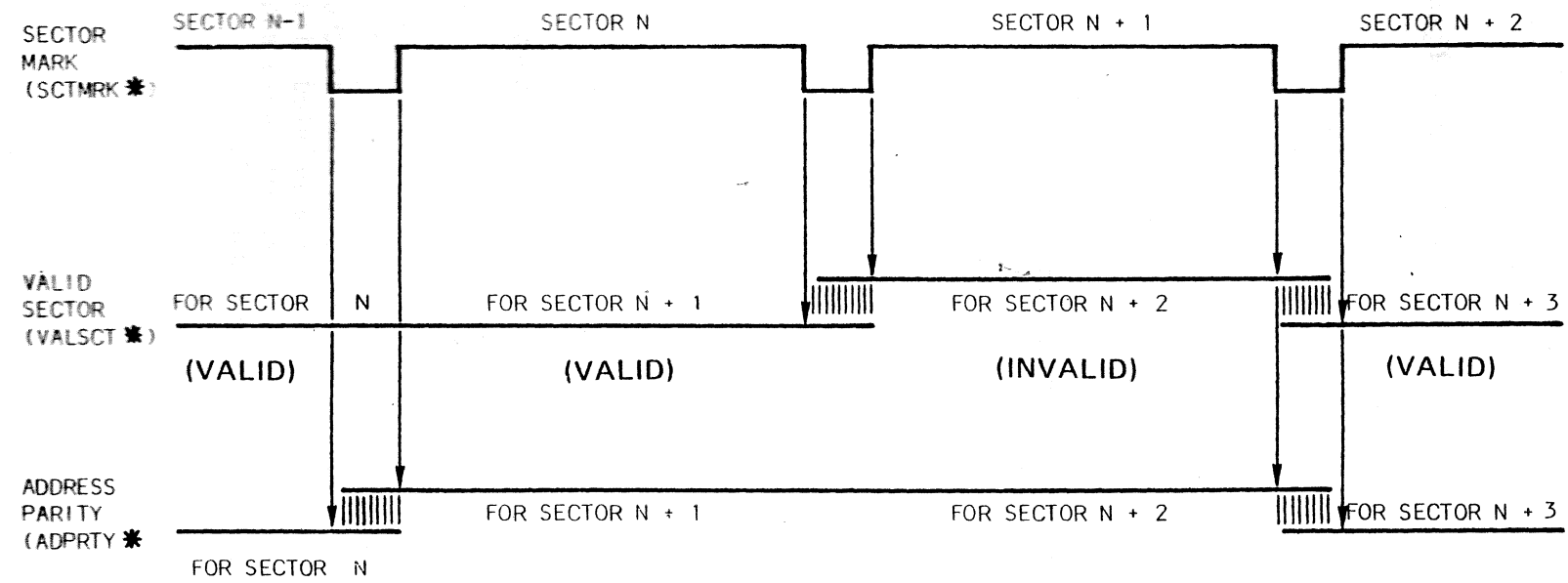

Figure 13 - Valid Sector/Address Timing



6.5 RECEIVERS/DRIVERS

- Drivers : 75451 or 75452 types
- Receivers : TTL type

The receivers must be level triggered and not edge triggered.

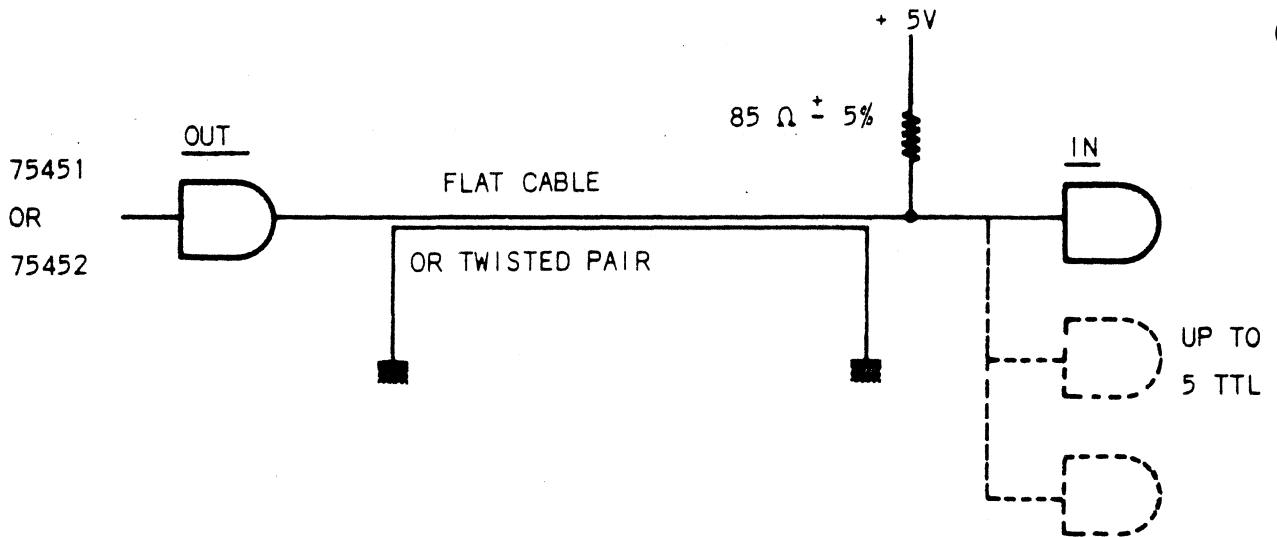

6.6 INTERFACE CABLE

The maximum cable length must not exceed 3 meters.
 Line impedance $Z \Omega 85 \Omega$

6.7 LOGIC CONNECTOR

Two logic connectors are to be used at the rear of the drive for mounting on the edge of a printed circuit board. The type required is an HE9 - 26 pin cable edge connector. Pin assignment is shown in Figure 14.

CE DOCUMENT DOIT ETRE CONSIDERE COMME ETANT D'USAGE INTERNE A CII-HB. IL NE PEUT ETRE COMMUNIQUE A DES TIERS SANS AUTORISATION EXPRESSE DE CELLE-CI

Cii Honeywell Bull COMPAGNIE INTERNATIONALE POUR L'INFORMATIQUE CII-HONEYWELL BULL	D140 OEM PRODUCT SPECIFICATION	SPEC. NO. BEM 1208	FOLIO 37	REV. A0
---	---------------------------------------	------------------------------	--------------------	-------------------

CiiHB CONNECTOR

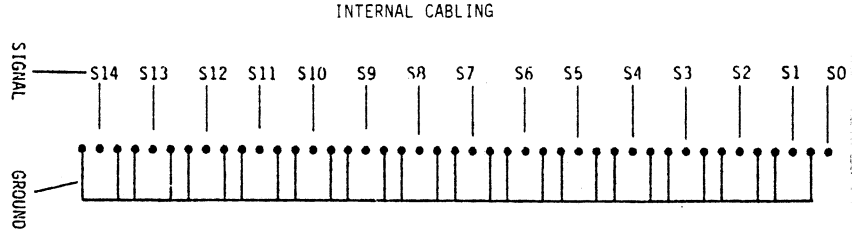
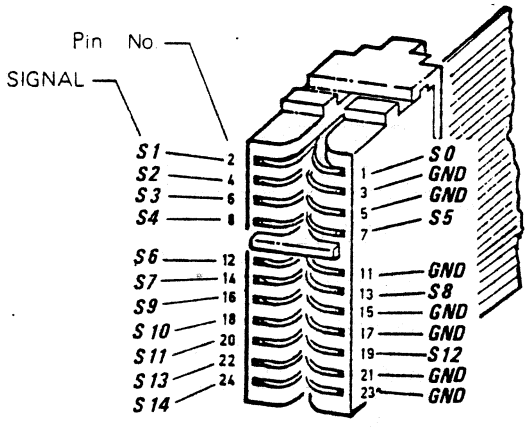

VIEW ON FLAT CABLE ENTERING THE Cii HB CONNECTOR

HE9 TYPE CONNECTOR

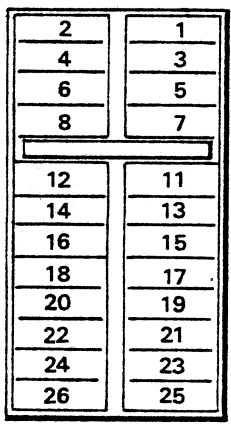

NOTE : Signal/pin allocation is the same as the CiiHB connector. Pins 25 and 26 are not connected

DETAILS OF BOARD FOR HE9 AND CiiHB CONNECTORS

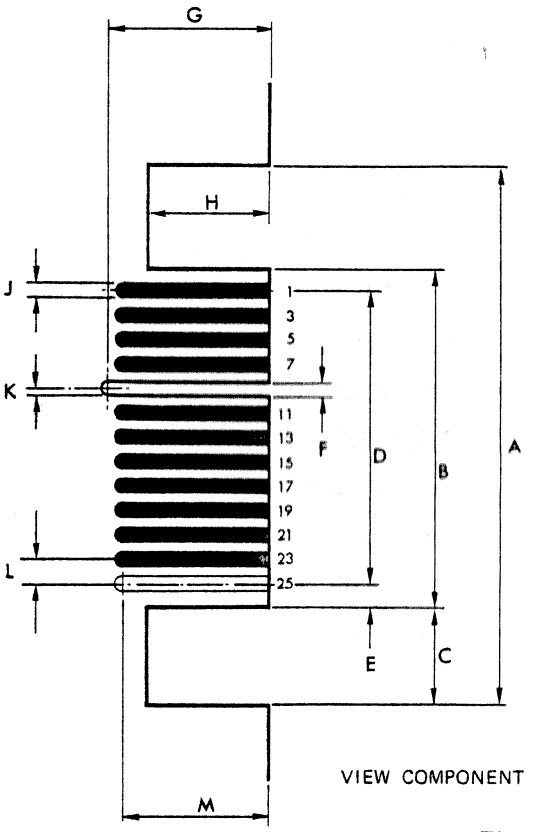

VIEW COMPONENT SIDE

	mm		in.	
	NOM.	TOL.	NOM.	TOL.
A	55,88	-	2.20	-
B	35,26	+0 -0,2	1.388	+003 -008
C	10,29	+0,12 -0	0.40	+005 -000
D	30,48	±0,15	1.200	±006
E	2,41	-	0.095	-
F	1,70	+0,2 -0,05	0.067	+008 -002
G	16,85	-	0.66	-
H	12,70	-	0.50	-
J	2,16	±0,05	0.085	±002
K	0,85	±0,025	0.033	±001
L	2,54	±0,15	0.10	±006
M	15,24	±0,15	0.60	±006

Figure 14. Logic connector



6.7 LOGIC CONNECTOR/continued...

Table 2 : LOGIC CONNECTOR PIN ASSIGNMENT J04

PIN N°	SIGNAL	PIN N°	SIGNAL
2	WRITE DATA	1	EARLY CLOCK
4	DATA CLOCK	3	GROUND
6	INDEX MARK	5	GROUND
8	SECTOR MARK	7	ADDRESS PARITY
12	LATE CLOCK	11	GROUND
14	RUN	13	READY TO SRW
16	VALID SECTOR	15	GROUND
18	FAULT	17	GROUND
20	READ ENABLE	19	FAULT RESET
22	READ DATA	21	GROUND
24	WRITE ENABLE	23	GROUND
26	RESERVED	25	RESERVED

Table 3 : LOGIC CONNECTOR PIN ASSIGNMENT J01

PIN N°	SIGNAL	PIN N°	SIGNAL
2	STROBE 1	1	RESERVED
4	STROBE 2	3	GROUND
6	ADLIN 0	5	GROUND
8	ADLIN 3	7	CARTRIDGE ACCESS
12	WRITE PROTECTED	11	GROUND
14	ADLIN 2	13	ADLIN 1
16	ADLIN 7	15	GROUND
18	INITIALIZE	17	GROUND
20	ADLIN 5	19	RESERVED
22	ADLIN 6	21	GROUND
24	ADLIN 4	23	GROUND
26	RESERVED	25	RESERVED



Cii Honeywell Bull

COMPAGNIE INTERNATIONALE POUR L'INFORMATIQUE CII-HONEYWELL BULL

D140 OEM PRODUCT SPECIFICATION

SPEC. NO.

BEM 1208

FOLIO

39

REV.

A0

7. ELECTRICAL REQUIREMENTS

7.1 INPUT POWER SUPPLIES

The power supplies required by the drive are shown in Table 4.

Table 4 : DRIVE POWER REQUIREMENTS

Voltage	Tolerance	Normal current	Surge current	Ripple	Max. current load
+ 35 V	+ 10% - 15%	2.5 A	6.5 A during 20 seconds		8 A
+ 12 V	± 5%	1.0 A		< 120 mV peak to peak	3 A
+ 5 V	± 5%	4.4 A		< 120 mV peak to peak	15 A
- 12 V	± 5%	0.85 A		< 120 mV peak to peak	3 A

Note 1

The current flowing in the 0V return line between the logic and power supply connectors must never exceed 15 amps. (in the event of a short-circuit between the power supply line and chassis ground).

Note 2

The short-circuit current flowing between the 0V line and the chassis ground must not exceed 20 mA over a frequency range of 100 KHz to 10 MHz.



7.2 INPUT POWER CONNECTOR

The recommended power connector is a 9 pin (BERG type, for example) edge connector. Connector pin assignment must correspond to the signal allocation on the main circuit board as shown in Figure 15b. Locating dimensions for the mating connector are shown in Figure 15a.

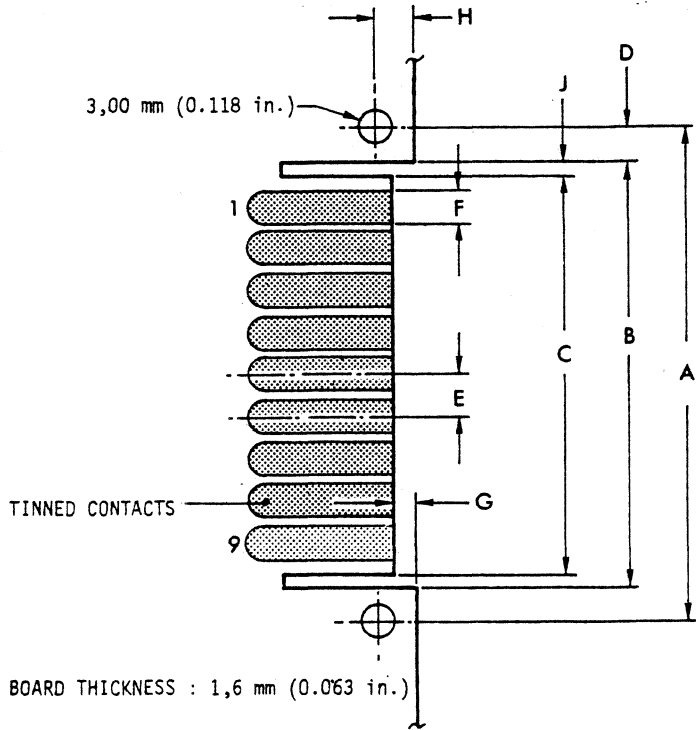

	mm	in.
A	45,72	1.800
B	39,32	1.548
C	36,78	1.448
D	3,20	0.126
E	3,96	0.156
F	3,048	0.120
G	2,00	0.078
H	3,81	0.150
J	1,27	0.050

Figure 15a

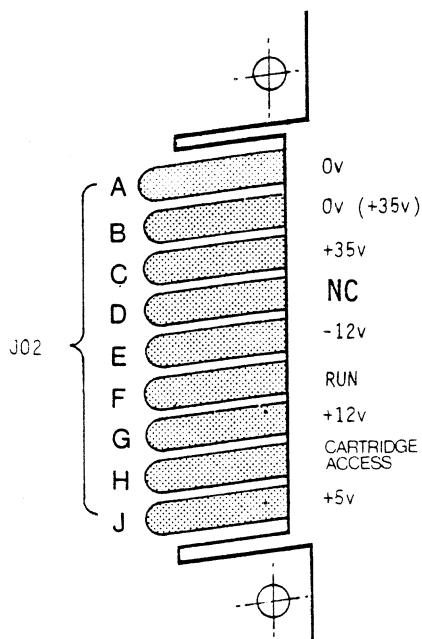

VIEW COMPONENT SIDE

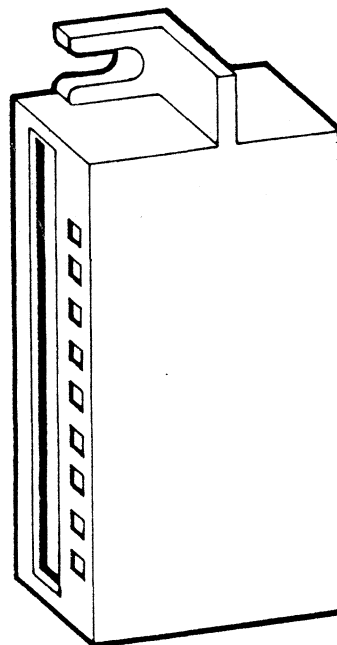

Figure 15b

CE DOCUMENT DOIT ETRE CONSIDERE COMME ETANT D'USAGE INTERNE A CII-HB. IL NE PEUT ETRE COMMUNIQUE A DES TIERS SANS AUTORISATION EXPRESSE DE CELLE-CI



Cii Honeywell Bull

COMPAGNIE INTERNATIONALE POUR
L'INFORMATIQUE CII-HONEYWELL BULL

D140 OEM PRODUCT
SPECIFICATION

SPEC. NO.

BEM 1208

FOLIO

42

REV.

A0

9. INSTALLATION

9.1 ENVIRONMENT CONDITIONS

9.1.1 Operating Environment

The D140 can operate in a normal non-air conditioned office environment. The atmospheric/climatic limits are tabulated in Table 5.

TABLE 5 : OPERATING ENVIRONMENT LIMITS

TEMPERATURE surrounding the drive	(°C/°F)
Dry bulb, maximum	40/104
Dry bulb, minimum	15/ 59
Dry bulb, linear Gradient/hour	5/ 9
Wet bulb, maximum	26/78.8
Wet bulb, minimum	7/44.6

RELATIVE HUMIDITY (%)

Maximum	80
Minimum	8
Gradient/hour	10

ATMOSPHERIC PRESSURE (mm Hg)

Maximum	780
Minimum	562

VIBRATIONS

0.02 in. : 5 to 10 Hz

Constant displacement of 0.02 in. : 5 to 10 Hz
0.25 g ... 10 to 100 Hz



Cii Honeywell Bull

COMPAGNIE INTERNATIONALE POUR
L'INFORMATIQUE CII-HONEYWELL-BULL

D140 OEM PRODUCT
SPECIFICATION

SPEC. NO.

BEM 1208

FOLIO

43

REV.

A0

9.1.2 Non-Operating Environment

The D140 drive will withstand the following climatic conditions during transportation.

- temperature range : - 35°C to 65°C (-31°F to 149°F)
during one week
- : 5°C to 45°C (41°F to 113°F)
during three months
- relative humidity : 5% to 95%

Media Storage

The storage temperature shall be within the range : - 40°C to + 65°C, the wet bulb reading not exceeding 30°C. For wet bulb temperatures between 0.5°C and 30°C, the disk shall be able to withstand a relative humidity of 8% to 80%.

Storage under the extreme conditions of the above range is not recommended. A temperature gradient of more than 10°C per hour should be avoided.

The ambient stray magnetic field intensity shall not exceed 4000 A/m.

9.2 INSTALLATION

9.2.1 Physical Installation

The rack mounting model may be installed in a 19 inch standard rack. It is possible to mount the drive either vertically or horizontally.

The overall dimensions of the rack installable unit are given in Figure 16.

9.2.2 Electrical Installation

Refer to Figure 17.

SPEC. NO.	FOLIO	REV.
BEM 1208	44	A0

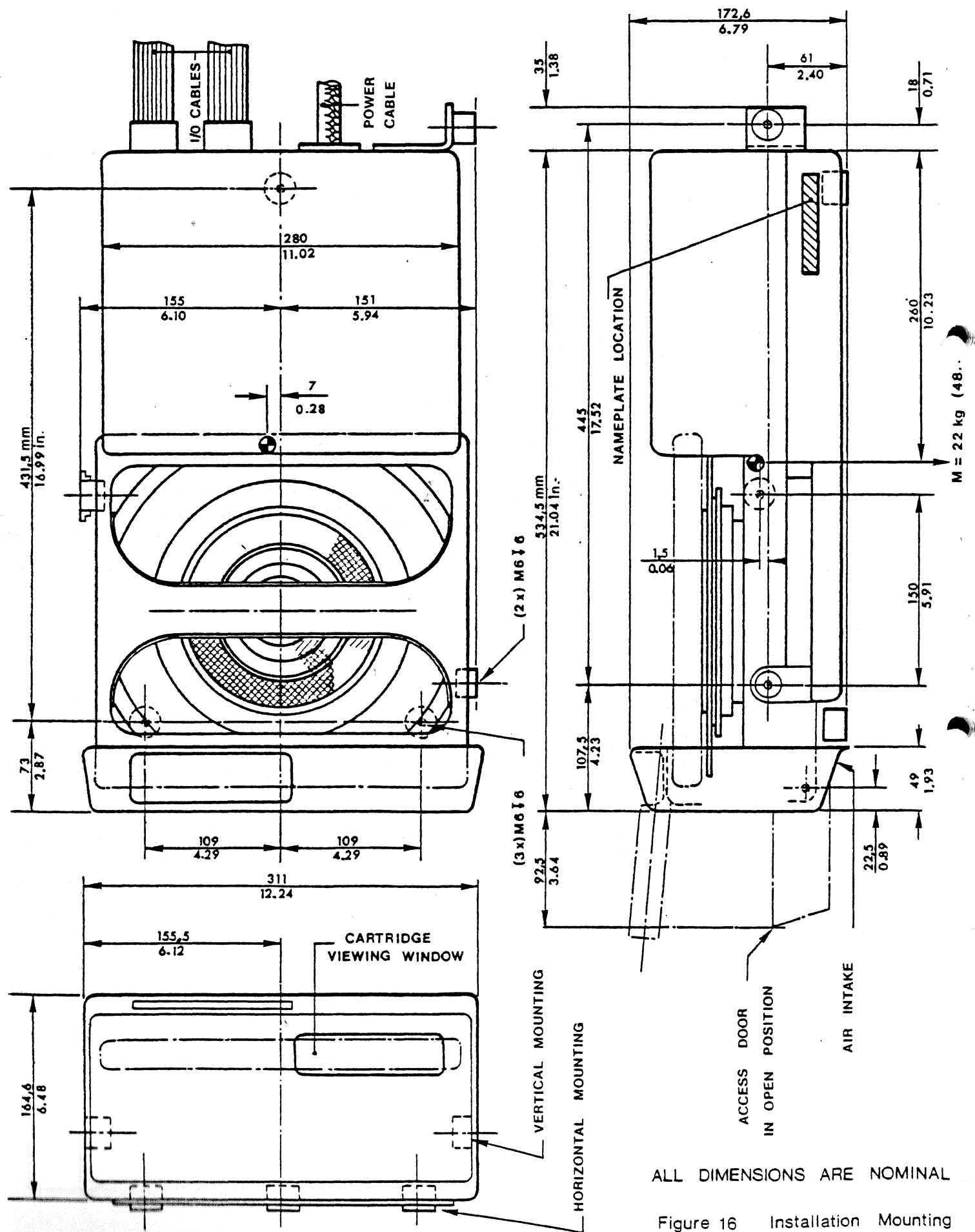

ALL DIMENSIONS ARE NOMINAL

Figure 16 Installation Mounting



Cii Honeywell Bull

COMPAGNIE INTERNATIONALE POUR
L'INFORMATIQUE CII-HONEYWELL BULL

D140 OEM PRODUCT
SPECIFICATION

SPEC. NO.

BEM 1208

FOLIO

46

REV.

A0

10. RELIABILITY

10.1 MEAN TIME BETWEEN FAILURE

Following an initial period of 200 hours, the MTBF should exceed 4000 for units manufactured in the first year of production, and 5000 hours in successive years. The MTBF is defined by the following expression:

$$\text{MTBF} = \frac{\text{Operating hours}}{\text{N}^\circ \text{ of equipment failures}}$$

Operating hours means the total power-on time less any maintenance time. Equipment failures are any stoppage or sub-standard performance of the equipment due to equipment malfunction, and does not include stoppages or substandard performance caused by operator error, bad environment, power failure, controller failure, cable/connector failure or any other failure not caused by the equipment.

10.2 MEAN TIME TO REPAIR

The mean time to repair is 0.8 hours; it is defined as the average time required for an adequately trained and competent serviceman to diagnose and repair a malfunction. Travelling time is not included.

10.3 USEFUL LIFE

The D140 drive is designed and constructed to give a service life of 5 years before factory overhaul or replacement is required on condition that any maintenance carried out is performed according to Cii Honeywell Bull maintenance manual procedures. It is permitted to repair or replace major parts during the service life.

11. MAINTENANCE

11.1 PREVENTIVE MAINTENANCE

No preventive maintenance is scheduled for the D140, no operator duties are required.

The air filter must be replaced every 4000 to 6000 hours, power-on time, depending on the state of the environment. This operation can be executed at any time when a Field Maintenance engineer is on site.

11.2 MAINTENANCE DOCUMENTATION

A complete maintenance documentation is available. This documentation comprises : Description - Installation, Maintenance and Tests, Illustrated Parts Catalogue.

11.3 SPECIAL TOOLING

No CE pack is required for maintenance purposes. Only one special tool is required for carriage replacement.

11.4 RECOMMENDED SPARE PARTS

Different levels of Initial Spare Kits (ISK's) have been established for on site maintenance purposes.

The number of machines serviced by the ISK's is to be calculated for a group of machines maintained by the same Field Service unit.

Under normal conditions electronic spares cover 20 machines and mechanical spares cover 50 machines.