

DATA MATION⁶⁶®

December

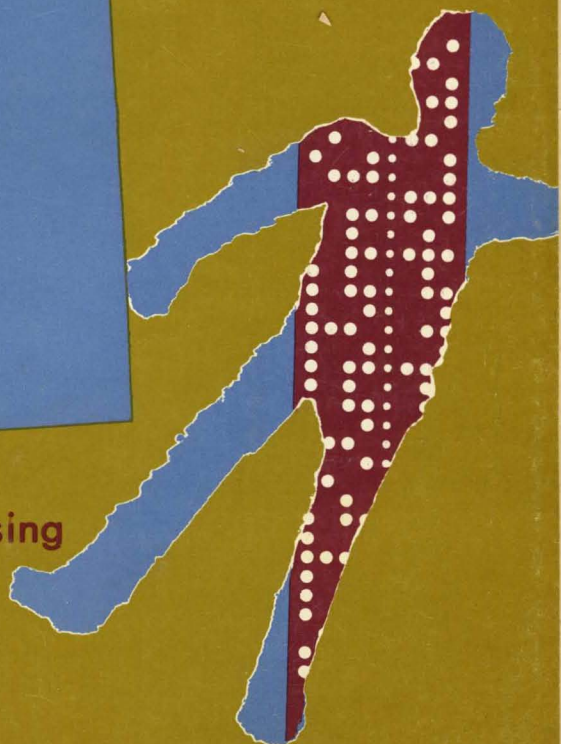

the social implications of information processing

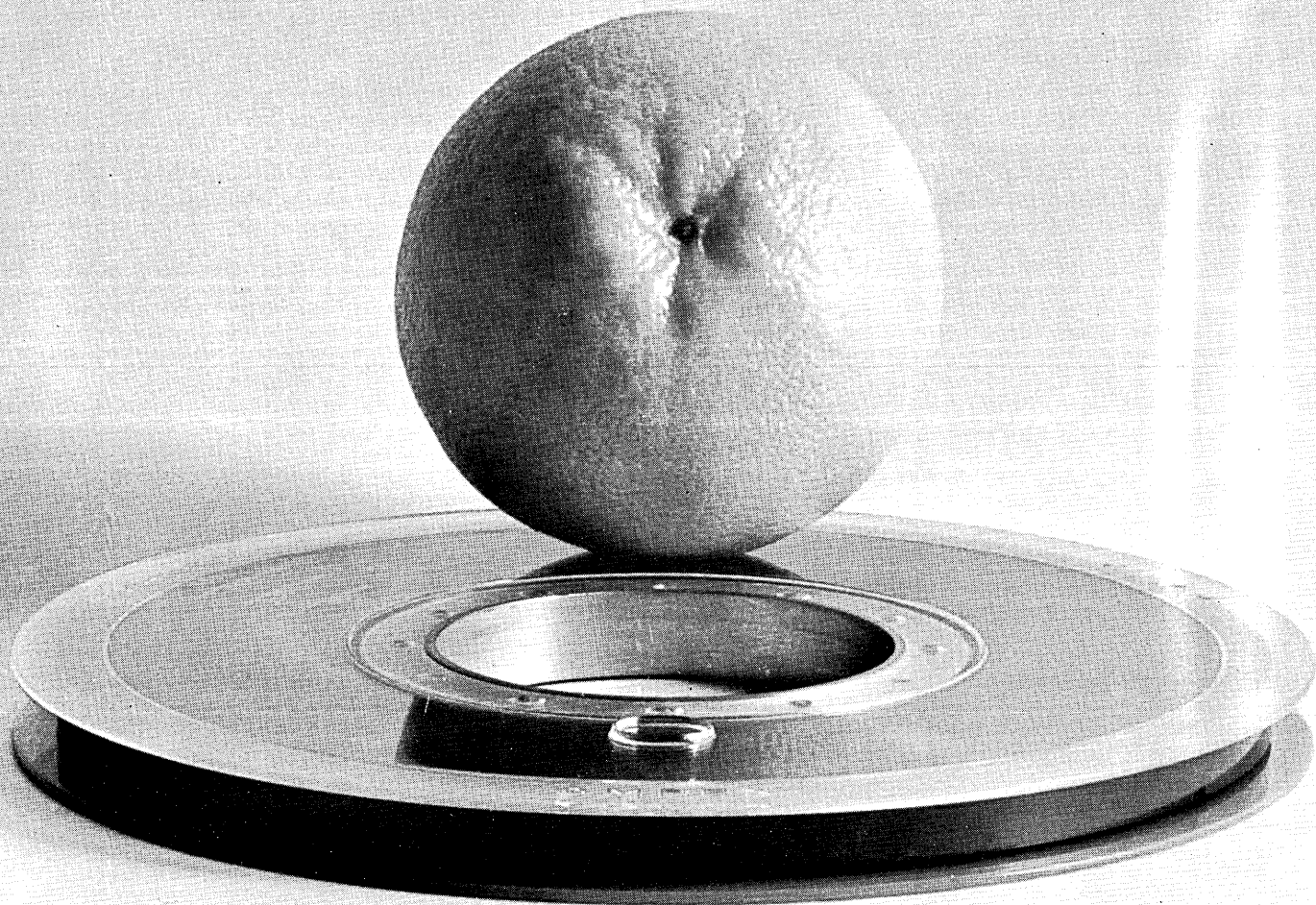

not a grapefruit in 500 miles

One microscopic bump or particle on a computer tape—equivalent in size to a grapefruit sitting on a 500-mile, four-lane highway—is all it takes to cause a parity error. There are no “grapefruits” on Ampex tape. New formula Ampex computer tapes are clean and

error-free to begin with, and are formulated to stay that way for hundreds of thousands of equipment passes. You get more data through-put, unparalleled data re-

AMPEX

CIRCLE 1 ON READER CARD

liability. Prove it on your own computer. Call your Ampex representative for a demonstration. Or for the latest information write Ampex Corporation, 401 Broadway, Redwood City, California 94063. You can be sure we won't sell you a lemon — or a grapefruit.



Our optical reader can do anything your keypunch operators do.

(Well, almost.)

It can't return from a two-day weekend with a three-day hangover. Or phone in sick. Or turn out half the work in twice the time. But it *can* read. And gobble data at the rate of 2400 type-written (or hand printed) characters a second. And compute while it reads. And reduce errors from a keypunch operator's one in a thousand to an efficient one in a hundred thousand.

Our machine reads upper and lower case characters in intermixed, standard type fonts. It can handle intermixed sizes and weights of paper, including carbon-backed sheets.

An ordinary computer program tells our reader what to do . . . to add, subtract, edit, check, or verify as it reads. Lets you forget format restrictions, leading and trailing zeros, skipped fields, and fixed record lengths. And our reader won't obsolete any of your present hardware because it speaks the same output language as your computer.

Our Electronic Retina Computing Reader can replace all—or almost all—of your keypunch operators. At least that's what it is doing for American Airlines.

If you have a volume input application, it can do the same for you. Tell us your problem and we'll tell you how.



RECOGNITION EQUIPMENT

 Incorporated

ONLY HONEYWELL OFFERS

TOMORROW'S BREED OF I/C COMPUTER TODAY...AND AT OFF-THE-SHELF PRICE

... μ -COMP DDP-416

\$15,000

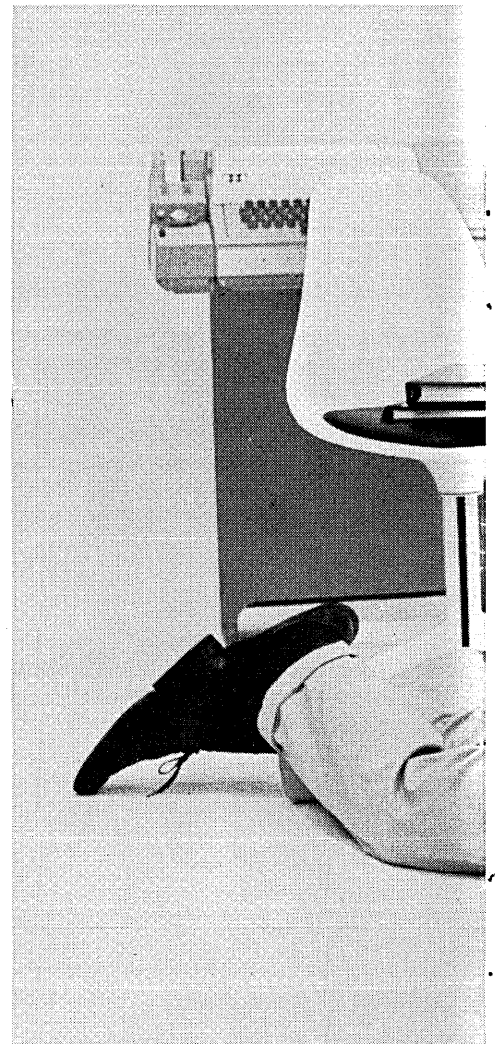

SPECIFICATION SUMMARY

Type	16-bit parallel, binary
Console	Movable
Addressing	Indirect
Memory Size	Up to 16,384
Cycle Time	960 nanoseconds
Add	1.92 μ secs
Single word I/O transfer	1.92 μ secs
Automatic (cycle stealing) I/O transfer	Over 1 mc (16 bit words)
Weight	250 lbs.
Temperature	0° to 45°C

BY ANY STANDARDS . . . the NEW μ -COMP DDP-416 on-line, real-time computer gives you a price/performance ratio that can't be beat: full size 16-bit capability, nanosecond speeds, plus I/C size and reliability. Only \$15,000.

TAKE RELIABILITY . . . most manufacturers are just now planning their first I/C computer. Honeywell, Computer Control Division announced the first commercial I/C computer a year ago . . . DDP-124, the second last month . . . DDP-516, the third today. Result! Field proven reliability and a thorough knowledge of how to work with I/C's. Example . . . DDP-416 MTBF: 4,000 hours or two years under normal 40-hour week operation.

UNPRECEDENTED EFFICIENCY . . . quick response to external conditions . . . ability to process several inputs and outputs simultaneously . . . service I/O requirements in order of priority without hold conditions. This kind of efficiency is expected only in higher priced computers.

The DDP-416 is directly compatible with ASCII 8-bit character codes. And the 30-command repertoire includes many "big-machine" functions like memory reference instructions: Load, Store, Add,

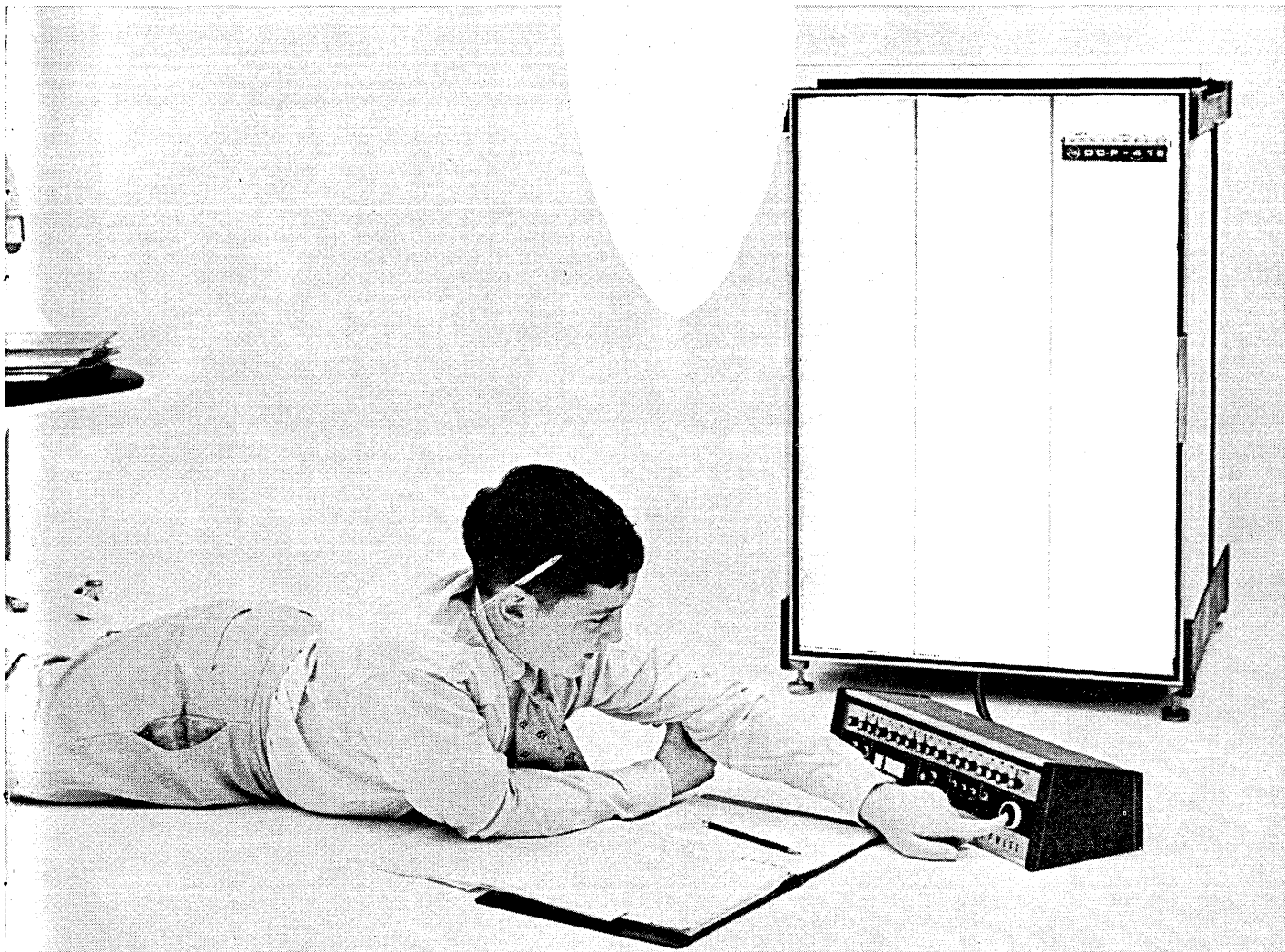

Donald, 12-year-old son of DDP-416 logic design engineer Bill Woods, writing software demonstration program for new μ -COMP computer.

Subtract, Logical AND, Exclusive OR, Increment Memory and Skip, Jump, Jump-Skip. And two-cycle I/O commands that select device, test status, and transfer data without I/O hold-off. Priority interrupt and power-failure protection are standard.

MODULAR CONSTRUCTION . . . system power supply, central processor and a 4,096 word memory (expandable to 16,384 words) are mounted in a single 24" x 24" x 38" cabinet. Tilt out construction gives you easy front access to both modules and interwiring. The control console is moveable and the entire computer may be mounted in a standard 19" rack.

EXPANSION CAPABILITY . . . memory parity, memory lockout, real-time clock and multiplexed channel for multi-station time-shared I/O capability are all easy to add as plug-in options.

And if your problem is too big for the DDP-416, or if you think you'll grow out of it too fast, you may want the more powerful μ -COMP DDP-516 for \$25,000.

SIMPLIFIED SOFTWARE . . . it may take a bright 12-year-old to work with the DDP-416, but you'll find it a snap to program. The package of 50 programs

is written in a simple format to give the real-time systems builder extended flexibility. You get mathematical and I/O subroutines, complete diagnostics, DESECTORIZING that lets you ignore memory addressing restrictions, a debug program, plus participation in our active users' group.

Best of all, if you decide to get the more powerful DDP-516 in the future, you can continue to use your DDP-416 programs because of direct compatibility.

DELIVERY . . . both hardware and software, second quarter of 1967.

**IMMEDIATE DELIVERY RESERVATION
FILL OUT AND RETURN COUPON NOW**

- Please reserve a DDP-416 and confirm approximate delivery date. Send more information by return mail. Hold this delivery date for me for 15-days so I can make a final decision and get my P.O. to you.
- Don't reserve a DDP-416 for me yet. I need more facts. Send me your DDP-416 summary brochure.
- I think I need a more powerful computer. Send me your DDP-516 summary brochure.

Name _____ Title _____
 Company _____
 Address _____
 City _____ State _____ Zip _____

Please attach this coupon to your letterhead — we'll take it from there.
 Honeywell, Computer Control Division
 Customer Services
 Old Connecticut Path
 Framingham, Mass. 01701

Honeywell

CC COMPUTER CONTROL DIVISION

Send us \$745 for this maintenance manual

(and we'll throw in
a very good paper tape reader)

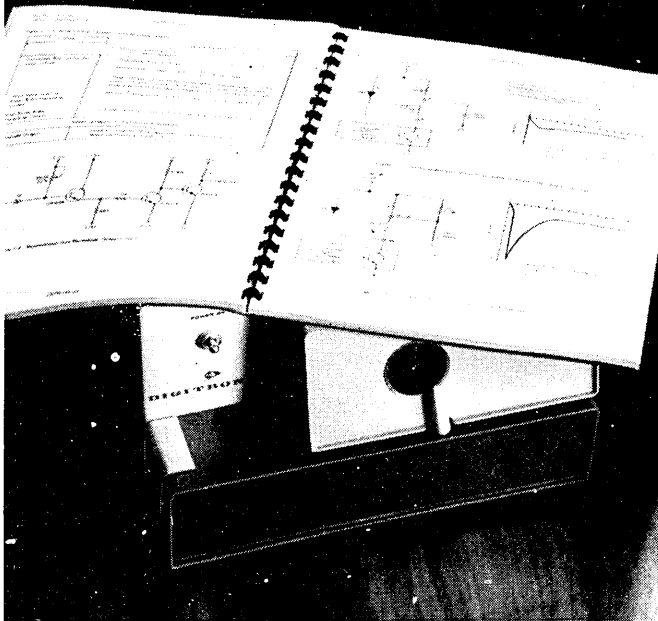

If you get the idea that we consider our Operating and Maintenance Manuals pretty valuable—you're right!

Actually, a Digitronics Paper Tape Reader requires very little adjustment and maintenance. But when you do have occasion to use one of these manuals, you'll discover that they're the finest in the industry. (Which is only appropriate—since our readers are also the finest.)

You can get valuable maintenance assistance from our Factory Service Center too, we might add. So why not investigate our complete line of readers today. Your nearest Digitronics representative is listed in EBG and EEM. Get in touch with him—and get a lot more for your money than merely hardware. Digitronics Corporation, Albertson, New York; or phone (516) HT 4-1000.

 **DIGITRONICS**
when every bit counts

CIRCLE 6 ON READER CARD

december
1966

volume 12 number 12

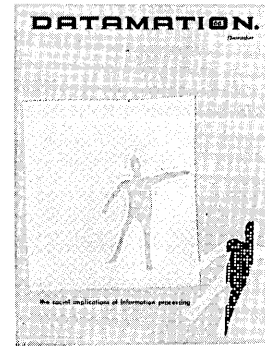

Publisher
Editor

GARDNER F. LANDON
ROBERT B. FOREST

Managing Editor & Art Director
Associate Editors

CLEVE MARIE BOUTELL
EDWARD K. YASAKI
WILLIAM J. ROLPH

Assistant Editor
Eastern Editor
European Editor
Contributing Editors

HEIDE H. THORSTENSON
ANGELINE PANTAGES
CHARLES WHITE
HOWARD BROMBERG
ROBERT V. HEAD

Washington Reporter
Editorial Adviser
Technical Consultant
Production Manager
Director of Circulation
Circulation Fulfillment

PHIL HIRSCH
ROBERT L. PATRICK
LOWELL AMDAHL
MARILEE PITMAN
FRANK DeCARLO
ALGENE TRAINA

Eastern District Managers

JAMES M. MORRIS
WARREN A. TIBBETTS
35 Mason Street, Greenwich, Conn. 06830
(203) 661-5400

New England District Manager
& Vice President

WARREN A. TIBBETTS
112 West Haven Rd.,
Manchester, N.H., [603] NAional 5-9498

Midwest District Manager

JOHN BRENNAN
205 West Wacker Drive, Chicago, Ill. 60606
[312] Financial 6-1026

Western District Manager

HAMILTON S. STYRON
& Vice President 1830 W. Olympic Blvd., Los Angeles, Cal., 90006
[213] 385-0474

EDITORIAL OFFICES
1830 WEST OLYMPIC BLVD.
LOS ANGELES, CALIF. 90006



Circulation audited by
Business Publications Audit



Member,
American Business Press, Inc.

DATAMATION is published monthly on or about the tenth day of every month by F. D. Thompson Publications, Inc., Frank D. Thompson, Chairman; Gardner F. Landon, President; Gilbert Thayer, Senior Vice President. Executive, Circulation and Advertising offices, 35 Mason Street, Greenwich, Conn. 06830 (203) 661-5400. Editorial offices, 1830 W. Olympic Blvd., Los Angeles, California 90006. Published at Chicago, Ill. DATAMATION is circulated without charge by name and title to individuals who qualify by our standards and are employed by manufacturers or users of automatic information-handling equipment in all branches of business, industry, government and the military. Available to others by subscription at the rate of \$15.00 annually; single issues (when available) \$1.50. Reduced rate for qualified students. Foreign subscriptions are on a paid basis only at a rate of \$25.00 annually. No subscription agency is authorized by us to solicit or take orders for subscriptions. Controlled circulation paid at Columbus, O. and Chicago, Ill. Form 3579 to be sent to F. D. Thompson Publications, Inc. Microfilm copies of DATAMATION may be obtained from University Microfilms, Inc., 313 No. First St., Ann Arbor, Michigan.

Printed by Beslow Associates, Inc.

This issue 70,411 copies

DATAMATION



Open These Gifts First

For those dreaming of computers for Christmas, or instrumentation using digital techniques, we have two free gifts for you — that really should be opened first.

Just published is a 540-page Handbook of Small Computers, which begins with a primer (or, what everyone should know about small computers), and goes on to describe, in detail, three of the most exciting small computers in the industry. The PDP-8/S, the PDP-8, and the LINC-8 are general purpose, on-line, real time, Fortran-speaking machines that are

friendly, approachable, creatively adaptable . . . Prices begin at \$10,000 for a complete computer.

The 330-page Digital Logic Handbook describes four series of FlipChip™ modules, which are not only ideal for interfacing with the computers, but from which most digital instrumentation can be made. The handbook describes the logic in detail, as well as applications.

Write for your presents.

digital
COMPUTERS • MODULES

DIGITAL EQUIPMENT CORPORATION, Maynard, Massachusetts 01754. Telephone: (617) 897-8821 • Cambridge, Mass. • New Haven • Washington, D. C. • Parsippany, N. J. • Rochester, N. Y. • Philadelphia • Huntsville • Pittsburgh • Chicago • Denver • Ann Arbor • Houston • Los Angeles • Palo Alto • Seattle • Carleton Place and Toronto, Ont. • Reading, England • Paris, France • Munich and Cologne, Germany • Sydney and West Perth, Australia • Modules distributed also through Allied Radio

Circle 7 on Reader Card



Great
Tape is tape
^

When it comes to wrapping a package or patching a cut or recording a symphony there is usually one brand of tape that does the job a little better than anything else . . . but people being what they are, not everyone uses it.

Likewise, in critical data processing applications, there is one precision tape that stands above the rest in terms of value . . . but not

everyone uses Computape either.

There are still tape users who have not discovered that, if they buy Computape, they get far more than a certified reel of reliable, quality recording tape. They still haven't found that the tape itself is only half the story . . . that unlike many other tape manufacturers, *Computron follows through.*

Those who do use Computape,

of course, are familiar, not only with the quick delivery, the fine performance, and the convenience features, but also with extras such as Computron's unique applications engineering service — available without charge, on short notice, in all parts of the country.

Perhaps you should be using Computape. Find out. Write today for the complete story.



COMPUTRON INC

122 CALVARY STREET, WALTHAM, MASSACHUSETTS 02154
CIRCLE 8 ON READER CARD

DATA MATION ⁶⁶®

december

1966

volume 12 number 12

- 23 THAT BEAST UPON THE WIRE, *a poem by Ray Bradbury.*
- 24 ECONOMIC GROWTH AND POVERTY, *by Richard R. Nelson. The role of technology in economic growth, and the role of economic growth in the elimination of poverty.*
- 28 AUTOMATION'S ROLE IN EMPLOYMENT, *by Martin R. Gainsbrugh. Changes in our economic structure — from farm to non-farm employment, from manufacturing to service industries — and in the composition of our workforce, have had the greatest effect on employment.*
- 33 THE COMPUTER'S PUBLIC IMAGE, *by Robert S. Lee. Study based on 3,000 personal interviews shows a public uneasiness over computer's purported ability to think.*
- 39 THE SCC 6700. *Dallas-based Scientific Control Corp. announces the SCC 6700 Time-Sharing Computer, a 24-bit machine using Berkeley-developed software.*
- 41 NOVA: A LIST-ORIENTED COMPUTER, *by Joseph E. Wirsching. Proposing a modern version of a drum computer, the author shows the advantages of list processing for columns and two-dimensional arrays.*
- 45 THE REVOLVING EXECUTIVE CHAIR, *by Henry J. Cadell. A thoughtful and persuasive explanation of the reasons for cyclic executive careers in growth industries.*
- 55 FJCC REPORT. *The Fall Joint Computer Conference was bigger than ever, attracting about 5000 registrants to San Francisco for sessions, panels, and exhibits.*
- 63 RAILROAD CONFERENCE REPORT. *Overwhelming statistics, first-generation systems and the lost freight car.*
- 82 BENCHLEY MUDDLES THROUGH AUTOMATION, *by Programmaticus. It's hard to believe that a tax refund can arouse more fears than going to the dentist.*
- 91 IEEE WORKSHOP ON MULTIPROGRAMMING. *Agreeing on certain universals, managers, users and designers attacked the new incompatibilities.*

automatic
information
processing
for business
industry & science

datamation departments

- | | | | |
|----|-----------------------|-----|----------------------|
| 9 | Calendar | 93 | World Report |
| 13 | Letters to the Editor | 97 | Washington Report |
| 17 | Look Ahead | 105 | Books |
| 21 | The Editor's Readout | 109 | People |
| 69 | News Briefs | 111 | Datamart |
| 75 | New Products | 116 | Index to Advertisers |
| 87 | New Literature | 118 | The Forum |

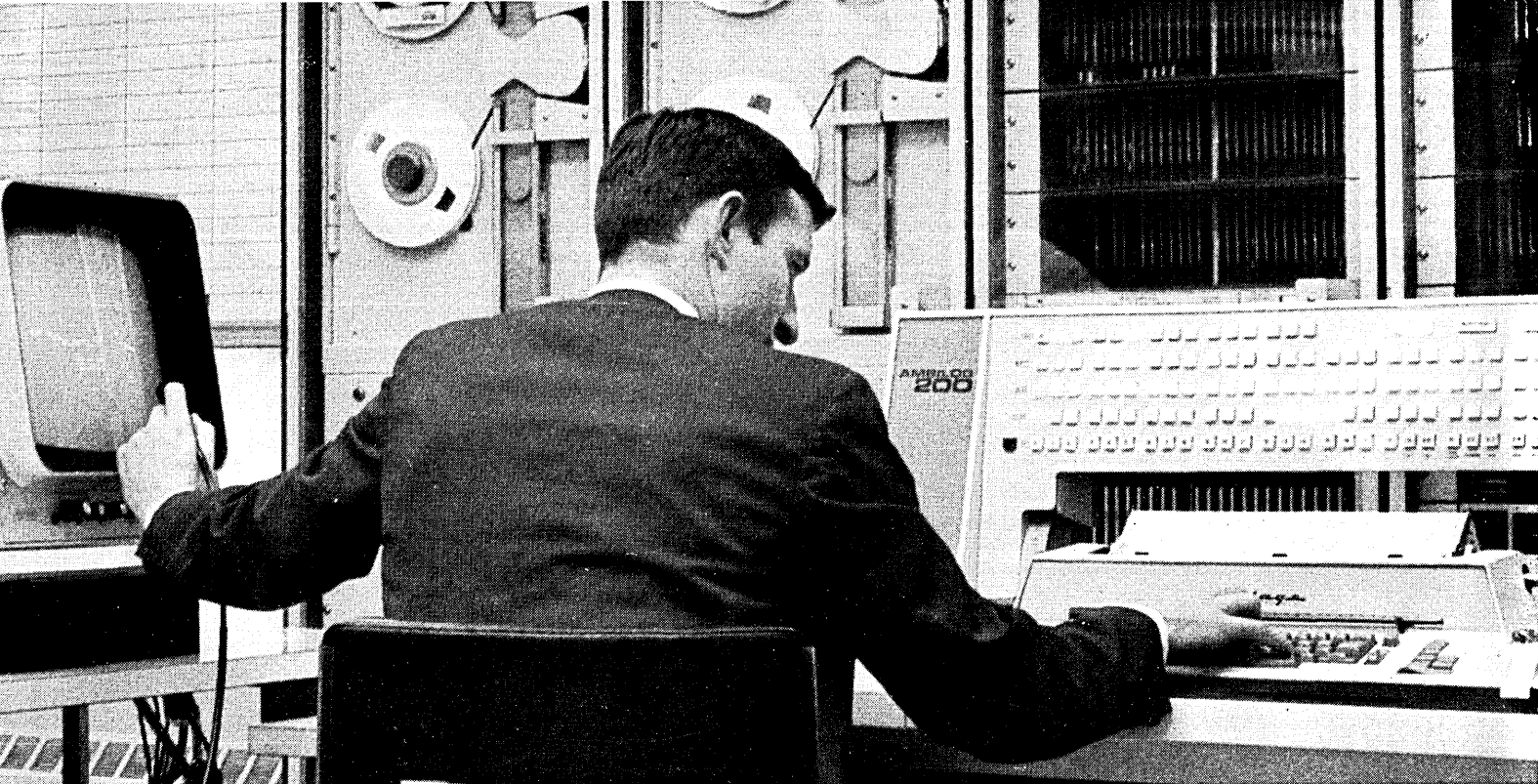

Adage makes the best computer on the market for signal processing. It's called Ambilog 200.

Combining the best of both analog and digital techniques, Ambilog 200 was designed right from the start for processing signals (time-related variables, often in analog form). Its unique hybrid structure and ability to handle efficiently both analog and digital information make possible at relatively low cost the extremely high computing rates required in signal processing applications.

DIGITIZING AND RECORDING

Up to several hundred inputs are routed under program control through an array of multiplexer switches, hybrid arithmetic elements, and a 14-bit, 4 microsecond analog-to-digital converter for recording or outputting. Ambilog 200 converts raw data to engineering units, including corrections for calibration error, at even faster sampling rates than conventional systems which simply "acquire" data.

WAVEFORM MEASUREMENT

Peak values, axis crossings, ratios of successive differences, and other characteristics of analog signals are measured in real time. Using complex programmed detection criteria,

incoming signals are monitored for events of interest, typically with a resulting 100-to-1 reduction in the bulk of magnetic tape output records.

RANDOM SIGNAL ANALYSIS

Parallel hybrid multiplication and summing, 2 microsecond 30-bit digital storage, and a flexible instruction format providing efficient list processing combine to make Ambilog 200 an extremely powerful tool for statistical signal analysis techniques. These include Fourier transformation, auto and cross correlation, power spectrum density analysis, and generation of histograms of amplitude spectra.

GRAPHIC DISPLAY

On-line CRT displays of incoming data, or of results derived by reduction and analysis, are generated at frame rates of about 30 per second using line-drawing elements. Other visual display configurations, intended as design aids, generate isometric or true-perspective projections of objects containing more than 1000 line segments, with arbitrary translation and rotation.

FUNCTION GENERATION

In generating arbitrary functions of one or more variables, quadratic or cubic interpolation is achieved at high speed by using hybrid arithmetic elements in parallel to evaluate a polynomial function. Or, where straight-line approximations are adequate, different values of slopes and intercepts for each line segment are fetched from memory for operating on the variable.

SOFTWARE

Programming aids are tailored to the specialized needs of signal processing tasks, and include an Adage assembly system, Fortran, programs for source language editing and on-line debugging and control, and a wide range of applications programs and subroutines. Ambilog 200 signal processing systems are currently being used for seismic research, dynamic structural testing, sonar signal analysis, wind tunnel testing, speech research, simulation, and biomedical monitoring.

For further details, write M. I. Stein, Product Manager, Adage Inc., 1079 Commonwealth Ave., Boston, Mass., 02215.

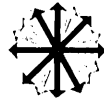
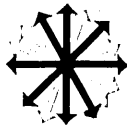

calendar

DATE	TITLE	LOCATION	SPONSOR/ CONTACT
Dec. 29	Conference: Computers & Literary Stylistics	IBM Auditorium New York, N.Y.	Joseph Raben Dept. of English Queens College Flushing, N.Y.
Jan. 6	Lecture: Systems Approach to Urban & Inner-City Transportation	Systems Research Case Tech. University Circle Cleveland, Ohio	Case Institute of Technology & Simon Ramo Foundation.
Jan. 15	Deadline: Papers for Colloquium on Information Retrieval		To: Lawrence Berul Auerbach Corp. 121 N. Broad Philadelphia, Pa
Jan. 16-19	Course: Printing and Publishing — The Management of Automation \$175	Twin Bridges Marriott Washington, D. C.	American Univ.
Jan. 17-18	Symposium: Simulation in Biomedicine	Mayo Clinic Rochester, Minn.	Central and Midwestern Sim- ulation Councils
Jan. 19	Symposium: Computers & Communications: Their System Interaction	Miramar Hotel Santa Monica, Calif.	IEEE
Jan. 23-27	Course: Methods of Operations Research \$225	Univ. of Miami Coral Gables, Fla.	Univ. of Miami
Jan. 27-28	Workshop: Simulation	College of Engineering Univ. of Missouri Columbia, Mo.	Univ. of Missouri
Feb. 1	Symposium: Computer Science and Statistics	Univ. of California Los Angeles, Calif.	UCLA, L.A. ACM & Ameri- can Statistical Assn.
Feb. 7-9	Convention: Aerospace & Electronic Systems	International Hotel Los Angeles, Calif.	IEEE
Feb. 8-15	EDP Trade Fair	Frankfurt Trade Center Frankfurt, Germany	U.S. Bureau of International Commerce
Feb. 25	CDP Examination	DPMA Test Centers 100 national locations	Data Processing Management Assn.
Feb. 13-17	SHARE XXVIII	Hilton Hotel San Francisco, Calif.	IBM Users' Group

You want
to know
how G-E
magnetic tape
can save
you money.
Right?

When defective tape causes unnecessary write checks, it can waste more dollars in computer time than the cost of the tape. Intensive quality testing of General Electric magnetic tape gives you:

- Higher reliability
- Better signal characteristics
- Greater computer throughput
- 1200- and 2400-foot lengths, 556 and 800 BPI

Write.

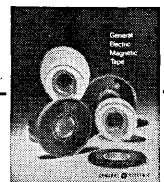

General Electric Co.
Room 912
2721 N. Central Ave.
Phoenix, Ariz. 85004

Please send my free copy of your new, full-color, 16-page catalog describing G-E magnetic tape.

NAME _____
COMPANY _____
STREET _____
CITY _____ STATE _____ ZIP _____

GENERAL  ELECTRIC

RCA's new 1- μ s Integrated Circuit Memory System is expandable up to 32,768 words X 36 bits

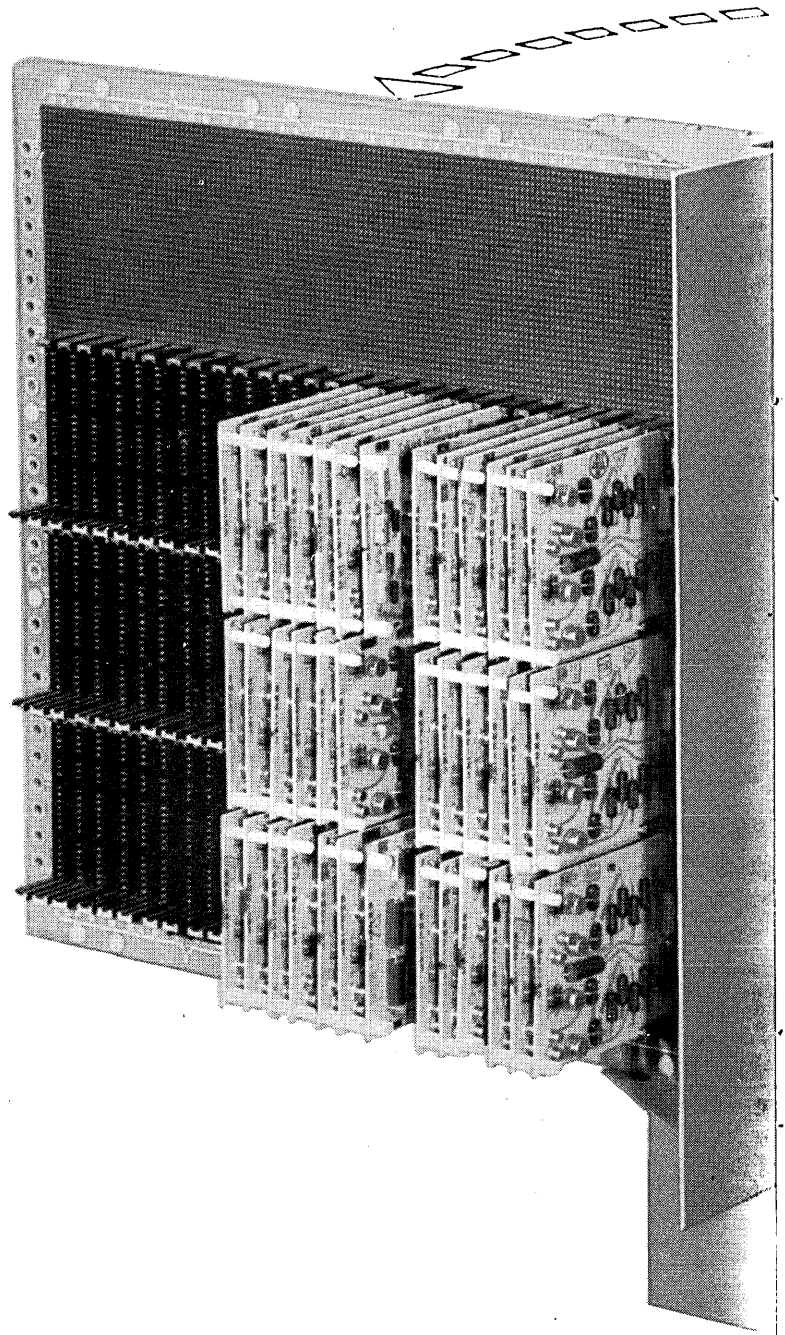

Integrated circuits in this new RCA memory system increase speed, reduce size, and lower power needs. Complete front-panel accessibility provides easy maintenance... panels slide out and open like a book. Field-proved RCA circuit modules assure high reliability. And you have maximum flexibility with such optional features as: expandable memory size, a self-tester, Read/Modify/Write operation, and easy interfacing. Ask about the new RCA 30/18 high-speed cores that make this system unique... and reduce the cost to you. A new 2- μ s system is also available. Call, write or wire your RCA Field Representative today for price and delivery information. For a technical data brochure, write RCA Electronic Components & Devices, Commercial Engineering, Section FD 12, Harrison, N. J. 07029.

RCA ELECTRONIC COMPONENTS AND DEVICES



The Most Trusted Name in Electronics

4,800 bps today

Collins' TE-216A-4D Data Modem doubles
the speed on your existing voice data line.
Available now.

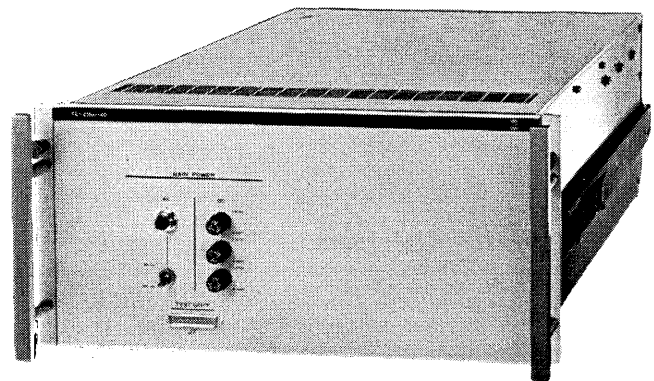

COMMUNICATION / COMPUTATION / CONTROL

Demonstrations of the new modem are being conducted in major cities. Write for date and place nearest you. Address communication to Manager, Data Equipment Sales, Collins Radio Company, Newport Beach, California 92663.



COLLINS RADIO COMPANY / DALLAS, TEXAS • CEDAR RAPIDS, IOWA • NEWPORT BEACH, CALIFORNIA • TORONTO, ONTARIO
Bangkok • Beirut • Frankfurt • Hong Kong • Kuala Lumpur • Los Angeles • London • Melbourne • Mexico City • New York • Paris • Rome • Washington • Wellington

CIRCLE 12 ON READER CARD



letters

camp response

Sir:

I read with more than passing interest Howard Bromberg's article, "Breaking Camp" (Sept. p. 70). It seems to me that before you develop on this subject any further you would seek the opinion of a real expert—someone in the computer business who is really "camp."

MEADE C. CAMP
Washington, D.C.

software sins

Sir:

I would like to add to Peter Jones' "Programming Paradoxes" (Sept., p. 157):

1. Once a computer is understood it becomes obsolete.
2. By the time an instruction manual is distributed to a programmer, the manufacturer will be printing the fourth revision to that manual.
3. The final debugged version of a software routine will arrive at the same time that your computer is being returned to the manufacturer.

BERNARD RAPKIN
Los Angeles, California

programmers & longevity

Sir:

Between "The Editor's Readout" (Oct., p. 21), and "The Forum" (Oct., p. 202), DATAMATION is taking quite a slap at the collective wrist of the computer programmers. Programmers "leaping from the tops of their Porsches" in fear of being replaced, or representing a new-wave "industry Cosa Nostra," should be flattered at eliciting such provocative prose, yet unswerving in the belief of their own worth.

There may have been a time when programmers taken as a group were overpaid, but this is no longer true. I'm sure that many talented, diligent, college-educated individuals can be found in their ranks, programmers whose dp experience spans years, and whose incomes are the same or little more than a garage mechanic's or mill worker's.

To paraphrase a statement by Einstein, computers are mysterious, but not malicious. So, too, the same statement can be applied to the high cali-

ber programmer. Needed is the understanding that programming in general, and for a user-company in particular, is a dead-end proposition, unless there is true incentive and genuine advancement to be had in other areas upon completion of the dp requirement. No one likes being kicked from pillar to post, or company to company, especially after working oneself out of a job well-done.

Nonetheless, it is easy to discern the trend toward free-standing computers slowing in relation to another trend toward telecomputing in centralized facilities accelerating. This picture offers the prospect whereby the programmer may come to roost amidst those of like feather. Such a facility can offer the long-range career opportunity necessary to foster professional skills and practices in an atmosphere of incentive and security for those whose bent is in that direction. N.L.R.M. RINGS
New Bedford, Mass.

feedbackput

Sir:

Re: the article by Sam and Anne Rosenfeld, "A Put-List for Enhanced Communication" (Oct., p. 49), I concur with an expanded put-list as a means of improving (i.e., further complicating) the technical vocabulary. I disagree, however, with the basic construction (particle + put) because the list of particles from which to choose is much too limited and not sufficiently technical.

To overcome these deficiencies, I favor a more liberal usage of prefixes. Thus the term thruput becomes intra-put. The data to be processed is, of course, the pre-put, and the data after processing is referred to as the post-put.

Incorrect pre-put is mis-put. When detected by the machine, mis-put results in rejected information (anti-put). If the mis-put goes undetected and intra-put actually occurs, the incorrect post-put is more precisely dys-put. After correction, mis-put may be handily called re-put. (It's easy to see that this is preferable to back-put, which can be confused with feedback or backlog.)

JERYL W. LAFON
Albuquerque, New Mexico.

going on-line

Sir:

Mr. Bloch's comment (Oct., p. 14) on my comment (July, p. 83) deserves further expansion. My original statement on preparation time for an installation was: "I have never seen an effective installation made in less than 18 months; I have never seen an effec-

DEPEND UPON DASHEW...

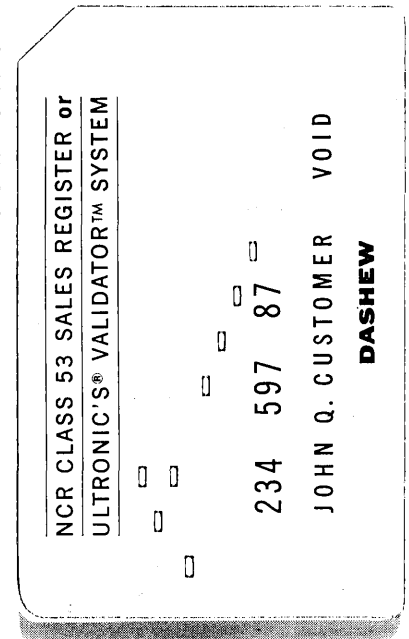

for ALL of your plastic card needs

The increasing demand for plastic credit and identification cards can only be met with automated equipment that produces cards of all types...in volume quantities, rapidly, and at a low cost per unit.

Only Dashew can provide this service. The Dashew 465 Databosser® is the world's fastest automatic embossing, stamping, and code punching system. Utilizing punched tabulating cards as input, the 465 can selectively emboss, print, and code punch plastic cards containing varying information, and output them in quantities up to 3000 per hour.

Dashew's total capability is unmatched in the industry; your plastic card problems can be handled from design to mailing. This single-source responsibility means reduced handling, maximum security of records, and greater speed and efficiency.

No matter where you are, Dashew is only a 'phone call away. Service centers are conveniently located in Los Angeles, Chicago, and Toronto.

Remember — Dashew, and only Dashew, is your one complete source for plastic card service!



Santa Monica — 2219 Main Street 213-392-3984

Chicago — 319 North Albany Street 312-533-1400

Toronto — 90 Thorncliff Park Drive 416-421-9585

CIRCLE 13 ON READER CARD

"In-contact" disc memories store 50% more bits per dollar

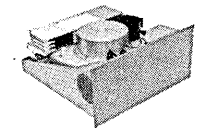
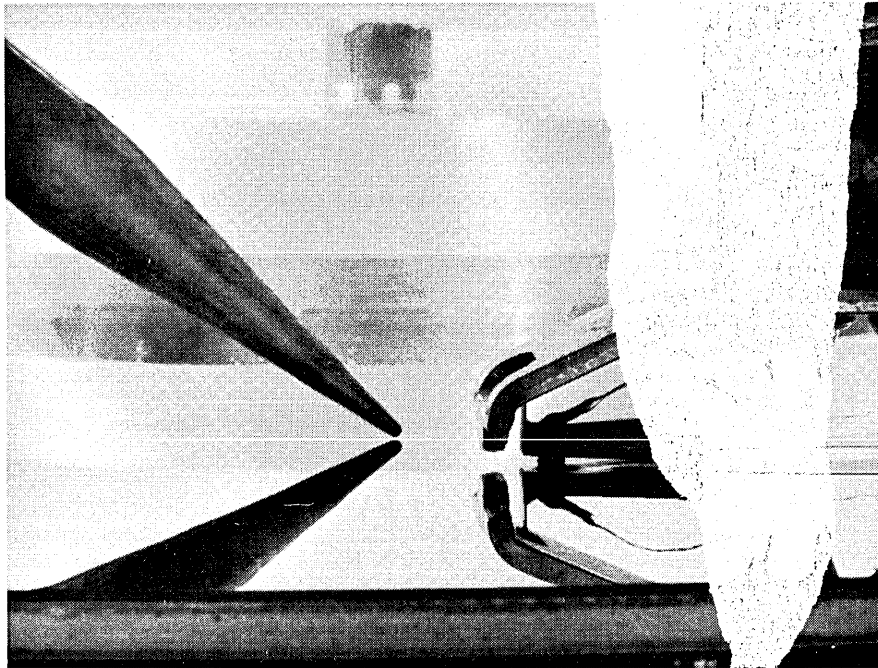

F Series disc memory system. Includes electronics. One head per track. Stores 100,000 bits per track. Available with 16, 32, or 64 tracks for max. capacity of 6,400,000 bits. Average access time: 16.7 ms. Data transfer rate: 3,000,000 bits/sec.

Data Disc put the read/write heads in gentle contact with the disc in order to record 3300 bits per inch of track. That's twice the storage density possible with floating head memories, and it means that you get about 50% more storage capacity for every dollar invested in equipment. □ If you're worried that head contact will cause wear, you ought to see the disc we've been spinning beneath in-contact heads for over 20,000 hours. The disc is not so much worn as polished, and it still reads out error-free data—just as we recorded it over two years ago. □ There are secrets to reliable in-contact recording, but we can tell you this much: we plate the discs with a thin rhodium armor to protect the magnetic storage medium. Then we polish the surface to a near optical finish that deviates from perfect smoothness less than 0.4 microinches A.A. The result is insignificant wear, and less than one transient dropout for every 10 billion bits.

F video buffer. Stores one video frame per track on up to 20 tracks. Records analog video to 4.2 Mc, digital video to 200,000 bits per frame.

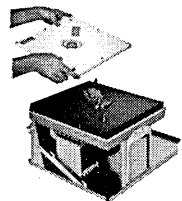
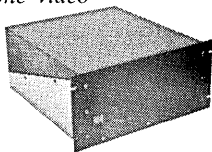

M-6 interchangeable-disc memory system. Includes electronics. Stores 12,000,000 bits per disc. Discs permanently encased in protective cartridge.

Data Disc, Incorporated, 1275 California Ave.
Palo Alto, California 94304 • Phone (415) 326-7602

DATA DISC

CIRCLE 14 ON READER CARD

Letters

tive on-line installation implemented in less than 36 months." I would like Mr. Bloch to explain how it is possible to perform the tasks defined below in less than the time shown under the first column.

Task	Minimum Time (months)	
	On-Line System	Batch System
Analysis of Feasibility	6	3
Vendor Selection (including bench marks)	6	3
Basic Planning	2	1
Training of Personnel (Retraining in OL systems)	3	2
Basic Design Parameters	3	1
Systems Design	6	3
Programming	6	4
Installation/Systems Test/Conversion Parallel	4	3
Totals	36	20

D. H. BRANDON
New York, New York

Editor's note: Mr. Bloch explains that American Motors' OLRT system was conceptualized in April '63 and put on the air in October '64. Noting that Mr. Brandon assumes a non-parallel situation, Mr. Bloch says that some of their steps were done in parallel. The reason for overlapping is that there are several programs in the chain and it was not necessary to have complete definition of all programs before starting on later phases. In the tabulation below, elapsed times are shown in parentheses:

Feasibility analysis	4/63-1/64 (8)
Vendor selection	12/63-3/64 (3)
Basic planning	3/64-5/64 (2)
Retraining	3/64-4/64 (1)
Design parameters	3/64-5/64 (2)
Systems design	3/64-7/64 (2)
Programming	5/64-9/64 (4)
Installation	7/64-10/64 (3)

The installation time indicates the first of 24 remote terminals nationwide that went on the air, Mr. Bloch points out.

Sir:

I am engaged in a survey study and collection of material in the broad field of law and data processing. Unfortunately, published works in this field are scattered among many journals in different fields and even incomplete bibliographies are difficult to come by; information about court decisions and actual experiences are not readily available.

I would appreciate hearing from anyone who has information about unpublished works, bibliographies, court decisions, personal experiences with legal problems concerning dp, etc., in this area. Any assistance would be gratefully acknowledged.

JOHN F. BANZHAF III
Computer Program Library
509 Fifth Avenue
New York, New York

What did Wilson Jones invent for "tab" records after the Nylon Post Binder?

Indexes for unburst sheets

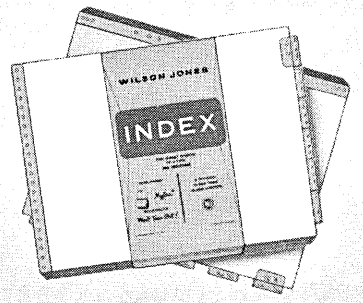
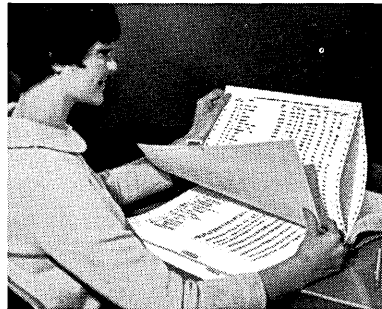

And we have them for burst sheets, too.

For EDP records housed in nylon and other plastic post binders, and in thin ring binders.

In sizes and punchings that match marginal punched sheets of all the sizes most widely used today. Both types: Alphabetical and Insertable.

All "Mylar"-reinforced at the binding edge to prevent tearing and pulling out.

If you have problems housing your printouts that you haven't solved, you haven't checked with your Wilson Jones stationer or "tab" supply dealer. He has the latest

in Wilson Jones binders and accessories to fit your particular record-housing requirements.

Wilson Jones is the inventor of the Nylon Post Binder—as well as Indexes for Unburst Sheets—and still makes the only complete line of binders and other housing accessories for data-processed marginal-punched sheets.

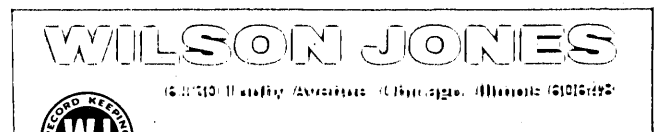

A Division of *Swingline*®, INC.

The new ADVANCE 6130, ready for delivery at \$34,500...

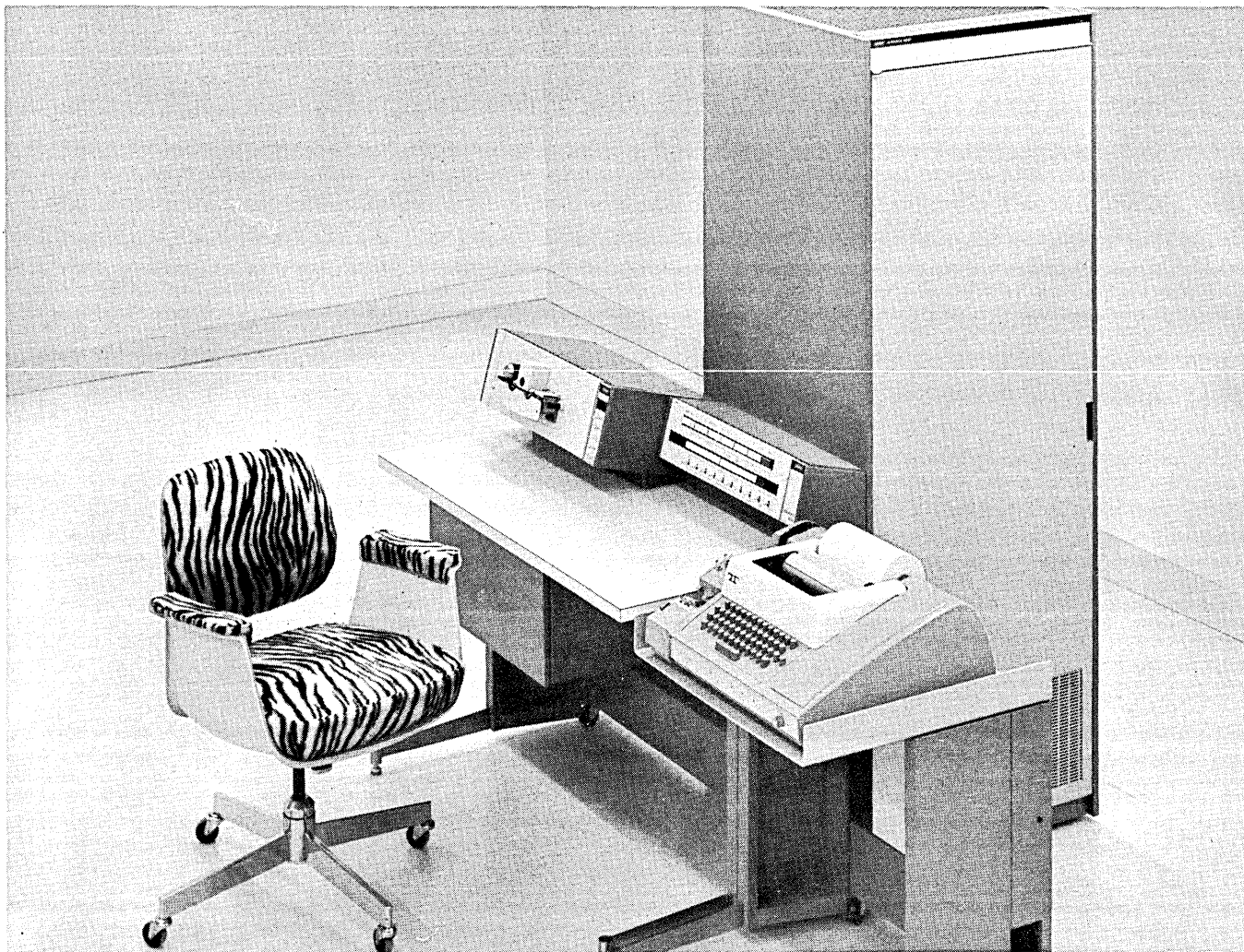

...we used to call it the "paper" tiger

Last July we announced the *ADVANCE 6130*, specially designed for real-time data acquisition and control applications.

At that time we couldn't promise immediate delivery and frankly called it our "paper tiger".

Right now our tiger is all hardware and purring smoothly. Software is also ready with FORTRAN, symbolic translator, and a real-time and batch processing monitor.

With a 900 nanosecond memory cycle time and 16-bit data word (plus parity and memory protect bits), the all integrated circuit 6130 computer can show its teeth in outperforming all competitive machines, including those most recently announced.

Should you like more information, please call or write: Computer Division, Electro-Mechanical Research, Inc. 8001 Bloomington Freeway, Minneapolis, Minn. 55420. Phone: (612) 888-9581.

COMPUTER DIVISION

EMR

look ahead

ATTENTION FOCUSED ON SDS PAY-AS-YOU-LOAD-AND-GO COBOL

The industry is warily watching Scientific Data System's latest marketing ploy, separate pricing of the Cobol compiler for its Sigma 7 (see Nov., p. 135). Obviously aimed at attracting scientific users -- "we don't charge you for software you won't use" -- the stratagem is being watched as a teensy trend toward separation of hardware and software prices.

Government officials, who have long sotto-voce-d wishes for such a separation, aren't sure this is the answer. Says one top federal edp man: "It would be more significant if they had separated out the operating system or, say, Fortran." And he wonders if the government will go along with the \$1K/month at each installation; SDS is evidently trusting customers to be honest ... not to share the compiler.

Software firms are enthusiastic about the move, hope it will work. But one software executive personally dislikes the idea: says it discriminates against the little user, who gets more software than he pays for ... wipes out an indirect software subsidy paid for by large defense-oriented firms. In effect, he says, the manufacturer robs binary accounts to support decimal customers. He'd like the idea better if it applied to application packages, usually too general to be useful to individual users.

One service bureau man likes the idea for smaller SB's, which he claims don't get the manufacturer support large users get. His outfit has tried to pressure IBM into offering separate prices for hardware and software, although he's also more interested in application packages, some of which are not available to service bureaus.

The competition is mostly pulling a wait-and-see. If the plan works, others will hop on the bandwagon. CDC notes it's charging separately for its 6000 series LP package and the 7094 simulator, and is investigating other software -- especially application packages -- for similar treatment. Interestingly, a CDC survey indicates half of its customers would be interested in separate software pricing. Smaller manufacturers also like the idea, but will undoubtedly await the market's verdict.

But the market is controlled by IBM. And, points out one competitor, one of IBM's greatest strengths is the support it gives away under the blanket of fat prices. The Jolly Gray Giant is not likely to change the ground rules of the game it runs.

PAY NOW, FLY LATER

Digitek's 1966 annual report described its kind of stockholder as one "... willing to roll with the punches." Which is probably what Digitek stockholders will be expected to do this fiscal year (ends May 31). Hit by the tight money market, too-rapid growth, some critical delays on fixed-price contracts, the 42-man software firm looks for a bad profit picture in '67. But Digitek president Jim Dunlap says the problems

(Continued on page 19)

who reads

DATAMATION.

?

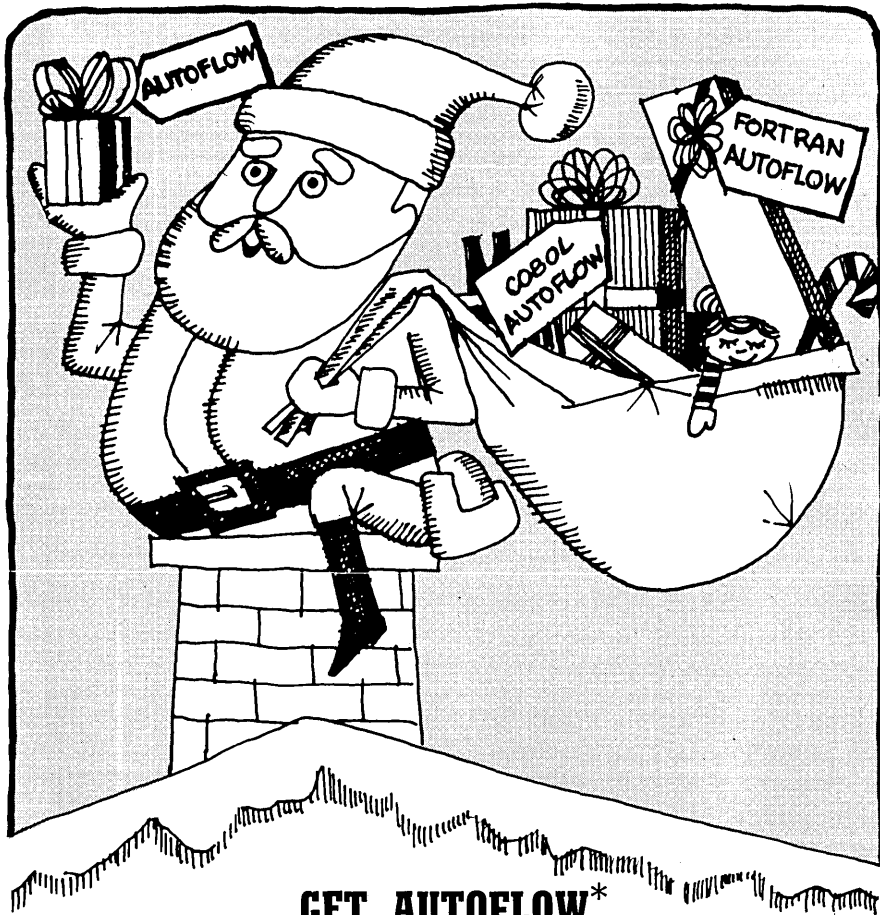

GET AUTOFLOW*

**FOR YOUR PROGRAMMERS THIS CHRISTMAS
IT'S USEFUL ALL-YEAR-ROUND**

Give your programmers a useful gift for Christmas. One they'll really appreciate . . . AUTOFLOW.

With ADR's AUTOFLOW you reduce time-consuming and tedious documentation chores . . . while providing your programmers with a new software system that will aid in debugging and in maintenance of programs.

AUTOFLOW is a Management gift, too. . . . It produces accurate up-to-date and standard documentation of your installation's computer programs.

AUTOFLOW Systems currently available from ADR, include:

- COBOL — IBM 360
- FORTRAN — IBM 360, 7090/94
- ASSEMBLY — IBM 360, 7090/94, 1401, 1410, 1460, RCA 501, SPECTRA 70

Make your New Year's resolution today!

Get usable documentation of ALL your COBOL, FORTRAN and Assembly Programs using AUTOFLOW . . .

Write today for detailed information . . .

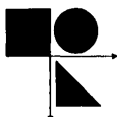

APPLIED DATA RESEARCH, INC.

Route 206 Center, Princeton, New Jersey 609-921-8550
with offices in Washington, D.C., Los Angeles, Calif., and New York City.

ADR is an equal opportunity employer (M/F)

*Trademark, patent pending

Circle 17 on Reader Card

DATAMATION

Moving?

If you're going to have a new business address, please fill out the form at the right now and return it to us. We'll make sure that DATAMATION keeps up with you. To save time, we need your old address, just as it's printed on the mailing label, (or the whole label is better yet) as well as your new address.

Name_____
Title_____
Company_____
Address_____
City_____
NEW ADDRESS
Name_____
Title_____
Company_____
Address_____
City_____
What is e_____
Your Sign_____

**define
your terms,
please**

Whatever your work in information processing, you'll communicate better with the help of this authoritative glossary.

an intro
DA
This 62-p
of techn
essing. It
tronics, c
This gloss
as a refe
familiarit
as a conv
responsib
Please us

DE
35 Mas
Please :
Name_____
Address_____
City_____

look ahead

COBOL CLAN GATHERS AT IMI

are primarily behind: bank debts have been paid off, the cash flow picture is steadily swinging around, new project controls installed, a separate marketing function established under Chuck Schwedes ... and tighter contracts are being written. The company, which zoomed to \$1.251 million in sales from \$381 thou the year before, expects to level off this year before trying to climb toward what Dunlap describes as the second dollar barrier -- \$5-15 million/yr. -- facing most companies.

Information Management, Inc., year-old San Francisco software firm, is evidently out to corner the industry's top Cobol talent. Joining well-known Cobol aficionado Stan Naftaly at IMI are Michael Cohn, formerly manager of IBM's 360 F level Cobol implementation, and Robert Skinner, IBM's rep on ASA Cobol and Codasyl committees. It's rumored that Cobol veteran Howard Bromberg will also join the firm as manager, plans and programs. New clients: 1st National City Bank, NY, and the Bank of California.

ON-LINE COACH FOR EXERCISING PATIENTS

In biomedical dp, a pioneering effort in computer-patient interaction is going on at NYU Rehabilitation Center. Through donations of equipment and manpower, an exercizer used in physical therapy has been interfaced with a Teletype unit on-line to a GE-265 system in Phoenix. The result is that the performance of the patient is being analyzed in seconds instead of the 15-plus hours required manually. As vital is that the computer tells the patient through lights on the black box (developed by Emic Avakian of Bunker Ramo) whether he is doing better than his previous effort; the next step should be computer control of the exercizer to change the task according to performance.

Calvin Moerer's TRAC system on the GE computer is permitting use of the 40-character code system devised; experimenters found it was the only time-sharing software which "renders the full power of the keyboard to the user."

NEW BAY AREA FIRM SET UP

A new firm -- Mobility Systems, Inc. -- has been formed in San Jose, Calif. Active since Sept., the company is headed by Arthur J. Critchlow, who has served as mgr., new systems & markets for IBM's Advanced System Development Div., and as manager, large systems, at GE. He's known in some circles as "father" of the RAMAC. Serving as a vp is Gus Perlman, well-known consultant and entrepreneur. The 10-man firm has a \$500K backlog.

NEWSPAPER CHAIN LINKED BY COMMUNICATIONS NET

A multiplexed communications network linking several plants of a midwestern newspaper chain is being set up by Ultronic for some \$500K. Initial application will be typesetting (all of the papers use hot metal), to be followed by allied accounting functions. The geographically-scattered plants will be linked to a dual processor by up to 48 phone lines transmitting at 10 cps. There will be a central multiplexor at the data center, as well as remote MPX's at each plant. First remote daily is slated to go on the air in March.

THAT'S DISC BIZ

Rumbles of financial problems haven't hurt sales of Digital Development Inc., San Diego disc maker. The company recently won a \$500K contract from Honeywell, is currently doing business at about \$180-200K/month. The company did \$1.35 million last year, figures it ought to make \$2 million "easy" this year. DDI has about a \$2 million backlog.

(Continued on page 113)

You won't believe how much software comes with Sigma 2.

Sigma 2 is small. But Sigma 2 is serious. That's why it has so much software. Enough, in fact, to make one computer do the work of two.

WELL,
HERE IT IS!

Sigma 2 is the only computer of its size that does multiprogramming. It does general purpose work in the background and, in less than 6 microseconds, can respond to a real-time foreground interrupt. And with a minimum amount of core.

A good computer never loaf. So we made Sigma 2 software powerful and modular enough to put every last bit of Sigma 2 hardware to work.

Starting software includes Basic Control Monitor, Basic FORTRAN, a basic assembler and a

library of mathematical and utility programs. And, if you need more horsepower, we'll add Real-Time Batch Monitor, SDS FORTRAN IV and an extended assembler.

Sigma 2 software is ready. We're delivering software and hardware to

I DON'T
BELIEVE IT.

customers right now. You'll get yours the same way. Together.

Do you need on-line control? Plus general purpose computation? Maybe you expected to pay \$500,000 to get the whole job done. Don't. Sigma 2, software and all, starts at \$26,000.

Sigma 2 lets you do very big things. In a small way.

SDS

Scientific Data Systems,
Santa Monica, California

editor's read ut

THE REAL WORLD SPEAKS

Ulric Neisser did a good thing at the recent Fall Joint Computer Conference. Speaking at the keynote session, the member of the department of Psychiatry of the University of Pennsylvania pricked a few of computerdom's most cherished bubbles. And he did it articulately, with deftness and humor.

Beginning in a quiet, conversational tone, Neisser asked the audience, "I wonder if you all realize how much you're being flattered?" He was referring to the three previous speakers, each of whom had developed rather impressive portraits of the implications of computers. Then he noted that it was the job of psychologists to question images: Is there *really* a computer revolution . . . one which is affecting our day-to-day living, including such activities as the war and the movement for social justice? The answer is, obviously, "no."

It's not new or surprising, Neisser said, that technology has an impact, or that computer specialists should be concerned with their work; it's natural for people to think their work is important. And he presented the image of the computer expert looking into the mirror and saying, "I have social impact." The audience laughed.

But, he stated, the early welter of worries, claims and counterclaims about the economic impact of computers have not been proven: computers have neither caused massive unemployment nor freed man for "creative" work. The economic effects of computers, like those of automatic elevators, are specific.

Neisser also denied that computers are significantly making an overall change in man's image of himself. Again, their psychological effects are varied and specific. To substantiate his point, he referred to a study conducted in 1963 by IBM's Dr. Robert S. Lee. (An interpretive summary of Lee's findings can be found on page 33 of this issue.) The psychological impact of computers, again, seems to be specific and correlates rather closely with people's projections of their own personalities and their views of what will happen in society in general.

He drew an analogy of technology to shadows. Seen dimly through a fog, the shadows are interpreted by different people as either an inn or a den of thieves. The shadows turn out to be the walls of a town containing both, where man can choose his company.

Noting that man is likely to reach the moon before he achieves machine speech recognition—"the space between words is more difficult to bridge than that between planets"—Neisser concluded there is no computer age, no wave upon which to surf . . . only patterns which do permit us, however, to aim. But, he concluded, "There is no computer revolution . . . only you people and what you decide to do."

It seems to us that the major contribution of Neisser's talk extends beyond the questioning of the economic and psychological impact of computers, although it is important for us to continually attempt to evaluate the effect of computers and information processing on the world around us.

Perhaps the most important idea implied by Neisser is that the computer industry try to direct the nature of its contributions to society . . . at least begin an attempt to work toward the solution of some of those important problems which are a part of our day-to-day lives. But the industry can do this only if it keeps lines open to the real, outside world . . . and listens to the likes of Dr. Neisser.

Librascope's new Series L210... when value is the object

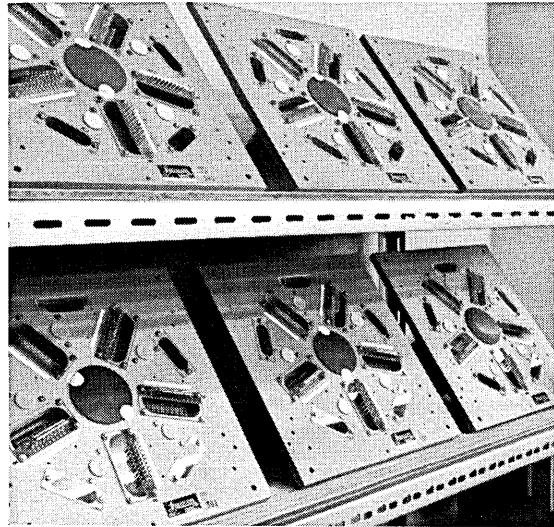

Librascope's new line of computer disc memory systems, designated the Series L210, offers the greatest cost savings in the industry.

Available in 15 different off-the-shelf models, the Series L210 provides the user low-cost disc memories with great flexibility in choice of access times, bit capacities, and number of recording heads. Their modular design enables a choice of storage capacities up to 2 million bits and a wide variety of combinations of recirculating registers and data tracks. Each memory system utilizes a single magnetic disc, 10 inches in diameter, in a compact package that measures less than 1 cubic foot and weighs 35 pounds.

Economically priced, 60 days delivery, and developed by the company which offers the largest line of disc memories in the computer industry... superior is the word for the Librascope Series L210. For complete details, write for our technical bulletin.

SERIES L210 MODELS			
	ACCESS TIME (Milliseconds)	TOP PLATE	BOTTOM PLATE
L110-8-1	8	A	C
L110-8-2	8	B	C
L210-8-1	8	A	A
L210-8-2	8	A	B
L210-8-3	8	B	B
L110-17-1	17	A	C
L110-17-2	17	B	C
L210-17-1	17	A	A
L210-17-2	17	A	B
L210-17-3	17	B	B
L110-25-1	25	A	C
L110-25-2	25	B	C
L210-25-1	25	A	A
L210-25-2	25	A	B
L210-25-3	25	B	B

Head Plates A = 72 data heads including spares
9 clock heads including spares
(in separate port)
B = 16 recirculating registers;
5 clock heads including spares
C = Blank Plate

COMPONENTS DIVISION

GP GENERAL
PRECISION INC.

LIBRASCOPE GROUP

808 Western Ave., Glendale 1, Calif.



THAT BEAST UPON THE WIRE

by Ray Bradbury

Suppose and then suppose and then suppose
That wires on the far-slung telephone black poles
Sipped up the billion flooded words they heard
Each night all night and saved the sense
And meaning of it all.
Then, jigsaw in the night, put all together,
And in philosophic phase
Tried words like moron child,
Numb-shocked electric idiot, mindless babe
Alone upon its spider-threaded harpstrung poles,
Incredulous of syllables that shimmer dazzle down
Along swift thunder-lightning streams
In sizzlings and fermentings of power.
Thus mindless beast, all treasuring of vowels
And consonants,
Saves up a miracle of bad advice
And lets it filter, seep, experiment,
One hissing stutter heart-beat whisper at a time
So one night soon someone in dark America
Hears sharp bell ring, lifts phone
And hears a voice like Holy Ghost gone far in nebulae—
That Beast upon the wire,
That pantomimes with lipless, tongueless mouth
The epithets and slaverings of a billion unseen lovers
Across continental madnesses of wire.
And with savorings and sibillance says:
Hell . . . and then O.
And then Hell-O.
To such Creation—
Such dumb brute Electric Beast,
What is your wise reply?

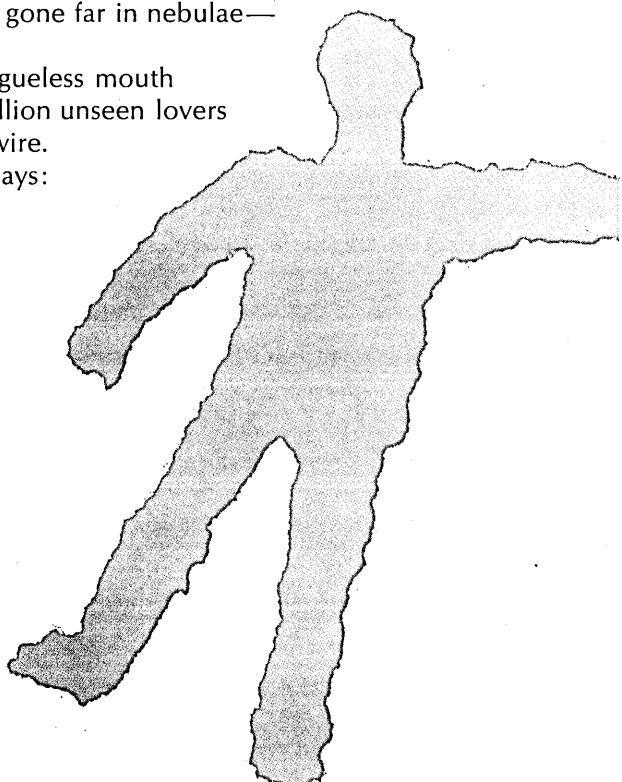

ECONOMIC GROWTH AND POVERTY

by RICHARD R. NELSON

The problems of poverty in the United States, and their resolution, are inextricably connected with the nature of the economic growth process and its pace and pattern. In the past, economic growth has been primarily responsible for lifting the bulk of the population further and further away from economic deprivation, but the adjustments required by growth have left in their wake new pockets of poverty. In the future, one of the key variables that will determine how rapidly we can eliminate poverty in the U.S. will be the rate of increase in average incomes. And one of the key factors that will determine the kinds of new pockets of poverty that will develop will be the adjustments required by growth and how well we respond to them. This paper explores certain aspects of this dual role of economic growth in the past, and the prospects for the future.

raising of average income levels

The concept of poverty is a relative one: What a society considers to be a socially acceptable standard of living tends to rise as average standards rise. But in terms of giving the average and most families a steady and rapid increase in the quantity of goods and services they are able to afford, the contribution of economic growth has been impressive. Economic growth clearly has been the single most important solvent of poverty in the U.S.

Since 1920, real gross national product (GNP) per capita has more than doubled. Reliable data on the distribution of income do not extend back very far. However, it is clear that in the U.S. the increase in average incomes has not been the result of spectacular gains for the very few and little progress for the many. The data since 1947

*Any views expressed in this paper are those of the author. They should not be interpreted as reflecting the views of The RAND Corporation or the official opinion or policy of any of its governmental or private research sponsors.

cause and effect

are quite good. As median family incomes increased by about 50% between 1947 and 1962, the percentage of families with incomes less than \$2000 (1962 prices) fell from 18% to 12%. The percentage of families with incomes of less than \$3000 fell from 32% to 20%.

Economists' understanding of the economic growth process is far from perfect. However, it is clear that there have been three principal factors that generated the increase in incomes we experienced.

First, there have been vast improvements in technological knowledge. Some of these improvements, such as the development of catalytic cracking techniques, significantly increased the quantity of goods and services that could be produced from given inputs of capital and labor. Others, such as the modern airplane and penicillin, widened the



An economist at the RAND Corp., Dr. Nelson has served on the staff of the President's Council of Economic Advisors and taught at both Oberlin and Carnegie Tech. He holds a BA from Oberlin and a PhD from Yale.

set of goods and services the economy was capable of producing. These latter kinds of technical advances have an impact on economic welfare that transcends the GNP measuring rod. Prior to the airplane it was impossible to travel across the country in less than three days, much less four hours. Prior to penicillin it was impossible to save the lives of many people who now can be saved. How much do we value these new capabilities? It is impossible to say with precision, but certainly far more than what we pay for them. Yet it is in terms of what we pay for them that they enter the GNP series. While without technical progress we still would likely have had a significant increase in GNP, this increase would have meant far less in terms of improved ability to meet wants.

The second major factor has been a doubling of the value of private plant and equipment per worker, and perhaps an even greater proportional increase in public capital. This increase, in itself, would have led to a significant increase in per worker output. But perhaps even more important, this increase in physical capital has been an essential complement to the technical progress we experienced. New capital was needed, and was created, to embody the new catalytic cracking processes, to produce penicillin, and to produce jet aircraft. And jet airplanes themselves are a form of capital. Without the large increase in physical capital, the advances in technology we achieved would have had far less of an impact.

Third, there have been significant increases in educational attainment. Between 1920 and 1964, average years of education per worker rose from 8 to 12. Like increases in physical capital stock, these increases in formal education would have contributed to increased productivity independently of advances in technology. However, like increased capital, the importance of increased educational attainments is strongly complementary to technical advance. Obviously, one of the factors that determined the kinds and quantities of technical advances we experienced was the stock of trained and educated people. And on the other hand, technical change, by changing the pattern of demand for goods and skills, and by presenting new structures and problems, has raised the importance to the manager and the worker of the added flexibility, the added ability to learn new things and to deal with new kinds of problems that some types of education impart.

There have been a number of studies attempting to divide the credit for increased productivity among these three factors (and a few others as well). There is little point in reviewing their conclusions here. The essential nature of the growth process obviously is their complementarity and interaction.

The doubling of per capita income since 1920 is the direct reflection of the doubling of output per worker. Both non wage and wage income per capita roughly have doubled. Non wage income (profits, rents, and interest) has grown in proportion to the capital stock on which that income is paid; in turn the capital stock per worker grew as much as it did because of the new investment opportunities opened by technical change. Wages have grown because the increased stocks of capital, improved technology, and better education of the work force have increased the value of workers to employers. When the labor market has been tight, competition among employers, complemented by union bargaining, has led to a rise in wages almost exactly in pace with the rise in average (and marginal) productivity.

adjustments required by economic growth

Of course, not all owners of capital, and not all workers, have shared in the fruits of progress. When aggregate

demand has not grown in pace with the output the labor force is capable of producing, the supply of labor has outrun the demand for it. The result has sometimes been stagnation of real wages but mostly it has been unemployment. And even when aggregate demand has been sufficient, certain groups have been hurt. As new capital has been created, embodying new technology or moving into expanding industries, the returns to old capital and capital in declining industries have declined. As demand for labor in certain industries and with certain skills has risen, the demand for labor in other industries and with other skills has fallen. Thus the economic growth process has a tendency to leave poverty in its wake.

These problems reflect inadequacy of two different kinds of adjustment. One kind of adjustment relates to overall balance between demand and capacity. The other has to do with the allocation of men over different industries and occupations.

Technical progress both increases the output the economy is capable of producing at full employment, and creates new investment opportunities. Sometimes investment opportunities opened by technical progress expand more rapidly than full employment output, sometimes less rapidly. Unless compensated by compensating changes in the interest rate the result will tend to be in the one case a rise, in the other a fall, in investment as a fraction of full employment GNP. And, unless balanced by a compensating change in the public and private savings rates generated at full employment, the result tends to be inflationary pressures in the first case, growing unemployment in the second.

While rapid technical progress has resulted in rapid growth of production, in the past it probably has spurred demand even more. Thus, Schumpeter associated the boom in the mid-19th century with rapid technical progress in the railroad and steel industries, and the boom of the 1920's with innovations in the automobile, chemical, and electrical industries. And he blamed the depression and unemployment of the 1840's and 1930's on a falling off of investment opportunities associated with lack of major innovation. In short, in the past it would appear that the rhythm of prosperity and depression has been largely due to the economic growth process, and there is little question that economic fluctuations have been a major source of economic hardship, particularly when depressions were deep and long.

In addition to adjusting to shifts in the rate of growth of investment opportunities, the economy must adjust to changing patterns of demand for goods, capital, and different kinds of labor. The shifting of resources is an essential part of the process by which society takes maximum benefit from the new opportunities opened by technological advance. In general, when new or improved products have been developed, society has chosen to shift labor and resources to their production and away from production of close substitutes. When the industries and their products were well established (like agriculture during the 1950's and 1960's), more often than not rapid technological change tends to cause cutbacks in employment.

But whether employment expands or contracts in the industry undergoing rapid technical progress may make little difference with respect to the adjustment problems involved. As employment in the aircraft industry expanded as a result of technical progress, railroads were adversely affected. The other side of the coin of the expansion in employment in the television industry in the early 1950's was the growing demise of the motion picture industry.

Whether the adjustment problems are easy or difficult depends not so much on the required shift in employment among industries, as the required shift in employment among skills and regions and the flexibility of the affected

work force with respect to occupation and location. The problems of the New England textile workers in the 1920's were not so much the decline in the New England textile industry, but the failure of other industries to grow up there, and the failure of many of the workers to move and, perhaps, to acquire a new skill.

prospects for the future

It appears quite likely that the future will see rates of growth that are quite high by historical standards. Since World War II, most advanced industrial countries have experienced significantly more rapid economic growth than their pre-World War II record. In the United States since 1947, growth of potential output has proceeded roughly 25% more rapidly than the 1900-1947 average. There was a slowdown in the late 1950's and early 1960's, but the evidence suggests that we are now back on a rapid growth track.

There are many possible reasons for this. I think that two are especially important. The first is that we have been putting more resources into advancing technology than before. The second is that we have done better in avoiding depressions than before. There is every prospect that these factors will continue.

Growth of per worker productivity due to rapid technical progress and increases in physical capital per worker spurred by that progress will, of course, do little directly to help the one-third of today's poor who are not in the work force. But if aggregate demand can be kept growing in pace with capacity output, and if skills workers have or can attain can be matched with those skills in growing demand, then growth of productivity (by increasing the amount management can be induced to pay labor) may do more to melt poverty among those in the work force than any other factor. And then we will be able to focus on the specific poverty problems of people not in the work force or other specially disadvantaged groups rather than worrying vaguely about a general poverty problem.

However, in recent years there has been considerable distress expressed that the problems of adjustment to growth will be especially serious. It has been suggested that because of the rapid pace of technical progress it will be difficult to keep demand growing in pace with full employment output; thus there will be tendencies to mass unemployment. It also has been suggested that, aggregate demand deficiency problems aside, the demand for highly skilled and educated labor will rise and that for the poorly educated will drop sharply, resulting in greatly increased structural unemployment.

I suspect that these spectres will not materialize. In contrast, I believe the prospects are good that with good but relatively simple policies, we will keep overall demand and supply in much better balance than we have in the past. Further, the labor force appears to be more flexible with respect to occupation and location than it was in the past, and the prospects are that if we take sensible policy actions, it will be increasingly flexible.

Demand deficiency unemployment—or failure to generate an adequate number of jobs—can stem from two causes. Wants can be so well satisfied at existing consumption levels that latent demands are non-existent or weak. Even if individuals had more purchasing power, they would buy little or no more. Or, latent demands may exist, but individuals or groups with these latent demands do not have the purchasing power to make their wants effective.

It is crystal clear that any demand deficiency problem existing now or in the foreseeable future will be of the

second sort, not the first. Even though the American economy has been characterized as affluent, in 1963 the average household had only \$6,600 to spend annually. Nor is there any reason to believe that individual wants will be satiated by income growth over the next few decades. Even if productivity growth increased from its present rate of 2.6% a year to 4.0% a year (which far exceeds anything we have sustained historically), it still would take almost a quarter of a century before average household income reaches \$15,000.

Further, there are large unmet public wants—for roads, schools, hospitals, urban renewal. The debate as to the proper mix of private and public consumption need not detain us here. The point is that the public sector represents another source of potential demand for goods and services.

the short-term problem

In the far future, the situation may be very different. Annual family incomes will reach \$50,000 in somewhat more than 100 years at present rates of productivity growth in roughly 60 years at a 4% growth rate. Satiation of desire for material goods would be a definite possibility for such a society. But in any case, this is a problem for the relatively far future. The problem of at least the next few decades is not how to keep employment high in a world where there are no wants for more goods and services. We do not live in an era where society, if it could make its preference effective, would take the bulk of productivity increases in additional leisure. Rather, the problem is to assure that strong and pressing private and public wants are reflected in effective demand so as to prevent unmet wants and unemployed labor from coexisting, or somehow to assure that sufficient income gets into the hands of those who have wants so that aggregate effective demand for goods and services grows in line with output potential.

In this kind of a situation, conventional fiscal policy (working through tax rate variations) and monetary policy can and will work, if pressed vigorously enough. Full employment should be easy to achieve and maintain through public expenditure on programs justified by their merit, through adjusting tax rates to provide adequate disposable income to those who have wants, and through flexible monetary policy. Indeed, because of its stimulating effect on investment demand, it is quite possible that with rapid technical progress a less expansionary, not a more expansionary, fiscal and monetary policy will be required. But in any case, the relationship between innovation and aggregate demand, stressed so strongly by Schumpeter and probably of major importance in the pre-World War II world is not of major significance, save as a guide for fiscal and monetary policy, in a world which has learned from Keynes and taken his lessons seriously.

If we can avoid the economic slack problem, this, in itself, will go a long way toward easing the structural adjustment problem, for history provides rather striking evidence that one of the most important variables determining the speed and effectiveness with which labor moves from declining industries and occupations to expanding ones is the strength of overall demand. When overall aggregate demand is weak, people laid off from one job cannot easily see other job opportunities. When few industries are expanding rapidly, few employers have much incentive to hire and train older or inexperienced workers.

This was the situation during the late 1950's and early 1960's. However, during periods when overall demand has been strong, the situation has been quite different. During the period of high overall civilian demand just after World War II, the structural composition of employment changed radically from the wartime patterns, but

overall unemployment remained below 4% of the labor force. During the Korean War, another great structural shift took place with untrained men learning rapidly to fill new jobs. It is only during years of overall slack that the process of adjustment is difficult for most.

The recent rollback of unemployment rates across the board is dramatic evidence. In mid-1965, we were operating with too much slack, but it is revealing that as aggregate demand increased faster than potential output, since 1961, unemployment rates among the unskilled, among Negroes, indeed among all those groups who were regarded earlier as in danger of prolonged structural unemployment, decreased most of all. Manufacturing employment which, during the period of overall slack, many people agreed was on a permanent decline, picked up, and by mid-'65 had surpassed Korean War levels.

work-force flexibility

I believe that the basic flexibility of the American economic system when aggregate demand is high often is greatly underestimated. Each year there is a significant turnover in the work force; between 1-2% leave the work force, and between 2-3% enter as young men relatively uncommitted to an occupation. In addition to the flexibility through entrance and retirement, the work force has considerable industrial, occupational, and geographical flexibility. During 1961 over 8 million workers, almost 12% of the labor force, changed their jobs; more than one-quarter made a shift in location.

In the future, the work force should be even more flexible geographically and occupationally. For better or worse geographical roots do not seem to sink into the ground as deeply these days. And the younger members of the work force should be especially flexible occupationally since more than two-thirds will be high school graduates or better, while in 1930 less than one-third of the new entrants were high school graduates.

It is quite possible that the technological advances we shall experience will increase the relative demands for highly trained and educated people and decrease the demand for the unskilled. This, certainly, is fortunate. The average educational attainments of the workers currently entering the work force is about 40% higher than of those currently retiring. While at present the percentage of the work force with a college degree is roughly 10%, during the next decade perhaps 20% of the new entrants to the work force will be college graduates. It would be unfortunate if the jobs these young entrants found available did not challenge their higher skills.

Of course, during the next decade a substantial fraction of the new entrants to the work force will not have the advantage of even a full high school education; perhaps as many as a third of the new entrants to the work force will be in this category. But this percentage is significantly lower than the percentage of the present work force that does not have a high school degree. It is highly likely that these people will have a harder time finding work than the better educated workers, but this has been the case for a long time, and the notion that there will be no jobs for people without a high school degree or better does not stand analysis, if we press ahead with programs to expand opportunities for vocational and occupational training and retraining.

In the first place, it is a safe bet that we shall continue to need many bus drivers, warehouse workers, truckers, construction workers, production line blue collar workers—occupations that traditionally have not required a high school degree.

Second, many of the technological changes we will experience almost certainly will reduce the skill and education requirements on many jobs; as will be attested to by

mathematicians who are leaving many kinds of computer programming jobs and the high-school-educated girls who are taking their place, it is far from true that technological advances always upgrade the needed formal training. Furthermore, a relative shortage of highly skilled labor is just the type of situation which stimulates technological changes which reduce skill requirements.

Third, more generally, we should not underestimate the extent to which unskilled labor can be trained and job specifications rewritten when there is a shortage of highly trained people. While this will not happen very rapidly when the overall economy is slack and employers can pick and choose, as I have pointed out, when overall demand has been high and skilled labor scarce, the occupational flexibility of labor has been clearly demonstrated.

the outlook

With better fiscal and monetary policies to prevent significant demand deficiency unemployment and to keep pressure on the labor market, and with better policies to expand opportunities for job training and retraining, we should be able to narrow the poverty problem to: the functionally illiterate; the (overlapping) Negro city dweller, trapped by his low educational level, his cultural background, and his skin which signals both; the poor farmer or farm worker; the elderly who no longer have the motivation to shift occupations on their own, and for whom there is little incentive for business firms to pick up the retraining and relocation tab; and those who, for a variety of reasons, are not effectively in the work force. But these always have been a hard core poverty problem; there is nothing new. What is new, if anything is, is that the problem is being made specific to these groups—so that we can focus on it and them—and that poverty as a general problem for the average, or even the somewhat sub-average, American worker and his family is disappearing as a problem.

I hope these comments do not sound complacent. I do not intend them to be. I am not content with our performance in the past, and I believe our performance can be greatly improved in the future.

But it is unlikely to be improved if we do not analyze the problem properly. We need better programs to assure that slack is minimized. We need better programs to facilitate structural adjustment. If we have these, growth will take care of a large share of the poverty problems. It will not take care of certain special groups. These require special policies and treatment. It is my belief that the chances of understanding, and taking, the special policies needed to deal with special groups will be enhanced, not diminished, if we understand that they are special groups whom economic growth will not help, rather than panicking about an overall, all-encompassing poverty problem.

Yet I know that to this audience at least I sound complacent, and this is another reason I am optimistic about the future. It is only five years now since Michael Harrington called attention to *The Other America*, and complained that Americans increasingly are unaware of the poverty and distress around them. Yet the very responsiveness to this comment suggests it is basically wrong. Never before have there been so many conferences, and seminars, and speeches, on the problems of poverty. Never before have we had federal programs aimed, in principle at least, at the entire poverty problem. This is not to say that these programs and policies are good enough at the present time. What is significant is the evidence that programs to eliminate poverty today have real political appeal. Since even without positive policies many of the problems should become less serious, I am optimistic that with strong positive policies we can make real headway toward eliminating poverty in the United States. ■

AUTOMATION'S ROLE IN EMPLOYMENT

creating not destroying

by MARTIN R. GAINSBROUGH

 As we entered November, we were in the 69th month of one of the longest periods of expansion in the business-cycle history of the United States. We have had 26 business cycles over the past century. We are now in the 27th. And from all signs, as 1966 ends, there will be even further expansion ahead for the American economy, but at a slower rate.

A demonstration of this expansion's future potential may be seen in Fig. 1, which shows the history of the periods of expansion and contraction of the past decade. Line 1 is a record of the gross national product, the most important economic statistic of our time, the best single measure we have of economic growth. Note from column F of this line that in the third quarter of 1954 we were at the trough of a business recession, the letter T standing for trough.

Beginning in the third quarter of '54 and continuing unbrokenly until the third quarter of '57, we were in an expansion, which reached its peak (the letter P) in the third quarter of '57. Those were three years of expansion, 36 months. In that expansion, we built excesses and imbalances that subsequently brought it to an end. The present expansion, too, will end at some future time from excesses and imbalances. Beginning in the third quarter of '57, column G of line 1, and running through column H of line 1, we were in recession, the recession of '57 to '58. Note how short and moderate our postwar periods of recession have been. This one lasted nine months. Beginning in the second quarter of '58 and continuing through the second quarter of '60, we were in our last period of expansion.

We worked hard to bring that one to an end. With the steel strike, we finally did. Beginning in the second quarter of 1960 (column 1) and ending in the first quarter of '61, we were in our last recession. It was a mild one; our GNP fell by less than one percentage point. And finally, beginning in the first quarter of 1961, we have been in the midst of one of the longest periods of expansion in this nation's history. Don't let anyone tell you that growth has slowed in the American economy. Our growth rate thus far in the 1960's compares most favorably with any experienced since the end of World War II.

Now, to the area that I will be discussing at considerable length—the data contained in Fig. 2 relative to employment and unemployment. Every statistic here is from official sources drawn either from the Bureau of the Census or from the Bureau of Labor Statistics. I want to deal intensively with the proposal very frequently put forth, that automation has contributed to job displacement to such

an extent that unemployment is becoming increasingly a major problem in the U.S. Lines 5 through 10 of Fig. 2 give the latest official statistics bearing both on employment and unemployment. The figures in line 8 on employment are particularly important. The figures for September 1966 show 74.2 million civilians at work in the American economy. That excludes the armed forces, or that figure would be up by another 3.3 million.

agricultural employment reduction

The last three columns of this table are set up to provide a balanced perspective. As may be seen from the column labeled "1955," in line 8, we have, since 1955, added 11.3 million people to payrolls in this country; since 1961, 7.5 million, and now a figure that is worthy of special emphasis, in view of the growing trend toward automation, 1.9 million more people at work in September of '66 than in September of '65. Next, line 9 shows that we are completing perhaps one of the most historic industrial transitions in the history of man. Over the same periods that I have indicated, starting first with 1955, we have reduced employment in agriculture by almost 2 million. This is the way we are resolving our agricultural problem. We will ultimately get down to one farmer at the rate we are going.

I said that at a meeting in Texas recently and after I was finished, one of the Texas farmers came up and said, "When we do get down to one farmer, even he will over-

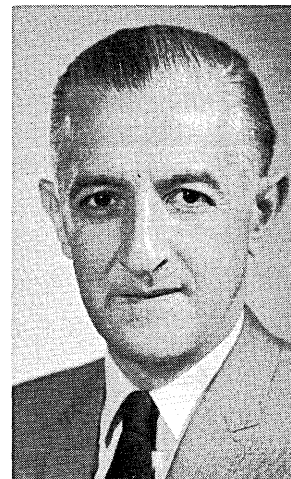

Mr. Gainsbrugh is senior vice president and chief economist, National Industrial Conference Board, New York City. He is an adjunct professor of economics at New York Univ., has been on the Advisory Committee on Management of ADP of the Executive Office of the President, a consultant to the Board of Governors of the Federal Reserve System and past president of the American Statistical Assn.

This is an updated version of an earlier paper, "Automation, Economic Growth and Jobs," presented at the Automation Forum of the Life Office Management Assn., March 29-31, 1965, and published in their proceedings.

produce." No other country can make the boast of having reduced its agricultural force to our current dimension—only 4 million employed in agriculture, to feed 197 million people. Even so, just within the past year there has been a further reduction of 400,000 in agricultural employment, compounding the problem of job creation in non-agricultural industries. Line 10 of Figure 2 shows that as a result of the shrinkage in farming pursuits, the process of job creation has become far more complicated.

We are now in the midst of a second and even more important transition. The first was from an agricultural to an industrial society. The second is a shift from commodity-producing industries to an increasingly service-oriented and service-centered society. This is where the jobs are now welling up increasingly. As shown in line 10, we have 13.9 million more people at work in nonagricultural pursuits than we had in 1963, 9.2 million more than in 1961, and 2.2 million more than a year ago. I stress the long-term trend, because some of those most concerned over the impact of automation have frequently ascribed the

rising employment of the Sixties to cyclical rather than to long-term forces. My comparisons are with the previous cyclical peak of the mid-Fifties, thereby removing that particular reservation.

See what has been happening in two key sectors of our society. First, line 14 does not show that displacement has gone on in manufacturing, in the capital-intensive industries that lend themselves to advanced mechanization, computerization and cybernation. Since 1955 we have added only 2.3 million workers to manufacturing, and a million in the past year. Meanwhile, we have increased manufacturing output by fully 63% through greater productivity per man-hour.

The area to explore intensively in connection with job creation, however, are the service industries, trade, retail and wholesale; finance, insurance and real estate; the whole gamut of personal services, recreation, tourism, travel; investment counseling; and medical care, both public as well as private.

In that connection, lines 27, 28 and 29 illustrate the

Fig. 1 Recovery Profile: National Output and Expenditures

RECOVERY PROFILE: NATIONAL OUTPUT AND EXPENDITURES													
Item	Business Cycle Turning Points*					Dollar Change Since							
	T-3rd Q.	P-3rd Q.	T-2nd Q.	P-2nd Q.	T-1st Q.	3rd Q.	1st Q.	2nd Q.	3rd Q.	4th Q.	1st Q. 1961	Year Ago	
	1954 (F)	1957 (G)	1958 (H)	1960 (I)	1961 (J)	1965 (K)	1966 (L)	1966 (M)	1966 (N)	1966 (O)	(1st Q. 1961- 3rd Q. 1966) (P)	(3rd Q. 1965- 3rd Q. 1966) (Q)	
1 GROSS NATIONAL PRODUCT	364.7	446.3	438.3	504.7	503.6	686.5	721.2	732.3	746.0		242.4 (48%)	59.5 (9%)	
2 END-PRODUCT DEMAND	366.9	443.1	443.4	500.8	507.1	677.8	712.3	720.0	735.2		228.1 (43%)	57.4 (8%)	
3 Personal consumption expenditures	237.3	283.8	287.4	326.3	328.4	435.0	455.6	460.1	470.0		141.6 (43%)	35.0 (8%)	
4 Durable goods	32.5	40.6	36.8	46.1	41.9	66.7	70.3	67.1	70.3		28.4	3.5	
5 Nondurable goods	118.4	137.7	139.3	152.0	154.1	191.4	201.9	205.6	208.3		54.2	16.9	
6 Services	86.3	105.6	111.3	128.1	132.4	176.9	183.4	187.4	191.4		59.0	14.5	
7 Gross private domestic investment	51.9	70.4	55.7	76.0	64.3	106.7	114.5	118.5	116.0		51.7 (80%)	9.3 (8%)	
8 Residential structures	20.3	20.0	19.5	23.1	21.7	27.8	28.6	28.0	25.2		3.5	-2.6	
9 Business investment	33.8	47.2	41.2	49.0	46.0	70.2	77.0	78.2	80.0		34.0	9.8	
10 Structures	13.1	18.1	16.7	17.9	18.4	24.4	28.5	27.9	27.3		8.9	2.9	
11 Producers' durable equipment	20.7	29.1	24.5	31.2	27.6	45.8	48.5	50.3	52.7		25.1	6.9	
12 Plant and equipment expenditures (1)	26.9	37.8	30.3	36.3	33.9	52.8	58.0	60.1	61.6	63.6	27.7	8.8	
13 Change in business inventories	-2.2	3.2	-5.1	3.9	-3.5	8.7	8.9	12.3	10.8		14.3	2.1	
14 Net exports of goods and services	1.9	5.5	2.4	3.5	6.6	7.1	6.0	4.7	4.7		-1.9	-2.4	
15 Exports	17.6	26.2	23.0	27.4	28.5	40.1	41.7	41.9	43.7		15.2	3.6	
16 Goods (1)	12.7	19.2	16.3	19.7	20.3	27.7	28.7	28.7	29.6		9.3	1.9	
17 Imports	15.8	20.7	20.6	23.8	22.0	33.0	35.6	37.3	39.0		17.0	6.0	
18 Goods (1)	10.1	13.1	12.6	15.6	13.9	20.9	24.0	25.3	26.2		12.3	5.3	
19 Government purchases of goods and services	73.7	86.6	92.8	98.8	104.3	137.7	145.0	149.0	155.3		51.0 (49%)	17.6 (13%)	
20 Federal	45.7	49.7	52.9	53.0	55.4	67.5	71.9	74.0	78.3		22.9	10.8	
21 National defense	39.9	44.8	45.7	44.4	46.9	50.7	54.6	57.1	61.3		14.4	10.6	
22 State and local	28.0	36.9	39.9	45.9	49.0	70.2	73.1	75.0	77.0		28.0	6.8	
23 PRODUCT COMPOSITION OF GNP:													
24 Goods output	194.9	238.2	224.6	262.2	251.5	347.5	366.0	371.6	n.a.		120.1b	24.1b	
25 Services	125.0	155.8	162.5	186.0	194.5	265.1	275.5	282.1	n.a.		87.6b	17.0b	
26 Structures	44.9	52.3	51.3	56.5	57.6	73.9	79.8	78.6	n.a.		21.0b	4.7b	
27 GROSS NATIONAL PRODUCT IN 1958 \$ (2)	407.2	455.2	439.5	489.8	482.7	618.2	640.5	643.5	650.7		168.0 (35%)	32.5 (5%)	
28 Implicit price index for GNP, 1958=100	89.5	98.0	99.7	103.0	104.3	111.0	112.6	113.8	114.6		- (10%)	- (3%)	
29 PERSONAL INCOME	289.8	354.7	356.0	401.3	406.6	541.9	564.6	573.5	585.0		178.4 (44%)	43.1 (8%)	
30 Disposable personal income (after tax)	257.3	311.6	314.5	350.4	354.8	476.2	495.1	499.9	507.3		152.5 (43%)	31.1 (6%)	
31 Less: Personal outlays	242.0	290.2	293.8	334.0	336.4	447.1	468.4	473.3	483.5		147.1	36.4	
32 Equals: Personal saving	15.3	21.5	20.7	16.5	18.4	29.0	26.7	26.6	23.8		5.4 (29%)	-5.2 (-18%)	
33 NATIONAL INCOME	302.9	369.5	359.3	417.1	412.2	562.7	595.7	604.1	n.a.		191.9b (47%)	41.4b (7%)	
34 Compensation of employees	207.1	258.1	253.1	295.0	294.8	395.6	419.6	427.9	438.1		143.3	42.5	
35 Proprietors' income (3)	40.1	44.7	46.3	46.6	47.4	56.7	58.4	57.9	57.3		9.9	0.6	
36 Rental income of persons	13.8	15.0	15.4	15.8	15.9	18.4	18.7	18.8	18.9		3.0	0.5	
37 Corporate profits before tax and after i.v.a.	38.2	45.9	37.8	51.6	45.0	74.0	80.0	79.9	n.a.		34.9b	5.9b	
38 Corporate profits before tax	38.9	47.2	37.5	51.8	45.0	75.0	82.7	82.8	n.a.		37.8b	7.8b	
39 Corporate profits after tax	20.9	26.0	20.2	27.8	24.4	44.1	48.7	48.7	n.a.		24.3	4.6	
40 Dividends	9.2	12.0	11.7	13.5	13.5	19.5	20.9	21.1	21.1		7.6	1.6	
41 Retained earnings	11.7	13.9	8.6	14.3	10.9	24.6	27.8	27.6	n.a.		16.7b	3.0b	
42 Net interest	3.8	5.7	6.6	8.0	9.2	18.1	19.1	19.6	20.2		11.0	2.1	
43 Per Capita, Constant (1958) Dollars													
44 Gross national product	2,501	2,653	2,530	2,716	2,642	3,172	3,266	3,273	3,301		659	129	
45 Personal income	1,926	2,107	2,049	2,166	2,144	2,551	2,608	2,614	2,640		496	89	
46 Disposable personal income	1,711	1,851	1,811	1,892	1,871	2,241	2,287	2,278	2,289		418	48	
47 Personal outlays	1,609	1,724	1,691	1,803	1,774	2,105	2,164	2,157	2,182		408	77	
48 Population, in thousands (4)	162,816	171,608	173,703	180,340	182,676	194,898	196,082	196,585	197,138		14,462	2,240	

(1) Not directly comparable with GNP concepts (2) Line 1 divided by line 28 (3) Includes noncorporate inventory valuation adjustment (4) Annual data, July 1; quarterly data, middle of period
 • Quarterly reference dates of peaks (P) and troughs (T) in the business cycle a—Anticipated b—Change to 2nd Quarter, 1966 n.a.—Not available

Sources: U.S. Department of Commerce; The Conference Board

10/17/66

AUTOMATION'S ROLE . . .

growth of employment in the civilian governmental sector. It may come as a surprise to some that 4 million more people are at work in government in '66 than there were in '53, with few more at work in the federal government than in 1955. The growth has come in the state and local sectors, in education, in medical care and related activities, largely from the population explosion and the response of state and local governments to such pressure, particularly for education.

You may note from line 13 what has been happening in the Sixties as we have offered the traditional incentives of greater profits to the venturer, the risk-taker in the private sector. Two million more jobs have been created in this nonagricultural sector.

It may have been true in the depressed '30's that we had a higher multiplier per dollar of government than of private investment. It can now be said, with business confidence high, that the multiplier for private investment is far greater. We have given an effective demonstration of how tax relief and tax reform can be productively employed by private consumers and by private business alike to contribute to the process of job creation.

unemployment changes

Until mid-1960's the United States had a persistent unemployment rate of 5% or more. Was automation a major factor in this uniquely sticky unemployment? The effect of automation is one possibility, and it is often so claimed. Here is a second, and in my judgment, a more warranted thesis.

The unemployment rate of 5% or more largely reflected the sweeping social and demographic changes of the past quarter-century, particularly in the second postwar decade, rather than the effects of automation. Five significant social and economic changes have contributed to a dramatic alteration in the composition and character of unemployment in the U.S.

The first of these changes may be illustrated by using a distribution of unemployed by age and sex. Who were the unemployed of the early 1960's? The majority were either women or teenagers. Those two groups accounted for at least 55% of all those seeking work as late as February 1965.

A generation ago, who were the unemployed? The jobless were then predominantly adult males. This is one of the sweeping changes in the character and composition of unemployment, from the adult male to today's teenagers and married women, preponderantly with husbands at work. A generation ago, adult males accounted for two-thirds of all the unemployed in the 1940 census. The increase in the number of unemployed teenagers is far more a result of the bulge in the postwar birthrate than it is of dislocations arising from automation. In 1940, 15% of the unemployed were under 20 years of age. By 1964, those under 20 years accounted for nearly 25% of all jobseekers.

Next, let's examine the rate of unemployment among the young seeking employment in 1964. The unemployment rate for 14- to 19-year-olds was 15.9%. In 1940, the corresponding rate was 29.9%, or nearly twice that of today. Eighteen is the average age of entrance into the labor market of at least half of our young people. The bulge in the unemployment rate thus reflects the bulge in the birthrate of 1946-47. Unemployment of teenagers arises far more from their increased labor-force participation rate than in earlier

generations. This is the underlying cause of their unemployment, rather than displacement by machines.

Let's turn to the second part of this first change. Adult women accounted for only 18.5% of the unemployed in 1940. Twenty-five years ago, there was only about one woman for each three adult males among the jobless. With the great increase in the number of women in the labor force since then, the proportion has increased to two adult women for each three adult men seeking work. Again, I would suggest that this phenomenon, like the teenage unemployment phenomenon, is far more related to social change than it is to the impact of automation and cybernation.

To sum up, the first change is the increased participation of teenagers and married women in the labor force and the problems that stem from that increased rate of participation.

The second major change in unemployment is reflected in the distribution by marital status of the unemployed. This flows from the thesis I have just advanced concerning the increased labor-force participation of adult females. There is a far greater proportion of married women among today's jobless. Married women constitute nearly 19% of all jobseekers in 1964, while they comprised only 3% of the jobless in 1940. This fivefold increase in the percentage of women among the unemployed is largely unrelated to automation. Instead, it too reflects their greater participation in the labor force under today's social conventions. There was relatively little change in their unemployment rate between 1940 and 1964. Unemployment is a combination of two variables: the total number of people in any age group in the labor force and the unemployment rate of each age group in the labor force. The two variables are far more revealing than the single statistic that is so frequently cited relative to unemployment.

Finally, under this head of unemployment by marital status, the unemployment rate for married men in 1964 was only 3%. In contrast, the national unemployment rate, already mentioned, was 5%.

The third change in the composition of unemployment is related to the first and second. There are more families in which the husband and wife both work.

If automation has been compounding the unemployment problem as some contend, it has certainly not intensified the degree of economic distress that accompanied unemployment. That was supposed to characterize the economic picture of today and tomorrow, as it was forecast several years ago by some students of automation. The lessening over the past quarter-century in the financial distress resulting from the unemployment of family heads is illustrated in Census and BLS figures. In March 1964, only 3.4% of the husband-wife families reported the head of the family out of work. By that time nearly 45% of the families with the head out of work had the wife or other family member bringing in a paycheck. In 1940, the head of the family was unemployed in 11% of all husband-wife families, and in only 25% of these families with the head out of work was the wife of another family member employed and thereby contributing to the family income.

The fourth change in the nature of unemployment concerns the family income of the unemployed today, as compared with that of earlier periods. Sticky unemployment, whatever its cause, has not brought with it greater economic distress. This is clearly revealed in BLS figures.

I had the honor of being a member of President Kennedy's Committee to Appraise Employment and Unemployment Statistics. This committee suggested the official data be expanded on who the unemployed are, what efforts they are making to find jobs, their work history and their income. In this study, which has taken a while

to be processed, the Bureau of Labor Statistics found that in 1962 the median family income of families with a member unemployed five weeks or more was \$4,853. Unemployment and economic distress do not necessarily go hand in hand in the American economy today. Since 1962, personal income in general and wages in particular have moved up, so this average would be even higher today.

The fifth major change in unemployment, and perhaps the most important point I can make in connection with automation, is that unemployment today is of far shorter duration than it has been in the past. A generation ago, unemployment was essentially hard-core in character. Once unemployed, you stayed unemployed for a considerable period of time. Figures show the average median duration of unemployment in 1940 was about seven months and over two-thirds of the jobless had been seeking work unsuccessfully for four months or longer. One of every two unemployed had been looking for work at least six months. In contrast, most unemployment now is of relatively short duration, less than seven weeks.

From these facts, we can conclude that while automation may be intensifying job displacement, as it is claimed, it is also directly accelerating job creation in other industries or indirectly creating new job opportunities through a higher national economic growth rate.

By way of summary up to this point, it would appear that it has contributed little to the stickiness of unemployment—at least thus far. Demographic and social changes, in contrast, have altered the character and composition of unemployment. The increased rate of labor-force participation by youth and adult females is a major factor in today's higher jobless rates, and in each instance sweeping social changes lie behind the increased prominence of these two groups.

displacement and retraining

The problems of automation, then, are primarily short-run. At least up to the present time, they have been largely problems of transition. The displacement that occurs when automation eliminates certain jobs often means that the skills of the displaced worker differ from the newer skills the economy wants. As automation progresses, workers must acquire these new skills and often find it necessary to relocate. New industries do not flourish precisely where the old perish. Gaps develop between the locations where workers are and where they are wanted. Pulling up stakes and moving is expensive, and at times, painful. So, too, is the necessary retraining. But this is the price of progress and economic growth. The apparent lack of new job opportunities in the face of job displacement is more illusory than real.

What we lack in our system of economic intelligence is a means of measuring job vacancies or employment opportunities. Can you visualize a system such as ours in which the bulk of the information we get relates to labor supply and only a limited amount of information is available as to labor demand?

We at the NICB, with funds granted us by the Ford Foundation, are now completing the first intensive survey of job vacancies in Rochester, N.Y. The total number of job vacancies in Rochester currently is in excess of total unemployment, or at least of those actively seeking employment, because there is a difference between the two.

I have developed two terms about unemployment that don't make me overly popular in certain quarters. The first is "voluntary unemployment." The second term is related to the first. In much the same way that we on occasion refer to the gainfully occupied, we can now refer to the gainfully unoccupied. There isn't too much of a spread

between the incomes of the two in certain instances.

All of this is a commentary on the inadequacies of our system of economic intelligence. I can't give you the type of information I would like to on the job vacancies that exist in our society. If we had such a measure of job vacancies, perhaps it would serve to offset the headlines that we see about job displacement. The reason we see these headlines is that job displacement tends to be obvious. It tends to be concentrated in a single firm or in a given industry. Instead, the creation of jobs, as I tried to demonstrate by referring to (p. 32) "Current Trends in Employment," tends to be more subtle, more indirect, and more widely diffused throughout the entire economy. Insofar as it can be measured, we do not find that unemployment has worsened in our time because of automation. Although the figures aren't as good as I would like them to be, I have tried to measure the extent of unemployment in the U.S. from 1900 to 1929. Those were three prosperous decades. They exclude the Great Depression. On the basis of such statistics as we have for that period, the unemployed averaged 4.7% of the labor force in those three decades. Unemployment for the period 1940-65, even before escalation, in contrast, averaged around 5%, putting the good years and the bad together. Again, it is hard to find in those figures any serious deterioration in the relationship between labor-force employment and economic growth arising from automation.

By way of summary, since 1955, total employment has risen by 11.3 million and nonfarm employment by almost 14 million. In the past year alone, the number at work increased by 1.9 million, largely in the private sector. As of the mid-1960's, the U.S. is nearing the culmination of a major industrial transition from agricultural to non-farm pursuits. It is accelerating a second shift of even greater significance, from commodity production to service activities. Over the past decade, the number at work on farms has been cut from 6.5 million to 4 million, and even so, farm output is still in excess of demand.

More people are at work in the service industries than in all of the commodity-producing industries combined. Now let me put the pieces together for you as I have enumerated them relative to automation, unemployment and economic growth.

conclusions

Here are my conclusions: High and continuing economic growth continues to characterize the American economy as of the mid-1960's. We believe this may be true of the third postwar decade as well as of the second. Automation has undoubtedly contributed toward today's higher growth rate. Job opportunities are created, as well as reduced, by automation. But the short-term costs of dislocations arising from automation are high.

The human costs may be too high. They can be reduced. But the rewards in terms of the capital and human resources that can be freed for other pursuits that do not lend themselves to mechanization and mechanical controls are also high. The more we free resources from the industries that lend themselves to mechanization—that are capital intensive—the more resources we have that can be moved into the service sectors, or into culture, recreation and the better things of life. I said the human costs of dislocation arising from automation are too high. To reduce these human costs, we need among other things better measures of labor demand. We need to start planning future labor requirements in much the same way that we now budget future capital requirements and reason from those budgets as to the subsequent impact on our society.

We need better measure not only of current labor de-

**AUTOMATION'S
ROLE . . .**

mand, but also of prospective job vacancies. Long-range manpower planning should now be going on right along with long-range capital planning.

We need also to adapt educational and vocational training to these changes in labor demand. We are still concentrating on agricultural vocational training, for ex-

ample, despite the record of job displacement in agriculture that has been mentioned.

We need also to adapt educational and vocational training to meet the accelerated tempo of economic change. The better the job that education does in preparing the individual for frequent change, for adaptation and upgrading during his occupational life span, the lower will be the short-term human costs of the improvement further mechanization and cybernation will undoubtedly bring to the living standards of future generations. ■

Fig. 2 Current Trends in Employment, millions of persons

Item	1965 Sept.	1966						Change, in Number, Since		
		Apr.	May	June	July	Aug.	Sept.	1955 (*55 Avg.- Sept. '66)	Feb. '61 (Feb. '61- Sept. '66)	Year Ago (Sept. '65- Sept. '66)
H 1 TOTAL LABOR FORCE	78.0	78.9	79.8	82.7	82.8	82.5	80.1	-	-	-
O 2 Civilian labor force	75.3	75.9	76.7	79.6	79.6	79.3	76.8	-	-	-
U 3 Unemployment	2.9	2.8	2.9	3.9	3.2	2.9	2.6	-	-	-
S 4 Employment	72.4	73.1	73.8	75.7	76.4	76.4	74.3	-	-	-
SEASONALLY ADJUSTED										
H S 5 Civilian labor force	75.6	76.7	76.3	77.1	77.1	77.4	77.1	11.3	5.5	1.5
O U 6 Unemployment	3.3	2.9	3.0	3.1	3.0	3.0	2.9	0	-2.0	-0.4
L R 7 15 weeks and over	0.7	0.6	0.5	0.5	0.4	0.5	0.5	-0.2	-0.9	-0.2
D V 8 Employment	72.3	73.8	73.2	74.0	74.1	74.3	74.2	11.3	7.5	1.9
E 9 Agriculture	4.4	4.5	4.1	4.2	4.1	4.2	4.0	-2.7	-1.8	-0.4
Y 10 Nonagricultural industries	67.9	69.3	69.2	69.8	69.9	70.2	70.1	13.9	9.2	2.2
11. WAGE AND SALARY WORKERS										
12 Total nonagricultural	61.2	63.4	63.5	64.0	64.1	64.2	64.2	13.6	10.8	3.0
P 13 <i>Private nonagricultural</i>	51.0	52.6	52.8	53.1	53.1	53.3	53.2	9.4	8.2	2.2
A 14 Manufacturing	18.2	18.9	19.0	19.2	19.1	19.3	19.2	2.3	3.1	1.0
Y 15 Durable goods	10.5	11.1	11.1	11.2	11.2	11.3	11.3	1.8	2.4	0.8
R 16 Nondurable goods	7.6	7.9	7.9	7.9	7.9	7.9	7.9	0.6	0.7	0.3
O 17 Nonmanufacturing	43.0	44.4	44.5	44.8	45.0	44.9	45.0	11.2	7.7	2.0
L 18 Mining	0.6	0.6	0.6	0.6	0.6	0.6	0.6	-0.2	-0.1	0
L 19 Contract construction	3.2	3.3	3.2	3.3	3.3	3.2	3.2	0.4	0.4	0
20 Transportation, public utilities	4.1	4.1	4.1	4.1	4.1	4.1	4.2	0.1	0.3	0.1
R 21 Service industries	35.2	36.4	36.5	36.7	36.9	36.9	37.0	11.0	7.0	1.8
E 22 Trade	12.8	13.1	13.2	13.2	13.3	13.3	13.3	2.8	2.0	0.5
C 23 Retail	9.4	9.7	9.7	9.7	9.8	9.8	9.8	2.1	1.5	0.4
O 24 Wholesale	3.3	3.4	3.4	3.5	3.5	3.5	3.5	0.7	0.5	0.2
R 25 Finance, insurance, real estate	3.0	3.1	3.1	3.1	3.1	3.1	3.1	0.8	0.4	0.1
D 26 Other service and misc.	9.2	9.5	9.5	9.5	9.6	9.6	9.6	3.3	2.1	0.4
S 27 Government	10.2	10.7	10.8	10.9	10.9	10.9	11.0	4.1	2.5	0.8
28 Federal	2.4	2.5	2.5	2.6	2.6	2.6	2.6	0.4	0.4	0.2
29 State and local	7.8	8.2	8.2	8.3	8.3	8.3	8.4	3.7	2.2	0.6
30 UNEMPLOYED										
31 14-19 years	1.0	0.9	1.0	1.0	1.0	0.9	0.9	n.a.	0	-0.1
32 20 years and over: Men	1.4	1.1	1.1	1.2	1.2	1.1	1.1	n.a.	-1.5	-0.3
33 Women	1.0	0.9	1.0	0.9	0.9	1.0	0.9	n.a.	-0.5	-0.1
34 Married men●	0.6	0.7	0.6	0.6	0.7	0.6	0.5	n.a.	-1.9	-0.1
35 Experienced wage-salary workers●	2.4	2.2	2.1	2.6	2.3	2.4	a	n.a.	a	a
36 White persons●	2.3	2.2	2.4	3.1	2.4	2.2	2.0	n.a.	-2.6	-0.3
37 Nonwhite persons●	0.6	0.6	0.6	0.8	0.8	0.7	0.6	n.a.	-0.6	0
38 UNEMPLOYMENT RATE, SEAS. ADJ.										
39 All civilian workers	4.4%	3.7%	4.0%	4.0%	3.9%	3.9%	3.8%	-	-	-
NUMBER OF HOURS										
40 AVG. HOURS, MFG., SEAS. ADJ.	41.0	41.5	41.5	41.3	41.0	41.4	41.4	0.3	1.7	0.4

Note: Household survey data are obtained by personal interview with members of a sample of households. Payroll employment data, obtained by mail questionnaire, are based on payroll records of business units. In addition to other differences between them, proprietors, the self-employed, domestic servants and unpaid family workers are excluded from the payroll data but not from the household survey.

● Not adjusted for seasonal fluctuations

n.a.—Comparable 1955 data not available

a—Not yet available

Sources: Bureau of the Census; Bureau of Labor Statistics

10/12/66

THE COMPUTER'S PUBLIC IMAGE

by ROBERT S. LEE

 In thinking and speculating about man's future relationship to the computer, perhaps it is best to start with an examination of where we are today. In line with this, I'd like to present some research findings which show that the computer has *already* had an impact on man's personality in certain rather significant respects. Now, I realize that this may be difficult to believe, particularly when we consider that what most people know of computers is a kind of second-hand knowledge—primarily based on their exposure to newspaper stories and television events such as election broadcasts. By and large, few people have yet seen a computer first-hand and even fewer have had any direct controlling contact with it. In other words, for the vast majority of the population, the computer is only something they know *about*—they do not have any direct knowledge based on personal experience with the machines.

Yet there has been a psychological impact—a dim awareness that because of the computer, the world is somehow a different place and that man's position in this world is no longer the same.

Let's take a look at some research evidence based on 3,000 personal interviews with a scientifically selected cross-section of the American public¹. This study was conducted in May 1963. Before starting the survey, we first did a considerable amount of intensive exploratory investigation to make sure that we would properly cover the great variety of attitudes, opinions and reactions that exist about the computer and its social implications. In what follows, I shall describe in simple qualitative terms some of the broad findings that emerged from this investigation.

One of the most striking things to be seen in the data is the extent to which computers have excited the popular imagination. Even though only a very small segment of the population has had any substantial direct contact

¹ The quantitative evidence for most of the findings discussed in this paper were presented in a technical presentation of this study delivered at the 19th annual conference of the American Assn. of Public Opinion Research in May 1964 at Excelsior Springs, Mo., and at the annual convention of the American Sociological Assn. held in Montreal in September of that year.

attitudes and misconceptions

with the machines or with the environment of data processing, there is an enormous amount of interest in the topic. To most people, the computer is still something remote from their everyday lives—it is something they only hear about and read about. Yet, they are quite aware of its existence and they are fascinated by it. They frequently describe the computer as "amazing," "fantastic," and "astounding," and many of them are intensely eager to find out more about these machines—how they work and what they can do. There is, of course, a widespread recognition that computers are extremely complicated—that you have to have a lot of education and specialized training to comprehend the details of how they work.

Although popular thinking about computers is often rather unsophisticated and oversimplified, we discovered that the basic problem-solving function of computers appears to be rather well understood. Computers are closely associated with arithmetic, a well-recognized general tool that has a multitude of uses. And, although it is thought of frequently in terms of payroll, accounting and other

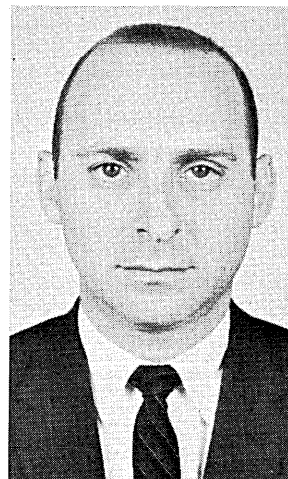

A sociologist, Dr. Lee is consultant for Communications Research at IBM Corporation where he studies public attitudes toward scientific and technological change. His recent article on attitudes toward automation appears in "The Corporation and its Publics," edited by John Riley. Co-founder of the University Seminar on Basic & Applied Social Research at Columbia U., he holds a PhD from NYU.

office and business applications, the computer is also associated with a variety of other functions such as scientific research, space guidance and military defense. There seems to be no one outstanding application which dominates public thinking about computers; it is properly understood to be a general-purpose problem-solving device.

There is widespread appreciation that the computer is beneficial—both now and even more so in the future. The computer is seen as an aid to business organizations, as a tool to help scientists speed up scientific progress, and as important to the man-in-space program.

This appreciation of the computer as a beneficial tool is highest among people who are familiar with the world of business, among those who have an interest in mechanical things, among people who have an optimistic outlook, and among those who are generally openminded and receptive to things that are new and different. And, as we might expect, it is the young college-educated people who are personally most interested in finding out more about computers and how they work.

popular misconceptions

The computer is a symbol of change—of innovation—of the future. Those with the greatest stake in the future and those who are psychologically most open to it are the people with the greatest interest and enthusiasm about the machines.

While the prevailing attitude toward computers is that they are an exciting and beneficial tool of progress, there are some fairly common misunderstandings about it. And, I'm afraid that perhaps we in the computer industry, in our enthusiasm, may have even contributed to some of these misconceptions.

First, there is the notion that the computer can do anything—that it can solve any problem. Then there is the idea that the computer always gives the right answer. People tend to generalize from the computer's well-known computational accuracy to the idea that the computer is infallible in solving the larger problems for which it may be used. Another popular misconception is the anthropomorphic notion that the machine is some sort of autonomous entity—a kind of superbrain which thinks as humans do and which can provide instant solutions to highly complicated problems that the ordinary man cannot even begin to understand.

There is very little popular understanding of the role that people play in solving problems with computers. By and large, the public does not understand the importance of systems development, of model building, of the program, or of the programmer. They don't understand the concept "garbage in, garbage out." What they see is the machine itself—not the human effort that makes it possible for the computer to do its job.

All this, of course, is not only false; it is also dangerous, as it leads to an unhealthy sense of awe for the machine as all powerful, as incomprehensible, and as independent of man's will. This sort of thinking leads to a feeling of uneasiness about computers which, we have found, can exist side by side with the widespread sense of excitement about the great benefits of these machines.

What all this means is that there are two completely independent currents of thought and emotion about the computer in our culture. The computer as a beneficial tool of man is the mainstream viewpoint, the dominant perspective about computers. But there is, however, this secondary undercurrent of uneasiness which is primarily related to the notion that the computer is an autonomous thinking machine.

Close and detailed analysis of the data shows that the central focus of this uneasiness about computers is *not* the threat of automation and job displacement. The main source of anxiety is the idea that there is some sort of science-fiction machine which can perform the functions of human thinking—functions which were previously thought to be the unique province of the human mind. This is reacted to as a down-grading of humans, and engenders a feeling of inferiority in relation to the abilities of computers. This idea—this disquieting undercurrent of uneasiness which co-exists with the prevailing excitement and optimism about computers—is a counter-theme of strong emotional significance for people. The anthropomorphic notion of a machine which can possibly out-think man is not easy to assimilate or to live with. It suggests that man is less unique than he thought and that he is therefore somehow less important.

man's image of self

It has been said that the scientific revolution has resulted in a number of assaults on man's egocentric conception of himself. Copernicus showed that our world is not the center of the universe, Darwin showed that man is part of the same evolutionary stream as animals, and Freud showed that man is not fully the master of his own mind. We now find that the emergence of electronic computers is another challenge to man's self-concept.

But what of the future—what will happen to our conception of ourselves and our machines as computers become more widely used? With the further development of time-sharing and a continued reduction in the costs of computing, in the years ahead we can expect to witness a "user explosion": there will be a vast increase in the number of people with access to computer terminals and various peripheral devices. Some day in the future, most people who will have direct daily contact with computers will not be computer experts such as engineers and other data processing professionals. The "new users" will be a different breed—they will be executives, managers, secretaries, sales persons, students and so forth. For them, the computer will be an auxiliary device, an aid in their daily work. This is in sharp contrast to the situation today where most people in contact with the machines have jobs primarily oriented around computers and data processing itself.

We can anticipate that such an increase in public visibility and contact with the machines is bound to have an effect on popular attitudes. But what will this effect be? Dr. Ulric Neisser has studied some 60 users of the Project MAC time-sharing facility at MIT and reports a marked absence of anthropomorphic notions or anxieties about the machine.² This leads him to believe that the uneasiness that exists about computers is simply a passing phase in our relationship to the machines—that as we come into closer everyday contact with them, we will come to accept them with psychological comfort as we do with so many other modern inventions and innovations.

My own data tend to bear out this idea that familiarity reduces the sense of uneasiness about computers. We find that when we look at non-technically trained college-educated people who are not in direct contact with the machines but who are indirectly exposed to the world of data processing and computers through their work or by knowing people who make use of the machines—such people are less likely to feel uneasy about computers than those of comparable background who have not had this type of exposure. In other words, in the more educated

² Neisser, U., *Computers as Tools and as Metaphors.* Address delivered at the Georgetown Univ. Conference on Cybernetics and Society, November 20, 1964.

Now, with Telescan, your central computer can collect data instantly from anyone, anywhere you operate.

We've just moved everyone in your organization at least one step closer to your central computer.

Your salesmen, on the road.

The girls in Personnel, downstairs.

The night watchman, in your plant across town.

The maintenance man, in your out-of-state plant.

Every one of them can now feed his particular type of data—inventories, claims, sales, ratings, schedules, research—to your computer.

Without going through the bother of a key-punch operation.



New 2 1/2¢
input device.

All that's needed is a pencil, some data collection forms, access to one of our new Telescan units, and Data-Phone* data communication service.

The pencils are nothing special; an ordinary one will do. And the paper is just an 8 1/2" x 11" data collection form designed to meet your specific needs; handling alphabetic, numeric, or alpha-numeric data.

Pencil and paper: that's what makes the Telescan System so simple, so versatile, so inexpensive.

Let's see just one example of how it works, bringing your branch order-

ing and inventory right to your main computing center.

Your people make on-the-spot records of sales and inventory changes on the data collection forms. Then feed them to Telescan which reads at a rate of 2400 sheets per hour.

Telescan records the data on magnetic tape for transmission by Data-Phone service to your central computer operation. (At 200, 556, or 800 cpi, in your specific computer format.)

All computation is done in your central office—at the lowest per-computation cost. Telescan then

transmits the computer data back to the branch location where it is printed out at 300 lines per minute.

That's really all there is to it. Other than six-month delivery (on time).

And the price: less than \$58K, which is about half of what you'd pay for the same capability elsewhere.

We'd like to tell you more about it. Optical Scanning Corporation, 47 Spencer Avenue, Fairless Hills, Pennsylvania 19030.



Call your computer. If it doesn't answer, call us.

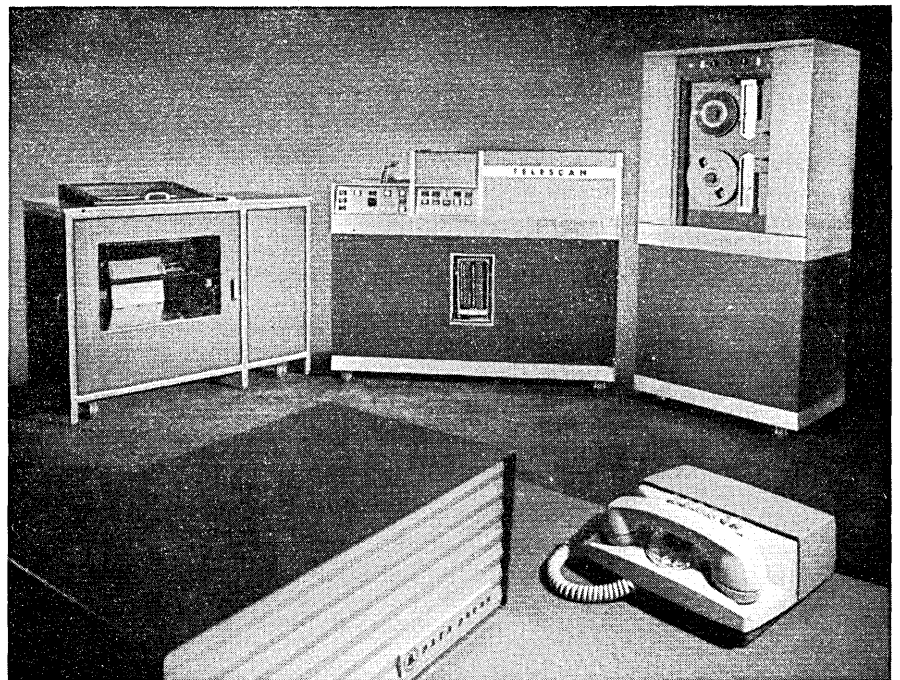

Complete Telescan installation.

*Service mark of AT&T Company.

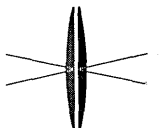

NEW FROM 3M!

"Scotch" Brand No.777 Computer Tape
offers you the ultimate
in long-range reliability and economy

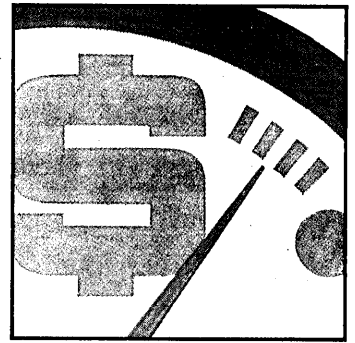

**MICRO-SECONDS ARE
DOLLARS**

A question: Do you consider that each time an error on tape makes your computer stop, examine and compensate, your money is wasted? It's even more costly when data is lost. When errors mount with repeated passes, the point is soon reached when continued use of that tape is economically prohibitive. The longer your tape performs reliably, the greater its real economy. Exclusive new "Scotch" Brand No. 777 computer tape gives you this.

"SCOTCH" IS A REGISTERED TRADEMARK OF 3M CO.

**EXTI
IN C**

A m
relia
bind
absco
tion
and
enab
grea
perf
tho
pea
kind
give
dram
any
deve

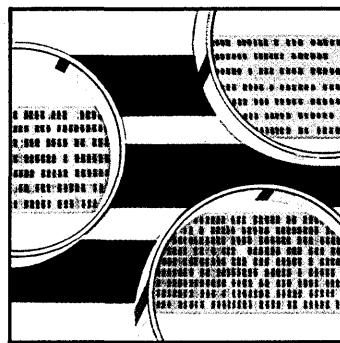
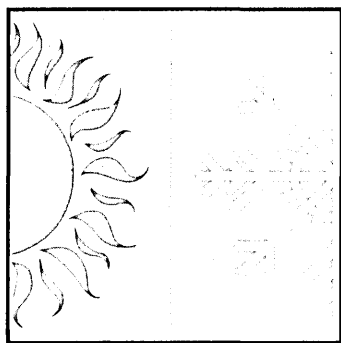
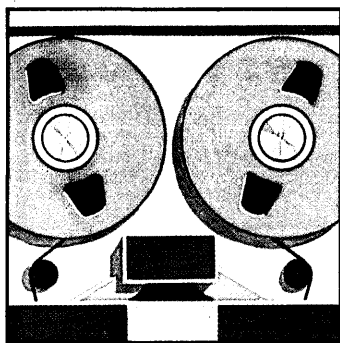

EXTENDED RELIABILITY IN CONTINUED USE

A major secret in No. 777's reliability is a special oxide binder formula. Applied with absolute precision, the exceptional stability, toughness and uniformity of this binder enables No. 777 to deliver greatly extended error-free performance. Tested over thousands of passes, repeatedly subjected to the kind of work-horse use you'd give a scratch tape, No. 777 dramatically out-performs any other computer tape ever developed.

RELIABILITY IN SHIPPING AND STORAGE

All computer tapes at times are subject to wide fluctuations in temperature and humidity — whether in sun-soaked highway transport or in 40-below-zero air cargo. These intense changes can generate new dropouts in a tape initially error-free. But "Scotch" Brand No. 777 maintains error-free reliability through both shipping cycles and long-term storage, just as it does in the controlled environment of your computer center.

COMPLETE COMPATIBILITY AT ALL BIT DENSITIES

In addition to its remarkable physical qualities, new "Scotch" Brand No. 777 Computer Tape is completely compatible for all computer densities whether the traditional 200, 556 or 800 bpi; or the newest 1600 bpi (3200 fci). Even if your data processing system utilizes lower densities, with "Scotch" Brand No. 777 you can profit directly from its exclusive long-range, error free reliability today—and still be prepared for tomorrow.

Whatever computer system you employ or plan to use, find out how 3M can cut your costs. Write: Market Services Department, Magnetic Products Division, 3M Company, St. Paul, Minn. 55119

Who knows more about computer tape than the people who perfected it?





From the original painting by Neil Boyle

SELENE

Planning Research teams are at work on five separate contracts with government and industry—all bearing on the moon shot and all demanding the highest level of expertise in computer technology.

Planning Research offers the nation's most complete non-hardware capability for the development of computer systems—from analysis of the total problem through system engineering, hardware system design, programming, and check-out. Applied to *any* computer system, Planning Research experience saves time or money, or both. For particulars, write to Mr. John N. Graham, Jr., Vice President for Computer Systems Design.

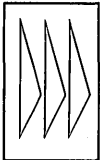

PLANNING RESEARCH CORPORATION

Home office: 1100 Glendon Avenue, Los Angeles, California 90024

Public Image . . .

segment of the population, uneasiness about computers seems to be highest among people who are most remote from them; it decreases with greater familiarity with the world of data processing, and it seems to be virtually nonexistent among people who have direct contact with the machines.

I am not very sure, however, that we can so easily extrapolate these findings to what will happen when we have the user explosion—especially when we consider the possible reactions of non-technical people to certain sophisticated applications that combine adaptive, heuristic programming with conversational mode interaction. I don't think that we will simply learn to "accept" the computer; rather, I think that we will eventually develop a new and broadened conception of man, himself, now that machines exist which he can use as an extension of his intellect.

In the long run, it will probably be the youngsters who grow up in a world of computers who will more truly understand the new relationship of man and the machine. They will not be handicapped by older concepts, they will not feel a sense of ego threat, and they will not be in some sort of identity crisis in relation to machines. Instead, I believe they will be eager to understand the new tools, to use them to extend their knowledge and to extend their freedom to build the kind of future they want. And, out of this, I think a new concept of man will develop—a concept of man which includes and which accepts his ability to amplify the powers of his mind.

brains & intellect

In the course of human evolution, millions of years ago, the hominoid brain went through a period of great enlarge-

ment in a relatively short span of time. Anthropologists used to believe that the development of tools took place after this period of rapid brain development—that an increase in man's ability to deal with his environment led to his becoming a tool-using animal. That latest evidence, I am told, contradicts this. It is now believed that the human brain went through its rapid period of enlargement some time *after* man started to use tools.

In commenting on this discovery, Jerome Bruner, president of the American Psychological Assn. at that time, pointed out that since this evolutionary development—that is, over the past 500-thousand-thousand years—the principal change in man has been alloplastic rather than autoplasic. "That is, he has changed by linking himself with new, external implementation systems rather than by any conspicuous change in morphology—that is 'evolution-by-prosthesis' . . ."³

In other words, after the great biological leap which was itself made possible by his development of tools, man's ability to behave more intelligently and to be a more important significant force in his environment was advanced by the further development of tools as an extension of his muscles and of his senses.

Today we are developing tools of an even higher order—machines that will be an intrinsic part of our intellectual equipment as they directly magnify our intellectual capabilities for intelligent thought and action.⁴ The major problem will be to learn how to use these new tools wisely for truly human purposes. And, in this effort, our focus should be on man—on man in his new identity as extended and enlarged by the machine, not on the machine itself as something separate from and apart from man. ■

³ Bruner, J. S., "The Course of Cognitive Growth," *American Psychologist*, 1964, 19, 1-15.

⁴ Chein, I., "On the Nature of Intelligence," *Journal of General Psychology*, 1945, 32, 111-126.

THE SCC 6700

Continuing the population explosion of new computers, Scientific Control Corp. of Dallas has announced the SCC 6700 Time Sharing Computer, making a total of six models available from this two-year-old company.

The 6700 is a 24-bit machine with core memory available in 4K modules up to a maximum of 128K. Cycle time is 1.75 usec, shortened by memory and instruction overlap. Single or multiple cpu's can be included in a system, with a typical configuration being two main processors and an SCC 660-2 for I/O control.

Character- and bit-addressable instructions are used and a paging structure allows memory allocation in 256- or 2048-word blocks. Each page may be interpreted as read/write, read-only, or execute-only storage. Secondary storage includes multiple 2-million-word drums and 1.6-billion-word discs. These units, and other peripheral equipment,

time sharing computer

are built by outside suppliers.

Time-sharing software offered with the 6700 is the Berkeley-developed system, produced under ARPA contract and now in the public domain. The monitor, executive, and subsystems include file protection that can be partially removed to allow communication between users via the computer. Other software features are the HELP question-answering service, SNOBOL string manipulation system, and LISP general-purpose list processing system.

Marketing of the SCC 6700 takes the company into a larger arena. Previous machines have been sold mainly to systems houses, who have then taken responsibility for programming and maintenance. SCC now will be providing support on its own.

Prices begin at about \$200K and can go to \$800K for a good-sized system. Delivery times are being quoted as six months from receipt of order. ■

First cost of digital computer tape? Forget it!

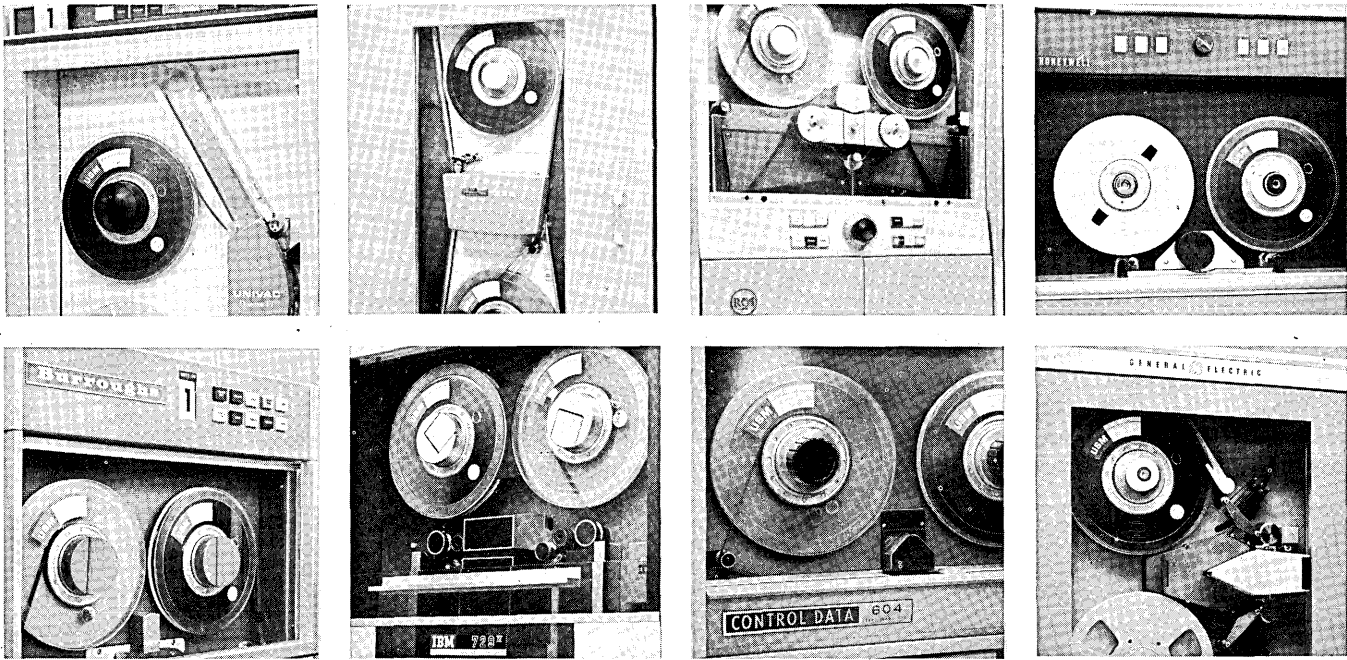

The real cost is the price-per-pass.

And on that basis, U.S. Tape with exclusive Duramil 7 may well be the lowest priced tape on the market today!

Duramil 7 makes possible the manufacture of computer tape with superior abrasion resistance and oxide adhesion . . . excellent scratch resistance. Coupled with **8+8 Total Surface Testing*** — a forward step in truly error-free tape certification — U.S. Tape with Duramil 7 records and maintains your data pass after pass after pass after pass. More passes, you'll find, than any other tape you can buy.

Give us a call to arrange your own evaluation program.

** Write for free booklet: "The facts about testing magnetic tape for digital computers."*



U.S. MAGNETIC TAPE COMPANY
HUNTLEY, ILLINOIS 60142 / A Subsidiary of Wabash Magnetics, Inc.

NOVA: A LIST-ORIENTED COMPUTER

a proposal

by JOSEPH E. WIRSCHING

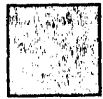

Since the advent of the internally-stored program computer, those of us concerned with problems involving massive amounts of computation have taken a one-operation, one-operand approach. But there is a very large class of problems involving massive amounts of computation that may be thought of as one-operation, many-operand in nature. Some familiar examples are numerical integration, matrix operations, and payroll computation.

This article proposes a computer, called NOVA, designed to take advantage of the one-operation, many-operand concept. NOVA would use rotating memory instead of high-cost random access memory, reduce the number of program steps, and reduce the number of memory accesses to program steps. In addition it is shown that NOVA could execute typical problems of the one-operation, many-operand type in times comparable to that of modern high-speed random access computers.

Rotating memories were used in early computers because of low cost, reliability, and ease of fabrication. These machines have been replaced by machines with more costly random access memories primarily to increase computing speed as the result of a decrease in access time to both operands and instructions.

the nova approach

Let us take two simple examples and use them to compare conventional computing techniques with those proposed for NOVA.

Example 1. Consider two lists (a 's and b 's) of which the corresponding pairs are to be added. With a conventional computer this is done with a program that adds the first a to the first b , the second a to the second b , etc., and counts the operations. The working part of such a program might consist of the following instructions:

Fetch a
Add b
Store $(a + b)$
Count, Branch, and Index

In general, the four or more instructions must be brought from the memory to the instruction register once for each pair in the lists. This seems to be a great waste when only one arithmetic operation is involved. Indeed it is, when one considers that the majority of computing work consists of the performance of highly repetitive operations that are merely combinations of the simple example given. Attempts have been made to alleviate this waste by incorporating "instruction stacks" and "repeat" commands into the instruction execution units of more recent computers.

Example 2. Consider three lists (a 's, b 's and c 's), where we wish to compute $(a + b) * c$ for each trio. There are two distinct methods by which this can be accomplished: first, by forming $(a + b) * c$ for each trio of numbers in the list, or second, by forming a new list consisting of $(a + b)$ for each a and b , and then multiplying each c by

the corresponding member of the new list. Clearly the second method is wasteful of memory space and wasteful of programming steps.

Next, let us take a look at the memory requirements for these two examples. First, the instructions are kept in a high-speed random access memory, and while the bulk of the variables need not be kept in a random access memory, they must be brought to one before the algorithm can be performed. This extra transfer may entail more instructions to perform the logistics. Thus the simplicity of the overall program is directly related to the size of the memory. The variables (a 's, b 's, etc.) are usually stored in consecutive memory locations. Except for indexing, this ordering of the data is not exploited.

In NOVA, lists of variables are kept on tracks of a rotating bulk memory. When called for, the lists of variables are streamed through an arithmetic unit and the results immediately replaced on another track for future use. This process takes maximum advantage of the sequential ordering of the variables. Instructions need only be brought to the instruction execution unit *once* for each pair of lists rather than once for each operand; thus the instructions need not be stored in a random access memory but may also be stored on the rotating bulk memory. This departure from the requirement for random access memory significantly reduces the cost of the computer, without sacrificing speed of problem solution.

solution of a network problem

Before going further into the structure of NOVA, let us consider a significant example, which shows that NOVA is well suited to the solution of differential equations using difference methods over a rectangular network.

Let Fig. 1 represent an artificial network used as a model for some physical process. Generally speaking, the method of advancing the variables at a mesh point (j, k) from one time step to the next involves only information from the neighboring mesh points. A typical hydrodynamic problem will require a list of 10 to 20 variables (physi-



Mr. Wirsching is supervisor of programming in the computation div. at Lawrence Radiation Laboratory, Livermore, Calif., specializing in the specification and evaluation of new computers and peripheral equipment. He has a B.S. in math from Univ. of Nevada.

This work was performed under the auspices of the U. S. Atomic Energy Commission.

cal quantities) at each mesh point. The traditional computer solution involves listing these variables to each point in a contiguous fashion and in a regular sequence with respect to the rows and columns of the array. If the total array does not fit into the fast memory, three adjacent columns (or rows) are brought to the fast memory; as a new column is calculated, the next column in sequence is brought in from bulk memory and the oldest of the three is written to bulk memory. In this fashion one proceeds across the array. This process is then repeated until some significant physical occurrence happens and the problem is ended.

In NOVA, the variables are organized into separate lists rather than by mesh point. From a computational standpoint this is possible since the main memory of NOVA may be essentially unlimited in size, at least exceeding the size of the largest present network problems. One then

Fig. 1 — Two-Dimensional Array

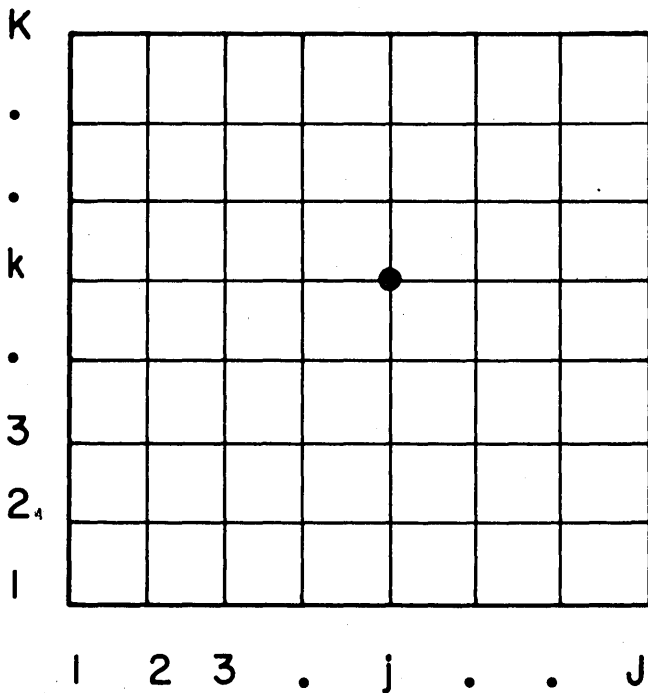

proceeds to execute operations on lists of variables rather than single variables, performing a single operation for all mesh points in the array in sequence.

Let us look more closely at the variables and their possible combinations. Let $U_{j,k}$ and $V_{j,k}$ be variables associated with the array of Fig. 1. These variables are listed sequentially by column in Fig. 2, along with further lists of the V column shifted by various increments.

With some concentration, one discovers in Fig. 2 that an arithmetic operation between $U_{j,k}$ and $V_{j,k}$ is simply a matter of taking the two columns as they exist and operating on them in pairs. To combine $U_{j,k}$ with a nearby neighbor, $V_{j,k-1}$, the V column is shifted down one place, at which time the proper neighboring variables are found opposite one another for the entire network. At certain boundaries of the array some elements have no proper neighbors. In NOVA these boundary elements must be handled separately in the same way as they must be handled separately in a conventional machine. In NOVA, calculations at boundaries may be temporarily inhibited by having a third input to the arithmetic unit which allows the calculation of a result for a pair of operands to proceed or not, as appropriate. This third input is defined as "conditions," and is brought as a bit string to the arith-

metic unit concurrently with the operands. This bit string may contain any number from one to several bits for each pair of operands.

Further observation shows not only that it is possible to obtain the nearest neighbors easily by shifting the columns of variables with respect to one another, but that any neighbor relationship can be obtained. In general, for an operation with a neighbor $\pm n$ rows away and $\pm m$ columns

Fig. 2 — Lists of Variables

Original Lists	V Shifted Down By 1	V Shifted Down By 2	V Shifted Down By K
$U_{0,0} \quad V_{0,0}$	-	-	-
$U_{0,1} \quad V_{0,1}$	$V_{0,0}$	-	-
$U_{0,2} \quad V_{0,2}$	$V_{0,1}$	$V_{0,0}$	-
$\cdot \quad \cdot$	$V_{0,2}$	$V_{0,1}$	-
$\cdot \quad \cdot$	\cdot	\cdot	-
$U_{1,0} \quad V_{1,0}$	$V_{0,K}$	$V_{0,K-1}$	$V_{0,0}$
$U_{1,1} \quad V_{1,1}$	$V_{1,0}$	$V_{0,K}$	$V_{0,1}$
$U_{1,2} \quad V_{k,2}$	$V_{1,1}$	$V_{1,0}$	$V_{0,2}$
$\cdot \quad \cdot$	\cdot	\cdot	\cdot
$\cdot \quad \cdot$	\cdot	\cdot	\cdot
$\cdot \quad \cdot$	\cdot	\cdot	\cdot
$U_{i,k}$	$V_{i,k}$	$V_{i,k-1}$	$V_{i-1,k}$
$\cdot \quad \cdot$	\cdot	\cdot	\cdot
$\cdot \quad \cdot$	\cdot	\cdot	\cdot
$\cdot \quad \cdot$	\cdot	\cdot	\cdot
$U_{J,K} \quad V_{J,K}$	$V_{J,K-1}$	$V_{J,K-2}$	$V_{J-1,K}$
	$V_{J,K}$	$V_{J,K-1}$	\cdot
		$V_{J,K}$	\cdot

away, the lists are offset by $\pm n \pm m \cdot K$, where K is the number of rows in the array.

Many problems (for example, payroll and inventory records) are essentially list-structured but do not require offsetting of variables. Clearly the NOVA structure is well suited for the solutions of these problems, also.

structure

The most difficult problem to be solved in the proposed computer is to synchronize movement of the columns of data that require offset. Buffers of various types could be used to solve this problem; they could range all the way from rotating memory devices or delay lines to core memories. The former are simple, direct, and low in cost but are limited in their general capabilities. On the other hand, a number of small random access buffer memories could be used for offsetting lists of variables and for facilitating special functions such as boundary calculations but at a higher equipment cost.

Fig. 3 shows a block diagram of the organization of NOVA. The rotating memory, which might be a disc or drum, would be composed of several hundred tracks, each storing several thousand words, with a total capacity between one and two million words. Each track would have an individual read-write head. The heads would be organized in such a way as to attain a high word-transfer rate, perhaps as high as one million words per second. With this in mind an ideal execution time for one addi-

Fig. 3 — Block Diagram of NOVA Computer

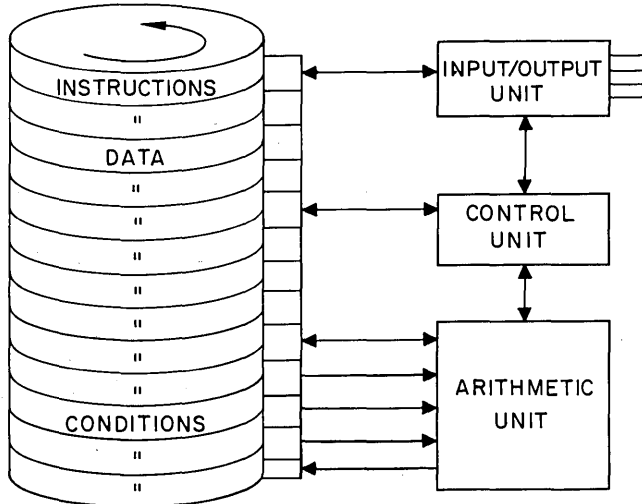

tion would be the time required to move two operands from the disc to the arithmetic unit; i.e., 1-2 microseconds. The disc synchronizer would be capable of simultaneously reading two lists of operands, writing one list of results, and reading one list and writing one list of conditional control information. In addition, instructions would be read from another channel in small blocks.

The bit string of conditions coming from the memory is used to control individual operations on pairs of operands in the lists, and in essence each bit (or bits) is a subordinate part of the individual operations. Conditions going to the memory are the subsidiary result of the operation

Fig. 4 — Buffering in Arithmetic Unit

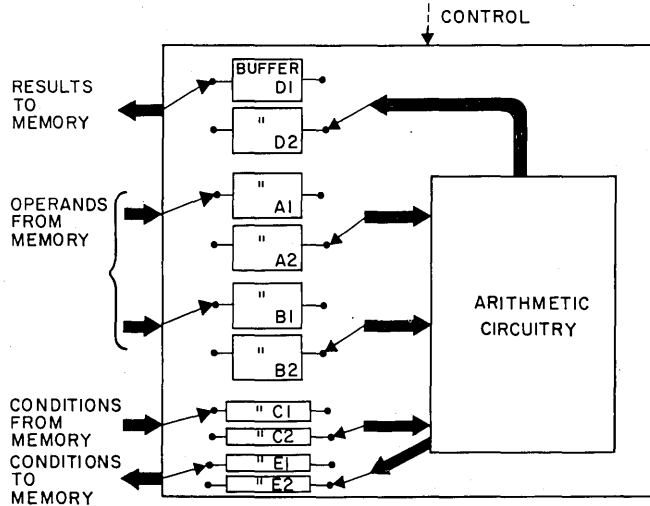

of one list upon another. These bit strings may be used later as control during another list operation. They want also contain information on the occurrence of an overflow or underflow, or on the presence of an illegal operand, etc.

Fig. 4 shows a suggested organization for the arithmetic unit that incorporates five sets of alternating buffers. Two sets are for lists of operands coming from the

memory, one set for lists of results going to the memory, and two sets for "conditions" (conditional control information) coming from and going to the memory. These buffers should be equivalent in length to the number of words on a track of the rotating memory.

The loading and unloading of the buffers to and from the rotating memory is dependent on the timing of the rotating memory, whereas the loading and unloading of the buffers to and from the arithmetic unit is guided solely by the rate at which the arithmetic can be performed. Here again it may also be possible to take advantage of the streaming nature of the operands by designing an "assembly-line" arithmetic unit in which more than one pair of operands could be in process at the same time. With this kind of unit it may be possible to execute additions at a rate equal to the word-transfer rate from the rotating memory; however, a multiplication or division of two lists may require several revolutions of the memory. The timing diagram of Fig. 5 shows several typical instructions being carried out. A certain amount

Fig. 5—Timing Diagram of Buffers, Rotating Memory, and Arithmetic Unit. Dotted line shows movement of data into a device; solid line shows movement out.

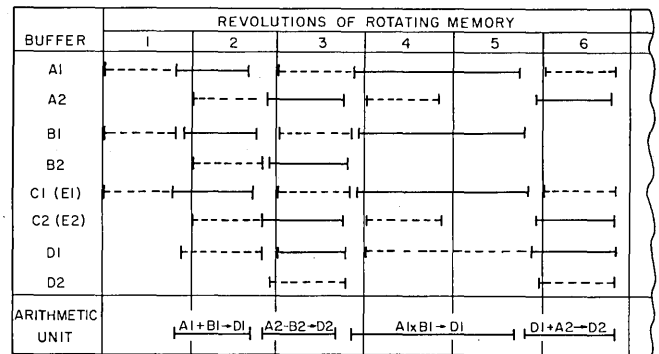

of look-ahead is required, but there is ample time for this, since instructions are prepared for execution at an average rate of less than one per revolution of the rotating memory.

While a detailed cost estimate has not been made for a simple prototype NOVA, a quick estimate would be \$50,000 for a head-per-track disc and \$50,000 for the arithmetic and control section, making a total of \$100,000. For a buffering scheme such as the one shown in Fig. 4 the cost would be considerably higher but would be offset by increased versatility.

conclusions

In the previous paragraphs we have demonstrated that NOVA is capable of handling network problems at a significantly lower cost than contemporary computers, and at a comparable speed. The availability of such a machine as NOVA would stimulate further interest in the one-operation, many-operand approach to computation and no doubt would uncover many other problems to which it could be applied.

Because NOVA makes it possible to easily establish neighbor-relationships between mesh points that are further away than nearest neighbors, it may be possible to develop new differencing techniques for the solution of coupled sets of differential equations. This may increase the accuracy or shorten the time required for their solution.

The memory, arithmetic, and other units needed for NOVA are commercially available now. No new technology would be required to fabricate a prototype model. In view of the potential advantages of such a machine, it seems clear that construction of a model would justify the minimal development costs.

DELEGATE SOFTWARE PACKAGES?

Are you going out of your software pickin' mind? Have you ever tried to delegate even a software program? Results pretty disappointing? How about a meeting near the completion date and a request for a major time extension? The original funds have been spent and there is an urgent appeal for more money to complete the project? With any kind of luck the documentation manuals will be started under the new price and time target extensions? And this is beginning to set your entire organizational objectives back by umpteen months? And the chief executive wants a summit meeting of the whole software matter tomorrow afternoon? And you want me to delegate software packages? To whom? To IDC? Who's that? Well, don't let your bad taste with previous companies embitter you against the idea! IDC can be defined this way...

IDC is a management-oriented software organization that has built its growth and reputation on the basic concept that "gung-ho" in business is a logical and profitable way of operation. IDC is a company that takes absolute pride in not only meeting its time commitments, but in beating them. Not once has IDC ever gone back to a customer and requested more money or more time to complete their firm fixed price contract. No wonder computer manufacturers and computer users alike have seen fit, time after time, to delegate their trust in IDC...to deliver entire software packages as well as hundreds of other programs of all types. If your computing requirements need an understanding and capable assist — a new perspective to your software management problems — perhaps you should call IDC now. 1621 East 17th Street, Santa Ana, Calif. Phone: (714) 547-8861.

**INFORMATION
DEVELOPMENT
COMPANY**

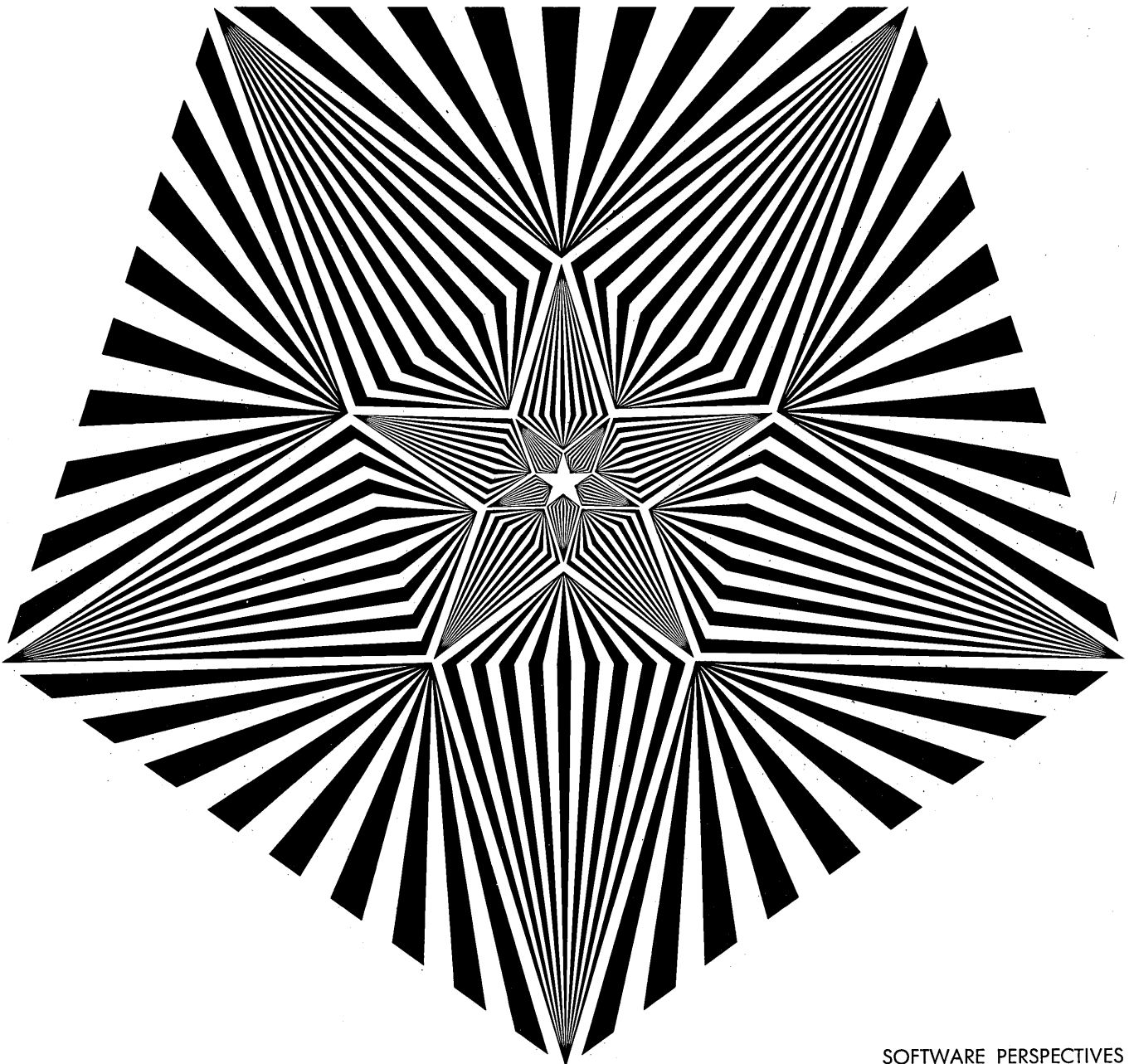

THE REVOLVING EXECUTIVE CHAIR

and how to stay in it

by HENRY J. CADELL

Everyone knows that growth industries offer attractive employment possibilities, with extraordinary challenge and commensurate compensation rewards. New problems to be conquered appear daily—possibly the same problems which were solved just a short time ago. But, because of the shifting quagmire upon which these decisions are based, they appear again today, dressed in new finery, offering the challenge anew.

The challenges, plus the titles, salaries and other incentives, justify a short expedition into a growth industry. While the expedition is not knowingly planned to be a short episode, certain factors dictate that it is, in reality, only a brief excursion.

Few people, both within and without the growth industries, will admit that the potential for personal failure is almost certain; that ability, knowledge and perseverance will not in themselves guarantee success. Certain cyclical forces, largely ignored in the past, dictate to a great extent success or failure. The tenure of the ranks of middle and top management can be compared to the brief tracery of a meteor entering the atmosphere—a short bright light, growing in intensity, and then . . . sudden darkness.

Many "meteorites" leave the growth industries as better men—better managers. After all, they have been tempered by the hottest fires: atmospheres of instability and insecurity. Others leave, consumed by defeat, their confidence shaken, questioning the very abilities which led them to test the growth industries, looking for the security of lesser positions, lesser responsibilities.

Even after their fall, few will admit that their brief showing and their eventual failure was a dichotomy—caused by cyclic changes beyond their control, on one hand, yet caused by their own decisions and their inability to change their attitudes.

Two of the basic factors which cause this dichotomy are the causes and results of a growth business—Orders and Plant Capacity.

The chart below is a simplified view of these factors—while the slope of the Orders line or the height of the

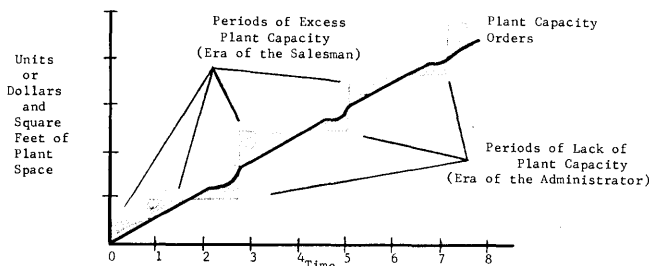

Plant Capacity line may vary, each can be adjusted to suit any growth business. The relationship of these two lines to each other dictates whether a business operates in the Era of the Administrator or the Era of the Salesman.

While the Orders Received line is generally portrayed as symmetrical, close examination will reveal minor plateaus which are encountered when the business changes from the Era of the Salesman to the Era of the Administrator. With luck, the plateaus are relatively short, since they have the effect of slowing the progress of the business.

Let's look at the chart. At time O, the start of the growth business, a single individual or a collection of individuals with peculiar talents incubate the idea and set the cycle in motion.

During the formative stages of the business, when obstacles loom over every horizon, the obstacles themselves cause a cohesive, working group to be formed. Communications are good, since only a small number of people are involved in decision-making. As problem areas are uncovered, they are quickly solved, since the higher echelon is tuned to recognize problems and also is tuned to respond. Decisions cannot be postponed—a delay in action could mean extinction at this stage.

There are few specialists, since specialists are a luxury which can be afforded only when the organization has started to mature.

In this atmosphere, the founders hammer out the basic philosophies and policies which guide the business to early success, but which may become the albatross around the neck of a maturing organization, as will be shown later.

During the formative period, few major personnel changes are encountered—partially because the selection of people is dictated by their immediate capacity to produce, but also because plant capacity is easily expanded in small steps to meet the rising order rate.

The Era of the Founder usually coincides with the first Era of the Salesman since, in our marketing-oriented economy, it is impossible for a business to succeed without the running start given to it by the Salesman.

The Era of the Salesman is typified by the question, "How many orders today?" Profits, schedules, technical problems are secondary. The Salesman *knows* that profits will take care of themselves, while delivery promises are made to be adjusted, broken or accepted with the gamble that the silver-tongued Salesman can satisfactorily explain delays to the customer without losing him. Technical problems, of course, will be solved on time, since the Founder, or Salesman, has hired optimistic, sales-oriented engineers who find themselves believing the promises made by the Salesman.

In this era, Salesmen are subject to few controls—major decisions and commitments are made quickly, and most times, not even recorded. Because of this "wheeler-dealer" attitude, an amazing esprit de corps develops, and

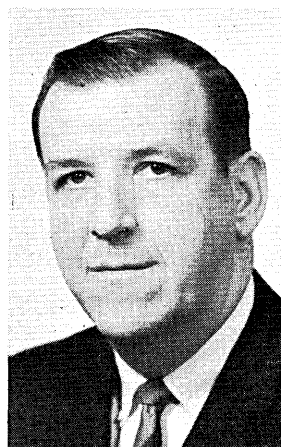

Mr. Cadell is a ten-year veteran of the computer business, a field that surely meets his requirements for a growth industry. He has held various positions in both sales and administration, has a BS in advertising and an MBA in marketing from Syracuse Univ.

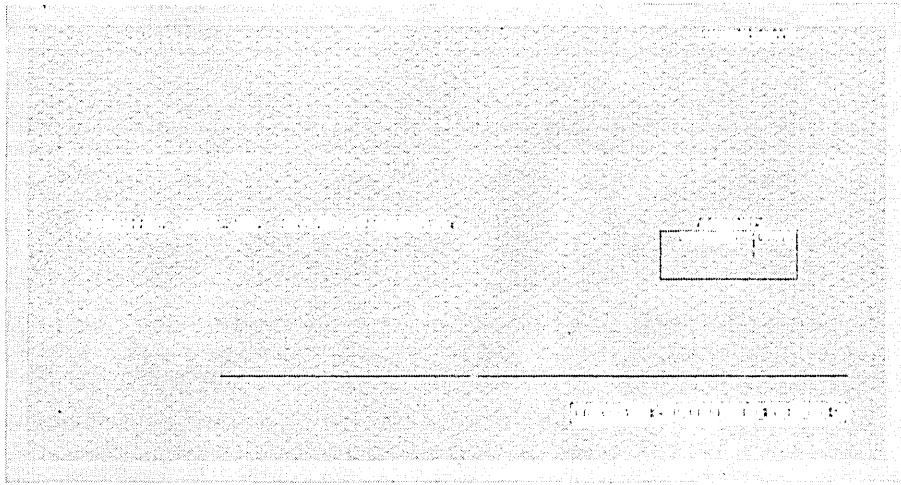

Before 

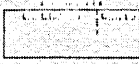
TAGRIGHT OF CALIFORNIA 856 SO. BEAVER STREET LOS ANGELES, CALIFORNIA 90018	CHECK DATE
MAIN OFFICE 18-44 NATIONAL BANK 2250 9TH & HIGH STREET	
	
⑆ 2250 0044 ⑆ 20054 7435 ⑆	

After 

Statement Service Co. Uses Addressograph® Methods to Increase Clerical Output 1/3 to Save Valuable E.D.P. Machine Time to Reduce Form Costs

"The use of Addressograph methods has increased clerical productivity by at least one-third", reports Mr. Wylie Adams, President of Statement Service Co., Los Angeles. Their services include computation of earnings, writing checks, maintaining payroll records and tax reporting. Mr. Adams gets optimum performance from his electronic accounting machines because he uses an Addressograph machine. This Addressograph machine automatically imprints each client's name, address, the bank name, and MICR encodes bank and account numbers. Single continuous forms of blank checks are used for all clients, eliminating the need to change forms. The result? Major savings of labor and the cost of forms. And valuable E.D.P. machine time is saved, providing more earning power for the company. And Addressograph methods need only one easily trained operator. Increasing your E.D.P. output is a good reason to call your nearby Addressograph Representative (listed in the Yellow Pages). Or write Addressograph Multigraph Corporation, Department T-6640, 1200 Babbitt Road, Cleveland, Ohio 44117.

 **Addressograph**
DIVISION OF
ADDRESSOGRAPH MULTIGRAPH CORPORATION

CIRCLE 25 ON READER CARD

EXECUTIVE CHAIR . . .

the organization is carried forward on the overwhelming tides of optimism.

This happy coalition of the Salesman and Founder lasts through the first major plant expansion, but the continuing success of the Salesman forges his doom. The first major plant expansion is taxed to the limit. Emphasis is shifted from securing new orders to making continual excuses for late delivery. With this shift in emphasis, you see the first glimmer of the Era of the Administrator.

The orders-oriented people become frustrated by long shipment cycles but, because of their inherent abilities and drive, they continue to secure new orders, further taxing the capacity of the plant. Here, possibly after the loss of a major order or two for contract non-performance, the need for Administrators becomes evident, and the Administrators start to infiltrate and have a more cogent voice in the organization. Eventually, because of the shipping problems and newly-instituted administrative controls, the orders-oriented people rebel—and are replaced, or they attempt to ignore the changing conditions—and are replaced. Of course, they are replaced by Administrators.

the unplanned bonanza

The Administrators, along with their reports, controls and fancy jargon, pride themselves on their strict control of expense accounts and their wonderful reporting and monitoring systems. They congratulate themselves on bringing the sales organization to "heel" by at last developing a commission plant that provides the utmost in incentive, but rewards only the fortunate few who stumble blindly into a major, unplanned bonanza. If there are any good Salesmen remaining, they, of course, leave or are replaced by the Administrators who enjoy sending in the daily or weekly reports. In fact, since the promotion road is based on administrative abilities such as accuracy and timeliness of reports, they spend more time preparing reports than is spent in making customer calls or presentations.

Strangely enough, while all this is going on, the orders rate continues to climb. For this, the Administrator takes credit, announcing to one and all that the controls, reports, etc., etc., have increased productivity and have not sapped the vigor from the business as some detractors have stated. What they have overlooked is the "overshoot" effect—that the enthusiasm generated by a good selling team will continue to fire the business for some time. Based on this overshoot effect, eventually the Administrators are forced to make the decision which seals their doom—
EXPAND THE PLANT.

In planning the expansion, the Administrators use the latest scientific forecasting techniques—but, being basically human, refuse to admit that their prognostications could be less optimistic than the Salesmen they replaced. Or, while they may belatedly recognize this, they are forced to fall back on the optimistic forecasts of the Founder/Salesman who laid out the basic philosophies and policies and forecasted a certain volume of business. To deviate downward would shatter their new-found success—after all, they have proven that they can sell. All aspects dictate a plant expansion program of at least the size planned by the Salesman. But, after authorizing the plant expansion, the overshoot effect has usually run its course and sales tend to level off or drop. Try as they may, the Administrators cannot reverse the downward trend since they have strangled themselves. In the midst of this frenzy, stockholders, bankers or backers force a change—key Administrators are replaced with competent Salesmen, and the cycle starts again. Plant capacity has again dictated a change in personnel, a change which was forged by the

people who are replaced, but yet, a change which was inevitable and literally beyond their control.

Few survive for any length of time in the same growth business because they are unadaptable modern day dinosaurs, and can be neatly catalogued as Salesmen or Administrators. They drift within the industry, from one company to the next (since all companies are in different phases of the cycle) and each makes his contribution within his proper cycle. After a time, each man serves his turn and either spins off to security in a small, stable company or drops from view—shaken, his confidence destroyed by the constant necessity to move about, not trusting himself and, of course, not trusting others.

But, are all doomed to failure, or are there some who are exempt from the dance of self-destruction?

Observations have shown that there are two general types of individuals who can survive for any significant length of time in a growth business. They can be recognized as either the Chameleons or the Technical Specialists.

The Chameleons are those superior individuals who can operate effectively both as Salesmen and Administrators, and are endowed with the ability to quickly recognize the subtle changes which herald the beginning of another era—and, in fact, can read the faint signs so well that they actually seem to lead the way.

The Chameleons, while in the minority, are the stalwarts of the business world—they are usually the industry spokesmen, the pacesetters who add stability to the company and capitalize on the cyclic instabilities of their competitors.

The Technical Specialists are those individuals who amass a profound knowledge of a very limited subject, and whose services are required by both the Salesmen and the Administrators.

While the Chameleons can achieve great success, the Technical Specialists can achieve only a moderate success, and this *only* at the expense of minor setbacks. In addition, this moderate success is possible only if the Technical Specialist sticks to his specialty and is not tempted to enter the mainstream of a decision-making position.

Both the Chameleons and the Technical Specialists have adjusted and have learned how to cope with the Orders/Capacity cycle, but they still must learn to anticipate and to cope with the Productivity Squeeze if they are to survive.

The Productivity squeeze is simply a basic exercise utilized by most top managements in a growth business. This play necessitates adherence to a pre-ordained volume forecast, without providing the necessary numbers of people or expense dollars to change the forecast into fact.

The Productivity squeeze results in the formulation of two basic laws, which may seem contradictory at first, but which in reality are compatible—depending on the time at which these laws go into effect.

The two basic laws are:

Most managers in a growth business are doomed to failure.

All new managers in a growth business are assured of instant success—but only for a short period of time.

Let's look at the first law, "Most managers in a growth business are doomed to failure."

Early in the life cycle of a growth business, future projections of volume are made which then become the goals for succeeding management teams. As the cycle switches from the Salesman to the Administrator and back again, each management team cannot successfully deviate from the ultimate goal established. The next chart below shows the effect.

At year two, the Administrators take control from the Salesmen. Because of the limitations in plant capacity,

the curve must of necessity be flattened out for the next few years, but after that must climb at a higher rate in order to achieve the original goal. In year five, the curve is again flattened, and also in year seven.

In year two, the Productivity Squeeze starts. Because the volume curve is flattened, personnel requirements are also cut back by top management, who ignore the fact that these people are required today in order to achieve the sharper upturn shown for future years.

With this personnel cut-back, Manager X must take certain actions to carry on the ever-increasing load of necessary work. In some cases, measurement tools such as essential reports are discarded, since the day-to-day work must be completed. Jobs are redefined to eliminate all but absolutely necessary work. Because the workload keeps increasing, all members of the working team work longer and longer hours. Finally, Manager X, whose effectiveness has been reduced because of the necessity to eliminate controls, must pitch in to assist his employees in their work. In order to assist his employees, he finds it necessary to cut back on his planning and integrating activities, and thereby seals his own doom. Now he can no longer

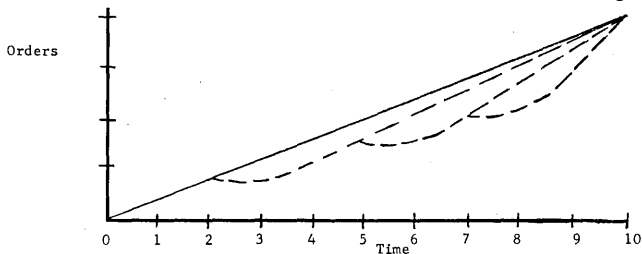

keep ahead, anticipate problems, and institute corrective action before these same problems develop into catastrophes. More time is spent redoing assignments, since there was not sufficient time or manpower to do them right the first time. The climax comes when Manager X temporarily abandons this work and, almost in a frenzy, puts together another plan that shows realistic staffing and funds and submits these plans to Manager B. He asks for an additional ten people and an extra \$100,000. After much delay, he is turned down, with instructions to further increase productivity, or else. . . .

With this message, he either resigns, or is replaced by a Shining Light (Manager SL) who has sold Manager B with his expert knowledge (usually from some other industry) and with his spiel of productivity increases from his last job.

Now the second law takes effect: "All new managers in a growth business are assured of instant success—but only for a short period of time."

Manager SL arrives on the scene and soon starts a tumult of activity. His cursory analysis shows that the proper controls for this organization are lacking; he needs reports, analyses and plans. "Why," he observes, "Manager X *had* to fail without these basic management tools." New work rules are instituted and because Manager SL lacks a basic knowledge of the specific business, these new work rules result in further decreases in productivity. Insecurity caused by the recent management change also causes a decrease in productivity—small groups of people find convenient hiding places to discuss rumors of further changes yet to come.

In spite of these further decreases in productivity, the initial efforts to measure workload, performance, etc., lead only to one conclusion: 20 additional men and \$200,000 are required in order to straighten out the mess left by Manager X. This is double the amount requested by Manager X, but once the new organization plan is prepared

and submitted to the higher echelon, it must be supported by Manager B, since Manager SL cannot be allowed to fail. Failure would, of course, impugn the selection and management capabilities of Manager B who hired Manager SL. Therefore, B himself sells the increased requirement to top management in order to demonstrate his own managerial capabilities. SL, with more people and more money (more than that required by his predecessor, X) now starts to get the job done.

About the time the organization becomes really effective (18 to 24 months), the Orders/Capacity relationship changes, which dictates a change in management and the Productivity Squeeze starts to function again.

adaptation—survival

If you remember, it was stated previously that the Chameleons or the Technical Specialists have learned to adapt and are relatively immune to the Orders/Capacity cycle. The Chameleons have sensed the on coming change, while the Technical Specialists remain secure within their field of specialized knowledge.

Because the Chameleons have sensed the coming change, they initiate the only effective course of action which can be taken: REORGANIZE. The timing of the reorganization is very important and must be immediately prior to the arrival of the next manager.

The basic rule which must be followed, after the timing problem is conquered, is simple: Transfer men to functions which they know and understand least. This immediately lessens the workload, since those who are experienced have picked up many tasks which, while not completely essential or recognized as within their job scope, are necessary to a smooth-functioning organization. With little knowledge of the impact, a man in a new job will quickly decide that these tasks are luxuries and should be eliminated. A 20% to 30% increase in productivity can be gained in this fashion immediately—it may make other organizations less effective, but it does increase his productivity. Also, new men will work longer hours in order to master a new assignment, and after a short break-in period will produce more because of these longer hours.

After the reorganization, a number of good excuses can be offered to the new manager, should the performance of the group be challenged:

1. The new organization was necessary, but could not be accomplished as long as the old boss was in power. And, of course, since he has gone, or is on his way out, this proves that the reorganization is justified.
2. While there may be problems today, they will be solved as soon as the new organization has shaken down. (Or, "I must have a chance to demonstrate the effectiveness of this new organization.")

One of the benefits to be achieved from a reorganization is that you will get the benefit of the boss's experience—and at the same time have him define exactly what he expects you to do. This definition of responsibility, in itself, can be the ticket to survival.

As has been shown, the problem of survival in a growth industry is a complex matter which is, to a great extent, independent of ability.

The Productivity Squeeze and the Orders/Capacity cycle have been identified to make you aware of some of the forces that can control an individual.

By now, some readers will have recognized the fact that they are caught in the midst of the Orders/Capacity cycle. The next step for these individuals is to truthfully answer the question, "If I look at myself honestly, would I classify myself as a Salesman, Administrator, Technical Specialist or Chameleon?" With a truthful answer and the basic understanding of the problems, each person can develop the techniques necessary to cope with the cycles and pressures. ■

Can a printer doodle a bar chart while waiting for another character to be transmitted from "slow" internal computer memory?

Such a prospect seems unreasonable unless we put aside the mechanical monster concept we associate with EDP output. Bulky paper feed mechanisms, whirling drums and chains, and inflexible forged metal type are increasingly awkward companions of flexible and speedy electronic data processors.

A more appropriate partner will soon be available through EBR technology. EBR, an acronym for direct Electron Beam Recording, makes it possible to print with electron beams which can be electronically deflected at data rates compatible with magnetic tape recording. Printing can be in a variety of character sizes and styles, with computer-drawn pictures, or with graphics inserted from an alternate image source.

Special electron sensitive film materials accept information at megacycle rates with the instantaneous image processing necessary to this system concept.

Appropriate logic provides for the organization and formatting of the alphanumeric and pictorial data presented to the EBR printer from the computer.

It is already possible to anticipate

this system because of advances in electron beam recording technology. The electron beam has long intrigued data processing designers as an input-output method because of its inherent speed and the ease with which it can be modulated, deflected and focused. Improvements in vacuum seal design at the 3M Company have enabled construction of an electron beam recorder in which the material is moved through a vacuum without affecting the recording properties of the material. Because of the high energy efficiency in direct recording, the recording material can be highly sensitive to electrons and yet instantly processed. This recording material can be used to create duplicate films, reproducible masters, or immediate hard copy on microfilm printers. Printing speeds of 60,000 characters per second and material cost of less than 1/10¢ per page open wide areas of possible application.

Progressive companies in such industries as banking, transportation, utilities, retailing, data processing services, publishing and manufacturing are planning significant savings in EDP output operations.

For more information and an EBR System Manual, write on your letterhead to:

3M Company
Attention: Rolf Westgard
(612-733-4995)
2501 Hudson Road
Dept. FDJ-126
St. Paul, Minn.

CRT displays with hard copy

On-line video terminals for the display of computer stored data are finding increasing acceptance. A limitation on this acceptance has been the difficulty of recording the display in permanent form. The mechanical alternative is between the slow character-at-a-time typewriter and costly faster printers. The relatively low-light level on the tube face made direct image hard copy difficult to achieve. Dry Silver emulsions can provide a dry print of the displayed image in a few seconds. Cost per print is less than on most office copiers. For information on how this could be adapted to your on-line displays, drop us a line.

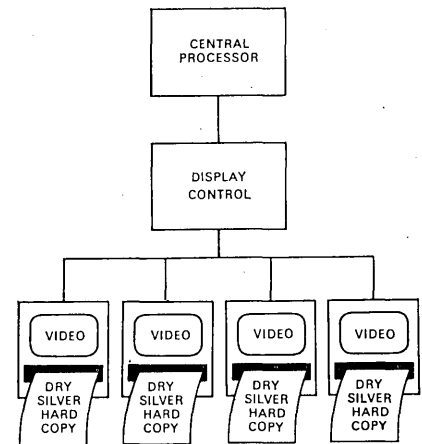

Looking for a job with a challenge?

Expanding programs in electronic data processing technology are creating openings for engineers, systems analysts and marketing personnel. The kind of a job you may be looking for.

Please submit inquiries to:
Employment Department
3M Company —
Information Systems
2501 Hudson Road
St. Paul, Minnesota 55119

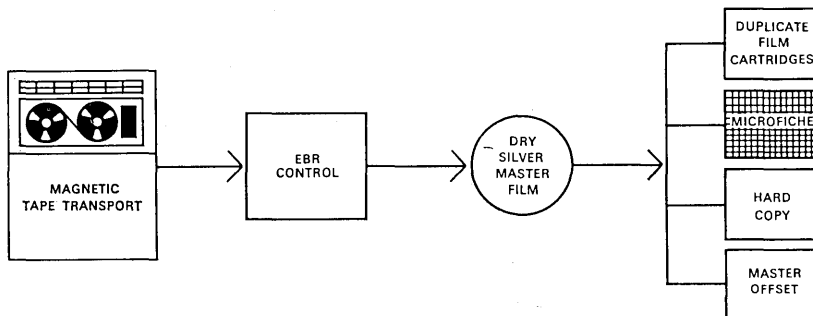

And 12 of them are brand new. Now, average access times of our 15 disk files range from 17 to 60 thousandths of a second. Capacities, from 1 million to *hundreds of billions* of characters.

Each features head-per-track all-electronic accessing. At a cost per character that's agreeably low.

Yet any one of these Burroughs disk files is only one of four good reasons why more businesses are choosing Burroughs computers.

Here are three others:

- 1) Software that's proven. No ifs. No buts. No maybes.
- 2) Self-managing operating system control.
- 3) The ability to multiprocess a variety of jobs simultaneously — including combinations of data communications and on-site work.

Shouldn't you investigate the best disk files plus computer advantages like these?

Burroughs Corporation

Detroit, Michigan 48232



**The 15 fastest, most powerful,
flexible, reliable random
access disk file subsystems
are made by Burroughs.**



WHEREVER COMPUTER PEOPLE MEET—THE TALK IS...

THE NEW COMCOR Ci-500

SAME COMPONENTS AS CI-5000



ALL SOLID-STATE



160 OPERATIONAL AMPLIFIERS

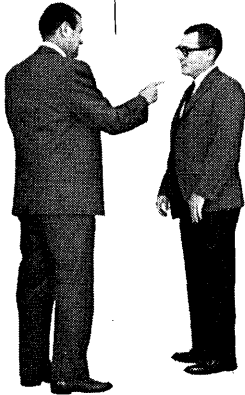

IT'S MEDIUM SIZE

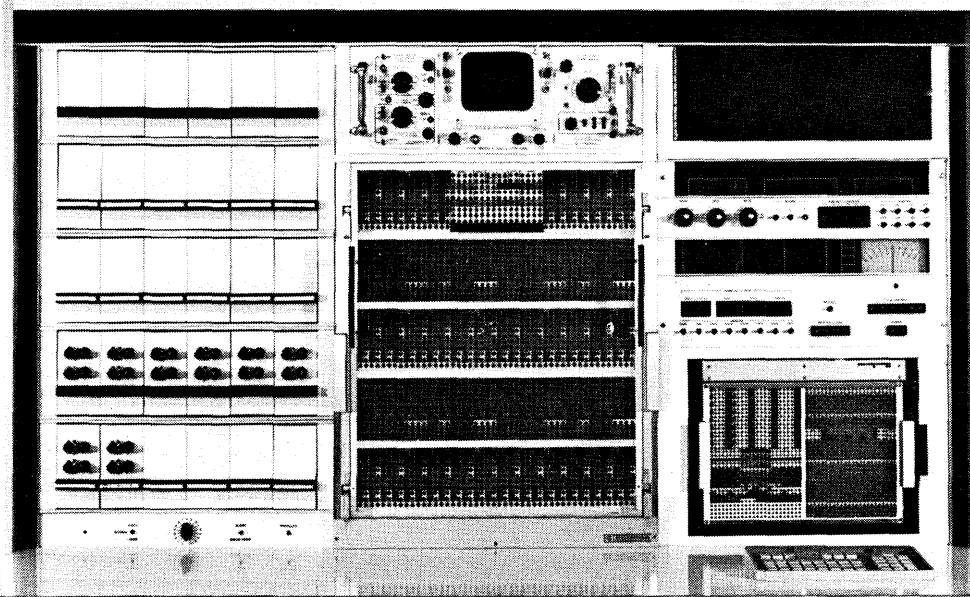

ANALOG/HYBRID

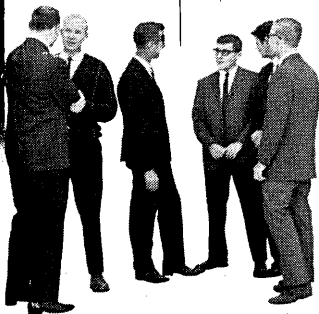

FLEXIBLE



First delivery of our newest system, the Ci-500 took place in October 1966. The Ci-500 is a medium-scale general-purpose analog/hybrid computer that will accommodate up to one-hundred and sixty 100-volt, 50-ma operational amplifiers. All computing components are identical to those used in the larger field-proven Ci-5000 system. High-speed digital logic circuits are used for address and

control functions—the flexibility inherent in all COMCOR systems makes interface with digital equipment for hybrid operation simple and inexpensive. The Ci-500 is the perfect system for simulating and solving your research, development, production, and processing problems. For delivery date, see your COMCOR representative or contact COMCOR direct. (714) 772-4510 TWX: 714-776-2060.



COMCOR

A SUBSIDIARY OF ASTRODATA, INC.

PUT COMCOR IN YOUR PROGRAM

1335 SOUTH CLAUDINA STREET / ANAHEIM, CALIFORNIA 92803

Career opportunities available now in engineering and marketing.

CIRCLE 28 ON READER CARD



*The grain
in Moore
Tab Card Forms
runs the long way
for high-speed
efficiency*

Continuous tab card forms may be collated with other form parts to produce required record copies.

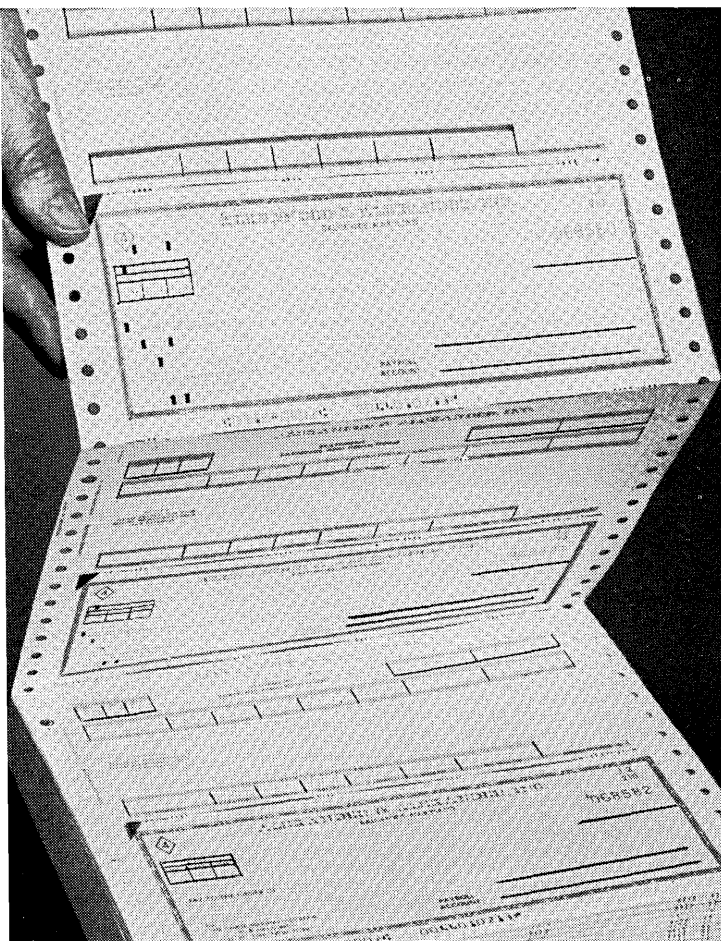

This assures maximum rigidity along card length—provides maximum dimensional stability for accurate interpretation of data under varying humidity conditions.

Moore offers the finest card in a wide and useful range of constructions and features.

Tab card check forms; chipless tab card voucher checks; machinable perforations that can provide processable stubs within 80-column cards.

Continuous cards can be incorporated into multi-part sets in the Moore Speediflex or Speediflo product. Speedisets can have up to 6 parts with 3-color printing and carbons thumb-notched or corner-cut for easy carbon removal.

Continuous tab card features include: multi-color litho-quality printing, with litho art effects. All Moore tab card products include consecutive and/or repetitive prepunching; consecutive numbering; corner cuts positioned as you need them; scores for folding; MICR fixed encoding; OCR forms for precision scanning; machinable perforations engineered to requirements of your data processing equipment.

Call the Moore man—let him demonstrate our quality-made tab card line. If you work with forms, we can show you how to make forms work for you.



Tab Card Voucher Checks—
continuous and chipless—can be built into
Moore Speediflex or Speediflo constructions.

Tab Card Sets include one or more
machinable source documents and
extra copies.

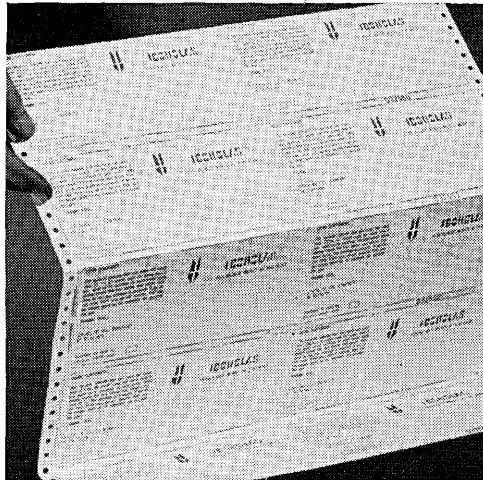
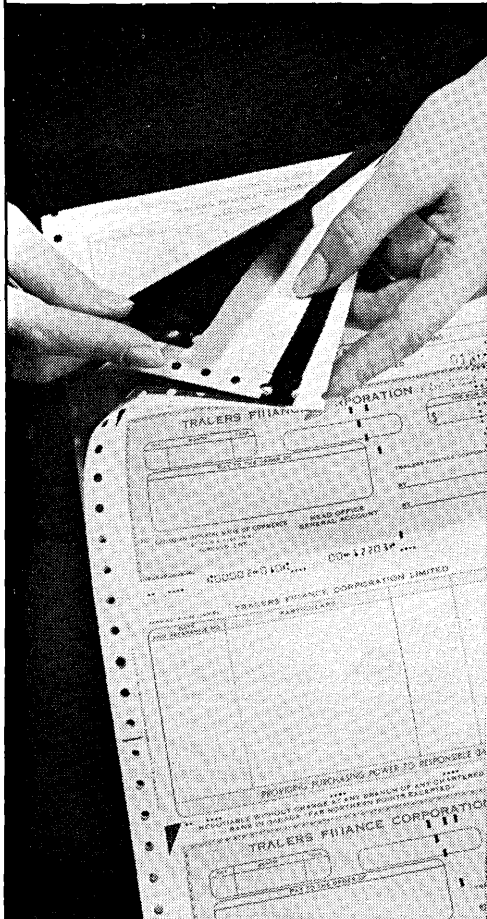

Two-Wide Tab
Cards increase
printer efficiency;
provide means for
statement billing
with return voucher
for direct input.

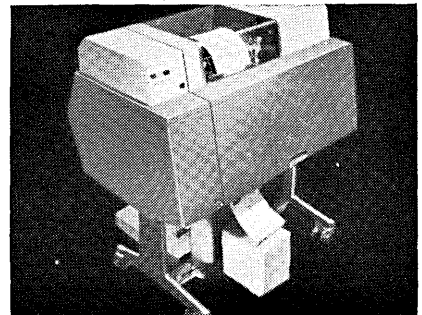
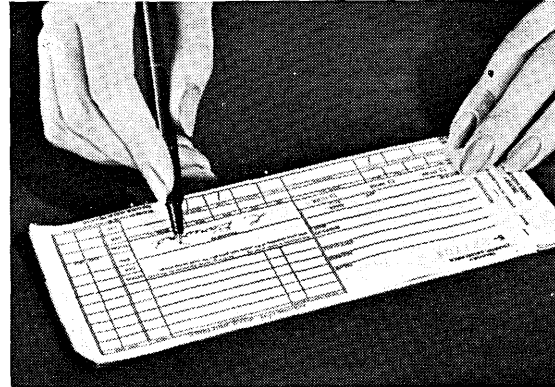

Moore's tab card line meets
all precision requirements.



Circle 29 on Reader Card

MOORE BUSINESS FORMS INC

'The right business form for every form of business' • Niagara Falls, N. Y. • Park Ridge, Ill.
Denton, Texas • Emeryville, California • Over 500 offices and factories in North America

Choose a Space Saver, Time Saver, Tape Saver. Our wrap-around case does more than provide a haven for your mag tape. Next time you order tape, remember these points.

It saves storage space . . . 50% of the space that conventional cases take up. Stacks evenly, too, on molded ridges.

It saves time. That little clasp opens at a touch, & the case remains a circle — easy to get in and out of. (Is that quicker than fitting a strap to a reel?)

It saves tape. Dust cannot get by the cushion seal that seats tightly on both rims of the tape reel, all

the way around. (No other space-saving case has it.)

There are other advantages. For example this case is precision molded of unbreakable, fire resistant LEXAN™.

Be Choosey. Every tape supplier will deliver your tape in Data Packaging reels and cases. Just ask.

Data Packaging Reels & Cases

205 Broadway, Cambridge, Massachusetts

Design and mechanical patents applied for.

LEXAN is a trademark of General Electric Corp.



Be Choosey.

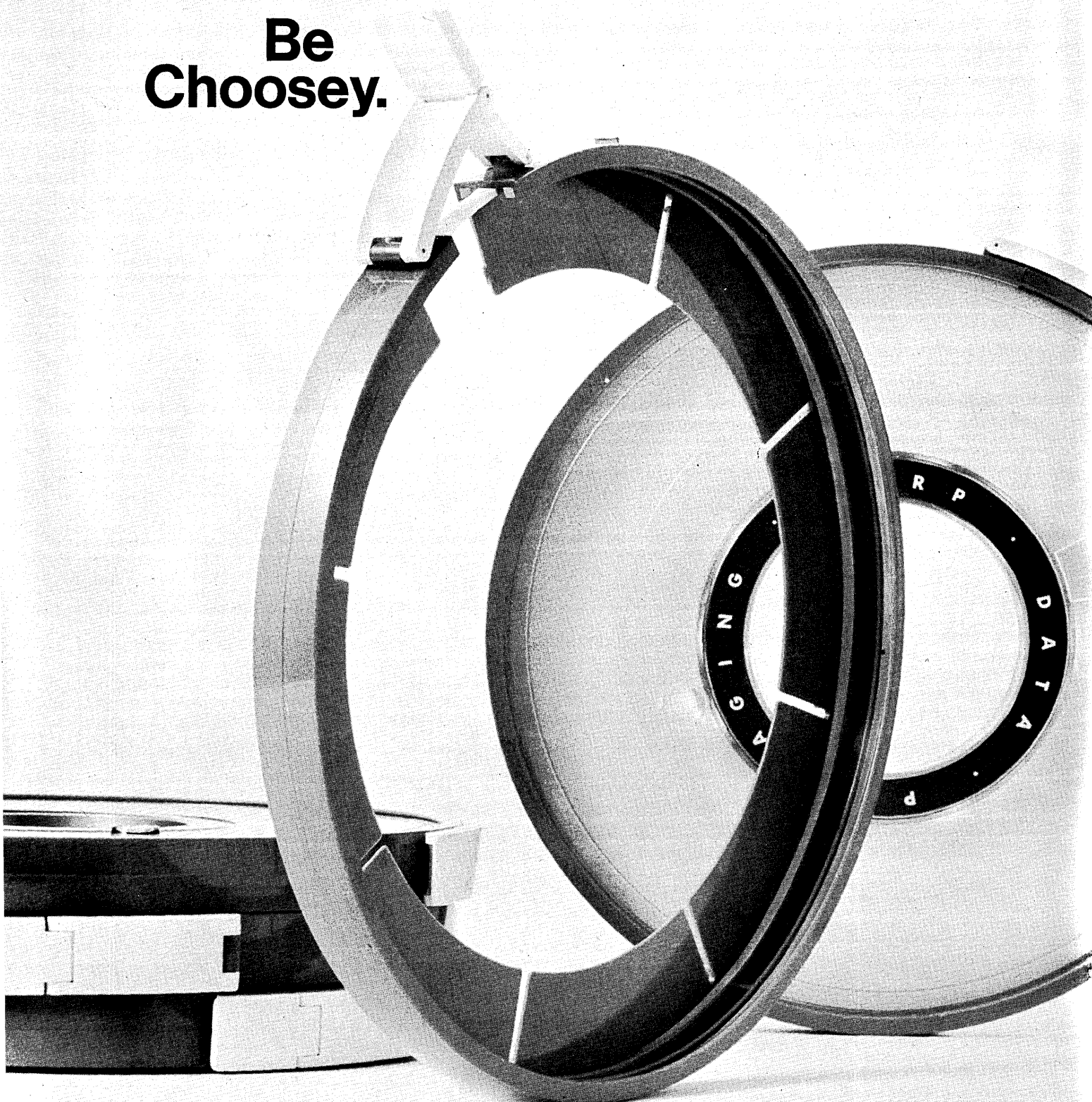

THE FJCC REPORT

 There was a man with a clipboard and a pencil in one of the elevators at the main conference hotel, counting the number of people riding up and down, and when asked what results he was getting he said "there aren't any results until we give the numbers to the computer."

This pervasiveness of the computer might have been a suitable theme for the Fall Joint Computer Conference in San Francisco. There were about 5000 registrants, plus 1300 students attending FJCC education programs, and a multitude of just plain folks who burrowed down to see the exhibits in Brooks Hall. Pretty soon there won't be any more laymen to explain computers to.

Time-sharing, once again, got much of the emphasis—both in sessions and exhibits. This time, though, there was an obvious growing awareness that data communications must be considered an integral part of the process. And there was some grumbling about the show biz nature of the time-sharing exhibits where, one disgruntled visitor said, you could shoot simulated pool, get some simulated psychiatric counseling, or play some simulated games but if you had a real problem requiring computation you were out of luck.

Physical facilities of the session halls were good, with PA systems that amplified without noticeable distortion or noise, operable slide machines, and nifty wireless microphones that could be passed about the audience to relay questions through the sound system. The post-session meeting rooms, for further informal questioning of the speakers and informal discussion, were also a hit.

Held in the main auditorium of Brooks Hall, sometime site of professional basketball games, the keynote session offered one key advantage: it allowed the audience to time the speakers on large digital clocks. Patrick Suppes won the longest talk

award with an excellent, detailed presentation of the experimental use of computers in education at Stanford University.

He rested his case for computer-assisted instruction on three primary points: 1) the long-time need for individualized instruction, which time-sharing permits at an economical level; 2) freeing the teacher for creative work; 3) as an aid to research and curriculum development. Suppes hopes that within the next 10-15 years there will be a computer terminal in each of one million elementary classrooms.

He described three levels of computer-student interaction: individual drill and practice, tutorial, and conversational (conceptual so far), and described the Stanford work in drill and practice in mathematics. One problem in search of a solution: auditory store and output to the student. The key technical problem for time-shared CAI: uptime.

GE Board Chairman Gerald L. Philippe described the impact of computers on his corporation, but suggested that computers are too sophisticated and esoteric to have achieved their full potential yet. Management consultant Harry M. Runyan reviewed some of the well-known implications of computers for the financial community.

But the most important talk at the keynote session came, unsurprisingly, from a computer industry outsider, Ulric Neisser of the Univ. of Pennsylvania's department of Psychiatry. A report on his talk, questioning the existence of a "computer revolution," appears in the Editor's Readout, p. 21.

At the Computers & Publishing session, John Perry (president of Perry Publications in Florida) spoke briefly with very little reference to his paper published in the Proceedings . . . a practice everyone is always demanding. Perry read a letter from the president of the company whose optical

scanner is used by the Perry newspapers. In the letter, Recognition Equipment's Phillipson noted that it costs 6¢ per 100 strokes by a keypunch operator, as against 3¢ for the equivalent by his readers. And the REI reader is being speeded up. Perry then said his staff is experimenting with full-page make-up for ads in cold type. This uses Perry-developed hardware. An experimental page-one make-up design being worked on has 999 combinations of layouts (different head positions and size, body size, picture positions, etc.).

Asked to justify automation in publishing, Perry said they've cut the time from 15 man-hours per page 15 years ago to four man-hours per page today.

A paper by C. J. Duncan and J. L. Dolly of the Univ. of Newcastle upon Tyne, not appearing in the Proceedings, surveyed the activity in Britain and Europe. They noted that there is a "growing demand for a proper programming language" for composition.

Some helpful numbers that place things in perspective were supplied by Arthur Gardner of Composition Information Services in Los Angeles. A recent CIS study shows 292 computers installed worldwide for typesetting applications, of which 30% are general-purpose machines, 70% special purpose. The movement, however, is toward the use of gp computers, he adds. The 292 installations today compare with 177 a year ago, and 70 two years ago.

The computer-generated music people were on hand again. Apparently it is now possible to simulate the sounds of some instruments—such as the flute—very well. But the purpose of this remains obscure. Two reasons given: "to obtain useful results and ask meaningful questions" and it would be "advantageous for certain purposes." One good reason for mechanical music was given by Dr. Arthur Roberts. He said that even though his "Concertina for 3600" takes 65 minutes of machine time to produce one minute of recorded music, "it's still cheaper than hiring musicians." Dr. Robert's compositions—or those of his computer—were interesting, using eighth and quarter tones and odd percussive effects, and some of the music will be used in a film from Argonne Laboratories on pattern recognition.

An indication of maturing efforts in commercial time-sharing was the increased interest in specific costs to the user. Those attending a session called Management of Multi-Access Systems heard descriptions of the services offered by KEYDATA, Tymshare, and CEIR. "Pricing proved to be the most

This New 3M Asynchronous Digital Recorder writes data at the rate of 2000 characters per second

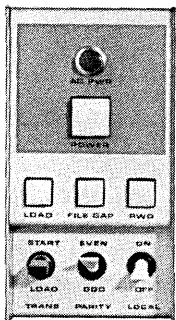

Revere-Mincom's new ADR-100 records during the start interval — that's why you never lose any data in the asynchronous mode, and why this 3M system accepts data at least four times faster than any other asynchronous digital recorder available to date. 2000 characters per second, internally produced inter-record gap if required.

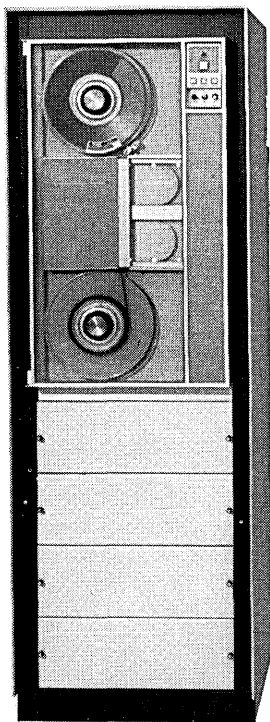

Perfect backup for all IBM systems. Using IBM-compatible 7- or 9-channel tape format, ADR-100's packing density (up to 800 bpi) is due to improved skew control with skew rated at less than 250 microinches. Single-capstan friction drive, no pinch rollers.



Developed and manufactured by the leader in instrumentation recording — Revere-Mincom in Camarillo.

Revere-Mincom Division **3M** COMPANY
300 SOUTH LEWIS ROAD • CAMARILLO, CALIFORNIA 93010

FJCC REPORT . . .

complex of our problems," Lee Garbrick of CEIR said. There, they figure 50 on-line hours per month as the average by one user; from this they could service over 100 users, and determine a monthly fee. "Total client cost for our services, including 50 hours of on-line computer time, Teletype rental and telephone line costs, have averaged from \$320 to \$340 a month," he said.

By contrast, Tymshare bases its price on terminal hook-up time, with some extra charge for storage space used.

Taking issue with this method of pricing, Charles Adams of KEYDATA said, "Pricing structures based simply on hours connected seems unrealistic for all but the simple services. Since each user requires differing file storage capacity, input rates and procedures, he should be charged roughly in proportion to actual utilization . . ." Adams said. (An interesting newsletter, incidentally, that keeps up with commercial time-sharing services offered and shows the variety of pricing in effect is called Time-Sharing System Scorecard, put out by Computer Research Corp. of Newton, Mass.)

Granting that file security was another concern of users and entrepreneurs, Thomas O'Rourke of Tymshare said that technologists might be overly touchy about the security issue. In the business world, he said, we have confidence in our banks, lawyers and accountants; perhaps a similar degree of confidence could be extended to operators of time-sharing computer centers.

The session Some Communications Aspects of Time-Sharing Systems started with a tutorial review of problems users can look forward to in data communications. Then Don Dantine of the Clark Equipment Co. talked about some things a user would like to have.

Dantine mentioned, for example, the need for an end-of-message character on a Teletype. Although Bell said it couldn't be done, a Teletype engineer said it was possible with a part that would probably cost only 15 cents. Then why couldn't this be added? Because then Bell would have to file special tariffs in 48 states.

"Here is a case where undue government regulation almost makes the satisfaction of users' needs impossible," Dantine said. There's regulation because of the need to protect the using public in monopoly or utility situations he said, but a Teletype can be had from Bell or Western Union, or the user could get an on-line typewriter

like the IBM 2741. "Here lies a problem that must be resolved realistically and to which the FCC must turn their attention so that their policies do not become a stumbling block to data communications progress."

Other papers described experimental networks at Bell Labs and between Lincoln Lab and SDC.

Natural Language Processing, a session chaired by Dr. H. R. J. Grosch, offered discussions of such systems as DEACON and CAINT, and the work of Dr. Thompson of CalTech and Dr. Simmons of SDC. The DEACON explanation was slide-assisted and one of them read: "Where did the Great Pumpkin rise this year?" Answer: "The data base does not sincerely believe in the Great Pumpkin."

The DEACON system is now in its third phase of development—will be transferred from the present GE-225 to a 600 series machine. Grosch feels that it may be usefully operational, in carefully chosen areas, in about two years.



An interesting thought mentioned in passing by Grosch: it's possible that the views and understanding of events are so different between different people—say, engineers and accountants—that this is a limiting factor in developing very large information systems.

The Man-Machine Interface session brought out, once again, the importance of software as Burton Fried of UCLA pointed out. Hardware is not all that important, he said, noting that the computer they're using is 10 years old and the console involves only \$5K worth of equipment.

James A. G. Russell from the Presbyterian Medical Center in San Francisco spoke on terminal requirements in biomedical applications. Medical users would like to see graphics for them—and the plea was renewed for a quiet terminal that costs the same amount of money as a Teletype.

S. H. Chasen of Lockheed-Georgia noted some graphic system requirements, and said that individual users will have to develop their own software for some time. Manufacturers

can't solve all the special-purpose problems, although they're not admitting it.

In 1965 Lockheed established a working model of a numerical control system using a CDC 3300 and mod 240 scopes. The system, he said, has posed software problems—in dynamic memory allocation. Having to bring in a large number of subroutines in working a control problem has led to response time delays.

Robert Glaser of the University of Pittsburgh talked about terminal needs in CAI. He said that devices are needed to permit the student to manipulate the subject matter; they use a device which is touch sensitive, has no keys, and permits changes of board design by putting cards with different symbols underneath the glass of the tablet. Also of interest to users of CAI is a Rand Tablet type of device on which the student can write or draw either directly on the tablet or on a piece of paper on top of it.

J. C. R. Licklider gave a summary of the presentations. He said a plea was made by the panel for generalness in these systems, but we haven't yet reached a state of generality and affordability in development of such systems. He commented that Fried's difficulty in getting his demonstration to work showed that even such beautiful systems as these are fallible but "unfortunately man-machine interaction is not far enough along to show more sophisticated difficulties." (Fried's problem was a malfunctioning WU line.)

And then there were the exhibits. One old pro observed that the best thing to do is go see the exhibits about every fourth convention; that way you find a whole lot of new and interesting things to look at.

RCA had a smash hit. Not that they were showing anything spectacular—but there's something irresistible about flying saucers with flashing lights, glass control towers, round theaters with stereophonic sound and girls in iridescent vinyl suits. Visitors waited as long as an hour and a half to get into the spaceship in groups of 14 or so, where they had a lurching circular ride with frequent stops for multi-colored displays in favor of RCA computers. Thence to a glass-enclosed balcony overlooking machinery furiously multi-processing, followed by coffee, cookies, funny old movies, and a sales pitch from a modern girl in antique clothes. Out into the light—only to be surrounded by eager RCA salesmen in red jackets. (We're going into such detail only for those unfortunates who couldn't spare the time to wait in line.)

Friden was hooked into Bolt Ber-

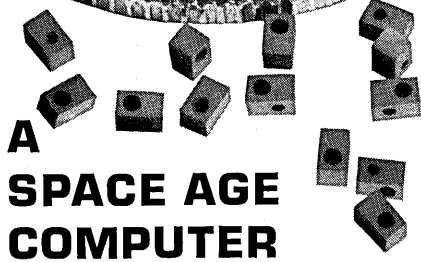
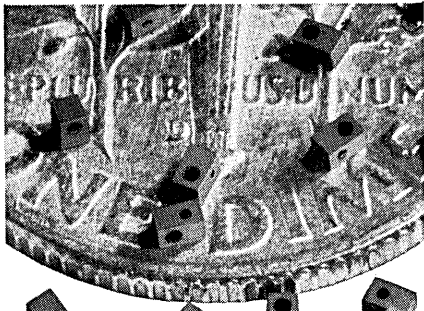

**A
SPACE AGE
COMPUTER
MEMORY PRICED
FOR INDUSTRIAL
CONTROL
BIAX®**

The unique advantages of BIAx memories are now available for numerical control; combustion, power plant and process control; and other industrial computer and data processing applications at a cost approaching 10 cents per bit in larger memory systems.

Using a new MicroBIAx storage element and semi-automated fabrication techniques, Raytheon Computer has developed the NANOLOK memory. This high-performance, low-cost memory is ideally suited for instrumentation control systems involving alarm set points, instrumentation scale factors, sequencing controls and table lookup routines.

MicroBIAx memories use tiny multiaperture ferrites instead of toroidal cores and have provided advanced performance and high reliability in aerospace, military and commercial data storage applications for the past five years.

NANOLOK performance means high-speed readout...up to 3 MC...and true non-destructive readout, including the reliability that comes with elimination of priming and regenerative cycles.

Information stored in NANOLOK is permanent. Repeated interrogation...even trillions of times...will not degrade signal output quality. Even after complete power failure, data is still on tap, ready for use when power is restored.

NANOLOK memories offer 3 MC readout rates as standard performance, capacities from 256 to 4096 words, word lengths to 120 bits. Operating temperature range is 0°C to 50°C.

Whether your requirement is low cost, high reliability, multi-megacycle readout, or all three, the NANOLOK memory may be your answer. All the information is permanently stored in Data File B-133. Write today. Raytheon Computer, 2700 S. Fairview St., Santa Ana, Calif. 92704.



CIRCLE 32 ON READER CARD

**FJCC
REPORT . . .**

anek and Newman's Telcomp with their 7100 Conversational Mode Terminal, an attractive descendent of the beloved Flexowriter. Sanders Associates had an impressive demonstration of the Model 720, on line to a computer back home. Watchers were invited to describe their needs for a system—number of terminals, distance from processor, etc.—and his information was keyed in. Zap. Back came a list of equipment, complete with prices, on the display screen.

Stromberg-Carlson announced their new Micromation system, equipment designed to replace line printers and able to turn out 90K characters a second on microfilm. Gerber had a plotter about as big as the side of a barn and the salesman said they had a bigger one back at the shop. Information Control Corp. had what looked like a winner: a small, simple light pen that's easy to hold and use, doesn't require a fiber-optic bundle, and costs about a third less than competitive units.

Hewlett-Packard stepped into the general-purpose computer field, although their machine will be marketed mainly for inclusion in systems. It's an upgraded version of the DSI 1000 and will be marketed by the Dymec Division.

General Precision Librascope showed off a woven plated-wire memory. Being produced now on a loom, the memory is said to have a full read cycle time of 100 nanoseconds in the NDRO mode, 250 nsec to read, modify and write.

Introduced by the Roytron Div. of Litton Industries was a 50-cps card-to-paper-tape converter that operates with edge-punched cards. The new unit operates bidirectionally—to cards or to paper tape.

A data collection/transmission system was introduced by Texas Instruments. The system consists of the mod 956 input station, which reads a 10-column badge, 80-column punched card, and accepts variable data. It can go on-line or can be connected to a central (incremental tape) station. There's also a mod 958 attendance station; it has a clock that coincides with the time that's being recorded at the central station.

Datalog Division of Litton again showed their MC 4000 photo-optical printer which operates at up to 6K lines/minute but they will soon come out with an 88-column version running at the same speed for \$9850. Raytheon again showed their real-time 520 system—have now sold 15

—mostly for telemetry and signal processing. They introduced a disc-based monitor for the 520, Real-Time boss, which enables the computer to handle real-time data, provide access, control, and display to remote stations, while doing background processing. Also new from Raytheon: the 300 Memory with a 900 nsec cycle time, and their DMS-400 display.

IBM had a 360/50 doing multi-programming (three different programs were run simultaneously). The IBM 2314 was hooked into the system—first time this disc file has been shown (414 million digits). They also showed a Data Cell, 2260 crt's, and the 4 Pi aerospace computer.

The EMR Computer Division brought their previously announced 6130 (six sold), but this one ran at 645 nsec (instead of the originally announced 900 nsec). They will soon be selling the units with 650 nsec cycle time.

Applied Dynamics showed, but hasn't actually publicly announced, their new Applied Dynamics Four, an analog computer (replacing their AD-256) for use with digital units in hybrids. Their analogs are used in hybrid systems with systems from such manufacturers as SDS, CDC, DEC, and CCC.

3M showed their ADR-100 asynchronous incremental digital recorder for the first time. They say the 100 can do the same job but 4 to 8 times faster than the fastest competitor.

First-time exhibitors included Thin Film Inc. which announced a 1½" tape which uses a nickel cobalt coating for a 5K bpi packing density—as opposed to the 2500 bpi permitted by present tapes coated with iron oxide. The plating material, they say, doesn't flake and is conductive enough to stay immune to high static charges. TFI also makes discs and drums, has one disc that can store as much data as seven comparable IBM discs.

Another first-timer was Tasker Instruments, showing their displays. They have picked up a contract from the Air Force and FAA for a large number of displays for use in conjunction with radar plane tracking.

CDC was there with the lovely spiral staircase again, at the top of which were military computers, one aerospace job for \$500K which can be held in one hand. (This miniaturization may pose the problem of computer theft.)

As usual at these conferences, some lucky companies seem to get all the free publicity. One of the clubs featuring topless amateur contests advertised that their act included secretaries, bookkeepers, housewives, and IBM operators. ■

Why we suspect Richard is developing Extrasensory Perception.

We've been keeping an eye on Richard. He seems to know exactly which order of Celanar Polyester Film should be shipped with impact recorders. What special roll lengths, widths and gauges each precision tape application needs. Exactly who gets what, when and where.

In fact, everyone from plant manager to shipping clerk seems to be developing extrasensory perception. So, you not only get the cleanest, strongest polyester film available, you also get extraordinary service. Service that complements the care we take in producing Celanar.

Air filtration systems in our Greer, S.C. plant, for example, trap dirt specks as tiny as 0.3 micron. To protect the cleanliness that makes Celanar a better base for computer and instrumentation tapes—and gives higher production yields in film conversion.

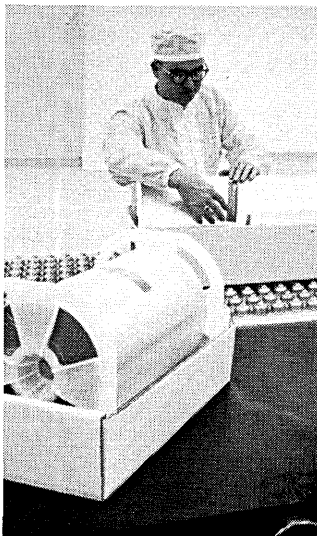

We radioactively inspect every foot of every roll. To keep Celanar more uniform.

Celanar film is stronger than the other polyester film, too. In both tensile break and tensile yield strengths. And Celanar is exceptionally free of visual defects, such as cross-buckles or wrinkles.

We've gone all the way to make Celanar your best buy for precision tape applications. Even to guarding it during shipment with impact recorders. To assure your receiving quality as high as we produced.

Send for complete details about Celanar Polyester Film—and how we can help you make the best use of it. Celanese Plastics Company, Dept. 113-L 744 Broad Street, Newark, N.J.

Celanese Plastics Company is a division of Celanese Corporation of America. Celanese® Celanar®



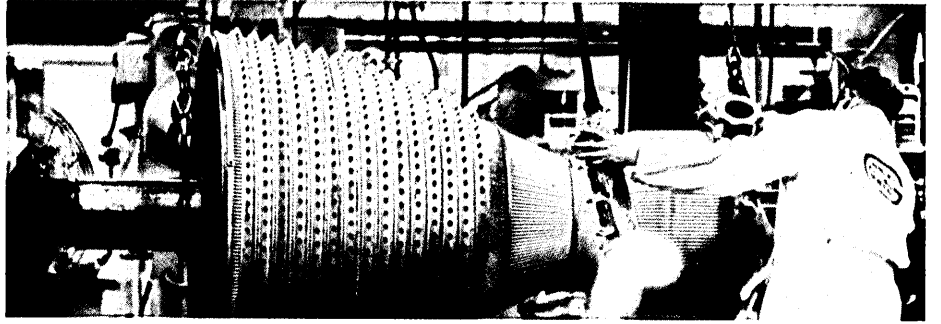
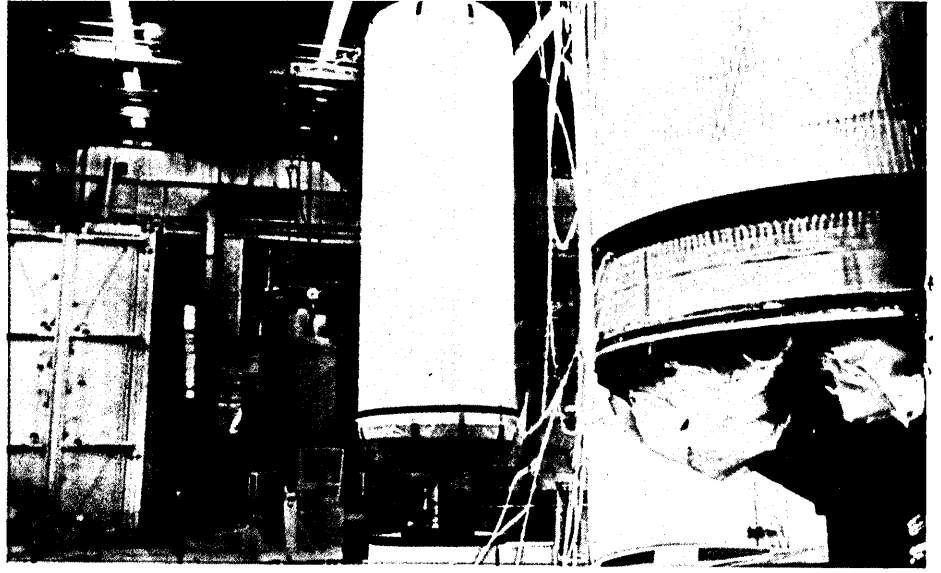
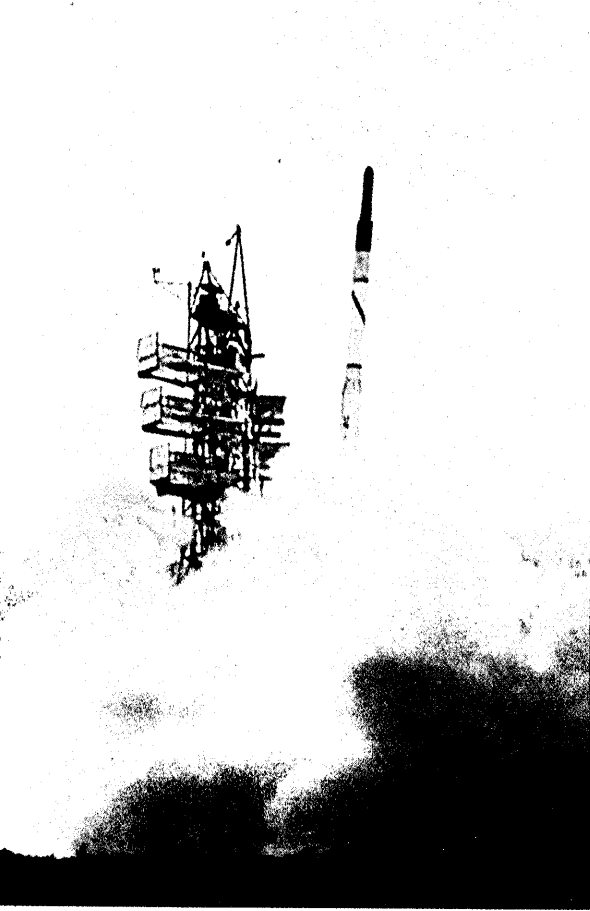

At Aerojet-General, all SYSTEM/360's are go...

Three IBM SYSTEM/360's are on line at the Sacramento Plant. All operating at full capacity.

One Model 30 SYSTEM/360 doubles the output at half the cost of a former setup. Two Model 30's do as much or more production than three previous systems.

No wonder Aerojet-General is pleased. And though the other systems were IBM's, we're just as pleased as Aerojet-General.

SYSTEM/360 took over with hardly a pause. Programs that emulate existing systems made it possible.

That's how A. W. Cole, Manager of the Computing Sciences Division, keeps the Division on schedule. Schedules at Aerojet-General are vitally important to projects like Polaris,

Minuteman, Titan and Apollo.

One SYSTEM/360 acts as a peripheral unit for two computers. It reads three output tapes, drives three printers, converts 1000 cards a minute to tape. Simultaneously.

Another SYSTEM/360 does general accounting. It picked up programs from the former system. Got 50% more output the day it went on the air. The IBM Basic Operating System (BOS/360) controls its operation.

A third SYSTEM/360 is on line at the firing line—a test stand for engine firings. It collects and reduces data on pre-firing functions. Transmits a "go-ahead" back to the test stand in a matter of minutes.

IBM Operating System (OS/360) with FORTRAN and ASSEMBLER programming languages, provides the control and communications for this system.

And, what about the future?

Aerojet-General looks to larger systems, huge data banks, complete management information in real-time, on-the-spot engineering computations with remote consoles linked to computers.

It looks like more SYSTEM/360's for so many of the business functions that will affect tomorrow's successes.

That's why other companies in all kinds of industries find SYSTEM/360 the way of the future.

IBM®

all projects on course.

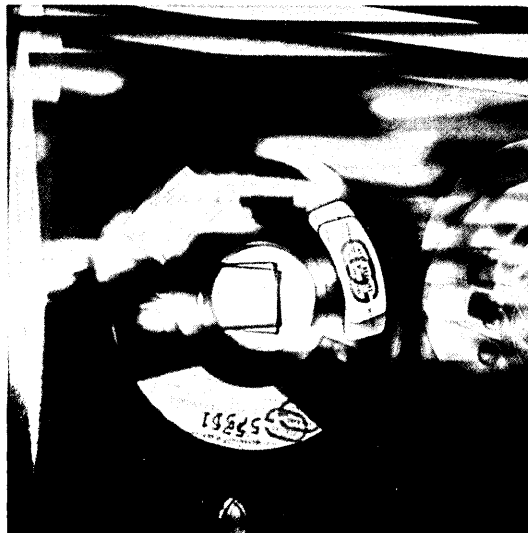

Fact:

A Universal Drum Memory System Can Be Designed

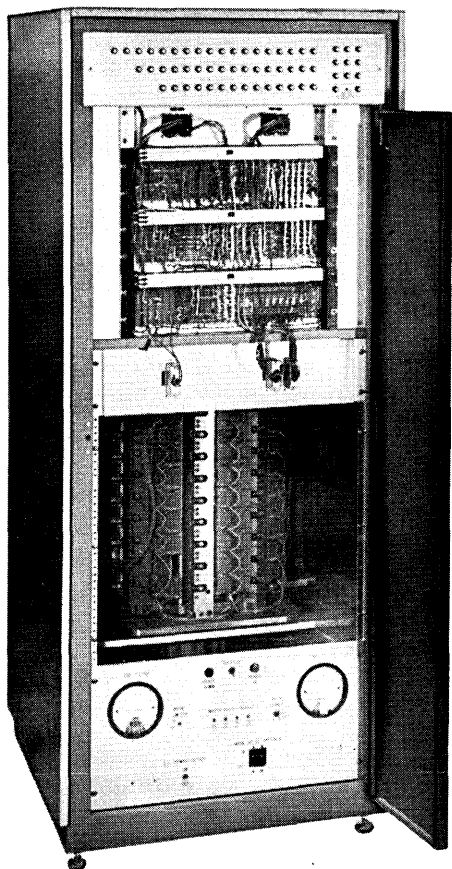

How do we know? Because we've done it. Universal, packaged design of our Type 1116 Drum Memory System gives it plug-in adaptability . . . to just about any computer type, size and brand.

Whether you're computer manufacturer, user or both, you shouldn't be without full details on our 1116. Total capacity exceeding 12,500,000 bits . . . adaptability to 16-, 18-, and 24-bit word systems . . . average access of 8.3 msec . . . read/write capability of one to sixteen 64-word blocks with two IOT commands . . . and memory bit cost of 0.35¢.

*Computers are known
by their MEMORIES*

... so is

Vermont Research
C O R P O R A T I O N

Box 20d

Precision Park • North Springfield • Vermont

P. S. If you're a computer-oriented designer or technician with a yen for the good life, Vermont-style, we may have just the assignment you've dreamed of. Contact R. A. Stover, V.P.

RAILROAD CONFERENCE REPORT

 The railroad industry has a horrendous information problem. The statistics of its operations are overwhelming, and the magnitude is compounded by the fact that much of each carrier's information must be communicated, often in real-time, to other carriers, to customers, and to federal, state and local government agencies. Add to this that many are now using manual or first-generation computer procedures when the need is for third and fourth generation automation.

If figures impress you, note a few that were bandied about during the annual meeting of the Data Systems Division of the Association of American Railroads in October:

There are 1.8 million freight cars in the U.S. which can be sitting empty somewhere or moving between any of 50,000 stations, carrying more than 5,000 major commodities for 100,000 shippers, involving uncounted tariffs (43 trillion if you count paper rates).

The problems and efforts to solve them, by individuals and by the entire industry, permeated the session, but keynote speaker Dr. Louis Rader of GE zeroed in on the best reason for rapid automation: More than \$500 million a year could be saved in five major application areas by implementing management information and control systems.

First, in car location and control—an area affecting almost all operations, he reported that most observers believe a 5 to 6% increase in car utilization could be obtained by use of an integrated management system. Such an increase would be the equivalent of adding nearly 100,000 boxcars to the fleet at a cost of \$1.3 billion. Automatic train makeup and dispatching could save half the \$200 million the tasks now cost manually. Automated billing could save about 75% of the paper shuffling.

Inventories, Rader noted, are now

a \$400 million item; tighter control through automation could reduce it by 10-20%. And finally, increased computerization in purchasing tasks could result in a 5 to 10% reduction in the annual purchase of more than \$15 billion worth of materials and supplies.

a federal push

The railroads can look for some help (and a push) toward increased automation from the federal government according to luncheon speaker Alan Boyd, Under Secretary of Commerce for Transportation. "Our information about transportation (a sector of the economy contributing 1/4 of GNP annually) is less satisfactory than it was 50 years ago when regulated carriers dominated the national transportation scene," he said. "In the executive branch . . . , we are trying to rationalize our decisions on investment in facilities such as highways based on our expectation of the growth in both passenger and freight movement; but since we know so little about what this movement is today we have great difficulty in forecasting what it might be tomorrow."

Under the High Speed Ground Transportation research and development Program, the government hopes to make research money available to help find a solution to adequate control of the national car fleet, said Boyd. More specifically, he noted that a "legitimate opportunity to contribute resources" would be in research on the development of a national information gathering and analysis system—a major factor in progress toward a unified transportation system.

The first and most arduous step toward communication of data between computers is, of course, standardization of codes and formats. According to committee reports at the meeting, AAR, often in conjunction with other

boxcars and computers

carrier associations, has developed or is working on such codes as the Standard Point Location, Transportation, Packaging, and Route codes. Some are especially difficult to devise since they deal with areas, like tariffs, which in themselves pose great data gathering problems.

Another obstacle to standard format development is fear of disclosure of competitive information. The Universal Machine Language Equipment Register is such a case. It would provide far more detailed freight car descriptions—all stored at a single computer center—than present registers. According to a DSD committee report, UMLER would increase from 60 to 154 the number of applications that can be processed from a coded car description. The price of processing would correspondingly decrease from \$400 to \$77 per application. Railroads are willing to provide this detail, but so far the four major independent car lines, which own almost 200,000 cars, have refused to supply more data than now required—for competitive reasons.

reluctance & pioneers

Some of the carriers show the same reluctance toward Telscar, a form of interroad exchange of car location information, according to the announced results of a questionnaire distributed by AAR. C. D. Edwards of New York Central questioned whether railroads should or could (economically) agree on a uniform approach to this problem. But he was quick to point out that "outside forces" were moving the industry in this direction. Major shippers, he said, are quickly accepting Telscar format and developing computer-oriented monitoring systems which are enabling them to know the carrier's mistakes in car movements before the carrier knows them himself. Thus, the carrier must move to develop his own

RAILROAD CONFERENCE . . .

system if the shipper is not to take over quality control.

Appropriately, H. L. Henning reported on the pioneering New York Central monitoring system—the first in the industry to keep track of car performance on a real-time continuous basis. Many guesstimates have been made on the actual amount of time that a car is in use under present systems, some saying it's as low as 2%. But, noted Henning, most figures like this account for only part of the total car time that must be broken out, i.e., loading, destination, loaded and traveling time. This is what NYCRR is doing now with almost 7,000 cars, computer-producing daily reports (on cars not performing up to standard) and summary reports on overall performance.

Three other railroads have agreed to provide the Central with moves of its cars on their roads, using the Telscar format. About 30,000 cars will ultimately be under the program which will cost about \$250,000 a year

in computer time and personnel. But, emphasized Henning, the savings will be many times that.

Centralized data banks for car and tariff data were discussed many times throughout the conference. Marvin Ehlers of Raildata had a suite where industry leaders could come to discuss his firm's proposal to operate a central data bank for car movement information—an effort that would take the cooperation of about two-thirds of the railroads. But speaker E. D. Williams of Union Carbide, a shipper, felt that more workable would be one central message switching computer (under AAR authority) which would link the individual carrier's data banks, eliminating duplication of effort.

Williams also noted that the industry should get to work on computerizing tariffs. You don't need to put all the 43 trillion tariffs in such banks since most are paper rates, he said. He felt that one central bank would be unworkable, proposing that seven regional banks, coinciding with the seven major rate-making bureaus, be set up initially. In addition to normal uses, the bureaus could file tariffs

with the ICC on magnetic tapes; carriers could use the data as input to their computerized rate analysis systems; and shippers could use it to optimize their distribution plans.

the missing freight car

To go back to the "where's my freight car" problem, the word real-time is being used in many present reporting systems, but the truth is that there is sometimes a several-hour delay between the time a car leaves a station and someone sends the move to a central office or computer. The ultimate in OLR is what the industry calls Automatic Car Identification. Several units for reading and transmitting numbers from passing cars have been tested in the past, but three more advanced systems are up for inspection and the Pennsylvania RR will pilot test them for six months on such factors as efficiency and reliability—through rain, snow, and mud.

The units include the Sylvania Kar-Trak system, containing an optical scanning unit which throws a beam on a reflective label of colored strips (denoting different digits) and feeds

What good is all that digital data if you can't make sense of it fast?

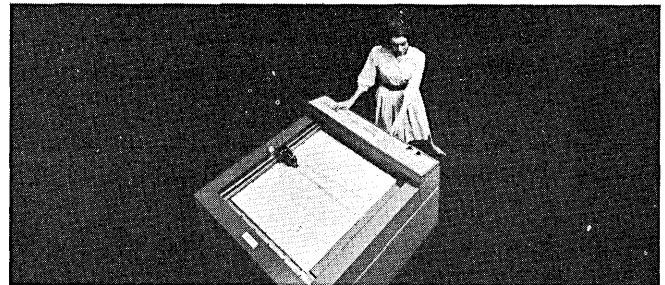

EAI DATAPLOTTERS turn masses of digital information into easily read graphics.

And fast! Our series 3500 DATAPLOTTER®, for example, can plot continuous curves faster than 2000 points per minute. It can operate *on-line* with most digital computing systems. Off-line, it can plot discrete points from magnetic and punched paper tapes at 350 points per minute and punched cards at 100 cards per minute. It will plot data from its own self-contained manual keyboard as fast as you can write it.

And accurately. With the pen running at 10 ips, the DATAPLOTTER will record with an accuracy of $\pm 0.015''$.

We offer a range of different DATAPLOTTERS. These are big machines with big capabilities.

Plotting surfaces are 45" x 60" and 30" x 30". Yet they will accept various sizes of paper and grip them accurately by

vacuum. An automatic paper advance handles roll paper.

You can change origin and expand or contract scaling on command. Only end points are required for drawing straight lines. An 8-pen turret provides multiple colors and linewidths.

A 48-character symbol printer delivers complete annotation of graphed points and lines, printing a wide variety of symbols with high speed and legibility.

We can offer you complete software for a variety of digital computers including the IBM 360 with 9-track or 7-track input.

If you're being overwhelmed by the amount of digital data your organization must handle, it's a good bet you need a DATAPLOTTER. We'll be glad to send you details. Or write to us about arranging a showing of our full-color film on DATAPLOTTER in action.

EAI® ELECTRONIC ASSOCIATES, INC.
West Long Branch, New Jersey

the data into a decoding transmission unit. WABCO's system features laser reading of a label with strips of different widths; and Abex Corp. has a microwave system which scans metal tags with the car's number in digits.

ACI and direct digital control should have extensive future use in the classification yard, where cars are taken off inbound trains and regrouped for different destinations. According to a talk by L. Payseure of C&O-B&O, over the last 15 years the industry has slowly progressed from remote control of track switches and retarders to computer control of these devices at the yard. Now the move is toward digital control of the operation, plus concurrent application of the computer in yard office clerical chores. A pioneering effort in automated "hump" yards was described by J. W. Germany of Southern Pacific. At the Eugene, Ore. yard a DDP-116 is being used to monitor and control all the switches, wheel detector devices, speed units, track circuits, etc.—automatically rerouting each car to its programmed track, producing outbound lists, and notifying operators of errors and problems.

While it is apparent some automation effort has been going on in most operating departments, G. M. Beischer of C&O-B&O claimed that data systems people have been avoiding the mechanical department. Maintenance records on locomotives and other rolling equipment have been kept manually and not very efficiently, he said. It was the prospect of merger that prompted the C&O-B&O to start on development of a data system for maintenance control. The first five years are being used to study activity of 10% of the fleet to develop patterns of comparison for the remaining 90%.

the manufacturers

Several other areas—error correction methods, simulation, programming management standards, engineering design, etc. were discussed in the workshops that spanned the three-day meeting. The conference planners had the good sense to make it a meeting by and for the industry. Sales pitches by manufacturers were almost non-existent except of course in the exhibits. IBM, which accounts for 158 of the 181 computers used at

railroads (according to a July AAR survey), did have a chance to speak extemporaneously at a session on terminal devices. Several railroaders vehemently complained that no interfaces were being provided by IBM between its computers and the railroad-owned telegraph lines. (IBM could be seen at the booths of communications-equipment makers discussing the problem the next day.) There were also a few gripes over the rather outmoded IBM 1978 terminal, designed specially for the railroads, which one attendee called an "old keypunch with a new cover."

In addition to IBM and manufacturers of ACI units, CDC was there with display equipment; RCA, hoping for more of the share of the railroad market, pitched two RR systems now installed and showed a Spectra 70 in operation; Rixon, Collins, and Western Union showed communications equipment.

As the good conference ended it was hard not to be overwhelmed by the enormity of what was said about the industry's problems—and what was not covered—unions, mergers, Telpak A&B suspension, cranky passengers . . .

—ANGELINE PANTAGES

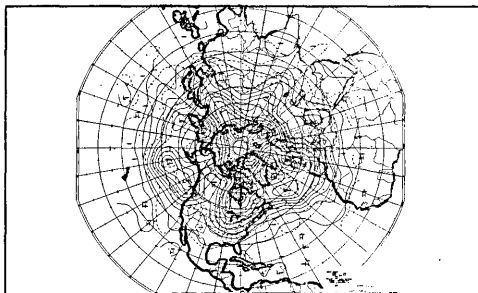

METEOROLOGY Weather maps

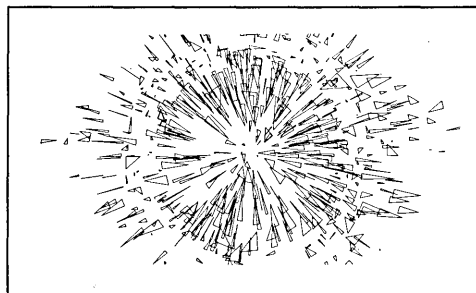

OPTICS* Lens calibration

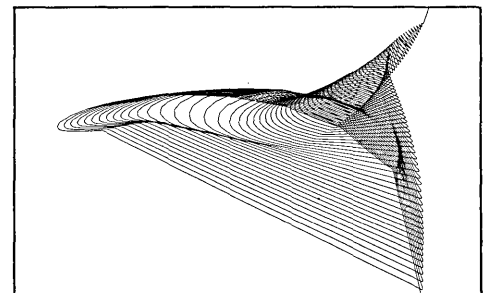

BALLISTICS* Projectile ricochet

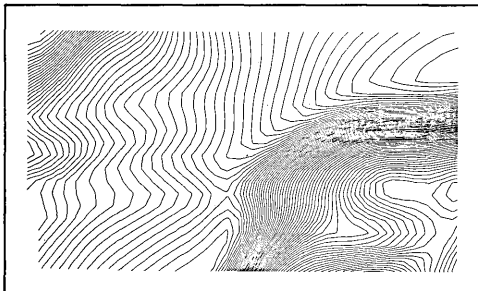

GEOPHYSICS Contouring

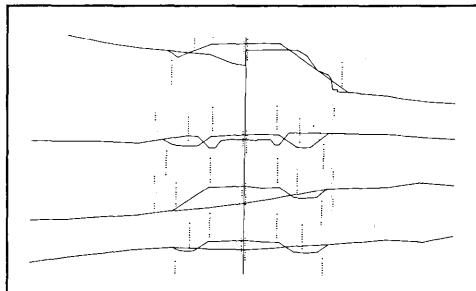

HIGHWAY PLANNING Cross sections

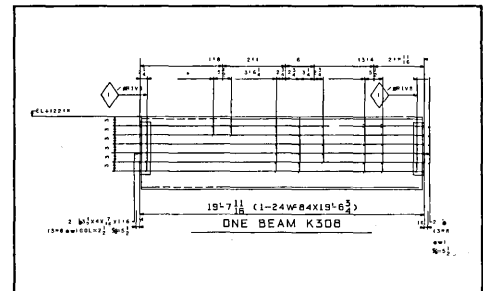

DESIGN AND DRAFTING Fabrication drawings

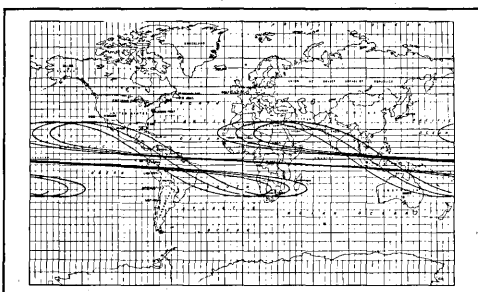

AEROSPACE Satellite orbits

Some typical problems we've been solving for over a decade.

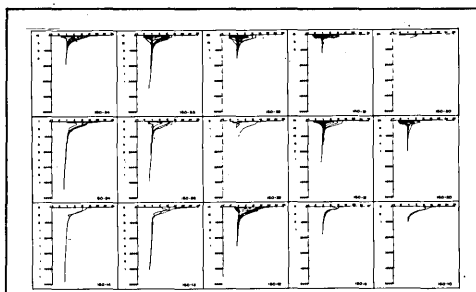

OCEANOGRAPHY Marsden squares

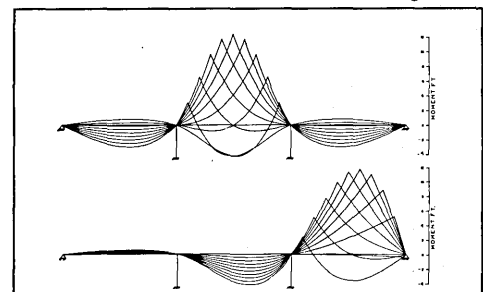

BRIDGE DESIGN Influence lines

*Winner in annual "Computers & Automation" Computer Art Contest.

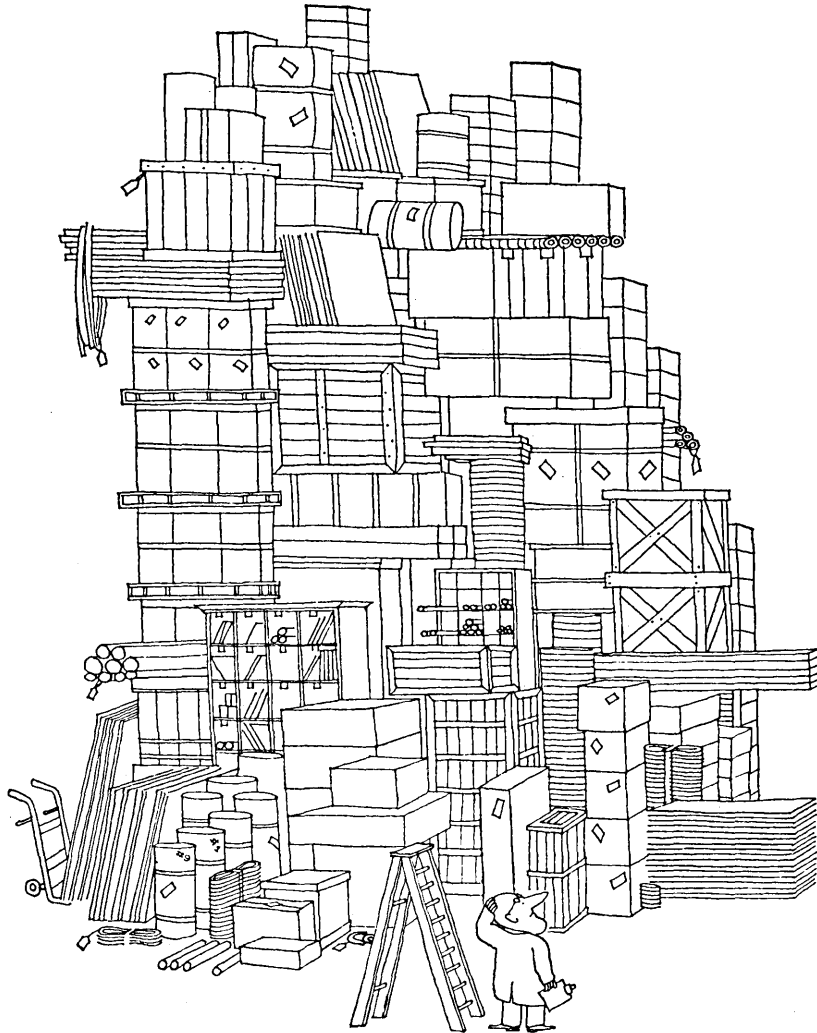

How to put your finger on one item out of 36,000

A division of H. K. Porter Company, Inc., does it by dialing a computer center. Any one of 36,000 items could be at any of seven warehouses and eight plants across the nation. When a product is sold, the information on punched cards is sent via Bell System Data-Phone* service over regular telephone lines to the Porter computer center in Pittsburgh. The information is instantly

recorded on magnetic tape and fed into the computer. In a matter of milliseconds, the computer tells the production status or inventory location of the product. And the entire order is processed for shipment in one working day. (It formerly took up to fourteen days.) As ordering information flows in, the computer updates the average monthly demand, economical production quantities,

and safety stocks. Replenishment orders are automatically produced when needed. The result has been a cut in inventories. And customer service is at its best. We can help you put your finger on the way to move information quickly and efficiently. Just call your Bell Telephone Business Office. Ask to have our Communications Consultant contact you.

*Service mark of the Bell System



Edit...

Enter

data, text, formats; use up to 1024 characters in any of 2080 spaces screen locations — off line.

Insert

data anywhere. Text opens up to make room for insertions — off line.

Delete

data anywhere. The text closes up the space left by deletions — off line.

all automatically

These are but a few of the *full-editing* capabilities that set the Sanders 720* Data Display apart from all others. Find out how much more you can do with your computer when a Sanders 720 Display is at your fingertips.

Call or write Data Systems Division, Sanders Associates, Inc., Nashua, New Hampshire 03060. Sales offices located in New York (212) 421-5664, Chicago (312) 631-3317, and Los Angeles (714) 624-8820.

*T.M., Sanders Associates, Inc.

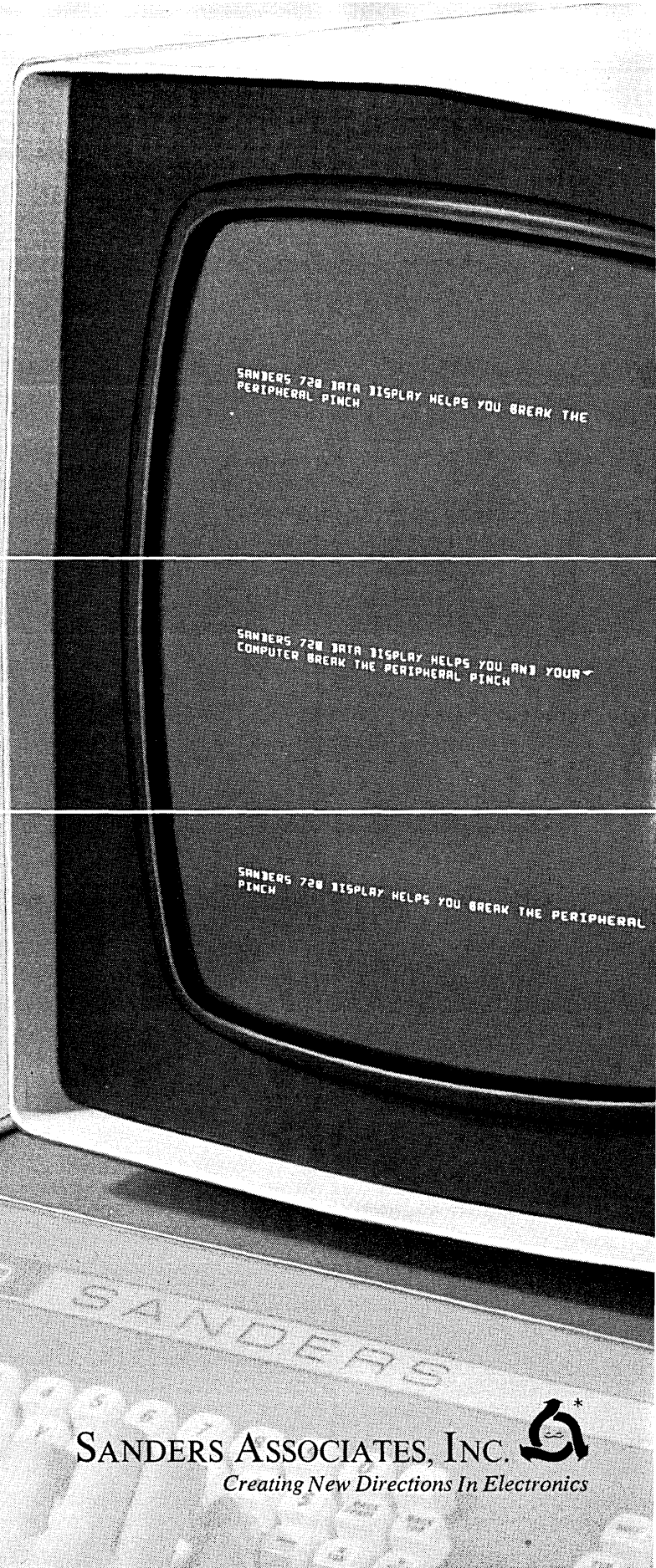

SANDERS ASSOCIATES, INC. 
Creating New Directions In Electronics

720 | SANDERS

CIRCLE 37 ON READER CARD

this is a commercial:

about commercial memory stacks. Like the one on the right, for instance.

It's one of 30 we designed and built this year for new computers. This one, as well as the 29 others, was developed by our responsive, technically talented engineering group. They're concerned solely with the design of economical, fast commercial stacks.

For most of the stacks, we used or adapted standard cores from stock. In the case of the well-arrayed model at the right, we quickly made a brand new one. That's why we have our own core-development plant, staffed by research ceramists, chemists and pilot line people. All specialists in ferrite cores.

Since 1961 we've been producing high reliability cores, stacks and memory systems for commercial, military and aerospace use, in one's and two's and production lots. For small computers, big computers, everyday computers and wayout computers.

If you're designing something new, all you have to do is tell us what you have in mind. We'll send you some cores to test and evaluate. Or, you might want an array to check out your electronics. If you're well into your design we'll build you a prototype stack. How's that for a commercial?

If you'd like a further word from our sponsor write or phone.

EM electronic memories

Memory systems, stacks, and cores for commercial, military and space applications

Dept. 2C, 12621 Chadron Avenue, Hawthorne, California 90250, (213) 772-5201

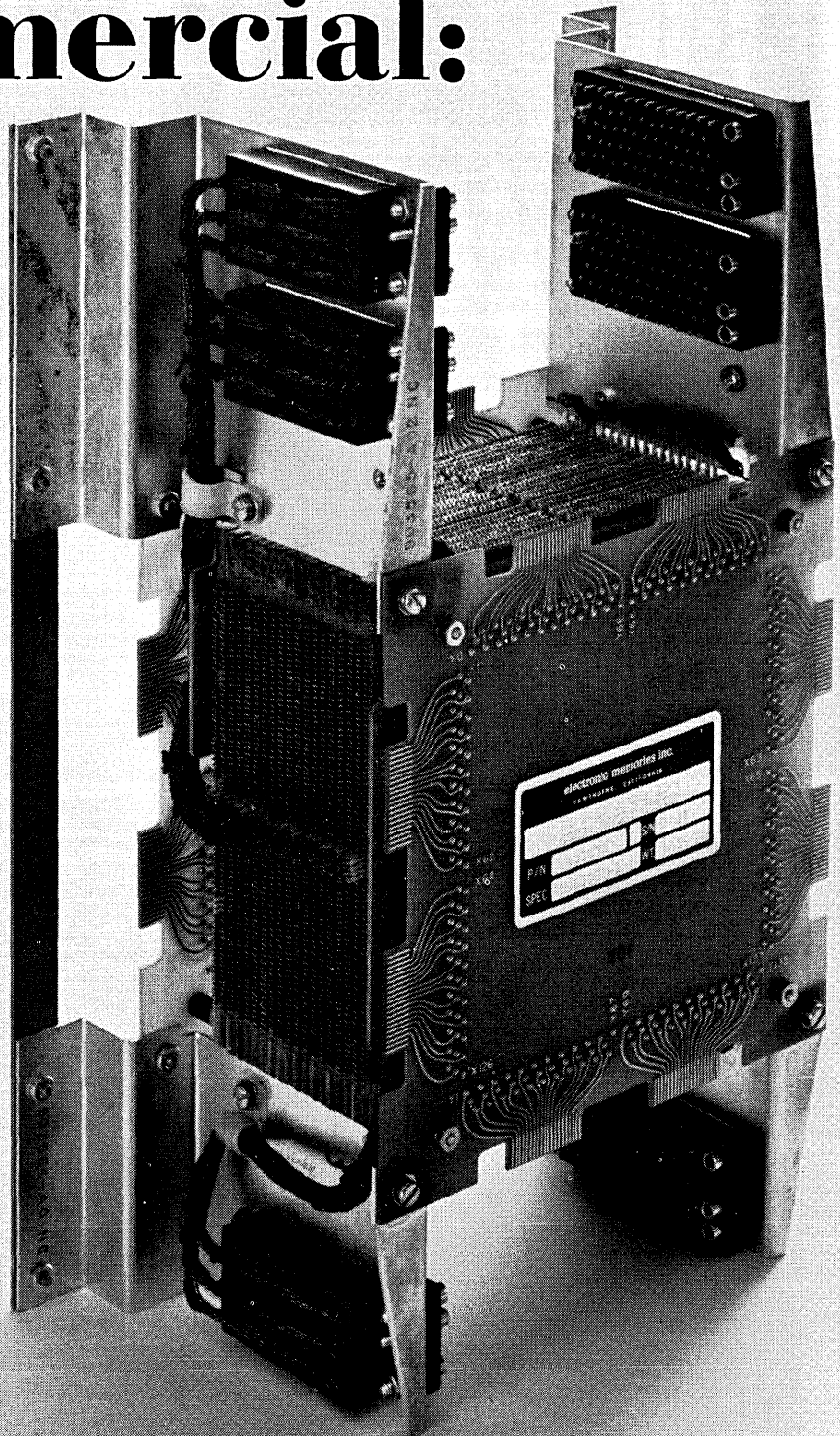

news briefs

BROOKS DISCUSSES PAST, PLANS FOR FEDERAL EDP

The author of the Brooks Bill, and the most important influence for sanity and economy in the federal government management of its edp resources, warned that a "regulatory approach" to the standards problem may be necessary if "voluntary cooperative efforts" don't succeed.

Congressman Jack Brooks, in a talk to an FJCC luncheon meeting last month, recounted some of the past history of edp mismanagement in federal circles and indicated that this history hadn't been completed yet. "Since approval of Public Law 89-306 last October, gradual progress has been made toward its implementation." Then he pointed out the paradox that edp has not yet been used to manage the government's massive edp investment.

Brooks indicated that a management information system—with a target date of Jan. 1, '67—will attempt to correct this situation. He also took a swipe at the notion of patenting of programs, claiming this would hinder the exchange of ideas and information. And he hinted that the federal government might, "if necessary," see that high school and college students get a chance to work with edp gear.

In a pre-luncheon press conference, Brooks tried unsuccessfully to hide his insights into edp behind a folksy politician mask. Turning to Norm Ream, he said, "Now you straighten me out if I make any mistakes. I'm only a lay preacher in this field, not an ordained minister." (Ream, by the way, has resigned his post as key computer official at the National Bureau of Standards, and has been appointed a special assistant to the Secretary of the Navy. His resignation emphasizes the seriousness of the internal dissension over the true edp mission of the NBS as defined in the Brooks Bill (see Oct. '66, p. 17)). At the press conference Brooks also underlined his firm opposition to expensive government R&D efforts.

COPYRIGHT AMENDMENT PASSES HOUSE COMMITTEE

In a statement issued to several data processing trade magazines, John F. Banzhaf III, New York computer law

specialist, reports that an amendment has been proposed to a bill revising U.S. copyright law which would "... permit a computer to scan and make use of a copyrighted work without the authorization of the copyright holder, if no non-transitory copy of the work were made."

As originally introduced, the bill made any use of a copyrighted work by the computer an infringement. Says Banzhaf, "A literal interpretation would have made it an infringement

to (1) have a substantial portion of a copyrighted work appear in a computer output; (2) prepare a substantial portion of a copyrighted work in a computer input format or medium (e.g., punch cards); (3) cause a computer to scan and store even temporarily within its memory a substantial portion of the work regardless of the input form or use of which the work was to be put."

While there is general agreement that (1) constitutes a "reasonable and necessary protection," the other two drew fire. As a result, the amended bill favorably reported by the House Committee on the Judiciary now defines as work as "... 'fixed' in a tangible medium of expression when its embodiment in a copy ... is sufficiently permanent or stable to permit it to be perceived, reproduced, or otherwise communicated for a period

NEW BASF MAGNETIC TAPE PLANT OPENS IN GERMANY

BASF (Badische Anilin- & Soda Fabrik) — large German chemical firm—dedicated a new magnetic tape manufacturing facility in Willstatt on Oct. 28. The plant, a tribute to thorough planning, so far represents a 70-million DM (\$17.5-million) investment, and is located on a site surrounded by an earthen wall (to slow the movement of air) and trees especially selected for their low pollen count. Huge containers for the solvent are located outside the plant.

Inside, clean rooms are monitored by counters which preclude particles larger than 0.3 microns. Light fixtures are so placed that they can be repaired without entry into the clean rooms. The facility will be used to produce audio, video, instrumentation and computer tape.

The plant, which employs 500, has been operational since April;

currently 20% of its output is computer tape of two types: 1-mil and 1½-mil mylar base. The facility joins four other plants in Germany, France and the U. S. (Computron, which is jointly and equally owned by BASF and GE).

The Willstatt plant will serve as the model for a tape manufacturing facility of about half its size now being constructed by Computron at Bedford, Mass. Scheduled for completion in June, the U. S. plant is expected to be in full production in October.

BASF estimates that '66 world sales of magnetic tape of all kinds will be approximately \$200-225 million, with \$125-150 million of that representing U. S. sales. The company thinks that its magnetic tape sales will reach \$80 million by 1969-70, with computer tape representing 30% of that total.

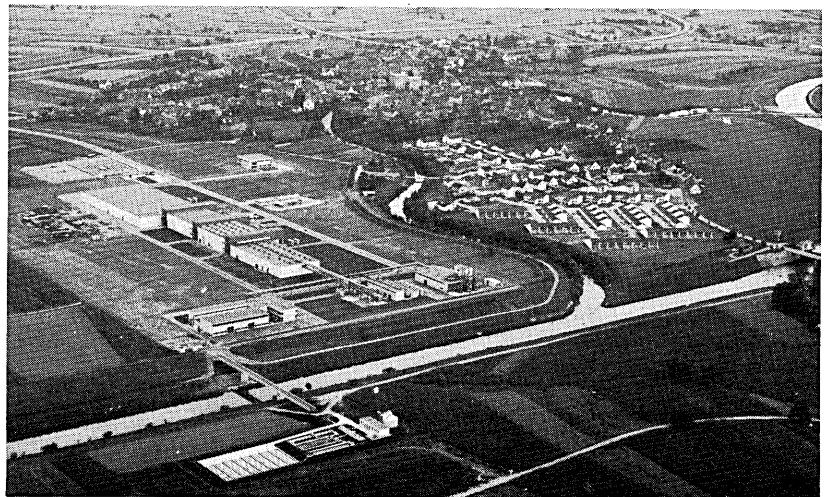



Strangest library in the world.

1300 requests a day, and not a book in sight.

In fact it rarely has a visitor. And the only sound in the reading room is from IBM computers duplicating programs to serve IBM customers.

Located 28 miles northeast of New York City, this country library is a computer-age phenomenon. Its bookless shelves are loaded with programs on tapes, cards and disks... programs developed by IBM and its customers.

The library began operations

nine years ago and started acquiring programs for distribution. Since then, computer technology has moved so swiftly that only a few of the original programs remain on file.

Now it takes the power and speed of IBM SYSTEM/360 to maintain, update and distribute the thousands of programs currently in the library. And it requires four trucks each day just to ship them out.

It even takes special equipment to handle the volume. Like a newly developed tape duplicator to process as much as 4 billion characters of information daily... the equivalent of 7000 books. And miniature tape reels to speed automatically updated program information to IBM customers.

Strange little library. None other quite like it.

And it's there when you need it... like all IBM services.

IBM

news briefs

of more than transitory duration." According to Banzhaf, it thus appears that (3) would no longer constitute an infringement.

The bill, although favorably reported to the House, still awaits Senate committee approval. Banzhaf urges interested parties to contact their representatives or senators. Computer organizations may wish to communicate directly with Rep. Emmanuel Celler (N.Y.), chairman, House Committee on the Judiciary; Senator John L. McClellan (Ark.), chairman, Subcommittee of Patents, Trade-Marks and Copyrights; or Senator James O. Eastland (Miss.), Chairman, Committee on the Judiciary.

NEW DATA TRANSMISSION CONCEPT ANNOUNCED

A new method of handling data transmission over telephone lines to reduce the effect of line distortion was announced at the Instrument Society of America's Second Annual Instrumentation Conference at Cocoa Beach, Fla.

Developed by Sang Y. Whang at Milgo Electronic Corp., the technique uses only a narrow portion of the bandwidth; other parts can be used for several Teletype channels.

The method is said to allow transmission of data at 2400 bits/second over nonequalized voice-grade lines.

SURVEY AND PROJECTION OF GERMAN MARKET REPORTED

A survey of the German market for EDP conducted for the U.S. Trade Center in Frankfurt am Main indicates that there were 2291 edp systems installed in Germany as of Jan. 1, '66, with another 2179 on order. "By 1974 the figure for plants installed (sic) will rise to 6000."

According to the survey, 11 of the 24 firms competing for the market are American, and control almost 90% of the market's current dollar volume, or 85.6% of the number of installed machines. IBM machines represent 68% of the total number of systems installed.

Small systems (up to 10,000 DM or approximately \$2500/month) comprise 32.5% of the systems installed and 59.8% of those on order. In terms of money value, small systems represent 9.7% of the systems installed and 22.4% of those on order. American firms hold 75.7% of small systems installations, and 98.9% of their value.

The report estimates that the increase in the total market will be 25%, although over what period is not clear.

Of this increase, systems with monthly rentals of 6,000 DM or less will represent 50%, with 40% going to systems renting for between 6K and 15K DM/month.

The survey, dated August, 1966, was conducted by the Institut für Marktforschung und Absatzförderung.

JUG-CAP GROUP FINISHES PLAN FOR CATALOG SERVICE

Format and details of a program library catalog and interchange service were settled at the November joint users group (JUG-CAP) workshop. Now JUG has only to endorse the plan and send it on to the ACM council for their consideration. The workshop also encouraged the program library committee to explore ways to make the format compatible with formats of program catalogs compiled by other agencies, such as NASA.

At a meeting after the workshop, JUG turned thumbs down on the proposed revised USA Standards Institute Code for Information Interchange (once known as ASCII). The "no" vote goes to the Information Processing Systems Standards Board.

ACM WILL PRESENT PROGRAM AT AAAS ANNUAL MEETING

The ACM will sponsor a session at the December meeting of the American Association for the Advancement of Science.

Four lectures will be grouped under the heading "The Time-Shared Computer: Achievements and Prospects." Richard Lemons of Informatics will discuss development and check-out of programs through remote terminals. Prof. David Evans, active in time-sharing at UC Berkeley and now at the Univ. of Utah, will talk about computer system design questions in handling the dynamic sharing of resources among independently written programs. Operating system design will be the subject of the lecture by Andrew Kinslow of IBM and Prof. Merrill Flood of the Univ. of Michigan will discuss communications aspects of time-sharing.

Chaired by MIT Prof. Jack B. Dennis, the session is scheduled for Dec. 28 at 9:30 a.m. in the Ambassador Room of the Shoreham Hotel, Washington, D.C.

FCC ANNOUNCES COMPUTER/COMMUNICATIONS INQUIRY

As one case or hearing after another involving communications and/versus data processing has confounded the

Federal Communications Commission, it has seemed apparent that sometime FCC would call for a hearing on the "regulatory and policy problems presented by the interdependence of computer and communication services and facilities." That's what FCC did Nov. 9, giving all interested parties until Dec. 12 to make recommendations on the nine major points in question:

A. Uses being made currently and those anticipated in the next decade of computers and communication channels and facilities for message or circuit switching (including storage and forwarding of data), data processing, general or special information services, and any combination of above.

B. The basis for and structure of charges to customers for above services.

C. Circumstances under which any of these services should be subject to regulation pursuant to provisions of Title II of Communications Act: when involving use of communications facilities and services; when furnished by established communications common carriers (cc); and when furnished by entities other than established cc's.

D. If any or all of such services are subject to regulation under the Act, whether they should be regulated or left in a free competitive market; if the latter, whether changes in existing provisions or law or regulations are needed.

E. If such services are not subject to regulation, should legislation (give nature) be enacted to bring such services under regulation by an appropriate governmental authority.

F. Whether existing rate-making, accounting and other regulatory procedures of the FCC insure fair and effective competition between cc's and other entities in sale of computer services involving the use of communications facilities; if not, what changes should be made.

G. Whether the rate structure, regulations, and practices in existing tariff schedules of cc's meet present and anticipated needs of the dp industry and customers. Specific reference can be made to tariffs on: interconnection of customer-provided facilities with cc facilities; shared use of equipment and services offered by cc's; and restrictions on use of services offered, including prohibiting resale.

H. What new cc tariff offerings or services are or will be needed to meet dp industry needs.

I. Any inadequacies of present cc transmission facilities in meeting needs, including accuracy and speed.

J. What measures are required in

DATA INTO PICTURES? PICTURES INTO DATA? USE LINK® DATA CONVERSION SYSTEMS.

SAMPLE INPUTS

Spacecraft Video Data
Microfilmed Data
Aperture Cards
Strip Chart Data
Micro Photographs
Oil Well Log Charts
Frequency Spectrum Data
Tracking Films
Seismograms
Radar Film Data
Telemetry Signals
Bubble Chamber Films
Mathematical Models

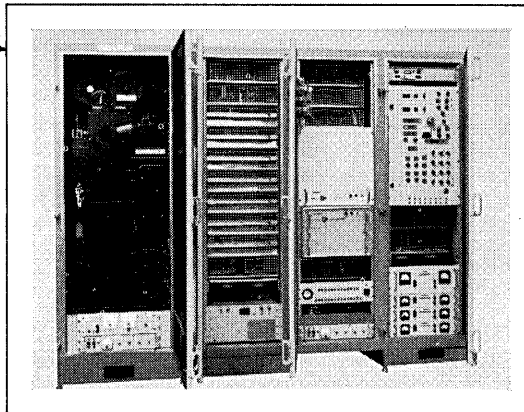

OUTPUTS

Updated Aperture Cards
High Resolution Space Photos
Computer Output Plots
Magnetic Tape
Punched Cards
Paper Tape
3-D Computer Graphics

Scanner/Recorder

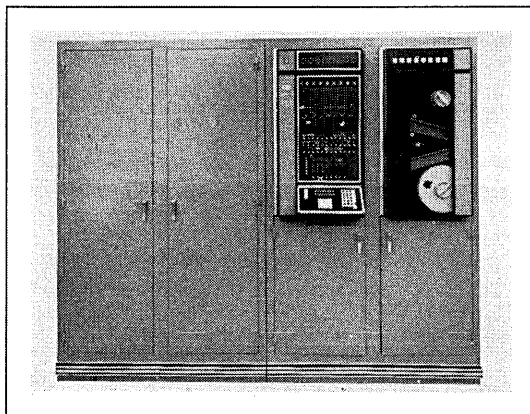

Computer

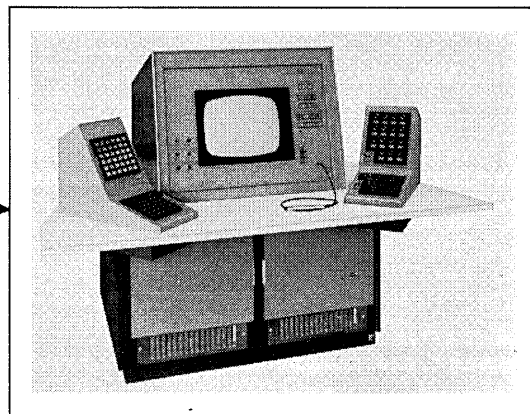

Control/Monitor Console



You can convert data into pictures or pictures into data with Link Flying Spot Scanner Conversion Systems. Just examine these applications:—

- Precision CRT film recording
- Precision film reading
- Updating and regeneration of microfilmed data
- High-density filmed data storage and retrieval
- Filmed data conversion
- Analysis of strip-chart data
- High-speed computer output on film (such as 3-D projections)
- Frequency spectrum film recording
- Automatic X-ray scanning
- High-resolution, broadband facsimile transmission

For example, the Mariner, Surveyor and Ranger

signals transmitted from Mars and the Moon were converted into photos by our systems. Maybe you'll recognize some of Link's Data Conversion Systems: Spacecraft TV Ground Data Handling System. Video Film Converter. Waveform Display/Analyzer. Radar Land Mass Simulator. Kinescope Recorder. Graphic Recorder and Processor. Automated Microfilm Aperture Card Updating System.

As you can see, our data conversion systems have the versatility to meet the most varied needs. We also custom-design video/photographic reduction systems for specific requirements. If we can assist in any way or if additional information is desired, please write to: Advanced Products Sales, General Precision, Inc., Link Group, 1451 California Avenue, Palo Alto, California.

**GP GENERAL
PRECISION INC.**

LINK GROUP

news briefs

both dp and communications to protect private and proprietary data stored in systems and transmitted, and what should government do about this issue.

Although Bernard Strassburg, FCC chief of the Common Carrier Bureau, gave a speech at ACM in October which hinted that the FCC inquiry was coming—and outlined it—the announcement took many computer people by surprise. Many are not at time of writing aware of the details of the inquiry; others—like service bureaus—don't want to answer the questions alone, but would be willing to band with their colleagues in a "united front" (if someone would only ask). IBM plans to be heard and probably GE—big on information service and service bureaus. The carriers should be able to put a lot of material together from old briefs since they have been involved in frays relating to this since about 1961, when the private microwave issue was settled and the Telpak issue began. Western Union has multiple interest since they started the computer-utility-by-carrier idea.

Some observers detest the question of regulation because it bodes a stifling of very young, very inexperienced projects—like time-sharing service. Many are happy that they can speak out on rate structures, perhaps keep alive the complaint on the recent erasure of Telpak A and B services—on which large numbers of users and service bureaus had based future computer plans. Too, some time-sharing service operators are looking forward to an expose of "flagrant pricing policies" of competitors.

Following approval of the questions, the FCC will set a deadline for answers in January.

● A new special interest group concerned with information handling in the behavioral sciences was formed at the 29th annual convention of the American Documentation Institute, held at Santa Monica, Calif., in October. It is open to those who qualify for ADI membership and work with publication, annotation, translation, coding, storage, retrieval, and dissemination of documents and data in the behavioral sciences. Chairman pro tem is Dr. Frieda Libaw, The Galton Institute, 8717 W. Third St., Los Angeles, Calif. 90048.

● A computer-controlled microfilm indexing system that replaces the familiar card files has been installed in the technical library at Lockheed Missiles & Space Co. Index entries are processed by an IBM 7094, then transferred from mag tape to micro-

film by a Stromberg-Carlson SC 4020. The 1.5 million entries required for the library can be stored in 40 microfilm cartridges, replacing the 720 card files needed before. Access has also been improved; the Bell & Howell reading machines, operated by a single switch, are said to cut search time for the user by half. By duplicating the microfilm catalog and adding reading machines, the file has been made available in other locations at the plant. To keep files current, the Lockheed-developed system calls for complete replacement of the index entries every three months.

● The University of Southern California's COMEX (Computer Exercise) is training air pollution control officers through simulation and computer games in conjunction with USC's Air Pollution Control Institute. The program simulates city economics, including the allocation and budgeting of municipal funds for air pollution control. Funded under a 2-year grant from the U.S. Public Health Service, the COMEXOPOLIS games are compiling and programming a data base on the U.S. urban community. The hopeful objective of the program is a strengthened attack on smog.

anyone for tea?!

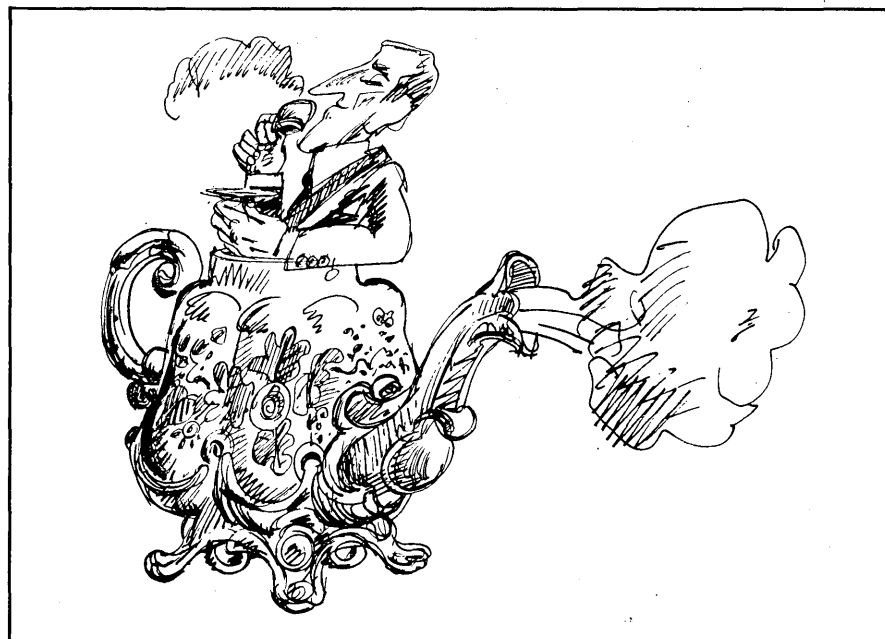

We are proud to announce the opening of our overseas affiliate, COSTELLO COMPUTER SALES, in London, England. Costellomen can now offer the same fine service to the British Isles and the European Continent that made them the computer reps of the West. Of course, we represent only the finest computer components and peripheral equipment obtainable. When you're in London . . . do drop by for tea.

in London it's...



COSTELLO COMPUTER SALES

York House, Empire Way
Wembley, Middlesex, England
Phone: 01-903-1923 (3 lines)

and out west it's...



COSTELLO & COMPANY

computer reps of the West

5795 W. Washington Blvd., Culver City, California 90230 / Phone: (213) 937-2980
535 Middlefield Rd., Palo Alto, California 94301 / Phone: (415) 321-3745
3922 N. 30th Avenue, Phoenix, Arizona 85017 / Phone: (602) 266-4448
5635 Yale Boulevard, Dallas, Texas 75206 / Phone: (214) 363-9031
2090 West Littleton Blvd., Littleton, Colorado 80120 / Phone: (303) 798-8635

CIRCLE 41 ON READER CARD

After we deliver a computer, we keep delivering.

What we deliver can save you time, headaches, and hard cash. Take off-the-shelf software for instance. Your NCR representative can deliver thoroughly documented and user-proven program packages for business, scientific and engineering applications right now. Software packages ranging from payroll to stepwise regression. From linear programming to bivariate correlation coefficient. (That's a sampling from the catalog of management information tools in the ready-to-run NCR library.)

When we deliver an RMC, 315, or 315-100, we deliver

the programming languages that are right for you. We're ready with Cobol, Neat, Best, RPG, Fortran IV, Fortran II and Neat Assembler. We're ready to deliver the right Sort/Merge routine to match your installation needs.

We're delivering an advanced operating system with automatic run-to-run control assuring the right file name and date version, and including dating flag options for any program in the system.

Software is a big reason why NCR is serving more and more customers every day. Give us a call. We deliver.



N C R

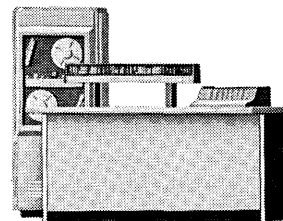

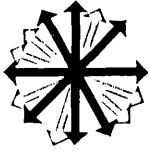

new products

desktop computer

An update of a unit introduced three years ago, the Mathatron Mod II is for scientific, engineering and statistical calculations. Among new features is a half-power (square root) function that mathematically closes parentheses and computes power to the $\frac{1}{2}$ of either a single quantity or the computation enclosed. A function key

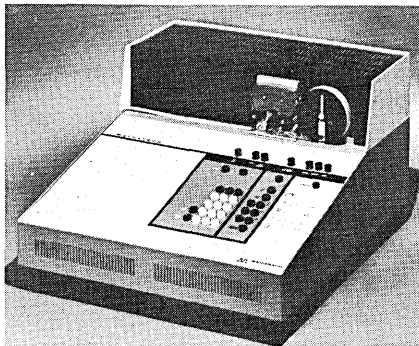

takes care of this at any point in the computation. A digit retention feature allows the operator to enter numbers of unlimited length. The unit automatically preserves the nine most significant digits and adds all additional entries to the exponent. And a memory lock device protects data in storage registers and the memory bank while the machine is turned off. Prices start at \$3,490. MATHATRONICS, Waltham, Mass. For information:

CIRCLE 100 ON READER CARD

graphic i/o

With LDX (long distance xerography), high-speed facsimile transmission has been possible. Now, with the LDX/Computer Adapter the transmission can be combined with graphic input to and printout from computers. Graphic data such as charts, graphs or grids is input to an LDX Scanner; transmitted to a computer center, the signal is converted to digital data by the adapter and stored in core or on mag tape. Output through the adapter is onto ordinary paper at up to 500 pages an hour. The printer, like the scanner, can be located away from the computer. Mod I is for use with IBM 360 computers, but models for other computers "may soon be available." Lease price for the adapter is \$1,050 per month, plus a basic monthly charge of \$1200 for

the scanner and printer. XEROX Corp., Rochester, N.Y. For information:

CIRCLE 101 ON READER CARD

facsimile transmission

Called the first "dial-a-document" capability, the Alden/Miracode system makes it possible to retrieve by telephone a full-size document stored in a central microfilm center. It uses Eastman Kodak's microfilm retrieval system and the AlpurFAX facsimile scanner, which scans onto mag tape a facsimile picture of the original document requested. The facsimile tape is then used to transmit the picture over standard phone circuits to an AlpurFAX recorder; the picture is full

size. Printing speed is three minutes/page over standard phone lines, and 30 seconds/page over Telpak. ALDEN ELECTRONIC & IMPULSE RECORDING EQUIPMENT CO. INC., Westboro, Mass. For information:

CIRCLE 102 ON READER CARD

bank sorter

The model 404 reads and sorts all recognition fields for magnetic characters at up to 600 documents a minute. It has 11 pockets, each holding about 225 documents; sorting stops and a light signals when a pocket is full, continuing automatically when it is emptied. The feeder holds about 1750 documents. An off-line unit, the 404 sells for \$29,900 and rents for \$790 a month. NATIONAL CASH REGISTER CO., Dayton, Ohio. For information:

CIRCLE 103 ON READER CARD

core memory system

The ICM-47 is an IC system with a full cycle time of 750 nsec, access time of 400 nsec. For 4K and 8K

PRODUCT OF THE MONTH

The 2116A is a 16-bit instrument computer with an expandable, basic 4K memory and 1.6-usec cycle time. Using integrated circuits, it operates in temperatures from 0° to 55° C with line voltages varying $\pm 10\%$, line frequency varying between 40 and 70 cycles, and humidity up to 95%. More than 20 HP instruments may be interfaced immediately to

the 225-pound unit, the interface consisting of a cable, connectors, and a plug-in I/O board. Output is to punched or mag tape, or hard copy. Software includes an assembler, FORTRAN with object codes that are configuration-independent, and basic control system. HEWLETT PACKARD, Palo Alto, Calif. For information:

CIRCLE 104 ON READER CARD

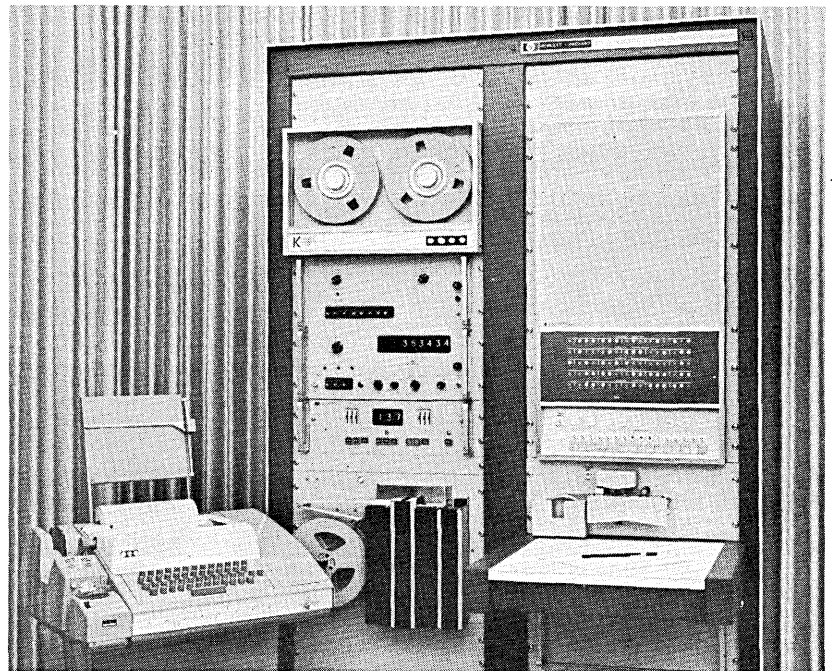

Here's the Univac® 9200: the first computer at tab equipment prices.

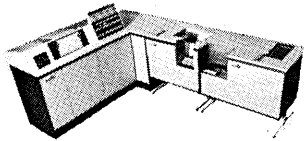

The Univac 9200 is the first in a series of interlinking computers. You can rent the 9200 for about \$1,000 a month or own it for less than \$45,000.

This low-priced system is compact and is internally programmed. It provides for card input/output with high-speed printing, and is delivered with a complete software library.

The memory starts at 8,192 bytes and can be expanded to twice that size. The high-speed memory of the powerful central processor provides many operating advantages. For example, simultaneous input/output and processing capability. The Univac 9200 offers more throughput... in less time... at lower operating cost than ever before possible.

When the 9200 is combined with the Univac 1001 Card Controller, the system automatically delivers more benefits. It can read from as many as four separate files at combined speeds of over 2000 cpm. This combination does the work of six conventional punched-card machines: Accounting machine, calculator, collator, sorter, reproducer, and summary punch.

The Univac 9200 provides varied input/output capabilities to meet your specific needs. Punched cards are read at 400 cpm. The Univac 1001 Card Controller provides dual 1000 cpm feeds for input speeds up to 1000/2000 cpm. Cards are punched at the rate of 75-200 cpm. A read/punch feature is available which means an additional file can be read concurrently at 2000 cpm. The basic printing speed is 250 alphanumeric lpm and can be increased up to 500 numeric lpm—within the same report if needed.

Built-in growth potential is easily realized with the 9200. In fact, the 9200 can be modified on-site to the Univac 9300 system.

No switch in processors is required.

The 9200 programs can be run on the Univac 9300 system immediately. Be sure to get all the facts. Call

UNIVAC
DIVISION OF SPERRY RAND CORPORATION

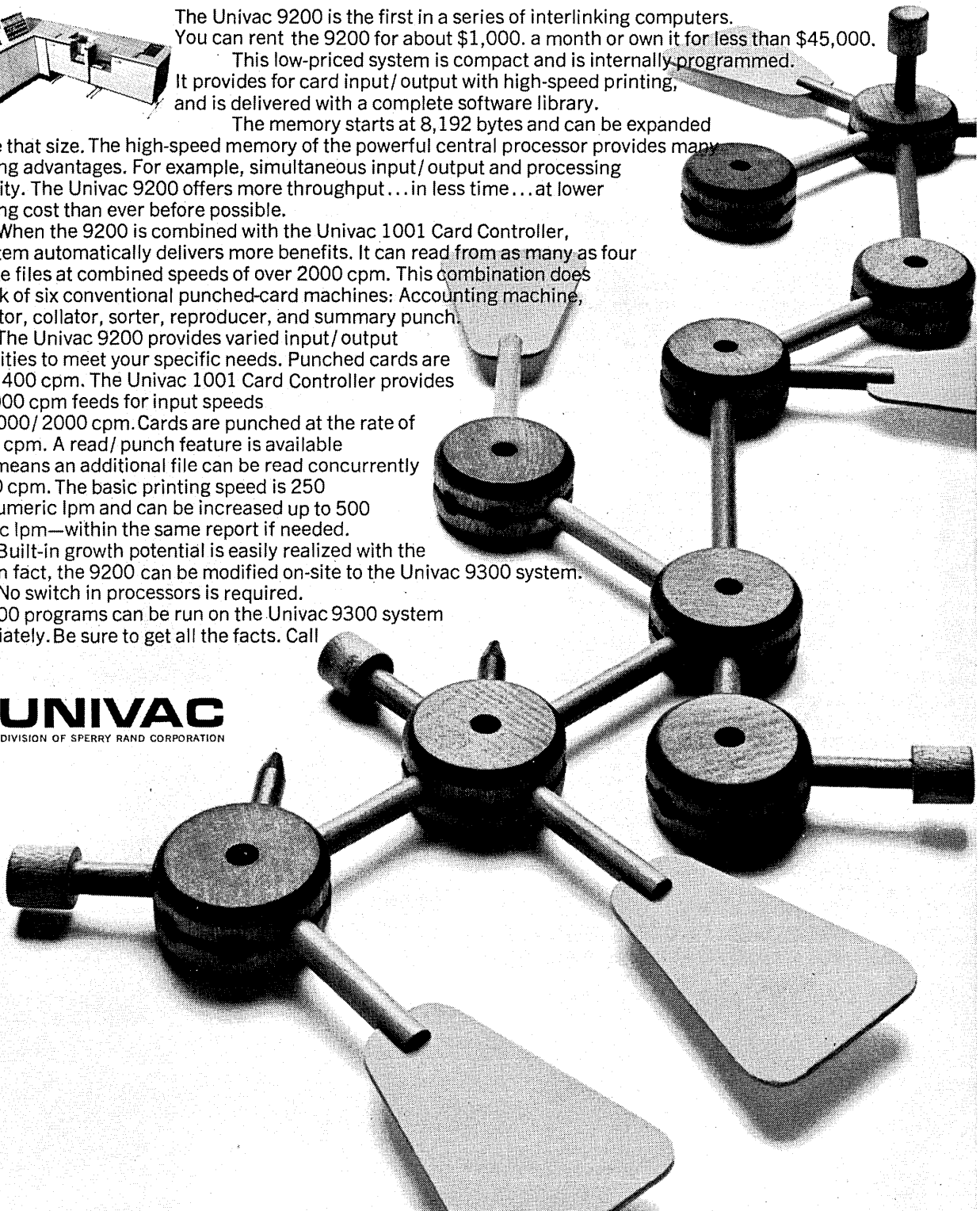

new products

memories, maximum word length is 28 bits/module; in 16K systems word lengths up to 14 bits are available. Stacking provides more capacity and extended word lengths. The unit uses a 2½D, 3-wire coincident current organization. HONEYWELL COMPUTER CONTROL DIV., Framingham, Mass. For information:

CIRCLE 105 ON READER CARD

interactive software

ESI is a proprietary engineering/scientific interactive language for users of compact-sized computers and potential subscribers to commercial time-shared networks. It has been implemented initially on the PDP-5, 8 and 8/S computers, giving them simplified capabilities of the joss system at RAND Corp. APPLIED DATA RESEARCH INC., Princeton, N.J. For information:

CIRCLE 106 ON READER CARD

gp computer

Third computer to be introduced by the firm in the last five months, the PDP-10 replaces the PDP-6. It has a memory cycle time of 1 usec, add time of 2.1 usec, and double-precision multiply time of 9.1 usec. Available in five configurations, the system has from 8K to 262K (36-bit) words of core, all directly addressable.

The PDP-10/10 has 15 index registers, 16 accumulators, 8K words of core, 300/50-cps paper tape reader and punch, console teleprinter, and two-level priority interrupt. The 10/20 configuration adds two DECTapes. And the 10/30 has 16K words of core and additional I/O devices. With the 10/40 and 10/50 comes time-sharing. The former has 16K words, extended order code, memory protection and

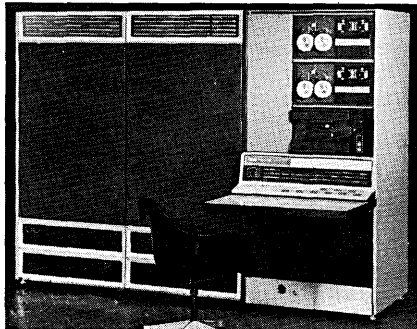

relocation features. The currently-operating software has facilities for real-time and batch processing. The 10/50 has 32K-plus words of core and a disc file for swapping.

There are also five levels of upward-compatible software. Thus a FORTRAN IV program compiled on the basic system can be link-loaded and run

December 1966

VITRO

Micro Modules

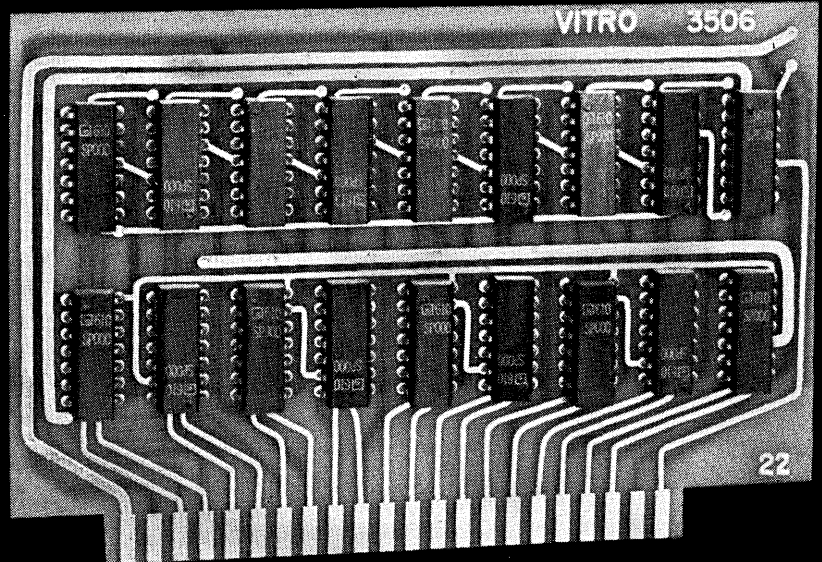

- all-new, highly competitive prices
- built-in drivers, inverters and buffers eliminate most interconnecting wiring
- up to 18 microcircuits per card enable high density and lower costs
- boards designed to meet MIL- and NASA standards
- boards keyed to assure proper mounting
- dual in-line packages easily replaced for ease of maintenance
- off-the-shelf delivery

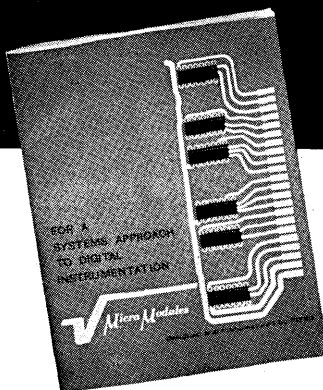

WRITE for this FREE 36 page catalog describing our complete line of card-mounted digital microcircuits. Brochure contains logic diagrams, connections, performance data, power supplies and card drawers. NEW price sheet is also included.

V-31

Vitro ELECTRONICS

Producers of NEMS-CLARKE Equipment
A Division of Vitro Corporation of America

919 Jesup-Blair Drive • Silver Spring, Maryland (301) 585-1000
2301 Pontius Avenue • Los Angeles 64, California (213) 477-6717

CIRCLE 44 ON READER CARD

Sometimes it takes a light touch to make plastics.

To make a plastic—take a monomer, add an initiator, and then add some energy to kick off the reaction. When it's over, you have polymer molecules—a plastic. The needed energy often comes from heat. But heat can evaporate the monomer before it has a chance to polymerize. Or it can damage a material being plastic coated.

A good alternate energy source is light. Just recently, our chemists discovered an initiator that is particularly effective in forming acrylic polymers on exposure to ultraviolet light.

It's triphenylphosphine. Several other triphenyl compounds are known as effective polymerizing agents at about 200°C. But we've found that these, and the phosphorus derivative, can also initiate *photopolymerization*. And triphenylphosphine is effective at room temperature.

Suppose you want to "pot" a delicate electronic circuit that would be harmed by heat. Take a methacrylate monomer to which our new initiator has been added. Drop the electronics into a bowl of this watery liquid and expose it to ultraviolet light. In a few minutes the circuit is encapsulated in a clear, solid plastic that is potentially very stable. (Many initiators leave a residue in the polymer that hastens its degradation. Triphenylphosphine doesn't.)

The suggested explanation of how and why all this happens gets into molecular complex formations and electron exchanges. Detailed discussion is available on request. It's all part of our continuing search for a better way.

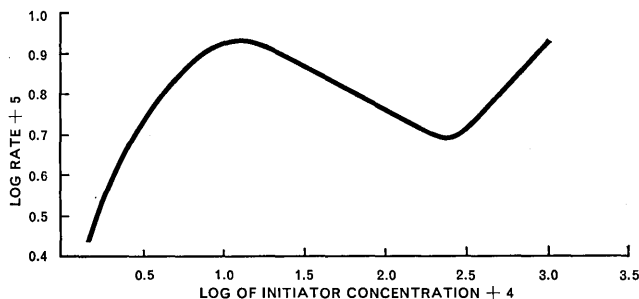

Effect of triphenylphosphine concentration on rate of polymerization of methyl methacrylate.



**General Motors
Research Laboratories**

Warren, Michigan 48090

MARK OF EXCELLENCE

CIRCLE 45 ON READER CARD

new products

under t-s without recompiling. The package includes real-time F-4, control monitor, and macro assembler. First deliveries are scheduled for September '67, and prices begin at \$110K. DIGITAL EQUIPMENT CORP., Maynard, Mass. For information:

CIRCLE 107 ON READER CARD

compact computer

For the second consecutive month, the company introduces a 16-bit computer. The newer and lower-priced DDP-416 is compatible with the 516 (see Nov., p. 30) and the older 116, of which there are 125 installations. Like the 516, the new 416 uses IC logic modules and has a memory cycle time of 960 nsec. But memory is expandable from 4K to only 16K, and the software package has 50 programs. It also has a parallel organization, multi-level indirect addressing, and a 30-command instruction repertoire. Options include a direct multiplexed channel for multistation time-shared I/O, direct memory access when I/O word rates of over 1 MC are needed, memory lockout, memory parity, and a real-time clock. Deliveries are scheduled to begin the second quarter of '67. Price of a 4K system with ASR-

33 teletypewriter is \$15K. HONEYWELL COMPUTER CONTROL DIV., Framingham, Mass. For information:

CIRCLE 108 ON READER CARD

voice response

The models 631 and 632 Speech-makers generate a variety of words from their 31-word vocabulary stored on photographic memory drums. The 631 has vocabulary selection by individual switch closures for each of the 31 words, while the 632 has a binary decoding matrix that performs the selection from a standard 5-bit binary code. Vocabulary storage is on 3-inch photographic film, like the soundtrack on movie films. COGNITRONICS CORP., Briarcliff Manor, N.Y. For information:

CIRCLE 109 ON READER CARD

automatic typewriter

A systems typewriter, the 1041/61 accepts paper tape up to eight channels, will duplicate tape or prepare another set with a different code configuration, simultaneously producing a hard copy. The punch operates at 18 cps, the reader at 30 cps, and the Selectric typewriter at 15.4 cps. DURA BUSI-

NESS MACHINES, Madison Heights, Mich. For information:

CIRCLE 110 ON READER CARD

digital plotter

Additions to the line of peripherals for the 520 computer include a plotter and tape drive. The former has a standard controller that handles each of the plotter operations by means of a single character output for each operation. An optional controller requiring single commands for all four plotter operations accepts data from memory in character format. This permits running off a mag tape drive.

The new tape transport is a 9-track unit (eight bits plus parity) for EBCDIC and other 8-bit formats. Tape speed is 75 ips and density is 800 bps. RAYTHEON COMPUTER, Santa Ana, Calif. For information:

CIRCLE 111 ON READER CARD

data collection

The Stored Program Data Acquisition System is designed to sample both analog and digital inputs, perform a-d conversion, format and record data on mag tape. A 4K (8 bit) core memory is used to store up to 100 program steps—entered through a 10-key keyboard as decimal digits—as well as act

the

MATRIX
CORPORATION
Computer Services Division

- MATRIX provides complete computer services to clients from coast to coast.
- Our services include Programming, Systems Design, Applications, Computer Time and Teleprocessing.
- We have the following computer systems:

GE 635	IBM 360/30
IBM 7094	IBM 360/40
IBM 7094 II	IBM 360/65 (1st quarter 1967)

IMMEDIATE OPENINGS ARE AVAILABLE FOR
SALES and MARKETING REPRESENTATIVES

B.S., B.A. or higher degree and at least one year of experience in the sale of data processing services are required.

If you meet the above qualifications and are interested in a challenging position in a rapidly growing organization, please submit resume or call

the
MATRIX
CORPORATION
Computer Services Division

635 Hawaii St., El Segundo, California 90245, (213) 679-8211
380 Madison Ave., New York, New York 10017, (212) OX 7-5940

CIRCLE 300 ON READER CARD

NEW PROGRAMMER CARD PUNCH SAVES TIME

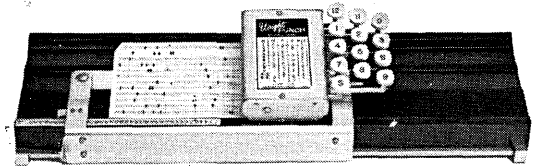

WRIGHT PUNCH MODEL 2600

- Precision desk-top model simple to use.
- Lets you make computer corrections on the spot.
- Handles 80-column-and-shorter cards.
- Does not duplicate or print.
- Only \$159 for accurate recording.

SEND NOW FOR COMPLETE DETAILS

Wright
LINE

DATA PROCESSING ACCESSORIES

170 GOLD STAR BOULEVARD, WORCESTER, MASS. 01606

A division of Barry Wright Corporation 

CIRCLE 46 ON READER CARD

Win a "roundabout" trip to Fort Lauderdale, Florida, as a guest of Systems Engineering Laboratories

First stop: Nassau!

Nothing to buy, nothing to try. You automatically qualify by filling out and mailing us the coupon below.

It's just a roundabout way to get you on our mailing list, to introduce you to our advanced systems capabilities and our field-proven computers...and to let you know about our SEL 840A 24-bit computer—the hottest real time software-hardware system going today.

Gentlemen:

I don't know what you're trying to prove, but I guess I've nothing to lose.

<input type="checkbox"/> I do	<input type="checkbox"/> I do not have any influence on the purchase of computer systems.	
<input type="checkbox"/> I do	<input type="checkbox"/> I do not have a current requirement.	
Name _____		
Title _____		
Company _____		
Address _____		
City _____	State _____	Zip Code _____
<small>Void wherever prohibited by law. Contest subject to all federal, state or local regulations.</small>		

Systems Engineering Laboratories

6901 West Sunrise Blvd., Fort Lauderdale, Florida 33310
Area Code 305 587-2900

Offices also in Washington, D. C.; Los Angeles, Calif.;
Boston, Mass.; San Francisco, Calif.; Cleveland, Ohio;
Huntsville, Ala.; and Orlando, Fla.

CIRCLE 27 ON READER CARD



new products

as a data buffer. A 16-channel multiplexer can be expanded to 100 channels, and data conversion rates are up to 100,000/second. INFORMATION CONTROL CORP., El Segundo, Calif. For information:

CIRCLE 112 ON READER CARD

crt-keyboard terminal

The Spectra 70/752 houses a video screen, keyboard, controls and power supply. The 12-inch screen generates alphanumeric and symbols at 120 cps and accommodates 20 54-character lines. There's also a 4-row keyboard



and a moveable cursor for error correction before transmission. The keyboard can be placed up to 20 feet away from the crt. RCA-EDP, Cherry Hill, N.J. For information:

CIRCLE 113 ON READER CARD

core memories

A line of memory systems has cycle times from 0.6 to 1.0 usec. Each modular unit has 8K (20-bit) words using 20-mil cores in a 2 $\frac{1}{2}$ D organization, and up to four modules will fit in a 19-inch rack. Monolithic IC's are used for all logic and information and address registers. BURROUGHS ELECTRONIC COMPONENTS DIV., Plainfield, N.J. For information:

CIRCLE 114 ON READER CARD

keyboard display

For use with Sigma computers, the mod 7550 desktop unit has an 8 $\frac{1}{2}$ x 11-inch CRT that can display up to 2K characters on 32 lines, 86 characters/line. The keyboard, a mod 37 Teletype key set, generates 96 ASCII graphics and 32 ASCII control characters. Additional keys generate frequently-used control codes and perform data routing. In text-editing applications, information can be erased, added or deleted from the display, lines can be justified left or right, and text can be rolled forward or backward or sorted by page. The unit will be available in mid-'67. SCIENTIFIC DATA SYSTEMS, Santa Monica, Calif. For information:

CIRCLE 115 ON READER CARD

program conversion service

Using its STAFF software package, this expanding service bureau organization is offering the conversion of existing programs written in FORTRAN IV to FORTRAN H for running on the 360's. The conversion software screens out statements that are incompatible or incomprehensible to the 360, and indicates changes that are required. ITT DATA SERVICES, El Segundo, Calif. For information:

CIRCLE 116 ON READER CARD

military computers

The 4 Pi line of three computers is said to be applicable to all military and space requirements. To customize for a particular application, a read-only memory is used to control the internal logic operation, thus obviating the rebuilding of logic circuitry. The series consists of the TC (tactical computer) for satellites, tactical missiles, helicopters and others. The CP (customized processor) is for avionics guidance and control and for mobile battlefield systems. EP (extended performance), for military and space applications requiring greater internal speed and capacity, is upward compatible with the 360/44. Memory cycle time of all three is 2.5 usec, instruction word lengths vary from 8-48 bits, and data words from 16-64 bits. IBM ELECTRONICS SYSTEMS CENTER, Owego, N.Y. For information:

CIRCLE 117 ON READER CARD

tape duplicator

The System 800 duplicates and verifies paper tapes from one through eight channels in any code structure at 120 cps. It will automatically verify or duplicate tape, or verify two tapes and perforate a third simultaneously. Errors can be corrected through use of a bit insert switch. It has five modes: duplicate, verify, verify/duplicate, bit echo/duplicate, and bit echo-verify/duplicate. TALLY CORP., Seattle, Wash. For information:

CIRCLE 118 ON READER CARD

lamp indicators

Two additions to the Replaceable Lamp Button-Lite series are the RBL-3 series, which has a spst momentary contact switch, and the RBL-4 series with a normally open, normally closed or spdt contact switch. They are available in 13 transparent and translucent button lens colors, and with legends. TRANSISTOR ELECTRONICS CORP., Minneapolis, Minn. For information:

CIRCLE 119 ON READER CARD

SYSTEMS FORMULATION & ANALYSIS ENGINEERS

For assignments in commercial on-line computer applications with emphasis on communications interface. Extensive experience required in hardware specifications and advanced systems, including multiprogramming and list processing. Requires B.S. in engineering, business or related field.

SR. SOFTWARE PROGRAMMERS

PROJECT ENGINEERS Computing Systems Peripheral Equipment Discs & Controllers

COMMUNICATIONS SPECIALIST

CIRCUIT DESIGN ENGINEERS

ELECTRICAL SYSTEMS LIAISON ENGINEERS

PACKAGING ENGINEERS (ALL LEVELS)

MECHANICAL DEVELOPMENT ENGINEER

RELIABILITY ENGINEERS

QUALITY CONTROL ENGINEERS

INDUSTRIAL ENGINEERS

EDP ANALYST

TEST EQUIPMENT DESIGN ENGINEERS

MEMORY DESIGN—RESEARCH

COMPONENT ENGINEERS

COMPUTER TECHNICIANS

SR. PRODUCT DESIGN ENGINEER

ARRANGE NOW FOR AN INTERVIEW IN YOUR AREA

Confidential interviews will be held soon in various parts of the country. To arrange an appointment, please send your resume, including experience, training and salary history, to Bill Holloway, Technical Placement.

digital systems

opportunities at NCR electronics division in los angeles

The National Cash Register Company

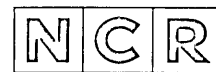

ELECTRONICS DIVISION
2837 W. El Segundo Blvd., Hawthorne, Calif.
Telephone: Area Code (213) 757-5111
An equal-opportunity employer

CIRCLE 302 ON READER CARD

BENCHLEY MUDDLES THROUGH AUTOMATION

do not
fold, spindle . . .

by PROGRAMMATICUS

The late Robert Benchley was noted for his sharp wit and his nimble pen. His series of "how to" short movies remain classics.

But Benchley came across best in writing, and this was especially so when he described his own exaggerated fears which were yet very human. His description of the mortal horror of going to the dentist remains as one of the world's most noble short essays.

The following manuscript was found upstairs in the bottom drawer of an old bureau, under some socks and papers.

Some years ago by a completely inexplicable process I overpaid my income tax by twenty-three cents. By return mail seventeen months later I got a strange document from the federal government. It bore some superficial resemblance to a check. It actually had the numerals \$00.23 printed on it, but these were difficult to find. The whole document was of an odd shape and size, was overprinted with a strange, light blue watermarking, and had a number of mysterious little holes eaten at the left. I suspected that some strange types of central African bookworm had chanced to infest the Government Printing Office and had eaten the holes.

This document was really quite frightening. Printed on it in huge letters were the words of a bold and cryptic warning: "DO NOT FOLD, SPINDLE, OR MUTILATE!" Of course I had no intention of folding or mutilating it. I was almost afraid to touch it. Since I did not know what "spindle" meant, I was afraid I might do this inadvertently.

I put this frightening document upstairs in the bottom drawer of an old bureau, under the paper which disguises the fact that the drawer boards are splintered somewhat. I tried to pretend that it had never come. Sometimes, though, I woke up in the middle of the night and would remember what I had done. In my mind's eye I could see it lying there under the paper, watching to see if I would spindle.

Once I even opened the drawer to see if it was still there but I could not bring myself to look under the paper. Instead I put some old socks over it so it could not get out. The socks were clean, but they did need darning.

Then, early last week, my crimes caught up with me. I got a very official letter from the Director of Internal Revenue asking why I had not deposited my refund. Without doubt the whole sordid story will now be made public, so I may as well face up to it.

Yesterday, quite by accident, I got some more insight into the whole question. I was on my way downtown to ask my attorney if there were any way to shorten my stay in Leavenworth for income tax finagling. While I was strolling along Madison Avenue I happened to notice some very large, colored metal boxes in a window. Some of the boxes had tiny flashing lights on them. Others had machines spinning inside. In the corner of the window a man was sitting at a desk. He was playing with a whole bunch of pasteboard rectangles, and they were all full of holes just like the ones in my mysterious document from the government.

I went around the corner into the building doorway to get a better look at the man playing with the little paste-

boards. Before I knew it I was in a queue of people lining up to go into the building, and I found myself being moved inexorably toward the lobby. Naturally I did not want to appear impolite by stepping boldly out of line, so I kept my place, wondering what great adventure awaited me. Actually, I hoped that I had inadvertently gotten into a line of people signing up for the draft, and that I would have to register and be sent immediately to training camp. After all, the government would look pretty silly sending a soldier to prison for income tax. They would at least have to wait till I got out, and by then they might have forgotten it.

But when I got in the building's lobby there were pretty girls in blue dresses busy assembling people into little groups. I decided this probably was not the draft board.

I was put politely into a group and we were led into the room where the big metal boxes stood. These boxes were really quite impressive close up. They seemed to make a steady quiet hum, and the ones with lights flashed continuously. One of the boxes would occasionally put forth an ear shattering clatter during which paper spewed out of it at an unbelievable rate. The man with the little pasteboards kept walking over to one small box. He put handfuls of these cards into the box. They were neatly stacked, and the box gobbled them up, one at a time, very rapidly. I presumed that this was some modern kind of incinerator, but there seemed to be no flame or smoke.

While we stood there politely, a man gave a speech which seemed to be about what the boxes were doing. I didn't understand much of it, but it seemed that a Dr. Watson or Weston had invented these boxes, and they were very useful for some purposes such as launching rockets or balancing bank accounts.

After half an hour or so we had looked at all the boxes and we were led back into the lobby again. The pretty girl in the blue dress gave each of us a set of booklets and papers. These were all covered with pictures of the boxes in color.

I went out the front door of the building through the crowd and down the street to the automat where I bought coffee and sat at a corner table to read the booklets the pretty girl had given me. I thought I might learn something.

I had looked at half the pictures in the first book when I noticed that there was a large envelope among the pile of materials. Of course I opened it immediately, since I am naturally snoopy. Inside there was a whole bunch of the mysterious pasteboards, all filled with holes!

I closed the envelope and put it back with the booklets. I left the automat furtively, turning my collar up and hoping no one had seen me. I was too disturbed to see my attorney. I took a cab straight home.

Last evening I built a fire and sat in front of it with a large brandy and soda. I tried to build up nerve enough to put all the things, including the one upstairs, into the fire and to pretend that I had never had them. Finally I decided such an action was so transparent I could never get away with it.

I don't know what the federal government will do with me, but however terrible it is, it is probably justified. I just sit here peeking out the front window curtains, waiting for the men from the FBI to drive up. I suspect it won't be long now. ■

introducing the balanced computer

Some computers emphasize computational speed. Others, flexibility. Still others, low cost. The new EAI 640 offers all three.

The balanced design of the EAI 640 assures high computer performance — in systems or for general purpose computation — at a price you'll find hard to believe.

Where else can you get all these features for under \$30,000?

1. 16-bit data word & memory protect
2. 1.65 microsecond complete memory cycle
3. Hardware multiply, divide and square root
4. 4K core memory—expandable to 32K
5. Teletype keyboard/printer
6. Paper tape reader and punch
7. 4 input/output channels

EAI 640

8. 4 interval timer interfaces

The balanced design of the EAI 640 means more computations per dollar.

The EAI 640 is not only a good, general-purpose digital computer, it can also be easily integrated into hybrid or special-purpose systems because of its extremely flexible I/O structure. Or it can be mated with scientific simulation systems, data acquisition/reduction systems, process control, and biomedical systems.

It's a truly versatile computer!

And we've balanced the powerful hardware with all the basic software: assembler, FORTRAN, loader, update and debug packages. We're also offering something unique for a machine in this class—the 640 Operations Interpreter, an on-line interactive language system specifically designed for scientists and engineers.

Full supporting services further balance the total system. They include special systems engineering, customer training, maintenance, and applications assistance with your specific problems.

Write for detailed information on its characteristics. Or better yet, contact your EAI representative. We think you'll find the balance is in your favor.



EAI® ELECTRONIC ASSOCIATES, INC.
West Long Branch, New Jersey 07764

Why Photocircuits' tape readers were selected for...

APOLLO
GEMINI
LEM
MINUTEMAN
TITAN II
SHILLELAGH
GSM 133
CENTAUR
DIMATE
LCSS
TEAMS

... because of the simplicity and reliability of the printed motor single capstan drive, with the electronic control of all tape movement. Troublesome, high-maintenance components such as pinch rollers, brakes and clutches have been completely eliminated.

The fully militarized 500RM was specifically designed as a military unit ... not a "beefed-up" version of a commercial tape reader. It has successfully passed mil specs, MIL-E-16400 Class 3, MIL-T-21200 Class 2 and MIL-T-945; tests for shock, vibration, RFI, altitude, salt, sand, dust and heat and cold.

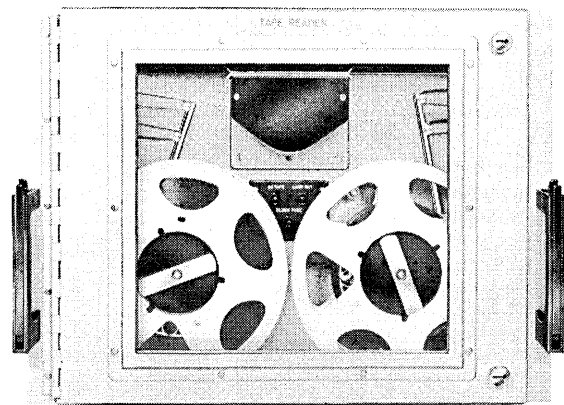

The 500RM reads bidirectionally at up to 1000 char/sec., has eight inch reels with proportional reel servos, accepts 5, 6, 7 or 8 level tape and has a MTBF of 5000 hours.

For full specifications on the 500RM, or on Photocircuits' complete line of commercial tape readers, contact: Photocircuits Corporation, Tape Reader Division, Glen Cove, N.Y.

Photocircuits
CORPORATION



TAPE READER DIVISION
Glen Cove, New York 11542

FROM THOMPSON — JUST PUBLISHED — TIMELY AS TOMORROW!

Computers and Pattern Recognition

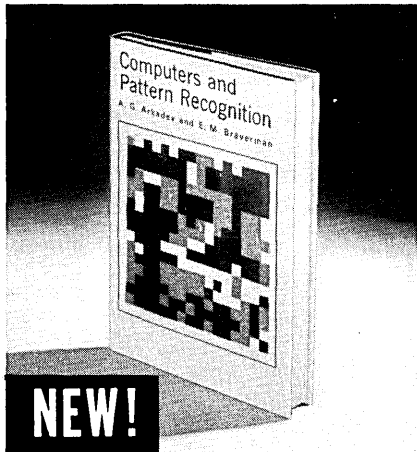

NEW!

from the U.S.S.R. — current work on pattern recognition and its relation to relevant research in the West...

by A. G. Arkadev and E. M. Braverman
(Translated from the Russian by J. D. Cowan and W. Turski)

This book fills an important need for up-to-date information about Soviet developments in a rapidly-growing field. The underlying assumption throughout is that images form "compact" sets in a suitable representative "space" whose "coordinates" are the distinct "features" of the patterns presented to the machine. The image-compactness hypothesis is used as a point of reference for the analysis of different designs for the construction of pattern-recognizing machines. The algorithms underlying two well-known Western machines, the PERCEPTRON and the PAPA are also discussed in terms of this hypothesis. **Contents include:** Dissecting Planes Algorithm; Algorithms Based on Potentials Method; Possible Ways of Further Improvement of Cognitive Machines.

125 pages, \$5.50

Numerical Analysis — An Introduction

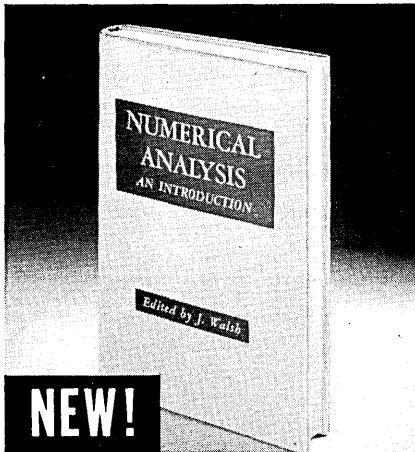

NEW!

for scientists, engineers and mathematicians — an introduction to developments of the past fifteen years...

Edited by J. Walsh, Dept. of Mathematics, the University, Manchester, England
(Based on a Symposium organized by the Institute of Mathematics and Its Applications, held in Birmingham, England)

Individual chapters in this book are largely self-contained. The account of theory and methods is sufficiently detailed for readers who want to go further to study the more advanced works listed in the references. Subjects covered include linear algebra and the eigenvalue problem, ordinary and partial differential equations, methods of approximation and function minimization, and some applications of modern techniques to industrial problems. A concluding chapter considers the effect of the growth of numerical work on teaching. **Contents include:** Applications of Computers to Pure Mathematics; Techniques of Operational Research; Computation in School and University Teaching. There are two complete indexes, one classified by subject, the other by author.

240 pages, \$12.00

Algebraic Number Theory

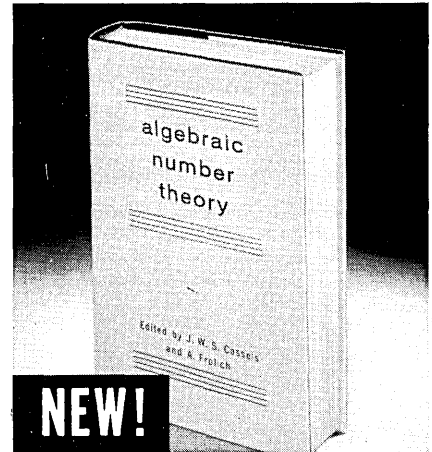

NEW!

for the non-specialist algebraist and number theorist — a grounding in contemporary basic theory

Edited by J. W. S. Cassels and A. Frohlich
(Proceedings of an Instructional Conference organized by the London Mathematical Society — a NATO Advanced Study Institute — with the support of the International Mathematical Union)

The opening chapters in this work give a broad introduction to algebraic number theory; followed by the elementary and utilitarian tools needed for class field theory. The section on class field theory should dispel forever the aura of mystery which has previously surrounded the subject. The emphasis throughout is on intelligibility; the reader who has mastered what is done here can approach the rest of the literature with confidence. The concluding chapter is Tate's thesis (Princeton, 1950), which has been seminal for later developments but was never published. **Contents include:** Cohomology of Groups; Zeta-functions and L-functions; Semi-simple Algebraic Groups; Applications of Computers to Class Field Theory; Fourier Analysis in Number Fields.

350 pages, \$16.00

Order yours today!

THOMPSON BOOK COMPANY

383 National Press Building
Washington, D. C. 20004

Please send me _____ copies of "Computers and Pattern Recognition" \$ _____
 Check _____ copies of "Numerical Analysis — An Introduction"
 Cash _____ copies of "Algebraic Number Theory"
 Money order Total \$ _____

Name _____

Address _____

City _____ State _____ Zip _____

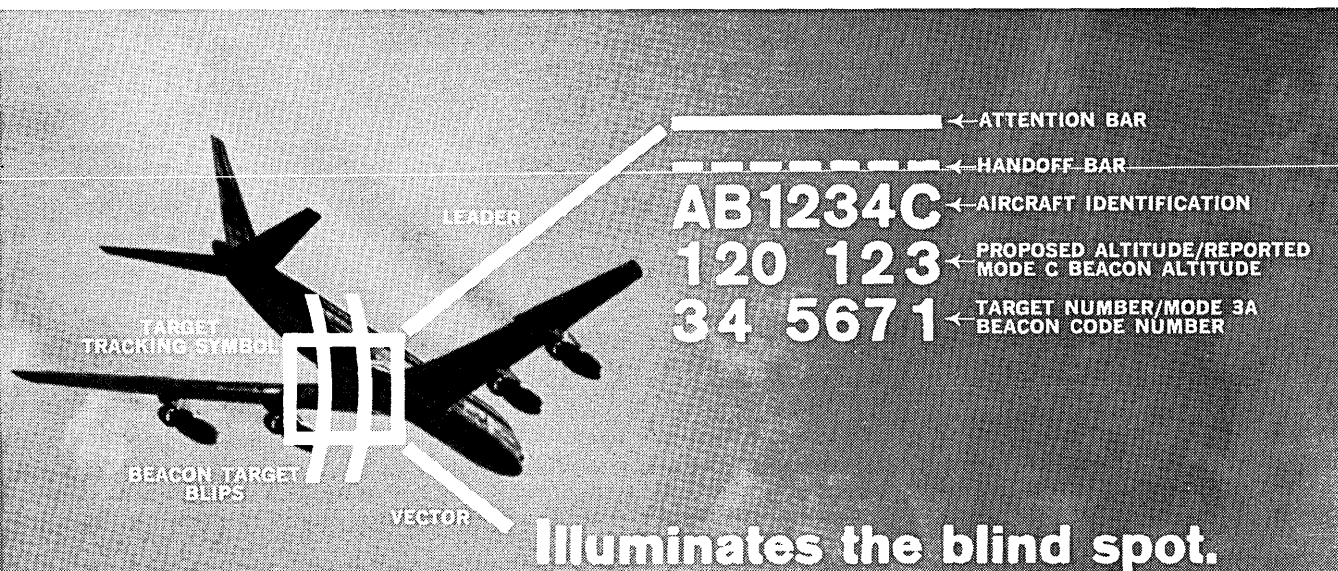

Lack of continuous and instantaneous altitude information has gone the way of the biplane.

An electronic Alpha-Numeric Generator system, developed by the Hazeltine Corporation and built around a Bryant Magnetic Memory Drum, enables air traffic control to "visually" pinpoint the altitude of every aircraft in their sector.

"Personalized" transponders in the aircraft continuously transmit a stream of vital information to the airport electronic control center. As it's processed, synchronization pulses in the drum release it in the form of a luminous block of reports—updated every 1½ seconds on the radar screen.

Because of the drum's large capacity, several radar screens, in many different locations, can be served simultaneously. Which means that a controller can literally "pass the airplane" to other controllers as the flight continues across country.

Hazeltine Corporation chose the Bryant drum for its reliability, dependable interfacing capability and low cost per bit. To find out how Bryant solves tough jobs in other fields write to 850 Ladd Rd., Walled Lake, Michigan 48088.

**BRYANT
COMPUTER PRODUCTS**



EX-CELL-O CORPORATION

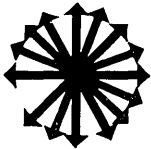

new literature

MEMORY CORE: History of development and product manufacturing facilities and capabilities are described in eight-page booklet. Memory planes and stacks for commercial, industrial and military requirements are illustrated. INDIANA GENERAL CORP., Electronics Div./Memory Products, Keasbey, N.J. For copy:

CIRCLE 140 ON READER CARD

TEACHING PROGRAMMING: Aided by magnetic tape, untrained personnel are taught how to program the NCR-500. Sixty hours of instructional material are made available to customers and prospects. Bulletin summarizes teaching novice programmers, analyzing complex computer applications, recording and duplication and advantages of taped lessons. AMPEX CORP., Redwood City, Calif. For copy:

CIRCLE 141 ON READER CARD

MICROCIRCUIT LOGIC MODULES: Described in eight-page catalog is 13-series microcircuit uni-cards based on the NAND logic system. Packaging density is achieved through use of a 62-pin connector which results in simplified wiring, fewer modules and low noise. Schematics show specifications for flip-flops, gates, decoders, diodes, drivers, multivibrators, specials and NANDS. CANOGA ELECTRONICS CORP., ADC DIGITAL PRODUCTS DIV., Chatsworth, Calif. For copy:

CIRCLE 142 ON READER CARD

DIGITIZED DRAFTING TABLE: Data sheet details features, four configurations in which tables are available, design criteria, specifications and prices. Table is designed to perform layout and drafting with numerical display, digitized drafting for punched tape or card, mag tape or on-line computer readout, automatic positioning from inputs, and I/O capability. DATA TECHNOLOGY, INC., Watertown, Mass. For copy:

CIRCLE 143 ON READER CARD

BIBLIOGRAPHY: Updated version of computers in medicine is 98 pages long and covers the following subjects: adp, analog and digital computers, cybernetics, data display feedback, in-

formation retrieval systems, information theory, operations research, punched card systems, statistics and systems analysis. MEDICAL LIBRARY, UNIVERSITY OF MISSOURI, Columbia, Miss. For copy:

CIRCLE 144 ON READER CARD

DATA ACQUISITION: Six-page booklet details the functions and applications of Dextir II, designed for industrial purposes. BECKMAN INSTRUMENTS INC., SYSTEMS DIV., Fullerton, Calif. For copy:

CIRCLE 145 ON READER CARD

HIGH SPEED PRINTERS: Four-page brochure describes MINITYPERS, designed for printing readout or any input code of up to 6 binary digits. Technical details are covered as well as illustrations of the 1200-lpm and 2400-

lpm 1 to 200 cpl printers. SHEPARD LABORATORIES INC., Summit, N.J. For copy:

CIRCLE 146 ON READER CARD

CURRENT DRIVER: Four-page bulletin describes mod 1720 intended for testing fast switching memory devices such as .012 O.D. ferrite cores, thin film, plated wires and ferrite laminates. Bipolar instrument has dual outputs, generates current pulses into sub-10/nsec region. COMPUTER TEST CORP., Cherry Hill, N.J. For copy:

CIRCLE 147 ON READER CARD

SIGNATURE ANALYZER: Brochure includes operational block diagram with specifications and a basic description of operation. Also detailed are the nature and usefulness of relay signature analyses, testing possibilities, and information displayed. ELECTROTEC CORP., Ormond Beach, Fla. For copy:

CIRCLE 148 ON READER CARD

RAILWAY SIMULATION: 19-page book details digital simulation of traffic flow with application to railway train movements. Reports initial investigation

URS needs data systems analysts, operations research analysts, military analysts, mathematicians, and systems and applications programmers.

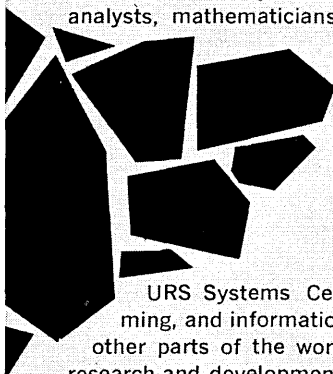

NO TWO JOBS ALIKE.

URS has grown for 15 years, and yet retains an environment in which the contribution of each individual is unique and important.

Individual effort comes first.

URS Systems Centers are engaged in system design, programming, and information processing operations in the United States and other parts of the world. (In addition, our Research Center performs research and development in the physical sciences and engineering.)

Are you currently engaged in systems design or programming in the following areas?

Simulation • Logistics • Management information systems • Computer programming aids, languages and applications

If you have such qualifications and are interested in a position offering professional growth and compensation based on your effort, send your inquiry or resume to:

URS*

CORPORATION

1811 Trousdale Drive Burlingame, California 94010

*Still known to some of our older friends as Broadview (BRC), United Research Services (URS), and various other aliases reflecting a spirit of experimentation. AN EQUAL OPPORTUNITY EMPLOYER—BY CHOICE!

CIRCLE 303 ON READER CARD



Now you can put a self-contained remote display console to work in your office for \$6,000.*

It's no longer necessary to buy — or rent — expensive multi-display control units to serve locations that only need 1 or 2 remote display stations.

The Raytheon Display Console, model 402, is the only low-cost equipment with its own control unit combined into the *same* package. And, because the 402 connects directly to a telephone dataset, there's no need for a separate interfacing console. Character generator, buffer memory, keyboard, telephone interface and power supply are all combined in one desk-top sized package which can be remotely connected to any general purpose digital computer.

The 402 can be easily moved from one location to another. Connect, and it's ready for quick-

response, on-line communication with regional offices, warehouses, or ticket offices. Ideally suited for remote computer time sharing applications.

If your problem is one of providing real-time access to computer-stored information from remote locations, send today for information about the new model 402 Display Console and other units in Raytheon's DIDS (Digital Information Display System) family. Write: *Manager of Industrial Sales, Dept. D 1266, Raytheon Company, Wayland, Massachusetts 01778. Or phone: (617) 358-2721 ext. 2911.*

*Rental prices available on request



new literature

into feasibility of simulating train movements in a gp computer using techniques developed for air traffic movements. Cost: \$1. U.S. CLEARINGHOUSE, Dept. of Commerce, Springfield, Va. 22151.

DATA COLLECTION: Four-page booklet describes how system is used by optical company to augment computer operations in production control, labor reporting, inventory and quality control. ADDRESSOGRAPH MULTIGRAPH CORP., Cleveland, Ohio. For copy:

CIRCLE 149 ON READER CARD

KEYBOARD SYSTEM: Features solid-state encoder, actuated by the keyboard switches which are similar to electric typewriter keys. For each key pressed, the encoder generates a corresponding code for entry into a computer, tape punch, information retrieval system or other data handling or display systems. All switch action occurs on the downstroke, allowing faster typing speeds. Brochure includes specifications and ordering information. TRAN-SISTOR ELECTRONICS CORP., Minneapolis, Minn. For copy:

CIRCLE 150 ON READER CARD

RANDOM-ACCESS MEMORY SYSTEM: With access and cycle times of 300 and 650 nsec, and storage capacity of over 1 million bits, 16,384 words of up to 84 bits. NANOMEMORY 650 is intended for real-time or high-speed computers and checkout systems. Covered in the 10-page brochure are selection techniques, I/O pulses and levels, electrical characteristics and timing requirements, timing and worse case power consumption charts, self-test capabilities and a functional diagram. ELECTRONIC MEMORIES INC., Hawthorne, Calif. For copy:

CIRCLE 151 ON READER CARD

INTERFACE UNITS: 28-page brochure describes how off-the-shelf components can be used to interface external analog and digital devices to SDS's Sigma 2 and 7. Included are functional descriptions of model 7914 analog input controller, model 7910 analog output controller, model 7922 analog and digital adapter, model 7929 8-bit I/O channel digital controller, digital I/O subsystem, frequency control subsystem and model 7900 device sub-controller. SCIENTIFIC DATA SYSTEMS, Santa Monica, Calif. For copy:

CIRCLE 152 ON READER CARD

Programmers — You only get one chance to pioneer a new technology...

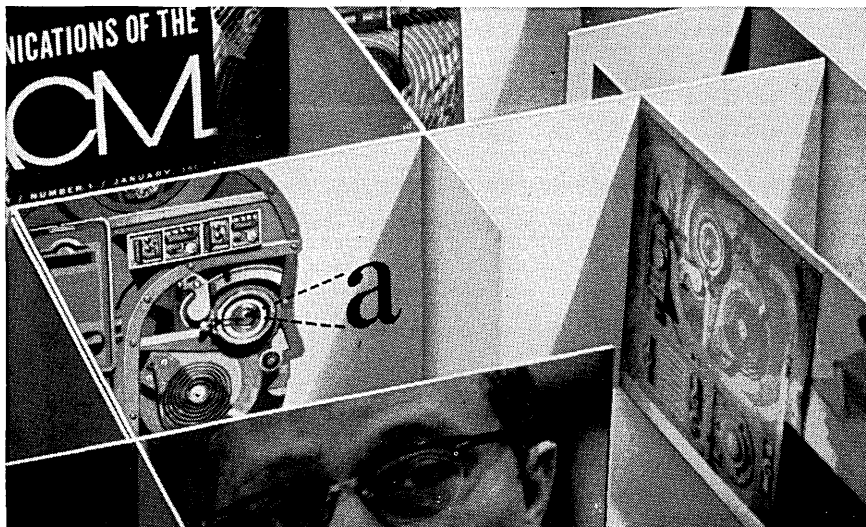

RCA GRAPHIC SYSTEMS DIVISION

Do you want to start at the beginning—the *ground floor* of a whole new area of technology—the “communications explosion” in graphic arts? The field of recording and reproducing graphic and textual information.

A field that brings together electronics, optics, photochemistry, electrostatics, mechanisms and data processing for ingenious new concepts that will revolutionize graphic reproduction.

In this new RCA division, you will have the opportunity to prove your creative ability, to test your imagination and to advance with a new and growing technology.

Openings exist at all levels for those who have a minimum of two years programming experience. Experience should include assembly language programming on binary computers, real-time or diagnostic programming, and experience in the development of systems software. A BS degree in engineering, mathematics or science is desirable. Experience in the Graphic Arts would be helpful, but is not necessary. If you are interested in this ground-floor opportunity, send a complete resume to:

Mr. E. V. Ward, Dept. **GS-7**
RCA Graphic Systems Division
U. S. Highway No. 1
Princeton, New Jersey 08540

An Equal Opportunity Employer M & F



The Most Trusted Name in Electronics

CIRCLE 304 ON READER CARD

SENIOR LEVEL OPENINGS FOR PROGRAMMERS SYSTEMS ANALYSTS

Smith Kline & French Laboratories, a leader in the rapidly growing health industry, has several outstanding opportunities for experienced (1-5 years) data processing personnel. All positions are located at our Philadelphia headquarters and offer liberal starting salaries plus excellent prospects for personal growth. For further information please send a complete resume, including current annual earnings, to:

WILLIAM G. EVANS, JR.

SMITH KLINE & FRENCH LABS

1514 Spring Garden Street
Philadelphia, Pa. 19101



An Equal Opportunity Employer

CIRCLE 330 ON READER CARD

MANAGER SYSTEMS AND EDP

Connecticut

One of our finest client companies is a manufacturer of electromechanical equipment for commercial markets and the most long-range aerospace programs. This multi-division firm, growing fast in the \$100 million area, requires a man to direct the systems and data processing function in most of its domestic operations.

The man we seek has fully managed systems planning and data processing with applications to production control, project management and accounting. He has personally programmed in earlier years but is now earning in the \$16,000-\$18,000 range. He is well organized, delegates easily, and deals effectively with other managers.

This is an outstanding opportunity for professional growth with an organization that is building a brilliant future. If you would like to explore it in confidence, write or send a resume of your background, including present earnings, to Henry D. Vezan.

VEZAN-WEST & COMPANY

Management Consultants
1000 Farmington Avenue
West Hartford, Conn. 06107

CIRCLE 306 ON READER CARD

PROGRAMMERS

GO WITH
THE ACTION

TRW DIVERSIFICATION AND GROWTH MEAN UNLIMITED CAREER OPPORTUNITIES EXIST FOR ENGINEERS DESIRING COMPUTER-ORIENTED PROFESSIONAL POSITIONS.

AT TRW SYSTEMS SPECIALISTS IN PROGRAMMING ARE ACTIVELY ADVANCING THE APPLICATION OF COMPUTER TECHNOLOGY TO UNDERWATER DEFENSE SYSTEMS, GEMINI AND APOLLO MISSION PLANNING AND ANALYSIS, ADVANCED BALLISTIC MISSILE STUDIES, ADVANCED SPACE PROBES, MARS STUDIES AND SPACE COMMUNICATIONS SYSTEMS.

(OPENINGS IN
LOS ANGELES,
HOUSTON
AND
WASHINGTON, D.C.)

SCIENTIFIC PROGRAMMERS—To assist in solution of problems arising in missile and space vehicle engineering and underwater defense systems. Will be responsible for analysis, programming and debugging of computer solutions. Positions require technical degree and experience in programming high speed digital computers.

DATA SYSTEMS ENGINEERS—To perform requirements analysis, system design, comparative evaluations and selection of elements for computer-based systems used in acquisition, recording and processing telemetry and instrumentation data. Software familiarity desirable. Technical degree and experience with on-line computers and system components required.

SYSTEMS PROGRAMMERS—To develop and/or modify control programs, i.e., supervisors, monitors, loaders, etc., for large-scale computing systems. Background in multiprocessors and multiprogramming desirable. Degree and related experience required.

PROGRAMMER ANALYSTS—To design and implement system and user oriented time-sharing programs in such areas as higher level language syntax checking, text editing and specialized compiling. Technical degree and related experience required.

REMOTE DATA SYSTEMS PROGRAMMERS—To develop software for remote operating systems and data management systems to allow time-shared remote information retrieval. Degree and experience in data management studies, information retrieval, time sharing or graphics.

TRW SYSTEMS
AN OPERATING GROUP OF TRW INC.

ONE SPACE PARK • REDONDO BEACH, CALIF.

TRW is an equal opportunity employer

SUBMIT RESUME IN CONFIDENCE TO J. R. ADAMOLI, DEPT. R-12

CIRCLE 305 ON READER CARD

IEEE WORKSHOP ON MULTIPROGRAMMING

 The IEEE Computer Group has often been criticized in the past for its inattention to programming. Many of these vocal critics should be hushed by the IEEE Workshop on Multiprogramming held in Lancaster, Pennsylvania in October. Over thirty attendees—18 authors of papers, three panel members and invited guests—attacked the subject and each other with startling vigor. Workshop chairman Joseph A. O'Brien of Adams Associates succeeded in attracting a well-diversified group of system and hardware designers, managers and users.

The tone of the session was set by the opening remarks of Jack Dennis of Project MAC, who carefully delineated the differences between the dedicated system, the general-purpose batch systems, and the true time-sharing systems developed up to this time. He suggested that there were certain "universals" for the future, such as:

- multi-programming is here to stay and is, in fact, the normal operating mode of the future.
- the one-level store notion advanced in ATLAS is becoming effective with the development of page and segmentation schemes.
- it is essential that users be able to recursively combine programs of their own and others to an arbitrary depth.

Dennis then went on to suggest that we are developing a set of "new incompatibilities." For the first time we have reached a position where many users will work in the same language, but the operating systems have become so different that we are no better off than we were in the past.

The often-postulated theory that the era of the special-purpose computer is over drew a surprisingly vigorous dissent from Ted Kallen (IBM) among others. The group agreed that the cost of hardware was rapidly declining, but there was no agreement that this would make special-purpose computers outdated. It was pointed out that the cost of software develop-

ment is increasing incrementally and that therefore special-purpose computers, although cheap to buy, would not be properly supported. The proponents of dedicated transaction systems and process control computers were essentially exempted from the discussion as most present concluded, albeit rather reluctantly, that general-purpose software now in use would not do the job for this class of user.

When the computer users came to bat, their experiences and backgrounds were so diverse that their shots flew in all directions. Nevertheless, they all agreed that the best sort of multiprogramming was that which the programmer did not see, i.e., that the paging was done unbeknownst to him. Furthermore, all the users seemed to agree that it was intolerable to permit one program to interfere with another. J. Bouvard (Honeywell) pointed out that up to now all multiprogramming systems have been designed to optimize the productivity of the hardware through encouraging a competitive scramble for resources while the direction of the future ought to be some attempt to increase user productivity by improving the response of the system to the user. Both Carl Fluke (Ling-Temco-Vought) and Burt Neff (Metropolitan Life Insurance) reported on their experiences with the Honeywell H-800 with multiprogramming hardware. These men made it very clear that multiprogramming as a way of life was here to stay. Although they expressed varying degrees of satisfaction with the system, having hardware switching does make multiprogramming far less difficult for the user.

One of the problems which continually popped up during the sessions was that of techniques for checking out a multiprogramming operating system. Although most systems in the past were checked out by being run until a blow-up occurred, it was pointed out that this simply wouldn't work in view of the trend toward more complex software. Clark Oliphint (RCA) suggested that we need com-

bined hardware-software monitors to obtain data during system runs, particularly during the pre-release stage. An opposing view toward the same end was presented by Dave Dahm (GE) who suggested the idea of reproducibility so that those responsible for the system could get a good look at the problem. The possibility of nested operating systems—using one system to check out a later version—was briefly examined although no real conclusions were reached.

Any discussion of multiprogramming would not be complete without a discussion of resource allocation. Led by Peter Neumann (Bell Laboratories), who noted the problems of allocation of storage, processor and I/O facilities, the discussion ranged over the whole field. Bob Daley (Project MAC) presented a possible approach to giving the user "infinite" storage facilities without the user being aware of where the actual data really is located. He projects a system in which the user need know only the name of the data he needs. Mel Pirtle (Univ. of California) indicated that some of the problems in the design of a time-sharing system could best be solved by a soldering iron appropriately applied. Pirtle suggests that in a small time-sharing system the balance between the speed of the random access device and the main memories must be carefully explored if the system is to attain any measure of efficiency. Les Belady (IBM Research) described the rarely reported M44 system which was an early IBM experiment in hardware paging. His historical data showed considerable evidence of the trade-offs of the various paging algorithms and the way in which they react when varying page sizes are applied.

Transaction systems and a dedicated system for medical data processing were described by Ron Batman (Univac), Bill Watso (Westinghouse), George Trimble (CUC), and Gary Breitbard (Stanford Univ.). All the described systems were quite different but the common thread was the systems' dedication to the task at hand even to the point of turning off all other users when the primary user was running.

Ben Cheydleur (Ford), in attempting to sum up this talkathon, noted again that Jack Dennis and his set of universals were the stars of the workshop. Cheydleur applauded the attempts of various groups to measure systems effectiveness through simulation and live data. He also spoke favorably of the interest in multiprogramming which is apparently growing among most users.

—PHILIP DORN



PDP-10 hardware is coming ... PDP-10 software is already here

PDP-10 system deliveries begin September 15, 1967, yet the software is complete and customer-proven *right now!*

Hardware and software are an integrated package. You can start with the Stand-Alone PDP-10/10 and easily expand to the more powerful Multiprogramming/Swapping Time-Sharing PDP-10/50 without discontinuity — no re-programming, no equipment trade-ins.

What can the 1.0 μ sec 36-bit PDP-10 do for you? Real time on-line data collection and analysis.

Scientific computation. Time sharing and batch-processing . . . all simultaneously if you wish. And more, much more.

Prices . . . a breakthrough \$110,000 for PDP-10/10 with 8,192 words of memory, to \$336,100 for PDP-10/50 with 32,384 words (expandable to 262,144 words — directly addressable)!

PDP-10's nearest competitor costs 50% more . . . Think about that.

Now write for further information.

DIGITAL EQUIPMENT CORPORATION, Maynard, Massachusetts 01754. Telephone: (617) 897-8821 • Cambridge, Mass. • New Haven • Washington, D. C. • Parsippany, N. J. • Rochester, N. Y. • Philadelphia • Huntsville • Pittsburgh • Chicago • Denver • Ann Arbor • Houston • Los Angeles • Palo Alto • Seattle • Carleton Place and Toronto, Ont. • Reading, England • Paris, France • Munich and Cologne, Germany • Sydney and West Perth, Australia • Modules distributed also through Allied Radio

Circle 54 on Reader Card

digital
COMPUTERS • MODULES

world report

TIME-SHARING CATCHES ON

Throughout Europe the rush to time-sharing has gathered tremendous momentum. Systems are popping up at a great pace in almost every country. Among those being finalised is a multi-access project for Paris Univ. understood to be based on an NCR-Elliott 4130 processor and Cram units. It will form the computing capacity for a school of computer science to do systems and software development and post-graduate education. In the U.K. one of Europe's largest mail order organisations, Great Universal Stores, is moving toward an integrated management information system based on 360's and on-line displays for management interrogation purposes; the latter are expected to be Raytheon units.

But the biggest commercial scheme settled recently has been with CEIR Ltd in the U.K. — backed by British Petroleum money — who have plumped for a 360/67 with plans for 400 terminals in client offices. Ultimate investment by CEIR is estimated at \$8 million, and customers will rent terminals at \$700 a month. CEIR sees the bulk of the demand coming from users needing high-speed turnaround, chiefly scientific, general engineering design and civil engineering work, with some short-run commercial jobs. Managing director Kendall expects CEIR to write the bulk of the software for the system.

OCR-B OPTICAL FONT GETS BIG VOTE IN U.K.

In a thoughtful mood two years ago, one of the U.K.'s Ministry of Technology computer kingpins said at the local JCC that the trouble with standards was that they were either too early or too late. Now one of the largest user groups over which he exercises considerable advisory influence has taken courage in both hands and plumped for an optical character standard on the OCR-B font now being formulated as an ISO recommendation.

In a "public declaration of intent" the U.K. EDP Committee for Nationalised Industries has given manufacturers early warning, for once, of the machines they are likely to buy for automatic document handling in the future. Britain's nationalised industries include the largest employers of labor in the country and as a user group have the largest number of machines installed. The list includes the National Coal Board (number one employer), the gas and electricity public services, the Post Office (which includes telephones), British Railways, the state airlines, BEA and BOAC.

Adoption of OCR-B must be the cue for every other organisation in the U.K. to give some serious thought to their dp standards — which could be unfortunate since the commercial stock-holding banks plumped as a body for E-13B shortly after American Bankers did. Acceptance of the OCR-B standard might be interpreted by some as gentle pressure from the government to encourage commerce and industry to look more favorably upon the new state banking Giro system being established by the Post Office.

(Continued on page 95)

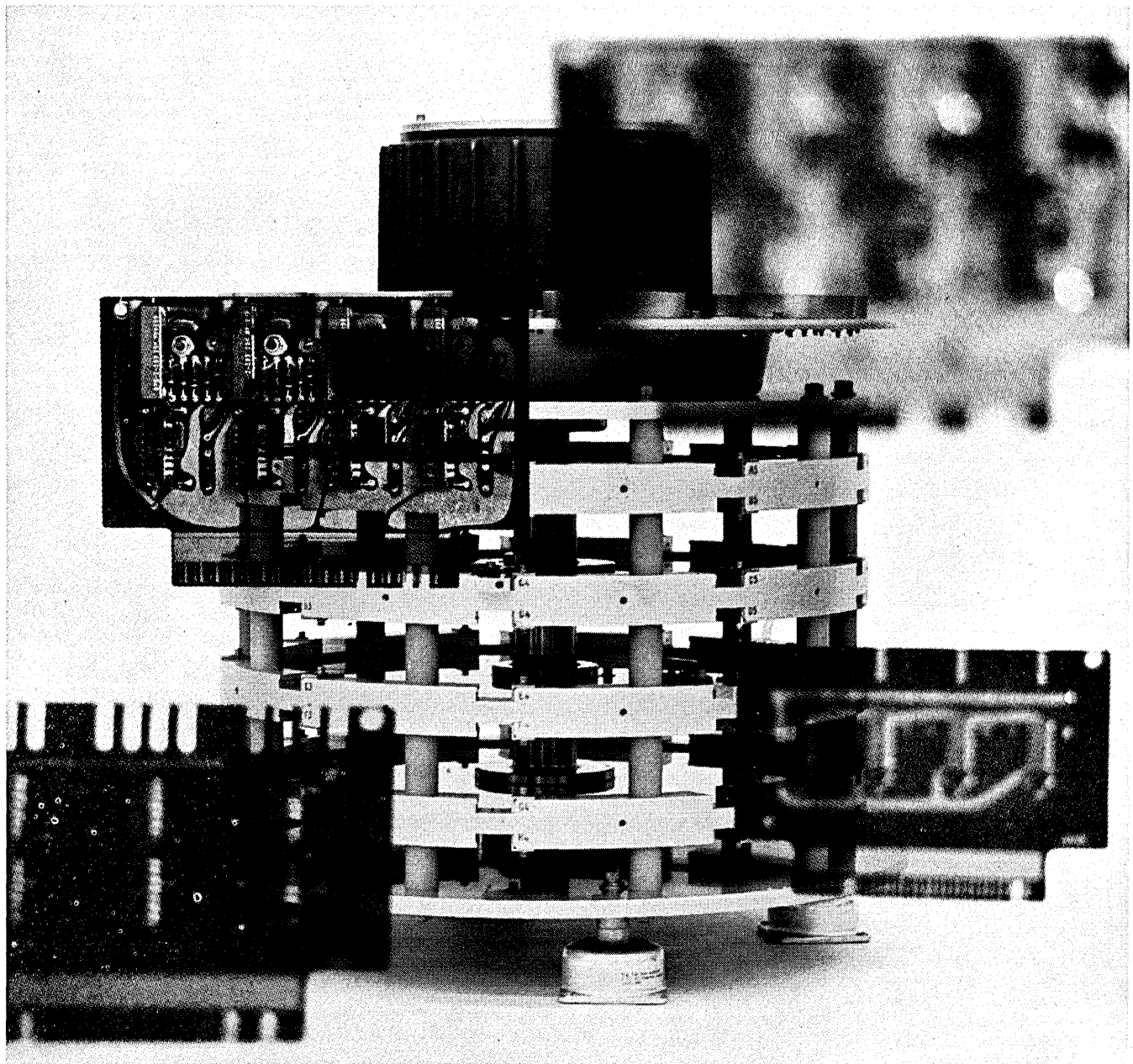

DISC MEMORIES ...? INTEGRATED CIRCUITS ...? 10 MEGABITS...? ?

Magne-Head Integrated Circuit Disc Memories with memory capacities from 100K bits to 10 Megabits are available with data transfer rates up to 2 Megacycles. The system interface is +5v. Power Nand DTL. The Magne-Head Integrated Circuit Disc Memory system offers modular growth from 100,000 to 10,000,000 bits. For information on any or all of our high-performance Magnetic Memory Components, write or call today. Write for: free TYPICAL DISC SPECIFICATION BULLETIN.

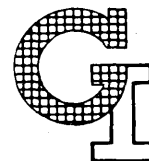

MAGNE-HEAD a division of General Instrument Corp.

13040 South Cerise Avenue / Hawthorne, California 90250 / 213 679-3377 / 772-2351 / TWX 910-325-6203

world report

(Continued from page 93)

AUSSIES PROJECT GROWTH, SEE GE TURN DOWN CONTRACT

General Electric, awarded the plum \$1.6-million contract to supply two 615's to the Australian government, has turned the award down. They say they're too busy filling orders for 600's to meet the delivery and back-up requirements ... The number of computers in use in Australia is expected to increase from the current 400 to between 1,200 and 1,400 by 1970, a government committee has reported. Conservative estimates suggest that while only 1,000 trained people were available this year, about 12,000 would be needed by 1970, and the demand would increase by about 1,500 a year between 1969 and '76. The government's own requirements would be for 1,500 programmers by '70, compared with 450 employed now.

T-S PROCESSORS BOW IN JAPAN

The first time-sharing systems in Japan were shown last month at the Electronic Computer Show. They are the Nippon Electric NEAC 2200/400 and Fujitsu's FACOM 230/50. This month, the first nationwide t-s system is due to be put on the air by Osaka Univ. and Nippon Electric. The NEAC 2200/500 will be linked to terminals on campus and to two Nippon Electric plants by a 1200-baud transmission line.

At Tokyo Univ. last month, the nation's largest and fastest processor went operational. The HITAC 5020E by Hitachi is said to be four times faster than its predecessor, multiplying two 32-bit words in 1 usec.

UNIFORM RAILROAD CODE ADVANCES CONTINENT RAILROADS

The railroads of Continental Europe are fast approaching an identification system to cover the movements of rolling stock in all the interlinked rail networks. France is furthest ahead: the national SNCF has Univac 1108's and 418's working out this problem. But the international scheme became feasible for Western Europe last year when International Union of Railways (UIC) agreed on a standard 12-digit marking for all rolling stock.

Big problem in designing a tracking scheme has been the development of a cheap identification unit that can be used on millions of freight and passenger cars. Trials in France and Holland indicate that an automatic inductive system is the answer, a technique that SCNF has successfully applied. Basically the inductive equipment comprises a small transmitter bolted onto wagons, and a trackside transmitter-receiver that picks up signals as a train flashes by at up to 100 mph. Most of the equipment coming into use was devised jointly by Philips Research Laboratories (Eindhoven) and Spootweg Sein Industrie (Utrecht).

BITS & PIECES

The French pensions and retirement benefits organisations will be installing a \$1 million ICT 1904 ... The French Navy has ordered two Pallas computers from the Compagnie des Compteurs for automatic message switching ... Hoover Electrical Appliances is building a worldwide dp system with 360's linking all of its manufacturing and sales offices and is preparing to use satellite communications for data transmission between Europe and the U.S. when facilities are available ... An Anglo-American venture for undertaking the study, analysis and systems management of defence programmes has been set up by Hawker Siddeley of the U.K. and Allied Research Associates of Concord, Mass.

BENSON-LEHNER BREAKS THE ON-LINE PLOTTER BOTTLENECK...

and reduces
computer plotting
time up to 50 times



CARD INPUT DELTA INCREMENTAL PLOTTER

INEXPENSIVE OPERATION...

use computer as a computer, not as a plotter input device

EXPANDABLE...

on site up-dating to magnetic tape or multiplexing

NEW USERS...

off-line as well as on-line

IMMEDIATE DELIVERY...

Hardware and Software... 360/1108/SPECTRA 70

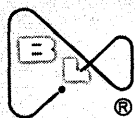

benson-lehner corporation 14761 CALIFA STREET, VAN NUYS, CALIFORNIA • 781-7100

washington report

FEDERAL SERVICE BUREAUS, USE OF OTHERS STUDIED

An edp service center for federal agencies in and around Slidell, La., is being considered by the General Services Administration (GSA) and NASA. They meet in January to discuss the project, which is now little more than a rough proposal. Meanwhile, a GSA-BOB-Commerce Dept. evaluation of a pilot service bureau at NBS is nearly finished; it will show that in-house service centers can profitably provide technical services as well as machine time.

This news may convince Congress to provide funds for a nationwide system. The nucleus would be large dp centers now operated by the Air Force, Navy, Internal Revenue, and other federal agencies. GAO already has begun studying their possible conversion to service bureaus, and hopes to have a report out by next summer.

A related GAO study aims at simpler processing of government data received from business firms. One tentative idea is to pay private service bureaus a fee to consolidate their clients' government reports and then submit the data to Uncle Sam on cards or tape.

UPCOMING: THE COMPUTER AS POLICY COORDINATOR

The hottest edp-related issue of the 90th Congress may be the computer's role as a policy coordinator. Last session, Sen. Ted Kennedy introduced a bill (SJ Res. 187) to study whether a computerized information retrieval system can give local, state and federal officials needed data about federal aid programs. This measure, together with another (S3509) establishing an umbrella-type agency to mesh related aid programs and reduce red tape, was the focus of a hearing last month by the GovOps subcommittee.

BOB director Charles Schultze, a witness, seemed far less confident than the Senators that the agency-computer approach — even if carefully engineered — could supply all the needed coordination. He suggested that the problem has to be better defined first, adding he was sure demographic and economic data needed by local officials can be computerized, and maybe "the business of what federal programs are available." Schultze agreed to give the subcommittee a written report, later, elaborating his views on present and future applications of dp equipment in the administration of federal aid programs.

THE FCC AND ON-LINE SERVICE BUREAUS

There's reaction to the impending FCC probe of on-line service bureau charges. "The basic problem is to make sure everyone pays the same unit communication charge for on-line data processing services," says CEIR president H. T. Robinson. FCC can regulate the communication part, he adds, without regulating dp charges. Others say that even if transmission rates are equal, small users will prefer the on-line to the pickup-delivery service (because of extra security and convenience, rather than time-saving) ... IBM is rumored planning a nationwide microwave dp service net ... An informed guess is that on-line dp will be a \$1-billion-plus business by 1970.

DP REVOLVING FUND: IN OR OUT?

It could be that the dp revolving fund set up by the Brooks Bill has been resurrected. From a supplemental 1967 appropriation bill, the Budget Bureau knocked out a request for \$10 million to launch the fund; this request was reportedly added at the last minute to the proposed fiscal '68 budget sent to the White House.

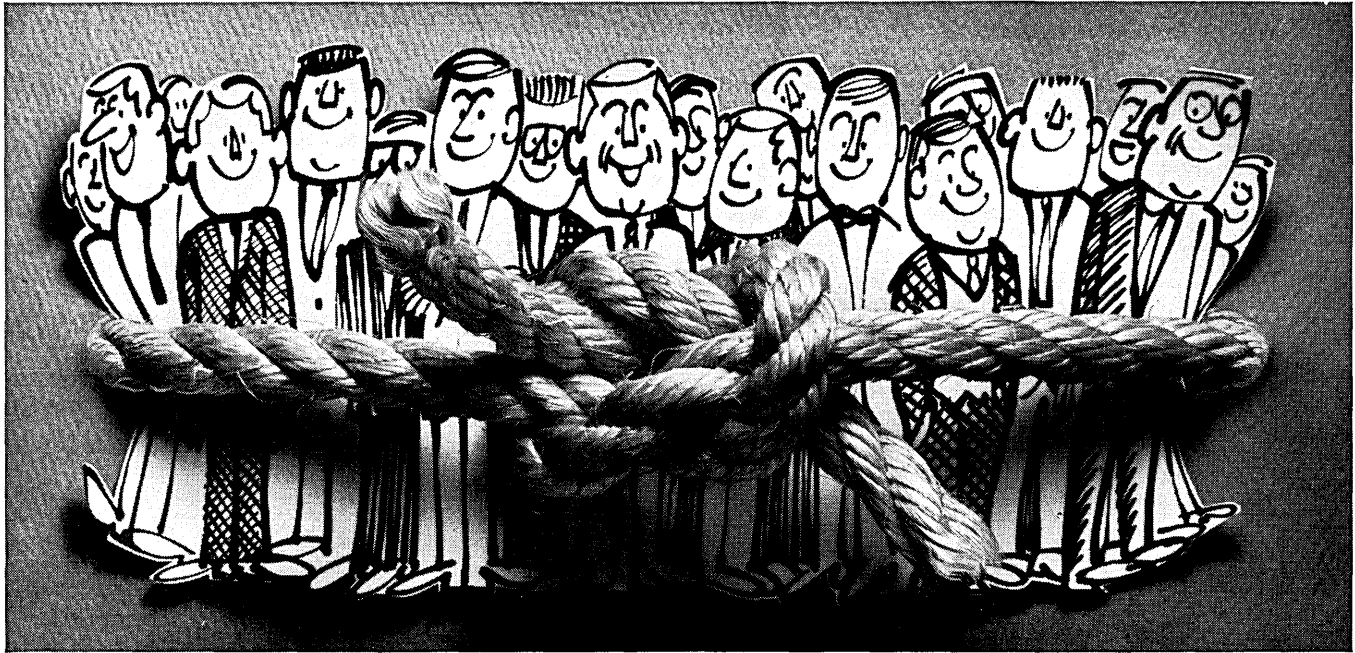

**Systems programmers rarely leave RCA.
We keep them with challenges, recognition, advancement,
rewards, satisfaction, and pleasant working conditions.
Join us.**

We offer them a chance to really *do* something.

More opportunity. Greater challenges.

A variety of projects with definite goals.

A say in hardware design.

And the salary to go with it.

Why should they leave?

Why shouldn't you join?

Write to us if you've had experience in language processors, operating systems, utility systems or communications systems.

We also have openings in Sales, Field Systems Sup-

port, Product Planning and Engineering.

Contact Mr. E. B. Schultz, Dept. SW-17, RCA Electronic Data Processing, Bldg. 202-1, Cherry Hill, Camden, New Jersey 08101.

An Equal Opportunity Employer M & F



The Most Trusted Name in Electronics

APOLLO/GEMINI:

*The challenge
of working on
the frontiers
of knowledge.*



Dr. G. F. Taylor,
Director, Information Processing
Houston Aerospace Systems Division
Lockheed Electronics Company

It's literally true today that you have the option of personally making an original contribution to man's flight to the moon and beyond. The tasks involved are so formidable they constitute the most stimulating challenge to programmers and analysts that I know of; to meet it we at the NASA Manned Spacecraft Center have at our disposal one of the largest and most modern selections of information processing equipment in the entire world. There's a career opportunity for you here that simply cannot be equalled anywhere else. And this applies whether your field is scientific or business processing.

In the area of scientific and engineering programming and analysis functions, we're dealing with state-of-the-art technical requirements. We cover the full spectrum of the Apollo aerospace technical disciplines from trajectory simulations to thermal and structures analysis and programming. We encourage our engineers to program—and our programmers to engineer. Analysts and high speed digital computers are inseparable.

A particularly challenging responsibility is the detailed "bit by bit" simulation of the Apollo Guidance Com-

puter, along with its mission environment. This particular simulation results in extremely accurate information on all phases of an Apollo flight, including the trajectory, control and propulsion systems, navigation, boost, re-entry and guidance systems. We're working on the very frontiers of knowledge here, and you may supply some of the answers we're looking for.

The many non-standard business data processing applications at the Manned Spacecraft Center are comparable in fascination. Preparation of Gemini flight plans is somewhat like reading a TV script well in advance. Configuration Management acquires its true meaning and significance when it is used to control the numerous contractors of the Apollo program. A unique application on a specially-designed computer analyzes transducer tests and feeds results to remote sites on a real-time basis. And a study for the complete automation of the Manned Spacecraft Center library is underway—as is one of the world's largest information retrieval systems for the Apollo program.

Seven complete systems, incorporating large, third-generation digital and

hybrid computers, are helping us perform our responsibilities to NASA today. More are on the way.

If these challenges intrigue you—if you want to be at the career center of man's expansion into space—then we want you on the Lockheed team where personal contribution is the chief responsibility.

Your work in Houston will permit you to undertake evening graduate courses through the doctorate level if you desire. And family living is unsurpassed. A magnificent community with fine schools, sailing, fishing, golf and attractive homes has grown up around the Manned Spacecraft Center. Theaters, museums and all the other cultural and entertainment advantages of a large metropolitan area are a few minutes drive away in Houston.

If you are a programmer, analyst or operator, drop me a note today outlining your experience and qualifications, or, if you prefer, telephone collect to my associate, Mr. R. K. Glasgow at (713) HU 8-0080. We will be glad to supply you with whatever further information you may wish to have.

Lockheed

Electronics Company

A Division of Lockheed Aircraft Corporation

16811 El Camino Real, Houston, Texas

An equal opportunity employer

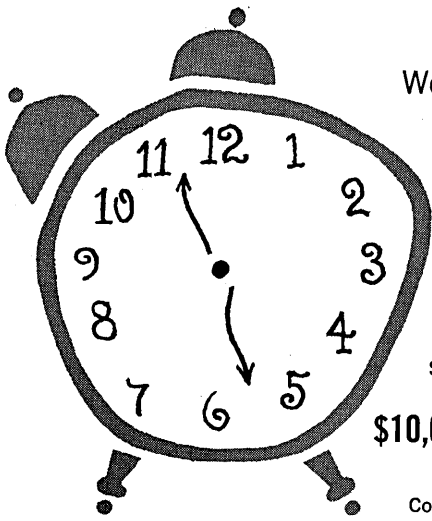

We can save you
real time
 to get that
 BETTER
 position

PROGRAMMERS
 SYSTEMS ANALYSTS
 MANAGERS
\$10,000 to \$50,000
 Finest Coast-to-Coast
 Clients
 Companies assume fees

Send Resume with Coupon in complete confidence to nearest R-H office.

ROBERT HALF PERSONNEL AGENCIES

World's Largest Financial & Systems Placement Service

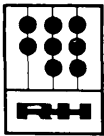

Baltimore: One Charles Center
 Boston: 80 Federal St.
 Chicago: 333 N. Michigan Ave.
 Cleveland: 1367 East 6th St.
 Detroit: 1114 Guardian Bldg.
 Los Angeles: 3600 Wilshire Blvd.
 New York: 330 Madison Ave.

Newark: 570 Broad St.
 Philadelphia: 2 Penn Center
 Pittsburgh: 429 Forbes Ave.
 St. Louis: 1015 Locust St.
 San Francisco: 111 Pine St.
 Stamford: One Atlantic St.

NAME _____

ADDRESS _____

WILL YOU RELOCATE OUT OF TOWN? _____ WHERE? _____

PRESENT EARNINGS? _____ SALARY REQUIRED? _____

CIRCLE 310 ON READER CARD

DEFENSE SYSTEMS PERSONNEL

*"To the members of the old gang
 wherever you are"*

KAP KAPPLER

*is doing it again
 taking a new approach to the old job*

THERE'S ROOM AT THE TOP

We will need:

Department Managers	Operations Researchers
Branch Managers	Programmers
Group Heads	Engineers
Section Heads	Human Factors

INSURE YOUR FUTURE

Send your resume

(It need not be neat, we will retype it)

*"All replies will be held in the strictest confidence to protect
 the innocent."*

INFORMATION SYSTEMS COMPANY

1111 WILSHIRE BOULEVARD
 LOS ANGELES, CALIFORNIA 90017

An Equal Opportunity Employer Both M & F

CIRCLE 309 ON READER CARD

• advanced systems programming research • planning, development & support of software • user liaison, education & services • documentation

PROGRAMMERS

We Wondered Whether . . .

- **YOU WERE AWARE OF OUR EXPANSION PLANS . . .** ground has been broken for a new building needed to house the dual processor IBM S/360 model 67 (late 1967) and the significant expansion in activities planned to more fully meet the computational needs of MIT and the other cooperating New England colleges.
- **YOU MIGHT BE INTERESTED . . .** that this expansion means a variety of new projects and research programs are starting which require a tremendous increase in our staff at all levels and provide a real opportunity for professional growth.
- **YOU HAD THESE QUALIFICATIONS . . .** minimal requirements—a degree & more than one year of experience in the above areas.
- **YOU HAD CONSIDERED . . .** that MIT offers a liberal benefit program including educational opportunities at the Institute as well as competitive salaries.

We invite your inquiry. Please forward your resume, including salary information to:
 Mr. Robert Nelson, Personnel Dept. (Bldg. E 19-285)

MASSACHUSETTS INSTITUTE OF TECHNOLOGY
 77 MASS. AVE., CAMBRIDGE, MASS. (617) UN 4-6900 (EXT. 4275)



COMPUTATION CENTER



An equal opportunity employer

CIRCLE 311 ON READER CARD



books

Introductory Computer Programming, by Fredric Stuart, John Wiley and Sons, 1966, \$5.95.

It is difficult to determine just who could use this book profitably. The generalized title, *Introductory Computer Programming*, is rather misleading in that roughly three-quarters of the book is devoted to NCE FORTRAN, and one-quarter to AFIT FORTRAN with statistical problems and appendices filling up the rest of a slim volume. The book is aimed at a group of people that includes engineers, psychologists, economists, accountants and others who use statistics and mathematics, and who could use the computer as a tool and aid in their work, as well as for the undergraduate student enrolled in courses in similar fields. Professor Stuart states that the book is not intended to train programmers in the professional sense of the word, and although the book is not intended as a self-teaching manual, "it could be so used provided that a computer is available." And that the book is "intended to train every man to become his *own* programmer, so that within his professional specialty he can deal directly with the computer whenever it is useful in that field." These goals are admirable and certainly deal with a realistic problem, but even from the point of view of a student, the author seems overwhelmed by them, and presents a book that seems at best still inadequate.

In reading a computer programming text, one does not expect the author to write in an observable literary style, but one can demand with reason that the paragraphs be well-organized, that the English be easy to follow rather than awkward, and that the definitions be concise, clear and well-written. The book is not consistently bad in these respects, and the point the author is trying to make usually eventually becomes clear, but one feels that the inclusion of a glossary at the beginning of the book might have been a good idea. Putting so many words in italics, quotes, parentheses, or inserting them as second definitions in the middle of a sentence tends to be rather confusing. The footnotes seem badly organized too, in the sense that they contain minor details and exceptions of questionable rele-

vance to the beginner, and which could have been incorporated into the text itself in any case.

Also, the entire reference list for reviewing such concepts as harmonic mean, standard deviation, and various trigonometric functions is contained in the footnotes. One is "forewarned" almost a third of the way through the textual material, that "some consultation with a good statistics textbook should be commenced early," and it hardly seems fair that the only indication that the book is supplementary is contained in the footnotes. *Introductory Computer Programming* is not a book for a high school graduate with a minimal math background and some logical ability, but for someone with, if not a broader background in math and statistics, at least ample opportunity for review in these fields at the college level.

GO TO statements, Sense Switches, and IF statements are all very well defined, explained, and illustrated, with the exception of the IF statement which contains a flowchart. The book contains a total of three small flowcharts, and although the importance of mastering flowcharting is emphasized, its most basic techniques are never explained, nor is the significance of the examples provided. The IF statement flowchart is particularly bad and explains nothing not already included in the general IF statement explanation. However, this is perhaps one of the functions of the instructor using this book in a course. But then by no means can the book be a self-teaching manual.

Perhaps the most coherent section of the book is Appendix B, with instructions for running the 1620. This portion is really very clearly and concisely written, but I would question its usefulness, as I would seriously question the availability of a computer to beginning students and lay-programmers. Perhaps free computer time for all interested serious students is possible at certain small colleges where a computer exists for academic use, but otherwise to attempt to learn programming by depending on this book and the availability of a computer for one's personal use seems rather unwise. And \$5.95 is quite a bit for a book of 155 pages with a minimum of very ordinary illustrations. SALLY STORY

SENIOR PROGRAMMER ANALYSTS

Our large-scale computing and data processing complex has a number of openings for experienced programmer analysts with solid academic achievements in any of a variety of scientific, mathematical, engineering or administrative disciplines. Candidates should ideally hold a Masters degree, although outstanding candidates with a Bachelors degree will also be considered.

The fields of systems programming, mathematical analysis and scientific programming, data reduction and real-time programming, computer graphics, configuration management, numerical tool control, test data analysis, and management information systems are among the many challenging assignments currently available to qualified applicants.

Third generation equipment encompassing time-sharing, multiprogramming, multiprocessing, and mass storage features will be utilized to enhance the computing center's services to the Laboratories research and development, engineering, and management groups.

Sandia is engaged in the design and development of the ordnance phases of nuclear weapons, and is responsible for major aspects of the Vela Satellite, Aerospace Nuclear Safety, Planetary Quarantine, and other comprehensive research and development programs. The Laboratory offers many advanced and specialized facilities to further the work of its scientists and engineers.

In addition to affording excellent opportunities for professional growth, Sandia offers liberal employee benefits including generous vacations and holidays, insurance and retirement plans, and educational aids.

Located in the growing Southwest, Albuquerque offers a temperate climate and ideal living conditions.

All qualified applicants will receive consideration for employment without regard to race, creed, color, sex or national origin. U. S. citizenship is required.

Send resume to Professional Employment Section 521, Sandia Corporation, P.O. Box 5800, Albuquerque, N. M. 87115.

SANDIA
CORPORATION
ALBUQUERQUE, NEW MEXICO
LIVERMORE, CALIFORNIA

PROGRAMMERS: Have Plans For The Future?

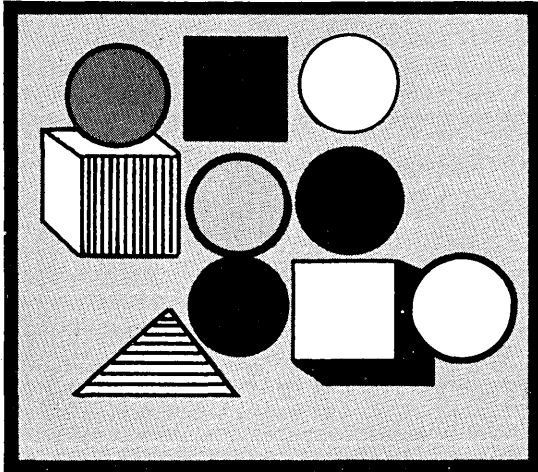

SO DO WE

Let's put our plans together and build a future that's even bigger.

We've told you that Honeywell is growing at a tremendous rate. We've recently even gone so far as to point out that Honeywell EDP sales have *tripled* in three years!

There are opportunities at Honeywell for growth and achievement. At Honeywell, we'll give you a desk, pencils and paper, then leave you to explore your area of specialization.

If you have plans for the future, one of the first on your list should include a visit to Honeywell. Write Mr. Edwin Barr.

Honeywell

ELECTRONIC DATA PROCESSING

200 Smith Street Dept. D-12 Waltham, Massachusetts

Opportunities exist in other Honeywell Divisions. Send resumes to F. E. Laing, Honeywell, Minneapolis, Minnesota 55408. An Equal Opportunity Employer.

CIRCLE 315 ON READER CARD

ENGINEER PROGRAMMER

Application: To program direct digital control computers for monitoring or closed loop control of industrial processes and other manufacturing operations.

Qualifications: Graduate engineer with some experience in digital hardware design. One to three years programming experience also required including some work with symbolic machine language.

Please send resume including qualifications, experience, and salary requirements to:

MANUFACTURING DEVELOPMENT

Personnel Department
Attention—Technical Placement

GENERAL MOTORS TECHNICAL CENTER

WARREN, MICHIGAN 48090

An Equal Opportunity Employer M/F

CIRCLE 313 ON READER CARD

CAREER MEMO

To PROGRAMMERS/ANALYSTS/ENGINEERS
From EVERETT KELLEY ASSOCIATES

If your present position lacks professional motivation . . . NOW is the time to let us program your professional future . . .

Consult our staff of experienced specialists who are at your disposal. They will open doors and arrange favorable interviews with selected clients. Utilize your total professional capability in:

- Scientific Programming
- Real Time Systems
- Software Development
- Operations Research
- Applied Systems
- Systems Design
- Consulting
- Digital or Logic Design
- Circuit Design
- Commercial Programming
- Mathematics
- Development Engineering
- Communications
- Sales/Marketing

Salary range: \$8,000-\$30,000. All expenses paid by client companies (fees, interviewing and relocation). Submit your resume in strict confidence, including salary requirements and geographic preference, directly to Mr. R. L. Keilholtz or Mr. Donald Wayne, or write for our composite resume form.



**EVERETT KELLEY
ASSOCIATES**
Consultants to the
Computer Industry



121 So. Broad Street (Suite 1300)
Philadelphia, Pa. 19107

CIRCLE 314 ON READER CARD

DATAMATION

REAL TIME PRO- GRAM- MERS

Challenging Opportunities In Real Time On-Line Computer Systems

Large scale computerized launch control systems and hybrid systems simulation requiring real time programming.

Complex systems simulation background helpful. BS degree in appropriate field necessary.

Other openings also available.

Write to A. D. Weber, Mail #6310
P.O. Box 179-D-2
Denver, Colorado 80201

MARTIN COMPANY
DENVER, COLORADO
 **MARTIN/MARIETTA**

"Live and Create in the High Country"
An Equal Opportunity Employer

CIRCLE 316 ON READER CARD
December 1966

PHILCO HOUSTON

. . . prime contractor and prime mover of the Manned Spacecraft Center, has exceptional opportunities for qualified programmers in these areas:

REAL TIME PROGRAMMING

Work will involve command and control simulation, display techniques and software development. Requires BS in mathematics, physics or engineering, as well as 1-7 years in programming of digital computers and design and development for real time applications. Experience also desirable in machine language programming for real time computers.

INFORMATION PROCESSING

Requires 1-5 years in programming of medium and large scale computers for information processing and data handling. Prefer COBOL experience.

For prompt and confidential consideration, send your resume to Mr. H. S. McDonald, Department 6018, Philco Houston Operations, 1002 Gemini Avenue, Houston, Texas 77058.



An equal opportunity employer

CIRCLE 317 ON READER CARD

UNIVAC men talk hardware and software with the broad accent of the systems analyst and the memory of an elephant.

Our long term status as the technological leader in scientific, real-time, on-line data processing systems demands it.

Their expertise and over all systems viewpoint encompass a broad technical map (from small aerospace computer to large real-time systems).

Our current programs range from R&D on anti-submarine warfare and guidance and control systems to applications of product line computers to missile range and satellite tracking nets.

Immediate openings in New Jersey, Pennsylvania, Washing-

ton, D. C. and California for Programmers.

The following openings are at our Division Headquarters in St. Paul, Minnesota:

- Scientific and real-time programmers
- Computer logic and systems designers
- Business systems programmers and analysts
- Computer circuit and hardware designers

Interested candidates are invited to submit resumes to Mr. R. K. Patterson, Employment Manager, UNIVAC Defense Systems Division, UNIVAC Park, St. Paul, Minnesota, Dept. 12-M.

UNIVAC

DIVISION OF SPERRY RAND CORPORATION
DEFENSE SYSTEMS DIVISION
2750 WEST SEVENTH BLVD.
ST. PAUL, MINN. 55116
AN EQUAL OPPORTUNITY EMPLOYER (M&F)

CIRCLE 318 ON READER CARD

Apollo • Poseidon Deep Submergence Systems

-at M.I.T.

The Instrumentation Laboratory's professional staff now exceeds 600 — engineers of all major disciplines, mathematicians and physicists.

They work on problems, from definition to solution, that consume their interest and challenge their abilities within an organization known for strong group and individual autonomy.

Opportunities exist across a broad span, with emphasis on the following:

Software — Systems Analysis, Simulation, Synthesis:

Advanced degree engineers or mathematicians are sought to develop guidance concepts and equations with application to spacecraft, missiles and submersible vehicles.

Control Systems Engineers with backgrounds in optimal control, servo control or airborne computers. Requirements range from recent BSEE to heavily experienced M.S.

Digital/Analog Evaluation: Experienced EE's to design, test and evaluate digital and analog circuitry (phase detectors, VCO loops, etc.). Solid state design feedback theory required.

Systems Simulation: Aeronautical Engineers or Mathematicians for analysis, simulation, development and design of navigation and guidance techniques for spacecraft and aircraft.

Programmers: Design procedures and data for testing complex computer programs within Real Time systems.

If you're interested, no personal sacrifice is required — salaries are competitive, benefits are liberal, and you may take graduate courses at MIT at full salary with generous tuition assistance.

Your resume will receive immediate, thoughtful consideration. Reply to Mr. John D. McCarthy, Professional Staffing, Building 10D, 68 Albany Street, Cambridge, Massachusetts, or call (617) UN 4-6900, Ext. 3544. MIT is an equal opportunity employer.



**Instrumentation Laboratory
Massachusetts Institute of Technology**

Computer Program Design (Southern California)

HUGHES Guidance and Controls Division has several openings for qualified persons who have the ability to create complex digital computer programs—and the desire to do the job thoroughly and efficiently. Satisfaction of current commitments on such systems as: PHOENIX, IRAM, VATE and ASG-18 requires experience in the design of real-time command and control programs, or of software programs for execution on an IBM 7094 or GE 635 computer.

Responsibilities include: specification, design, implementation, check-out and support of computer programs for a wide variety of applications including:

- Airborne Navigation & Fire Control
- Digital Simulation of Airborne Computer and its environment
- Automatic In-Flight & Depot System Testing
- Assemblers & Compilers
- Automation of Electronic Equipment Design

Requires: an accredited degree in Engineering or Mathematics, a minimum of three years of professional experience and U.S. citizenship.

Please airmail your resume to:

Mr. Robert A. Martin
Head of Employment
HUGHES Aerospace Divisions
11940 W. Jefferson Blvd.
Culver City 19, California

HUGHES

HUGHES AIRCRAFT COMPANY
AEROSPACE DIVISIONS



An equal opportunity employer — M & F

computer careers

Should you base your career on just one interview? Make your choice from among several career positions!

EUROPEAN and NATIONWIDE CHOICE

N.Y., N.J., NEW ENGLAND, WASHINGTON, D.C., PHILA., MINNESOTA, TEXAS, HUNTSVILLE, FLORIDA, ARIZONA, CALIFORNIA AND OTHERS

Contact us if you have some experience or interest in any of the following:

- Scientific Computation** — Data Reduction or Numerical Analysis—Unusual Outerspace/Lunar and Advanced Programs
- Software Development** — Languages, Compilers, Assemblers, Monitors or Sub-Routines
- Real Time Systems** — Message, On Line, Process Control
- Systems** — Planning, Design, Analysis of State of the Art Massive Data Handling of I.R. Systems
- Technical Representatives** — Programming and Systems support to Sales
- Digital or Logical Design**
- Management Sciences**
- Sales and Marketing**

Unique opportunities exist in the \$9000-25,000 class for Managers & Seniors and Men who can accept management responsibility and professional growth

MGT. INFO SYSTEMS and/or REAL TIME COMMUN

NOW — NOW
Exceptional Jr. Posts
available

All expenses are assumed by our client companies.

Write in confidence, including present salary, acceptable locations or call (Collect) Mr. Nellissen (Area Code 212) Plaza 9-1720

a&n
ALBERT, NELLISSEN, INC.

*Leading Consultants to Management
in the Data Processing Field*

510 MADISON AVENUE, N.Y., N.Y. 10022
CIRCLE 319 ON READER CARD

December 1966

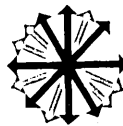

people

■ James M. Adams, Jr. is joining the Association for Computing Machinery, New York City, as education director. He most recently served DPMA in a similar capacity.

■ Richard G. Lamb has been elected vice president of Auerbach Corp., Philadelphia, Pa. He will continue in his present post of corporate treasurer.

■ Computing Reporting Systems, Inc., Los Angeles, a credit reporting firm, has named Gilbert C. Rittscher director of computer operations. A former secret agent in the Army, he most recently was a project manager with Informatics, Inc., Los Angeles.

■ Dr. Donald L. Drukey, manager of System Development Corp.'s research and technology div., has been elected a vice president of the Santa Monica, Calif. corporation.

■ The MITRE Corp., Bedford, Mass., has promoted Edward L. Lafferty to head, information processing systems department.

■ Frank Heart, well known AFIPS official, is leaving Lincoln Labs after 15 years to join Bolt Beranek & Newman, Cambridge, Mass.

■ Vincent J. Grillo, Jr. is a new vp in the computer sciences div. of Computer Sciences Corp., El Segundo, Calif. He is a former president and founder of Computer Dynamics Corp. of Washington, D.C.

■ Richard T. Dorrance has relinquished his center directorship with URS to become a design consultant in the Bay Area.

■ Lester Tepper has been elected a vp of C-E-I-R, Inc. Washington, D.C. He will continue to serve as associate director of the company's applied research and management sciences division.

■ Henry F. Sherwood has been appointed vice president, Diebold Europe. He was director of Diebold's Research Program in Europe.

■ Milton Bryce has been appointed manager, data processing and systems, The Quaker Oats Company, Chicago, Ill. He was previously a dp manager with Univac.

now available

free computer career salary analysis for 1965

Albert, Nellissen, the leading consultants to management in the Computer field, has recently finished its survey of successful national staffing assignments and wage levels for 1965. This survey analysis is now available without charge or obligation. It covers the following technology areas:

- Scientific or Real Time or Message Switching
- Systems Programming
- Commercial Applications and Data Processing
- Circuit, Logic & Hardware Design
- Sales/Marketing

circle reader service number 358 on card in back or tear out coupon and send to:

ALBERT, NELLISSEN, INC.

510 Madison Avenue
New York, N.Y. 10022

Please send me your free 1965
Computer Career Analysis.

Name _____

Address _____

City _____ State _____

CIRCLE 358 ON READER CARD

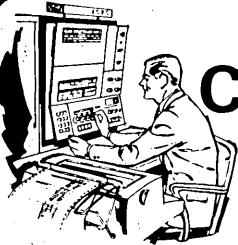

Free COMPUTER CAREER BULLETIN

Our Computer Career Bulletin is truly unique. It is prepared by our staff of recognized professionals each of whom has had extensive "hands on" computer exposure and who regularly consult with industry in matters relating to computer organizational planning and staffing.

The digest is comprehensive and will allow you to examine in detail the broadest possible range of computer opportunities and their long range potential existing across the nation. You will find the bulletin an excellent gauge for measuring the progress of your career to date in terms of responsibility, exposure and compensation. Salaries range from \$8,400 to \$25,000 per year.

For immediate consideration, please forward a detailed experience resume, including position desired, salary history and requirements, and any geographical preferences and/or restrictions. All inquiries will be held in strict confidence.

source



"exclusively data processing"
FORMERLY EDP PERSONNEL, INC.

In San Francisco —
Mike Parr, 111 Pine Street, Suite 1015, (415) 434-2410
In Chicago —
Dave Grimes, 100 S. Wacker Drive, Suite 212, (312) 782-0857
CLIENT COMPANIES ASSUME OUR CHARGES

CIRCLE 323 ON READER CARD

COMPUTER PROGRAMMER

for

The Service Bureau Corp.

SBC, one of the world's best known data processing service organizations, is seeking an experienced analyst for stimulating assignments in current programs and new development work. Basic requirements are:

1. Degree in Engineering or Mathematics
2. 2-year background in large computers; conversant with machine language.

This is an excellent opportunity to accelerate your career in a field that has tremendous growth potential. Reply in strictest confidence to:

Mr. R. J. Mathias

The Service Bureau Corporation
Subsidiary of IBM Computing Sciences Division
1350 Avenue of the Americas, New York, N.Y. 10019
Tel: (212) 262-2498

An Equal Opportunity Employer

CIRCLE 322 ON READER CARD

Western Geophysical Company

A Division of Litton Industries

Western needs programmers and technical analysts to work in the exciting field of seismic exploration. Challenging work and wide-open opportunity. Programming experience combined with analytic ability and background most desired.

Cliff Phillips L. L. Armond
520 N. Market St. 933 N. LaBrea Ave.
Shreveport, La. 71107 Los Angeles, Calif. 90038

WESTERN 
GEOPHYSICAL
DIVISION OF LITTON INDUSTRIES

CIRCLE 321 ON READER CARD

FREE! CAREER OPPORTUNITIES BULLETIN

A complete and comprehensive listing of outstanding positions at salaries from \$6,000 to \$30,000 with National Companies for:

ENGINEERS • ANALYSTS • PROGRAMMERS

Our professional staff combines Customized Service with technical know how to insure for you maximum career development in the following areas:

- Circuit Design
- Digital or Logic Design
- Switching
- Communications
- Hardware Design
- Manufacturing
- Reliability
- Software Development
- Scientific Programming
- Real Time Systems
- Business Systems
- Commercial Programming
- Diagnostic Programming
- OPS Research

No charge to you for our custom service. All expenses paid by client companies (fees, interviewing & relocation). Expedite your development by sending resume in confidence with present salary and geographic preference to Frank Daniele, Director:



La Salle Associates

Professional Search Dept.

2136 Locust Street, Philadelphia, Pa. 19103

For your free bulletin without any obligation, circle subscriber service card.
Please use home address only.

CIRCLE 320 ON READER CARD

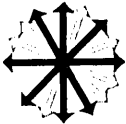

datamart

Address all replies to box number advertisements as follows:

Box.....

DATAMATION

F. D. Thompson Publications, Inc.
35 Mason Street
Greenwich, Conn. 06830
Classified Advertising

PROFESSIONAL SERVICES

UNGERLEIDER & CO.

Representatives for
EDP Equipment & Services

P.O. Box 1180 Alexandria, Va. Area Code 703 768-6700

JOHN P. FRANCIS

Consultant
computer system/logic design
product planning; analysis; research
5730 Busch Drive
Malibu, California
(213) 457-2420

USED EQUIPMENT

FOR SALE: UNIVAC S.S. 90
40,000 digits fast 10,000 digits high
speed drum memory 3 Index Registers,
Mul. Div. Program Interrupt 600 LPM
Printer. Box 12-1.

WANTED: Additional 20K for IBM 1620 Model 1, also
interested in Plotter & Discs. Please state asking
price and date available. Reply to:

Pacific Computing Service
13794 Beach Blvd.
Westminster, Calif. 92683
(714) 534-8444

We will buy your IBM Data Processing Equip. out-
right. Or sell, rent or lease IBM Data Processing
Equipment to you with full IBM maintenance con-
tract. Global Tab. Equip. Corp., a subsidiary of In-
ternational Typewriter Exchange, 1229 W. Washing-
ton Blvd., Chicago, Ill. 60607, SE 3-1200.

IBM unit record equipment needed immediately.
407, 402, 1401, 083, etc. Complete installations
for lease with systems assistance. Data Equip-
ment Sales, Inc., 1107 Reliance Life Bldg. Tele-
phone 214 R12-6736, Dallas, Texas.

When it's time to buy or sell a
single keypunch or a complete
EDP system, it's time to contact
COMPUTER
WORLD TRADE CORPORATION

CWT is currently selling, at a fraction of the original cost:
IBM 1401 (several models); IBM accounting machines (402,
403, 407, 419); IBM calculating punches (602, 604).
CWT is also prepared to buy IBM computers, all models,
that can be delivered within the next 6 months.

For full details, prices, appraisals, please call or write—

COMPUTER WORLD TRADE CORPORATION
300 E. 44 St., N.Y. 10017 (212) 682-6570
Also Atlanta • Chicago • Houston • San Francisco

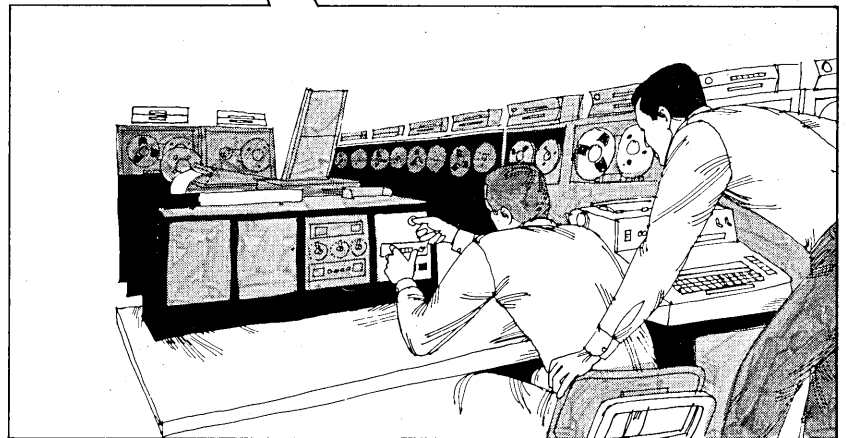
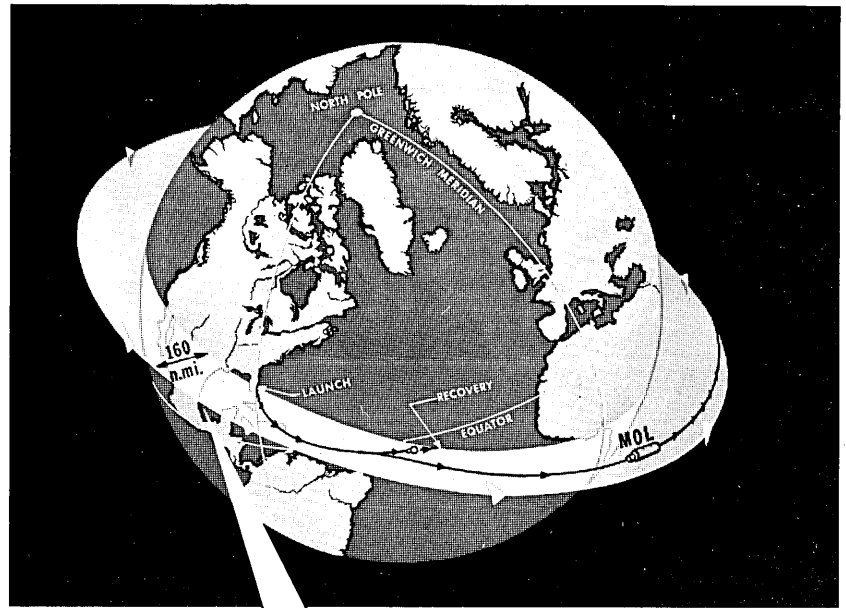

Correct Orbital Apogee-Perigee Doesn't Just Happen ... It's Planned.

At AC Electronics, Scientific Programmers develop these plans with large scale, third-generation computers. *You* could help develop similar plans as a member of AC Electronics' scientific-professional team.

This team needs additional experienced Scientific Programmers with B.A., B.S., E.E. and/or M.S. degrees in Engineering, Math or Physics for computer complexes throughout the country. Present AC Scientific Programming Staffs are located in Boston, Cape Kennedy, Houston, Milwaukee and Santa Barbara. These installations are engaged in several diverse and challenging projects, including:

DATA REDUCTION
DESIGN AUTOMATION
ELECTRONIC SYSTEMS DESIGN
REAL TIME

SIMULATION
(GUIDANCE/NAVIGATION SYSTEMS AND
MISSION CHECKOUT/VALIDATION)
TRAJECTORY (MISSILE AND SPACECRAFT)

If you want challenge, are an experienced Scientific Programmer and have one or more of the above degrees, send your resumé, including salary requirements, to R. W. Schroeder, Dir. of Scientific and Professional Employment, Dept. 5753, AC Electronics Div., Milwaukee, Wis. 53201.



AC ELECTRONICS
DIVISION OF GENERAL MOTORS
An Equal Opportunity Employer



MARK OF EXCELLENCE

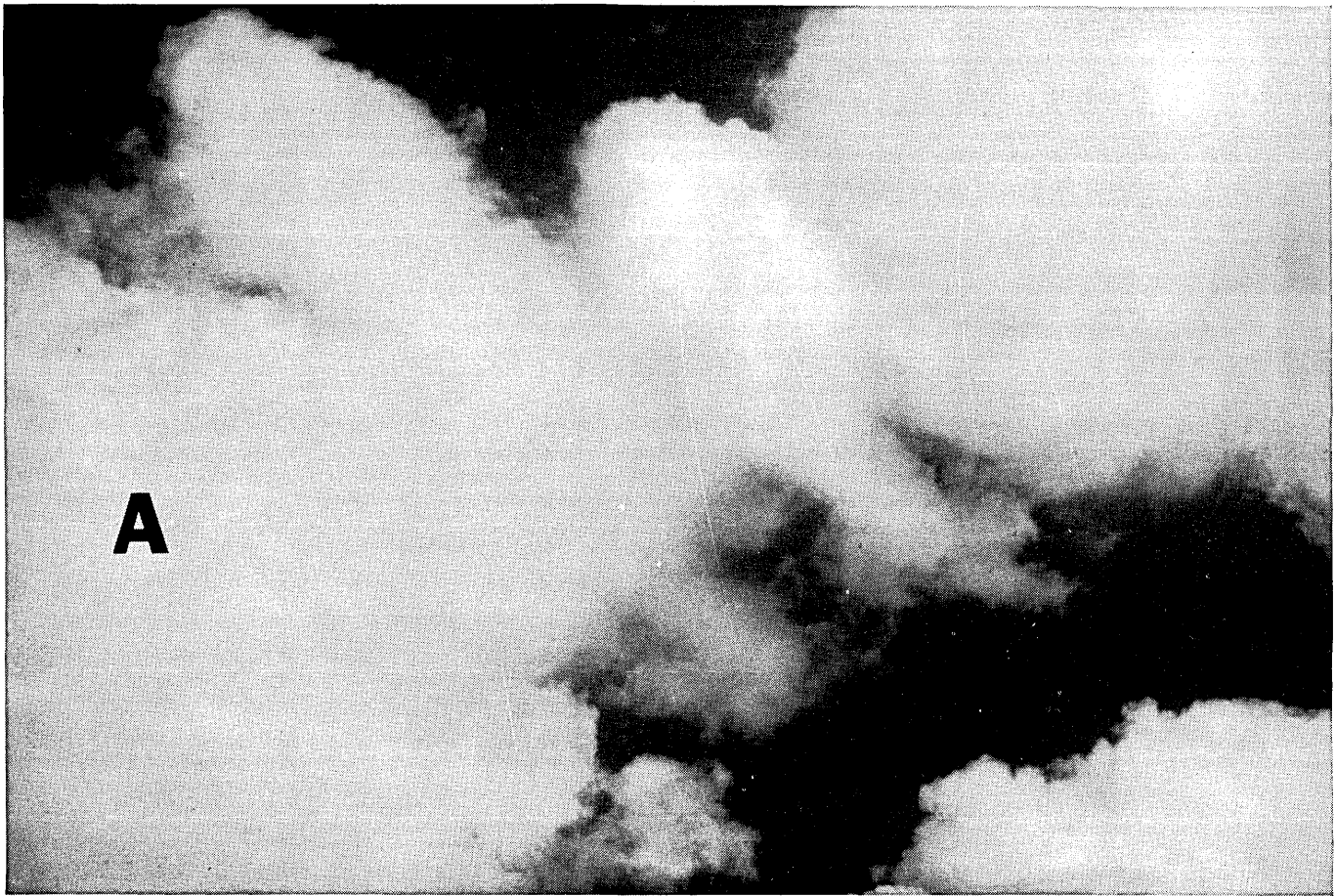

WANTED:

INDIVIDUALS WITH WAY-OUT IDEAS.

IBM's Federal Systems Division needs individuals whose thinking is literally out of this world.

Programmers and analysts capable of spearheading the probe for faster, more efficient, advanced orbiting and ground support systems for space and defense.

Individuals who can solve problems involving trajectory telemetry orbit determination. Develop large-scale centralized computer control facili-

ties. Facilitate re-entry data reduction.

And other far-out problems.

If you have a B.S. or advanced degree and a minimum of two years' experience, you may qualify in one of these challenging career areas with IBM: Space control center analysis • Systems programming • Scientific programming • Applications programming • Programming analysis • Aerospace computer design applications.

To get your career off the ground, send a resume today to:

Mr. John V. Croker, Dept. 701-Z
IBM Corporation
9045 Lincoln Boulevard
Los Angeles, California 90045
An Equal Opportunity Employer

IBM®

look ahead

(Continued from page 19)

REVOLVING EXECUTIVE CHAIR

Meanwhile, a new outfit -- Janus Research -- in San Jose, Calif., is setting up to make IBM 1316-type disc packs. The firm, headed by Phillippe Yaconelli, is shooting for first deliveries late next year. And Disc Pack Corp. in Hawthorne, Calif., has delayed first deliveries from last September to early '67.

John Paivinen has resigned as general manager of EMR's computer div. It's rumored he'll head up the semiconductor division of General Instruments. Earl Wallich is new acting g.m. Another who has stepped aside is Univac's Fred Raach. Replacing him as vp and general mgr. of the Univac Division is E. C. Thompson, former manufacturing vp. And at Uptime, F. O'Neil Griffin has left. New president is James E. Larson; new g.m. & executive vp is John Peper.

RUMORS AND RAW RANDOM DATA

Sober thought dept.: If it takes \$1 of capital assets to produce \$1 revenue in the computer game, and if IBM is a \$10 billion company in 1971, how many companies by then will be able to afford 10% of the market? ... Latest RCA fringe benefit: no lease payments until the Spectra 70 is in and running ... CDC's Chicago office has booked \$10 million in business since July 1, including \$6½-million worth of 211 display terminals for Allstate Insurance's armada of 360's. ... A new company, Standard Memories, has been established in Santa Ana, Calif. Headed by John Flood, formerly of Decision Control, Inc., the firm will make i.c. and core memory systems. ... The rumble is that SDS has sold some 240 Sigma 7's and 2's. The "2" orders could be worth \$20 million face value, although most are undoubtedly going at OEM "fleet" rates. Meanwhile, we hear Three C's hopes to peddle 700 of its new 516 in the first year. ... Certron, LA tape certification firm, is buying an audio mag tape maker. ... One estimate of IBM's manufacturing costs for the 360: 12-15% of sales price. The same source guesses RCA's costs to be 30-35%. ... Matrix Corp. has captured a contract long held by CEIR — all data processing work for Caltex. Matrix's new NYC center, opening this month, will handle the job on its 7094 I initially, replacing it with a 360 ASP (mod 65 with a 40 support cpu) in July. ... Computers for Industry and Business, New York firm specializing in tabulation programs and computerized tax accounting, has fallen by the wayside, declaring bankruptcy ... One possible explanation for the inability to get 360's up and running at so many places: a shortage of trained customer engineers. MAI is allegedly raiding IBM's CE forces something fierce in some areas. ...

It's rumored Western Union will order 5 or 6 1108's for its "utility." And Clark Equipment has ordered two 1108's, which won out over GE and the /67. GE's file management system — IMRADS — will play a large role in Clark's plans for the 1108. ... IBM withdraws its support of UCLA's Western Data Processing Center April 1. On that date the free 7094 will give way to a 360/75 to be paid for by UCLA. The /75 will give way to a /91 in '69. IBM will continue to provide \$100K/yr. for computing time for folks from WDPC member institutions. The move is a result of re-evaluation of IBM funding policies and of computing at UCLA, which will be changed to "centrally directed, decentrally operated."

**Career
opportunities
in the
COMPUTER
SCIENCES
are available
for graduate
mathematicians,
engineers and
physicists.**

A variety of openings exist on IIT Research Institute's professional staff in such fields as programming system development, automatically programmed tools (APT), graphical input-output research and development on software and hardware, scientific computer applications, operations research, and statistics. Members of the professional staff enjoy excellent salary and fringe benefits (including tuition-paid study for advanced degrees) and the constant challenge of exciting work.

IIT Research Institute is an independent, contract research organization serving industry and government. Its activities encompass nearly all of the physical and biological sciences and their related technologies.

If you have a strong interest and capability in computer science and technology, please communicate in confidence with Mr. Ronald C. Seipp,

IITRI IIT
Research
Institute

10 West 35th Street, Chicago, Ill. 60616
An Equal Opportunity Employer M/F

CIRCLE 327 ON READER CARD

WHAT IS YOUR TRUE WORTH?

FREE Data Processing
Opportunities Bulletin

Every month, in the privacy of your own home, you can evaluate the nation's finest openings in the data processing field. Cadillac, the nation's largest executive and professional placement service, represents the majority of the nation's top companies. Their best jobs at salaries from \$6,000 to \$75,000 appear in our monthly Data Processing Opportunities Bulletin.

Our placements show that the average data processing man is worth 10% to 20% more than his present income. The Bulletin helps you evaluate yourself in today's market. Both the Bulletin and our *confidential* placement service are free. Client companies pay all costs.

For your free Bulletin, without any obligation circle Subscriber Service Card No. 354. Please use *home address only*.



LON D. BARTON, *President*
Cadillac Associates, Inc.*

29 E. Madison Bldg. Chicago, Ill. 60602
Financial 6-9400

* "Where More Executives Find Their Positions Than Anywhere Else in the World."

CIRCLE 354 ON READER CARD

**To Iterate Is Human,
To Recurse Divine**

PL/I

If you would like to move to the forefront of the compiler industry, a few openings exist at all levels. Send your resume with complete salary history to:

DIGITEK CORPORATION

6151 W. CENTURY BLVD., LOS ANGELES, CALIF. 90045, (213) 670-9040

CIRCLE 326 ON READER CARD

DATAMATION

Pocket-Size Computers —

*We have hundreds of them**



What we need are **COMPUTER ENGINEERS**

Foxboro Instruments and Computer-Controlled Systems are well established in all major process industries — and they're calling for more. We need your knowledge to help us meet this steadily growing demand. In return, we can offer career-building opportunities in the fascinating field of process and energy control — PLUS a pleasant professional environment designed to encourage individual initiative and creativity.

DESIGN ENGINEER — CIRCUIT DESIGN: BS or MSEE with 3-5 years' experience in digital circuit design. Emphasis on integrated circuits is desirable. Some knowledge of logic design, programming, and computer organization is required. Will participate in the design and application of solid state digital and analog circuits as applied to computer control systems and related products. Also, the design of advanced I/O equipment which interface digital computers.

SENIOR DESIGN ENGINEER — DIGITAL CIRCUIT DESIGN: BSEE with 4-6 years' experience in circuit design of high speed digital circuitry above 2 megacycles. Emphasis on integrated circuit design application. Should have background in noise, signal propagation and all logical element design problems. Proven ability to handle project efforts in circuit engineering. Contributes to system logic organization for analyzing optimum logic and circuit configuration.

SYSTEMS ENGINEERS: BS or MS in engineering. Minimum 3 years' experience including project engineering, programming, instrumentation, application of digital computer equipment, system start-up and customer negotiation. Ability to define system specification, design, checkout, etc. Technical decisions on application requirements, manpower capabilities, time and cost. Principal technical responsibility for customer projects.

SENIOR SYSTEMS ANALYSTS: Computer process control. Advanced ME or ChE preferred. Must have 5-10 years' experience in chemical, refinery or power plant computer automation. Simulation and process modeling experience desirable.

DIGITAL PROJECT ENGINEERS: BSEE with training in computer technology. At least two years' experience in computer applications, with knowledge of logic design, programming and proven ability in project engineering. Responsible for equipment specification and design on customer projects.

PROGRAMMERS AND SENIOR PROGRAMMERS: Engineering or Scientific degree desired with systems programming ability. At least 2 years' solid programming. Mathematic analysis and process control experience plus knowledge of assemblers and compilers is desirable to handle industrial process control problems.

*While the supply lasts, we'll be happy to send a (free) miniature abacus — shown here actual size — to all professional employment inquiries related to our current openings. Forward your resume — in strict confidence — to:

John G. Willett
Supervisor, Technical Recruiting
THE FOXBORO COMPANY
Neponset Avenue, Foxboro, Massachusetts

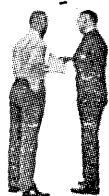

FOXBORO®

*Specialists in
Process and Energy Control*

An Equal Opportunity Employer

advertisers' index

AC Electronics Division of General Motors	111
Adage, Inc.	8
Addressograph Division of	
Addressograph Multigraph Corporation	46
Albert, Nellissen, Inc.	109
American Telephone and Telegraph and	
Associated Companies	66
Ampex Corp.	Cover 2
Applied Data Research, Inc.	18
Bellcomm, Inc.	117
Benson-Lehner Corporation	96
Bryant Computer Products,	
A Division of Ex-Cell-O Corporation	86
Burroughs Corporation	50
Cadillac Associates, Inc.	114
The Callahan Center for Computer Personnel	116
Celanese Plastics Company	59
Collins Radio Company	12
Comcor, A Subsidiary of Astrodata, Inc.	51
Computer Division, Electro-Mechanical Research Inc.	16
Computron Inc.	6
Costello & Company	73
Dashew Business Machines	13
Data Disc Incorporated	14
Data Packaging Corporation	54
Datamation Magazine	99, 102
Department of Defense, Computer Institute	81
Digital Equipment Corporation	5, 92
Digitek Corporation	114
Digitronics Corporation	4
Drew Employment Agency, Inc.	117

Electronic Associates, Inc.	64, 65, 86
Electronic Memories	68
Ferroxcube Corporation of America	Cover 4
The Foxboro Company	115
General Electric Co.	9
General Motors Research Laboratories	78
General Motors Technical Center	106
General Precision Inc., Librascope Group	22
General Precision Inc., Link Group	72
Robert Half Personnel Agencies	104
Honeywell, Computer Control Division	2, 3
Honeywell Electronic Data Processing	106
Hughes Aircraft Company	108
IBM	60, 61, 70, 112
IIT Research Institute	114
Information Development Company	44
Information Systems Company	104
Everett Kelley Associates	106
La Salle Associates	110
Litton Industries	110
Lockheed Electronics Company, A Division of	
Lockheed Aircraft Corporation	103
MAC Panel Company	Cover 3
Magne-Head, A Division of General Instrument Corp.	94
Martin Company	107
Massachusetts Institute of	
Technology, Computation Center	104
Massachusetts Institute of	
Technology, Instrumentation Laboratory	108
The Matrix Corporation, Computer Services Division ...	79
Moore Business Forms Inc.	52, 53
The National Cash Register Company	74
The National Cash Register Company,	
Electronics Division	81
Optical Scanning Corporation	35
Philco	107
Photocircuits Corporation, Tape Reader Division	84
Planning Research Corporation	38
Raytheon Company	88
Raytheon Computer	58
RCA Electronic Components & Devices	10, 11
RCA Electronic Data Processing	98
RCA Graphic Systems Division	89
Recognition Equipment Incorporated	1
Revere Mincom Division, 3M Company	56
Sanders Associates, Inc.	67
Sandia Corporation	105
Scientific Data Systems	20
The Service Bureau Corporation, A Subsidiary of IBM ...	110
Smith, Kline & French Labs	90
Source EDP	110
Systems Engineering Laboratories	80
Thompson Book Company	85
F. D. Thompson Publications, Inc.	116
3M Company	36, 37, 49
TRW Systems	90
Univac Division of Sperry Rand Corporation,	
Defense Systems Division	107
Univac Division of Sperry Rand Corporation	76
URS Corporation	87
U. S. Magnetic Tape Company, A Subsidiary of	
Wabash Magnetics, Inc.	40
Vermont Research Corporation	62
Vezan-West & Company	90
Vitro Electronics, A Division of	
Vitro Corporation of America	77
Wilson Jones Co.	15
Wright Line	79

★ ★ ★ ★ ★
 Could we have won
 the Revolutionary War
 with today's
 Department of Defense?
 ★ ★ ★ ★ ★

**THE
FREE
ENTERPRISE
PATRIOT**

By JOHN RICKEY

In humorous satire that bites without bitterness, author John Rickey recounts the cannon building adventures of a colonial blacksmith faced with the red tape frustrations of today's defense contractors. First serialized in Research/Development magazine and now in its second printing, the "Patriot" rings with the author's knowledge of industry-government relationships.

☆ SOLD ONLY BY MAIL ☆
 Send \$1.50 per copy (cash with order) to Dept. FEP, F. D. Thompson Publications, 205 W. Wacker Drive, Chicago, Illinois 60606.



★ ★ ★ ★ ★

COMPUTER SPECIALISTS

You recognize this, of course,

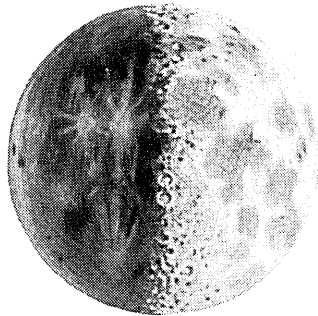

but have you ever thought
how computers can be used to
get there and beyond?

Bellcomm, the systems engineering contractor for the National Aeronautics and Space Administration, has openings for imaginative computer specialists interested in contributing to manned spaceflight.

We need people who can:

- analyze data processing requirements of advanced missions
- determine functional requirements for the next generation of spaceborne computers
- study optimal computer organization for reliability (hardware and software)
- define computer systems for supporting launch and flight operations of multiple missions
- develop management procedures for controlling computer resources
- define ground network for distribution of data transmitted from space
- evaluate data management systems
- determine impact of new programming techniques for all of the above

If you believe you are such a person, Bellcomm will welcome your inquiry. Send your résumé to Mr. N. W. Smusyn, Personnel Director, Bellcomm, Inc., Room 1418-E 1100 17th St., N.W., Washington, D. C. 20036.

Bellcomm is an equal opportunity employer.



Bellcomm, Inc.
A Bell System Company

Don't send us your resume

until you've read ours.

It's only fair.

Before you tell us all about yourself, we think you have the right to know all about us. It's the best way to be sure you choose the placement organization than can most effectively advance your career.

And advancing your career is exactly what Drew is trained to do. It is one of the largest EDP placement specialists in New York. It has been helping professionals like yourself to make more of their talents for years.

The most valuable advantage Drew offers you is the people it can help you meet. Our placement executives work closely with nearly every important New York-based company that employs skilled systems analysts and programmers. So, when jobs become available, they're usually the first to know.

But they don't waste your time arranging interviews for every job. Drew specialists in every area of EDP review the openings first, then match the right man to the right job. So that both parties are satisfied.

As you can see, Drew is an authority on EDP careers in New York. We've even written a booklet on it—the only one of its kind. (If you'd like a copy, we'll be happy to send you one.)

Now that you've read our resume, we'd like to read yours. The more we know about you, the more we can do to help you find the spot you want.

DREW Personnel Placement Center
160 Broadway, N.Y.C. 10038
Employment Agency Inc. (212) 964-8150 D

Here's my resume.

Field of interest:
Cml. Sci. & Engrg.

Please send free copy of guide to EDP careers in New York.

Name _____

Address _____

City _____

State _____ Zip _____

All correspondence in confidence, of course.

CIRCLE 329 ON READER CARD

the forum

The Forum is offered for readers who want to express their opinion on any aspect of information processing. Your contributions are invited.

PROGRAMMING PARADOXES RESOLVED

Publication in September (The Forum, p. 157) of the "Thirteen Programming Paradoxes" has prompted letters from readers anxious to extend the number beyond 20. One reader, however, attempts here to resolve each of the original 13, point by point.

1. The paperwork required by management, the distance between design and programs, the number of people on the programming team, the time spent by everyone concerned in planning it, are all proportional to the total size of the system. Reliability, flexibility, efficiency, elegance, etc., of anything (particularly in the developmental stage) is inversely proportional to the number of moving parts, and a large software system has lots.
2. A great composer when asked to explain the meaning of one of his compositions replied, "Play it again." A software system's code is its own description. Each instruction represents some logical operation, and to the extent that anything could be left out, the code is imperfect. The only way to completely describe the reaction of a system to all machine and peripheral environments is to present the code, or its logical equivalent, in some other language. To say that the description of a system bears no relation to the system itself is to say that it is not the system.
3. The more sophisticated the software, the less likely it is to satisfy any particular set of needs, precisely, in the most efficient possible way. But it is more likely to perform useful work of the anticipated kind (the breadth of anticipation is a measure of sophistication) for more people, more often, at more reasonable net cost — and with fewer programmers. It is folly, however, to try to modify a sophisticated system to an ill-suited use, or to use only 1% of its capabilities.
4. When the system programmers declare the system works, it has worked once and will work again some day.
5. I suspect that the larger and faster the machine, the fewer the situations in which it is economically sound to write tight, elegant code. If this is not true, then the developers and users of compilers have been astonishingly wrong.
6. The ideal computer programmer writes perfect code. The ideal computer manufacturer hires only ideal programmers, and has not found him yet.
7. The more human-like a computer becomes, the less it spends time computing and the more it spends time doing more human-like work. This is as it should be.
8. The importance of an advance in software technology is directly proportional to the number of vested interests it affects and to the amount of careful consideration it merits.
9. The value of a person's opinion on the value of software has nothing at all to do with whether he ever wrote code.
10. The world's best programmer has to be someone.
11. A software committee of one is limited by its own horizon, and will specify software useful only that far.
12. To study top management plans and then do the opposite will indeed produce high quality software — by comparison — for your competitors.
13. The more difficult and complicated a program, the longer will be the time required for its completion, and the more programmers will be assigned to it.

J. R. Landau
Santa Clara, Calif.



computer systems specialists

\$10,000 to \$16,000

The Department of Defense Computer Institute (DODCI) provides career opportunities

for digital computer systems specialists including recently discharged junior officers from the military service and recent college graduates interested in Civil Service careers.

The Institute is expanding its role of instructing senior military and civilian Department of Defense executives in the application of data processing techniques and the use, operation, and management of digital computers systems. The Institute operates in an academic atmosphere and has access to extensive research, training, and equipment facilities of the Naval Command Systems Support Activity (NAVCOSSACT).

Digital Computer Systems Specialist \$10,000 to \$15,550

Applicants must be able to develop curricula and course materials, prepare and deliver lectures, moderate seminars, give formal briefings and assist in the analysis and the design of military ADP systems. Applicants' background should include broad experience in the development analysis and/or management of ADP systems and/or real time command and control ADP applications. The faculty of the Institute are provided opportunities to continue their education and broaden this experience in the ADP field by attendance at approved courses in seminars and visits to operational computer installations.

Excellent opportunities for advancement

Send resume and applications to Director, Department of Defense Computer Institute, Code 101, Navy Yard, Washington, D.C. 20390.

*An Equal Opportunity Employer,
U. S. Citizenship required.*

CIRCLE 301 ON READER CARD

FOR MAC PANEL CIRCLE 2 ON READER CARD →

look what we've done at age 8

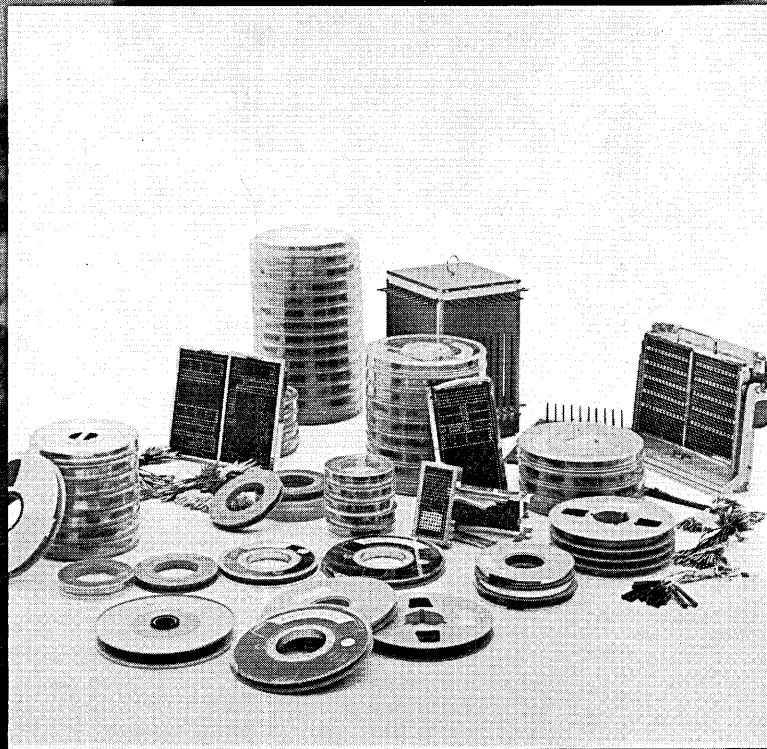

Part of being young is that our imagination grows every day. MAC continually looks for new ideas and better ways to serve your data processing needs. We're dedicated to this end. It's our only business. MAC Panel Co., High Point, N. C.

MAC

Core, plane or stack problems?

Take 'em to the experts. (Us.)

Core? Construction? Format? Hostile environment? Whatever your problem, we've probably seen—and solved—it before. If not, Ferroxcube experts will always find the shortest path to the right answer. For instance—

Application: Core memory stack for real-time display system in ship-board fire control computer.

Problem: Hostile thermal environment, critically limited space restrictions.

Solution: Single-area, double mated printed-circuit board construction; bus-wire bridging to allow air-flow cooling of 30-mil wide temperature range cores.

Application: Core memory stack for navigational guidance computer in commercial avionics system.

Problem: Mil-reliability at commercial prices; NDRO operation; volume reproducibility.

Solution: Single-area, single-mated plane, plastic laminated terminal frame construction; bootstrap patterns with 30-mil cores on extremely tight centers.

Application: Low cost core memory stack for state-of-the-art commercial-computer main memory.

Problem: High speed, low noise, high output uniformity, repairability, expandability, 650 ns cycle time, ease of access and interface.

Solution: 2½D organization; planar construction to offer lowest cost and convenient access; 20-mil cores; stack mounted diode modules.

Application: Core memory stack for guidance computer in missile-borne avionics package.

Problem: Extremely hostile mechanical and thermal environments, critical space limitations.

Solution: Continuously-wired, folded-stack construction; wide

temperature range cores wired using novel shock and vibration damping techniques.

What's *your* problem? Cores? We pioneered them. We have 20-, 30- and 50-mil cores in both standard and wide temperature range types covering a broad spectrum of switching and drive current parameters. Planes and stacks? We use a wide variety of printed circuit board or laminated frame-strip construction techniques, 2½D, 3D or linear select. Cost? We meet and lick this problem every day. It's part of being the experts.

Want more information? Write for Bulletins 6005 & 6006.

Ferroxcube 

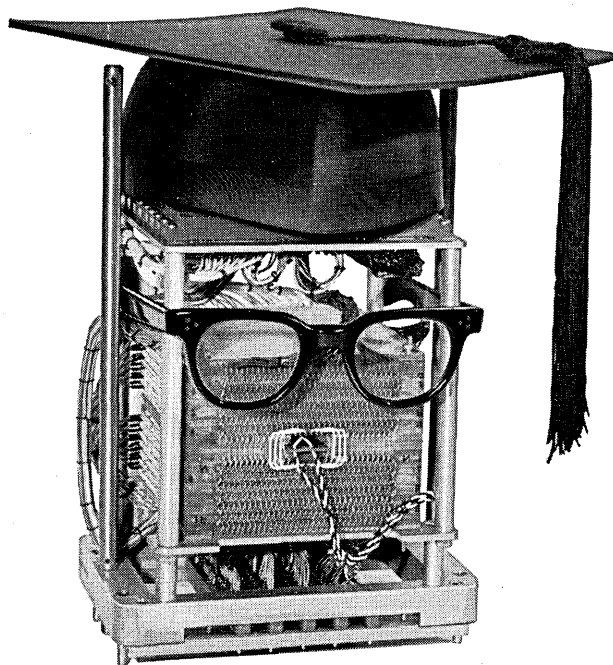

FERROXCUBE
CORPORATION
OF AMERICA
Saugerties, New York
914-246-2811

Boston
617-899-3110

Chicago
312-261-7880

Dallas
214-255-0441

Los Angeles
213-837-1484

Minneapolis
612-888-4681

New York Area
201-267-5888

Phoenix
602-265-1792

Philadelphia
215-927-6262

Washington, D.C.
703-893-4900

CIRCLE 3 ON READER CARD