

← DATA COMMUNICATIONS →

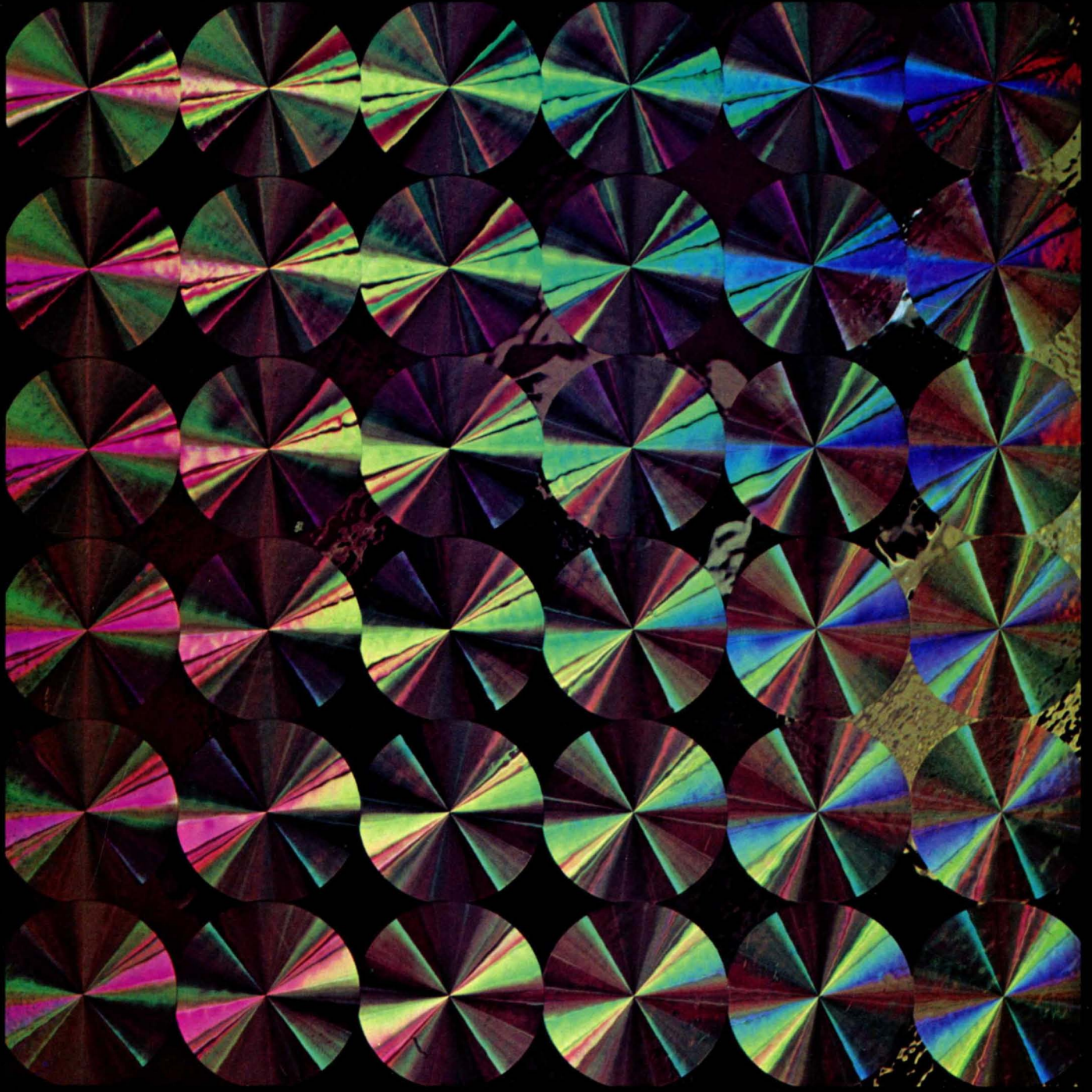

Interface '76, conflicts in communications (page 50)
Also: magnetic media myths and dp managers move up . . .

Datum Magnetic Tape Systems at work!

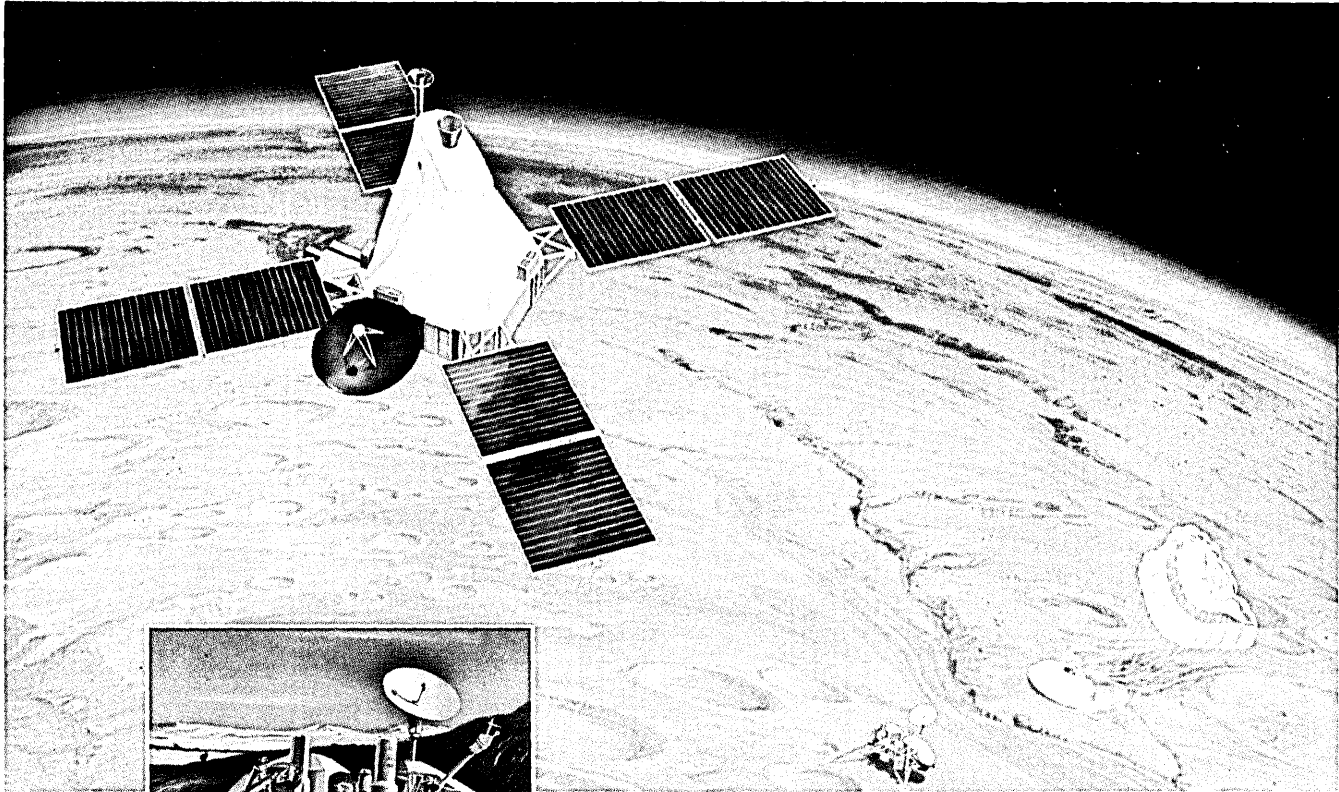

Several of the 3000 Datum mag tape memory systems installed to date . . . are used in an image-enhancement system at JPL that will increase the clarity of pictures from all NASA/JPL deep space probes. For instance, in the Viking mission to Mars pictured above, the Viking lander will descend to the Martian surface and send back pictures and data gathered in its search for microbial life. Viking data will also identify organic molecules, will determine elements and properties of Martian surface and soil and will gather seismological and meteorological data. Viking orbiter will take pictures of Mars, measure concentrations of water vapor, gather surface-temperature data and relay lander data to Earth.

For reliable response to rugged standards, specify DATUM disk or magnetic tape memory systems or controllers. Control as many as four disks or mag tape transports; handle multi-speed, multi-density (1600, 800, 556 and 200 bpi) tapes. You'll get immediate delivery for most minicomputers. Systems and controllers are compatible with your computer software; components plug together and into the computer for uncomplicated installation. Complete with controls, power supply, all necessary cables, diagnostic software and instruction manual.

Datum also manufactures minicomputers, minicomputer-directed data acquisition and control systems, timing instrumentation, digital cassette recorders and rotating drum memories.

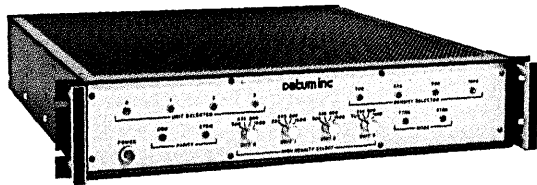

Datum Model 5191
Magnetic Tape Controller

Datum inc

Peripheral Products Division

1363 S. State College Blvd., Anaheim, Ca 92806 • 714/533-6333
EUROPE: Datum House, Cranford Lane, Harlington, Middlesex,
UK • 01-897-0456

Talk to us...
We communicate
So do all our
KeyProcessing™ Systems

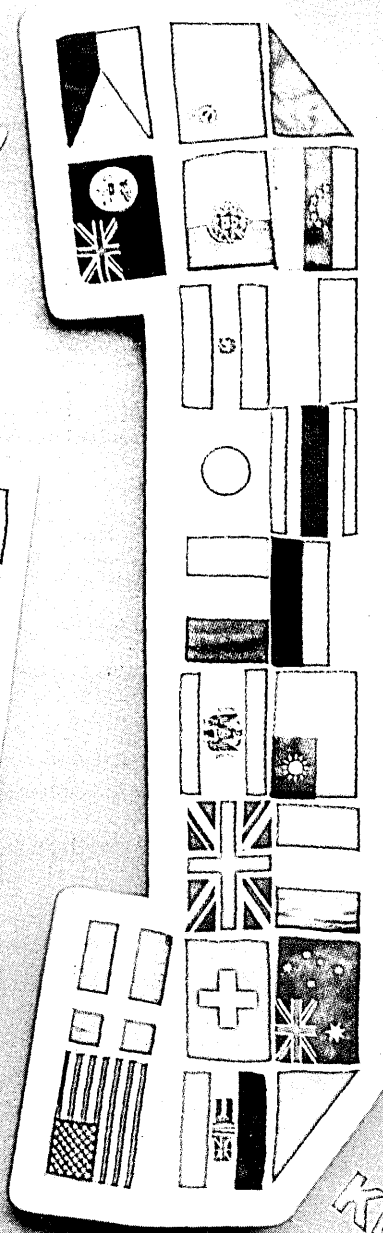
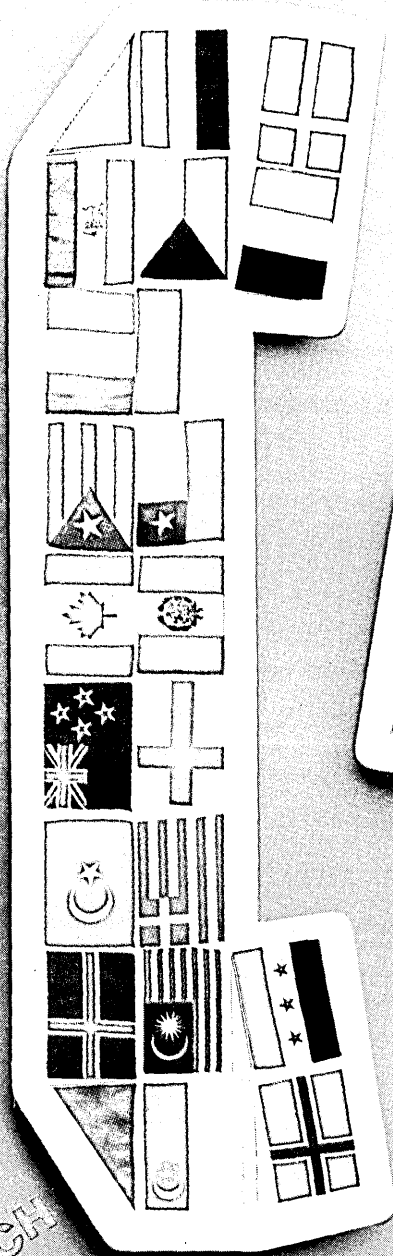

Signaling a new era

in data entry communications, CMC's TeleBatch™ option does it all — remote data entry, remote job entry, and remote printing — all concurrent with a full complement of active keystations.

The KeyProcessing Family

offers the widest range of data entry systems available today. With features and options that will serve you tomorrow too. Like TeleBatch, and the industry's most comprehensive array of management control reports.

TeleBatch

provides decentralized data entry without sacrificing centralized control over quality and procedures. TeleBatch is fast, with speeds up to 19,200 bps. And it's simple to operate — with unique Communications Control Batches automatically performing all operator and remote batch terminal functions.

Our customers say

that CMC's Management Control Reports are outstanding. The TeleBatch Log, for example, improves the effectiveness of communications by providing an audit trail of important communications statistics.

CMC KeyProcessing Systems are installed and communicating throughout the world.

KEYPROCESSING™

Talk to us,
you'll be pleased you did. Call or write
today for more information.

KeyProcessing and TeleBatch
are trademarks of

CMC Computer Machinery
Corporation

2500 Walnut Avenue, Marina del Rey, P.O. Box 92300
Los Angeles, CA 90009 Telephone: (213) 390-8411

CIRCLE 4 ON READER CARD

TELEBATCH™

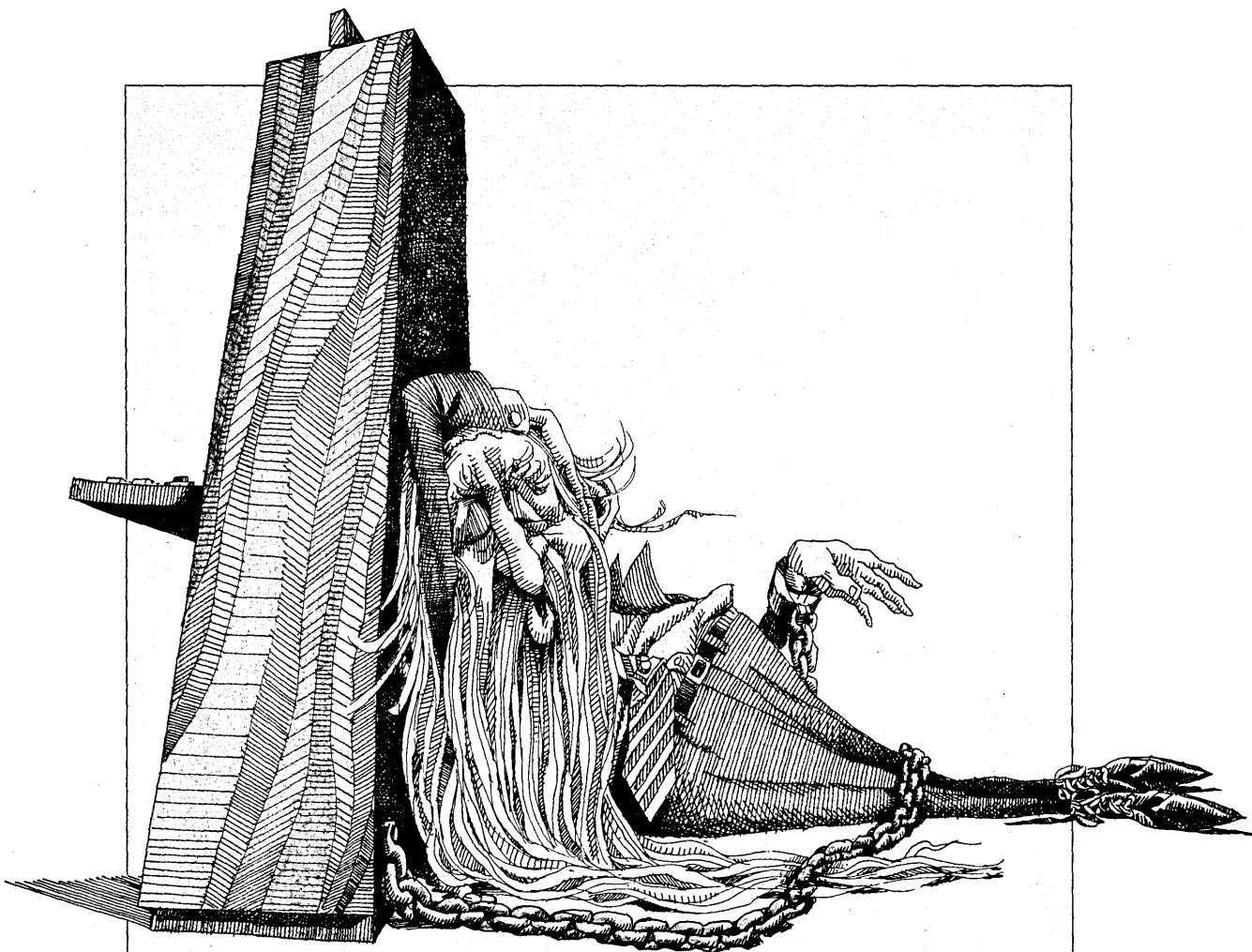

**If you only need a computer for 3 years,
you shouldn't have to settle for more.**

If your company isn't quite ready for a long term computer relationship, look into ITEL's IBM 370 system lease with early termination privileges.

It's a three to seven year lease that lets you keep your freedom and conserve capital at the same time.

For example, ITEL will lease you an IBM 370 central processing unit, plus ITEL's 7330 disk subsystem and ITEL memory at up to 40% savings over IBM's rental on an equivalent system.

Who's behind this good news?

The people who pioneered IBM 370 financial packaged leases. The same people who have over half a billion dollars in IBM computer leasing experience.

Your financial alternative.

ITEL
CORPORATION
FINANCIAL SERVICES GROUP

One Embarcadero Center San Francisco, California 94111. Phone: (415) 983-0300

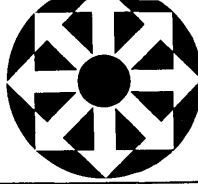

DATA MATION[®] 76

VOLUME 22 NUMBER 3

This issue 137,500 copies

MARCH 1976

FEATURES

Conflict in Communications

Once upon a time, not very long ago, computer users decided to standardize on character sets. Unfortunately, computer equipment manufacturers didn't go along. As a result, we use Baudot, ASCII, EBEDIC, SBT and others. A new battle is shaping, and this time the odds are much higher. Instead of only inconvenience, the user risks high costs, loss of freedom of choice, and even captivity.

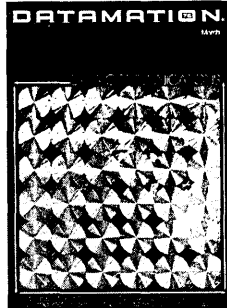

50 COMPATIBILITY OR CHAOS IN COMMUNICATIONS?

Ray W. Sanders and Vinton G. Cerf. The user can make the choice this time if he acts quickly.

56 INTERFACE '76

Coping with communications costs is the main theme of this year's data communications show; also a preview of the exhibits.

65 ERASING MYTHS ABOUT MAGNETIC MEDIA

Sidney B. Geller. Magnetic recording will resist anything outside of absolute catastrophe, and even then it might pull through.

75 ROOM AT THE TOP FOR THE DP MANAGER

Robert J. Greene. Bonuses, stock options, and a key to the executive washroom.

82 AN EXAMPLE OF STRUCTURED DESIGN

Bill Inmon. Over 31,000 lines of code in 14-man-months.

92 IBM AND MULTIPROCESSING

David N. Freeman. While other mainframe vendors championed tight-coupling, IBM stayed loose until pressure from customers finally forced a change.

112 HIPO FOR DEVELOPING SPECIFICATIONS

Martha Nyvall Jones. Even when the user can't really specify all of his requirements, and doesn't understand data processing that well, the situation isn't hopeless.

132 A PROGRAMMER'S ABC'S

David H. H. Diamond. "K" is for Kludge.

141 THE PRICE OF PROTECTION

Angeline Pantages. Faced with threats from external forces, including acts of God, and internal forces, including criminally inclined staffers, a dp security manager has a full-time job.

221 THE FORUM

A.J.L. Thorpe. Keeping a programming team together, as a "family," can quadruple its output.

NEWS IN PERSPECTIVE

161 LITIGATION

An Wang's early work in core memories. The fight for core memory patents — intrigue, threats and huge sums of money.

164 SECURITY

Is the encryption algorithm secure enough?

166 TECHNOLOGY

Talk is cheap on Jim Thornton's hyperchannels.

170 SERVICES

The computers that hum away at tax filing time.

178 EFTS

Meet the man who'll manage the EFTS commission.

181 COMMUNICATIONS

Huge new markets in telecommunications. Aid proposed for cable television. Evidence piles up for a breakup of AT&T. AT&T's DDS expansion plan may be in jeopardy.

186 MARKETING

Should happiness come with a price? A fledgling firm with wings.

188 NETWORKS

Who controls packet switching protocols?

190 BENCHMARKS

Now it's typewriters: Losing a customer; Its own terminals; Patent infringement charged; Judgment against Burroughs; Data General buy; NCR acquisition; Leases for IBM in POS; Staying afloat?

DEPARTMENTS

7 LETTERS

The dp director, audio/visual documentation, defining "professionalism," ire over forum on women, and more.

13 PEOPLE

Tosh Nakahiro: always wanted to be on-line; V. R. "Buck" Pleters II: doesn't have to sell the sizzle anymore.

17 LOOK AHEAD

22 CALENDAR

DataCom, micrographics, displays bloom in the spring.

27 SOURCE DATA

Books on computers and the law, programming languages, & data base systems reviewed; book briefs, reports, courses.

47 EDITOR'S READOUT

Red, white, and dollar green appear to be the colors of

our bicentennial. There are some deeper problems beneath the blatant merchandising of our nation's history.

194 HARDWARE

A low cost version of Digital Equipment's PDP-10; also a 2,400 line per minute printer for only \$3K.

208 SOFTWARE AND SERVICES

IBM's Virtual Storage Personal Computing: help on the way for "non-dp-pro" problem solvers?

216 ADVERTISERS' INDEX

About The Cover
Reflecting diversity within standardization, our uniformity of shapes breaks up into myriad hues . . . character sets of another color, perhaps. Design and photography is by Barbara Benson.

If your system fails, restore it in seconds with

Tbar®

SYSTEM RESTORAL™

Reroute or transfer dozens . . . even hundreds . . . of data lines individually or simultaneously in seconds. Push a button or flip a switch on any T-Bar SYSTEM RESTORAL switch, and you're back on-line in seconds. It's that easy.

Use T-Bar SYSTEM RESTORAL Data Communication Switches individually or in packaged combinations.

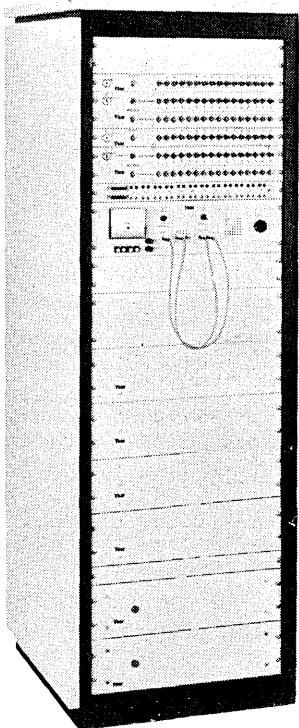

5100 T-Bar Fallback Switches provide BACK-UP control for RS232 data lines, 4-wire Telco, 303 type wide band or video terminals with the flip of a toggle or the push of an illuminated button.

5400 T-Bar Spare Modem Switches replace a suspect modem with a spare for SYSTEM RESTORAL or test.

5500 T-Bar Bypass Switches provide RECONFIGURATION capability by rerouting one of a group of RS232 data lines or 4-wire Telco lines.

ALL T-Bar SYSTEM RESTORAL Data Communications Switches are available with local, on-site remote, on-site computer and off-site remote controls. Can you restore as simply as this? If not, write or phone today for more information.

Tbar®

DATA COMMUNICATIONS SWITCHING EQUIPMENT

141 Danbury Road, Wilton, CT 06897 • Phone: 203/762-8351 • TWX: 710/479-3216

CIRCLE 137 ON READER CARD

DATAMATION.

EDITORIAL STAFF

Editor	John L. Kirkley
Articles Editor	Richard A. McLaughlin
International Editor	Angeline Pantages
European Editor	Nancy Foy
Communications Editor	Phil Hirsch
Industry Editor	W. David Gardner
Products Editor	Michael Cashman
Source Data Editor	Daniel P. Schlosky
Calendar Editor	Gloria Tidstrand
News Editor	Tom McCusker
Bureau Managers	
San Francisco	Edward K. Yasaki
Los Angeles	Edith D. Myers
Washington, D.C.	Phil Hirsch
	Pamela Evans
	Angeline Pantages
	W. David Gardner
New York	
New England	
Correspondents	
Minneapolis	James K. Johnson
Southwest	Robert F. Alexander
Australia	Ken McGregor
Editorial Advisor	Robert L. Patrick
Technical Advisor	Lowell Amdahl
Contributing Editors	Paul Armer, Howard Bromberg, Philip H. Dorn, Louis B. Marienthal, Carl Reynolds, F. G. Withington

EDITORIAL OFFICES

Headquarters: 1801 S. La Cienega Blvd., Los Angeles, CA 90035. Phone (213) 559-5111. **Eastern:** 35 Mason St., Greenwich, CT 06830, (203) 661-5400. 134 Mt. Auburn St., Cambridge, Mass. 02138, (617) 354-2125; 9805 Singleton Dr., Bethesda, MD 20034, (301) 530-7271. **Southwestern:** 2711 Cedar Springs, Dallas, TX 75201. (214) 744-0161. **Western:** 2680 Bayshore Frontage Rd., Suite 401, Mountain View, CA 94043, (415) 965-8222. **Foreign:** 8 Pellerin Rd., London N. 16; (01) 249-1177; 74 Stafford Road, Artarmon, Sydney, NSW 2064, Australia, 41-5748.

GRAPHIC DESIGN & PRODUCTION

Art & Production Director	Cleve Marie Boutell
Advertising Production Manager	Marilee Pittman
Production Assistant	Alberta R. Martin

CIRCULATION

35 Mason Street, Greenwich, CT 06830
Circulation Manager Suzanne A. Ryan
Marketing Research Manager Deborah Dwellley
Publisher James M. Morris
Assistant Publisher F. Douglas De Carlo
 Circulation audited by Business Publications Audit



Member American Business Press, Inc.



DATAMATION is published monthly on or about the first day of every month by Technical Publishing Company, 1301 South Grove Ave., Barrington, Illinois 60010; Arthur L. Rice, Jr., Chairman of the Board; James B. Tafel, President; Gardner F. Landon, Executive Vice President. Executive, Circulation and Advertising offices, 35 Mason Street, Greenwich, CT 06830, (203) 661-5400. Editorial offices, 1801 S. La Cienega Blvd., Los Angeles, CA 90035. Published at Chicago, Ill.

DATAMATION is circulated without charge by name and title to certain qualified individuals who are employed by companies involved with automatic information handling equipment. Available to others by subscription at the rate of \$24; \$40 Air Mail annually in the U.S. and Canada. Reduced rate for qualified students, \$14. Foreign subscriptions are available for £20.00 or for the equivalent of \$40 U.S. in most West European currencies. Sole agent for all subscriptions outside the U.S.A. and Canada is J. B. Tratsart, Ltd. 154 A Greenford Road, Harrow, Middlesex HA13QT, England. No subscription agency is authorized by us to solicit or take orders for subscriptions. Controlled circulations paid at Columbus, OH and Form 3579 to be sent to Technical Publishing Company, P.O. Box 2000, Greenwich, CT 06830. © Copyright 1976 Technical Publishing Company. ® "Datamation" registered trademark of Technical Publishing Company. Microfilm copies of DATAMATION may be obtained from University Microfilms, A Xerox Company, 300 No. Zeeb Road, Ann Arbor, Michigan 48106. Printed by Beslow Associates, Inc.

DATAMATION

ADR SOFTWARE HELPS LEEDS & NORTHRUP MAKE SENSE OUT OF THE ENVIRONMENT.

With the help of ADR software, Leeds & Northrup's Corporate Systems department administers and schedules critical resources in an ever-changing environment.

Thirteen full-time programmers maintain, service and improve a library of over 3,000 programs that range from payroll and accounting systems support to systems for control of parts and materials. In the eight months that ADR's ROSCOE™ On-Line Conversational Programming System has been in use, maintenance time appears to have been reduced 50% from the system previously used. This comes to an estimated cost avoidance of \$26,000, which will pay for the entire cost of ROSCOE and its maintenance on four terminals in its first year.

JCL errors have also been markedly reduced. Instead of filling out lengthy JCL cards, keypunching and waiting up to four hours to get cards into the system, the programmer just sits at a ROSCOE supported remote terminal and keys in requested information shown on the CRT display. JCL is in the system in three minutes or less. If an error is made, the programmer knows about it immediately and can correct it on the spot.

ROSCOE's direct access conversational data entry features give the sequence of information that is needed automatically. What's more, the information goes directly to the system without stops and delays usually associated with manual data entry.

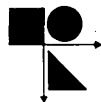

APPLIED DATA RESEARCH

SOFTWARE PRODUCTS DIVISION

Route 206 Center
Princeton, New Jersey 08540
Telephone: (609) 924-9100

Joe Dupon, Manager of Computer Technology, credits these features with many dramatic savings in time and increases in efficiency through reduced coding and programmer keying time, reduction of manual operations, less waiting for data entry, fewer chances for error, and reduction of error correction time.

Other ADR software that Leeds & Northrup has installed includes The Librarian® and MetaCOBOL®.

The Librarian safeguards the maintenance and retrieval of application programs. MetaCOBOL was used to convert from DOS ANS Cobol to OS ANS Cobol in less than half the time Joe Dupon estimated it would take.

According to Joe Dupon, "an important point about ADR's software products—ROSCOE™, LIBRARIAN and MetaCOBOL—is that they have always worked to specifications.

The program packages that have been shipped to us have had a virtual zero defect level. As a result, we have never hesitated to put them to work in our system without the lengthy trial and test procedures we normally use with other products."

For more information on what ADR software can do for you, call or write Applied Data Research, Inc., Route 206 Center, Princeton, New Jersey 08540. Phone: 609-924-9100

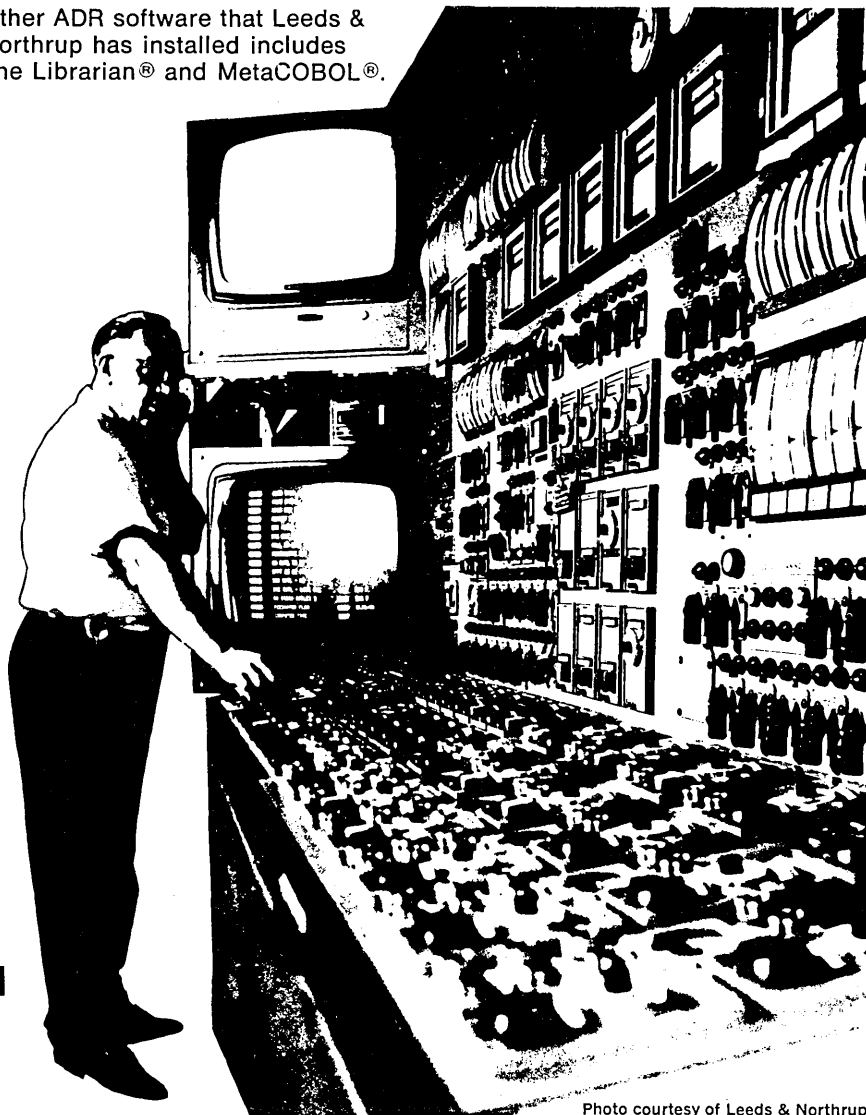

Photo courtesy of Leeds & Northrup

ADR software products: in use at over 5000 installations worldwide.

U.S. offices in Boston (617) 245-9540, Chicago (312) 694-2244, Cleveland (216) 228-0880, Houston (713) 526-3188, Los Angeles (213) 826-5527, New York (212) 986-4050, Princeton (609) 924-9100, Washington, D.C. (703) 281-2011.

Foreign offices in Australia, Austria, Belgium, Brazil, Canada, Denmark, England, Finland, France, Israel, Italy, Japan, Korea, Mexico, Netherlands, New Zealand, Norway, Philippines, Puerto Rico, Republic of South Africa, Singapore, Spain, Sweden, Switzerland, Taiwan, Thailand, West Germany.

Time was when high speed printing meant a high speed line printer.



Times have changed.

And so have printers. No longer is high speed line printing the sole realm of the expensive line printer.

Centronics has changed all that. Our new 103 and 503 serial impact printers can give

you up to 340 lines per minute. Not only are they the fastest, most efficient serial impact printers you can buy, but, in some applications, they can keep pace with line printers costing twice as much.

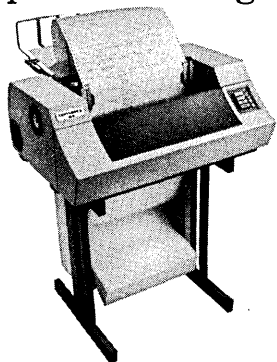

How do they do it? By a unique combination of printing speed, slew rate and intelligence. Both the 103 and the 503 are 165-character-per-second, 132-column printers.

Both are bidirectional — which is the intelligence part. They print right-to-left, left-to-right at 70 to 340 lines per minute. Moving to the nearest character on the next line to be printed — wherever it may be. There is no carriage return and no carriage return deadtime (in the 400 milliseconds it takes to effect a carriage return, these printers print 80

characters). A big boost for throughput.

If performance is why you buy a printer, you want to learn more about our model 103.

If economy is your thing, the model 503 gives you the best

performance for the money anywhere. Our catalogs and spec sheets give you complete information. Send for your copies today.

We want to change your mind about printers. Centronics Data Computer Corp., Hudson, New Hampshire 03051.

CENTRONICS® PRINTERS

Centronics — Marketing Services Dept.
Hudson, N.H. 03051

103/503

- Send catalog and specification sheets.
- Have a sales representative call.
- I am particularly interested in a printer for:

_____ (describe application)

Name _____
Position _____
Company _____
Company Address _____

Centronics Data Computer Corp., Hudson, N.H. 03051, Tel. (603) 883-0111, Twx. 710-228-6505, Tlx. 94-3404; Eastern Region: (617) 272-8545 (MA); Central Region: (513) 294-0070, Twx. 810-459-1784 (OH); Western Region: (714) 979-6650, Twx. 910-595-1925 (CA); Centronics Data Computer (Canada) Ltd., Ontario, Tel. (603) 883-0111, Twx. 710-228-6505; Centronics Data Computer (UK) Ltd., Cheam, Surrey, England, Tel. 643 0821-4, Tlx. 851 945756; Centronics Data Computer, GmbH, 6 Frankfurt/Main., West Germany, Tel. 663321/22, Tlx. 841 413224; Centronics of Puerto Rico, Dorado, Puerto Rico, Tel. (809) 796-1881, Tlx. 3859349

letters

The dp director

The Editor's Readout ("Civil War in the Corporation," Nov. '75, p. 45) was more like a resounding clang than a familiar ring. The following comments relate to my organization's efforts to provide a communications interface between the dp technicians and the end product users . . .

The dp director's position in the organizational structure must be comparatively equal with other members of the corporate staff. If he is subordinate to any other staff member, he will be unable to assist objectively all corporate functional activities.

Technical proficiency may be a prerequisite for his position, but a dp director will not be effective until he or she has a complete working knowledge of the company, including its objectives, organization, limitations, problems, and top management's policies and expectations. He should be a very active member of the corporation's planning staff. . .

From the start, the dp director must take some action that fosters credibility in the position. He must develop a reputation as a helpful and valuable technical advisor early in the game. Good areas for doing this are the dp department's application production schedule and automation of routine, time-consuming administrative tasks. Utility programs can frequently improve the latter, while an objective analysis of users' functional needs (as opposed to demands) can aid in the former. Such action can go a long way toward closing that communications gap.

The dp director must be an educator, salesman, and devil's advocate. He can improve the dp knowledge of functional decision makers, removing whatever machine mystique remains. He can help make systems work the way they should, can sell good systems or application changes, and can put a damper on those frequently unnecessary but nice-to-have applications that are wasting the available ADP resources.

The dp director must act as the interpreter between the user and dp personnel. He must be able to make convincing responses to questions such as "What does a tape drive problem have to do with my not getting that report?" and "What difference will a one day delay make?"

Last but not least, the dp director must have infinite patience and be the best coordinator on the staff. As each separate user proposes new systems or

systems changes, the proposals must be forwarded to the dp director for review, evaluation, and comment. As part of the review, the dp director must insure that each proposal is coordinated with every other functional agency even remotely involved in the action.

MAJOR CHARLES W. CLARK
*Management Information
Systems Officer
Department of the Army
APO New York*

Crystal ball dropped

You unfortunately omitted Sperry Rand from the list of top data processing companies in 1985. (Tom McCusker "The Industry in '76," Jan. p. 66).

While crystal ball gazing is hazardous at best, my crystal ball shows Sperry Rand among the leaders in 1985, and I so reported in my speech to the Computer Industry Association.

DAVID L. MORDY
*Vice President
Donaldson, Lufkin & Jenrette
New York, New York*

Professional definitions needed

It seems to me that one facet of the programmer professionalism problem has not yet been explored. Who is the

"professional" defining the application to be programmed? In most applications, I believe, the programmer/analyst must come to understand his application even *better* than the customer. Thus the programmer's professionalism encompasses not only programming and computer aspects, but also the science, technology, and practice of the application he faces.

Is it reasonable to expect a professional programmer (or whoever) to professionally handle a job on a payroll system this month, then an application on bridge design next month?

Before we can proceed much further on this, I think we need to define more clearly our field, our functions, and our responsibilities. We must define how we interface with the professionalism of the application.

C. E. PRICE
Kingston, Tennessee

Audio/visual walkthroughs

The epitaph of many dead systems could read: "Because of its complexity, modification to meet current needs is economically prohibitive." Inspired by some excellent audio/visual on os/vs1, I'll ask the following question: Could the lifespan of large systems be

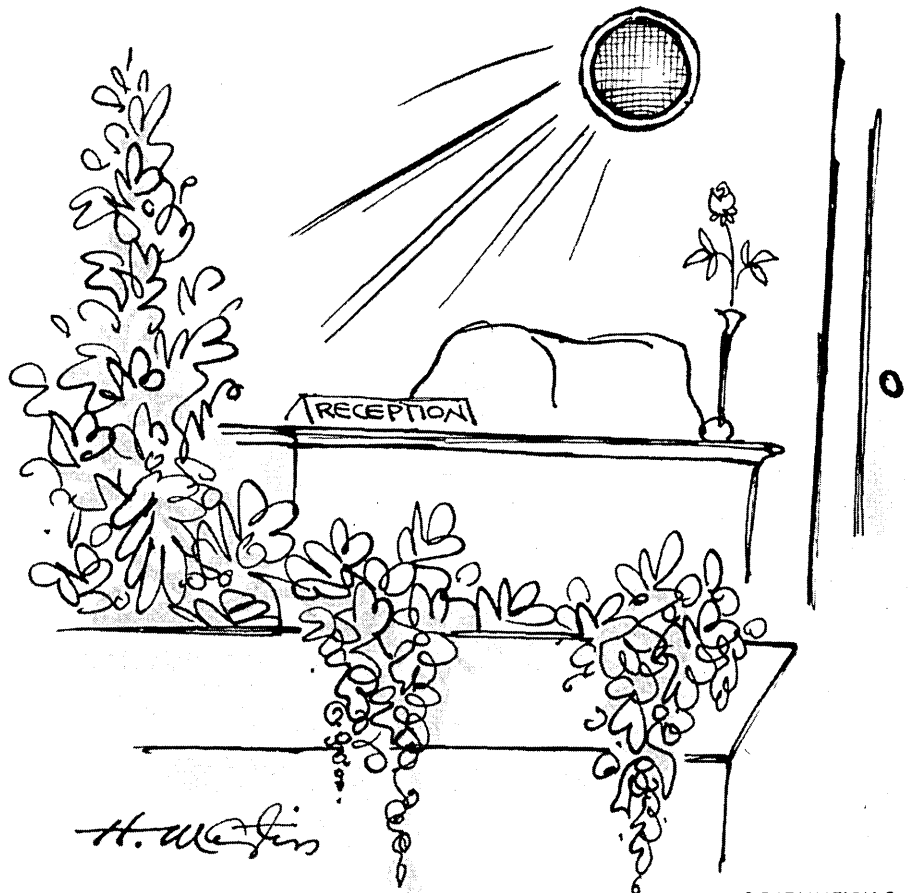

© DATAMATION ®

"Good evening, office plants. This is vice president Harrison P. Dinwittie with a recorded after-office-hours program of news of special interest to you. Please welcome the following to the lobby garden: African violets, Monstera deliciosa, philodendron and century plants. Making the rounds and speaking to you individually will be newly employed night watchman, Joe Dempster . . ."

letters

increased by developing documentation into audio/visual training material to be tutored to maintenance programmers?

If programs are viewed as corporate assets, then the preservation of their usefulness is a corporate responsibility. Furthermore, it would be reasonable to assume that the quality of training and orientation that a maintenance programmer has undergone concerning a particular system is directly related to:

- 1) Time spent on research prior to a needed patch, and consequently, the timeliness of the patch itself;
- 2) The correctness of the patch relative to the overall system;
- 3) Programmer morale as a result of accomplishment.

A big plus concerning formal training is that proven training material would reduce management's dependence on technicians by allowing easy transfer of technical responsibility. One method of documenting could involve audio/visual recording of structured walkthroughs with subsequent editing of film, HIPO charts, actual code, and minutes of the meeting. Additionally, the minutes of the meeting and major points could be condensed onto audio cassettes. Therefore, the documentation would consist of a series of "instant walkthroughs" for all modules in the system.

Documentation need not be developed to the "formal training material" stage. However, the fact remains that even the slightest refinement in our ability to instill in maintenance programmers a better understanding of the systems that they maintain, should result in more effective maintenance throughout the lifespan of the system.

DON BABIN
Auditor
Walgreens
Deerfield, Illinois

Palme's parallel processes

Mr. Palme's article ("Languages for Reliable Software," Dec. '75, p. 77) says: "If a program is only going to be executed on one cpu, then there is no need for parallel processes in which the order of execution is undefined."

Indeed? Are operating systems not programs? What about real-time processing? Dangerous, yes, but it's just a matter of keeping your wits about you; as is everything.

PATRICIA KRIBS
Los Angeles, California

Hex buttons needed

In the midst of the electronic calculator

explosion there is a vacuum. Where are the hexadecimal machines?

The only manufacturer I know about, Texas Instruments, has discontinued its line. Perhaps others like myself do not want to use hex flash cards, and a market could be generated for some enterprising company.

It is ironic that a computer designed a chip that could get me $10^x \sqrt{\arccos y}$ at the touch of a button; but when that program dumps, the programmers have to do all the hex mathematics manually.

ROBERT STEINBERG
Programmer
American Telephone and
Telegraph Company
New Brunswick, New Jersey

Lerner's Law

An additional "law" to be added to "The Ten Laws of Teleprocessing" (David Hebditch, Nov. '75, p. 62) would explain the phenomenon of same program, same data, same environment, and different (or no) results. Thus (humbly), Lerner's Law: *If it ran last Tuesday, it may not run today.*

BRUCE R. LERNER
Washoe County School District
Reno, Nevada

Wooster?

There ain't no such place as "Wooster, Mass." (Dec. '75, p. 17). Perhaps you mean "Worcester?"

DAVID AMES
Watertown, Massachusetts
Yeah, some folks in our Grenitch, Conn. office caught the typo also.

✱

Beware the wrath of . . .

Mr. Patrick's December ('75) Forum ("You've Come a Long Way, Baby," p. 193) is an embarrassment to the entire profession. It is not advice, but rather a catalog of the usual prejudices against women. His basic themes are that men are somehow trained from childhood for professional careers while women are not; that women must be like men in order to succeed; and that even in the face of discrimination by men, women must bear the entire responsibility for their own advancement. . . .

Mr. Patrick's two examples are so biased as to be incredulous. In the first, the woman succeeds because she can fix cars, and in the second, she fails because she has a husband and family. The two situations are just not comparable. In the second example, the project is in trouble, which is a different position for any manager. To show one woman failing because she wasn't S.O.B. enough is to imply that all women would fail because they aren't like men. Why doesn't Mr. Patrick generalize from the fact that it was a male manager who started the mess in the first place?

RICHARD M. KOOLISH
Cambridge, Massachusetts

. . . While I can't totally agree with Mr. Patrick, I do believe he has a point. It's true that "A woman must still be considered outstanding to be considered 'equal' to her male counterparts." His sweeping generalization that women usually display less drive to climb the ladder to middle management—and often have less

need to climb that ladder—also has a ring of truth to it. But this kind of generalization also makes it harder for a woman with drive to get ahead.

. . . I do not want to be asked in an employment interview how I am planning to manage two children, a house, and a job—unless my husband is going to be asked the same question. I want my previous work, my professional activities, my education, and the papers I have published determine where I go next.

MARY POPPENDIECK
Madison, Wisconsin

. . . Where have you been all these years? There are a few hundred women in the computer field in middle and upper management positions. It is unfortunate that these women did have to "try harder" than their male counterparts to prove their worth. However, this has resulted in women managers with truly superior technical skills who worked their way up through the ranks, and male managers with only adequate technical ability who got to the top by simply passing the grade in a managerial training program. So who is more valuable to the company?

HENRIETTE SCHORR
Sunnyvale, California

Mr. Patrick replies: It is difficult to remain calm amid all the shrieking, but hints for getting ahead are more valuable than a litany of the sins of the past. Anyone who aspires must understand that promotion goes to the one that is outstanding among the candidates selected. Being equal is like being present—you don't get the job.

✱

LIKE MONEY IN THE BANK

The new Dataproducts Model 2290 printer offers superior printing quality at 900 LPM with a full 64-character ASCII set.

For about half the cost of current high-speed line printers.

Couple that with extraordinary low operating costs and the 2290 is like money in the bank, twice over.

So why pay twice as much (and more) if 900 LPM is all you need?

PERFORMANCE PLUS ECONOMY

The 2290 was designed (from the proven technology of our 2200 series) to meet the requirements of the new high-performance, minicomputer-based systems.

So you can count on maximum operating economy in medium and large business data processing systems, distributed processing, and remote terminals at 9600 baud and up.

What's more, the 136-column 2290 is interface compatible with our 2230 (300 LPM) and 2260 (600 LPM), and over 70% of its parts are interchangeable with these field-proven models.

A little extra economy you can bank on with Dataproducts.

FEATURES YOU CAN BANK ON

The 2290, like all 2200 series printers, offers two unique systems:

The patented friction-free Mark IV print-hammer system for consistent high-quality printing and unmatched reliability.

And a patented system for automatic detection of lack of paper movement.

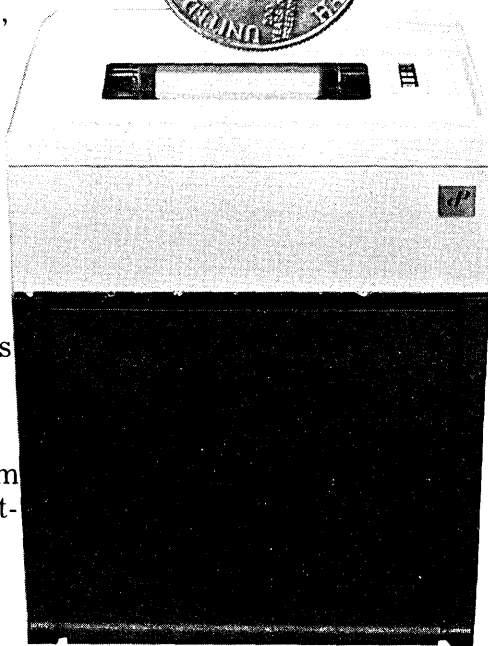

Plus, a 90° swing-open gate for fast ribbon and paper loading.

An adjustable paper stacker for uniform stacking of forms.

An optional direct-access vertical format unit that eliminates paper tape to allow printing of new formats direct from the CPU.

An acoustical cabinet for quiet operation in office atmospheres.

Little wonder that, with these outstanding features (and many more), Dataproducts is the world's leading independent manufacturer of line printers.

For all the facts and figures on the 900-LPM 2290, write for our brochure.

Better yet, call us collect and bank the unnecessary cost of a stamp.



Dataproducts

The Line Printer Company

6219 De Soto Avenue/Woodland Hills, CA 91365
(213) 887-8451; Telex: 67-4734

THE NEW 900-LPM 2290

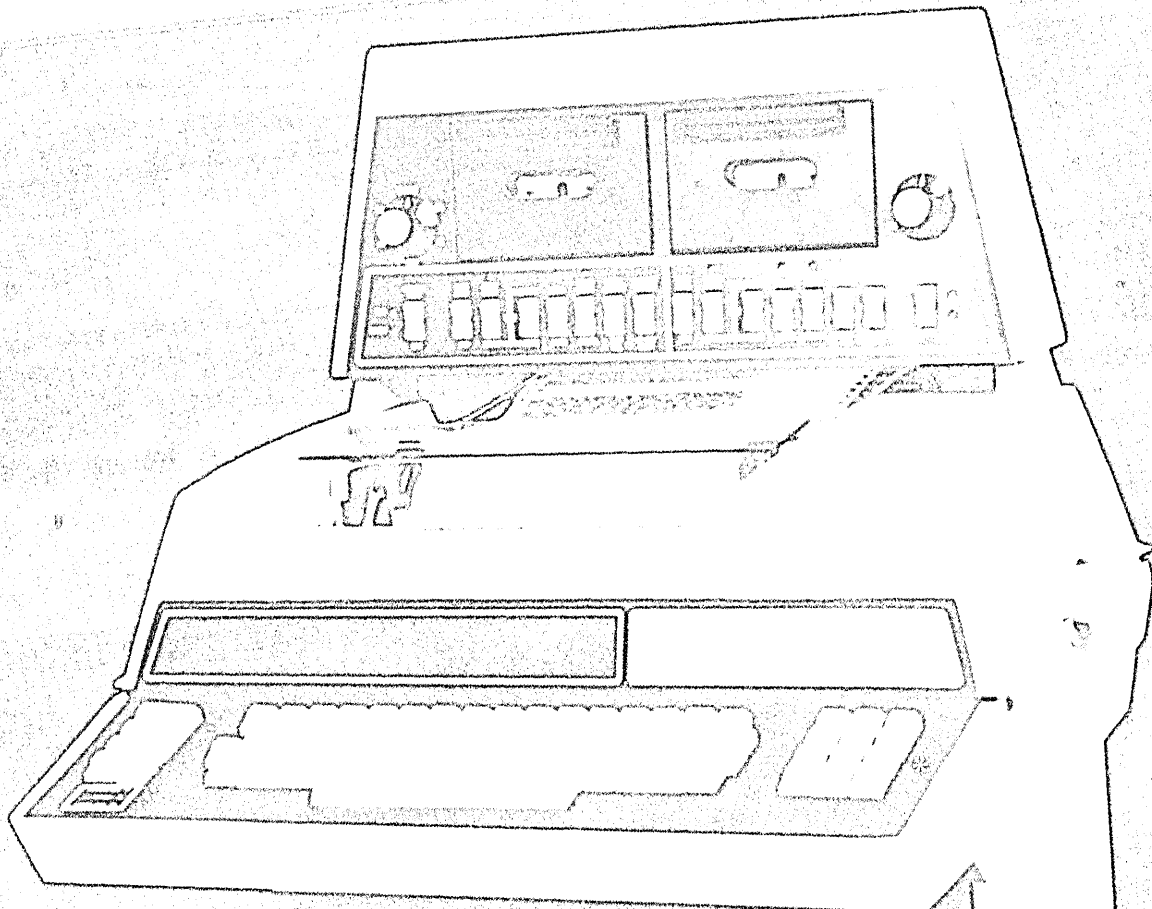

GE's
the most
3000

er-
satile
d

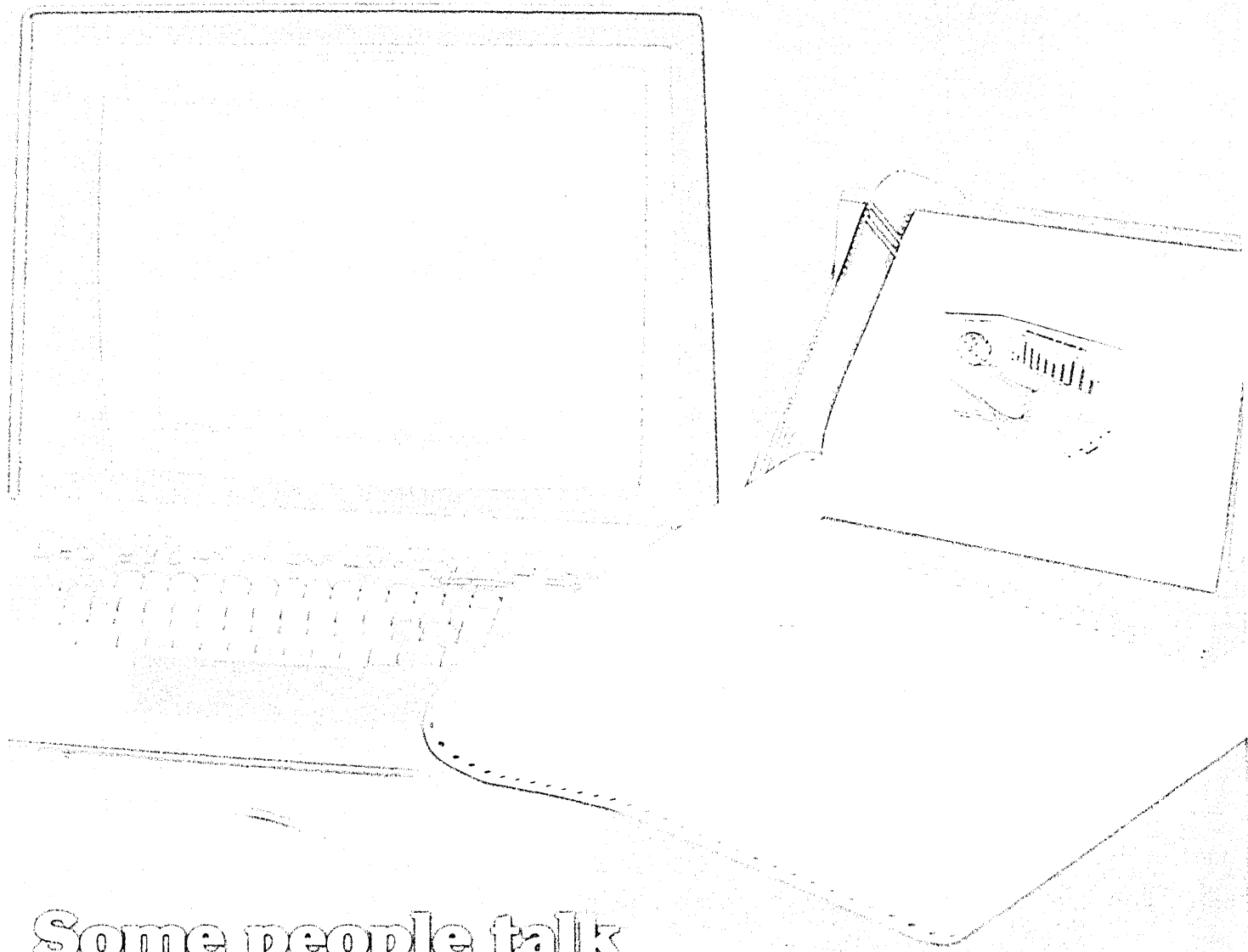

Some people talk
about machine and device
independent graphics software.

DISSPLA has been working for years!

Our DISSPLA graphics software system is driving Tektronix, IBM 2250, Vector General CRTs, Calcomp, Zeta, Xynetics, Hill, Gerber, HP plotters, RR30, COMp30, SC-020, SC-030 and Calcomp microfilm—in most models. Turnkey DISSPLA versions are available for IBM 360/370, CDC 6000 series and UNIVAC 1100 series computers under a dozen operating systems. DISSPLA has proven to be so versatile and easy to use that it is the de facto standard at virtually all of our user sites. These include banks, leading telephone laboratories, oil companies, naval and air force centers, government agencies, service bureaus, universities, nuclear research centers, aerospace centers, and more. We gladly furnish a list of our customers. Don't take our word for it—ask them!

DISSPLA is a system of interlinked FORTRAN subroutines also used from COBOL, ALGOL, and PL/I. Features include quality fonts, 3-D hidden line surfaces, projected maps, bar charts, pie graphs, shading, interpolation, smoothing, photocomposition and on-and-on.

Write for details: Set of Beginners, Intermediate and Advanced Manuals available for \$20 (includes postage only in USA).

DISSPLA

Display Integrated Software System and Plotting Language
Appropriate software product #465500

For more information call Sunny (Texas) (714) 565-8098 or (714) 452-0170
Or write

ISOCO

Integrated Software Systems Corporation
4816 Sorrento Valley Blvd., Suite N, San Diego, California 92121

In Europe contact Repko bv van Blankenburgstraat 33
The Hague (Holland)
Telephone 070-403225

CIRCLE 133 ON READER CARD

people

“The Guts of the Business”

Tosh Nakahiro firmly believes a data processing system should be operations oriented.

“I quit designing accounting systems ten years ago,” says the outgoing Nakahiro, whose company (he’s founder and president) CMS Industries, Inc., provides, among other things, an on-line system for small businesses, particularly for distributors. “Our system is designed around inventory control with other things, including accounting, being appendages.”

He says he’s seen too many systems, utilizing expensive hardware, performing mainly accounting tasks and having no part in “the guts of the operation.” He feels a system should be geared to “lightening the work load at the operations level.” Nakahiro’s company began development of its on-line system early in 1968 and put its first customer on-line in June 1970. Their on-line customers now are all distributors but they hope to get into other things like manufacturing and maybe hospitals.

Nakahiro started his company early in 1967 as a systems design consulting firm but “I always wanted to be on-line.” He had his first brush with designing an on-line system in 1964, with Tidewater Oil

Co. and subsequently designed, developed, and got one up and running while data processing manager for Occidental Petroleum Co.

CMS became a batch service bureau in September 1969, running on first a 360/30 then a 40. Since Oct. 1971 they have used a 370/145 and, since first going to on-line service in '70, they have eliminated batch. “I can provide on-line service cheaper than batch.”

The company still does some consulting and this year is beginning to market some of the software it has developed for its own system.



TOSH NAKAHIRO

“I always wanted to be on-line”

American-born Nakahiro is as fluent in Japanese as he is in English and has “a lot of contacts” in the Los Angeles Japanese community. He has used both these facts in his marketing but it hasn’t been as easy as he once supposed. Most of the Japanese businessmen in the L.A. area have parent companies in Japan. Nakahiro is learning to do business the Japanese way. “There

are the many amenities you have to go through before you get down to business. And, in a Japanese company, no one person ever makes a decision.”

Nakahiro wasn’t always as sure of what he wanted to do as he is now. He quit college three times before graduating from UCLA in 1955 with a degree in industrial engineering. He worked in between times, selling life insurance and as an engineer for Douglas Aircraft.

He learned from working at Douglas that he didn’t want to work in a company having anything to do with government contracts . . . “too much waste.” So, after graduation, he went to work for Square D Electric. That didn’t afford much promise so he moved to Cannon Electric where he eventually found himself in a group called Systems & Procedures. When he joined the group it was monitoring paperwork flow but shortly after it was told to “study computers.” He did and has been studying them ever since.

He became interested in on-line systems as early as 1962. “I sat down with some IBM representatives but they didn’t have anything.” He built a pseudo on-line system around a Librascope LGP 21.

Nakahiro has built his company from one man to 35 in its eight years of existence. He contends his on-line system is international in that he has terminals in Toronto and Vancouver in addition to New Jersey, Chicago, Atlanta, Dallas, Seattle and Los Angeles. He wants to be bigger. Most of his business to date has come through referrals. “We’re going to promote this thing now . . . target more carefully on our prospects.” *

Making COM More Attractive

In some circles, there’s an old bro-mide that says you should “sell the sizzle and not the steak.” That is, you should whet the buyer’s appetite by talking about the benefits he gets from the purchase of a product. But the new marketing vice president of Quantor says this phase in the sale of COM systems has passed. “You don’t have to go in and sell the sizzle any more,” says V. R. “Buck” Pieters II. He thinks the interest in computer output microfilm today is five times greater than it was three years ago.

Pieters explains that people who have risked their jobs by installing COM at one place of employment have moved elsewhere and taken



V. R. PIETERS II

“you don’t have to sell the sizzle any more”

with them the experiences of their success. They’ve become missionaries. “I’ve never met an unhappy customer, once they’ve started on COM,” he adds.

No newcomer to the field, Pieters has been in the marketing end of COM for seven years. Prior to joining Quantor in Mountain View, Calif., he had been national marketing manager for Stromberg-Data-graphix.

While acknowledging that the COM market is growing slowly, he points to recent developments that make it easier for the user to produce microfiche. This is the mini-computer front-end which also

(Continued on page 14)

HELP ECOLOGY...

STAMP OUT PAPER TAPE!

Record ANSI/ECMA cassettes 33 times faster synchronously, 8333 times faster asynchronously, read 6.7 and 1667 times faster, respectively, with Dicom's 330 digital cassette unit (single or dual drive). It emulates paper tape reader/punch units transparently to the host system. With a capacity equal to over a mile of paper tape, it's more reliable, compact and convenient to use.

Integrate our 330 tape drive into your system using existing interfaces, and stamp out paper tape. Get the facts, then the industry's best cassette system, from Dicom.

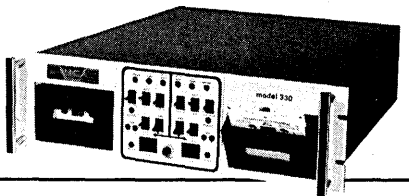

- Please send me specifications/ applications data on the 330
- Please contact me for help in implementing a cassette module

My application is _____

Name _____

Title _____

Organization _____

Address _____

City _____ State _____

Zip _____ Telephone _____



DICOM INDUSTRIES

715 North Pastoria Avenue
Sunnyvale, CA 94086
(408) 732-1060 TWX 910-339-9285

CIRCLE 112 ON READER CARD

COM

serves to relieve the host computer of some of its processing load. What does it do for the user? "He can take any tape not formatted for COM, from any computer, or any tape formatted for any other COM device, and the software supplied by the COM vendor will do all the titling and indexing, everything the host computer had been doing," says Pieters. And because they've also made it easier for the user to get his data into fiche form—all he has to know are the parameters of the tape he has—the COM recorder is being taken out from under the system department.

"That's why all the COM service bureaus have gone to that machine," he says. "And that's why seven out of ten in-house users are

going to that machine." According to Pieters, about 80% of current shipments have that mini front-end.

For years people have been talking about storing data bases on film, rather than on disc packs. Pieters says that's a concept that makes a lot of sense, but has yet to be implemented. "To my knowledge," he says, "no company today is providing a method of retrieving from a mass data base" on film. He adds that they hope to be, "the latter part of this year or early next year."

This year, too, Quantor is scheduled to break through the \$100 price barrier for film readers. Along about May or June, Pieters says, they'll be shipping a model that, in quantity, will sell for about \$85, a price that he expects will make COM all the more attractive. *

In New Posts

F. L. "MIKE" HARVEY joined University Computing Co. as president of its U.S. operations . . . FRANCIS LEEMAN was appointed president of Mohawk Data Sciences Corp.'s MDS International Service Corp., headquartered in Brussels, Belgium . . . MILFRED E. BARNETT was promoted to director, data management systems programs, Electronic Systems Div., Bunker Ramo Corp. . . . JOHN J. EGAN, Jr. was appointed national sales manager for the Commercial Systems Div. of Computer Automation, Inc. . . . ALBERT LAMPERT was elected senior vice president, planning and finance, and a director of Aspen Systems Corp. . . .

SofTech, Inc. named WILLIAM F. HANCOCK, JR. vice president and general manager of its Management Systems Div. . . . DR. ROBERT R. KESSELL, formerly director of Prudential Line's data services department, joined the Information Sciences Div. of the Rockland Research Center, Orangeburg, N.Y., in the dual capacity of division controller and associate research scientist for financial systems . . . WILLIAM H. SCOTT was named director of logistics planning at the Electronic Systems Div. of Bunker Ramo Corp. . . . Booz, Allen & Hamilton Inc. elected JOHN C. REECE a vice president with responsibility for information systems practice in the Chicago area. *



"Gentlemen, our three year study has proved conclusively that we have wasted the entire period of thirty-six months."

© DATAMATION •

UCC-2

**DOS UNDER OS.
DON'T EVEN CONSIDER CONVERTING
TO OS WITHOUT IT.**

***CALL 1-(800) 527-3250 AND
FIND OUT WHY.**

*Here's exactly what will happen when you call. One of our staff will take your name and address and immediately send you a brochure explaining exactly what UCC TWO (DUO) DOS Under OS is all about. (In Texas, call 214-638-5880 collect.)

When you've seen how UCC TWO can eliminate the chaos... and much of the expense... of converting to OS, call this number again. We'll arrange a presentation at your convenience.

Here are some reasons why almost 400

installations have converted to OS with UCC TWO.

- Lets you run DOS jobs as if they were OS jobs, without reprogramming.
- You can plan the conversion to fit your work schedule. Instead of the other way around.
- You can spread the job-and the cost-of converting over months.
- And still get all the facilities and features of OS from the start.

UCC

We're going to
be the IBM of software
companies.

CIRCLE 24 ON READER CARD

University Computing Company • P.O. Box 47911 • Dallas, Texas 75247 • A Wyly Company

MORE COMPUTER LIFE SUPPORT: PACKAGED SYSTEMS FROM INTERDATA

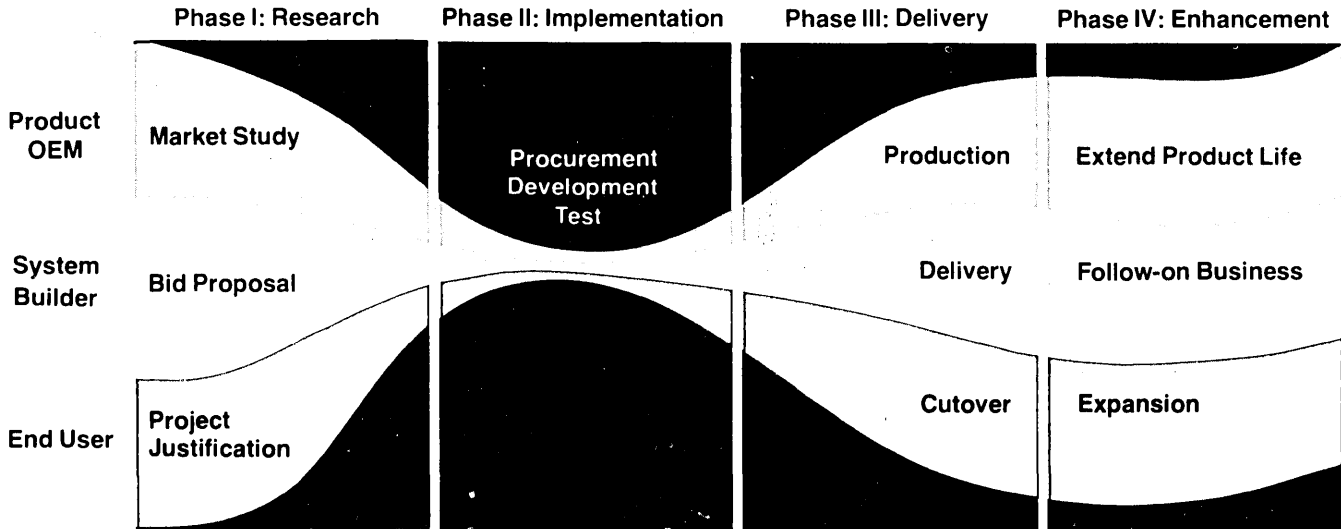

Interdata's computer products and services exist for one reason—to satisfy our customers: the Product OEM, the System Builder and the End User. Each of these computer buyers is involved with a Computer Life Cycle with four specific Phases—Research, Implementation, Delivery and Enhancement. Interdata responds to customer needs during each Phase with Computer Life Support.

IPAC/16 and IPAC/32: Today's computers for tomorrow's user.

Solve tomorrow's problems today with a packaged system from Interdata. IPAC/16 system includes a 16-bit Model 6/16 with 64KB memory. IPAC/32 has a 32-bit Model 7/32 with 128KB memory.

The IPAC system provides the Product OEM, System Builder and End User with a complete configuration of Interdata components for one low packaged price. IPAC is ready to use immediately for program development work in real-time process control, data communications, scientific research, or virtually every facet of data processing.

Today's IPAC includes an Interdata processor with memory and multi-tasking Opera-

ting System, 10MB Disc System, 400 CPM Card Reader, 200 LPM Line Printer, Carousel 30 Terminal. With free customer training, hardware installation and our full service warranty. Hardware and software to use in every phase of your Computer's Life Cycle.

IPAC/16, \$33,500. IPAC/32, \$43,500. Everything you need in a packaged system tomorrow...at a price you can afford today.



Send me more.

My Computer Application is _____.

I want information on IPAC/16

IPAC/32

My needs are: Immediate

Six Months One Year

For Reference Only

Name _____ Title _____

Company _____

Address _____

City _____ State _____ Zip _____

Telephone _____

INTERDATA®

Interdata, Inc.
Subsidiary of PERKIN-ELMER
Oceanport, N.J. 07757
(201) 229-4040

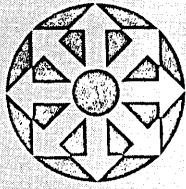

LOOK AHEAD

BUSY WINTER AT WANG

Salesmen from component manufacturers have been particularly busy at Wang Laboratories this winter. The reason? No one knows for sure, not even the component salesmen who get individual orders for separate components. Whatever it is, it must be significant, though.

For one thing, Wang has been gearing up its printer production line to produce a new low-to-medium cost/performance matrix printer. Wang sells printers to its customers but not as many as the high activity on the production line would warrant, so the speculation is that Wang may be entering the oem market with the printer. And word has leaked out of a new drum plotter that is microprocessor-driven (the Intel 8080 salesman has been busy at Wang, it seems). The plotter should come with continuous form paper, so if the price is right it could knock off many crt-based plotting systems.

In addition, some industry prognosticators are betting Wang will announce more bells and whistles for the firm's 2200 series in an effort to piggyback on the marketing hoopla over IBM's 5100. Wang and others have found that many time-sharing users -- typically cautious folk -- were willing to look at standalone equipment after IBM announced the 5100. And many of those users have been buying in recent months.

NEW PACKAGE WOULD DELIVER VSAM TO OS USERS

Installations with an IBM 370/155 or 165 without the DAT box, or even 360/65 users, now can avail themselves of VSAM that runs under OS. Recently completed by ITEL Corp., San Francisco, it goes into Beta test this month. Even those planning to go to MVS or VS-1 can benefit from it because it gives them a chance to convert their data sets to VSAM. An Amdahl user running under MVT is also interested in it. It's too early, though, to tell how much faster it runs than VSAM under virtual.

THIRD TIME THE CHARM?

Leonard Palmer used to be a Burroughs salesman. Now he could become one of Burroughs' biggest creditors. In the third go-round of a suit he filed against Burroughs back in 1971, Palmer won a judgment for \$3.48 million in trebled damages (p. 190).

Palmer was president of Palmer Data Service which operated a service bureau in the San Francisco area called CompuTerminal. He accused Burroughs of violation of the Sherman Antitrust Act in diverting its (Burroughs') customers to a third service bureau when it abandoned the service bureau business in the area. A jury agreed with him in early 1974 and awarded \$3.8 million in damages. Judge Stanley Weigel felt the amount of damages was high and ordered a retrial on that issue alone. He presided at the second trial at which, Palmer said, "no real evidence was presented." The second jury agreed Burroughs was guilty of wrong-doing but levied no damages. Judge Weigel didn't agree with this either, ordered a third trial and personally bowed out. The third trial was presided over by a visiting judge from Boston, Charles E. Wysynanski. This ended Feb. 6 with the \$3.48 million judgment. Palmer, who described himself as "heavily in debt" (he has been devoting himself entirely to the case since it was filed in '71) said he was more pleased by the "personal vindication" in the judgment than by the amount of money. Burroughs has indicated it will appeal. "They could stall," said Palmer, "but it could cost them \$1,000 a day in interest."

LOOK AHEAD

\$3 MILLION SALE...OF CUSTOMERS?

When Singer Corp. decided to drop its business machines division (February, p. 108) most observers felt one part of the division which would survive was Singer M&M Computer Industries, Inc., an Orange, Calif., producer of remote batch terminals. M&M was acquired by the Aerospace and Marine Div. of Singer in May of 1972. It became part of the Business Machines Div. in July 1974. It was continuously profitable, a novelty within Singer Business Machines.

It was a surprise early last month when Singer said it would sell the subsidiary to Harris Corp. A source close to Singer M&M said the sale was to be for some \$3 million cash and he felt both Singer and Harris were making a mistake. He estimated the worth of M&M at "two and one-half times that" if it were to continue to operate. He felt Harris was simply buying customers it hoped it would convert to its own remote batch terminals. In mid-February the M&M force had been cut by 30% including all top officers. It was felt only a few sales and service people would be kept by Harris which said it will operate M&M through its Data Communications Div. in Dallas.

DEC'S 'UNANNOUNCED' FACTORY SYSTEM

Digital Equipment Corp. has a fascinating factory data collection system at its peripherals plant in Westfield, Mass. The PDP-11-based system with remote terminals is used to control metal fabrication work flow. DEC's Industrial Products Group started examining the system closely a few months ago and similar factory data collection systems have begun popping up at user sites in the U.S. and the U.K., particularly in the textile, steel and machinery industries.

Strangely, the system has never been announced and it can't be found in DEC's catalog. Insiders are betting that will change though. The Industrial Products Group has been working on operating systems and applications programs for PDP-11-based factory data collection systems and the feeling is that someday DEC will actually offer the systems officially.

HONEYWELL TO HOLD CUSTOMERS WITH AN EMULATOR

Some Honeywell 200 and 2000 users have been getting restless. And a few have been leaving the Honeywell fold for competing equipment. Where, they wonder, is that promised series 60/64 software that will enable them to upgrade easily? Help, we hear, is on the way late this spring in the form of a software emulator for 200 and 2000 users. Meanwhile, Honeywell software specialists continue to work on the so-called native mode software for the Level 64 machines. Honeywell says 200 and 2000 bailouts haven't been higher than normal attrition.

INTELLIGENT DATA ENTRY TERMINAL FOR COMPUTEK?

Competition in the sophisticated intelligent terminal data entry market may heat up later this spring when Computek should be entering that hotly competitive market. Visitors at the terminal manufacturer's plant in Cambridge, Mass., report seeing prototype systems in the firm's system test area. The grapevine has it that the new entry will be based on Computek's 200 line but a new, powerful cpu will have 32K bytes of memory instead of 16K. The firm has been working on a new software system tentatively called CDES (for Computek Data Entry System). The equipment presumably would be available in both standalone and clustered configurations.

(Continued on page 192)

WHAT DO ALL THESE PEOPLE HAVE IN COMMON?



They're all using the same computer at the same time.

The Hewlett-Packard 2000 System.

The ideal low cost business satellite that supports up to 32 simultaneous users.

Through their personal interactive terminal in the office, or even miles away, each user can concurrently perform remote job entry to a host IBM or CDC computer. They access IBM HASP or UT 200 protocols from simple BASIC programs, or through HP's Telecommunication Supervisory Package which automatically schedules and spools IBM HASP MRJE operations.

Each user can submit remote batch jobs, check job status, scan and selectively print job output, and control final printing on a 2000 System high speed printer.

There is also a Source Data Entry package that helps reduce input errors. Data is entered, edited and validated locally on HP 2640 CRT Terminals.

Additionally, all users can process data concurrently, create and manipulate local files (up to 120 megabytes of on-line storage), and share all peripherals for program development.

All in all, the HP 2000 is the sensible, low cost way to increase the power of your IBM or CDC computer, no matter where it is.

Think what that can do for your business. And write for detailed information.

**THE HEWLETT-PACKARD 2000 SYSTEM.
COMPUTER ACCESS FOR BUSINESS.**



Sales and service from 172 offices in 65 countries.
1501 Page Mill Road, Palo Alto, California 94304

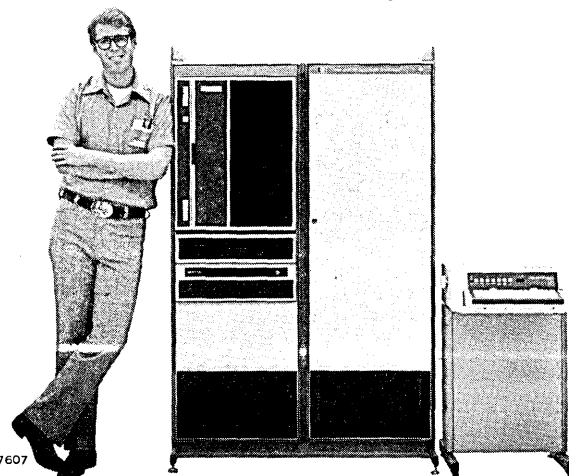

47607

Introduce DEC/SYS

The Bridge

The best of the big systems:

Powerful, reliable multi-stream batch.

Concurrent general-purpose time-sharing with up to 64 on-line, interactive terminals.

Complete higher-level languages with interactive debuggers—FORTRAN, COBOL, APL, BASIC, and ALGOL.

A comprehensive Business Instruction Set.

A large-scale Data Base Management System.

Remote diagnostic capability. Process-structured architecture.

Integrated file/address space.

A powerful, flexible command language.

A large microprogrammed instruction set and true virtual memory demand paging to accommodate big programs.

True large-scale capacity—up to 800 million bytes of high-speed, on-line disc storage and up to 1.2 million bytes of main memory.

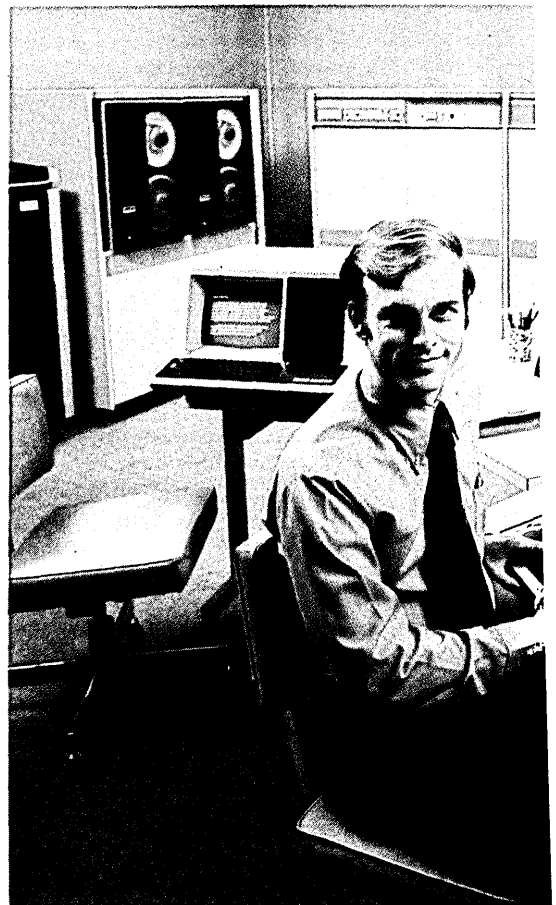

Using TEM-20

Computer

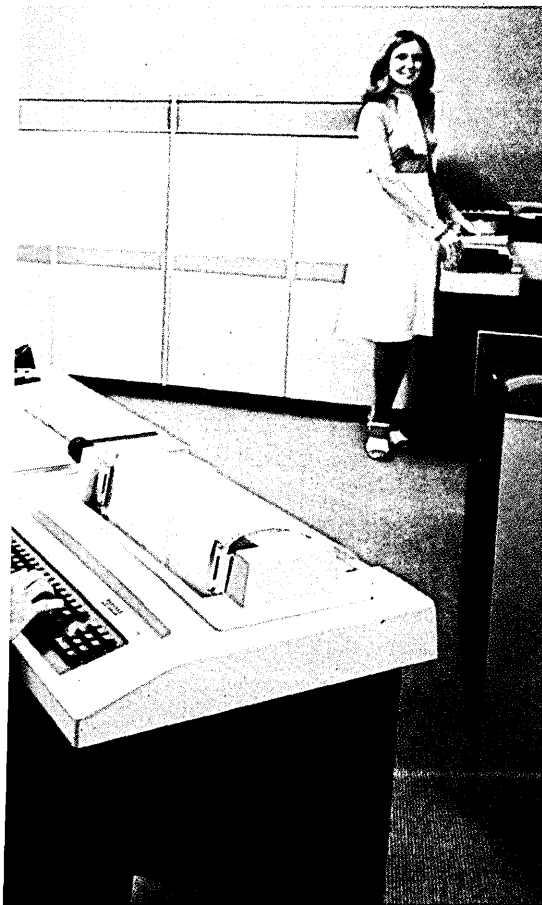

With the best of the small:

Low price—total system cost of under \$10,000 per month.
Ease of operation.
Low operating costs—no operating staff.
Ease of installation.
Small physical size.
It's all in the DECSYSTEM-20. The first computer that bridges the gap between large and small systems. By giving you the best features of both.

And it's available for delivery right now.

To find out more about how the DECSYSTEM-20 can help your operation, call or write: Digital Equipment Corporation, Large Computer Group, Marlborough, MA. 01752, 617-481-9511, ext. 6885. In Canada: Digital Equipment of Canada, Ltd. In Europe: 81 route de l'Aire, 1211 Geneva 26. Tel: 42 79 50.

Prices apply to U.S.A. only.

- Please send me more information on DECSYSTEM-20, The Bridge Computer.
- Please have a salesman contact me.

digital

LARGE COMPUTER GROUP

Name _____ Title _____

Company _____

Address _____

City _____ State _____ Zip _____

Telephone _____

Send to: Digital Equipment Corporation, Large Computer Group, 200 Forest St., Marlborough, MA. 01752.

calendar

MARCH

Data Processing Institute Conference '76 and Trade Show, **March 28-31**, Ottawa. Theme is "The Human Side of Computing" and will include sessions on the future of data processing, the status of dp people, the role of the auditor, structured programming, data communications for today and tomorrow, and how to get ahead. Fees: \$40, member; \$50, nonmember. Contact: Ms. Sandy Duggan, Registration Chairman, DPI Conference '76, Box 2458, Station D, Ottawa, Ontario, Canada K1P 5W6.

INTERFACE '76, **March 29-31**, Miami Beach. A variety of workshops will highlight the 4th annual data communications conference and exposition, cosponsored by DATAMATION magazine. Leaders in the field will discuss products and services, methods and procedures, specific applications, and will provide in-depth analyses of current issues. In addition a DataComm school for newcomers and as a refresher course will be presented. More than 200 exhibitors will display products, equipment, and services. Fees: \$95, three days; \$50, one day; team discounts available. Contact: INTERFACE '76, 160 Speen St., Framingham, Mass. 01701; toll-free (800) 225-4620; in Massachusetts, (617) 879-4502 (collect).

APRIL

ACM Symposium on Graphic Languages, **April 26-27**, Miami. Special interest groups on programming languages and computer graphics of the Assn. for Computing Machinery are sponsoring this event in cooperation with Florida International Univ. Papers will explore such topics as languages for animation, languages for picture processing, language extensions for graphics, and graphic subroutine packages. Fees: \$30, member; \$40, nonmember; \$10, students. Contact: Prof. Toby Berk, Mathematics-Science Dept., Florida International Univ., Miami, Fla. 33144, (305) 552-2743.

7th Annual Pittsburgh Modeling and Simulation Conference, **April 26-28**, Pittsburgh. Special emphasis for this year's conference will include social, economic, educational, urban and global aspects of the subject. Previously unpublished papers will be presented. Sponsors are the Univ. of Pittsburgh's school of engineering, in cooperation with the IEEE and the ISA. Fees: \$40; add \$5 after April 9. Contact: William G. Vogt, 348 Benedum Engrg. Hall, Univ. of Pittsburgh, Pittsburgh, Pa. 15261.

COMtec Conference, **April 26-30**, Chicago. Computer Micrographics Technology, an association of organizations involved in the advancement of computer micrographics, hosts this seminar and conference. The first two days will cover hardware and software systems analysis, film duplication, and storage and retrieval. The last two days will concentrate on engineering, CAD-CAM, Business and the Real-time World, and Science. Fee: \$25, add \$10 after April 1. Contact: Jack Abbott, CETEC Corp., 290 Fischer Ave., Costa Mesa, Calif. 92626, (714) 540-1024.

IEEE International Symposium on Circuits and Systems, **April 27-29**, Munich. This meeting will concentrate on the theory and design of circuits and systems in electrical engineering science, and will include a section on computer oriented methods for design, layout and manufacturing. Contact: Rudolf Saal, Technical Univ. Munich, Arcisstr. 21, D 8000 Munich 2, Germany, (089) 2105 8501.

National Micrographics Assn. 25th Conference and Exposition, **April 27-30**, Chicago. Computer-output-microfilm (COM) in active business systems will be featured at this meeting, which is expected to attract an audience of 10,000 to 12,000. Sessions will detail such areas as COM in "Engineering Data/Manufacturing," "Office and Administrative Systems," "Graphic COM Systems," and "COM Software." General theme of this silver anniversary conference is "'76 Spirit of Micrographics." Complete registration includes all technical sessions, seminars and exhibits, as well as two luncheons, the awards banquet, and a champagne brunch. Fee: \$157, of which \$40 is a membership fee; add \$10 after April 13. Contact: NMA, Conference Dept., 8728 Colesville Rd., Silver Spring, Md. 20910, (301) 587-8444.

MAY

14th Annual National Convention, Assn. for Educational Data Systems, **May 3-7**, Phoenix. This organization, comprised of administrators, teachers, systems analysts, and programmers from vocational, public, and private schools, has chosen as this year's theme, "Today's Revolution: Computers in Education." The winner of the 13th annual programming contest conducted for students in grades 7-12 will be a guest. Contact: Rick Meyer, Convention Coordinator, PUHSD, 2526 W. Osborn Rd., Phoenix, Ariz. 85281, (602) 257-3131.

Society for Information Display, International Symposium, **May 4-6**, Beverly Hills. Original papers, including state of the art tutorials, will describe significant developments in display hardware and software techniques, devices, systems, applications, human factors, and economics. Fees: \$40, member; \$50, nonmember; add \$10 after April 19. Contact: Lewis Winner, 152 W. 42nd St., New York, N.Y. 10036, (212) 279-3125.

U.S. Exhibition, Computers, Related Equipment and Systems, **May 11-15**, Milan, Italy. The U.S. Dept. of Commerce is sponsoring this exhibition as a showcase for "what's new" in U.S. equipment and technology. The computer market in Italy is estimated at about \$450 million, of which imports account for about \$250 million. Contact: Donald T. Mathes, Office of Int'l. Marketing, DIBA, Rm. 1012, U.S. Dept. of Commerce, Washington, D.C. 20230, (202) 967-3957.

ON THE AGENDA

Data Base Technology Conference, April 6-8, London, Brunel Univ., Uxbridge, Middlesex, England. **8th Annual ACM Symposium on Theory of Computing**, May 3-5, Hershey, Pa., ACM/SIGACT, Emily Friedman, (213) 825-2360. **National Computer Conference**, June 7-10, New York, AFIPS, 210 Summit Ave., Montvale, N.J. 07645. *

Conferences are generally listed only once. Please check recent issues of DATAMATION for additional meetings scheduled during these months.

Point by point, line by line:

See why our lowest-cost Graphics package has no competition.

Our 1024 X by 780 Y viewable points separate Graphics from mere graphing. The price has never been lower. But Tektronix' new 4006-1 provides the same superior information capacity that has made us the company for all your graphics needs.

We'll throw you a curve. Tektronix will graph circles around the competition. Now, thanks to our new low priced 4006-1, we're in the same ballgame with mere alphanumeric terminals.

Graphics to gain. Nothing to lose. Add the graphics extra at an everyday price: \$2995 or \$150 a month on a two year lease. Alphanumerics? Up to 2590 on screen characters. Plus a spectacular package that includes confirmed compatibility with most mainframes through proven interfaces and time-tested software packages. And expert maintenance that follows you all over the world.

Plug-in peripherals standing by. Like our 4631 Hard Copy Unit for up to four 4006-1's with 8½"x11" copies, or

4923 Digital Cartridge Tape Recorder for low-cost, off-line storage.

Why wait for graphics? Let graphics wait on you. See what our fine-line, full-line graphics can mean for your applications. Check out the whole story and all the prices right now with your local Tektronix Sales Engineer. Or write:

Tektronix, Inc.
Information Display Group
P.O. Box 500
Beaverton, Oregon 97077



CIRCLE 61 ON READER CARD

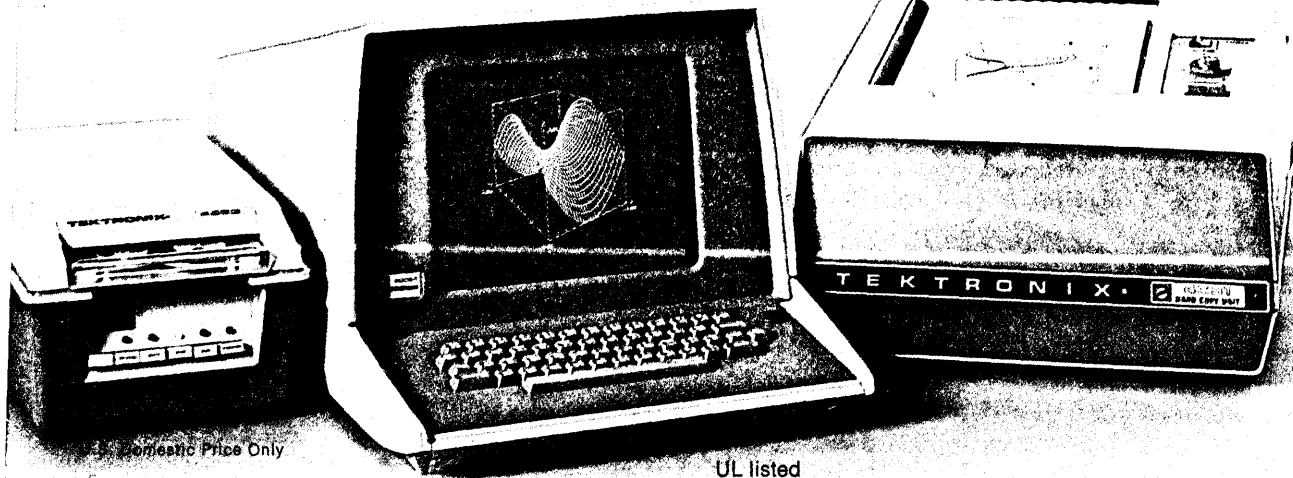
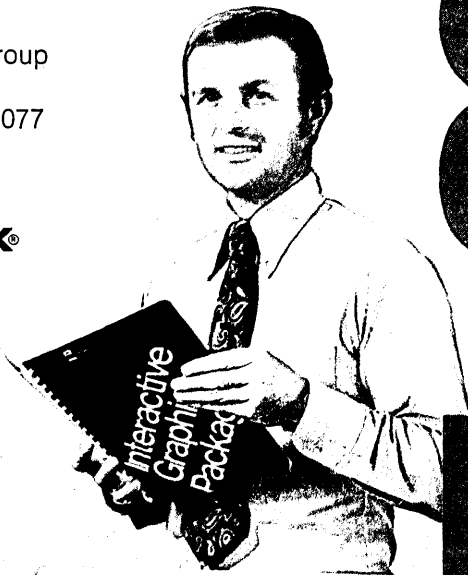

Minimum Price Only

UL listed

Graphics has no competition.

LIGHTWEIGHT

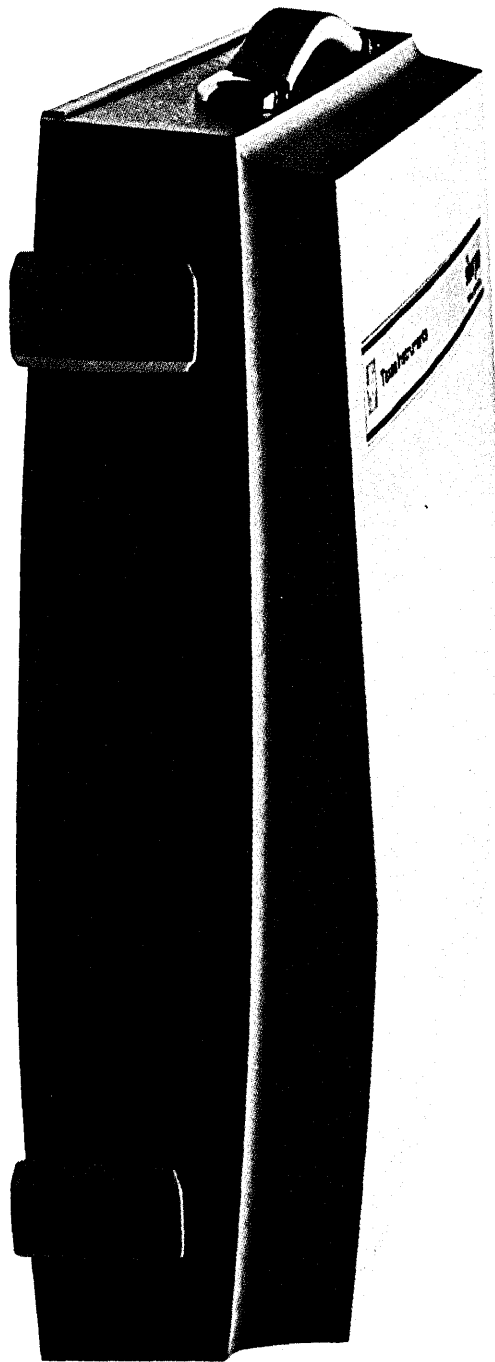

See these products at the Computer Caravan and NCC.

\$1995/13 LBS.

The new "Silent 700*" Model 745 Portable Data Terminal from Texas Instruments is the new lightweight champion. It weighs only 13 pounds...*half* as much as the currently most popular portable...our own Model 735.

Its price is also light...\$1995 at quantity one...the lowest on the market for a full-capability 30-characters-per-second portable terminal. And, of course, quantity discounts are available.

The 745 is really the first portable terminal ever to achieve that "briefcase mobility" everybody's been wanting, which means it travels easily with you...all day.

And, for stationary computer I/O needs, the 745 has a new lightweight companion...the Model 743 KSR terminal. The 743 is a compact keyboard send-receive terminal ideal for computer input/output. What's more, it sells for only \$1395, in quantity one.

Either way, these two new terminals from TI are the lightest and quietest available, and extend the "Silent 700" tradition of price/performance leadership.

*Trademark of Texas Instruments.

SILENT 700

electronic data terminals

Yes! I am interested in the new "Silent 700" Electronic Data Terminals. My application requires:

Model 745 portable Model 743 KSR

Please send me more information.

Please have your representative call me.

NAME _____

TITLE _____

COMPANY _____

PHONE _____

ADDRESS _____

_____ ZIP _____

Mail to: Texas Instruments Incorporated

P.O. Box 1444, M/S 784

Houston, Texas 77001

HEAVYWEIGHT

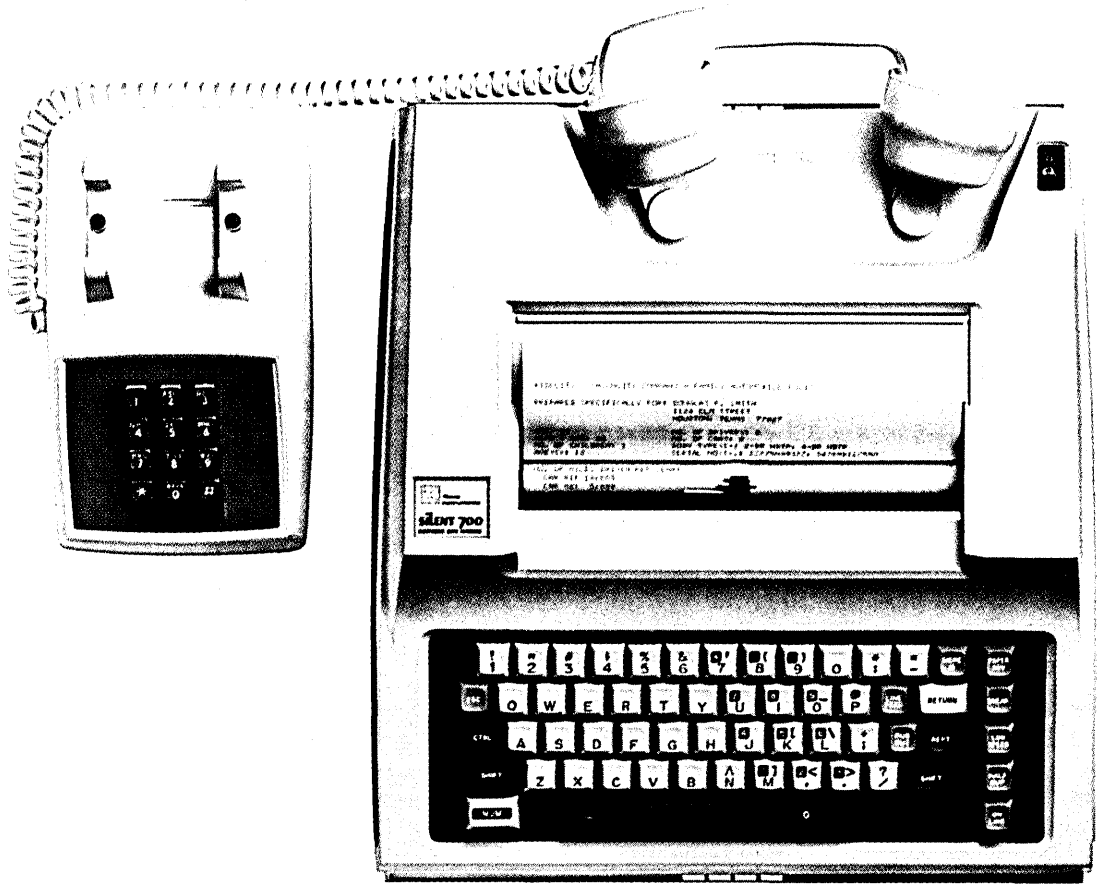

CAPABLE/RELIABLE

When it comes to communications capabilities...for insurance, real estate, financial, manufacturing, or wholesale and retail needs...the new Model 745 portable terminal is a real heavyweight. True to the "Silent 700" heritage, it's fast, quiet and reliable.

The field-proven thermal printing technique gives you quiet printing at 30 characters per second...for a fast, hard copy of crucial information.

The 745 portable interfaces via a built-in acoustic coupler or auxiliary EIA port, whereas the KSR interfaces via TTY, EIA or integral modem. Both feature either half- or full-duplex operating modes, standard parity options and an ANSI standard

keyboard with an embedded numeric key pad.

At the heart of each model is a TI micro-processor...the key element contributing to its compactness, high reliability and superior performance capabilities.

The new lightweight, low-cost "Silent 700" portable...it gives your field representatives the capability to get the right information to close the sale...with a call...on the spot.

For more information, contact your nearest TI office. Or, write Texas Instruments Incorporated, P.O. Box 1444, M/S 784, Houston, Texas 77001. Or, call Data Terminal Marketing at (713) 494-5115, extension 2126.



Arlington, Va. (703) 527-2800 • Atlanta, Ga. (404) 458-7791 • Boston, Ma. (617) 890-7400 • Chicago, Il. (312) 671-0300 • Clark, Nj. (201) 574-9800 • Cleveland, Oh. (216) 464-4990 • Costa Mesa, Ca. (714) 540-7311 • Dallas, Tx. (214) 238-5318 • Dayton, Oh. (513) 253-6128 • Denver, Co. (303) 751-1780 • Detroit, Mi. (313) 353-0830 • El Segundo, Ca. (213) 973-2571 • Hamden, Ct. (203) 281-0074 • Houston, Tx. (713) 494-5115 • Indianapolis, In. (317) 248-8555 • Milwaukee, Wi. (414) 475-1690 • Minneapolis, Mn. (612) 835-5711 • Mobile, Al. (205) 344-8082 • Philadelphia, Pa. (215) 628-3434 • Phoenix, Az. (602) 249-1313 • San Francisco, Ca. (415) 392-0229 • Seattle, Wa. (206) 455-1711 • St. Louis, Mo. (314) 569-0801 • Sunnyvale, Ca. (408) 732-1840 • Winter Park, Fl. (305) 644-3535 • Amstelveen, Holland 020-456256 • Bedford, England 0234-58701 • Beirut, Lebanon 452010 • Cheshire, England 061-442-8448 • Copenhagen, Denmark 01/91-74-00 • Essen, Germany 0201/20916 • Frankfurt, Germany 0611/39/90/61 • Freising, Germany 08161/801 • Helsinki, Finland 90-408-300 • Milan, Italy 02-688/8051 • Montreal, Canada (313) 353-0830 • Nice, France (93) 20-01-01 • Oslo, Norway 02-68-94-87 • Paris, France (1) 630-2343 • Slough, England 0753-33411 • Stockholm, Sweden 62 71 59/62 71 65 • Sydney, Australia 831-2555 • Tokyo, Japan (03) 402-6181 • Toronto, Canada (313) 353-0830

TEXAS INSTRUMENTS
INCORPORATED

CIRCLE 39 ON READER CARD



At last, a system that makes credit verification as simple as it should be.

Ideally, credit card and check verification should be a simple "yes" or "no" proposition.

Unfortunately, at a lot of banks, supermarkets and other retail outlets, it's a complicated, time consuming process.

To solve the problem, Bell has designed the fast and simple to operate Transaction* telephone system.

The system includes the Transaction telephone terminal, the switched network, and 407 type data station interface. Plus, the data base computer.

The terminal itself is intended as the remote telephone in a digital inquiry-voice answer system. It has a single slot through which automatic dialing and bank or credit cards are passed. (If it's a check, the user keys in the account number.)

The Transaction telephone automatically

enters customer and user information by reading the magnetically encoded ABA Track II stripe found on the back of most major bank and credit cards. It also fully buffers all of the data input.

Sequential instruction lights guide the user through the simple data input procedure. While the data is being entered, the telephone dials the number of the data base needed for verification. All of the buffered information is then sped through the switched network and the 407 type data station. Customer information is withdrawn, and an audio or visual response is relayed to the user.

In addition, the terminal can be used as a regular telephone. And it's available in Touch-Tone® or rotary.

For the surprisingly low cost and complete details, contact your Bell Account Representative.

*Trademark of AT&T Co. ® Registered trademark of AT&T Co.



The Transaction Telephone System.

Another part of the Bell System's end-to-end data commitment.

source data

SOURCE DATA provides information on books, courses, references, reports, periodicals, and vendor publications.

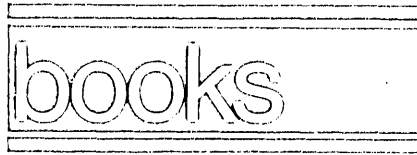

Your Computer and the Law
by Robert P. Bigelow and Susan H. Nycum
Prentice-Hall, 1975
283 pp. \$18.95

The growing maturity of the data processing industry can be empirically demonstrated in a number of ways. First, the number of primary vendors is decreasing while the count of those offering secondary services is increasing. Second, the number of people and variety of skills employed in the business seem to be expanding rapidly. Third, dp's importance to the gross national product and balance of payments receives ever-increasing federal attention. And finally, the lawyers have moved in to grab their piece of the pie.

Twenty years ago we did not buy computers; we got together with some engineers and built one. Ten years ago, we wrote a one-page letter listing some box numbers, prices and delivery dates, and the machine appeared. Now, months are spent in detailed and difficult negotiations leading to thick documents written in a strange language. It clearly isn't ALGOL or COBOL but it is equally unreadable to the average manager.

Your Computer and the Law, probably the first of a stream of such books, has been written to alert the computer manager to the legal hazards and pitfalls that can arise from a variety of situations. The authors, both practicing lawyers and well-known ACM activists, frame the problems legalistically. Generalizing makes some of the points harder to follow but perhaps it needs to be that way. As the first chapter states "The book is no substitute for the lawyer and his advice in particular situations." But it is a stab at awakening computer people to some of the problems they can expect to encounter in the normal course of dp business.

Among the subjects covered are proprietary rights (who owns the software); contracting (who does what to whom); computer errors (who pays for mistakes); and privacy (to whom does the new legislation apply, and what rights are now given to each individual). Especially valuable are the

appendices which include checklists for communications services and computer contracts, reprints of the appropriate copyright circulars, and a short article dealing with insurance matters.

Bigelow and Nycum must be good lawyers; they suggest, hint and view with alarm rather than stating with algorithmic certainty that given A, B will result. There are basic differences between dp and the law. We in dp believe that given known inputs, the outcome can be predicted. Lawyers believe that it is sufficient to outline the problem areas and indicate that there may be a problem. The volume lists the areas where at least one unhappy computer owner/user has run afoul of the legal system.

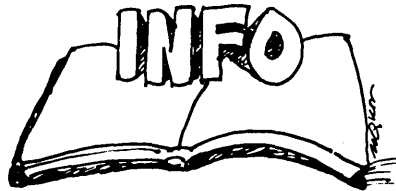

No matter if we dream of an earlier unfettered era, the lawyers are here to stay. As the business grows more complex, the overhead for legal services can be expected to consume a greater percentage of the budget. Bigelow and Nycum have not overwhelmed us with legal theory, but they have suggested enough horror stories to cause more than a few sleepless nights for a dp manager.

—Philip H. Dorn

Mr. Dorn is an industry consultant and one of Datamation's contributing editors.

The Structure and Design of Programming Languages
by J. E. Nicholls
Addison-Wesley, 1975
572 pp. \$17.95

The third in a series of systems programming texts sponsored by IBM, Nicholls' book is true to its title, emphasizing design characteristics of high level procedural programming languages. The book is highly readable and well organized. Its only shortcoming is that it does not seem to be targeted to a well-defined group of readers. As the author admits, the book is not rigorous enough for language designers, but is probably a little above most users and many language implementors. The strength of the book lies in the well structured approach to the subject matter which may very well assist users and implementors to express their needs in terms that language

designers can understand.

The book is divided into two parts. The first deals with the background and technical foundations of programming languages. It covers the influence of users and applications on language design (i.e., ease-of-use, transferability, ease-of-debugging, ease-of-documentation), the implementation of languages and its influence on language design, and the underlying theory of programming language design, such as how and why they differ from natural languages, mathematical methods of description, and some of the tools used in the analysis.

Part two describes the elements of programming languages. It shows how users and applications have shaped the design of some of the current languages. The examples include several languages, some of which are: FORTRAN, ALGOL 60, COBOL, and PL/I. One of the major topics that recurs throughout this part is that of "structure" (i.e., the pattern on which languages are formed and which provides the underlying basis for their design and implementation). Some of the structures discussed are "program structure," "data and storage structure," "control structure," and "recursive structure." Strong emphasis is placed on the relationships of these structures.

There are excellent annotated bibliographies at the end of each chapter. The one on design of high level languages is certainly one of the best.

The development of advanced programming languages cannot occur without the means for translating them. This book illustrates some of those means, using existing languages as models. Overall the book does a good job describing the subject matter and is a necessary addition to the computer sciences library.

—Richard L. Gauthier

Mr. Gauthier is president of RLG Associates and has over 16 years experience with computers and general systems. He has taught courses in systems programming and higher level languages, and is co-author of "Designing System Programs."

Data Base Systems: A Practical Reference
by Ian Palmer
Q. E. D. Information Sciences, Inc.,
141 Linden St., Wellesley, Mass.
02181 (1975)
356 pp. \$34.50 (\$29.50 if prepaid)

Selection and installation of a Data Base Management System (DBMS) is a major strategic decision for the management of an enterprise. Such a decision will impact business operations and greatly affect application system design, programming techniques, system testing, and computer operations. The added facilities provided by a DBMS widen the horizons of applica-

EXTEL'S NEW 30 CPS PRINTER IS:

- MICROPROCESSOR CONTROLLED.
- MECHANICALLY UNCOMPLICATED. ELECTRONICALLY SOPHISTICATED.
- EVERYTHING YOU NEED IN A 30 CPS OUTPUT (R/O) PRINTER.

OUR 5 X 7 DOT MATRIX CHARACTER-AT-A-TIME IMPACT PRINTING PROVIDES EASY READABILITY. ORIGINAL PLUS TWO COPIES. PROGRAM CONTROL PERMITS ON-LINE TYPE-STYLE CHANGE FOR HEADLINING OR ACCENTING OR EMPHASIZING TEXT:

(UC) UPPER AND (LC) LOWER CASE

(UC) EXPANDED (LC) CHARACTERS

(UC) BOLD FACE (LC) CHARACTERS

TRUE UNDERLINING

STANDARD CHARACTER SETS INCLUDED ARE IN ASCII OR 5 LEVEL CODE.
TTS (6 LEVEL) CODE AVAILABLE AT EXTRA COST.

AND AT NO EXTRA COST:

BUILT IN SERVICE DIAGNOSTICS.

ALL STANDARD SPEEDS TO 30 CPS WITH TRUE 30 CPS THROUGH-PUT...

EVEN WITH
REPEATED
"SHORT-LINE"
PRINTING

BECAUSE
FILL CHARACTERS
ARE
NORMALLY
NOT
REQUIRED!

STANDARD LINE INTERFACES: EIA RS 232C. DC LOOP. MIL 188C.

THESE ADDED SMALL-COST OPTIONS
MAKE THIS OUTSTANDING PRINTER A
SELF-STANDING R/O TERMINAL:

BUILT-IN MODEMS WITH 103 OR 108 OR 113 COMPATABILITY.

SELECTIVE CALLING - FOR MOST WIDELY USED 5/6/8 LEVEL
PROCEDURES.

A 20 CHARACTER ANSWER BACK.

PAGE FORMATTING - 8-1/2" x 11" FORMAT FROM PLAIN PAPER
FOR CONVENIENCE IN FILING.

NATIONAL OR SPECIAL CHARACTER SETS - INCLUDING LOWER
CASE DESCENDERS.

IN A COMPACT, COMPLETELY SELF-CONTAINED UNIT - 12-5/8" WIDE;
17-3/8" DEEP; AND 5" HIGH (WITHOUT PAPER ROLL); 25 LBS.

CALL OR WRITE FOR BROCHURE

CIRCLE 31 ON READER CARD

The quiet, uncomplicated,
multi-copy teleprinter
—over 35,000 in worldwide
use. Sales and service
in 80 countries.



EXTEL CORPORATION
310 Anthony Trail
Northbrook, IL 60062
(312) 564-2600
Telex: 72-4398



source data

tion design possibilities and permit development of a new generation of cost-effective systems which do a better job of serving the information needs of an enterprise. The measure of success is determined by the extent of management/user commitment to data base approaches, project planning, and sufficient analysis to select DBMS software based on the application needs and personnel capabilities of an enterprise.

Although the advantages of data base technology have been recognized for more than 16 years, significant differences of opinion still exist concerning the type of data manipulation and data description functions which should be made available to users. Many of the varied viewpoints have been incorporated into DBMS packages currently available from software vendors and hardware manufacturers. Current standardization efforts have only intensified the controversy over fundamental issues. Little wonder that both current DBMS users and prospective users alike are often confused by conflicting statements made by equally qualified experts in data base systems.

Data Base Systems by Ian Palmer is an authoritative comprehensive reference which effectively presents the state of the art of data base technology. It is a valuable reference for students, data base technicians, DBMS users, and prospective users.

The reference presents an excellent overview of basic concepts and terminology followed by general discussion of data integration, complex structures, data independence, concurrency, integrity, privacy, performance, and compatibility. How these functions and facilities affect data base software design are considered for CODASYL, IBM, Guide/Share, ANSI, Relational and Waghorn approaches.

Chapter 4 contains a comparison of 23 major data base and file management systems. The description of each system is conveyed effectively without burying the reader in a mass of detail. However, the reader must be familiar with terms described in previous chapters to fully understand system descriptions.

The 28-page chapter, "Installing a Data Base System," should be required reading for all who contemplate obtaining a DBMS. The practical advice in this chapter, including data base disadvantages, management difficulties, and conversion of existing systems, is well worth the price of this reference.

In the reviewer's opinion, the most delightful part is the description in an informal, open approach of 12 case

studies covering manufacturing, financial, life insurance, medical, and government installations. User insights and experience (both good and bad) are rarely seen in published form.

Data Base Systems is a must for all interested in maintaining a state of the art knowledge of data base technology.

—R. F. Schubert

Mr. Schubert is director of MIS—Technical Advancements for the B. F. Goodrich Co., Akron. He has been active on several CODASYL committees.

BOOK BRIEFS . . .

Origins of Digital Computers

Brian Randell, ed.
Springer-Verlag New York, Inc.
2nd ed., 175 Fifth Ave., New York,
N.Y. 10010 (1975)
464 pp. \$14.90

This book should appeal to students and professionals interested in the history of digital computers and in technical details of the forerunners of the modern electronic computer. Original papers that comprise the text date from 1837 ("On The Mathematical Powers of the Calculating Engine," Charles Babbage) through 1972 ("The Bletchley Machines," D. Michie). Between these points are papers by Ludgate, Hollerith, and other magic names in this field—Eckert, Hopper, Atanasoff, Mauchly, and Von Neumann.

Although quite technical in nature, the book contains valuable material that describes the invention of complex computing machines. A bibliography covers references to early inventions such as mechanical adding and calculating machines, automatic draw-locks and musical automata, electromagnetic calculating devices, and the earliest digital electronic devices.

**Career Management:
A Guide to Combating Obsolescence**
Harold G. Kaufman, ed.
IEEE Press, 345 E. 47th St.,
New York, N.Y. 10017 (1975)
448 pp. \$17.95 (\$13.45 IEEE
member)

During the initial evaluation of this book, the continuing thought was "This is interesting material, but does it really relate to people involved in data processing?" Somewhere along the way the obvious answer appeared: the book talks to people in a work environment, therefore it talks to people in the dp world. The volume is compiled from articles and papers published from 1963 through 1975 relevant to the problem of obsolescence of knowledge and skills among technical professionals. It focuses on two fronts: how management can effectively create a stimulating climate, and how the individual can design a career management program to keep up to date.

The volume, in 8½ x 11 format, contains reprints from various sources by professionals in management, con-

tinuing education, psychology, and personnel. Graphs, charts, and illustrations enhance the book; two of the most meaningful sections are "The Information Explosion: How to Cope With It" and "Career Management for Individual Growth and Development." The other four sections are entitled "Obsolescence: The Problem and Its Causes," "Managing for Technical Vitality," "Continuing Education: What Management Should Know," and "Educational Options for Self-Development."

**The Existential Pleasures of
Engineering**
by Samuel C. Florman
St. Martin's Press, 1976
160 pp. \$7.95

The philosophy of "existentialism" (treated here as "a rejection of dogma and a reliance on individual impulses and intuition") and the science of engineering technology are often thought to be mutually exclusive concepts. This volume attempts to demonstrate that engineering is an "expression of mankind's most elemental impulses and most sublime aspirations." Wide pendulum swings have greeted the engineer throughout the last century, ranging from adulation surrounding every technological advance, to public outcry against technology as the "root of all evil." One criticism among others claims that scientific technology has caused a severe environmental crisis. Regardless of the reader's viewpoint, he will find in this book an interesting slant on today's culture and its relationship with science and technology.

Cost-Effective Telecommunications
by Richard A. Kuehn
American Management Assns.,
135 W. 50th St., New York, N.Y.
10020 (1975)
152 pp. \$16.95

Many facets of the telecommunications field are discussed in this treatment of an increasingly important subject. The book explains operation of telecommunications systems, and gives how-to information on controlling costs. A discussion of voice communication and written record transmission is followed by a chapter on data communications. The final chapter deals with the state of the art and is followed by several appendices of tables and charts.

**Protection of Information in
Computer Systems**
by David D. Clark and
David D. Redell
IEEE Computer Society, 1975
260 pp. \$12 (\$9 members)

Structured Programming
by Victor R. Basili and Terry Baker
IEEE Computer Society, 1975
241 pp. \$12 (\$9 members)

These 8½ x 11 paperbacks are tutorials presented at COMPCON Fall '75. The first deals with mechanisms inside

Introducing the revolutionary
new Interrogator 880™
Security System that controls,
monitors, and documents
the movement of people
and vehicles through
specific points from
one central location...
to anywhere in the world.

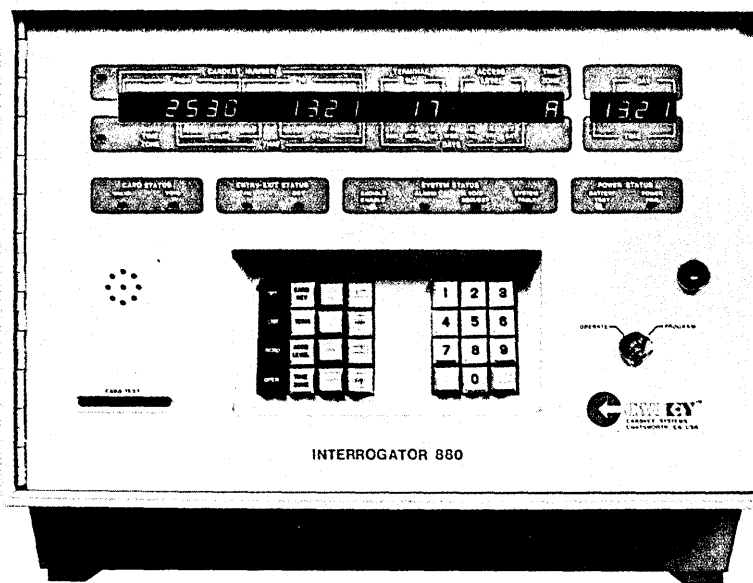

There is no other security system currently being produced with the performance capabilities of the Interrogator 880.

The Interrogator 880 is a dedicated mini-computer, programmed to control, monitor and command from a central location to and from as many central points on or off the premises as needed. You may retrieve, through hard copy reports, magnetic tapes, or route data through interfacing equipment direct to a main frame computer. The system may begin with a simple installation and thereafter be field-expanded to meet your growing requirements.

Once a Cardkey Securiti-Card™ is issued, it need never be retrieved. All commands and controls are programmed through the 880, which issues any changes in levels of security. The Interrogator 880 completely controls and

monitors entry/exit at all card reader terminal locations by permitting or denying access. It will record both valid and invalid entry attempts and even report reasons for denying access. It can also control elevators, doors,

parking gates, as well as monitor alarms and any environmental conditions such as fire, flood, temperature, pressure and noise levels.

Since its recent introduction, the Interrogator 880 already has been

field-proven by utility companies, government agencies, institutions, high rise buildings, data-processing centers, financial organizations, the petroleum industry and many manufacturing firms.

Because the Interrogator 880's applications are so diverse, we've only mentioned a few. Its application capabilities are limited only by your own imagination. No matter what your own perplexing problems—in the area of security—the 880 can handle them.

Call or write for a free security analysis. Or simply ask for additional technical information.



CARDKEY SYSTEMS

A DIVISION OF GREER HYDRAULICS, INC.

20339 NORDHOFF STREET
CHATSWORTH, CALIFORNIA 91311
(213) 882-8111/TELEX 651-375

European Manufacturing and Sales Office:
43/45 Millford Road, Reading, Berks RG1 8LG, England
Telephone: 0734 582804 TELEX: 847733

Finding jobs for more and more people... Fujitsu is on-line.

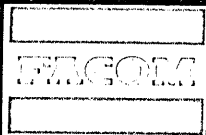
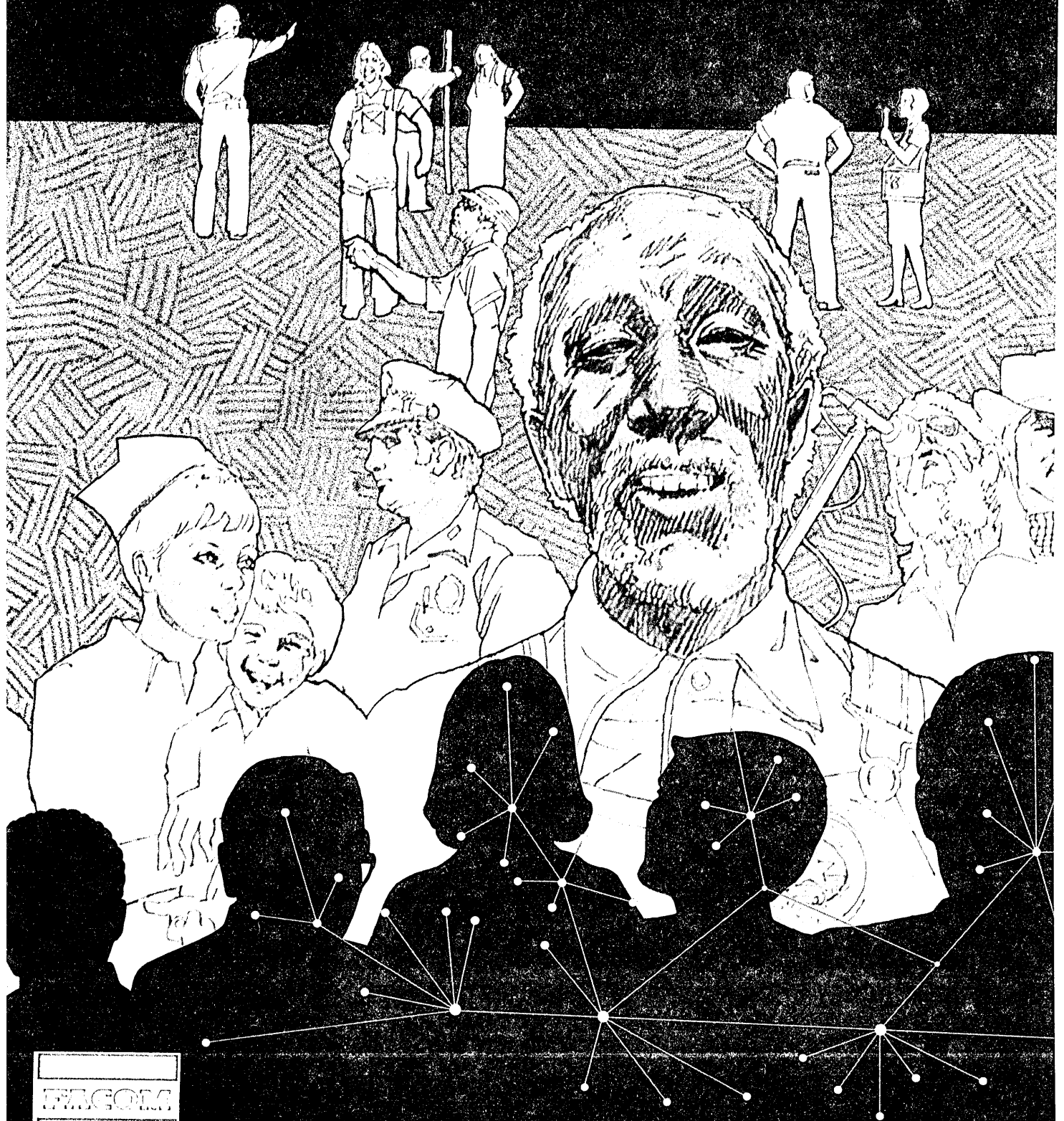

MAIN PRODUCTS Electronic Computers & Peripheral Equipment (FACOM) Telegraph & Data Communication Equipment Remote Control &

Fujitsu is on-line finding jobs for more and more people. Fifteen years ago the Japanese government asked us to build a system which would make it easier for people to know when and where jobs open up. We responded by setting up an on-line network throughout the entire country.

Now, by simple punching a card, a man who is a thousand miles away in Okinawa can learn whether or not there's a position open for him in Tokyo.

We're the connection between employer and employee, too. Companies use our services to

recruit personnel from all over Japan.

Why us?

Because Fujitsu has the muscle and skill to solve just about any data communications problem.

We're a leading main frame maker whose line spans everything from mini to very large scale computers.

We're one of the world's biggest suppliers of tele-

communications equipment of all kinds. And we're uniquely experienced in meshing the two into tailor-made data communications systems.

So when you've got a communications problem, call on Fujitsu. We can bridge the gap.

FUJITSU LIMITED

Communications and Electronics
Marunouchi, Tokyo, Japan

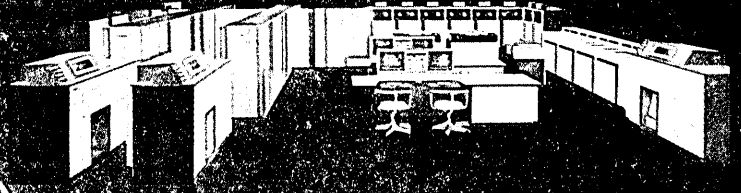

CIRCLE 45 ON READER CARD

source data

the computer system which control accessing of information. The lecturers have divided the privacy/security discussion into two parts — "statics," which considers how to enforce a given set of protection constraints, and "dynamics," which considers what happens when these constraints are changed. There are numerous examples and an extensive reference list.

The second tutorial includes an introduction to the major ideas of structured programming, theoretical and practical foundations, and detailed presentations of a major application program system. The lecturers use one section to stress the top-down evolutionary character of the process, and conclude with advantages and disadvantages of structured programming in a large organization.

The books may be ordered from the IEEE Computer Society, 5855 Naples Plaza, Suite 301, Long Beach, Calif. 90803.

Business Systems

by Theodore C. Willoughby and James A. Senn
Assn. for Systems Management,
24587 Bagley Rd., Cleveland, Ohio
44138 (1975)
656 pp. \$13.50 (20% discount for
ASM members)

This updated version of the original textbook, published in 1963, seems comprehensive and well-organized. The text's advantages include a pleasing format, well designed charts and figures, and a bibliography following each chapter. The book is intended for the systems professional as well as others in business management who will interact with systems analysts.

The book is divided into six major sections and could be read as separate units. Sample chapter titles: Systems and Management, Economic and Analytic Principles of System Change, Flowcharts and Decision Tables, Information Systems Project Organization and Planning, Modeling and Simulation, Hardware and Software Selection, Programming Management, Forms Control, and Security.

This book seems to be an excellent choice for understanding and using business systems.

**The Auerbach Annual—
1975 Best Computer Papers**
Isaac L. Auerbach, ed.
Petrocelli/Charter, 1975
257 pp. \$17.50

Eleven international organizations in the field of information science submitted the 23 papers which comprise this volume. Papers for this annual publication were chosen from among the scores written during 1974 for their contributions to the state of the art, and as significant additions to the lit-

erature on computer sciences.

Some of the more prominent authors represented are James L. Elshoff, "Some Programming Techniques for Processing Multi-Dimensional Matrices in a Paging Environment"; Victor Rosenberg, "The Scientific Premises of Information Science"; and Louis Pouzin, "A Proposal for Interconnecting Packet Switching Networks."

Topics include: the information revolution improving the quality of life, measurement of systems performance, design of indexed sequential files, domains of protection and the management process, person-through-person computing, the cost of developing large scale software, and evaluation of the impact of information systems.



Dp in Japan

Second only to the U.S. in numbers of computers installed, Japan has increased its number of computer systems in operation in the past two decades to over 30,000 units, totaling in value (as of March '75) to nearly \$6.5 billion. About 55% of this value is in computers of domestic manufacture. Details of what is happening in Japan's computer industry and the extent of the country's dp usage are documented in the multicolored, 60-page report, *Edp in Japan*. Facts and statistics, set forth in an easy-to-read format, supply basic information on the present state of dp in the country. Price: \$12 plus 50¢ surface postage (\$2 airmail to U.S.). JAPAN ELECTRONIC COMPUTER CO., LTD., New Kokusai Bldg., 4-1 Maronouchi 3-chome, Chiyoda-ku, Tokyo 100, Japan.

Data Communications

Users rate Bell System facilities and services highest for reliability, ease of installation, and promptness of repair. This and other results of a survey are detailed in *All About Data Communications Facilities*, a 26-page report describing and analyzing communications services supplied by telephone companies and other common carriers.

The 44-page *All About Modems* contains detailed specifications of over 280 data communications modems from 48 vendors. Basic principles and applications of modems are explained, and their distinguishing characteristics and features are analyzed. A survey of user experience is included with ratings of more than 120 popular models.

Price: \$10 each. DATAPRO RESEARCH CORP., 1805 Underwood Blvd., Delran, N.J. 08075.

Computer Documentation

A three-volume abridgment of the 10-volume, 3,000-page *Keystone* computer documentation standards, developed with the aid of 15 large companies, is available. Entitled *OneTwoThree*, this is a how-to-do-it guide which discusses 14 types of computer documentation, and contains 275 illustrations and 370 examples of sample pages. The work is claimed to enable dp personnel inexperienced with formal documentation to produce such documentation correctly on first try. Price: \$595. ONETWOTHREE, P.O. Box 2753, Seal Beach, Calif. 90740.

Data Bases and Networks

Two recent reports in the Infotech State of the Art series are *Data Base Systems and Network Systems and Software*. The format of these oversize volumes contains in-depth analyses of the report material followed by presentations and invited papers from leading practitioners in the field. Annotated bibliographies, subject indexes, and cumulative subject indexes to previous volumes complete the format of these useful reports.

The comprehensive 722-page *Data Base Systems* seems to have a practical bias; theory is discussed as applicable to the user environment. Fifteen systems are discussed in detail, while features of others are outlined; and individual papers on more popular systems (IDMS, TOTAL, IMS, ADABAS, System 2000, MARK IV, DMS 1100) are included, as well as papers on lesser known systems. Ian Palmer, R. F. Schubert, G. Schussel, D. S. Appleton, and L. J. Cohen are among the contributors.

The 692-page volume on networks contains analyses of design approaches, protocols, reliability, performance, security, data bases in networks, and data communications. Presentations and papers on these topics include Louis Pouzin, "Network Design Philosophies" and "Network Protocols"; D. L. Hebditch, "Performance Estimating for Network Systems"; V. G. Cerf, "An Assessment of Arpanet Protocols"; and there are a host of others.

Each volume is \$145, or \$775 for eight reports on a subscription basis. INFOTECH INFORMATION LTD., Berkshire, England.

FOR DATA CIRCLE 201 ON READER CARD

Non-impact Printers

Major changes in markets for all types of printer products, manifold business

TSP Computers. Buying a computer to do what you need right now is one thing. But how about two years, five years from now? Or even a few months from now, when you maybe discover you're already outgrowing all that shiny new stuff you just bought. That's when a MODCOMP system proves your safest investment. Now and for the future. Because every one of our computers is fully upward compatible with all the others. From the smallest tabletop mini. To our largest 32-bit machine. So you can add on as you need to. Interchange processors or peripherals. Expand into a distributed processing network. Without expensive reprogramming or engineering changes. We're not called "Modular" for nothing.

TSP Software. Whoever said that manufacturers' software is all alike? MODCOMP users will tell you that our real-time multi-programming systems are the easiest they have ever used. But simplicity is only part of the story. When we design an operating system, our software team works hand-in-glove with our hardware experts. So that the software will get the most out of all the features we build into our hardware. And vice versa. The results can be seen in superfast execution times that commonly beat the best any comparable systems can offer.

TSP Networks. The switch is on. From big stand-alone computers to integrated distributed processing networks. Our MAXNET operating system was designed for just that purpose. And it's been out working in the field for almost two years. In measurement and control networks of all shapes and sizes. To find out how a network system might solve your own problem, talk to us. We know more about them than anybody.

TSP Peripherals. Buy from MODCOMP, and we supply all the system pieces you need. A complete selection of keyboard terminals, graphic displays and EDP peripherals. Including all types of disc storage, mag tape units, impact and electrostatic printers, card and paper tape equipment — you name it. Meaning that MODCOMP is your single source for Total Systems Performance — and total systems service.

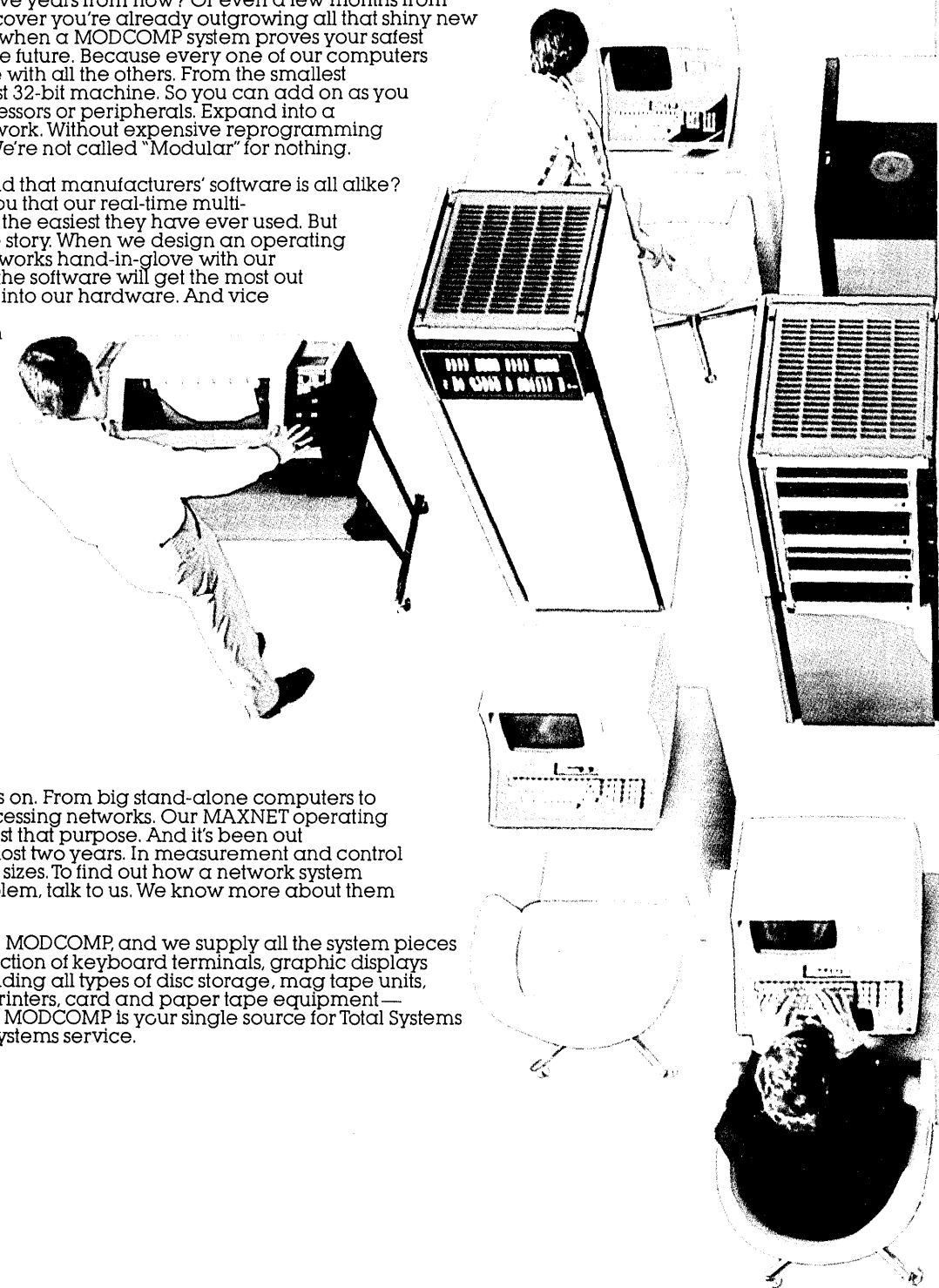

***TSP = Total**

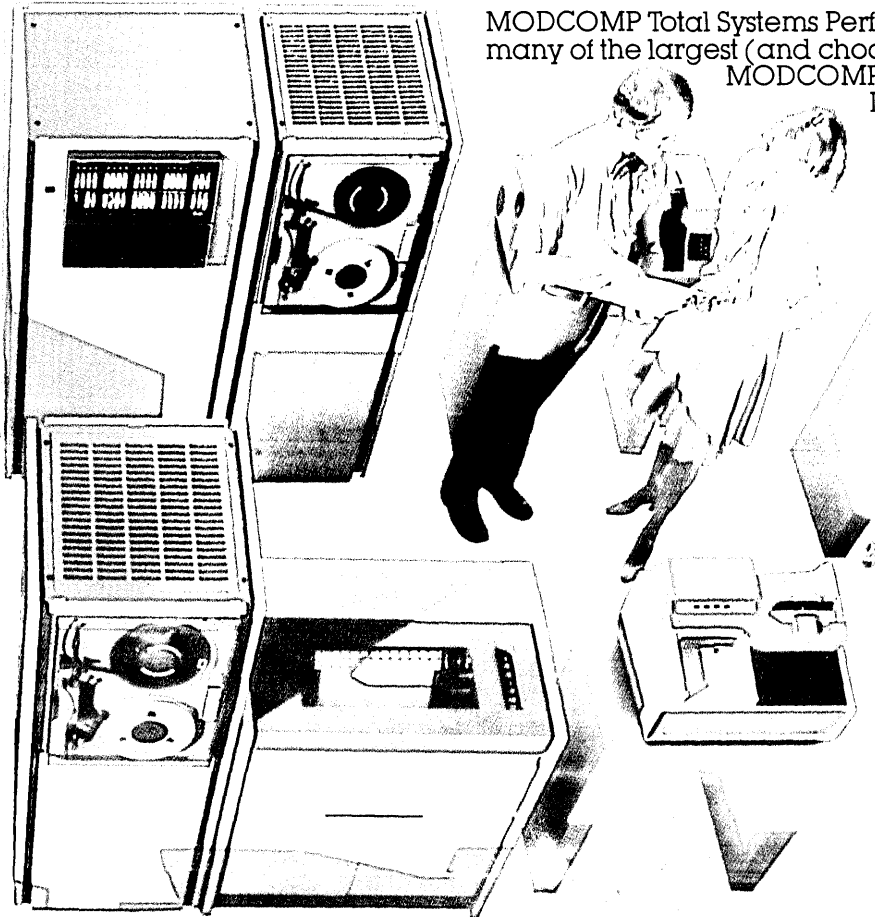

MODCOMP Total Systems Performance has won the confidence of many of the largest (and choosiest) computer users. They know that MODCOMP TSP gives them a lot more for their money

In many different ways. Using standard systems products, a MODCOMP TSP system is up and running faster. Is easier to use. And requires far less

investment in software. Totally supported by MODCOMP, it offers greater reliability and security. And is the easiest to build on to as future needs expand. For industrial and scientific process control. For high speed data communications and information processing systems.

MODCOMP TSP leads the way. Here are a few of the reasons why.

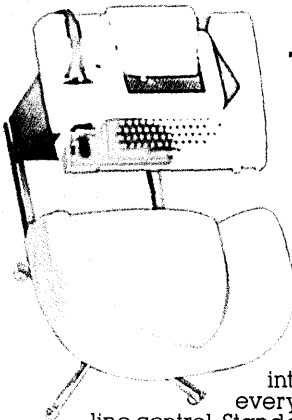
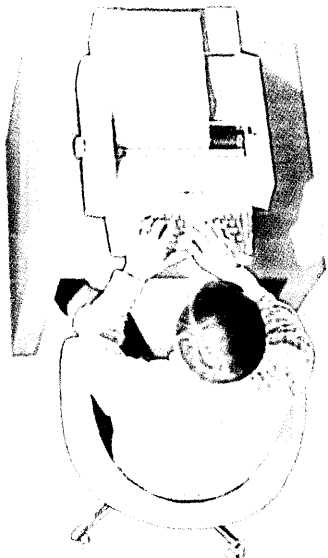
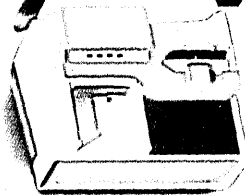
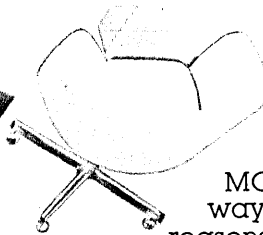
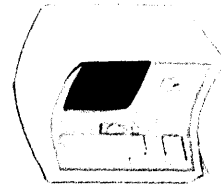

TSP Data Communications. Our specialized communications hardware and software tools offer the data communications specialist a wider range of systems capabilities than anyone else in the minicomputer industry can provide. Including processors with firmware macros for efficient data manipulation; direct memory interface to our versatile Universal Communications Subsystem, and MAXCOM, the operating system designed exclusively for communications use. Full details are in our 32-page communications brochure. Send for it.

TSP Process Interfaces. MODCOMP has designed and makes the most comprehensive line of process interfaces available from any computer company. For everything from laboratory instrumentation to aluminum pot line control. Standard analog and digital I/O products include capabilities for low/high-level, differential/single-ended, and high/low-speed sampling of process signals. And all are fully supported by our operating systems.

Systems Performance.

CIRCLE 120 ON ENQUIRY CARD

TSP Sales. When you need a problem solved, you need someone who can help you solve it. Not a pencil-pushing order-taker. Our team of sales engineers and field analysts work with you right from the start. To configure a system to get your particular job done. In the best way. At the least cost. Most of the time from standard products right off the MODCOMP shelves. But if your need calls for special design, they'll help you with that, too. All part of our Total Systems Performance. It gives you a great feeling of security.

TSP Training. To keep your computer personnel up to snuff on the programming and operation of MODCOMP systems, our full time staff of instructors conduct regularly scheduled courses at our Training Center in Ft. Lauderdale, Florida. If you prefer, we will also arrange on-site instruction courses at your location.

TSP Service. Over 80 MODCOMP service centers provide on-the-spot service for every piece of MODCOMP-supplied equipment. Hardware. Software. Peripherals and process interfaces. The works. Meaning that just one phone call gets you the professional service you need. Fast. And our support engineers and programmers are always on call to help solve problems and assist with new hardware and software start-ups.



TSP. The proof. Let us show you proof-positive no other computer company can match. By actual demonstration on our own equipment at the MODCOMP Computer Center nearest you (they're located in major cities across the U.S. and Europe). No weeks of waiting for benchmark results from some far away factory. We show you what MODCOMP TSP can do. Here, and now.

To find out more about how Total Systems Performance can be put to work for you, send for the MODCOMP TSP brochure.

Modular Computer Systems, 1650 West McNab Road,
Ft. Lauderdale, FL 33309. Phone (305) 974-1380.
TWX: 510-955-9820.

European Headquarters: Export House, Woking, Surrey,
England. Phone (04862) 71471. Telex: 859348.

TSP*

***TSP=Total Systems Performance.**

MODCOMP SALES OFFICES: ALBUQUERQUE, NM/ATLANTA, GA/BOSTON, MA/CHICAGO, IL/CINCINNATI, OH/DALLAS, TX/DENVER, CO/DETROIT, MI/HOUSTON, TX/HUNTSVILLE, AL/INDIANAPOLIS, IN/KANSAS CITY, KS/LOS ANGELES, CA/MONTREAL, CN/NEW YORK, NY/ORLANDO, FL/PHILADELPHIA, PA/PITTSBURGH, PA/ROCHESTER, NY/SAN JOSE, CA/SEATTLE, WA/TORONTO, CN/WASHINGTON, DC/
INTERNATIONAL OFFICES OR REPRESENTATIVES IN ENGLAND/FRANCE/BELGIUM/WEST GERMANY/NORWAY/SWEDEN/JAPAN

CIRCLE 120 ON ENQUIRY CARD

PRINTED IN U.S.A.

source data

forms, and specialty papers are seen as a result of a "skyrocketing growth" in shipments of non-impact printer products, coupled with new products announced by major suppliers. So finds the 195-page report, *Non-impact Printers*, which also details changes in technologies and user preferences through 1985. Market survey results and market-share analysis of over 20 leading suppliers are given. Price: \$595. INTERNATIONAL RESOURCE DEVELOPMENT, INC., 46 Main St., New Canaan, Conn. 06840.

Data Bases in Europe

The 66-page *Data Bases in Europe*, edited by Gordon Pratt, is a directory to machine-readable data bases and data banks in Europe. Available data bases and data banks are listed by subject, and an index of the originating and operating organizations is given with addresses, telephone numbers, telex numbers, and specific named contacts. Explanations of acronyms and abbreviations, cross references, and a select list of published sources are also supplied. Price: \$18. ASLIB, R&D Dept., 36 Bedford Row, London WC1R 4JH, England.

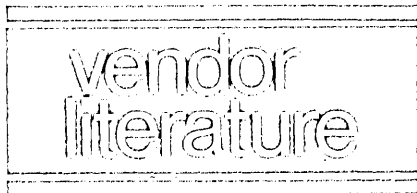

Data Management System

Aladin (A Language for Decision Information), Infonet's new data management system, is so easy to learn, it is claimed in a 4-page brochure, that the user can create a consolidated report in less than an hour. The system helps non-computer-oriented managers to insert variables, order unique formats, and obtain one-time reports. *Aladin* entries are consolidated in a central data base, and through Infonet's nationwide datacom network, companies can link multiple locations through a common data resource. (Infonet is this vendor's Information Network Div.) COMPUTER SCIENCES CORP., Los Angeles, Calif. 90045.

FOR COPY CIRCLE 202 ON READER CARD

Modem Digest

A quarterly publication, *Modem Digest*, is offered free to help "clarify common technical and operational problems in data communications." A recent issue covers envelope-delay distortion and its effects on high-speed data transmission. Future issues will discuss self-diagnostic modems, mov-

ing to higher-speed transmission, and multiplexing. This vendor manufactures modems, multiplexors, acoustic

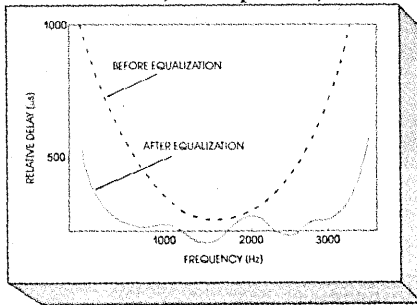

couplers, and associated data-communications equipment. TELE-DYNAMICS, Fort Washington, Pa.

FOR COPY CIRCLE 203 ON READER CARD

Calculator as Terminal

A 4-page application summary discusses the use of the HP 9830 desktop calculator as a computer time-sharing terminal. With the addition of certain ROM/Data Comm. packages, the programmable calculator converts to an intelligent computer terminal with built-in cassette for off-line storage, a memory for creating and editing programs, and a selection of I/O devices. Also discussed are setting-up operations, commands for sending and receiving programs and data, and selection of proper modem. HEWLETT-PACKARD CO., Palo Alto, Calif.

FOR COPY CIRCLE 206 ON READER CARD

(Continued on page 148)

**OptimaDesk...
the data console
with the one thing you've
been waiting for.**

Everything.

Every feature you'll ever conceivably want, including the ones that cost extra in other data consoles (rolled front edge, chrome legs and the like.) Every color from Burnt Orange to Sky Blue to Black; eleven standard colors in all. Standard widths are 24", 45" and 66", each in a choice of keyboard or desk heights. And the two styles you see here are just the beginning.

Above all, the OptimaDesk is the finest quality furniture ever built for electronic instruments. And the price is right. The 45" model is around \$231, for instance.

Write to us for complete information.

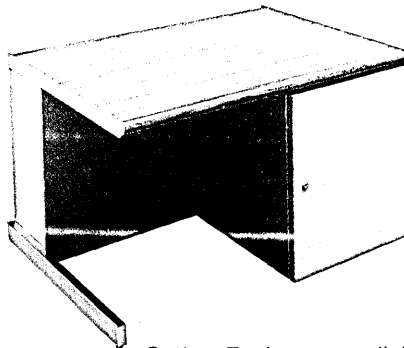

OPTIMA®

Optima Enclosures, a division of Scientific-Atlanta, Inc. 2166 Mountain Industrial Blvd., Tucker, Georgia 30084 or call (404) 939-6340

CIRCLE 99 ON READER CARD



How to turn 32 bits into \$10 million in 90 days.

It isn't all that hard, but you better start with the right system. We did.

Ours is the SEL 32 Mini. The SEL 32 is a true, real, all-the-way 32-bit system. Not some quasi-32, or 32-bit hardware tied into 16-bit software, or two 16-bit systems struggling along in hopeful tandem.

Take hardware. The SEL 32 hardware embraces a wide range of intricate performance capabilities. It's the only hardware which employs micro-programmable, independent processor-based I/O, so it doesn't have to steal cycles. And it won't become obsolete, because you can upgrade its capabilities by changing just a board or two.

The SEL 32 software is a programmer's delight. It's already been successfully proven in the field, in a variety of applications, for more than five years. So you know it's tried, tested, seasoned, reliable. As for completeness, it includes 750,000 lines of code which, put against other systems, makes an interesting comparison. A comparison which we seriously invite.

You can buy an SEL 32 Mini for as little as \$18,000. And a volume commitment from you brings its own reward in the form of a sizable discount from us.

All this has led to new orders for us of about \$10 million in the past 90 days...or better than a \$100,000 per

day. (Frankly, with all the SEL 32 has to offer, we're a bit surprised it took that long.)

But the real question is, what does our success mean to you? Well, it means that you can buy the most impressive, field-proven, true 32-bit system on the market today, at an attractive price, from the company with the foresight to build it, the service personnel to help you maintain it, and the financial strength to stand behind it.

Write or call us today for a comprehensive brochure on the SEL 32 Mini.

Who knows, it might do for you what it did for us.

SYSTEMS
ENGINEERING LABORATORIES

- CALL ME
- SEND ME MORE INFORMATION
- I HAVE PRESENT NEED FOR SYSTEM

NAME _____
COMPANY _____
PHONE _____
ADDRESS _____
CITY _____
STATE _____ ZIP _____

SYSTEMS Engineering Laboratories
6901 West Sunrise Boulevard, Fort Lauderdale, Florida 33313
(305) 587-2900

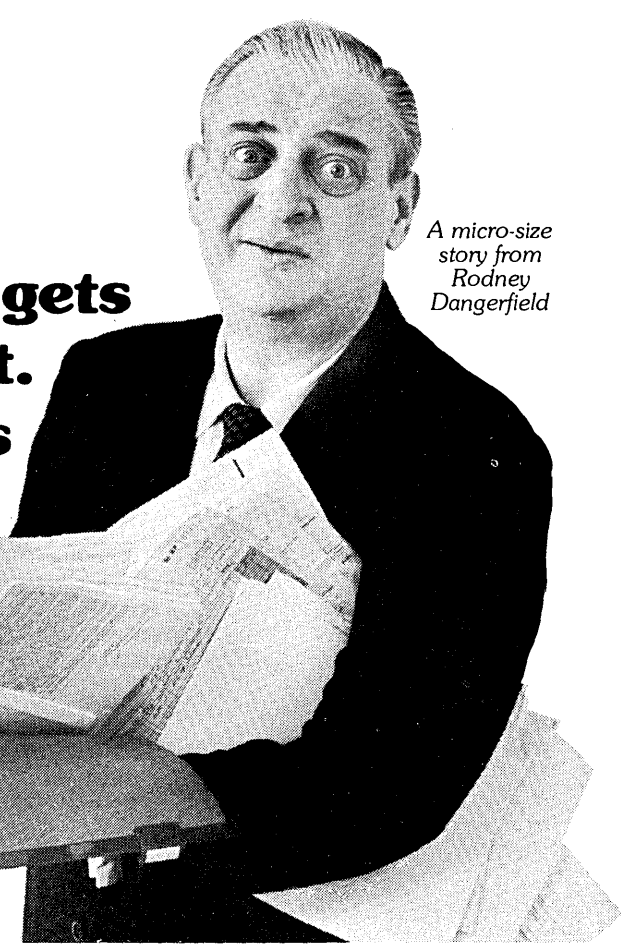

*A micro-size
story from
Rodney
Dangerfield*

**I know a guy who gets
plenty of respect.
He's a big business
magnate. Travels all
over. He just
got back
from Zurich.
He went there to
get his watch fixed.**

But he tells me with all his money
he's still got problems. The more business he does the more paperwork he gets.
He told me it's driving him nuts! I told him, Don't tell me — tell 3M.
If they can't help you, nobody can!

3M Microfilm can help with 5 different systems!

System #1: Automatic Cameras and Reader Printers.

Retrieve, copy, refile records in as little as 28 seconds!

System #2: Microdisc. Forget sorting and batching! "Tag" records as you film them . . . then let Microdisc locate them by their "tags" in seconds.

System #3: Engineering Microfilm. Put drawings on camera cards in 45 seconds.
Get a dry full-size print in 15 seconds or ten prints in 60 seconds flat.

System #4: COM. 3M has the two best ways to get data from tape to end-user through microfilm. One uses laser-beam technology and host computer software and is totally dry. The other is programmable — and can even produce graphs and charts!

System #5: Micropublishing.

Mail a 300-page catalog on a film the size of a post card . . . pay less for the printing and only 13¢ for the postage!

Only 3M offers you all five!

For details, write
Microfilm Systems Division,
3M Company, St. Paul, MN 55101.

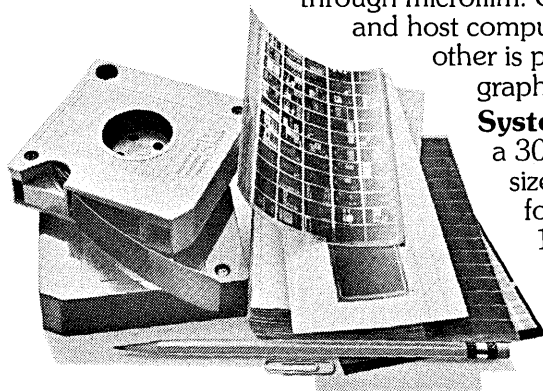

Even if your building survives, your business may die.

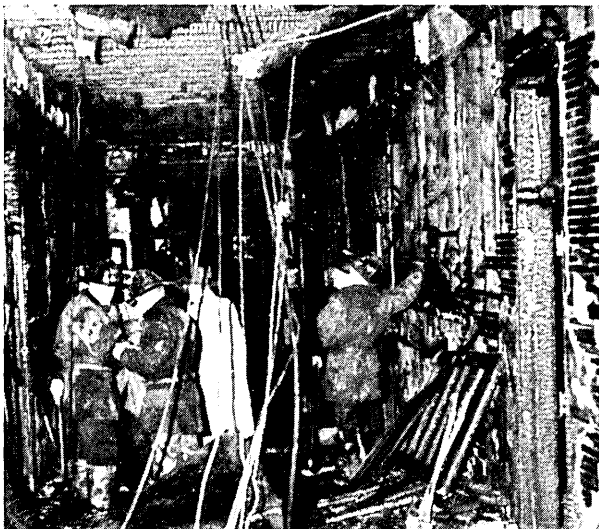

The gloomy fact is, even a minor blaze can cause enough damage and business interruption to close you down for good.

It happens every day. To all kinds of businesses.

Because there's just no such thing as fool-proof fire *prevention*.

For this very reason, you need a fire *protection* system that quenches the flames faster. Before they can do extensive damage. And allows you to get right back to work. With no clean-up. And a minimum of downtime.

Fenwal Fights Fire with Halon

The Fenwal Fire Suppression System does both. Because it uses Halon 1301. A chemical you may have seen demonstrated on TV. When released as



a vapor by a Fenwal system, Halon literally snuffs out flames. Faster than water. Faster than CO₂.

Faster than anything yet developed. And dry — no wet mess to clean up.

Safe for Even Delicate Things

What's just as important, Halon 1301, unlike water and CO₂, won't damage whatever it is you're trying to protect.

Sensitive equipment. Sensitive material. Sensitive anything. And it won't harm people.

Putting a Damper on Downtime

This all adds up to two very important advantages you don't get with other fire protection methods: 1. A Fenwal system gives you the fastest jump on the flames because you don't have to evacuate the area before it's released.

2. *You can go right back to work. There's no clean-up. No water damage. No extensive business interruption.*

Now Make Us Prove It

We believe our Halon Fire Suppression Systems are the solution to a lot of serious fire problems.

We've been designing and installing them for years. More systems than any other manufacturer. And we've perfected a number of different systems to protect all kinds of environments.

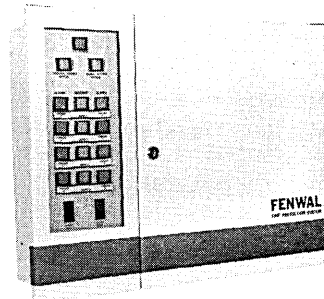

Quite simply, they work.

We make sure of that. Before we install them. And after. With the best after-sales back-up in the business.

What's more you can't ever outgrow a Fenwal system because they're modular in design. Easy to extend.

Of course no one's ever bought any fire protection system after reading a one-page ad.

So we've prepared a special film which shows our system in action.

It proves you can save your building without killing your business.

To view "The Fireaters" just call us at (617) 881-2000. Or write Fenwal Incorporated, Ashland, Massachusetts 01721. A Division of Walter Kidde & Company, Incorporated.

FENWAL

Nobody in the world has more experience in fire and explosion suppression systems.

Our local, service-oriented distributors are listed in the yellow pages under "Fire Protection".

FM Approved—UL Listed

Word/One

Interactive Text Processing System.

You get a good deal more



Now the most widely used interactive text processing software is available for installation on your 360/370 system.

When you lease our text processing software you get a good deal more than a couple of tapes and a stack of manuals.

You get all the people resources it takes to get Word/One up and running smoothly on your in-house hardware. Our team of specialists will evaluate your requirements. Plan the installation. Then we will install Word/One. Maintain it. Enhance it. We train your operations, technical and end user personnel. And after Word/One is installed and

running we will still be there whenever you need us.

PROVEN SYSTEM

It is the only way we know how to run a business. Maybe that's because we are a service company, not a software house. For the past six years, we have been the leading vendor of time shared text processing services. We still are. During that time Word/One has evolved into what we believe is the finest interactive text

processing system anywhere. More than 350 companies have logged more than one million hours of use on Word/One for a variety of text applications.

Now this same proven system is available on your in-house computer. Prove Word/One out for yourself. There's no risk. Take advantage of our time shared service to conduct a competitive evaluation of Word/One before installation.

You will find we have built into Word/One powerful text entry, edit-

than a couple of tapes and a stack of manuals.

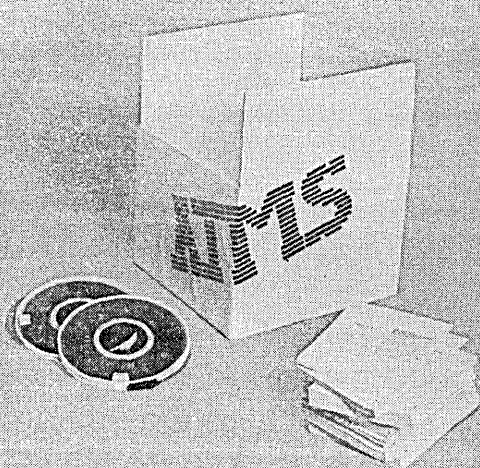

ing and formatting capabilities that can be readily employed by both the novice and the more sophisticated user. And a good deal more.

CONSIDER THESE ADVANTAGES

The Word/One text processing system:

- operates on less hardware
- eliminates the need for in-house systems support
- eliminates the need for additional systems software (like CICS)
- provides a peakload backup facility through the shared system
- provides on-going systems enhancements
- provides on-going user training

If you currently use ATS or ATMS, there's no conversion problem. Word/One is compatible.

Word/One was designed to operate in the IBM 360/370 multiprocessing environment and run directly under the operating system, taking full advantage of the OS/VS1 and OS/VS2 systems. A DOS version is also available.

If you are seriously considering in-house text processing software, we want you to take a closer look at the Word/One alternative.

FREE COMPETITIVE EVALUATION

Use this coupon for a detailed Word/One write up.

Or, for more information on how you can conduct a free competitive evaluation of the Word/One system, call our Vice President of Marketing, Bill Mahony, directly at 212-741-4705.



Bowne Time Sharing, Inc.
345 Hudson Street
New York, New York 10014

- Send information on the Word/One text processing software.
- I am interested in the Word/One time shared service.
- Please have a representative call.

name _____ title _____

company _____ phone _____

address _____

city _____ state _____ zip _____

Sometimes there's just no room for error.

It's no different in the computer room.

Perfect performance has never been more important than it is today.

At densities up to 6250 CPI, even the smallest error can compound tremendously because of masking by the GCR format. Ask your Graham product technology man to explain.

While higher densities may help you reduce your library size, the smaller the library the better the tape should be.

Since you could be needing fewer reels of tape now, you can easily afford Epoch 4.

If you want to get more throughput, get Epoch 4.



**GRAHAM
MAGNETICS**

Graham, Texas 76046

CIRCLE 70 ON READER CARD

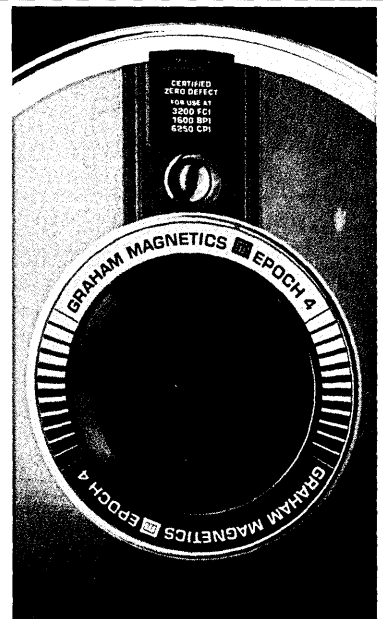

Editor's Readout

John L. Kirkley, Editor

Promises to Keep

So far the bicentennial is a bust.

As many have observed, it's more of a buy-centennial.

Two hundred years of this country's history all pointing toward a year of unrelenting hucksterism . . . the longest advertising campaign ever. Every car dealer, hardware store, and soap manufacturer is ablaze with patriotism.

But the target of this ad blitz, the average citizen, is curiously unmoved by our two hundredth birthday. He's being subjected to a year of political rhetoric, a Freedom Train that whisks him by this country's historical documents on a conveyor belt, and, happily, some excellent tv specials.

It's quite a show. But with few exceptions, most of the people we know are caught up in making a living, fighting inflation, worrying about doctors' strikes . . . getting through the day-to-day process of living, surviving.

Why the apathy? Surely a little opportunistic merchandising can't be the only reason for our lack of enthusiasm.

Perhaps it goes deeper. Perhaps it's our reaction to some important myths we've lost, some promises to ourselves that we've failed to keep.

We've seen ourselves as an invincible world power. Vietnam destroyed that. We've looked to our government for moral guidance, ethical leadership. We found Watergate. Throughout the world we've preached the virtues of democracy and lavishly distributed foreign aid. In return our embassies have been stoned and one country after another has turned to some form of communism.

So when, in the name of the bicentennial, some politician stands up and tells us how great we are, we feel uncomfortable. Our shortcomings are all too apparent, our myths are shattered.

A parallel and interrelated situation exists in the short, startling life of the computer. Back in the late fifties and sixties, there was once a full-fledged computer mythology. The computer was to be mankind's saviour, creating leisure, accelerating the evolution of the species, solving our greatest social and technological problems. Simon Ramo, from a plant-bedecked aerie in Canoga Park, California, played matchmaker with the doctrine of "Intellectronics" — the wedding of man's intellect with the awesome power of the computer. (A few years later both parties filed for divorce on the grounds of mutual incompatibility.)

The computer did not live up to these inflated promises; in many instances it created more problems than it solved. Often we used it for the wrong reasons on the wrong jobs.

Joe Weizenbaum, in his excellent book *Computer Power and Human Reason*, (we'll review it in the April issue) makes the point that computers arrived just in time to "save" many of the enormously complex social institutions that marked the postwar decades. He cites the welfare system as a prime example. The invention of the computer made it possible to ". . . save very nearly intact, indeed, to entrench and stabilize . . . social and political structures that otherwise might have been either radically renovated or allowed to totter under the demands that were sure to be made on them. The computer, then, was used to conserve America's social and political institutions. It buttressed them and immunized them, at least

NEW PTS/1200 PROCESSING SYSTEM GRANTS "SIX FREEDOMS" TO REMOTE SITES. GET THE GOOD WORD.

PTS/1200

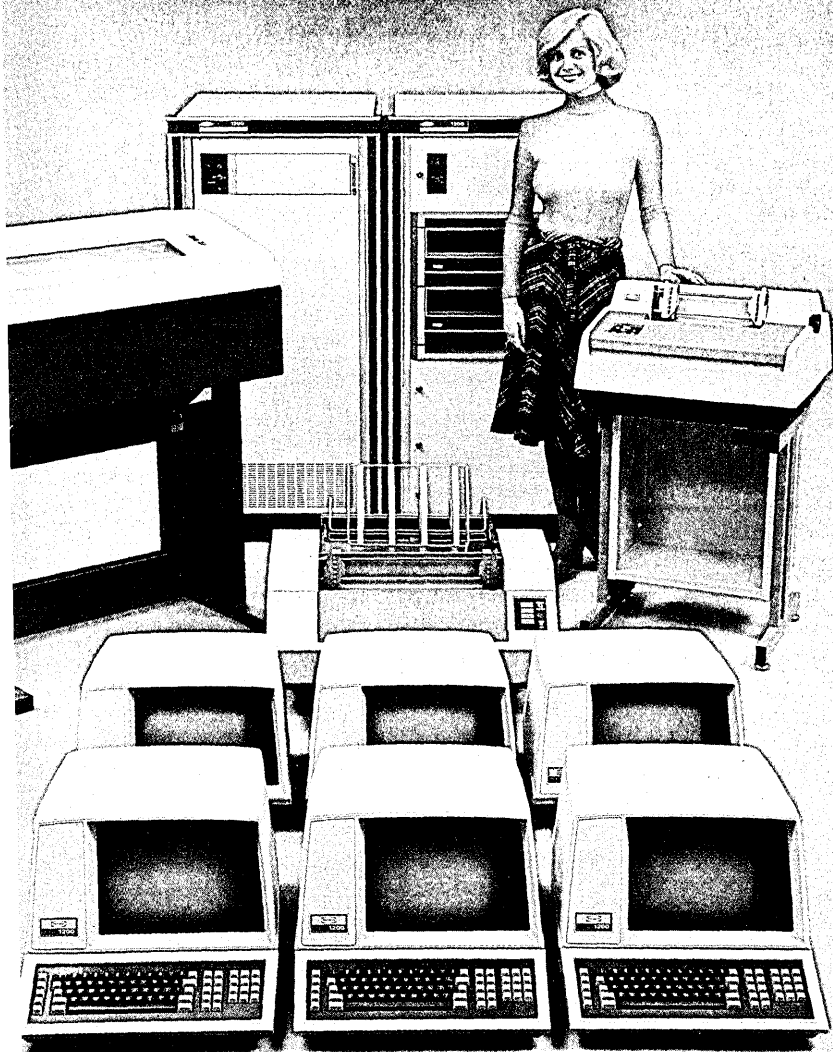

Raytheon's new PTS/1200 distributed processing system gives companies with extensive branch operations new independence from centralized information handling.

The versatile, cost-effective PTS/1200 system allows remote sites to perform their own:

- source data entry and pre-processing, including editing and validating;
- file and record maintenance — creating, accessing and updating locally stored data;
- unattended two-way communications, either in point-to-point or multi-point networks;
- stand-alone batch processing — and disc storage up to 20 million bytes of capacity;
- fast, flexible report printing, in many formats;
- 3270 terminal emulation on-line with 360/370 computers.

Ready-to-use software gets your data up fast — and you can program your own applications easily. The system can utilize up to 24 terminals simultaneously. It reduces computer line costs and forms costs, expedites data retrieval and reports, improves productivity and requires minimal operator training.

A demonstration says it all. To arrange that, write to Raytheon Data Systems, Marketing Department, 1415 Boston-Providence Turnpike, Norwood, MA 02062 — or telephone 800-225-9874 (toll-free). When you build better information processing systems... **the Word gets around.**

INTELLIGENT TERMINALS, MINICOMPUTERS AND TELECOMMUNICATIONS SYSTEMS

RAYTHEON DATA SYSTEMS

RAYTHEON

temporarily, against enormous pressures for change.”

It maintained the old order, the old myths. Attempts to reexamine the fundamental underpinnings of those myths were buried under an avalanche of complexity made possible by the automatic processing of data. And this is essentially the situation today.

At least in the world of business data processing, now into its third decade, a way out of this dilemma is being indicated. For one thing, corporate and data processing managers are much more aware of the computer's capacities and its limitations.

And, because of the computer's intolerance for ambiguity, the company that is involved with dp has had to carefully examine, understand, and simplify existing organizational structures. Corporate leaders are demanding that the computer be adapted to fit corporate needs, not the other way around. The move to distributed processing is one of the sensible, functional answers to this demand.

Could this drive away from complexity and bureaucracy and toward simple, functional systems be transferred to our political and social structure?

Yes . . . but only if our leaders and all of us clearly understand and are committed to common national goals.

Suppose, for example, we made a *real* national commitment to achieving a harmonious balance between ourselves and our environment. Not that we'd attempt to revert to a tribal, hunter/gatherer form of society. Or, God help us, establish a new Federal agency. Instead we'd want to design simple, but elegant, closed ecological systems that have a non-violent, nurturing effect on the environment.

(An ancient example is the terraced rice paddies of the Orient . . . the land stays fertile for a thousand years. In this country we created a dust bowl in one generation.)

We might decide, for example, that current recycling efforts are ineffective, stopgap measures. We might decide that most products are to be designed *by the manufacturer* to be 100% recyclable; others should be designed never to wear out.

Obviously a basic change in the way we now do business. But even more, a basic departure from the 19th century notion that nature must be conquered and exploited — instead an admission that man and nature are inseparable.

Right now, in the year of our two hundredth birthday, it's difficult to make these kinds of promises to ourselves. We hear the platform rhetoric but we fear that the words are hollow platitudes.

We would welcome national leaders who would be able to restore our faith in government and direct us toward meaningful, humanistic goals — a direction diametrically opposed to the vapid boosterism and rapacious materialism that has marred this bicentennial.

We have the technical tools we need to achieve these goals. And beneath the apathy and easy cynicism we have the strength and resiliency to keep the promises we make to ourselves.

All the potential is here. Unlocking it could make America's third century its greatest ever.

And what a bicentennial birthday present that would be.

✱

Compatibility or Chaos in Communications

by Ray W. Sanders, Contributing Editor, and Vinton G. Cerf

Sides are being drawn for a showdown between computer manufacturers and standards organizations over data communications protocols. If the vendors win, the users lose.

The world of data communications is rapidly moving into a new generation of terminal equipment and network architectures. It is also moving toward a major conflict. Some computer vendors are attempting to introduce sets of rules and procedures for data transmission which will make it very difficult for a user to transmit data between that manufacturer's equipment and any other. Meanwhile, standards organizations around the world are rapidly coming to agreement on how such major incompatibilities can be avoided.

We are again witnessing the saga of the large manufacturers attempting to dominate the customer community through standards of their own design while the users try to formulate less constraining industry-wide standards. This time, unlike the confrontation which led to multiple incompatible character codes, the outcome may be different. Today's user is more sophisticated, and because of the size of specific market segments, has greater economic clout.

Before he can influence the outcome of the current clash, however, the user must learn something about his alternatives. And that means he must learn something about a subject he may have studiously avoided. If the user chooses to neglect his education any longer, he will be made captive of his mainframe vendor, his costs will be higher than need be, and his choice of new developments in the marketplace will be limited.

If he chooses instead to get involved, he must learn the basic vocabulary and fundamental issues in networking. He may even have to change his conception of what a network is. Fortunately,

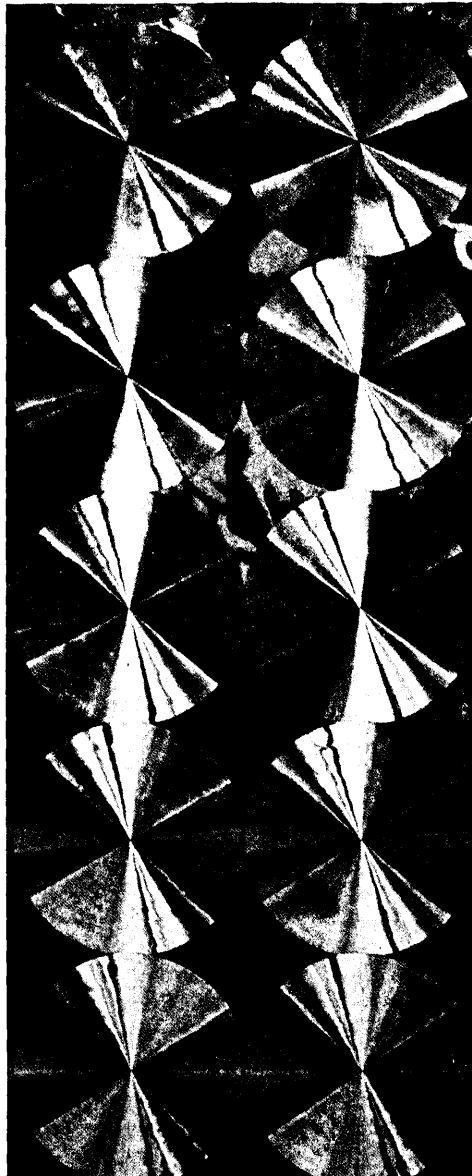

the subject isn't as difficult as it's been painted.

How the problems evolved

It's true that things were even simpler once. When we first began using terminals, we connected them to computers on a "point to point" basis, either through a cable, a leased phone line, or a dial-up telephone line. The terminal talked directly with the computer and we treated the communications medium, whether only a simple cable or the whole Bell system, as a simple pipe or black box—unless or until it failed.

As the use of teleprocessing and the distances involved became greater, communications "networks" like the one illustrated in Fig. 1 (p. 52) were born. Since common carriers like AT&T usually charge for their service on the basis of distance, we came to make extensive use of "multipoint" or "multidrop" networking, where a single phone line was shared by several terminals. Multipoint networking in turn led us to assigning addresses to terminals and having the computer or its communications processor continually "poll" each address to find out whether that terminal was ready to send or receive data.

All of this led to the difficulties now being experienced. Response times are often long because polling is being performed on communications facilities of limited bandwidth where only one or at most a few terminals can be used simultaneously. Costs are still high because dedicated private line connections are required even where only small traffic loads are generated. Reliability is less than it might be since a

failure in one point of a multipoint configuration can take down an entire set of terminals, or even the whole computer system; and isolating the malfunction can often be extremely difficult.

Even more important, sometimes the specific method of connecting terminals to computers precludes a terminal from accessing more than a single computer. In many cases, as data processing managers have found to their dismay, a terminal cannot access different applications programs or processes in the same computer!

Not all computer communication networks use multipoint networking. Many dedicated networks make use of point-to-point private line connections. Even here polling is often used if the computer communicates with a "cluster controller" sitting between the terminals and the line. Thus, even where multipoint connections are not a part of the network topology, some of their disadvantages are still sometimes experienced.

Of course there are exceptions to the scenario described. The public switched telephone network is used to overcome some of those connectivity problems. In fact, we would probably not have much of a time-sharing industry were it not for the switching capability of the phone system. However there are many cases where that switching capability is not adequate. The principal problems are response times for setting up calls and the costs of the calls themselves. The recent introduction of a one minute charging period in the U.S., instead of a three minute minimum, should alleviate some of the cost problem. Even so, the relative inflexibility of the service, the cost, and the long circuit setup times restrict the phone system's usefulness, especially for applications like electronic funds transfer and point-of-sale.

Changing the concept of a network

To solve our data communications problems we must change our concept of networks. Instead of looking at them as sets of communication lines and separate pieces of equipment, networks of the future should be viewed as more or less homogeneous structures to which computers and terminals attach. A network will take on much of the appearance of the switched telephone network, rather than look like the structure shown in Fig. 1, but it may function differently than the existing phone system.

Public data networks currently being implemented by existing or new common carriers will certainly be of this new homogeneous form. Many private networks with a single or fixed

group of users may be of this form too. Whether public or private, these networks will have to provide functions the phone system does not, including provisions for data security.

There are a number of networks now in existence which operate as homogeneous structures and provide special data communications functions. The ARPA net is a well known example. Others are the SITA network for international air carriers, and TYMNET, DATRAN, and TELENET in the U.S. Announced AT&T and ITT systems (January, p. 100) may become additional U.S. alternatives. The EPSS, DATAPAC, TRANSPAC, DDX, EDS, and NDN networks being implemented in the United Kingdom, Canada, France, Japan, Germany, and the Nordic countries, respectively, are other examples. Further, Spain has implemented the CTNE network and important activity is taking place in Brazil, South Africa, and Australia. A large number of private networks are also in the planning or implementation phase.

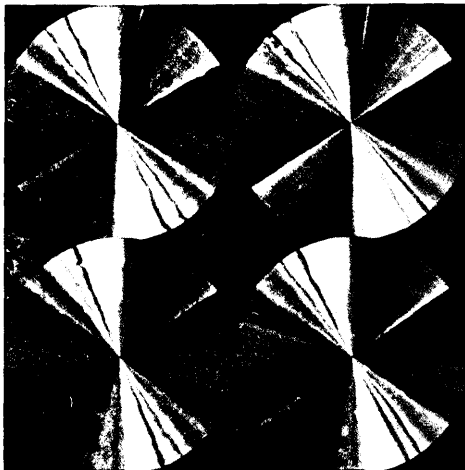

Access methods

How can these networks be made to serve us better than we are now being served? The answer lies partly in the method in which a device gains access to the communications medium, the "access method" or "protocol." The access method directly affects response times, reliability, costs, and other problem areas.

How can the method of network access affect response times? As was mentioned, there are two principal methods in which terminals and computers now access each other. One is by use of the switched telephone network; the other through polling over dedicated lines. In the former case, response times are long because the time to make a connection is long. In the case of polling (considering only the more common half duplex polling for the moment), the response time is long because one transaction with one terminal must be completed before a

transaction with another can begin.

This unavoidable fact of life of half-duplex polling would not appreciably affect response times if only very short messages were sent or if only very high communication rates were used on channels with very low propagation delays. However the real world must make use of moderate and even low speed communication facilities. There is nothing to be done about message sizes in many instances either, nor about the propagation delay of some channels (including satellite channels).

Full duplex polling allows for some overlap of operations, but not enough to substantially alleviate the problem. A radically different approach is required.

Ideally, messages and responses would be presented to the network in a fashion which would altogether overcome the disadvantages of polling. To do this, provision must be made for carrying on several transactions simultaneously on a single access port. One solution is to distinguish transactions from each other through identifiers included *within* the messages transmitted. If this is done, the messages identify their sources and destinations, making polling unnecessary.

For this to work, the network and its users must recognize and know how to handle the identifiers. This means some form of network access protocol must be established. That protocol, it turns out, must define the formats of data messages and control messages, and the sequence in which they appear.

How can the method of network access reduce errors? In many installations, unbuffered terminals are still used for data traffic though buffered terminals are known to provide better error control. The best error control an unbuffered terminal can achieve is the detection of an error through some parity check. Buffered terminals can detect errors and call for retransmissions, but only if they know how to notify each other about errors and recognize the requests for retransmission. Again, a protocol is required.

How can the method of access affect user costs? Costs are directly related to the ability of one user to share resources with others. A data communications network can more efficiently share resources if those resources are allocated only when data is actually being sent. Polling protocols are particularly inefficient since polling messages must be sent continually, even when no meaningful user data is to be transferred. Here too, a message by message protocol is a desirable alternative to polling. The same arguments can apply to some cases of dedicated private line and dial-up connection.

Other important problems can also

COMPATIBILITY

be solved by a message oriented network access protocol. Certainly, access to multiple terminals and computers from individual ports on a network can only be achieved by message to message destination identification. Reliability can be increased; since there can be multiple paths within the net, the entire communication process does not depend upon a single facility, as is the case with multi-point or other dedicated private line networks.

As far as management flexibility and fault isolation are concerned, a properly defined protocol can again be of great value. Network reconfiguration can become primarily a question of modifying network addresses rather than reconfiguring lines. Fault isolation becomes easier too, since the protocol provides a means of identifying the sources of errors.

A completely separate issue is data security. The protocol can help assure that access to certain ports on the network is denied unauthorized users.

In summary, a network access protocol should include means for:

- identifying destinations of data on a message by message basis;
- isolating errors and malfunctions;
- transmitting interleaved messages to multiple computers and terminals;
- precluding the delivery of messages to unauthorized users.

(An ancillary requirement comes about when a network access protocol is used in a packet switching network; a means of controlling the flow of data into the network must also be provided. This issue is discussed briefly later.)

Layers of network access protocols

Now that there appear to be good arguments for providing a message oriented network access protocol, it is important to understand just what alternatives are possible and just what kinds of standards make sense. There are four levels or layers of protocol which form the basis of most current network access standards. These are:

- physical circuit protocol standards (which define how devices are physically connected to the network—and sometimes some switching signals);
- link control protocol standards (which define how a terminal talks to the network over its physical circuit);
- packet level protocol standards (which define how messages are identified to the network for routing and control);
- application level protocol standards (which determine how terminals

and application programs talk to each other).

As will be seen, it is not necessary that all four levels exist in any one application.

Physical circuit protocol

The physical circuit protocol standards include both electrical standards and any others necessary for physically connecting to a network. At present there are American and international physical standards which are adhered to by computer and terminal manufacturers and by providers of data communication equipment and networks. Although there are a number of standards organizations in existence, the two most important at this level are the Electronic Industries Association in the U.S. and the international CCITT (International Telegraph and Telephone Consultative Committee).

Typical of existing standards of these organizations are the EIA RS232 data circuit interchange and the CCITT V.24 recommendation which is essentially equivalent to it. These standards define the data, clocking, and control leads (including the number of pins in a plug) which are used for passing data between data terminal equipments (DTEs) and data communications equipments (DCEs). The term "data communication equipment" is used broadly to mean any communications processor, or even line, which serves as

the "point of entry" for a terminal accessing a network.

In addition, standards now exist for establishing physical circuit connection between data terminal equipment and circuit switching networks such as the dial telephone network through the use of automatic calling and/or answering equipment. Such standards are covered in CCITT recommendation V.25, for example. Thus there are existing standards for achieving both physical connections and circuit switched access to a network.

However, there has been much effort in the last few years on defining new standards which results in a simpler interface. These are defined as "X.-" series recommendations and, over the years, they are expected to displace the older "V.-" series. The principal new data interchange standard is called "X.21." Agreement has been essentially obtained on X.21 between the common carriers and a number of manufacturers. However, since X.21 calls for a significant change, an interim recommendation "X.21 bis" will be used first; it calls for implementing the X.21 protocol but retaining the physical V.24 interface.

For both X.21 and X.21 bis, protocols are defined for the establishment of physical circuits for three types of service: leased circuit (private line) service, direct call switched service,

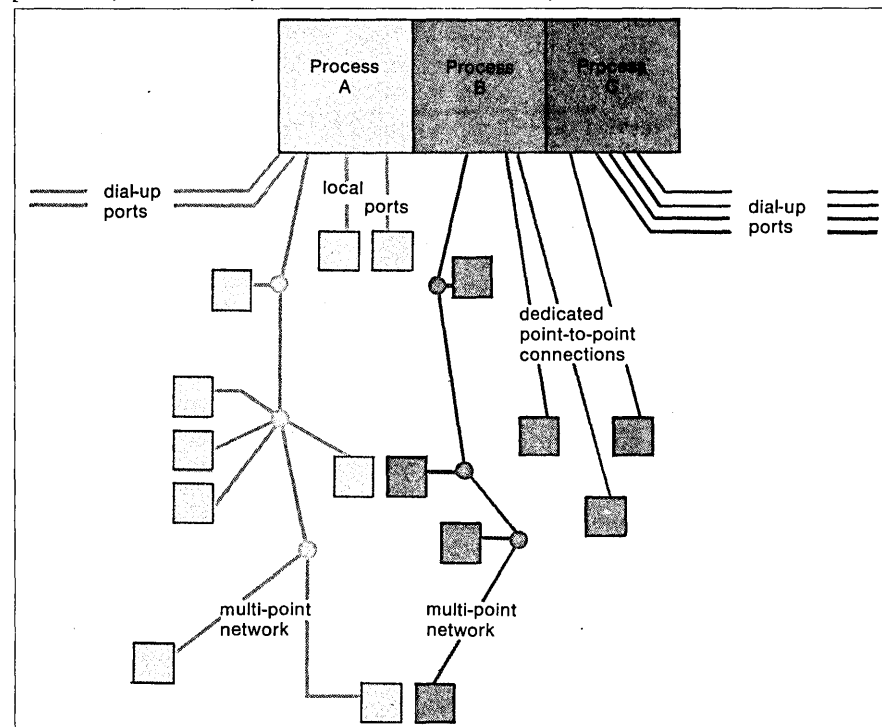

Fig. 1. The "old" conception of a network is as a fixed or nearly fixed set of lines and pieces of equipment, radiating from the computer, whose specifications are largely determined by the mainframe and its systems software. Future networks, private and public, will be designed as more or less homogeneous structures to which computers and terminals attach through single—or perhaps dual—connections. The point is that the communications network can and should be looked on as a separate entity, distinct from the computer and terminal hardware, whose properties can be independently specified by the user.

and address call switched service.

Leased circuit (private line) service is intended for those applications where continuous connection is required between a terminal and a network switch processor (such as a packet switcher) or between two terminals. Direct call and address call services both involve circuit switching. The difference is that a direct call is one which is always switched to the same destination whenever a connection is requested, like a "hot line." An address call is one where the destination is designated by the terminal, like a dial-up call (but not using a phone dial). Over the next several years, X.21-type physical circuit standards will become more and more prevalent. They will provide the user and manager with a simpler physical interface plus more flexible and faster call setup procedures.

Link control protocol

The most elementary layer of protocol is at the physical circuit level as described above. In many future data communications networks, this level will be the only one required except for the application level protocol. Such may well be the case, for example, for many of the transaction oriented applications represented by the point-of-sale and EFTS markets.

However, to attain the multiple access and error control benefits of modern networking technology, a logical link level protocol (also called frame level protocol) is required. The purposes of this level are to provide means for:

- exchanging data across the terminal/network interface once a physical connection is made;
- controlling errors on a communication link;
- providing full duplex (two-way) as well as half-duplex (one way at a time) information exchange;
- operating on circuits with long propagation delays (such as satellite circuits).

Data links are assumed to be synchronous in order to make use of data link controls. (It's not essential that clocking be provided by a modem to achieve synchronous-like operation, but this is usually the case.) A means of establishing character synchronism must be included in the protocol.

The most prevalent link control standard in operation today is the Binary Synchronous Communication (BSC) protocol. It is deficient in meeting certain future needs in that it is a half-duplex protocol and byte-oriented. It is not transparent to data information fields at the byte level and not all line control characters are included in the error control implementation.

Even so, this protocol, first introduced by IBM in the '60s, has served and will continue to serve a large market need.

For the past several years, manufacturers and standards organizations have been attempting to define a data link control protocol which would overcome the deficiencies of BSC. IBM announced a Synchronous Data Link Control (SDLC) procedure which is now being introduced in its newer products. The International Organization for Standards (ISO) has produced a similar, but somewhat more general standard (more accurately, a *set* of permissible standards) known as High Level Data Link Control (HDLC). Future data link control procedures are assuredly going to make use of these new approaches. (The essence of these procedures is illustrated in Fig. 2, p. 54.)

Two different basic modes of operation are allowed under HDLC. One is a "primary/secondary" mode in which one DTE (or perhaps a piece of network data switching equipment) acts as the primary or control station. One or more additional DTEs act as secondary stations where their actions are always controlled by the primary. Except that a restricted type of full-duplex action can take place (one secondary can be responding to the primary while the primary is sending to the same or another secondary), this mode of operation does not go very far to overcome the queuing problems of polled multipoint operation.

The other mode of operation is called the primary/primary mode. In this case only two-point operation is assumed and each of the two stations involved act both as primary and secondary stations in a fully symmetrical manner. Thus, either station can initiate actions on the link. IBM's SDLC has thus far been publicly announced as a primary/secondary protocol. However, a primary/primary mode becomes important when interconnecting two data communication networks since this obviates the requirement for choosing one or the other of the two to be in "control."

Data link control procedures like HDLC and SDLC have a variety of potential uses. In relatively simple networks, they can be the means for transmitting data between computers and terminals over data transmission lines. In more complex networks, they become the means for transferring packet level blocks of information between data terminal equipments and a network.

Packet-level protocol

It is clear that networks can be established which only include a few of the possible levels of protocol. However, many features which are technically achievable can be realized only

if all levels discussed here are implemented. In particular, the advantages of the so-called packet switched networks can be realized only if a packet level protocol is included in at least the host computer's access to the net. (Other terminal data streams might be translated to appropriate packet level formats by the network if the terminals cannot do this themselves.)

Although there have been a number of different standards suggested by different agencies for packet level protocols, we are going to concentrate this discussion on one. It is easier to describe the features of a single approach. Much more important, this single approach being described has today the highest probability of being universally accepted as an international industry standard.

The standard is a proposed version of the CCITT X.25 recommendation (which incorporates a physical circuit protocol and a link control protocol as well as the packet level protocol). While not yet ratified, it has gained widespread support from common carriers and manufacturers (and, more important, from a significant number of commercial and government enterprises which have growing data communication requirements).

The proposed standard is a fortunate accumulation of a diverse set of practical experiences gained from experimental networks in the U.S. (ARPA), France (CYCLADES), England (EPSS), and other countries. The experience of designing and implementing operational networks such as DATAPAC (Canada), TELENET (U.S.), and TRANSPAC (France), DDX (Japan) among others, has also provided inputs and an impetus to reach an international agreement at a common carrier level. The results of the standards deliberations will be important for private networks as well as public.

Two approaches have been developed for packet switching. One of these is the "datagram" approach, the other "virtual call." Briefly, a "datagram" is a packet of information which is sent by a DTE (computer or terminal) to another DTE as a stand-alone block. All sequencing of packets (guaranteeing that the order in which they are received is the same as the order in which they were sent) and detection of missing packets is a function of the dialogue between sender and receiver and *not* of the network.

The other approach, using "virtual calls," again allows messages to be divided into blocks at the sending end of a connection. However, the network guarantees the order of arrival of packets will be the same as the order of sending. In addition, the virtual call approach possesses greater ability to

Protocols on Top of Protocols

Three kinds of protocols must be understood by a terminal just to gain access into a packet switched network. These protocols represent conventions which must be followed for the data terminal equipment (DTE) to communicate with the data communication equipment (DCE), the terminal's point of contact with the network.

The data formats for two of the three protocols, the link control protocol and the packet level protocol, are illustrated in Fig. 2. The example chosen shows the transmission format defined by a proposed version of international recommendation CCITT X.25. This proposed standard incorporates in its definitions a physical level protocol (X.21 or X.21 bis), a link control protocol (one of the many possible subsets of HDLC), and a packet level protocol. It does not include an application level protocol—the protocol which operates between, say, a terminal and the application program it is accessing—as thus far that level is defined by the computer manufacturer. Therefore the details of the application level field are not depicted. (Nor is anything shown for the physical level protocol, which deals primarily with pins, signals, and voltage levels and with setting up physical connections through circuit-switching networks.)

Link control header

The first piece of the transmission is the link control header. It begins with a unique 8-bit *flag* (the character 01111110) which acts as a delimiter for a "frame" of data. (Under HDLC, all data between flags is modified by a simple algorithm so that this sequence of bits can never appear except as a flag.)

The link control header's second field is an *address* byte which is used to show which end of the terminal/network connection is initiating an exchange. This byte has only two possible legitimate values. Eight zeroes indicates the network side is initiating the transmission or that the message is a response from the terminal to a message initiated by the network; a one bit and seven zeroes indicates that the terminal/computer side initiated the communication.

The control byte is used to supervise the shuttling of information between the terminal and the network. It has several possible uses, such as

for indicating that the following packet is an information packet or a link supervision message like "ready to receive."

The link control header shipped to the network DCE from the terminal is not transmitted through the network; it serves only in the interchange of information between terminal and network.

Packet header

The first two bytes of information in the packet header (or more accurately, the first four bits and the next twelve bits) are used to identify the destination of the packet. The four bit field marked *ID* in the figure can have only two values, either 0001 or 1001. The first signifies that the packet is being transmitted to an individual terminal or computer directly; the second is used for sending a transmission to a device via a cluster controller.

The next 12 bits in the header constitute a *logical channel number*, or *virtual circuit number*. There are two fundamental types of virtual circuits, permanent and switched. A permanent virtual circuit, linking

terminal to computer for instance, is one where a logical channel number is assigned by agreement at the time the service is initialized.

A switched virtual circuit is one which is under the dynamic control of the data terminal equipment. Thus, one of the types of packets which is defined in the protocol is a "call request" packet which allows the user to place a call to a specific terminal or computer attached to the network. Each such attachment is assigned a number, similar to a telephone number. The call request packet is used to assign a currently unused logical channel number to be used for the duration of the call in place of the generally much longer terminal or computer attachment number. At the completion of the call, the logical channel number is released for reuse.

Since 12 bits are available for the logical channel number, there are conceptually 4096 virtual circuits which can be supported simultaneously over a single physical connection to the network.

The *control* field within the packet header plays a role similar to that of the control field in the link header. It is used to indicate (again, only between the DTE and DCE) such things as: (1) this packet is a call set up request or disconnect; (2) this is a data transfer; (3) an interrupt of the device at the other end is required; or (4) the flow of data should be temporarily stopped. It is also used in error and exception condition handling.

Information field (user data)

As mentioned, this field's format is determined by the computer manufacturer or by the applications software in the host computer. It is the part of the transmission for which standardization efforts have been least effective. Thus it represents one of the user's biggest unsolved compatibility problems.

The field may be any length, not necessarily a multiple of eight bits. It is untouched by the network and its equipment.

Link control "trailer"

The last three bytes of any frame of information are the two bytes reserved for the *Frame Check Sequence* (a cyclic redundancy check polynomial) and the flag byte which indicates the end of one frame and the beginning of another.

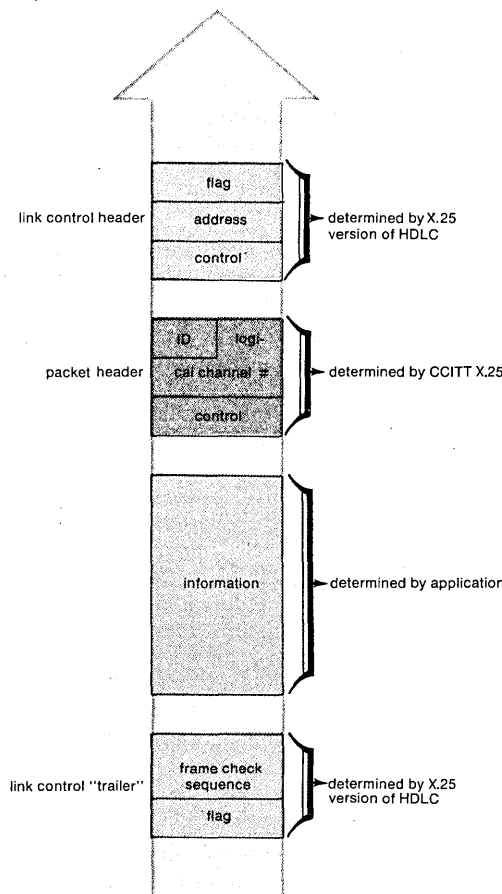

Fig. 2. Network frame format

✱

regulate message flow at the access points of a network than does the datagram approach. Although arguments about the two approaches have sometimes been quite violent, the initially diametrically opposite viewpoints have become softened as proponents of each have begun incorporating features of the other into their version (as so often happens with supposedly disparate technologies, and even cultures). In any case, the X.25 recommendation discussed here is of the virtual call type.

Application level protocol

At the three levels of protocol discussed—physical, link, and packet—agreement has been reached by a significant number of organizations around the world. Standardization at these levels is not only possible, but likely to become a near term reality. The situation at the business end of the spectrum, the exact structure of the information field, is much more difficult to standardize. It is at this level we are going to experience the greatest difficulty when we try to get terminals from different manufacturers to communicate with each other.

Even here, though, the situation is not hopeless. At the elemental character level, there is international agreement on use of International Alphabet No. 5 (CCITT) which is very similar to the U.S. ASCII standard. This alphabet is supported by essentially every equipment supplier using the Roman alphabet. Thus we are in pretty good standards shape when we wish to transfer files of pure text.

The situation becomes much more difficult when we step beyond the realm of pure text transmission. Many terminals have features which are not alphabet dependent but character string dependent. Terminals with formatting and text editing capabilities are typical examples. But there is no recognized standard character string for identifying protected field formats for display terminals, for instance, except for de facto standards of specific hardware vendors.

The situation will not significantly improve as a push is made toward distributed data processing. As terminals perform more and more data processing functions, reaching agreement on standards so that different terminals can work together becomes increasingly difficult. Moreover, a dominant supplier intent on protecting his market share can include critical timing dependencies in his equipment so that not only do certain character strings become necessary for proper operation, but they must occur within specific time windows. If past experience is a key to the future, standardization at

the application level will move very slowly, and mostly through de facto standards setting.

One approach to solving the application standard problem has been to introduce the concept of a "virtual terminal." The idea here is that an imaginary terminal is logically defined which has all the attributes of real terminals. For example, character string standards are defined which have one to one correspondences with features offered by specific real terminals, although the character strings may not be the same as those used by any specific terminal. There are two ways to use the virtual terminal approach. Either the network operator must supply translators which transform the application level protocol of some specific real terminals to that of the network's imaginary standard terminal, or users must attach real terminals which have been programmed to operate directly in network virtual terminal protocol.

This approach has been the object of intense study and development in the ARPA and CYCLADES projects among others. Although conceptually it is an elegant approach to solving the application level protocol problem, it is difficult to implement due to the subtleties hidden in the logical design of terminals.

Since standardization at the application protocol level is so difficult to address, we must question the real merit of standardization at the other levels. After all, if I cannot count on standardization at this level, why should I try to enforce it at any other? The answer lies in the freedom which one can expect in the future. Even if there is no application level standard for one network application, having standardized the network access protocol at least allows me to add different applications to the network without restriction. Moreover, once a specific application level protocol from one manufacturer has been in use long enough to become a de facto standard, then having a standard access gives the users much greater freedom in using competitive products which have embraced the de facto standard.

Conclusions

Over the past several years there has emerged a remarkable unanimity regarding the basic structure of a standard method for accessing data communication networks. The SNA network architecture announced by IBM possesses, from the logical structure point of view, very similar attributes to many proposed standards, including the X.25 proposal discussed above. The protocols announced by Digital Equipment Corp., Burroughs, Honeywell, and others also possess very simi-

lar basic structures. There appears to be little technical justification for each of the manufacturers to support network access protocols which differ only in details.

We are at a point where standardization at the network access level can be a practical reality. There are benefits for all in adopting network access standards. From the user's point of view, it broadens his field of choice by giving him access to a competitive marketplace. From the manufacturer's viewpoint, it opens new markets which would not be economically viable without the resource sharing advantages such standardization implies.

There is much to be gained by all in agreeing to abide by the forthcoming network access standards. In today's world, the customer is king. By insisting that suppliers adhere to these standards, he will ensure not only his own future, but a brighter future for the industry as well. *



Mr. Sanders is President of Computer Transmission Corp. (TRAN), a firm which designs and produces hardware and software for medium and large scale digital communication networks. Prior to founding TRAN, he was vice president and director of engineering at ITT Gilfillan, and before that, a founder of Space Electronics Corp. (which later became Space General Corp.) He is also one of Datamation's contributing editors.

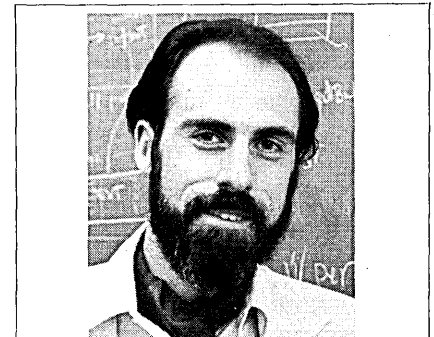

Mr. Cerf is an assistant professor of engineering at Stanford Univ. Until January he served as chairman of IFIP Working Group 6.1, on packet networking. He has been an active participant in the ARPANET project since 1969, with particular interest in communication protocol design.

Data Communications: Coping With Cost

The issues at Interface '76 conference this month: How to operate in a \$3.6 billion yearly market. What's being offered? What are the alternatives?

INTERFACE '76 Cost effectiveness in the use of data communications will be stressed in all of the 37 topics to be discussed during Interface '76, a conference and exhibit at the Miami Beach convention center March 29-31. The organizers of the affair, the fourth such annual event to be held, envision their audience of about 4,000 as being essentially the elite in data communications-using installations and who have, among other management problems, the prime one of coping with costs.

The theme is "Managing for Cost Effectiveness Through Data Communications."

It is a timely subject as computer users prepare to invest substantial sums in expanding teleprocessing capabilities. Users are boosting their spending this year for communications equipment by 30 to 40%, according to a DATAMATION study of spending plans by a selection of data processing installations (February, p. 52).

A study by the New York research firm of Frost and Sullivan shows that the vendors of data communications equipment and services expect a rise in spending for their products and services of 22.5% a year during the next three years. That study estimated the 1975 market at about \$3.6 billion, consisting of: \$860 million for modems and multiplexors, \$1 billion for terminals, \$50 million for communications features for central computers, \$100 million for software, \$150 million for systems design, \$1 billion for transmission circuits and \$200 mil-

lion for system operations.

Many of the suppliers of that equipment will participate in an equipment and services exhibit that is part of Interface '76. In late January, the organizers were expecting some 75 firms to show up for the three-day exhibit (see page 58).

It is the fourth such conference and exhibit devoted exclusively to the subject of data communications. Previous affairs have been held in Dallas and New Orleans. It is sponsored by DataComm Interface, Inc., 160 Speen St., Framingham, Mass. Although much of the content of the conference program is aimed at persons directly involved in the operations of communications-based data processing, special attention also is being given to the needs of the non-technicians through a two-day course on basics.

Called the DataComm School, it will be held in four sessions during the first two days of the conference and address the following subjects: *Fundamentals for Managers*, ranging from basic single-line transmission principles to network operations justification; *Communications Services and Interfaces*, listing characteristics of the latest transmission service offerings of common, specialized and value-added carriers; *Communications Processors and Software*, a discussion of available processors, their software counterparts, and their purposes; *Terminals and Terminal Systems*, a review of configurations from touchtone phones to complete satellite systems.

The school will be conducted by communications consultants Richard Kuehn, of RAK Associates, and Murray

Robinson, of Murray H. Robinson and Associates, and by Grant Hagerty, senior marketing representative with Olivetti Corp. of America.

Remainder of the program consists of six product workshops, three workshops on network methods, 14 applications sessions and 14 highlight sessions.

Product workshops: A review by experts on various products who will weigh alternative offerings according to applications needs.

Network methods workshops: A briefing by data communications consultants who, it is hoped by the organizers, will provide decision-making criteria for attendees having some computer and communications experience.

Applications sessions: Speakers from 14 major commercial, industrial and public service sectors will discuss their use of data communications.

Highlight sessions: Speakers representing users and vendors will address 14 topics relating to both product and policy evaluation. Among the topics is an update on the FCC's recent ruling on interconnection and privacy in data communications.

Registration fee for the three-day conference is \$95, and \$50 for one day. For installations with more than two persons attending the conference a discount is being offered. The third and each additional attendee will be charged \$50 for three days or \$25 for each single day.

In late January, the organizers had named 57 speakers, but expected eventually to have 115 to 135 when the conference opens. Following are the subjects and speakers:

Product Workshops:

Host, Front-End and Mini Processors: Ronald Sander, U. S. Senate and Kenneth Brantley, Martin Marietta.
Data Base and Communications Software: Robert Hernandez, Zayre Corp.
Couplers, Modems and Multiplexers: William Durrenberger, Motorola.
Transmission Services: James Holmes, Datacomm consultant and Al Sill, Western Union.
CRT'S and Teleprinters: Sam Vilari, DataPro Research.
Remote Batch, Data Entry and Satellite Systems: Roy Salzman, Arthur D. Little, Inc.

Methods Workshops

Network Planning: Ralph Berglund, DataComm Consultant, and Richard L. Deal, Richard L. Deal Assoc.
Network Implementation: Dr. Dixon Doll, DMW Associates, and Donald Dittberner, Dittberner Assoc.
Network Management: Einar Steferud, Network Management Assoc. and Samuel McCuchan, U. S. Army.

Highlight Sessions

Who's Ahead in Transmission Services: Herbert Ranzinger, Union Carbide, Lloyd Isaacs, Chrysler Corp., John Scorce, Datran.
Worldwide Nets Require Diplomacy: Dr. Philip Enslow, Jr., Georgia Institute of Technology. John Wheeler, Xerox, Gerhard Mueller, General Electric.
Protocols or Promises for Productivity: David Horton, Bell Canada, George Comant, Digital Equipment Corp., Saroj Kar, Telecomm Computer Corp.
Datacomm Needs Standards Management: Dennis Branstad, Nat'l. Bureau of Standards, David Carlson, Bell Telephone Laboratories
Fax and Word Processing: Howard M. Anderson, Yankee Group.
Keys to Privacy with Data Communications: Arthur Bushkin, Systems Development Corp., Charles Riviere, Richard L. Deal Assoc., Willis Ware, Federal Government.
Common Carrier Interconnect Policy Update: Bernard Strassburg, Data Communications Consult.
Maintenance Managing with Distributed Computing: John Nuwer, Atlantic Richfield.

Five-Year Planning for Datacomm: Joseph Ferreira, Diebold Group, Alan Kamman, Arthur D. Little, Inc.

Applications Sessions:

Banking: David Yancey, Bank of America, William Knight, Nixdorf.
Securities: Milton Lieberman, Merrill, Lynch, Pierce, Fenner & Smith.
Insurance: Robert Madan, Equitable Life Assurance.
Manufacturing: Allan Bobko, PPG Industries.
Process Industries: Barry Webster, Sun Oil Company
Retailing: Samuel Lynch, Zayre Corp.
Wholesaling: Ross Wells, American Hardware Stores.
Transportation/Distribution: Gordon Lew, American Airlines.
Service Industries: Frank Bilieki, Holiday Inns, Inc.
Computer Services: Max Beere, TRW, Laslo Rakoczi, Tymshare, Kenneth Morioka, Control Data Corp., Philip Tenkhoff, Computer Sciences Corp.
Utilities: Charles Many, New York Telephone Co.
Government—Law Enforcement:

CONFERENCE AT A GLANCE

Data Communications Interface '76, March 29-31, Miami Beach Convention Center, Miami Beach, Fla.

	9:00	10:00	11:00	12:00	1:00	2:00	3:00	4:00	5:00	
MONDAY	Keynote						Applications: Banking, Securities, Insurance, Manufacturing, and Process Industries.			
	DataComm School #1 Fundamentals for Managers						DataComm School #2 Comm Services & Interfaces			
	Network Planning: Objectives, Justification, Budgeting, and Staffing						Network Implementation: Design, Vendor Selection, Installation, and Maintenance			
	Hosts, Front Ends, and Minis		Data Base and Comm Software				Couplers, Modems, and Multiplexers		Transmission Services	
	Who's Ahead in Transmission Services.						Worldwide Nets Require Diplomacy			
							We're Going to Point of Transaction			
							Consultant's Corner			
	EXHIBITS OPEN 10:30-5:30									
	Applications: Retailing, Wholesaling, Transportation/Distribution, Service Industries, Computer Services						Applications: Banking, Insurance, Manufacturing (Repeat Sessions)			
	DataComm School #3 Comm Processors and Software						DataComm School #4 Terminals and Terminal Systems			
Network Management: Involvement, Accountability, Payback and Expansion						Network Implementation: (Repeat Session)				
Network Planning: (Repeat Session)						Hosts, Front Ends, and Minis (Repeat Session)		Data Base and Comm Software (Repeat Session)		
CRT's and Teleprinters		Remote Batch, Data Entry, and Satellite Systems				DataComm Software Needs Standards Management				
Protocols or Promises for Productivity						Terminals Grow into Minis Via Micros				
Data Base Management Decentralizes Again						Consultant's Corner				
EXHIBITS OPEN 10:00-5:30										
Applications: Utilities, Government/Law Enforcement, Health Care and Education						Applications: Government/Law Enforcement, Health Care, Education (Repeat Session)				
Applications: Retailing, Service Industries, Transportation/Distribution, Computer Services (Repeat Session)						Maintenance Managing with Distributed Computing				
Common Carrier Interconnect Policy Update						CRT's and Teleprinters (Repeat Session)		Remote Batch, Data Entry and Satellite Systems (Repeat Session)		
Network Management: (Repeat Session)						Carriers Are Offering Package Deals				
Couplers, Modems, and Multiplexers (RS)		Transmission Services (RS)				Five-Year Planning for Data Comm				
Keys to Privacy in DataComm						Consultant's Corner				
Data Entry is Still in Transition										
EXHIBITS OPEN 10:00-5:00										
	9:00	10:00	11:00	12:00	1:00	2:00	3:00	4:00	5:00	

COPING WITH COST

Dr. Paul Polishuk, Former Deputy Director, Office of Telecommunications, U. S. Dept. of Commerce.

Health Care: Jerry Vogt, Shared Medical Systems, John Marshall, Shared Medical Systems.

Education: Howard Dockery, University of Iowa.

We're Going to Point of Transaction: William Bauchwitz, TRW.

Data Base Decentralizing
Again: Arthur Lynch, Data General, Bruce Weiner, Data Base Mgmt. Systems, Inc., Michael O'Connell, Digital Equipment Corp.

Terminals are Growing into Mini Systems via Micros: Elton Sherman, Conrac Corp., David Caplan, Raytheon Data Systems.

Data Entry's Still in Transition: Andrew Olson, Data Communications Consult.

Carriers are Offering Package Deals: Robert O'Hare, Robert O'Hare & Assoc.



Product Preview

AMERICAN TELEPHONE & TELEGRAPH CO., Morristown, N.J. Terminal Printer

Booth 502

As has been rumored for over a year, AT&T is about to introduce (by mid year) a wider printer for its Dataspeed 40 family of terminals. The wide tractor printer expands print capability from 80 columns to 132. This will probably fuel IBM's fires that the Dataspeed 40s are really data processing and not communications oriented products—but then everything is beginning to look alike anyway. AT&T is reluctant to price the new printer but will say that it will add approximately 30 to 45% to the rental of an 80-column unit, which costs approximately \$75-130/month, depending on lease arrangements. And we thought tariffs were more complicated than they had to be!

FOR DATA CIRCLE 215 ON READER CARD

APPLIED DIGITAL DATA SYSTEMS, INC., Hauppauge, N.Y. Crt Terminal

Booth 219

If your crt application will never require hardcopy output, then you're just the target customer this firm had in mind when it designed its latest tty-compatible offering, the Consul 520. The 520 is a "more basic" version of the very successful Consul 580. A total of 1920 characters are arranged on the screen in 24 lines of 80 characters. Dark characters are displayed on a light screen for increased legibility. The 520 uses a bonded faceplate tv monitor to produce a bright display and help eliminate glare and distortion. The 520 operates in a choice of five transmission rates communicating via either EIA RS232 or 20 ma current loop interfaces. Front panel controls allow the user to choose between scrolling or wraparound presentation and either full duplex or half duplex transmission modes. An automatic line feed button is standard. Single units are priced at \$1,595.

FOR DATA CIRCLE 216 ON READER CARD

DELTA DATA SYSTEMS CORP., Cornwells Heights, Pa. Crt Terminal

Booth 411

The DELTA 4500 will undoubtedly be one of the hits of the show, incorporating as it does full keyboard programmability and up to 16K of memory. The unit displays 25 lines of 80 characters. A paging feature permits display of all stored characters in any format without computer assistance. Functions that can be supported out of the local memory include error

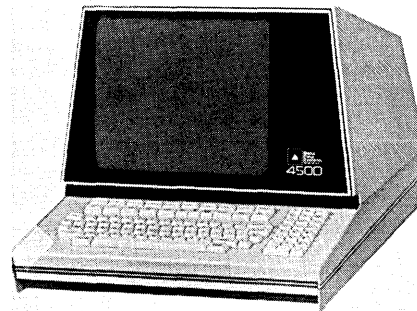

checking, text editing, formatting, and off-line processing operations. A "printer on-line" mode allows the terminal to operate on the communications line simultaneously with keyboard input functions. Prices are approximately \$14K each for orders of six units, that come with 4K random access storage, 4K programmable read-only memory, and 2K of refresh memory. First shipments go to the field this month.

FOR DATA CIRCLE 217 ON READER CARD

INFOTON INC., Burlington, Mass. Crt Terminal

Booth 214

For a price of only \$990 each in quantities of 25, the Vistar/GTX includes as standard 24 lines of 80 5x7 dot matrix characters, 15 switch selectable baud rates, both EIA RS232 and 20 or 60 ma current loop interface, high resolution white P4 phosphor, detachable solid state keyboard, and more.

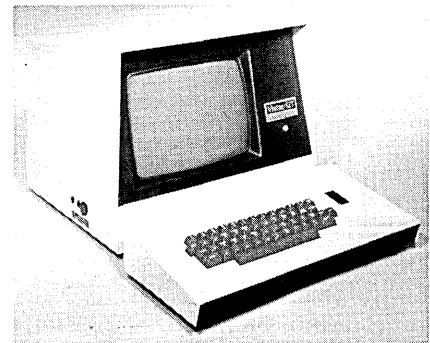

Baud rates can range from 50-9600, and if that isn't sufficient the user can always use external equipment for higher performance. First units went to the field last month.

FOR DATA CIRCLE 218 ON READER CARD

NORFIELD ELECTRONICS, INC., Norwalk, Conn. Terminal Controller

Booth 814

The intelligent terminal control unit was primarily developed to support AT&T Data Speed model 40 crt terminals, but the programmable unit

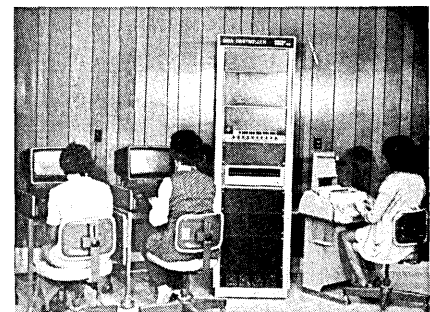

can also be used with other EIA and current loop interfaced asynchronous terminals. The controller supports both local and remote cluster requirements and offers store and forward capability as an option. Typical systems are configured to control 16 local devices which can be a mix of video displays and hardcopy printers. Baud rate support of terminal devices is determined by the number reporting to the controller, with 16 asynchronous terminals capable of operating simultaneously at 1800 baud. Memory sizes

in the controller are usually 32K but can be expanded up to 128K to satisfy user requirements. Prices start around \$15K for an eight-line configuration with one synchronous line output and 16K of memory. Store and forward capability runs an additional \$7-10K, and every eight asynchronous communications ports adds \$2,500 to the base price.

FOR DATA CIRCLE 219 ON READER CARD

**RCA GLOBAL COMMUNICATIONS, INC.,
New York, N.Y.**

Communications Service Booth 111
February was the scheduled start of a commercial satellite service based on the RCA Satcom I, launched last December 12. The voice and data grade service is offered commercial and government users for domestic service only. RCA bears end-to-end responsibility for operation of the 4800 and 9600 baud circuits. Typical prices are approximately \$1K per month for a New York to California link for 1-11 cir-

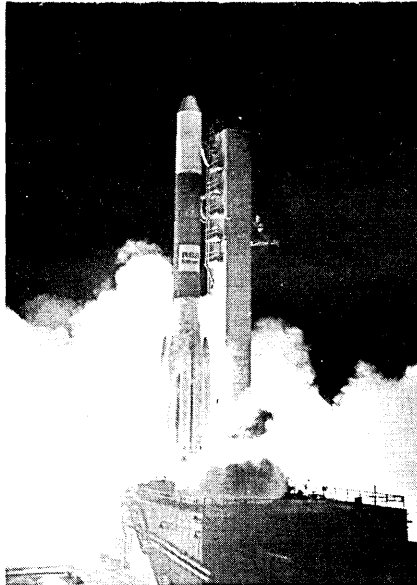

cuits. No special ground equipment need be separately acquired by the user; all is furnished by the vendor. The 4 kHz bandwidth lines can be multiplexed (with user equipment) for more efficient channel usage. As usual in communication pricing schedules, there is a raft of additional little charges such as termination and local loop fees, plus additional charges for service outside standard service areas, much like the local telco.

FOR DATA CIRCLE 220 ON READER CARD

**SPECTRON CORP.,
Moorestown, N.J.**

Diagnostic Equipment Booth 809
Display and monitoring of all data and control characters passing through an interface is what the D601B Datascope does best. It's an expanded ver-

sion of the manufacturer's D601 with the following bells and whistles added: full-duplex display, automatic stop, external control, remote display capability, idle suppression, tape track indicator, expanded code selection, etc. Data speeds go up to 9600 baud. Any RS232C interface is accommodated. A 9-inch viewing screen displays a total of 375 characters (15 lines of 25 characters) as 7x9 dot matrices. Incoming data "ripples" from left to right and top to bottom with one full blank line for demarcation between old and new data. The Datascope can be left on-line indefinitely and records incoming data on an endless loop tape that can store 25 minutes of traffic at 2400 baud rates. The base price of the D601B is \$7,500, with the most expensive option (full-duplex display) priced at \$1,200. First units go to the field this month.

FOR DATA CIRCLE 222 ON READER CARD

While the D601B Datascope offers users nearly every possible feature as standard equipment, the D-600 is for the more cost-constrained user. It's a very basic system (at \$2,800), offering only display of all data and control codes passing through a communications link. The user can add additional features as they are required.

FOR DATA CIRCLE 228 ON READER CARD

The DPU-2400 digital patch unit is an attempt to make rearranging interconnections between modems, multiplexors, terminals and computers easier. Up to 16 EIA RS232 leads are switched, patched and monitored. Patching is accomplished with a proprietary plug using proven and tested components. A monitor position is available at all times regardless of normal or patch operation. The DPU-2400 is priced at \$90 in quantities of 16.

FOR DATA CIRCLE 223 ON READER CARD

**TELENET COMMUNICATIONS CORP.,
Washington, D.C.**

Communications Services Booth 209

Beginning in the second quarter of the year, Telenet will offer public dial in ports for terminals operating at 1200 baud. This is thought to be the only carrier offering dial in packet switched service at this speed. No hardware installation of any kind is required. Charges will be based on the duration of calls, with the actual tariff yet to be filed with the Federal Communications Commission at press time.

Also beginning in the second quarter will be network service for the recently introduced IBM 3767 keyboard printer terminal and the IBM 5100 portable computer. Both terminals will be supported at 300 bps when operating in

IBM 2741 model. Here again the public dial in charges will be based on call duration, but should range between \$.90 to \$2.40 per hour.

FOR DATA CIRCLE 224 ON READER CARD

**SCOPE DATA, INC.,
Orlando, Fla.**

Teleprinter

Booth 216

The model 200-XL teleprinter features 132 column output, switch selectable operation from 10 to 240 cps, and quiet non-impact printing. It's available in keyboard send/receive (KSR) and receive only (RO) configurations with current loop, EIA RS232C and parallel interfaces with 64- and 256-bit first-in-first-out (FIFO) buffers to aid throughout. The 200-XL is priced at \$1,800 in quantities of 100; first units have gone to the field.

FOR DATA CIRCLE 221 ON READER CARD

**TIMEPLEX, INC.,
Hackensack, N.J.**

Modems

Booth 614

The M103D and M103C modems use LSI technology to provide low cost Bell 103-type units that can be strapped for any Bell 103 or 113 configuration. Full diagnostic and troubleshooting capabilities for fast fault isolation are incorporated. The two model numbers indicate a standalone and card version, respectively. Prices start at \$250 for standalone versions; \$250 is also the unit price for 100 oem orders and above.

FOR DATA CIRCLE 225 ON READER CARD

Also on display at the show will be two models of a direct dial system interface unit called the TSU-I and TSU-II to replace the Bell Data Service Unit. With the TSU, a standard EIA RS232 device can be used at switch selectable speeds of 2.44, 4.84, 9.64, 19.2, or 56 kilobaud. The interface units are priced at \$300-400, and will be available in June.

FOR DATA CIRCLE 226 ON READER CARD

**THE VADIC CORPORATION
Mt. View, Calif.**

Automatic Calling

Booth 106

The VA831 communication interface adaptor makes it possible to implement a Bell 801 (or compatible equivalent) automatic calling unit in a communications environment without having to obtain parallel transmission port. The 801 thus appears to be just another modem on the serial interface to the incoming communication. The VA831 operates at 110, 134.5, 150, 300, and 1200 baud. The price is \$500 in quantities of one to nine. First units are in the field.

FOR DATA CIRCLE 227 ON READER CARD

You can pay a lot for a terminal that does a little
 or you can pay a little
 for a terminal that does a lot.

COMMUNICATIONS FLEXIBILITY The Consul 980A is designed to attach either to IBM systems using binary synchronous protocols or to Honeywell, Univac, Burroughs and numerous other CPUs using either parallel synchronous or asynchronous serial communications.

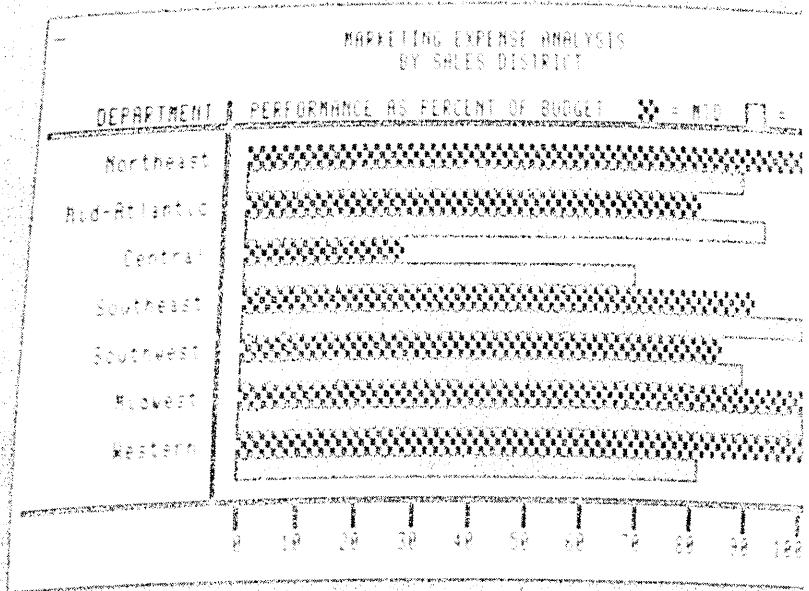

SCREEN The Consul 980A's highly legible screen can be used to display dual intensity formats or an unlimited number of graphic presentations. Full upper and lower case capabilities are standard.



ADDS \$3,200
 CONSUL 980A
 \$90/month (incl. lease,
 3 year lease -
 purchase not includ-
 ing maintenance.)

1. The first part of the document
describes the general situation
of the company and its
financial position. It also
mentions the main objectives
of the management and the
strategies to be followed.
2. The second part of the document
contains the detailed financial
statements for the year
ended 31st December 1999.
These include the Profit and
Loss Account, the Balance
Sheet, and the Cash Flow
Statement. The figures are
expressed in thousands of
dollars.

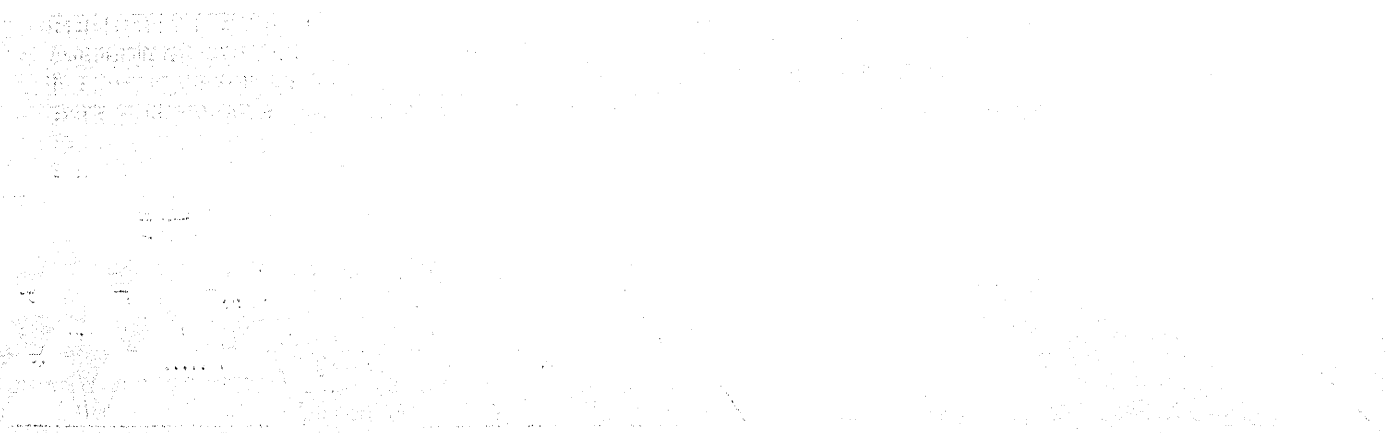

3. The third part of the document
contains the management's
discussion and analysis of the
company's performance during
the year. It provides a
detailed explanation of the
factors that have influenced
the company's results and
outlooks for the future.
4. The fourth part of the document
contains the auditor's report
on the financial statements.
The auditor has expressed an
unqualified opinion on the
financial statements, which
means that they are true and
fair in all material aspects.

Here's an easy way to improve your printing output.



If the quality of your printed output does not reflect the quality of your organization, or, if your throughput is less than it could be because your printers are down too often, Grumman has a low cost, easy-to-apply answer: just hook up an IBM printer to your system with our printer controller.

Our printer controller interfaces an IBM 1403 model -2, -3, or -N1 to a variety of computers (Burroughs, CDC, Data General, DEC, Digital Scientific/IBM 1130, Univac, Xerox, and others on request). The IBM 1403 printer has compiled an unsurpassed record for print quality and reliability in thousands of installations. Now you can have the same benefits without having an IBM computer. And at less cost than the IBM user, because our

Grumman printer controller costs less than IBM's.

Are you considering a change in your system, such as an upgrade, or a change in manufacturer? You may find that for the same or less money you can improve your print quality and throughput with the IBM 1403 and Grumman printer controller, instead of the printer your computer vendor supplies.

For multi-vendor installations we can add a switch to your controller to allow you to connect the IBM 1403 to either of two different computers.

You can rent, lease or buy both the printer and controller. For full information, call or write Joe McDonough, Grumman Data Systems Corp., 45 Crossways Park Dr., Woodbury, N.Y., 11797. (516) 575-3034. Telex 96-1430. TWX 510-221-1842.

Grumman Data Systems

Products and services that lower the cost of computing.

GRUMMAN



Comparing COM? Come To The Leader.

**You've met the microfilm "giants."
Now meet the COM company. The
only company that offers you the
complete COM system. Equipment.
Software. Service. And supplies.
Not someone else's. Ours.**

**Only one company invented COM.
The others discovered it. So if you
need image -- talk to a giant.
But if you need COM, talk to us.**

The COM company.

Datagraphix[®]

Stromberg Datagraphix A General Dynamics Subsidiary
P.O. Box 82449, San Diego, CA 92138, (714) 283-1038

March, 1976

CIRCLE 27 ON READER CARD

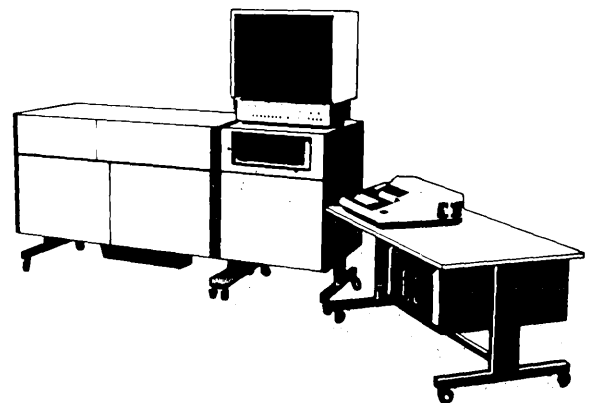

ANNOUNCING SYSTEM 700 BY MEGADATA

All the power of a minicomputer system at a computer terminal price.

Now, with the new Megadata System 700 programmable intelligent terminal system, any application can benefit from its full minicomputer power to streamline and simplify the most complex information processing system.

Megadata application-oriented terminals are currently serving virtually every sector of business and industry in applications including:

Inventory Control Order Processing and Distribution Control Banking and Monetary Transfer Reservation Systems Text Editing Data Input, Verification and Updating Payment Processing Word Processing

Megadata System 700—Truly innovative features make it the most advanced terminal available—

Full 12-bit minicomputer capability 4096-word memory expandable to 64K 126-key keyboard with up to 71 application programmed function keys 15-inch diagonal display Assembly language programming 12 status lights Communications compatibility with virtually any protocol, format, line discipline or speed Software compatibility with any host CPU Full complement of peripherals including disc, tape, cassette, and both high and low speed printers

For complete information and technical specifications, call John Hill, Vice President of Sales.

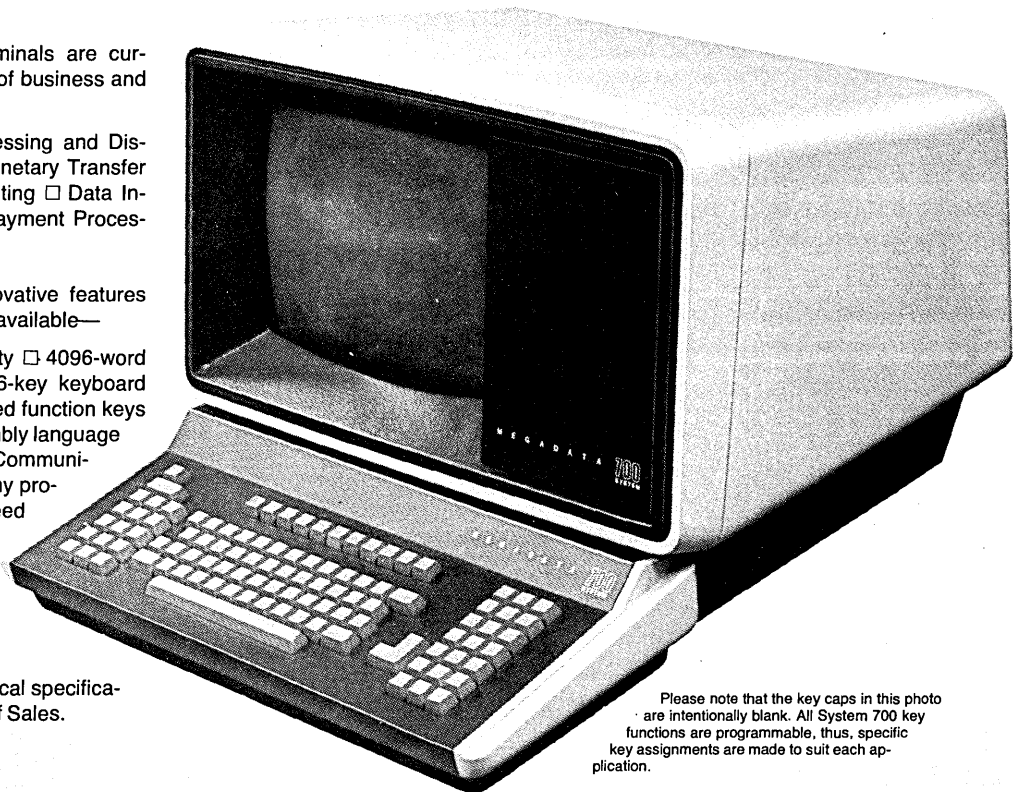

Please note that the key caps in this photo are intentionally blank. All System 700 key functions are programmable, thus, specific key assignments are made to suit each application.



MEGADATA

Megadata Computer and Communications Corporation
35 Orville Drive, Bohemia, NY 11716, (516) 589-6800, Telex 14-4659



Magnetic media, especially tape and magnetic stripe cards like credit cards, are often exposed to electromagnetic, x-ray, or other fields. Tests were conducted by the National Bureau of Standards to determine whether airport x-ray devices for screening carry-on baggage, like this one at Dulles Interna-

tional Airport, can erase magnetically recorded media. (The image of the tape in the container is just visible on the screen to the right of the device's operator.) Similar tests were run using metal detectors like the one in the background.

Erasing Myths About Magnetic Media

by Sidney B. Geller

Subjected to magnets, lasers, microwaves, radar and even nuclear radiation, magnetic media will usually survive.

There are stories concerning the intentional or accidental destruction of data on magnetic media which have gained considerable credence because they have been repeated so often in various forms. One popular one deals with a computer technician (or night watchman) who attaches a flashlight with a magnetic holder onto the wall of a magnetic tape vault. His action is said to result in a costly loss of important data on many reels of tape through erasure by the flashlight's permanent magnet.

These stories could not be true, as the results of studies performed by the National Bureau of Standards Institute for Computer Sciences and Technology can attest. In conjunction with the Institute's study of computer systems security, the real-life effects (and non-effects) of different types of devices

and fields on magnetically recorded data have been tested. A small portion of the results of the tests, the portion dealing with the effects of permanent magnetic fields, has been previously released; but the studies have now gone far beyond the effects of simple magnets to include effects of airport metal detectors, nuclear radiation, lasers, radar, and microwaves. The results indicate that magnetic media are really quite safe from most threats, and that they can be easily protected from those things to which they are susceptible.

In the NBS testing, recorded computer magnetic tapes, digital cassettes, and magnetic stripe plastic credit cards were used as the experimental media. However, the results are also directly applicable to magnetic cartridges and flexible and rigid discs because the magnetic particles used in all of these

media are similar gamma ferric oxides.

The principal interest in the studies lay in the cases of subtle data erasure which may not be discovered for some time because there is no visible evidence of physical damage. However, environmental conditions which affect the media materials were also noted. In all tests, a number of control media of the same type always accompanied the test media to make certain that unknown events which might occur in transit did not affect the final results.

Decreases in signal levels from their original values and losses of data caused by the various devices and fields were measured. A signal level loss of less than 50% was not considered to result in a loss of data because the data can be recovered during the normal operations of dp systems through the various reproducing processes.

ERASING MYTHS

Magnetic fields

One big threat to magnetic media is permanent magnets. Permanent magnets are simple devices which can produce strong, steady, magnetic erasing fields, and are easily carried and concealed. In addition, they require no external power sources for producing or maintaining their fields.

In one test series, a large horseshoe magnet was placed in direct contact with the outer flange of a tape reel and at various distances from the reel. This magnet produced a field which was considerably more intense than that of, say, a flashlight magnet. In fact, it was strong enough to lift 40 lbs (18 kg). When placed directly against the edge flange of the reel, a signal level reduction of 80% resulted at the beginning of the tape, (See Fig. 1, Page 68). The signal loss decreased continuously along the tape surface from that maximum 80% until a point 350 feet (107 meters) along the tape where the signal level was 50% of the original recording level. At this point, a tape can still be read!

The decrease in signal loss, from 80% down to 50% over 350 feet, is explained by the fact that the layers of tape which are further into the reel experience a progressively weaker magnetic field and therefore a lesser erasing effect.

When the same horseshoe magnet was held 1 inch (25mm) from the edge of the reel, the maximum signal loss was 22%; this signal level reduction would not result in *any* data loss.

Since a magnetic field's intensity falls off approximately as the cube of the distance from the magnet (at 10 inches away from the magnet its field is roughly 1/1,000 as strong as it is 1 inch away), it is impossible for any concealable magnet to cause any data loss on tapes stored 6 inches (0.15 meter) away from the closest point the magnet can be placed.

A considerable amount of further protection is offered by the vault wall when it is made of a ferromagnetic material (i.e., one to which the magnet will adhere) since this reduces the magnetic field strength by "short-circuiting" or shielding the field and reducing the effective erasing capability of the magnet. In fact, the horseshoe magnet produced no discernible signal loss at 1 inch from the tape when a ferromagnetic material was placed between the magnet and the tape. It should be noted however that *almost any small permanent magnet can cause serious erasure if it is placed against the side of the reel or in direct contact with any accessible surface of the magnetic media.*

Another approach to intentional tape erasure sometimes suggested consists of hiding a magnet in a tape vault for a period of time and somehow gradually erasing tapes. However, if a magnet is sufficiently strong to erase a tape (or any magnetic medium), it will do its damage instantaneously or not at all. Time is not a factor. The particles in a recorded tape change their signal levels and magnetic directions in a few billionths of a second.

The amount of erasure which the hidden magnet can produce depends upon the peak value of the magnetic field to which the stored tapes have been subjected. That is, the greatest signal erasure is caused at the instant the magnet is brought closest to the medium because the medium experiences the maximum field strength at this position. As before, the effect of spacing between the tape and the magnet will determine if any loss will occur.

There are many commonplace devices which incorporate permanent magnets as part of their normal configurations, for example, telephone receivers, transistor radio loudspeakers, and voltmeters. Devices of this type were placed in contact with recorded strips of magnetic media and were able to cause small signal level de-

side a tape installation. Power could then be applied to the magnet through a large number of batteries and the entire vault erased in one burst by a properly aimed field. This approach was tested experimentally at a local scrap metal yard. A large lifting electromagnet was placed over recorded tapes at various heights. At the closest test distance of 1.3 feet (0.41 meter), no data loss was incurred.

It should be noted that the magnetic media read/write head is also an electromagnet. Unfortunately, it is capable of becoming permanently magnetized and causing slight erasure of data while it is in the process of reading a tape or cassette. This can be avoided through the regular use of a handheld head demagnetizing or degaussing device which is readily available.

Varying magnetic fields are produced by and extend into the space around many commonly encountered devices such as motors, generators, transformers, television receivers, etc. In fact, most electrical devices which operate from a power line produce a 60Hz magnetic field.

It was found that when devices such as transformers and motors are enclosed in shielding materials, they cause no signal erasure even when placed in almost direct contact with the media.

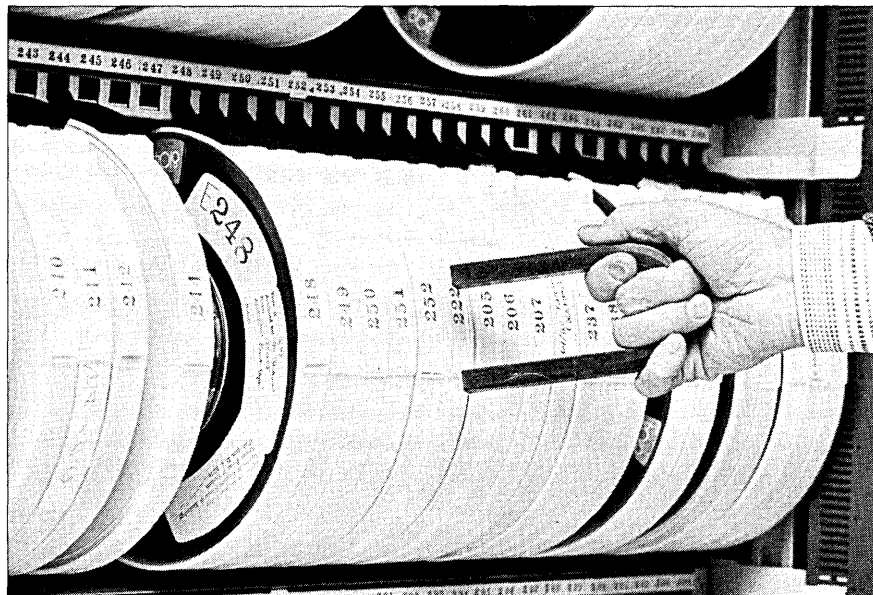

Since tapes, discs, and mag stripe cards are recorded magnetically, they can be erased magnetically, and the greatest threat to them is from a strong, close, magnetic field.

creases; however, no data losses were experienced.

Based upon the preceding experimental results, it can also be concluded that the flashlight story (and all other versions) are completely unfounded.

The field from an electromagnet is almost identical in its erasing characteristics to a permanent magnetic field. It was suggested that a very large electromagnet of the type used in scrap metal yards for lifting materials could be concealed in a van and parked out-

However, it was also found that some unshielded power supply transformers could cause erasure upon contact with the media when they were carrying high current loads. In all cases, electrical equipment which was enclosed in cabinets that provided at least 2 to 3 inches of spacing from the internal electrical components caused no erasure of recorded signals.

Airport metal detectors

There is considerable concern about

the effects of airport metal detectors on recorded magnetic media which are carried through them. Many of these metal detectors are of the "active" type which fill their walk-through space with their own internally generated varying magnetic fields. Tests were performed on a number of different kinds of walk-through detectors in both the Washington National and Dulles International airports. Recorded computer tapes were moved through in many different locations within the detectors and then tested for a loss of data. There was no observed instance of erasure or data loss. The highest field intensity encountered during the tests was in a unit which was rated at 398 A/m (5 Oe). This field intensity is not capable of producing any significant signal loss as can be seen from Fig. 2 (Page 68).

Recently the production of this highest intensity unit has been discontinued; therefore, most of the detectors which will be encountered in the future will probably generate weaker fields. This trend towards reduced field strength units is highly desirable because of factors which must be considered for detectors that are used with people. A voluntary performance standard for walk-through detectors has been prepared by the Law Enforce-



Airports pose a variety of potential threats. In addition to the x-ray devices and walk-through metal detectors, there are handheld metal detectors (here one is purposely being passed over magnetic stripe credit cards in the man's breast pocket) and even radar. The results of NBS tests, in everyday environments and in some nearly inconceivable situations, show that magnetic recording is almost accident proof.

ment Standards Laboratory of the National Bureau of Standards. This standard recommends that the allowable generated magnetic field in walk-through metal detectors used for law enforcement should be held to a maximum value of approximately 95 A/m (1.19 Oe), a level much too small to cause erasure of magnetic media.

Handheld metal detectors are sometimes used as backup surveillance devices in airports. The magnetic fields generated by these devices are significantly lower in magnitude than their walk-through counterparts. As expected, exposure to these handheld detectors produced no effects on the recorded data even when they were placed in direct contact with the media housings.

Microwave ovens

Recorded cassettes were placed directly into a microwave oven in order to subject them to the maximum microwave energy. The cassettes were removed after they became warm enough to assure that the microwave field had achieved its full intensity. There was no measured data loss. This also indicated that if any external leakage fields exist around ovens or other microwave devices of similar power, they would be unable to cause any data erasure.

Radar signals

Recorded magnetic computer tapes are often transported through areas in which radar antenna are transmitting signals, around airports, aboard ships, and in defense installations. A series of radar tests was performed by the NBS Institute for Computer Sciences and Technology with the cooperation of the Radar Division of the Naval Research Laboratory.

Recorded magnetic tapes were irradiated by L-band, C-band, and X-band radar systems; the L- and C-bands radiated 200,000 watts of peak power and the X-band radar radiated 500,000 watts of peak power. The tapes were placed for 10 seconds directly into the radar signal paths at distances of 100 feet (30.5 meters), 50 feet (15.2 meters), and 10 feet (3 meters) from stationary, non-scanning antennas. There was no observable loss in signal level produced at any of these distances by any of the radar units. It is not likely that these radars could cause signal erasure unless the media were at the point of maximum field strength, almost in contact with the antenna. The ineffectiveness of the radar electromagnetic field for erasing signals is again due to the fact that the magnetic component of the electromagnetic field loses its strength very rapidly with distance from the antenna.

X-rays

All forms of magnetic media are

often subjected to x-ray energy in both dental examination and airport surveillance systems. Tests were performed with various recorded magnetic media in both the NBS Dental and Radiation Physics laboratories. The media were subjected to extremely high (lethal) x-ray dosages and no data losses were produced. Recorded media were also subjected to x-ray inspection at the Washington National and Dulles International airports with no resultant loss of data.

High voltages

High voltages which were generated both at the NBS High Voltage Laboratory and by automobile ignition coils were applied directly across recorded magnetic media. The laboratory voltage generator outputs were increased to more than 15,000 volts until air breakdown occurred between the electrodes. The ignition coils produced arcs which struck directly onto the recorded magnetic stripes on the surfaces of plastic cards. No signal or data losses resulted from these tests. This resistance to signal loss is valid so long as the high voltage fields do not produce excessive arcing which overheats or damages the media.

Nuclear radiation

A recorded digital magnetic tape cassette was subjected to a gamma-ray dose of approximately 3.0 megarads in the NBS gamma-ray pool. After a 1½ hour exposure, there was no observed data loss from the media. It has been reported that data on recorded magnetic media is able to survive the effects of the electromagnetic energy component resulting even from nuclear detonation providing that the media materials are not damaged or otherwise altered by the radiated energy.

Automobiles

Magnetic media carried within the passenger compartment of numerous automobiles experienced no data losses. Within the engine compartment, test cassettes experienced very little signal level decreases and no data losses even though they were put into contact with the ignition coil, generator, the starter motor, and the battery cable while starting the engine. Capacitive discharge electronic ignition systems produced no observable changes in the recorded signals.

Television receivers

Television receivers are sources of magnetic fields, high voltages, and x-ray energy. Tests were performed by placing recorded magnetic media both in the interior and exterior regions of different receivers. Media were placed in close proximity to the high voltage circuits which are also the sources of the x-rays. No signal level losses were

ERASING MYTHS

observed. It has been suggested that the degaussing coils which are found in color receivers might pose a potential erasure threat to recorded media which are stored on the cabinet. Tests were performed using five different color tv receivers with their chassis removed from the cabinets and with the recorded media placed as closely as possible to the degaussing coils. No signal

losses were observed which could be attributed to these coils. However, because of the many magnetic field producing components in television receivers and the many untested models, it is prudent not to use the cabinet tops as a storage space for computer magnetic media.

Light and laser beams

Recorded media were subjected to light sources ranging from infrared through an intense ultraviolet light

source with no resultant data loss. The radiation from a laser beam also has no effect on the stored data if spread over a large area on the surface of the medium. However, a focused laser light beam can be made sufficiently intense to either heat or destroy the physical medium itself. (As a matter of fact, laser beams are used for recording in both of these modes, i.e., heat or "thermoremanent" recording and the medium burning mode. In thermoremanent recording, a sharply focused

Magnets and Magnetic Recording

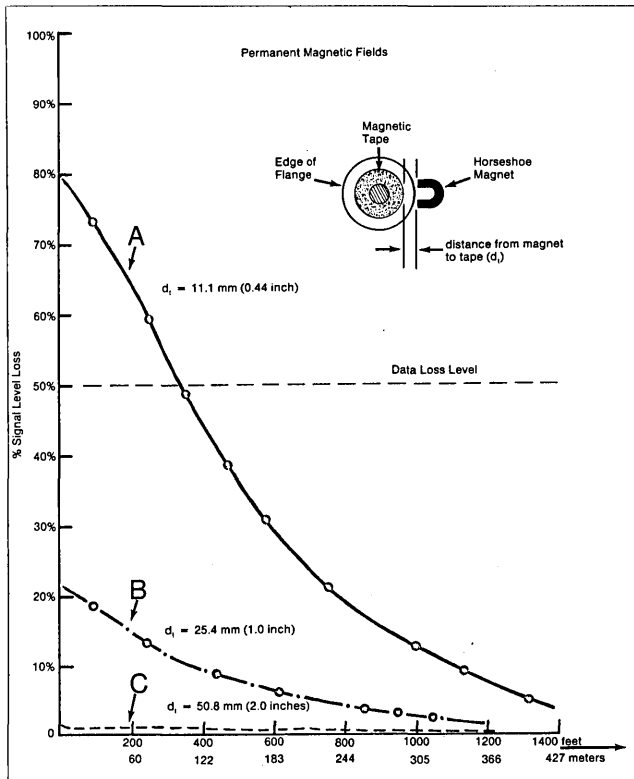

Fig. 1.

The ability of magnetic media to resist the erasure of recorded information depends primarily upon a quality known as "coercivity," which is measured in magnetic field strength units of amperes per meter (A/m) and oersteds (Oe), where one oersted converts to 79.6 amperes per meter. The higher the coercivity of a material, the more difficult it is to record onto or erase information from its magnetic surface.

To completely erase a recorded signal, it is necessary for the strength of the erasing field to be greater in value than the coercivity of the medium. For example, the coercivities of typical magnetic media used in dp applications range from 20,000 to 23,000 A/m (250 to 300 Oe); therefore, any magnetic field whose peak strength is less than these values cannot completely erase a signal recorded on them.

The read/write head of a magnetic tape drive typically has a field strength of 750 to 1,500 Oe. In the tests mentioned in the text, a 1,000 Oe horseshoe magnet was used. Fig. 1 illustrates the magnet's effect on a reel of magnetic tape when placed at distances of 0.44 inches (11.1 mm), 1.0 inch (25.4 mm), and 2.0 (50.8 mm) inches. Since the strength of a magnetic field falls off approximately as the cube of the distance from the magnet (at 10 inches away its

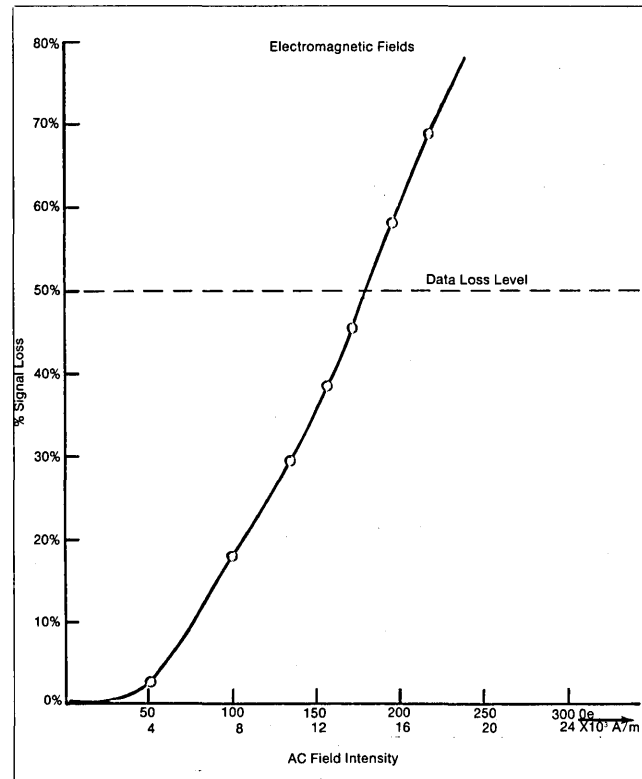

Fig. 2.

field is roughly 1/1000 as strong as at 1 inch away), and since dp equipment can usually read a signal which has fallen to one half of its original recorded level, the 1,000 Oe magnet held 0.44 inches from the tape's surface is capable of erasing the first 350 feet (107 meters) of data. At a distance of 1 inch (25.4 mm) from the tape's surface, the magnet is incapable of fully erasing any recorded data.

The field from an electromagnet is nearly identical in its erasing characteristics to a permanent magnet's field, and follows the same inverse-cube law. However, its field strength depends on the current driven through its windings. It has been found that time-varying magnetic fields, such as the 60Hz fields of most electromagnets, follow what may be called the "peak rule." That is, the actual extent of the erasure of the stored data is caused by the maximum field value to which the media is subjected as the field varies through its values. As with permanent magnets, the erasure occurs almost instantaneously.

Fig. 2 illustrates the effects of 60Hz electromagnetic fields on recorded cassettes placed entirely within the fields. Note that even at "zero" distance, a relatively intense 8,000 A/m (100 Oe) field can reduce a recorded signal only by approximately 18%.

24 Reasons You Should Be Using DATRAN's DatadialTM

The Nation's First Digital Switched Dial-up Service.

	DDD	WATS	Datadial
1. Digital transmission	NO	NO	YES
2. Full duplex, 4-wire circuits	NO	NO	YES
3. Minimum call time	1 MIN	1 MIN AVERAGE	NONE (1¢ min)
4. Call-in, call-out on same line	YES	NO	YES
5. Maximum monthly usage charge	NO	NO	YES
6. Average call set-up time	11.1-17.6 SEC	11.1-17.6 SEC	0.8 SEC
7. Billing increment	60 SEC	60 SEC	1 SEC
8. Detail billir.g*	YES	NO	YES
9. "Camp-on" call back	NO	NO	YES
10. Automatic blocking of unauthorized in-bound calls	NO	NO	YES
11. Abbreviated dialing	NO	NO	YES
12. Highest transmission rate (BPS)	3600-4800	3600-4800	9600
13. Clear-to-send time	150-200 MS	150-200 MS	0.2 MS
14. Guaranteed error rate performance	NO	NO	99.95% ERROR FREE SECONDS
15. Non-blocking switching	NO	NO	YES
16. Automatic and manual dialing	YES	YES	YES
17. Out-of-service indicator	NO	NO	YES
18. Automatic circuit testing during call set-up	NO	NO	YES
19. Automatic calling standard feature	NO	NO	YES
20. Loop-back testing standard feature with all services	NO	NO	YES
21. Two-way simultaneous data transmission	NO	NO	YES
22. Standard RS-232 interface	YES	YES	YES
23. Minimum monthly usage charge	NO	YES	NO
24. Approximate usage charge for a 100 mile, 5 minute call	\$1.45	\$1.75 (measured WATS)	8¢ (at 2.4 kbps)

*OPTIONAL

Write or call: DATRAN, Data Transmission Company, 8130 Boone Blvd., Vienna, Virginia 22180, (703) 893-2450

The Switch Is On!

DATRAN

ERASING MYTHS

laser beam heats up tiny localized points on a special type of substrate which is placed into a magnetic field. As the points cool back to room temperature, they remain magnetized. In the "burning" mode, small localized areas of a special coating are actually burned away—these areas represent the stored information.)

In summary, no response to laser beam energy other than its heating effect can cause a loss of stored data; hence if undetected data destruction at a distance is intended, a laser beam is not a practical technique.

Pressure

Magnetically encoded plastic credit cards are often subjected to pressures in the pocket, wallet, or in cases. The effects of pressure were tested by placing 2,000 lbs (900 kg) of weight on a number of individual credit cards. There was no loss of magnetically encoded data.

Heat

It is possible that magnetic tapes, cassettes, or magnetic stripe plastic credit cards will be left in a closed car during the summer. In some areas of the southwestern U.S., the temperature can rise to more than 200°F in some parts of the vehicle. Tests were performed over a range of 100°F (30°C) to 360°F (182°C). It was found that plastic digital cassette housings and credit cards began to physically distort at approximately 200°F (93°C) and could no longer be transported properly by their drives. Two reels of computer magnetic tapes functioned after exposure to 210°F (99°C), and then refused to load into the tape transport after they had been subjected to 230°F (110°C). The only apparent physical change was a loss of tape stiffness. At first, this appeared to be a permanent condition since these tapes had not recovered after six weeks in storage. However, after two months, they began to run again; the data could be recovered, but the oxide appeared to be shedding badly. In such cases, if possible, the data should be copied as soon as possible onto new tapes and the shedding tapes discarded.

It is recommended that computer tapes should be stored in vault temperatures of between 60°F (16°C) to 80°F (27°C) and relative humidities of 40-60%. The operating environment should be in the same approximate ranges as the vault in order to reduce temperature cycling effects.

Every heat test which was performed was terminated due to the physical failure of the media materials and housings rather than the magnetic

data energy loss. In order to override these limitations and to isolate the physical effects from the magnetic effect, in one test a recorded plastic credit card was constrained by aluminum plates to prevent warping. There was no data loss observed after the card had been heated to 360°F (182°C) which was the oven temperature limit. Theoretically, gamma ferric oxide particles, which are the prevalent magnetic constituents used in most magnetic storage media, are capable of retaining data up to a temperature of approximately 1247°F (675°C). This temperature is known as the Curie temperature. On the other hand, chromium dioxide particles, used in audio and video tapes, have a Curie temperature of approximately 275°F (135°C) and are therefore far more susceptible to a heat related data loss.

Cold

Theoretically, the magnetic oxide particles in the media will not lose any of their magnetization at temperatures which are well below their Curie temperature. However they may become stiff and moisture may condense upon them when subjected to very low temperatures. Recorded computer tapes which were stored at -60°F (-51°C) for 24 hours could be read without loss after being dried and relaxed (by careful, slow unwinding and rewinding) in the laboratory environment for one day.

Tapes which have been subjected to extremely low temperatures for long periods of time should be relaxed and dried for a number of days at gradually increasing temperatures to relieve stresses which develop with time. The shrinking of the tape due to exposure to excess cold can produce layer-to-layer adhesion which can then cause tape tearing and surface coating damage in portions of the reel.

Also, tapes which are cycled between temperature and humidity extremes can develop severe stresses within the reel due to the pressures caused by the plastic flow of the tape materials. These stresses can lead to damaged regions on the tapes.

Time

It has been found that data losses can occur on recorded magnetic computer tapes when they are stored unused in a vault for long periods of time (*Datamation*, Oct. 1974, p. 72). These losses are believed to be caused by the plastic flow tendencies of the tape materials. This flow causes distortions in the physical structure of wound tapes. It has been found that certain recording techniques and densities result in more data losses with time than others. A program of tape exercising can reduce these time loss effects. This exer-

cising usually consists of a regular winding, rewinding, and relaxing the stored tapes in the operating environment.

Magnetic media are tough

Magnetic computer tapes and discs are reliable storage media whose failures are almost always attributable to the physical deterioration of the media rather than to the deterioration of the data. In fact, the theoretical lifetime of the magnetically encoded data is virtually endless under ideal environmental and handling conditions. Fortunately, many environmental conditions which cause data losses through physical media deterioration can be controlled with housekeeping techniques such as temperature and humidity controls, regular media exercise schedules, and computer operator training.

The study has found that a magnetic field supplies the *only* kind of energy that can cause undetected data destruction without any accompanying physical distortion or damage to the magnetic storage media. It has been determined that normally there is no need to shield the stored data against x-rays, high voltage fields, nuclear radiation, high frequency fields, or light energy. Most important, a spacing of only a few inches is sufficient to protect the recorded media against magnetic fields which are far more intense than are ever found in the normal environment or that can be produced by a concealable magnet. Therefore, the stories of data destruction at a distance by magnets on flashlights and in repairmen's tool boxes are completely unfounded; only direct magnet-to-media contact can cause serious losses.

*



Mr. Geller is the manager of the Magnetic Media Group of the Institute for Computer Sciences and Technology at the National Bureau of Standards. He has been active in the development of standard reference magnetic media and reference measurement systems.

One of his earlier papers, "The Effects of Magnetic Fields on Magnetic Storage Media Used in Computers," (NBS Technical Note 735, July 1972) is rather well known; it covered a small portion of the subject matter of this article.

Solutions to some of the world's toughest communication requirements started with one simple message.

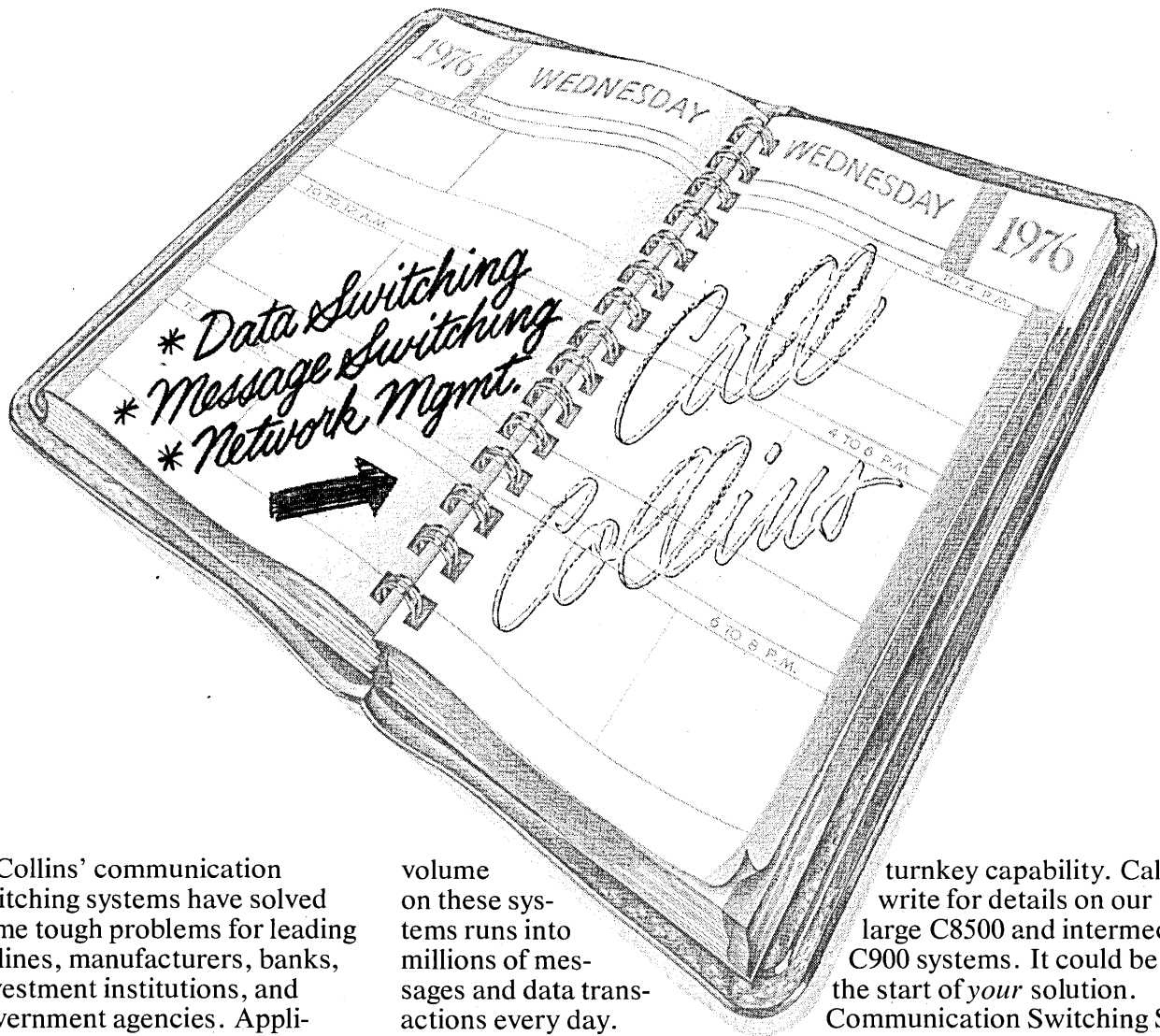

Collins' communication switching systems have solved some tough problems for leading airlines, manufacturers, banks, investment institutions, and government agencies. Applications that demand high speeds and capacities, utmost reliability, and the know-how to make it all work. The total traffic

volume on these systems runs into millions of messages and data transactions every day.

If your business depends on extensive message and data communications over a distributed network, we have the experience to help you. Plus total

turnkey capability. Call or write for details on our large C8500 and intermediate C900 systems. It could be the start of *your* solution. Communication Switching Systems Marketing, Collins Radio Group, Rockwell International. Contact us in one of the cities listed.



Rockwell International

Dallas
214/690-5000

New York
212/661-6530

London
01-759-9911

Paris
686-10-03

Frankfurt
(0) 6106-4093

Rome
851-104

1975 Brand Preference in First Place with

AND IT'S NO WONDER. HAZELTINE OFFERS
FROM SIMPLE TELETYPEWRITER REPLACEMENT

For Rent or Purchase



Hazeltine 1000

Offering a low priced teletypewriter terminal offering a standard display plus choice of two baud rates from 100 to 300, as well as parity generation and checking. \$49/month



Hazeltine 1200

Offering all the features and options of the Hazeltine 1000, this model features a wide character set capability, a variety of baud character rates, plus an optional printer for Hazeltine thermal impact printers. \$65/month

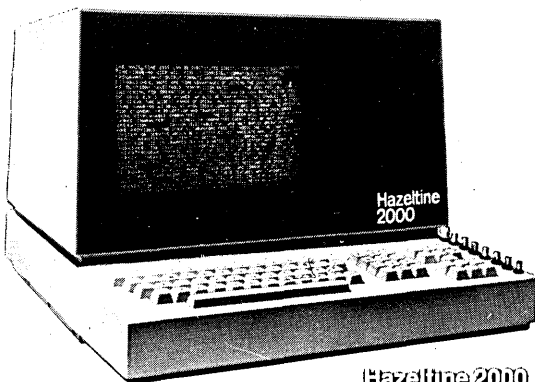

Hazeltine 2000

Features fully buffered 128 character display plus dual video intensity, powered rolling capabilities, direct cursor accessibility, choice of two standard baud rates, interfaces to Hazeltine printers, dual paper cassette and remote monitors and much more. \$98/month

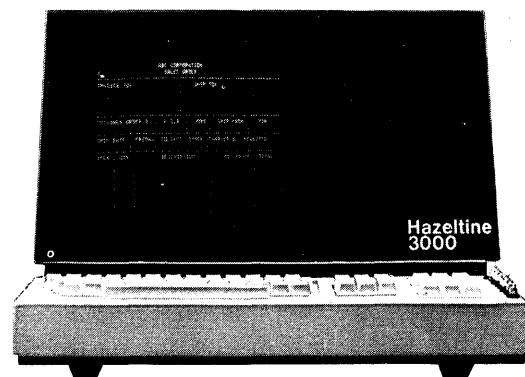

Hazeltine 3000

A 'custom' terminal at an 'off-the-shelf' price. Combining the major features of the Hazeltine 2000, it offers a microprocessor based polling interface, compatible with network communication disciplines of most computer manufacturers. \$125/month

Hazeltine Corporation Computer Peripheral Equipment, Greenlawn, N.Y. 11740 (516) 549-8800 Telex 96-1435

East: N.Y. (212) 586-1970 □ Conn. (203) 875-6429 □ Boston (617) 261-5867 □ Phila. (215) 676-4348 □ Wash., D.C. (703) 979-5500 □ Rochester (716) 254-2479.
Midwest: Chicago (312) 986-1414 □ Columbus (614) 864-4714 □ Detroit (313) 559-8223. South: Dallas (214) 233-7776 □ Atlanta (404) 393-1440 □ Houston (713) 783-1760
Orlando (305) 628-0132. West: San Mateo (S.F.) (415) 574-4800 □ L.A. (213) 553-1811 □ Denver (303) 770-6330 □ Seattle (206) 242-0505

Studies List Hazeltine End-Users and OEM's.*

THE FULL RANGE OF VIDEO DISPLAY TERMINALS TO ENHANCED EDITING AND POLLING CAPABILITIES.

For OEM Purchase

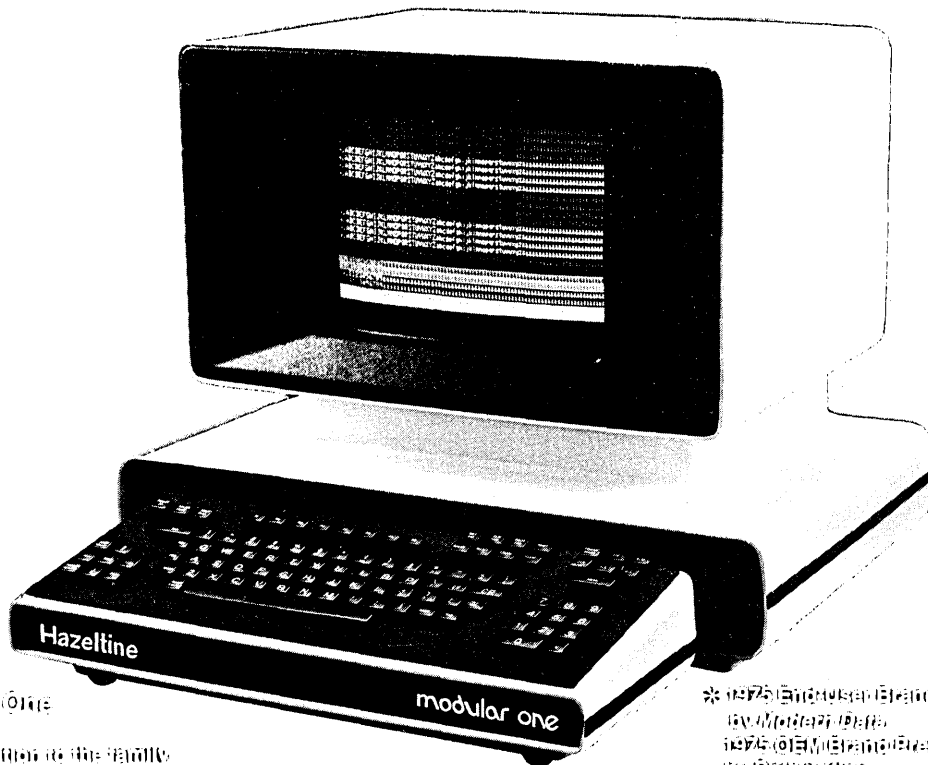

Modular One

The new addition to the family of video processors based modular design permits the user to add optional functions through the use of plug-in modules. The seven terminals all feature high speed most features can be implemented in the field as well as the factory. (See the description of the OEM's form.)

* See the studies listed in the studies list by Hazeltine Data and the studies listed in the studies list by Dataflex.

Introduces you to the family of video processors based modular design permits the user to add optional functions through the use of plug-in modules. The seven terminals all feature high speed most features can be implemented in the field as well as the factory. (See the description of the OEM's form.)

And to discover all Hazeltine products are

available by worldwide sales, service and technical support from the Company with over 20 years experience in the field of electronics.

Call your nearest Hazeltine office for a demonstration now.

Canada: MISCOE Data Communications Equipment Services, Ltd. ☐ Toronto (416) 678-7354 ☐ Montreal (514) 631-4381 ☐ Vancouver, B.C. (604) 731-0714.
 Mexico: BPM de Mexico ☐ Mexico City (905) 557-0011. England: Hazeltine Ltd. 01-948-3111 Telex (851)-928572.
 Germany: Hazeltine GmbH 0611-590748 Telex (841)-416924. France: Hazeltine SARL 9246279 Telex (842) 64601

FOR WORLDWIDE SALES INFORMATION CALL: (516) 549-8800

You said, 'APL is great, but...'

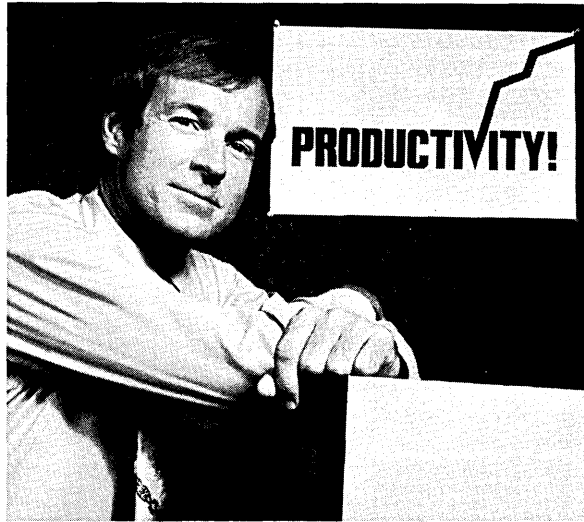

Now BCS offers a greater APL... no 'buts' about it!

Some say APL may be the most significant development since the introduction of Arabic numerals to replace Roman numerals. And most people who have been heavily exposed to it will admit that APL is the most important development since COBOL. But many time-sharing users, while agreeing that the productivity of APL programming is fantastic, say that their previous commitments and heavy investments in other software languages make APL a bit impractical for their purposes. BCS listened, then we did something about it.

Now BCS offers a quantum leap in APL capability — MAINSTREAM[®]APL.

- Fully competitive in price and capability
- Calls both FORTRAN and Assembler sub-routines from APL
- An exceptionally powerful editor in addition to the standard APL editor
- Lets you read COBOL and FORTRAN data files from APL
- Lets you access several other languages on the same machine
- Easy to learn — and the training is free.

With APL, BCS will run your existing timesharing programs (APL, FORTRAN, COBOL, etc.), get your new development efforts off to a fly-

ing start, and then you can do five times more work in the same amount of time—and there's no buts about it. Find out how by calling Jim Rough at (206) 773-9090, or fill in the coupon below.

We can help.

BCS

BOEING COMPUTER SERVICES, INC.

Boeing Computer Services, Inc.
PO. Box 708
Dover, New Jersey 07801

D-1

I'd like to know more about MAINSTREAM-APL, no "buts" about it.

- Current APL user
- Interested in using MAINSTREAM-APL
- Interested in consolidating all of my timesharing on one machine
- Information for my files only

Name _____

Organization _____

Title _____ Phone _____

City _____

State _____ Zip _____

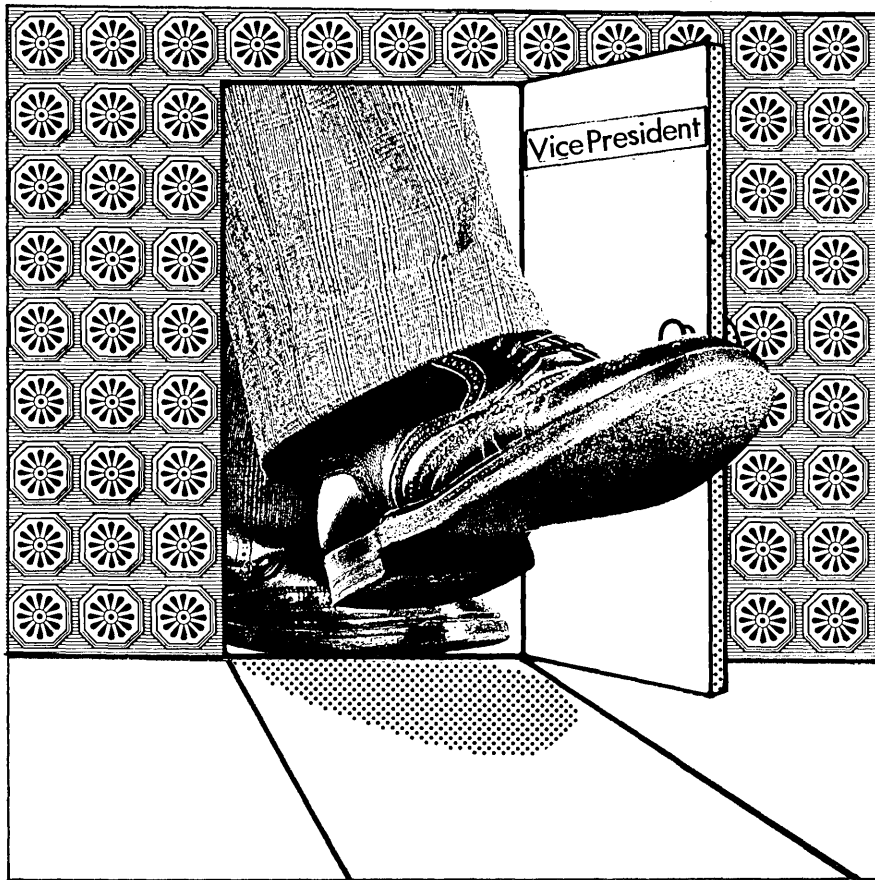

Room at the Top for the DP Manager

by Robert J. Greene

All the indicators—title, salary, bonus plans, and organization chart level—suggest that the status of the top dp manager is advancing.

The rising importance of the data processing function over the last 10 to 15 years is apparent. Gone are the days when the top dp manager was a shirt-sleeves supervisor responsible for processing the payroll on some mysterious machine. Here are the days when we hear that a Fortune 100 firm has named the dp executive as a vice president, officer of the company, and member of the board of directors.

It matters little what we call this manager: director of MIS, manager of EDP, vice president of information systems. What is important is that we are speaking about the individual who has overall responsibility for the numerous facets of a firm's mechanized data processing capability.

The status of any function is very closely tied, or at least demonstrated by, the status of the executive in charge of it. The rapid rise of the dp function's senior manager's status appears to reflect the current trend for data processing to permeate every facet of the typical firm.

It will be demonstrated here that the top data processing executive:

1. Is reaching higher levels in the corporate organizational chart,
2. Is receiving substantially more salary, and

3. Is becoming eligible for executive level compensation "goodies": bonuses, stock options, and the like.

Organizational status

A 1975 study which included over 1,000 U.S. firms¹ showed the following distribution with regard to organizational status of the dp executive:

Organizational Level	% of Companies
Department Manager	32.8%
Director	31.4%
Assistant Vice President	3.0%
Vice President	20.9%
Senior Vice President	2.9%
Other	9.0%

Almost 30% of the dp executives then have achieved the vice presidential level. The study also showed that

¹ Hansen's 1975 Weber Salary Survey on Data Processing Positions in the United States, published by A. S. Hansen, inc., 1080 Green Bay Road, Lake Bluff, Illinois 60044.

MSI has a smarter terminal...

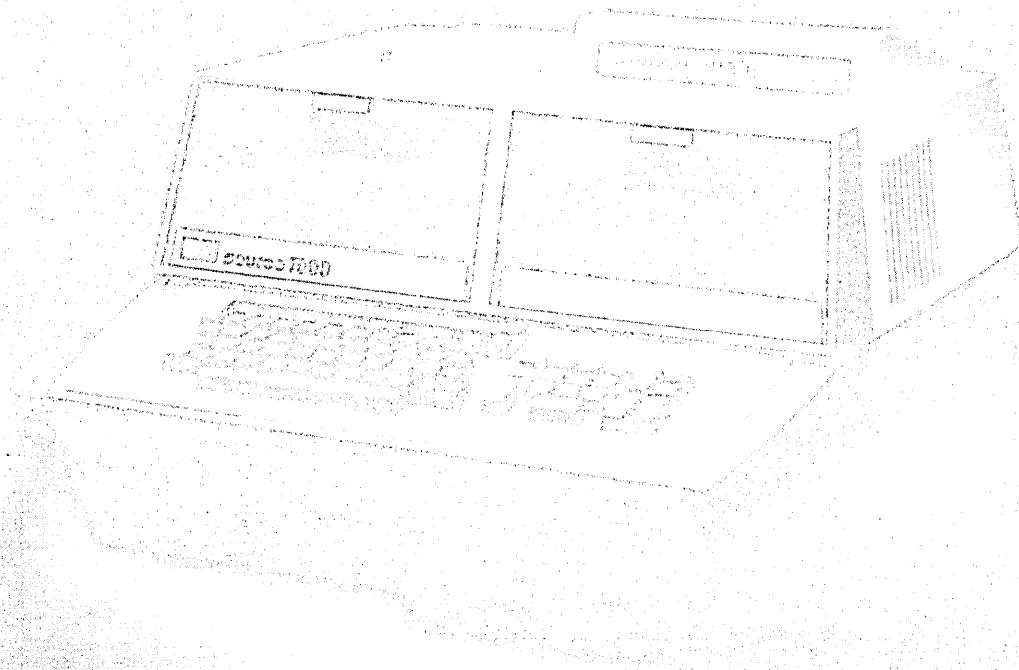

the SOURCE 7600

Smarter than MSI's portable hand-held terminals... because the new SOURCE 7600 comes off-line workstations incorporating a powerful microprocessor enabling the non-technical clerical operator to create and apply a wide variety of flexible data input formats.

Smarter than glorified teletypewriter replacements... because the SOURCE 7600 adds extra capabilities to 1200 baud two-way communications for optimizing source data preparation input.

Smarter than those supersophisticated on-site minicomputer or online systems... because the SOURCE 7600 accomplishes almost every accounting-type data input handling requirement without the expensive overhead of systems support and management... or the high cost of a delicate data communications network.

Write today for "Data Entry: Factoring A New Alternative," a complete description of the advantages and benefits offered by MSI SOURCE 7600 systems.



340 Fischer Avenue, Costa Mesa, California 92627 (714) 549-6000 DATA CORPORATION

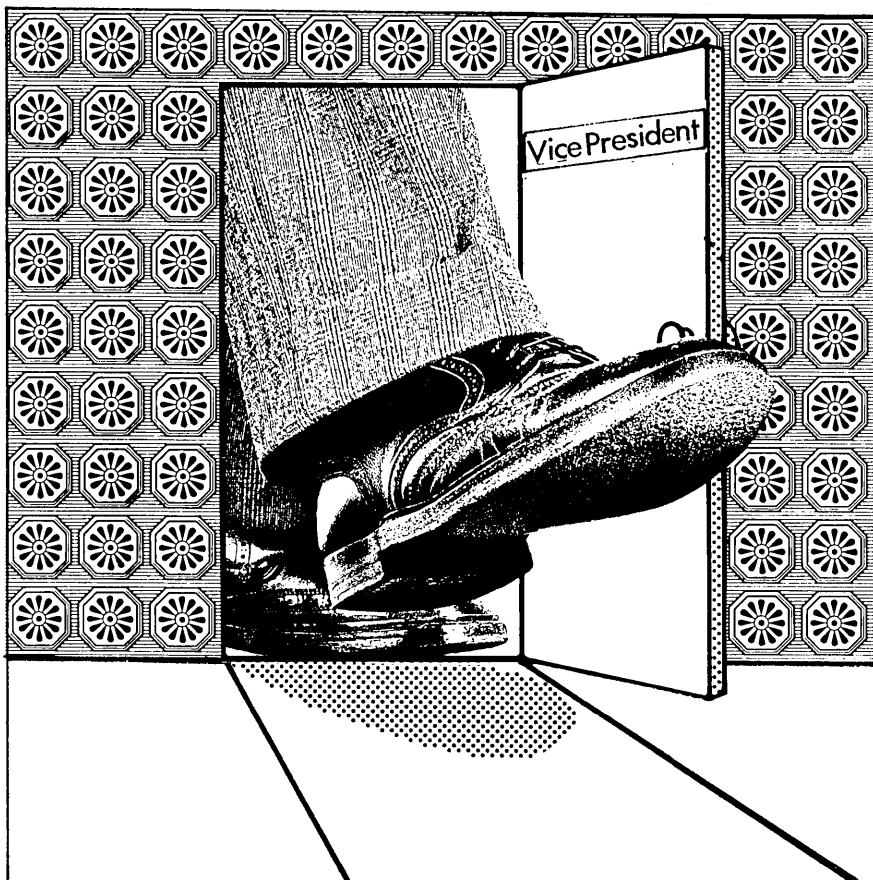

Room at the Top for the DP Manager

by Robert J. Greene

All the indicators—title, salary, bonus plans, and organization chart level—suggest that the status of the top dp manager is advancing.

The rising importance of the data processing function over the last 10 to 15 years is apparent. Gone are the days when the top dp manager was a shirt-sleeves supervisor responsible for processing the payroll on some mysterious machine. Here are the days when we hear that a Fortune 100 firm has named the dp executive as a vice president, officer of the company, and member of the board of directors.

It matters little what we call this manager: director of MIS, manager of EDP, vice president of information systems. What is important is that we are speaking about the individual who has overall responsibility for the numerous facets of a firm's mechanized data processing capability.

The status of any function is very closely tied, or at least demonstrated by, the status of the executive in charge of it. The rapid rise of the dp function's senior manager's status appears to reflect the current trend for data processing to permeate every facet of the typical firm.

It will be demonstrated here that the top data processing executive:

1. Is reaching higher levels in the corporate organizational chart,
2. Is receiving substantially more salary, and

3. Is becoming eligible for executive level compensation "goodies": bonuses, stock options, and the like.

Organizational status

A 1975 study which included over 1,000 U.S. firms¹ showed the following distribution with regard to organizational status of the dp executive:

Organizational Level	% of Companies
Department Manager	32.8%
Director	31.4%
Assistant Vice President	3.0%
Vice President	20.9%
Senior Vice President	2.9%
Other	9.0%

Almost 30% of the dp executives then have achieved the vice presidential level. The study also showed that

¹ Hansen's 1975 Weber Salary Survey on Data Processing Positions in the United States, published by A. S. Hansen, inc., 1080 Green Bay Road, Lake Bluff, Illinois 60044.

MSI has a smarter terminal...

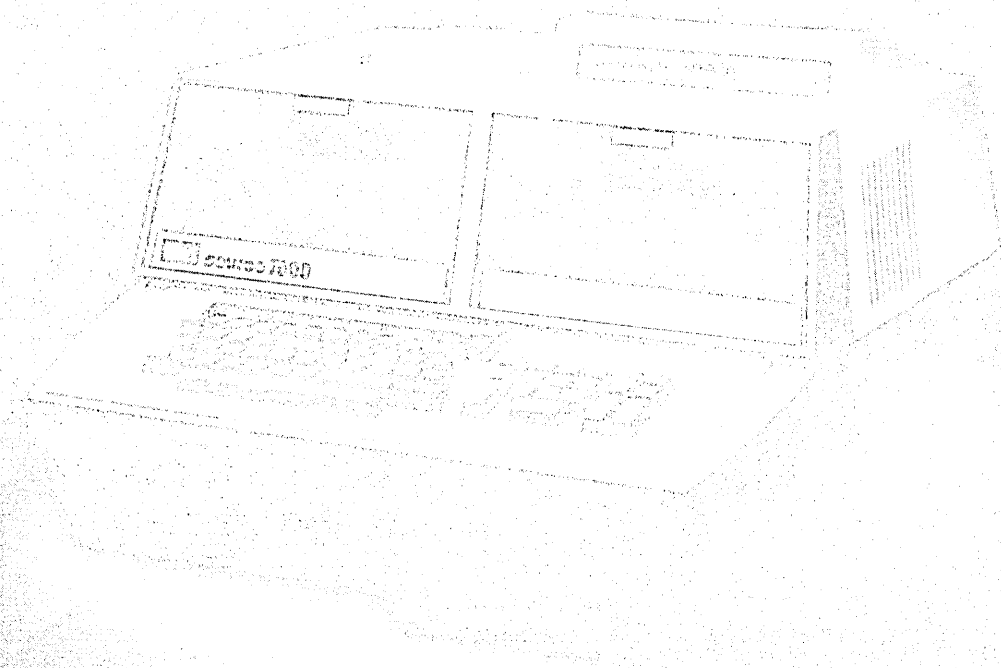

the SOURCE 7600

Smarter than MSI's portable hand-held terminals... because the new SOURCE 7600 consists of two workstations, incorporating a powerful microprocessor, enabling the non-technical clerical operator to create and apply a wide variety of flexible data input forms.

Smarter than modified teletypewriter central units... because the SOURCE 7600 adds extra capabilities to 1200 baud two-way communications for automated, on-line data preparation input.

Smarter than those super-sophisticated on-site microcomputer or online systems... because the SOURCE 7600 accommodates almost every accounting type data input handling requirement without the expensive overhead of systems support and management... or the high cost of a delicate data communications network.

Write today for "Data Entry Terminal With 2 Stations" or request a descriptive of the advantages and benefits offered by MSI SOURCE 7600 system.



340 Fischer Avenue, Costa Mesa, California 92626 (714) 539-6000 DATA CORPORATION

MSI SOURCE 7600 SYSTEM

ROOM AT THE TOP

34.8% of the managers are company officers, which perhaps is an even more compelling argument that this position is increasingly located on executive row.

Salary

The dp manager is collecting a larger salary, too. In 1971, the position averaged \$23,764 countrywide. In 1975, that number was \$29,588. The numbers become more impressive when one looks at the average salary by dp installation size:

Installation Size Rental	Avg. Salary
Up to \$12,000/Month	\$22,400
\$12,000- \$25,000	26,000
\$25,000- \$50,000	28,600
\$50,000- \$75,000	30,700
\$75,000-\$150,000	32,500
Over \$150,000	35,900

Late in 1975, this author conducted a study of 80 very large dp users who were involved in extensive telecommunications and on-line systems. The top dp executive position showed an average salary of \$54,651, with the high salary reported well over \$85,000.

Other executive compensation

The 1975 survey also asked responding firms to indicate what other forms of compensation the top data processing executive was eligible for. The results are listed in Table 1.

It is evident that an increasing percentage of the dp executives are becoming eligible for bonus and stock options plans, which historically have been limited to the very top echelons of corporate management. Though other "perquisites," such as a key to the executive rest room, were not included in the survey questionnaire, it is probable that the dp executives are using the goldplated fixtures over those sinks in increasing numbers.

Are there other signs?

In the process of conducting the previously mentioned special study including only large dp users, another trend became apparent. The very large users tend to have multiple dp centers. These centers are created to service divisions, subsidiaries, or regions for the large firm, and their existence gives rise to another phenomenon: additional levels of management positions within the function.

The top dp executive's position description includes responsibility for all facets of dp systems, programming, operations, peripheral operations, and the management functions which include administration, hardware and

software planning, and the like. But the "clean" organizational chart which in the past may have looked like Fig. 1 will today very often look like Fig. 2. And you can't tell all the players without a program!

With the growing prominence of decentralization of a corporation's dp capabilities, the top corporate position has new responsibilities in the position description; he provides overall direction, standards of quality, and centralized planning through the corporate staff to the regional or divisional centers. This is not "more of the same" by any means, because it requires the individual to perform the traditional executive functions: planning, organizing, directing, and controlling. And it has to be done through more levels of supervision, which further strengthens the executive nature of the position.

It is apparent, after comparing the 1975 survey and the special study de-

scribed earlier, that significant differences exist between the average salaries paid the manager who has a single shop and the manager who has to control multiple installations. The latter is very often required to coordinate management activities with subsidiary or divisional general management. The most extreme case of coordination complexities falls on the shoulders of the corporate dp executive who has responsibility for the overall direction of the data processing capability, yet has to face the fact that he only has "dotted line" or functional control over the divisional or subsidiary dp executives, who may report to their divisional or subsidiary general management.

Conclusion

The top dp manager is enjoying higher organizational status, is earning more salary and is being afforded addi-

Eligible for bonus?	Yes	48.3%
	No	51.7%
Type of bonus plan?		
Individual performance incentive (Median reward as % of salary — 20%)		21.8%
Profit sharing (Median reward as % of salary — 10%)		18.0%
Management bonus with all participants receiving same % of salary (Median reward as % of salary — 15%)		17.1%
Stock grants (Median grant as % of salary — 10%)		1.0%
Eligible for stock options?	Yes	26.4%
	No	73.6%
(Median option as % of salary — 24.0%)		

Table 1.

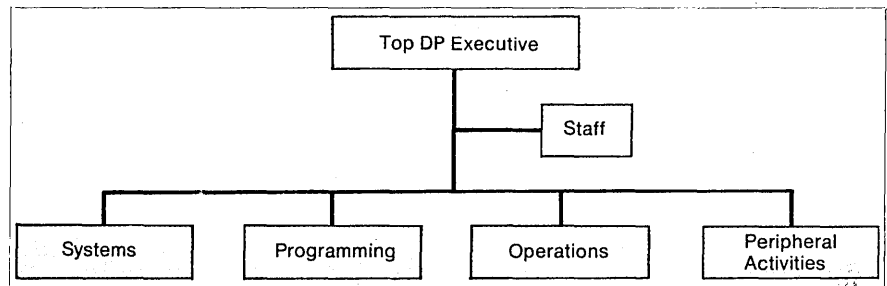

Fig. 1. The "old" org chart implied the dp manager was a shirt-sleeves line supervisor.

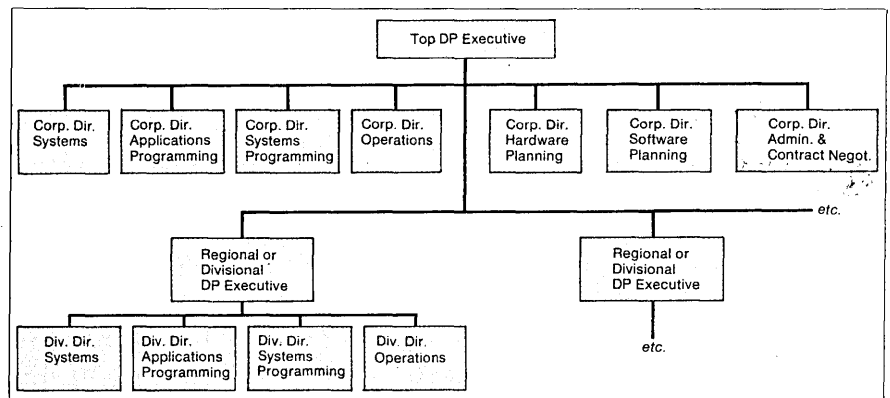

Fig. 2. As the data processing function becomes more integral to the operation of a company's business, the top dp executive assumes more corporate responsibility.

Rockwell International's Space Division is adding two EAI PACER 781 large scale analog consoles to its Downey, California hybrid computer laboratory. The contract to EAI also includes a custom-designed interface for integration of the analog units with Rockwell's digital computers. This expansion brings the simulation facility's major equipment complement up to a total of six 781 100-volt analog consoles, plus three digital computers. To be fully on-line in March, the expanded lab will conduct mathematical modeling and flight simulation tasks in association with NASA's Space Shuttle Program, including vehicle separation studies, entry, energy management maneuvers, approach and landing, simulations of backup flight control systems, combined system checkout, and vehicle hardware evaluation studies.

Two low cost, high performance Laboratory Chromatograph Data Systems were introduced at the 1976 Pittsburgh Conference on Analytical Chemistry, March 1-5 in Cleveland. Joining the EAI LabPACETM family of analytical data systems are the LP-25, shown here, for on-line application with up to eight GC's and the LP-50 for automatic data acquisition and composition calculations for up to sixteen instruments in simultaneous operation. EAI also announced availability of its new LP-1000 "total capability" LabPACE system that features both foreground and background computational capabilities, designed for control laboratory, method development and research applications.



Just how fast is a hybrid computer? An analysis by the Scientific Computation Department shows that today's modern hybrid systems attain digital-equivalent speeds of up to 150 million operations per second for the solution of differential equations. The EAI Multi-Variable Function Generator, if added to the hybrid system, adds another equivalent 50 million operations to the system speed, resulting in an overall potential of some 200 million operations per second! By way of comparison, one of the major "super-digital" computers can operate at about 2 million operations per second. This advantage for the hybrid technique in simulation assumes running the digital and the hybrid systems at equivalent accuracies with solution frequencies of about 1000 Hz.

For further information on developments of interest in hybrid computation and simulation, contact . . .



Dept. DATA-03
Electronic Associates, Inc.
195 Monmouth Parkway
West Long Branch, N.J. 07764

The Hybrid Computer People

ROOM AT THE TOP

tional forms of compensation. The implications as to the status of the dp function within the typical U.S. firm are obvious. And the opportunities for the dp specialist to enjoy expanded career path opportunities into upper management are more numerous.

Is this a windfall? An opportunity it is, but a gift it is not. Compensation specialists today are extremely adept at evaluating the worth of positions to a firm and are not noted for being magnanimous when establishing equitable salary ranges for positions. It is simply that a firm typically relies (more and more) on its data processing capabilities to conduct business. In retailing, point-of-sale data capture has caused data processing to become an integral part of its operations. In the financial community, the advent of Electronic Funds Transfer may promise total chaos if the designers and caretakers of the dp systems do not apply the highest skill levels available to accurately process and audit transactions. And the same kinds of technological innovation are causing similar effects in other sectors of business.

Perhaps the moral of what has been presented here is that the opportunity for the professional dp manager is there. But it will require those aspiring to the lofty heights to exercise caution in attempting to leave the realm of the technician and move into Executive Row without arming themselves with the managerial skills necessary for them to be effective. People skills, such as effective communication and persuasive abilities are fundamental requirements. Administrative skills, such as effective delegation, management development, financial forecasting, and long range planning must be developed. Without these tools, the trip to the paneled office may be traumatic. *



Mr. Greene is a compensation consultant with the Philip H. Weber Salary Administration Services of A. S. Hansen, inc. He has an MBA from the Univ. of Chicago.

Now, you can have TWX on our time-sharing terminals.

If you're like many time-share users, you occasionally need the domestic or international communications capabilities that TWX™ subscribers enjoy.

Well, with our new Plus TWX™ option, you can access the TWX network from 30-character-per-second machines.

Use our Plus TWX, alternate-use feature conveniently on our 33 ASR/MSR, 300 ASR, 300 KSR/MSR, and 300 ASR/MSR terminals. Depending on the configuration you choose you can work with data at up to 30 cps and send and receive TWX messages at 10 or 15 cps.

Plus TWX terminals have automatic

answering so you can receive messages when the terminal is unattended. And remember, when you can access the TWX network you can also send Telegram, Mailgram®, Telex and international messages.

For optimum time-share and communications capabilities in one terminal, or throughout your terminal system, contact me, Z. V. Zakarian, President, Western Union Data Services Company, 800-631-7050 (New Jersey 201-529-1170).

Or write to 70 McKee Drive, Mahwah, New Jersey 07430.

For paper and other supplies, call 800-631-7064.

"That's right, TWX and data on this 30 cps terminal—and low cost, too!"
Z.V. Zakarian

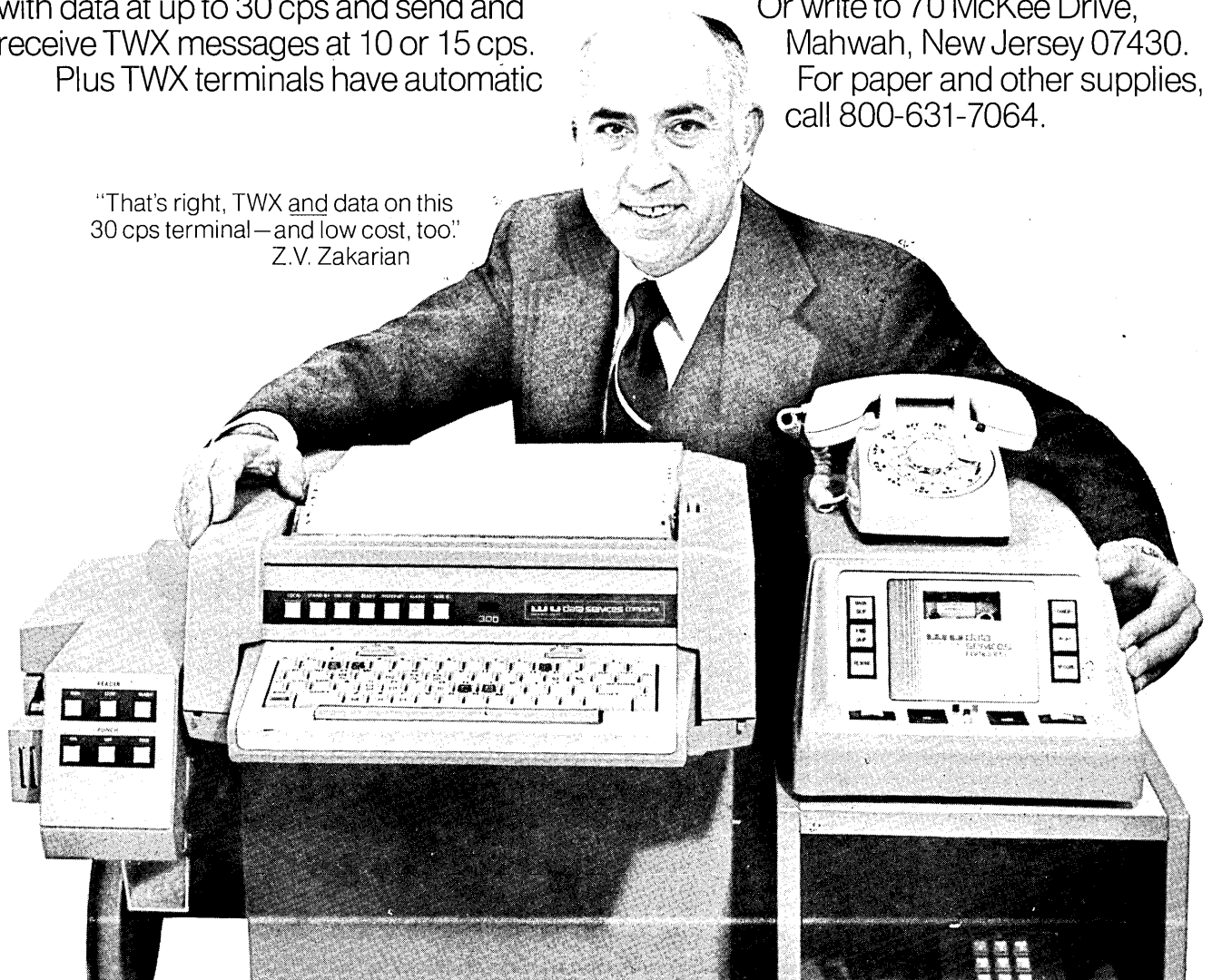

W U data services company
western union

Ask Control Data for a line of industry compatible "worry-free" DISK PACKS and CARTRIDGES.

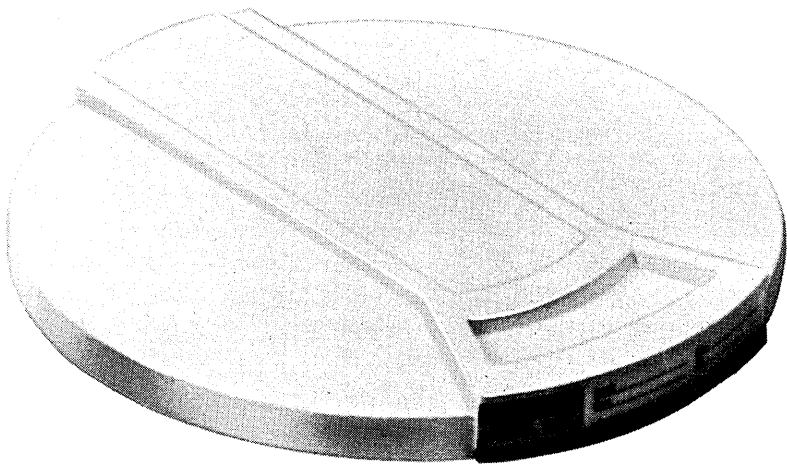
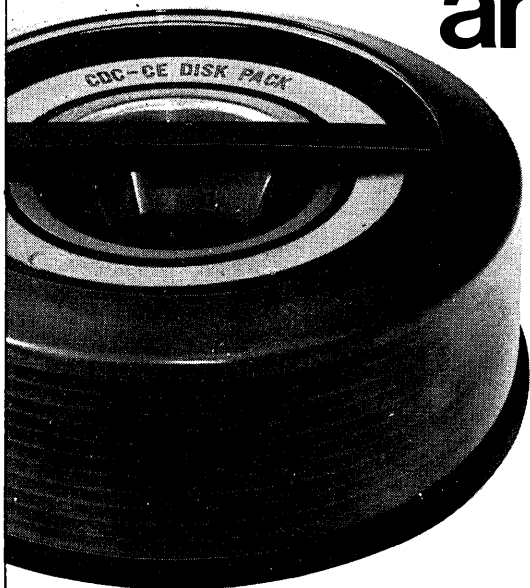

PACK TYPE:		DRIVE TYPE:		CHARACTERISTICS:		
CDC MODEL #:	IBM MODEL #:	IBM DRIVE:	CDC DRIVE:	TPI:	BPI:	8-bit Byte capacity:
846	2315	2310	—	100	1100	1.25
846-2	—	—	—	100/200	2200	2.5/5.0
847	5440	5444	9425	100	2200	2.5
848	—	—	9427	200	2200	5.0
849	1316	2311	23111	—	—	—
851	—	—	854/857	100	1100	7.25
869	2316	2314	23141	100	2200	29.2
871	—	—	841	—	—	—
873	—	—	23142	200	2200	60.0
876	—	—	9760	200	6038	40.0
storage module	—	—	—	—	—	—
877	—	—	9762	400	6038	80.0
879	3336	3330	33301	—	—	—
881	—	—	844	200	4040	100.0
882	3336-11	3330-11	33302	400	4040	200.0
883	—	—	844-41	—	—	—
889	3348-35	3340	9778	300	5500	35.0
892	3348-70	—	—	—	—	70.0

We have it.

Tested to tighter specs than industry standards, to help you prevent data loss. Backed by a lifetime warranty.

NEW! DATA MODULES FOR IBM 3340 TYPE DRIVES!

Control Data now supplies compatible 35 and 70 MByte data modules utilizing their total technology: heads, disks and drives.

FLEXIBLE DISKS

CDC's experience in making flexible disk drives helps in making better flexible disks. Available hard or soft-sectored for CDC 9400, IBM 3740 and other systems, in convenient storage boxes that hold ten indexed disks and adhesive-backed color-coded labels.

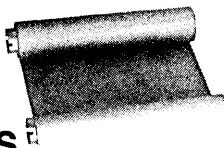
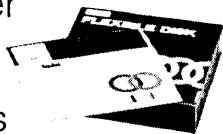

PRINTER RIBBONS

Control Data stocks broad selections of ink strengths and formulas. Ribbons, in both fabric and film, are available in various sizes. CDC Quality Control maintains consistency from first print-out to last... gives you more pages of clear print-out per dollar before the ribbon needs to be changed.

CUSTOMER ENGINEERING PACKS

Available for all disk pack models for precise alignment, adjustment and maintenance. Compatible with IBM customer engineering packs when appropriate.

PRECISION-PRINTED BUSINESS FORMS



Precision printing and registration on continuous forms can make the difference between fast through-put and frequent interruptions to re-align the printer.

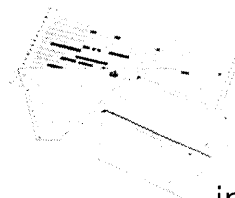

You get this precision printing and registration in CDC custom continuous forms, stock tabulating forms, custom snap-out forms, OCR scanning forms, and specialized forms.

Ask us about these "worry-free" EDP supplies, too!

HALF-INCH MAGNETIC TAPE

One premium grade is offered. Usable up to 6250 cpi. The tape is extensively tested on Control Data certifying equipment to assure that each reel meets or exceeds ANSI specifications.

Call your local CDC Sales Office. Or, mail the coupon today.

Do it.

Mr. H. L. Peterson, Business Products
Control Data Corporation, Dept. D-36
P. O. Box 1980 Twin Cities Airport, St. Paul, MN 55111

Tell me more about: Your Disk Packs for my _____ computer. Data Modules Flexible Disks
 Customer Engineering Packs Magnetic Tapes Business Forms Printer Ribbons

Name _____ Title _____
Company _____
Address _____ City _____
State _____ Zip _____ Phone _____



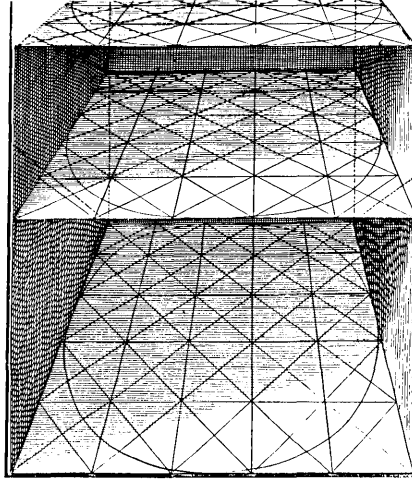

An Example of Structured Design

by Bill Inmon

Producing 11 lines of code per hour through structured design and programming is one of the advantages.

Quick and accurate development of computer programs is a longstanding goal of the data processing community. Recently programmers and program designers have begun to formalize some of their practices by using concepts of structured programming and structured design. How do these concepts interact with the goals of quick and accurate program development?

An example of how one system was developed using these tools in a limited amount of time is given here. The specifics of the system may not be important—it happened to be a cost accounting system, necessitated by a large government contract, which broke down the cost of the final product to costs of component parts at the lowest level. However the problems that arose in the development of this system, and the way they were handled, are important because these same basic problems usually occur in development of most types of systems.

System overview

Here is a profile of the system under discussion:

1. Length of system development—4 months.
2. Manpower—14 man-months (7 programmers—2 full time, 5 part time).
3. Scope of project—tasks included internal design (i.e., the building of detailed programming specifications from a broad description of the problem), programming, unit test-

ing, integrated testing, documentation, and the building and maintenance of a large data base.

4. Total number of lines of coding—approximately 31,000, not including system-support coding, such as Job Control coding, test-data generators, etc.
5. Language—COBOL interfacing the data base with DL1.
6. Machine—IBM 370/145, with TSO.
7. Data base environment.
8. Programmer coding productivity @ 200 hours per month—that is, approximately 11 lines per hour.
9. Number of programs and modules—50
10. Median module size—5.4 pages.
11. Type of application—financial.
12. Technical complexity—mild.
13. Programming logic complexity—moderate.
14. Design considerations—structured programming, structured design.

A group of programmers was organized into a "chief programmer team." The chief programmer was responsible for the design of all programs. He did the actual coding of some critical programs, and organized and coordinated the programming of the other programs in the system. Two programmers were on the team full time and five other programmers contributed to the team effort. Programs were designed adhering to the principles of

structured design. Principally, programs were kept small and designed "functionally." Large programs were divided into modules. The coding of programs was structured. No GOTO statements were allowed, and other conventions of structured programming were followed.

The overriding constraint on the system development was time. Because of contractual obligations program design, programming, debugging, and implementation had to be completed in four months. The deadline was not extendable.

The structuring of the data base reflected a strong user orientation and was not designed for easy program manipulation. At the outset of the project, only two programmers had extensive data base experience. In preparation for future on-line considerations, the system was to be updated by transactions. Reports were generated directly from the data base. In terms of programming logic complexity, the system was straightforward except for several internal relationships. Technically, the complexity of the system was not beyond the ability of the chief programmer team.

Design goals

The design goals of the system were greatly influenced by these program development priorities:

1. Speed of development
2. Program and algorithmic accuracy
3. Maintainability of programs
4. System flexibility

Add-on.

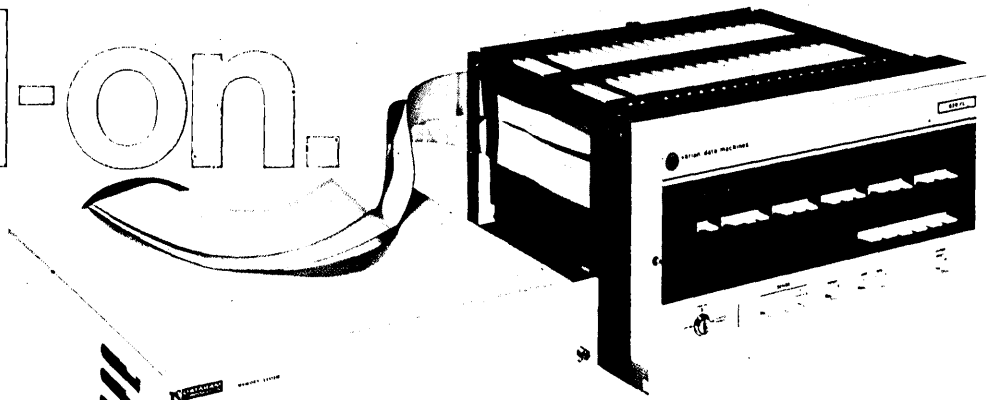

Add-in.

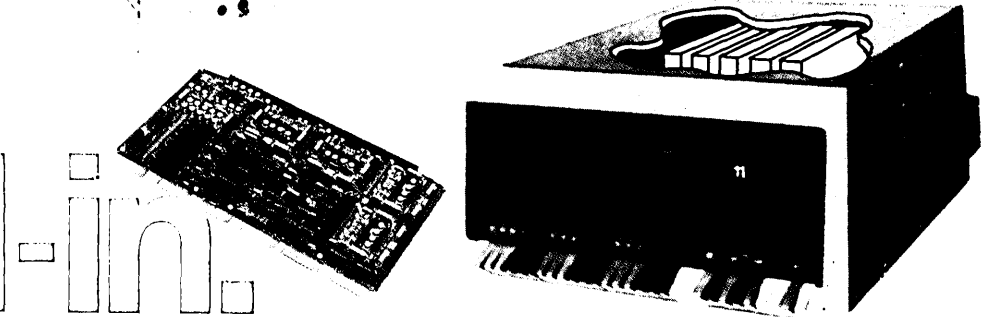

Mini-Memory. From Dataram.

Either way, you get more memory, more throughput, more performance.

Everything but more cost.

If you're looking for a way to get more from your minicomputer without putting too much more into it, our family of ADD-ON/ADD-IN mini-memories adds up to the right answer for you.

We're Dataram Corporation, and as the only company dedicated exclusively to core memory products, we make all of our own core, sell raw core to the outside market, string in high volume in three offshore locations, supply stacks to minicomputer manufacturers, maintain our own extensive manufacturing capability, and market a complete line of systems.

Including our new, expanded family of ADD-ON/ADD-IN systems that's ready to go to work for your minicomputer:

Data General	DEC	Varian	Interdata
Nova 830	PDP-8/A	620/f	Model 50
Nova 1200	PDP-8/E	620/i	Model 55
Nova 1210	PDP-8/F	620/L	Model 70
Nova 1220	PDP-8/M	620/L-100	Model 74
Nova 1230	PDP-11/05	622/i	7/16
Nova 2/4	PDP-11/10	V-71	7/32
Nova 2/10	PDP-11/15	V-72	8/32
Nova 3/4	PDP-11/20	V-73	
Nova 3/12	PDP-11/35	V-74	DCC
	PDP-11/40	V-75	116
	PDP-11/45		116E

Whether you're adding it on or in, Dataram will meet your mini-memory requirements with new, reliable 16K single-board design that delivers the performance you want, and saves you money while doing it. Find out more—return this coupon at once, or call us at 609-799-0071.

I'd like more answers about mini-memories for my _____ minicomputer.

Please send information.

Please have a salesman contact me.

Name _____

Title _____ Phone _____

Company _____

Address _____

City _____ State _____ Zip _____



PRINCETON-HIGHTSTOWN ROAD
CRANBURY, NEW JERSEY 08512
TEL: 609-799-0071 TWX: 510-685-2542

UNITED KINGDOM & IRELAND, GMT Electronic Systems Ltd., Epsom, Surrey, England, Tel. Epsom 20641/France, Munzig International, S.A.R.L., Rungis, France, Tel. 686 1473
WEST GERMANY, O.E.M.-Elektronik GmbH, Stuttgart, West Germany, Tel. 0711-478683/BENELUX COUNTRIES, Synelec Information Systems, Brussels, Belgium, (02) 647-67-12
SCANDINAVIA, Munzig International, Vallentuna, Sweden, Tel. 0762-27102/SWITZERLAND, Interrest AG, Bern, Switzerland, Tel. 031/224481
SPAIN, Aupoca, Madrid, Spain, Tel. 457 53 12/ISRAEL, K.D.M. Electronics Ltd., Tel Aviv, Israel, Tel. 58232
INDIA, Industrial Electronic Instruments, Ahmedabad, India, Tel. 79281/JAPAN, Matsushita Electric Trading Co., Ltd., Osaka, Japan
AUSTRALIA & NEW ZEALAND, Anderson Digital Electronics Pty. Ltd., Mt. Waverley, Victoria, Australia, Tel. (03) 543-2077

See things your way

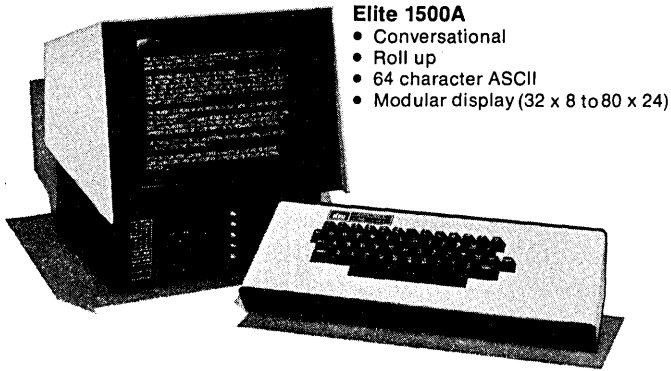

- Elite 1500A**
- Conversational
 - Roll up
 - 64 character ASCII
 - Modular display (32 x 8 to 80 x 24)

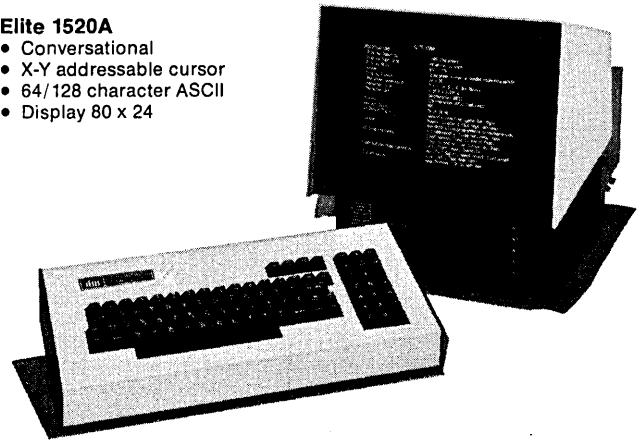

- Elite 1520A**
- Conversational
 - X-Y addressable cursor
 - 64/128 character ASCII
 - Display 80 x 24

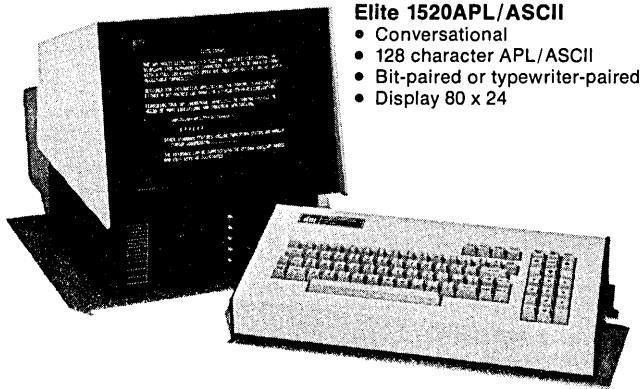

- Elite 1520APL/ASCII**
- Conversational
 - 128 character APL/ASCII
 - Bit-paired or typewriter-paired
 - Display 80 x 24

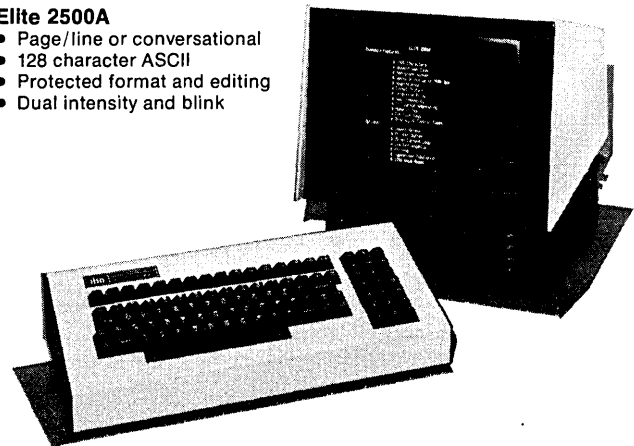

- Elite 2500A**
- Page/line or conversational
 - 128 character ASCII
 - Protected format and editing
 - Dual intensity and blink

with Datamedia Elite Video Terminals

A family of video terminals that offers a wide range of features to perform an even wider range of data entry and display tasks.

If you're with an OEM firm or a system house, and look at peripherals with one eye on cost and the other on performance, you'll want to take a long look at these proven products from Datamedia.

Their modular design makes troubleshooting a breeze, and facilitates conformance to your system needs, and their quality workmanship assures that those needs will be met longer than you thought possible.

And if you believe in service after the sale the way Datamedia does, you'll appreciate the new dimension we've given to the word "responsive."

Datamedia. We've been seeing things the right way for users in industry, business services, government, education, medicine and research around the world.

Why don't you see what we can do for you.

Datamedia Corporation

7300 N. Crescent Boulevard • Pennsauken, NJ 08110 • TEL: 609-665-2382 • TWX: 710-892-1693

138 Duvall Lane • Gaithersburg, MD 20760 • 301-948-1670

Scientific Devices — Midwest • 3300 South Dixie Drive • Suite 212 • Dayton, OH 45439

5456 McConnell Avenue • Suite 150 • Los Angeles, CA 90066 • 213-397-3556

Canada: Datamex, Ltd., Ontario/Quebec • France: Perinel, 631.18.05 • Holland: Infodes Holland B.V., 055-230700 • Italy: Eltron s.r.l., (030) 55-26-41554 • Sweden: Teleinstruments ab, 08-38 03 70 • Switzerland: Teledynamics, 01-56 35 55 • United Kingdom: Mellor Data, 020629 • West Germany: Video Data Systems GmbH, (0 61 81) 7 39 51 • Australia: Inteltec Pty. Ltd., 232-3118 • Japan: Protech, Inc., (03) 384-0225.

STRUCTURED DESIGN

The traditional consideration of production run efficiency was only of incidental importance. It was not ignored; it simply gave way to the higher priorities. The major attention was directed towards the building of a workable system. Once the requirements of the system were met, consideration was given to run time efficiency (i.e., when there was enough time to make such a consideration, which usually was not the case).

Several schemes were contemplated for organizing the project. The only way deemed feasible because of the time constraint was to write program specifications while concurrently programming and testing other parts of the system. Obvious pitfalls to this approach were recognized before proceeding; however, because of the lack of time, no other method was possible. This type of project organization probably should be used only when the situation demands it. In such a case, very close control and coordination is an absolute must because poor communications can lead to a large scale waste of effort.

To attain the design goals, all large programs were highly modularized. As much as possible, a module was designed for general usage, so that it would be reusable in other parts of the system. In this way repetitious coding was eliminated or at least drastically reduced. Each module was physically separate from any other module, i.e., the source text which comprised a module was developed, compiled, and stored apart from any other module. The intent of the design was to make modules small, about four pages of source text per module. However, the size of a module was ultimately determined by its function. Each module had a limited and well-defined function, and the environment of the module was likewise limited and well defined. In this manner, the overall functions of a program were broken into smaller, isolated functions.

Early in the system design, it was recognized that there were different levels of functionality along which a program could be divided. An example of levels of functionality is shown by the difference between two large updating programs that were part of the system. Both programs were to read transactions and update the data base according to the contents of the transaction.

Another way to view an updating program is from the traditional actions of adding, deleting, or replacing data in the data base. In this case, as a

transaction enters the program, it is categorized into one of the three major functions, and is handled along those functional lines.

Program flexibility and modularization

The flexibility of the programs in the system was difficult to assess. However two characteristics of the system point to the fact that structured design produces some flexibility. One is that changes in it were made with a minimum of effort. The largest change required four days, and the next largest, less than a day. The second characteristic is the fact that errors were quickly located and corrected. It appeared that the major factor contributing to system flexibility was the isolation by function that was achieved by structured design. When a problem occurs, it is easy to eliminate many modules from consideration since their functions may have nothing to do with the problem.

Data coupling was extensively used in the interfacing of modules with each other. (Data coupling occurs when all input and output to and from the called module are passed as parameters or arguments—i.e., as data elements). The independence gained here enhanced both the reusability of a module and the isolation of a module by function from other modules.

In other ways, the modular approach accelerated the development of the system. The physical separation of modules meant that more than one person could simultaneously contribute to a program. In fact at one time, five programmers were actively working on modules of the same program.

A byproduct of using a modular approach was the lessening of the total learning time involved in the translation of programming specifications into code. This occurred because, as a programmer completed a module, he was assigned another similar one. He still had the previous coding fresh in mind and could therefore quickly grasp the new programming specifications.

Another feature of adopting a modular approach occurred when a programmer completed a module and was then free to work on other systems. In a conventional system, a programmer is tied to a program until he finishes it; and if a problem in his area of expertise arises while writing the program, something must suffer. However, if a program is broken into small modules, many breaking points result naturally, and the problems involved in conventional methods of programming are minimized.

Despite advantages in using a modular approach, there were also some disadvantages. One problem arose in the interfacing of modules. In spite of

careful attention given to the flow of data to and from other modules, there still were some errors. The number and order of parameters, their characteristics, and the interpretation of their values were in some cases misunderstood. Another problem arose in the organization necessary for the direction of several people working on the same problem simultaneously. Modules were being developed so rapidly that coordination of testing, linking, and integrating them became a large task.

Structured walkthrough

One of the techniques that led to the quick completion of the project was that of the structured walkthrough. A walkthrough, or mental execution of the program by the programming team, was done for each program.

After a programmer had compiled a program and scrutinized it for obvious errors, he sent the chief programmer and several other programmers involved copies of his source text. After time was allowed for the group to examine the text (usually a few hours), the team met and collectively performed a mental execution of the program. A list of errors was made as each logical path was followed. The interface with modules either calling or called by the module being examined was carefully checked as well. At the end of the walkthrough, the list of errors was given to the author.

In this manner most errors were caught before any testing had occurred. Also, the team members who reviewed the text became familiar with a part of the system other than their own. This helped to establish a common base of understanding of all components of the system.

Coincidentally, while the team reviewed the interface with other modules, errors (usually from miscommunication) were also spotted in other modules. It was also not uncommon to have a program or module execute correctly the first time it was tested. One of the major factors in the success of the system was the shortness of the time spent in testing, and the major contributor to it was structured walkthroughs.

Program testing

One reason why testing and debugging went smoothly was the fact that the design of the system included programming specifications for debugging. Not only did programming specifications define the function of a program or module, but they also required variables to be inserted and manipulated solely for the purpose of debugging.

The most effective technique was using an activity variable in each

An amazing new tool:

DOSSIER

Automate your next conversion.

Dossier automatically provides all the current program and file information you need to make any of the system changes listed below. How? That's the amazing part. Dossier translates executable code from your core image library into completely accurate systems documentation. All with no user input, all for \$780. It's not so amazing that more than seventy DOS and DOS/VS installations are using Dossier.

upgrade disk drives to 3344 and others

install a Data Base system

convert from DOS to OS

consolidate or rewrite application systems

plus... other system changes requiring accurate and complete program and file information



Computer Concepts, Inc.

6443 S.W. Beaverton Highway
Portland, Oregon 97221/503-297-4721

Please send more information on DOSSIER.

NAME

COMPANY

ADDRESS

CITY

STATE

ZIP

PHONE

CIRCLE 105 ON READER CARD

STRUCTURED DESIGN

module. Initially the activity variable is set up as inactive. As a module was invoked, the value of the activity variable was changed to indicate that it was active. As control was relinquished, the variable was returned to the inactive state. When a dump occurred, it was easy to trace the path of active modules, arriving at the final

down of large programs into modules, and structured programming.

The major criterion, that of speed of development, was certainly enhanced by structured design. A modular programming approach alone would not have made it possible to write the large programs needed in the amount of time allotted.

The other design goals—flexibility and maintainability—cannot yet be effectively evaluated since the system has remained relatively stable in its

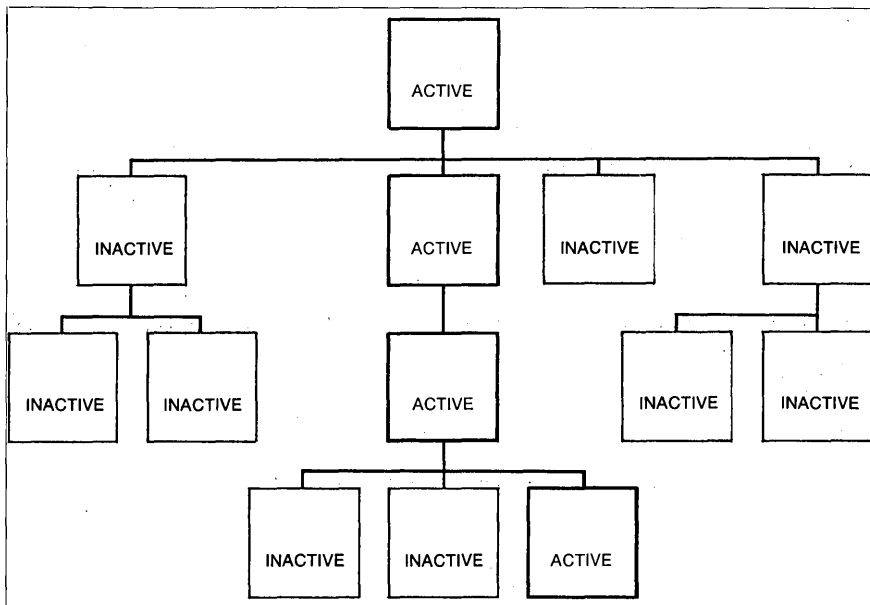

Fig. 1. By using an "activity" variable in each module, the flow of control through the program can be reconstructed and non-active modules ignored in debugging.

one in which activity had occurred (see Fig. 1).

Another useful technique was to display the parameters of a module at the time of invocation. Because of data coupling, the complete set of relevant data was available for determining the state of the module.

An additional technique that proved to be useful was the gathering of statistics internally by each module. Typically, a module would keep track of how many times it had been invoked, the parameters it had been called with, what type of internal results it had generated, etc. Data of this type made reconstruction and analysis of program activity an easy task. They also helped to identify areas of code that had never been tested. Also, it helped to locate areas of code that were critical in the efficient running of the program.

Summary

The most pleasing and surprising aspect of the project was the smoothness with which debugging and testing were accomplished. This smoothness is reflected by the high programmer productivity rate of approximately 11 lines per hour. We felt that several factors contributed to this success—structured walkthroughs, the break-

short lifetime. The few changes made do point to a high degree of maintainability. Structured design, used in conjunction with the complementary techniques of structured programming and walkthroughs, did make possible a level of speed and accuracy in system development not previously attainable. Based upon our experience with developing this system, structured design is as powerful in practice as has been predicted in theory. *

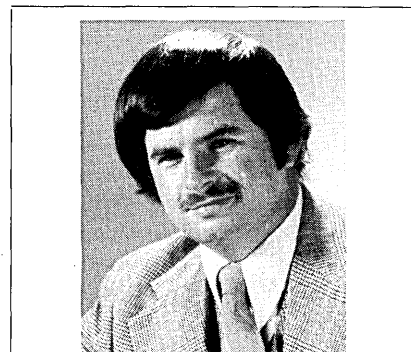

Mr. Inmon is a chief programmer for GTE Sylvania Electronics Systems Group in Mountain View, Calif. He received an M.S. in computer science from New Mexico State Univ.

DP Dialogue

Notes and observations from IBM that may prove of interest to data processing professionals.

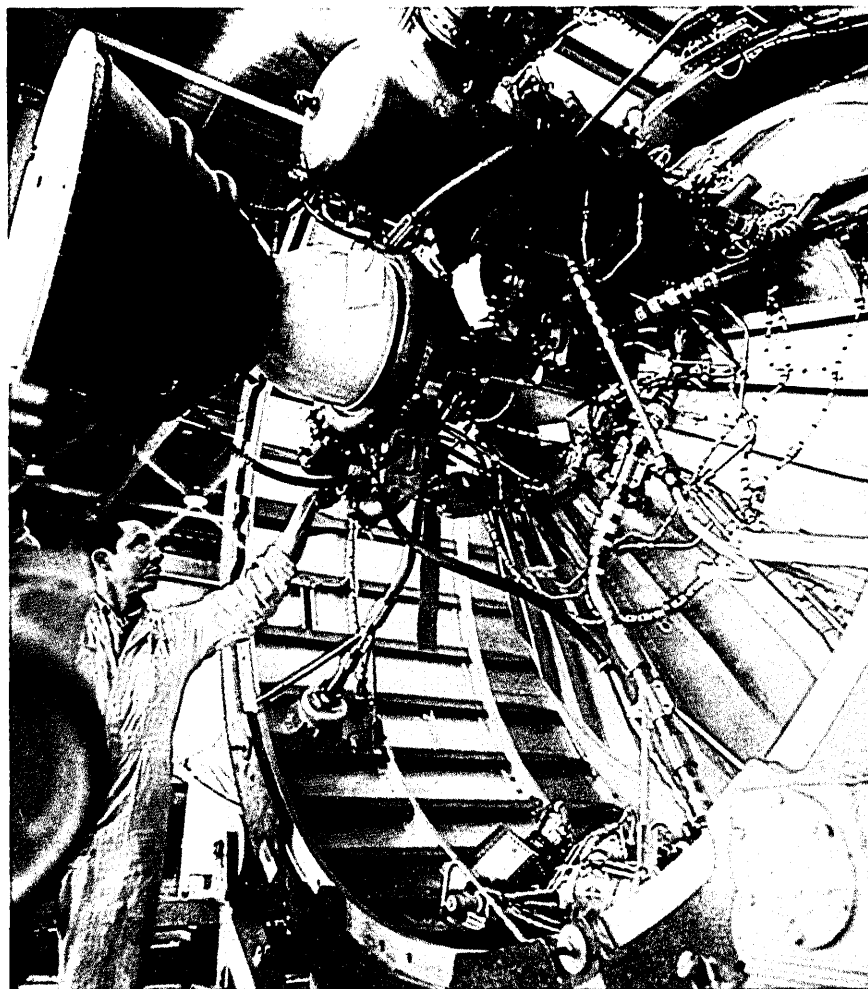

An integrated data base approach like AEIMS helps Martin Marietta design and produce the Titan III Space Launch Vehicle.

A New Data Base Concept for Engineers

High personnel costs . . . stringent reliability requirements . . . expanding documentation needs. They all make it increasingly important for engineering firms to assure that up-to-date, accurate information is readily available to every user within the organization.

Traditionally, many engineering and manufacturing companies have treated every department as a separate entity.

Each would have its own data base and computer programs. With that approach to information handling, however, data corrections or modifications made in one area might have taken a week or longer to reach other departments. The impact on the company's ability to respond to an urgent bid request, or to solve a production problem, could be critical.

To help improve the speed and accuracy of communication between departments, IBM has developed the Administrative Engineering Information Management System (AEIMS) concept. It is a terminal-oriented approach to storing and updating information in a central data base . . . from initial contract award to final product.

The AEIMS concept is designed to eliminate the need for redundant data files, enable many different users to share information when they need it, and help prevent the discrepancies that often crop up in separate data bases.

The Data Systems division of Martin Marietta's Aerospace Group in Denver has already established a system using a similar concept. Called the Technical Requirements Management System (TRMS), Martin Marietta's data base approach is made up of various subsystems corresponding to the functions of requirements identification, planning and scheduling, configuration verification, document status and parts data. The TRMS system uses IBM's Information Management System (IMS) which runs on Martin Marietta's System/370 Model 168 computer based in Orlando, Florida.

"Our greatest administrative problem used to be lack of crosstalk among departments," says David Lucero, chief of configurations management operations. "Now that data entry and corrections can be made directly at our IBM 3270 display terminals, we can operate with the assurance that all of us have exactly the same up-to-date information."

Another benefit is reduced paper generation. Instead of requesting extensive reports on a scheduled basis and then analyzing them manually, people in each department can now select the specific information they need, when they need it.

From an operational point of view, Don Edmunds, TRMS product manager for data systems, says: "Our data base system was developed in close consultation with users. As a result, it is flexible enough to be effective for everything — from our smallest to our most complex projects. Most importantly, the system costs are being recovered through productivity gains."

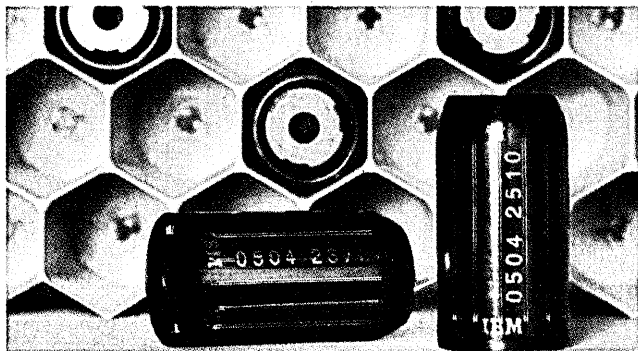

The 3850 Mass Storage System is a revolutionary new way to put vast amounts of data under system control, resulting in fewer errors and lowered operating costs.

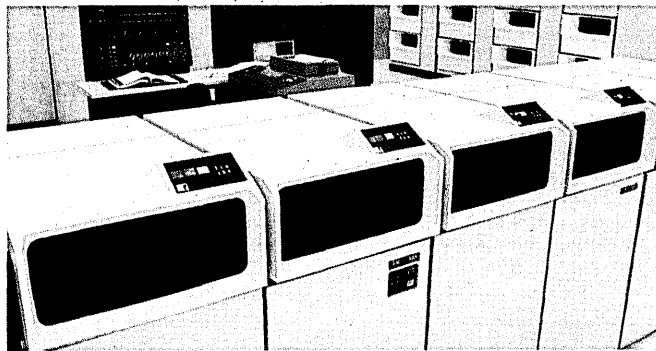

The 3344 and the 3350 contain about twice as much data per square inch as the 3330 Model 11, while for most users the cost per megabyte is typically cut in half.

Putting Storage Systems Under the Microscope

Because of the importance of storage to the entire data processing function, new developments in storage devices are causing users to take a fresh look at their overall storage systems. As part of such studies, IBM has been assisting with in-depth analyses of the performance of storage installations. The ultimate aim is to determine the optimum storage configuration for each installation.

These comprehensive storage system evaluations go far beyond the speed and cost of specific devices. They include factors such as supplies, labor and the cost of error recovery. They are based on comprehensive records of actual usage, generated in most cases by IBM Systems Management Facilities (SMF), an adjunct of the computer operating system that logs performance.

The evaluations answer questions such as: Which data sets are employed most frequently? What is the average data set size for tape and disk? Can high density recording increase system performance?

Results of such studies may be expressed in detailed reports accompanied by usage graphs. Taking into account the nature and objectives of the installation, the studies can lead to recommendations for achieving maximum storage efficiency through the best possible combination of devices.

The systems analysis and recommendation approach worked out quite successfully for the large installation at Trans World Airlines in Kansas City, Missouri. According to Richard D. Pearson, TWA staff vice president—commercial data processing, "We have already begun to achieve the efficiencies and cost savings anticipated in the original study."

Dramatic Advances In Storage Devices

Behind these analyses is a story of continuing progress in IBM storage. Particularly noteworthy are the 3850 Mass Storage System (MSS) and the 3344 and 3350 Direct Access Storage, which have made possible greatly improved price/performance levels for direct access storage.

The 3850 MSS can be thought of as providing "virtual" capability for direct access storage devices, much as virtual storage (VS) does for mainframe storage. Up to 472 billion bytes can

be placed in a "virtual online mode" under direct system control with the MSS. That is the equivalent of 4,720 disk packs (3336 Model 1)—all accessible without manual intervention and at sharply reduced costs per megabyte transferred.

An important characteristic of both the 3344 and the 3350 is fixed-media technology—non-removable sealed head/disk assemblies. Since there are no disk packs or data modules to mount, efficiency and security are improved. And fewer mechanical parts and less restrictive tolerances are an aid to reliability.

Where Fixed-Media Storage Fits In

IBM studies have shown that a growing number of users, particularly those with large installations, rarely if ever change many of their disk packs. For all practical purposes, once they mount a disk pack containing application data, it remains online for as long as they plan to use it.

It's in installations like these that the fixed-media 3344 and 3350 can take over important areas of disk storage and provide improved direct access storage performance at new low costs per megabyte. However, portable storage media—the 3330 and the 3340—will continue to be needed to meet special requirements.

In the IBM storage spectrum, each type of product has a function at which it excels. Together, in the right configuration, they can handle the complete range of storage requirements for any given installation. It is to make sure that each configuration represents the utmost in overall efficiency that IBM helps with comprehensive storage system evaluations. Information on them can be obtained through the IBM Data Processing Division branch office.

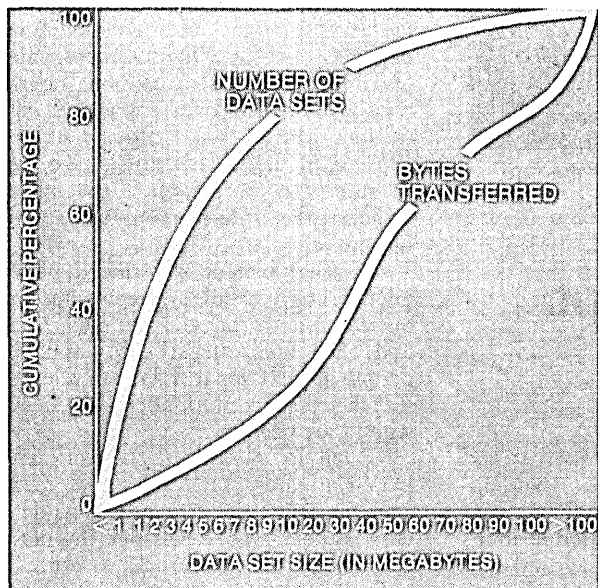

For a typical installation, this graph shows cumulative percentages in terms of number of data sets and bytes transferred. Note that the many small data sets contribute only a small part of the total data transferred.

24-Hour Banking Is a Hit in Baton Rouge

Pay day is Friday. But now pay day is different.

You get your pay check before lunch hour, as usual—but you no longer need rush to the bank before it closes.

Instead, you can deposit your check at any time you choose over the weekend and withdraw cash at the same time. How? With an online, full service teller machine called the IBM 3614 Consumer Transaction Facility.

In Baton Rouge, Louisiana, this kind of convenience is a reality for customers of the Fidelity National Bank. Fidelity's six 3614s stand ready to accept deposits to checking and savings accounts and dispense cash from them 24 hours a day, seven days a week.

"In fact, our 3614s can handle almost any teller transaction," says Frank S. Craig Jr., president of the Fidelity National Bank of Baton Rouge. "That includes transferring funds from one account to another, accepting installment loan payments and informing customers of their current account balances. You can even order a new supply of checks through them."

Five of Fidelity's machines are "through the wall" models located at branch banking offices, while the sixth



A 3614 automated teller machine in use around the clock at Fidelity National Bank at Baton Rouge, La.

is in the lobby of the main office. All it takes to operate them is a magnetically encoded plastic card, which the bank makes available to its customers, together with a personal identification number. The customer inserts the card

in a slot in the 3614 and keys in his personal ID number. Simple instructions for each step of a transaction appear on a display panel in the machine.

"The public reception of the 3614s
(Continued on next page)

Environmental Research Aided by TSO



Alive and well in Redondo Beach, this starfish lives in a mixture of ordinary and recycled sea water.

For snails, starfish and sea urchins who live in the King Harbor area of the California coast, life has never been better. At least that's what studies of the sea creatures seem to indicate to scientists at Southern California Edison.

According to Kevin A. Muench, chief marine research scientist and director of the utility's Redondo Beach laboratory, preliminary results of a novel research program show that growth of marine life is expanding, due to the warmer temperatures of water that has been used to cool power plant condensers and has then been returned to the harbor.

Key to the study is the interactive IBM Time Sharing Option (TSO), together with PL/1, a powerful IBM language. Using them, scientists can speed data to the central computer for analysis and return. Throughout Southern California Edison, some 250 people—including scientists and engineers involved with construction and power

supply, and financial and customer service personnel—can sit down at remote terminals and communicate directly with the computer whenever they need to.

Robert Umbaugh, Edison's data processing manager, reports, "By putting TSO on System/370 Model 168, we've eliminated outside timesharing charges of \$400,000 a year. TSO, PL/1 and VS BASIC, have made the computer as much a part of the engineer's tools as a desk or pencil. With them we're getting a lot more for less."

While long active in marine monitoring, Southern California Edison began its specific research program at Redondo Beach over a year ago to assess any potential disruption of biological patterns caused by water which returns to the harbor several degrees warmer.

The long-range goal of the program is predictive biological modeling, which will help the utility plan and operate future power plants in ways that will maintain a balanced marine life.

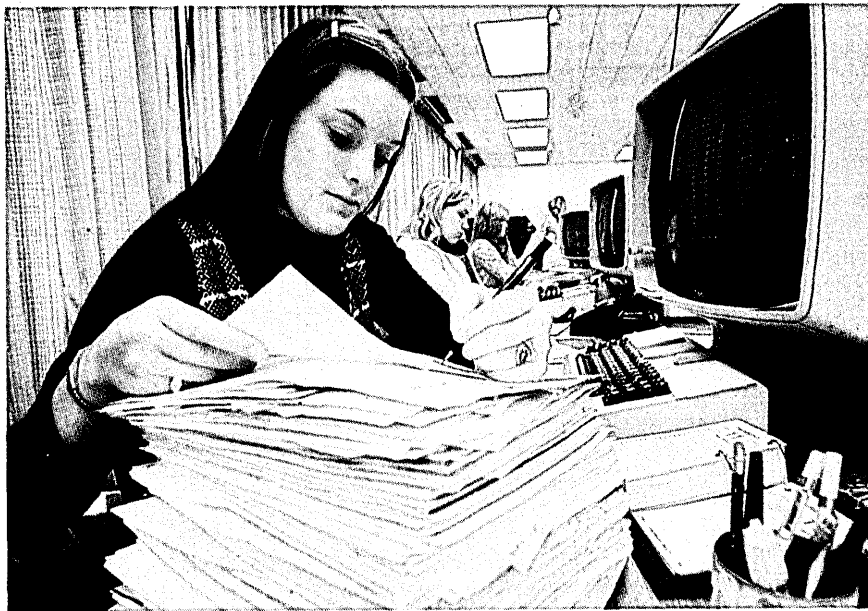

Using a new computerized mail tracking system, clerks enter information regarding incoming requests directly into IBM 3277 Display Stations at National Guardian Life Insurance Company.

Computerized Mail System Tracks Customer Correspondence

Over 3,000 pieces of mail—many of which require immediate responses—arrive every morning at the National Guardian Life Insurance Company in Madison, Wisconsin. By noon, all the mail has been opened, sorted, logged, categorized according to request and distributed to the appropriate department.

“The key to our new control system is a computer program designed to keep track of all our correspondence through every stage of processing,” says Spencer Francis, director of systems and data processing. “Using the computer, we can locate a file immediately, simply by typing in the name of the policyholder at a terminal, with-

out making phone calls to five or six different departments.”

Before using the computer, all written requests were handled by jotting down a policy number and a brief description of the request on ordinary index cards. But as Francis comments, “Index cards have a way of getting lost. Besides, it took a great deal of time for our clerks to sort through all the cards to check on the status of a request.”

Under the new “Call-Up” program, every incoming letter is assigned a unique file number which includes a code indicating the nature of the request such as policy changes, accounting changes or general maintenance.

This number, along with the name of the policyholder or the agent who wrote the letter, is entered into the company’s IBM System/370 Model 135 via several 3277 Display Stations in the records department. The department to which the file is sent is also noted, so that any file can be located within seconds.

In the case of a request for a change of beneficiary, for example, the letter is routed to the policy change department which responds by sending out the correct forms. That information, along with a follow-up date to check on whether the completed forms have been received, is entered at a 3277 terminal handling policy changes. A daily list of files which have reached their follow-up dates is printed and sent to the relevant departments.

“With this system, we can find out the status of a request within seconds, simply by keying in a name at the terminal,” says Francis. “It has also been a tremendously effective tool to help us spot potential bottlenecks and keep an accurate record of the number of requests handled by each department.”

In addition to current status of change requests, information about more than 120,000 policy files can be accessed at the terminals. The company’s data base also includes files retained for five years after they become inactive, as well as new policy applications and information regarding National Guardian’s investment portfolio.

The Call-Up program took only a few months to write and test according to senior systems programmer Jim Hartman. “The 3277 terminals are particularly well suited to our operation—very fast and flexible. And our people were able to learn how to operate them within a few minutes,” he adds.

“Agents have been impressed with our faster response time,” says Francis. “We feel the system gives us a valuable competitive edge in providing a high level of service for our customers.”

24-Hour Banking...

(Continued from preceding page)

has been tremendous,” says Mr. Craig. “We haven’t been able to keep up with the demand from our customers for their cards. It seems that ‘anytime banking’, as we call it, meets a real need, especially on weekends. We’re particularly pleased that deposits through the 3614s have exceeded withdrawals.”

In recent months, the full-function 3614 has been installed at a number of

banks and financial institutions across the country. It is part of the IBM 3600 Finance Communication System, a family of terminals designed to speed and simplify banking operations.

At Fidelity, installation of the 3614s was preceded by the development of an integrated Customer Information File (CIF), through which information on every customer and type of account can be accessed both by the 3614s and by IBM display terminals. Fidelity is proceeding with plans for a complete online teller network as the next phase in implementing the 3600 system.

DP Dialogue appears regularly in these pages. As its name suggests, we hope DP Dialogue will be a two-way medium for DP professionals. We’d like to hear from you. Just write: Editor, DP Dialogue, IBM Data Processing Division, White Plains, N.Y. 10604.

IBM®

Data Processing Division

76-2

DATAMATION

DATAcom

Data Base Management System

The "Best kept secret in DB software" is getting out fast!

Here are 8 reasons why:

- 1 High speed sequential processing** / Savings and Loan processes a full 2314 pack of data sequentially on a 360-Mod 50 in just over seven minutes.
- 2 Data Compression** / Bank was able to save two spindles of a 2314 and an additional control unit.
- 3 Programming Ease** / FM company was able to convert an entire new application after a demonstration prior to formal installation training.
- 4 Processing Efficiency** / Insurance customer directly converted a three hour per day run to insure that DATAcom would not "degrade" performance. Without tuning, the update run was reduced to 40 minutes.
- 5 Data Access** / Savings and Loan is able to serve all its customers from any of 35+ branches on any account knowing any of the following — name, mortgage number, loan number, address or account number.
- 6 Response Time** / With DATAcom/DC an electronics distributor is able to get 1 second response time in an order entry application.
- 7 Memory Efficiency** / All users require only 25K plus buffers.
- 8 Ease of Use** / No full time data base administrator required.

DATAcom/DB is what the most sophisticated, impartial, cost-conscious professional judges of software performance are buying in data base management systems. They operate on a P & L basis and are directly dependent on user satisfaction. These *professionals*, the people who know software best, are *the fastest growing part of our customer list*. DATAcom/DB features are simply not available elsewhere and particularly not at this price level... and *professionals buy value!*

Consider these features: Simple programming. Great flexibility in data file design. Multiple logical keys. Concurrent multipartition operations. Faster high-speed batch sequential capability than any other D/B system. Wide variety of cost-saving features including data compression by file. Multiple levels of data security. Supports all IBM languages. Fully re-entrant and multi-tasking for high volume on-line systems.

If DATAcom seems too good to be true, *make us prove it.*

The professionals do.

Call or write today and get the complete story in any benchmark situation you care to structure.

I'm a professional. Please prove DATAcom/DB to me. D-3!

Name

Title

Firm

Address

City

State

Zip

Phone

cim an Insyte Company

Computer Information Management Company
3707 Rawlins Street, Dallas, Texas 75219 214/526-4280

DATAcom Data Base Management System and Data Communications Monitor are the *only* DB/DC systems designed for each other... and you!

IBM and Multiprocessing

by David N. Freeman

Until recently, IBM gave more support to loosely-coupled multiprocessor systems. But the long term potential for cost effectiveness and recoverability favors tightly-coupled systems.

Like most manufacturers of general purpose computers, IBM made little effort to link two or more computers together prior to 1960. SAGE (the 1955 multiple-computer air defense system) and SABRE (American Airline's 1958 passenger reservation system using duplexed mainframes) were IBM's first major specialized multiprocessors; these one-of-a-kind projects trained many engineers and programmers who subsequently turned up as IBM's principal architects for general purpose multiprocessors.

Prior to 1961-62, many large IBM customers installed several cpu's at one site, each with its own operations staff and cadre of systems and applications programmers. Shared among these cpu's were—at most—libraries of magnetic tape reels. Little disc storage was used for programs and data prior to 1961-62, and this storage was almost always private to each cpu.

Early shared-disc IBM systems included configurations coupling 1410s to one another and to larger processors such as 7010s and 7090s. The primary objective for sharing discs among 1410s was high availability; if one computer broke down or underwent preventive maintenance, the other could be used for urgent batch and on-line processing. Sharing programs and data dynamically among two computers was relatively rare, requiring a major software effort by the customer or his local IBM support group.

In the early '60s, another technique for linking two 7040/7090 series computers together was conceived by a group of IBM's largest scientific customers, primarily from the petroleum and aircraft industries. The Direct Coupled System (DCS) comprised a 7040 or 7044 ("704X") as the *front-end system*, servicing slow speed peripherals and communications lines, and a 7090 or 7094 ("709X") as a

main processor. Rather than sharing disc storage, DCS used a channel-to-channel (CTC) adapter to move SYSIN streams (source decks and associated control cards) from the front-end system to the main processor, returning SYSOUT streams (print images and punched output images) to the front-end system.

The primary function of the DCS front-end system was to control card readers and printers, in contrast to its ASP and JES3 successors, described later. A peculiarity of IBM's pricing of card reader and printer attachments justified installation of a complete computer just for these functions. It was considerably cheaper (and more flexible in operation) to attach multiple unit-record devices to a 704X than to a 709X mainframe. Direct coupling furnished multiple-printer capability to a large 709X installation for approximately the same cost as attaching printers directly to the 709X. Also, there were advantages in using the cheaper core of the 704X for buffering card inputs and printer/punch outputs rather than the expensive and scarce 709X core. This problem was also attacked in another way by using an off-line card-to-tape machine such as a 1401 (for IBM installations), 1004 (for Univac installations), and 960A (for CDC installations).

From 1960 to the present, these two types of *loosely-coupled* multiprocessing systems—shared-disc and channel-coupled systems—have been actively developed by IBM, receiving increased marketing emphasis since announcement of their Multiple Virtual Storages (MVS: Release 2 and thereafter of OS/VS2.) operating system three years ago.

Large scientific and commercial installations often need:

- more raw horsepower than can be

conveniently delivered by one cpu,

- higher availability than can be furnished by a uniprocessor—less downtime due to preventive/emergency maintenance,
- fewer interruptions of communications-oriented systems—by segregating them from batch processing onto dedicated cpu's,
- functionally-organized machine rooms—collecting all card processing into one area, printing to a second, tape handling into a third, etc., and,
- multiple generations of application programs and associated operating systems—efficiently processing intermixed batch jobs from two different hardware generations or operating systems (such as DOS and OS jobs submitted through the same card reader).

Burroughs, CDC, DEC, Honeywell/GE, Univac/RCA, and foreign manufacturers have historically devoted more effort to *tightly-coupled* configurations of their large mainframes, where two or more cpu's share main memory and peripherals under control of a single operating system. By 1971, prior to the announcement of OS/VS and its support of tightly-coupled systems, Burroughs had developed and delivered its Multiprocessor B6700, CDC its 6500 (two 6400s sharing main storage) and 6700 (6400 sharing main storage with a 6600), DEC its 1055 and 1077, Honeywell/GE its tightly-coupled 600s, and Univac its Multiprocessor 1108. IBM's competitors used hardware and software designs similar to IBM's Multiprocessor/65 and full-duplex Model 67. CDC's architecture for the 6500 and 6700 was a true tightly-coupled design, where a single copy of the operating

system simultaneously drove both cpu's. In addition CDC offered support for two cpu's sharing ECS (Extended Core Storage); ECS is used for storing input and output images, frequently used modules of the operating system, and swapped out programs.

DCS evolves into ASP

By the mid-'60s, direct coupling had been tuned and enhanced by IBM (with substantial help from the SHARE membership) so that its popularity was growing rapidly. The 1964 announcement of System/360 dismayed DCS users, who found no support for multiprocessor configurations in the original os/360 specifications.

System/360 strongly affirmed IBM's architectural commitment to large uniprocessors, reflecting current unit costs for hardware and apparent negative economies of scale for multiprocessors. The System/360 multiplexor channel permitted attachment of many slow speed peripherals to any system, small or large. In particular, the pricing anomaly which had stimulated interest in DCS—using the cheaper core and unit-record attachments of a 704X to indirectly support a 709X—vanished in System/360, the costs of whose peripherals were insensitive to cpu model. Core storage for Model 65s and 75s was quite expensive but, per byte, only slightly more than for 40s and 50s.

DCS users had not relied solely on the pricing anomaly to justify two computers for a single production operation. During 1961-66, these users compiled a substantial library of pre-processing, postprocessing, utility, and operator-convenience programs for their 704Xs, whose cpu power was generally lightly used. Originally, the principal activity of the DCS 704X was keeping its peripherals busy: starting various card readers and printers whenever they finished prior operations, responding to SYSIN and SYSOUT requests from the main processor, and notifying the operator whenever card readers were empty, card stackers full, or printers jammed.

Altogether this activity typically used 20 to 30% of the 704X's computational power, irrespective of the load on its main processor. Imaginative installation managers and system programmers designed many 704X programs to use this otherwise wasted capacity, particularly printing and data editing utility programs not requiring the computational power of the main processor. (704X computers had several character-handling instructions appropriate for utility programs; 709X computers were word-oriented scientific computers, entirely lacking character-handling instructions.) These

programs had to be carefully integrated with SYSIN/SYSOUT and CTC handlers, so that I/O needs of the expensive main processor got highest service priority on the 704X, residual time being devoted to the concurrent utility operations.

From this came much of IBM's multiprogramming expertise: priority processing, task management, and *spooling* (concurrent management of slow speed and disc I/O with batch processing, described later). The 704X computer was internally multiprogrammed, whereas the 709X computer processed one batch job at a time, this job having access to almost all core memory and all tapes and discs. Thus, IBM successfully implemented *specialized multiprogramming* for 704X computers but encountered none of the core-allocation and device-allocation problems that so sorely plagued multiprogrammed operating systems for System/360.

The uniprocessor limitation of os/360 forced DCS users to rethink their requirements for concurrent utility functions, since the latter were unavailable in os versions announced during 1964-66. Early releases of os/360 had very poor throughput—in particular, they did not support concurrent spooling and data-editing tasks—so most DCS users waited until 1967-68 before migrating to System/360.

By that date, IBM had formally committed the Attached Support Processor (ASP) option for os/360. Initially ASP was a straight conversion of the DCS front-end system to a simple multi-tasking monitor under os/360, plus DCS-like support for a single batch stream on the main processor. Functionally, ASP performed well. However, the cost-effectiveness of os/360 was still quite poor in 1968, when ASP be-

came available. Using one os/360 system to feed SYSIN images to a second os/360 configuration resulted in very high supervisory overheads and low performance of unit-record equipment attached to the *support processor*, as the front-end system was called under ASP.

From 1969 to the present, the central ASP development team in California has collaborated with major users to tune this subsystem and reduce its cpu overhead and resident main storage requirements below 30% and 500K bytes, respectively. Due to the continuing high cpu overhead of IBM job-management and I/O-supervision modules, few ASP installations have been able to achieve less than 30% support-processor overhead on, for example, a System/370 Model 155 with two local card readers, three printers, and half a dozen remote job entry (RJE) stations.

To ASP, IBM and users added many functions, as they did to DCS, besides SYSIN/SYSOUT handling, such as

(a) pre-execution setup of reels and disc packs,

(b) control of two or more main processors by one support processor (one of the "main processors" may in fact be a collection of batch-processing resources from the support processor—core, cpu power, and peripherals; usage of the support processor as a main processor is called a *local main operation*),

(c) enlarged repertoire of console commands, such that operators manage batch processing primarily with ASP commands rather than os/360 Job Management commands (which manipulate the Reader/Interpreters, Output Writers, Job and Step Initiators, etc.), and

(d) priority scheduling of main

IBM MULTIPROCESSORS PRIOR TO SYSTEM/360

- | | |
|------|---|
| 1955 | SAGE—Semi-Automatic Ground Equipment
Multiple special purpose computers at each of several sites around the North American perimeter, to furnish data-reduction and reporting for air defense. |
| 1958 | SABRE—Airline reservation system for American Airlines
Twin 7090s initially, each capable of processing incoming messages from dozens of agent terminals. One cpu was on-line, the other in "hot standby" status. |
| 1960 | 1410 operating system
Simultaneous Peripheral Operations On-line (SPOOL) permitted card-to-tape/disc and tape/disc-to-printer operations concurrent with one batch job stream on a single or dual 1410/7010 configuration. |
| 1962 | DCS—Direct Coupled System
7040/7044 channel-coupled to 7090/7094, the former managing all card and printer equipment, exchanging card images for print images from the larger computer. |
| 1963 | MSC multiprocessor
Custom-designed hardware and operating system to support Gemini and Apollo programs, originally using several 7090s sharing LCS (large core storage), later implemented with multiple System/360 Model 75s. |

MULTIPROCESSING

processor(s), considering such important job attributes as:

- estimated running time
- estimated cpu time
- estimated core requirement (maximum overall job steps; not used in DCS)
- user-specified deadlines
- external priorities: urgent, normal, deferrable, etc.
- SYSIN/SYSOUT quantities (non-standard ASP priority parameter)
- availability and mount status of reels and packs.

Among today's ASP installations, each values these scheduling and resource management facilities somewhat differently. Some rely heavily on pre-execution setup, others have few needs for mountable reels and packs. Priority scheduling with heavy weight to user-supplied deadlines is critical for some installations, others follow a first-come-first-served policy.

Suffice it to say that the ASP user community is *relatively large* in terms of gross revenue to IBM (if not in numbers of installations) and *vociferous* about its needs for on-going IBM support of loosely-coupled configurations. Representative large installations include the computer centers of the City Univ. of New York (two four-megabyte Model 168s), Stanford Linear Accelerator Center (two Model 168s plus a Model 91), Bell Telephone Laboratories (Murray Hill, Whippany, and Holmdel), and McDonnell Automation (St. Louis and Burbank).

ASP-like support is provided by JES3, one of IBM's job entry subsystems for the largest virtual storage System/370 configurations. JES3 retains much of the command language and internal architecture of ASP, although its technique for moving SYSIN and SYSOUT data sets has been considerably redesigned, as discussed later.

Evolution of spooling

Another development which was to affect the evolution of multiprocessing systems appeared as an option in an early-'60s version of the IBM 1410 operating system, an option entitled *Simultaneous Peripheral Operations On-Line*. The SPOOL acronym was adopted for similar facilities in IBM's operating systems for System/360: initially DOS/360 and OS/360, later TSS/360, CP/67,

and the VS operating systems for System/370. In the single-processor 1410 environment, SPOOL permitted the operator to initiate a card-to-tape or card-to-disc operation concurrent with processing a stream of batch jobs. Core memory, peripherals, and a small amount of CPU power were required to keep various SPOOL functions—typically one card-to-disc and one disc-to-printer utility—operating at nearly full speed. The objective of SPOOL was to move a SYSIN stream to a fast-access device (tape or disc) prior to presenting it for batch processing, so that processing would run much faster.

Additional CPU overhead due to transcribing card images to disc was more than compensated for by improved overall CPU utilization during batch processing. Without spooling, the CPU utilization remains consistently below 20%. SYSIN spooling shortens the completion time, essentially doubling the overall CPU utilization. By

unmodified OS/360 and ASP, as shown in Table 1. Local efforts such as that of the author and his colleagues at the Triangle Universities Computation Center were quite similar to HASP; the need for such a facility, and an obvious way to design it, arose simultaneously at many locations during 1966-67.

Tightly-coupled multiprocessors

HASP was originally designed for large uniprocessor installations, which were common early in the life of System/360. A typical customer rented a 128K Model 40 in 1966, traded up to a 256K Model 50 two years later, and—load and funds permitting—to a 512K Model 65 by the early '70s. If a rental customer outgrew the capacity of one IBM model, he was able to upgrade without software and operational hardships—such was the successful upward compatibility of System/360 hardware. (Rental revenues from these upgrades helped make System/360

YEAR	1967	1969	1971	1973	1975	1977
HASP/JES2	5%	20%	50%	70%	85%	85%
ASP/JES3	0%	5%	7%	10%	10%	12%
Unmodified OS	90%	70%	40%	18%	4%	2%
Other	5%	5%	3%	2%	1%	1%

Table 1. Estimated percentages of OS/360 configurations using HASP-like and ASP-like spooling systems: 1967-1977.

spooling SYSOUT images as well, the elapsed time is reduced still further, and the average CPU utilization is almost 50%, of which 10% is overhead due to the SPOOL activity.

Soon after the initial release of OS/360, it became obvious that the IBM Job Management facility had been grossly misdesigned. In addition to a clumsy interface to the console operator and a primitive algorithm for scheduling jobs, OS/360 required creation of a new sequential data set on disc for each user's source deck. Likewise, it required separate sequential data sets for his printed and punched outputs. To allocate, fill, and delete these data sets not only required horrendous CPU time but also non-trivial operator cooperation and intervention. A SPOOL-like function was clearly needed.

Several SPOOL projects were defined and implemented by leading-edge IBM customers. The Houston Automatic Spooling Priority (HASP) system, developed by an IBM team at the Manned Spacecraft Center in Houston, soon became the standard front-end software subsystem for users requiring uniprocessor spooling. HASP received considerable functional enhancements during 1967-71 and became the dominant technique for handling SYSIN and SYSOUT by 1971, surpassing in number and total value of installations both

IBM's most profitable series; the average configuration was much larger than had been anticipated, due in large part to operating systems of extraordinary size using much CPU overhead.)

Some of the largest HASP installations began to encounter needs for high availability (percentage of 24 hours system is operable) and MTBF (mean time between failures). A typical response was to order a second full-sized HASP configuration, particularly if the overall workload justified a second computer. However, the negative economies of scale became bothersome; was it really cost-effective to operate two large Model 50s under HASP rather than a single Model 65? Each HASP configuration required a non-trivial OS supervisor and HASP region in core storage, plus several low speed peripherals; installations with *n* HASP or ASP systems were paying this hardware ante *n* times. However, this alternative was the only reasonable one for large scale IBM customers with high availability requirements during the late 1960s.

IBM had designed and announced a tightly-coupled multiprocessor version of System/360 Model 65, MP65. However, the specialized version of OS/360 required to support MP65 was delivered late (1969) and with serious cost-performance shortcomings. It was observed that adding a second Model 65

Tektronix Graphics now has a mind of its own.

The 4051 BASIC Graphic Computing System: Off-line computing and editing: On-line processing in any language.

Introducing an intelligent solution to your time-sharing budget crunch. The 4051 can pay for itself in one year's time-sharing savings or less. Its built-in 8K of workspace (expandable to 32K), mag tape storage, and complete editing capability can take you off-line and take a huge bite out of connect-time charges. Out of CPU time. Out of storage costs.

The system that makes time stand still. The 4051 includes the off-line pre-processing power you've always wanted . . . whenever you want it. It offers cost-saving editing capacity. Terminal capability. The super-efficiency of Graphics.

You program locally in BASIC. Enhanced with many extras, and designed so you can get your teeth into Graphics instantly. Commands like MATRIX DRAW, WINDOW, VIEWPORT, ROTATE, and much more.

Ready to grow . . . with support for the novice to the programming pro. Plus time-saving applications software. Plus a full complement of 4051 peripherals standing by.

Just \$280./mo. Lease price.* Only Tektronix' advanced technology can save you so much time for such a small cost. Your local Sales Engineer can set up a demonstration right on your desk. Why waste time? Talk to him now, or write:

Tektronix, Inc.
Information Display Group
P.O. Box 500
Beaverton, Oregon 97077



TEKTRONIX®

CIRCLE 54 ON READER CARD

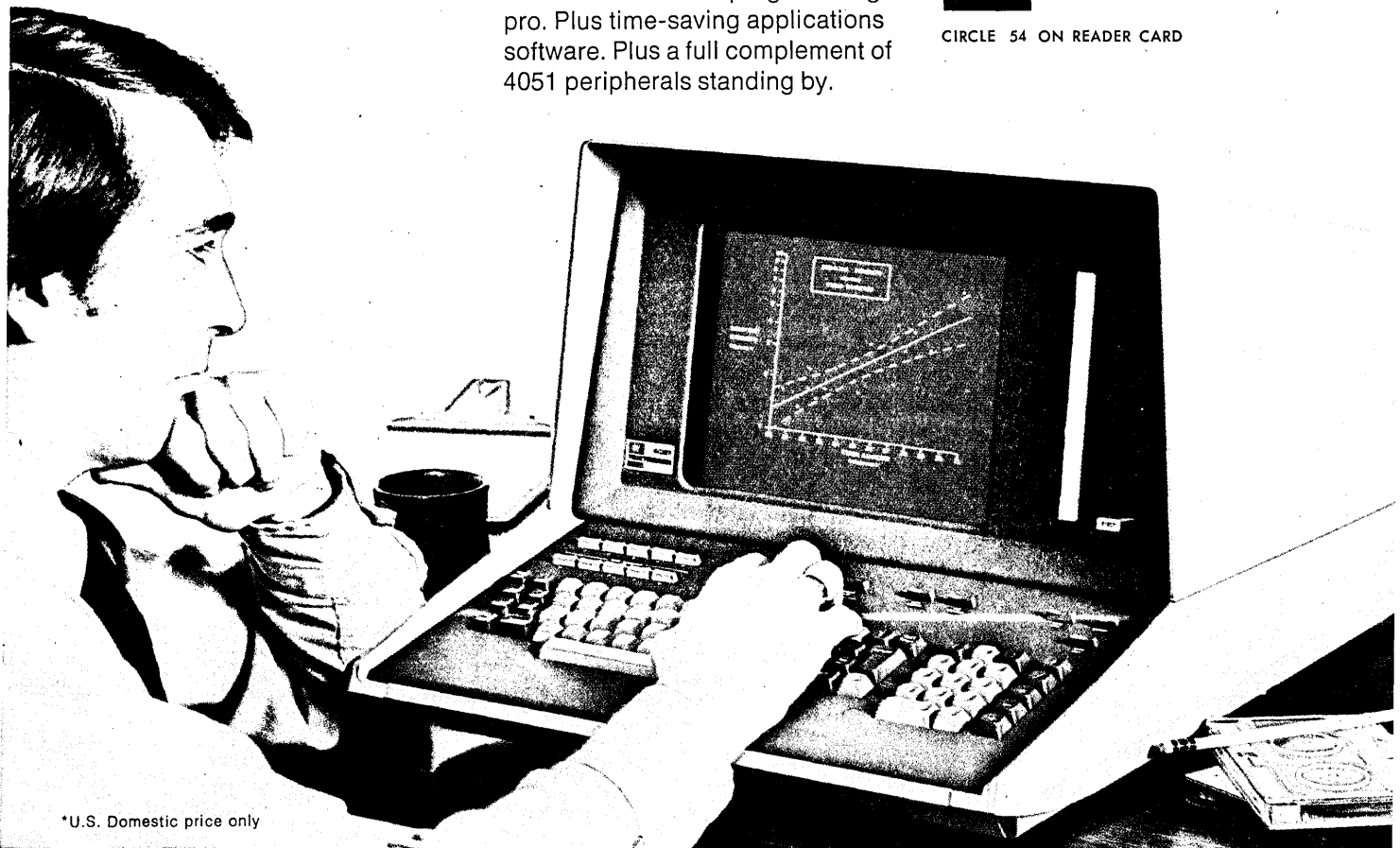

*U.S. Domestic price only

MORE COMPUTER LIFE SUPPORT: THE MODEL 6/16 FROM INTERDATA.

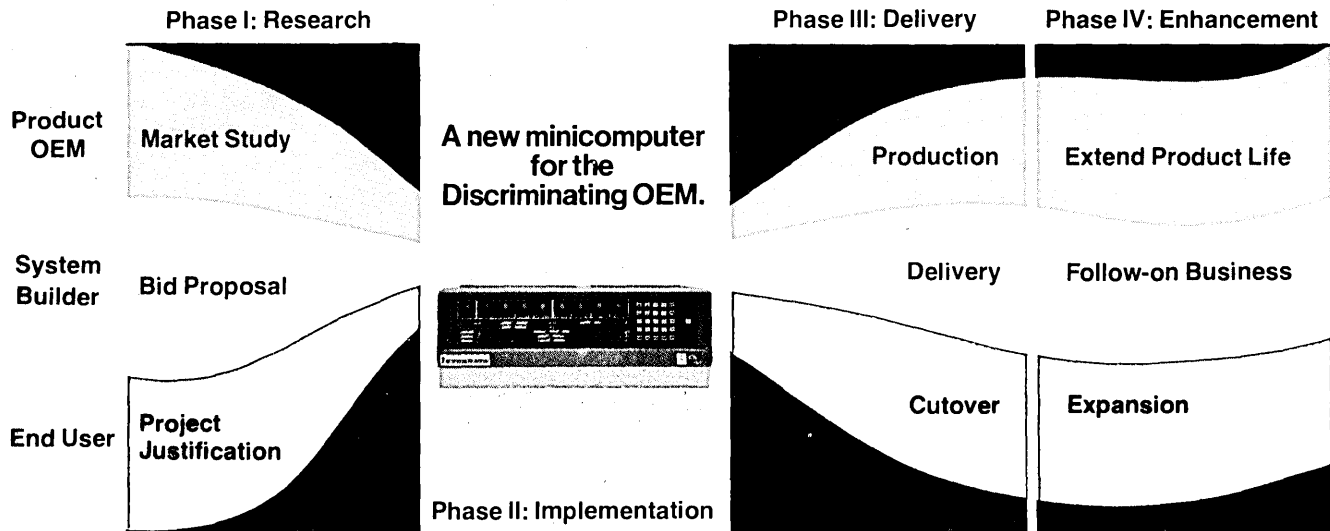

The new Interdata Model 6/16 minicomputer offers Product OEM's economical high performance throughout their Computer's Life Cycle — particularly during the Implementation Phase.

Here's how:

Low price. The Model 6/16 hardware costs less than the comparable Nova 3 or PDP 11/04. Today, you can buy an 8K-byte Model 6/16 core processor for \$1,736 in quantities of 100. Or a MOS processor for \$1,364 in the same quantities.

Optimizing software. The Model 6/16 software minimizes your software development costs. OS/16MT2 optimizes your use of the 6/16 in real-time, program development and computational applications. And we offer you cost-saving languages such as BASIC, CAL and FORTRAN.

Upward compatibility. The Model 6/16, as with all Interdata computers, has IBM-like architecture. This means the 6/16 is compatible with, and can be field-expanded into, any 32-bit Interdata computer. By offering you the option of upward compatibility, Interdata helps protect your investment.

Our reputation. The Model 6/16 is backed by the combined experience in and reputation for quality products and services of Interdata

Interdata's computer products and services exist for one reason — to satisfy our customers: the Product OEM, the System Builder and the End User. Each of these computer buyers is involved with a Computer Life Cycle with four specific Phases — Research, Implementation, Delivery and Enhancement. Interdata responds to customer needs during each Phase with Computer Life Support.

and The Perkin-Elmer Corporation.

All of this adds up to Computer Life Support for the Product OEM when he buys an Interdata Model 6/16. The discriminating buyer will find that the Model 6/16 not only outperforms any comparable micro- or minicomputer — but saves him money.

Make us prove it. Send in this coupon. Or call us. Today.

Gentlemen:

I want proof.

My computer application is _____.

Send more on the Model 6/16.

Have an Interdata representative contact me.

Name _____ Title _____

Company _____

Address _____

City _____ State _____ Zip _____

Telephone _____

INTERDATA®

Interdata, Inc.
Subsidiary of PERKIN-ELMER
Oceanport, N.J. 07757
(201) 229-4040

YOUR PAPER WORRIES ARE OVER!

GRAPHIC CONTROLS DELIVERS.



Texas Instruments Silent 700®

We offer you fast, off-the-shelf delivery, from inventory, of thermal paper to fit the Texas Instruments Silent 700® machines. No problem for us. We produce in quantity and stock in distribution centers strategically located throughout the U.S. and Canada. You'll never run short again!

And that's not all. We'll supply you with paper that's whiter and easier to read than you're now using. In addition to our standard roll paper, we give you the option of fan fold packs, and cross-perforated roll paper... perforated every 11 inches. And we offer production flexibility for letterheads and special formats.

All this and low price, too. **Lowest price in the industry!**

So, stop worrying and start filling out the coupon. For even faster action, call the Coated Products Division—Sales Service Dept., at (716) 853-7500, Ext. 378. Graphic Controls delivers!

Please start me off with a complimentary roll and your brochure showing the lowest prices in the industry.

Number of your Silent 700 Machines _____
Estimated annual usage _____ rolls.

I have an immediate need—have your representative call.

D-3-76

Name _____

Company _____

Address _____ Phone No. _____

City _____ State _____ Zip _____



COATED PRODUCTS DIVISION
GRAPHIC CONTROLS CORPORATION
189 VAN RENSSELAER STREET, BUFFALO, NEW YORK 14210

SUPER BEE 3

polling video display terminal



"My new micro-programmable Super Bee 3 provides a Daisy Chain Port for POLLING yet requires NO CONTROLLER UNIT! A 4800 baud asynchronous/synchronous data transmission combines with the many other exceptional features and functions offered in my other Super Bee terminals to give you an unmatched price to performance ratio."

SUPER BEE

p.s.

We can also custom program to your polling requirements. For example: Burroughs, ICL, Univac, IBM

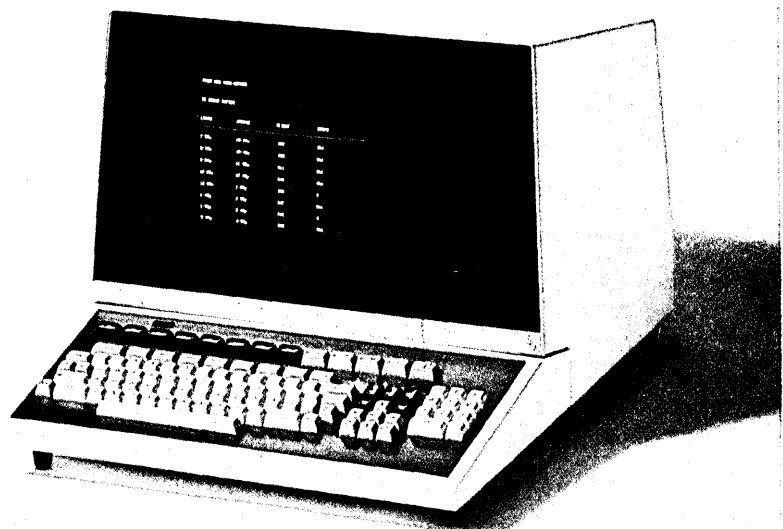

Another Quality Product from

BEEHIVE TERMINALS

BEEHIVE MEDICAL ELECTRONICS, Inc.

870 West 2600 South • Box 25668 • Salt Lake City, Utah 84125 • (801) 487-0741 • TWX 910-925-5623

MULTIPROCESSING

cpu to a uniprocessor configuration increased total throughput by at most 30%—even for a compute-bound job load. Also, specialized core memories required for MP65 and its architectural cousin, the full-duplex Model 67, were considerably more expensive than uniprocessor memories. Together with an uninspired sales effort by IBM, these factors deterred most Model 65 installations from upgrading to MP65. Possibly 3% of all Model 65 cpu's were MP's.

Nonetheless, IBM's architects and technically astute customers saw that tightly-coupled systems could significantly raise availability and cost-effectiveness if (a) overall reliability of the os itself could be raised, (b) more of the incremental power of the second cpu could be delivered to user jobs, (c) incremental hardware costs for pooling two cpu's with a single main storage, channels, and peripherals could be lowered considerably *vis a vis* MP65 and the full-duplex Model 67, and (d) the supervisory overheads for tightly-coupled multiprocessors—resident main storage areas plus cpu overhead—could be held to levels only slightly higher than for uniprocessors.

Another requirement for tightly-coupled configurations was the capability to gracefully partition hardware and os software, so that a "checkout subsystem" could be quickly and comfortably configured for preventive or emergency maintenance. For example, if a configuration comprised four half-megabyte memory modules, six high speed channels, and various peripherals together with two cpu's, it was reasonable to postulate a checkout subsystem comprising one cpu, one memory module, one or two channels, a magnetic tape drive (for diagnostic programs), a printer, and an operator console.

The host os would have to be capable of gracefully adapting to loss of checkout-system hardware. The extreme rigidity of os/360 with respect to hardware configurations (requiring a SYSGEN for most major additions or deletions of memory and peripherals) made it unsuitable for tightly-coupled configurations needing sporadic partitioning into checkout and production subsystems.

Multiple HASP mainframes

Faced with these obstacles, most os/360 customers acquired additional large mainframes—Models 50 and 65 of System/360, Models 145, 155, and 165 of System/370—and either ran them as giant ASP networks (one support processor driving several main processors) or as decoupled HASP configurations. The latter strategy is indeed "fail soft"; if one system fails due

to hardware or os breakdown, the other systems are totally unaffected. Nonetheless, the hardware costs cited earlier have been painful, as well as costs for multiple os packs and drives, maintenance of system libraries on these packs, and multiple operations staffs.

Among the thorniest operational problems for installations with multiple HASP systems has been where and how to run each batch job. On-line systems for time-sharing, inquiry, and message-switching can be preassigned to particular machines, but it is clumsy to receive batch work from RJE stations and distribute it cost-effectively and reliably among several decoupled systems. It would be more convenient to use one mainframe to enter all jobs from local readers and various communications controllers, then distribute them among all mainframes according to (a) urgency, (b) availability of the computers (some may be undergoing maintenance, others may already be heavily loaded), and (c) any special resources required by each job, such as strong floating-point power, a particular on-line data set, or a one-of-a-kind peripheral.

This kind of system is conceptually similar to ASP, with the job entry mainframe playing the role of master. It has the same vulnerability as ASP to loss of the job-entry mainframe during preventive or emergency maintenance. It should be stressed how clumsy it has been to switch communications equipment and associated modems, multiplexors, and systems software among IBM computers. With the gradual advent of distributed computing—non-trivial processing power inserted into terminals and remote and local communications controllers—abrupt, operator-managed shifts of hardware among host computers are no longer tolerable. What seems to be needed is a multiprocessor complex of cpu's, memory modules, channels, and duplexed communications equipment such that episodes of preventive/emergency maintenance cause minimum disruption to remote users. This hypothetical model is, of course, the tightly-coupled configuration described earlier.

In summary, loosely-coupled architecture can meet availability needs of an RJE network only if the front-end is itself a tightly-coupled, substantially-redundant multiprocessor system.

Shared-spool HASP

As early as 1970, several large computer centers with multiple HASP systems considered how to create a single job stream environment for their batch users. Whether their communications equipment was attached to one computer or (more commonly) spread over several, their operations managers

were eager to manage a single job stream which would flow to various computers according to (a) current/imminent workloads, (b) availability of particular data sets and other hardware/software resources, (c) maintenance status of each mainframe, and—sometimes—(d) user requests for particular mainframes.

(In order to furnish a highly-reliable service, it is undesirable for users to specify a particular cpu in their JCL. However, an installation having a wide range of cpu's must acknowledge the special suitability of, say, a Model 195 for scientific jobs and a Model 145 for file processing. If a user requests the 195 for a two-hour run, perhaps his job should be held in queue if this

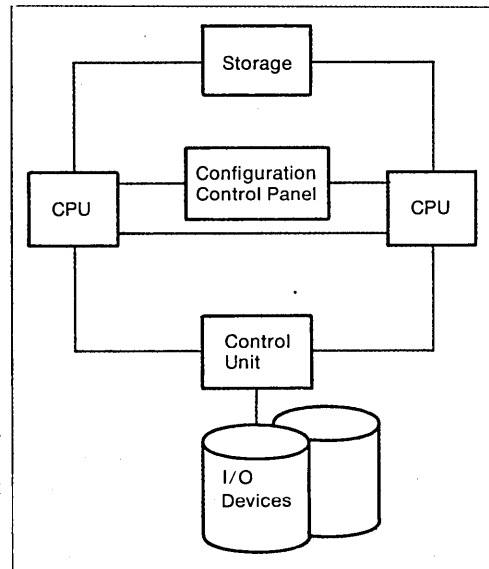

Fig. 1. Tight coupling, defined in IBM parlance as where two mainframes share the same main memory, is supported by IBM only for situations where the mainframes are of the same model. Since tightly coupled configurations promise greater resource availability and better cost effectiveness, they are expected to become more prevalent. Figure courtesy of IBM, from "Introduction to OS/VS2 Release 2," GC28-0661-1.

mainframe is fully loaded or undergoing maintenance, even if the 145 is idle.

(The problem of equitable charging for heterogeneous cpu, memory and i/o resources is quite difficult and chronically unsolved at IBM installations. Hence, a user seeking a least-cost configuration for his job must choose between (a) specifying a preferred mainframe and suffering sporadic turnaround delays, or (b) accepting a randomly-selected mainframe.)

By the late '60s, the principal computer center of the U.S. National Institutes of Health in Bethesda, Maryland already had several large System/360 computers running under HASP, with a fast-increasing workload of predominantly scientific batch jobs and various

UCC-6

**NOW, YOU CAN SAY GOODBYE TO
PDS COMPRESSION.**

***CALL 1-(800) 527-3250 AND
FIND OUT WHY.**

*Here's exactly what will happen when you call. One of our staff will take your name and address and immediately send you a brochure explaining exactly what UCC-SIX PDS Space Management is all about. (In Texas, call 214-638-5880 Collect.)

When you've seen how UCC-SIX can solve your PDS compression problems, call this number again. We'll arrange a presentation at your convenience.

UCC-SIX has made PDS compression a thing of the past in almost 50 OS installations because it:

- Automatically inventories and controls PDS disc space.
- Eliminates ABENDS and "dump and restore" operations caused by exhausted PDS disc space.
- Minimizes disc investment.
- Saves programmer and machine time.

UCC

We're going to
be the IBM of *software*
companies.

You can make it in the OEM systems business in 7½ seconds.

It takes only 2½ seconds if you have a push-button telephone. Because all you really have to know is the phone number for Microdata.

714/540-6730.

Call us and find out about the most powerful OEM computer systems on the market. Completely integrated systems. Computers. Disc drives. Tape transports. PRISM™ display terminals. Ready-to-use software. We make it all. So you get single-source responsibility, support and service.

And that's not all you get.

Our systems utilize microprogramming to give you superfast response time and total protection of your proprietary software. It helps that we've got

more experience in microprogramming than any other company in the world.

And our systems use a high-level block-structured language that can cut your coding, debugging and programming costs by more than half. Computer language is something we understand - we're the same company that developed ENGLISH™, the most advanced multi-user operating system in existence.

With our line-up of powerful OEM systems and in-depth support, we think we can help you make it.

Why not take a few seconds and find out.

Contact Microdata Corporation, 17481 Red Hill Avenue, Irvine, California 92714, Telephone 714/540-6730, TWX 910-595-1764.

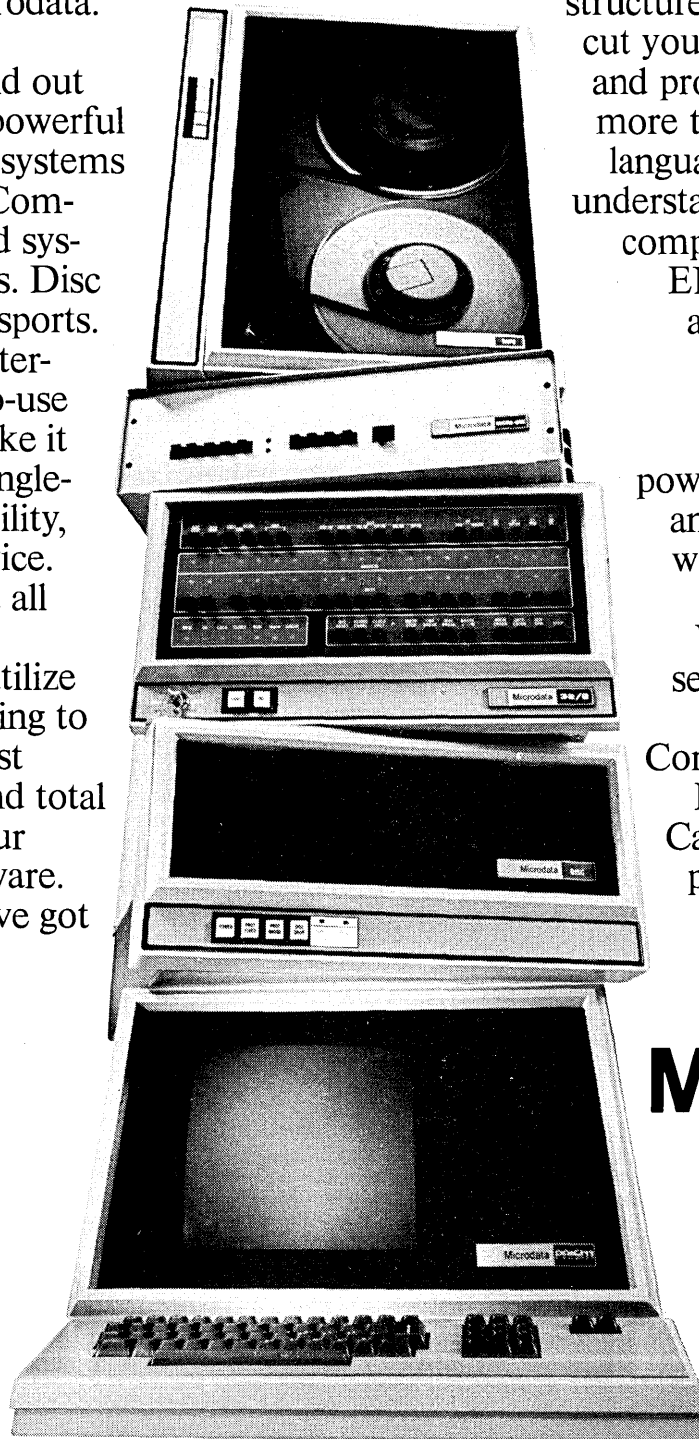

Circle for Immediate Need 36 and for Information Only 37 on Reader Card

Microdata

How 170 Of The World's Airlines Know When They're Coming Or Going:

INCOTERM®

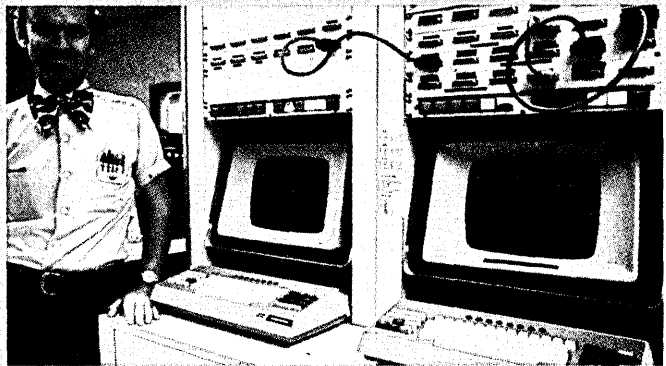

Aeronautical Radio, Inc., better known as ARINC, is the communication services arm of the air transport industry.

Among its principal functions are all handling, switching and processing of voice and data messages, both air-ground-air and point-to-point, for most of the airlines of the world . . . 170 of them. It all adds up to more than a million messages every day, making ARINC's the largest private message switching and processing system in existence.

To keep track of this complex system, and to perform a number of specialized functions within it, ARINC turned to INCOTERM. The ARINC mainframe feeds the airlines' processors at the rate of 2400 bits per second — about 3000 words a minute; ARINC uses INCOTERM Intelligent Display terminals to selectively monitor any of the many medium speed channels between the ARINC system and airline computers with which it interconnects. Through this monitoring function INCOTERM provides a powerful trouble-shooting tool to identify hardware, software, or transmission difficulties that may arise.

Elsewhere in the ARINC system, ground radio operators use INCOTERM as the input device that allows them to transcribe air-to-ground voice messages exactly as they are transmitted . . . information about fuel use, engine times, maintenance, pilot and crew scheduling, arrivals and departures.

INCOTERM was chosen for these jobs because of its powerful, built-in minicomputer. Tasks which previously required access to the message switching mainframe are now performed far faster, more simply and for less money right in the terminal. Utilizing the programmable capabilities of the terminal, many data entries can be represented by a simple keystroke. Departures/arrivals and other air-to-ground message data are recorded in the appropriate airline's computers — often thousands of miles away — almost at the moment they happen.

Because of ARINC, just about all of the world's airlines are relying on equipment from INCOTERM . . . whether they know it or not.

Of course, it was bound to happen eventually . . .

INCOTERM: More Power To Your Terminal.

INCOTERM®
CORPORATION

6 Strathmore Road
Natick, Massachusetts 01760
(617) 655-6100

For people who are torn between the heady savings of a distributed system and the comforting simplicity of a centralized computer utility...

Our meeting...THE CRISIS IN EDP ORGANIZATION: The Impact of Minis, Data Bases, and Distributed Systems

Choosing the right route for your company is tough — when you consider such hard facts as these . . .

A centralized system in a decentralized company can create big problems. But will you be able to explain the virtues of a *distributed* system to your management?

Setting up a centralized data base can save your company a lot by reducing data redundancy. But will your management balk at the high cost of keeping the data base up to date?

And virtual storage can certainly accommodate a company's future growth. But will your company *really* need that much storage capacity — even five years from now?

Our timely 2½-day CRISIS IN EDP ORGANIZATION briefing can help you with problems like these. It'll be held in Chicago, May 3-5, 1976.

As a special feature, the speakers will present in-depth case histories of actual firms that have set up different systems. Everything will be covered — hardware and software packages, costs, the role of outside consultants, and results. These studies will vividly illustrate the pros and cons of each system — and show you how others have dealt with *their own* crisis in EDP organization.

You'll also be interested in our TELEPROCESSING course, which runs in New York during April and in Chicago during June. Plus our 24 other EDP-related programs — which cover such areas as minicomputers, privacy legislation, project management, sys-

tems and procedures, EDP auditing, and microfilm systems.

Phone us for action. To register for the EDP organization briefing — or to get complete information on any of our valuable programs — phone Vern Lautner, our Management Systems Division Manager, at **212-586-8100, extension 514**. Or mail the coupon.

It'll be a start on the right route.



MANAGEMENT SYSTEMS DIVISION
The American Management
Associations
135 W. 50th St., New York, N. Y. 10020
Att.: Vern Lautner

- Please send complete information on Briefing Session #6333-04DA, THE CRISIS IN EDP ORGANIZATION: THE IMPACT OF MINIS, DATA BASES, AND DISTRIBUTED SYSTEMS, to be held May 3-5, 1976, in Chicago.
- Please register me for the above briefing.
- Please send information on your programs in the following systems areas:

Name _____

Title _____

Company _____

Street _____

City _____ State _____ Zip _____

6-7618X

WHEN YOU BUY A GOULD PRINTER/PLOTTER, IT'S A PACKAGE DEAL.

A Gould electrostatic printer/plotter is like two machines wrapped up into one neat little package.

It can do the work of a printer and a drum plotter. And it can do it fast, on-line. As much as 800 times faster than drum or pen plotters.

SOFTWARE IS EASY TO USE.

As important as powerful hardware is, we know that being able to talk to your CPU is just as important. So we give you easy-to-use software like our PLOT package which provides plotting and line printer emulation.

Plus direct on-line DMA interfaces for the IBM 360/370, NOVA/ECLIPSE, PDP-11 and HP 2100.

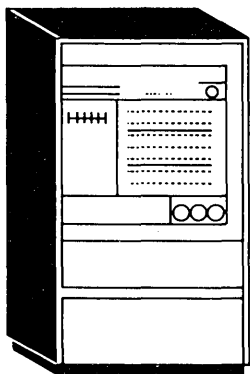

On-line operation-computer

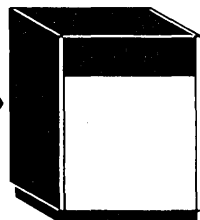

Controller

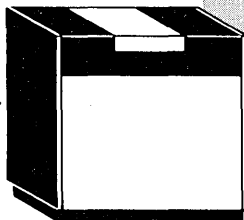

Gould printer/plotter

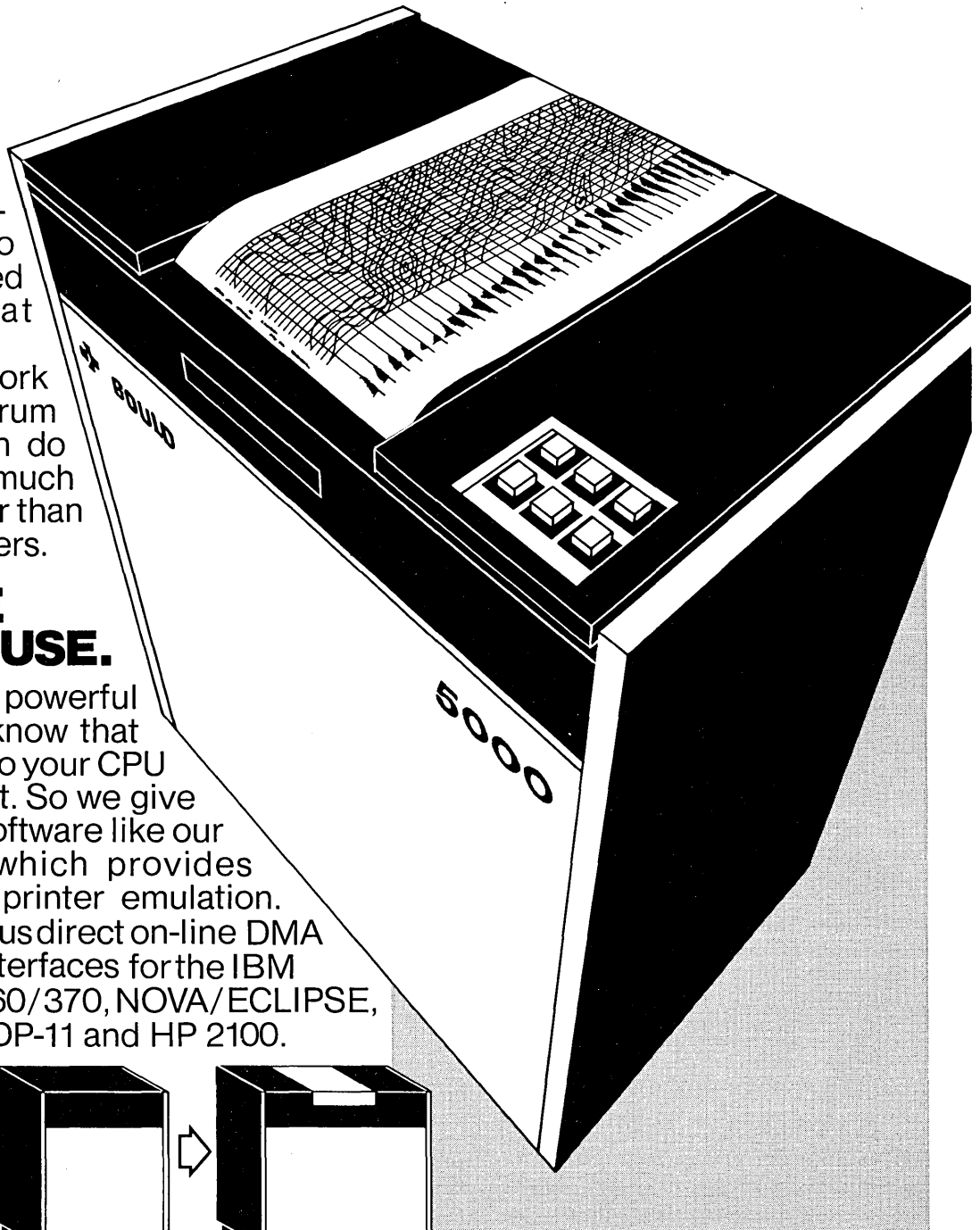

What's more, the whole package printer/plotters are installed as comes ready to go. Because Gould complete systems.

UNMATCHED GRAPHICS AND PRINT-OUT.

This is part of the Gould package too. Because with our patented-dielectric paper, toner head and matrix approach to getting dots on paper, you always get high-density, crisp, readable copy. Whether it's engineering or scientific drawings, charts or alphanumericics.

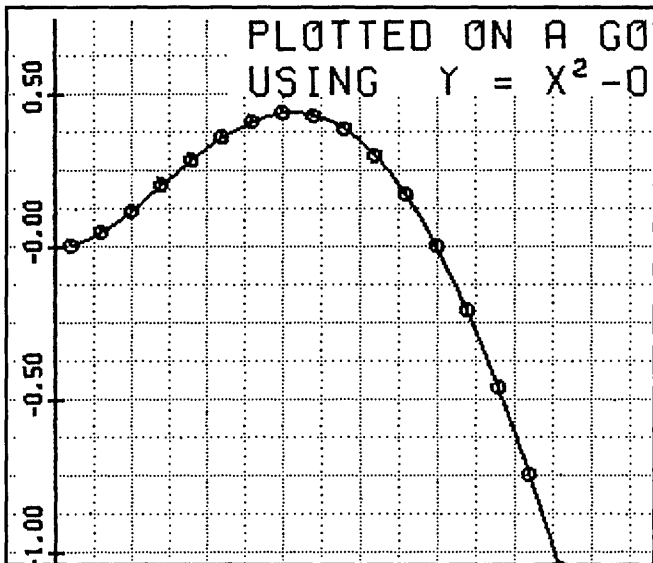

LATEST FINISH	SCHED. FINISH	SLACK	73
10/25/73		0.0	←
10/25/73		0.0	←
11/01/73		0.0	←
11/01/73		0.0	←
11/08/73		0.0	←
11/08/73		0.0	←
03/06/74		13.0	△
12/07/73		1.0	△
11/30/73		0.0	△
01/22/74		7.0	△

SYMBOLS AVAILABLE IN							
10	⊠	26	42	∞	58	†	74
11	*	27	∫	43	δ	59	‡
12	⊗	28	⊃	44	€	60	←
13		29	∨	45	η	61	×

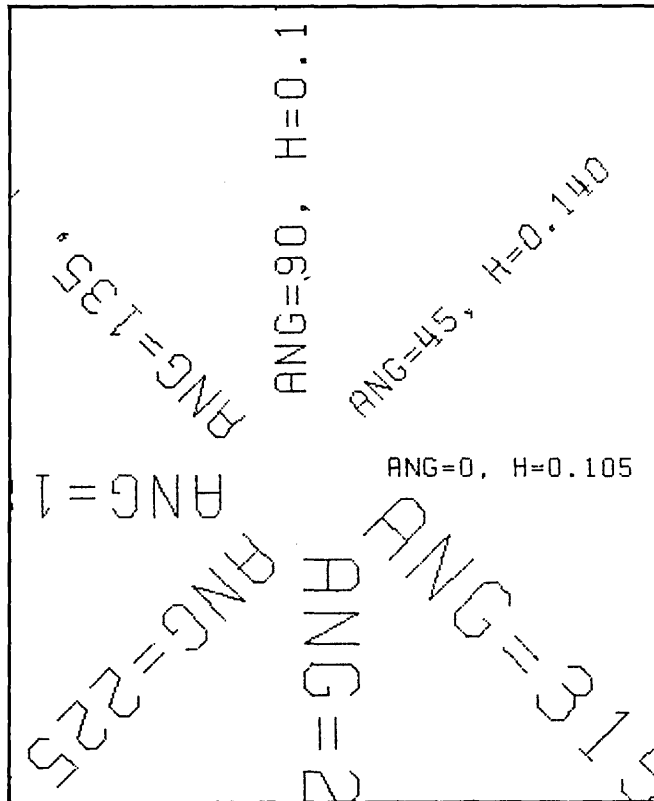
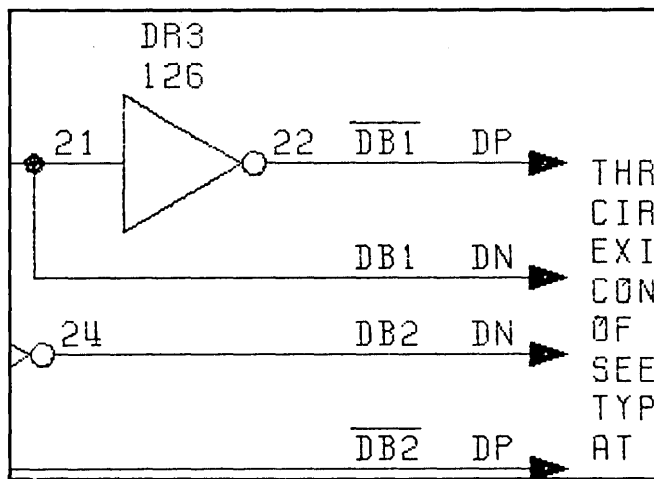

ALL THE SUPPORT YOU NEED.

Don't worry about equipment support when you deal with Gould. Our package comes complete with a service organization. Backed by Gould's own factory-trained service technicians.

So cut yourself in on a package deal. For our free color catalog, write Gould Inc., 3631 Perkins Avenue, Cleveland, Ohio 44108.



**FOR INFORMATION
CALL TOLL FREE (800) 648-4990.**

Why is David Craig smiling?

For one thing, he's solving his worldwide data processing problems by using DATA 100 products, including 15 KEYBATCH® data entry systems like this one.

David Craig is vice president of data processing at Texas-based Brown & Root, Inc., a worldwide engineering/construction firm. His problem is to coordinate the processing of data from sites around the world—from Singapore, London, Bahrain . . . and even Bagdad, Arizona.

He has DATA 100 systems installed in 36 such locations, and they communicate via satellite, or phone lines, around the clock with his central data center in Houston.

He's smiling because he gets quick answers to faraway job sites; he has rugged, dependable equipment; and DATA 100 service is available to him at 300 locations throughout the world.

In seven years of operation we've known many David Craigs. In fact, we have over 1,300 customers using our distributed

processing terminal systems worldwide.

Our products include:

- *The Model 74 KEYBATCH System*—High-speed key-to-disk data entry from up to 16 keystations at the job site directly into the processing stream.
- *The Model 77 Remote Entry System*—The low-cost programmed key-to-diskette communications device with one or two key stations for the smaller business data processing user.
- *The Model 76 Remote Batch Terminal System.*
- *The Model 78 Remote Processing System*—That accommodates a wide range of peripheral options to suit customer needs.

And we're easy to find . . . with marketing and service subsidiaries

in Australia, Austria, Belgium, Canada, France, Germany, Italy, The Netherlands, Spain, Switzerland, the United Kingdom and the United States . . . plants in England, Ireland, the United States . . . and distributors in Ireland, the Western Pacific and Scandinavia.

Put a smile in your operations, too. Contact Corporate Headquarters: 6110 Blue Circle Drive, Minnetonka, Minnesota U.S.A. 55343 (Phone 612/941-6500) . . . or International Headquarters: 111 Marlowes, Hemel Hempstead, Herts.HP1 1BB, England (Phone 0442/66511).

DATA 100
C O R P O R A T I O N
CIRCLE 67 ON READER CARD



MULTIPROCESSING

time-sharing and inquiry applications. Even prior to the first (1970) and second (1972) waves of System/370 announcements, it was clear that multiple large mainframes would be required by NIH indefinitely. Having selected the HASP front-end system, NIH was faced with the operational dilemmas already described. Together with other concerned SHARE members, NIH applied substantial pressure to IBM to support a shared-spool version of HASP.

IBM adamantly refused to implement shared-spool HASP, claiming that ASP was its exclusive support for loosely-coupled 360s. IBM pointed out that ASP already had—or would soon have—most of the operator-convenience and installation-management features of HASP. Unfortunately, ASP had much higher cpu overhead and resident-memory requirements than HASP.

During 1967-72, SHARE members competed intensely for IBM support and enhancements of these two front-end systems. At the same time, the main os/360 development group within IBM was energetically trying to im-

prove the functions and performance of standard Job Management, which was originally intended to meet all user needs and not to require the “crutch” of a HASP or ASP. Gradually during the 1970-72 interval, unenhanced os/360 Job Management lost out as a long-term competitor, as is evident from Table 1. The HASP-ASP rivalry became increasingly polarized and emotional, within IBM as well as among the SHARE and GUIDE memberships.

As IBM's support commitment vacillated between HASP and ASP, many in-

stallations switched from one front-end system to the other. For example, the Cornell Univ. Computer Center began with HASP in 1967, switched to ASP two years later, and seriously considered returning to HASP in the early '70s. (Cornell currently operates VM/370 on its 370/168, running a customized os/MVT subsystem in one virtual machine.)

One of the bellwether HASP installations, Stanford Linear Accelerator Center, also switched from HASP to ASP, concurrent with adding two 370/

Type	First OS/VS2 Release	Comments
Uniprocessor	1	
Tightly-coupled Multiprocessor	2	Two 158 or 168 cpu's (but not a combination). Performance typically twice that of single cpu with half-sized memory. Requires JES2 (HASP-like front end) for Releases 2 and 3 of OS/VS2, JES2 or JES3 thereafter.
Shared-spool Multiprocessor	3	Any number of cpu's (145 and above). Trivial throughput loss compared to decoupled systems. Requires JES2.
Channel-coupled Multiprocessor	4(?)	Requires one master cpu. Non-trivial throughput loss compared to decoupled systems. Requires JES3.

Table 2. Uniprocessor/Multiprocessor option of OS/VS2.

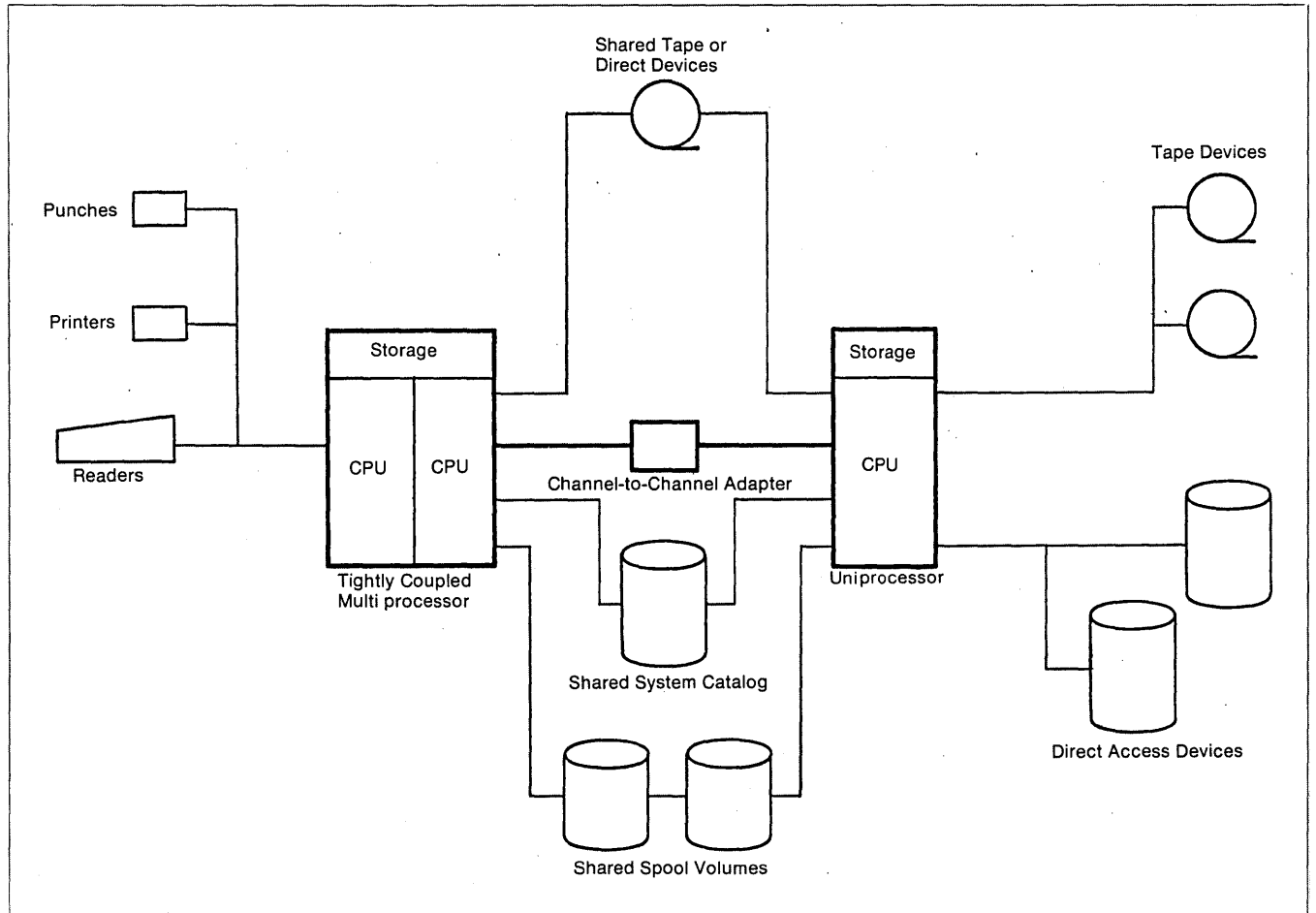
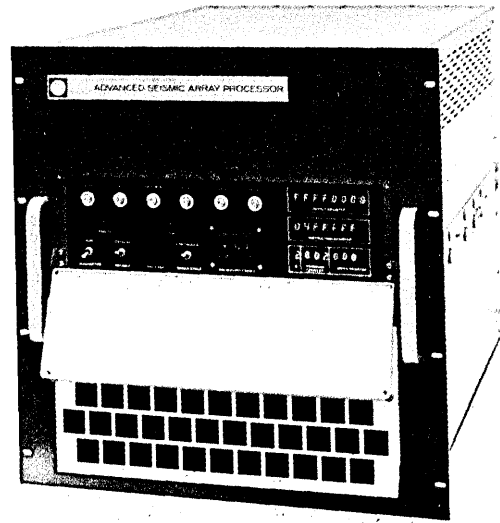

Fig. 2. Loose coupling, where the processors are connected through a channel-to-channel adaptor or where they share peripherals, or both, must be used if the cpu models are not identical. One or more of the cpu's in a loosely coupled configuration may actually be a tightly coupled pair (and in fact,

this is almost mandatory if the system is to provide high availability for an on-line terminal or RJE network). Figure courtesy of IBM, from "Introduction to OS/VS2 Release 2," GC28-0661-1.

advanced scientific array processor
really delivers...

ASAP^{TM†}



A 32-bit, floating point peripheral that can be used for FFT's, correlation, convolution, computation of Weiner filter operators and other array processing functions. ASAP is microprogrammable and includes a flexible memory structure that can be applied to your current and future applications.

ASAP accomplishes arithmetic operations in a fraction of the time required by the larger systems (a floating-point multiply and two floating-point adds in 430 nanoseconds; 100 point Weiner filter operators in less than 10 milliseconds), while accuracy is assured through the 32-bit, floating-point arithmetic and coefficient tables. Input data can be 16- or 32-bit fixed point or IBM 32-bit, floating-point format. Conversion takes place on input and output. The unit can be easily interfaced to a wide variety of CPU's.

DOES YOUR 360/370 NEED ADDITIONAL PROCESSING POWER?

ASAP can also improve the performance of large computer systems in many applications. For example, operating on-line with ESL's IBM 370-158, ASAP provides the processing speeds and capacity to perform high-volume signal analysis, 2-dimensional filtering using the FFT and related array processing functions, and the maximum likelihood classification algorithm commonly used in LANDSAT data processing.

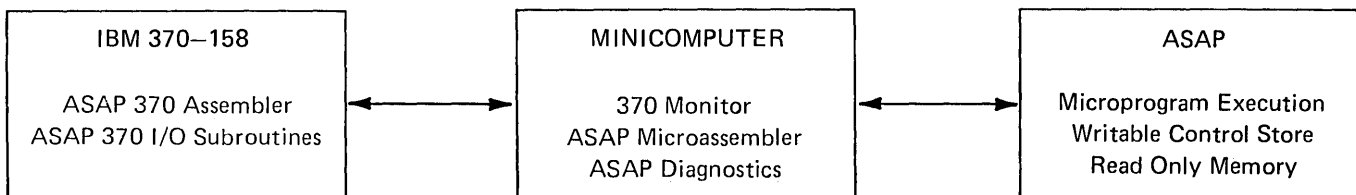

red indicates operating software modules.

†ASAP is a trademark of ESL Incorporated.



ESL Incorporated

495 JAVA DRIVE SUNNYVALE, CALIFORNIA 94086
PHONE (408) 734-2244 TWX (910) 339-9256

MULTIPROCESSING

168s to its 360/91. However, the principal migration was from unmodified OS/360 to HASP, as shown in Table 1.

NIH refused to accept ASP, due to its overhead and clumsy operator and user protocols. It implemented a shared-spool HASP approach. This effort required about six man-months and 2,000 lines of assembler code, almost entirely modifications to HASP.

This project was watched with great interest by other large HASP installations—and also by IBM development groups and the ASP user community. If the feasibility of shared-spool HASP could be demonstrated, would IBM officially support it? Would ASP users migrate to shared-spool HASP? How would its performance and availability stack up against ASP's and against those of IBM's competitors?

Subsequent to successfully implementing shared-spooled HASP, the NIH team began to export their code selectively to other installations. In the long-standing SHARE tradition, this code was distributed free and at the recipient's risk. Two years later, over a dozen major installations were using shared-spool HASP. Subsequent to the release of Version-4 HASP with OS/VS2, Mellon Bank of Pittsburgh updated the NIH code to Version 4. At present, 75 installations are using shared-spool HASP, and over 200 installations have requested the NIH or Mellon Bank codes.

IBM finally caved in to increasing pressure from multiple-cpu HASP customers in early 1974. Having promoted and defended ASP as its exclusive offering for loosely-coupled cpu's for nearly a decade, this was a major strategic change. IBM's delivery of a shared-spool, HASP-like system called "Multi-Access JES2" with Release 3 of OS/VS2 has reactivated the HASP-ASP competition, which today persists in the JES2-JES3 dichotomy.

Users now have three broad multiprocessing options within the System/370 line, as shown in Table 2 (p. 107). Tightly-coupled 158s and 168s are supported by Release 2 (and subsequent releases) of OS/VS2. Shared-spool configurations similar to HASP are supported starting with Release 3. ASP-like configurations have been supported by JES3 under OS/VS2 since late 1975.

The future

It is too early to detect trends among large System/370 users, but it seems reasonable to predict that:

- Almost all current HASP installations with multiple large mainframes will migrate to Multi-Access JES2.
- Most established ASP installations will migrate to JES3.
- IBM will try to "marry" JES2 and

JES3 over the next few years, selecting superior features from each system.

- Tightly-coupled configurations will become increasingly popular.

With IBM's "terminology decommitment" of their Future Systems line in mid-75, it is difficult to predict when and with what architecture IBM's next generation of large mainframes will appear. However, broad trends in cpu's, main memories, peripherals, and communications equipment seem to support the following speculations:

1. *Large configurations of 370s and the next generation of machines will typically have at least two cpu's tightly-coupled to an easily partitioned collection of memory modules, channels, and peripherals.*

This trend is evident in IBM's recent enhancement of tightly-coupled 158 and 168 configurations, whereby (a) main memories of varying sizes are permitted and (b) channels can be automatically switched among cpu's.

2. *Both tightly-coupled and loosely-coupled configurations will receive full OS support.*

Tightly-coupled configurations have long-term potential for greater cost-effectiveness and recoverability—self-diagnosis and automatic reconfiguration subsequent to central-hardware failures—than loosely-coupled configurations. However, many users already own or lease long-term their current 145s, 158s, and 168s; to support multiple different IBM mainframes requires a loosely-coupled OS, since identical mainframes are currently required for tightly-coupled System/370s.

3. *Channel-to-channel (CTC) architecture has an uncertain future versus the shared-disc approach.*

JES3 deviates importantly from ASP in this respect. Whereas ASP transferred SYSIN and SYSOUT data among cpu's over CTC's, as well as operator and job-management messages, JES3 uses CTC's only for messages. JES3 uses the shared-disc approach for spooling. In this respect, JES2 and JES3 have significantly converged.

Disadvantages of CTC's include their *bandwidth*—typically a single channel is used between two cpu's for all SYSIN, SYSOUT, and message traffic. Another disadvantage is their *synchronous operation*—one cpu cannot successfully send or receive data until the other responds. Should one cpu operate for prolonged intervals disabled for interrupts, the other cannot proceed with various vital CTC transmissions. A third disadvantage is its *volatility*—storing shareable data on disc provides inherent backup and ample queuing space, whereas data received over a CTC often requires subsequent capture on disc.

Advantages of CTC's include (a)

their low hardware cost, (b) their reliability, and (c) their low overhead for communicating short messages among loosely-coupled cpu's.

4. *IBM will ultimately offer a single OS for multiprocessor configurations, which can be subsetted and customized during system generation.*

The costs to IBM for maintaining distinct HASP-like and ASP-like front-end systems are substantial. The rivalry among proponents of these systems has become stale, no longer yielding competitive improvements. With Release 3 of OS/VS2, IBM has shown its capability to deliver a single control program which can be generated on site to support uniprocessors, tightly-coupled multiprocessors, and loosely-coupled multiprocessors with a HASP-like front end. It is only a matter of time until IBM announces an "ASP-like" front-end option for this same control program—although its syntax and internal design may move significantly closer to HASP and JES2.

5. *External specifications and the general architecture of this surviving OS will be continued into the next generation.*

IBM and user experiences with OS/360, HASP, ASP, OS/VS2, etc., demonstrate amply that users dislike migrating among operating systems and associated front-end subsystems. The successful approach of sharing disc drives—soon, trillion-bit storage facilities as well—among several mainframes will probably be continued into the next generation, serving as the primary interchange point for SYSIN and SYSOUT data, control tables, and resource allocation and measurement tools among all mainframes. *



Dr. Freeman has been in data processing for over 20 years. During his career he was a manager of various OS/360 and DOS/360 projects while at IBM's Development Lab in Endicott, development manager for the Triangle Universities Computation Center, director of computing activities for the Univ. of Pennsylvania, and director of university computing and information processing at Rutgers Univ. He is now a senior associate at Ke-tron, Inc., Wayne, Pa.

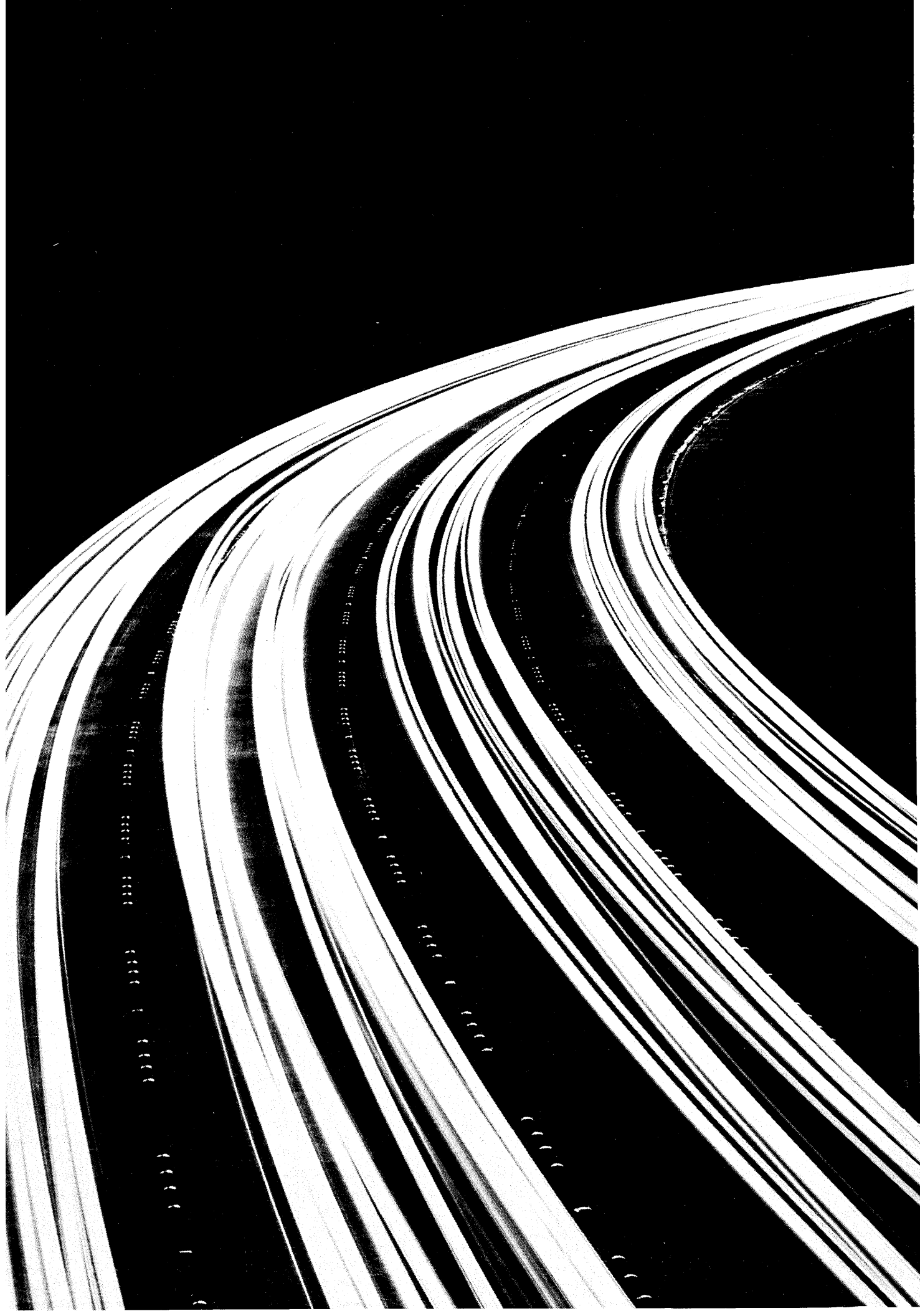

Build your timesharing system like a freeway.

The BTI 4000 interactive timesharing system offers you an orderly, straightforward way to grow. It's available in 16-port increments, from 16 to 256 ports. And adding ports is like adding lanes to a freeway: all the original equipment is retained, and a complete parallel system is "plugged in." Port capacity is doubled, tripled, or more.

This efficient approach to growth is made possible by BTI's unique mass memory data bus, which allows "clustering" of systems to share processor and mass storage resources.

Just as a driver can use any lane on the freeway, your users can be handled by any available port in the system. To each user, the clustered system looks like a single system.

System mass storage can be expanded just as simply. The minimum storage is 5 million bytes and maximum capacity is over 4 billion bytes. You can expand in increments of 2.4, 36 or 73 million bytes.

Users will appreciate the capability of the 4000's BASIC-X language—a powerful extension of BASIC created and continually improved in response to timeshare users' needs.

BTI 4000. Expandability from 16 to 256 ports. Software a programmer can love. 10¢ per terminal hour ownership costs—including 24 hour service availability.

Get all the facts on our system before you buy or lease any system.

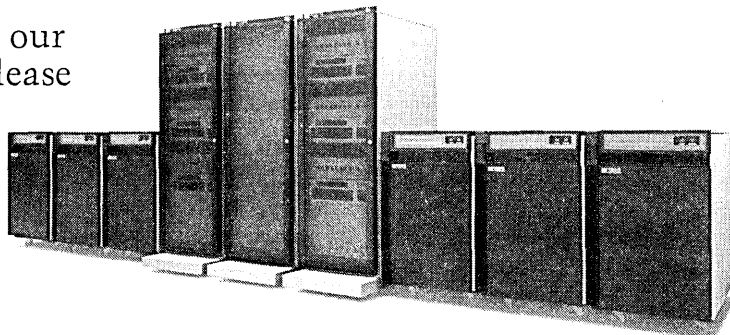

BASIC Timesharing

Timesharing systems built by the company with timeshare experience.

Home office: 650 North Mary Avenue, Sunnyvale, California 94086. Sales offices: East: Cherry Hill, New Jersey (609) 795-2334; Southeast: Atlanta, Georgia (404) 433-0900; Midwest: Schaumburg, Illinois (312) 882-2111; West: Sunnyvale, California (408) 733-1122

March, 1976

CIRCLE 16 ON READER CARD

111

HIPO for Developing Specifications

by Martha Nyvall Jones

The code was muddled. There were layers of modifications. And no written specifications were available. In other words, it was a normal situation.

A precise definition of user requirements is essential to the development of a correct data processing system. Too frequently, the contents of specification packages are fuzzy, inaccurate, and incomplete, resulting in systems with these same characteristics. Imagine, then, undertaking a dp project with *no* written user specifications, yet delivering a quality system which meets user requirements in all respects. This may seem impossible, but it has been achieved using a technique known as HIPO to develop and document system specifications.

Before examining the methodology of HIPO, consider conventional modes of defining requirements. Ideally, the user, perhaps assisted by dp personnel, prepares a specification package. This describes what the system is and what it is to accomplish. Requirements for input, output, stored data, logical processing, control, testing, performance, and documentation are detailed. These completed business specifications are accepted by dp, which now assumes project responsibility. A systems analyst transforms the business specifications into system design and programming specifications. The latter are delivered to programmers for implementation and coding. This is a sound approach to specification development.

- Often a user has neither the time nor the experienced personnel to produce adequate business specifications. In the extreme, the user may not be able to produce *any* written specifications; therefore, using the traditional approach, system development would never begin.
- In seemingly complete specifications, omissions may not be discovered until programming has been finished, causing costly modifications.
- Misunderstanding specification detail becomes more likely with each level of interface between the user and the programmer. If these misunderstandings are not corrected early in the development cycle, built-in programming errors are

the consequence.

- Users may not gain many of the possible benefits of a proposed system. If they do not understand data processing, users may not request valuable output which could be readily obtained at little or no additional expense.

A better means of deriving statements of user requirements is needed, one which ensures that the statements are complete and correct. HIPO fulfills this need.

What's a HIPO?

HIPO is an acronym for Hierarchy plus Input, Process, and Output. It is a method of graphically describing a software entity such as a system or program as an arrangement of functions to be performed. Primarily developed for design and documentation purposes, HIPO has evolved as part of the Improved Pro-

The users remarked that this was the first time they had understood how their system worked.

gramming Technologies which include Structured Programming, Top-Down Development, Chief Programmer Teams, Structured Walk-Throughs, and Development Support Libraries.

The hierarchy portion of HIPO involves a tree-like structure similar to an organization diagram (see Fig. 1, p. 114). It is composed of functions or actions. Each function on the hierarchy is represented as a box and can be described within that box as a verb (action) and an object (data affected). The verb-object format thus names as well as defines the function.

The top box on the hierarchy describes the entire piece of software in terms of a single function. Each level below is a subset of the function above it. This hierarchy of functions is created by a technique known as functional decomposition, where a function is exploded into increasingly lower levels of detail until all subfunctions have been defined. Determining the main function of the software, decomposing it into a hierarchy of subfunctions, and naming

the subfunctions is not a trivial exercise. It requires a great deal of insight, creativity, and experience on the part of the designer.

Every box on the hierarchy has a corresponding IPO (input, process, and output) diagram. The IPO provides a visual description of what takes place within each box. In producing the IPO diagram, any conditions for the execution of subfunctions are evaluated; thus the performance of subfunctions is controlled.

Top level functions on a hierarchy contain the control logic. They determine when and in what order lower level functions are to be invoked. They consist primarily of CALLS, PERFORMS, DO loops, and IF-THEN-ELSE statements. Lower level functions are the workers; here sequential coding statements are predominantly found.

For illustration, let us consider the construction of HIPO's as a design aid for an inventory control application where specifications do exist. The user requires that orders received from customers be processed against an inventory master file to reflect the day's business on product inventory. During this process, inventory master records are to be updated to show new quantities on hand. Back order situations and reorder requirements are to be identified, sales statistics updated, and a report showing the day's activities printed.

Again, see Fig. 1. The top box of the hierarchy is named "Maintain Inventory Control." This states what function the total piece of software is to perform. The name chosen should encompass all subtasks while limiting the program to *only* those subtasks. "Maintain Inventory Control" can now be broken down into three subfunctions: one devoted to getting the input, one devoted to processing the input, and one devoted to producing the output. Therefore, a possible set of first level subfunctions might be "Gather Inventory Data," "Update Inventory Master," and "Produce Order Status Listing." Each of these subfunctions must now be examined as a prime function and further subdivided as shown.

An example IPO for the function "Update Inventory Master" is presented in

Little Moe.

Codex launches the mightiest modem series yet.

There's nothing like it for bringing data into a port.

Little Moe. The new Codex LSI family of high speed data modems that combines LSI technology with proven Codex operational performance, to produce a fleet of third generation modems unmatched for versatility, dependability, reliability and performance.

Choose from eight mighty little modems: the Codex LSI 9600, LSI 7200 and LSI 4800 for point-to-point, full-duplex circuits with all the options and diagnostics you expect from the high speed modem leader...



The revolutionary LSI 96FP, LSI 72FP and LSI 48FP "Fast Poll" multipoint series mates outbound speeds of 9600, 7200 and 4800 bps with a speedy 9 msec RTS/CTS delay at 4800 bps inbound, to produce the optimum in multipoint system response time and throughput...

The LSI 48I CCITT V.27 compatible units let you go full speed ahead when you operate

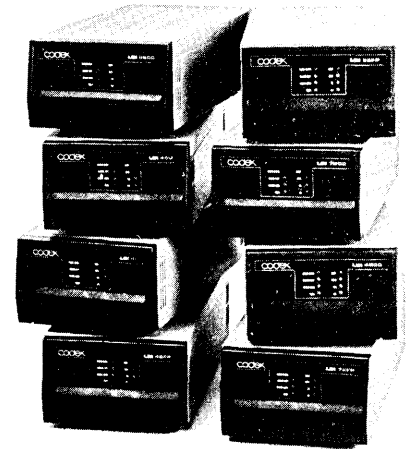

point-to-point or multipoint in international waters... the LSI 48D gets you reliably past the shoals when you navigate on the DDD network.

Little Moe is supported with a new wave of optional network diagnostics. The Circuit Quality Monitoring System (CQMS) combines five standard test and diagnostic functions into a single package for complete central site control. The Multipoint Network Control System (MNCS) provides monitoring, test and restoral functions for the ultimate in multipoint network performance.

Drop Codex a line. Find out how Little Moe can pilot your data communications network safely, reliably and economically.

member of
IDCMA

Codex Corporation, 15 Riverdale Avenue, Newton, Massachusetts 02195, (617) 969-0600, Telex: 92-2443

Codex Europe S.A., Bte 7/Av. de Tervuren 412, B-1150 Brussels, Belgium, Tel: 762.23.51/762.24.21, Telex: 26542

March, 1976

CIRCLE 38 ON READER CARD

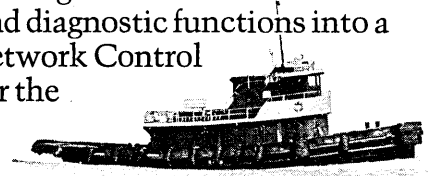

codex
We'll get you through

Fig. 2 (p.121). Data fields from the inventory master are prefixed by M, those from the order transaction by O. QUANTITY-AVAILABLE is an internal data field. Note that QUANTITY-AVAILABLE is transformed within this function. The way it is transformed is dependent upon the contents of M-ON-HAND and O-QUANTITY REQUESTED. The subfunctions "Reduce Inventory On Hand," "Update Total Sales," and "Revise Activity Date" are performed sequentially; "Determine Quantity Back Order" and "Calculate Reorder Requirements" are executed conditionally.

HIPO was successfully employed in an entirely new area, specification development, in a real life situation at the John Hancock Mutual Life Insurance Co. in Boston, where a pilot project using all of the Improved Programming Technologies was recently completed. This project was the redesign and rewrite of the complex calculation portion of an existing Payroll System for District Agents, along with several interface programs. The current system had been modified to the point that it was a hodge-podge of processing—prone to error and largely unintelligible even to the most experienced programmer. With contract negotiations soon to take place, it was essential that a correct and maintainable system be developed within seven months.

No written specifications were available and the old programs could not serve as a source of information for the new design because of the muddled code and the large number of modifications requested. Some other method of approaching the problem was obviously needed.

Since HIPO and functional decompo-

sition were to be used in designing the system, it was decided to use the concept of "function" as a means of investigating and documenting user requirements. Because this was a pilot project and the techniques were untried by the programming team, there was uncertainty as to exactly what a function was.

A way of determining the functions of the system was found. Over approximately two months, a series of one-to-two hour biweekly meetings was held. Attendees included the chief and backup programmers on the project and three individuals from the user area. Early meetings had no set format, and the discussion dealt with generalities of the system. From the discussions a list of probable functions was formed ("reduce inventory," "update sales," etc.). Future meetings concentrated on these probable functions one at a time. In most cases, presumed functions proved to be valid functions.

At the conclusion of a meeting, another function was selected for the following meeting. This allowed the users to gather specific details concerning the function to be examined. By focusing in-depth on one function at a time, all present could explore and absorb a small comprehensible portion of the system.

Immediately following each meeting the chief programmer documented in prose the details of requirements defined during the discussion. Later, the chief, assisted by the backup, created a mini-hierarchy and IPO's depicting the function discussed and any subfunctions. As more and more functions were determined, relationships between them appeared.

It was then possible to arrange the small structures into a larger hierarchy and to define controlling upper level functions. With the completion of the hierarchy and IPO's, not only had sys-

tem requirements been defined, but the design had been simultaneously accomplished! The HIPO's were refined, and Structured Walk-Throughs of the design were held with the users and the full programming team. Level by level the HIPO's were examined from the top down to ascertain that all functions were present and the details of input, processing, and output were correctly interpreted. This specification development and design phase of the project required approximately 4½ months or about two-thirds of the system development life cycle. After this intensive design effort, coding and testing progressed easily and quickly.

With minor modifications, the requirement statement IPO's were refined into design IPO's which became programming IPO's and finally, documentation IPO's.

The project was completed and went into production on schedule and under budget. The resulting program contained 18 modules and approximately 11,000 lines of code. The programming techniques fulfilled expectations, producing a quality piece of software that is well documented and is now being easily maintained.

The program has been modified at least every other week since it was put into production in May 1975. (These modifications were required as the result of contract negotiations with the union.) Some of the changes have been minor ones involving less than 10 lines of code. Some have been extensive, including one of 772 lines.

Updating the documentation IPO's for this application has been rather difficult because the changes have been so frequent. Under these conditions, maintaining any form of documentation is difficult. In our case, a librarian, a person with clerical rather than program-

(Continued on page 121)

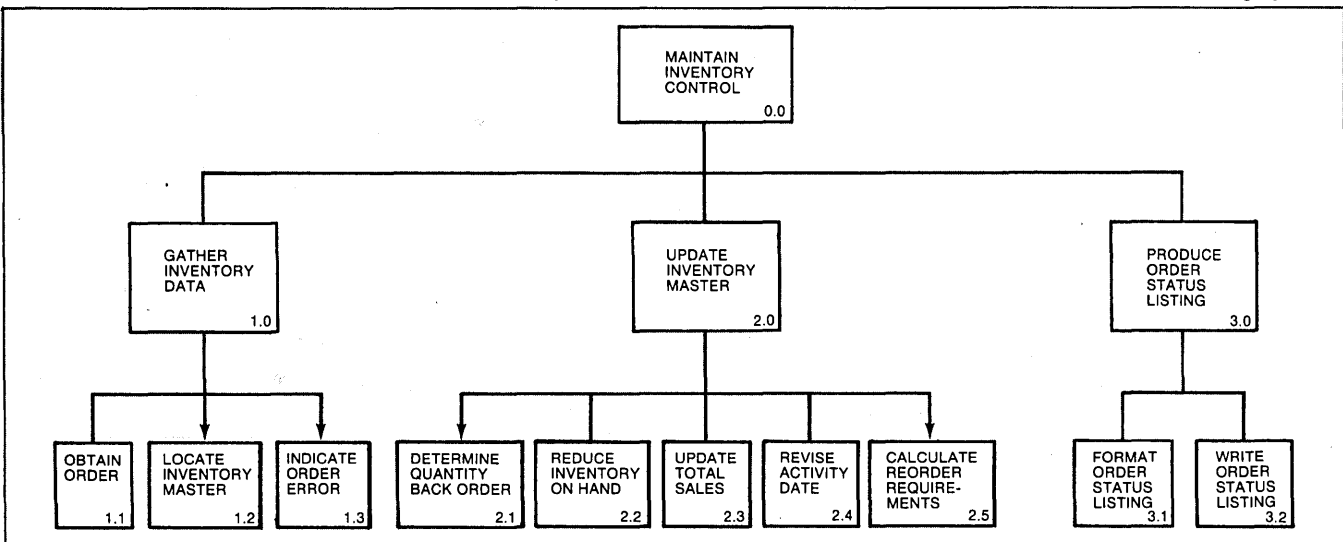

Fig. 1. Part of the process of creating requirements specifications through Hierarchical Input, Process, and Output, is defining the basic functions to be performed and decomposing those functions into subfunctions. In the real world, such definition often isn't done

neatly from the top down. But that's fine; HIPO allows for starting in the middle and working up as new functions are defined or discovered. (The arrow heads point to modules which are conditionally executed.)

HEWLETT-PACKARD

COMPUTER ADVANCES

TESTING GETS DOWN TO BASIC

Test automation can be too much of a success. Suddenly everyone wants time on the computer.

Up to now that has meant buying more minicomputers—or letting your project wait.

Not anymore. Now there's a simple, economical alternative.

Hewlett-Packard has just introduced Multi-user Real-time BASIC, a programming language that can let you implement multiple stations for compo-

nent and product testing or control applications on a small computer.

Yes. You can now put more terminals on your existing 2100 or 21MX minicomputer. With concurrent access to programs, instruments and peripher-

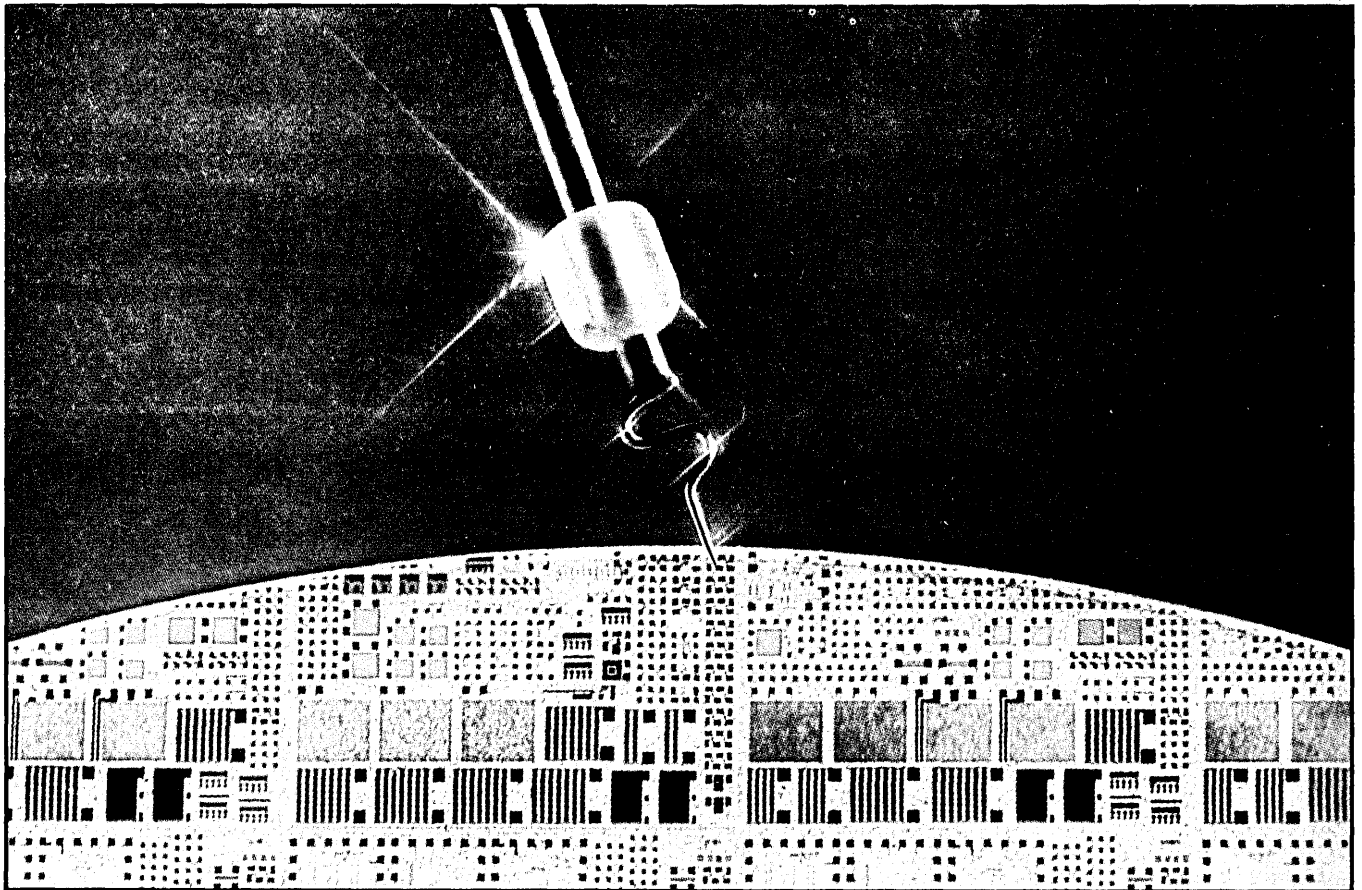

HP's new edition of BASIC provides the instructions needed to automate sensors or quickly generate tests for complex products such as the IC's shown above.

**BASIC
Continued**

als, and additional work stations, it's realistic for you to expect to multiply work throughput.

Designed to work in conjunction with Hewlett-Packard's RTE operating systems, this new version of BASIC is specifically oriented to the real time environment. It has the fast response, automatic scheduling and built-in instrument calls you need to simplify control of real time activities.

Naturally, it retains the comfortable "friendly," simplicity associated with BASIC. Technicians can use its conversational programming mode

to generate their own programs. They don't have to delay their own work waiting for outside programming help.

There's a bonus, too. Real-time BASIC can call up routines in FORTRAN, ALGOL or assembly language,

**FOR THE FIRST TIME-A
SYSTEM THAT PROVIDES
REAL-TIME CAPABILITIES TO
MULTIPLE BASIC USERS.**

allowing a brief subroutine to deal with those test situations that call for extremely high-speed multiple measurements. These subroutines can be added or modified on-line without interfering with other users.

Now you can expand your minicomputer application to serve more of the demands being made on it. Now, the same minicomputer can concurrently be serving production line Q.C. test functions, helping you develop new products and working on the development of new programs.

Too good to be true? There's a simple way to find out. Just check "A" on the attached card. [A]

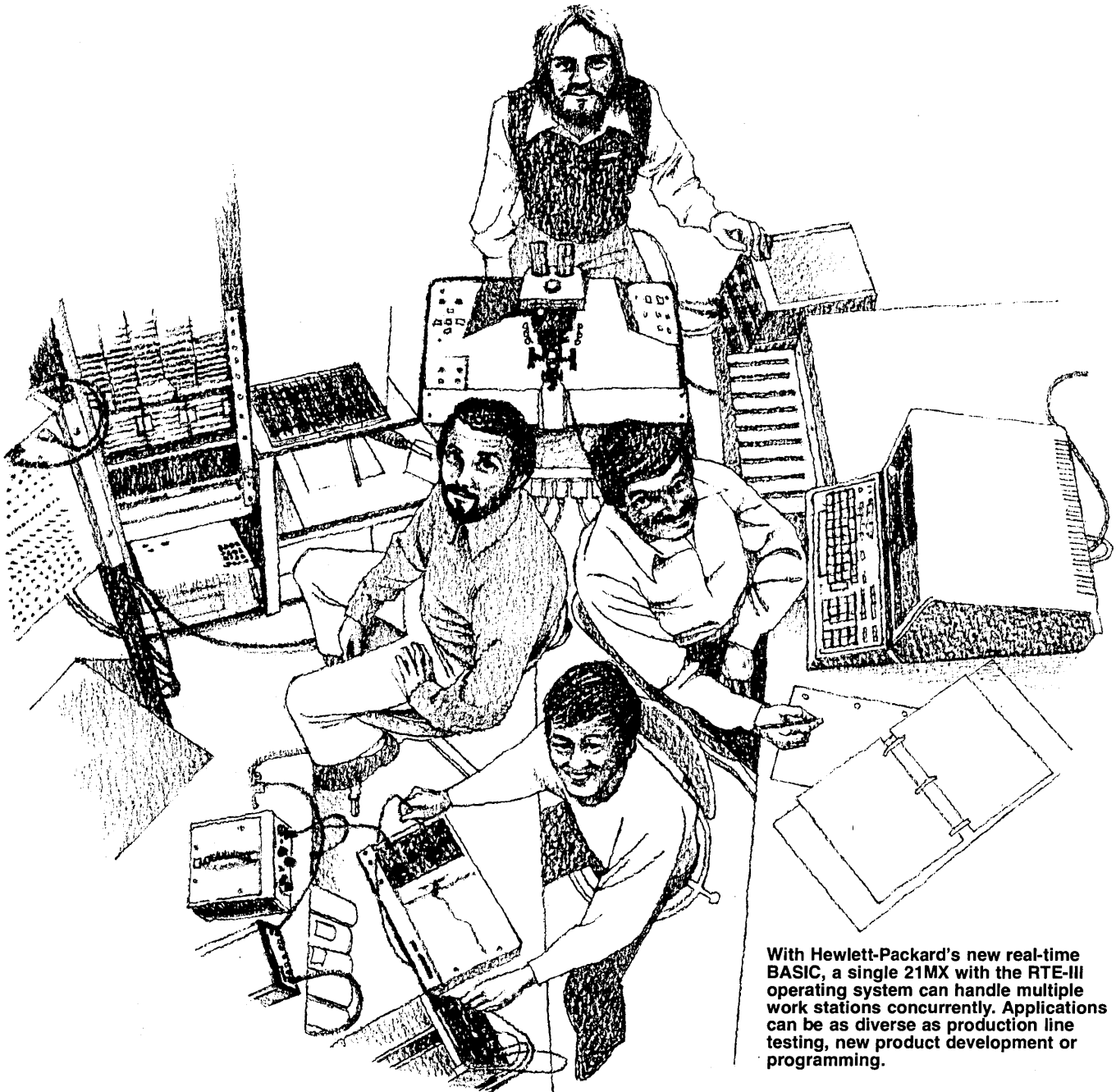

With Hewlett-Packard's new real-time BASIC, a single 21MX with the RTE-III operating system can handle multiple work stations concurrently. Applications can be as diverse as production line testing, new product development or programming.

INNOVATIONS IN TECHNOLOGY

TWO NEW TERMINALS & CUSTOM CHARACTER SETS

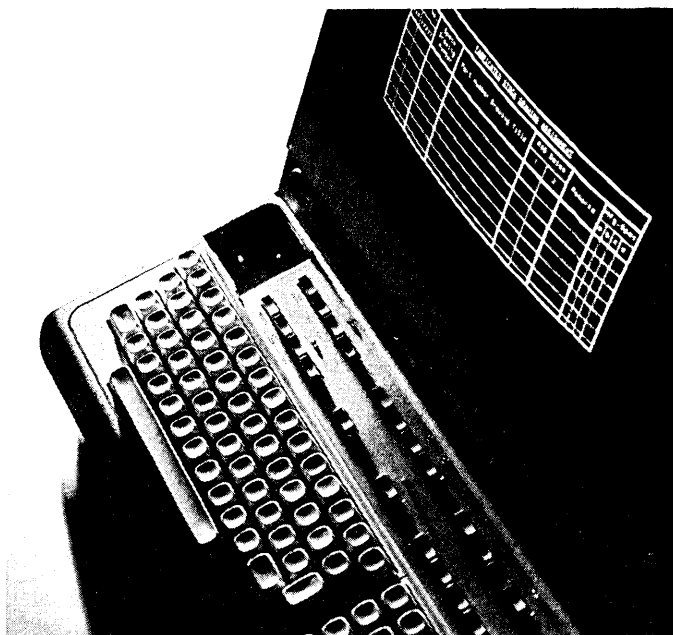

Hewlett-Packard terminals' high-resolution 7x9 dot matrix and half-dot shifting capability permit smoother, more readable characters and continuous line segments to be displayed.

Two new terminals take the flexibility of plug-in technology a step further, providing a bilingual capability that extends right down to the keyboard. At the flip of a switch, the 2640C displays the Russian Cyrillic alphabet, the 2640K the Japanese Katakana alphabet.

In both terminals, not only is the second language actually marked on the keyboard, but the letters are placed on the keys on which native users of the languages expect to find them. Special training for special keyboards is unnecessary.

Another flip of the switch, and the keyboard and display convert instantly back to English.

And now you can design your own character sets. HP's new Character Set Accessory Kit makes it possible to generate special symbols for unique applications. For example, special symbols such as those often used in the sciences can be generated to make the terminal "speak the language" of your application.

Simply fill in a dot matrix work-

sheet with your character design and translate it into a bit format suitable to have converted into a PROM which is then mounted on a PROM Character Board.

Like our off-the-shelf 128 character Roman set, our 64-character math set and our 64-character line drawing set, your original creation sim-

ply plugs into your Hewlett-Packard terminal. In fact, our standard sets were created using the same kit now available to you.

For more information on the 2640K, the 2640C or the "how to" of do-it-yourself character generation on either 2640 or 2644 terminals, check "B" on the reply card. 

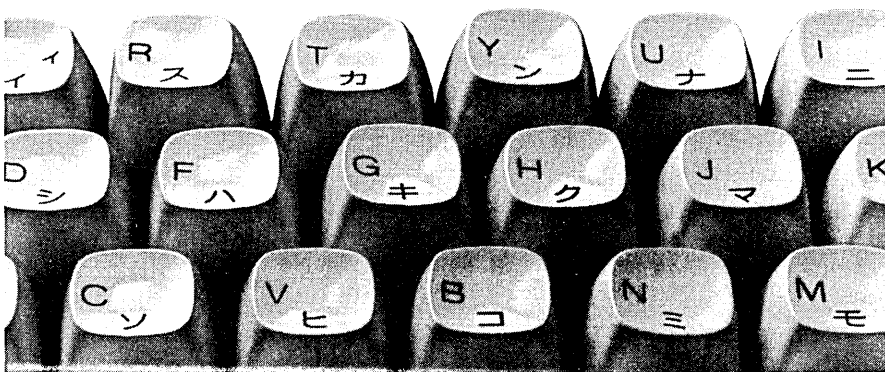

The two new members of HP's terminal family change languages at the flick of a switch: English/Russian and English/Katakana (Japanese).

FIND NAME IS SMITH

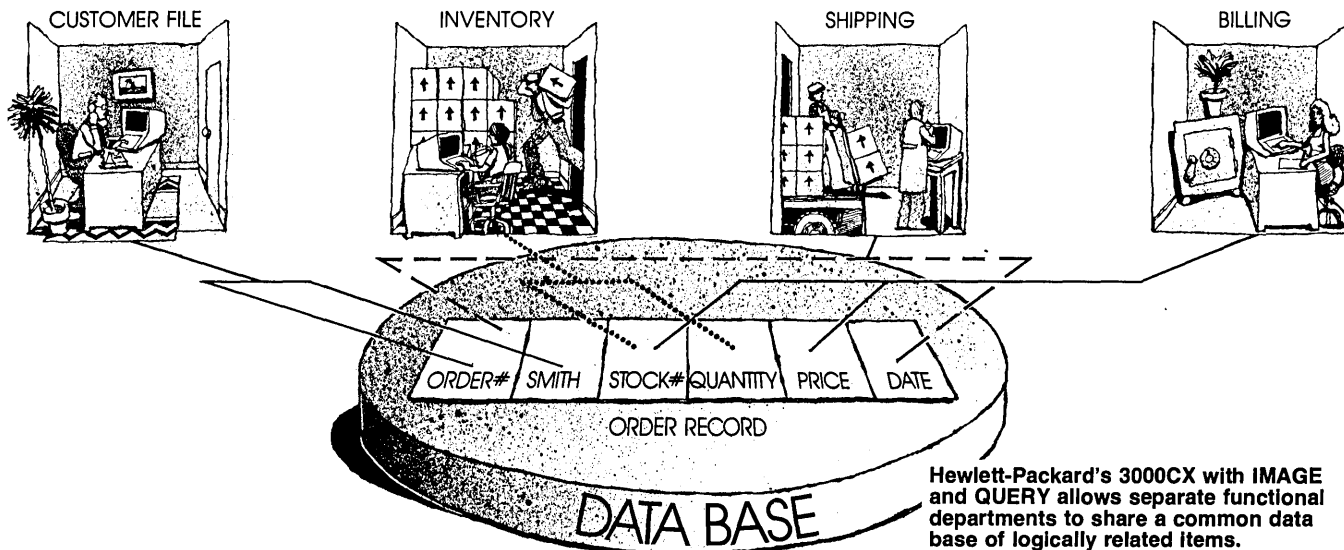

Hewlett-Packard's 3000CX with IMAGE and QUERY allows separate functional departments to share a common data base of logically related items. "Chained" access on key data such as order number eliminates time-consuming sequential searches.

Advanced Computer Architecture & Sophisticated Software Make Data Base Management Possible

Mr. Smith lives in half-a-dozen places simultaneously in most computer systems. There are his name and address, his current orders, backorder data, possibly a record of activity on his account to date, billing information, discounts he is entitled to—with much of the same data in multiple individual files.

If you wanted to pull together all your information on Mr. Smith, it would certainly take a considerable programming effort.

You couldn't just walk up to one of several terminals on a small computer and type in "Find name is Smith" without doing some application programming beforehand. But with a Hewlett-Packard 3000CX computer, that programming is provided by QUERY, designed to let people find information they need for planning and for reports without being computer programmers.

On a small computer, that's quite a breakthrough.

It took a combination of advanced computer architecture and sophisticated software to make it possible. QUERY, in fact, is an extension of an innovative Hewlett-Packard Data Base Management System called IMAGE.

IMAGE eliminates redundant data, by eliminating redundant files. In the process, it also reduces the errors that creep into information that must be kept and updated in many places.

Instead of being shackled to its point of origin, order department, shipping, accounting or whichever, all data is entered and accessed in a single

data base.

Safeguards are provided to prevent the wrong people from changing or accessing information. For example, any department might be able to access Mr. Smith's name and address, but only the order department would be able to change the quantities on his order; only accounting could access his discount rate.

Here's how it works. For those who manage the system, IMAGE provides a simple "Data Base Definition" language that allows them to set up network relationships by arranging data into "master" sets and "detail" sets. With these relationships established, IMAGE employs partially inverted file structures that allow rapid retrieval of linked data without running up computer "overhead" maintaining large indices. Because master data sets can share detail data sets, the data is available for many applications.

As a company's needs grow, IMAGE provides still another benefit. Data structures can be expanded or modified *without* reprogramming existing applications.

To minimize search time, IMAGE provides four distinct access methods. And since IMAGE interfaces on the CALL level with multiple host languages (COBOL, FORTRAN, RPG

and SPL), programmers can use the system without compromising on the language that is best for the application. A comprehensive set of standard utilities allows the user to simply create, utilize, back-up, restore or restructure the data base. Batch and terminal modes can be used concurrently for optimum throughput.

QUERY picks up where IMAGE leaves off to put the data base directly into the user's hands. Simple, English-like commands, such as "Find name is Smith," allow you to retrieve all data linked to a specified key value with a single command.

Similarly simple commands allow users to search, sort, report, update and delete records at a terminal without interfering with other concurrent terminal users or batch operations.

Further, QUERY makes spontaneous, unanticipated reports convenient and affordable. It not only extracts data from the system, it can also format it, complete with titles, column headings, automatic page numbering, plus automatic totals, sub-totals and averages—with entries sorted by as many as five fields!

Computers have always promised more than just a faster way to add and subtract numbers. Thanks to the Hewlett-Packard 3000CX, that "more" is no longer limited to the costly capabilities of large-scale computers. A checkmark at "C" on the attached card will bring you the whole, surprising story. Once you have read it, we think you'll find it hard to settle for a computer that does less at any price.

HEWLETT  **PACKARD**

Sales and service from 172 offices in 65 countries.
1501 Page Mill Road, Palo Alto, California 94304



22653

HIPO

ming background, produces the new documentation. The functional design has made this updating easier, since only the functions (and hence IPO's) affected by the change require updating. This is not true of a process oriented flowchart.

In addition, the experience offered valuable new insight regarding HIPO. *It was discovered to have demonstrated significance as a tool for developing specifications.* User reaction to HIPO was enthusiastic. The design Walk-Throughs of the hierarchy and IPO's assured the users that all requirements were defined. They even said that this was the first time they had understood how their system worked.

Getting into it

If obtaining an adequate definition of requirements is a problem in your organization, HIPO may be of help. Before experimenting with this method, certain preliminary steps should be taken.

- Gain the support of top management in both the dp and application areas. Make certain they understand and approve the use of HIPO for requirements development.

- For best results, use all of the Improved Programming Technologies. The techniques are interdependent and complementary, therefore the synergetic effect is realized by employing all the parts. If for some reason all of the techniques cannot be used, the Chief Programmer Team and the Development Support Libraries may be eliminated. These organizational techniques are supportive, while HIPO, Top-Down Development, Structured Programming, and Structured Walk-Throughs are so mutually dependent that it is almost impossible to isolate their use.
- Carefully select the first project. It should be of moderate size and complexity with an estimated development period of six to nine months. More benefits can be gained from the experience if the completion date is not critical.
- Expect an altered development cycle. Specification development and design will be taking place concurrently. Good functional design is a complicated and lengthy process, but it will result in much less time spent coding and testing.
- Assign project responsibility, including requirements development and design, to a capable and willing individual. A chief program-

mer should have both technical and managerial abilities and should be able to communicate and interface effectively with users, management, and team members.

- Thoroughly train team members, through formal education if possible, in the use of HIPO, functional decomposition, and any other programming techniques to be employed in the project.
- If available, obtain the consulting services of an individual experienced in the technologies. Functional decomposition is a difficult concept to understand, and the assistance of an expert during the critical requirements development and design phase is well worth the expense.

Once the project and personnel have been selected, the following guidelines can be observed by the chief programmer or designer to get started.

- Request that the user allow you to observe and investigate any existing manual procedures in order to acquire an introductory understanding of the proposed system.
- Set up a regular series of meetings with the user. Keep them short (approximately 1½ hours) and frequent (two to four per week).

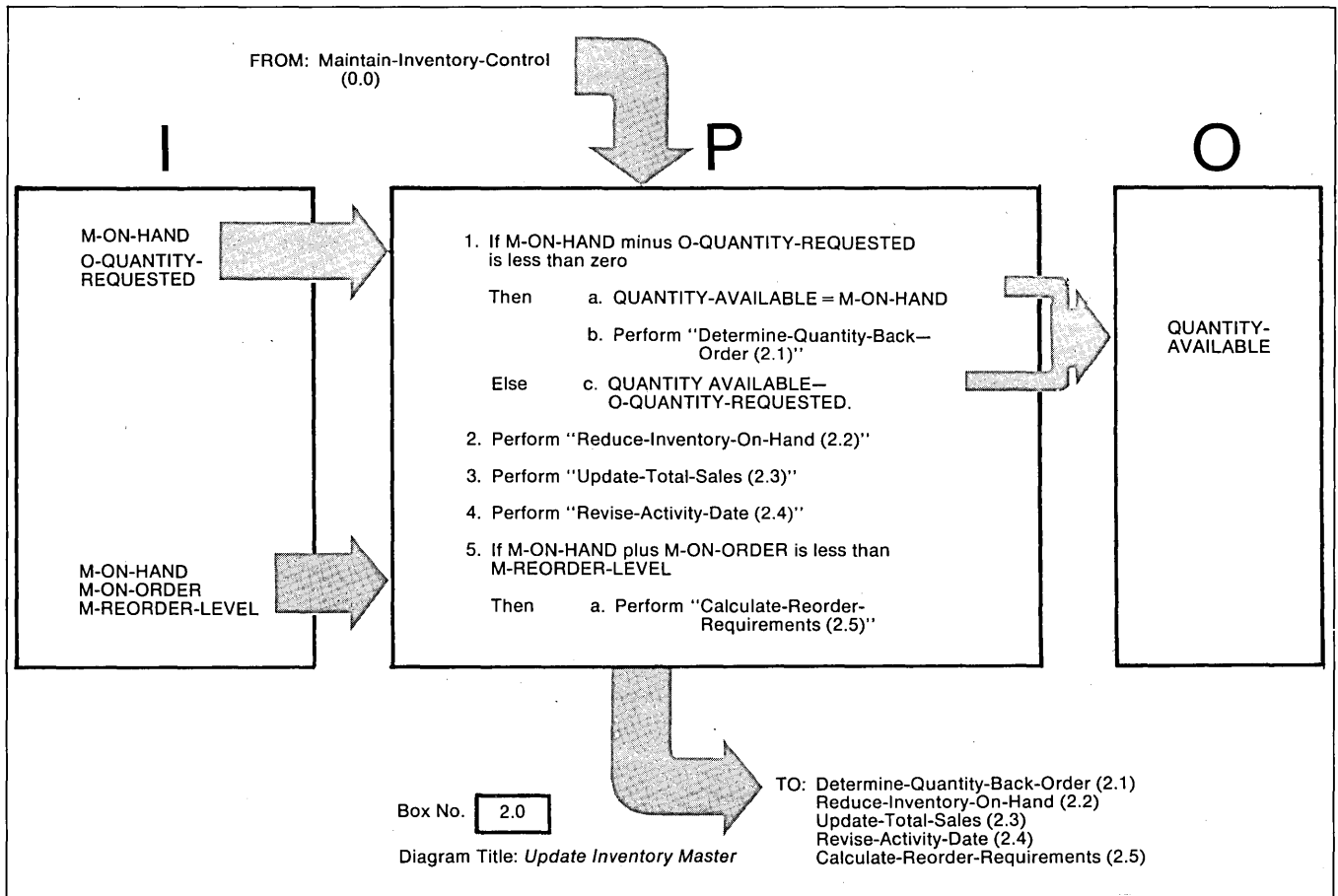

Fig. 2. Each function or subfunction must be exploded into its three components (input data, process to be performed on that data, and output). Processing statements imply a further breakdown of func-

tions to be performed for which IPO diagrams might be produced. The processing illustrated is from box 2.0 on Fig. 1. Vertical arrows depict the flow of control within the program.

In 1969 we introduced the fastest, most powerful supermini available.

In 1971 we introduced the fastest, most powerful supermini available.

In 1973 we introduced the fastest, most powerful supermini available.

Now meet SLASH 7

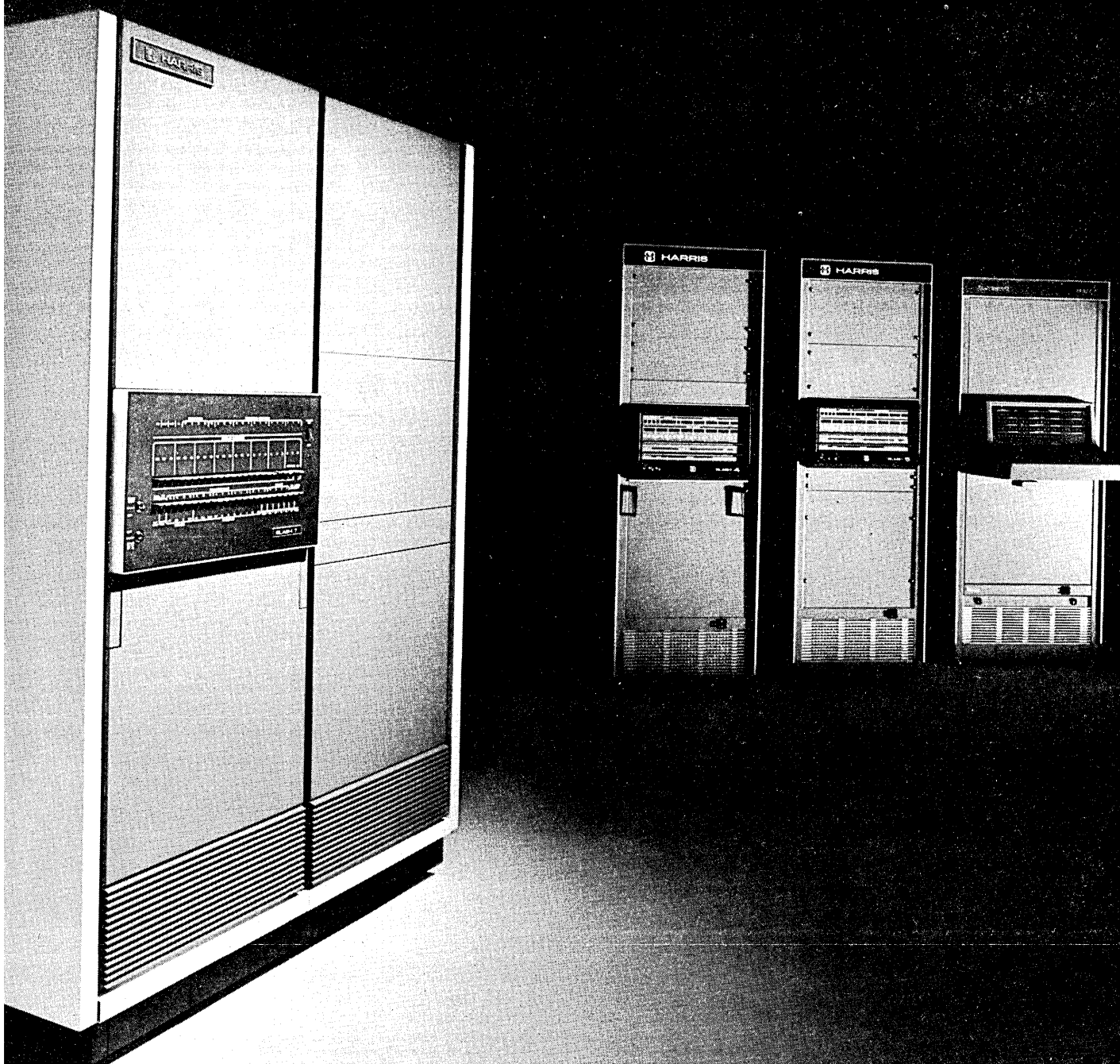

SLASH 7.

The newest,
fastest,
most powerful
supermini anyone ever
built...even us.

You can see that SLASH 7's heredity is speed and power. The kind of innate speed and number-crunching power that real-time FORTRAN programming takes advantage of. The kind of speed and power that has made the term "computer limited" obsolete.

SLASH 7 is the SuperMini in more ways. Its supported by software that's been tested and retested, validated and revalidated, proven and reproven countless thousands of times in demanding user situations. And, supported by a complete line of high-performance standard peripherals.

The Harris SLASH 7's super specs and capabilities are impressive. For example: multiprocessor capabilities, multiported core and bipolar memories, I/O

processors, concurrent real-time batch, and interactive processing.

CPU cycle time: 400 ns (minimum)

Maximum DMA rate per second: 15MB

Integer add (register to memory): 0.95 microseconds,

multiply: 2.22 microseconds,

divide: 6.37 microseconds

Specs good enough to win any benchmark; we'd like to run one for you.

And while SLASH 7's capabilities far surpass competitive machines, our prices do not. Get all the facts about SLASH 7, the SuperMini, and compare them yourself.

Write Harris Computer Systems, 1200 Gateway Drive, Fort Lauderdale, Florida 33309, Europe: Techmation N.V., Gebouw 105/106 Schiphol-Oost, Netherlands.

HARRIS



**COMMUNICATIONS AND
INFORMATION HANDLING**

CIRCLE 42 ON READER CARD

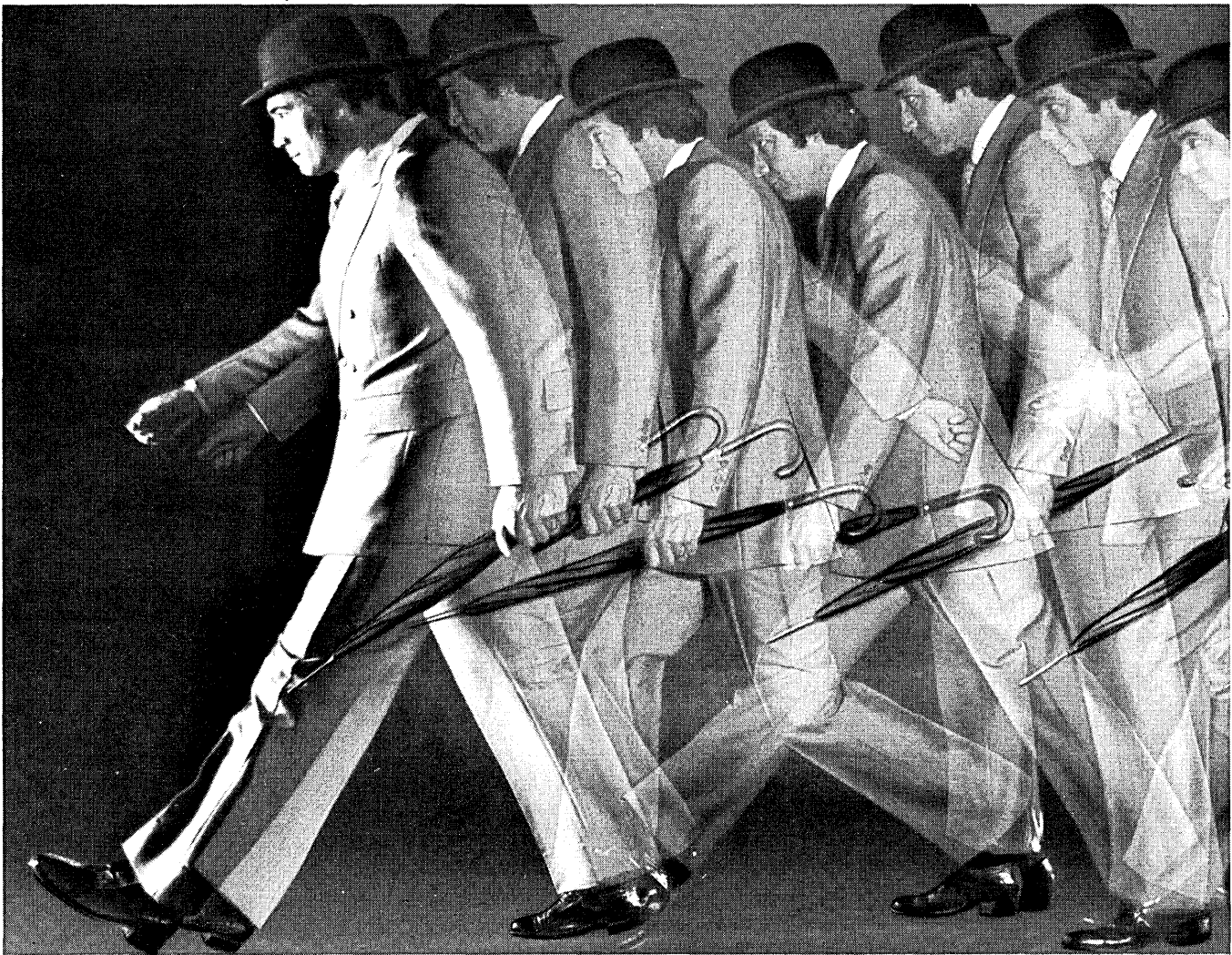

How to stay one step ahead...

Today you need to handle a lot more information, in less time. You need to make faster decisions, absorb more data, keep in touch with all that's going on worldwide. In short, you need an efficient communications system that you can rely on.

HOWEVER SIMPLE OR COMPLEX YOUR NEEDS

Whether you're a multinational company, a developing country, or a small yet rapidly expanding business, Cable & Wireless know-how can help you. We can install a telephone, telex or tropospheric scatter system. Build a satellite communications system or computer-linked data transmission unit. Nothing's too large—or too small.

WE'VE ALL THE EXPERIENCE IN THE WORLD

Cable & Wireless has played a major role in communications right from the start—over a century ago. We've worked throughout the world. At the present moment, among other projects, we're helping to ex-

pand Iran's total number of telephones to two million within less than three years—possibly the most intensive programme for increasing telephone capacity undertaken by any state. In the Caribbean we're involved in installation of the world's longest island-hopping microwave system. And, on a smaller scale, we're setting up a music system for a hotel in Bahrain!

CALL US TODAY

Now we can design, install and handle a system that meets *your* exact requirements—using the most relevant components selected from prestige manufacturers. Ask your secretary to call us at the address below and arrange an appointment as soon as possible.

And make sure you stay one step ahead.



U.S. Office: Cable & Wireless (NYK) Inc., Graybar Building, Suite 2020, 420 Lexington Av., New York 10017. Tel: 212-889-9020. Telex: 12094.
Head Office: Mercury House, Theobalds Road, London, WC1X 8RX. Tel: 01-242 4433. Telex: 23181.

HIPO

- Begin by discussing generalities of the system and desired outputs. By clarifying and defining vague areas, establish a list of probable functions.
- In future meetings, focus on an individual function. Determine under what circumstances the function will be performed, what data will be acted upon, what the processing will be and what outputs will be produced. Be alert for the appearance of any new functions. After the meeting, document in prose the details of requirements discussed. Then, prepare a mini-hierarchy and corresponding IPO's.
- As insight into the system is gained, relationships between functions will appear. Arrange the small hierarchies into a larger hierarchy, in effect, building it from the middle up. Establish control functions at the upper levels.
- Take a fresh look at the hierarchy from the top down. Do the names reflect the actions taking place and the objects being acted upon? Does true functional decomposition exist? This analysis may change the structure of the hierarchy. Functions may move to different levels, even different legs, of the hierarchy. They may require further explosion. They may be determined not to be functions at all, but rather portions of other functions. Revise IPO's to reflect the altered hierarchy, taking care that no requirements detail is omitted.
- Schedule design Walk-Throughs with the user and programming team. Before each Walk-Through, distribute HIPO's to all attendees so that they can familiarize themselves with the material to be reviewed. Begin at the top of the hierarchy and proceed downward through each function. Look for errors and omissions in the HIPO's. At the conclusion of design Walk-Throughs, the user must agree that all functions are present and all requirements detail are correct. With the design completed, implementation can begin.

It works

The major benefits of using HIPO in specification development are:

- A description of system requirements represented in HIPO form and mutually accepted by the user area and dp is *more complete, more accurate, more transparent, and more concise* than standard business specifications.
- Since requirements and design are being developed simultaneously, a

saving of time and money is realized. There is no need to develop programming specifications from business specifications. With minor modifications, requirement IPO's can be refined into design IPO's, implementation IPO's, and finally documentation IPO's.

- When the specification-design phase is completed, a more exact estimate of remaining resource requirements is possible. Detailed HIPO's represent a measurable checkpoint in the development cycle of a system. Manpower and computer costs for implementation and testing can be reassessed with a greater degree of accuracy than by using traditional methods of development.
- Users become acquainted with hierarchical design, IPO's, and the concept of "function" during specification development. This familiarity helps them to follow design Walk-Throughs and to understand their system more readily.
- The capability of developing specifications through HIPO allows an application area in need of a dp system to request it even though they might lack the resources to deliver written business specifications. Not only can a quality system that meets all requirements be delivered to the user, but dp can introduce the user to system enhancements available at little or no additional cost.

The Improved Programming Technologies are in a state of evolution. HIPO, as a technique, has evolved from sole use as a documentation tool to use as a design aid as well. In this latest advance, HIPO has successfully fulfilled two of the greatest needs in the dp industry by providing a means of precisely defining user requirements, and expanding the essential lines of communication between user and dp. *



Mrs. Jones is a senior systems engineer in EDP-Administrative and Financial Systems at John Hancock Mutual Life Insurance Company in Boston. She is presently working on systems design and acting as a structured programming consultant within her organization.

make money selling payroll?

forget it...

Unless you use WINNER, the money-making payroll/personnel software from Wang.

WINNER gives you the benefits of customer service payroll, plus Scope, A.C.H. transfer, plus automatic employee account transfers, plus extra income from personnel reports that cover everything from ERISA to union dues.

Join the 4,000 companies benefiting from Wang payroll/personnel software.

Write JOE NESTOR at Wang Laboratories, Inc., Tewksbury, MA 01876, or call (617) 851-4111.

WANG

JOE NESTOR, Wang Laboratories, Inc. 836 North Street, Tewksbury, MA 01876 (617) 851-4111

How can WINNER help my P & L

Name _____

Title _____

Co. _____

Add. _____

Cy/St. _____

Zip _____

Tel. _____

Comp. _____ Mod. _____

WANG

D-3

CIRCLE 130 ON READER CARD

Look at scanning. Key/disk. Look at performance.
And costs. Look at multimedia.

When you look at the best... you'll see the Cummins KeyScan™ Data Entry System.

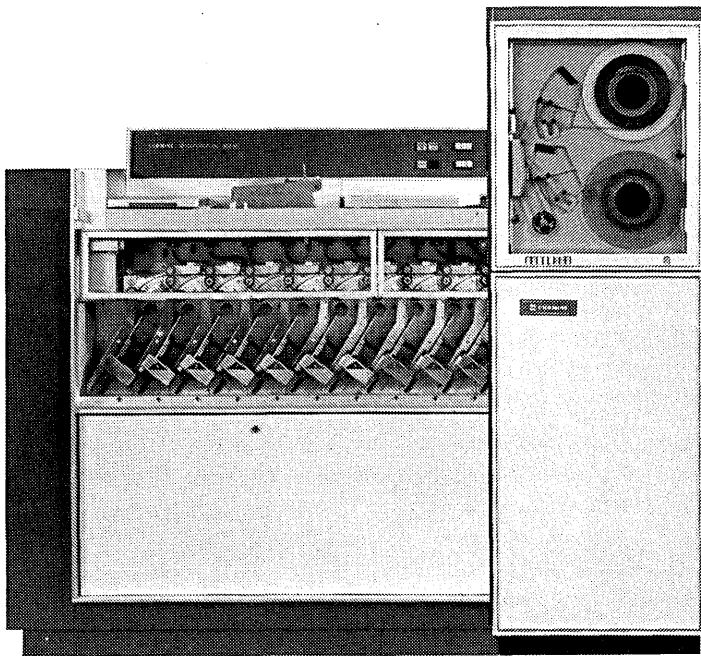

Look at scanning. With KeyScan, a single key stroke of each unrecognized character provides re-entry of rejects without rehandling while still scanning the same block of documents. Data from all documents is edited and balanced by batch, in a single pass through the System.

Look at key entry. Cummins key/disk terminals provide more power per dollar than any other key entry system.

Look at both. KeyScan is a shared processor, key/disk scanning system that affords unparalleled flexibility. It's the first multimedia data entry system, the only high performance system *and* it's moderately priced.

Whether you need an OCR scanning system, a stand-alone key/disk system, or an off-line print station . . . KeyScan enables you to select what you need at a price you can afford.

And, as your requirements change, you can reconfigure your hardware and software to do the new job . . . the best way.

All this from a company with systems, programming, and forms design support, and over 45 branch sales and service offices located across the country. So write today for our new 4400 KeyScan System brochure. Write: Cummins, 836 Waukegan Rd., Glenview, IL 60025. Or better yet, call us at 312/724-8000 and make an appointment to visit our demonstration facilities.

And remember, when you think data entry, look at Cummins KeyScan Multimedia Data Entry System. Then look at other systems and you decide which is best.

4400

KeyScan Multimedia Data Entry System

29-1371

CA CUMMINS
CUMMINS-ALLISON CORP.

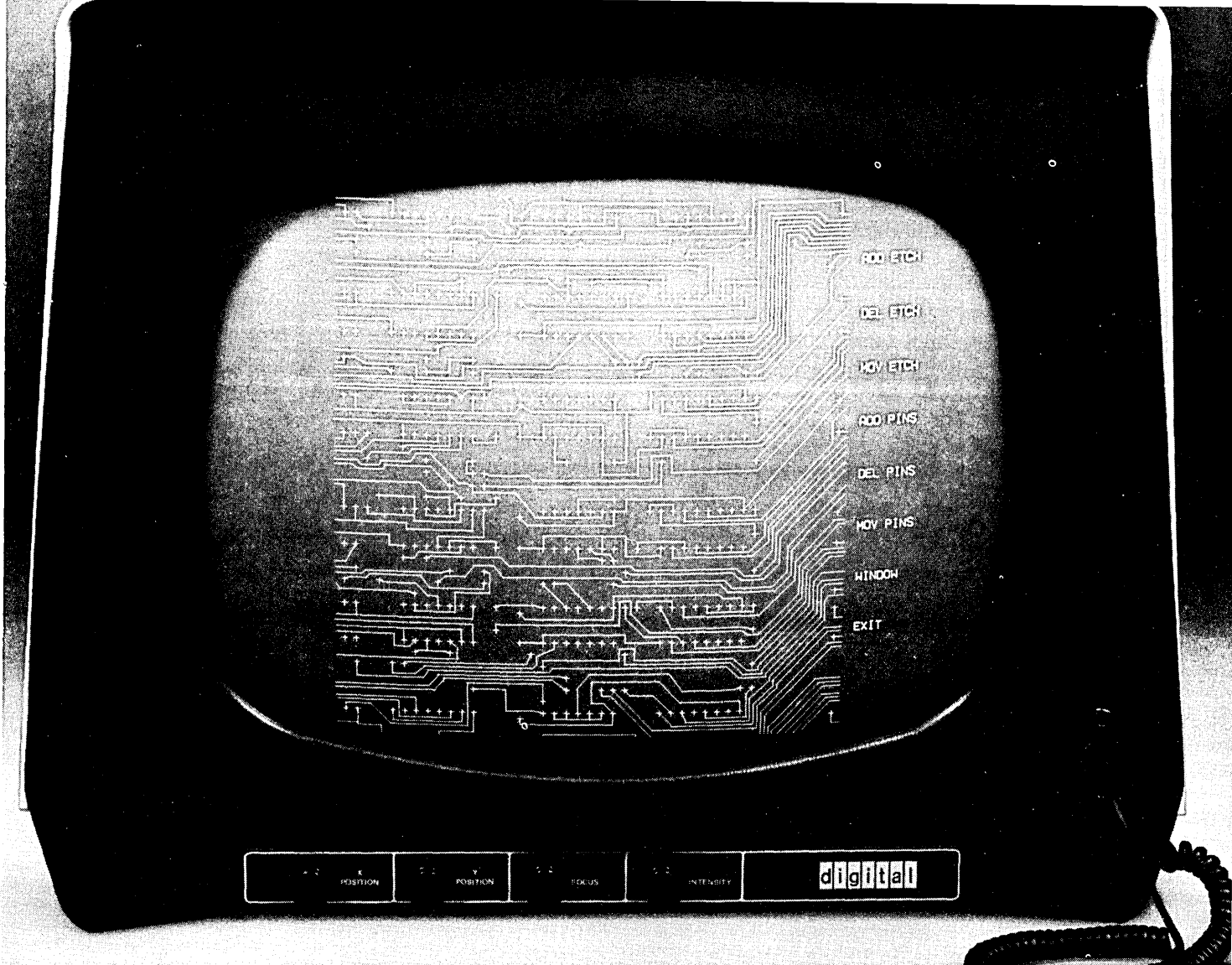

Digital's PDP-11 just improved its image.

Introducing the VS60, Digital's high-performance graphics system for the 11 family.

You're looking good if you start off with a great mini-computer like Digital's PDP-11. Adding VS60 high performance graphics is one way to look even better.

With the VS60, you get a 21-inch CRT with light pen and a display processing unit with hardware vector and character generators. You also get sub-routining with automatic stacking, scaling and 2-D translation standard. Subscripting and superscripting — standard. Plus upwards compatibility with over 500 VT11 graphics terminals already installed.

And the VS60 gives you something no other high-performance system offers — the Digital name plate. It means full line compatibility with 6 different PDP-11 processors. 60 different peripherals. And 2 different operating systems, RT-11 and RSX-11. With RSX-11 software, the VS60 can be configured as a satellite terminal called the GT62.

A Digital name plate also means you get one source for all your equipment. Plus the support represented by a worldwide sales and distribution network of over 3,500 software and service specialists in 36 countries.

So if you're interested in high performance graphics, look at the big picture. Look at performance, flexibility and support. Then look up your Digital sales

representative. Or write for our brochure. Digital Equipment Corporation, Marlboro, MA 01752. (617) 481-9511, Ext. 6937. European headquarters: 81 route de l'Aire, 1211 Geneva 26. Tel: 42 79 50. Digital Equipment of Canada, Ltd.

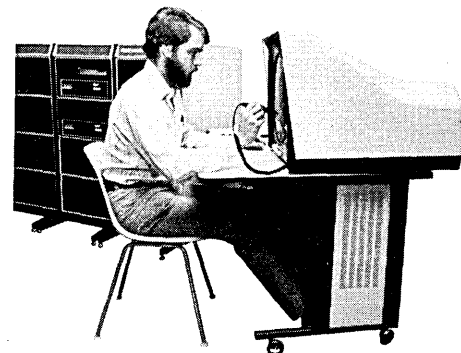

digital

We'll give them a run for the money!

Inquire.®

Bigger is better? That sounds like a lot of IMS to us.

But if you believe that there is something truly ingenious about a low cost, single system DBMS with almost unlimited freedom of application and expansion, then you've come to Inquire®.

Advanced Concept

With Inquire, data bases can stand by themselves. Or be linked dynamically. Data element relationships are made when a data base is used, rather than when it is built, giving data base designers and users unique flexibility.

Inquire DBMS is as comfortable with transaction-oriented applications as with analytic applications. Personnel and inventory control can be handled as easily as market research or text look-up.

Off and running

Thanks to Inquire's Multi-File, there is no need to predetermine data base relationships. New applications can be rapidly installed, as they evolve. Data base security is intact; information remains recoverable and accountable.

Management reporting is then immediately available—right from

the instant of data base creation.

Inquire offers a new perspective from the start.

We speak your language

Inquire understands plain English.

Allows both programmers and non-programmers easy access. Now the user is free to deal with the content of the data base, without worrying about how to get there.

The Command Query Language assists the user with comprehensive diagnostics; a macro facility for pre-storing command strings; and interactive prompting!

Speaking of interfaces

Inquire's Host Procedural Language Interface (PLI) allows COBOL, PL/1, FORTRAN, or assembler programs data base access via multiple keys. PLI is written as a set of re-entrant modules—permanently resident and shared by all users. Of course, Inquire's PLI is multi-thread; acts independently of data organization and storage techniques.

Speaking of structure

Inquire employs a partially inverted hierarchical or network data structure. Any number of data elements can be quickly searched, following a path of least resistance.

And search time does not directly increase with data base size.

Double Whammy

Besides giving you a super DBMS, Inquire possesses superior multi-key retrieval and report generation capabilities. Batch or on line with the same language. That's twice as much—twice as fast!

Single us out

Now that you know us better, you can see just how ingenious we are. Inquire DBMS means business. And economy. And speed. All you want in a DBMS and more.

So, instead of talking turkey with our competition, come speak English with us. Give Bob Schreier, our VP of Information Management, a call at 703-578-3430. Or write Bob at: Inquire, Infodata Systems Inc. 5205 Leesburg Pike, Falls Church, Virginia 22041. He'll be happy to discuss the future with you.

INQUIRE®
Infodata Systems

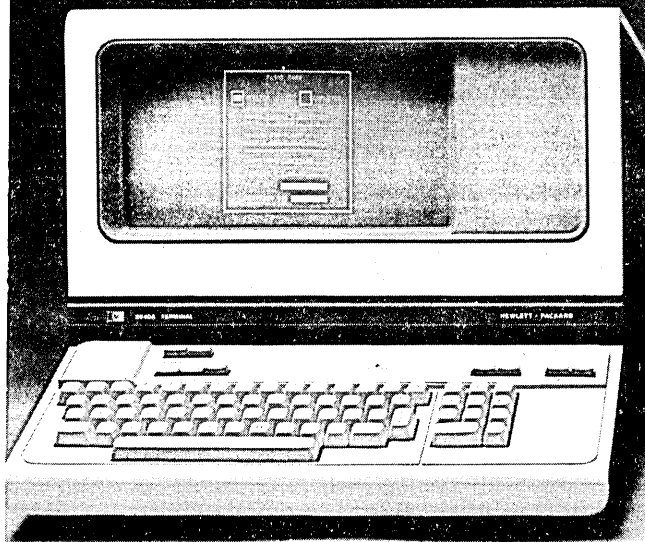

HP 2640A—with economical simplified keyboard.

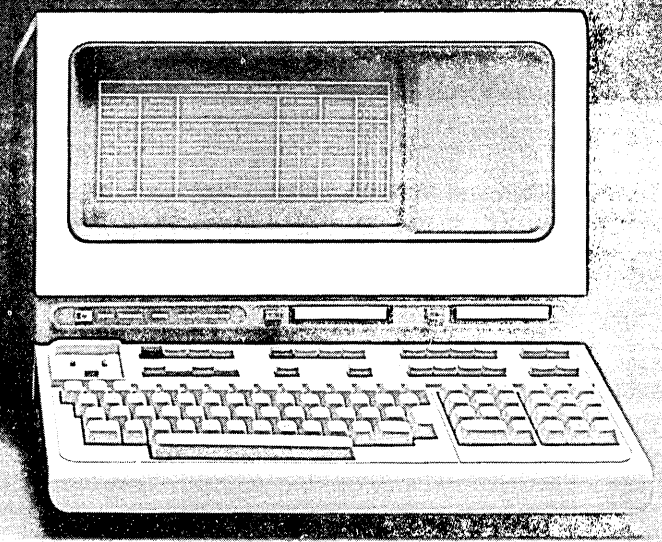

HP 2644A—incorporates twin cartridge integrated mass storage.

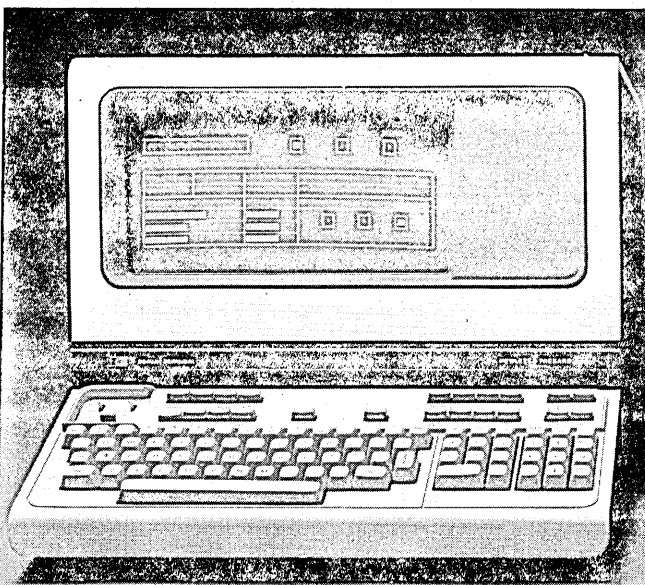

HP 2640A—includes modular design, self test and many other standard features.

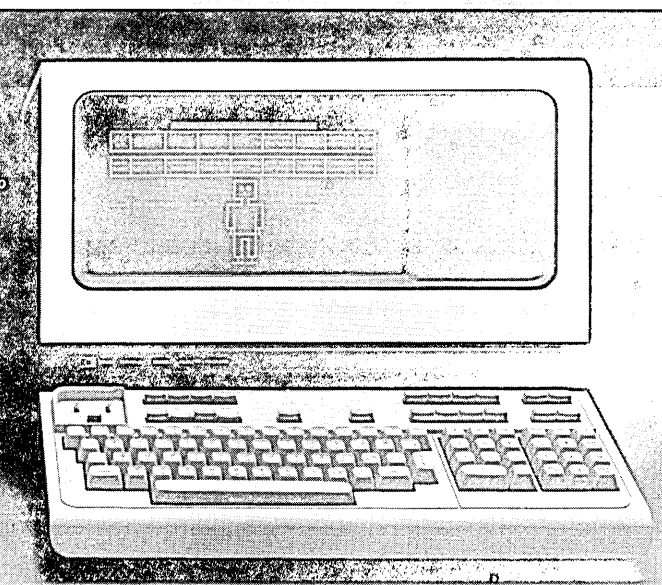

HP 2640C—Cyrillic terminal displays Russian characters.

FORM FITTING.

A Hewlett-Packard terminal lets you generate the forms you need without taking up valuable computer time and without special programming. A plug-in Forms Drawing option lets you generate almost any form your company is used to using—just the way your company is used to using it—right from the terminal keyboard.

Familiar-looking forms stop mistakes; cut down on time wasted as operators try to decide what goes where.

Then, from the same keyboard, add in protected fields as further assurance that the right in-

formation won't wind up in the wrong places.

For still greater operator convenience, you may want to lock in form headings—while the data under them is continuously updated and transmitted to the computer. Or use inverse video, optional half-brightness, underline, or even blinking characters to clarify where information goes and what mustn't be forgotten.

The Hewlett-Packard 2640 terminal series offers, in addition, powerful local editing and formatting capabilities. Modular design. Built-in self-test. An unusually readable display. Optional character

fonts (you can even design your own). Or, choose the 2644A Mini DataStation for the same features in a terminal with mass storage capability for stand alone operation and the convenience of two 110,000 byte, pocket-sized data cartridges.

Call your local Hewlett-Packard office, or write for all the details on the terminal family that fits your way of doing business.



Sales and service from 172 offices in 65 countries.
1501 Page Mill Road, Palo Alto, California 94304

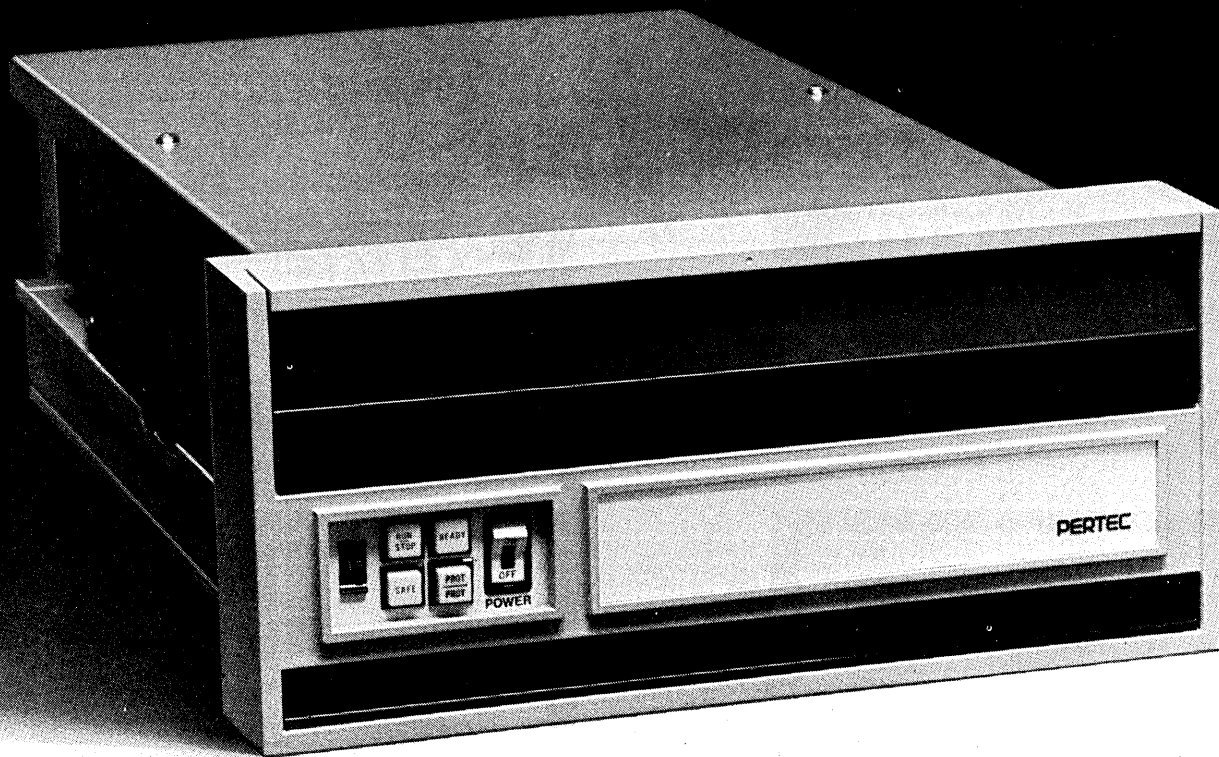

Very expensive.

You're looking at a superbly engineered disk drive:
The Pertec D3000.

In its class of disk drives, the D3000 is expensive.
(There *are* less expensive drives available.)

The D3000 is the best-engineered disk drive. (35/40 msec average seek time; internal power supply; exclusive "Power Save" feature; 100 tpi, 2200 bpi; 200 tpi, 4400 bpi; Air-Purge Cycle during start-up; etc.; etc.)

The D3000 is a superbly-tested disk drive. (Ave. burn-in: 49 hours; MTBF: 5865.96 hours.)

**You don't have to be a snob to buy one.
You don't have to be rich to keep one.**

The Pertec D3000 series disk drives have a capacity range of 3 to 25 megabytes. Three series models and 25 variations provide this range.

The D3000's recoverable-error rate of less than 1×10^{10} bits transferred offers OEMs superior data reliability over the entire range of specified environmental conditions. Each with a $\pm 1\%$ spindle speed control.

Parts commonality throughout the Pertec series (no need to stock parts for every model. Spare parts inventories are absolutely minimal), top *and* front loading, easy-to-serve "Flip-Top" boards, and interface compatibility with other disk drives make the D3000 an owner's dream. (And a

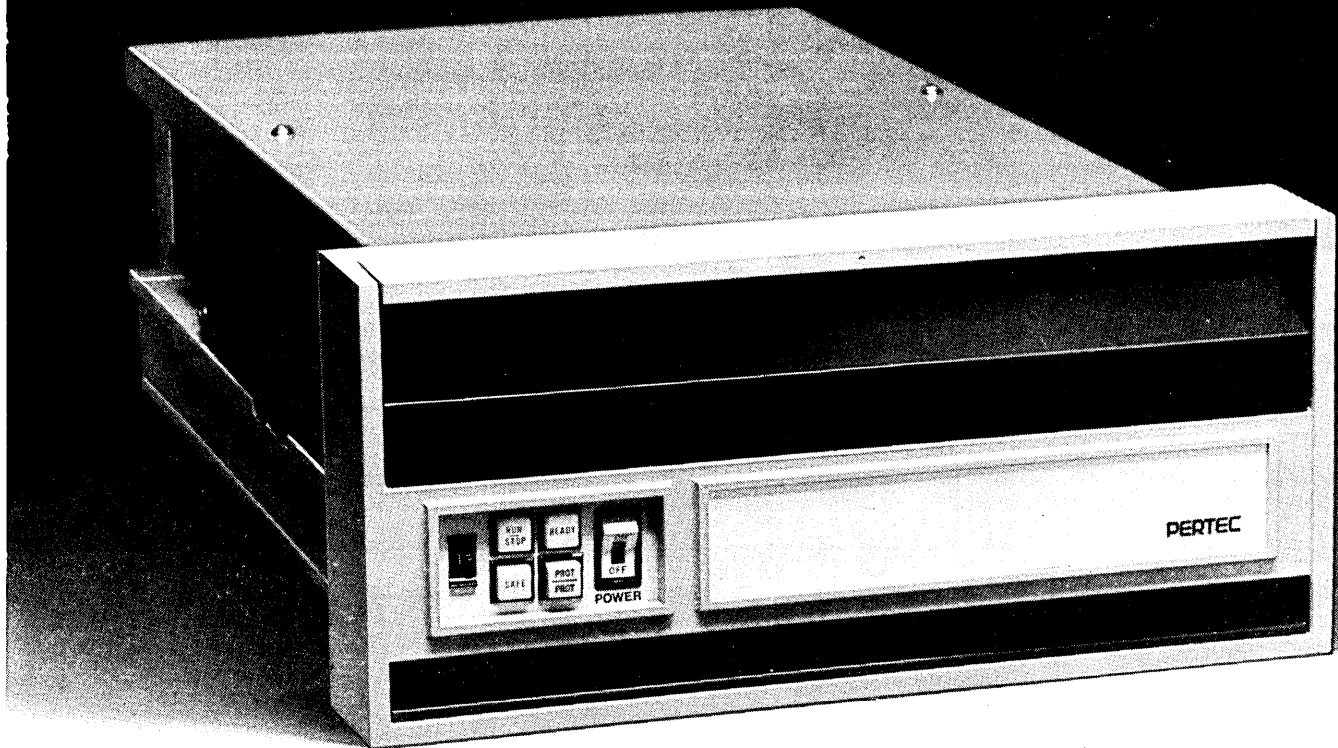

Not very costly.

serviceman's dream: Only two *hinged* printed-circuit boards. No need to use an extender card.)

Simplify your new controller design: Use our formatter.

Pertec's F3000 Series Disk Formatter saves the cost and effort of designing (and building) a special formatter/controller. The F3000 performs all formatter functions required to control and transfer data to and from up to *four* drives.

Turn good money into safe money.

The D3000 costs you less to own. (It's true.)

And it costs less to service.

And it costs less to carry in your inventory.

And as you grow, it costs less to expand.

So put your money on an expensive disk drive: The Pertec D3000.

And watch good money turn into safe money.

PERTEC

Peripheral Equipment Division, 9600 Irondale Avenue, Chatsworth, CA 91311.
Boston (617) 890-6230; Chicago (312) 696-2460;
Los Angeles (213) 996-1333; London (Reading) 582-115.

CIRCLE 40 ON READER CARD

A Programmer's ABC's

A is the algorithm
It makes its neat recursive way
Into a stack.
It will be back,
But only after some delay.

B is a bug, the user's sore,
Our hardware's going out the door.
The fixes all turned out no use.
While managers receive abuse.
But brightly, brightly do I shine.
Since I can prove it's yours, not mine.

C stands for COBOL.
What a pity
It was designed
By a committee.

D is for data, aren't you glad
Your data's never, ever bad
For all our software's written so
Bad data makes the system blow.

E's word is hard, so I will strive
To spell it. Here we go; C5
C2 C3 and then C4
C9 and then C3 once more.
To programmers, may heaven bless 'em all,
That's EBCDIC in hexadecimal.

F is futility and fumble
And other things which make us grumble.
On one more word this letter's stuck
If you don't know it, well, hard luck!

G is for garbage; he whose sin
It was to put such input in
By rule must stand beneath the spout
When his output's coming out.

H is for Hollerith. He designed
The card code, which we've since refined
For use on tapes and discs and drums
And several other mediums.
(Else, if you like, "on discs and dra,
And several other media").

I is for interface, that's the line
Between your subroutine and mine.
If you'd avoid a grave dissension
Please use *my* register convention.

J is the holly jest or joke
Which mirth and laughter doth provoke;
Manipulating byte and bit,
We're filled with merriment and wit.
For who could less than cheerful be
When writing down B-X-L-E?
We laugh until each face turns red
To use that queer instruction, ED.
Observe the giggling hysterics
Induced by just one "move numerics."
Still funnier is (avoid it lest
You split your sides) Translate and Test.
And when at last we've had our fun,

And all the coding has been done,
We laugh until we start to cry,
When to execute we try.

K is a kludge which you say
You require to avoid some delay
But that interim fix
Forms a habit that sticks
And you'll find that it's in there to stay.

L is for language; use these three.
Cobol, Fortran, RPG.
Avoid all others, friend, and shun
Those with the suffix "L slash I."

M is a manager. Some are fat
And do not know what they are at.
Some other managers are thin
Look at the mess they get us in.
In general they're a useless tribe
(Except, of course, your humble scribe).

N is the Noon. Much more than dreary night
The noontime hour sees rise the rotting dead,
Who from their wooden cells go muttering forth.
Then will you hear them speak of ancient wrongs,
Of projects cancelled, systems vague and strange,
Of intricate enhancements ill designed,
And long-lost deadlines. Then also do they chart
Forgotten job-streams flowing in the night
To since-discarded listings. Men they curse
Who plucked procrustean schedules from the air
And then departed, called to high estate
In distant companies long since forgot.
Great deeds they now recall, and happier days,
And rusted hardware, powered once again
By memory and misted rosy dream.
Delay lines fill, and vacuum tubes warm up
And heroes (greater than the men we know)
Who never from their standards did depart
Stand forth among them, calling them to war.
Then should the Living shudder and know fear
And tremble at the muttering of the Dead.
But hoary time, in envy lest these shades
Usurp the little space of those who breathe
Now moves the clock unto the hour of one
And sends them back to work 'til coffee-break.

O is the office where I sit
And think, and work a little bit.
My office has a wooden door
Or else I'd work a good deal more.

Here lies the spec of program **P**.
The task of coding fell on me.
Who ('til I'd done)
Revealed to none
Its non-computability.

Q stands for quibble, which you do
When I am arguing with you.
("A quibble" I define to be
A point with which I disagree.)

R is response time. Slow and yet more slow
The man-machine communications flow.

The simple promise of every Documation product: More value for every dollar.

It's a promise everybody makes. But not everybody can deliver. At Documation we can and do deliver more value for your dollar in every product we make. Consistently.

In five short years, we've built a major company around the philosophy that we will offer the best price performance, most cost effective products available. We started our company with a better idea - the Vacuum Pick system of card-handling. Our first card-handlers weren't cheaper - but they were better than anything else on the market. So people bought them. And the word got around that our card-handlers were so reliable that they needed very little service. And people bought more of them. The proof of our value theory is in our sales.

To build better products you have to have better ideas. So we put together one of the best engineering departments anywhere. Our engineers don't wait to see what our competitors are going to do. They do it themselves. First.

Witness the Documation-developed microprocessor. It's the cost-efficient heart of both our LC50 Multifunction Card Processor and our DOC 2250 high-speed impact line printer.

We don't just design it better, we build it better. At Documation we call the way we do things vertical integration. You might call it do-it-yourself. Our machine components have to be precision-milled. So we mill them ourselves on computer-controlled



automatic milling machines. Material comes in our door as raw metal and goes out as precision parts in our equipment. We even use computer controlled coordinate measuring machines to assure the accuracy and precision of the parts we manufacture.

But the real test of value for our products is the value they can add to your products. Take a look at what our two newest products can do for you. With the LC50 you can build a DP system with greater output at a

greatly reduced cost and add some 706,000 small business firms to your list of potential customers.

The DOC 2250 is our fighting machine in the printer field. It lets you sell a printer that's about twice as fast as the 1200 line printers at just about the same cost. Or sell a printer that's a touch faster than well known 2000 LPM printers at around half the cost.

It's really very simple. The more value we offer you, the more value you can offer your customers. So contact Mr. Roy Ostrander, V.P., Box 1240, Melbourne, Florida 32901. Telephone (305) 724-1111. It could be the most valuable contact you'll ever make.



DOCUMATION
INCORPORATED

Another good reason for getting your terminals from ICE.

The new Interdata Carousel 300.

You can now get the new Interdata Carousel 300 printers from ICE. And fast, because we have them in stock. The Interdata Carousel 300 is a high print quality, up to 12-part forms, 30 cps microprocessor-controlled terminal. It features 132-character print line with interchangeable print fonts and APL, 128-character buffer with unique Space Jump™ and addressable tabulation. It has a unique graphic capability for

plotting and charting. At \$2995 or \$99 per month lease, it's easily the best printer on the market.

And ICE offers more than the Carousel 300. We have the most efficient terminals available today. Like Texas Instruments 735, 733 KSR and the new 745 and 743 KSR portable terminals; the DEC/LA-36; ADDS 580 and 980 and Lear Siegler ADM-1, -2 and -3.

Since we buy in volume,

you can get these terminals from us at the lowest prices. If you'd like to lease our terminals, we'll be happy to arrange all the leasing details for you. Service? We support our systems with factory-trained technicians and a complete spare parts depot. If you need one terminal or a hundred, call ICE today.

\$2995 or \$99 per mo.



ICE INTERNATIONAL
COMPUTER
EQUIPMENT, INC.

SALES OFFICES

WESTERN REGION:

San Francisco
2030 Union Street
San Francisco, California
94123
(415) 563-7155

Los Angeles
11222 La Cienega Blvd., Suite 570
Los Angeles, California
90304
(213) 641-2001

MIDWESTERN REGION:

Chicago
3166 Des Plaines Avenue
Des Plaines, Illinois 60018
(312) 694-3777
(312) 298-0777

Opening soon—New York and Houston

Why Documation can sell you a 2250 line printer for the price of many 1200 line printers.

It's a simple, provable fact: Documation's DOC 2250 offers more output for less money than any other printer on the market. Here's why.

At Documation, "Research & Development" is a bit more than a name on the door to the engineering lab. Quite a bit more. Instead of sitting on their slide rules waiting for some genius to come up with a great new technical application, Documation's engineers constantly research ways to build more efficient equipment at a price advantage. One secret of the DOC 2250's cost efficiency is its integrated controller - a Documation-developed microprocessor. The controller communicates through its interface with the host system, decodes all commands, controls the printer hardware and reports various errors and status.

Other advances our design department made standard on the DOC 2250 are:

- Fully-buffered print line.
- Interchangeable character arrays.
- A Universal Character Set buffer that allows any character set to be used.
- 2250 LPM with a 48 character set.
- Vertical Forms

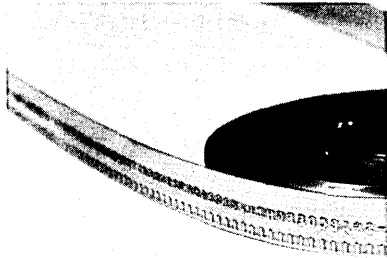

Control buffer that allows format control for pages up to 24 inches in length and establishes either 6 or 8 lines per inch.

- A powered forms stacker accommodating forms 3 to 24 inches in length.
- Acoustically-insulated powered cover that holds operating noise to 74 dba.
- Resident micro-diagnostics and maintenance independent of host system.
- Up to 6 part forms.
- Paper slew up to 100 inches per second.

After we design and develop it, we build it. Documation's facility is an integrated

manufacturing plant not just an assembly line. Tour our plant and you'll see stacks of metal waiting to be turned into precision parts for our printers and card readers on our computer-controlled automatic milling machines, circuit boards being manufactured, and finally, painstaking assemblage and testing of all Documation equipment. What this means to you is that we don't get hung up on somebody else's production schedule or somebody else's price boost.

Frankly, DOC 2250 is our first entry in the highly competitive printer field. But, just as frankly, we know it's the best on the market. All we ask is the chance to prove it to you. A few years ago we were the dark horse candidate in the card processor field. Today we're #1 - because we built a better, more cost-efficient product. We intend to follow the same course in printer products. And if you'll compare our product, feature for feature with any other printer, you'll see how our printer can give your system a real competitive edge. For more details, call or write Mr. Roy Ostrander, Vice President, Box 1240, Melbourne, Florida 32901. Telephone (305) 724-1111.

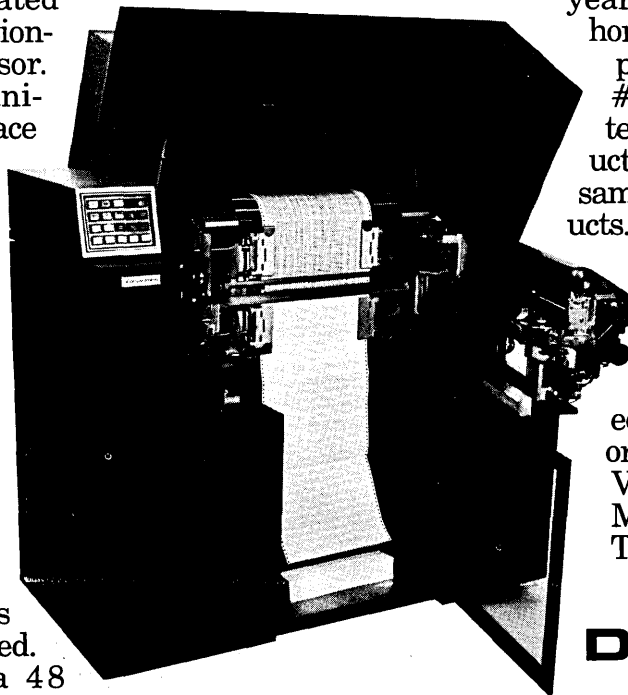

DOCUMATION
INCORPORATED

Prime Computer Introduces TEMPUS

a Computer Family for Distributed Data Processing

PRIME Computer wants you to know about the industry's best kept secret: PRIME Computer. We're a full line supplier serving four business segments: computational processing, business data processing, data communication, and data acquisition and control.

A Family of Processors:

Level 1 through Level 4 compatibility permits programs written for small, dedicated systems to run on large, virtual memory configurations without modification while complex transaction processing software can be developed on a multiuser system and run on a smaller real time system with no reprogramming.

Unique Pricing:

Entire systems can be configured from \$20,000 to \$300,000, and offer a throughput capability equal to \$1,000,000 data processors.

Newly Enhanced Operating System:

The enhanced PRIMOS Operating System offers three years of proven production capability while featuring Virtual Memory, Paging, Segmentation, and Memory Management Concepts previously found only on large data processing mainframes.

Competitive Specifications:

Up to 8 million bytes of main memory, 2K bytes of 80 nanosecond access cache memory, 2 million byte data transfer rate, on-line disk capacity in excess of 1.2 billion bytes, and multi-user Virtual

Memory Addressing up to 512 million bytes for each user.

Supporting Software:

Users of TEMPUS systems can create data bases and write programs in FORTRAN IV, COBOL, BASIC and assembler languages which are upward and downward compatible across the entire range of processors.

System Integrity:

Automatic Error Correction Code provides high uptime while a sophisticated ring structure file system protects data base applications.

Distributed Data Processing:

A feature in the TEMPUS family, designed and developed to co-exist with your big computer by off-loading at any level required.

Over 1,000 computer systems world-wide serving a broad range of applications. All systems are available for delivery now with proven software.

PRIME

For additional information, contact your local Prime Computer Office or write Prime Computer World Headquarters, Box 2600, Framingham, MA 01701.



1. For computational processing
2. For business data processing
3. For data communication
4. For data acquisition and control

Programmer's ABC's

At quiet terminals my patience fails.
Next time I'll try the U. S. Mails.

S is for slip, of color pink,
And on it writ
"Your programs stink."

T is time-sharing, I have been
Communing with the Great Machine
There, in an interactive state,
My deepest thoughts I did relate,
All eager to communicate.
It answered; but, to my dismay,
Had nothing interesting to say.

U was a user. He was rash
And parted quickly with his cash.
He bought with his investment huge
A powerful, expensive kludge.
Because his system was a joke
This user very soon went broke.
Since for his stuff he couldn't pay
We had to take it all away.
We all lost money on the deal
And soon the pinch began to feel.
The sales department hired more men
And went and sold the kludge again.

V is the vision, vision bright
Which keeps us working in the night.
O'er dumps we labor in the day

While dreaming of a better way.
We seek the coder's holy grail,
The program that will never fail.

Worry and work both start with W.
Insidious, they come to trouble you
The day the program's due to run
Though the coding's not yet done.
You've no design, and no test data.
The spec you plan to write up later.
But worry puts you off your feed
Decisive action's what you need.
Rush to your desk, brook no delay,
Sit down and write your resume.

X (Xenophobia) disgraces
Those folk who hate all other races.
Myself, I feel a hatred keen
Only for that damned machine.

Y was an innocent youth
Who took up our profession uncouth.
Though he'd try and he'd try,
He never could lie,
And got fired for telling the truth.

Z is for Zero, written so
That 0 cannot look like O
Which stands for one. Alas for me,
My programs map to binary.
No other reason need be sought
Why half my work comes out to naught.

—David H.H. Diamond

When You Lease It from RCA The GE TermiNet* 30 Gives You These 3... Speed... Flexibility... Economy!

The GE TermiNet 30 mag tape ASR matrix printer is designed to give you three major benefits—you save time, money and trouble. And it's simply more economical when you lease the TermiNet 30 from RCA. We offer a nationwide service network to back you, too. The RCA lease price includes maintenance by data communications specialists based in over 140 cities. Seven warehouse locations coast to coast ensure fast delivery and prompt installation.

The TermiNet offers many features including:

- Prints at 10, 20 or 30 cps
- Transmits at speeds up to 1200 Baud
- Single cassette magnetic tape; stores 100,000 characters
- Versatile editing capability
- Answerback (supplies 20 characters)
- Vertical tabulation and form out
- Adjustable pin-feed platen 4" — 9½"
- Data-Phone+ (Dial-Up) capabilities (hardwired or telephone acoustical coupler)
- Permits terminal use with data access arrangement (DAA), Type 1001B CBT
- Ribbon cartridge — a snap to install. Your operators will love it
- 300-Baud originate — only automatic answerback integral modem
- Interface options
- 8-level ASCII code

For full details and rates call or write:

RCA Service Company, A Division of RCA
Technical Services Bldg. 204-2, Cherry Hill Offices
Camden, N.J. 08101. Phone: (609) 779-4129

RCA

*Registered trademark of General Electric Company + Registered servicemark of AT&T.

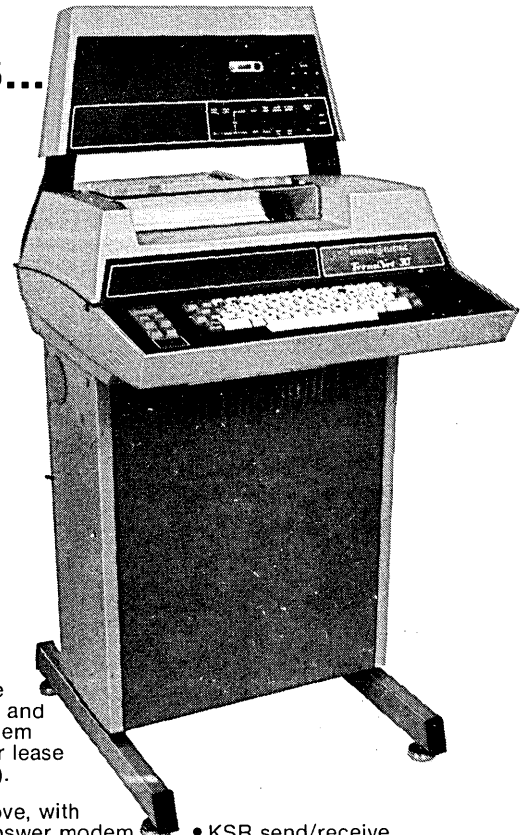

- ASR with mag tape
With single cassette and
originate-only modem
\$135/mo. on 1-year lease
(incl. maintenance).

- Same as above, with
automatic answer modem
\$145/mo. on 1-year lease
(incl. maintenance).

- KSR send/receive
\$90/mo. on 1-year lease
(incl. maintenance).



the world's
fastest,
least expensive
facsimile
system...

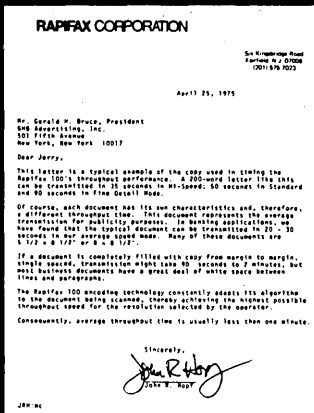

can transmit
this page
in 35 seconds
coast-to-coast,
or internationally.

(that's the least of it)

Our 35-second facsimile transmission is less expensive than special delivery. Often, less than airmail. Always, less than Telex, TWX, Telegrams, Couriers and slow facsimile.

The Rapifax 100 is more than a business convenience. It's a money-saving alternative that practically guarantees that your hard copy mail will get through. Four to twelve times faster than other facsimile. Using existing direct distance dialing facilities.

In fact, it can cut thousands of dollars off your monthly phone bill through its speed and unique labor-saving features. Like automatic line verification. Automatic polling. Confirmation of delivery. Automatic Document Feder. Unattended operation. Cutting paper to size, eliminating waste.

And, the Rapifax 100 is supported by our own national field service and telephone diagnostic centers.

AT INTERFACE '76 — BOOTH 305

for a demo, free savings survey or literature, call or write

RAPIFAX
CORPORATION

6 Kingsbridge Road, Fairfield, N.J. 07006 (201) 575-7023
toll free 800-631-1155

The \$253-a-month Sycor 350.



Remote data entry and file management at a price that's close to home.

For \$253 a month you can lease a Sycor 350 for three years. That's the lowest-priced flexible disk-based intelligent terminal on the market. It includes 16k bytes of memory, dual disk drives, and maintenance from one of our 100 service centers. Fast 60-day delivery, too.

And you get all the advantages of remote data entry and file management. That means each entry your operators make is checked, edited and validated by the Sycor 350. So it's virtually error-free. And all subsequent data entries continuously upgrade your local data base. Simply key in a code number and you get instant random access to up to 500,000 characters of clean data for construction of invoices, inventory reports, payrolls, sales analyses, and other vital business functions.

It all adds up to more productivity in your data entry operations, more CPU time for your big jobs, more timely and accurate management reports, and more efficient use of expensive communications lines.

That's the whole theory behind Sycor's family of intelligent terminals for distributed data entry and processing networks. Whether it's a stand-alone or clustered configuration, Sycor has a system which will match the throughput requirements of your remote sites.

Find out how Sycor intelligent terminals can make a big impact on your bottom line by contacting one of our 30 sales offices. They're in the Yellow Pages. Or send in the coupon. Better yet, contact Ken Wilson, our product marketing manager, at (313) 995-1371.

- Send me your latest Sycor 350 brochure.
 Have a salesman call me at _____

Name _____ Title _____

Company _____

Address _____

City _____ State _____ Zip _____

SYCOR

Corporate Offices, Ann Arbor, MI 48104

See the Sycor 350 at the 1976 Computer Caravan when it comes to your area.

Ask CONTROL DATA about their full range of Engineering Services.*

They have them all.

- Installation and maintenance of CDC computer systems, worldwide
- Third party maintenance (non-CDC systems)
- Computer facilities site planning
- Design and construction management of computer centers
- Computer facility support services
- Worldwide parts & logistics support
- Refurbishment of both CDC and non-CDC equipment
- Radio and data communications maintenance
- Installation, test, and repair of medical electronic equipment
- Technical training for customers

*Control Data offers you a complete spectrum of maintenance agreement options and prompt, highly professional attention, tailored to your needs. Call CDC collect (612) 853-7600 for more information or write CDC, Box 1980, Twin Cities Airport, St. Paul, MN 55111.

 CONTROL DATA
CORPORATION

The Price of Protection

- Task forces of computer users must be formed to examine and advise on privacy law proposals.

- A landmark study by the Institute of Internal Auditors will be "must" reading on auditing and controls.

- The liability law may be extended to include dp personnel, as well as engineers and designers.

- Computer-assisted fraud is growing at a rate of 400% a year.

These action items and revelations are just a sampling of what came out of one of the past year's most constructive meetings—the annual Computer Security Conference and Workshop of the Computer Security Inst. More than 150 people attended the three-day meeting, and increasing numbers of computer personnel with "security" and "auditing" in their titles showed up.

The conference itself was well stocked with leading industry speakers and experts on auditing, privacy, security, law, insurance, etc. And much interchange of ideas resulted by breaking the day up into speeches, workshops and roundtables, and by organizing lunch tables by industry one day, by title another.

Task forces on privacy

One of the more constructive discussions was on privacy law. Joseph Overton, legislative assistant to Rep. Barry Goldwater Jr., spoke eloquently on historical transgressions against personal privacy and on present fears. Currently there are mixed emotions on legislating privacy in the private sector, with the government anxious for corporations to adopt standards voluntarily. But the public is intimidated by modern technology, and the question is "What can the private sector sacrifice for [the public's] better mental climate?"

At a workshop session on privacy, attendees were presented with a series of possible prohibitions and requirements of a privacy law. The users were plainly worried, not having thought it

through as yet to such detail. Several groups concluded that user task forces to examine proposals and advise government were mandatory. Such task forces could be by industry, equipment type, or could cut across those boundaries. The users recommended that the Computer Security Inst. organize such a task force and seminars on the subject.

Auditing practices

Joseph Wasserman,

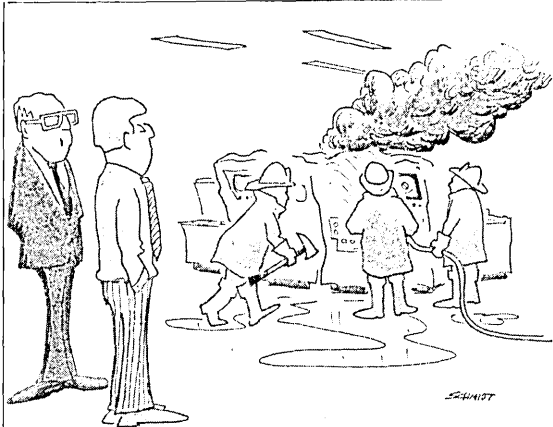

"To tell the truth, when you said 'she's overheating', we thought you meant . . ."

© DATAMATION ®

of practices and techniques for auditing and for dp organizations. More than 40 major organizations are being visited.

Wasserman hopes the report will help companies decide such questions as whom the auditing department reports to (he feels it should report to the vice president of administration), what the proper profile for the audit staff is (the dp man who knows some auditing, or vice versa), and what the responsibility of the auditor is in systems design.

Computer-assisted fraud

Leonard Krauss, Ernst and Ernst, gave us the term CAF (Computer-Assisted Fraud), which is one of the biggest new "markets" in the industry. It is currently grossing a paltry (known) \$100 million a year, but the growth rate is projected to be 400% annually.

Among Krauss' do's and don'ts: don't watch people, watch functions. (Disbursements and receipts account for 75% of the fraud.) Look out for irregular masterfile updates, programmed traps in application programs, too many tapes (they can constitute an extra set of books), and bogus reports. Examine tape library logs, keep an inventory of off-site backup tapes, make surprise audits.

president of Computer Audit Systems, reported on the status of the IBM-funded study being done for the Inst. of Internal Auditors. The landmark study is expected to result in a survey of the state of the art in auditing control, as well as in two manuals

NEW BOOKS

MICROARCHITECTURE OF COMPUTER SYSTEMS

edited by REINER HARTENSTEIN and RODNAY ZAKS

1975. about 292 pages.
US \$25.00 / Dfl. 60.00.

This volume contains the papers presented at the first EUROMICRO workshop on microarchitecture of computer systems held in Nice, June 23-25, 1975.

Scope of the book:

- Systematic use of hardware primitives for process coordination.
- Steps towards systematic design of multi microprocessor systems.
- Recent developments in microprogramming applications, techniques, and education.
- The impact of operating system theory on hardware organization and related methods for design and description.
- Trends towards integration of hardware and software engineering.
- Characteristics and applications of LSI microprocessors.

COMPUTERS IN EDUCATION

Proceedings of the 2nd IFIP World Conference, Marseilles, September 1-5, 1975.

edited by O. LECARME and R. LEWIS

1975. about 1025 pages.
US \$83.50 / Dfl. 200.00.

The scope of the contributed papers (in excess of 160), published in full, ranges from the social implications of the generalized use of computers in education to the detailed description of on-going experiments including hardware, software and pedagogical content.

The main topics covered are:

- The contribution of computer science to pedagogy.
- The influence of computer science on the contents and methods of teaching for all disciplines in primary, secondary and University education.
- The evaluation of the role of computers in teaching (hardware, software and specific languages).
- The training in Computer Science of teachers of all disciplines.
- Training in the various branches of informatics.
- The use of computers in continuous training programmes.
- The contribution of Computer Science to teaching in developing countries.

NORTH-HOLLAND PUBLISHING CO.

P.O. Box 211
AMSTERDAM, The Netherlands

Sole distributors for the U.S.A. and Canada
American Elsevier Publ. Co.
52 Vanderbilt Avenue
NEW YORK, N.Y. 10017

A real workhorse solution for heavier loads: our 2-megabyte mini with software, off the shelf.

Economy priced and ready to go: a field-proven, system organized computer.

When bigger computing loads depend on a good hard-working system, depend on General Automation to put it all together: a powerful price/performance package complete with solid software support (available today—no six-month runaround).

You'll call it a workhorse. We call it the GA-16/440, the top end of our new Solution Series computer family. With well over 100 systems shipped to date, it's already proven itself in a wide range of applications.

Cost-efficiency's optimized throughout the 440 system. More main memory capacity—up to two million bytes—and a more versatile Memory

For multi-terminal applications, it's the only mini in its price range to offer ANSI-74 COBOL with an ISAM package. 440 also runs macroassembler, FORTRAN IV and BASIC. In both batch and foreground/background real-time operating systems.

Out-performs computers costing many times its price. We're talking \$5370* for a system with 16K words of 720ns core; about forty-grand for our 256K with MMS.

440 is just one member of the Solution Series, in the broadest, most compatible family produced today. So if you want to segment a project produce a smaller, less expensive system

GENERAL AUTOMATION

Management System (MMS), to enhance memory utilization and program protection.

440 cuts down your programming and interface design, with the biggest selection of software tools and I/O devices in the industry, bar none.

Developed for our SPC-16 mini family, GA's compatible, user-proven software boasts such depth—it's easy to pick precisely what you need. For a simple dedicated application. Or a large multi-program real-time system.

or remote your acquisition and control functions, we've got what it takes to get your job done right. In minimum time, at minimum cost.

For full details, write our corporate headquarters: General Automation, 1055 South East Street, Anaheim, California 92805. (714) 778-4800.

Also General Automation, Paris, France and G.A. Computer Ltd., Ontario, Canada.

**(Maximum discount)*

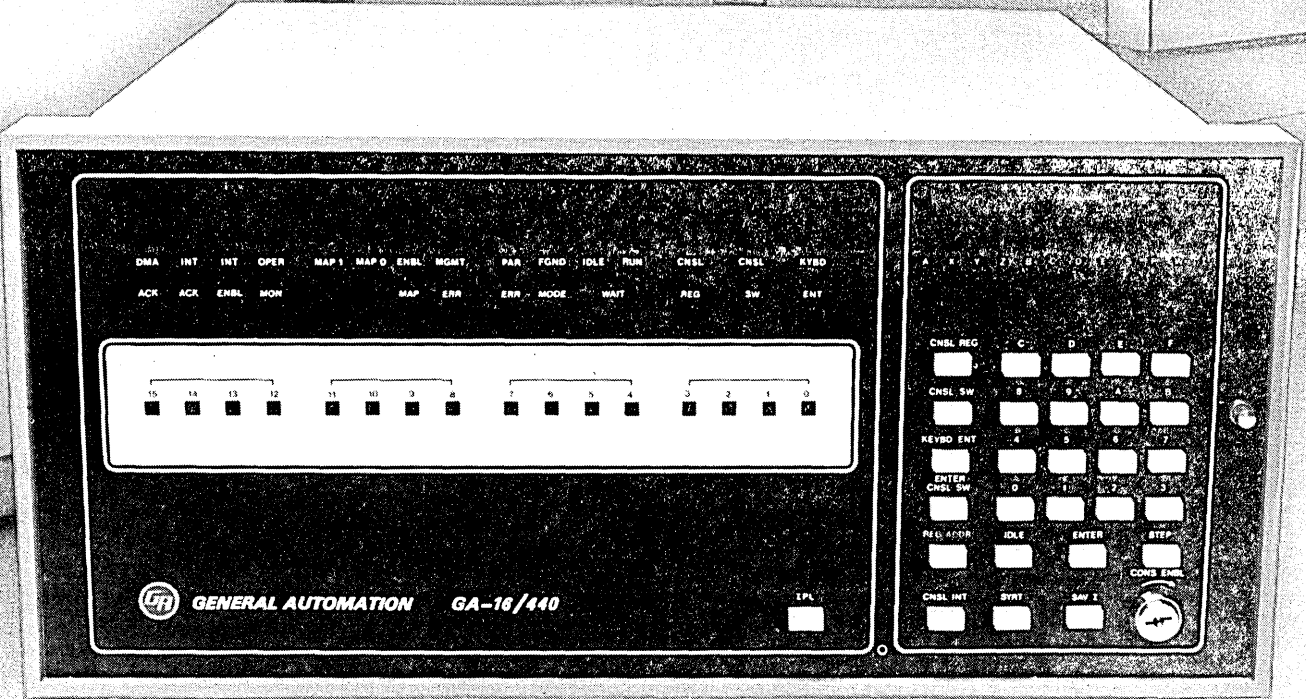
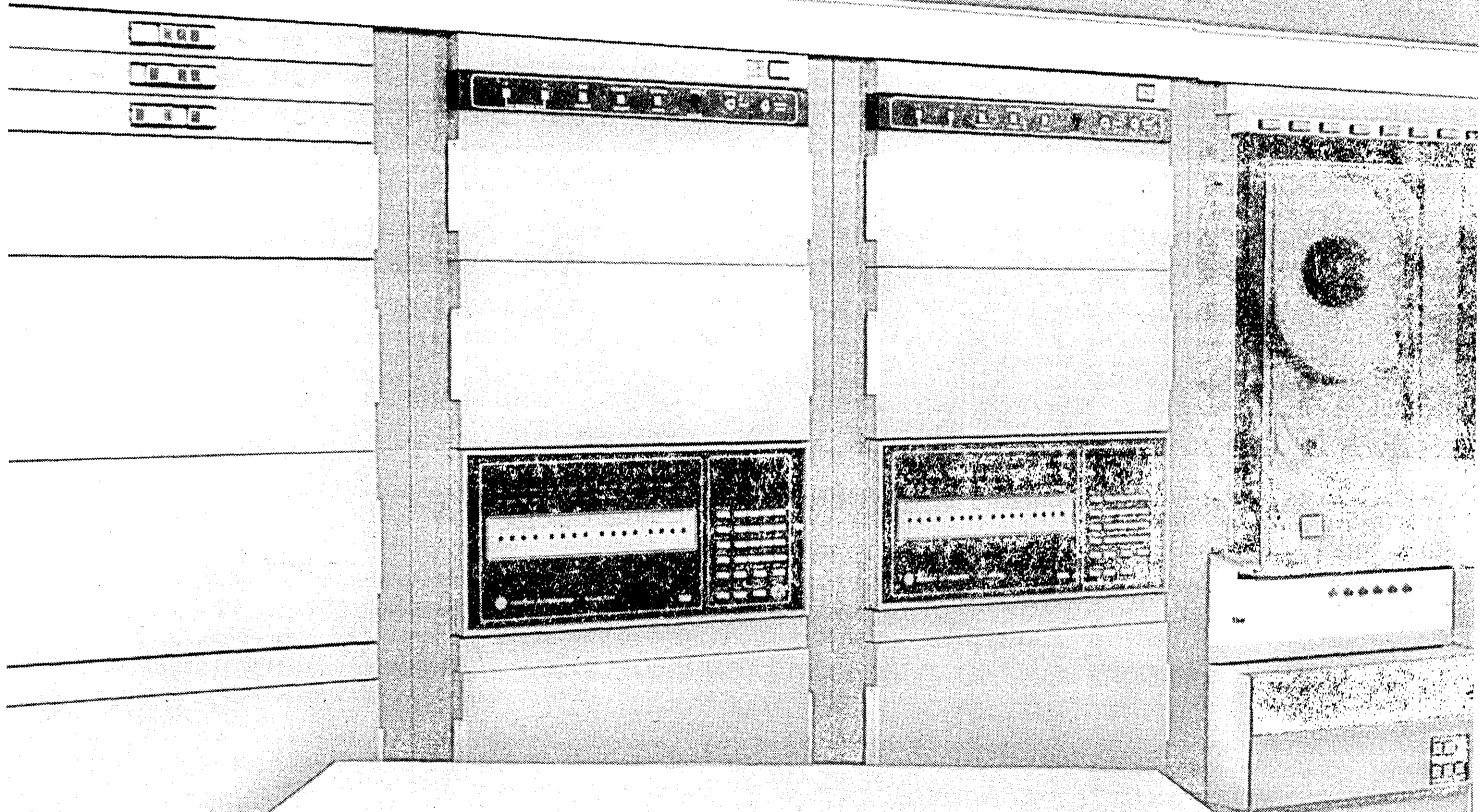

DMA INT INT OPER MAP 1 MAP 0 ENBL MGMT PAR FGND IDLE RUN CHSL CHSL RYSD
ACK ACK ENBL MON MAP ERR ERR MODE WAIT REG SW ENT

15 14 13 12 11 10 9 8 7 6 5 4 3 2 1 0

 GENERAL AUTOMATION GA-16/440

CHSL REG C D E
CHSL SW 8 9 0
KEYSD ENT 4 5 6
ENTER CHSL SW 1 2 3
REG AFER IDLE ENTER STEP
CHSL INT SWT SW 1



WESTI — the only teleprocessing monitor that made it!



WESTI was rated among the 25 best packages out of 1400 in Datapro Research Corporation's annual user survey.

Ratings were based on ease of installation, vendor support, documentation, throughput/efficiency, and overall satisfaction.

WESTI is a moneysaving DOS and DOS/VS teleprocessing interface that manages terminals, application programs, user core areas, disk workspace, display format files, and user work areas.

Send coupon today for our WESTI Information Manual—or a 90-day trial of the system.



Westinghouse Electric Corporation—OSP
2040 Ardmore Boulevard
Pittsburgh, Pa. 15221

I have a DOS or DOS/VS system and want a greater return on my teleprocessing system investment.

Please send: WESTI Information Manual.
 salesman to discuss possible WESTI applications.
 90-day trial.

Name _____

Title _____ Phone _____

Company _____

Address _____

City _____ State _____ Zip _____

Current teleprocessing system _____

Terminals used _____

CIRCLE 138 ON READER CARD

PROTECTION

And keep note of changes in personal behavior of employees. (Krauss noted one firm discovered that a systems manager committed suicide because he was involved in fraud. The firm had disregarded drastic changes in the manager's behavior months before.) For a more complete checklist, write Ernst & Ernst, 140 Broadway, New York, N.Y. 10005.

It was stated in another session that the liability law affecting designers, engineers, etc., will be expanded to cover the dp and systems operations of an organization. That means that dp personnel can be sued for civil or criminal negligence or wrongdoing.

Guarding against disasters

Robert Jacobson, Chemical Bank, spoke on "Innovative Methodology for Computer Risk Analysis" and helped users think about protecting against the rare but totally disastrous possibility of having the dp center wiped out by fire, flood, explosion, etc.—and how to convince management to pay the freight for protection. Among the steps of his "disciplined and structured thinking" are to rank specific threats (earthquakes, fire, theft, etc.) according to greatest possibility of occurrence and extent of loss to both physical assets and data. The user should decide what to protect against; he should select countermeasures, with the stipulation that security should be put on a return on investment basis.

Management consultant Belden Menkus detailed "elements" for the user's program of vital records protection: Select the information needed to support emergency operations restoration. Isolate these records. Keep backup files current so recovery won't create garbage. Simulate emergencies routinely and without warning. Don't count on your vendor to provide backup in his data center. Users should be getting together with similar installations for emergency backup.

DP insurance

Guy Migliaccio of Marsh and McLennan gave his well-known "Formula for Evaluating and Purchasing EDP Insurance." First he made a big point of the losses incurred by insurance companies in 1975 (\$2.4 billion in three quarters)—an ominous sign for the costs and coverage of dp insurance. His list was too long to recap. An interested reader may obtain the whole treatise from Migliaccio's New York offices (Or see "Burning Down the Data Center," Oct. 1975, p. 40.)

All in all, it was an enjoyable and rewarding three days.

—Angeline Pantages

We not only make all this communications equipment. We make it all work together.

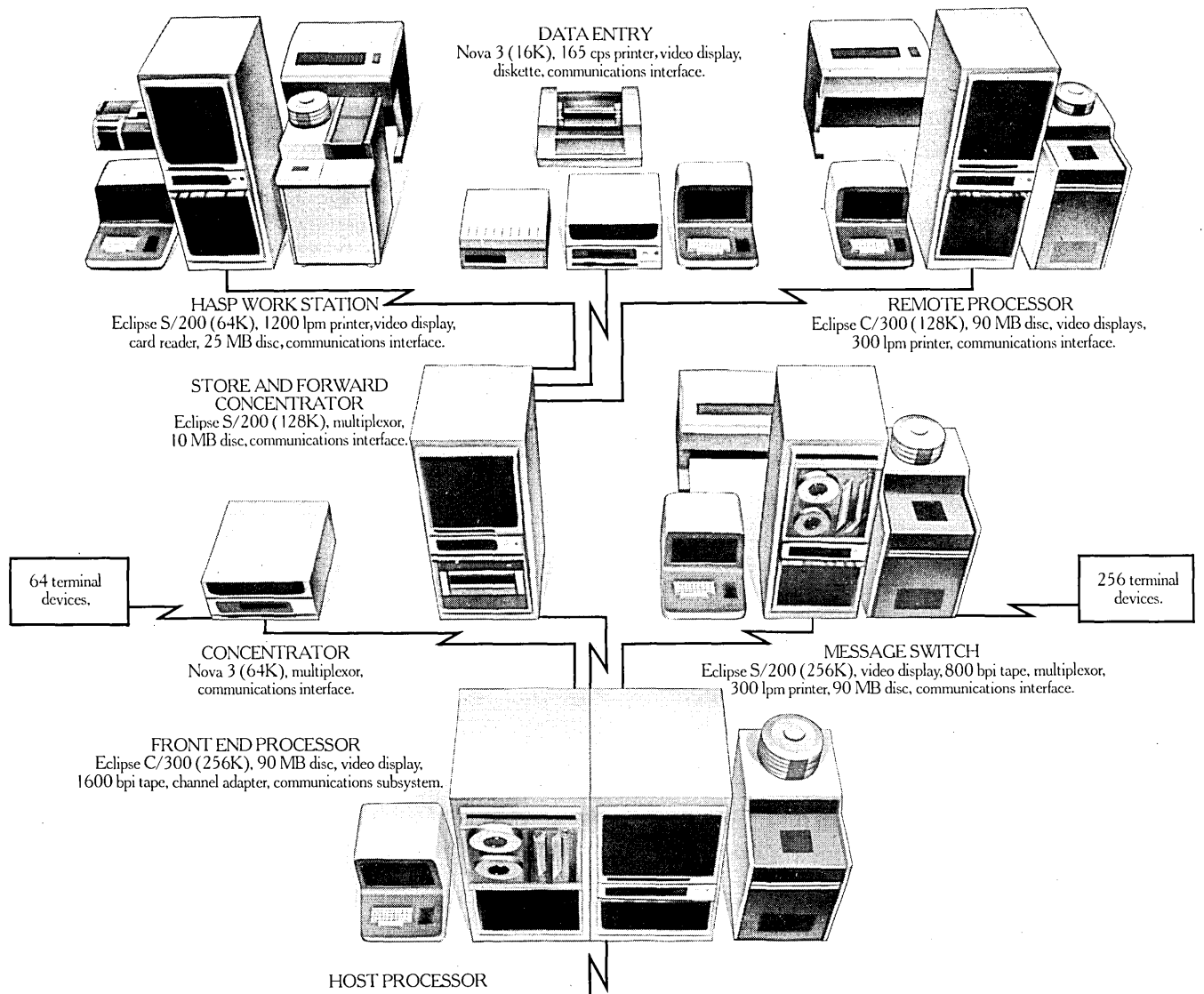

If you buy your communications equipment from Data General, you can avoid a lot of problems.

It's easy to configure your system. Because you get to pick from all the standard communications equipment you see here. And you get to use all the Data General communications software you don't see here.

And it's just as easy to expand a Data General communications system. Because it's completely modular. All our computers share the same

architecture. All our peripherals and interfaces are interchangeable with all our computers. All our software and all your applications programs are upward compatible.

But a Data General communications system isn't just less trouble.

It's also less expensive. You don't have to buy more than you need. You don't have to buy as many network spares. Because our subsystems are completely interchangeable. And you can get quantity discounts on your hardware.

And when you buy all your equipment from Data General, you don't have to wonder who's responsible for service and maintenance. We are.

Write for more information. That way, you'll end up with a communications system that works with you instead of against you.

Data General

• Data General, Dept. M1, Route 9, Southboro, Mass. 01772 (617) 485-9100. Data General (Canada) Ltd., Ontario. Data General Europe, 15 Rue Le Sueur, Paris 75116, France. Data General Australia, Melbourne (03) 82-1361/Sydney (02) 908-1366.

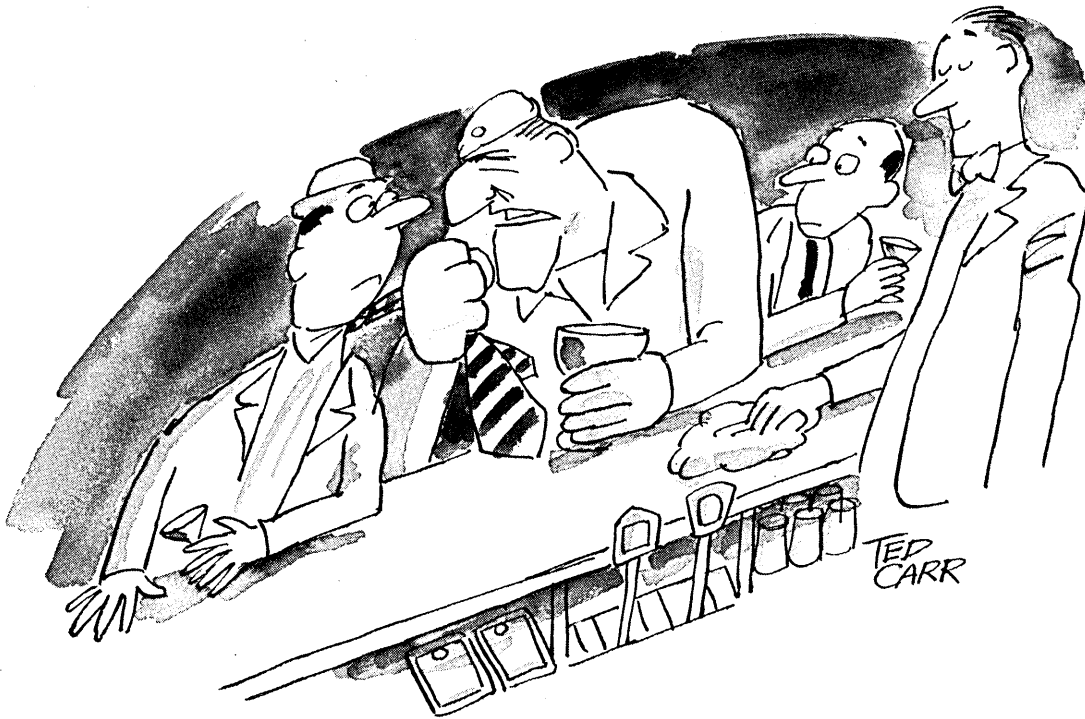

"It's economy, reliability and versatility! That's how Teletype sold 600,000 model 32 and model 33 data terminals."

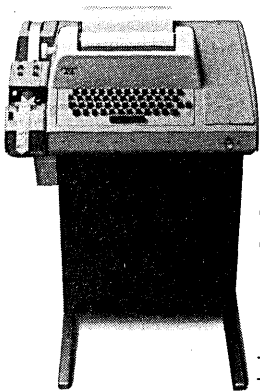

The Teletype® model 33 is the standard of the industry because it delivers outstanding economy, reliability and versatility in a wide range of applications. From message communications to computer input/output. On switched network as well as private-line systems.

For more information about the model 33, write or call: Teletype Corporation, Dept. 81Y, 5555 Touhy Ave., Skokie, Ill. 60076. Phone 312/982-2000.



Teletype is a trademark and service mark registered in the United States Patent and Trademark Office.

Just because our new Dumb Terminal (the ADM-3) is making a big splash doesn't mean we lack smarts. Take the tried-and-true ADM-2, for example. Thousands of these smart video terminals are out in the field. Working and working well.

The ADM-2 gives users and OEMs all the smart features they're looking for. Standard features, mind you, not options. Features like full editing facilities and 16 function keys (instead of the usual 8). Detachable keyboard. Both upper and lower case. 24 lines and 1920 characters on a 12" diagonal screen. Special numeric key pad. Protected data. Dual intensity. Up to 8 screen status indicators. Eight selectable data rates from 110 to 9600 baud. 4 transmission keys.

Optional ADM-2 Modular, executive walnut exterior.

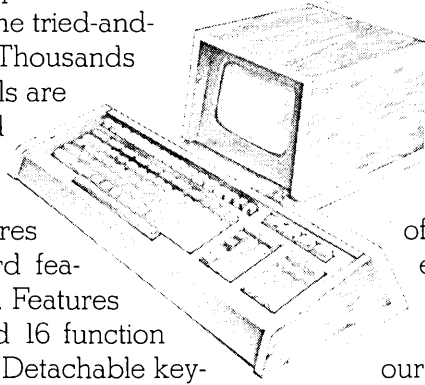

Keyboard lock. Easy system interface.

More standard features than anybody else has to offer, at a price that's even more reasonable than you would expect.

But you also have your options. Our ADM-2 Modular with detachable keyboard features a separate electronics package and a 9" or 15" screen. And you get a choice of exteriors — there's one for the office and an executive version in rich walnut. Smart looks at a smart, optional price.

So if you've been hearing a lot about our Dumb Terminals, it's because we had a lot of smarts to begin with. To get further intelligence on our smart ADM-2, contact: Lear Siegler, Inc.,

E. I. D./Data Products, 714 N. Brookhurst St., Anaheim, Calif. 92803. Telephone (714) 774-1010.



ANYBODY WHO CAN DELIVER THOUSANDS OF TERMINALS CAN'T BE ALL DUMB.

**THE ADM-2.
SMART TERMINAL.
SMART BUY.**



INTERFACE '76
See you in booth 105.

source data

(Continued from page 39)

Micro-recording

An illustrated, multicolor 8-page brochure describes a micro-recording system "capable of providing immediate access to any one of thousands of stored records." Product features and performance specifications are provided on the SRM sequential numbering microfilm recorder and the Syncro-Search reader/printer which together make up the system. BELL & HOWELL, Chicago, Ill.

FOR COPY CIRCLE 207 ON READER CARD

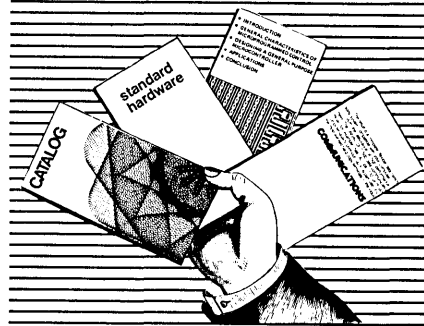

Graphics Service

An illustrated 8-page brochure describes the data support and service bureau-type services related to data collection, reduction and analysis, and

data display available from this vendor. Expertise is offered in cartography, civil engineering, environmental/pollution monitoring, general strip chart analysis, graphic arts, geophysical applications, automated drafting, land management and usage, oceanography, oil exploration, and other applications. DIGITAL GRAPHICS INC., Rockville, Md. 20852.

FOR COPY CIRCLE 205 ON READER CARD

Telecommunications Products

An illustrated 36-page telecommunications products catalog describes the major products in this company's line of video, voice, and data transmission systems. Included are multiplex systems, data transmission systems, microwave radio transmitter-receivers, supervisory and control systems, etc. Technical data, illustrations of each item, and reference sources for further information on over 60 products are supplied. GTE LENKURT INC., San Carlos, Calif.

FOR COPY CIRCLE 204 ON READER CARD

NMA Buyer's Guide

The sixth edition of the National Micrographics Association's *Buyer's Guide* is a single source of reference to micrographic equipment, products, and services available throughout the industry. The 64-page publication in-

cludes a geographic as well as alphabetic listing of company names and addresses. NATIONAL MICROGRAPHICS ASSN., Silver Spring, Md.

FOR COPY CIRCLE 208 ON READER CARD

Microfilm Software

Microfiche titling and indexing are two of the capabilities of Info-Link One, a software package for use with Kodak KOM-80 and KOM-90 microfilmers. Available extraction options and additional features are described in a 4-page brochure. EASTMAN KODAK CO., Rochester, N.Y. 14650.

FOR COPY CIRCLE 209 ON READER CARD

courses

Manager's Self-Study

Three courses for self-study are part of the Wiley Professional Development Programs Series. *How to Manage by Objectives* by Paul Mali is a short course in the fundamentals of managing by objectives concept, and can serve as a practical operating guide as well as a resource in training programs and management seminars. The 288-page loose-leaf book contains exercises

Just published! Tab rewrites the book on how to buy & store floppy disks!

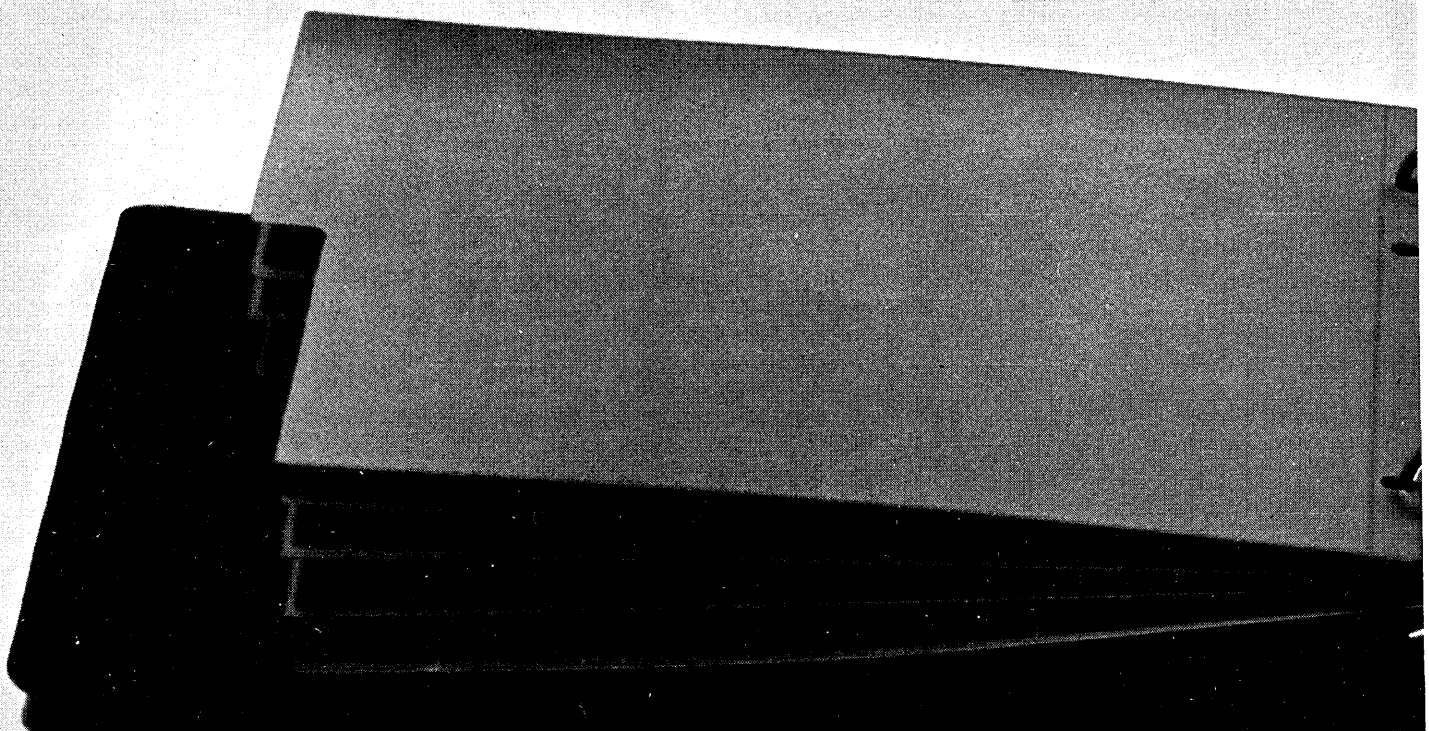

source data

and review materials.

Two short courses by Elwood S. Buffa in the same loose-leaf format are entitled *Modern Production Management*. The first, *Managing Day-to-Day Operations* (280 pp.), covers principles and techniques for making short-term decisions necessary to operations control. Analytical methods are stressed early in the course. The second, the 298-page *Planning and Designing Productive Systems*, has as its objective the analysis of long-range planning and decision making that commit an organization and its resources to a specific productive system design.

A feature of the three courses is a pre- and post-test, one which the reader takes after reading the introduction, and then takes again after concluding his study. Price: \$29.95 each. WILEY & SONS, INC., 605 Third Ave., New York, N.Y. 10016.

Canadian Data Communications

A 3-day course on the fundamentals of data communications for computer professionals and technically oriented managers will be held in Toronto (April 20-22), Vancouver (April 27-29), Ottawa (May 11-13), and Mon-

treau (June 1-3). Univ. of Waterloo faculty who are also members of the Canadian Computer Communications Networks Group will lecture on basic concepts, operational systems, etc. Fee: \$400 (includes textual material). Mrs. Elise Devitt, UNIV. OF WATERLOO, CCNG, E-4, Waterloo, Ontario, Canada N2L 3G1.

Brandon Courses

The spring semester of courses of interest to the dp community include four in structured programming, design, testing, and management; two workshops in dp management; three courses in dp long range planning; two in dp operations management; two in preparing system changes; one in computer contract negotiation; and two for improving communication among people in dp. These are one- to five-day courses and are priced from \$215 to \$650 (reference materials and lunches included). New York, San Francisco, Chicago, Washington, and Hartford are host cities.

Brandon is also co-sponsoring with the Univ. of Kentucky a Washington Conference Series for top management and computer professionals. Three 3-day conferences include *Distributed Processing: Trade-offs and Potentials* (March 15-18), *Improving COBOL Programming Productivity* (April 6-9), and *Computer Performance Im-*

provement (May 10-13). Tuition for each conference: \$520 (includes reference materials, lunches, and university credit). BRANDON SYSTEMS INST., INC., 1611 N. Kent St., Arlington, Va. 22209.

For Women Only

A first course for women executives, *Management Skills for Women*, is designed to help integrate "who you are with what you do." Building management skills along with balancing the demands of work and private life are the emphases in this three-day course to be held in Chicago (April 5-7 and July 26-28), and New York (Aug. 9-11). Fees: \$470 (\$410 for AMA members); team fees available. AMERICAN MANAGEMENT ASSNS., 135 W. 50th St., New York, N.Y. 10020.

Teleprocessing Systems

A four-day course on design and implementation planning of teleprocessing systems is scheduled for Atlanta (April 5-8), Chicago (June 7-10), and New York (July 19-22). Covered will be planning for a data communications system, data transmission services, transmission equipment, interactive crt and hardcopy terminals, etc. Fee: \$540 (\$470 for AMA members); team fees available. AMERICAN MANAGEMENT ASSNS., 135 W. 50th St., New York, N.Y. 10020. *

You'll flip!

Now you can buy your single- and dual sided floppy disks from Tab in a standard package that includes protective vinyl sleeves with pocketed index cards, a sturdy ring binder and a complete sequential numeric/color-coded filing system!

All For The Price Of Floppies Alone! If you're tired of being boxed in by your present floppy storage, you can buy our new Flip Floppy system without disks. For the cover-to-cover story on this novel way to buy and store

floppies, contact your local Tab representative. Tab Products Company, 2690 Hanover Street, Palo Alto, Calif. 95304.

TAB
PRODUCTS CO.

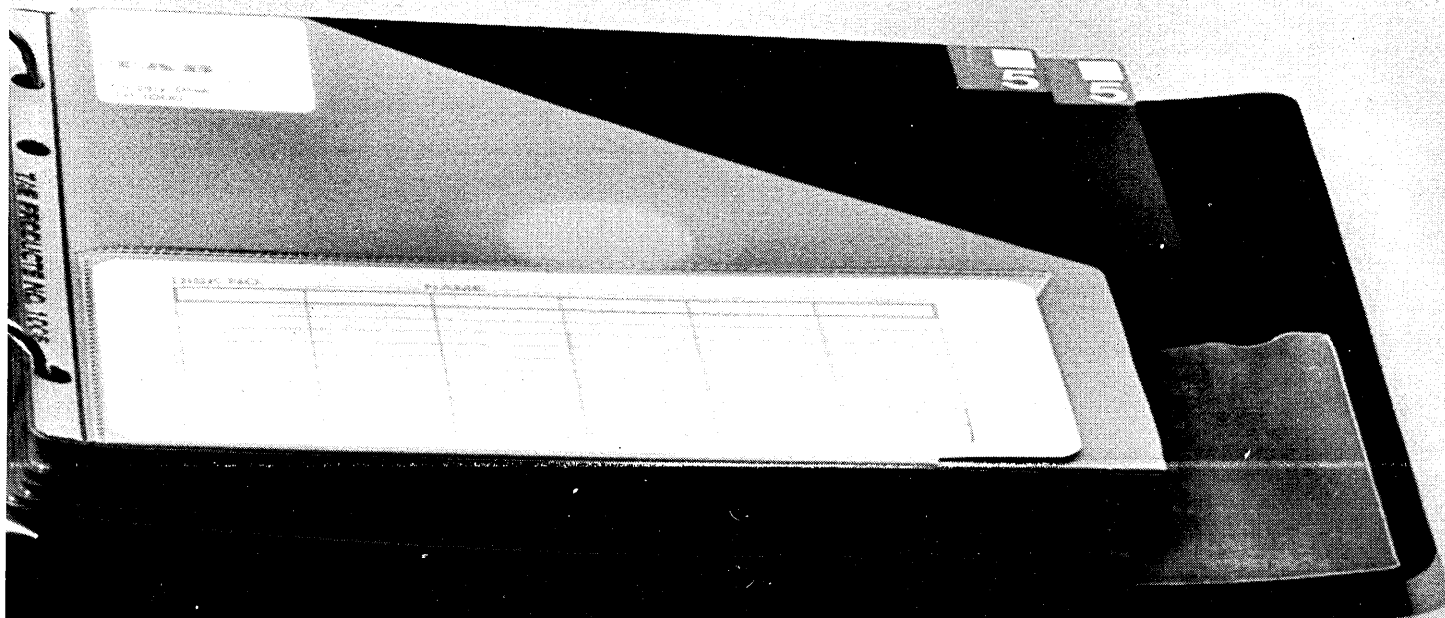



BASF invented magnetic tape back when 3M meant great giftwrap tape.

Back in 1932, when a phone call cost a nickel and Prohibition was still the Noble Experiment, BASF invented magnetic tape . . . the forerunner of all of today's high-density data processing media. The state of the art has advanced considerably since then, and of course we have some fairly impressive competition. That's why, here at BASF, we've never been content being first. We can only settle for being best. And we've had more time to get that way than anyone else in the business.

As part of a worldwide organization with 1,500 scientists and engineers working full-time on research and development, we've had some extraordinary advantages. We've had ample opportunity to develop tape-slitting techniques that give a cleaner, more debris-free edge; coating and polishing methods for the most durable surface on the market; and a disk pack balancing system that can't come unglued. It's not how long we've been around that counts; it's what we've done with our time. Ask our customers

. . . most people who choose BASF make it their only choice. BASF Systems, Bedford, Massachusetts 01730.



BASF The Original.

Computer Tapes Disk Packs Flexydisks Word Processing Supplies

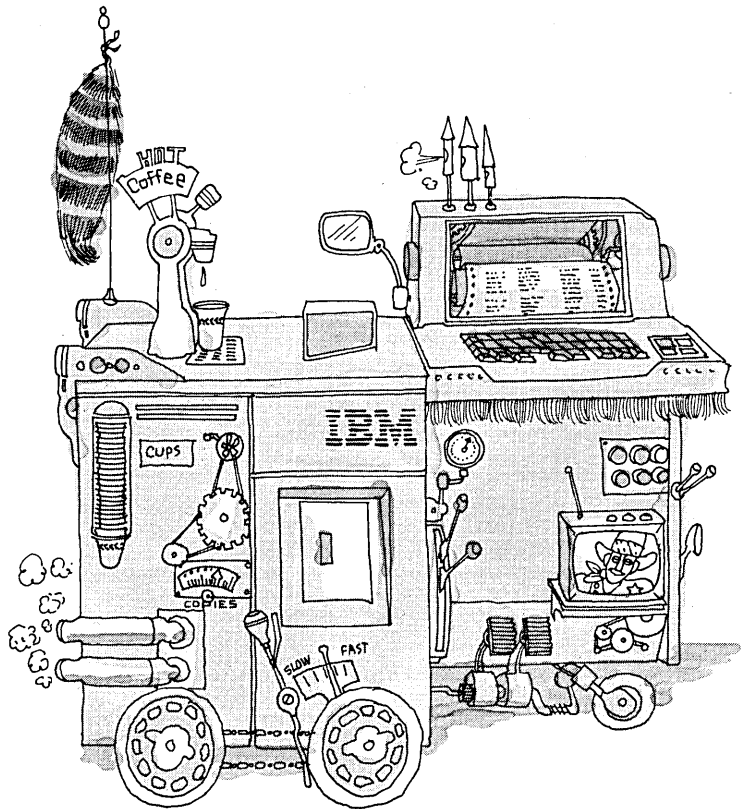
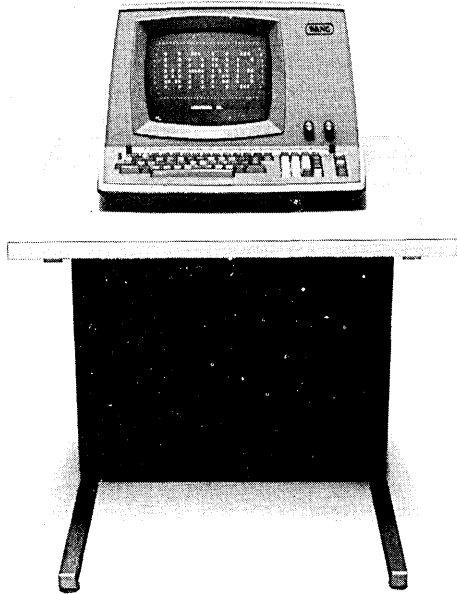

A lot of companies confuse the computer they need with the one they've heard about.

The Wang 2200 Line of Small Computer Systems and the IBM System 32.

The Wang 2200 Line fits any need. Small or large. Business or scientific. Because it's a complete product line, not just one computer.

The Wang 2200 Line comes with many different processors and 35 system peripherals. Which means there's a Wang computer system that fits your needs precisely.

With the IBM System 32, you

must fit one size—large. And pay for capabilities you won't use.

The Wang 2200 Line starts at under \$10,000. And it expands as you expand.

No matter how much computer you need, Wang can provide just that much. And whenever you need greater capability, it too will be exactly what you need.

All things considered, are you interested in the one computer system designed for you, or the one you've heard about?

For more information on the Wang 2200 Line of Small Computer Systems, please call (617) 851-4111 or write:

Wang Laboratories, Inc.,
Dept. D-3 836 North St.,
Tewksbury, Mass. 01876.

WANG

**We happen to make a better
small computer than IBM.**

Wang Europe S.A., Buurtweg 13, 9412 Ottergem, Belgium

Varian Introduces The V76 It Remembers Time Is Money

The increasing demands of information processing obviously increases your computer time. And time is money. The V76 is a general purpose, microprogrammed computer system for scientific, industrial and data communications application. It outperforms the high class minicomputers such as the PDP-11/70, ECLIPSE, or the HP-3000.

You save money because of the new low cost 64K memory. The dual-ported semiconductor MOS 660ns memory provides the same performance as an identically configured core memory for one-third the price, or less than seven cents a byte.

With our high performance Cache system you can execute your programs almost twice as fast. Our new Megamap allows you to process up to one million words of on-line data. This combination of large resident memory, Megamap and Cache, is a highly cost effective method to process more information, reduce exe-

cutiion time and save additional money.

The Varian V76, with an unlimited range of application, and a broad, flexible, high-performance, open-ended selection of computer hardware, firm-ware and software allows you to design the system that best suits your complex information processing demands.

A network of field service engineers, analysts and a full staff of factory experts are committed to serving you with system configuration, hardware and software specials, installation, operator training and systems management.

Find out about the economy-minded Varian V76 computer system by calling any of our 38 worldwide offices listed below. For a free product brochure write Varian Data Machines, 2722 Michelson Drive, P.O. Box C-19504a, Irvine, CA 92713, (714) 833-2400. In Europe, contact Varian Associates, Ltd., Molesey Road, Walton-on-Thames, Surrey, England, Telephone 28971.

Helping a Fast World Move Faster

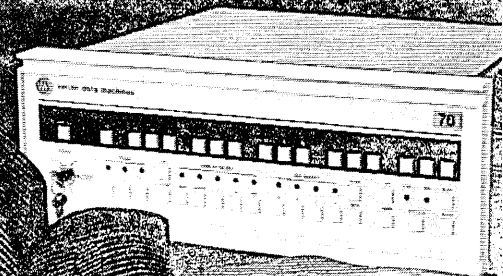

 **varian**

U.S. OFFICES: Los Angeles (213) 598-4438, San Diego (714) 276-9462, San Francisco (408) 738-5630, Seattle (206) 641-4500, Denver (303) 770-2151, Dallas (214) 231-5145, Houston (713) 781-0105, St. Louis (314) 739-6433, Chicago (312) 692-7184, Detroit (313) 845-9950, Cleveland (216) 238-6960, Orlando (305) 299-1592, Atlanta (404) 252-0047, Washington, D.C. (301) 773-6670, Philadelphia (215) 643-2355, New York City (212) 325-5248, Rochester (716) 586-3273, Boston (617) 890-6072.
INTERNATIONAL OFFICES: Brussels (02) 4662000, Darmstadt (06151) 86386, München (089) 8126093, Bensberg (02204) 61066, Amsterdam (020) 15 94 10, Stockholm (08) 820030, Zug (042) 23 25 75, Surrey 093 22 28971, Toronto (416) 457-4130, Montreal (514) 332-2840, Vancouver (604) 736-5821, Ottawa (613) 224-6521, Calgary (403) 276-4456, Melbourne 560 7133, Sydney 43 0673, Sao Paulo (011) 240-3449, Singapore 2352602, Tokyo 403-7101, New Zealand 697-099, Taipei 559082.

CIRCLE 10 ON READER CARD

59309A ASCII DIGITAL
HEWLETT-PACKARD
B I 7 9
CALENDAR
ADDRESS

Enter Next Regression Model

RANGE

TRIG

$X = 123 \times 2$

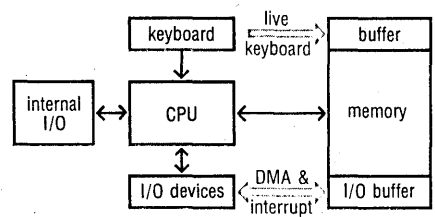

Introducing the HP 9825 with vectored priority interrupt, direct memory access, live keyboard, multidimensional arrays, buffered I/O...

That's big-system computing performance.

The all-new 9825 Computing Calculator: a very versatile, very powerful device for high-speed problem-solving and for interfacing applications. Consider these performance-oriented features:

Vectored priority interrupt allows virtually simultaneous processing of multiple jobs. It's easily programmed to suspend processing, gather or send data and messages to instruments and peripherals, then automatically return to the original job.

Live keyboard lets you interact with the system while a program is running to examine or change program variables—or even perform keyboard calculations.

Up to 400k transfers per second direct memory access provides mini-computer speeds which allow real-time data acquisition and data transfer with high-speed devices.

High-speed, 250k byte tape cartridge with 6-second average access time permits rapid processing of data and loading of programs.

Multidimensional arrays allow you to organize data logically, thus saving program space and execution time. A 20 x 20 matrix can be inverted in 10 seconds.

Buffered I/O increases throughput by providing a programmable software buffer between the program and an external device.

Memory load and record allows you to suspend processing whenever you want and store the complete contents of memory on tape—including data and pointers—for continuation later on.

High level language (HPL) offers you power and efficiency for handling equations, data manipulation,

and input/output operations. Yet it is easy to learn and use.

Other features and capabilities enhance 9825 performance and versatility: for example, upper and lower case alphanumerics on both the display and printer; interfacing to any of eight HP calculator peripherals through three I/O slots, and up to 45 different instruments via HP Interface Buses.

Simultaneous processing of several diverse jobs.

Say you're using a 9825 to control an instrument test stand, and acquiring data from it at speeds in excess of 1000 bytes a second; then printing the results on the new HP 9866B Thermal Line Printer. At the same time, the same 9825 can also be processing and plotting a statistical problem. And through the 9825's live keyboard, you can check the

progress of either program and even change parameters if you desire. It seems the 9825 is doing all these operations simultaneously, thanks to its speed, buffered I/O, and interrupt capability.

Unexpected performance from a computing calculator

All this performance comes in a 26-pound, 5" x 15" x 19" package. Yet, with all its power and computer-like features, the 9825 still retains the friendliness and simplicity of a calculator. You don't have to be a programmer to get performance out of a 9825; nor do you need to be a systems expert to do interfacing applications. When you know all the facts, we think you'll agree the 9825 is a great buy. Write for your free copy of the 16-page 9825 brochure, or call your local HP sales office for more information.

HP computing calculators put the power where the problems are.



Sales and service from 172 offices in 65 countries.
P.O. Box 301, Loveland, Colorado 80537

Interactive Terminals? Ask Sanders.

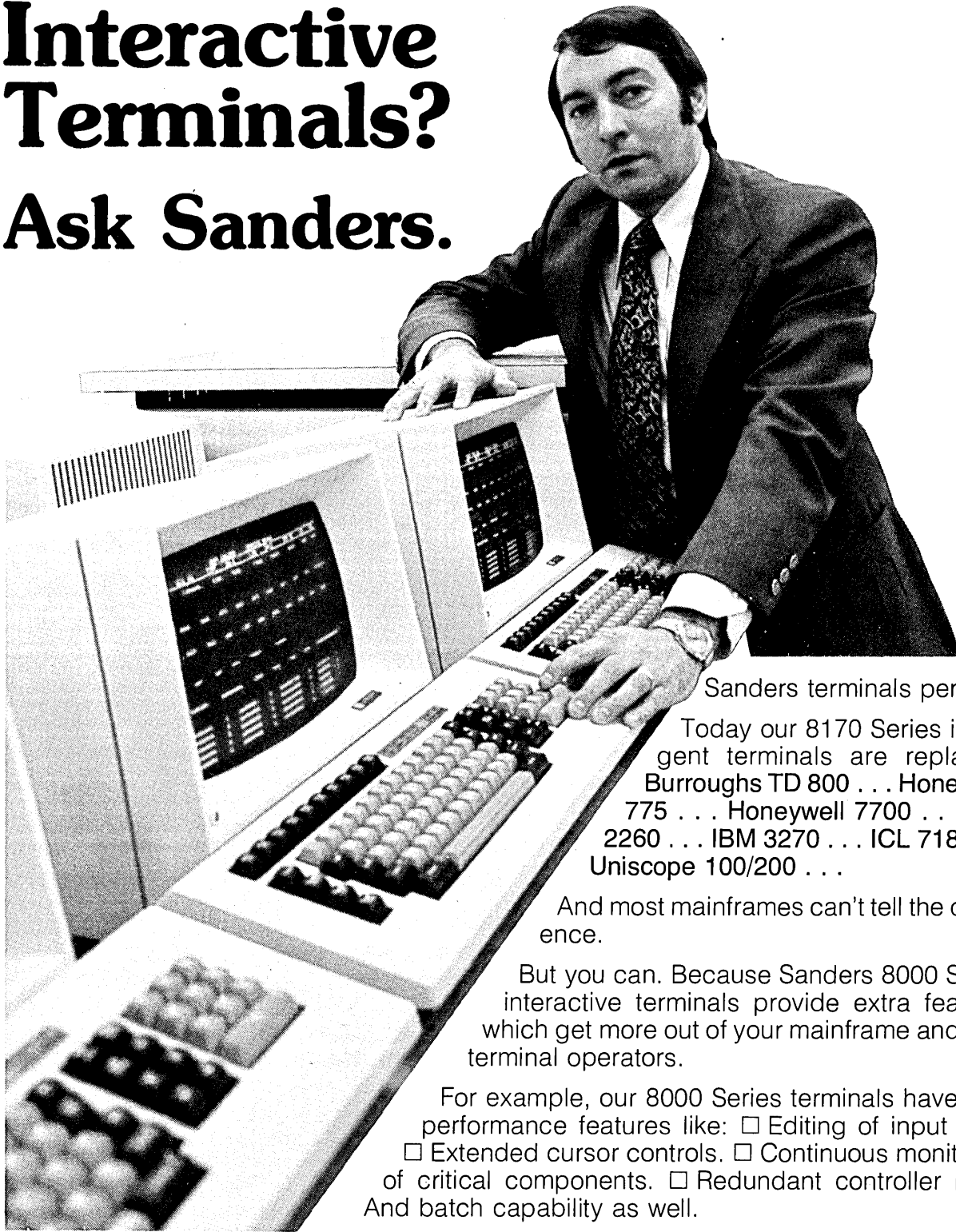

Sanders terminals perform.

Today our 8170 Series intelligent terminals are replacing Burroughs TD 800 . . . Honeywell 775 . . . Honeywell 7700 . . . IBM 2260 . . . IBM 3270 . . . ICL 7181 . . . Uniscope 100/200 . . .

And most mainframes can't tell the difference.

But you can. Because Sanders 8000 Series interactive terminals provide extra features which get more out of your mainframe and your terminal operators.

For example, our 8000 Series terminals have high performance features like: Editing of input data. Extended cursor controls. Continuous monitoring of critical components. Redundant controller logic. And batch capability as well.

Ask Sanders.

Sanders . . . the intelligent answer



Home Office: Daniel Webster Highway, South Nashua, New Hampshire 03060 (603) 885-4200 • Regional Offices: Eastern: Washington, D.C. • Western: Los Angeles • Federal: Washington, D.C. • District Offices: Atlanta • Cherry Hill (N.J.) • Chicago • Dallas • Los Angeles • New York • International Subsidiaries: England (London) (Manchester) • West Germany • International Distributors: Australia • Denmark • Italy • Japan • New Zealand • Venezuela

Employment opportunities are open for key programming, engineering and management personnel.

New Hytype Terminal for OEM's!

Fine print quality, graphics versatility and high speed tabbing.

We call it HyTerm and we've given it all the proven HyType reliability and maintenance ease. HyTerm is controlled by a microprocessor for speed, efficiency and versatility. It utilizes the new Diablo HyType II Printer mechanism noted for its typewriter print quality and speed. HyTerm is interface compatible to RS-232C and communicates in standard ASCII code. Both Receive Only (RO) and Send/Receive (KSR) models are available. All logic and circuitry, microprocessor, memory, and power supply are contained within the cover. Printer flexibility is maintained so software can initiate the mechanism's unique graphics performance, and its inherent high-speed horizontal and vertical tabbing and backwards printing capabilities.

Other features: efficient handling of pre-printed forms, variable format control, escape-code functions, full ASCII character set, keyboard overflow buffer, 158 character print buffer, and data error detection. Numeric pad, control panel, pin feed platen, form tractor feed, and split platen options available. For complete specifications and features, write Diablo Systems, Inc., 24500 Industrial Blvd., Hayward, California 94545, or Diablo Systems, S.A., Avenue de Fre 263, 1180 Brussels, Belgium.



Diablo Systems, Incorporated
A Xerox Company

CIRCLE 25 ON READER CARD

YOU ARE WATCHING A DIABLO MODEL 1620 TERMINAL IN OPERATION.
HERE IS A BRIEF DESCRIPTION OF ITS CAPABILITIES.

OVERVIEW

The 1620 is a microprocessor-driven data communications terminal which provides reliable, low cost operation and wide versatility in an office and functional laboratory. The 1620 provides an standard many features which are optional or not available on other terminals. It utilizes the Diablo HyType II printer mechanism, which provides steady, clear, high quality printing of both text and graphics in a variety of easily-changeable and multiple styles. An RS-232C interface and ASCII coding provide rapid conversion to almost any hardware and software system.

PRINTERS

The print mechanism is a standard Diablo HyType II model 1145 impact printer, employing interchangeable printwheels (HyType font), quickly replaceable ribbon cartridges, and microprocessor-controlled carriage advance and carriage positioning. Multiple printing areas in 85 character-per-second, but built-in motion accumulation and software-controlled backwards printing can increase total printing speed even further. Many types of graphics can also be printed by utilizing the HyType II 1128" horizontal resolution and 1128" vertical resolution. All 94 printing ASCII characters can be printed.

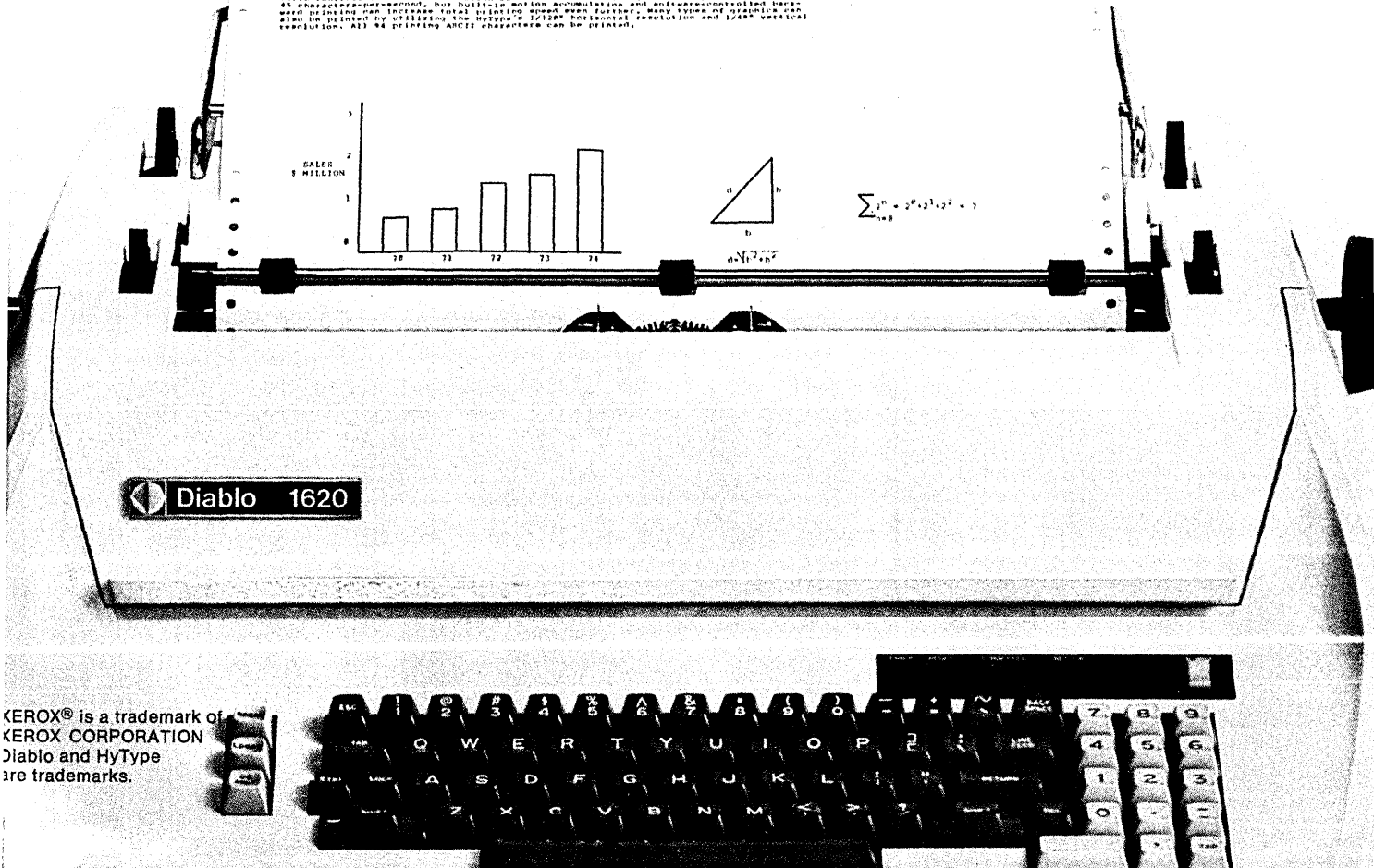

XEROX® is a trademark of
XEROX CORPORATION
Diablo and HyType
are trademarks.

FRONT ROW CENTER ON THE WORLD OF DATA COMMUNICATIONS

MIAMI BEACH CONVENTION CENTER

FREE
FOR
ADMIT ONE

MIAMI BEACH • MARCH 29-31, 1976

ADMIT
ONE



THE STAGE IS SET FOR INTERFACE 76

And you can be there—*front row center*—on all the excitement! This year, as in the past, INTERFACE 76 continues to be the Data Communications Conference and Exposition. Co-sponsored by DATAMATION Magazine, INTERFACE 76 combines thoroughly experienced conference management with this major source of editorial excellence to bring you the most comprehensive and productive data communications event ever held.

INTERFACE 76 has, as its goal, cost effective management on all levels through data communications. That goal is reached through complete management programs tailored to you. Regardless of your level of expertise in data communications, you can follow a comprehensive program at INTERFACE 76. Sessions are structured in contiguous groups to ensure that you receive thorough coverage of the subjects to meet your needs. (Attention—EDP, Datacomm and Communications Management—General and Financial Management, too Shouldn't your organization benefit from this kind of comprehensive coverage?)

Co-sponsored by

DATAMATION[®]
Magazine

HELD OVER—1975'S BIG HIT

The **Data Comm School** is just one of our show stoppers. Pupils in the Data Comm School study fundamentals of data communications with emphasis on management decision-making rather than technical details. There's lots of new material designed for novices, experienced staffers and management from other areas who want an introduction to and an overview of data communications.



With over 125 speakers to hear and hundreds of exhibits to see, you'll be front row center on the world of data communications.

AN EXPANDED PROGRAM DESIGNED IN DEPTH

The INTERFACE 76 Conference Program is three full days, 41 different fact-filled sessions with over 125 speakers, designed to bring you the latest information on the world of data communications.

In *Methods Workshops*, you'll study latest methods and procedures needed to plan, implement and maintain a data communications system. Emphasis will be on the latest networking approaches.

Follow that up in our *Product Workshops* to thoroughly understand the role of specific products and services in data communications systems. These workshops also offer guidelines on equipment evaluation and selection.

Hear in-depth analyses of today's important topics. INTERFACE 76 *Highlight Sessions* are forums for the issues and answers that closely affect the User community.

Apply this input of information to your specific industry. It's sure to be included among the 14 major areas covered in the *Applications Sessions*. Here, four-member panels of experienced users will employ a case study approach in describing their use of data communications.

A complete listing of program titles and descriptions is contained in our brochure.

INTERFACE 76—CLEARLY THE CRITICS CHOICE

A team of consultants and industry editors working in data communications have structured program content to be most logical, vital and productive for attendees.

Program Committee

Ralph Berglund, Industry Consultant
John Buckley, Pres., Telecommunications Mgmt. Corp.
Richard L. Deal, Pres., Richard L. Deal & Assoc.
Donald Dittberner, Pres., Dittberner Assoc., Inc.
Dr. Dixon R. Doll, Pres., DMW Telecommunications Corp.
Philip H. Dorn, Pres., Dorn Computer Consultants, Inc.
Dr. Philip H. Enslow, Jr., Prof., Georgia Inst. of Tech.
Phil Hirsch, Editor of Data Channels
Richard A. Kuehn, Pres., RAK Associates
Robert A. Lively, Pres., Lively Communications
Einar Stefferud, Pres., Network Mgmt. Assoc.
Bernard Strassburg, Communications Consultant & Former Chief, FCC Common Carrier Bureau

And here's our INTERFACE 76 Industry

Editors Advisory Board

Ken Bourne, COMMUNICATIONS NEWS
John Kirkley, DATAMATION
Arnold Keller, INFOSYSTEMS
Robert M. Patterson, MINICOMPUTER NEWS
Alan Kaplan, MODERN DATA
William R. Schulhof, THE OFFICE
Jim Hughes, TELECOMMUNICATIONS
Ray H. Smith, TELEPHONE ENGINEER AND MGMT.
Leo Anderson, TELEPHONY

APPEARING SOON IN OUR THEATER BY THE SEA

INTERFACE 76 will be staged in one of the finest convention sites in the country—the centrally located Miami Beach Convention Center. For attendee convenience, *free shuttle bus service* between the Convention Center and all convention hotels will be provided by INTERFACE 76 conference management.

Convention hotels include Miami Beach's most popular. Special conference rates range from \$21-\$47 for room accommodations.

Complete hotel registration information will be furnished upon receipt of Conference Registration Coupon, or call our INSTANT INFO number below.

To register for INTERFACE 76, simply fill out and mail coupon to:

INTERFACE 76
160 Speen Street
Framingham, Massachusetts 01701

Note the special "team rate" discounts when you register 3 or more from the *same location* of your organization.

REGISTRATION FEE	3 Full Days	One Day
1st and 2nd attendees	Each \$95	\$50
3rd and more attendees	Each \$50	\$25

Mail to:

INTERFACE 76
160 Speen Street
Framingham, Massachusetts 01701

Name	Organization	Address	City	State	Zip	Telephone()

My check for registration payable to DataComm Interface, Inc. in amount of \$_____ is enclosed.

Please bill me. Please send brochure.

FOR INSTANT/INFO CALL TOLL FREE (800) 225-4620

WITHIN MASSACHUSETTS, CALL COLLECT (617) 879-4502

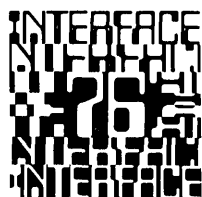

INTERFACE 76

CIRCLE 160 ON READER CARD

Try pricing out the cost of lost data.

Then you'll know why over half the certified digital cassettes in use throughout the world today are made by Information Terminals.

A dropped bit could mean only a misspelled name. It could also mean a check a hundred or a thousand times too big, a carload shipment sent to the wrong destination, or a fleeting moment in time lost forever!

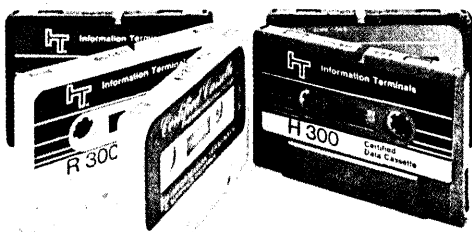

100% Certified. You can be sure with ITC.

To help protect you, your company and your projects against such losses, ITC tests its computer grade information storage media 100% *after assembly*.

This means every ITC computer grade digital cassette, floppy disk, FLIPPY™ disk, 1/4-inch Data Cartridge and Mini-Cassette is checked for perfect mechanical and recording operation before it leaves our hands. 100% Certified. You're sure with ITC.

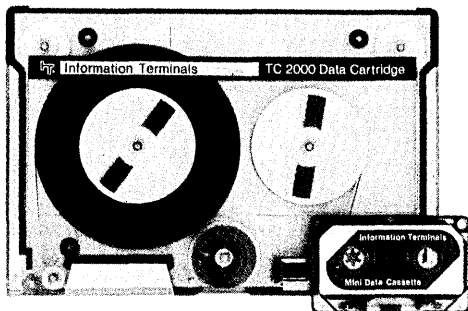

A medium for every message.

ITC 100% CERTIFIED DIGITAL CASSETTES. Five Series, to fit just about every system and environmental requirement, from computer room or business office to desert, jungle or frigid mountain top.

ITC 100% CERTIFIED FLOPPY AND FLIPPY™ DISKS. One-sided floppies and two-sided FLIPPIS™.

No matter what or who's diskettes you've been using, there's a 100% Certified ITC disk you can depend on.

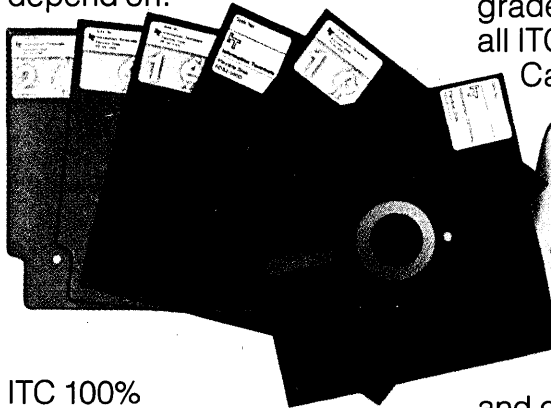

ITC 100% CERTIFIED 1/4-INCH DATA CARTRIDGES. ITC's new 1/4" Data Cartridges, with exclusive new features for new levels of performance and reliability.

ITC 100% CERTIFIED MINI-CASSETTES. A unique new approach to data storage in hand-held and desktop digital devices. ITC's MI-50 Mini-Cassette

packs 50 feet of data capture in a package smaller than a box of pocket matches.

ITC MAGNETIC CARDS FOR WORD PROCESSING SYSTEMS.

High quality products for the Office,

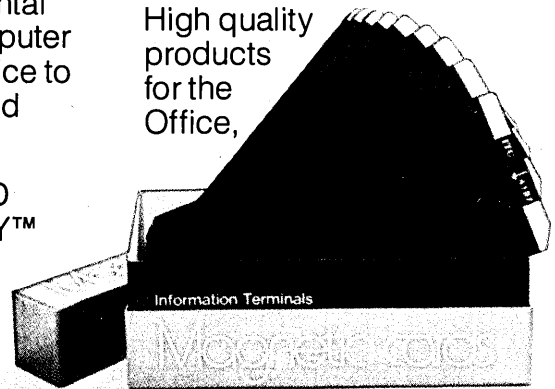

from the leading producer of 100% Certified computer grade magnetic media. Like all ITC products, our Mag

Cards feature consistently high performance from one shipment to the next.

Write for Information on ITC computer grade and word processing media, and our cassette and diskette testing and alignment equipment. Or call your nearest ITC distributor or representative.

Information Terminals
323 Soquel Way
Sunnyvale, California 94086
Telephone (408) 245-4400

In Europe:
Information Terminals SA
Case Postale 296
1215 Geneva
Switzerland

Litigation

An Wang's Early Work in Core Memories

Boston court case turns up Wang's discoveries—and the tragic case of a public works inspector

In 1956, an inspector of streets and sidewalks for the Los Angeles Department of Public Works decided he was the inventor of magnetic core memory. In an effort to substantiate his claim, the inspector filed a patent interference action against Dr. An Wang of Boston, who had performed the early work on magnetic core memory at the Harvard Computation Laboratory.

The interference against Wang by a Los Angeles sidewalk inspector whose stature in the scientific community was precisely zero would at first appear to be an affair of personal bravado on the part of the Los Angeles man, Frederick W. Viehe. The whole matter, however, was not a light affair.

The invention of magnetic core memory, of course, was crucial to the development of the entire computer industry, in much the same way perhaps as the invention of the internal combustion engine was central to the development of the automotive industry. Core memories were developed in the late 1940s and during the 1950s, and represented the first truly inexpensive and reliable method of computer memory storage.

Came to light in court

The strange case of Frederick Viehe comes to light for the first time with mention of his name in voluminous legal proceedings between NCR and the Massachusetts Institute of Technology (MIT) over magnetic core storage patents in Federal District Court in Boston (Sept. '75, p. 108). MIT maintains that it holds a key magnetic core patent—through the work of MIT professor Jay Forrester—while NCR charges among other things, that the MIT patent is invalid because it was based on Dr. Wang's work at Harvard. MIT is attempting to collect patent royalties from NCR, which is resisting.

Viehe filed his patent (called "electronic relay circuit") in 1947 and Wang filed his patent ("pulse transfer control-

ling devices") in 1949. Viehe updated his patent on later occasions and apparently incorporated some of Wang's work into his. The case was not finally resolved until late 1959, but the two men never met. Complicating matters further was the often mysterious hand



"He was very much an individualist," his son, Frederick, recalls. He was very intense and sometimes he was difficult to live with."

Payment from IBM

Viehe set up his homemade electron-

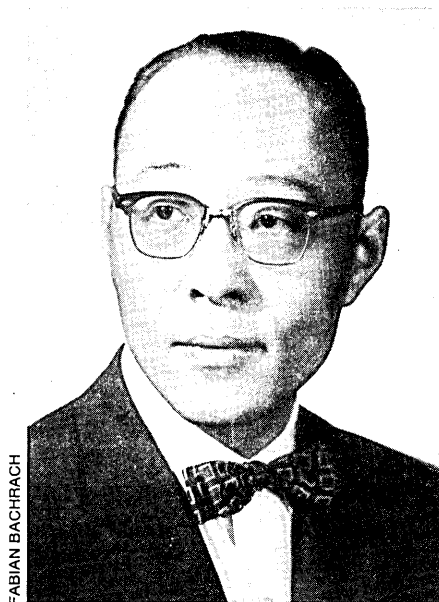

DR. AN WANG, left, in the winter of 1947-48 at Harvard campus before a mobile radar station, and today as the president of Wang Laboratories in Tewksbury, Mass.

of IBM, which was involved in the matter in ways that are not always clear.

First of all, who was Frederick Viehe?

Born in South Carolina about 1912, he developed an interest in electricity from his clergyman-father and apparently received most of his formal education in the field while serving a hitch as an electrician's mate in the Navy. He completed one year of college at the Univ. of Delaware and eventually landed as an inspector at the Los Angeles Department of Public Works. He died in 1960.

ics laboratory in his house, and, from hardware stores, purchased off-the-shelf items like electrical transformers that he used in his studies. His work was such that he was paid several hundred thousand dollars for patent rights. IBM was one company that paid Viehe for his work and there are indications that other firms may have paid for patent rights too.

Secrecy surrounds Viehe and his work. One of Viehe's lawyers said he couldn't remember much about Viehe's work while another lawyer said that

news in perspective

Viehe had sworn him to secrecy on his work. When Viehe died, press reports described him as a simple public works inspector who left \$625,000 in savings accounts alone but who was "sworn to secrecy" by the party that bought his "secret invention."

Viehe's son says that IBM was the party that bought his invention and that IBM stipulated that his father not discuss his invention. IBM, however, now says it never placed any secrecy restrictions on Viehe's work.

Viehe's friends and acquaintances never understood the electronic work that was a private passion for him. "Many people thought he was a nut, I guess," says the younger Viehe. "I think it must have been terrible for him not to be able to talk to anyone about the work that he was doing and that he loved.

"Other scientists wouldn't associate with him. He had no education to speak of, you see. I remember that he was offered a good research job once, but the people who would have worked for him resisted his appointment because of his lack of education."

Won most claims

Reed C. Lawlor, a Los Angeles attorney who represented Viehe in many of his patent litigations, said that Viehe had been involved in more than 100 patent claims and that "he won most of them." Lawlor was representing Viehe at the start of the patent interference case with Wang, but Lawlor did not finish the case. Apparently the two men quarreled.

IBM had purchased patent rights to An Wang's magnetic core memory work for \$400,000 in 1956 and during the patent dispute between Wang and Viehe, IBM purchased rights to the Viehe work, but IBM kept this information secret from Wang. When the U.S. Patent Office decided the case in 1959—basically in Wang's favor—Wang learned for the first time that IBM had purchased rights to Viehe's patent too.

"It is my suspicion," says An Wang today, "that IBM was using Viehe's application and my application to induce both of us to reach early agreements with IBM."

Although Viehe's core memory work did not ultimately stand up against Wang's—Wang won 15 of the items in the patent interference while Viehe won only one—his work prevailed against all other early core memory inventors. Moreover, Viehe's pioneering work must be regarded as all the more extraordinary because he worked alone and on a part time basis without the synergistic benefits of other scientists to

associate with, and without financial backing.

"He was truly a rough-hewn inventor," says Gregg Evans, another of Viehe's attorneys. "He was a great individualist. Even when he got all that money for his inventions, he was bound and determined that the money wouldn't change him. The only concession he made was that he went out and bought a new Chevrolet. Other than that, he continued to live very modestly."

The Fight for Core Memory Patents—

Few will dispute the contention that one of the early major achievements of the emerging computer technology after World War II was the development of magnetic core memory at MIT. What is now becoming evident for the first time is that the principal parties had to contend with extraordinary major problems—each other.

Indeed, the court record of the MIT-NCR case tells a tale of negotiations nearly hopelessly snarled in complications of byzantine proportions as IBM, RCA, MIT and a company called Research Corp. fought over patent rights to magnetic core memory.

The most fascinating documents are memos by J. William Hinkley, a top executive of Research Corp., a New York company that represented MIT and other colleges in support of basic research. MIT had transferred its core memory patent rights over to Research Corp. In his 1962 memos, Hinkley tells a tale of intrigue, spiced with mentions of threats and large sums of money.

In a five-page memo, Hinkley discusses separate meetings he had with Dr. James R. Killian, chairman of MIT, and James Birkenstock, an IBM vice president who packaged IBM's patent and other business deals.

All kinds of pressure

"Killian asked me many questions about Birkenstock's threats," the memo states. "I told him that at our first meeting Birkenstock had stated clearly that IBM intended to bring all kinds of pressure on MIT through its officers and board of trustees specifically mentioning that M. J. Kelly of IBM was on MIT's Executive Committee, and that Killian was on the board of IBM. I also told him that at a later meeting Birkenstock had threatened to 'go to Washington' to exert pressure on the Institute and Research Corp. Killian was particularly concerned about this and I told

Tragedy in the desert

In the end, all that IBM money never did Viehe much good. With great reluctance and hesitation he quit his job—Viehe's son says his father just couldn't bring himself to leave the routine of his simple job, which he had come to hate. Now, free to work full time on his electronic inventions, Viehe and his wife went to test some of his new work on the Mojave Desert in 1960, a few months after he left his sidewalk inspector's job.

Viehe's car became stuck in volcanic ash in the desert and he left to get help. He never made it: he died of exposure

him of my several experiences in Washington with strangers to the problem knowing and repeating the Birkenstock line."

The major matter at issue among the various parties was the fact that the U. S. Patent Office had favored Jan Rajchman of RCA over MIT's Prof. Jay Forrester in a patent proceeding. RCA had filed its patent before MIT. The parties were struggling to reach a settlement that would be agreeable to all.

A particularly sticky problem was presented by the Patent Office ruling that favored RCA. If it held up, MIT, Research Corp., Prof. Forrester, and IBM, which held a license to the MIT work, would all be left out in the cold.

As for a settlement with RCA, Hinkley stated that "much depended on what pressures IBM might bring to bear on RCA through their cross-licensing agreements."

RCA case looked good

In the memo, Hinkley said he believed that RCA would prevail over MIT in the patent interference and he said that Julius Stratton, MIT's president, told him he felt the same way. Hinkley stated also that Stratton told him IBM's patent counsel, Fish Richardson & Neave, and general counsel, Cravath, Swain & Moore, both felt that MIT would lose the interference action.

Hinkley stated further that the negotiations between IBM and MIT were carried out by Killian and Stratton for MIT, and by Birkenstock, Albert L. Williams and Thomas J. Watson Jr. for IBM. Hinkley mentioned that MIT was seeking as much as \$60 million from IBM.

In another four-page memo, Hinkley said: "Stratton also reported that some time ago IBM withdrew its financial support for the computation center at MIT as part of the pressure. It was reinstated after the IBM em-

in the 130 degree heat of the desert and when his wife was found in the car a few days later, her condition had deteriorated to the point that she never quite recovered and died several months later. Frederick Viehe was 48 when he died.

Details of the Wang-Viehe patent case and new documents produced in the NCR-MIT case (see accompanying story) tend to elevate the importance of Wang's work in magnetic core memory.

Who, then, is An Wang?

A native of mainland China, An Wang obtained a bachelor of science degree in Shanghai and came to Harvard Univ. in 1945 where he earned a

Ph.D. in applied physics and engineering. Later he joined the staff of the Harvard Computation Laboratory, which was then headed by professor Howard Aiken. (Today, Wang is best known as the president of Wang Laboratories of Tewksbury, Mass.—a computer firm whose sales are expected to approach \$100 million this year.)

Wang at Harvard

DATAMATION asked Dr. Wang to recall his core memory work at Harvard, and he replied as follows:

"Mass memory (in the late 1940s) consisted of rotating magnetic drums.

Vacuum tube flip flops, acoustic delayed lines and storage crt tubes were considered the major potential for high speed memory.

"The Harvard computation lab was under the direction of Dr. Aiken. In the very beginning of my work Dr. Aiken mentioned that he was using rotating magnetic drums for storage of information, which was slow and bulky. He wondered if there was any way magnetic media could be utilized for storage without any mechanical motion. I was intrigued by his suggestion and started to think continually of how magnetic media could be used for recording and playback without mechanical motion...

"I knew by then that a toroid core could be magnetized one way by sending current through a winding around the core in one direction. It would magnetize another way in another direction. The problem of how to get the magnetized information out without motion and without destroying its magnetic property baffled me, and maybe others before me.

"Then, one day in early June (1948), while walking back from lunch towards the computation lab, a sudden idea occurred to me that I should not have to worry about destroying the magnetic information so long as I could find it in the process of destroying it. Once I knew the information I could always restore it by rewriting into it. The difference between what was originally magnetized one way and another would tell me what was originally stored and I would have ample means to restore. I believe that was the first time a single magnetic core could be looked upon as a one bit storage device in which data could be stored and later retrieved and restored...

"This is the basic core memory idea separated from the matrix idea of coincident current system that the MIT group under Jay Forrester was developing. It was interesting to note that the MIT group had the matrix coordinate idea, trying to use neon light for memory earlier, but failed. After they heard about my core development at Harvard they came to talk to me. Then they applied their coincident current method into the core memory."

MIT in the limelight

Through the years, Prof. Forrester and MIT have received most of the publicity for their work with magnetic core storage, as well as most of the money—several million dollars, \$13 million from IBM alone.

Wang's story as an entrepreneur is also interesting. He started his firm in 1951 on a shoestring. He concentrated in research and development in the broad and then-emerging field of digital equipment, particularly magnetic core

Intrigue, Threats and Money

ployees at the center at the Institute had complained bitterly. Stratton apparently showed Mr. Watson some figures developed at MIT which showed that the computation center was indeed a very profitable operation for IBM."

In the end a settlement was worked out among the principals. MIT got \$13 million from IBM of which about \$1.5 million went to Prof. Forrester and \$1.6 million went to Reserach Corp. IBM kept its license to the MIT patent and the firm's competitors were forced to contend with the MIT patent in the business world. RCA appears to have received little more than some patent licensing advantages for giving up its core memory patent.

Hinkley is now dead, but his memos can be expected to be the subject of testimony if and when a trial in the case begins. In a brief filed in the case, MIT is critical of the Hinkley memos, saying they were written "... at a time when relations between Hinkley and MIT were strained. Even cursory examination of these two memoranda demonstrates that they are tainted in their entirety by bias and thus wholly untrustworthy... These memoranda constitute hearsay evidence of the rankest sort."

Another document on file in the case prepared by MIT offers insight into the relationship between MIT and IBM while the two were working on government-backed contracts including the Whirlwind computer and air defense computers which were part of the gigantic SAGE contract.

In January of 1954 top IBM executives were given an expensive tour and demonstrations of MIT's Digital Computer Laboratory.

"Dr. Forrester," the report states, "recalls that at this meeting T. J. Watson Jr. inquired about application of magnetic core storage to commercial manufacturing."

The incident was just one instance of the younger Watson's ability to visualize the coming importance of computers for his firm and for the world. During the late 1940s and early 1950s, IBM top management in general and Thomas Watson Sr., in particular, resisted committing IBM heavily to computer technology.

The document also outlines several instances of cases in which MIT complained about IBM's performance on the project. The following comments were gleaned from the document:

"The technical side of IBM's project... suffers badly from lack of leadership. Little, if any, initiative is evident. (June 1953)

"We should consider what we can do to help IBM during this critical period. Perhaps some of our senior men should spend more time at Poughkeepsie. (November 1953)

"IBM is falling behind schedule. They have a tendency to underestimate time schedules. (February 1954)

"Forrester has discussed the unsatisfactory progress of the AN/FSQ-7 program at IBM with IBM management. IBM has failed to recognize the magnitude of the job and to establish the requisite organization. (July 1954)"

The MIT document noted that IBM had earlier protested, calling the SAGE computer Whirlwind 2 "because 'Whirlwind' was closely identified with the MIT digital computer laboratory."

Still later, in February of 1955, MIT took note of an IBM advertisement that implied that the firm—and not MIT—was the developer of magnetic core memory. In commenting on the ad, the MIT document stated: "For nearly two years prior to this advertisement MIT had been operating magnetic core memories with five times the performance quoted..."

—W.D.G.

devices. Later he broadened the firm's activities into the field of digital data systems.

One novel wrinkle of Wang's formation of his company is that he bootstrapped it alone, foregoing the classical method of acquiring venture capital from other sources. He still controls 52% of the firm's stock. "I didn't need outside help," he recalls. "I started by hiring a part time college student. I dou-

bled sales every year, but because I started so small, it took me several years to get big."

And why did he turn his nose up at venture capital? "I would have been under great pressure to perform for the investors," he says and adds with the trace of a smile: "Besides, it gave me a chance to make mistakes on a small scale."

—W. David Gardner

Security

Encryption Algorithm: Key Size is the Thing

An encryption algorithm for protecting stored and transmitted computer data has come under attack. Proposed earlier as a federal standard, it was due last month to go to the Secretary of Commerce for his signature.

"I could figure out from looking at the standard how to make it a helluva lot more secure than it is. There are a lot of other people who could do the same," says Prof. Martin E. Hellman of Stanford Univ. He adds that the standard will have to be changed in a few years at a sizable cost and inconvenience to computer users, whereas it could easily be modified today and made into a system whose security would last for many more years.

Hellman's assertions, however, do not seem to ruffle Dr. Ruth Davis, director of the Institute of Computer Sciences and Technology at the National Bureau of Standards. She calmly explains that the standard is for federal agencies only, is not mandatory, and that the algorithm is secure under present technology. Further, she says the standard can be changed ("a standard is not invariant") when the technology comes along to make the encryption system insecure.

Hellman, a professor in the electrical engineering department, and graduate student Whitfield Diffie, with whom he collaborates, say their conversations with representatives from the NBS and the National Security Agency have been unsatisfactory. They further contend that the NSA has an interest in seeing the adoption of a standard that is less than totally secure, possibly giving the intelligence community the capability of breaking the users' codes and thus compromising security.

At this point in the history of data processing, there should be no question about the need for data security. The current vintage of operating systems was not designed to prevent their being penetrated. Researchers at a number of centers have demonstrated how they have managed to compromise remote

access computer systems (February '74, p. 90, March '75, p. 107).

Without resorting to such sophistication, however, one can also get to confidential data stored on discs or tapes. A story currently making the rounds is



DR. RUTH M. DAVIS

If a standard has a life of five years, it's a good standard

of a customer list stored on a removable magnetic medium that was missing for a few days, only to suddenly reappear. The suspicion is that it had been copied.

Wiretapping next

To date, wiretapping to gain access to data being transmitted appears to be uncommon. Donn Parker of the Stanford Research Institute says that of the 380 or so cases of computer abuse he's learned about in the last five years, only one may have involved wiretapping—and even that isn't fully verified. But researchers say that as the ends of transmission lines become hardened, the wire becomes the weakest link.

Even microwave transmissions are susceptible to eavesdropping. One can tune across the bandwidth and listen in

on a voice channel. In digital systems, one can look for key words, like a telephone number, and intercept data headed for, say, the Internal Revenue Service. And it's purportedly even easier in packet switching, which has a header with a calling number, the number called, the priority, and so on. With a little register one could look for and record those messages that accompany target bit patterns.

Thus the interest in adopting cryptography to protect data.

Cryptographers agree that a system must be secure even against an opponent who knows every detail of how it works. The security cannot be in the cryptographic device itself, since it is to be publicly available. Rather, it should be in the key, which determines the relationship between the message or unencrypted data (called plaintext) and the cryptogram (called ciphertext).

Combination lock

An analogy is a combination lock. One can take it apart and learn how it works. The thing that's secret is the combination. Admittedly someone could try to crack your lock by going through all possible combinations, so you must make the number of combinations high enough to discourage that.

The NBS system, submitted by IBM, is an encryption algorithm designed to be implemented in LSI. It acts upon the user's key to both encipher and decipher a serial bit stream. That key consists of 64 bits, eight of which are used for parity.

At issue is that key size.

"A large key by itself does not guarantee security," Hellman emphasizes. "But the point we're making here is that a small key guarantees insecurity." He thinks the selection of a 56 bit key was made very carefully. Had a 48 bit key-size been proposed, it could have been shown to be totally insecure, and yet 64 bits would currently make it too difficult and expensive for even the intelligence community to crack. The result: a large enough combination (the key-space) to thwart the prankster, the curious, and your business competitors, but not quite large enough to be secure against an organization with the where-withal of the NSA. (The National Security Agency "reigns today as the supreme arbiter of all matters cryptologic in the U.S.," writes expert David Kahn in the January issue of *Playboy*. "It promulgates cryptologic doctrine . . . coordinates the code-breaking agencies of the Army, the Navy and the Air Force . . . It cracks the codes of foreign governments and daily submits the solutions to U.S. officials as high as the President.")

The 56 bit key size is too small, Hellman says. "If it were 64 bits, it would be adequate today but barely adequate 10 years from now." He thus favors

Making the transition to COM should never be a do-it-yourself project.

A good working relationship with your COM supplier is probably as important as the equipment itself.

The best relationship requires the supplier's willingness to commit time, people, and facilities to your service.

To illustrate: About five years ago, Kodak began discussing the need for COM with a major insurance company. Our first step was to assemble a group of systems experts from several disciplines. Their work led to a proposal showing how we could help serve the needs existing at that time. Initial savings were predicted to be \$40,000 a year.

The Kodak proposal was accepted and the prediction was correct.

Our people stayed involved through the installation period and beyond. The result has been a very high level of performance and service support. Additionally, Kodak's Output Monitoring Program makes it easy to sample and test results to be sure the electronic and imaging subsystems are performing well.

Today, we are

Kodak people — working together to make COM work for you.



helping to sustain the climate of acceptance for COM in this organization: We provide training programs for key people, develop updated cost analyses, make new COM application proposals.

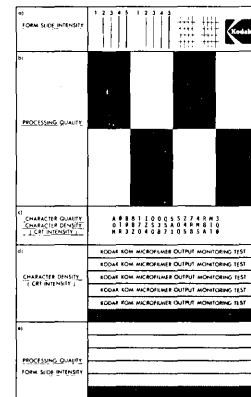

Test tape image to help you spot any change in output.

Our ideas and involvement wouldn't be welcome for long if they didn't produce results: Last year, this company saved \$175,000 in paper costs alone. Results like that are good for both parties.

Computer output microfilming is a major management decision. The closer you are to COM, the sooner you may gain by asking Kodak to come in. If you are in a position to make this kind of decision for your company, we would like to send you an informative overview of microfilm and

the computer. Write today. Eastman Kodak Company, Business Systems Markets Division, Dept. DP6678, Rochester, N.Y. 14650.



news in perspective

going to a key size that is variable, possibly up to 768 bits (which fits in with the present algorithm's design).

Davis says the 56 bit key is good for today's technology, and meets today's needs. "A standard's objectives are different from technological objectives," she explains. "If a standard has a life of five years, it's considered to be a good standard. I wasn't even aiming at 10 years." But why not go to a larger key?

We could, she admits. "But you have to look at the objectives of a standard. It isn't to be at the front edge of technology." She feels the standard should be something good enough for the present time to meet current needs. "If we went to 72 bits or to 110, I'm not so sure that we still wouldn't want to change the standard in five years. I'm not sure we're that good at predicting technology." And the 128-bit key suggested by Hellman and Diffie? "There's no way to prove that with technological advances someone isn't going to break a 128 bit key," Davis says. She adds that with such technologies as the Josephson junction and superconductivity, it's also possible "We won't even be using this same kind of methodology for data security."

And the disadvantages of a larger key? She says it's primarily in the cost of the semiconductor chip in which the algorithm is implemented, as well as the number of chips that would be required. (The current algorithm, by the way, has been implemented in silicon by two or three semiconductor firms, according to Dr. Davis. She was suffering from the flu and reached at home for this interview, but she recalled that one of the suppliers used two chips that cost less than \$100.)

But Davis is also convinced the NBS would receive even more criticism if it went to a 128 bit key. "We'd come under strong criticism if we tried to lead the technology," she says. Such critics, she adds, would ask whether the NBS is implying there really is that kind of threat . . . that the technology is such that only a 250 bit key is secure. "And our answer would be, 'No, we don't know that.'" One has to look at trade-offs, she explains, and they think they've come up with a nice size for the situation in 1976.

A spokesman for an independent peripherals manufacturer agrees with that. Asking that his name not be mentioned, he says of the algorithm, "I would like

to see it adopted." He says his study of the algorithm, admittedly not a detailed examination, indicates that it would aid users in achieving data security. His concern, and the reason he made the study, was that the algorithm might be used against peripherals makers in their attempts to be plug-compatible with IBM systems.

"We felt that if IBM wanted to play tricks, they could play tricks. They could stick two of them in, one with their own private code and one for the user. And then you'd really be stuck."

Stanford's Hellman and Diffie, however, see a vulnerability that they wish the NBS would explain to all users. Files that should remain confidential for more than five or 10 years should not be presumed safe under this system, they say. They figure a key can be broken in one day at a cost of some \$10,000—numbers that are disputed by the people at the NBS. They could be off by an order of magnitude, they admit, but say that the cost of computation drops by an order of magnitude every five years. "In many cases," says Hellman, "we feel (the key) is adequate for now, but we also feel that for all cases it is not adequate for 10 years from now."

It may well be, as suggested by one participant in this controversy, that the issue is not a technical one about the size of a key or the possibilities of wire-tapping to gain access to someone else's data. Rather, it has to do with the confidence—or lack of it—of the public, of society, in our computer and data communications systems. If someone does manage to crack a key and read data that everyone thought was securely encrypted and stored, and this makes headlines, the computer community again ends up with egg on its collective face. So why not, he asks, adopt the 128 bit key and, hopefully, do away with scare headlines?

But with the algorithm receiving the Commerce Secretary's blessing, this apparently is not to be. Equally apparent is the industry's move to encryption to achieve the data security that people need. As a result observers, including Ruth Davis, see the need for computer scientists who are knowledgeable in cryptography, who can advise on its efficacy—or the lack of it.

—Edward K. Yasaki

Technology

Talk is Cheap Over Thornton's Channels

In the 15 years that he spent at Control Data Corp. James E. Thornton built large scale computers. In the three years since he left the company he's been looking at ways to get more use from them.

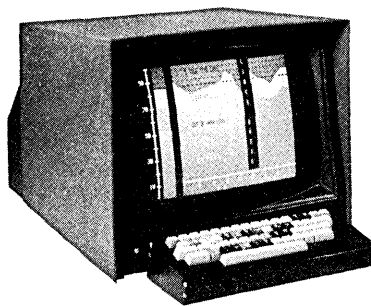

UNBELIEVABLE!!!!
The Intecolor® 8001
A Complete 8 COLOR
Intelligent CRT
Terminal
\$1,995*

"Complete" Means

- 8080 CPU • 25 Line x 80 Character/Line • 4Kx8 RAM • PROM Software
- Sockets for UV Erasable PROM • 19" Shadow Mask Color CR Tube
- RS232 I/O • Sockets for 64 Special Graphics • Selectable Baud Rates to 9600 Baud • Single Package • 8 Color Monitor • ASCII Set
- Keyboard • Bell • Manual

And you also get the Intecolor® 8001 9 sector Convergence System for ease of set up (3-5 minutes) and stability.

Additional Options Available:

- Roll • Additional RAM to 32K • 48 Line x 80 Characters/Line • Light Pens
- Limited Graphics Mode • Background Color • Special Graphic Characters
- Games

*Quantity 100 (Unit Price \$2,495.)

ISC WILL MAKE A BELIEVER OUT OF YOU!



Intelligent Systems Corp.® 4376 Ridge Gate Drive, Duluth, Georgia 30136
Telephone (404) 449-5961

Bell & Howell's new 3800 Series COM



(It's chiefly for the non-clairvoyant.)

If you could foresee your exact COM needs for the next three ... four ... five ... or even more years, there might be another single configured system that would serve as well as our field-upgradable 3800 series.

If you could read clearly in the stars whether you might eventually require a front end mini preprocessor, for example, the latest Bell & Howell COM array would lose one of its big advantages. And if you could only predict what peripherals you need — lineprinter, CRT, disc, tape drive, or the entire combination — our 3800 would be just another COM series to you.

But, if you're like the other ungifted 99% of us, you'll appreciate this new hedge against the uncertainties of an "iffy" economy and hard-to-predict corporate changes and growth rates.

You can enjoy this freedom without sacrifice, too. Our 3800 Series is competitive in price, speed, and operator convenience. Attractively styled. Accompanied by strong, flexible software. And backed by Bell & Howell's worldwide sales service and support organization.

Your Bell & Howell COM representative can give you some other sensible reasons for choosing the 3800 Series. To get in touch with him, call Pat Flynn, collect, at (714) 752-1940 or write him at 401 South of The Waves Beach, CA 92660. (He may even make you an attractive offer on your slightly-used crystal ball.)

MICROIMAGER GROUP

 BELL & HOWELL

CIRCLE 90 ON READER CARD

© 1981 Bell & Howell

THIS OEM ASKED US FOR A HEAD START.

Management Systems Technology in Chicago was in the market for a minicomputer and a disc. We said, "There's a better way."

Then, we introduced them to the Hewlett-Packard DISComputer concept.

Some vendors offer systems in which a disc, controller and mini-computer have been *put* together. In contrast, the elements of the HP DISComputer were *designed* together.

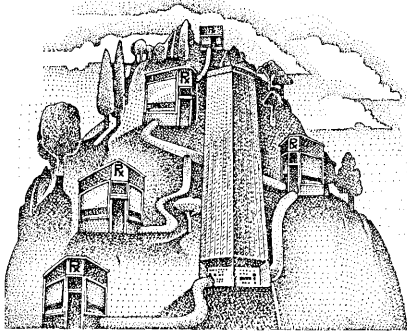

Management Systems Technology, Inc., builds a system that provides druggists real-time data on patient profiles and drug interactions, prints labels, handles billing and taxes. At its heart a Hewlett-Packard DISComputer.

This means you don't get bogged down trying to optimize the performance of our hardware. Instead, you can jump ahead and put your efforts into developing your own systems.

You can also benefit from advanced HP software. RTE-III, the newest member of the RTE family, gives access to 64 partitions, up to 128K words of main memory, plus multiple languages and multi-programming.

At \$17,655*, the MX/65 DISComputer price/performance ratio is exceptional.

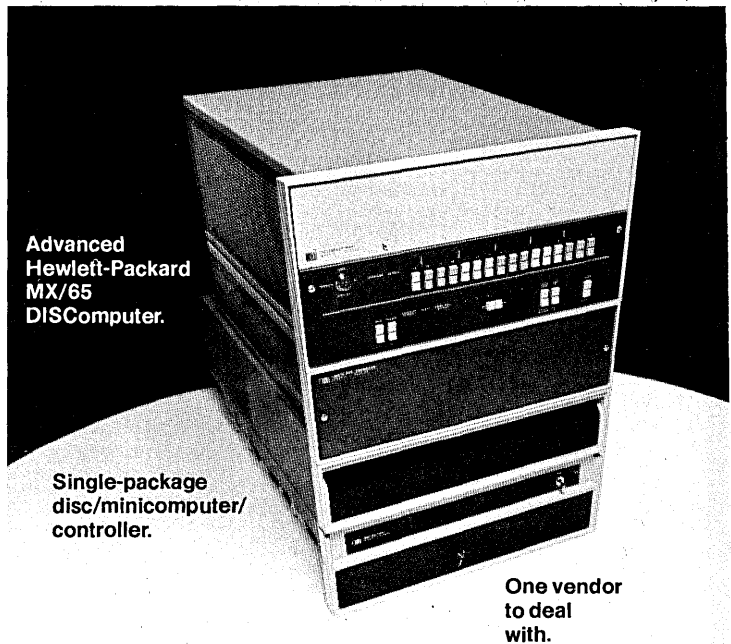

Advanced Hewlett-Packard MX/65 DISComputer.

Single-package disc/minicomputer/controller.

One vendor to deal with.

The further economies of dealing with a single vendor could help turn a head start into a winning performance any day of the week.

Just ask Management Systems Technology in Chicago.

THE HEWLETT-PACKARD MX/65 DISCOMPUTER AT A GLANCE

Minicomputer:	Controller:	Disc:
8K to 128K words. Solid state 4K RAM memory. Microprogrammable. Parity, EAU, floating point standard. Brownout-proof power supply. Optional Dynamic Mapping System.	Links to multiple CPU's. Combined seek/data transfer. Built-in error detection and correction. Automatic track switching. Data protect and recovery features.	25 msec average seek time. 15 Mbytes of storage, expandable to 120 Mbytes. Exceptional 937 Kbyte transfer rate. Operates over wide power and environment range.

*DOMESTIC USA OEM PRICES QUANTITY 50 WITH 32K MEMORY, 15 MBYTE DISC.

NOW WHAT CAN WE DO FOR YOU?



Sales and service from 172 offices in 65 countries.
1501 Page Mill Road, Palo Alto, California 94304

news in perspective

Large central computer sites find increasing demand from their users to provide on-line services and thus an increasing crush of disc and tape storage drives. Whether or not the large centralized concept was the right direction to take, Thornton hopes he'll be able to give these centralized sites "a little more room in which to maneuver."

His fledgling St. Paul, Minn., company, Network Systems Corp., has been working on a network storage management system which would enable multiple large computers at a central site to be hooked to each other and to multitudes of peripherals of different makes in local interconnect schemes in order



JAMES E. THORNTON
He'd supply "room to maneuver" to large central installations

to, among other things, share large data bases (May '75, p. 18).

One of the problems in building such networks is that of getting the massive numbers of storage devices close enough to the mainframes. Typically, today's conventional mainframe channels and peripheral controllers must be within 200 feet of each other. A second problem is in the managing of shared storage devices—the file management and the control of input and output. Present methods of assigning the control of such local networks to a host processor is expensive and inadequate for growth, Thornton says. His company's solution to this second problem is a powerful network control processor which it has designed, but not yet built.

Its solution for the first problem is Network Systems' first product—a channel and controller adaptor scheme called "hyperchannels." Adaptors attached to the channels of large computers on one end and to the controllers of disc or tape drives on the other would allow the transmission of data back and forth over coaxial cable at 50 million bits per second at a distance of up to 1,000 feet.

Other features of the hyperchannel scheme make it more than just a solution to the mainframe-storage device proximity problem. It also increases I/O throughput, allows mainframes to communicate with non-compatible disc or tape drives, and with far more of these than with conventional channels.

As explained by Thornton, the micro-processor-based adaptors convert parallel data from the channel to serial form and vice versa and modulate and demodulate the serial waveform at interfaces

between the cpu, the storage unit, and the cable. A temporary buffer storage in the adaptors permits the processor or storage devices to operate at their maximum data transfer rates. And the adaptors also convert the serial signals to match almost any kind of device, regardless of the manufacturer or the model of the device.

For example, the company points out, its first customer—an installation at the Dept. of Defense—will use the scheme to connect a Control Data 6660 and two 7600s to IBM compatible tape drives made by Storage Technology Corp. In another case, an installation seeking to take data gathered on a Digital Equipment Corp. minicomputer system and

To match our terminal systems, you could deal with at least five different salesmen...



and still worry about service.

See us instead! We supply cost-effective terminals for every application, including these:

ATS—The Trendata® 4000, with its Selectric-style keyboard and 30 cps printer in an attractive console, provides 2741 compatibility plus higher performance. Computer-controlled margins, spacing, horizontal/vertical tabs, and pagination for fast, crisp forms printing.

APL—Our Model 4000 offers total compatibility with USASCII, Correspondence, and EBCDIC code sets in this powerful timesharing mode. Typewriter paired keyboard has keytops engraved with APL characters for ease of data entry.

TSO-TTY 33/37 or IBM 2741 compatibility at the flick of a switch... 132 or 158 print positions, also switch selectable... typewriter-style keyboard with ANSI, Correspondence, or EBCD layout... all on our Model 4000.

TRENDwriter—Teletype-compatible 30 cps TRENDwriter with full 132 print

positions is the ideal replacement for KSR teletypewriters. Matrix printer... full USASCII character set.

SELECTRIC—Rugged Model 1000 with acoustically insulated, heavy-duty I/O-type Selectric, plus conveniently grouped controls and status indicators, in a human-engineered work station compatible with systems using IBM 2741.

Trendata Service—Trendata supports its customers with factory-trained service personnel nationwide.

Call (408) 732-1790 or write.

Trendata
An Applied Magnetics Company
Terminals for all reasons
610 Palomar Avenue
Sunnyvale, CA 94086

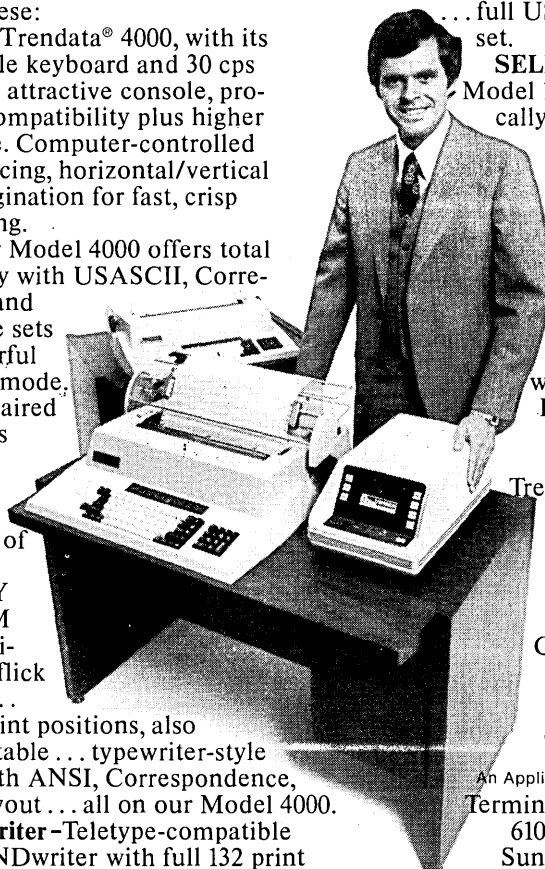

CIRCLE 165 ON READER CARD

news in perspective

process it on IBM and CDC processors without having to change the media, is interested in the hyperchannels concept.

It's also conceivable, says a Network Systems marketing consultant, that a high speed IBM 3330 disc storage device could be hooked to a 360/40 model IBM mainframe because the hyperchannel adapts each other's transfer data rates. Conversely, the channel speed on a 370/158, although twice that of the 3330's data transfer rate, could operate at maximum channel speed when transferring and receiving data to and from the disc drive. It also could address more than 100 controllers instead of the eight controllers that is normal on a channel without the adaptor.

The company will price the adaptors at about \$25,000 each, or \$50,000 for a system in which a channel and peripheral controller adaptor are used. It thinks the price will be attractive to users seeking more channel throughput, since the alternative is to acquire more channels (at up to about \$250,000 for a pair of channels on a 370/168, for instance). It has identified about 200 "viable" customers for the product out of some 1,200 locations where multiple large computers are installed.

"It's an obvious bread and butter item," says Thornton who formally will announce the availability of hyperchannels (a name that still is being market tested) in mid-May and will deliver in July. But his longer range plan is to build and produce the dedicated multiprocessor that would enable input/output control of local networks to be shifted from a host processor. He says it would operate at supercomputer speeds and have a total input/output rate of 400 megabits a second. It would be priced at from \$175,000 to \$355,000, according to the configuration.

Thornton says he's aware that other suppliers may come up with similar schemes and that mainframers also might conceivably offer that kind of I/O throughput. But he says his company is way ahead of the independents and that mainframers must face the fact that such a product is a "major step" on their part and "the impact on their equipment would be heavy." Mainframers prefer to offer mainframe upgrades rather than low-priced solutions to the problems that large central sites face in handling growing demands for on-line storage.

Thornton, who headed the design of

Control Data's STAR supercomputer and worked with supercomputer designer Seymour Cray on the development of CDC's 6000 series of large computers, left CDC three years ago when that company "seemed to be moving out of the large computer world and into computer services." (In retrospect, he observes that CDC seems to be "hanging in there" in the large computer field.)

He spent a year studying the state of semiconductor technology and formed Network Systems two years ago last month with funding from private sources in the Minneapolis-St. Paul area. The company so far has raised \$900,000 and will need additional funding if the hyperchannel offering meets its marketing expectations. At that time, the present staff of 14 probably will be doubled, Thornton says.

—Tom McCusker

Services

The Taxing Question for Computers

"I am sorry to say that the 1040 Form is more complex than last year's and this package is larger than last year's."

This is the first sentence of the second paragraph of a letter from Commissioner of Internal Revenue Donald C.

UNIVERSAL BILLING SYSTEM

The Value Computing Comput-A-Charge system spans vendors and operating systems. The best system for those companies with a mixture of installations—anywhere in the world.

IBM DOS/DOS VS VM • IBM OS/VS1, VS2, ASP • BURROUGHS 6700/7700
HONEYWELL 200/2000 • UNIVAC SERIES 70 • UNIVAC 1100 SERIES • CDC 3300

COMPUT-A-CHARGE is Value Computing's performance reporting and user charge back system. It shows Data Center Management where system inefficiencies are occurring to focus corrective actions. By means of trend analysis, management can spot and correct potential problems before they become critical. COMPUT-A-CHARGE can assist in planning by reducing the risk inherent in changes or additions to hardware or software.

99 Mamaroneck Ave.
White Plains, N.Y. 10601
(914) 428-8850

198 Park Road
W. Hartford, Conn. 06119
(203) 232-2017

4415 W. Harrison Street
Hillside, Ill. 60162
(312) 449-2200

2182 Dupont Drive
Irvine, Calif. 92664
(714) 833-0520

6350 LBJ Freeway
Dallas, Texas 75240
(214) 387-0083

31 Wellesley Street East
Toronto, Ont., Canada
(416) 964-1855

Informa s.a.
7 rue Pasquier
Paris, France
265-45-65

NAMIC a.s.
29 Skippergaten
Oslo 1, Norway
02-41-30-03

VALUE COMPUTING INC.

300 VCI Building/West Marlton Pike
Cherry Hill, NJ 08002

- Please send additional information
 Please have a salesman call

Operating System _____

NAME _____

COMPANY _____

TITLE _____ PHONE _____

ADDRESS _____

CITY _____ STATE _____ ZIP _____

VALUE COMPUTING INC.

The Computer Operations Company

W. Marlton Pike, Cherry Hill, N.J. 08002 • (609) 429-4200

Covered with mud, dropped off a desk, and working like a champ.

Our 300 is a 30 CPS, portable terminal that operates via regular telephone lines. It's lightweight, compact, and a joy to work with.

It's also the most reliable terminal of its kind ever built by anyone.

Our salesman who tossed a 300 from his desk a year ago, the dropped his out of a race going transmission, creating a mess that was literally

harder on our transmission our machine. The 300's 100% characters that are typed operating as before.

Seemingly determined to destroy our unit, the same rain that did his same 300 into the trunk of his car, he connected a canister filled with water with muddy water, giving our machine a thorough bath. Not to mention a partially good excuse for never working again.

The 300 came through with nothing, it survived every abuse imaginable in perfect condition.

If you're looking for an easy way to get your work done, you'll find it in the 300. It's the only terminal in its class that's been tested by the U.S. Army at (2000) 25 miles.

Computer Technology Systems, Inc.,
East St. Louis, Ill. 62201
Telephone: 312-332-1100

Enclosed is 300 portable terminal
and a portable terminal...



\$4,500 worth of multi part burster for

\$2,995!

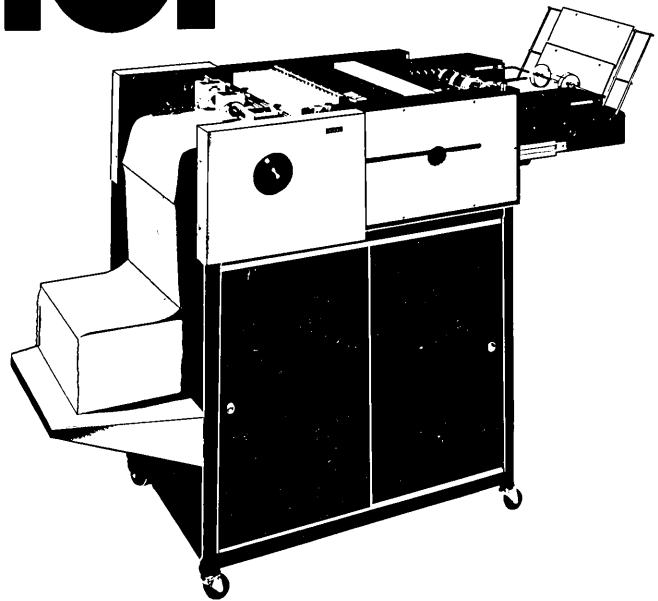

New! Tab 2470 Burster: More Work For Less Money!!

It's a burster/stacker (#2472), a burster/stacker/table (#2474) or a burster/stacker/splitter/table (#2476). But most of all, it's a work horse that costs far less than competitive models, yet offers features many don't!

Features! Features! Features!

Variable stacker speed lets you adjust overlap; high-speed stacker clear control switch lets you make split runs—hit the clear switch and speed up throughput;

new table base stores forms, holds trimbasket; continuous variable speed; adjustable tear points, special rollers reduce carbon tracking, give cleaner reports; highly reliable electronic speed control, static eliminator included; forms damage prevention assured with our unique jam-detector that stops machine almost instantly; sound-reducing safety cover—lift cover, machine stops—prevents operation unless cover in position.

Built & Backed By Tab!

Behind every new 2470 multi part burster is Tab Products

Company and its depth of experience in providing efficient computer accessory products to help you optimize your data processing operation. For a complete presentation of our new 2470, contact your local Tab representative, or write Tab Products Company, 2690 Hanover Street, Palo Alto, California 94304

TAB
PRODUCTS CO.

news in perspective

which went from zero to 66,000 returns in two years and the following year was out of business.

Then there are Dynatax of Wichita, Kansas and Tax Accountant Computer Service (formerly Computer Tax Service) of Glendale, Calif., which used to be independent but now are subsidiaries of United Data Centers of Greenwich, Conn. which, in turn, is a subsidiary of Tymshare, Inc., Cupertino, Calif.

Up 35%

Jim Mann, president of the Data Centers Div. of Tymshare, which has responsibility for the tax preparing operations, says business is up this year by 35% over last year. The operations handle 33 different state returns.

Another reorganization/absorption saw what once was Multicomp Inc. of Wellesley Hills, Mass., merging in 1972 with Call-A-Computer, a subsidiary of Standard Information Systems, Waltham, Mass. In 1973 the tax return portion of the operation became the Multitax Div. of Standard Information Systems. This group is unique among computerized tax return preparation services in that it does it on-line on a time-sharing basis providing terminals for CPA and

attorneys' offices. The Standard time-sharing center is based on three Control Data 3600s.

The only two publicly owned companies in the computerized tax return preparation business are Unitax and Computax Services, Inc. of El Segundo, Calif., which is 50.4% owned by Commerce Clearing House, Inc. of Chicago. Computax is the acknowledged number one in the field in terms of number of returns processed.

Claiming to be number one in Iowa, Wisconsin, Minnesota, and maybe Illinois is Sta-Fed Computer Tax of Cedar Rapids Iowa. Carlton Hall, president of Sta-Fed, says his firm's business is up 20% this year from the 1974 tax year, to an estimated 180,000 returns from 154,000. In addition to the above states, Sta-Fed operates in Missouri and handles state returns of all the five midwestern states.

Hall sees his future growth rate as compounding by 15 to 20% each year. He attributes "50% at least" of his current growth to the increasing complexity of tax laws and forms. He noted that in Minnesota and Wisconsin which recently passed legislation complicating state tax returns, his business is up higher than in other states. He said his

business in Minnesota is up 70% this year whereas in Missouri, which recently simplified the state tax return, growth was only 10%.

Backed off

Sta-Fed has offices in Des Moines and Cedar Rapids Iowa; St. Louis, Missouri; Chicago, Illinois; Milwaukee and Madison, Wisconsin; and Minneapolis, Minnesota. Hall said his company has tripled its staff in the six years of its existence. "We backed off of geographic growth three years ago. We don't have all the business in the states we're in." He said it's conceivable they might look at geographic expansion sometime in the future.

Like Sta-Fed, Unitax has seven offices: Portland, Ore.; San Mateo and Anaheim, Calif.; Phoenix, Ariz.; Michigan City, Indiana; Detroit, Mich.; and Chicago, Ill. States whose returns Unitax can handle are Oregon, California, Arizona, Michigan, Ohio, Indiana, and Illinois.

Farrell said Unitax expects to process more than a half million returns this year, up from 450,000 last year.

Farrell is president of the National Assn. of Computerized Tax Processors, a five year old group formed to interrelate with the IRS and state tax boards. "We need to be informed of changes. We help them with their needs and explain our needs; get them to understand our problems." The association holds one full meeting each year in August in Washington, D.C. It has 25 members of whom 19 are processors. The rest are associate members involved in related activities.

An acknowledged accomplishment of the NACTP is that the IRS and some state tax boards are beginning to get forms out more quickly. The group also has done some institutional advertising. Some would like to see the group do more such as developing a code of ethics. They feel there has been a lack of accomplishment attributable to a reluctance on the part of members to become involved with their own competition.

Reluctant to talk

Many of the firms in the business are reluctant to talk about share of market and how many returns they prepare. Autotax and Dynatax wouldn't nor would Digitax of Bethpage, N. Y. Josh DeFanzo of Digitax said his firm's reluctance was because different firms count differently—some count by taxpayer and some include all returns, federal, state, and city.

Number one in the business, Computax, was an association holdout in its early years but it joined a year ago.

Like just about everything else, the cost of preparing tax returns by computer has gone up. Unitax said it had to increase its prices by eight percent

**IF YOUR DISC PACKS
& CARTRIDGES ARE
CONTAMINATED,
YOU NEED
A RANDOMEX CLEANER.**



**IF THEY ARE ERROR-FREE,
YOU ALREADY HAVE ONE!**

- Models for all packs and cartridges • Fully automatic
- 98% effective • The industry standard • Used by 95% of manufacturers • New, more efficient cleaning solution

Write for details.

RANDOMEX Randomex Inc./27303 Warrior Drive
Rancho Palos Verdes, CA 90274/(213) 377-9887

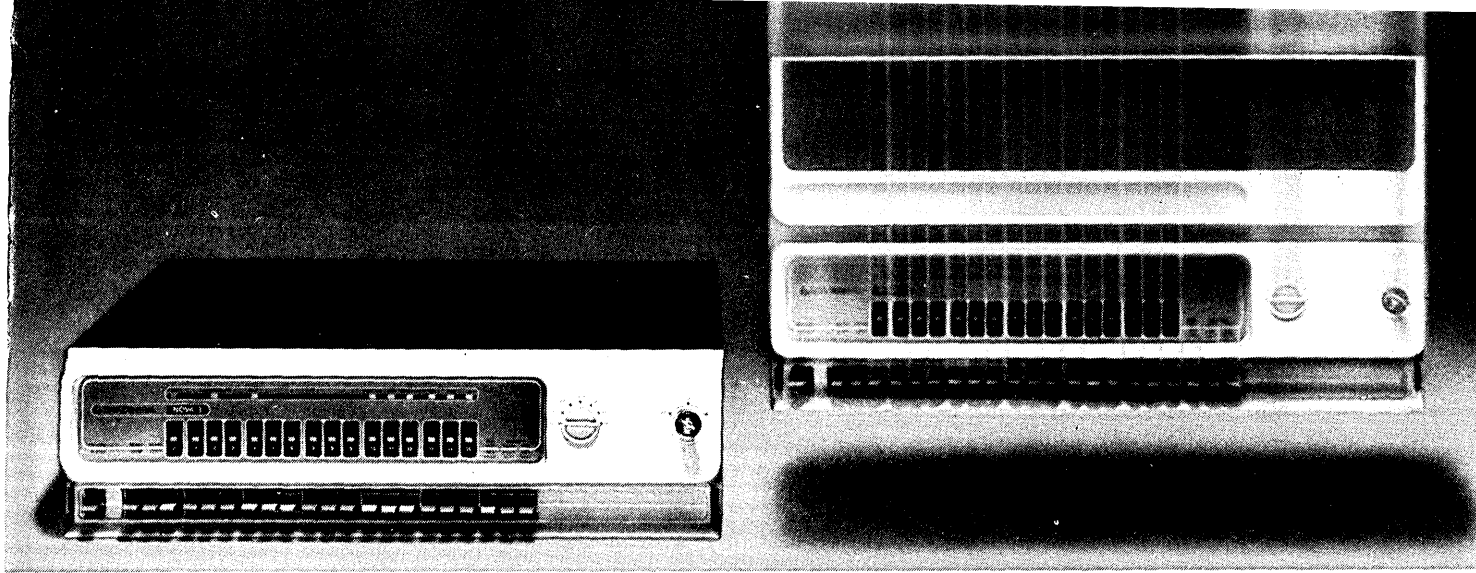

The biggest thing to ever hit the OEM market, gets even bigger.

The four slot version of the Nova 3 gets pretty big. Up to 32K words of memory. But Nova 3 doesn't stop there. If you want to go further, consider the 12 slot Nova 3.

It can take on up to 128K words of memory. And our optional Memory Management Unit makes efficient use of all that memory, without a lot of systems overhead.

If you're going to need more I/O than the 12 slot Nova 3 can give you, there's an optional 12 slot expansion chassis.

And if one fully expanded Nova 3 still isn't big enough to handle the problem, you can add more Nova 3's and make multiprocessor systems. And they come with standard off-the-shelf software.

Why do we go to the trouble of offering such a wide range of configurations?

So you can meet any number of different systems requirements with the same processor. Without buying a lot of

different spares. Without training your people in a lot of different test and maintenance procedures.

And so you can take your smallest product and make it a lot bigger. Without systems redesign. Without rebuilding your interfaces. Without rewriting your software.

And, no matter how small a Nova 3 you start out with, you get big performance. Nova 3 executes instructions in only 700 nanoseconds. Or more than twice as fast as the computers you're apt to compare it with.

Yet for all its bigness, there is one small feature in the Nova 3. Price. You can get a 64K word MOS memory Nova 3 with Memory Management Unit, Automatic Program Load and Power Fail Protection for just \$16,800* (Or a smaller Nova 3 for an even smaller price. A 4K MOS system for \$2,600*.)

Write for the brochure.

You may discover that bigger is better.

*Single unit price before OEM and quantity discounts get figured in.

DataGeneral

Nova 3: The biggest thing to ever hit the OEM market.

•Data General, Dept. N8, Route 9, Southboro, Mass. 01772 (617) 485-9100. Data General (Canada) Ltd., Ontario. Data General Europe, 15 Rue Le Sueur, Paris 75116, France. Data General Australia, Melbourne (03) 82-1361/Sydney (02) 908-1366.

A Capsule Report from Entrex Key-Disk Users...



Concurrent Data Entry

"In Charlotte County, the Sheriff's Office retrieves tag registration data, the Tax Collector posts the latest real estate tax payments, the Assessor calculates land values, while my department is printing out paychecks for all of them."

—Honorable Dick R. Lawhorne,
Elected Clerk of the Circuit Court
Charlotte County,
Punta Gorda, Florida



Communications

"We enhanced our on-line system with an ENTREX communications-based system, because it offered greater reliability, less cost, and increased capabilities. We now receive 25,000 BankAmericard transactions from our customers in Akron, Toledo, and Dayton per day."

—Glen Davis,
Senior Administrative Officer,
City National Bank
Columbus, Ohio

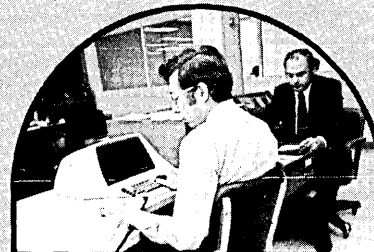

ISAM Files

"Utilizing ENTREX's ISAM feature, we have developed an extensive file network, which is used throughout the company to provide access to vital operational data at speeds matching on-line mainframe lookup."

—John R. Steiger,
Manager of Management
Information Systems
VariTyper Division,
Addressograph Multigraph Corp.
East Hanover, New Jersey

Productivity

"The batch balancing, conditional verification, and data generation features of the ENTREX System have doubled our productivity."

—R. J. Denton,
Vice President,
Bancshares Dataline Corporation
Chattanooga, Tennessee



System Compatibility

"ENTREX's system compatibility allowed me to upgrade from System 380 to System 480 with minimal reprogramming and no disruption to productivity."

—Bill Pearce,
Data Entry Manager,
Data Processing of the South, Inc.
Charlotte, North Carolina



Pre-Processing

"The Department of Public Aid has cut mainframe processing time in half by pre-processing data on the ENTREX System."

—Garry E. Paddick,
Chief, Bureau of
Information Services
Illinois Department of Public Aid
Springfield, Illinois



We offer a range of products to meet the diversified needs of all our Users, including cost/effective keypunch replacement, communications-based remote data entry, and powerful source data generation and pre-processing systems.

If you would like to hear more about us, our representative will be happy to explain why our User-oriented design philosophy has made us the technological leader in source data processing. Call today.

ENTREX

168 Middlesex Turnpike
Burlington, Mass. 01803. 617-273-0480

Atlanta, GA, 404/634-6391 • Baltimore, MD, 301/997-3310 • Boston, MA, 617/273-0480 • Charlotte, NC, 704/568-3510 • Chattanooga, TN, 615/892-1302 • Chicago, IL, 312/782-5427 • Cleveland, OH, 216/741-3636 • Clifton, NJ, 201/472-0382 • Columbus, OH, 614/861-4280 • Dallas, TX, 214/630-3343 • Detroit, MI, 313/365-0108 • Hartford, CT, 203/563-3866 • Houston, TX, 713/467-3715 • Indianapolis, IN, 317/352-1739 • Kansas City, MO, 816/531-1931 • Los Angeles, CA, 213/879-1960 • Louisville, KY, 812/283-1169 • Madison, WI, 608/221-1547 • Miami, FL, 305/949-4544 • New York, NY, 212/682-2130 • Oklahoma City, OK, 918/582-0572 • Philadelphia, PA, 215/265-2270 • Pittsburgh, PA, 412/341-8686 • St. Louis, MO, 314/727-0480 • San Francisco, CA, 415/692-5551 • Springfield, IL, 217/789-7709 • Toronto, Ontario, 416/495-1234

CIRCLE 59 ON READER CARD

news in perspective

this year because of increased costs. Others noted similar increases.

An exception was Digitax. DeFanzo said his company had "frozen prices completely" this year and, in some cases, was offering sizable discounts. These were returns involving depreciation schedules.

Computer equipment used by the tax preparers varies as widely as do the kinds of returns states require. Unitax operates a "beefed up" Honeywell 2400 in its 40,000 sq. ft. center in Anaheim and this month will bring in an IBM 360/50. Data entry equipment is Inforex. Sta-Fed uses a 360/50 in Des Moines and has a System 3 in its Cedar Rapids headquarters. For data entry it uses IBM 3742s and 129s.

Autotax uses a 370/135 in its Falls Church, Va., headquarters and rents time in five other areas it serves on a variety of IBM machines, during tax season. Its data entry is both mag tape and 80 column cards. Autotax considers itself one of the "biggies." It handles state returns in 33 states and reports its business this year is up 12% over last year.

In data centers

Dynatax, with 15 offices, processes returns on 360 and 370 machines in Tym-

share owned data centers. Data entry is both key-to-disc and keypunch with key-to-disc predominating.

Digitax uses a 360/50 in its Bethpage headquarters and has a 370 machine in Chicago. The company has five offices, handles returns for 23 states, and reports its business this year is up 20% over last.

And individual tax returns aren't the only ones moving more and more to the computer. Computax, which started the whole business with individual returns in 1964, moved into partnership returns and corporation returns in the 1972 tax year. Unitax began with individual returns in 1965 and got into partnership returns in the 1974 tax year and corporation returns with the 1975 tax year.

Many major accounting firms developed or are developing their own preparation systems.

Fast Tax of Dallas has two programs specially geared to corporation returns. There's the Profile System which has, on-line, prior years' historical tax files so that the practitioner may instantly, and remotely, scan historical data of all clients to identify taxpayers affected by present and proposed legislation and project the tax consequences of multiple assumptions for multiple years. The other system is the Video Audit which

automatically generates as a byproduct of an audit, federal and multiple state returns and comparative financial statements, making the preparation of the returns almost completely automatic.

For in-house use

And there are firms offering software for companies wanting to prepare their returns by computer in-house. Two of these are Foresight Systems of Los Angeles and Saab USA Inc. of New York City.

Whether prepared by computer or not every return filed this year will be processed by computer. The IRS has Honeywell 2000 series computers in ten service centers throughout the country and a complex including an IBM 1401 and a number of 360s and 370s at its main national center in Martinsburg, W.Va. Data entry is direct via crt's to tape. Magnetic tape records of returns processed by regional centers are sent to the national center where information is matched against the national master tax filed, which contain one complete account for every taxpayer.

Computers at the national center are used to match current-year tax returns against the master files to come up with such information as who failed to file returns, who owes taxes for previous years, who has refunds coming or who has filed duplicate claims for refunds. The matching process also reveals any

SP-75 MAKES THE ASSEMBLY LANGUAGE ATTRACTIVE

If you have decided that the assembly language is indispensable for your programming applications, you can achieve the self-documentation and software reliability you need, while preserving computing efficiency.

The SP-75 is a structured programming macro package designed for the IBM Basic Assembly Language (Bal), F and H assemblers. DOWHILE, DOEND, IFTHEN, ELSE, and IFEND macros are included: The macro package may be used in card form as part of your source decks or may be included in your user macro library.

The predicates in the DOWHILE and IFTHEN macros relate signed full-word integers using IBM extended mnemonic codes. Individual relations are combined by AND-OR logic. Predicate evaluation ends, immediately after the first relation that makes the predicate true or false.

Any program can be expressed using combinations of these fundamental structures and other branchless assembly code. The SP-75 can provide efficient structured programming in a real-time and interactive environment as well.



STRUCTURED SOFTWARE, INC.

P.O. Box 3, Columbia, Md. 21045
301-997-3921

CIRCLE 124 ON READER CARD

*Qualified assistance
is now available to users of*

VTAM NCP

- Non-standard terminal support
- Feasibility studies & surveys
- System upgrade & conversion
- Enhancements & extensions
- Design and implementation

 **ON-LINE
SOFTWARE
INTERNATIONAL**

CONTINENTAL PLAZA • 411 HACKENSACK AVENUE
HACKENSACK, NEW JERSEY 07601 • (201) 489-0400

CIRCLE 118 ON READER CARD

news in perspective

discrepancies or unusual characteristics of a return that would suggest a need for an audit.

There's a computer in every taxpayer's future this year, at least two and maybe three.

—Edith Myers

EFTS

Unconfirmed But Working

"It's going to be an uphill battle."

Jack Benton was talking in mid-February about a job he didn't officially have yet. He was awaiting Senate confirmation of his appointment as executive director of the National Commission on Electronic Funds Transfer.

He was nominated for the job by President Ford in January and by the commission itself in its first meeting held Feb. 6.

Just getting the commission going was something of an uphill battle. It was created by Congress in August of 1974 to recommend action and legislation in connection with the development of public or private electronic funds transfer systems.

It wasn't until October of 1975 that the President nominated William B. Widnall, retired Congressman from New Jersey, to be the commission's chairman, and announced 13 other appointments. And finally, the commission had its first meeting last month.

Although unconfirmed in February, Benton was working and had an office, at 1000 Connecticut Ave., ninth floor, and "eight to ten people helping out, full and part time."

He wasn't sure what size staff he eventually would seek. "I hope we get the funding that was in the bill, \$1 million a year but we may use external consultants. It's not always necessary to build skills in-house."

Benton feels he has an "in-depth knowledge" of EFT. To accept the executive directorship of the commission he resigned a position with TRW as Director of Financial Industry Planning. "At TRW I was very much involved with EFT developments and banking. I have been tracking EFT carefully for the last four years."

Private and public

Benton said he'd worked closely with a number of large commercial banks and was "intimately involved with every

TRW installation in the banking field." He also acted in an ex-officio advisory capacity to the Atlantic Payments project. As a consultant before he joined TRW, Benton worked mostly in the public sector with such clients as the government of the state of California, the Ore-

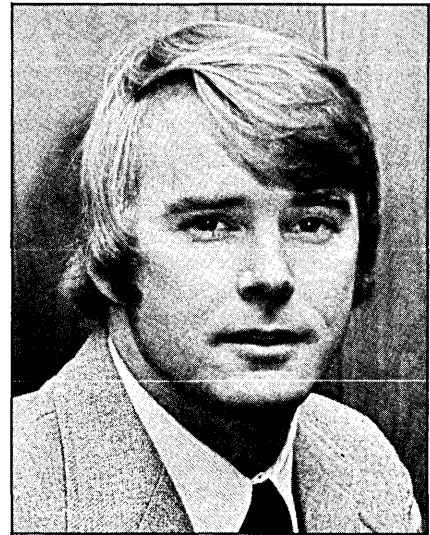

JACK BENTON
"an uphill battle"

gon state government, the Albuquerque, New Mexico school district and the Los Angeles Police Department.

"I'm a systems guy, not an engineering type." For his public sector clients he did such things as planning, budget,

Talk to us about Terminals

AJ has one of the best selections of computer terminals in the business, backed by our own nationwide sales and service. Take a look at our line-up of quality terminals—

- **AJ 230** The popular Model 33 Teletype with built-in acoustic coupler, plus mobile stand for easy portability. (Also available in auto-answer and TWX/DDD versions.)
- **AJ 841** Our original, rugged Selectronic™ terminal. A cost effective replacement for the IBM 2741.
- **AJ 630** A solid state, non-impact printer terminal that

offers a 140 character line plus fast, quiet operation. (APL is an option.)

- **AJ 830** A new 30 cps impact printer terminal with high print quality. It also features addressable horizontal and vertical tabs.

If you're thinking about terminals, think about Anderson Jacobson. Better yet, write or give us a call and let us tell you more.

 **ANDERSON
JACOBSON**

1065 Morse Avenue • Sunnyvale, CA 94086 • (408) 734-4030

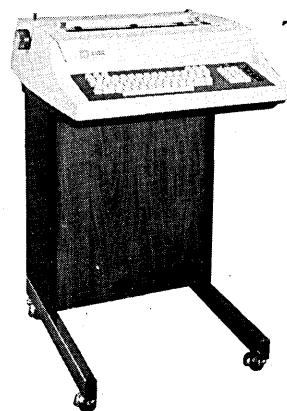

THE AJ 830

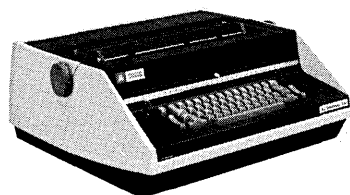

THE AJ 841

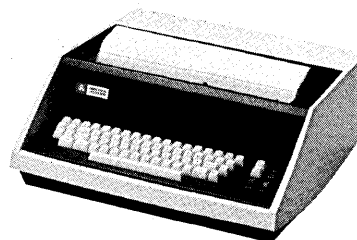

THE AJ 630

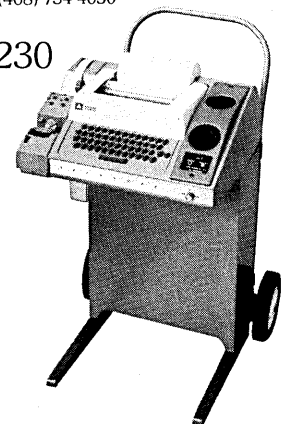

THE AJ 230

news in perspective

economic analysis, cost analysis, and resource analysis. "I used to think of myself as a systems analyst but learned when I went to TRW that that means a computer guy and I'm not a computer guy."

He did some writing during his consultant days and is the author of "Managing the Organization Decision Process."

Before consulting, Benton was with Rand Corp. for three years in the Resource Analysis Department. Earlier he

was in Pakistan with USAID as a Public Administration Advisor and worked with the Office of Economic Opportunity while pursuing graduate studies.

He holds a doctorate in Public Administration from the Univ. of Southern California and a master's degree in public administration from Maxwell School of Syracuse.

Wanted the job

Benton is quick to admit he sought the job he was hoping to be confirmed

to last month. He made his first inquiry last June. "I wrote to Sen. Jake Garn who is on the Senate Banking Committee and told him of my interest and qualifications." Sen. Garn wrote back inviting him to come to Washington. "I went and met a couple of other Senators on the Senate Banking Committee . . . told them I have an in-depth knowledge of EFT and of resource analysis planning."

In December he received another invitation to Washington—this time from the President's personnel office in the White House. He went and met Widnall and "other members of the government." After Christmas, he said, "I was told, in effect, that the decision probably would be made to nominate me after a thorough review by the FBI." He was nominated by the President when the FBI review was completed.

He sees his job with the commission as "a challenge I very much wanted. We've got a lot of work to do. We're not all of a sudden going to become the smartest people in the world on EFT."

He sees himself and his staff as "acting as a conduit for information between industry and the banks. We will analyze, evaluate and synthesize. We will try to determine what the outcomes would be of paths A, B, and C."

Lots to deal with

The kind of information he will have to deal with is proliferating. Both banks and vendors continue active in the EFT arena even as his staff is being formed. In Chicago, Continental Bank and the Federal Home Loan Bank of Chicago signed a contract to develop a shared electronic network which will be available to savings and loan customers in the middle of this year. Under the agreement, Continental will provide computer linkage between terminals it has installed at Dominick's and National supermarkets and FHLB computers. The link will enable savings and loan institutions whose data processing functions are performed by the Federal Home Loan Bank to offer their customers, upon approval of the Federal Home Loan Bank Board in Washington, the convenience of cashing checks and withdrawing or depositing to s&L savings accounts through Continental's terminals.

The FHLB performs data processing functions for 158 savings and loan associations in Illinois, Wisconsin, Michigan, and Indiana. Continental operates a check-cashing service at 63 Dominick's stores and is installing terminals to provide the service at 137 National stores. The stores' own check-cashing cards or the Continental Banking card can be used to operate the terminals.

s&L customers will use the same terminals to conduct their financial transactions, and will use a magnetically encoded card, issued by their savings and loan association, for access to the

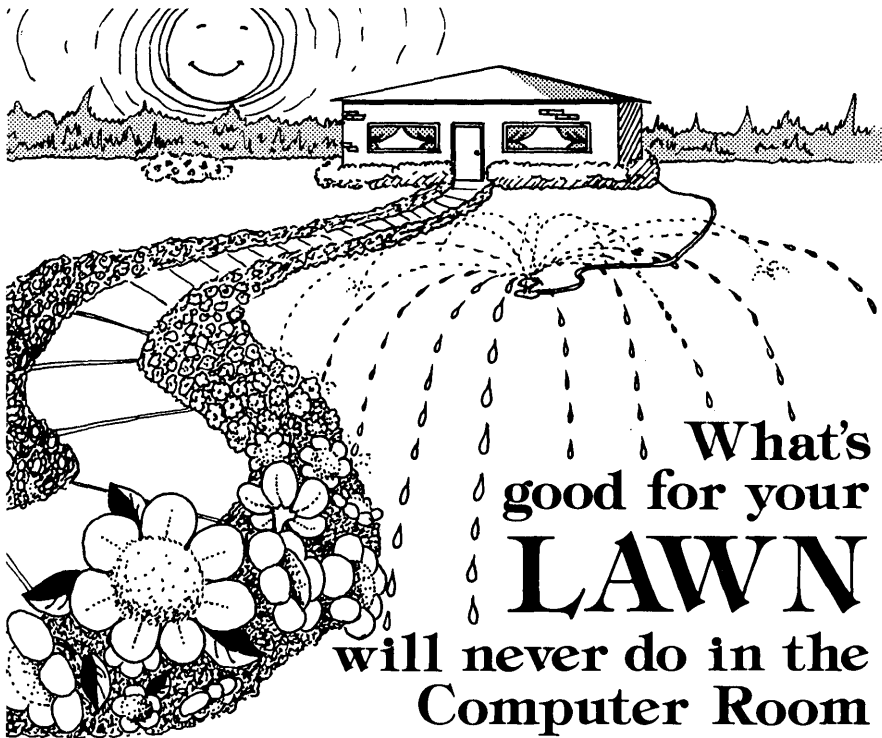

What's
good for your
LAWN
will never do in the
Computer Room

WATER & HUMIDITY are just great for Bermuda or St. Augustine, but they will never do around your computer installation. And if Water & Humidity or Heat & Cold do creep into the computer room, how will you know? Easily, with EWA.

EWA monitors what is happening in your controlled environment, even to minute amounts of water and humidity. Should you wish, this system can trigger other mechanisms to protect your precious hardware and software from the dangers of the elements. And EWA is self-supervised, including checking its own power supply.

At a most reasonable cost.

Isn't your computer installation worth a phone call? Certainly your peace of mind is.



**hydro-temp
controls, inc.**

203 carondelet street · suite 817
new orleans, louisiana 70130 · 504-522-0541

CIRCLE 132 ON READER CARD

terminal.

In California, California Federal Savings and Loan Assn. installed six more Remote Service Units (RSU's) at supermarkets in the Los Angeles area, bringing the total in operation to 11. Three of the new RSU's are at Von's Grocery Co. markets and three at Hughes Markets. The RSU's are linked to Cal Fed's central computer and provide customers with access to their savings accounts.

In New York City, the New York Automated Clearing House (NYACH) opened to handle consumer preauthorized electronic payments in the Second Federal Reserve District consisting of New York State, the northern half of New Jersey and Fairfield County, Conn. The transactions, payrolls, annuities, and repetitive payments such as insurance drafts, are to be handled in a batch environment with magnetic tapes being sent to NYACH by participating commercial banks and thrift institutions.

The NYACH has been processing some 2,000 transactions per week since last July in a pilot operation.

In the charge card arena, Interbank Card Assn. which handles Master Charge cards has joined National BankAmericard in offering a debit card which can be used at point-of-sale locations for direct fund transfers as well as check guarantee and at automated teller machines to initiate withdrawal transactions. The card is to be called Signet.

Year-end figures released by the Treasury Department show that since the Direct Deposit program for Social Security checks began in early 1975, 2,671,648 recipients had received payments under the program.

NCR Corp. started a new publication, EFTS Digest, which features capsule summaries of developments in EFTS.

And Comptroller of the Currency James E. Smith released a survey of 4,700 national banks, which had a 97% response, and showed that 10% of the banks had at least one automated teller machine.

That's a lot to analyze, evaluate and synthesize.

—E.M.

Communications

Huge New Markets in Telecommunications

New telecommunications markets worth several billion dollars could be created by investing a relatively small amount of federal R&D money, says a report now being prepared by the Commerce Dept.'s Office of Telecommunications. The report, in draft form, is being drawn up in anticipation that Congress will make available \$1.25 billion in the next fiscal year, beginning Oct. 1, for non-broadcast telecommunications research.

Legislation authorizing the money was passed in the House in January and appeared headed for quick consideration in the Senate so that the money could be appropriated in time to be spent in FY '77.

The Commerce report says the new markets could be created by reducing certain technical and regulatory "barriers"—for example, funding demonstration projects in fields like cable television where existing private suppliers aren't financially able to invest in innovative technology themselves.

The Office of Telecommunications (OT) proposes federal support for four types of telecommunications technolo-

gy:

—*Establishment of an experimental broadband cable tv system.* This project hopefully would lead, in three years, to "an industry-supported market demonstration of new services . . . that will enhance education, health, public administration, and business." The OT report adds that "studies indicate the total market for broadband goods and services could amount to \$30 billion a year by 1990," as compared with \$1 billion now.

—*Development and demonstration of small, high data rate (1-3 gigabits/second) earth stations that could communicate directly with space satellites.*

Let us show you the drawing power of HP's computer plotters.

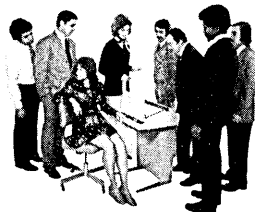
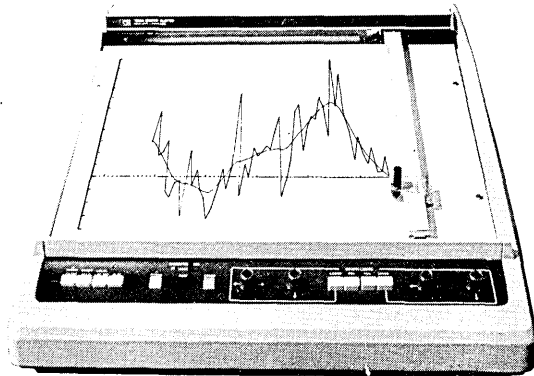

Our Graphic Plotters always draw a crowd when they start to work. Everyone around is quick to notice how the plotter reduces stacks of computer data into meaningful charts and graphs.

The plotters work wonders for electronic and mechanical designers. And sales managers, financial people, researchers, chemists or anyone else who uses data from a computer, time-share terminal or computer-operated measurement system.

With a minimum of software, they let you have graphics for engineering, research, marketing and financial problems. On any size paper up to 11 x 17 inches (28 x 43 cm). In red, blue, green or black.

And prices start at just \$3750 (domestic USA price).

For more information on why HP's Graphic Plotters are a top drawing item, write: Hewlett-Packard, 16399 West Bernardo Drive, San Diego, CA 92127. If you wish, you can have a live demonstration just for the asking. Then draw your own conclusions.

11607

HP Graphic Plotters. Built for times when a fine line separates success from failure.

HEWLETT  PACKARD

Sales and service from 172 offices in 65 countries.

news in perspective

This effort could help produce "new markets (worth) in excess of \$1 billion."

—*Installation of an optical fiber distribution network in an office building complex.* "A variety of wideband terminals" would be connected to it, and the network would also be attached to one or more conventional, carrier-provided long-distance communications networks. According to the OT report, the U.S. Postal Service has "expressed interest" in an evaluation of fiber optics technology for possible use in its planned electronic mail distribution system. "While credible projections (of the future fiber optics-related market) are not available, domestic sales are expected to be very high—perhaps measured in billions of dollars per year for new computers, terminals, and interconnect equipment," OT added.

—*Research aimed at developing more cost effective land mobile radio systems and digital mobile receivers.* The basic output would be "engineering methods" that could broaden the commercial market, particularly in urban areas, and meanwhile promote great efficiency in use of the spectrum.

Besides funding demonstration projects, OT wants to attack a number of

alleged administrative barriers—for example, technology transfer. It is proposing to act as a conduit for transferring satellite technology from DOD, NASA, and other federal agencies to commercial suppliers.

"The implementation of direct satellite communications systems using small (5 to 10 ft. diameter antenna) earth station technology in frequency bands other than 4/6 GHz (gigaHertz) is being delayed in the U.S. because of the absence of technical demonstrations that the risks can be eliminated. These delays are permitting the Japanese and Europeans . . . to gain a significant techno-

Aid Proposed for Cable Television

Federal policy should give significantly greater encouragement to cable tv and significantly less to commercial tv, says the communications subcommittee of the House Commerce Committee.

One way of doing this would be through a bigger federal investment in two-way CATV demonstration projects. These were some of the other recommendations: Low-interest federal loans to promote installation of cable translator systems in rural areas; changes in pending copyright legislation to distribute costs more equitably among CATV operators; greater reliance on state/local regulation and less on the FCC; abolition of all general limitations on cable tv operators' freedom to carry distant commercial tv signals.

In a footnote, the subcommittee staff said it "plans an engineering study to reexamine the allocation by the FCC of the non-government portion of the (frequency) spectrum," and will use the results to "make recommendations—legislative or otherwise—to Congress."

Pointing out that commercial tv stations "occupy over one-half of the most valuable portion of the electromagnetic spectrum," the report argued they don't deserve such a large allocation considering the limited amount of local programming provided, the lack of multiple outlets in sparsely-populated areas, the inability to provide non-entertainment services, and other alleged shortcomings. *

Don't Write It...



Say It!



AUDIOPORT™ 160 and 116. The portable audio terminals that are going places in . . . order entry, tracking systems, insurance rating, payment calculations and other data entry and inquiry systems in all parts of the U.S.

New... AUDIOPORT™ 400 Modems. WE403/401J compatible for acoustic coupled terminals and push-button phones.

Sure there are applications requiring print-out or display . . . but don't use an expensive approach where you don't need it. The **AUDIOPORT™** in conjunction with a voice response system can do most any application. . . except simpler and at lower cost!

And the **AUDIOPORT™** provides the expanded capabilities so necessary to a successful audio system. . . numeric and alphanumeric keyboards. . . built-in speaker. . . low cost (the more you use, the less they are) and you can take it with you.

TRANSCOM INCORPORATED 
a subsidiary of
HI-G, INCORPORATED
580 Spring Street
Windsor Locks, Conn. 06096
(203) 623-2481

logical lead . . . Much of the technology is available in the research stage, (from) DOD agencies and contractors, but technology transfer to the civilian, commercial marketplace is nonexistent.

Regulatory policy

Another alleged administrative barrier is FCC regulatory policy. The commission, says OT, lacks the technical expertise to properly evaluate the often-conflicting recommendations presented by industry. The Office of Telecommunications proposes to fill this void, and in the process, help "increase regulatory quality" as well as the commission's "responsiveness to the needs of industry and the public."

Specifically, OT would provide technical advice, develop proposed standards involving, for example, interconnection of terminals and networks, and submit recommendations to FCC regulatory proceedings accompanied by economic and technical analyses of the alternatives.

"Both specialized and traditional communications common carriers will be offering a variety of competing services under varying tariff prices," the report added. "Most potential users will not have the technical competence to make sophisticated measurements to determine the quality of reliability of services." OT wants to develop user-

oriented performance criteria and measurement methods; these would assist users in comparing service offerings and in "determining whether a particular service performs as described by the offeror."

The OT report has been read by several telecommunications suppliers and "a number of criticisms have been received," says one source. Some companies are worried about "unnecessary" federal regulation. Others, which have special expertise in a particular telecommunications field, fear they will have to share their secrets with competitors. Still others feel that OT hasn't addressed the most serious problems—for example, according to this view, U.S. telecommunications technology hasn't developed faster because of government restrictions on what can be exported.

OT is now soliciting additional information from these and other sources, and expects to publish the final version of the report in April. By then, Congress may have enacted the currently-pending legislation which provides money to support a telecommunications demonstration program. If that happens, there is a good chance the OT report, as finally approved, will be relied on to determine how the funds are spent.

The bill passed by the House in January is HR9630—the "Educational Broadcasting Facilities and Telecommunications Demonstration Act of 1976." If enacted, it will enable the Department of Health, Education, and Welfare (HEW) to make grants to "public and private non-profit agencies, organizations and institutions." *

Evidence Piles up for AT&T Breakup; FCC Report Questions Rate Structure

Ma Bell is a lousy bookkeeper. As a result—accidentally or on purpose—no one outside the company can really determine whether AT&T's charges are reasonable.

This, in essence, is one major conclusion of a voluminous analysis, filling nearly 1,500 pages, that a special trial

staff of the Federal Communications Commission released late this winter.

On the basis of the data that was available, the staff said:

Bell's interstate customers were overcharged \$1.655 billion between 1971 and 1975 and they should receive refunds; the company's 1975 rate base

BEEMAK TABCARD HOLDERS

FOR SYSTEM 3—80 COL.—51 COL.
RACKS — TRAYS — ACCESSORIES

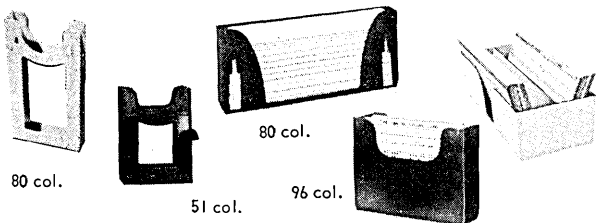

80 col.

51 col.

80 col.

96 col.

Holders with magnets or adhesive strip. Spring clips for attaching to shelves.

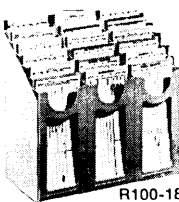

R100-18

Racks made with any holder in any size or configuration.

Vinyl envelopes available with adhesive back or magnets. Special sizes made to fit your needs.

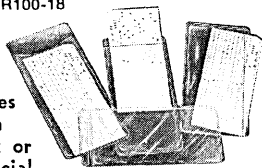

BP950

for System 3

Unbreakable carrier protects cards traveling thru plant. Visible, accessible.

Write for information

BEEMAK PLASTICS

7424 Santa Monica Blvd., Los Angeles, Calif. 90046 Phone: (213) 876-1770

We've got a display terminal to solve your text editing problem

A DELTA display terminal with full text editing capabilities.

- Extended memory for recovering large amounts of text
- Large, bright, easy-to-read characters
- Reliable, trouble-free performance
- Extensive text editing features
- Upper/lower case character set
- Nationwide service
- Simple operation

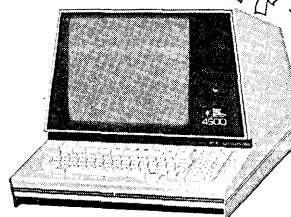
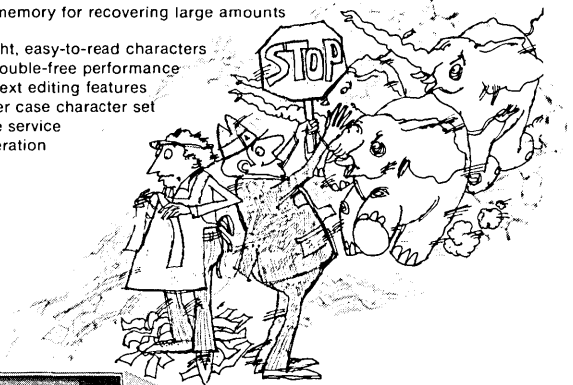

Handing your text on a DELTA display terminal is positively charging. Contact us quickly for more data.

 Delta Data Systems Corporation
Woodhaven Industrial Park
Cornwells Heights, PA 19020
(215) 639-9400

DELTA DATA SYSTEMS, LTD.
London: 01-580-7621

Service in 42 locations in the U.S. and 13 European countries and Canada.

news in perspective

should be reduced \$3.2 billion; and its current and prospective revenues should be reduced \$807 million annually. These recommendations for reductions stem from the trial staff conclusion that Bell, for years, has been loading its rate base with some expenses that don't benefit the rate payer—like the cost of institutional advertising—while greatly overcharging for other expenses because it has "little or no control" over them.

Other major conclusions:

—AT&T should be forced to divest itself of Western Electric, its manufacturing subsidiary, because the benefit to the public of the present arrangement is minimal and declining. It said divestiture represents the only effective way of injecting competition into the telecommunications marketplace. The staff said the commission should draft divestiture legislation and submit it to Congress.

—Until divestiture occurs, Bell's equipment purchases should be supervised by the FCC's common carrier bureau to make sure they are competitive. Also, the commission should disallow from the Bell System rate base "that portion of (its) purchases from Western Electric which represents Western profit." This penalty would end only when

Bell was able to show "affirmatively" that the independents were being given an "equitable opportunity" to sell to Bell operating companies.

"The notion that Western Electric ought to be separated from the Bell System is an old, old contention that has never survived the test of reasoned evidence," said AT&T shortly after the FCC trial staff's recommendations were released. Although allowing that the staff, because of its adversary role, is entitled to some bias, AT&T added that the recommendations "represent a disservice even to that role since in nearly every instance they are the most radical positions presented in the course of these proceedings."

Dataspeed controversy

These recommendations have obvious potential impact on the rates charged to users of data communications. But the most intriguing aspect of the trial staff report may be its effect on the Dataspeed 40 controversy now raging between AT&T and various makers of intelligent terminals, led by IBM.

Late last year, AT&T submitted a tariff to the FCC covering a synchronous, clus-

tered version of the Dataspeed 40; soon afterward, IBM and others objected to it. The ostensible bone of contention is whether the Dataspeed 40 is data processing equipment, as IBM and its allies maintain, or communications equipment as maintained by the phone company. But actually the issue is whether AT&T will be allowed to get out from under its 1956 consent decree—which limits Bell to the marketing of regulated communication services—and compete with IBM and the others in the rapidly-growing value-added, computer-based telecommunication services market. Bell already has announced plans to go into this business. (February, p. 111).

Early in February, the FCC's common carrier bureau persuaded the phone company, for the third time, to delay the effective date of the Dataspeed 40 tariff so the bureau staff could continue analyzing the arguments. As things stood last month, the tariff was to have gone into operation March 3. Under the rules, the commissioners can delay it a maximum of two months beyond March 3, after which they must either accept or reject it. The betting in late February was that the commission would accept, probably without further delay, and meanwhile launch an inquiry or hearing in which the combatants will be able to continue their wrestling match.

IBM has suggested one way of resolv-

9 WAYS TO MAKE YOUR EDP SYSTEM MORE PRODUCTIVE

Data processing moves ahead so fast, it's almost impossible to keep up with the changes — unless you "go back to school," which is why thousands of EDP people and business executives benefit from the remarkable seminars, on all phases of EDP, created by Advanced Management Research. Recognized authorities skillfully communicate up-to-the-minute details on their specialties in a workshop atmosphere. Call or write today for complete information, including time and place of upcoming sessions, about as many seminars as you wish (see bottom of ad).

- 1 Data Base Design 76**
Definitive survey of Data Base Management Systems, applicable to all EDP installations including mini-computers. Continually updated 3-day seminar, already attended by over 4,000 professionals.
- 2 Data Entry & Source Data Automation**
Complete guide to improving Data Entry function. Detailed examination of criteria, including cost factors, for selecting the optional input equipment for any EDP system. 3-day seminar.
- 3 Developing Computerized Financial Reporting Systems**
How to develop, utilize and improve automated general ledger accounting systems. Intensive 3-day seminar will benefit both data processing managers and financial executives.
- 4 Evaluating and Selecting Small Business Computers**
Why risk a costly misjudgment? Attend this 3-day seminar before you investigate, purchase or lease any SBC. AMR's knowledgeable, impartial faculty reviews pros and cons of all available equipment.
- 5 Managing Data Center Operations**
Can your Data Center maintain or enhance productivity while improving cost effectiveness? Managers and supervisors re-

evaluate ways to deal with budget and personnel problems, new technology, other areas. 3 days.

- 6 Micrographic Records Systems — Microfilm/COM**
As paper costs soar, business and government turn to Computer Output Microfilm. AMR's 3-day seminar shows how COM reduces cost of computer reports and facilitates data collection, storage and retrieval.
- 7 Mini-Computers**
Many new applications, new economies are possible with Mini-Computers, Micro-Computers and Micro-Processors. Comprehensive 3-day seminar for all business, EDP, engineering people involved in selection or use of minis.
- 8 Productivity Through Structured Programming**
Structured Programming reduces time, costs, errors in many kinds of organization. Managers, systems analysts and programmers learn and practice proven techniques at this 3-day seminar/workshop.
- 9 Project Management in the Data Processing Environment**
How to control all phases of single and multiple projects. In-depth presentation of latest techniques specially developed for data processing situations. 3 days.

Please send me, without obligation on my part, complete information and schedules for the seminars I have checked here.

To find out when these seminars will be held in a city convenient for you, please call **(212) 765-6400** and ask for Miss Barth — or mail the coupon. Complete information, including seminar outlines will be furnished without obligation.

- | | |
|---|---|
| <input type="checkbox"/> 1. Data Base Design 76 | <input type="checkbox"/> 5. Managing Data Center Operations |
| <input type="checkbox"/> 2. Data Entry & Source Data Automation | <input type="checkbox"/> 6. Micrographic Records Systems—Microfilm/COM |
| <input type="checkbox"/> 3. Developing Computerized Financial Reporting Systems | <input type="checkbox"/> 7. Mini-Computers |
| <input type="checkbox"/> 4. Evaluating and Selecting Small Business Computers | <input type="checkbox"/> 8. Productivity Through Structured Programming |
| | <input type="checkbox"/> 9. Project Management in the Data Processing Environment |

amr® international, inc. DM 3/76

ADVANCED MANAGEMENT RESEARCH
1370 Avenue of the Americas, New York, N.Y. 10019 (212) 765-6400

Name _____ Title _____
Company _____ Phone _____
Address _____
City _____ State _____ Zip _____

ing the Dataspeed 40 argument: the FCC should "seek modification (of the consent decree) from the Department of Justice so as to make perfectly clear that AT&T may continue to offer its terminal equipment . . . on an unregulated basis." Although not explicitly stated, this would require AT&T to set up a separate, armslength subsidiary. None of the subsidiary's costs could be subsidized by AT&T's regulated services, nor would

Bell be entitled to a special price if it purchased any products from the subsidiary.

Although AT&T objects strongly to the IBM idea, the notion of a breakup of the Bell system seems to be getting increasingly popular. Aside from the Justice Dept., which is trying to bring about divestiture through its antitrust suit, and the FCC trial staff, which wants Congress to pass a bill, there are indications that

key members of the House and Senate are also becoming concerned about concentration in the telecommunications market.

Rumblings from Congress

Last fall, the communications subcommittee of the House Commerce Committee conducted an FCC oversight hearing. "Apparently, the commission lacks the will or ability to engage in policy planning, to devise any standards for tariffs, or to implement a (minimally capable) accounting system" said Subcommittee Chairman Torbert H. Macdonald (Massachusetts). "We want to know the reasons for this sad state of affairs."

At about the same time, Macdonald told the National Association of State Regulatory Utility Commissioners: "There are undoubtedly many ways in which the federal government and the states can work cooperatively . . . but let me emphasize that such a partnership will not (include) a joint effort to rebuild legal barriers to competition in this industry . . . We expect you to cooperate with the national policy allowing competition."

In February, a Senate Judiciary subcommittee began hearings on S2028, "The Competitive Improvements Act." Its major purpose is to require federal regulatory agencies to choose, and enforce on a consistent basis, competitive

AT&T's DDS Expansion Plan May Be in Jeopardy

AT&T's authority to offer Dataphone Digital Service (DDS) in 19 additional cities at bargain basement rates has been reaffirmed by the Federal Communication Commission's common carrier bureau despite strenuous objections from a commission trial staff. And some observers think that while the phone company won that battle, it might have lost the war.

Last December, the FCC permitted AT&T to extend DDS from five markets served by the initial offering to 19 others. But the trial staff requested reconsideration of this order. The request was denied last month. Common Carrier Bureau Chief Walter Hinchman, who wrote the ruling, added, however, that the commission

couldn't decide whether AT&T's latest DDS expansion plan—this one covering 40 more cities—should be authorized. Reason: Bell hasn't supplied adequate cost information.

It was this same lack of information that motivated the trial staff to oppose letting AT&T expand DDS beyond the initial five cities.

Soon after Hinchman's decision was announced, AT&T Vice President J. R. Billingsley met with the common carrier bureau staff, and worked out a "mutual agreement," as the company put it, regarding what additional cost information Bell must submit to permit an FCC decision on the request to offer DDS in 40 more cities. *



The \$500,000 digital cassette

All digital cassettes may look alike but looks alone are deceiving. They tell nothing about quality. Quality that assures long life, accurate performance and maximum protection for your data. Quality that takes a substantial dollar commitment—a commitment most manufacturers don't bother to spend. Kybe invested \$500,000, 11 years, and countless redesigns to bring you the best digital

cassette money can buy at any price. Best of all, you can probably buy Kybe cassettes—and Kybe quality—for less than you're spending right now. Find out what to look for in a digital cassette and what makes Kybe your best buy. Contact Kybe for complete details.



CIRCLE 95 ON READER CARD

We've got a display terminal to solve your data retrieval problem

A DELTA display terminal that handles large display formats.

- Bright, easily readable characters minimize eye fatigue
- Simplified keyboard helps reduce operator errors
- High speed data transfer rates to 500,000 cps
- Accommodates large formats with many lines
- Line drawing for forms, charts and graphs
- Up to 3072 characters of display memory
- Nationwide customer service
- Reliable operation

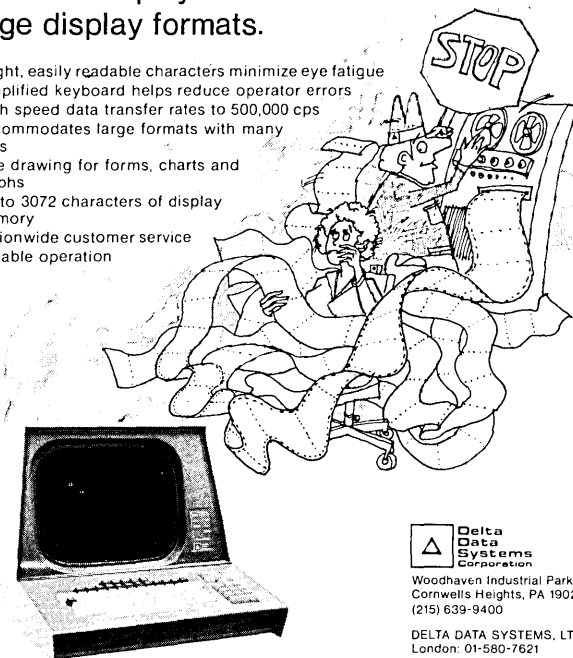

Stay on top of the situation with a DELTA display terminal. Call or write for more information now.

Delta Data Systems Corporation
Woodhaven Industrial Park
Cornwells Heights, PA 19020
(215) 639-9400
DELTA DATA SYSTEMS, LTD.
London: 01-580-7621

Service in 42 locations in the U.S., and 13 European countries and Canada.

CIRCLE 109 ON READER CARD

news in perspective

alternatives in their decisionmaking. Former FCC commissioner Ken Cox, who's now a senior vp of MCI—possibly AT&T's least-favorite competitor—was among those testifying on S2028.

It isn't clear that legislation is really needed to make the FCC inject more competition into its regulatory decisions—particularly if the commission does so on its own. For example, it could adopt the trial staff's suggestion and draft a bill that would divest AT&T of Western Electric. Or, it could follow up on IBM's recommendation to seek modification of the 1956 consent decree, thus encouraging the phone company to market the Dataspeed 40 through a separate subsidiary.

Evidence accumulates

Traditionally, the FCC has been extremely sensitive to criticism from Capitol Hill, and has attempted to forestall specific legislative mandates through "voluntary" action. The current Congressional debate on competition in the telecommunications market probably hasn't reached a critical point yet, but it's continuing and meanwhile the evidence is accumulating.

The trial staff's report comes right on

the heels of a recommendation of Common Carrier Bureau Chief Walter Hinchman (February, p. 118) calling for drastic changes in Bell's private line rates. One of his major conclusions was that AT&T's present cost-accounting methods provide "an unwarranted protective umbrella" enabling Bell to cover all the economic losses on its competitive services with "very high or excessive

Marketing

Should Happiness Come With a Price?

Jokingly, and more often with seriousness, computer equipment vendors classify customers into two groups: those who are happy with equipment that works, and those who scream when it doesn't.

Computer marketing man Louis E. Schultz wondered recently if a buyer would be willing to pay extra for happiness. Specifically, Schultz wanted to know whether minicomputer original equipment manufacturers (oem's) would agree to pay a premium not only for vendor support after buying mini-

earnings" from its monopoly services.

And last fall, the President's chief telecommunications advisor—John Eger, acting director of the Office of Telecommunications Policy (OTP)—told Congressman Macdonald's communications subcommittee that the marketing of communication terminals and the resale/sharing of circuits should be deregulated. Eger added that AT&T, along with other carriers, should offer such services through arm's length subsidiaries.

—Phil Hirsch

computer peripherals but for extra support from the vendor before the sale was made.

Schultz, who heads the business management office at Control Data Corp's Magnetic Peripherals, Inc. subsidiary at Oklahoma City which sells minicomputer hard and flexible disc drives, polled what he considered the "key decision makers" in a "representative number" of traditional oem's—12 large computer makers, 11 minicomputer makers and the 1,200 systems houses who sell minicomputer-based systems.

The findings were as might have been expected: some would and some wouldn't, and some would pay more than others. Many considered that the pre and post sales support services are part of the parcel and therefore should

ANNOUNCING PENRIL'S 48/MULTI MODEM

FOR THE EXTRA-ORDINARY LOW
PRICE OF \$2,395 IN SINGLE QUANTITY!

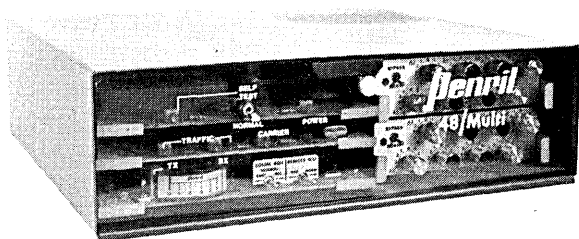

This budget-saving 48/MULTI modem features:

- Multi-point application
- Exceptional performance at 4800 bps

- One-time adjustable equalizer
- Ideal polled network operation
- No special equipment or tools needed
- Built-in diagnostics

All for only \$2,395 in a modem contained on three plug-in circuit cards. Replaces a similar model that sold for over \$3,400.

And deliveries of the 48/MULTI — 30-day ARO beginning January 1, 1976.

Penril Corp. / Data Communications Division

5520 Randolph Road • Rockville, Maryland 20852
301/881-8151

come without an extra charge. And those who said they'd agree to pay for some extra services qualified this by saying that if the price of two competitors was the same, the order would go to the one offering the extra services at no additional charge.

One of Schultz's conclusions in a 15,000-word report on his study is that "there is a reluctance on any original equipment manufacturer's part to add anything to the cost of the basic product—but the services are obviously worth something."

Schultz listed eight pre-sale and five post-sale services that might be charged a buyer (see box) and found that while there was general apathy toward pre-sales extras, there indeed was interest in some post-sale extras, particularly when the supplier provided oem's with regionally located spare parts inventories. There also was interest in systems integration support and some oem's said they'd pay a small premium for getting help in evaluating engineering support before they selected a miniperipheral and for getting dedicated followup support from salesmen after they've received the order.

One purpose of the study was to find out whether a vendor should make an investment in any of these extra services and why. While all but two respondents rejected the notion of paying a premium

"X"-PLUS

Some oem's will pay extra for pre-sales and post-sales support on purchases of minicomputer peripherals. Here's a rating of the services and the percentage of the sales price oem's would pay as a premium: (pre-sales services are noted.)

1. Regionally located spare parts inventories 2.2%
2. Systems integration support 1.6
3. Quick response from factory on evaluation questions, requests and observations (pre-sales) 1.5
4. Salesman's followup support 1.5
5. Quick response by factory personnel to delivery

- and technical questions 1.3
6. Regionally located support engineers for quick solutions to minor problems 1.2
7. Highly trained technical salesmen (pre-sales) 1.0
8. Evaluation engineering support on site (pre-sales) ... 1.0
9. Engineering consultation on peripheral controller design details (pre-sales) 0.9
10. Engineering consultation on systems design (pre-sales) 0.9
11. Competitive comparison information (pre-sales) 0.3
12. A "how to" controller design manual (pre-sales) 0.3
13. A system design publication (pre-sales) 0.3

for published competitive comparisons, one of the buyers who would pay was a big buyer who said he'd pay a 2.5% premium. Schultz said the \$5,000 cost to publish that material could in the case of that buyer result in a return of \$75,000 from a premium on about 1,000 peripherals. This leads Schultz to conclude that some services "that do have value to some prospects should be priced separately as an option."

Schultz, who has been in miniperipherals marketing during more than half of his 16 years in the computer

field, spent six months on his study. He presented the analysis as the thesis for his master's degree in business administration at Pepperdine Univ. in Los Angeles. He admits that in a market where "cost of the system is of such high priority that the oem will waive any extra in favor of lower price," it is difficult for marketeers to make a foolproof investment decision. "But there's nevertheless a lot of valuable information here for analysis."

He received his M.B.A. last December. *

Computer Scheduled MAGNETICALLY

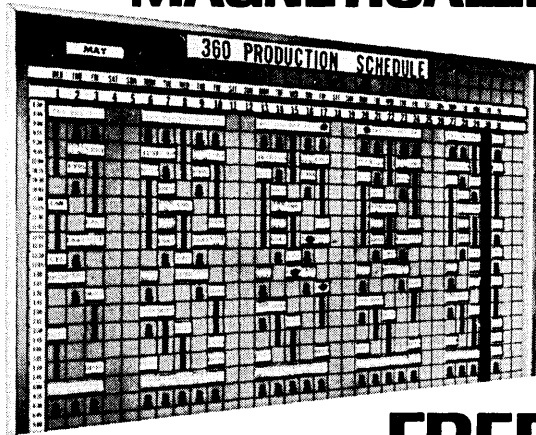

Write for 16 Page Illustrated Catalog **FREE**

- Keep your computer running—not idle.
- Schedule in 6, 10, 15 & 30 min. cycles, for daily, weekly or monthly periods.
- Know in advance when slack periods or heavy work loads are coming.
- Make changes & additions immediately.
- Every hour saved saves you \$20-\$40-\$60.

Representation throughout most of the United States
TELEPHONE 201-938-6000

METHODS RESEARCH

70 Asbury Avenue, Farmingdale, N.J. 07727

CIRCLE 97 ON READER CARD

We've got a display terminal to solve your order entry problem

A DELTA display terminal for handling large amounts of data.

- Automatic tab to data fields reduces input time
- Light pen capability for fast decisions
- Up to 3072 characters can be displayed
- Reliable, trouble-free performance
- Nationwide service—42 locations
- Bright, easy-to-read characters
- Easy-to-use keyboard

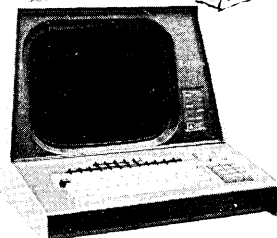
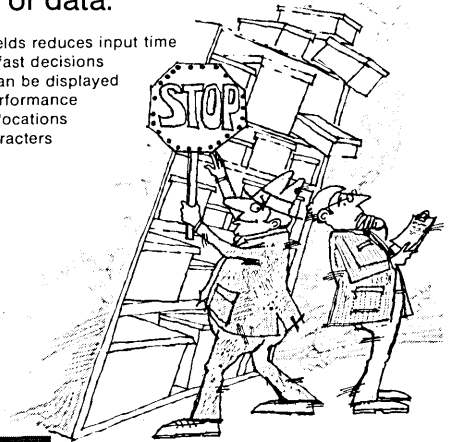

 Delta Data Systems Corporation

Woodhaven Industrial Park
Cornwells Heights, PA 19020
(215) 639-9400

DELTA DATA SYSTEMS, LTD.
London: 01-580-7621

Service in 42 locations in the U.S. and 13 European countries and Canada.

Don't let order entry become a pain in the neck.
Ask for details about DELTA display terminals today.

CIRCLE 110 ON READER CARD

news in perspective

Fledgling Firm With Wings

Where else but in California's Orange County would you be likely to find a company, less than a year old, with its own air force.

The company is Western Peripherals, Anaheim, formed last April to produce and market tape and disc interface systems for Digital Equipment Corp. and Data General minicomputers. The "air force" consists of two light airplanes which the president, Randy Knapp, says are important to the 13-employee firm "because service is critical in our business."

The company's end user customers are generally small business men "who don't want to even think about computers." As for its oem customers, "they don't want to think about interfaces."

The firm uses Sirvess, Inc. for general maintenance around the country but its own technicians "are ready to respond to any telephone call." Knapp said their longest response time has been eight hours. Two of the company employees are licensed pilots.

Knapp feels he picked "exactly the right time" to start his company. "There's a lot of money out there now and we had the ability to go to the marketplace for money as soon as we turned

profitable." Western Peripherals shipped its first product last August and has been profitable since September, said Knapp.

The company was doing \$100,000 per month in business in February and growing at the rate of 50% per month, according to its president. "We're purposely slowing it down now."

Even the name "has worked for us," said Knapp. It's such a general name people think it's been around before. Many say "yeah, we used to do business with you." *

Networks

Protocol Control: Carriers or Users?

There is a heated international argument over who will control packet switched communication networks—the carriers or the users. The argument gained steam late last month when CCITT's study group VII prepared to meet in Geneva to continue work on a standard protocol for such networks.

CCITT is an international organization sponsored by most of the world's telephone carriers (PTTs). The group's major function is to develop standards—officially called "Recommendations"—which are then adopted by its members. These Recommendations are crucial because without them customers of one carrier cannot communicate with customers of another, and that would prevent most if not all message transmission across national borders. While all CCITT members are aware of their interdependence, the proliferation of packet networks has made them even more aware of a new market, and they are vigorously competing for control of it.

The main market for packet services at the moment is the multiterminal data communications user, who generally has enough volume to make packet switching cost effective, and enough money to acquire new hardware and software. But many multiterminal users believe they can maximize the benefit of packet service only by employing end-to-end communication protocols designed for their specific systems. This contention makes the carriers livid and helps explain why the argument was gathering heat at the Geneva meetings.

The most vocal advocate of user-specified end-to-end protocols is Louis Pouzin, director of Cyclades, a packet network servicing a number of French research establishments. Pouzin sees the carriers as suppliers of transmission pipe and little more, at least as far as large volume data communications users and user groups are concerned. He believes these customers should be able to lease

Super. because it's sonic

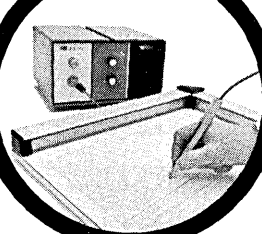

graf/pen graphic digitizer

It's the supersonic digitizer. It uses sound as its ranging medium. Which makes it more flexible to use. And more reliable.

Use it free of tablet. In working areas up to 6 foot square. In two or three dimensional applications.

Use graf/pen to eliminate tedious keyboard entry. It traces any form of graphic material into digital intelligence. Its limitless alphanumeric capability sets up streamlined business and inventory control systems.

Graf/pen is faster. More accurate.

It interfaces to virtually any minicomputer, programmable calculator, RS-232 device or off-line system.

Write. Or call Rolf Kates, our vp/marketing. Today. Ask him to explain fully how graf/pen got to be super. By being sonic.

SAC SCIENCE
ACCESSORIES
CORPORATION

970 Kings Highway West, Southport, Connecticut 06490
(203) 255-1526

CIRCLE 122 ON READER CARD

the needed bandwidth by the month, say, and allocate the individual channels among themselves. Also, these customers rather than their carriers should control the flow of packets between the end points of the message path.

Typically the end points are the ports on the terminal side of a remote concentrator and the cpu side of a central computer's front end processor. The codes include those that specify individual port addresses, control the initiation and termination of each transmission, limit the delivery of additional messages to prevent a receiving terminal from being overloaded, keep track of error-free messages, and perform related functions.

Pouzin's scheme is generally referred to as "datagram service" to distinguish it from "virtual call service," where the carrier specifies—partly or completely—the end-to-end protocol.

Pouzin realizes that even if a user leases only bandwidth from a carrier, a terminal/network interface is still required. But he insists that IBM's SDLC protocol largely solves that problem, since it is already being implemented by a number of other manufacturers and link control standards based on SDLC are under development for use within the United States and worldwide.

All of the carriers oppose Pouzin's basic scheme—ostensibly because giving the customer such freedom would pre-

vent them from charging for network service, allocating channels among independent users, and performing most of the other functions they now provide the user, and charge him for. There is some doubt that this objection is valid.

Pouzin says he's talking only about *some* users. Their datagram traffic would flow over dedicated channels in parallel but separate from the virtual call traffic generated by the carrier's other customers. Thus, the latter packets could be controlled in the usual way. As far as datagram customers are concerned, since the carrier would be providing only transmission capacity, his responsibilities would be limited accordingly. So would his revenues, of course, which suggests one possible reason for the opposition to Pouzin's scheme.

What's involved is not just the charge for communication service, per se. Some carriers—notably AT&T, Bell Canada, and probably the British and French PTTs—see the burgeoning datacom market as a place for them to sell systems as well as channels. They realize that by specifying the end-to-end protocol, they can gain a competitive advantage over the equipment suppliers in marketing computer front ends, remote controllers, and intelligent terminals to the end user.

Equipment manufacturers are also aware of this relationship. One result is that IBM and Bell Canada have been

arguing for some time about how to resolve their differences regarding end-to-end communication protocols as embodied in SNA—the IBM scheme—and SNAP, the protocol developed by Bell Canada for its new Datapac network. Other equipment suppliers, having a far smaller market share at stake than IBM, figure they aren't threatened.

Meanwhile, Bell Canada and CNCP Telecommunications are vigorously competing for primacy in the Canadian packet network business. Bell's Datapac system is scheduled to go into operation sometime this summer, while CNCP's In-foswitch network will be available "in the latter part of 1976." It is not exactly accidental that the two companies have differing views on virtual call service.

An analogous situation may be developing in the U.S., where Telenet already is offering a packet switched service, and AT&T—if it follows through on its plan for "communications processing"—seems likely to do so.

The chief bone of contention at the Geneva meetings is a proposed virtual call protocol officially submitted by Britain and France (where it already has been adopted as an "interim standard"), but largely written by Bell Canada and Telenet. It specifies in great detail the codes and procedures that a user's packet terminal would have to implement to transmit virtual call messages through a carrier's network. —P.H.

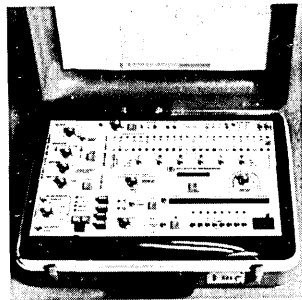

INTRODUCING...THE NEW INTERSHAKE



FOR EVEN BETTER DIAGNOSTICS OF
DATA COMMUNICATIONS SYSTEMS

- It accepts all codes and line disciplines at data rates up to 64 Kbps.
- It receives, stores and retransmits data from a 1024 character memory.
- It provides for all aspects of full and half duplex testing.
- Its library of over 100 test functions includes loop instructions for software-like test programming.
- It calculates the Block check character for receive and transmit messages including bi-synch, SDLC and others.
- It provides for manual entry of eight 128-step programs in non-volatile memory.
- It contains eight preprogrammed stored tests of up to 128 steps each.
- It provides for simultaneous CRT display of the full duplex data stream.
- It provides for CRT display of all language codes in alphanumeric and hexadecimal.

Come see us with the COMPUTER CARAVAN '76 in Boston, New York, Washington, D.C., Atlanta, Detroit, Chicago, Dallas, Los Angeles and San Francisco, March—May.

Care to learn more? Write or call us today:



ATLANTIC RESEARCH CORPORATION
5390 CHEROKEE AVENUE • ALEXANDRIA, VIRGINIA 22314 • 703-354-3400

CIRCLE 135 ON READER CARD

There's a DELTA display terminal that's right for you — regardless of your application

- User-programmable and non-programmable display terminals, plus associated peripherals and complete systems
- Many keyboards and character sets to meet your application
- Complete applications/software assistance and services
- Nationwide customer service in 42 locations
- Full documentation with every terminal
- Reliability you can count on

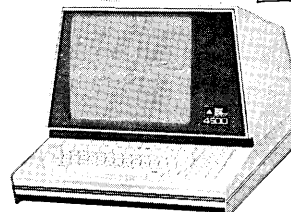
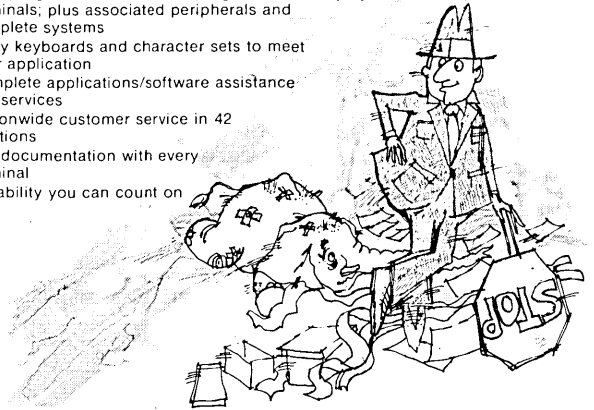

If you've got a job for a display terminal, let us prove that one of ours will do that job better—and save you time and money, too. Call or write for literature, demonstration or applications assistance.



Delta Data Systems Corporation
Woodhaven Industrial Park
Cornwells Heights, PA 19020
(215) 639-9400

DELTA DATA SYSTEMS, LTD.
London: 01-580-7621

Service in 42 locations in the U.S., and 13 European countries and Canada.

CIRCLE 111 ON READER CARD

News in Perspective

BENCHMARKS

Losing a Customer: Microdata Corp. president, Donald W. Fuller, told stockholders the company expects to lose its second biggest customer, Basic Four Corp. The mini-manufacturer's president said he expects Basic Four to begin making its own processor. The small business systems company accounted for approximately 16% of Microdata's gross sales which totaled \$5 million in the fiscal quarter ended last Nov. 30. The only Microdata customer accounting for more is Automatic Data Processing which buys Reality, the company's small business system package. Fuller said Microdata's processor backlog from Basic Four runs until the end of 1976.

Its Own Terminals: Remaining quiet as to whether or not it will build its own processor, Basic Four Corp. has announced it will produce its own crt terminals. The company currently buys terminals from Lear Siegler. Basic Four's new president, Theodore J. Smith, who left Sycor late last year to join the Irvine, Calif., small business systems company, said he will be resolving additional "make or buy" questions this year. He said the firm is "not interested in an acquisition" to gain instant manufacturing capability.

Patent Infringement Charged: Milgo Electronic Corp. has charged AT&T, Western Electric Co., Southwestern Bell, and Boeing Computer Services, Inc., a user of AT&T modems, with infringing four of its modems patents. The Miami, Fla., firm filed a patent infringement suit in the U.S. District Court in Kansas. The suit alleges that AT&T Dataphone modems No. 208 and 209 manufactured by Western Electric infringe Milgo patents. In addition to damages, Milgo is seeking a temporary and permanent injunction against the manufacture, lease, sale, or use of the Bell modems. Milgo also has filed a declaratory relief suit against Codex Corp. in response to a recent demand by Codex that Milgo cease the marketing of certain ICC modems that Codex claims infringe on a recently issued Codex patent. This suit was filed in the U.S. District Court in Southern California.

Judgment Against Burroughs: A six-member San Francisco jury found for Palmer Data Corp. which charged Burroughs Corp. with activity to prevent

Palmer from obtaining customers in the San Francisco area. The jury levied trebled damages of \$3.4 million. The suit was filed by Palmer in 1971. It accused Burroughs, which pulled out of the service business in the area in 1970, of conspiring with another local firm, Cubit, a subsidiary of Purity Stores, to transfer all of its data service business to Cubit. The suit said Burroughs had offered to transfer its customers to Palmer for a sum of money and Palmer refused. The company said Burroughs then made the same offer to Cubit and was accepted. Palmer went into bankruptcy subsequent to filing the suit. It was represented in the action by attorney Joseph Alioto, son of the former San Francisco mayor.

Now It's Typewriters: IBM, on trial on civil charges of monopolizing the computer systems market, now is under investigation by the Federal Trade Commission regarding its position and practices in the office-typewriter industry.



FRANK T. CARY

IBM said it had received a letter from the FTC advising it that the FTC staff would investigate "to determine whether IBM monopolizes, or has attempted to monopolize, or has engaged in unfair methods of competition in the office-typewriter market." Frank T. Cary, IBM's chairman and chief executive officer said IBM would cooperate.

Data General Buy: Data General has agreed in principle to acquire Incoterm, Natick, Mass., manufacturer of dedicated intelligent terminal systems for the

banking, transportation, and insurance industries. Terms of the proposed acquisition call for the exchange of 2.5 shares of Incoterm stock for each share of Data General with value of the exchange estimated at \$38 million. The move is subject to final approval of both companies, their boards of directors and the stockholders of Incoterm. Data General's bylaws do not require stockholder approval.

NCR Acquisition: Directors of NCR and Data Pathing Inc., a producer of factory data collection systems, have approved acquisition of Data Pathing by NCR for 1.35 million shares of stock worth approximately \$38 million. The transaction is subject to stockholder approval which is expected in May. In addition to the central block of NCR stock involved in the deal, an additional 190,000 shares will be reserved by NCR for exercise of current outstanding options and warrants for Data Pathing stock.

Leases for IBM in POS: IBM has come up with long term leases for its previously purchase-only retail and super-market point-of-sale terminals. The longest lease offered covers a 60 month term. It enables purchase option accrual of up to 50% of the terminals and unlimited use without extra charge. IBM calls the lease program its alternative term plan (ATP). It also covers two financial terminals. Features of the ATP include unlimited one year extensions and some price protection in that prices can be raised no more than five percent per year.

Staying Afloat?: Walter Haefner, the Swiss industrialist whose seemingly infinite faith and apparently bottomless bank account have kept Datran afloat for the past several months, will be the subject of a Federal Communications Commission inquiry. The commission wants to know whether Haefner's investments in Datran and its parent, Wyly Corp., will give him ownership of either of the two corporations, and whether this is barred by a section of the Communications Act that restricts alien ownership of U. S. common carriers. Meanwhile, the commissioners allowed Haefner to advance Datran another \$10 million on an interim basis and substitute his collateral for \$2.4 million of Wyly's money which is being held by the First National City Bank as security for a line of credit to Datran. *

Your freight goes first.

With United Airlines' "First Freight," you get guaranteed priority boarding and reserved space—to 113 cities.

Priority boarding.

"First Freight" is our priority air freight service, and it's always the first freight loaded in our planes. The big "1" on every piece makes sure of that. We're so sure your shipment will go on the flight you specify that we'll refund your premium if it doesn't.

Reserved space.

Just call United at least 6 hours before departure of the flight you need. (United has over 1,500 scheduled flights a day.) We'll reserve space for your freight and, as long as it arrives at our freight terminal 90 minutes before flight time, we'll make sure it's the "First Freight" loaded.

Special handling.

"First Freight" is segregated all the way on United—in our terminals and in the air. And every piece is monitored all the way by our computerized A.F.I.S., the industry's most advanced air freight monitoring system. No restrictions on piece count or weight, either. If our planes will take it, so will we.

Just say, "First Freight."

When that shipment has to be there, call United or your freight forwarder. Yours can be the "First Freight" there—to any of our 113 cities.



If your emergency shipment is one piece, under 50 pounds and less than 90 inches in total dimensions, you may find United's Small Package Dispatch more convenient to use. Call United Air Freight for details.

No.1 in the U.S. sky

UNITED AIRLINES CARGO

LOOK AHEAD

(Continued from page 18)

TRILLION BIT MEMORY IN FOUR YEARS

Yes Virginia, there will be a trillion bit memory. And it will be all in one tube. While we don't recommend holding your breath until its arrival, a Lexington, Mass., memory firm, may indeed be able to produce one in four years. The company, Micro-Bit Corp., is currently working on a production model MOS electron beam memory that has a 4 million bit memory tube capable of storing 40 million bits in a 10-tube cluster.

The unit, like an earlier pre-production prototype that has already been successfully tested (April '75, p. 17) will be shipped to Control Data this summer. Next year Control Data, which is an investor in Micro-Bit, expects to market four or five units to large computer installations. They see the trillion bit memory tube being available within four years.

AND NOW, IN LAS VEGAS...

California may have seen the last of Frank Marchuk's Laser Computer Corp. and, for that matter, of Marchuk himself. Last month, after failing to convince Orange County Superior Court Judge Bruce Summers that he had a case in a suit he brought against Flick-Reedy Corp. and Bekins Moving and Storage Co. (Sept. '75, p. 18), he named Las Vegas as his place of permanent residence. And the phone long listed for Laser Computer Corp. had been disconnected.

Marchuk had charged Bekins and Flick-Reedy with having stolen some property belonging to Laser Computer when they repossessed equipment he had purchased from Flick-Reedy for a health enhancement institute he operated briefly. Judge Summers heard the plaintiff's case during which Marchuk repeated earlier allegations that a big cause of Laser Computer Corp.'s demise was stolen plans and documents which never were recovered. The judge then granted a defense motion and said, in effect, there was no case. In exchange for a Flick-Reedy promise it wouldn't press for court costs, Marchuk signed away any right to appeal. He once maintained an office for Laser Computer in Las Vegas. Maybe he'll try to get it going again there.

RUMORS AND RAW RANDOM DATA

Now that IBM has upgraded its 168, the company should be announcing upgrades for its 135 and 145 soon. The colossus of Armonk has a bigger machine--the 178?--on the shelf and its future will be decided by the competitive inroads made by the likes of Amdahl, Burroughs, Cray Research and Control Data...At the recent IBM users SHARE meeting at the San Francisco Hilton, Amdahl Corp. ran bus trips to its plant in nearby Sunnyvale from a bus terminal next to the hotel... Control Data next month will announce the availability of its PLATO (programmed learning and teaching operation) system for management training applications (October '75, p. 18). CDC chairman Bill Norris says such training can be delivered at a quarter of the cost of traditional "standup" methods...Computer mainframe activity is still a major factor in the revenues of services-oriented Control Data--37% last year, the same as services revenue. Peripherals account for the remaining 26%...Cray Research was about to ship the first model of the Cray-1 64 bit word machine last month to an unidentified customer on a six-month trial basis, and some speculated the 500,000 word vector machine might be going either to ERDA's Los Alamos labs or to the National Center for Atmospheric Research in Colorado. Meanwhile Cray Research was seeking to raise about \$10 million through a public stock offering...AFIPS thinks it will sell all 904 booths at the National Computer Conference June 7-10 in New York's Coliseum, a record. In late February 258 companies had signed up for 884 booths.

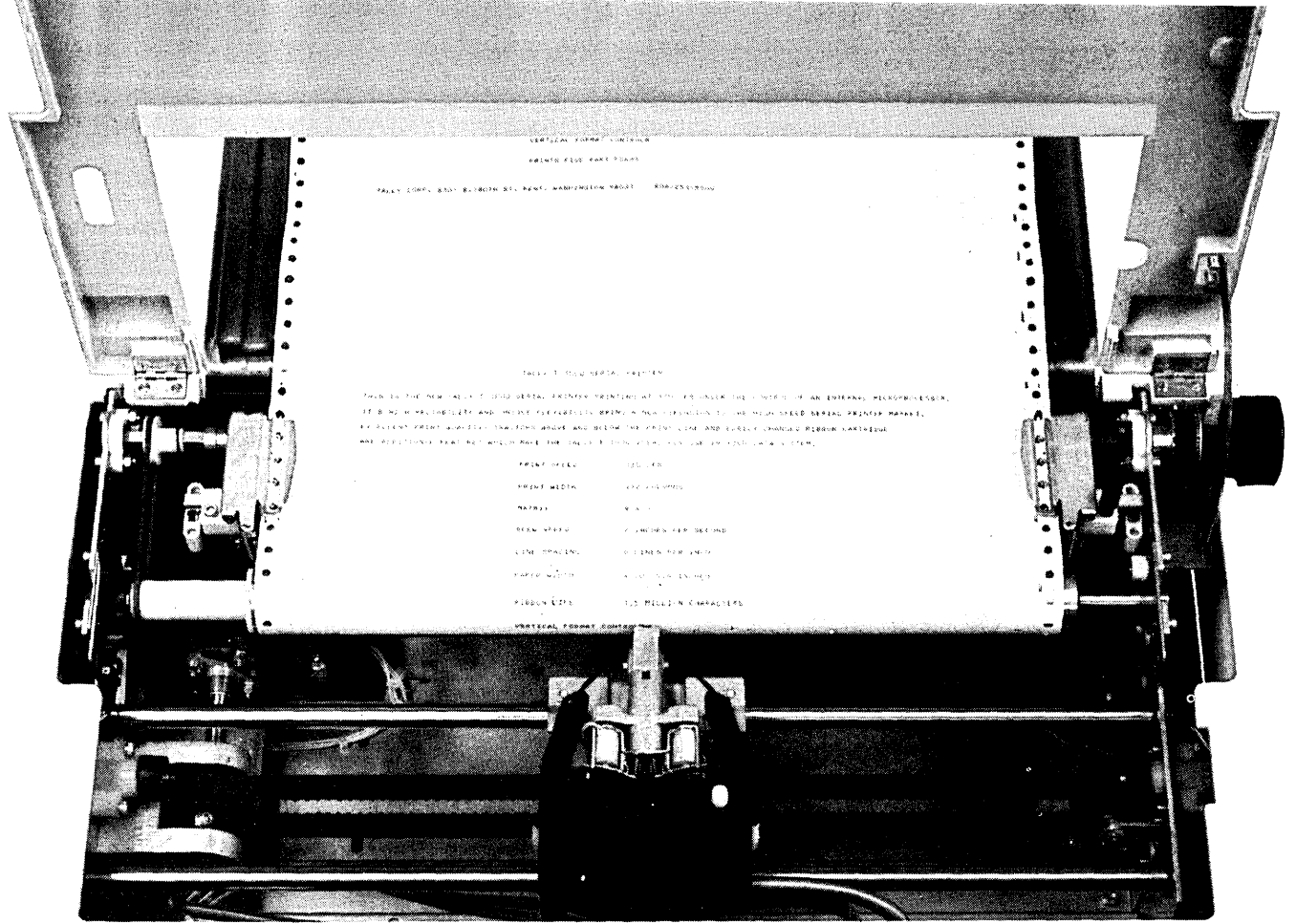

JOIN THE SERIAL PRINTER SWITCH

You'll prefer Tally's design simplicity and realistic reliability.

If you want a 120 character per second matrix printer that keeps running after the others have quit, that has better print quality (a 9 x 7 matrix font) and that is priced low, then direct your attention to the Tally T-1120. You'll get advanced design features like microprocessor electronics, low acoustic noise level, digitally controlled print head advancement, tractor engagement above and below the print line for positive paper advancement and positioning, and a

snap-in ribbon cartridge. And that's just the beginning.

Forms flexible for data processing duty, you'll find the 132 column, multi-copy T-1120 is just the ticket for your minicomputer, business system or communications terminal. For all the facts, call your nearest Tally sales office.

Tally Corporation, 8301 S. 180th Street, Kent, WA 98031. Phone (206) 251-5524.

OEM Sales Offices:

New York (516) 694-8444,
Boston (617) 742-9558,
Chicago (312) 965-0690,
Seattle (206) 251-6730,
Los Angeles (213) 378-0805,
San Francisco (408) 245-9224.

Business Systems Sales Offices:

Eastern Region (201) 671-4636,
Western Region (415) 254-8350.

TALLY

hardware

Off-line

Now you can take a \$495 computer course and get the computer thrown in free. That's what Wintek Corp., Lafayette, Ind., is offering this month and next in a program designed to give engineers, scientists, and management hands-on experience with microprocessor hardware and software. Each attendee receives a "WINCE" 6800 microcomputer to use at the workshop and to take home at the end. The \$495 price applies to courses being held in San Diego (March 15-17), and St. Petersburg Beach, Florida (March 31-April 2), with a session held in Boeglerhof, Alpbach, Tirol, Austria costing slightly more at \$645. Interested parties should contact the company directly for additional information. Phone (317) 742-6802.

Looking for something a little out of the ordinary in a pocket calculator? How about Casio's Biolator. The new model cannot only perform addition, subtraction, multiplication, and division, but can also warn you that you might be accident prone tomorrow, for also on the IC chip are biorhythm tables, the controversial measure of a person's physical, emotional, and intellectual conditions. By entering the date of birth, the calculator can indicate where the subject is on the cycles, which have lengths of 23 days for physique, 28 days for sensitivity, and 33 days for intellect. Casio is based in Fairfield, N.J.

Exactly why we don't know, but Japan's Matsushita Electric Industrial Co. has developed a tv set with a built-in ink spitting color facsimile printer. Copies on any kind of plain paper take "only" two minutes...

Air France pilots are undergoing flight training instruction for the supersonic Concorde transport in a simulator developed by Le Matériel Téléphonique, one of ITT's sister companies. Three computers are used to reproduce all flying conditions that might be encountered by Concordes.

Volkswagen doesn't think as small as it used to. Its cars are bigger now--and so are the systems used to design them. The Wolfsburg (Germany) headquarters has just placed an order for a CDC CYBER 173 and two large scale graphics terminals.

Fast, Inexpensive Printer

Some of the most exciting products result from combining technologies used in separate applications into a common one. That's the case with the first two models of high-speed electrostatic printers from this well known plotter manufacturer. It was, in fact, the stepper motor drives from its plotter line that made it possible for the 8210 to print at a 2400 line per minute clip across 80 columns without costing a fortune. The 8210 is priced at only \$3K. It wasn't that long ago that IBM introduced the 3211 2,000 lpm printer for more than \$100K! A second model, the 8230, may turn out to be even more popular than the 8210: the 8230 runs a little slower (1,400 lpm) but prints 132-column lines. It's priced

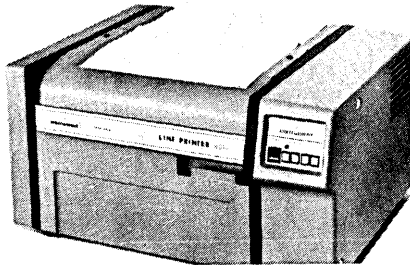

at \$3,785.

Initially the new printers will be offered to mini users. Potential customers will be asked to order either a serial RS232 interface (if one isn't on the mini already), or an interface for a Centronics or Data Products printer. Data General, for one, has cooperated with the manufacturer and has the part number required identified and ready to send to its customers eyeing these printers. For some users, at least, the capability of getting a complete 64K memory dump in less than 30 seconds seems just around the corner. Delivery is currently four months, but the manufacturer has 60 day ARO as a goal for the near future. HOUSTON INSTRUMENTS, Austin, Texas.

FOR DATA CIRCLE 231 ON READER CARD

Networking

The M3200 PACUIT Network Management and Switching System is said to combine the best of both worlds, hence the name: packet + circuit. Microprocessing hardware enables users to communicate with each other from remote terminals and with a central computer in a concurrent synchronous and asynchronous mode to facilitate network operation. The PACUIT switching method differs from

traditional packet switching systems in that such systems group data from individual or multiple terminals together at a node (switch) for block transmission to the next node. These systems temporarily buffer (store) the data at each node while they perform error checking and response functions. In contrast, a PACUIT network contains multiple channels traveling between the same source and destination nodes. Since all data in the network have common source and destination nodes, there's no need to error check or buffer data at each intermediate node. Thus, only the source and destination switches perform PACUIT control functions, while all intermediate nodes operate in a time-division, circuit-switched mode for through traffic. The M3200 system is physically and logically a full-duplex operation and carries data in both directions concurrently. Consecutive PACUITs may be transmitted in either direction without waiting for the response to each one in turn.

A technique known as dynamic bandwidth allocation is also featured on the M3200. It permits the reassignment of time slots in the network to different channels, allocating greater bandwidth to channels with higher traffic rates. The network is transparent to its resources in the sense that no source-to-destination protocol or code conversion are performed by the standard switches at network nodes. Thus, terminals and computers that are normally compatible over direct links (point-to-point) are also able to communicate with one another over the network.

Bear in mind that the M3200 is a collection of cooperating hardware and software with numerous features and options. It's therefore not so easy to price as a box: it's a true system. The first installation is going into operation for Pacific Telephone and Telegraph Co. in a digital data network uniting the 19 campuses of the California State Universities and Colleges. This system cost \$600K; absolute minimum systems are priced at approximately \$100K. COMPUTER TRANSMISSION CORP., El Segundo, Calif.

FOR DATA CIRCLE 232 ON READER CARD

Calculator Printer

The gold medal goes to Texas Instruments for introducing a low-cost printer that attaches to all of its hand-

The intelligent off-line plotting system that grows with you.

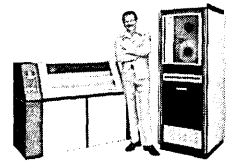

Zeta 6000 Series...with expandable general-purpose computer.

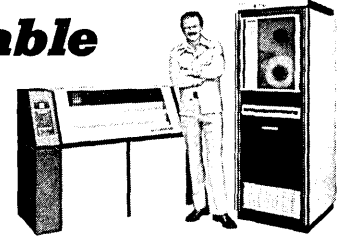

Meet the first off-line plotting system built with your future growth in mind. It's a tape drive, a 36-inch Zeta drum plotter, and a PDP-11 — with lots of room in the rack for system expansion.

Ideal for unattended operations calling for multiple copies of one or more plots, the 6000 operates at speeds up to 4,000 steps per second (14.14 ips diagonal)—and features a special speed selector for optimum speed/quality output.

Key features of the control electronics include: unattended plotting from 1 to 159 files per tape, unlimited multiple plots, searching out desired files, storing and editing of plotting sequences.

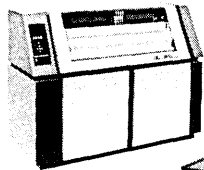
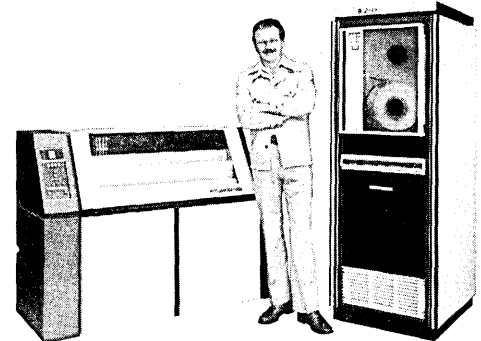

If you're in engineering, highway or city planning, structural design, map making, management reporting or electronic data processing, the 6000 Series is your plotting system. It grows on you.

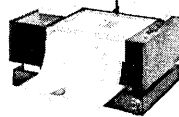

Free literature awaits. 1043 Stuart Street, Lafayette, CA 94549.

 **Zeta Research**
Plotting the Future ...

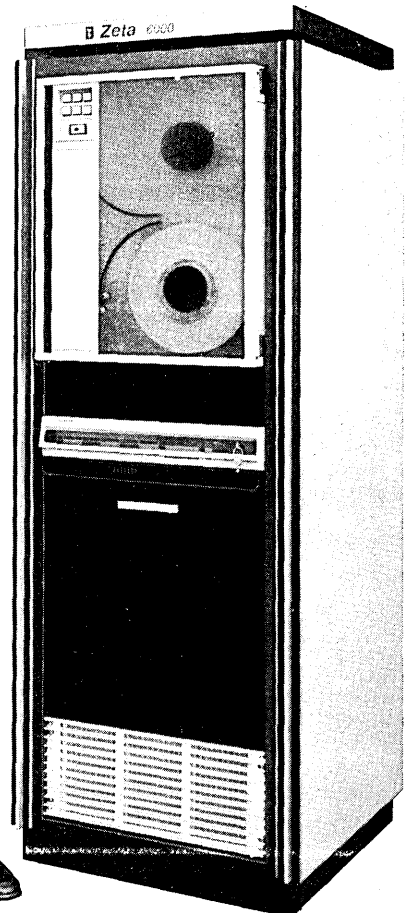
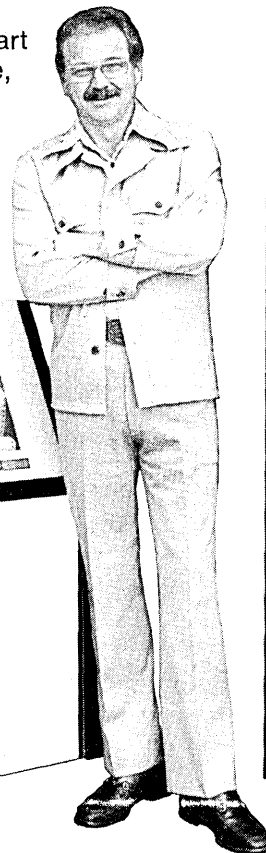
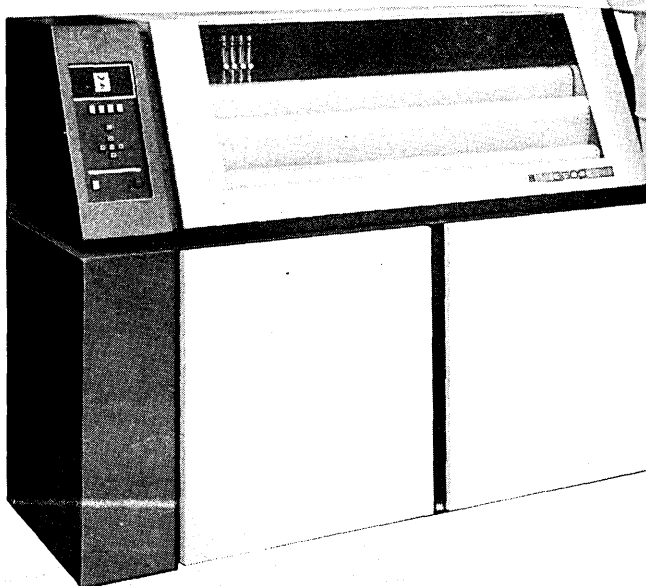

hardware

held programmable calculators. It's dubbed the PC-100, with the pc standing for "print cradle." The printer can be used for printing out program steps and problem solutions. The calculator is inserted into the cradle where it can be used for anything from printing out long amortization schedules for the business world, or listing every step in an iterative problem for scientists. The printer weighs approximately seven pounds and measures about 10 inches square and four inches high. Print and paper advance controls are built into



the printer, which is fully controllable from the calculator keyboard or card program. The price seems reasonable at \$295—which means you can now have a complete stored program computer, including card input (cards about the size of gum sticks) and 20-column hardcopy for around \$600. TEXAS INSTRUMENTS INC., Dallas, Texas.

FOR DATA CIRCLE 233 ON READER CARD

Data Entry Terminal

The SOURCE 7600 is a programmable off-line remote data terminal for use with either in-house or contracted computer service centers, and as such represents a departure from this manufacturer's line of handheld data entry terminals. The 7600 incorporates an Intel 8080 processor that is permanently programmed with a full set of basic programming commands to allow the on-site, nontechnical operator to create original formats for data input. There's also a full typewriter keyboard and a separate accounting-style numeric touchpad for rapid entry of numeric data. One Philips-type cassette drive is standard; a second cassette is optional for greater convenience in loading programs, editing and duplicating cassettes. An external line printer can be interfaced to the SOURCE 7600 for on-

site generation of full-page printouts and automatic completion of forms, invoicing, and other records. A 32-position LED display permits the operator to edit each line of data while still buffered before it is printed on the 32-character journal tape. Prices range from \$3,500 to \$4,500 in quantities of 1-10 before discounts take effect. Production quantities will be available in April. MSI DATA CORP., Costa Mesa, Calif.

FOR DATA CIRCLE 234 ON READER CARD

product spotlight

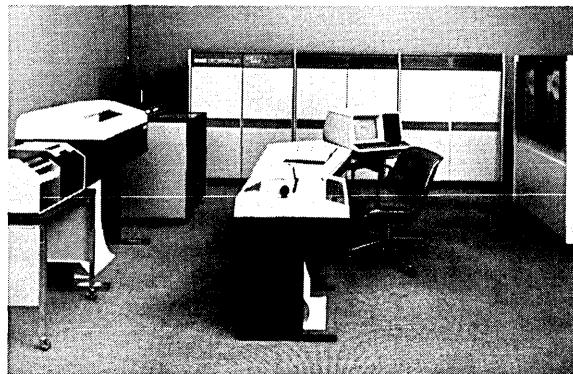

The New DEC

Most of us were probably beginning to think that since Digital Equipment Corp. was in both the minicomputer and large scale time-sharing businesses, with wholly different machines to approach them with, that's the way the mini king wanted it. Now, with the DECSYSTEM-20, it's obvious that it wasn't. The DECSYSTEM-20 is more than another computer system; it's the missing link that ties DEC's widely successful minicomputer products together with high performance machines in the class of 370/145s and more. The new system shows the direction Digital is taking for the next half decade.

As a system, the DECSYSTEM-20 features a 36-bit word cpu, core memory, controllers and a front-end PDP-11 processor, all integrated into a single functional unit. As such the system offers concurrent time-sharing, batch, and transaction processing modes in a complement of common high-level languages. Up to one megabyte of memory can be obtained with the system. A field proven demand paging virtual memory system comes standard with the model 20, as it does with other members of the DECSYSTEM family. The cpu knows 383 logically grouped instructions, many that reduce resulting program size. There are hardware stack instructions to facilitate reentrant (shareable) coding, a full business instruction set, and 70-bit double precision fixed and floating point arithmetic handy for scientific applications.

Upward software compatibility for PDP-11 users is made largely possible

Voice Response

There have been quite a few voice response units on the market over the years but perhaps none like this one, called the model 200 voice generator. Digital vocabularies for this device are generated by automatic computer analysis of real speech. This means that the intonation and dynamic characteristics of the speaker are preserved, while at the same time the vocabulary data is compressed, allowing economical storage in ROMs or dynamic stor-

with a new operating system called TOPS-20. It represents the merging of the TENEX system, developed on the PDP-10 by Bolt, Beranek & Newman for the Defense Department's ARPA net, with the TOPS-10 technology developed for commercial applications by DEC. DEC is being honest about the high-level language compatibility between its 16-bit and 36-bit product designs: "Significant effort is going into higher level language compatibility and subsequent releases on BASIC will provide for full compatibility with RSTS BASIC PLUS." Networking is a key objective of the DECSYSTEM-20, although not in the first software releases. Full implementation of DECNET will be phased in together with other vendors' network interfaces. Some thought has also been given to unattended operation. Should a system crash occur, any nearby user can press the start switch which automatically bootstraps the system. DEC is also experimenting with remote diagnostic capability in an attempt to reduce the mean time to repair of the DECSYSTEM-20 to one hour.

A minimum configuration consists of the KL20 processor and PDP-11/40 front end, 64K words of storage on the KL20 and 32K on the PDP-11, a 100 megabyte disc and a 75 ips tape drive, eight communications lines, plus an LA36 keyboard. This system is priced at \$250K, but most systems will go for around \$300K to \$350K, DEC believes, or around \$10K/month. Shipments are underway. DIGITAL EQUIPMENT CORP., Marlboro, Mass.

FOR DATA CIRCLE 230 ON READER CARD

age. Messages can be of any length—words, phrases, sentences—all individually addressable. Since the actual speech generator is a relatively inexpensive synthesizer, it's possible for multiple synthesizers to be operating simultaneously from a single vocabulary store. It's claimed that only two percent of the storage space of a mini is required to store voice messages. Evaluation units with a standard 48-word vocabulary are available now, priced at \$2,500. **SPEECH TECHNOLOGY CORP.**, Santa Monica, Calif.

FOR DATA CIRCLE 235 ON READER CARD

Phototypesetter

The Comp/Set 510 direct entry phototypesetter is capable of composing high quality type in sizes ranging from 5½ to 74 points in 70 size gradations. A new optic system that enables the operator to easily set the type in the 70 gradations is the key. A second model, the 560 is the foreign language version of the 510 and has the same point size range. Type discs are available in 10 foreign languages for the 560. The 510 is capable of setting 70 different sizes in four fonts of 112 characters each from a single type disc with self-contained character width programming. Additional features include 45 pica line length, hyphenless justification with fail/safe overset control, manual

and automatic mortise control, and automatic leader insertion and leading. All typesetting and function commands are under keyboard control at all times. A large 12-inch video screen displays the two-line field and in addition, up to 512 characters in green 14 point type. The 510 is priced at \$12,950. **ADDRESSOGRAPH MULTIGRAPH CORP.**, Cleveland, Ohio

FOR DATA CIRCLE 236 ON READER CARD

Honeywell Minis

Honeywell has invaded the oem mini-computer market full force with systems to do battle with the likes of Lockheed's System/III, Data General's Nova and Eclipse lines, and ubiquitous DEC. The systems feature semiconductor memory available in 8-32K chunks on the model 6/34 and 8-64K blocks on the models 6/36 and 6/06. The 6/06 is a low-cost extension of Honeywell's System 700 minicomputer line, which is largely end user and communications oriented.

Key specs: a six megabyte per second Megabus data path and architecture that will eventually allow implementation of systems with up to 16 million bytes of directly addressable memory. Cycle times of 300 nsec for each 16-bit word; 64 vectored interrupts; 20 traps for identifying program-error conditions. Level 6 GCOS/BES1 is

the operating system, featuring multi-tasking and program development capabilities.

A basic 8K rack-mountable model 6/34 with parity, multiply/divide, real-time clock and bootstrap loader is priced at \$2,634 in quantities of 50. A 6/34 with 16K, visual display console, dual diskettes, 60 lpm printer and



FORTRAN compiler goes for \$17,500. A 24K 6/36 configured as a data collection system can be purchased for \$39,850, including two multiple device controllers, six crt's, a 300 lpm printer, and 1.25 million words of disc storage. **HONEYWELL INC.**, Wellesley Hills, Mass.

FOR DATA CIRCLE 237 ON READER CARD



CAS/CPA... the most complete, most flexible job accounting and statistical package available today

Sure there are a lot of DP accounting packages on the market and a lot of people develop their own. We even had a pretty good one that achieved moderate success.

But we're the people who have never been satisfied with just good software products so we decided to give you the best accounting and statistical product available... anywhere.

We spent over 16 man years making CAS/CPA the most complete, most flexible package you'll find. We added more than 60,000 lines of new code to build in everything you would want in an accounting and statistical software system.

Since no two computer systems are exactly alike, we let you charge back for the usage of various resources at rates you determine... depending on the resource and amount of activity.

CAS/CPA helps you to recover all your data center operating costs including non-CPU items. It will help you determine when you'll need additional equipment and what the new charges will have to be to insure total cost recovery.

Best of all, CAS/CPA will easily process over 600,000 SMF records rapidly and efficiently. You can produce multiple CPA reports by passing

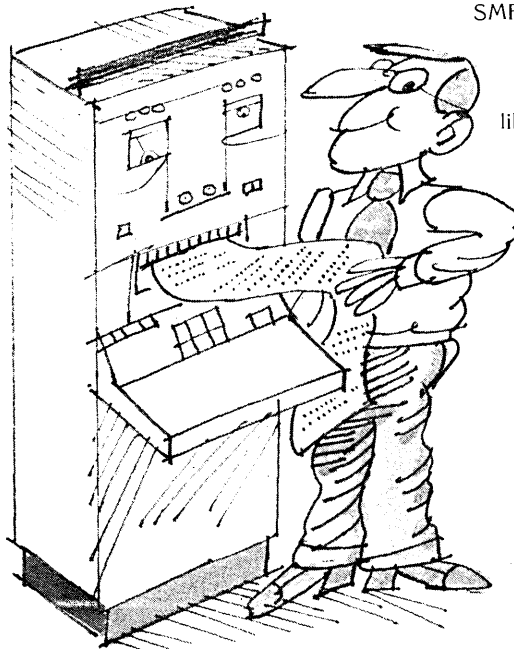

SMF data only once and without invoking the sort. In fact, you can produce over 200 variations of reports from a single pass. Think of the savings in time, energy, and equipment usage.

You can give your users valuable reports like job turnaround analysis and resources used by program so that they can see exactly what a job costs.

If you need to recover your costs and statistically report on data center operations, check on the one product that gives you everything in a single package —CAS/CPA. It gives you information that anyone can understand.



Boole & Babbage

850 Stewart Dr., Sunnyvale, CA 94086, (408) 735-9550

My users can't understand their bills, and I want all the information out of my operation I can possibly get. Please send me information on CAS/CPA...the single package answer.

Name.....Title.....
 Company.....
 Address.....
 City.....State.....
 Zip.....Phone.....

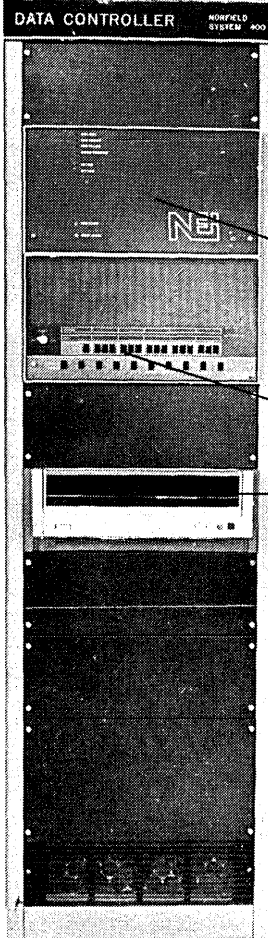

What's that? You've never heard of **data controller 400**

Input/Output Electronics
Contains all input/output electronics, including terminal and communications interface cards. Completely modular construction.

Control Electronics
Contains all internal control circuits. All circuits are modular.

Mass Storage
MAXI400 utilizes 2.5 megabytes to 5 megabyte moving head disc drive. MINI400 utilizes 256K dual floppy disc drive. MICRO400 utilizes semiconductor memory (1K to 10K).

MAXI400
Illustrated

Would you like to know more about Data Controller 400? Write or phone today for complete facts.

NE norfield
electronics inc.

3 Depot Place/Norwalk, CT 06855/Phone: (203) 853-2777

See us at Booth 926/INTERFACE '76/Miami Beach Convention Center/March 29, 30, 31
CIRCLE 117 ON READER CARD

hardware

Microcomputer

Intel's competitors are starting to gang up on the success of the 8080 microprocessor. One of the first products to do battle with the "industry standard" is the SYSTEM 80. Though claimed to be fully compatible with the 8080 microprocessor, the system is said to offer four times the speed of typical 8080 based microcomputers and features an extended addressing capability of up to 1 megabyte of memory. A full range of core and semiconductor memories is offered to complement the SYSTEM 80. The unit consists of an asynchronous bipolar MSI central processor, a minimum of 16K x 8 read/write memory, direct memory access, ROM bootstrap loader, RS232 interface,



operator panel, and a 5-slot, 5¼-inch chassis with integrated power supply. There are three basic speed/memory configurations: the first features a core memory with 650 nsec cycle time; the second includes an NMOS semiconductor memory with 450 nsec cycle time; and the third is a high-speed NMOS version with 180 nsec cycle time. Memories can be intermixed to optimize solutions to cost, performance, and nonvolatility requirements. Basic system prices begin at \$4,150 for 16K bytes of core memory, or \$4,500 for 32K bytes of semiconductor. SYSTEM 80s are available now. ELECTRONIC MEMORIES & MAGNETICS CORP., Hawthorne, Calif.

FOR DATA CIRCLE 238 ON READER CARD

Serial Printer

The basic design for this printer caused quite a stir at its debut in Chicago at the 1974 National Computer Conference. It drew flocks of prospective customers at the time, but some were heard to mutter that it should have been designed as a 132-column unit and not 80. That oversight has been taken care of.

The Okidata 132-column printer is a desktop or pedestal-mounted model that produces 132 columns of 5x7 dot matrix characters at the rate of 125 lines per minute, or 265 characters per second. That's fully 100 cps faster than

BROWNOUT PROBLEMS?

Solve them with 98% efficient AC LINE REGULATORS

TOPAZ AC Line Regulators solve brownout problems once and for all. Whether your application is a large computer system or a small instrument, TOPAZ regulators are the best available solution.

Here are some reasons why:

- **HIGH EFFICIENCY** reduces heat losses and feeder costs.
- **FAST RESPONSE** prevents problems caused by rapid short term voltage fluctuations.
- **NO DISTORTION** is added to the output wave form.
- **SMALL SIZE AND WEIGHT** ease handling and reduce space requirements.
- **LOW AUDIBLE NOISE** permits use in office areas without the annoying noise common to constant voltage transformers.
- **OUTPUT VOLTAGE** is unaffected by input frequency variations.

All this plus TOPAZ noise suppression and quality at a price lower than you'd pay for regulators without these features. So, if you have a brownout problem, write for our brochure or give us a call—we know we can help.



500 VA to 100 KVA
Priced from
\$190.

TOPAZ SOLUTIONS TO
ELECTRONICS POWER PROBLEMS

3885 Ruffin Road, San Diego, Ca. 92123 • (714) 279-0831

CIRCLE 126 ON READER CARD

Randal Data Systems

Still Making The Best Data Terminals Better

When you distribute data terminals manufactured by the best names in the business — like DEC, Diablo, Lear Siegler, Techtran — how do you make the best terminals better?

Consider the DECprinter LA180 — newest addition to our product line. A new, low-cost 180 character per second matrix printer with all of DEC's field-proven reliability. It comes with a wide array of features — top-of-form, adjustable forms length, self test — altogether the most cost effective matrix printer on the market in its standard configuration. *And still we make it better* — with exclusive options like RS232 interface with 512 character buffer (expandable to 1024 ch.) and a polling adapter.

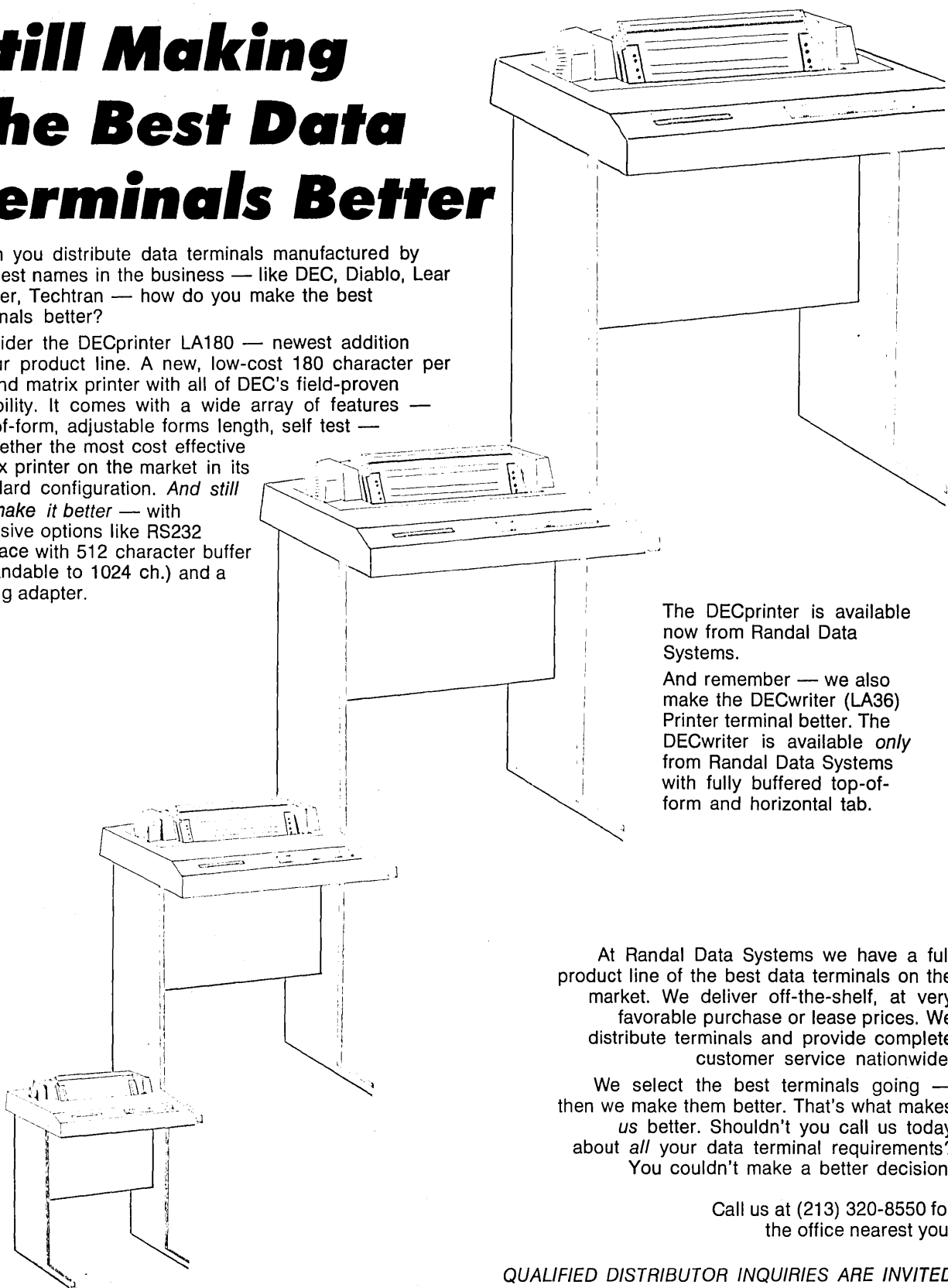

The DECprinter is available now from Randal Data Systems.

And remember — we also make the DECwriter (LA36) Printer terminal better. The DECwriter is available *only* from Randal Data Systems with fully buffered top-of-form and horizontal tab.

At Randal Data Systems we have a full product line of the best data terminals on the market. We deliver off-the-shelf, at very favorable purchase or lease prices. We distribute terminals and provide complete customer service nationwide.

We select the best terminals going — then we make them better. That's what makes *us* better. Shouldn't you call us today about *all* your data terminal requirements? You couldn't make a better decision.

Call us at (213) 320-8550 for the office nearest you.

QUALIFIED DISTRIBUTOR INQUIRIES ARE INVITED



randal data systems, inc.

365 MAPLE AVENUE, TORRANCE, CALIFORNIA 90503 • PHONE (213) 320-8550

hardware

most of the unit's competitors, and it's priced cheaper, too: \$1,700 in quantities of 100. It's available, too: 60 days ARO is currently being quoted. Among the printer's other features are a new proprietary print head that utilizes 22 pin drivers instead of the standard seven or nine found on other models; constant current drivers which are credited with more than tripling head life, and an unlimited duty cycle. The

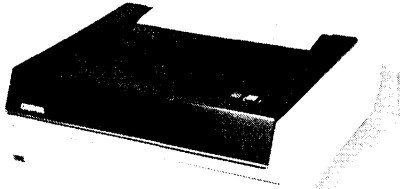

print font is available with full upper and lower case characters—the lower case is complete with descenders; you can choose from six or eight lines per inch at the flick of a switch, check the unit out with a self-test feature, run five-ply fanfold paper ranging in width from 5-16 inches through, etc. OKI-DATA CORP., Moorestown, N.J.

FOR DATA CIRCLE 239 ON READER CARD

S/32 Enhancements

As if IBM's System/32 weren't selling like hotcakes anyway, its designers have gone and made it an even more desirable machine. Starting around the middle of the year you can obtain an S/32 with as much as 13.7 megabytes of fixed disc storage, up from the previous high of 9.1 megabytes. The access time and transfer rate for the new disc remain the same, however, averaging 72.5 msec and 889,000 bytes per second, respectively. Since the disc unit is an integral part of the S/32's design, no separate price is listed for it; IBM simply states that the five S/32 models with the increased disc capacity now range in price from \$39,530 to \$44,410.

Card support is now available for the S/32 in the form of the 129 80-column card data recorder and the 5496 96-column data recorder. (Card support will be available in November.)

If yours is one of the installations attempting to move away from reliance on cards for input wherever possible, take heart, for there's a data collection system available for S/32 and System/3 users similar to that which

(Continued on page 205)

March, 1976

EUROMICRO NEWSLETTER

The international journal of microprocessing and microprogramming

Scope

The main purpose of the Newsletter is to facilitate the international flow of information in the field of micro-processing and micro-programming. The Newsletter contains, in addition to reports on recent research and technological progress, comprehensive surveys, state-of-the-art reports, short communications and announcements pertinent to the micro field.

The journal includes in particular:

theory, design, research, languages, simulation, emulation, teaching aids and evaluation/diagnostic methods

relating to:

micro-programming, micro-processing, micro-processor systems and networks, distributed computing, MSI/LSI components, computer structures, modular systems, integrated hardware/software design, micro-architecture of computer systems.

The EUROMICRO NEWSLETTER is the forum of the European Association for Micro-processing and Micro-programming (EUROMICRO). It commenced publication in October 1974 on a quarterly basis. From January 1976, the EUROMICRO NEWSLETTER will be published and distributed by North-Holland Publishing Company, both for the EUROMICRO membership, which includes a personal subscription and the regular subscribers. Information about the Association is available from EUROMICRO, P.B. 233, 60206 Compiègne, France.

EUROMICRO

The membership to EUROMICRO is open to all persons active in the field. For 1976, the personal membership fee amounts to FF 55, payable to EUROMICRO, B.P. 233, 60206 Compiègne, France. Apart from a reduced fee at conferences, the membership includes a personal subscription to the EUROMICRO NEWSLETTER.

Editorial Organization

EUROMICRO's policies are set by its Board of Directors which also acts as the Board of Editors for the Newsletter. It includes National Correspondents for the countries active in the Association, with a balance between university and industry representatives.

Regular Subscriptions

The annual subscription price amounts to US \$36.00/Dfl. 90.00 (post-paid). The Newsletter is sent by air to the USA and Canada at no extra cost.

Free Specimen Copies

These are available upon request from North-Holland Publishing Co., P.O. Box 211, Amsterdam, The Netherlands.

ORDER FORM

To: North-Holland Publishing Co.,
attn. Mr. D. Malt,
c/o American Elsevier Publ. Co., 52 Vanderbilt Avenue, New York, N.Y. 10017

- Please enter my subscription to EUROMICRO NEWSLETTER
For 1976: US \$36.00/Dfl. 90.00 (post-paid)
 Check enclosed Please send specimen copy

Name: _____

Address: _____

Datamation

0230

CIRCLE 98 ON READER CARD

The '76 NCC Landmarks

June 7-10

This is the year of landmarks at the National Computer Conference, June 7-10 in New York. The '76 NCC . . . during our Nation's Bicentennial . . . will explore the latest trends in computer science and technology, systems and applications, societal concerns, EDP management, and professional issues. And that's only the beginning. Other landmarks include the largest exhibit program ever held at an NCC, plus the 25th anniversaries of both the first Joint Computer Conference and the first commercially available electronic digital computer.

Register now for the world's most comprehensive computer conference. More than 100 information-packed sessions will cover 12 major areas including complex systems, architecture and hardware, software, computer communications and networking, applications, and education. And more than 275 organizations will display their latest computer products and services on three floors of the New York Coliseum.

Heading five plenary sessions will be a keynote address by J. Paul Lyet, Chairman and Chief Executive Officer of Sperry Rand Corporation. In addition, the NCC will feature a variety of special events and activities, including a unique networking demonstration and a Pioneer Day Program pay-

ing tribute to individuals from the Moore School of Electrical Engineering. And for an added fee, program registrants may also choose among a number of Professional Development Seminars.

Apply now for the *NCC Bicentennial Card* covering all four days of the conference, including exhibits. You'll save \$15 on full-conference registration. Just fill in the coupon for advance registration, or to get all the facts on the '76 NCC.

'76 NCC, c/o AFIPS, 210 Summit Avenue,
Montvale, New Jersey 07645

DTM

Please send me my *NCC Bicentennial Card* covering advance registration; my \$60 fee is enclosed.

Please send me all the facts on '76 NCC.

Name _____

Company _____

Street _____

City _____ State _____ Zip _____



 '76 NCC
Landmarks
in Data Processing

The Versatility Package

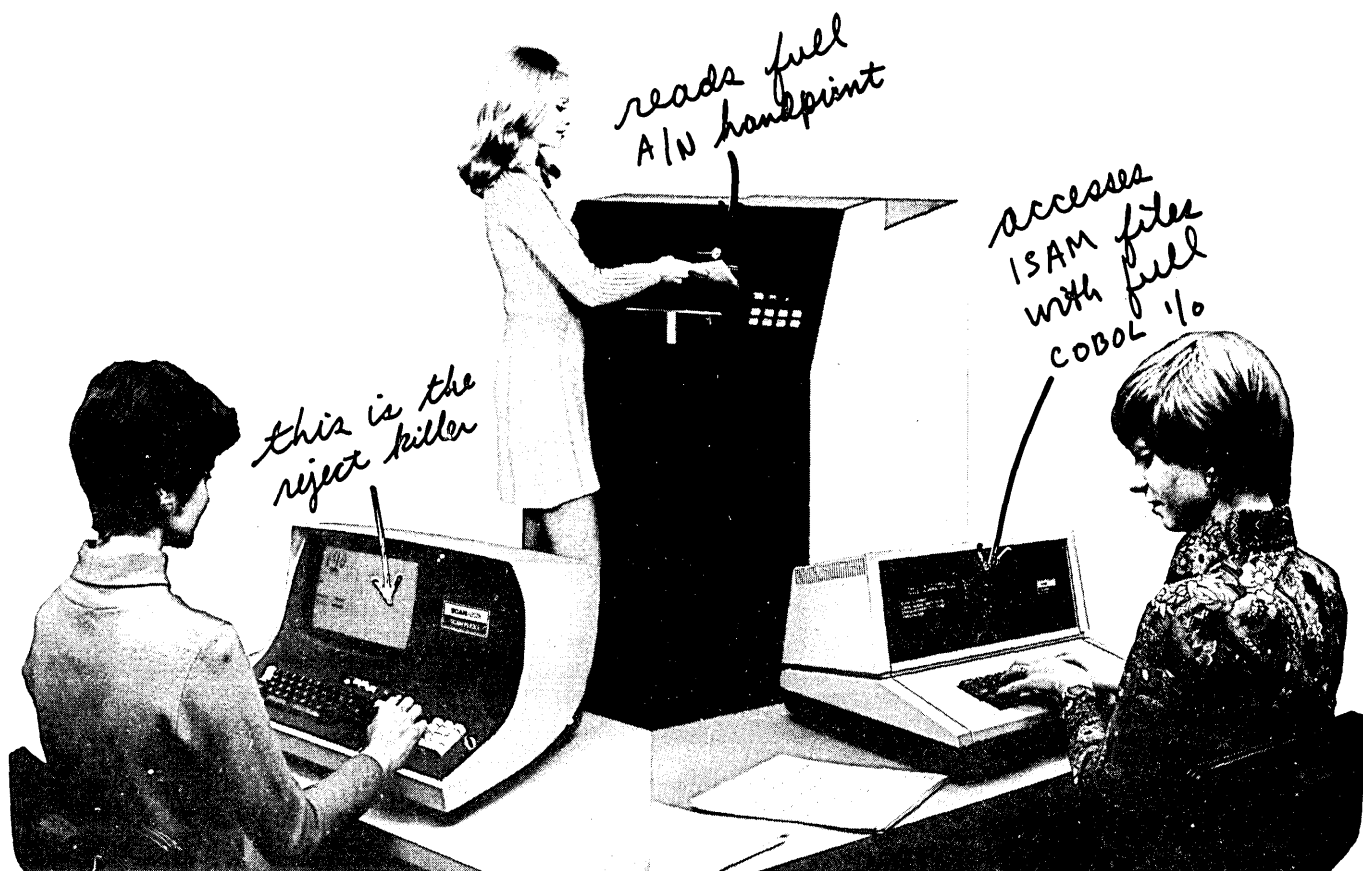

It's what data entry is coming to.

If you've been looking for a way to get more data entry performance while spending fewer data entry dollars, Scan-Data has a package of capabilities that should help you do just that.

It's called The Versatility Package, because it's built around the industry's most versatile data entry facilities — optical character recognition, shared-processor key entry, communications, advanced system software — and extended by a wide variety of options to provide the specific system you need to accomplish your job.

The Versatility Package. It's available now, only from Scan-Data. It offers a balanced solution to the demands on your data entry operation. And a balanced budget as well.

Find out what versatility in data entry can do for you. Contact Marketing Vice President Richard C. Thompson at 215-277-0500 today for more information.

The Versatility Package. From Scan-Data.
It's what data entry is coming to.

SCANDATA

Scan-Data Corporation
800 East Main Street Norristown, Pennsylvania 19401 215-277-0500 Telex: 846485

hardware

has been available on the System/7. Collected data can be processed directly on a computer capable of reading 80-column or 96-column cards or diskettes, or can be sent to a remote computer through a data communications telephone link. Workers can enter information from 80-column or 96-column cards, badges, or numerically coded keys on data entry stations. Each station is capable of handling eight different customer definable transactions. Users can tailor the system to specific applications by completing fill-in-the-blank formats. As many as 15 entry stations in any configuration (including magnetic or punched-hole badge readers) can be attached to the system controller. Configurations vary from \$16K to \$58K depending on particular models. Rental ranges are \$445 to \$1,765/month. IBM CORP., GENERAL SYSTEMS DIV., Atlanta, Ga.

FOR DATA CIRCLE 240 ON READER CARD

Crt Terminal

The W1625 is a microprocessor-based video terminal that can be customized to meet customer needs simply by inserting or removing read-only memories. The ROMs modify such operative characteristics as communication protocols and peripheral controls. The ROMs are implemented in several ways: straight ROMs that cannot be altered; EPROMs, which allow the user to get the programming in order before committing the logic to circuitry; and ROMs

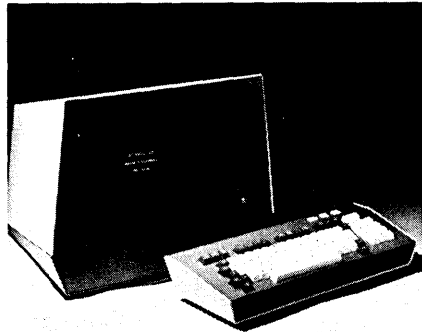

that can be program loaded from tape.

The terminal displays 24 lines of 80 characters and has sufficient storage capacity for five video pages. A controller is available for handling up to 24 terminals and, in addition, up to four hardcopy printers. Communication rates go as high as 9600 baud. Available in the third quarter of the year, the basic W1625 will be priced at \$2,800 single quantity, for a terminal equipped with asynchronous communication capability, a synchronous printer port, and "wrap around on insert" screen management. WESTING-

HOUSE CANADA LTD., Hamilton, Ontario, Canada.

FOR DATA CIRCLE 241 ON READER CARD

Microprocessor Emulator

A microprocessor emulator that provides from two to four times the throughput of Intel's 8080 microprocessor unit is the first commercial product to come on the market from this systems house—though it has designed many computers for other well known manufacturers. It's called the 8080E, for enhanced, and it consists of 79 multiple-sourced integrated circuits occupying less than 80 square inches of pc board area. The 8080E is aimed

primarily at current or prospective users of the 8080 set. The user that might be most interested in the 8080E however is probably the one who is beginning to realize that more power is required than the 8080 can supply. The 8080E is then the logical upgrade.

As is, the unit is software compatible with Intel's unit. For now the instruction set is the same, but it is possible to add/delete/alter instruction codes in the unit's microrom to make up classes of new or additional instructions. In performance, the 8080E runs at 180 nsec machine cycles, compared to 500 nsec on the Intel. The 8080E can be manufactured under a license agreement from its developers and is also

MOST SOFTWARE DESIGNERS WOULD BE UNABLE TO TOUCH THESE ASSIGNMENTS... A FEW WILL TAKE THEM ON & ADVANCE THE STATE OF THE ART

Our client, one of the nation's largest and most prestigious equipment and systems innovators, is

looking for individuals with outstanding technical credentials in the field of complex real-time software systems, preferably command and control, weapons, radar and communications.

A background in some of these areas will be considered: Data

Base Management; Radar & Communications System

Programming; Radar, Weapons,

Missile Simulation; Operating System Software Development;

Real-time Software Design;

Software Project Management; Weapon System Software

Development; New Business Acquisition; Micro Programming Systems;

Real-time Executive System Design; Computer Systems

Architecture. If you have a successful background

in some of these areas, we can offer long-term career

opportunities that include attractive immediate

rewards and extraordinary advancement potential.

Please write in complete confidence to:

LRC ASSOCIATES

6845 Elm Street, McLean, Virginia 22101

Representing an Equal Opportunity Employer M/F/H
U.S. CITIZENSHIP REQUIRED

LRC

CIRCLE 142 ON READER CARD

TIME MOVES ON



...and it's time to move to UNITED!

HARDWARE — IBM 360/195, OS-HASP (RJE), 2.2 meg, 3330's, 2314's (360/65 fallback)

SOFTWARE — UAL/ACS ICES! MPSX, GPSS, PMS, SSP, OSIRIS, BMD, All standard compilers, and more.

COMMUNICATIONS — 2000 to 9600 BAUD, Dedicated or Dial-Up, Auto-Answer WATS lines.

SERVICE — Guaranteed Turnaround!

COST — You'll Save Up To 50%!

EXPERIENCE — Over 4 years serving companies on a nationwide basis.

RELIABILITY — Better than 98.5% uptime!

The move to United will save you time and substantially decrease your data processing expense. Let us show you. Contact us today to schedule a benchmark or for additional information.



UNITED AIRLINES

Computer and Communications Services Division
Denver Technological Center
5350 South Valentia Way
Englewood, Colorado 80110
Phone (303) 779-2000

CIRCLE 128 ON READER CARD

WHEN THE USERS SAY THIS

"SLICK really does do the same job as the more expensive products. It's easy to use and trouble free so why pay more."

Mr. Dean Sauro
McQUAY-PERFEX
Minneapolis, Minn.

"Considering the price of SLICK and its performance, there's no reason to pay more for a library system. It's simple to use and easy to install."

Mr. Bob Martin
CHATTANOOGA ELECTRIC POWER BOARD
Chattanooga, Tenn.

WHY PAY MORE FOR A SOURCE PROGRAM LIBRARY MAINTENANCE SYSTEM?

SLICK is the price performance leader of Source Program Library Maintenance Systems.

SLICK is installed in over one hundred locations throughout the world and costs only \$78.00 per month.

Evaluate it on a free 15 day trial and receive a TI-1200 Electronic Calculator for your efforts.



Write today for details.

National Computing Industries

6075 Roswell Road, Atlanta, Georgia 30328 / (404) 252-9474

CIRCLE 116 ON READER CARD

available directly from the company. Single units are priced at approximately \$1,200 or \$200 per board in production quantities. TECHNOLOGY MARKETING INC., Costa Mesa, Calif.

FOR DATA CIRCLE 242 ON READER CARD

Microfiche Display/Printing

The model 96 microfiche display/printer features both rapid access to fiche housed in special containers and hardcopy printout capability. Frames on the same fiche are displayed on the 12 x 11½-inch screen in less than three seconds. Frames on different fiche appear in less than five seconds, including the refiling of the previous fiche. Image positioning and focus are achieved with local controls. No warmup is needed.

For hardcopies, a touch of the print button delivers an electrostatic print up to 11 x 11-inches in just 10 seconds. Magnification ranges for the 96 are available from 20X to 48X. The unit is priced at \$5,990 for two national standard configurations of 24X and 42X fiche magnifications. ADDRESSOGRAPH MULTIGRAPH CORP., Cleveland, Ohio

FOR DATA CIRCLE 243 ON READER CARD

Smallest System/3

The machine that caused the revolutionary small business computing phenomenon is now available in an even smaller model, the System/3 model 4. Unlike its siblings, however, the model 4 is designed to control a group of terminals in an on-line, work station environment, which helps stave off one of the few bad raps ever put on IBM's biggest selling computer: batch processing orientation. No keypunching or card handling need take place around the model 4. There's even concurrent processing of up to four tasks



or programs on the 4, input or controlled from up to five local visual display work stations. Printers can be substituted to provide printed copy. The new S/3 comes in one storage size: 64K "positions" of MOSFET. Typical applications anticipated for the 4 are inquiry, file updating, order entry and other interactive applications. Prices range from \$50,540 to \$54,460, or \$1,706 to \$1,861 on standard monthly rental. First installations are slated for June. IBM, GENERAL SYSTEMS DIV., Atlanta, Ga.

FOR DATA CIRCLE 244 ON READER CARD



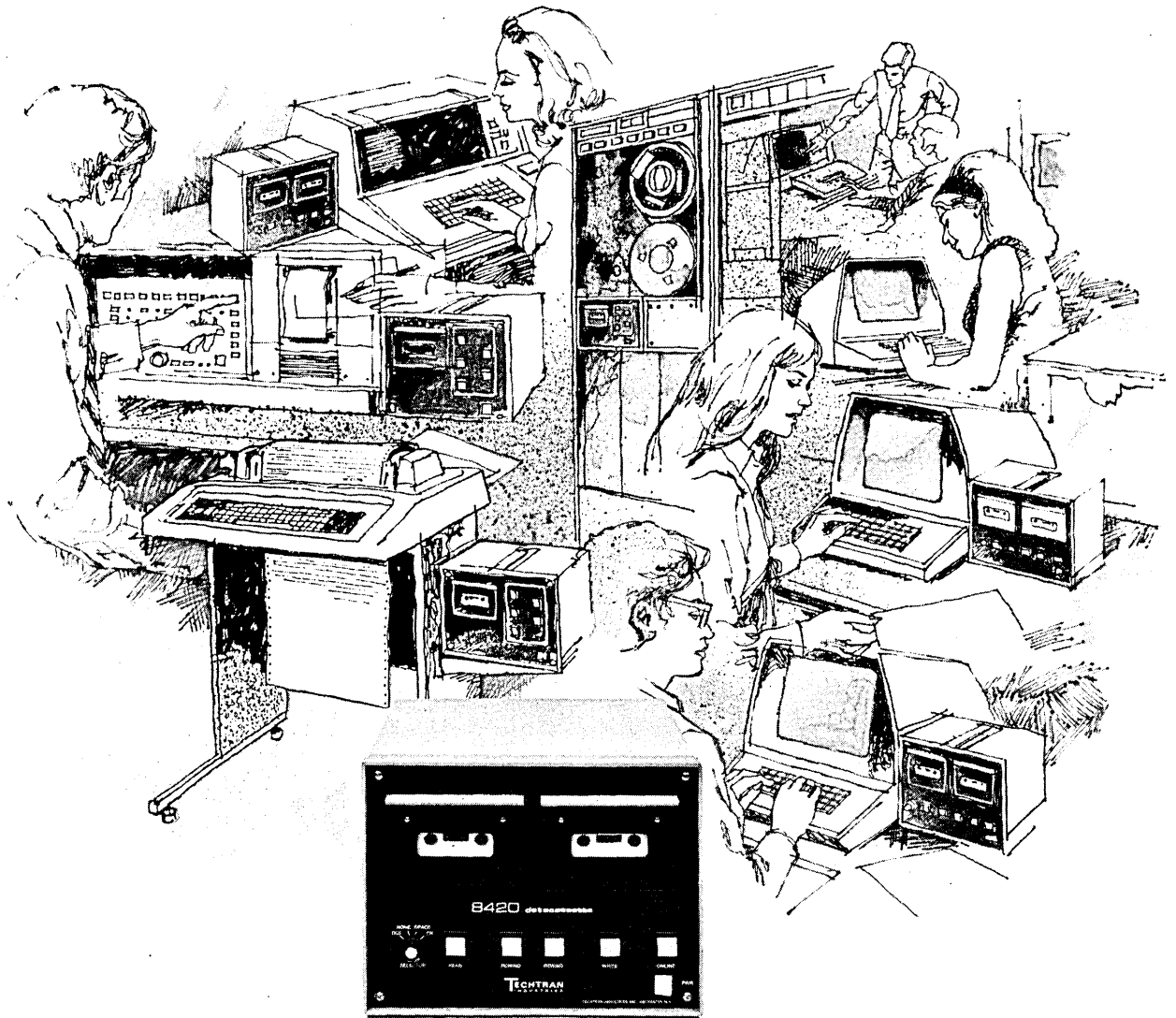

The logical addition

... low cost, single or dual DATACASSETTE Recorders

Plug Compatible with: • *Terminals*
 • *Keyboard-printers* • *CRT'S*
 • *Minicomputers* • *Dataloggers*

Built-in Logic lets you: • *Store* • *Retrieve*
 • *Edit* • *Update* • *Transmit* • *Format*

Techtran offers the **only** full family of DATACASSETTES
 • High Density Storage • Selectable Speeds
 • High Speed Search and Edit • Online/offline capability

Add a Techtran DATACASSETTE
— It's the logical thing to do.

Techtran
 INDUSTRIES INC.

580 Jefferson Road, Rochester, New York 14623 (716) 271-7953

Call or write for more information.

Please send me more information on the logical addition.

NAME _____

TITLE _____

COMPANY _____

ADDRESS _____

CITY _____ STATE _____

ZIP _____ PHONE _____

Techtran Industries Inc., 580 Jefferson Road, Rochester, New York 14623
 (716) 271-7953

software & services

Updates

A contract study to investigate the feasibility of a standard command language for the projected European Economic Community's EURONET on-line information network has been awarded to INSPEC, the information services division of the Institution of Electrical Engineers, London. The first phase of EURONET will create a community-wide telecommunications network giving on-line access to a number of scientific and technical data bases. The adoption of a common command language for the network should make it easier for users to move freely between different systems and data bases.

Readers who were interested in the new "MINICOMPUTER SOFTWARE QUARTERLY" publication and circled "bingo" number 257 in the October '75 issue (p. 154) will have to go through the exercise again. The issues are directories of programs available from software firms, mini users, colleges, consultants, etc. See the original listing for more detailed information. (For data circle 253 on reader cards.)

The developers of the ADABAS data base management system at software ag really like their chief competitor (IBM) in a way. Recent postmarks coming from the Reston, Virginia, office have been carrying the message "Buy your hardware from the biggest and your software from the best."

Six software products out of seven marketed in 1975 in Europe by Westinghouse Management Systems S.A. have been chosen for the DATApro 1975 Software Honor Roll, which includes 25 packages selected by American users of over 1,400 software packages. Packages are evaluated on the basis of five criteria: efficiency/performance, ease of implementation, quality of technical support, ease of use, and quality of documentation. The six products included a disc utility for IBM DOS users, a spooling package (DOS ASAP), Fast Dump Restore for IBM OS users, Quikjob, the WESTI Teleprocessing Interface, and RELO-PLUS, an automatic relocation utility.

Compatibility Is For Others To Worry About Dept: There is no definition of compatibility in IBM's French-English-French Data Processing glossary.

CICS Program Development

Progenitor is a fitting name for this on-line application program generator, since it was used to develop this company's Distributor's Automated Real Time System (DARTS) that has been around for several years. Progenitor consists of a terminal interface manager and three program generators for developing interactive application programs in modular form. It produces COBOL code to create the interface between any IBM or 370 computer operating under CICS (Customer Information Control System) OS/VS1 and any 3270-type terminal. The terminal interface module contains logic that allows it to automatically perform approximately 50% of the work in any individual application program. Processing options may be specified with parameter cards. The three program generators include a map and table generator for producing programs to determine how data will be displayed on the crt and control the temporary storage of data, a validation generator that compares the file requirements of the program being generated to the customer's file organization, and a file generator for providing file-independent access. Progenitor is priced at \$25K. A batch processing program module generator and a typewriter terminal module generator are optional. CMS INDUSTRIES, INC., Los Angeles, Calif.

FOR DATA CIRCLE 246 ON READER CARD

Disc Housekeeping

The Disc Space Manager automatically performs all periodic maintenance to direct access storage volumes supported under IBM's OS and VS operating systems. Among the operations that can be accomplished with DSM are scratching selected data sets or members of partitioned data sets, copying contents to backup files, uncataloging data set names, compressing partitioned data set members when a designated capacity is reached, and preparing catalog, volume table of contents (VTOC) and program data set (PDS) lists for management. User exit facilities have been designed into the program to enable installations to easily perform the scratching and uncataloging functions according to installation requirements. DSM operates from a 56-76K partition on all releases of the OS, SVS, and MVS operating systems and supports all currently announced IBM-compatible direct access storage de-

vices. The package is available on a one-time license agreement price of \$1,475 or \$45/month on a renewable six-month license agreement. MHT SERVICES INC., Englewood, N.J.

FOR DATA CIRCLE 247 ON READER CARD

Dump Diagnosis

It's no longer necessary to agonize over the encoded contents of an IBM abnormal ending (ABEND) memory dump when the Dump Formatting Program is on any VS1, VS2 or OS MFT/MVT IBM system. The program is automatically called whenever a program ends abnormally. It causes a normal dump, plus a diagnostic reformatting of all internal tables with the vital information printed out in plain English. Ascertaining the cause of aborted runs much more quickly can't help save an installation money and program scheduling headaches. The Dump Formatting program is priced at \$200 for OS systems and \$495 for VS installations. Add \$100 for the source code. A free three week trial is offered with the program. BOOLE & BABBAGE, INC., Sunnyvale, Calif.

FOR DATA CIRCLE 248 ON READER CARD

Electricity Consumption

Tables that General Electric has used to help plot energy consumption trends are now offered concerned utilities, manufacturing companies, financial institutions, universities and government agencies for helping to plan future needs. The Electricity Consumption Analysis Data (ECAD) program is available from GE's MAP Service on its MARK III Information Services (time-sharing) Network. ECAD was assembled from federal government sources reported on a month-by-month basis since 1971. Four electric utility operation variables (electricity sales, weather, employment, per capita income, and industrial activity) for five customer sectors (residential, commercial, industrial, resale, and other) plus 11 correlated weather and economic variables for 63 local utilities provide a total of more than 1,900 time series that can be run. The 63-utility sample constitutes two-thirds of U.S. kilowatt-hour consumption. ECAD data can be combined with other economic, industrial, marketing and financial data banks and even other analytic tools in GE's MAP Service, in addition to the user's own data files.

As in all time-sharing rates, there

7 programmers, 2 supervisors, the "impossible" 2500 programs, and MARK IV



As reported
by George Seeley
Supervisor of
Division Systems
Fiber Glass Division
PPG Industries

"We did it in three years from scratch — designed, implemented, and went operational with:

1. a product-costing data base covering 5000 products
2. an order-entry and invoicing system for annual sales of \$90 million, and
3. programs covering all divisional DP requirements for daily operations — personnel, payroll, accounting, product planning and marketing.

"And we did the entire job — some 2500 programs in all — with just seven analyst/programmers and two supervisors.

"The key to this 'impossibility,' as some genuinely felt it to be, is the MARK IV® System.

"We had tried to develop our Order Entry System in Cobol, but user requirements changed so rapidly we were unable to provide quick response. MARK IV gave us overnight turnaround. We were able to meet schedule requirements that would have been impossible with Cobol or PL/1.

"In developing our product costing data base with MARK IV, we designed and programmed as we went along. In conjunction with IMS and DL/I — and MARK IV is a natural teammate with DL/I — we completed our work in a fraction of the time it would have taken with Cobol. And we didn't have to teach our people any new languages.

"Now we have a product-cost data base that gives us the complete picture from raw materials and labor to inventory and material requirements. And we're implementing another MARK IV module for work scheduling. When it's finished, we'll have a tailor-made system that meets our information needs from start to finish.

"Our system has been running for about a year. And with extreme reliability."



WHAT IS MARK IV?

The MARK IV System is the most versatile and widely used computer software product for application implementation, data management, and information processing in the world. There are six powerful models (prices start at \$10,000) in daily use at 900 computer sites in 40 countries. A program written in MARK IV requires approximately one-tenth the statements of Cobol. Users say that no other system offers the power, flexibility, and simplicity of MARK IV.

If budget limits your programming staff, MARK IV gets the work done anyway!



NORTH AMERICAN HEADQUARTERS
MARK IV Systems Company
21050 Vanowen St., Canoga Park, Calif. 91304
Offices in Atlanta, Chicago, Dallas, Los Angeles,
New York, Washington, D.C., Toronto, Canada

INTERNATIONAL OFFICES
Informatics S.A.
267, route de Meyrin, CH 1217 Meyrin 2 (Geneva)
Switzerland; Telephone: 022/41.76.50
London, Copenhagen, Paris, Stockholm, Frankfurt
Computer Applications Co., Ltd.
3-1 Hitotsubashi 2-chome
Chiyoda-ku, Tokyo, 101 Japan
Telephone: Tokyo (03) 263-7241

Get an Independent Report

For a copy of this report and a MARK IV information packet, use the coupon below.

Informatics MARK IV Systems Company
21050 Vanowen St., Canoga Park, Calif. 91304

Name _____

Title/Position _____

Firm _____ Dept. _____

Address _____

City _____ State/Province _____ Zip _____

software & services

are many dependent pricing variables, including system resource units, terminal connect charges (in this case \$10/hour), a turn-on fee (\$100), etc., but once that's taken care of, processing costs approximately \$5 for each variable processed. GENERAL ELECTRIC CENTER FOR ENERGY SYSTEMS, Washington, D.C.

FOR DATA CIRCLE 249 ON READER CARD

Trust Fund Accounting

The Common Trust Fund Valuation program automates the calculation and manual posting of market values, income, and profits for investment units of common trust funds. Announced in conjunction with the First National Bank of Denver, the package interfaces with "virtually all" personal trust accounting systems that process common trust fund investments—as long as they're run on IBM OS systems.

Comprehensive data on individual holdings is stored in a data base. Necessary accounting information is extracted from the data base and moved

through routines that add up-to-date prices and perform any required adjustments on each investment unit. For output, the new program produces unit values for fixed income, equity, municipal bond, and mortgage loan common funds, as well as unit values for income and gain or loss. These outputs can be automatically transferred to the trust accounting system. Statistical reports, including an activity log, statement of assets and liabilities, and accrued interest/dividend schedules are also generated. Common Trust Fund Valuation is available either in package form (for something around \$5K) or as a service from this vendor. PROPRIETARY COMPUTER SYSTEMS, INC., Van Nuys, Calif.

FOR DATA CIRCLE 250 ON READER CARD

"Shorthand" Cobol

SHORTHAN is just what its name suggests, a shorthand way of entering COBOL source statements. It is not a pre-compiler, but rather a means of reducing the COBOL coding effort required by using easy to remember abbreviations which, in turn, automatically generate COBOL source code. This eliminates the need for monotonous and redundant aspects of COBOL coding. Abbreviations are usually determined

from the first letter of each expanded word. For example, LABEL RECORDS ARE STANDARD would be coded on a keypunch form as LRAS and expanded accordingly. The purchase price is a one-time charge of \$500 plus travel expenses associated with the installation. A training session, documentation, and warranty are included in the price. A 30-day trial period is offered. C. W. JACKSON & ASSOCIATES, INC., Tampa, Fla.

FOR DATA CIRCLE 252 ON READER CARD

Job Mix Optimization

Production job scheduling is still very much an art and not a science, but this job mix optimization package just might shed some light on the process in large IBM shops. JOMO essentially rates jobs in terms of how much of a system's resources it uses. This information can be used by the scheduler or the operator to determine which jobs can be run side by side in multiprogramming systems with minimum impact, and which combinations should be avoided. While scheduling is more complex than that, JOMO just might be able to help the scheduler resolve situa-





(Continued on page 214;

Software Spotlight is on page 212)

HP9830A USERS: HAS THIS EVER HAPPENED TO YOU?



Memory overflow problems can now be a thing of the past. The EM-30 Extended Memory System eliminates the necessity of re-designing your programs as a result of ERROR 2.

-  You can now economically expand the read/write memory capacity of your 9830 to a full 32K bytes.
-  You can easily work with large arrays of data without resorting to peripheral storage.
-  With the EM-30 you are assured of full compatibility with all software, peripherals, and HP ROM options.
-  The EM-30 is a direct plug-in replacement for HP memory and you can install it in minutes with just a screwdriver.

The HP9830A* already approaches the power of a minicomputer. The EM-30 Extended Memory System significantly furthers the dimensions of this versatile machine by giving you minicomputer memory capacity with desk-top convenience. For as little as \$4,230 you can expand a fully loaded 15K byte 9830 to 32K bytes. You can integrate the extended memory capability of the EM-30 into the 9830 without changing any of your existing programs.

The design of the EM-30 Extended Memory System is based on proven 4K RAM chips for low power requirements and high reliability. All units have passed extensive tests to ensure that they are consistent with the high quality and reliability that you expect from HP products.

INTRODUCTORY OFFER: Send us a list of your ROM's, options and peripherals and we will send you a cassette containing a collection of appropriate commercial programs. Your name will be added to a growing list of 9830 users who are interested in a mutual exchange of programs and techniques. For additional information circle the reader number or call us collect.



Infotek Systems

733 E. Edna Place • Covina, Calif. 91723
(213) 966-7431 • TWX 910-584-1812



CIRCLE 133 ON READER CARD

Tired of not getting the information you need from your data processing system?

It's not going to get any better . . . and that's the bad news. But there is a way to change all that . . . and that's the good news. It's from Formation, the people who understand that you need more than just the newest hardware advances. You need information.

Tired of reading 'Turnkey' success stories, and wondering if one can be written for you?

Wonder no longer, Formation's MAVERICK Systems provide an "off-the-shelf" framework to answer your unique information requirements. Utilizing minis, peripherals, and proven experience in data base/communications to deliver a wonderful answer.

Tired of putting off till tomorrow what your system can't deliver today?

Only problem is that your hoped-for "tomorrow" never comes. Unless you decide to hasten its arrival with more hardware, more software, more peripherals . . . more dollars. It's like trading today for the future. Think about it.

Wake up the Maverick spirit inside you.

The Formation family of MAVERICK Systems has been helping a growing number of data processing users in business, industry, utilities and the government get the information they want . . . fast enough and enough enough. And add the new applications and increased functionality they had talked about . . . for too long.

The MAVERICK Systems provide data processing answers that offer the break in tradition their name reflects. Molding a range of hardware capabilities to your needs, and integrating them to meet the information processing requirements of your organization today . . . and tomorrow. Bringing fourth-generation power and performance, and mini-generation price to large multiprocessor data base/communications systems. And smaller specialized systems too.

Tell us what you're getting tired of in data processing, and what you'd like to get from your data processing system.

We do more than just listen.
The MAVERICKS. From Formation.



formation® 823 East Gate Drive
Mt. Laurel, NJ 08057
609-234-5020

I'm tired of hearing that my _____ system can't
(model)

_____. I'd like to hear how Formation's
MAVERICK Systems can change all that.

Name _____
Title _____ Phone _____
Company _____
Address _____
City _____ State _____ Zip _____

Wake up the MAVERICK spirit inside you.

software & services

software spotlight

Friendly Computing

With Virtual Storage Personal Computing (VSPC), IBM has attempted to expand the sphere of potential computer users to a new low in sophistication, or what the firm likes to call the "problem solver" community. These are people who would like to use the power of the data processing system, but have neither the time nor the inclination to become intimately involved with the intricacies of classical data processing.

IBM has had a problem in this product area. Its Time-Sharing Option (TSO) submonitor was really oriented toward programmers and system developers and had more features than many people required. The VM/CMS

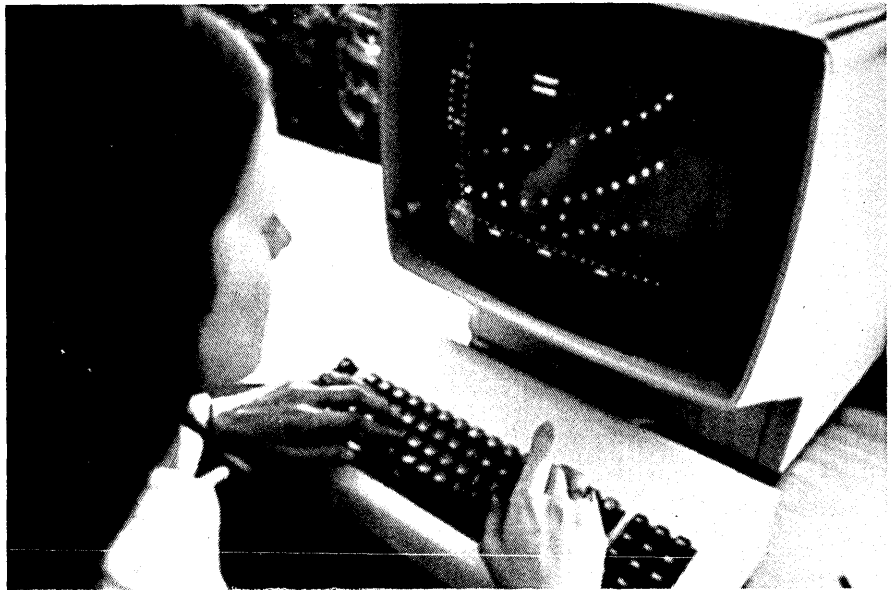

(Virtual Machine/Conversational Monitor System) was, again, great for system designers developing an application, but not very good in the production world. Plus, there was a very high penalty in overhead. Something had to be done: text handling applications similar to Stanford University's Wylbur have been slipping through the giant's fingers. Something had to be done.

VSPC is the result. A non-sophisticated set of approximately 40 instruc-

tions has been created that includes such commands as LOG-ON, MERGE, CHANGE, SAVE, FIND, OFF, SEND, and others for specifying character strings attempts to make computing more accessible. More "friendly." Procedures can be created out of these instructions and executed by using simple words and phrases on terminal keyboards. Programs will usually be created by the user, but IBM has some new ones for VSPC, including Business Analysis, statistics, and mathematics

AT AMERICAN
THERMOPLASTIC
COMPANY
622 Second Avenue/Pittsburgh, Pennsylvania/15219
412/781-9657

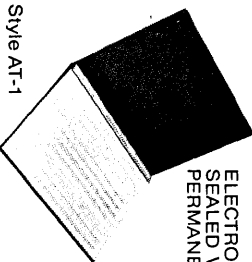

Style AT-1

ELECTRONICALLY
SEALED VINYL FOR
PERMANENT FILING

Styles for burst and unburst binding. Utilizes exclusive binding Mechanism.
All Sizes. Choice of colors.
For prices and samples write today. Also request our new general catalog.

GENUINE
PRESSBOARD
FOR ECONOMY

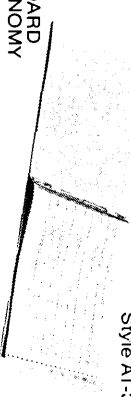

Style AT-3

American ThermoPlastic offers you a choice! DATA PROCESS BINDERS

Name _____
Title _____
Address _____
City _____ State _____ Zip _____

CIRCLE 100 ON READER CARD

AT LAST!

BURROUGHS ON-LINE SOFTWARE

- DATA COMMUNICATIONS SOFTWARE
- SYSTEMS DEVELOPMENT SOFTWARE
- ON-LINE APPLICATIONS SOFTWARE:
PAYROLL • LABOR DISTRIBUTION
GENERAL LEDGER • FINANCIAL CONTROL

Now! Proven software packages for a Burroughs on-line data processing environment. Developed by an experienced Burroughs on-line user.

SYSTEMS RESEARCH
INCORPORATED
241 Building
East Lansing,
Michigan 48823
Ph. (517) 351-2530

**Systems
Research
Incorporated**

CIRCLE 125 ON READER CARD

DATAMATION

routines. The programming languages themselves are VS APL, VSPC FORTRAN, and VS BASIC. VSPC can be used with most models of 370 equipment, from the model 115 through the 168.

What kind of capabilities does the package have? IBM gives several examples. A manufacturing manager can use VSPC to create a routine to show how changes in raw material prices affect company revenue. A financial analyst could use the program to help compute short-term investment data. Engineers can solve relatively complex equations and analyze detailed laboratory data.

Users can interact with the system through many IBM terminals, including the 3767 and 2741 communication terminals, the 3770 and 1050 data communication systems and the 3270 information display.

Like most IBM software releases of late, security considerations have not been overlooked in VSPC. The system maintains a user "profile," a description of the user's identification code, password, attributes and privileges. Similarly, accounting statistics are kept in terms of connect time by user, cpu time, the amount of direct access storage used, the number of accesses, and the number of hardcopy pages requested. This data is available either combined with or separate from the

370's standard accounting file, the SMF data. Users can access all data files that are available to other submonitors such as IMS or GIS through the batch entry facility of VSPC.

If VSPC is vulnerable—both to user inquiries and to possible competitive products—it's in the predictable area of overhead. IBM wisely hesitates to state that so and so many terminals can be serviced by a given model 370. Each customer will be "counseled" individually because of the effects of the amount of batch work already on the system, the amount of CICS and IMS activity, the types of terminals that will be used (higher-speed terminals require more buffer area, the number of terminals that will have to be supported concurrently, and the types of applications being performed under VSPC. About the only guidelines available are IBM's findings after the first tests with the system—and the company has not yet put VSPC through stress testing. (The product will be available in the second and third quarters, however.) If you're a 370/115 or 370/125 user with the full 256K of storage, figure on 100K of real storage for VTAM and 30K real for VSAM, access methods that many users already have. (Storage sizes are given in real recommended partition sizes.) An additional 60K of real is required for VSPC, plus

approximately 15K per active user. About three concurrent users would seem about the reasonable maximum. The only other machine IBM has fired it up on is a 768K 370/145 running VS/1 and it was able to support 40 active terminals, but IBM admits that not much else was running on the system at the time. The product will probably sell best to very large users with lots of computing capacity (or overcapacity), and those benchmarks are not available yet. One important point to remember: The data processing manager has control over the amount of cpu time and the library data storage space available to VSPC users. This could conceivably become an internal problem as the VSPC users expand and request that more of the computer be allocated to them. On the other hand, if an installation wishes to make the computer more accessible, it must realize that it will probably have to increase the size of the system. Which means more money, of course.

OS/VS1 users can get VSPC during the second quarter; VS/2 users will have to wait until the third quarter, and DOS/VS users will have to wait until the last quarter of 1976. Prices for these respective users are \$1,100, \$1,200, and \$900 per month. IBM CORP., White Plains, N.Y.

FOR DATA CIRCLE 251 ON READER CARD * *

why lease alpha when tso is free?

Responsiveness, ease-of-use, minimal system overhead,
flexibility, reliability, user satisfaction, lower total cost, . . .

Interested?

Call Ward Clark at (202) 244-1900 or your nearest COMNET
marketing representative for details on installing ALPHA
on your IBM 360/370 computer system or using ALPHA
on COMNET's nationwide time-sharing service.

COMNET

COMPUTER NETWORK CORPORATION

5185 MacArthur Boulevard, Washington, D. C. 20016 (202) 244-1900
1250 Broadway, 20th Floor, New York, New York 10001 (212) 594-6150
301 Fifth Avenue, Suite 1403, Pittsburgh, Pennsylvania 15222 (412) 288-0134

software & services

tions where resource contention is not clearly defined. Every time a production run goes through the system, JOMO automatically updates its library of resource ratings. There is a slight penalty for JOMO's constant monitoring—approximately 20 cpu minutes per day. On the other hand, we've visited os shops that could easily save that much by running better combinations of jobs. The system is priced at \$4K but for a while will be priced at \$2,495 as an introductory offer. LABYRINTH SYSTEMS LTD., New York, N.Y.

FOR DATA CIRCLE 254 ON READER CARD *

A literate robot named Dot
who loved to read novels a lot
could never recall
the aesthetics at all,
but only page number and plot.

Computers won't flourish, we know,
for another half-century or so,
for the iconoclast
machine may be fast,
but man is intrinsically slow.

The robot a young couple trusted
to baby-sit, just up and busted,
for it dandled the wee
young thing on its knee,
changed a wet diaper—and rusted.

—Gloria Maxson

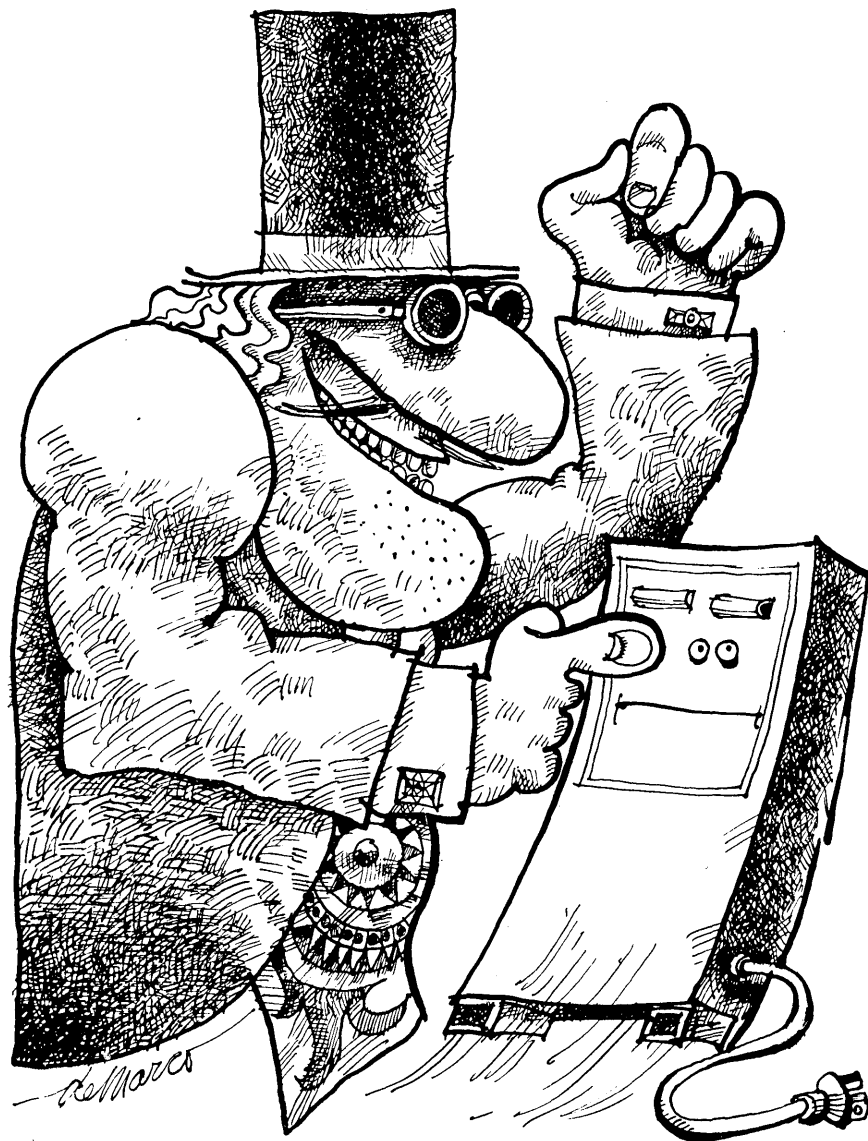

Buy protection. Or else.

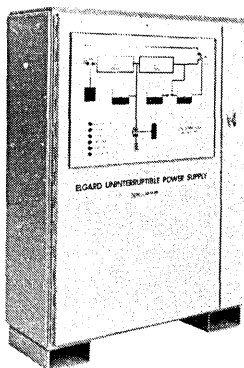

Or else when the power fails, your computer can lose its mind, its memory... and your data. But an Elgard Uninterruptible Power System can give your computer all the protection it needs—up to several hours of back-up time, plus continuous isolation from line spikes and transients. Elgard models are available in 0.5KVA through 40KVA capacities.

You'd better buy protection. Get in touch with us for complete information. Before your computer is rubbed out. Elgar Corporation, 8225 Mercury Ct., San Diego, California 92111, Phone (714) 565-1155.



ELGAR
Elgar also is a leading producer of AC Line Conditioners and AC Power Sources.

CIRCLE 162 ON READER CARD

Perform a death-defying act.

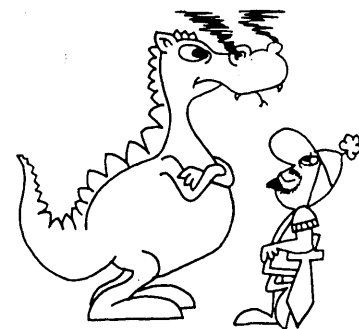

Stop smoking.

Give Heart Fund
American Heart Association

“IDMS?”

It's the easy-to-use, yet powerful database system that saved us \$50,000 the first year.”

“We had narrowed our selection down to IDMS and one other system that appeared cheaper. But when we factored in systems programming, training costs, additional hardware needed, etc., we realized we'd save \$50,000/year with IDMS.”

Our customer above, a major manufacturer, discovered what so many other users have long known: IDMS is extremely economical, because it is extremely efficient and complete.

When you buy IDMS this is what you get as part of the price:

1. A brilliantly simple and powerful implementation of the CODASYL specifications for IBM and UNIVAC SPECTRA equipment.
2. A system that requires very little core.
3. An excellent data dictionary. Competing systems don't have — or charge extra.
4. The ability to use any communications monitor you choose — including your own in-house developed system.
5. The IDMS DML processor — which catches most database program errors in one pass to greatly reduce program development time.
6. The highly successful CULPRIT retrieval system — which allows user departments to access IDMS databases.

There's much more to tell you, and we'd like to begin by sending a technical brochure. Like to use the coupon below to order it?

Like some hard facts on this easy system?

Name/Title _____

Company _____

Address _____

City _____ State _____ Zip _____

- I'd like a technical report on IDMS
 I'd like a Cullinane representative to call.



Cullinane Corporation

Wellesley Office Park, 20 William St.
Wellesley, Mass. 02181. (617) 237-6601

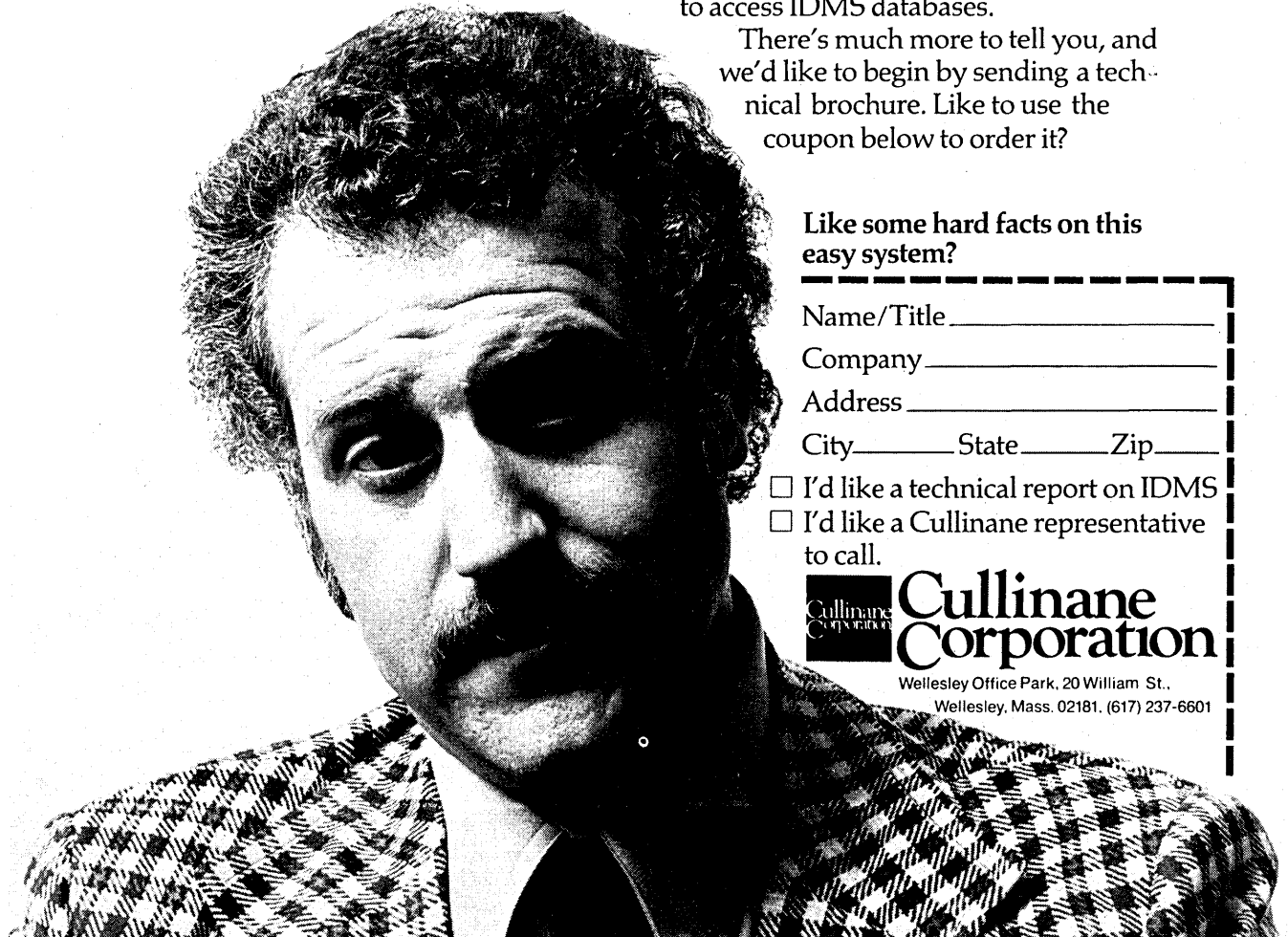

advertisers' index

Advanced Management Research . . . 184	DatagraphiX 63	Information Processing Incorporated 224
AFIPS 202	DATAMATION 167	Integrated Software Systems Corporation 12
American Management Associations 103	Datamedia Corporation 84	Intelligent Systems Corp. 166
American Telephone and Telegraph Company 26	Dataproducts 9	Interdata 16, 96
American Thermoplastic Company . . 212	Dataram Corporation 83	International Computer Equipment . 134
Anderson Jacobson 178	Datran 69	Itel Corporation 2
Applied Data Research Corporation 5	Datum, Peripheral Equipment Division Cover 2	†Itel Corporation 160-M
Applied Digital Data Systems Inc. 60, 61	Delta Data Systems Corporation 183, 185, 187, 189	Johnson Systems 222
Atlantic Research Corporation . . . 189	Diablo Systems Incorporated, A Xerox Company 157	Kybe Corporation 185
BASF Systems 150, 151	Digital Equipment Corporation 20, 21, 127	Lear Siegler, Inc., Electronic Instrumentation Division 147
BASIC Timesharing 110, 111	Dicom Industries 14	LRK Associates 205
Beehive Medical Electronics, Inc. 98	Documation Incorporated . . . 133, 135	McDonnell Douglas Corporation . . 218
Beemak Plastics 183	Eastman Kodak Company, Business Systems Markets Division 165	Megadata Computer and Communications Corporation . . . 64
Bell & Howell Business Equipment Group 167	Electronic Associates, Inc. 78	†Memorex Corporation 160-CC, DD, EE, FF
The Boeing Company 218	Elgar Corporation 214	Methods Research 187
Boeing Computer Services, Inc. . . . 74	Entrex 176	Microdata Corporation 101
Boole & Babbage 197	ESL Inc. 108	†Mini-Computer Systems International 160-J
Bourns Management Systems . . Cover 3	Extel Corporation 28, 29	Modular Computer Systems Inc. 35, 36, 37, 38
Bowne Timesharing 44, 45	Fenwal Incorporated 43	MSI Data Corporation 76
Cable & Wireless 124	Formation 211	National Computing Industries . . . 206
Cadillac Associates, Inc. 219	Fox-Morris Personnel Consultants 219	Norfield Electronics 198
Cardkey Systems, A Division Greer Hydraulics, Inc. 31	Fujitsu Limited 32, 33	†Norsk Data 160-Z, 160-AA
Centronics Data Computer Corp. 6	General Automation 142, 143	North-Holland Publishing Company 141, 201
Codex Corporation 113	General Electric 10, 11	On-Line Software Incorporated . . . 177
Comnet 213	Gould Inc., Instrument Systems Division 104, 105	Optima Enclosures, a division of Scientific Atlanta, Inc. 39
Collins Radio Group, Rockwell International 71	Graham Magnetics 46	Penril Corp. Data Communications Division 186
Computer Concepts 86	Graphic Controls Corporation 97	Pertec Peripheral Equipment Division 130, 131
Computer Information Management Company 91	Grumman Data Systems 62	Prime Computer Inc. 136
Computer Machinery Corporation . . 1	Harris Computer Systems 122, 123	Quest Systems Inc. 218
Computer Transceiver Systems Inc. . 171	Hazeltine Corporation 72, 73	†Racal-Milgo Limited 160-O
Computer Transmission Corporation 224	Hewlett-Packard 19, 115, 116, 117, 118, 119, 120, 129, 154, 155, 168, 181	Randal Data Systems 199
Comserv Corporation 218	Houston Instrument, Division of Bausch & Lomb 223	Randomex, Inc. 174
Control Data Corporation . . 80, 81, 140	Hydro-Temp Controls, Inc. 180	Rapifax Corporation 138
Cullinane Corporation 215	IBM 87, 88, 89, 90	Raytheon Data Systems 48
Cummins-Allison Corp. 126	Incoterm Corporation 102	RCA Service Company, A Division of RCA, Technical Services 137
Data Communications Interface 158, 159	Infodata Systems Inc. 128	†Regnecentralen 160-E
Data General 145, 175	Informatics Mark IV Systems Company 209	
Data 100 Corporation 106	Information Terminals 160	
†Data Recording Instrument Company Limited 160-U	Infotek Systems 210	

Romac & Associates219
 RSVP Services219

Sanders Data Systems, Inc.156
 †Sanders Associates, Inc.160-Q
 Scan-Data Corporation203
 Science Accessories Corporation ...188
 Scope Data173
 †Selenia160-F
 †Software International160-X
 Source EDP217
 Structured Software, Inc.177
 Sycor139
 Syncom Incorporated200
 System Industries160-I
 Systems Engineering
 Laboratories40, 41
 Systems Research, Inc.212

Tab Products Company ..148, 149, 172
 Tally Corporation193
 T-Bar Incorporated4
 Technical Publishing Company ...179
 Techtran Industries Inc.207
 Tektronix, Inc.23, 95
 Teletype Corporation146, Cover 4
 †Tesdata Systems
 Corporation160-V, 160-W
 Texas Instruments Incorporated,
 Digital Systems Division24, 25
 3M Company, Microfilm
 Products Division42
 Topaz Electronics198
 Transcom, A Division of
 Hi-G, Inc.182
 Trendata, An Applied
 Magnetics Company169
 †TRW Data Systems160-R, 160-S

United Air Lines191
 United Airlines, Computer
 Systems Division206
 University Computing
 Company15, 100

Value Computing Inc.170
 Varian Data Machines153
 Varian Graphics204
 Versatec, Inc.220

Wang Laboratories, Inc.125, 152
 Western Union Data
 Services Company79
 Westinghouse Computer and
 Instrumentation Division144

Zeta Research195

†European Insert Advertisers

tp Technical
 Publishing Company

Arthur L. Rice, Jr., Chairman of the Board
 James B. Tafel, President
 Gardner F. Landon, Exec. Vice President
 Calverd F. Jacobson, Financial Vice President
 and Treasurer
 Thomas A. Reynolds, Jr., Secretary
 M. Jay Turner, Jr., Director of Circulation
 Paul C. Jarvis, Director of Information Services

Advertising Offices

Eastern District Managers
A. Treat Walker,
Warren A. Tibbetts: Greenwich, Ct. 06830
35 Mason St. (203) 661-5400

New England District Manager & Vice President
Warren A. Tibbetts: Manchester, N.H. 03104
112 W. Haven Rd.
(603) 625-9498

Midwest District Manager
John M. Gleason: Chicago, Ill. 60606
205 W. Wacker Drive
(312) 346-1026

Western Manager and Senior Vice President
Hamilton S. Stryon: Los Angeles, Calif. 90035
1801 S. La Cienega Blvd.
(213) 559-5111

District Manager
Alan Bolté, Jr.: Los Angeles, Calif. 90035
1801 S. La Cienega Blvd.
(213) 559-5111

Western District Manager
James E. Filiatrault: Mountain View, CA 94043
2680 Bayshore Frontage Rd.
Suite 401
(415) 965-8222

U.K., Scandinavia, Benelux
Intergroup Communications, Inc.
Wallace K. Ponder, European Director
Paul D. Dimmock, Regional Manager
31 Lyncroft Avenue
Pinner, Middx. HA5 1JU
England
Tel: (01) 868 9289
Cables: PACOM, Pinner

Germany, Austria, Eastern Europe
Fritz Taeuber
Solteauer Strasse 85
D-340 Lueneburg
Germany
Tel: (0 41 31) 43 849

France, Switzerland, Italy, Spain
Gerard Lasfargues
32 rue Desbordes Valmores
75016 Paris
France
Tel: (1) 288 90 22

Japan
Shigeru Kobayashi
Japan Advertising Communications, Inc.
New Ginza Building
3-13 Ginza 7-chome
Chuo-ku, Tokyo 104, Japan
Tel. (03) 571-8748

Other tp Magazines

Plant Engineering *Pollution Engineering*
Power Engineering *Purchasing World*
Research/Development *Consulting Engineer*

**Beat the Big One...
 Heart Attack
 Give Heart Fund** 

**1976
 Computer
 Salary
 Survey!**

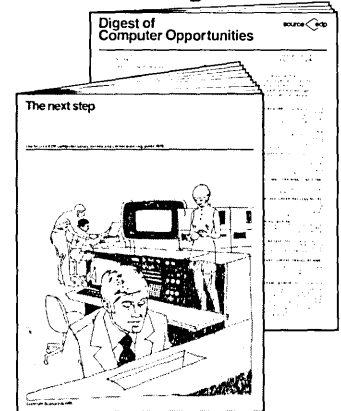

**Send for your
 free copy today!**

Do you know how much money your colleagues earn for performing the same duties you perform? Do you know which computer skills are most lucrative and what you can do to gain them? Do you know the "six steps" needed to become MI Director?

Source Edp does. And we'll share what we know with you. Our tenth annual salary survey and career planning guide, "The Next Step", is now available without charge. This comprehensive study provides an in-depth analysis of the strategies and techniques you can employ right now to maximize long-term career development. You'll also receive our latest "Digest of Computer Opportunities" describing specific career openings currently available within our client organizations nationwide. Just fill out the reader service card and we'll send you your copies absolutely free. Or write:

Source Edp Corporate Headquarters
 100 South Wacker Drive
 Chicago, Illinois 60606
 (P.S. Be sure to use home address and indicate position title).

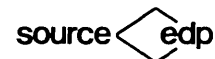

Regional Offices:

Atlanta	404/634-5127
Boston	617/237-3120
Chicago	312/782-0857
Cleveland	216/771-2070
Dallas	214/638-4080
Detroit	313/352-6520
Houston	713/626-8705
Irvine, CA	714/833-1730
Kansas City	816/474-3393
Los Angeles	213/386-5500
Minneapolis	612/544-3600
NJ-NY	201/687-8700
New Orleans	504/523-2576
Northfield, IL	312/446-8395
Oak Brook, IL	312/986-0422
Palo Alto	415/328-7155
Philadelphia	215/665-1717
San Francisco	415/434-2410
St. Louis	314/862-3800

CAS III 2A3

NO MATTER HOW YOU LOOK AT IT ...

CAS III

IS THE MOST FLEXIBLE, MOST USER-ORIENTED
FINANCIAL REPORTING SOFTWARE
ON THE MARKET TODAY!

SYSTEM HIGHLIGHTS

- Clerically Driven/User Controlled
- Comprehensive Data Base
- New Concept in Documentation (Interdependent Referencing)
- Multi-Company (Service and Corporate Environments)
- Application Program Changes are Eliminated
- Modular Installation Based Upon Your Requirements
- User Controlled Report Writer
- Multiple Years of History
- Firm and Flexible Budgeting (Department, Cost Center, Account Level)
- High Volume Automatic File Maintenance
- Independent Edit/Validation Function
- Account Analysis to Detailed Transaction Level

COMPUTER REQUIREMENTS

- IBM 360/370, Univac 9400
- Available DOS and OS
- Interface to Any Data Base Manager

WHY NOT?

Let COMSERV take the proper look at your requirements soon.

Call or write —

SANFORD ROSEN

3050 Metro Drive
Minneapolis, Minn. 55420
(612) 854-2020

comserv
CORPORATION

CIRCLE 107 ON READER CARD

COMPUTER PERFORMANCE ANALYST

Boeing Computer Services, in Seattle, WA, is seeking experienced computer performance analysts with background in configuration design to:

- Analyze computer workload to determine peak resource requirements
- Perform benchmarking of new hardware/software components
- Analyze performance of existing IBM 360/370 large scale data centers
- Determine performance bottlenecks, and recommend solutions
- Develop conceptual and practical models of data centers and data centers operational procedures

Candidates must have at least 5 years of Data Processing experience of which two years should be on IBM hardware/software. Experience with some of the performance tools desirable. Educational background in Computer Science, Engineering, Mathematics or Physics preferred.

Send your résumé to The Boeing Company, P.O. Box 3707-TBB, Seattle, WA 98124.

An equal opportunity employer.

BCS

BOEING COMPUTER SERVICES, INC.

CIRCLE 140 ON READER CARD

SENIOR REAL TIME SYSTEMS SOFTWARE ANALYSTS

McDonnell Douglas Technical Services Co., Inc., Houston Astronautics Division has immediate openings for employment at the Johnson Space Center for individuals with extensive aerospace real-time systems software analysis experience. Assignments in the areas indicated below can be expected, as they apply to analysis of the Space Shuttle Orbiter on-board multi-computer system:

- Flight systems software development integration
- CPU/IOP Microcode evaluation
- Processing time and memory loading optimization
- Functional partitioning and bus configuration analyses
- Multi-computer synchronization and intercomputer communication studies
- CPU/IOP hardware/software trade studies

Please send your resume, including complete salary history, or write for an employment application to:

Ralph A. Patterson, Dept. DAT-03
McDonnell Douglas Corporation
16915 El Camino Real
Houston, Texas 77058

All replies will be held in strict confidence.

MCDONNELL DOUGLAS



An Equal Opportunity Employer m/f

CIRCLE 143 ON READER CARD

Even Webster's Knows About QUEST

QUEST (kwest). v. 1. To make a search; to go on a quest.

QUEST SYSTEMS, INC. n. 1. A corporation founded in 1968. 2. The largest professional recruitment firm in the U.S. functioning solely in the computer sciences; its client companies pay all employment fees, interviewing and relocation expenses. Quest is known for its deep personal commitment to relate to each candidate as an individual with individual goals. 3. Its professional staff averages over 6 years of experience in EDP recruiting (additionally, staff members have direct hands-on experience in programming, systems, hardware sales, etc.) 4. Quest is presently searching for programmers and analysts (commercial, scientific, systems software) for over 3,500 client companies in the U.S. Quest has openings in over 700 U.S. towns and cities. 5. Methodology — see Questsystem.

QUESTSYSTEM (kwest sis'tem). n. 1. Discussing with an individual what he would like to be doing in light of what he has been doing. 2. Analyzing the realities of his objectives as they relate to the current job marketplace. 3. Contacting client companies and other Quest staff personnel to identify positions of possible interest. 4. Introducing the job candidate to his prospective employers by providing complete details to each about the other, ensuring the efficacious use of everyone's time. 5. Arranging interviews. 6. If employment offers are extended, Quest assists in evaluating the responsibilities, compensation and opportunities (and relates those to the initially stated objectives). The Questsystem has been working for thousands of professionals at no expense, whatsoever. Ask your friends of their past dealings with Quest. Then, put the Questsystem to work for you. For additional information on this subject, please inquire directly to Quest Systems, Inc. (All inquiries/resumes received will be responded to immediately and in confidence.)



QUEST SYSTEMS INC.

6400 Goldsboro Road

Washington, D. C. 20034 (301) 229-4200

Baltimore: (301) 265-1177 • Philadelphia: (215) 667-3322

CIRCLE 144 ON READER CARD

EDP SEARCH

WHY IS FOX-MORRIS THE FIRST CHOICE OF EDP PROFESSIONALS?

A recognized staff of professional experts offering LOCAL, REGIONAL & NATIONAL COVERAGE through our direct branches as well as coast to coast coverage through our 75 member firms of National Personnel Consultants, Inc.

Completely confidential service geared to your career objectives. Unparalleled contacts with industry based on years of successful results. Professional resume evaluation and career guidance. Client companies assume all employment costs—including interview expense, relocation (if necessary) and search fee. SEND RESUME DIRECT, OR CIRCLE NUMBER BELOW ON READER CARD.

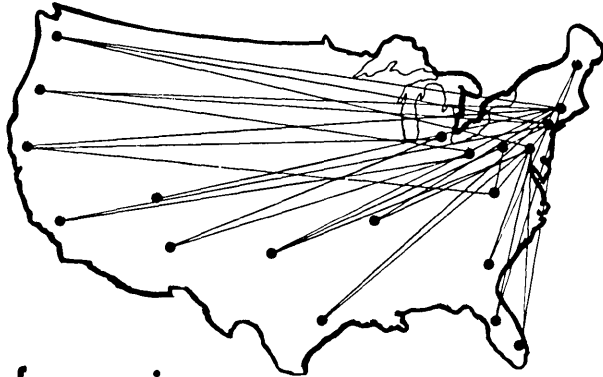

fox-morris personnel consultants

Philadelphia: (215) 561-6300, 1500 Chestnut St., Philadelphia, Pa. 19102
 New York: (212) 697-1820, 605 Third Ave., New York, N.Y. 10017
 Pittsburgh: (412) 232-0410, 6 Gateway Center, Pittsburgh, Pa. 15222
 Wilmington: (302) 654-4465, 2005 Concord Pike, P.O. Box 7017, Del. 19803
 Princeton: (609) 452-8135, P.O. Box 3490, U.S. Rt. 1, Princeton, N.J. 08540
 Baltimore: (301) 296-4500, 409 Washington Ave., Baltimore, Md. 21204
 Charlotte: (704) 527-4980, 4000 Park Road, Charlotte, N.C. 28209
 Atlanta: (404) 321-3888, 2200 Century Pkwy., N.E., Atlanta, Ga. 30345

CIRCLE 141 ON READER CARD

WHAT IS YOUR TRUE WORTH?

FREE JOB OPPORTUNITIES BULLETIN

Cadillac Associates represents the nation's largest and most respected professional placement service. Our close relationship with the nation's finest firms generates continuous career opportunity information and allows us to confidentially present your qualifications to those at "decision-making" levels.

Our bulletin, published quarterly, listing available opportunities in the Systems & Data Processing field is available free of charge and will be mailed to your home upon your request.

For your free bulletin, without any obligation, circle reader service card #115. Please USE HOME ADDRESS ONLY!

FREE CONFIDENTIAL PLACEMENT SERVICE

If you desire immediate assistance in locating an opportunity consistent with your objectives (professional/financial/geographic), CALL OR WRITE TODAY. A member of our staff of SYSTEMS & EDP SPECIALISTS will reach you by telephone to discuss your objectives and how we might help you satisfy them. A resume, or some details of background, will be appreciated.

Remember: Our client firms are located from coast to coast and assume all expenses (agency fee, interviewing & relocation).



E. W. MOORE
 Executive Vice President
CADILLAC ASSOCIATES, INC.*
 32 West Randolph St. Chicago, Ill. 60601
 Financial 6-9400

*"Where More Executives Find Their Positions Than Anywhere Else in The World."

CIRCLE 115 ON READER CARD

Bringing the "right people" together takes Romac experience

Romac's depth and experience offer more options in EDP, Accounting and Finance. Our 14 offices are staffed with knowledgeable professionals with experience at IBM, Honeywell and national accounting firms. Your Romac Partner knows what it takes to "bring the right people together" ...from both viewpoints. Always in confidence. Always fee paid.



& ASSOCIATES/Personnel Consultants

Contact Romac & Associates, President H. B. Dunn at 125 High St., Boston, Ma., 02110, for transmission to our network Partners in Portland, Hartford, New Haven, Stamford, Rhode Island, Buffalo, Rochester/Syracuse, Wellesley Hills, Ma., Boston, Washington, D.C., Charlotte and Atlanta.

March, 1976

PROGRAMMERS AND ANALYSTS

Free Employment Service

Serving Northeast, Southeast and Midwest U.S.

- Scientific and commercial applications
- Software development and systems programming
- Telecommunications
- Control systems
- Computer engineering
- Computer marketing and support

Call or send resume or rough notes of objectives, salary, location restrictions, education and experience (including computers, models, operating systems and languages) to either one of our locations. Or check the reader service card for a free sample resume. We will answer all correspondence from U.S. citizens and permanent residents and will guarantee our best efforts in a professional and ethical manner to all qualified applicants that we think we can help. Our client companies pay all of our fees.

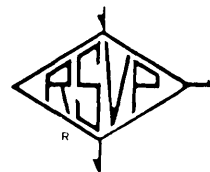

RSVP SERVICES, Dept. M
 Suite 700, One Cherry Hill Mall
 Cherry Hill, New Jersey 08002
 (609) 667-4488

RSVP SERVICES, Dept. M
 Suite 300, Dublin Hall
 1777 Walton Road
 Blue Bell, Penna. 19422
 (215) 629-0595

RSVP SERVICES

Employment Agency for Computer Professionals

CIRCLE 145 ON READER CARD

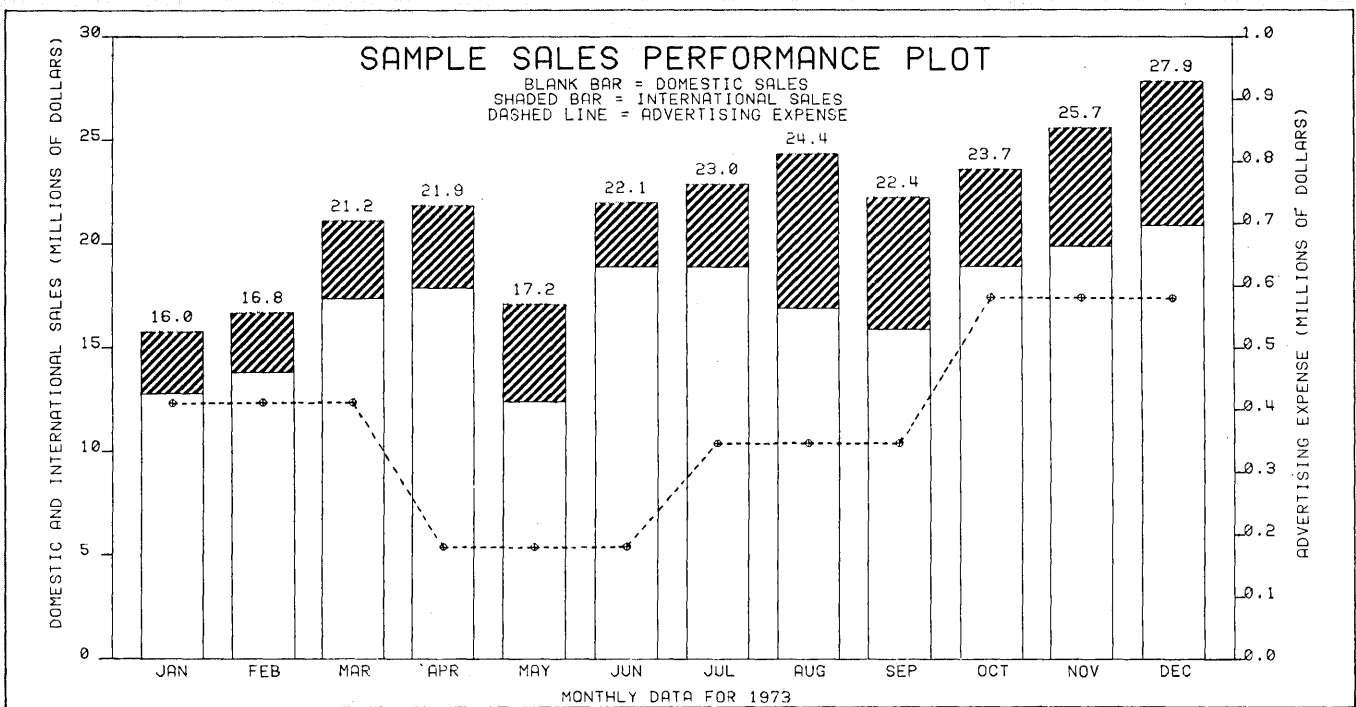

One plot is worth thirty pages of printout.

There is no shortage of data. The smallest minicomputer can swamp you with a stream of alphanumeric characters. But words and numbers aren't information. Not when they are buried in pages of printout.

Why not use an electrostatic line printer that draws? Plotting translates pounds of data into a picture. And that data compaction does more than cut paper cost. It helps you interpret information. Isolate complex variables. Spot trends. Reveal subtle changes.

Pictorialized information is powerful proof, too. Charts, diagrams, maps, and other graphics are persuasive.

Adding print/plot capability is practical. Printing up to 1000 lines per minute, the Versatec printer/plotter costs less than an impact printer of comparable speed. Maintenance cost is about one-third that of impacts. And it's far quieter.

You get a complete output package. Versatec computer-matched controllers and Versaplot™

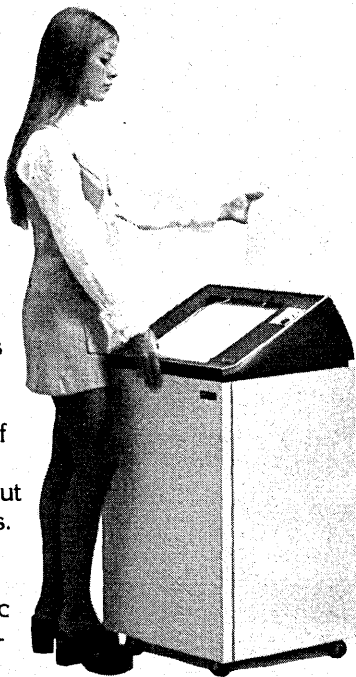

FORTRAN software make plotting as easy as plugging in. Simple subroutines allow programming of virtually any graphic representation with a few words of instruction.

So if you use your computer to organize information, improve productivity, or aid decision-making, consider the line printer that draws—The Versatec printer/plotter.



Versatec
2805 Bowers Avenue
Santa Clara, CA 95051
(408) 988-2800

Send me your 16-page brochure. My special interest:

- Line printing
- Plotting
- Plotting software
- Permanent copy from CRT display

My computer model: _____

Name _____

Telephone _____

Company _____

Address _____

City _____ State _____ Zip _____

™Versaplot is a Versatec Trademark

the forum

Family Programming Teams

A lot of noise has been made in the name of Structured Programming. Staggering increases in productivity, reliability and maintainability have been claimed. If you were not careful, you could be led to believe that all this comes from eliminating GO TO statements, but huge programming productivity increases don't come from using technicalities alone. As Baker and Mills have been so careful to point out, IBM's Chief Programmer Team approach is as much an organizational solution to the problem of increasing productivity as a technical one. A related organizational solution, "family teams," can yield even greater benefits.

If there is one cardinal rule to observe in managing programmers, it is the sanctity of the team:

Split new work against established teams; don't form new teams against each new project.

The idea of the family is important here. I have had a close interest in training data processing staff for about as long as I have been a father. It struck me recently that "raising" young programmers presents many of the problems of raising children. But while most children are fortunate enough to be brought up in a stable family environment, most programmers' upbringing is closer to that of an underprivileged orphan. In their first impressionable years, they are shuttled from one team leader to another, each of whom has his own view of good programming practice.

Typically after four years, many junior programmers are unproductive and unpredictable, and their programs are unreliable and unmaintainable. But what can you expect after their orphanage-style upbringing?

In contrast, people in "family teams" help each other and compensate for each other. The team evolves an identity and a pride in performance. For data processing management, the only actions required have to do with reinforcing the tribal structure. At a practical level, this means decent storage and working space, nicely demarcated, allowing each team member to communicate freely with the other members of the family but keeping disturbances from neighboring families to a minimum.

Another reinforcement involves rigorous respect for the hierarchical lines of authority, responsibility, and communication. Couple this with an eye-for-an-eye approach to performance, and you will have robust teams of high motivation.

The beauty of the team arrangement is that it almost always works, although sometimes in fairly mysterious ways. The team recognizes the goals and constraints, so although there may be running teams and passing teams and scrambling teams, all usually do well, one way or another.

The troubles with new teams

To pick a team every time a project comes up, from an anonymous pool of programmers, is a terrible thing. If such an approach is used, a comprehensive management system

must be instituted. Consider the problems in administering these systems:

- Estimating. (How anyone does it with an unfamiliar team is beyond me.)
- Planning/commitment.
- Staff scheduling, vacations, sickness etc.
- Staff movement from an apparently completed project to a newly scheduled project.



© DATAMATION ®

- Communications of policy, technical or administrative matters that may need subtle explanation.
- Maintenance of systems, where the original team members have now spread to the four corners of the department.
- Training. (The staff member probably moves before the supervisor recognizes the need; and anyway, the supervisor is not likely to see the person again, so why bother?)
- Quality control.

OVER 500

DP Managers Have Selected the JOHNSON Job Accounting Report System

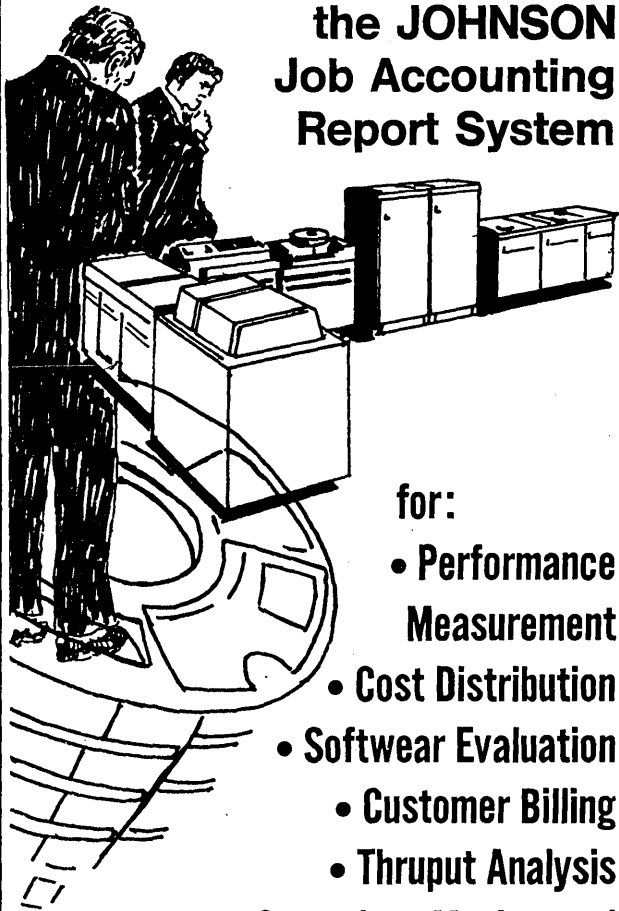

for:

- Performance Measurement
- Cost Distribution
- Software Evaluation
- Customer Billing
- Thruput Analysis
- Operations Monitor and
- Resource Utilization

supports:

**MFT- MVT-VS1-VS2- MVS- HASP
DOS- DOS/VS- POWER/VS**

Send for a free copy of our 30-page
Systems Characteristics Manual

JOHNSON

SYSTEMS INCORPORATED

Westgate Research Park
1651 Old Meadow Road
McLean, Virginia 22101
(703) 893-8700, Telex 89-9100

the forum

- Office space allocation. On any given Friday, 10% of the people are packing; on Monday they are still trying to locate their belongings, and the turmoil stops effective work by everyone else.

Even assuming that data processing managers can come to grips with all this, the motivations are such that the results are unsatisfactory. Ask a programmer in such an environment what he feels like, and what would he say? Probably that he feels like an auto-assembly worker, with little sense of involvement and nothing much to see for his efforts. Moreover, he will say that he has a pretty neutral feeling for his job, the department, and the company.

All of the above management problems are solved by the family team approach. Moreover, the systems for planning, directing, controlling and motivating can *only* work effectively with this type of organization.

Know what can be done

Knowing the limits of a team and its members is a big advantage. The concept that the sort of work that an individual or a team or a department tackles should be limited by previous experience is not usually among the prime planning considerations. In my view, it should be. In the execution of the job, the benefits are obvious. The achievements of departments that have put sensible limits on themselves so far exceed those of the uncritical big-thinkers, that deciding to work within known limits is a positive, aggressive, and mature response to a very muddled state of affairs. In any case, if one-tenth of the ingenuity that is currently put into trying to make ad hoc teams work is put into segmenting large system tasks, the distortion is probably negligible.

Minimizing the unknowns

A programming task can be characterized by: the size of the job, the hardware used, the software used, the application know-how needed, and the people doing the job.

Where only one of these aspects is new, the job will turn out successfully. With two unknowns, there may be trouble. Note that with a pool-of-programmers approach, the people and their interactions are unknown every time, so unless the job is a replica of some previous job, there is no assurance of success. With three (or more) unknowns, you have an almost cast iron guarantee of failure.

Thus, the team leader and data processing management should be preoccupied with the skills and experience of the programmers. The goal in scheduling work should be to extend each team member in *one* new direction. Because the bulk of the work being done is familiar, the department is productive and predictable. The people feel competent and assured. Isolated efforts in new directions extend and interest the staff. And the department's overall capability grows.

This is not a simple thing to manage. Dictation of in-house systems development policy by the level of maturity of this capability is not easy to swallow. But the whole issue is as central to success as are realistic technical and application objectives, or stable hierarchical teams.

The probable benefits of this whole approach are that programming productivity will be quadrupled. If that seems extravagant, consider the facts. In 1957, the average U.S. data processing department produced about 240 COBOL statements per month—designed, programmed, and tested. In 1975, the average U.S. department did exactly the same. Stable hierarchical teams should double that output. This is not difficult to do; the few departments that are anything

WHAT SIZE DIGITAL PLOTTER DO YOU NEED?

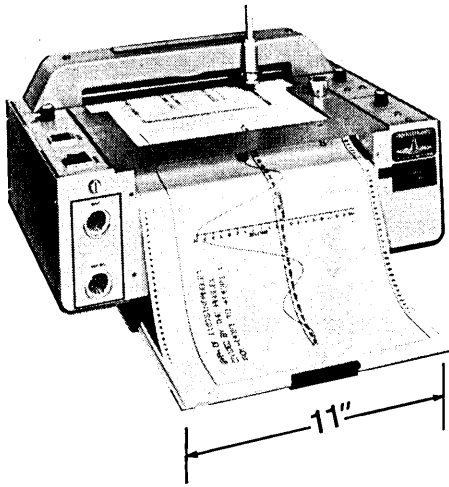

DP-1 — \$3550
450 Steps/Second
11" Wide x 144' Long
Circle item 32

If you *plot a lot*, size is important. Many data processors, researchers, financial analysts and mechanical design people are perfectly content with the 11" wide DP-1. It's fast, accurate and economical. But larger size is important to many chart makers, N/C checkers, etc. The DP-3, with its 22" width paper, is popular in offline, online and time sharing modes. But big? The DP-7 is a real Texas-size plotter (fast on the draw) with a full 36" plotting width and 3 automatically selectable pens to add color in a hurry! Weather map makers, subdivision planners, and geophysical mappers insist on a DP-7. How about you?

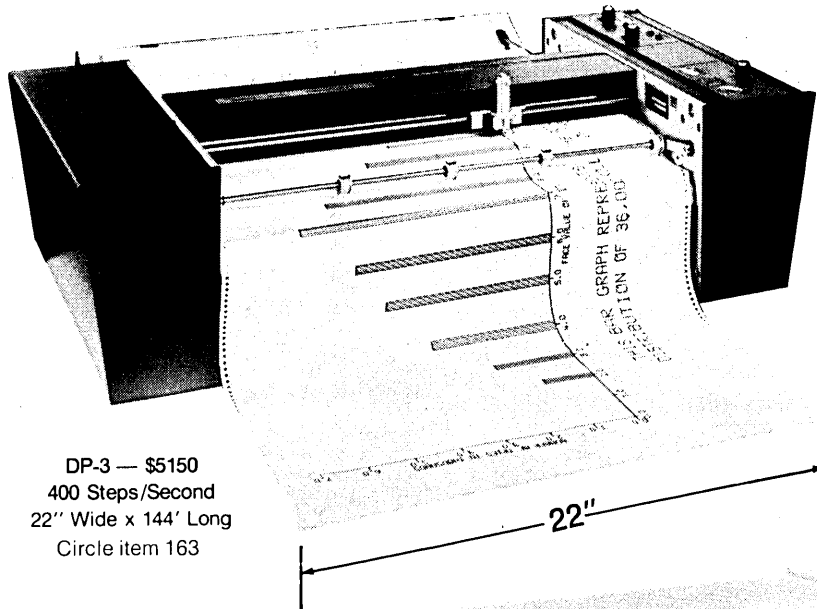

DP-3 — \$5150
400 Steps/Second
22" Wide x 144' Long
Circle item 163

COMPLØT® has them all

* A registered trademark of Houston instrument

Circle item 164

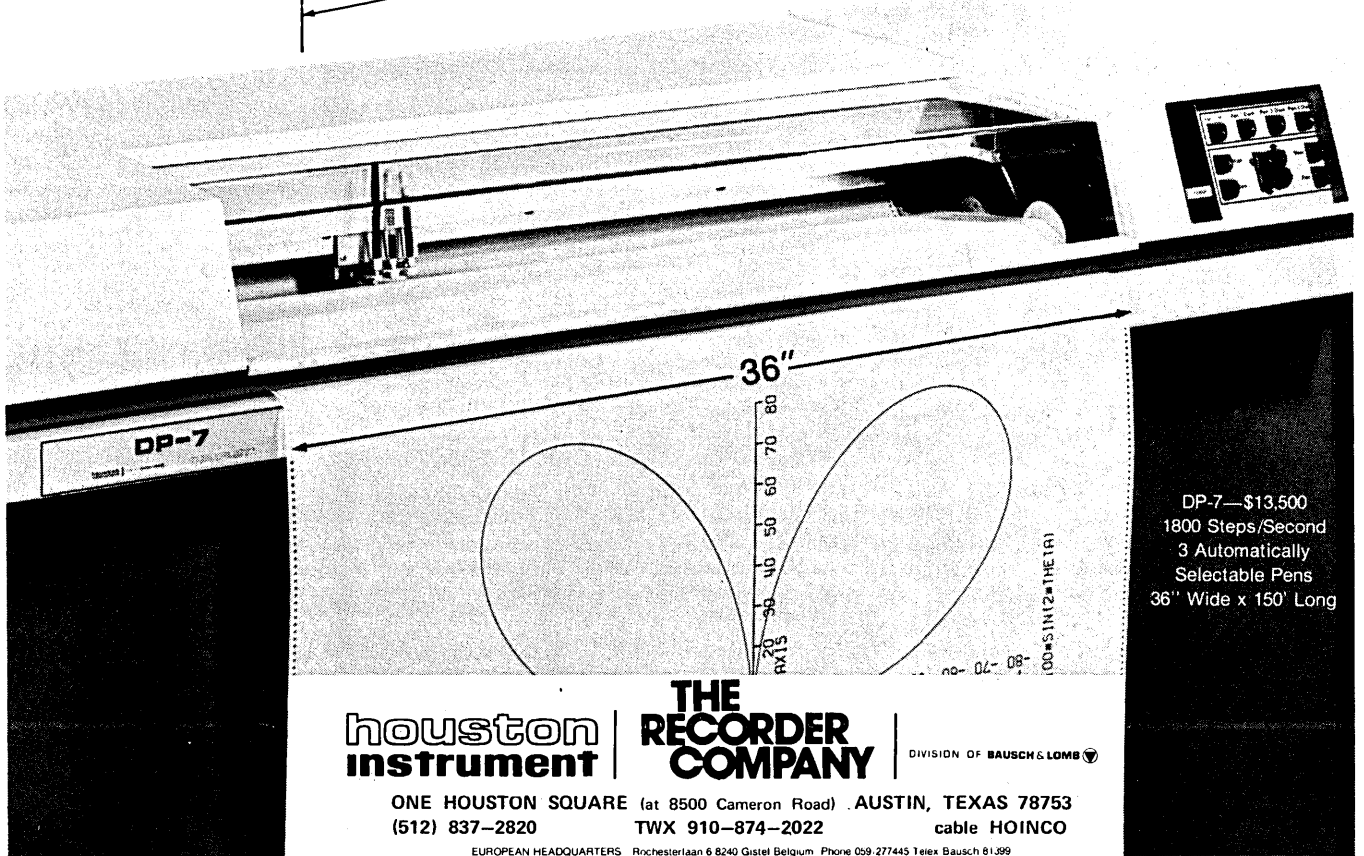

DP-7—\$13,500
1800 Steps/Second
3 Automatically
Selectable Pens
36" Wide x 150' Long

**houston
instrument**

**THE
RECORDER
COMPANY**

DIVISION OF BAUSCH & LOMB

ONE HOUSTON SQUARE (at 8500 Cameron Road) AUSTIN, TEXAS 78753
(512) 837-2820 TWX 910-874-2022 cable HOINCO

EUROPEAN HEADQUARTERS Rochesterlaan 6 8240 Gistel Belgium Phone 09-277445 Telex Bausch 81399

When I think networking products and systems, I think Tran.

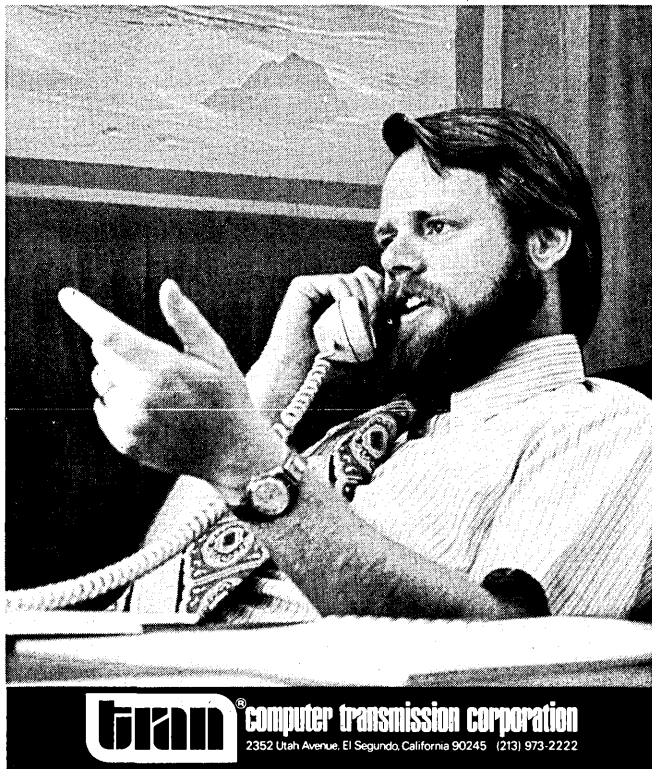

Tran® computer transmission corporation
2352 Utah Avenue, El Segundo, California 90245 (213) 973-2222

CIRCLE 106 ON READER CARD

MULTIUSER COBOL FOR Mini's

"The total on-line system solution"

- Interactive, Tutorial
- Large Data Base
- On-line Debugging
- Multiuser SORT
- Indexed I/O
- Multi-Branch

ANS'74 BLIS/COBOL DOS/VS

For more information in a hurry call...

IP MINICOMPUTER SOFTWARE **305/293-9431**

6237 EDGEWATER DR. • ORLANDO, FLA., 32810

CIRCLE 134 ON READER CARD

the forum

like organized do achieve this performance. Will scheduling within the limits of proven capacity (with one unknown), result in increasing productivity still further? In my view it will. But quadrupling performance to 960 statements per month? This will only be achieved by adding the final polish.

Having fun at it

The one thing the family teams approach lacks is a bit of fun and excitement. The technology is almost under control. There is little panic. There is not even much confusion to be tackled (or succumbed to). In its favor, it offers clear responsibility and authority, a self-contained working environment, recognizable and measurable results, interaction with the user and a chance to work within the bounds of one's steadily expanding competence. It provides warmth and incentive in its stable family structure, with acknowledged leaders, on-the-job training, and established succession. Yet it is a demanding climate.

To add the final polish, team leaders need flair. This is especially so when the programmers notice that they no longer live in a super-heated environment, but in a steady 9 to 5 arrangement, with quadrupled performance.

The excitement/fun/additional satisfaction require:

- A sense of pace and color—a team cannot be serious or flat-out all the time; variety is the spice.
- Occasional record-breaking endeavors.
- Occasional mind-stretching technical problems upon which production work does not depend.
- Papers or seminar contributions.
- Periodic prominence inside the department, company, and hopefully, industry.

Beyond all this, and left out because it is often considered unacceptable, is bonus money. For money the 240-statements-a-month programmer will produce 2,400 a month (well, almost!) Bonus money, as distinct from salary, goes far beyond being a hygienic factor. It is a massive force for realism and clarity in the department. It is a massive force for productivity. The resulting tempo and affluence are a major positive factor in creating high morale. All around, a department is much better off with five 1,500-statements-per-month people than with ten 750-statements-per-month people—especially if the performers are paid ("only") twice as much.

Much rests on the competence of the team leaders. If a stable hierarchy prevails, this won't be much of a problem. Leaders train their successors in their own image. Their programs are *always* admired by the user and the operators and the other programmers. It is important to recognize these people and their seminal influence on the performance of the whole department. In the main, they seem to be able to pass on their art by example, rather than by the formulation of guidelines or standards. Like so much else in the business, it is a matter of arranging personal interactions so that minds can relate, and learning and understanding follow.

— A. J. L. Thorpe

Presently manager of IBM services for the Hoskyns Group, a consulting, programming, and facilities management firm in London, Mr. Thorpe has been teaching and managing programmers in the U.S. and England for 15 years.

"OMR..."



...for decentralized data collection ...as accurate as verified keypunch

Yes, as accurate as verified keypunch . . . and source data used directly, so there are no delays or errors in entering data. Plus . . . a series of powerful off-line edits (on-line too!) mean a "smart OMR" and improved quality of computer reports.

With a Bourns Optical Mark Reader, you get a really good deal. You get faster turnaround on input data with source data entry. You spend less because OMR data entry preparation is just one step. You improve accuracy of data entry because OMR intelligence comes before your computer.

What else? Well, how about an entire company dedicated to solving your problems. From application, card design, programing, and field service to the guys and gals at the factory, we have a whole bunch of people just waiting to do their best for you.

For the latest in "smart OMR's," why not call today? It might make your life a little less complicated. Bourns, Inc.—Management Systems Division, 6600 Jurupa Avenue, Riverside, California 92504. Phone: 714-687-7220.

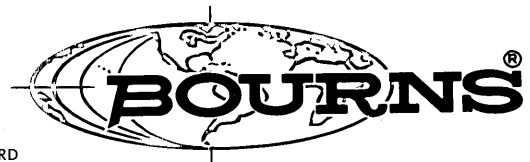

CIRCLE 2 ON READER CARD

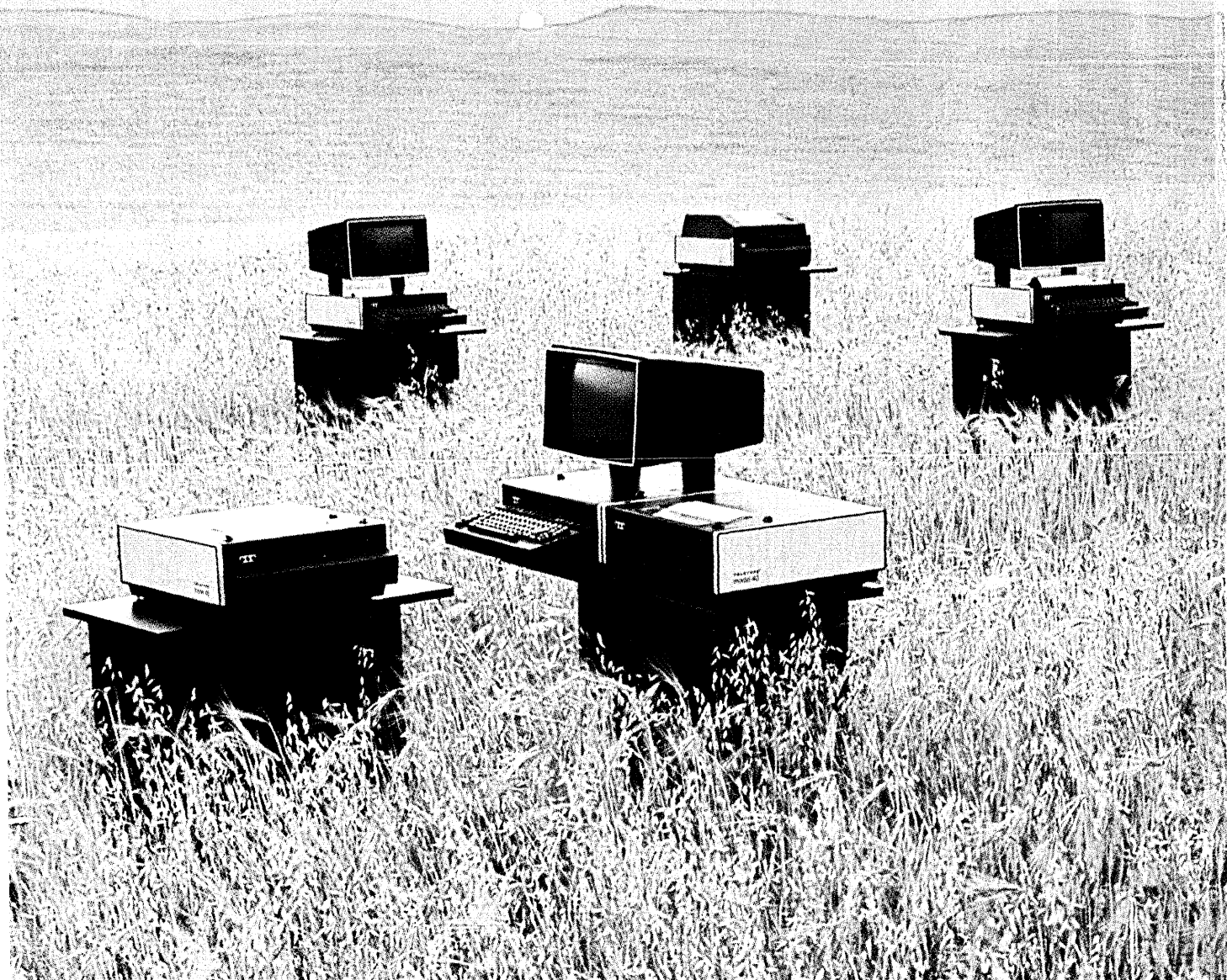

Where other data terminal systems grow old, this one is designed to simply grow.

The Teletype® model 40 is the data terminal system to start with because it's completely modular, and is designed to grow as your needs grow.

The display, operator console, printer and controller modules form the heart of the model 40 system and permit a variety of configurations to suit your application.

There's a wide range of options, too, such as expandable memory with scrolling; half/full duplex modes; fixed and variable field transmission; protected formats; a variety of on-line controls; current loop and EIA (RS232) interfaces; and speeds from 110 to 4800 bps. Printer options include 80 column friction and adjustable tractor feed units.

And don't worry about obsolescence. Since the model 40 design consists of separate modules, you can select only those capabilities you need now—and add others later.

Add it all up. The model 40 system offers outstanding reliability, versatility and economy. And delivery is sooner than you may expect. No wonder you can't beat the model 40 on a price/performance basis. To start with. Or to grow with.

For complete information, please contact our Sales Headquarters at: 5555 Touhy Ave., Skokie, Ill. 60076. Or call Terminal Central at: 312/982-2000.

Teletype is a trademark and service mark registered in the United States Patent and Trademark Office.



The Teletype model 40 system. Nothing even comes close.