

Digital Equipment Corporation  
Maynard, Massachusetts

digital

LARS BORG  
PDP-15 Systems

# Operator's Guide

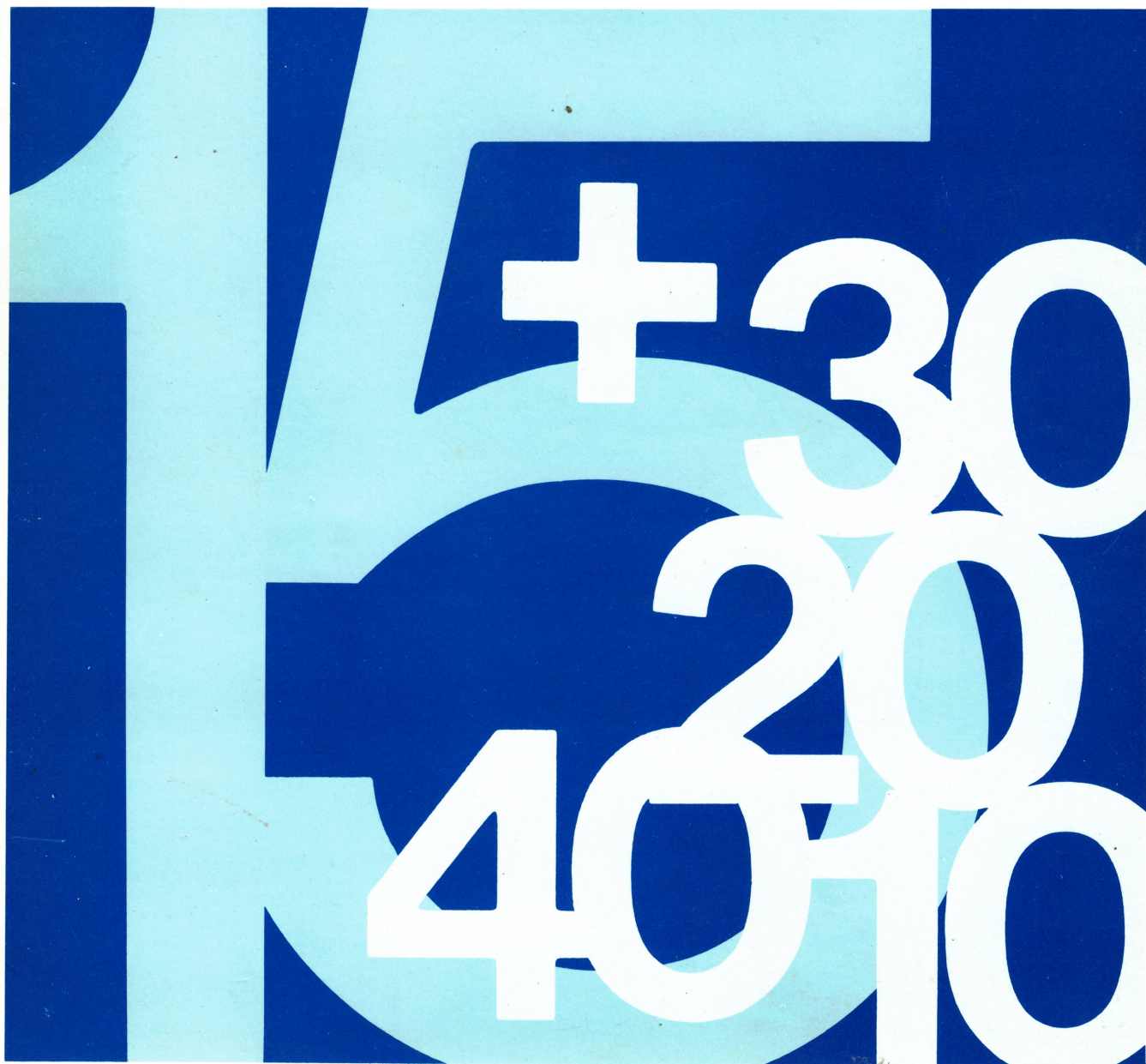

# **PDP-15 OPERATOR'S GUIDE**



1st Edition February 1970  
2nd Printing (Rev) September 1970

Copyright © 1970 by Digital Equipment Corporation

The material in this manual is for information purposes and is subject to change without notice.

The following are trademarks of Digital Equipment Corporation, Maynard, Massachusetts:

DEC	PDP
FLIP CHIP	FOCAL
DIGITAL	COMPUTER LAB

# PDP-15 FAMILY OF MANUALS

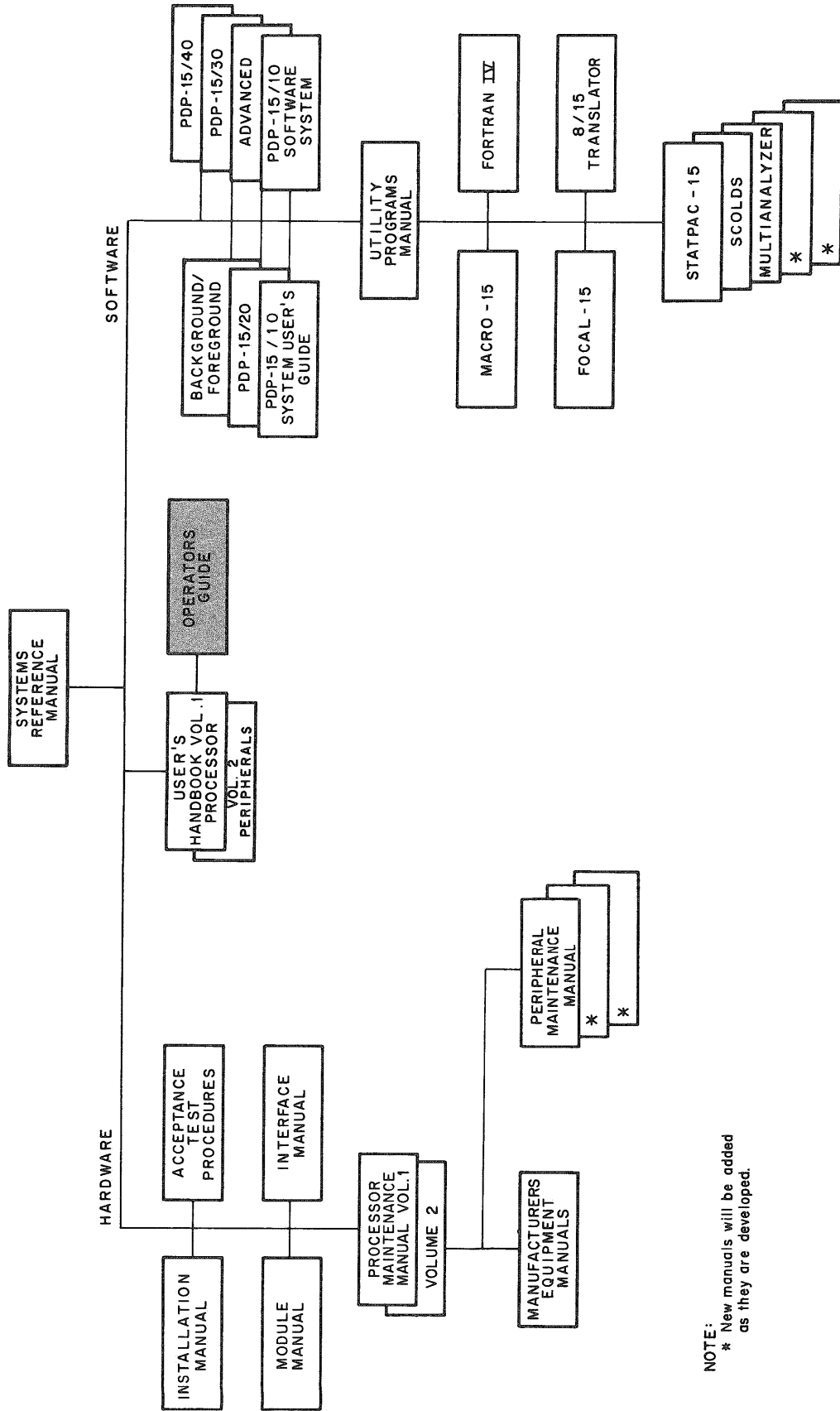

NOTE:  
 \* New manuals will be added as they are developed.

**SYSTEMS REFERENCE MANUAL** – Provides overview of PDP-15 hardware and software systems and options, instruction repertoire, expansion features, and descriptions of system peripherals. (DEC-15-GRZA-D)

**USER'S HANDBOOK VOLUME 1, PROCESSOR** – Principal guide to system hardware includes system and subsystem features, functional descriptions, machine-language programming considerations, instruction repertoire, and system expansion data. (DEC-15-H2DA-D)

**VOLUME 2, PERIPHERALS** – Features functional descriptions and programming considerations of peripheral devices. (DEC-15-H2DA-D)

**OPERATOR'S GUIDE** – Lists procedural data, including operator maintenance, for using the operator's console and the peripheral devices associated with PDP-15 Systems. (DEC-15-H2CA-D)

**PDP-15/10 SYSTEM USER'S GUIDE** – Features COMPACT and Basic I/O Monitor operating procedures. (DEC-15-GG1A-D)

**PDP-15/20 SYSTEM USER'S GUIDE** – Lists Advanced Monitor System operating procedures. (DEC-15-MG2A-D)

**BACKGROUND/FOREGROUND MONITOR SYSTEM USER'S GUIDE** – Lists operating procedures for the DECTape and disk-oriented Background/Foreground monitors. (DEC-15-MG3A-D)

**PDP-15/10 SOFTWARE SYSTEM** – Describes COMPACT software system and Basic I/O Monitor System. (DEC-15-GR1A-D)

**PDP-15/20/30/40 ADVANCED MONITOR SOFTWARE SYSTEM** – Describes Advanced Monitor System; programs include system monitor language, utility, and application types; operation, core organization, and input/output operations within the monitor environment are discussed. (DEC-15-MR2A-D)

**PDP-15/30 BACKGROUND/FOREGROUND MONITOR SOFTWARE SYSTEM** – Describes Background/Foreground Software System including the associated language, utility, and applications program. (DEC-15-MR3A-D)

**PDP-15/40 DISK-ORIENTED BACKGROUND/FOREGROUND MONITOR SOFTWARE SYSTEM** – Describes Background/Foreground Monitor in disk-oriented environment; programs include language, utility, and application types. (DEC-15-MR4A-D)

**MAINTENANCE MANUAL VOLUME 1, PROCESSOR** – Provides block diagram and functional theory of operation of the processor logic; lists preventive and corrective maintenance data. (DEC-15-H2BA-D)

**VOLUME 2, ENGINEERING DRAWINGS** – Provides engineering drawings and signal glossary for the basic processor and options. (DEC-15-H2BA-D)

**INSTALLATION MANUAL** – Provides power specifications, environmental considerations, cabling, and other information pertinent to installing PDP-15 Systems. (DEC-15-H2AB-D)

**ACCEPTANCE TEST PROCEDURES** – Lists step-by-step procedures designed to insure optimum PDP-15 Systems operation.

**PDP-15 MODULE MANUAL** – Provides characteristics, specifications, timing and functional descriptions of modules used in PDP-15 Systems. (DEC-15-H2EA-D)

**INTERFACE MANUAL** – Provides information for interfacing devices to a PDP-15 System. (DEC-15-H0AA-D)

**UTILITY PROGRAMS MANUAL** – Provides utility programs common to PDP-15 Monitor systems. (DEC-15-YWZA-D)

**MACRO-15** – Provides MACRO assembly language for the PDP-15. (DEC-15-AMZA-D)

**FORTRAN IV** – Describes PDP-15 version of the FORTRAN IV compiler language. (DEC-15-KFZA-D)

**FOCAL-15** – Describes an algebraic interactive compiler level language developed by Digital Equipment Corporation. (DEC-15-KJZA-D)



# CONTENTS

		Page
CHAPTER 1 PROCESSOR		
1.1	Console Controls and Indicators	1-1
1.2	Operating Procedures	1-9
1.2.1	Power On	1-9
1.2.2	Program Load Procedure	1-10
1.2.3	Start Program Procedure	1-10
1.2.4	Manual Control of Processing	1-12
1.2.5	Memory Examination	1-12
1.2.6	Data Storage from Console	1-12
1.2.7	Manual Execution of Instruction	1-13
1.2.8	Reset	1-13
1.3	Memory Bank Selection	1-14
1.4	BB15 Controls and Indicators	1-15
1.4.1	MPI5 Memory Parity	1-18
1.4.2	KT15 Memory Protect/Relocate	1-18
CHAPTER 2 TELETYPEWRITER SETS		
2.1	Teletype Models 33 ASR and 35 KSR	2-1
2.1.1	Controls and Indicators	2-1
2.1.2	Loading Paper	2-2
2.1.2.1	Roll Paper Procedure	2-2
2.1.2.2	Form Paper Procedure	2-4
2.1.3	Ribbon Replacement	2-6
2.1.4	Installing Paper-Tape in Punch (Teletype Model 33 ASR only)	2-8
2.1.5	Installing Punched Paper-Tape in Reader (Teletype Model 33 ASR only)	2-9
2.1.6	Keyboard Operating Procedures	2-9
2.1.7	Duplicating Paper Tapes	2-9
2.1.8	Correcting Paper Tapes	2-9
2.1.9	Chad Disposal	2-10

## CONTENTS (Cont)

		Page
CHAPTER 3 CARD READER		
3.1	CR03B Card Reader	3-1
3.1.1	Controls and Indicators	3-1
3.1.2	Loading and Removing Cards	3-3
3.1.3	Error Indicators and Corrective Actions	3-3
3.1.4	Cleaning	3-4
CHAPTER 4 LINE PRINTERS		
4.1	LP15C Line Printer and Control (1000 lpm)	4-1
4.1.1	Controls and Indicators	4-1
4.1.2	Format Tape Preparation	4-10
4.1.3	Paper Installation	4-13
4.1.4	Ribbon Installation	4-13
4.1.5	Start Up Procedure	4-15
4.2	LP15F Line Printer and Control (356 lpm)	4-16
4.2.1	Controls and Indicators	4-16
4.2.2	LP15F Paper Loading Procedure	4-19
4.2.3	Vertical Paper Positioning	4-20
4.2.4	Ribbon Installation	4-20
4.2.5	LP15F Line Printer Start Up Procedure	4-24
CHAPTER 5 PAPER-TAPE READER AND PUNCH		
5.1	PC15 High-Speed Paper-Tape Reader and Punch	5-1
5.1.1	Controls	5-1
5.1.2	Paper Tape Reader Operating Procedure	5-2
5.1.3	Paper Tape Punch Tape Installation	5-5
5.1.4	Placing Punch in Service	5-7
5.1.5	Removing Punched Tape	5-7
5.1.6	Chad Removal	5-7
5.1.7	Splicing and Repairing Paper Tape	5-8
5.1.7.1	End of Tape	5-8
5.1.7.2	Torn Tape	5-8

## CONTENTS (Cont)

		Page
CHAPTER 6 DISK DRIVES		
6.1	RP02 Disk Pack Drive and RP15 Disk Pack Control	6-1
6.1.1	Controls and Indicators	6-1
6.1.1.1	Drive Unit	6-1
6.1.1.2	RP15 Indicator Panel	6-4
6.1.1.3	RP15 Control Panel	6-9
6.1.2	Disk Pack Installation Procedure	6-11
6.1.3	Starting Procedure and Operating Mode Selection	6-11
6.1.4	Write Protect Features	6-11
6.1.4.1	Selected Unit Read Only	6-12
6.1.4.2	Selected Unit Lock-Out	6-12
6.1.5	Formatting Disk Packs	6-12
6.2	RS09 DECdisk Drive and RF15 DECdisk Control	6-12
6.2.1	Controls and Indicators	6-13
6.2.1.1	Drive Unit	6-13
6.2.1.2	RF15 Control Panel	6-15
6.2.1.3	RF15 Indicator Panel	6-16
6.2.2	Power Turn-On Procedure	6-19
6.2.3	Transfer Rate Selection	6-20
6.2.4	Disk Number Selection	6-20
6.2.5	Write Lockout Selections	6-21
CHAPTER 7 MAGNETIC TAPE TRANSPORTS		
7.1	TU20 Magnetic Tape Transport and TC59 Magnetic Tape Control	7-1
7.1.1	Controls and Indicators	7-2
7.1.2	Tape Installation Procedure	7-4
7.1.3	Placing the Tape Unit On-Line	7-6
7.1.4	Tape Removal Procedure	7-7
7.1.5	Care and Cleaning	7-8
7.1.5.1	Care of Tape	7-8
7.1.5.2	Tape Transport Cleaning Procedure	7-9
7.2	TU55 DECtape Transport and TC02 DECtape Control	7-10



## CONTENTS (Cont)

		Page
7.2.1	Controls and Indicators	7-12
7.2.2	Operating Procedures	7-13
7.2.2.1	DECtape Installation Procedure	7-14
7.2.2.2	Placing the DECtape Transport On-Line	7-14
7.2.2.3	DECtape Removal Procedure	7-14
7.2.2.4	Format Generation	7-15
7.2.2.5	Care and Cleaning	7-15
7.3	TU56 Dual DECtape Transport and TC15 DECtape Control	7-16
7.3.1	Controls and Indicators	7-16
7.3.2	Control Modes and Functions	7-22
7.3.3	Operating Procedures	7-22
 CHAPTER 8 DISPLAY DEVICES		
8.1	VP15A Storage Tube Display and Control	8-1
8.1.1	Controls and Indicators	8-1
8.1.2	VP15A Turn-On Procedure	8-3
8.1.3	Self-Test Procedure	8-3
8.2	VP15B/BL Oscilloscope Display, Control, and Optional DEC Type 370 Light Pen	8-4
8.2.1	Controls and Indicators	8-6
8.2.2	Operating Procedures	8-6
8.2.3	Light Pen Operation	8-7
8.2.3.1	Sensitivity Adjustment	8-7
8.2.3.2	Normal Operation Procedure	8-8
8.2.3.3	Optional Operating Procedure	8-8
8.3	VP15C/CL Oscilloscope Display, Control & Optional DEC Type 370 Light Pen	8-8
8.3.1	Controls and Indicators	8-8
8.3.2	Operating Procedure	8-10

## CONTENTS (Cont)

		Page
CHAPTER 9 PLOTTERS		
9.1	XY15AA/AB/BA/BB Incremental Plotter and XY15 Control	9-1
9.1.1	Controls and Indicators	9-1
9.1.2	Installation of Chart Roll	9-2
9.1.3	Installation of Single-Sheet Chart Paper	9-4
9.1.4	Operational Checkout	9-5
9.1.4.1	Reticles	9-6
9.1.4.2	Removal of Chart Paper	9-6

## ILLUSTRATIONS

Figure No.	Title	Art No.	Page
1-1	PDP-15 Control Console	69181-1	1-7
1-2	Power Controls and Indicators (Rear View) (Front View)	4980-18 4980-22	1-11 1-11
1-3	Memory Bank Selection Switches	4980-25	1-14
1-4	BB15 Indicator Panel	5116-1	1-15
1-5	BB15 Control Switches	5144-2	1-15
2-1	Teletype Model 33 ASR		2-3
2-2	Teletype Model 35 KSR		2-3
2-3	Roll Paper Installation	15-0100	2-4
2-4	Form Paper Installation	15-0099	2-5
2-5	Ribbon Installation		2-7
3-1	Card Reader CR03B	3886	3-2
4-1	LP15C Line Printer	5116-16	4-4
4-2	LP15C Line Printer Controls and Indicators	5116-15	4-5
4-3	LP15C Line Printer Controls and Indicators	5116-18	4-6
4-4	LP15C Control Panel Switches	15-0240	4-7
4-5	LP15 Indicator Panel	5144-3	4-8
4-6	Format Tape Preparation		4-11
4-7	Tape Punch		4-12

ILLUSTRATIONS (Cont)

Figure No.	Title	Art No.	Page
4-8	Tape Alignment		4-12
4-9	Paper Loading		4-14
4-10	Paper Alignment		4-15
4-11	Ribbon Installation		4-16
4-12	LP15F Line Printer	5116-12	4-18
4-13	LP15F Paper Tape Tension and Width Adjustments	5116-8	4-19
4-14	LP15F Paper Loading	5116-14	4-21
4-15	LP15F Line Printer Controls	5116-2	4-22
4-16	LP15F Top Control Panel	5116-19	4-23
4-17	LP15F Inside Control Panel	5116-11	4-24
4-18	Drum-Gate Ribbon Installation		4-25
4-19	Installation of Ribbon Core on Fixed Ribbon Holder		4-26
5-1	Paper-Tape Reader and Punch	4980-11	5-2
5-2	Orienting the Tape	69282-16B-3	5-3
5-3	Installing Tape in Paper-Tape Reader	4972-1,2,4 4973-3	5-4
5-4	Installing Tape in High-Speed Paper-Tape Punch	5338-1	5-6
6-1	Disk Pack Drive Unit RP02	4354	6-3
6-2	Drive Unit RP02 Controls and Indicators	4354	6-4
6-3	RP15 Indicator Panel	5144-1	6-9
6-4	RP15 Control Panel	4830-1	6-10
6-5	RS09 DECdisk Drive, Write Lockout Control Panel	5003-11	6-13
6-6	RS09 DECdisk Drive, Power Controls and Indicators	5003-14	6-13
6-7	RF15 Control Panel	5003-20	6-15
6-8	RF15 Indicator Panel	5003-18	6-16
6-9	Disk System Configuration	15-0241	6-21
7-1	TU20 Magnetic Tape Transport	3409	7-1
7-2	Magnetic Tape Transport, Type TU20 Controls and Indicators	3409	7-2
7-3	Write-Enable Ring Installation	69282-16A-2	7-5
7-4	Starting Tape in Tape Insertion Slot	69282-16A-8	7-6



## ILLUSTRATIONS (Cont)

Figure No.	Title	Art No.	Page
7-5	Starting Tape on Takeup Reel	69282-16A-3	7-7
7-6	Tape Transport Tape Path	69119-4D	7-11
7-7	TU55 DECtape Transport	4980-6	7-13
7-8	TU56 Dual DECtape Transport	5116-13	7-17
7-9	TC15 Indicator Panel	5116-20	7-18
8-1	VP15A Storage Tube Display	5116-4	8-2
8-2	VP15A, Rear View	5116-5	8-4
8-3	VP15/BL Oscilloscope Display	5305	8-5
8-4	VP15C Oscilloscope Display	5116-6	8-9
8-5	VP15C Oscilloscope Display, Rear View	5116-9	8-9
9-1	CALCOMP Plotters	2775,6	9-3

## TABLES

Table No.	Title	Page
1-1	Console Controls	1-1
1-2	Console Indicators	1-8
1-3	Memory Bank Selection	1-14
1-4	BB15 Indicator Panel	1-16
2-1	Teletype Model 33 ASR Controls and Indicators	2-1
3-1	Card Reader Controls and Indicators	3-1
4-1	LP15C Line Printer Controls and Indicators	4-1
4-2	LP15 Indicator Panel	4-9
4-3	LP15F Line Printer Controls and Indicators	4-17
5-1	Paper-Tape Reader and Punch Controls	5-1
6-1	Drive Unit Controls and Indicators	6-1
6-2	RP15 Indicator Panel	6-4
6-3	RP15 Control Panel Controls and Indicators	6-10
6-4	RS09 DECdisk Drive Controls and Indicators	6-14
6-5	RF15 Control Panel	6-15
6-6	RF15 Indicator Panel	6-16
7-1	TU20 Magnetic Tape Transport Controls and Indicators	7-2
7-2	TU55 DECtape Transport Controls and Indicators	7-12

TABLES (Cont)

Table No.	Title	Page
7-3	TU56 Dual DECTape Transport Controls and Indicators	7-16
7-4	TC15 Indicators	7-19
8-1	VP15A Storage Tube Display Control and Indicators	8-1
8-2	VP15B Oscilloscope Display Controls	8-6
8-3	VP15C Oscilloscope Display Controls	8-10
9-1	Plotter Controls and Indicators	9-1

## Preface

This manual provides the operator with information to control processing operations of the PDP-15 and its peripheral devices. Controls and indicators are identified and described, and step-by-step instructions for their use are provided.

Operating instructions for the PDP-15 Processor are provided in Chapter 1. Chapter 2 contains instructions for the operation of the Teletypewriter Set, standard peripheral equipment in all PDP-15 systems.

Chapters 3 through 9 present operating procedures for the peripheral equipment.

<u>Chapter</u>	<u>Peripheral</u>
3	CR03B Card Reader
4	LP15C Line Printer and Control (1000 lpm)
4	LP15F Line Printer and Control (356 lpm)
5	PC 15 High-Speed Paper-Tape Reader and Punch
6	RP02 Disk Pack Drive and RP15 Disk Pack Control
6	RS09 DECdisk Drive and RF15 DECdisk Control
7	TU20/TU30 Magnetic Tape Transport and TC59 Magnetic Tape Control
7	TU55 DECTape Transport and TC02 DECTape Control
7	TU56 Dual DECTape Transport and TC15 DECTape Control
8	VP15A Storage Tube Display (Tektronix Type 611) and Control
8	VP15B/BL Oscilloscope Display (Tektronix RM503), Control, and Optional DEC Type 370 Light Pen
8	VP15C/CL Oscilloscope Display (DEC VR12), Control, and Optional DEC Type 370 Light Pen
9	XY15AA/AB/BA/BB Incremental Plotter and XY15 Control

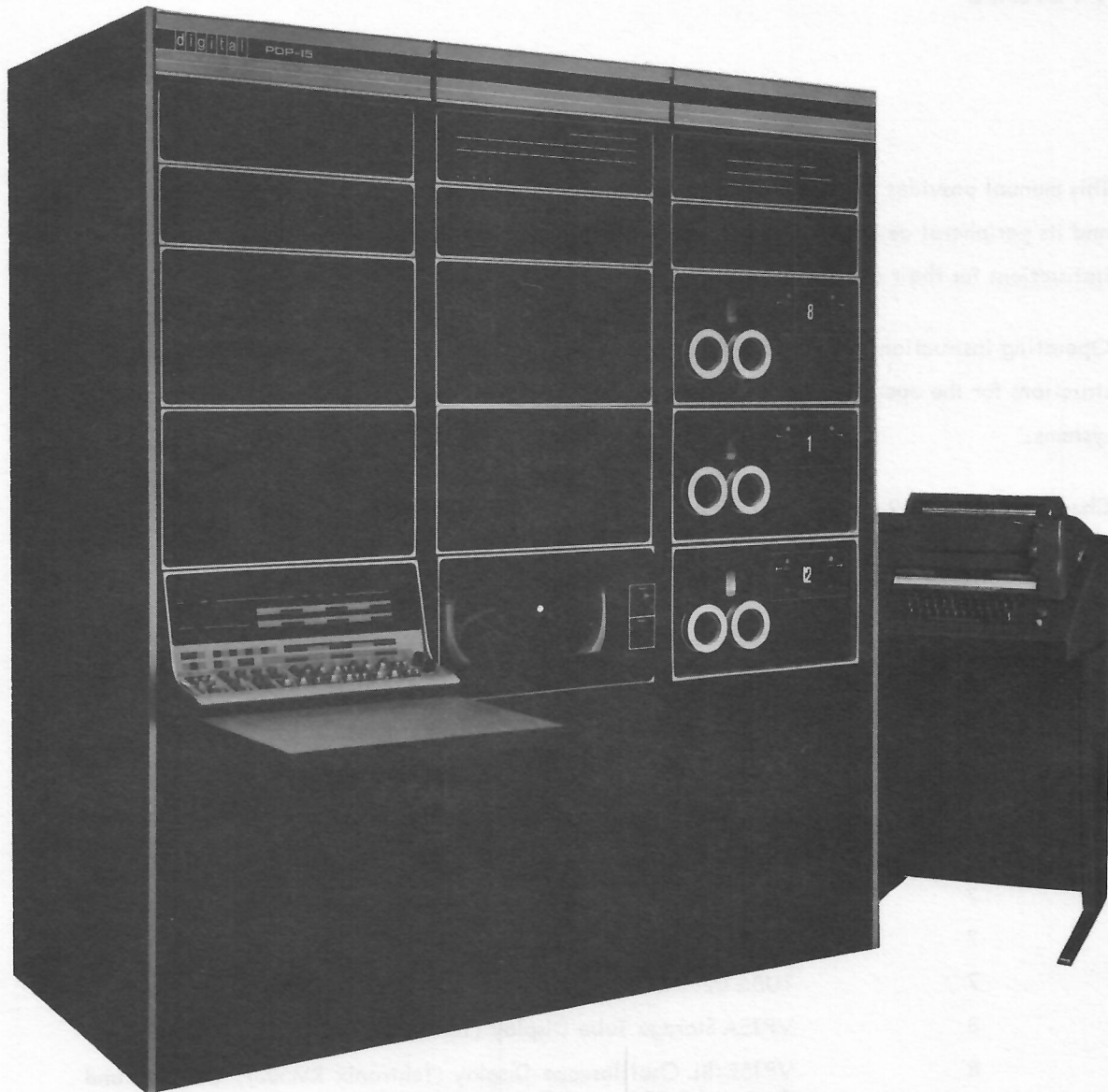

Vertical Storage Unit  
VHS II Disk Drive  
Control Unit  
Digital Display (DSD) Control  
Optional Disk Drive  
XYS/AS/ASR Terminal Plotter and XYS Control

Preface

The manual provides  
and its operation  
instructions for the  
Digital POP-15  
storage for the  
control

# Chapter 1

## Processor

### 1.1 CONSOLE CONTROLS AND INDICATORS

The PDP-15 console (see Figure 1-1) provides the switches and indicators required for operator initiation, control, monitoring, and maintenance of the system. Any of twenty-four 18-bit registers can be displayed at any one time to provide the operator with visual indications of all registers and buses.

Console controls and indicators are described in Tables 1-1 and 1-2, respectively. The two rows of key-type switches are identified by corresponding rows of labels located just below the dark, indicator portion of the console. The upper row of labels identify the rear switches; the lower row of labels identify the front switches. Unless otherwise indicated, a switch function is active when the rear half of the switch is depressed or, in the case of momentary contact switches, when the elevated half of the switch is momentarily depressed.

Table 1-1  
Console Controls

Control	Type	Function
Repeat Speed/ System Power	Potentiometer/ switch	Controls the rate of repeat activity when the system is in repeat mode. The repeat rate is continuously variable from 1 Hz to 10 kHz. When rotated beyond detent at full counterclockwise position, removes all power to system.
DATA	Eighteen two- position rocker switches	Word length (bits 00-17) register switches to provide binary data that can be read either into the accumulator by execution of an OAS (OR the switch content with the accumulator content) instruction, or into memory under control of the DEPOSIT or executed by the EXEC switch.
ADDRESS	Fifteen two- position rocker switches	Specifies a memory location. These switches are used in conjunction with the START, DEPOSIT and EXAMINE switches.

Table 1-1 (Cont)  
Console Controls

Control	Type	Function
START	Spring-loaded momentary-contact switch	Initiates program execution at the memory location specified by the setting of the ADDRESS switches.
CONT	Spring-loaded momentary-contact switch	<p>a. Resumes program execution at the point that it was halted, determined by the contents of the program counter (PC).</p> <p>b. In conjunction with other control switches (SING TIME, SING STEP, SING INST), steps the program sequentially through the desired time states (SING TIME), major states (SING STEP), or instruction (SING INST).</p>
DEPOSIT THIS	Spring-loaded momentary-contact rocker switch	Places the contents of the DATA switches in the memory location designated by the ADDRESS switches.
DEPOSIT NEXT	Spring-loaded momentary-contact rocker switch	Places the contents of the DATA switches in succeeding memory locations; the location is specified by the ADDRESS switches plus the number of times the NEXT switch is depressed.
EXAMINE THIS	Spring-loaded momentary-contact rocker switch	Places the contents of memory location specified by the ADDRESS switches in the memory buffer (MB) register.
EXAMINE NEXT	Spring-loaded momentary-contact rocker switch	Places the contents of the memory location specified by the ADDRESS switches plus the number of times the NEXT switch is depressed into the memory buffer (MB) register.
<p>NOTE</p> <p>Operation of the DEPOSIT THIS/NEXT and EXAMINE THIS/NEXT switches does not affect the AC, LINK, XR, LR and PC registers.</p>		
STOP	Spring-loaded momentary-contact rocker switch	<p>Terminates program execution when the instruction that is in progress has been executed.</p> <p style="text-align: center;">NOTE</p> <p>Operation of the STOP switch does not inhibit I/O data channel activity.</p>

Table 1-1 (Cont)  
Console Controls

Control	Type	Function
EXEC	Spring-loaded momentary-contact rocker switch	Causes the instruction specified by the contents of the DATA switches to be executed. Program will stop following execution of the one instruction.
RESET	Spring-loaded momentary-contact rocker switch	Clears major registers (MB, AC, LINK, PC, IR, XR, LR) and control flip-flops (flags, option select). The clearing prevents any overlap of previous operations from interfering with new operations. Typically RESET is activated prior to reading in programs from paper tape.
READIN	Spring-loaded momentary-contact rocker switch	<p>Initiates the hardware read-in process when transferring information from paper tape into memory. The data is read into memory starting at the location specified by the ADDRESS switches.</p> <p style="text-align: center;">NOTE</p> <p>STOP is the only switch active while the machine is running. If, at any time, the machine must be reset while the RUN light is on, RESET and STOP switches should be depressed simultaneously. This is an unconditional reset procedure that should be used with caution, because data can be lost.</p>
REG GROUP	Two-position rocker switch	Determines which group of registers the Register Select switch can access for display in the REGISTER indicators. When the front of the REG GROUP switch is depressed, the contents of the register specified in the left-hand window of the Register Select switch are displayed in the REGISTER indicators. When the rear of the REG GROUP switch is depressed, the register, bus, or status information specified in the right-hand window of the Register Select switch are displayed on the REGISTER indicators; typically this second group is used for maintenance purposes.
Register Select	Twelve-position rotary switch	<p>In conjunction with the REG GROUP switch, selects the register, bus, or status data and control signals to be displayed in the REGISTER indicators.</p> <p>The following summarizes the REGISTER display contents for each position of the Register Select and REG GROUP switches.</p>

Table 1-1 (Cont)  
Console Controls

Control	Type	Function
<p>AC PC OA MQ PL/SC XR LR EAE</p> <p>DSR I/OB STA</p> <p>MO</p> <p>Register Select Switch in position:</p> <p>ABU BBU CBU SFT IOA SUM</p>		<p>With REG GROUP switch down (left-hand Register Select switch window determines REGISTER Display) the REGISTER indicators display the contents of:</p> <p>Accumulator register Program Counter register Operand Address register Multiplier Quotient register (EAE option) Priority Level/Step counter Index register Limit register Extended Arithmetic Element Discrete States (EAE option) Data Storage register Input/Output bus Input/Output Status (indicates only when the processor is stopped) Memory Output register</p> <p>With REG GROUP switch up (right-hand Register Select switch window determines REGISTER display) the REGISTER indicators display contents of:</p> <p>A bus B bus C bus Shift bus Input/Output address Sum bus</p> <p style="text-align: center;">NOTE</p> <p>The EAE, A bus, B bus, C bus, and Shift bus output indications are complementary. Therefore, when these functions are selected for display, a lamp is off to indicate a logic 1 (assertion) and lighted to indicate a logic 0 (negation).</p>
<p>Register Select Switch in position:</p> <p>M1</p>	<p>Twelve-position rotary switch</p>	<p>With REG GROUP switch up (right-hand Register Select switch window determines REGISTER display) the REGISTER indicators display contents of:</p> <p>Control Discretes Group 1</p> <p>Bit 00 - Division shift to the D bus 01 - Multiply shift to the D bus 02 - Single left rotate (RAL) to the D bus 03 - Single right rotate (RAR) to the D bus</p>





Table 1-1 (Cont)  
Console Controls

Control	Type	Function
SING TIME	Two-position rocker switch	In conjunction with the Continue (CONT) switch, permits the manual stepping of the program through individual time states of each major state.
SING STEP	Two-position rocker switch	In conjunction with the Continue (CONT) switch, permits the manual stepping of the program through individual major states of each instruction.
SING INST	Two-position rocker switch	In conjunction with the Continue (CONT) switch, permits the manual stepping of the program through one instruction at a time.
REPT	Two-position rocker switch	<p>With this switch in the ON position, the processor will repeat the key function depressed by the operator at the rate specified by the repeat speed setting.</p> <p>START - program execution will restart at a repeat rate of from 1 Hz to 3 kHz after the machine halts.</p> <p>EXECUTE - the instruction in the data switches will be executed at the repeat clock rate (1 Hz to 10 kHz).</p> <p>CONTINUE - program execution will continue at the repeat clock rate (1 Hz to 10 kHz) after halting.</p> <p>DEPOSIT: - the Deposit This; Deposit Next THIS, NEXT or Examine This; Examine Next EXAMINE: function will be repeated at the THIS, NEXT rate of from 1 Hz to 3 kHz.</p> <p>Depressing STOP or turning off the Repeat (REPT) switch will halt the repeat action.</p>
PROT	Two-position rocker switch	When set (back half of switch depressed) depressing START causes the system to start in protect (user) mode. This switch is active only when the KM15 protect option is installed.
BANK MODE	Two-position rocker switch	When set (back half of switch depressed) depressing START causes the system to start in bank mode permitting direct addressing of 8,192 (1777g) words of core memory. When switch is not set (front half depressed) depressing START causes the system to start in page mode permitting direct addressing of 4,096 (777g) words of core memory.
CLOCK	Two-position rocker switch	Inhibits program control of the real-time clock. Program control of the real-time clock resumes when the CLOCK switch is OFF.

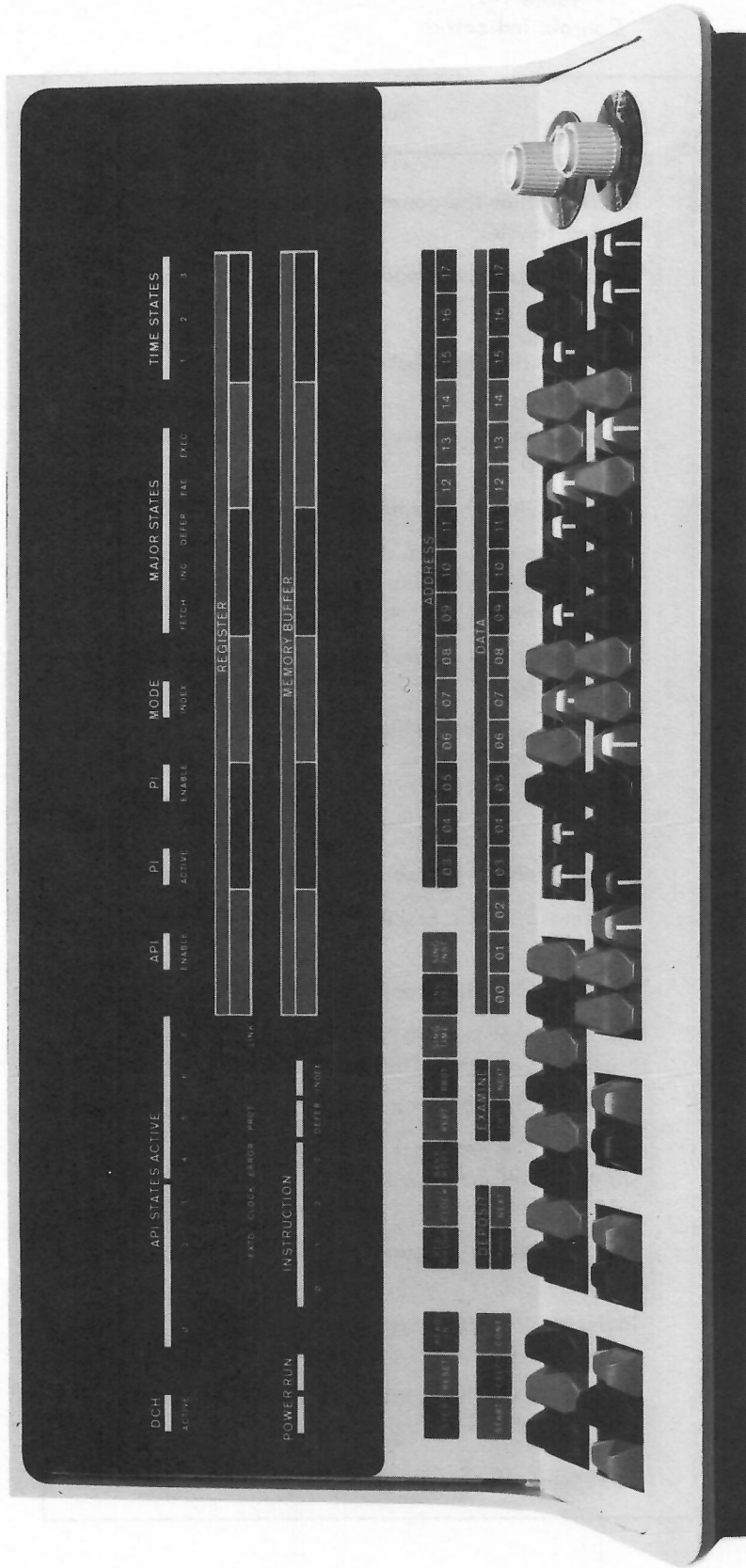

Figure 1-1 PDP-15 Control Console

Table 1-2  
Console Indicators

Indicator	Function
POWER	Indicates that the power supply voltages are at operating levels.
RUN	Indicates that the program execution is in progress.
EXTD	Always on.
CLOCK	Indicates that the real-time clock facility is enabled.
ERROR	Indicates that a memory parity error has been detected.
PROT	Indicates that the memory user mode is enabled.
DCH ACTIVE	Lights when the data channel is being serviced, i.e., data is being transferred between core memory and a device via the I/O bus.
API ENABLE	Lights when the automatic priority interrupt system is activated.
API STATES ACTIVE 0-3 4-7	Indicates API level(s) active. Hardware levels. Software levels.
MAJOR STATES	
FETCH	Indicates that the processor is in the fetch state.
INC	Indicates that the processor is in the increment state.
DEFER	Indicates that the processor is in the defer state.
EAE	Indicates that the processor is in the EAE (extended arithmetic element) instruction state.
EXEC	Indicates that the processor is in the execute state.
TIME STATES 1,2,3	Indicates the processor time states. When all time states are off machine is in time state 2A of the ADD instruction.
PI ACTIVE	Indicates that a program interrupt is pending service.
PI ENABLE	Indicates that the program interrupt system is enabled (under program control).
MODE INDEX	Indicates that the processor is operating in page mode and therefore indexing can be accomplished.
LINK	Displays state of the Link bit.

Table 1-2 (Cont)  
Console Indicators

Indicators	Function
INSTRUCTION	Displays contents of the 6-bit program word in-instruction field.
0-3	Displays the instruction operation code.
DEFER	Indicates that the operand is indirectly addressed.
INDEX	Indicates that the operand address is indexed when in page mode or that the upper 4K (of an 8K bank) is addressed when in bank mode.
MEMORY BUFFER 00-17	Displays the contents of the currently accessed memory address.
REGISTER 00-17	In conjunction with the setting of the REG GROUP and Register Select switches, displays: <ul style="list-style-type: none"> <li>a. data in a register.</li> <li>b. data on a bus.</li> <li>c. control signal levels.</li> </ul>

## 1.2 OPERATING PROCEDURES

Use the processor controls and indicators to perform basic manual control functions.

### 1.2.1 Power On

Figure 1-2 shows the power controls and indicators on the 715 Power Supply, located at the bottom of the H963D cabinet (bay 00). Proceed as follows:

<u>Step</u>	<u>Procedure</u>
1	Set the Repetition Speed/System Power control to OFF. Then set the primary ac power circuit breaker on. The power-on indicator lamp should light and the elapsed time meter should start.
2	Set the dc power circuit breaker to ON. This should remain on at all times.
3	Turn on all peripheral equipment circuit breakers.

<u>Step</u>	<u>Procedure</u>
4	Rotate the Repetition Speed/System Power control clockwise from the OFF position

NOTE

To prevent power from being turned off and keys from being activated at the console, set the console lock switch on the power supply (see Figure 1-2) to the LOCK position. Otherwise, the console lock switch should remain in the UNLOCK position (down).

### 1.2.2 Program Load Procedure

To load a program from paper tape, perform the following steps:

<u>Step</u>	<u>Procedure</u>
1	Turn System power switch ON.
2	Load program tape according to procedure in Chapter 2, or Chapter 5, if high-speed paper-tape reader is available.
3	Set program start address into Console Address switches.
4	Press STOP switch.
5	Press RESET switch.
6	Press READIN switch. Paper-tape is now read into core memory.

NOTE

At completion of paper-tape read-in, the processor reads the last word transferred to core memory as an instruction and executes it.

The above procedure is also used for tabulating other types of data stored on paper tape.

### 1.2.3 Start Program Procedure

To begin data processing at a specified address, perform the following steps:

<u>Step</u>	<u>Procedure</u>
1	Press STOP switch.
2	Press RESET switch.
3	Enter desired starting address in ADDRESS switches.
4	Press START switch. Selected program will now be executed.

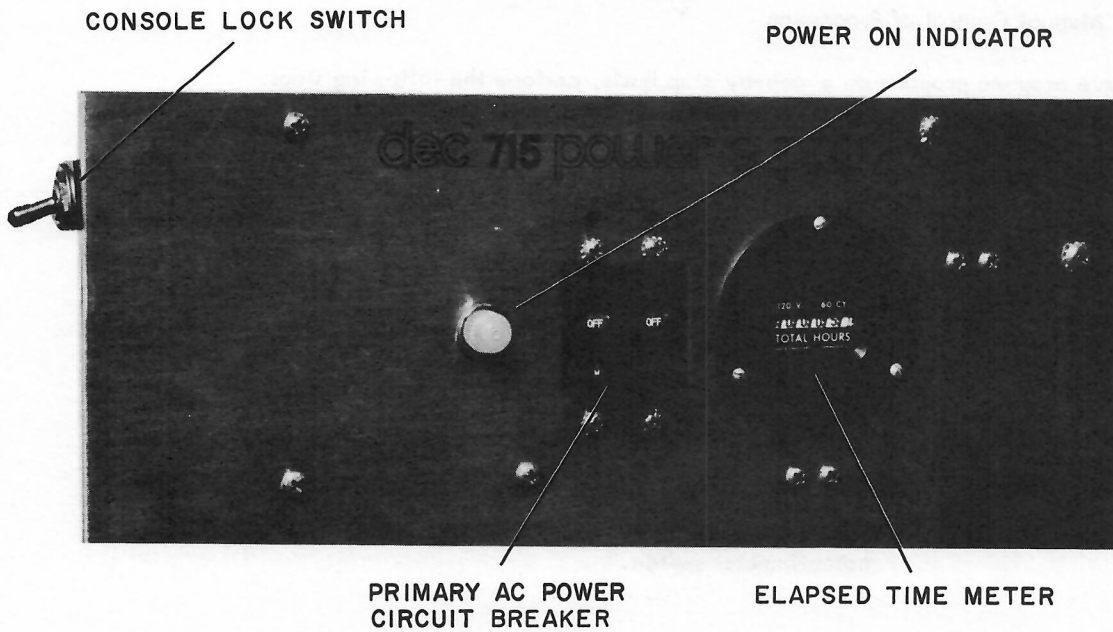

Rear View

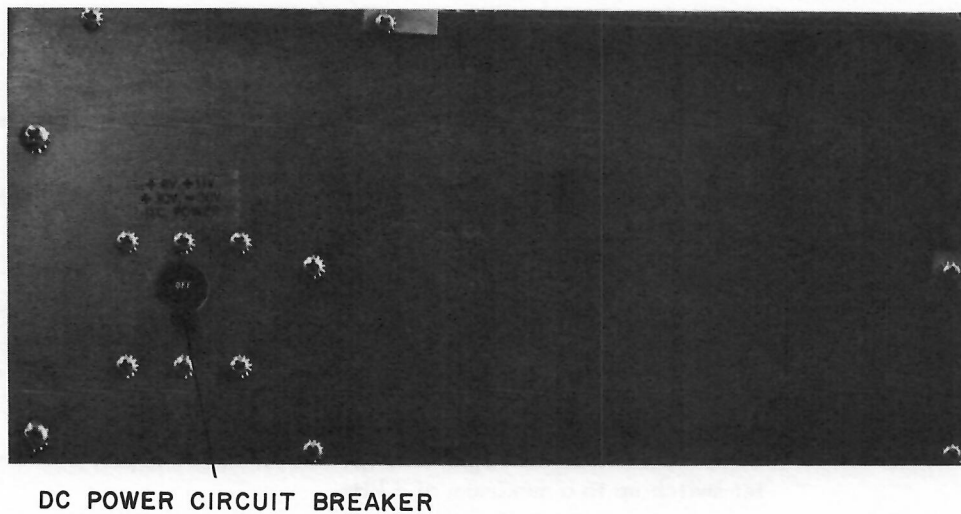

Front View

Figure 1-2 Power Controls and Indicators



#### 1.2.4 Manual Control of Processing

To observe program progress on a step-by-step basis, perform the following steps:

<u>Step</u>	<u>Procedure</u>
1	Set the SING INST or SING STEP or SING TIME switch for the desired operation; single instruction, single step (major state) or single time (time state) respectively.
2	Set the ADDRESS switches to specify the selected starting address.
3	Press the START switch. The results of the instruction, step, or time is available at the console displays.
4	Advance the program operation by pressing the CONT (continue) switch; or if desired, control the functions repetition rate with the repeat speed control portion of the Repeat Speed/System Power potentiometer switch.

#### 1.2.5 Memory Examination

To examine the contents of a selected core memory address, perform the following steps:

<u>Step</u>	<u>Procedure</u>
1	Set the ADDRESS switches to the memory location to be examined.
2	Press the EXAMINE THIS switch to observe the contents of the selected address.
3	To observe the next sequential memory address in the MEMORY BUFFER display, press the EXAMINE NEXT switch. Each time the EXAMINE NEXT switch is pressed, the MEMORY BUFFER display will show the contents of the next sequential memory location; or, with the REPT switch depressed, will advance through memory locations automatically at the rate determined by the repeat speed control portion of the Repetition Speed/System Power potentiometer switch up to a maximum of 3 kHz.

#### 1.2.6 Data Storage from Console

To manually insert data into a specific memory location, perform the following steps:

<u>Step</u>	<u>Procedure</u>
1	Set the DATA switches to the binary configuration of the data that is to be deposited into core memory.
2	Set the ADDRESS switches to specify the memory location where the data is to be stored.



Step

Procedure

3

Press the DEPOSIT THIS switch; or, to deposit data in sequential memory locations, set the DATA switches to the data word configuration and press the DEPOSIT NEXT switch. Each time the DEPOSIT NEXT switch is depressed, the current DATA switch configuration will be deposited in the next sequential memory location.

NOTE

Examination and depositing of information into or out of memory can be conducted without affecting the contents of the PC, AC, XR, LR and L. Thus a program can be stopped, an arbitrary location can be loaded or examined and the program can be continued by depressing the Continue (CONT) switch. While the program is running (RUN indicator light on) the EXAMINE, EXAMINE NEXT, DEPOSIT, DEPOSIT NEXT, START, EXEC (execute), and CONT switches are not effective. The program must be stopped by depressing the STOP switch or by depressing the SING TIME, SING INST, or SING STEP switches. This interlock was provided to prevent accidental destruction of an operating program. Switches which are active during RUN are located on the upper left of the console panel.

1.2.7 Manual Execution of Instruction

To manually execute an instruction encoded at the console, proceed as follows:

Step

Procedure

1

Set the DATA switches to the binary format of the instruction word.

2

Press the EXEC key. The processor will halt after executing the instruction.

1.2.8 Reset

To clear the machine states, and the I/O control and devices, press the RESET key. If the machine is hung (e.g., non-existent memory has been referenced and the memory protect option is not installed), press both the STOP and RESET keys at the same time.

NOTE

Do not perform this last step unless necessary because the contents of memory locations will be destroyed.

### 1.3 MEMORY BANK SELECTION

Each 8K memory bank is equipped with a pair of memory bank selection switches, shown in Figure 1-3. These switches are used to assign a specific bank address to each 8K memory bank that is implemented. The upper switch is associated with memory address bit 03 (MA03), and the lower switch is associated with memory address bit 04 (MA04). Together, they assign a bank address as indicated in Table 1-3.

Table 1-3  
Memory Bank Selection

Bank	Upper Switch MA03	Lower Switch MA04
0 (0-8K)	Down (0)	Down (0)
1 (8K-16K)	Down (0)	Up (1)
2 (16K-24K)	Up (1)	Down (0)
3 (24K-32K)	Up (1)	Up (1)

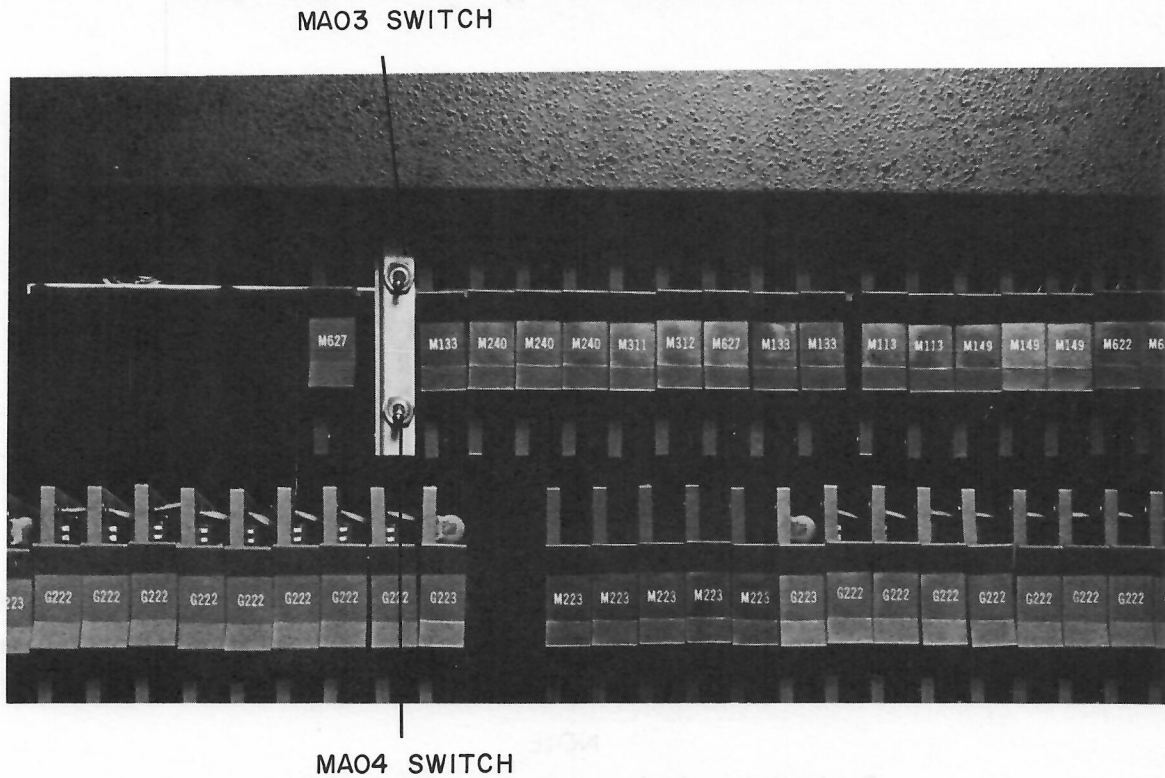

Figure 1-3 Memory Bank Selection Switches

## 1.4 BB15 CONTROLS AND INDICATORS

The BB15 controls and indicators are shown in Figures 1-4 and 1-5. The functions of each indicator on the BB15 indicator panel are listed in Table 1-4.

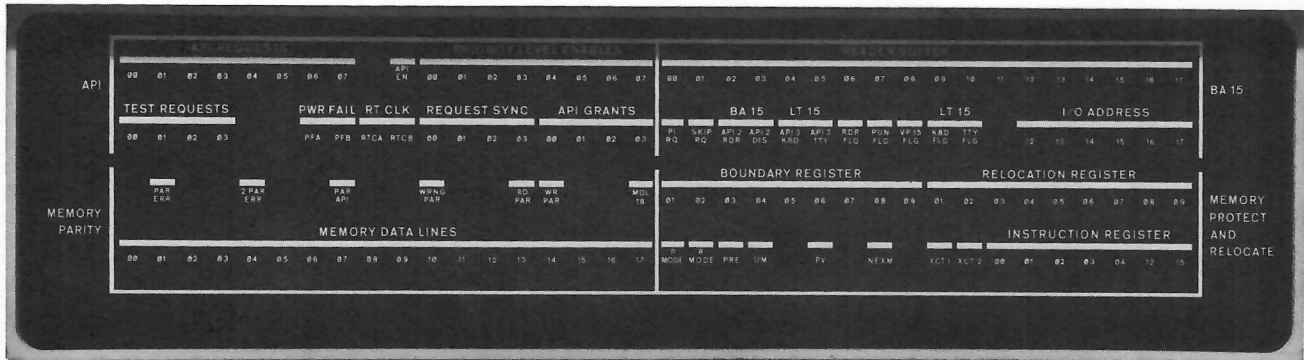

Figure 1-4 BB15 Indicator Panel

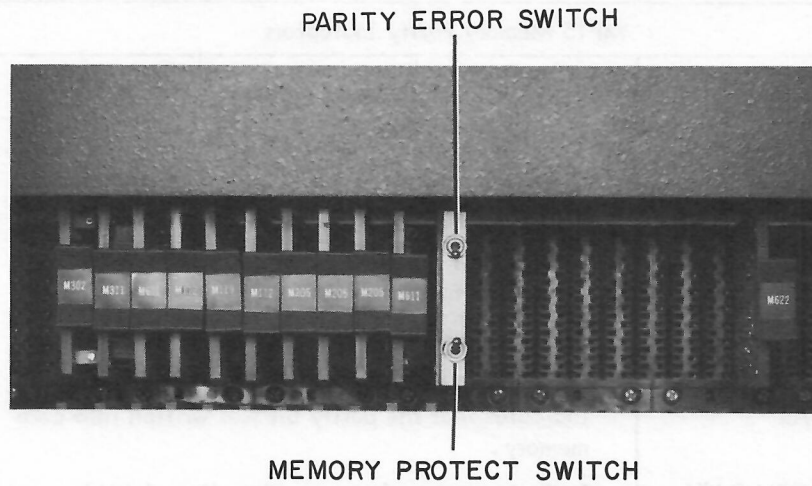

Figure 1-5 BB15 Control Switches

Table 1-4  
BB15 Indicator Panel

Indicator	Function
KA15 Automatic Priority Interrupt Indicators	
API REQUESTS 00-07	Each lamp lights when the associated API level is requested by a device.
TEST REQUESTS 00-03	Each lamp lights when the associated hardware API level 00-03 is tested.
PRIORITY LEVEL ENABLES	The API EN and one of eight lamps (00-07) light when the associated API level is enabled.
API GRANTS	Each lamp lights when API GRANT is sent to all devices on requested hardware API level 00-03.
REQUEST SYNC	Indicates that a particular API level (0-7) has been requested, and that level is enabled.
PWR FAIL	PFA indicates a request from the KF15 power fail option for an API break. PFB indicates that the power fail API request has been granted.
RT CLK	RTCA indicates a request from the KW15 real time clock option for an API break. RTCB indicates that the real time clock API request has been granted.
MP15 Memory Parity Indicators	
PAR ERR	Indicates a parity error has been detected.
2 PAR ERR	Not used
PAR API	Indicates an API request initiated by the MP15 Memory Parity option.
WRNG PAR	Lights when the force wrong parity flop FWP is set. Used for maintenance purposes only.
RD PAR	Indicates that the parity bit was read from core memory.
WR PAR	Indicates that the parity bit was written into core memory.
MEMORY DATA LINES 00-17	Indicates status of memory data lines (MDL).
MDL 18	Indicates status of parity bit on MDL 18.
BA15 Indicators	
READER BUFFER 00-17	Indicates contents of 18-bit Reader Buffer register.

Table 1-4 (Cont)  
BB15 Indicator Panel

Indicator	Function
BA15 Indicators (Cont)	
PI RQ SKIP RQ API 2 RDR API 2 DIS API 3 KBD API 3 TTY RDR FLG PUN FLG VP15 FLG KBD FLG TTY FLG I/O ADDRESS	Indicates program interrupt has been requested. Indicates an IOT instruction test for a skip condition has been satisfied. Indicates API level 2 interrupt by high-speed paper-tape reader. Indicates API level 2 interrupt by display. Indicates API level 3 interrupt by Teletype keyboard. Indicates API level 3 interrupt by Teletype printer. Indicates flag raised by high-speed paper-tape reader. Indicates flag raised by high-speed paper-tape punch. Indicates flag raised by VP15 display device. Indicates flag raised by Teletype keyboard. Indicates flag raised by Teletype printer. Indicates I/O device address and subdevice selection bits.
KM15 Memory Protect and KT15 Memory Protect/Relocate Indicators	
BOUNDARY REGISTER RELOCATION REGISTER P MODE R MODE PRE UM PV NEXM	Indicates the address below which the user can not go in Protect Mode; and the last 256 word page available to the user in relocate mode. Indicates the contents of the 9-bit Relocation Register, which specifies the first address to which the user is to be relocated. Indicator lamp lights when KT15 is in Memory Protect-only mode. Indicator lamp lights when KT15 is in Memory Protect and Relocate mode. Indicates preliminary entry into User mode. Indicator lamp lights when KM15 is in User mode. Indicates protect violation flag is up. Indicates nonexistent memory violation has occurred.



Table 1-4 (Cont)  
BB15 Indicator Panel

Indicator	Function
KM15 Memory Protect and KT15 Memory Protect/Relocate Indicators (Cont)	
XCT1	Indicates that one XCT instruction has been de-coded.
XCT2	Indicates that an illegal XCT of XCT has been attempted by a user.
INSTRUCTION REGISTER	Indicates contents of a 7-bit KM15 Instruction Register that is used to detect illegal user in-structions, such as HLT, OAS, and IOTs.

The two BB15 control switches shown in Figure 1-5 are used to control the MP15 Memory Parity option and the KT15 Memory Protect/Relocate option.

#### 1.4.1 MP15 Memory Parity

The upper switch shown in Figure 1-5 controls the memory parity option when it is implemented.

- a. When the switch is placed in the up position and the program interrupt (PI) facility is enabled, a parity error causes a program interrupt.
- b. When the switch is placed in the down position, the computer halts if a parity error is detected.

#### 1.4.2 KT15 Memory Protect/Relocate

The lower switch shown in Figure 1-5 controls the memory protect/relocate option when it is implemented.

- a. When the switch is placed in the up position, the KT15 provides only memory protection.
- b. When the switch is placed in the down position, the KT15 provides complete memory protection and relocation capabilities.

## Chapter 2

### Teletypewriter Sets

#### 2.1 TELETYPE® MODELS 33 ASR AND 35 KSR

The Teletype® Model 33 ASR is standard on the PDP-15/10; Teletype Model 35 KSR is standard on the PDP-15/20, 15/30, and 15/40. These teletypewriter sets can be used to type in or print information at rates of up to ten characters per second. The keyboard control includes an eight-bit buffer to hold the last character (ASCII code) struck on the keyboard and a flag to signal the processor of the presence of a character. The printer control contains an eight-bit buffer to hold one character while it is being printed. When the Teletype Model 33 ASR is used as the principal program input device, its paper-tape reader and punch are interfaced to the system; this is the case with the PDP-15/10.

##### 2.1.1 Controls and Indicators

Teletype Model 33 ASR and Teletype Model 35 KSR are illustrated in Figures 2-1 and 2-2 respectively. Controls for these Teletypes, other than keyboard control functions, are described in Table 2-1. Use of the keyboard control functions for both models are described in Paragraph 2.1.6.

Table 2-1  
Teletype Model 33 ASR Controls and Indicators

Control/Indicator	Type	Function
REL (Punch)	Pushbutton	Disengages the tape in the punch to allow tape removal or tape loading.
B. SP. (Punch)	Pushbutton	Backspaces the tape in the punch by one space, allowing manual correction or rubout of the character just punched.
ON, OFF (Punch)	Alternate action pushbuttons	Controls use of the tape punch with operation of the Teletype keyboard/printer.

® Teletype is a registered trademark of the Teletype Corporation, Skokie, Illinois.

Table 2-1 (Cont)  
Teletype Model 33 ASR Controls and Indicators

Control/Indicator	Type	Function
START/STOP FREE (Reader)	3-position switch	Controls use of the tape reader with operation of the Teletype. In the lower FREE position the reader is disengaged and can be loaded or unloaded. In the center STOP position the reader mechanism is engaged but de-energized. In the upper START position the reader mechanism is engaged and operated under program control.
LINE/OFF/LOCAL	3-position rotary switch	Controls application of primary power in the Teletype and controls data connection to the processor. In the LINE position the Teletype is energized and connected as an I/O device of the computer. In the OFF position the Teletype is de-energized. In the LOCAL position the Teletype is energized for off-line operation, and signal connections to the processor are broken. Both line and local use of the Teletype require that the computer be energized through the console POWER switch.

### 2.1.2 Loading Paper

Roll paper is loaded directly into the teletypewriter equipped for its use. Space must be provided for the perforated fanfold paper carton behind the teletypewriter equipped for that type of paper.

2.1.2.1 Roll Paper Procedure - Figure 2-3 illustrates paper threading for the Model 33 ASR friction-feed typing unit (for roll paper). A friction-feed teletypewriter set accommodates a standard roll of paper 8-1/2 in. wide and 5-in. in diameter. Install the roll by performing the following steps:

<u>Step</u>	<u>Procedure</u>
1	Insert the paper roll spindle into the roll of paper so that an equal length of spindle is exposed at either end of the roll.
2	Place the roll of paper into the paper recess of the cover so that the ends of the paper roll spindle rest in slots provided, and so that the paper will unroll forward from the bottom.





Figure 2-1 Teletype Model 33 ASR



Figure 2-2 Teletype Model 35 KSR

Step

Procedure

3

Raise the lid on the cover. Fold the leading edge of the paper back and crease it to present a smooth edge for threading. The paper should unroll from the bottom of the roll, pass forward and up, over the paper straightener, and down and under the platen. Release the pressure roller tension by moving the pressure lever frontward. Push the paper in as far as it will go. Reapply the pressure roller tension and advance the paper by turning the platen knob clockwise, as viewed from the right, until the paper can be passed under the paper guide. Release tension on the pressure roller again, and straighten the paper. Reapply the pressure roller tension to hold the paper in place. Close the cover lid.

NOTE

When typing units are stored or out of service for an extended period of time, release the pressure roller by moving the pressure lever forward.

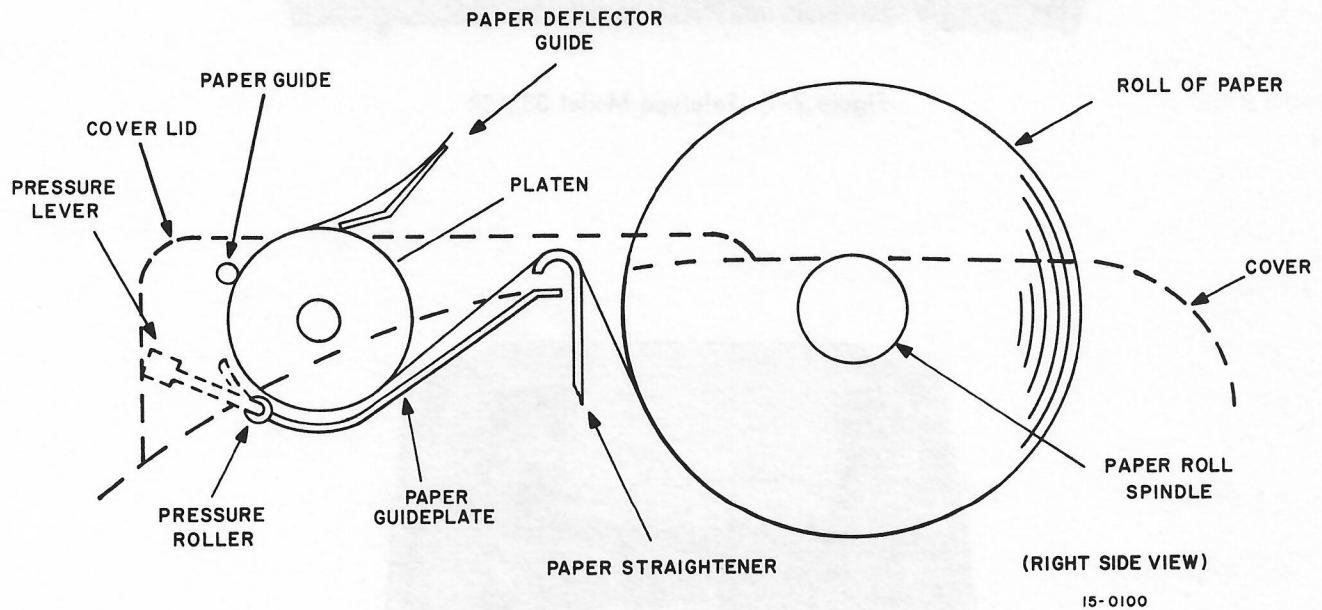
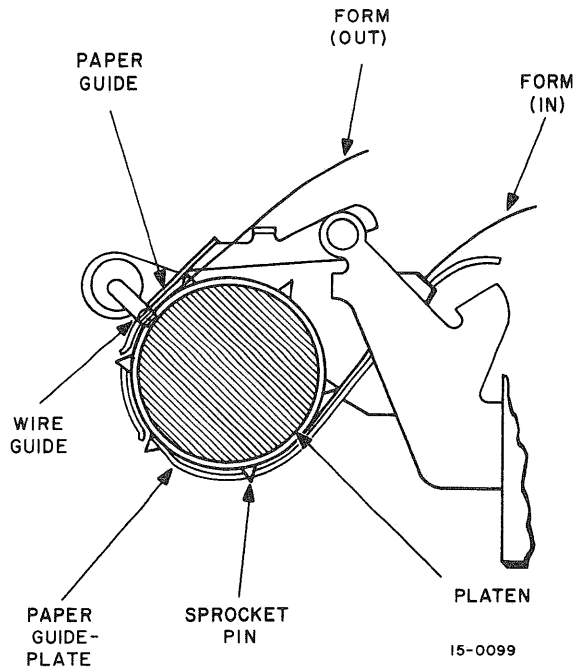

Figure 2-3 Roll Paper Installation\*

2.1.2.2 Form Paper Procedure - Figure 2-4 illustrates form threading for the Model 35 KSR sprocket-feed typing unit (for form paper).

\* Illustration is reproduced by permission of Teletype Corporation, Copyright 1962, 1963, and 1964 by Teletype Corporation.



(a) Model 33 ASR

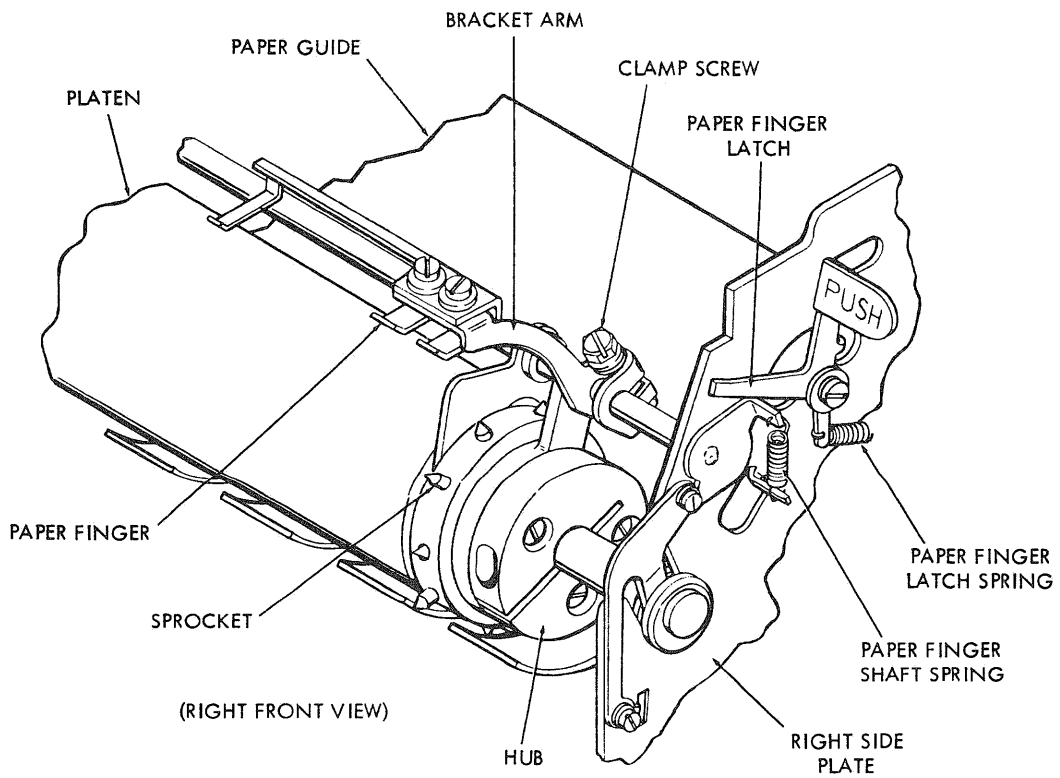

(b) Model 35 KSR

Figure 2-4 Form Paper Installation\*

\* Illustration reproduced by permission of Teletype Corporation, Copyright 1962, 1963 and 1964 by Teletype Corporation.

A sprocket-feed, teletypewriter set, accommodates 8-1/2 in. wide forms of various lengths. They are normally passed to the typing unit from a conveniently located stack of forms.

Install form paper in the Model 35 KSR by performing the following steps:

<u>Step</u>	<u>Procedure</u>
1	Raise cover by depressing the cover release buttons on each side of the cover lid.
2	Place the leading edge of the form fold paper through the slot at the top-rear of the unit and guide the paper over the paper guide to the rear of the platen.
3	With the paper flush against the underside of the platen, rotate the platen knob until the paper appears at the front of the platen.
4	Release the paper finger bracket by pressing the paper finger latch (PUSH) located above the right ribbon reel.
5	Hold the paper against the platen and rotate the platen knob until 2-inches of paper extends above the platen. Ensure that the sprocket engages the holes on both sides of the paper.
6	Push the paper finger bracket down to the platen so that the fingers hold the paper against the platen.
7	Close and secure the cover. Raise the plastic dome by holding both sides and lifting.
8	Hold the lead edge of the paper forward and close the dome in back of the paper.

### 2.1.3 Ribbon Replacement

Figure 2-5 illustrates ribbon threading for the Model 33 ASR. To replace ribbon perform the following steps:

<u>Step</u>	<u>Procedure</u>
1	Raise the lid on the cover. Pull both spools off the friction spindles.
2	Engage the hook that is on the end of the ribbon in the hub of the empty spool; or if there is no hook, pierce the end of the ribbon over the point of the arrow in the hub of the empty spool.
3	Wind a few turns of ribbon onto the empty spool in the direction indicated by the arrow, and ensure that the reversing eyelet has been wound upon the spool.
4	Place the spools on the shafts in such a manner that the ribbon feeds to the rear from the right side of the right spool and from the left side of the left spool.
5	Turn each spool slightly until the driving pin on the spool engages the hole in the spool.

<u>Step</u>	<u>Procedure</u>
6	Pull the ribbon around the right vertical post and through the slot in the reverse arm.
7	Place the ribbon in the right slot of the ribbon guide, around the rear of the guide on both the right and left side, and through the left slot of the guide. Pull it forward on the left side through the reverse arm slot and around the left side of the vertical post.
8	Rotate the spool to take up any slack.

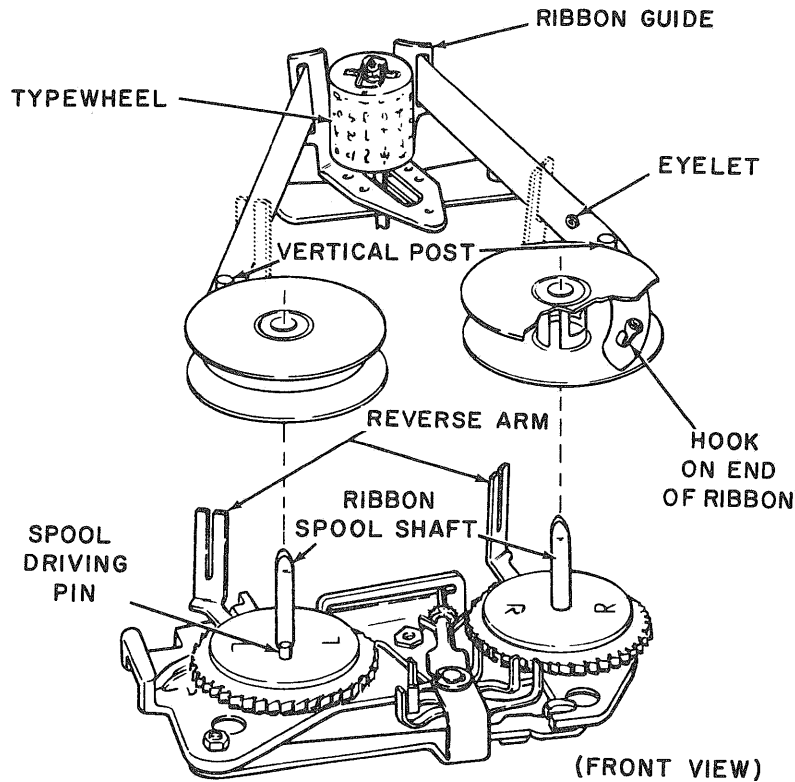

Figure 2-5 Ribbon Installation\*

To replace ribbon in the Model 35 KSR perform the following steps:

<u>Step</u>	<u>Procedure</u>
1	Raise the cover by depressing the cover release buttons on each side of the cover lid.
2	Raise the reel retaining clips on the top of the two ribbon spools.

\*Illustration reproduced by permission of Teletype Corporation, Copyright 1962, 1963, and 1964 by Teletype Corporation.

<u>Step</u>	<u>Procedure</u>
3	Observe ribbon path between spools and carefully lift the spools off the shafts and remove the ribbon from the ribbon guides.
4	Unwind approximately 3 feet of ribbon from a new spool and place this spool on the right-hand spool shaft so that the ribbon feeds to the front from the right-hand side of the spool. Secure the spool by pushing the retaining clip down on top of the spool.
5	Thread the ribbon over the front of the roller, through the ribbon guide next to the roller, and through the ribbon guides in front of the platen.
6	Engage the hook, that is on the end of the ribbon, in the hub of an empty take-up spool; or, if there is no hook, pierce the end of the ribbon over the point of the arrow in the hub of the empty spool.
7	Turn the take-up spool a few turns clockwise, and ensure that the reversing eyelet has been wound upon the spool hub.
8	Place the ribbon into the guide slot next to the take-up spool and across the front of the roller next to the guide slot. Turn the spool to take up the slack in the ribbon, and place the take-up spool on the shaft.
9	Secure the spool by pushing the retaining clip down on top of the spool. Close the cover.

#### 2.1.4 Installing Paper-Tape in Punch (Teletype Model 33 ASR only)

Perform the following steps to install new blank paper-tape in the Model 33 ASR paper-tape punch:

<u>Step</u>	<u>Procedure</u>
1	Place paper tape roll on correct spool according to the following: <ul style="list-style-type: none"> <li>a. For the 2-in. inside diameter tape roll, use the tube-type spool.</li> <li>b. For the 1-in. inside diameter tape roll, use the two-piece spool.</li> </ul>
2	Assemble the tape with the spool into the tape punch cover so that the leading edge of the tape is always at the top of the roll.
3	Raise the punch cover.
4	Manually feed the tape from the top of the roll into the guide at the back of the punch and advance the tape through the punch by manually turning the friction wheel.
5	Close the punch cover.
6	Energize the punch by pressing the ON pushbutton, and produce about 2 ft of leader. To produce the leader, simultaneously press and hold both the REPT and RUBOUT keys until a sufficient amount of leader has been punched.

### 2.1.5 Installing Punched Paper-Tape in Reader (Teletype Model 33 ASR only)

Perform the following steps to install paper-tape in reader:

<u>Step</u>	<u>Procedure</u>
1	Set the reader START/STOP/FREE switch to the FREE position.
2	Release the cover guard by means of the latch at the right and open cover.
3	Place the leading edge of the punched tape over the reader sprocket wheel so that the small holes in the tape engage the sprocket feeder and the leader is at least three holes past the sprocket wheel.
4	Close reader cover.

### 2.1.6 Keyboard Operating Procedures

Facilities are provided on the keyboard to generate the American Standard Code for Information Interchange (ASCII). The keyboard utilizes two SHIFT keys and one control (CTRL) key. The SHIFT key is used to generate the code combinations for printing characters appearing on the upper keytops (e.g., \$ that appears above 4 on the keytop). The CTRL key is used to generate the codes for the control characters appearing on the upper keytops (e.g., WRU appears above E on the keytop).

### 2.1.7 Duplicating Paper Tapes

To duplicate and obtain a typed listing of an existing ASCII formatted tape:

- a. Load the tape to be duplicated into the paper-tape reader as described in Paragraph 2.1.5.
- b. Set teletypewriter LINE/OFF/LOCAL switch to LOCAL position.
- c. Set the reader START/STOP/FREE switch to the START position. Punch and printer operates until tape being duplicated is completely read.

### 2.1.8 Correcting Paper Tapes

Corrections to insert or delete information on a perforated tape can be made by duplicating the correct portion of the tape and manually punching additional information or inhibiting punching of information to be deleted. This is accomplished by duplicating the tape and carefully observing the information being typed as the tape is read. In this manner the reader START/STOP/FREE switch can be set to the STOP position just before the point of the correction is typed. Information to be inserted can then be punched manually by means of the keyboard. Information can be deleted by depressing the OFF pushbutton and operating the reader until the portion of the tape to be deleted has been typed. It may be necessary to backspace and rub out one or two characters on the new tape if the reader is

not stopped precisely on time. The numbers of the characters to be rubbed out can be determined exactly by the typed copy. Be sure to count spaces when counting typed characters. Continue duplicating the tape in the normal manner after making the corrections.

#### NOTE

New, duplicated, or corrected perforated tapes should be verified by typing them off-line and carefully proof-reading the typed copy.

#### 2.1.9 Chad Disposal

Chad (paper-tape punchings) accumulates in a chad box beneath the paper tape punch. Chad should be disposed in the following manner before the box is completely full:

- a. Lift the front of the chad box slightly and pull toward the front until it becomes disengaged.
- b. Carefully dump chad into a suitable container away from system equipment.

#### CAUTION

Chad and accompanying dust can cause equipment malfunction if drawn into the equipment by the cooling fan.

- c. To replace the chad box, push it toward the rear until the bent surface, located at the front of the chad box, engages the stand. An embossing located on the front bottom surface of the flanged surface engages an oblong hole in the stand and holds the chad box in place.



## Chapter 3

### Card Reader

#### 3.1 CR03B CARD READER

The CR03B Card Reader provides the PDP-15 with a punched-card data input facility. It reads standard 80-column, 12-row, punched cards at a rate of up to 200 cards per minute. Solid-state circuit design and continuous status checks ensure system reliability.

The output hopper can store 450 cards in their original deck orientation.

##### 3.1.1 Controls and Indicators

Card Reader Operator controls and indicators are illustrated in Figure 3-1 and described in Table 3-1.

Table 3-1  
Card Reader Controls and Indicators

Control/Indicator	Type	Function
ON/OFF	Toggle switch	Enables power to all reader circuits except the motor.
MOTOR START	Pushbutton switch	Starts the drive motor, provided no error conditions exist (see Paragraph 3.1.3).
	Green indicator lamp	When lighted, indicates power is applied to drive motor.
READ START	Pushbutton switch	Enables card reading to proceed under program control.
	Green indicator lamp	Remains lighted as long as cards may be read. Will be extinguished when card reading is disabled by an error condition or by depressing the READ STOP switch.
READ STOP	Pushbutton switch	Disables card reading under program control.
	Red indicator lamp	Remains lighted as long as program controlled card reading is disabled for any reason.

Table 3-1 (Cont)  
Card Reader Controls and Indicators

Control/Indicator	Type	Function
PICK FAIL STACKER FAIL HOPPER EMPTY STACKER FULL DARK CHECK LIGHT CHECK SYNC FAIL	Red indicator lamps	Conditions indicated by these lamps disable automatic card readings and stop the reader drive motor. Refer to Paragraph 3.1.3 for operator action required.

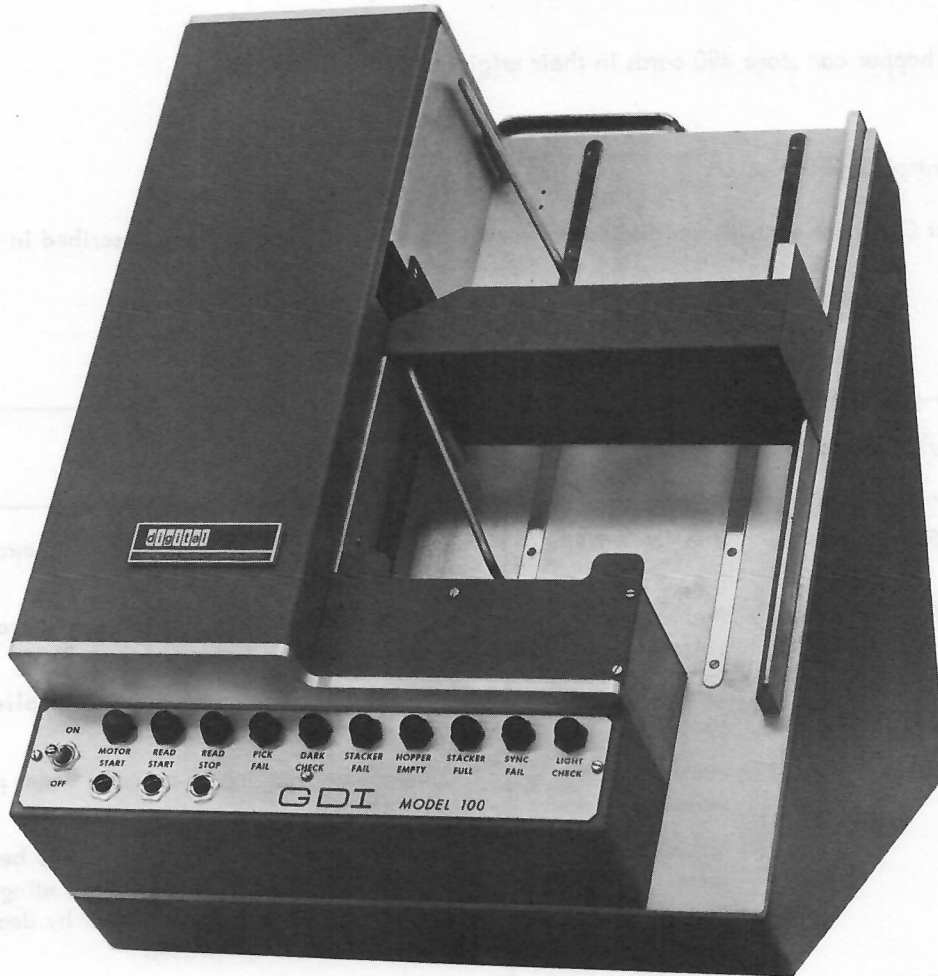

Figure 3-1 Card Reader CR03B

### 3.1.2 Loading and Removing Cards

Perform the following steps to load cards into the reader, place the reader on-line and remove processed cards.

<u>Step</u>	<u>Procedure</u>
1	Before placing the card decks in the feed hopper, riffle the deck by holding it at one end and flipping the cards with the thumb sliding over the card edges at the opposite end of the deck. Then hold the other end of the deck and repeat the same action. This process promotes trouble-free operation by expelling foreign particles from the deck and reduces the tendency of the cards to cling together and cause card jam.
2	Place deck in feed hopper, printed side down and cut-corner of cards at left front corner of deck.

#### NOTE

If assembled deck stands taller than 3-1/2 in. (about 450 cards), place first three inches of deck in reader and add subsequent positions of deck as reading proceeds.

3	Press MOTOR START and READ START pushbuttons, to place reader on-line. Cards will be read under program control.
4	Processed cards may be removed while the reader is on-line if the card deck height in the output stacker does not exceed 3-1/2 in. This condition is detected by the stack follower. Therefore, remove processed cards by sliding them from under the follower without lifting it.

#### NOTE

If card deck in output stacker is permitted to exceed 3-1/2 in. the card reader will go off-line and shut down automatically and the STACKER FULL indicator will light.

5	The card reader may be taken off-line manually by pressing the READ STOP pushbutton.
---	--

### 3.1.3 Error Indicators and Corrective Actions

The card reader has error detection circuits which halt operation and identify the error to the operator by means of red indicator lamps on the control panel. The indicators, their significance, and the operator action called for in each error condition, are listed below. After taking the recommended action, unless corrective maintenance is required, depress MOTOR START, then READ START, to resume operation.

- a. PICK FAIL: A card has not entered the read station after two successive pick attempts. Clear card track. Remove cards from feed hopper and riffle, then, reload. (See loading instructions in Paragraph 3.1.2.)
- b. DARK CHECK: Indicates a photo cell malfunction. Report the unit for corrective maintenance.
- c. STACKER FAIL: Three cards have left the read station and none of them has reached the output hopper; clear card track.
- d. HOPPER EMPTY: No cards in feed hopper. Load hopper if additional card data is to be processed.
- e. STACKER FULL: Too many cards in output hopper. Remove cards from hopper.
- f. SYNC FAIL: Failure of the sync pulse, an internal timing signal. Report the unit for corrective maintenance.
- g. LIGHT CHECK: Indicates a photo cell malfunction. Report the unit for corrective maintenance.

#### 3.1.4 Cleaning

At least twice a week, dust the outside of the machine, ensuring that the hoppers are clean. Then, open the card cover and clean the area of the card track, using a vacuum device or a soft, lint-free cloth.

## Chapter 4 Line Printer

### 4.1 LP15C LINE PRINTER AND CONTROL (1000 lpm)

Line Printer LP15C (see Figure 4-1) prints 1000 lines per minute, using a 132-column, 64-character print drum. The information transfer between the PDP-15 and the LP15C control is accomplished via the multi-cycle data channel facility; the information transfer between the LP15C control and the line printer is accomplished on a demand/grant character-at-a-time basis.

#### 4.1.1 Controls and Indicators

The LP15C Line Printer controls and indicators are illustrated in Figures 4-2 through 4-4 and are described in Table 4-1. The LP15C indicator panel is illustrated in Figure 4-5 and is described in Table 4-2.

Table 4-1  
LP15C Line Printer Controls and Indicators

Control/Indicator	Type	Function
START	Pushbutton indicator	Connects the printer ON LINE with the external data source. START control is inhibited when operation is in the TEST PRINT mode.
STOP	Pushbutton indicator	Stops operation in both the TEST PRINT and ON LINE modes of operation.
TEST PRINT	Pushbutton indicator	Causes the printer to print out a selected test pattern. Pressing the STOP switch stops printer operation and advances the paper to the next form. If there is no vertical format unit (FU) tape, the form will not advance. TEST PRINT is inhibited when operating in the ON LINE mode.
MANUAL PRINT	Pushbutton	Puts printer under manual control.

Table 4-1 (Cont)  
LP15C Line Printer Controls and Indicators

Control/Indicator	Type	Function
TOP OF FORM	Pushbutton indicator	Advances paper to the first print position of the next form. If there is no vertical format tape on the FU reader, the paper will advance one line. TOP OF FORM is inhibited during on-line or test print operation.
NO PAPER	Indicator	Indicates paper is no longer in the upper set of tractors. Indicator remains lit until paper is replaced.
PAPER LOW ALERT	Indicator	Indicates that less than 30 lines of paper supply remain. On-line printing, one line at a time for each depression of the START switch is permitted until the paper supply is exhausted.
YOKE OPEN	Indicator	Indicates yoke is open.
ALARM STATUS	Indicator	Indicates alarm condition due to low paper supply, no paper, or power up sequence in process.
ON	Pushbutton indicator	Causes power to be applied to the printer. When the switch is illuminated, the printer is ready for operation.
OFF	Pushbutton	Causes power to be removed from the printer. The OFF switch will be illuminated when the main circuit breaker is on.
FORM POSITION	Control	Controls the print on the page. Clockwise rotation lowers the print on the page while counterclockwise rotation raises the print on the page. The scale and printer (see Figure 4-10) associated with the FORM POSITION knob can be used as a reference when starting a new form. The FORM POSITION knob can be turned while the printer is running.
PENETRATION	Controls	Two PENETRATION knobs control print density. They must be aligned so that the print density is equal across the page. Counterclockwise rotation of the knobs darken the print. It is necessary to make an adjustment each time a form of different thickness is fed into the printer. The thicker the form, the less penetration required. Stop the printer before making any adjustments.
YOKE OPEN/CLOSE	Toggle switches	Two YOKE OPEN/CLOSE switches must be operated simultaneously. Pressing down on both switches opens the yoke. Pressing up on both switches closes the yoke. It is automatically prevented from exceeding its limit in either direction.

Table 4-1 (Cont)  
 LP15C Line Printer Controls and Indicators

Control/Indicator	Type	Function
Vertical FORM TENSION	Control	Adjusts vertical tension applied to paper.
Horizontal FORM TENSION	Control	Two horizontal FORM TENSION controls are used to position the tractors laterally to handle various size paper. An upper and lower tractor on each side work in unison. The FORM TENSION controls also provide horizontal tension to the paper.
PHASING	Control	Centers the hammers so that a full character is printed. If the lines of print have portions of characters clipped off, rotate the knob until the full characters are printed.





Figure 4-1 LP15C Line Printer



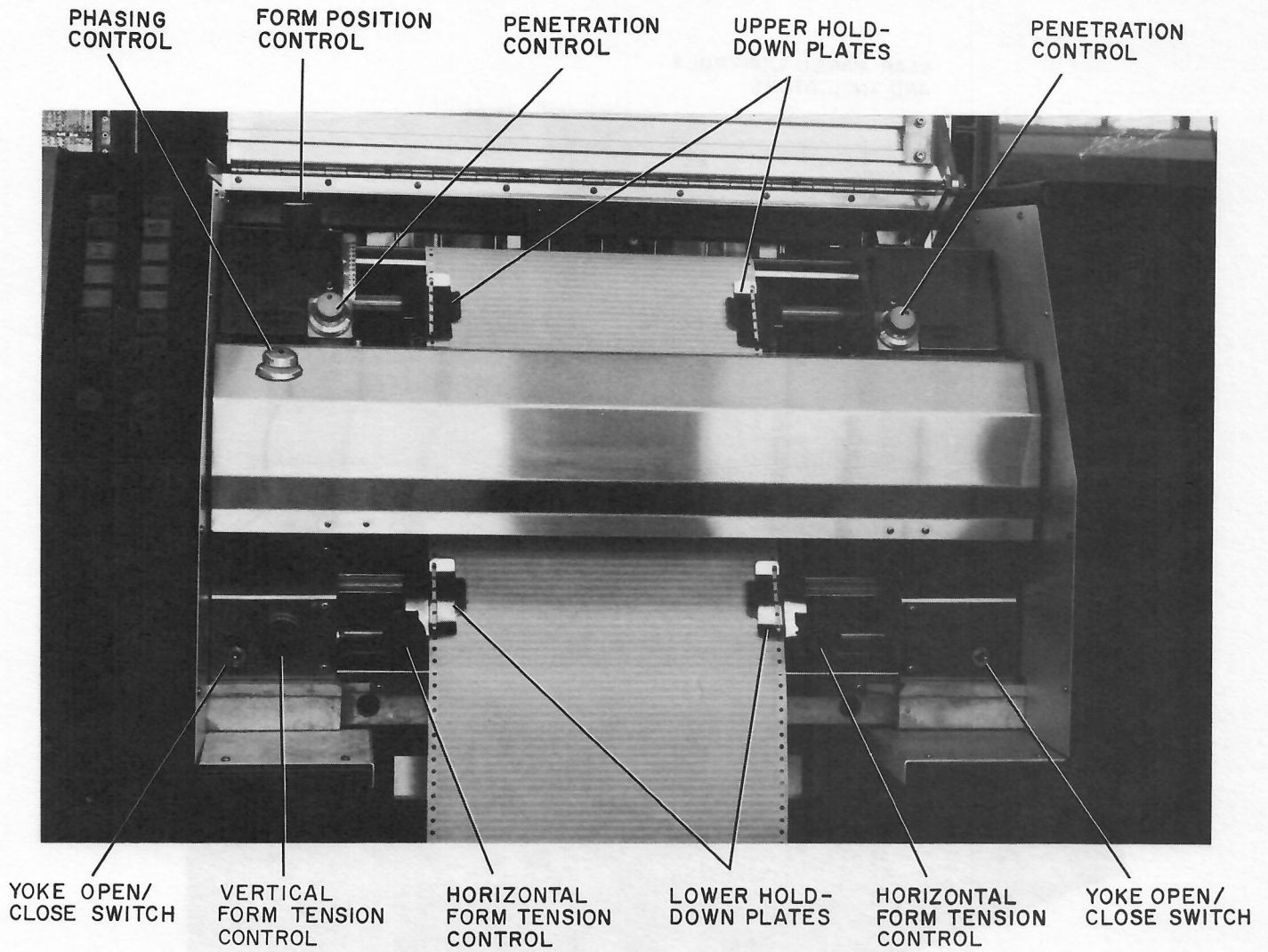
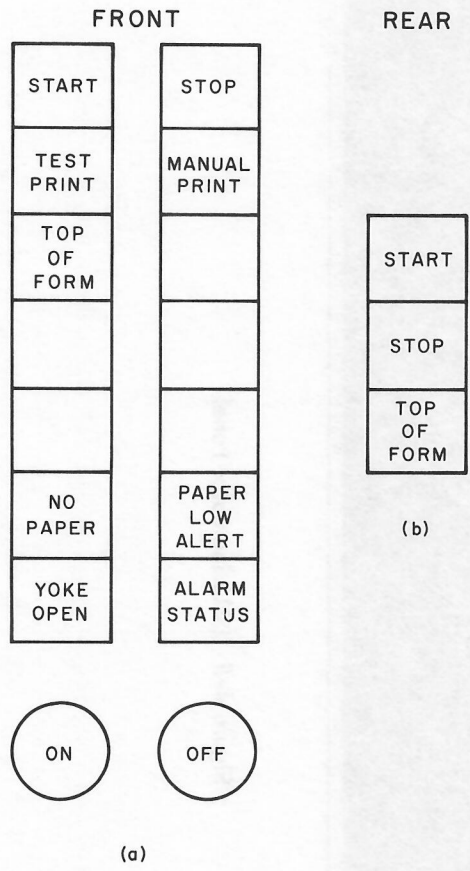

Figure 4-2 LP15C Line Printer Controls and Indicators

REAR PANEL CONTROLS  
AND INDICATORS



Figure 4-3 LP15C Line Printer Controls and Indicators



15-0240

Figure 4-4 LP15C Control Panel Switches

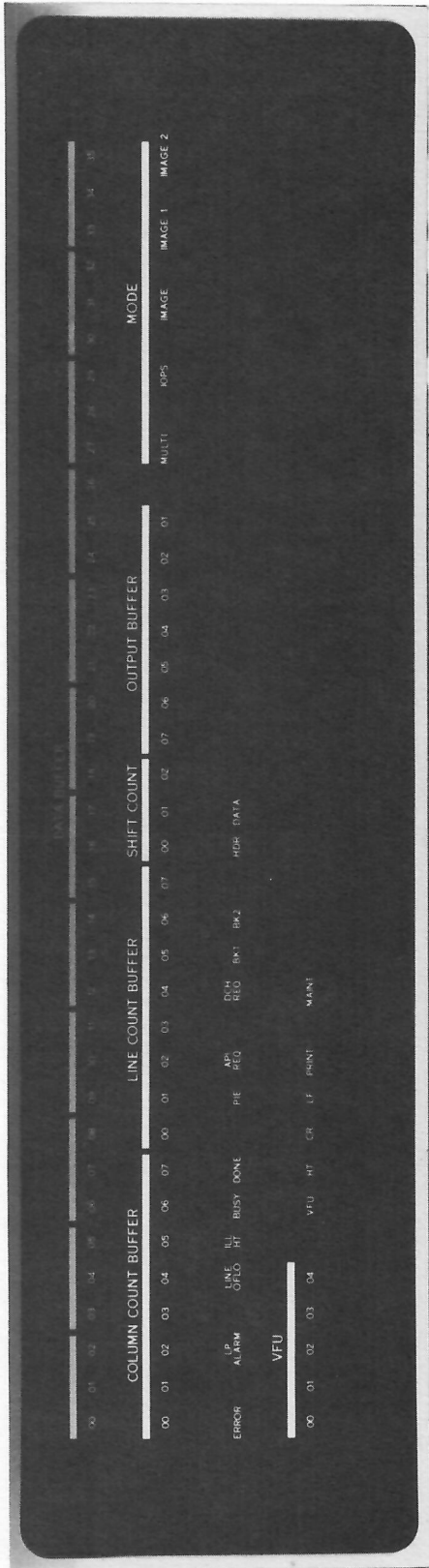

Figure 4-5 LP15 Indicator Panel

Table 4-2  
LP15 Indicator Panel

Control/Indicator	Function
DATA BUFFER	36-bit register used to store two 18-bit data words from PDP-15 memory.
COLUMN COUNT BUFFER	8-bit incrementing counter indicating the number of characters sent to the printer.
LINE COUNT BUFFER	8-bit decrementing counter indicating the number of lines remaining to be printed in multi-line mode.
SHIFT COUNT	3-bit incrementing counter indicating number of data buffer shifts completed during an IOPS mode data transfer.
OUTPUT BUFFER	7-bit display of data lines to printer.
MODE:	
MULTI	Indicates multi-line operation in either IOPS or IMAGE mode.
IOPS	Indicates IOPS (Input-Output Programming System) mode. Five 7-bit characters are packed into two 18-bit PDP-15 words.
IMAGE	Indicates IMAGE mode. Only one 7-bit character per 18-bit word is used.
IMAGE 1	Indicates transfer of first data word to printer in IMAGE mode.
IMAGE 2	Indicates transfer of second data word to printer in IMAGE mode.
ERROR	Indicates one or more of the following three error conditions has occurred.
LP ALARM	Indicates line printer is disconnected from controller or malfunction has occurred at printer.
LINE OFLO	Indicates that more than specified number of characters have been transferred without a control character.
ILL HT	Indicates that a HT has been received after the last tab stop has been passed.
BUSY	Indicates that line printer controller and line printer are in use.
DONE	Indicates that line printer operation has been completed.
PIE	Indicates that line printer controller is connected to PDP-15 Program Interrupt system.
API REQ	Indicates that API flag on API level 03 is requesting service due to error or done condition.
DCH REQ	Indicates data channel is active (words being transferred from PDP-15 to LP15).

Table 4-2 (Cont)  
LP15 Indicator Panel

Control/Indicator	Function
BK 1	Indicates first word of a header pair or data word pair is being transferred from PDP-15 to the controller.
BK 2	Indicates second word of a header word pair or data word pair is being transferred from PDP-15 to the controller.
HDR	Indicates header word pair is being transferred.
DATA	Indicates data word pair is being transferred.
VFU (00-04)	Displays contents of LP15F VFU register. Not used with LP15C.
VFU	Indicates a VFU character is being processed by LP15F. Not used with LP15C.
HT	Indicates horizontal tab is being processed.
CR	Indicates carriage return is being processed.
LF	Indicates line feed has been forced by line printer controller.
PRINT	Indicates printing operation in progress.
MAINT	Indicates maintenance mode operation.

#### 4.1.2 Format Tape Preparation

The standard paper is 11 inches wide, with 66 lines per page. Vertical column spacing is controlled by a punch-tape loop in a tape reader located in the line printer. The vertical tape unit will accept format lengths from 11 inches (min.) to 22 inches (max.). To prepare additional format tapes, use format tape number 87723-1 and tape punch number 52384 (Mohawk Data Science part numbers). Perform the following steps:

<u>Step</u>	<u>Procedure</u>
1	Take a sample of a pre-printed form and place a strip of tape over it. For paper forms less than 11 inches, use two or more forms that have not been separated.
2	Adjust the tape so that line 0 is aligned with the top of the paper (see Figure 4-6). Mark the tape lightly at each line to be printed at the channel specified. Channel one is used for Top of Form.
3	Cut the format tape straight across the bottom edge. Be sure the cut passes through the center of the guide hole, as shown.



Step

Procedure

- 4 Adjust the tape punch for 6 or 8 lines per inch (lpi), whichever is required. The line spacing has wide notches for 6 lpi and narrow notches for 8 lpi. Use the notches seen from the control knob side of the paper punch (see Figure 4-7).
- 5 Insert the format tape into the punch. Use the pins and guide lines to align the tape with the punch.
- 6 Insert the puncher into the appropriate channel.

NOTE

Top of Form (channel one) is generally punched to coincide with the first line of print for each sheet of paper.

- 7 Punch and advance tape.
- 8 After every two inches of tape advance, remove the tape and turn the control knob counter-clockwise. Then reload the tape. This action prevents the tape-punch line spacing bar from becoming disengaged.
- 9 After punching, remove the tape and apply glue to the area indicated at the top of the format tape. Loop the tape and align the bottom edge line with the 0 line, as shown in Figure 4-8.
- 10 Glue the tape ends together. Be careful to align the guide holes. Use the pins on the tape punch to provide good alignment.

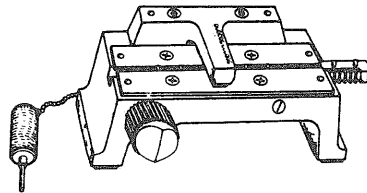

Figure 4-7 Tape Punch\*

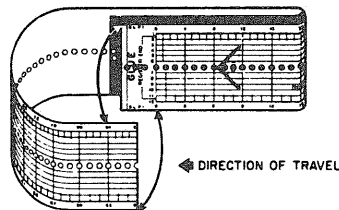

Figure 4-8 Tape Alignment\*

\* Illustration reproduced by permission of Mohawk Data Sciences Corp., Herkimer, New York.



### 4.1.3 Paper Installation

<u>Step</u>	<u>Procedure</u>
1	Make sure the format tape to be used is correctly installed on the Vertical Format Unit. Push the TOP OF FORM switch (yoke must be closed). Press the Open/Close Yoke switches until the yoke has completely opened (see Figure 4-9). Flip all four hold-down plates on the tractors to an open position and unlock the tractor lock lever on lower right-hand lever.
2	Thread the paper up through the open yoke throat and place on the upper tractors so that the paper guide holes fit over the pins. Use the tractor knobs to move either set of tractors, right or left, to adjust to the paper width. Close the upper hold-down plates.
3	Grasp the paper below the yoke and gently pull it taut. Place the paper guide holes over the pins of the lower tractors and close the hold-down plates.
4	Adjust the right hand tractors to establish an appropriate horizontal tension.
5	Adjust the Paper Tension knob to establish an appropriate vertical tension.
6	Lay the plastic scale, which pivots on the yoke assembly, onto the paper.
7	Close the lock lever on the lower right-hand tractor (see Figure 4-10) to provide uniform lateral movement of all four tractors. Using the plastic scale as a reference move the tractors to set the left hand margin of the paper form.
8	Open all four paper hold-down plates. Move the paper form (do not move the tractor pins) vertically to place the paper forms first line of print between the two black lines at the bottom of the plastic scale. (With the yoke closed and the printer operating this position may be adjusted slightly by using the Form Position knob.)
9	Close the paper hold-down plates and press the CLOSE switches until the yoke has closed. After the paper has been advanced a sufficient amount to reach the rear of the printer, position the paper between the paper puller roller rings and over the static eliminator bar.

### 4.1.4 Ribbon Installation

<u>Step</u>	<u>Procedure</u>
1	Open the canopy and press the OFF push-button. Remove the Ribbon Guard Plate by lifting it up and away.
2	Wind the old ribbon onto the top mandrel by using the ribbon hand crank (see Figure 4-11). The end of the ribbon is taped to the bottom mandrel. Remove the tape.

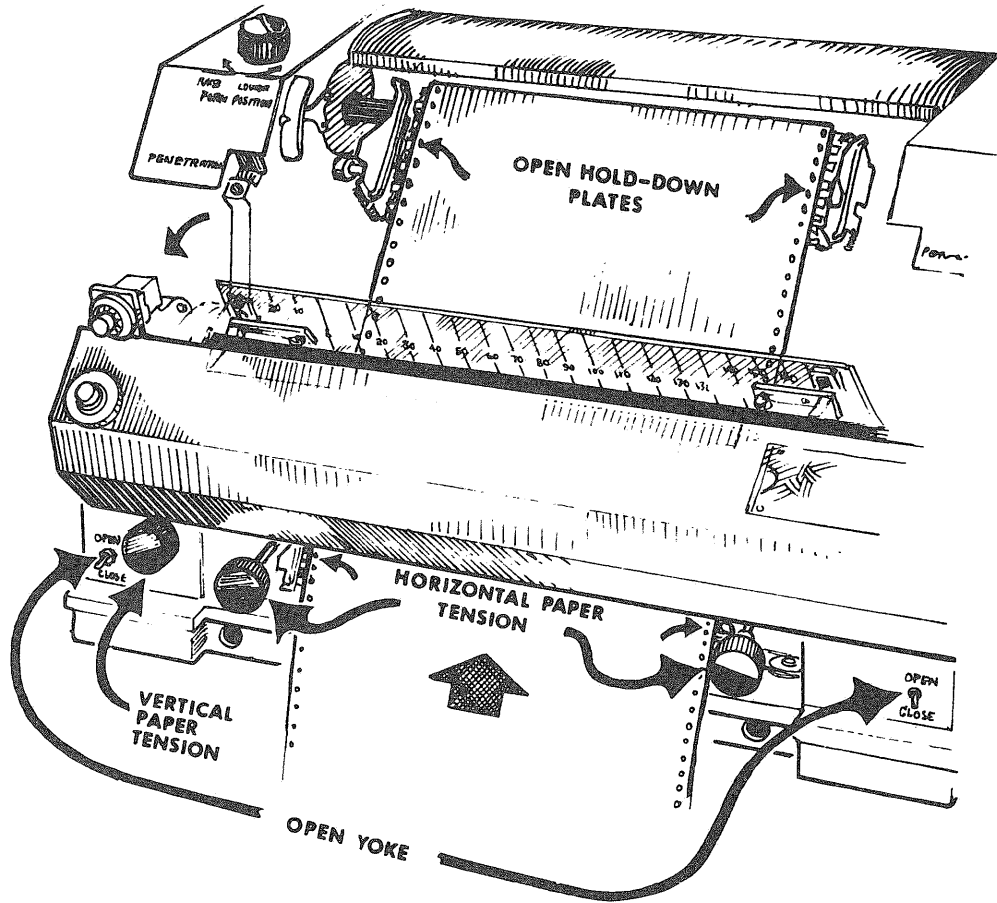

Figure 4-9 Paper Loading\*

<u>Step</u>	<u>Procedure</u>
3	Open the yoke.
4	Remove the top mandrel by pushing to the left and lifting out.
5	Remove the bottom mandrel and place it on top position.
6	Install the new ribbon on the bottom so that it feeds <ul style="list-style-type: none"> <li>a. from the bottom of the mandrel up through the yoke throat opening</li> <li>b. around the ribbon guide</li> <li>c. through the ribbon edge caster units between the blades of the ribbon edge sending-out unit</li> <li>d. over the bar and onto the top of the upper mandrel.</li> </ul>
7	Tape the ribbon to the mandrel.

\* Illustration reproduced by permission of Mohawk Data Sciences Corp., Herkimer, New York.

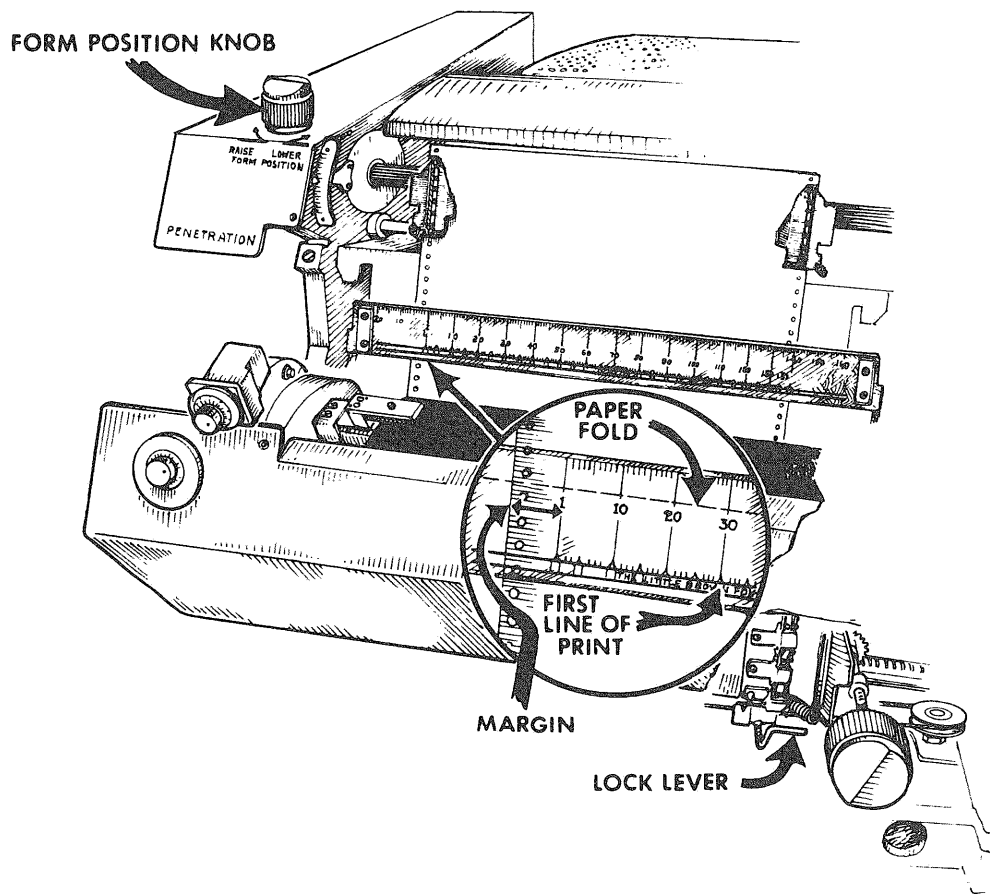

Figure 4-10 Paper Alignment\*

#### 4.1.5 Start Up Procedure

##### NOTE

Make sure that the line printer power cord is properly installed and the main circuit breaker is on.

<u>Step</u>	<u>Procedure</u>
1	Press ON button on left-hand control panel and wait for ON indicator to light.
2	Depress START button and wait for START indicator to light. This indicator lit signifies that the printer has full power and is on-line and ready to receive data.

\*Illustration reproduced by permission of Mohawk Data Sciences Corp., Herkimer, New York.

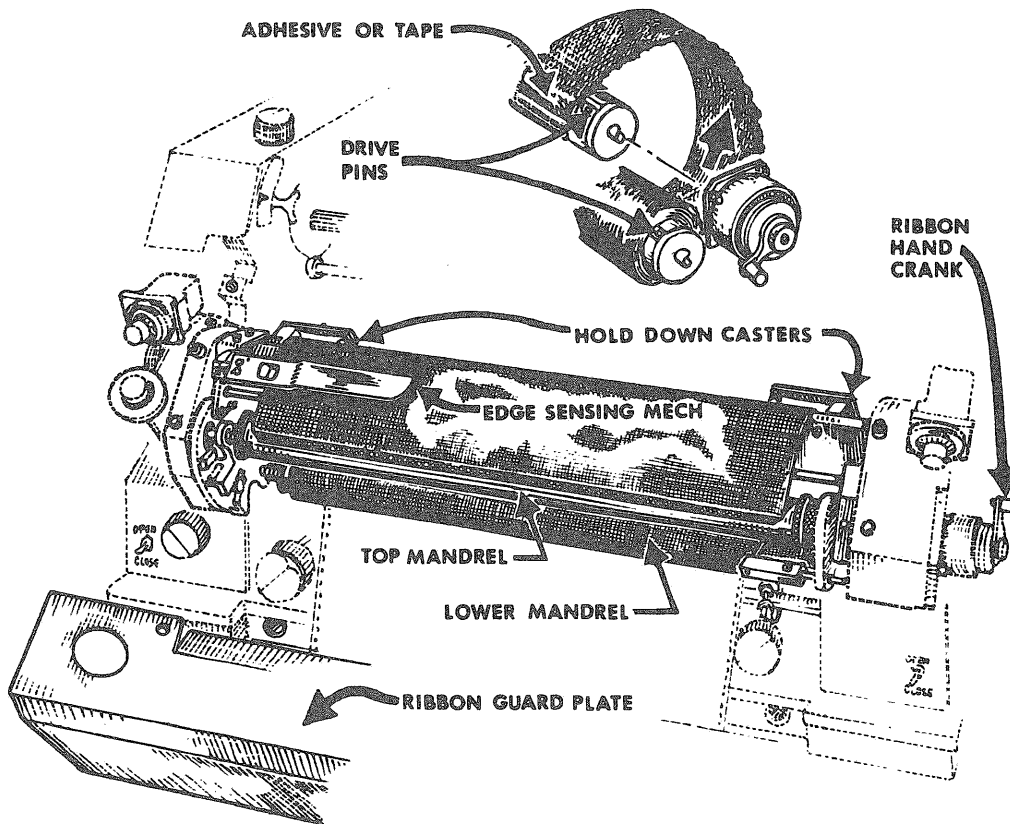

Figure 4-11 Ribbon Installation\*

#### 4.2 LP15F LINE PRINTER AND CONTROL (356 lpm)

Line Printer LP15F (see Figure 4-12) prints 356 lines per minute, using an 80-column or 120-column, 64-character print drum.

##### 4.2.1 Controls and Indicators

The LP15F Line Printer controls and indicators are illustrated in Figures 4-13 through 4-16 and are described in Table 4-3. The LP15F Indicator Panel is illustrated in Figure 4-5 and is described in Table 4-2.

\*Illustration reproduced by permission of Mohawk Data Sciences Corp., Herkimer, New York.

Table 4-3  
LP15F Line Printer Controls and Indicators

Control/Indicator	Type	Function
Paper Vertical Adjustment	Control Knob	Adjusts vertical alignment of printing form to plus or minus one line; can be adjusted during printing if desired.
Copies Control	Lever	Adjusts the distance between hammer bank and character drum for different numbers of print copy.
Drum Gate Latch	Knob	Used to latch or unlatch drum gate.
Power	Panel Indicator	Indicates ac power is applied to printer.
READY	Panel Indicator	Indicates printer power is up, interlocks are satisfied and PRINT INHIBIT switch is OFF.
ON LINE	Panel Indicator	Indicates printer is in ON LINE mode of operation.
TOP OF FORM	Momentary toggle switch	Advances tractors to top-of-form position; disabled in ON LINE mode.
PAPER STEP	Momentary toggle switch	Advances paper one line; disabled in MASTER CLEAR and ON LINE modes.
ON LINE/ OFF LINE	Momentary toggle switch	Selects mode of operation for printer.
DRUM GATE	Maintenance panel indicator	Indicates unlatching of drum gate.
PAPER FAULT	Maintenance panel indicator	Indicates paper torn or missing.
PRINT INHIBIT	Maintenance panel indicator	Indicates PRINT INHIBIT switch is ON.
MASTER CLEAR	Momentary toggle switch	Initializes the printer to ensure that logic elements are in proper state.
PRINT INHIBIT	Toggle switch	Initializes hammer drivers during maintenance.
Main Power Circuit Breaker	--	Applies ac power to printer.
Horizontal Tension Adjustment	--	Adjusts horizontal tension of paper.
Paper Width Adjustment	--	Adjusts right tractor for paper widths tolerance; left tractor is factory-adjusted.

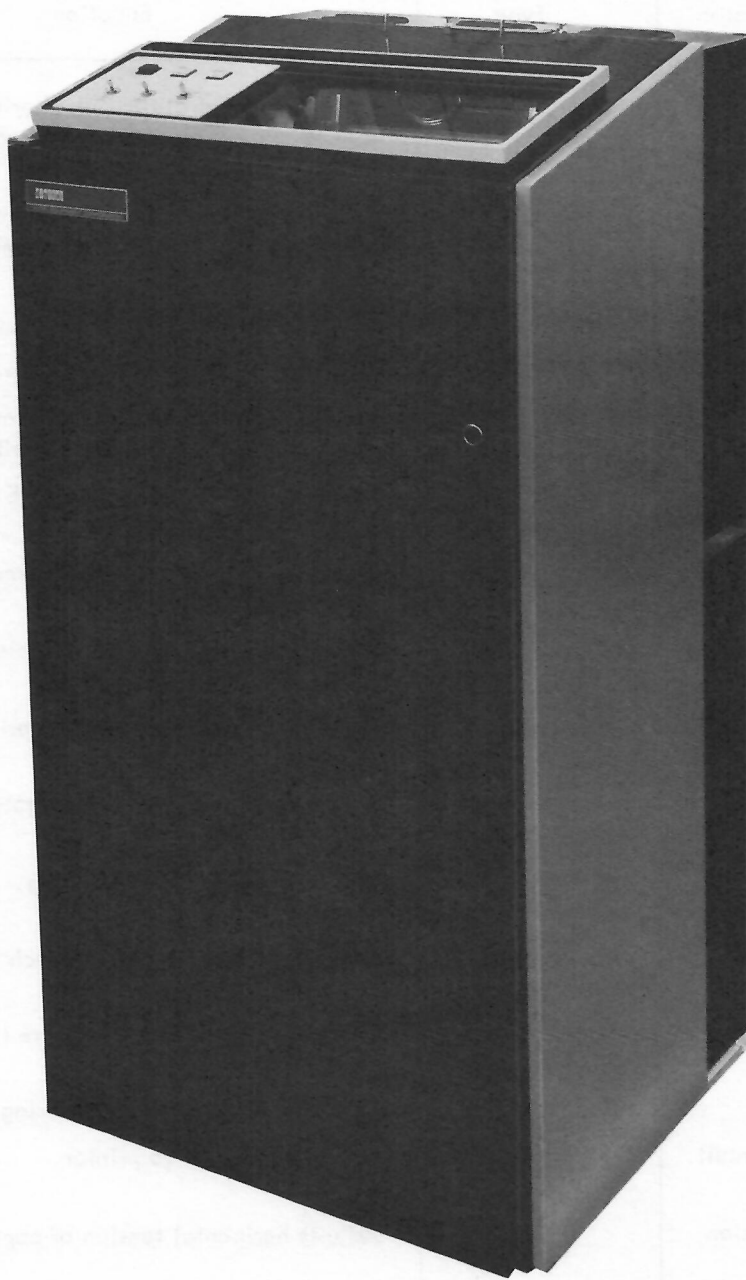

Figure 4-12 LP15F Line Printer

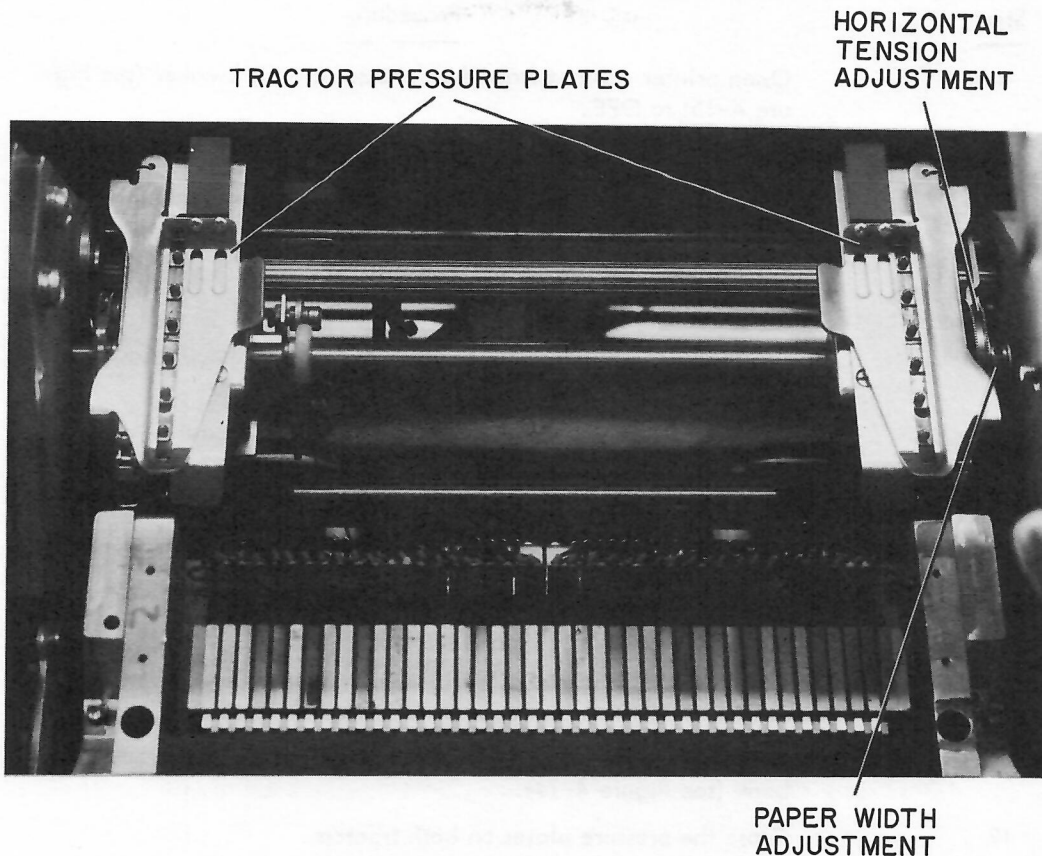

Figure 4-13 LP15F Paper Tension and Width Adjustments

#### 4.2.2. LP15F Paper Loading Procedure

##### NOTE

Before placing carton of paper in bottom of printer, cut the sides of the carton on a diagonal from top-rear to bottom-front. This will prevent the perforations of the edges of the paper from tearing as they are fed to the printer mechanism.

When the paper is properly loaded, the top-of-form cam allows the printer to print all lines on the 11-inch page, except one line preceding and two lines following each perforation. A subsequent form-feed signal to the printer automatically advances the paper so that the next line occurs two lines past the perforation on the next sheet. Load the paper as follows:



<u>Step</u>	<u>Procedure</u>
1	Open printer cabinet front door and set circuit breaker (see Figure 4-15) to OFF.
2	Make sure line printer power cord is properly installed.
3	Make sure input cable from data source to connector J1 is connected.
4	Set circuit breaker to ON; make sure that the POWER indicator and PAPER FAULT indicator light.
5	Unlatch and open drum gate A2A1; make sure that the DRUM GATE indicator lights.
6	Set TOP OF FORM switch to up position and release.
7	Set COPIES CONTROL lever to number of copies desired.
8	Open the spring-loaded pressure plates on both tractors (see Figure 4-16).
9	Place paper on tractor pins; perform step 6 if adjustment of right tractor for paper width is required.
10	Loosen paper width adjustment setscrew (see Figure 4-13); set right tractor to correct paper width; tighten setscrew.
11	Align paper perforation with top-of-form indicators on hammer bank (see Figure 4-14).
12	Close the pressure plates on both tractors.
13	Use the horizontal tension adjustment (see Figure 4-13) for proper paper tension.
14	Close and latch drum gate A2A1; make sure that the PAPER FAULT and DRUM GATE indicators go off.

#### 4.2.3 Vertical Paper Positioning

When lined paper is used, the characters being printed can be set to appear directly on the print line by adjusting the paper vertical adjustment control (see Figure 4-15).

#### 4.2.4 Ribbon Installation

<u>Step</u>	<u>Procedure</u>
-------------	------------------

#### NOTE

Use plastic gloves supplied with ribbon when installing or replacing ribbon.

1	Open cabinet front door and set circuit breaker (see Figure 4-17) to OFF.
---	---



TOP-OF-FORM INDICATORS

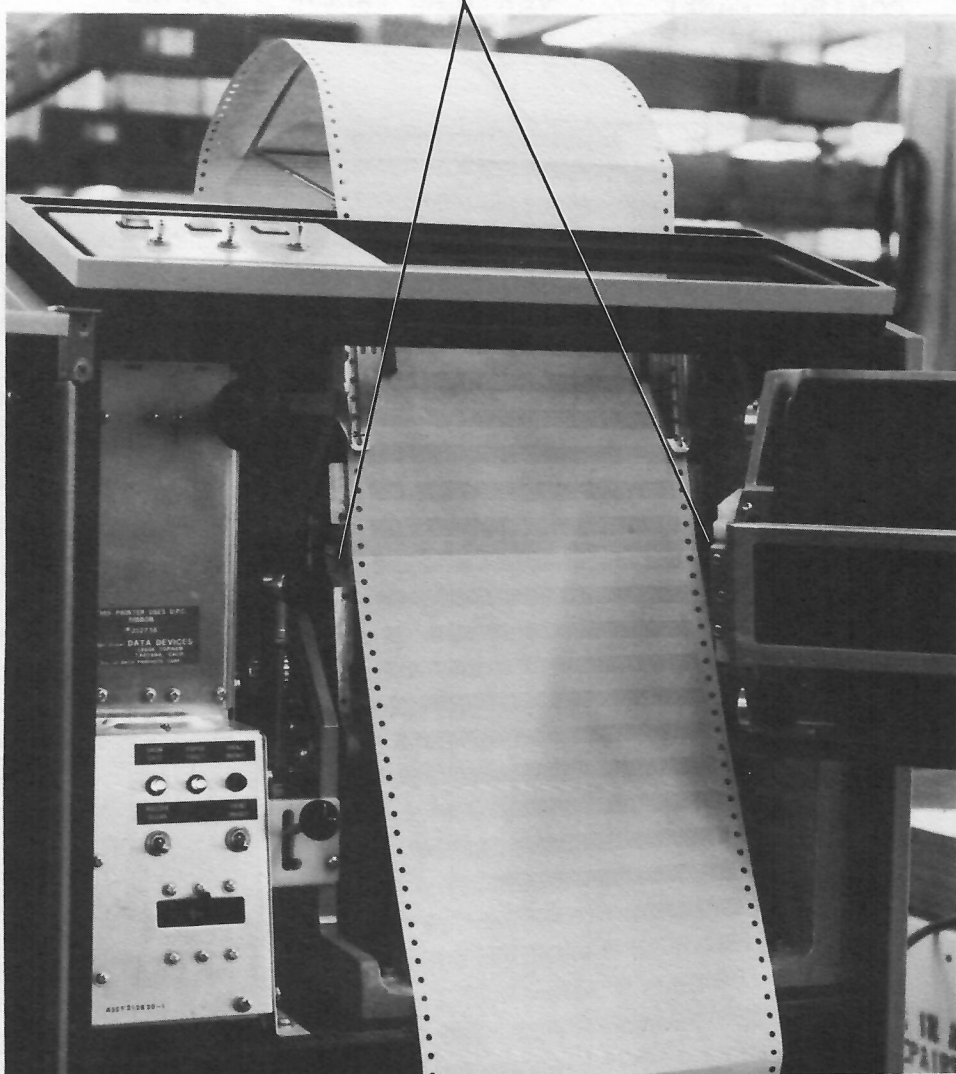

Figure 4-14 LP15F Paper Loading

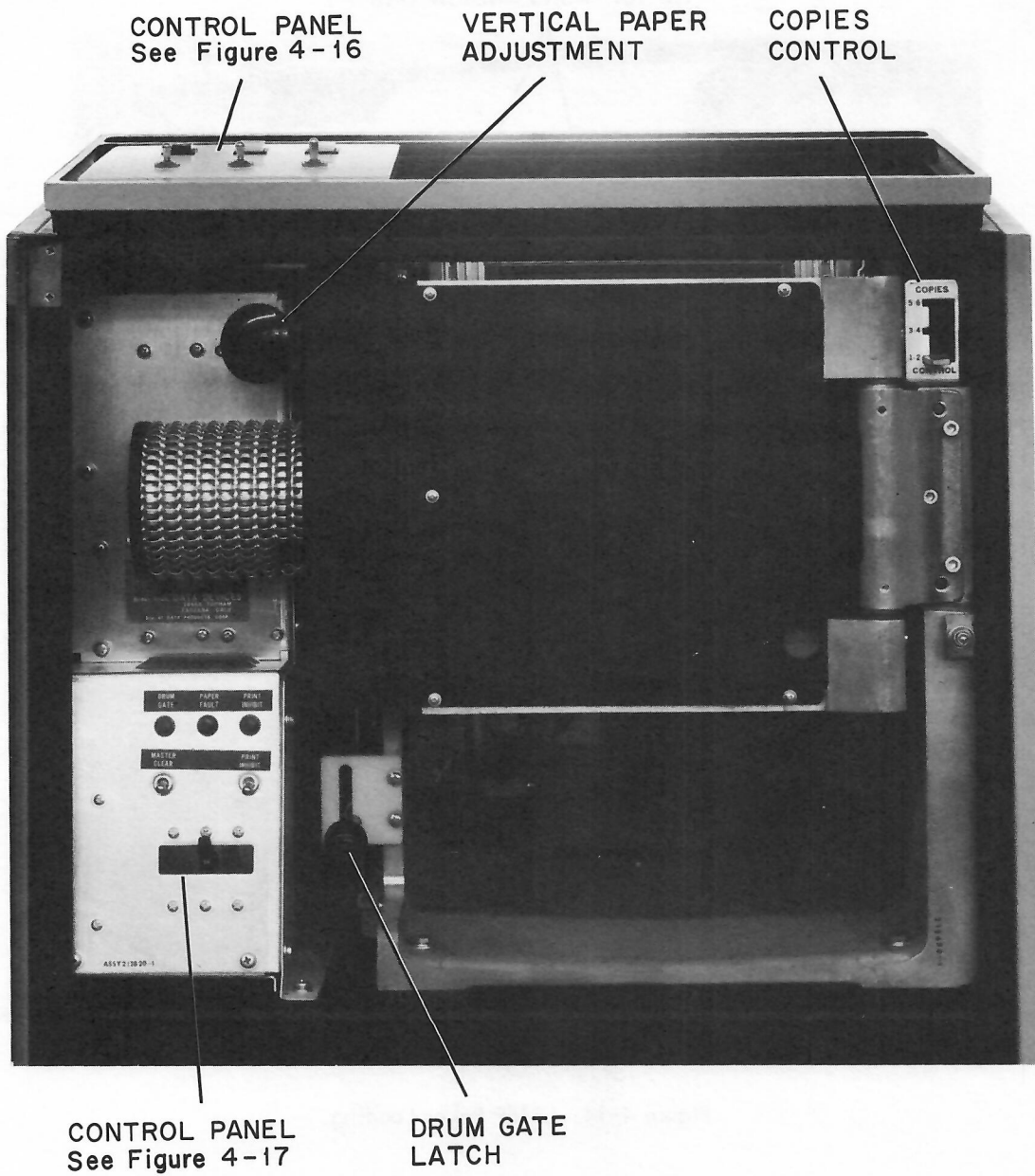

Figure 4-15 LP15F Line Printer Controls

<u>Step</u>	<u>Procedure</u>
2	Move drum gate latch to the left and up.
3	Swing drum gate A2A1 fully open.
4	Grasp paper guide finger tab (see Figure 4-18) and swing paper guide open.
5	Hold ribbon cores together and remove ribbon from box.
6	Place fully wound ribbon core over top floating ribbon holder (see Figure 4-18).
7	Push against floating holder spring and place opposite core end over top fixed ribbon holder ensure holder guide pin slips into slot on core end (see Figures 4-18 and 4-19).
8	Unwind second ribbon core and bring ribbon down and over character drum (see Figure 4-18).
9	Place core on bottom ribbon holders as in step 7 for top holders.
10	Close paper guide.
11	Close drum gate A2A1; move drum gate latch down and to the right.

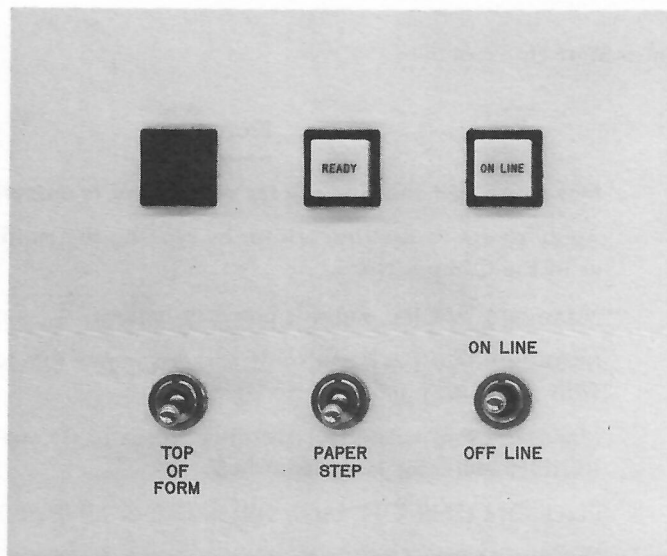

Figure 4-16 LP15F Top Control Panel

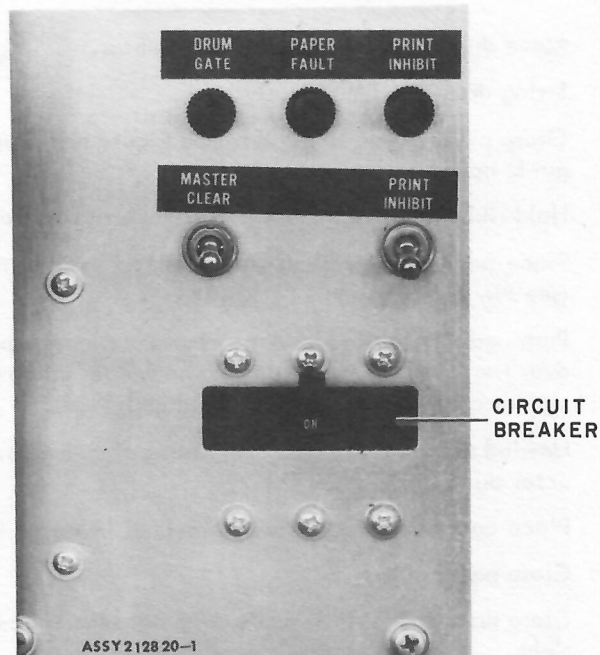
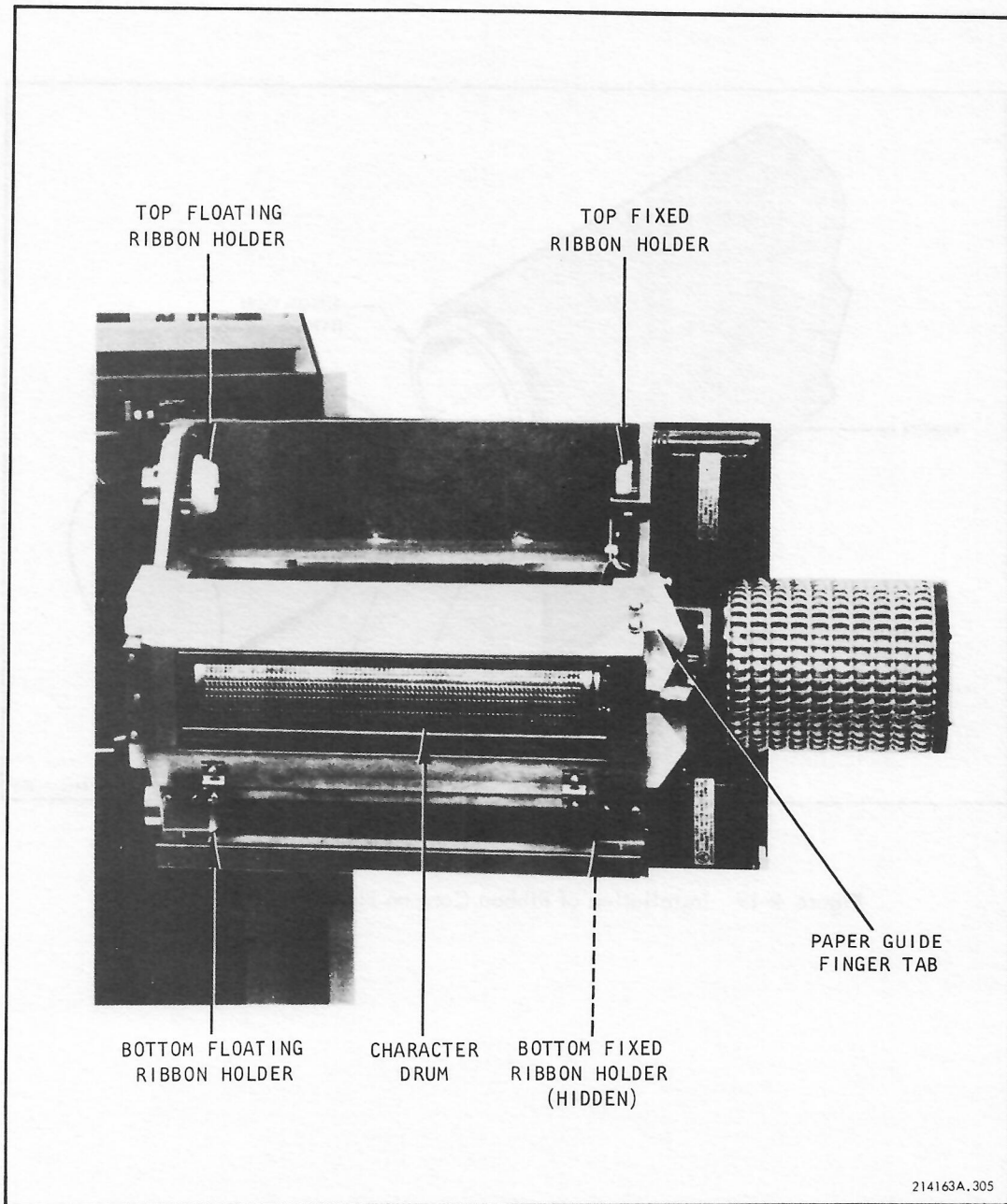

Figure 4-17 LP15F Inside Control Panel

#### 4.2.5 LP15F Line Printer Start Up Procedure

<u>Step</u>	<u>Procedure</u>
1	Make sure that the line printer power cord is properly installed.
2	Apply power to the line printer by placing the main circuit breaker in the ON position.
3	Make sure that the paper is properly loaded.
4	Make sure that the paper fault and drum open indicators are off. Wait for READY indicator to light.
5	Make sure that the PRINT INHIBIT switch is off and PRINT INHIBIT indicator is extinguished.
6	Place ON LINE/OFF LINE switch to ON LINE position.
7	Ensure that ON LINE indicator on top control panel is illuminated.
8	The printer and controller are up to full power, on line, and are ready to receive data from the LP15F Controller.





214163A.305

Figure 4-18 Drum-Gate Ribbon Installation\*

\*Illustration reproduced by permission of Data Products Corporation, Copyright 1970 by Data Products Corporation, Woodland Hills, California.

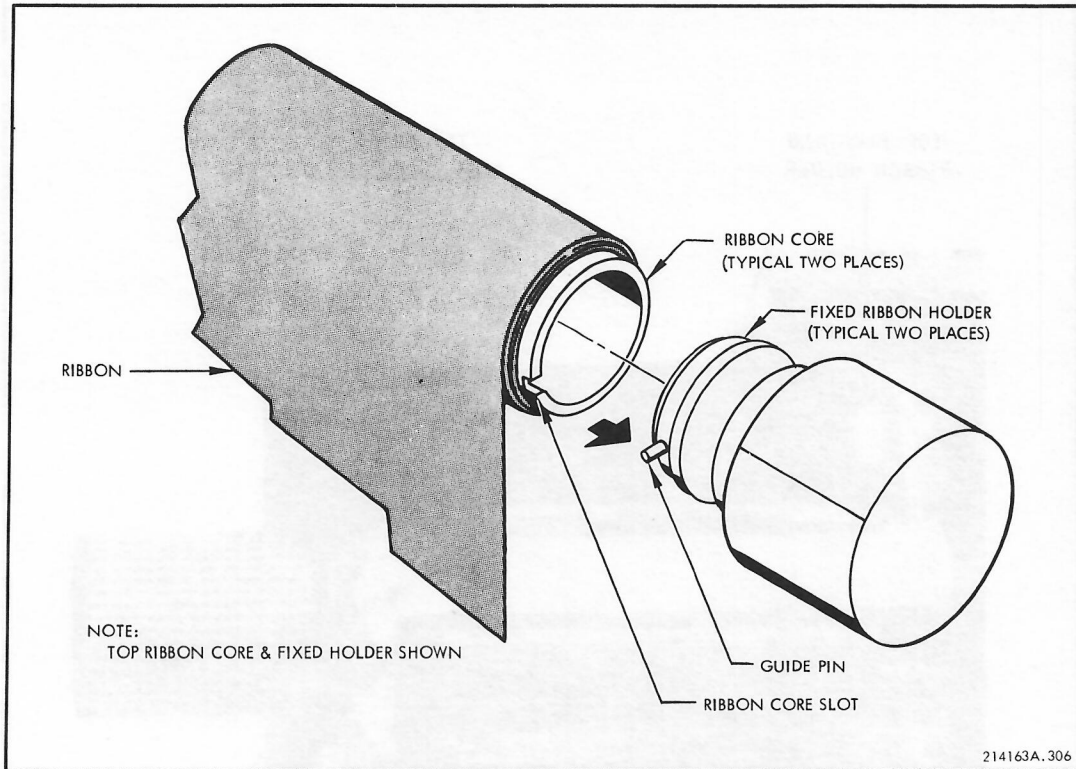

Figure 4-19 Installation of Ribbon Core on Fixed Ribbon Holder\*

\*Illustration reproduced by permission of Data Products Corporation, Copyright 1970 by Data Products Corporation, Woodland Hills, California.

## Chapter 5

### Paper-Tape Reader and Punch

#### 5.1 PC15 HIGH-SPEED PAPER-TAPE READER AND PUNCH

High-Speed Paper-Tape Reader and Punch Type PC15 is standard on PDP-15/20, -15/30, and -15/40 Systems. The perforated paper-tape reader photoelectrically senses eight-channel paper-tape at a rate of 300 lines per second. Under program control, data is read in either alphanumeric (one-line) or binary (three-line) modes. The use of a paper-tape reader buffer and buffer-full flag permits the continuation of processing during the reading functions.

The paper-tape punch (50 characters per second) is mounted on the same chassis as the reader. In alphanumeric mode, an output instruction causes an eight-bit character to be transferred from the PDP-15 accumulator to a punch buffer, from which it is punched on the tape. In binary mode, an 18-bit word is transferred from the accumulator. Fanfold paper-tape is normally used with the high-speed paper-tape reader and punch.

##### 5.1.1 Controls

Front Panel Controls are illustrated in Figure 5-1 and described in Table 5-1.

Table 5-1  
Paper-Tape Reader and Punch Controls

Control	Type	Function
FEED (Reader)	Momentary-contact pushbutton	When depressed, causes tape to advance without reading; also clears the reader out-of-tape flag to permit automatic read operation.
ON LINE/ OFF LINE	Two-position rocker switch	When in ON LINE position the reader can be activated from the computer.
FEED (Punch)	Momentary-contact pushbutton	When depressed, causes tape to advance punching only feed holes.

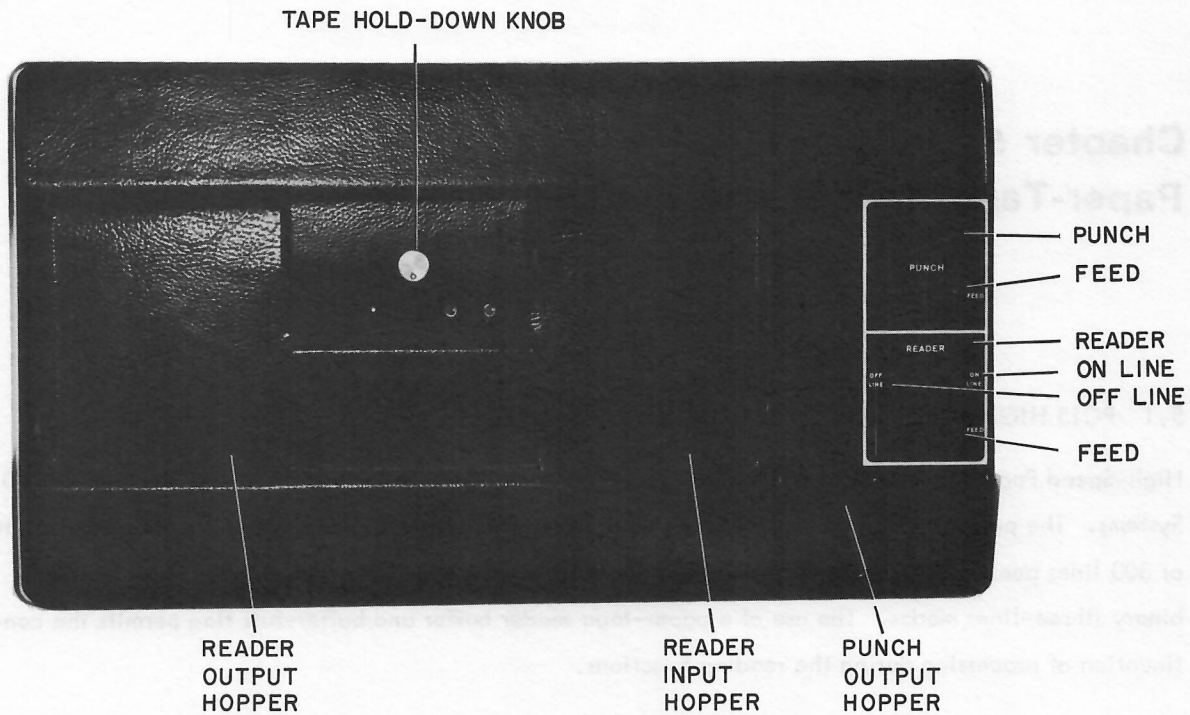

Figure 5-1 Paper-Tape Reader and Punch

### 5.1.2 Paper Tape Reader Operating Procedure

Directions for initiating read-in from the console are given in the console operating procedures, Chapter 1 of this manual. The only operator function directly associated with the tape reader is loading the tape. The tape is stored in flat packets of fanfold form; that is, the tape is folded back and forth upon itself. One of the tape surfaces is imprinted with arrows at frequent intervals along the length of the tape. The arrows indicate the direction which the tape must advance in the read operation. To install a tape in the reader, proceed as follows:

<u>Step</u>	<u>Procedure</u>
1	Set the processor POWER switch ON.
2	Set ON LINE/OFF LINE switch to OFF LINE.
3	On the tape reader, rotate tape hold-down knob clockwise (Figure 5-1).
4	Hold the packet of tape in both hands as shown in Figure 5-2 and open it to a fold at which printed arrows are visible. Orient the tape so that the arrows point from the operator's right to left.
5	Without changing its relative position, fold the complete packet into the right hand. With the left hand, pull the end of the tape toward the direction in which the arrows point, opening out the first two folds.



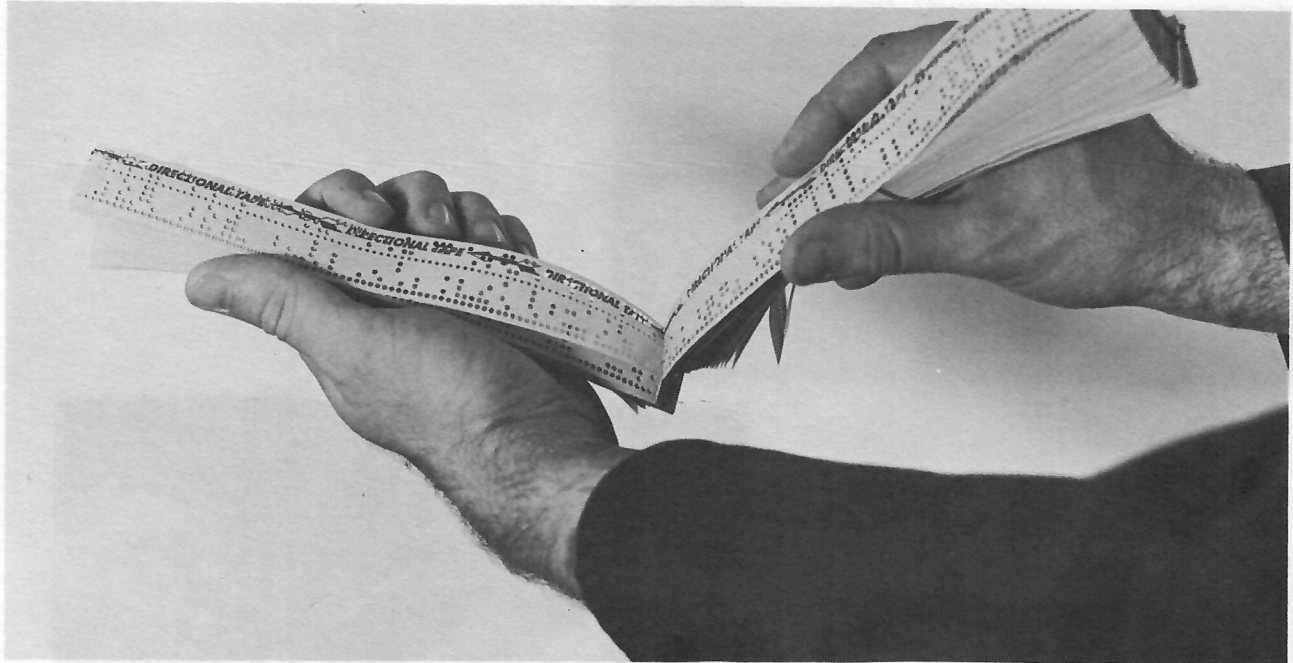

Figure 5-2 Orienting the Tape

<u>Step</u>	<u>Procedure</u>
6	Place the lower end of the packet diagonally into the corner of the lower feed pocket, as shown in Figure 5-3a.
7	Bend the upper end of the packet toward the read station and thrust it into the upper feed pocket (Figure 5-3b). The packet will be supported in the feed position.
8	Place the extended part of the tape edgewise under the tape re- tainer, shown in Figure 5-3c. The tape should now be lying flat across the read station, the printed side should be up, and the arrows should point from right to left.
9	Position the tape so that the first crease is a few inches beyond the read station and ensure that the feed holes are engaged by the feed sprocket. Rotate the tape hold-down knob counter- clockwise.
10	Stand the free end of the tape in the receiving pockets so that the first fold is oriented toward the read station.
11	Depress the FEED switch momentarily, and observe that the tape moves from right to left and begins to fold automatically into the receiving pockets. Advance the tape sparingly; do not let the data portion of the tape reach the read station (Figure 5-3d).

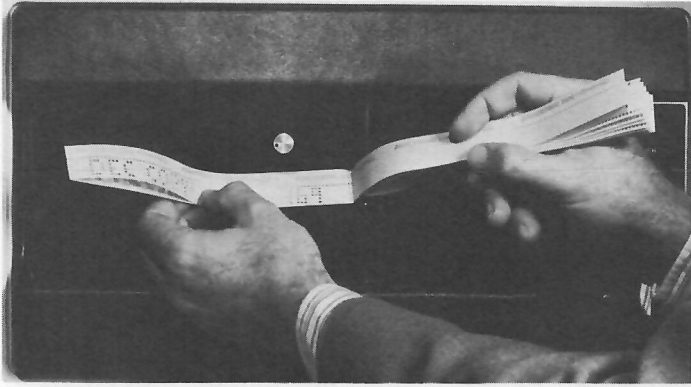

Figure 5-3a

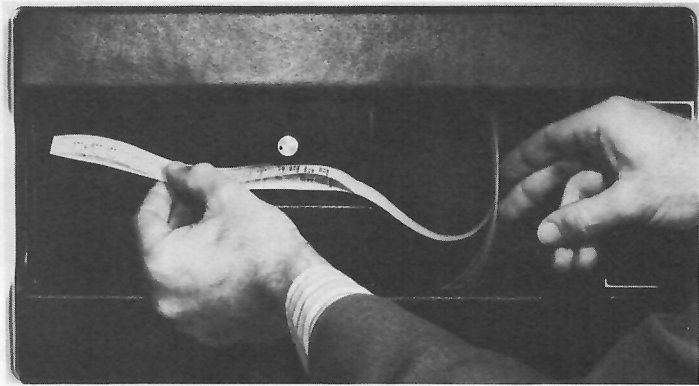

Figure 5-3b

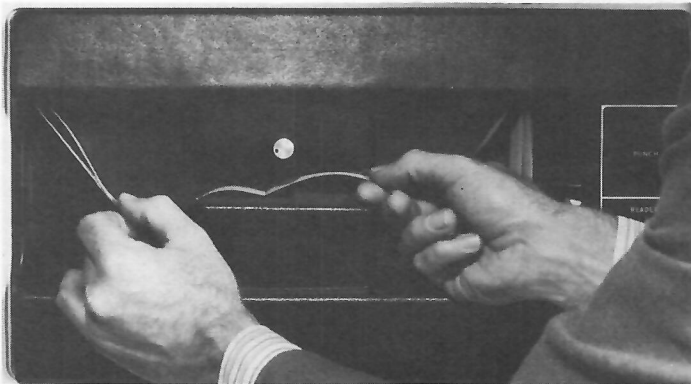

Figure 5-3c

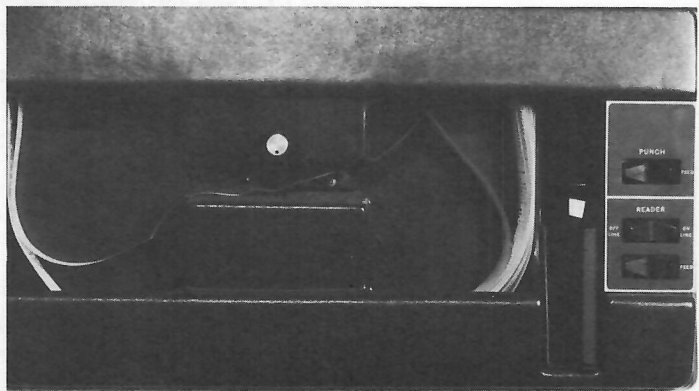

Figure 5-3d

Figure 5-3 Installing Tape in Paper-Tape Reader

<u>Step</u>	<u>Procedure</u>
11 (cont)	NOTE

Always depress the reader FEED switch momentarily. This action is necessary to clear the out-of-tape flag which was set automatically when the last tape was removed.

12	Set ON LINE/OFF LINE switch to ON LINE.
----	---

The tape is now prepared for read-in. If read-in is to be under control of the program, no further action is required. If the program directions specify manual read-in, follow the console procedure for reading-in from paper-tape.

### 5.1.3 Paper Tape Punch Tape Installation

New paper-tape is imprinted with directional arrows, and has no perforations of any kind. Tape is furnished in 1000-ft lengths in fanfold form, packed in pasteboard boxes. One of the narrow sides of the box is clearly marked and perforated for opening. To install tape in the punch unit, remove this side of the box completely, then proceed as follows:

<u>Step</u>	<u>Procedure</u>
1	Slide the reader/punch unit out from the cabinet frame and insert the box of tape. Position the box with the open side up so that the arrows on the tape are pointing from right to left (see Figure 5-4a).
2	Draw the end of the tape off to the right, arrow side down, twist the end slightly counterclockwise and pass it through the tape guides (see Figure 5-4a).
3	Pass the tape over the arm of the out-of-tape microswitch and under the backing plate, making sure that the arrows are on the under side of the tape (see Figure 5-4a).
4	Open the hinged tape retainer outward, exposing the drive sprocket (see Figure 5-4b).
5	Place the end of the tape between the metal tape guide-plates which are under the chad chamber. Push the tape forward until the end passes over the sprocket; close the tape retainer (see Figure 5-4b).
6	Turn the tape-advance control counterclockwise and observe that the tape advances, then slide the unit back into position in the cabinet frame (see Figure 5-4b).

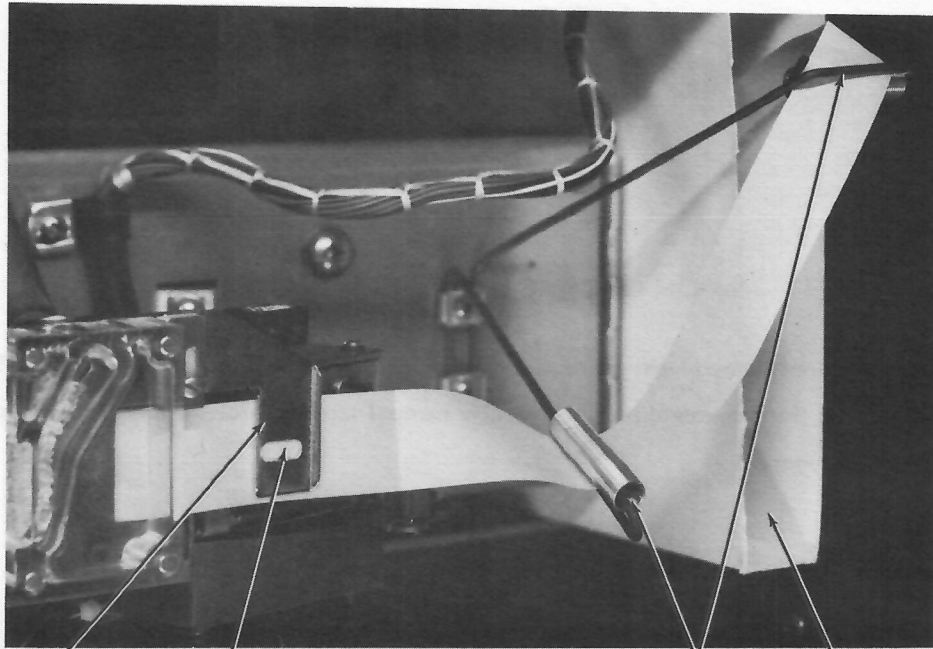

BACKING PLATE      OUT-OF-TAPE SWITCH (BELOW TAPE)      TAPE GUIDES      FEED BOX

Figure 5-4a

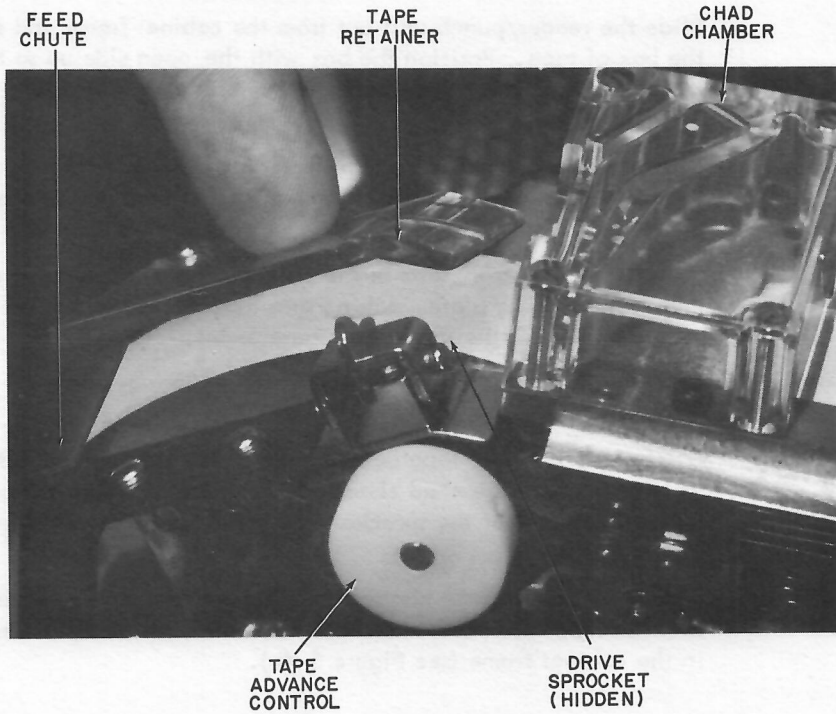

FEED CHUTE      TAPE RETAINER      CHAD CHAMBER

TAPE ADVANCE CONTROL      DRIVE SPROCKET (HIDDEN)

Figure 5-4b

Figure 5-4 Installing Tape in High-Speed Paper-Tape Punch

#### 5.1.4 Placing Punch in Service

To place the Punch in service, proceed as follows:

<u>Step</u>	<u>Procedure</u>
1	Set the processor POWER switch ON. This applies power to both the processor and the tape unit.
2	Depress and hold the FEED switch until four or five folds (about three feet) of tape are run into the tape punch output hopper (see Figure 5-1).
3	Since the punching of feed holes starts only at some distance from the beginning of tape, tear off the tape end neatly at the first crease and discard it. This will leave about two feet of data-free leader, fully punched with feed holes, for handling and threading the finished tape.

#### 5.1.5 Removing Punched Tape

To remove punched tape, perform the following steps:

<u>Step</u>	<u>Procedure</u>
1	After punching has been completed, depress the punch FEED switch and run off about two feet of data-free trailer; tear off the output tape at a crease, and remove it.
2	Depress the punch FEED switch again to run off a new leader. The unit is now prepared for the next program.

#### 5.1.6 Chad Removal

The small disks of paper which are punched out of the tape are called chad. The punches at the punch station strike upward and deposit the punch-outs in the chad chamber (see Figure 5-4b). From there the chad is conducted by gravity, through a tube, into a removable box.

#### CAUTION

Remove the chad as directed.

- a. Remove and empty the chad box before it becomes one-quarter full.
- b. Remove any chad or dust which has accumulated elsewhere in the compartment using a suitable vacuum cleaning device or a clean, slightly dampened cloth.
- c. Replace the chad box.



### 5.1.7 Splicing and Repairing Paper Tape

Splicing tape is not desirable but may be necessary in the following situations:

5.1.7.1 End of Tape - After most of the tape in the box has been punched, the approaching end of the supply is indicated by special coloring on the remaining tape. When this coloring is observed, install new tape as soon as possible in order to avoid running out of tape during a program. If the specially colored portion of the tape should appear during a program, proceed as follows:

<u>Step</u>	<u>Procedure</u>
1	Depress the Control Console STOP switch.
2	Depress the punch FEED switch and feed out the last of the tape.
3	Load new tape into the unit as described in Paragraph 5.1.3.
4	Place the unit in service as described in Paragraph 5.1.4.
5	Restart the program by depressing the CONT switch on the control console.
6	Remove the finished tape by performing procedure in Paragraph 5.1.5.
7	Splice the leader of the second length of tape to the trailer of the first length, using rubber cement, so that the spliced section has the following characteristics: <ol style="list-style-type: none"><li>The splice overlap is about three inches.</li><li>The portion containing the splice forms a flag segment of the same length as others in the tape (8-1/2 in.). Do not splice over a fold.</li><li>The folds at each of the spliced segment are opposite directions.</li><li>The arrows of both tape portions are on the same side of the tape and point in the same direction.</li><li>The feed holes in the overlap coincide exactly.</li><li>The splice does not overlap the data portion of either tape.</li></ol>

5.1.7.2 Torn Tape - If a punched tape has been torn between data holes or through the data portion and duplicate tape is not readily available, proceed as follows:

<u>Step</u>	<u>Procedure</u>
1	Align the torn edges to restore the original unbroken form as closely as possible.
2	Secure the two pieces together with transparent mending tape on each side of the line of feed holes.

#### NOTE

If the feed holes are covered, punch the mending tape to clear the holes.

## Chapter 6

### Disk Drives

#### 6.1 RP02 DISK PACK DRIVE AND RP15 DISK PACK CONTROL

The RP15 Disk Pack Control interfaces the RP02 Disk Pack Drive (see Figure 6-1) to the PDP-15. Transfers are made through a single-cycle data channel. Up to eight RP02 drives can be handled on the same control. The total capacity of the RP02 drives is 10.24 million words. The total bulk storage capacity with eight RP02 drives is 81,920,000 18-bit words. Average transfer time for the RP02 drive is 7.4 microseconds per word. Average access time is 50 milliseconds.

##### 6.1.1 Controls and Indicators

6.1.1.1 Drive Unit - Disk Pack Drive Unit (RP02) controls and indicators are illustrated in Figure 6-2 and described in Table 6-1.

Table 6-1  
Drive Unit Controls and Indicators

Control/Indicator	Type	Function
ENABLE-DISABLE	Rocker switch	<p>ENABLE Position - The switch enables the Logical connection between the controller and the Model RP02 drive.</p> <p>DISABLE Position - The switch disables the Logical connection between the controller and the Model RP02 drive. If the Model RP02 drive is performing an operation under the command of the controller, changing the state of the switch will give an off-line indication to the controller.</p>
READ/WRITE- READ ONLY	Rocker switch	<p>READ/WRITE Position - The switch enables read write circuitry.</p> <p>READ ONLY Position - The switch disables the write and erase circuitry to allow a READ ONLY operation.</p>

Table 6-1 (Cont)  
Drive Unit Controls and Indicators

Control/Indicator	Type	Function
Unit Number/Ready	Green indicator (large number)	The number legend of this indicator can be changed easily to indicate the unit address of the disk pack in the system. This indicator lights when the drive has reached operational speed and the heads are positioned to track 000 on the initial load operation. The indicator (green) signifies that the disk pack drive is ready for instructions. The indicator goes off when the STOP switch is depressed or when system power is removed.
File Monitor 128 64 32 16 8 4 2 1	Neon indicators (8)	Displays the track address (weighted binary number readout).
FILE UNSAFE	Red indicator	An unsafe condition disables heads; terminates read, write or erase operations; drops ready; and lights the FILE UNSAFE indicator on the operator panel. Manual intervention is required to clear the condition when it occurs. Placing the START-STOP switch in the STOP position resets the indicator.
READ ONLY	White indicator	Indicates that READ/WRITE - READ ONLY switch is in READ ONLY position and all data stored in disk pack is safe.
START - STOP	Rocker switch	The START position of this switch is operable when the main power switch to the unit is on, a pack has been loaded and the cover closed. The START position of this switch energizes the drive motor and, when the disk pack speed is greater than 1700 rpm and the pack stabilization delay of 60 seconds has expired, loads the heads and positions them to cylinder 000. With the switch in the STOP position, power to the motor is removed and the carriage is retracted, which unloads the heads. Dynamic braking stops the spindle within 12 seconds.



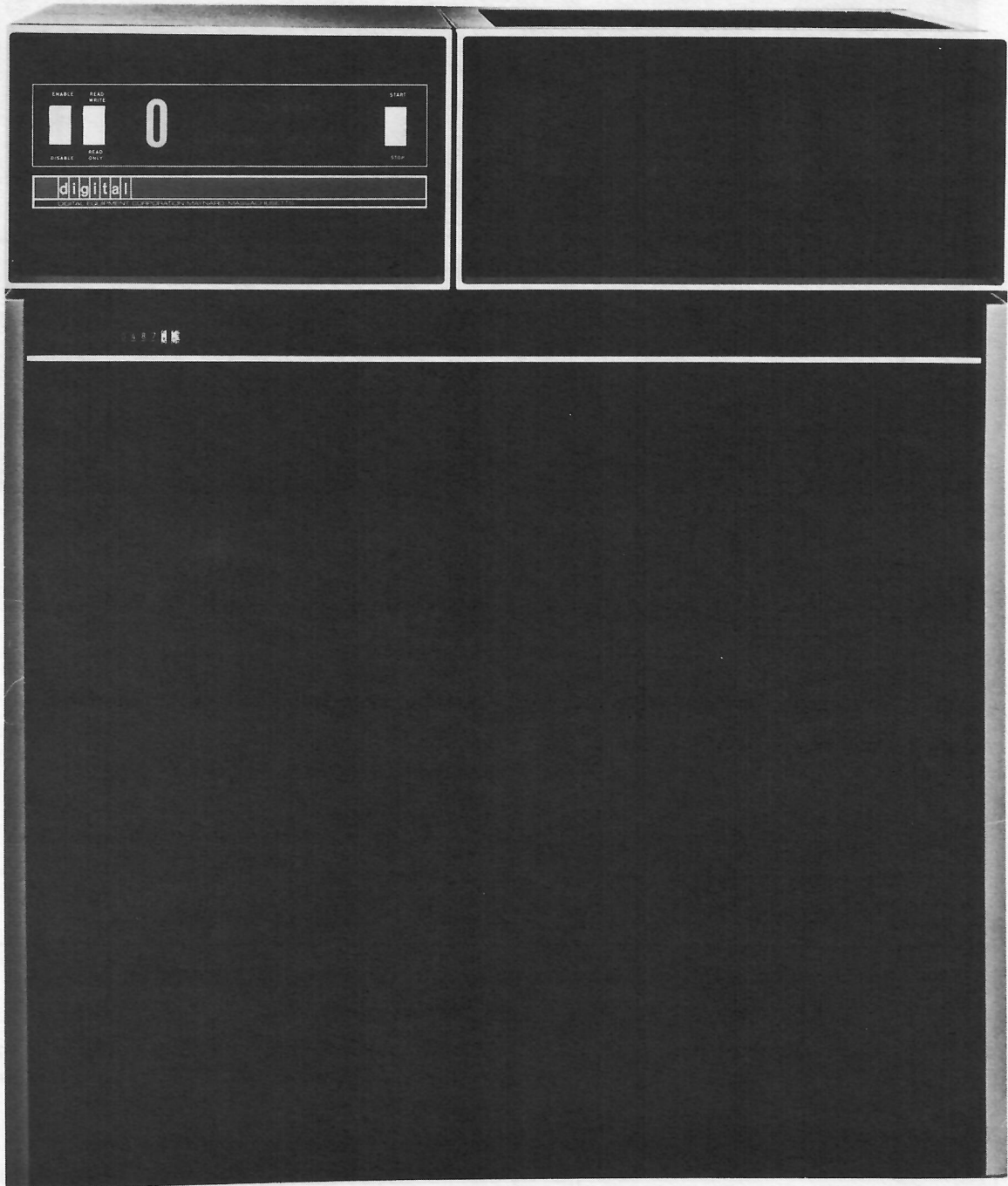

Figure 6-1 Disk Pack Drive Unit RP02

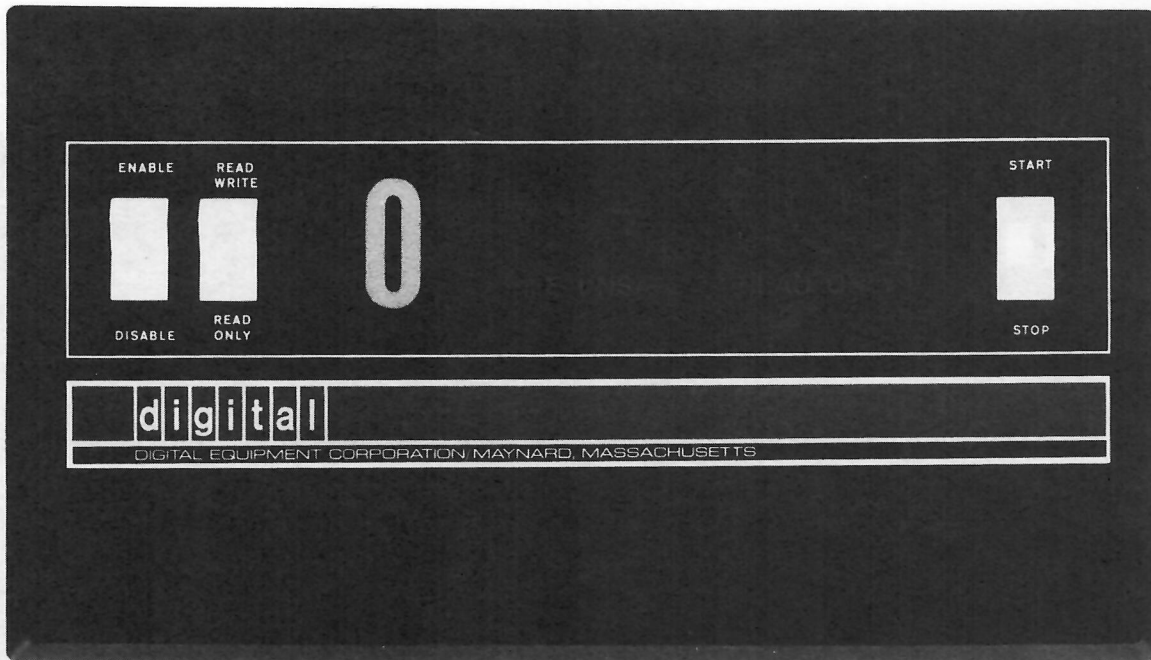

Figure 6-2 Drive Unit RP02 Controls and Indicators

6.1.1.2 RP15 Indicator Panel - The Disk Pack Controller RP15 Indicator Panel is illustrated in Figure 6-3 and described in Table 6-2.

Table 6-2  
RP15 Indicator Panel

Indicator	Function
BUFFER REGISTER 00 through 35	36-bit register (2 PDP-15 words) which interfaces the PDP-15 and the RP15
SHIFT REGISTER 00 through 35	36-bit data register which assembles the serial data read from the disk drive unit (RP02) or serializes the data being transferred to the disk drive unit.
LONGITUDINAL PARITY REGISTER 00 through 35	36-bit register which accumulates bit position odd parity for each sector of data. E.g., 00 accumulates odd parity for data bit 00 of each word in the sector.

Table 6-2 (Cont)  
RP15 Indicator Panel

Indicator	Function
WORD COUNT 03 through 17	18-bit register which is loaded with the two's complement of the number of words desired in a single transfer command. Each word transferred increments the WORD COUNT register. Only 15 bits are indicated.
CURRENT ADDRESS 01 through 17	18-bit register which is loaded with the initial memory address reference in a single transfer command. Each word transferred increments the current address. Only 17 bits are indicated.
SECTOR WORD COUNT SWC OVFL0	Sector Word Count Overflow - A bit which is set when required number of words (36-bit words) have been transferred to or from the disk.
SWC00 through SWC06	7-bit register which counts the words read or written in a single sector (word of 36 bits).
ERROR STATUS	
FE	Format Error - A bit which is set when a parity error occurs in a header word.
WE	Word Error - A bit which is set when a parity error occurs in a data word.
LE	Longitudinal Error - A bit which is set when a parity error occurs in a bit position of a single sector.
WCE	Write Check Error - A bit which is set when a data word read from memory does not compare with a paired data word read from the disk during a Write Check operation.
TE	Timing Error - A bit which is set when a data word misses a transfer to or from the processor's memory.
PE	Programming Error - A bit which is set when an illegal series of RP15 instructions has been issued.
HNF	Header Not Found - A bit which is set when a complete revolution of the disk has passed while searching unsuccessfully for a header word (unique sector address).
WPE	Write Protect Error - A bit which is raised when either of two Write Protect functions have been violated.
NEC	Non-Existent Cylinder - A bit which is present while an illegal cylinder address resides in the cylinder address register.
NEH	Non-Existent Head - A bit which is present while an illegal head address resides in the head address register.
NES	Non-Existent Sector - A bit which is present while an illegal sector address resides in the sector address register.

Table 6-2 (Cont)  
RP15 Indicator Panel

Indicator	Function
EOP	End of Pack - A bit which is set when the physical end of a disk pack unit is reached before the word count is complete.
SUSI	Selected Unit Seek Incomplete - A bit which is raised when a fixed time has passed (approximately 150 ms) while unsuccessfully seeking a particular cylinder address.
SUFU	Selected Unit File Unsafe - A bit which is raised when an unsafe condition exists in the RP02 Drive unit.
SELECTED UNIT CYLINDER ADDRESS 00 through 07	8-bit register which indicates the cylinder in which the heads, in the selected unit, are positioned.
UNIT ATTENTION 00 through 07	8-bit status register which indicates those units which have completed a Seek operation. There are eight-bit positions and up to eight units on-line, therefore, this bit position indicates the unit status. E.g., 06 indicates unit attention on unit 06.
UNIT STATUS	
SUOL	Selected Unit On-Line - A flag which is raised when the selected unit has power and is placed on-line by a switch located on the console of the selected unit (RP02).
SU RDY	Selected Unit Ready - A flag which is raised when the selected unit is ready for data transfer.
SUSU	Selected Unit Seek Underway - A flag which is raised during a Seek operation on the selected unit.
SURO	Selected Unit Read Only - A flag which is raised while a Read-Write/Read Only switch, located on the console of the selected drive unit (RP02), is in the READ ONLY position.
SULO	Selected Unit Lock-Out - A flag which is raised when the Lock-Out switch, located in the lower right-hand corner of the logic panel, is in the LOCK-OUT position, and the unit select register is equal to the lock-out register; and the cylinder address register is equal to or less than the LOA register.
FORMAT GENERATOR 00 through 08	9-bit register which controls Formatting operations during Write, Write All, and Format instructions.
MAINTENANCE	
MR00 through MR05	Maintenance Register - 6-bit register which simulates the RP02 Drive for maintenance routines.

Table 6-2 (Cont)  
RP15 Indicator Panel

Indicator	Function
MNT	A bit that is set when the control is in the maintenance mode.
CONTROL STATE	
READ	Read State - A bit which is set when the control is in the READ state; i.e., the control is in the READ state while searching for a header word during a Write function. Therefore, the state of the control at any instant does not always agree with the function being executed.
WRITE	Write State - A bit which is set when the control is in the WRITE state.
SEEK	Seek State - A bit which is set when the control is beginning a Seek.
CLR HEAD	Clear Head State - The state the controls enter when all heads are disabled.
INC HEAD	Increment Head State - The state the control enters when the current head is being disabled and the next head being selected.
RECAL	Recalibrate - The state the control enters while executing a Recalibrate function.
IDLE	Idle State - The non-busy state of the control.
CYLINDER ADDRESS	
CAR00 through CAR07	Cylinder Address Register - 8-bit register which is loaded with the desired cylinder address.
HEAD ADDRESS	
HAR00 through HAR07	Head Address Register - 5-bit register which is loaded with the desired head address.
SECTOR ADDRESS	
SAR00 through SAR03	Sector Address Register - 4-bit register which is loaded with the desired sector address.
SWITCH MODE	
FMT	Format - A bit which is set while the Format/Normal switch is in the FORMAT position.
NORM	Normal - A bit which is set while the Format/Normal switch is in the NORMAL position.
LOCK-OUT	Lock-Out - A bit which is set while the Lock-Out switch is in the LOCK-OUT position.

Table 6-2 (Cont)  
RP15 Indicator Panel

Indicator	Function
<p>LOCK-OUT</p> <p>LO00 through LO02</p> <p>LOA00 through LOA02</p>	<p>Lock-Out - 3-bit register which is controlled by switch settings and can be set to an octal number equal to the unit number of the desired unit cylinders to be locked out.</p> <p>Lock-Out Address - 3-bit register whose octal contents (controlled by switch settings) define the octal cylinders (inclusive) which are Write Protected in the selected unit defined by LO00 through LO02.</p>
<p>FUNCTION</p> <p>FR00 through FR02</p>	<p>Function Register - 3-bit register whose octal contents define one of eight functions to be executed.</p>
<p>UNIT SELECT</p> <p>UR00 through UR02</p>	<p>Unit Register - 3-bit register whose octal contents define the unit which is selected.</p>
<p>CONTROL STATUS</p> <p>BUSY</p> <p>DED</p> <p>GO</p> <p>ATD</p> <p>DISK FLG</p> <p>JOB DONE</p> <p>ATT FLAG</p> <p>ERR FLG</p>	<p>Busy - A bit which is set when the control is in a state other than IDLE.</p> <p>Done and Error Disable - A bit which is set when the Job Done and Error flags are disabled from the Program Interrupt (PI) and Automatic Priority Interrupt (API) port.</p> <p>When set, this bit signals the control to execute the current state of the function register.</p> <p>Attention Disable - A bit which is raised when the Attention flags (eight) are disabled from the PI and API port.</p> <p>Disk Flag - A flag which is raised as an OR of Job Done flag, Attention flag, and Error flag.</p> <p>Job Done - A flag which is raised at the completion of a function.</p> <p>Attention Flag - A flag which is raised when a Seek has been completed. This flag is an OR condition of UA00 through UA07.</p> <p>Error Flag - A flag which is raised as an OR of all error conditions.</p>

Table 6-2 (Cont)  
RP15 Indicator Panel

Indicator	Function
CONTROL STATUS (Cont)	
BK RQ	Break Request - A bit which is raised to request an access to memory.
WC OVFL0	Word Count Overflow - A bit which is raised when the desired number of word transfers are complete.

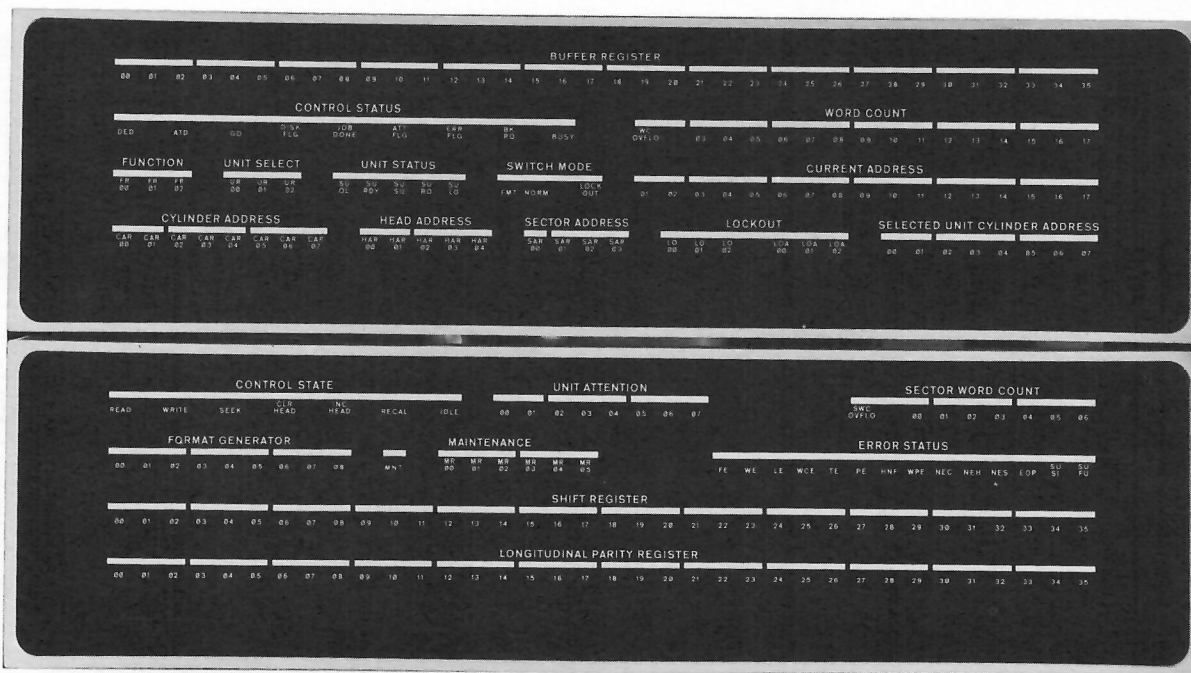

Figure 6-3 RP15 Indicator Panel

6.1.1.3 RP15 Control Panel - The RP15 control panel controls and indicators are illustrated in Figure 6-4 and are described in Table 6-3. Operator usage of the controls is explained in Paragraph 6.1.3.



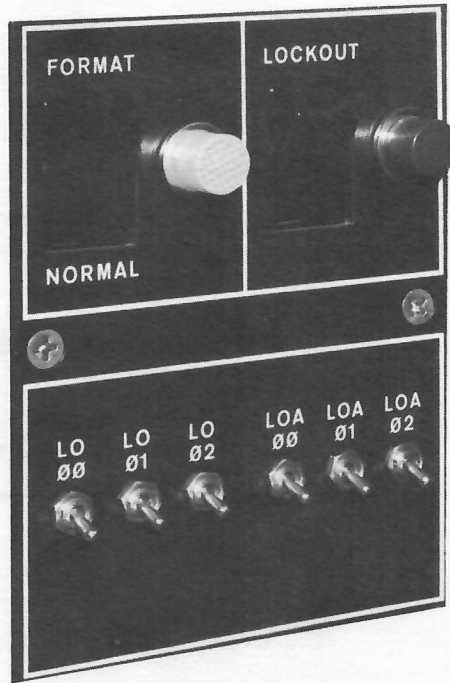

Figure 6-4 RP15 Control Panel

Table 6-3  
RP15 Control Panel Controls and Indicators

Control/Indicator	Type	Function
FORMAT/NORMAL	2-position rocker switch	In FORMAT position, conditions the controller for "write-all" format operation and in NORMAL position, conditions the controller for normal operation.
Format/Normal	Indicator	Lights when FORMAT-NORMAL switch is in FORMAT position.
LOCKOUT	2-position rocker switch	In LOCKOUT position, enables the controller to "write protect" memory cylinder addresses as selected by the LO and LOA toggle switches.
Lockout	Indicator	Lights when the LOCKOUT switch is in LOCK-OUT position.
LO 00 through 02	Toggle switches (3)	Determine the octal designation of unit (up to 8) on which the locked out address has been set by the LOA switches.
LOA 00 through 02	Toggle switches (3)	Determine the cylinder address (in octal) below which writing may not occur on the unit designated by the LO switches.



### 6.1.2 Disk Pack Installation Procedure

To install disk pack in the Disk Pack drive unit, perform the following steps:

#### NOTE

A mechanical brake extends to secure the spindle for removal or placement of the disk pack. The brake operates when the spindle cover is open.

<u>Step</u>	<u>Procedure</u>
1	Raise the cabinet cover.
2	Lower the disk pack onto the spindle.
3	Secure the disk pack to the spindle by twisting the cover handle clockwise.
4	Lift the disk pack cover off the disk pack and close the cabinet cover.

### 6.1.3 Starting Procedure and Operating Mode Selection

The following steps describe the Disk Pack unit starting procedure and two operating modes.

<u>Step</u>	<u>Procedure</u>
1	Place START/STOP switch in START position. Spindle motor will start and after approximately 60 seconds the Unit Number/Ready indicator will light signifying that the unit is ready for data transfer.

#### NOTE

START/STOP switch is interlocked with cabinet cover and is disabled if cover is not closed and disk pack secured to motor spindle.

2	When it is necessary to operate the unit off-line, place the ENABLE/DISABLE switch in the DISABLE position. Normal operation requires this switch to be in the ENABLE position.
3	If stored data protection is essential, place the READ/WRITE - READ ONLY switch in the READ ONLY position. This disables the erase and record electronics.

### 6.1.4 Write Protect Features

Two types of write-protect are provided in the disk pack system. Both prohibit the write operation from occurring and raise the appropriate interrupts.

6.1.4.1 Selected Unit Read Only - Mounted on the console of each RP02 drive unit is a switch labeled READ/WRITE-READ ONLY. In the READ/WRITE position, both Read and Write are enabled on the selected unit.

When the READ/WRITE-READ ONLY switch is in the READ ONLY position, the entire selected unit is "Write Protected". Should a unit which is "Selected Unit Read Only" designated be selected and a write function requested, the appropriate interrupts would be raised and the "Write Request" prohibited.

6.1.4.2 Selected Unit Lock-Out - Mounted in the lower right-hand corner of the RP15 logic panel is a group of switches labeled as shown in Figure 6-4. To the right of the switch labeled LOCK-OUT is a red indicator which lights when the Lock-Out switch is in the LOCK-OUT position. When this indicator is off, both Read and Write operations are enabled on the selected unit.

When the red lock-out light is on Selected Unit Lock-Out is enabled. However, only the unit described by the octal contents of the switch register labeled LO00 through LO02 are affected. The number of cylinders which are Write Protected, are cylinders 0 through the cylinder described by the octal contents of the switch register labeled LOA00 through LOA02 (inclusive). For example, if the setting of the switches is as follows:

LOCK-OUT = 1 (Red Light Lighted)  
LO00 through LO02 = 3  
LOA00 through LOA02 = 6

then the cylinders 0 through 6 (inclusive) of unit three are Write Protected.

Should a unit which is Selected Unit Lock-Out designated be selected and a Write function requested in those cylinders which are protected, the appropriate interrupts would be raised and the "Write Request" prohibited.

#### 6.1.5 Formatting Disk Packs

A formatting program is provided with the RP15 Software package.

### 6.2 RS09 DECDISK DRIVE AND RF15 DECDISK CONTROL

The RF15 DECDisk Control interfaces the RS09 DECDisk Drive to the PDP-15. The RF15 operates under program control for control and status transfers, and through the multi-cycle data break facility for data transfers. Up to eight RS09 drives can be handled by one RF15 control. Each RS09 can store

262,144 18-bit words. The total bulk storage capacity with eight RS09 drives is 2,097,152 18-bit words. Word transfer times are selectable at 16, 32, or 64  $\mu$ s per word. Average access time is 16.7 ms.

## 6.2.1 Controls and Indicators

6.2.1.1 Drive Unit - RS09 DECdisk Drive controls and indicators are illustrated in Figures 6-5 and 6-6 and described in Table 6-4.

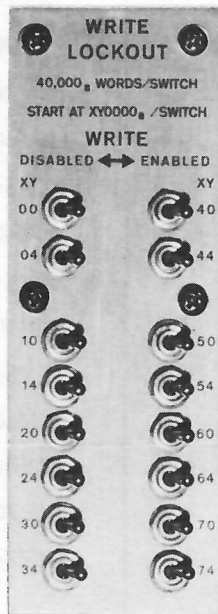

Figure 6-5 RS09 DECdisk Drive,  
Write Lockout Control Panel

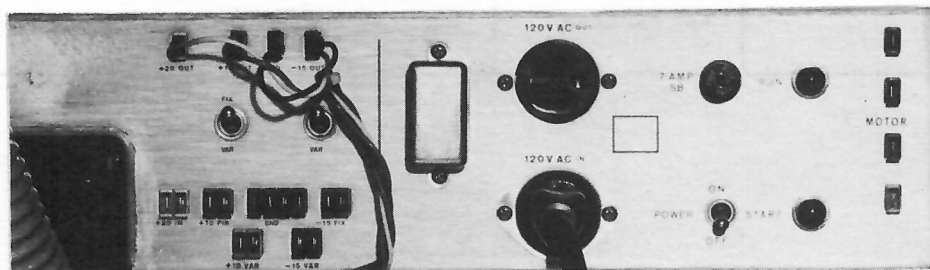

Figure 6-6 RS09 DECdisk Drive,  
Power Controls and Indicators

Table 6-4  
RS09 DECdisk Drive Controls and Indicators

Control/Indicator	Type	Function
WRITE LOCKOUT XY00 - XY74	Toggle switches	Each switch enables or disables writing on eight tracks as follows:  XY00: Tracks 0 <sub>8</sub> -7 <sub>8</sub> XY04: Tracks 10 <sub>8</sub> -17 <sub>8</sub> XY10: Tracks 20 <sub>8</sub> -27 <sub>8</sub> XY14: Tracks 30 <sub>8</sub> -37 <sub>8</sub> XY20: Tracks 40 <sub>8</sub> -47 <sub>8</sub> XY24: Tracks 50 <sub>8</sub> -57 <sub>8</sub> XY30: Tracks 60 <sub>8</sub> -67 <sub>8</sub> XY34: Tracks 70 <sub>8</sub> -77 <sub>8</sub> XY40: Tracks 100 <sub>8</sub> -107 <sub>8</sub> XY44: Tracks 110 <sub>8</sub> -117 <sub>8</sub> XY50: Tracks 120 <sub>8</sub> -127 <sub>8</sub> XY54: Tracks 130 <sub>8</sub> -137 <sub>8</sub> XY60: Tracks 140 <sub>8</sub> -147 <sub>8</sub> XY64: Tracks 150 <sub>8</sub> -157 <sub>8</sub> XY70: Tracks 160 <sub>8</sub> -167 <sub>8</sub> XY74: Tracks 170 <sub>8</sub> -177 <sub>8</sub>
FIX/VAR (left)	Toggle switch	For maintenance use. Operator must ensure that switch is in FIX position.
FIX/VAR (right)	Toggle switch	For maintenance use. Operator must ensure that switch is in FIX position.
POWER	Toggle switch	Applies ac power to the RS09.
START	Red indicator	Lights for 10 to 20 seconds when POWER switch is first turned on.
RUN	Red indicator	Lights when POWER switch is turned on.

6.2.1.2 RF15 Control Panel - The RF15 control panel is illustrated in Figure 6-7 and described in Table 6-5.

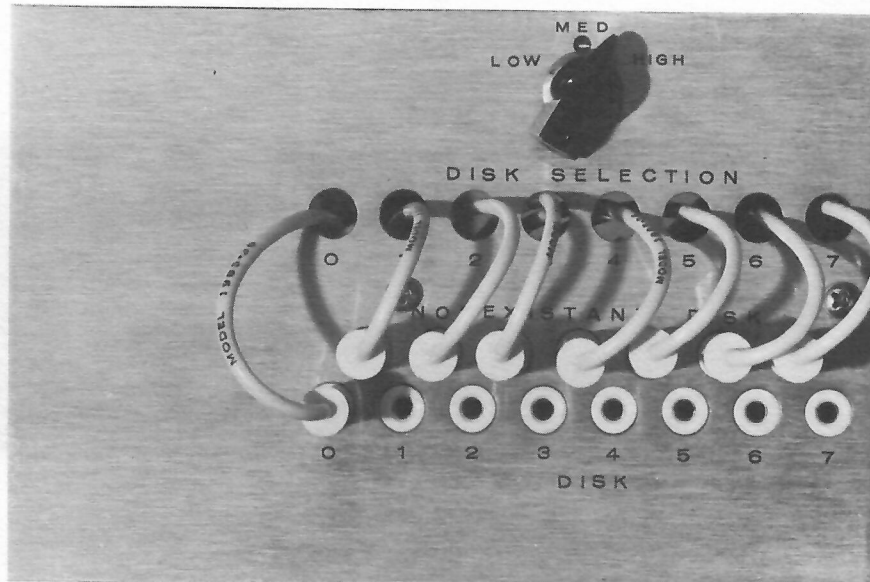

Figure 6-7 RF15 Control Panel

Table 6-5  
RF15 Control Panel

Control/Indicator	Type	Function
LOW/MED/HIGH	Three position rotary switch	Selects low, medium, or high data transfer rates as follows: LOW: 1 word/64 $\mu$ s MED: 1 word/32 $\mu$ s HIGH: 1 word/16 $\mu$ s
DISK SELECTION	Banana plugs and jacks (8 plugs; 15 jacks, 8 jacks for available disks and 7 jacks for non-existent disks)	Assign selection numbers to the RS09 DEC-disk Drives.

6.2.1.3 RF15 Indicator Panel - The RF15 Indicator Panel is illustrated in Figure 6-8 and described in Table 6-6.

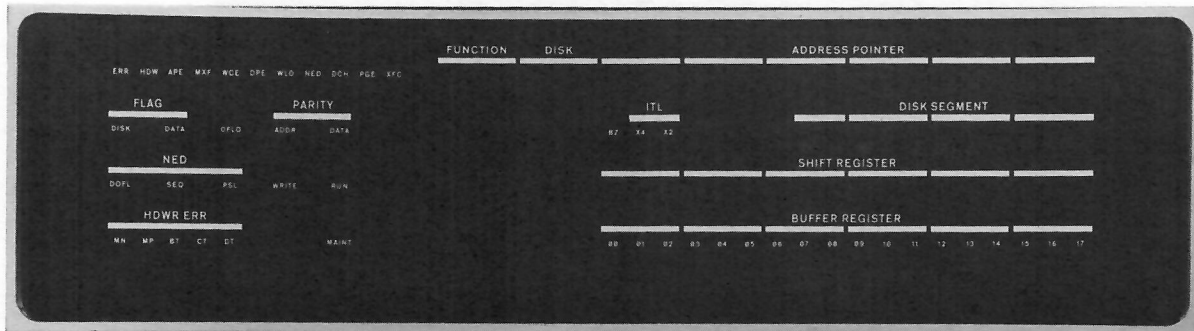

Figure 6-8 RF15 Indicator Panel

Table 6-6  
RF15 Indicator Panel

Indicator	Function
ERR	The error status bit is the logical OR of error status bits HDW, APE, MXF, WCE, DPE, WLO and NED. The flag indicated by this bit will interrupt the processor and condition the SKIP IOT (Input/Output Transfer) instruction.
HDW	Hardware error status. Unrectified signal pairs from the RS09 failed to transmit an alternating bit stream. An extra or missing bit is implied.
APE	Address parity error. Can occur anytime the disk is busy.
MXF	Missed transfer. Disk has been busy and has missed transferring data at least twice in succession from the same address. (More than one disk revolution has occurred without a transfer.) Either the control hardware has failed or the DCH channel has been overloaded and could not respond to the RF15 request. The Error flag is raised to signal the program.
WCE	Write check error. Indicate a comparison error exists between the word from core memory and the word read from the disk during Write check. The Error flag is raised and all further checking is stopped.



Table 6-6 (Cont)  
RF15 Indicator Panel

Indicator	Function																				
DPE	Data parity error. This error status bit is raised whenever the data parity bit does not agree with the computed parity of the data word just read. The control transfers the data word containing the parity error and raises the Error flag. No further transfers will occur until the program intervenes.																				
WLO	Write lockout. Error status bit that is raised when an attempt is made to write in a protected region.																				
NED	Nonexistent disk. Any disk called for or sequenced into, which does not exist, causes this error condition. A jumper panel on the RF15 provides the facility for rearranging disk physical numbers with control selected numbers. All unallocated select lines are jumpered to indicate a select error to the control. Sequencing into disk 10 <sub>8</sub> also causes the NED error condition. The Error flag is raised to signal the program. Bits 15, 16, and 17 of the Status register contain the number of the NED. Bit 14 will contain a one if disk 10 <sub>8</sub> is sequenced into.																				
DCH	Data channel timing error. This status bit is raised whenever the processor has not completed a DCH transfer before the disk control was ready to transfer data. No Error flag is raised. This status bit is intended as a warning that the DCH channel is very likely overburdened.																				
PGE	Programming error. This status bit is set whenever the program issues an illogical command to the disk. Further, if the command directly conflicts with the operation of the control, it will be ignored. No Error flag is raised. This status bit is provided as a warning to the programmer.																				
XFC	Transfer complete. The job requested via the program, READ, WRITE, or WRCHK, is finished. The flag indicated by this bit will interrupt the processor and condition the SKIP IOT.																				
Function Register - AC	<p>Bits 15, 16, and 17. The function of these bits is displayed below.</p> <table border="1" data-bbox="678 1423 1312 1623"> <thead> <tr> <th data-bbox="678 1423 792 1486">BIT 15 (FO)</th> <th data-bbox="841 1423 954 1486">BIT 16 (F1)</th> <th data-bbox="1003 1423 1117 1486">BIT 17 (INT)</th> <th data-bbox="1166 1423 1312 1455">FUNCTION</th> </tr> </thead> <tbody> <tr> <td data-bbox="711 1497 727 1528">0</td> <td data-bbox="857 1497 873 1528">0</td> <td data-bbox="1019 1497 1036 1528">X</td> <td data-bbox="1182 1497 1312 1528">No effect</td> </tr> <tr> <td data-bbox="711 1528 727 1560">0</td> <td data-bbox="857 1528 873 1560">1</td> <td data-bbox="1019 1528 1036 1560">X</td> <td data-bbox="1182 1528 1263 1560">READ</td> </tr> <tr> <td data-bbox="711 1560 727 1591">1</td> <td data-bbox="857 1560 873 1591">0</td> <td data-bbox="1019 1560 1036 1591">X</td> <td data-bbox="1182 1560 1263 1591">WRITE</td> </tr> <tr> <td data-bbox="711 1591 727 1623">1</td> <td data-bbox="857 1591 873 1623">1</td> <td data-bbox="1019 1591 1036 1623">X</td> <td data-bbox="1182 1591 1279 1623">WRCHK</td> </tr> </tbody> </table> <p data-bbox="630 1644 1393 1759">Bit 17 indicates the interrupt state of the control during the last transfer before a Load Function Register command. If Bit 17 is a one, the Disk flags will request an API/PI break; if it is zero, no API/PI requests will be made.</p>	BIT 15 (FO)	BIT 16 (F1)	BIT 17 (INT)	FUNCTION	0	0	X	No effect	0	1	X	READ	1	0	X	WRITE	1	1	X	WRCHK
BIT 15 (FO)	BIT 16 (F1)	BIT 17 (INT)	FUNCTION																		
0	0	X	No effect																		
0	1	X	READ																		
1	0	X	WRITE																		
1	1	X	WRCHK																		
DISK	Three bits of the disk selection register.																				

Table 6-6 (Cont)  
RF15 Indicator Panel

Indicator	Function
ADDRESS POINTER	The first 7 bits from left to right indicate the contents of the track address register, and the following 11 bits the content of the word address register.
FLAG	DISK This level is the logical OR of the two conditions which cause an API or PI break - the ERROR flag and the TRANSFER COMPLETE flag.
	DATA The flag which requests a multi-cycle data break was reset.
OFLO	The computer has overflowed its word count register and set this flag to stop further DCH transfers.
PARITY	ADDR A parity error on the "B" or address track has been detected.
	DATA A parity error on the current data track has been detected.
BZ	The disk is presently BUSY and engaged in a data transfer.
ITL	X4 When this bit is set, the operator has selected the LOW transfer rate, and every fourth bit is being transferred. ITL stands for interlace.
	X2 Same as X4 except that the operator has selected the MED transfer rate.
NED	DOFL During a transfer, the control has attempted to sequence into a ninth disk, which does not exist. NED means nonexistent disk.
	SEQ During a transfer, the control has attempted to sequence into a disk unit which does not exist. The difference between DOFL and SEQ is that in SEQ a disk could be added, i.e., the system capacity was not exceeded. With DOFL the control has asked for a disk address greater than 7 <sub>8</sub> .
	PSL A nonexistent disk unit has been specified by the program. It has not been sequenced under a transfer, so the error is a direct programming mistake.
WRITE	A write operation is taking place.
RUN	The RF15 is busy and properly synchronized.
HDWR ERR	MN A missing negative pulse or extra positive pulse from the ATT track bipolar signal pair has been detected.
	MP A missing positive or extra negative pulse from the ATT track bipolar signal pair has been detected.
	BT Any pulse of the bipolar signal pair from the BTT track has been detected as missing or extra.
	CT Any pulse of the bipolar signal pair from the "C" track has been detected as missing or extra.
	DT Any pulse of the bipolar signal pair from the addressed data track has been detected as missing or extra.



Table 6-6 (Cont)  
RF15 Indicator Panel

Indicator	Function
MAINT	The controller is in Maintenance mode.
DISK SEGMENT	Indicates contents of the disk segment register; this register contains the present position of the disk. The disk segment register is a dynamic shift register which assembles the serial address from the disk and holds it for comparison with the word address.
SHIFT REGISTER	Indicates contents of the shift register. The shift register is a serial to parallel converter for data transfers between the buffer register and the RS09 DECdisk Drive read/write circuitry.
BUFFER REGISTER	Indicates contents of the buffer register. The buffer register is the data holding register for transfers between the control and the processor.

### 6.2.2 Power Turn-On Procedure

Turn power on as follows:

<u>Step</u>	<u>Procedure</u>
1	Make sure that the circuit breaker and the LOCAL/OFF/REMOTE switch of the 855 Power Control are OFF.
2	Insert power cord plug in the appropriate power socket.
3	Make sure that FIX/VAR switches are at FIX.
4	Make sure that POWER switch of each RS09 Motor Control Chassis (Figure 6-6) is OFF.
5	Turn the 855 Power Control circuit breaker ON.
6	Sequentially turn the POWER switch of each RS09 Motor Control Chassis ON, waiting for the START light to go OFF before turning the next POWER switch ON.

#### CAUTION

Do not turn on more than three RS09 DECdisk Drives at a time. Doing so may trip the 855 Power Control circuit breaker.

#### NOTE

With more than three disks in a system, it may be necessary to repeat Steps 4 through 6 in the event of a power failure. The total starting current might exceed the capacity of the 855 Power Control circuit breaker.

7	Switch the LOCAL/OFF/REMOTE switch of the 855 Power Control to REMOTE.
---	--

### 6.2.3 Transfer Rate Selection

Select transfer rates by setting the LOW-MED-HIGH switch on the RF15 control panel (Figure 6-7) to the desired transfer rate.

LOW: 1 word per 64  $\mu$ s  
MED: 1 word per 32  $\mu$ s  
HIGH: 1 word per 16  $\mu$ s

#### CAUTION

Transfer rates must be the same for reading as they were for writing or the data will become garbled.

### 6.2.4 Disk Number Selection

Select disk numbers at the RF15 control panel (Figure 6-7) as follows:

#### NOTE

The DISK SELECTION wires are wired to the RF15 DECdisk Control. Under program control, the RF15 activates one DISK SELECTION wire at a time. Each DISK jack is wired to a unique RS09 DECdisk Drive, unless fewer than eight RS09s exist in the system. The NONEXISTENT DISK jacks are wired to the RF15, making it possible for the RF15 to detect a disk selection error if the program attempts to select a nonexistent disk.

<u>Step</u>	<u>Procedure</u>
1	Assign disk selection numbers to the disks by plugging the DISK SELECTION wires into the DISK jacks for the disks. Any disk may be assigned any disk selection number. The physical location of each disk is shown in Figure 6-9. The disk numbers shown in Figure 6-9 correspond to the DISK jack numbers on the RF15 control panel.
2	Plug the remaining wires into the NONEXISTENT DISK jacks.

DISK 7 (RS09C)	DISK 4 (RS09C)	RF15	PDP-15
DISK 6 (RS09B)	DISK 3 (RS09B)	DISK 1 (RS09B)	
DISK 5 (RS09D)	DISK 2 (RS09D)	DISK 0 (RS09D)	

15-0241

Figure 6-9 Disk System Configuration

### 6.2.5 Write Lockout Selections

Groups of eight tracks may be protected from being written on by setting the WRITE LOCKOUT switches on the RS09 control panel shown in Figure 6-5. Refer to Table 6-4 for track assignments to each WRITE LOCKOUT switch.

#### NOTE

This disk is designed for continuous operation. All design parameters of the RS09 disk system are based on continuous operation. Do not turn off the disk except for maintenance purposes.

#### CAUTION

Should the disk be turned off for more than 24 hours, the ambient relative humidity must be maintained at 55% or lower. Failure to comply with this humidity requirement may result in a damaged disk.

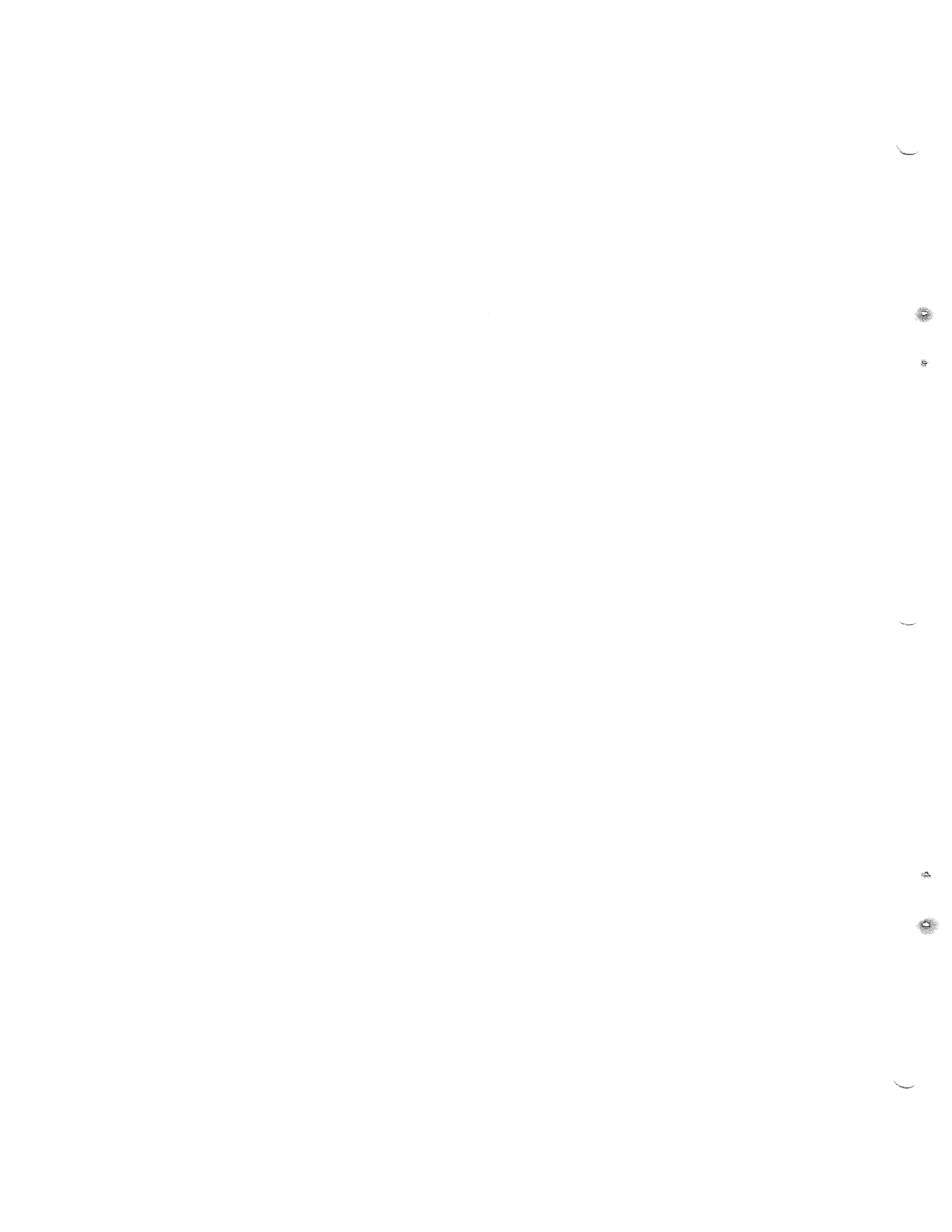

## Chapter 7

# Magnetic Tape Transports

### 7.1 TU20 MAGNETIC TAPE TRANSPORT AND TC59 MAGNETIC TAPE CONTROL

The Automatic Magnetic Tape Control, Type TC59, transfers data to and from industry-compatible transports via the data channel facility. Up to eight transports can be handled by a single control, and both BCD and binary modes are available. One rack-mounted TC59 control can handle both seven- and nine-channel transports at both 45 and 75 IPS. Read/write functions, recording density, and tape manipulation functions are controlled by status registers which can be loaded and read by the PDP-15.

The Type TU20 Magnetic Tape Transport can read and write seven or nine channel industry-compatible tapes at 45 inches per second and 200, 556, or 800 bits per inch (bpi). One 18-bit PDP-15 word is written as three tape-characters on the Type TU20(BA) at 200, 556 or 800 bpi. Its nine-channel counterpart, the Type TU20(AA) Magnetic Tape Transport, operates at the same speed with a density of 800 bpi and writes an 18 bit word as two characters.

The TU30(BA) and TU30(AA) Magnetic Tape Transports are seven- and nine-channel units that operate at 75 inches per second. The density options are the same as those of the TU20.

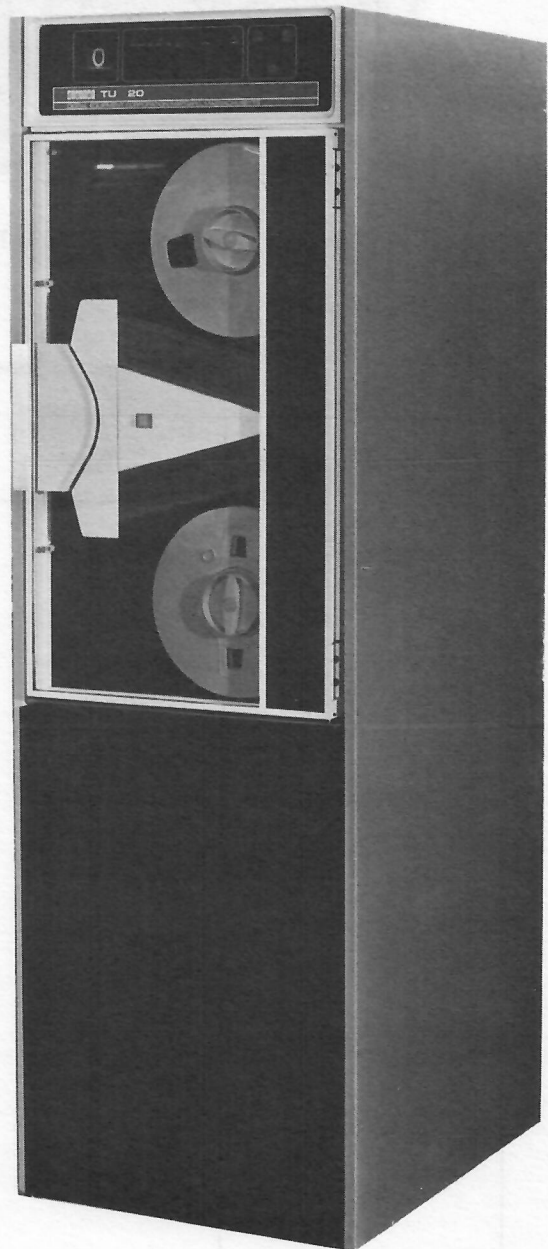

Figure 7-1 TU20 Magnetic Tape Transport

### 7.1.1 Controls and Indicators

An overall view of the TU20 Magnetic Tape Transport is shown in Figure 7-1. The controls and indicators on the Type TU20 Magnetic Tape Transport Control Panel are illustrated in Figure 7-2 and described in Table 7-1.

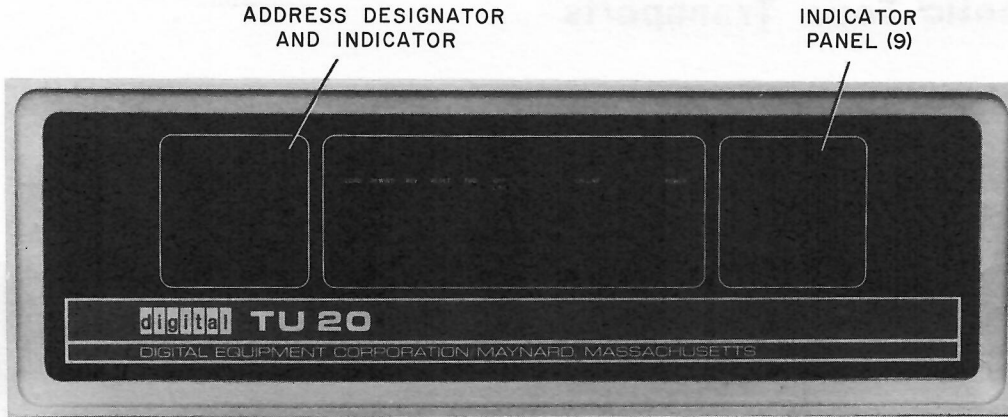

Figure 7-2 Magnetic Tape Transport, Type TU20 Controls and Indicators

Table 7-1  
TU20 Magnetic Tape Transport Controls and Indicators

Control/Indicator	Type	Function
POWER	Rocker switch	Applies prime power to the tape unit. Indicator above switch remains lighted as long as power is on.
ON LINE	Rocker switch	Connects the unit into the system and places it under control of the system program. While the unit is so connected, the FWD, REV and REWIND switches are inoperative.
OFF LINE	Rocker switch	Removes the unit from system control and places it under manual control. Makes the FWD, REV and REWIND switches operative, provided the LOAD indicator is on.
LOAD	Rocker switch	With power on and the tape correctly installed, places the vacuum system in operation, starts the tape-moving machinery, and places the unit in operable status until the LOAD indicator lights. The indicator stays on as long as the unit is in operable status.
		NOTE LOAD switch must be held down until associated LOAD indicator lights above switch.

Table 7-1 (Cont)  
TU20 Magnetic Tape Transport Controls and Indicators

Control/Indicator	Type	Function
FWD	Rocker switch	Moves the tape in the forward direction (from file reel to takeup reel); usable only when the unit is OFF LINE. Once this switch is depressed, the tape continues in forward motion until either the load point or the end point is reached, or until the operator depresses the RESET switch.
REV	Rocker switch	Moves the tape in the reverse direction (from takeup reel to file reel); usable only when the unit is OFF LINE. Once the switch is depressed, the tape continues to move until the tape comes off the takeup reel, or until the operator depresses the RESET switch.
REWIND	Rocker switch	Moves the tape at high speed from takeup reel to file reel. Once the switch is depressed, the rewind operation continues until the load point is reached or until the operator depresses the RESET switch.
RESET	Rocker switch	Stops the FWD, REV, and REWIND operations. The RESET indicator will be on except when a FWD, REV, REWIND, or LOAD operation is taking place.
SELECT	Panel indicator	The tape unit has been addressed by the system.
READY	Panel indicator	The unit is in operable status, and in on-line and available for system use.
LOAD POINT	Panel indicator	The tape stands at the load point.
END POINT	Panel indicator	The tape has reached the end point.
WRITE LOCK	Panel indicator	It is not possible to write on the tape. (The write-enable ring is not on the file reel.) Lights when power is applied and file reel installed; goes off when LOAD indicator lights.
WRITE STATUS	Panel indicator	Writing is in progress. Lights only when unit is on-line.
9	Panel indicator	Indicates tape unit has nine tracks.
7	Panel indicator	Indicates tape unit has seven tracks.
REWIND	Panel indicator	Indicates tape is being rewound.



Table 7-1 (Cont)  
TU20 Magnetic Tape Transport Controls and Indicators

Control/Indicator	Type	Function
Transport	3-position spring-return center-off slide switch	Located on front of tape transport between vacuum chambers (see Figure 7-1). Switch positions function as follows:
START		Pushing switch to this position performs the same function as the LOAD switch on the operator panel.
BRAKES		Pushing switch to this position releases brakes on the two transport hubs. While the switch is held in this position, the reels can be rotated by hand.
		NOTE
		This is an electrical switch and not a mechanical release; it will operate only when power is on.
Address Designator	Thumbwheel switch	Determines the system address (0-8) of the Tape Transport.
Address Indicator	Panel indicator	Located just above Address Designator Switch. Indicates system address selected by that switch.

### 7.1.2 Tape Installation Procedure

To install tape in the unit, perform the following steps:

<u>Step</u>	<u>Procedure</u>
1	If it is intended to write on the tape, insert the write-enable ring in the groove on the file reel (see Figure 7-3).  If no writing is to be done on the tape, remove the write-enable ring from the groove.
2	Turn the key on the upper mounting hub counter-clockwise as far as it will go.
3	Hold the reel with the grooved side toward the unit, and fit the reel onto the hub, pressing it on firmly as far as it will go.
4	While holding the reel firmly back on the hub, turn the hub key clockwise until tight to secure the reel on the hub.
5	Depress the POWER switch on; observe that the POWER switch indicator lights.

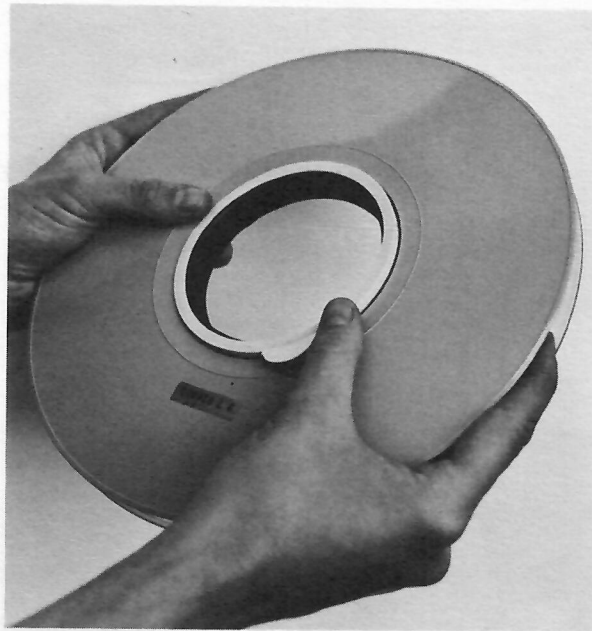

Figure 7-3 Write-Enable Ring Installation

Step

Procedure

6

While holding the transport switch to the BRAKES position, draw about three feet of the tape from the reel.

**CAUTION**

Always use care in handling loose tape. Make sure that it cannot be trampled or snagged, or accumulate dirt. Because the tape is easily damaged by heat, do not let it get close to any electronic components.

7

Hold the tape as shown in Figure 7-4 with the tape aligned with the reel and passing above the upper vacuum chamber guides. Now start the tape edgewise into the upper part of the tape insertion slot.

8

Slip the tape edgewise into the full length of the tape insertion slot.

9

Lay the end portion of the tape on the top of the takeup reel hub so that the tape end lies a few inches past one of the finger holes in the reel flange.

10

While holding the transport switch to BRAKES, use the finger to hold the tape against the hub, and turn the takeup reel four complete turns clockwise (see Figure 7-5).

11

Verify that the tape path is as follows:

From the bottom of the file reel; over the upper vacuum chamber guide and into the upper end of the tape insert slot; out of the lower end of the tape insert slot; under the lower vacuum chamber; and onto the top of the takeup reel.

Step

Procedure

11 (Cont)

CAUTION

There must be no twist in the tape, anywhere.

12

The unit is now ready to be placed on-line.

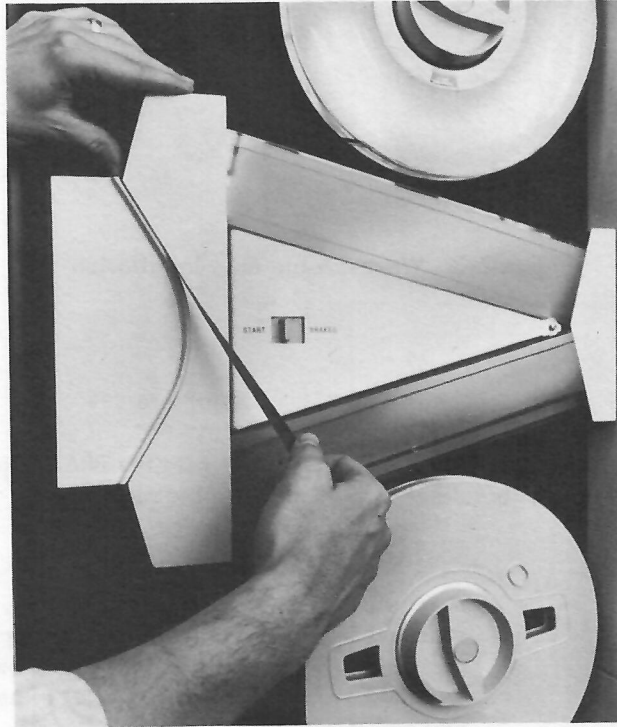

Figure 7-4 Starting Tape in Tape Insertion Slot

### 7.1.3 Placing the Tape Unit On-Line

Perform the following steps to place the unit in system operation:

Step

Procedure

1

Verify that the following panel indicators are lighted: 7 or 9; POWER; Address Designator; OFF LINE; RESET; and WRITE LOCK (only if write-enable ring is not in file reel). SELECT indicator may be on or off.

2

Press LOAD switch or START switch. Observe that tape is down into both vacuum chambers; transport machinery is on; the LOAD indicator lights; and WRITE LOCK indicator goes off.



Figure 7-5 Starting Tape on Takeup Reel

<u>Step</u>	<u>Procedure</u>
3	Depress FWD switch. Observe that FWD indicator comes on; RESET indicator goes off; tape moves a short distance (to load point); FWD indicator goes off again; and RESET and LOAD POINT indicators come on.
4	Depress ON LINE switch. Observe that OFF LINE indicator goes off; and ON LINE and READY indicators come on. The unit is now under program or console control.

#### 7.1.4 Tape Removal Procedure

To remove the tape file reel for storage, perform the following steps:

<u>Step</u>	<u>Procedure</u>
1	If LOAD POINT indicator is on depress OFF LINE switch and proceed to Step 3; if it is not on (tape stands in data portion) depress the OFF LINE switch and proceed to Step 2.

<u>Step</u>	<u>Procedure</u>
2	Depress the REWIND switch and observe: <ol style="list-style-type: none"> <li>a. Tape is in motion from takeup reel to file reel and REWIND indicator is on.</li> <li>b. Tape stops; REWIND indicator goes off and LOAD POINT indicator comes on.</li> </ol>
3	Set the transport switch to BRAKES and observe: <ol style="list-style-type: none"> <li>a. LOAD POINT indicator goes off.</li> <li>b. Tape-transport machinery stops.</li> <li>c. Vacuum is removed.</li> </ol>
4	While holding the transport switch to BRAKES, turn the file reel by hand and wind the rest of the tape onto the upper (file) reel.
5	Turn the key on the upper mounting hub to the left as far as it will go.
6	Remove the file reel from the hub.

### 7.1.5 Care and Cleaning

Information provided under this heading is essential to trouble-free operation of data storage equipment magnetic tape.

7.1.5.1 Care of Tape - Magnetic tape affords reasonably stable data storage. Its accuracy and usefulness, however, can be impaired by unfavorable environmental conditions or by incidents occurring during handling. The tape can be damaged, or suffer data distortion or loss from friction, physical shock, extremes of temperature or humidity, magnetic influences and particle contamination. To avoid these conditions the following precautions should be taken.

- a. When handling the tape, avoid pinching, rubbing and physical shock which can damage the oxide material.
- b. Store the tape where temperature is maintained between 40 and 90 degrees Fahrenheit with relative humidity between 20 and 80%.
- c. Keep tape away from magnets, electrical coils, and high current wiring; strong magnetic fields can distort or destroy data stored on tape.
- d. Particle contamination is a common cause of tape data errors. This problem is caused by displacement of particles of the oxide material or by foreign particles such as dust. To minimize trouble from these sources, store the tape in a dust-free location and carefully follow unit cleaning directions in Paragraph 7.1.5.2.

The reflective tabs which mark the load point and end point of a tape are of separate material and are stuck to the back (shiny side) of the tape. Avoid disturbing these tabs. However, a tab can be moved if it should be necessary to shorten a tape because of damage. Peel the tab off the tape surface very



carefully and stick it on again at the new location. Be sure to position the tab along the same edge of the tape from which it was removed. The load point tab must be placed along the outer edge of the tape when the tape is installed in the unit. The end point tab must be positioned along the opposite edge.

7.1.5.2 Tape Transport Cleaning Procedure - Clean the tape unit after each sixteen hours of use following the methods described below:

- a. Use the cleaning kit provided for the purpose. Except when otherwise instructed, clean with a wiper or swab moistened lightly with solvent. Discard soiled wiper and swabs promptly. Where applicable, follow directions which accompany the kit.

#### WARNING

Tape head cleaner fluid and fumes are toxic. Provide good ventilation. Avoid breathing fumes and prolonged contact with skin. Cap the container tightly before storage to prevent evaporation, and store away from sun and heat to prevent pressure build up.

- b. Clean the capstans, pinch rollers and roller guides while rotating them by hand. Check for binding or loosened bearings and, if present, report the unit for corrective maintenance.

#### CAUTION

Do not use a strong solvent. If the solvent supplied with the kit is not available, use denatured alcohol. A stronger solvent may damage the rubber pinch rollers and painted surfaces. Do not allow solvent to drip on parts not to be cleaned. Never allow solvent to reach bearings as it may cause serious damage by dissolving the lubricant.

- c. Cleaning and inspection is performed as described in the following steps:

<u>Step</u>	<u>Procedure</u>
1	Open the transparent door of the unit and wipe the exposed surfaces of the transport with a slightly dampened cloth to remove dust (see Figure 7-1).
2	Remove the tape from the unit. Remove the head cover and capstan cover.
3	Disengage the retaining spring which secures the glass cover of each vacuum chamber (see Figure 7-6) and remove spring and cover.
4	Clean the chamber covers using a commercial glass cleaner such as Windex.
5	Clean the vacuum chamber roller and fixed guides.

<u>Step</u>	<u>Procedure</u>
6	Wipe off the inner surfaces of the vacuum chambers with a clean, dry cloth. Moisten a wiper sparingly with solvent and clean the perpendicular surface of each chamber.
	CAUTION
	Do not clean the top and bottom walls of the vacuum chambers with solvent. These surfaces have a covering of adhesive material which can be damaged by solvent.
7	Clean all items shown along the tape path in Figure 7-6, including the tape contact surface of the magnetic head.
8	Reinstall the vacuum chamber covers.
9	If the transparent door of the unit is dirty, clean with a mild solution of soap and water.
	CAUTION
	The material of the transparent door is acrylic resin plastic. Rubbing with a dry cloth will give this material a charge of static electricity which will attract dust. Therefore, only soap and water should be used for cleaning. Do not polish.
10	Install a tape in the unit, place the unit in manual operating mode, and check performance as follows: <ul style="list-style-type: none"> <li>a. Move the tape forward and backward for about one-second intervals. Observe that it is leaving the drive capstan without twist or curl and that it is not riding hard against the top or bottom of either vacuum chamber.</li> <li>b. Move the tape forward and observe that the tape runs onto the takeup reel without scraping the reel flanges. Reverse the tape and observe that it runs onto the file reel without scraping the flanges. If the tape fails to track properly in any way, report the unit for corrective maintenance.</li> </ul>
11	Reinstall the head and capstan covers.

## 7.2 TU55 DECTape TRANSPORT AND TC02 DECTape CONTROL

The TC02 DECTape Control controls up to eight TU55 DECTape transports. Binary information is transferred to and from the PDP-15 at the rate of one 18-bit word every 200  $\mu$ s, using the data channel facility. Mode of operation, function, and direction of motion are controlled by status registers which can be loaded and read by the computer.



RETAINING  
SPRINGS

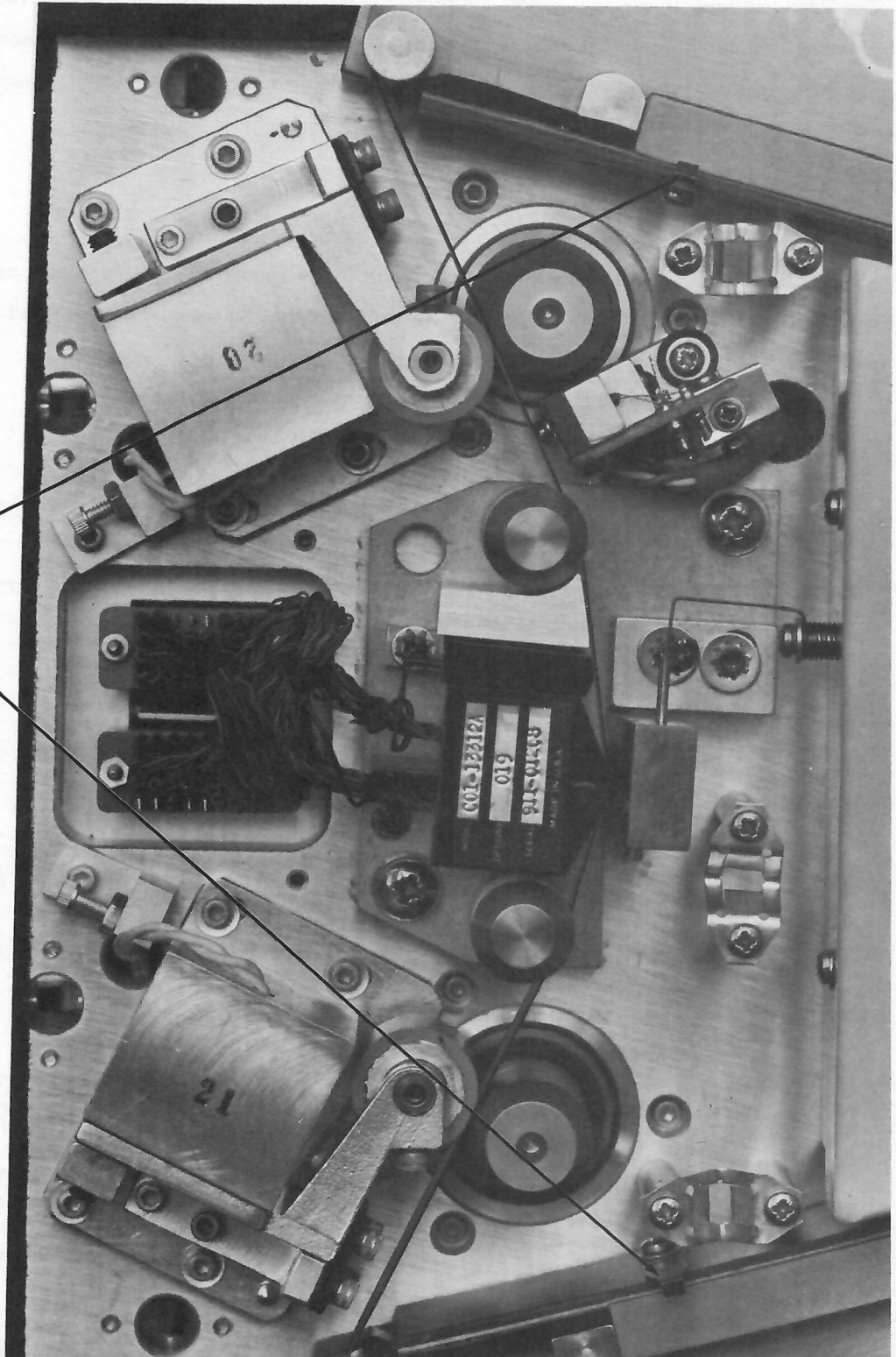

Figure 7-6 Tape Transport Tape Path

The TU55 DECtape Transport provides bidirectional reading and writing of DECtape reels. Each 3-in. diameter reel can hold 3,000,000 bits of information (over 150,000 18-bit words) recorded at 375 bits per inch. The tape moves at 80 in. per second and requires no vacuum columns, pinch-rollers, or capstans.



### 7.2.1 Controls and Indicators

The DECtape transport unit is rack mounted, with the reel mounting hubs, tape path and all controls and indicators located on the front panel. The controls and indicators are illustrated in Figure 7-7 and described in Table 7-2.

Table 7-2  
TU55 DECtape Transport Controls and Indicators

Control/Indicator	Type	Function
Tape Protection	Two-position rocker switch	
WRITE ENABLED		Permits writing on the tape.
WRITE LOCK		Inhibits writing on the tape.
WRITE ENABLED	Indicator lamp	When lit writing is permitted.
Unit Selection	Barrel switch	
1 through 8		Determines the address code by which the unit is accessed by the central processor for data transfer.
OFF LINE		When this position is selected, prevents processor selection of the unit.
Unit Control	Three-position rocker switch	
REMOTE		Places the unit under the control of the processor; disables the Tape-Reverse and Tape-Advance switches.
OFF		Removes power from the drive motors and releases the brakes on the hubs; disables the Tape-Reverse and Tape-Advance switches, and prevents the unit from being selected by the processor.
LOCAL		Prevents the unit from being selected by the processor; permits use of the Tape-Reverse and Tape-Advance switches.

Table 7-2 (Cont)  
TU55 DECtape Transport Controls and Indicators

Control/Indicator	Type	Function
REMOTE	Indicator lamp	When lit, indicates that the unit is under the control of the processor.
 (Tape Advance)	Momentary-contact rocker switch	Moves the tape in the forward direction (left to right).
 (Tape Reverse)	Momentary-contact rocker switch	Moves the tape in the rewind direction (right to left).

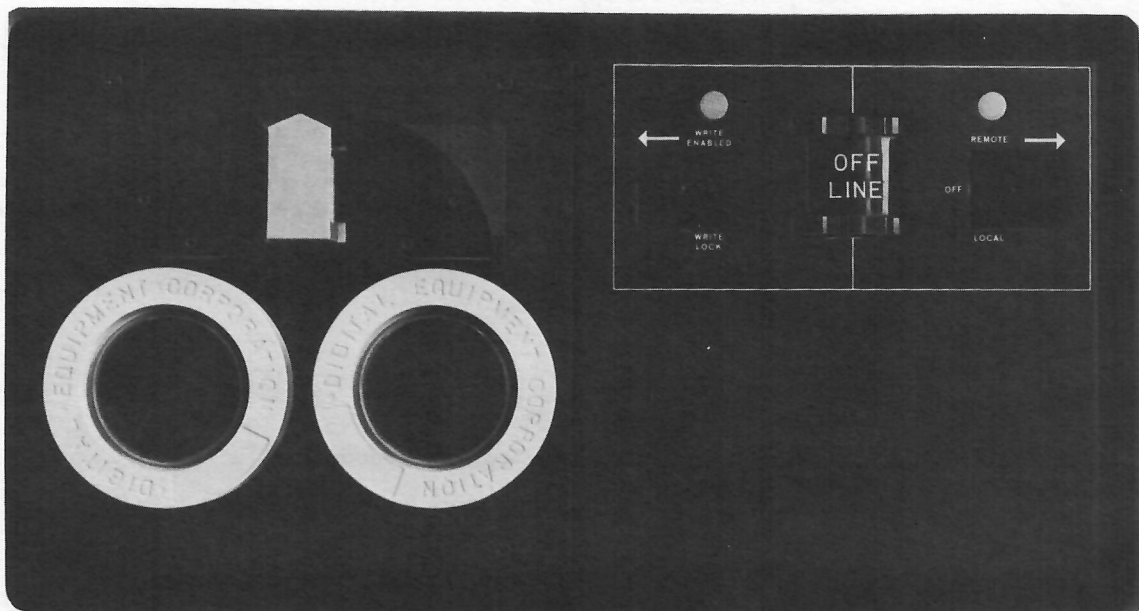

Figure 7-7 TU55 DECtape Transport

### 7.2.2 Operating Procedures

The tape transport unit operates automatically under program control. The operator controls the unit when removing and installing tape, and placing the unit on-line. These procedures are described in the following paragraphs.



7.2.2.1 DECTape Installation Procedure - To mount reels of DECTape on the transport, perform the following steps:

<u>Step</u>	<u>Procedure</u>
1	Set the Transport Control switch to OFF.
2	Hold the reel with the labeled side out, the blank side toward the transport. Depress the reel onto the left-hand mounting hub until it is solidly seated all around.
3	Lead the tape over the two tape guides and the magnetic head to the right-hand side of the takeup reel.
4	Hold the tape end against the hub of the takeup reel, rotate the reel clockwise and wind four or five turns of tape onto the reel.
5	Verify that power is applied to the unit; set the Transport Control switch to LOCAL.
6	Depress the Tape-Advance switch (→) and run at least 15 more turns of tape onto the takeup reel.

7.2.2.2 Placing the DECTape Transport On-Line - To place the transport on line, perform the following steps:

<u>Step</u>	<u>Procedure</u>
1	Verify that the Transport Control switch is set to LOCAL or OFF and that system power is on.
2	Verify that the desired tape is properly loaded.
3	Set the WRITE switch to permit writing (WRITE ENABLE) or to inhibit writing (WRITE LOCK) as required.
4	Set the Transport Selector switch in accordance with program instructions.
5	Set the Transport Control switch to REMOTE.

NOTE

To remove the transport from system service, set the Transport Control switch to LOCAL or OFF.

7.2.2.3 DECTape Removal Procedure - To remove reels of DECTape perform the following steps:

<u>Step</u>	<u>Procedure</u>
1	Set the Transport Control switch to LOCAL.
2	Depress the Tape-Reverse (←) switch and hold until all tape is wound onto the left-hand reel.
3	Set the Transport Control switch to OFF.

Step

Procedure

4

Remove the reel of tape from the mounting hub as follows:

- a. Place finger tips of both hands under the outer flange at the bottom of the reel, and thumbs on the mounting hub.
- b. Pull outward on the flange with finger tips while pressing on the hub with thumbs until the reel moves slightly.
- c. Rotate the reel and mounting hub one-half turn and loosen the opposite side of the reel in the same manner.
- d. Draw the reel from the hub.

7.2.2.4 Format Generation - Format a tape in the following situations:

- a. When new unformatted tape is to be used.
- b. When data tape of obsolete application is to be reused, and a different length of data blocks is required.
- c. When, through long use or mischance, the accuracy of a tape is reduced, as evidenced by errors. (Be sure to store the data elsewhere before reformatting the tape.)

To format a tape, use the program furnished for that purpose with the DECtape system. Operating instructions which accompany this program call for the use of a switch labeled WRTM-NORMAL (Write Timing Mark-Normal). This switch is on the DECtape Control panel located in the DECtape equipment rack. If there is more than one DECtape rack, the panel is located in the rack nearest to the processor. Use the switch only as directed by the program.

7.2.2.5 Care and Cleaning - The following precautions are necessary in handling and storing the tape since data loss, errors, or tape damage may occur and efficiency may be impaired by extremes of temperature and humidity, magnetic influence, and foreign substances.

- a. Store the tape where the temperature will be between 40 and 90 degrees Fahrenheit, and where the relative humidity will be between 20 and 80 percent.
- b. Protect the tape from contact with any magnets or electrical coils since strong magnetic fields can distort or destroy the tiny magnetic fields on the tape.
- c. Dust and other foreign substances can produce read errors, if allowed to accumulate around the magnetic head and tape guides of the unit. To avoid this, once a week, remove the reels of DECtape, and wipe the entire front panel with a clean cloth. Then clean the two tape guides and magnetic head, using the cleaning kit supplied. Do not remount the reels of DECtape until the guides and head are dry, as the head cleaner can destroy the bond between the oxide and the polyester backing of magnetic tapes.

## WARNING

Head cleaner fluid and fumes are toxic. Provide good ventilation and avoid prolonged contact with skin, and breathing of fumes. After use, cap cleaner container tightly to prevent evaporation, and store away from sun and heat to prevent pressure buildup.

### 7.3 TU56 DUAL DECtape TRANSPORT AND TC15 DECtape CONTROL

The TC15 DECtape Control controls up to eight TU55 DECtape transports or up to four TU56 Dual DECtape transports. Binary information is transferred to and from the PDP-15 at the rate of one 18-bit word per 200  $\mu$ s, using the data channel facility. Mode of operation, function, and direction of motion are controlled by status registers that can be loaded and read by the computer. The TC15 is on I/O status bit 10.

The TU56 Dual DECtape Transport provides bidirectional reading and writing of DECtape reels. Each 3-in. diameter reel can hold  $2.7 \times 10^6$  bits of information (150,000 18-bit words) recorded at  $350 \pm 55$  bits per inch. The tape moves at  $93 \pm 12$  in. per second and requires no vacuum columns, pinch-rollers, or capstans.

#### 7.3.1 Controls and Indicators

The dual DECtape transport unit is rack mounted, with the reel mounting hubs, tape path and all controls and indicators located on the front panel. The controls and indicators are illustrated in Figure 7-8 and described in Table 7-3. The TC15 indicator panel is illustrated in Figure 7-9 and described in Table 7-4.

Table 7-3  
TU56 Dual DECtape Transport Controls and Indicators

Control/Indicator	Type	Function
WRITE	Indicator lamp	When lit, writing is permitted.
Data Protection	Two-position rocker switch	
WRITE ENABLE		Permits writing on the tape.
WRITE LOCK		Inhibits writing on the tape.
Transport Selector 0 through 7	Digit switch	Designates the numerical code whose generation by the central processor establishes communication between the processor and the transport through the TC15 DECtape Control.

Table 7-3 (Cont)  
 TU56 Dual DECtape Transport Controls and Indicators

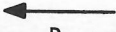
Control/Indicator	Type	Function
 (Tape Advance)	Momentary-contact rocker switch	Moves the tape in the forward direction (left to right).
 (Tape Reverse)	Momentary-contact rocker switch	Moves the tape in the rewind direction (right to left).
Transport Control	Three-position rocker switch	
REMOTE		Places the transport under the control of the processor; disables the Tape-Reverse and Tape-Advance switches.
OFF		Removes power from the drive motors, disables the Tape-Reverse and Tape-Advance switches, and prevents the transport from being selected by the processor; i.e., places the transport off line.
LOCAL		Prevents the transport from being selected by the processor; permits use of the Tape-Reverse and Tape-Advance switches.
REMOTE SELECT	Indicator lamp	When lit, indicates that the transport is under the control of the processor.

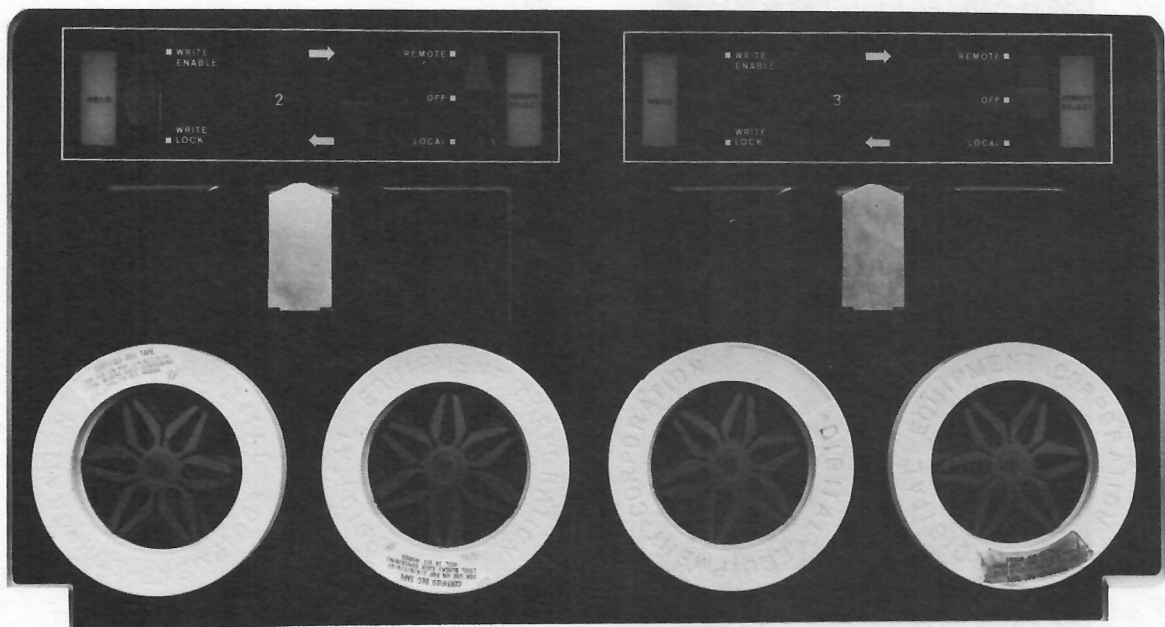

Figure 7-8 TU56 Dual DECtape Transport



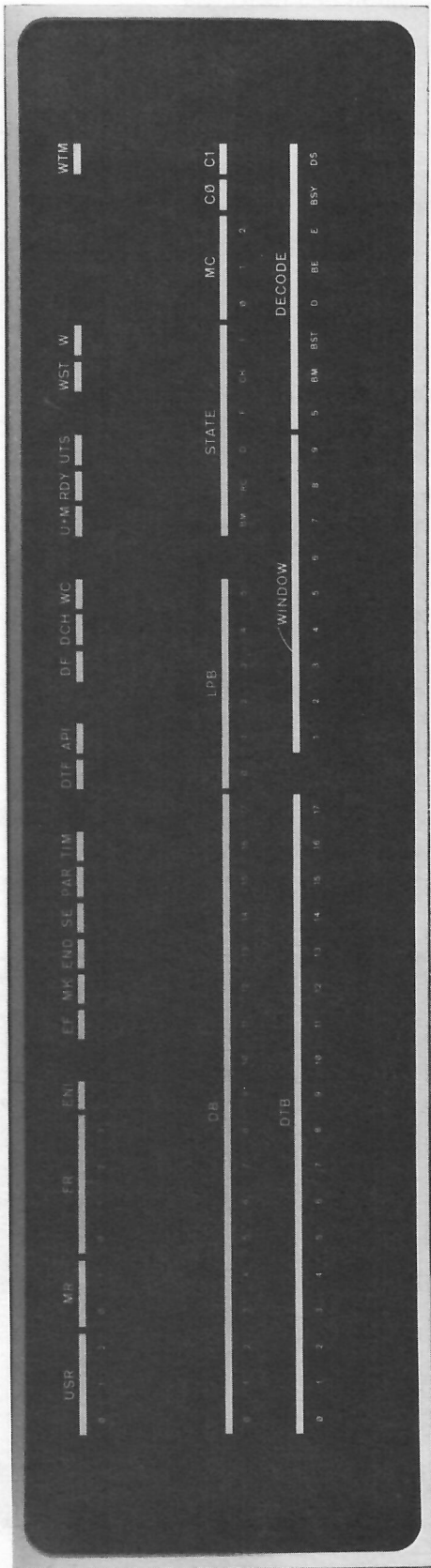

Figure 7-9 TC15 Indicator Panel

Table 7-4  
TC15 Indicators

Indicator	Function
USR	<p>Indicates contents of Unit Select Register. This register contains the number of the tape transport selected by the central processor. The unit select register is comprised of bits 0, 1, and 2 of TC15 status register A.</p>
MR	<p>Indicates contents of Motion Register. This register contains the Forward/Reverse and Go/Stop commands that are issued from the central processor. Coding is as follows:</p> <p style="padding-left: 40px;">Bit 0 False (Lamp Off): Forward            Bit 0 True (Lamp On): Reverse            Bit 1 False (Lamp Off): Stop            Bit 1 True (Lamp On): Go</p> <p>The Motion Register comprises bits 3 and 4 of TC15 status register A.</p>
FR	<p>Indicates contents of Function Register. This register contains Normal/Continuous, Read/Write, etc., commands issued from the central processor. Coding is as follows:</p> <p style="padding-left: 40px;">Bit 0 False (Lamp Off): Normal Mode            Bit 0 True (Lamp On): Continuous Mode            Bits 1, 2, 3 = 000 (0g): Move            Bits 1, 2, 3 = 001 (1g): Search            Bits 1, 2, 3 = 010 (2g): Read Data            Bits 1, 2, 3 = 011 (3g): Read All            Bits 1, 2, 3 = 100 (4g): Write Data            Bits 1, 2, 3 = 101 (5g): Write All            Bits 1, 2, 3 = 110 (6g): Write Timing and Mark Track            Bits 1, 2, 3 = 111 (7g): Unused (Causes select error)</p> <p>The Function Register comprises bits 5, 6, 7, and 8 of TC15 status register A.</p>
ENI	<p>Indicates status of the Enable Interrupt Register. This 1-bit register (bit 9 of TC15 status register A) is loaded by the central processor. When lit, the ENI indicates that the interrupt logic in the TC15 is enabled; i.e., the TC15 is connected to the PDP-15 program interrupt (PI) system and to the PDP-15 automatic priority interrupt (API) system. When off the ENI indicates that the TC15 interrupt logic is disabled; i.e., the TC15 is disconnected from the PI and API systems.</p>
EF	<p>Indicates status of Error Flag bit (bit 0) in TC15 status register B. EF is the logical OR of error bits MK, END, SE, PAR, and TIM. When the EF flag is raised, the TC15 activates the interrupt line to the central processor, provided that the ENI bit is set, and activates the I/O skip when the I/O skip command is issued.</p>

Table 7-4 (Cont)  
TC15 Indicators

Indicator	Function
MK	Indicates mark-track error. MK lights when an erroneous code is read from the mark track. The mark-track error bit is bit 1 of TC15 status register B.
END	Indicates that end zone on either end of tape is over the read head. End zone status is stored in bit 2 of TC15 status register B.
SE	<p>Indicates Select Error. Select Error status is stored in bit 3 of TC15 status register B. SE lights under any of the following conditions:</p> <ul style="list-style-type: none"> <li>a. The central processor loads the TC15 with a unit select code that 1) does not correspond with the setting of any of the Transport Selector switches on the DECTape transports, or 2) corresponds with the settings of two or more Transport Selector switches that are set to the same number.</li> <li>b. The processor loads the TC15 with a Write function code, but the WRITE ENABLE/WRITE LOCK switch on the selected transport is set to the WRITE LOCK position.</li> <li>c. The processor loads the TC15 with a function code to which no function has been assigned yet; i.e., function code 111.</li> <li>d. The processor loads the TC15 with the Write Timing and Mark Track function code, but the WRTM-NORMAL switch is set to NORMAL.</li> <li>e. The processor loads the TC15 with a Move, Search, Read, or Write function code, but the WRTM-NORMAL switch is set to WRTM.</li> </ul>
PAR	Indicates parity error detected during Read Data function. Parity error status is stored in bit 4 of TC15 status register B.
TIM	<p>Indicates timing error. Timing error status is stored in bit 5 of TC15 status register B. TIM lights when:</p> <ul style="list-style-type: none"> <li>a. A data break request is not answered within 170 <math>\mu</math>s for all functions except Write All, which is 66 <math>\mu</math>s; delay causes loss of data.</li> <li>b. The DECTape Flag (DTF) is not cleared by the processor before the TC15 attempts to set it again. This means that the condition which had set DTF was not serviced.</li> <li>c. The processor loads the TC15 with a Read Data or Write Data function code after the data block has already started to pass under the tape head. As a result, the function can not be performed on the entire block.</li> </ul> <p style="text-align: center;">NOTE</p> <p style="text-align: center;">TC15 status register B bits 6, 7, 8, 9, and 10 are not used.</p>

Table 7-4 (Cont)  
TC15 Indicators

Indicator	Function
DTF	Indicates status of DECTape Flag bit (bit11) in TC15 status register B. Lights when each DECTape operation is complete.
API	Indicates that the TC15 is requesting an interrupt on its API (Automatic Priority Interrupt) channel.
DF	Indicates that the TC15 is requesting a data break from the processor when a word is ready to be transferred to or from the TC15.
DCH	Data Channel. Indicates that the TC15 is requesting a data transfer on the multicycle data channel.
WC	Indicates status of Word Count flag. The WC flag is cleared whenever the word count register overflows.
U + M	Unit or motion delay. Indicates the waiting period after a transport is set in motion.
RDY	Rate Delay. Indicates the status of the rate delay logic in the TC15. RDY lights when the tape reaches 50% of final speed.
UTS	Up to speed. Lights when selected DECTape transport reaches normal operating speed.
WST	Write set. Indicates conditions exist to set Write Enable.
W	Write enable. Indicates that a write function is in process.
WTM	Write timing mark. Indicates that WRTM-NORMAL switch is in WRTM position.
DB	Data Buffer*
LPB	Longitudinal Parity Buffer*
STATE	Indicates state generator status*
MC	Master Counter*
C0	Clocking counter 0*
C1	Clocking counter 1*
DTB	DECTape Buffer*
WINDOW	Displays contents of window register*
DECODE	Displays output of decode logic from window register*

\*Indicators DB, LPB, STATE, MC, C0, C1, DTB, WINDOW, and DECODE are primarily maintenance aids; therefore, detailed descriptions are omitted from this Operator's Guide. For detailed descriptions of these indicators, refer to the TC15 Maintenance Manual.

### 7.3.2 Control Modes and Functions

The TC15 DECtape Control operates in either the Normal mode (NM) or Continuous mode (CM) as determined by program selection. In the Normal mode, the data transfer and flag indications are controlled by the format of the information on tape. In the Continuous mode, data transfer and flag indications are controlled by a word count (WC) read from core memory as well as the format of the information on tape. WC is stored at address 000030. Current Address (CA) of data transfer is stored at address 000031.

The normal mode differs from the continuous mode primarily in the time at which the DECtape flag (DTF) is set. The DECtape flags which occur in the normal mode are inhibited in the continuous mode until a word count overflow has occurred. In both modes, data break requests occur only when a word count overflow has not occurred during the currently specified function.

### 7.3.3 Operating Procedures

The DECtape transport operates automatically under program control. The operator controls the transport when removing and installing tape, and placing the transport on-line. These procedures are the same as those for the TU55 DECtape Transport described in Paragraphs 7.2.2.1 through 7.2.2.5.

## Chapter 8

### Display Devices

#### 8.1 VP15A STORAGE TUBE DISPLAY AND CONTROL

The VP15A Storage Tube Display (Figure 8-1) is a point-plotting display device. Points are displayed in a 1024 x 1024 bit matrix on an 8-1/4" x 6-3/8" surface. Two IOT (Input/Output Transfer) instruction-selectable modes of operation are provided: Store and Non-store. In the Store mode, plotted points are stored on the screen and remain visible for up to 15 minutes without refreshing the display. In the Non-store mode, a faster response time is achieved, but points displayed must be refreshed at least 30 times a second in order to keep them visible. In the Store mode, the display may be erased manually, by pressing a pushbutton switch on the VP15A Storage Tube Display, or automatically, with an IOT command from the PDP-15 central processor.

The VP15A Control, mounted in cabinet H963E, provides the timing for point intensification and for programmable erasing of the display. The VP15A Control has no operator controls or indicators.

##### 8.1.1 Controls and Indicators

VP15A Storage Tube Display controls and indicators are illustrated in Figure 8-1 and are described in Table 8-1.

Table 8-1  
VP15A Storage Tube Display Control and Indicators

Control/Indicator	Type	Function
ERASE	Pushbutton switch	Erases any information stored on the CRT. The pushbutton is lighted when power is applied.
VIEW	Pushbutton switch	Switches the display from the holding mode - reduced brightness - to normal viewing brightness. The pushbutton is lighted when the display is in the holding mode.
INTENSITY	Potentiometer	Controls the brightness of the display on the CRT during normal operation.

Table 8-1 (Cont)  
VP15A Storage Tube Display Controls and Indicators

Control/Indicator	Type	Function
WRITE THRU	Potentiometer	Controls the brightness of the display on the CRT during write-through operation.
FOCUS	Potentiometer	Controls beam focus.
OPERATING LEVEL	Potentiometer	Controls target backplate potential, which must be monitored while adjusting.
POWER	Toggle switch	Applies power to the display unit.
TEST SPIRAL	3-position push-pull switch	Middle position selects normal operating mode. Push position selects Store test mode. Pull position selects focus test mode.

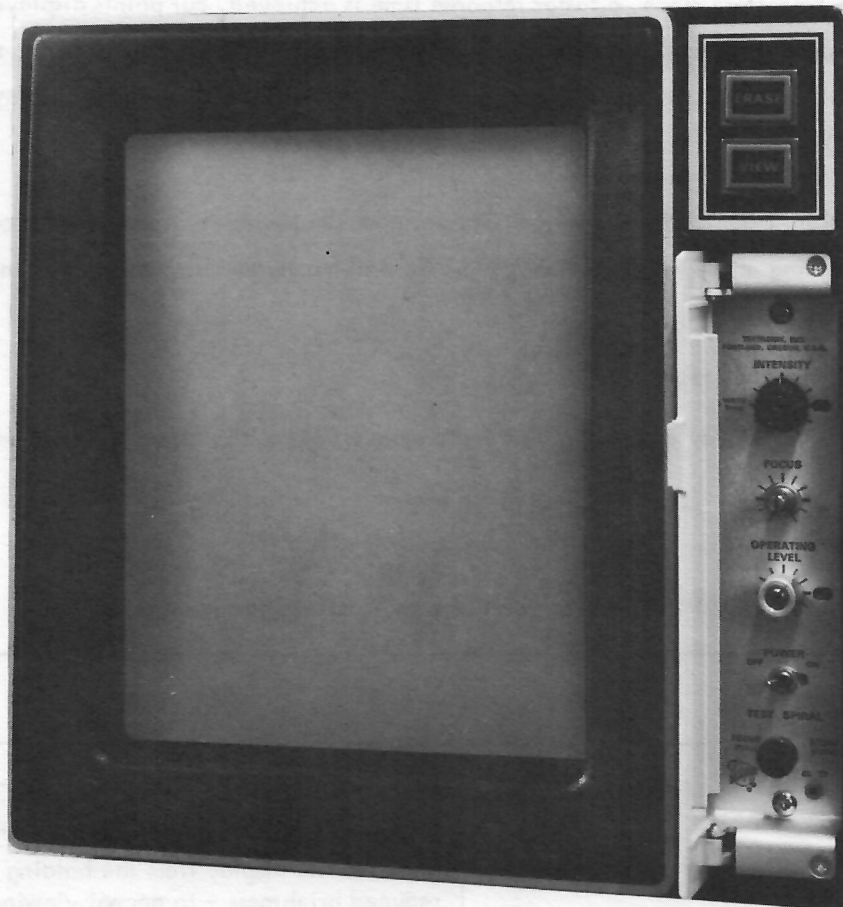

Figure 8-1 VP15A Storage Tube Display



### 8.1.2 VP15A Turn-On Procedure

Turn the VP15A on as follows:

<u>Step</u>	<u>Procedure</u>
1	Make sure that cabinet ac circuit breaker is on and that the power cord is plugged in.
2	Rotate INTENSITY and FOCUS controls to mid-range. Do not disturb setting of OPERATING LEVEL control.
3	Turn POWER switch on. Notice that ERASE switch lights and that after warmup, the storage tube glows bright.
4	Momentarily press ERASE switch. Observe that storage tube glows dim and that intensity of glow is evenly distributed throughout display area.
5	Pull TEST SPIRAL switch. Observe that a spiral waveform is displayed.
6	Adjust INTENSITY and FOCUS controls for desired intensity and best overall focus.
7	Push TEST SPIRAL switch back to center position.

### 8.1.3 Self-Test Procedure

The following VP15A tests are performed independently of the computer program. This procedure is intended for testing the VP15A prior to the start of automatic operation or after suspecting a malfunction during automatic operation.

<u>Step</u>	<u>Procedure</u>
1	Turn POWER switch off.
2	Disconnect cables from X, Y, and Z INPUTS connectors and REMOTE PROGRAM connector at rear of display unit (see Figure 8-2).
3	Perform Turn-on procedure in Paragraph 8.1.2.
4	While watching the screen, slowly rotate INTENSITY control clockwise; should a bright spot appear, quickly rotate INTENSITY control counterclockwise. A bright spot indicates that repair is required. It should be possible to rotate the INTENSITY control fully clockwise without getting a bright spot on the screen. If no bright spot appears, rotate control to mid-range and continue to Step 5.
5	Push TEST SPIRAL switch to STORE position until a stored spiral is displayed. The spiral should be visible for 60 to 90 seconds. Then VIEW switch should light, indicating that VP15A is in Hold mode.

<u>Step</u>	<u>Procedure</u>
6	Momentarily press VIEW switch. Spiral should reappear and lamp behind VIEW switch should turn off for 60 to 90 seconds.
7	Turn POWER switch off.
8	Reconnect cables at rear of display unit.

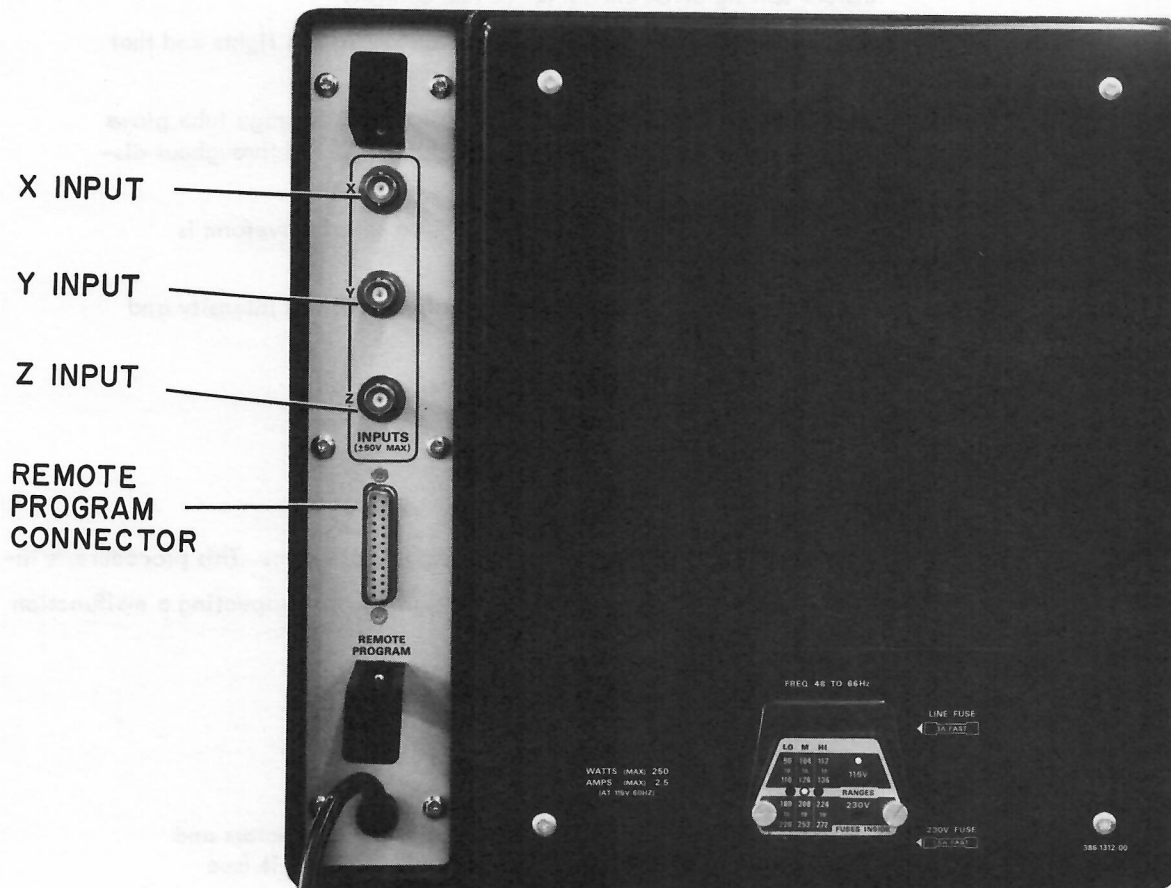
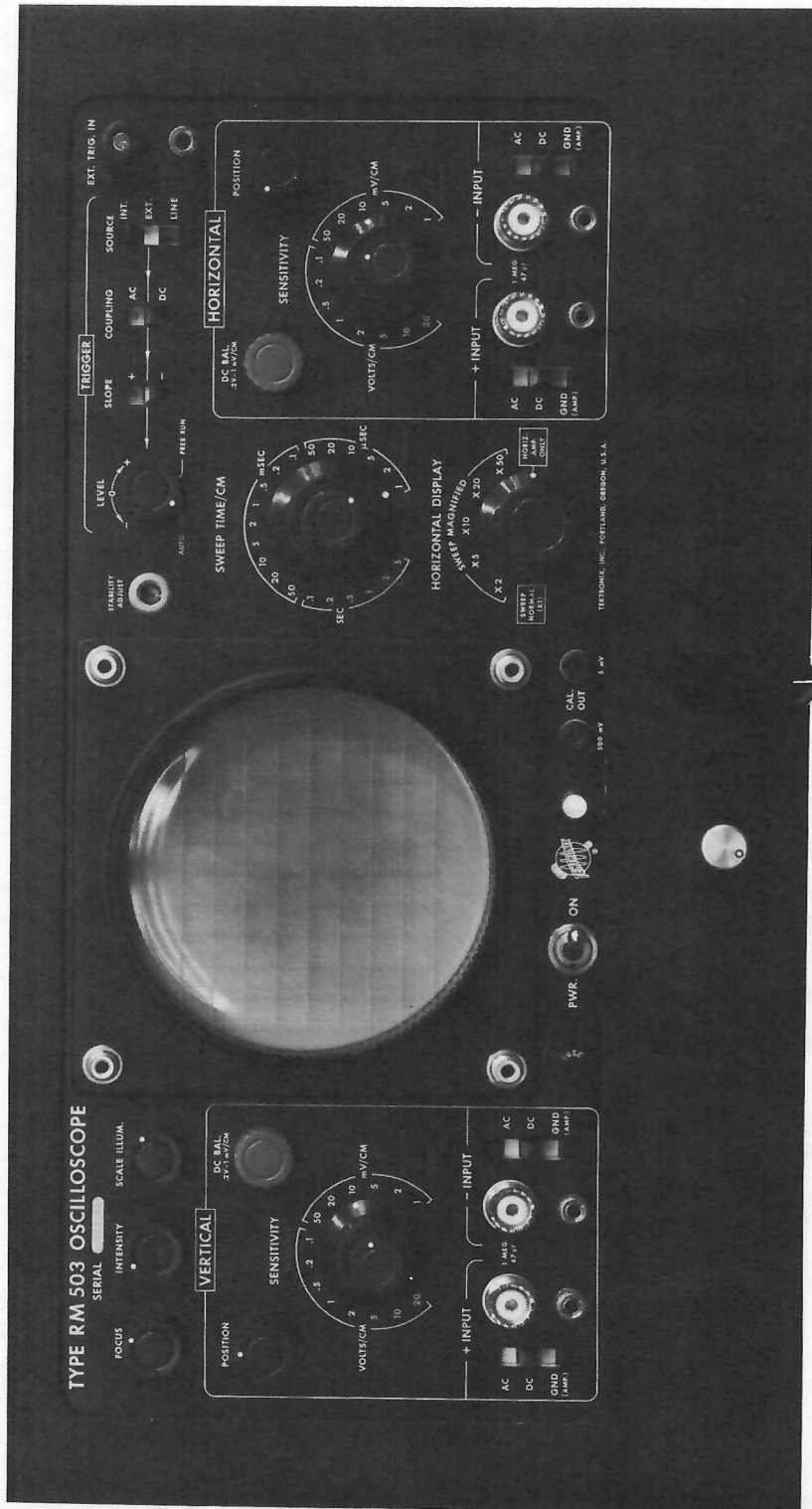

Figure 8-2 VP15A, Rear View

## 8.2 VP15B/BL OSCILLOSCOPE DISPLAY, CONTROL, AND OPTIONAL DEC TYPE 370 LIGHT PEN

The VP15B Oscilloscope Display is a point-plotting display device. Points are displayed in a 1024 x 1024 bit matrix on an 8 cm x 10 cm surface. The VP15/BL Oscilloscope Display is a VP15B with the DEC Type 370 Light Pen (see Figure 8-3). The VP15B/BL Control, mounted in cabinet H963E, provides the timing for point intensification. The VP15B/BL Control has no operator controls or indicators.



DEC TYPE 370 LIGHT PEN

Figure 8-3 VP15/BL Oscilloscope Display

### 8.2.1 Controls and Indicators

Table 8-2 lists the functions of VP15B front panel controls most frequently used by the operator.

Table 8-2  
VP15B Oscilloscope Display Controls

Control	Type	Function
FOCUS	Potentiometer	Focuses the display on the CRT.
INTENSITY	Potentiometer	Controls brightness of display.
SCALE ILLUM.	Potentiometer	Controls graticule illumination.
VERTICAL POSITION	Potentiometer	Controls vertical positioning of the display.
HORIZONTAL POSITION	Potentiometer	Controls horizontal positioning of the display.
PWR. ON	Toggle switch	Applies primary power to the VP15B.

### 8.2.2 Operating Procedures

The VP15B operates automatically under program control once primary power is applied and initial display adjustments have been made. Perform the following initial adjustments:

<u>Step</u>	<u>Procedure</u>
1	Connect display to suitable source of power and set PWR. ON switch to ON. Rotate the INTENSITY control fully counterclockwise and allow five minutes warm-up time.
2	Set the HORIZONTAL DISPLAY switch to HORIZ AMP ONLY.
3	Set all INPUT switches to GND.
4	Set both the VERTICAL and HORIZONTAL SENSITIVITY switches to .2 V/cm. Rotate both VARIABLE controls fully clockwise until they snap into the CALIBRATED position.
5	Set both POSITION controls to mid-range and rotate the INTENSITY control clockwise until a spot appears.

#### CAUTION

If the spot is too bright, the phosphor on the CRT may be damaged. Never increase the intensity to the point where a halo appears around the spot.

- |   |   |
|---|---|
| 6 | Adjust the FOCUS control to produce the smallest, roundest spot possible. Note the vertical and horizontal position of the spot on the face of the CRT. |
|---|---|



<u>Step</u>	<u>Procedure</u>
7	Set the VERTICAL SENSITIVITY control to 1 mV/cm. Make sure that the VARIABLE control remains in the CALIBRATED position.
8	Use the VERTICAL DC. BAL control to move the spot back to the same vertical position noted in Step 6.
9	Set the HORIZONTAL SENSITIVITY control to 1 mV/cm. Make sure that the VARIABLE control remains in the CALIBRATED position.
10	Use the HORIZONTAL DC. BAL control to move the spot back to the same horizontal position noted in Step 6.
11	Adjust both DC. BAL controls so that the spot does not move as the SENSITIVITY controls are switched from .2 V/cm to 1 mV/cm.

### 8.2.3 Light Pen Operation

#### 8.2.3.1 Sensitivity Adjustment - Adjust the light pen sensitivity as follows:

<u>Step</u>	<u>Procedure</u>
1	Make certain all light pen on/off controls are off.
2	Energize display system and set desired pattern on the CRT.
3	Set light pen sensitivity (threshold) control to minimum setting.
4	Press the light pen pushbutton switch.
5	Hold light pen perpendicular to face of CRT and touch light pulse of interest.
NOTE	
Proper adjustment of sensitivity control is possible only if the pen is held perpendicular to and physically against the face of the tube.	
6	Slowly turn sensitivity control toward maximum position until light pen just detects the light pulse.
7	Release light pen pushbutton.
8	Move pen to another light pulse and touch face of CRT.
9	Press light pen pushbutton.
10	The light pulse should be detected. If it is, the sensitivity control is now adjusted correctly. If the pulse is not detected, repeat Steps 5 through 9 until correct adjustment is obtained.

### 8.2.3.2 Normal Operation Procedure

<u>Step</u>	<u>Procedure</u>
1	Touch face of CRT over light pulse to be detected.
NOTE	
If light pen is not held perpendicular to face of CRT or does not touch the CRT, the light pen may not detect the pulse properly.	
2	Press light pen pushbutton until pulse is detected.
3	Release light pen pushbutton.
4	Repeat Steps 1 through 3 each time a light pulse is to be detected.

### 8.2.3.3 Optional Operating Procedure

<u>Step</u>	<u>Procedure</u>
1	Turn light pen on.
2	Touch face of CRT over pulse to be detected.
3	Remove light pen from face of CRT.
4	Repeat Steps 2 and 3 each time a light pulse is to be detected.

#### NOTE

Although this mode of operation has certain advantages, care must be taken when placing the pen on the CRT to prevent detection of the wrong light pulse.

## 8.3 VP15C/CL OSCILLOSCOPE DISPLAY, CONTROL & OPTIONAL DEC TYPE 370 LIGHT PEN

The VP15C Oscilloscope Display (Figure 8-4) is a point-plotting display device. Points are displayed in a 1024 x 1024 bit matrix on a 6-3/4 in. x 9 in. surface. The VP15C/CL Oscilloscope Display is a VP15C with the DEC Type 370 Light Pen (see Figure 8-3).

The VP15C/CL Control, mounted in cabinet H963E, provides the timing for point intensification. The VP15C/CL Control has no operator controls or indicators.

### 8.3.1 Controls and Indicators

VP15C Oscilloscope Display controls and indicators are illustrated in Figures 8-4 and 8-5 and are described in Table 8-3.

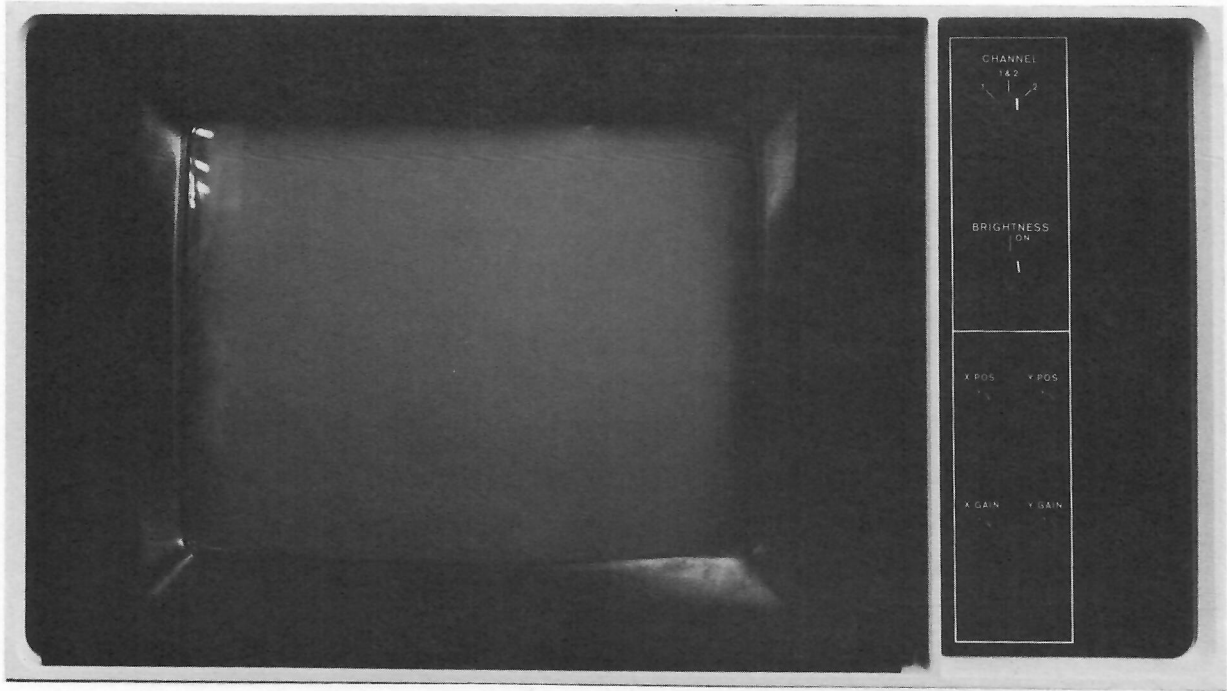

Figure 8-4 VP15C Oscilloscope Display

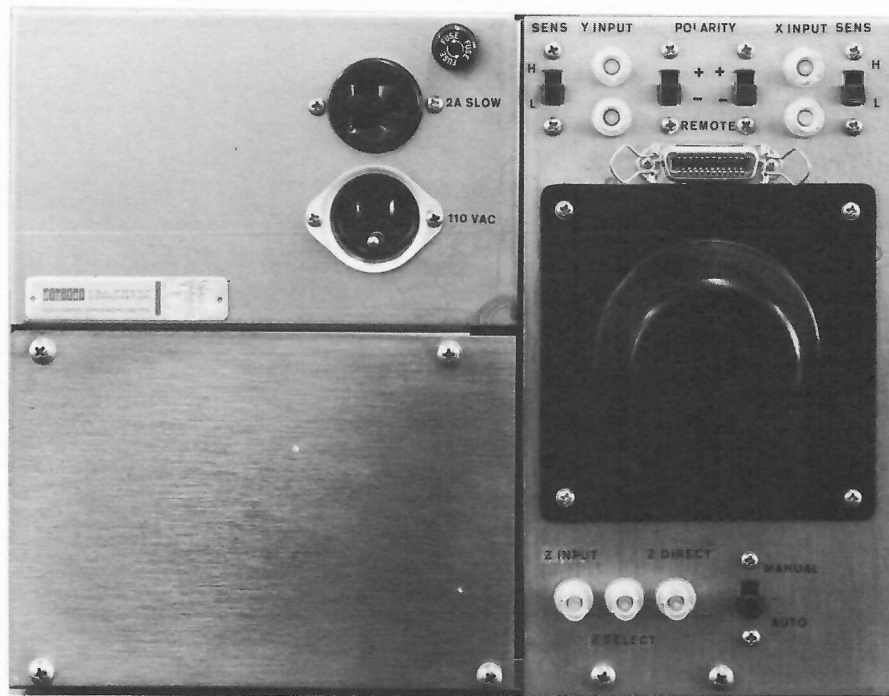

Figure 8-5 VP15C Oscilloscope Display, Rear View



Table 8-3  
VP15C Oscilloscope Display Controls

Control	Type	Function
CHANNEL	Three-position rotary switch	Selects intensity channel 1, 1 & 2, or 2 for display when a channel select signal is asserted and the Z signal is multiplexed.
BRIGHTNESS	Potentiometer-switch	Turns power on and off and controls display brightness. A pilot lamp lights when the display is on.
X POS	Potentiometer	Controls horizontal position of the display.
Y POS	Potentiometer	Controls vertical position of the display.
X GAIN	Potentiometer	Controls horizontal magnitude of the display.
Y GAIN	Potentiometer	Controls vertical magnitude of the display.

### 8.3.2 Operating Procedures

The VP15C operates automatically under program control, once the display power has been turned on. No special manual operating procedures are required. Use of the light pen supplied with the VP15CL is described in Paragraph 8.2.3.

## Chapter 9

### Plotters

#### 9.1 XY15AA/AB/BA/BB INCREMENTAL PLOTTER AND XY15 CONTROL

Incremental Plotters XY15AA and XY15AB are 12-in. drum plotters, CALCOMP Model 565. Incremental Plotters XY15BA and XY15BB are 31-in. drum plotters, CALCOMP Model 563. Plotting increments are 0.01 in. per step for the XY15AA and XY15BA and 0.005 in. per step for the XY15AB and XY15BB. Plotting rates are 18,000 steps per minute for the XY15AA, XY15AB, and XY15BB; and 12,000 steps per minute for the XY15BA.

##### 9.1.1 Controls and Indicators

There are no operator controls on the XY15 Plotter Control. CALCOMP plotter controls and indicators are illustrated in Figure 9-1 and described in Table 9-1.

Table 9-1  
Plotter Controls and Indicators

Control/Indicator	Type	Function
POWER ON/OFF	2-position rotary switch	Applies prime power to plotter.
CARRIAGE FAST RUN	3-position center-off spring-return rotary switch	Moves the pen carriage rapidly to the left or right at the rate of 120 steps per second when using 60 cps power, or 100 steps per second when using 50 cps power.
Power	Neon indicator	When illuminated, indicates prime power is applied to plotter circuits.
CARRIAGE SINGLE STEP	3-position center-off spring-return rotary switch	The pen carriage to be moved in single-step increments either to the left or right. This control, in combination with the DRUM SINGLE STEP control, permits the operator to accurately align the carriage on a point or fixed coordinate on the paper.

Table 9-1 (Cont)  
 Plotter Controls and Indicators

Control/Indicator	Type	Function
CHART DRIVE ON/OFF	2-position rotary switch	In OFF position, disables the front and rear chart takeup motors. This permits the use of single sheets of chart paper in place of the paper rolls supplied with the instrument.
PEN UP/DOWN	2-position rotary switch	Provides a means of manually raising and lowering the pen from the surface of the drum.  NOTE  When the instrument is first turned on, or if the pen is removed and replaced when the plunger is in the PEN-UP position, the pen may remain down even when the PEN switch is turned to UP. When this occurs, turn the PEN switch first to DOWN, then to UP.
DRUM FAST RUN	3-position center-off spring-return rotary switch	Causes the drum to be stepped rapidly up or down at the rate of 120 steps per second. The switch is used in the same manner as the CARRIAGE FAST RUN control to move the pen to any desired area of the chart, or for operational checkout of the drum control circuits and the drum step motor.
DRUM SINGLE STEP	3-position center-off spring-return rotary switch	Causes the drum to be moved in single-step increments either up or down. This control, in combination with the CARRIAGE SINGLE STEP control, permits the operator to accurately align the pen on a point or fixed coordinate on the chart.

### 9.1.2 Installation of Chart Roll

To install a roll of chart paper in the instrument, first make sure that it is evenly wound on the core; i.e., that the ends are not coned. Straighten coned rolls by tamping the end with the protruding core against a flat surface. Then perform the following steps:

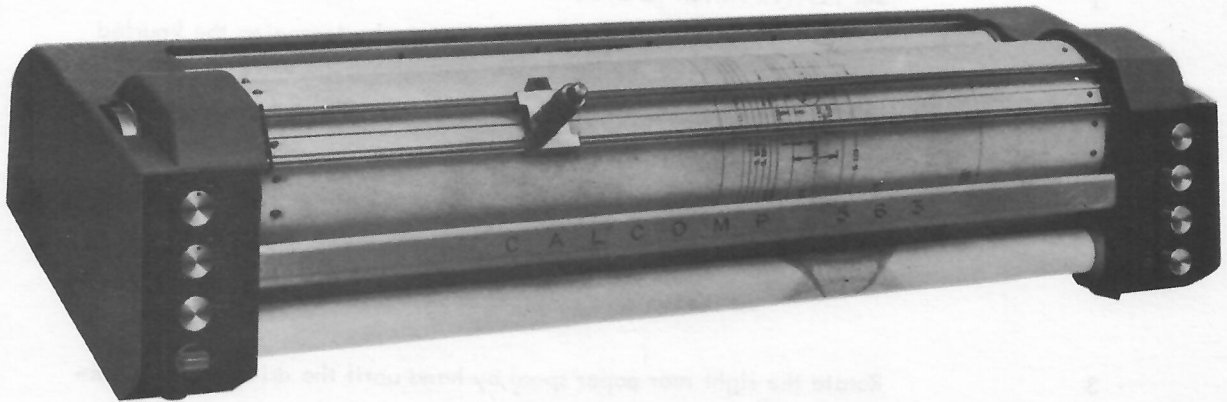

(a) Model 563

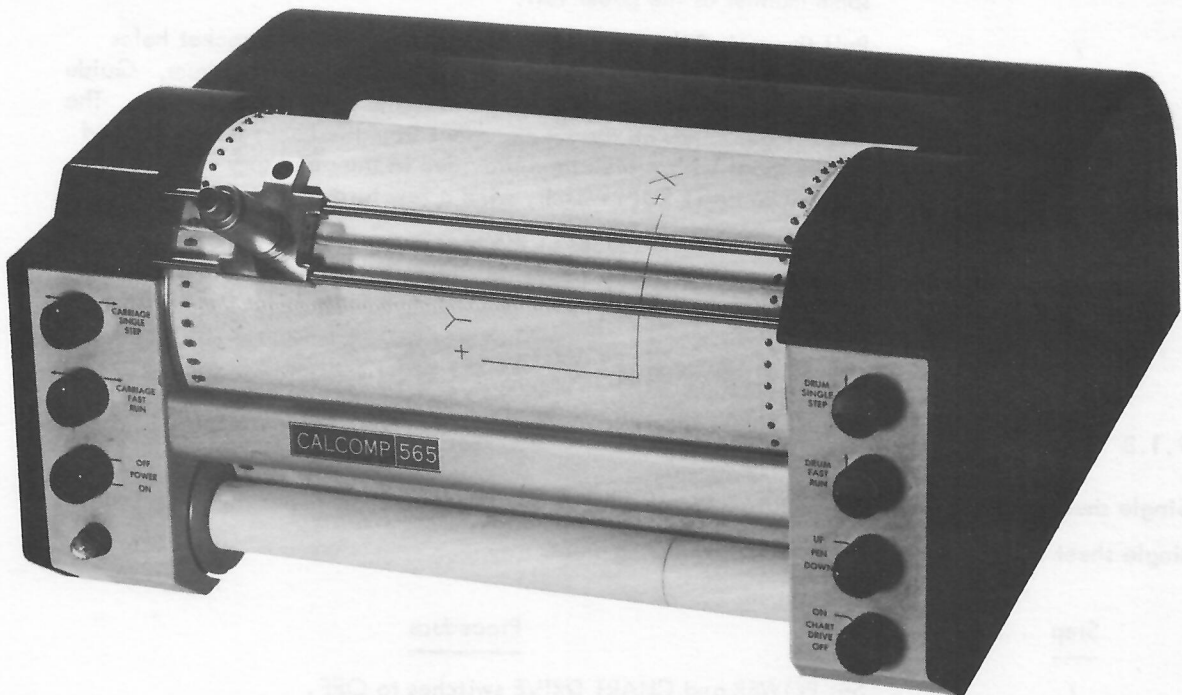

(b) Model 565

Figure 9-1 CALCOMP Plotters

<u>Step</u>	<u>Procedure</u>
1	Set POWER switch to OFF.
2	Remove the pen assembly from the carriage by loosening the knurled nut at the bottom of the pen holder and lifting the assembly out of the carriage.
CAUTION	
Use care not to drop the pen assembly or any of its parts. The assembly is constructed of soft steel to close tolerances, and can be rendered inoperative by nicks or dents.	
3	Rotate the right rear paper spool by hand until the drive key is pointing upward.
4	Hold the new roll of chart paper so that the key slot in the core is pointing upward. Using your thumb, push the idler spool (left-hand end) to the left, and slip the left-hand end of the roll on the spool. Do not force the idler spool aside with the paper roll, as this tends to cone the end and thus cause misalignment.
5	Lower the paper roll into the paper well and slide the right end onto the drive spool. Ensure that the drive key engages the key slot in the core.
6	Install a paper roll core on the two front spools below the drum, in the same manner as the paper roll.
7	Pull the end of the paper over the drum so that the sprocket holes on both edges of the paper engage the sprockets on the drum. Guide the chart paper under the carriage rods and behind the tear bar. The chart paper winds on the takeup spool from the back; fasten the end on the spool with scotch tape provided in the accessory kit. Using the DRUM FAST RUN switch, wind a few turns onto the takeup spool.
8	Scales on the inside faces of the rear paper spools indicate the approximate amount in feet of paper remaining on the roll. The black scale is for 0.003-in. chart papers and the blue scale is for 0.002-in. paper.

### 9.1.3 Installation of Single-Sheet Chart Paper

Single sheets of chart paper may be used for plotting in place of the chart paper roll. To install a single sheet of chart paper, perform the following steps:

<u>Step</u>	<u>Procedure</u>
1	Set POWER and CHART DRIVE switches to OFF.
2	Remove the pen assembly from the carriage.
3	Slide the chart paper sheet under the carriage rods onto the drum surface.

<u>Step</u>	<u>Procedure</u>
4	Fasten the top edge of the paper to the drum with two or three short pieces of tape. Rotate the drum by hand, keeping the paper smooth and flat against the drum surface. Fasten the bottom edge of the paper in the same manner as the top.

#### 9.1.4 Operational Checkout

The following steps are intended to provide an overall check of the operation of the Model 565 plotter prior to the start of automatic recording.

<u>Step</u>	<u>Procedure</u>
1	Install the pen assembly in its carriage.
2	Set POWER and CHART DRIVE switches to ON.
3	Set DRUM FAST RUN to UP position. Check that the pen traces a vertical line on the chart paper.
4	Turn the PEN switch to DOWN, then UP. Check that the pen lifts off the drum surface.
5	Set the PEN switch to DOWN position, then set the DRUM FAST RUN to DOWN position. Check that the pen again traces a vertical line on the chart paper.
6	Set the CARRIAGE FAST RUN switch to the left position. Check that the pen traces a horizontal line on the chart and that the carriage step motor stops when the carriage reaches its limit of travel. Repeat with the CARRIAGE FAST RUN switch in the right-hand position.
7	Alternately operate the CARRIAGE SINGLE STEP and DRUM SINGLE STEP switches. Check that both the carriage and the drum move one step only each time one of the switches is operated.
8	Move the carriage near the left margin of the chart paper. Set CARRIAGE FAST RUN switch to the right position and DRUM FAST RUN to the down position. Allow the instrument to run until the carriage reaches the right side of its track, then return both switches to off (center) position. Check that the pen traces a 45-degree line on the chart. Check the line carefully for any evidence of discontinuity.
9	Operate the DRUM SINGLE STEP switch several times to reposition the pen either above or below its position at the end of step 8.
10	Set CARRIAGE FAST RUN switch to the left position and DRUM FAST RUN switch to the up position. Allow the instrument to run until the carriage reaches the left side of the track, then return both switches to OFF position. Check that the pen again traces a 45-degree line on the chart and that this line is exactly parallel to the line traced in step 8.
11	Repeat steps 8 through 10, changing the switch positions to produce two 45-degree lines at right angles to the first two. Again check for discontinuities and make certain the two lines are parallel.

9.1.4.1 Reticles - Two alignment reticles are provided to permit manual alignment of the carriage to the desired zero point. One of these (P/N 20-168) replaces the pen assembly and shows the exact point on which the pen will fall; the other (P/N 20-169) occupies a special receptacle in the carriage, and indicates a point exactly one inch from the pen measured along the X-axis in the positive direction. The latter reticle can be left in the carriage at all times. When installing either reticle, rotate it as it is inverted to prevent damage to the O-ring.

9.1.4.2 Removal of Chart Paper - The roll of chart paper or single sheet of chart paper should be removed in the reverse sequence to the installation procedure described above. If a single sheet of chart paper is used, any remaining tape adhesive should be cleaned from the drum surface with acetone or a good commercial grade of cleaning solvent.



**Digital Equipment Corporation  
Maynard, Massachusetts**

**digital**