Cassette, Cartridge and Diskette Drives

by George King

Designers usually base their choice of whether to use a cassette, cartridge or flexible disk drive on differences in stored information integrity, data storage capacity and speed of operation. Since manufacturers of all three systems are aggressively improving their products and making them more competitive, system engineers cannot automatically choose one type of drive over another because of its inherent characteristics. For example, cassette and cartridge drive vendors are trying to overcome the inherently faster access times offered by random access floppy disk drives by increasing tape speed or increasing the number of tracks for storing data.

The state-of-the-art is changing in a number of other ways, too. Manufacturers are adding more electronics to controllers and interfaces to make their drives more flexible. Many of them are offering drives in miniature versions. Consequently, a smaller, lighter, less expensive unit may be able to do the same work as a large standard size at a substantial savings in cost per bit.

These changes in technology makes your decision on which drive to use no longer quite so "obvious". It pays — in higher reliability, more design flexibility, larger number of options and substantial savings — for you to review the three types of drives to determine which one can handle the needs of your system most effectively.

cassette drives

The earliest of the three recording systems, the cassette drive, descended from the audio cassette, has hardly changed during the last five years, though improvements in reliability, operating speed and packing density characterize the newer units. Well established ECMA and ANSI standards have led to a level of product uniformity not shared by the other two types of drives. Almost all units use phase encoding to record data, written block by block and stored in serial form. In almost all instances, preamble and postamble are generated automatically at the start and end of each block. The typical packing density is 800 bits per inch (31.5 bits per mm.). Standard control functions usually include at least: write, stop, reverse, read on block, read continuously, check read one block, erase, rewind to beginning of tape (BOT), rewind for cassette removal.

Data flow checking is usually also automatic: read-after-write check (RAW); drop in and drop out check; bit timing check; cycle redundancy check (CRC) where two charac-

ters are recorded at the end of each data block and during RAW the CRC for the block is recalculated and compared; and parity checking of received data. A series of status functions also can include: no cassette inserted in unit; cassette compartment not closed; cassette improperly inserted; no power; whether or not the file is protected; and in two sided tape whether A or B is in position. Some units provide buffers and also variable tape speed for read/write and search.

The level of reliability for cassettes is high with a mean time before failure (MTBF) at a minimum of 5,000 hours; the encoded information, if reasonably protected from the environment, is reliable for over a year.

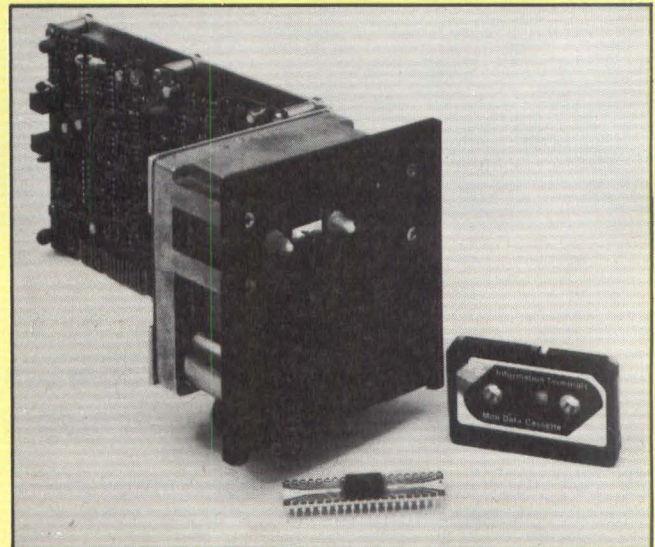

Model 6409 minicassette recorder from Raymond Engineering packs 64 kbytes of unformatted information onto each side of the tape.

Although many units use the simple mechanical drives typical of older audio cassette systems, there is a trend toward capstan and servo motor controlled drives, particularly as higher tape speeds and packing densities become more common. Undergoing a "mini" revolution, the minicassette has now reached the stage of proposed ANSI standards. These cassettes are used where size, weight, power consumption and cost are major considerations. Raymond Engineering, for example, introduced the Mini-Raycorder last year. Its small size, less than 17 cubic inches, makes it suitable for portable terminals, desk top calculators and portable test equipment. Power requirements are so low,

Table 1 — Capability Comparison Of Three Types Of Drives

Drive Parameters	Full-Size Cassette	Minicassette	Full-Size Cartridge	Minicartridge	Full-Size Diskette	Minidiskette
Unformatted Capacity (kilobytes)	720	64	2870	772	400 single density 800 double density	110 single density 220 double density
Tracks	2	1	1, 2 or 4	1 or 2	77	35
Heads	1	1	1	1	1	1
Data Transfer Rate (kbits/second)	24	2.4	48	24 or 48	250 single density 500 double density	125 single density 250 double density
Relative Velocity of Medium Over Head (inches/second)	30	3	30	30	120	80
Average Access Time (seconds)	20		20	11.2	0.286	0.566
Typical Drive Size (inches)	4 x 6 x 8	3 x 3 x 1.1	3 x 7 x 10	3 x 4 x 4.1 (4. x 5 x 4.5)	4.6 x 8.5 x 14.2	4 x 6 x 8
Typical Weight (pounds)	5	1	4	1 (3.2)	14	3
Typical Voltage Requirement (volts)	+12, -12, +5	+5	+18, -18, +5	+12, +5	+24, -15, +5	+12, -12, +5
Typical Drive Price (qty 1) Without Controller	\$750	\$260	\$850	\$250	\$600	\$390
Media Size (inches)	4 x 2.5 x 0.4	2 x 1.3 x 0.3	4 x 6 x 0.665	2.4 x 3.2 x 0.4	8" sq. envelope	5.25" sq. envelope
Media Price (qty 1)	\$8.00	\$7.70	\$18.00	\$14.00	\$6.50	\$4.50
Unformatted KBits/Dollar (Drive + Media)	7.6	1.9	26.5	23.4	5.3 single density 10.6 double density	2.2 single density 4.5 double density
Recording Density (bits per inch)	800	800	1600	800 or 1600	3200 single density 6400 double density	2580 single density 5160 double density

Note: These values for storage capabilities and approximate costs come from a typical drive of each type for storage. Although the numbers for other makes of drives may differ — sometimes significantly — from those listed, this table should help you narrow your choice to a couple of possible types to investigate intensively.

less than 1.5 watts at 5.0 volts, that it can be operated by battery. Like many of the newer units, it uses servo motor control for accurate tape tension and minimum head and tape wear. The unit stores 64K bytes/side unformatted with a data transfer rate of 2400 bits per second and an 800 packing density. Tape speed is from 3 to 20 ips.

The move toward miniaturization has produced two unusual transports, each of which uses a different type of tape package. Although neither the MicroVox Wafer by Micro Communications nor the Unireel by Interdyne truly fall into the cassette category, we have included them here for convenience sake.

The MicroVox wafer is a very small, thin, continuous loop cartridge. It contains a single reel of tape available from 5 to 50 feet in length (in 5 foot increments) with a tape width of 0.07 inch. At maximum length it stores 1.44 million flux changes at 2400 fci. Its mylar tape is coated with a low-head-friction dispersion of chromium dioxide instead of the more standard ferric oxide. All digital wafers are certified for no errors at 2400 fci. The software inter-

face systems are available in three configurations: write only, read-write, and hybrid read-write, which can be ordered at two tape speeds 1.5 ips and 3 ips. The MicroVox Wafer drive costs \$150 to \$200 in OEM quantities.

The Unireel is a single cylindrical reel of magnetic tape. It measures 2-1/8th inches (84 mm.) in diameter. The companion small, self-threading tape drive, according to the manufacturer, achieves the simplicity, reliability and low cost of single motor cartridge drives. It is loaded with 150 feet of computer grade tape 0.150 inch (3.81 mm) wide, certified at 1600 fci. Its formatted capacity is approximately 140,000 bytes at a recording density of 800 bpi. The simplicity of transport contributes to a calculated MTBF of 12,000 hours for drive and electronics. Accidental loss of one or more power supplies will not cause tape damage or spills under any operating mode. Internal logic prevents accidental tape run-off. The Unireel drive costs from \$100-150 in OEM quantities.

Units with 2- or 4-track capabilities can provide higher data density per unit length of tape. Some current state-of-

Economical Digital Cassette Recorder for Data Capture and Preparation

Based on the success of their digital cassette recorder, DCR 1, Philips is introducing a new range of digital cassette recording systems that comply with the relevant ECMA standards governing magnetic tape cassettes parameters and the methods of recording, replaying and file structuring. The new range gives original equipment manufacturers and end users a choice of ready made solutions to a wide variety of data collection and data preparation applications.

Market trends show that there is an increasing need for a low cost data storage medium offering serial registration without random access. It is the claim of Philips that their digital cassette technology offers the best cost-to-performance ratio of any such interchange storage medium available today. Philips are convinced that the cassette medium will now become a more attractive alternative to such media as paper tape, punched cards and cartridge due to the convenience of handling, the compliance with ECMA standards and the low price.

The range comprises the DCR 3 digital cassette recorder which is also available without electronics and known as the DCT 3, two versions of the DCR 4 digital cassette

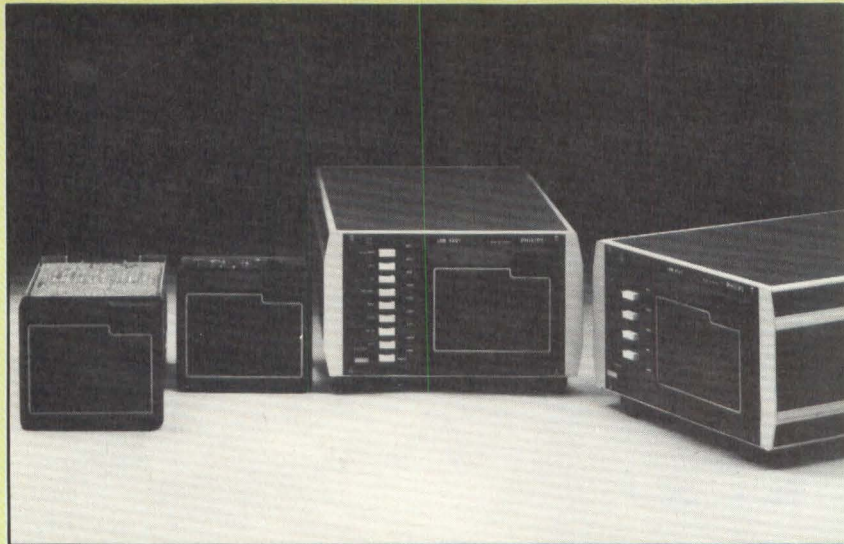

recorder and two intelligent cassette terminals, types LDB 4101 and LDB 4201.

The DCR 3 succeeds the DCR 1 and can be used, at minimum initial cost, in all original equipment at present utilizing the DCR 1. It is a data capture device for small business machines, visible record computers and high grade terminals. The DCR 4 is a low cost, uni-directional drive system available in a write-only version (data collection for statistical purposes) and a read-after-write version (higher data integrity). CMOS electronics ensure low power consumption. To cater to OEMs wishing to integrate the Philips drive assembly into a system of their own design, the DCT 3 pro-

vides a quality cassette transport.

Data logging requirements met in applications like electronic cash registers and automatic test and measuring systems can be solved with the LDB 4101. This write-only cassette system is available in FACIT 4070-compatible and serial interface (RS 232C) versions.

The LDB 4201 is a read-after-write cassette input system available in serial, current and parallel interface versions. Higher data integrity through an error correction system together with micro-processor control permit the LDB 4201 to be used in on-line and off-line data entry and data preparation applications. Philips, P.O. Box 523, Eindhoven, The Netherlands. **Circle 149**

the-art drives also operate at fairly short access times. For example, Tape II by Lexitron Corp. is challenging floppy disk drives in density and transfer speeds. According to Lexitron President Richard O. Bailey, the four track cassettes contain 508 square inches of usable storage surface, compared to 38 square inches for the standard floppy disk, and can transfer a full page of text to the video display screen in one-half second. Access time is slower than for a floppy disk, but Lexitron claims that in heavy word processing applications the format, density and transfer speeds make actual document production highly competitive.

Increasingly, manufacturers are attempting to reduce the complexity of interfacing cassette drives with the CPU by including interface electronics. A typical manufacturer may supply an equal number (most commonly eight) of data input and output lines with strobe and a separate line for rewind, plus several other lines — all TTL-compatible. This interface eliminates the user's concern with such transport functions as start and stop time, leader length, encoding/decoding and the need for external clocking. Self-clocking provides speed tolerant recording, according to Electronic Processors, claiming that it essentially eliminates effects of flutter, wow and head misalignment — three problems nor-

mally associated with low-cost digital cassette drives. As a result, transports so equipped commit less than 1×10^7 soft errors and less than 1×10^8 hard errors.

Designers appear to be discovering an increasing number of applications for cassette drives, many of which were first introduced to replace paper tape units. Jack Morros, application engineering technician for Triple I believes that in the next two to three years cassette drives will expand even more into microprocessor loading applications, such as data logging and analysis, storage for microprocessor development systems and portable program loaders. He also believes that the use of microprocessors for control of transport functions, data encoding and formatting, and interfacing will expand.

Kevin M. Corbett, marketing manager of Memodyne Corp., reports that "new applications are arriving every day" and notes that Memodyne's equipment is used in low power recording devices for such functions as measurement and collection of temperature, pressure, air purity, water purity and seismic information; recording parameters of engine performance on trucks, buses, trains and automobiles; keyboard to cassette storage; external memory for minicomputers; collecting data for billing and point of sales machines; program minicom-

puters and desk top calculators, machine and process control tools; input/output storage for data communications; inventory control systems; and computer peripheral memory.

cartridge drives

The need for higher operating speeds and greater storage capacity than available from cassette drives led to the development of the data cartridge. Typical cartridges contain 1/4-inch wide by 300-foot long high-performance magnetic tape capable of recording 1600 bpi on up to 4 tracks. For example, 3M specifies its cartridges as capable of operating between 0 and 90 ips. Holes in the tape provide light passages for optical sensing of BOT, load point, early warning and EOT. All cartridges have a file protect mechanism. Most tape transports use capstan drives.

Just as with cassettes, cartridge drive manufacturers are expanding the data storage capacity of their equipment. Sycor has developed a 440 system option specifically dedicated to providing a low cost dump/restore medium for fixed disk storage. It utilizes a 3M-type cartridge. Special stand-alone dump-restore utilities operate from a pre-established common file or from a single RUN command. With a capacity of 5.76 Mbytes, it can dump 5 Mbytes of disk storage in 7 minutes. The unit uses a double-density

encoding technique and a phase-locked loop data separator to achieve 3200 double ANSI density. Data is recorded in a continuous, unformatted stream at 60 ips. No time is lost by the usual stop-start operation, because the data is written unformatted at 2048 byte records with a CRC (cyclic redundancy code) checking polynomial at a data rate of 24 Kbytes per second.

In another approach to increasing the data capability of a cartridge unit, National Computer Systems has developed a cartridge carousel system that houses 16 quarter inch tape cartridges in a removable pack. The pack mounts on a drive unit containing one to four read/write stations, operating mechanism and logic circuitry. Cartridges are loaded processed and unloaded at the nearest available station and all four stations can be in operation at the same time. Dual I/O ports and two 8080 microprocessors in the logic circuitry simplify computer to peripheral interfaces. While the cost of the carousel about equals that for floppy disk drives, the system stores 112 times more than a 250K floppy. One cartridge holds 1,814,528 bytes of 512-byte records.

Recording density. Many cartridge drive applications require maximum data storage per cartridge. Serial recording fundamentally offers a higher packing density than parallel recording. Block size is the most significant factor for determining packing density.

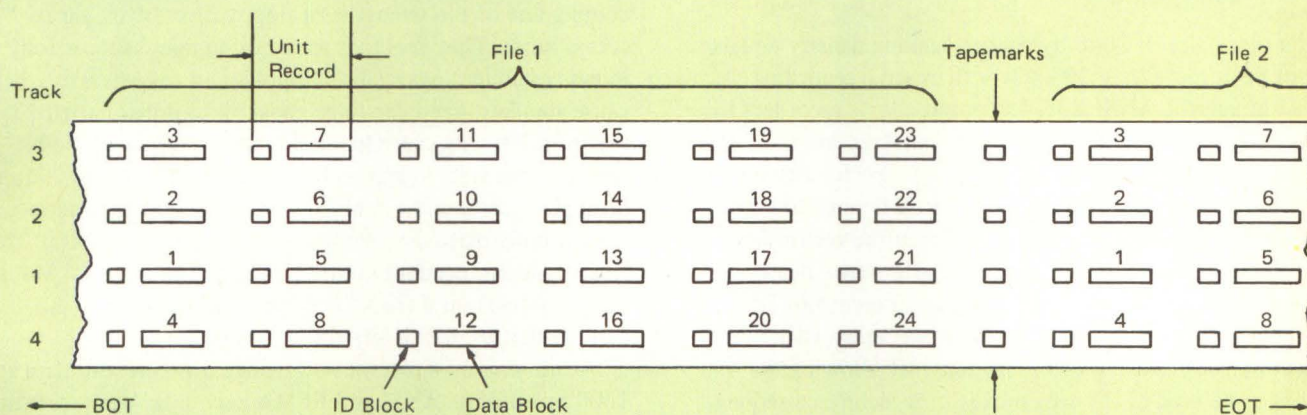

Interdependent Track Operation

A cartridge recorder with interdependent track operation can file data on all 4 tracks, because of wide tolerance allowances. It does not require a change-of-track algorithm.

Interdependent track operation must follow these rules:

- * A "write unit record" command generates the ID and data block, that can only exist as a unit record.
- * A "rewrite data block" command updates or rewrites a data block as required, but the ID block is not normally erased or rewritten.
- * If the ID or data block cannot be written, a reverse and a forward space over the last good record must precede a rewrite attempt on an erase operation.
- * When erasing a unit record because the ID and data block cannot be written in the space provided, an "erase a gap" command, started at the gap before the bad record, deletes the entire record from this area on the tape. (Positioning in this gap should observe the preceding rule).

* If tape marks are used to signify the end of a data file, then 4 recorded tapemarks across the tape prevent inadvertent movement into a new file on each track.

* Track 1 is assumed to be the physical tape reference location of the other 3 unit records or tapemarks in each specific group of 4.

operational example

A typical task performed by a formatter system involves locating a specific unit record in a set of cartridges, just inserted into the drive, and updating that unit record. Knowing the file number, file size and record number, the system first searches by mark count to locate the specific file. Then searching by block count, the system uses the record number divided by 4 to position the tape quickly to within a few records of the one required. A "read ID block" command provides further information for positioning to the correct track and unit record, which the system can access and update.

For 1/4" wide 4-track tapes recorded serially, the ANSI Proposed Standard X3B/44 defines the byte as 8 bits, preamble and postamble as 16 bits, CRCC (cyclic redundancy checking code) as 16 bits, IRG (interrecord gap) as 1.2" minimum, density as 1600 bpi track or 200 bytes/inch-track and tape length as 3600" minimum. Maximum cartridge capacity equals $200 \times 3600 \times 4 = 2.88 \times 10^6$ bytes. If the linear overhead/block equals 48 bits or 6 bytes and $N = \text{bytes/block}$, then packing density in percent,

$$d = 100 \times [N/200] \div [N/200 + 6/200 + 1.2]$$

Then the maximum number of bytes,

$$B_{\max} = 100N/(N + 246) = 2.88 \times 10^6 [N/(N + 246)]$$

For the minimum ANSI block size of 6 bytes, the packing density approximates 4%; for the maximum ANSI block of 2048 bytes, about 90%.

For parallel recording on the same cartridge, the following definitions apply: frame = 1/2 byte or 4 bits across the tape; byte = 8 bits or 2 frames; preamble and postamble = 16 bits linearly; CRCC = 16 bits or 4 frames or 2 bytes; IRG = 1.2"; density = 1600 bpi/track or 6400 bpi or 800 bytes/inch; and length of tape = 3600". If the linear overhead/block = 36 bits, then the packing density in percent,

$$d = 100 \times [N/800] \div [N/800 + 36/1600 + 1.2]$$

Thus, the total number of parallel-recorded bytes,

$$B_{\max} = 100N/(N + 978) = 2.88 \times 10^6 [N/(N + 978)]$$

For a block size of 2048 bytes, the packing density equals about 68%, more than 20% lower than serial recording.

Although the ANSI X3B/44 format allows recorders to store more data on each cartridge, parallel recording on the 4 tracks is faster, because rewinding the tape for accessing each track takes nearly 40 sec and search time is slow, too. If the cartridge drive were to use a serpentine recording pattern, it would need an exotic read-after-write head.

Data Electronics has developed a serial recording technique based on interdependent track operation. (See nearby box for an explanation of the format.) By allowing the 4 tracks to be used as the tape moves, this technique sequentially records unit records across the tracks as the file fills up with data. The recorder can then use a RAW head and, in effect, create a continuous, yet sequential, record file, accessible in less than 1/4th the time and easily overwriteable. Recorders with this capability are suited for transaction-oriented applications, such as point-of-sale, data logging and business machines.

Four-track parallel recording provides two important advantages: high data transfer rate and low search time. Operating at 30 ips, a parallel track recorder can transfer up to 192 Kbits/s; a serial recorder, only 48 Kbits/s. The high rate makes 4-track parallel machines more suitable for such ap-

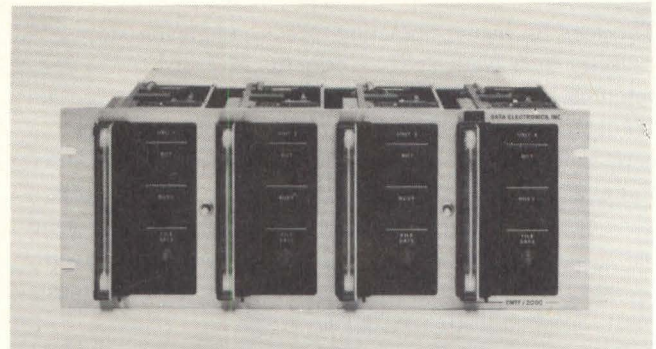

Four 6400 BPI cartridge drives, mounted in a Data Electronics CMTF-2000 Series formatter that occupies a 7" panel space, can record on-line up to 46 Mbytes at 24 Kbytes/s.

plications as program loading and disk back-up. Data Electronics has recently placed a unit with a 6400 BPI recording density. This drive sells for approximately one-third more than the company's 1600-BPI unit, but has 4 times the capacity — 11.5 Mbytes unformatted.

Cartridge drive manufacturers are working hard at overcoming one of the strengths of floppy disk drives, short access times. They feel that they can compete successfully in many applications against floppies and cassettes, too, because standard-sized cartridge capacity of unformatted 23 Mbits on 4 tracks exceeds the number of unformatted bits recorded per side on standard-sized (8") diskettes (3.2 Mbits in single density and 6.4 Mbits in double density) and recorded unformatted on Philips-type cassettes (2 Mbits). The recently-introduced miniature cartridge can store 1.4 Mbits (unformatted) on 4 tracks and the first recorders to use 5-1/4" diskettes, 875 Kbits/side.

At the present time, most cartridge drives record data at 1600 bpi and use ANSI and ECMA encoding. Very recently a recorder with 3200-bpi rate has been introduced. If this equipment should prove its cost effectiveness in the field, Herm Brooks of Tandberg Data said that most cartridge drive manufacturers would offer similar high-speed models.

At the present time, head technology, mechanical wear and magnetic problems limit cartridge search speed to 30 ips. Research and development work will make a 60-ips

Table 1 Typical Performances for Cassette, Cartridge and Diskette Drives

	Cassette	Mini-cassette	Cartridge	Mini-cartridge	Diskette	Minidiskette
Storage Capacity/Size (Kilobytes)	360/track	60/track	2048/track	336/track	243,400,800	80,125,250
Data Transfer Rate (Kilobits/sec)	12.8	16	48	24, 48	250, 500	125, 250
Random Ave. Access Time (sec)	36	11.2	20	11.2	0.26	0.37
Soft Errors	1×10^7	1×10^7	1×10^8	1×10^8	1×10^9	1×10^9



Carousell 5200, marketed by National Computer Systems, holds up to 16 full-size cartridges for recording digital data.

speed possible in 2-3 years, predicted an industry spokesman. Beyond that point, problems increase exponentially.

The minicartridge, the 3M-developed shirt pocket version of the full-sized cartridge, contains 140 feet of 0.150-inch tape in a package measuring 2.4 x 3.2 x 0.5 inches. Qantex has developed a MINIDRIVE, a highly compact unit 3 x 4 x 4.125 inches, weighing one pound to use the miniature cartridge. The transport uses a servo loop that includes a solid state optical tachometer for precise speed control of the low inertia DC motor. The MINIDRIVE, available with 800 bpi or optional 1600 bpi packing density, transfers 24,000 or 48,000 bps at a tape speed of 30 inches per second. Storage capacity of from 168,000 to 772,000 depends on packing density and number of tracks.

Applications. Unattended data logging is the prime application area for cartridge drives, particularly in harsh environments, where dust, dirt, heat and cold are problems.

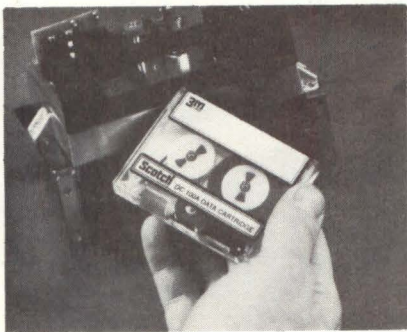

Intended for point-of-sale terminals, automatic typewriters and similar equipment in which size is critical, the DCD-1 data recorder, manufactured by 3M, uses a minicartridge, slightly smaller than a standard Philips-type cassette.

Citing the high reliability of the cartridge and the recorder, Herm Brooks said that the medium fails before the recorder, does; he stressed that most high-volume data logging operations usually cannot permit too many errors to occur. For example, a system that monitors a chemical plant operation could create hazardous conditions, if the logger erred too often.

Other applications of data cartridge drives include: replacement for paper tape punch/reader; memory loader for an onboard computer system; numerical control machine tools; hand-held text computer; small business OEM system; program and data storage with microcomputer system. Mohawk Data Sciences projects such contemplated applications as a data logger for the telephone industry recording origin/destination and length of calls, a logging device on toll roads recording car types, toll amounts and average distances traveled, and for the printing industry which is beginning to use magnetic tape control of press operations.

Interfacing a recorder with a minicomputer requires the drive to conform with the computer's handshaking rules and protocol. However, if every make of mini or micro were equipped with an RS-232C interface, then the interface problem would disappear for many makes of recorders. The lack of a commitment to this standard means that the user or the supplier of the recorder must supply a special interface for the computer in the system.

Cartridge drive manufacturers solve the interface problems in a number of different ways. In one typical solution, Tandberg Data designed its controller/interface to connect its cartridge recorder specifically with 8080 microprocessors and at the same time make it compatible with other types of microprocessors. Capable of handling up to four drives in a daisy chain, the interface contains all the normal for-

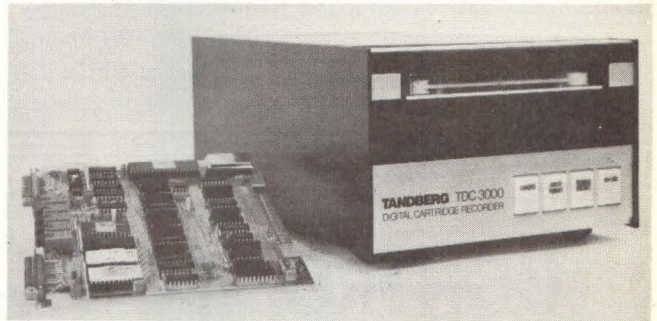

Tandberg Data TDC 3000 cartridge recorder, shown with RS-232C I/O controller card removed from its normal internal position, internal position, interfaces with most communication computer systems.

mating functions plus the interface logic for the processor bus to eliminate the need for a separate formatter. Data transfer takes place with direct memory access. The interface performs such functions as decoding, tape motion control, generation of proper block gaps, writing and reading of data, automatic generation of tape marks, high-speed search. Data transfer on the processor bus is under DMA control. The controller generates the proper memory address based upon an assigned start address. Two 4K PROMs store the program. The instruction set contains an edit function that permits the user to update the last block read automatically without overwriting the preceding or following blocks. During read or read-after-write, the microprocessor calculates and checks CRC characters.

flexible disk drives

Many applications cannot tolerate the long access time that serial storage of cassette and cartridge drives provide. Nor can they stand the high cost of random-accessible large rigid disk drives that provide short access times. One of the first companies to solve these two problems, IBM developed a

low-cost flexible disk and transport to allow random high-speed access to recorded data. The IBM unit proved so successful that it became the accepted standard for the industry. And IBM-compatibility became the goal of all floppy disk drive manufacturers. They accepted IBM's Diskette OEM's Information Manual, GA21-9190-2, as the standard. ANSI standards under development for diskette drives are also based on this manual.

Each standard-sized diskette consists of a 0.003-inch thick oxide-coated mylar disk permanently captured in an 8-inch square jacket. Openings in the jacket provide head and index hole access plus drive spindle-mounting. At the present time, IBM-compatible drives record on one surface only and rotate at 360 rpm.

The system records data serially on diskettes with 77 concentric tracks; numbering starts with 00 on the outside track and ends up with 76 on the inside track. Each track consists of 26 sectors, numbered 01 to 26, whose locations are pre-recorded on the floppy. Index track 00 contains information about data labels, the system and the diskette. Since two tracks are assigned as alternates and one as a space, 73 tracks are used to record data. The system writes data in 128-byte records (one sector), or a total $73 \times 26 \times 128 = 242,944$ bytes/diskette. In addition to data, each sector contains ID, track and sector number, and CRC information.

Bit density requires 13,262 flux transitions/radian. Recording technique uses double frequency, most significant bit first. Users can expect 1×10^9 soft errors (nominal) and 1×10^{12} hard errors (nominal). Transfer rate is 31,250 bytes/sec.

A typical IBM-compatible diskette recorder, such as those available from Applied Data Communications, provide a track-to-track step time of 10 ms and a settling time of 10 ms. Average latency is 83 ms and head loading time is 50 ms. Head life expectancy is 3 years and the oxide medium should withstand 200,000 passes in contact with the head.

IBM-compatibility constraint. Just after manufacturers had begun marketing IBM-compatible diskette transports, system designers started asking for recorders with greater storage capacity on each disk. To satisfy this demand, floppy disk drive manufacturers developed a number of encoding techniques and increased track density — none of which are IBM-compatible. As a matter of fact, almost none of the non-IBM-compatible transports available from various manufacturers are compatible with each other. (See the nearby boxed item for a discussion of flexible disk recording.) And as expected, recording on both sides of the diskette doubles the storage capacity without destroying IBM-compatibility. At the present time, a small number of manufacturers have introduced two-side diskette transports.

Minidiskettes. Manufacturers of standard-sized floppy disk drives found that many applications could not justify the cost of their transports, yet required the fast access of this type of equipment. This need led to the development of the minifloppy drive. In the effort to reduce the cost of the drives but keep equipment reliability high, various manufacturers developed some interesting mechanisms, particularly in the methods of stepping the heads across the tracks.

Resembling a full-size diskette, the minidiskette is per-

CONTROLLED SAVINGS!

**New fanfold tape reader
with attached controller
— all for less than \$1300**



53 John Street, Cumberland, R. I. 02864
Phone: (401) 724-8500 TWX 710-387-1171

Our model 2100 equipped with a controller is one of the best values in paper tape readers today. It's both hardware and software compatible with Digital Equipment's PDP 8 and PDP 11 as well as Data General's Nova 2, 3 and 1200. The Model 2100 gives you something extra: a unique power conservation system which reduces motor operating temperature. Write or call for additional information.

DIGITRONICS
Comtec Information Systems, Inc.

CIRCLE 32



**SUPER BRIGHT
TAPE AND DISC DRIVE
EXERCISERS**

From the largest independent maker of Disc and Tape Drive Exercisers, you get the most complete, most advanced line of universal testers. For Incoming Inspection Production Test Field Service. Send for our comprehensive literature and price list.



2536 Fender, Fullerton, CA 92631 • (714) 992-0410

CIRCLE 34

MORE THAN 385 PRECISION SPROCKETS TO SOLVE YOUR FILM, TAPE AND CHART DRIVE PROBLEMS

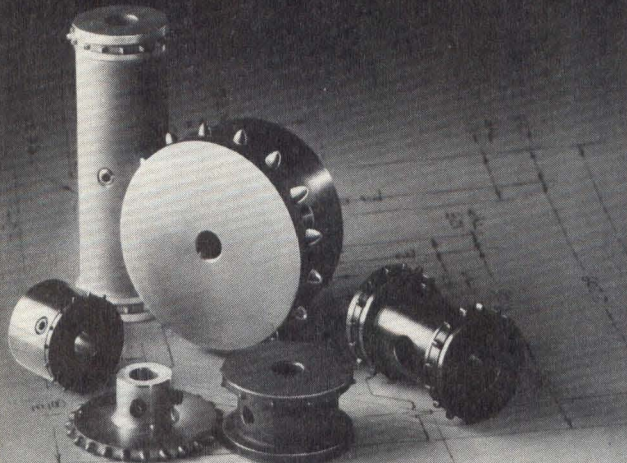

Drives perforated media with unvarying accuracy. Maintains media integrity. Standard sizes from 5mm to 105mm diameter, from 1/4" to 4", specials to 9". Aluminum, steel, stainless, and molded plastic. Geneva starwheel and drives.

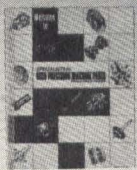

Our catalog tells all.

LaVezzi machine works, inc.

900 N. Larch Ave. • Elmhurst, Ill. 60126 • (312) 832-8990

CIRCLE 35

manently housed in an envelope measuring 5.25 inches square with the necessary apertures for drive spindle, head and sector hole access. For soft-sectored applications, the user may initialize the surface in any desired format, but the usual format usually consists of 128 bytes/record and 18 records/track. For hard-sectored applications, the user may employ diskettes with 16 sector holes, plus an index hole. Minidiskettes are available with 35 and 40 tracks. Typical capacities for unformatted (FM encoding) data approximates 100 Kbytes; for 40-track surfaces and initialized (FM encoding) data, 80 Kbytes on 18-sector tracks. Typical capacities for double density recording with data encoded in MFM or M² FM on 40 tracks is about 250 Kbytes. However, as noted in the May, 1977 issue of this magazine on page 82, Micropolis is marketing a minidiskette drive that stores 315 Kbytes of data on 77 tracks. Track density and flux change density determine the mini-floppy drive transfer rate. At the present time, rates of 125, 250 and 500 Kbits/sec at rotational speed of 300 rpm are available.

Interfacing. Characteristic differences between microcomputers and minicomputers divide full-size and mini flexible disk drive interfacing problems into two different categories. In the case of microcomputers, diskette drives can transfer data so fast — typically at 250 Kbits/s for single-frequency and 500 Kbits/s for double-frequency recording — and require such precise timing that microcomputers cannot keep up with and handle the bit stream. Therefore, system designers must decide how to get the data into and out of the processor and how to control the drive. They must also decide to what use they are going to put the disk-stored information. If the system is a stand-alone that interfaces with no other systems, close by or far away, then the format of the stored data is not critical, because the disks are not expected to be read on other systems. However, many applications require that the diskette be read by a number of different systems, some of which may not be completely compatible with the original recording equipment. In such applications, the floppy drive must record the data in a format common to all the systems expected to make use of the recorded information.

Since the only standard format that exists is the so-called IBM 3760 for single density recording, system designers often opt for it. In such cases, a designer can exercise 3 options: he can build his own controller/formatter with the latest LSI chips, or with older MSI devices; or he can buy his units from a company marketing them; or he can buy flexible disk drives with a built-in controller/formatter. Only a manufacturer who expects to sell large numbers of systems can economically justify designing and building his own controller/formatters. Even when he uses an LSI single chip in his design, the manufacturer must incorporate about 30 supporting IC devices and write a program more than one thousand words long to run the LSI device. According to one industry spokesman, it takes a large amount of expertise to design, write software for, debug and test a controller/formatter. Claiming that relatively few floppy disk drive makers build their own controllers, he said that microcomputer system OEMs quite often design the controller, because they can tailor it to exact rather than general-purpose specifications.

CIRCLE 36 ►

Since microcomputers cannot handle the fast bit stream of data from the flexible disk drive, you can use a buffer to store the information temporarily, or you can directly access the computer memory. Direct access does not require a buffer, because the host CPU memory operates at least as fast as the floppy drive. The programmed I/O approach costs considerably less to implement than direct memory access (DMA). But programmed I/O ties up the CPU during the transfer of data. Since the DMA approach does not tie up the computer during data transfer, the CPU may perform other processing tasks during the transfer interval.

The host computer may contain a microprocessor to interface with and control the floppy disk drive directly, or you can use a microprocessor-based controller to off-load the CPU. Either way, it is possible to define a general-purpose interface for programmed I/O. DMA interfacing cannot be so well defined, because the microcomputer architecture, which varies with the chip used, determines what is needed. If the new DMA LSI devices become standard, they will ease the problem enormously.

Since the minicomputers operate faster than microcomputers, they do not require buffers for programmed I/O interfacing with flexible disk drives. Nevertheless, a system designer must decide whether to interface the floppy directly with the minicomputer's operating system. He must also choose between using programmed I/O or DMA interface. Since most manufacturers provide a programmed I/O interface that ties up the host for typically 4 ms for every sector of transferred data, time-intensive applications or systems that must operate in real time or

respond to interrupts from the outside world may not be able to tolerate this tie-up. Hence, systems intended for such applications should use a microprocessor-based controller/formatter to provide DMA via the system bus. This arrangement, which must be transparent to the minicomputer host and compatible with the CPU's operating system, requires you to write a driver program, usually stored in a ROM. Therefore, the controller manufacturer must supply hardware and software.

Since no industry standards on minicomputers exist, each minicomputer family requires its own interface for floppy disk drives. Some manufacturers market controllers with a general-purpose interface card, plus a special-purpose card that matches the controller to a specific minicomputer; others do not. The decision of how to design the controller boils down to how much intelligence you put into the controller and how much of the intelligence you are willing to sacrifice by using a standard card and bus and putting a special-purpose card at the end of the bus to interface with the minicomputer. You must determine whether this loss significantly affects the proposed application or not.

Intelligent (microprocessor-based) controllers very often solve application problems. Citing two typical examples, the spokesman described a minicomputer-based medical system in which computations resulted in a 90-95% utilization factor of the host CPU. Since the system used a non-intelligent controller to interface with the flexible disk, the maker decided to substitute an intelligent controller. He wrote a program for the CPU main memory to command

IEE's Family of Argus Alphanumeric Display Subsystems

The ideal display for process control, word-processing and test equipment. Fourteen different configurations to choose from: 32, 64, 128 or 256-character capacity panels in either neon-orange (filterable to red) or NEW GREEN!

Mini-128

Mini-256

Maxi-256

Maxi-64

Maxi-32

Available in either "Mini" or "Maxi" character sizes. This Space-saving, versatile alternative gives you a choice, not a substitute.

Available From Stock!

IEE

- Unbelievably high contrast, high brightness, with 120° cone viewing angle
- Available now with memory, character generation, integral drive electronics
- Simple, versatile interface; easy to use

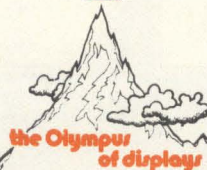

- 5 x 7 dot matrix characters
- Character heights from .2" (5.08 mm) to .32" (8.13 mm)
- For further information, request Bulletin No. AG-3

the controller. In the revised system, the computer takes a few microseconds to tell the controller that it's ready to transmit data and then goes on to other processing tasks. The controller executes its program and compresses an entire main memory segment into one disk — and expands the data out back again into memory, when required. This arrangement has just about doubled minicomputer capacity and allows it to handle other tasks. In the second application, a manufacturer who had been using a minicomputer maker's standard I/O interface with a floppy drive installed an intelligent DMA controller and improved total system throughput by a factor of three. Since the price of "intelligence" has dropped so low, "dumb" controllers make less economic sense than they used to, concluded the spokesman.

Since minifloppies transfer data at 1/2 the rate of standard-size floppies, the interface problems are somewhat easier to solve. In many applications, the minifloppy needs no buffer between the CPU and the drive. However, since no formatting standards exist, it's just as complex as for non-standard formatting (double density) for standard floppies according to one maker.

Changing floppy disk technology. Industry spokesmen differ in their beliefs how floppy disk technology will change. Although Bill Miller, Wangco, personally favors grey code recording, he expects MFM encoding to become most widely accepted for single head, one- and two-sided, two head and double-density recording. On the other hand, Jeff Harman, PerSci, claims that customers prefer M²FM encoding, because it provides wider timing margins with higher peak shifts.

In a little more than a year, double-bit density, double-side drives will become standard for standard diskettes and minidiskettes. Doubling the track density suffers from humidity problems due to the hygroscopic nature of the mylar substrate and from thermal expansion problems. Although you can compensate for thermal expansion differences, you can't readily compensate for humidity. Narrower tracks required by higher density diskettes cause more difficult-to-solve problems in standard — rather than in the micro-size disks, because the relative changes between tracks are greater. Existing systems can handle the shorter steps between tracks. Designing the system to expand at the same rate as the diskette would compensate for temperature expansion problems. On the other hand, water absorption from varying humidity levels can cause nonuniform and unpredictable expansion of the diskette substrate. This lack of uniformity can cause errors when the mechanism tries to compensate for a momentary change in track position. Although you could design a servomotor to seek the center of the track, it would be complex and expensive, according to Miller.

In an effort to improve diskette throughput, manufacturers are investigating the possibility of substituting metal foil substrates in place of oriented polyethylene terephthalate (mylar). To provide the compliance necessary to conform to existing types of heads, the foil must be very thin and it could cut the diskette cardboard holder. A flat read/write head would eliminate the need for compliance and allow using a more rigid foil substrate, believes Miller. Non-compliant diskettes could rotate at up to 1800 rpm, reduce

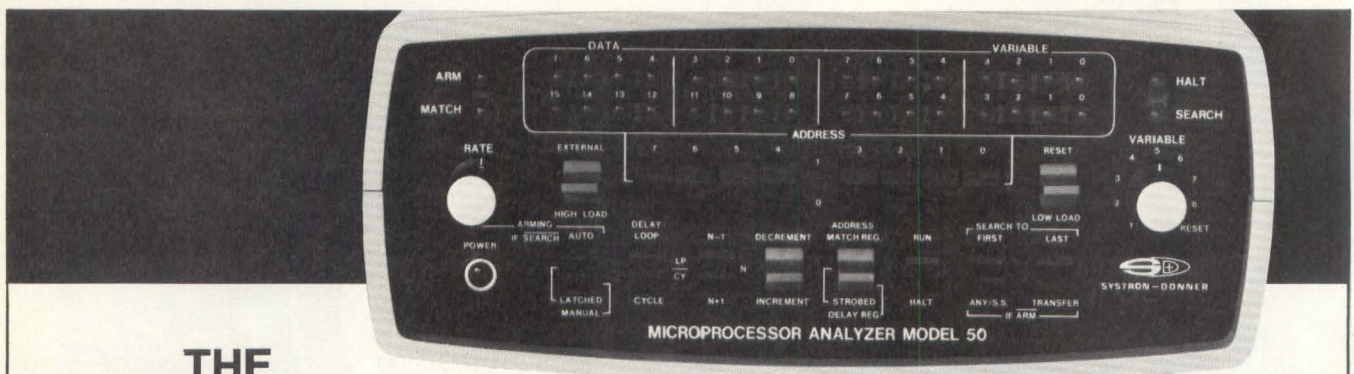

THE HOT NEW S-D MICROPROCESSOR ANALYZER ONLY \$865

but Model 50 does more than a 32-channel logic analyzer costing 3 times as much. **First Universal Analyzer:** Useable with all microprocessor families that have accessible bus structure up to 16 bits data and 16 bits address.

Unique Search Modes: Identify the first and last instruction in a program loop, then step forward or backward through programs.

Passive or Interactive: Use as a passive real time monitor or interactive breakpoint generator.

Find out more about the time-saving (to put it mildly) Model 50 features such as delay by loops or cycles or combinations, single or multiple cycle or loop steps, dual clock, N - 1/N + 1 strobe, multiple unit capability, etc. Contact:

SYSTRON  DONNER

10 Systron Drive • Concord, CA 94518 • Phone (415) 676-5000

CIRCLE 40

The fabulous **Phi-Deck**[®] family of 5 cassette transports under \$100 in quantities of 10

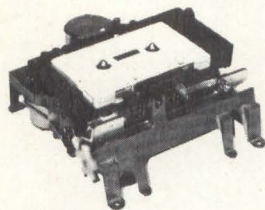

- Featuring:
- Die-cast frames
 - Remote controllable
 - Precise, fast head engage/disengage
 - Quick braking
 - Search FF/rewind 120 ips
 - Speed ranges from .4 to 20 ips

Electronic packages and mag heads for most applications

For application in:

- | | |
|-----------------------------------|---------------------------------------|
| 1. Micro processing | 7. Security/automatic warning systems |
| 2. Data recording/logging/storage | 8. Test applications |
| 3. Programming | 9. Audio visual/education |
| 4. Instrumentation | 10. Telephone interconnect |
| 5. Industrial Control | 11. Hi-Fi |
| 6. RS232 Data storage | 12. Point of sale |



Title A Division of the Economy Co. dd
4605 N. Stiles P.O. Box 25308
Oklahoma City, Oklahoma 73125 (405) 521-9000

- I am interested in application no. _____
 Have Representative call Send application notes

Name _____ Title _____
Company Name _____
Address _____
City _____ State _____ Zip _____
Phone Number _____

CIRCLE 42

The new, **Accuflo**[®] ink roll is a miser with ink.

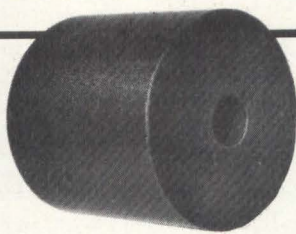

Ink-bearing plastics simplify inking. The plastic ink roll contains its own ink supply. When the ink gives out, you replace the roll. That's when Accuflo plastic pays off. Here's why:

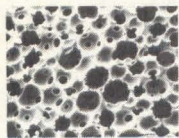

Magnified 60X

Accuflo holds more ink. Large pores in Accuflo's interior give it high ink capacity and permit the use of inks with high pigment content.

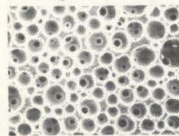

Accuflo gives up its ink slowly. Fine pores on the inking surface control ink emission. Large land areas give you even distribution — uniform inking.

A strong, dimensionally stable Accuflo ink roll engineered for your O.E.M. needs can simplify your inking system and give you hundreds of thousands of crisp impressions from a single roll.

Write for a free **Accuflo Design Guide**.

PORELON, INC. A SUBSIDIARY OF JOHNSON DIVERSIFIED, INC.
Racine, Wisconsin 53403. U.S.A.

CIRCLE 43

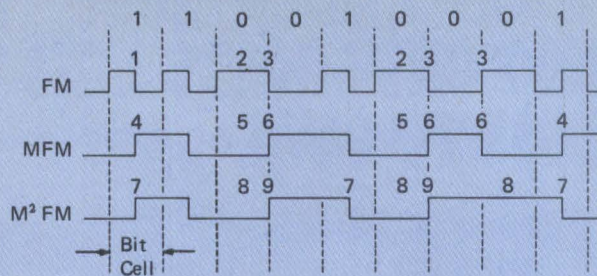

ENCODING MODE RULES

- FM** Each ONE produces a transition at the center of the bit cell time (1); a ZERO preceded by a ONE produces a transition (2); and a ZERO preceded by a ZERO produces a transition at the bit cell time (6).
- MFM** Each ONE produces a transition at the center of the bit cell time (4); a ZERO preceded by a ONE produces no transition (5); and a ZERO preceded by a ZERO produces a transition at the beginning of the bit cell time (6).
- M² FM** Each ONE produces a transition at the center of the bit cell time (7); an odd ZERO produces no transition (8); and an even ZERO produces a transition at beginning of the bit cell time (9).

Note: Circled numbers appear in the nearby timing diagrams to clarify when the transitions produce ZEROs and ONEs.

access time and increase throughput substantially.

Although increased diskette speed improves data throughput, the specific application and the host computer determines the required data handling speed. Even though microprocessors usually cannot handle data at a high rate of speed some microprocessor-based computers must be able to store large quantities of data.

choosing the correct drive

The opening statements in this article said that you should choose the drive on the basis differences in stored information integrity and reliability of the transport, storage capacity, speed of operation and cost. First, let's discuss reliability. MTBF (mean time between failures), MTTR (mean time to repair), media life (mean number of head passes/track), design life, data integrity and periodic maintenance requirements are the component parts of drive reliability specifications. The implications and importance of all these specs, except data integrity, are simple to understand and readily available. Data integrity warrants further discussion.

Three types of errors that destroy data integrity are

can't p. 88

called soft, hard and seek. Hard errors are due to magnetic media defects that cause an improper signal. These errors are usually not possible to correct. Soft errors are usually caused by contaminants (airborne or due to wear particles) that pass between the head and the magnetic medium. The wiping action of the head or a self-cleaning wiper generally removes most of these contaminants. Random electrical noise of a few μ s duration and small defects in the written data or track not detected during the write operation may also generate soft errors. Seek errors occur when the head reads data in nonexistent or improper locations.

To describe errors and how they occur let's look at a typical diskette drive, many of which indicate errors segregated into these four categories: data, parity, seek and controller.

- Data errors originate when disk data is absent or unrecognizable, when the read data contains an erroneous CRC code or when no index hole is found on the diskette during the formatting operation. The most common source of data errors is the absence of a diskette during operation. The controller looks for data and when it finds none, it executes an error return. The next most important error source is dirty, worn or miswritten diskettes. Magnetic dirt can drop bits or inject extraneous bits into the data stream.

Controller CRC logic detects these types of errors. Third in importance, head alignment, if skewed or not aligned in the center of the track, affects signal strength or creates media interchangeability problems. Fourth in importance, the lack of index marks during formatting and writing an entire track of data generates a data error.

- Parity errors are indicated when the controller checks the parity on each command that it receives and verifies that it contains an error. Detecting an error aborts the command.

- Seek errors arise when the system selects a nonexistent track or logical unit, when it improperly "homes" (track 00) during an initialization and when the track byte of the header read does not match the expected value. Improperly set unit select mapping jumpers cause most of this type of error. For example, setting the unit select switch so that no logical drive 0 exists or so that logical drive 0 maps to a nonexistent physical drive results in an error. A misaligned head can also cause seek errors.

- Controller errors indicate faults in controller operation or switch violations. Every time the controller is initialized, it executes extensive self-testing microcode for a fixed time interval. If the controller detects a malfunction, it responds by lighting the controller error indicator, sets the done and error flags to the CPU interface and refuses to accept new commands.

FLEXIBLE DISK DRIVE RECORDING MODES

Designers who attach a flexible (floppy) disk drive to a computer make many decisions that directly affect system cost/performance ratios. One of the first and perhaps most significant decisions they must make involves selecting a recording mode.

IBM compatibility

In systems that require IBM-compatibility the designer must select single-density recording, since IBM data entry equipment, generally considered as the standard for data interchange between various equipment incorporating floppy disks, uses this format and double frequency, or FM, code. With a constant frequency signal and fixed speed disk rotation recording, density varies from 1836 data bits-per-inch (722 bits-per-centimeter) on the outside track to 3268 bits-per-inch (1286 bits-per-centimeter) on inside track.

Single-density FM recording is most reliable and requires a relatively inexpensive controller consisting of encoding and decoding logic. For example, this IBM-compatible mode, which encodes the digital data into electronics-generated ("soft") sectors, uses simple read and detection clock system without write precompensation.

The FM mode may also record in a format noncompatible with the IBM. Disks with "hard" sectors, identified by punched holes, can store nearly 400K bytes rather than approximately 300K bytes in a single-density compatible mode.

maximum storage capacity

Quite often data storage capacity is more important than IBM-compatibility. In maximum capacity applications, designers could select double-density recording that roughly provides twice the data storage

and transfer rate offered by single-density recording.

This choice leads to making a second decision.

Which type of recording mode should the designer call for? At the present time, many floppy disk drives most frequently use two codes — MFM and modified MFM (M^2 FM). (Other techniques are also available, but they require much more complex encoding and decoding logic in the controller). Phase-locked loop type data separators readily decode both codes.

encoding algorithms

All three double-frequency modes, FM, MFM and M^2 FM, encode serial binary information (bits) according to the set of clock-bit and data-bit rules listed in the nearby table and the nearby timing diagrams illustrate how the three encoding schemes relate to each other.

MFM and M^2 FM encoding record data with twice the density as FM with no increase in flux change density. However, to realize double density, the system must use a more expensive and complex write precompensation circuit to overcome bit shift problems. It also requires a more sophisticated (and more expensive) read detection circuit.

The choice between MFM and M^2 FM is not obvious, and you can make a case for either. In fact, some floppy disk drive manufacturers use MFM, while others use M^2 FM, and some offer you a choice of either one. Both modes provide about the same reliability at approximately the same cost. However, the modes are not compatible with each other; a unit that records data on a disk in one mode cannot read information recorded in the other mode.

[Information furnished by Memorex Corp. and PerSci, Inc.]

Buyer's Guide

CASSETTE DRIVE PRODUCT MANUFACTURERS

The cassette drive manufacturers listed here offer full-size cassettes with the exception of Interdyne, which also markets a special cassette called Unireel. Microcommunications only offers a special endless-loop drive called Wafer. Contact manufacturers directly for catalog information or circle the appropriate number on the reader service card.

Electronic Processors, Inc.
1265 W. Dartmouth Ave.
Englewood, CO 80110
(303) 761-8540 Circle 153

Facit-Addo, Inc.
66 Field Point Rd.
Greenwich, CT 06830
(203) 622-9150 Circle 154

Interdyne
14761 Califa St.
Van Nuys, CA 91411
(213) 787-6800 Circle 155

Meca
7344 Wamego Trail
Yucca Valley, CA 92284
(714) 365-7686 Circle 156

Memodyne Corp.
385 Elliot St.
Newton Upper Falls, Ma 02164
(617) 527-6600 Circle 157

Micro Communications Corp
80 Bacon St.
Waltham, MA 02154
(617) 899-8111 Circle 159

Micro Designs, Inc.
Box 2480
Berkeley, CA 94702
(415) 465-1861 Circle 158

Raymond Engineering, Inc.
217 Smith St.
Middleton, CT 06457
(203) 632-1000 Circle 160

Redactron Corp.
100 Parkway Dr. S.
Hauppauge, NY 11787
(516) 543-8700 Circle 161

Triple I
Box 25308
Oklahoma City, OK 73125
(405) 521-9000 Circle 162

CARTRIDGE DRIVE PRODUCT MANUFACTURERS

All of the cartridge drive manufacturers listed here offer full-size cartridges with the exception of Quantex, which offers a mini-cartridge; 3M Data Products offers full-size and minis. Because cartridge drive manufacturers may change their products at any time, we recommend that you check all potential sources of supply for their latest data sheets. For catalog information, either contact the manufacturer directly or circle the appropriate number on the reader service card.

Data Electronics, Inc.
370 N. Halstead St.
Pasadena, CA 91107
(213) 351-8991 Circle 163

National Computer Systems
4401 W. 76th St.
Minneapolis, MN 55435
(612) 831-4100 Circle 164

Mohawk Data Sciences Corp.
Palisade St.
Herkimer, NY 13350
(315) 867-6000 Circle 165

Redactron Corp.
100 Parkway Dr. S.
Hauppauge, NY 11787
(516) 543-8700 Circle 166

Quantex
200 Terminal Dr.
Plainview, NY 11803
(516) 681-8350 Circle 167

Sycor, Inc.
100 Phoenix Dr.
Ann Arbor, MI 48104
(313) 971-0900 Circle 168

Tandberg Data, Inc.
4901 Morens Blvd.
San Diego, CA 92117
(714) 270-3990 Circle 169

3M Data Products
3M Center
St. Paul, MN 55101
(612) 733-8863 Circle 170

DISKETTE DRIVE PRODUCT MANUFACTURERS

The diskette drive manufacturers listed here offer full-sized diskettes with the exception of Micropolis and Wangco, who market only minidiskettes; Pertec and Shugart also offer minidiskettes. Because diskette drive manufacturers may upgrade their products, we recommend you contact all of them for any changes. For catalog information, contact the manufacturer directly or circle the appropriate number on the reader service card.

Applied Data Communications
1509 E. McFadden Ave.
Santa Ana, CA 92705
(714) 547-6954 Circle 171

California Computer Prod.
2411 W. La Palma Ave.
Anaheim, CA 92801
(714) 821-2011 Circle 172

Control Data Corp.
Box 12313
Oklahoma City, OK 73112
(405) 946-5421 Circle 173

Data Systems Designs, Inc.
3130 Coronado Dr.
Santa Clara, CA 95051
(408) 249-9353 Circle 177

Ex-Cell-O Corp. Remex
Box 19533
Irvine, CA 92713
(714) 557-6860 Circle 174

General System Int.
1440 Allec St.
Anaheim, CA 92805
(714) 956-7183 Circle 175

Hewlett-Packard Data Sys.
11000 Wolfe Rd.
Cupertino, CA 95014
(408) 257-7000 Circle 176

Innovex Corp.
75 Wiggins Ave.
Bedford, MA 01730
(617) 275-2110 Circle 178

Memorex Corp.
San Tomas at Central Epwy.
Santa Clara, CA 95052
(408) 987-1000 Circle 179

Micropolis Corp.
9017 Reseda Blvd.
Northridge, CA 91324
(213) 349-2328 Circle 180

PerSci, Inc.
4087 Glencoe Ave.
Marina del Rey, CA 90291
(213) 822-7545 Circle 181

Pertec Computer Corp.
21111 Erwin St.
Woodland Hills, CA 91364
(213) 999-2020 Circle 182

Scientific Micro Systems
777 E. Middlefield Rd.
Mt. View, CA 94043
(415) 964-5700 Circle 190

Shugart Assoc.
415 Oakmead Pkwy.
Sunnyvale, CA 94086
(408) 733-0100 Circle 183

Sykes Datatronics, Inc.
375 Orchard St.
Rochester, NY 14606
(716) 458-8000 Circle 184

Tri-Data
800 Maude Ave.
Mountain View, CA 94043
(415) 969-3700 Circle 185

Wangco, Inc.
5404 Jandy Pl.
Los Angeles, CA 90066
(213) 390-8081 Circle 186

Xebec Systems Inc.
2985 Kifer Rd.
Santa Clara, CA 95051
(408) 988-2550 Circle 187

double-sided floppy disk drive

Shugart Associates, the leading independent (non-IBM) manufacturer of floppy disk drives, announced the introduction of its SA850/851 double-sided single/double density floppy disk drive. Orders for the new units are being taken and deliveries began in May 77, according to Shugart.

The new SA850/851 double-sided floppy stores up to four times the data of a standard floppy drive — or 1600K bytes unformatted and 1200K bytes formatted. The SA 850/851 is available with single density (FM encoding) and double density (M²FM) capability as standard features.

Single quantity price on the drive will be about 26 percent more than the standard Shugart SA800/801 floppy drive — about \$750. OEM quantity pricing will also be about 25 percent more than the SA800/801 floppy drive.

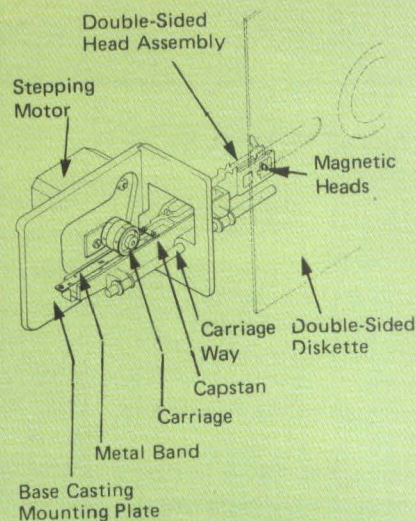

SA850 double-sided floppy disk drive reads and writes data on both sides of a diskette using a double-headed actuating arm. Actuating arm assembly has two metal flexures in which the proprietary Shugart R&W heads are mounted. When actuated by the drive electronics, the top flexure closes onto the diskette making physical contact with it and applying pressure against the lower head for proper data conformity. The read/write heads utilized in the SA850 are the same as those used in Shugart's standard SA800 floppy drives.

Capability comparison

Table 1 lists the important capabilities of the three types of drives. Since the drive technology is changing rapidly, the tabulated values indicate the approximate picture of the moment. Use the table as a rough guide to help you investigate and choose the type of drive you need.

Making the choice.

To choose the drive best suited for a specific application, you should answer these questions:

- Do you need random access or will serial access do?
- How fast must the transfer rate be?
- How reliable is the mechanical part of the drive?
- How reliable are the media?
- How important is the error rate?
- How easily can you file and mail the media?
- Is it important for the drive to be IBM-compatible or ANSI-compatible?
- Is the drive available from a second source or can you substitute another make without a major redesign?
- How do the prices compare?

To illustrate how a designer may use the answers to these questions, let's first assume that you've determined your application needs a full-size diskette drive. First, emphasize mechanical reliability, because usually the electronic reliability is a lesser problem. Remember that a highly reliable floppy disk drive may cost more initially, but can save the user money in the long run by reducing maintenance and down time.

Diskette users most often worry about media interchangeability, reliability, audible noise and media wear. Although interchangeability is related to IBM-compatibility, some drives are more compatible than others. The IBM format is

forgiving enough to cover most drives, but it does not guarantee compatibility between different makes. A world of many types of computer-based systems that talk to each other makes true compatibility very important. Audible noise can create problems in a number of applications, such as in offices and hospitals; in other applications, noise doesn't matter. Since disk wear around the hub and on the read/write surface affects data integrity, the drive must keep wear to a minimum.

the future

Although drive manufacturers will continue to improve their products by making them store more data faster, more reliably than ever, other nonmechanical technologies may begin displacing them. For example, Tandberg Data's Herm Brooks predicts that bubble memories could displace electromechanical recording on magnetic media in a large number of applications. However, bubble memories do not seem to lend themselves to removal from systems for long-term data storage on shelves and then to being returned to the system for readout. He ended his look into the future by noting that digital systems need an ultimate solution to the storing of data — an optical memory that writes and reads at enormous speeds, uses little power, occupies little space — all at a very low cost per bit.

Coming Next Month

A Benwill/Technocast report on patent activity in floppy disk drives.