

901181-385

SPC9800 COMPUTER ASSEMBLY LANGUAGE
PROGRAMMERS REFERENCE MANUAL

EVANS & SUTHERLAND COMPUTER CORPORATION

MARCH 1985

LIST OF EFFECTIVE PAGES

On a changed text page, the portion affected by the latest change is indicated by a vertical line in the outer margin of the page. Change number 0 indicates an original page.

<u>PAGE NUMBER</u>	<u>CHANGE NUMBER</u>
i - viii	0
1-1 - 1-2	0
2-1 - 2-8	0
3-1 - 3-102	0
4-1 - 4-28	0
A-1 - A-6	0
B-1 - B-6	0
C-1 - C-2	0

Portions of this manual include material extracted from "Model 980 Computer Basic System Use and Operation" T.I. Computer Assembly Language, and DX980 General Purpose Operating System with permission of the publisher, Copyright © 1 August 1978, Texas Instruments Incorporated.

Copyright © 1985

EVANS & SUTHERLAND COMPUTER CORPORATION
Salt Lake City, Utah

The contents of this document are not to be reproduced or copied in whole or in part without the written permission of Evans & Sutherland.

Many concepts in this document are proprietary to Evans & Sutherland, and are protected as trade secrets or covered by U.S. and foreign patents or patents pending.

Evans & Sutherland Computer Corporation assumes no responsibility for errors or inaccuracies in this document. It contains the most complete and accurate information available at the time of publication, and is subject to change without notice.

901181-385
FRONT MATTER

CONTENTS

	Page
List of Effective Pages	ii
Illustrations	vii
Tables	vii

SECTION 1 GENERAL INFORMATION

1.1 Scope of Manual	1-1
1.2 References	1-1

SECTION 2 HARDWARE FEATURES

2.1 General	2-1
2.2 Computer Organization	2-1
2.3 Data and Instruction Formats	2-4
2.4 Register Organization	2-4
2.5 Memory Protect/Privilege Instruction Feature	2-6
2.6 Program Relocation Feature	2-7
2.7 Priority Interrupt Feature	2-7

SECTION 3 MACHINE INSTRUCTIONS AND CODING CONVENTIONS

3.1 General	3-1
3.1.1 Instruction Descriptions	3-1
3.1.2 Addressing Modes	3-6
3.1.3 Extended Format Addressing	3-9
3.2 Load Instructions	3-9
3.2.1 Double Load Registers A and E (DLD)	3-9
3.2.2 Load Register A (LDA)	3-11
3.2.3 Load Register E (LDE)	3-11
3.2.4 Load Register M (LDM)	3-12
3.2.5 Load Register X (LDX)	3-13
3.2.6 Load Register File (LRF)	3-13
3.3 Store Instructions	3-15
3.3.1 Double Store Registers A and E (DST)	3-15
3.3.2 Store Register File (SRF)	3-16
3.3.3 Store Register A (STA)	3-17
3.3.4 Store Register E (STE)	3-18
3.3.5 Store Register X (STX)	3-18

901181-385
FRONT MATTER

	Page
3.4 Branch Instructions	3-19
3.4.1 Branch on Incremented Index (BIX)	3-20
3.4.2 Branch and Link (BRL)	3-21
3.4.3 Branch Unconditional (BRU)	3-22
3.4.4 Idle (IDL)	3-23
3.4.5 Load Status Block and Branch (LSB)	3-24
3.4.6 Load Status Block, Reset Interrupt, & Branch	3-25
3.4.7 Store Status Block and Branch (SSB)	3-26
3.5 Arithmetic Instructions	3-28
3.5.1 Add to Register A (Add)	3-28
3.5.2 Double Length Add (DAD)	3-29
3.5.3 Divide (DIV)	3-30
3.5.4 Double Length Subtract (DSB)	3-31
3.5.5 Increment Memory by One (IMO)	3-32
3.5.6 Multiply (MPY)	3-32
3.5.7 Register Add (RAD)	3-33
3.5.8 Register Complement (RCO)	3-34
3.5.9 Register Decrement (RDE)	3-35
3.5.10 Register Increment (RIN)	3-36
3.5.11 Register Invert (RIV)	3-38
3.5.12 Register Subtract (RSU)	3-39
3.5.13 Subtract From Register A (SUB)	3-40
3.6 Compare Instructions	3-41
3.6.1 Compare Logical Character String (CLC)	3-41
3.6.2 Compare Algebraic (CPA)	3-43
3.6.3 Compare Logical (CPE)	3-44
3.6.4 Register Compare Algebraic (RCA)	3-45
3.6.5 Register Compare Logical (RCL)	3-46
3.7 Skip Instructions	3-47
3.7.1 Decrement Memory and Test (DMT)	3-47
3.7.2 Skip on Equal (SEO)	3-48
3.7.3 Skip on Even (SEV)	3-49
3.7.4 Skip on Greater Than or Equal (SGE)	3-50
3.7.5 Skip on Greater Than (SGT)	3-50
3.7.6 Skip on Less Than or Equal (SLE)	3-51
3.7.7 Skip on Less Than (SLT)	3-52
3.7.8 Skip on Minus (SMI)	3-53
3.7.9 Skip on No Carry (SNC)	3-54
3.7.10 Skip on Not Equal (SNE)	3-54
3.7.11 Skip on Not All Ones (SNO)	3-55
3.7.12 Skip on No Overflow (SNV)	3-56
3.7.13 Skip on Not All Zeros (SNZ)	3-57
3.7.14 Skip on Carry (SOC)	3-58
3.7.15 Skip on Odd (SOD)	3-58
3.7.16 Skip on All Ones (SOO)	3-59
3.7.17 Skip on Overflow (SOV)	3-60
3.7.18 Skip on Plus (SPL)	3-61
3.7.19 Skip on Sense Switch Equal (SSE)	3-62
3.7.20 Skip on Sense Switch Not Equal (SSN)	3-63
3.7.21 Skip on Zero (SZE)	3-63

901181-385
FRONT MATTER

	Page
3.8 Shift Instructions	3-64
3.8.1 Arithmetic Left Shift Register A (ALA)	3-64
3.8.2 Arithmetic Left Shift Double (ALD)	3-65
3.8.3 Arithmetic Right Shift Register A (ARA)	3-66
3.8.4 Arithmetic Right Shift Double (ARD)	3-67
3.8.5 Circular Left Shift Double (CLD)	3-67
3.8.6 Circular Right Shift Register A (CRA)	3-68
3.8.7 Circular Right Shift Register B (CRB)	3-69
3.8.8 Circular Right Shift Double (CRD)	3-70
3.8.9 Circular Right Shift Register E (CRE)	3-70
3.8.10 Circular Right Shift Register L (CRL)	3-71
3.8.11 Circular Right Shift Register M (CRM)	3-72
3.8.12 Circular Right Shift Register S (CRS)	3-72
3.8.13 Circular Right Shift Register X (CRX)	3-73
3.8.14 Logical Left Shift Register A (LLA)	3-74
3.8.15 Logical Left Shift Double (LLD)	3-74
3.8.16 Logical Right Shift Register A (LRA)	3-75
3.8.17 Logical Right Shift Double (LRD)	3-76
3.8.18 Left Test For Ones in Register A (LTO)	3-77
3.8.19 Left Test for Zeros in Register A (LTZ)	3-78
3.8.20 Normalize (NRM)	3-79
3.8.21 Right Test for Ones in Register (RTO)	3-80
3.8.22 Right Test for Zeros in Register A (RTZ)	3-81
3.9 Logical Instructions	3-82
3.9.1 Logical AND With Register A (AND)	3-82
3.9.2 Logical OR With Register A (IOR)	3-83
3.9.3 Register AND (RAN)	3-84
3.9.4 Register Exclusive OR (REO)	3-85
3.9.5 Register OR (ROR)	3-86
3.10 Bit Manipulation Instructions	3-87
3.10.1 Set Register A Bit to ONE (SABO)	3-87
3.10.2 Set Register A Bit to Zero (SABZ)	3-87
3.10.3 Set Memory Bit to One (SMBO)	3-88
3.10.4 Set Memory Bit to Zero (SMBZ)	3-89
3.10.5 Test Register A Bit for One (TABO)	3-90
3.10.6 Test Register A Bit for Zero (TABZ)	3-91
3.10.7 Test Memory Bit for One (TMBO)	3-92
3.10.8 Test Memory Bit for Zero (TMBZ)	3-93
3.11 Move Instructions	3-94
3.11.1 Move Character String (MVC)	3-94
3.11.2 Register Exchange (REX)	3-96
3.11.3 Register Move (RMO)	3-97
3.12 Input/Output Instructions	3-98
3.12.1 Auxiliary Processor Initiate (API)	3-98
3.12.2 Automatic Transfer Instruction (ATI)	3-98
3.12.3 Read Direct Single (RDS)	3-99
3.12.4 Write Direct Single (WDS)	3-101

SECTION 4 ASSEMBLER CHARACTERISTICS AND DIRECTIVES

	Page
4.1 General	4-1
4.2 Symbolic Assembly Program	4-1
4.2.1 Assembler Coding Line Format	4-6
4.2.2 Segmented Source Programs	4-8
4.2.3 Assembler Object Format	4-9
4.2.4 Assembler Error Messages	4-9
4.3 Assembler Directives	4-9
4.3.1 Block Ending Symbol (BES)	4-12
4.3.2 Base Register Reset (BRR)	4-12
4.3.3 Base Register Set (BRS)	4-13
4.3.4 Block Starting Symbol (BSS)	4-14
4.3.5 Generate Byte Address (Byte)	4-15
4.3.6 Referencing Common Storage	4-15
4.3.7 Generate Word Address or Data (Data)	4-16
4.3.8 Define Entry Point Symbol (DEF)	4-16
4.3.9 End of Source (END)	4-20
4.3.10 Equate (EQU)	4-21
4.3.11 Flag Bit Address (FLAG)	4-22
4.3.12 Format a New Instruction (FRM)	4-22
4.3.13 Page Heading (HED)	4-23
4.3.14 Object Identifier (IDT)	4-23
4.3.15 Conditional Assembly (IF)	4-24
4.3.16 Start Listing (LIS)	4-25
4.3.17 Operation Define (OPD)	4-25
4.3.18 Origin (ORG)	4-26
4.3.19 Page Eject (PEJ)	4-27
4.3.20 Referenced External Symbols (REF)	4-27
4.3.21 Stop Listing (UNL)	4-28

APPENDIX A INSTRUCTION EXECUTION TIMES (IN MICROSECONDS)

APPENDIX B INSTRUCTION INDEX

APPENDIX C ILLEGAL INSTRUCTION OPERATION CODES

901181-385
FRONT MATTER

ILLUSTRATIONS

Figure	Page
2-1 SPC9800 Computer Block Diagram	2-2
3-1 Register-Memory Instruction Fields	3-6
4-1 Source Coded Main Program	4-2
4-2 Source Coded Subroutine	4-3
4-3 Assembled Main Program	4-4
4-4 Assembled Subroutine	4-5
4-5 Example of Byte and Data Usage	4-19

TABLES

Table	Page
2-1 SPC9800 Computer Characteristics	2-3
2-2 SPC9800 Computer Addressable Registers	2-4
2-3 Status Register Bit Functions	2-5
2-4 SPC9800 Computer Interrupts	2-8
3-1 SPC9800 Computer Machine Instructions by Functional Group	3-2
3-2 Assembly Language Coding Format & Instruction Execution Symbols	3-5
3-3 Register-Memory Instruction Addressing Modes and Coding Conventions	3-7
4-1 Assembler Error Messages	4-10
4-2 Assembler Directives	4-11
C-1 Illegal Instruction Codes	C-1

HARDWARE MAINTENANCE

This manual concerns software procedures only. Equipment maintenance must be referred to qualified service personnel. There are electrical hazards inside this equipment capable of causing DEATH if proper safeguards are not observed.

SECTION 1

GENERAL INFORMATION

1.1 SCOPE OF MANUAL

This manual covers the SPC9800 computer assembly language. It describes all of the computer machine instructions and the associated symbolic assembly language coding conventions. Beginning with Section 2, an overview of the SPC9800 computer is presented with specific information on the hardware features that affect assembly language. Section 3 presents the machine instructions and the symbolic coding conventions. Section 4 follows with a general description of the assembler (SAPGFL) and a list of assembler directives. Included in Section 4 are sample assembly listings produced by SAPFL. The appendixes at the rear of the manual contain instruction execution times, an alphabetical and numerical listing of instruction operation codes, and a table of illegal operation codes.

1.2 REFERENCES

The SPC9800 Software Users Manual contains user descriptions and operating instructions for the system software supplied with the computer. Among other subjects, it gives information on how to assemble, load, and execute an assembly language program.

901181-385
GENERAL INFORMATION

BLANK

10/1/68
10/1/68
6/1/68

10/1/68
10/1/68
10/1/68
10/1/68
10/1/68
10/1/68
10/1/68
10/1/68

SECTION 2

HARDWARE FEATURES

2.1 GENERAL

This section contains a brief block diagram discussion of the computer, a table of computer characteristics, and a list of programmable registers. Included is a bit-by-bit breakdown of the status register.

2.2 COMPUTER ORGANIZATION

The computer is functionally organized into a central processing unit (CPU), a memory, an input/output (I/O) unit, and a power supply. Figure 2-1 shows a block diagram of the basic system. The Direct Memory Access Channel (DMAC) is an I/O channel used for peripheral devices having a relatively fast rate of data transfer. The Data Bus is an I/O channel used for peripheral devices having a relatively slow rate of data transfer. Table 2-1 lists some of the more important characteristics of the computer.

901181-385
HARDWARE FEATURES

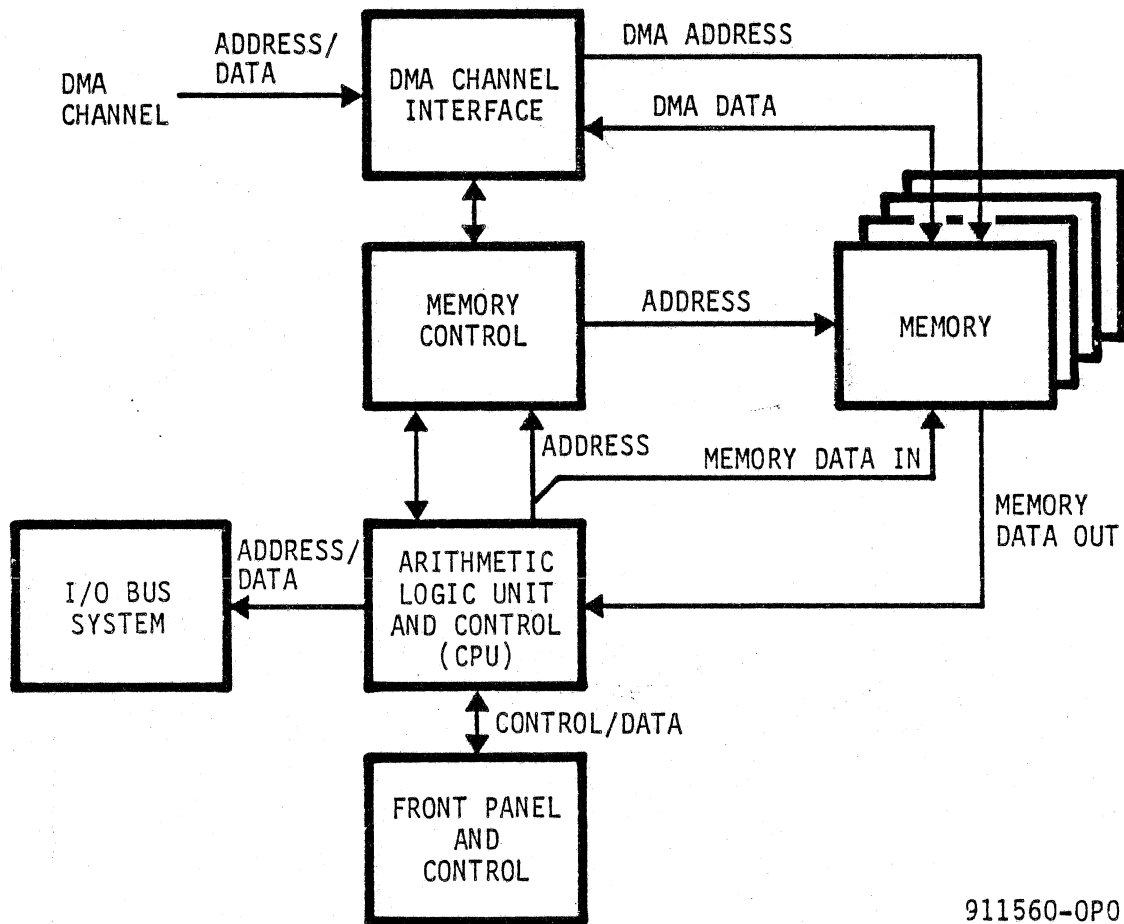

911560-0P0

FIGURE 2-1
SPC9800 COMPUTER BLOCK DIAGRAM

901181-385
HARDWARE FEATURES

TABLE 2-1
SPC9800 COMPUTER CHARACTERISTICS

ORGANIZATION

Parallel operation
Single level indirect addressing
Two's complement arithmetic
Eight addressable registers, plus status register
Bipolar ROM control for CPU

MEMORY

Static Semiconductor memory

16-bit word length

Capacity of 262,144 words in 65,536 word increments

All of memory can be addressed using an 8-location page mapper.
65,536 words can be directly addressed at a given time.

750 or 333 nanosecond read or write cycle

INPUT/OUTPUT

One direct memory access channel (DMAC) port

Single word parallel transfer
Three million words per second burst rate maximum

A processor-controlled data bus with 4 ports

Bit serial transfer
16-bit parallel transfer

Three priority interrupts

Internal interrupts
DMAC interrupts
Data bus interrupts

INSTRUCTION SET

98 basic instructions (covered in Section 3)

OTHER FEATURES

Memory protect/privileged instruction feature
Hardware bootstrap loader

901181-385
HARDWARE FEATURES

2.3 DATA AND INSTRUCTION FORMATS

Both the data and instruction words are 16 bits long. The bit positions within a word are numbered 0 (most significant bit) through 15 (least significant bit). Data is represented in binary two's complement form with bit 0 indicating the algebraic sign. A zero in the first bit indicates a positive sign. The range of integers representable in one 16-bit word is from -2^{15} to $+2^{15} - 1$.

Double length operands such as products from multiplication, dividends for divides, and quantities for double-length arithmetic shifts have the following format:

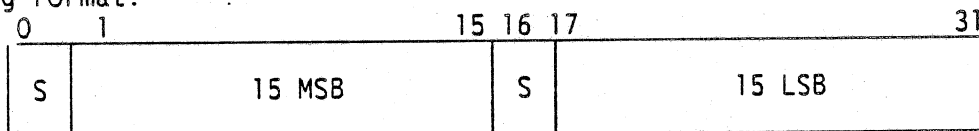

Input, output, and status register related instructions are 32 bits long and occupy two consecutive 16-bit words. The register-to-memory instructions may be 16 or 32 bits long.

2.4 REGISTER ORGANIZATION

Eight 16-bit registers are directly addressable via the instruction formats involving registers. These registers with their respective address, designation, and function are listed in Table 2-2.

TABLE 2-2
SPC9800 COMPUTER ADDRESSABLE REGISTERS

Register Address	Designation	Function
0	A	Primary arithmetic register.
1	E	Secondary (extension) arithmetic register.
2	X	Index register for operand address modification.
3	M	Maintenance register for temporary storage.
4	S	Storage register for temporary storage.
5	L	Link register to hold return address for subroutine linkage.
6	B	Base register to hold base address for operands.
7	PC	Program counter to hold the address of the next instruction.

901181-385
HARDWARE FEATURES

In addition to these eight registers, the status register may be directly affected by the instruction set. The status register is used to hold the present condition of the computer and to enable or disable interrupts. The status register together with the program counter constitutes the "status block". The functions of the status register bits are listed in Table 2-3.

TABLE 2-3
STATUS REGISTER BIT FUNCTIONS

Bits	Function
0,1	Compare Indicators - Indicate the result of the last compare operation. <div style="margin-left: 40px;"> 00 - less than 01 - equal to 10 - greater than 11 - unused bit setting </div>
2	Overflow Indicator - Turned on or off by those instructions that may result in a number that is outside of the range of the associated register(s).
3	Carry Indicator - Turned on or off by an add or -subtract instruction that may result in a carry into the sign bit of a register.
4	Privileged Instruction and Memory Protect Interrupt Control <div style="margin-left: 40px;"> 0 - Disabled 1 - Enabled </div>
5	Memory Protect Address Violation - May not be set under program control. <div style="margin-left: 40px;"> 0 - No Violation 1 - Violation </div>
6	PIF Instruction Violation - May not be set under program control.
7	Data Bus Interrupt Control <div style="margin-left: 40px;"> 0 - Disabled 1 - Enabled </div>
8	Not Used

PIF - Privileged Instruction Feature

901181-385
HARDWARE FEATURES

TABLE 2-3 (CONTINUED)
STATUS REGISTER BIT FUNCTIONS

Bits	Function
9	PIF* Lower Limit Address Bias 0 - Disabled 1 - Enabled
10	Index Control 0 - Post Indexing 1 - Pre-indexing
11	Not Used
12	DMAC Interrupt Control 0 - Disabled 1 - Enabled
13	Not Used
14	Not Used
15	Not Used

*PIF - Privileged Instruction Feature

2.5 MEMORY PROTECT/PRIVILEGED INSTRUCTION FEATURE

When enabled, the memory protect/privileged instruction feature (MP/PIF) allows program execution to occur only within a specified area of memory. It also causes certain instructions to be treated as illegal. This feature may be used to protect the operating environment from destruction during execution of an undebugged program.

The system may use this feature to prevent a user program from inadvertently storing data over a system program or another user program. The MP/PIF can also prevent program execution from proceeding beyond the region that the given program occupies in memory; thus, a program cannot inadvertently branch into the middle of another program. Finally, when the MP/PIF is enabled, a user can neither disrupt input/output activity that the system has in progress nor bring the computer to an idle.

901181-385
HARDWARE FEATURES

Before enabling the MP/PIF feature, it is first necessary to load the MP/PIF lower limit and upper limit registers that define the limits within which execution will be constrained. Both registers are loaded using the WDS instruction (refer to paragraph 3.12.4) just as if the MP/PIF registers were external to the computer. Register address zero defines the lower limit, and register address one defines the upper limit. These boundary locations and all memory outside of the boundaries are protected by the MP/PIF feature. The MP/PIF feature is then enabled by setting bit 4 of the status register.

2.6 PROGRAM RELOCATION FEATURE

The program relocation feature (PRF) allows a program to be loaded anywhere within the SPC9800 65K address space, but to execute as though it were loaded starting at location zero. When used by a system program, this allows programs to be moved from one point in address space to another with no affect on the operation of the program. It also allows programs to be stored in an absolute rather than relocatable form, thus requiring less storage space.

The lower limit register used by the MP/PIF is also used by the PRF. If the system sets bit 9 of the status register at the time control is transferred to the user program, the contents of the lower limit register plus one is added into the address calculations for each memory access. For example, suppose a program is assembled as an absolute program with origin at location 0000_{16} . Also, suppose that the entry point to the program is location 0020_{16} , and that it is convenient for the system to load the program at location 1000_{16} . The system loads the program starting at 1000_{16} , places $0FF_{16}$ in the lower limit register, and performs an LSB instruction (refer to paragraph 3.4.5) to transfer to the program. The LSB must set bit 9 of the status register and load the program counter with 0020_{16} . Note, that although the instruction executed is at 1020_{16} , the program counter contains 0020_{16} . If, for instance, a trap were to occur, the value 0020_{16} in the program counter would be saved for the return.

2.7 PRIORITY INTERRUPT FEATURE

The SPC9800 Computer responds to three different types of interrupts. These interrupts, in order of priority include: internal interrupt, DMAC interrupt, and data bus interrupt. The two lower priority interrupts are input/output interrupts, and their occurrence depends on the system hardware configuration. The internal interrupts include the detection of an illegal operation code, a memory protect violation, and a privileged instruction violation. When any internal or input/output interrupt occurs, computer control traps to low order memory as listed in Table 2-4, assuming the proper status register bits are set to enable the interrupt. Note that the illegal operation code interrupts cannot be masked by the status register.

901181-385
HARDWARE FEATURES

TABLE 2-4
SPC9800 COMPUTER INTERRUPTS

Interrupt Type	Trap Address (Hex)	Status Register Bits	
		Mask Bit	Interrupt Bit
Internal			
Illegal op-code	0002	-	- ¹
MP violation	0002	4	5
PIF violation	0002	4	6
DMAC	0004	12	-
Data Bus	0006	7	-

NOTE¹

The illegal op-code interrupt is detected when none of the other internal interrupts cause the trap to 0002₁₆.

SECTION 3

MACHINE INSTRUCTIONS AND CODING CONVENTIONS

3.1 GENERAL

This section describes the machine instructions and the related assembly language coding conventions for the SPC9800 Computer. Table 3-1 groups the 98 instructions by function, and references a separate paragraph on each instruction for more detailed information. Appendix B contains an alphabetical and hexadecimal index to these same paragraph numbers. General coding conventions applicable to the label, operation, operand, and comment fields of the symbolic assembly language are covered in Section IV of this manual.

3.1.1 INSTRUCTION DESCRIPTIONS

Each instruction description referenced in Table 3-1 contains the following information about the instruction:

- Instruction word field breakdown

- Description of instruction execution

- Status register bits affected by instruction execution

- Execution time

- Assembly language coding conventions

- Instruction example

901181-385
MACHINE INSTRUCTIONS AND DECODING CONVENTIONS

TABLE 3-1
SPC9800 COMPUTER MACHINE INSTRUCTIONS
BY FUNCTIONAL GROUP

MNEMONIC	DESCRIPTION	PARAGRAPH NO.
<u>Load Instructions</u>		3.2
DLD	Double Load Registers A and E	3.2.1
LDA	Load Register A	3.2.2
LDE	Load Register E	3.2.3
LDM	Load Register M	3.2.4
LDX	Load Register X	3.2.5
LRF	Load Register File	3.2.6
<u>Store Instructions</u>		3.3
DST	Double Store Registers A and E	3.3.1
SRF	Store Register File	3.3.2
STA	Store Register A	3.3.3
STE	Store Register E	3.3.4
STX	Store Register X	3.3.5
<u>Branch Instructions</u>		3.4
BIX	Branch on incremented Index	3.4.1
BRL	Branch and Link	3.4.2
BRU	Branch Unconditional	3.4.3
IDL	Idle	3.4.4
LSB	Load Status Block and Branch	3.4.5
LSR	Load Status Block, Reset In- Interrupt, and Branch	3.4.6
SSB	Store Status Block and Branch	3.4.7
<u>Arithmetic Instructions</u>		3.5
ADD	Add to Register A	3.5.1
DAD	Double Length Add	3.5.2
DIV	Divide	3.5.3
DSB	Double Length Subtract	3.5.4
IMO	Increment Memory by One	3.5.5
MPY	Multiply	3.5.6
RAD	Register Add	3.5.7
RCO	Register Complement	3.5.8
RDE	Register Decrement	3.5.9
RIN	Register Increment	3.5.10
RIV	Register Invert	3.5.11
RSU	Register Subtract	3.5.12
SUB	Subtract from Register A	3.5.13

901181-385
MACHINE INSTRUCTIONS AND DECODING CONVENTIONS

TABLE 3-1 (CONTINUED)
SPC9800 COMPUTER MACHINE INSTRUCTIONS
BY FUNCTIONAL GROUP

MNEMONIC	DESCRIPTION	PARAGRAPH NO.
<u>Compare Instructions</u>		3.6
CLC	Compare Logical Character String	3.6.1
CPA	Compare Algebraic	3.6.2
CPL	Compare Logical	3.6.3
RCA	Register Compare Algebraic	3.6.4
RCL	Register Compare Logical	3.6.5
<u>Skip Instructions</u>		3.7
DMT	Decrement Memory and Test	3.7.1
SEQ	Skip on Equal	3.7.2
SEV	Skip on Even	3.7.3
SGE	Skip on Greater Than or Equal	3.7.4
SGT	Skip on Greater Than	3.7.5
SLE	Skip on Less Than or Equal	3.7.6
SLT	Skip on Less Than	3.7.7
SMI	Skip on Minus	3.7.8
SNC	Skip on No Carry	3.7.9
SNE	Skip on Not Equal	3.7.10
SNO	Skip on Not All Zeros	3.7.11
SNV	Skip on No Overflow	3.7.12
SNZ	Skip on Not All Zeros	3.7.13
SOC	Skip on Carry	3.7.14
SOD	Skip on Odd	3.7.15
SOO	Skip on All Ones	3.7.16
SOV	Skip on Overflow	3.7.17
SPL	Skip on Plus	3.7.18
SSE	Skip on Sense Switch Equal	3.4.19
SSN	Skip on Sense Switch Not Equal	3.4.20
SZE	Skip on Zero	3.4.21

901181-385
MACHINE INSTRUCTIONS AND DECODING CONVENTIONS

TABLE 3-1 (CONTINUED)
SPC9800 COMPUTER MACHINE INSTRUCTIONS
BY FUNCTIONAL GROUP

MNEMONIC	DESCRIPTION	PARAGRAPH NO.
<u>Shift Instructions</u>		3.8
ALA	Arithmetic Left Shift Register	3.8.1
ALD	Arithmetic Left Shift Double	3.8.2
ARA	Arithmetic Right Shift Register A	3.8.3
ARD	Arithmetic Right Shift Double	3.8.4
CLD	Circular Left Shift Double	3.8.5
CRA	Circular Right Shift Register A	3.8.6
CRB	Circular Right Shift Register B	3.8.7
CRD	Circular Right Shift Double	3.8.8
CRE	Circular Right Shift Register E	3.8.9
CRL	Circular Right Shift Register L	3.8.10
CRM	Circular Right Shift Register M	3.8.11
CRS	Circular Right Shift Register S	3.8.12
CRX	Circular Right Shift Register X	3.8.13
LLA	Logical Left Shift Register A	3.8.14
LLD	Logical Left Shift Double	3.8.15
LRA	Logical Right Shift Register A	3.8.16
LRD	Logical Right Shift Double -	3.8.17
LTO	Left Test for Ones in Register A	3.8.18
LTZ	Left Test for Zeros in Register A	3.8.19
NRM	Normalize	3.8.20
RTO	Right Test for Ones in Register A	3.8.21
RTZ	Right Test for Zeros in Register A	3.8.22
<u>Logical Instructions</u>		3.9
AND	Logical AND with Register A	3.9.1
IOR	Logical OR with Register A	3.9.2
RAN	Register AND	3.9.3
REO	Register Exclusive OR	3.9.4
ROR	Register OR	3.9.5
<u>Bit Manipulation Instructions</u>		3.10
SABO	Set Register A Bit to One	3.10.1
SABZ	Set Register A Bit to Zero	3.10.2
SMBO	Set Memory Bit to One	3.10.3
SMBZ	Set Memory Bit to Zero	3.10.4
TABO	Test Register A Bit for One	3.10.5
TABZ	Test Register A Bit for Zero	3.10.6
TMBO	Test Memory Bit for One	3.10.7
TMBZ	Test Memory Bit for Zero	3.10.8

901181-385
MACHINE INSTRUCTIONS AND DECODING CONVENTIONS

TABLE 3-1 (CONTINUED)
SPC9800 COMPUTER MACHINE INSTRUCTIONS
BY FUNCTIONAL GROUP

MNEMONIC	DESCRIPTION	PARAGRAPH NO.
<u>Move Instructions</u>		3.11
MVC	Move Character String	3.11.1
REX	Register Exchange	3.11.2
RMO	Register Move	3.11.3
<u>Input/Output Instructions</u>		3.12
API	(Not Supported)	3.12.1
ATI	Automatic Transfer Instruction	3.12.2
RDS	Read Direct Single	3.12.3
WDS	Write Direct Single	3.12.4

The status register bits are defined in Table 2-3. The symbols used in presenting the instruction assembly language coding formats and the symbols used in presenting an abbreviated form of instruction execution are listed in Table 3-2. The symbols and directives used in the instruction examples are explained in Section IV.

TABLE 3-2
ASSEMBLY LANGUAGE CODING FORMAT
AND INSTRUCTION EXECUTION SYMBOLS

	Symbol	Definition
Instruction Execution	()	Contents of enclosed register or address
	—	Replaces
	*	Indirect addressing
Assembly Language Coding Format	@	Extended format
	=	Immediate operand
	[]	Optional item
	Lower case alphabetic characters	User supplied item
	␣	Required blank space (one or more)

901181-385
MACHINE INSTRUCTIONS AND DECODING CONVENTIONS

3.1.2 ADDRESSING MODES

The computer instruction set can be broken down into a number of different format types. The addressing modes associated with all but one of the format types are straightforward, and are included in the individual instruction descriptions. The remaining instruction format type, register-memory instructions, is more involved and is described in this paragraph and referenced by the instruction descriptions when applicable.

The format of register-memory instructions is shown in Figure 3-1. The addressing mode is determined by the I, X, and B fields as shown in Table 3-3.

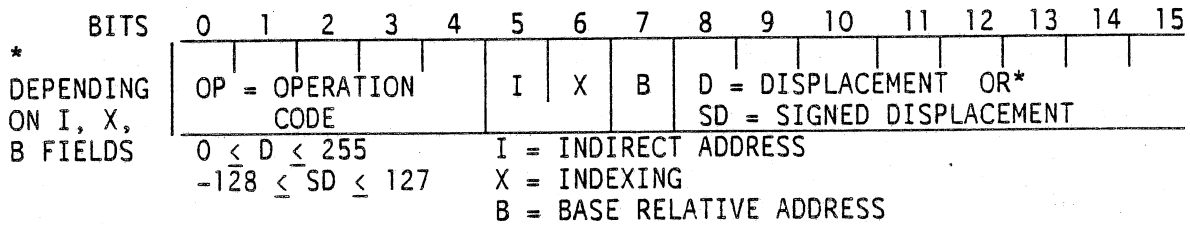

FIGURE 3-1
REGISTER-MEMORY INSTRUCTION FIELDS

901181-385
MACHINE INSTRUCTIONS AND DECODING CONVENTIONS

TABLE 3-3
REGISTER-MEMORY INSTRUCTION ADDRESSING
MODES AND CODING CONVENTIONS

IXB BITS	Effective Operand Address, EOA	Symbolic Coding Convention		Addressing Mode
		Operation	Operand	
000	(PC) ¹ + SD	MNU ¹ @MNU @MNU	ADRS ² =NUM ^{3, 5} NUM, 7 ⁵	PC relative
001	(B) ¹ + D	MNU MNU	ADRS, 1 ADRS ⁴	Base register relative
010	(PC) + (X) ¹ + SD	MNU	ADRS, 2	Indexed PC relative
011	(B) + (X) + D	MNU MNU	ADRS, 3 ADRS, 2 ⁴	Indexed base register relative
100	((PC) + SD)	MNU MNU MNU @MNU	*ADRS *ADRS, 4 ADRS, 4 ADRS ⁵	Indirect PC relative
101	((B) + D)	MNU MNU MNU MNU	*ADRS, 1 *ADRS, 5 ADRS, 5 *ADRS ⁴	Indirect base register relative
110	((PC) + SD) + (X) ⁷ ((PC) + (X) + SD) ⁸	MNU MNU MNU @MNU	*ADRS, 6 *ADRS, 2 ADRS, 6 ADRS, 2 ^{5, 6}	Indirect, Indexed, PC relative
111	Immediate value is the SD	MNU MNU	=NUM NUM, 7	Immediate

- NOTES: 1. PC - Program Counter (points to next instruction); B - Base Register; X - Index Register; MNU - Instruction Mnemonic.
2. Symbolic name of address.
3. Number, literal, or address.
4. Under BRS directive.
5. All extended format instructions are regarded as PC relative because the assembler zeros the SD field. This means the computer must add the PC to the zeroed SD to locate the extended data/address. Note that the computer increments the PC to the next location before the instruction is executed.
6. Post-indexing, regardless of status register bit 10.
7. Post-indexing if status register bit 10 = 0.
8. Pre-indexing if status register bit 10 = 1.

901181-385
MACHINE INSTRUCTIONS AND DECODING CONVENTIONS

NOTE

To fully understand Table 3-3, all of Paragraph 3.1.2 and 3.1.3 must be read.

In general, calculation of the Effective Operand Address (EOA) of the memory data involved in the instruction includes indirect addressing if bit I is set, indexing if bit X is set, and base relative addressing if bit B is set. If all three of these bits are set, an immediate operand is assumed by the computer. If immediate addressing is specified for a load, add, subtract, or algebraic compare instruction, the displacement field (D) is treated as an 8-bit signed quantity and bit eight is extended through bits 0 to 7 to provide a 16-bit operand. If immediate addressing is specified for a store instruction, D is treated as the EOA.

The index control bit in the status register permits optional pre-indexing or post-indexing. This controls the relation of indexing to indirect addressing. If the index control bit is one, indexing precedes indirect addressing. If the index control bit is zero, indexing follows indirect addressing. If indirect addressing is not involved, the two modes are equivalent. Additional addressing capability is available with the optional memory protect/privileged instruction feature. If status register bit 9 is set, the lower limit address is added to the computer calculated address for every memory access.

Table 3-3 also lists the symbolic coding conventions available with register-memory instructions, and hence shows the transliteration process performed by the assembler in developing the I, X, and B fields. In order to translate the operand address expression of a register-memory instruction, the assembler first evaluates the expression as a 16-bit number and then modifies the expression in one of the following ways:

For program counter relative instructions, a number one greater than the assembler location counter is subtracted.

For base register relative instructions, the base register value or the number associated with a BRS directive (refer to Section 4 of this manual) is subtracted.

For extended format instructions (described in next paragraph), the expression remains unmodified.

For single length immediate instructions, or base register relative instructions under the BRR directive (refer to Section 7 of this manual), the expression is truncated to an eight-bit value.

If the resulting address is unattainable under the defined conditions, a field size error is indicated by the assembler.

901181-385
MACHINE INSTRUCTIONS AND DECODING CONVENTIONS

3.1.3 EXTENDED FORMAT ADDRESSING

It is possible to extend the format of certain register-memory instructions and to include data or indirect addresses within these instructions. When this feature is used, the instruction is referred to as an extended format instruction. The extended format instruction coding forms are flagged by note 5 in Table 3-3. The assembler interprets the coded instruction and fills the I, X, B and SD fields as follows:

If the I, X, B, and SD fields are 0, 0, 0, 0, respectively, the next sequential location in memory is used for the operand, and the program counter is incremented a second time. (The first increment is normal to locate the next word in memory.) If the instruction is of the double precision type, such as DLD, DST, DAD, or DSB, the next two sequential memory locations are used for the operand, and the program counter is incremented a third time. The assembler, in this case, generates only one word of data for these double-length instructions. The programmer must supply the second word, typically with a DATA directive.

If the I, X, B, and SD fields are 1, 0, 0, 0, respectively, the effective address is obtained from the next sequential location in memory, and the program counter is incremented a second time.

If the I, X, B and SD fields are 1, 1, 0, 0, respectively, the content of the next sequential memory location is added to the content of the index register to form the effective address, and the program counter is incremented a second time.

NOTE

The indexing is unconditionally performed as post-indexing for double-word instructions; bit 10 of the status word is ignored in this case.

3.2 LOAD INSTRUCTIONS

The load instructions listed in Table 3-1 are described in the following paragraphs.

3.2.1 DOUBLE LOAD REGISTERS A AND E (DLD)

Machine Format:

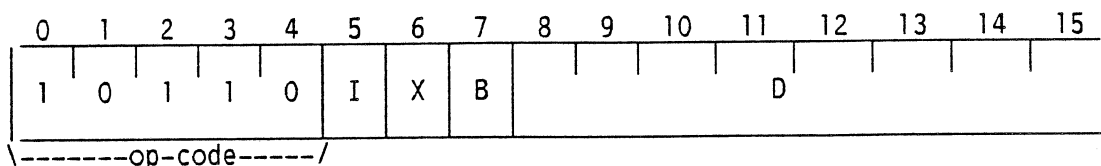

Instruction Execution: (EOA, EOA+1) → (A,E)

where EOA is developed in accordance with Table 3-3.

901181-385
MACHINE INSTRUCTIONS AND DECODING CONVENTIONS

Description: Register A is loaded with the contents of the effective operand address, EOA, and register E is loaded with the contents of the EOA plus one. If the IXB fields are 7₁₆ (immediate addressing), load E with the sign extended displacement field, D, and load A with the extended sign (all zeros or all ones).

Status Affected: None

Execution Time: (refer to Appendix A)

Symbolic Coding: Refer to Table 3-3 for the assembly language coding formats available with the DLD instruction. The DLD mnemonic replaces the MNU operation field (in Table 3-3) and optional label and comment fields may be used.

Examples:

			<u>Before</u>		<u>After</u>
DLD	\$+1		(A) = 0054 ₁₆		AE30 ₁₆
DATA	>AE30,>3239	→	(E) = 16BC ₁₆		3239 ₁₆
			(EOA) = AE30 ₁₆		No Change
			(EOA+1) = 3239 ₁₆		No change
@DLD	BASE		(A) = CC45 ₁₆		1064 ₁₆
:		→	(E) = A0A0 ₁₆		7558 ₁₆
BASE DATA	>1064,>7558		(EOA) = 1064 ₁₆		No change
			(EOA+1) = 7558 ₁₆		No change

901181-385
MACHINE INSTRUCTIONS AND DECODING CONVENTIONS

3.2.2 LOAD REGISTER A (LDA)

Machine Format:

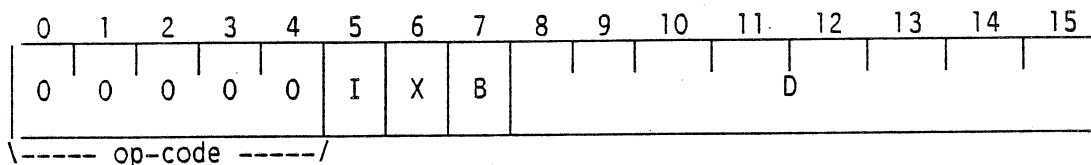

Instruction Execution: (EOA) → (A) where EOA is developed in accordance with Table 3-3.

Description: Register A is loaded with the contents of the effective operand address, EOA. If the IXB fields are 7₁₆ (immediate addressing), load A with the sign extended displacement field, D.

Status Affected: None

Execution Time: (refer to Appendix A)

Symbolic Coding: Refer to Table 3-3 for the assembly language coding formats available with the LDA instruction. The LDA mnemonic replaces the MNU operation field (in Table 3-3) and optional label and comment fields may be used.

<u>Examples:</u>	<u>Before</u>	<u>After</u>
LDA =-1 →	(A) = 05A3 ₁₆ (EOA) = 07FF ₁₆	FFFF ₁₆ No change
HERE LDA \$ →	(A) = F6EF ₁₆ (HERE) = 00FF ₁₆	00FF ₁₆ No change

3.2.3 LOAD REGISTER E (LDE)

Machine Format:

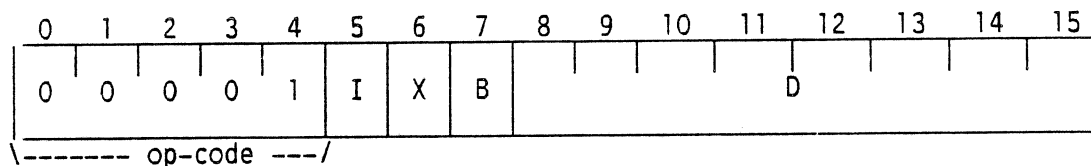

901181-385
MACHINE INSTRUCTIONS AND DECODING CONVENTIONS

Instruction Execution: (EOA) → (E) where EOA is developed in accordance with Table 3-3.

Description: Register E is loaded with the contents of the effective operand address, EOA. If the IXB fields are 7₁₆ (immediate addressing), load E with the sign extended displacement field, D.

Status Affected: None

Execution Time: (refer to Appendix A)

Symbolic Coding: Refer to Table 3-3 for the assembly language coding formats available with the LDE instruction. The LDE mnemonic replaces the MNU operation field (in Table 3-3) and optional label and comment fields may be used.

<u>Examples:</u>	<u>Before</u>	<u>After</u>
LDE BOT,2	(E) = A6B7 ₁₆	0333 ₁₆
:	(X) = 0001 ₁₆	No change
BOT DATA >F,>0333	(EOA) = 0333 ₁₆	No change

3.2.4 LOAD REGISTER M (LDM)

Machine Format:

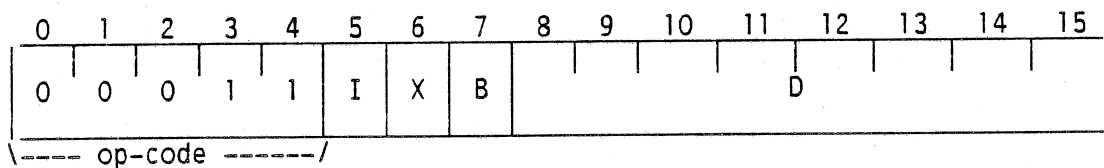

Instruction Execution: (EOA) → (M) where EOA is developed in accordance with Table 3-3.

Description: Register M is loaded with the contents of the effective operand address, EOA. If the IXB fields are 7₁₆ (immediate addressing), load M with the sign extended displacement field, D.

Status Affected: None

Execution Time: (refer to Appendix A)

Symbolic Coding: Refer to Table 3-3 for the assembly language coding formats available with the LDM instruction. The LDM mnemonic replaces the MNU operation field (in Table 3-3) and optional label and comment fields may be used.

901181-385
MACHINE INSTRUCTIONS AND DECODING CONVENTIONS

Examples:

	<u>Before</u>	<u>After</u>
EXEC @LDM =PRB	(M) = 1124 ₁₆	Address of PRB
:		
→		
PRB DATA >0006	(EXEC+1) =	Address
DATA >0000		of PRB
DATA >0050, BUFFER		No change

3.2.5 LOAD REGISTER X (LDX)

Machine Format:

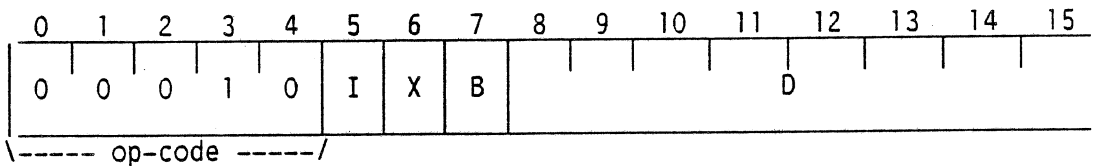

Instruction Execution: (EOA) → (X) where EOA is developed in accordance with Table 3-3.

Description: Register X is loaded with the contents of the effective operand address, EOA. If the IXB fields are 7₁₆ (immediate addressing), load X with the sign extended displacement field, D.

Status Affected: None

Execution Time: (refer to Appendix A)

Symbolic Coding: Refer to Table 3-3 for the assembly language coding formats available with the LDX instruction. The LDX mnemonic replaces the MNU operation field (in Table 3-3) and optional label and comment fields may be used.

<u>Examples:</u>		<u>Before</u>	<u>After</u>
CHCT LDX = -32	→	(X) = 0000 ₁₆	FFE0 ₁₆
		(CHCT) = 17E0 ₁₆	No change

3.2.6 LOAD REGISTER FILE (LRF)

Machine Format:

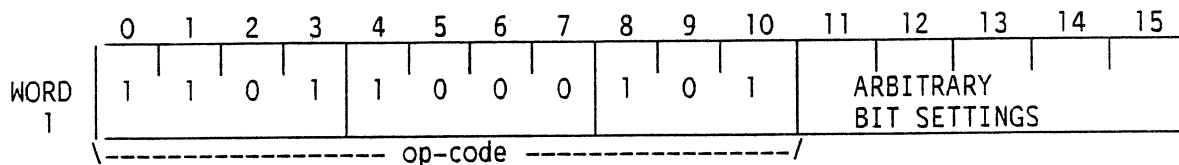

901181-385
MACHINE INSTRUCTIONS AND DECODING CONVENTIONS

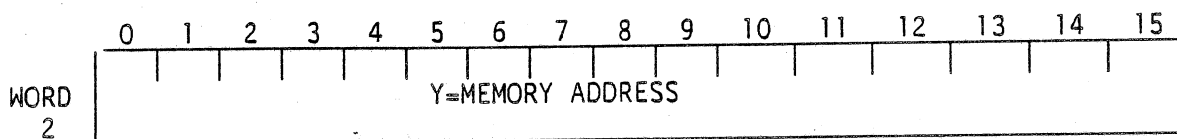

Instruction Execution: (Y, Y+1, Y+2, Y+3, Y+4, Y+5, Y+6) → (A, E, X, M, S, L, B)

Description: Registers A, E, X, M, S, L, and B (the register file) are loaded from sequential memory locations starting at the address specified by Y (second word of the instruction).

Status Affected: None

Execution Time: (refer to Appendix A)

Symbolic Coding: The assembly language coding formats for the LRF instructions are as follows:

Label	⊘	Operation	⊘	Operand	⊘	Comment	
[label]		@LRF		adrs		[comment]	where "address"
			or				is the symbolic
[label]		LRF				[comment]	name of a 16-bit
[label]		DATA		adrs		[comment]	memory address.

Example:

```

                LRF  @MEMA
                :
MEMA           DATA >300, >06AA, >FFEO, >1A61, >0000, >1121, >8A04
    
```

	<u>Before (Hex)</u>	<u>After (Hex)</u>
Register file	(A) = 0000	0300
	(E) = 0002	06AA
	(X) = FFFF	FFEO
	(M) = 200D	1A61
	(S) = 0C00	0000
	(L) = FA00	1121
	(B) = 0601	8A04

901181-385
MACHINE INSTRUCTIONS AND DECODING CONVENTIONS

3.3 STORE INSTRUCTIONS

The store instructions listed in Table 3-1 are described in the following paragraphs.

3.3.1 DOUBLE STORE REGISTERS A AND E (DST)

Machine Format:

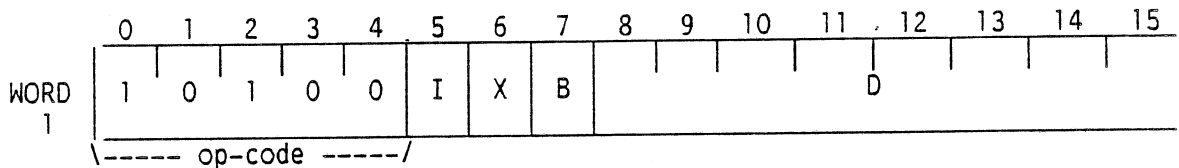

Instruction Execution: $(A,E) \rightarrow (EOA,EOA+1)$ where EOA is developed in accordance with Table 3-3.

Description: Store the contents of register A into the contents of the effective operand address, EOA, and store the contents of register E into the contents of EOA plus one. If the IXB fields are 7_{16} (immediate addressing), the displacement field, D, is the EOA.

Status Affected: None

Execution Time: (refer to Appendix A)

Symbolic Coding: Refer to Table 3-3 for the assembly language coding formats available with the DST instruction. The DST mnemonic replaces the MNU operation field (in Table 3-3) and optional label and comment fields may be used.

Example:

DST TOP	.	→	<u>Before</u>	<u>After</u>
			$(A,E) = 4441_{16}, 4D4E_{16}$	No change
TOP BSS 2			$(TOP, TOP+1) = 4C55_{16}, 434B_{16}$	$4441_{16}, 4D4E_{16}$

901181-385
MACHINE INSTRUCTIONS AND DECODING CONVENTIONS

3.3.2 STORE REGISTER FILE (SRF)

Machine Format:

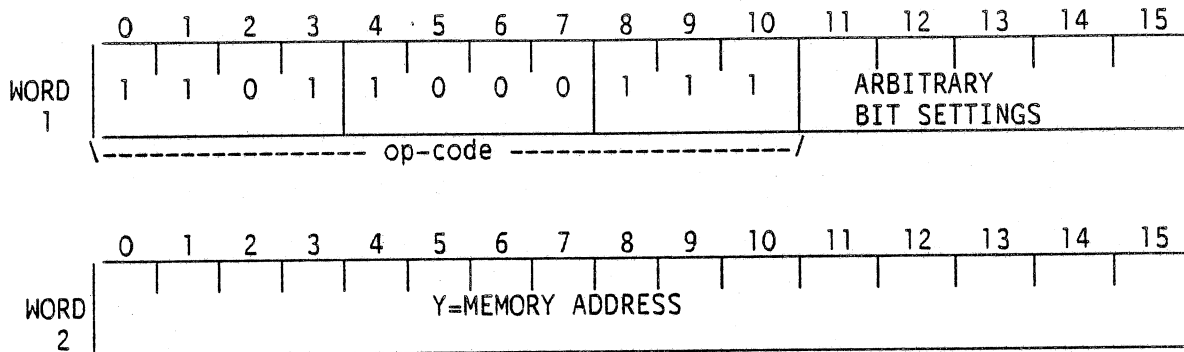

Instruction Execution: (A,E,X,M,S,L,B) → (Y,Y+1,Y+2,Y+3,Y+4,Y+5,Y+6)

Description: Store the contents of registers A, E, X, M, S, L, and B (register file) into sequential memory locations starting at the address specified by Y (second word of the instruction).

Status Affected: None.

Execution Time: (refer to Appendix A)

Symbolic Coding: The assembly language coding formats for the SRF instruction are as follows:

Label	Operation	Operand	Comment
[label] ⅈ	@SRF ⅈ	adrs ⅈ	[comment] where "adrs" is the symbolic name of a 16-bit memory address.
	or		
[label] ⅈ	SRF ⅈ		[comment]
[label] ⅈ	DATA ⅈ	adrs ⅈ	[comment]

901181-385
MACHINE INSTRUCTIONS AND DECODING CONVENTIONS

Example:

SRF	SAVE	Register file	<u>Before (Hex)</u>	<u>After (Hex)</u>
DATA			(A) = 0001	
.			(E) = DE03	
.			(X) = 0004	
SAVE BSS	7		(M) = 0101	No change
			(S) = FFFF	
			(L) = 23A3	
			(B) = 0800	
			(SAVE) = FA03	0001
			(SAVE+1) = 0004	DE03
			(SAVE+2) = FFDE	0004
			(SAVE+3) = DE80	0101
		Memory locations	(SAVE+4) = 3A40	FFFF
			(SAVE+5) = 11AB	23A3
			(SAVE+6) = CE00	0800

3.3.3 STORE REGISTER A (STA)

Machine Format:

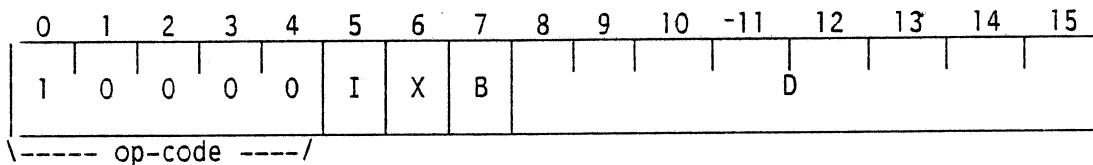

Instruction Execution: (A) → (EOA) where EOA is developed in accordance with Table 3-3.

Description: Store the contents of register A into the contents of the effective operand address, EOA. If the IXB fields are 7₁₆ (immediate addressing), the displacement field, D, is the EOA.

Status Affected: None

Execution Time: (refer to Appendix A)

Symbolic Coding: Refer to Table 3-3 for the assembly language coding formats available with the STA instruction. The STA mnemonic replaces the MNU operation field (in Table 3-3) and optional label and comment fields may be used.

Example:

STA DEST, I	→		<u>Before</u>	<u>After</u>
		(A) =	D8C0 ₁₆	No change
		(DEST) =	0642 ₁₆	D8C0 ₁₆

901181-385
MACHINE INSTRUCTIONS AND DECODING CONVENTIONS

3.3.4 STORE REGISTER E (STE)

Machine Format:

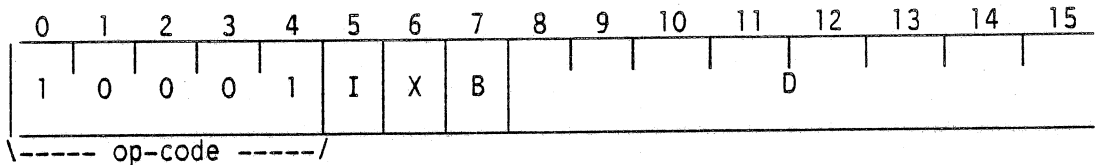

Instruction Execution: (E) → (EOA) where EOA is developed in accordance with Table 3-3.

Description: Store the contents of register E into the contents of the effective operand address, EOA. If the IXB fields are 7_{16} (immediate addressing), the displacement field, D, is the EOA.

Status Affected: None

Execution Time: (refer to Appendix A)

Symbolic Coding: Refer to table 3-3 for the assembly language coding formats available with the STE instruction. The STE mnemonic replaces the MNU operation field (in Table 3-3) and optional label and comment fields may be used.

Example:

STE =6	→		<u>Before</u>	<u>After</u>
		(E) =	$1AE9_{16}$	No change
		(Memory location 6) =	$788B_{16}$	$1AE9_{16}$

3.3.5 STORE REGISTER X (STX)

Machine Format:

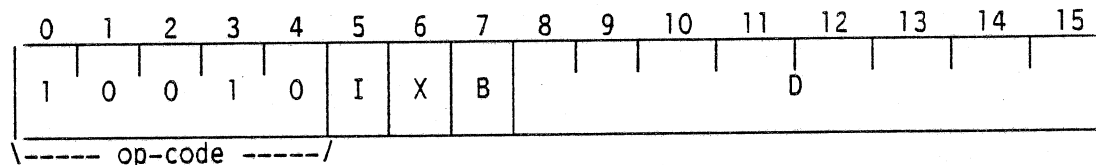

Instruction Execution: (X) → (EOA) where EOA is developed in accordance with Table 3-3.

901181-385
MACHINE INSTRUCTIONS AND DECODING CONVENTIONS

Description: Store the contents of register X into the contents of the effective operand address, EOA. If the IXB fields are 7_{16} (immediate addressing), the displacement field, D, is the EOA.

Status Affected: None

Execution Time: (refer to Appendix A)

Symbolic Coding: Refer to Table 3-3 for the assembly language coding formats available with the STX instruction. The STX mnemonic replaces the MNU operation field (in Table 3-3) and optional label and comment fields may be used.

Example:

@STX FARAWY,2	→		<u>Before</u>	<u>After</u>
		(X) =	0002 ₁₆	No change
		(FARAWY+2) =	1007 ₁₆	0002 ₁₆

NOTE

The content of register X is both stored and used as the index.

3.4 BRANCH INSTRUCTIONS

The branch instructions listed in Table 3-1 are described in the following paragraphs.

901181-385
MACHINE INSTRUCTIONS AND DECODING CONVENTIONS

3.4.1 BRANCH ON INCREMENTED INDEX (BIX)

Machine Format:

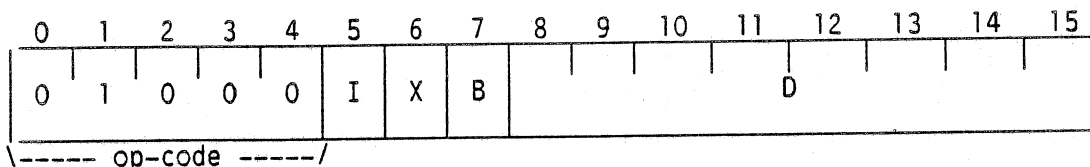

Instruction Execution: $(X)+1 \rightarrow (X)$; if $(X) \neq 0$, $EOA \rightarrow PC$
 if $(X) = 0$, PC is not affected
 where EOA is developed in accordance with Table 3-3.

Description: Increment the contents of register X by one: if the resulting X register value is non-zero, place the effective operand address, EOA, in the program counter and continue execution from that point; if the resulting X register value is zero, continue execution with the next sequential instruction. If the IXB fields are 7_{16} (immediate addressing), the displacement field, D, is the EOA. The BIX instruction is commonly used in loop control where register X contains a negative loop count.

NOTE

The extended format BIX instruction is allowed since an extra program counter increment occurs on the fall through condition. If the BIX instruction is single length, the IXB bits are zero, and the displacement field is zero, the next word is skipped when the X register is incremented to zero. When the X register is incremented to a non-zero quantity, the next word is executed.

Status Affected: None

Execution Time: (refer to Appendix A)

Symbolic Coding: Refer to Table 3-3 for the assembly language coding formats available with the BIX instruction. The BIX mnemonic replaces the MNU operation field (in Table 3-3) and optional label and comment fields may be used.

Example:

BIX DOG	→		<u>Before</u>	<u>After</u>	
		(X) =	$FFA6_{16}$	$FFA7_{16}$	where the BIX instruction is at $1B64_{16}$ and DOG is at $1B20_{16}$.
		(PC) =	$1B64_{16}$	$1B20_{16}$	

901181-385
MACHINE INSTRUCTIONS AND DECODING CONVENTIONS

The following instruction application example illustrates use of the BIX instruction to sum a buffer's contents.

```

      .
      .
      .
      LDX  =-32
      LDA  =0
LOOP   ADD  BUFFER+32,2
      BIX  LOOP
      .
      .
      .
BUFFER BSS  32
  
```

3.4.2 BRANCH AND LINK (BRL)

Machine Format:

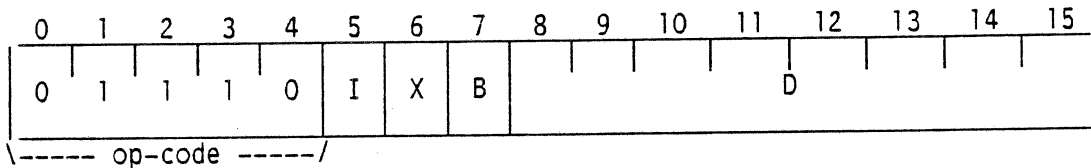

Instruction Execution: (PC) → (L); EOA → (PC) -where EOA is developed in accordance with Table 3-3.

Description: Load the contents of the program counter into the link register, L, place the effective operand address, EOA, in the program counter, and continue execution from that point. If the IXB fields are 7₁₆ (immediate addressing), the displacement field, D, is the EOA. The BRL instruction is commonly used for subroutine linkage. To return, the subroutine typically uses either an RMO L,P or REX L,P instruction. The return may also be accomplished by storing the contents of the link register in memory and branching indirectly through that memory location with a BRU instruction.

NOTE

The extended format BRL instruction places the address of the first word beyond the double-length BRL instruction in the link register.

Status Affected: None

Execution Time: (refer to Appendix A)

Symbolic Coding: Refer to table 3-3 for the assembly language coding formats available with the BRL instruction. The BRL mnemonic replaces the MNU operation field (in Table 3-3) and optional label and comment fields may be used.

901181-385
MACHINE INSTRUCTIONS AND DECODING CONVENTIONS

Example:

BRL CAREA	→	(L) =	<u>Before</u>	<u>After</u>	where CAREA is at 0580 ₁₆ and in the range -128 ₆ PC ≤ 127.
		(PC) =	032A ₁₆	055E ₁₆	
			055D ₁₆	0580 ₁₆	

The following instruction application example illustrates use of the BRL instruction to execute a subroutine.

```

(Main program)
.
.
BRL WRITE
.
WRITE EQU $ (Write subroutine)
.
RMO 5,7 (Return to instruction following BRL WRITE)

```

3.4.3 BRANCH UNCONDITIONAL (BRU)

Machine Format:

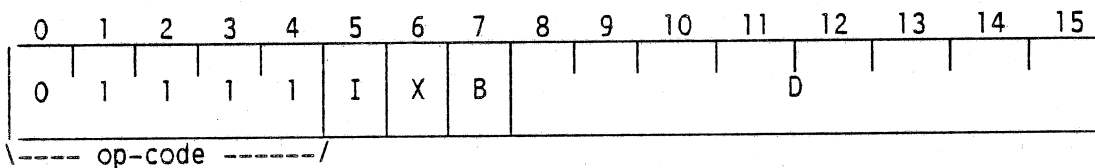

Instruction Execution: EOA → (PC) where EOA is developed in accordance with Table 3-3.

Description: Place the effective operand address, EOA, in the program counter and continue execution from that point. If the IXB fields are 7₁₆ (immediate addressing), the displacement field, D, is the EOA.

NOTE

The extended format BRU instruction alters the program counter in the same manner as single-length BRU instructions.

Status Affected: None

Execution Time: (refer to Appendix A)

901181-385
MACHINE INSTRUCTIONS AND DECODING CONVENTIONS

Symbolic Coding: Refer to Table 3-3 for the assembly language coding formats available with the BRU instruction. The BRU mnemonic replaces the MNU operation field (in Table 3-3) and optional label and comment fields may be used.

Example:

@BRU TAB,2	→	(PC) =	<u>Before</u>	<u>After</u>	where TAB is at
		(X) =	1B13 ₁₆	0850 ₁₆	
			0050 ₁₆	No change	0800 ₁₆ .

3.4.4 IDLE (IDL)

Machine Format:

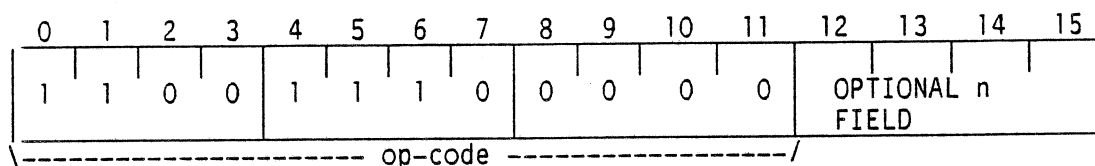

Instruction Execution: HALT

Description: The idle instruction causes the computer to pause. If the idle instruction is encountered in the RUN mode, the RUN indicator and RUN switch are turned off, and the IDLE indicator is turned on. The computer re-enters the RUN mode if an interrupt occurs or if the RUN switch is activated. If an idle instruction is encountered during single instruction execution, the IDLE indicator is turned on. The idle instruction is restricted, meaning it is considered illegal if the memory protect/privileged instruction feature is enabled.

Status Affected: None

Execution Time: (refer to Appendix A)

901181-385
MACHINE INSTRUCTIONS AND DECODING CONVENTIONS

Symbolic Coding: The assembly language coding format for the ILD instruction is as follows:

Label		Operation		Operand		Comment
[label]	ø	IDL	ø	n	ø	[comment]

where "n" can be used to flag the reason for the idle when the instruction register is displayed on the computer front panel. If no flag is desired, "n" may be coded as a zero. ($0 \leq n \leq 15$).

Example: IDL 1

3.4.5 LOAD STATUS BLOCK AND BRANCH (LSB)

Machine Format:

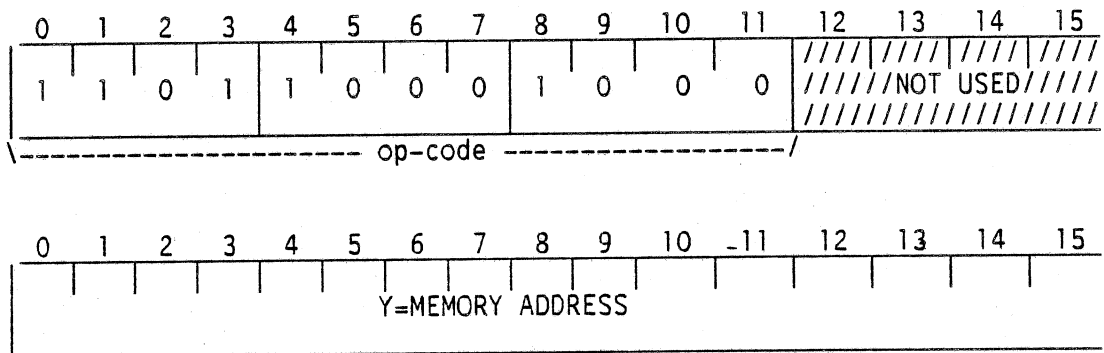

Instruction Execution: (Y,Y+1) → (PC,ST)

Description: The program counter is loaded with the contents of memory location Y and the status register is loaded with the contents of memory location Y+1. Program execution continues at the location specified by the new contents of the program counter. Status register bits 5 (memory protect violation), and 6 (PIF violation), are unconditionally cleared to zero by the LSB instruction. The instruction is also restricted, meaning it is considered illegal if the memory protect/privileged feature is enabled. Interrupts, other than internal, are inhibited for one instruction following an LSB.

NOTE

This LSB instruction is commonly used for an exit from interrupt processing or for a return from a subroutine. The address Y points to the program counter and status register preserved by an SSB instruction upon entrance to an interrupt processing or subroutine program.

901181-385
MACHINE INSTRUCTIONS AND DECODING CONVENTIONS

Status Affected: All status register bits are affected as indicated by memory location Y+1, with the following exceptions: bits 5, and 6, are unconditionally cleared to zero.

Execution Time: (refer to Appendix A)

Symbolic Coding: The assembly language coding formats for the LSB instruction are as follows:

Label	Operation	Operand	Comment	
[label] ⅈ	@LSB ⅈ	adrs ⅈ	[comment]	where "adrs" is the symbolic name of a 16-bit memory address.
		or		
[label] ⅈ	@LSB ⅈ		[comment]	
[label] ⅈ	DATA ⅈ	adrs ⅈ	[comment]	

Example:

```

@LSB PROG5                    →                    Before (Hex)    After (Hex)
                                                  (PC, ST) = 0400,0850    1A69,0010
                                                  (PROG5,PROG5+1) = 1A69,0010    No change
  
```

3.4.6 LOAD STATUS BLOCK, RESET INTERRUPT, AND BRANCH (LSR)

Machine Format:

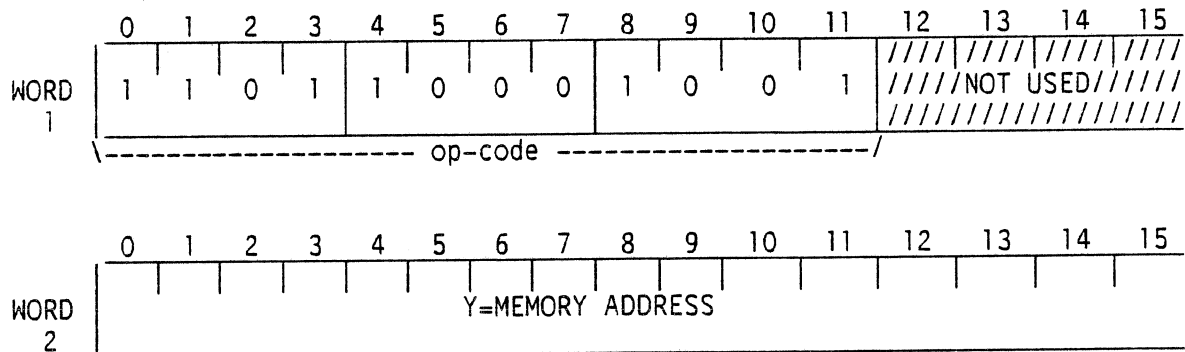

Instruction Execution: (Y,Y+1) →(PC,ST): reset highest priority vectored interrupt if applicable.

Description: Execution of the LSR instruction is identical to LSB (paragraph 3.4.5).

901181-385
MACHINE INSTRUCTIONS AND DECODING CONVENTIONS

Status Affected: All status register bits are affected as indicated by memory location Y+1, with the following exceptions: bits 5 (memory protect violation), and 6 (PIF violation) are unconditionally cleared to zero.

Execution Time: (refer to Appendix A)

Symbolic Coding: The assembly language coding formats for the LSR instruction are as follows:

Label		Operation		Operand		Comment	
[label]	⌀	@LSB	⌀	adrs	⌀	[comment]	where "adrs"
			or				is the symbolic
[label]	⌀	@LSB	⌀			[comment]	name of a 16-bit
[label]	⌀	DATA	⌀	adrs	⌀	[comment]	memory address.

Example:

LSR	→		Before (Hex)	After (Hex)
DATA CATA		(PC, ST) =	13A5,0110	075D,0010
		(CATA,CATA+1) =	075D,0010	No change

3.4.7 STORE STATUS BLOCK AND BRANCH (SSB)

Machine Format:

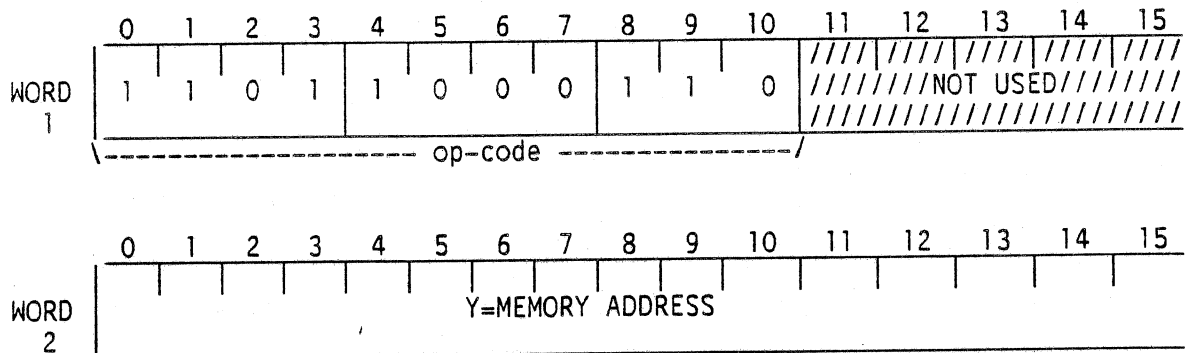

901181-385
MACHINE INSTRUCTIONS AND DECODING CONVENTIONS

Instruction Execution: (PC,ST) →(Y,Y+1); Y+2 →(PC)

Description: The program counter is stored in memory location Y and the status register is stored in memory location Y+1. Program execution continues at memory location Y+2. Interrupts, other than internal, are inhibited for one instruction following an SSB.

NOTE

The SSB instruction is commonly used for entrance to interrupt processing and subroutine programs. Return from these type of programs is accomplished by an LSB instruction.

Status Affected: Bits 7 (data bus interrupt), and 12 (DMAC interrupt) of the status register are cleared to zero according to the computer interrupt priority scheme. These bits are cleared so that when an interrupt occurs, all interrupts of lower or equal priority are disabled. The three types of interrupts in order of priority are as follows: internal interrupt, DMAC interrupt, and data bus interrupt.

Execution Time: (refer to Appendix A)

Symbolic Coding: The assembly language coding formats for the SSB instruction are as follows:

Label	⊘	Operation	⊘	Operand	⊘	Comment
[label]		@SSB		adrs		[comment] where "adrs" is the symbolic name of a 16-bit memory address.
			or			
[label]		SSB				[comment]
[label]		DATA		adrs		[comment]

Example:

SSB		→		<u>Before (Hex)</u>	<u>After (Hex)</u>
DATA	>0A23		(PC, ST)=	07A2,0110	0A25,0110
			(0A23 ₁₆ , 0A24 ₁₆)=	08B6,0010	07A2,0110

901181-385
MACHINE INSTRUCTIONS AND DECODING CONVENTIONS

3.5 ARITHMETIC INSTRUCTIONS

The arithmetic instructions listed in Table 3-1 are described in the following paragraphs.

3.5.1 ADD TO REGISTER A (ADD)

Machine Format:

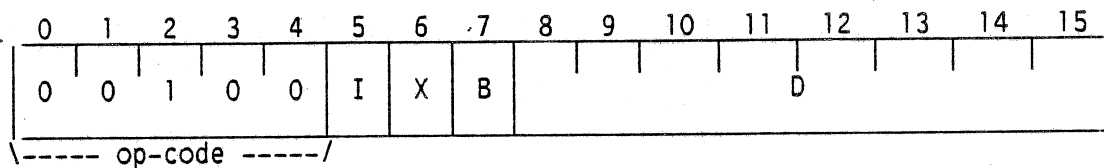

Instruction Execution: $(EOA) + (A) \rightarrow (A)$ where EOA is developed in accordance with Table 3-3.

Description: Add the contents of the effective operand address, EOA, to the contents of register A and place the sum in register A. If the IXB fields are 7_{16} (immediate addressing), the sign extended displacement field, D, is added to register A.

Status Affected: If the sum from the ADD instruction is outside the range of -2^{-15} to $2^{15}-1$, the overflow indicator (bit 2 of the status register) is turned on. If the sum is within the same range, the overflow indicator is turned off. If the add operation results in a carry into the sign position (bit 0), the carry indicator (bit 3 of the status register) is turned on; otherwise, it is turned off.

Execution Time: (refer to Appendix A)

Symbolic Coding: Refer to Table 3-3 for the assembly language coding formats available with the ADD instruction. The ADD mnemonic replaces the MNU operation field (in Table 3-3) and optional label and comment fields may be used.

Example:

ADD	*BSC	→		<u>Before</u>	<u>After</u>
ADD	BSC	→	(A) =	$4B10_{16}$	$5F0C_{16}$
			(BSC) =	$003A_{16}$	No change
			$(003A_{16}) =$	$13FC_{16}$	No change

901181-385
MACHINE INSTRUCTIONS AND DECODING CONVENTIONS

3.5.2 DOUBLE LENGTH ADD (DAD)

Machine Format:

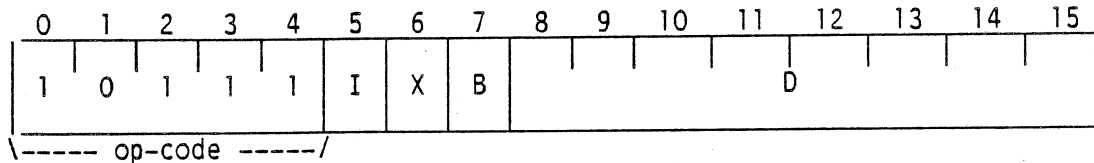

Instruction Execution: $(EOA, EOA+1) + (A, E) \rightarrow (A, E)$ where EOA is developed in accordance with Table 3-3.

Description: Add the concatenation of the contents of the effective operand address, EOA, and EOA+1 to the concatenation of registers A and E (register A is the most significant half of the second concatenation). At completion of the add operation, bit 0 of register E is forced to agree with bit 0 of register A. If the IXB fields are 7_{16} (immediate addressing), the displacement field, D, with its sign extended 24 bits becomes the double-length operand.

NOTE

Prior to the addition, ensure that the two sign bits associated with each double-length word are identical. If the two sign bits in the same double-length word are different, the result of the add may not be valid.

Status Affected: If the sum from the DAD instruction is outside the range of -2^{30} to $2^{30}-1$, the overflow indicator (bit 2 of the status register) is turned on; otherwise, the overflow indicator is turned off. If the add operation results in a carry into the sign position (bit 0 of register A), the carry indicator (bit 3 of the status register) is turned on; otherwise, the carry indicator is turned off.

Execution Time: (refer to Appendix A).

Symbolic Coding: Refer to Table 3-3 for the assembly language coding formats available with the DAD instruction. The DAD mnemonic replaces the MNU operation field (in Table 3-3) and optional label and comment fields may be used.

Example:

	→		(A, E) =	<u>Before (Hex)</u>	<u>After (Hex)</u>
DAD PRICE				0069,73B4	016A,5034
		(PRICE, PRICE+1) =		0100,5C80	No change

901181-385
MACHINE INSTRUCTIONS AND DECODING CONVENTIONS

3.5.3 DIVIDE (DIV)

Machine Format:

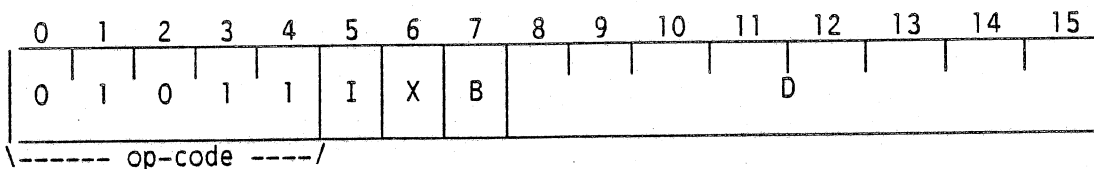

Instruction Execution: $(A,E)/(EOA) \rightarrow (A_{quo}, E_{rem})$ where EOA is developed in accordance with Table 3-3.

Description: Divide the concatenation of registers A and E (with the most significant half in register A) by the contents of the effective operand address, EOA. Place the quotient in register A and the remainder in register E. The sign of the remainder will be the same as the sign of the original dividend, except when the sign is set positive in the case of a zero remainder. If the IXB fields are 7_{16} (immediate addressing), the displacement field, D, with its sign extended eight bits is used as the divisor.

Status Affected: If the magnitude of most significant half of the dividend (register A) is greater than or equal to the magnitude of the divisor, the overflow indicator (bit 2 of the status register) is turned on and the contents of registers A and E remain unchanged. Otherwise, the overflow indicator is turned off.

Execution Time: (refer to Appendix A)

Symbolic Coding: Refer to Table 3-3 for the assembly language coding formats available with the DIV instruction. The DIV mnemonic replaces the MNU operation field (in Table 3-3) and optional label and comment fields may be used.

Example:

@DIV =600	→	(A,E) =	<u>Before (Hex)</u>	<u>After (Hex)</u>
		(EOA) =	0019,78A0	0588,01E0
			0258	No change

901181-385
MACHINE INSTRUCTIONS AND DECODING CONVENTIONS

3.5.4 DOUBLE LENGTH SUBTRACT (DSB)

Machine Format:

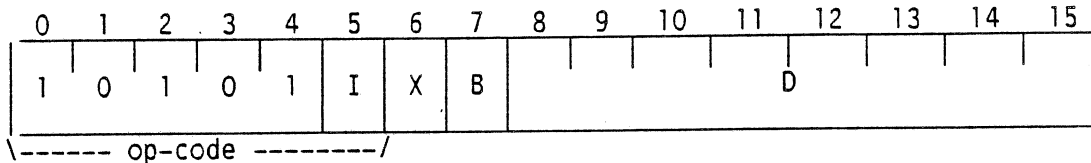

Instruction Execution: (A,E) - (EOA,EOA+1)→(A,E) where EOA is developed in accordance with Table 3-3.

Description: Add the two's complement of the concatenation of the contents of the effective operand address, EOA, and EOA+1 to the concatenation of registers A and E (register A is the most significant half of the second concatenation). Place the result in registers A and E. At the completion of the two's complement addition, bit 0 of register E is forced to agree with bit 0 of register A. If the IXB fields are 7_{16} (immediate addressing), the displacement field, D, with its sign extended 24 bits becomes the subtrahend.

NOTE

Prior to the subtraction, ensure that the two sign bits associated with each double-length word are identical. If the two sign bits in the same double-length word are different, the result of the add may not be valid.

Status Affected: If the result of the DSB instruction is outside the range of -2^{30} to $2^{30}-1$, the overflow indicator (bit 2 of the status register) is turned on; otherwise, the overflow indicator is turned off. If there is a carry into the sign position (bit 0 of register A), the carry indicator (bit 3 of the status register) is turned on; otherwise, the carry indicator is turned off.

Execution Time: (refer to Appendix A)

Symbolic Coding: Refer to Table 3-3 for the assembly language coding formats available with the DSB instruction. The DSB mnemonic replaces the MNU operation field (in Table 3-3) and optional label and comment fields may be used.

Example:

DSB DECIMAL,5	→	(A,E) = 6D11,6F51 (DECIMAL) = 0396 (0396 ₁₆ ,0397 ₁₆) = 1AA9,1486	<table style="width: 100%; border-collapse: collapse;"> <tr> <td style="text-align: left;"><u>Before (Hex)</u></td> <td style="text-align: left;"><u>After (Hex)</u></td> </tr> <tr> <td>6D11,6F51</td> <td>5268,5ACB</td> </tr> <tr> <td>0396</td> <td>No change</td> </tr> <tr> <td>1AA9,1486</td> <td>No change</td> </tr> </table>	<u>Before (Hex)</u>	<u>After (Hex)</u>	6D11,6F51	5268,5ACB	0396	No change	1AA9,1486	No change
<u>Before (Hex)</u>	<u>After (Hex)</u>										
6D11,6F51	5268,5ACB										
0396	No change										
1AA9,1486	No change										

901181-385
MACHINE INSTRUCTIONS AND DECODING CONVENTIONS

3.5.5 INCREMENT MEMORY BY ONE (IMO)

Machine Format:

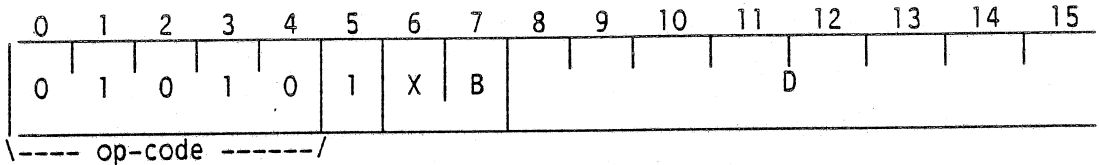

Instruction Execution: (EOA) +1→(EOA) where EOA is developed in accordance with Table 3-3.

Description: Increment the contents of the effective operand address, EOA, by one, and replace the contents of the EOA with the result. If the IXB fields are 7_{16} (immediate addressing), the displacement field, D, becomes the EOA.

Status Affected: None

Execution Time: (refer to Appendix A)

Symbolic Coding: Refer to Table 3-3 for the assembly language coding formats available with the IMO instruction. The IMO mnemonic replaces the MNU operation field (in Table 3-3) and optional label and comment fields may be used.

Example:

@IMO	BOX,2	→	(X) =	Before	After
				0008_{16}	No Change
			(BOX+8) =	$634A_{16}$	$634B_{16}$

3.5.6 MULTIPLY (MPY)

Machine Format

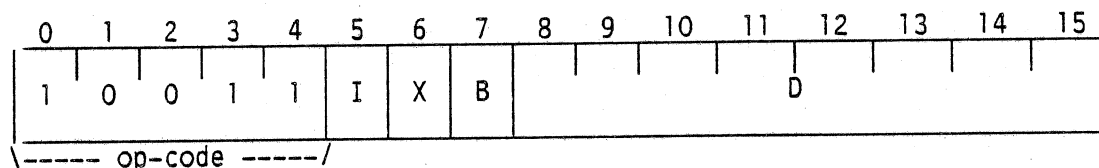

Instruction Execution: (A)x(EOA)→(A,E) where EOA is developed in accordance with Table 3-3.

901181-385
MACHINE INSTRUCTIONS AND DECODING CONVENTIONS

Description: Multiply register A by the contents of the effective operand address, EOA. Place the double-length result in registers A and E, the most significant part being in register A. At completion of the multiplication, bit 0 of register E is forced to agree with bit 0 of register A. If the IXB fields are 7₁₆ (immediate addressing), the displacement field, D, with its sign extended eight bits becomes the operand.

Status Affected: If both operands are equal to the maximum negative number (-2^{15}), the overflow indicator (bit 2 of the status register) is turned on and the result in registers A and E will be indeterminate. Otherwise, the overflow indicator is turned off.

Execution Time: (refer to Appendix A)

Symbolic Coding: Refer to Table 3-3 for the assembly language coding formats available with the MPY instruction. The MPY mnemonic replaces the MNU operation field (in Table 3-3) and optional label and comment fields may be used.

Example:

MPY ARG,1	→	(A,E) =	<u>Before (Hex)</u>	<u>After (Hex)</u>
		(ARG) =	0003,1020	FFFF,FFFD
			FFFF	No change

3.5.7 REGISTER ADD (RAD)

Machine Format:

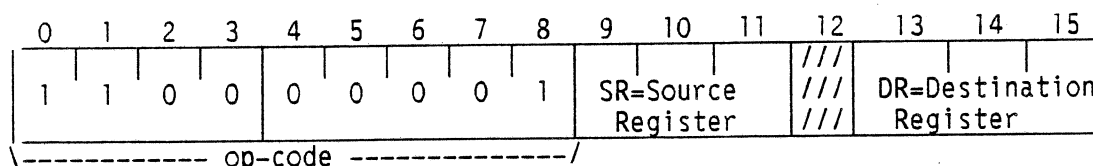

Instruction Execution: (SR) + (DR) → (DR)

Description: Add the contents of the registers specified by the SR and DR fields. Place the result in the register specified by the DR field. If bit 12 of the machine format is set to one and bits 13 to 15 are zeroed, the status register is specified as the destination register. In this case the instruction is restricted, meaning it is considered illegal if the memory protect/privileged instruction feature is enabled. Interrupts, other than internal, are inhibited for one instruction following this special case of the RAD instruction.

901181-385
MACHINE INSTRUCTIONS AND DECODING CONVENTIONS

Status Affected: If the SR register contains -2^{15} , the overflow indicator (bit 2 of the status register) is turned on and the DR register is set to -2^{15} ; otherwise, the overflow indicator is turned off.

Execution Time: (refer to Appendix A)

Symbolic Coding: The assembly language coding format for the RCO instruction is as follows:

Label		Operation		Operand	Comment
[label]	ø	RCO	ø	sreg,dreg ø	[comment]

where "sreg" and "dreg" are expressions that address the source and destination registers, respectively, in accordance with Table 2-2. The special case when "dreg" equals eight is covered in the "Description" paragraph.

Example:

RCO 2,2	→	(X) =	<u>Before</u> 000F ₁₆	<u>After</u> FFF1 ₁₆
---------	---	-------	-------------------------------------	------------------------------------

3.5.9 REGISTER DECREMENT (RDE)

Machine Format:

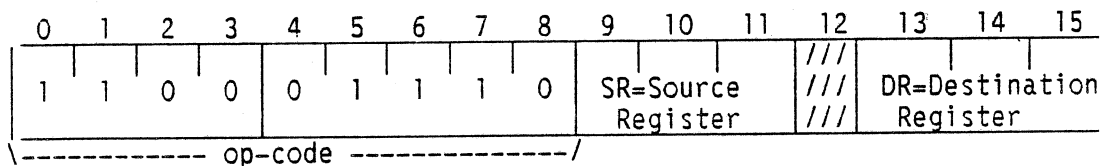

Instruction Execution: (SR)-1 → (DR)

Description: Subtract one from the contents of the register specified by the SR field and place the result in the register specified by the DR field.

NOTE

If the maximum negative number (-32768) is decremented, the maximum positive number ($+32767$) is placed in the DR register.

901181-385
MACHINE INSTRUCTIONS AND DECODING CONVENTIONS

Description: Add one to the contents of the register specified by the SR field and place the result in the register specified by the DR field.

NOTE

If the result of the RIN is considered to be a 15-bit signed number, incrementing the maximum positive number (+32767) results in the maximum negative number (-32768). If the result of the RIN is considered to be a 16-bit positive number (as in address calculation), incrementing the maximum positive number (65535) results in zero.

If bit 12 of the machine format is set to one and bits 13 to 15 are zeroed, the status register is specified as the destination register. In this case the instruction is restricted, meaning it is considered illegal if the memory protect/privileged instruction feature is enable. Interrupts, other than internal, are inhibited for one instruction following this special case of the RIN instruction.

Status Affected: None

Execution Time: (refer to Appendix A)

Symbolic Coding: The assembly language coding format for the RIN instruction is as follows:

Label	Operation	Operand	Comment
[label] ⌀	RIN	sreg,dreg ⌀	[comment]

where "sreg" and "dreg" are expressions that address the source and destination registers, respectively, in accordance with Table 2-2. The special case when "dreg" equals eight is covered in the "Description" paragraph.

Example:

RIN 7,5	→		
		(L) = <u>Before</u>	<u>After</u>
		(PC) = 622B ₁₆	0226 ₁₆
		0225 ₁₆	No change

901181-385
MACHINE INSTRUCTIONS AND DECODING CONVENTIONS

3.5.11 REGISTER INVERT (RIV)

Machine Format:

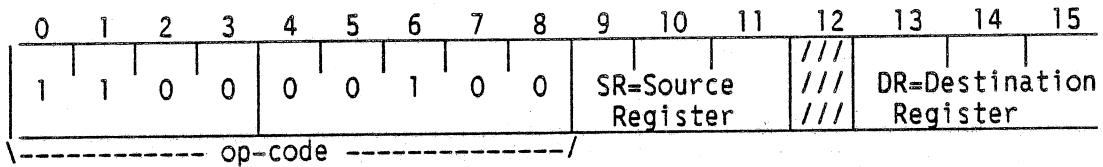

Instruction Execution: $-(SR)-1 \rightarrow (DR)$

Description: Replace the contents of the register specified by the DR field with the one's complement of the contents of the register specified by the SR field. This means each bit of the SR register is complemented individually. If bit 12 of the machine format is set to one and bits 13 to 15 are zeroed, the status register is specified as the destination register. In this case the instruction is restricted, meaning it is considered illegal if the memory protect/privileged instruction feature is enabled. Interrupts, other than internal, are inhibited for one instruction following this special case of the RIV instruction.

Status Affected: None

Execution Time: (refer to Appendix A)

Symbolic Coding: The assembly language coding format for the RIV instruction is as follows:

Label	Operation	Operand	Comment
[label] ⌀	RIV	⌀ sreg,dreg ⌀	[comment]

where "sreg" and "dreg" are expressions that address the source and destination registers, respectively, in accordance with Table 2-2. The special case when "dreg" equals eight is covered in the "Description" paragraph.

Example:

E	EQU 1				
X	EQU 2		(X)=	<u>Before</u>	<u>After</u>
				121C ₁₆	FCFA ₁₆
		→			
			(E)=	0305 ₁₆	No change
	RIV E,X				

901181-385
MACHINE INSTRUCTIONS AND DECODING CONVENTIONS

3.5.12 REGISTER SUBTRACT (RSU)

Machine Format:

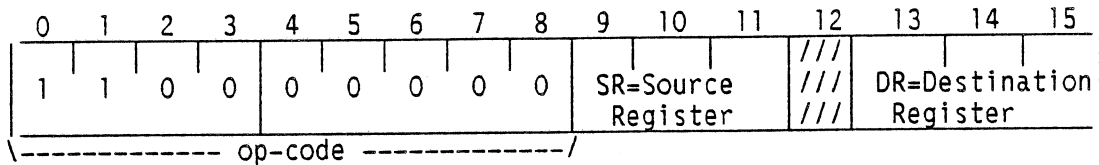

Instruction Execution: (DR) - (SR) → (DR)

Description: Subtract the contents of the register specified by the SR field from the contents of the register specified by the DR field. Place the result in the register specified by the DR field. If bit 12 of the machine format is set to one and bits 13 to 15 are zeroed, the status register is specified as the destination register. In this case the instruction is restricted, meaning it is considered illegal if the memory protect/privileged instruction feature is enabled. Interrupts, other than internal, are inhibited for one instruction following this special case of the RSU instruction.

Status Affected: If the result of the RSU instruction is outside the range of -2^{15} to $2^{15}-1$, the overflow indicator (bit 2 of the status register) is turned on; otherwise, the overflow indicator is turned off. If there is a carry into the sign position (bit 0), the carry indicator (bit 3 of the status register) is turned on; otherwise, the carry indicator is turned off.

Execution Time: (refer to Appendix A)

Symbolic Coding: The assembly language coding format for the RSU instruction is as follows:

Label	Operation	Operand	Comment
[label] ⌀	RSU ⌀	sreg,dreg ⌀	[comment]

where "sreg" and "dreg" are expressions that address the source and destination registers, respectively, in accordance with Table 2-2. The special case when "Dreg" equals eight is covered in the "Description" paragraph.

Example:

RSU 6,5	→		<u>Before</u>	<u>After</u>
		(L) =	56A2 ₁₆	5567 ₁₆
		(B) =	013B ₁₆	No change

901181-385
MACHINE INSTRUCTIONS AND DECODING CONVENTIONS

3.5.13 SUBTRACT FROM REGISTER A (SUB)

Machine Format:

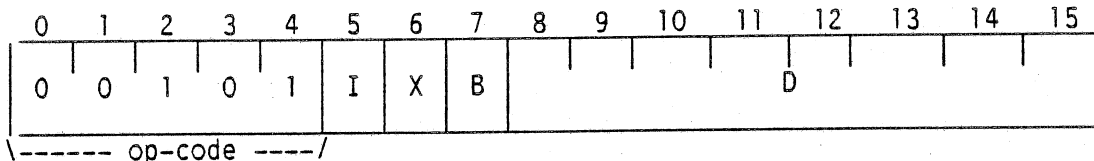

Instruction Execution: $(A) - (EOA) \rightarrow (A)$ where EOA is developed in accordance with Table 3-3.

Description: Add the two's complement of the contents of the effective operand address, EOA, to the contents of register A. Place the result in register A. If the IXB fields are 7_{16} (immediate addressing), the sign extended displacement field, D, is subtracted from register A.

Status Affected: If the result of the SUB instruction is outside the range of -2^{15} to $2^{15}-1$, the overflow indicator (bit 2 of the status register) is turned on; otherwise, the overflow indicator is turned off. If there is a carry into the sign position (bit 0), the carry indicator (bit 3 of the status register) is turned on; otherwise, the carry indicator is turned off.

Execution Time: (refer to Appendix A)

Symbolic Coding: Refer to Table 3-3 for the assembly language coding formats available with the SUB instruction. The SUB mnemonic replaces the MNU operation field (in Table 3-3) and optional label and comment fields may be used.

Example:

THIS SUB =28	→		<u>Before</u>	<u>After</u>
		(A) =	0005 ₁₆	FFE9 ₁₆
		(THIS) =	2F1C ₁₆	No change

901181-385
MACHINE INSTRUCTIONS AND DECODING CONVENTIONS

3.6 COMPARE INSTRUCTIONS

The compare instructions listed in Table 3-1 are described in the following paragraphs.

3.6.1 COMPARE LOGICAL CHARACTER STRING (CLC)

Machine Format:

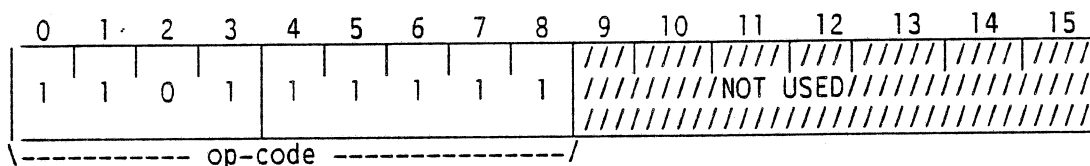

Instruction Execution: $(M_1):(Y_1), (M_2):(Y_2), \dots (M_n):(Y_n)$
where M_1, M_2, \dots, M_n and Y_1, Y_2, \dots, Y_n are byte strings in memory.

Description: Perform a consecutive byte-by-byte logical comparison of two byte strings in memory defined in general registers as follows:

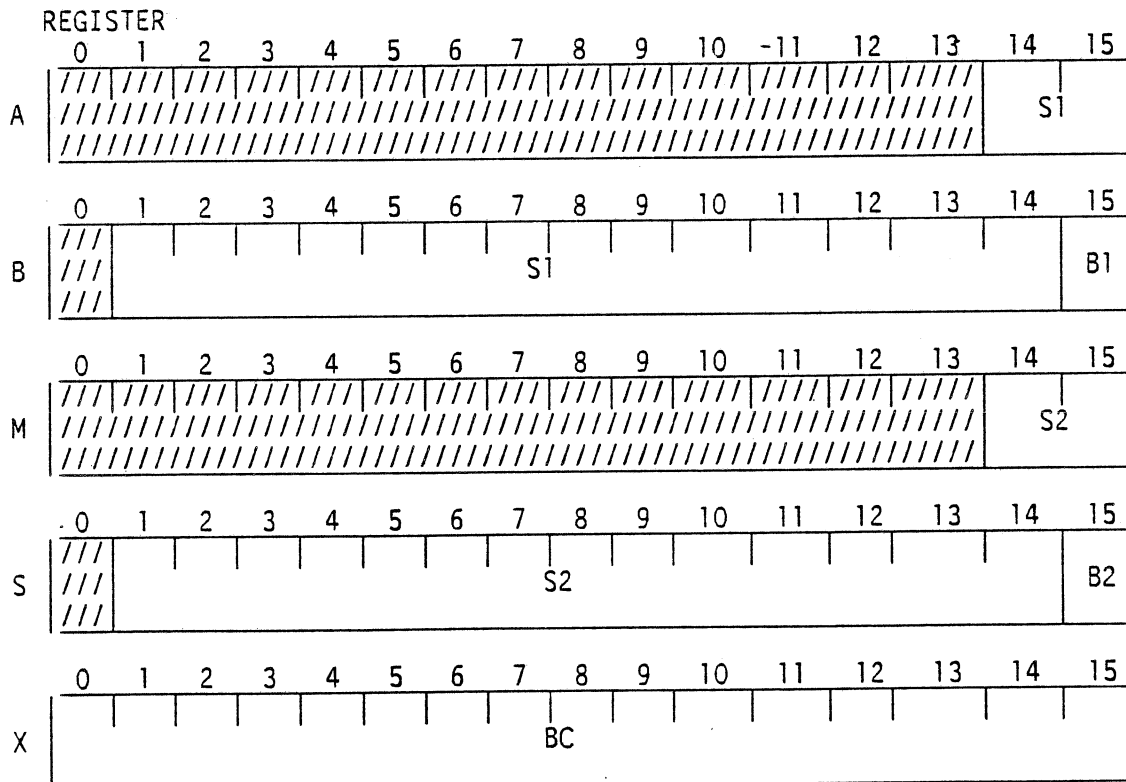

901181-385
MACHINE INSTRUCTIONS AND DECODING CONVENTIONS

where, S1 and S2 are the starting word addresses of the two byte strings. The most significant bits of the S1 and S2 addresses are in the A and M registers, respectively.

B1 and B2 indicate the position of the first byte in the words addressed by S1 and S2, respectively. A logic zero indicates the first byte is in the most significant half (left half) of the first word; a logic one indicates the first byte is in the least significant half (right half) of the first word.

BC indicates the number of bytes to be compared (up to 65,535).

The first non-equal comparison encountered terminates the CLC instruction with the number of bytes left to be compared loaded in register X. In addition, registers A and E will contain the byte address of the next byte that would have been processed in string 1 and registers M and S will contain the byte address of the next byte that would have been processed in string 2. If the CLC instruction is interrupted, the general registers contain the same information as that described for a non-equal comparison when the interrupt is taken. Note that register X will contain all zeros only when all byte comparisons, or all but the last byte comparison, are found to be equal.

Status Affected: Bits 0 and 1 of the status register are modified as follows by the CLC instruction.

	Bit 0	Bit 1
Each Compare Equal	0	1
Byte ₁ > Byte ₂	1	0
Byte ₁ < Byte ₂	0	0
Unused Bit Setting	1	1

If the byte count (BC) in register X is specified as zero, no comparison is performed and status register bits 0 and 1 are set to 01 unconditionally.

Execution Time: (refer to Appendix A)

Symbolic Coding: The assembly language coding format for the CLC instruction is as follows:

Label	Operation	Operand	Comment
[label] ⌀	CLC ⌀	sreg,dreg ⌀	[comment]

901181-385
MACHINE INSTRUCTIONS AND DECODING CONVENTIONS

Example:

CLC	→	(A) =	Before (Hex)	After (Hex)
		(E) =	0000	0000
		(M) =	0574	0578
		(S) =	0000	0000
		(X) =	06A6	06AA
			000B	0007
		(02BA,02BB,...)	= 5123,64AC,...	No change
		(0353,0354,...)	= 5123,64AD,...	No change

3.6.2 COMPARE ALGEBRAIC (CPA)

Machine Format:

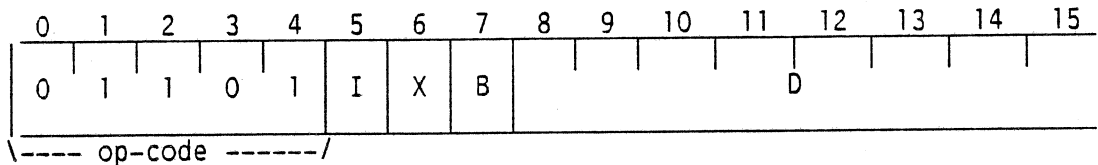

Instruction Execution: (A):(EOA), algebraically where EOA is developed in accordance with Table 3-3.

Description: Perform an algebraic compare (bit 0 reflects sign) between the contents of register A and the contents of the effective operand address, EOA. The contents of register A and the contents of EOA are not affected by the compare. Set status register bits to indicate the result of the compare (refer to the next paragraph). If the IXB fields are 7₁₆ (immediate addressing), the displacement field, D, sign extended to 16 bits is compared with register A.

Status Affected: Bits 0 and 1 of the status register are modified as follows by the CPA instruction.

	Bit 0	Bit 1
(A) > (EOA)	0	0
(A) = (EOA)	0	1
(A) < (EOA)	1	0
Unused Bit Setting	1	1

Execution Time: (refer to Appendix A)

Symbolic Coding: Refer to Table 3-3 for the assembly language coding formats available with the CPA instruction. The CPA mnemonic replaces the MNU operation field (in Table 3-3) and optional label and comment fields may be used.

901181-385
MACHINE INSTRUCTIONS AND DECODING CONVENTIONS

3.6.4 REGISTER COMPARE ALGEBRAIC (RCA)

Machine Format:

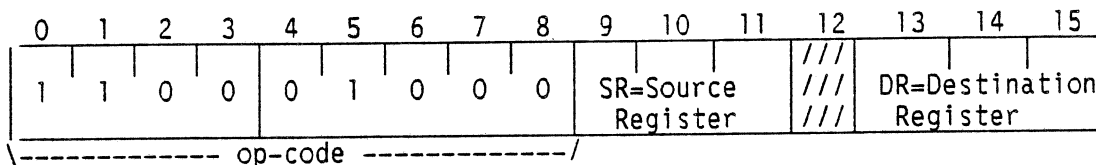

Instruction Execution: (SR) : (SR), algebraically

Description: Perform an algebraic compare (bit 0 reflects sign) between the contents of the register specified by the SR field and the contents of the register specified by the DR field. The status register bits are set to indicate the result of the compare (refer to the next paragraph). If bit 12 of the machine format is set to one and bits 13 to 15 are zeroed, the status register is specified as the destination register. In this case the instruction is restricted, meaning it is considered illegal if the memory protect/privileged instruction feature is enabled. Interrupts, other than internal, are inhibited for one instruction following this special case of the RCA instruction.

Status Affected: Bits 0 and 1 of the status register are modified as follows by the RCA instruction.

	<u>Bit 0</u>	<u>Bit 1</u>
(SR) < (DR)	0	0
(SR) = (DR)	0	1
(SR) > (DR)	1	0
Unused Bit Setting	1	1

Execution Time: (refer to Appendix A)

Symbolic Coding: The assembly language coding format for the RCA instruction is as follows:

Label	Operation	Operand	Comment
[label] ⌀	RCA ⌀	sreg,dreg ⌀	[comment]

where "sreg" and "dreg" are expressions that address the source and destination registers, respectively, in accordance with Table 2-2. The special case when "dreg" equals eight is covered in the "Description" paragraph.

901181-385
MACHINE INSTRUCTIONS AND DECODING CONVENTIONS

Example:

S	EQU	4	→	(S) =	1054 ₁₆	
X	EQU	2		(X) =	B666 ₁₆	Status register bits 0 and 1 set to 00
RCA X,S						

3.6.5 REGISTER COMPARE LOGICAL (RCL)

Machine Format:

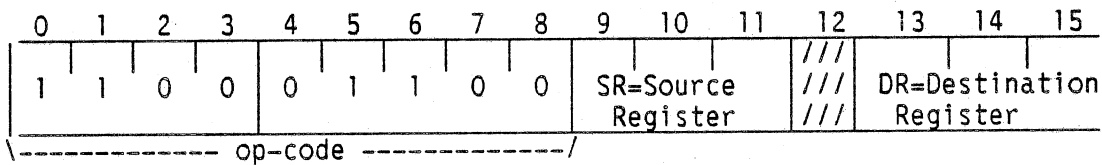

Instruction Execution: (SR) : (DR), logically

Description: Perform a logical compare (unsigned numbers) between the contents of the register specified by the SR field and the contents of the register specified by the DR field. The status register bits are set to indicate the result of the compare as detailed in paragraph 3.6.4. If bit 12 of the machine format is set to one and bits 13 to 15 are zeroed, the status register is specified as the destination register. In this case the instruction is restricted, meaning it is considered illegal if the memory protect/privileged instruction feature is enabled. Interrupts, other than internal, are inhibited for one instruction following this special case of the RCL instruction.

Status Affected: Refer to paragraph 3.6.4.

Execution Time: (refer to Appendix A)

Symbolic Coding: The assembly language coding format for the RCL instruction is as follows:

Label	Operation	Operand	Comment
[label] ⌀	RCL	⌀ sreg,dreg ⌀	[comment]

where "sreg" and "dreg" are expressions that address the source and destination registers, respectively, in accordance with Table 2-2. The special case when "dreg" equals eight is covered in the "Description" paragraph.

901181-385
MACHINE INSTRUCTIONS AND DECODING CONVENTIONS

Execution Time: (refer to Appendix A)

Symbolic Coding: Refer to Table 3-3 for the assembly language coding formats available with the DMT instruction. The DMT mnemonic replaces the MNU operation field (in Table 3-3) and optional label and comment fields may be used.

Example:

DMT	BASE,2		(X) =	<u>Before</u>	<u>After</u>	
BRU	\$-10	→		0009 ₁₆	No change	Control will
BRU	RESET		(BASE+9) =	0001 ₁₆	0000 ₁₆	now branch
						to RESET

3.7.2 SKIP ON EQUAL (SEQ)

Machine Format:

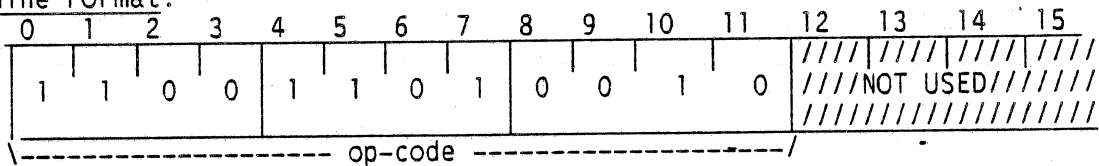

Instruction Execution: (ST)_{0,1} = 01, skip next word

(ST)_{0,1} ≠ 01, execute next word

Description: Skip the next sequential word if the result of the last compare operation was equal (status register bits 0 and 1 set to 01). If the result was something other than equal, execute the next word.

Status Affected: None

Execution Time: (refer to Appendix A)

Symbolic Coding: The assembly language coding format for the SEQ instruction is as follows:

Label	Operation	Operand	Comment
[label]	SEQ	[operand]	[comment]

901181-385
MACHINE INSTRUCTIONS AND DECODING CONVENTIONS

Example: The SEQ instruction in the following example will skip a word only if the contents of registers S and X are equal.

```

.
.
RCL          2,4
SEQ
.
.

```

3.7.3 SKIP ON EVEN (SEV)

Machine Format:

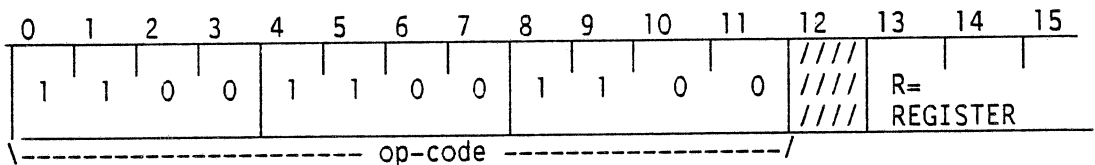

Instruction Execution: (R)₁₅ = 0, skip next word
(R)₁₅ = 1, execute next word

Description: If bit position 15 of the register specified by the R field is zero, skip the next sequential word; otherwise, execute the next word.

Status Affected: None

Execution Time: (refer to Appendix A)

Symbolic Coding: The assembly language coding format for the SEV instruction is as follows:

Label		Operation		Operand		Comment
[label]	⌀	SEV	⌀	reg	⌀	[comment]

Example:

A	EQU	0									
			→	(A) =	<u>Before</u>	<u>After</u>					
					A620 ₁₆	No change					
	SEV	A		(PC) =	0132 ₁₆	0134 ₁₆ (skip)					

901181-385
MACHINE INSTRUCTIONS AND DECODING CONVENTIONS

3.7.4 SKIP ON GREATER THAN OR EQUAL (SGE)

Machine Format:

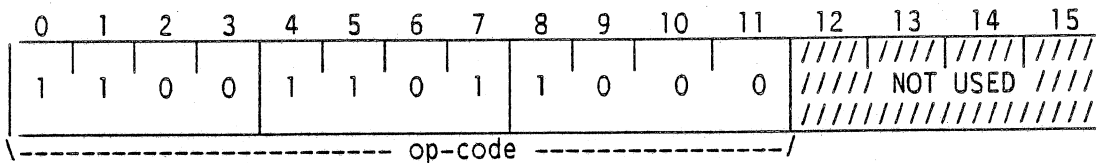

Instruction Execution: (ST)_{0,1} = 00, skip next word
 (ST)_{0,1} = 00, execute next word

Description: If the result of the last compare operation was greater than or equal (status register bits 0 and 1 other than 00), skip the next sequential word; otherwise, execute the next word.

Status Affected: None

Execution Time: (refer to Appendix A)

Symbolic Coding: The assembly language coding format for the SGE instruction is as follows:

Label	Operation	Operand	-Comment
[label]	SGE	ø	[comment]

Example: The SGE instruction in the following example will skip a word only if the content of register X is logically greater than or equal to the content of register S.

```

:
:
RCL      2,4
SGE
:
:

```

3.7.5 SKIP ON GREATER THAN (SGT)

Machine Format:

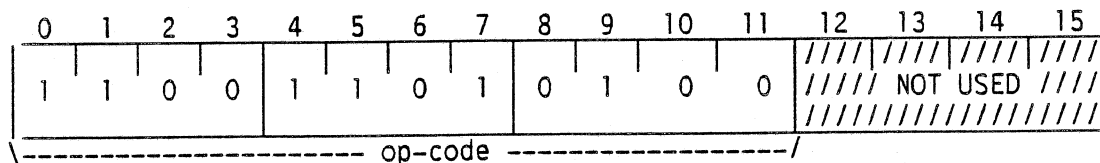

Instruction Execution: (ST)_{0,1} = 10, skip next word
 (ST)_{0,1} ≠ 10, execute next word

901181-385
MACHINE INSTRUCTIONS AND DECODING CONVENTIONS

Description: If the result of the last compare operation was greater than (status register bits 0 and 1 set to 10), skip the next word; otherwise, execute the next word.

Status Affected: None

Execution Time: (refer to Appendix A)

Symbolic Coding: The assembly language coding format for the SGT instruction is as follows:

Label	Operation	Operand	Comment
[label]	SGT		[comment]

Example: The SGT instruction in the following example will skip a word only if the content of register X is logically greater than the content of register S.

```

.
.
RCL          2,4
SGT
.
.

```

3.7.6 SKIP ON LESS THAN OR EQUAL (SLE)

Machine Format:

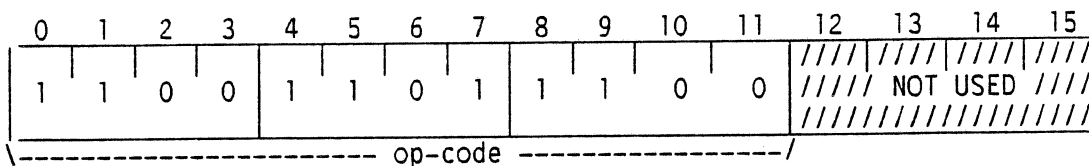

Instruction Execution: (ST)_{0,1} ≠ 10, skip next word
(ST)_{0,1} = 10, execute next word

Description: If the result of the last compare operation was less than or equal (status register bits 0 and 1 other than 10), skip the next sequential word; otherwise, execute the next word.

Status Affected: None

Execution Time: (refer to Appendix A)

901181-385
MACHINE INSTRUCTIONS AND DECODING CONVENTIONS

Symbolic Coding: The assembly language coding format for the SLE instruction is as follows:

Label	Operation	Operand	Comment
[label] ⌀	SLE	⌀	[comment]

Example: The SLE instruction in the following example will skip a word only if the content of register X is logically less than or equal to the content of register S.

```

.
.
RCL           2,4
SLE
.
.

```

3.7.7 SKIP ON LESS THAN (SLT)

Machine Format:

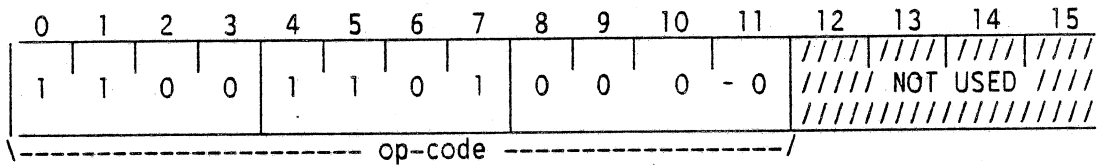

Instruction Execution: (ST)_{0,1} = 00, skip next word
(ST)_{0,1} ≠ 00, execute word

Description: If the result of the last compare operation was less than (status register bits 0 and 1 both set to zero), skip the next word; otherwise, execute the next word.

Status Affected: None

Execution Time: (refer to Appendix A)

Symbolic Coding: The assembly language coding format for the SLT instruction is as follows:

Label	Operation	Operand	Comment
[label] ⌀	SLT	⌀	[comment]

901181-385
MACHINE INSTRUCTIONS AND DECODING CONVENTIONS

Example: The SLT instruction in the following example will skip a word only if the content of register X is logically less than the content of register S.

```

      .
      .
RCL      2,4
SLT
      .
      .
    
```

3.7.8 SKIP ON MINUS (SMI)

Machine Format:

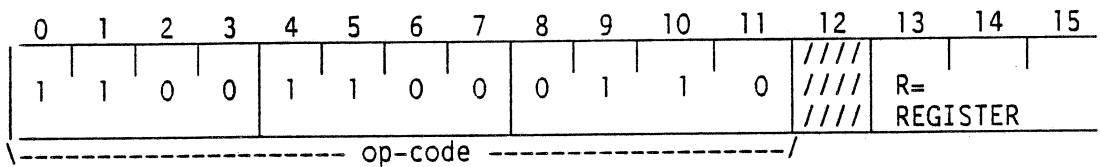

Instruction Execution: (R)₀ = 1, skip next word
 (R)₀ = 0, execute next word

Description: If bit position 0 of the register specified by the R field is one, skip the next word; otherwise, execute the next word.

Status Affected: None

Execution Time: (refer to Appendix A)

Symbolic Coding: The assembly language coding format for the SMI instruction is as follows:

Label	Operation	Operand	Comment
[label] ⌀	SMI	reg ⌀	[comment]

Example:

SMI 3	→		
		Before	After
		(M) = 62AE ₁₆	No change
		(PC) = 23FE ₁₆	23FF ₁₆ (no skip)

901181-385
MACHINE INSTRUCTIONS AND DECODING CONVENTIONS

3.7.9 SKIP ON NO CARRY (SNC)

Machine Format:

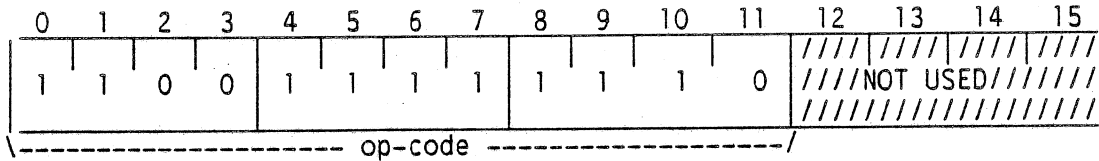

Instruction Execution: (ST)₃ = 0, skip next word
(ST)₃ = 1, execute next word

Description: If the last instruction affecting the carry indicator (bit 3 of the status register) did not turn it on, the next word is skipped; otherwise, execute the next word.

Status Affected: None

Execution Time: (refer to Appendix A)

Symbolic Coding: The assembly language coding format for the SNC instruction is as follows:

Label	Operation	Operand	Comment
[label] ⌀	SNC ⌀	⌀	[comment]

Example: The SNC instruction in the following example will skip a word if the sum of register A and the contents of location TABLE did not produce a carry into bit 0.

```

:
:
ADD      TABLE
SNC
:
:

```

3.7.10 SKIP ON NOT EQUAL (SNE)

Machine Format:

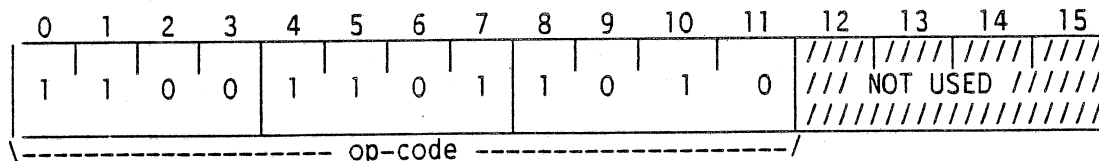

901181-385
MACHINE INSTRUCTIONS AND DECODING CONVENTIONS

Instruction Execution: (ST)_{0,1} ≠ 01, skip next word
(ST)_{0,1} = 01, execute next word

Description: If the result of the last compare operation was less than or greater than (status register bits 0 and 1 other than 01), skip the next word; otherwise, execute the next word.

Status Affected: None

Execution Time: (refer to Appendix A)

Symbolic Coding: The assembly language coding format for the SNE instruction is as follows:

Label	Operation	Operand	Comment
[label]	SNE		[comment]

Example: The SNE instruction in the following example will skip a word if the content of register X is logically less than or greater than the content of register S.

```

:
:
RCL          2,4
SNE
:
:

```

3.7.11 SKIP ON NOT ALL ONES (SNO)

Machine Format:

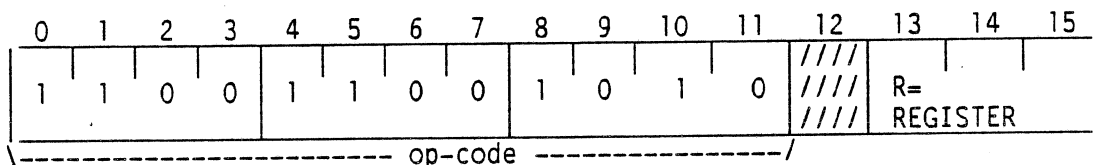

Instruction Execution: (R) ≠ FFFF₁₆, skip next word
(R) = FFFF₁₆, execute next word

Description: If at least one bit position of the register specified by the R field is zero, skip the next word; if all bit positions are ones, execute the next word.

Status Affected: None

Execution Time: (refer to Appendix A)

901181-385
MACHINE INSTRUCTIONS AND DECODING CONVENTIONS

Symbolic Coding: The assembly language coding format for the SNO instruction is as follows

Label [label]	ϕ	Operation SNO	ϕ	Operand reg	ϕ	Comment [comment]	where "reg" is an expression that addresses a register in accordance with Table 2-2.
------------------	---	------------------	---	----------------	---	----------------------	---

Example:

X	EQU	2	→	(X) =	<u>Before</u> FFEF ₁₆	<u>After</u> No change
	SNO	X		(PC) =	2111 ₁₆	2113 ₁₆ (skip)

3.7.12 SKIP ON NO OVERFLOW (SNV)

Machine Format:

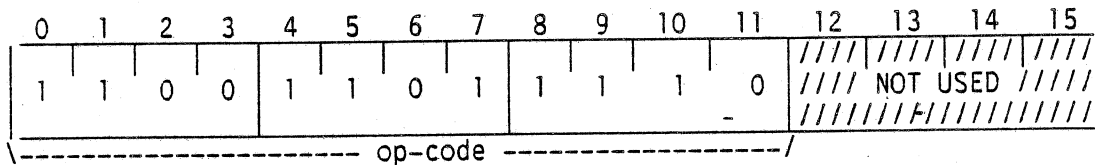

Instruction Execution: (ST)₂ = 0, skip next word
(ST)₂ = 1, execute next word

Description: If the last instruction affecting the overflow indicator (bit 2 of the status register) did not turn it on, the next word is skipped; otherwise, execute the next word.

Status Affected: None

Execution Time: (refer to Appendix A)

Symbolic Coding: The assembly language coding format for the SNV instruction is as follows:

Label [label]	ϕ	Operation SNV	ϕ	Operand	ϕ	Comment [comment]
------------------	---	------------------	---	---------	---	----------------------

901181-385
MACHINE INSTRUCTIONS AND DECODING CONVENTIONS

Example: The SNV instruction in the following example will skip a word if the sum of register A and the contents of location TABLE did not cause an overflow.

```

      .
      .
      .
ADD    TABLE
SNV
      .
      .
  
```

3.7.13 SKIP ON NOT ALL ZEROS (SNZ)

Machine Format:

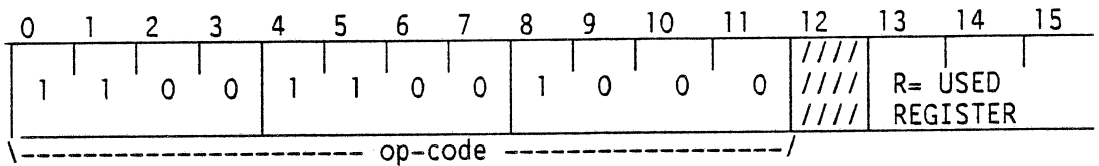

Instruction Execution: (R) ≠ 0, skip next word
(R) = 0, execute next word

Description: If at least one bit position of register specified by the R field is one, skip the next word; if all bit positions are zeros, execute the next word.

Status Affected: None

Execution Time: (refer to Appendix A)

Symbolic Coding: The assembly language coding format for the SNZ instruction is as follows:

Label		Operation		Operand		Comment
[label]	Ø	SNZ	Ø	reg	Ø	[comment]

where "reg" is an expression that addresses a register in accordance with Table 2-2.

Example:

SNZ 1	→	(E) = 2100 ₁₆ (PC) = 1103 ₁₆	<table style="width: 100%; border-collapse: collapse;"> <tr> <td style="text-align: center;"><u>Before</u></td> <td style="text-align: center;"><u>After</u></td> </tr> <tr> <td style="text-align: center;">No change</td> <td style="text-align: center;">No change</td> </tr> <tr> <td style="text-align: center;">1105₁₆ (skip)</td> <td style="text-align: center;">1105₁₆ (skip)</td> </tr> </table>	<u>Before</u>	<u>After</u>	No change	No change	1105 ₁₆ (skip)	1105 ₁₆ (skip)
<u>Before</u>	<u>After</u>								
No change	No change								
1105 ₁₆ (skip)	1105 ₁₆ (skip)								

901181-385
MACHINE INSTRUCTIONS AND DECODING CONVENTIONS

3.7.14 SKIP ON CARRY (SOC)

Machine Format:

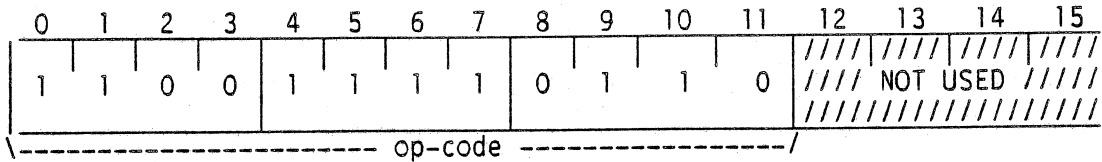

Instruction Execution: (ST)₃ = 1, skip next word
(ST)₃ = 0, execute next word

Description: If the last instruction affecting the carry indicator (bit 3 of the status register) turned it on, the next word is skipped; otherwise, execute the next word.

Status Affected: None

Execution Time: (refer to Appendix A)

Symbolic Coding: The assembly language coding format for the SOC instruction is as follows:

Label		Operation		Operand		-Comment	-
[label]	Ø	SOC	Ø		Ø	[comment]	

Example: The SOC instruction in the following example will skip an instruction if the sum of register A and the contents of location TABLE results in a carry into bit 0.

```

.
.
ADD          TABLE
SOC
.
.

```

3.7.15 SKIP ON ODD (SOD)

Machine Format:

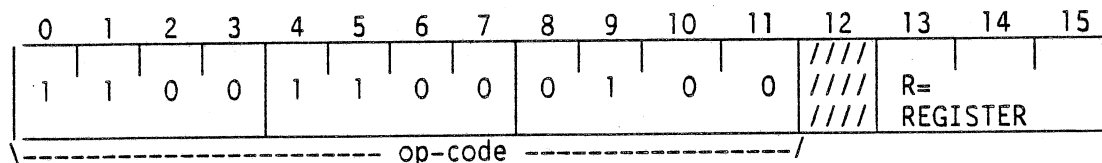

901181-385
MACHINE INSTRUCTIONS AND DECODING CONVENTIONS

Instruction Execution: (R)₁₅ = 1, skip next word
(R)₁₅ = 0, execute next word

Description: If bit position 15 of the register specified by the R field is one, skip the next word; otherwise, execute the next word.

Status Affected: None

Execution Time: (refer to Appendix A)

Symbolic Coding: The assembly language coding format for the SOD instruction is as follows:

Label [label]	Ø	Operation SOD	Ø	Operand reg	Ø	Comment [comment]
------------------	---	------------------	---	----------------	---	----------------------

where "reg" is an expression that addresses a register in accordance with Table 2-2.

Example:

X	EQU	2	→		<u>Before</u>	<u>After</u>
				(X) =	0004 ₁₆	No change
				(PC) =	0010 ₁₆	-0011 ₁₆ (no skip)
	SOD	X				

3.7.16 SKIP ON ALL ONES (S00)

Machine Format:

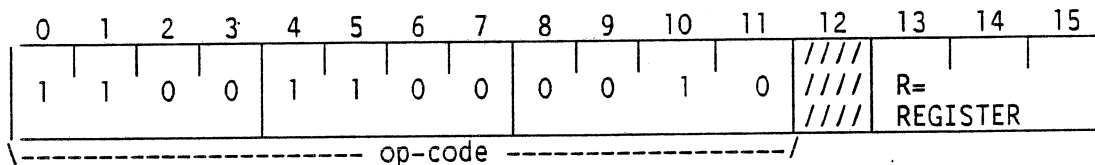

Instruction Execution: (R) = FFFF₁₆, skip next word
(R) ≠ FFFF₁₆, execute next word

Description: If all bit positions of the register specified by the R field are one, skip the next word; otherwise, execute the next word.

Status Affected: None

Execution Time: (refer to Appendix A)

901181-385
MACHINE INSTRUCTIONS AND DECODING CONVENTIONS

Symbolic Coding: The assembly language coding format for the SOO instruction is as follows:

Label [label]	∅	Operation SOO	∅	Operand reg	∅	Comment [comment]
------------------	---	------------------	---	----------------	---	----------------------

where "reg" is an expression that addresses a register in accordance with Table 2-2.

Example:

SOO 0	→	(A) =	<u>Before</u> FFFF ₁₆	<u>After</u> No change
		(PC) =	0101 ₁₆	0103 ₁₆ (skip)

3.7.17 SKIP ON OVERFLOW (SOV)

Machine Format:

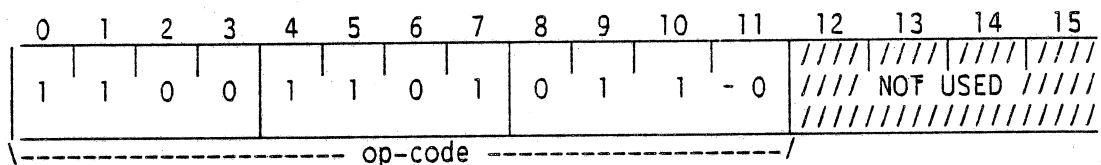

Instruction Execution: (ST)₂ = 1, skip next word
(ST)₂ = 0, execute next word

Description: If the last instruction affecting the overflow indicator (bit 2 of the status register) turned the indicator on, the next word is skipped; otherwise, the next word is executed.

Status Affected: None

Execution Time: (refer to Appendix A)

Symbolic Coding: The assembly language coding format for the SOV instruction is as follows:

Label [label]	∅	Operation SOV	∅	Operand ∅	∅	Comment [comment]
------------------	---	------------------	---	--------------	---	----------------------

901181-385
MACHINE INSTRUCTIONS AND DECODING CONVENTIONS

Example: The SOV instruction in the following example will skip a word if the sum of register A and the contents of location TABLE causes an overflow.

```

      .
      ADD      TABLE
      SOV
      .
  
```

3.7.18 SKIP ON PLUS (SPL)

Machine Format:

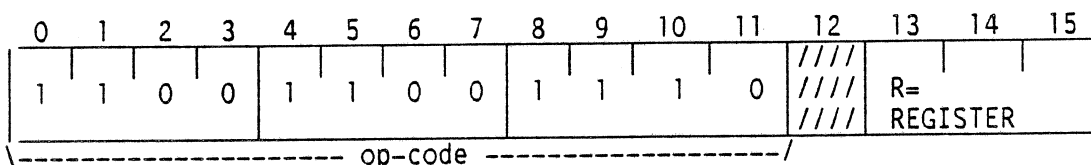

Instruction Execution: (R)₀ = 0, skip next word
 (R)₀ = 1, execute next word

Description: If bit position zero of the register specified by the R field is zero, skip the next word; otherwise, execute the next word.

Status Affected: None

Execution Time: (refer to Appendix A)

Symbolic Coding: The assembly language coding format for the SPL instruction is as follows:

Label	Operation	Operand	Comment
[label] ⅈ	SPL ⅈ	reg ⅈ	[comment]

where "reg" is an expression that addresses a register in accordance with Table 2-2.

Example:

L	EQU	5							
			→	(L) =	<u>Before</u>	<u>After</u>			
					F32B ₁₆	No change			
	SPL	L		(PC) =	0908 ₁₆	0909 ₁₆ (no skip)			

901181-385
MACHINE INSTRUCTIONS AND DECODING CONVENTIONS

3.7.19 SKIP ON SENSE SWITCH EQUAL (SSE)

Machine Format:

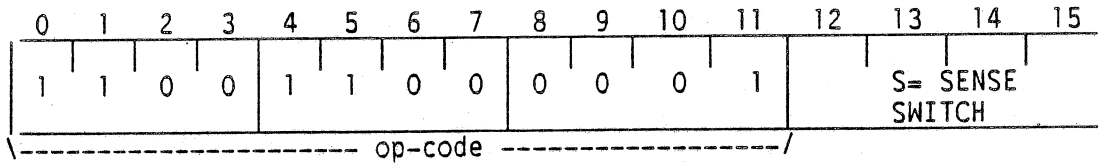

Instruction Execution: Refer to "description" paragraph.

Description: The S field bits of the machine format correspond to the computer front panel sense switches as follows:

Sense Switch	S Field Bit
1	12
2	13
3	14
4	15

Test only the sense switches whose corresponding S field bits are one. If the tested switches are on, skip the next word; otherwise, execute the next word. If all S field bits are zero, SSE will always skip and SSN will never skip.

Status Affected: None

Execution Time: (refer to Appendix A)

Symbolic Coding: The assembly language coding format for the SSE instruction is as follows:

Label	Operation	Operand	Comment
[label]	SSE	ss	[comment]

where "ss" is an expression that specifies the sense switches to be tested.

Example: The following SSE instruction will skip a word if sense switches 2 and 3 are on (switches 1 and 4 are not tested).

```

:
:
SSE      6
:
:

```

901181-385
MACHINE INSTRUCTIONS AND DECODING CONVENTIONS

3.7.20 SKIP ON SENSE SWITCH NOT EQUAL (SSN)

Machine Format:

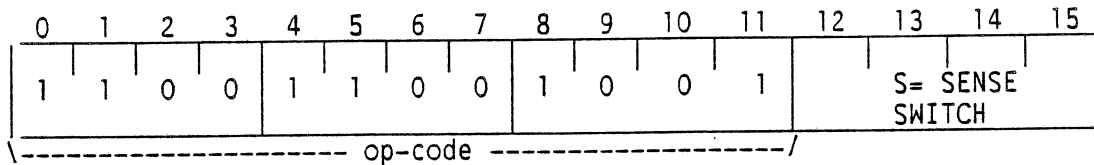

Instruction Execution: Refer to "description" paragraph.

Description: Refer to paragraph 3.7.19 for the relationship between the machine format S field bits and the computer front panel sense switches. Test only the sense switches whose corresponding S field bits are one. If any of the test switches are off, skip the next word; otherwise, execute the next word.

Status Affected: None

Execution Time: (refer to Appendix A)

Symbolic Coding: The assembly language coding format for the SSN instruction is as follows:

Label		Operation		Operand		Comment
[label]	ø	SSN	ø	ss	ø	[comment]

where "ss" is an expression that specifies the sense switches to be tested.

Example: The following SSN instruction will skip a word if sense switch 1 is off (switches 2, 3, and 4 are not tested).

```

SSN          8

```

3.7.21 SKIP ON ZERO (SZE)

Machine Format:

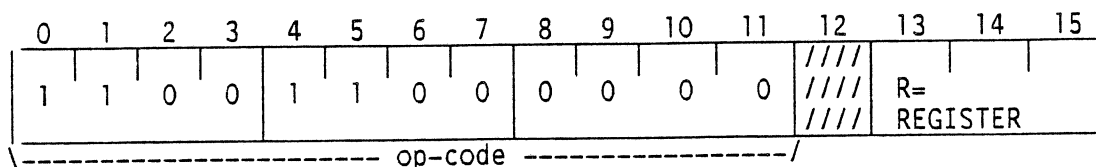

901181-385
MACHINE INSTRUCTIONS AND DECODING CONVENTIONS

Status Affected: If the sign bit and bit 1 of register A differ at any time during the shift operation, the overflow indicator (bit 2 of the status register) is turned on; otherwise, it is turned off. In either case, the sign bit is not affected.

Execution Time: (refer to Appendix A)

Symbolic Coding: The assembly language coding format for the ALA instruction is as follows:

Label [label]	ø	Operation ALA	ø	Operand count	ø	Comment [comment]
------------------	---	------------------	---	------------------	---	----------------------

where "count" is an expression that specifies the shift count.

Example:

ALA 5	→	(A) =	<u>Before</u> 537B ₁₆	<u>After</u> 6F60 ₁₆	(the overflow indicator is turned on)
-------	---	-------	-------------------------------------	------------------------------------	---------------------------------------

3.8.2 ARITHMETIC LEFT SHIFT DOUBLE (ALD)

Machine Format:

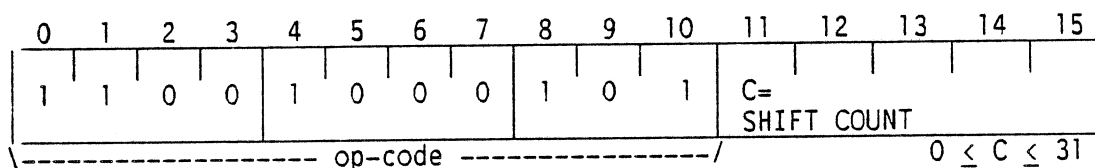

Instruction Execution: Shift (A,E) left C places; zero fill vacated bits

Description: Shift the double-length word formed by bits 1 through 15 of both registers A and E to the left the number of bit positions specified by the C field. The sign bits (bit 0) of registers A and E are not involved in the shift. Bit 0 of register E are shifted into bit 15 of register A. Bit positions vacated by the shift are filled with zeros and bits shifted off the left end (bit 1 of register A) are lost. If the C field is zero, no shift takes place but the sign of register E is forced to agree with the sign of register A.

Status Affected: If the sign bit and bit 1 of register A differ at any time during the shift operation, the overflow indicator (bit 2 of the status register) is turned on; otherwise, it is turned off. In either case, the sign bit is not affected.

Execution Time: (refer to Appendix A)

901181-385
MACHINE INSTRUCTIONS AND DECODING CONVENTIONS

Symbolic Coding: The assembly language coding format for the ALD instructions is as follows:

Label		Operation		Operand		Comment
[label]	ø	ALD	ø	count	ø	[comment]

where "count" is an expression that specifies the shift count.

Example:

ALD 10	→	(A,E) =	<u>Before (Hex)</u> C3C1,86A1	<u>After (Hex)</u> 8435,8400	(the overflow indicator is turned on)
--------	---	---------	----------------------------------	---------------------------------	---------------------------------------

3.8.3 ARITHMETIC RIGHT SHIFT REGISTER A (ARA)

Machine Format:

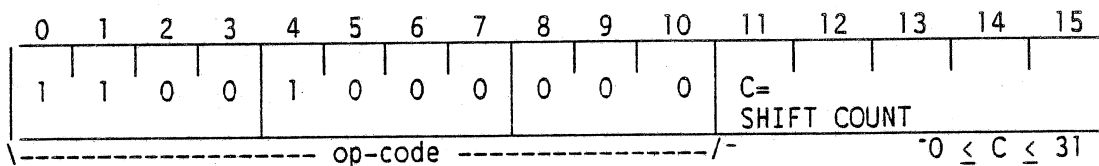

Instruction Execution: Shift (A) right C places; sign fill vacated bits

Description: Shift the contents of register A to the right the number of bit positions specified by the C field. Bit positions vacated are filled with the original sign bit (bit 0) and bits shifted off the right end are lost. If the C field is zero, no shift takes place.

Status Affected: None

Execution Time: (refer to Appendix A)

Symbolic Coding: The assembly language coding format for the ARA instruction is as follows:

Label		Operation		Operand		Comment
[label]	ø	ARA	ø	count	ø	[comment]

where "count" is an expression that specifies the shift count.

Example:

ARA 3	→	(A) =	<u>Before</u> 8321 ₁₆	<u>After</u> F064 ₁₆
-------	---	-------	-------------------------------------	------------------------------------

901181-385
MACHINE INSTRUCTIONS AND DECODING CONVENTIONS

3.8.4 ARITHMETIC RIGHT SHIFT DOUBLE (ARD)

Machine Format:

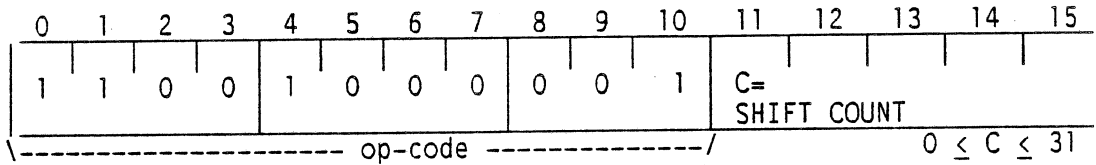

Instruction Execution: Shift (A,E) right C places; sign fill vacated bits

Description: Shift the double-length word formed by registers A and E to the right the number of bit positions specified by the C field. Bit 0 of register E is forced to agree with bit 0 of register A and bits shifted out of bit 15 of register A are shifted into bit 1 of register E. Bit positions vacated by the shift are filled with the original sign bit (bit 0 of register A) and bits shifted off the right end are lost. If the field is zero, no shift takes place but the sign of register E is forced to agree with the sign of register A.

Status Affected. None

Execution Time: (refer to Appendix A)

Symbolic Coding: The assembly language coding format for the ARD instruction is as follows:

Label		Operation		Operand		Comment
[label]	⊘	ARD	⊘	count	⊘	[comment]

where "count" is an expression that specifies the shift count.

Example:

FIVE EQU 5	→	(A,E) =	<u>Before (Hex)</u>	<u>After (Hex)</u>
			2F03,1100	0178,0C88
ARD FIVE				

3.8.5 CIRCULAR LEFT SHIFT DOUBLE (CLD)

Machine Format:

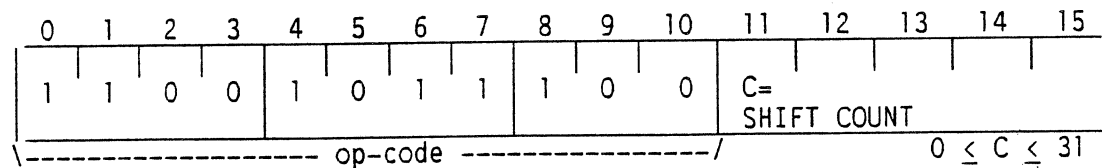

901181-385
MACHINE INSTRUCTIONS AND DECODING CONVENTIONS

Instruction Execution: Shift (A,E) left C places, circularly

Description: Shift the double-length word formed by registers A and E to the left the number of bit positions specified by the C field. Bits shifted out of bit 0 of register A are shifted into bit 15 of register E. Bits shifted out of bit 0 of register E are shifted into bit 15 of register A. If the C field is zero, no shift takes place.

Status Affected: None

Execution Time: (refer to Appendix A)

Symbolic Coding: The assembly language coding format for the CLD instruction is as follows:

Label [label]	ϕ	Operation CLD	ϕ	Operand count	ϕ	Comment [comment]
------------------	---	------------------	---	------------------	---	----------------------

where "count" is an expression that specifies the shift count.

Example:

CLD 8	→	(A,E) =	Before (Hex) 5350,4F54	After (Hex) 504F,5453
-------	---	---------	---------------------------	--------------------------

3.8.6 CIRCULAR RIGHT SHIFT REGISTER A (CRA)

Machine Format:

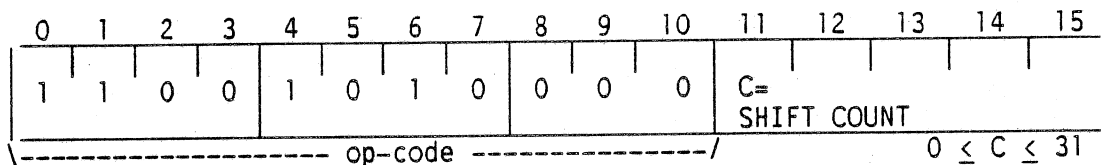

Instruction Execution: Shift (A) right C places, circularly

Description: Shift the contents of register A to the right the number of bit positions specified by the C field. Bits shifted out of position 15 are shifted into position 0. If the C field is zero, no shift takes place.

Status Affected: None

Execution Time: (refer to Appendix A)

901181-385
MACHINE INSTRUCTIONS AND DECODING CONVENTIONS

Symbolic Coding: The assembly language coding format for the CRA instruction is as follows:

Label [label]	ø	Operation CRA	ø	Operand count	ø	Comment [comment]
------------------	---	------------------	---	------------------	---	----------------------

where "count" is an expression that specifies the shift count.

Example:

FOUR EQU 4	→	(A) = $\frac{\text{Before}}{\text{FAD9}_{16}}$		$\frac{\text{After}}{9\text{FAD}_{16}}$
CRA FOUR				

3.8.7 CIRCULAR RIGHT SHIFT REGISTER B (CRB)

Machine Format:

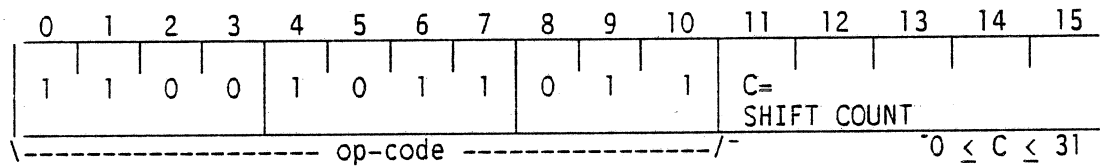

Instruction Execution: Shift (B) right C places, circularly

Description: Shift the contents of register B to the right the number of bit positions specified by the C field. Bits shifted out of position 15 are shifted into position 0. If the C field is zero, no shift takes place.

Status Affected: None

Execution Time: (refer to Appendix A)

Symbolic Coding: The assembly language coding format for the CRB instruction is as follows:

Label [label]	ø	Operation CRB	ø	Operand count	ø	Comment [comment]
------------------	---	------------------	---	------------------	---	----------------------

where "count" is an expression that specifies the shift count.

Example:

CRB 15	→	(B) = $\frac{\text{Before}}{0105_{16}}$		$\frac{\text{After}}{020A_{16}}$
--------	---	---	--	----------------------------------

901181-385
MACHINE INSTRUCTIONS AND DECODING CONVENTIONS

3.8.8 CIRCULAR RIGHT SHIFT DOUBLE (CRD)

Machine Format:

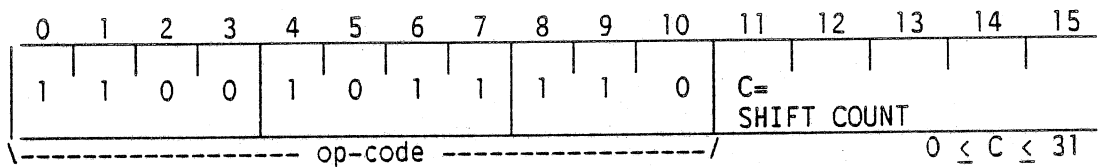

Instruction Execution: Shift (A,E) right C places, circularly

Description: Shift the double-length word formed by registers A and E to the right the number of bit positions specified by the C field. Bits shifted out of position 15 of register E are shifted into position 0 of register A. Bits shifted out of position 15 of register A are shifted into position 0 of register E. If the C field is zero, no shift takes place.

Status Affected: None

Execution Time: (refer to Appendix A)

Symbolic Coding: The assembly language coding format for the CRD instruction is as follows:

Label		Operation		Operand		Comment
[label]	ø	CRD	ø	count	ø	[comment]

where "count" is an expression that specifies the shift count.

Example:

CRD 6	→	(A,E) =	Before (Hex) F6A9,24B1	After (Hex) C7DA,A492
-------	---	---------	---------------------------	--------------------------

3.8.9 CIRCULAR RIGHT SHIFT REGISTER E (CRE)

Machine Format:

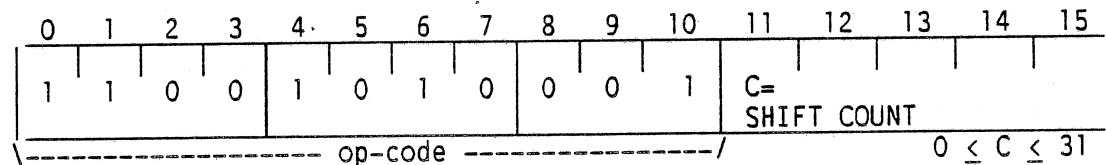

Instruction Execution: Shift (E) right C places, circularly

Description: Shift the contents of register E to the right the number of bit positions specified by the C field. Bits shifted out of position 15 are shifted into position 0. If the C field is zero, no shift takes place.

901181-385
MACHINE INSTRUCTIONS AND DECODING CONVENTIONS

Status Affected: None

Execution Time: (refer to Appendix A)

Symbolic Coding: The assembly language coding format for the CRE instruction is as follows:

Label	Operation	Operand	Comment
[label] ⌀	CRE ⌀	count ⌀	[comment]

where "count" is an expression that specifies the shift count.

Example:

ONE EQU 1 . CRE ONE	→	(E) =	<table style="border: none; display: inline-table;"> <tr> <td style="text-align: center; padding-right: 5px;"><u>Before</u></td> <td style="text-align: center;"><u>After</u></td> </tr> <tr> <td style="text-align: center;">24AC₁₆</td> <td style="text-align: center;">1256₁₆</td> </tr> </table>	<u>Before</u>	<u>After</u>	24AC ₁₆	1256 ₁₆
<u>Before</u>	<u>After</u>						
24AC ₁₆	1256 ₁₆						

3.8.10 CIRCULAR RIGHT SHIFT REGISTER L (CRL)

Machine Format:

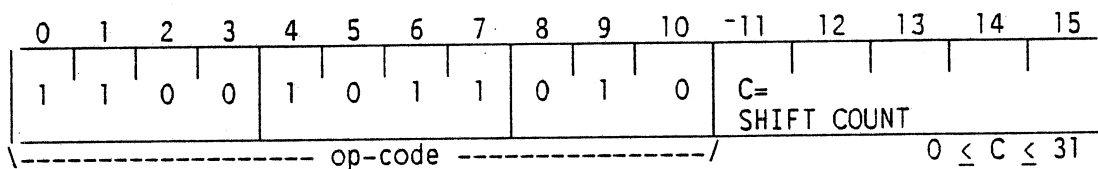

Instruction Execution: Shift (L) right C places, circularly

Description: Shift the contents of register L to the right the number of bit positions specified by the C field. Bits shifted out of position 15 are shifted into position 0. If the C field is zero, no shift takes place.

Status Affected: None

Execution Time: (refer to Appendix A)

Symbolic Coding: The assembly language coding format for the CRL instruction is as follows:

Label	Operation	Operand	Comment
[label] ⌀	CRL ⌀	count ⌀	[comment]

where "count" is an expression that specifies the shift count.

901181-385
MACHINE INSTRUCTIONS AND DECODING CONVENTIONS

Example:

CRL 5 → (L) = $\frac{\text{Before}}{62FF_{16}}$ $\frac{\text{After}}{FB17_{16}}$

3.8.11 CIRCULAR RIGHT SHIFT REGISTER M (CRM)

Machine Format:

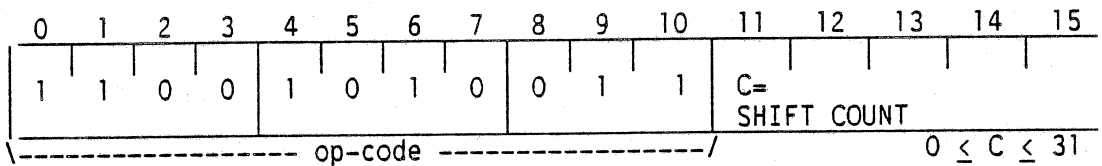

Instruction Execution: Shift (M) right C places, circularly

Description: Shift the contents of register M to the right the number of bit positions specified by the C field. Bits shifted out of position 15 are shifted into position 0. If the C field is zero, no shift takes place.

Status Affected: None

Execution Time: (refer to Appendix A)

Symbolic Coding: The assembly language coding format for the CRM instruction is as follows:

Label	Operation	Operand	Comment
[label]	CRM	count	[comment]

where "count" is an expression that specifies the shift count.

Example:

CRM 8 → (M) = $\frac{\text{Before}}{2630_{16}}$ $\frac{\text{After}}{3026_{16}}$

3.8.12 CIRCULAR RIGHT SHIFT REGISTER S (CRS)

Machine Format:

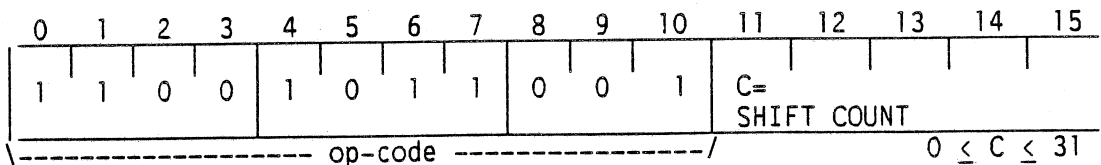

901181-385
MACHINE INSTRUCTIONS AND DECODING CONVENTIONS

Instruction Execution: Shift (S) right C places, circularly

Description: Shift the contents of register S to the right the number of bit positions specified by the C field. Bits shifted out of position 15 are shifted into position 0. If the C field is zero, no shift takes place.

Status Affected: None

Execution Time: (refer to Appendix A)

Symbolic Coding: The assembly language coding format for the CRS instruction is as follows:

Label	Ø	Operation	Ø	Operand	Ø	Comment
[label]		CRS		count		[comment]

where "count" is an expression that specifies the shift count.

Example:

CRS 2	→	(S) =	Before	After
			CD94 ₁₆	3365 ₁₆

3.8.13 CIRCULAR RIGHT SHIFT REGISTER X (CRX)

Machine Format:

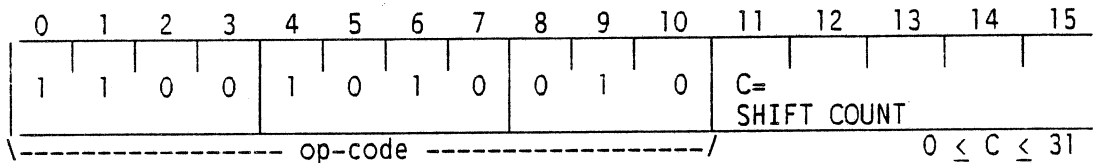

Instruction Execution: Shift (X) right C places, circularly

Description: Shift the contents of register X to the right the number of bit positions specified by the C field. Bits shifted out of position 15 are shifted into position 0. If the C field is zero, no shift takes place.

Status Affected: None

Execution Time: (refer to Appendix A)

Symbolic Coding: The assembly language coding format for the CRX instruction is as follows:

Label	Ø	Operation	Ø	Operand	Ø	Comment
[label]		CRX		count		[comment]

where "count" is an expression that specifies the shift count.

901181-385
MACHINE INSTRUCTIONS AND DECODING CONVENTIONS

Example:

F15 EQU 15	→	(X) =	<u>Before</u>	<u>After</u>
			00B2 ₁₆	0164 ₁₆
CRX F15				

3.8.14 LOGICAL LEFT SHIFT REGISTER A (LLA)

Machine Format:

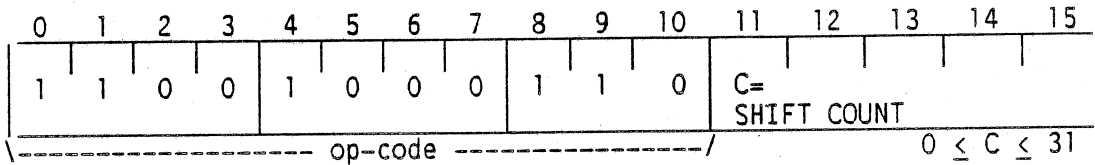

Instruction Execution: Shift (A) left C places; zero fill vacated bits

Description: Shift the contents of register A to the left the number of bit positions specified by the C field. Bit positions vacated are filled with zeros and bits shifted off the left end are lost. If the C field is zero, no shift takes place.

Status Affected: None

Execution Time: (refer to Appendix A)

Symbolic Coding: The assembly language coding format for the LLA instruction is as follows:

Label		Operation		Operand		Comment
[label]	⊘	LLA	⊘	count	⊘	[comment]

where "count" is an expression that specifies the shift count.

Example:

LLA 4	→	(A) =	<u>Before</u>	<u>After</u>
			CD94 ₁₆	3365 ₁₆

3.8.15 LOGICAL LEFT SHIFT DOUBLE (LLD)

Machine Format:

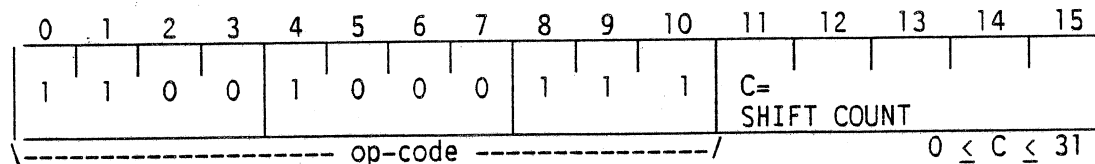

901181-385
MACHINE INSTRUCTIONS AND DECODING CONVENTIONS

Instruction Execution: Shift (A,E) left C places; zero fill vacated bits

Description: Shift the double-length word formed by registers A and E to the left the number of bit positions specified by the C field. Bit positions vacated are filled with zeros, bits shifted out of position 0 of register A are lost, and bits shifted out of position 0 of register E are shifted into position 15 of register A. If the C field is zero, no shift takes place.

Status Affected: None

Execution Time: (refer to Appendix A)

Symbolic Coding: The assembly language coding format for the LLD instruction is as follows:

Label	Operation	Operand	Comment
[label] ⌀	LLD	⌀ count ⌀	[comment]

where "count" is an expression that specifies the shift count.

Example:

LLD 3	→	(A,E) =	Before (Hex)	After (Hex)
			F2F0,1108	9780,8840

3.8.16 LOGICAL RIGHT SHIFT REGISTER A (LRA)

Machine Format:

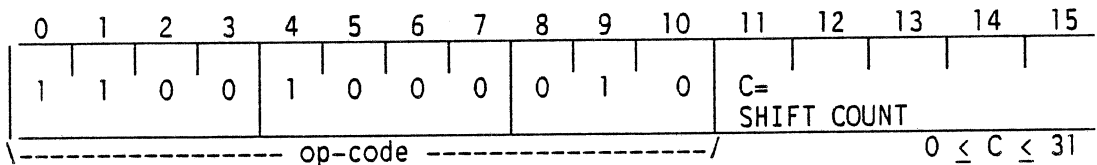

Instruction Execution: Shift (A) right C places; zero fill vacated bits

Description: Shift the contents of register A to the right the number of bit positions specified by the C field. Bit positions vacated are filled with zeros and bits shifted off the right end are lost. If the C field is zero, no shift takes place.

Status Affected: None

Execution Time: (refer to Appendix A)

901181-385
MACHINE INSTRUCTIONS AND DECODING CONVENTIONS

Symbolic Coding: The assembly language coding format for the LRA instruction is as follows:

Label		Operation		Operand		Comment
[label]	ø	LRA	ø	count	ø	[comment]

where "count" is an expression that specifies the shift count.

Example:

SEVN EQU 7	→	(A) =	<u>Before</u>	<u>After</u>
			3CF ₁₆	0079 ₁₆
LRA SEVN				

3.8.17 LOGICAL RIGHT SHIFT DOUBLE (LRD)

Machine Format:

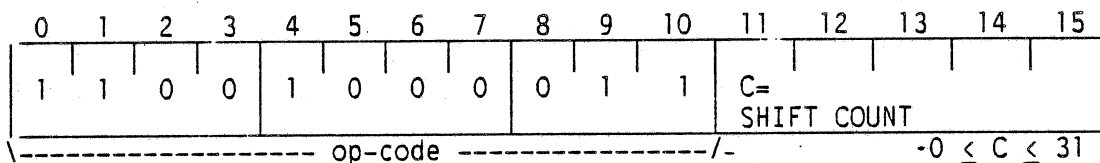

Instruction Execution: Shift (A,E) right C places; zero fill vacated bits

Description: Shift the double-length word formed by registers A and E to the right the number of bit positions specified by the C field. Bit positions vacated are filled with zeros, bits shifted out of position 15 of register A are shifted into position 0 of register E, and bits shifted out of position 15 of register E are lost. If the C field is zero, no shift takes place.

Status Affected: None

Execution Time: (refer to Appendix A)

Symbolic Coding: The assembly language coding format for the LRD instruction is as follows:

Label		Operation		Operand		Comment
[label]	ø	LRD	ø	count	ø	[comment]

where "count" is an expression that specifies the shift count.

901181-385
MACHINE INSTRUCTIONS AND DECODING CONVENTIONS

Example:

LRD 12 → (A,E) = Before (Hex) After (Hex)
 0214,5F67 0000,2145

3.8.18 LEFT TEST FOR ONES IN REGISTER A (LTO)

Machine Format:

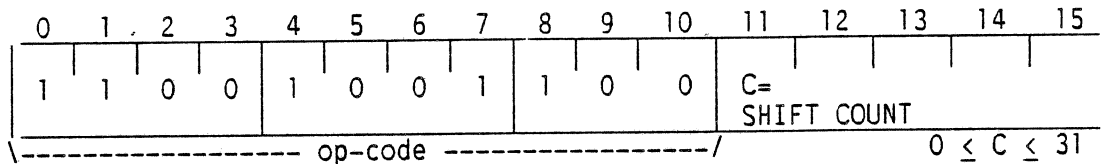

Instruction Execution: Shift (A) left C places or until a one is found in bit 0; leading zeros count → (X); zero fill vacated bits.

Description: Logically shift the contents of register A to the left the number of bit positions specified by the C field or until a one appears in bit 0 of register A. Bit positions vacated by the shift are filled with zeros. If a one is shifted into bit 0, it is set to zero and register X is loaded with a count of the number of zeros shifted out of bit 0. If a one is not found after shifting the number of bits specified by the C field, register X is loaded with the value of the C field. If the C field is zero, bit 0 of register A is complemented and register X remains unchanged.

NOTE

The LTO instruction is commonly used to determine which bits of a status word returned from a peripheral device are set.

Status Affected: None

Execution Time: (refer to Appendix A)

Symbolic Coding: The assembly language coding format for the LTO instruction is as follows:

Label	Operation	Operand	Comment
[label]	∅ LTO ∅	count ∅	[comment]

where "count" is an expression that specifies the shift count.

901181-385
MACHINE INSTRUCTIONS AND DECODING CONVENTIONS

Example:

SIX EQU 6	→	(A) = <u>Before</u> 3C2B ₁₆	(A) = <u>After</u> 70AC ₁₆	
LTO SIX		(X) = FF03 ₁₆	0002 ₁₆	("one" found after two shifts)

3.8.19 LEFT TEST FOR ZEROS IN REGISTER A (LTZ)

Machine Format:

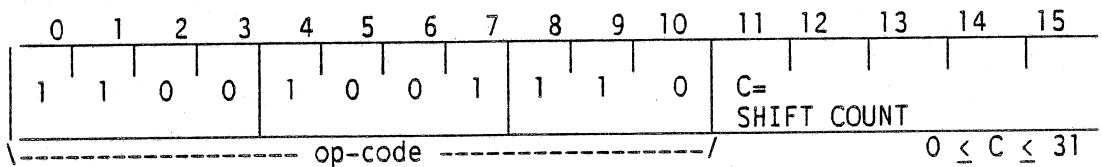

Instruction Execution: Shift (A) left C places or until a zero is found in bit 0; leading ones count →(X); zero fill vacated bits

Description: Logically shift the contents of register A to the left the number of bit positions specified by the C field or until a zero appears in bit 0 of register A. Bit positions vacated by the shift are filled with zeros. If a zero is shifted into bit 0, it is set to one and register X is loaded with a count of the number of ones shifted out of bit 0. If a zero is not found after shifting the number of bits specified by the C field, register X is loaded with the value of the C field. If the C field is zero, bit 0 of register A is complemented and register X remains unchanged.

Status Affected: None

Execution Time: (refer to Appendix A)

Symbolic Coding: The assembly language coding format for the LTZ instruction is as follows:

Label		Operation		Operand		Comment
[label]	Ø	LTZ	Ø	count	Ø	[comment]

where "count" is an expression that specifies the shift count.

Example:

LTZ 3	→	(A) = <u>Before</u> FC02 ₁₆	(A) = <u>After</u> E010 ₁₆	
		(X) = 0080 ₁₆	0003 ₁₆	(no "zeros" found in three shifts)

901181-385
MACHINE INSTRUCTIONS AND DECODING CONVENTIONS

3.8.20 NORMALIZE (NRM)

Machine Format:

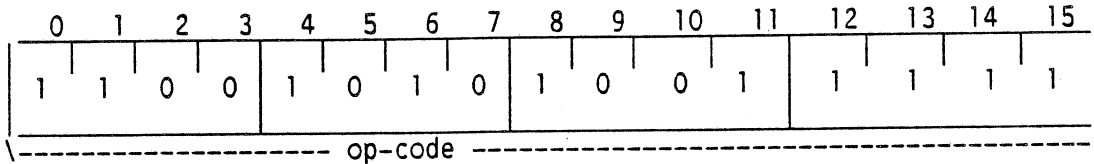

Instruction Execution: Shift (A,E) left until (A)₀ ≠ (A)₁; shift count → (X); zero fill vacated bits

Description: Shift the double-length word formed by registers A and E to the left until bit 0 of register A is different from bit 1 of register A. Bit positions vacated by the shift are filled with zeros and bit 0 of register E is forced to agree with bit 0 of register A. Bits shifted out of bit 1 of register E are shifted into bit 15 of register A. The total number of bits shifted to perform the normalization is loaded in register X. If the contents of registers A and E are both zero and the NRM instruction is executed, a count of 31 is stored in register X and registers A and E remain at zero. If registers A and E are all ones and the NRM instruction is executed, a count of 30 is stored in register X and registers A and E both contain 8000₁₆.

Status Affected: None

Execution Time: (refer to Appendix A)

Symbolic Coding: The assembly language coding format for the NRM instruction is as follows:

Label [label]	⊘	Operation NRM	⊘	Operand	⊘	Comment [comment]
------------------	---	------------------	---	---------	---	----------------------

Example:

NRM									
	→	(A,E) =		<u>Before (Hex)</u>		<u>After (Hex)</u>			
				0062,B87A		6270,7A00			
		(X) =		0AB2		0008			

901181-385
MACHINE INSTRUCTIONS AND DECODING CONVENTIONS

3.8.21 RIGHT TEST FOR ONES IN REGISTER (RTO)

Machine Format:

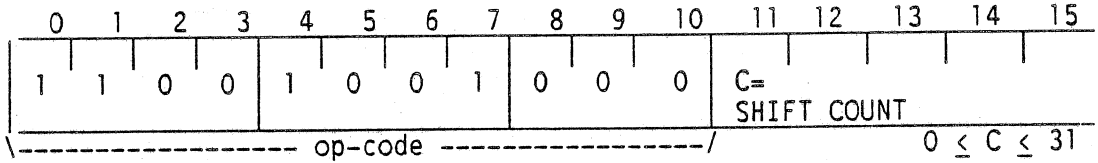

Instruction Execution: Shift (A) right C places or until a one appears in bit 15; trailing zeros count → (X); zero fill vacated bits

Description: Logically shift the contents of register A to the right the number of bit positions specified by the C field or until a one appears in bit 15. Bit positions vacated by the shift are filled with zeros. If a one is shifted into bit 15, it is set to zero and register X is loaded with a count of the number of zeros shifted out of bit 15. If a one is not found after shifting the number of bits specified by the C field, register X is loaded with the value of the C field. If the C field is zero, bit 15 of register A is complemented and register X remains unchanged.

Status Affected: None

Execution Time: (refer to Appendix A)

Symbolic Coding: The assembly language coding format for the RTO instruction is as follows:

Label	Operation	Operand	Comment
[label] ⌀	RTO	count ⌀	[comment]

where "count" is an expression that specifies the shift count.

Example:

EGHT EQU 8	→	(A) = $\frac{\text{Before}}{6BA4_{16}}$	(A) = $\frac{\text{After}}{1AE8_{16}}$
RTO EGHT		(X) = 0905_{16}	0002_{16}

901181-385
MACHINE INSTRUCTIONS AND DECODING CONVENTIONS

3.8.22 RIGHT TEST FOR ZEROS IN REGISTER A (RTZ)

Machine Format:

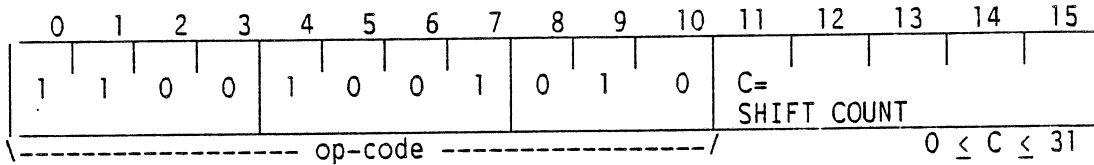

Instruction Execution: Shift (A) right C places or until a zero appears in bit 15; trailing ones count → (X)

Description: Logically shift the contents of register A to the right the number of bit positions specified by the C field or until a zero appears in bit 15. Bit positions vacated by the shift are filled with zeros. If a zero is shifted into bit 15, it is set to one and register X is loaded with a count of the number of ones shifted out of bit 15. If a zero is not found after shifting the number of bits specified by the C field, register X is loaded with the value of the C field. If the C field is zero, bit 15 of register A is complemented and register X remains unchanged.

Status Affected: None

Execution Time: (refer to Appendix A)

Symbolic Coding: The assembly language coding format for the RTZ instruction is as follows:

Label	Operation	Operand	Comment
[label] ⌀	RTZ	⌀ count ⌀	[comment]

where "count" is an expression that specifies the shift count.

Example:

RTZ 5	→	(A) = $F601_{16}$	<u>Before</u>	<u>After</u>
		(X) = $FFFF_{16}$		$7B01_{16}$
				0001_{16}

901181-385
MACHINE INSTRUCTIONS AND DECODING CONVENTIONS

3.9 LOGICAL INSTRUCTIONS

The logical instructions listed in Table 3-1 are described in the following paragraphs.

3.9.1 LOGICAL AND WITH REGISTER A (AND)

Machine Format:

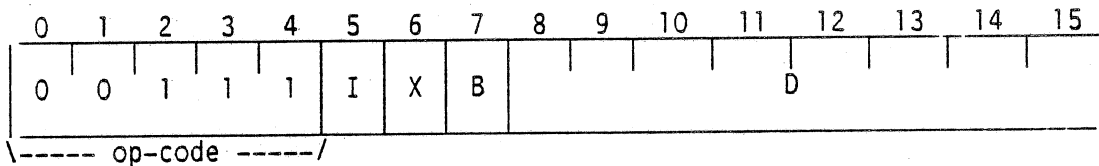

Instruction Execution: (A) AND (EOA) → (A) where EOA is developed in accordance with Table 3-3.

Description: Perform a bit-by-bit logical AND between the contents of register A and the contents of the effective operand address, EOA. Place the result in register A. If the IXB fields are 7₁₆ (immediate addressing), the operand to be AND'ed with register A consists of zeros in bits 0 to 7 and the displacement field, D, in bits 8 to 15. The Logical AND operation is defined as follows:

(A) Bit	(EOA) Bit	Result
0	0	0
0	1	0
1	0	0
1	1	1

Status Affected: None

Execution Time: (refer to Appendix A)

Symbolic Coding: Refer to Table 3-3 for the assembly language coding formats available with the AND instruction. The AND mnemonic replaces the MNU operation field (in Table 3-3) and optional label and comment fields may be used.

Example:

MASK AND =>B6	→	(A) =	<u>Before</u> F637 ₁₆	<u>After</u> 0036 ₁₆
		(MASK) =	3FB6 ₁₆	No change

901181-385
MACHINE INSTRUCTIONS AND DECODING CONVENTIONS

3.9.2 LOGICAL OR WITH REGISTER A (IOR)

Machine Format:

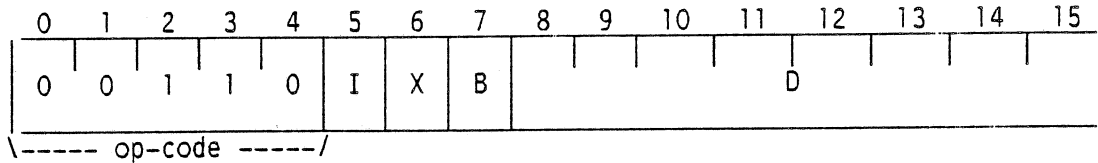

Instruction Execution: (A) OR (EOA) → (A)

Description: Perform a bit-by-bit logical OR between the contents of register A and the contents of the effective operand address, EOA. Place the result in register A. If the IXB fields are 7_{16} (immediate addressing), the operand to be OR'ed with register A consists of zeros in bits 0 to 7 and the displacement field, D, in bits 8 to 15. The logical OR operation is defined as follows:

(A)	(EOA)	
Bit	Bit	Result
0	0	0
0	1	1
1	0	1
1	1	1

Status Affected: None

Execution Time: (refer to Appendix A)

Symbolic Coding: Refer to Table 3-3 for the assembly language coding formats available with the IOR instruction. The IOR mnemonic replaces the MNU operation field (in Table 3-3) and optional label and comment fields may be used.

Example:

IOR HEX,2	→	(A) =	<u>Before</u> 0108 ₁₆	<u>After</u> 3138 ₁₆	where, (X) = 0018 ₁₆
		(HEX + 18 ₁₆) =	3030 ₁₆	No change	

901181-385
MACHINE INSTRUCTIONS AND DECODING CONVENTIONS

3.9.3 REGISTER AND (RAN)

Machine Format:

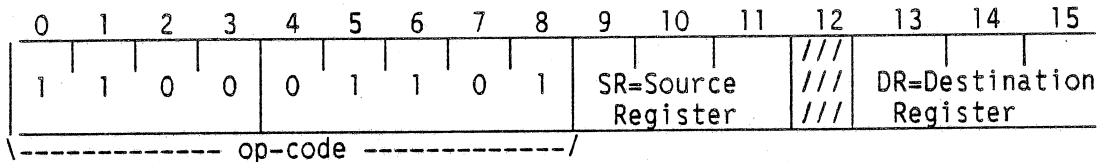

Instruction Execution: (SR) AND (DR) → (DR)

Description: Perform a bit-by-bit logical AND between the contents of the registers specified by the SR and DR fields. Place the result in the register specified by the DR field. The logical AND operation is defined in paragraph 3.9.1. If bit 12 of the machine format is set to one and bits 13 to 15 are zeroed, the status register is specified as the destination register. In this case the instruction is restricted, meaning it is considered illegal if the memory protect/privileged instruction feature is enabled. Interrupts, other than internal, are inhibited for one instruction following this special case of the RAN instruction.

Status Affected: None

Execution Time: (refer to Appendix A)

Symbolic Coding: The assembly language coding format for the RAN instruction is as follows:

Label	Operation	Operand	Comment
[label] ♂	RAN	♂ sreg,dreg ♂	[comment]

where "sreg" and "dreg" are expressions that address the source and destination registers, respectively, in accordance with Table 2-2. The special case when "dreg" equals eight is covered in the "Description" paragraph.

Example:

RAN 0,3	→		<u>Before</u>	<u>After</u>
		(M) =	B8A5 ₁₆	0820 ₁₆
		(A) =	0F70 ₁₆	No change

901181-385
MACHINE INSTRUCTIONS AND DECODING CONVENTIONS

3.9.4 REGISTER EXCLUSIVE OR (REO)

Machine Format:

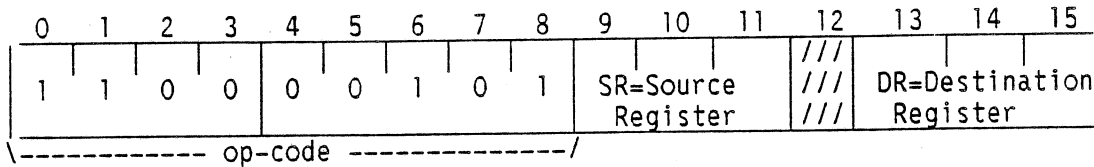

Instruction Execution: (SR) exclusive OR (DR) → (DR)

Description: Perform a bit-by-bit logical exclusive OR between the contents of the registers specified by the SR and DR fields. Place the result in the register specified by the DR field. The exclusive OR operation is defined as follows:

(SR)	(DR)	Result
<u>Bit</u>	<u>Bit</u>	<u>Result</u>
0	0	0
0	1	1
1	0	1
1	1	0

If bit 12 of the machine format is set to one and bits 13 to 15 are zeroed, the status register is specified as the destination register. In this case the instruction is restricted, meaning it is considered illegal if the memory protect/privileged instruction feature is enabled. Interrupts, other than internal, are inhibited for one instruction following this special case of the REO instruction.

Status Affected: None

Execution Time: (refer to Appendix A)

Symbolic Coding: The assembly language coding format for the REO instruction is as follows:

Label	Operation	Operand	Comment
[label] ⌀	REO	⌀ sreg,dreg ⌀	[comment]

where "sreg" and "dreg" are expressions that address the source and destination registers, respectively, in accordance with Table 2-2. The special case when "dreg" equals eight is covered in the "Description" paragraph.

901181-385
MACHINE INSTRUCTIONS AND DECODING CONVENTIONS

Example:

A EQU 0	→	(S) =	<u>Before</u>	<u>After</u>
S EQU 4			3862 ₁₆	63C3 ₁₆
REO A,S		(A) =	5BA1 ₁₆	No change

3.9.5 REGISTER OR (ROR)

Machine Format:

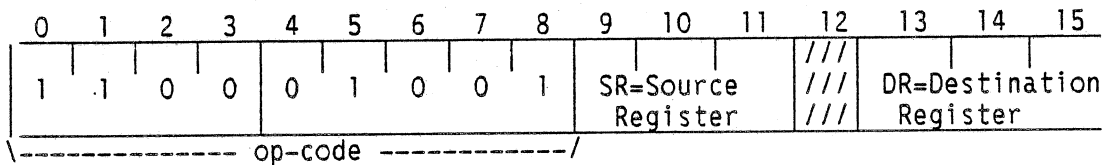

Instruction Execution: (SR) OR (DR) → (DR)

Description: Perform a bit-by-bit logical OR between the contents of the registers specified by the SR and DR fields. Place the result in the register specified by the DR field. The logical OR operation is defined in paragraph 3.9.2. If bit 12 of the machine format is set to one and bits 13 to 15 are zeroed, the status register is specified as the destination register. In this case the instruction is restricted, meaning it is considered illegal if the memory protect/privileged instruction feature is enabled. Interrupts, other than internal, are inhibited for one instruction following this special case of the ROR instruction.

Status Affected: None

Execution Time: (refer to Appendix A)

Symbolic Coding: The assembly language coding format for the ROR instruction is as follows:

Label	Operation	Operand	Comment
[label] ⌀	ROR	⌀ sreg,dreg ⌀	[comment]

where "sreg" and "dreg" are expressions that address the source and destination registers, respectively, in accordance with Table 2-2. The special case when "dreg" equals eight is covered in the "Description" paragraph.

Example:

ROR 4,3	→	(M) =	<u>Before</u>	<u>After</u>
			0005 ₁₆	0035 ₁₆
		(S) =	0030 ₁₆	No change

901181-385
MACHINE INSTRUCTIONS AND DECODING CONVENTIONS

3.10 BIT MANIPULATION INSTRUCTIONS

The bit manipulation instructions listed in Table 3-1 are described in the following paragraphs.

3.10.1 SET REGISTER A BIT TO ONE (SABO)

Machine Format:

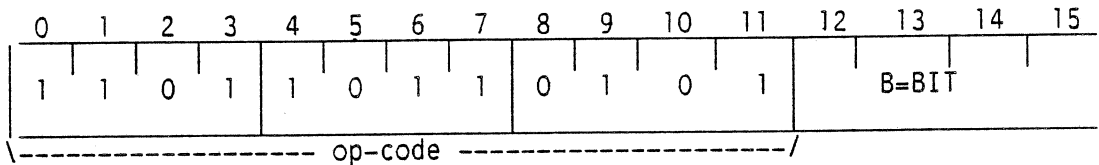

Instruction Execution: $1 \rightarrow (A)_{\text{bit } B}$

Description: Set the bit in register A specified by the B field to one.

Status Affected: None

Execution Time: (refer to Appendix A)

Symbolic Coding: The assembly language coding format for the SABO instruction is as follows:

Label		Operation		Operand		Comment
[label]	Ø	SABO	Ø	bit	Ø	[comment]

where "bit" is an expression that specifies the bit in register A to be set to one.

Example:

SABO 4	→	(A) =	<u>Before</u>	<u>After</u>
			2200_{16}	$2A00_{16}$

3.10.2 SET REGISTER A BIT TO ZERO (SABZ)

Machine Format:

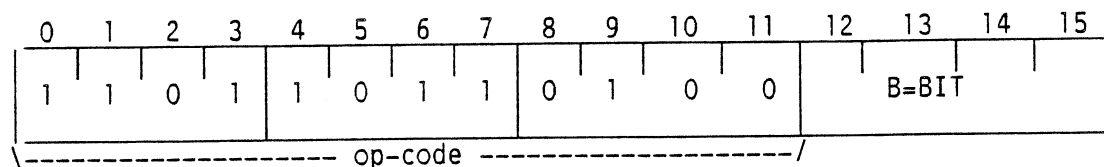

901181-385
MACHINE INSTRUCTIONS AND DECODING CONVENTIONS

Instruction Execution: $0 \rightarrow (A)_{bit\ B}$

Description: Set the bit in register A specified by the B field to zero.

Status Affected: None

Execution Time: (refer to Appendix A)

Symbolic Coding: The assembly language coding format for the SABZ instruction is as follows:

Label [label]	ϕ	Operation SABZ	ϕ	Operand bit	ϕ	Comment [comment]
------------------	---	-------------------	---	----------------	---	----------------------

where "bit" is an expression that specifies the bit in register A to be set to zero.

Example:

FIFTN	EQU	15	→	(A) =	<u>Before</u> FFF ₁₆	<u>After</u> FFE ₁₆
		SABZ		FIFTN		

3.10.3 SET MEMORY BIT TO ONE (SMBO)

Machine Format:

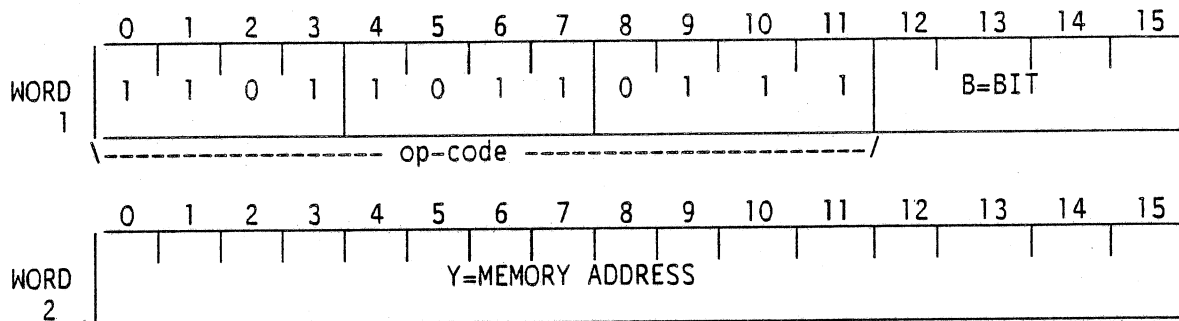

Instruction Execution: $1 \rightarrow (Y)_{bit\ B}$

Description: Set the bit, in memory location Y, specified by the B field to one.

Status Affected: None

Execution Time: (refer to Appendix A)

901181-385
MACHINE INSTRUCTIONS AND DECODING CONVENTIONS

Symbolic Coding: The assembly language coding formats for the SMBO instruction are as follows:

NOTE

The FLAG directive in the second coding format is described in Section 4.

Label		Operation		Operand		Comment
[label]	ø	SMBO	ø	bit, adrs	ø	[comment]

or

[label]		FLAG		adrs		[comment]
[label]	ø	SMBO	ø	bit	ø	[comment]

where "bit" and "adrs" are expressions that must be evaluated to specify a bit in memory to be set to one. First, the "bit" expression is divided by 16. The resulting quotient is added to the value of the "adrs" expression to form the memory word address, Y. The remainder becomes the B field and specifies the bit in word Y to be set to one.

Example:

SMBO 17, STATUS							
	→ (STATUS+1) =			<u>Before</u>		<u>After</u>	
				0013 ₁₆		4013 ₁₆	

3.10.4 SET MEMORY BIT TO ZERO (SMBZ)

Machine Format:

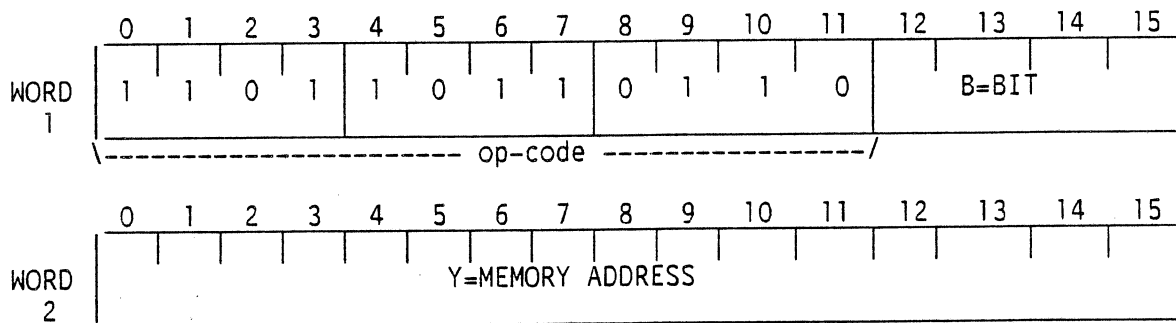

Instruction Execution: $0 \rightarrow (Y)_{bit B}$

Description: Set the bit, in memory location Y, specified by the B field to zero.

Status Affected: None

901181-385
MACHINE INSTRUCTIONS AND DECODING CONVENTIONS

Execution Time: (refer to Appendix A)

Symbolic Coding: The assembly language coding formats for the SMBZ instruction are as follows:

NOTE

The FLAG directive in the second coding format is described in Section 4.

Label		Operation		Operand		Comment
[label]	ø	SMBZ	ø	bit, adrs	ø	[comment]

or

[label]		FLAG		adrs		[comment]
[label]	ø	SMBZ	ø	bit	ø	[comment]

where "bit" and "adrs" are expressions that must be evaluated to specify a bit in memory to be set to zero. First, the value of the "bit" expression is divided by 16. The resulting quotient is added to the value of the "adrs" expression to form the memory word address, Y. The remainder becomes the B field and specifies the bit in word Y to be set to zero.

Example:

SMBZ 15, MEM	→	(MEM) =	<u>Before</u> 2A23 ₁₆	<u>After</u> 2A22 ₁₆
--------------	---	---------	-------------------------------------	------------------------------------

3.10.5 TEST REGISTER A BIT FOR ONE (TABO)

Machine Format:

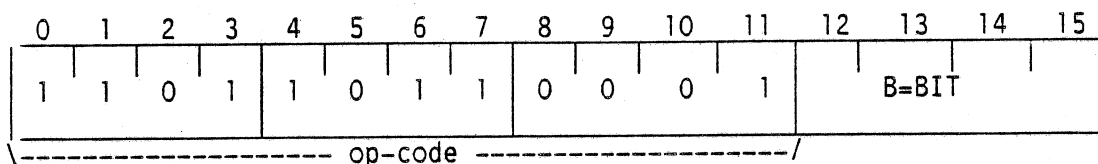

Instruction Execution: (A)_{bit B} = 1; skip next word
(A)_{bit B} = 0; execute next word

Description: If the bit in register A specified by the B field is a one, skip the next word. If the bit is a zero, execute the next word.

Status Affected: None

Execution Time: (refer to Appendix A)

901181-385
MACHINE INSTRUCTIONS AND DECODING CONVENTIONS

Symbolic Coding: The assembly language coding format for the TABO instruction is as follows:

Label	Operation	Operand	Comment
[label]	Ø TABO	Ø bit	Ø [comment]

where "bit" is an expression that specifies the bit in register A to be tested.

Example:

TABO 6	→		<u>Before</u>	<u>After</u>
		(A) =	02A3 ₁₆	no change
		(PC) =	1179 ₁₆	117B ₁₆

3.10.6 TEST REGISTER A BIT FOR ZERO (TABZ)

Machine Format:

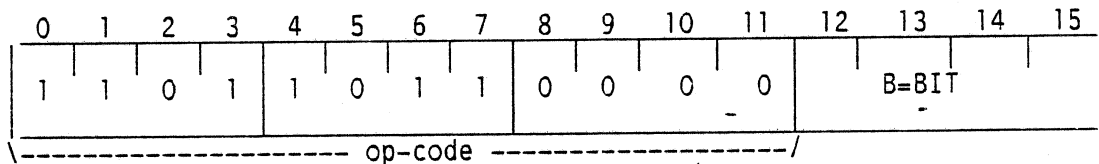

Instruction Execution: (A)_{bit B} = 0; skip next word
(A)_{bit B} = 1; execute next word

Description: If the bit in register A specified by the B field is zero, skip the next word. If the bit is one, execute the next word.

Status Affected: None

Execution Time: (refer to Appendix A)

Symbolic Coding: The assembly language coding format for the TABZ instruction is as follows:

Label	Operation	Operand	Comment
[label]	Ø TABZ	Ø bit	Ø [comment]

where "bit" is an expression that specifies the bit in register A to be tested.

901181-385
MACHINE INSTRUCTIONS AND DECODING CONVENTIONS

Example:

SEVN EQU 7	→	(A) =	<u>Before</u> F5C6 ₁₆	<u>After</u> No change
TABZ SEVN		(PC) =	1311 ₁₆	1312 ₁₆

3.10.7 TEST MEMORY BIT FOR ONE (TMBO)

Machine Format:

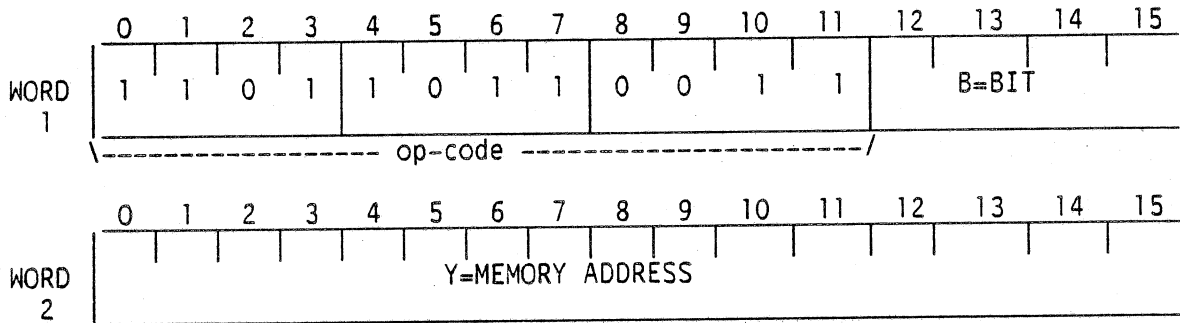

Instruction Execution: (Y)_{bit B} = 1; skip next word
(Y)_{bit B} = 0; execute next-word

Description: If the bit, in memory location Y, specified by the B field is one, skip the next word. If the bit is zero, execute the next word.

Status Affected: None

Execution Time: (refer to Appendix A)

Symbolic Coding: The assembly language coding formats for the TMBO instruction are as follows:

NOTE

The FLAG directive in the second coding format is described in Section 4.

901181-385
MACHINE INSTRUCTIONS AND DECODING CONVENTIONS

Label	Operation	Operand	Comment
[label]	Ø TMBO	Ø bit, adrs	Ø [comment]
		or	
[label]	Ø FLAG	Ø adrs	Ø [comment]
[label]	Ø TMBO	Ø bit	Ø [comment]

where "bit" and "adrs" are expressions that must be evaluated to specify a bit in memory to be tested. First, the value of the "bit" expression is divided by 16. The resulting quotient is added to the value of the "adrs" expression to form the memory word address, Y. The remainder becomes the B field and specifies the bit in word Y to be tested.

Example:

TMBO 4,TEST	→	(TEST) =	<u>Before</u>	<u>After</u>
		(PC) =	0800 ₁₆	No change
			2AEF ₁₆	2AF1 ₁₆

3.10.8 TEST MEMORY BIT FOR ZERO (TMBZ)

Machine Format:

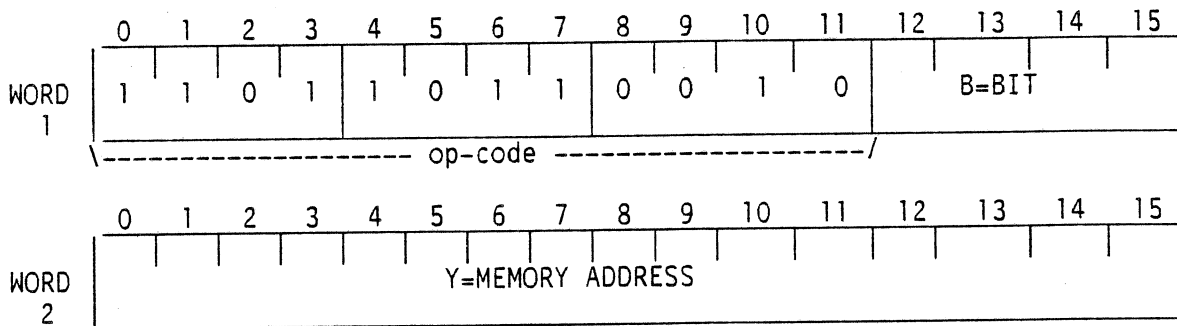

Instruction Execution: (Y)_{bit B} = 0; skip next word
(Y)_{bit B} = 1; execute next word

Description: If the bit, in memory location Y, specified by the B field is zero, skip the next word. If the bit is one, execute the next word.

Status Affected: None

Execution Time: (refer to Appendix A)

901181-385
MACHINE INSTRUCTIONS AND DECODING CONVENTIONS

Symbolic Coding: The assembly language coding formats for the TMBZ instruction are as follows:

NOTE

The FLAG directive in the second coding format is described in Section 4.

Label	Operation	Operand	Comment
[label]	Ø TMBZ	Ø bit adrs Ø	[comment]
or			
[label]	Ø FLAG	Ø adrs Ø	[comment]
[label]	Ø TMBZ	Ø bit Ø	[comment]

where "bit" and "adrs" are expressions that must be evaluated to specify a bit in memory to be tested. First, the value of the "bit" expression is divided by 16. The resulting quotient is added to the value of the "adrs" expression to form the memory word address, Y. The remainder becomes the B field and specifies the bit in word Y to be tested.

Example:

TMBZ 0,LOC	→		<u>Before</u>	<u>After</u>
		(LOC) =	808A ₁₆	No change
		(PC) =	077D ₁₆	077E ₁₆

3.11 MOVE INSTRUCTIONS

The move instructions listed in Table 3-1 are described in the following paragraphs.

3.11.1 MOVE CHARACTER STRING (MVC)

Machine Format:

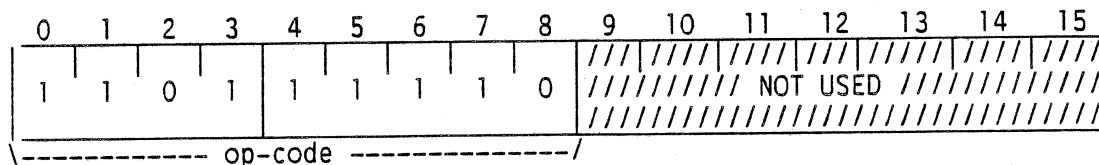

901181-385
MACHINE INSTRUCTIONS AND DECODING CONVENTIONS

Instruction Execution: $(M_1, M_2, \dots, M_n) \rightarrow (Y_1, Y_2, \dots, Y_n)$
where M_1, M_2, \dots, M_n and Y_1, Y_2, \dots, Y_n are byte strings in memory

Description: Move a string of consecutive bytes from one location in memory to a second location in memory. The starting addresses of the two memory locations (S1, B1 moved to S2, B2) and the number of bytes to be moved (BC) are established in general registers as described in paragraph 3.6.1. The content of byte address S1, B1 is moved to S2, B2, and then the two byte addresses are incremented. The byte move and address increment process is repeated until BC bytes have been moved in this manner.

CAUTION

If the displacement between S1, B1 and S2, B2 is less than the length of the byte string (BC) to be moved, and S1, B1 is less than S2, B2, the bytes from the source string (S1, B1) in the overlap addresses will be replaced before they are to be moved. In particular, if the move displacement is one byte, the first byte of the source string will be placed in all of the destination addresses.

Status Affected: None

Execution Time: (refer to Appendix A)

Symbolic Coding: The assembly language coding format for the MVC instruction is as follows:

Label [label]	Operation MVC	Operand	Comment [comment]
------------------	------------------	---------	----------------------

Example:

MVC	→	<u>Before (Hex)</u>	<u>After (Hex)</u>
		(A) = 0000	0000
		(E) = 0574	0577
		(M) = 0000	0000
		(S) = 06A6	06A9
		(X) = 0003	0000
		(02BA, 02BB) = 5123, 64AC	No change
		(0353, 0354) = F125, 0398	5123, 6498

901181-385
MACHINE INSTRUCTIONS AND DECODING CONVENTIONS

3.11.3 REGISTER MOVE (RMO)

Machine Format:

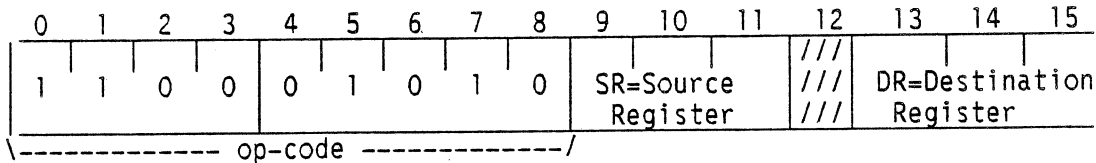

Instruction Execution: (SR)→(DR)

Description: Move the contents of the register specified by the SR field to the register specified by the DR field. The contents of the register specified by the SR field remain unchanged. If bit 12 of the machine format is set to one and bits 13 to 15 are zeroed, the status register is specified as the destination register. In this case the instruction is restricted, meaning it is considered illegal if the memory protect/privileged instruction feature is enabled. Interrupts other than internal, are inhibited for one instruction following this special case of the RMO instruction.

Status Affected: None

Execution Time: (refer to Appendix A)

Symbolic Coding: the assembly language coding format for the RMO instruction is as follows:

Label		Operation		Operand	Comment
[label]	Ø	RMO	Ø	sreg,dreg Ø	[comment]

where "sreg" and "dreg" are expressions that address the source and destination registers, respectively, in accordance with Table 2-2. The special case when "dreg" equals eight is covered in the "Description" paragraph

Example:

RMO 5,0					
	→	(A) =	<u>Before</u>	<u>After</u>	
		(L) =	0003 ₁₆	1C25 ₁₆	
			1C25 ₁₆	No change	

901181-385
MACHINE INSTRUCTIONS AND DECODING CONVENTIONS

3.12 INPUT/OUTPUT INSTRUCTIONS

The input/output instructions listed in Table 3-1 are described in the following paragraphs.

3.12.1 AUXILIARY PROCESSOR INITIATE (API)

NOTE

This instruction is not supported by the SPC9800 and will result in a no operation if execution is attempted. (The PC will be incremented a second time as though the instruction were a double word instruction.)

3.12.2 AUTOMATIC TRANSFER INSTRUCTION (ATI)

Machine Format:

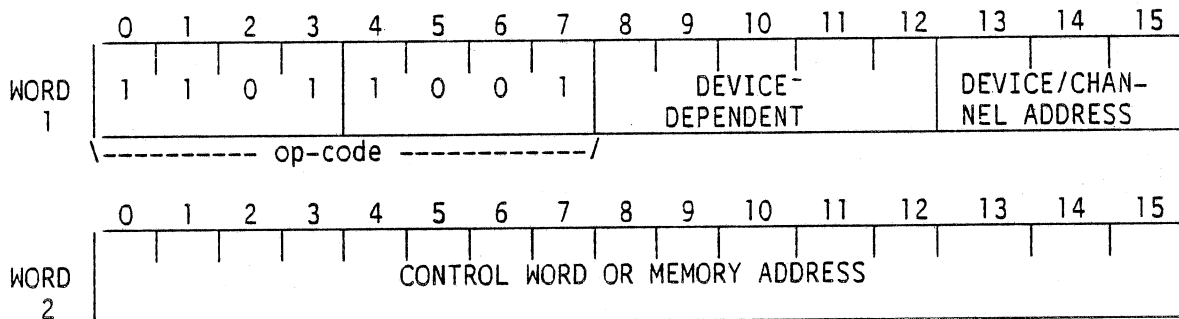

Instruction Execution:

External device data →Memory, or
Memory data →External device

Description: The ATI instruction is used to control the Direct Memory Access Channel (DMAC). The first word of the ATI instruction addresses one of eight possible device controllers (bits 13 to 15) and supplies any necessary device dependent data (bits 8 to 12). The second word of the ATI instruction is interpreted by the addressed device controller as a single word functional command or as an address pointing to a list in memory containing command related data. After the second word has been interpreted, the specified DMAC data transfer takes place. The ATI instruction is restricted, meaning it is considered illegal if the memory protect/privileged instruction feature is enabled.

901181-385
MACHINE INSTRUCTIONS AND DECODING CONVENTIONS

Status Affected: None

Execution Time: (refer to Appendix A)

Symbolic Coding: The assembly language coding format for the ATI instruction is as follows:

Label	Operation	Operand	Comment
[label]	ATI	dev	[comment]
[label]	DATA	adrs	[comment]

where "dev" is the symbolic name for the least significant eight bits of word one of the ATI instruction and "adrs" is the symbolic name of the 16-bit address comprising word two.

The following example reads sector zero, track zero from the floppy disk to memory location >200.

```

ATI      0
DATA    DCBK
DCBK    DATA  >800
        DATA  >20
        DATA  >200
    
```

3.12.3 READ DIRECT SINGLE (RDS)

Machine Format:

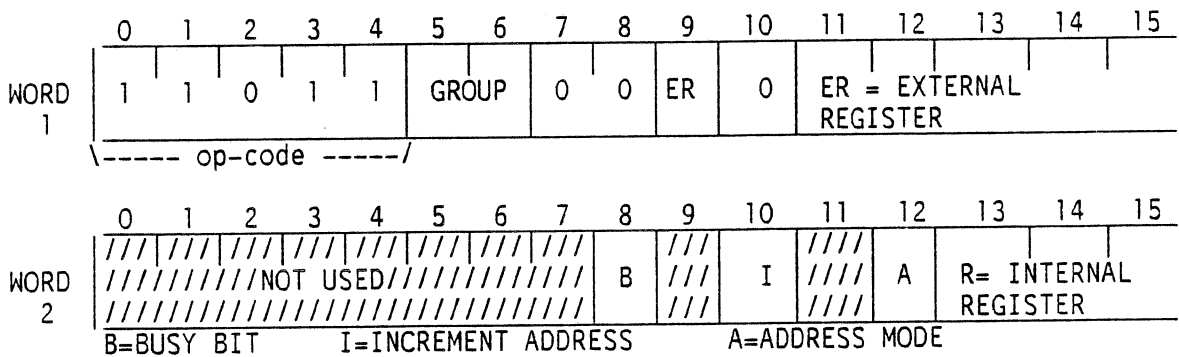

901181-385
MACHINE INSTRUCTIONS AND DECODING CONVENTIONS

Instruction Execution: External device data →(R) or ((R))

Description: The RDS instruction uses the input/output data bus to read one word of data from an external device to a register or memory location. The external device is specified by the GROUP and ER fields of word one of the RDS instruction. The GROUP field selects 1 of 4 groups and the ER field picks 1 of 64 external devices in the chosen group. This allows for a maximum of 256 data bus ports, however, in most cases GROUP zero is specified. The destination register or memory location is specified by the A and R fields of word two of the RDS instruction. The R field selects 1 of 8 registers in accordance with Table 2-2 and the A field is the associated indirect bit. If the A field is zero, the destination of the read is a register; if the A field is one, the destination of the read is the memory address contained in the selected register. If the A field is one, the I field bit in word two is set to a one or zero to increment or decrement, respectively, the memory address in the selected register each time the RDS instruction is executed. The B field is set to a one when the device addressed by the GROUP and ER fields may not be ready to transfer data when queried by the RDS instruction. If the B field bit is one and no data transfer takes place, the instruction following the RDS instruction is executed. If the B field bit is one and a successful data transfer takes place, the instruction following the RDS instruction is skipped. If the B field bit is zero, the instruction following the RDS instruction is unconditionally executed. The RDS instruction is considered illegal if the memory protect/privileged instruction feature is enabled.

Status Affected: None

Execution Time: (refer to Appendix A)

Symbolic Coding: The assembly language coding format for the RDS instruction is as follows:

Label		Operation		Operand		Comment
[label]	Ø	RDS	Ø	dev	Ø	[comment]
[label]	Ø	DATA	Ø	biar	Ø	[comment]

where "dev" is the symbolic name of a 16-bit number that is OR'ed with the RDS op-code to develop word one of the instruction. "biar" is the symbolic name of a 16-bit number that represents the B, I, A, and R fields of word two.

901181-385
MACHINE INSTRUCTIONS AND DECODING CONVENTIONS

Example: The following example reads a word from the device connected to external register 18₁₆ into register A. The busy bit option is also used.

```

RDS          >18
DATA        >80
    
```

3.12.4 WRITE DIRECT SINGLE (WDS)

Machine Format:

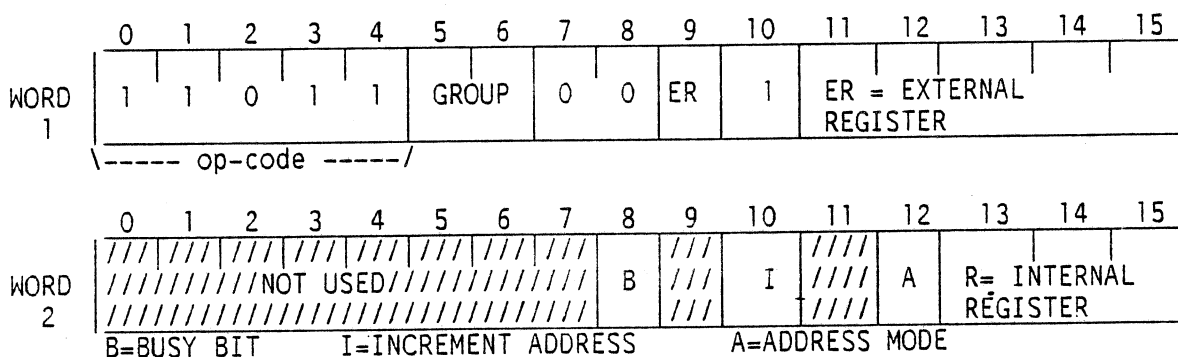

Instruction Execution: (R) or ((R)) → External device

Description: The WDS instruction uses the input/output data bus to write one word of data from a register or memory location to an external device. The source register or memory location is specified by the A and R fields of WDS word two and the destination device is specified by the GROUP and ER fields of WDS word one. These fields along with the B and I fields of WDS word two perform the same function as those described in paragraph 2.12.3 for the RDS instruction. The WDS instruction is restricted, meaning it is considered illegal if the memory protect/privileged instruction feature is enabled.

Status Affected: None

Execution Time: (refer to Appendix A)

901181-385
MACHINE INSTRUCTIONS AND DECODING CONVENTIONS

Symbolic Coding: The assembly language coding format for the WDS instruction is as follows:

Label	Operation	Operand	Comment
[label] ⅈ	WDS	ⅈ dev	ⅈ [comment]
[label] ⅈ	DATA	ⅈ biar	ⅈ [comment]

where "dev" is the symbolic name of a 16-bit number that is OR'ed with the WDS op-code to develop word one of the instruction. "biar" is the symbolic name of a 16-bit number that represents the B, I, A, and R fields of word two.

Example: The following example writes a word in register A to the external device connected to external register 10₁₆. The busy bit option is not used.

```

.
WDS            >10
DATA           >0
.

```

SECTION 4

ASSEMBLER CHARACTERISTICS AND DIRECTIVES

4.1 GENERAL

This section describes the Symbolic Assembly Program (SAPGFL) from the user point of view and the 22 assembler directives available to the assembly language programmer. The SAPGFL description covers source program coding fields, object program output, error messages that may accompany the assembly listing, and sample source programs and associated assembly listings. Operation of SAPGFL is covered in the SPC9800 System Users manual.

4.2 SYMBOLIC ASSEMBLY PROGRAM

SAPGFL is a general assembler that handles paper tape, card, floppy disk or cassette media. Figure 4-1 is a sample source main program, written in symbolic assembly language and ready to be prepared for input. Figure 4-2 is a source subroutine. Source programs input to SAPGFL generate two outputs. The first output is an object program that can be loaded into the computer and executed or linked with other object programs.

901181-385
ASSEMBLER CHARACTERISTICS AND DIRECTIVES

SYMBOLIC CODING FORM

	5	10	15	20	25	30	35	40	45
		HED	SPC9800		MAIN PROGRAM				
		IDT	ILLUS		6 CHARS. FOR OBJECT				
		ORG	1000		TELL SAP RUN-TIME				
		BRS	1000		ORIGIN				
BASE		DATA	1000						
		REF	SUB		EXT. REF. FOR LINKING				
START		LDA	BASE		ACTUALLY SET BASE				
		RMO	0,6		FOR EXECUTION				
		@BRL	SUB		ADD 2 NOS. TOGETHER				
		DATA	ADDR1		ADDR. OF FIRST NO.				
		DATA	ADDR2		ADDR. OF SECOND NO.				
		STA	ANSWER		ANSWER IN REG.A				
		.	.		MORE EXECUTABLE				
		.	.		INSTRUCTIONS AND				
		.	.		ASSEMBLER				
		.	.		DIRECTIVES.				
ADDR1		DATA	7		FIRST NO.				
ADDR2		DATA	8		SECOND NO.				
ANSWER		BSS	1						
		END	START						

FIGURE 4-1
SOURCE CODED MAIN PROGRAM

The object program can be output on cassette, floppy disk, or other media. The second output is an assembly listing as depicted in Figure 4-3 for the main program and Figure 4-4 for the subroutine. Note the following about the assembly listings:

The items listed under A are an exact reproduction of the handwritten entries on the coding sheet.

The items under B are a hexadecimal representation of the corresponding instructions and constants as assembled by the assembler.

The items under C show the hexadecimal addresses of the instructions, constants, and areas of storage specified by the programmer.

The items under D show the decimal line or sequence number of the source statements to be used in case the program is changed.

SAPGFL is a two-pass assembler, meaning it scans the source program twice. During the first pass, the source program is read and a symbol table is generated. This is accomplished with the use of a location counter in the assembler. The location counter keeps track of the storage locations that will be

901181-385
ASSEMBLER CHARACTERISTICS AND DIRECTIVES

required by the object program. When a source statement contains a name, the current setting of the location counter is assigned to the name. Each name and the address assigned to it is placed in the assembler's symbol table. During the second pass, the symbol table is used to complete the assembly, and to produce the object with its assembly listing. If bulk storage is available, the assembler will copy the source to bulk storage during pass one. Since the output from the first pass is used as input data for the second pass, this eliminates the requirement to manually enter the source data twice. The assembler automatically repositions the cassette or diskette source file before entering pass 2 to eliminate any manual repositioning.

SYMBOLIC CODING FORM

	5	10	15	20	25	30	35	40	45
		IDT	SUB		6	CHARS.	FOR	OBJECT	
		DEF	SUB		DEFINE	ENTRY	POINT	FOR	
A		EQU	0		LINKING				
L		EQU	5		GIVE	REGISTERS	SYMBOLIC		
P		EQU	7		NAMES.				
POINT		BSS	2		RESERVE	LOCATIONS			
HERE		BSS	2						
SUB		RMO	L,A		L	POINTS	TO-FIRST	DATA	
		STA	POINT		WORD	AFTER	@BRL		
		RIN	A,A		POINTER	TO	SECOND	DATA	
		STA	POINT+1		WORD	AFTER	@BRL		
		LDA	*POINT		GET	ADDR1			
		STA	HERE		STORE	ADDRESS	IN	THIS	
		LDA	*POINT+1		SUBROUTINE				
		STA	HERE+1		GET	AND	SAVE	ADDR2	
		LDA	*HERE		PICK	UP	FIRST	NO.	
		ADD	*HERE+1		ADD	SECOND	NO.		
		RIN	L,L		MOVE	POINTER	PAST	DATA	
		RIN	L,P		WORDS	AND	RETURN		
		END	SUB						

FIGURE 4-2
SOURCE CODED SUBROUTINE

901181-385
ASSEMBLER CHARACTERISTICS AND DIRECTIVES

2	C	B	D	A		
	SPC9800		MAIN	PROGRAM		SHEET 0001
			0001	HED	SPC9800 MAIN PROGRAM	
			0002	IDT	ILLUS 6 CHARS. FOR OBJECT	
	03E8		0003	ORG	1000	TELL SAP RUN-TIME
		03E8	0004	BRS	1000	ORIGIN AND BASE
	03E8	03E8	0005	BASE	DATA	1000
			0006	REF	SUB	EXT.REF.FOR LINKING
	03E9	00FE	0007	START	LDA	BASE
	03EA	C506	0008		RMO	0,6
	03EB	7400	0009	@BRL	SUB	ADD 2 NOS. TOGETHER
			0000			
X	03EC	0000				
	03ED	03F0	0010	DATA	ADDR1	ADDR.OF FIRST NO.
	03EE	03F1	0011	DATA	ADDR2	ADDR.OF SECOND NO.
	03EF	8002	0012	STA	ANSWER	ANSWER IN REG.A
			0013	.	.	MORE EXECUTABLE
			0014	.	.	INSTRUCTIONS AND
			0015	.	.	ASSEMBLER
			0016	.	.	DIRECTIVES.
	03F0	0007	0017	ADDR1	DATA	7
	03F1	0008	0018	ADDR2	DATA	8
	03F2		0019	ANSWER	BSS	1
			0020		REF	SUB1
		0001	0021	SUB2	DATA	SUB1
X	03F3	0000				
		0000	0022	WORD	COMM	6
		0000	0023		DATA	WORD+2
C	03F4	0002				
		03E9	0024	END	START	
COMMON		0006				

SPC9800 MAIN PROGRAM

Symbol	ADDR1	03F0	ADDR2	03F1	ANSWER	03F2	BASE	03E8	SHEET 0002
Table	START	03E9	SUB	0000	SUB1	0001	R SUB2	03F3	
	WORD	0000							

0000 ERRORS

NOTES

1. In the left column, P=Program counter relocatable
X=External reference
C=Common (to programs)
2. In the symbol table, R=Unreferenced symbol
U=Undefined (error)
M=Multidefined
Q=Multidefined unreferenced
3. A,B,C, and D references at top of page are explained in Paragraph 4.2

FIGURE 4-3
ASSEMBLED MAIN PROGRAM

901181-385
ASSEMBLER CHARACTERISTICS AND DIRECTIVES

	C	B	D		A		
						SHEET 1	
			0001		IDT	SUB	6 CHARS.FOR OBJECT
			0002		DEF	SUB	DEFINE ENTRY POINT FOR
		0000	0003	A	EQU	0	LINKING
		0005	0004	L	EQU	5	GIVE REGISTERS SYMBOLIC
		0007	0005	P	EQU	7	NAMES
P	0000		0006	POINT	BSS	2	RESERVE LOCATIONS.
P	0002		0007	HERE	BSS	2	
	0004	C550	0008	SUB	RMO	L,A	L POINTS TO FIRST DATA
	0005	80FA	0009		STA	POINT	WORD AFTER @BRL
	0006	C300	0010		RIN	A,A	POINTER TO SECOND DATA
	0007	80F9	0011		STA	POINT+1	WORD AFTER @BRL
	0008	04F7	0012		LDA	*POINT	GET ADDR1
	0009	80F8	0013		STA	HERE	STORE ADDRESS IN THIS
	000A	04F6	0014		LDA	*POINT+1	SUBROUTINE
	000B	80F7	0015		STA	HERE+1	GET AND SAVE ADDR2
	000C	04F5	0016		LDA	*HERE	PICK UP FIRST NO.
	000D	24F5	0017		ADD	*HERE+1	ADD SECOND NO.
	000E	C355	0018		RIN	L,L	MOVE POINTER PAST DATA
	000F	C357	0019		RIN	L,P	WORDS AND RETURN.
			0020		END	SUB	

SHEET 0002

Symbol	A	0000	HERE	0002	L	0005	P	0007
Table	POINT	0000	SUB	0004				
		0000						ERRORS

NOTE

Refer to NOTES in Figure 4-3.

FIGURE 4-4
ASSEMBLED SUBROUTINE

901181-385
ASSEMBLER CHARACTERISTICS AND DIRECTIVES

4.2.1 ASSEMBLER CODING LINE FORMAT

The symbolic input line accepted by the assembler may contain a label field, operation field, operand field, and a comment field; or the entire line may be a comment. An input line is the first 64 characters read from a card or a floppy disk file, or in the case of cassette or paper tape, an input line is a string of characters terminated with a special end-of-line sequence. The end-of-line sequence for cassette consists of a carriage return (CR), line feed (LF), X-OFF (press the CTRL and S keys at the same time), and rub out. The input line may exceed 64 characters, not including the end-of-line characters in the cassette and paper tape case, but only 64 characters are processed and only 59 are printed on the listing to the right of the line number. The input line is free form within the limits listed in the following paragraphs.

4.2.1.1 COMMENT LINES

Comment lines provide the user with the ability to annotate program listings. They are indicated by an initial character which is either a period (.) or an asterisk (*). The remaining characters are arbitrary. The comment line in no way affects the assembly process. The line is merely reproduced in the printed output.

4.2.1.2 LABEL FIELD

Labels (also called symbols or names) are provided for symbolic references to instructions, values, and data. A label is composed of from one to six characters. The first character of a label must be a letter. The remaining may be any characters EXCEPT the following:

+Plus	*Asterisk	(Left Paren.	>Greater Than
-Minus	/Slash)Right Paren.	,Comma

If a label is used, the first character must begin the input line. The label is terminated by the first space.

At assembly time, the labels are stored as variable length data. One or two character labels require one word of memory, three or four character labels take two words, an five or six characters require three words. Therefore, if the symbol overflow error occurs during assembly, labels should be shortened or omitted.

4.2.1.3 OPERATION FIELD

The operation field describes the required action. It may be an instruction mnemonic or an assembler directive. The field consists of from one to four characters followed by a space or the end-of-line characters. The first character of the operation field must be preceded by at least one space.

901181-385
ASSEMBLER CHARACTERISTICS AND DIRECTIVES

4.2.1.4 OPERAND FIELD

The operand field consists of a sequence of expressions separated by commas, and is terminated by a space or the end-of-line characters.

exp₁, exp₂, exp₃

If two commas appear successively, the value of the missing expression is understood to be zero. If the currency symbol (\$) appears as an element in an expression, the current value of the assembler's location counter is used as its numeric equivalent.

Expressions may be strings of items separated by arithmetic operators and terminated by a space, comma, or end-of-line characters. The arithmetic operators are:

Addition	+
Subtraction	-
Multiplication	*
Division	/

If two operators appear in succession, a zero item is assumed.

An item consists of a symbolic address, dollar sign (\$), or a numeric value. If the first character of an item is not numeric, \$, or >, it is assumed to be symbolic. Numeric items may be octal, decimal, or hexadecimal. An octal item is a string of octal characters (0 to 7), the first of which is zero. A decimal item is a string of numeric characters (0 to 9), the first of which is non-zero. Hexadecimal item is a greater than symbol (>) followed by a string of hexadecimal digits (0 to 9 and A to F). When using paper tape input, the back slash (\) may be used in place of > to indicate hexadecimal.

Expressions are evaluated left to right using normal arithmetic precedence; i.e., all multiplications and divisions are performed first in order of occurrence followed by additions and subtractions performed in order of occurrence. All quantities are treated as integers. In division only the quotient is retained and any remainder is discarded. Division by zero is performed as division by one and is not considered as an error. Sample expressions are:

```
JOE+TOM*3/BOB
$+5
LEA-6
5034
XYZ+>F4
```

901181-385
ASSEMBLER CHARACTERISTICS AND DIRECTIVES

NOTE

All expressions are acceptable in absolute assemblies, but multiplication and division involving labels is not allowed in relocatable assemblies. Hence, the first sample would cause a relocation error in a relocatable program.

4.2.1.5 COMMENT FIELD

Comments may optionally be written on any line. Any characters that appear between the space that terminates the operand field and the end-of-line characters or card column 64 are treated as commentary. The comment field has no effect on the assembly process.

4.2.2 SEGMENTED SOURCE PROGRAMS

The assembler provides the capability of storing a single source program on more than one physical section of the storage medium, enabling long programs to be conveniently stored on cassette or paper tape. (Segmenting cannot be done to disc files.) To segment a source program, divide it and add the flag record (=) as follows:

```
*   first line of program
      :
      :                               first segment
      :
*   last line of first segment
=
/*

*   first line of next segment
=   immediately follows last line
*   of preceding segment
      :                               intermediate segment
      :
      :
=
/*
```

901181-385
ASSEMBLER CHARACTERISTICS AND DIRECTIVES

TABLE 4-1
ASSEMBLER ERROR MESSAGES

MESSAGE NUMBER	MESSAGE	MEANING (AND CORRECTIVE ACTION)
1	FIELD SZ	Address beyond reach (use @ for extended format)
2	UNDF OP	Undefined operation code (check list of valid of codes)
3	LONG SYM	Symbol > 6 characters
4	MDF O/F	OPD or FRM multiply defined (rename label)
5	FRM > 16	FRM fields contain more than 16 bits
6	CAD > 10	Address expression has > 10 elements
7	UNDF SYM	Symbol not defined (label probably omitted)
8	MDF SYM	Symbol multiply defined (rename labels)
9	RELOC	A relocation error (use only one relocatable label in arithmetic expression, or ORG statement can use only one relocatable label)
10	SYM OVF	Too many symbols have been defined (cut out symbols or divide program)
11	BAD NUM	Numeric element not valid (properly define item in label or address field)
12	IMP R/D	A REF or DEF symbol has been used improperly (REF symbol defined inside and outside the program, DEF symbol not defined in the program)
13	X RF USE	A REF symbol has appeared invalidly in an unrelocatable expression
14	IXB ERR	Address mode error (improper use of IXB field)
15	OPD ERR	No such format number (OPD format numbers 0 to 8)
16	ADR MODE	Illegal addressing mode (improperly written address)

901181-385
ASSEMBLER CHARACTERISTICS AND DIRECTIVES

TABLE 4-2
ASSEMBLER DIRECTIVES

DIRECTIVE MNEMONIC	DESCRIPTION	PARAGRAPH NO.
BES	Block Ending Symbol	4.3.1
BRR	Base Register Reset	4.3.2
BRS	Base Register Set	4.3.3
BSS	Block Starting Symbol	4.3.4
BYTE	Generate Byte Address	4.3.5
COMM	Common Storage	4.3.6
COML	Labeled Common Name	4.3.6
DATA	Generate Word Address or Data	4.3.7
DEF	Define Entry Point Symbol	4.3.8
END	End of Source	4.3.9
EQU	Equate	4.3.10
FLAG	Flag Bit Address	4.3.11
FRM	Format a New Instruction	4.3.12
HED	Page Heading	4.3.13
IDT	Object Identifier	4.3.14
IF	Conditional Assembly	4.3.15
LIS	Start Listing	4.3.16
OPD	Operation Define	4.3.17
ORG	Origin	4.3.18
PEJ	Page Eject	4.3.19
REF	Referenced External Symbols	4.3.20
UNL	Stop Listing	4.3.21

901181-385
ASSEMBLER CHARACTERISTICS AND DIRECTIVES

4.3.1 BLOCK ENDING SYMBOL (BES)

The BES directive evaluates the operand field and advances the location counter by that amount. If a label is present, it is assigned to the new value of the location counter. BES is similar to BSS, except the label is applied to the first location past the reserved area. The assembly language coding format for the BES directive is as follows:

Label		Operation		Operand		Comment
[label]	⌀	BES	⌀	exp	⌀	[comment]

where "exp" is typically a decimal number specifying the reserved area in words. If "exp" involves a symbol, it must be previously defined as an absolute quantity.

The following example reserves 50 words with TEN associated with the first word following the reserved area.

Label		Operation		Operand
TEN		BES		50

4.3.2 BASE REGISTER RESET (BRR)

The BRR directive informs the assembler that the base register is not available to the assembler for addressing purposes. The programmer can still specify base register addressing with the mode field. The BRR directive informs the assembler to use the base register for addressing purposes only in the event the mode field specifies that type of addressing. (This is the initial condition of assembly.) Under BRR directive control, if D is the unsigned displacement in register-memory instructions, then $0 \leq D \leq 255$ when the mode field contains B=1, or else a field size error occurs. The assembly language coding format for the BRR directive is as follows:

Label		Operation		Operand		Comment
[label]	⌀	BRR	⌀			[comment]

901181-385
ASSEMBLER CHARACTERISTICS AND DIRECTIVES

4.3.3 BASE REGISTER SET (BRS)

The BRS directive informs the assembler of the value the base register will contain at run time. The operand field of the BRS directive defines a 16-bit value that will be placed in the B register by the programmer. When the BRS is used and the assembler encounters subsequent register-memory format instructions that would produce field size errors if program counter relative, the assembler will attempt to generate these base register relative. In this case, if D is an unsigned 16-bit evaluation of the displacement expression and B is the value assembled in the base register, then $0 \leq D-B \leq 255$ or else a field size error occurs. The assembly language coding format for the BRS directive is as follows:

Label	Operation	Operand	Comment
[label]	Ø BRS	Ø exp Ø	[comment]

where "exp" is the symbol for a 16-bit base value to be used. An example of BRS usage follows:

Label	Operation	Operand	Comment
	BRS	CAT	DEFINE BASE VALUE TO ASSEMBLER
	.		
	.		
	@LDA	=CAT	PUT ADDRESS OF CAT IN BASE REGISTER
	RMO	A,B	
	.		
	.		
CAT	BES	350	CAT IS DEFINED OUT OF PROGRAM COUNTER REL. RANGE
	BSS	10	

901181-385
ASSEMBLER CHARACTERISTICS AND DIRECTIVES

4.3.4 BLOCK STARTING SYMBOL (BSS)

The BSS directive reserves an area of memory. The first location in the reserved area is associated with the label in the name field of the BSS directive. The location of the area reserved is that defined by the location counter, which is then advanced past the reserved area. The no object code is generated by the BSS directive. If the programmer desires some value(s) to be assembled in the reserved area, he must do so by other means. The assembly language coding format for the BSS directive is as follows:

Label	Operation	Operand	Comment
[label]	Ø BSS	Ø exp Ø	[comment]

where "exp" is typically a decimal number specifying the reserved area in words. If "exp" involves a symbol, it must be previously defined as an absolute quantity. An example of the BSS directive follows:

Location Counter	Label	Operation	Operand	Comments
03AA		BRU	TOM	BRANCH AROUND AREA
03AB	AREA	BSS	40	RESERVE AREA
03D3	TOM	LDA	AREA	REFERENCE AREA

A common usage of symbols in a BSS operand is an expression which defines the length of a reserved area. In the following example, if the length of TABA is likely to change, but TABB must always be the same length as TABA, it may be symbolically stated as follows:

Label	Operation	Operand	Comment
TABA	BSS	50	MIGHT CHANGE
TABB	BSS	TABB-TABA	ALWAYS SAME AS TABA

901181-385
ASSEMBLER CHARACTERISTICS AND DIRECTIVES

4.3.5 GENERATE BYTE ADDRESS (BYTE)

When using the byte string manipulation instructions, MVC and CLC, it is necessary to address data using byte rather than word addresses. The BYTE directive may be used to generate these byte addresses. Its usage is similar to that of the DATA directive when generating word addresses. The assembly language coding format for the BYTE directive is as follows:

Label	Operation	Operand	Comment
[label]	Ø	BYTE	Ø exp ¹ ,exp ² ,...exp ⁿ Ø [comment]

where "exp₁, exp₂,...exp_n" are evaluated and assigned to successive pairs of memory words. If a label is used, it is assigned to the first word of the first byte address.

Each byte address requires two words in the following format:

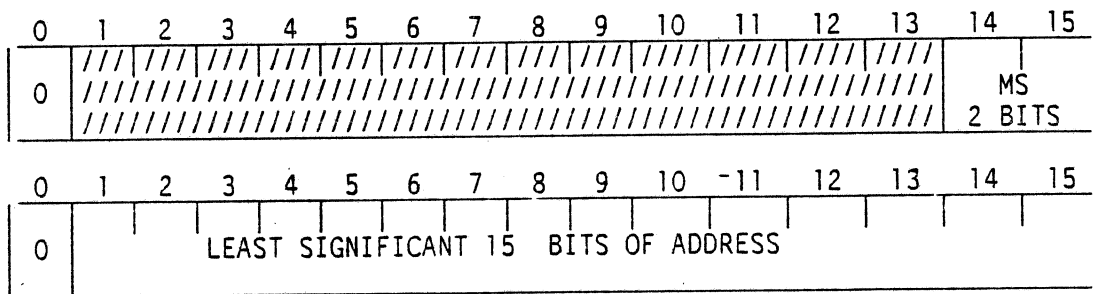

An expression in a BYTE operand field is evaluated as a word address and then multiplied by two to obtain the byte address. If the expression is preceded by a colon(:), the byte address is also incremented by one. The assembly listing in Figure 4-5 shows the BYTE evaluation process.

4.3.6 REFERENCING COMMON STORAGE

4.3.6.1 NAMED COMMON LABEL (COML)

The COML directive is used to start a new labeled common block. The label field must be used and gives the name of the new block. Storage reservation (given by the COMM directive) is started at zero for the new common block; all COMM directives following any given COML directive, up to the next COML directive, cause storage to be reserved in that common block. The assembler generates no entry in the common table if no COMM directives appear for a COML directive. Every assembly begins with an implicit COML directive in effect giving the name of FORTRAN blank common, 'ØBLANK', and the occurrence of the END directive automatically terminates the immediately preceding COML block. The length of a COML block is determined by the sum of the sizes given on all COMM directives appearing under that COML

901181-385
ASSEMBLER CHARACTERISTICS AND DIRECTIVES

directive. See paragraph 4.3.7 for examples. The assembly language coding format for the COML directive is as follows:

```
label      ␣      COML      ␣      comment
```

NOTE

COML is supported in revisions *E and later of
SAPG, part number 943253.

4.3.6.2 RESERVE COMMON STORAGE (COMM)

The COMM directive reserves the given number of words in the currently active common block. If a label appears, it is assigned a value corresponding to the first word of the block, relative to the beginning of the currently active block. The assembly language coding format for the COMM directive is as follows:

```
[label]    ␣      COMM      ␣      exp      ␣      [comment]
```

Several examples of the use of COML and COMM follow. In all cases, assume that there are no COML and COMM directives in the program besides those explicitly given.

Example 1: referencing FORTRAN blank common.

```
      .  
      .  
      .  
X     COMM    30  
Y     COMM    10  
J     COMM     1  
      .  
      .  
      .  
      END
```

Blank common is 41 words long, and it is the only common block present.
Example 2: referencing labeled common only.

```
      .  
      .  
      .  
COM1  COML    30  
X     COMM     2  
J     COMM     1  
      .  
      .  
      .  
      END
```

901181-385
ASSEMBLER CHARACTERISTICS AND DIRECTIVES

Location	Code	Line	Label	Operation	Operand
	00FF	C8C9	0013	DATA	'HI'
P 0100	0107	0014	THERE	DATA	HERE+2, THERE-6, >100, 100, 0100
P 0101	00FA				
	0102	0100			
	0103	0064			
	0104	0040			
P 0105	0105	0015	HERE	DATA	HERE, THERE, >100+104, THERE-HERE
P 0106	0100				
	0107	0168			
	0108	FFFB			
P 0109	0000	0016	HERE1	BYTE	HERE1
	010A	0212			
P 010B	0000	0017		BYTE	:HERE1
	010C	0213			
P 010D	0000	0018		BYTE	:HERE+6
	010E	0217			
P 010F	0000	0019		BYTE	HERE1, :HERE1, :HERE1+6, >100
	0110	0212			
P 0111	0000				
	0112	0213			
P 0113	0000				
	0114	021F			
	0115	0000			
	0116	0200			
	0117	0000	0020	BYTE	>100+>104, THERE-HERE
	0118	0408			
	0119	FFFF			
	011A	FFF6			
P 011B	0000	0021		BYTE	HERE+2, THERE-6, :>100, 100, :0100
	011C	020E			
P 011D	0000				
	011E	01F4			
	011F	0000			
	0120	0201			
	0121	0000			
	0122	00C8			
	0123	0000			
	0124	0081			

FIGURE 4-5
EXAMPLE OF BYTE AND DATA USAGE

901181-385
ASSEMBLER CHARACTERISTICS AND DIRECTIVES

Common block COM1 is 32 words long, and the name 'COM1' is defined for the linking loader. Note that since no COMM entries occurred prior to the COM1 COML statement, blank common has length zero and hence is not entered.

Example 3: Referencing blank and labeled common.

```

      .
      .
A     COMM    20    in blank common
B     COMM    10    in blank common
      .
      .
X     COMM                                blank common is terminated at 30 words, and a new
      .                                common block started, named X.
      .
C     COMM     5    in block X
      .
      .
D     COMM     7    in block X
      .
      .
Y     COML                                block X is 12 words long, and a new block started,
      .                                named Y.
      .
      .
END                                block Y has no COMM directives in it, so has length 0.
      .                                This is most likely an inadvertent error, but must
      .                                be detected by noticing that Y fails to appear in the
      .                                common summary.
```

A common name may appear in an address field, and will address the first word of the common block. However, it may be used in this way only after at least one COMM directive has appeared in it.

901181-385
ASSEMBLER CHARACTERISTICS AND DIRECTIVES

COMM is used in a manner similar to FORTRAN COMMON. If a FORTRAN program and assembly language program are merged via link edit, any references in the FORTRAN program to labeled COMMON and references in the assembly language program to COMM defined storage are references to the same area of memory. In many applications this simplifies communications between the two programs. The following COMM directive would be used by a program requiring use of 12 words of common storage referenced as WORD.

Label	Operation	Operand
WORD	COMM	12

4.3.7 GENERATE WORD ADDRESS OR DATA (DATA)

The DATA directive is used for data generation. The assembly language coding format for the DATA directive is as follows:

Label	Operation	Operand	Comment
[label]	DATA	exp ¹ ,exp ² ,...exp ⁿ	[comment]

where "exp₁,exp₂,...exp_n" are expressions or strings that are evaluated and assigned to successive memory locations.

The DATA statement is used to define alphanumeric strings using the following format:

Label	Operation	Operand
CAT	DATA	'STRING'

STRING is a string of characters enclosed in single quotes. The string will be produced in ASCII code, two characters per word, packed left to right. If there is an odd number of characters in the string, the last word contains a delete code in the last character position. If a label is used, it is assigned to the first memory location involved. Figure 4-5 contains examples of several types of operands that may be used in a DATA statement.

4.3.8 DEFINE ENTRY POINT SYMBOL (DEF)

The program-linking assembler directives DEF and REF allow the programmer to symbolically link independently assembled programs that are to be loaded and executed together. Symbolic linkages between programs are created by means of symbols defined in one program and used as operands in another program. Such symbols are termed linkage symbols. A linkage symbol is called a defined entry point symbol in the program in which it is defined; it is a referenced external symbol in the program in which it is used as an operand. Every linkage symbol must be properly identified as such in the source program. A linkage symbol used as an external symbol is identified in each using program by the REF directive. A linkage symbol used as an

901181-385
ASSEMBLER CHARACTERISTICS AND DIRECTIVES

entry point must be identified in the defining program by the DEF directive. The assembly language coding format for the DEF directive is as follows:

Label	Operation	Operand	Comment
[label] ⌀	DEF ⌀	sym ¹ ,sym ² ,...sym ⁿ ⌀	[comment]

where "sym₁, sym₂, ...sym_n" are symbols defined elsewhere in the program that may be used as entry points by other programs. A referenced symbol that is not defined in the program is flagged in the listing as an error.

In the following sequence, SQRT is identified as an entry-point symbol.

Label	Operation	Operand	Comment
SUBRO	BSS	10	
	DEF	SQRT	
	.		
	.		
SQRT	STA	SAVE	

4.3.9 END OF SOURCE (END)

The END directive terminates the assembly of a program. It also supplies a point in the program to which control is transferred after the program is loaded. The END directive must always be the last statement in the source program. The assembly language coding format for the END directive is as follows:

Label	Operation	Operand	Comment
[label] ⌀	END ⌀	[exp] ⌀	[comment]

where "exp" specifies the point to which control is transferred when loading is complete. If the operand field is invalid, the statement is flagged as a possible error. If the operand field is blank, no program entry address is defined.

901181-385
ASSEMBLER CHARACTERISTICS AND DIRECTIVES

The point to which control usually is transferred is the first instruction in the program, as shown in the following sequence:

Location Counter	Label	Operation	Operand
		ORG	>2000
2000	AREA	BSS	50
2032	BEGIN	LDA	=3
		.	
		.	
		END	BEGIN

Here control will be transferred to BEGIN at location 2032₁₆. If the operand field were blank, control would be transferred to location 000₁₆, a point outside of this program. When several object programs are joined by link editing, one is specified as the main program. Its transfer point is taken as the transfer point for the link edited program.

4.3.10 EQUATE (EQU)

The EQU directive is used to define a symbol in the label field by assigning to it the value of an expression in the operand field. The assembly language coding format for the EQU directive is as follows:

Label	Operation	Operand	Comment
sym	Ø	EQU	Ø exp Ø [comment]

where "sym" in the label field is given the same value as "exp" in the operand field. The expression in the operand field can be relocatable or absolute, and the symbol is similarly defined. Any symbols in the expression must be previously defined.

If the expression in the operand field or the symbol in the label field, or both, are invalid, or are not present, the EQU statement is flagged as an error in the listing and is not used. The EQU directive is the usual way of equating symbols to register numbers, input/output unit numbers, immediate data, actual addresses, and other arbitrary values. The examples below illustrate how this might be done:

Label	Operation	Operand	Comment
REGX	EQU	2	REGISTER X
I0125	EQU	125	INPUT/OUTPUT DATA
TEST	EQU	>3F	IMMEDIATE DATA
TIMER	EQU	80	ACTUAL ADDRESS

901181-385
ASSEMBLER CHARACTERISTICS AND DIRECTIVES

To reduce programming time, the programmer can equate symbols to frequently used compound expressions and then use the symbols as operands in place of the expressions. Thus in the statement:

Label	Operation	Operand
FIELD	EQU	ALPHA-BETA+GAMMA

FIELD is defined as ALPHA-BETA+GAMMA and may be used in place of it. Note, however, that ALPHA, BETA, and GAMMA must all be previously defined and only one may be a relocatable value. FIELD can be used anywhere in the program.

4.3.11 FLAG BIT ADDRESS (FLAG)

The FLAG directive is used by the assembler to specify a relative starting address for memory bit-referencing instructions (SMBO, SMBZ, TMBO, and TMBZ). The FLAG directive may be used at any time, but until it is used, the starting memory address for the memory bit-referencing instructions is 0000₁₆. The assembly language coding format for the FLAG directive is as follows:

Label	Operation	Operand	Comment
[label] ⌀	FLAG ⌀	exp ⌀	[comment]

where "exp" is an expression that evaluates as the 16-bit memory word address used in conjunction with memory bit-referencing instructions.

The following example zeros bit 5 of location ABC with the use of the FLAG directive.

```
FLAG    ABC
SMBZ    5
```

4.3.12 FORMAT A NEW INSTRUCTION (FRM)

The FRM directive is used to create an instruction. The label field of the FRM directive is referenced as an op-code and the operand field of the FRM directive breaks the created instruction down into fields. The assembly language coding format for the FRM directive is as follows:

Label	Operation	Operand	Comment
label ⌀	FRM ⌀	exp ₁ , exp ₂ , ... exp _n ⌀	[comment]

where "label" is the expression representing the op-code (must be one to four characters) and "exp₁, exp₂, ... exp_n" are expressions for positive values whose sum is 16.

901181-385
ASSEMBLER CHARACTERISTICS AND DIRECTIVES

When the label is used as an op-code, n fields of the associated operand field are evaluated, truncated to the length specified by the corresponding exp in the FRM directive, and placed in the output word. The following example illustrates use of the FRM directive.

	Label	Operation	Operand
0010	ABC	FRM	5,5,6
		.	
		.	
1000 F846 0020		ABC	>1F,1,6

In the first line of this example, ABC is defined to have three fields of 5, 5, and 6 bits, respectively. When ABC is subsequently used as an operation code, the assembler puts 1F₁₆ in the first 5 bits, 1 in the next 5 bits, and 6 in the last 6 bits of the instruction. Thus, the second line in his example shows the assembled instruction 1111 1000 0100 0110₂, or F846₁₆.

4.3.13 PAGE HEADING (HED)

The remaining characters in the line containing the HED directive are printed as page headings on the output listing. The first HED is used as the heading of all pages up to and including the page containing the second HED. Subsequent HED directives appear as page headings on the first page following the one on which the HED appears, and subsequent pages, until another HED is encountered. The assembly language coding format for the HED directive is as follows:

Label		Operation		Comment
[label]	Ø	HED	Ø	comment

The program in Figure 4-3 makes use of the HED directive.

4.3.14 OBJECT IDENTIFIER (IDT)

The IDT directive reproduces the symbol appearing in the operand field as the program name in the object program. Names less than six characters have trailing blanks. If the name has more than six characters, the output will be truncated, and the name will consist of the first six characters. If the IDT directive is not present, the name will consist of six asterisks. The assembly language coding format for the IDT directive is as follows:

Label		Operation		Operand		Comment
[label]	Ø	IDT	Ø	sym	Ø	[comment]

where "sym" is the symbol for the program name.

901181-385
ASSEMBLER CHARACTERISTICS AND DIRECTIVES

4.3.15 CONDITIONAL ASSEMBLY (IF)

The IF directive alters the assembly process in accordance with the results of a conditional test. The operand field of the IF directive consists of two expressions and an optional symbol. The two expressions are evaluated and compared. If they are not equal, the assembly process continues with the next line. If the values are equal, the assembly process is suspended under the influence of the optional symbol. If the symbol is not present, assembly is suspended for one line. If the symbol is present, assembly is suspended until the input line with the same symbol in its label field is found.

All lines suspended from the assembly process are treated as comments; i.e., they are printed but no code is generated. Two or more IF statements may have overlapping ranges. This directive allows assembly-time modification of a program.

NOTE

Mathematical expressions cannot be used in the third (optional symbol) field of the operand.

The assembly language coding format for the IF directive is as follows:

Label	Operation	Operand	Comment
[label]	Ø	IF Ø	exp ₁ ,exp ₂ ,[sym] Ø [comment]

where "exp₁, exp₂" are the two expressions to be evaluated and compared and "sym" is the optional symbol.

The following example illustrates usage of the IF directive.

Label	Operation	Operand	Comment
TTYVAL	EQU	2	TEST ASSUMES ONE DATA TERMINAL AT STANDARD ADDRESS
ASR	EQU	2	TTY1-ASSUMED ASR AT STANDARD ADDRESS
TIP	EQU	3	TTY2-ASSUMED TIP AT STANDARD ADDRESS
TYPE1	CRA	3	ROTATE 50 CHARS PRINT OK
	IF	TTYVAL,ASR	IF TTYVAL=2, REF DATA TERM 2
	WDS	TIP	
	IF	TTYVAL,TIP	IF TTYVAL=1, REF DATA TERM 1
	WDS	ASR	
	DATA	BIT8ON	
	BRU	\$-2	

901181-385
ASSEMBLER CHARACTERISTICS AND DIRECTIVES

4.3.16 START LISTING (LIS)

The LIS directive initiates printing of the assembly listing. Printing continues until the UNL directive is encountered. If a complete assembly listing is desired, no LIS directive is required. The assembly language coding format for the LIS directive is as follows:

Label	Operation	Comment
[label] ⌀	LIS ⌀	[comment]

4.3.17 OPERATION DEFINE (OPD)

The OPD directive is used to define an operation code. The label field of the OPD directive is referenced as the defined op-code mnemonic and the operand field of the OPD directive establishes the op-code bit settings and format type of the defined op-code. The first item in the operand field is evaluated as a 16-bit number and stored as the op-code. The second item in the operand field indicates the format type for the defined instruction. When the label in the name field of the OPD directive appears as an op-code mnemonic, the accompanying operand field is OR'ed in with the defined op-code bit settings in accordance with the defined format type to assemble the instruction in the object program. Any op-code defined with the OPD directive takes precedence over the standard symbolic op-code. The assembly language coding format for the OPD directive is as follows:

Label	Operation	Operand	Comment
label ⌀	OPD ⌀	bits,n ⌀	[comment]

where "bits" is the hexadecimal representation of the defined op-code, "label" is the expression for the defined op-code mnemonic (must be one to four characters), and "n" defines the format type as follows:

- SPACE - Register-Memory \
- 0 - Register-Memory >Identical Formats
- 1 - Register-Memory /
- 2 - Register-Register
- 3 - Register Shift and IDLE
- 4 - Register Skip
- 5 - Status Indicator Skip
- 6 - Data Bus Input/Output
- 7 - Sense Switch Skip and Register Bit
- 8 - Direct Memory Access Channel and Auxiliary Processor

901181-385
ASSEMBLER CHARACTERISTICS AND DIRECTIVES

The final merging of the operation code and the operand fields is performed using a logical OR. Thus the operation code may be used to force setting of any bit to one. For example:

	Label	Operation	Operand	Comments
	10009 XYZ	OPD	>9800,1	FORMAT TYPE 1
OAC 9AFF	1010 JOE	XYZ	JOE,2	COMMENT

In the first line, XYZ is defined to be the mnemonic of an operation code. The first part of the operand specifies the machine operation code (9800_{16} or $1001\ 1000\ 0000\ 0000_2$) and the second part of the operand specifies format type 1, or a register-memory format.

In this example, the 5-bit operation code ($1001\ 1_2$) for a hardware multiplication instruction ($>9800=MPY$) is specified. Line two shows the assembled result when the defined operation is subsequently used. Format type 1 causes the assembler to look for an optional label, a required operation code, a required first operand field, and an optional second operand field. The operation code (9800) is OR'ed with the IXB tag (2) to produce $1001\ 1010_2$ or $9A_{16}$. The B bit is not set; therefore, the operand is program counter relative. Since the program counter is pointing to the instruction in location $0A0D_{16}$, the program counter relative address of JOE ($0A0D_{16} - 0001_{16} = 0A0C_{16}$) is minus one, or FF_{16} . The OR'ed result produces the machine instruction $9AFF_{16}$.

Similarly, a new multiply instruction may be defined that is always base register relative by setting the B bit in the first field of the OPD operand as follows:

Label	Operation	Operand
MPB	OPD	>9900,1

4.3.18 ORIGIN (ORG)

The ORG directive sets the value of the location counter to the value of the expression in the operand field. Any symbol in the expression must be previously defined. If the operand field is invalid, the ORG directive is not used. The ORG directive is commonly used to force loading of a program in specified memory locations. The assembly language coding format for the ORG directive is as follows:

Label	Operation	Operand	Comment
[label]	ORG	exp	[comment]

where "exp" is typically a decimal number specifying the location counter setting. If "exp" involves a symbol, it must be previously defined.

901181-385
ASSEMBLER CHARACTERISTICS AND DIRECTIVES

The following example shows how the ORG directive can be used for other purposes.

Operation	Operand
ORG	\$+500

This ORG directive increases the location counter by 500. Therefore, in this case the directive provides an alternate way to reserve storage areas.

NOTE

If the operand field of any ORG contains an absolute value instead of a relocatable expression, an absolute object is output; otherwise, a relocatable object is output.

4.3.19 PAGE EJECT (PEJ)

The PEJ directive ejects the remainder of the current assembly listing page. The assembler begins a new page with the heading from the current HED directive and the PEJ itself is printed as the first line on the new page. The assembly language coding format for the PEJ directive is as follows:

Label	Operation	Comment
[label] ⌀	PEJ ⌀	[comment]

4.3.20 REFERENCED EXTERNAL SYMBOLS (REF)

The REF directive identifies a linkage symbol as an external symbol that is referenced in the program using the REF directive. Each such external symbol must be identified in a REF directive. The assembly language coding format for the REF directive is as follows:

Label	Operation	Operand	Comment
[label] ⌀	REF ⌀	sym ₁ ,sym ₂ ,..,sym _n ⌀	[comment]

where "sym₁,sym₂, ..sym_n" are symbols that must be defined in another program and identified in that program as an entry-point symbol with the DEF directive.

901181-385
ASSEMBLER CHARACTERISTICS AND DIRECTIVES

As an example, if MTPLY is an entry point symbol in another program, the using program identifies it as an external symbol as follows:

Operation	Operand
REF	MTPLY

The only way an external symbol may be referenced is as a full 16-bit address. The SAP assembler allows an external symbol to be used in an arithmetic calculation. For example, use of MTPLY+2 is allowed. To link to a program named SINE, the following coding might be used:

Label	Operation	Operand
PROGA	BSS	2
	REF	SINE
	.	.
ADSIN	@BRL	SINE

4.3.21 STOP LISTING (UNL)

The UNL directive terminates the assembly listing process until an LIS directive is encountered. However, error messages are still printed. The assembly language coding format for the UNL directive is as follows:

Label	Operation	Comment
[label] ⌀	UNL ⌀	[comment]

901181-385

APPENDIX A

INSTRUCTION EXECUTION TIMES
(IN MICROSECONDS)

This appendix groups the instructions by format type to facilitate presentation of the execution times.

901181-385
INSTRUCTION EXECUTION TIMES
(IN MICROSECONDS)

REGISTER-MEMORY INSTRUCTIONS

MNEMONIC	NAME	4 MHz OPERATION		6 MHz OPERATION	
		MEM REF*	IMMED ADDR	MEM REF**	IMMED ADDR
ADD	Add to Register A	1.75	0.75	0.83	0.33
AND	Logical AND with Register A	1.75	0.75	0.83	0.33
BIX	Branch on Incremented Index	1.25	1.25	0.67	0.67
BRL	Branch and Link	1.50	1.50	0.83	0.83
BRU	Branch Unconditional	1.25	1.00	0.67	0.50
CPA	Compare Algebraic	1.75	0.75	0.83	0.33
CPL	Compare Logical	1.75	0.75	0.83	0.33
DAD	Double Length Add	2.75	1.00	1.33	0.50
DIV	Divide	7.75	6.75	4.67	4.17
DLD	Double Load Registers A and E	2.75	1.00	1.33	0.50
DMT	Decrement Memory and Test	2.75	2.75	1.33	1.33
DSB	Double Length Subtract	2.75	1.00	1.33	0.50
DST	Double Store Registers A and E	2.75	2.75	1.33	1.33
IMO	Increment Memory by One	2.75	2.75	1.33	1.33
IOR	Logical OR with Register A	1.75	0.75	0.83	0.33
LDA	Load Register A	1.75	0.75	0.83	0.33
LDE	Load Register E	1.75	0.75	0.83	0.33
LDM	Load Register M	1.75	0.75	0.83	0.33
LDX	Load Register X	1.75	0.75	0.83	0.33
MPY	Multiply	6.25	5.25	3.83	3.33
STA	Store Register A	2.00	2.00	1.00	1.00
STE	Store Register E	2.00	2.00	1.00	1.00
STX	Store Register X	2.00	2.00	1.00	1.00
SUB	Subtract from Register A	1.75	0.75	0.83	0.33

*Add the following to execution times, when applicable: 0.25 microseconds for indexing, 0.75 microseconds for indirect addressing, and 0.25 microseconds for DAD, DLD, DST, and DSB extended format.

**Add the following to execution times, when applicable: 0.17 microseconds for indexing, 0.33 microseconds for Indirect addressing, and 0.17 microseconds for DAD, DLD, DST and DSB extended format.

901181-385
INSTRUCTION EXECUTION TIMES
(IN MICROSECONDS)

REGISTER SHIFT INSTRUCTIONS

<u>MNEMONIC</u>	<u>NAME</u>	<u>4 MHZ OPERATION EXECUTION TIME</u>	<u>6 MHZ OPERATION EXECUTION TIME</u>
ALA	Arithmetic Left Shift A	0.75+SC*/4	0.33+SC*/6
ALD	Arithmetic Left Shift Double	1.00+SC/4	0.50+SC/6
ARA	Arithmetic Right Shift A	0.75+SC/4	0.33+SC/6
ARD	Arithmetic Right Shift Double	1.00+SC/4	0.50+SC/6
CLD	Circular Left Shift Double	0.75+SC/4	0.33+SC/6
CRA	Circular Right Shift A	0.75+SC/4	0.33+SC/6
CRB	Circular Right Shift B	0.75+SC/4	0.33+SC/6
CRD	Circular Right Shift Double	0.75+SC/4	0.33+SC/6
CRE	Circular Right Shift E	0.75+SC/4	0.33+SC/6
CRL	Circular Right Shift L	0.75+SC/4	0.33+SC/6
CRM	Circular Right Shift M	0.75+SC/4	0.33+SC/6
CRS	Circular Right Shift S	0.75+SC/4	0.33+SC/6
CRX	Circular Right Shift X	0.75+SC/4	0.33+SC/6
LLA	Logical Left Shift A	0.75+SC/4	0.33+SC/6
LLD	Logical Left Shift Double	0.75+SC/4	0.33+SC/6
LRA	Logical Right Shift A	0.75+SC/4	0.33+SC/6
LRD	Logical Right Shift Double	0.75+SC/4	0.33+SC/6
LTO	Left Test for Ones	1.00+SC/4	0.50+SC/6
LTZ	Left Test for Zeros	1.00+SC/4	0.50+SC/6
RTO	Right Test for Ones	1.00+SC/4	0.50+SC/6
RTZ	Right Test for Zeros	1.00+SC/4	0.50+SC/6

*SC=Shift Count

REGISTER TO REGISTER INSTRUCTIONS

<u>MNEMONIC</u>	<u>NAME</u>	<u>4 MHZ OPERATION EXECUTION TIME</u>	<u>6 MHZ OPERATION EXECUTION TIME</u>
RAD	Register ADD	1.25	0.67
RAN	Register AND	1.25	0.67
RCA	Register Compare Algebraic	1.25	0.67
RCL	Register Compare Logical	1.25	0.67
RCO	Register Complement	1.25	0.67
RDE	Register Decrement	1.00	0.50
REO	Register Exclusive OR	1.25	0.67
REX	Register Exchange	1.50	0.83
RIN	Register Increment	1.00	0.50
RIV	Register Invert	1.00	0.50
RMO	Register Move	1.00	0.50
ROR	Register OR	1.25	0.67
RSU	Register Subtract	1.25	0.67

901181-385
INSTRUCTION EXECUTION TIMES
(IN MICROSECONDS)

REGISTER SKIP INSTRUCTIONS

<u>MNEMONIC</u>	<u>NAME</u>	<u>4 MHz OPERATION EXECUTION TIME</u>	<u>6 MHz OPERATION EXECUTION TIME</u>
SEV	Skip on Even	1.00	0.50
SMI	Skip on Minus	1.00	0.50
SNO	Skip on Not All Ones	1.00	0.50
SNZ	Skip on Not All Zeros	1.00	0.50
SOD	Skip on Odd	1.00	0.50
SOO	Skip on All Ones	1.00	0.50
SPL	Skip on Plus	1.00	0.50
SZE	Skip on Zero	1.00	0.50

INDICATOR SKIP INSTRUCTIONS

<u>MNEMONIC</u>	<u>NAME</u>	<u>4 MHz OPERATION EXECUTION TIME</u>	<u>6 MHz OPERATION EXECUTION TIME</u>
SEQ	Skip on Equal	1.00	0.50
SGE	Skip on Greater Than or Equal	1.00	0.50
SGT	Skip on Greater Than	1.00	0.50
SLE	Skip on Less Than or Equal	1.00	0.50
SLT	Skip on Less Than	1.00	0.50
SNC	Skip on No Carry	1.00	0.50
SNE	Skip on Not Equal	1.00	0.50
SNV	Skip on No Overflow	1.00	0.50
SOC	Skip on Carry	1.00	0.50
SOV	Skip on Overflow	1.00	0.50

SENSE SKIP INSTRUCTIONS

<u>MNEMONIC</u>	<u>NAME</u>	<u>4 MHz OPERATION EXECUTION TIME</u>	<u>6 MHz OPERATION EXECUTION TIME</u>
SSE	Skip on Sense Switch Equal	1.00	0.50
SSN	Skip on Sense Switch Not Equal	1.00	0.50

901181-385
INSTRUCTION EXECUTION TIMES
(IN MICROSECONDS)

MULTI-REGISTER INSTRUCTIONS

<u>MNEMONIC</u>	<u>NAME</u>	<u>4 MHz OPERATION EXECUTION TIME</u>	<u>6 MHz OPERATION EXECUTION TIME</u>
LRF	Load Register File	7.00	3.17
LSB	Load Status Block and Branch	3.25	1.50
LSR	Load Status Block, Reset Interrupt, and Branch	3.25	1.50
SRF	Store Register File	7.00	3.17
SSB	Store Status Block and Branch	3.25	1.50

BYTE MANIPULATION INSTRUCTIONS

<u>MNEMONIC</u>	<u>NAME</u>	<u>4 MHz OPERATION EXECUTION TIME</u>	<u>6 MHz OPERATION EXECUTION TIME</u>
CLC	Compare Logical Character String	5.50+2.50/Byte	3.50+1.33/Byte
MVC	Move Character String	5.25+2.50/Byte	3.33+1.33/Byte

MEMORY BIT MANIPULATION INSTRUCTIONS

<u>MNEMONIC</u>	<u>NAME</u>	<u>4 MHz OPERATION EXECUTION TIME</u>	<u>6 MHz OPERATION EXECUTION TIME</u>
SMBO	Set Memory Bit to One	3.25	1.50
SMBZ	Set Memory Bit to Zero	3.25	1.50
TMBO	Test Memory Bit for One	2.75	1.33
TMBZ	Test Memory Bit for Zero	2.75	1.33

REGISTER BIT MANIPULATION INSTRUCTIONS

<u>MNEMONIC</u>	<u>NAME</u>	<u>4 MHz OPERATION EXECUTION TIME</u>	<u>6 MHz OPERATION EXECUTION TIME</u>
SABO	Set Register A Bit to One	1.00	0.50
SABZ	Set Register A Bit to Zero	1.00	0.50
TABO	Test Register A Bit for One	1.25	0.67
TABZ	Test Register A Bit for Zero	1.25	0.67

901181-385
INSTRUCTION EXECUTION TIMES
(IN MICROSECONDS)

MISCELLANEOUS

<u>MNEMONIC</u>	<u>NAME</u>	<u>4 MHz OPERATION EXECUTION TIME</u>	<u>6 MHz OPERATION EXECUTION TIME</u>
ATI	Automatic Transfer Initiate	2.50	1.17
IDL	Idle	1.00	0.50
NRM	Normalize	1.25 → 8.75	0.67 → 5.67
RDS	Read Direct Single	3.75 → 5.25	1.83 → 2.83
WDS	Write Direct Single	3.50 → 5.00	1.67 → 2.67

APPENDIX B

INSTRUCTION INDEX

ALPHABETICAL INSTRUCTION INDEX

<u>MNEMONIC</u>	<u>HEXADECIMAL CODE</u>	<u>NAME</u>	<u>PARAGRAPH</u>
ADD	2000	Add to Register A	3.5.1
ALA	C880	Arithmetic Left Shift A	3.8.1
ALD	C8A0	Arithmetic Left Shift Double	3.8.2
AND	3800	Logical AND with Register A	3.9.1
API	DD00	(Not Supported)	3.12.1
ARA	C800	Arithmetic Right Shift A	3.8.3
ARD	C820	Arithmetic Right Shift Double	3.8.4
*ATI	D900	Automatic Transfer Initiate	3.12.2
BIX	4000	Branch on Increment Index	3.4.1
BRL	7000	Branch and Link	3.4.2
BRU	7800	Branch Unconditional	3.4.3
CLC	DF80	Compare Logical Character String	3.6.1
CLD	CB80	Circular Left Shift Double	3.8.5
CPA	6800	Compare Algebraic	3.6.2
CPL	6000	Compare Logical	3.6.3
CRA	CA00	Circular Right Shift A	3.8.6
CRB	CB60	Circular Right Shift B	3.8.7
CRD	CBC0	Circular Right Shift Double	3.8.8
CRE	CA20	Circular Right Shift E	3.8.9
CRL	CB40	Circular Right Shift L	3.8.10
CRM	CA60	Circular Right Shift M	3.8.11

*Privileged instructions

901181-385
INSTRUCTION INDEX

ALPHABETICAL INSTRUCTION INDEX (CONTINUED)

<u>MNEMONIC</u>	<u>HEXADECIMAL CODE</u>	<u>NAME</u>	<u>PARAGRAPH</u>
CRS	CB20	Circular Right Shift S	3.8.12
CRX	CA40	Circular Right Shift X	3.8.13
DAD	B800	Double Length Add	3.5.2
DIV	5800	Divide	3.5.3
DLD	B000	Double Load Registers A and E	3.2.1
DMT	4800	Decrement Memory and Test	3.7.1
DSB	A800	Double Length Subtract	3.5.4
DST	A000	Double Store Registers A and E	3.3.1
*IDL	CE00	Idle	3.4.4
IMO	5000	Increment Memory by One	3.5.5
IOR	3000	Logical OR with Register A	3.9.2
LDA	0000	Load Register A	3.2.2
LDE	0800	Load Register E	3.2.3
LDM	1800	Load Register M	3.2.4
LDX	1000	Load Register X	3.2.5
LLA	C8C0	Logical Left Shift A	3.8.14
LLD	C8E0	Logical Left Shift Double	3.8.15
LRA	C840	Logical Right Shift A	3.8.16
LRD	C860	Logical Right Shift Double	3.8.17
LRF	D8A0	Load Register File	3.2.6
*LSB	D880	Load Status Block and Branch	3.4.5
*LSR	D890	Load Status Block, Reset Interrupt, and Branch	3.4.6
LTO	C980	Left Test for Ones	3.8.18
LTZ	C9C0	Left Test for Zeros	3.8.19
MPY	9800	Multiply	3.5.6
MVC	DF00	Move Character String	3.11.1
NRM	CA9F	Normalize	3.8.20
**RAD	C080	Register Add	3.5.7
**RAN	C680	Register AND	3.9.3
**RCA	C400	Register Compare Algebraic	3.6.4
**RCL	C600	Register Compare Logical	3.6.5
**RCO	C100	Register Complement	3.5.8
**RDE	C700	Register Decrement	3.5.9
*RDS	D800	Read Direct Single	3.12.3
**REO	C280	Register Exclusive OR	3.9.4
**REX	C780	Register Exchange	3.11.2
**RIN	C300	Register Increment	3.5.10
**RIV	C200	Register Invert	3.5.11
**RMO	C500	Register Move	3.11.3
**ROR	C480	Register OR	3.9.5
**RSU	C000	Register Subtract	3.5.12
RTO	C900	Right Test for Ones	3.8.21
RTZ	C940	Right Test for Zeros	3.8.22

*Privileged instructions

**Privileged instructions when status register is the destination register.

901181-385
INSTRUCTION INDEX

ALPHABETICAL INSTRUCTION INDEX (CONTINUED)

<u>MNEMONIC</u>	<u>HEXADECIMAL CODE</u>	<u>NAME</u>	<u>PARAGRAPH</u>
SABO	DB50	Set Register A Bit to One	3.10.1
SABZ	DB40	Set Register A Bit for Zeros	3.10.2
SEQ	CD20	Skip on Equal	3.7.2
SEV	CCC0	Skip on Even	3.7.3
SGE	CD80	Skip on Greater Than or Equal	3.7.4
SGT	CD40	Skip on Register Than	3.7.5
SLE	CDC0	Skip on Less Than or Equal	3.7.6
SLT	CD00	Skip on Less Than	3.7.7
SMBO	DB70	Set Memory Bit to One	3.10.3
SMBZ	DB60	Set Memory Bit to Zero	3.10.4
SMI	CC60	Skip on Minus	3.7.8
SNC	CFE0	Skip on No Carry	3.7.9
SNE	CDA0	Skip on Not Equal	3.7.10
SNO	CCA0	Skip on Not All Ones	3.7.11
SNV	CDE0	Skip on No Overflow	3.7.12
SNZ	CC80	Skip on Not All Zeros	3.7.13
SOC	CF60	Skip on Carry	3.7.14
SOD	CC40	Skip on Odd	3.7.15
SOO	CC20	Skip on All Ones	3.7.16
SOV	CD60	Skip on Overflow	3.7.17
SPL	CCE0	Skip on Plus	3.7.18
SRF	D8E0	Store Register File	3.3.2
SSB	D8C0	Store Status Block and Branch	3.4.7
SSE	CC10	Skip on Sense Switch Equal	3.7.19
SSN	CC90	Skip on Sense Switch Not Equal	3.7.20
STA	8000	Store Register A	3.3.3
STE	8800	Store Register E	3.3.4
STX	9000	Store Register X	3.3.5
SUB	2800	Subtract from Register A	3.5.13
SZE	CC00	Skip on Zero	3.7.21
TABO	DB10	Test Register A Bit for One	3.10.5
TABZ	DB00	Test Register A Bit for Zero	3.10.6
TMBO	DB30	Test Memory Bit for One	3.10.7
TMBZ	DB20	Test Memory Bit for Zero	3.10.8
*WDS	D820	Write Direct Single	3.12.4

*Privileged instructions

901181-385
INSTRUCTION INDEX

HEXADECIMAL INSTRUCTION INDEX

HEXADECIMAL CODE	MNEMONIC	NAME	PARAGRAPH
0000	LDA	Load Register A	3.2.2
0800	LDE	Load Register E	3.2.3
1000	LDX	Load Register X	3.2.5
1800	LDM	Load Register M	3.2.4
2000	ADD	Add to Register A	3.5.1
2800	SUB	Subtract from Register A	3.5.13
3000	IOR	Logical OR with Register A	3.9.2
3800	AND	Logical AND with Register A	3.9.1
4000	BIX	Branch on Incremented Index	3.4.1
4800	DMT	Decrement Memory and Test	3.7.1
5000	IMO	Increment Memory by One	3.5.5
5800	DIV	Divide	3.5.3
6000	CPL	Compare Logical	3.6.3
6800	CPA	Compare Algebraic	3.6.2
7000	BRL	Branch and Link	3.4.2
7800	BRU	Branch Unconditional	3.4.3
8000	STA	Store Register A	3.3.3
8800	STE	Store Register E	3.3.4
9000	STX	Store Register X	3.3.5
9800	MPY	Multiply	3.5.6
A000	DST	Double Store Registers A and E	3.3.1
A800	DSB	Double Length Subtract	3.5.4
B000	DLD	Double Load Registers A and E	3.2.1
B800	DAD	Double Length Add	3.5.2
**C000	RSU	Register Subtract	3.5.12
**C080	RAD	Register Add	3.5.7
**C100	RCO	Register Complement	3.5.8
**C200	RIV	Register Invert	3.5.11
**C280	REO	Register Exclusive OR	3.9.4
**C300	RIN	Register Increment	3.5.10
**C400	RCA	Register Compare Algebraic	3.6.4
**C480	ROR	Register OR	3.9.5
**C500	RMO	Register Move	3.11.3
**C600	RCL	Register Compare Logical	3.6.5
**C680	RAN	Register AND	3.9.3
**C700	RDE	Register Decrement	3.5.9
**C780	REX	Register Exchange	3.11.2

**Privileged instructions when status register is the destination register.

901181-385
INSTRUCTION INDEX

HEXADECIMAL INSTRUCTION INDEX (CONTINUED)

HEXADECIMAL CODE	MNEMONIC	NAME	PARAGRAPH
C800	ARA	Arithmetic Right Shift A	3.8.3
C820	ARD	Arithmetic Right Shift Double	3.8.4
C840	LRA	Logical Right Shift A	3.8.16
C860	LRD	Logical Right Shift Double	3.8.17
C880	ALA	Arithmetic Left Shift A	3.8.1
C8A0	ALD	Arithmetic Left Shift Double	3.8.2
C8C0	LLA	Logical Left Shift A	3.8.14
C8E0	LLD	Logical Left Shift Double	3.8.15
C900	RTO	Right Test for Ones	3.8.21
C940	RTZ	Right Test for Zeros	3.8.22
C980	LTO	Left Test for Ones	3.8.18
C9C0	LTZ	Left Test for Zeros	3.8.19
CA00	CRA	Circular Right Shift A	3.8.6
CA20	CRE	Circular Right Shift E	3.8.9
CA40	CRX	Circular Right Shift X	3.8.13
CA60	CRM	Circular Right Shift M	3.8.11
CA9F	NRM	Normalize	3.8.20
CB20	CRS	Circular Right Shift S	3.8.12
CB40	CRL	Circular Right Shift L	3.8.10
CB60	CRB	Circular Right Shift B	3.8.7
CB80	CLD	Circular Left Shift Double	3.8.5
CBC0	CRD	Circular Right Shift Double	3.8.8
CC00	SZE	Skip to Zero	3.7.21
CC10	SSE	Skip on Sense Switch Equal	3.7.19
CC20	S00	Skip on All Ones	3.7.16
CC40	SOD	Skip on Odd	3.7.15
CC60	SMI	Skip on Minus	3.7.8
CC80	SNZ	Skip on Not All Zeros	3.7.13
CC90	SSN	Skip on Sense Switch Not Equal	3.7.20
CCA0	SNO	Skip on Not All Ones	3.7.11
CCC0	SEV	Skip on Even	3.7.3
CCE0	SPL	Skip on Plus	3.7.18
CD00	SLT	Skip on Less Than	3.7.7
CD20	SEQ	Skip on Equal	3.7.2
CD40	DGT	Skip on Greater Than	3.7.5
CD60	SOV	Skip on Overflow	3.7.17
CD80	SGE	Skip on Greater Than or Equal	3.7.4
CDA0	SNE	Skip on Not Equal	3.7.10
CDC0	SLE	Skip on Less Than or Equal	3.7.6
CDE0	SNV	Skip on No Overflow	3.7.12
*CE00	IDL	Idle	3.4.4
CF60	SOC	Skip on Carry	3.7.14
CFE0	SNC	Skip on No Carry	3.7.9

*Privileged instructions

901181-385
ILLEGAL INSTRUCTION OPERATION CODES

BLANK