

IBM 3197 Model D Display Station User's Guide

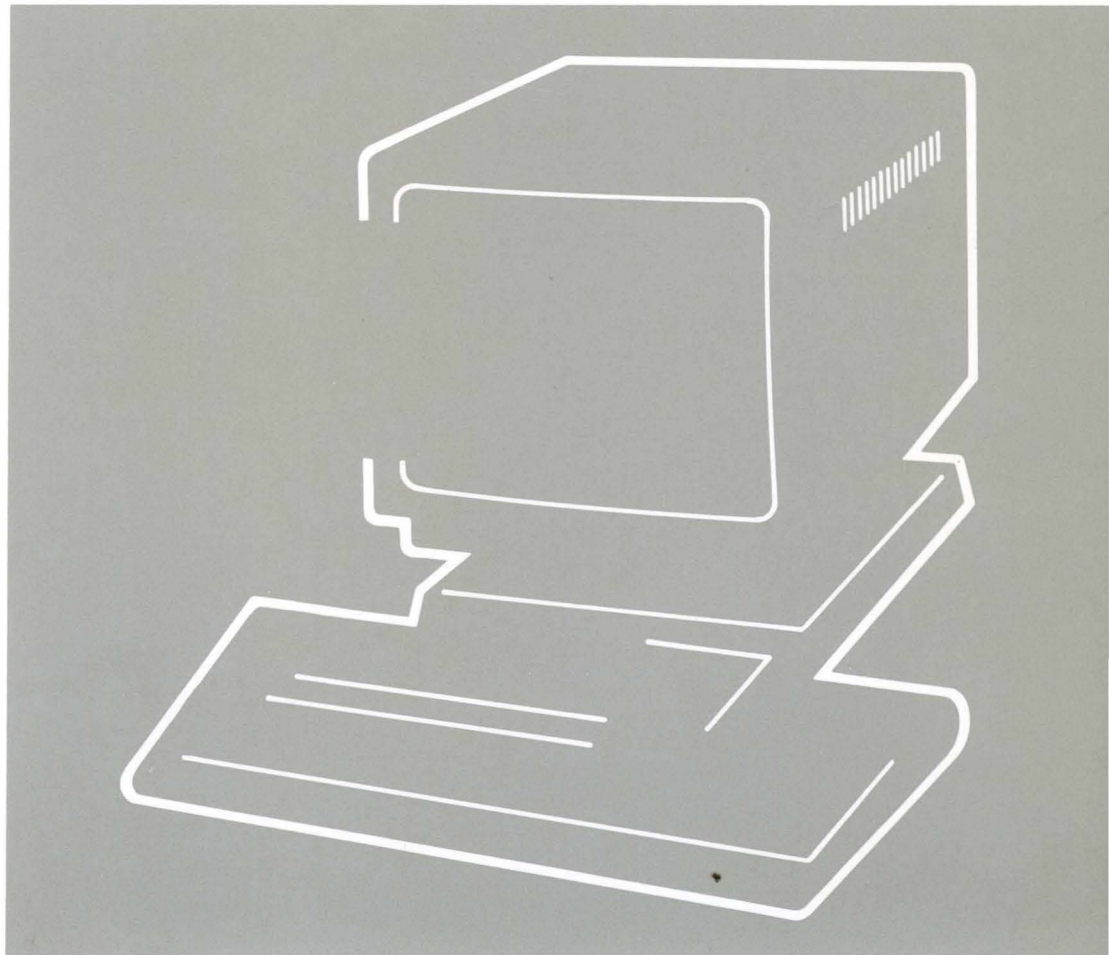

GA18-2545-1
Part Number 6457157
File Number S5250/S36/S38-06

IBM 3197 Model D Display Station User's Guide

Federal Communications Commission (FCC) Statement

Warning: This equipment generates, uses, and can radiate radio frequency energy and if not installed and used in accordance with the instruction manual, may cause interference to radio communications. It has been tested and found to comply with the limits for a Class A computing device pursuant to Subpart J of Part 15 of FCC Rules, which are designed to provide reasonable protection against such interference when operated in a commercial environment. Operation of this equipment in a residential area is likely to cause interference in which case the user at his own expense will be required to take whatever measures may be required to correct the interference.

The above FCC statement applies only to those machines in the U.S.

Second Edition (July 1987)

This major revision obsoletes GA18-2545-0. Changes are occasionally made to the information herein; any such changes will be reported in subsequent revisions or Technical Newsletters.

References in this publication to IBM products, programs, or services do not imply that IBM intends to make these available in all countries in which IBM operates. Any reference to an IBM licensed program in this publication is not intended to state or imply that only IBM's licensed program may be used. Any functionally equivalent program may be used instead.

Publications are not stocked at the address given below. Requests for IBM publications should be made to your IBM representative or to the IBM branch office serving your locality.

A form for readers' comments is provided at the back of this publication. If the form has been removed, comments may be addressed to IBM Corporation Information Development, Department 6R1J, 180 Kost Road, Mechanicsburg, PA 17055 U.S.A. IBM may use or distribute whatever information you supply in any way it believes appropriate without incurring any obligation to you.

About This Manual

Purpose

This manual is for operators and supervisory personnel of the IBM 3197 Model D display station. It describes how to:

- Use each key
- Enter, modify, and remove information
- Respond to messages and error codes
- Perform operator tasks.

Organization

This manual contains the following information:

Chapter 1 identifies the locations and explains the functions of the switches and controls, and the display screen (operating status line and message line).

Chapter 2 identifies the unique features of the 122-key typewriter keyboard.

Chapter 3 describes how to operate the display station using a 122-key typewriter keyboard.

Chapter 4 identifies the unique features of the IBM enhanced keyboard.

Chapter 5 describes how to operate the display station using the IBM enhanced keyboard.

Appendix A lists the error codes and the related recovery procedures.

Appendix B provides information about 122/124-key and IBM enhanced keyboard layouts for languages other than U.S. English.

Related Publications

IBM 5250 Information Display System Planning and Site Preparation Guide, GA21-9337, provides cable specifications to assist in planning for the installation.

If You Need More Information

You may wish to refer to one of the following publications:

- *IBM 3197 Model D Display Station Problem Solving Guide*, GA18-2547.
- *IBM 3197 Model D Display Station Setup Instructions*, GA18-2546.
- *IBM 3197 Display Station Description*, GA18-2544.
- *IBM 5250 Information Display System Functions Reference Manual*, SA21-9247.
- *Creating Displays: Screen Design Aid and System Support Program*, SC21-7902, describes how to change the function of command keys.

Contents

Chapter 1. Becoming Familiar with Your Display Station	1-1
Switches and Controls	1-2
Power Switch	1-3
Power-On Light	1-3
Brightness Control	1-3
Contrast Control	1-3
Security Keylock	1-3
Adjusting Angle of the Video Element	1-4
Adjusting Keyboard Slope	1-5
Display Screen	1-6
Symbols on the Operating Status Line	1-10
Symbols in Normal Communication Mode	1-10
Symbols in Setup Mode	1-13
Symbols in Printer Setup Mode	1-16
Chapter 2. The 122-Key Typewriter Keyboard	2-1
Keyboard Layout of the U.S. English 122-key Typewriter Keyboard	2-1
Key Functions	2-3
System Request	2-4
Attention	2-4
Clear	2-5
Erase Input	2-5
Print	2-5
Help	2-5
Hex	2-5
Play	2-6
Test	2-6
SetUp	2-6
Printer Setup Mode	2-6
Record	2-7
Pause	2-7
Character Backspace	2-8
Field Advance	2-8
Field Exit	2-8
Shift Lock	2-9
Shift	2-9
Reset	2-9
Quit	2-9
Enter	2-9
Data Entry	2-10
Field Backspace	2-12
Duplicate	2-12
Zoom	2-12
Jump	2-13

New Line	2-13
Insert Mode	2-13
Delete	2-13
Cursor Movement	2-14
Roll	2-14
Home	2-14
Rule	2-14
Field+	2-16
Field-	2-16
Numeric	2-17
Command	2-18
Local Scroll	2-18
Setup Mode	2-19
Printer Setup Mode	2-21
Katakana-Unique Shift Keys (124-Key Keyboard)	2-22

Chapter 3. Operations Using the 122-key Typewriter Keyboard 3-1

Modes	3-1
Test Mode	3-1
Normal Communication Mode	3-1
Setup Mode	3-1
Record Mode	3-2
Play Mode	3-2
Printer Setup Mode	3-2
Setup Mode Operation	3-3
Offline Setup Functions	3-3
Select the Terminal Mode	3-4
One-Display Mode Operation	3-6
Two-Display Mode Operation	3-6
Display-Printer Mode Operation	3-11
Select the Multinational Character Set	3-12
Set the Keyboard ID	3-13
Set Station Address 1	3-14
Set Station Address 2	3-15
Set the Printer Address	3-17
Online Setup Functions	3-19
Select Ruler Style	3-20
Display Dim Interval Adjustment	3-21
Adjust Alarm Volume	3-22
Adjust Clicker Volume	3-23
Enable/Disable Clicker Action	3-24
Enable/Disable Cursor Blink	3-25
Select Cursor Style	3-26
Enable/Disable Extended Display	3-27
Enable/Disable Cursor Locator (Row/Col)	3-28
Record Mode Operation	3-29
Assigning Keystroke Sequences to Command Keys	3-29
Play Mode Operation	3-32
Playing Back Keystroke Sequences Assigned to Command Keys	3-32
Record/Play Exercise	3-33
Printer Setup Mode Operation	3-36
Specifying Printer Functions	3-36
Cancelling Printer Operation	3-37
Inquiring Printer Status	3-37

Display-Printer Mode Selection	3-38
Offline Printer Setup Mode Operation	3-39
Online Printer Setup Mode Operation	3-40
Specifying Character Pitch	3-41
Specifying Line Pitch	3-42
Specifying Print Quality	3-43

Chapter 4. The IBM Enhanced Keyboard 4-1

Keyboard Layout of the U.S. English IBM Enhanced Keyboard	4-1
---	-----

Key Functions	4-3
System Request	4-4
Attention	4-4
Clear	4-5
Print	4-5
Help	4-5
Hex	4-5
Play	4-5
Test	4-5
SetUp	4-6
Printer Setup Mode	4-6
Record	4-6
Pause	4-7
Local Scroll	4-7
Character Backspace	4-8
Field Advance	4-8
Field Backspace	4-8
Field Exit	4-8
CapsLock	4-9
Shift	4-9
Reset	4-9
Quit	4-9
New Line	4-9
Enter	4-10
Data Entry	4-10
Insert Mode	4-11
Duplicate	4-11
Zoom	4-12
Home	4-12
Page Up and Page Down	4-12
Jump	4-12
Rule	4-12
Erase Input	4-13
Delete	4-13
Cursor Movement	4-13
Double Speed Cursor	4-13
Field+	4-14
Field-	4-14
Numeric	4-15
Function	4-16
Setup Mode	4-17
Printer Setup Mode	4-19
Katakana-Unique Shift Keys (IBM Enhanced Keyboard)	4-21

Chapter 5. Operations Using the IBM Enhanced Keyboard 5-1

Modes	5-1
Test Mode	5-1
Normal Communication Mode	5-1
Setup Mode	5-1
Record Mode	5-1
Play Mode	5-2
Printer Setup Mode	5-2
Setup Mode Operation	5-3
Offline Setup Functions	5-3
Select the Terminal Mode	5-4
One-Display Mode Operation	5-6
Two-Display Mode Operation	5-6
Display-Printer Mode Operation	5-11
Select the Multinational Character Set	5-12
Set the Keyboard ID	5-13
Set Station Address 1	5-14
Set Station Address 2	5-15
Set the Printer Address	5-17
Online Setup Functions	5-19
Select Ruler Style	5-20
Display Dim Interval Adjustment	5-21
Adjust Alarm Volume	5-22
Adjust Clicker Volume	5-23
Enable/Disable Clicker Action	5-24
Enable/Disable Cursor Blink	5-25
Select Cursor Style	5-26
Enable/Disable Extended Display	5-27
Enable/Disable Cursor Locator (Row/Col)	5-28
Record Mode Operation	5-29
Assigning Keystroke Sequences to Function Keys	5-29
Play Mode Operation	5-32
Playing Back Keystroke Sequences Assigned to Function Keys	5-32
Record/Play Exercise	5-33
Printer Setup Mode Operation	5-38
Specifying Printer Functions	5-38
Cancelling Printing Operation	5-39
Inquiring Printer Status	5-39
Display-Printer Mode Selection	5-40
Offline Printer Setup Mode Operation	5-42
Online Printer Setup Mode Operation	5-44
Specifying Character Pitch	5-45
Specifying Line Pitch	5-46
Specifying Print Quality	5-47

Appendix A. Error Codes and Recovery Procedures A-1

00XX (Error Codes Appearing at Position B) A-2

90XX (Error Codes Appearing in Position A or C) A-6

XXX (Alpha Characters Appearing at Position C) A-8

Appendix B. Keyboard Layouts for Languages Other Than U.S. English B-1

Glossary X-1

Index X-3

Figures

- 1-1. Locations of Switches and Controls 1-2
- 1-2. 1920 Character Screen Format 1-7
- 1-3. 3564 Character Screen Format 1-8
- 1-4. 3280 Characters Screen Format 1-9
- 1-5. Operating Status Line Symbols in Normal Communication Mode 1-10
- 1-6. Symbols in Setup Mode 1-13
- 1-7. Symbols for Printer Setup Mode 1-16
- 2-1. IBM 3197 122-key Typewriter Keyboard Layout (U.S. English) 2-2
- 2-2. Relationship between Shift Status and Keytop Character 2-22
- 3-1. Selection of Print Functions 3-40
- 4-1. IBM 3197 IBM Enhanced Keyboard Layout (U.S. English) 4-2
- 4-2. Relation Ship between Shift Status and Keytop Character 4-21
- 5-1. Selection of Print Functions 5-44
- B-1. Austrian/German Keyboard B-2
- B-2. Belgian Keyboard B-3
- B-3. Canadian French Keyboard B-4
- B-4. Danish Keyboard B-5
- B-5. Finnish/Swedish Keyboard B-6
- B-6. French (AZERTY) Keyboard B-7
- B-7. Italian Keyboard B-8
- B-8. Japanese Katakana Keyboard B-9
- B-9. Norwegian Keyboard B-10
- B-10. Portuguese Keyboard B-11
- B-11. Spanish Keyboard B-12
- B-12. Spanish-Speaking Keyboard B-13
- B-13. Swiss-Bilingual-French Keyboard B-14
- B-14. Swiss-Bilingual-German Keyboard B-15
- B-15. U.K. English Keyboard B-16
- B-16. Dutch Keyboard B-17

Chapter 1. Becoming Familiar with Your Display Station

Your display station is made up of three workstation elements: video, logic, and keyboard elements. Each element can be easily disconnected and replaced if you have operating problems.

The display station can attach either of the following two types of keyboard elements.

- 122/124-key Typewriter Keyboard (124-key for Japanese Katakana and 122-key for the U.S. and other countries)
- IBM Enhanced Keyboard (102-key for the U.S., 103-key for the countries other than the U.S., 104-key for Japan)

This manual describes the functions and operations of the 3197 display station using the U.S. English 122-key Keyboard and the U.S. English 102-key IBM Enhanced Keyboard.

For key-top nomenclatures and keyboard layouts for countries other than the U.S., refer to Appendix B, "Keyboard Layouts for Languages Other Than U.S. English."

Switches and Controls

Figure 1-1 shows the locations of switches and controls on the display station.

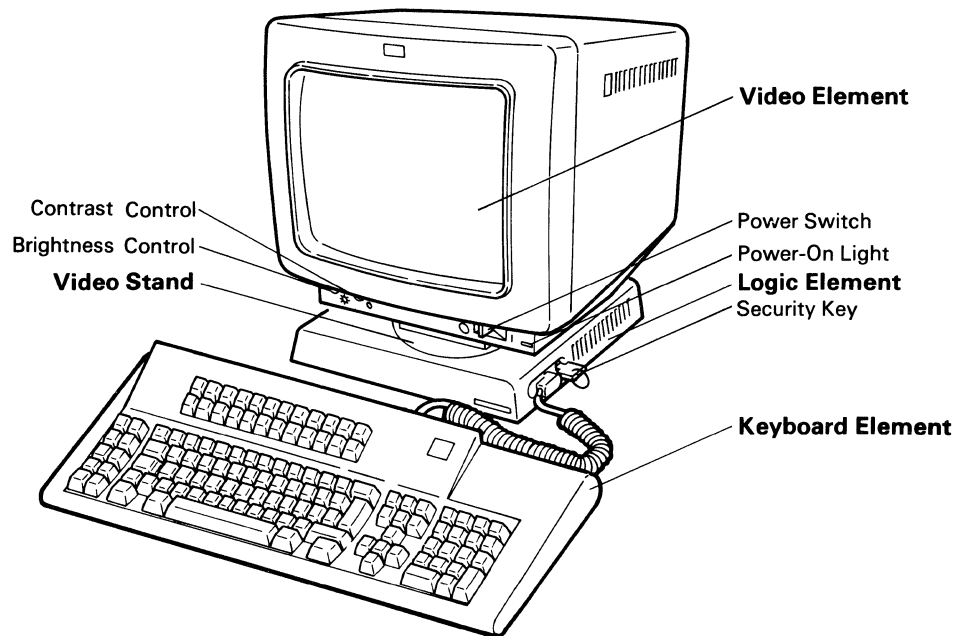

Figure 1-1. Locations of Switches and Controls

Note: There are two different types of keyboards. Figure 1-1 shows the 122-key typewriter keyboard. The other type is the IBM enhanced keyboard.

Warning: An improperly wired outlet or plug can place hazardous voltages on accessible metal parts of this display station. The power cord and plug (when supplied) on your display station have been approved for use with this display station and meets the necessary testing laboratory/test house standards. For your safety, the power cord and plug must be connected to a properly wired and grounded outlet. The customer is responsible for the outlet and plug wiring.

If it becomes necessary to change the power cord or plug or if the outlet is improperly wired, have the change made according to local or national code. A new power cord may be ordered from your IBM sales representative.

The function of each switch or control is described below.

Power Switch

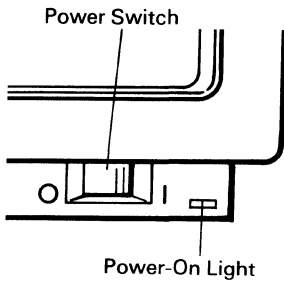

When the switch lever is moved to the right (toward I), the display station's power is turned on. Moving the lever to the left (toward O) turns the display station's power off.

When you power on the display station, tests will run to make sure all elements are operating as they should. If there are any problems during these tests, an error code appears on the operating status line (see Figure 1-2), and an alarm may sound. See Appendix A, "Error Codes and Recovery Procedures" for a description of the error codes.

Power-On Light

When the power switch is set to | (on), this indicator lights.

Brightness Control

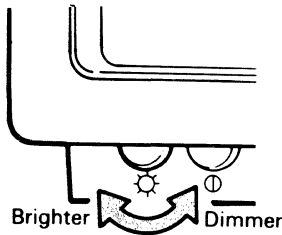

Turning this knob counterclockwise dims the screen. Turning it clockwise brightens the screen.

Contrast Control

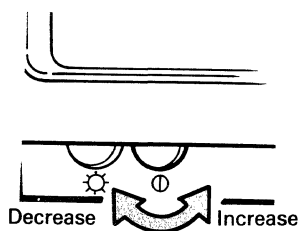

Turning this knob counterclockwise increases the contrast between the characters displayed and the background display. Turning it clockwise decreases the contrast between the characters displayed and the background display.

Security Keylock

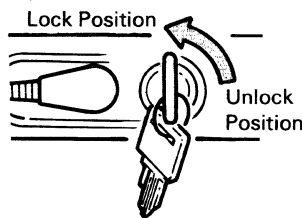

When the security key is in the locked position, the security keylock prevents anyone from entering or viewing data on the display screen and a **X** symbol appears on the operating status line (bottom line of the display screen.)

When a printer is attached to the display station and is in operation, even if the security key is locked, the printer can receive and print data from the host system.

To unlock the keylock and operate the display station, insert the key and turn it clockwise until it stops. The key can be removed from the keylock in either the locked or the unlocked position.

Adjusting Angle of the Video Element

The video element can be rotated 90 degrees to the right or the left.

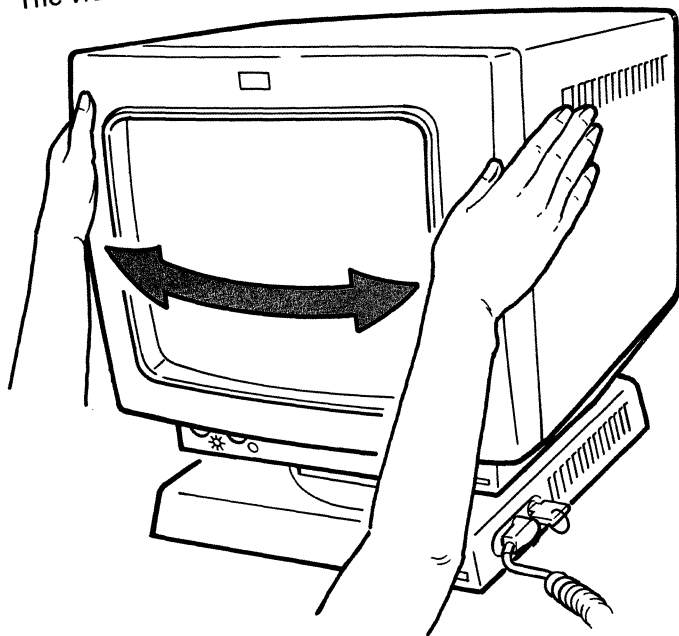

The video element can also be tilted up or down.

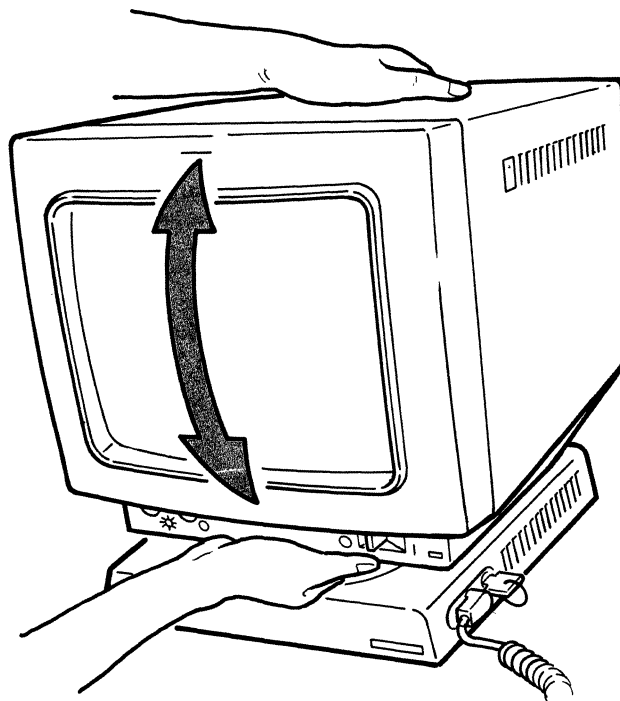

Adjusting Keyboard Slope

You can select two keyboard angles for both types of keyboards.

To adjust the keyboard to the highest angle, turn the keyboard over and flip the legs down from the underside of the keyboard. The legs lock into place.

With the legs locked into the keyboard, the keyboard sits at the minimum angle.

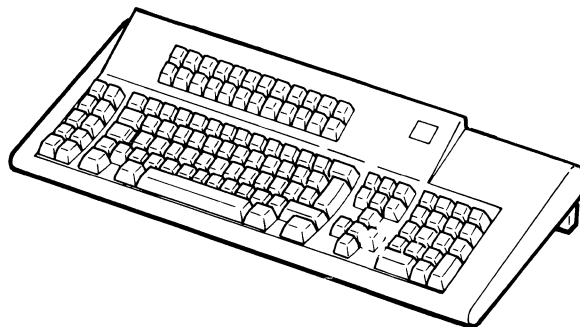
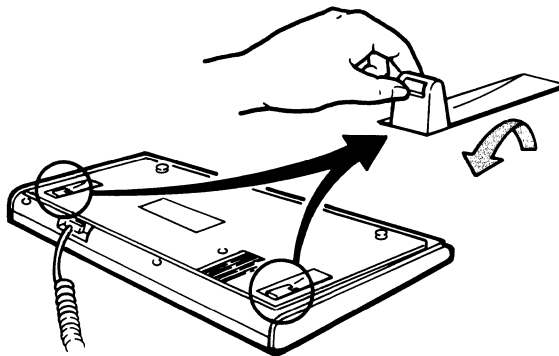
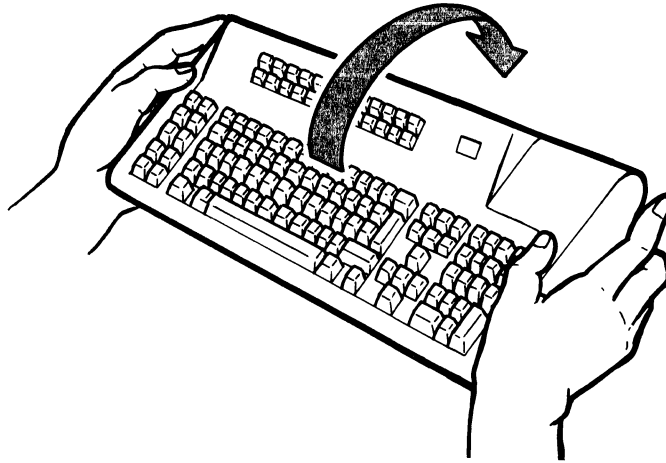

Display Screen

Your display screen is divided into two basic areas: data area and message area.

The data area is used to display the data received either from your keyboard or the host system. The data area can display up to 1920 characters (24 lines of 80 characters), 3564 characters (27 lines of 132 characters) and 3280 characters (41 lines of 80 characters). Selection of the data area format depends on the selected terminal mode or the host application program. For additional details about the terminal mode, see Chapter 3 for the 122-key typewriter keyboard and Chapter 5 for the IBM enhanced keyboard.

The message area is divided into two sub-areas: message line and operating status line. The message line is a dedicated area to display error messages and help text received from the host system or the controller. The detailed information about the error messages is described in Appendix A.

The area below the separator line is the operating status line and is used to display the operating status of your display station or the attached printer. The messages of the symbols displayed on this line are described in the following section.

Figure 1-2 shows the standard format (1920 characters) of your display station. The 25th line is message line and the 26th line is the operating status line.

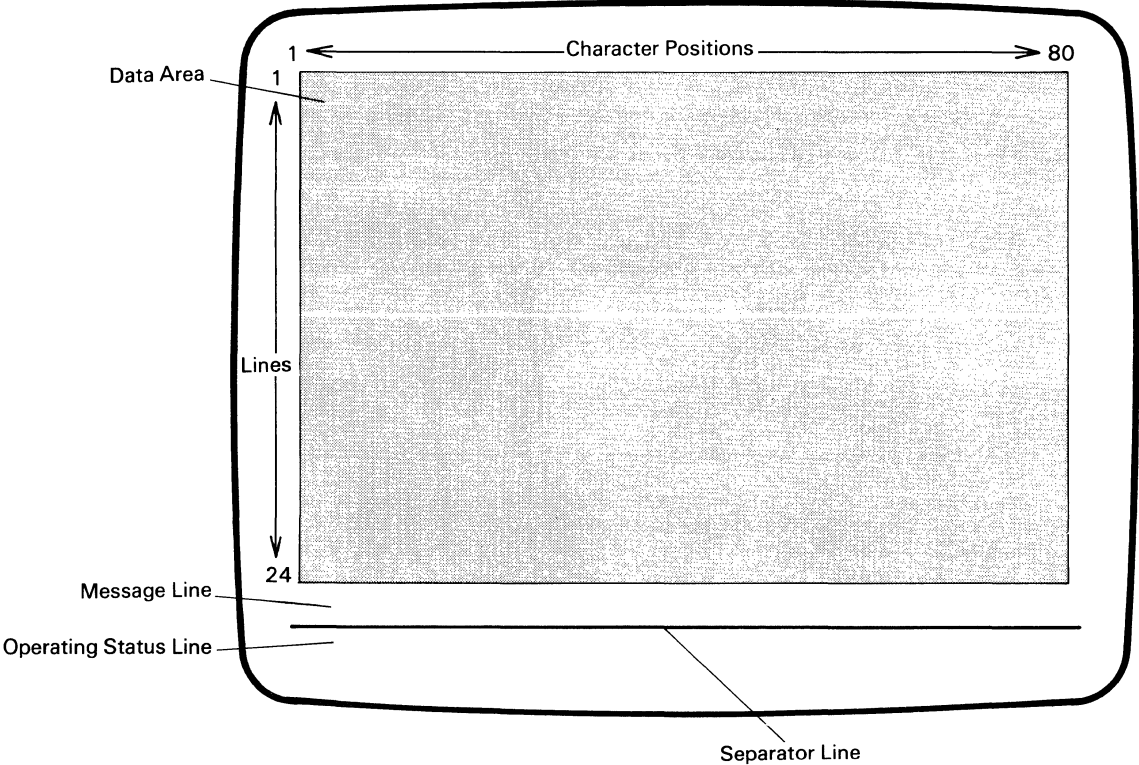

Figure 1-2. 1920 Character Screen Format

Figure 1-3 shows the condensed screen format (3564 characters) of your display station. The 28th line is the message line and the 29th line is the operating status line.

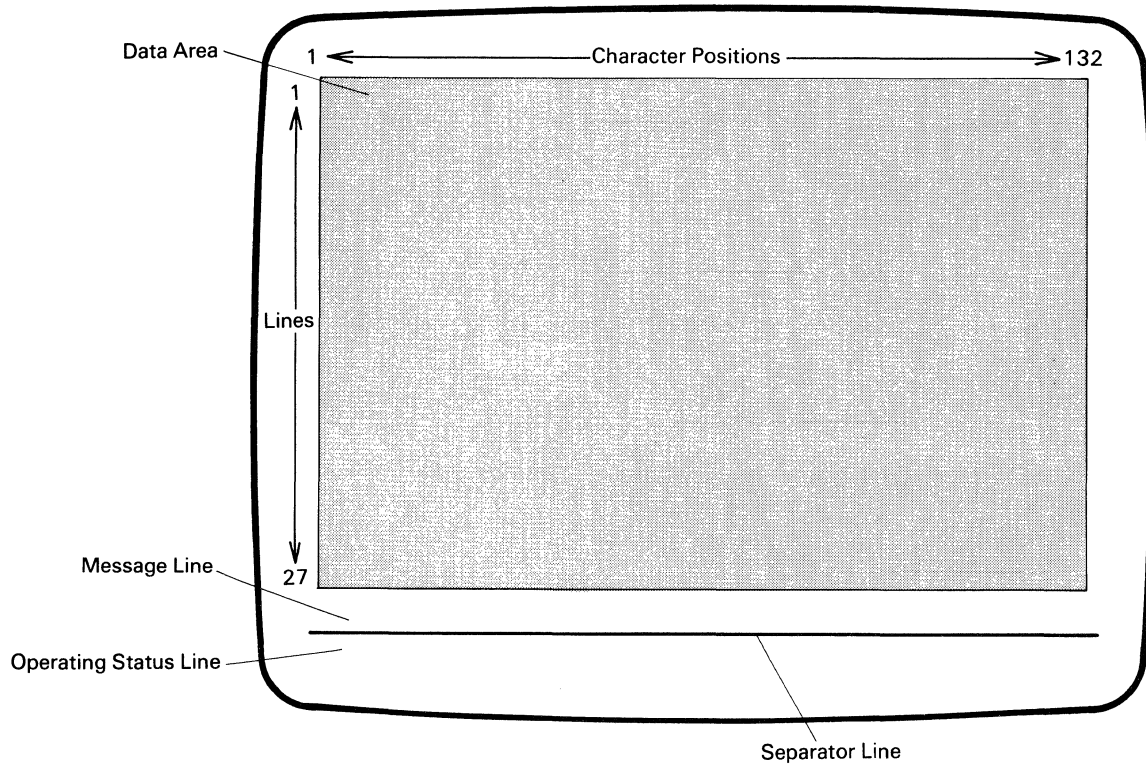

Figure 1-3. 3564 Character Screen Format

Figure 1-4 shows the split screen format (3280 characters) that consists of two data areas: one from logical display station 1 and the other from logical display station 2. The 25th and 44th lines are the message lines and the 45th line is the operating status line.

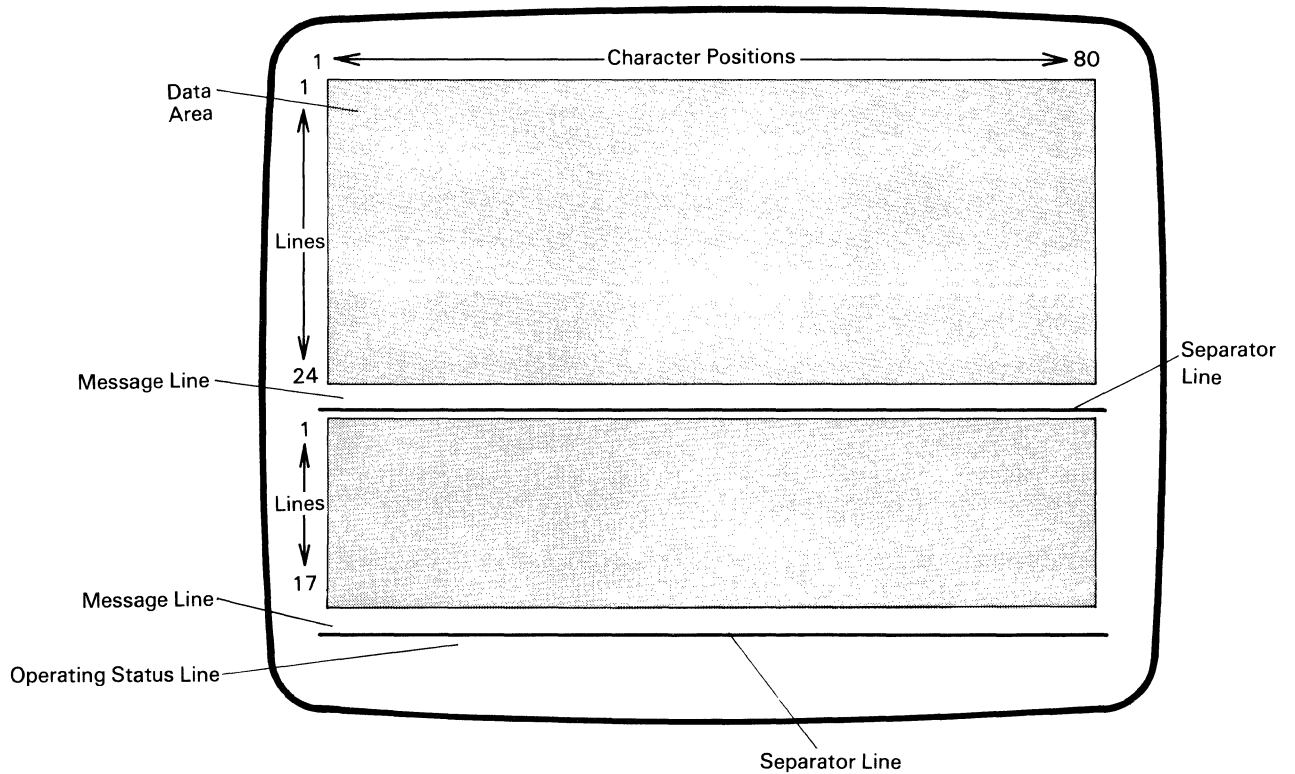

Figure 1-4. 3280 Characters Screen Format

Symbols on the Operating Status Line

The various symbols appearing on the operating status line are used to indicate:

- Operational status of the display station
- Operational errors or machine failures detected by your display station
- Selection of the available functions.

The symbols available for the operating status line vary depending on the modes: normal communication, setup, record/play, and printer setup. The following sections describe the location and the meanings of the symbols in normal communication, setup and printer setup modes.

For the symbols in record/play mode, refer to "Record/Play Operation" in Chapter 3 for the 122-key typewriter keyboard and Chapter 5 for the IBM enhanced keyboard.

Symbols in Normal Communication Mode

The symbols that are displayed on the operating status line during communication with the host system are shown in Figure 1-5.

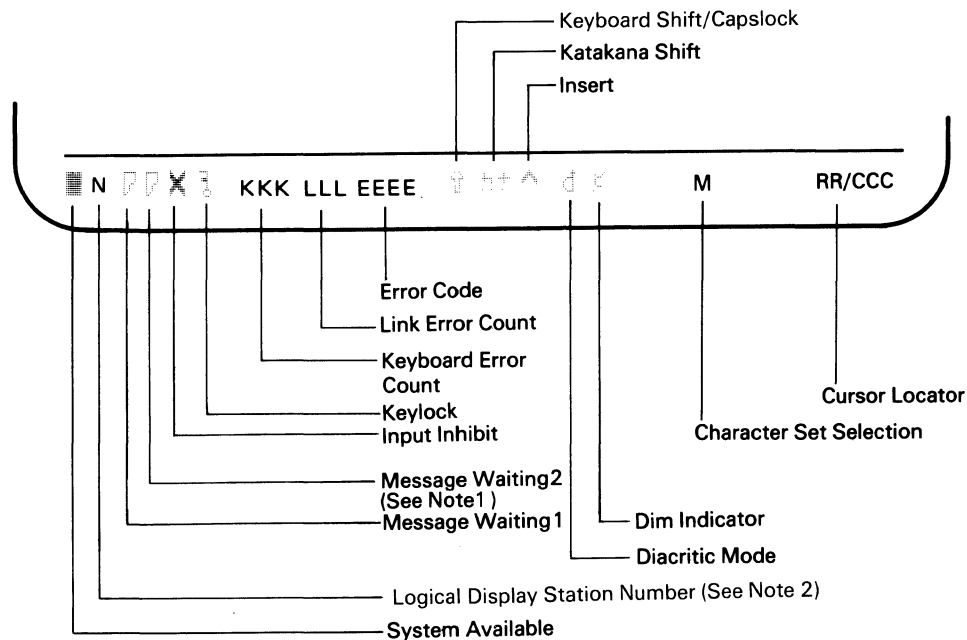

















Notes:

1. If you select one-display or display-printer mode (see chapter 3 or 5 for more information), the Message Waiting 2 does not appear.
2. If you select two-display mode, the active logical display station number (1 or 2) will be indicated.

Figure 1-5. Operating Status Line Symbols in Normal Communication Mode

The following table explains the operating status line symbols for normal communication mode and the actions to take, if required.

Symbol	Symbol Name	Meaning/Action
	System Available	The host system connected to your display station is operating and available.
N	Logical Display Station Number	Indicates which logical display station is currently active. (two-display mode only)
 or 	Message Waiting 1	The blank symbol () indicates that the host system has one or more messages for logical display station 1 and the display screen for logical display station 1 is active. If logical display station 1 is inactive, the symbol is a solid one ().
 or 	Message Waiting 2	The blank symbol () indicates that the host system has one or more messages for logical display station 2 and the display screen for logical display station 2 is active. If logical display station 2 is inactive, the symbol is a solid one ().
	Input Inhibit	Your input will not be accepted by the system. This symbol appears when: <ul style="list-style-type: none"> • The host system is processing your input. • The host system is very busy. • An error condition was recognized by the host system. <p><i>Note:</i> If the condition is not an error and this symbol remains for an abnormal length of time, contact your supervisor.</p>
	Keylock Locked	The security key of your display station is locked. Nothing can be displayed until it is unlocked.
KKK	Keyboard Error Count	Indicates the number of keyboard errors since you set your display station power switch to (on). (Appears only when the extended display function is enabled.)
LLL	Link Error Count	Indicates the number of link parity errors since you set your display station power switch to (on). (Appears only when the extended display function is enabled.)
EEEE	Error Codes	A four-digit number. These error codes define your operational errors. A short audible alarm sounds. Refer to Appendix A, "Error Codes and Recovery Procedures" to clear errors.
	Keyboard Shift	The keyboard is in upshift.
	Katakana Shift	The keyboard is in Katakana shift. (Only for users who have a Katakana keyboard.)
	Insert	Indicates that you pressed the Ins (Insert) key.
	Diacritic Mode	Indicates that your display station is in diacritic mode. This symbol appears when you press an accent key: circumflex (^), grave accent (`), tilde (~), cedilla (¸), diaeresis (¨), or acute accent (´). Diacritic mode is a function of the host system program and not of the display station. To find out how to use diacritic mode, see your system operator or the system program manual.

Symbol	Symbol Name	Meaning/Action
	Dim Indicator	Indicates that you have not pressed any key for 2, 5, 10 or 20 minutes depending on the setting of the display dim interval adjustment in setup mode (either offline or online setup mode). (The screen is blank, except the operating-status line.) Press any key to restore the original display image.
M	Multinational Character Set	Indicates when one of the following is selected in test mode or when the extended display is enabled: <ul style="list-style-type: none"> ● The multinational character set ● A country-specific character set.
RR/CCC	Cursor Locator	Indicates the row and column where the cursor is currently positioned.

Symbols in Setup Mode

While in setup mode (either offline or online setup mode), the current selections of your display station functions are displayed on the operating status line. Some of the function selections are available only in offline setup mode. Those selections can be changed for the operation's needs (see Chapter 3 or Chapter 5 for more information about your keyboard type).

Figure 1-6 shows the available symbols for setting your display station functions.

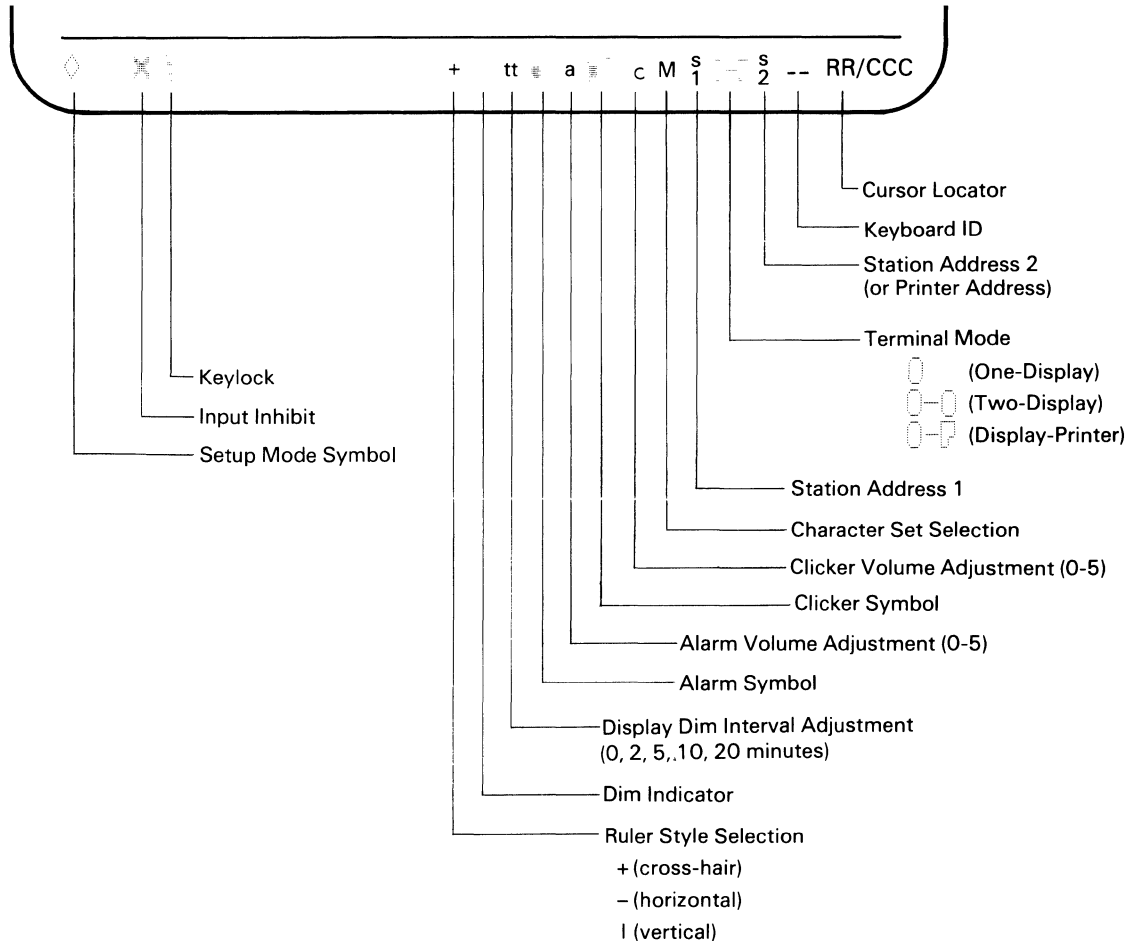

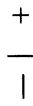









Figure 1-6. Symbols in Setup Mode

Symbol	Symbol Name	Meaning/Action
	Input Inhibit	Your input will not be accepted by the system. This symbol appears when the security key of your display station is locked. You cannot change the selection of the setup mode functions. Pressing the Reset key clears this symbol and the security keylock symbol.
	Keylock Locked	The security key of your display station is locked.
	Ruler Style	This symbol shows which ruler style (cross-hair +, horizontal —, vertical) is currently selected. To enable or disable the ruler, the Rule key should be used (see the description of the Rule key in Chapter 2 for the 122-key typewriter keyboard and Chapter 4 for the IBM enhanced keyboard).
	Dim Indicator	This indicator shows the location on the screen of the display dim interval adjustment selection (next to this indicator).
tt	Display Dim Interval Adjustment	The numbers (0, 2, 5, 10 and 20) means the time interval to start the auto display dim function.
	Alarm Symbol	This symbol shows the location on the screen of the alarm volume adjustment selection (next to this symbol).
a	Alarm Volume Adjustment	The number (0 to 5) shows the level of the alarm volume currently selected. The value 0 means no alarm sound will be generated. The value 5 means the highest sound level available.
	Clicker Symbol	This symbol shows the location on the screen of the clicker volume adjustment selection (next to this symbol).
c	Clicker Volume Adjustment	The number (0 to 5) shows the level of the clicker volume currently selected. The value 0 means no clicker sound will be generated. The value 5 means the highest sound level available.
M	Character Set Selection	This symbol means the multinational character set currently selected. Pressing the Cmd21 (F21/F9) key alternates the character set with the country unique character set. The symbol 'M' also disappears.
	Station Address 1 Selection	The number (0 to 6) means the station address for you display station (in case of two-display mode operation, this station address is for logical workstation 1).
	One-Display Mode Symbol	This symbol shows one screen image, and indicates one-display mode is currently selected. One-display mode implies operation of one workstation with one workstation address.
	Two-Display Mode Symbol	This symbol indicates that two-display mode is currently selected. Two-display mode implies operation of two workstations with two workstation addresses.
	Display-Printer Mode Symbol	This symbol indicates that display-printer mode is selected. Display-printer mode implies operation of one display station with one workstation address and one printer with one printer address.

Symbol	Symbol Name	Meaning/Action
N0	Station Address 2 Selection	The number (0 to 6) means the station address for the logical workstation 2 is currently selected. This selection is used only for the operation of two-display mode.
	Printer Address Selection	The number (0 to 6) means the printer address for the printer attached to the display station (same position as workstation 2). This selection is used only for the operation of display-printer mode.
--	Keyboard ID	This symbol shows your keyboard ID.
RR/CCC	Cursor Locator	This symbol indicates the cursor locator function enabled. Pressing the Cmd11 (F23/F11) key disables or enables this function.

Symbols in Printer Setup Mode

When you attach a printer to your display station, you have to select the printer functions such as character size, line spacing, printer emulation type, and so on.

Pressing the Setup key on the 122-key typewriter keyboard or the F13/F1 key on the IBM enhanced keyboard while pressing and holding the Alt key makes your display station enter printer setup mode. While in printer setup mode, the current status of the printer function selections is displayed by symbols on the operating status line. You can newly set or change the printer functions from the attached keyboard. (See "Printer Setup Mode Operation" in Chapter 3 for the 122-key typewriter keyboard and Chapter 5 for the IBM enhanced keyboard.)

Figure 1-7 shows the symbols for the printer setup mode.

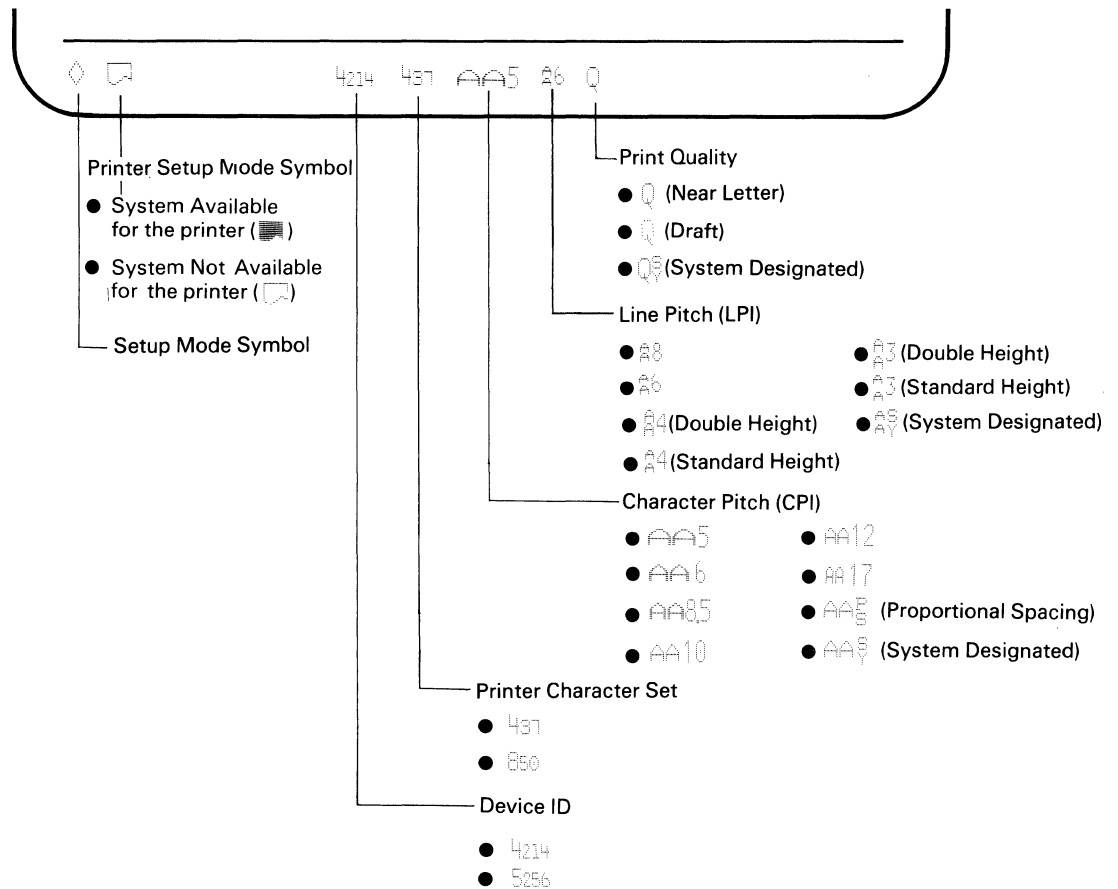















Figure 1-7. Symbols for Printer Setup Mode

Symbol	Symbol Name	Meaning/Action
◇	Setup Mode	This symbol will be displayed with the printer setup mode symbol when the display station enters printer setup mode.
 or 	Printer Setup Mode	Either symbol means that the display station is in printer setup mode. The symbol () means that the host system is available for the attached printer. The  means the host system is not available for the attached printer.
	Character Pitch Selection	The number next to the  indicates the character pitch (characters per inch) currently selected. Up to eight character pitch selections are available depending on the printer attached to the display station. For more information about character pitch selections, refer to chapter 3 or 5, "Printer Setup Mode Operation" of this manual.
	Line Pitch Selection	The number next to the  indicates the line pitch (line per inch) currently selected. Up to seven line pitch selections are available depending on the printer attached to the display station. For more information about line pitch selections, refer to chapter 3 or 5, "Printer Setup Mode Operation" of this manual.
	Print Quality	The symbol indicates one of the three print qualities (Near Letter, Draft and System Designated). For more information, refer to chapter 3 or 5, "Printer Setup Mode Operation" of this manual.
4214 or 5256	Device ID	Either  or  indicates which IBM printer the attached printer emulates. The printer attached to your display station is a PC printer and is needed to emulate the printer; either IBM 4214 or IBM 5256.
437 or 850	Printer Character Set	Either  or  indicates the available character set for the attached printer. If the attached printer is either the IBM 4201 or the IBM 4202, select 437. If the attached printer is the IBM 5201, select 850. If your keyboard is a Katakana keyboard, neither character set is available.

Chapter 2. The 122-Key Typewriter Keyboard

This chapter describes the keyboard layout of the U.S. English 122-key keyboard and the function of each key.

Keyboard Layout of the U.S. English 122-key Typewriter Keyboard

The arrangement of the data entry keys is almost the same as that of a typewriter. The function keys surrounding the data entry keys are arranged for ease of use while in power data entry operation.

Figure 2-1 on page 2-2 shows the keyboard layout of the U.S. English 122-key typewriter keyboard.

The top two rows of keys have a command (Cmd) number on the top half of the key and a symbol or words on the overlay surrounding the top two rows. The functions on the overlay are used to make display and keyboard adjustments (discussed later in this book). To use the command function assigned to the key, see your host system operating manual.

The right side of the keyboard has a calculator-like keypad for entry of numeric data.

Appendix B contains keyboard layouts for languages other than U.S. English.

Keyboard Overlay

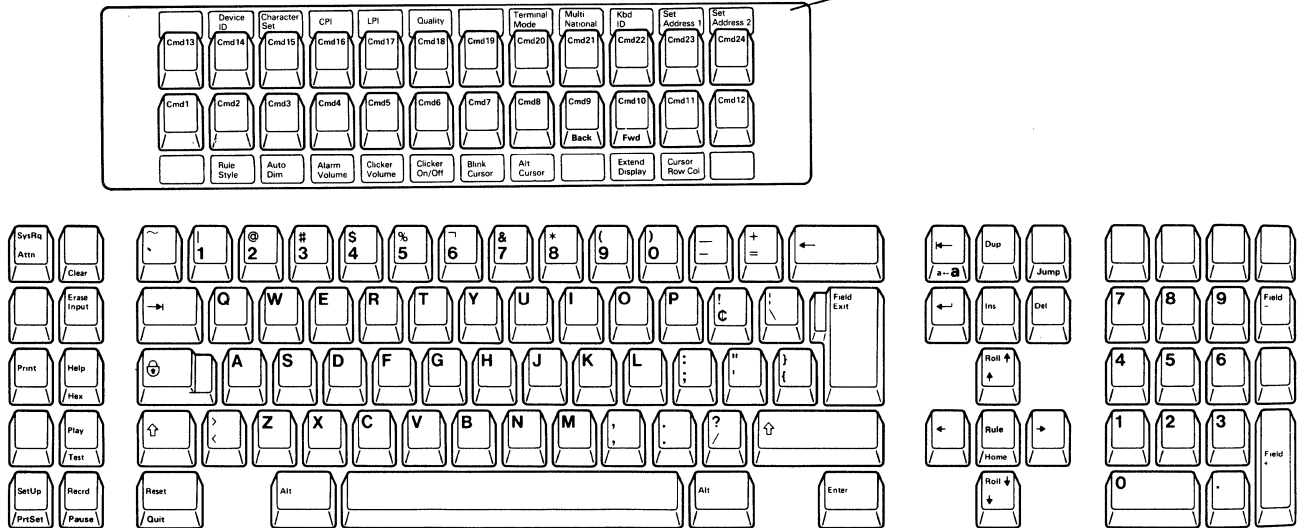
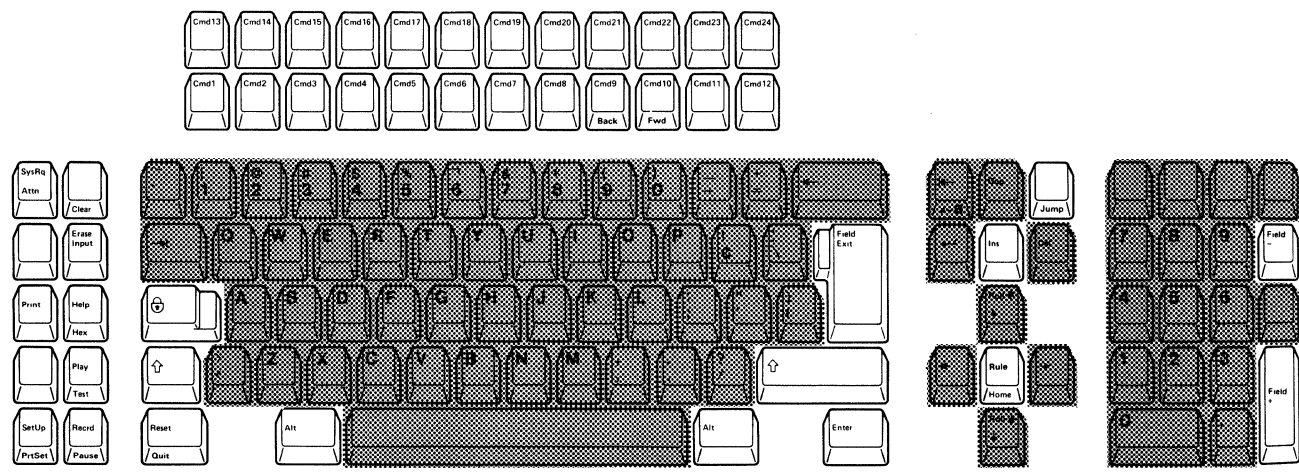

Figure 2-1. IBM 3197 122-key Typewriter Keyboard Layout (U.S. English)

Many of the data-entry keys are typematic (repeat-action) keys. The following figure shows which keys are typematic (shaded) and which are non-typematic (unshaded).



Key Functions

This section describes all key functions and identifies the locations of the keys used to activate the functions.

Command (Cmd) keys are used to pass information between the display station and the host system programs and to perform display station operations.

Some keys have a name printed on the front of the key. To activate the key function, that key must be pressed while pressing and holding an Alt key.

The names printed on the top of a key are the functions activated when it is pressed alone.

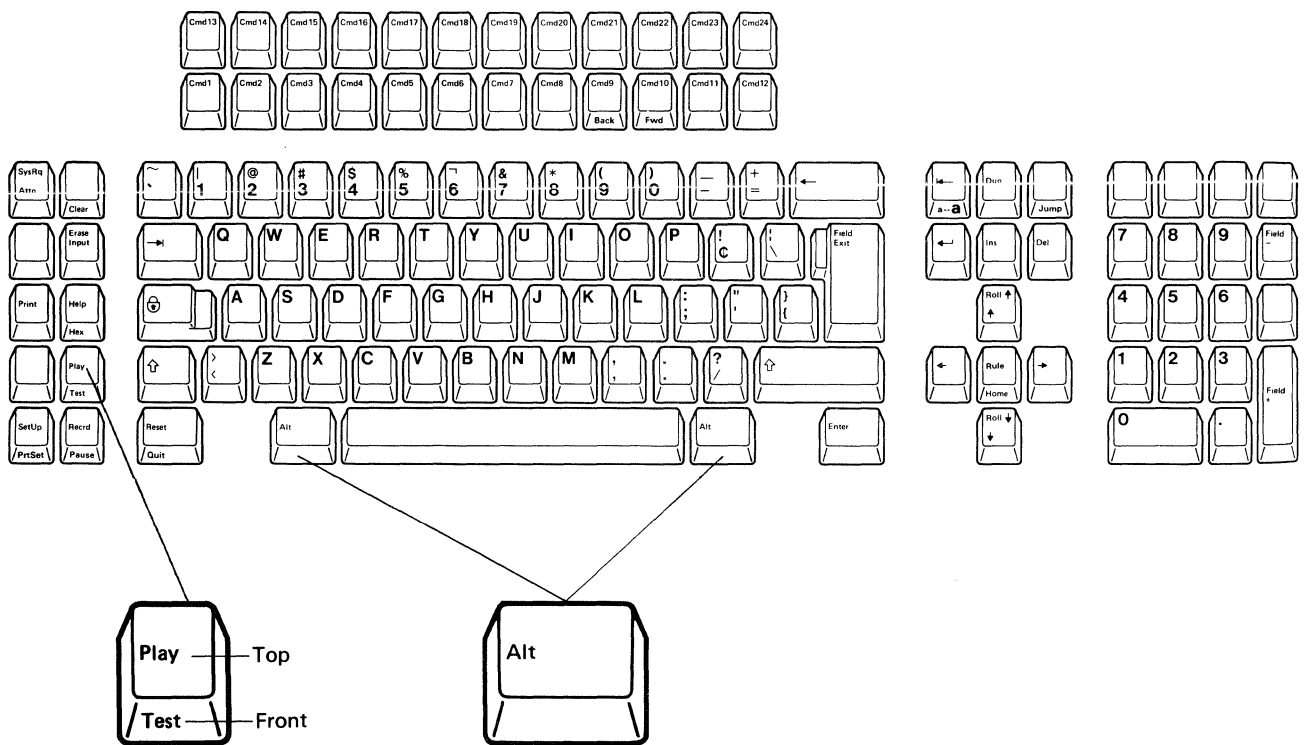

The highlighted keys (shown on the left) are described with the associated functions after this figure.

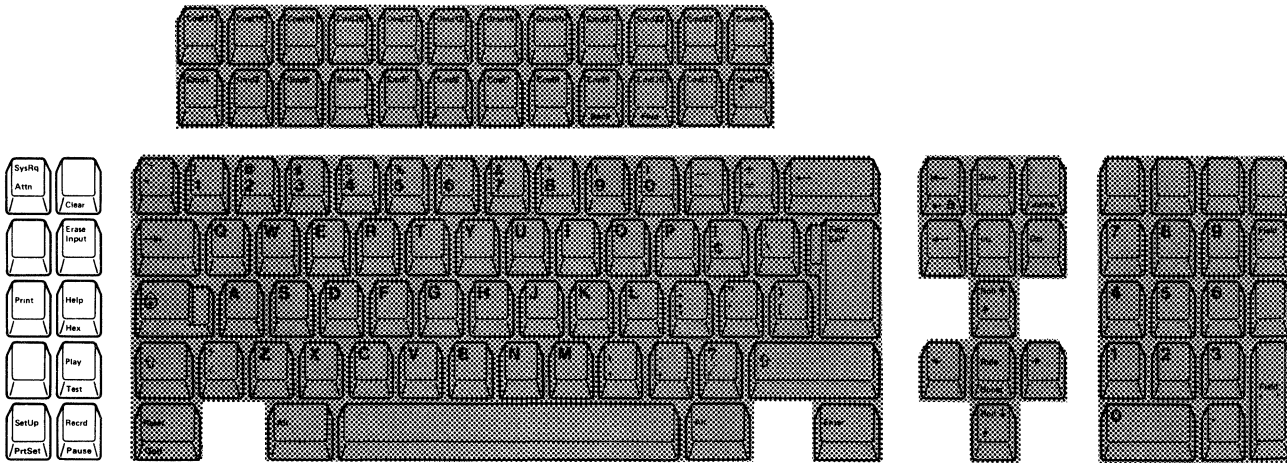

System Request



Then



This function can vary depending on the host system. With most systems, this function is used to:

- Start and select an alternate job
- Notify the host system that the display station is ready to select a new program or activity
- Request that the keyboard be unlocked (after normal error-recovery action has failed) so data can be entered.

To use this function, press and hold the Shift key and press the System Request (SysRq) key. Then press the Enter key.

To cancel this function, press the Reset key, then press the Enter key.

Attention



The Attention function (activated by pressing the Attention key) is used to temporarily stop the present display station activity to select a new activity.

Clear

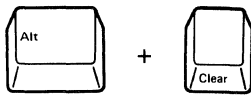

When you press and hold the Alt key, then press the Clear key, the display screen goes blank (except for the cursor, the operating status line, and the message line).

A host system program can change the way this function operates, allowing recovery if you accidentally press the Clear key. Call your host system operator or refer to the host system operating manual.

Erase Input



The erase input function erases the display screen and moves the cursor to the first input position on line one. To operate this function, press and hold the Shift key, then press the Erase Input key.

When the display station is under program control, this function erases all the characters from an input field and moves the cursor to the home position (usually the first input position of the first input field) on the display screen.

Print



The print function (activated by pressing the Print key) sends a print request to the host system. If supported, the host system program selects the printer for printing the data displayed on the display screen.

To cancel the printing operation of the printer attached to the display station, press the Quit key (pressing and holding the Alt key and then press the Reset key) after entering printer setup mode (press the Setup key while pressing and holding the Alt key).

Help



The help function (activated by pressing the Help key) provides (1) an explanation of current error conditions or (2) help information from the host system. The host system must be programmed to provide the Help function. See Appendix A, "Error Codes and Recovery Procedures" for more information about error codes.

Hex

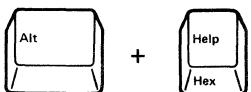

The hex function is used to enter the hexadecimal value for a character. To enter a hexadecimal value, press the Hex key while pressing and holding the Alt key, then enter the corresponding hexadecimal value using the alphanumeric keys. (Refer to the *IBM 5250 Function Reference Manual*, SA21-9247 for a hexadecimal value for each character.)

Play



The play function (activated by pressing the Play key) is used to play back often-used keystroke sequences (words or sentences) recorded in a Command (Cmd) key (see the description of the Record function). See Chapter 3, “Operations Using the 122-key Typewriter Keyboard” for more information about this function.

Test

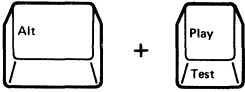

Pressing the Test key while pressing and holding the Alt key enables the display station to run additional display station tests. This key sequence is valid only when the test pattern is on the screen. See the *IBM 3197 Model D Display Station Problem Solving Guide*, GA18-2547, for instructions. Press the Reset key to exit test mode.

SetUp



When the SetUp key is pressed, the display station enters setup mode, allowing you to:

- Select the multinational character set (offline setup mode only)
- Select the keyboard ID (offline setup mode only)
- Set the station address for workstation 1 (offline setup mode only)
- Set the station address for workstation 2 (offline setup mode only)
- Set the printer address (offline setup mode only)
- Select the terminal mode (offline setup mode only)
- Select the display dim interval
- Select the ruler style
- Adjust the alarm volume
- Adjust the clicker volume
- Enable/disable the clicker action
- Enable/disable the cursor blink
- Select the cursor style
- Enable/disable the extended display
- Enable/disable the cursor locator.

When you press the SetUp key again, the display station exits from setup mode. (For more information, see Chapter 3, “Operations Using the 122-key Typewriter Keyboard”).

Printer Setup Mode



Pressing the SetUp key while pressing and holding the Alt key enables the display station to enter printer setup mode.

The printer setup mode allows you to:

- Set the device ID (device ID mode only)
- Select the printer character set (offline printer setup mode only)
- Set the character pitch
- Set the line pitch

- Specify the print quality.

When you press the Printer Setup Mode key while pressing and holding the Alt key, the display station exits from printer setup mode. For more information, see Chapter 3, “Operations Using the 122-key Typewriter Keyboard.”

Record



The record function (activated by pressing the Record key) records the keystroke sequences assigned to the Command (Cmd) keys. See Chapter 3, “Operations Using the 122-key Typewriter Keyboard” for more information about the record function.

Pause

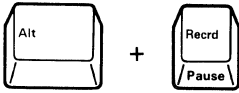

The pause function (activated by pressing the Recrd key while pressing and holding the Alt key) temporarily halts the record operation (see the description of the record key function). Pressing this key again enables continuing the record operation, but the Pause key is recorded in the keystroke sequence. In the playback operation of that keystroke sequence, if the playback stops because of the Pause function, press the Play key to continue the playback. (See Chapter 3, “Operations Using the 122-key Typewriter Keyboard” for more information about the record/play functions.)

The highlighted keys (in the center) are described with the associated functions after this figure.

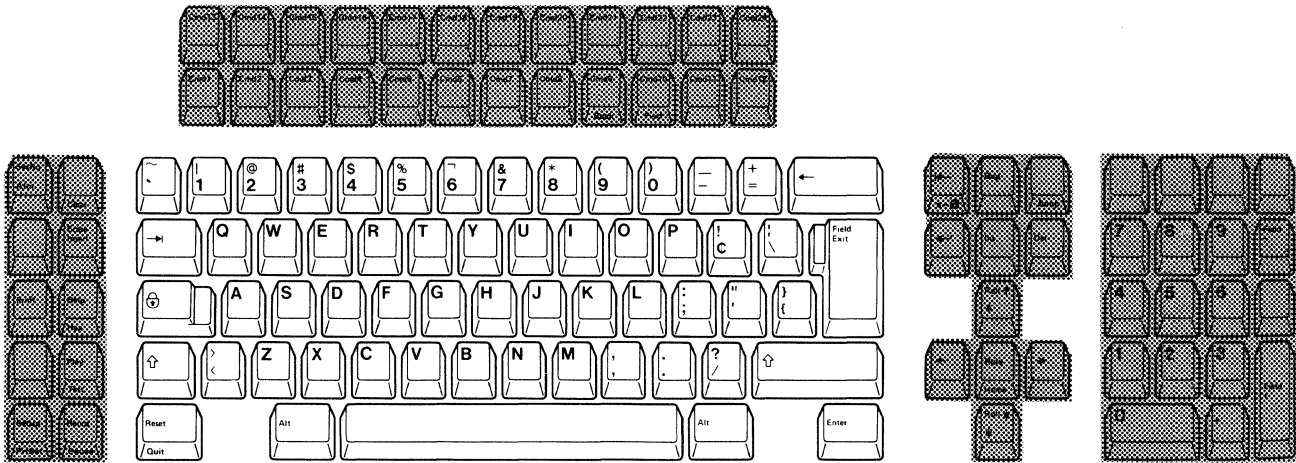

Character Backspace

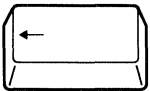

The character backspace function (activated by pressing the Character Backspace key) moves the cursor back to the previous position in which data can be entered.

If the cursor is in the first position of an input field, it moves back to the last position of the preceding input field.

Field Advance

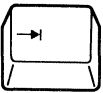

The field advance function (activated by pressing the Field Advance key) moves the cursor to the first position of the next input field.

Field Exit

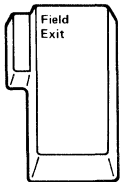

The field exit function (activated by pressing the Field Exit key) causes the cursor to exit an input field, and null characters (displayed as blank) are inserted from the current cursor location to the end of the field.

When you press the Field Exit key in a right-adjust field, the data to the left of the cursor is shifted to the right. The vacated positions are filled with zeros or blanks as specified by the program, and the cursor advances to the next input field.

Shift Lock

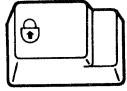

When the Shift Lock key is pressed:

- The keyboard locks in upper shift.
- The alphabetic characters (A through Z) are entered as uppercase letters.
- The symbols on the top of the numeric keys and the punctuation marks on the upper half of the other keys are entered.

To return the keyboard to lower shift, press and release either Shift key.

Shift

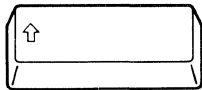

When either Shift key is pressed and held down:

- The alphabetic characters (A through Z) are entered as uppercase letters.
- The symbols on the top of the numeric keys and the punctuation marks on the upper half of the other keys are entered.

Reset

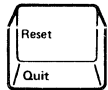

The reset function (activated by pressing the Reset key) is used to (1) unlock the keyboard when locked because of an error condition and (2) end the command, help, insert, and system request functions.

The reset function does not unlock a keyboard that is locked by the host system.

Quit

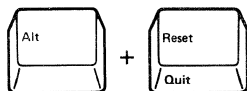

The quit function (activated by pressing and holding the Alt key, then by pressing the Quit key) ends a recording sequence and playback sequence (for more details, refer to Chapter 3, "Operations Using the 122-key Typewriter Keyboard").

This key is also used to stop the printing operation and cancel the printing of the remainder of the file in printer setup mode. The attached printer, then, starts printing the top of the next file.

Enter



The Enter key is used to send to the system data you have typed on the display screen.

Data Entry

Data is entered on the display screen in the same way as it is on an ordinary typewriter. Pressing a data entry key causes the character shown on the keytop to appear on the display screen as data.

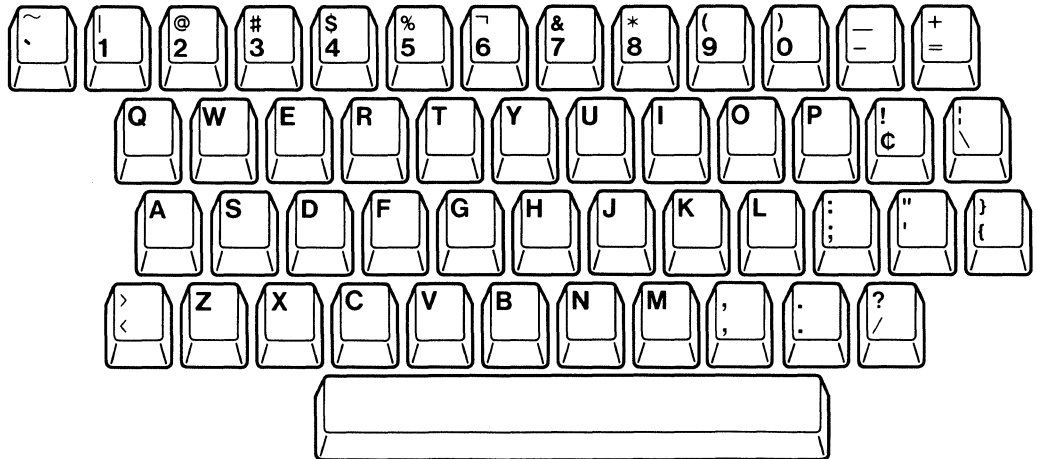

This page intentionally left blank.

The highlighted keys (to the right of center) are described with the associated functions after this figure.

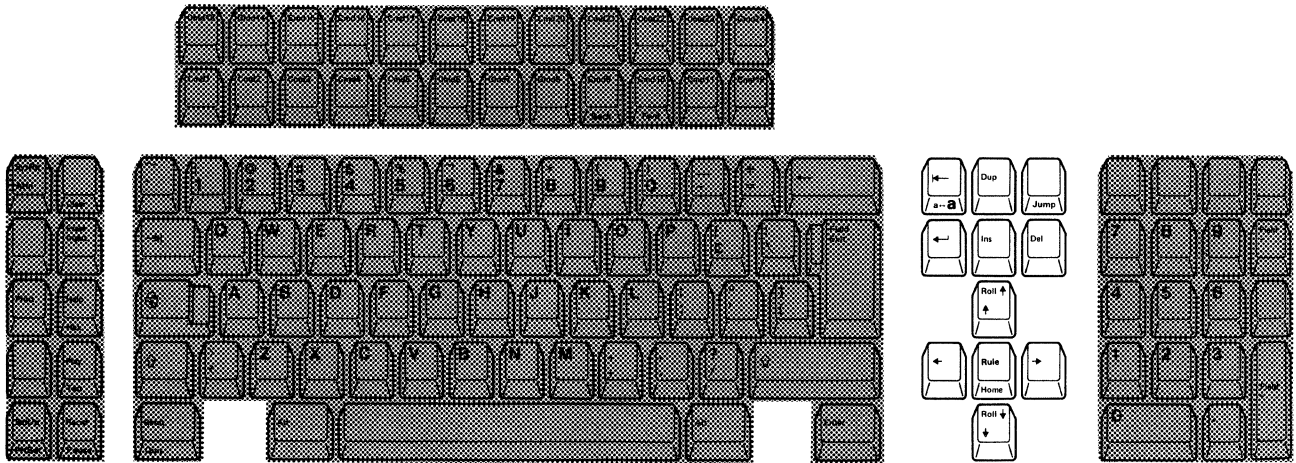

Field Backspace



The field backspace function (activated by pressing the Field Backspace key) moves the cursor back to the first position of the current field. If the cursor is already in the first character position, it moves back to the first position of the previous field.

Duplicate



When the duplicate function is activated by pressing the Duplicate key in a field programmed to allow duplication, an asterisk with an overscore (^{*}) is placed in the cursor position. This requests the program to duplicate the data from the same field in the previous record.

Zoom



The zoom function (activated by pressing the a↔a key while pressing and holding the Alt key) allows you to change the screen format from the split screen to the non-split screen (full screen) or the non-split screen to the split screen in two-display terminal mode.

Note: In case of the non-split screen in two-display terminal mode, pressing the Jump key while pressing and holding the Alt key changes the screen data by switching the connection between logical workstation 1 and logical workstation 2.

Jump

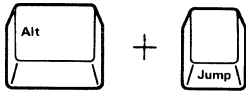

The Jump function (activated by pressing the Jump key while pressing and holding the Alt key) allows you to change the active screen (where a cursor resides) from one split screen to the other (when the screen format is split) in two-display terminal mode. When the screen format is non-split, this key allows you to make the hidden screen active.

The repeated key action changes the active screen to the previous condition.

Note: In two-display terminal mode, the display screen can be split into two; 24 lines of 80 characters and 17 lines of 80 characters. Either of the split screens is always active. The upper half split screen connects to logical workstation 1 and the other connects to logical workstation 2.

New Line



The new line function (activated by pressing the New Line key) is used to move the cursor to the first input position of the first input field in the next line (usually the leftmost position of the next line).

Insert Mode



The insert function (activated by pressing the Insert key) allows you to insert a character into an existing input field without writing over data already there.

When a new character is inserted at the cursor location, characters to the right of the cursor will shift one position to the right.

Null characters, displayed as blanks, must be in the rightmost positions of the field where the insert will be performed. If you attempt to insert more characters than there are nulls, the input-inhibit symbol appears on the operating status line, and the keyboard locks. Pressing the Reset key removes the symbol and unlocks the keyboard.

To leave insert mode, press the Reset key.

Delete



The delete function (activated by pressing the Delete key) is used to delete data from an input field. When you press the Delete key, the character at the cursor location is deleted, and all characters to the right of the cursor (in the same input field) shift one position to the left. Null characters are inserted into the right end of the field as the characters in the field are shifted left.

This key is also used to delete the recorded keystroke sequence in record mode (see the description of the Record key).

Cursor Movement

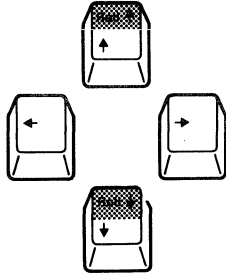

The four cursor movement keys move the cursor in the direction indicated by the arrow without affecting the existing data.

When the cursor reaches the edge of the display screen by pressing a cursor movement key, the cursor goes off the edge and reappears at the opposite edge of the display screen. (This cursor movement is called “wrap”).

Roll



The roll function is used to move data on the display screen up or down. The roll function is activated by pressing and holding a Shift key, then by pressing the desired Roll key.

Pressing the Roll up key causes the next page (data below the current display screen) to replace the current data. Pressing the Roll down key causes the previous page (data above the current display screen) to replace the current data.

Home

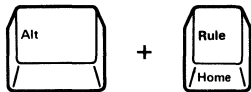

The home function operates in two ways. Pressing and holding the Alt key then pressing the Home key moves the cursor to the home position (usually the first input position of the first input field).

When the display screen is unformatted, pressing and holding the Alt key then pressing this key moves the cursor to the first input position on line one.

Rule



The rule function (activated by pressing the Rule key) enables or disables the indication of the ruler (one of the three selectable ruler styles; vertical, horizontal, and cross-hair) that can be specified by the Rule Style (Cmd2) key in setup mode. See Chapter 3, “Operations Using the 122-key Typewriter Keyboard” for more information about the ruler style function.

This page intentionally left blank.

The highlighted keys (at the right) are described with the associated functions after this figure.

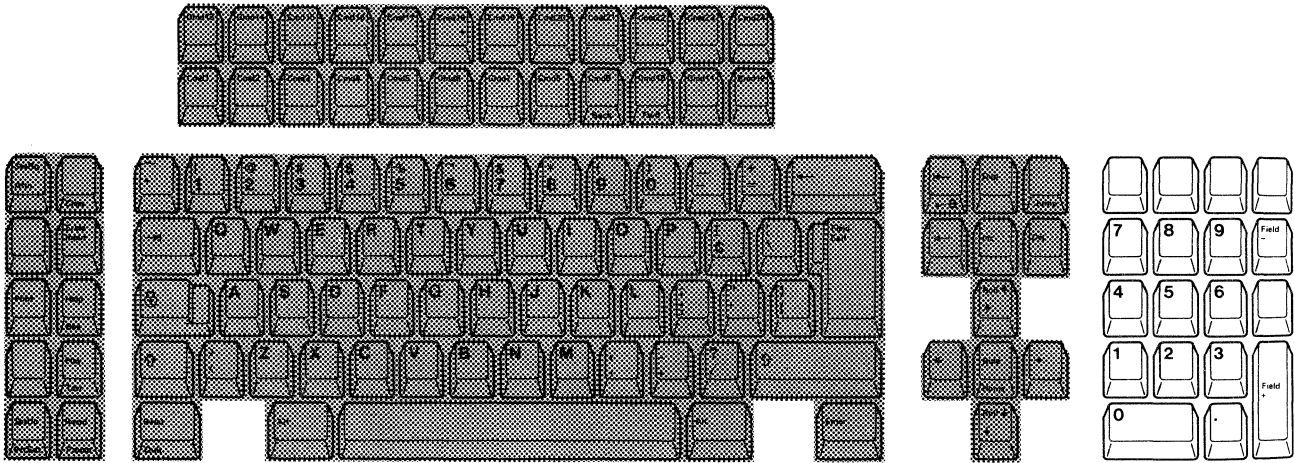

Field +

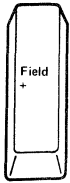

The field+ function (activated by pressing the Field+ key) operates in the same way as a field exit function in all fields.

When you are entering numeric data, the Field+ key can be used instead of the Field Exit key.

Field -



The field- function (activated by pressing the Field- key) can vary depending on the system. On most systems the field- function operates the same as the field+ and field exit functions, except that it is allowed only in signed-numeric and numeric-only fields. Pressing the Field- key inserts a - (minus) sign in the last position of a signed numeric-only field, or it changes the last position of a numeric-only field to an alphabetic character. (This alphabetic character is used to tell the host system the numeric value of the last position and that it is a negative field.) Pressing the Field- key causes an error if used in any field not programmed to accept negative numbers as input.

Numeric

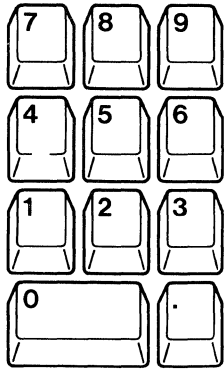

The numeric functions are used to enter numeric data with calculator-like efficiency.

The highlighted keys (at the top) are described with the associated functions after this figure.

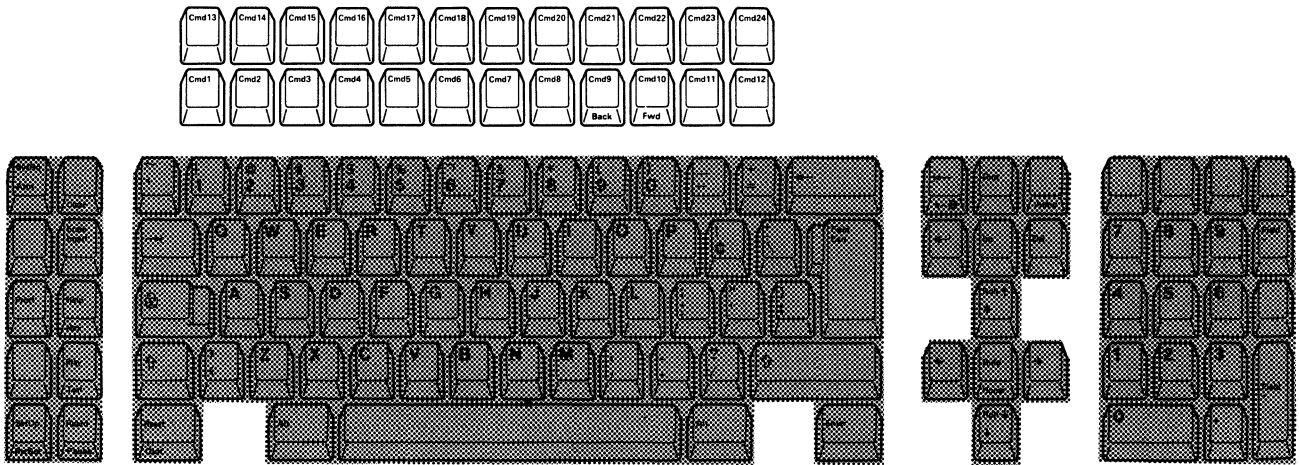

Command

Some key functions are activated by pressing the Command (Cmd) keys at the top of the keyboard. Specific command functions vary depending on how they are assigned in the host system program.

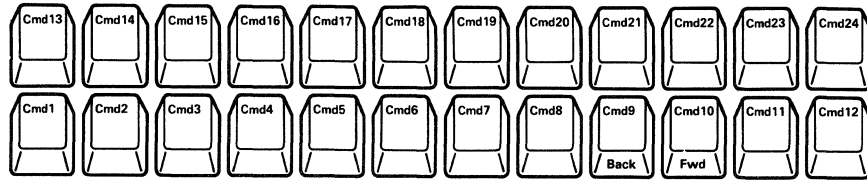

Local Scroll

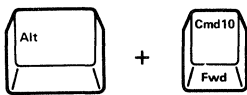

The local scroll function is used to move data up or down on the split screen in two-display terminal mode operation. When the split screen is inactive, pressing and holding the Alt key and then pressing either the Fwd (Cmd10) or Back (Cmd9) key enables this function.



Pressing the Fwd key while pressing and holding the Alt key scrolls up the next data line by line.

Pressing the Back key while pressing and holding the Alt key scrolls down the previous data line by line.

Setup Mode

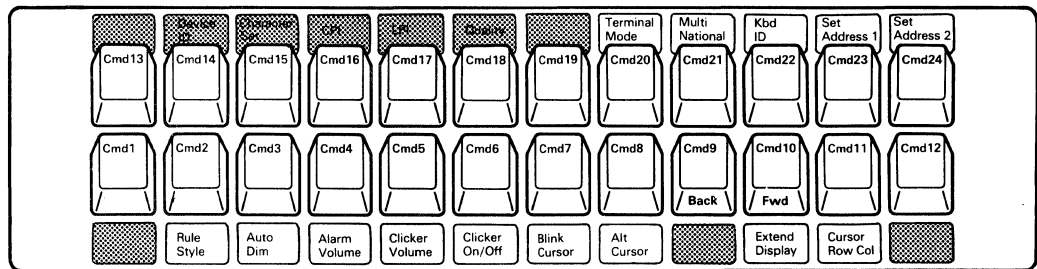

The Command keys that have printing in black or blue on the overlay also activate setup mode functions. These functions are activated only when the SetUp key is pressed prior to pressing the desired Command key. To exit setup mode, press the SetUp key. The display station will return to normal communication mode.

The following table describes the functions of the Command keys in setup mode. For more information see Chapter 3, "Operations Using the 122-key Typewriter Keyboard."

Setup Mode Key	Function™
Terminal Mode Cmd20	Changes the current selection among three terminal modes (one-display, two-display and display-printer).
Multinational Cmd21	Selects either the multinational character set or the country-specific character set.
Kbd ID Cmd22	Changes the current value of the keyboard ID. Pressing and holding this key automatically increments the ID from -- through 63. When the key is released, the ID displayed at that time will be selected. When the keyboard ID reaches 63, sequence starts over again from --.
Set Address 1 Cmd23	Changes the current address of logical display station 1. Pressing and holding this key automatically increments the address from 0 to 6. When the key is released, the address displayed at that time will be selected. When logical display station 1 address reaches 6, the sequence starts over again from 0.
Set Address 2 Cmd24	Changes the current address of logical display station 2. Pressing and holding this key automatically increments the address from 0 to 6. When the key is released, the address displayed at that time will be selected. When logical display station 2 address reaches 6, the sequence starts over again from 0.
Set Printer Address Cmd24	Changes the current address of the printer attached to the display station. Pressing and holding this key increments the address 0 to 6 when you select the display-printer mode using the Terminal Mode key. When this key is released, the address displayed at that time will be selected. When the printer address reaches 6, the sequence starts over again from 0.
Rule Style Cmd2	Changes the current ruler (one of the three styles; vertical, horizontal, and cross-hair) at the cursor position in the data area as well as the ruler style symbols in the operating status area when the ruler function is enabled by the Rule key. If the ruler function is disabled, one of the three ruler style symbols that you selected appears on the operating status line. Pressing and releasing this key cyclicly changes the style from vertical, horizontal, to cross-hair.
Auto Dim Interval Cmd3	Changes the current auto dim interval (time required to start the auto dim function) and increments the interval from 0 to 20 minutes. Five selections; 0, 2, 5, 10, and 20 are available. After the longest interval is reached, it returns to 0.
Alarm Volume Cmd4	Adjusts the alarm volume. Pressing this key increases the alarm volume until the highest level is reached. After the highest level is reached, the alarm volume returns to off and the sequence starts over.
Clicker Volume Cmd5	Adjusts the volume of click sound. Pressing this key increases the clicker volume until the highest level is reached. After highest level is reached, the clicker volume returns to off and the sequence starts over.
Clicker On/Off Cmd6	Enables or disables the keyboard clicker.
Blink Cursor Cmd7	Enables or disables the cursor blink.
Alt Cursor Cmd8	Alternately selects either underscore or block-style cursor. When the current cursor style is underscore-style, pressing this key changes it to block-style.

Setup Mode Key	Function
Extend Display Cmd10	Enables or disables the extended-display function. When enabled, each field attribute in the data area and the message line will be displayed as a two-digit hexadecimal number. Each hexadecimal value will be displayed in single-character cell. In addition, the station addresses, multinational character set symbol, controller link parity error count, terminal mode and keyboard link parity error count will be displayed on the operating status line.
Cursor Row/Col Cmd11	Displays the current cursor location by line number and column position. Pressing this key again blanks the indication.

Printer Setup Mode

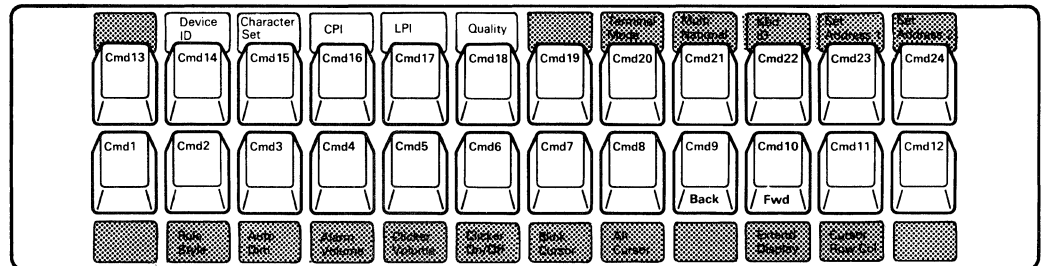

The Command keys that have printing in green on the overlay also activates printer setup mode functions. These functions are activated only when the Setup key is pressed while pressing and holding the Alt key, prior to pressing the desired Command key. To exit printer setup mode, press the SetUp key while pressing and holding the Alt key.

The following table describes the functions of the command keys in printer setup mode. For more information, see Chapter 3, "Operations Using the 122-key Typewriter Keyboard."

Setup Mode Key	Function
Device ID Cmd14	Alternately changes the device ID from 4214 to 5256 or from 5256 to 4214. The device ID number represents a system printer or a workstation printer either IBM 4214 or IBM 5256, that the printer attached to your display station emulates.
Character Set Cmd15	Alternately changes the printer character set from 437 to 850 or from 850 to 437. (Not available for the Katakana keyboard.)
CPI Cmd16	Displays the current character pitch of the printer attached to your display station. Pressing this key changes the current character pitch to the desired one from the eight selections (see Chapter 3 for more details).
LPI Cmd17	Displays the current line pitch of the printer attached to your display station. Pressing this key changes the current line pitch to the desired one from the seven selections (see Chapter 3 for more details).
Quality Cmd18	Displays the current print quality (characters to be printed by the attached printer). Pressing this key changes the current print quality to the desired one from the three selections (see Chapter 3 for more details).

Katakana-Unique Shift Keys (124-Key Keyboard)

The Katakana keyboard has four Shift keys and two Shift Lock keys.

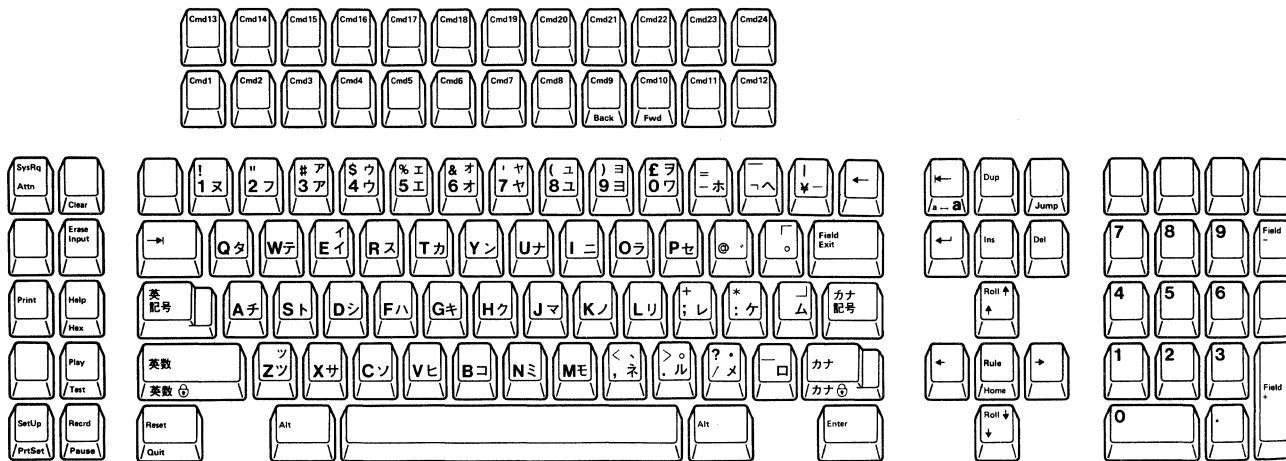

Each data key on the Katakana keyboard has two to four characters or symbols on its keytop. To select any of the four characters, one of the Shift or Shift Lock keys must be pressed first. Figure 2-2 shows the relationship between the shift status (including Shift Lock) and the characters on the keytop.

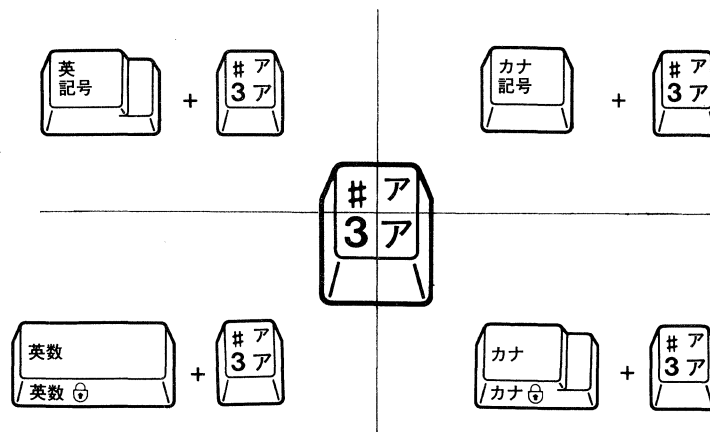

Figure 2-2. Relationship between Shift Status and Keytop Character

Your display station stays in alphanumeric shift status, except when you lock it in Katakana-shift status. This means when you want to enter alphanumeric data, you simply press the alphanumeric key. When you want to enter a Katakana character, you first press the Katakana Symbol or Katakana-Shift key before pressing the corresponding character key.

There are two Shift Lock keys: alphanumeric and Katakana. These two Shift Lock keys are used to:

- Enter a continuous alphanumeric or Katakana character stream from the keyboard.
- Force either Katakana-shift lock or alphanumeric shift lock, which overrides any host-specified shift status.

The following table shows the operating status line symbol for each shift or shift lock status.

Key Name	Shift Status	Operator Indicator
英記号	Alpha Symbol	↑
英数	Alphanumeric	No indication
英数 ⊕	Alphanumeric-Shift Lock	No indication
カナ記号	Katakana Symbol	↑ カナ
カナ	Katakana	カナ
カナ ⊕	Katakana-Shift Lock	↑ カナ

Chapter 3. Operations Using the 122-key Typewriter Keyboard

Modes

The IBM 3197 display station operates in six modes: test, normal communication, setup, record, play, and printer setup.

Test Mode

There are two test sub-modes: basic assurance test and offline test. In basic assurance test (BAT) sub-mode, the self-diagnostic program automatically runs the hardware functions. In offline test sub-mode, additional tests can be executed. For more details on these tests, refer to the *IBM 3197 Model D Display Station Problem Solving Guide*, GA18-2547.

Normal Communication Mode

In this mode, the display station can send data to and receive data from the host system. Also in display-printer mode, the printer attached to your display station can receive and print data from the host system.

Setup Mode

The display station has two setup sub-modes: offline setup and online setup.

In offline setup mode, the number of logical workstations, address for each workstation, and necessary parameters for communication with the host system should be specified.

In online setup mode, the various functions available for the display station should be specified.

Record Mode

Pressing the Record key in normal communication mode causes the display station to enter record mode. In this mode, an often-used keystroke sequence can be assigned to a particular Command (Cmd) key. Refer to "Record Mode Operation" for additional information.

Play Mode

Once the keystroke sequences are recorded while in record mode, those keystroke sequences can be recalled to any position in the data area when the play key is pressed in normal communication mode and the designated Cmd key is pressed. Refer to "Play Mode Operation" for additional information.

Printer Setup Mode

There are two printer setup sub-modes: offline printer and online printer.

In offline printer setup mode, a printer character set, and a device ID can be specified. In addition, all functions of the online printer setup mode can be selected or set in offline printer setup mode.

In online printer setup mode, your desired character pitch, line pitch, and print quality for the printing format can be selected.

The printer setup mode functions are described later in this chapter.

Setup Mode Operation

In setup mode, two types of setup mode functions are available; offline setup and online setup functions.

The offline setup functions should be determined at the initial machine setup stage. Or if you want to change the functions because of terminal configuration changes, you should determine the offline setup function, before changing the online setup functions.

In addition, all online setup functions can be selected or set in offline setup mode.

Note: All setup functions, after being selected, will be stored and will not be reset when the display station power switch is set to O (off).

The following sections describe the procedures for specifying both offline setup and online setup mode functions.

Offline Setup Functions

The offline setup functions can be specified after pressing the SetUp key *only* when the display station is in the offline test sub-mode of test mode. The functions available are:

- Select the terminal mode
- Select the multinational character set
- Set the keyboard ID
- Set station address 1
- Set station address 2
- Set the printer address.

Note: If you perform any of the previous offline setup functions, the host system and the IBM 5294 Control Unit (if the IBM 3197 is remotely attached) may have to be reconfigured. Contact your supervisor.

The following sections describe the procedure for specifying each offline setup mode function.

Help for the user

For ease of use, each setup function is described in a separate sub-section. However, when you need to setup two or more setup functions at the same time, you can set them successively in setup mode without turning power off and on when following the setup procedure for each setup function.

Select the Terminal Mode

Note: The selection of the terminal mode should be made based on your terminal configuration. Consult your supervisor or system operator before starting this procedure.

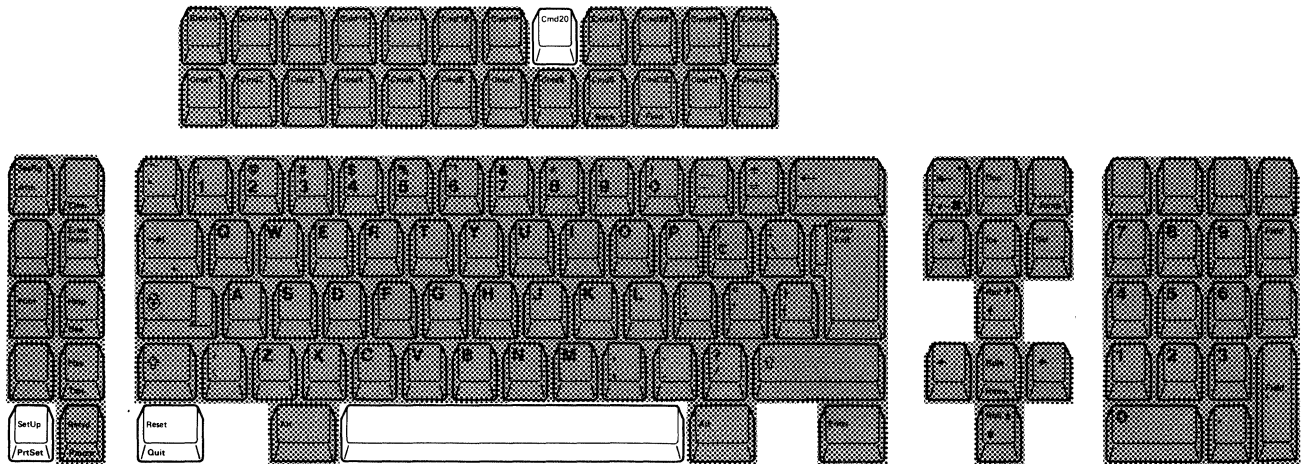

1. Set the power switch to O (off).
2. Press and hold the space bar and set the power switch to | (on). Hold the space bar until the test pattern appears.
3. Press the SetUp key. A diamond (◊) and one of the following terminal mode symbols appear on the operating status line.

◊ One-Display Mode

◊-◊ Two-Display Mode

◊-P Display-Printer Mode

The symbols on the operating status line are shown as follows:

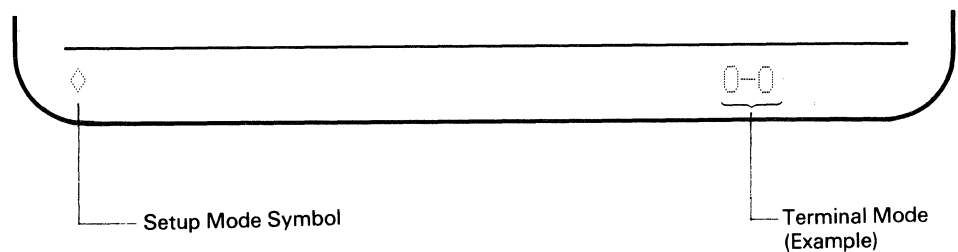

4. Press and release the Cmd20 key. The terminal mode symbol changes each time you press the Cmd20 key.

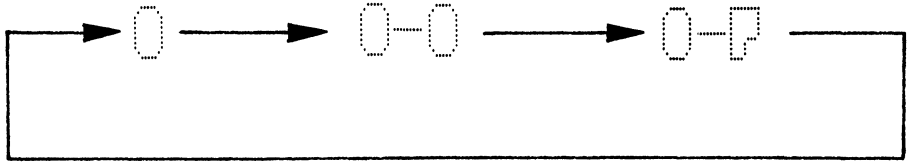

5. Release the Cmd20 key when the terminal mode symbol you want to select, appears.
6. Press the SetUp key again. The diamond disappears as you exit from setup mode. Once selected, the terminal mode will be stored and will not be reset when the display power switch is set to O (off).
7. Press the Reset key to enter normal communication mode.

The following sections describe what can be done in each terminal mode (one-display, two-display or display-printer mode).

One-Display Mode Operation

In one-display mode, your display station has one display station address and works as a single display station.

In this mode, either of the two screen formats; 24 lines x 80 characters (1920 characters) and 27 lines x 132 characters (3564 characters), can be selected by the host system application programs. The following figures show the differences of the two screen formats.

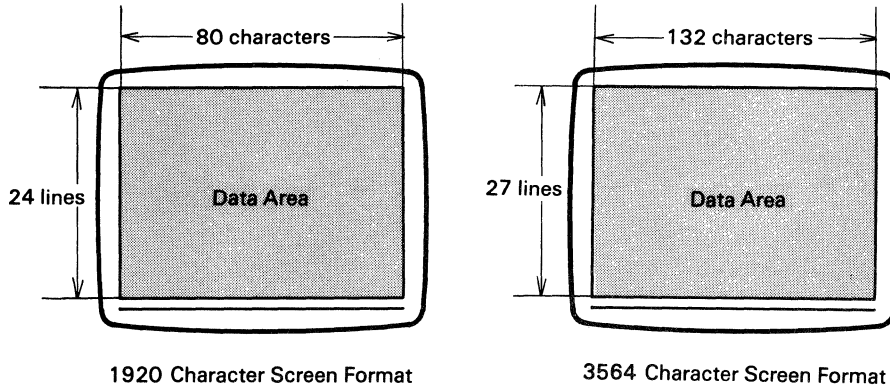

Two-Display Mode Operation

In two-display mode, your display station has two display station addresses and works as two display stations.

Like the one-display mode operation, the above two screen formats are used by the host system application programs. In addition, the display station locally supports the screen format of 41 lines x 80 characters (3280 characters) where data from the two display stations (logical display stations) can be displayed simultaneously. This screen format is called "split screen". The following figure shows the format of the split screen.

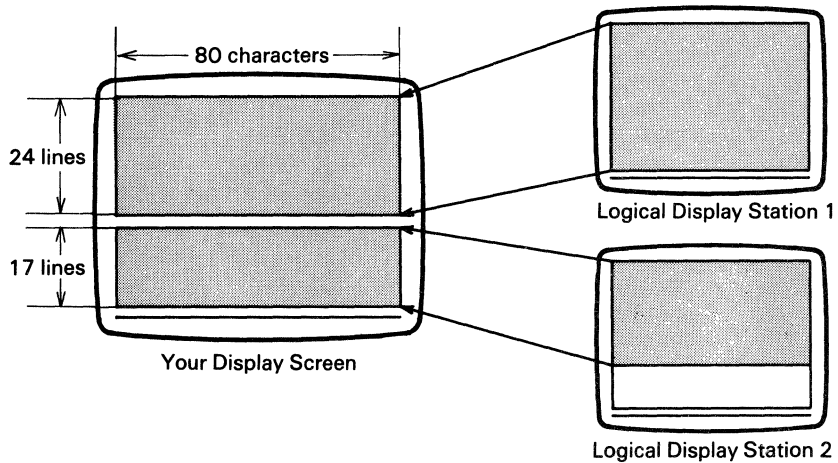

The upper half of the screen displays the full screen (24 lines x 80 characters) from the one display station (logical display station 1) and the lower half of the screen displays a part of the screen (17 lines x 80 characters) from the other display station (logical display station 2). For the lower half of the screen, using the Local Scroll keys (Back and Fwd keys), the screen can be scrolled up or down line by line to display the hidden 7 lines (in other words, the lower half of the screen only displays 17 lines out of the 24 lines full screen at one time).

Your display station also displays the full screen data from either of the two display stations (logical display station 1 and 2) on the display screen format of the 24 lines x 80 character or 27 lines x 132 characters. This display screen format is called "non-split screen".

With the Zoom (a↔a) key, the display screen format can be changed from the split screen to the non-split screen or from the non-split screen to the split screen. At initial power-on time, the display screen format is set to the non-split screen.

In summary, the following functions are available in two-display mode.

- Local Scroll function
- Jump function
- Zoom function

The following sections describe in more detail the above functions.

Split Screen

Your display station interacts with the host system using the two display stations (logical display station 1 and 2) simultaneously because your display station has two display station addresses.

As described above, in split screen, the display screen is divided into two data areas. The upper half of the screen displays the full screen data (24 lines x 80 characters) and the lower half displays a part of the full screen (17 lines x 80 characters).

The cursor that indicates which of the split screens is currently active, resides in the upper half screen at the first time when the screen is split. See the figure on the next page.

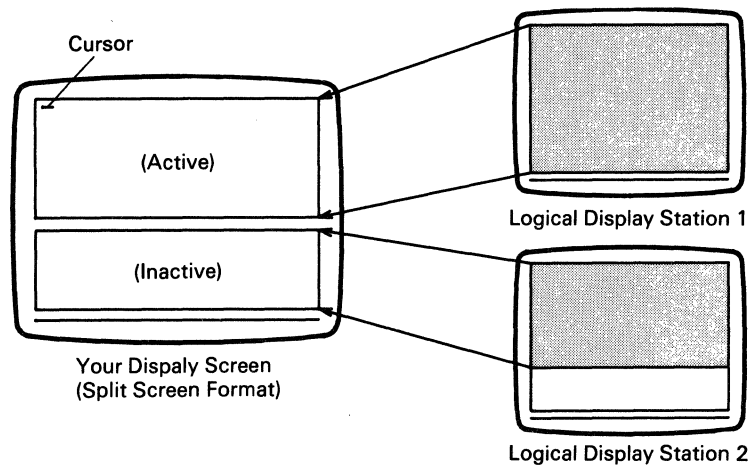

In the above screen, you can key in data using the upper half of the screen. The lower half of the screen only displays a part of the data of display station 2 (logical display station 2). In other words, the data on the lower half can be used as a reference.

Local Scroll

The lower half screen can be scrolled by the Local Scroll (Fwd and Back) keys within the range of 7 lines. Local scroll is functional only when the lower screen is not active. See the following figure.

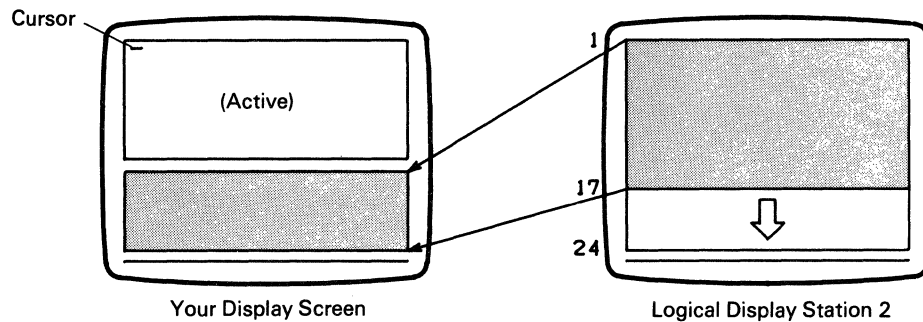

If the lower half screen displays the top 17 lines of the full screen of display station 2, pressing the Fwd key scrolls down the lower half screen of your display station line by line until the bottom line shows the 24th line of data of logical display station 2.

When the scrolling reaches the 24th line of data of display station 2, it stops. By pressing the Back key, the scrolling starts over again from the bottom to the top of the data of display station 2.

Jump

If you have completed the operation on the data of display station 1 and want to key in data to logical display station 2, pressing the Jump key changes the current active screen to the lower screen. The cursor moves from the upper half screen to the lower half screen.

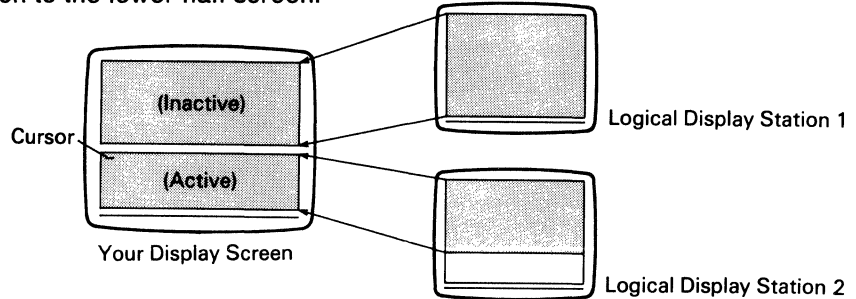

Now, you can key in data on the lower half of the screen (logical display station 2).

Note: While in split screen, if the host system specifies the 132 characters x 27 lines screen format for the active screen, your display screen automatically changes from split screen to non-split screen and the specified screen format will be displayed on the screen. In the same condition, if the host system specifies the same screen format for the inactive screen, the 80 characters x 24 lines screen format (active screen) will be displayed.

Non-Split Screen

Your display screen can interact with the host system using either one of the logical display stations, but only one at a time. The display of the data from one logical display station can be switched to the other one (see the figure shown below).

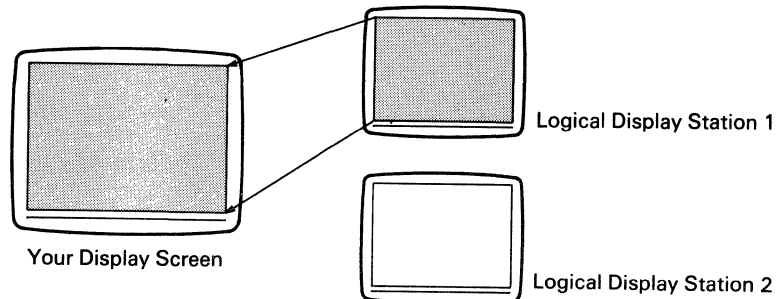

At initial power on time, the full screen data of display station 1 is displayed on your display screen and data can be keyed in.

Jump

Pressing the Jump key alternates the display from one logical display station to the other.

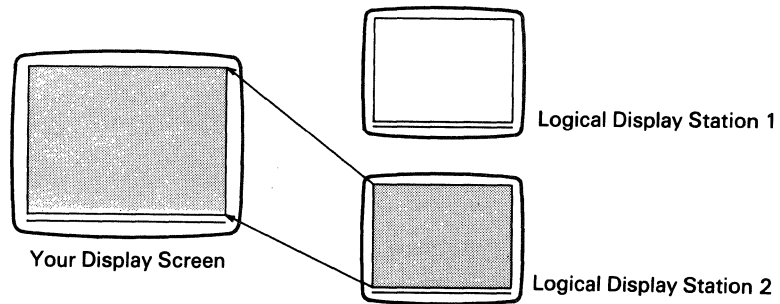

Zoom for Split and Non-Split Screens

When you need to change the screen format from the split screen to the non-split screen or from the non-split screen to the split screen, press the Zoom key (a↔a) key.

The following figures show the transition of the current display screen to the display screen after pressing the Zoom key.

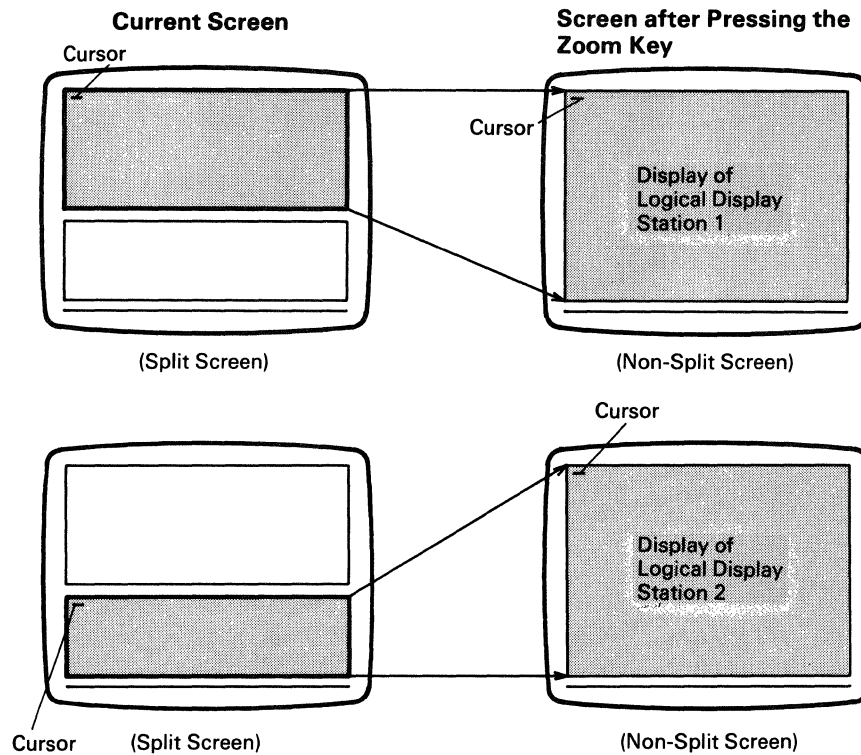

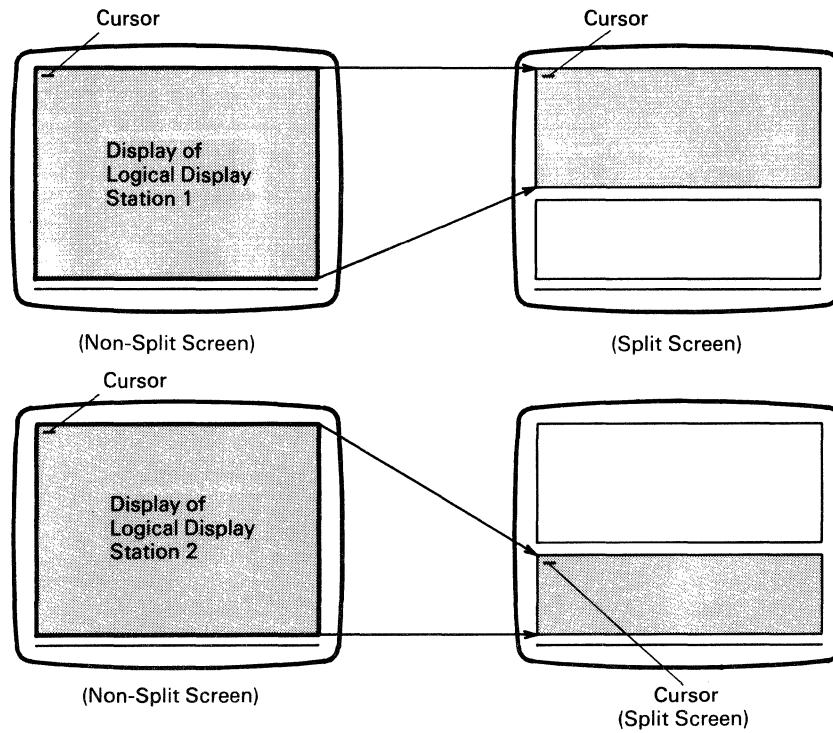

Note: The shaded area shows the active screen.

Display-Printer Mode Operation

In this mode, your display station is logically connected to both the display station 1 and the printer attached to your display station.

Your display station has one logical display station address (station address 1), you cannot use the functions of the Jump, Local Scroll, and Zoom keys. For the operation of the printer functions, see the "Printer Setup Mode Operations" later in this chapter.

Select the Multinational Character Set

Note: Multinational character set is a function of your host system. Do not select multinational character set unless you consult your system operator.

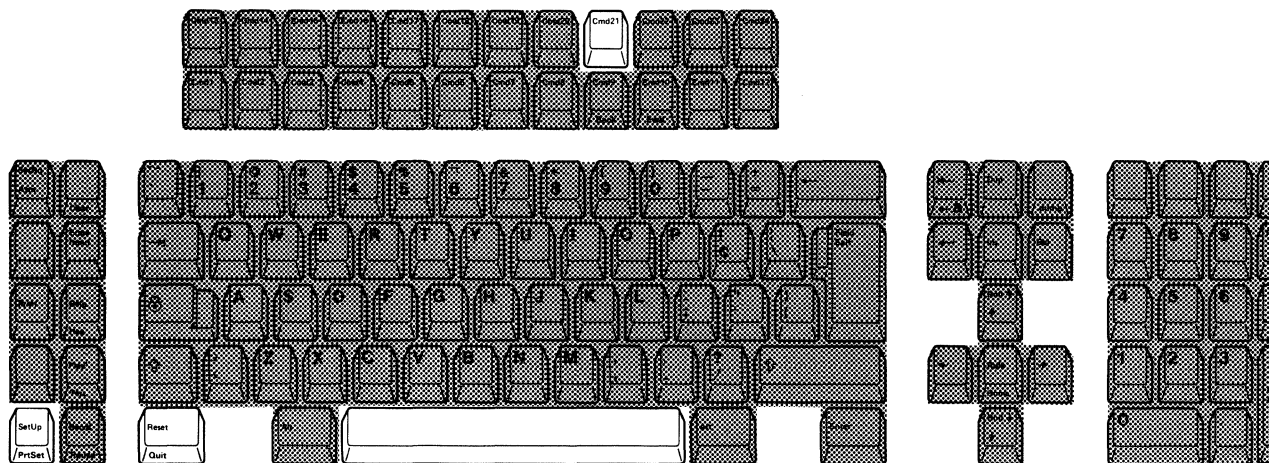

1. Set the power switch to O (off).
2. Press and hold the space bar and set the power switch to | (on). Hold the space bar until the test pattern appears.
3. Press the SetUp key. A diamond (◊) appears on the operating status line.
4. Press the Cmd21 key to alternately select the multinational character set. When an 'M' appears on the operating status line, the multinational character set is selected.

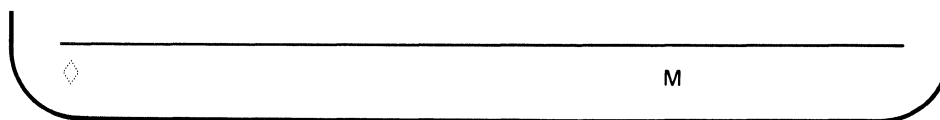

5. Press the SetUp key. The diamond disappears as you exit from setup mode. Once selected, the multinational character set will be stored and will not be reset when the display station power switch is set to O (off).
6. Press the Reset key to enter normal communication mode.

Set the Keyboard ID

This function defines the ID of your keyboard. Your keyboard ID should *always* be set to two dashes "--" unless your system operator provides a different ID number.

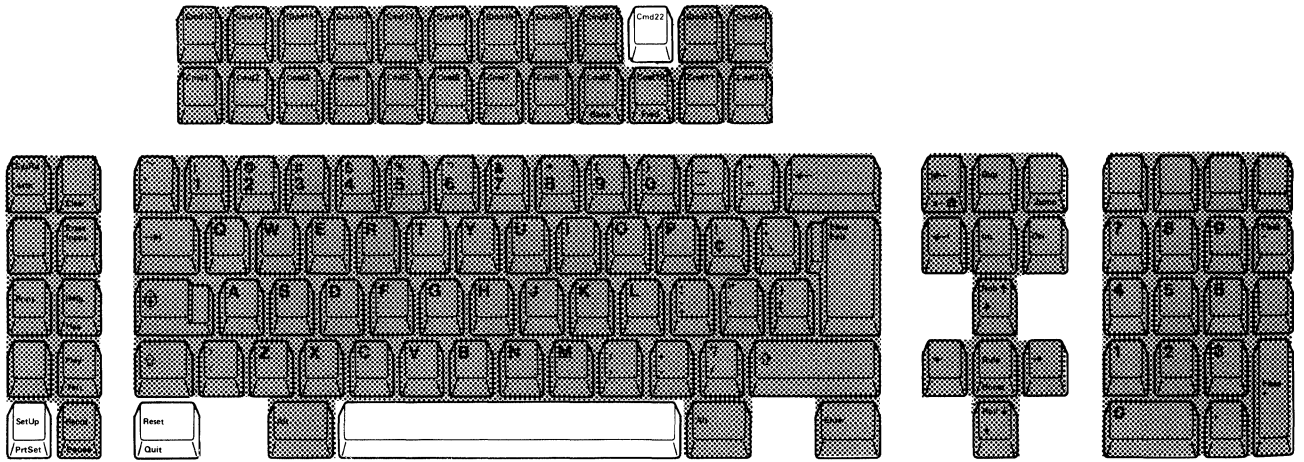

1. Set the power switch to O (off).
2. Press and hold the space bar and set the power switch to | (on). Hold the space bar until the test pattern appears.
3. Press the SetUp key. A diamond (◊) appears on the operating status line.

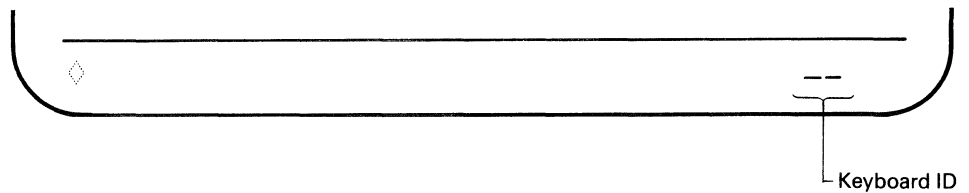

4. The keyboard ID is displayed at the right side of the operating status line. If you press and hold the Cmd22 key, the keyboard ID increases.
Note: A "--" immediately follows the number 63 when the keyboard ID key is pressed.
5. Release the Cmd22 key when your desired keyboard ID appears on the screen.
6. Press the SetUp key. The diamond disappears as you exit from setup mode. Once selected, the keyboard ID will be stored and will not be reset when the display station power switch is set to O (off).
7. Press the Reset key to enter normal communication mode.

Set Station Address 1

This function defines the address of your display station 1.

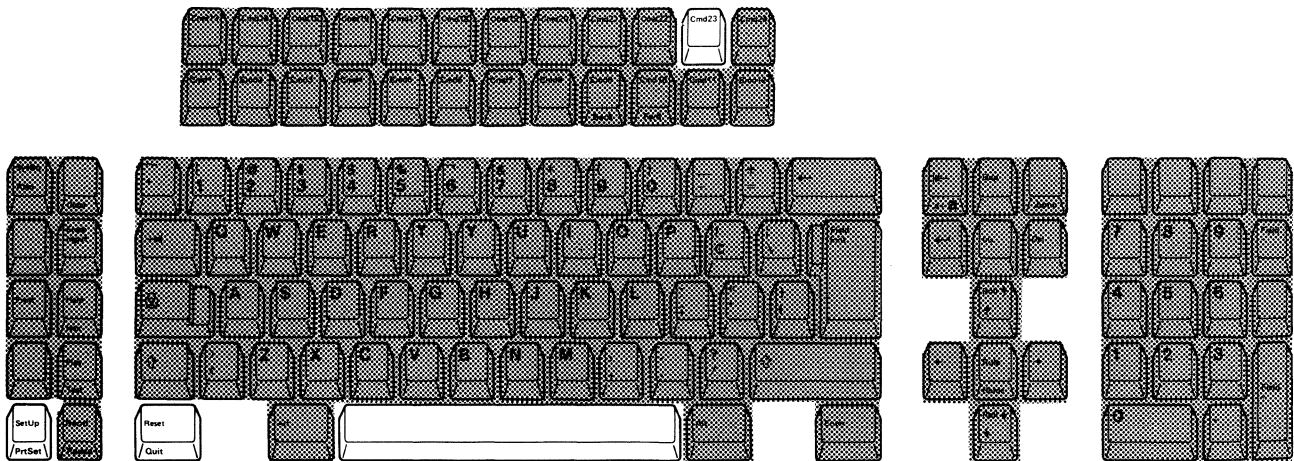

1. Set the power switch to O (off).
2. Press and hold the space bar and set the power switch to | (on). Hold the space bar until the test pattern appears.
3. Press the SetUp key. A diamond (◊) appears on the operating status line.
4. The station address of your display station 1 is displayed at the right side of the operating status line. If you press and hold the Cmd23 key, station address 1 increases. When the address reaches 6, the sequence starts over again from 0.

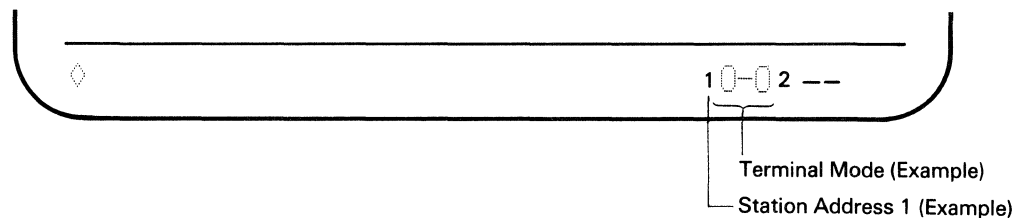

5. Release the Cmd23 key when your desired address of station address 1 appears on the operating status line.
6. Press the SetUp key. The diamond disappears as you exit from setup mode. Once selected, station address 1 will be stored and will not be reset when the display station power switch is set to O (off).
7. Press the Reset key to enter normal communication mode.

Set Station Address 2

This function defines the address of your display station 2.

Note: You need the setting of station address 2 because you selected two-display mode in the terminal mode selection (refer to the procedure for specifying the terminal mode).

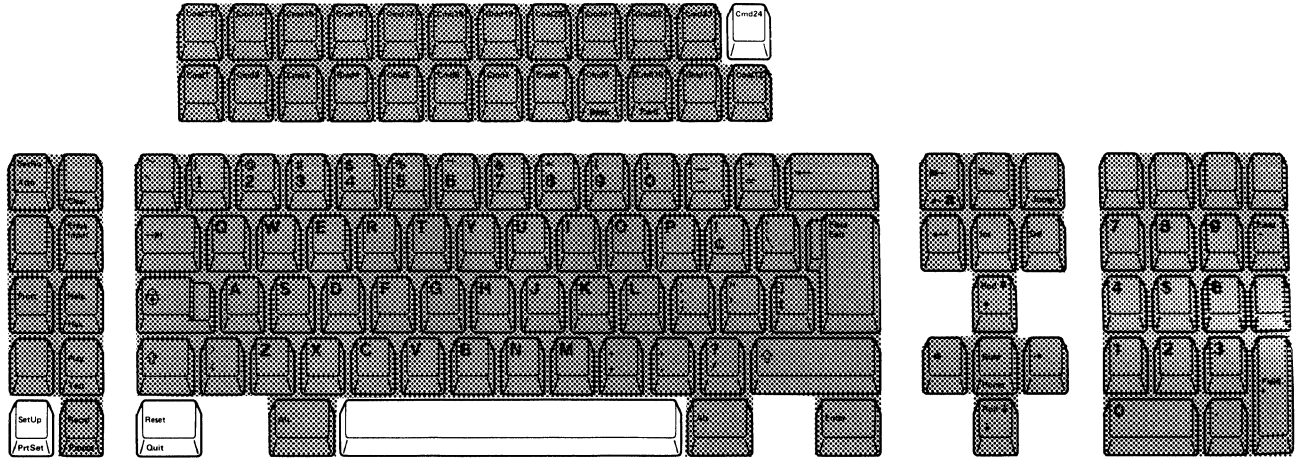

1. Set the power switch to O (off).
2. Press and hold the space bar and set the power switch to | (on). Hold the space bar until the test pattern appears.
3. Press the SetUp key. A diamond (◊) appears on the operating status line.
4. The station address of your display station 2 is displayed at the right side of the terminal mode symbol on the operating status line. If you press and hold the Cmd24 key, the address of station address 2 increases. When the address reaches 6, the sequence starts over again from 0.

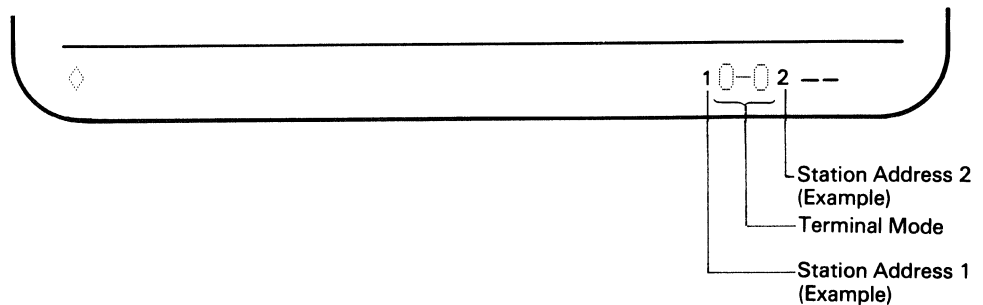

5. Release the Cmd24 key when your desired address of station address 2 appears on the operating status line.

6. Press the SetUp key. The diamond disappears as you exit from setup mode. Once selected, station address 2 will be stored and will not be reset when the display station power switch is set to O (off).
7. Press the Reset key to enter normal communication mode.

Set the Printer Address

This function defines the address for the printer that is attached to the display station.

Note: You need the setting of the printer address because you selected display-printer mode in the terminal mode selection (refer to the procedure for specifying the terminal mode).

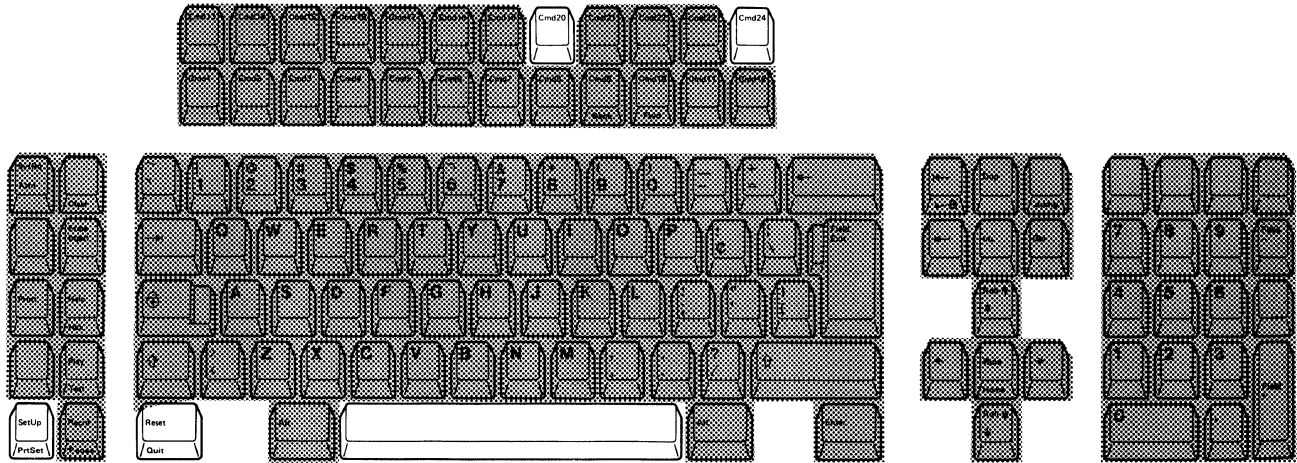

1. Set the power switch to O (off).
2. Press and hold the space bar and set the power switch to | (on). Hold the space bar until the test pattern appears.
3. Press the SetUp key. A diamond (◊) appears on the operating status line.
4. Press and release the Terminal Mode (Cmd20) key until "0-P" appears at the left of the keyboard ID symbol "--".

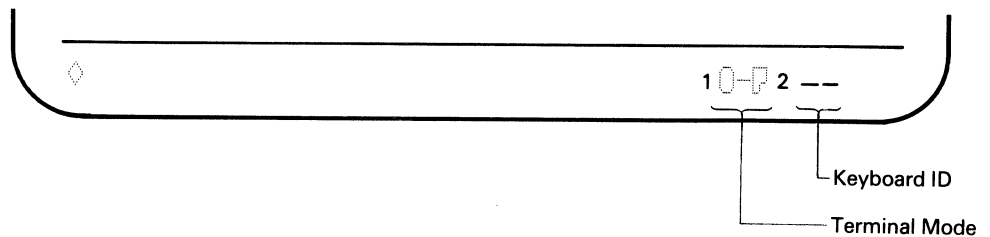

5. The printer address of the printer attached to the display station is displayed on the operating status line. If you press and hold the Cmd24 key, the printer address increases. When the address reaches 6, the sequence starts over again from 0.

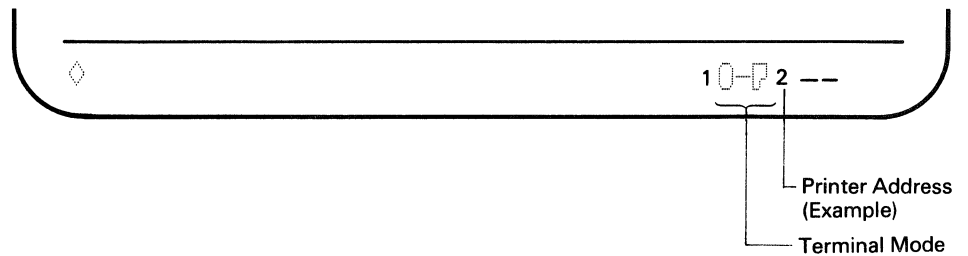

Note: The printer address can be selected from among seven numbers (0 to 6). The address assigned to your display station cannot be selected as the printer address.

6. Release the Cmd24 key when your desired printer address appears on the operating status line.
7. Press the SetUp key. The diamond disappears as you exit from setup mode. Once selected, the printer address will be stored and will not be reset when the display station power switch is set to O (off).
8. Press the Reset key to enter normal communication mode.

Online Setup Functions

The online setup functions can be specified after pressing the SetUp key while the display station is in normal communication mode. The functions available are:

- Select the ruler style
- Select the auto display dim interval
- Adjust the alarm volume
- Adjust the clicker volume
- Enable/disable the clicker action
- Select the cursor style
- Enable/disable the cursor blink
- Enable/disable the extended display
- Enable/disable the cursor locator.

Note: The above setup mode functions can also be specified in the offline test sub-mode of test mode.

The following sections describe the procedures for specifying each online setup mode function.

Help for the user

For ease of use, each setup function is described in a separate sub-section. However, when you need to setup two or more setup functions at the same time, you can set them successively in setup mode without turning power off and on when following the setup procedure for each setup function.

Select Ruler Style

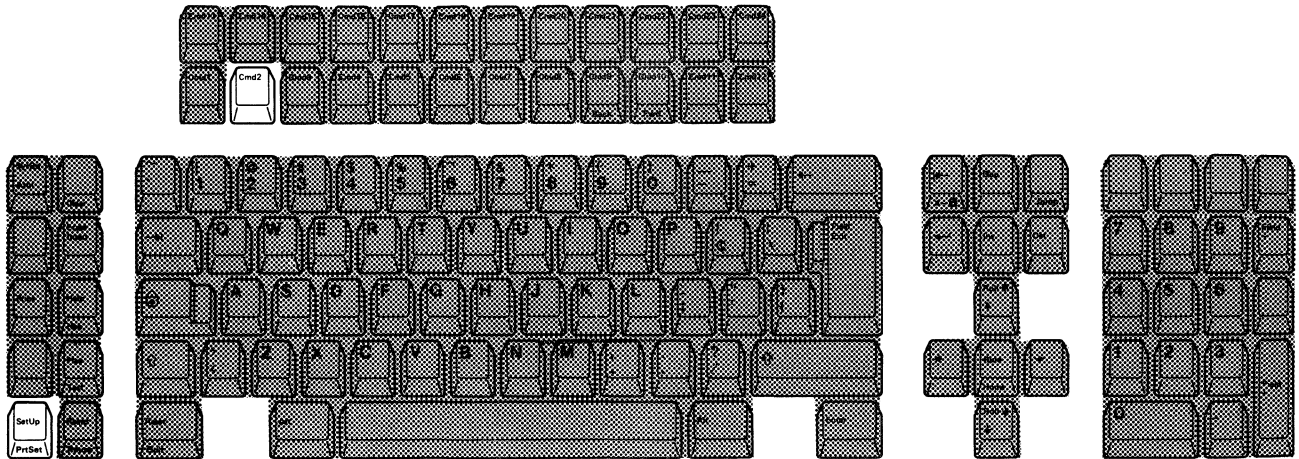

1. Press the SetUp key. A diamond (◊) and the current ruler style (vertical, horizontal, or cross-hair) appear on the operating status line.

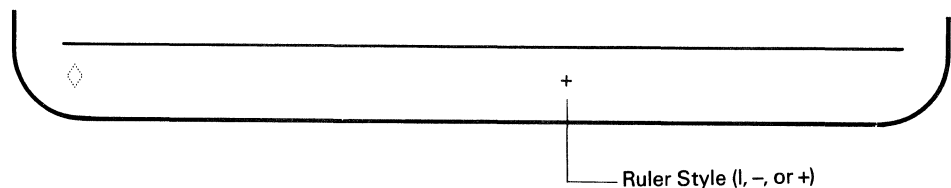

2. Press and release the Cmd 2 key until the desired ruler style appears on the operating status line. The ruler style will be changed from vertical (|), horizontal (-) to cross-hair (+).

Note: To enable the ruler function, you have to press the Rule key.

3. Press the SetUp key. The diamond disappears as you exit from setup mode. Once selected, the ruler style will be stored and will not be reset when the display station power switch is set to O (off).

Display Dim Interval Adjustment

Note: When display dim is enabled (⦿ symbol is displayed), the screen will blank except for the operating status line if no key is pressed and no data is received from the host system for the specified time (0, 2, 5, 10 and 20 minutes).

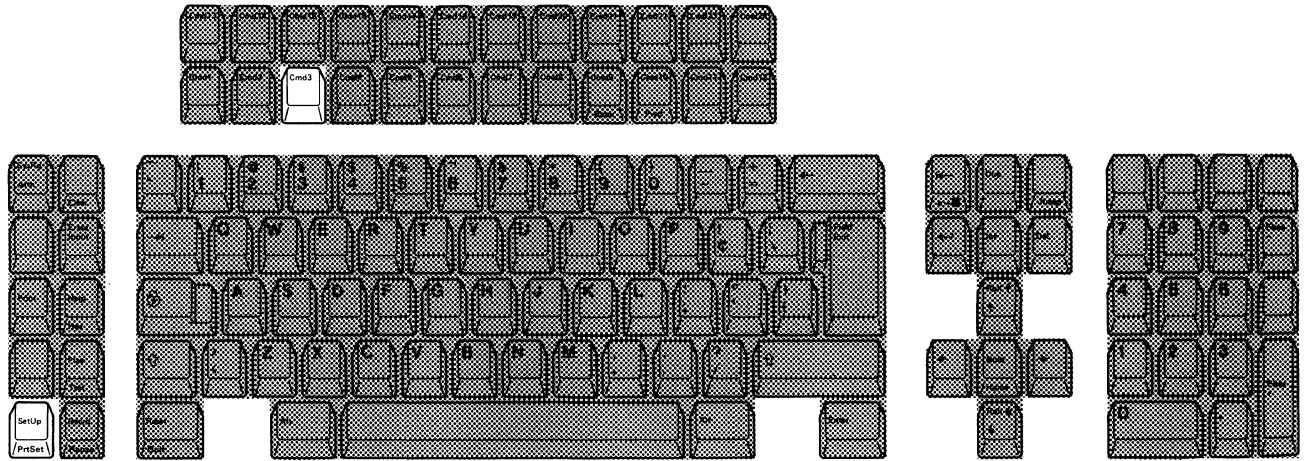

1. Press the SetUp key. A diamond (◇) and the Display Dim Indicator (⦿) appear on the operating status line.

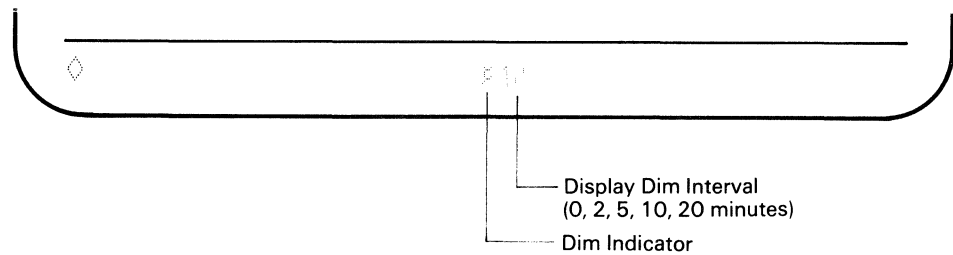

2. Press and release the Cmd3 key until the desired time among 5 selections (0, 2, 5, 10 and 20 minutes) appears on the operating status line.
3. Press the SetUp key. The diamond disappears as you exit from setup mode. Once selected, the auto display dim will be stored and will not be reset when the display station power switch is set to O (off).

Adjust Alarm Volume

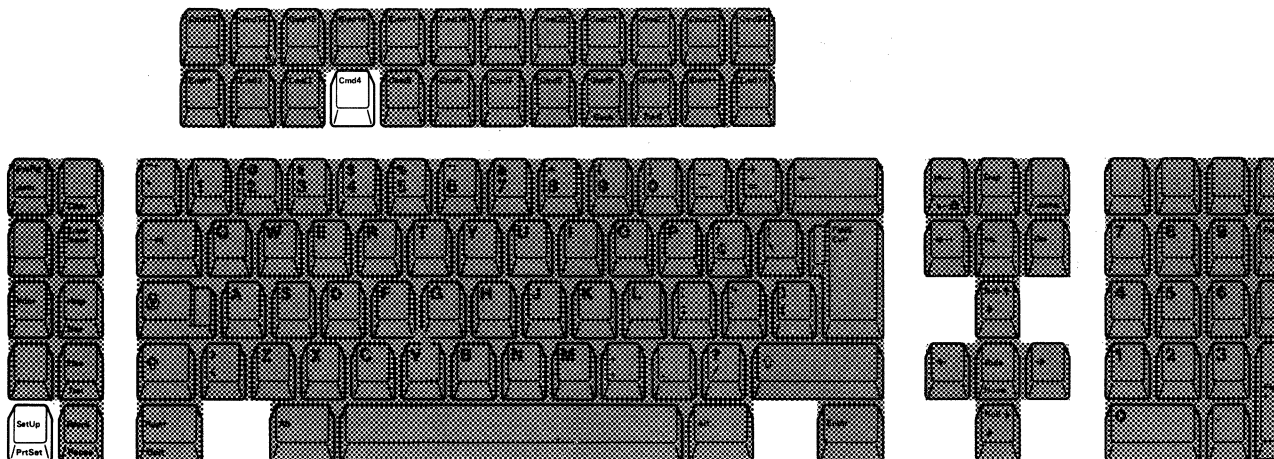

1. Press the SetUp key. A diamond (◊) and the alarm symbol (■) appear on the operating status line.

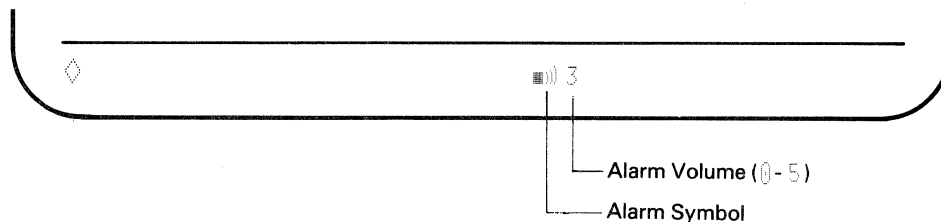

2. You can choose one of six possible alarm volumes, (0 to 5). Volume level 0 means the alarm is off.

Press and hold Cmd4 key until your desired alarm volume appears on the operating status line. The volume level increases until the highest level is reached. After the highest level (5) is reached, the alarm volume returns to off and the sequence starts over.

3. Press the SetUp key again to exit from setup mode. Once selected, the alarm level will be stored and will not be reset when the display station power switch is set to O (off).

Adjust Clicker Volume

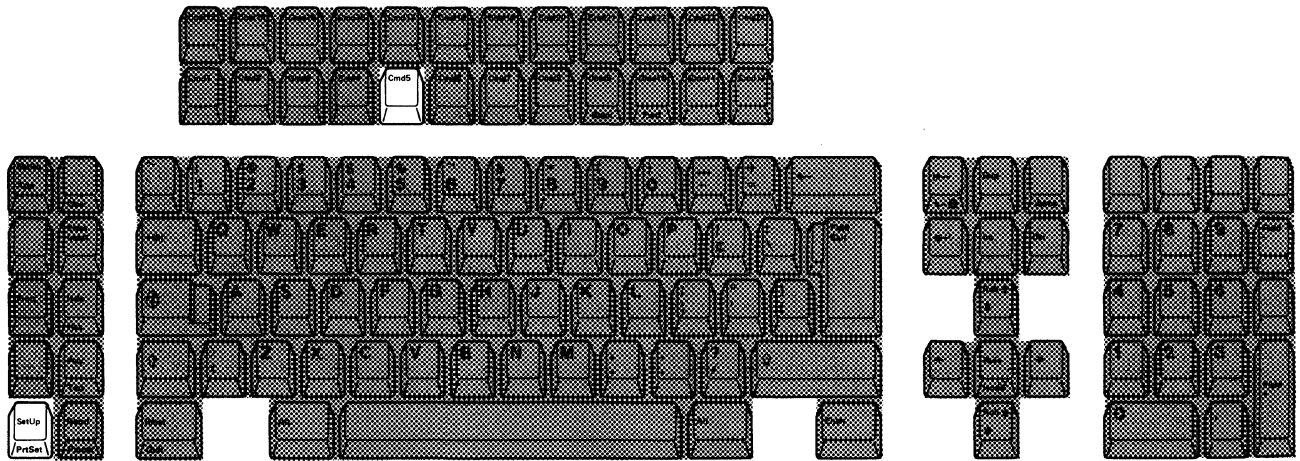

1. Press the SetUp key. A diamond (◊) and the clicker symbol appear on the operating status line.

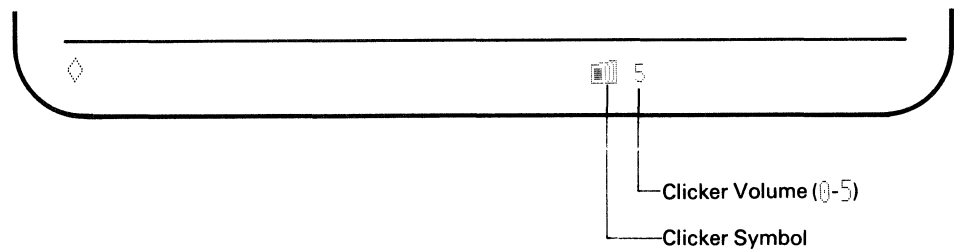

2. You can choose from six possible clicker volumes, (0 to 5). Volume level 0 means the clicker is off.

Press and hold the Cmd5 key until your desired clicker volume appears on the operating status line. The clicker volume level increases until the highest level (5) is reached. After the highest level is reached, the clicker volume returns to off (0) and the sequence starts over.

3. Press the SetUp key. The diamond disappears as you exit from setup mode. Once selected, the volume will be stored and will not be reset when the display station power switch is set to O (off).

Enable/Disable Clicker Action

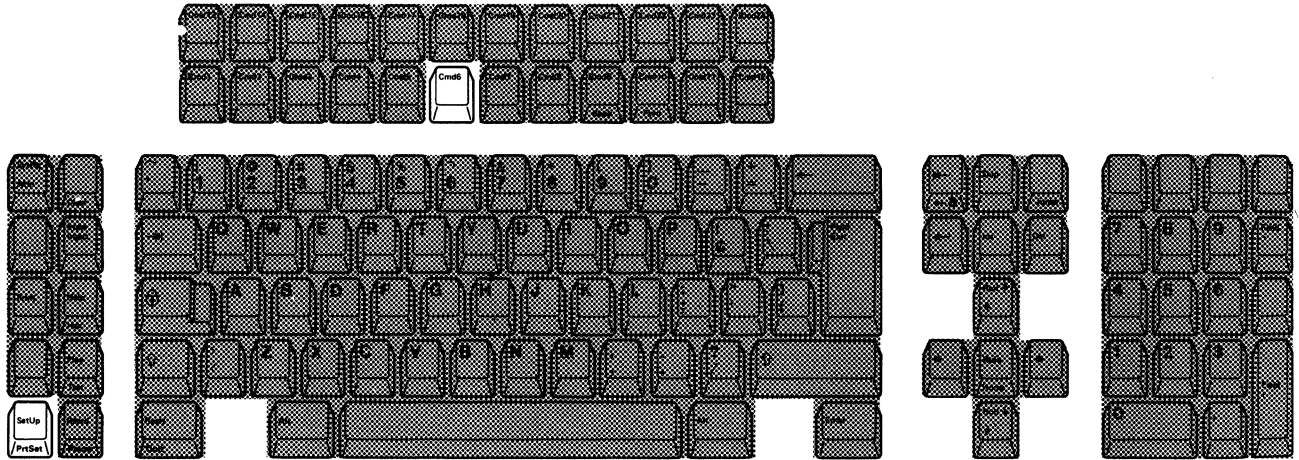

1. Press the SetUp key. A diamond (◊) and the clicker symbol appear on the operating status line.

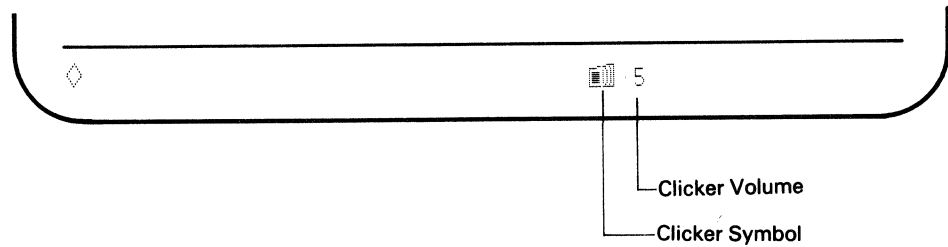

2. Press the Cmd6 key to alternately enable or disable the clicker.

Note: When you press the Cmd6 key: if you hear a click, clicker action is enabled; if you do not hear a click, clicker action is disabled.

3. Press the SetUp key again. The diamond disappears as you exit from setup mode. Once selected, the clicker action will be stored and will not be reset when the display station power switch is set to O (off).

Enable/Disable Cursor Blink

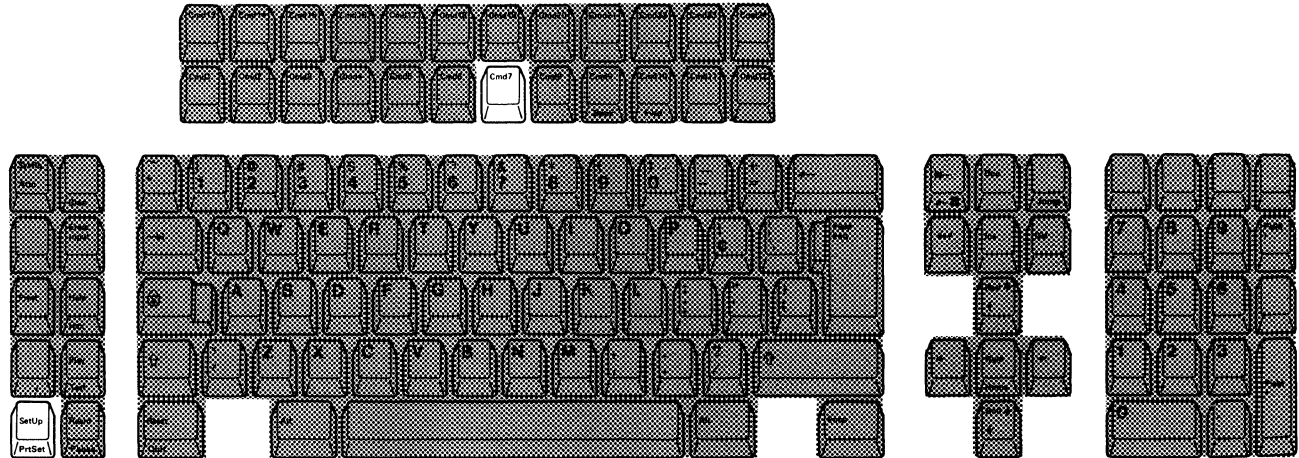

1. Press the SetUp key. A diamond (◊) appears on the operating status line.

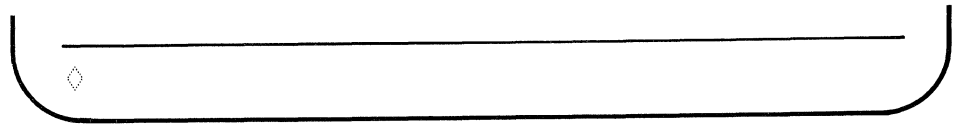

2. Press the Cmd7 key to alternately cause the cursor to blink or not to blink (see the cursor on the data area of the screen).
3. Press the SetUp key again. The diamond disappears as you exit from setup mode. Once selected, the cursor action will be stored and will not be reset when the display station power switch is set to O (off).

Select Cursor Style

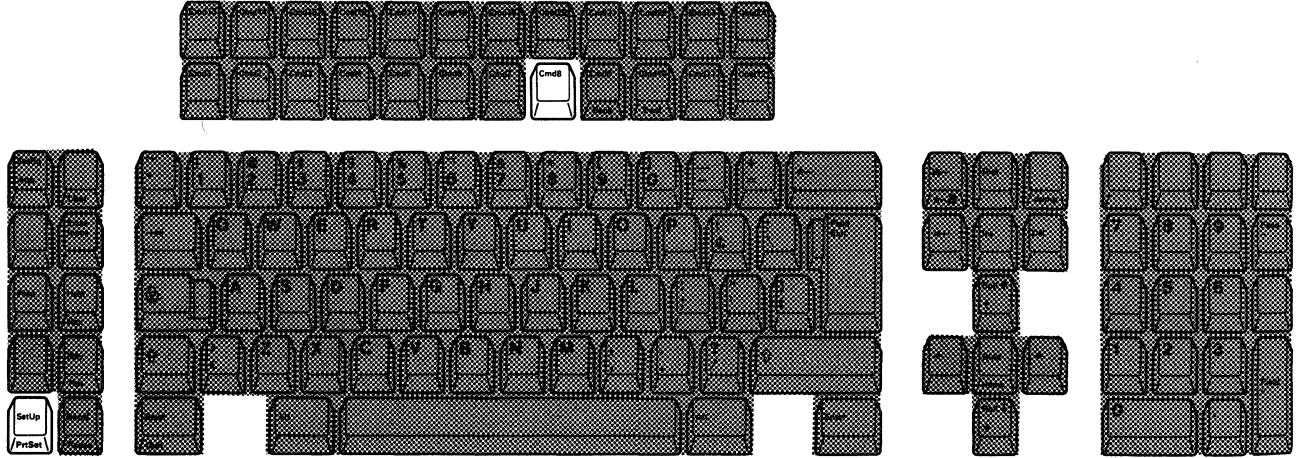

1. Press the SetUp key. A diamond (◊) appears on the operating status line.

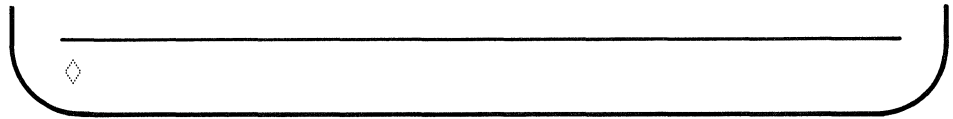

2. Press the Cmd8 key to alternately select either an underscore-style or block-style cursor (see the cursor style on the data area of the screen).
3. Press the SetUp key again. The diamond disappears as you exit from setup mode. Once selected, the cursor style will be stored and will not be reset when the display station power switch is set to O (off).

Enable/Disable Extended Display

Note: Extended display allows you to display field attributes.

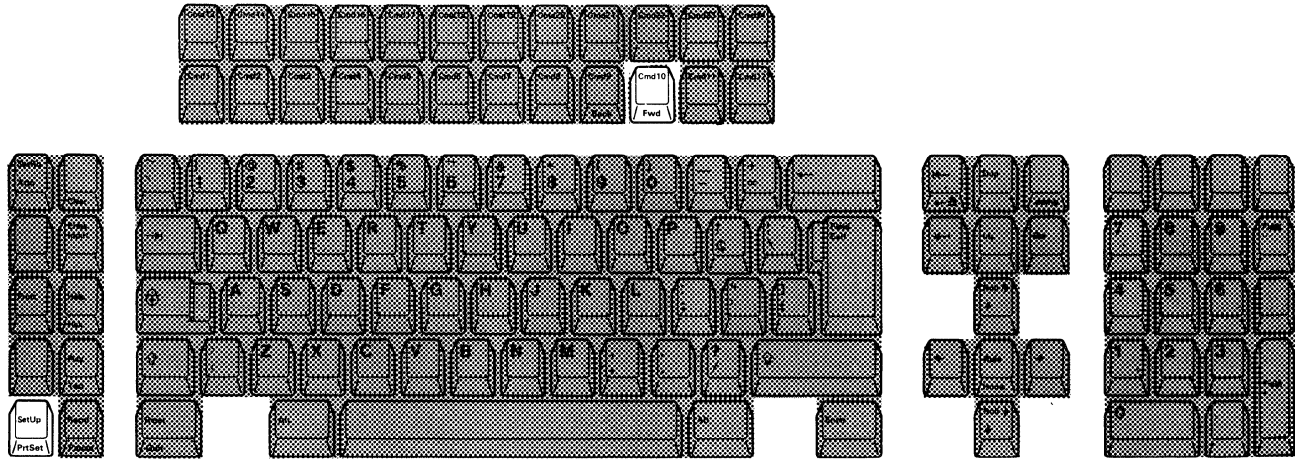

1. Press the SetUp key. A diamond (◊) appears on the operating status line.

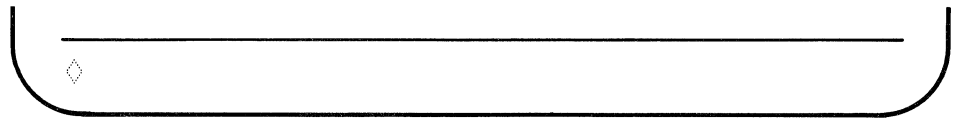

2. Press the Cmd10 key to enable or disable the supported extended display capability of the display station. When enabled, additional information is displayed in two areas:
 - In the data area and message lines; an attribute character for each field appears in hexadecimal form.
 - On the operating status line; the status of the following setup function will appear.

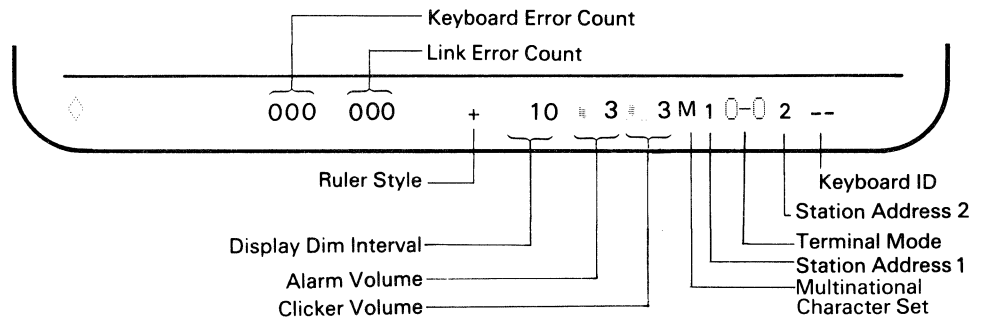

- In all unformatted areas on the screen, dots appears.
3. Press the SetUp key. The diamond disappears as you exit from setup mode. Once selected, the extended display value will be stored and will not be reset when the display station power switch is set to O (off).

Enable/Disable Cursor Locator (Row/Col)

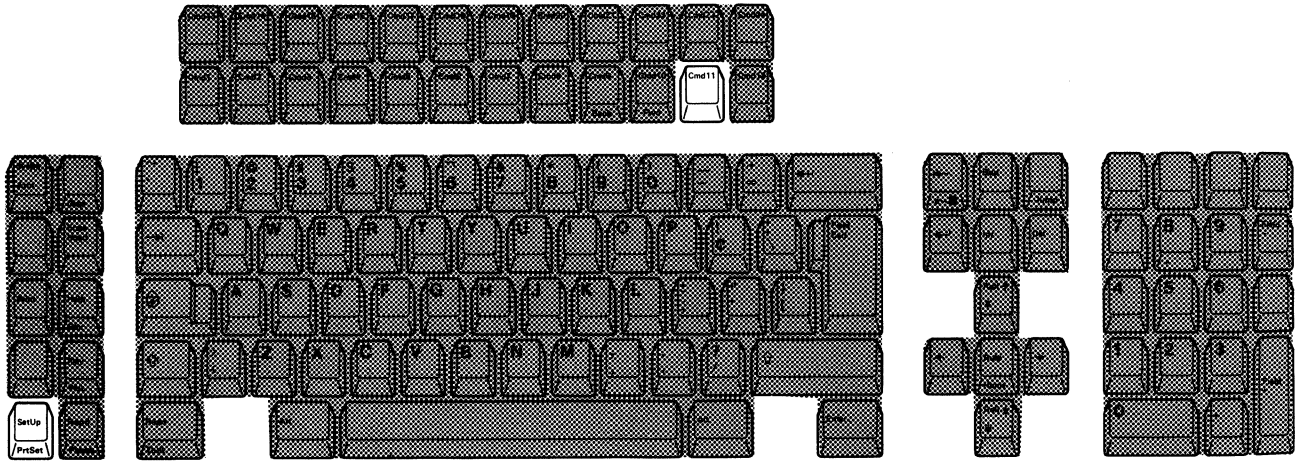

1. Press the SetUp key. A diamond (◊) appears on the operating status line.

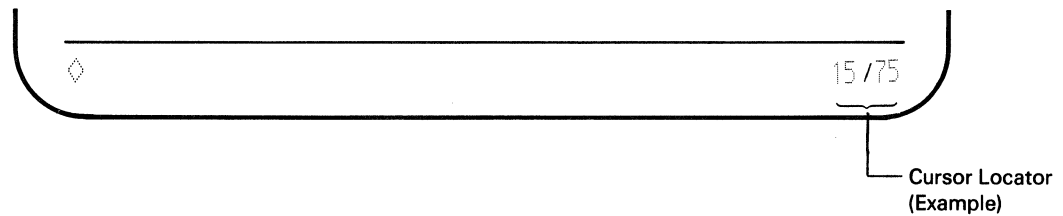

2. Press the Cmd11 key to alternately display or blank the cursor locator (row/column) on the operating status line.

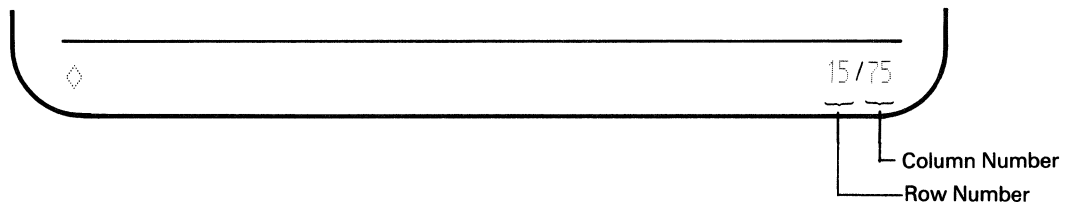

3. Press the SetUp key again. The diamond disappears as you exit from setup mode. Once selected, the row/column action will be stored and will not be reset when the display station power switch is set to O (off).

Record Mode Operation

Assigning Keystroke Sequences to Command Keys

As described in the explanation of the Record key, you can assign recorded keystrokes to any of the 24 Command (Cmd) keys. The maximum number of keystrokes that can be recorded is 1500. The exercise for the record/play operation (after "Play Mode Operation" section) will help you become familiar with the record mode operation.

1. Press the Record (Recrd) key. A 'R' appears on the operating status line. The number to the right of the 'R' shows the remaining number of keystrokes that can be recorded.

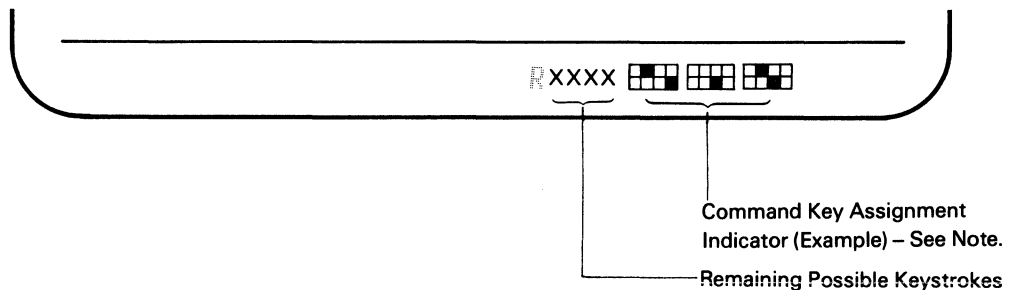

Note: The Command Key Assignment indicator shows you (by a solid box) which Cmd keys have already been assigned for recording keystrokes.

2. Press any one of the 24 Command keys to which you want to assign a word or message. The Cmd key number is displayed, in place of the "Command Key Assignment Indicator."

If the alarm sounds and the number increases when the Command key is pressed, there is something already recorded for that Command key. If you do not want to destroy the recorded key sequence, press the Record key to exit from record mode. *You must exit, then re-enter record mode before pressing a new Command key or the key sequence assigned to the previously selected Command key will be erased.*

To delete the entire keystroke sequence assigned to a particular Command key, press the appropriate Command key, and then press the Delete key.

Note: If an error code appears on the operating status line during record mode, see Appendix A, "Error Codes and Recovery Procedures."

3. Type the keystroke sequences you want to save. As you type, notice that the number following the 'R' on the operating status line decreases.

Note: If you want to temporarily stop recording the keystroke sequence, press the Pause key; after you press the Pause key again, you can continue recording the keystroke sequence.

4. Press the Record key if you do not want to record any more keystroke sequences. The keystroke sequence is saved even if the display station power switch is set to O (off), and can be played back by pressing the Play key and the appropriate Command key.

Notes:

1. Each make/break key (such as Shift, Alt or Pause key) recorded in a keystroke sequence counts as two keystrokes.
2. While in record mode, if you attempt to record AID keystroke sequences (Cmd, Enter, Clear, Attn, SysRq) that cause an input inhibit condition, the keystroke sequences will be recorded.

However, when the keystroke sequence is played back, only the keystroke sequence (including the AID key) just before the first AID key was pressed will be played back. An input inhibit condition will occur and the remaining keystroke sequences will be ignored by the host system.

3. The following keystrokes cannot be assigned to any Command key.
 - Play
 - Setup
 - Record
 - Printer Setup Mode keys
 - Two-Display Mode keys.
4. The following three functional keys are applicable in record mode.
 - *Pause key:* When you want to insert some words or sentences in playback operation, press this key at the place where you want to insert them. The pause action will be recorded as well as other keystroke sequences. To continue the record operation, press the Pause key again.
 - *Quit key:* If you change your mind before recording some words or sentences, press this key to exit from record mode.

Note: If you press the Quit key after pressing the Target Cmd key and recording some keystrokes, the entire keystrokes you previously recorded and the keystrokes you newly entered will be deleted.

- *Delete key:* When you want to delete the currently recorded keystrokes, press this key after pressing the target Cmd key.

Warning:

1. All recorded keystroke sequences are accessible anytime the display station is powered-on.

2. **Before exiting from record mode, do not turn the power switch to off. Otherwise, the recorded data may be lost.**

Play Mode Operation

Playing Back Keystroke Sequences Assigned to Command Keys

As described in the explanation of the Play key, the display station can play back keystroke sequences that were assigned to a particular Command (Cmd) key. The exercise of the record/play operation after this section will help you become familiar with the play mode operation.

1. Position the cursor at the location where you want the keystroke sequence to begin.
2. Press the Play key. A 'P' and the command key assignment indicator appear on the operating status line.

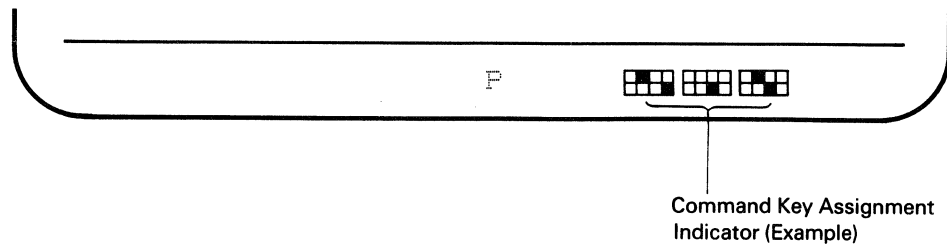

3. Press the same Command key you used to record the keystroke sequence. The keystroke sequence will be automatically played back starting at the location of the cursor. When the playback completes, the 'P' disappears from the operating-status line.

Note: If an error code appears on the operating status line during play mode, see Appendix A, "Error Codes and Recovery Procedures."

Note: In play mode, the following two functions are operational.

- **Pause:** When you recorded the pause function during a record mode operation, the function is automatically executed (playback action stops). At the pause you can key in any words or sentences and press the Play key to continue the playback sequence.
- **Quit:** During the playback operation, you can cancel the playback sequence anytime by pressing the Quit key.

Record/Play Exercise

Task: Record the name 'ABC Company' in the Cmd1 key and play back the name at the first position of the second line on the screen.

1. Make sure that the display station is in normal communication mode. In normal communication mode, the screen should look like this:

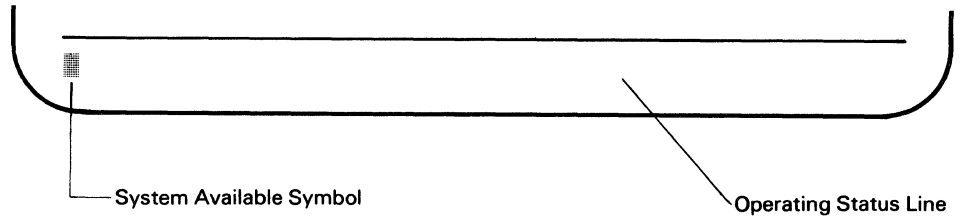

2. Press the Record key. A 'R' appears on the operating status line. The remaining number of keystrokes appears next to the 'R.'

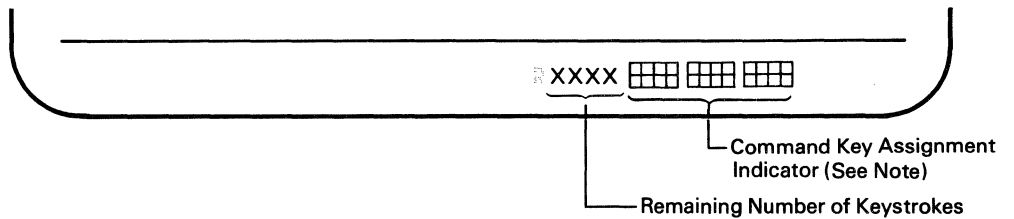
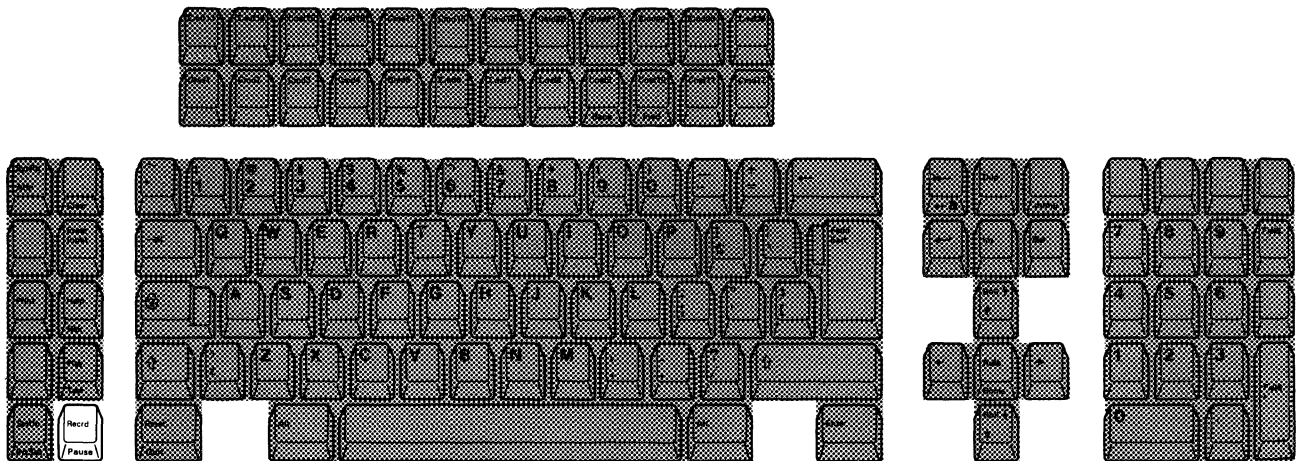

Note: This indicator shows you the status for the function keys that have already been used for recording keystroke sequences. The solid box represents the assigned key and the frame box represents the non-assigned key.

3. Press the Cmd1 key (the key where you will record the data).

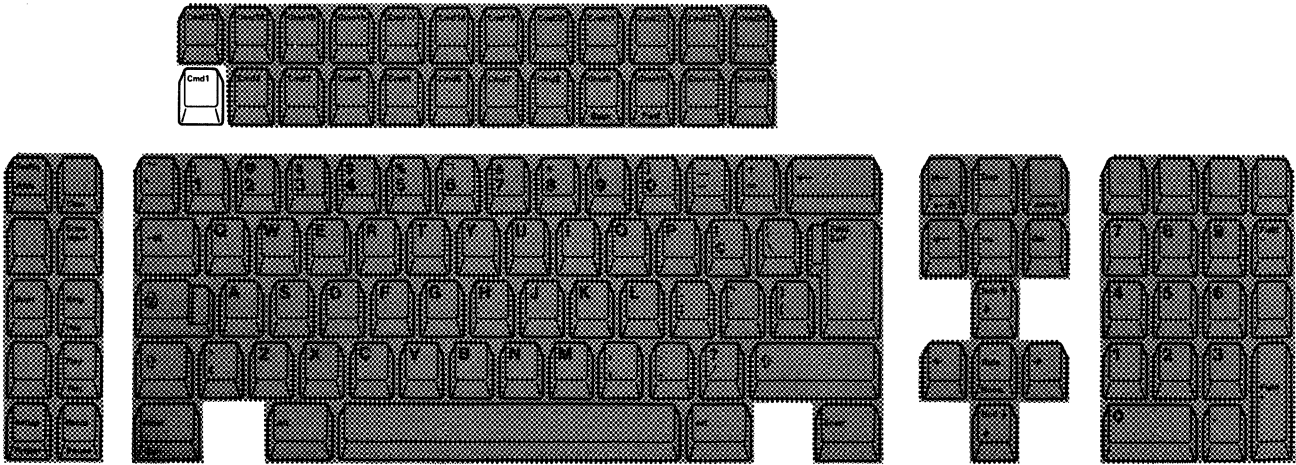

4. Type in 'ABC Company' at the location of the cursor. In this exercise, the cursor is assumed to be located in the home position (first row, first column).

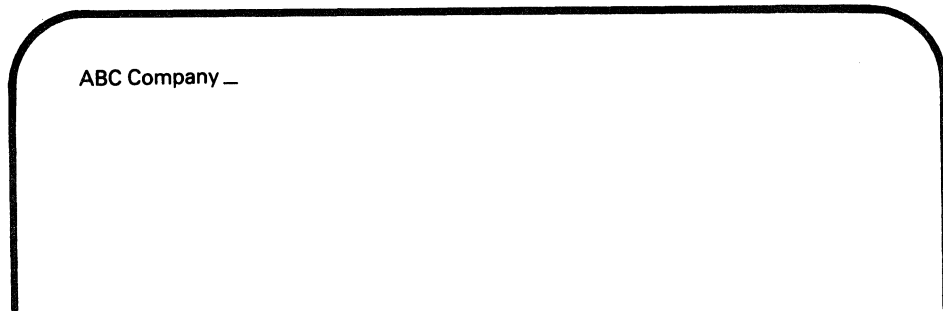

5. Verify that the company name is correctly typed in. Press the Record key again and the 'R' disappears from the operating status line.

If the keystroke sequence is not typed correctly, press the Record (Recrd) key and return to step 1 on page 3-33.

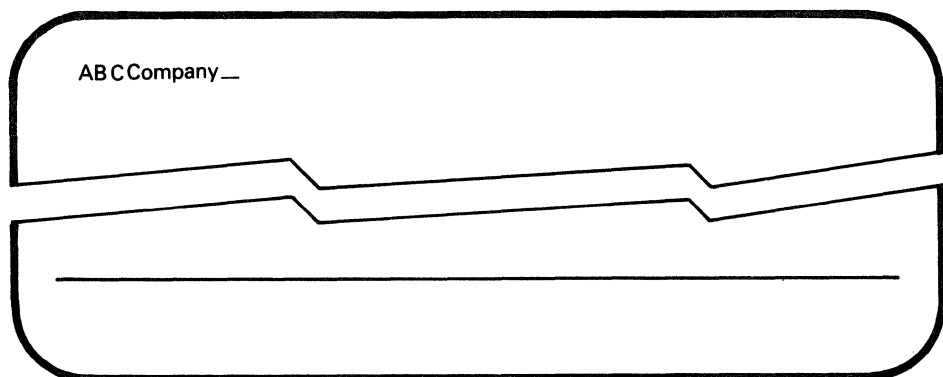

6. Move the cursor to the first position of the second line. To play back the keystroke sequence, press the Play key. An uppercase 'F' appears on the operating status line.

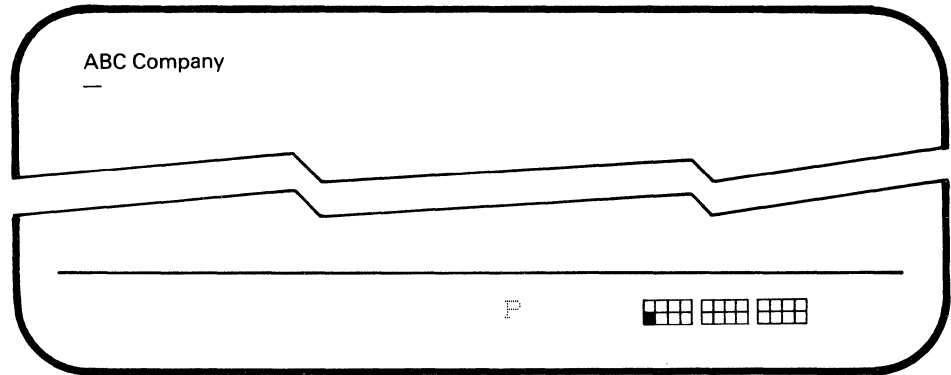

7. Press the Cmd1 key, 'ABC Company' appears at the cursor position, the cursor moves to the next input position, and the 'F' disappears.

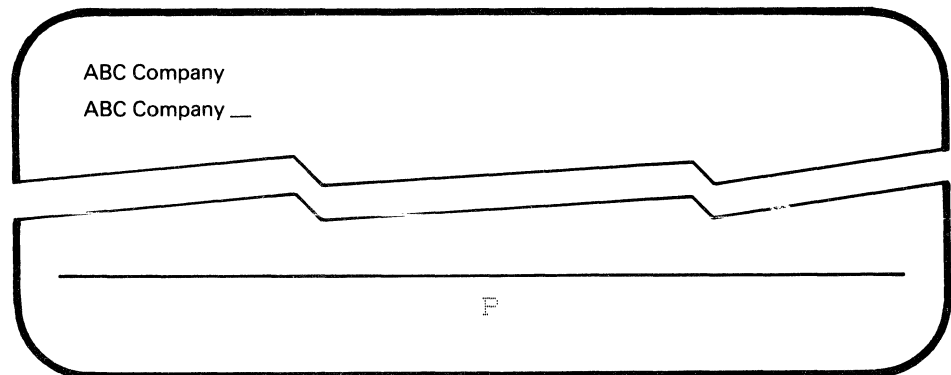

The task is complete. You can continue entering data from the location of the cursor.

Printer Setup Mode Operation

Your display station can attach any of the following IBM PC printers as a system controlled printer.

- IBM Proprinter (IBM 4201 Model 1)
- IBM Proprinter II (IBM 4201 Model 2)
- IBM Proprinter XL (IBM 4202)
- IBM Quietwriter Printer I (IBM 5201 Model 1)
- IBM Quietwriter Printer II (IBM 5201 Model 2)
- IBM Quietwriter Printer III (IBM 5202)

In printer setup mode, you can specify printer functions such as character pitch, line pitch and print quality for print on the attached printer. You can also cancel printing using the Quit key or inquire printer status in this mode.

Notes:

1. *Do not power off the attached printer while the IBM 3197 is in normal communication mode and the host system is transmitting print data. Otherwise, the print data may be lost.*
2. *Do not power off and on the attached printer in a fast sequence. Some seconds are needed between powering off and on the attached printer for the IBM 3197 to re-initialize the printing format of the attached printer.*
3. *When you attach the IBM 5202 printer to your display station, the code page number 850 should be specified for the pluggable fonts. In addition, you also have to set the setup switch group 2 (six switches) to the following combination.*

Switch Number	1	2 and 3	4	5	6
Switch Position	ON	ANY	OFF	OFF	ON

4. *The NLQ II font is not supported when the IBM 4201 Model 2 is attached to the IBM 3197.*

Specifying Printer Functions

To specify the printer functions, follow the steps shown below.

1. Select the display-printer mode () and the printer address in the offline setup mode selection. (Refer to the "Select the Terminal Mode" in the previous section.)
2. Enter the offline printer setup mode and specify the :
 - Printer Character Set
 - Device ID.

3. Exit from the offline printer setup mode and then enter the online printer setup mode and specify the :

- Character Pitch
- Line Pitch ↵
- Print Quality.

Note: The above three functions can also be specified in offline printer setup mode.

4. Exit from the online printer setup mode and return to the normal communication mode. All of the selected settings will be stored and will not be reset when the display station power switch is set to O (off).

Cancelling Printer Operation

To cancel the printing of the current print file, do the following steps.

1. Enter the online printer setup mode.
2. Press the Reset key while pressing and holding the Alt key. Then the printing of current print file will be cancelled.
3. Exit from the online printer setup mode and return to normal communication mode.

Note: The printer continues printing data that were sent to the printer buffer prior to your print cancel request.

Inquiring Printer Status

If the printer does not work or stops printing during a print operation, do the following steps.

1. Enter the online printer setup mode.
2. Check printer setup mode symbol or error codes displayed on the operating status line. If there is an error code, see Appendix A, "Error Codes and Recovery Procedures." If there is a printer setup mode symbol, see the "Symbols in Printer Setup Mode" in Chapter 1.
3. Exit from the online printer setup mode and return to normal communication mode.

Display-Printer Mode Selection

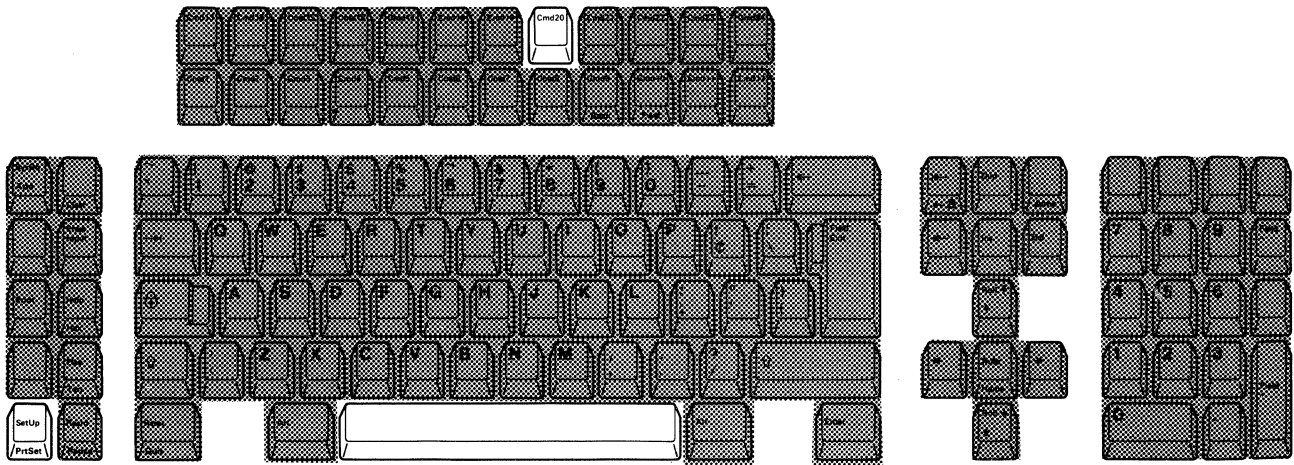

1. Set the power switch to O (off).
2. Press and hold the space bar and set the power switch to | (on). Hold the space bar until the test pattern appears.
3. Press the SetUp key. A diamond (◊) appears on the operating status line.
4. Locate the symbol of the terminal mode at the right side of the operating status line. That symbol should be one of the following symbols (◊ , ◊-◊ and ◊-P).

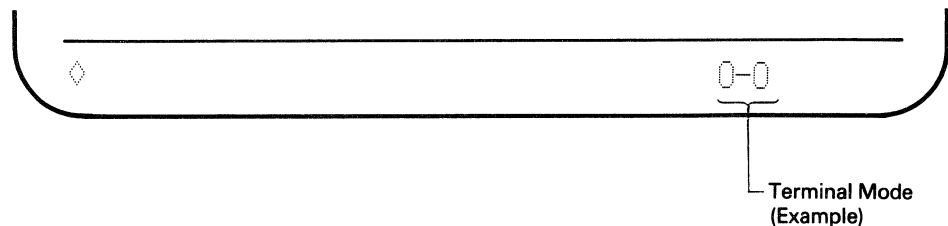

5. If the symbol of terminal mode is other than ◊-P , press and release the Cmd20 key until ◊-P appears at the position of the operating status line; then release the Cmd20 key. If the symbol is ◊-P , go to the next step.
6. Press the SetUp key. The diamond disappears as you exit from setup mode.

You have now selected and recorded display-printer mode.
Continue to the next offline printer setup mode operation.

Offline Printer Setup Mode Operation

Note: Before starting this section you have to get information about your printer character set and device ID from you supervisor.

1. Press and hold the Alt key and press the SetUp key to enter offline printer setup mode. A diamond (◊) and a printer setup mode symbol () appear at the left side of the operating status line. At the right side of the operating status line, the printer character set symbol appears.

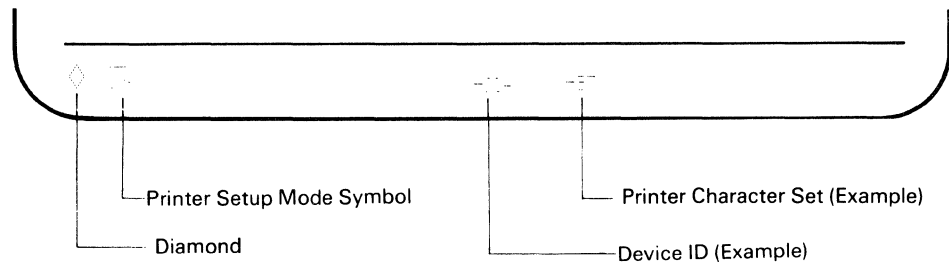

2. Press and release the Cmd15 key. The number for the printer character set column alternately changes from 437 to 850 or vice versa. Select either 437 or 850.

Note: Select 437 if an IBM Proprinter (IBM 4201) or an IBM Proprinter XL (IBM 4202) is attached. Select 850 if an IBM Quietwriter Printer I and II (IBM 5201) or an IBM Quietwriter Printer III (IBM 5202) is attached.

3. Press and hold the Alt key and then press the Cmd14 key to enter device ID mode. The device ID symbol appears on the operating status line.
4. Press and release the Cmd14 key. The number for the Device ID alternately changes from 4214 to 5256 or from 5256 to 4214. Select either one.

Note: The printers available for your display station emulate the functions of either the IBM 4214 or the IBM 5256. Both the IBM 4214 and the IBM 5256 are the system printers for the System/36 and the System/38.

5. Press and hold the Alt key and then press the Cmd14 key to exit from device ID mode.
6. Press and hold the Alt key and press the SetUp key to exit from offline printer setup mode.
7. Press the Reset key to enter normal communication mode.

You have now selected all the required settings for offline printer setup mode. Continue to the next online printer setup mode operation.

Online Printer Setup Mode Operation

You can specify print functions such as character pitch, line pitch and print quality for the printout of the attached printer.

However, selection of the print functions has a limitation depending on the device ID selected in offline printer setup mode (previous section).

Determine selections for character pitch, line pitch, and print quality before going through the online printer setup mode operation. Figure 3-1 shows the summary of the possible selections which depend on the device ID.

Device ID	Print Functions		
	Character Pitch (CPI)	Line Pitch (LPI)	Print Quality
4214	AA5 (5 CPI) AA6 (6 CPI) AA8.5 (8.5 CPI) AA10 (10 CPI) AA12 (12 CPI) AA17 (17.1 CPI) AA _{PS} (Proportional Spacing) AA _Q (System Designated)	BB8 (8 LPI) BB6 (6 LPI) BB4 (Double Height) BB4 (Standard Height) BB4 (Double Height) BB4 (Standard Height) BB4 (System Designated)	CC (Draft) QQ (Near Letter) QS (System Designated)
5256	AA5 (5 CPI) AA6 (6 CPI) AA8.5 (8.5 CPI) AA10 (10 CPI) AA12 (12 CPI) AA17 (17.1 CPI) AA _{PS} (Proportional Spacing)	BB8 (8 LPI) BB6 (6 LPI) BB4 (Double Height) BB4 (Standard Height) BB4 (Double Height) BB4 (Standard Height)	CC (Draft) QQ (Near Letter)

Figure 3-1. Selection of Print Functions

Notes:

1. In the above table, selection of both double height and proportional spacing functions are not supported by the IBM 4201. The IBM 5201 does not support double height, but does support proportional spacing if you select a "PS" labelled font cartridge from the IBM "Quiet"™ Electronic Fonts in Character Set A, and insert it in font slot 'A' on the printer.
2. When you specify values for character pitch and line pitch, that are different from the ones specified by the host system, data will be printed in accordance with your locally specified print format. If you specify print functions: "System Designated" for Device ID 4214, and "CPI 10 and LPI 6" for Device ID 5256, data will be printed in the system specified print format.
3. When using the attached printer, if you press the Line Feed key, be sure to press the Form Feed key and also to keep correct print alignment.

Specifying Character Pitch

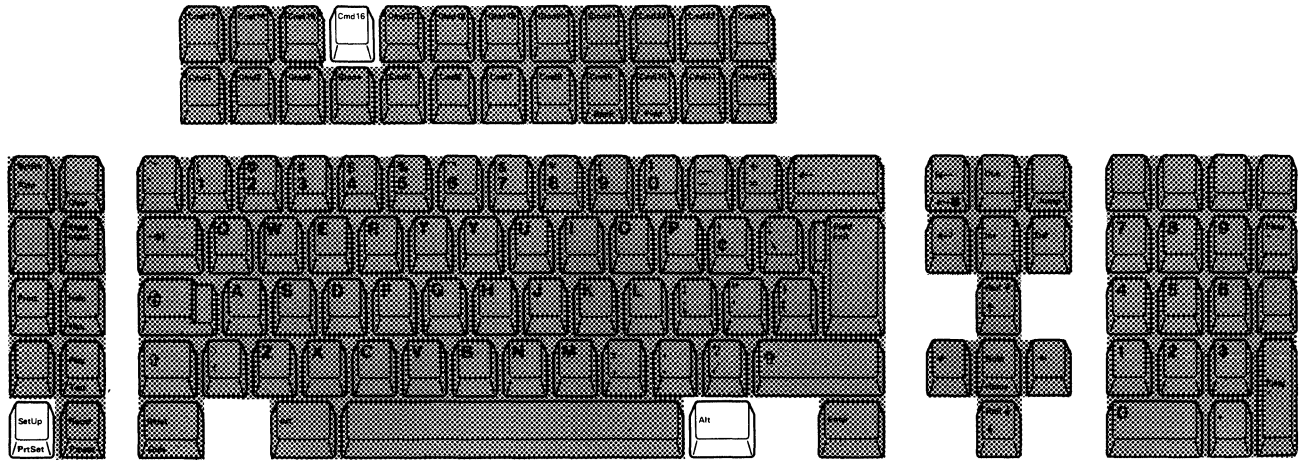

1. Press and hold the Alt key and press the SetUp key to enter online printer setup mode. Check that the following symbols are displayed on the operating status line.

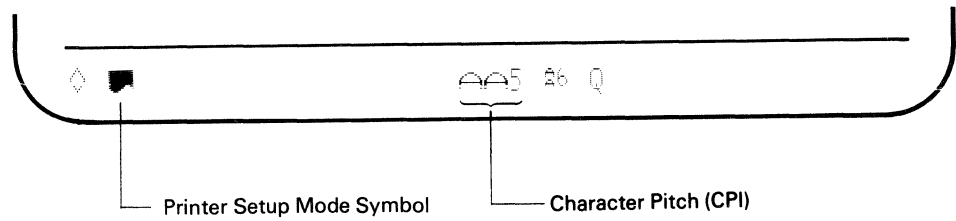

2. Press and release the Cmd16 key. Each time you press the Cmd16 key, the character pitch selection symbol will change in the following order.

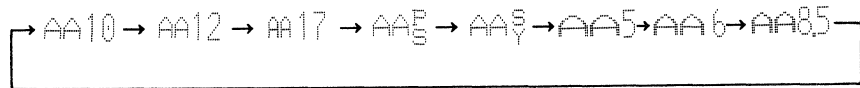

Note: The selection of the character pitch is limited when you select the 5256 Device ID. See Figure 3-1, for additional information.

3. If you want to exit from online printer setup mode, press and hold the Alt key and then press the SetUp key.

If you need to specify the line pitch and the character quality, go to the next section.

Specifying Line Pitch

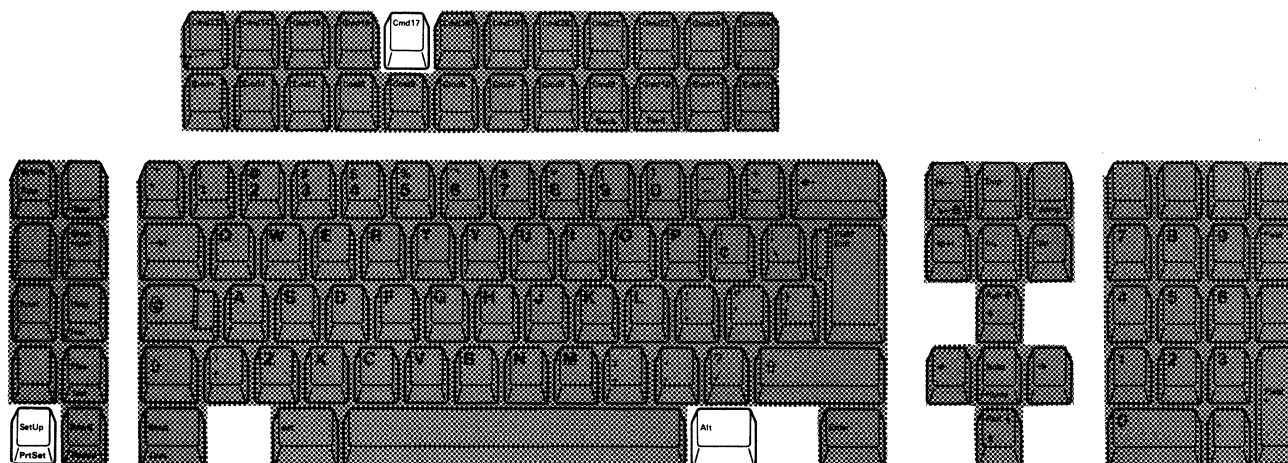

1. Locate the symbol for line pitch on the operating status line.

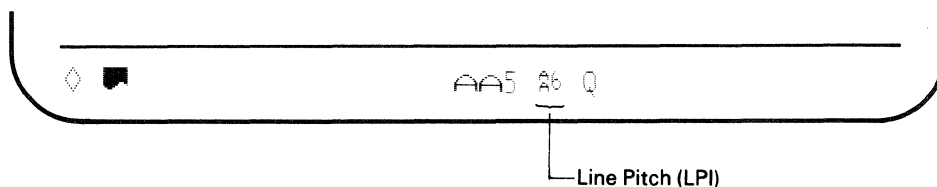

2. Press and release the Cmd17 key. Each time you press the Cmd17 key, the line pitch selection symbol will change in the following order.

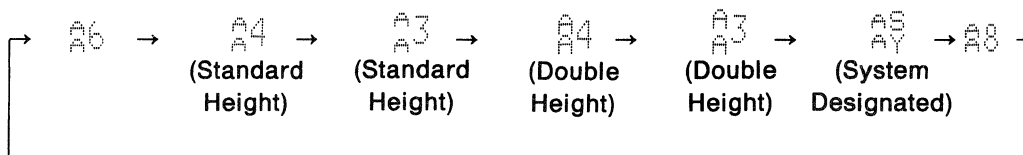

Note: The selection of the line pitch selections are limited when you select the 5256 Device ID. See Figure 3-1, "Selection of Print Functions" for additional information.

3. If you want to exit online printer setup mode, press and hold the Alt key and then press the SetUp key. If you need to specify the print quality, go to the next section.

Specifying Print Quality

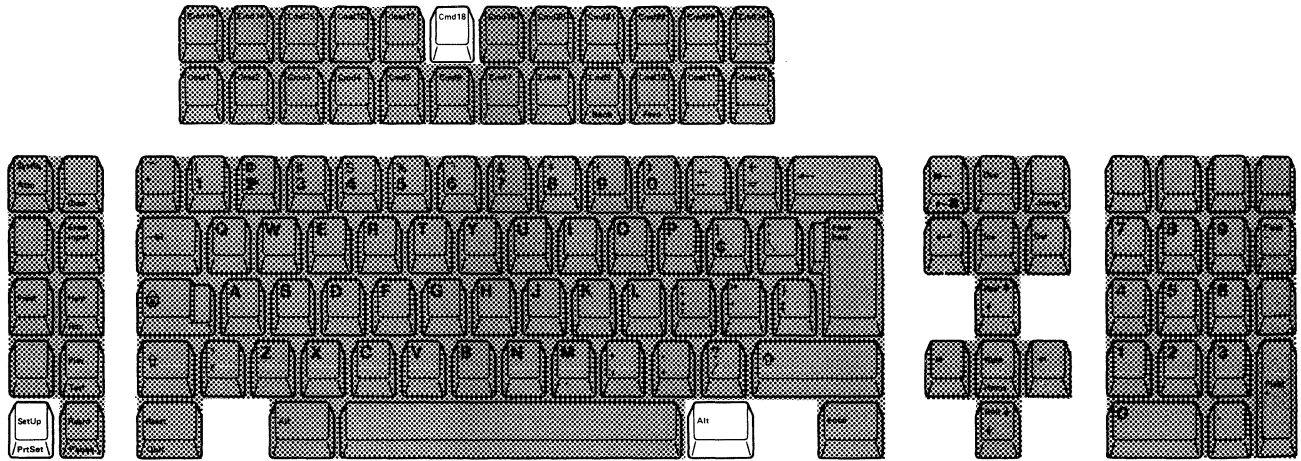

1. Locate the symbol for print quality on the operating status line.

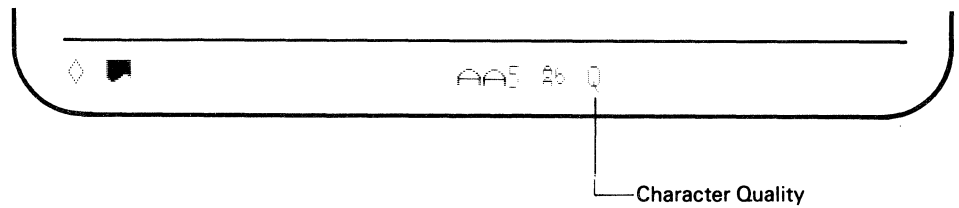

2. Press and release the Cmd18 key. Each time you press the Cmd18 key, the print quality selection symbol will change in the following order.

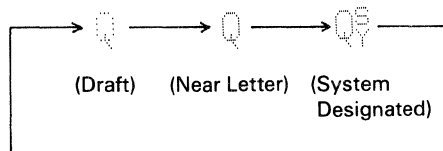

Note: When you select the 5256 Device ID, the system designated print quality is not available.

3. Press and hold the Alt key and then press the SetUp key to return the display station to normal communication mode.

You have now completed all the necessary settings of the printer setup mode functions.

Chapter 4. The IBM Enhanced Keyboard

This chapter describes the keyboard layout of the U.S. English IBM enhanced keyboard and also the function of each key.

Keyboard Layout of the U.S. English IBM Enhanced Keyboard

The arrangement of the data entry keys is almost the same as that of a typewriter. The function keys surrounding the data entry keys are arranged for ease of use while in power data entry operation.

Figure Figure 4-1 shows the keyboard layout of the U.S. English IBM enhanced keyboard.

The top row of keys has a Function (F) number both on the top and bottom half of the key and a symbol or words on the overlay. Top numbers are accessed using the Shift key. The functions on the overlay are used to make display and keyboard adjustments. To use the function assigned to the key, see your host system operating manual.

The right side of the keyboard has a calculator-like keypad for entry of numeric data.

Appendix B contains keyboard layouts for languages other than U.S. English.

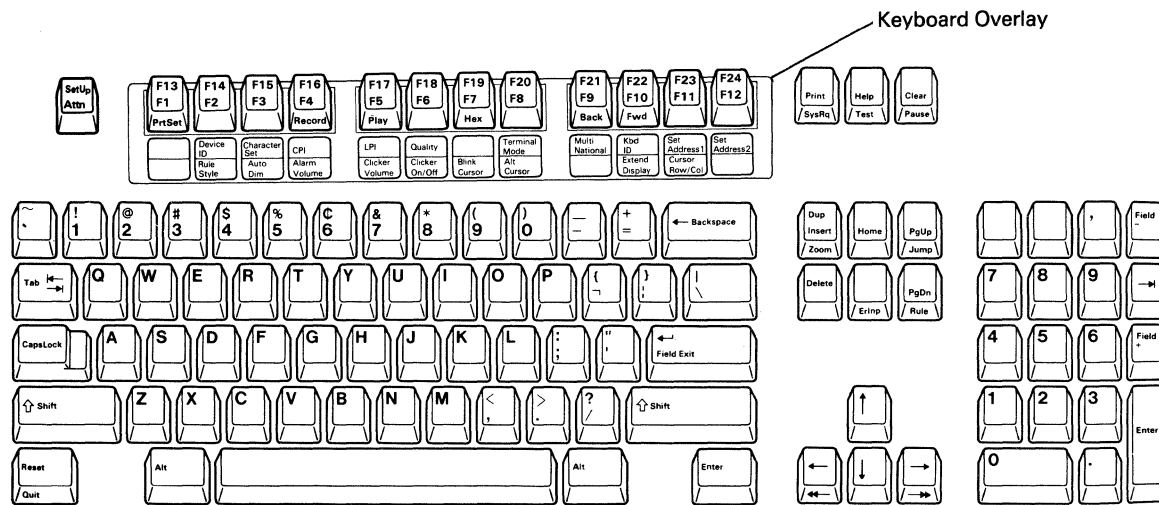
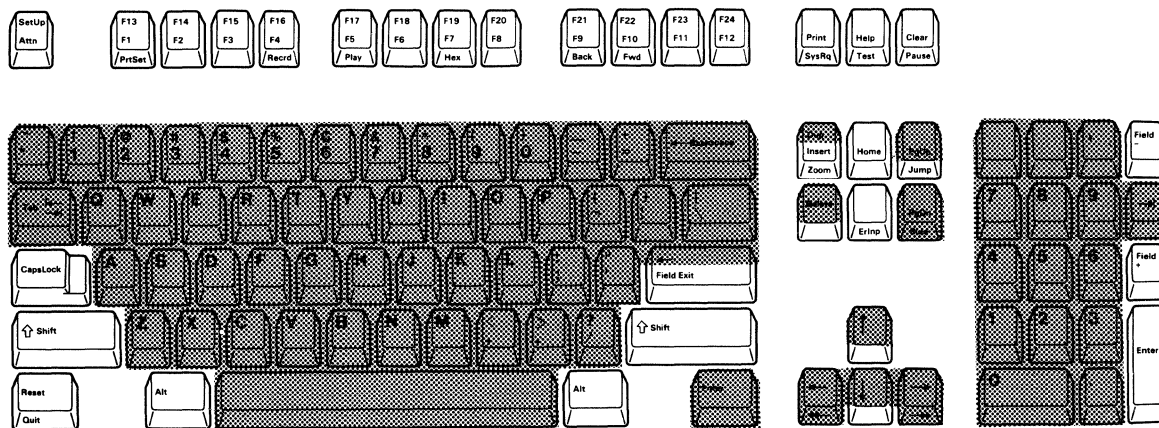

Figure 4-1. IBM 3197 IBM Enhanced Keyboard Layout (U.S. English)

Many of the data-entry keys are typematic (repeat-action) keys. The following figure shows which keys are typematic (shaded) and which are non-typematic keys (unshaded).



Key Functions

This section describes all key functions and identifies the locations of the keys used to activate these functions.

Function keys are used to pass information between the display station and the host system programs and to perform display station operations.

Some keys have a name printed on the front. To activate the key function, that key must be pressed while pressing and holding an Alt key.

The names printed on the top of a key are the function activated when it is pressed alone.

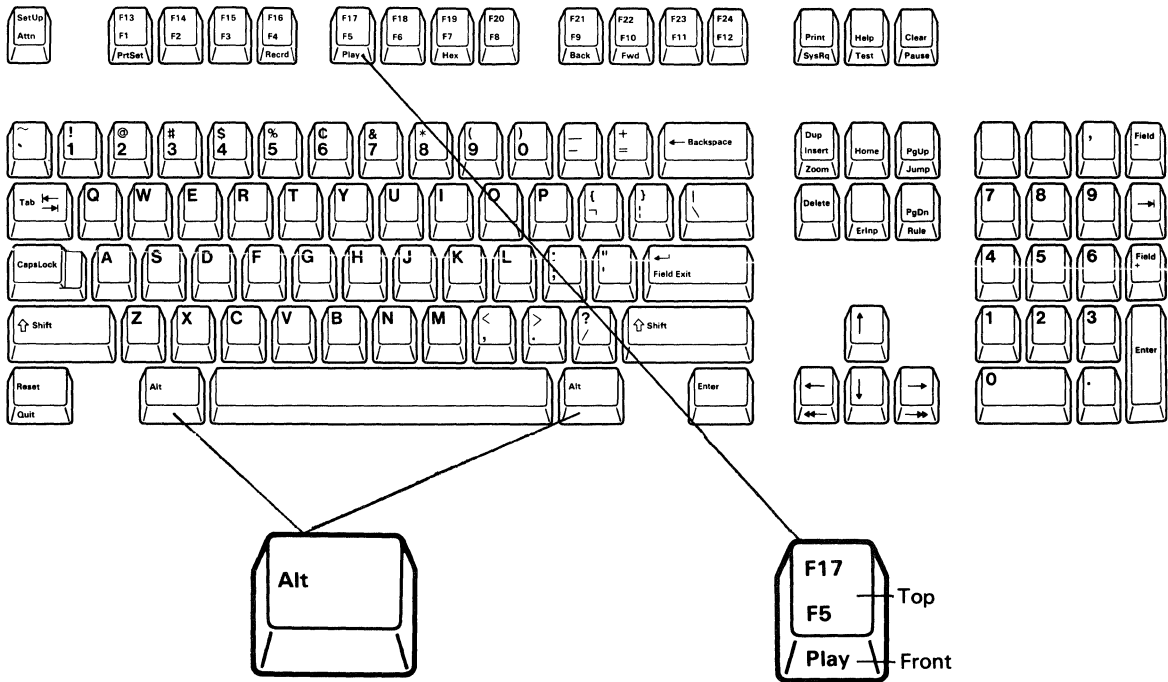

The highlighted keys (shown at the top) are described with the associated functions after this figure.

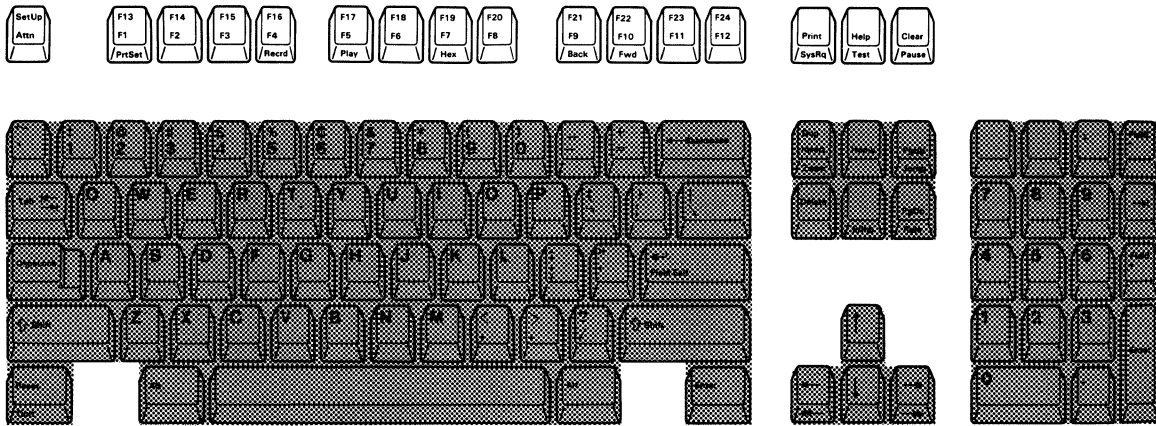

System Request

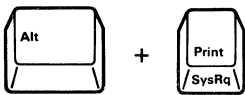

Then



This function can vary depending on the host system. With most systems, this function is used to:

- Start and select an alternate job
- Notify the host system that the display station is ready to select a new program or activity
- Request that the keyboard be unlocked (after normal error-recovery action has failed) so data can be entered.

To use this function, press and hold the Alt key and press the System Request (SysRq) key. Then press the Enter key.

To cancel this function, press the Reset key before pressing the Enter key.

Attention



The attention function (activated by pressing the Attention key) is used to temporarily stop the present display station activity to select a new activity.

Clear



When the Clear key is pressed, the display screen goes blank (except the cursor, the operating status line, and the message line).

A host system program can change the way this function operates, allowing recovery if you accidentally press the Clear key. (See your system operator or host system operating manual.)

Print



The print function (activated by pressing the Print key) sends a print request to the host system. If supported, the host system program selects the printer to print the data displayed on the display screen.

To cancel the printing operation of the printer attached to the display station, press the Quit key (press and hold the Alt key and then press the Reset key) after entering printer setup mode (press the F13/F1 key while pressing and holding the Alt key).

Help



The help function (activated by pressing the Help key) provides (1) an explanation of current error conditions or (2) help information from the host system. The system must be programmed to provide the Help function. See Appendix A, "Error Codes and Recovery Procedures" for more information about error codes.

Hex

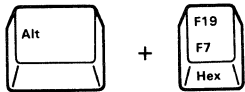

The hex function is used to enter the hexadecimal value for a character. To enter a hexadecimal value, press the Hex key while pressing and holding the Alt key, then enter the corresponding hexadecimal value using the alphanumeric keys. (Refer to the *IBM 5250 Function Reference Manual, SA21-9247*, for the hexadecimal value for each character.)

Play



The play function (activated by pressing the F17/F5 key while pressing and holding the Alt key) is used to play back often-used keystroke sequences (words or sentences) saved in the Function (F) keys (see the description of the record function).

See Chapter 5, "Operations Using the IBM Enhanced Keyboard" for more information about this function.

Test

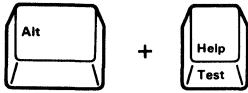

Pressing the Test key while pressing and holding the Alt key enables the display station to run additional display station tests. This key sequence is valid only when the test pattern is on the screen. See the *IBM 3197 Model D Display Station Problem Solving Guide*, GA18-2547, for instructions. Press the Reset key to exit from test mode.

SetUp

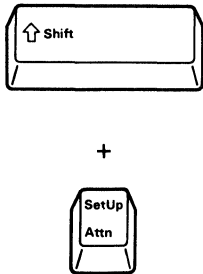

When the Shift key is pressed and held and the SetUp key is pressed, the display station enters setup mode, allowing you to:

- Select the multinational character set (offline setup mode only)
- Select the keyboard ID (offline setup mode only)
- Set the station address for workstation 1 (offline setup mode only)
- Set the station address for workstation 2 (offline setup mode only)
- Set the printer address (offline setup mode only)
- Select the terminal mode (offline setup mode only)
- Select the display dim interval
- Select the ruler style
- Adjust the alarm volume
- Adjust the clicker volume
- Enable/disable the clicker action
- Enable/disable the cursor blink
- Select the cursor style
- Enable/disable the extended display
- Enable/disable the cursor locator

When the Shift key is pressed and held and you press the SetUp key again, the display station exits from setup mode. For more information, see Chapter 5, "Operations Using the IBM Enhanced Keyboard."

Printer Setup Mode

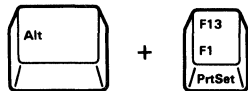

Pressing the F13/F1 key while pressing and holding the Alt key enables the display station to enter printer setup mode.

The printer setup mode allows you to:

- Set the device ID (Device ID mode only)
- Select the printer character set (offline printer setup mode only)
- Set the character pitch
- Set the line pitch
- Specify the print quality.

When you press the F13/F1 key while pressing and holding the Alt key, the display station exits from printer setup mode. For more information, see Chapter 5, "Operations Using the IBM Enhanced Keyboard".

Record

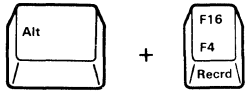

The record function (activated by pressing and holding the Alt key and pressing the F16/F4 key) records the keystroke sequences assigned to the Function (F) keys. See Chapter 5, "Operations Using the IBM Enhanced Keyboard" for more information about the record function.

Pause



The pause function (activated by pressing and holding the Alt key and then pressing the Clear key) temporarily stops the record operation (see the description of the record key function). Pressing this key again enables continuing the record operation for the keystroke sequence. In the playback operation of that keystroke sequence, if the playback stops because of the pause function, press the Play key to continue the playback. See Chapter 5, "Operations Using the IBM Enhanced Keyboard" for more information about the record/play functions.

Local Scroll

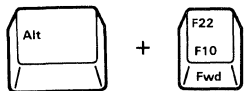

or

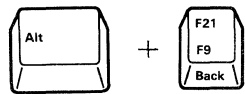

The local scroll function is used to move data up or down on the split screen in two-display terminal mode operation. When the split screen is inactive, pressing and holding the Alt key and then pressing either the Fwd or Back key enables this function.

Press the Fwd key while pressing and holding the Alt key scrolls up the next data line by line.

Pressing the Back key while pressing and holding the Alt key scrolls down the previous data line by line.

The highlighted keys (in the center) are described with the associated functions after this figure.

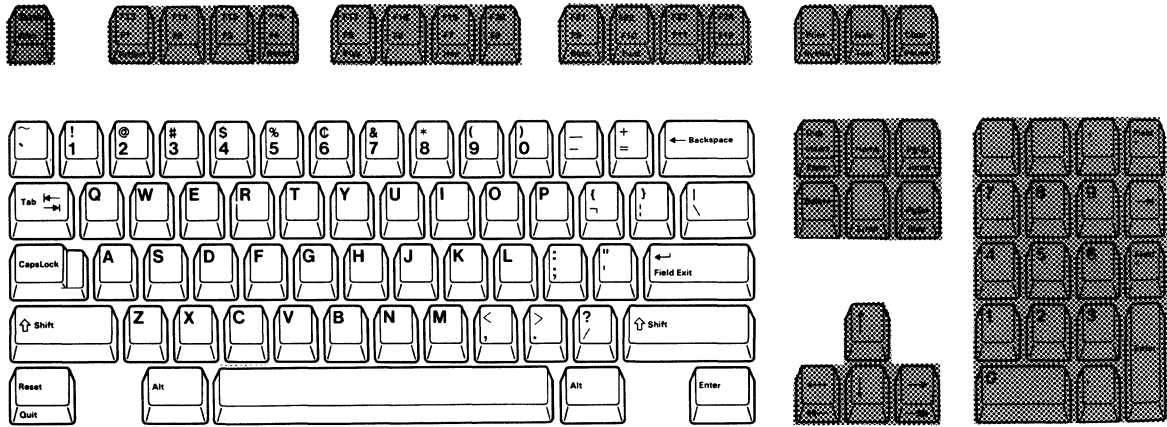

Character Backspace

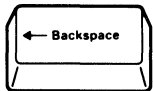

The character backspace function (activated by pressing the Character Backspace key) moves the cursor back to the previous position in which data can be entered.

If the cursor is in the first position of an input field, it moves back to the last position of the preceding input field.

Field Advance



The field advance function (activated by pressing the Field Advance key) moves the cursor to the first position of the next input field.

Field Backspace

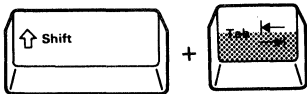

Pressing and holding the Shift key while pressing the Field Backspace key moves the cursor back to the first position of the current field. If the cursor is already in the first character position, it moves back to the first position of the previous field.

Field Exit

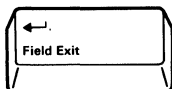

The field exit function (activated by pressing the Field Exit key) causes the cursor to exit an input field, and null characters (displayed as blank) are inserted from the current cursor location to the end of the field.

When you press the Field Exit key in a right-adjust field, the data to the left of the cursor are shifted to the right. The vacated positions are filled with zeros or

blanks as specified by the program, and the cursor advances to the next input field.

CapsLock

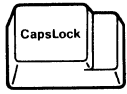

When the CapsLock key is pressed, alphabetic characters (A through Z) are entered as uppercase letters. If the Shift key is pressed while CapsLock is enabled, typing an alphabetic key causes a lowercase letter to be entered. Typing a non-alphabetic key with a Shift key pressed causes the character on the top half of the key to be entered.

To return the keyboard to lower shift, press the CapsLock key again.

Shift

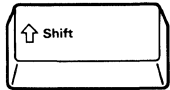
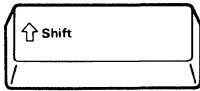

When either of Shift keys is pressed and held down:

- The alphabetic characters (A through Z) are entered as uppercase letters.
- The symbols on the top of the numeric keys and the punctuation marks on the upper half of the other keys are entered.

Reset



The reset function (activated by pressing the Reset key) is used to (1) unlock the keyboard when locked because of an error condition and (2) end the function key, help, insert, and system request functions.

The Reset function does not unlock a keyboard that is locked by the host system.

Quit

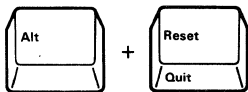

The quit function (activated by pressing and holding the Alt key, then by pressing the Quit key) ends a recording sequence or a playback sequence (for more details, refer to Chapter 5, "Operations Using the IBM Enhanced Keyboard").

This key is also used to stop the printing operation and cancel the remainder of the print file in printer setup mode. The attached printer then starts printing the top of the next file.

New Line

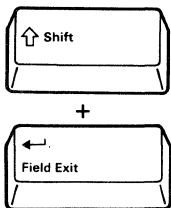

The new line function (activated by pressing and holding a Shift key and then pressing the Field Exit key) is used to move the cursor to the first input position of the first input field on the next line (usually the leftmost position of the next line).

Enter



The Enter key is used to send to the system data you have typed on the display screen.

Data Entry

Data is entered on the display screen in the same way as it is on an ordinary typewriter. Pressing a data entry key causes the character shown on the keytop to appear on the display as data.

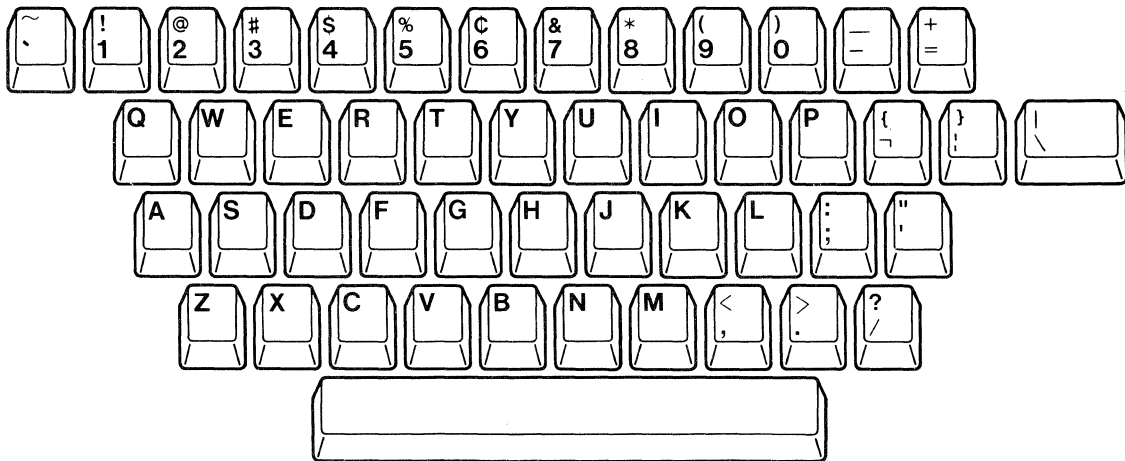

The highlighted keys (to the right of center) are described with the associated functions after this figure.

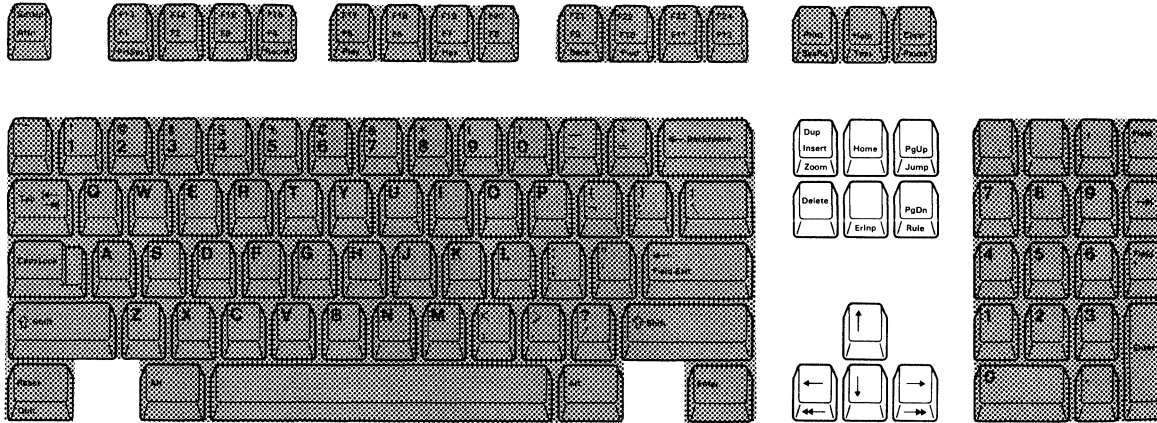

Insert Mode



The Insert function (activated by pressing the Insert key) allows you to insert a character into an existing input field without writing over data already there.

When a new character is inserted at the cursor location, characters to the right of the cursor will shift one position to the right.

Null characters, displayed as blanks, must be in the rightmost positions of the field where the insert will be performed. If you attempt to insert more characters than there are nulls, the input-inhibit symbol appears on the operating status line, and the keyboard locks. Pressing the Reset key removes the symbol and unlocks the keyboard.

To exit from insert mode, press the Reset key.

Duplicate



When the Shift key is pressed and held and the Duplicate key is pressed, the Duplicate function is activated. In a field programmed to allow duplication, an asterisk with an overscore ($\bar{*}$) is placed in the cursor position. This requests the program to duplicate the data from the same field in the previous record.

Zoom

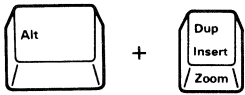

The zoom function (activated by pressing the Zoom key while pressing and holding the Alt key) allows you to change the screen format from the split screen to the non-split screen (full screen) or from the non-split screen to the split screen in two-display terminal mode.

Home



The home function operates in two different ways. Pressing the Home key moves the cursor to the home position (usually the first input position of the first input field). When the display screen is unformatted, pressing this key moves the cursor to the first input position on line one.

Page Up and Page Down



The page up and page down functions are used to move data up or down on the display screen.



Pressing the PgUp key replaces the current data on the screen with the previous page (data above the current display screen). Pressing the PgDn key replaces the current data on the screen with the next page (data below the current display screen).

Jump

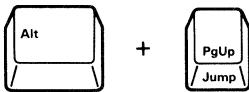

The Jump function (activated by pressing the Jump key while pressing and holding the Alt key) allows you to change the active screen (where a cursor resides) from one split screen to the other (when the screen format is split) in two-display terminal mode. When the screen format is non-split, this key allows you to make the hidden screen active.

The repeated key action changes the active screen to the previous condition.

Note: In two-display terminal mode, the display screen can be split into two screens; 24 lines of 80 characters and 17 lines of 80 characters. One of the split screens is always active. The upper half split screen connects to logical display station 1 and the other connects to logical display station 2.

Rule

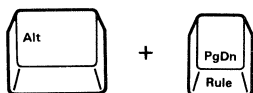

The rule function (activated by pressing and holding the Alt key and then pressing the PgDn key) enables or disables the indication of the ruler (one of the three selectable ruler styles; vertical, horizontal, and cross-hair) that can be specified by the Rule Style key (F14/F2) key in setup mode.

See Chapter 5, "Operations Using the IBM Enhanced Keyboard" for more information about the ruler style function.

Erase Input

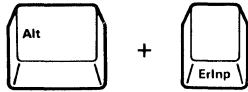

The erase input function erases the display screen and moves the cursor to the first input position on line one. To operate this function, press and hold the Alt key, then press the Erase Input key.

When the display station is under program control, this function erases all the characters from an input field and moves the cursor to the home position (usually the first input position of the first input field) on the display screen.

Delete



The delete function (activated by pressing the Delete key) is used to delete data from an input field. When you press the Delete key, the character at the cursor location is deleted, and all characters to the right of the cursor (in the same input field) shift one position to the left. Null characters are inserted into the right end of the field as the characters in the field are shifted left.

This key is also used to delete the recorded keystroke sequence in record mode (see description of the Record key).

Cursor Movement

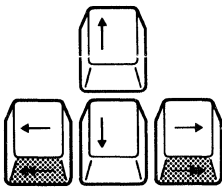

The four Cursor Movement keys move the cursor in the direction indicated by the arrow without affecting the existing data.

When the cursor reaches the edge of the display screen by pressing a cursor movement key, the cursor goes off the edge and reappears at the opposite edge of the display screen. (This cursor movement is called "wrap").

Double Speed Cursor



Pressing these keys while holding down the Alt key moves the cursor two positions at a time in the direction of the arrow. These keys are repeat-action keys.

The highlighted keys (at the right) are described with the associated functions after this figure.

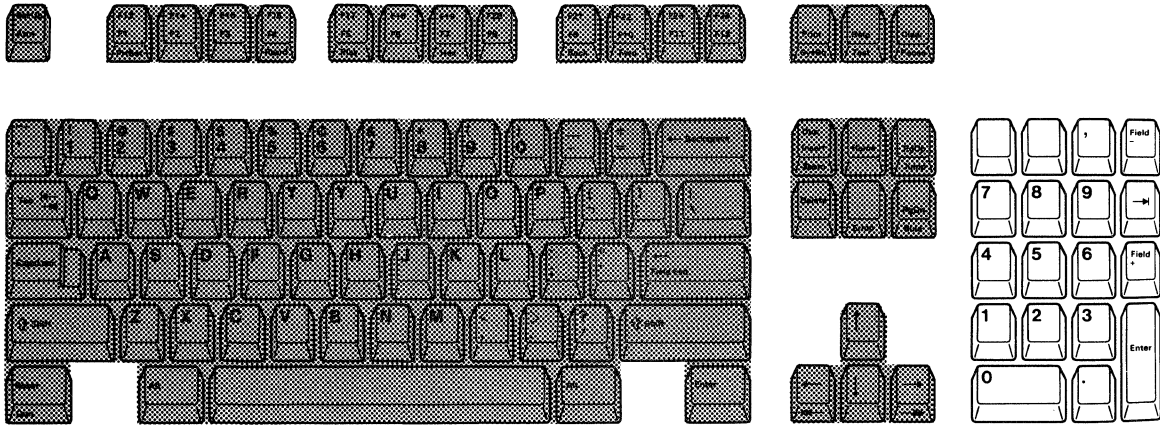

Field +



The field + function (activated by pressing the Field + key) operates in the same way as a field exit function in all fields.

When you are entering numeric data, the Field + key can be used instead of the Field Exit key.

Field -



The field - function (activated by pressing the Field - key) can vary depending on the system. On most systems the field - function operates the same as the field + and field exit functions, except that it is allowed only in signed-numeric and numeric-only fields. Pressing the Field - key inserts a - (minus) sign in the last position of a signed numeric-only field, or it changes the last position of a numeric-only field to an alphabetic character. (This alphabetic character is used to tell the host system the numeric value of the last position and that it is a negative field.) Pressing the Field - key causes an error if used in any field not programmed to accept negative numbers as input.

Numeric

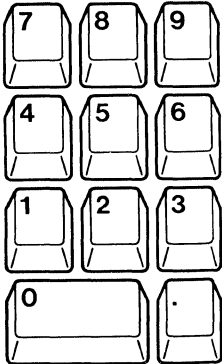

The Numeric keys are used to enter numeric data with calculator-like efficiency.

The highlighted key (at the top) are described with the associated functions after this figure.

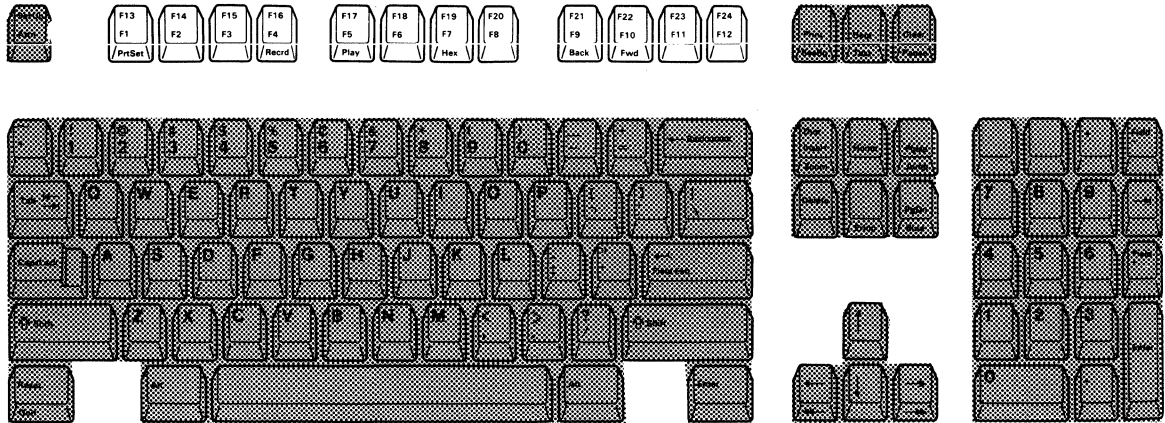

Function

Some key functions are activated by the Function (F) keys. Specific functions vary depending on how they are assigned in the system program.

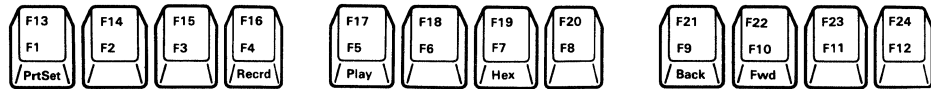

Functions 1 through 12 are accessed by pressing the desired function key.
 Functions 13 through 24 are accessed by pressing and holding either Shift key followed by pressing the desired function key.

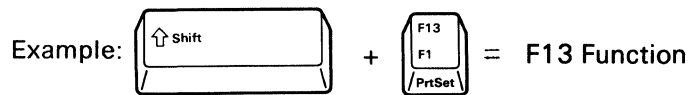

Setup Mode

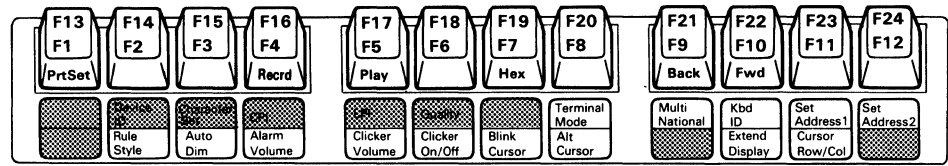

The function keys that have printing in black or blue on the overlay also activate setup mode functions. These functions are activated only when the Shift key is pressed and held and the SetUp key is pressed prior to pressing the desired Function (F) key. To disable any setup mode function, press and hold the Shift key and press the SetUp key. The display station will return to normal communication mode.

The following table describes the functions of the Function (F) keys in setup mode. For more information see Chapter 5, "Operations Using the IBM Enhanced Keyboard."

Setup Mode Key	Function
Rule Style F2	<p>Changes the current ruler style (one of the three styles-vertical, horizontal, and cross-hair) at the cursor position in the data area as well as the ruler style symbols in the operating status area when the ruler function is enabled by the Ruler (Rule) key. If the ruler function is disabled, one of the three ruler style symbols that you selected appears on the operating status line.</p> <p>Pressing and releasing this key cyclicly changes from the vertical, the horizontal to the cross-hair style.</p>
Auto Dim Interval F3	<p>Changes the current auto dim interval (time required to start the auto dim function) and automatically increases the interval from 0 to 20 minutes. Five selections, 0, 2, 5, 10, and 20 are available. After the longest interval is reached, it returns to 0.</p> <p><i>Note:</i> The dim indicator is displayed on the operating status line.</p>
Alarm Volume F4	Adjusts the alarm volume. Pressing this key increases the alarm volume until the highest level is reached. After the highest level is reached, the alarm volume returns to off and the sequence starts over.
Clicker Volume F5	Adjusts the volume of the click sound. Pressing this key increases the clicker volume until the highest level is reached. After the highest level is reached, the clicker volume returns to off and the sequence starts over.
Clicker On/Off F6	Enables or disables the keyboard clicker.
Blink Cursor F7	Enables or disables the cursor blink.
Alt Cursor F8	Alternately selects either underscore-style or block-style cursor. When the current cursor style is underscore, pressing this key changes it to block-style.
Extend Display F10	Enables or disables the extended-display function. When enabled, each field attribute in the data area will be displayed as a two-digit hexadecimal number. Each hexadecimal value will be displayed in a single-character cell. In addition, the terminal mode, station address, multinational character set symbol, controller link parity error count, and keyboard link parity error count will be displayed on the operating status line.
Terminal Mode F20	Changes the current selection among three terminal modes (one-display, two-display and display-printer). When the key is released, the terminal mode at that time will be selected.
Multinational F21	Selects either the multinational character set or the country-specific character set.
Kbd ID F22	Changes the current value of the keyboard ID. Pressing and holding this key automatically increments the ID from -- through 63. When the key is released, the ID displayed at that time will be selected. When the keyboard ID reaches 63, sequence starts over again from -- .
Cursor Row/Col F11	Displays the current cursor location by line number and column position. Pressing this key again blanks the indication.
Set Address 1 F23	<p>Changes the current address of display station 1. Pressing and holding this key automatically increments the address from 0 to 6. When the key is released, the address displayed at that time will be selected.</p> <p>When the station address reaches 6, sequence starts over again from 0.</p>

Setup Mode Key	Function
Set Address 2 F24	Changes the current address of display station 2. Pressing and holding this key automatically increment the address from 0 to 6. When the key is released, the address displayed at that time will be selected. When the station 2 address reaches 6, the sequence starts over again from 0.
Set Printer Address F24	Changes the current address of the printer attached to the display station. Pressing and holding this key increments the address from 0 to 6 when you select the display-printer mode using the terminal mode key. When this key is released, the address displayed at that time will be selected. When the printer address reaches 6, the sequence starts over again from 0.

Printer Setup Mode

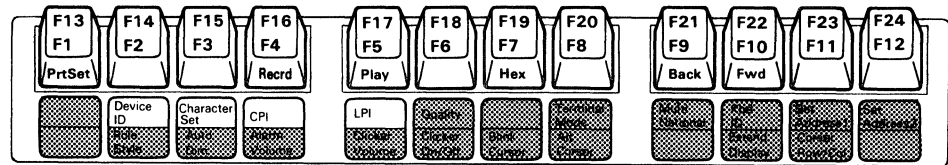

The Function keys that have printing in green on the overlay also activates printer setup mode functions. These functions are activated only when the PrtSet (F13/F1) key is pressed while pressing and holding the Alt key, prior to pressing the desired function key. To exit printer setup mode, press the PrtSet (F13/F1) key while pressing and holding the Alt key.

The following table describes the functions of the Function keys in printer setup mode. For more information, see Chapter 5, "Operations Using the IBM Enhanced Keyboard" on page 5-1.

Printer Setup Mode Key	Function
Device ID F14	Alternately changes the device ID from 4214 to 5256 or from 5256 to 4214. The device ID number represents a system printer or a workstation printer (either IBM 4214 or IBM 5256) that the printer attached to your display station emulates.
Character Set F15	Alternately changes the printer character set from 437 to 850 or from 850 to 437. (Not available for the Katakana keyboard.)
CPI F16	Displays the current character pitch of the printer attached to your display station. Pressing this key while pressing and holding the Shift key changes the current character pitch to the desired one from the eight selections (see Chapter 5 for more details).

Printer Setup Mode Key	Function
LPI F17	Displays the current line pitch of the printer attached to your display station. Pressing this key while pressing and holding the Shift key changes the current line pitch to the desired one from the seven selections (see Chapter 5 for more details).
Quality F18	Displays the current print quality (characters to be printed by the attached printer). Pressing this key while pressing and holding the Shift key changes the current print quality to the desired one from the three selections (see Chapter 5 for more details).

Katakana-Unique Shift Keys (IBM Enhanced Keyboard)

The Katakana keyboard has two keyboard operating modes; alphanumeric and Kana. Switching the keyboard operation mode can be done by pressing the Alphanumeric/Kana () key. If you are in the Kana mode, pressing this key changes the mode to alphanumeric mode.

In alphanumeric keyboard operation mode, you can use the keyboard like a U.S. English keyboard. In Kana operation mode, you can use it like a Kana keyboard. In each mode, there are two shifts available; shift up and shift lock. Figure 4-2 shows the relationship between the shift status (including capslock) and the characters on the keytop.

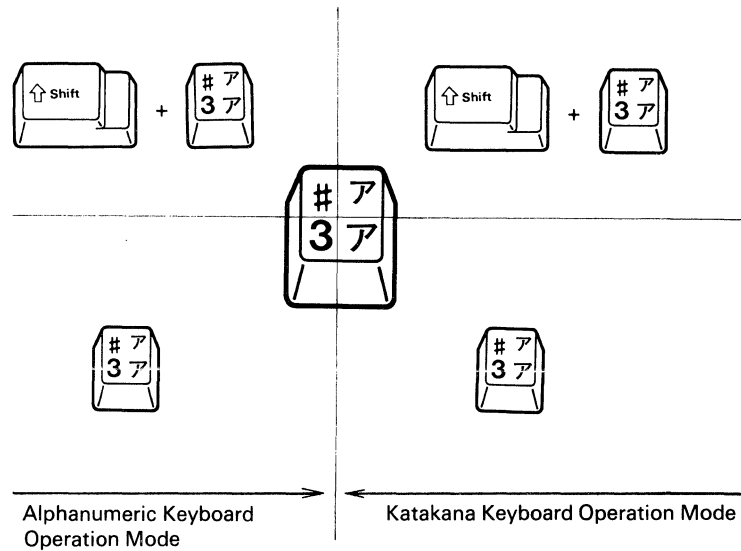

Figure 4-2. Relation Ship between Shift Status and Keytop Character

There are two Shift Lock keys: alphanumeric and Katakana. These two Shift Lock keys are used to:

- Enter a continuous alphanumeric or Katakana data stream from the keyboard.
- Force either Katakana-shift lock or alphanumeric shift lock, which overrides any host-specified shift status.

The following table shows the operating-status line symbol for each shift or shift lock status in each keyboard operation mode.

Mode	Key Name	Shift Status	Operator Indicator
Alphanumeric (英数)	↑	Alphanumeric-Symbol	↑
	None	Alphanumeric-Shift	No indication
Katakana (カナ)	↑	Katakana Symbol	↑ カナ
	None	Katakana	カナ

Chapter 5. Operations Using the IBM Enhanced Keyboard

Modes

The IBM 3197 display station operates in six modes: test, normal communication, setup, record, play and printer setup.

Test Mode

There are two test sub-modes: basic assurance test and offline test. In basic assurance test (BAT) sub-mode, the self-diagnostic program automatically runs to verify the hardware functions. In offline test sub-mode, additional tests can be executed. For more details on these tests, refer to the *IBM 3197 Model D Display Station Problem Solving Guide*, GA18-2547.

Normal Communication Mode

In this mode the display station can send data to and receive data from the host system. Also in display printer mode, the printer attached to your display station can receive and print data from the host system.

Setup Mode

The display station has two setup sub-modes: offline setup and online setup.

In offline setup mode, the number of logical workstations, address for each workstation, and necessary parameters for communication with the host system should be specified.

In online setup mode, the various functions available for the display station should be specified.

Record Mode

Pressing the Record key in normal communication mode causes the display station to enter record mode. In this mode, an often-used keystroke sequence (words or sentence) can be assigned to a particular Function (F) key. Refer to "Record Mode Operation" for additional information.

Play Mode

Once the keystroke sequences are recorded while in record mode, those keystroke sequences can be recalled to any position in the data area when the Play key is pressed in normal communication mode and the designated F key is pressed. Refer to "Play Mode Operation" for additional information.

Printer Setup Mode

There are two printer setup sub-modes: offline printer and online printer.

In offline printer setup mode, a printer character set and a device ID can be specified. In addition, all functions for the online printer setup mode can be selected or set in offline printer setup mode.

In online printer setup mode, your desired character size and style, and line spacing for the printing format can be selected.

The printer setup mode functions are described later in this chapter.

Setup Mode Operation

In setup mode, two types of setup mode functions are available; offline setup and online setup function.

The offline setup functions should be determined during the initial machine setup time. Or if you want to change the functions because of terminal configuration changes, you should determine the offline setup functions before changing the online setup functions.

In addition, all of the online setup functions can be selected or set in offline setup mode.

Note: All setup functions after being selected will be stored and will not be reset when the display station power switch is set to O (off).

The following sections describe the procedures for specifying both offline setup and online setup mode functions.

Offline Setup Functions

The offline setup functions can be specified after pressing the SetUp key only when the display station is in the offline test sub-mode of test mode. The functions available are:

- Select the terminal mode
- Select the multinational character set
- Set the keyboard ID
- Set station address 1
- Set station address 2
- Set the printer address.

Note: If you perform any of the previous offline setup functions, the host system and the IBM 5294 Control Unit (if the IBM 3197 is remotely attached) may have to be reconfigured. Contact your supervisor.

The following sections describe the procedure for specifying each offline setup mode function.

Help for the user

For ease of use, each setup function is described in a separate sub-section. However, when you need to setup two or more setup functions at the same time, you can set them successively in setup mode without turning power off and on when following the setup procedure for each setup function.

Select the Terminal Mode

Note: The selection of the terminal mode should be made based on your terminal configuration. Consult your supervisor or system operator before starting this procedure.

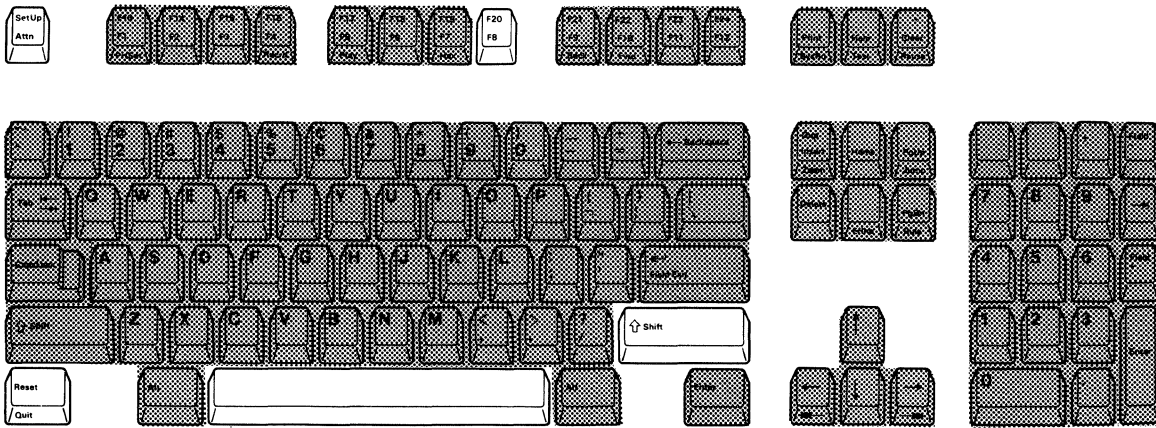

1. Set the power switch to O (off).
2. Press and hold the space bar and set the power switch to | (on). Hold the space bar until the test pattern appears.
3. Press and hold the Shift key and then press the SetUp key. A diamond (◊) and one of the following terminal mode symbols appear on the operating status line.

◊ One-Display Mode

◊-◊ Two-Display Mode

◊-P Display-Printer Mode

The symbols on the operating status line are shown as follows:

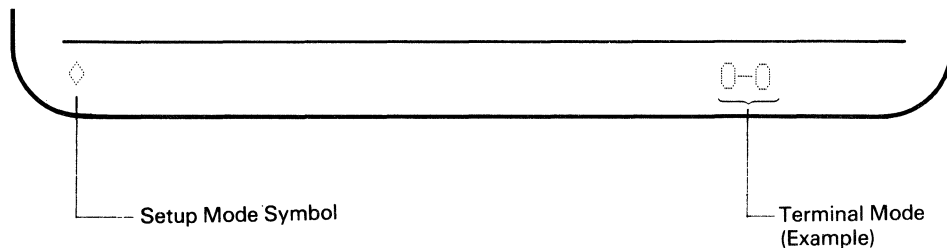

4. Press and release the F20/F8 key while pressing and holding the Shift key. The terminal mode symbol changes each time you press the F20/F8 key in the following order.

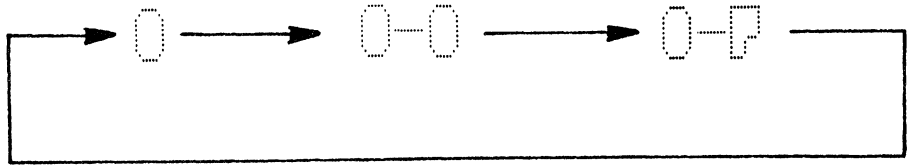

5. Release both the F20/F8 key and the Shift key when the terminal mode symbol you want to select, appears.
6. Press and hold the Shift key and then press the SetUp key. The diamond disappears as you exit from setup mode. Once selected, the terminal mode will be stored and will not be reset when the display power switch is set to O (off).
7. Press the Reset key to enter normal communication mode.

The following sections describe what can be done in each terminal mode (one-display, two-display or display-printer mode).

One-Display Mode Operation

In one-display mode, your display station has one display station address and works as an ordinary single display station.

In this mode, either of the two screen formats; 24 lines x 80 characters (1920 characters) and 27 lines x 132 characters (3564 characters), can be selected by the host system application programs. The following figures show the differences of the two screen formats.

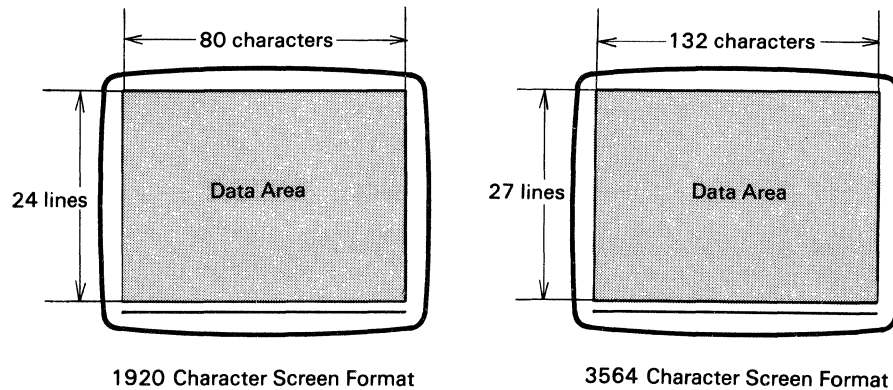

Two-Display Mode Operation

In two-display mode, your display station has two display station addresses and works as two display stations.

Like the one-display mode operation, the above two screen formats are used by the host system application programs. In addition, the display station locally supports the screen format of 41 lines x 80 characters (3280 characters) where data from the two display stations (logical display stations) can be displayed simultaneously. This screen format is called "split screen". The following figure shows the format of the split screen.

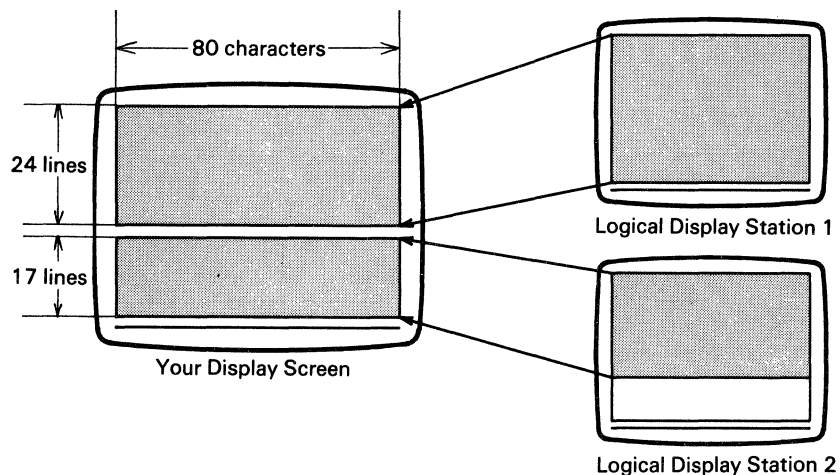

The upper half of the screen displays the full screen (24 lines x 80 characters) from the one display station (logical display station 1) and the lower half of the screen displays a part of the screen (17 lines x 80 characters) from the other display station (logical display station 2). For the lower half of the screen, using the Local Scroll keys (Back and Fwd keys), the screen can be scrolled up or down line by line to display the hidden 7 lines (in other words, the lower half of the screen only displays 17 lines out of the 24 lines full screen at one time).

Your display station also displays the full screen data from either of the two display stations (logical display station 1 and 2) on the display screen format of the 24 lines x 80 characters or 27 lines x 132 characters. This display screen format is called "non-split screen".

With the Zoom key, the display screen format can be changed from the split screen to the non-split screen or from the non-split screen to the split screen. At initial power-on time, the display screen format is set to the non-split screen.

In summary, the following functions are available in two-display mode.

- Local Scroll function
- Jump function
- Zoom function

The following sections describe in more detail the above functions.

Split Screen

Your display station interacts with the host system using the two display stations (logical display station 1 and 2) simultaneously because your display station has two display station addresses.

As described above, in split screen the display screen is divided into two data areas. The upper half of the screen displays the full screen data (24 lines x 80 characters) and the lower half displays a part of the full screen (17 lines x 80 characters).

The cursor that indicates which of the split screens is currently active resides in the upper half screen the first time the screen is split. See the figure below.

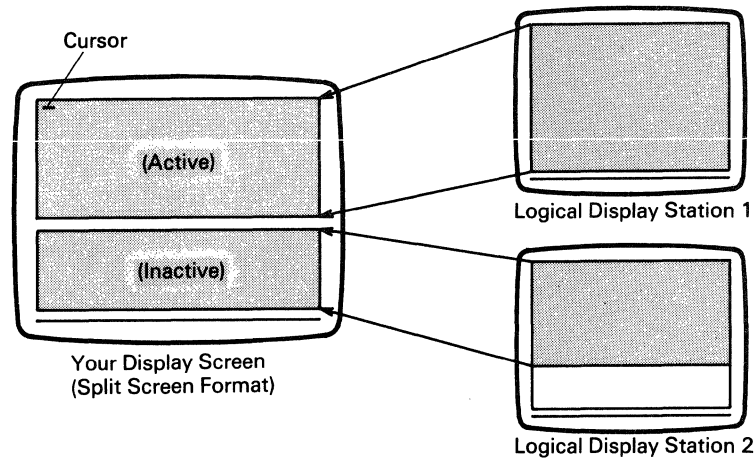

In the above screen, you can key in data using the upper half of the screen. The lower half of the screen only displays a part of the data of display station 2 (logical display station 2). In other words, the data on the lower half can be used as a reference.

Local Scroll

The lower half screen can be scrolled by the Local Scroll (Fwd and Back) keys within the range of 7 lines. Local scroll is functional only when the lower screen is not active. See the following figure.

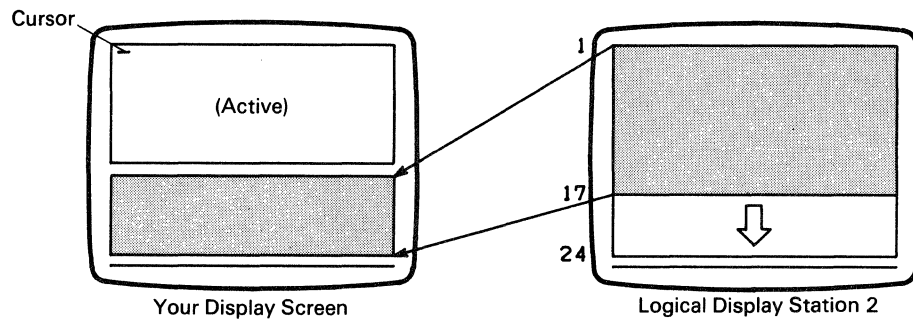

If the lower half screen displays the top 17 lines of the full screen of display station 2, pressing the Fwd key, scrolls down the lower half screen of your display station line by line until the bottom line shows the 24th line of data of logical display station 2.

When scrolling reaches the 24th line of data of display station 2, scrolling stops. By pressing the Back key, the scrolling starts over again from the bottom to the top of the data of display station 2.

Jump

If you have completed the operation on the data of display station 1 and want to key in data of logical display station 2, pressing the Jump key changes the current active screen to the lower screen. The cursor moves from the upper half screen to the lower half screen.

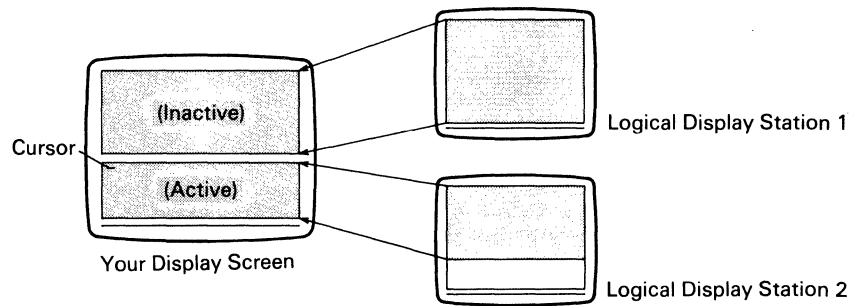

Now, you can key in data on the lower half of the screen (logical display station 2).

Note: While in split screen, if the host system specifies the 132 characters x 27 lines screen format for the active screen, your display screen automatically changes from split screen to non-split screen and the specified screen format will be displayed on the screen. In the same condition, if the host system specifies the same screen format for the inactive screen, the 80 characters x 24 lines screen format (active screen) will be displayed.

Non-Split Screen

Your display screen can interact the host system using either one of the logical display stations, but with only one at a time. The display of the data can be switched from one logical display stations to the other one (see the figure shown below).

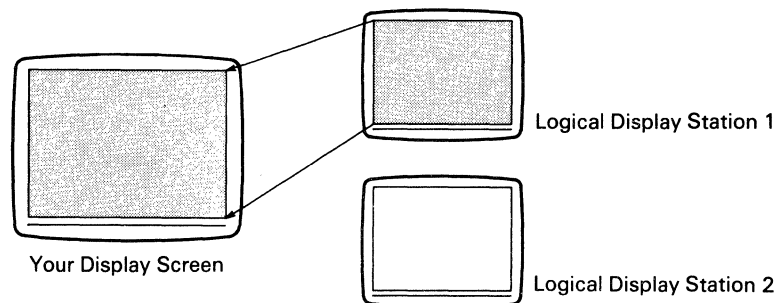

At initial power on time, the full screen data of display station 1 is displayed on your display screen and data can be keyed in.

Jump

Pressing the Jump key (while pressing and holding the Alt key) alternates the display from one logical display station to the other.

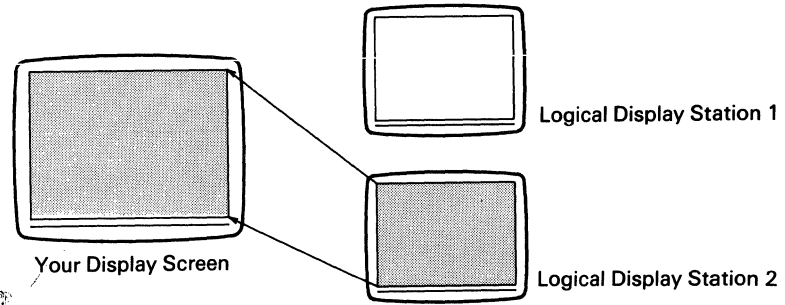

Zoom for Split and Non-split Screens

When you need to change the screen format from the split screen to the non-split screen or from the non-split screen to the split screen, press the Zoom key.

The following figures show the transition of the current display screen to the display screen after pressing the Zoom key.

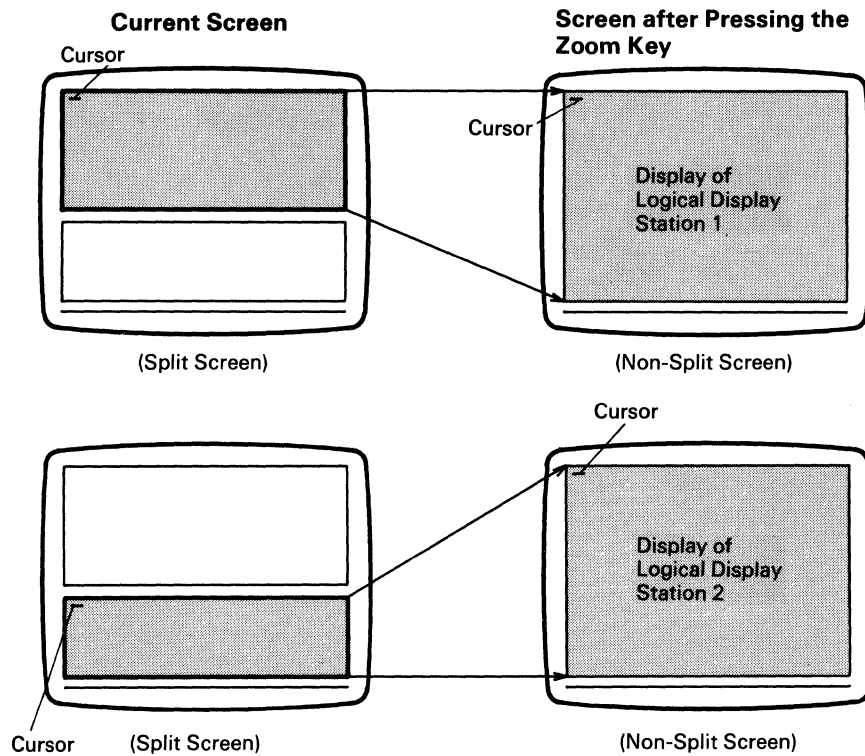

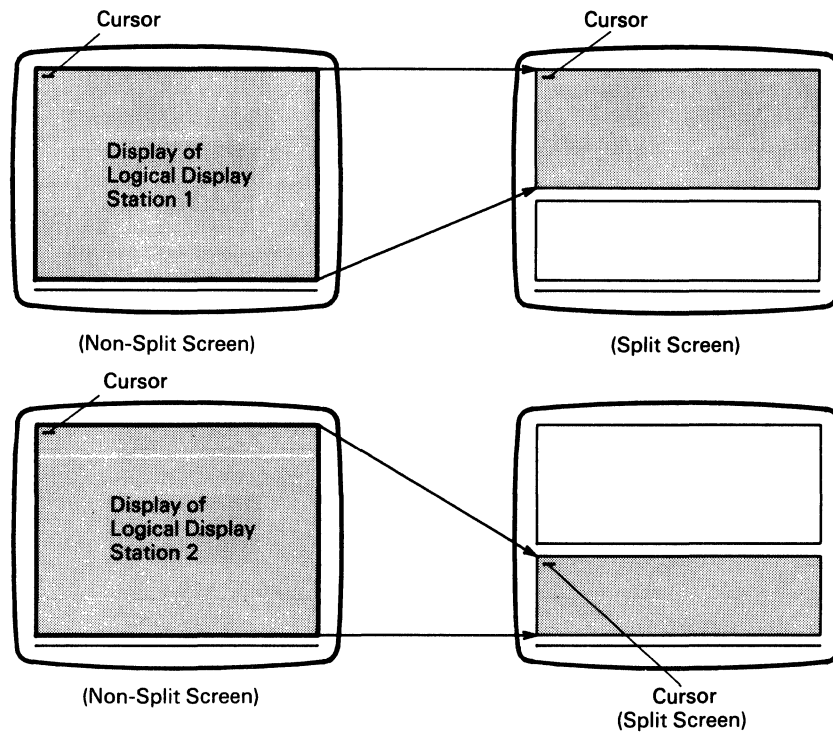

Note: The shaded area shows the active screen.

Display-Printer Mode Operation

In this mode, your display station is logically connected to both display station 1 and the printer attached to your display station.

Your display station has one logical display station address (station address 1), you cannot use the functions of the Jump, Local Scroll keys, and Zoom keys. For the operation of the printer functions, see the "Printer Setup Mode Operations" later in this chapter.

Select the Multinational Character Set

Note: Multinational character set is a function of the host system. Do not set multinational character set unless you consult your system operator.

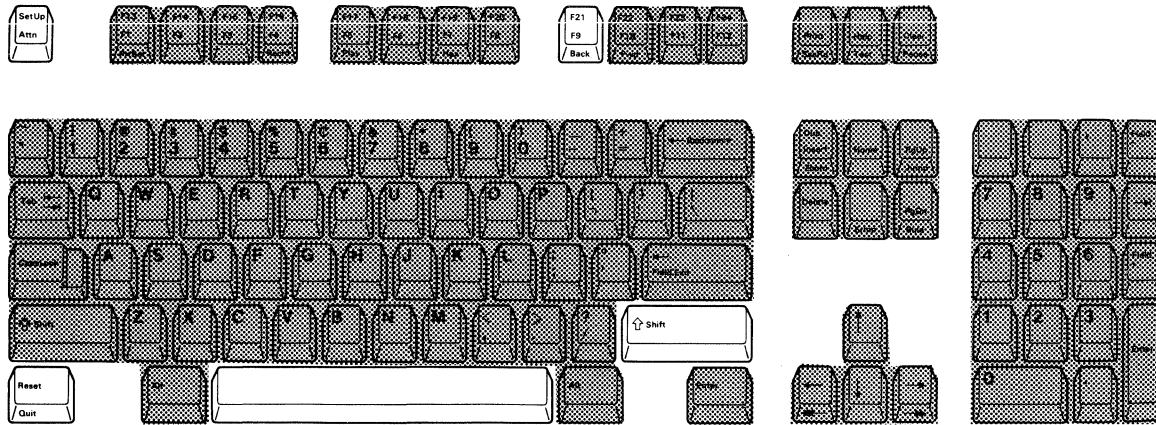

1. Set the power switch to O (off).
2. Press and hold the space bar and set the power switch to | (on). Hold the space bar until the test pattern appears.
3. Press and hold the Shift key, and then press the SetUp key. A diamond (◊) appears on the operating status line.
4. Press and hold the Shift key and then press the F21/F9 key, to alternately select the multinational character set. When an 'M' appears on the operating status line, the multinational character set is selected.

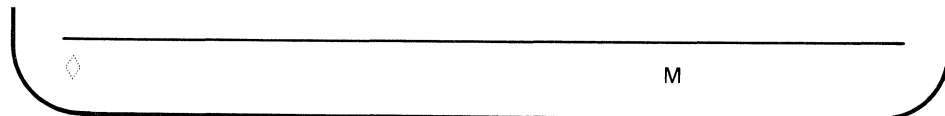

5. Press and hold the Shift key and then press the SetUp key. The diamond disappears as you exit from setup mode. Once selected, the multinational character set will be stored and will not be reset when the display station power switch is set to O (off).
6. Press the Reset key to enter normal communication mode.

Set the Keyboard ID

This function defines the ID of your keyboard. Your keyboard ID should *always* be set to "--" unless your system operator provides a different ID number.

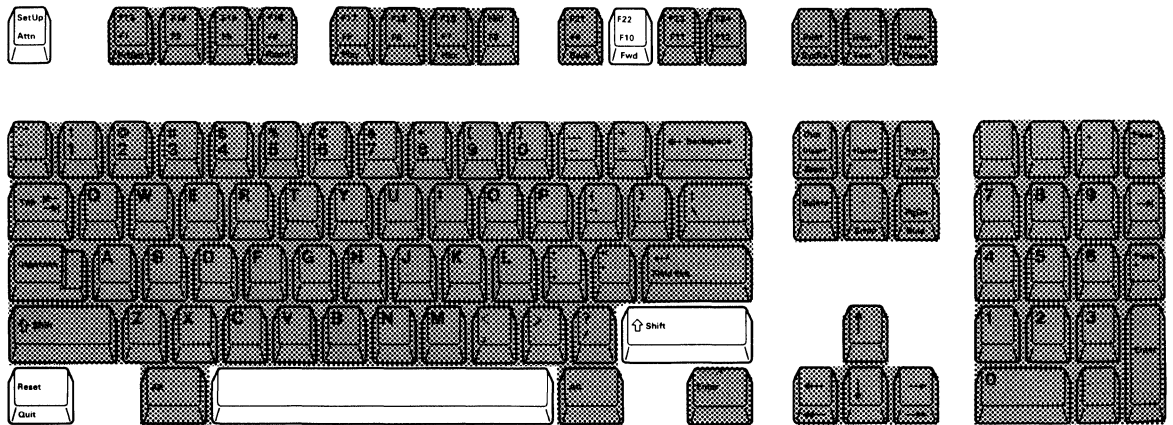

1. Set the power switch to O (off).
2. Press and hold the space bar and set the power switch to | (on). Hold the space bar until the test pattern appears.
3. Press and hold the Shift key and then press the SetUp key. A diamond (◊) appears on the operating status line.

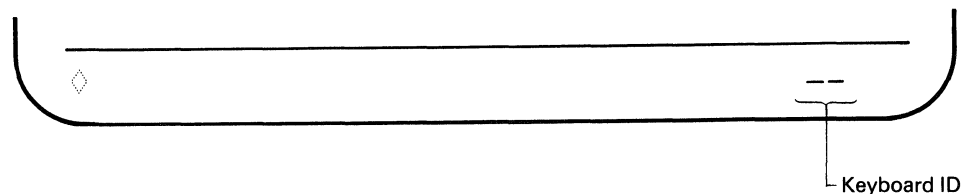

4. The keyboard ID will be displayed at the right side of the operating status line. If you press and hold the F22/F10 key while pressing and holding the Shift key, the keyboard ID increases.

Note: A "--" immediately follows the number 63 when the keyboard ID key is pressed.

5. Release both the F22/F10 key and the Shift key when your desired keyboard ID appears on the screen.
6. Press and hold the Shift key and then press the SetUp key. The diamond disappears as you exit from the setup mode. Once selected, the keyboard ID will be stored and will not be reset when the display station power switch is set to O (off).
7. Press the Reset key to enter normal communication mode.

Set Station Address 1

This function defines the address of your display station.

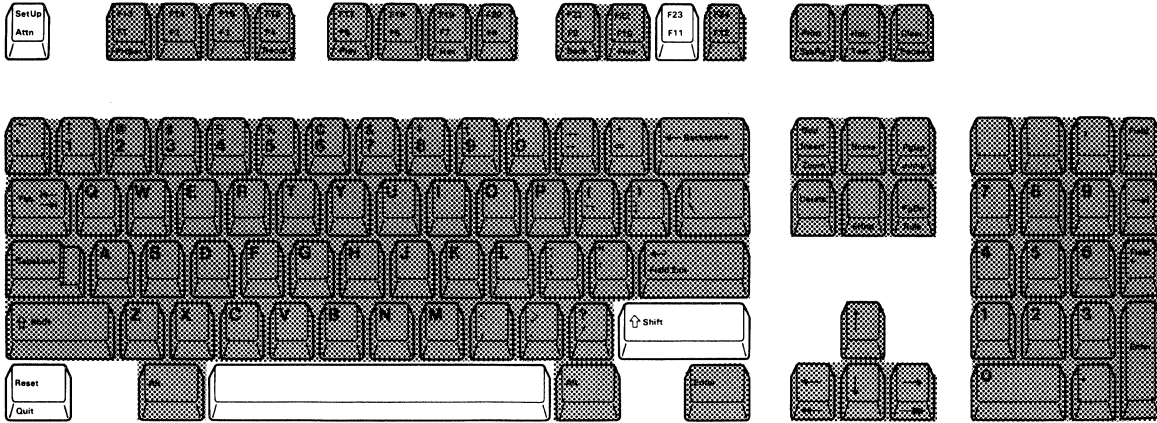

1. Set the power switch to O (off).
2. Press and hold the space bar and set the power switch to | (on). Hold the space bar until the test pattern appears.
3. Press and hold the Shift key and then press the SetUp key. A diamond (◊) appears on the operating status line.
4. The station address of your display station 1 will be displayed in the operating status line. If you press and hold the F23/F11 key while pressing and holding the Shift key, station address 1 increases. When the address reaches 6, the sequence starts over again from 0.

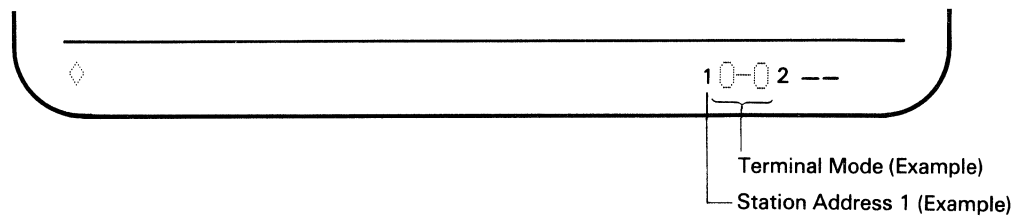

5. Release both the F23/F11 key and the Shift key when your desired address of station address 1 appears on the screen.
6. Press and hold the Shift key and then press the SetUp key. The diamond disappears as you exit from the setup mode. Once selected, the station address will be stored and will not be reset when the display station power switch is set to O (off).
7. Press the Reset key to enter normal communication mode.

Set Station Address 2

This function defines the address of your display station 2.

Note: You need the setting of station address 2 because you selected two-display mode in the terminal mode selection (refer to the procedure for specifying the terminal mode).

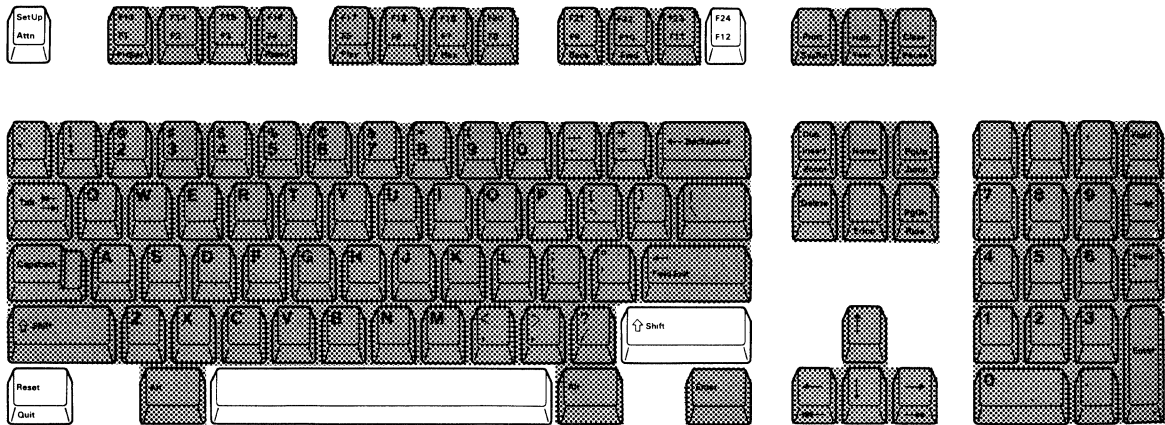

1. Set the power switch to O (off).
2. Press and hold the space bar and set the power switch to | (on). Hold the space bar until the test pattern appears.
3. Press and hold the Shift key and then press the SetUp key. A diamond (◊) appears on the operating status line.
4. The station address of your display station 2 is displayed at the right of Terminal Mode Symbol on the operating status line. If you press and hold the F24/F12 key while pressing and holding the Shift key, station address 2 increases. When the address reaches 6, the sequence starts over again from 0.

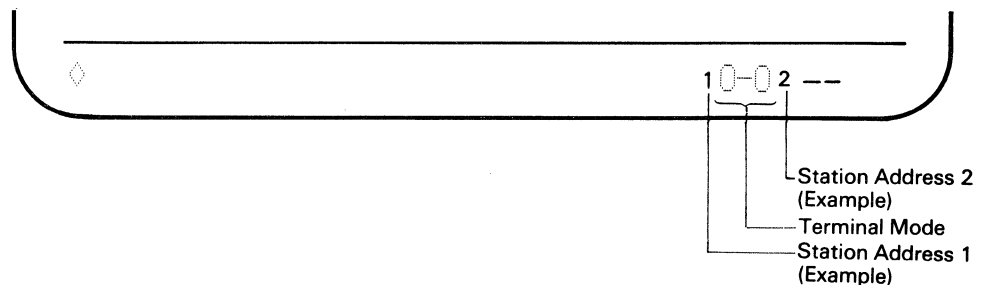

5. Release both the F24/F12 key and the Shift key when your desired address of station address 2 appears on the operating status line.
6. Press and hold the Shift key and then press the SetUp key. The diamond disappears as you exit from setup mode. Once selected, station address 2 will be stored and will not be reset when the display station power switch is set to O (off).
7. Press the Reset key to enter normal communication mode.

Set the Printer Address

This function defines the address for the printer that is attached to the display station.

Note: You need the setting of the printer address because you selected display-printer mode in terminal mode selection (refer to the procedure for specifying the terminal mode).

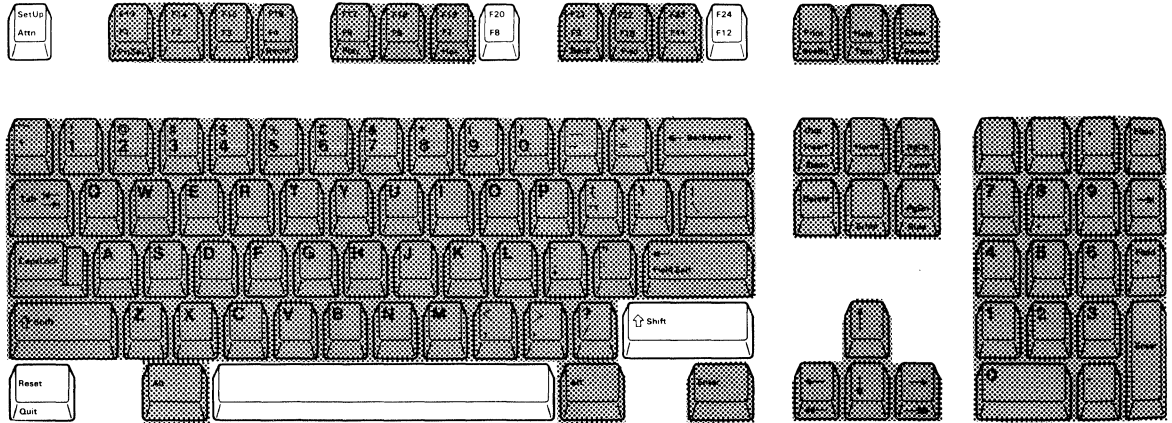

1. Set the power switch to O (off).
2. Press and hold the space bar and set the power switch to | (on). Hold the space bar until the test pattern appears.
3. Press and hold the Shift key and then press the SetUp key. A diamond (◊) appears on the operating status line.
4. Press and hold the Shift key and then press and release the Terminal Mode (F20/F8) key until " ◊-P " appears at the left of the keyboard ID symbol "--".

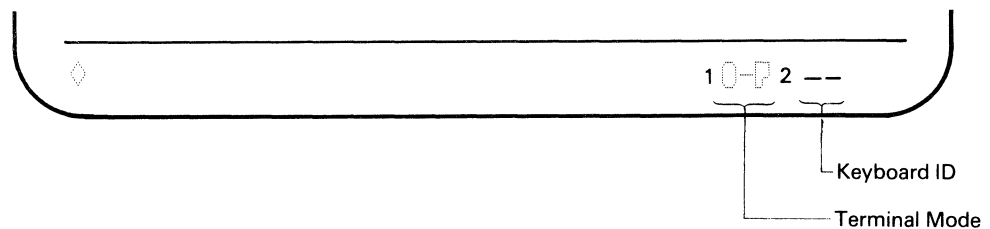

5. The printer address of the printer attached to the display station is displayed on the operating status line. If you press and hold the F24/F12 key while pressing and holding the Shift key, the printer address increases.

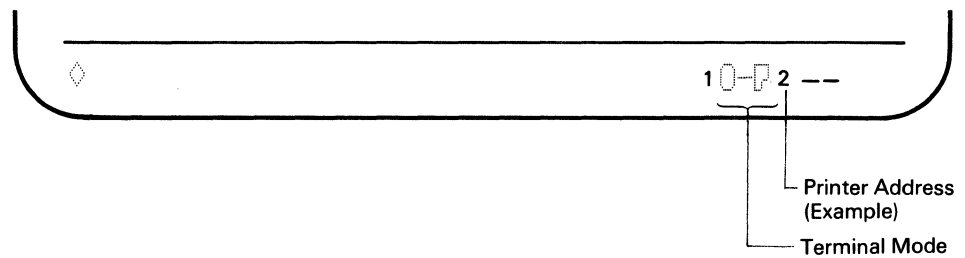

Note: The printer address can be selected from seven numbers (0 to 6). The address assigned to your display station cannot be selected as the printer address.

6. Release both the F24/F12 key and the Shift key when your desired printer address appears on the operating status line.
7. Press and hold the Shift key and then press the SetUp key. The diamond disappears as you exit from setup mode. Once selected, the printer address will be stored and will not be reset when the display station power switch is set to O (off).
8. Press the Reset key to enter normal communication mode.

Online Setup Functions

The online setup functions can be specified after pressing the SetUp key while the display station is in normal communication mode. The functions available are:

- Select the ruler style
- Select the auto display dim interval
- Adjust the alarm volume
- Adjust the clicker volume
- Enable/disable the clicker action
- Enable/disable the cursor blink
- Select the cursor style
- Enable/disable the extended display
- Enable/disable the cursor locator.

Note: The above setup mode functions can also be specified in the offline setup mode.

The following sections describe the procedures for specifying each online setup mode function.

Help for the user

For ease of use, each setup function is described in a separate sub-section. However, when you need to setup two or more setup functions at the same time, you can set them successively in setup mode without turning power off and on when following the setup procedure for each setup function.

Select Ruler Style

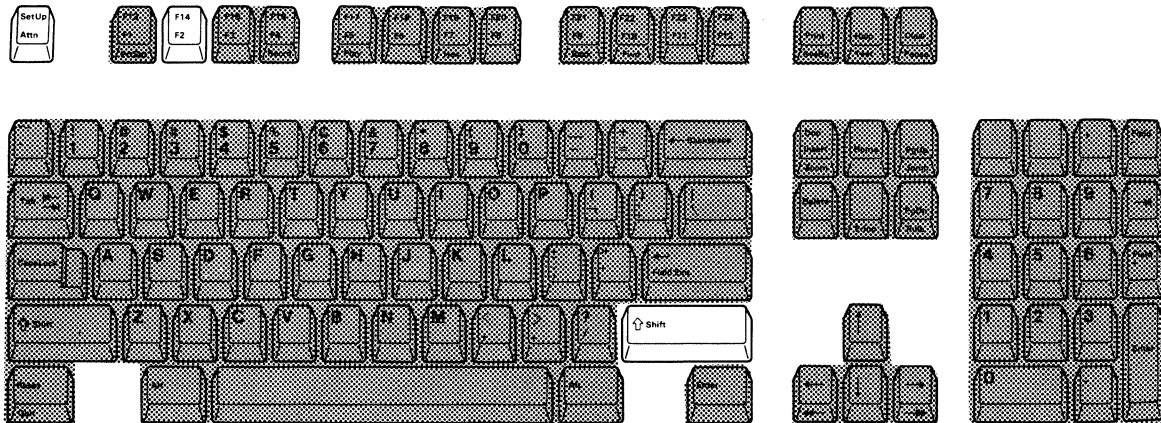

1. Press and hold the Shift key and then press the SetUp key. A diamond (◊) and the current ruler style (vertical, horizontal, or cross-hair) appear on the operating status line.

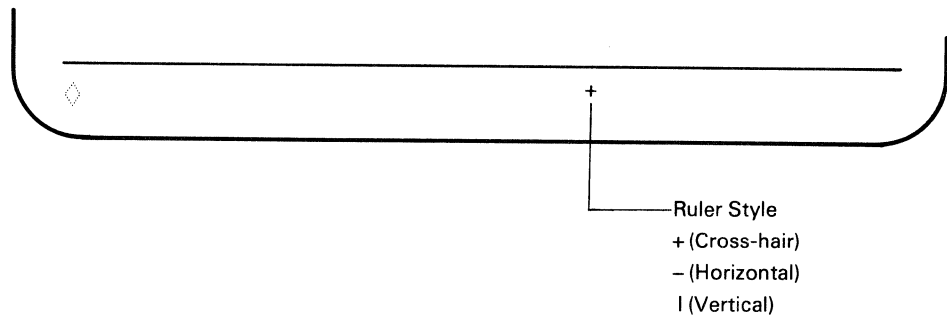

2. Press and release the F14/F2 key until the desired ruler style appears on the operating status line. The ruler style will be changed from vertical (|), horizontal (-) to cross-hair (+).



Note: To enable the ruler function, you have to press the Rule key.

3. Press and hold the Shift key and then press the SetUp key. The diamond disappears as you exit from setup mode. Once selected, the ruler style will be stored and will not be reset when the display station power switch is set to O (off).

Display Dim Interval Adjustment

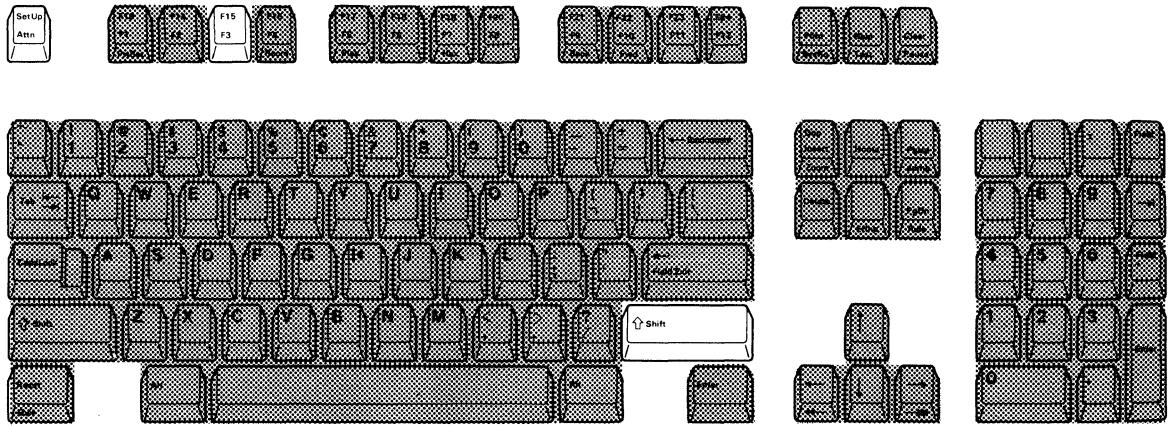
Note: When display dim is enabled ( is displayed), the screen will blank, except for the operating status line, if no key is pressed and no data is received from the host system for the specified time (0, 2, 5, 10 and 20 minutes).



1. Press and hold the Shift key, and press the SetUp key. A diamond () and the Display Dim Indicator () appear on the operating status line.

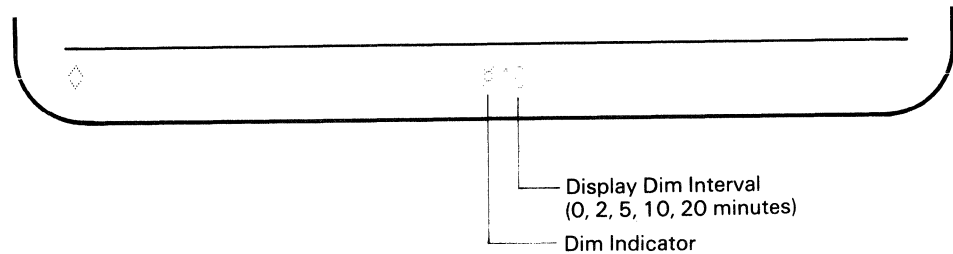

2. Press and release the F15/F3 key until the desired time among 5 selections (0, 2, 5, 10 and 20 minutes) appears on the operating status line.
3. Press and hold the Shift key and press the SetUp key. The diamond disappears as you exit from setup mode. Once selected, the auto display dim will be stored and will not be reset when the display station power switch is set to O (off).

Adjust Alarm Volume

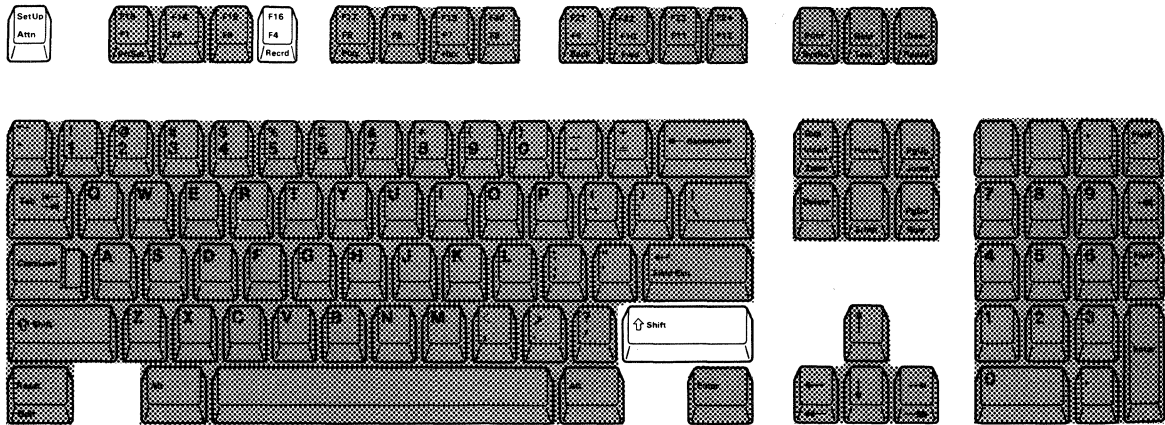

1. Press and hold the Shift key, and press the SetUp key. A diamond (◊) and the alarm symbol (■) appear on the operating status line.

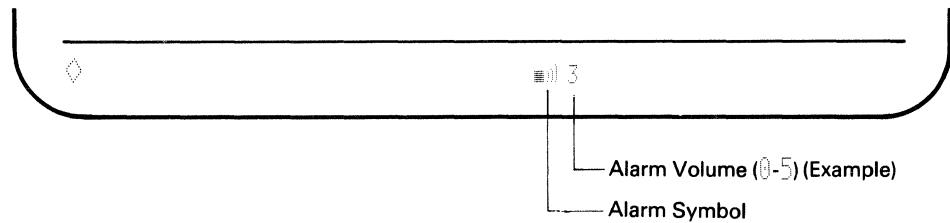

2. You can choose one of six possible alarm volumes, (0 to 5). Volume level 0 means the alarm is off.

Press and hold the F16/F4 key until your desired alarm volume appears on the status line. The volume level increases until the highest level is reached. After the highest level (5) is reached, the alarm volume returns to off (0) and the sequence starts over.

3. Press and hold the Shift key and press the SetUp key. The diamond disappears as you exit from setup mode. Once selected, the alarm level will be stored and will not be reset when the display station power switch is set to O (off).

Adjust Clicker Volume

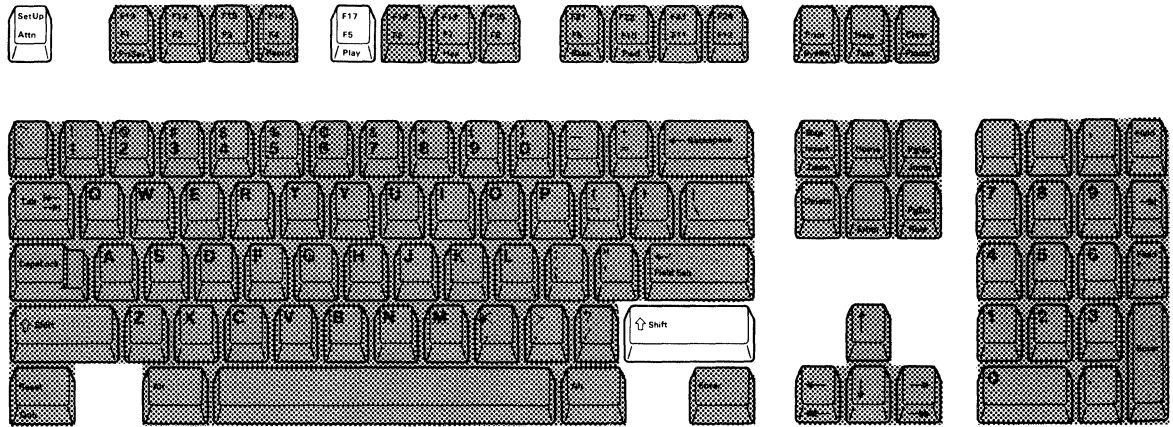

1. Press and hold the Shift key, and press the SetUp key. A diamond (◊) appears on the operating status line.

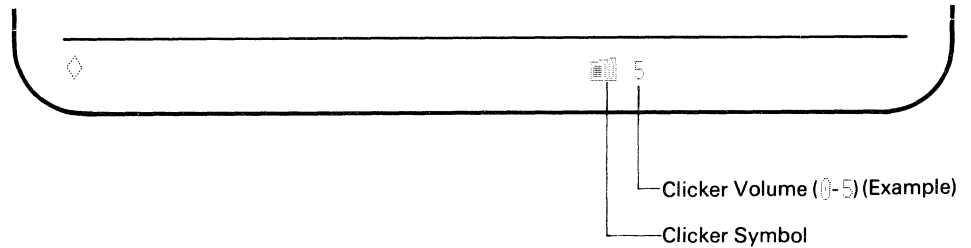

2. You can choose from six possible clicker volumes, (0 to 5). Volume level 0 means the clicker is off.

Press and hold the F17/F5 key until your desired clicker volume appears on the status line. The clicker volume level increases until the highest level (5) is reached. After the highest level (5) is reached, the clicker volume returns to off (0) and the sequence starts over.

3. Press and hold the Shift key and press the SetUp key. The diamond disappears as you exit from setup mode. Once selected, the volume will be stored and will not be reset when the display station power switch is set to O (off).

Enable/Disable Clicker Action

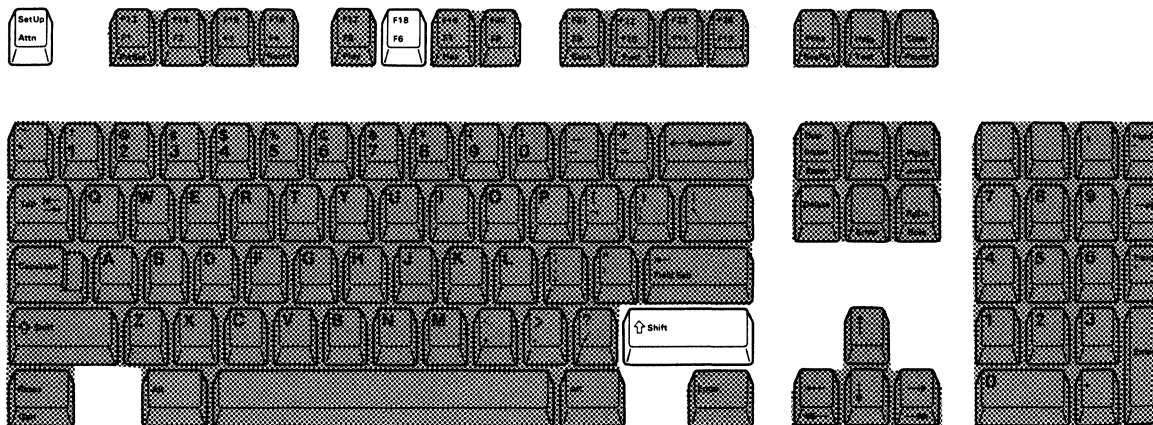

1. Press and hold the Shift key, and press the SetUp key. A diamond (◊) and the clicker symbol appear on the operating status line.

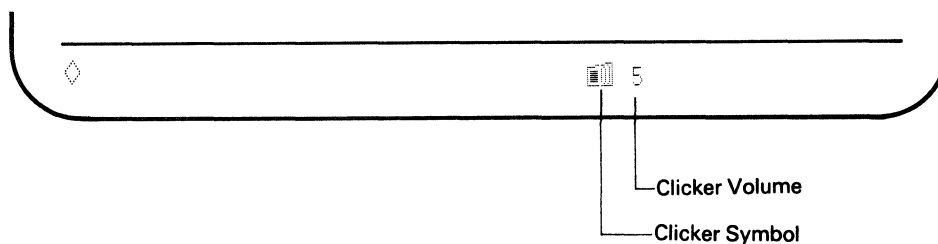

2. Press the F18/F6 key to alternately enable or disable the clicker.

Note: When you press the F18/F6 key: if you hear a click, clicker action is enabled; if you do not hear a click, clicker action is disabled.

3. Press and hold the Shift key, and press the SetUp key again. The diamond disappears as you exit from setup mode. Once selected, the clicker action will be stored and will not be reset when the display station power switch is set to O (off).

Enable/Disable Cursor Blink

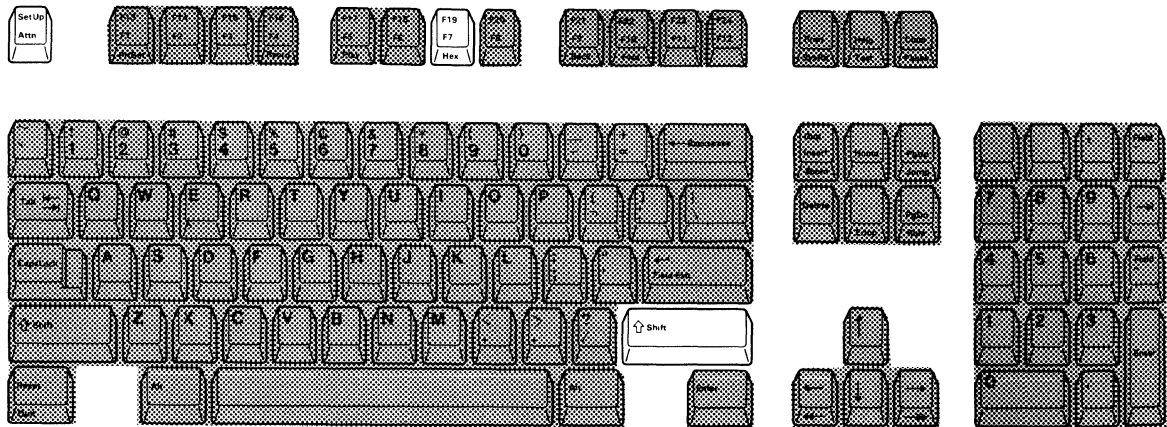

1. Press and hold the Shift key, and press the SetUp key. A diamond (◊) appears on the operating status line.

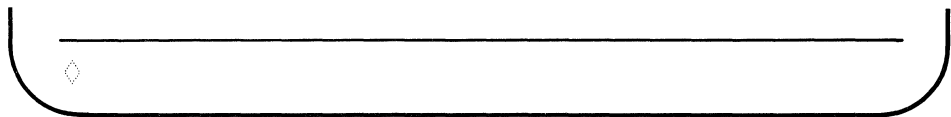

2. Press the F19/F7 key to alternately cause the cursor to blink or not to blink (see the cursor on the data area of the screen).
3. Press and hold the Shift key, and press the SetUp key again. The diamond disappears as you exit from setup mode. Once selected, the cursor action will be stored and will not be reset when the display station power switch is set to O (off).

Select Cursor Style

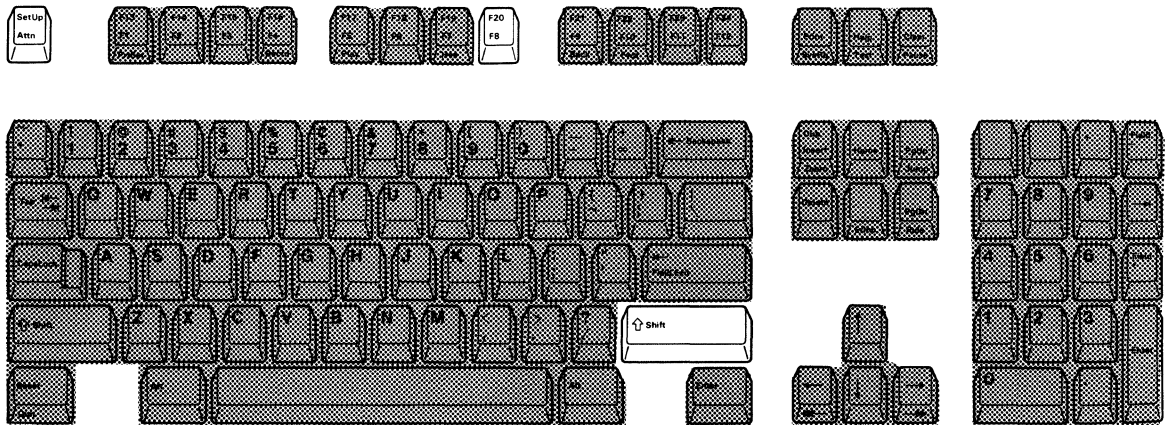

1. Press and hold the Shift key, and press the SetUp key. A diamond (◊) appears on the operating status line.

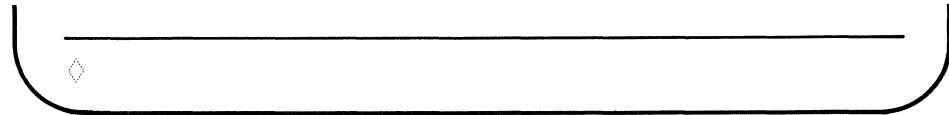

2. Press the F20/F8 key to alternately select either an underscore-style or block-style cursor (see the cursor style on the data area of the screen).
3. Press and hold the Shift key, and press the SetUp key again. The diamond disappears as you exit from setup mode. Once selected, the cursor style will be stored and will not be reset when the display station power switch is set to O (off).

Enable/Disable Extended Display

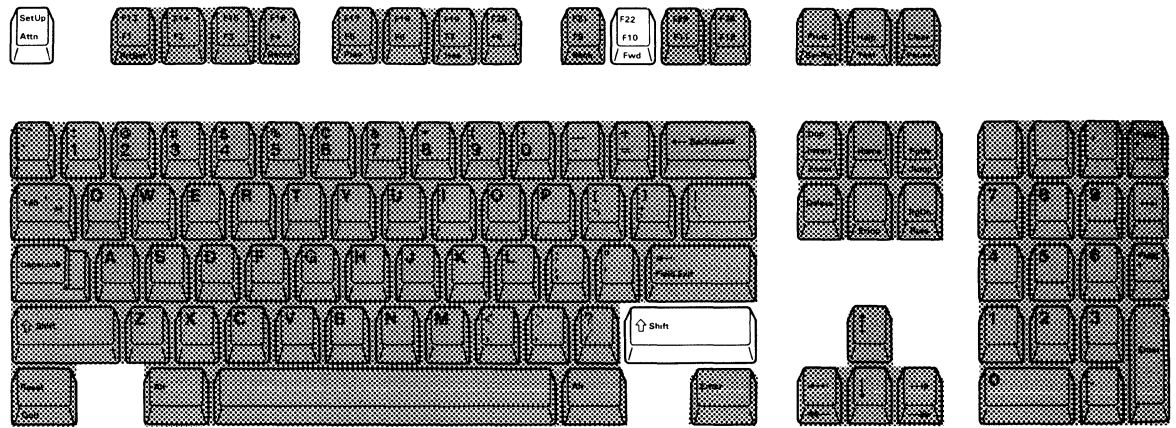

Note: Extended display allows you to display field attributes.

1. Press and hold the Shift key, and press the SetUp key. A diamond (◊) appears on the operating status line.

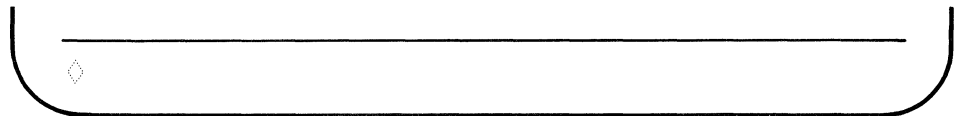

2. Press the F22/F10 key to enable or disable the supported extended display capability of the display station. When enabled, additional information is displayed in two areas:
 - In the data area and message lines, an attribute character for each field appears in hexadecimal form.
 - On the operating status line, the status of the following setup function will appear.

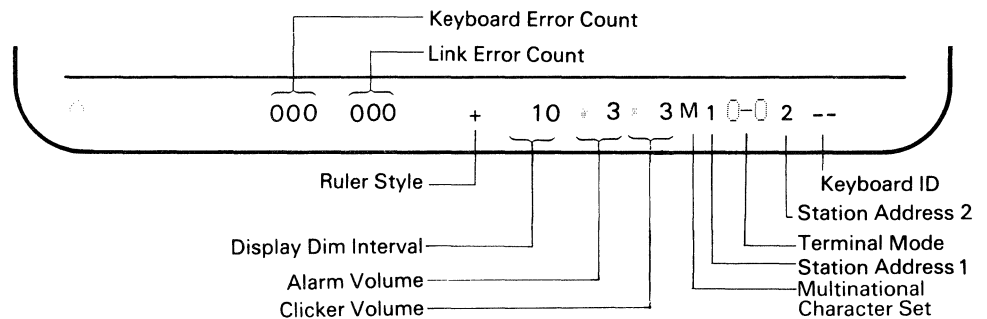

- In all unformatted areas on the screen, dots appear.
3. Press and hold the Shift key and press the SetUp key. The diamond disappears as you exit from setup mode. Once selected, the extended display value will be stored and will not be reset when until the display station power switch is set to O (off).

Enable/Disable Cursor Locator (Row/Col)

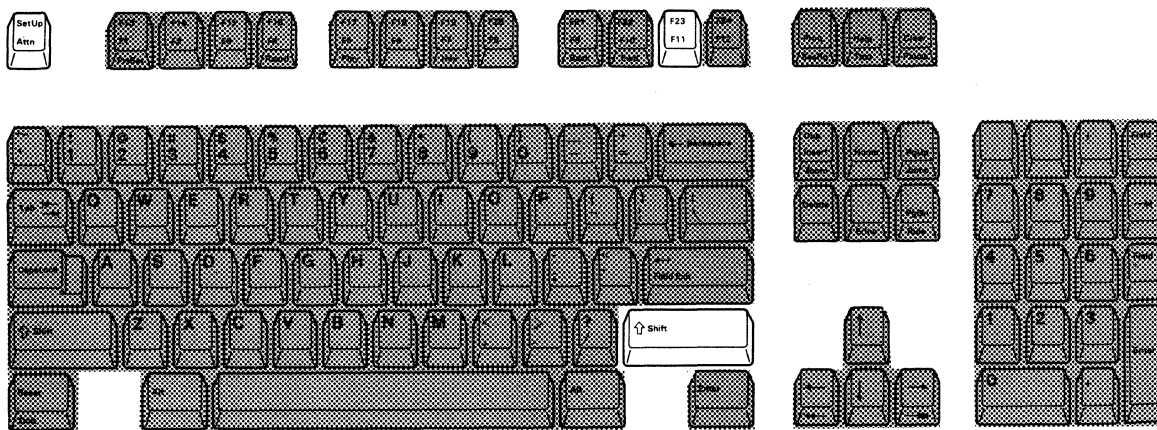

1. Press and hold the Shift key, and press the SetUp key. A diamond (◊) and the cursor locator appear on the operating status line.

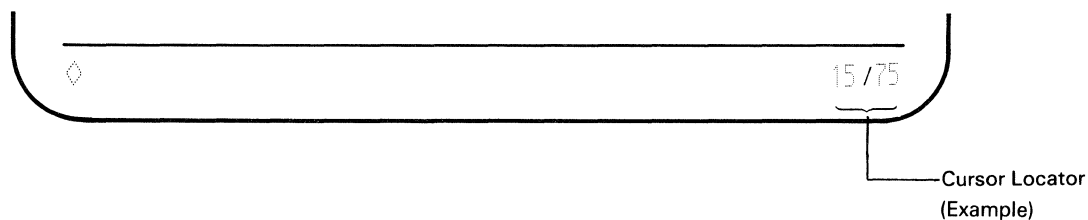

2. Press the F23/F11 key to alternately display or blank the cursor locator (row/column) on the operating status line.

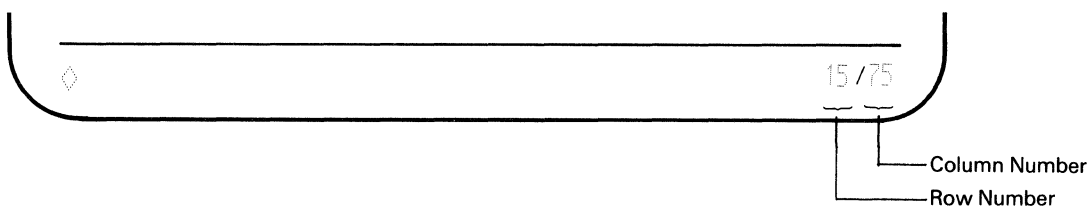

3. Press and hold the Shift key, and press the SetUp key again. The diamond disappears as you exit from setup mode. Once selected, the row/column action will be stored and will not be reset when the display station power switch is set to O (off).

Record Mode Operation

Assigning Keystroke Sequences to Function Keys

As described in the explanation of the Record key, you can assign recorded keystrokes to any of the 24 Function (F) keys. The maximum number of keystrokes that can be recorded is 1500. The exercise for record/play operation at the end of this chapter will help you to become familiar with record mode operation.

1. Press and hold the Alt key, and press the Recrd (F16/F4) key. A 'R' appears on the operating status line. The number to the right of the 'R' shows the remaining number of keystrokes that can be recorded.

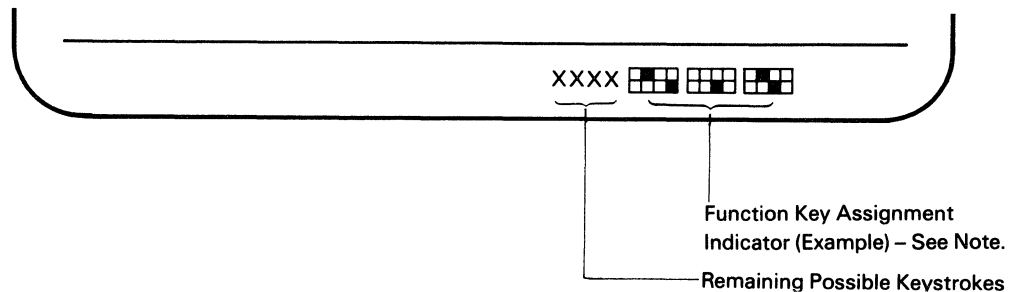

Note: The Function Key Assignment indicator shows you (by a solid box) which F keys have already been assigned for recording keystrokes.

2. Press any one of the 24 Function keys to which you want to assign a word or message. The related F key number is displayed in place of the "Function Key Assignment Indicator".

If an alarm sounds and the number increases when the Function key is pressed, there is something already recorded for that Function key. If you do not want to destroy the recorded key sequence, press the Record key to exit record mode. *You must exit, then re-enter record mode before pressing a new Function key or the key sequence assigned to the previously selected Function key will be erased.*

To delete the entire keystroke sequence assigned to a particular Function key, press the appropriate Function key, and then press the Delete key.

Note: If an error code appears on the operating status line during record mode, see Appendix A, "Error Codes and Recovery Procedures."

3. Type the keystroke sequence you want to save. As you type, notice that the number following the 'R' on the operating status line decreases.

Note: If you want to temporarily stop recording the keystroke sequence (for example, you want to insert some words in playback operation), press the

Pause key. When you press the Pause key again, you can continue recording the remaining keystroke sequence.

4. Press and hold the Alt key, and press the Record (Recrd) key if you do not want to record any more keystroke sequences. The keystroke sequence is saved even if the display station power switch is set to O (off), and can be played back by pressing the Play key and the appropriate Function key.

Notes:

1. *Each make/break key (such as Shift, Alt or Pause key) recorded in a keystroke sequence is counted as two keystrokes.*
2. *While in record mode, if you attempt to record AID keystroke sequences (Cmd, Enter, Clear, Attn, SysRq) that cause an input inhibit condition, the keystroke sequences will be recorded.*

However, when the keystroke sequence is played back, only the keystroke sequence (including the AID key) just before the first AID key was pressed will be played back. An input inhibit condition will occur and the remaining keystroke sequences will be ignored by the host system.

3. *The following keystrokes cannot be assigned to any Function key.*
 - *Play*
 - *Setup*
 - *Record*
 - *Printer Setup Mode Keys*
 - *Two-Display Mode Keys*
4. *The following three functional keys are applicable in record mode.*
 - *Pause key: When you want to insert some words or sentences in playback operation, press this key at the place where you want to insert them. The pause action will be recorded as well as other keystroke sequences. To continue the record operation, press the Pause key again.*
 - *Quit key: If you change your mind before recording some words or sentences, press this key to exit record mode.*

Note: If you press the Quit key after pressing the target F key and recording some keystrokes, the entire keystrokes you previously recorded and the keystrokes you newly entered will be deleted.

- *Delete key: When you want to delete the currently recorded keystrokes, press this key after pressing the target F key.*

Warning:

1. All recorded keystroke sequences are accessible anytime the display station is powered-on.

2. Before exiting from record mode, do not turn the power switch to off. Otherwise, the data recorded may be lost.

Play Mode Operation

Playing Back Keystroke Sequences Assigned to Function Keys

As described in the explanation of the Play key, the display station can play back keystroke sequences that were assigned to a particular Function (F) key. The exercise of record/play operation after this section will help you to become familiar with play mode operation.

1. Position the cursor at the location where you want the keystroke sequence to begin.
2. Press and hold the Alt key, and press the Play (F17/F5) key. A 'P' and the Function key assignment indicator appear on the operating status line.

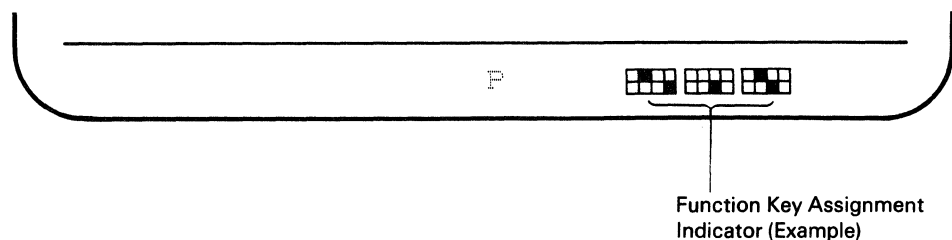

3. Press the same function key you used to record the keystroke sequence. The keystroke sequence will be automatically played back starting at the location of the cursor. When the playback completes, the 'P' disappears from the operating status line.

Note: If an error code appears on the operating status line during play mode, see Appendix A, "Error Codes and Recovery Procedures."

Note: In play mode, the following two functions are operational.

- **Pause:** When you recorded the pause function during a record mode operation, the function is automatically executed (playback action stops). At the pause you can key in any words or sentences and press the Play key to continue the playback sequence.
- **Quit:** During playback operation, you can cancel the playback sequence any time by pressing the Quit key.

Record/Play Exercise

Task: Record the name 'ABC Company' in the F1 key and play back the name at the first position of the second line on the screen.

1. Make sure that the display station is in normal communication mode. In normal communication mode, the screen should look like this:

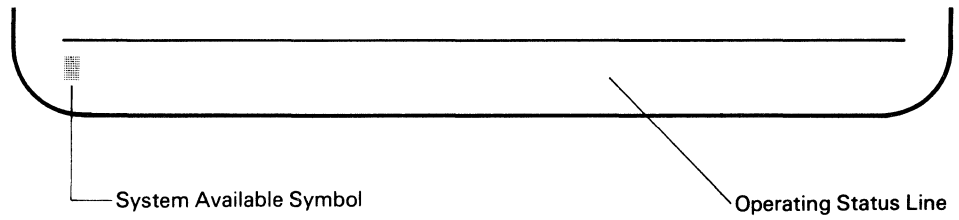

- To record a keystroke sequence, press and hold the Alt key and press the Record key. A 'R' appears on the operating status line. The number of keystrokes remaining appears next to the 'R'.

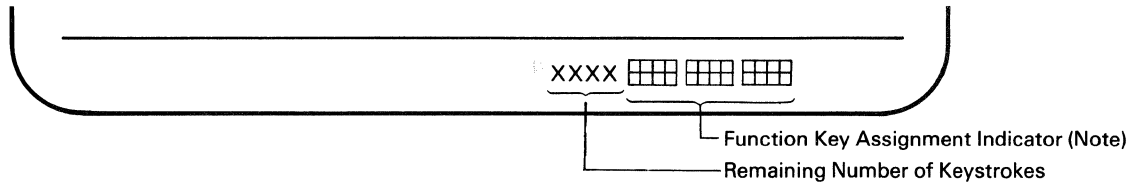
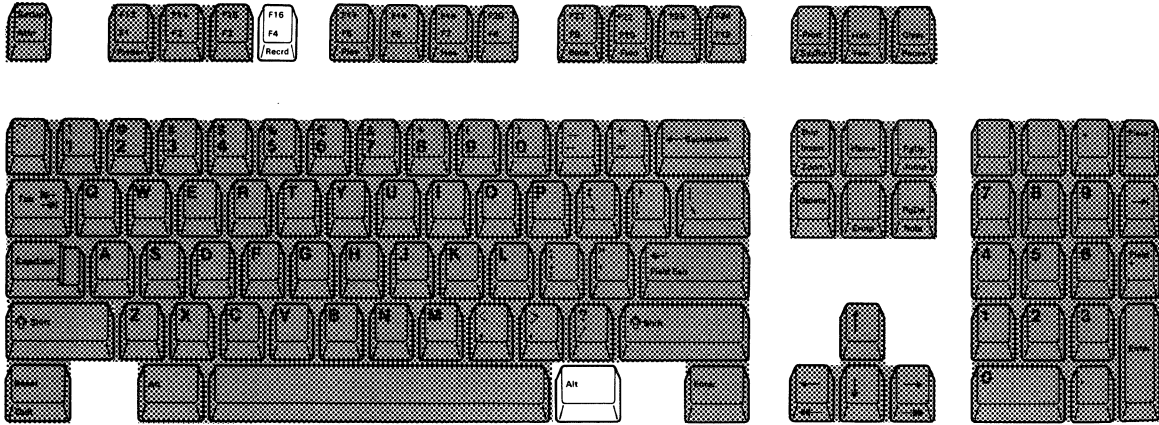

Note: This indicator shows you the status about the function keys that have already used for recording keystroke sequences. The solid box represents the assigned key and the frame box represents the non-assigned key.

3. Press the F1 key (the key where you plan to record the data).

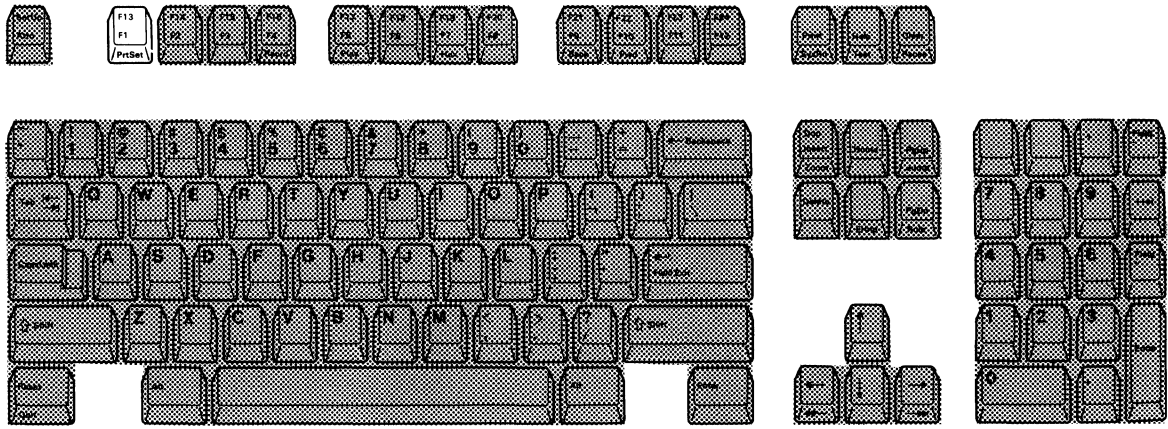

4. Type in 'ABC Company' at the location of the cursor. In this exercise, the cursor is assumed to be located in the home position (first row, first column).

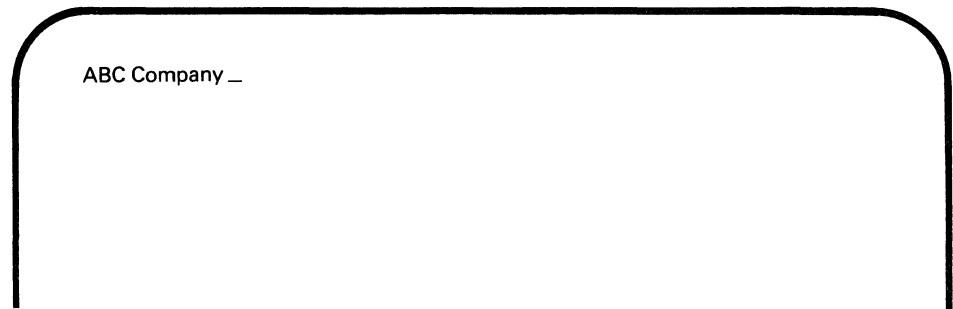

5. Verify that the company name is correctly typed in. Press and hold the Alt key, and press the Record key again. The 'R' disappears from the operating status line.

If the keystroke sequence is not typed correctly, press the Record (Recrd) key while pressing and holding the Alt key and return to step 1.

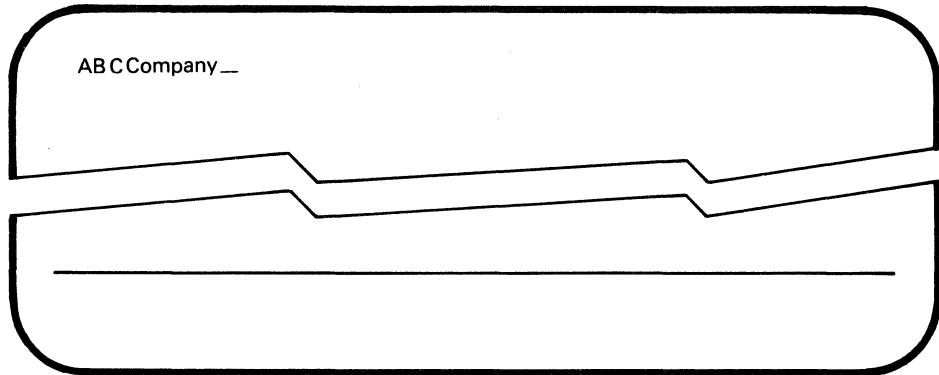

6. Move the cursor to the first position of the second line. To play back the keystroke sequence, press the Play key while pressing and holding the Alt key. A 'P' appears on the operating status line. A 'P' appears on the operating status line.

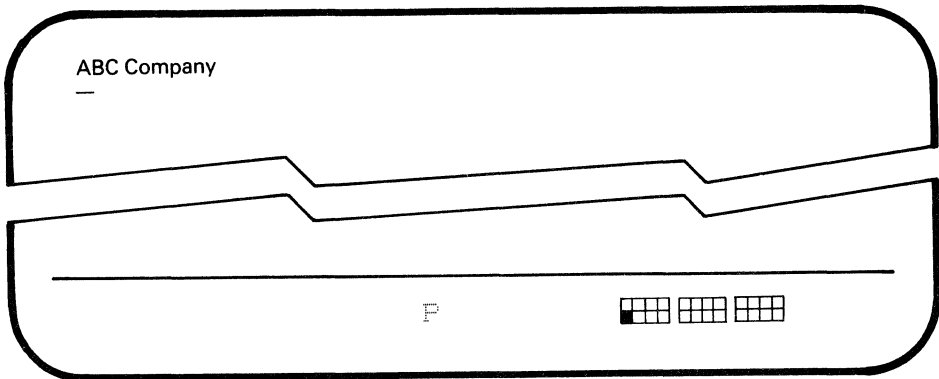

7. Press the F1 key, 'ABC Company' appears at the cursor position, the cursor moves to the next input position and the 'P' disappears.

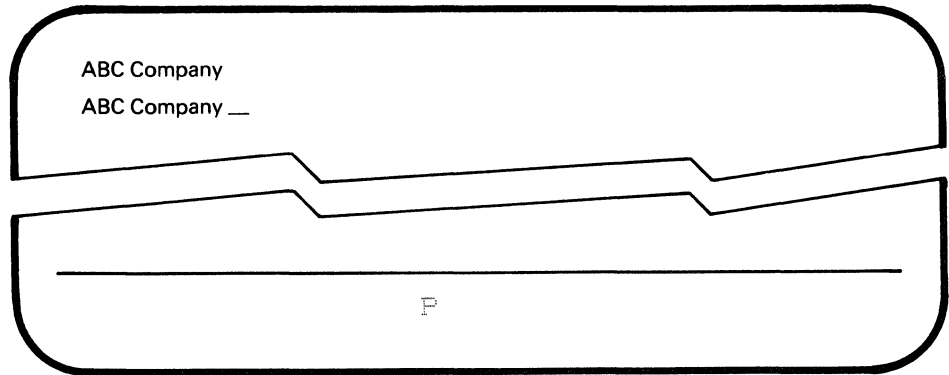

The task is complete. You can continue entering data from the location of the cursor.

Printer Setup Mode Operation

Your display station can attach any of the following IBM PC printers as a system controlled printer.

- IBM Proprinter (IBM 4201 Model 1)
- IBM Proprinter II (IBM 4201 Model 2)
- IBM Proprinter XL (IBM 4202)
- IBM Quietwriter Printer I (IBM 5201 Model 1)
- IBM Quietwriter Printer II (IBM 5201 Model 2)
- IBM Quietwriter Printer III (IBM 5202)

In printer setup mode, you can specify printer functions such as the character pitch, line pitch and print quality for print out of the attached printer. You can also cancel printing using the Quit key or inquire printer status in this mode.

Notes:

1. *Do not power off the attached printer while the IBM 3197 is in normal communication mode and the host system is transmitting print data. Otherwise, the print data may be lost.*
2. *Do not power off and on the attached printer in a quick sequence. Some seconds are needed between powering off and on the attached printer for the IBM 3197 to re-initialize the printing format of the attached printer.*
3. *When you attach the IBM 5202 printer to your display station, the code page number 850 should be specified for the pluggable fonts. In addition, you also have to set the setup switch group 2 (six switches) to the following combination.*

Switch Number	1	2 and 3	4	5	6
Switch Position	ON	ANY	OFF	OFF	ON

4. *The NLQ II font is not supported when the IBM 4201 Model 2 is attached to the IBM 3197.*

Specifying Printer Functions

To specify the printer functions, follow the steps shown below.

1. Select display-printer Mode (**O-P**) and the printer address in the offline setup mode selection. (Refer to the "Select the Terminal Mode" in the previous section.)
2. Enter the offline printer setup mode and specify the :
 - Printer Character Set
 - Device ID.

3. Exit from the offline printer setup mode and then enter the online printer setup mode and specify the :

- Character Pitch (Characters Per Inch)
- Line Pitch (Lines Per Inch)
- Print Quality.

Note: The above three functions can also be specified in offline printer setup mode.

4. Exit the online printer setup mode and return to the normal communication mode. All of the selected settings will be stored and will not be reset when the display station power switch is set to O (off).

Cancelling Printing Operation

To cancel the printing of the current print file, do the following steps.

1. Enter the online printer setup mode.
2. Press the Reset key while pressing and holding the Alt key. Then the printing of current print file will be cancelled.
3. Exit from the online printer setup mode and return to normal communication mode.

Note: The printer continues printing data that were sent to the printer buffer prior to your print cancel request.

Inquiring Printer Status

If the printer does not work or stops printing during a print operation, do the following steps.

1. Enter the online printer setup mode.
2. Check printer setup mode symbol or error codes displayed on the operating status line. If there is an error code, see Appendix A, "Error Codes and Recovery Procedures." If there is a printer setup mode symbol, see the "Symbols in Printer Setup Mode" in Chapter 1.
3. Exit from the online printer setup mode and return to normal communication mode.

Display-Printer Mode Selection

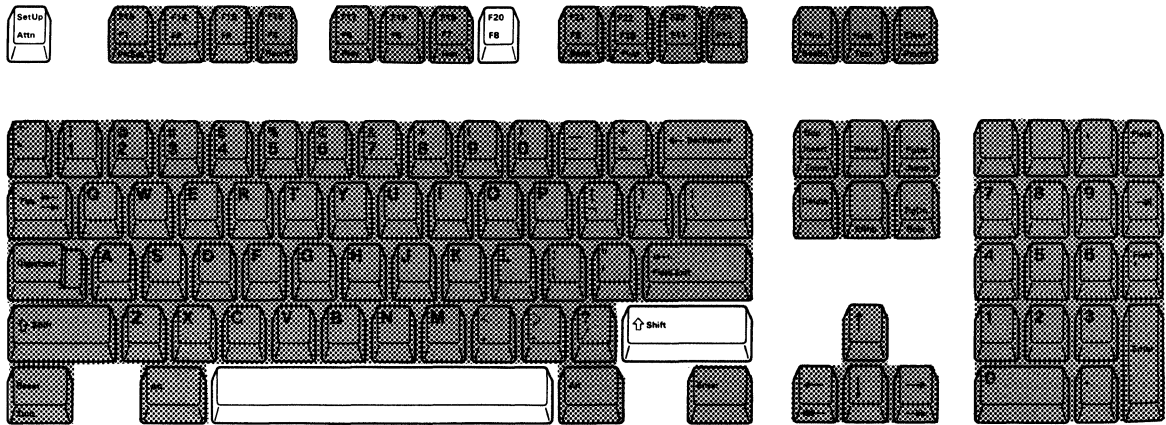

1. Set the power switch to O (off).
2. Press and hold the space bar and set the power switch to | (on). Hold the space bar until the test pattern appears.
3. Press and hold the Shift key and then press the SetUp key. A diamond (◊) appears on the operating status line.
4. Locate the symbol of the Terminal Mode at the right side of the operating status line. That symbol should be one of the following symbols (◊ , ◊-◊ and ◊-◊).

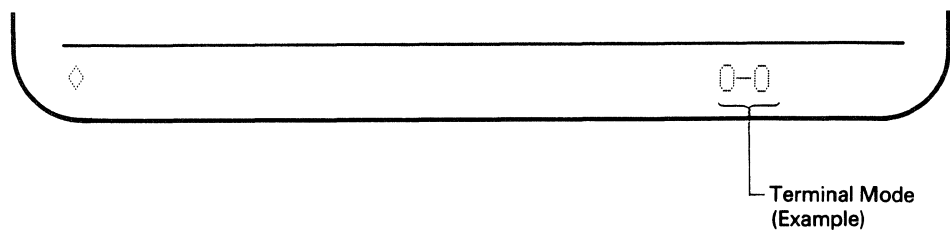

5. If the symbol of Terminal Mode is other than ◊-◊ , press and release the F20/F8 key while pressing and holding the Shift key until ◊-◊ appears at the position of the operating status line, then release both the F20/F8 key and the Shift key. If the symbol is ◊-◊ , go to the next step.

6. Press and hold the Shift key and press the SetUp key. The diamond disappears as you exit from setup mode.

You have now selected the display-printer mode and recorded it.
Continue to the next offline printer setup mode operation.

Offline Printer Setup Mode Operation

Note: Before starting this section you have to get information about your Printer Character Set and Device ID from your supervisor.

1. Press and hold the Alt key and press the PrtSet (F13/F1) to enter offline printer setup mode. A diamond (◊) and printer setup mode symbol () appear at the left side of the operating status line. At the right side of the operating status line the printer character set symbol appears.

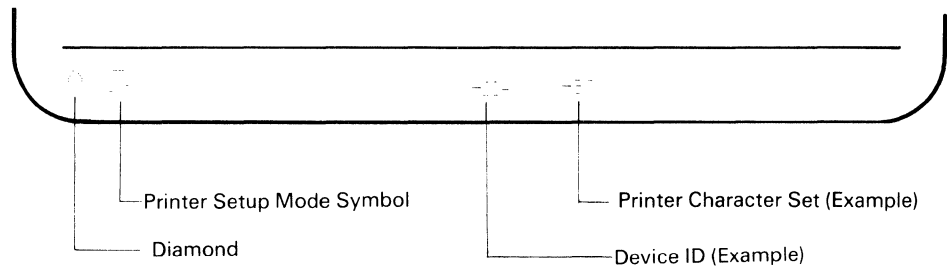

2. Press and hold the Shift key and press and release the F15/F3 key. The number for the printer character set column alternately changes from 437 to 850 or vice versa. Select either 437 or 850.

Note: Select 437 if an IBM Proprinter (IBM 4201) or an IBM Proprinter XL (IBM 4202) is attached. Select 850 if an IBM Quietwriter Printer I and II (IBM 5201) or an IBM Quietwriter Printer III (IBM 5202) is attached.

3. Press and hold the Alt key and then press the F14/F2 key to enter device ID mode. The device ID symbol appears on the operating status line.
4. Press and release the Shift key together with F14/F2 key. The number for the Device ID alternately changes from 4214 to 5256 or from 5256 to 4214. Select either one.

Note: The printers available for your display station emulate the functions of either the IBM 4214 or the IBM 5256. Both the IBM 4214 and the IBM 5256 are the system printers or the workstation printers for the System/36 and the System/38.

5. Press and hold the Alt key and press the F14/F2 key to exit from device ID mode.
6. Press and hold the Alt key and press the PrtSet key (F13/F1) key to exit from offline printer setup mode.
7. Press the Reset key to enter normal communication mode.

You have now selected all the required settings for offline printer setup mode.
Continue to the next online printer setup mode operation.

Online Printer Setup Mode Operation

Now you can specify the print functions such as the character pitch, line pitch and print quality for the printout of the attached printer.

However, selection of the print functions has a limitation depending on the device ID selected in offline printer setup mode (previous section).

Determine the possible selection of the character pitch, line pitch and print quality before doing the online printer setup mode operation. Figure 5-1 shows the summary of the possible selections depending on the device ID.

Device ID	Print Functions		
	Character Pitch (CPI)	Line Pitch (LPI)	Print Quality
4214	AA5 (5 CPI) AA6 (6 CPI) AA8.5 (8.5 CPI) AA10 (10 CPI) AA12 (12 CPI) AA17 (17.1 CPI) AA (Proportional Spacing) AA (System Designated)	BB8 (8 LPI) BB6 (6 LPI) BB4 (Double Height) BB (Standard Height) BB (Double Height) BB (Standard Height) BB (System Designated)	CC (Draft) CC (Near Letter) CC (System Designated)
5256	AA5 (5 CPI) AA6 (6 CPI) AA8.5 (8.5 CPI) AA10 (10 CPI) AA12 (12 CPI) AA17 (17.1 CPI) AA (Proportional Spacing)	BB8 (8 LPI) BB6 (6 LPI) BB4 (Double Height) BB (Standard Height) BB (Double Height) BB (Standard Height)	CC (Draft) CC (Near Letter)

Figure 5-1. Selection of Print Functions

Notes:

1. In the above table, selection of both double height and proportional spacing functions are not supported by the IBM 4201. The IBM 5201 does not support double height, but does support proportional spacing if you select a "PS" labelled font cartridge from the IBM "Quiet"™ Electronic Fonts in Character Set A, and insert it in font slot 'A' on the printer.
2. When you specify values for character pitch and line pitch, that are different from the ones specified by the host system, data will be printed in accordance with your locally specified print format. If you specify print functions: "System Designated" for Device ID 4214, and "CPI 10 and LPI 6" for Device ID 5256, data will be printed in the system specified print format.
3. When using the attached printer, if you press the Line Feed key, be sure to press the Form Feed key and also to keep correct print alignment.

Specifying Character Pitch

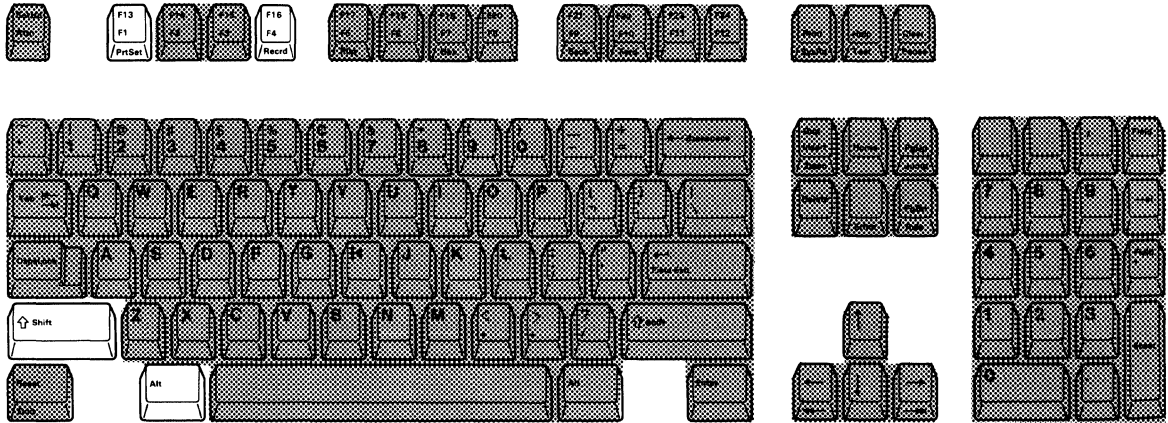

1. Press and hold the Alt key and then press the PrtSet (F13/F1) key to enter online printer setup mode. Check that the following symbols are displayed on the operating status line.

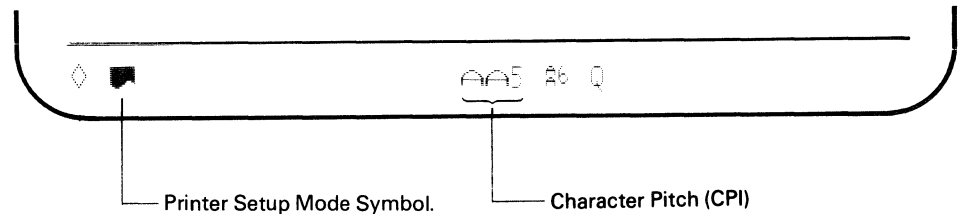

2. Press and hold the Shift key and then press the F16/F4 key. Each time you press the F16/F4 key while holding down the Shift key, the character pitch selection symbol will change in the following order.

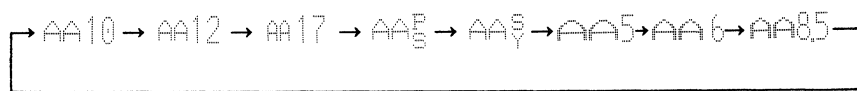

Note: The selection of the character pitch selections is limited when you select the 5256 Device ID. See Figure 5-1, "Selection of Print Functions" for additional information.

3. If you want to exit from online printer setup mode, press and hold the Alt key and then press PrtSet (F13/F1) key.

If you need to specify the line pitch and the print quality, go to the next section.

Specifying Line Pitch

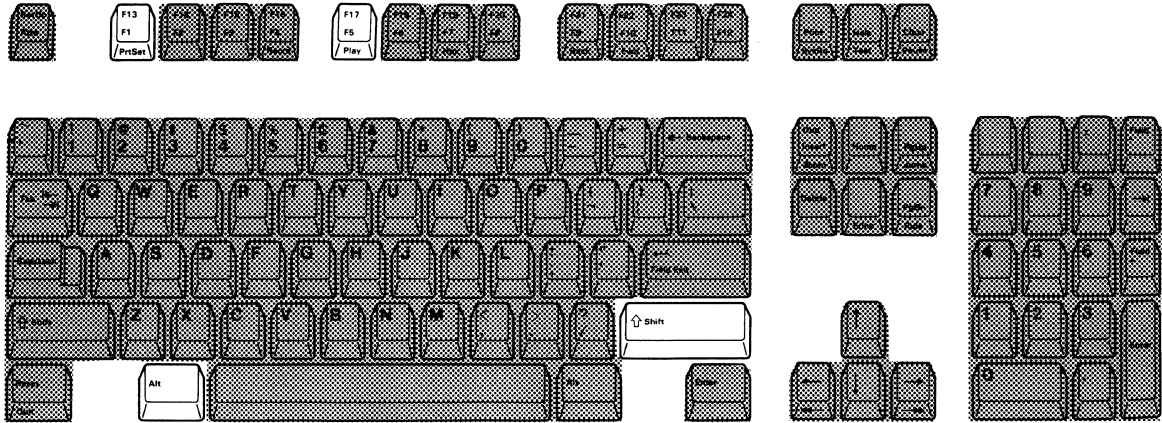

1. Locate the symbol for the line pitch on the operating status line.

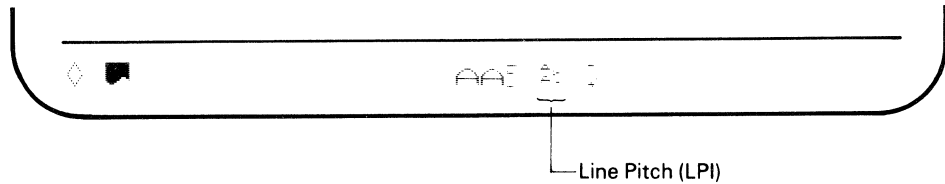

2. Press and hold the Shift key and then press the F17/F5 key. Each time you press the F17/F5 key while holding down the Shift key, the line pitch selection symbol will change in the following order.

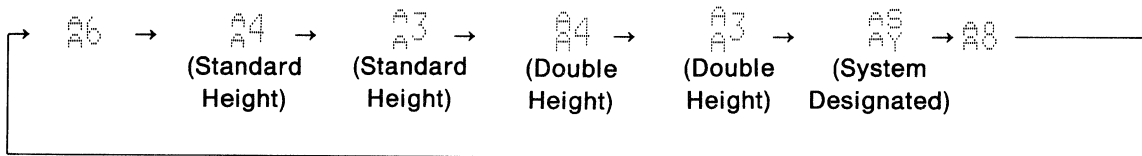

Note: The selection of the line pitch selections is limited when you select the 5256 device ID. See Figure 5-1, "Selection of Print Functions" for additional information.

3. If you want to exit from online printer setup mode, press and hold the Alt key and then press PrtSet (F13/F1) key. If you need to specify the print quality, go to the next section.

Specifying Print Quality

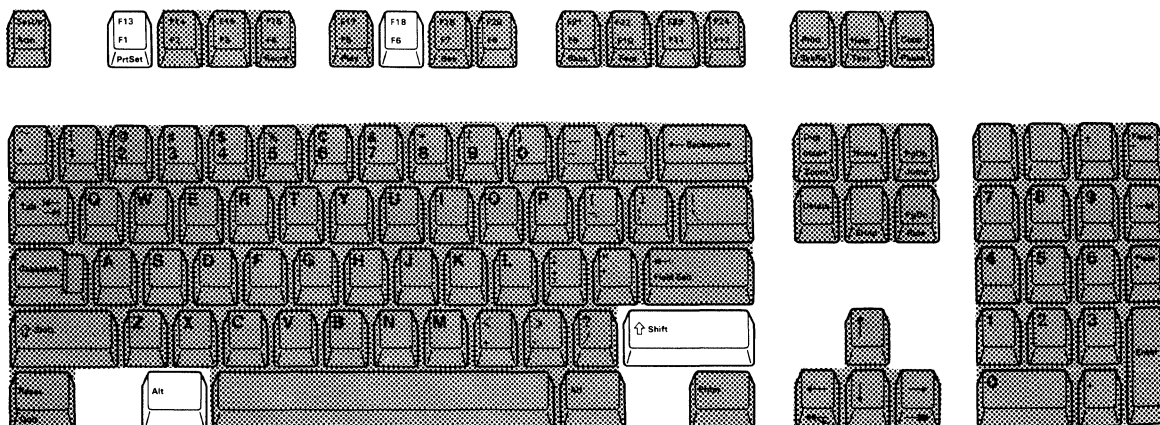

1. Locate the symbol for print quality on the operating status line.

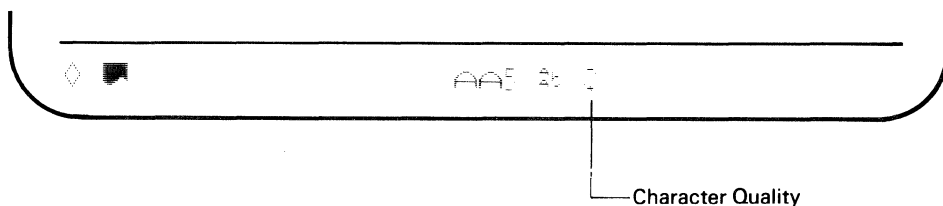

2. Press and hold the Shift key and then press the F18/F6 key. Each time you press the F18/F6 key while holding down the Shift key, the print quality selection symbol will change in the following order.

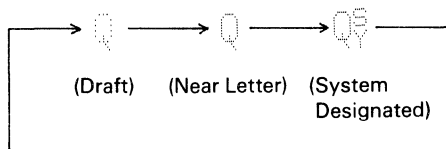

Note: When you select the 5256 Device ID, the system designated print quality is not available.

3. Press and hold the Alt key and then press the PrtSet (F13/F1) key to return the display station to normal communication mode.

You have now completed all the necessary settings of the printer setup mode functions.

Appendix A. Error Codes and Recovery Procedures

The display station is checked either by the host system or the built-in self-diagnostic program during communication or when the power switch is set to | (on). If errors are detected, the error codes can appear in four different positions on the display screen, depending on the nature of the problem.

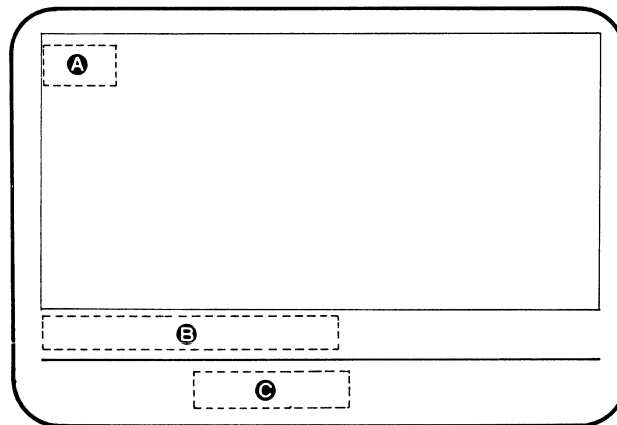

Non-Split Screen

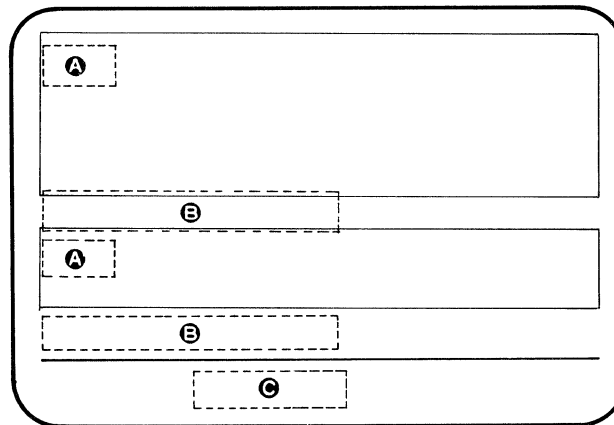

Split Screen

Error codes appearing in positions **A** and **B** are from the host system. If an error code appears in **B**, pressing the Help key may explain more about the error and may give the necessary recovery action.

Error codes 90XX, L, K, LK, NV1, AD1 and AD2 appearing at **C** on the operating status line, are controlled by the IBM 3197 display station. Error codes L, K, and LK, are used to isolate a failing element. For more details about isolation procedures, refer to the *IBM 3197 Model D Display Station Problem Solving Guide*, GA18-2547.

The following tables list and explain all error codes, causes, and recovery actions.

00XX (Error Codes Appearing at Position B)

Error Code	Cause	Recovery Action
0000	You pressed the Help key. However, either no error code was displayed or the error was issued by a program that does not support the Help key.	Press the Reset key. Continue entering information or refer to the meaning for the previously displayed error code and perform the recovery procedure.
0001	The host system or remote workstation controller has not kept up with the rate you are entering information. The last character you entered was not recognized.	Press the Reset key. Continue entering information.
0002	The host system or remote workstation controller received an invalid key code and does not know which key you pressed.	Press the Reset key. Try to continue entering data. If the error cannot be reset or still occurs, report the problem to your system operator.
0003	You pressed an invalid key after pressing and holding the Alt key.	Press the Reset key.
0004	You attempted to enter data into a field that does not allow keyboard input.	Press the Reset key.
0007	At least one field on the display requires that you enter data before the display can be changed or moved. (The cursor goes to the first character position of the first mandatory-entry field.)	Press the Reset key. Enter the required data.
0010	You tried to enter data into a field that will accept only signed numeric data. Valid characters are 0 through 9.	Press the Reset key. Continue by using valid characters.
0011	You attempted to enter data into the last position of a signed numeric field.	Press the Reset key. Make sure that the data is correct, and exit from the field by using the Field -, Field +, or Field Exit key.
0012	Either there is no more room in the field or the cursor is in the last position of the field. Do not use the Insert key to change data or to enter the last character into this field.	Press the Reset key. Correct the field, if necessary, and continue.
0013	You attempted to leave a field after you pressed the Insert key.	Press the Reset key.
0014	You pressed a key function that moves the cursor out of the field. However, the requirements of this mandatory-fill field have not been met. (Mandatory-fill fields must be filled completely or left blank.)	Press the Reset key. Enter data to fill the entire field, or move the cursor to the start of the field and use the Field -, Field +, or Field Exit key to blank out all of the field.

Error Code	Cause	Recovery Action
0015	You entered data into a self-check field. The number and the check digit you just entered do not correspond.	Press the Reset key. Check that you have correctly entered the number and check digit. If you have entered them correctly, check that the number is valid for a self-check field. If the numbers are valid but this error still occurs, report the problem to your system operator.
0016	You pressed the Field – key, but the field you were in is not a signed numeric field or, for some systems, a numeric-only field.	Press the Reset key. Continue to enter data or press the Field Exit key to blank out all of the field.
0017	You pressed the Field –, Field +, or Field Exit key. However, the requirements for this mandatory-fill field have not been met. A mandatory-fill field must be filled completely or you must exit from the first position of the field.	Press the Reset key. Enter data to the end of the field, or move the cursor to the start of the field and use the Field –, Field +, or Field Exit key to blank out all of the field.
0018	You must use a non-data key, such as the Field Exit key or a cursor movement key, to leave this field.	Press the Reset key. Use a non-data key to leave this field.
0019	You pressed the Dup key, which is not permitted in this field.	Press the Reset key. Continue, but without using the Dup key in this field.
0020	You pressed a key that is not allowed in this field. This is either a right-adjust or a signed numeric field. You must exit the field before pressing any of the following: Command/Function keys, Character Backspace key, Enter key, Print key, Help key, Roll keys, and the Home key (when the cursor is in the home position).	Press the Reset key. The cursor is in the same position as when you pressed the invalid key. Continue by pressing the Field +, Field –, or Field Exit key.
0021	The cursor is positioned in a mandatory-enter field. A mandatory-enter field must have data entered in it before you can exit the field by pressing the Field +, Field –, or Field Exit key.	Press the Reset key. Enter the required data.
0022	A system error occurred. The status of the present field is not known. This error can occur during an insert or delete operation.	Press the Reset key. Check the display to determine if the insert or delete function was done properly. If not done properly, correct the field.
0023	You pressed the Hex key but the first key pressed was not a character A through F or 4 through 9; or the second key pressed was not a character A through F or 0 through 9. This error also occurs when a hexadecimal code is used in a numeric-only, signed numeric, alpha-only, or feature I/O field.	Press the Reset key. Continue by using the correct keys.

Error Code	Cause	Recovery Action
0026	You pressed the Field – key to exit a numeric-only field, but the last position of the field was not a number 0 through 9.	Press the Reset key. Correct the last position of the field, or exit the field by using the Field+ or Field Exit key.
0027	You pressed a key that is not used by this display station.	Press the Reset key. Continue by using valid keys.
0028	You pressed a key that is not used by this display station.	Press the Reset key. Continue by using valid keys.
0029	The second key pressed during a diacritic-key function did not produce a valid combination.	Press the Reset key. Enter a valid combination.
0040	The 'data set ready' line is inactive and it should be active.	Recovery from this error must be made at the 5294 Control Unit.
0042	The receive clock signal failed during a receive operation.	Recovery from this error must be made at the 5294 Control Unit.
0043	The 'data set ready' line is active and it should be inactive.	Recovery from this error must be made at the 5294 Control Unit.
0044	The 30-second communications time-out has expired with no valid data being received.	Recovery from this error must be made at the 5294 Control Unit.
0050	Either the 'clear to send' line was inactive while the 'request to send' line was active or the 'clear to send' line was active while the 'request to send' line was inactive.	Recovery from this error must be made at the 5294 Control Unit.
0051	The transmit clock signal failed during a transmit operation.	Recovery from this error must be made at the 5294 Control Unit.
0052	The 5294 Control Unit detected an internal error.	Recovery from this error must be made at the 5294 Control Unit.
0054	The 5294 Control Unit received an invalid command from the system during communications.	Recovery from this error must be made at the 5294 Control Unit.
0097	An attempt was made to run online verification tests not supported by the host program.	Press the Reset key. Continue to use the display station without performing the verification tests.

Error Code	Cause	Recovery Action
0099	An error occurred before sign-on. The key function you pressed is not valid at this time.	Press the Reset key. Use the correct procedure to sign on. (On most systems, you can initiate sign-on by pressing the SysRq/Attn key.)
	An error occurred during sign-on. Either the host system is not operating or the remote workstation controller is not communicating with the system.	Press the Reset key. Use the correct procedure to sign on. If the error persists, contact the system operator and ensure that the system is operating.
	An error occurred after sign-on. The program or utility did not recognize the key you pressed.	Press the Reset key. Try to run a different type of job or procedure. If the error occurs again, contact the system operator to determine if there is a problem with the system. If the error does not occur again, there is a system programming problem or a keying error.

90XX (Error Codes Appearing in Position A or C)

Error Code	Cause	Recovery Action
9001	Your record table is full. There is no room to enter additional keystrokes.	Press the Recrd key. To enter a new keystroke sequence, remove the keystroke sequence defined for one Command (or F) key as follows: Press the Recrd key, press that Command (or F) key, then enter the new keystroke sequence. Or, to erase the stored keystroke sequence, press the Recrd key, press that Command (or F) key, then press the Delete key.
9002	Invalid record table format	Press the Reset key and continue your record/play operation.
9003	While performing the record or play function, you pressed a key other than the Alt, Recrd, Reset, or Shift before pressing a valid Command (or F) key.	Press the Reset key or a valid Command (or F) key.
9004	While performing the record or play function, you pressed a Command (or F) key with the Alt key pressed.	Press the Command (or F) key only.
9007	While performing the record function, you pressed the Play, Setup, PrtSet, Zoom, or Jump key. These are not valid sequence keys.	Press a valid sequence key.
9010	While performing the play function, you pressed a Command (or F) key that does not have a keystroke sequence assigned to it.	Press the Reset key or a Command (or F) key that has a keystroke sequence assigned to it.
9012	While performing setup functions, you pressed a key with no setup function assigned to it.	Press the Reset key or a key with a setup function assigned to it.
9013	While performing the test function, you pressed an invalid key.	Press the Reset key or Test key.
9015	You pressed the Reset key with an Alt key, or pressed the Pause key in normal communication mode.	Press the Reset key without the Alt key pressed.

Error Code	Cause	Recovery Action
9016	You pressed several keys at the same time.	Press the keys one at a time. If you cannot recover from the problem, the keyboard element is failing. Refer to the <i>IBM 3197 Display Station Problem Solving Guide</i> , GA18-2547.
9018	While the host system is specifying the cursor to blink, you tried to change the cursor to the normal one.	Press the Reset key.
9019	Record Mode After pressing the Pause key in record mode, you pressed the SetUp, PrtSet or Play key.	Press a valid key other than SetUp, PrtSet or Play key.
	Play Mode While playback is suspended due to Pause, you pressed the SetUp, PrtSet or Recrd key.	Press a valid key other than SetUp, PrtSet or Recrd key.
9030	Jump key was pressed when not in two-display mode.	Press the Reset Key
9031	Back or Fwd key was pressed when the local scroll function is not available.	
9032	Zoom (a↔a) key was pressed when not in two-display mode.	
9051	While performing printer setup functions, you pressed a key with no printer setup function assigned to it.	Press the Reset key or a key with a printer setup function assigned to it.
9052	Printer not ready or end of paper.	Printer data may be lost. Check your attached printer and make the printer ready.

XXX (Alpha Characters Appearing at Position C)

Error Code	Cause	Recovery Action
L	The logic element is failing.	Refer to the <i>IBM 3197 Display Station Problem Solving Guide</i> , GA18-2547.
K	The keyboard element is failing.	<ol style="list-style-type: none"> 1. Set the power switch to O (off). 2. Make sure that the keyboard cable is tightly connected to the logic element. 3. Set the power switch to (on). 4. Does the error code still appear? YES, the keyboard element is failing. Refer to the <i>IBM 3197 Display Station Problem Solving Guide</i>, GA18-2547.
LK	The logic element or keyboard element is failing.	Refer to the <i>IBM 3197 Display Station Problem Solving Guide</i> , GA18-2547.
NV1	Setup data is incorrect or destroyed.	Re-set the setup functions, if required, referring to the appropriate procedures in this manual.
AD1 and AD2	The address of your display station has not been entered. The incorrect address is being set.	Re-set the station address (or printer address) using the setup procedures in this manual.

Appendix B. Keyboard Layouts for Languages Other Than U.S. English

Figures B-1 through B-15 show the keyboard layouts for languages other than U.S. English. The table shown below is a quick index for each keyboard layout.

Keyboard Layout	Figure Number	Page
Austrian/German	B-1	B-2
Belgian	B-2	B-3
Canadian French	B-3	B-4
Danish	B-4	B-5
Finnish/Swedish	B-5	B-6
French (AZERTY)	B-6	B-7
Italian	B-7	B-8
Japanese Katakana	B-8	B-9
Norwegian	B-9	B-10
Portuguese	B-10	B-11
Spanish	B-11	B-12
Spanish-Speaking	B-12	B-13
Swiss-Bilingual-French	B-13	B-14
Swiss-Bilingual-German	B-14	B-15
U.K. English	B-15	B-16
Dutch	B-16	B-17

122-Key Keyboard

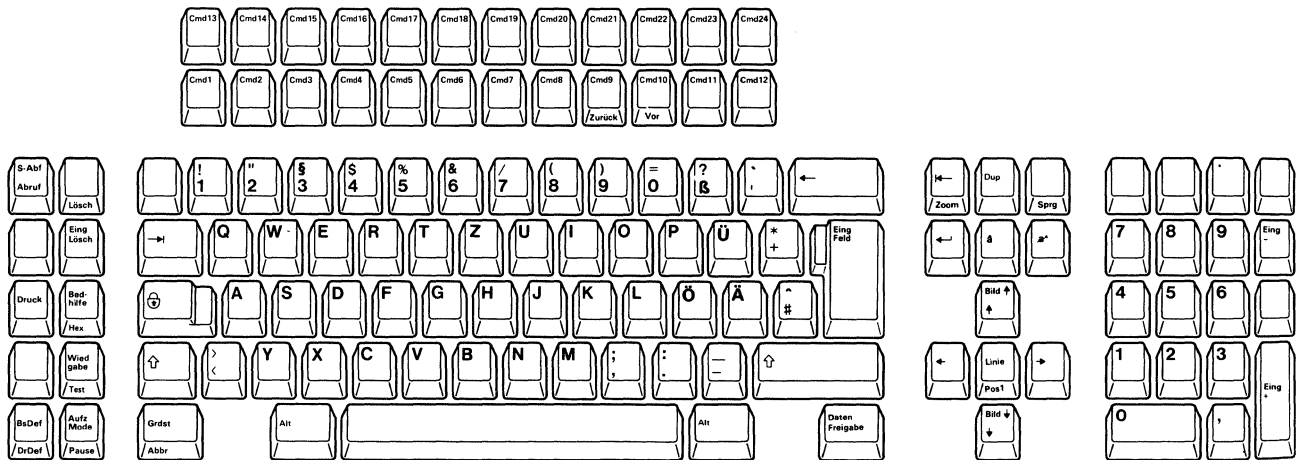

103-Key Keyboard

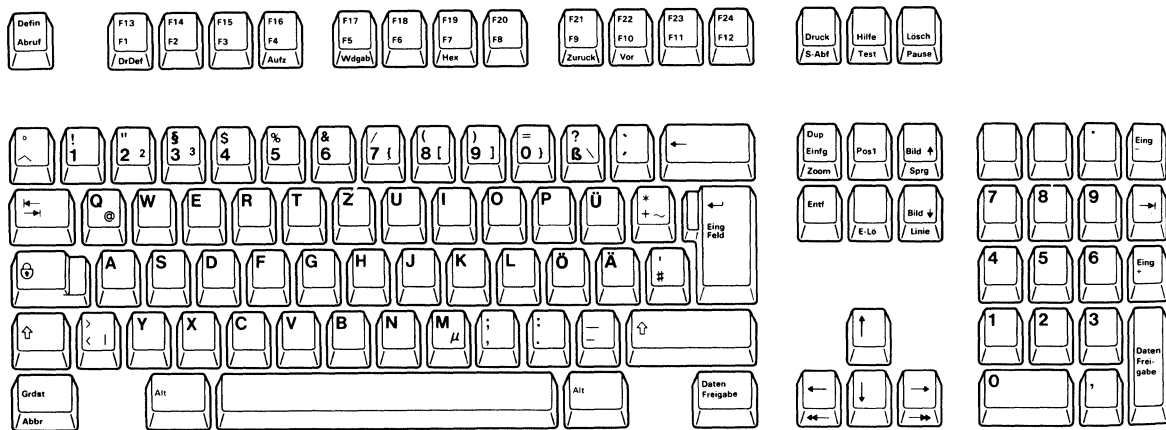
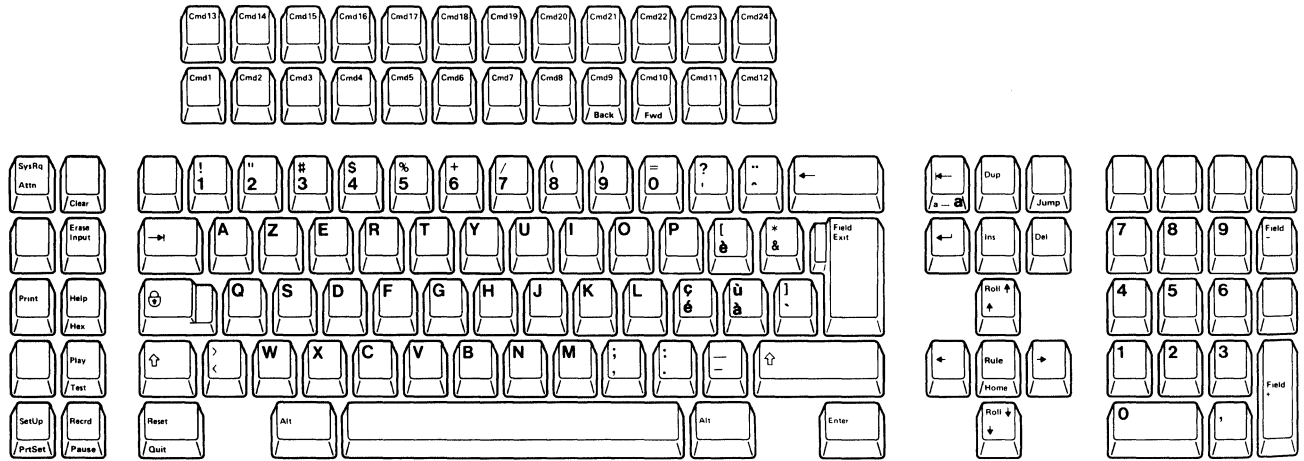

Figure B-1. Austrian/German Keyboard

122-Key Keyboard



103-Key Keyboard

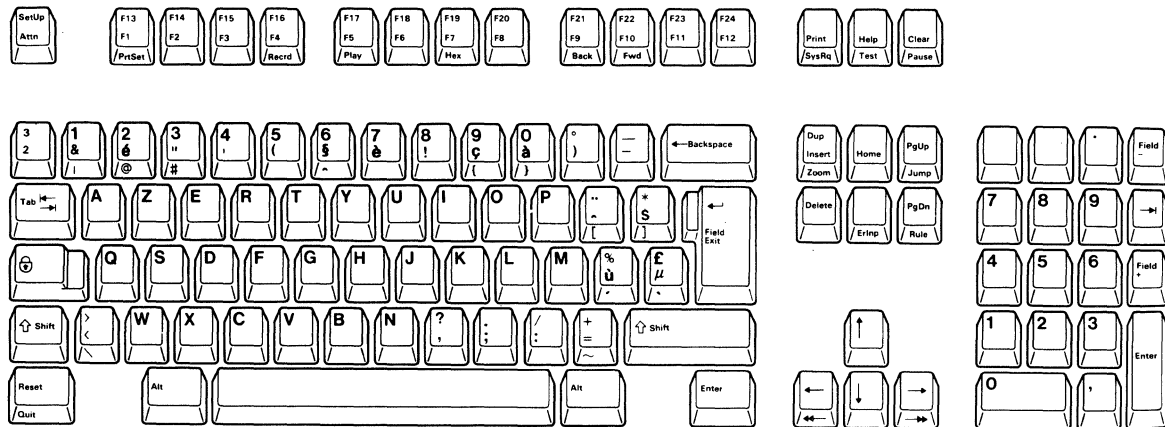
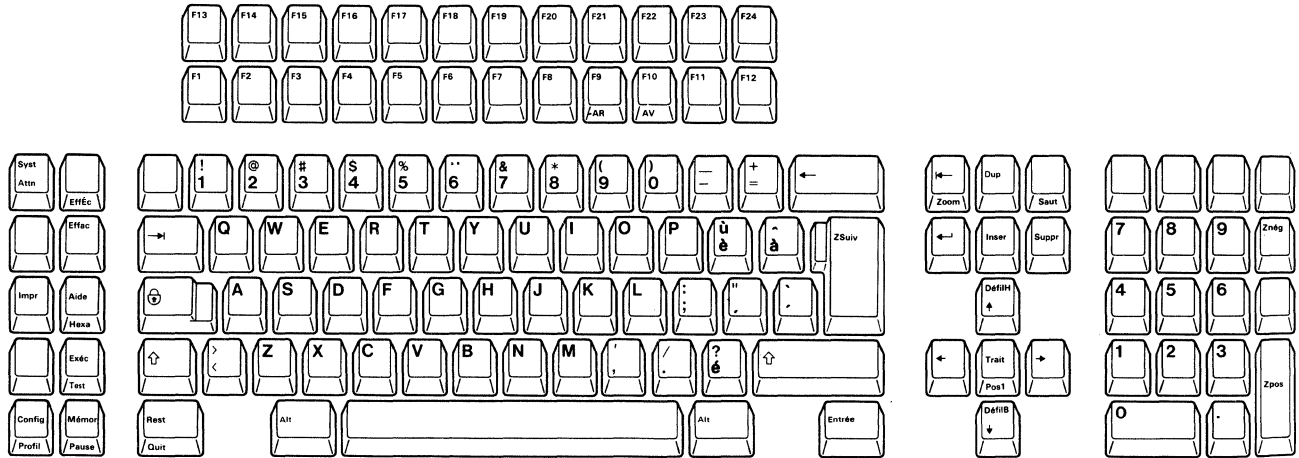

Figure B-2. Belgian Keyboard

122-Key Keyboard



103-Key Keyboard

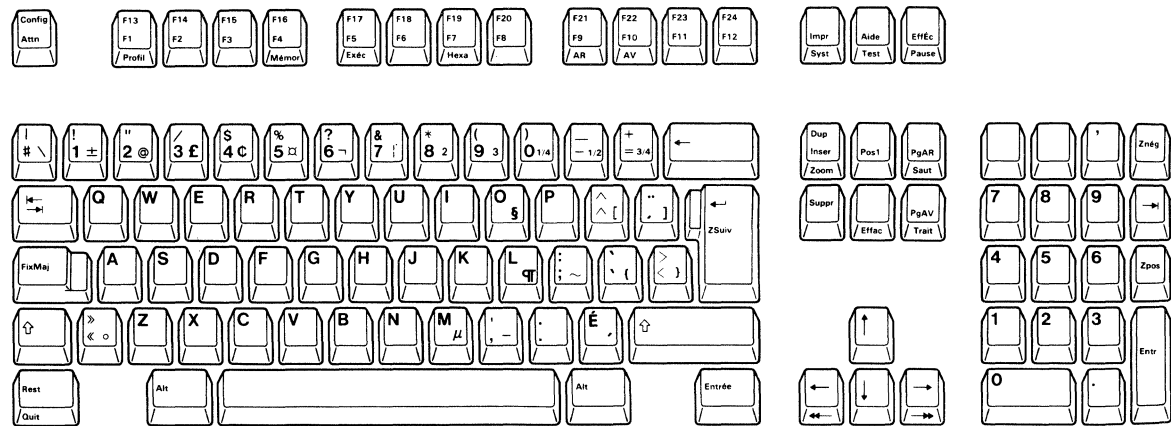
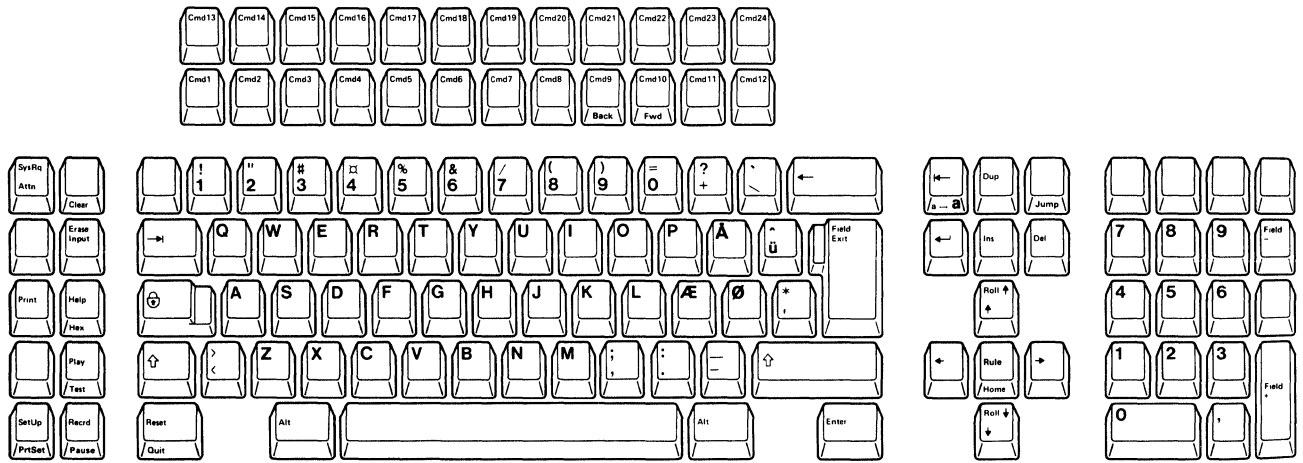

Figure B-3. Canadian French Keyboard

122-Key Keyboard



103-Key Keyboard

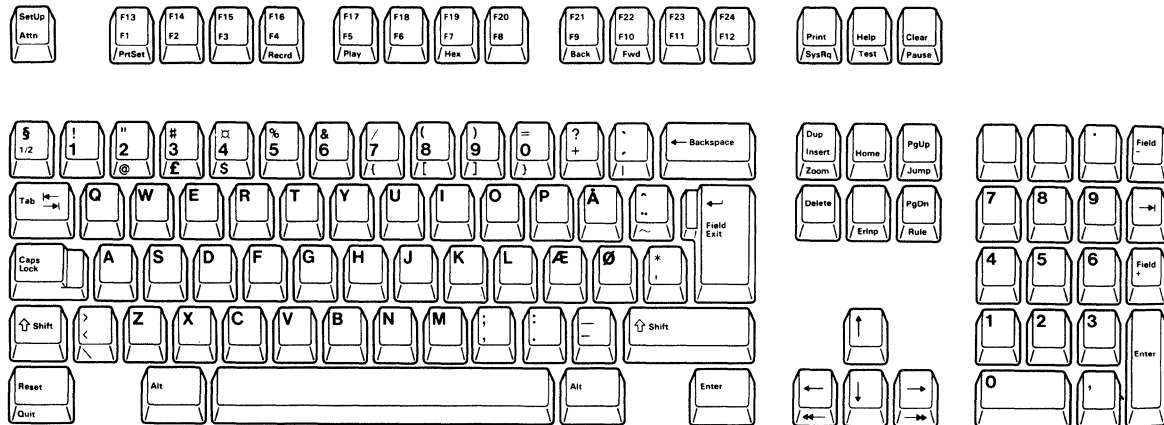
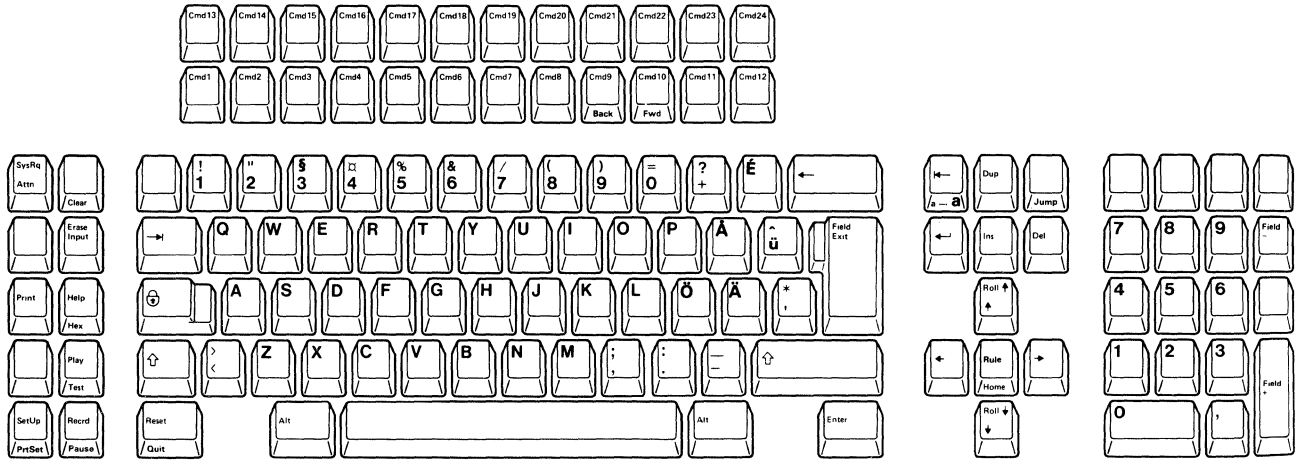

Figure B-4. Danish Keyboard

122-Key Keyboard



103-Key Keyboard

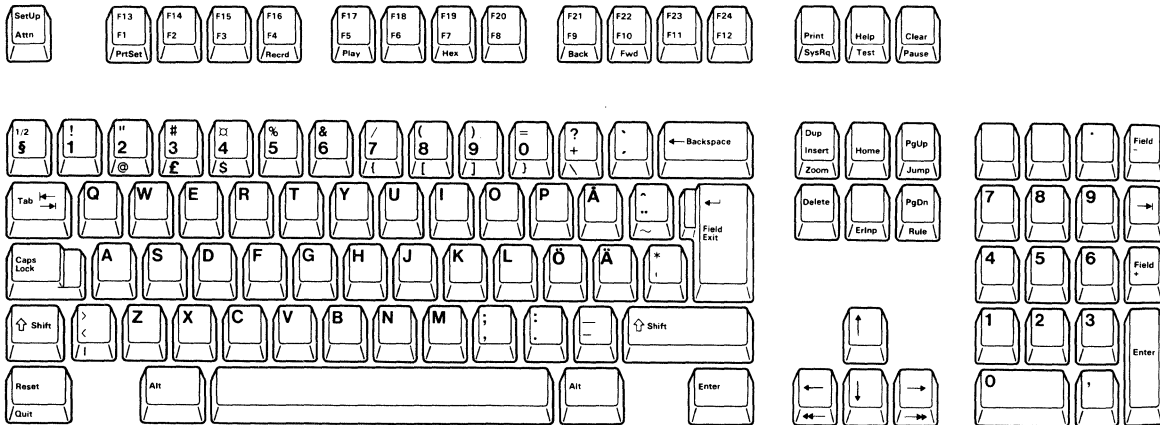
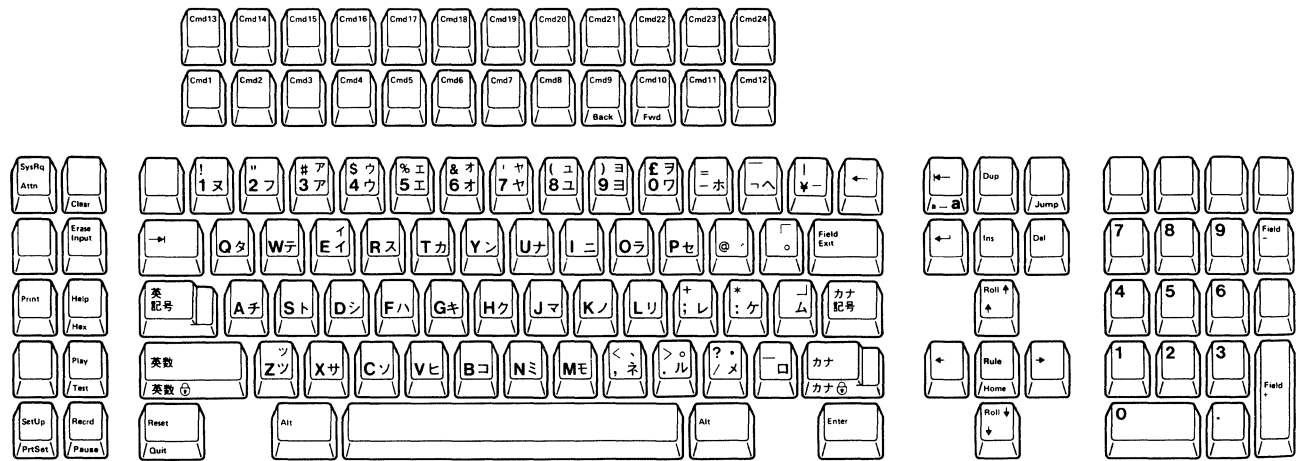

Figure B-5. Finnish/Swedish Keyboard

124-Key Keyboard



104-Key Keyboard

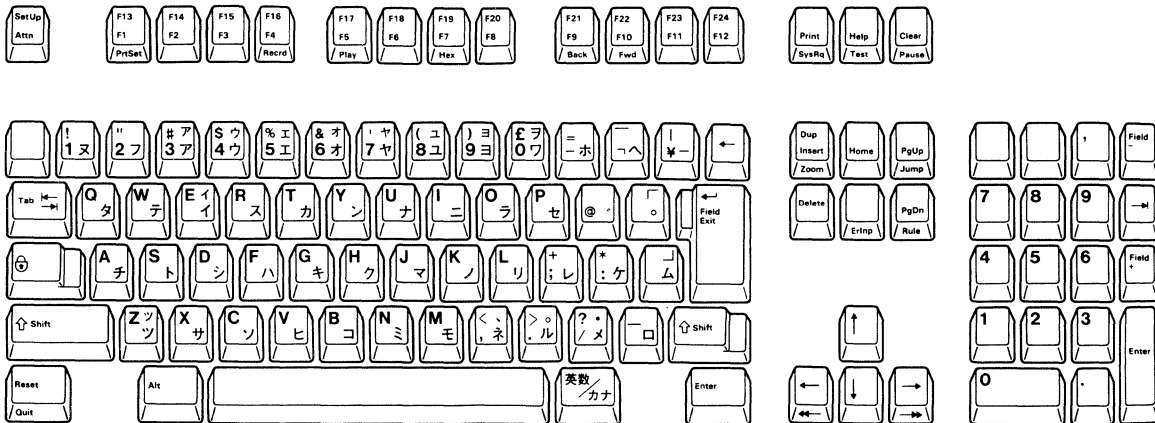
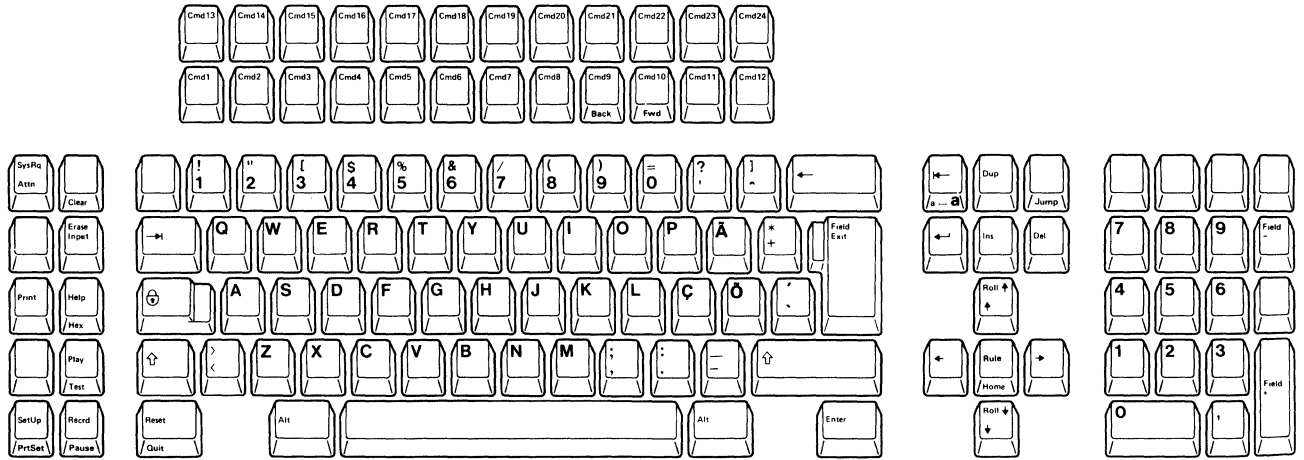

Figure B-8. Japanese Katakana Keyboard

122-Key Keyboard



103-Key Keyboard

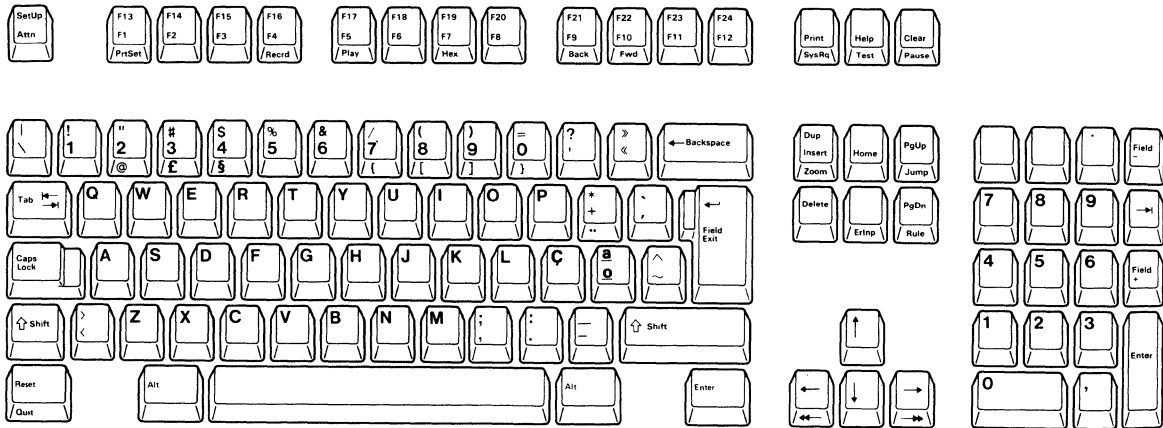
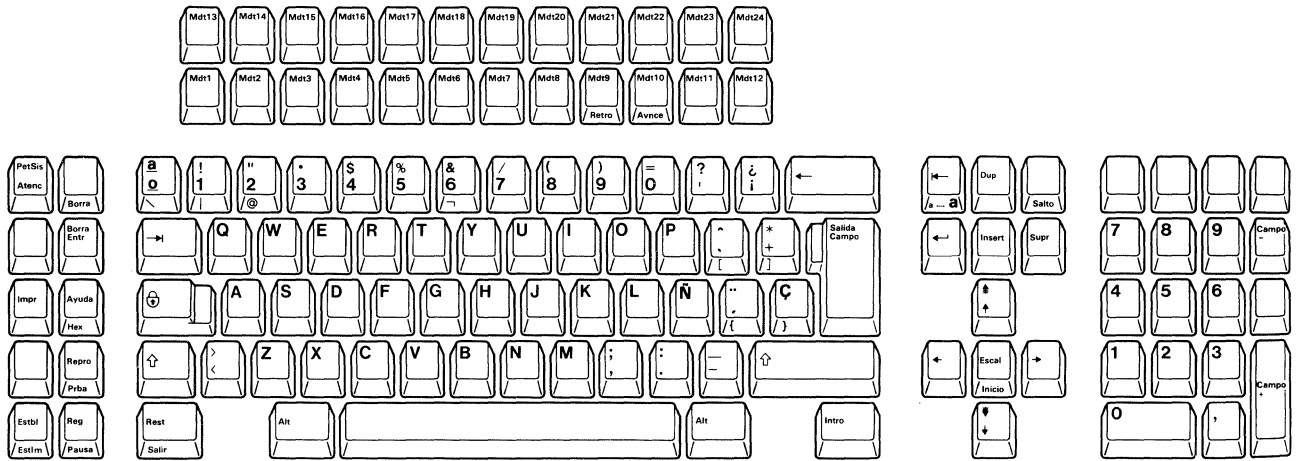

Figure B-10. Portuguese Keyboard

122-Key Keyboard



103-Key Keyboard

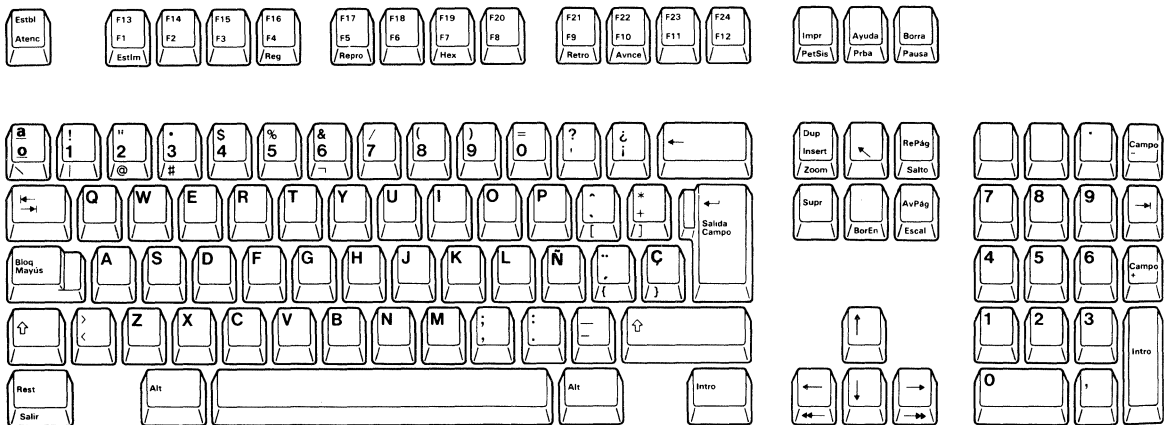
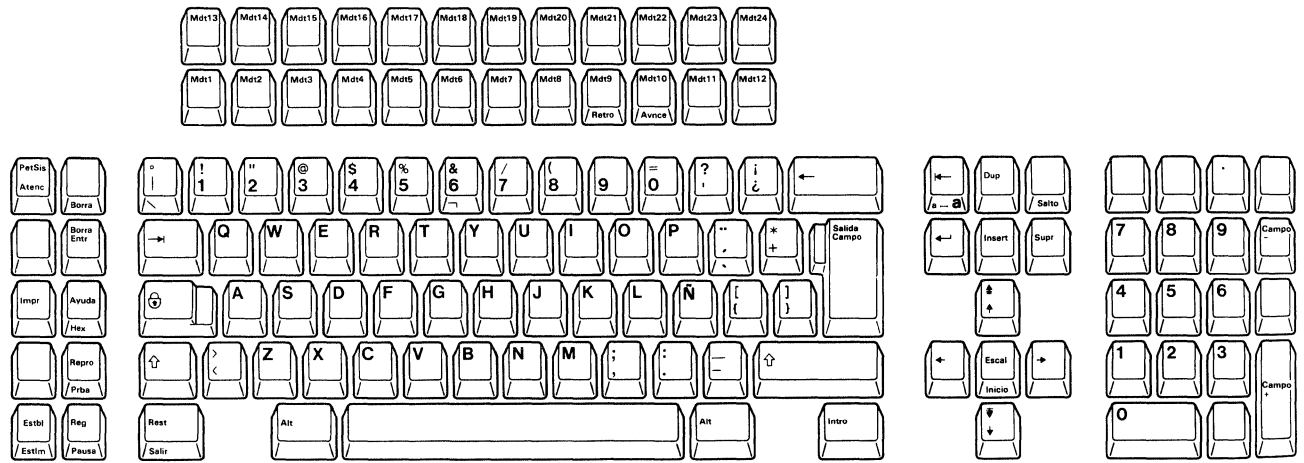

Figure B-11. Spanish Keyboard

122-Key Keyboard



103-Key Keyboard

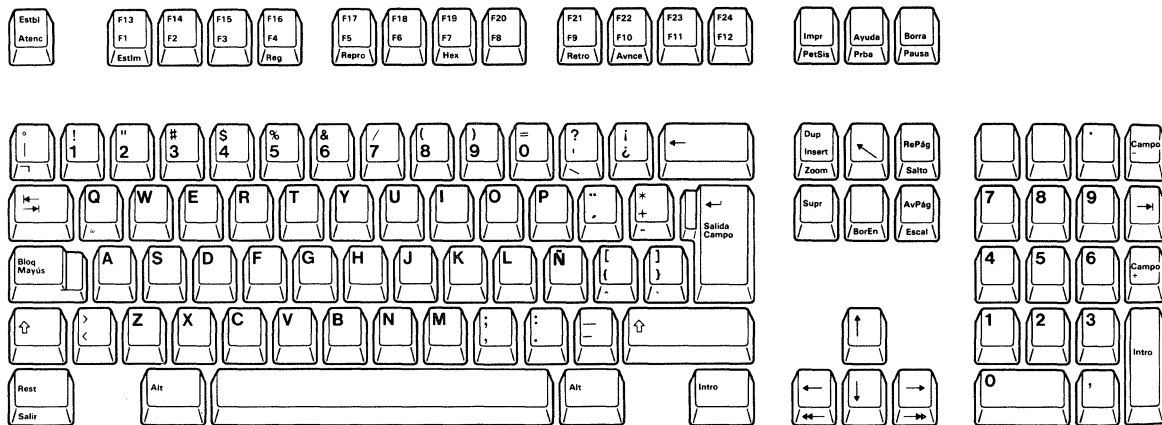
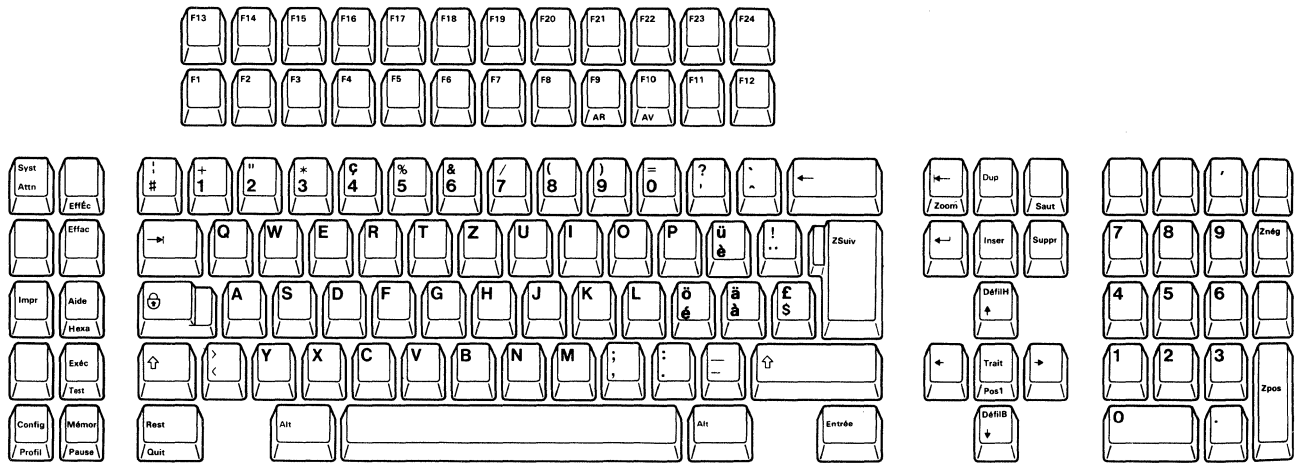

Figure B-12. Spanish-Speaking Keyboard

122-Key Keyboard



103-Key Keyboard

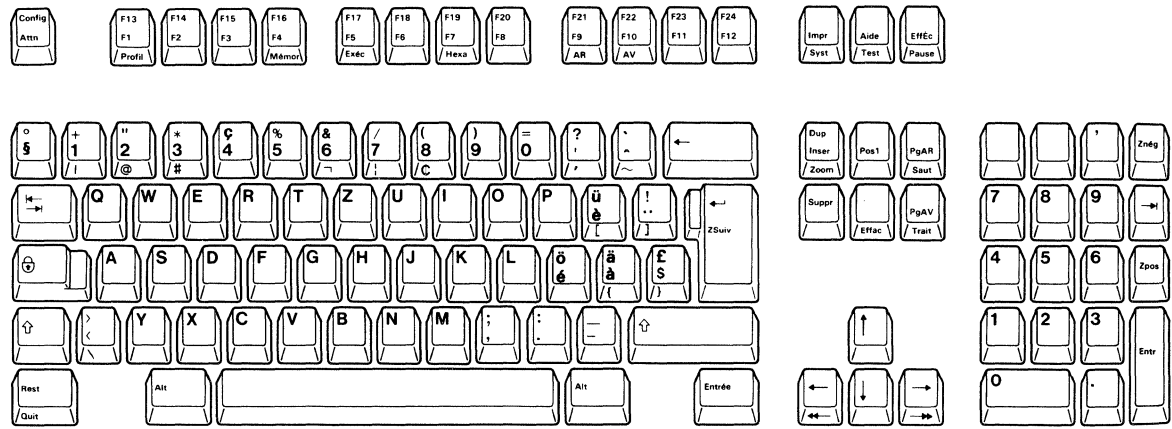
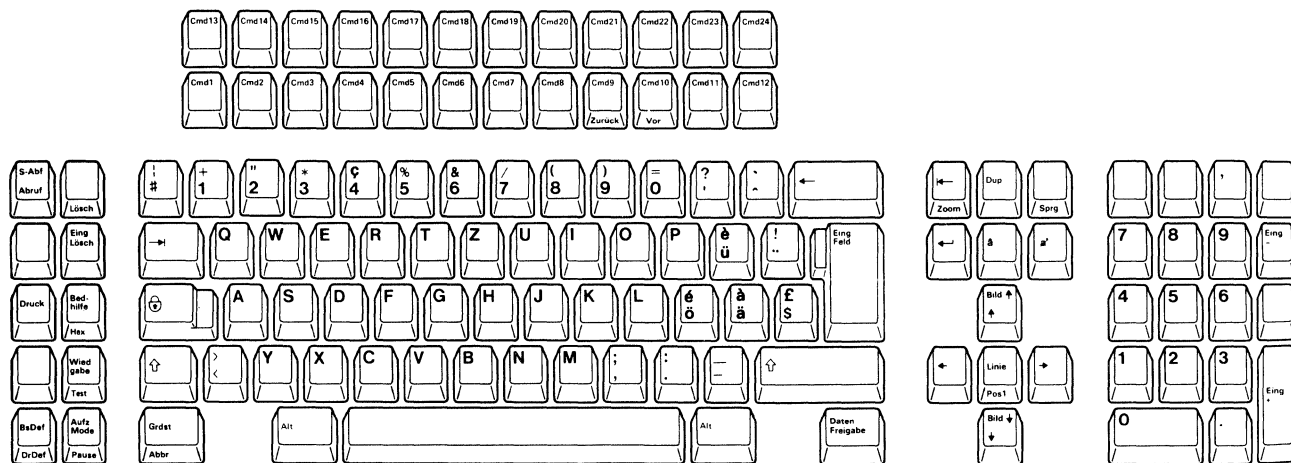

Figure B-13. Swiss-Bilingual-French Keyboard

122-Key Keyboard



103-Key Keyboard

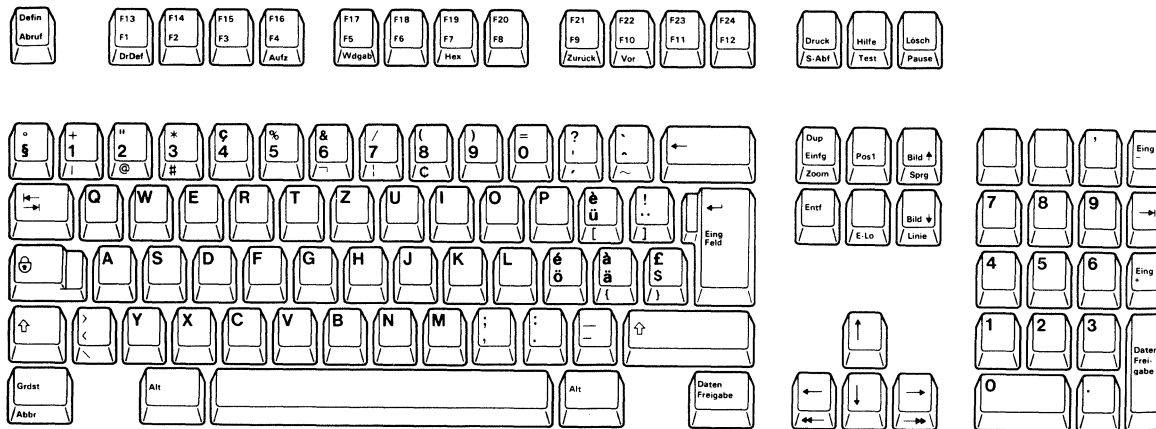
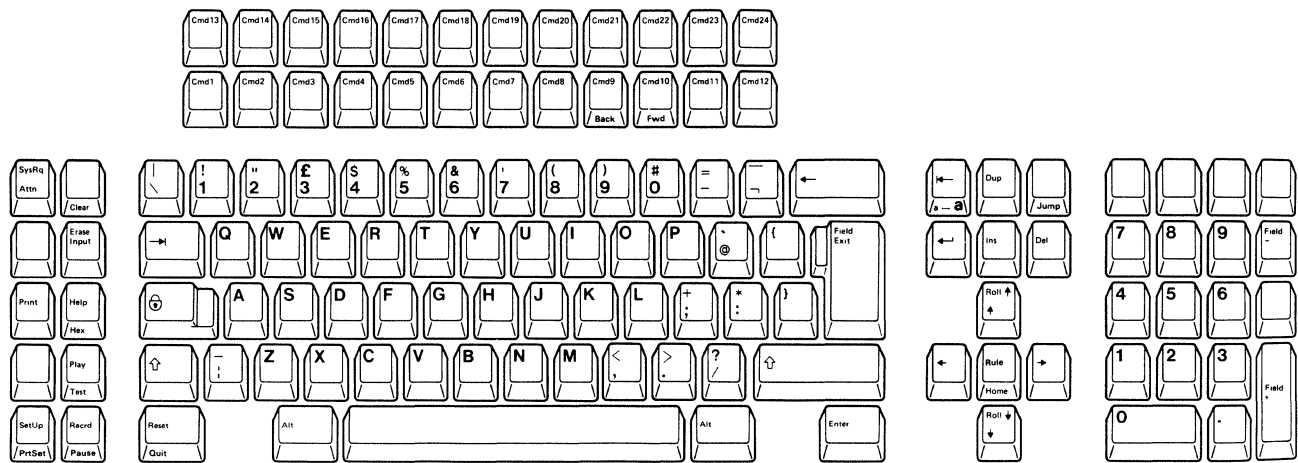

Figure B-14. Swiss-Bilingual-German Keyboard

122-Key Keyboard



103-Key Keyboard

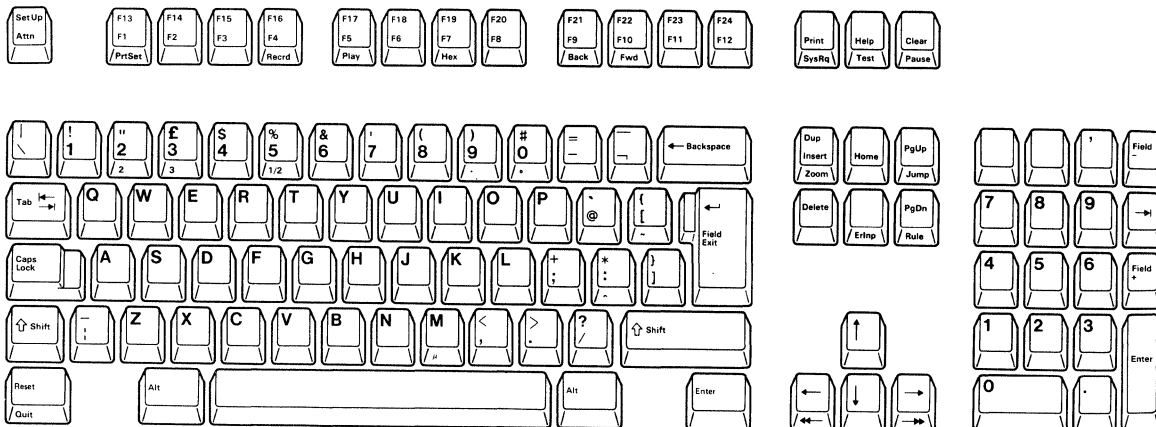

Figure B-15. U.K. English Keyboard

103-Key Keyboard

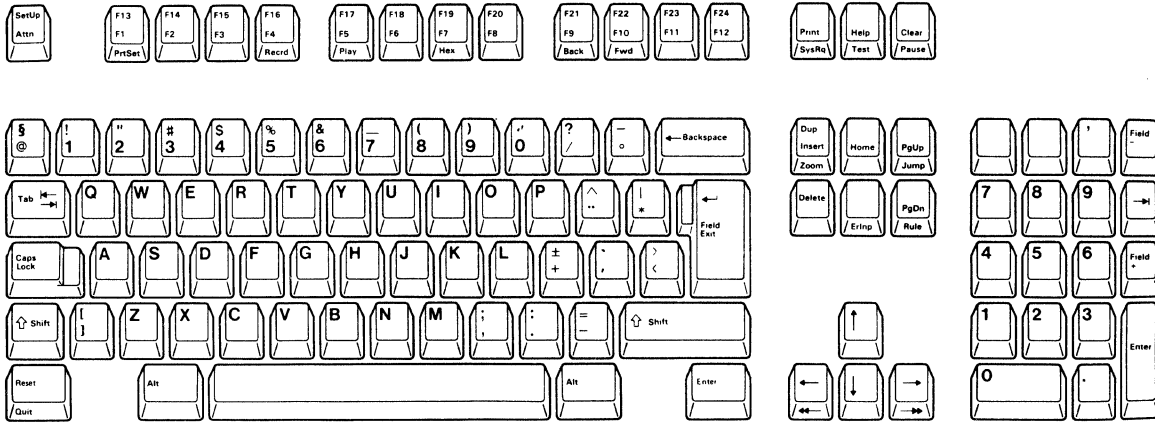

Figure B-16. Dutch Keyboard

Glossary

This glossary defines terms and abbreviations that are used in this manual. If you do not find the terms you are looking for, refer to the Index or to the *IBM Vocabulary for Data Processing, Telecommunications, and Office Systems*, GC20-1699.

alphanumeric. Consisting of both letters and numbers, and often other symbols.

attribute. A characteristic. For example, attributes of a displayed field could include brightness and reverse image.

blank character. A character that is not displayed but occupies a position on the display screen.

cable-thru. A special feature or standard function that allows multiple workstations to be attached to the same host system through a single cable path.

character location. A location on the display screen at which one character can be displayed.

clicker. A mechanism that sounds when a key is pressed and accepted for processing.

command. An instruction that directs the system to perform an operation.

command key. One of 24 keys on the top row of the 122-key keyboard that is used for operating or adjusting the display.

command keys. The keys on the top rows of the keyboard that are used with the Cmd key (or F key) to request a pre-assigned action of the system or program.

communication cable. A cable that carries commands and data between the host system and the display stations or printers.

controller. See *control unit* or *workstation controller*.

control unit. A device used to coordinate and control operations of one or more attached workstations and to synchronize their operation with that of the host system.

cursor. A movable marker on the display screen that may appear as an underscore or as a rectangular block. The cursor indicates where the next character entered from the keyboard will appear.

display. The visual information on the screen.

display field. See *field*.

display screen. An electronic vacuum tube, similar to a TV display tube, used to display characters.

display station. An input/output device containing a display screen and an attached keyboard.

display station operator. A person who uses the keyboard to perform operations at a display station.

display system. The group of display stations and printers that are attached to a system.

field. One or more consecutive positions on the display screen set aside to contain a specific type of data; for example, a name or telephone number.

formatted display. A display screen with fields established for specific information that may be restricted to the use of certain keys; for example, a field reserved for credit card numbers cannot contain letters. Contrast with *free key mode*.

free key mode. An operating mode that allows the entering of data without control by a system program (unformatted). Contrast with *formatted display*.

function key. One of 12 keys on the top row of the 102-key keyboard that is used for operating or adjusting the display station.

hexadecimal. A numbering system with a base of 16. Valid digits range from 0 through F, where F represents the highest units position, which is equivalent to decimal 15.

home position. The first input position of the first input field on a display screen.

host system. The main computer and the programming necessary to execute customer jobs. The host system can have numerous display stations or printers attached.

image. The characters or attributes shown on the display.

input field. An area on the display in which an operator enters data. Input fields are blank on the display and can be preceded by a prompt.

keystroke sequence. The sequence of keys pressed while performing the record function.

message line. The line below the separator line on which messages and error codes appear.

multinational character set. The 188-character (or 184-character) display and printer character set that includes special characters and symbols for different languages.

normal image. A display that has light characters on a dark background.

null character. A blank that is displayed as the result of zeros occupying character positions in the buffer.

offline. The status of equipment or a processing operation that is not being controlled by a control unit or a processing unit.

online. The status of equipment or a processing operation that is being controlled by a control unit or a processing unit.

operating status line. The line near the bottom of the display that indicates the operating state of your display station and the system to which it is connected.

operator's manual. A book, produced by the programmers of a system, that contains the procedures for operating the system. Other names for the operator's manual are the system procedures manual, the user's guide, and the job instructions book.

power cord. A cord that plugs into a wall outlet supplying electrical power.

printer. A device that provides printed hardcopy output.

program. A series of coded instructions, written for a computer, that performs a specific job; for example, order entry or payroll. The program is stored in the host system and can be accessed by the display station using the Cmd key procedure.

security keylock. A key-operated switch used to control the use of the keyboard and/or data communications operations.

system. See **host system**

system operator. A person who uses a display station (designated as the system console) to activate certain system functions and to control and monitor system operation.

typematic keys. Keyboard keys that repeat their function when pressed and held down.

unformatted display. See *free key mode*.

workstation. A display station or printer.

workstation address. The characters or codes that identify a specific workstation in a cable-thru arrangement.

Index

A

- adjusting angle 1-4
 - keyboard 1-5
 - video element 1-4
- alarm symbol 1-14
- alarm volume key
 - 102-key (IBM enhanced) 4-18
 - 122-key (typewriter) 2-20
- alarm volume selection
 - 102-key (IBM enhanced) 5-22
 - 122-key (typewriter) 3-22
- alt cursor key
 - 102-key (IBM enhanced) 4-18
 - 122-key (typewriter) 2-20
- attention key
 - 102-key (IBM enhanced) 4-4
 - 122-key (typewriter) 2-4
- auto dim interval key
 - 102-key (IBM enhanced) 4-18
 - 122-key (typewriter) 2-20

B

- blink cursor key
 - 102-key (IBM enhanced) 4-18
 - 122-key (typewriter) 2-20
- brightness control 1-3

C

- cancelling printing operation
 - 102-key (IBM enhanced) 5-39
 - 122-key (typewriter) 3-37
- capslock key (IBM enhanced) 4-9
- character backspace key
 - 102-key (IBM enhanced) 4-8
 - 122-key (typewriter) 2-8
- character pitch 1-17, 3-41, 5-45
- character set symbol 1-14
- clear key
 - 102-key (IBM enhanced) 4-5
 - 122-key (typewriter) 2-5
- clicker action selection
 - 102-key (IBM enhanced) 5-24
 - 122-key (typewriter) 3-24
- clicker on off key
 - 102-key (IBM enhanced) 4-18
 - 122-key (typewriter) 2-20
- clicker symbol 1-14

- clicker volume key
 - 102-key (IBM enhanced) 4-18
 - 122-key (typewriter) 2-20
- clicker volume selection
 - 102-key (IBM enhanced) 5-23
 - 122-key (typewriter) 3-23
- command keys 2-18
- contrast control 1-3
- CPI key
 - 102-key (IBM enhanced) 4-19
 - 122-key (typewriter) 2-21
- cursor blink selection
 - 102-key (IBM enhanced) 5-25
 - 122-key (typewriter) 3-25
- cursor locator 1-12
- cursor locator action
 - 102-key (IBM enhanced) 5-28
 - 122-key (typewriter) 3-28
- cursor movement keys
 - 102-key (IBM enhanced) 4-13
 - 122-key (typewriter) 2-14
- cursor row/col key
 - 102-key (IBM enhanced) 4-18
 - 122-key (typewriter) 2-21
- cursor style selection
 - 102-key (IBM enhanced) 5-26
 - 122-key (typewriter) 3-26

D

- data area 1-6
- data entry key
 - 102-key (IBM enhanced) 4-10
 - 122-key (typewriter) 2-10
- delete key
 - 102-key (IBM enhanced) 4-13
 - 122-key (typewriter) 2-13
- device ID 1-17, 3-36, 5-38
- device ID key
 - 102-key (IBM enhanced) 4-19
 - 122-key (typewriter) 2-21
- diacritic mode 1-11
- dim indicator 1-12
- dim indicator symbol 1-14
- dim interval selection
 - 102-key (IBM enhanced) 5-21
 - 122-key (typewriter) 3-21
- display-printer mode operation
 - 102-key (IBM enhanced) 5-11
 - 122-key (typewriter) 3-11
- display-printer mode selection
 - offline
 - 102-key (IBM enhanced) 5-42
 - 122-key (typewriter) 3-39

- online
 - 102-key (IBM enhanced) 5-44
 - 122-key (typewriter) 3-40
- display screen 1-6
- double speed cursor keys 4-13
- duplicate key
 - 102-key (IBM enhanced) 4-11
 - 122-key (typewriter) 2-12

E

- enter key
 - 102-key (IBM enhanced) 4-10
 - 122-key (typewriter) 2-9
- erase input key
 - 102-key (IBM enhanced) 4-13
 - 122-key (typewriter) 2-5
- error codes and recovery procedures A-1
- error count 1-11
- extend display key
 - 102-key (IBM enhanced) 4-18
 - 122-key (typewriter) 2-21
- extend display selection
 - 102-key (IBM enhanced) 5-27
 - 122-key (typewriter) 3-27

F

- field advance key
 - 102-key (IBM enhanced) 4-8
 - 122-key (typewriter) 2-8
- field backspace key
 - 102-key (IBM enhanced) 4-8
 - 122-key (typewriter) 2-12
- field exit key
 - 102-key (IBM enhanced) 4-8
 - 122-key (typewriter) 2-8
- field + key
 - 102-key (IBM enhanced) 4-14
 - 122-key (typewriter) 2-16
- field - key
 - 102-key (IBM enhanced) 4-14
 - 122-key (typewriter) 2-16
- function keys 4-16

H

- help key
 - 102-key (IBM enhanced) 4-5
 - 122-key (typewriter) 2-5
- hex key
 - 102-key (IBM enhanced) 4-5

- 122-key (typewriter) 2-5
- home key
 - 102-key (IBM enhanced) 4-12
 - 122-key (typewriter) 2-14

I

- IBM enhanced keyboard 1-1
- input inhibit 1-11
- inquiring printer status
 - 102-key (IBM enhanced) 5-39
 - 122-key (typewriter) 3-37
- insert mode key
 - 102-key (IBM enhanced) 4-11
 - 122-key (typewriter) 2-13

J

- jump key
 - 102-key (IBM enhanced) 4-12
 - 122-key (typewriter) 2-13

K

- katakana shift keys 2-22, 4-21
- key functions
 - IBM enhanced keyboard 4-3
 - 122-key typewriter keyboard 2-3
- keyboard angle 1-5
- keyboard ID key
 - 102-key (IBM enhanced) 4-18
 - 122-key (typewriter) 2-20
- keyboard ID selection
 - 102-key (IBM enhanced) 5-13
 - 122-key (typewriter) 3-13
- keyboard ID symbol 1-15
- keyboard layout
 - IBM enhanced keyboard 4-2
 - 122-key typewriter keyboard 2-2
- keyboard shift 1-11
- keyboard type 1-1
 - IBM enhanced keyboard 1-1, 4-1, 5-1
 - 122/124-key typewriter keyboard 1-1, 2-1, 3-1
- keys
 - IBM enhanced keyboard 4-3
 - 122-key typewriter keyboard 2-3

L

line pitch 1-17, 3-42, 5-46
local scroll keys
 102-key (IBM enhanced) 4-7
 122-key (typewriter) 2-18
LPI key
 102-key (IBM enhanced) 4-20
 122-key (typewriter) 2-21

M

message area 1-6, 1-7
message waiting 1-11
mode
 normal communication 3-1, 5-1
 play 3-2, 5-2
 printer setup 3-2, 5-2
 record 3-2, 5-1
 setup 3-1, 5-1
 test 3-1, 5-1
multinational character set 1-12, 3-12, 5-12
multinational character set key
 102-key (IBM enhanced) 4-18
 122-key (typewriter) 2-20
multinational character set selection
 102-key (IBM enhanced) 5-12
 122-key (typewriter) 3-12

N

new line key
 102-key (IBM enhanced) 4-9
 122-key (typewriter) 2-13
normal communication mode 1-10, 3-1, 5-1
numeric keys
 102-key (IBM enhanced) 4-15
 122-key (typewriter) 2-17

O

one-display mode operation
 102-key (IBM enhanced) 5-6
 122-key (typewriter) 3-6
operating status line 1-7

P

page down (PgDn) key 4-12
page up (PgUp) key 4-12
pause key
 102-key (IBM enhanced) 4-7
 122-key (typewriter) 2-7
play key
 102-key (IBM enhanced) 4-5
 122-key (typewriter) 2-6
play mode operation
 102-key (IBM enhanced) 5-32
 122-key (typewriter) 3-32
power-on light 1-3
power switch 1-3
print key
 102-key (IBM enhanced) 4-5
 122-key (typewriter) 2-5
print quality 1-17, 3-43, 5-47
print quality key
 102-key (IBM enhanced) 4-20
 122-key (typewriter) 2-21
printer address setting
 102-key (IBM enhanced) 5-17
 122-key (typewriter) 3-17
printer character set 1-17, 3-36, 5-38
printer character set key
 102-key (IBM enhanced) 4-19
 122-key (typewriter) 2-21
printer setup mode 1-16, 3-2, 5-2
printer setup mode key
 102-key (IBM enhanced) 4-6
 122-key (typewriter) 2-6
printer setup mode keys
 character set 2-21, 4-19
 CPI 2-21, 4-19
 device ID 2-21, 4-19
 LPI 2-21, 4-20
 quality 2-21, 4-20
printer setup mode operation
 offline
 102-key (IBM enhanced) 5-42
 122-key (typewriter) 3-39
 online
 102-key (IBM enhanced) 5-44
 122-key (typewriter) 3-40

Q

quit key
 102-key (IBM enhanced) 4-9
 122-key (typewriter) 2-9

R

record key
 102-key (IBM enhanced) 4-7
 122-key (typewriter) 2-7

record mode operation
 102-key (IBM enhanced) 5-29
 122-key (typewriter) 3-29

record/play exercise
 102-key (IBM enhanced) 5-33
 122-key (typewriter) 3-33

reset key
 102-key (IBM enhanced) 4-9
 122-key (typewriter) 2-9

roll keys
 122-key (typewriter) 2-14

rule key
 102-key (IBM enhanced) 4-12
 122-key (typewriter) 2-14

ruler style key
 102-key (IBM enhanced) 4-18
 122-key (typewriter) 2-20

ruler style selection
 102-key (IBM enhanced) 5-20
 122-key (typewriter) 3-20

ruler style symbol 1-14

S

screen format
 1920-character 1-7
 3280-character 1-9
 3564-character 1-8

security keylock 1-3

separator line 1-7

set address 1 key
 102-key (IBM enhanced) 4-18
 122-key (typewriter) 2-20

set address 2 key
 102-key (IBM enhanced) 4-19
 122-key (typewriter) 2-20

set printers address key
 102-key (IBM enhanced) 4-19
 122-key (typewriter) 2-20

setup key
 102-key (IBM enhanced) 4-6
 122-key (typewriter) 2-6

setup mode 1-13, 3-1, 5-1

setup mode keys
 alarm volume 2-20, 4-18
 auto dim interval 2-20, 4-18
 cursor row/col 2-21, 4-18
 extend display 2-21, 4-18
 keyboard ID 2-20, 4-18
 multinational 2-20, 4-18

ruler style 2-20, 4-18

set address 1 2-20, 4-18

set address 2 2-20, 4-19

set printer address 2-20, 4-19

terminal mode 2-20, 4-18

setup mode operation
 offline setup
 102-key (IBM enhanced) 5-3
 122-key (typewriter) 3-3

online setup
 102-key (IBM enhanced) 5-19
 122-key (typewriter) 3-19

shift key
 102-key (IBM enhanced) 4-9
 122-key (typewriter) 2-9

shift lock key (typewriter) 2-9

station address indicator 1-14

station address 1 setting
 102-key (IBM enhanced) 5-14
 122-key (typewriter) 3-14

station address 2 setting
 102-key (IBM enhanced) 5-15
 122-key (typewriter) 3-15

switches and controls
 brightness control 1-3
 contrast control 1-3
 locations 1-2
 power-on light 1-3
 power switch 1-3
 security keylock 1-3

symbols 1-10

normal communication mode 1-10
 cursor locator 1-12
 diacritic mode 1-11
 dim indicator 1-12
 error count 1-11
 input inhibit 1-11
 keyboard shift 1-11
 keylock 1-11
 logical display station number 1-11
 message waiting 1-11
 multinational character set 1-12
 system available 1-11

printer setup mode 1-16
 character pitch 1-17
 device ID 1-17
 line pitch 1-17
 print quality 1-17
 printer character set 1-17
 printer setup mode symbol 1-17

setup mode 1-13
 alarm 1-14
 character set 1-14
 clicker 1-14
 cursor locator 1-15
 dim indicator 1-14
 input inhibit 1-14
 keyboard ID 1-15
 ruler style 1-14
 station address 1-15

- station address 1 1-14
- terminal mode 1-14
- system available 1-11
- system request key
 - 102-key (IBM enhanced) 4-3
 - 122-key (typewriter) 2-4

T

- terminal mode key
 - 102-key (IBM enhanced) 4-18
 - 122-key (typewriter) 2-20
- terminal mode selection
 - 102-key (IBM enhanced) 5-4
 - 122-key (typewriter) 3-4
- terminal mode symbol 1-14
- test key
 - 102-key (IBM enhanced) 4-6
 - 122-key (typewriter) 2-6
- test mode 3-1

- two-display mode operation
 - 102-key (IBM enhanced) 5-6
 - 122-key (typewriter) 3-6
 - non-split screen 3-9, 5-9
 - split screen 3-7, 5-7
 - zoom for split and non-split screens 3-10, 5-10
- typewriter keyboard 1-1

V

- video angle 1-4

Z

- zoom key
 - 102-key (IBM enhanced) 4-12
 - 122-key (typewriter) 2-12

This manual is part of a library that serves as a reference source for systems analysts, programmers, and operators of IBM systems. You may use this form to communicate your comments about this publication, its organization, or subject matter, with the understanding that IBM may use or distribute whatever information you supply in any way it believes appropriate without incurring any obligation to you.

Note: Copies of IBM publications are not stocked at the location to which this form is addressed. Please direct any requests for copies of publications, or for assistance in using your IBM system, to your IBM representative or to the IBM branch office serving your locality.

Possible topics for comment are:

Clarity Accuracy Completeness Organization Coding Retrieval Legibility

If you wish a reply, give your name, company, mailing address, and date:

Note: Staples can cause problems with automated mail sorting equipment.
Please use pressure sensitive or other gummed tape to seal this form.

Cut or Fold Along Line

What is your occupation? _____

Number of latest Newsletter associated with this publication: _____

Thank you for your cooperation. No postage stamp necessary if mailed in the U.S.A. (Elsewhere, an IBM office or representative will be happy to forward your comments or you may mail directly to the address in the Edition Notice on the back of the title page.)

Reader's Comment Form

----- Cut or Fold Along Line -----

IBM 3197 Model D Display Station Setup Instructions (File No. S5250/S36/S38-06) Printed in U.S.A. GA18-2545-1

Fold and tape

Please Do Not Staple

Fold and tape



BUSINESS REPLY MAIL

FIRST CLASS PERMIT NO. 40 ARMONK, N.Y.

NO POSTAGE
NECESSARY
IF MAILED
IN THE
UNITED STATES

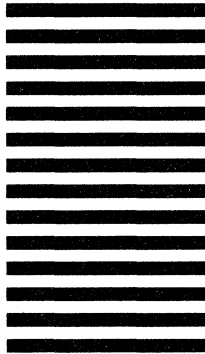

POSTAGE WILL BE PAID BY ADDRESSEE

International Business Machines Corporation
 Department 6R1J
 180 Kost Road
 Mechanicsburg, PA 17055

Fold and tape

Please Do Not Staple

Fold and tape

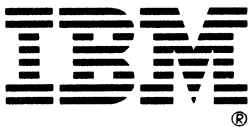

This manual is part of a library that serves as a reference source for systems analysts, programmers, and operators of IBM systems. You may use this form to communicate your comments about this publication, its organization, or subject matter, with the understanding that IBM may use or distribute whatever information you supply in any way it believes appropriate without incurring any obligation to you.

Note: Copies of IBM publications are not stocked at the location to which this form is addressed. Please direct any requests for copies of publications, or for assistance in using your IBM system, to your IBM representative or to the IBM branch office serving your locality.

Possible topics for comment are:

Clarity Accuracy Completeness Organization Coding Retrieval Legibility

If you wish a reply, give your name, company, mailing address, and date:

What is your occupation? _____

Number of latest Newsletter associated with this publication: _____

Thank you for your cooperation. No postage stamp necessary if mailed in the U.S.A. (Elsewhere, an IBM office or representative will be happy to forward your comments or you may mail directly to the address in the Edition Notice on the back of the title page.)

Note: Staples can cause problems with automated mail sorting equipment.
Please use pressure sensitive or other gummed tape to seal this form.

Cut or Fold Along Line

Reader's Comment Form

----- Cut or Fold Along Line -----

IBM 3197 Model D Display Station Setup Instructions (File No. S5250/S36/S38-06) Printed in U.S.A. GA18-2545-1

Fold and tape

Please Do Not Staple

Fold and tape



BUSINESS REPLY MAIL

FIRST CLASS PERMIT NO. 40 ARMONK, N.Y.

NO POSTAGE
NECESSARY
IF MAILED
IN THE
UNITED STATES

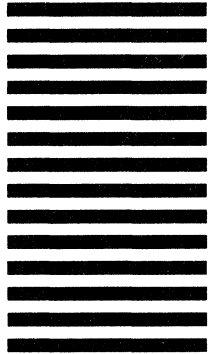

POSTAGE WILL BE PAID BY ADDRESSEE

International Business Machines Corporation
 Department 6R1J
 180 Kost Road
 Mechanicsburg, PA 17055

Fold and tape

Please Do Not Staple

Fold and tape



GA18-2545-1
Part Number 6457157
File Number S5250/S36/S38-06

IBM 3197 Model D Display Station User's Guide (File No. S5250/S36/S38-06) Printed in U.S.A. GA18-2545-1



GA18-2545-01

