

GA66-0004-0
File No. S370-08

Systems

**IBM 3614
Consumer Transaction Facility
Operator's Guide
With Expanded Function Feature Group**

IBM

GA66-0004-0
File No. S370-08

Systems

**IBM 3614
Consumer Transaction Facility
Operator's Guide
With Expanded Function Feature Group**

IBM

PREFACE

This 3614 Operator's Guide is written for the person responsible for taking care of the IBM 3614 Consumer Transaction Facility. This guide contains descriptions of the 3614, how to start it up, shut it off, load currency or statement cards, reconcile the currency used, and resolve problems.

The guide is divided into three separate sections:

- General Information — GI
- Operating Procedures — OP
- Problem Recovery — PR

Each section may be used independently of any other section; however, page cross-references exist within one section to ease transition to the other sections.

Some of the devices, options, and features described in this publication may not be available in every locale. Consult your local IBM sales representative for detailed information about product availability.

Because security methods vary among financial institutions, they should be modified to suit individual needs.

This 3614 Operator's Guide has been modified by means of TNL GN66-0009 to include the Track-3 optional feature. Machines which are built with the Track-3 feature are also known as Version 6. Thus, the Operator's Guide for Version 5 (Order Number GA66-0004) becomes an Operator's Guide for Version 6 with the addition of this Technical Newsletter.

This edition also includes information about three new features: Transaction Journaling, Transaction Chaining, and Check Cashing.

The 3600 System Operating Guide includes a tab and space in the Operating Procedures section for the storing of this manual. It is recommended that this manual be placed in the 3600 Operating Guide so that all operating information is contained in one binder

First Edition (December 1976)

The information in this guide is subject to change. Future editions will include such changes. A Reader's Comment form is included at the back of the guide. Any comments or suggestions may be sent to:

International Business Machines Corporation,
Department A52
5600 Cottle Road
San Jose, CA 95193

CONTENTS

<i>Page</i>	
ii	Preface
vi	IBM 3614 Consumer Transaction Facility
GI-1	GENERAL INFORMATION
GI-1	Introduction to the 3614
GI-1	What is the 3614?
GI-1	3614 Types
GI-1	How is it used?
GI-2	Consumer Use
GI-2	User Console
GI-3	Guidance Display Screen and Keyboard
GI-3	Deposit Slot
GI-4	Keyboard
GI-4	Transaction Type
GI-5	Account Type
GI-5	Numeric Entry
GI-5	Cancel
GI-6	Change
GI-6	OK
GI-7	Typical Transaction
GI-7	Transaction Description
GI-10	Internal Units
GI-11	Card Reader
GI-11	Escrow Unit
GI-12	Document Feed Mechanism
GI-13	Transaction Statement Printer
GI-13	Depository
GI-14	Operator/CE Panel
GI-15	Indicator Lamps
GI-15	Power On
GI-15	TSLD
GI-15	RLSD
GI-15	Carrier Detect
GI-15	Ready
GI-15	DSBL Unit
GI-15	Display
GI-16	Switches
GI-16	Reset
GI-16	Execute
GI-16	Control
GI-16	Cassette Jack
GI-17	Data Entry
GI-17	Disable (DSBL) Unit
GI-17	Denomination Select
GI-18	Function Select
GI-18	Enter and Clear Key Functions
GI-19	Enter Key A
GI-19	Enter Key B
GI-19	Clear Key A
GI-19	Clear Key B
GI-19	Special Display
GI-20	3614 Test
GI-20	Enter Configuration
GI-20	Display Counter
GI-20	Clear Counter

- GI-21 Power Control
- GI-21 Power Control Panel
- GI-21 Alarm Test Panel
(Model 2 or Model 12 only)
- GI-22 Remote Control
- GI-22 Remote Controls and Indicators
- GI-22 Indicators
- GI-22 Alarms
- GI-23 Controls
- GI-24 Problems

- OP-1 OPERATING PROCEDURES**
- OP-1 How to Start Up Your 3614
- OP-7 How to Shut Off Your 3614
- OP-8 How to Reconcile Your Cash
- OP-9 Operations Maintenance
- OP-9 Printer Hopper Loading
- OP-9 Depository Envelope Unloading
- OP-10 Printer Ink Cartridge Replacement
- OP-11 Penetration Alarm and Battery Test
- OP-12 Protective Window Cleaning
(Model 2 or 12 only)
- OP-13 Envelope Holder Loading (Optional Feature)
- OP-14 Display Hood Servicing (Model 2 or 12)

- PR-1 PROBLEM RECOVERY**
- PR-1 Problems — Start
- PR-1 Power Problems
- PR-1 3614 Test Procedure
- PR-2 Problems — 3614 Test
- PR-3 Problems Not Found By The 3614 Test
- PR-4 Problem Resolution
- PR-4 A. The 3614 does not open for transactions.
- PR-4 B. The 3614 closes during normal business hours.
- PR-5 C. Transactions take too long, or too many bills are being sent to the reject bin.
- PR-5 D. System computer or remote control and indicator panel (if installed) signals intervention or attention required. May also signal cash low or statement card low.
- PR-6 E. The reader does not accept the customer card, or does not accept the customer personal identification number, or returns it with no action.
- PR-6 F. Protective window does not open or close properly. (Model 2 or Model 12 only)
- PR-7 G. The 3614 either issued no bills or damaged bills to the customer.
- PR-7 H. The 3614 keeps the customer's card.
- PR-7 J. Power goes off and does not come on, or DC ON lamp is off.
- PR-8 K. The 3614 often resets and repeats a start-up.

- PR-9B L. Customer Area Lamp Failure
— 50 Hz power 3614s.
- PR-10B M. Interior Service Lamp Failure
— 50 Hz power 3614s.
- PR-11 N. Bill Jam in the Document Feed
Mechanism (DFM)
- PR-12 P. Document Jam in Escrow Unit
- PR-13 Q. Card Reader Jam
- PR-13 R. Service Door Problems
- PR-14 S. Communication Problems
- PR-15 T. Freezing Weather Condition Failures
- PR-16 U. Depository Jam Removal
- PR-17 V. Printer Problems
- PR-19 W. Start-Up Problems
- PR-19 X. Curled or Warped Bills Not
Feeding Properly

- PR-20 Call for Service
- PR-21 3614 Trouble Report

- A-1 **Special Instructions for Japanese Installations**
- X-1 **INDEX**

IBM 3614 CONSUMER TRANSACTION FACILITY

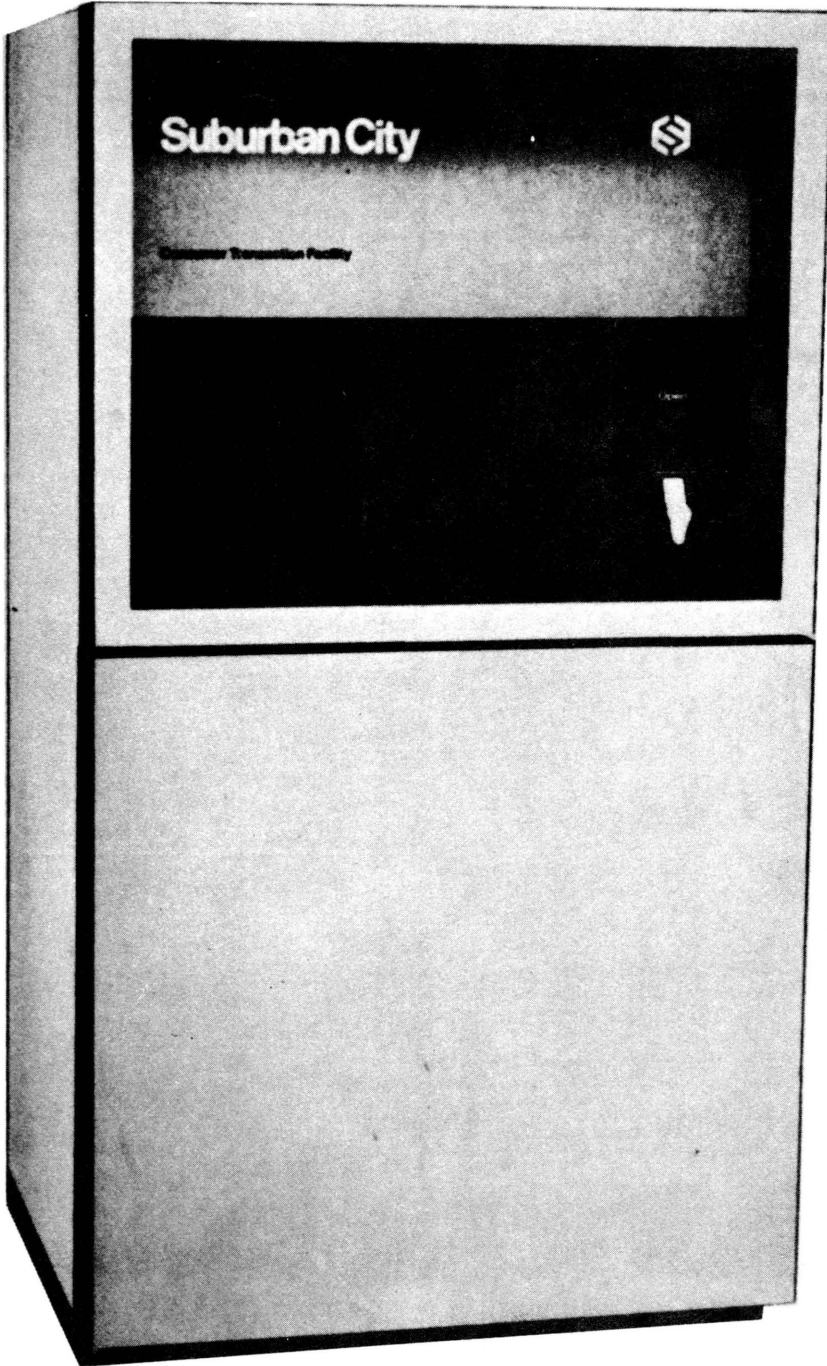

General Information

NOTES

INTRODUCTION TO THE 3614

What is the 3614?

The IBM 3614 Consumer Transaction Facility is a self-service banking terminal and part of the IBM 3600 Finance Communication System. The 3614 lets your customers withdraw cash and ask about their account balance. Other business transactions can be accomplished by special transaction procedures.

3614 Types

The Model 1 dispenses bills of a single denomination and is installed inside an institution for use during normal business hours.

The Model 2 dispenses bills of a single denomination and is installed through an exterior wall. A customer may use this terminal at any time of the day or night, or as established by the institution, even through the institution is closed for business.

The Model 11 dispenses bills of two denominations, but is otherwise similar to the Model 1.

The Model 12 dispenses bills of two denominations, but is otherwise similar to the Model 2.

Models 11 and 12 are called Dual Document Feed models.

Optional features for all models of the 3614 include a transaction statement printer, a depository unit, transaction chaining, transaction journaling, and check cashing. These last three features are also known as Expanded Function Features.

This 3614 Operator's Guide has been modified by means of TNL GN66-0009 to include the Track-3 optional feature. A third track on the magnetic stripe of the user's identification card may be read, updated, and rewritten as part of the 3614 transaction processing.

How is it Used?

Your customer is issued a plastic card with a magnetic stripe containing identification data. When the card is inserted into a slot in the 3614, a series of instructions on a display screen direct him step-by-step through the transaction.

Besides inserting an identification card to use the terminal, the customer is required to enter a personal identification number on a keyboard to verify his identity.

After the customer has selected the type of transaction and completed the keyboard entries, the information that was entered is processed by a computer. When approved by the computer, the 3614 displays a message instructing the customer to remove his card or select the next function in order to complete the transaction. If the transaction is a cash withdrawal, the cash is then issued through the issue slot.

The computer can also direct the 3614 to end a transaction and retain the customer's card within the machine.

CUSTOMER USE

User Console

An OPEN sign tells the customer the terminal is ready for use. The transaction starts when the magnetically-coded card is inserted in the horizontal slot below the OPEN sign.

The keyboard is used to enter identification and transaction information. Some of the keys have lights to help the customer make valid entries. An audio tone indicates that a keyboard entry has been sensed by the 3614.

The display screen guides the customer through the steps of a transaction. Light for the panel area is supplied by a recessed lamp.

Models 2 and 12 (through-the-wall models) have a protective window covering the access area (except for the card slot) when the facility is not in use. A safety clutch prevents the window from closing if anything is in the way.

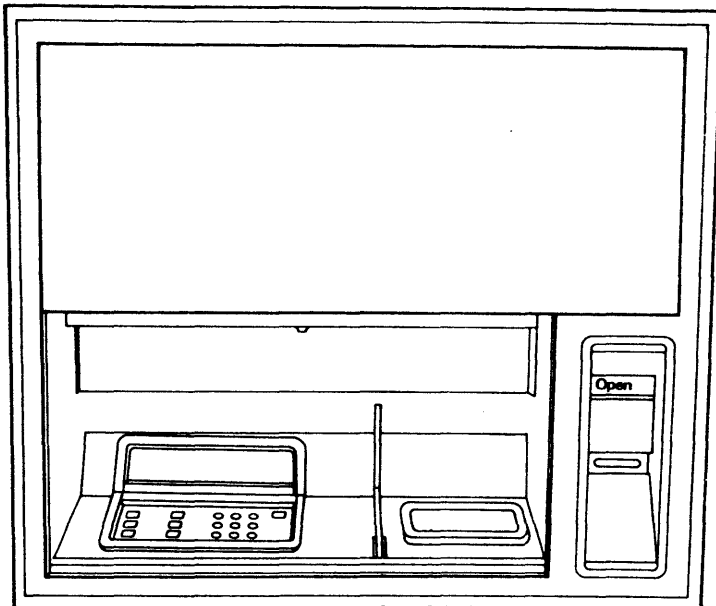

Guidance Display Screen and Keyboard

A display screen just above the keyboard shows messages to help the customer complete the transaction. These messages instruct the customer step-by-step through each type of transaction.

The keyboard is divided into three general areas: transaction type, account type, and numeric keys.

An audio tone sounds when each keyboard action is sensed.

The transaction and account keys have internal lamps that stay on when a key is pressed.

The keyboard is used to enter the personal identification number, the type of account, and the amount of the transaction. Other single keys are used for correction, cancel, and completion (OK key). A Change key, giving the customer a choice of denomination mixes, can also be included for Models 11 and 12. The keyboard configuration depends on individual institutional requirements; thus, not all keys are available on all machines.

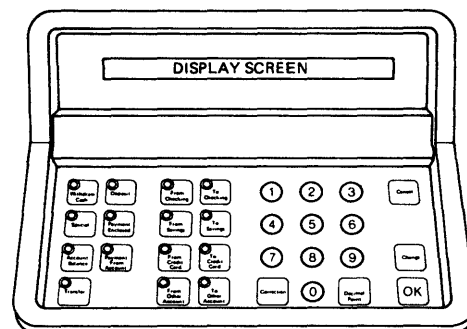

Deposit Slot

A deposit slot to the right of the keyboard is used for inserting an envelope containing a deposit. The slot is protected by a controlled flap that opens during a user sequence and closes after a deposit has been made. The flap closes after a reasonable time if no deposit has been made.

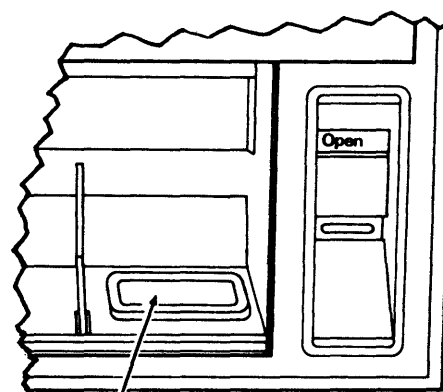

Deposit
Slot

KEYBOARD

Transaction Type

When the 3614 is ready for the customer to select a transaction, the transaction type (blue) keys are lit. The customer then presses one key to select the required transaction. After selection, the key that was pressed remains lit and the other lamps go out.

The Withdraw Cash key allows the customer to withdraw cash from an account. After approval by the institution's computer, the terminal issues cash to the customer.

The Special key allows the customer to request special services provided by the institution, such as ordering checks. A special numeric code entered at the keyboard indicates the type of service requested.

The Account Balance key allows the customer to check the current balance of an account. When the keyboard entry procedure has been completed, the balance is shown on the display.

The Transfer key allows the customer to transfer funds from one account to another (for example, from checking to savings).

The Deposit key allows the customer to make a deposit to an account. When the keyboard entry procedure has been completed, the customer is prompted to place an envelope, containing the deposit, into the depository.

The Payment Enclosed key allows the customer to make a bill payment by deposit. When the keyboard entry procedure has been completed, the customer is prompted to place an envelope, containing the payment and bill, into the depository.

The Payment From Account key allows the customer to make a bill payment from an account. When the keyboard entry procedure has been completed, the customer is prompted to place an envelope, containing the bill, into the depository.

The Cash Check key allows the customer to cash a check drawn against an account of another financial institution. The amount keyed in must be an amount which the 3614 can dispense using the denominations available. Checks may be written for any amount equal to or greater than the amount keyed in by the customer. However, no provision is made for automatically crediting to an account any difference between the check amount and the amount of cash requested by the customer. This difference must be credited by the bank. When the keyboard entry procedure has been completed, the customer is prompted to place an envelope, containing the check, into the depository. The transaction is terminated after the cash is issued.

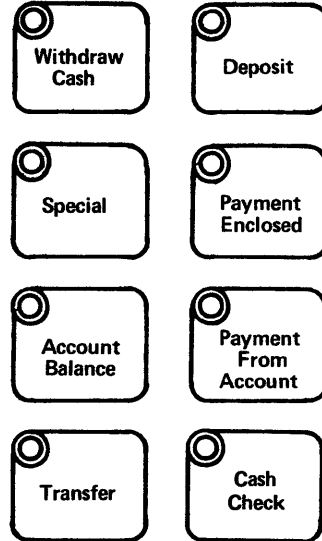

Account Type

After selecting the transaction type, the display prompts the customer to select a "from" account or a "to" account (green key). Only one "from" account key may be selected for any one transaction: From Checking, From Savings, From Credit Card, or From Other Account. A "from" account is not selected for a Deposit, Payment Enclosed, or some Special accounts. After selection, the key pressed remains lit and the others in the group go out.

The "from and to other account" keys permit the customer to select any one of several accounts as designated by the institution. The "other accounts" may be any three digit number from 000 to 999 inclusive as defined by the institution. Leading zeros must be included (for example: 004 might be for Christmas Club).

One "to" account key may also be selected if the transaction type is a transfer from one account to the other. A "to" account key is also selected following a deposit.

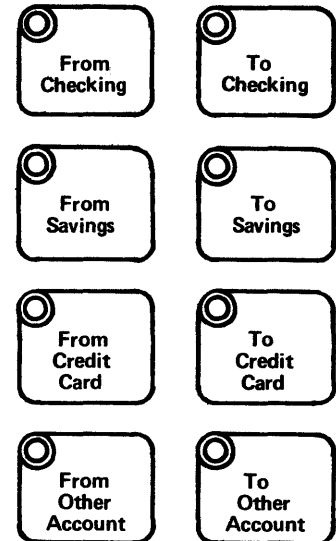

Numeric Entry

The third group of keys is used to enter a personal identification number, special account number, or an amount. The keys are numbered from 0 through 9, a Decimal Point, and a Correction key, and are pressed like an adding machine - the most significant number first. The Decimal Point key is used to place the decimal point. As an option, primarily for World Trade use, the Decimal Point key may be replaced by a comma, or triple zero (000). If a mistake is made, the Correction key is pressed, and the amount is re-entered.

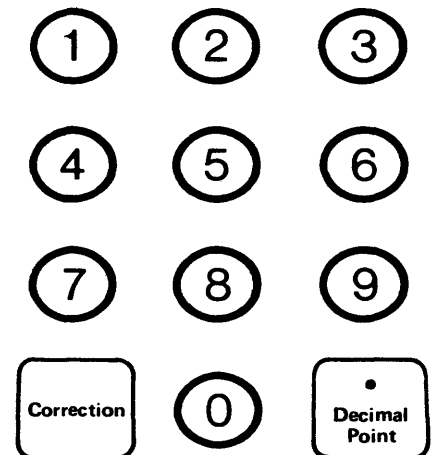

Cancel

The Cancel key can be used to cancel the transaction, if it is pressed at any time before the customer's card is removed or before the depository is actuated for a deposit or payment. The key is inactive after the customer's card is removed or after the depository is actuated.



GI – 6

Change

The Change key is a 3614 Model 11 and Model 12 optional feature used to modify mix of bills when two denominations can be dispensed. Normal denomination mix will usually offer the least number of bills to satisfy the requested amount. The guidance screen displays the mix of denominations and instructs the customer to press the OK key or Change key. Each depression of the Change key increases the number of smaller denomination bills in the mix. This can be continued until all the bills are of the smaller denomination or until the escrow's bill capacity has been exceeded (20 bills is the maximum).



If the mix has been changed so that the maximum number of smaller denomination bills are included in the mix and the total number does not exceed 20 bills, the next depression of the Change key will cause the maximum number of larger denomination bills to be displayed. This feature allows the customer to return to any of the denomination mixes.

When the customer is satisfied with the denomination mix, he presses the OK key and the transaction continues in a normal manner.

OK

The OK key indicates that key entry selections are complete and can be processed by the 3614. Pressing the OK key during entry of an amount for a withdrawal transaction automatically results in a decimal point and two zeros being added to the amount entered.



The OK key also allows a customer to use a personal identification number that has fewer digits than the maximum number of digits specified by the bank. As an example, a bank may specify an eight digit personal identification number as maximum, but permits their customers to select their own variable length personal identification numbers. The OK key must be pressed to terminate the entry if the customer's personal identification number is less than the bank maximum. However, the OK key is not used when the customer's personal identification number length is the same as the bank maximum.

TYPICAL TRANSACTION

Transaction Description

The description illustrates a typical customer transaction. The example transaction is a \$50.00 withdrawal from a checking account. The 3614 is a Model 2 (through-the-wall). The messages displayed are samples and can vary according to your institution's needs.

Note: *The OPEN sign above the card reader slot shows that the 3614 is ready to accept transactions.*

- 1. Insert card into the card reader slot.

A decal at the horizontal slot area shows the correct way to insert the card. The card is partially pushed into the slot and the 3614 pulls it into the facility. If the magnetic data has been recorded correctly, the protective window (Models 2 or 12 only) slides up to give access to the keyboard/display screen area.



- 2. Observe the displayed message.

The displayed message instructs the customer to enter a personal identification number. Your institution may designate any number of digits up from four to a total of sixteen.

KEY IN PERSONAL NUMBER

- 3. Enter the personal identification number.

Using the numeric keys, the customer presses the desired numbers in sequence. If the number of digits in the personal identification number is less than the maximum number specified by the bank, the customer must press the OK key to terminate the entry. As each key is pressed, a tone sounds.

Note: *If the customer allows too much time to pass between key entries, the card is returned and a message tells him to start the transaction over.*

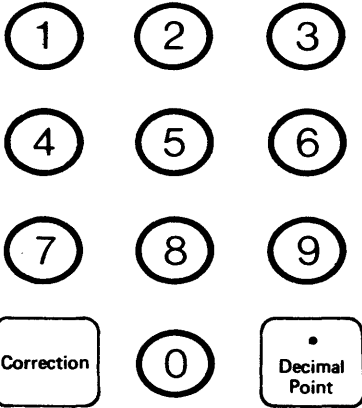

- 4. Observe the displayed message.

A message now directs the customer to select the type of transaction. The transaction type keys now light up.

CHOOSE ACTION - USE BLUE KEYS

GI – 8

5. Select the transaction type.

If the customer wishes to receive cash, he presses one of the lighted transaction keys — in this case, **Withdraw Cash**. As the key is pressed, a tone sounds. The **Withdraw Cash** key stays lit and the others go out.

Note: *If the Chaining feature is being used to allow multiple transactions, **Withdraw Cash** or **Cash Check** must be the last in the series.*

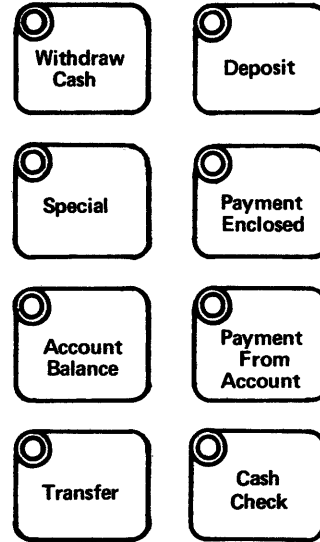

6. Observe the displayed message.

A message now directs the customer to select the account type. The account type keys then light (the **Withdraw Cash** key stays lit).

CHOOSE FROM ACCOUNT – USE GREEN KEYS

7. Select the account type.

The customer next selects his checking account and presses the **From Checking** key. As the key is pressed, the tone sounds, the **From Checking** key stays lit, and the remaining account keys go out.

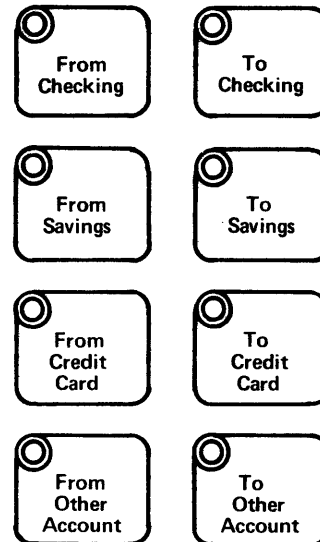

8. Observe the displayed message.

A message display directs the customer to enter the amount wanted.

KEY IN DOLLARS AND CENTS, USE DECIMAL

9. Key in the Amount.

The customer enters the amount required (50.00) on the numeric keys. As each key is pressed, the tone sounds.

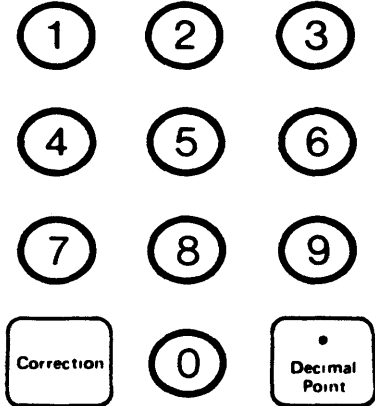

10. Observe the displayed message.

The customer follows the instruction and presses the OK key. If using a 3614 model 11 or 12 with the Change key option, he will also get a display showing the mix of two denominations. If the mix is acceptable, he presses the OK key. If the customer wishes to have more of the smaller denomination bills in the mix, he presses the Change key.

\$50.00 KEYED IN --- IF CORRECT, PRESS OK

2 X \$20.00 2 X \$5.00 OK OR CHANGE

After pressing the OK key, the next message shows YOUR REQUEST IS BEING PROCESSED — WAIT. This delay permits the transaction to be processed by the computer. Following this delay, the guidance screen displays REMOVE CARD.

YOUR REQUEST IS BEING PROCESSED --- WAIT

REMOVE CARD

Note: If this had not been a cash issue operation and the Chaining feature had been in use, the panel would have displayed CHOOSE NEXT ACTION OR REMOVE CARD.

11. Collect the cash.

The card reader partially ejects the card from the slot. The customer removes his card, and the requested number of bills is issued to him through the issue slot. The transaction is now complete.

The customer can again insert his card and start another transaction. If no other transaction is made, the protective window descends after about 25 seconds.

GI - 10

INTERNAL UNITS

This drawing shows the locations of the 3614 parts that you will be working with.

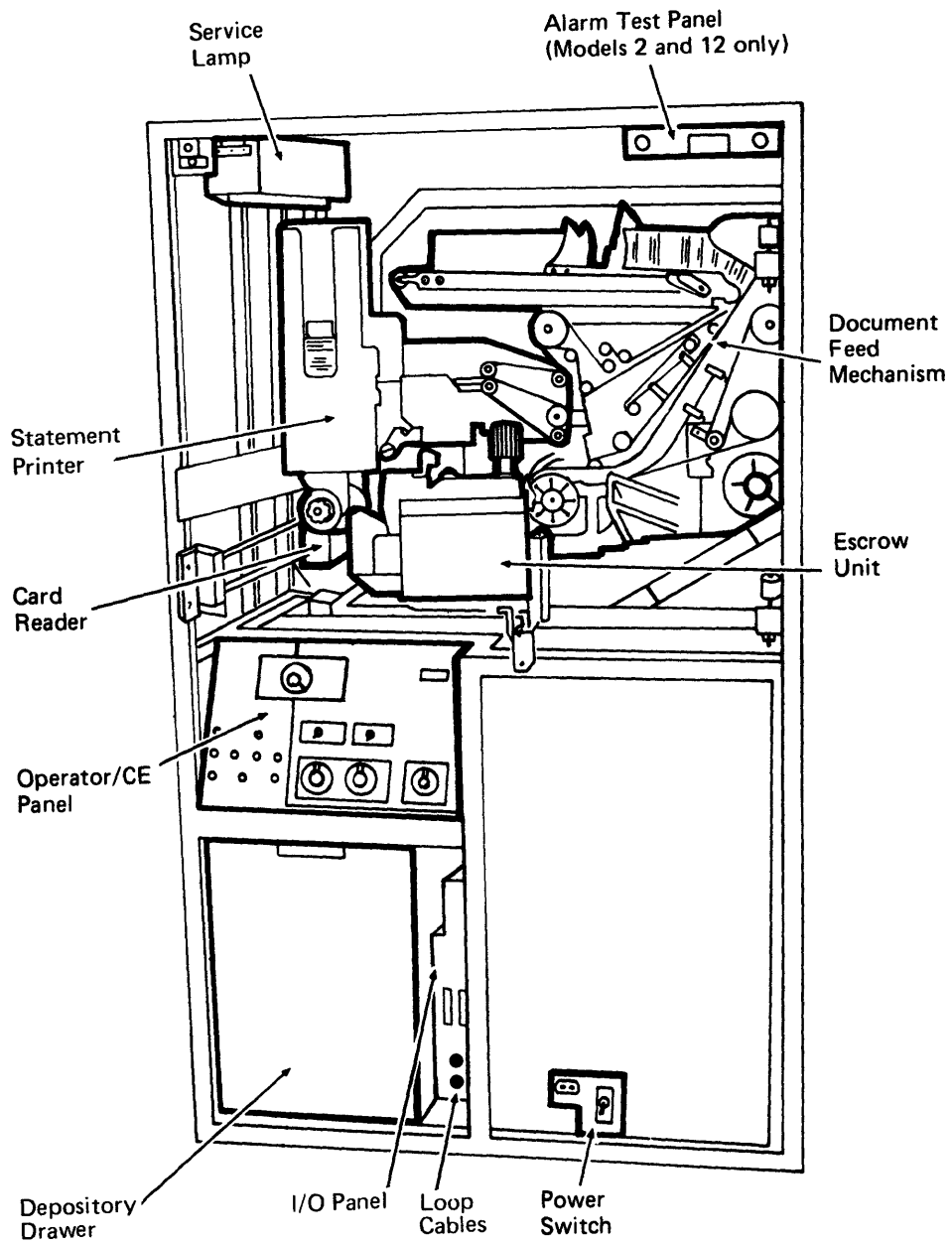

Card Reader

The card reader senses the magnetic data on the customer's card and holds the card while the customer performs a transaction. After the transaction has been processed and authorized by the computer, the card is returned to the customer and the transaction is completed.

If the card has been reported stolen or is otherwise invalid, it is either dropped into a holding bin or returned to the customer (depending on institution policy), and the transaction is not completed.

The card reader is mounted on slide rails and can be moved to the rear of the 3614. The top can be opened for the reader to be cleaned or card jams cleared.

Track-3 (T-3) is a 3614 optional feature for World Trade Corporation only. A third track is located next to the other two tracks within the magnetic stripe on the user's identification card. This third track provides a method of storing data that can be written, read, and updated on the card as a part of the 3614 transaction processing. Track-3 may be used alone or with standard two-track operation.

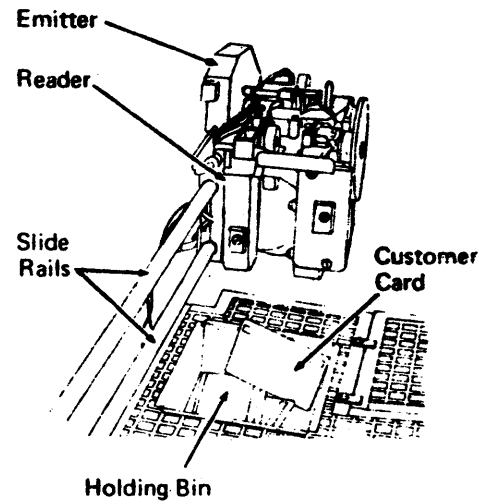

Escrow Unit

The escrow unit receives the bills from the document feed mechanism (DFM) stacker and statements from the printer, and feeds them through the issue slot to the customer. If any documents are improperly fed into the escrow unit, all documents in that transaction are sent to the retain bin, and the 3614 repeats the transaction automatically. If the Transaction Journaling feature is in use, all journal statements are also sent to the retain bin.

The escrow unit is mounted on the same hinged gate as the DFM and can be checked when the gate is opened.

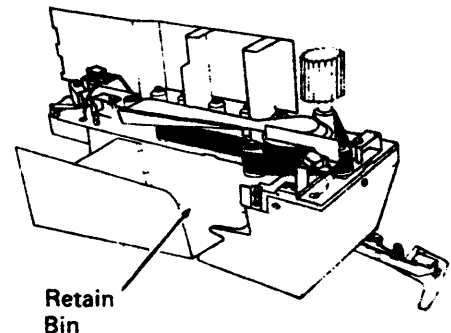

Document Feed Mechanism

The document feed mechanism (DFM) feeds bills to the escrow unit and is in three sections: hopper, transport, and stacker.

The hopper holds the bills and consists of a separator belt, a restraint belt, two switches to signal Cash Low and Cash Out, and several other drive elements.

The transport carries the bills from the hopper to the stacker between two moving belts. Three photocells monitor the bill movement to check for proper feed, transport, and stacking of the bills.

The stacker is at the bottom of the transport and stacks the bills in the escrow unit.

The entire document feed mechanism (single or dual feed) is mounted on a hinged gate that swings out. The single DFM is loaded from the rear of the machine without need to swing the gate out; hopper 2 of a dual DFM machine is loaded similarly. However, the DFM gate must be swung out to load or service hopper 1 side of a dual DFM machine.

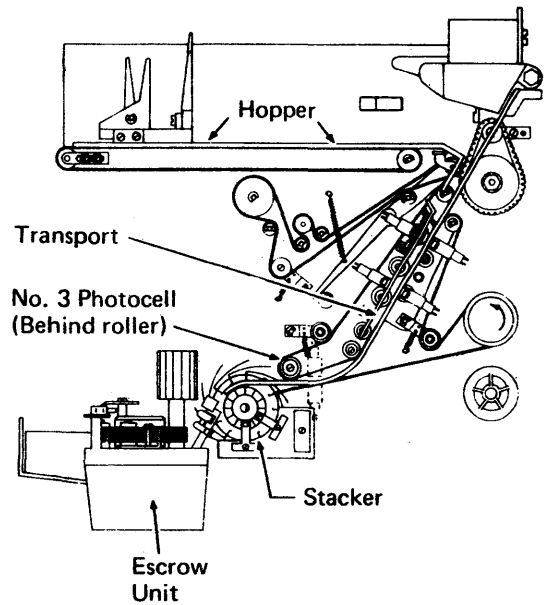

Single DFM, Rear View

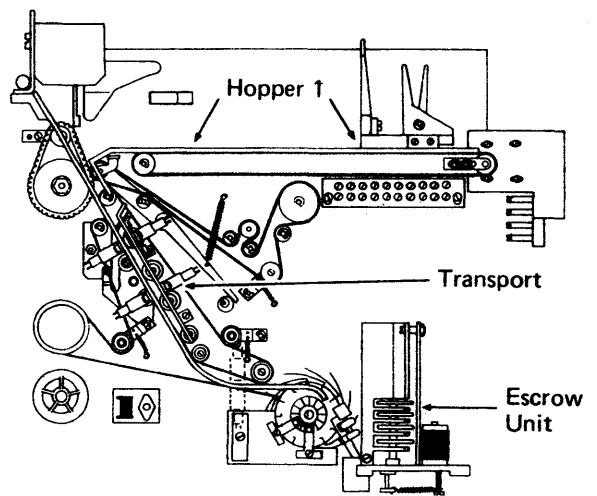

Dual DFM, Hopper 1 Side

Transaction Statement Printer

The Transaction Statement Printer is an optional feature for the 3614 that prepares printed statements for the customer in conjunction with various banking transactions. A maximum of four lines of 34 characters each are printed on a statement card.

The printer consists of a 900 card hopper, a feed mechanism, a print unit, and a forms transport.

As an option, transaction journal statements may be printed and are retained in the 3614 for banking use. Another option permits printing two transaction statements; both statements are issued to the customer so that he can keep one and enclose the other in a deposit envelope.

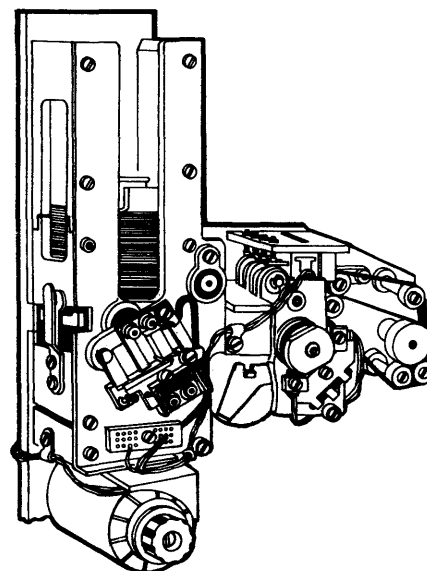

Transaction Statement Printer

Depository

The Depository Unit is an optional feature located behind the user console. The deposit slot is readily accessible to the user at the front of the machine. It accepts envelopes containing documents for deposit, bill payment, and check cashing.

After a customer keys in his personal identification number, presses a Deposit, Payment Enclosed, or Cash Check key, and keys the amount, the depository door opens. This allows the user to insert an envelope with his deposit into the depository slot. Deposits are placed in the deposit slot one at a time and are conveyed into the depository drawer just beneath the depository unit. This drawer is accessible only when the service door at the rear of the 3614 is open.

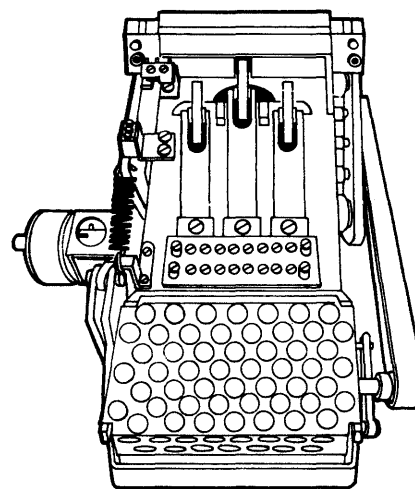

Depository, Internal Machine View

OPERATOR/CE PANEL

The operator/CE panel is used by both you and the service representative to operate or service the 3614. With the switches, display, and panel lamps, you can:

- Determine whether the 3614 is operating correctly.
- Display the 3614 bill count or reset it to zero (for both feed mechanisms on Models 11 and 12).
- Enter configuration information that gives the 3614 identification.
- Enter or clear the keys.
- Enable or disable a remote control and indicator panel (if one is attached).

A number (numeric decal) in the upper right corner of the operator/CE panel designates the version level of the particular machine. Machines not at Version 3 level do not have a version number on the panel.

A brief description of the various controls and indicators follows. Detailed instructions for using these controls are included in subsequent sections.

Caution: Whenever the service door is opened, check the display for AAAA. If this display is on, a customer transaction is in progress or a journal statement is being printed. Wait until the display changes to be sure that the motors do not start to run while the 3614 is being serviced.

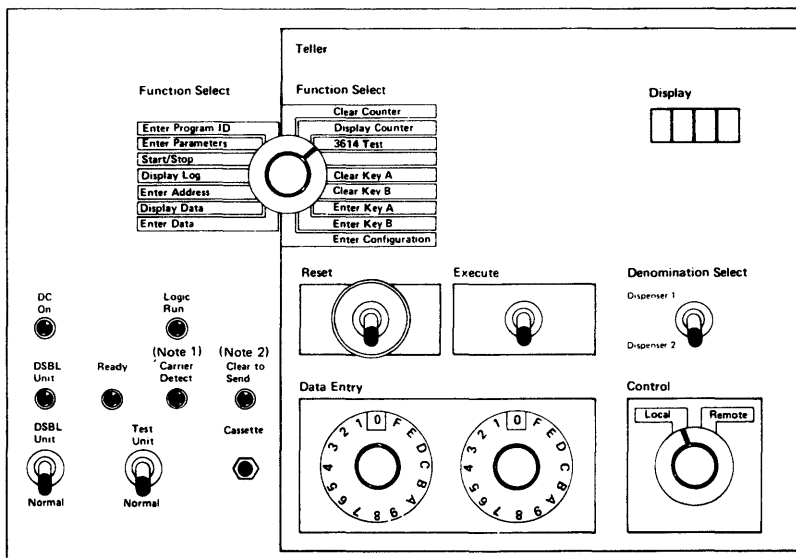

Note 1: Labeled RLSD on 600 BPS Remote Loop (WTC only).

Note 2: Labeled TSLD on 600 BPS Remote Loop (WTC only).

INDICATOR LAMPS

Power On

This lamp is lit when the 3614 has power.



Logic Run

When the 3614 is operating, the Logic Run lamp is on. (It will be off for several seconds after POWER ON.)



Transmit Signal Line Detect

This lamp position is labeled TSLD (Transmit Signal Line Detect) on all 600 bps remote loop attached World Trade Corporation 3614s. The TSLD lamp shows that the 3614 is ready to send data to the system computer.



Receive Line Signal Detect

This lamp is labeled RLSD (Receive Line Signal Detect) on all 600 bps remote loop attached World Trade Corporation 3614s. The RLSD lamp is on when the 3614 senses a clear connection to the system computer. When the lamp flashes, there are signal interruptions on the line.



Ready

The Ready lamp is used when the 3614 is connected to a 3601 Controller.

When the lamp is on, no communication problems exist. If it is flashing, or off, a communications problem does exist.



DSBL Unit

The DSBL unit lamp is on when the Disable Unit switch is in the DSBL (disable) position. See description of the Disable Unit switch.

The 3614 has this lamp if it is connected to a 3601.



Display

This 4-character display is used to check the data entered into the 3614. It also shows other data for your use in case of problems.



SWITCHES

Reset

The Reset switch is used by the machine operator during the start-up procedure and by the service representative while servicing the machine.

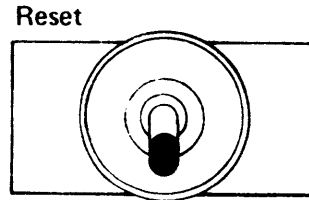

Execute

The Execute switch causes the 3614 to read the Function Select and Data switches on the panel and to take appropriate action.

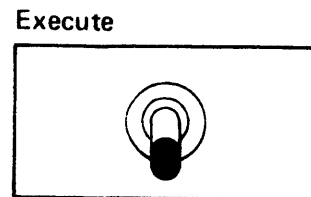

Control

The Control switch is used with a remote control and indicator panel (if one is installed on your system). See page GI-22 for a description of these functions.

In the Local position, machine power is controlled by the Power On/Off switch on the power panel. Controls on the remote panel (Test Unit, Disable, and Remote Power) are disabled when this switch is in the Local position. In the Remote position, machine power can also be controlled from the Power On/Off switch on a remote panel. This Control switch should be in the Remote position only if you have a remote panel.

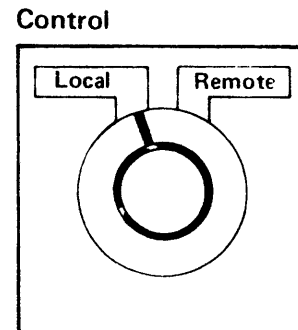

Cassette Jack

The cassette jack is used by the service representative for diagnostic purposes.



Data Entry

The two Data Entry rotary switches are used to enter data or control information into the 3614.

Data Entry

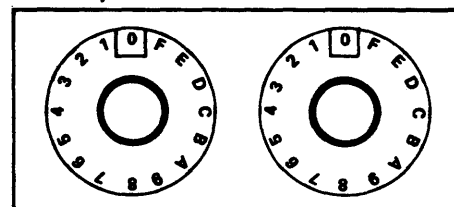

Disable (DSBL) Unit

The Disable (DSBL) switch removes the 3614 from the 3601 communications loop, it operates only when power is on (Power On/Off switch is set to On). When this switch is UP, the signals in the loop are bypassed around the 3614 and allow other terminals to function normally.



Denomination Select

This switch is installed only on the 3614 Models 11 and 12, dual document feed machines. Each of the two document feeds has its own counter to keep track of documents issued from the escrow. The switch is used in conjunction with Clear Counter or Display Counter positions of the Function Select switch. Set the switch to Dispenser 1 to reset or to display the counter value for dispenser 1. Set the switch to Dispenser 2 to reset or to display the counter value for dispenser 2.

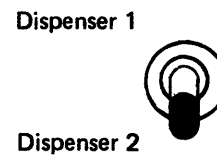

FUNCTION SELECT

The Function Select rotary switch is used to select various IBM 3614 functions. You will use the functions on the right side of the switch. The functions on the left side are used only by the service representative.

The Function Select switch is read by the 3614 each time the Execute switch is raised.

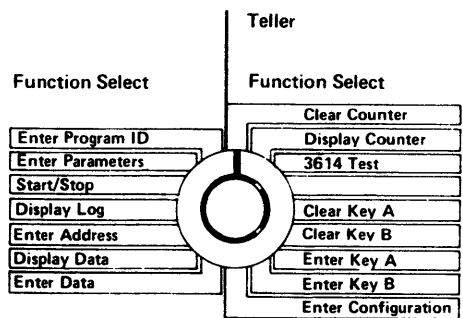

Enter and Clear Key Functions

The 3614 uses secret key numbers as a security measure to protect the 3614 from possible fraud. Key numbers are entered with the Data Entry switches.

Key numbers may be removed for security reasons under unique circumstances such as during certain maintenance procedures or as directed by each financial institution. When such key numbers have been cleared, it is your responsibility to re-enter any keys and restore normal operation.

Enter Key A

The Enter Key A position of the Function Select switch is used to enter or change Key A. Two characters are entered at a time by setting the Data Entry switches and raising the Execute switch. This is repeated until the key is entered. Complete details are given in the Operating Procedures (OP) section.

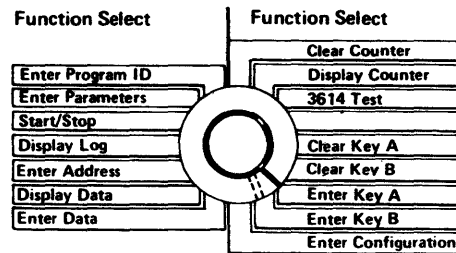

Enter Key B

Key B is entered the same way as Key A.

Clear Key A

The Clear Key A position of the Function Select switch is used to clear Key A by changing it to all zeros. After setting this switch to Clear Key A and raising the Execute switch, the 3614 will have cleared the key, and the display will show 00—.

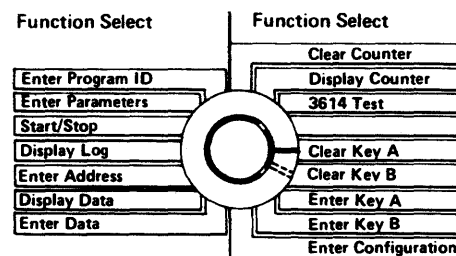

Clear Key B

Key B is cleared the same way as Key A.

Special Display

The unlabeled position of the Function Select switch can be used to display four characters which indicate a reason for the 3614 going closed. Raising the Execute switch will result in the following display:

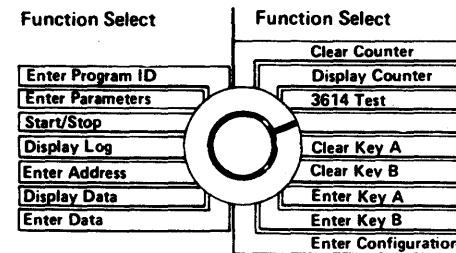
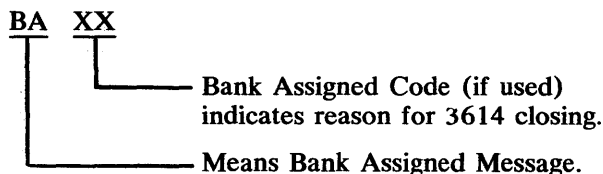

3614 Test

The 3614 Test position of the Function Select switch performs an automatic test which checks that the 3614 is ready to be opened for transactions. The test is started by the Execute switch.

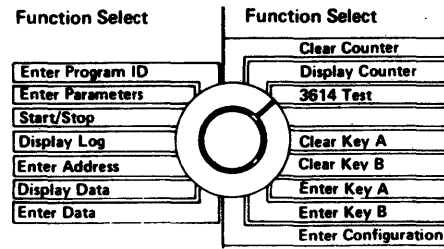

Enter Configuration

The Enter Configuration position of the Function Select switch, along with the Execute and Data switches, enters configuration data into the 3614. Further details are provided in the Operating Procedures (OP) section.

After the 3614 is installed, the configuration data characters should be recorded on the Enter Configuration label for convenient reference.

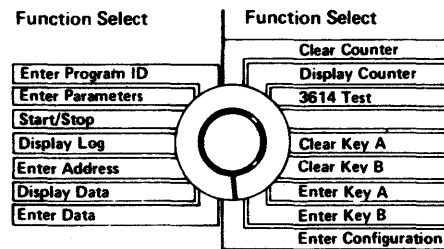

Display counter

The Display Counter position of the Function Select switch, with the Execute switch raised, displays the total number of bills issued since the counter was last cleared. Rejected bills or any bills fed by the 3614 Test are not counted. If you have a Model 11 or 12, use the Denomination Select switch to display the total number of bills issued from the selected dispenser.

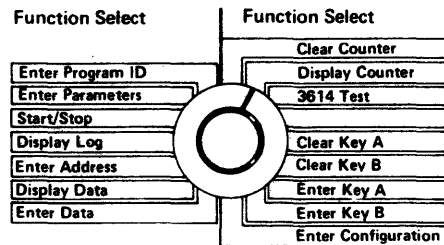

Clear Counter

The Clear Counter position of the Function Select switch, with the Execute switch raised, resets the bill count to zeros. If you have a Model 11 or 12, use the Denomination Select switch to clear each counter.

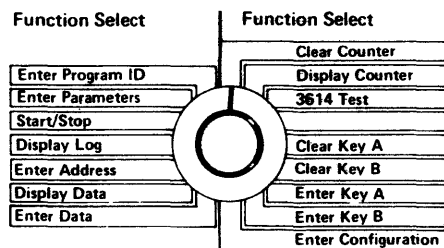

POWER CONTROL

Power Control Panel

The Power On/Off switch on the power control panel controls power for the 3614. It can remove power during periods of non-use of the 3614. With this switch Off, power is still supplied to a circuit that operates a fan and also charges two batteries. These batteries power a storage unit that contains Keys A and B, and the configuration data. This eliminates your having to re-enter key and configuration data every time power is removed. In the Model 2 and 12, power is also supplied to the heater and heat circulating fans when Power On/Off is Off.

The Emergency Disconnect switch is only used to shut off (down position) all power in the 3614. It should not be used for normal power control.

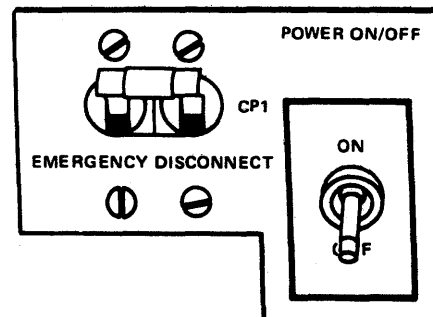

Alarm Test Panel (Model 2 or Model 12 Only)

The Alarm Test and Alarm Control switches on this panel provide a test of the penetration grid alarm. Follow your institution's instructions for use of the test panel, keeping in mind that the test circuit can activate alarm systems.

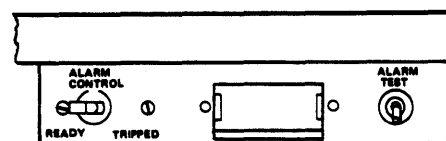

REMOTE CONTROL

Remote Controls and Indicators

The 3614 provides a connector to attach a cable for sending various indicator and control signals to a remote panel. IBM does not manufacture this panel, but it can be made by independent vendors. The design of the panel may vary depending on the institution's needs. Refer to *IBM 3600 Finance Communication System, Installation Manual — Physical Planning*, Form GA27-2766, for additional information.

Indicators

The following indicator and control signals are available at the connector:

Open	Indicates that the 3614 is opened for business.
Closed	Indicates that the 3614 is closed, not available for business.
Attention Required	Indicates that the 3614 needs operator action.
Cash Low	Indicates that only a small number of bills remain in the DFM hopper (either hopper if the machine is dual feed), and more should be loaded.
Busy	Indicates that a transaction is in progress. This indicator will remain on until the end of the time-out which follows each transaction, or during the protective window time-out period in the case of the 3614 Models 2 or 12.
Ready	Indicates that the 3614 is communicating with the 3601.
Forms Low	Indicates that only a small number of forms remain in the printer hopper and more should be loaded.

Alarms

Service Door Open	Indicates that the rear service door is open.
Grid Penetration	Indicates that the front of the 3614 has been penetrated or that the alarm is being tested.
Lock Switches	Indicate the status of 3614 Model 2 or 12 combination lock.

Controls

The following controls are operational only if the 3614 Control switch is placed in the Remote position (see GI-16).

Remote Power On/Off	Provides similar power control as the Power On/Off switch on the 3614 panel. This remote switch is interlocked with the service door switch to prevent power being turned on by the remote switch when the service door is open.
Test Unit	Provides the same function as the Test Unit switch on the operator/CE panel.
Disable	Provides the same function as the Disable switch on the operator/CE panel.

PROBLEMS

If your 3614 has a problem, it is important to determine the cause as quickly as possible. Some problems can be corrected by the operator, but others require the services of a service representative.

Problems can be divided into four types:

- A 3614 problem that you can correct.
- A 3614 problem that requires your service representative.
- A failure of the communication line network.
- A failure in another part of the local 3600 System.

The operator plays a key role in problem recovery. The problem recovery procedures in this guide can help you provide maximum service for your customers.

If a problem occurs in the 3614, there are several aids in the 3614 to help you correct the problem.

Sometimes a service representative is required. If so, after the problem has been corrected, you should verify proper operation with him. Reload the bills and enter the key and configuration data only after the machine is running properly.

The problem recovery procedures are found in the Problem Recovery (PR) section of this guide.

Operating Procedures

NOTES

HOW TO START UP YOUR 3614

Controls on the operator/CE panel and the ON/OFF switch on the power panel are used to open the 3614 for operation.

If you are not able to complete any part of this start-up procedure successfully, go to the Problem Recovery procedures on page PR-1, unless directed otherwise.

Note: In the following text, dashes (—) in the displays represent blank or dark characters.

1. Open the rear service door.
2. Turn the DSBL switch, if present, to Normal (down position). Turn the Power On/Off switch on the power panel to On (up position).
3. Raise Reset to allow proper start-up sequence.

A sequence of start-up displays should occur. Wait until these displays stop (as long as two minutes).

If the Display stops at — — — —, skip to step 7.

If the Display stops at 14 — —, proceed to the next step.

If the Display stops at any other value, go to PR-19, problem W, step 2.

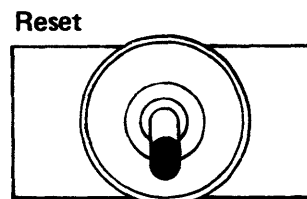
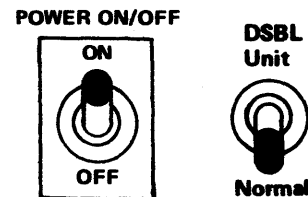

Display

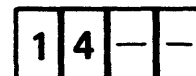

4. Enter Key A (8 pairs of characters). Keys A and B are known by your institution.

- a. Turn Function Select to Enter Key A.
- b. Set Data Entry switches to two characters of the required key.

Enter from left to right, for example:

00 - 2E - 3D - 4C - 5B - 38 - 5A - 9F

- c. Raise Execute.

Look at the display. The two rightmost characters are those you have just entered. If you make an error raise the Execute switch two or more times until the display shows — — — —, followed by 00 — —. This clears the key to all zeros. Start over (step 4b or 5b).

- d. Repeat steps "b." and "c." for each additional (7 more) pair of characters.
- e. Raise Execute once again. The display should show — — — —.
- f. Turn Function Select away from Enter Key or Clear Key positions to avoid clearing them by accident.

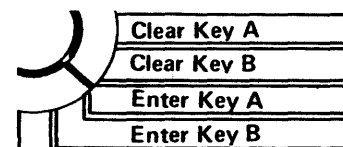

Data Entry

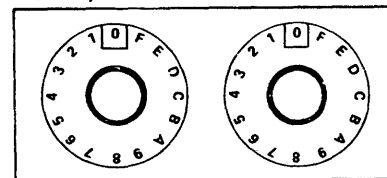

Execute

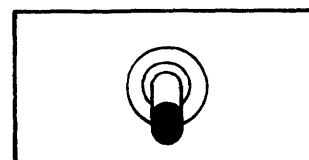

Display



OP - 2

5. Enter Key B (8 pairs of characters).
 - a. Turn Function Select to Enter Key B.
 - b. Repeat steps 4b through 4f (above).

Note: The rear door override switch must be in the "open" (in) status for Enter Key A or Enter Key B function. If an Enter Key A or Enter Key B function is executed with the door override switch out, an EE91 is displayed, and the key is not entered.

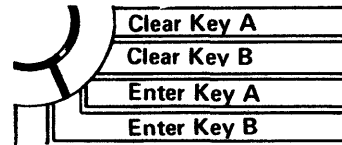

6. Enter configuration (three pairs of characters). This configuration is shown on the label next to the words Enter Configuration, and is assigned individually for each terminal. As an example, let us assume that the configuration for your terminal is "ABCDEF".

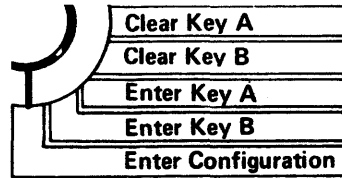

- a. Turn Function Select switch to Enter Configuration.
- b. Set the Data Entry switches to the first two characters (AB).
- c. Raise Execute. The display should show AB— —.
- d. Set the Data Entry switches to the second pair of characters (CD).
- e. Raise Execute. The display should now show ABCD.
- f. Set the Data Entry switches to the third pair of characters (EF).
- g. Raise Execute. The display should now show EF— —.
- h. Raise Execute again. The display should now show — — — — (all blanks) to confirm the right amount of configuration data.

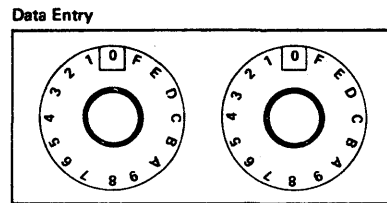

Execute

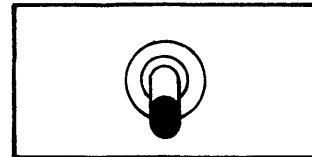

If a mistake is made at any point in the operation, raise Execute (one or more times) until the display shows — — — —. Start with step "a." again to enter correct configuration designation.

7. If you have not already reconciled your previous cash load, do so now. See page OP-8 for procedure.

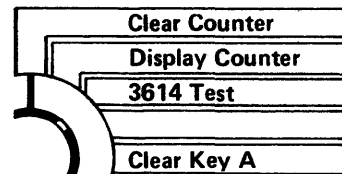

8. Reset the bill counter.
 - a. Turn the Function Select switch to Clear Counter.
 - b. Raise Execute. The display should now show 0000.
 - c. If you have a Model 11 or 12 machine, perform steps "a" and "b" separately for Denomination Select switch in position 1, and then in position 2.

Display

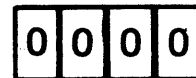

9. BILL PREPARATION - Inspect bills to be loaded.

Successful performance of the 3614 depends on the condition of the bills, through fanning, and proper loading. Remove all questionable bills.

a. New bills

Inspect for packing glue, damaged edges, and curled edges. New bills are especially subject to sticking together because of ink and moisture. Bend and twist the packet of bills to break down any tendency to stick together **1**. Feather the packet sidewise as shown **2** and fan all four edges twice **3** to be sure that the bills are not stuck together. Then, feather the bills lengthwise and fan all four edges again **4** as added assurance that all bills are separated.

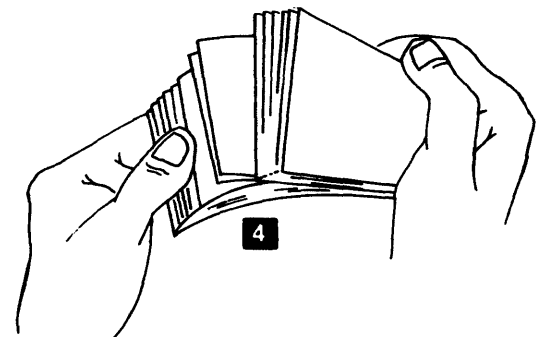
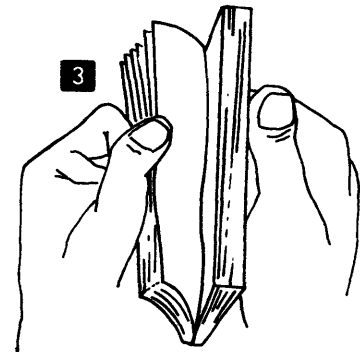
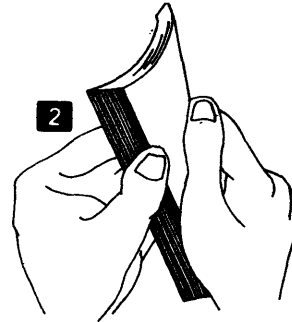
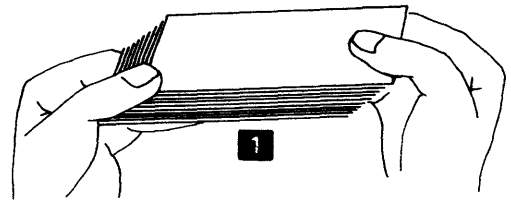

b. Used bills

Used bills require a very close inspection before they can be loaded into the 3614. They should be individually inspected for:

- Staples, pins, and paper clips
- Excessive wear (limp)
- Curled, torn, or folded edges
- Weak creases from folds
- Tears or other damage
- Tape, sticky contaminants, or moisture
- Holes larger than 1/16 inch (2 mm) diameter.

Bills having any of the above defects must be removed to ensure correct DFM and Escrow feeding.

c. Jogging of bills

A joggle plate is mounted on the inside surface of the door of lobby machines; a joggle fence is mounted on top of the lock cover of the service door of the through-the-wall machines. These joggle surfaces provide for jogging and squaring bills prior to loading. These surfaces are also used for joggling printer statements.

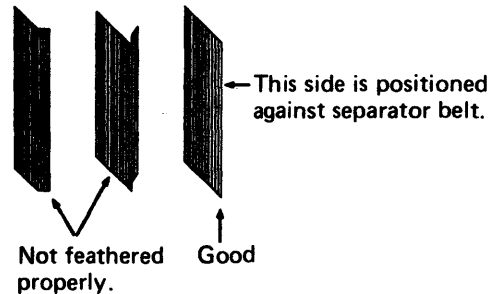

10. DFM HOPPER LOADING

This description is written in terms of the single document feed mechanism (DFM); however, loading the dual DFM for the 3614 Models 11 and 12 is similar. When loading the dual DFM, unlatch the document feed gate and swing it out for access to the feed nearest the front of the machine. (refer to GI-10 and GI-12). Be sure to load the proper denomination of bills into the correct hopper.

Note: *The Swiss 50 Franc note is the largest Swiss denomination which may be loaded into hopper 1. An exception to normal loading (largest denomination into hopper 1) may be made which allows Swiss 100 Franc notes to be loaded into hopper 2.*

- a. Record the number of bills that are to be loaded for later reconciliation (see page OP-8).
- b. Before loading the DFM hopper, prepare the bills as described in preceding step 9. **Proper bill preparation is essential to prevent jams and misfeeds.**

Bills must be loaded with warp or curled side (if any) toward the feed area as shown. The feed area is adjacent to the pinch-point **3**.

- c. Load the DFM hopper as follows:

- Step 1.** Raise the billguide **2**. (Models 1 and 2 only).
- Step 2.** Raise the bill restraining finger **1**. Move the hopper weight **4** away from the feed area.
- Step 3.** Insert one bill in the pinchpoint **3**.
- Step 4.** Place 25 - 50 more bills against the feed switch arm **5**. The bills must follow the curve of the dispenser as shown.
- Step 5.** Lower the bill restraining finger **6**. Feather 150 - 200 more on the sloped surface against the 25 - 50 already loaded **8**.
- Step 6.** Continue loading the hopper with the remaining bills. The bills should be vertical at the feed area, and the top edge should lean slightly away from the feed area as the distance from the feed area increases **10**. **DO NOT PACK TIGHTLY.**
- Step 7.** Lower the billguide **7**. (Models 1 and 2 only).
- Step 8.** Move the document weight **9** to the bills so that they are held in place but **NOT COMPRESSED.**

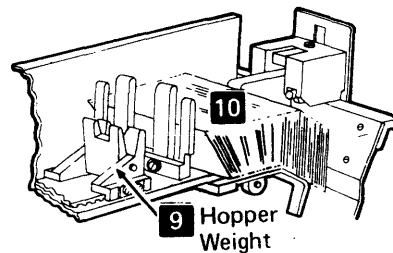
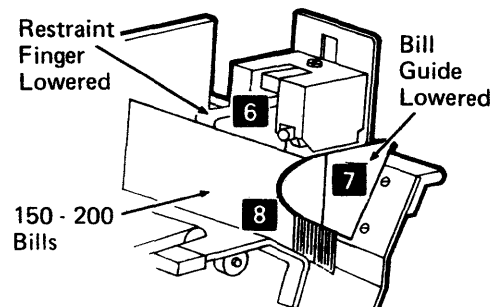
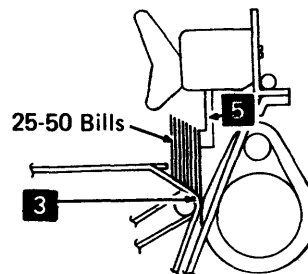
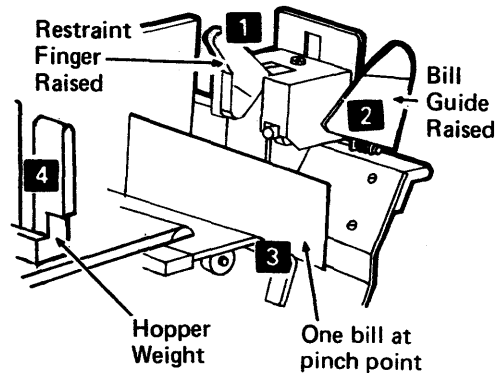
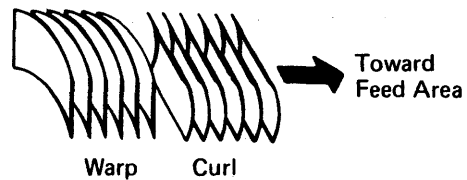

11. Check that the document feed mechanism (single or dual) and the escrow unit are clean and that the DFM gate is closed and properly latched. Be sure that the card reader is latched in place at the front of the 3614.
12. If you have a transaction statement printer, be sure that its hopper is loaded with statement cards. See OP-9 for hopper loading.
13. Perform the 3614 Test. This test automatically checks circuits and mechanical functions of the machine.

- a. Turn the Function Select to 3614 Test.
- b. Raise Execute.
- c. The test should begin with --AA in the display.

If the display does not show --AA, turn to page PR-1 and follow the instructions.

Note: *The mechanical checks include moving 10 bills down each document feed path, through the escrow unit, and into the reject bin. If a printer feature is installed, a statement is printed and dispensed with the currency. If a deposit feature is installed, the deposit flap is opened and closed.*

- d. If a problem is found by the test, a problem number (EEXX) is shown in the display. If this happens, try the 3614 Test up to 4 more times - two or three feed errors may occur after currency is first loaded. If still unsuccessful, turn to page PR-1 and follow the instructions.

If no problem is found during the test, the display will show COC0. Verify that the above noted mechanical checks were performed.

- e. If the statement printer feature is installed, retrieve the printed statement from the retain bin and check for clear printing and centering on the card. The printed statement card should look similar to the one shown at the right. If printing is not good, turn to page PR-17.

- f. After the 3614 Test has been successfully completed, close and lock the service door. The system computer should now open the 3614 for transactions.

- c. one or more transaction tests should be performed before your customers use the machine (see page OP-6).

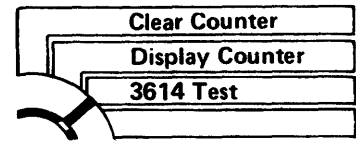

Execute

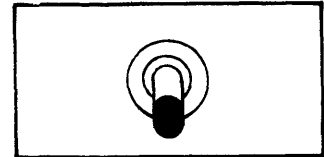

Display

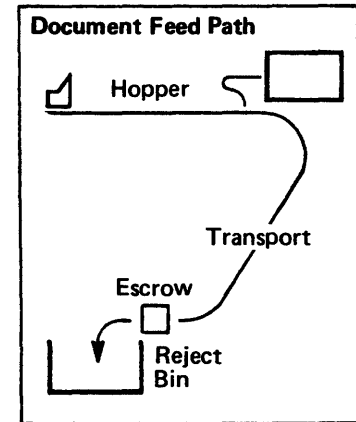

Display



Display

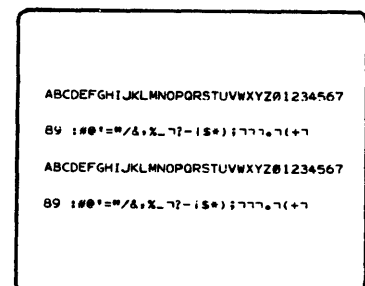
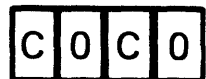

Printed Statement Card

OP – 6

14. Transaction test

The transaction test using a test identification card simulates a customer transaction. It verifies that the correct keys and configuration data were entered, and the 3614 is operating correctly.

One of the tests performed should be a cash withdrawal transaction in the amount equal to the bill denomination which has been loaded (one bill). If you have a Model 11 or 12 machine, request the amount of the smaller denomination; then request the amount of the larger denomination which has been loaded. It is important to verify that the amount issued is the same as the amount requested.

A transaction test may be programmed by the institution to keep the protective window of the Model 2 or 12 open and provide time to replace the customer area lamp as described on pages PR-9A and PR-9B.

If the 3614 does not open or you are unable to perform the tests, go to the problem recovery procedures on page PR-1.

- a. Be sure the service door is closed and locked.
- b. Examine the keyboard area in the front of the machine. Is it clean? Is the OPEN sign on? Is the customer lamp turned on? Is the protective window clean (Model 2 or 12 only)?
- c. Perform the Transaction Tests provided by your institution. Refer to pages GI-7 through GI-9 for the description of a typical transaction.
- d. Store the test card and handle the money as instructed by your institution.

HOW TO SHUT OFF YOUR 3614

1. Follow the procedure set by your institution to advise the system computer that you are going to CLOSE your 3614.
2. Open the rear service door.

Caution: Whenever the service door is opened, check the operator/CE panel display for AAAA. If this display is on, a customer transaction is in progress or a journal statement is being printed. Wait until this display is gone to be sure you do not interrupt a customer transaction.

3. Remove all cash and perform the cash reconciliation (see page OP-8).
4. Remove all cards from the card holding bin.
5. Position the power control switches as indicated in one of the following boxes:

- DSBL switch to DSBL Unit (up position) and then Power On/Off switch to OFF (down position).
- Power On/Off switch to OFF (down position).
- DSBL switch to DSBL Unit (up position).

The correct box should have been marked by your institutional representative when the 3614 was installed.

6. Close and lock the service door.

Display

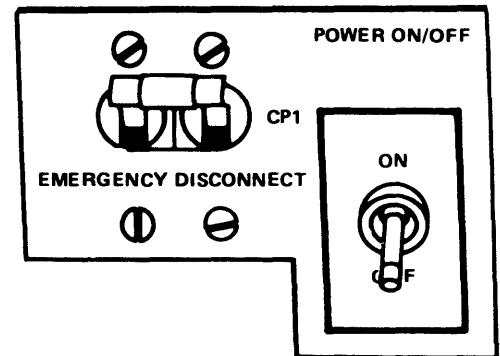

DSBL
Unit



Normal

HOW TO RECONCILE YOUR CASH

This method of cash reconciliation is a sample procedure for use until your institution develops its own. (On dual DFM, record for each hopper.)

1. Record the number of bills that were initially loaded into the hopper.
2. Turn the Function Select to Display Counter. (On dual DFM, set the Denomination Select to Dispenser 1 or 2.) Raise Execute. Record the number shown in the display. This is the number of bills issued, up to 9999.
3. Empty the reject bin (to the left of the escrow unit), count the number of bills, and record the number. (On dual DFM, sort bills by denomination and count separately.)

Note: Any transaction statement in the retain bin is an indication that the customer's statement was not delivered to him. All transaction journal (feature) statements are printed and then retained in the retain bin. Such transaction statements should be removed and processed in accordance with your institution's procedures.

4. Slide the document weight to the left, lift the bill restraint finger and billguide, then remove the bills from the hopper. Count and record the number. (Count for each hopper on dual DFM.)
5. Remove the bills from the separator throat area by following the jam removal procedure on page PR-11. Count the bills and record the number. (On dual DFM, sort the bills by denomination and count separately.)
6. Add the numbers in steps 2, 3, 4, and 5.
7. Compare this figure with the number of bills loaded at the start (step 1); they must be equal. If you are consistently unable to reconcile your cash and you suspect a machine problem, call your service representative (see page PR-20).

When you reload the 3614, be sure to record the number of bills loaded on a new reconciliation sheet.

	DFM 1	(DFM 2)
INITIAL LOAD		
TOTAL		

OPERATIONS MAINTENANCE

Printer Hopper Loading

The Transaction Statement Printer uses IBM System/3 type cards. If the hopper becomes empty, the printer is disabled. To load the hopper with more printer statement cards, perform the following steps:

1. Open the service door.
2. Remove the card weight from the hopper.
3. Grasp a handful of cards from the supply box and fan them with the other hand to keep them from sticking together.
4. Place the cards, edges down, on the flat joggle plate surface (see OP-3) and joggle them to align card edges.
5. Carefully place cards in the hopper, face down with the top of the card toward the printer exit rolls.
6. Repeat steps 3 through 5 until the hopper is full.
7. Gently tap exposed edges of the cards so that they are uniformly lined up.
8. Replace weight on top of cards in the hopper, close the service door, and resume operation.

Note: To avoid damage to feed rolls, a minimum of 10 cards should be in the hopper before replacing the card weight.

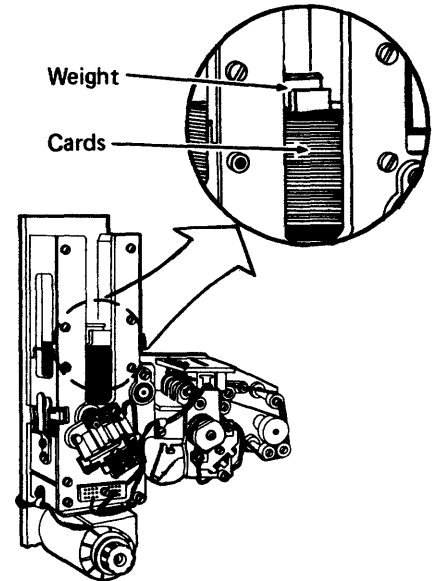

Depository Envelope Unloading

At time intervals specified by your institution, plan to retrieve envelopes that have been deposited. Open the rear service door. Remove the depository drawer lock(s) if included in your 3614. Push the safety latch to the right and slide the depository drawer to the rear of the unit for removal of envelopes. After removing the envelopes, slide the depository drawer back to the closed position and close the rear service door of the unit.

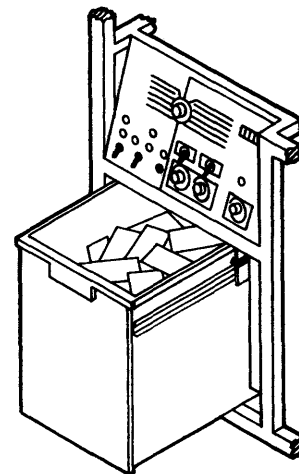

Printer Ink Cartridge Replacement

The printer ink cartridge should be replaced when needed for clear printing. The printer ink cartridge replacement is a customer responsibility; the cartridge may be purchased from an IBM Branch Office (IBM part number 433894). Open the service door of the machine for access to the print unit. Lower the ink cartridge bracket by moving the bracket down and to the right. Lift out the used ink cartridge, remove the metal shaft, and discard the used cartridge. Unwrap the new ink cartridge, insert the metal shaft, install the cartridge in the ink cartridge bracket, and raise the bracket to operating position. Be sure that the wide side of the shaft end is flat in the bottom of the ink cartridge bracket when the bracket is closed. After replacing the ink cartridge, perform the 3614 Test Procedure (PR-1) and check the test statement card for clear printing. Close the service door and resume normal operation.

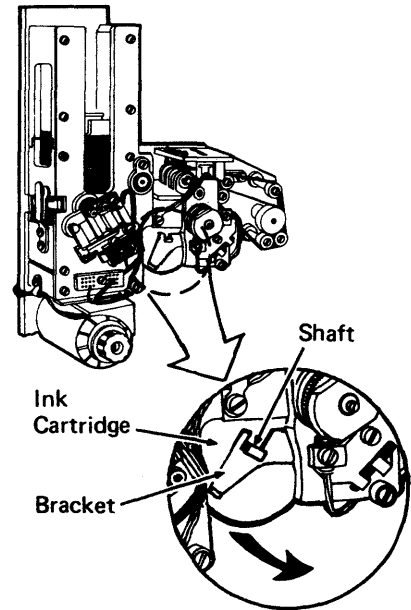

Penetration Alarm and Battery Test

If you have a 3614 Model 2 or 12, your institution should establish a time and procedure for use of the alarm test panel. Keep in mind that the test circuit can activate alarm systems.

The Control switch is normally in the Ready position unless the Test switch has been raised or a penetration has been attempted. Proper operation can be tested by raising the Test switch and observing that the Control switch changes from Ready position to Tripped position. If the Control switch fails to change, the battery should be replaced. When the battery first fails to cause a tripped condition, there is still enough power in the battery to activate alarm conditions. After any test, be sure to reset the Control switch to Ready position.

Replacement batteries may be purchased from IBM under part number 1165663. Two types of battery holding assemblies are used. One type unit has battery terminals as part of the battery holder, and the second type unit has the battery terminals at the ends of two wire jumpers.

For the unit having the terminals as a part of the battery holder, the used battery is easily removed by pushing the battery out of its holder toward the center of the machine. Remove the seal from the end of the new battery and slide it back into its holder. It does not matter which end of the battery is on the right or left. Slide the right hand end into the guide first and press to the right. Then, slide the left end into the battery holder.

The second type battery holder requires that the battery be pushed out of its holder toward the center of the machine before the terminals can be snapped off the ends of the used battery. Remove the seal from the end of the new battery, snap the battery terminals onto the new battery, and slide the battery back into its holder.

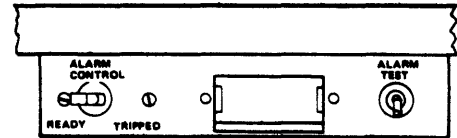

OP – 12

Protective Window Cleaning (Model 2 or 12)

The back side of the protective window for the 3614 Model 2 or 12 should be cleaned periodically. Remove, clean, and reinstall the window as follows:

1. Open the rear service door of the 3614.
2. Turn off power to the 3614.
3. For easier access to the front panel T-handle locking bolt, unlatch and swing out the DFM gate.
4. Reach in to the T-handle locking bolt (Figure 1) just above the card reader unit, and turn it counterclockwise at least six full turns (this releases the front cover and allows it to swing out on its hinges).

Note: A detent prevents the front cover from swinging out prematurely.

5. Go to the front of the 3614, grasp the front cover at the card reader opening and swing it open (Figure 2). Lift the staybrace out of its storage channel, and lock the front cover open (Figure 2).
6. Lift the window rail latch handle (Figure 3), pivot the bottom of the right guiderail to the right, and lift the protective window out of the 3614 (Figure 3).
7. Clean both sides of the window with a mild detergent and a soft cloth. Do not use rough or abrasive cleaners. Rinse and dry thoroughly.
8. Slide the window back into place. Be sure the stud on the window lift mechanism fits into the slot at the top rear of the window (Figure 3).
9. Pivot the right guiderail back to its vertical operating position and push the rail latch handle down into the locked position.
10. Restore the cover staybrace into its storage channel and close the front cover. Push the front cover in firmly.
11. Return to the rear of the 3614.

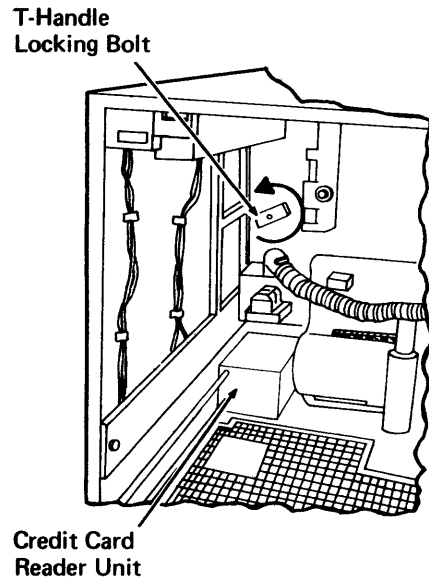

Figure 1

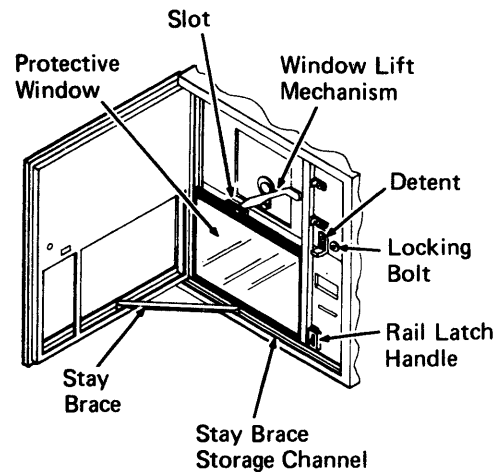

Figure 2.

12. Push in on the T-handle locking bolt as you start to turn it clockwise and continue turning the T-handle until the front cover is tight.
13. If opened, pivot the DFM gate back to the latched operating position.
14. Turn on the 3614 power.
15. Close the rear service door of the 3614 for normal operation.

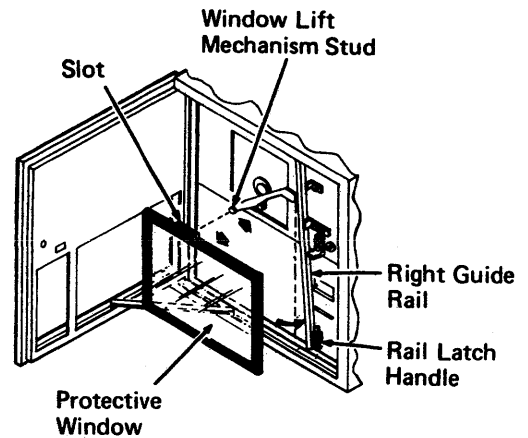
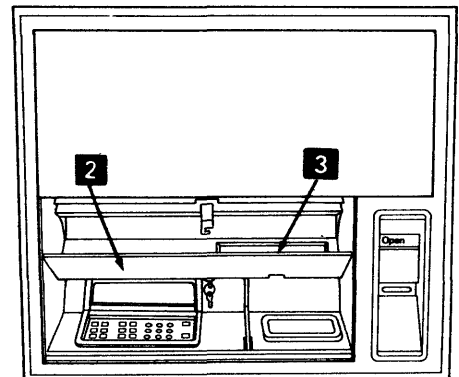
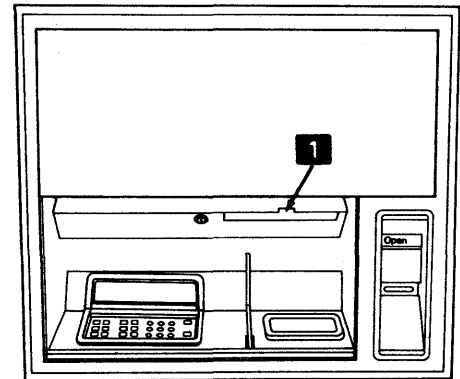

Figure 3

Envelope Holder Loading (Optional Feature)

1. If the 3614 is a Model 2 or Model 12 (through-the-wall), insert the magnetic card needed to open the protective window and gain access to the envelope holder. If you wish to load the envelope holder from the top, the special lamp key is needed for the customer area lamp cover.
2. Envelope loading can be accomplished by either of two methods as follows:
 - a. If the lamp key is not readily available, insert envelopes a few at a time by pushing them up into the envelope holder opening **1**.
 - b. Use the lamp key to unlock the lamp cover and envelope holder **2**. Insert the key into the keyhole near the center of the cover, support the cover to prevent it from falling, turn the key, and gently lower the cover.

Lift the envelope weight **3** and fill the holder with envelopes (approximately 75). Install the weight, close the cover, and lock it.
3. For Models 2 or 12, remove the magnetic card.



Display Hood Servicing (Model 2 or 12)

The guidance display screen hood is provided with all 3614 through-the-wall models. The hood reduces sunlight glare for easier viewing of the displayed message. The hood also provides additional message security to the user by reducing the ability of anyone else to observe the displayed message. The display hood can be easily removed for cleaning, or it can be removed if its function is not required.

The display hood mounts within the keyboard-display bezel; the customer can adjust it for best individual viewing of the display message. To remove the hood, insert the blunt end of a pencil into the pivot pin hole on the right side of the keyboard-display bezel. Press the pin to the left until it is free of the pivot hole and slide the hood out of the bezel.

Clean the display hood with a mild detergent and a soft cloth. Do not use rough or abrasive cleaners. Rinse and dry thoroughly. The display window may be similarly cleaned while the display hood is removed.

To install the display hood, put the left pivot pin into the pivot hole on the left side of the keyboard-display bezel. Then, press the right pivot to the left until it clears the inside of the bezel and slide the hood into position with both pivot pins in the pivot holes.

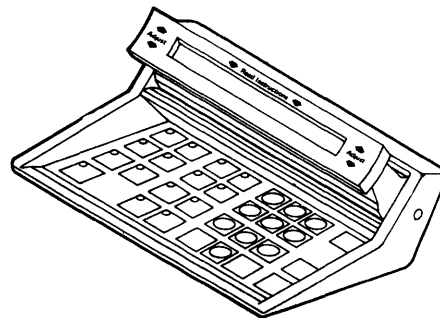
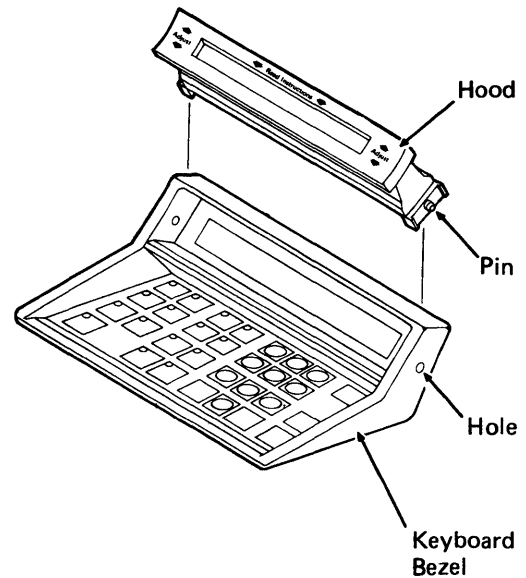

Hood Mounted in Bezel

Problem
Recovery

NOTES

PROBLEMS — START

Power Problems

If power fails to turn on, make sure that the power cord is plugged into a good power outlet. Turn the control switch to Local, and attempt to turn power on. If power does come on with the control switch in Local position, but does not in the Remote position, then check the remote panel Power On/Off switch status. If power still fails to turn on, call for service (see page PR-20).

3614 Test Procedures

1. Open the rear service door to the operator/CE panel. If the display shows AAAA, a customer transaction is in progress or a journal statement is being printed. Wait until the display changes.
2. Turn Function Select to 3614 Test.
3. Raise Execute.
4. Observe the display. It should show --AA during the test, followed by one of the codes described below.
5. This test feeds ten bills from each DFM hopper into the escrow retain bin and tests various circuits and functions. If the printer feature is installed, a receipt is printed, and if the depository feature is installed, the deposit flap is opened and closed.

If C0C0 display is shown, no problem was detected. If the 3614 is connected for loop operation, the Ready lamp should remain on continuously to verify proper loop operation. Verify that the preceding mechanical operations were performed, turn to PR-3 for further instructions.

If an EEXX display is shown, an error was found (XX = any numbers). Turn to page PR-2 and follow instructions.

If a 14 -- is shown, it may be the result of an incorrect configuration designation having been entered. Re-enter the configuration designation (refer to OP-2) and return to step 2 above. If a 14 -- is shown a second time, turn to page PR-20 and follow instructions.

If the display does not show either C0C0 or EEXX, turn to page PR-8 and follow instructions.

If the display shows C0C0, but some mechanical operations were not performed, re-enter configuration designation (OP-2) and rerun the test.

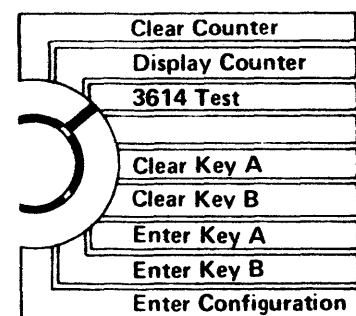

Execute

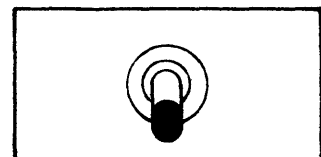

Display



Display

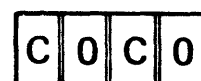

PROBLEMS — 3614 TEST

Note: Look up the number shown in the display. An abbreviated problem description and the needed corrective action is shown. If more information is needed, go to the referenced page. In some cases, there is no problem resolution that you can take, so you will have to call your service representative.

Error Display	Problem and Corrective Action	Reference Page	See Problem
EE11	Key B is zero. Enter correct key (see OP- 1). If still EE11, call your service representative.	PR- 20	
EE12	Key B is incorrect. Enter correct keys (see OP- 1).	PR- 14	S, Step 3
EE13	Key A has not been entered. Enter correct key (see OP- 1). If still EE13, call your service representative.	PR- 20	
EE21	Card Reader jam. Clear the jam.	PR- 13	Q
EE22	Clean card reader path and photocell	PR-13	Q, Step 1
EE23	You will be unable to correct this problem; call your service representative.	PR-20	
EE41	Printer statement card jam.	PR- 18	V
EE42	Printer statement cards out.	OP- 9	
EE43	Printer error. Check hopper; rerun test.	PR- 18	V
EE51	Any DFM photocell is dark. Remove obstruction or clean lamp or cell.	PR- 11	N, Step 3
EE52	Inadequate cash supply in single DFM or dual DFM hopper 2. Reload the DFM hopper.	OP- 4	
EE53	Escrow jam. Clear bill reject and feed paths.	PR- 12	P
EE54	Protective window won't open or close (Model 2 or 12).	PR- 6	F
EE55	Depository jam.	PR- 17	U
EE56	Bill feed error. For single DFM machines, be sure configuration byte is correct. Clean feed path, check for jam or loading problem. Rerun test several times before calling for service representative.	PR- 11	N
EE57	Escrow jam. Remove jam at stacker or reject bin.	PR- 12	P
EE58	Cash Issue gate is open or there is Depository jam.	PR- 12 or PR- 17	P, Step 3 U
EE59	Inadequate cash supply in dual DFM hopper 1. Reload the DFM hopper.	OP- 4	
EE5B	Inadequate cash supply in both dual DFM hoppers. Reload the DFM hoppers.	OP- 4	
EE91	Service door switch.	PR- 13	R
EE92	Service door switch	PR- 13	R
EE93	Clean feed paths and photocells; rerun test. If still EE93, call your service representative.	PR- 11 PR- 20	
EE94	Keyboard error. Check for debris, vandalism – rerun test. If still EE94, call your service representative.	PR- 20	
EE95	3614 Test was attempted with DFM gate unlocked. Close and lock DFM gate.		

PROBLEMS NOT FOUND BY THE 3614 TEST

1. Read the problem descriptions.
2. Find the most correct problem description and go to the referenced page. If there is another similar problem, try it next.

Problem Description	Go to Page	Problem Identity
3614 does not open (for transactions).	PR-4	A
3614 closes during normal business hours.	PR-4	B
Transaction takes too long or too many bills are being rejected.	PR-5	C
System computer or remote indicator panel signals Intervention or Attention Required.	PR-5	D
Card Reader does not take card or returns it with no action.	PR-6	E
Protective window does not open or close properly (Model 2 or 12).	PR-6	F
3614 issues no bills, damaged bills, or not enough bills to customer.	PR- 7	G
Keeps customer's card.	PR-7	H
Power goes off and does not come on, or DC ON lamp is off.	PR-7	J
3614 often resets and repeats a start-up.	PR-8	K
Customer area lamp failure, 50 Hz.	PR- 9B	L
Interior service lamp failure, 50 Hz.	PR - 10B	M
Document feed mechanism (DFM) jam. (Refer also to PR- 19, Problem X.)	PR-11	N
Document jam in escrow unit.	PR-12	P
Card reader jam.	PR-13	Q
Service door problem.	PR-13	R
Communication problem.	PR-14	S
Freezing weather condition.	PR-15	T
Depository jam removal.	PR-16	U
Printer not printing properly. Printer jam removal.	OP-10 PR-17	V
Start-up problems.	PR-19	W
Curled or warped bills not feeding properly.	PR-19	X

PROBLEM RESOLUTION

A. The 3614 Does Not Open for Transactions

1. Examine the operator/CE panel indicator lamps. If the Logic Run lamp does not turn on within a few seconds after power on, see page PR-20.

If Ready lamp is off or flashing, see page PR-14, problem S, step 4.

If RLSD lamp or TSLD lamp is off, see page PR-14.

If RLSD lamp is on or flashing and TSLD lamp is off, re-enter key and configuration data (see page OP-1). Turn Power On/Off switch to Off, then back On. If problem continues, see page PR-20.

2. Bills may be damaged or improperly loaded.
Reload bills, test, and attempt to open (see page OP-3).
3. Operator/CE panel display keeps changing (see page PR-8).
4. Possible communication problem with 3601 or system computer.
Be sure the DSBL switch (if present) is a Normal (down position).
Call system operator and make sure the system connection is good.
5. Key or configuration data may be wrong.
Re-enter correct keys and configuration data (see page OP-1, 2).
6. Possible depository jam or hardware malfunction (see page PR-16).
7. If you cannot resolve the problem, see page PR-20.

B. The 3614 Closes During Normal Business Hours

1. Check for Special Display code meaning (see page GI-19).
2. A jam or dust may be in the card reader or bill feed path.
Clear all feed paths (see pages PR-11, 12, 13). Run 3614 test, then make a test transaction.
3. If you are unable to resolve the problem, see page PR-20.

C. Transactions Take Too Long or Too Many Bills Are Being Sent to the Reject Bin

1. Bill condition is poor, or the hopper is not loaded correctly.
Remove bills and reload (see page OP-3, 4).
2. Jam or dirt may be in the bill feed path.
Clear the jam and clean the photocells and lamps, as shown on PR-11.
3. If you are unable to resolve the problem, see page PR-20.

D. System Computer or Remote Control and Indicator Panel (If Installed) Signals Intervention or Attention Required. May Also Signal Cash Low or Statement Cards Low.

1. Not enough bills in the 3614.
Load more bills (see pages OP-3, 4).
2. Not enough statement cards.
Load more statment cards.
3. A jam or debris may be clogging the card reader, bill feed path, or printer path.
Examine each feed path, clear jam, remove debris (see pages PR-11, 12, 13, 17).
4. Key A has not been entered (see page OP-1).
5. If you are unable to identify a problem, see page PR-1.
6. If you are unable to resolve the problem, see page PR-20.

PR – 6

E. The Reader Does Not Accept the Customer Card, or Does Not Accept the Customer Personal Identification Number, or Returns The Card With No Action

1. Possible vandalism or dirt.

Remove dirt (sticks, gum, etc.) from card reader slot and card reader, then clean read head with wipes (see page PR-13).

2. Card reader slot or card reader may be frozen due to weather conditions.

Turn to page PR-15.

3. The 3614 is CLOSED for transactions.

It must be OPEN to operate; see Operating Procedures section. If unable to Open, see problem A, page PR-4.

4. Card may be damaged or invalid.

If card is still in the 3614, open service door and remove card. Follow your institution's procedure for handling damaged or invalid cards.

5. Key A may be incorrect.

Notify the host computer operator of your intentions and re-enter keys (see page OP-1).

6. If you are unable to resolve the problem, turn to page PR-20.

F. Protective Window Does Not Open or Close Properly (Model 2 or Model 12 Only)

1. Possible vandalism, damage, or dirt. Advise your security officer if there is obvious vandalism.
2. Door may be frozen shut due to weather conditions.

See page PR-15.

3. The 3614 is CLOSED for transactions.

To OPEN, see page OP-1.

4. If you are unable to resolve the problem, see page PR-20.

G. The 3614 Either Issued No Bills or Damaged Bills to the Customer

1. Jam or dirt may be in the bill feed path.
Clear all feed paths (see PR-11, 12).
2. The issue slot may be jammed by dirt or debris.
Check and clear the cash issue gate; see page PR-12.
3. Cash issue gate may be frozen shut because of weather conditions.
See page PR-15.
4. Defective bills in hopper or incorrect loading.
Remove bills and reload, as shown on page OP-3.
5. If you are unable to resolve the problem turn to page PR-20.

H. The 3614 Keeps the Customer's Card

1. Card is invalid, damaged, or stolen.
Open service door and remove the card from the reader. Follow your institution's procedure for handling damaged, invalid, or stolen cards.
2. The card reader may be jammed.
Clear jam and clean the reader (see page PR-13), then run the transaction test on page OP-6.
3. Key A may be incorrect.
Notify the host computer operator of your intentions and re-enter Key A (see page OP-1), then run the transaction test on page OP-6.
4. If you are unable to resolve the problem, see page PR-20.

J. Power Goes Off and Does Not Come On, or DC ON Lamp Is Off

1. No input power (Is the 3614 Power switch on?).
Be sure the 3614 power cord is plugged into the receptacle. Check with maintenance that the building power is on.
2. If you have a remote control and indicator panel, the problem may be there.
Turn Control to Local on the operator/CE panel.
If the power comes on, the remote panel is the problem.
3. If you are unable to resolve the problem, turn to page PR-20.

PR – 8

K. The 3614 Often Resets and Repeats a Start-Up

1. There are several problems that can make the 3614 reset (to 0000) and repeat a start-up sequence or stick in a repeating series of operator/CE panel displays. If the series stops at 12— —, 14— —, or — — — — (all blanks), go to step 2. In all other cases go to step 3.
2. Incorrect configuration data or intermittent power source.
 - a. If lights inside the 3614 and/or in the building flicker when the reset/start-up sequence starts, the power source is faulty. Contact building maintenance personnel.
 - b. Configuration data may be in error. Re-enter configuration (OP-2) and return to interrupted procedure.
 - c. If problem persists, turn to PR-20.
3. Machine malfunction. If the display continues to change or stops at a display different than those above, turn to PR-20.

L. Customer Area Lamp Failure — 50 Hz Power 3614s

Note: This page is to be used with machines having 50 Hz power only. PR-9A and PR-10A pages are for 3614s using 60 Hz power, and are removed by the Technical Newsletter which provided this page.

If the keyboard area remains dark when the 3614 is OPEN, the lamp assembly should be replaced. Lamp replacement and purchase is a customer responsibility. Use a new IBM lamp, PN 1707265, or an equivalent lamp. The IBM lamp (PN 1707265) may be purchased from an IBM Branch Office or Parts Distribution Center. Replacement steps will vary depending upon whether the 3614 is a 3614 Model 2 or Model 12 (through-the-wall), and depending upon whether a depository envelope holder is installed. The key for the lamp cover is needed. For the 3614 Model 2 or Model 12, a special magnetic card is also needed to open the protective window.

3. If the 3614 is a Model 2 or Model 12 insert the card into the card slot. The protective window will open so you can reach the lamp cover.
4. Insert the lamp key in the keyhole on the underside of the lamp cover.
5. Support the cover to prevent it from falling, turn the key and lower the cover gently. For machines having the depository envelope holder, the customer lamp cover latch must also be moved to lower a second access cover (Figure 1).

Note: While the lamp cover is open, all power to the lamp assembly is turned off and the lamp can be safely replaced.

6. Grasp the lamp firmly and pull it forward until the contact prongs are clear of the sockets. The lamp can now be lowered out of the fixture.

Caution: During this operation, avoid rapid or excess motion that could break the lamp against the metal covering.

7. To install the new lamp, reverse the procedure just completed and enter the contact prongs into the right side of the sockets; then push them into place until the lamp rests against the sockets. *Do Not* move the lamp to the left after inserting.
8. For machines having the optional depository envelope holder, raise and latch the upper access cover. Lift the lamp cover into place and check that the lamp turns on as the cover reaches its normal position. If the lamp does not come on, turn to page PR-20.
9. Turn the key to lock the cover in place, and remove the key. If you have a 3614 Model 2 or Model 12, then remove the magnetic card. Check that the protective window comes down after the card is removed.

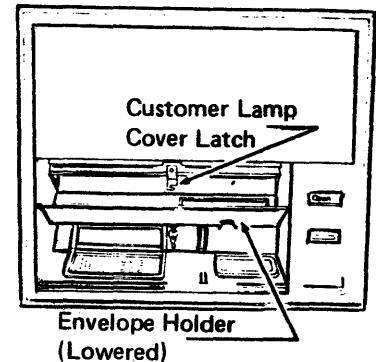

Figure 1

M. Interior Service Lamp Failure — 50 Hz Power 3614s

If the interior service lamp fails to turn on when the 3614 rear service door is opened, the lamp must be replaced. Lamp replacement and purchase is a customer responsibility.

The IBM lamps (PN 1707265 or PN 4160028) may be purchased from an IBM Branch Office or Parts Distribution Center.

Always replace the lamp assembly with a new IBM lamp assembly PN 1707265 for 240 V machines, or PN 4160028 for 110 V machines, or an equivalent lamp.

1. Loosen the two thumb screws and lower the lamp cover.
Note: Power is automatically removed from the lamp as the cover lowers.
2. Grasp the lamp firmly and pull forward until the contact prongs are clear of the sockets.
3. Reverse the removal procedure and enter the contact prongs into the right side of the sockets and push them up into place until the lamp rests against the sockets.
Do Not move the lamp to the left after inserting.
4. Raise the cover and tighten the two thumb screws. The lamp will turn on as the cover closes. If the lamp does not come on, turn to page PR-20.

N. Bill Jam in the Document Feed Mechanism (DFM)

This description is written in terms of a single document feed mechanism (DFM) machine; however, jam removal is similar for the dual DFM machine, except that the feed mechanism gate must be opened and swung out for access to the feed nearest to the front of the machine.

DANGER

Keep your hands and clothing away from all belts and the stacker wheel when any drive motors are running or if AAAA (TRANSACTION IN PROCESS) is shown in the display window.

1. Separator throat jam or last bill removal.
 - a. If only the last bill is to be removed, go to step "f."
 - b. Lift the bill restraint finger **3**.
 - c. Squeeze and move the document weight **1** to the left.
 - d. Move all bills **2** to the left.
 - e. Turn knob **11** in a counterclockwise direction until bills are free of the transport belts; then remove the bills.
 - f. To remove the last bill from the pinch point (throat area) **4**, pull out on the spring loaded restraint arm stop **7**, push down on the restraint arm end and hold it against the small diameter portion of the stop, release the stop **7**, and remove the bill from the pinch point.
 - g. Release the restraint arm and check to be sure that the restraint arm stop snaps back to its original position.
 - h. If there is also a transport jam, continue to step 2; otherwise, skip to step 3.

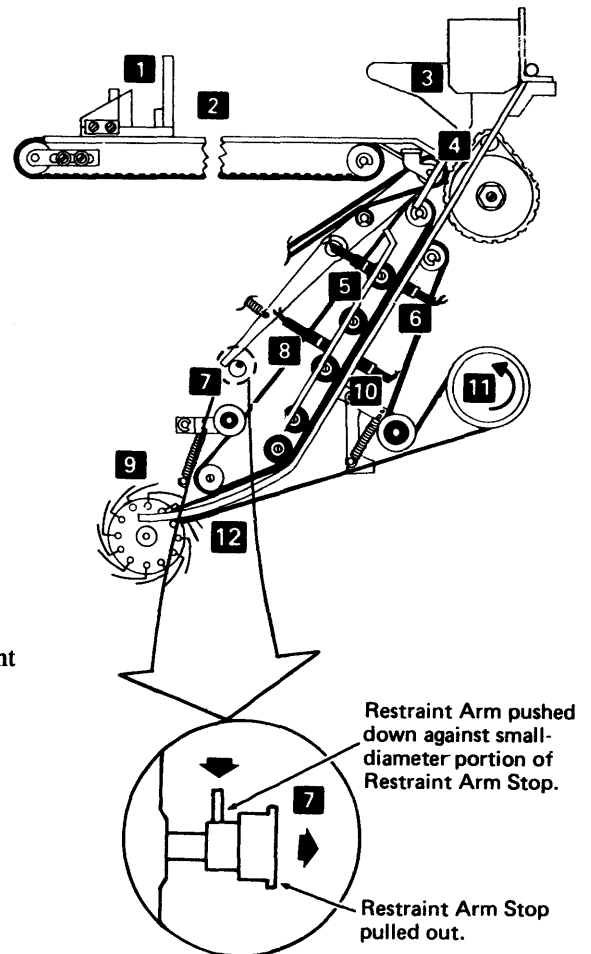

2. Transport jam (separator to stacker path).
 - a. With left hand, grasp the jammed bills.
 - b. With right hand, turn knob **11** as shown while pulling jammed bills toward stacker wheels **9** until the bills are free of the transport belts.
 - c. If the escrow unit is jammed, see page PR-12.

Note: If the jam is at the stacker wheel, turning the wheel may aid in removal.

3. Clean the lamps **8**, **5**, and the light sensors **6**, **10**, with a brush; also, clean the lamp and light sensor **12**, next to the stacker wheels. Wipe the entire path with a lint-free cloth. The brush and wipes are supplied by IBM.
4. Reload the hopper and run several 3614 Tests to check the operation. See pages OP-4 and OP-5 for load and test instructions. If bill jams continue, turn to page PR-20.

PR - 12

P. Document Jam in Escrow Unit

If you are not able to remove the jam as specified below, call your service representative (see page PR-20).

1. Turn Function Select switch to the blank position below the 3614 Test. This prevents unintentional machine start up or altering of machine data.
2. Escrow unit to retain bin jam.
 - a. Remove jammed document carefully from area **2**, or area above retain bin.
 - b. Go to step 4 on page PR-11.
3. Escrow unit to cash issue gate jam.
 - a. Operate the latch **3** and carefully swing out the entire document feed mechanism (DFM).
Note: The card reader must be in its normal (forward) position.
 - b. Remove jammed bills carefully.
 - c. Swing the DFM all the way forward into the 3614 and latch it in place.
 - d. Go to step 4 on page PR-11.
4. Cash issue gate jam.
 - a. Repeat steps 3a and 3b (above).
 - b. Remove any jam or debris from the cash issue gate **1**.
 - c. Repeat steps 3c and 3d (above).

Function Select

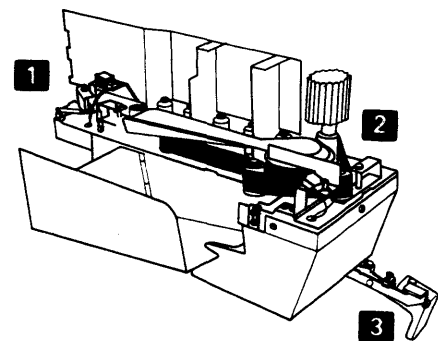
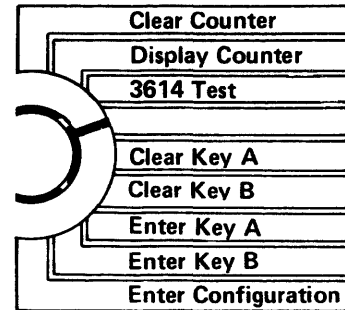

Q. Card Reader Jam

1. Open the service door, unlatch and swing out the document feed mechanism (DFM).
 2. Locate the card reader **1** (left side).
 3. Press the release catch **8** and pull the reader to the rear of the machine.
 4. Press the card bed latch **2** and raise the card bed so the card path is exposed.
 5. Remove the card or other object that may have caused the jam.
 6. Clean the entire inside surface, including all small feed wheels **3**, using a lint-free wiper dampened with isopropyl alcohol. Clean the lamp **4** and remove all dust or particles from the small hole in the light sensor **7** with a brush. The wipers and brush are supplied by IBM.
- Caution: Do not clean the outside top of the card reader, as the switches may be damaged.**
7. The read/write head should be cleaned using the following procedure. Loosen thumbscrew **6** approximately four full turns (do not remove screw). Swing the head pressure spring clear of the head assembly **5**. The head can now be raised and wiped clean with a wiper dampened with isopropyl alcohol. Lower the head and secure in the reverse order.
 8. Close top of reader. Press down firmly on top of the latch **2** until lock is engaged.
 9. Push the reader forward as far as it will go. Be sure that the release catch **8** is latched.
 10. If card jams continue to occur and you suspect the card reader is not working correctly, turn on PR-20.

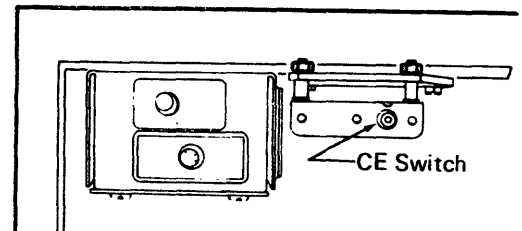
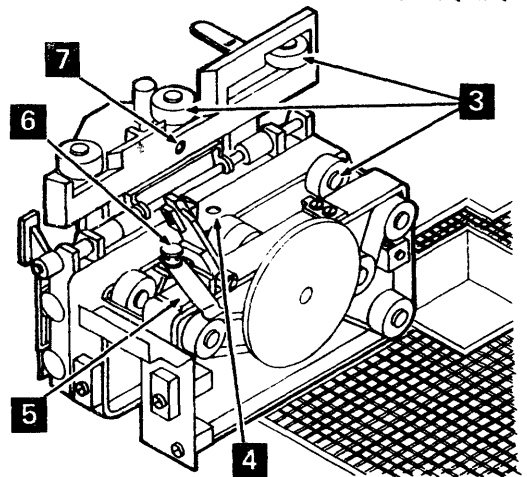
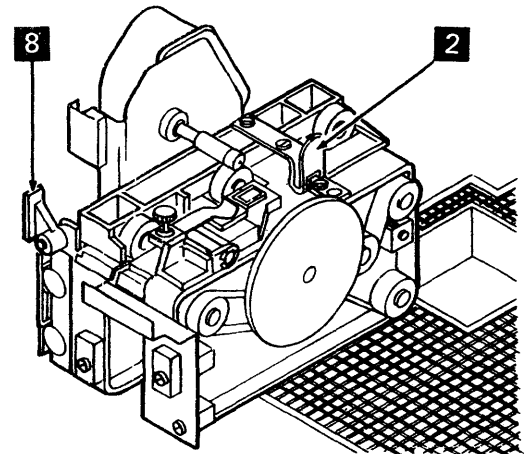
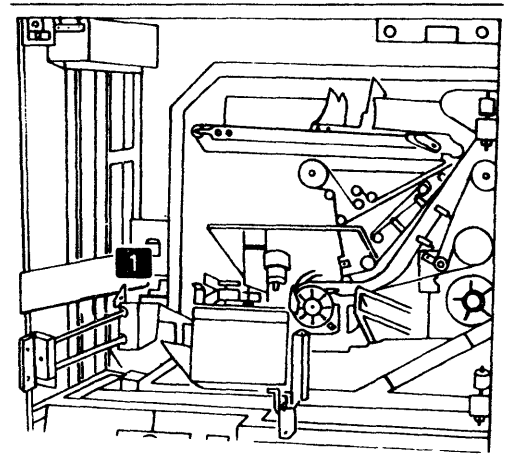

R. Service Door Problems

There are three switches mounted in the upper left corner of the 3614 that sense when the service door is open. The CE switch is normally pulled out by the service representative when he is testing the machine. When this switch is pulled out, the 3614 senses that the service door is closed. If it is pulled out, push it in, release it, and rerun the 3614 test.

An EE91 is displayed when an Enter Key A or Enter Key B function is executed with the door override switch out.

If an error number is still shown in the display, turn to page PR-20.

S. Communication Problems

1. If the TSLD or RLSD lamps are off, the problem is usually not in the 3614. Re-enter configuration data (see OP-2) and rerun the 3614 Test to verify the problem.

If no trouble is found, turn to page PR-20.

2. If the display shows EE12 and Key B has been entered correctly, the problem may be caused by incorrect keys in storage at the system computer. Call your system computer operator.

If no trouble is found, turn to page PR-20.

3. If the Ready lamp is off or flashing, a communication problem with the 3601 Controller may exist. Be sure that the DSBL switch is at Normal position (down). Call the control operator at the 3601 to verify that the 3601 was loaded using the proper IPL customer diskette, and is ready to communicate with its loop devices. When the 3601 is ready to communicate, the Ready lamp should be on and not flashing.

Note: For installations in Japan, see Addendum A-1 for special instructions.

If the Ready lamp continues to be off or flashing, refer to your IBM 3600 Finance Communications Systems Operating Guide (Form GA27-2776) for detailed Problem Recovery Procedures. Use the appropriate section of Problem Recovery Procedures depending upon the type of equipment you have:

- 3614 without RLSD lamp, but with DSBL Unit switch — refer to Local Branch Procedures.
 - 3614 with RLSD lamp and with DSBL Unit switch — refer to Remote Branch, 600-bps Remote Loop Procedures.
4. If still unable to determine the problem, turn to PR-20.

T. Freezing Weather Condition Failures

The 3614 Model 2 or Model 12 (through-the-wall) can operate in freezing weather; however, certain conditions can cause problems if the power to the 3614 has been cut off for extended periods.

The following conditions may cause problems if the power has been turned off:

- Exposure to rain followed by below freezing temperatures.
- Low building temperature (10°C to 15°C) when the outside temperature is below freezing and there is high humidity (above 70% RH) inside the building.
- Heavy snow melting on the 3614 followed by below freezing temperatures.

The parts of the 3614 that might be affected under the above conditions are:

- Protective window frozen shut.
- Issue slot frozen shut.
- Card lockout frozen shut.

Depending upon the severity of the frozen condition, it is recommended that the machine be allowed to warm up for as much as one hour. An attempt should then be made to achieve normal operation before trying to clear the frozen condition.

Frost or ice on the inside of the protective window may be removed after removing the protective window (refer to OP-12).

If power has not been off, the 3614 operations should not be affected. For more information on environmental requirements, contact your IBM physical planning representative.

PR – 16

U. Depository Jam Removal

If this 3614 does not have a depository and the 3614 Test gives an EE55 error, re-enter the configuration code (OP-2), and retry the 3614 Test. If the EE55 error still occurs, turn to PR-20.

Turn off power. The depository flap at the front of the 3614 should be closed, thus providing easier access into the open rear of the depository unit. Open the depository drawer located at the lower left side of the 3614. Verify that the depository is not full (most jam error indications will be caused by a full depository). If not full, turn power on, run the 3614 Test — if the error code still exists, call for service, see page PR-20. If the problem was caused by a full depository or was cleared by running the 3614 Test, replace the depository drawer, close the service door, and return to normal operation.

The depository drawer may be removed completely from the machine for cleaning or for better access to the bottom of the depository unit. To remove the drawer, push the safety latch to the right, and pull the drawer back until it stops. Continue to press the latch, raise the back of the drawer and slide the drawer off the guide rails. To replace the drawer, align the rollers (each side of the drawer) with the guide rails and push in until the drawer stops part way in. Lift the back of the drawer again and push in to get the rollers past the stop on the guide rails.

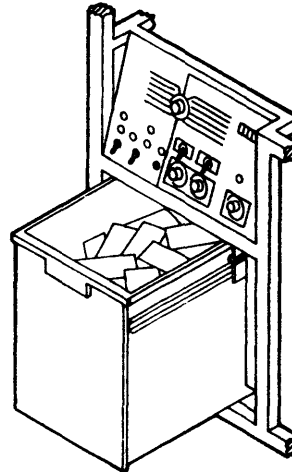

V. Printer Problems

Poor Printing (see page OP-10)

1. Ensure that ink cartridge **5** is in raised position.
2. Ensure that ink cartridge **5** is in good condition.
3. Ensure that statement cards **1** are good.

Jams

If the Transaction Statement Printer fails to eject a statement following a transaction, the problem is usually caused by a card jam at one of four areas — hopper, print station, post-print station, or serpentine path. Open the rear service door and turn off 3614 power. Visually check the printer to determine where a jam occurred.

1. Hopper Jam **1**.
 - a. Remove all cards from hopper.
 - b. Examine lowest card(s) and discard any that are bent or torn.
 - c. Examine hopper and remove any debris which contributed to card jam.
 - d. Manually turn the hand crank knob at the end of the motor shaft clockwise to be sure obstructions have been removed.
 - e. Reload hopper.
2. Print Station Jam **2**.
 - a. Lift the printer station card guide.
 - b. Remove the defective card.
 - c. Clear all debris from print area.
 - d. Turn the manual cycle knob on the end of the motor shaft clockwise to be sure that all obstructions have been removed.
3. Post-Print Station Jam **3**.
 - a. Remove the defective card from the station.
 - b. Look for the cause of the jam and clear all debris from this area.
 - c. Turn the manual cycle knob on the end of the motor shaft clockwise to be sure that all obstructions have been removed.
4. Serpentine Path Jam **4**.
 - a. Remove the jammed cards(s) from the pathway.
 - b. Look for the cause of the jam and clear all debris from this area.
 - c. Turn the manual cycle knob on the end of the motor shaft clockwise to be sure that all obstructions have been removed. Observe that belts ride on the center of rollers and realign, if necessary.

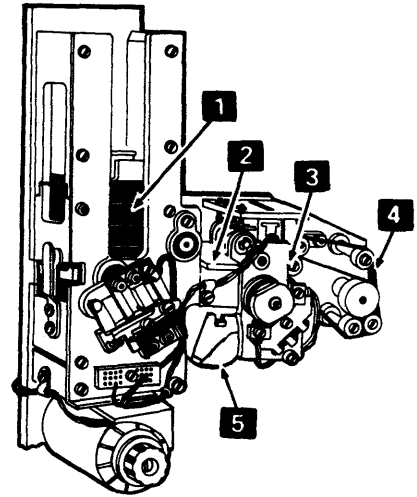

PR – 18

After clearing any jam, turn on power, and rerun the 3614 Test (PR-1). If no statement is printed, re-enter the configuration (OP-2) and rerun the test. If a problem still exists, call for service (see page PR-20).

W. Start-Up Problems

1. If the start-up display sequence stops and shows 14 — —, Key B must be re-entered. Turn to OP-1 and repeat the entire start-up procedure.
2. If the start-up display sequence stops and shows 12— — or 12XX (XX = any characters), the system computer may not be working the 3614 at this time. Contact your system computer operator if either display remains on for several minutes.

If the system computer cannot contact the 3614, turn to page PR-14.
3. If the display repeats 0000 and goes through the start-up sequence, go to Problem K, on page PR-8.
4. If the 3614 Test display shows other than EEXX or COC0, turn to Problem K (PR-8).
5. If the start-up sequence stops and some single number other than 14 — — or — — — — (all blanks) is displayed, re-enter Key A and Key B (refer to OP-1). Then, turn off power momentarily; turn the power on again and rerun the test. If the problem is not resolved, turn to page PR-20.

X. Curled or Warped Bills Not Feeding Properly

Excessively curled or warped bills which create bill feed problems (jams, skewed bills, or fail to feed) result from various conditions. Specific causes and corrective actions are as follows:

1. Stresses induced in the paper by manufacturing or printing processes, or as a result of incorrect packaging.
 - a. Sort out and do not use the curled or warped bills.
 - b. Straighten the bills at the time they are loaded into the DFM.
 - c. Report the problem to the supplier of the bills for corrective action.
2. Drastic and/or rapid changes in the climatic environment to which the bills are exposed will stress the paper and cause bills to warp. As an example, bills stored in a cool and/or humid environment (such as a bank vault) may warp excessively when moved into a hot and/or dry environment (such as a 3614 Model 2).
 - a. Straighten the bills at the time they are loaded into the DFM.
 - b. Maintain storage environment of bills to be used in the DFM at similar conditions as the DFM operating environment, or
 - c. Precondition bills to be used in the DFM by storing them for at least 48 hours in an environment similar to that of the DFM. Bills should be constrained to remain flat during preconditioning.

CALL FOR SERVICE

1. Check that all money has been removed from the 3614. You should have done a cash reconciliation when you removed the bills from the single or dual DFM and the reject bin (see page OP-8).
2. Complete a Trouble Report. The form is shown on page PR-21 and additional pads of these forms are available (GX26-1637-1).

It is especially important that this report be filled out accurately.

3. Call for service. For handy future reference, the telephone number is _____ (To be filled in when the 3614 is installed.)

IBM 3614 Trouble Report

Form No. GX26-1637-1 U/M 025
Printed in U.S.A.

Date: _____

Time: _____

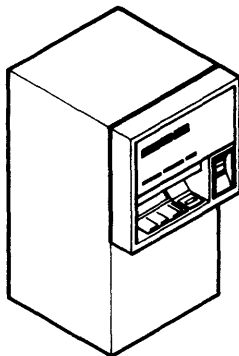

Facility Identification: _____

3614 Operator: _____

Power won't turn on.
(Is the power cord plugged into a good outlet?)

1. Write down the characters showing in the display after you have run the 3614 Test.

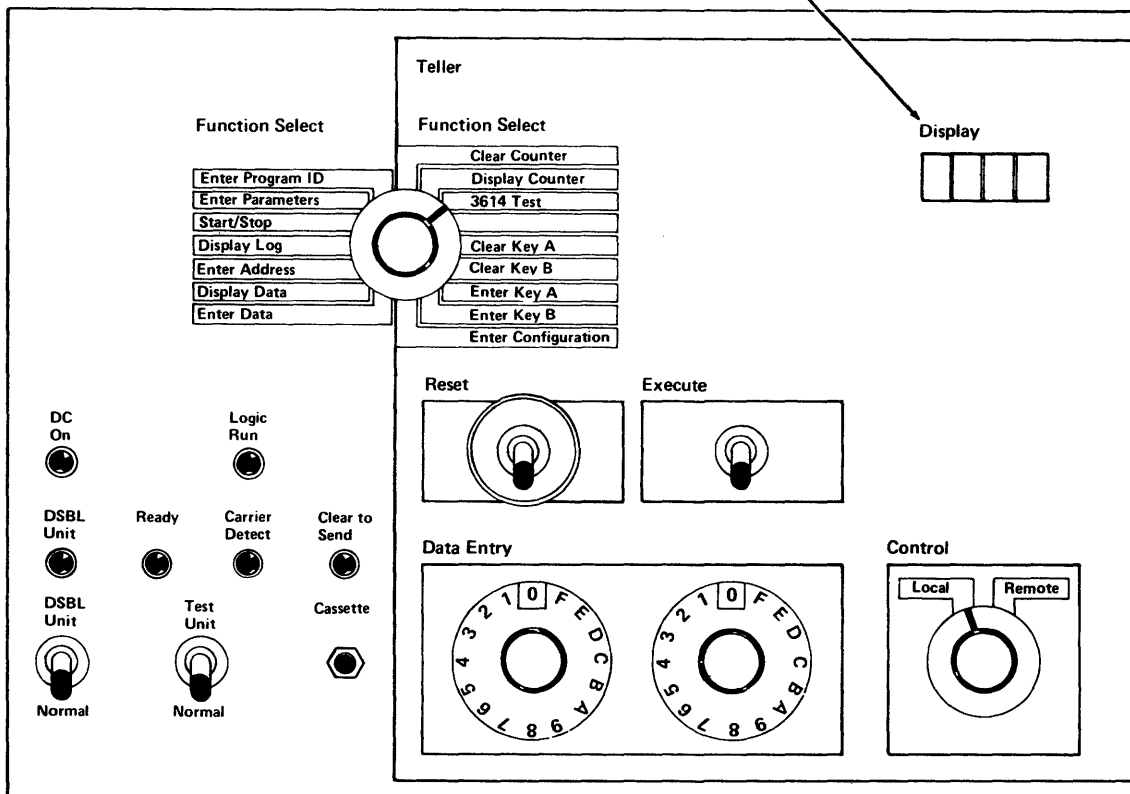

2. Mark an X over each lamp that is off and an F over lamps that are flashing (your machine may not have all the lamps).

3. Describe the problem and write down the problem number if known. _____

4. Give this report to the service representative.

SPECIAL INSTRUCTIONS FOR JAPANESE INSTALLATIONS

1. Before informing the 3601 Control Operator of your problem, make sure that all cables and connectors to the Nippon Telephone and Telegraph (NTT) facilities are in place and secure, that power to the NTT equipment (where applicable) is on and that all switches, etc. . . , are in the correct operating position. If your communications problem still exists, inform the 3601 Control Operator of your findings.
2. When this 3614 was installed, the installing CE was instructed to give to the customer two 4-pin test plugs, P/Ns 1864271 and 1864272. These test plugs were to be retained by you in a convenient place for future telephone company central office Wrap tests.

After reporting a communications problem to the telephone company, a telephone company service representative may ask you to unplug the 3614 Communications Cable from the connector where it attaches to the telephone line and install one of the special test plugs. The telephone company can then test their lines.

If the problem has still not been determined, turn to page PR-20.

INDEX

A

Access area GI-2
 correction key GI-5
Account balance GI-4
Account type
 description GI-5
 selection GI-5
Alarm test panel GI-21
Alarm, penetration grid GI-21
Attention Required PR-5
Audio tone GI-2,3

B

Batteries GI-21, OP-11
Bill count GI-20
Bill feed error PR-2
Bill jam
 Cash Issue Gate PR-12
 Document Feed Mechanism (DFM) PR-11
 Escrow Unit PR-12
Bill loading
 bill loading OP-4
 caution OP-4
Bill movement GI-8
Bills, inspection
 (see also inspecting bills)
 new bills OP-3
 used bills OP-3
 juggling of bills OP-3

C

Call for service PR-21
Cancel GI-5
 if pressed GI-5
 used to GI-5
Card reader
 access to GI-11
 how to use GI-11
 illustration GI-11
 purpose GI-11
Card reader jam PR-13
Cartridge replacement OP-10
Cash Check GI-4
Cash Issue Gate is open PR-12
Cash issue slot GI-1

Cash Low GI-12
Cash Out GI-12
Cassette Jack GI-16
Change key GI-6
Clear counter GI-20
Clear key GI-18
Clear Key A GI-19
Clear Key B GI-19
Clutch, safety GI-2
Communication problem PR-2
Communication problems PR-14
Communications loop GI-17
Control switch GI-16
Controller GI-15
Correction GI-3, GI-5
Corrective actions
 bill feed error PR-2
 Card Reader jam PR-2
 Cash Issue Gate is open PR-2
 communication problem PR-2
 customer door is open PR-2
 depository jam PR-2
 DFM photocell is dark PR-2
 escrow jam PR-2
 keeps customer's card PR-3
 Key B is incorrect PR-2
 Key B is zero PR-2
 keyboard error PR-2
 money is low or out PR-2
 power goes off PR-3
 printer error PR-2
 printer statement card jam PR-2
 printer statement cards out PR-2
 repeats a start-up PR-8
 service door switch PR-2
 start PR-1
 start-up PR-19
 3614 does not open PR-3, PR-4
 3614 closes PR-3, PR-4
Customer
 area lamp failure, 50 Hz PR-9B
Customer door
 does not close PR-6
 does not open PR-6
Customer door won't open or close PR-2
Customer use GI-2
Customer's card GI-1

D

Data entry
 enter control information GI-17
 enter data GI-17
 switches GI-17
Decimal point GI-5
Denomination Select GI-17
Deposit GI-4
Deposit Slot GI-3
Depository Envelope Unloading OP-9
Depository jam PR-2
Depository unit GI-13
DFM photo cell is dark PR-2
Disable (DSBL) unit GI-17
Display counter GI-20
Display hood servicing OP-14
Display screen GI-3
Document Feed Mechanism (DFM)
 access to GI-12
 bill loading OP-4
 danger PR-11
 hopper
 Cash Low GI-12
 Cash Out GI-12
 purpose GI-12
 stacker GI-12
 transport
 bill movement GI-12
 moving belts GI-12
 photocells GI-12
DSBL Unit lamp GI-15

E

Emergency Disconnect switch GI-21
Enter Configuration GI-20, OP-2
Enter control information GI-17
Enter data GI-17
Enter key GI-18
Enter Key A GI-19
Enter Key B GI-19
Envelope Holder Loading OP-13
Error display PR-2
Escrow jam PR-2
Escrow Unit
 access to GI-11
 cash issue door GI-11
 purpose GI-11
 reject bin GI-11
Execute switch GI-16

F

Failure
 customer area lamp, 50 Hz PR-9B
 freezing weather condition PR-15
 interior service map, 50 Hz PR-10B
Freezing weather condition PR-15
Function keys
 account GI-3
 transaction GI-3
Function Select
 clear counter GI-20
 clear Key A GI-19
 clear Key B GI-19
 display counter GI-20
 enter configuration GI-20
 enter Key A GI-19
 enter Key B GI-19
 3614 test GI-20

G

Guidance display
 description of GI-3
 location of GI-3
 messages GI-3
 screen GI-2
Guidance, customer GI-2, GI-3

I

Indicator lamps
 descriptions GI-15
 display GI-15
 DSBL unit GI-15
 logic run GI-15
 power on GI-15
 ready GI-15
 remote GI-22
Inspecting bills
 new bills OP-3
 used bills OP-3
Install, 3614
 inside GI-1
 outside GI-1
Interior service lamp, 50 Hz PR-10B
Intervention Required PR-5

J

Jams

card reader PR-13
cash issue gate PR-12
Document Feed Mechanism (DFM) PR-11
Escrow Unit PR-12
reject bin PR-12
separator throat PR-11
transport PR-11

K

Key A has not been entered PR-2
Key B is incorrect PR-2
Key B is zero PR-2
Keyboard GI-1
 account GI-3
 amount GI-3
 keys GI-2
 lights GI-2
 transaction GI-3
Keyboard error PR-2

L

Lamp

area lamp failure PR-9B
interior service PR-10B
Lamps (see indicator lamps)
Locations, internal units GI-10
Logic run lamp GI-15

M

Magnetic stripe GI-1
Magnetically-coded card GI-2
Message GI-1
Money is low or out PR-2

N

Numeric entry GI-5

O

OK

indication of GI-6
use of GI-6
OK key GI-3, GI-6

Operator/CE panel

brief description GI-14
cassette jack GI-16
how to use GI-14
indicator lamps
 carrier detect GI-15
 clear to send GI-15
 display GI-15
 DSBL unit GI-15
 logic run GI-15
 power on GI-15
 ready GI-15
 RLSD GI-15
 TSLD GI-15

switches

cassette jack GI-16
clear counter GI-20
clear key GI-18
clear Key A GI-19
clear Key B GI-19
control GI-16
data entry GI-17
disable (DSBL) unit GI-17
display counter GI-20
enter configuration GI-20
enter key GI-18
enter Key A GI-19
enter Key B GI-19
execute GI-16
function select
 reset GI-16
 3614 test GI-20

P

Panel

alarm test GI-21
clutch, safety GI-2
display GI-2
power control GI-21
protective GI-2
Payment Enclosed GI-4
Payment from Account GI-4
Penetration grid alarm
 control GI-21
 remote control GI-22
 test GI-21, OP-11
Personal number GI-1
Photocells GI-12
Plastic card GI-1
Power GI-21
 batteries GI-21
 DC ON lamp is off PR-7
 does not come on PR-7
 emergency disconnect switch GI-21

goes off PR-7
on/off switch GI-21
remote GI-22
3614 shut down OP-7
Power control panel GI-21
Power goes off PR-3
Power on lamp GI-15
Power on/off switch GI-21
Printer hopper loading OP-9
Printer problems PR-17
Problem descriptions PR-2
Problem recovery
 aids GI-24
 communication line GI-24
 part of 3600 GI-24
 philosophy GI-24
 requires assistance GI-24
 start-up PR-22
 you can correct GI-24
Problem resolution (see also corrective action) PR-2
Problems, 3614 (see corrective actions)
Procedure
 bill loading OP-4
 how to reconcile cash OP-8
 how to shut down OP-7
 how to start OP-1
 inspecting bills OP-3
 transaction test OP-6
Protective window cleaning OP-12

R

Ready lamp GI-15
Receive line signal detect GI-15
Retain bin GI-11
Remote Control
 alarms GI-22
 grid penetration GI-22
 attachment of GI-22
 connector GI-22
 controls GI-23
 Disable GI-23
 Remote Power On/Off GI-23
 test unit GI-23
indicators
 Attention Required GI-22
 Busy GI-22
 Cash Low GI-22
 Closed GI-22
 Open GI-22
 Ready GI-22
 Service Door Open GI-22
Report, trouble (3614) Reset switch PR-21
Reset switch GI-16

S

Safety clutch GI-2
Service door problems PR-13
Service door switch PR-2
Special display GI-19
Special transaction GI-4
Startup problems PR-3
Switches
 cassette jack GI-16
 control GI-16
 data entry GI-17
 denomination select GI-17
 disable (DSBL) unit GI-17
 emergency disconnect GI-21
 execute GI-16
 function select GI-18
 power on/off GI-21
 remote GI-22
 reset GI-16

T

Through-the-wall model GI-2
Track-3 GI-11
Transaction description
 chaining GI-8
 collect cash GI-9
 enter identification GI-7
 insert card GI-7
 key in amount GI-9
 select account GI-8
 select transaction GI-8
Transaction test OP-6
Transaction type
 description GI-4
 selection GI-4
Transactions
 business GI-1
 does not open PR-4
 special GI-1, GI-4
 start GI-2
 take too long PR-5
 too many bills PR-5
 typical GI-7
Transaction statement printer GI-13
Transfer GI-4
Transmit signal line detect GI-15
Trouble report PR-21
Types, 3614
 Model 1 GI-1
 Model 2 GI-1
 Model 11 GI-1
 Model 12 GI-1

U

Units, internal GI-10
User console GI-2

W

Withdraw Cash GI-4
World Trade machine GI-16

3600 GI-1
 Finance Communication System GI-1
3601 GI-15
3614
 Attention Required PR-5
 Consumer Transaction Facility GI-1
 does not open PR-4
 closes, then opens PR-4
 how is it used GI-1
 how to reconcile cash OP-8
 how to shut off OP-7
 how to start OP-1
 internal units GI-10
 Card Reader GI-11
 Depository GI-13
 Document Feed Mechanism GI-12
 Escrow Unit GI-11
 Transaction Statement Printer GI-13
 Intervention Required PR-5
 issues damaged bills PR-7
 issues no bills PR-7
 keeps the customer's card PR-7
 Model 1 GI-1
 Model 2 GI-1
 Model 11 GI-1
 Model 12 GI-1
 ready for use GI-2
 repeats a start-up PR-8
 test procedure PR-1
 trouble report PR-21
3614 Test GI-20
3704 GI-15
3705 GI-15

Your comments, please . . .

This manual is part of a library that serves as a reference source for systems analysts, programmers, and operators of IBM systems. Your comments on the other side of this form will be carefully reviewed by the persons responsible for writing and publishing this material. All comments and suggestions become the property of IBM.

IBM 3014 CONSUMER SATISFACTION FACILITY OPERATOR'S GUIDE (THE NEW 3014-001) ROBERT MACLENSON and COMPANY LIMITED 0000-0000-0

Fold

Fold

Business Reply Mail
No postage stamp necessary if mailed in the U.S.A.

First Class
Permit 2078
San Jose
California



Postage will be paid by:

International Business Machines Corporation
Department A60
5600 Cottle Road
San Jose, CA 95193

Fold

Fold



International Business Machines Corporation
Data Processing Division
1133 Westchester Avenue, White Plains, New York 10604
(U.S.A. only)

IBM World Trade Corporation
821 United Nations Plaza, New York, New York 10017
(International)

Your comments, please . . .

This manual is part of a library that serves as a reference source for systems analysts, programmers, and operators of IBM systems. Your comments on the other side of this form will be carefully reviewed by the persons responsible for writing and publishing this material. All comments and suggestions become the property of IBM.

IBM 3614 Consumer Transaction Facility Operator's Guide (File No. S3/U-U8) Robert MacLennan and Company Limited GA66-0004-0

Fold

Fold

Business Reply Mail
No postage stamp necessary if mailed in the U.S.A.

First Class
Permit 2078
San Jose
California



Postage will be paid by:

International Business Machines Corporation
Department A60
5600 Cottle Road
San Jose, CA 95193

Fold

Fold



International Business Machines Corporation
Data Processing Division
1133 Westchester Avenue, White Plains, New York 10604
(U.S.A. only)

IBM World Trade Corporation
821 United Nations Plaza, New York, New York 10017
(International)

BM / Technical Newsletter

This Newsletter No. GN66-0009
Date 17 June 1977

Base Publication No. GA66-0004-0
File No. S370-08

Previous Newsletters None

3614 Consumer Transaction Facility Operator's Guide (With Expanded Function Feature Group)

© IBM Corp. 1977

This Technical Newsletter provides replacement pages for the subject publication. Original pages to be replaced by new pages are:

Front Page, Preface	PR-1 to 6
iii to vi	PR-9B, 10B
GI-1, 2	PR-13 to 16
GI-11, 12	
GI-15, 16	X-1 to X-4

Remove PR-9A, 10A without replacement.

A change to the text or an illustration is indicated by a vertical line to the left of the change.

Summary of Amendments

1. Revise pages to comply with Track-3 optional feature.
2. Identify responsibility for replacing lamps and sources for obtaining them.

Note: *Please file this cover letter at the back of the manual to provide a record of changes.*

IBM 3614 Consumer Transaction Facility Operator's Guide (File No. S370-08) *Printed in Great Britain by Robert MacLehose and Company Limited* GA66-0004-0



International Business Machines Corporation
Data Processing Division
1133 Westchester Avenue, White Plains, New York 10604
(U.S.A. only)

IBM World Trade Corporation
821 United Nations Plaza, New York, New York 10017
(International)