

The IBM logo consists of the letters "IBM" in a bold, white, sans-serif font, centered within a dark, textured square background.

Systems Reference Library

General Information — Binary Synchronous Communications

This publication describes the Binary Synchronous Communications (BSC) procedures in general terms. The major topics covered are: BSC concepts (including transmission codes and data-link operation), message formats, additional data-link capabilities, and planning considerations.

A comprehensive listing of all related publications and their abstracts is provided in the IBM Tele-Processing Bibliography, Form A24-3089.

PREFACE

This publication, intended as a general introduction to the subject, provides the reader with an overall view of the basic BSC transmission procedures as they pertain to the data link. It describes the capabilities and flexibility inherent in the standard BSC, as well as the additional options available.

For detailed information on implementation of BSC related to a specific machine or system, consult the component-description manual pertaining to the specific unit.

The users of this manual are cautioned that contents are subject to change at any time and without prior notice by IBM.

First Edition

Significant changes or additions to the contents of this publication will be reported in subsequent revisions or Technical Newsletters.

This manual has been prepared by the IBM Systems Development Division, Product Publications, Dept. 860, P. O. Box 12275, Research Triangle Park, North Carolina 27709. Address comments concerning the manual to this address.

CONTENTS

| | | | |
|--|----|---|----|
| INTRODUCTION | 5 | Message Sync | 18 |
| Communications Facilities | 5 | Pad Characters | 18 |
| Data-Link Concept | 5 | Timeouts | 18 |
| Point-to-Point Data Link | 6 | Transmit Timeout | 19 |
| Multipoint Data Link | 6 | Receive Timeout | 19 |
| BSC CONCEPTS | 7 | Text Timeout | 19 |
| Transmission Codes | 7 | Long Timeout | 19 |
| Operation of the Data Link | 7 | ADDITIONAL DATA-LINK CAPABILITIES | 20 |
| Error Checking | 10 | Transparent-Text Mode | 20 |
| VRC/LRC | 10 | WABT (Wait Before Transmit) | 21 |
| CRC-16 | 11 | ITB (Intermediate Block Check) | 21 |
| VRC/CRC-16 | 11 | Conversational Mode | 21 |
| CRC-12 | 11 | Switched-Network (Dial-Up) Operation | 22 |
| Data-Link Control | 11 | Fast-Selection Method | 22 |
| SYN--Synchronous Idle | 11 | PLANNING CONSIDERATIONS FOR BSC | 24 |
| SOH--Start of Heading | 12 | Planning for a Multipoint Data Communications Network | 24 |
| STX--Start of Text | 12 | Communications over Switched (Dial-Up) Facilities | 24 |
| ETB--End of Transmission | 12 | Communications over Voice-Grade Lines | 24 |
| ETX--End of Text | 12 | Situation | 24 |
| EOT--End of Transmission | 12 | Scope | 25 |
| ENQ--Enquiry | 12 | EBCDIC | 25 |
| ACK 0, ACK 1--Affirmative Acknowledgment | 12 | USASCII | 25 |
| NAK--Negative Acknowledgment | 12 | Six-Bit Transcode | 25 |
| DLE--Data Link Escape | 12 | Transparent Data | 25 |
| Alternating Affirmative Acknowledgments | 12 | Summary | 26 |
| MESSAGE FORMATS FOR BASIC OPERATION | 13 | Identifying a Code-Sensitive Channel | 26 |
| Headings | 13 | Recovery | 28 |
| Text | 13 | Communications over Wideband Channels | 28 |
| Point-to-Point Operation (with Contention) | 14 | APPENDIX: SYSTEM/360 INTERNAL PROCESSOR CODES | 29 |
| Multipoint Operation (Centralized) | 14 | Extended Binary-Coded-Decimal Interchange Code | |
| Additional Format Considerations | 16 | (EBCDIC) | 29 |
| Sync Patterns | 16 | American Standard Code for Information Interchange Ex- | |
| Character Phase | 18 | tended to Eight Bits (ASCII-8) | 30 |
| Bit Phase | 18 | | |



The Binary Synchronous Communications (BSC) procedures provide a set of well-defined "ground rules" for the synchronous transmission of binary-coded data. BSC expands the transmission capabilities of present and future Tele-processing facilities through its ability to accommodate a variety of codes for the transmission of data (i. e., EBCDIC--Extended Binary-Coded-Decimal Interchange Code, USASCII*, and Six-Bit Transcode). Also available is a Transparency feature that removes the usual code restrictions for control characters and permits transmitting various forms of raw data within the normal message format, including:

- packed decimal
- floating-point numbers
- specialized user codes
- machine-language programs

Using this unique feature, each transmitted character is treated only as a distinct "bit pattern" without any associated control significance.

In this system all data is transmitted as a serial stream of binary digits (zero bits and one bits--refer to Figure 1). These binary digits are used to encode the characters comprising each transmission-code set. The synchronous designation indicates that the active receiving stations on a communications channel (data link) are locked in step with the transmitting station through the recognition of a specified pattern ("sync pattern") at the beginning of each transmission.

These procedures incorporate the basic line-control characters necessary for data-link operation: SYN, SOH, STX, ETB, ETX, EOT, ENQ, ACK (actually ACK 0 and ACK 1), NAK, DLE. Each of

these control characters is defined in the code sets (EBCDIC, USASCII, Six-Bit Transcode) described in these BSC procedures. In addition, these characters are fully described under "Data-Link Control." When these control characters are used as specified, the data link can be designed for either a point-to-point operation (two stations only) or a multipoint operation (two or more stations). In addition to the data-link control and control characters, also described in these BSC procedures are: normal data-link operations (including checking), standard message formatting, additional capabilities, and planning considerations.

COMMUNICATIONS FACILITIES

Private-line or switched (dial-up) communications facilities may be used to implement BSC. These may be obtained from communications common carriers, or, if equivalent, they may be customer-provided. The communications facilities must provide for half-duplex message transmission (alternately in either direction on a nonsimultaneous basis). If desired, four-wire (full-duplex) channels can be used, thus reducing the normal line-turnaround delays associated with half-duplex facilities. Message transmission, however, is always in only one direction at a time.

For all BSC operations, the data link can be designed for either a point-to-point or multipoint operation, depending on the requirements of the user. The specific data-set equipment used at each channel-termination point (station) is determined by the type of communications channel, as well as by the operating speed of the terminal equipment located at each station. BSC is capable of accommodating a broad range of medium- and high-speed equipment.

DATA-LINK CONCEPT

Data link refers to the communications channel, the data sets (or line adapters), and the communications-control portion of each of the stations on the channel. Each data link must be considered a separate entity with complete message compatibility throughout the link. This total channel and station-control compatibility is an inherent part of BSC, and it can be extended easily to other data links within the same communications network, provided BSC is employed throughout. The terminal equipment located at each station can vary. This equipment can range from a basic send/receive reader and printer terminal, to

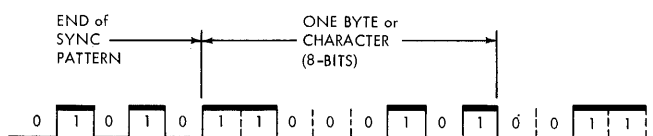

Note:
The number of bits per character is dependent on the code set and checking method used.

Figure 1. Transmission of Binary Coded Data (EBCDIC)

*NOTE: This is compatible with the United States of America Standard Code for Information Interchange (USASCII code). However, this does not imply full compatibility with other manufacturers' synchronous devices using the USASCII code.

a control unit serving several input/output devices, or a processor interconnected to the communications line.

The message traffic between stations in the data link is maintained in orderly fashion through the use of unique line-control characters. These characters are described under "Data-Link Control."

Point-to-Point Data Link

When the data link is designed to operate on a point-to-point basis, all transmissions are between only two stations. If the data link is of a permanent-connection type (e.g. --leased line), then these transmissions are always between the same two stations. However, if the connection is of a switched type,

then the two stations involved can change with each transmission, since all stations in the switched network are accessible (on a point-to-point basis).

Multipoint Data Link

All transmission over the data link designed for multipoint operation is between one sending unit and one or more receiving units. For this operation one station is always assigned as the master station. Control of the data link is always maintained by the master for all transmissions within the multipoint data link. This master-station control is referred to as a centralized multipoint operation. All transmissions in this type of operation are initiated by selection or polling from the master, and are between the master and one or more of the other stations in the data link.

The major function of BSC is to implement the transfer of data from one location to another in an organized manner using communications facilities. This data is transferred in the form of binary-coded messages (0 bits, 1 bits) containing text information (message body) and heading information (message identification and destination). In addition, data-link-control characters are required with each message to define various portions of the message and control its transmission.

All BSC data is transmitted in binary form using one of the following code sets, as specified by the user: EBCDIC, USASCII, or Six-Bit Transcode. Each of these code sets consists of graphic characters (numeric, alphabetic, special); functional characters (e.g., HT--horizontal tab, DEL--delete); and data-link-control characters (e.g., SOH--start of heading, STX--start of text).

TRANSMISSION CODES

The BSC procedures can accommodate three specific codes from the 8-bit level to the 6-bit level. These codes each provide different capacities for total graphic and function assignments. These capacities reflect the flexibility of each of these codes and are as follows:

- EBCDIC (Extended Binary-Coded-Decimal Interchange Code)--256 assignment positions, Figure 2.
- USASCII (United States of America Standard Code for Information Interchange)--128 assignment positions, Figure 3.
- Six-Bit Transcode--64 assignment positions, Figure 4.

When any of these codes are employed with transparent mode, the flexibility of the system is further increased since the bit arrangement for each of the assignable positions is treated only as a specific "bit pattern" within transparent text. For this mode of operation, all assignment restrictions are removed from the code set being used. Thus the parity bit is also available as a data bit when transmitting transparent USASCII-coded data. This additional BSC capability means that, within the standard message format (see the "Message Formats for Basic Operation" section), any type of coded information can be handled using transparent mode. Transparent-text mode is described in the "Additional Data-Link Capabilities" section.

OPERATION OF THE DATA LINK

The data link can be designed to operate either point-to-point (two stations) or multipoint (two or more stations). For point-to-point operation a contention situation prevails, whereby both stations can attempt to acquire the line simultaneously. To minimize this possibility, a station can bid for the line using the ENQ (Enquiry) control character. ENQ provides a concise signal when attempting to acquire the line, and thus leaves a maximum time for line monitoring. Once the line is acquired, message transmission can start. (For a dial-up type connection, refer to "Switched-Network Operation" in the "Additional Data-Link Capabilities" section.)

All multipoint operation uses polling and selection from the master station (a preassigned controlling station). Polling is an "invitation to send" transmitted from the master station to a specific remote station. Selection is a "prepare to receive" notification from the master to one, several, or all remote stations to copy the following message(s). These capabilities permit the master station to not only specify the transmitting station but also control the direction of transmission. Each station in the data link is assigned a unique primary identification that is used to acquire the station's attention during either polling or selection. If the stations in the data link contain multiple input and output capabilities, then each station identity can consist of up to seven characters. The first character is the station number, while the additional characters indicate the specific component(s) desired. Once the station responds affirmatively, after its attention is acquired, then message transmission can start.

The message consists of one or more blocks of text data. The text is transmitted in blocks to provide more accurate and efficient error control. This text data is the body of the message and is identified by an STX (start of text) character immediately preceding each block of text. In addition, each block of text except the last is immediately followed by an ETB (end of transmission block) character or, optionally, an ITB (intermediate block) character. The last block of text in a message is immediately followed by an ETX (end of text) character.

The text of the message can be preceded by a heading that contains auxiliary information (e.g., station control, priority) pertaining to the following text data. The heading is identified by an SOH (start

| | | 00 | | | | 01 | | | | Bit Positions 0,1 |
|-----------------------|------|-----|-----|-----|-----|----|----|----|----|-------------------|
| | | 00 | 01 | 10 | 11 | 00 | 01 | 10 | 11 | Bit Positions 2,3 |
| Bit Positions 4,5,6,7 | 0000 | NUL | DLE | DS | | SP | & | - | | |
| | 0001 | SOH | DC1 | SOS | | | | / | | |
| | 0010 | STX | DC2 | FS | SYN | | | | | |
| | 0011 | ETX | DC3 | | | | | | | |
| | 0100 | PF | RES | BYP | PN | | | | | |
| | 0101 | HT | NL | LF | RS | | | | | |
| | 0110 | LC | BS | ETB | UC | | | | | |
| | 0111 | DEL | IL | ESC | EOT | | | | | |
| | 1000 | | CAN | | | | | | | |

| | | 10 | | | | 11 | | | | Bit Positions 0,1 |
|-----------------------|------|----|----|----|----|----|----|----|----|-------------------|
| | | 00 | 01 | 10 | 11 | 00 | 01 | 10 | 11 | Bit Positions 2,3 |
| Bit Positions 4,5,6,7 | 0000 | | | | | | | | 0 | |
| | 0001 | a | i | | | A | J | | 1 | |
| | 0010 | b | k | s | | B | K | S | 2 | |
| | 0011 | c | l | t | | C | L | T | 3 | |
| | 0100 | d | m | u | | D | M | U | 4 | |
| | 0101 | e | n | v | | E | N | V | 5 | |
| | 0110 | f | o | w | | F | O | W | 6 | |
| | 0111 | g | p | x | | G | P | X | 7 | |
| | 1000 | h | q | y | | H | Q | Y | 8 | |
| | 1001 | i | r | z | | I | R | Z | 9 | |

Note: ETB = EOB } Duplicate Assignments
ESC = PRE }

| | | 00 | | | | 01 | | | | Bit Positions 0,1 |
|-----------------------|------|-----|-----|-----|-----|----|----|----|----|-------------------|
| | | 00 | 01 | 10 | 11 | 00 | 01 | 10 | 11 | Bit Positions 2,3 |
| Bit Positions 4,5,6,7 | 1001 | | EM | | | | | | | |
| | 1010 | SMM | CC | SM | | ¢ | l | : | | |
| | 1011 | VT | | | | . | \$ | , | # | |
| | 1100 | FF | IFS | | DC4 | < | * | % | @ | |
| | 1101 | CR | IGS | ENQ | NAK | (|) | _ | ' | |
| | 1110 | SO | IRS | ACK | | + | ; | > | = | |
| | 1111 | SI | IUS | BEL | SUB | ! | ¬ | ? | " | |

| | | 10 | | | | 11 | | | | Bit Positions 0,1 |
|-----------------------|------|----|----|----|----|----|----|----|----|-------------------|
| | | 00 | 01 | 10 | 11 | 00 | 01 | 10 | 11 | Bit Positions 2,3 |
| Bit Positions 4,5,6,7 | 1010 | | | | | | | | | |
| | 1011 | | | | | | | | | |
| | 1100 | | | | | | | | | |
| | 1101 | | | | | | | | | |
| | 1110 | | | | | | | | | |
| | 1111 | | | | | | | | | |

Note: Current activities in committees under the auspices of USASI may result in changes to the characters, the card codes assigned to the characters and/or the structure of the eight bit representation of USASCII devised by the Institute. Such changes may cause the characters, their card codes and/or the structure of the eight-bit representation of USASCII implemented in System/360 (ASCII-8) to be different from the future USA standards. Since a difference of this nature may eventually lead to a modification of System/360, it is recommended that users employ caution in their system implementation of those characters, their card codes and/or the structure of the eight-bit representation so that any retrofit impact on their system will be minimal.

Figure 2. EBCDIC Character Assignments

United States of America Standard
Code for Information Interchange
(USASCII)

| Bit Positions | | | | b7 | b6 | b5 | 0 0 0 | 0 0 1 | 0 1 0 | 0 1 1 | 1 0 0 | 1 0 1 | 1 1 0 | 1 1 1 |
|---------------|----|----|----|-----|-----|----|-------------|-------------|-------------|-------------|-------------|-------------|-------------|-------------|
| b4 | b3 | b2 | b1 | | | | | | | | | | | |
| 0 | 0 | 0 | 0 | NUL | DLE | SP | 0 | @ | P | ' | P | | | |
| 0 | 0 | 0 | 1 | SOH | DC1 | ! | 1 | A | Q | a | q | | | |
| 0 | 0 | 1 | 0 | STX | DC2 | " | 2 | B | R | b | r | | | |
| 0 | 0 | 1 | 1 | ETX | DC3 | # | 3 | C | S | c | s | | | |
| 0 | 1 | 0 | 0 | EOT | DC4 | \$ | 4 | D | T | d | t | | | |
| 0 | 1 | 0 | 1 | ENQ | NAK | % | 5 | E | U | e | u | | | |
| 0 | 1 | 1 | 0 | ACK | SYN | & | 6 | F | V | f | v | | | |
| 0 | 1 | 1 | 1 | BEL | ETB | ' | 7 | G | W | g | w | | | |
| 1 | 0 | 0 | 0 | BS | CAN | (| 8 | H | X | h | x | | | |
| 1 | 0 | 0 | 1 | HT | EM |) | 9 | I | Y | i | y | | | |
| 1 | 0 | 1 | 0 | LF | SUB | * | : | J | Z | j | z | | | |
| 1 | 0 | 1 | 1 | VT | ESC | + | ; | K | [| k | } | | | |
| 1 | 1 | 0 | 0 | FF | FS | , | < | L | \ | l | | | | |
| 1 | 1 | 0 | 1 | CR | GS | - | = | M |] | m | } | | | |
| 1 | 1 | 1 | 0 | SO | RS | . | > | N | ^ | n | ~ | | | |
| 1 | 1 | 1 | 1 | SI | US | / | ? | O | _ | o | DEL | | | |

Figure 3. USASCII Character Assignments

| | | | | | | | | |
|---------------|------|-------|------|------|------|------|------|------|
| Bit Positions | 0 | 1 | 0 | 1 | 0 | 1 | 0 | 1 |
| | 0 | 0 | 0 | 1 | 1 | 0 | 1 | 1 |
| 2345 | 0000 | 0001 | 0010 | 0011 | 0100 | 0101 | 0110 | 0111 |
| | SOH | & | - | 0 | A | J | / | 1 |
| | B | K | S | 2 | C | L | T | 3 |
| | D | M | U | 4 | E | N | V | 5 |
| | F | O | W | 6 | G | P | X | 7 |
| | H | Q | Y | 8 | I | R | Z | 9 |
| | STX | SPACE | ESC | SYN | . | \$ | , | # |
| | < | * | % | @ | BEL | US | ENQ | NAK |
| | SUB | EOT | ETX | EM | ETB | DLE | HT | DEL |

Figure 4. Six-Bit Transcode Character Assignments

of heading) character that immediately precedes it. Thus the message can contain both a heading and a text portion; however, these BSC procedures also provide for variations.

As each message block is completed, it is checked for transmission accuracy at the receiver before the transmission continues. (NOTE: When VRC is used, each character is checked as it is received.)

Error Checking

Each block of data transmitted can be error checked in one of several ways, depending on the code and functions employed. These checking methods are:

odd-parity checking by character, called VRC (vertical-redundancy checking); and checking by message block using either LRC (longitudinal-redundancy checking) or CRC (cyclic-redundancy checking). Checking is always done at the receiving station. For VRC, this occurs as the data is received; for LRC or CRC, it occurs following each block of transmitted data. After each transmission, the receiving station replies with ACK 0 or ACK 1--data accepted, continue sending--or NAK--data not accepted (e.g., a transmission error detected), retransmit previous block. Retransmission of a block of data following an initial NAK is usually attempted at least three additional times. If the transmitting station does not receive a reply following a data block, or the reply is garbled, the transmitting station can request a retransmission of the reply by sending an ENQ. When the transmitting station completes the entire transmission, it terminates the transmission by sending an EOT (end of transmission). The specific error-checking capabilities available for BSC, by code set, are shown in Table I.

VRC/LRC

VRC is an odd-parity check performed on a per-character basis, with the USASCII character set. It is not available with either the EBCDIC or Six-Bit Transcode character sets. The VRC odd-parity check is performed on each character including the LRC character (this is the accumulated check character).

LRC is a longitudinal-redundancy check on the total data bits by message block. An LRC character is accumulated at both the sending and receiving terminals during the transmission of a block. This accumulation is called the "block-check character" (bcc), and it is transmitted immediately following an ETB, ETX, or ITB character. The transmitted bcc is compared with the accumulated bcc character at the receiving station for an equal condition. This equal comparison indicates a good transmission of the previous block.

The LRC accumulation is reset by the first STX or SOH character received in a transmission. All STX and SOH characters received thereafter, until the next line turnaround, are included in, but do not reset, the accumulation. No SYN characters are accumulated. Following an ITB bcc, the accumulation is also reset. (NOTE: LRC is a basic form of CRC.)

Table I. Error-Checking Capabilities

| Transmission Code | Transparency | VRC/LRC | CRC-12 | CRC-16 | VRC/CRC-16 |
|-------------------|--------------|---------|--------|--------|------------|
| EBCDIC | No Yes | | | X X | |
| USASCII | No Yes | X | | | X |
| Six-Bit Transcode | No Yes | | X X | | |

VRC/LRC--Vertical-Redundancy Checking/Longitudinal-Redundancy Checking

CRC-12 and CRC-16--Cyclic-Redundancy Checking (using 12 bits or 16 bits)

VRC/CRC-16--Vertical-Redundancy Checking/Cyclic-Redundancy Checking (using 16 bits)

CRC-16

The CRC-16 is a more powerful means of block checking than LRC. It permits the checking of any code set using the checking polynomial $X^{16} + X^{15} + X^2 + 1$. This polynomial has the prime factors $(X + 1)$ and $(X^{15} + X + 1)$.*

A cyclic-redundancy check (CRC) uses an arithmetic accumulation that is reset with the first STX or SOH in a transmission block, and restarted with the character following. Thereafter, any STX and SOH characters received before a line turnaround are included in and do not reset the accumulation. The accumulation is reset immediately following an ITB bcc. The reset accumulation is all zero bits. Syne-idle characters are not accumulated. Also, within blocks of transparent text (following DLE STX), the first DLE (data-link escape) character in all two-character DLE sequences is excluded from the bcc (e.g., DLE ETX, DLE DLE, DLE SYN).

VRC/CRC-16

The use of the bcc is identical to CRC-16; however, with the VRC, an odd-parity check is performed on all characters except the CRC character. The VRC check is inhibited during transparent mode and this bit position is used as data.

CRC-12

This is a means of block checking any code set using the checking polynomial $X^{12} + X^{11} + X^3 + X^2 + X + 1$.

*The polynomials are taken over the field of the integers modulo two; that is, the field consists of the two elements 0, 1. Carries are ignored.

This polynomial has the prime factors $(X + 1)$ and $(X^{11} + X^2 + 1)$. The bcc is generated and compared in the same manner as for CRC-16.

Data-Link Control

Control of the data link is maintained through the use of these unique control characters:

- SYN--synchronous idle
- SOH--start of heading
- STX--start of text
- ETB--end of transmission block
- ETX--end of text
- EOT--end of transmission
- ENQ--enquiry
- ACK--affirmative acknowledgment (actually, alternating replies of ACK 1 and ACK 0 are used with BSC)
- NAK--negative acknowledgment
- DLE--data-link escape

Two other functions are provided as optional features and are described in the "Additional Data-Link Capabilities" section. These additional functions are:

- ITB--Intermediate block-check character
- WABT--wait-before-transmit sequence

Several variations in the designations and compositions of the data-link-control characters exist among the various code sets. For example, DLE sequences are actually used for ACK 0 and ACK 1. These variations are defined in Figure 5. Those characters that remain identical throughout the code sets are designated by nc (no change).

SYN--Synchronous Idle

Used to establish synchronism and as a time fill in the absence of any data or control character to maintain synchronism.

| DATA LINK Character | Code Chart Sequence | | |
|---------------------|---------------------|---------|-------------------|
| | EBCDIC | USASCII | Six-Bit Transcode |
| SYN | nc | nc | nc |
| SOH | nc | nc | nc |
| STX | nc | nc | nc |
| ETB | EOB(ETB) | nc | nc |
| ETX | nc | nc | nc |
| EOT | nc | nc | nc |
| ENQ | nc | nc | nc |
| ACK 0 | DLE '70' | DLE 0 | DLE - |
| ACK 1 | DLE / | DLE 1 | DLE T |
| NAK | nc | nc | nc |
| DLE | nc | nc | nc |
| ITB | IUS | US | US |
| WABT | DLE " | DLE ? | DLE W |

nc--no change

'--Indicates the hexadecimal representation (no graphic assignment).

Figure 5. Character Conversion Chart

SOH--Start of Heading

Precedes a block of heading characters. A heading consists of auxiliary information (such as routing and priority) necessary for the system to process the text portion of the message.

STX--Start of Text

Precedes a block of text characters. Text is that portion of a message treated as an entity to be transmitted through to the ultimate destination without change. STX also terminates a heading.

ETB--End of Transmission Block

Indicates the end of a group (block) of characters started with SOH or STX. The blocking structure is not necessarily related to the processing format. The block-check character is sent immediately following ETB. ETB requires a reply indicating the receiving station's status (ACK 0, ACK 1, NAK, or, optionally, WABT).

ETX--End of Text

Terminates a block of characters started with STX and transmitted as an entity. The block-check character is sent immediately following ETX. ETX requires a reply indicating the receiving station's status.

EOT--End of Transmission

Indicates the conclusion of a message transmission, which may contain one or more blocks, including text and associated headings. It causes a reset of all stations on the line (unless it erroneously occurs within a text or heading block).

ENQ--Enquiry

Used as a request for a response, to obtain identification and/or an indication of station status (ACK 0, NAK, etc.). It can also be used to obtain a repeat transmission of a reply, if a transmission was not received when expected or was garbled.

ACK 0, ACK 1--Affirmative Acknowledgment

These replies indicate the previous block was accepted and the receiver is ready to accept the next block of the transmission.

NAK--Negative Acknowledgment

Indicates that the previous block was unacceptable, and the receiver is ready to accept a retransmission of the erroneous block. It is also the "not-ready" reply to a station selection.

DLE--Data-Link Escape

A control character used exclusively to provide supplementary line-control signals, including wait before transmit (WABT), alternating affirmative acknowledgments (ACK 0 and ACK 1), and start of transparent text. The sequences DLE STX and DLE ETX initiate and terminate transparent text. In addition, other control sequences using DLE are available to provide active control characters within transparent text as required. For additional information, refer to "Transparent Text Mode" in the "Additional Data-Link Capabilities" section.

Alternating Affirmative Acknowledgments

The BSC procedures exclude the specific use of ACK, and instead use ACK 1 and ACK 0 alternately as affirmative replies. The use of ACK 1 and ACK 0 provide a sequential checking control for a series of replies. (Refer to Figure 7 for a specific example of the use of ACK 1 and ACK 0.) Thus it is possible to maintain a running check to ensure that each reply corresponds to the immediately preceding message block. (NOTE: ACK 0 is used as the positive reply to normal selection.)

MESSAGE FORMATS FOR BASIC OPERATION

The proper formatting of messages for BSC is essentially using the specific data-link-control characters as defined. Specific formatting rules are provided for heading and text data for both point-to-point and multipoint operations. Basic operation for BSC is either point-to-point operation with contention or centralized multipoint operation. Switched-network operation is discussed under "Additional Data-Link Capabilities."

The various timeouts provided for BSC operation comprise a significant factor in all message formatting. These govern such things as various maximum waiting times and frequency of sync-idle insertions for timing purposes.

HEADINGS

The heading is a block of data starting with SOH and containing one or more characters that may be used for station control (e.g., message identification, routing, and priority). With block checking, the SOH initiates the block-check-character (bcc) accumulation. (An initial SOH resets the bcc and is not included in the new bcc accumulation.) The length of a block of heading data is generally not fixed, although specific terminals and applications may use fixed-length headings. The heading is terminated by STX. Only the first SOH or STX in a transmission block, preceding a line turnaround, causes the bcc to reset. All succeeding STX or SOH characters (until a line turnaround, ETB, ETX, or ENQ) are included in the bcc. This permits the entire transmission (excluding the first SOH or STX) to be block checked as shown by the following example:

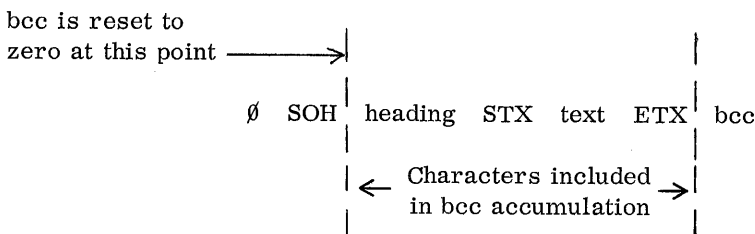

NOTE: Ø represents the required "sync pattern." Refer to the "Additional Format Considerations" section.

If block checking is desired for the heading alone, the heading can be ended with ETB. This is followed by the bcc and appears as follows:

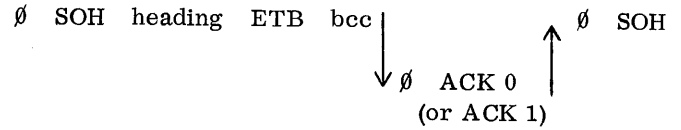

The heading can be terminated prematurely by use of the ENQ (indicating "disregard this block"). The use of this character is as follows:

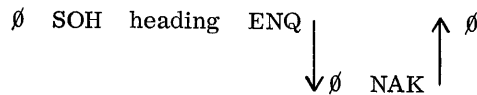

NOTE: The negative reply is required here since the heading ended with a forced error condition. Transmission should continue following this sequence.

TEXT

The text data is the most significant portion of the transmission. It is transmitted in complete units called messages, which are initiated by STX and concluded with ETX. Each message is considered an entity for BSC operation; that is, it is a complete unit that can stand alone and is not necessarily directly related to other messages being transmitted. A message can be subdivided into smaller blocks for ease in processing and more efficient error control. Each block starts with STX and ends with ETB (except for the last block of a message, which ends with ETX). A single transmission from one station can contain

any number of messages (linked into one transmission). Intermediate message blocking can also be accomplished by using ITB for special situations (see "Additional Data-Link Capabilities").

The block-check character (bcc) is transmitted immediately after the ETB or ETX. Immediately

following the transmission of the bcc, a line turnaround occurs to permit the receiving station to reply either affirmatively or negatively to the received block.

A block of text data can be terminated prematurely by using an ENQ character, which signals the receiver to "disregard this block." The negative reply should always be used in this situation since the block ended with a forced error condition.

The following are examples of various forms of block transmission for text data:

- a. Last text block of a message--

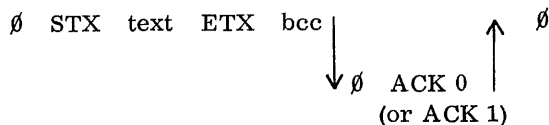

- b. Other than the last text block--

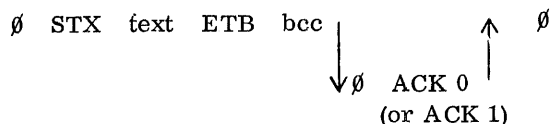

- c. Disregard this block--

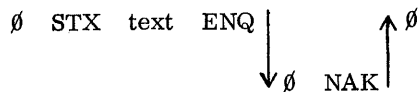

POINT-TO-POINT OPERATION (WITH CONTENTION)

This type of operation is available for either privately owned lines or leased private lines. When transmission is started, an initialization sequence (consisting of \emptyset ENQ) must be instituted by the station attempting to acquire the line. A station receiving this sequence (and ready for message reception) replies with \emptyset ACK 0. If the station is not ready to receive, it replies with either of the following:

- \emptyset WABT Optional (indicating a temporary not-ready condition)

- \emptyset NAK (indicating a prolonged not-ready condition)

The format for the total initialization phase, including the start of the actual message transmission, is:

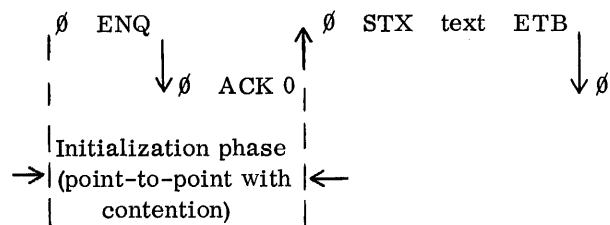

To avoid the problems associated with propagation delays and simultaneous transmission requests, each station is assigned a priority. When the higher-priority station sends an ENQ to acquire the idle line, it will not accept an ENQ from the lower-priority station. The station continues to send ENQ until it receives one of the following replies: ACK 0, NAK, or WABT. If the higher-priority station receives an ENQ and it has not initiated a request for the line, then it replies with ACK 0 (if ready to receive), WABT, or NAK. Thus, the lower-priority station can gain control of the line for a transmission only when the line is left free by the higher-priority station.

Message transmission is terminated and the line is returned to an idle state by transmission of the EOT signal.

The order in which the various functions occur and how they are interrelated is defined by Figure 6. This diagram covers both point-to-point and multipoint operation. It also covers several items (such as timeouts and switched-network operation) that are discussed in detail later in this publication.

MULTIPOINT OPERATION (CENTRALIZED)

In multipoint operation, one station in the data link is assigned as the master station, and the remaining stations are designated as remote stations. All transmissions for this type of operation (termed centralized multipoint) are controlled by the master station by means of polling and selection. By sequentially polling each remote station, the master station controls the incoming message traffic. The outgoing traffic is controlled from the master by selection of the desired remote station to receive the message. If more than one remote station is required to receive the message, group selection is used.

The initialization phase for multipoint operation is accomplished by the master station transmitting the following sequence:

- \emptyset EOT

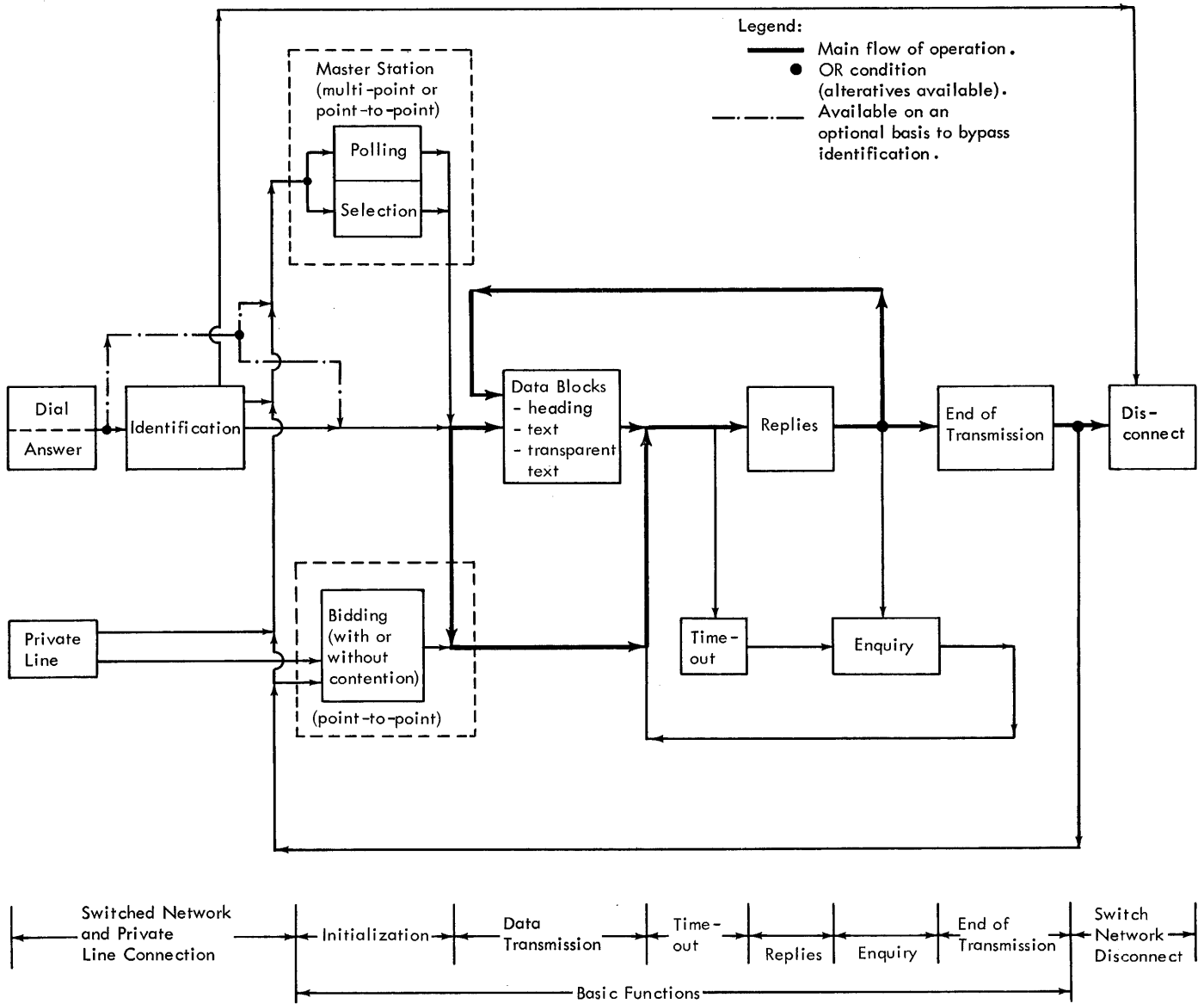

Figure 6. BSC Line Control Operations

This sequence ensures that all monitoring remote stations are now in control mode and thus prepared to receive either a poll or a selection from the master. The polling or selection sequence transmitted while in control mode designates the station(s) that are to transmit or receive data. This also defines the specific unit required if the station has several available. An example of the complete sequence transmitted from the master station is:

| | |
|---|--|
| \emptyset EOT pad | \emptyset $\alpha \dots$ ENQ |
| Initialization phase (multipoint centralized) | $\underbrace{\alpha \dots}$ poll or selection sequence |

NOTE: A "pad" of at least one character time must follow the EOT before transmission of the "sync pattern" preceding the polling or selection sequence. Refer to the "Additional Format Considerations" section for a description of "pad" characters. α represents the graphics assigned for station identification.

The polling and selection sequences are differentiated in one of several ways. They can consist of from one to seven characters followed by ENQ. For specific sequences, refer to the appropriate component-description manual.

The replies possible from the remote station when it is polled are:

- a. Positive reply when remote station is prepared to send heading data--
 \emptyset SOH heading
- b. Positive reply when remote station is prepared to send text data--
 \emptyset STX text
- c. Positive reply when remote station is prepared to send transparent text data--
 \emptyset DLE STX transparent text
- d. Negative reply when remote station has nothing to send--
 \emptyset EOT

The replies possible from the remote station when it is selected are:

- a. Positive reply indicating the remote station is prepared to receive--
 \emptyset $\alpha \dots$ ACK 0
The additional graphics (α) are optionally available for supplementary control (up to seven graphics), preceding an affirmative, negative, or wait-before-transmit signal.
- b. Negative reply indicating the remote station is not ready to receive--
 \emptyset $\alpha \dots$ NAK

- c. Reply indicating the remote station is temporarily not ready to receive and should be reselected until either an ACK 0 or NAK is received--
 \emptyset $\alpha \dots$ WABT (optional)

The complete formatting of message traffic for a multipoint operation is shown in Figure 7. This includes both the polling and the selection of two different remote stations from a master station. The station identification for the two different operations is handled by upper- and lower-case alphabetic characters for this example, while the component designations are: 1--for printer, and 6--for reader.

ADDITIONAL FORMAT CONSIDERATIONS

The "sync pattern" and "pad" characters are an integral part of block and control-sequence formats in BSC operation over a data link. The sync pattern ensures that all active stations in the data link are in step. The pad character is used to ensure full transmission and reception of every message. Neither of these considerations is reflected in the received message; however, each must be properly provided for in the original message format before transmission.

Sync Patterns

Transmission over the data link is serial by bit, serial by character, with synchronism of the transmitted data established by transmission of a "sync pattern." This pattern must be sent at the start of each transmission block to ensure that the receiving stations are in step with the sending station. Synchronism of all transmitted data is maintained at the bit level and character level through use of this sync pattern. This means that each bit received must be in the proper time relationship so that it can be correctly identified (sampled). Also, each series of bits must be received in the correct time phase to ensure assembly of the proper bits to form the correct character.

The sync pattern is used to establish both character synchronism (character phase) and bit synchronism (bit phase). This pattern must always precede a transmission, and the pattern can differ for character phase and bit phase. The character-phase sync pattern is always required, but a bit-phase sync pattern generated by the BSC station is unnecessary when operating with certain self-clocked data sets. (NOTE: The total required sync pattern is always represented by the symbol \emptyset in all formatted message examples in this publication.)

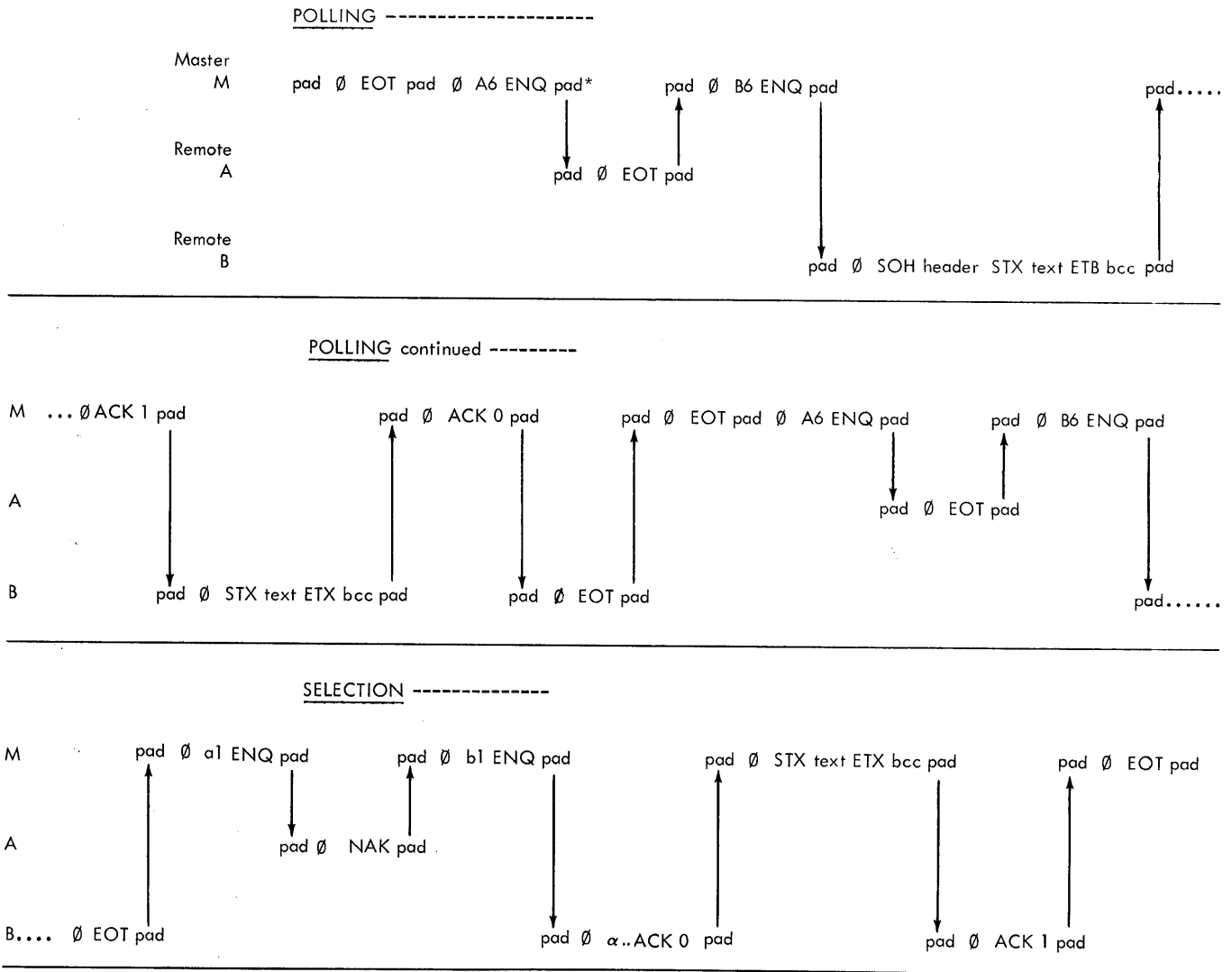

* The pad characters may be overlapped time-wise on a full duplex (4-wire) channel, however pad characters are sequential on half duplex channels.

Figure 7. Typical Data Link Message Traffic (Centralized Multipoint Operation)

Character Phase

The sync pattern for establishing character phase consists of at least two consecutive SYN characters. If more than two consecutive SYN characters are sent, the sync pattern ends with the last transmitted SYN.

Character phase must be re-established for each transmission. This is accomplished by the receiving station's recognizing and "locking" into character phase by means of the transmitted sync pattern (SYN SYN). This character phase remains locked on at these stations until either (1) a line-turnaround character or the end-of-transmission character is received, or (2) a timeout completes.

Bit Phase

Bit phase is established before character phase and this must be accomplished before the character-phase sync pattern is transmitted. In cases where the data set is self-clocked and bit phase is automatically established by the data set, only the sync pattern for the character phase need be transmitted by the BSC station equipment.

However, when the clocking (bit timing) is performed by the terminal equipment (by means of an internal clock), a special bit-phase sync pattern must precede the SYN SYN (character phase) sequence. This bit-phase sync pattern can be in the form of four consecutive SYN characters (SYN SYN SYN SYN) transmitted immediately before the character-phase SYN SYN sequence. The bit-phase sync pattern can also be represented by 16 consecutive bits consisting of alternating zeros and ones (01010101010101). The choice of the bit-phase sync pattern is arbitrary and depends only on the transmitting device.

Message Sync

To assure the receiver that the in-step condition is maintained during transmission of the entire message, additional sync-idles are inserted in the message by the transmitter. The sync-idle sequence is automatically inserted in heading and text data at one-second intervals. For normal data SYN SYN is inserted, while for transparent data DLE SYN is inserted at these time intervals. This technique permits receiving stations to continuously verify that they are in step. Also, this permits a station that is out of step and hunting for character phase to re-establish correct sync during the transmission of normal data. Sync-idle characters are not included in the bcc accumulation, and are stripped

from the message at the receiving station. They have no external effect upon the messages.

Pad Characters

To ensure that the entire message or control signal is properly transmitted by the data set, an extra character (pad character) is added following each turnaround character (e.g., NAK, EOT, ENQ). When ETX and ETB cause line turnaround, the pad character follows the bcc. This character is necessary to ensure that the last significant character (e.g., ETB bcc, ETX bcc, or NAK) is sent before the data-set transmitter turns off. The pad character does not affect, nor is it recognized by, the receiving station.

A time lapse of one character time following either a line turnaround or an EOT is required before the station starts to transmit, to ensure that the remote stations are prepared to receive. Thus a station preparing to transmit must either delay transmission one character time following line turnaround, or insert a pad character preceding the first character of the sync pattern of the next message.

The pad character may consist of any one of the following:

- all 1 bits,
- alternating 1 and 0 bits, or
- a single SYN character (only at the start of a transmission).

An example of the proper use of pad characters follows:

```
data  ETX  bcc  Pad                Pad  Ø  STX  data
                ↓                ↑
                Pad  Ø  ACK 0  Pad
```

NOTE: The pad characters may be overlapped in time on a full-duplex (four-wire) channel; however pad characters are sequential on half-duplex (two-wire) channels.

TIMEOUTS

Timeouts are used during the reception of control, heading, and text data to ensure efficient utilization of the line. They prevent indefinite data-link tie-ups due to false sequences or missed turnaround signals. This is accomplished by providing a fixed time basis within which any particular operation must occur. Due to the vast differences and requirements for the various operations, four specific timeout functions are provided: transmit, receive, text, and long.

Transmit Timeout

This is nominally a one-second timeout that establishes the rate at which sync idles are automatically inserted into transmitted heading and text data. In normal data two consecutive sync-idle characters (SYN SYN) are inserted every second, while for transparent data only one transparent sync-idle sequence (DLE SYN) is inserted every second. These sync idles are inserted in the message for timing purposes only, and have no effect on the message format.

Receive Timeout

This is nominally a three-second timeout, and is used as follows:

- a. Limits the waiting time allowed for a transmitting station to receive a reply.
- b. Permits any receiving or monitoring station to check the line for sync-idle signals. These sync idles indicate that the transmission is continuing; thus this timeout is reset and restarted each time a sync idle is detected.
- c. Limits the time any remote station in a multi-point network will remain in control mode while monitoring an idle line for its identity code. This timeout provides system security against a false station polling or selection address. This timeout runs whenever the

station is in control mode. It is reset and restarted each time an end signal (EOT, ENQ, NAK, WABT, ACK 0) is recognized, as long as the station remains in control mode.

Text Timeout

This is used by each selected receiving station as a reasonableness test on heading and text data. It places a maximum limit on the length of a received block. This timeout causes the station to drop character phase if an end-of-block character (ETB or ETX) is not received to terminate the header or text data within the time period. This timeout period is established by each specific station type.

Long Timeout

This timeout is used by a master station in a multi-point network, the receiving station in a point-to-point network with contention, and by any stations operating in a switched network. It protects against prolonged periods of inactivity, such as when a receiving station in a point-to-point network with contention misses an EOT. The duration of this timeout must be established separately for each line, since this is influenced by the maximum length of transmission as well as by the number of enquiry retries permitted.

ADDITIONAL DATA-LINK CAPABILITIES

These additional capabilities are available on an optional basis to further increase the flexibility of the data link. They include transparent-text mode, WABT function, ITB function, conversational mode, and fast-selection method.

TRANSPARENT-TEXT MODE

This mode permits greater versatility in the range of coded data that can be transmitted. This is because all data, including the normally restricted data-link line-control characters, are treated only as specific "bit patterns" when transmitted in transparent mode. Thus, unrestricted coding of data is permitted for transparent-mode operation. This is particularly useful for transmitting binary data, packed-decimal data, and unique specialized codes, in addition to complete machine-language programs.

Any data-link control characters transmitted during transparent mode and required to be effective must be preceded by a DLE. Thus the following sequences are effective during transparent-mode operation:

- DLE ENQ Indicates a "disregard this block of transparent data" and returns to normal mode.
- DLE DLE Used when a bit pattern equivalent to DLE appears within the transparent data to permit transmission of the DLE as data.
- DLE ITB Terminates an intermediate block of transparent data. Does not call for a reply, since the transmission continues. Normally, transparent intermediate blocks have a particular fixed length for a given system. If the next intermediate block is transparent, it must start with DLE STX.

The DLE STX following an intermediate transparent block should be preceded by SYN SYN, to permit any station out of sync and hunting to correctly synchronize with the transmission.

All replies, enquiries, and headers are transmitted in normal mode. Transparent data is received on a character-by-character basis; thus character phase is maintained in the usual manner.

Example of a block of transparent data is as follows:

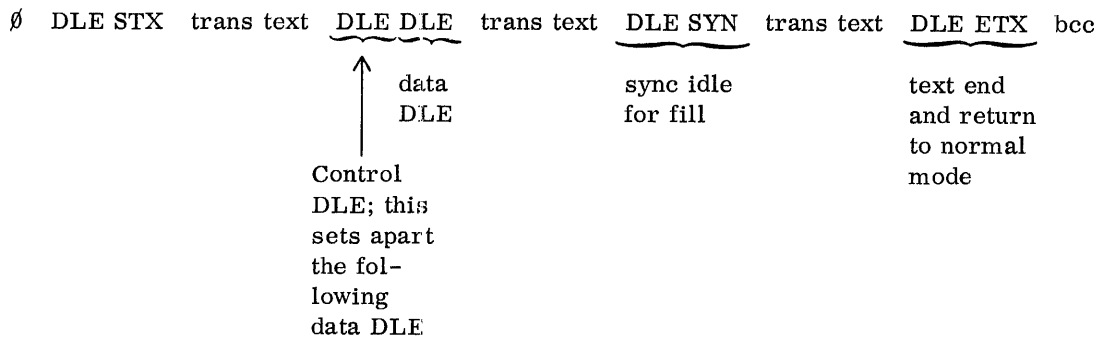

| <u>Sequence</u> | <u>Use</u> |
|-----------------|--|
| DLE STX | Initiates the transparent mode for the following block of data. |
| DLE ETB | Terminates a block of transparent data, returns the data link to normal mode, and calls for a reply. |
| DLE ETX | Terminates the transparent data, returns the data link to normal mode, and calls for a reply. |
| DLE SYN | Used as sync or fill sequence for transparent mode. |

The extent of transparent data is determined by the DLE STX and the DLE ITB, DLE ETB, or DLE ETX sequences, which initiate and terminate the transparent mode. Thus, the length of a transparent message can vary with each transmission.

For checking the transmitted transparent data, either CRC-16 or CRC-12 is available (depending on the code set used). Refer to "Error Checking" for the available options. If the system has VRC in normal mode, this is suppressed within transparent-text blocks. This permits using the parity bit as an

additional data-bit position for each character transmitted as transparent data.

WABT (WAIT BEFORE TRANSMIT)

This sequence indicates a "temporary not ready to continue receiving" condition. It can be transmitted

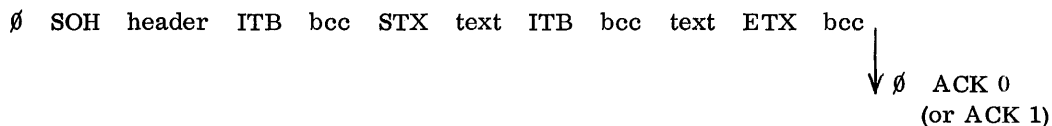

by a receiving station following a block of text data, a block of heading data, or in reply to an initial selection (enquiry signal). It is considered to be neither an affirmative nor negative reply. However, this signal does provide circuit assurance. The WABT is normally used rather than allow a "no reply" timeout to occur at the transmitter. This character sequence is comprised of a DLE (data-link escape) and a defined follower character (which depends on the transmission code). An example of how the WABT sequence is used follows:

NOTE: For unrestricted binary transparent data, ITB's are permitted only at pre-established fixed intervals throughout the transparent text, and the receiver must be aware of this interval.

CONVERSATIONAL MODE

This mode provides for transmitting heading and/or text data as a reply to a complete message (message block ending with ETX). This reply is called a



.... bcc

ITB (INTERMEDIATE BLOCK CHECK)

This provides for the use of the ITB character (shown as IUS--information unit separator--in the code charts) as an indication of the end of a subgroup (intermediate block) of characters.

The receipt of an ITB character does not initiate a line turnaround. However, the block-check accumulation is reset following the ITB bcc. Each successive intermediate block need not be preceded by either an STX or SOH, once the major block is

conversational reply and can be used only in place of an affirmative reply (when the message just received ended with ETX or DLE ETX).

The conversational reply should be used only when the message-sending station is aware that it will receive such a reply. For example, a conversational reply might be sent because the received message was an enquiry, or it might be a pre-established routine that all replies will be conversational replies. In all cases, however, the message-sending station should be aware of the procedure so that it can properly receive this reply.

An example of a conversational reply follows:

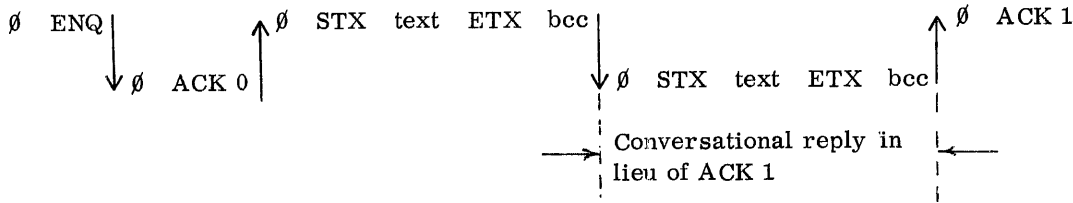

NOTE: Conversational mode allows for one conversational response per message transmission.

SWITCHED-NETWORK (DIAL-UP) OPERATION

When operating in a switched network, the point-to-point connection can be established by either manual or automatic means. Manually dialed connections can be operated as either a point-to-point line with contention, a point-to-point line without contention (using bidding), or a line with polling and selection. When employing automatic calling and answering equipment, both stations start in "circuit-assurance mode" until each has properly identified itself. Once identification is completed, the stations revert to the normal BSC procedures required for the operation (either point-to-point or multipoint). When both stations have completed their message transmissions, a disconnect signal is sent.

The "circuit-assurance mode" is entered when the called station goes "off-hook." At this time the calling station is notified by a signal from its data set that a connection with another data set has been established. Once this indication is received, the calling station sends either of the following messages:

WRU--who are you (the transmitted sequence is: ENQ). This requests the called terminal to identify itself.

I am/WRU--(the transmitted sequence is: α... ENQ)

NOTE: α indicates the graphics permitted for station identification and supplementary control purposes. This message identifies the calling station and requests the called station to identify itself.

Either message is then followed by an identification message from the called station:

ID--(the transmitted sequence is: α... ACK 0)

NOTE: If the received ID is unsatisfactory, then either station can initiate a disconnect sequence.

Additional signals available as a reply to the WRU or the I AM/WRU message are: NAK or WABT.

NAK--This indicates that a "not ready to continue" condition exists at the called station.

WABT--(optional) This indicates that a "temporary not ready to continue" condition exists at the called station. If WABT is available, then the use of the NAK reply indicates a "not ready to continue" condition of significant length exists.

Both stations exit from circuit-assurance mode when any of the following sequences are sent or received:

ENQ EOT--returns the data link to normal operation, control mode.

ENQ SOH--initiates a block of header data.

ENQ STX--initiates a block of text data.

ENQ DLE STX--initiates a block of transparent-text data (when used).

All signals other than those just described are considered as errors. If a valid reply is not received by the calling station (following either a WRU or an I AM/WRU) within the receive timeout period, the request message can be retransmitted. However, the data link must continue in circuit-assurance mode during this time. This time interval that a station remains in circuit-assurance mode is determined by the long timeout.

The call between stations is terminated by the transmission of the disconnect sequence:

ENQ DLE EOT

This sequence may be initiated by either station when operating on a switched-network basis. When operating with a master station, the master station normally initiates the disconnect sequence. As this sequence is transmitted and received, each station returns to an "on-hook" condition and the line is dropped.

FAST-SELECTION METHOD

The fast-selection method is provided for a multi-point operation to eliminate the usual line turnarounds and the associated delays. This method links the station-selection address to the first block of heading data and/or text data, all in a single message trans-

mission. This is most significant for systems requiring fast responses and for systems using short messages. The following formats are available for use when fast selection is desired:

- a. Station identity linked to heading data--

Ø A α... SOH heading ETB

station
identity
and
selection
sequence

- b. Station identity linked to heading and text data--

Ø A α... SOH heading STX text ETB

- c. Station identity linked to text data--

Ø A α... STX text ETB

NOTE: The blocks in the above examples can also be subdivided by using the ITB (intermediate block check) character.

Additional blocks of heading and text data can be transmitted to the selected station in the normal manner following this first message block (provided the station was selected successfully).

When using this fast-selection method, the receiving station is restricted in its use of the negative reply. The receiving station is not permitted to reply negatively to selection. A negative reply at the end of the first message block indicates that the station is selected but that this block was not accepted, and it requests retransmission of this block. An ACK 1 at this time indicates that this block was accepted. WABT indicates the station is temporarily "not ready to continue," but it does not imply either affirmative or negative acknowledgment of the block. The ENQ character should then be used to solicit the ACK 1 or NAK reply. If the selection is in error, or the station is not available (e.g., off line), no reply is returned to the transmitting station.

PLANNING CONSIDERATIONS FOR BSC

Several additional considerations must be made when planning for BSC. The items listed in the following pertain to various specific parts of the communications area; for any given situation, usually only one of these items will apply.

PLANNING FOR A MULTIPOINT DATA COMMUNICATIONS NETWORK

When planning a multipoint network, using common-carrier provided facilities, any configuration having more than ten stations per line requires advance consultation with a representative of the local common carrier during the initial planning stages. This is necessary to ensure that the specific communications network desired can be furnished by the common carrier.

COMMUNICATIONS OVER SWITCHED (DIAL-UP) FACILITIES

For switched-network operation, procedures should be provided to permit the connection to be broken and re-established (by hanging up and redialing the number) whenever transmission difficulties are experienced. This procedure provides the opportunity for establishing a totally different communications path, with improved transmission capabilities, when the connection is re-established.

COMMUNICATIONS OVER VOICE-GRADE LINES

BSC can operate with Western Electric Data Sets 201 over any of the following voice-grade communications facilities:

1. Common-Carrier Switched Telephone Network using Western Electric Data Set 201A, which operates at 2000 bits per second (bps).
2. Telephone Company Type 3004 Private Line Service* or Western Union Class F Channels using Western Electric Data Set 201A, which operates at 2000 bps in a multipoint or point-to-point configuration.
3. Telephone Company Type 3004 Private Line Service* or Western Union Class F Channels using Western Electric Data Set 201B, which operates at 2400 bps in a point-to-point or multipoint configuration.

*Formerly Schedule 4, Type 4B Channels

4. Telephone Company Type 3005 Private Line Service** using Western Electric Data Set 201B, which operates at 2400 bps in a point-to-point configuration only.

There is no code sensitivity or degradation in the predictable error rate when transmitting data over configurations 1, 2, or 4. Likewise, there is no degradation when transmitting in the EBCDIC or USASCII format over any of the four voice-grade configurations. An increase in the error rate may be experienced when transmitting code-independent (transparent) data over Telephone Company Type 3004 Private Line Service or Western Union Class F Channels with the Western Electric Data Set 201B (configuration 3).

It is recommended that systems transmitting transparent data use one of the code-insensitive configurations listed (1, 2, or 4). Where the occurrence probability of the code sequences that can cause increased error rates is low, the user may choose to utilize configuration 3. However, he must be aware of the possible effects that this decision may have on his system operation and what steps he must take to recover from these situations when they arise.

As an aid in evaluating each situation individually, the following detailed description of the code-sensitivity condition is provided. Included are descriptions of the cause, extent, and recovery.

Situation

The Bell System Data Communications Technical Reference for the Western Electric Data Sets 201 indicates that the stability of the sync-recovery circuits is affected by repeated bit sequences that may occur in the data. These bit sequences, when they occur, produce excessive jitter in the recovered sync signal and can cause data errors.

In particular, Data Set 201B may be sensitive to repeated binary "one-zero" (1-0) bit sequences when operating on a Type 3004 Service or Class F Channel whenever the line characteristics closely match the minimum requirements for this type of facility. This type of facility is referred to as a "limiting 4B channel." The code sensitivity is lessened or may not exist when the characteristics of the channel exceed the minimum requirements.

When Data Set 201B is operating on a "limiting 4B channel" and there is a sequence of more than 40 bits of the binary one-zero (1-0) bit pattern, then the receiving data set may lose phase synchronization

**Formerly Schedule 4, Type 4C Channels

with the transmitting data set, resulting in data errors. This condition may also occur when the majority of the bits transmitted are of the one-zero pattern.

In addition to the sensitivity to the one-zero (1-0) bit sequence, Data Set 201B, when operating on a "limiting 4B channel," is alternately sensitive to sequences of "zero-one" (0-1) bits. This alternate sensitivity is due to the way the business machine presents the binary bits to the data set and the way the data set transmits the data. The data set transmits the serial bits it receives from the business machine in pairs called "dibits." The data set is sensitive only to the one-zero dibit; however, as used, there is an equal probability that a sequence of one-zero bits will be transmitted as either one-zero dibits or zero-one dibits. Likewise, a sequence of zero-one bits may be transmitted either as one-zero or zero-one dibits. The particular state for any one transmission is the result of the relative timing between the business machine and the data set at the beginning of the transmission. A message may be transmitted in one state during one transmission and in the other state during a subsequent retransmission.

The recovery characteristics of Data Set 201B are shown in Figure 8. For the purposes of identification, the following definitions are made:

- Weak Dibit = the one-zero (1-0) dibit
- Weak Bits = A sequence of bits that results in the weak dibit
- Good Dibit = Non-weak dibit
- Good Bits = A sequence of bits that does not result in weak dibits

A good dibit occurring in the first 10 bits will cause the data set to return to the normal operating state (approximately center state). After 10 weak bits, a good dibit will compensate for two weak dibits; after

20 weak bits, a good dibit will compensate for only one weak dibit.

Scope

The types of data that the BSC procedures can accommodate and that must be considered for this situation are described in the following.

EBCDIC

The characters made up of the all "one-zero" bits ('AA')*, or the all "zero-one" bits ('55'), are not defined in EBCDIC and will therefore not be transmitted under this code. These characters will be restricted when they are defined in the future. The remaining EBCDIC characters have a sufficient mixture of dibits to prevent a loss of synchronization from occurring.

USASCII

All the characters in USASCII have a sufficient mixture of dibits to prevent a loss of synchronization from occurring. This characteristic of the USASCII code is a result of using the odd-parity bit.

Six-Bit Transcode

The Six-Bit Transcode allows for all the 64 possible character combinations of a six-bit code. Therefore, like transparent data, any and all character combinations can and will occur. The Transcode ESC and N characters consist of all one-zero and all zero-one bits, respectively. When these characters occur, they will allow the data set to drift out to a point where data with a high predominance of one-zero dibits could cause the data set to eventually lose synchronization. Therefore, when used in this restricted manner, the Transcode can contribute to a synchronization problem. In normal use, the probability of this occurring is small.

Transparent Data

Packed Decimal. The packed-decimal '55' character consists of all zero-one bits. A sequence of more than five of these characters (5555555555) may be encoded by the data set into 20 one-zero dibits (40 bits) and may therefore cause the data set to lose

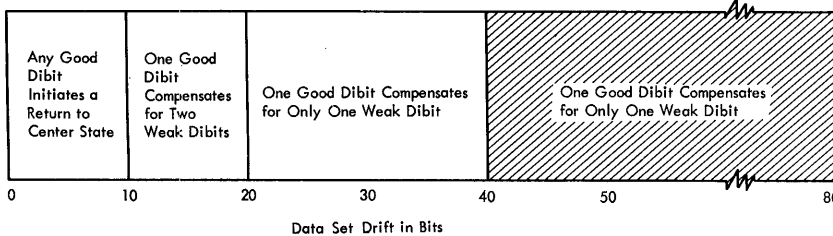

Legend:

- Weak Dibit - The "one-zero" (1-0) dibit
- Weak Bits - Sequences of bits which result in the weak dibit
- Good Dibit - any non-weak dibit
- Good Bits - any bits which do not result in weak dibits.

- 0 to 40 Bits - in sync
- 40 to 80 Bits - May go out of sync depending on quality of line.
- 80 Bits - As far out of sync as the data set will go. If not out after 80 bits, it will not go out of sync.

Figure 8. Recovery Characteristics of Western Electric Data Set 201B

*This symbol ' ' indicates a hexadecimal representation.

synchronization. A shorter sequence of fives, followed by characters with a great predominance of fives, may also cause the data set to lose synchronization. In either case, a prerequisite for the data set losing synchronization is that the data set must be out of sync with the character.

When the data set is in sync with the start of a character, a loss of synchronization will not occur. This is due to the fact that the all-binary one-zero character ('AA') does not occur in packed decimal. Therefore, when a packed-decimal message is blocked by a code-sensitive connection, it can be successfully transmitted by repeated transmissions.

Programs. In transmitting programs, the '55' or 'AA' characters occur purely at random. Unless specifically inserted as data or constants, sequences of these characters will normally occur only occasionally. Thus, in general applications the probability of either of these characters occurring in patterns sufficiently long to cause a loss of synchronization is low. The probability of having a data pattern that could not be successfully transmitted (i. e., one having sequences of both '55' and 'AA' characters) is still lower.

Other Binary Data. The probability of sequences of '55' or 'AA' characters occurring in sufficient lengths to cause a loss of synchronization may be defined only with knowledge of the source. It must be assumed that such patterns can and will occur.

Summary

In summary, there are no inherent synchronization problems in transmitting in either the EBCDIC or the USASCII code. For the transmission of Transcode and transparent data (packed decimal, programs, and other binary data), the code-sensitivity condition does not exist when any of the following communications configurations are used:

1. Data Set 201A, when operating on the switched telephone network.
2. Data Set 201A, when operating in a point-to-point or multipoint configuration on any Type 3004 Service or Class F Channel.
3. Data Set 201B, when operating on a Type 3005 Service. This service is available only for point-to-point configurations.

The code-sensitivity condition will be encountered only with the combined condition of operating over a "limiting 4B channel" and transmitting a long sequence of binary one-zero (1-0) dibits.

Identifying a Code-Sensitive Channel

When the probability of obtaining data with weak patterns is low, the user may decide to take advantage of configuration 3. However, the user must be prepared to take proper steps to recover from messages that cannot be successfully transmitted using normal techniques.

This condition is recognized by a combination of timeouts and negative responses to a transmitted message. Normal error-recovery procedures will cause the retransmission of the message a number of times before posting a message to the operator. When the data contains either the 'AA' or '55' characters (N and ESC characters for Transcode), but not both, the error condition will most likely clear due to the scrambling effect of the data set. However, when this does not occur, the operator receives a posting indicating that the message could not be successfully transmitted. At this point, there is no indication of whether the posted condition was caused by noise on the channel or other error conditions, or by the combination of a code-sensitive connection and catalytic data. Therefore further isolation is necessary.

The operator should initiate steps to determine the existence of a code-sensitive connection. This procedure (outlined in Figure 9) utilizes predetermined sequences transmitted to the receiving-terminal operator. These message sequences require that the terminal respond normally to the messages but should not operate upon the text. First a known good message of approximately 100 characters (all 'FF') should be transmitted. If the response to this message is an ACK, then the connection may be assumed to be capable of transmitting a normal message. When a NAK response is received over several retries, then other than a code-sensitive cause for the errors may be assumed, and normal error procedures should be followed.

Following the ACK response to the known good message, another test message should be transmitted. This time the message is made up of 15 contiguous (adjacent) characters of 'AA' (or N) followed by 15 contiguous characters of '55' (or ESC), followed by 15 characters of '00' (or SOH), and completed with 15 characters of 'FF' (or DEL). If the connection is code-sensitive, then this test message causes sync errors. This message should be transmitted at least three times seeking a NAK response to each transmission. Several timeouts may occur with each transmission due to loss of synchronization by the receiving data set. A single NAK response

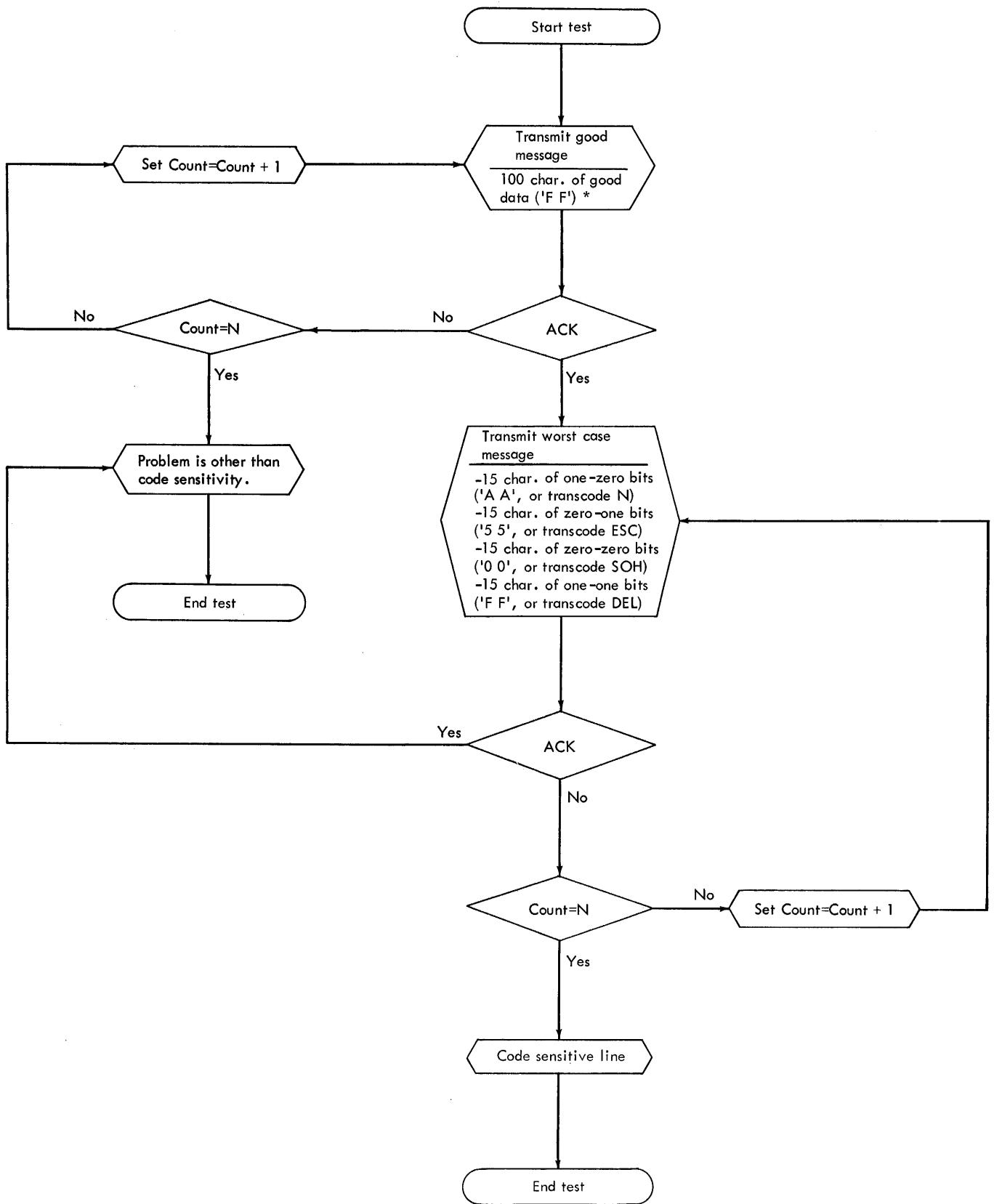

* This symbol ' ' indicates a hexadecimal representation

Figure 9. Procedure For Code Sensitivity Testing

may be due to a transient noise condition. If any of the responses is ACK, then the connection should be assumed to be not code-sensitive, and normal error procedures should be followed. When the required number of NAK's has been obtained, then the connection may be assumed to be code-sensitive. Note that the existence of a code-sensitive connection does not infer that either the communications channel or the data set is failing. As previously stated, Data Set 201B operating over Type 3004 Private Line Service or Class F Channels may experience code sensitivity.

Recovery

Once code sensitivity has been established, several alternatives are available to the user. The original message may be printed out in order to determine the existence of sequences of both the 'AA' and '55' characters (N and ESC). If the message contains one of the weak patterns but not both, then continued retransmission may be tried to allow the random operation with the dibit clock to remove the weak data patterns. If this is unsuccessful, or if sequences of both '55' or 'AA' (ESC and N) exist, then alternate means must be used to handle the message. One such means is to "exclusive OR" the 'C9' (Transcode 9) or other scrambling character with each character in the message. First, however, send a message informing the receiving-station operator of the operation to be performed; then transmit the scrambled message. This technique requires that the receiving station be able to unscramble the received message. If this technique is not desired or cannot be used, then other alternate message routing should be used.

When the communications connection is identified to be code-sensitive and the frequency of occurrence of messages with weak patterns is high, then a change in the configuration (to one which is not code-sensitive) should be considered.

COMMUNICATIONS OVER WIDEBAND CHANNELS

Western Electric Data Set 303 series equipment is susceptible to losing bit synchronization any time it transmits a continuous sequence of more than 500 binary zero bits. This condition can be avoided by specifying (to the common-carrier representative when placing your order) that the data-set equipment should be delivered with a Universal Scrambler installed on each data set. The specific equipment involved is Western Electric Wideband Data Stations 303B, 303C, and 303D.

NOTE: This condition is not relevant if the message traffic does not provide the possibility for transmission of a contiguous string of 500 or more zero bits at any time.

Western Electric Data Set 301B is not code-sensitive, and is capable of transmitting and receiving all code sequences without any effect on the bit synchronization. Currently available wideband data-set equipment and the related operating speeds (in bits per second--bps) are:

| <u>Equipment</u> | <u>Speed</u> |
|---|--------------|
| Western Electric Wideband Data Station 303B | 19,200 bps |
| Western Electric Data Set 301B | 40,800 bps |
| Western Electric Wideband Data Station 303C | 50,000 bps |
| Western Electric Wideband Data Station 303D | 230,400 bps |

APPENDIX: SYSTEM/360 INTERNAL PROCESSOR CODES (EBCDIC and ASCII-8)

The numbering convention for the bit positions within a character differ for each of the codes. The conventions are:

| | |
|-------------|----------------------|
| <u>Code</u> | <u>Bit Positions</u> |
| EBCDIC | 01234567 |
| ASCII-8 | 76X54321 |

EXTENDED BINARY-CODED-DECIMAL INTERCHANGE CODE (EBCDIC)

| | | | | | | | |
|-----------------------|-------------|-------------|---------------------|-----|-------------|-------------|---------------------|
| | 00 | 01 | ← Bit Positions 0,1 | | 10 | 11 | ← Bit Positions 0,1 |
| | 00 01 10 11 | 00 01 10 11 | ← Bit Positions 2,3 | | 00 01 10 11 | 00 01 10 11 | ← Bit Positions 2,3 |
| Bit Positions 4,5,6,7 | 0000 | NUL | DLE | DŠ | | | |
| | 0001 | SOH | DC1 | SOS | | | |
| | 0010 | STX | DC2 | FŠ | SYN | | |
| | 0011 | ETX | DC3 | | | | |
| | 0100 | PF | RES | BYP | PN | | |
| | 0101 | HT | NL | LF | RS | | |
| | 0110 | LC | BŠ | EOB | UC | | |
| | 0111 | DEL | IL | PRE | EOT | | |
| | 1000 | | CAN | | | | |
| | | | SP | & | - | | |
| | | | / | | | | |

| | | | | | | | |
|-----------------------|-------------|-------------|---------------------|---|-------------|-------------|---------------------|
| | 00 | 01 | ← Bit Positions 0,1 | | 10 | 11 | ← Bit Positions 0,1 |
| | 00 01 10 11 | 00 01 10 11 | ← Bit Positions 2,3 | | 00 01 10 11 | 00 01 10 11 | ← Bit Positions 2,3 |
| Bit Positions 4,5,6,7 | 0000 | | | | | | 0 |
| | 0001 | a | i | | | A | J |
| | 0010 | b | k | s | | B | K |
| | 0011 | c | l | t | | C | L |
| | 0100 | d | m | u | | D | M |
| | 0101 | e | n | v | | E | N |
| | 0110 | f | o | w | | F | O |
| | 0111 | g | p | x | | G | P |
| | 1000 | h | q | y | | H | Q |
| | 1001 | i | r | z | | I | R |
| | | | | | | | 1 |
| | | | | | | | 2 |
| | | | | | | | 3 |
| | | | | | | | 4 |
| | | | | | | | 5 |
| | | | | | | | 6 |
| | | | | | | | 7 |
| | | | | | | | 8 |
| | | | | | | | 9 |

| | | | | | | | |
|-----------------------|-------------|-------------|---------------------|-----|-------------|-------------|---------------------|
| | 00 | 01 | ← Bit Positions 0,1 | | 10 | 11 | ← Bit Positions 0,1 |
| | 00 01 10 11 | 00 01 10 11 | ← Bit Positions 2,3 | | 00 01 10 11 | 00 01 10 11 | ← Bit Positions 2,3 |
| Bit Positions 4,5,6,7 | 1001 | | EM | | | | |
| | 1010 | SMM | CC | SM | ç | ! | : |
| | 1011 | VT | | | . | \$ | , |
| | 1100 | FF | IFS | DC4 | < | * | % |
| | 1101 | CR | IGS | ENQ | NAK | (|) |
| | 1110 | SO | IRS | ACK | | + | ; |
| | 1111 | SI | IUS | BEL | SUB | | ¬ |
| | | | | | | ? | " |

| | | | | | | | |
|-----------------------|------|----|----|----|--|--|--|
| | 00 | 01 | 10 | 11 | | | |
| | | | | | | | |
| Bit Positions 4,5,6,7 | 1010 | | | | | | |
| | 1011 | | | | | | |
| | 1100 | | | | | | |
| | 1101 | | | | | | |
| | 1110 | | | | | | |
| 1111 | | | | | | | |

Note: Current activities in committees under the auspices of USASI may result in changes to the characters, the card codes assigned to the characters and/or the structure of the eight bit representation of USASCII devised by the Institute. Such changes may cause the characters, their card codes and/or the structure of the eight-bit representation of USASCII implemented in System/360 (ASCII-8) to be different from the future USA standards. Since a difference of this nature may eventually lead to a modification of System/360, it is recommended that users employ caution in their system implementation of those characters, their card codes and/or the structure of the eight-bit representation so that any retrofit impact on their system will be minimal.

EBCDIC chart explanation (continued)

Control Character

| | | | | | |
|-----|--|-----|-------------------------|------|------------------------------|
| NUL | Null | PRE | Prefix (or ESC, Escape) | SI | Shift In |
| PF | Punch Off | SM | Set Mode | SMM | Start of Manual Message |
| HT | Horizontal Tab | PN | Punch On | DLE | Data Link Escape |
| LC | Lower Case | RS | Reader Stop | DC1 | Device Control 1 |
| DEL | Delete | UC | Upper Case | DC2 | Device Control 2 |
| RES | Restore | EOT | End of Transmission | DC3 | Device Control 3 |
| NL | New Line | SP | Space | DC4 | Device Control 4 |
| BS | Backspace | SOH | Start of Heading | NAK | Negative Acknowledge |
| IL | Idle | STX | Start of Text | SYN | Synchronous Idle |
| CC | Cursor Control | ETX | End of Text | CAN | Cancel |
| DS | Digit Select | ENQ | Enquiry | EM | End of Medium |
| SOS | Start of Significance | ACK | Acknowledge | SIJB | Substitute |
| FS | Field Separator | BEL | Bell | IGS | Information Group Separator |
| BYP | Bypass | VT | Vertical Tabulation | IFS | Information Record Separator |
| LF | Line Feed | FF | Form Feed | IUS | Information Unit Separator |
| EOB | End of Block (or ETB, End of Transmission Block) | CR | Carriage Return | IFS | Information Field Separator |
| | | SO | Shift Out | | |

Special Graphic Characters

| | | | | | |
|----|--------------------------|---|--------------------|---|-------------------|
| ¢ | Cent Sign | * | Asterisk | > | Greater-than Sign |
| . | Period, Decimal Point |) | Right Parenthesis | ? | Question Mark |
| < | Less-than Sign | ; | Semicolon | : | Colon |
| (| Left Parenthesis | ~ | Logical NOT | # | Number Sign |
| + | Plus Sign | - | Minus Sign, Hyphen | @ | At Sign |
| | Vertical Bar, Logical OR | / | Slash | ' | Prime, Apostrophe |
| & | Ampersand | , | Comma | = | Equal Sign |
| ! | Exclamation Point | % | Percent | " | Quotation Mark |
| \$ | Dollar Sign | _ | Underscore | | |

AMERICAN STANDARD CODE FOR INFORMATION INTERCHANGE EXTENDED TO EIGHT BITS (ASCII-8)

| Bit Positions | 00 | | | | 01 | | | | 10 | | | | 11 | | | |
|---------------|-----|-----|----|----|----|----|----|----|----|----|----|----|----|----|----|-----|
| | 00 | 01 | 10 | 11 | 00 | 01 | 10 | 11 | 00 | 01 | 10 | 11 | 00 | 01 | 10 | 11 |
| 0000 | NUL | DLE | | | SP | 0 | | | | | @ | P | | | ' | p |
| 0001 | SOH | DC1 | | | ! | 1 | | | | | A | Q | | | a | q |
| 0010 | STX | DC2 | | | " | 2 | | | | | B | R | | | b | r |
| 0011 | ETX | DC3 | | | # | 3 | | | | | C | S | | | c | s |
| 0100 | EOT | DC4 | | | \$ | 4 | | | | | D | T | | | d | t |
| 0101 | ENQ | NAK | | | % | 5 | | | | | E | U | | | e | u |
| 0110 | ACK | SYN | | | & | 6 | | | | | F | V | | | f | v |
| 0111 | BEL | ETB | | | ' | 7 | | | | | G | W | | | g | w |
| 1000 | BS | CAN | | | (| 8 | | | | | H | X | | | h | x |
| 1001 | HT | EM | | |) | 9 | | | | | I | Y | | | i | y |
| 1010 | LF | SUB | | | * | : | | | | | J | Z | | | j | z |
| 1011 | VT | ESC | | | + | ; | | | | | K | [| | | k | { |
| 1100 | FF | FS | | | , | < | | | | | L | \ | | | l | |
| 1101 | CR | GS | | | - | = | | | | | M |] | | | m | ~ |
| 1110 | SO | RS | | | . | > | | | | | N | ^ | | | n | ~ |
| 1111 | SI | US | | | / | ? | | | | | O | _ | | | o | DEL |

Note: Current activities in committees under the auspices of USASI may result in changes to the characters, the card codes assigned to the characters and/or the structure of the eight bit representation of USASCII devised by the Institute. Such changes may cause the characters, their card codes and/or the structure of the eight-bit representation of USASCII implemented in System/360 (ASCII-8) to be different from the future USA standards. Since a difference of this nature may eventually lead to a modification of System/360, it is recommended that users employ caution in their system implementation of those characters, their card codes and/or the structure of the eight-bit representation so that any retrofit impact on their system will be minimal.



International Business Machines Corporation
Data Processing Division
112 East Post Road, White Plains, N.Y. 10601
(USA Only)

IBM World Trade Corporation
821 United Nations Plaza, New York, New York 10017
(International)

READER'S COMMENT FORM

General Information--Binary Synchronous Communications
SRL

A27-3004-0

- Your comments, accompanied by answers to the following questions, help us produce better publications for your use. If your answer to a question is "No" or requires qualification, please explain in the space provided below. Comments and suggestions become the property of IBM.

- | | Yes | No |
|--|--------------------------|---|
| ● Does this publication meet your needs? | <input type="checkbox"/> | <input type="checkbox"/> |
| ● Did you find the material: | | |
| Easy to read and understand? | <input type="checkbox"/> | <input type="checkbox"/> |
| Organized for convenient use? | <input type="checkbox"/> | <input type="checkbox"/> |
| Complete? | <input type="checkbox"/> | <input type="checkbox"/> |
| Well illustrated? | <input type="checkbox"/> | <input type="checkbox"/> |
| Written for your technical level? | <input type="checkbox"/> | <input type="checkbox"/> |
| ● What is your occupation? _____ | | |
| ● How do you use this publication? | | |
| As an introduction to the subject? <input type="checkbox"/> | | As an instructor in a class? <input type="checkbox"/> |
| For advanced knowledge of the subject? <input type="checkbox"/> | | As a student in a class? <input type="checkbox"/> |
| For information about operating procedures? <input type="checkbox"/> | | As a reference manual? <input type="checkbox"/> |
| Other _____ | | |
- Please give specific page and line references with your comments when appropriate. If you wish a reply, be sure to include your name and address.

COMMENTS:

- Thank you for your cooperation. No postage necessary if mailed in the U. S. A.

Staple

Fold

Fold

FIRST CLASS
PERMIT NO. 155
RALEIGH, N. C.

BUSINESS REPLY MAIL
NO POSTAGE NECESSARY IF MAILED IN THE UNITED STATES

POSTAGE WILL BE PAID BY . . .

IBM Corporation
P. O. Box 12275
Research Triangle Park
North Carolina 27709

Attention: Product Publications, Dept. 860



Cut Along Line

Fold

Fold



International Business Machines Corporation
Data Processing Division
112 East Post Road, White Plains, N.Y. 10601
(USA Only)

IBM World Trade Corporation
821 United Nations Plaza, New York, New York 10017
(International)

Additional Comments: