



SC21-7734-7

File No. S38-20

IBM System/38

IBM System/38 Programming Reference Summary

Program Numbers: 5714-SS1
5714-RG1
5714-UT1
5714-CB1
5714-RC1
5714-UT2
5714-BA1
5714-WP2
5714-WP1
5714-CV2
5714-PL1
5714-GP1



SC21-7734-7

File No. S38-20

IBM System/38

IBM System/38

Programming Reference Summary

Program Numbers: 5714-SS1

5714-RG1

5714-UT1

5714-CB1

5714-RC1

5714-UT2

5714-BA1

5714-WP2

5714-WP1

5714-CV2

5714-PL1

5714-GP1

Eighth Edition (September 1985)

This major revision makes obsolete SC21-7734-6. Changes or additions to the text and illustrations are indicated by a vertical line to the left of the change or addition.

This edition applies to Release 7.0, Modification Level 0, of the following:

- IBM System/38 Control Program Facility (Program 5714-SS1)
- IBM System/38 RPG III (Program 5714-RG1)
- IBM System/38 Interactive Data Base Utilities (Program 5714-UT1)
- IBM System/38 COBOL (Program 5714-CB1)
- IBM System/38 Remote Job Entry Facility (Program 5714-RC1)
- IBM System/38 Advanced Printer Function Utility (Program 5714-UT2)
- IBM System/38 BASIC (Program 5714-BA1)
- IBM System/38 OFFICE/38-Text Management (Program 5714-WP2)
- IBM System/38 OFFICE/38-Administrative Management (Program 5714-WP1)
- IBM System/38 OFFICE/38-Personal Services/38 (Program 5714-WP3)
- IBM System/38 Conversion Reformat Utility (Program 5714-CV2)
- IBM System/38 PL/I (Program 5714-PL1)
- IBM System/38 Business Graphics Utility (Program 5714-GP1)

and to all subsequent releases and modifications until otherwise indicated in new editions or Technical Newsletters. Changes are periodically made to the information herein; any such changes will be reported in subsequent revisions or Technical Newsletters.

References in this publication to IBM products, programs, or services do not imply that IBM intends to make these available in all countries in which IBM operates. Any reference to an IBM licensed program in this publication is not intended to state or imply that only IBM's licensed program may be used. Any functionally equivalent program may be used instead.

Publications are not stocked at the address given below. Requests for IBM publications should be made to your IBM representative or to the IBM branch office serving your locality.

This publication could contain technical inaccuracies or typographical errors. A form for readers' comments is provided at the back of this publication. If the form has been removed, comments may be addressed to IBM Corporation, Information Development, Department 245, Rochester, Minnesota, U.S.A. 55901 IBM may use or distribute whatever information you supply in any way it believes appropriate without incurring any obligation to you.

© Copyright International Business Machines Corporation 1979,
1980, 1981, 1982, 1983, 1984, 1985

Contents

ABOUT THIS MANUAL	vii
If You Need More Information	viii
CHAPTER 1. CL COMMAND MENU GROUPS	1-1
CHAPTER 2. COMMAND SYNTAX DIAGRAMS	2-1
Commands	2-3
Command Definition Statements	2-275
CHAPTER 3. COMMAND MATRIX	3-1
CHAPTER 4. USER PROFILE MATRIX	4-1
CHAPTER 5. CPF OBJECT TYPES	5-1

CHAPTER 6. OBJECT AUTHORITY REQUIRED	
FOR COMMANDS AND OBJECTS	6-1
Normal Authority by Object Type	6-3
Operational Authority by Object Type	6-5
Commands Common to All Objects	6-8
Applications	6-10
Chart Formats	6-10
Classes	6-11
Commands	6-11
Control Unit Descriptions	6-12
Data Areas	6-12
Data Queues	6-13
Device Descriptions	6-14
Device Emulation	6-15
Documents	6-16
Document Lists	6-16
Edit Descriptions	6-16
Files	6-17
Finance	6-24
Forms Control Tables	6-25
Graphic Symbol Sets	6-25
Job Descriptions	6-26
Job Queues	6-26
Jobs	6-27
Journals	6-30
Journal Receivers	6-32
Libraries	6-33
Line Descriptions	6-34
Message Files	6-34
Message Queues	6-35
Output Queues	6-36
Print Images	6-36
Programs	6-37
Readers	6-39
Session Descriptions	6-40
Spelling Aid Dictionary	6-41
Spooled Files	6-42
Subsystem Descriptions	6-43
System Reply List	6-44
System Values	6-44
Tables	6-45
User Profiles	6-45
Writers	6-46

CHAPTER 7. IBM-SUPPLIED OBJECTS	7-1
Card Files	7-3
Classes	7-4
Control Unit Descriptions	7-4
Data Base Files	7-4
Device Descriptions	7-5
Diskette Files	7-5
Edit Descriptions	7-5
Graphic Symbol Sets	7-6
Job Descriptions	7-6
Job Queues	7-7
Libraries	7-7
Message Files	7-8
Message Queues	7-9
Output Queues	7-9
Printer Files	7-10
Programs	7-10
Subsystem Descriptions	7-10
Tables	7-11
Tape Files	7-11
User Profiles	7-11
 CHAPTER 8. SYSTEM VALUES	 8-1
Date and Time	8-4
Editing	8-4
System Control	8-5
Library List	8-7
Allocation	8-7
Message and Logging	8-8
Storage	8-8

CHAPTER 9. DDS	9-1
Physical and Logical File Keywords–Group Listing	9-3
Physical and Logical File Keyword Descriptions	9-5
Display File Keywords–Group Listing	9-10
Display File Keyword Descriptions	9-13
Printer File Keywords–Group Listing	9-24
Printer File Keyword Descriptions	9-26
BSC File Keywords–Group Listing	9-29
BSC File Keyword Descriptions	9-30
Communications File Keywords–Group Listing	9-32
Communications File Keyword Descriptions	9-33
Mixed File Keyword Descriptions	9-35
DDS Keyword and Value Abbreviations	9-36
DDS Edit Codes	9-40
CHAPTER 10. RPG III	10-1
RPG Operation Codes	10-3
RPG Edit Codes	10-8
CHAPTER 11. CPF GRAPHICS	11-1
Data Types for Graphics Routine Parameters	11-3
Data Types in GDDM	11-4
Data Types in PGR	11-8
CHAPTER 12. CHARACTER CODES	12-1
Decimal-to-Hexadecimal Chart: Printable	
Character and Control Characters	12-3
Hexadecimal-to-Binary Character Conversion	12-12



About This Manual

This manual is designed to help the programmer working with System/38 who knows what to do but cannot remember how to do it.

The *IBM System/38 Programming Reference Summary* contains summaries (not usually explanations) of information (commands and summary charts) from the System/38 licensed programs.

The *Programming Reference Summary* will help the programmer find the information he needs without his having to search through the various guides and reference manuals. Detailed explanations of the summaries can be found in the manuals listed under *If You Need More Information*.

Note: This manual follows the convention that *he* means *he* or *she*.

IF YOU NEED MORE INFORMATION

Information found in the *Programming Reference Summary* is explained in detail in the following manuals:

- *IBM System/38 Control Language Reference Manual, SC21-7731*, describes commands and parameters that are used for various programming functions.
- *IBM System/38 Control Program Facility Reference Manual—Data Description Specifications, SC21-7806*, describes the data description specifications that are used for describing files.
- *IBM System/38 Control Program Facility Programmer's Guide, SC21-7730*, explains how to use the functions introduced in the concepts manual using the commands and data description specifications explained in the reference manuals.
- *IBM System/38 RPG III Reference Manual and Programmer's Guide, SC21-7725*, provides detailed information about designing and creating RPG programs.
- *IBM System/38 COBOL Reference Manual and Programmer's Guide, SC21-7718*, provides detailed language information and information about files and debugging for the COBOL programmer.
- *IBM System/38 COBOL Reference Summary, SC21-7781*, outlines clauses and statements used in System/38 COBOL.
- *IBM System/38 Screen Design Aid Reference Manual and User's Guide, SC21-7755*, contains information about the purposes of SDA and the system support for SDA, and explains how to use SDA.
- *IBM System/38 Data File Utility Reference Manual and User's Guide, SC21-7714*, describes how to create and maintain data base files using DFU.
- *IBM System/38 Source Entry Utility Reference Manual and User's Guide, SC21-7722*, provides information about adding and changing source statements using the provided source entry applications.
- *IBM System/38 Query Utility Reference Manual and User's Guide, SC21-7724*, provides information about designing, creating, and executing query applications.
- *IBM System/38 Data Communications Programmer's Guide, SC21-7825*, describes System/38 data communications, how to configure communications devices, and how to use communications functions.

- *IBM System/38 Remote Job Entry Facility User's Guide*, SC21-7914, describes how to use System/38 as a remote job entry work station to a host system.
- *IBM System/38 Guide to Publications*, GC21-7726, describes the contents of System/38 manuals and the reading sequences for them. It also defines terms used in System/38 manuals and provides a master index for System/38 manuals.
- *IBM System/38 OFFICE/38-Text Management Reference Manual and User's Guide*, SC09-1022, describes how to create, revise, browse, and print documents.
- *IBM System/38 Advanced Printer Function Utility User's Guide*, SC21-7973, describes how to create a symbol set and form design that can be merged with other data to produce specialized documents.
- *IBM System/38 3270 Device Emulation Reference Manual and User's Guide*, SC21-7961, describes how to emulate a 3270 device attached to the host system with which the System/38 is linked.
- *IBM System/38 OFFICE/38-Administrative Management: Using and Managing Administrative Management*, SC09-1040, describes how to use the utilities calendar function, correspondence control function, management message facility.
- *IBM System/38 PL/I Reference Manual and Programmer's Guide*, SC09-1051, describes PL/I as implemented on the System/38.
- *IBM System/38 OFFICE/38-Business Graphics Utility User's Guide and Reference Manual*, SC09-1059, describes how to create business charts on the System/38.
- *IBM System/38 Control Program Facility Graphics Programmer's Guide*, SC21-8006, describes the application program interface to graphics on the System/38.
- *IBM System/38 Control Program Facility Graphics Reference Manual*, SC21-8007, provides detailed reference information for the application program interface to graphics on the System/38.
- *IBM System/38 Finance Support User's Guide*, SC21-9099, describes how to use the System/38 Finance Support product to support finance terminals that are attached to the System/38.
- *IBM System/38 OFFICE/38-Personal Services/38 Introduction*, GC09-1071, describes how to use the major functions of PS/38.
- *IBM System/38 OFFICE/38-Personal Services/38 Planning and Installation Guide and Reference*, SC09-1070, describes how to fit PS/38 into your current operations.

- *IBM System/38 OFFICE/38–Personal Services/38 Learning by Example* manuals, which illustrate how to use all the functions of PS/38:
 - *Primer*, SC09-1069
 - *Handling Mail*, SC09-1076
 - *Finding and Handling Filed Documents*, SC09-1077
 - *Sending Messages and Memos*, SC09-1078
 - *Editing Text Documents*, SC09-1079
 - *Handling Text Documents*, SC09-1080
 - *Working with Calendars*, SC09-1081
 - *Working with Personal Directories*, SC09-1082
 - *Administering*, SC09-1083

Chapter 1. CL Command Menu Groups

This section contains all of the command selection menus. The menus are grouped by verbs and subjects which help you locate commands according to their function or object type.

If you enter DSPMNU MENU(CMDGRP) specifically or by default, the command grouping menu will be shown:

```
CMDGRP          COMMAND GROUPING MENU

Select one of the following:
  1. All Commands Menu          ALLCMD
  2. Verb Menu                  VERB
  3. Subject Menu               SUBJECT
  4. Object Management Menu     OBJ
  5. Data Base File Menu       DBF
  6. File Menu                  FILE
  7. Device Management Menu     DEVMGT
  8. Programming Menu          PGM
  9. Program Debug Menu        DBG
 10. Message Handling Menu      MSGHDL
 11. Utilities Menu (If Installed) UTL
 12. Input/Output Spooling Menu SPL
 13. System Control Menu       SYSCTL
 14. Work Management Menu      WRKMGT
 15. Configuration Menu       CFG
 16. Security Menu            SEC
 17. Save/Restore Menu        SAVRST

Option or command: _____ Or menu: _____
Partial command name: _____
CF1-Exit   CF2-Previous menu   CF16-Execute with no prompt
```

The following options are available to you from this menu:

- ALLCMD (all commands menu). From this menu you can select any IBM-supplied command for prompting. Command names for languages and utilities that have not been installed will appear but cannot be selected from this menu.
- VERB (verb menu). This menu lists the verb components of IBM-supplied command names (verbs perform actions upon subjects). From this menu you can select another menu that lists all commands that perform the function implied by the verb. For example, if you selected the DLT menu, a menu would be presented that contains all commands that delete a subject on the system.

The verb menu has the following format:

Verb Menu

1.	Add Menu	ADD
2.	Allocate Menu	ALC
3.	Answer Menu	ANS
4.	Apply Menu	APY
5.	Begin Menu	BGN
6.	Browse Menu	BRW
7.	Call Menu	CALL
8.	Cancel Menu	CNL
9.	Change Menu	CHG
10.	Check Menu	CHK
11.	Clean Menu	CLN
12.	Clear Menu	CLR
13.	Close Menu	CLO
14.	Commit Menu	CMT
15.	Compare Menu	CMP
16.	Convert Menu	CVT
17.	Copy Menu	CPY
18.	Create Menu	CRT
19.	Deallocate Menu	DLC
20.	Declare Menu	DCL
21.	Define Menu	DFN
22.	Delay Menu	DLY
23.	Delete Menu	DLT
24.	Design Menu	DSN
25.	Display Menu	DSP
26.	Do Menu	DO

27.	Dump Menu	DMP
28.	Duplicate Menu	DUP
29.	Edit Menu	EDT
30.	Eject Menu	EJT
31.	Emulate Menu	EML
32.	End Menu	END
33.	Enter Menu	ENT
34.	Execute Menu	EXC
35.	Format Menu	FMT
36.	Go Menu	GO
37.	Grant Menu	GRT
38.	Hold Menu	HLD
39.	Initialize Menu	INZ
40.	Journal Menu	JRN
41.	List Menu	LST
42.	Load Menu	LOD
43.	Manage Menu	MNG
44.	Merge Menu	MRG
45.	Monitor Menu	MON
46.	Move Menu	MOV
47.	Open Menu	OPN
48.	Override Menu	OVR
49.	Patch Menu	PCH
50.	Power Menu	PWR
51.	Prepare Menu	PRP
52.	Printer Menu	PRT
53.	Query Menu (if installed)	QRY
54.	Receive Menu	RCV
55.	Reclaim Menu	RCL
56.	Release Menu	RLS
57.	Remove Menu	RMV
58.	Rename Menu	RNM
59.	Reorganize Menu	RGZ
60.	Replace Menu	RPL
61.	Reroute Menu	RRT
62.	Restore Menu	RST
63.	Resume Menu	RSM
64.	Retrieve Menu	RTV
65.	Return Menu	RTN
66.	Revoke Menu	RVK
67.	Rollback Menu	ROLL
68.	Save Menu	SAV
69.	Send Menu	SND
70.	Service Menu	SRV

71. Set Menu	SET
72. Sign Menu	SIGN
73. Start Menu	STR
74. Stop Menu	STP
75. Submit Menu	SBM
76. Terminate Menu	TRM
77. Trace Menu	TRC
78. Transfer Menu	TFR
79. Vary Menu	VRV
80. Verify Menu	VFY
81. Wait Menu	WAIT

- SUBJECT (subject menu). This menu lists the subject components of IBM-supplied command names, as well as other subjects. From this menu you can select other menus that contain commands and other menus that are related to a subject. For example, if you selected the CLS (Class) menu, the next menu would offer the create, delete, and display commands for classes, as well as other menus from which additional class-related functions can be selected.

The subject menu has the following format:

Subject Menu

1.	Access Code Menu	ACC
2.	Advanced Printer Function Menu	APF
3.	Application Menu	APP
4.	Attention Menu	ATN
5.	Authority Menu	AUT
6.	Autostart Job Entry Menu	AJE
7.	Basic Menu	BAS
8.	Breakpoint Menu	BKP
9.	BSC Menu	BSC
10.	BSC File Menu	BSCF
11.	Card Menu	CRD
12.	Card File Menu	CRDF
13.	Chart Menu	CHT
14.	CL Menu	CL
15.	Class Menu	CLS
16.	COBOL Menu	CBL
17.	Command Menu	CMD
18.	Command Definition Stmt Menu	CMDDEF
19.	Commit Menu	CMT
20.	Communications Menu	CMN
21.	Communications Entry Menu	CMNE
22.	Communications File Menu	CMNF
23.	Configuration Menu	CFG
24.	Control Menu	CTL
25.	Control Unit Menu	CTLU
26.	Control Unit Description Menu	CUD
27.	Data Menu	DTA
28.	Data Area Menu	DTAARA
29.	Data Base Menu	DB
30.	Data Base File Menu	DBF
31.	Data Queue Menu	DTAQ
32.	Definition Menu	DEF

33.	Device Menu	DEV
34.	Device Description Menu	DEV D
35.	Device Management Menu	DEV MGT
36.	Device Mode Menu	DEV MOD
37.	Device Service Menu	DEV SRV
38.	DFU Menu (if installed)	DFU
39.	Dictionary Menu	DCT
40.	Directory Menu	DIR
41.	Diskette Menu	DKT
42.	Diskette File Menu	DKTF
43.	Display File Menu	DSPF
44.	Distribution Menu	DST
45.	Document Menu	DOC
46.	Edit Description Menu	EDTD
47.	Emulation Menu	EML
48.	File Menu	FILE
49.	File Member Menu	MBR
50.	Finance Menu	FNC
51.	Forms Control Table Menu	FCT
52.	Graphics Menu	GPH
53.	Group Menu	GRP
54.	Image Menu	IMG
55.	Intelligent Work Station Menu	IWS
56.	Input/Output Spooling	SPL
57.	Internal Machine Menu	INT
58.	Job Menu	JOB
59.	Job Description Menu	JOB D
60.	Job Queue Menu	JOB Q
61.	Job Queue Entry Menu	JOB QE
62.	Job Service Menu	JOBSRV
63.	Journal Menu	JRN
64.	Journal Receiver Menu	JRNRCV
65.	Library Menu	LIB
66.	Library List Menu	LIBL
67.	Line Menu	LIN
68.	Line Description Menu	LIND
69.	Locks Menu	LCK
70.	Logical File Member Menu	LFM
71.	Logical File Menu	LF
72.	Menu Menu	MNU
73.	Message Menu	MSG
74.	Message Description Menu	MSGD
75.	Message File Menu	MSGF
76.	Message Handling Menu	MSGHDL

77. Message Queue Menu	MSGQ
78. Mixed Device File Menu	MXDF
79. Network Menu	NET
80. Object Management Menu	OBJ
81. Object Service Menu	OBJSRV
82. Output Queue Menu	OUTQ
83. Pass-Through Menu	PASTHR
84. Personal Services Menu	PS
85. Physical File Member	PFM
86. Physical File Menu	PF
87. PLI Menu	PLI
88. Print Image Menu	PRTIMG
89. Printer Menu	PRT
90. Printer File Menu	PRTF
91. Profile Menu	PRF
92. Program Debug Menu	DBG
93. Programming Menu	PGM
94. Programming Change Menu	PGMCHG
95. Query Menu (if installed)	QRY
96. Reader Menu	RDR
97. Reader Entry Menu	RDRE
98. Recovery Menu	RCY
99. Reply List Menu	RPYL
100. RJE Menu (if installed)	RJE
101. RJE Control Menu	RJECTL
102. Routing Entry Menu	RTGE
103. RPG III Menu	RPG
104. Save File Menu	SAVF
105. Save/Restore Menu	SAVRST
106. Security Menu	SEC
107. Service Management Menu	SRVMGT
108. Session Menu	SSN
109. Session Description Menu	SSND
110. Source Menu	SRC
111. Spooled File Menu	SPLF
112. Submit Job Menu	SBMJOB
113. Subsystem Menu	SBS
114. Subsystem Description Menu	SBSD
115. System Menu	SYS
116. System Control Menu	SYSCTL
117. System Value Menu	SYSVAL
118. Table Menu	TBL
119. Tape Menu	TAP
120. Tape File Menu	TAPF

121. Text Menu	TXT
122. Trace Menu	TRC
123. User Menu	USR
124. User Profile Menu	USRPRF
125. Utilities Menu (if installed)	UTL
126. Work Management Menu	WRKMGT
127. Work Station Entry Menu	WSE
128. Writer Menu	WTR
129. Writer Entry Menu	WTRE

- OBJ (object management menu). From this menu you can select commands and other menus that are related to object management.

The object management menu has the following format:

Object Management Menu

1. Check Object	CHKOBJ
2. Create Duplicate Object	CRTDUPOBJ
3. Display Object Description	DSPOBJD
4. Move Object	MOV OBJ
5. Rename Object	RNMOBJ
6. Library Menu	LIB
7. Locks Menu	LCK
8. Object Service Menu	OBJSRV
9. Save/Restore Menu	SAVRST
10. Security Menu	SEC

- DBF (data base file menu). From this menu you can prompt for a command used to submit data base jobs, or you can select other menus that are related to data base files.

The data base file menu has the following format:

Data Base File Menu

1.	Close File	CLOF
2.	Display Data Base Relations	DSPDBR
3.	Open Data Base File	OPNDBF
4.	Start Data Base Reader	STRDBRDR
5.	Submit Data Base Job	SBMDBJOB
6.	Commit Menu	CMT
7.	File Menu	FILE
8.	File Member Menu	MBR
9.	Journal Menu	JRN
10.	Journal Receiver Menu	JRNRCV
11.	Logical File Menu	LF
12.	Physical File Menu	PF

- FILE (file menu). From this menu you can select another more specific device file or the data base file menu.

The file menu has the following format:

File Menu

1.	BSC File Menu	BSCF
2.	Card File Menu	CRDF
3.	Communications File Menu	CMNF
4.	Data Base File Menu	DBF
5.	Diskette File Menu	DKTF
6.	Display File Menu	DSPF
7.	Mixed Device File Menu	MXDF
8.	Printer File Menu	PRTF
9.	Save File Menu	SAVF
10.	Spooled File Menu	SPLF
11.	Tape File Menu	TAPF

- DEVMGT (device management menu). From this menu you can select other more specific device file menus.

The device management menu has the following format:

Device Management Menu

1.	Control Unit Menu	CTLU
2.	Device Menu	DEV
3.	Diskette Menu	DKT
4.	Emulation Menu	EML
5.	Line Menu	LIN
6.	Printer Menu	PRT
7.	Tape Menu	TAP

- PGM (programming menu). From this menu you can select menus for more specific programming functions, such as a specific programming language menu (if the programming language is installed), a menu for debugging functions, a menu for source file functions, or a menu listing utilities (installed or not).

The programming menu has the following format:

Programming Menu

1.	Call Program	CALL
2.	Change Program	CHGPGM
3.	Delete Program	DLTPGM
4.	Display Program	DSPPGM
5.	Display Program References	DSPPGMREF
6.	Manage Program Table	MNGPGMTBL
7.	Transfer Control	TFRCTL
8.	BASIC Menu	BAS
9.	CL Menu	CL
10.	COBOL Menu	CBL
11.	Graphics Menu	GPH
12.	Object Management Menu	OBJ
13.	PLI Menu	PLI
14.	Program Debug Menu	DBG
15.	RPG III Menu	RPG
16.	Source Menu	SRC
17.	Utilities Menu	UTL

- DBG (program debug menu). From this menu you can select commands associated with program debug functions.

The program debug menu has the following format:

Program Debug Menu

1.	Add Program	ADDPGM
2.	Change Debug	CHGDBG
3.	Change HLL Pointer	CHGHLLPTR
4.	Change Pointer	CHGPTR
5.	Change Program Variable	CHGPGMVAR
6.	Display Debug	DSPDBG
7.	Display Program Variable	DSPPGMVAR
8.	End COBOL Debug	ENDCBLDBG
9.	End Debug	ENDDBG
10.	Enter COBOL Debug	ENTCBLDBG
11.	Enter Debug	ENTDBG
12.	Remove Program	RMVPGM
13.	Breakpoint Menu	BKP
14.	Trace Menu	TRCDTA

- MSGHDL (message handling menu). From this menu you can select other menus that offer functions associated with message handling.

The message handling menu has the following format:

Message Handling Menu

1.	Log Menu	LOG
2.	Message Description Menu	MSGD
3.	Message File Menu	MSGF
4.	Message Menu	MSG
5.	Message Queue Menu	MSGQ
6.	Reply List Menu	RPYL

- UTL (utilities menu [if installed]). From this menu you can prompt for or invoke commands that control utilities that are installed.

The utilities menu has the following format:

Utilities Menu

1.	Design Format	DSNFMT
2.	Edit Document	EDTDOC
3.	Edit Source	EDTSRC
4.	Edit Text	EDTTXT
5.	Enter Admin Management	ENTADM
6.	Enter Personal Services	ENTPS
7.	Format Data	FMTDTA
8.	Advanced Printer Function Menu	APF
9.	DFU Menu (if installed)	DFU
10.	Finance Menu	FNC
11.	Graphics Menu	GPH
12.	Query Menu (if installed)	QRY
13.	RJE Menu (if installed)	RJE
14.	Text menu	TXT

- SPL (input/output spooling menu). From this menu you can select other menus that offer functions associated with input and output spooling.

The input/output spooling menu has the following format:

Input/Output Spooling Menu

1.	Job Queue Menu	JOBQ
2.	Output Queue Menu	OUTQ
3.	Reader Menu	RDR
4.	Spooled File Menu	SPLF
5.	Submit Job Menu	SBMJOB
6.	Writer Menu	WTR

- SYSCTL (system control menu). From this menu you can select other menus that offer functions associated with system and subsystem control.

The system control menu has the following format:

System Control Menu

1.	Display Log	DSPLOG
2.	Job Menu	JOB
3.	Subsystem Menu	SBS
4.	System Menu	SYS
5.	System Value Menu	SYSVAL

- WRKMGT (work management menu). From this menu you can select other menus that offer functions associated with class, job, and subsystem control.

The work management menu has the following format:

Work Management Menu

- | | | |
|----|----------------------------|------|
| 1. | Class Menu | CLS |
| 2. | Job Description Menu | JOB |
| 3. | Job Menu | JOB |
| 4. | Subsystem Menu | SBS |
| 5. | Subsystem Description Menu | SBSD |

- CFG (configuration menu). From this menu you can prompt for a command to display the configuration of a device, or you can select other menus associated with communications environment configurations and devices.

The configuration menu has the following format:

Configuration Menu

- | | | |
|-----|---------------------------------|-----------|
| 1. | Configure Distribution Services | CFGDSTSRV |
| 2. | Display Device Configuration | DSPDEVCFG |
| 3. | Communications Menu | CMN |
| 4. | Control Unit Description Menu | CUD |
| 5. | Device Description Menu | DEV |
| 6. | Device Mode Menu | DEVMOD |
| 7. | Edit Description Menu | EDTD |
| 8. | Line Description Menu | LIND |
| 9. | Print Image Menu | PRTIMG |
| 10. | System Menu | SYS |
| 11. | Table Menu | TBL |

- SEC (security menu). From this menu you can prompt for commands used for maintaining the security of the system and the objects on the system. Certain menu options are available to the security officer only.

The security menu has the following format:

Security Menu

1.	Change Object Owner	CHGOBJOWN
2.	Change Document Owner	CHGDOCOWN
3.	User Profile Menu	USRPRF
4.	Access Code Menu	ACC
	Authorization	
5.	Display Access Code Authority	DSPACCAUT
6.	Display Object Authority	DSPOBJAUT
7.	Grant Access Code Authority	GRTACCAUT
8.	Grant Document Authority	GRTDOCAUT
9.	Grant Object Authority	GRTOBJAUT
10.	Grant User Authority	GRTUSRAUT
11.	Restore Authority	RSTAUT
12.	Revoke Access Code Authority	RVKACCAUT
13.	Revoke Document Authority	RVKDOCAUT
14.	Revoke Object Authority	RVKOBJAUT

- SAVRST (save/restore menu). From this menu you can prompt for commands used to perform save and restore operations on the system. You can also select other menus for display that deal with save/restore media.

The save/restore menu has the following format:

Save/Restore Menu

	Object	
1.	Restore Object	RSTOBJ
2.	Save Changed Objects	SAVCHGOBJ
3.	Save Object	SAVOBJ
4.	Object Management Menu	OBJ
5.	Save File Menu	SAVF
	Document	
6.	Restore Document	RSTDOC
7.	Save Document	SAVDOC
	Library	
8.	Restore Library	RSTLIB
9.	Save Library	SAVLIB
	System	
10.	Restore Authority	RSTAUT
11.	Restore User Profiles	RSTUSRPRF
12.	Save System	SAVSYS
	Associated Functions	
13.	Diskette Menu	DKT
14.	Tape Menu	TAP

- CMD (command menu). From this menu you can prompt for commands and you can select menus used for defining your own CL commands.

The command menu has the following format:

Command Menu

- | | | |
|----|------------------------------|-----------|
| 1. | Change Command | CHGCMD |
| 2. | Create Command | CRTCMD |
| 3. | Delete Command | DLTCMD |
| 4. | Display Command | DSPCMD |
| 5. | Edit Source | EDTSRC |
| 6. | List Command Usage | LSTCMDUSG |
| 7. | Command Definition Stmt Menu | CMDDEF |
| 8. | Object Management Menu | OBJ |

- SRVMGT (service management menu). From this menu you can prompt for commands and select menus used for service management functions.

The service management menu has the following format:

Service Management Menu

- | | | |
|----|-------------------------|---------|
| 1. | Prepare APAR | PRPAPAR |
| 2. | Reclaim Storage | RCLSTG |
| 3. | Device Service Menu | DEVSrv |
| 4. | Internal Machine Menu | INT |
| 5. | Job Service Menu | JOBSRV |
| 6. | Object Service Menu | OBJSRV |
| 7. | Programming Change Menu | PGMCHG |

CHAPTER 2. COMMAND SYNTAX DIAGRAMS

Commands 2-3
Command Definition Statements 2-325

Notes:



Chapter 2. Command Syntax Diagrams

This section lists alphabetically all the CL commands that are used in CPF and in the other licensed programs. For each command, a brief description and the syntax diagram are provided. If an IBM-supplied data base or device file(s) is associated with a command, the file name(s) is given following the syntax diagram of the command.

For an explanation of how to read the syntax diagrams, refer to the *CL Reference Manual*. For an explanation of the relationship between commands and their associated device or data base files, see the *CL Reference Manual, Appendix D—Files Used by CL Commands*.

COMMANDS

ADDACC (Add Access Code)

Defines a new access code to the system, allowing subsequent use of the new code when a document is filed.

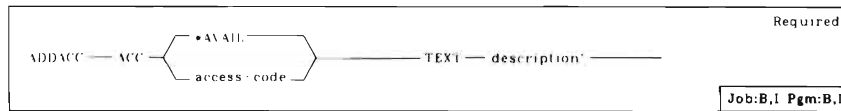

ADDAJE (Add Autostart Job Entry)

Adds an autostart job entry to a subsystem description.

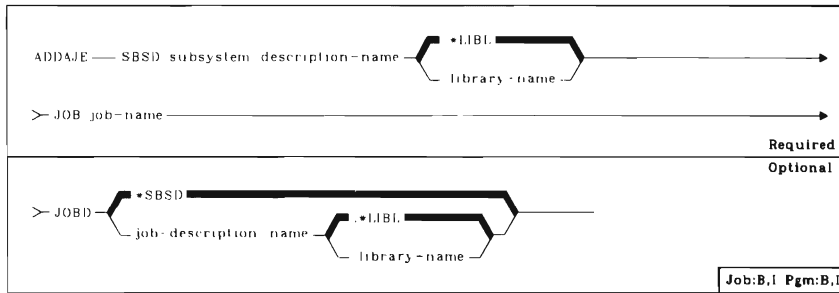

ADDBKP (Add Breakpoint)

Adds breakpoints to a program that is being debugged (using the ENTDBG command).

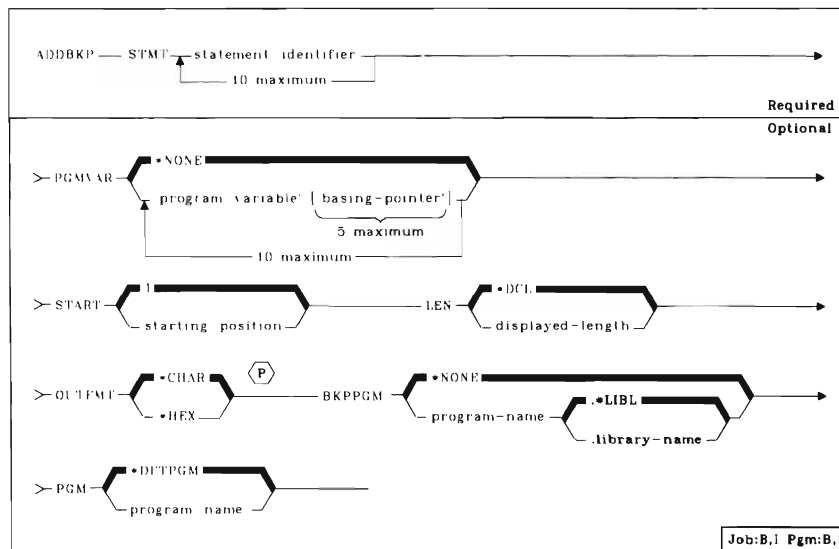

ADDBSCDEVE (Add BSC Device Entry)

Adds to a mixed file one or more BSC-program-device entries with the specified BSC device name and attributes.

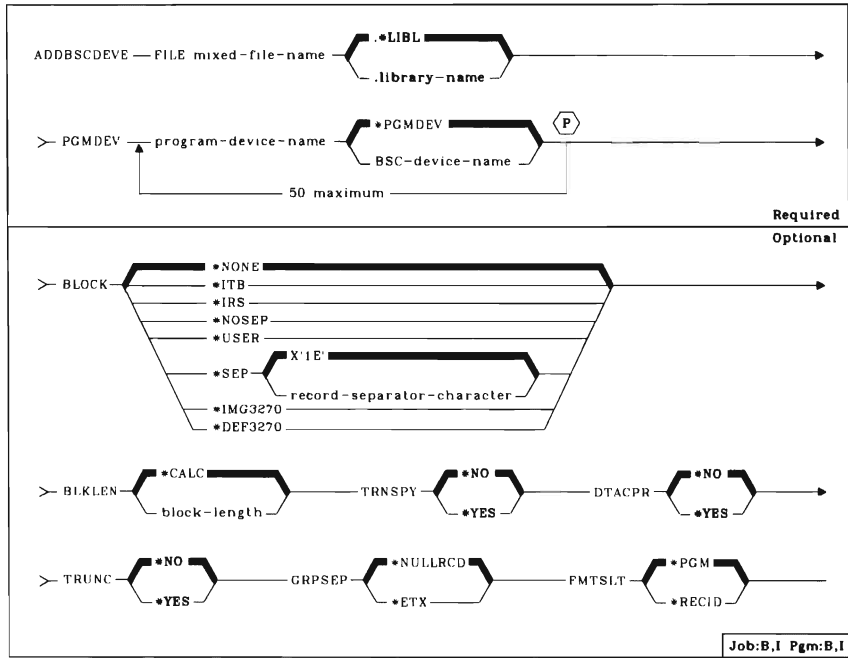

ADDCMNDEVE (Add Communications Device Entry)

Adds to a mixed file one or more communications-program-device entries (LU-1 and/or PEER) with the specified communication-device name and attributes.

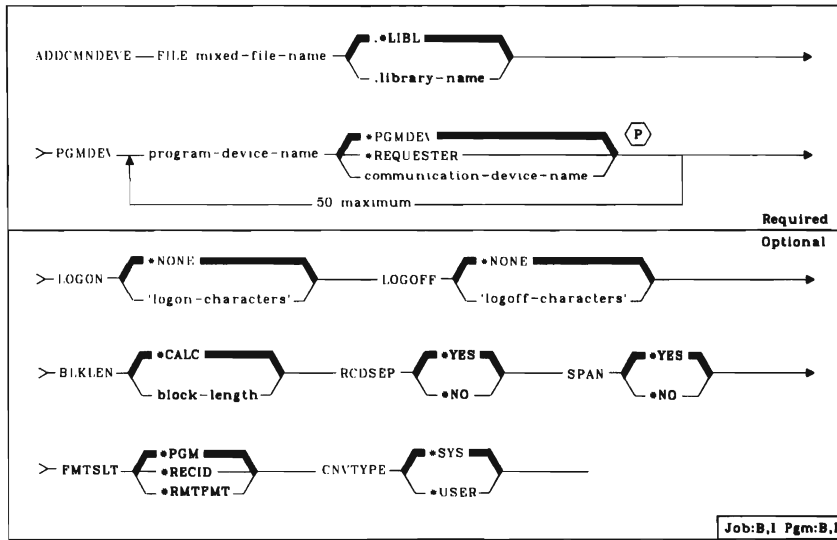

ADDCMNE (Add Communications Entry)

Adds a communications entry to an existing subsystem description. The subsystem must not be active when this command is entered.

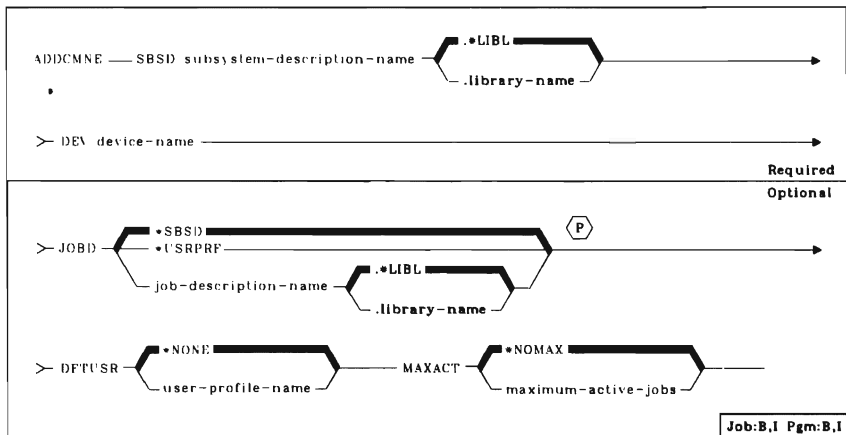

ADDDEVMODE (Add Device Mode Entry)

Adds a mode entry to a peer device description for which you have operational rights; this allows the peer device to be varied on.

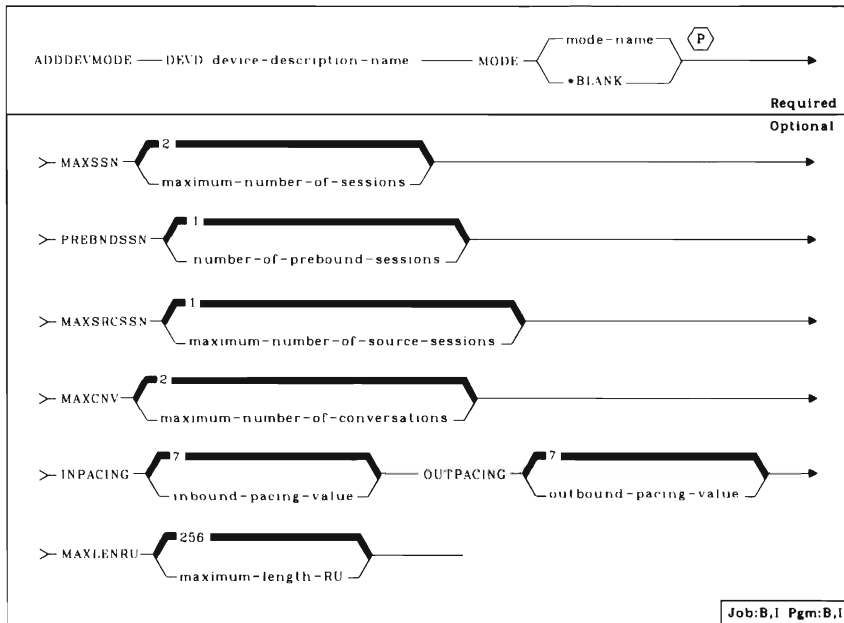

ADDDSPDEVE (Add Display Device Entry)

Adds to a mixed file one or more display-program-device entries with the specified display device name and attributes.

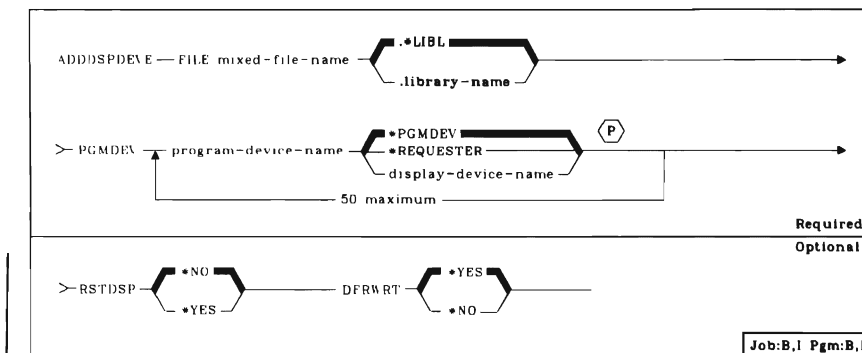

ADDFCTE (Add Forms Control Table Entry)

Adds a new forms entry to an existing RJEF forms control table (FCT).

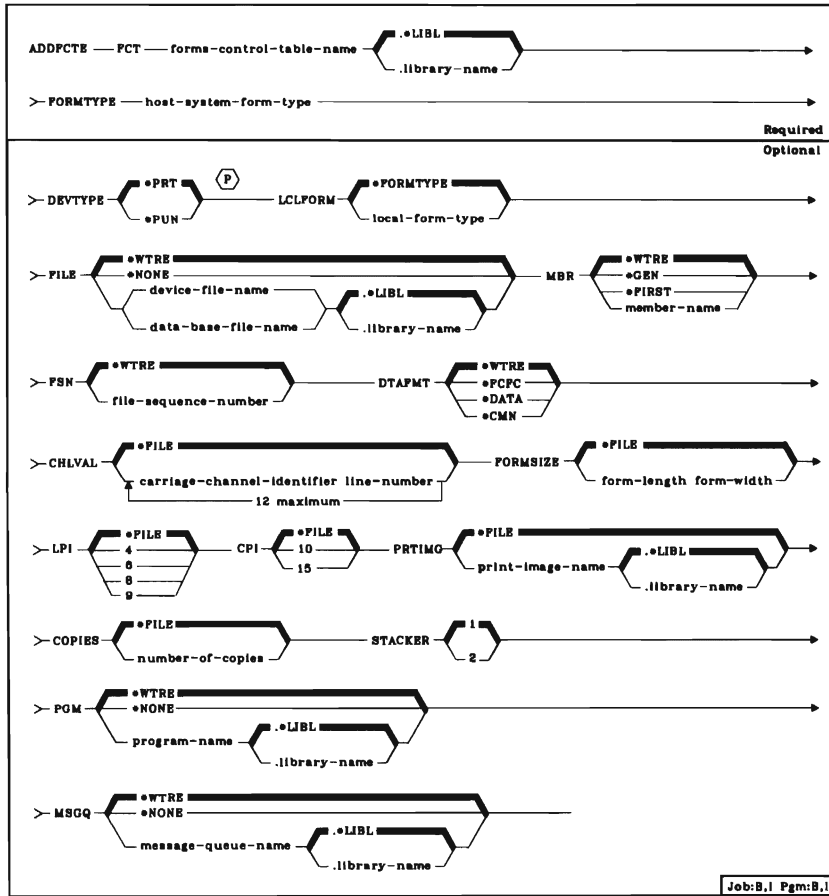

ADDJOBQE (Add Job Queue Entry)

Adds a job queue entry to a subsystem description to define a job queue for the subsystem.

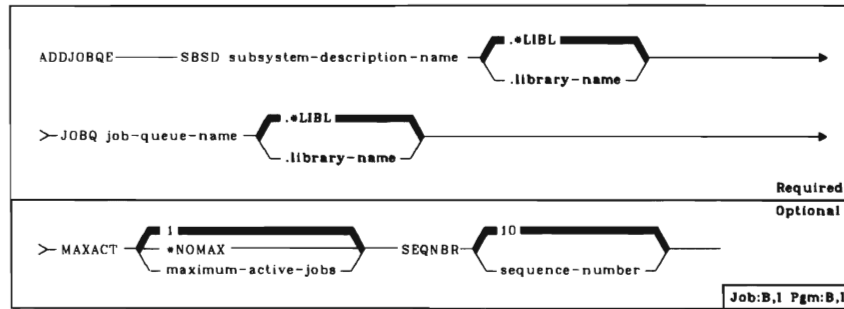

ADDLFM (Add Logical File Member)

Adds a member to a logical file.

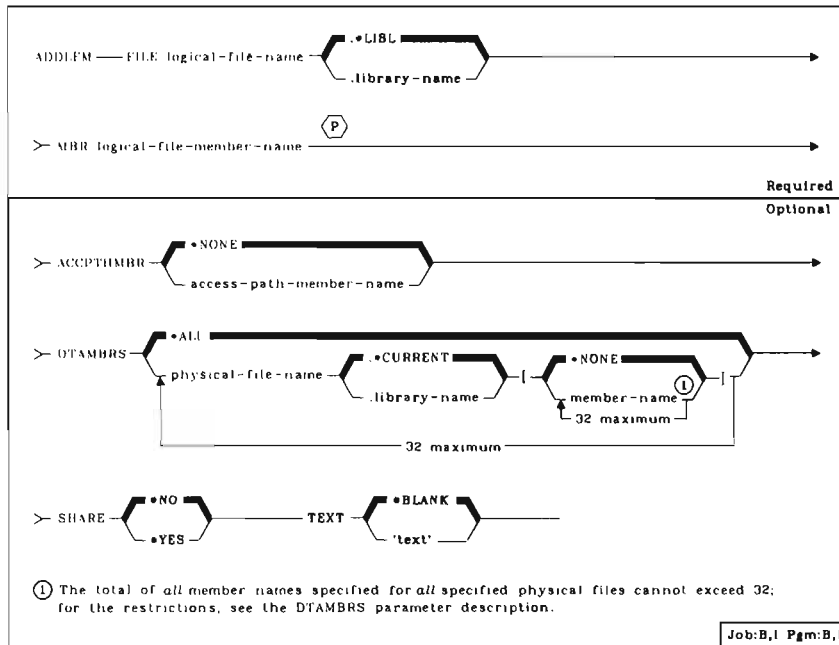

ADDLIBLE (Add Library List Entry)

Adds a library name to the beginning or end of the user portion of the library list for the process in which the command was entered.

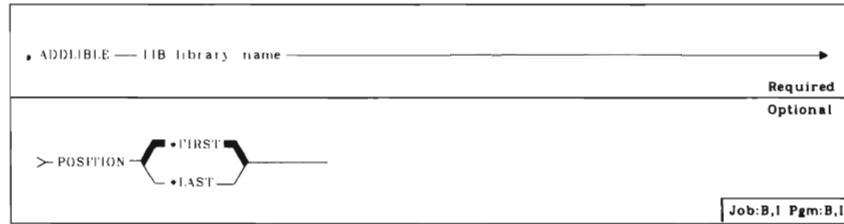

ADDMSGD (Add Message Description)

Adds a message description to a message file.



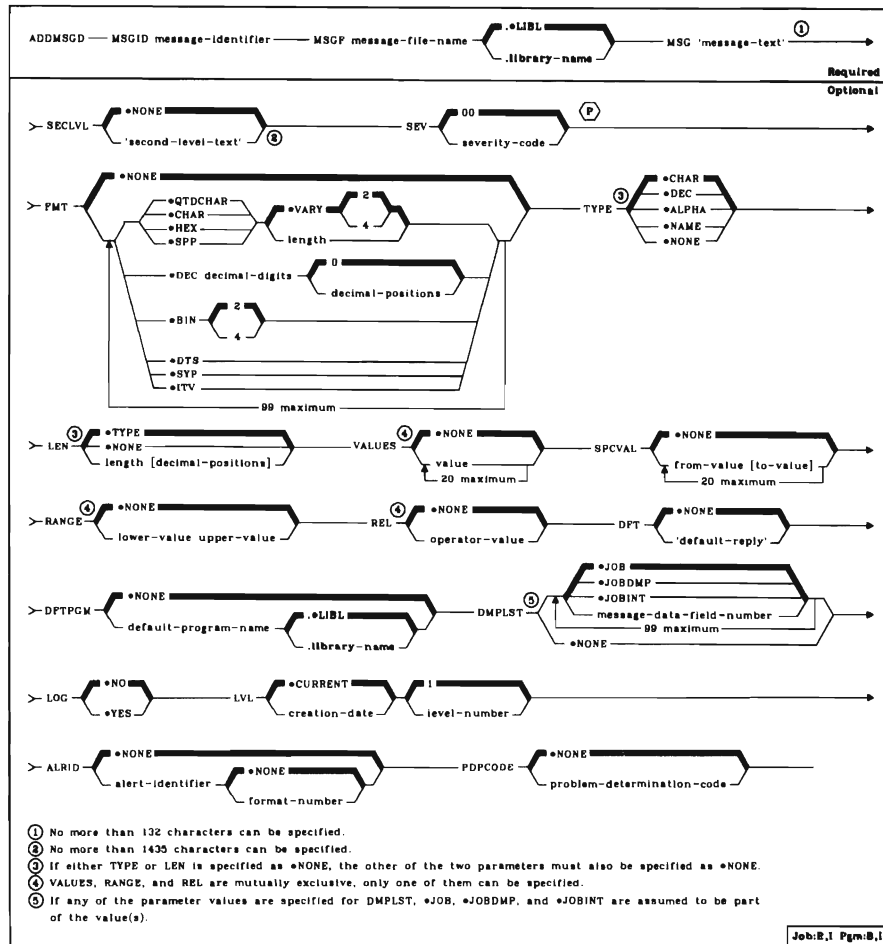

ADDPFM (Add Physical File Member)

Adds a member to a physical file.

ADDPFM	FILE	physical-file-name	{	*LIBL	}	→							
			{	.library-name	}								
>	MBR	physical-file-member-name					→						
Required													
>	EXPDATE	{	*NONE	}	SHARE	{	*NO	}	TEXT	{	*BLANK	}	→
		{	expiration-date	}		{	*YES	}		{	'description'	}	
Optional													
Job:B,I Pgm:B,I													

ADDNETJOBE (Add Network Job Entry)

Adds a network job entry to the network job table on the system.

ADDNETJOBE	FROMUSRID	user-id	ACTION	{	*REJECT	}	→				
				{	*FILE	}					
				{	*SUBMIT	}					
Required											
>	SBMUSER	{	QUSER	}	^P	→					
		{	user-profile	}							
>	MSGQ	{	*USRPRF	}	→						
		{	*NONE	}							
		{	message-queue-name	}	{	*LIBL	}	→			
					{	.library-name	}				
>	JOBQ	{	QBATCH.*LIBL	}	→						
		{	job-queue-name	}	{	*LIBL	}	→			
					{	.library-name	}				
Optional											
Job:B,I Pgm:B,I											

Data base source file-QANFNJE

ADDPGM (Add Program)

Adds program names to the list of programs to be debugged (using the ENTDBG command).

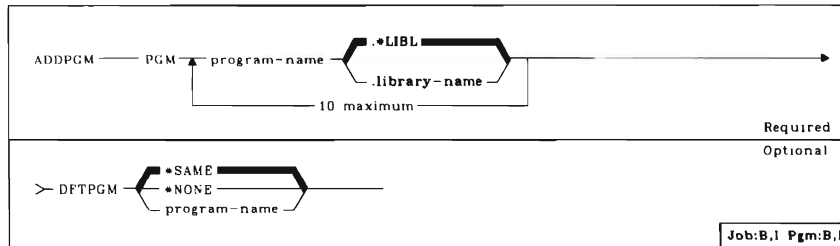

ADDRJECMNE (Add RJE Communications Entry)

Adds a new communications device file entry to an existing RJEJ session description.

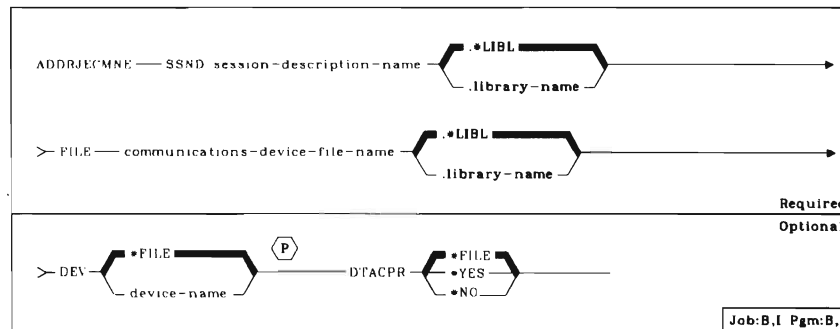

ADDRJERDRE (Add RJE Reader Entry)

Adds a new RJEF reader entry to an existing RJEF session description.

ADDRJERDRE	SSND session-description-name	<input type="checkbox"/> .LIBL	<input type="checkbox"/> .library-name	→
> RDR	<div style="border: 1px solid black; padding: 2px;">Select one of the following: •AUTO RD1 RD15</div>			→
				Required
> JOBQ	<input type="checkbox"/> .NONE	<input type="checkbox"/> .LIBL	<input type="checkbox"/> .library-name	→
	<input type="checkbox"/> job-queue-name			Optional
> MSGQ	<input type="checkbox"/> .NONE	<input type="checkbox"/> .LIBL	<input type="checkbox"/> .library-name	→
	<input type="checkbox"/> message-queue-name			
				Job:B,I Pgm:B,I

ADDRJEWTRE (Add RJE Writer Entry)

Adds a new RJEF writer entry to an existing RJEF session description.

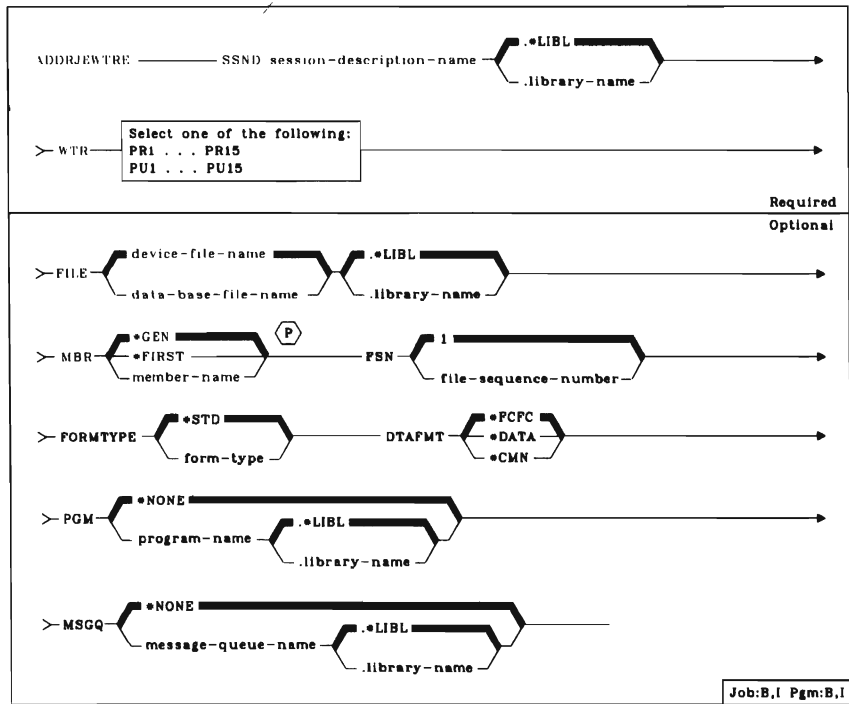

ADDRPYLE (Add Reply List Entry)

Adds an entry to the system-wide automatic message reply list. The automatic message reply list is a system-wide entity used as a source for default responses to inquiry messages.

ADDRPYLE — SEQNBR sequence-number (P)		Required
		Optional
> MSGID	<input type="checkbox"/> *ANY <input type="checkbox"/> message-identifier	
> CMPDTA	<input type="checkbox"/> ^① *NONE <input type="checkbox"/> comparison-data	<input type="checkbox"/> ^③ 1 <input type="checkbox"/> message-data-start
> RPY	<input type="checkbox"/> ^② *DFT <input type="checkbox"/> *RQD <input type="checkbox"/> message-reply	<input type="checkbox"/> *NO <input type="checkbox"/> *YES DUMP
^① No more than 28 characters can be specified. ^② No more than 32 characters can be specified. ^③ Defaults to 1 if comparison data specified.		Job:B,I Pgm:B,I

ADDRTGE (Add Routing Entry)

Adds a routing entry to a subsystem description.

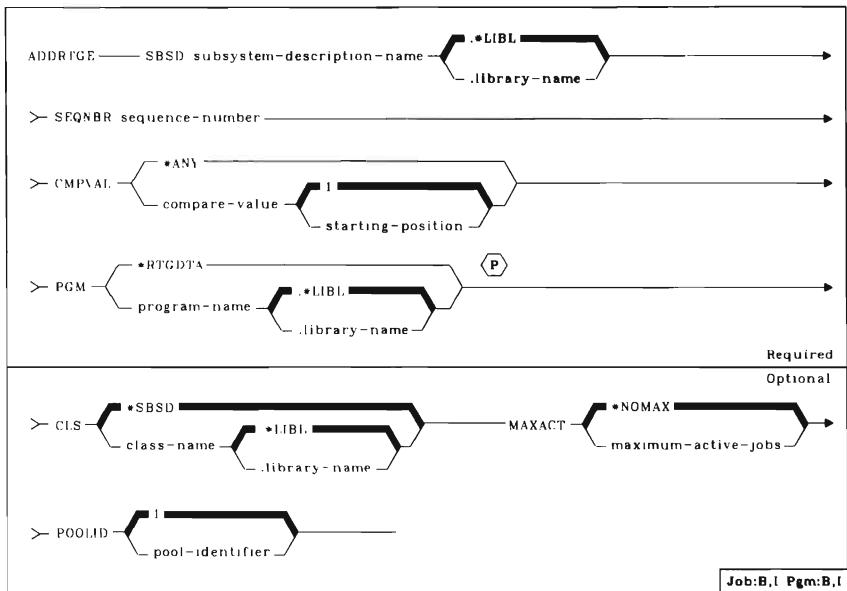

ADDTRC (Add Trace)

Adds traces to a program being debugged (using the ENTDBG command).

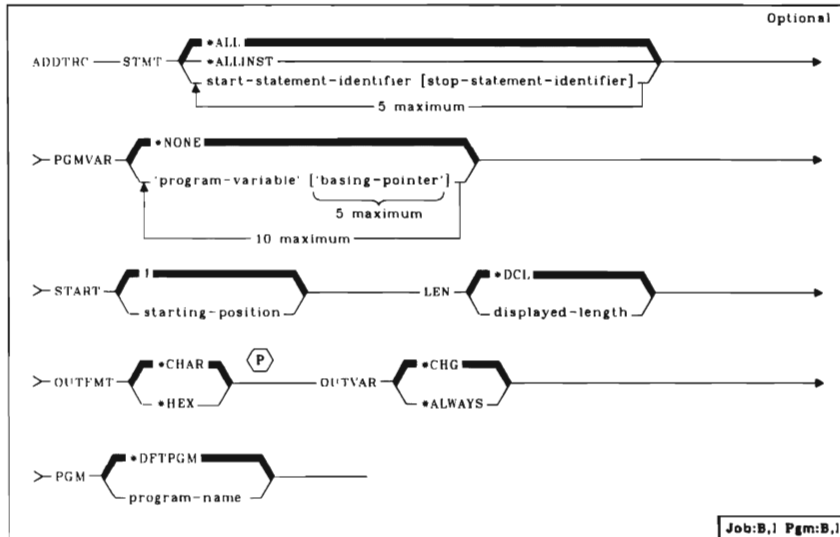

ADDWSE (Add Work Station Entry)

Adds a work station entry to a subsystem description.

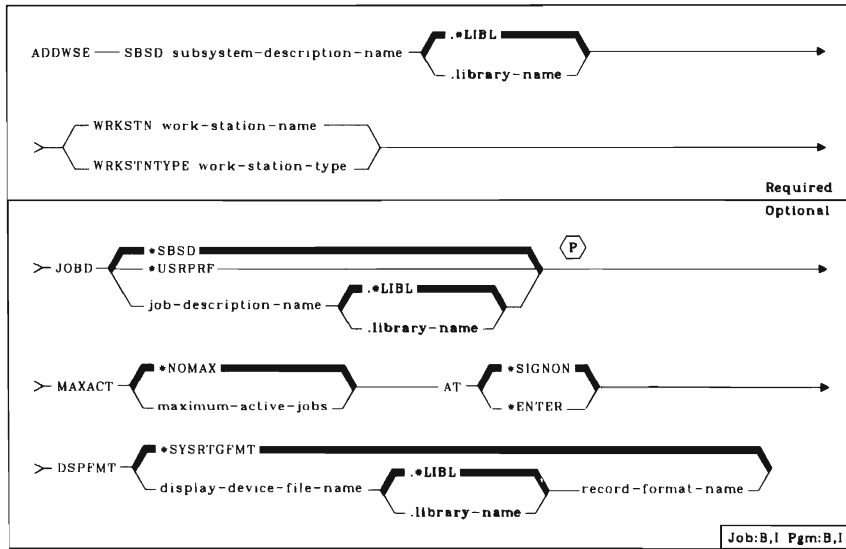

ALCOBJ (Allocate Object)

Allocates an object for use by the requester.

ALCOBJ	→
Y OBJ	object name •LIBL object-type ^① lock-state ^② •FIRST member-name
	.library-name 50 maximum
	Required
Y WAIT	•CLS seconds-to-wait
	Optional
① The following object types are valid: •DEVD, •DTAARA, •DTAQ, •PCT, •FILE, •LIB, •MSGQ, •PGM, •SBSD, and •SSND. Refer to the OBJ parameter description for the lock states that are valid for each object type.	
② If valid for the specified object type, one of the following lock states can be specified: •SHRRD, •SHRUPD, •SHRNUP, •EXCLRD, or •EXCL.	
	Job:B,I Pgm:B,I

ANSLIN (Answer Line)

Identifies a communications line that has been manually answered by the system operator.

ANSLIN	LINE line-description-name	Required
		Job:I

APYJRNCHG (Apply Journalled Changes)

Applies changes to a member of a data base file that have been journalled to a backup version of the file. This is to recover after an operational error or some form of damage.

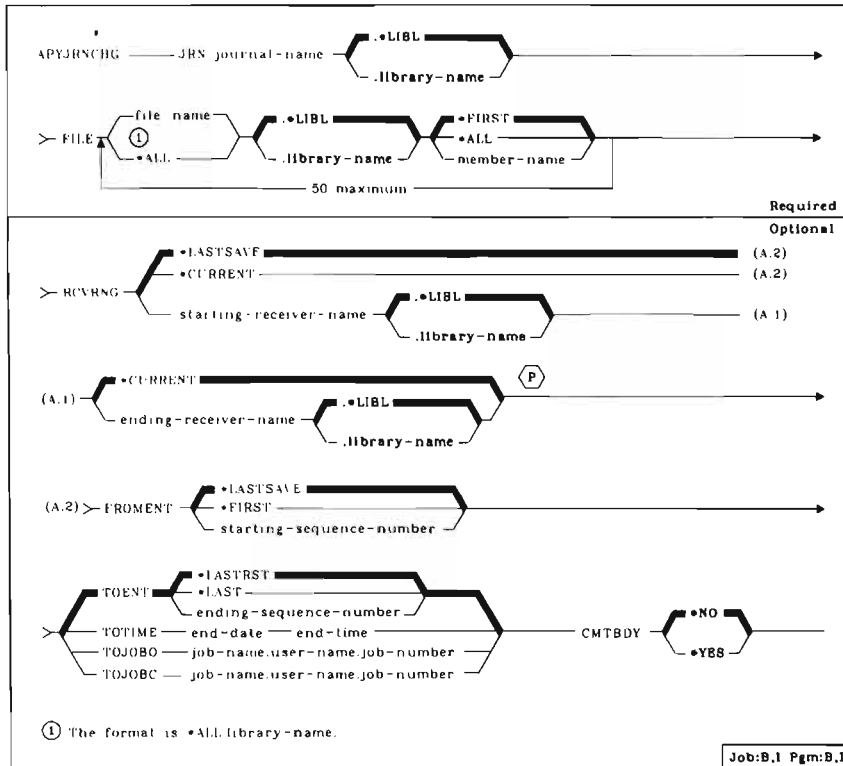

APYPGMCHG (Apply Programming Change)

Applies a programming change or program patch to a licensed program either temporarily or permanently.

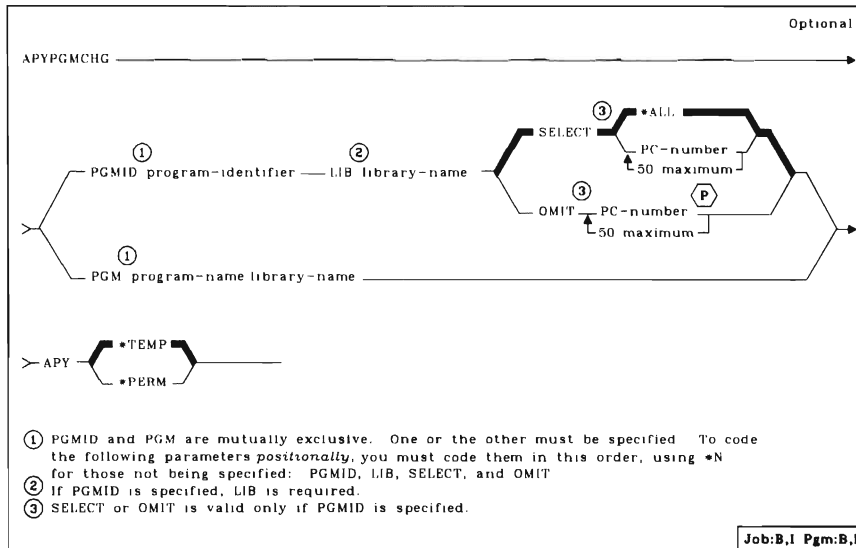

BGNBAS (Begin BASIC)

Begins an interactive BASIC session.

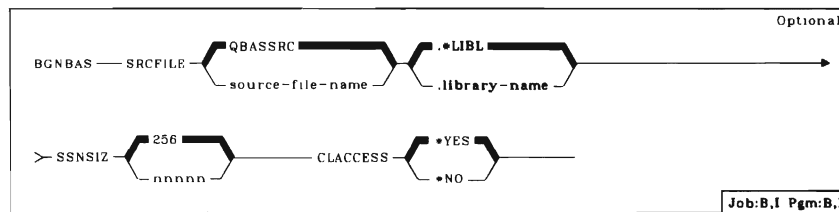

Data base source file: QBASSRC

BGNCMTCTL (Begin Commitment Control)

Establishes the commitment control environment by specifying the level of record locking to occur. You can also specify a message queue, a file, or a data area to receive an entry identifying the last successful transaction before an abnormal termination or routing step termination (with uncommitted changes).

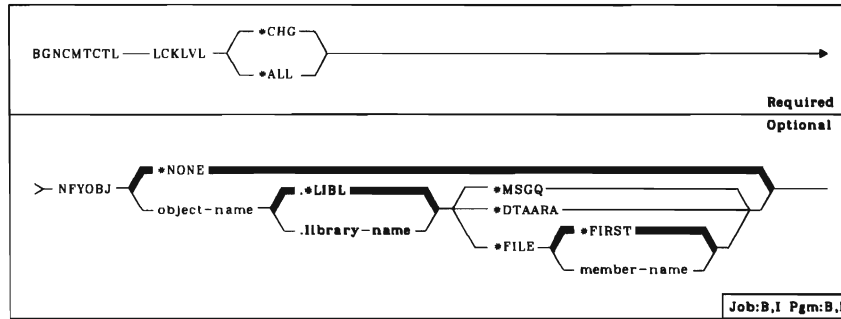

BGNIWSSRV (Begin Intelligent Work Station Services)

Establishes PC to System/38 communication and allows data transfer between PC and System/38 applications.

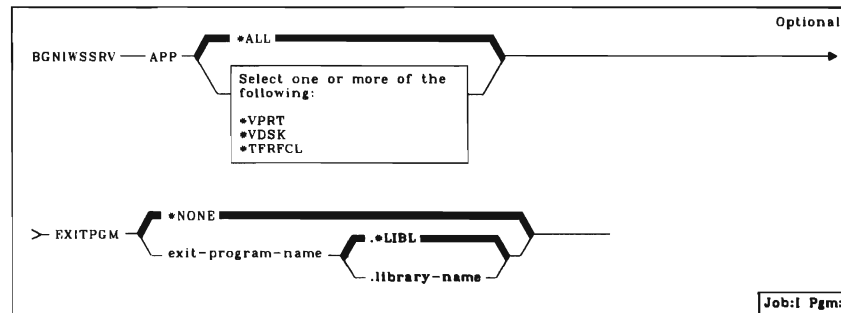

BGNPASTHR (Begin Pass-Through)

Allows you to pass through to a target system (a remote system) where you can sign on as if you were attached locally. This command uses the System/38 APPC support to connect your display station to the target system.

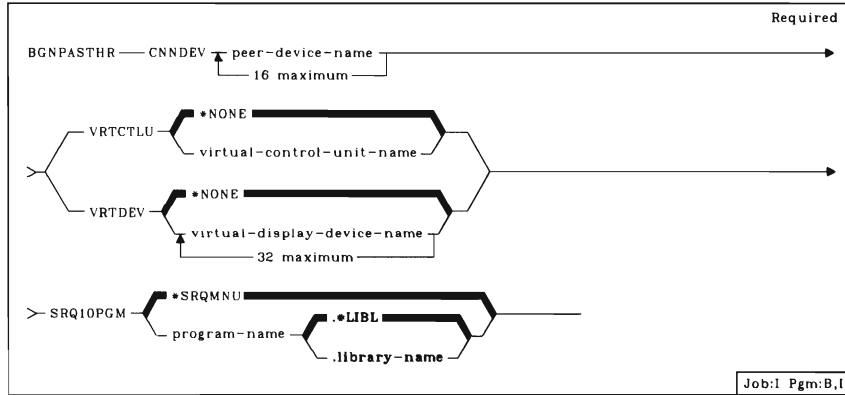

BRWPFM (Browse Physical File Member)

Browses a physical data base file member.

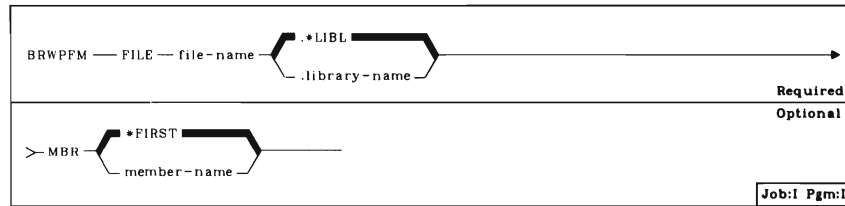

CALL (Call Program)

Invokes a program and optionally passes parameters to it.

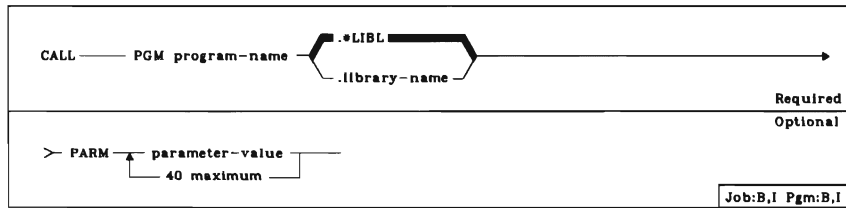

CFGDSTSRV (Configure Distribution Services)

Changes the configuration of the distribution network. You can add, remove, and display entries from the next system table, the routing table, and the secondary node ID table.

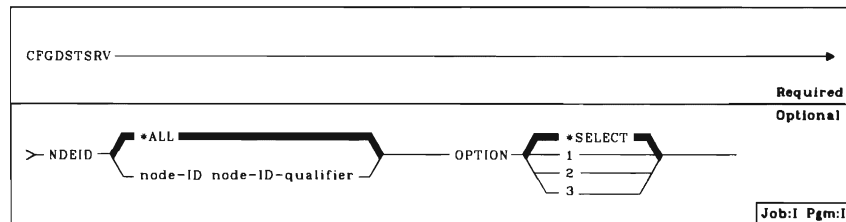

Data base source file—QASNADSA
Data base source file—QASNADSC
Data base source file—QASNADSR

CHGACGCDE (Change Accounting Code)

Changes the accounting code of a job. The job can be on a job queue, or it can be active within a subsystem.

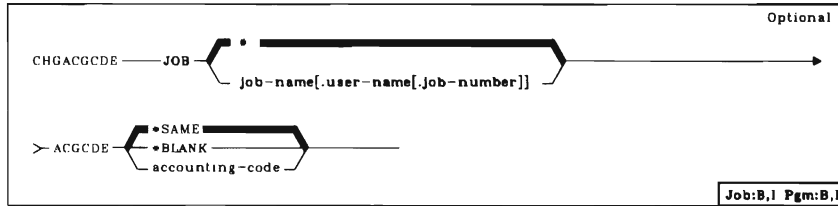

CHGAJE (Change Autostart Job Entry)

Changes an autostart job entry in a subsystem description.

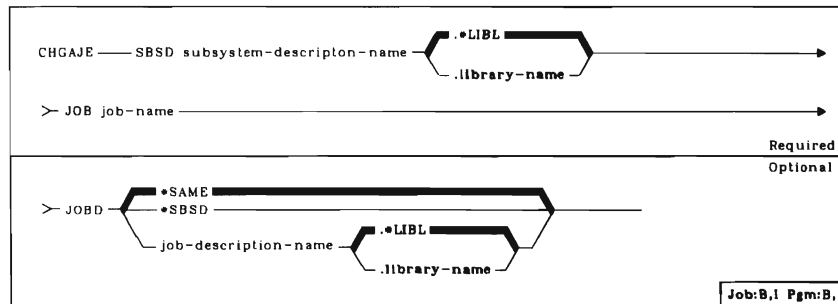

CHGBSCF (Change BSC File)

Changes the attributes of a BSC file.

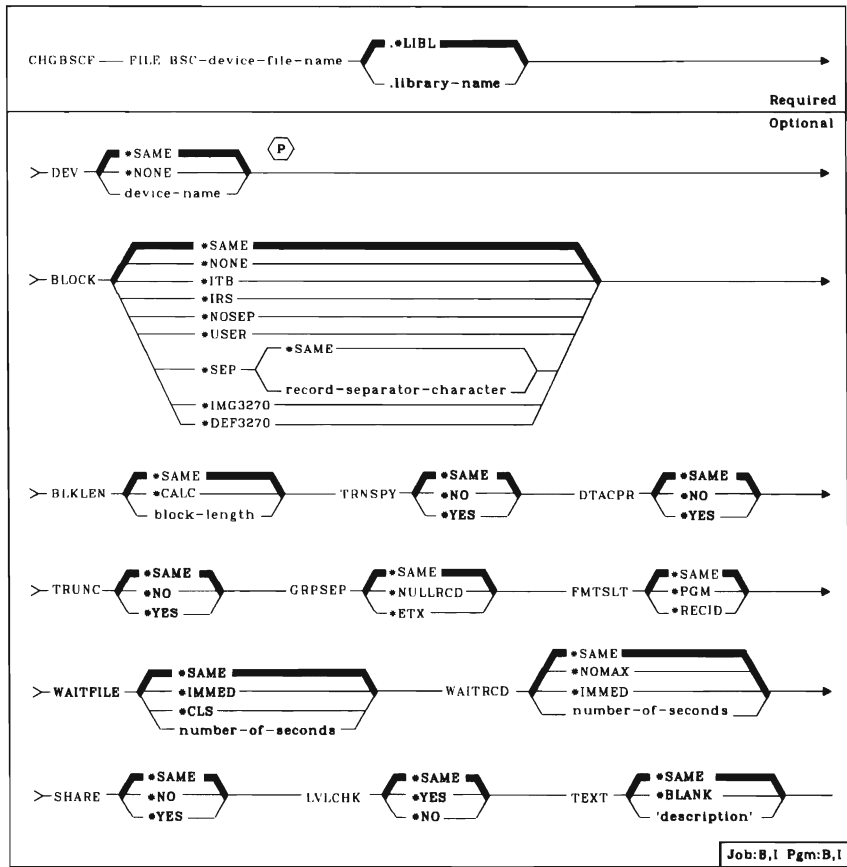

CHGCMD (Change Command)

Changes the attributes of a command definition.

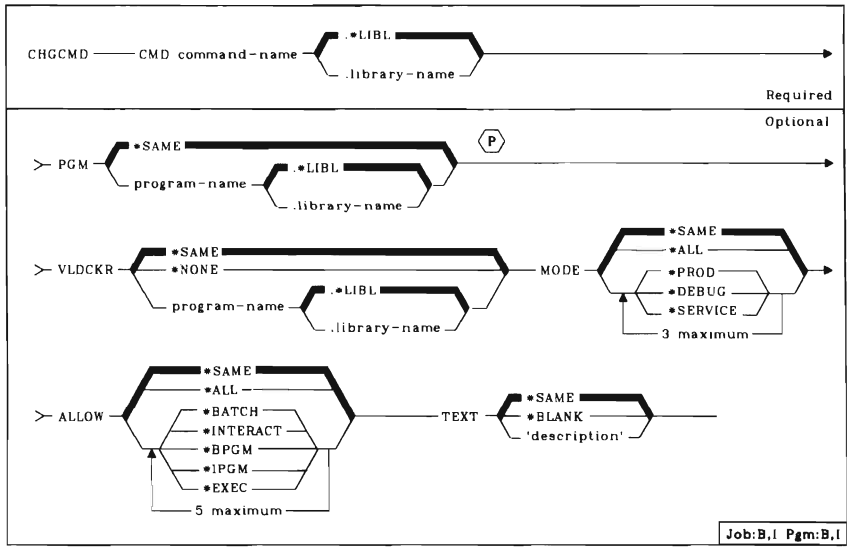

CHGCMNE (Change Communications Entry)

Changes the attributes of a communications entry in an existing subsystem description.

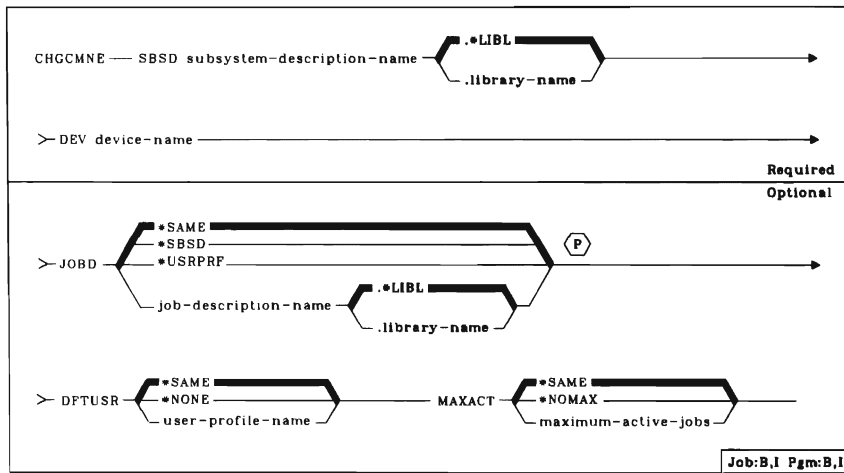

CHGCMNF (Change Communications File)

Changes the attributes of a communications device file.

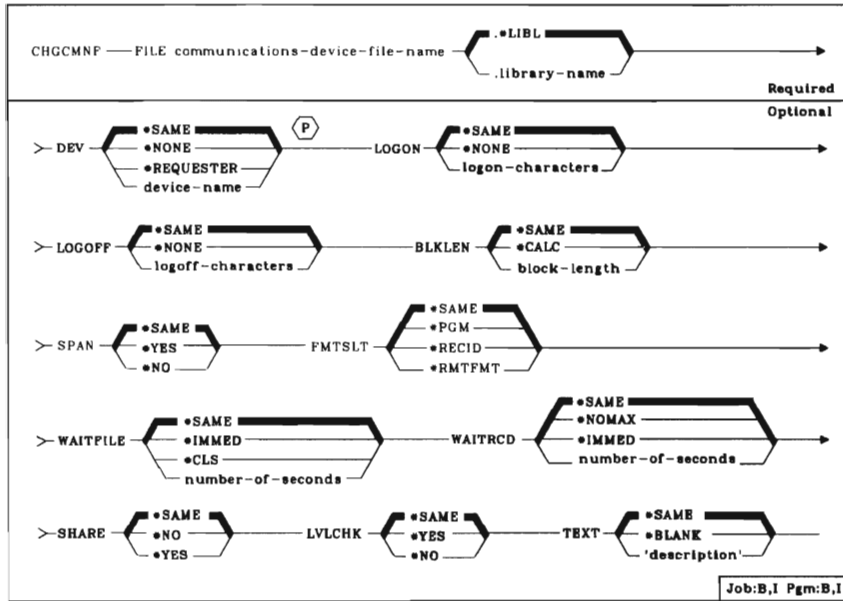

CHGCNPA (Change CSNAP Attributes)

Changes the current short-term statistics sampling attributes of CSNAP.

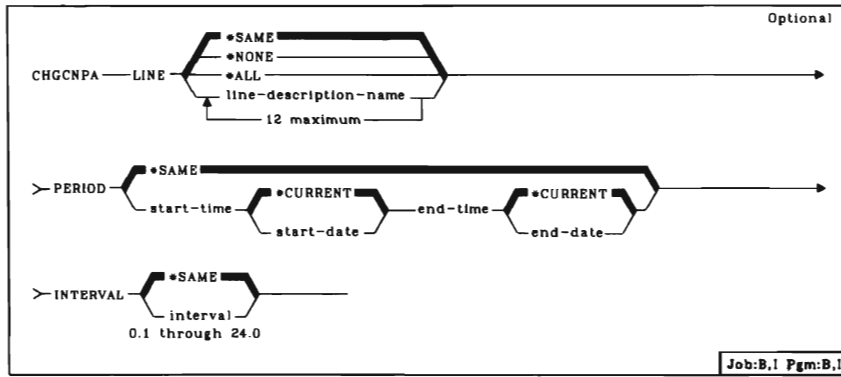

CHGCRDF (Change Card File)

Changes the attributes of a card file.

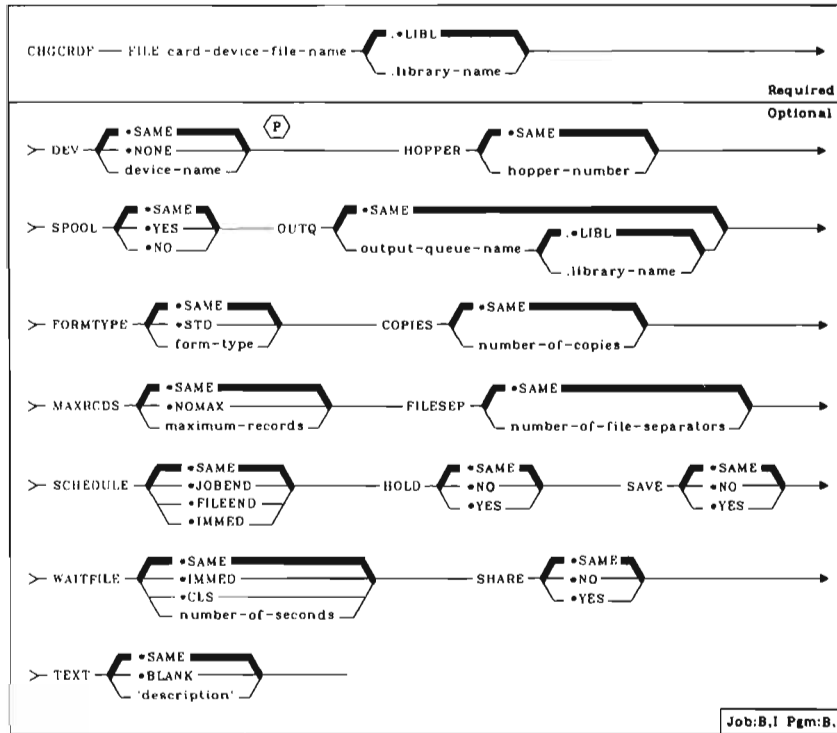

CHGCUD (Change Control Unit Description)

Changes the description of a control unit.

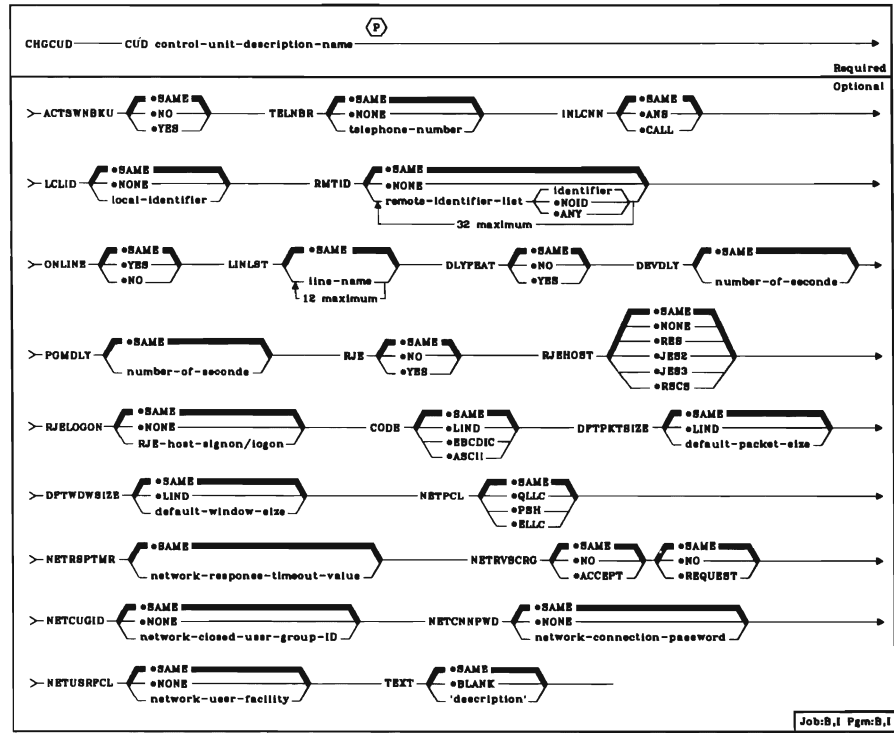

CHGDBG (Change Debug)

Changes debug options specified on the ENTDBG command.

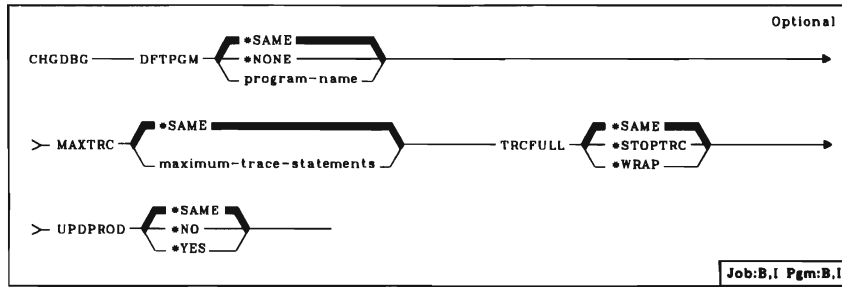

CHGDEVD (Change Device Description)

Changes the description of a device.

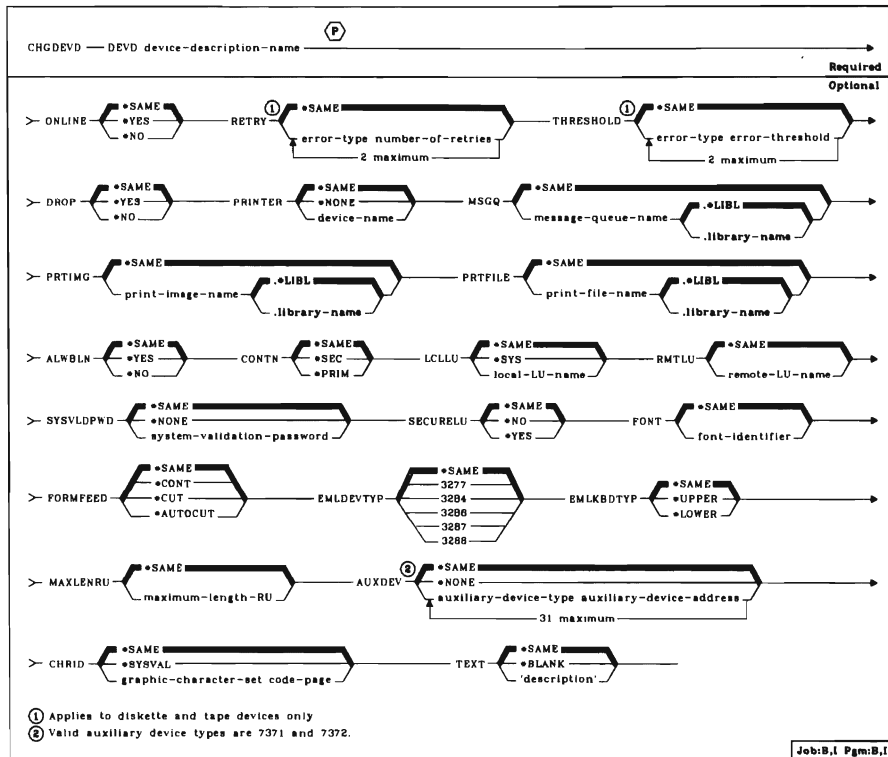

CHGDEVMODE (Change Device Mode Entry)

Changes the attributes of a mode entry in a PEER device description for which you have operational rights; this allows the peer device to be varied on.

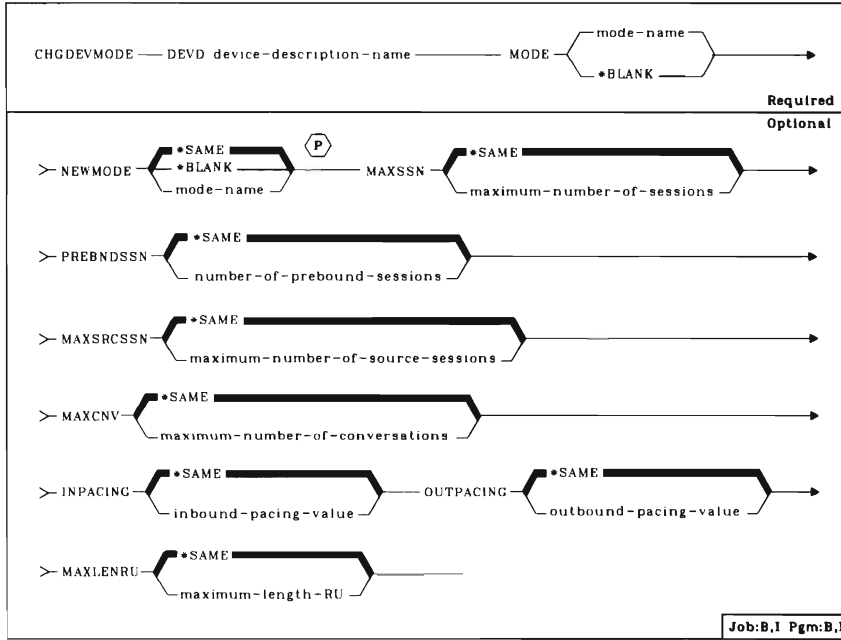

CHGDFUDEF (Change DFU Definition)

Begins a prompting sequence for interactive modification of a DFU application. Your responses to the prompts are used to create a new application or to replace the original application.

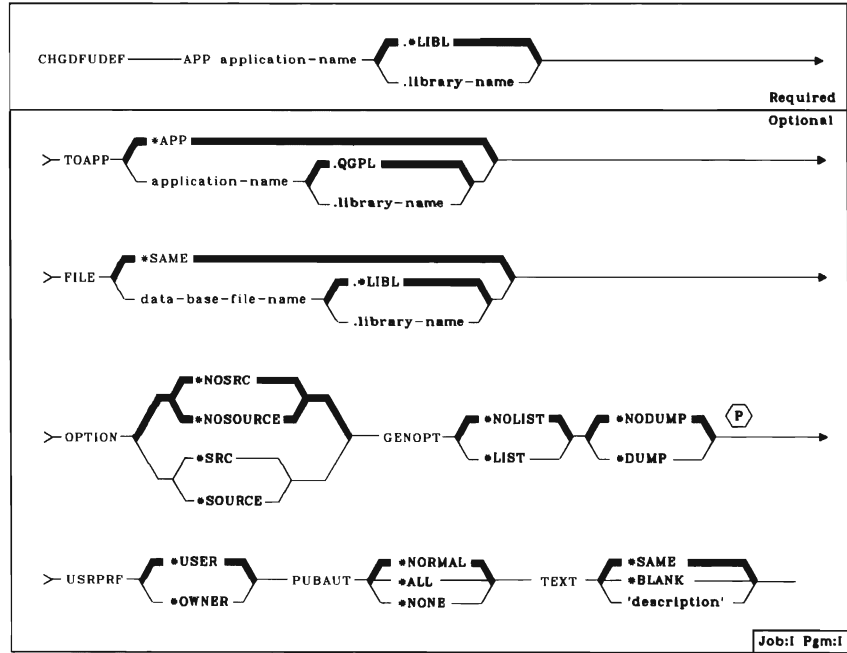

CHGDKTF (Change Diskette File)

Changes the attributes of a diskette file.

CHGDKTF		FILE	diskette-device-file-name	.LIBL	.library-name	Required					
>	DEV	*SAME *NONE	device-name	(P)	VOL	*SAME *NONE	volume-identifier 50 maximum	LABEL	*SAME *NONE	data-file-label	Optional
>	LOC	Select one of the following: *SAME *S1 *S12 *M12 *S2 *S23 *M1 *S3 *S123 *M2		*SAME *FIRST *CURRENT -position	*SAME *LAST *WRAP *ONLY -position	EXCHTYPE	*SAME *STD *BASIC *H *I				
>	CODE	*SAME *EBCDIC *ASCII	CRTDATE	*SAME *NONE	creation-date	EXPDATE	*SAME *NONE *PERM	expiration-date	SPOOL	*SAME *NO	
>	OUTQ	*SAME	output-queue-name	.LIBL	.library-name	MAXCRDS	*SAME *NOMAX	maximum-records			
>	SCHEDULE	*SAME *JOBEND *FILEEND *IMMED	HOLD	*SAME *NO *YES	SAVE	*SAME *NO *YES					
>	WAITFILE	*SAME *IMMED *CLS number-of-seconds	SHARE	*SAME *NO *YES	TEXT	*SAME *BLANK 'description'					
Job:B,I Pgm:B,I											

CHGDOCOWN (Change Document Owner)

Transfers document ownership from one user to another user; the second user then becomes the primary owner.

CHGDOCOWN		DOC-document-object-name	300 maximum	OWNER-user-profile-name	Required
>	NEWOWN	user-profile-name			
① Either the DOC or OWNER parameters must be specified, but not both.					
Job:B,I Pgm:B,I					

CHGDSPF (Change Display File)

Changes the attributes of a display file.

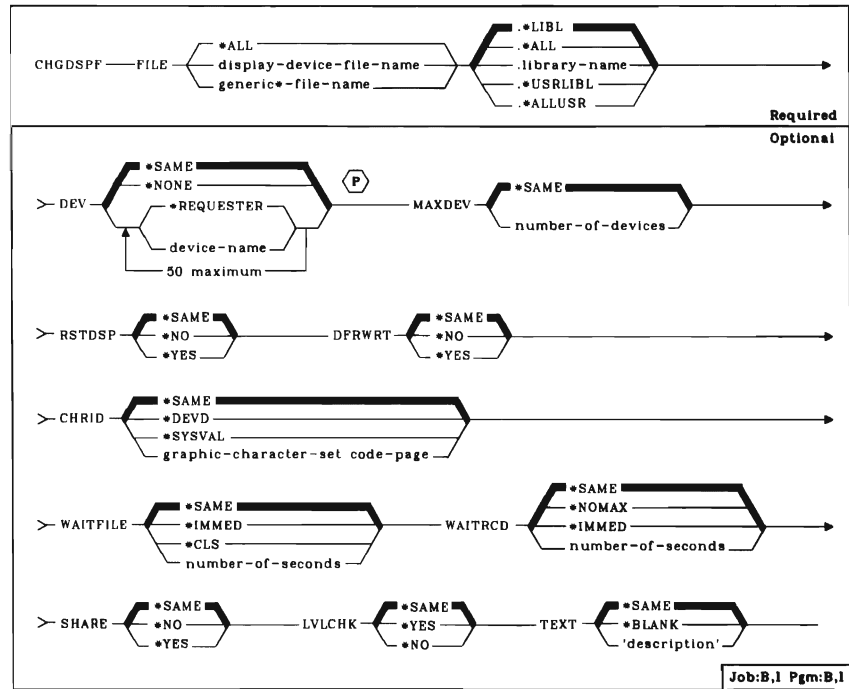

CHGDTA (Change Data)

Allows you to add, change, delete, or display records of an existing data base file member using the specified DFU application.

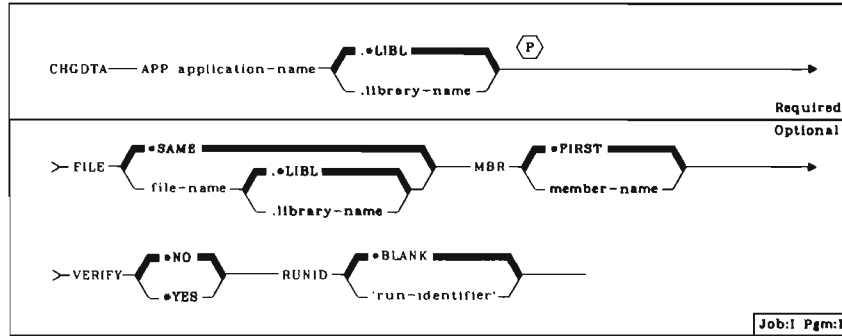

Printer files – QDTALOG, QDTAPRT
 Display files – QDDFUP1, QDDFUP2

CHGDTAARA (Change Data Area)

Changes the value of a data area.

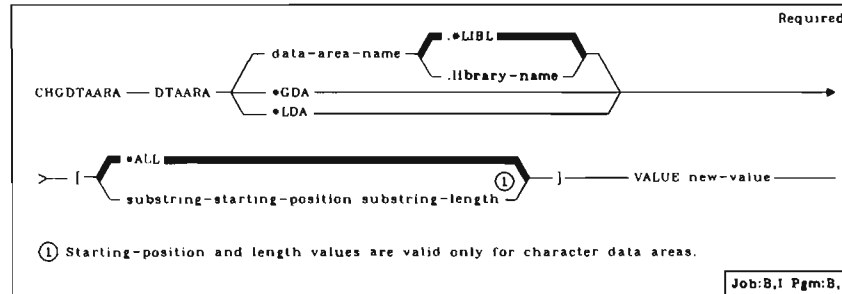

CHGFCT (Change Forms Control Table)

Changes the attributes of an existing RJEF forms control table (FCT).

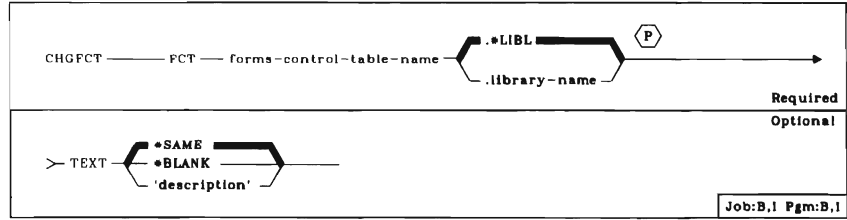

CHGFCTE (Change Forms Control Table Entry)

Changes a forms entry in an existing RJEJ forms control table (FCT).

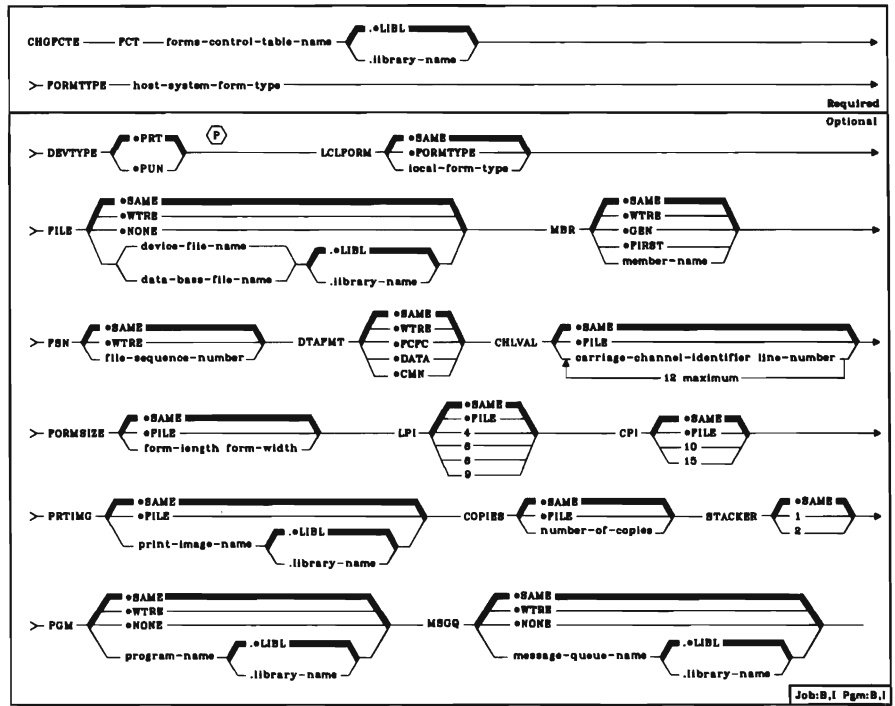

CHGGRPA (Change Group Attributes)

Changes the group attributes of a job.

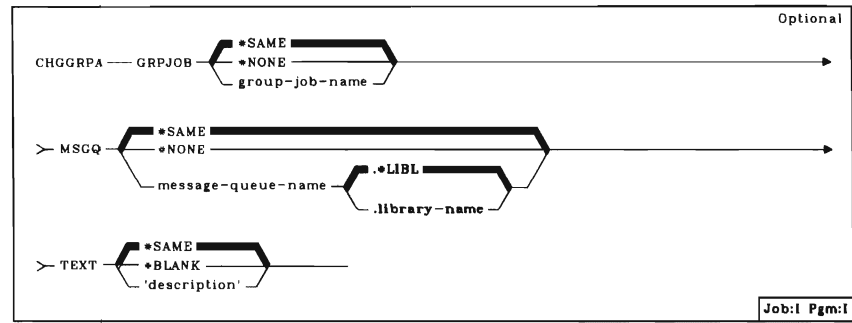

CHGHLLPTR (Change High-Level Language Pointer)

Allows you to change or copy a pointer variable declared in a high-level language program.

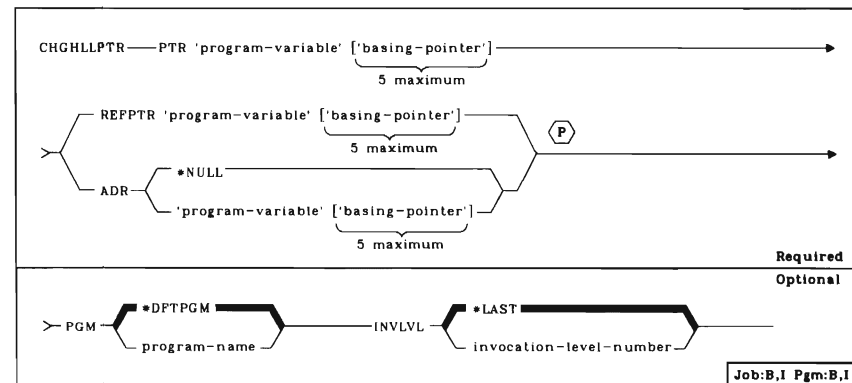

CHGJOB (Change Job)

Changes the attributes of a job including priority, output queue, and message level.

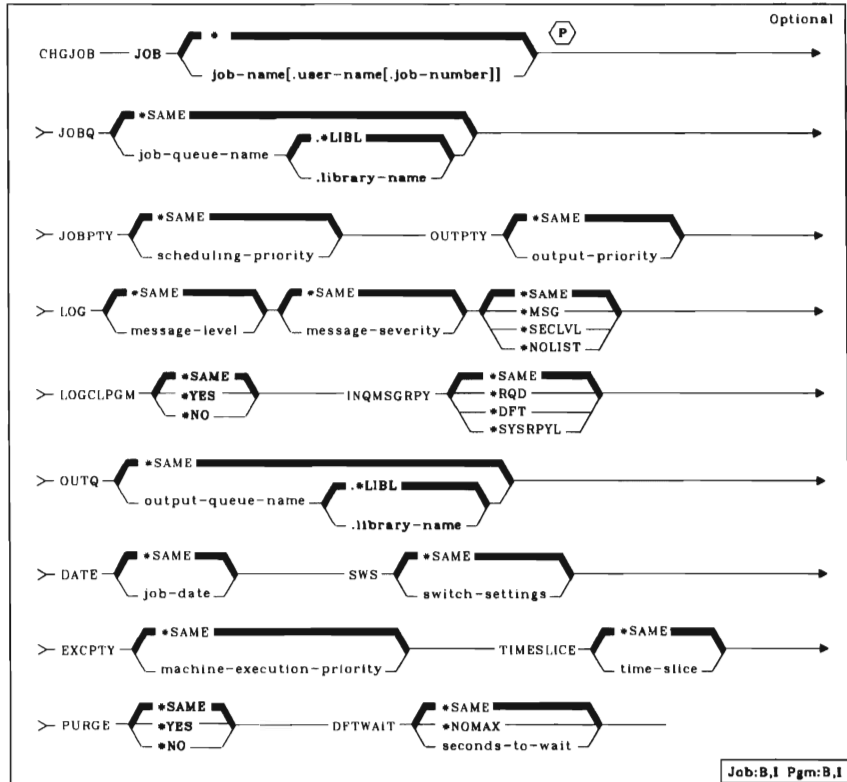

CHGJOB (Change Job Description)

Changes the attributes of a job description.

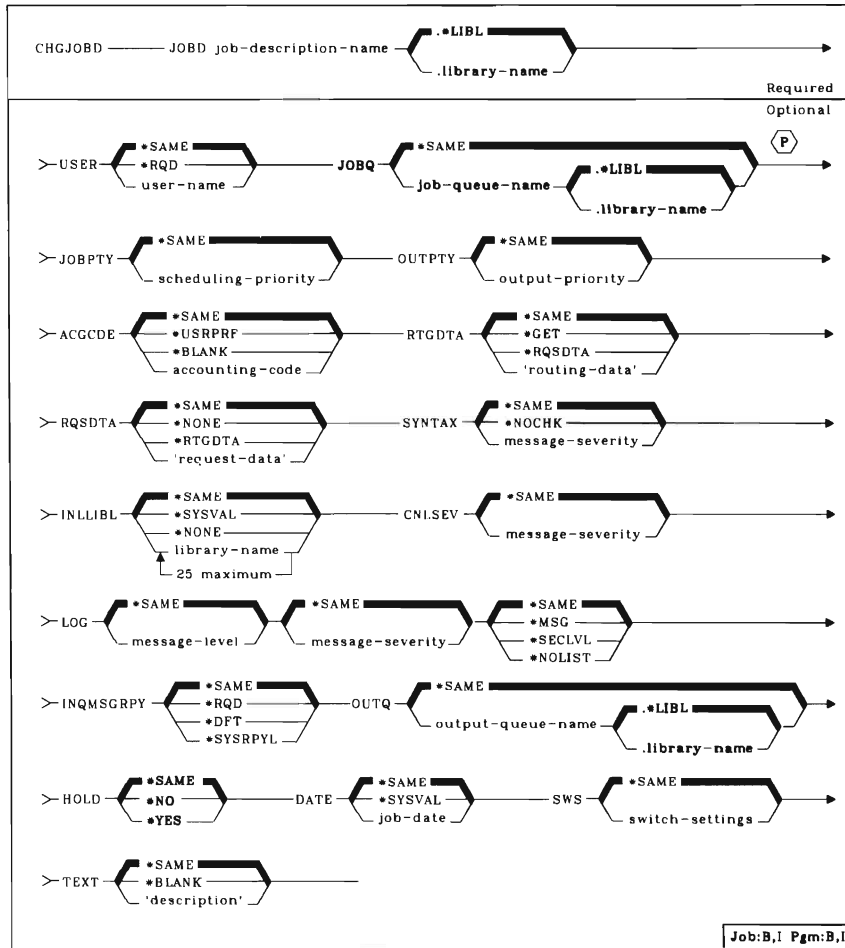

CHGJOBQE (Change Job Queue Entry)

Changes a job queue entry in the subsystem description.

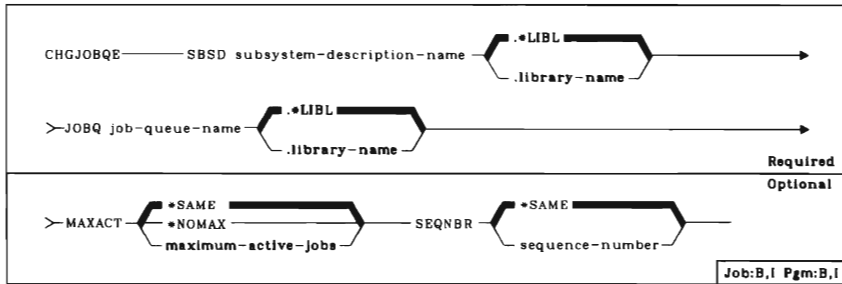

CHGJRN (Change Journal)

Changes the attributes of a journal.

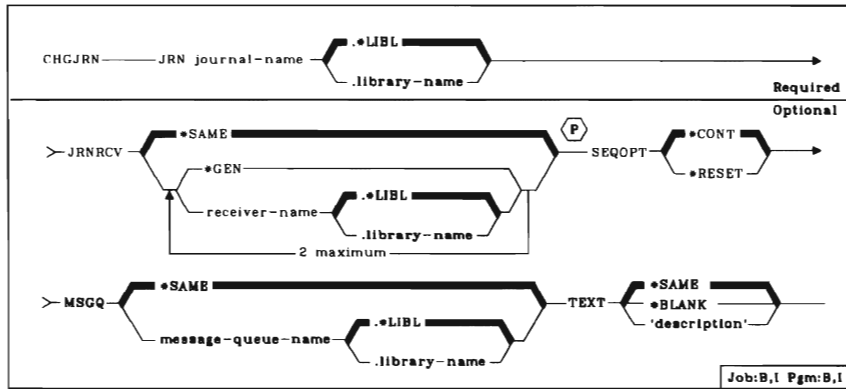

CHGKBDMAP (Change Keyboard Map)

Allows the user to change the PA (Program Attention) and PF (Program Function) key assignment defaults provided by System/38 or a previously specified keyboard mapping.

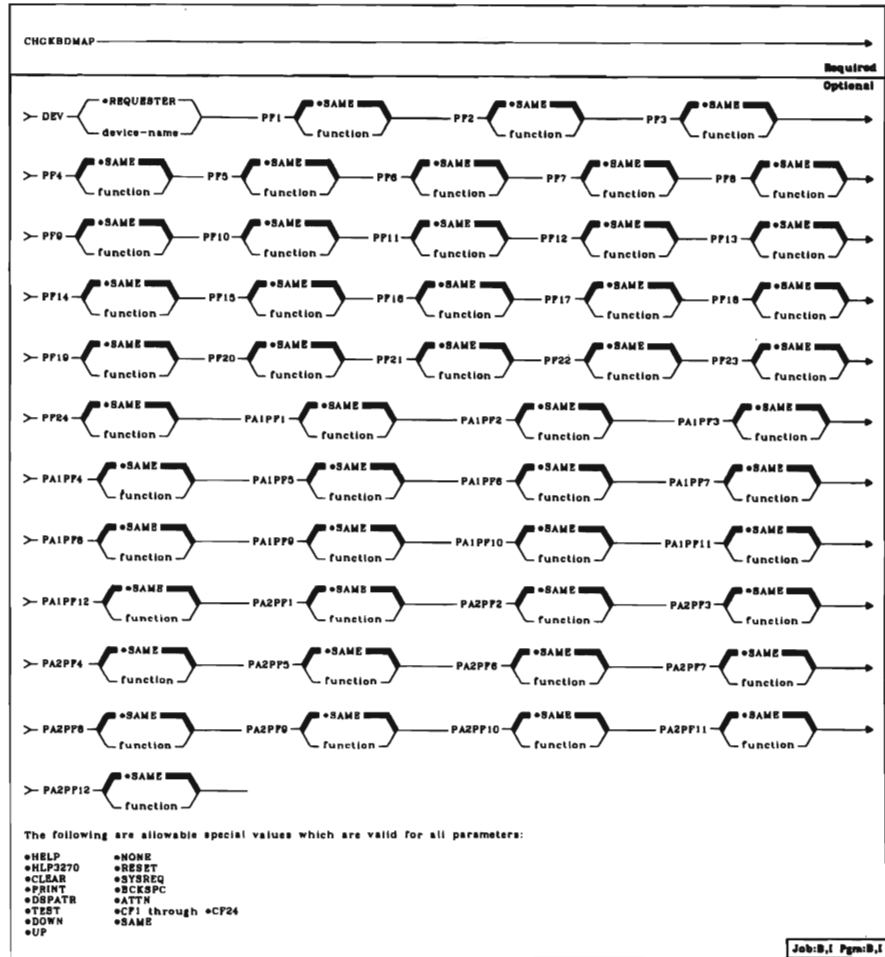

CHGLF (Change Logical File)

Changes the attributes of a logical file and its members.

CHGLF FILE logical-file-name		<input type="checkbox"/> .LIBL <input type="checkbox"/> P <input type="checkbox"/> .library-name	Required
> MAXMBS	<input type="checkbox"/> *SAME <input type="checkbox"/> *NOMAX maximum-members	MAINT	<input type="checkbox"/> *SAME <input type="checkbox"/> *IMMED <input type="checkbox"/> *REBLD <input type="checkbox"/> *DLY
> RECOVER	<input type="checkbox"/> *SAME <input type="checkbox"/> *NO <input type="checkbox"/> *AFTSTRCPF <input type="checkbox"/> *STRCPF	FRCACPTH	<input type="checkbox"/> *SAME <input type="checkbox"/> *NO <input type="checkbox"/> *YES
> UNIT	<input type="checkbox"/> *SAME <input type="checkbox"/> *ANY unit-identifier	FMTSLR	<input type="checkbox"/> *SAME <input type="checkbox"/> *NONE program-name <input type="checkbox"/> .LIBL <input type="checkbox"/> .library-name
> PRCRATIO	<input type="checkbox"/> *SAME <input type="checkbox"/> *NONE number-of-records-before-force		
> WAITFILE	<input type="checkbox"/> *SAME <input type="checkbox"/> *IMMED <input type="checkbox"/> *CLS number-of-seconds	WAITRCD	<input type="checkbox"/> *SAME <input type="checkbox"/> *IMMED <input type="checkbox"/> *NOMAX number-of-seconds
> SHARE	<input type="checkbox"/> *SAME <input type="checkbox"/> *NO <input type="checkbox"/> *YES	LVLCHK	<input type="checkbox"/> *SAME <input type="checkbox"/> *YES <input type="checkbox"/> *NO
		TEXT	<input type="checkbox"/> *SAME <input type="checkbox"/> *BLANK 'description'

Job:B,I Pgm:B,I

CHGLFM (Change Logical File Member)

Changes the attributes of a logical file member.

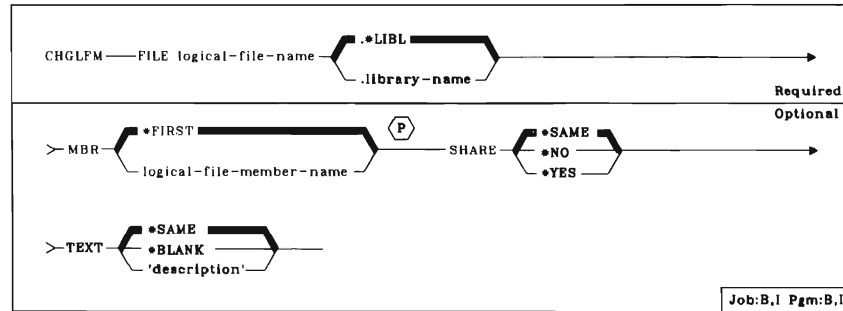

CHGLIND (Change Line Description)

Changes the description of a communications line.

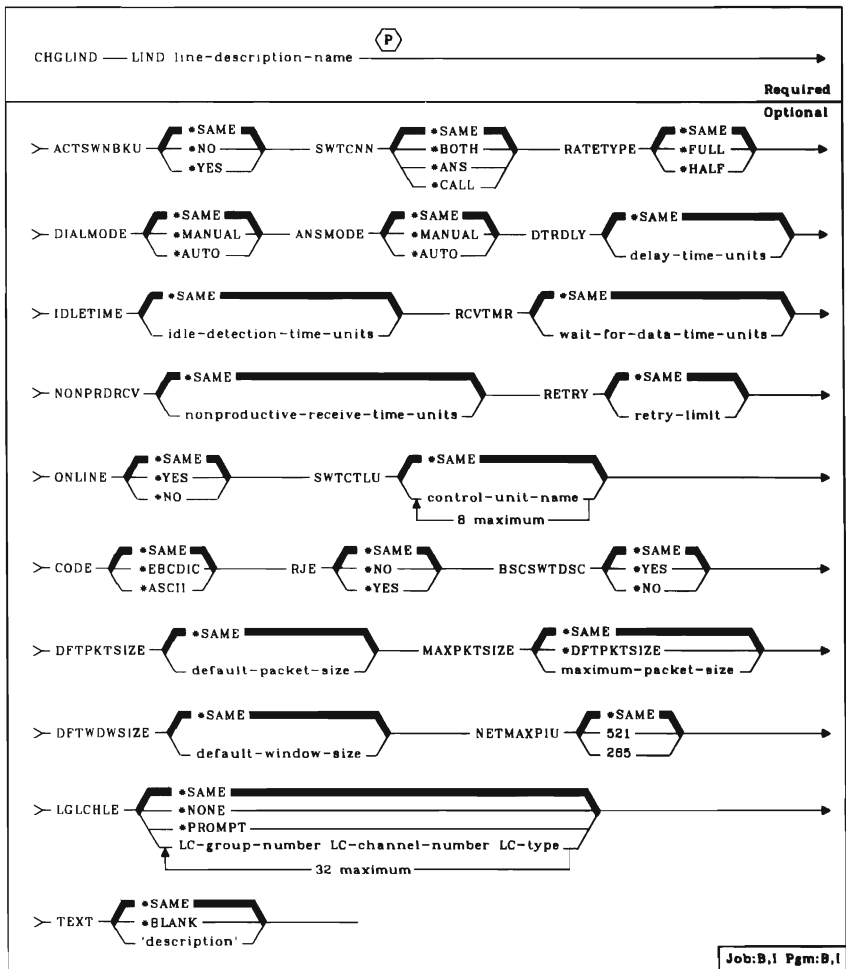

CHGMSGD (Change Message Description)

Changes the attributes of a predefined message in a message file.

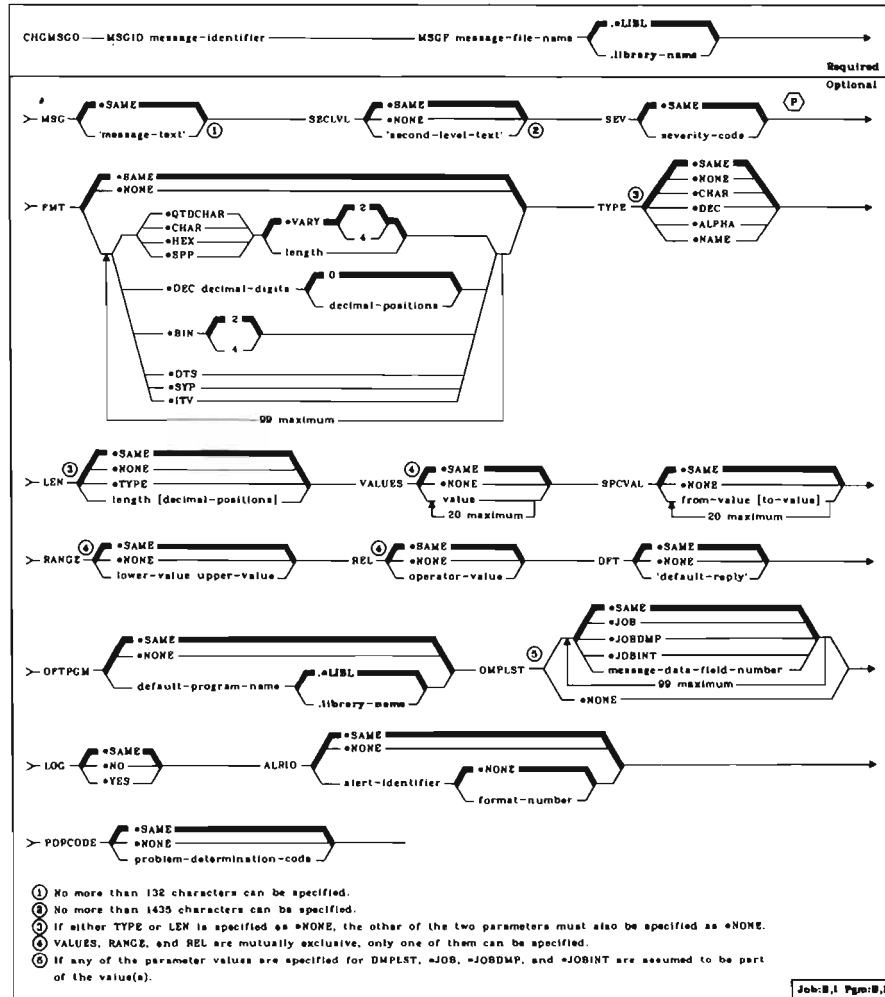

CHGMSGQ (Change Message Queue)

Changes the attributes of a message queue.

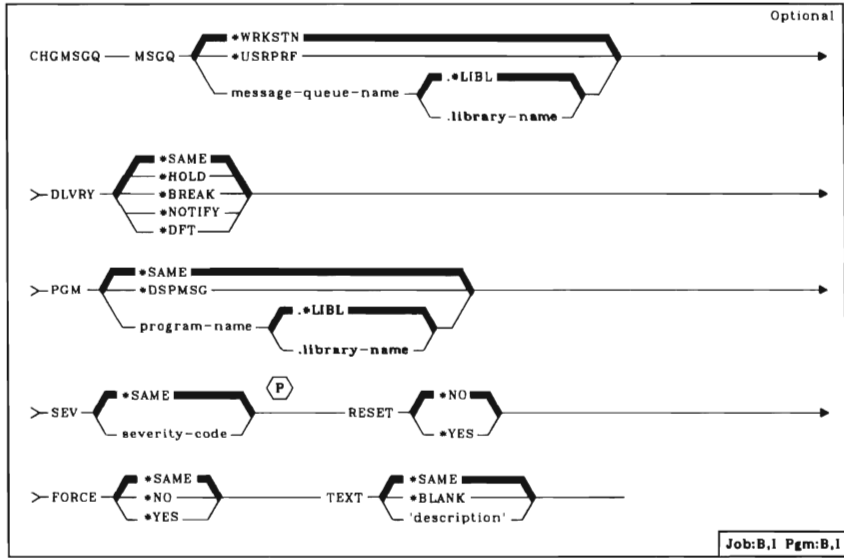

CHGMXDF (Change Mixed File)

Changes the attributes of a mixed file.

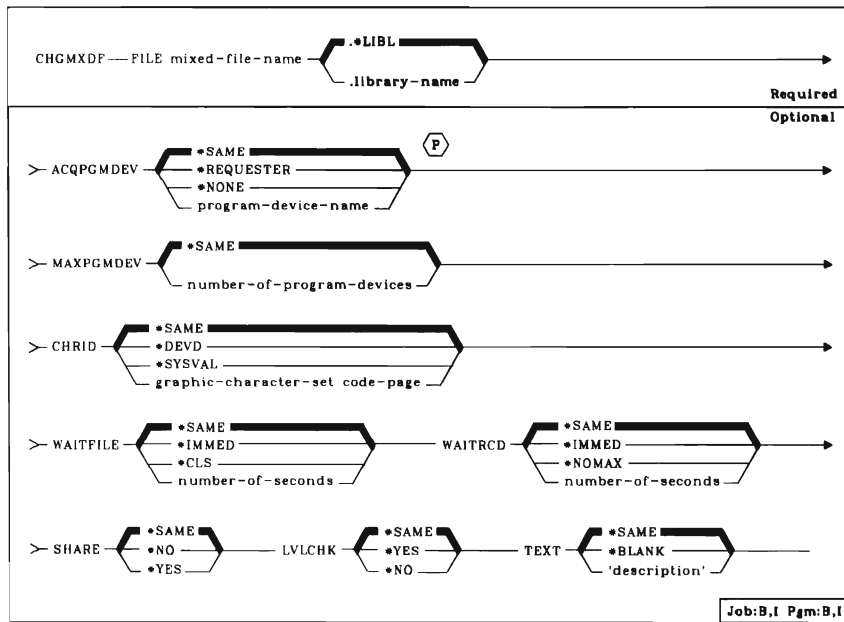

CHGNETA (Change Network Attributes)

Changes the network attributes of a system. This command can be issued to start alert processing, to stop alert processing, to change the name of a control unit through which alert messages are sent to the host, or to change the system name.

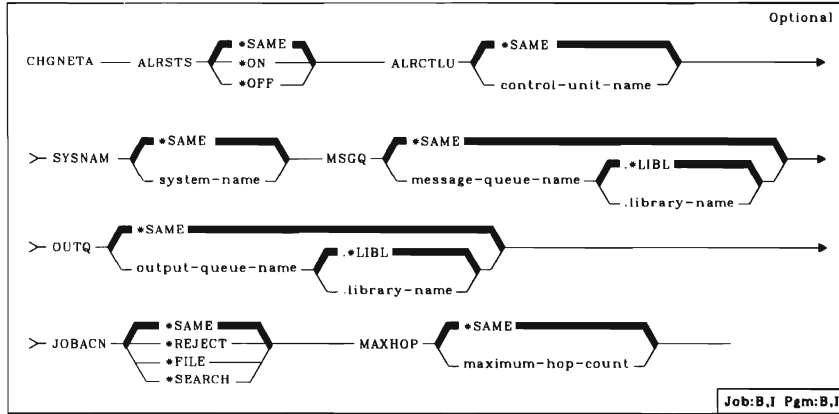

CHGNETJOBE (Change Network Job Entry)

Changes an existing network job entry in the system.

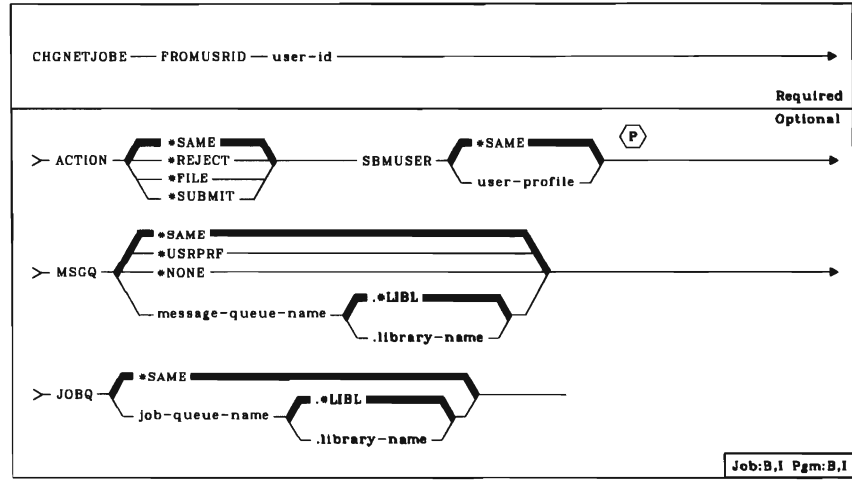

CHGOBJOWN (Change Object Owner)

Changes the owner of an object.

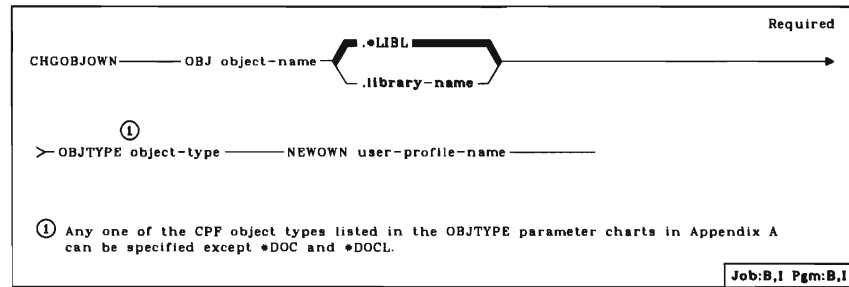

CHGOUTQ (Change Output Queue)

Changes the attributes of an output queue.

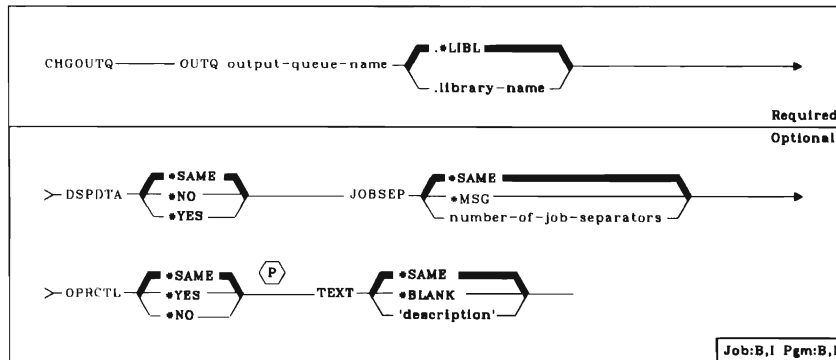

CHGPF (Change Physical File)

Changes the attributes of a physical file and its members.

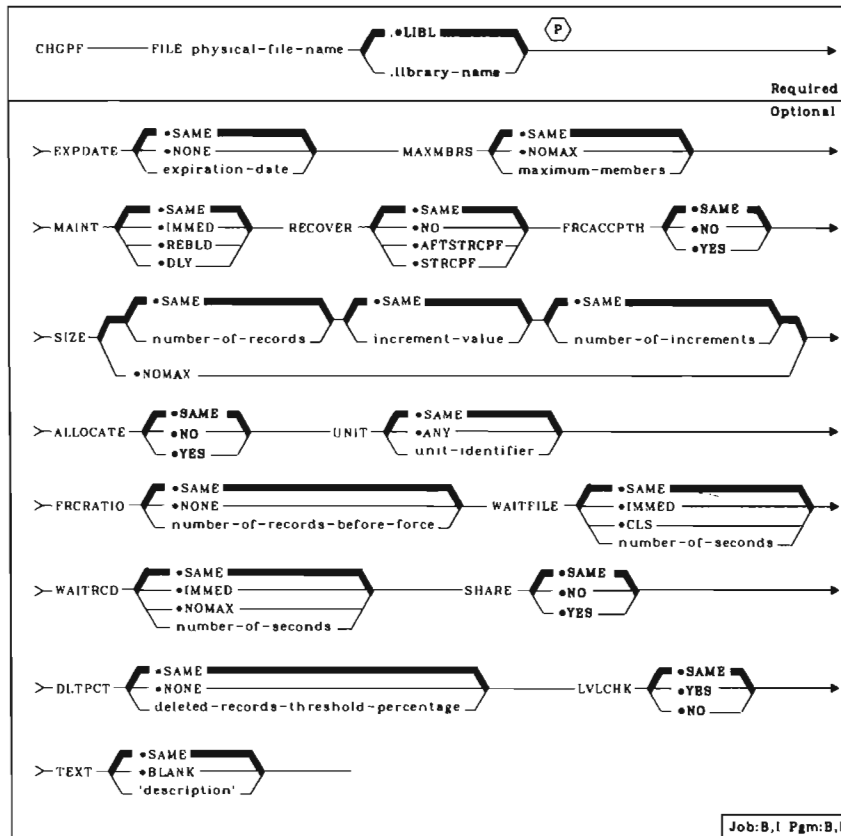

CHGPFM (Change Physical File Member)

Changes the attributes of a physical file member.

CHGPFM	FILE	physical-file-name	<input type="checkbox"/> .LIBL	_____	_____
			<input type="checkbox"/> .library-name	_____	_____
> MBR	<input type="checkbox"/> *FIRST	_____	<input type="checkbox"/> (P)	_____	_____
		physical-file-member-name			Required
> EXPDATE	<input type="checkbox"/> *SAME	_____	SHARE	<input type="checkbox"/> *SAME	_____
	<input type="checkbox"/> *NONE	expiration-date		<input type="checkbox"/> *NO	_____
				<input type="checkbox"/> *YES	_____
> TEXT	<input type="checkbox"/> *SAME	_____			_____
	<input type="checkbox"/> *BLANK	'description'			_____
					Optional
Job:B,I Pgm:B,I					

CHGPGM (Change Program)

Changes the attributes of a program without recompilation.

CHGPGM	PGM	<input type="checkbox"/> ① program-name	<input type="checkbox"/> ② .USRLIBL	<input type="checkbox"/> (P)	_____
		generic-name	<input type="checkbox"/> .library-name		_____
		<input type="checkbox"/> *ALL			Required
> OPTIMIZE	<input type="checkbox"/> *SAME	_____	USRPRF	<input type="checkbox"/> *SAME	_____
	<input type="checkbox"/> *YES	_____		<input type="checkbox"/> *USER	_____
	<input type="checkbox"/> *NO	_____		<input type="checkbox"/> *OWNER	_____
				PRCCRT	<input type="checkbox"/> *NO
					<input type="checkbox"/> *YES
> TEXT	<input type="checkbox"/> *SAME	_____			_____
	<input type="checkbox"/> *BLANK	'description'			_____
					Optional
① *ALL or a generic request cannot be specified with *USRLIBL for the library qualifier.					
② QSYS and QGDMM cannot be specified for the library.					
Job:B,I Pgm:B,I					

CHGPGMVAR (Change Program Variable)

Changes the value of a variable in a program being debugged (using the ENTDBG command).

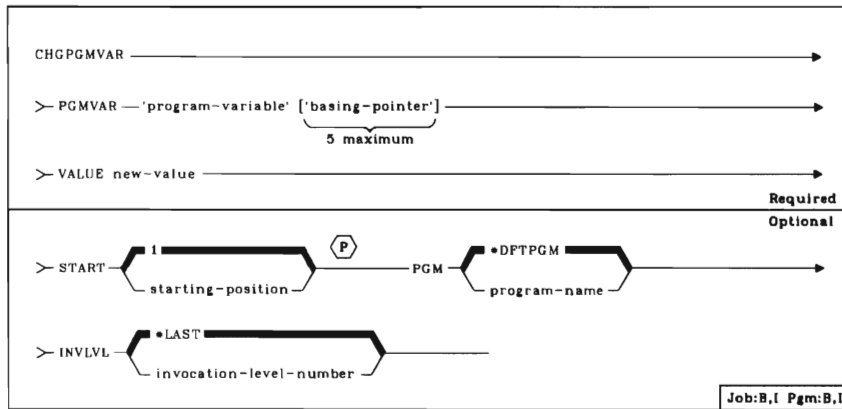

CHGPRTF (Change Printer File)

Changes the attributes of a printer file.

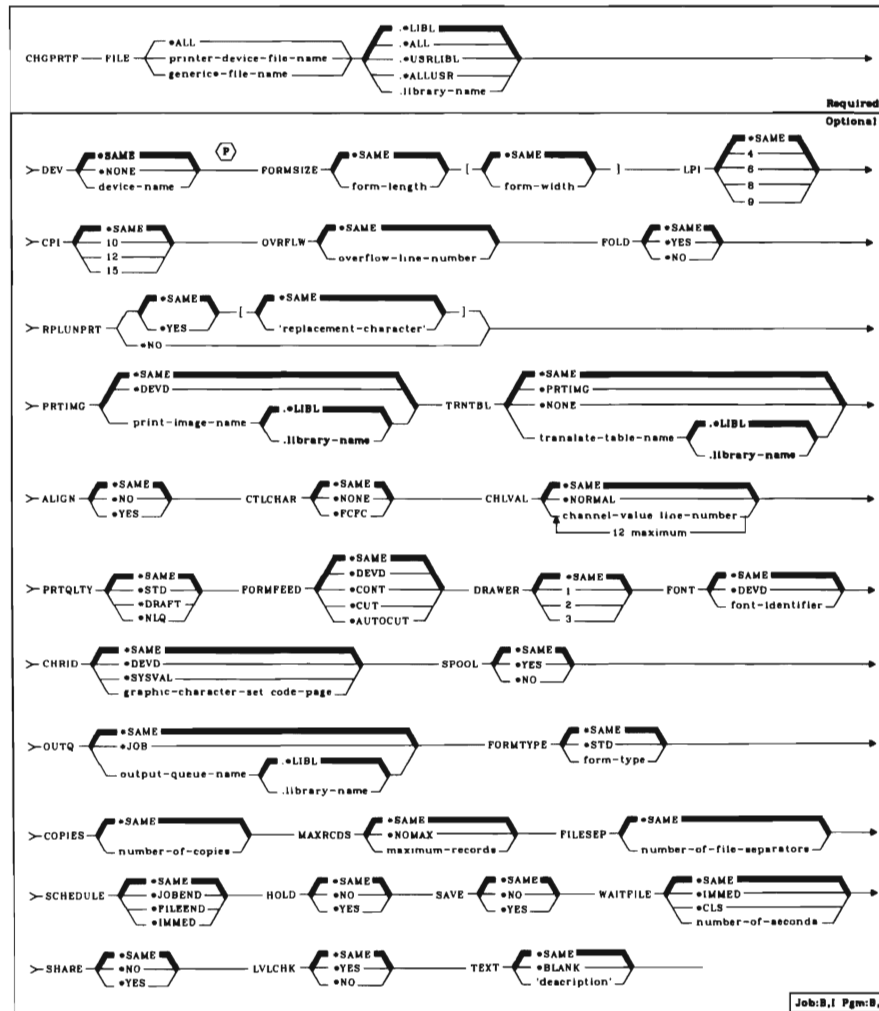

CHGPTR (Change Pointer)

Changes the value of a pointer in a program being debugged (using the ENTDBG command).

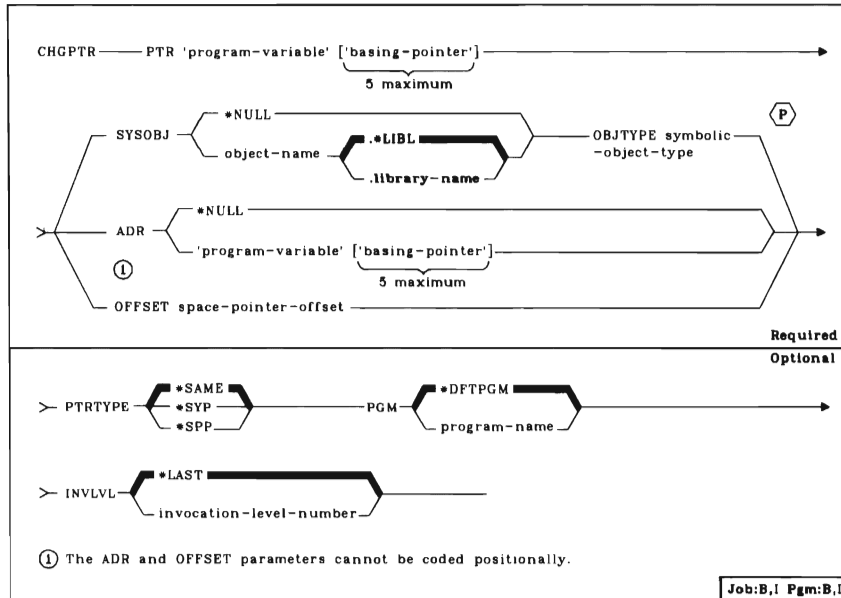

CHGQRYDEF (Change Query Definition)

Begins a prompting sequence for interactive modification of a query application. Your responses to the prompts are used to create a new application or to replace the original application.

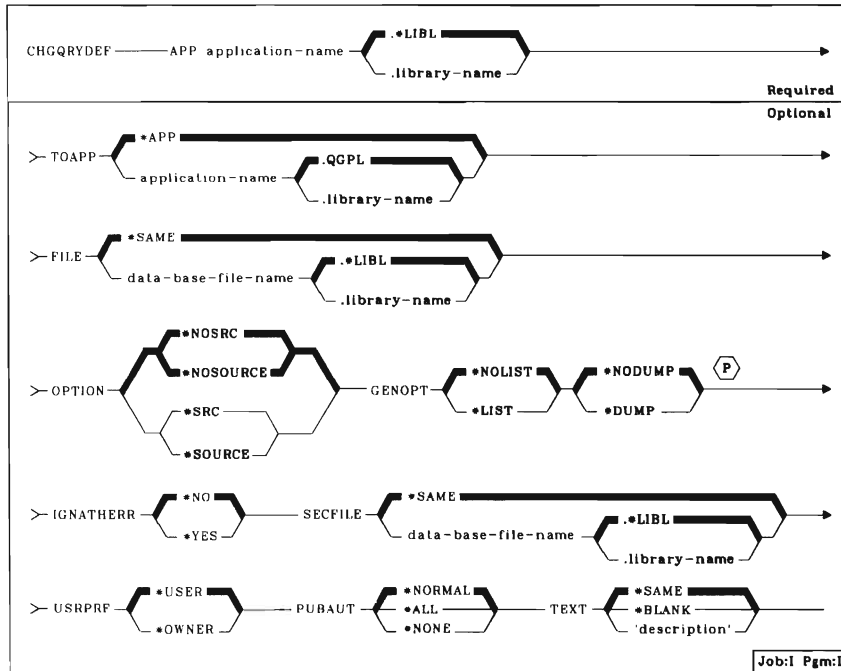

CHGRJECMNE (Change RJE Communications Entry)

Changes the attributes of a communications file entry in an existing RJEF session description.

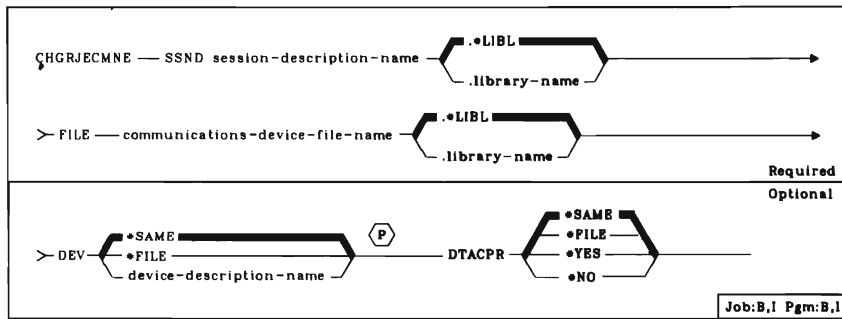

CHGRJERDRE (Change RJE Reader Entry)

Changes the attributes of an RJEF reader entry in an existing RJEF session description.

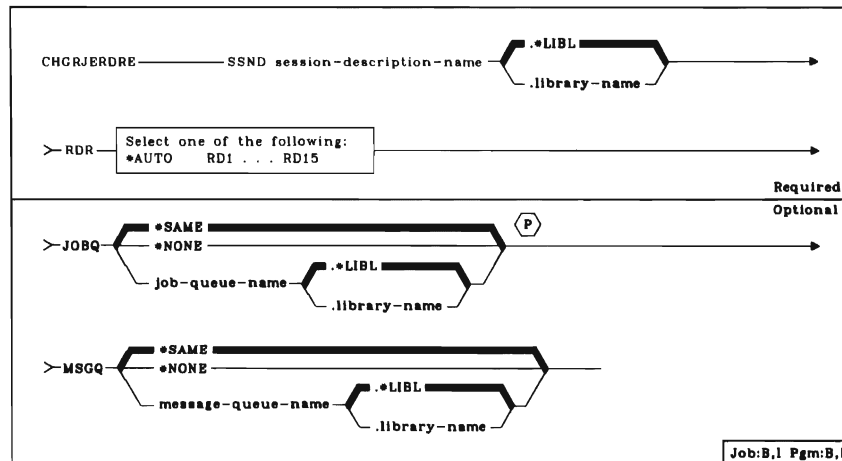

CHGRJEWTRE (Change RJE Writer Entry)

Changes the attributes of an RJEF writer entry in an existing RJEF session description.

CHGRJEWTRE	SSND session-description-name	.LIBL	
		.library-name	
> WTR	Select one of the following: PR1 . . . PR15 PU1 . . . PU15		
			Required
			Optional
> FILE	*SAME	.LIBL	
	device-file-name	.library-name	
	data-base-file-name		
> MBR	*SAME		
	*GEN		
	*FIRST		
	member-name	FSN	
		file-sequence-number	
> FORMTYPE	*SAME		
	*STD		
	form-type	DTAFMT	
		*SAME	
		*FCPC	
		*DATA	
		*CMN	
> PGM	*SAME	.LIBL	
	*NONE		
	program-name	.library-name	
> MSGQ	*SAME	.LIBL	
	*NONE		
	message-queue-name	.library-name	
			Job:B,I Pgm:B,I

CHGRPYLE (Change Reply List Entry)

Changes any of the attributes of a reply list entry, except for the sequence number.

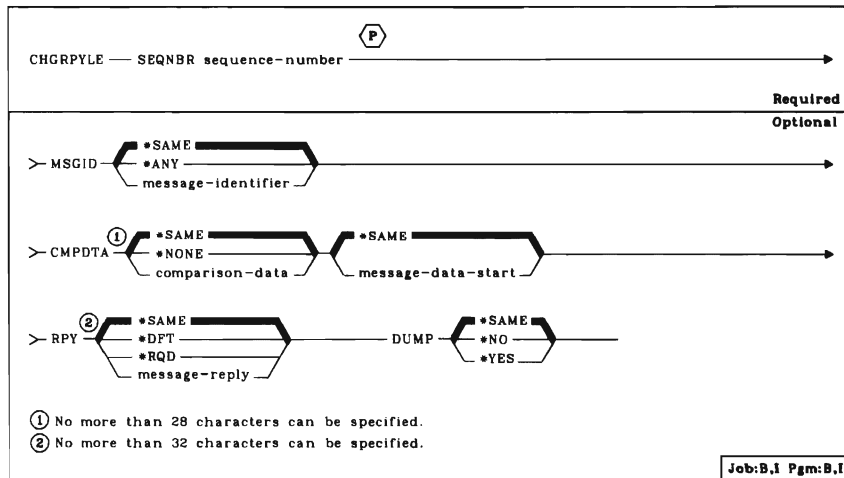

CHGRTGE (Change Routing Entry)

Changes a routing entry in a subsystem description.

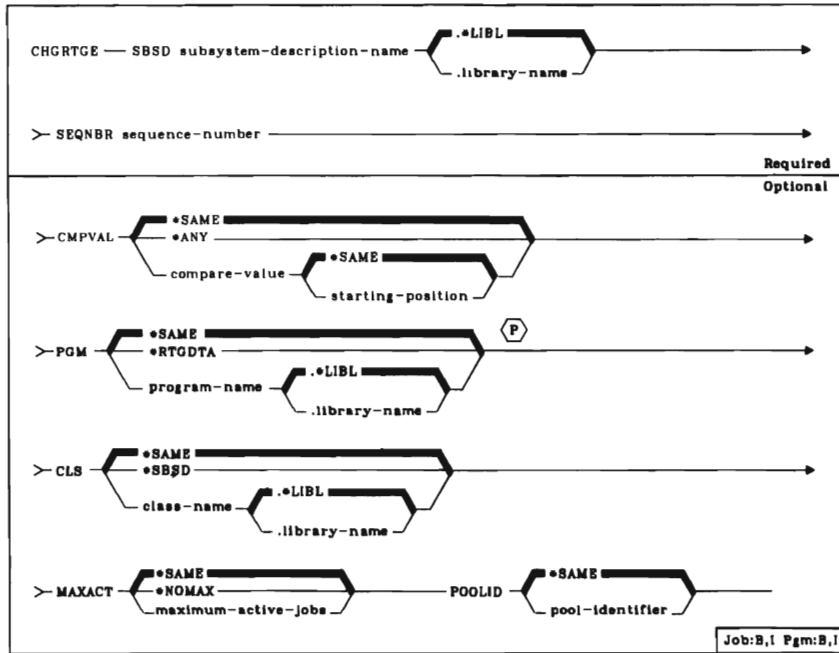

CHGSAVF (Change Save File)

Changes one or more of the attributes of a specified save file.

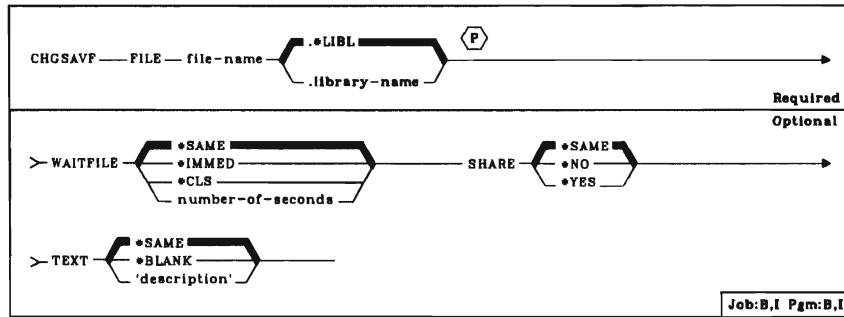

CHGSBSD (Change Subsystem Description)

Changes the operational attributes of a subsystem description.

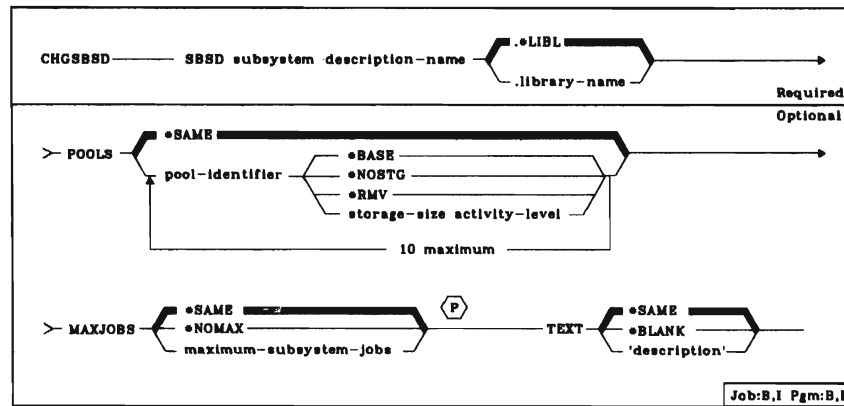

CHGSPLFA (Change Spooled File Attributes)

Changes the attributes of a spooled output file.

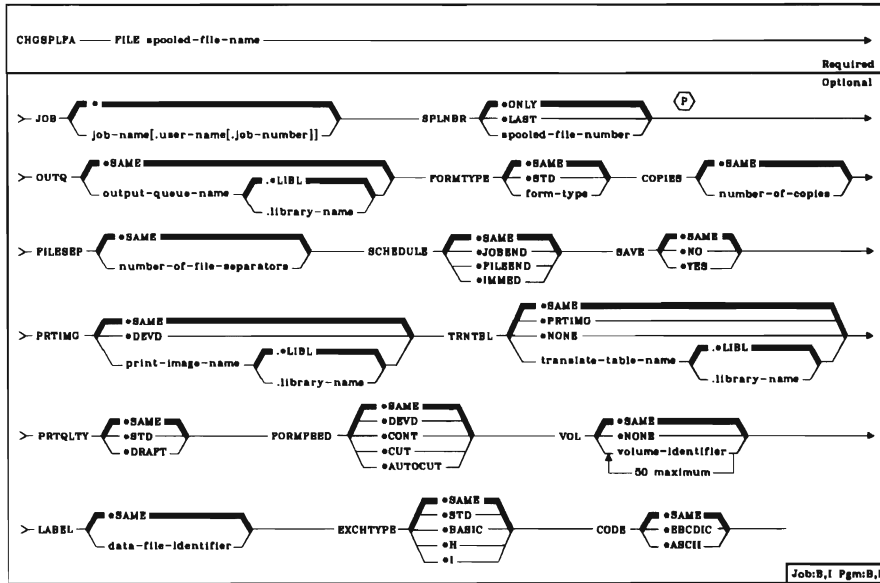

CHGSRCPF (Change Source Physical File)

Changes the attributes of a source physical file and its members.

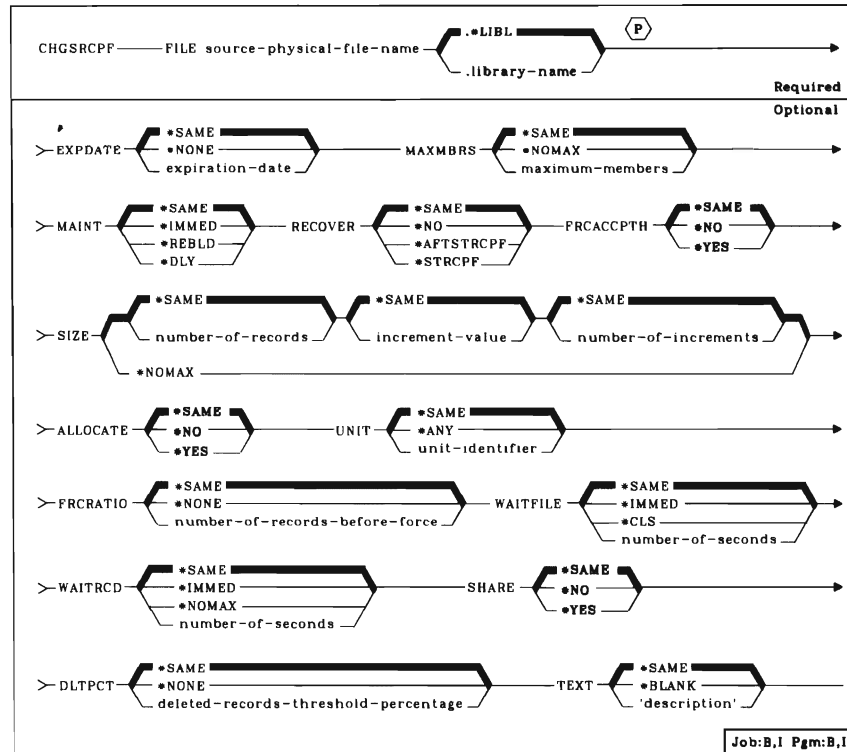

CHGSSND (Change Session Description)

Changes the attributes of an existing RJEF session description.

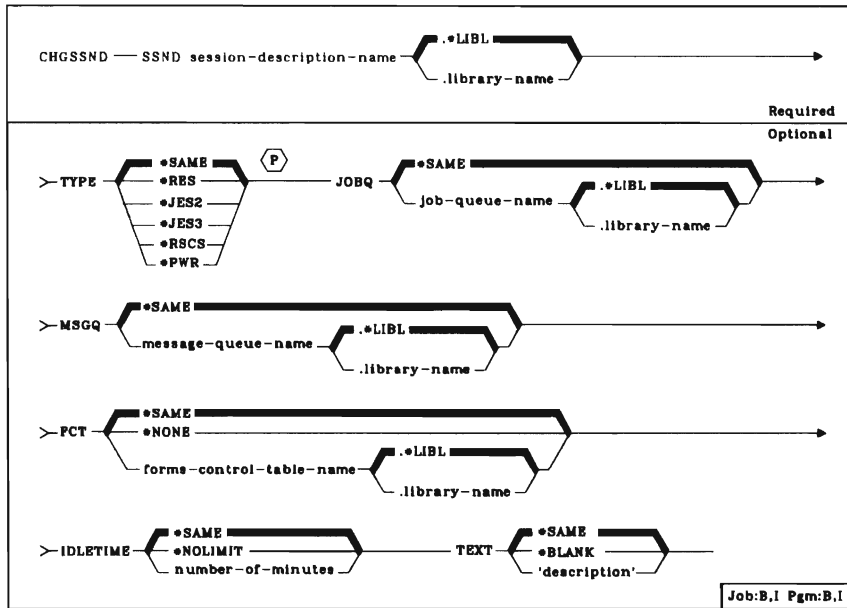

CHGSSNMAX (Change Session Maximum)

Used to dynamically change the maximum number of sessions the local system will allow through a mode on a peer device.

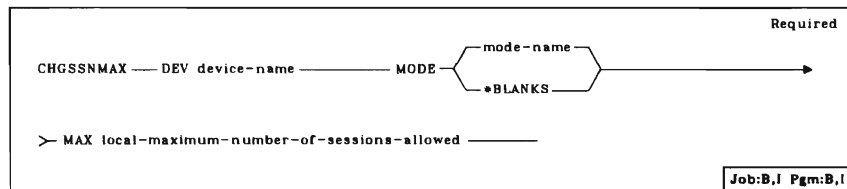

CHGSYSLIBL (Change System Library List)

Changes the system portion of the library list for the job in which the command is entered.

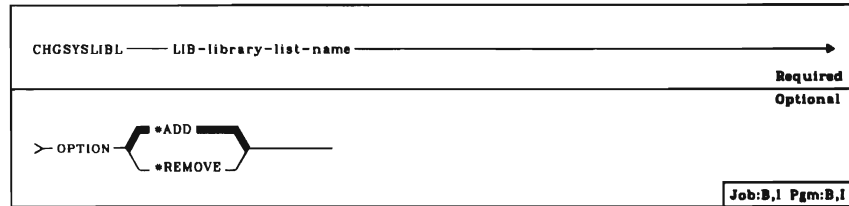

CHGSYSVAL (Change System Value)

Changes the value of a system value.

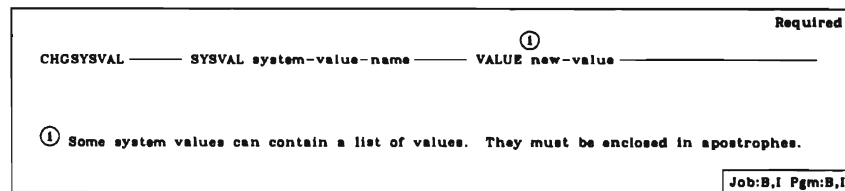

CHGTAPF (Change Tape File)

Changes the description of a tape file.

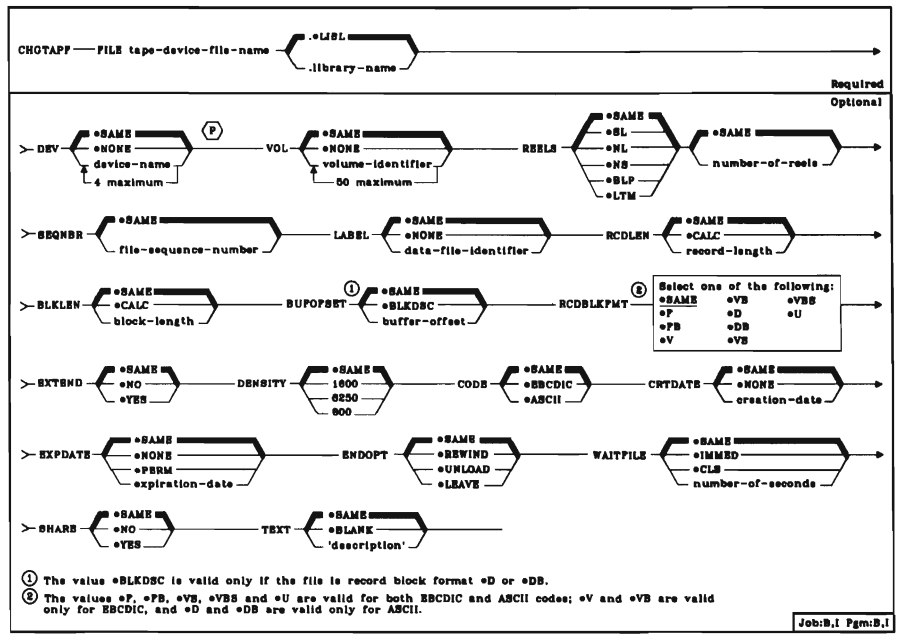

CHGUSRPRF (Change User Profile)

Changes the characteristics of a user profile. This command is used by the security officer.

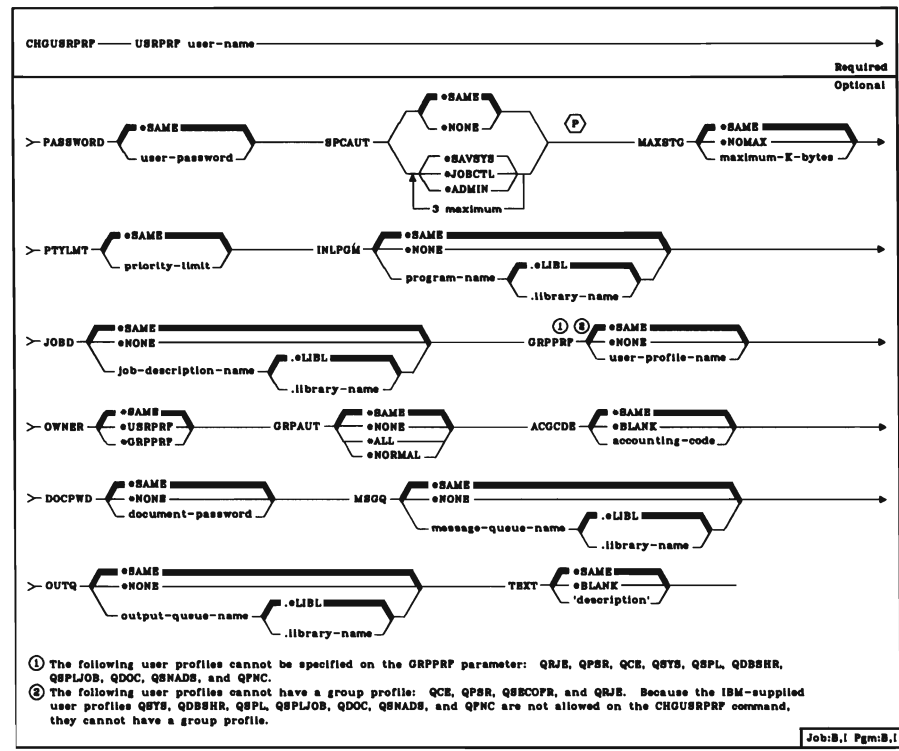

CHGVAR (Change Variable)

Changes the value of a CL variable in a CL program. Valid only in a CL program.

CHGVAR _____ VAR CL-variable-name _____ VALUE expression _____	Required
	Pgm:B,I



CHGWSE (Change Work Station Entry)

Changes a work station entry in a subsystem description.

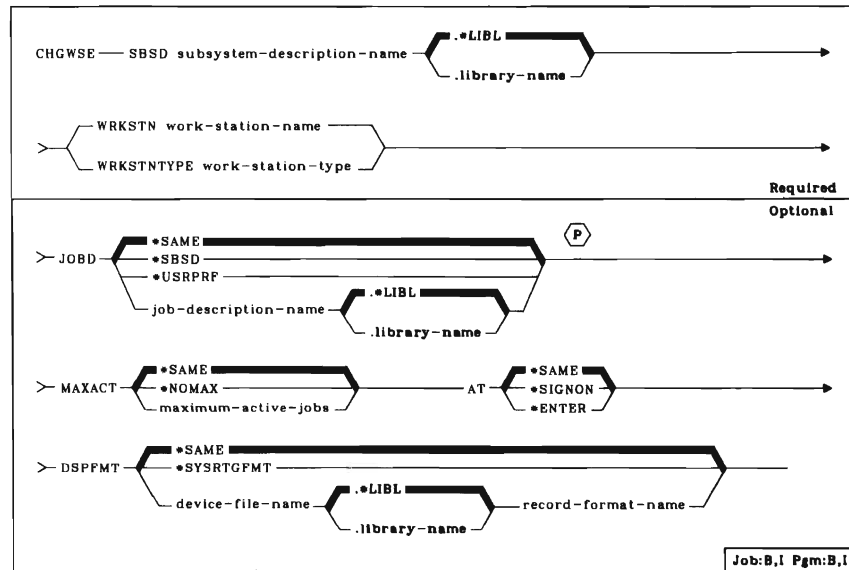

CHGWTR (Change Writer)

Allows you to change the form type being produced by the writer and the output queue from which the spooled files are being processed.

CHGWTR — WTR writer-name _____		Required
		Optional
> OUTQ	<input type="checkbox"/> *SAME _____ <input type="checkbox"/> output-queue-name _____ <input type="checkbox"/> *LIBL _____ <input type="checkbox"/> .library-name _____	
> FORMTYPE	<input type="checkbox"/> *SAME _____ <input type="checkbox"/> *ALL _____ <input type="checkbox"/> *STD _____ <input type="checkbox"/> form-type _____	<input type="checkbox"/> *SAME _____ <input type="checkbox"/> *NOMSG _____ <input type="checkbox"/> *MSG _____
	OPTION	<input type="checkbox"/> *NORDYP _____ <input type="checkbox"/> *FILEEND _____
		Job:B,I Pgm:B,I

CHKDKT (Check Diskette)

Searches a specified range of diskettes for a unique volume identifier and/or file label. If the correct diskette is found, the search stops at that diskette and no other diskettes are searched.

CHKDKT _____														
> LOC	<table border="1"> <tr> <td colspan="3">Select one of the following:</td> </tr> <tr> <td><input type="checkbox"/> *M12</td> <td><input type="checkbox"/> *S1</td> <td><input type="checkbox"/> *S12</td> </tr> <tr> <td><input type="checkbox"/> *M1</td> <td><input type="checkbox"/> *S2</td> <td><input type="checkbox"/> *S23</td> </tr> <tr> <td><input type="checkbox"/> *M2</td> <td><input type="checkbox"/> *S3</td> <td><input type="checkbox"/> *S123</td> </tr> </table>	Select one of the following:			<input type="checkbox"/> *M12	<input type="checkbox"/> *S1	<input type="checkbox"/> *S12	<input type="checkbox"/> *M1	<input type="checkbox"/> *S2	<input type="checkbox"/> *S23	<input type="checkbox"/> *M2	<input type="checkbox"/> *S3	<input type="checkbox"/> *S123	<input type="checkbox"/> *FIRST _____ <input type="checkbox"/> starting-diskette -position _____
Select one of the following:														
<input type="checkbox"/> *M12	<input type="checkbox"/> *S1	<input type="checkbox"/> *S12												
<input type="checkbox"/> *M1	<input type="checkbox"/> *S2	<input type="checkbox"/> *S23												
<input type="checkbox"/> *M2	<input type="checkbox"/> *S3	<input type="checkbox"/> *S123												
		<input type="checkbox"/> *LAST _____ <input type="checkbox"/> *ONLY _____ <input type="checkbox"/> *WRAP _____ <input type="checkbox"/> ending-diskette -position _____												
		Required												
> VOL	<input type="checkbox"/> *LOC _____ <input type="checkbox"/> volume-identifier _____	<input type="checkbox"/> *NO _____ <input type="checkbox"/> *YES _____												
		Optional												
> LABEL	<input type="checkbox"/> *NONE _____ <input type="checkbox"/> file-label _____	<input type="checkbox"/> *NONE _____ <input type="checkbox"/> CRTDATE _____ <input type="checkbox"/> creation-date _____												
		Job:B,I Pgm:B,I												

CHKOBJ (Check Object)

Checks object existence and, optionally, object authorizations so that a user can verify that an object exists and can verify his rights to the object before trying to access it.

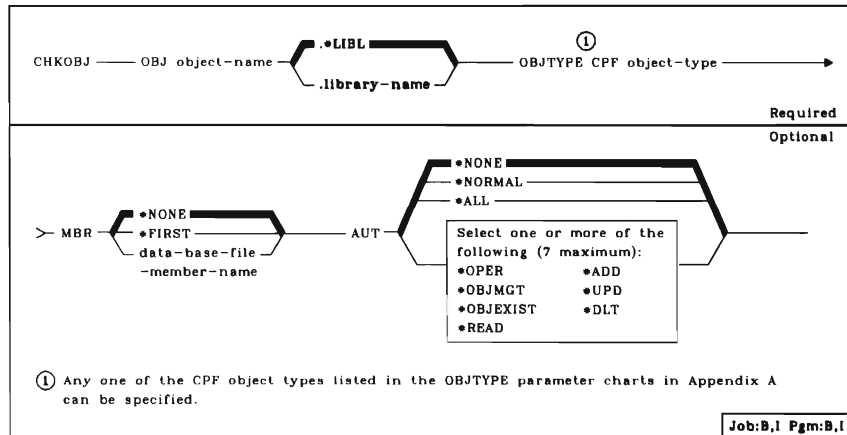

CHKTAP (Check Tape)

Searches a volume mounted on the specified device for a unique volume identifier and/or file label.

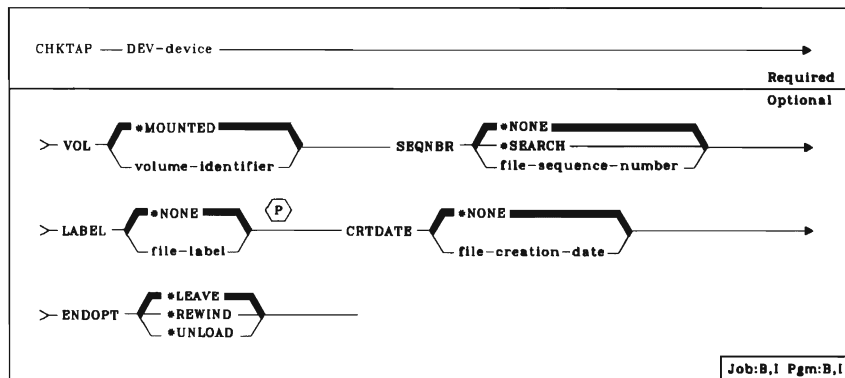

CLNPRT (Clean Printer)

Cleans the type faces of the print train on the 3203 Model 5 Printer.

CLNPRT _____ DEV 3203-device-name _____	Required
	Job:B,I Pgm:B,I

CLOF (Close File)

Closes a data base file. (This command works in conjunction with the OPNDBF command.)

CLOF _____ OPNID opnid-name _____	Required
	Job:B,I Pgm:B,I

CLRDKT (Clear Diskette)

Deletes all files from the diskette label area and defines a single file, named DATA, covering the entire diskette.

CLRDKT _____	Required																		
> LOC <table border="1"><tr><td colspan="3">Select one of the following:</td></tr><tr><td>*M12</td><td>*S1</td><td>*S12</td></tr><tr><td>*M1</td><td>*S2</td><td>*S23</td></tr><tr><td>*M2</td><td>*S3</td><td>*S123</td></tr></table> <table border="1"><tr><td>*FIRST</td><td>*LAST</td></tr><tr><td>starting-diskette</td><td>ending-diskette</td></tr><tr><td>-position</td><td>-position</td></tr></table>	Select one of the following:			*M12	*S1	*S12	*M1	*S2	*S23	*M2	*S3	*S123	*FIRST	*LAST	starting-diskette	ending-diskette	-position	-position	
Select one of the following:																			
*M12	*S1	*S12																	
*M1	*S2	*S23																	
*M2	*S3	*S123																	
*FIRST	*LAST																		
starting-diskette	ending-diskette																		
-position	-position																		
> VOL <table border="1"><tr><td>*LOC</td></tr><tr><td>volume-identifier</td></tr></table> CHECK <table border="1"><tr><td>*YES</td></tr><tr><td>*NO</td></tr></table> SUFFIX <table border="1"><tr><td>*NO</td></tr><tr><td>*YES</td></tr></table>	*LOC	volume-identifier	*YES	*NO	*NO	*YES	Optional												
*LOC																			
volume-identifier																			
*YES																			
*NO																			
*NO																			
*YES																			
	Job:B,I Pgm:B,I																		

Diskette file-QSYSDKT

CLRJOBQ (Clear Job Queue)

Removes all inactive entries from a job queue.

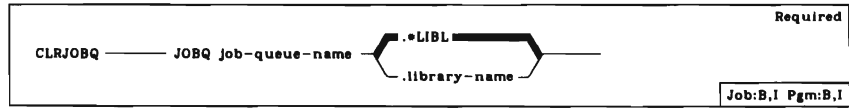

CLRLIB (Clear Library)

Deletes all objects for which the user has delete rights from the library.
The library is not deleted.



CLROUTQ (Clear Output Queue)

Removes all inactive entries from an output queue.

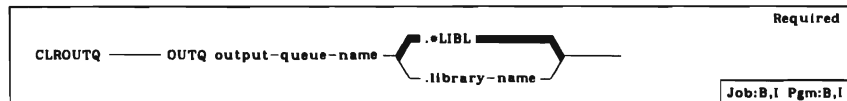

CLRPFM (Clear Physical File Member)

Removes all data including deleted records in a physical file member.

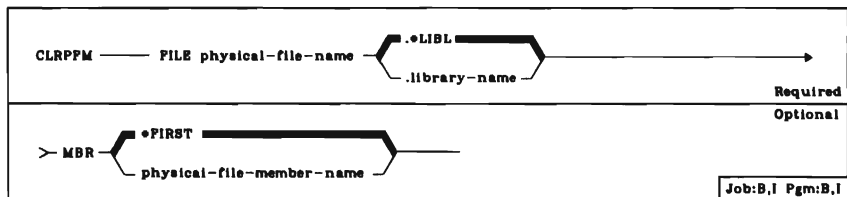

CMPJRNIMG (Compare Journal Images)

Gives you the capability to compare and note the differences between (1) the before and after images of record-level changes (updates, puts, deletes, rollback-updates, and rollback-deletes) for a specific file/member (IMAGES(*BOTH) was specified for JRNPF command), or (2) the after and *previous-after* image of a particular relative record (IMAGES(*AFTER) was specified for the JRNPF command).

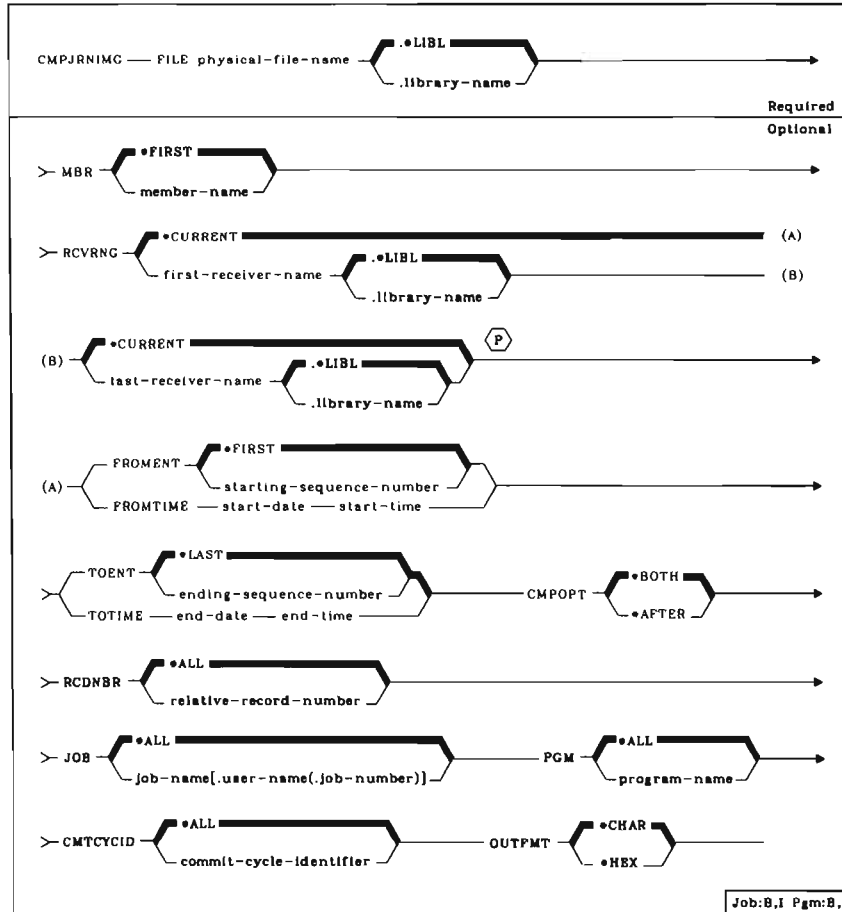

CNLJOB (Cancel Job)

Cancels a job and its inline data files, if any. Spooled output files can also be canceled. The job may be on a job queue, it may be active within a subsystem, or it may have already completed execution.

CNLJOB — JOB job-name[.user-name[.job-number]] —————→	
	Required
Optional	
> OPTION — { *CNTRLD / *IMMED } ——— DELAY — { 30 / delay-time } —————→	
> SPLFILE — { *NO / *YES } ——— LOGLMT — { *SAME / *NOMAX / maximum-logged-entries } —————→	
	Job:B,I Pgm:B,I

CNLNETF (Cancel Network File)

Cancels a file from a user's queue of network files.

CNLNETF — FILE — file-name —————→	
	Required
Optional	
> MBR ^① — { *ONLY / *ALL } ——— member-name ——— NBR — { *LAST / *ONLY / *ALL } ——— number ——— USER — { *CURRENT } ——— user-name —————→	
① If MBR(*ALL) is specified, NBR(*ALL) must also be specified.	
	Job:B,I Pgm:B,I

CNLRCV (Cancel Receive)

Cancels a request for input previously issued by a RCVF or SNDRCVF command for which WAIT(*NO) is specified. Valid only in a CL program.



CNLRDR (Cancel Reader)

Terminates a spooling reader.

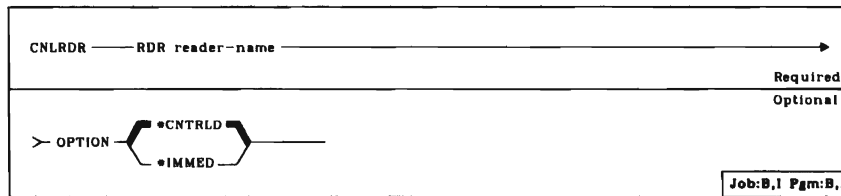

CNLRJERDR (Cancel RJE Reader)

Terminates an RJEF reader job and holds the associated RJEF reader job queue.

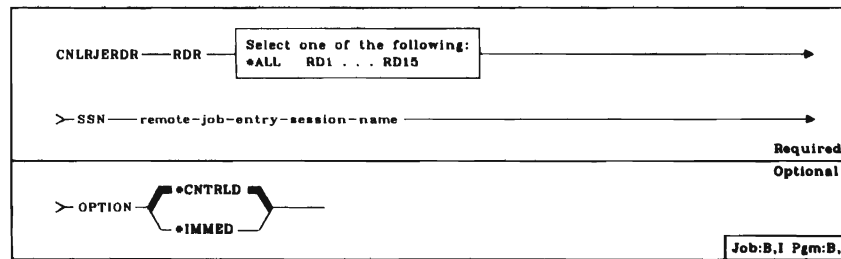

CNLRJEWTR (Cancel RJE Writer)

Terminates an RJEF writer.

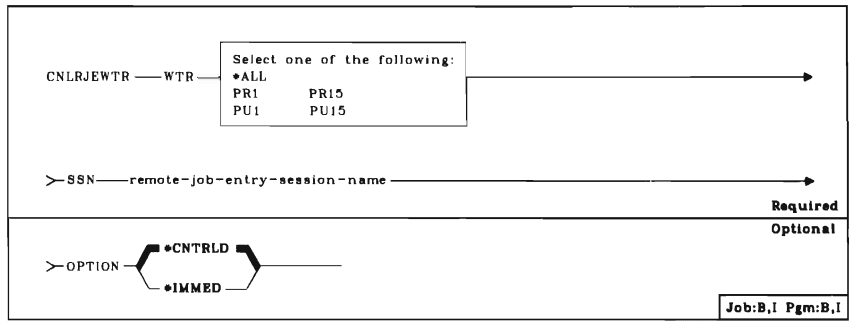

CNLRQS (Cancel Request)

Cancels a previously requested operation (command).



CNLSPLF (Cancel Spooled File)

Removes a spooled output file from an output queue.

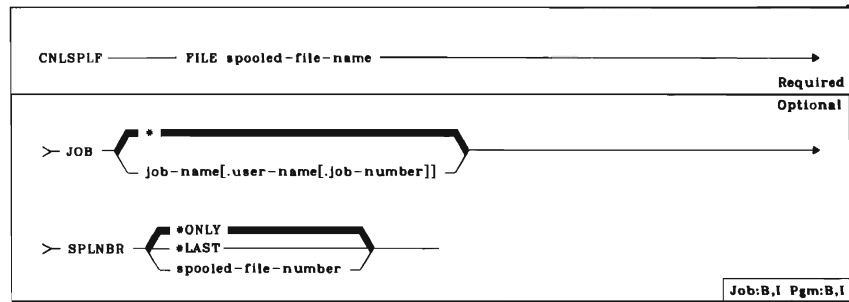

CNLWTR (Cancel Writer)

Terminates a spooling writer.

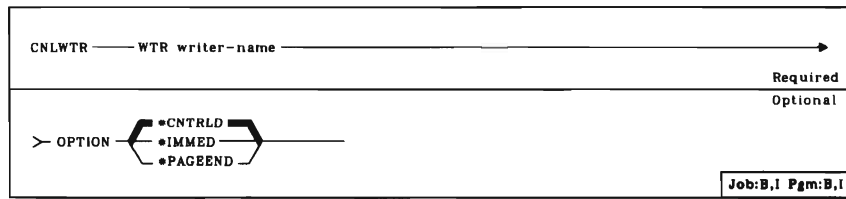

COMMIT (Commit)

Establishes a new commitment boundary: all pending changes that have been made to the data base files under commitment control since the last commitment boundary was established are made permanent.

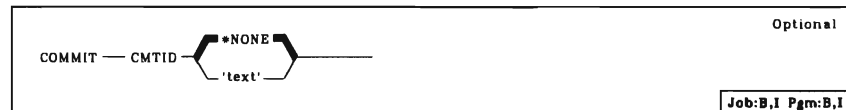

CPYF (Copy File)

Copies all or part of a file from the data base or an external device to the data base or an external device.

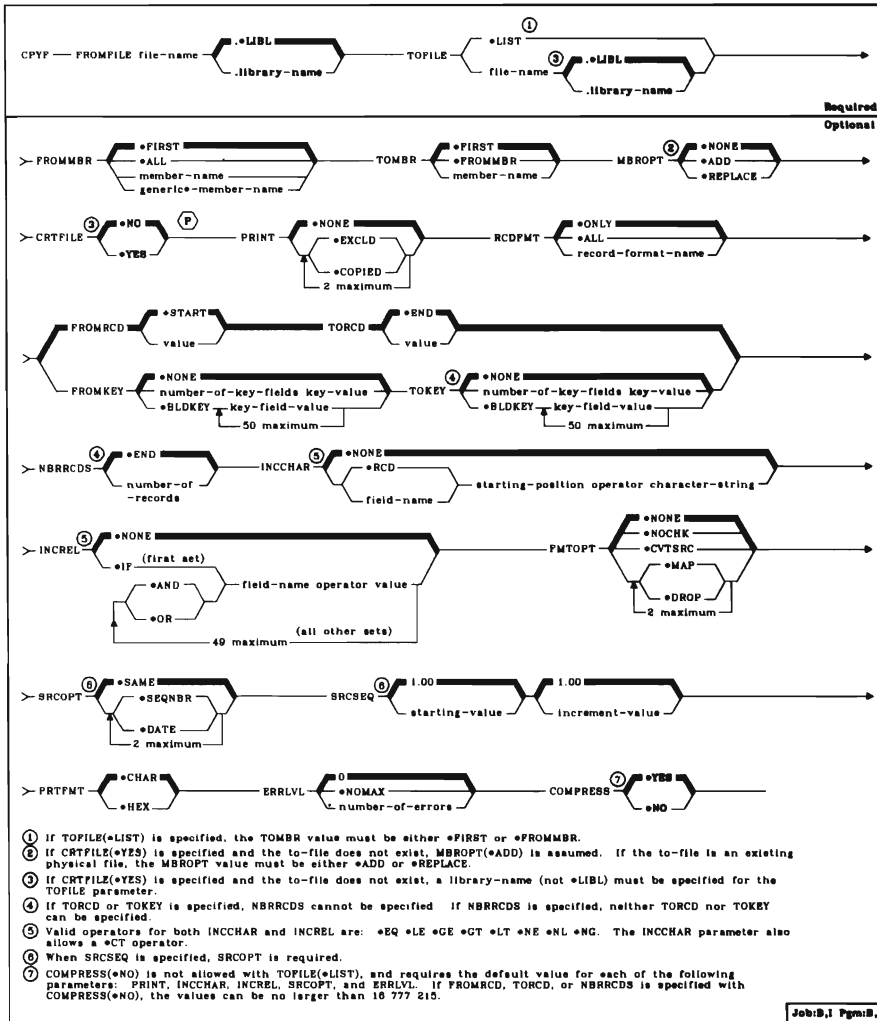

Printer file—QSYSPRT

The combinations of device and/or data base files with which the CPYF command can be used are shown in the following chart. An X indicates that the corresponding file types are a valid combination for copying a file.

From-File	To-File				
	Physical	Printer ¹	Diskette	Card	Tape
Physical	X ²	X	X	X	X
Logical	X ²	X	X	X	X
Diskette	X	X	X ³	X	X
Card	X	X	X	X	X
Tape	X	X	X	X	X
Inline ⁴	X	X	X	X	X

¹A program-described printer file can be used, or TOFILE(*LIST) can be specified to produce a formatted listing of the from-file records using the IBM-supplied printer file, QSYSPRT.

²If the to-file does not exist before the copy operation, and the from-file is either a physical or logical file, CRTFILE(*YES) can be specified to allow the copy operation to create a physical file for the to-file.

³If both the from-file and to-file are diskette files, the to-file must be spooled (SPOOL(*YES) is specified on the CRTDKTF, CHGDKTF, or OVRDKTF command), or the copy operation will not be able to open both the from-file and to-file.

⁴An inline file is one that is included in a batch job. See the //DATA command for more information about inline files.

CPYFRMDKT (Copy From Diskette)

Copies one or more files from diskette to an output file or to the printer. The from-file *must* be a diskette file for this command, but the to-file can be a physical, program-described, card, printer, tape, or diskette file, or the special value *LIST to print the records using the printer file QSYSPT.

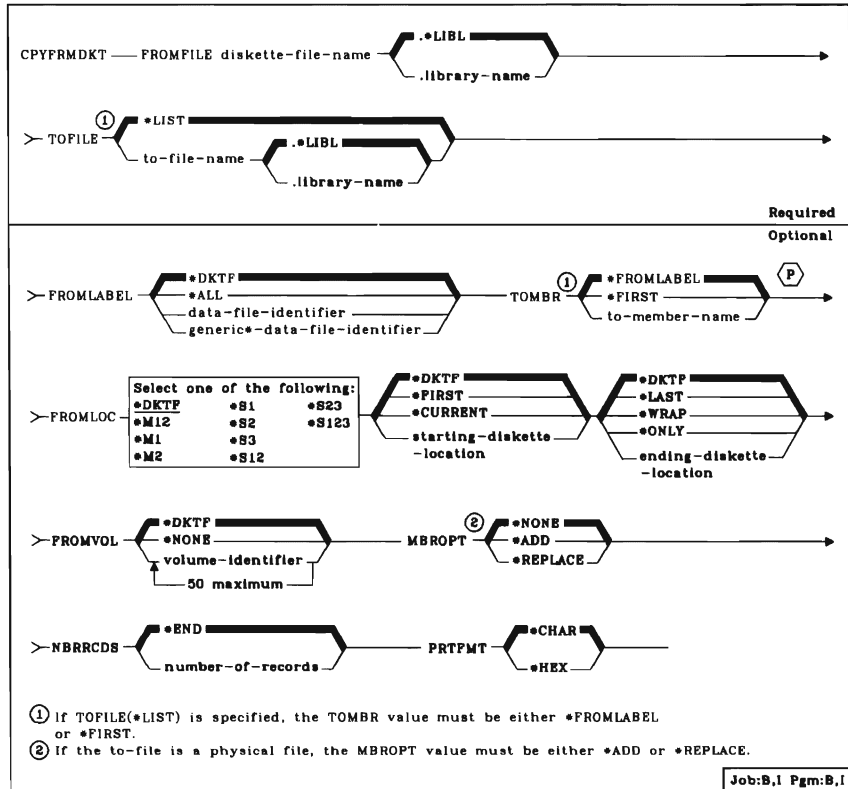

Printer File—QSYSPT

CPYFRMTAP (Copy From Tape)

Copies records from a tape file to an output file or to the system printer.

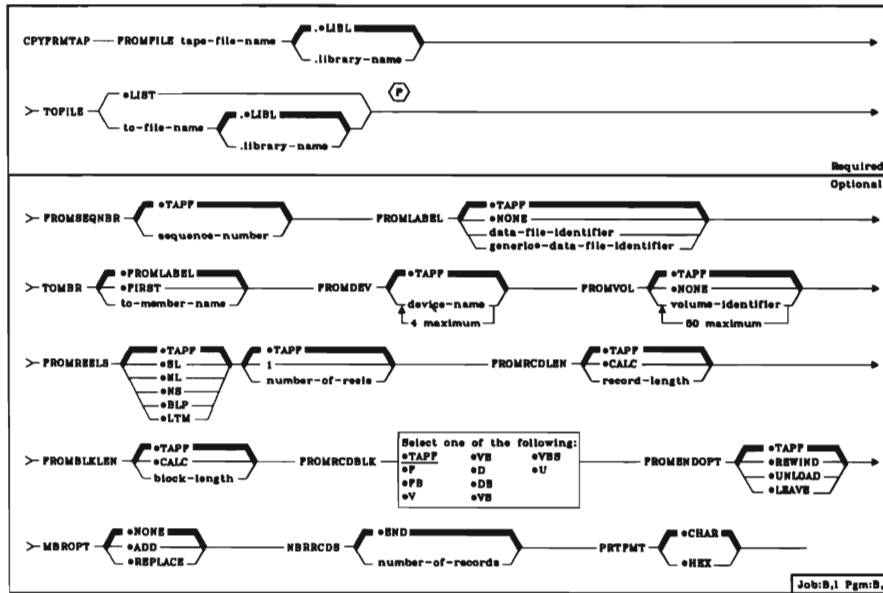

Printer File—QSYSPT

CPYFRMVDSK (Copy From Virtual Disk)

Copies a PC file on a virtual disk to a System/38 physical file.

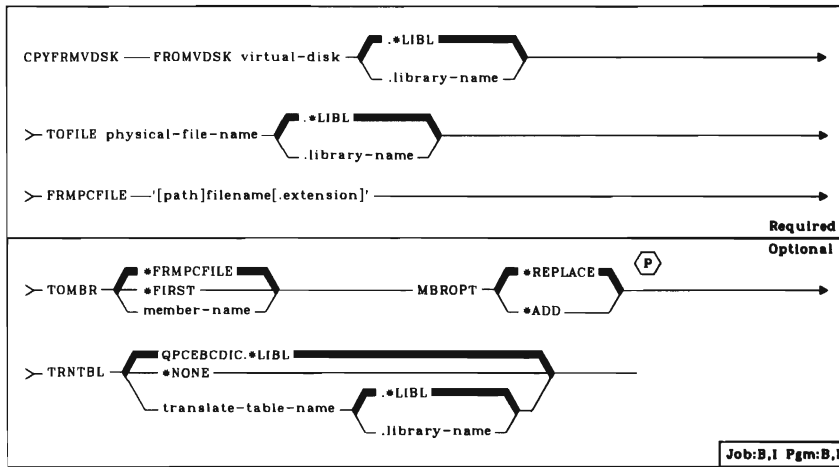

CPYTOVDSK (Copy To Virtual Disk)

Copies a member from a System/38 data base file to a PC file on a virtual disk.

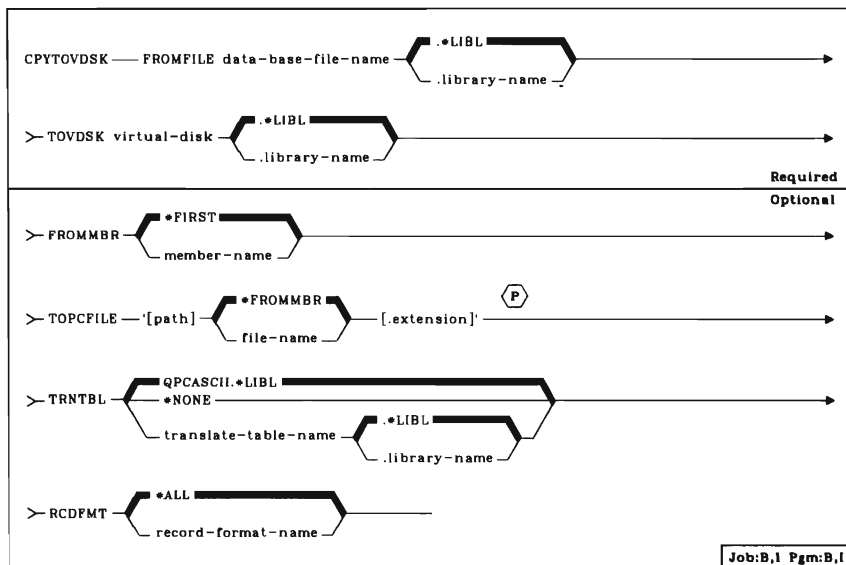

CPYSPLF (Copy Spooled File)

Copies data from a spooled file to a data base file.

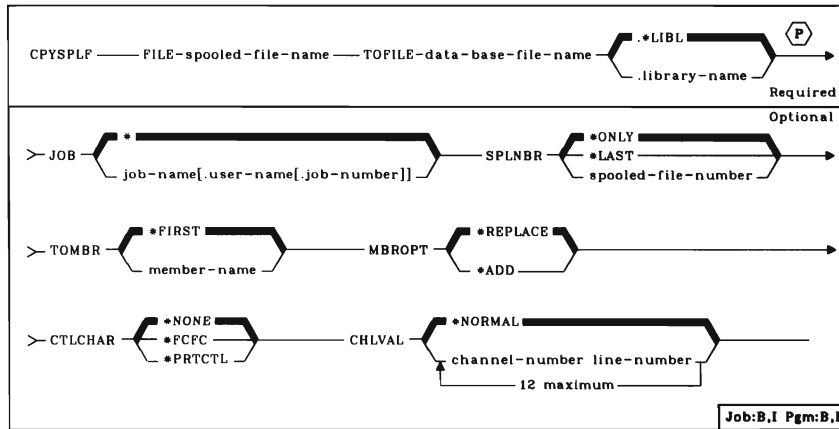

CPYSRCF (Copy Source File)

Copies a data base source file to a physical source file.

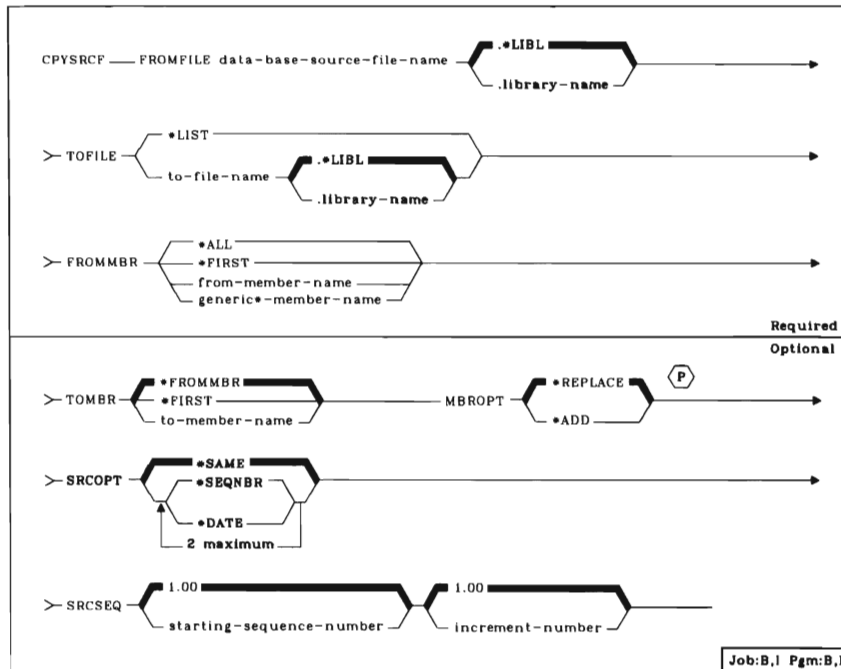

Printer file—QSYSPRT

CPYTODKT (Copy To Diskette)

Copies one or more files to a diskette file. The from-file can be a physical, logical, card, tape, or diskette file, or a spooled inline file.

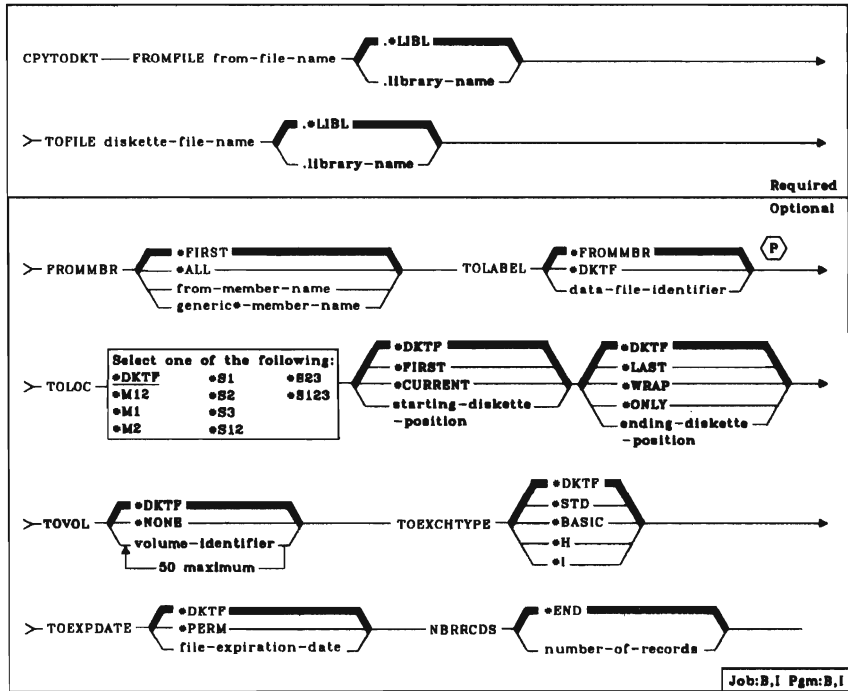

CPYTOTAP (Copy To Tape)

Copies records to a tape file; overrides issued for the from-file (the file from which the records are being copied) or to-file (the file that is to receive the copied records) within the process will apply to both the files.

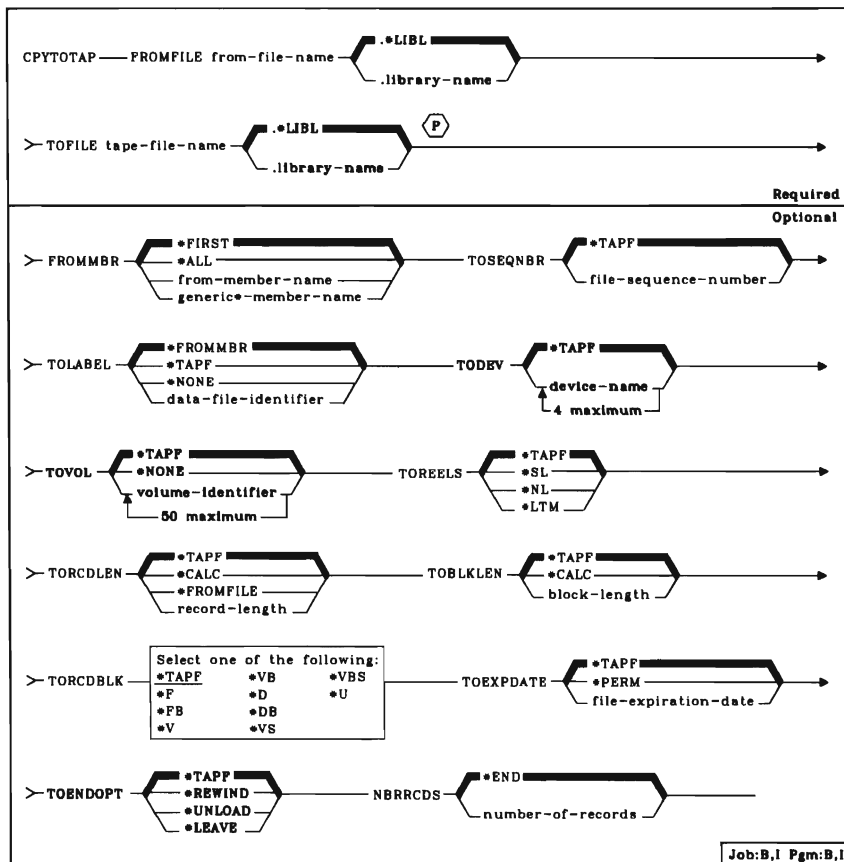

CRTBASPGM (Create BASIC Program)

Compiles the contents of a source file member that contains BASIC statements, and stores the output as a program object in a library.

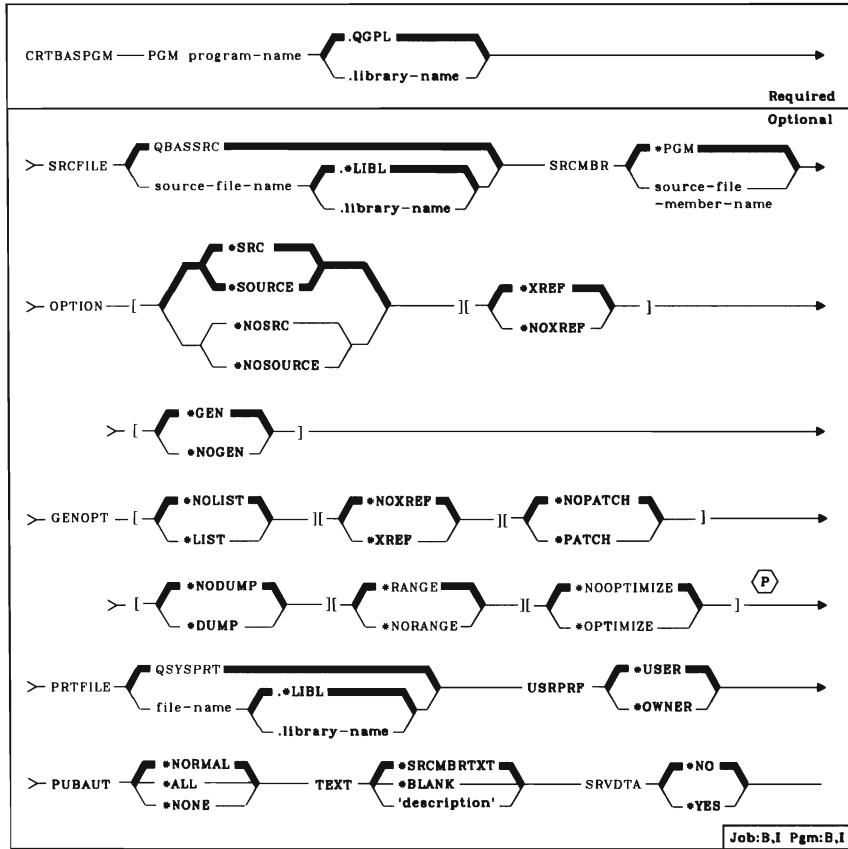

CRTBSCF (Create BSC File)

Creates a BSC file from command parameters and data description specifications (DDS).

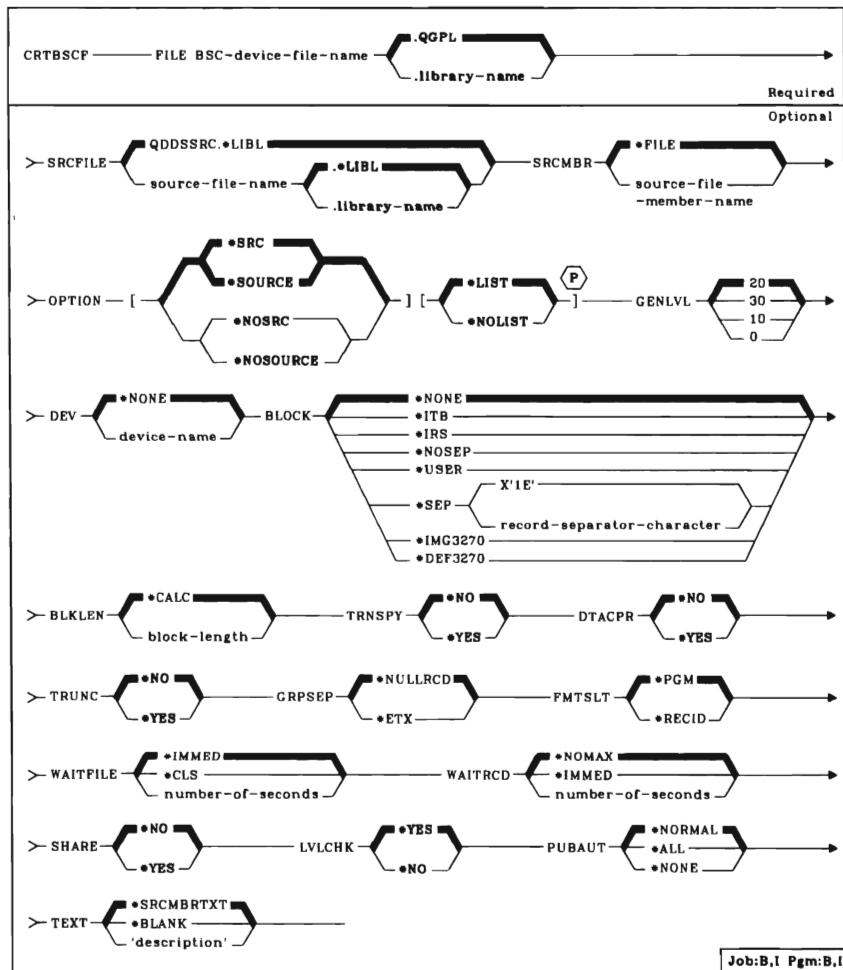

Printer file-QPDDSSRC
Data base source file-QDDSSRC

CRTCLPGM (Create COBOL Program)

Invokes the COBOL compiler to create an executable COBOL program from a COBOL source program.

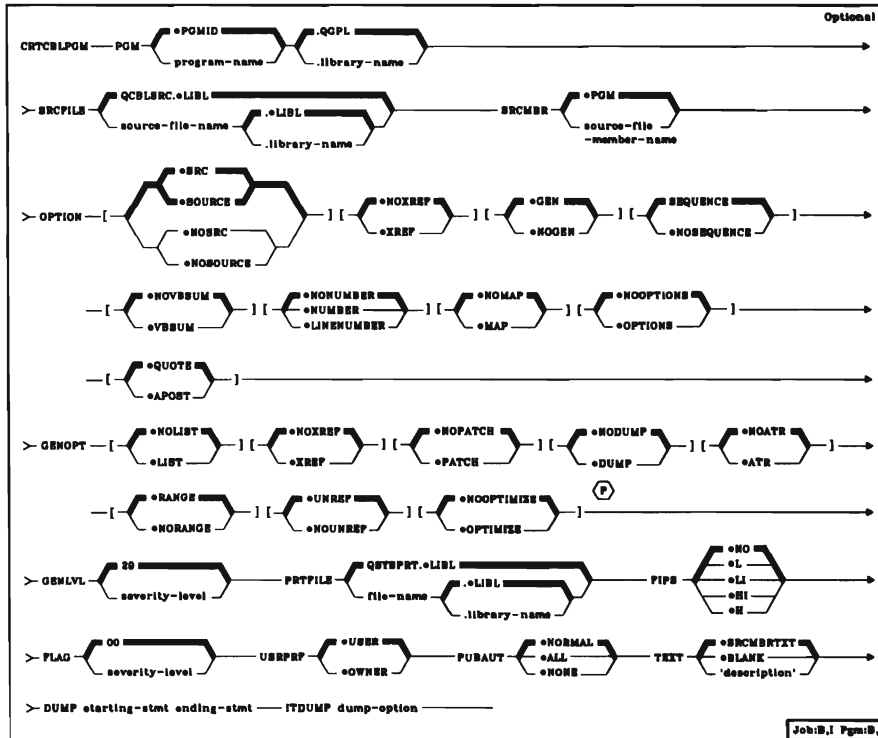

Printer file—QSYSPRT
Data base source file—QCBLSRC

CRTCLPGM (Create Control Language Program)

Invokes the control language compiler to create an executable control language program from control language source.

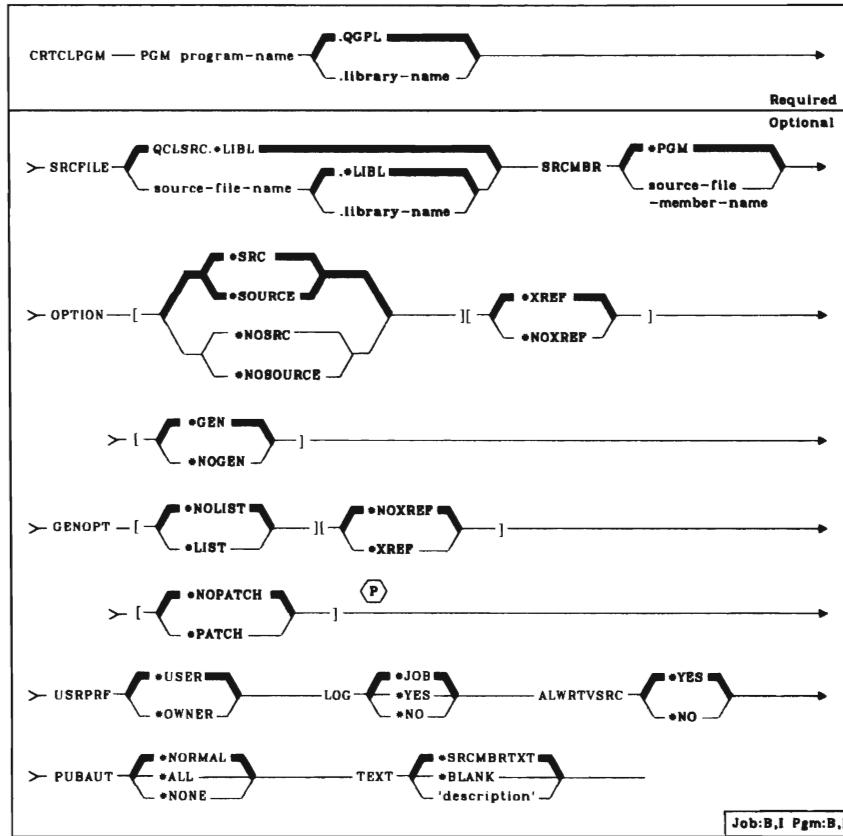

Printer file—QSYSVRT
Data base source file—QCLSRC

CRTCLS (Create Class)

Creates a class.

CRTCLS	CLS class-name	<input type="checkbox"/> .QOPL	<input type="checkbox"/> P	
		<input type="checkbox"/> .library-name		
				Required Optional
Y EXCPTY	<input type="checkbox"/> 50	<input type="checkbox"/> machine-execution-priority	TIMESLICE	<input type="checkbox"/> 10000
				<input type="checkbox"/> time-slice
Y PURGE	<input type="checkbox"/> *YES	DPTWAIT	<input type="checkbox"/> 120	<input type="checkbox"/> *NOMAX
	<input type="checkbox"/> *NO			<input type="checkbox"/> seconds-to-wait
Y CPUTIME	<input type="checkbox"/> *NOMAX			
	<input type="checkbox"/> maximum-CPU-time			
Y MAXTMPSTG	<input type="checkbox"/> *NOMAX			
	<input type="checkbox"/> maximum-temporary-storage			
Y PUBAUT	<input type="checkbox"/> *NORMAL	TEXT	<input type="checkbox"/> *BLANK	
	<input type="checkbox"/> *ALL		<input type="checkbox"/> 'description'	
	<input type="checkbox"/> *NONE			

Job:B,I Pgm:B,I

CRTCMD (Create Command)

Creates a new, user-defined command from command parameters and command definition statements. The command definition statements must first be entered in a source file member. The specified program is the command processing program (CPP) for the command you are creating.

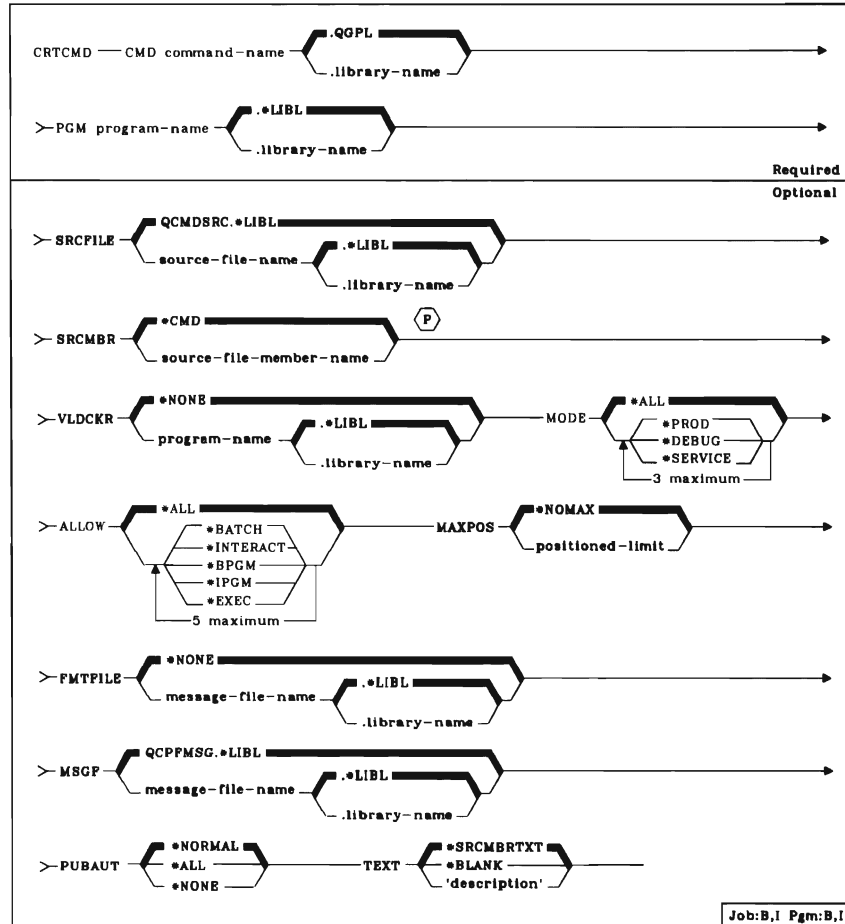

Printer file—QSYSVRT
Data base source file—QCMSDRC

CRTCMNF (Create Communications File)

Creates a communications file from command parameters and data description specifications (DDS).

CRTCMNF	FILE	communications-device-file-name	.QQPL	.library-name	Required
					Optional
> SRCFILE	QDDSSRC.QGPL	source-file-name	.LIBL	.library-name	
> SRCMBR	*FILE	source-file-member-name			
> OPTION	*SRC	*SOURCE	*NOSRC	*NOSOURCE	*LIST
					*NOLIST
> GENLVL	20	30	10	0	DEV
					*NONE
					*REQUESTER
					device-name
					LOGON
					*NONE
					logon-characters
> LOGOFF	*NONE	logoff-characters	BLKLEN	*CALC	block-length
					RCDSEP
					*YES
					*NO
> SPAN	*YES	*NO	FMTSLT	*PGM	*RECID
					*RMTFMT
					CNVTYPE
					*SYS
					*USER
> WAITFILE	*IMMED	*CLS	number-of-seconds	WAITRCD	*NOMAX
					*IMMED
					number-of-seconds
> SHARE	*NO	*YES	LVLCHK	*YES	*NO
					PUBAUT
					*NORMAL
					*ALL
					*NONE
> TEXT	*SRCMBRTXT	*BLANK	'description'		

Job:B,I Pgm:B,I

Printer file—QPDDSSRC

Data base source file—QDDSSRC

CRTCRDF (Create Card File)

Creates a card file from command parameters.

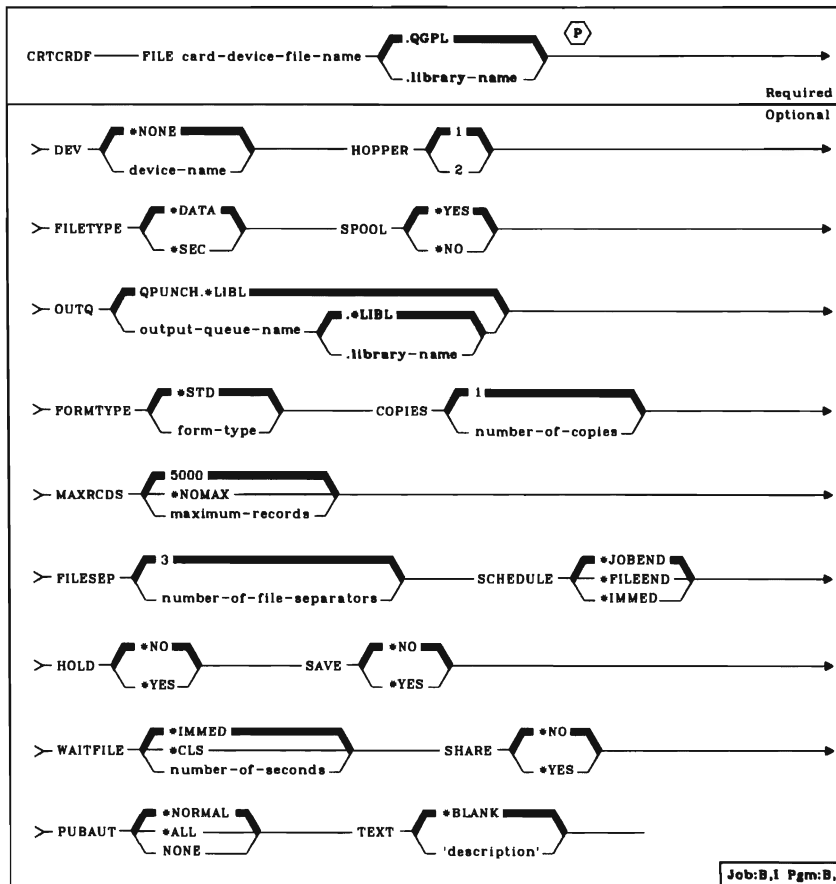

CRTCUD (Create Control Unit Description)

Creates a control unit description.

CRTCUD — CUD control-unit-description-name		TYPE control-unit-type		①			
MODEL model-number		CTLADR control-unit-address		②			
				Required Optional			
Y SWITCHED	<input type="checkbox"/> NO <input type="checkbox"/> YES	LINE	<input type="checkbox"/> NONE line-name	SELECT	<input type="checkbox"/> NO <input type="checkbox"/> YES	TELNBR	<input type="checkbox"/> NONE telephone-number
Y INLCNN	<input type="checkbox"/> ANS <input type="checkbox"/> CALL	EXCHID	<input type="checkbox"/> NONE exchange-identifier	LCLID	<input type="checkbox"/> NONE local-identifier		
Y RMTID	<input type="checkbox"/> NONE remote-identifier-list 32 maximum	IDENTIFIER	<input type="checkbox"/> NOID <input type="checkbox"/> ANY	SSCPID	SSCP-identifier	ONLINE	<input type="checkbox"/> YES <input type="checkbox"/> NO
Y LINLST	line-name 12 maximum	SWNBKU	<input type="checkbox"/> NO <input type="checkbox"/> YES	DLYFEAT	<input type="checkbox"/> NO <input type="checkbox"/> YES	DEV	device-name 254 maximum
Y DEVOLY	120 number-of-seconds	PGMDLY	120 number-of-seconds	RJE	<input type="checkbox"/> NO <input type="checkbox"/> YES		
Y RJEHOST	<input type="checkbox"/> NONE <input type="checkbox"/> RES <input type="checkbox"/> JES2 <input type="checkbox"/> JES3 <input type="checkbox"/> RSCS	RJELOGON	<input type="checkbox"/> NONE RJE-host-signon/logon	EML3270	<input type="checkbox"/> NO <input type="checkbox"/> YES		
Y MAXLENPIU	321 205	DTACPR	<input type="checkbox"/> NO <input type="checkbox"/> YES	LINKTYPE	<input type="checkbox"/> NONE <input type="checkbox"/> SDLCPRI <input type="checkbox"/> SDLCSEC <input type="checkbox"/> BSC <input type="checkbox"/> BSCT <input type="checkbox"/> X25LLP <input type="checkbox"/> X25LLS	CODE	③ <input type="checkbox"/> LIND <input type="checkbox"/> EBCDIC <input type="checkbox"/> ASCII
Y X25ADR	X25-control-unit-address	DFTPKTSIZE	<input type="checkbox"/> LIND default-packet-size	DFTWDSIZE	<input type="checkbox"/> LIND default-window-size		
Y NETPCL	<input type="checkbox"/> QLLC <input type="checkbox"/> PSH <input type="checkbox"/> ELLC	NETRSPTMR	network-response-timeout-value	NETRVSCRG	<input type="checkbox"/> NO <input type="checkbox"/> ACCEPT		<input type="checkbox"/> NO <input type="checkbox"/> REQUEST
Y NETCUGID	<input type="checkbox"/> NONE network-closed-user-group-ID	NETCNPWD	<input type="checkbox"/> NONE network-connection-password				
Y NETUSRFLC	<input type="checkbox"/> NONE network-user-facility	PUBAUT	<input type="checkbox"/> NORMAL <input type="checkbox"/> ALL <input type="checkbox"/> NONE	TEXT	<input type="checkbox"/> SAME <input type="checkbox"/> BLANK description		
① Valid control unit types are *WSC, *WSCC, 3411, 3430, 5251, 5294, 4701, 3694, *PASS, *PU2, 3274, *PEER, *BSC, and *BSCT. ② Default for non-X.25 is *LIND, default for X.25 is *EBCDIC.							
Job: B.1 Pg:m: B.1							

CRTDEVD (Create Device Description)

Creates a device description for an external device.

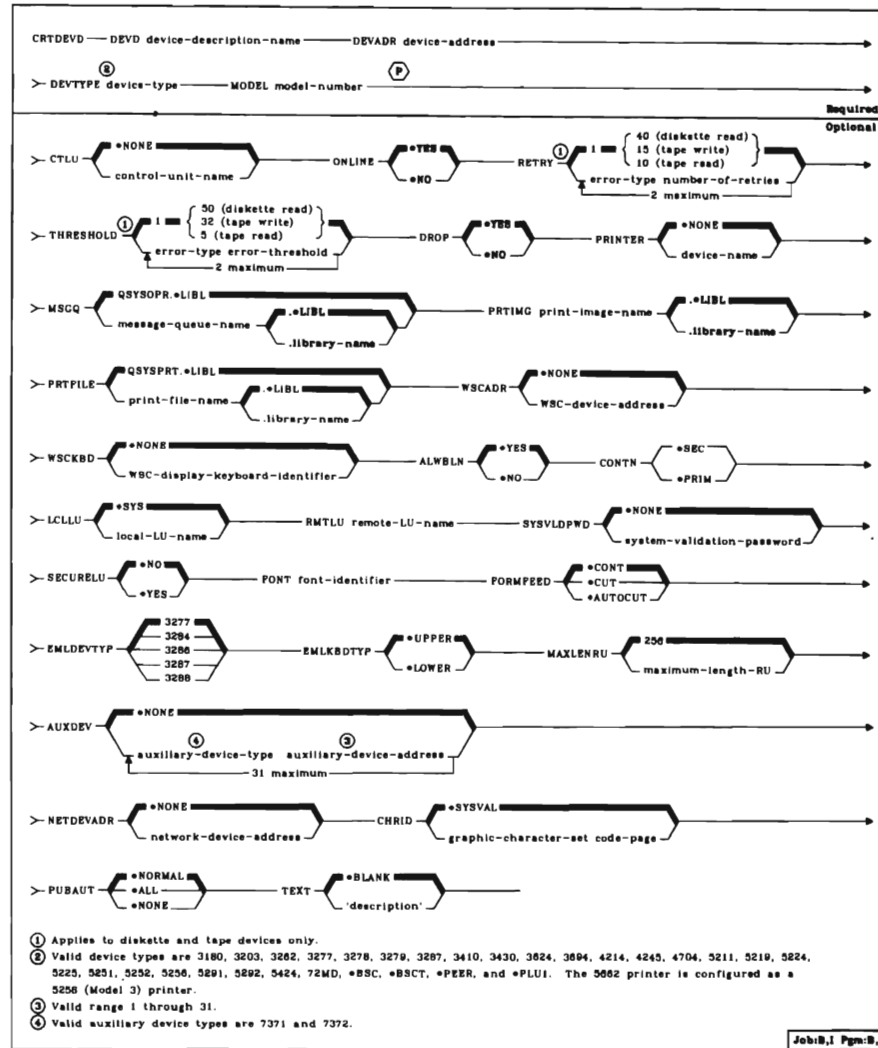

CRTDFUAPP (Create DFU Application)

Creates an executable data file utility application from an existing definition.

CRTDFUAPP		APP	application-name	<input type="checkbox"/> .QCPL	→	
				<input type="checkbox"/> .library-name		
					Required	
					Optional	
>	SRCFILE	<input type="checkbox"/> QUDSSRC	<input type="checkbox"/> .LIBL	→		
		<input type="checkbox"/> *SAVDFN				
		source-file-name	<input type="checkbox"/> .LIBL	→		
			<input type="checkbox"/> .library-name			
>	SRCMBR	<input type="checkbox"/> *APP	→			
		source-file-member-name				
>	OPTION	<input type="checkbox"/> *NOBRC	<input type="checkbox"/> *NOBRC	<input type="checkbox"/> *GEN	<input type="checkbox"/> *PRCSAV	→
		<input type="checkbox"/> *NOSOURCE	<input type="checkbox"/> *NOSOURCE	<input type="checkbox"/> *NOGEN	<input type="checkbox"/> *NOFRCSAV	
		<input type="checkbox"/> *SRC	<input type="checkbox"/> *SRC			
		<input type="checkbox"/> *SOURCE	<input type="checkbox"/> *SOURCE			
>	GENOPT	<input type="checkbox"/> *NOLIST	<input type="checkbox"/> *NODUMP	<input type="checkbox"/> *USER	→	
		<input type="checkbox"/> *LIST	<input type="checkbox"/> *DUMP	<input type="checkbox"/> *OWNER		
			<input type="checkbox"/> (P)	USRPRP		
>	PUBAUT	<input type="checkbox"/> *NORMAL	TEXT	<input type="checkbox"/> *SAME	→	
		<input type="checkbox"/> *ALL		<input type="checkbox"/> *BLANK		
		<input type="checkbox"/> *NONE		'description'		

Job:B.1 Pgm:B.1

Printer file-QSYSPRT
Data base source file-QUDSSRC

CRTDFUDEF (Create DFU Definition)

Begins the prompting sequence for interactive definition of a DFU application. Your responses to the prompts are used to create a DFU application.

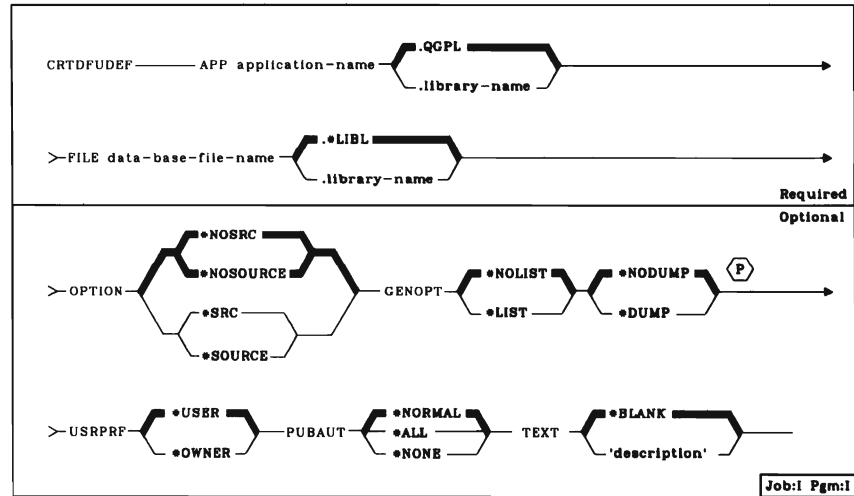

CRTDKTF (Create Diskette File)

Creates a diskette file from command parameters.

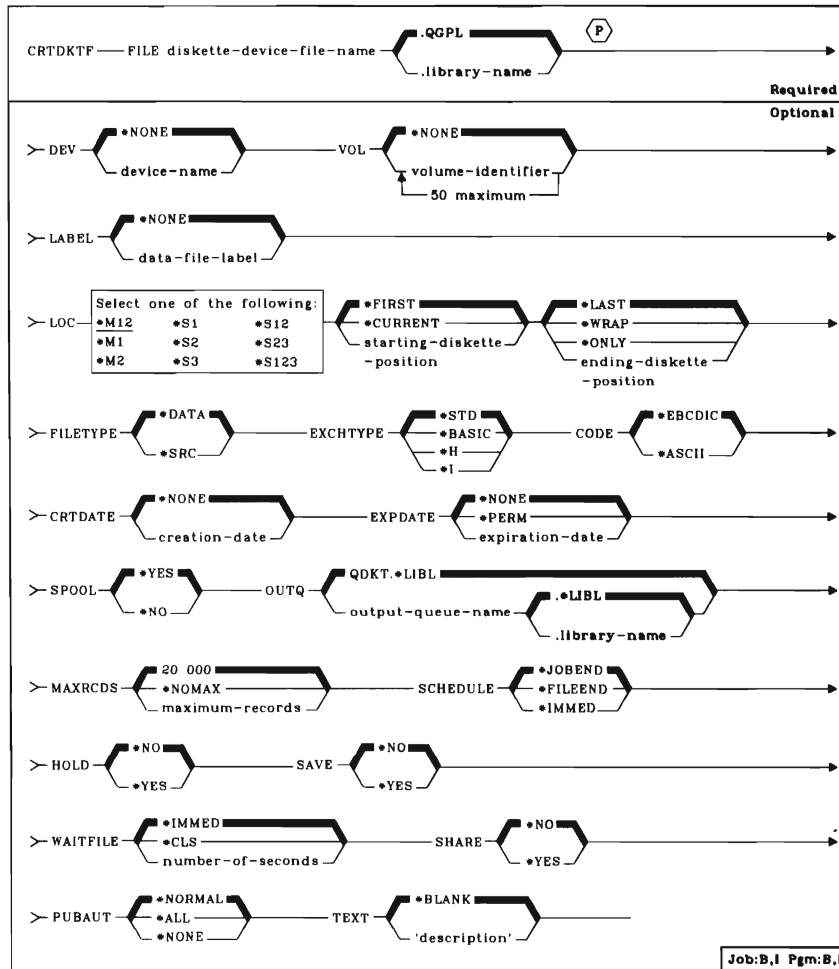

CRTDSPF (Create Display File)

Creates a display file from command parameters and, optionally, data description specifications (DDS).

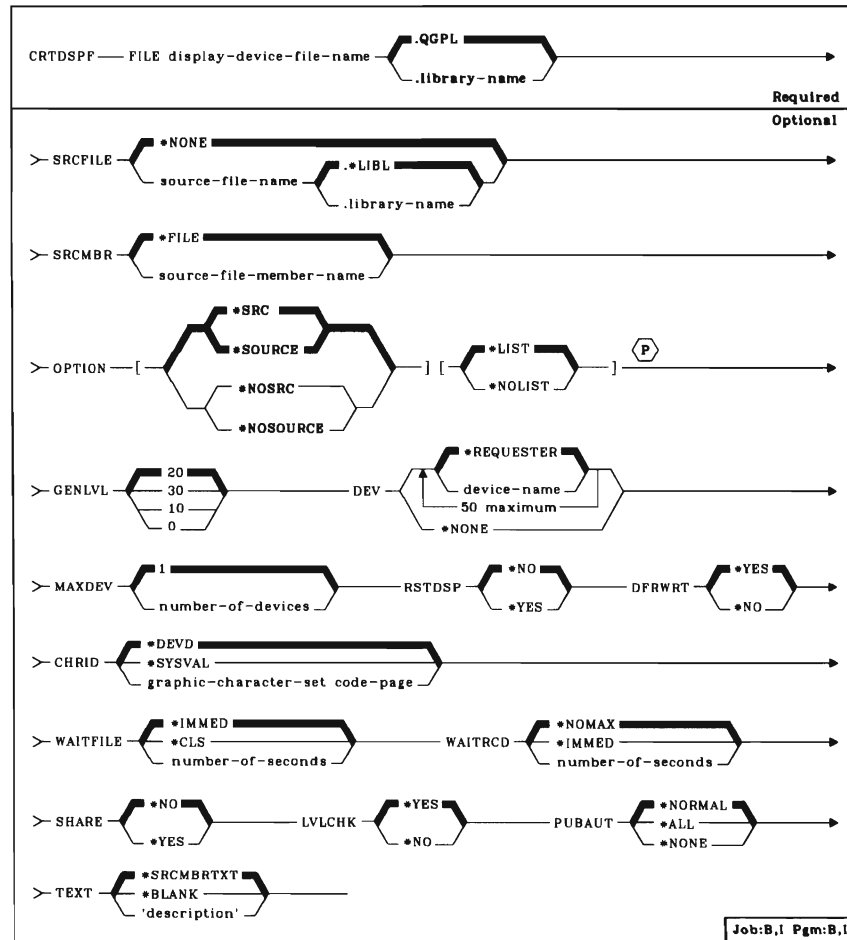

Printer file—QPDDSSRC

Data base source file—QDDSSRC

CRTDTAARA (Create Data Area)

Creates a data area.

CRTDTAARA	DTAARA data-area-name	QCPL	library-name	
TYPE	DEC	CHAR	LGL	
LEN	length [decimal-positions]	VALUE	initial-value	P
PUBAUT	NORMAL	ALL	NONE	
TEXT	BLANK		'description'	
Required Optional				
Job:B,I Pgm:B,I				

CRTDTAQ (Create Data Queue)

Creates a data queue and stores it in a specified library.

CRTDTAQ	DTAQ data-queue-name	QCPL	library-name	
MAXLEN	maximum-entry-length			P
FORCE	NO	YES		
PUBAUT	NORMAL	ALL	NONE	
TEXT	BLANK		'description'	
Required Optional				
Job:B,I Pgm:B,I				

CRTDUPOBJ (Create Duplicate Object)

Duplicates a single object or a group of objects which can be renamed and stored in the same library as the original object or can retain the name of the original object, as long as it is stored in a library other than the library that contains the original object.

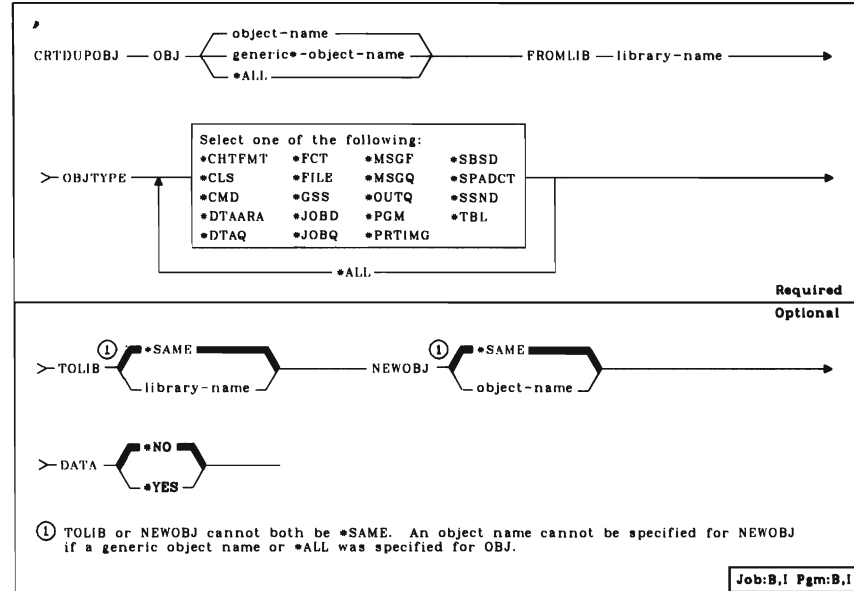

CRTEDTD (Create Edit Description)

Creates the description of a user-defined edit code.

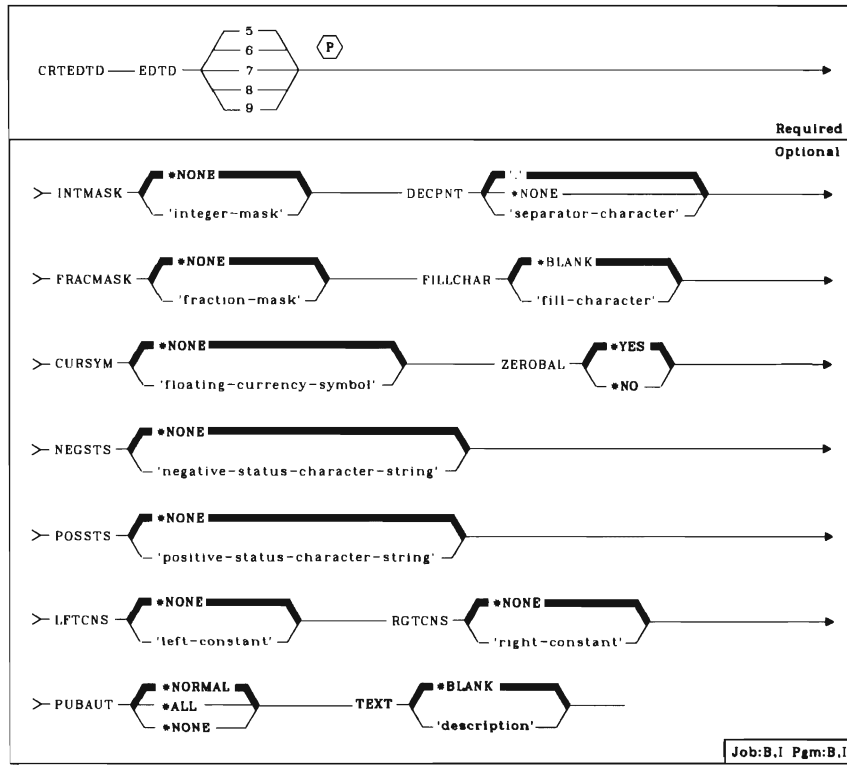

CRTFCT (Create Forms Control Table)

Creates an RJEJ forms control table (FCT) with no entries.

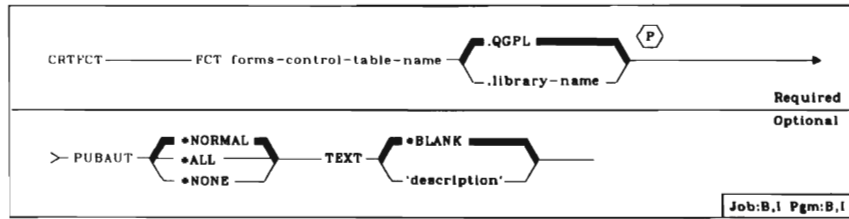

CRTJOBBD (Create Job Description)

Creates a job description.

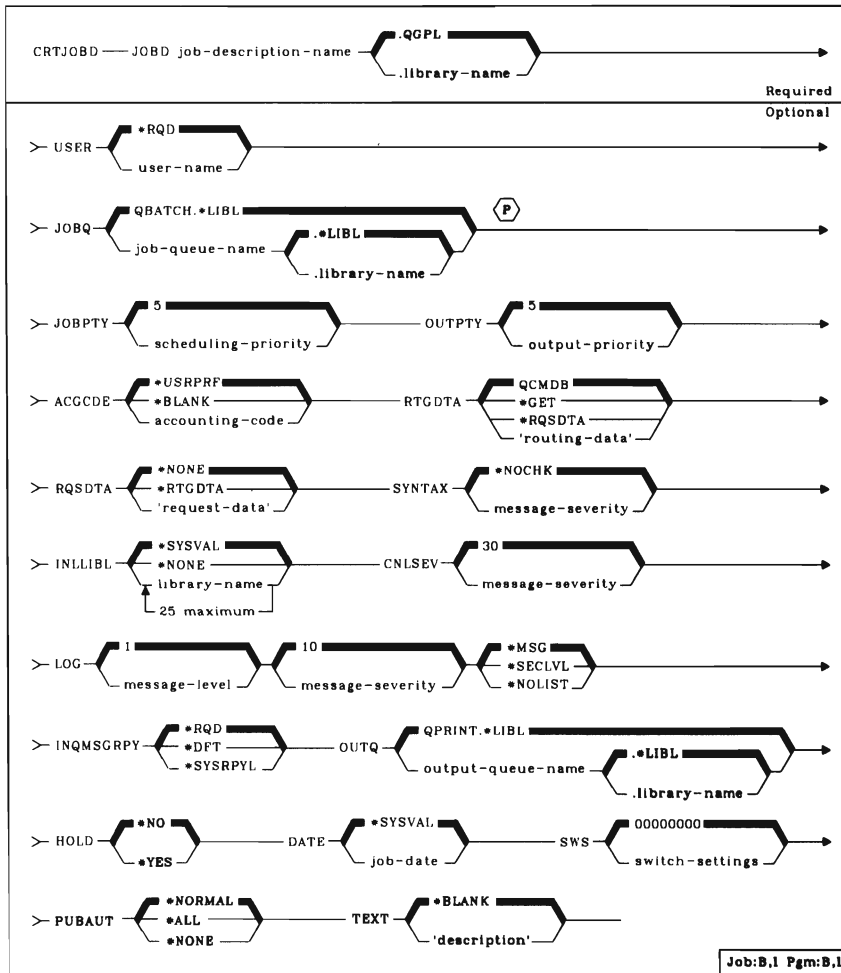

CRTJOBQ (Create Job Queue)

Creates a job queue.

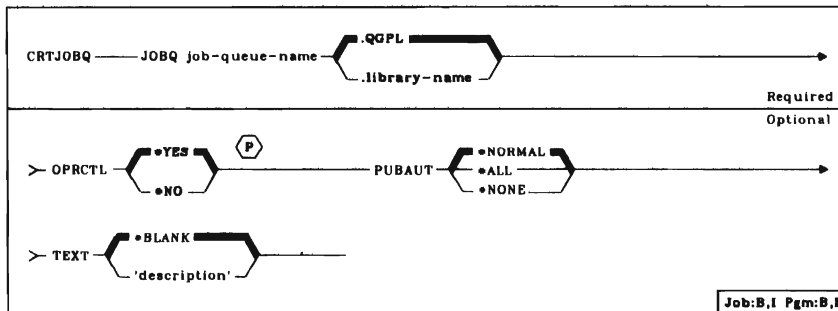

CRTJRN (Create Journal)

Creates a journal and attaches the specified journal receivers to it.

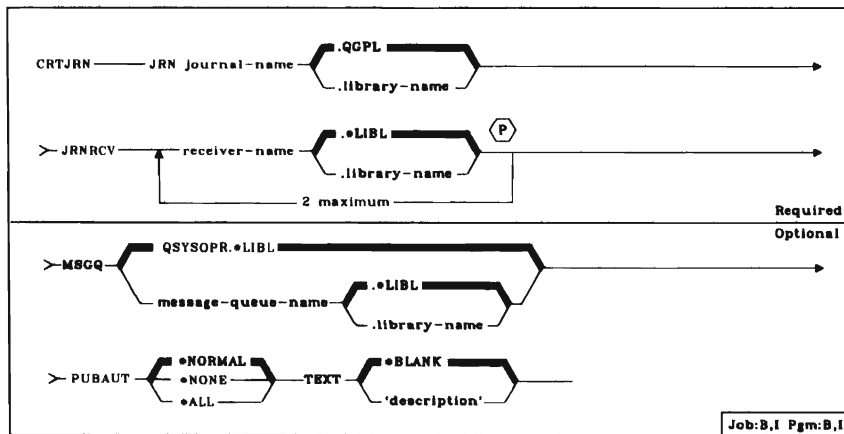

CRTJRNRCV (Create Journal Receiver)

Creates a journal receiver.

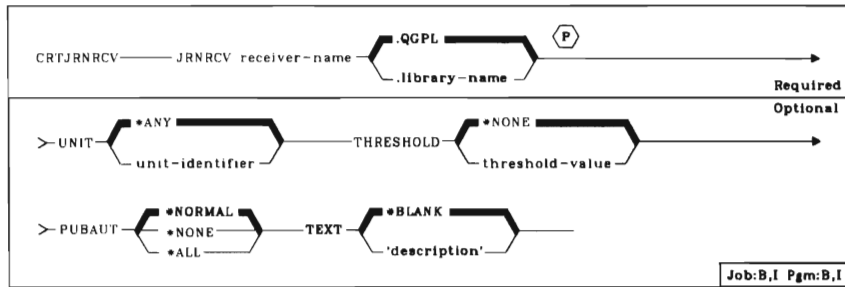

CRTLF (Create Logical File)

Creates a logical file from command parameters and data description specifications (DDS).

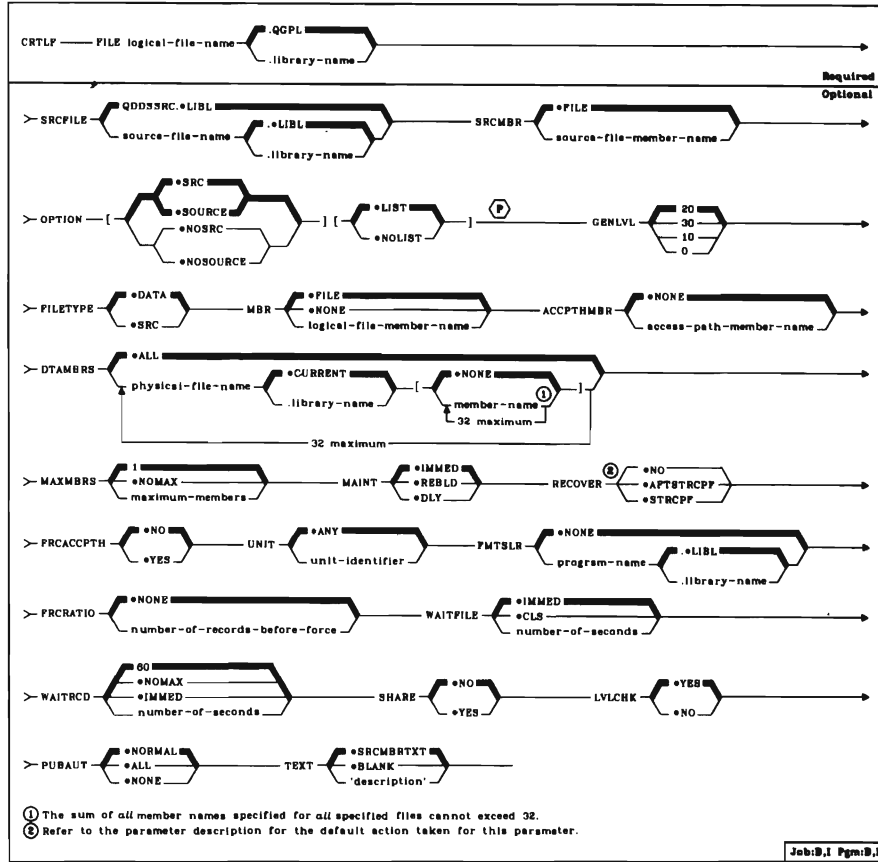

Printer file—QPDDSSRC

Data base source file—QDDSSRC

CRTLIB (Create Library)

Creates a library.

CRTLIB LIB library-name		Required
		Optional
> TYPE	<input type="checkbox"/> PROD <input type="checkbox"/> TEST	<input type="checkbox"/> PUBAUT <input type="checkbox"/> NORMAL <input type="checkbox"/> ALL <input type="checkbox"/> NONE
		TEXT <input type="checkbox"/> BLANK <input type="checkbox"/> 'description'
		Job:B,I Pgm:B,I

CRTLIND (Create Line Description)

Creates a line description for a communications line.

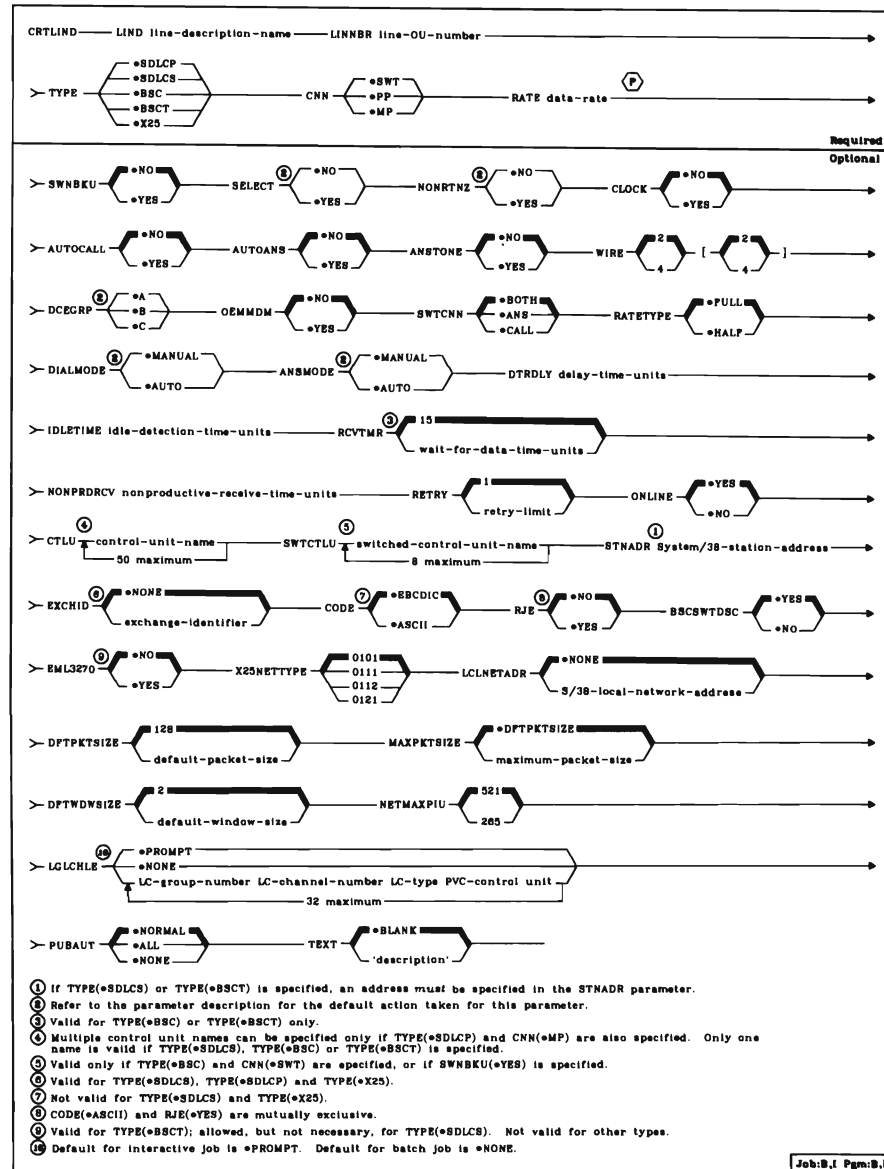

CRTMSGF (Create Message File)

Creates a message file.

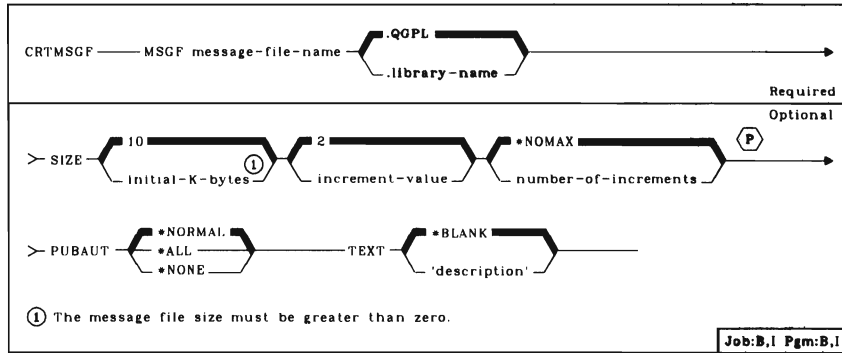

CRTMSGQ (Create Message Queue)

Creates a message queue.

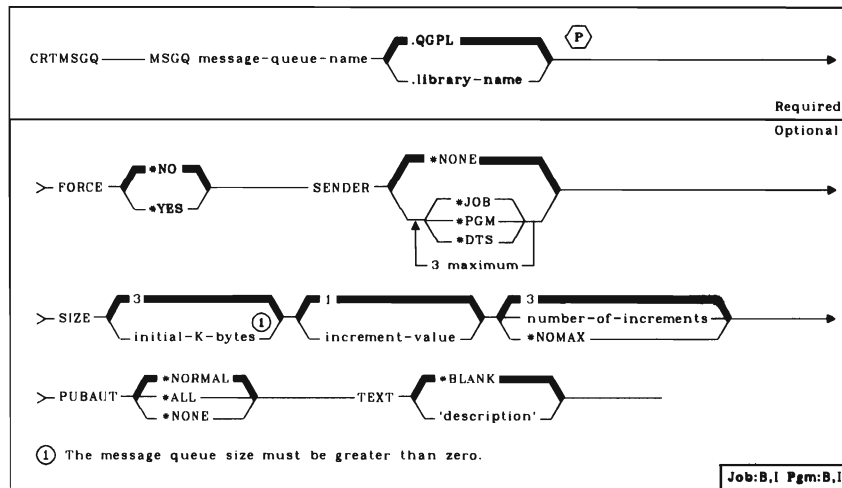

CRTMXDF (Create Mixed File)

Creates a device file that may be used to communicate with both displays and program to program devices.

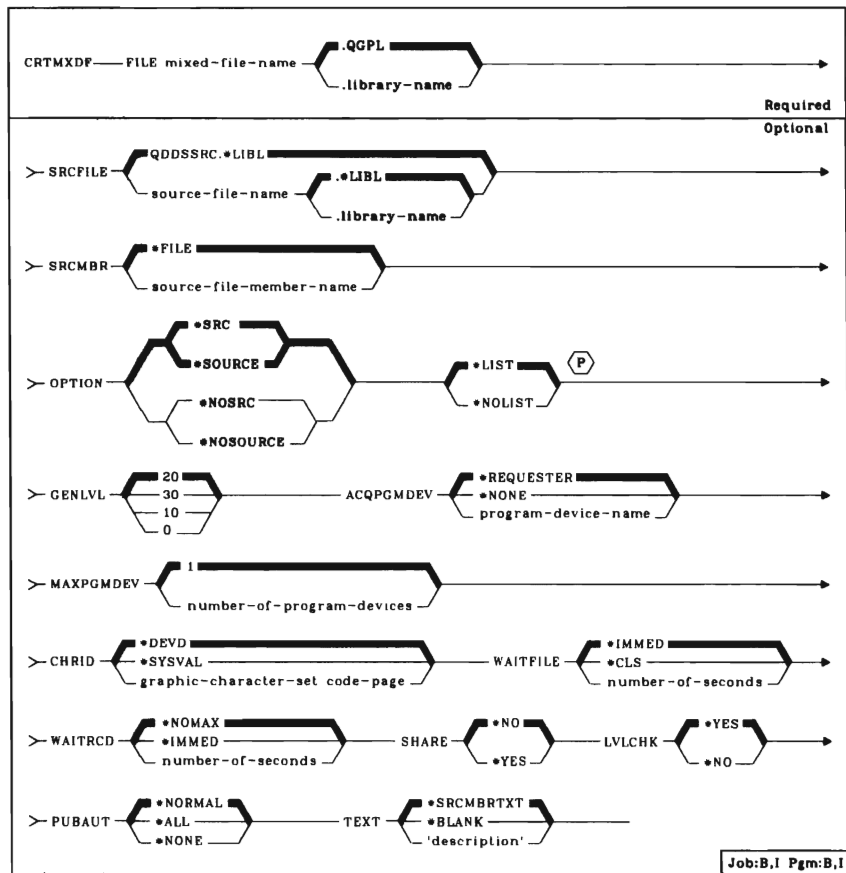

Data base source file—QDDSSRC
Printer file—QPDDSSRC

CRTOUTQ (Create Output Queue)

Creates an output queue.

CRTOUTQ	OUTQ	output-queue-name	QGPL	library-name	Required
> DSPDTA	*NO	JOBSEP	1	number-of-job-separators	Optional
	*YES			*MSG	
> OPRCTL	*YES	PUBAUT	*NORMAL		
	*NO		*ALL		
			*NONE		
> TEXT	*BLANK				
	'description'				

Job:B,I Pgm:B,I

CRTPF (Create Physical File)

Creates a physical file from command parameters and, optionally, data description specifications (DDS).

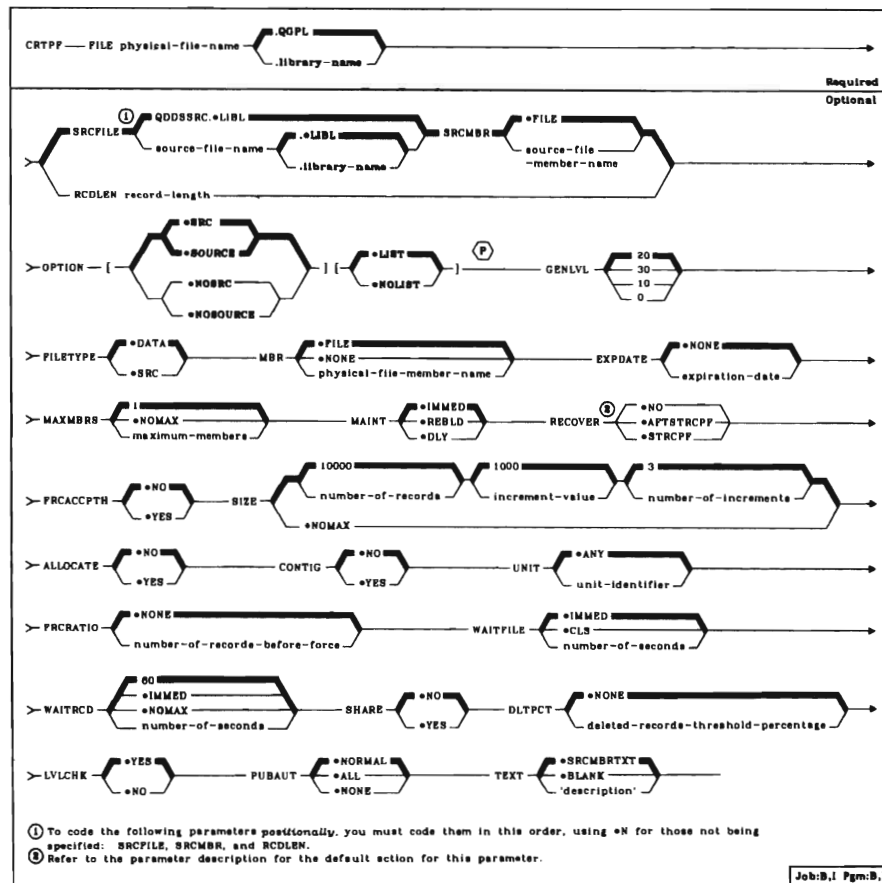

Printer file—QPDDSSRC

Data base source file—QDDSSRC

CRTPLIPGM (Create PL/I Program)

Invokes the PL/I compiler to compile a PL/I source member into an executable program.

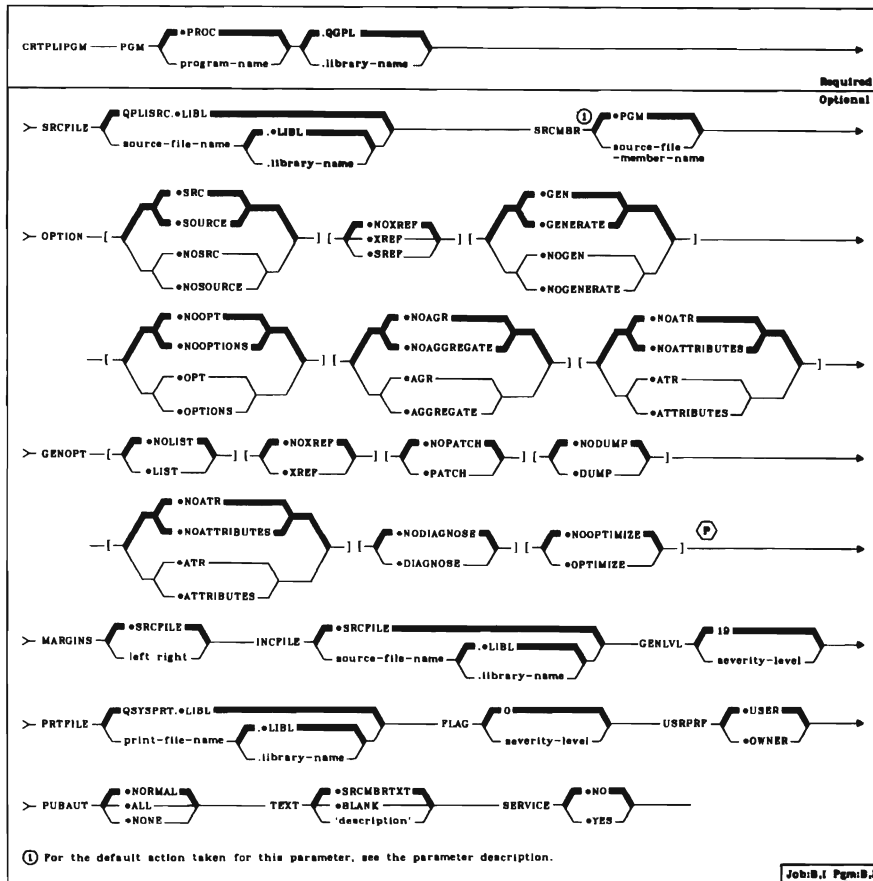

CRTPTRF (Create Printer File)

Creates a printer file from command parameters and, optionally, data description specifications (DDS).

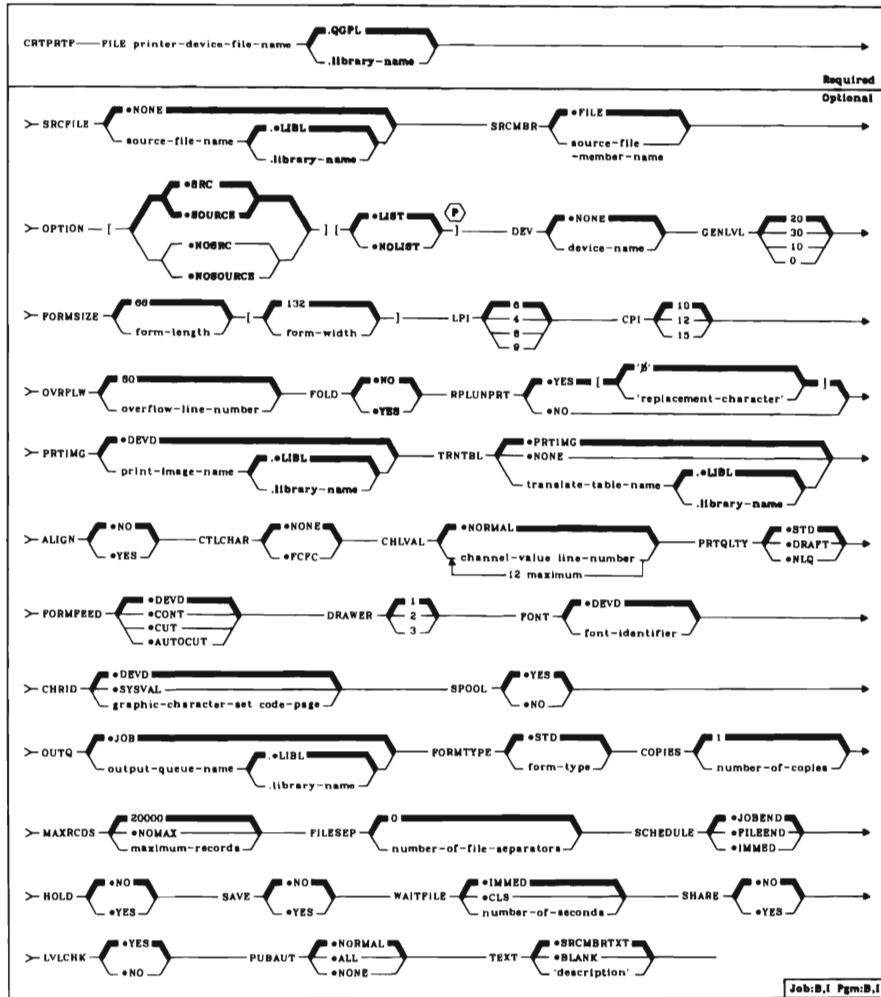

Data base source file-QPLISRC
Printer file-QSYSPT

CRTPRTIMG (Create Print Image)

Creates a print image for a specific print belt or print train to be used on a system printer.

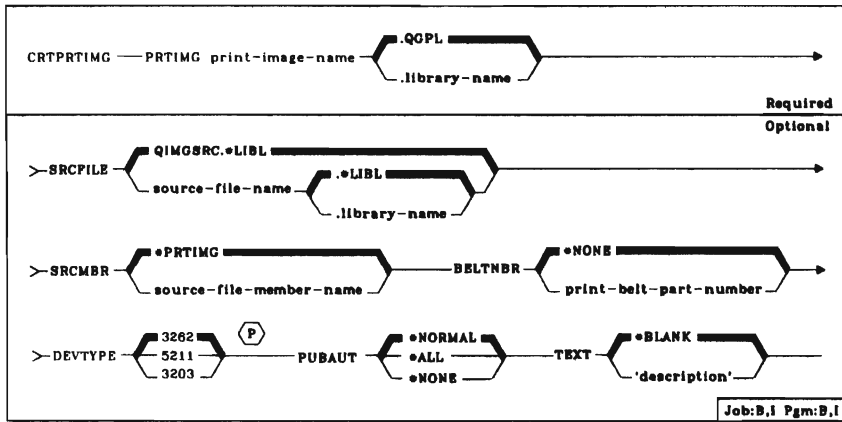

Data base source file—QIMGSRC

CRTQRYAPP (Create Query Application)

Creates an executable query application from an existing definition.

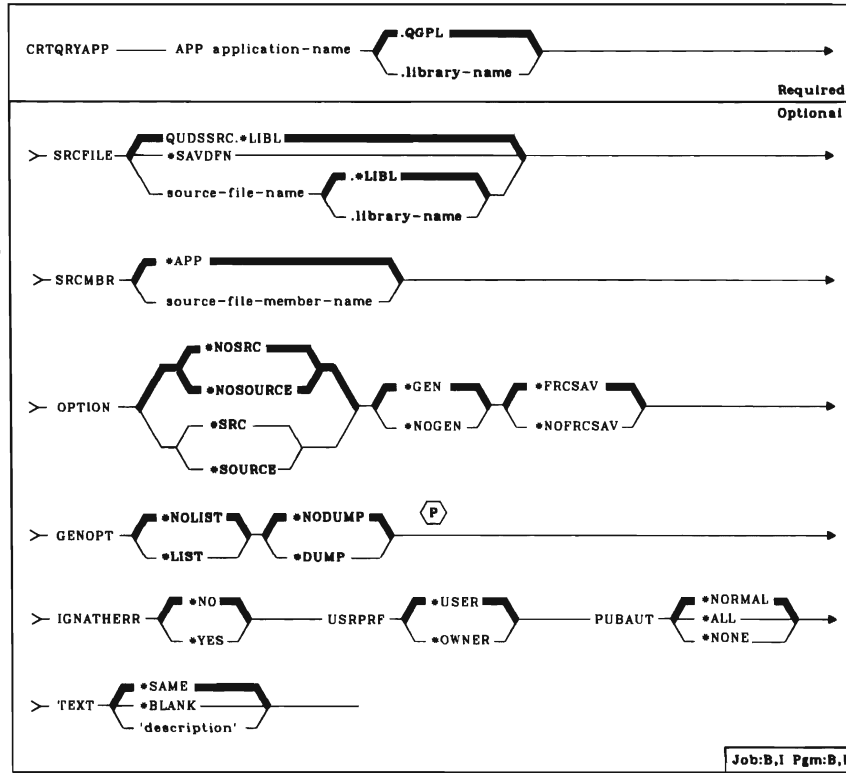

Printer file—QSYSPRT
Data base source file—QUDSSRC

CRTRJECFG (Create RJE Configuration)

Creates the objects required for defining, creating, and operating RJEf.

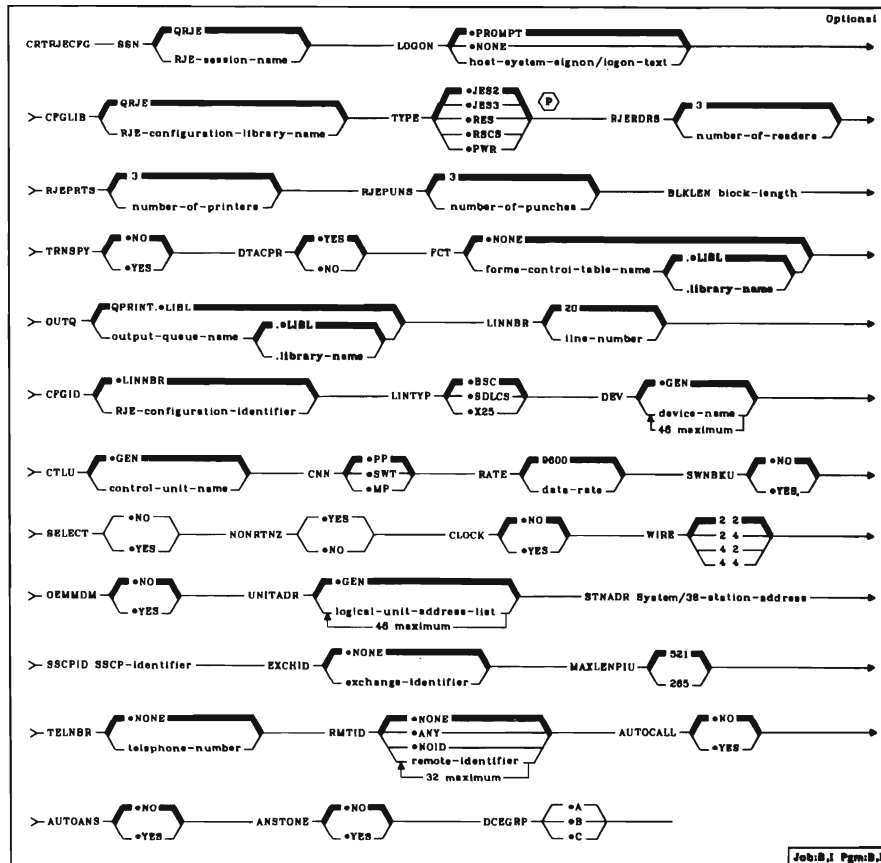

CRRTRPGGM (Create RPG Program)

Invokes the RPG compiler to create an executable RPG program from an RPG source program.

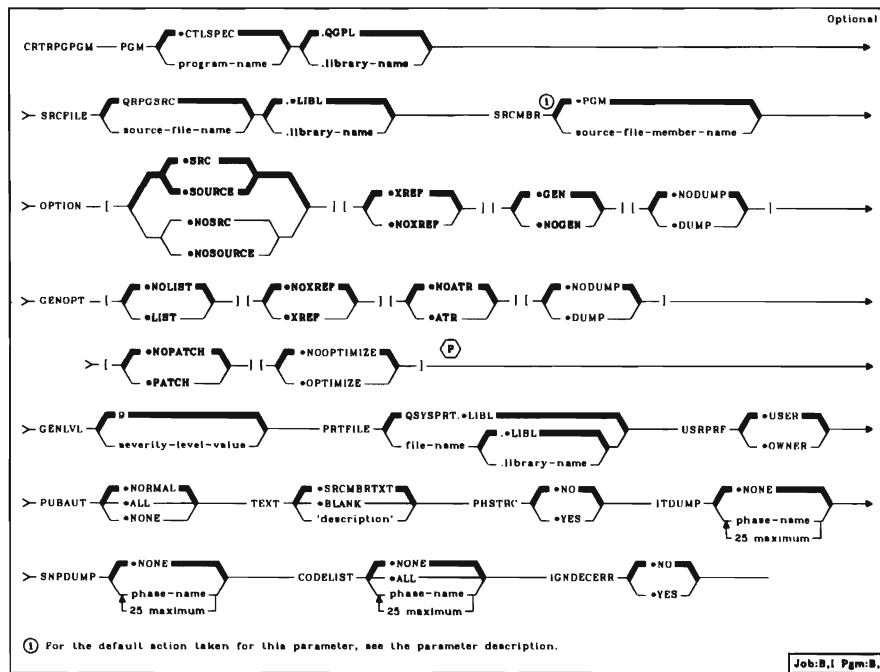

Printer file—QSYSVRT
Data base source file—QRPGSRC

CRTRPTGM (Create Auto Report Program)

Invokes the RPG compiler to create an executable RPG program that contains auto report specifications.

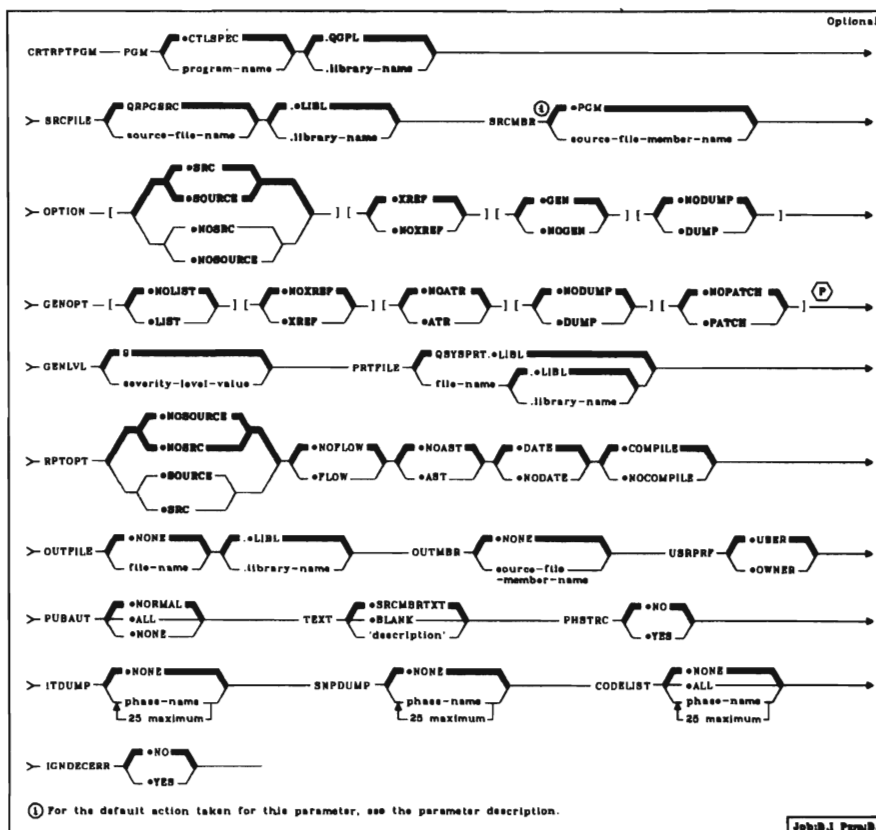

Printer file—QSYSPT
Data base source file—QRPGSRC

CRTSAVF (Create Save File)

Creates a save file. This file contains a file description, and can be used with save and restore commands to contain data that would otherwise be written to tape or diskette.

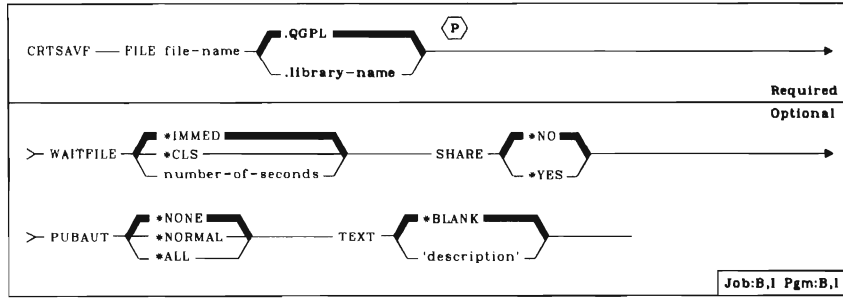

CRTSBSD (Create Subsystem Description)

Creates a subsystem description.

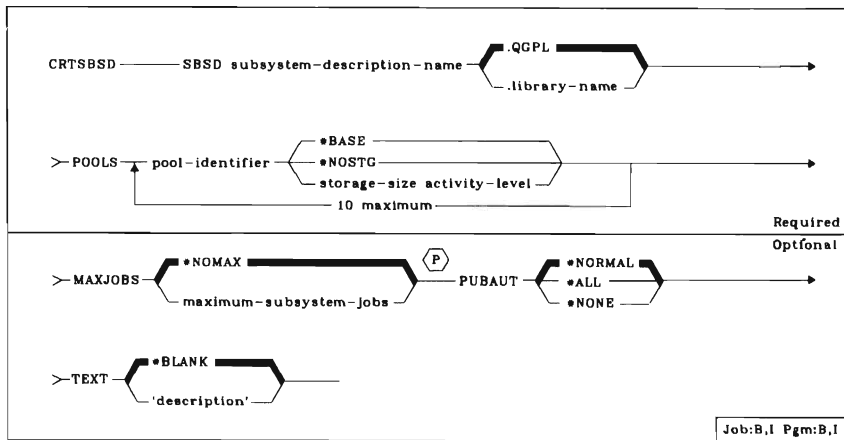

CRTSPADCT (Create Spelling Aid Dictionary)

Creates a user spelling aid dictionary. This dictionary can be used with the Text Management Utility (EDTTXT or EDTDOC) when performing spellcheck functions such as spelling aid and spelling verification.

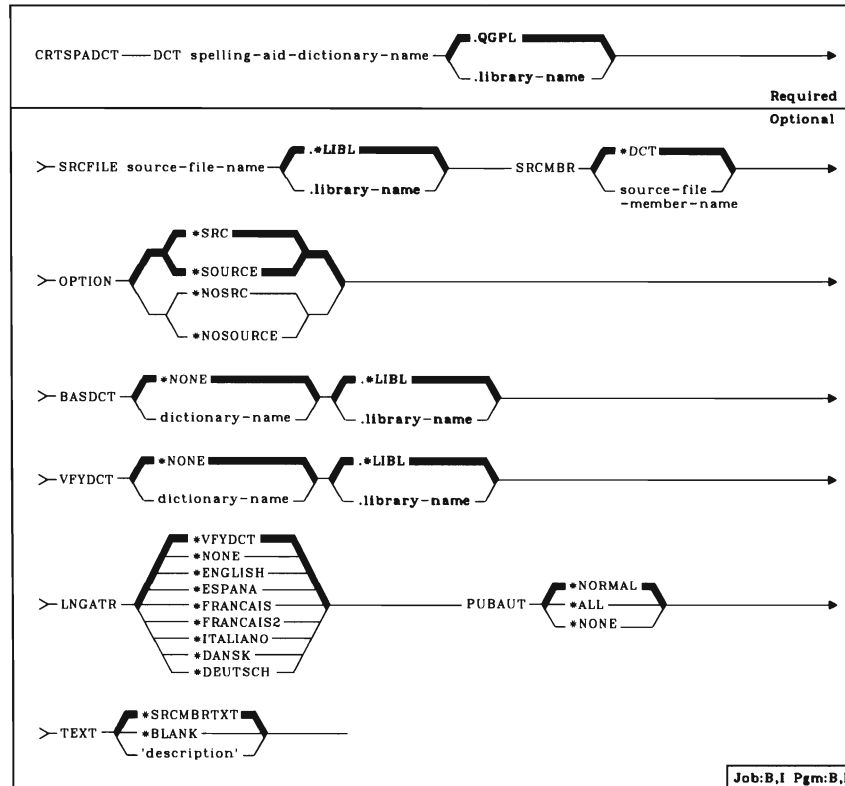

Printer file—QSYSPRT

CRTSRCPF (Create Source Physical File)

Creates a source physical file from command parameters.

CRTSRCPF	FILE	source-physical-file-name	.QCPL	library-name	Required
					Optional
Y RCDLEN	92	record-length	MBR	•NONE •FILE source-file-member-name	P
Y EXPDATE	•NONH	expiration-date	MAXMBRS	•NOMAX maximum-members	ACCP' TH
					•ARRIVAL •KEYED
Y MAINT	•IMMED •REBLD •DLY		RECOVER	•NO •AFTSRCPF •SRCPF	FRCACCP' TH
					•NO •YES
Y SIZE	10 000	number-of-records	1000	increment-value	499
					number-of-increments
					•NOMAX
Y ALLOCATE	•NO •YES		CONTIG	•NO •YES	UNIT
					•ANY unit-identifier
Y FRCRATIO	•NONE	number-of-records-before-force	WAITFILE	•IMMED •CLS	number-of-seconds
Y WAITRCD	60 •IMMED •NOMAX	number-of-seconds	SHARE	•NO •YES	
Y DLT'PCT	•NONE	deleted-records-threshold-percentage	PUBAUT	•NORMAL •ALL •NONE	
Y TEXT	•BLANK	'description'			

Job:B.I Pgm:B.I

Printer file—QPDDSSRC

Data base source file—QDDSSRC

CRTSSND (Create Session Description)

Creates an RJEF session description.

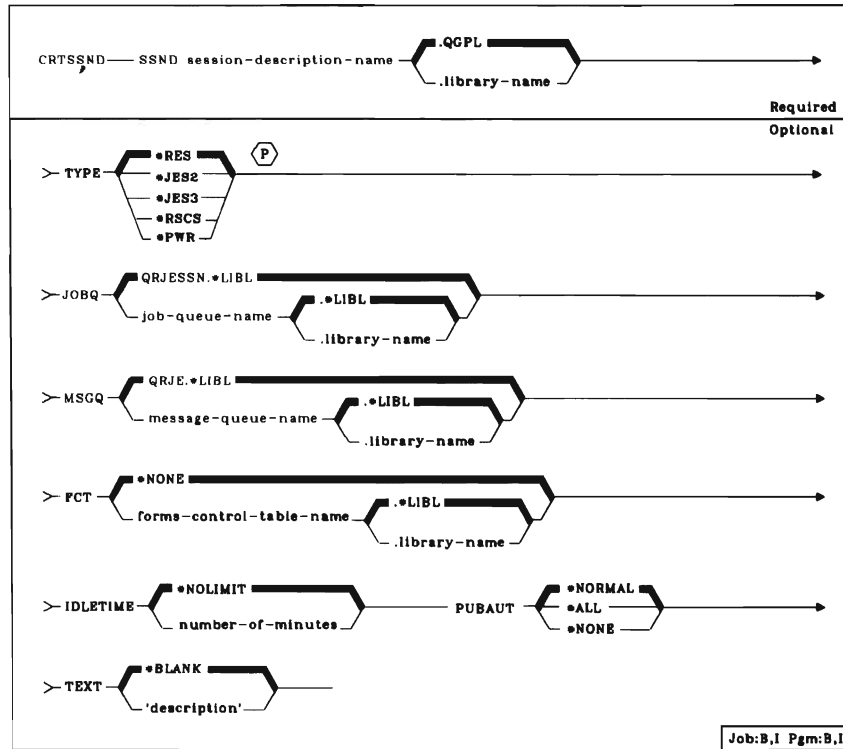

CRTTAPF (Create Tape File)

Creates a tape file from command parameters.

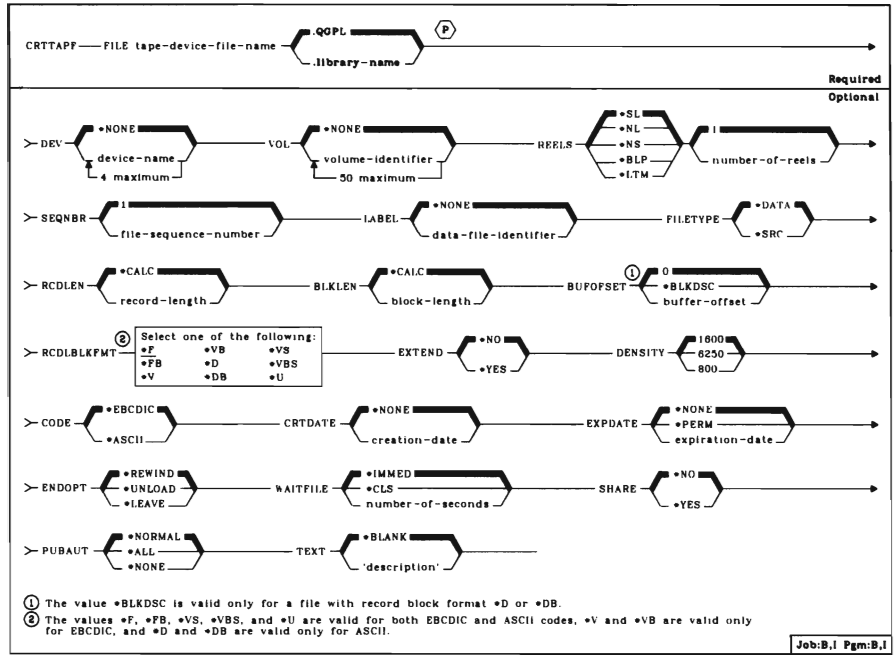

CRTTBL (Create Table)

Creates a table (for example, a translate table).

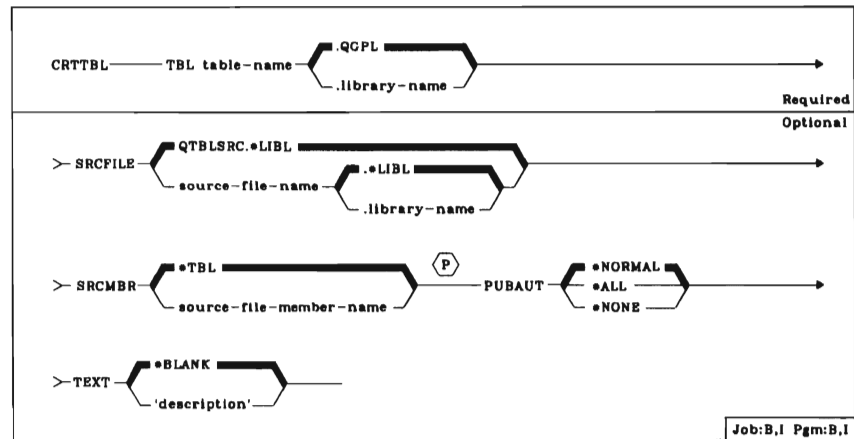

Data base source file—QTBSRC

CRTUSRPRF (Create User Profile)

Identifies an authorized user to the system and creates a user profile for that user.

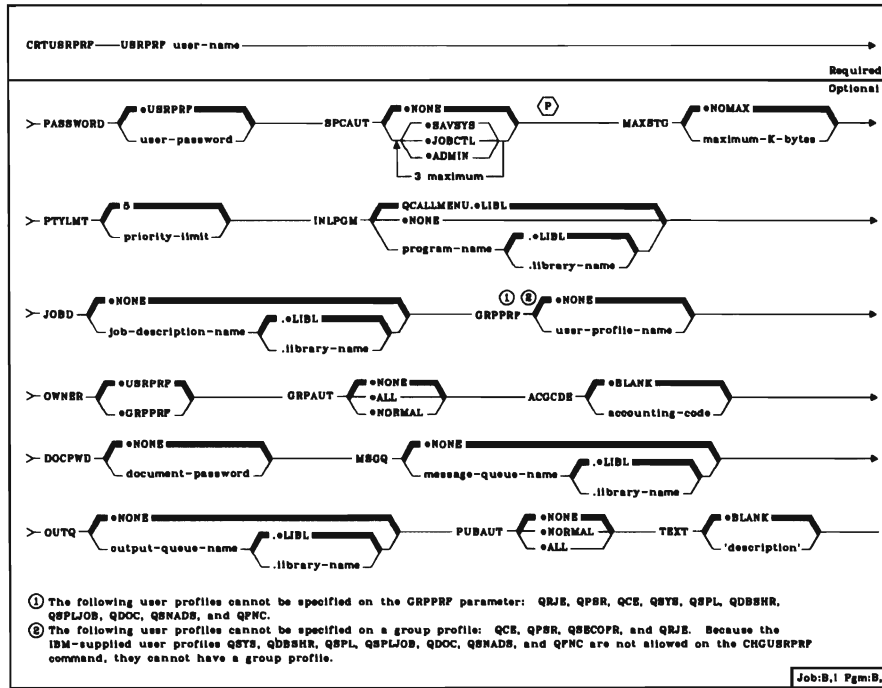

CVTDAT (Convert Date)

Converts the format of a date value from one format to another. Valid only in a CL program.

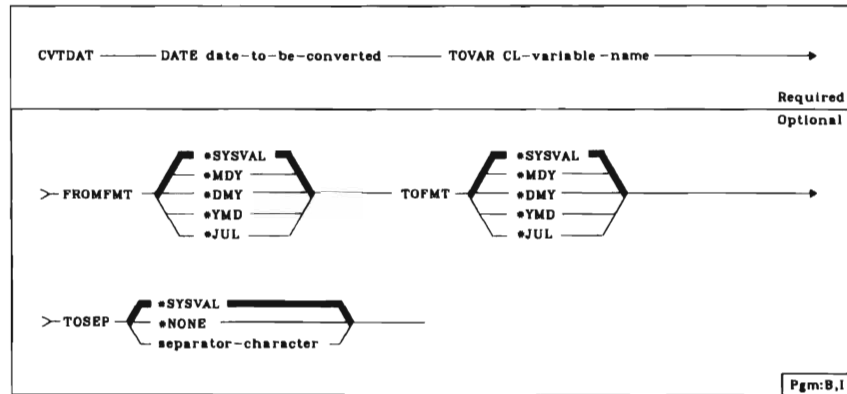

CRTVDSK (Create Virtual Disk)

Creates and formats a virtual disk. The virtual disk can be accessed from a PC using PC Support/38.

CRTVDSK — VDSK virtual-disk-name		.QCPL	→
		.library-name	
			Required
> SIZE	360	DIR	112
	number-of-kilobytes		number-of-directory-entries
			Optional
> PUBAUT	*NORMAL	TEXT	*BLANK
	*ALL		'description'
	*NONE		
			Job:B,I Pgm:B,I

CVTTOVDSK (Convert To Virtual Disk)

Creates a virtual disk that is a copy of a virtual diskette created by FSU (IBM System/38 File Support Utility).

CVTTOVDSK — FROMVRTDKT virtual-diskette-name		*LIBL	→
		.library-name	
			Required
> TOVDSK	virtual-disk-name	.QCPL	→
		.library-name	
			Optional
> FROMMBR	*FIRST		
	member-name		
			Job:B,I Pgm:B,I

DATA (Data)

Indicates the beginning of an inline data file in a batch input stream.

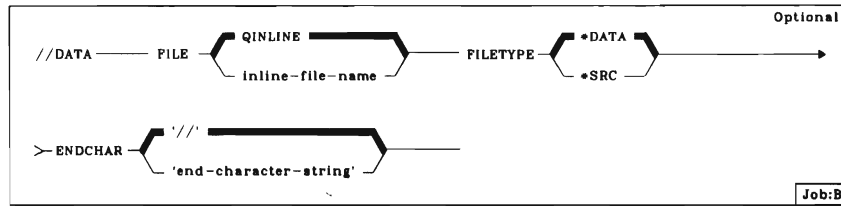

DCL (Declare CL Variable)

Defines a control language variable for use in the CL program in which this command is used. Valid only in a CL program.

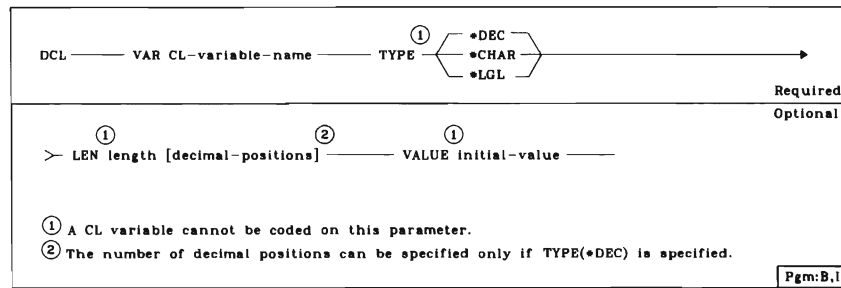

DCLDTAARA (Declare Data Area)

Specifies that an existing data area is to be used in a CL program. Valid only in a CL program.

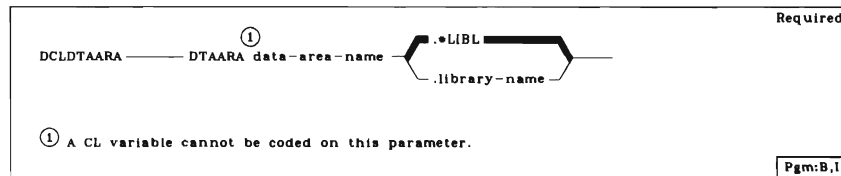

DFNKBDMAP (Define Keyboard Map)

Overrides the PA (Program Attention) and PF (Program Function) key assignment defaults provided by System/38.

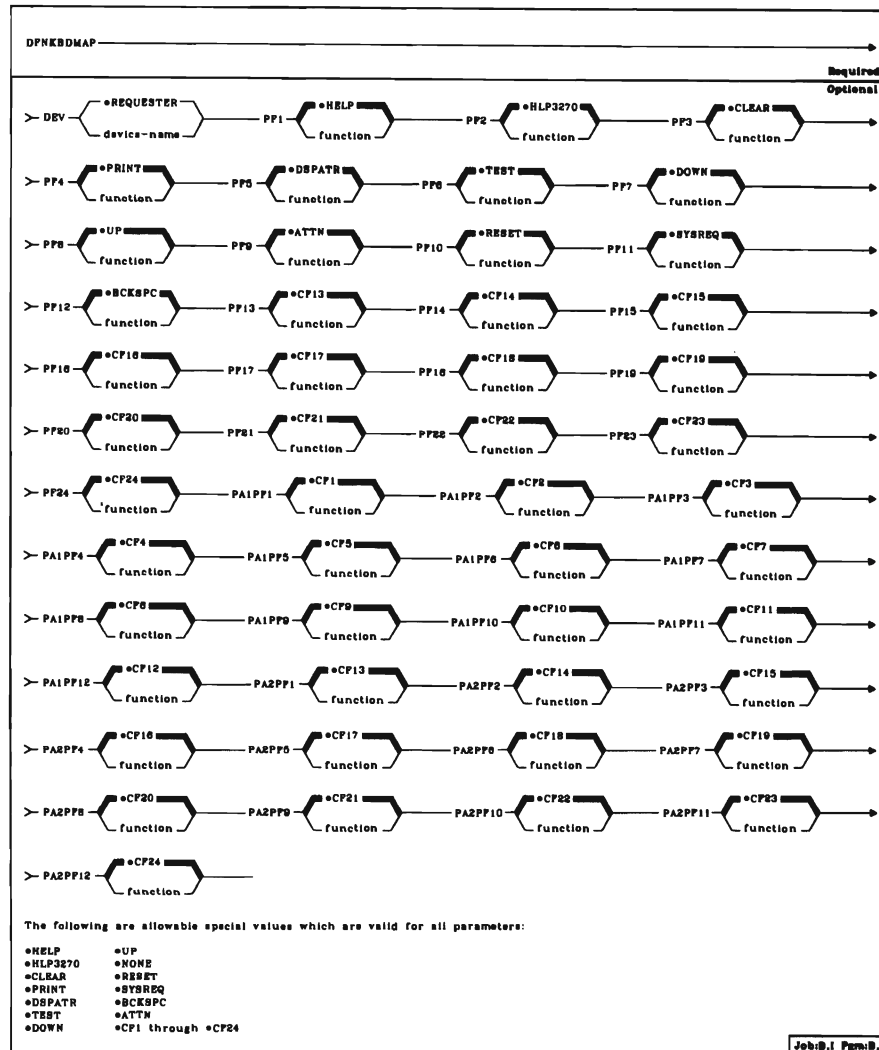

DLCOBJ (Deallocate Object)

Deallocates an object allocated by the ALCOBJ command. If the DLCOBJ command is not used, the objects are automatically deallocated at the end of the routing step.

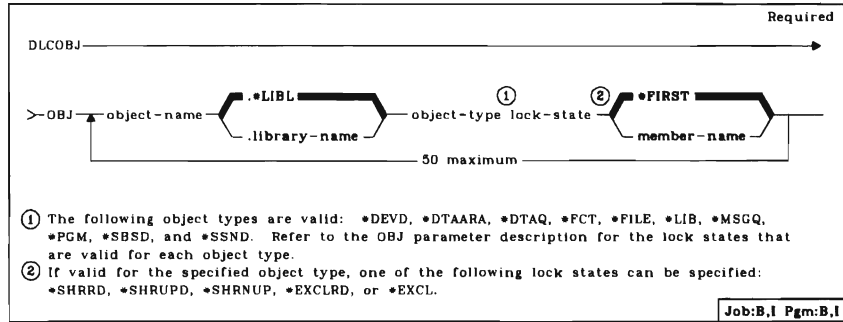

DLTCHTFMT (Delete Chart Format)

Deletes a chart format or a group of chart formats from one or more libraries.

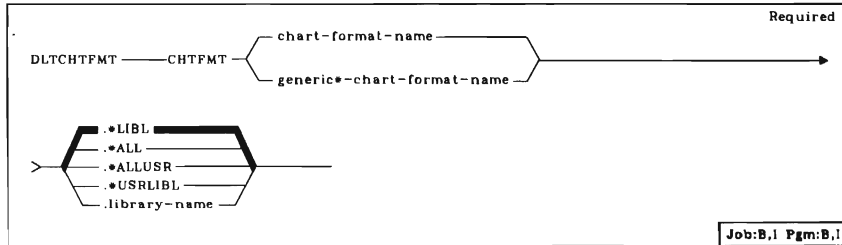

DLTCLS (Delete Class)

Deletes a class.

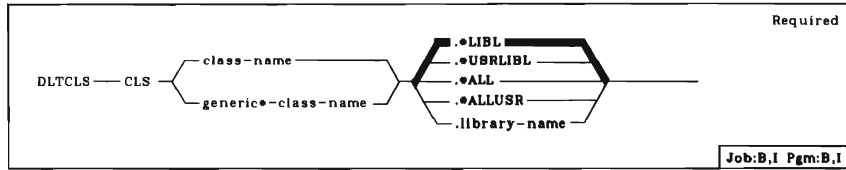

DLTCMD (Delete Command)

Deletes a command object.

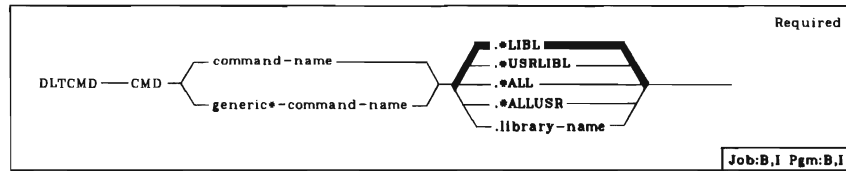

DLTCUD (Delete Control Unit Description)

Deletes a control unit description.

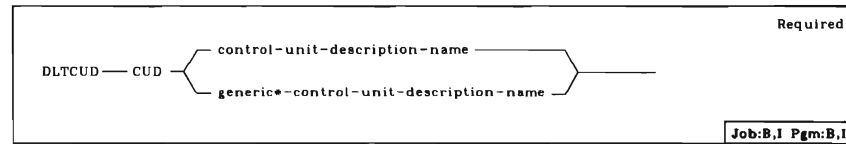

DLTDEVD (Delete Device Description)

Deletes a device description.

DLTDEVD — DEVD	<input type="text" value="device-description-name"/> <input type="text" value="generic-device-description-name"/>	Required
		Job:B,I Pgm:B,I

DLTDFUAPP (Delete DFU Application)

Deletes a data file utility application.

DLTDFUAPP — APP program-name	<input type="text" value=".LIBL"/> <input type="text" value=".library-name"/>	Required
		Job:B,I Pgm:B,I

DLTDKTLBL (Delete Diskette Label)

Deletes a file label from a diskette.

DLTDKTLBL — LABEL data-file-identifier	→					
> LOC	<table border="1"><tr><td>Select one of the following:</td></tr><tr><td>*M12 *S1 *S12</td></tr><tr><td>*M1 *S2 *S23</td></tr><tr><td>*M2 *S3 *S123</td></tr></table> <input type="text" value="*FIRST"/> starting-diskette-position	Select one of the following:	*M12 *S1 *S12	*M1 *S2 *S23	*M2 *S3 *S123	→
Select one of the following:						
*M12 *S1 *S12						
*M1 *S2 *S23						
*M2 *S3 *S123						
Required						
> VOL	<input type="text" value="*LOC"/> volume-identifier	<input type="text" value="*YES"/> CHECK <input type="text" value="*NO"/>				
		SUFFIX <input type="text" value="*NO"/> <input type="text" value="*YES"/>				
Optional						
> CRTDATE	<input type="text" value="*NONE"/> creation-date	OPTION <input type="text" value="*SCRATCH"/> <input type="text" value="*RMV"/> <input type="text" value="*ERASE"/>				
		Job:B,I Pgm:B,I				

DLTDOC (Delete Document)

Deletes a document and control information about the document from the system.

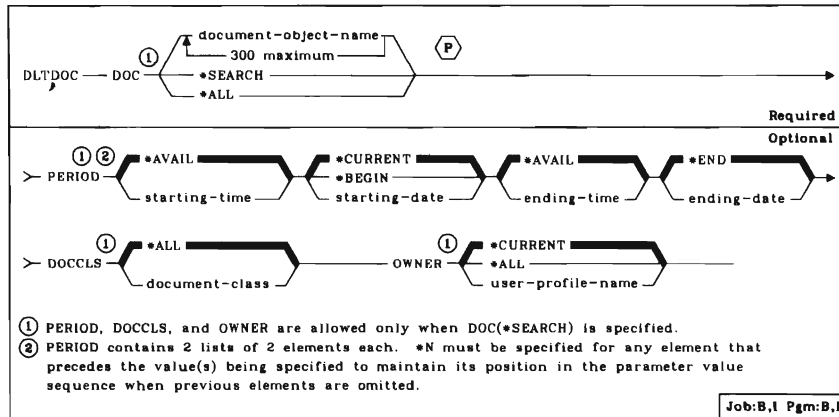

DLTDOCL (Delete Document List)

Deletes a document list from the system.

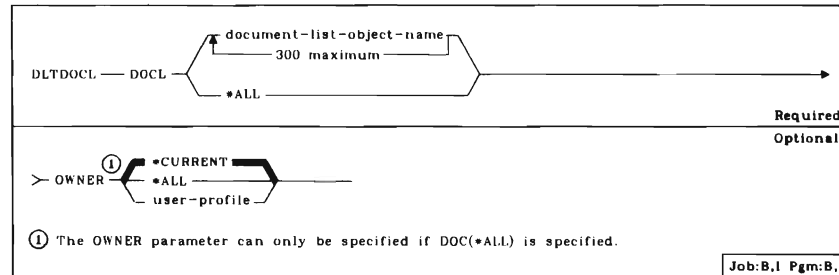

DLTDTAARA (Delete Data Area)

Deletes a data area.

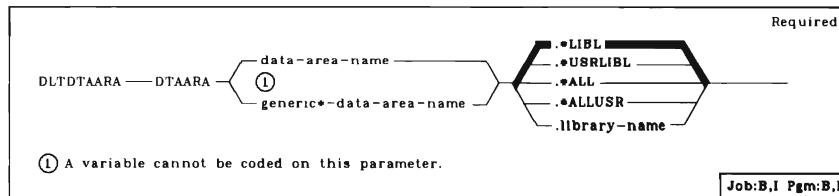

DLTDTAQ (Delete Data Queue)

Deletes the specified data queue(s) from the system.

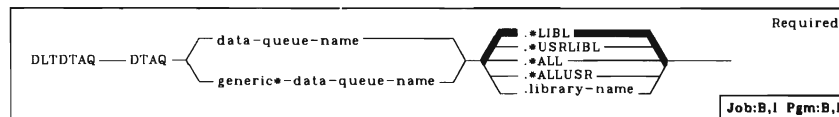

DLTEDTD (Delete Edit Description)

Deletes an edit code description.

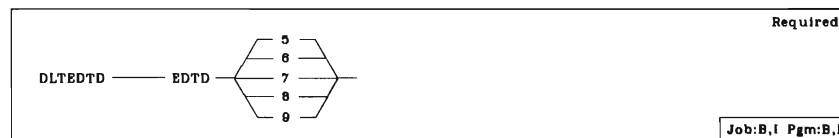

DLTF (Delete File)

Deletes a file.

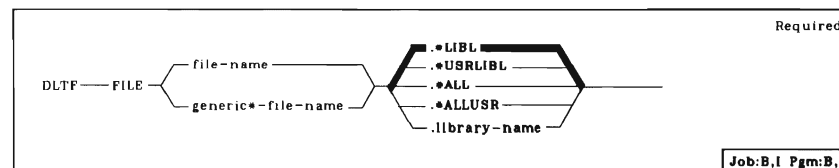

DLTFCT (Delete Forms Control Table)

Deletes an inactive RJE forms control table (FCT).

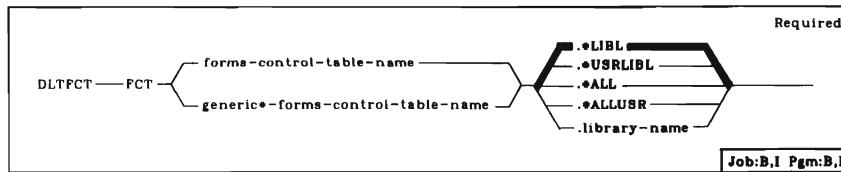

DLTGSS (Delete Graphics Symbol Set)

Deletes a graphics symbol set or group of graphic symbol sets from one or more libraries.

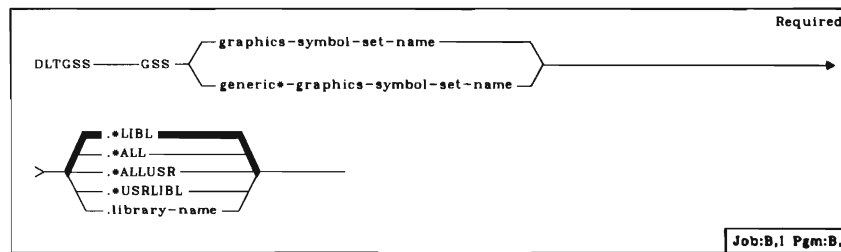

DLTJOB (Delete Job Description)

Deletes a job description.

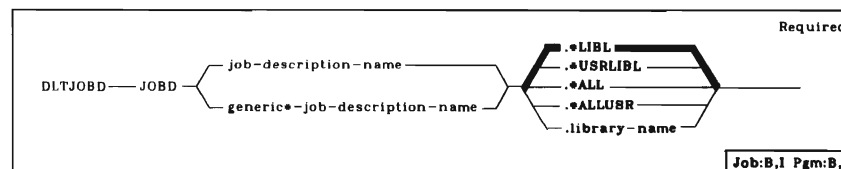

DLTJOBQ (Delete Job Queue)

Deletes a job queue.

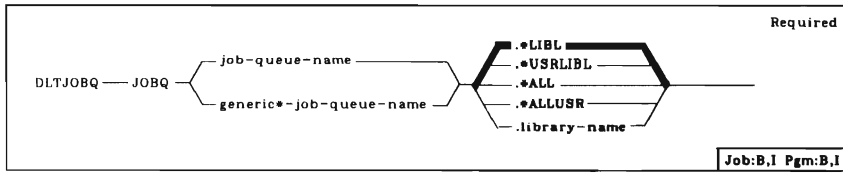

DLTJRN (Delete Journal)

Deletes a journal.

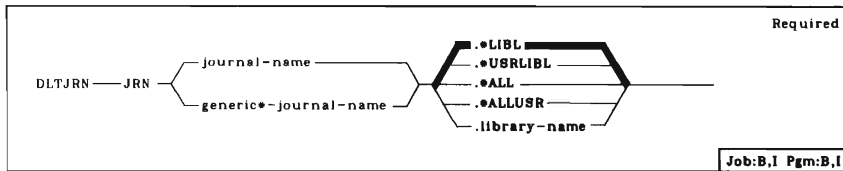

DLTJRRCV (Delete Journal Receiver)

Deletes a journal receiver.

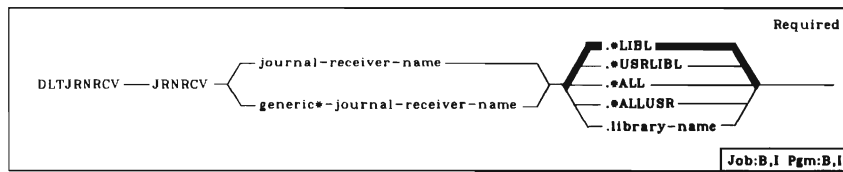

DLTLIB (Delete Library)

Deletes a library and all objects in the library, provided the user has delete rights for the library and all objects in it.



DLTLIND (Delete Line Description)

Deletes a line description.

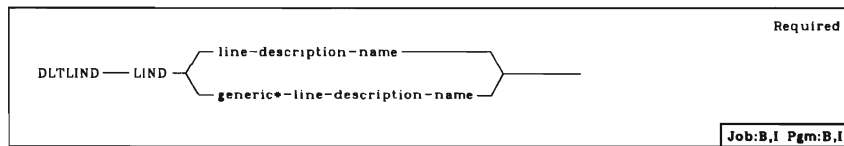

DLTMSGF (Delete Message File)

Deletes a message file.

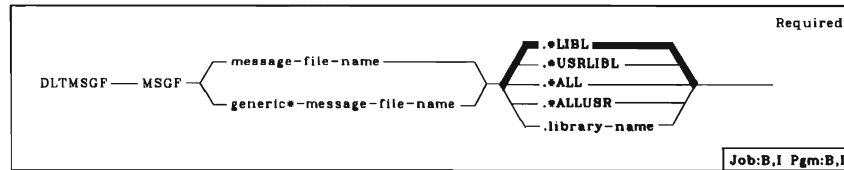

DLTMSGQ (Delete Message Queue)

Deletes a message queue.

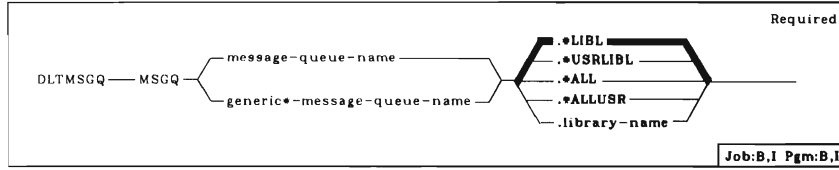

DLTOUTQ (Delete Output Queue)

Deletes an output queue.

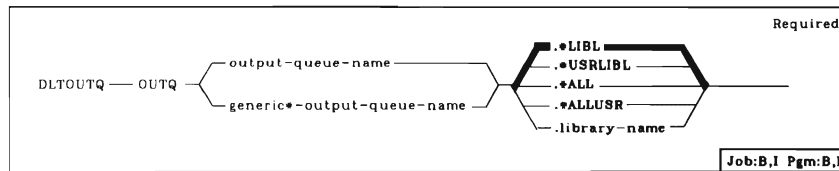

DLTOVR (Delete Override)

Deletes one or more file overrides (including message file overrides) previously specified in an invocation.

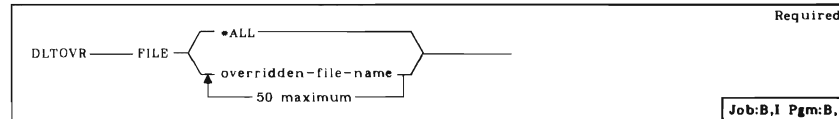

DLTPGM (Delete Program)

Deletes a program.

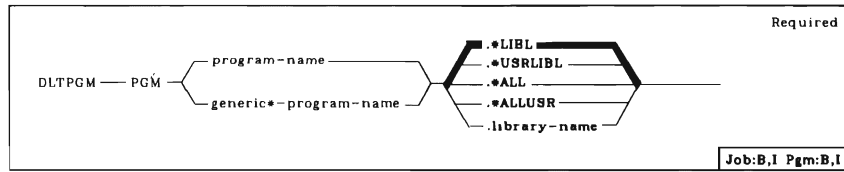

DLTPRTIMG (Delete Print Image)

Deletes a print image.

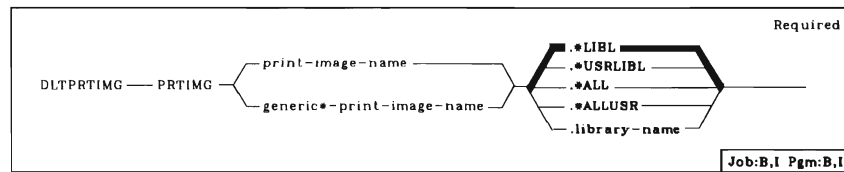

DLTQRYAPP (Delete Query Application)

Deletes a query application.

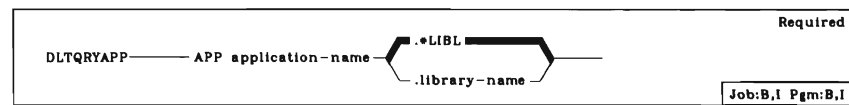

DLTRJECFG (Delete RJE Configuration)

Deletes the objects required for operating RJE, except for the forms control tables and output queues.

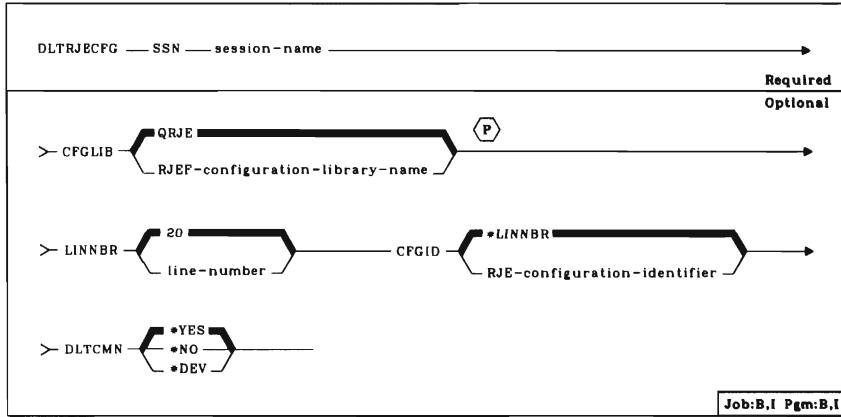

DLTSBSD (Delete Subsystem Description)

Deletes a subsystem description.

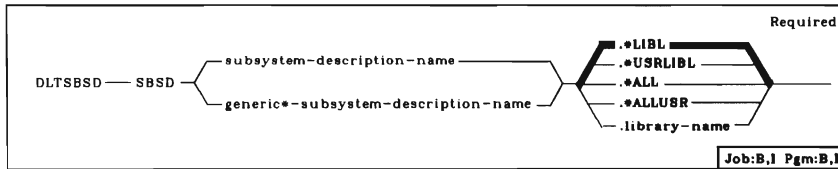

DLTSPADCT (Delete Spelling Aid Dictionary)

Deletes the specified spelling aid dictionary from the system.

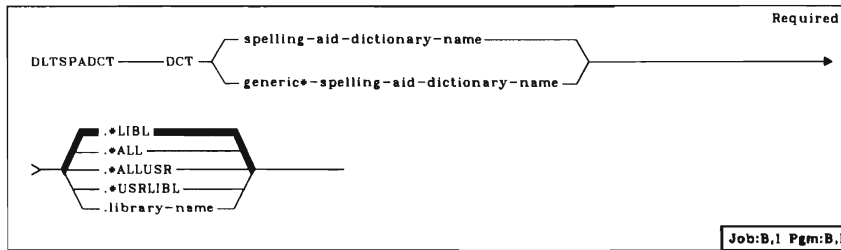

DLTSSND (Delete Session Description)

Deletes an inactive RJEF session description.

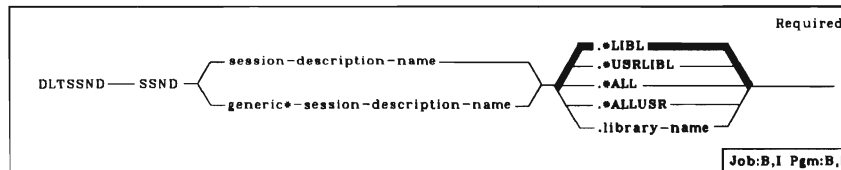

DLTTBL (Delete Table)

Deletes a table.

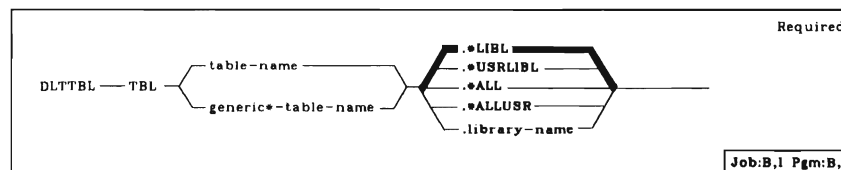

DLTUSRPRF (Delete User Profile)

Deletes a user profile.

DLTUSRPRF _____ USRPRF user-name _____	Required
	Job:B,I Pgm:B,I

DLYJOB (Delay Job)

Allows your current job to wait for a specified number of seconds, or until a specified time of day, before execution resumes.

DLYJOB { DLY number-of-seconds _____ RSMTIME HH-MM-SS _____ }	Required
	Job:B,I Pgm:B,I

DMPCLPGM (Dump CL Program)

Dumps all variables (declared in the CL program in which the command executes) and all messages on the program's message queue to a spooled printer file. Valid only in a CL program.

DMPCLPGM _____	Required
	Pgm:B,I

Printer file-QPPGMDMP

DMPJOB (Dump Job)

Dumps the basic data structures or specific invocations of the current job (or of the job being serviced as a result of a previously issued SRVJOB command). The information is dumped to a spooled printer file.

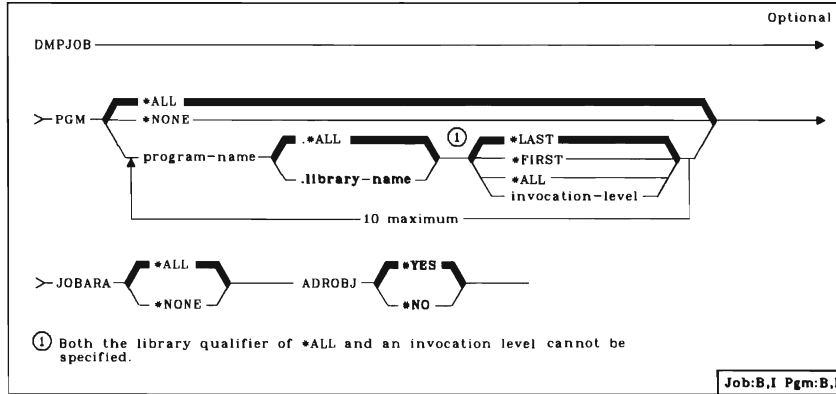

Printer file—QPSRVDMP

DMPJOBINT (Dump Job Internal)

Dumps the machine data structures that are related to the machine process in which the current job is executing.

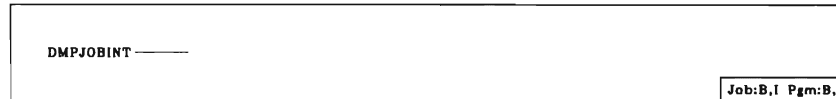

DMPOBJ (Dump Object)

Dumps the contents and/or attributes of a CPF object.

DMPOBJ	_____	OBJ	object-name	_____	.LIBL	_____	_____	_____	①	OBJTYPE	CPF-object-type	_____	Required
					.library-name								
① Any one of the CPF object types listed in the OBJTYPE parameter charts in Appendix A can be specified.													
												Job:8,1 Pgm:8,1	

Printer file—QPSRVDMP

DMPYSOBJ (Dump System Object)

Dumps the contents and/or attributes of MI system objects.

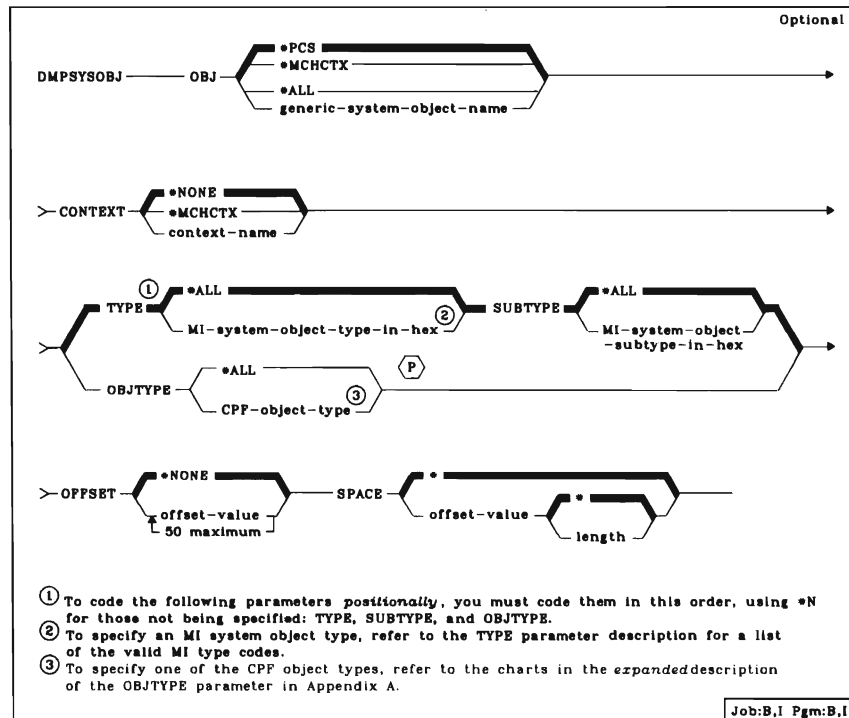

Printer file—QPSRVDMP

DMPTAP (Dump Tape)

Dumps label information or data blocks or both from standard labeled or nonlabeled magnetic tape to a spooled printer file.

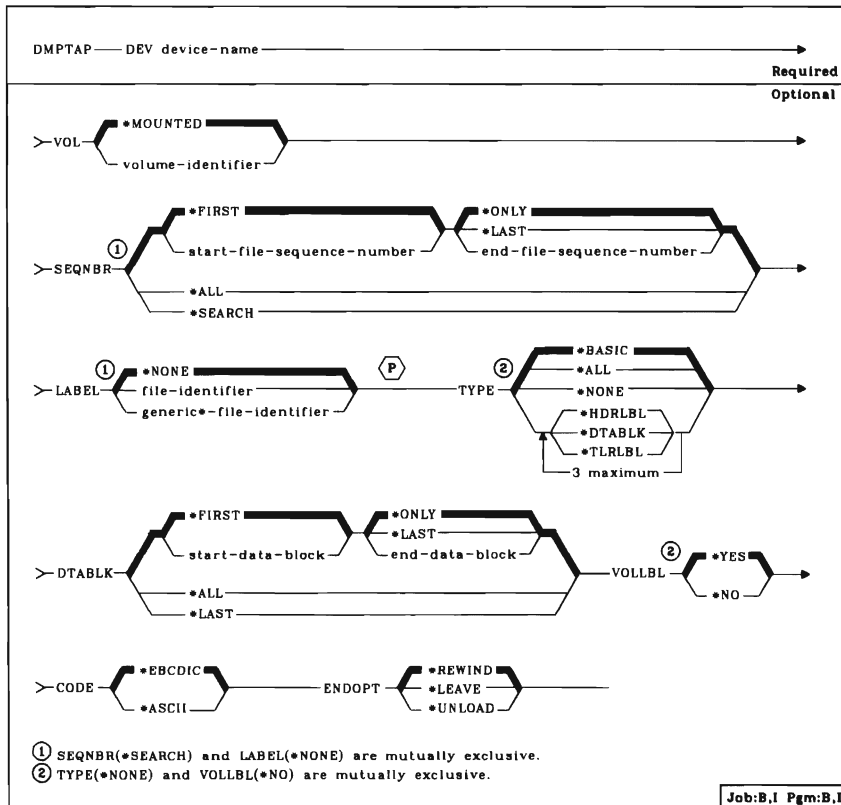

Printer file—QPTAPDMP

DO (Do)

Specifies the start of a do group in a CL program.



DSNAPF (Design Advanced Printer Function)

Invokes a menu that offers options for designing customized forms.



DSNDFUAPP (Design DFU Application)

Begins the prompting sequence for interactive definition of a DFU application.

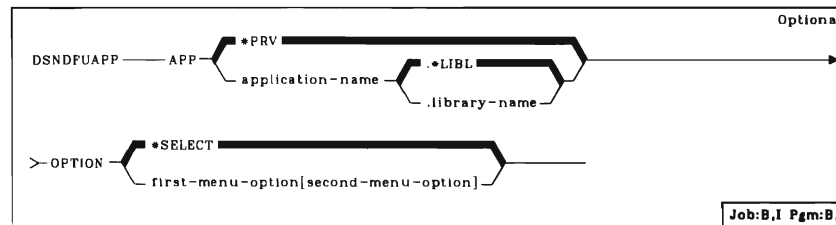

DSNFMT (Design Format)

Invokes the screen design aid (SDA) to design and test a display format.

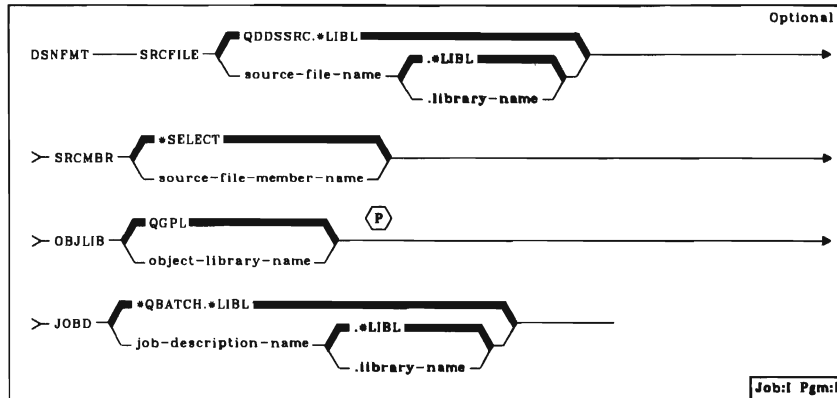

Printer file—QSYSPRT

Data base source file—QDDSSRC

DSNQRYAPP (Design Query Application)

Begins the prompting sequence for interactive definition of a query application.

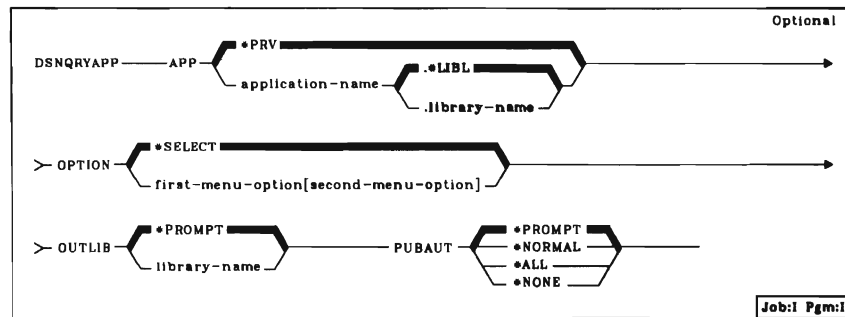

DSPACC (Display Access Code)

Displays the access codes currently defined in the system.

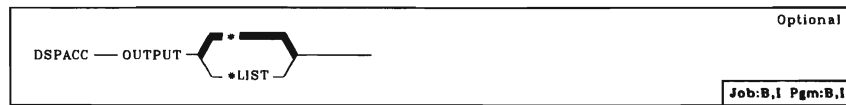

Printer file—QP DSPACC

DSPACCAUT (Display Access Code Authority)

Displays the access codes that a user or group of users is currently authorized to.

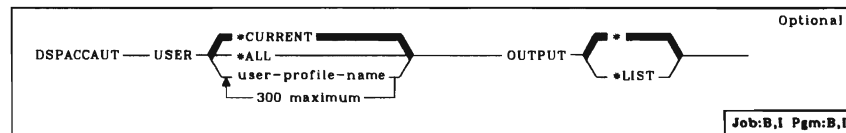

Printer file—QP DSPAAU

DSPACTJOB (Display Active Jobs)

Displays performance and status information for the active jobs in the system.

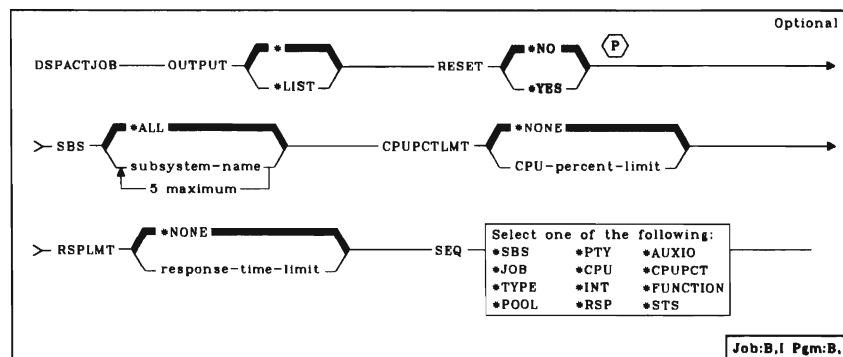

Printer file—QP DSPAJB

DSPAUTUSR (Display Authorized Users)

Displays the authorized users of the system and their passwords.

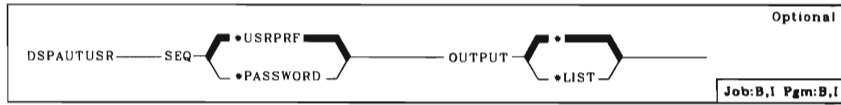

Printer file—QPAUTUSR

DSPBKP (Display Breakpoints)

Displays breakpoints in a program being debugged (using the ENTDBG command).

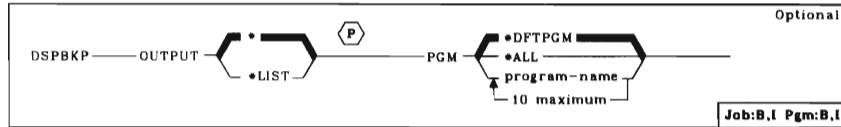

Printer file—QPDBGDSP

DSPCHLSTS (Display Channel Status)

Displays information about the logical channel status of a specified X.25 communications line description.

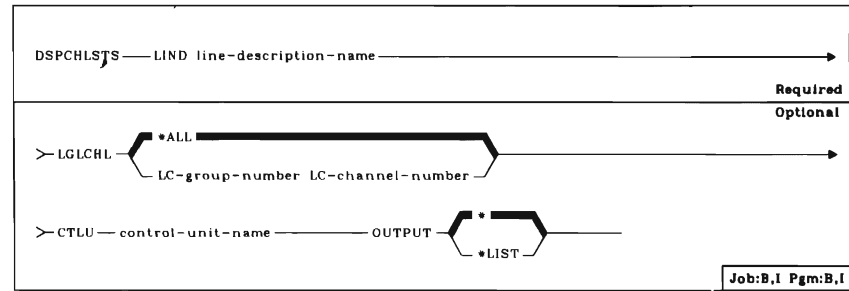

DSPCHT (Display Chart)

Displays a chart defined by the Business Graphics Utility. You can enter this command to display a chart on your work station without entering BGU.

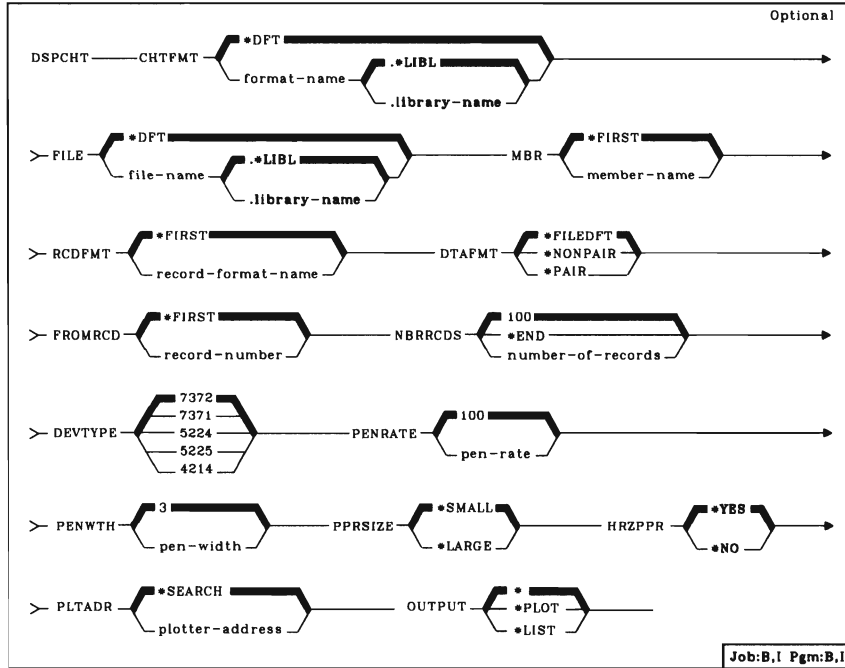

DSPCLS (Display Class)

Displays the attributes of a class.

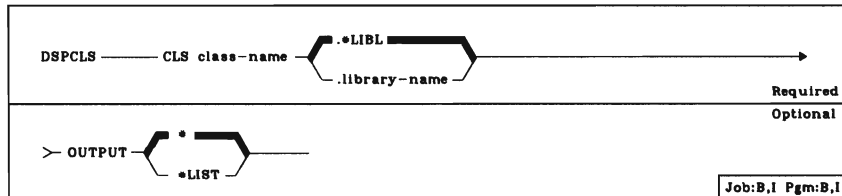

Printer file-QPDSPCLS

DSPCMD (Display Command)

Displays the values specified in the CRTCMD (Create Command) command.

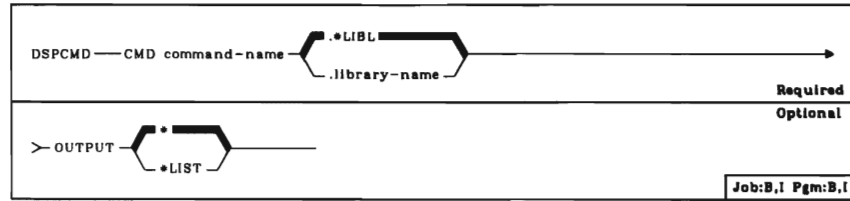

Printer file—QSYSPRT

DSPCNPA (Display CSNAP Attributes)

Displays the short-term statistics sampling attributes of CSNAP.

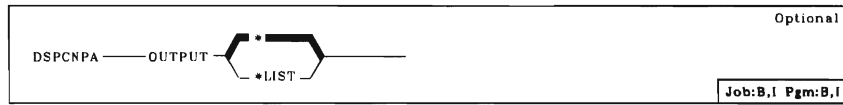

Printer file—QPCNPDSP

DSPCTLSTS (Display Control Unit Status)

Displays the configuration of one or all control units and their devices.

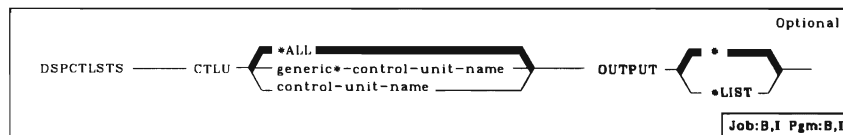

Printer file—QPDVCDSP

DSPCUD (Display Control Unit Description)

Displays the description of a control unit.

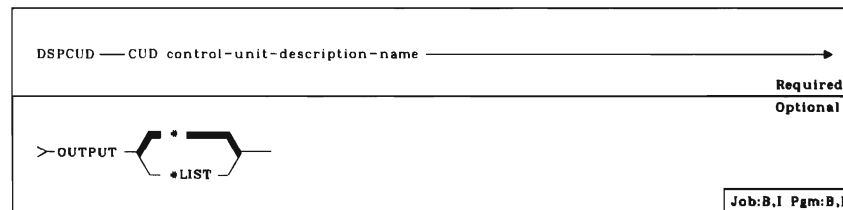

Printer file—QPDCCTLM

DSPDBG (Display Debug)

Displays the debug options, the current invocation stack, and the names of programs being debugged (using the ENTDBG command).

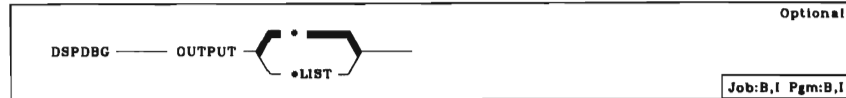

Printer file—QPDBGDSP

DSPDBR (Display Data Base Relations)

Provides cross-reference information about data base files.

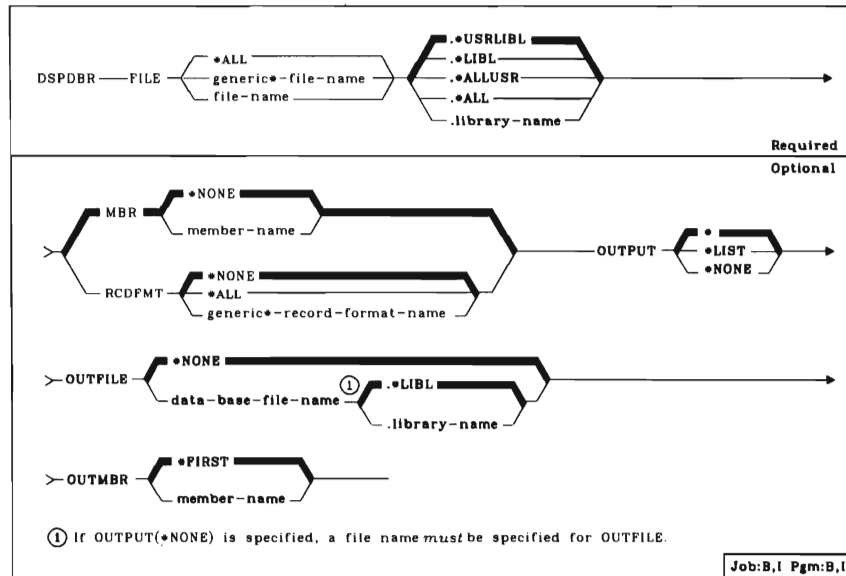

Printer file—QPDSPDBR
Data base file—QADSPDBR
Outfile—QADSPDBR
Format name—QWHDRDBR

DSPDEVCFG (Display Device Configuration)

Displays the device configuration of the system.

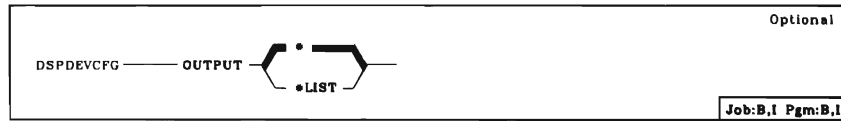

Printer file—QPDCDCFG

DSPDEVD (Display Device Description)

Displays the description of a device.

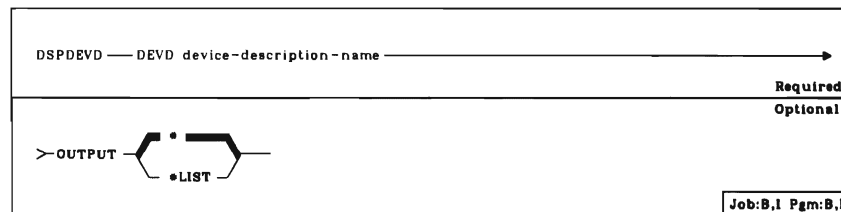

Printer file—QPDCDEVD

DSPDEVSTS (Display Device Status)

Displays the status of one or all devices on the system.

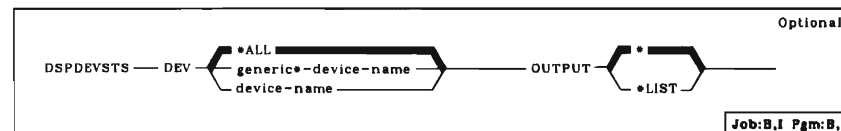

Printer file—QPDVCDSP

DSPDIR (Display Directory)

Displays all directory entries, in alphabetic sequence, or a single entry within the system distribution directory.

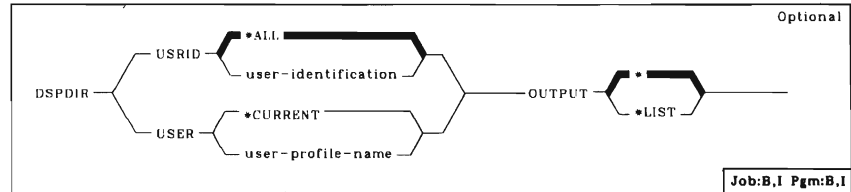

Printer file—QPDSDDL
Printer file—QPDSPSM

DSPDOCAUT (Display Document Authority)

Displays the users to whom you have granted document authority, as well as users who have granted document authority to you through the Grant Document Authority (GRTDOCAUT) command.

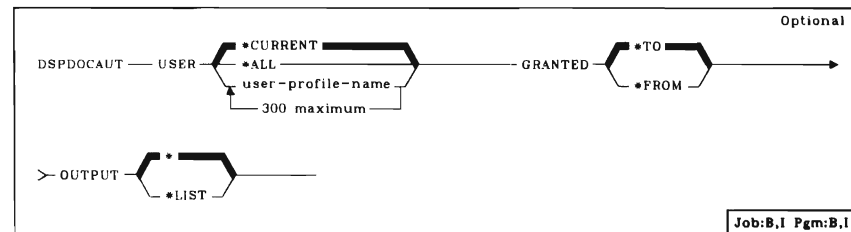

Printer file—QPDSFDA

DSPDKT (Display Diskette)

Displays the names of files residing on the diskette.

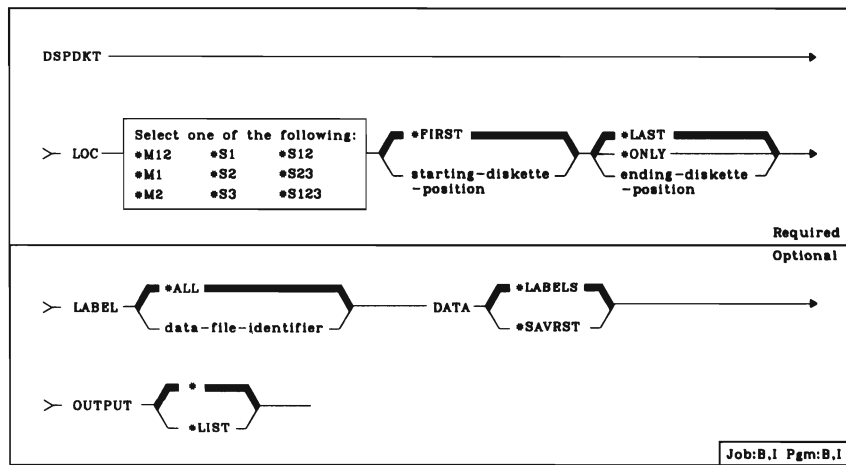

Diskette file—QSYSDKT

DSPDSTSRV (Display Distribution Services)

Displays or prints the next system table, routing table, or secondary node ID table configuration.

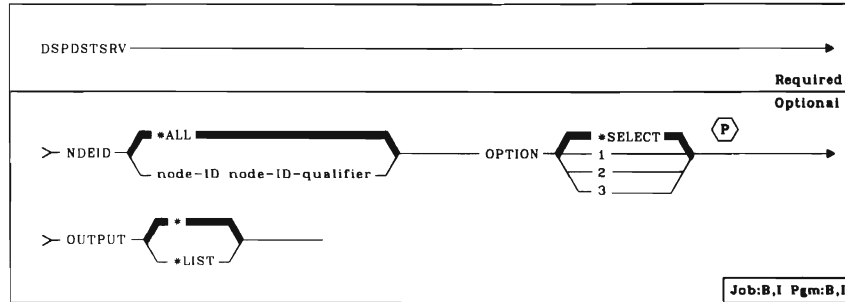

Data base source file—QASNADSC
Data base source file—QASNADSR
Data base source file—QASNADSA
Printer file—QPDSTSRV

DSPDSTSTS (Display Distribution Status)

Displays and controls the distribution requests on the SNADS send queues.

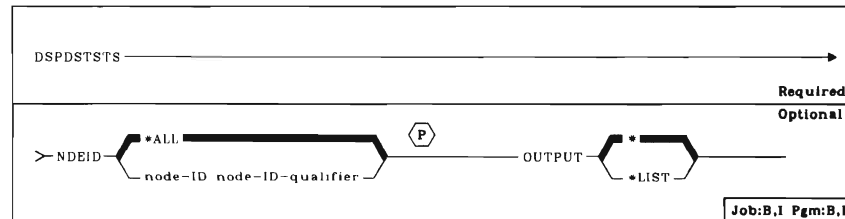

Data base source file—QASNADSC
Printer file—QPDSTSTS

DSPDTA (Display Data)

Executes a DFU application to display records in a data base file.

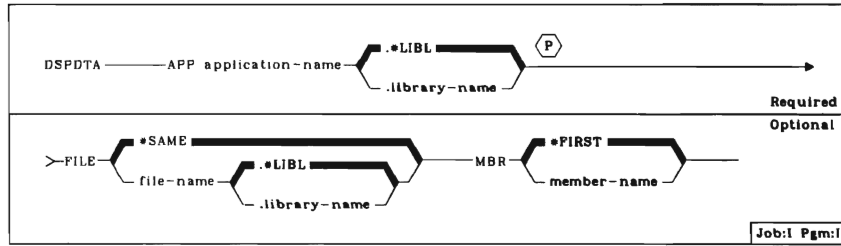

Printer file—QDTAPRT

Display files—QDDFUP1, QDDFUP2

DSPDTAARA (Display Data Area)

Displays the value and attributes of a data area.

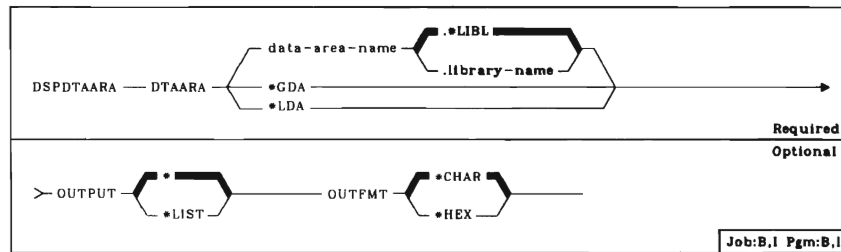

Printer file—QPDSPDTA

DSPEDTD (Display Edit Description)

Displays an edit description associated with a user-defined edit code.

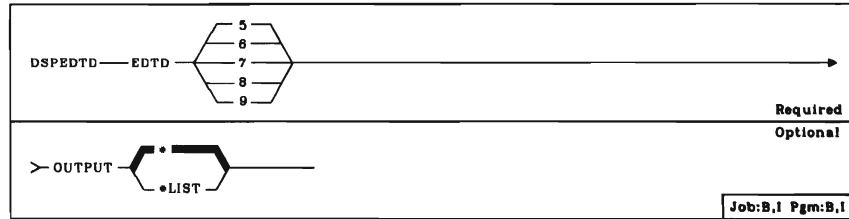

Printer file—QPDCEDSP

DSPFCT (Display Forms Control Table)

Displays the entries in an RJEF forms control table (FCT).

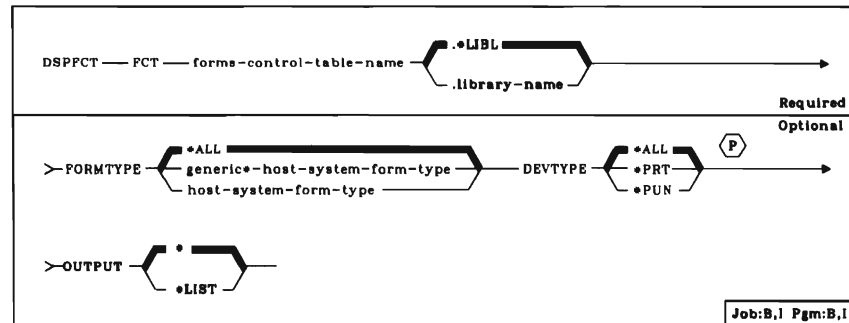

DSPFD (Display File Description)

Displays the description of a file.

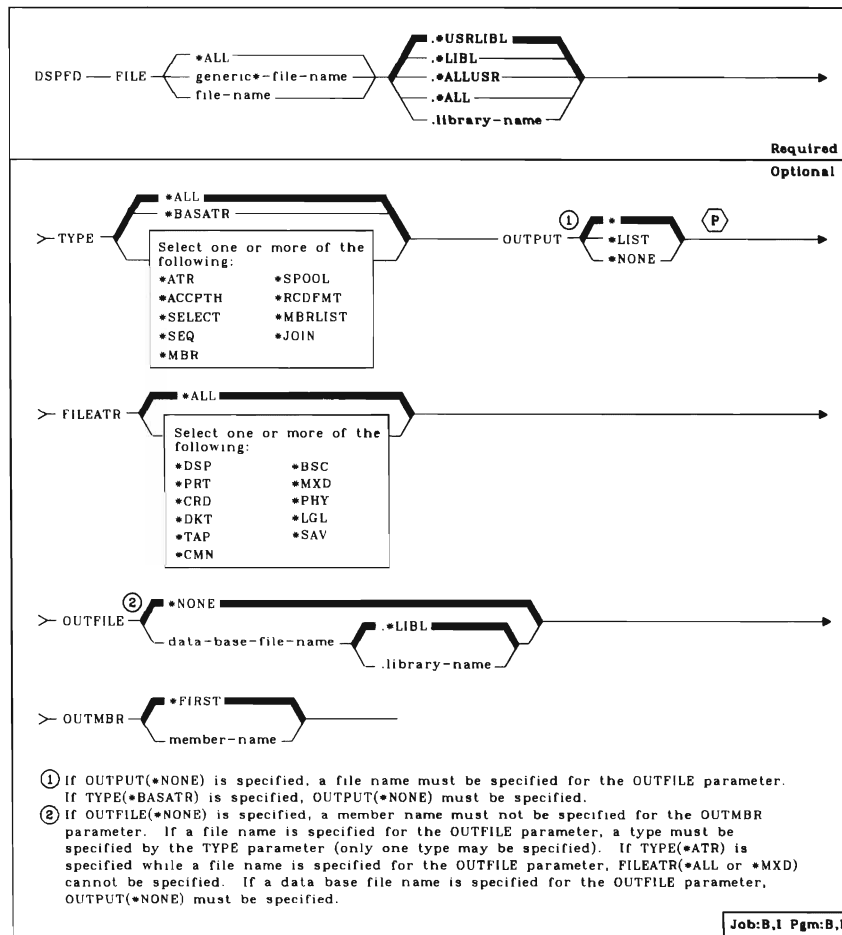

Printer file—QPDSFPD

For a complete list of files used by the Display File Description command, refer to the *Control Language Reference Manual*.

DSPFFD (Display File Field Description)

Displays field-level information for a file.

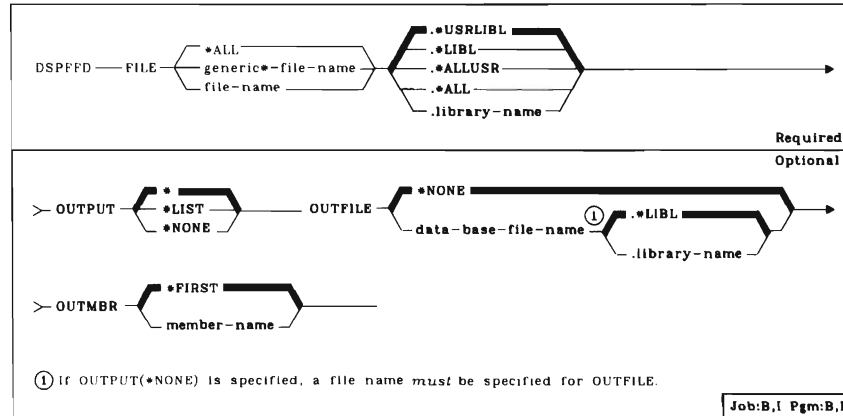

Printer file—QPDSPPFD
Data base file—QADSPFFD
Out file—QADSPFFD
Format name—QWHDRFFD

DSPFNCHLP (Display Finance Help)

Displays the *Online User's Guide for the System/38 Attachment of IBM 4700 Finance Terminals*.

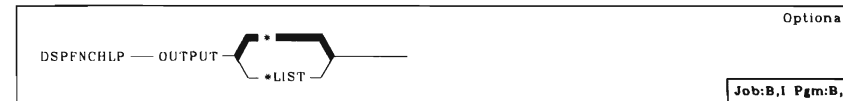

Data base source file—QHFNHELP
Data base source file—QHFNLIST
Printer file—QSYSPRT

DSPJOB (Display Job)

Displays information about a job.

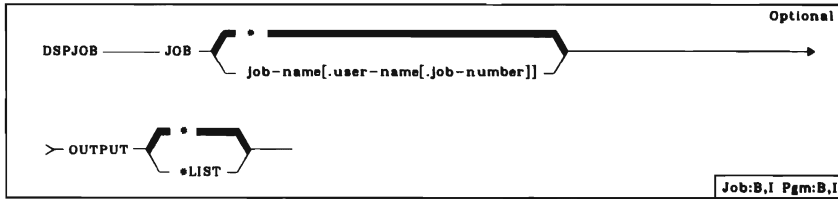

Printer file—QPDSJOB

DSPJOB (Display Job Description)

Displays a job description.

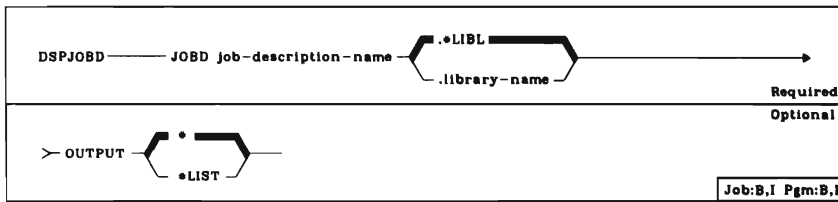

Printer file—QPRTJOB

DSPJOBLOG (Display Job Log)

Displays the requests and related messages for a partially completed job, or the requests of a job on the job queue that has not started execution.

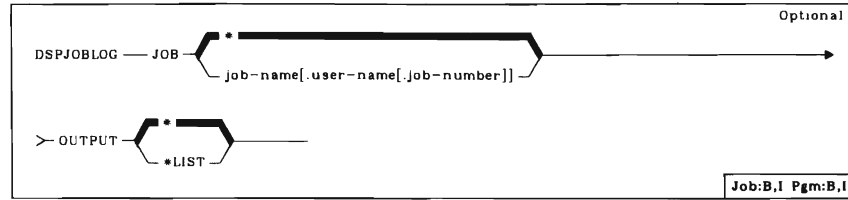

Printer file—QPJOBLOG

DSPJOBQ (Display Job Queue)

Displays the status of all job queues or the status of jobs on a specific job queue.

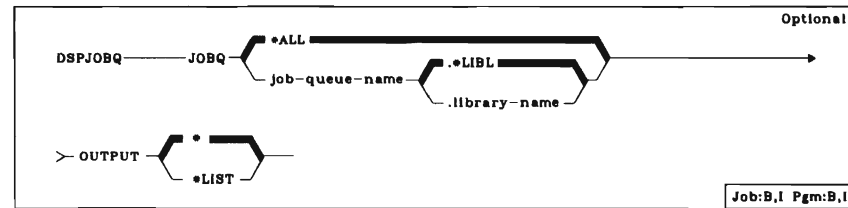

Printer file—QPRTSPLQ

DSPJRN (Display Journal)

Displays (or prints) journal entries from one or more journal receivers.
Output can also be directed to a data base file.

	Required	Optional
DSPJRN JRN journal-name <input type="checkbox"/> LIBL <input type="checkbox"/> library-name		
> FILE <input type="checkbox"/> ALLFILE <input type="checkbox"/> file-name <input type="checkbox"/> LIBL <input type="checkbox"/> library-name <input type="checkbox"/> FIRST <input type="checkbox"/> ALL <input type="checkbox"/> member-name		
① 50 maximum		
> RCVMSC <input type="checkbox"/> CURRENT (A,2) <input type="checkbox"/> LIBL <input type="checkbox"/> library-name (A,1)		
(A,1) <input type="checkbox"/> CURRENT (P) <input type="checkbox"/> LIBL <input type="checkbox"/> library-name		
(A,2) FROMENT <input type="checkbox"/> FIRST <input type="checkbox"/> starting-sequence-number TOENT <input type="checkbox"/> LAST <input type="checkbox"/> ending-sequence-number		
FROMTIME date time TOTIME date time		
> NBRENT <input type="checkbox"/> ALL <input type="checkbox"/> value JRNCDE <input type="checkbox"/> ALL <input type="checkbox"/> CTL <input type="checkbox"/> code <input type="checkbox"/> ENTTP <input type="checkbox"/> ALL <input type="checkbox"/> RCD <input type="checkbox"/> entry-type		
8 maximum 10 maximum		
> JOB <input type="checkbox"/> ALL <input type="checkbox"/> job-name [user-name (job-number)] PGM <input type="checkbox"/> ALL <input type="checkbox"/> program-name		
> CMTCYCID <input type="checkbox"/> ALL <input type="checkbox"/> commit-cycle-identifier ENTDTALEN 100 <input type="checkbox"/> field-length		
OUTFMT <input type="checkbox"/> CHAR <input type="checkbox"/> HEX		
> OUTPUT <input type="checkbox"/> LIST <input type="checkbox"/> NONE <input type="checkbox"/> OUTFILE <input type="checkbox"/> NONE <input type="checkbox"/> file-name <input type="checkbox"/> LIBL <input type="checkbox"/> library-name <input type="checkbox"/> OUTMBR <input type="checkbox"/> FIRST <input type="checkbox"/> member-name		
① The format is *ALL library-name		

Job:B,1 Pgm:B,1

Data base file—QADSPJRN

Printer file—QPDSJRN

Journal Output

Out file—QADSPJRN

Format name—QJURDJE

Job Accounting Output

Out file—QACBACG

Format name—QWTJAJBE

Printer Accounting Output

Out file—QAPTACG

Format name—QSPJAPTE

DSPJRNA (Display Journal Attributes)

Displays the creation and operational attributes of a journal, including the names of the journal receivers currently attached to the journal.

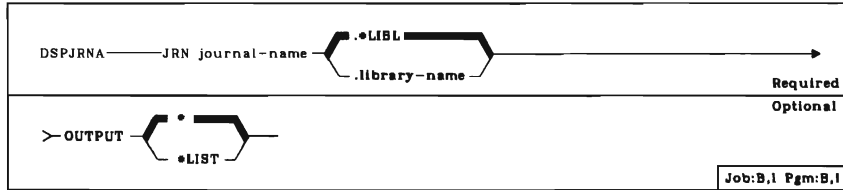

Printer file—QPDPSPJRNA

DSPJRMNU (Display Journal Menu)

Provides a menu from which you can select options for journal operations.



DSPJRNRCVA (Display Journal Receiver Attributes)

Displays the creation and operational attributes of a journal receiver, including the name of the journal that the receiver is now attached to or was last attached to.

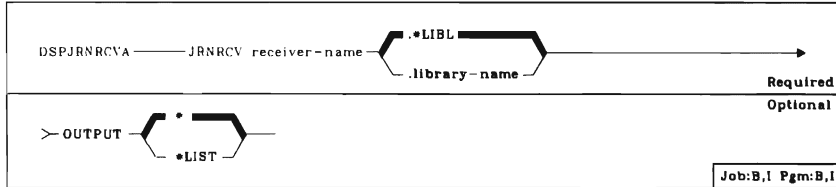

Printer file-QPDSPRCV

DSPKBDMAP (Display Keyboard Map)

Displays the current CF-to-PF map for the 3270 work station device from which the command was issued.

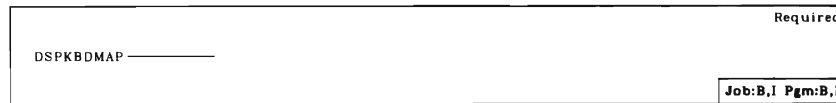

DSPLIB (Display Library)

Displays the name, type, and subtype of each object in a library.

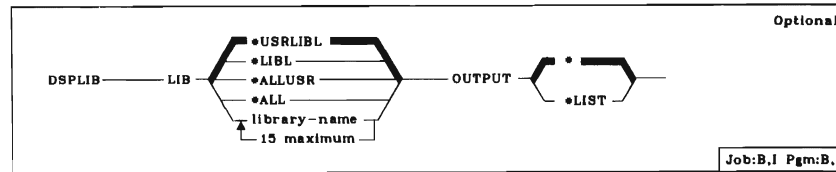

Printer file-QPDSPLIB

DSPLIBL (Display Library List)

Displays the names of the libraries in the user's current library list.

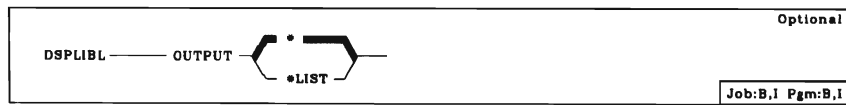

DSPLIND (Display Line Description)

Displays the description of a communications line.

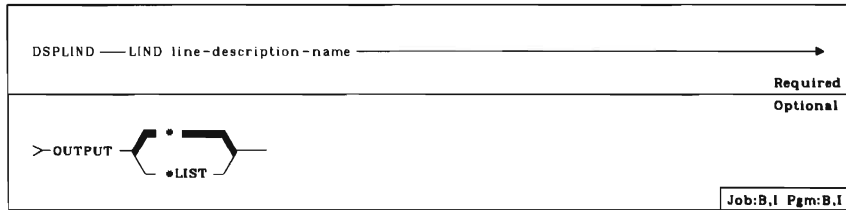

Printer file—QPDCLINE

DSPLINSTS (Display Line Status)

Displays the hierarchical configuration and the status of communications lines and the attached control units and devices.

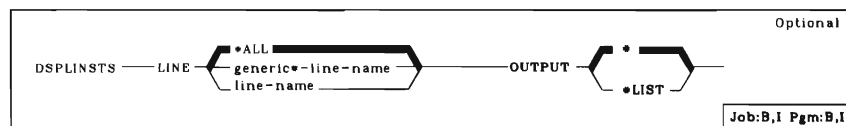

Printer file—QPNETSTS

DSPLNKSTS (Display Link Status)

Displays information about the logical link status of a specified communications line description.

DSPLNKSTS — LIND line-description-name	→	Required
> LGLLNK — *ALL — control-unit-name	OUTPUT — *LIST	Optional
		Job:B,I Pgm:B,I

DSPLOG (Display Log)

Displays the history log, the service log, or the programming change log.

DSPLOG — LOG — QHST	→	Optional
		QSRV
		QCHG
> PERIOD — ① *AVAIL — *CURRENT	→	
		*BEGIN — *AVAIL — *CURRENT
		start-time — start-date — end-time — end-date
		[—]
> JOB — *NONE	→	Ⓟ
		Job-name[.username[.job-number]]
		5 maximum
> MSGID — *ALL — message-identifier	→	
		5 maximum
	OUTPUT — *LIST	
① *PERIOD contains 2 lists of 2 elements each. *N must be specified for any element that precedes the value(s) to be specified, to maintain its position in the parameter value sequence.		
		Job:B,I Pgm:B,I

Printer file—QPDSPLLOG

DSPMNU (Display Menu)

Allows you to display a variety of menus: the Command Grouping menu, the Verb menu that lists the commands whose names have a common verb component, the Subject menu that lists commands and menus associated with a particular subject, or a specific menu name.

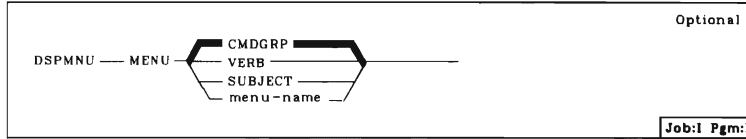

DSPMODSTS (Display Mode Status)

Displays the status of a mode entry that has been added to a peer device description.

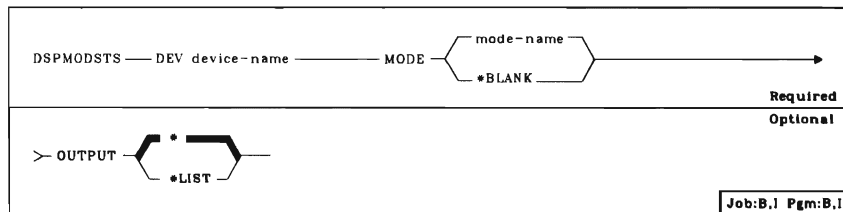

Printer file-QPDCMODE

DSPMSG (Display Messages)

Displays the messages received at a message queue.

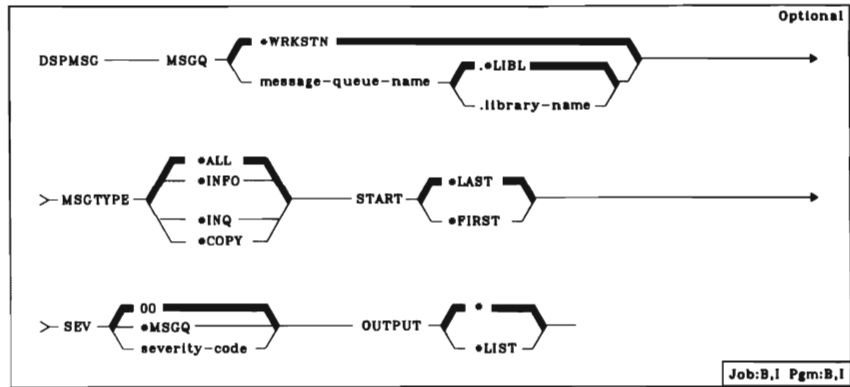

Printer file—QPDSMSG

DSPMSGD (Display Message Description)

Displays message descriptions of one or more messages contained in a message file.

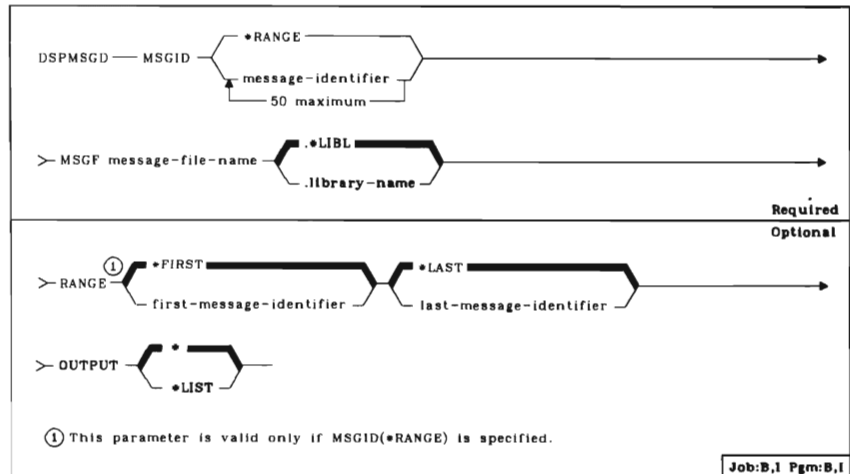

Printer file—QPMSGD

DSPMSGF (Display Message File)

Displays attributes of messages in a message file. For each message, the message identifier, severity code, and first-level text are shown.

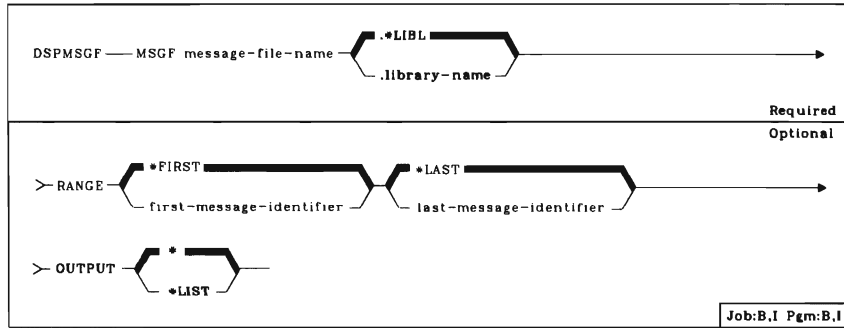

Printer file—QPMSGD

DSPNETA (Display Network Attributes)

The Display Network Attributes (DSPNETA) command is used to display the following attributes of a system:

- The status of alert processing
- The name of the control unit through which alert messages are sent to the host
- The current system name and any pending system name

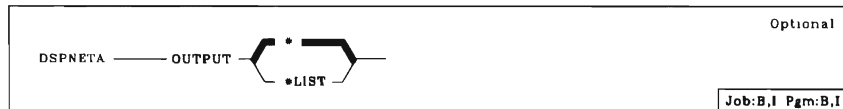

Printer file—QPDSPNET

DSPNETF (Display Network Files)

Displays or prints a list of files that have arrived for a user, or creates an output file containing a list of the files.

DSPNETF	—	USER	{ *CURRENT *ALL user-name }	—	OUTPUT	^① { * *LIST *NONE }	Optional
>	OUTFILE	{ *NONE data-base-file-name }	{ *LIBL .library-name }				
>	OUTMBR	^② { *FIRST member-name }					

① OUTPUT(*NONE) can be specified only if a file name is specified for OUTFILE.
② A member name can be specified for OUTMBR only if a file name is specified for OUTFILE.

Job:B,I Pgm:B,I

Printer file—QPNFDNTF

Data base source file—QANFDNTE

DSPNETJOB (Display Network Job Entry)

Displays the network job entries.

DSPNETJOB	—	OUTPUT	{ * *LIST }	Optional
-----------	---	--------	----------------	----------

Job:B,I Pgm:B,I

Data base source file—QANFNJE

Printer file—QPNFNTE

DSPOBJD (Display Object Description)

Displays the description of an object or group of objects.

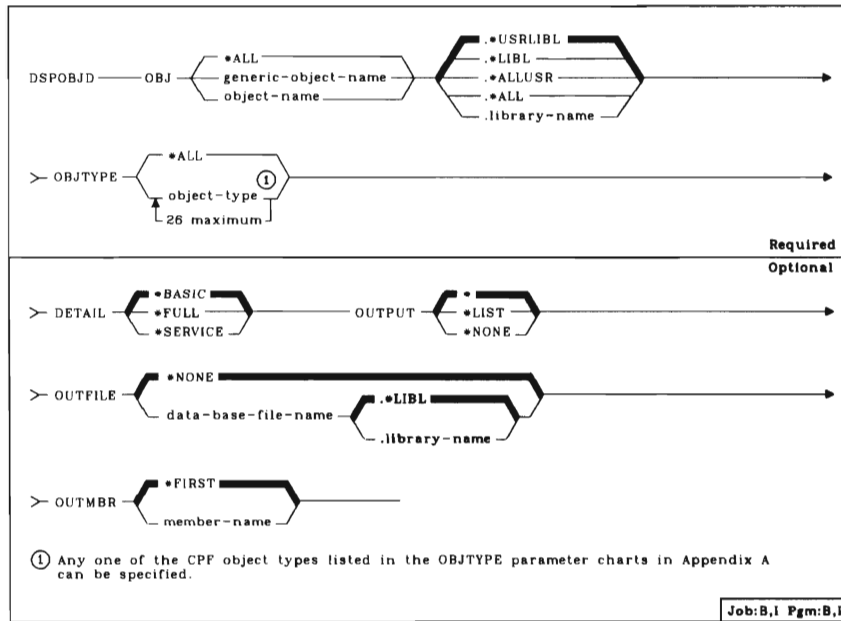

Printer file—QPRTOBJD
Out file—QADSPOBJ
Format name—QLIDOBJD

DSPOBJLCK (Display Object Lock)

Displays all the object lock requests in the system for the specified object.

Note: This command does not show record locks for data base files.

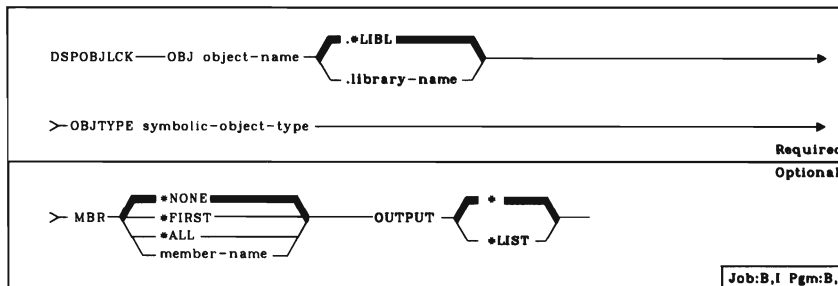

Printer file—QPDSPOLK

DSPOUTQ (Display Output Queue)

Displays the status of all output queues or the status of jobs on a specific output queue.

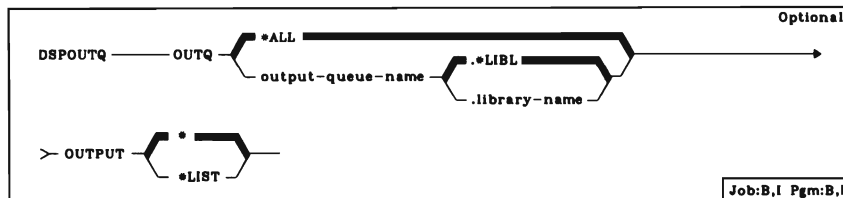

Printer file—QPRTSPLQ

DSPOVR (Display Override)

Displays file override information.

DSPOVR	FILE	<input checked="" type="checkbox"/> ALL overridden-file-name	<input type="checkbox"/> P	MARGOVR	<input checked="" type="checkbox"/> YES <input type="checkbox"/> NO	Optional
>	INVNBR	<input checked="" type="checkbox"/> CURRENT invocation-number		OUTPUT	<input checked="" type="checkbox"/> <input type="checkbox"/> LIST	
						Job:B,I Pgm:B,I

Printer file—QPDSPOVR

DSPPGM (Display Program)

Displays information about a program.

DSPPGM	PGM program-name	<input checked="" type="checkbox"/> LIBL .library-name	<input type="checkbox"/> P		Required	
>	OUTPUT	<input checked="" type="checkbox"/> <input type="checkbox"/> LIST			Optional	
						Job:B,I Pgm:B,I

Printer file—QPDPGM

DSPPGMCHG (Display Programming Change)

Displays programming changes (PCs) and locally generated programming changes (patches) for the specified licensed program and library.

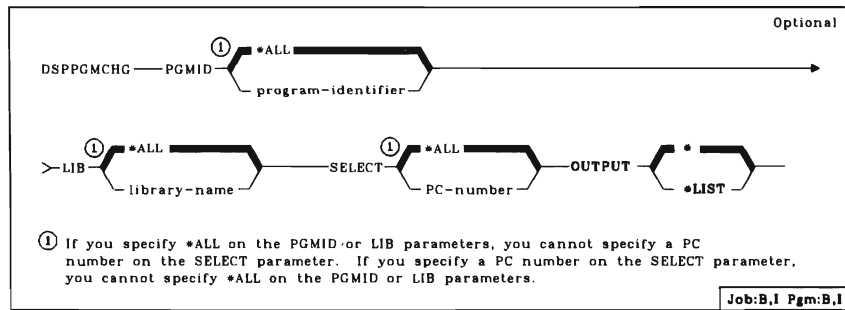

Printer file—QPDSPPC

DSPPGMMNU (Display Program Menu)

Invokes the programmer menu. This command can be used instead of the CALL QPGMMENU function, and allows you to pass parameters to specify and control the data which is to appear in the associated fields on the programmer menu.

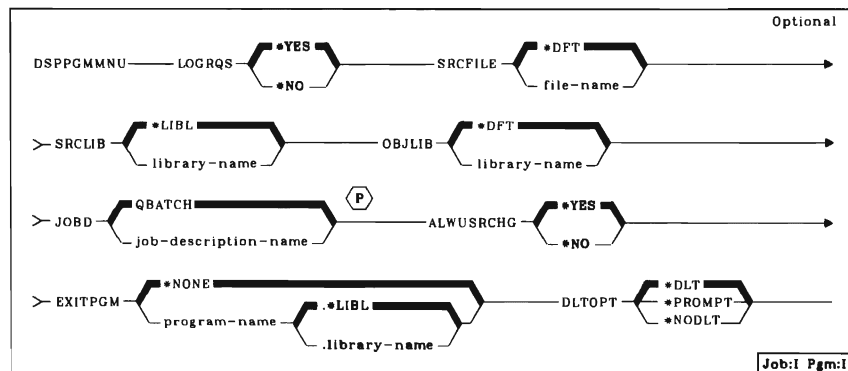

DSPPGMREF (Display Program References)

Displays a list of files and external objects referenced by a program.

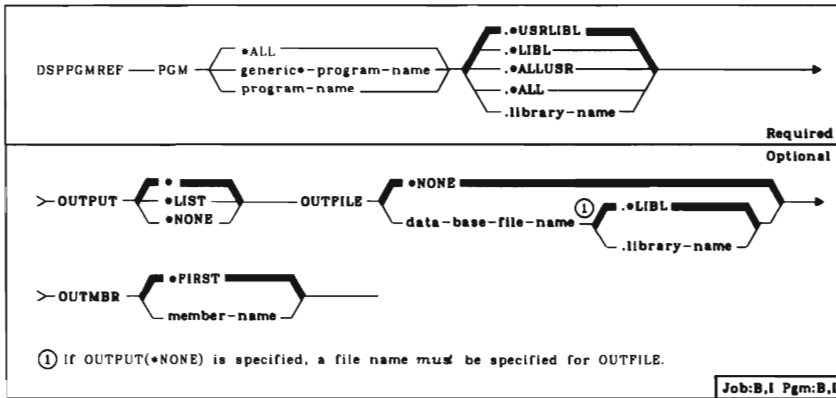

Printer file—QPDSPPGM
Data base file—QADSPPGM
Out file—QADSPPGM
Format name—QWHDRPPR

DSPPGMVAR (Display Program Variable)

Displays the current value of a variable or pointer in a program being debugged.

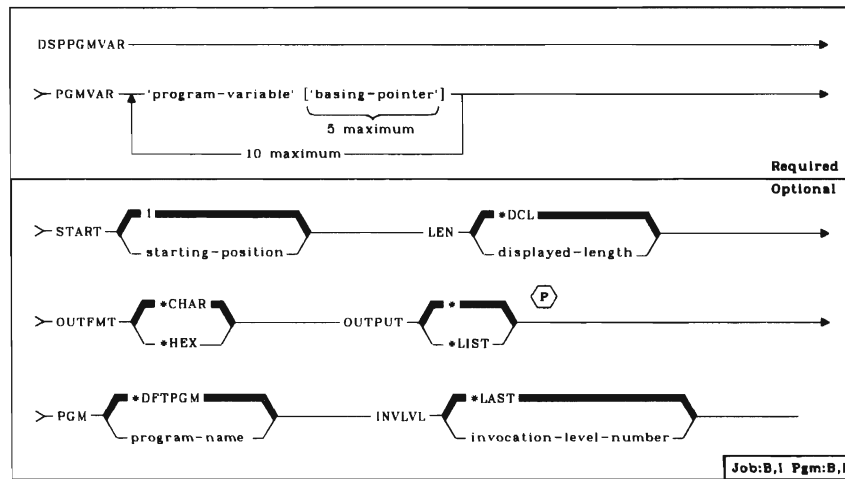

Printer file—QPDBGDSP

DSPRCDLCK (Display Record Lock)

Displays the current record lock status of a particular data base physical file member.

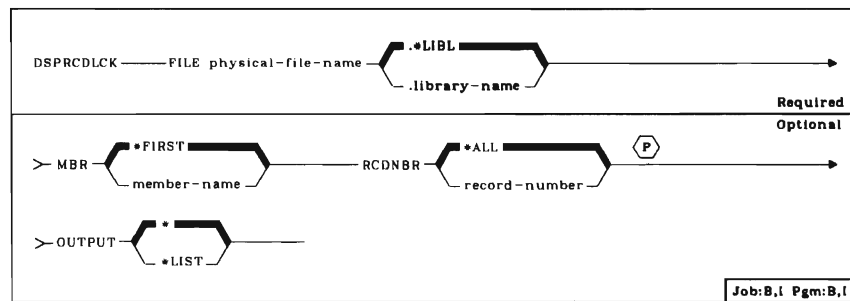

Printer file—QPDSPRLK

DSPRDR (Display Reader)

Displays the current status of all spooling readers, or displays detailed information about a specified spooling reader.

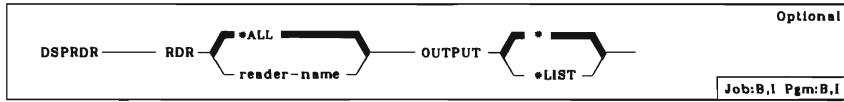

Printer file—QPRTRDWT

DSPRJECFG (Display RJE Configuration)

Displays all RJE configuration objects associated with one or more named session descriptions.

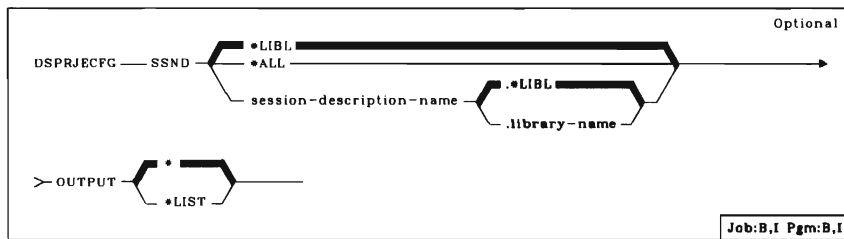

DSPRJESSN (Display RJE Session)

Displays the status of an active RJE session.

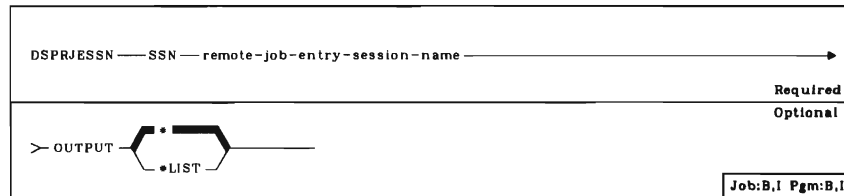

DSPRPYL (Display Reply List)

Displays or prints all the reply entries currently in the reply list.



DSPSAVF (Display Save File)

Displays the save/restore information in a save file.

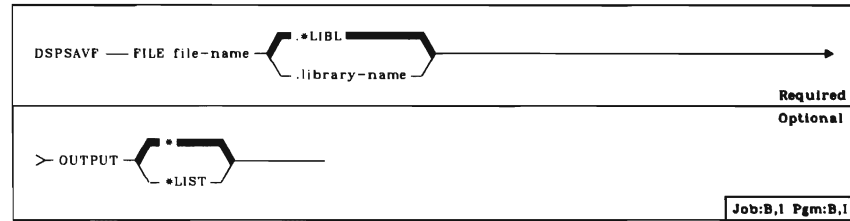

Printer file—QPSRODSP

DSPSBMJOB (Display Submitted Jobs)

Displays the status of all submitted jobs in the system except those submitted with DSPSBMJOB(*NO).

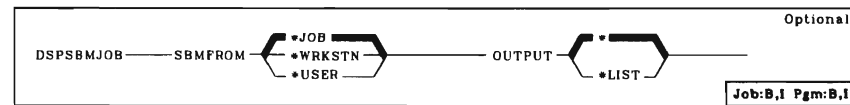

Printer file—QPDSBS

DSPSBS (Display Subsystem)

Displays the status of jobs being processed by a subsystem.

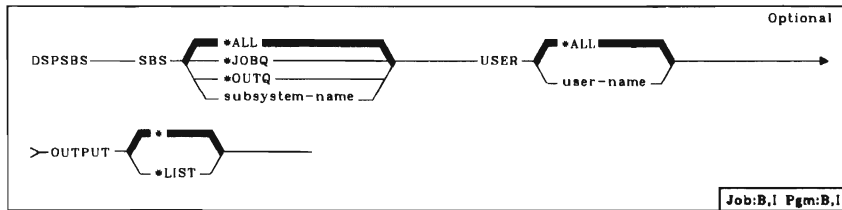

Printer file-QPDSPSBS

DSPSBSD (Display Subsystem Description)

Displays a subsystem description.

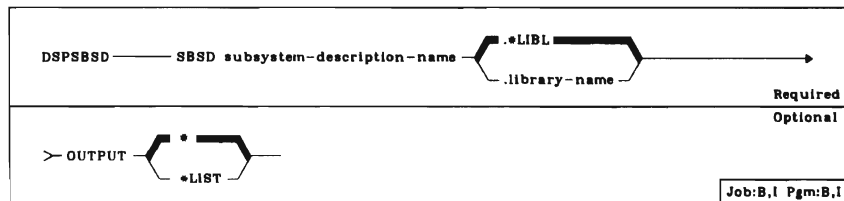

Printer file-QPRTSBSD

DSPSPLF (Display Spooled File)

Displays the data records in a spooled output file.

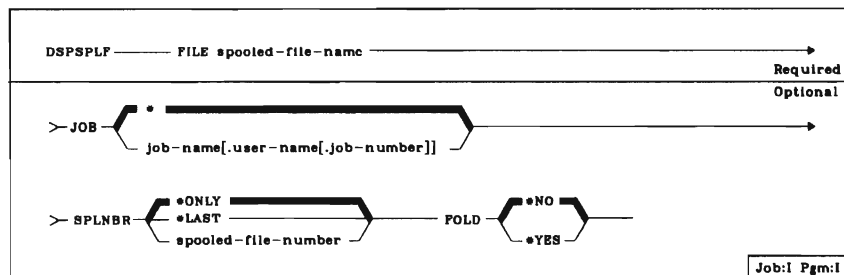

DSPSPFLA (Display Spooled File Attributes)

Displays the attributes of a spooled output file.

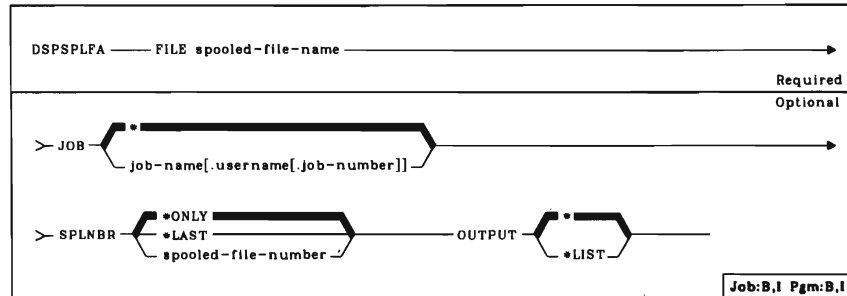

Printer file—QPDSPSFA

DSPSRVSTS (Display Service Status)

Displays the current service status of a job.

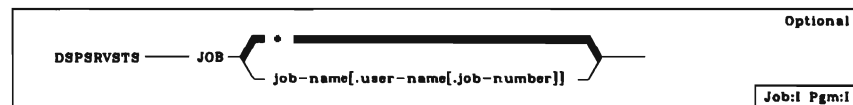

DSPSSND (Display Session Description)

Displays the current contents of an RJEF session description.

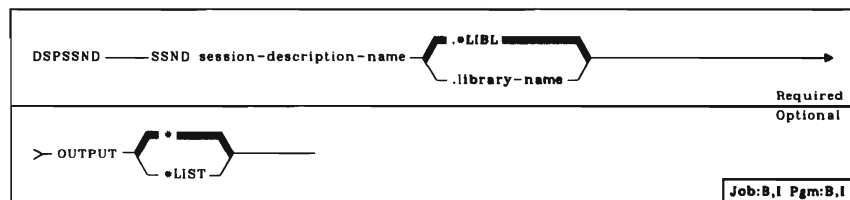

DSPPSYS (Display System)

Displays the status of system jobs and subsystems.



Printer file—QPDSPPSYS

DSPPSYSSTS (Display System Status)

Displays information about system activities and storage allocation.

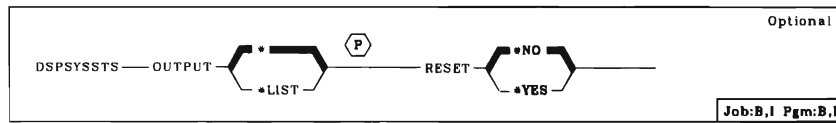

Printer file—QPDSPPSTS

DSPPSYSVAL (Display System Value)

Displays the current value of a system value.

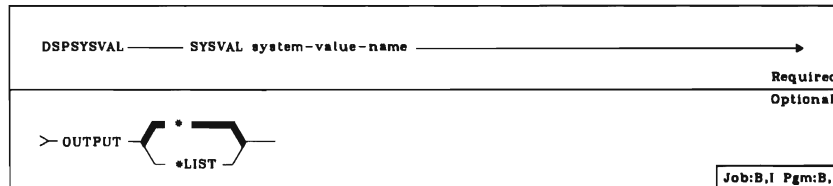

Printer file—QPDSPPSVL

DSPTAP (Display Tape)

Displays the names of files residing on the tape.

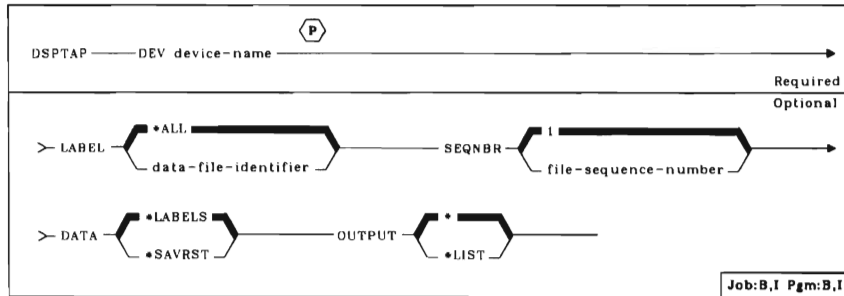

Printer files—QPTAPDSP, QPSRODSP
Tape file—QSYSTAP

DSPTRC (Display Trace)

Displays the traces in a program being debugged (using the ENTDBG command).

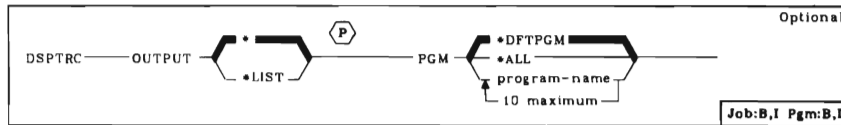

Printer file—QPDBGDSP

DSPTRCDTA (Display Trace Data)

Displays the output of the trace just executed (used with the ENTDBG and ADDTRC commands).

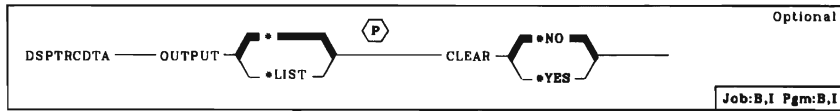

Printer file—QPDBGDSP

DSPUSRPRF (Display User Profile)

Displays the contents of a user profile.

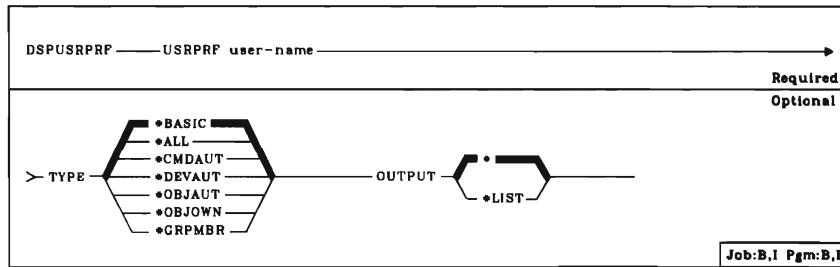

Printer file—QPUSRPRF

DSPWTR (Display Writer)

Displays the current status of all spooling writers, or displays detailed information about a specified spooling writer.

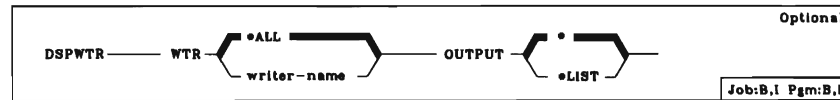

Printer file—QPRTRDWT

DUPDKT (Duplicate Diskette)

Copies the VTOC, IPL, and data records from one diskette to other diskettes.

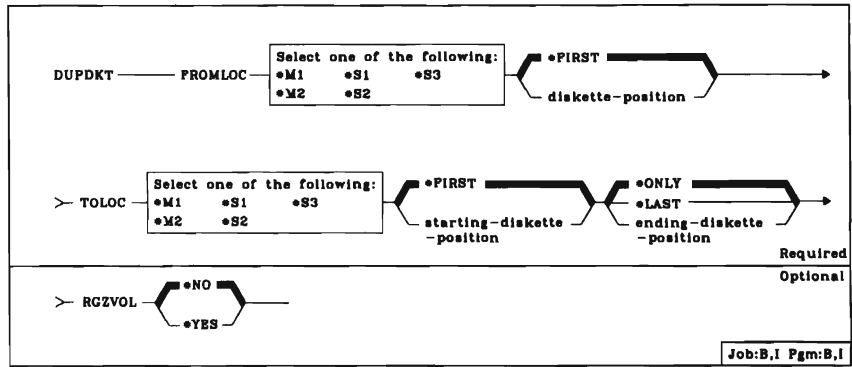

EDTDOC (Edit Document)

Invokes the OFFICE/38 Text Management utility so you can obtain a document without using the primary option menu before and after using Text Management.

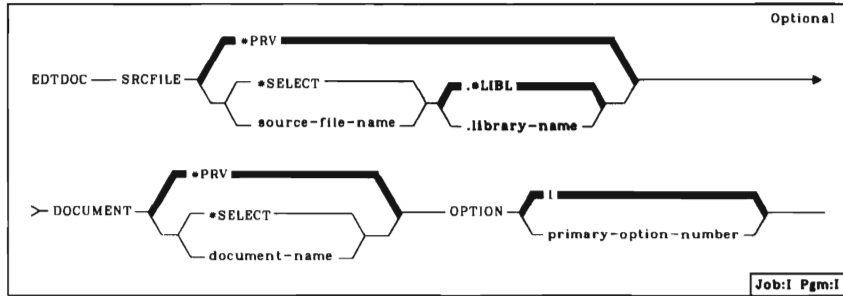

EDTSRC (Edit Source)

Invokes the source entry utility (SEU) to edit source (create a source member, add new records, and change existing records).

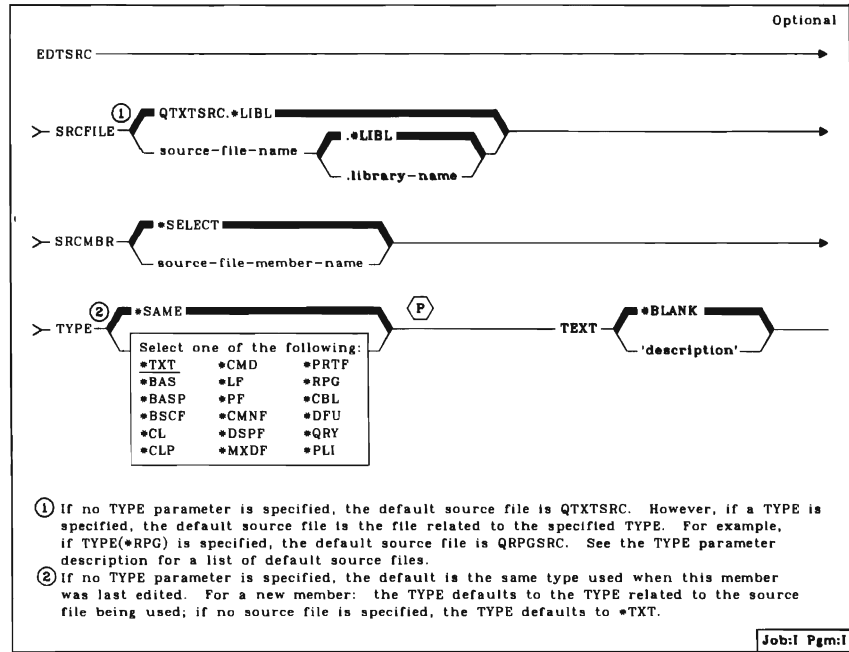

Printer file—QPSUPRTF
 Data base source file—QTXTSRC

EDTTXT (Edit Text)

Invokes the OFFICE/38 Text Management utility so you can select options for creating, revising, browsing, and printing documents, and for filling in a form document.

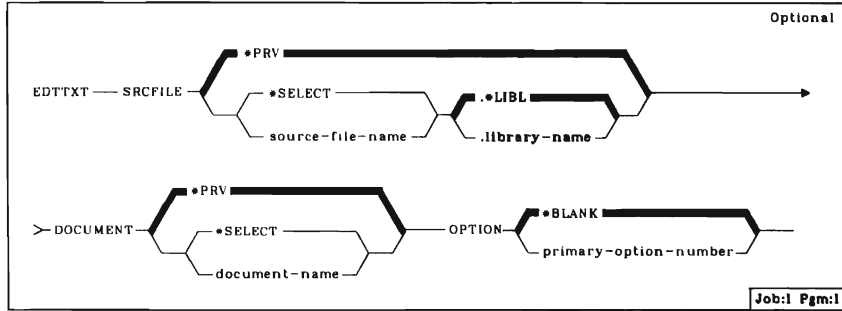

EJTEMLOUT (Eject Emulation Output)

Forces the last data received from the host to the spooled file or printer by closing the printer file, then reopening it so more data can be spooled or printed.

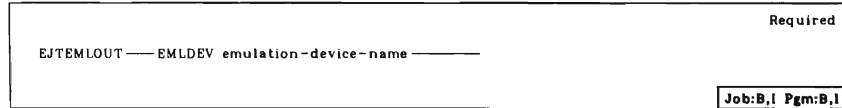

ELSE (Else)

Specifies the action to be taken for the ELSE condition of an IF command in a CL program. Valid only in a CL program.

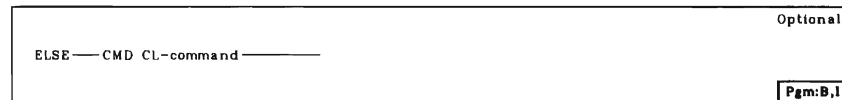

EML3270 (Emulate 3270 Display)

Starts a 3270 work station emulation session.

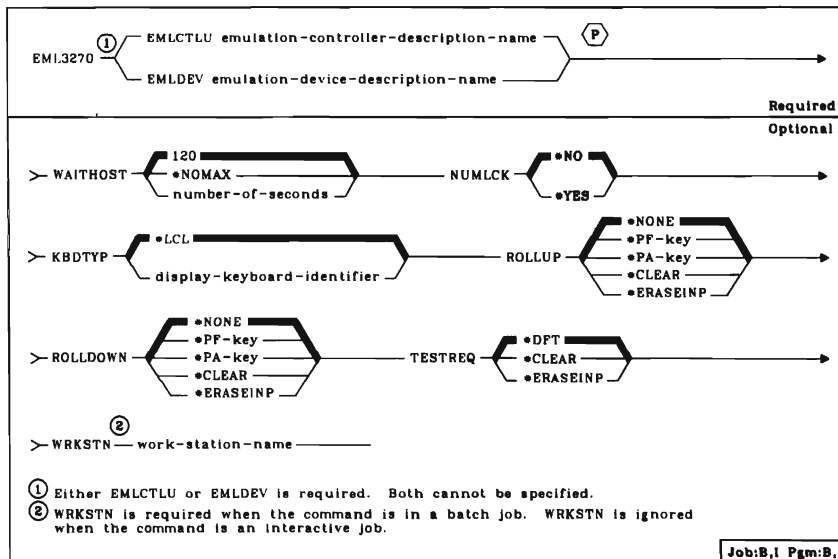

EMLPRTKEY (Emulate Printer Key)

Causes the printer emulation that is using the specified printer emulation device to send either a *PA1 or *PA2 key to the host.

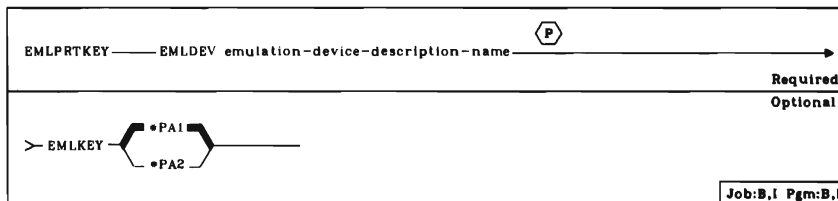

Printer file—QPEN PRTF

ENDCBLDBG (End COBOL Debug)

Terminates COBOL debug mode (used with the ENTCBLDBG command).

ENDCBLDBG — PGM program-name	.LIBL	Optional
	.library-name	Pgm:I

ENDCMTCTL (End Commitment Control)

Notifies the system that changes to the affected files are no longer under commitment control; uncommitted changes are rolled back and are not made permanent.

ENDCMTCTL —	Optional
	Job:B,I Pgm:B,I

ENDDBG (End Debug)

Terminates debug mode (used with the ENTDBG command).

ENDDBG —	Optional
	Job:B,I Pgm:B,I

ENDDO (End Do Group)

Specifies the end of a do group in a CL program. Valid only in a CL program.

ENDDO _____	Pgm:B,I
-------------	---------

ENDINP (End Input)

Indicates the end of the input in a batch input stream.

//ENDINP _____	Required
	Job:B

ENDJOB (End Job)

Indicates the end of a job in a batch input stream.

//ENDJOB _____	Job:B
----------------	-------

ENDJRNPF (End Journaling Physical File Changes)

Ends the journaling of changes for a physical file and all its members.

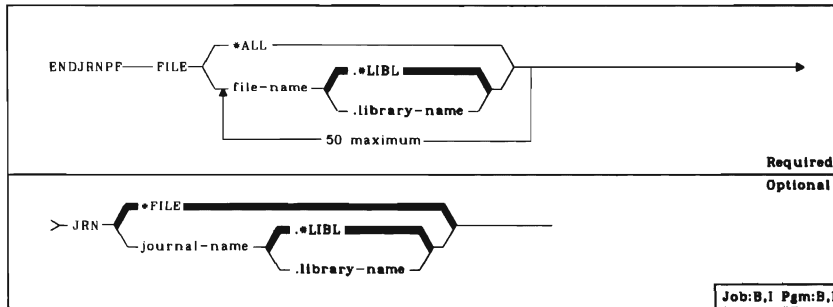

ENDLOG (End Logging)

Ends the logging of all data base operations within the routing step (used with the LOGDBF command).



ENDPASTHR (End Pass-Through)

Terminates a pass-through session.

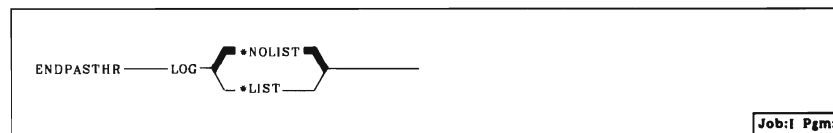

ENDPGM (End Program)

The last source statement in a CL program. Valid only in a CL program.

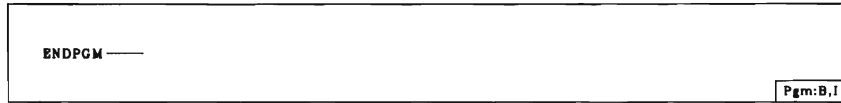

ENDSRV (End Service)

Terminates inter-job servicing (used with SRVJOB command).



ENTADM (Enter Administrative Management)

Invokes the OFFICE/38 Administrative Management utility so you can select options to provide prompts for management of the utility's functions, calendar management, correspondence control, or a message facility.

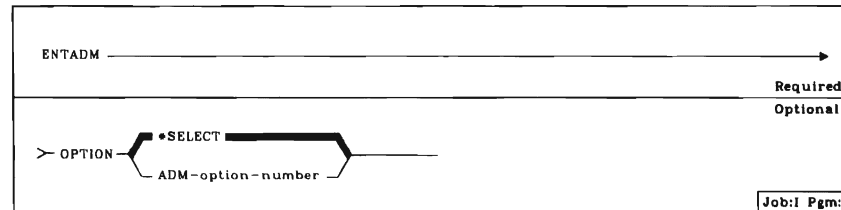

ENTBGU (Enter BGU)

Invokes the OFFICE/38 Business Graphics Utility.



ENTCBLDBG (Enter COBOL Debug)

Places a COBOL program in debug mode by activating COBOL source language debugging statements.

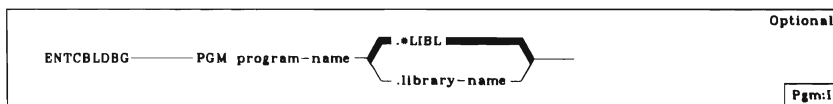

ENTDBG (Enter Debug Mode)

Initiates debug mode.

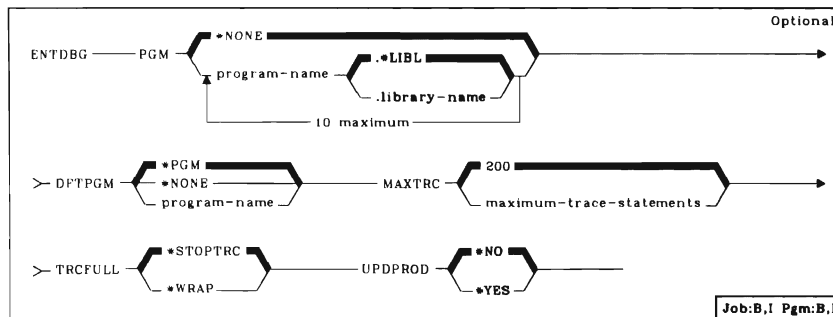

ENTPS (Enter Personal Services)

Allows you to use the personal services functions provided by IBM System/38 OFFICE/38–Personal Services/38 (PS/38).

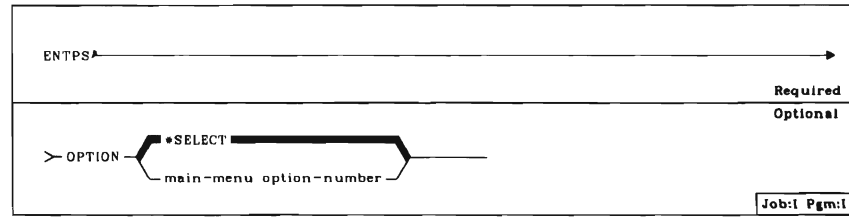

EXCBASPRC (Execute BASIC Procedure)

Executes a BASIC procedure that has been saved as a member of a source file.

EXCBASPRC — SRCMBR member-name —————→	
	Required
Optional	
> SRCFILE — QBASSRC —————→	
source-file-name —	. *LIBL —————→
	.library-name —
	SSNSIZ — 256 —————→
	nnnnn —
> CLACCESS — *YES —————→	
	*NO —
	Job: B, I Pgm: B, I

Data base source file—QBASSRC

FMTDTA (Format Data)

Invokes the Conversion Reformat Utility.

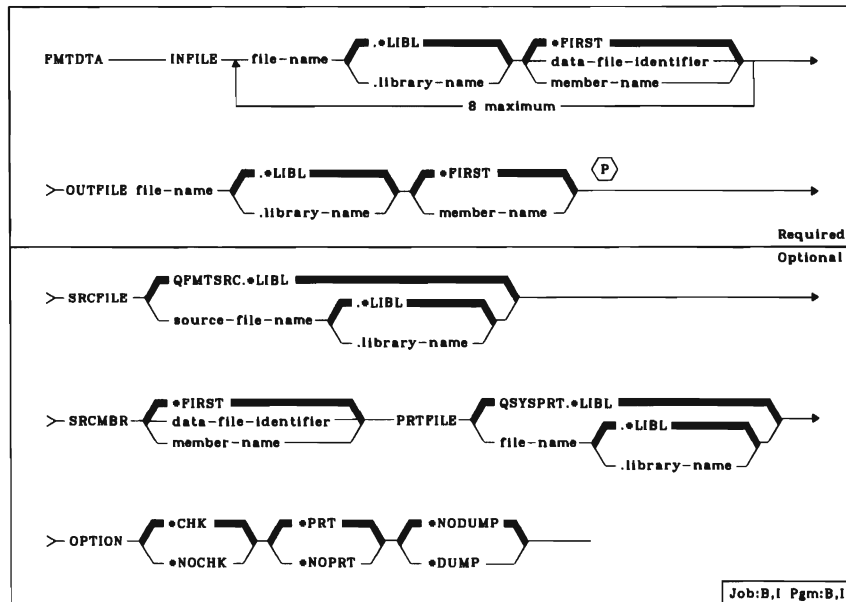

Printer file-QSYSPT

FMTRJEDTA (Format RJE Data)

Executes the RJEF format utility, which converts data written in a compressed format to data written in a decompressed format.

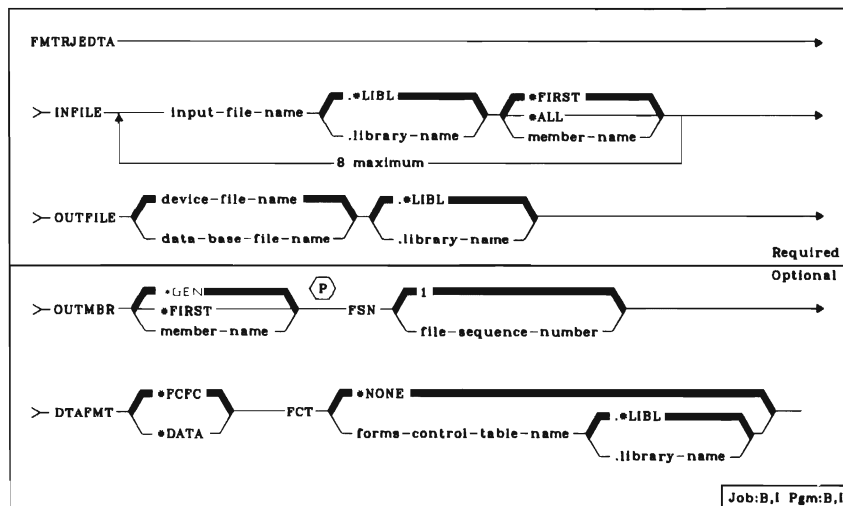

GOTO (Go To)

Branches to another CL command in a CL program. Valid only in a CL program.

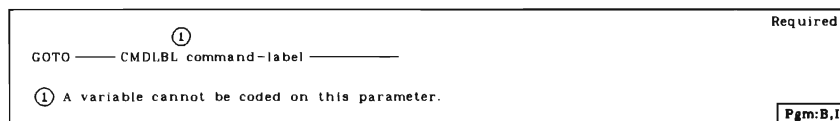

GRTACCAUT (Grant Access Code Authority)

Grants the specified user's authority to receive documents filed with the specified access codes without having been explicitly named as the owner of the document when it was filed.

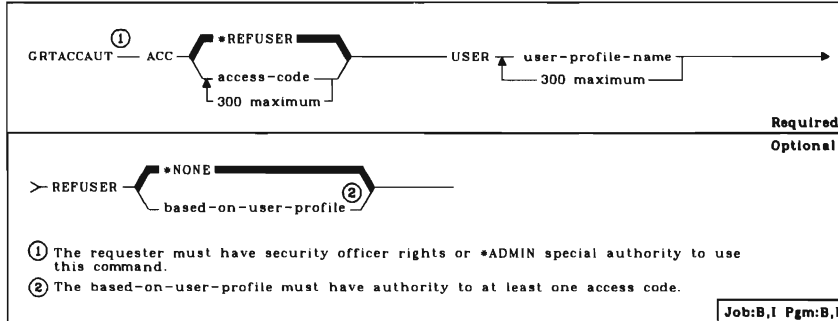

GRTDOCAUT (Grant Document Authority)

Allows one user to permit another user to work on the first user's nonpersonal documents.

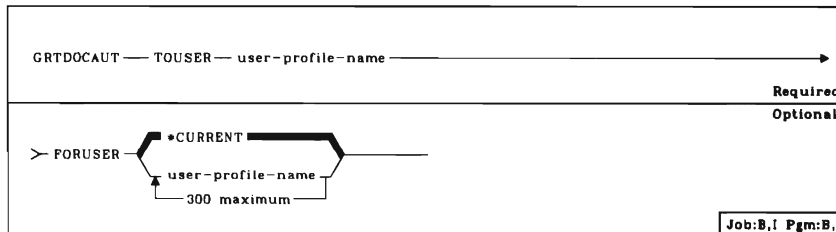

GRTOBJAUT (Grant Object Authority)

Grants authority for the use of objects.

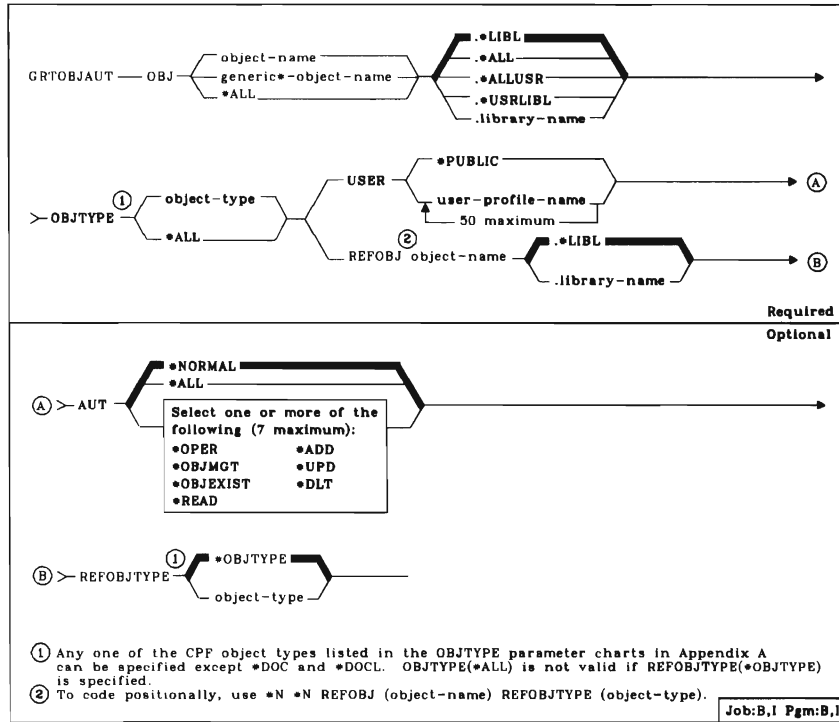

GRTUSRAUT (Grant User Authority)

Grants authority to a user profile by referencing another user profile.

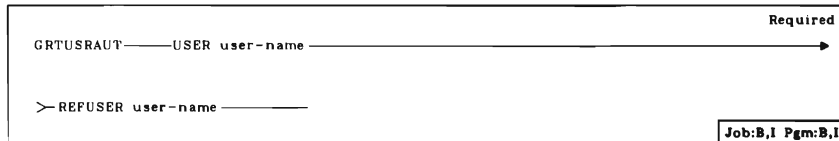

HLDCMNDEV (Hold Communications Device)

Allows the operator to stop communication through the specified device description in either of two ways: controlled or immediate.

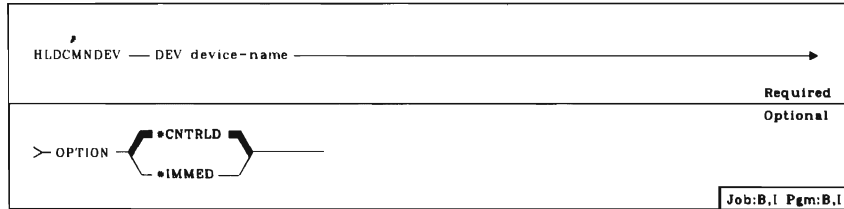

HLDJOB (Hold Job)

Makes a job ineligible for processing by the system. The job may be on a job queue, it may be active within a subsystem, or it may have already completed execution.

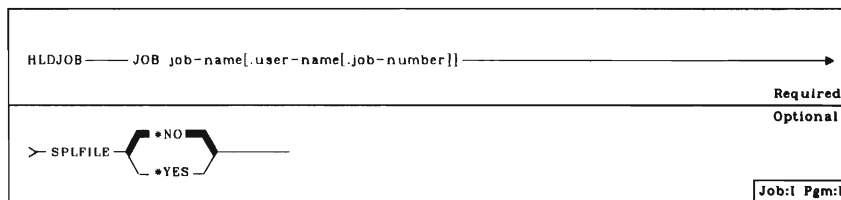

HLDJOBQ (Hold Job Queue)

Prevents entries on a job queue from being selected for execution.

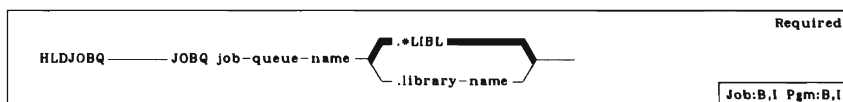

HLDOUQ (Hold Output Queue)

Prevents entries on an output queue from being processed by a spooling writer.

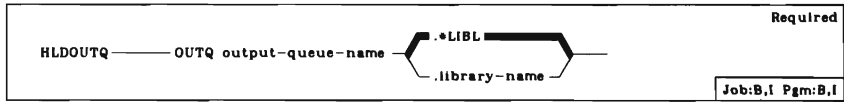

HLDRDR (Hold Reader)

Prevents further processing by a spooling reader.



HLDSPLF (Hold Spooled File)

Prevents further processing of a spooled file by a spooling writer.

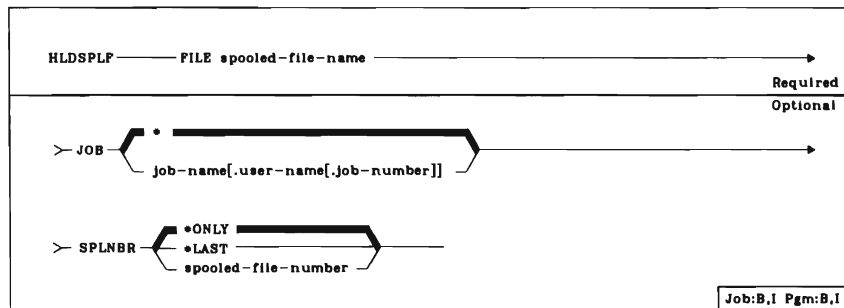

HLDWTR (Hold Writer)

Prevents further processing by a spooling output writer.



IF (If)

Evaluates a logical expression and executes a CL command only if the result is true. If the CL command is DO, the entire do group is executed. Valid only in a CL program.

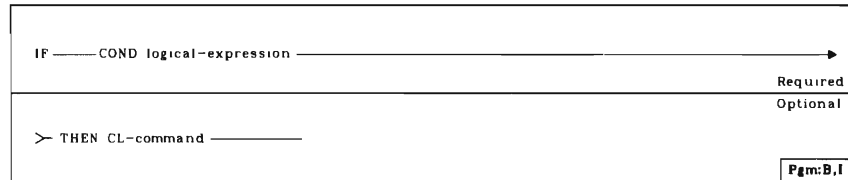

INZDKT (Initialize Diskette)

Initializes and formats a diskette and checks for defects.

INZDKT _____																				
> LOC	<table border="1"> <tr> <td colspan="3">Select one of the following:</td> </tr> <tr> <td>•M12</td> <td>•S1</td> <td>•S12</td> </tr> <tr> <td>•M1</td> <td>•S2</td> <td>•S23</td> </tr> <tr> <td>•M2</td> <td>•S3</td> <td>•S123</td> </tr> </table>	Select one of the following:			•M12	•S1	•S12	•M1	•S2	•S23	•M2	•S3	•S123	<table border="1"> <tr> <td>•FIRST</td> <td>•LAST</td> </tr> <tr> <td>starting-diskette</td> <td>ending-diskette</td> </tr> <tr> <td>-position</td> <td>-position</td> </tr> </table>	•FIRST	•LAST	starting-diskette	ending-diskette	-position	-position
Select one of the following:																				
•M12	•S1	•S12																		
•M1	•S2	•S23																		
•M2	•S3	•S123																		
•FIRST	•LAST																			
starting-diskette	ending-diskette																			
-position	-position																			
		Required																		
> NEWVOL	<table border="1"> <tr> <td>•NONE</td> <td>•BLANK</td> </tr> <tr> <td>volume-identifier</td> <td>owner-identifier</td> </tr> </table>	•NONE	•BLANK	volume-identifier	owner-identifier	Optional														
•NONE	•BLANK																			
volume-identifier	owner-identifier																			
> FMT	<table border="1"> <tr> <td>•DATA</td> <td>•STD</td> <td rowspan="5">SCTSIZ</td> <td rowspan="5"> <table border="1"> <tr> <td>•YES</td> </tr> <tr> <td>•NO</td> </tr> </table> </td> </tr> <tr> <td>1</td> <td>128</td> </tr> <tr> <td>2</td> <td>256</td> </tr> <tr> <td>2D</td> <td>512</td> </tr> <tr> <td>•DATA2</td> <td>1024</td> </tr> <tr> <td>•SAVRST</td> <td></td> <td></td> <td></td> </tr> </table>	•DATA	•STD	SCTSIZ	<table border="1"> <tr> <td>•YES</td> </tr> <tr> <td>•NO</td> </tr> </table>	•YES	•NO	1	128	2	256	2D	512	•DATA2	1024	•SAVRST				
•DATA	•STD	SCTSIZ	<table border="1"> <tr> <td>•YES</td> </tr> <tr> <td>•NO</td> </tr> </table>			•YES	•NO													
•YES																				
•NO																				
1	128																			
2	256																			
2D	512																			
•DATA2	1024																			
•SAVRST																				
> SUFFIX	<table border="1"> <tr> <td>•FMT</td> <td>•EBCDIC</td> </tr> <tr> <td>•YES</td> <td>•ASCII</td> </tr> <tr> <td>•NO</td> <td></td> </tr> </table>	•FMT	•EBCDIC	•YES	•ASCII	•NO														
•FMT	•EBCDIC																			
•YES	•ASCII																			
•NO																				
<p>① If FMT(•SAVRST) is specified, NEWVOL must also be specified and CODE(•ASCII) cannot be specified</p>																				
Job:B,I Pgm:B,I																				

Diskette file-QSYSDKT

INZPFM (Initialize Physical File Member)

Initializes a physical file member to the specified number of default or deleted records.

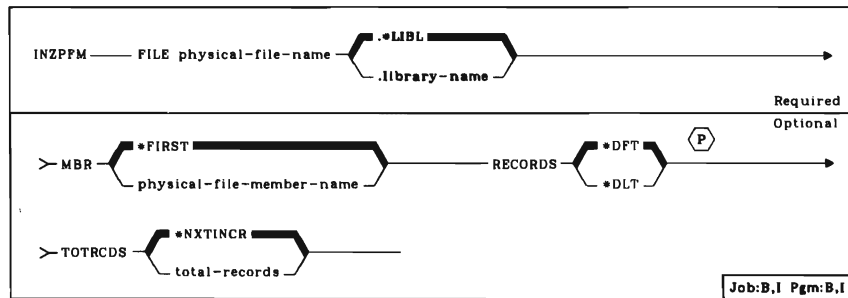

INZTAP (Initialize Tape)

Initializes and writes standard volume labels on a tape.

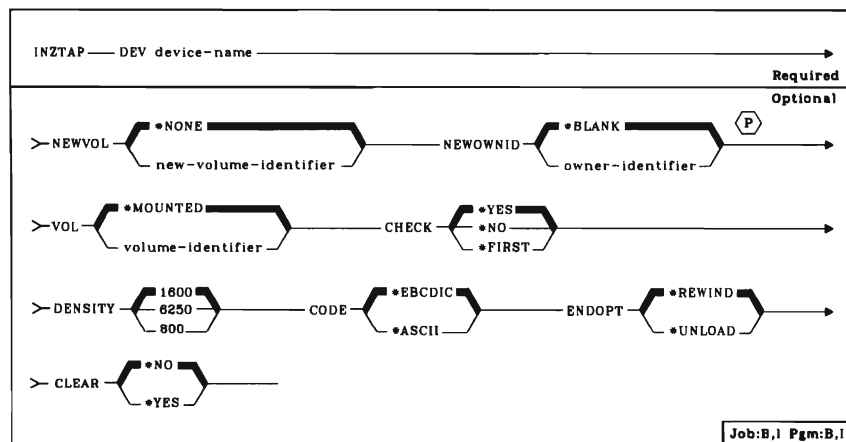

Tape file—QSYSTAP

JOB (Job)

Defines the beginning of a job in a batch input stream.

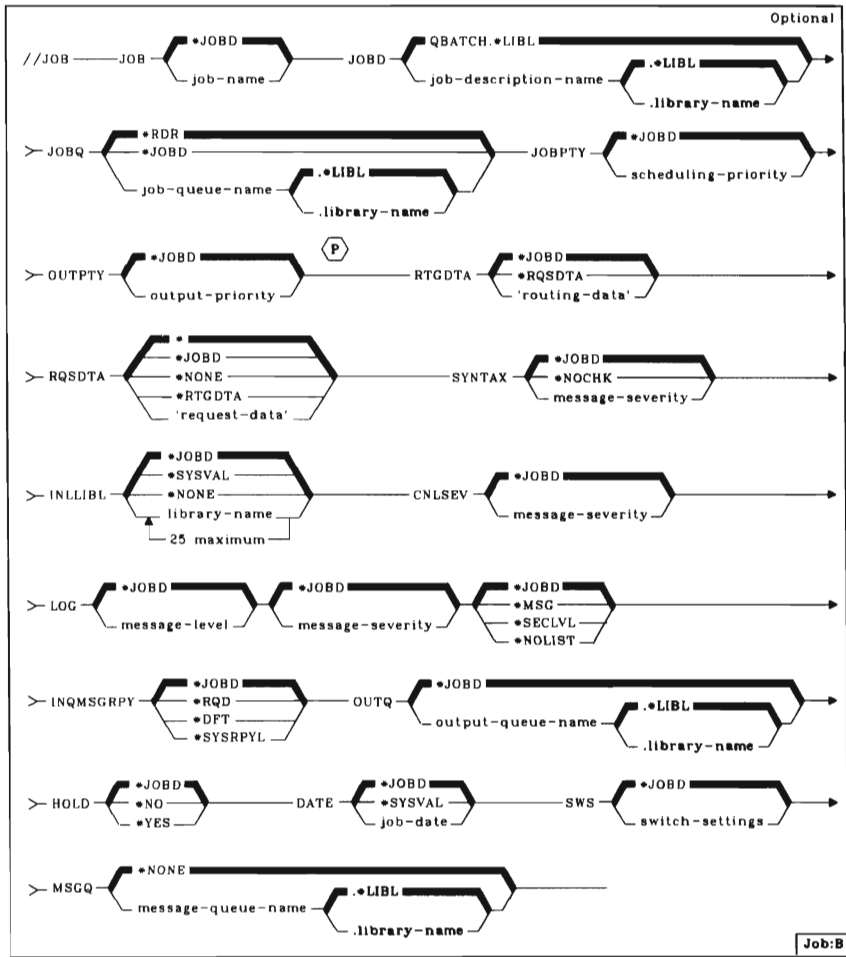

JRNPF (Journal Physical File)

Starts journaling changes made to all members of a physical file into a journal.

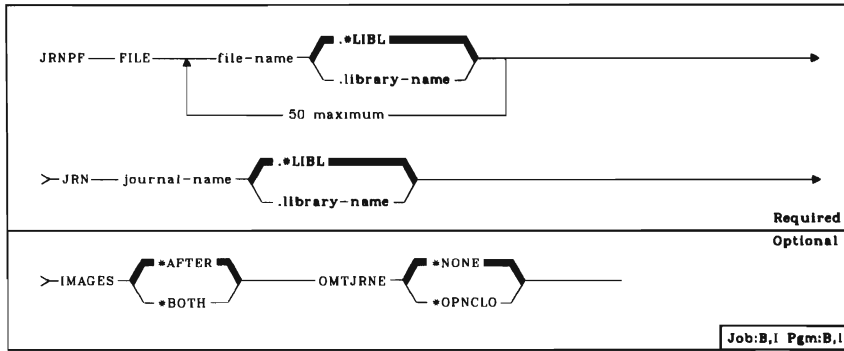

LODPGMCHG (Load Programming Change)

Loads programming changes (PCs) from diskette into a library.

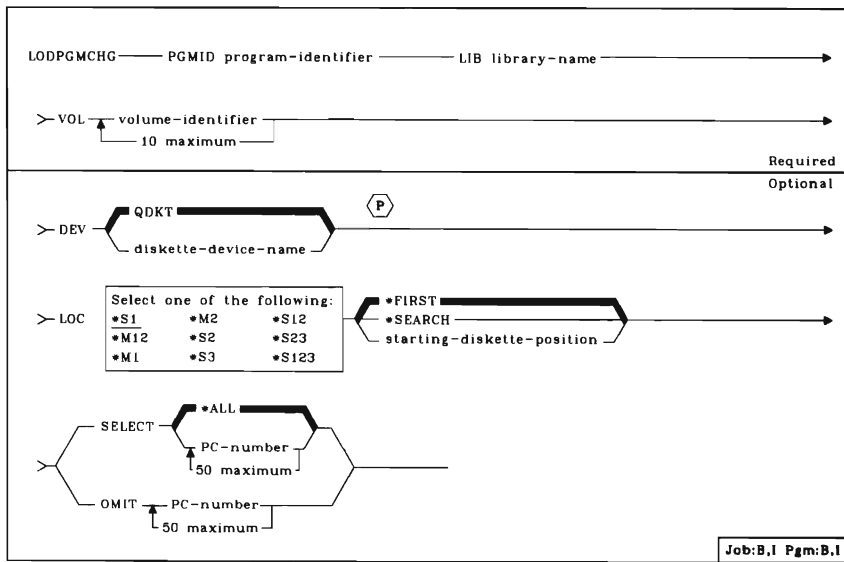

Diskette file—QSYSDKT

LOGDBF (Log Data Base File)

Begins the logging of all data base operations for the job or routing step that modify the specified data base files.

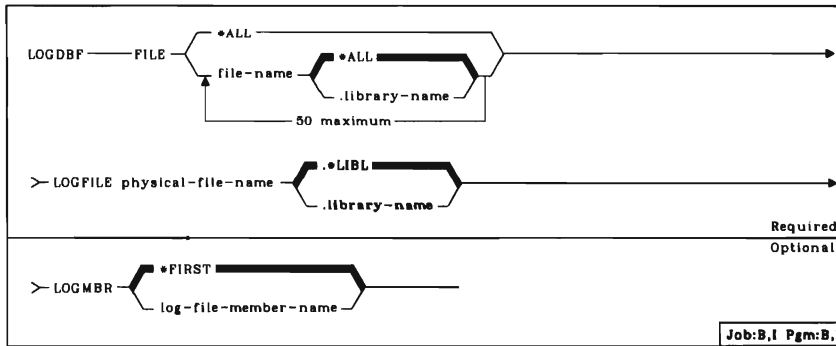

LSTCMDUSG (List Command Usage)

Produces a cross-reference listing of a specified group of CL commands that are used in a specified group of CL programs.

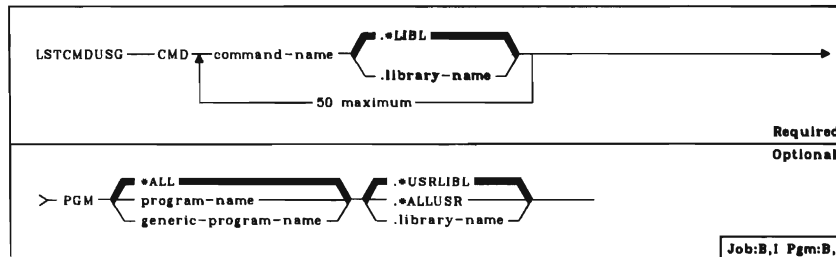

Printer file—QSYSVRT

LSTCNPDTA (List CSNAP Data)

Prints short-term CSNAP (Communications Statistical Network Analysis Procedure) line and station statistics. The listing is spooled to printer file QPCSMPT.

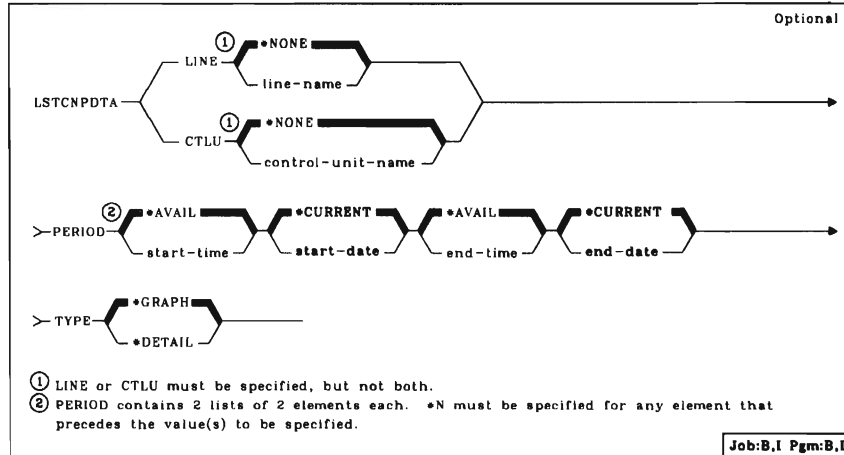

Printer file—QPCSMPT

LSTCNPST (List CSNAP History)

Prints CSNAP (Communications Statistical Network Analysis Procedure) history data. The listing is spooled to printer file QPCSMPT.

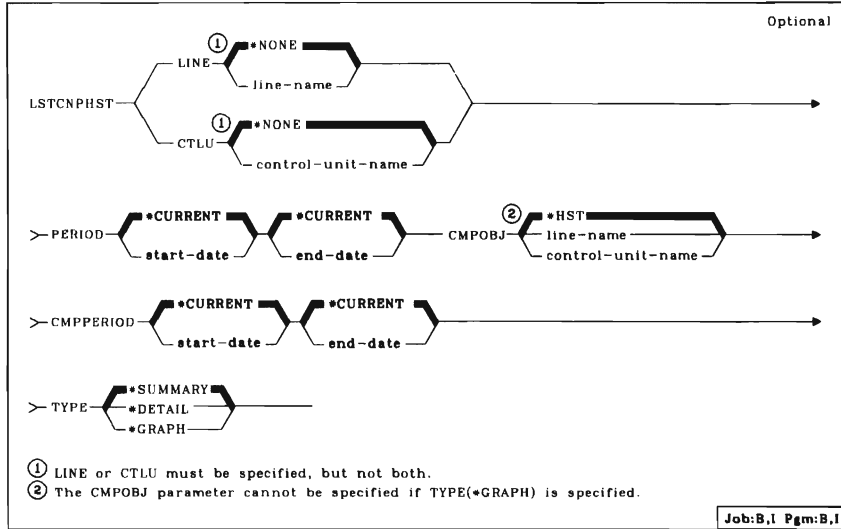

Printer file-QPCSMPT

LSTERRLOG (List Error Log)

Prints error log data from the machine error log.

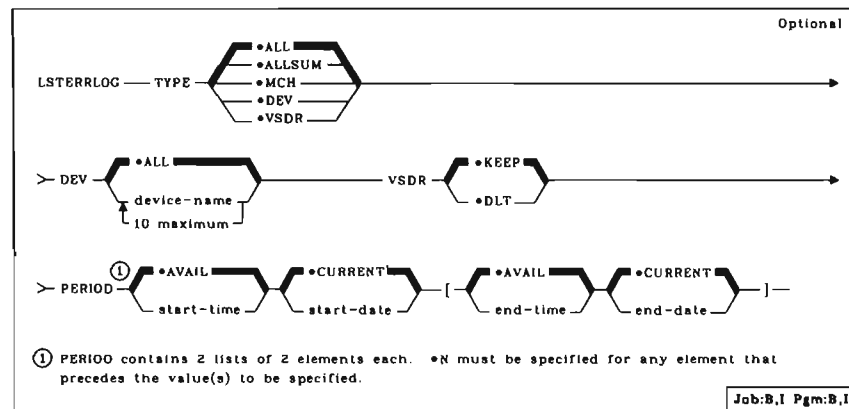

Printer file-QPCSMPT

LSTINTDTA (List Internal Data)

Prints the contents of internal machine data areas.

LSTINTDTA — TYPE —	<ul style="list-style-type: none">•DMP•ECLOG•MTR•NOTES	→	Required
> DMPID dump-identifier		→	Optional
> PERIOD	<ul style="list-style-type: none">•AVAIL — start-time•CURRENT — start-date [— <ul style="list-style-type: none">•AVAIL — end-time•CURRENT — end-date] —	→	
<p>① If •DMP is specified, the DMPID parameter must be specified. ② PERIOD contains 2 lists of 2 elements each. •N must be specified for any element that precedes the value(s) to be specified.</p>			
			Job:B,I Pgm:B,I

Printer file—QPCSMPT

MNGDEVTBL (Manage Device Table)

Allows you to create finance device tables and, once they are created, allows you to add or delete device names in these tables.

MNGDEVTBL — DEVTBL —	<ul style="list-style-type: none">•SELECTdevice-table-name	→	Optional
> TEXT	<ul style="list-style-type: none">•BLANK'description'	→	
			Job:I Pgm:I

MNGDIR (Manage Directory)

Displays, adds, changes, removes, and deletes entries in the system distribution directory.

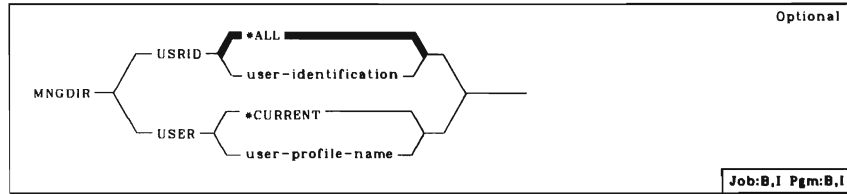

MNGDSTL (Manage Distribution List)

Displays, adds, and changes distribution lists.

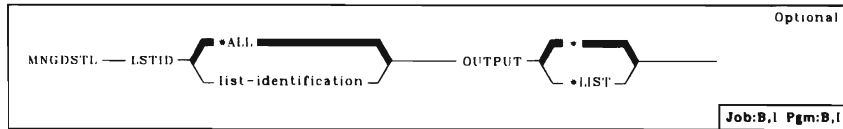

MNGPGMTBL (Manage Program Table)

Allows you to create finance program tables and, once they are created, allows you to add or delete program names in these tables.

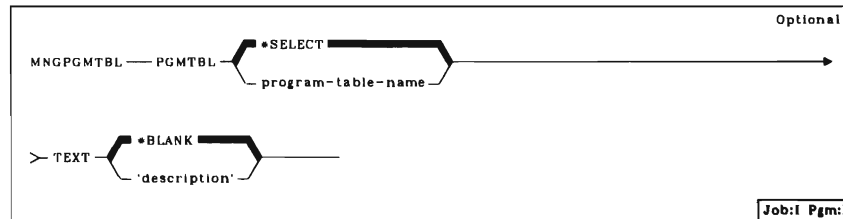

MNGUSRTBL (Manage User Table)

Allows you to create finance user tables and, once they are created, allows you to add or delete user IDs to these tables.

MNGUSRTBL	—	USRTBL	{ *SELECT	_____	Optional
			{ user-table-name	_____	
> TEXT	{ *BLANK	_____			
	{ 'description'	_____			
					Job:1 Pgm:1

MONMSG (Monitor Message)

Monitors for the arrival of messages sent to the program message queue of a CL program. Valid only in a CL program.

MONMSG	—	MSGID	①	message-identifier	_____	Required
				50 maximum	_____	Optional
> CMPDTA	{ *NONE	_____	②	EXEC CL-command	_____	
	{ comparison-data	_____	①			
① A variable cannot be coded on this parameter.						Pgm:B,1
② If this MONMSG command is specified immediately after the PGM command or the last DCL command, only the GOTO command is valid here.						

MOV OBJ (Move Object)

Removes an object from its current library and places it in another library.

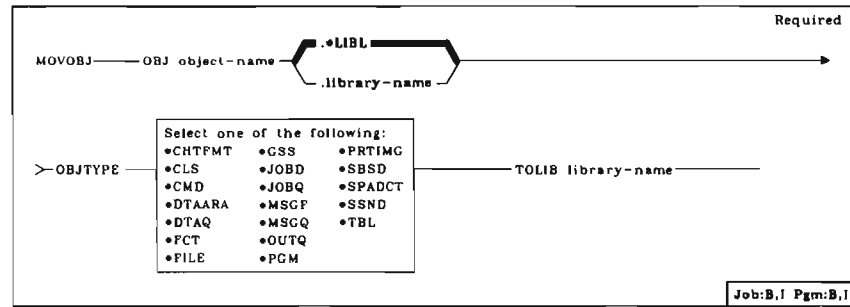

MRGFORMD (Merge Form Description)

Merges a spooled output file with a form definition data base file designed with the DSNAPF (Design Advanced Printer Function).

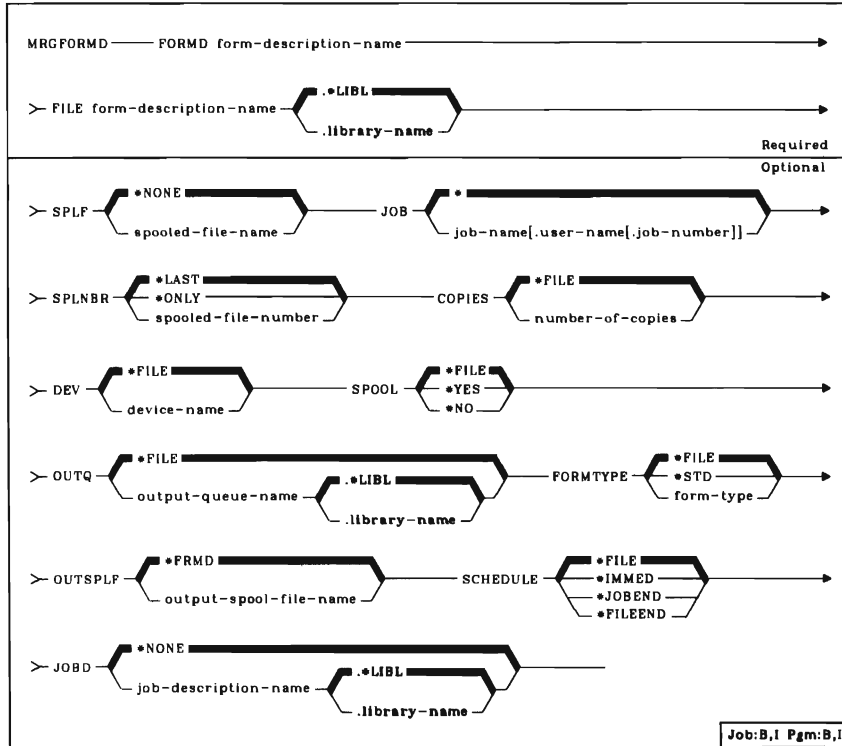

OPNDBF (Open Data Base File)

Opens a data base file member.

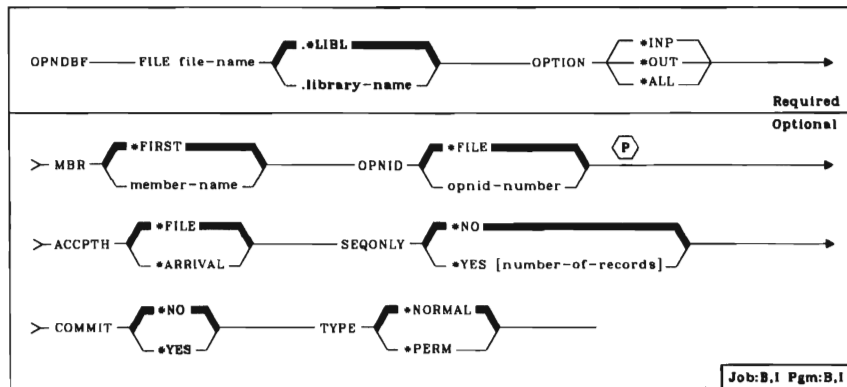

OVRBSCF (Override with BSC File)

Allows the execution time override of a file used by a program with a BSC (binary synchronous communications) file.

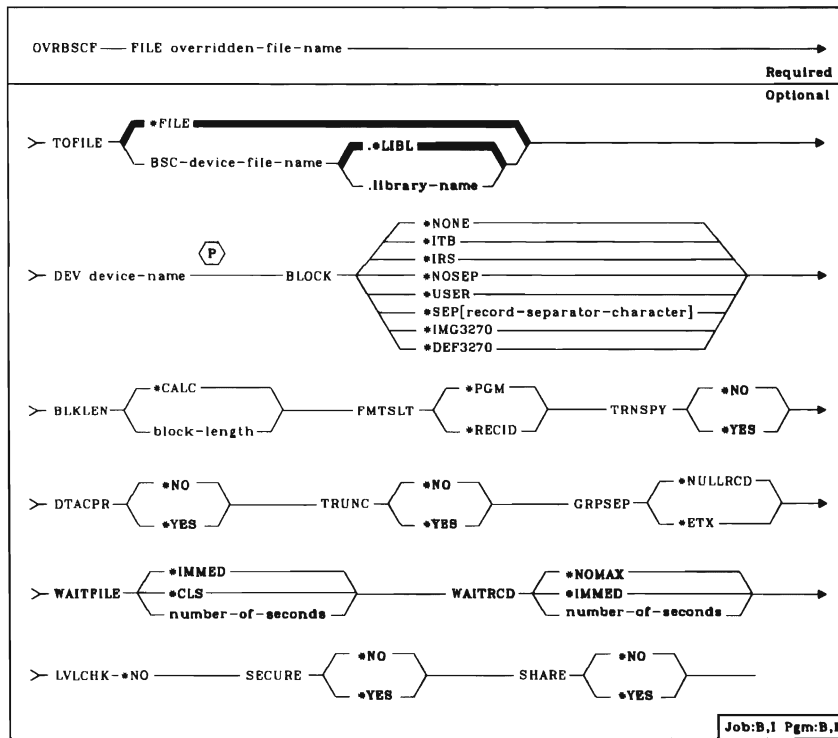

OVRCMNF (Override with Communications File)

Allows the execution-time override of a file used by a program with a communications file.

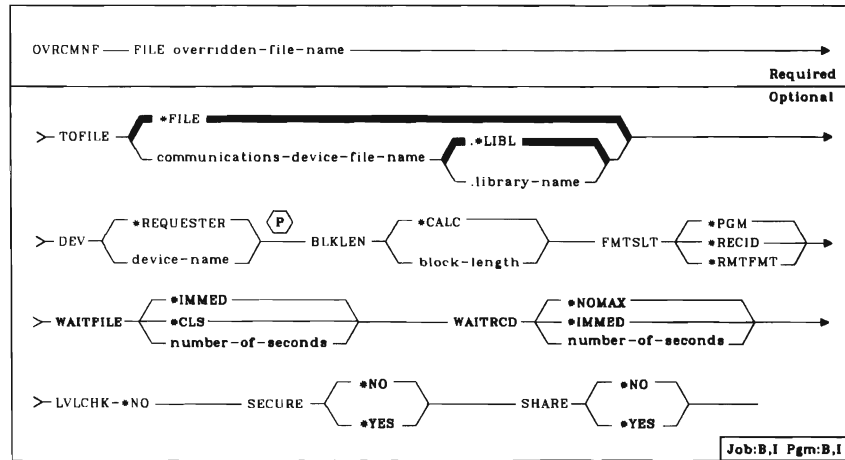

OVRCRDF (Override with Card File)

Allows the execution-time override of a file used by a program with a card file.

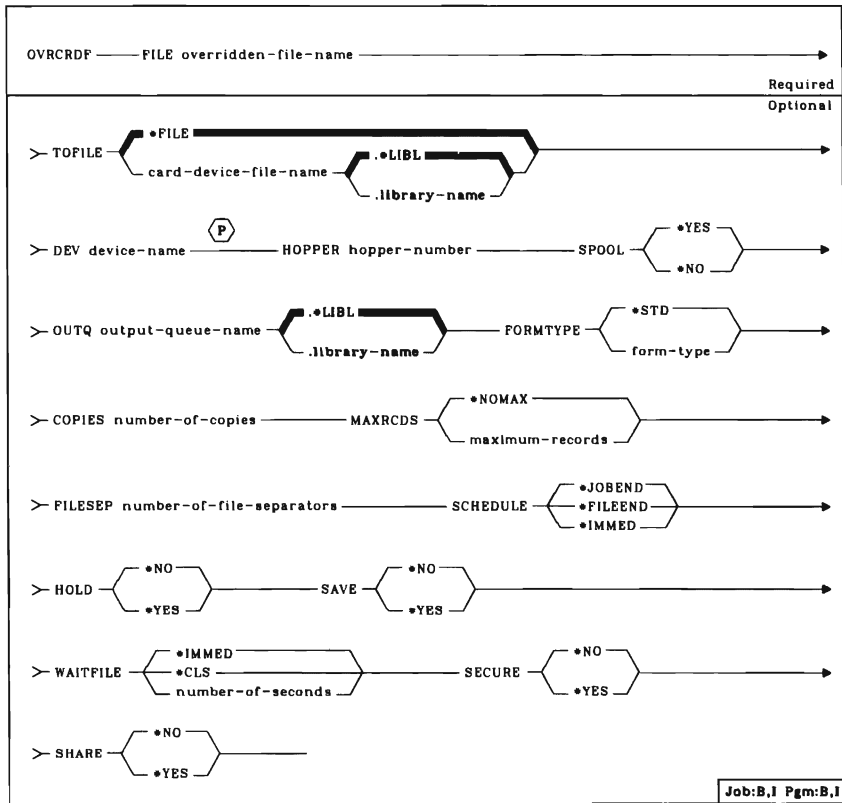

OVRDBF (Override with Data Base File)

Allows the execution-time override of a file used by a program with a data base file.

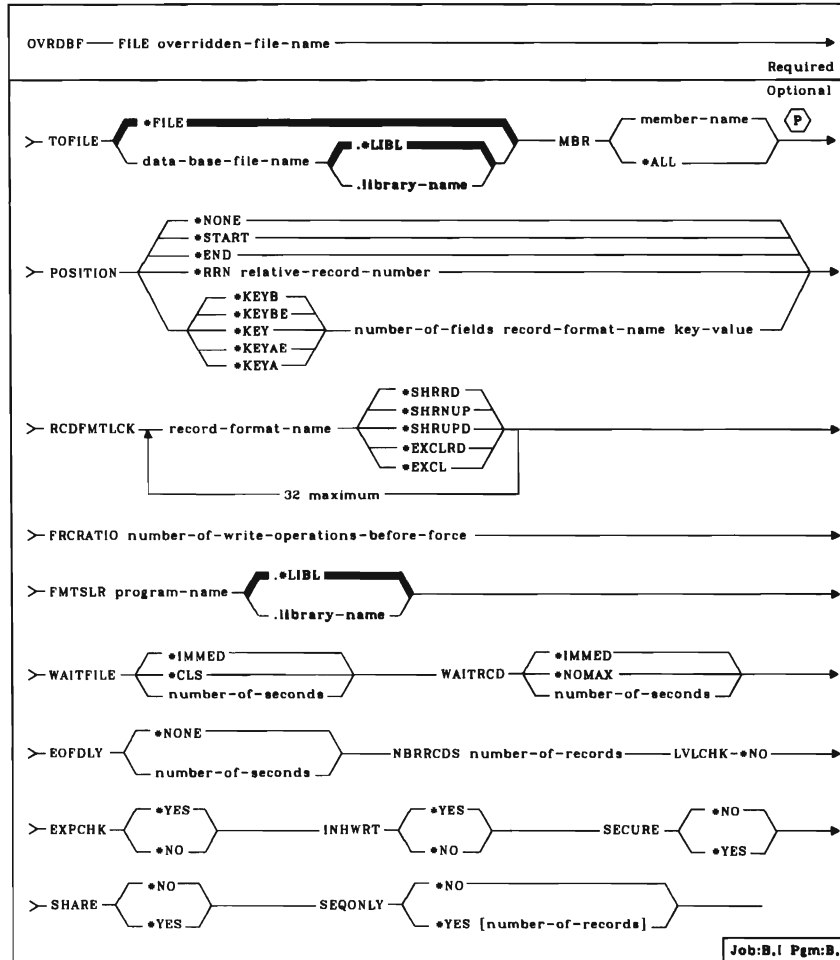

OVRDKTF (Override with Diskette File)

Allows the execution-time override of a file used by a program with a diskette file.

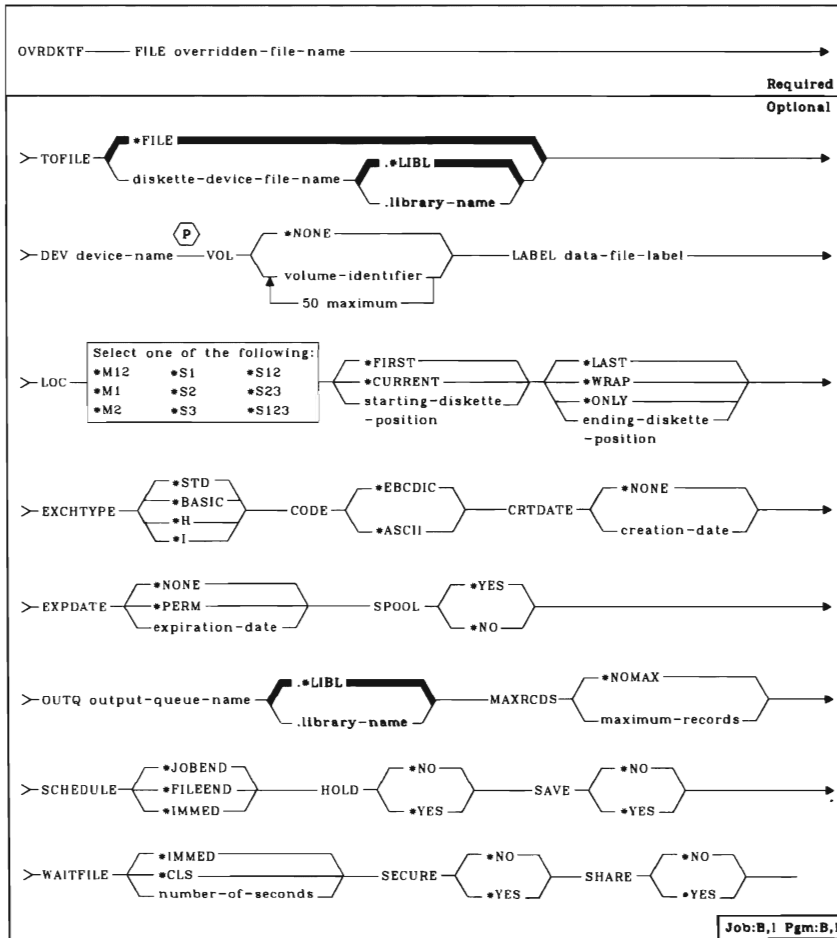

OVRDSPF (Override with Display File)

Allows the execution-time override of a file used by a program with a display file.

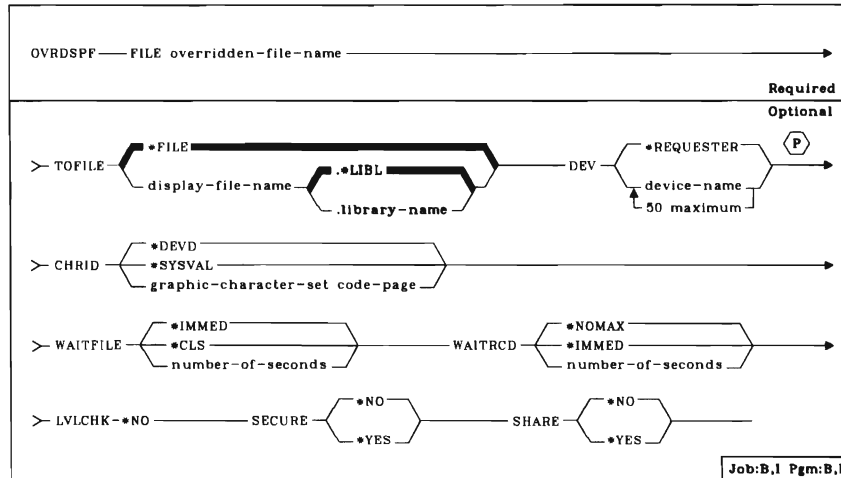

OVRMSGF (Override with Message File)

Overrides the name of the message file specified by a program.

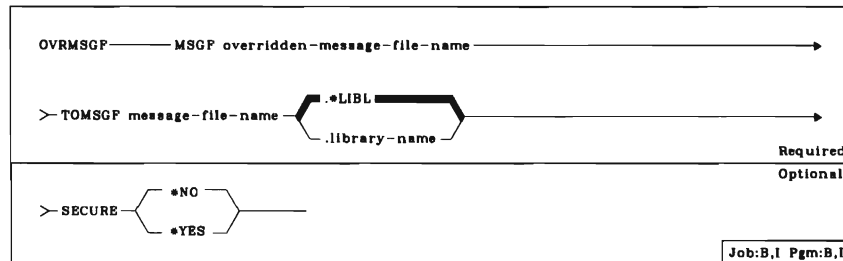

OVRMXDF (Override with Mixed File)

Overrides (replaces) (1) the file named in the program, (2) certain parameters of a file that is used by the program, and (3) certain parameters of the file to be processed.

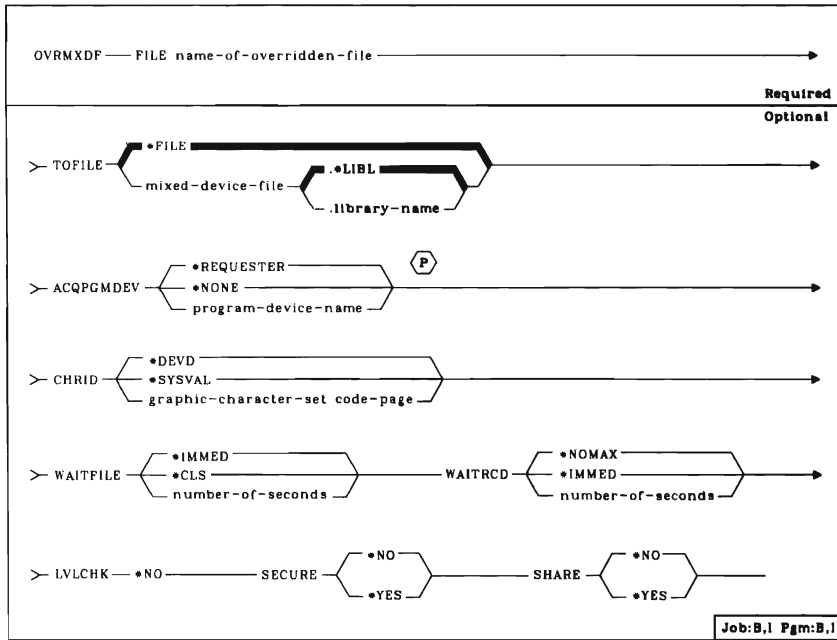

OVRPRTF (Override with Printer File)

Allows the execution-time override of a file used by a program with a printer file.

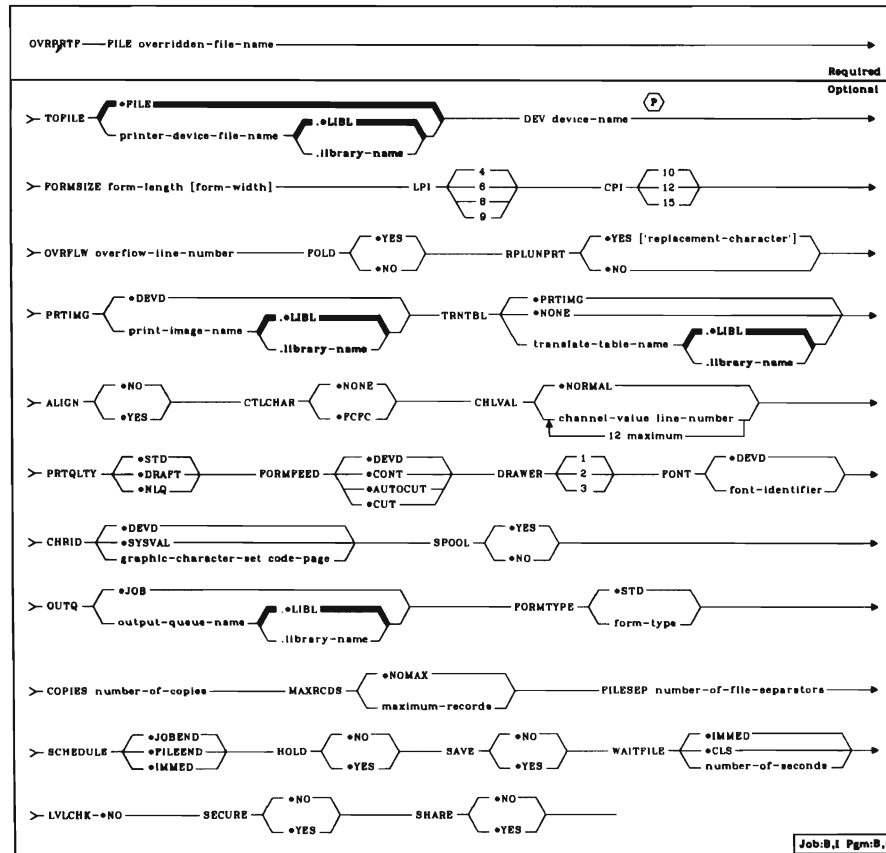

OVRSAVF (Override Save File)

Overrides or replaces a file named in a program, overrides certain attributes of a file that are used by a program, or overrides the file named in a program and certain attributes of the overriding file.

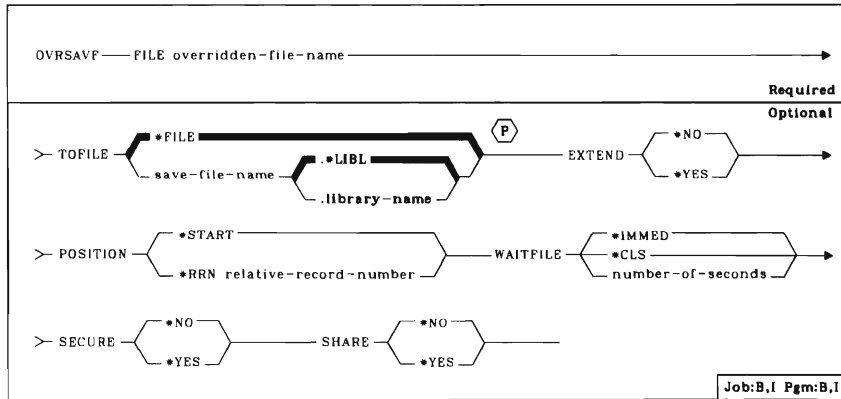

OVRTAPF (Override with Tape File)

Allows the execution-time override of a file used by a program with a tape file.

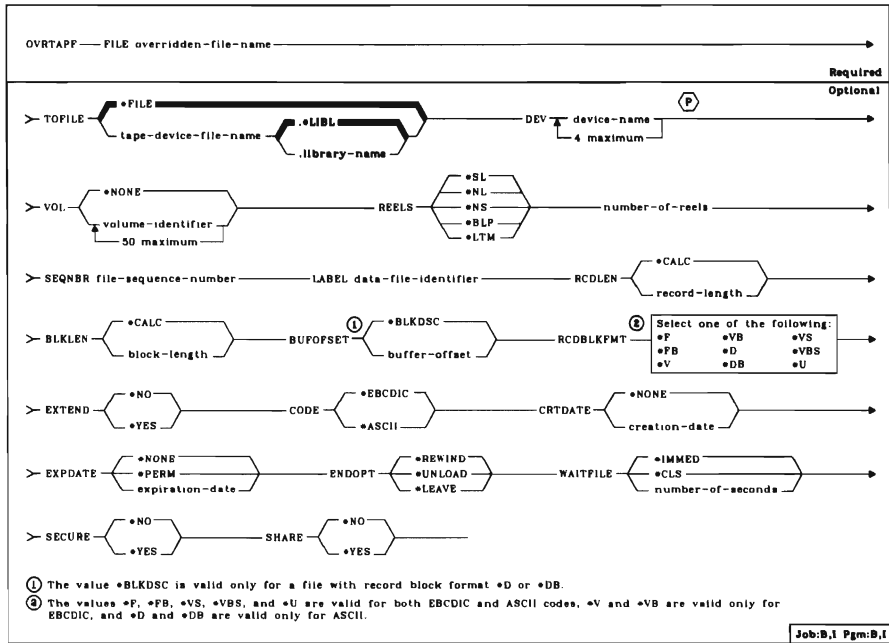

PCHPGM (Patch Program)

Repairs a program at the MI program template level.

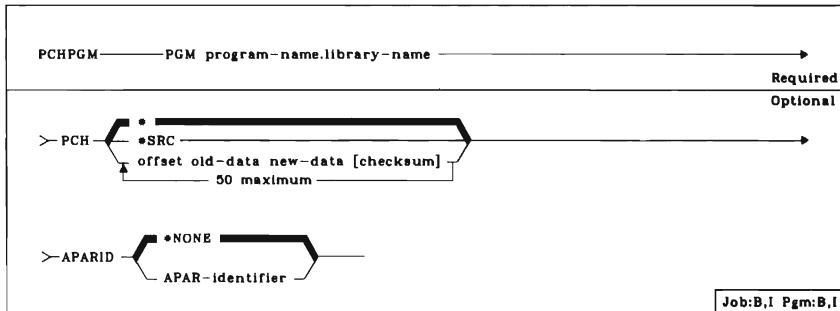

Printer file—QPPCHPGM

PGM (Program)

Specifies the beginning of a CL program. Valid only in a CL program.

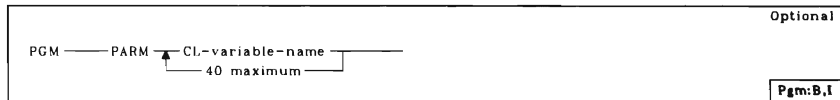

PRPAPAR (Prepare APAR)

Records data on diskette for possible submission with an APAR.

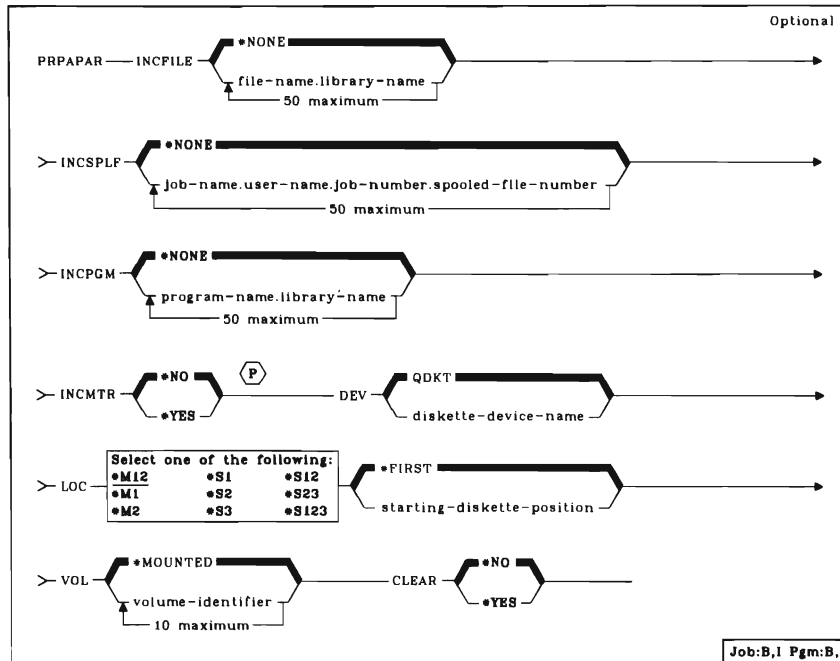

Diskette file—QSYSDKT

PRTDOC (Print Document)

Prints a document with no interactive displays shown.

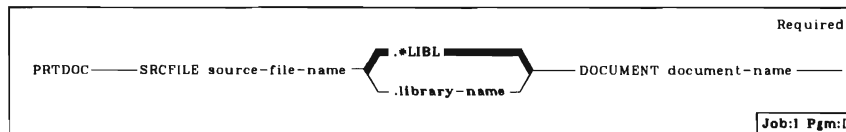

Printer file—QSYSPRT

PWRCTLU (Power Control Unit)

Turns the 3411 tape control unit power supply on or off.

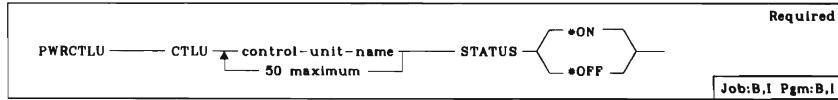

PWRDEV (Power Device)

Turns the power supply for the 5424 MFCU, and the 3203, 3262, and 5211 Printers, on or off.

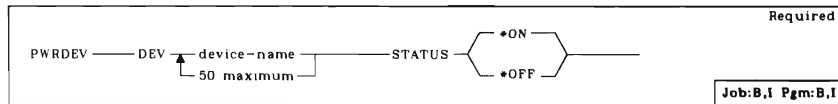

PWRDWNSYS (Power Down System)

Prepares hardware and software for a power down, and powers the System/38 down.

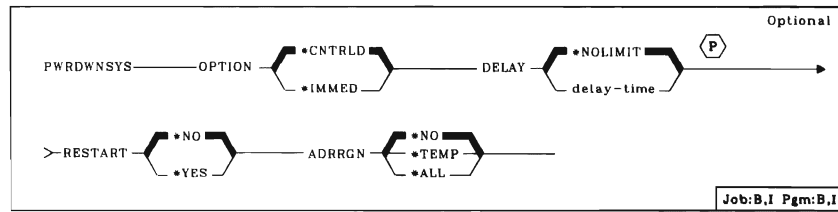

QRYDTA (Query Data)

Executes an existing query application to create a report.

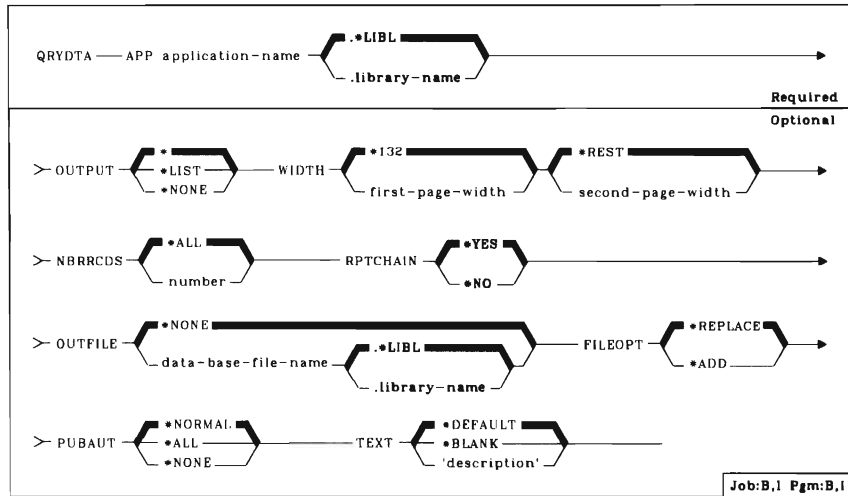

Printer files—QQRYPRT, QQRYPRT2
Display files—QQRDYS, QQRDYS2

RCLRSC (Reclaim Resources)

Frees static storage that is no longer needed by a high-level language program that has finished executing.

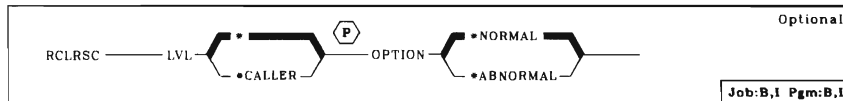

RCLSTG (Reclaim Storage)

Performs a general cleanup of auxiliary storage.

RCLSTG _____
Job: I Pgm: I

Printer file—QPRCLDMP

RCVDTAARA (Receive Data Area)

Copies the contents of a data area into a corresponding CL variable.
Valid only in a CL program.

RCVDTAARA — DTAARA data-area-name _____	Required
① A variable cannot be coded on this parameter.	
	Pgm: B, I

RCVF (Receive File)

Reads a record from a display file. Valid only in a CL program.

RCVF — DEV — FILE _____	Optional
device-name	
> RCDPMT — FILE _____	
record-format-name ①	WAIT — YES _____
	NO _____
① A CL variable cannot be coded on this parameter.	
	Pgm: B, I

RCVJRNE (Receive Journal Entry)

Allows a specified user exit program to continually receive journal entries one at a time.

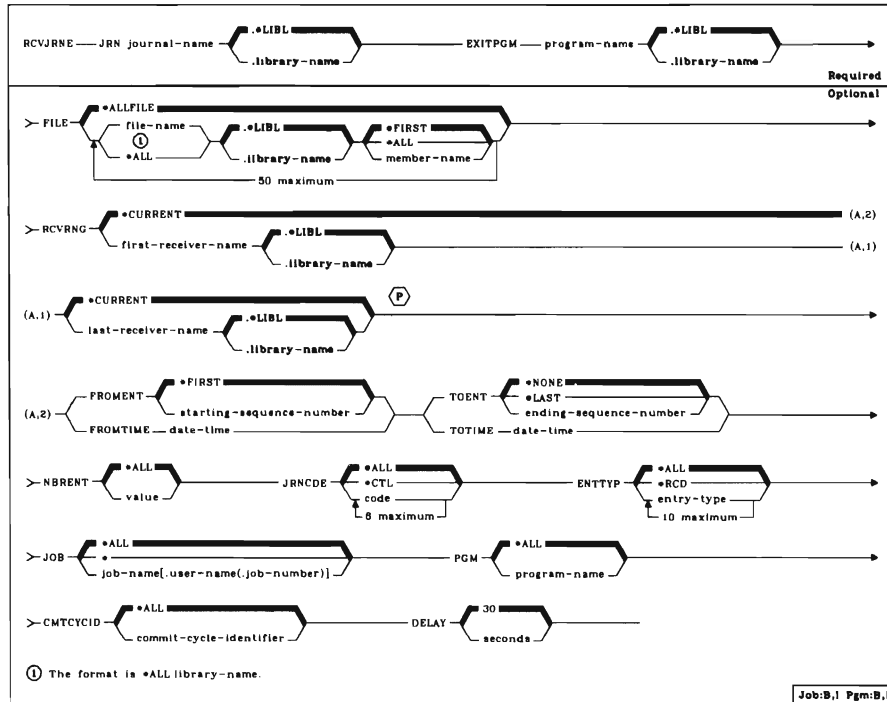

RCVMSG (Receive Message)

Receives a message. Valid only in a CL program.

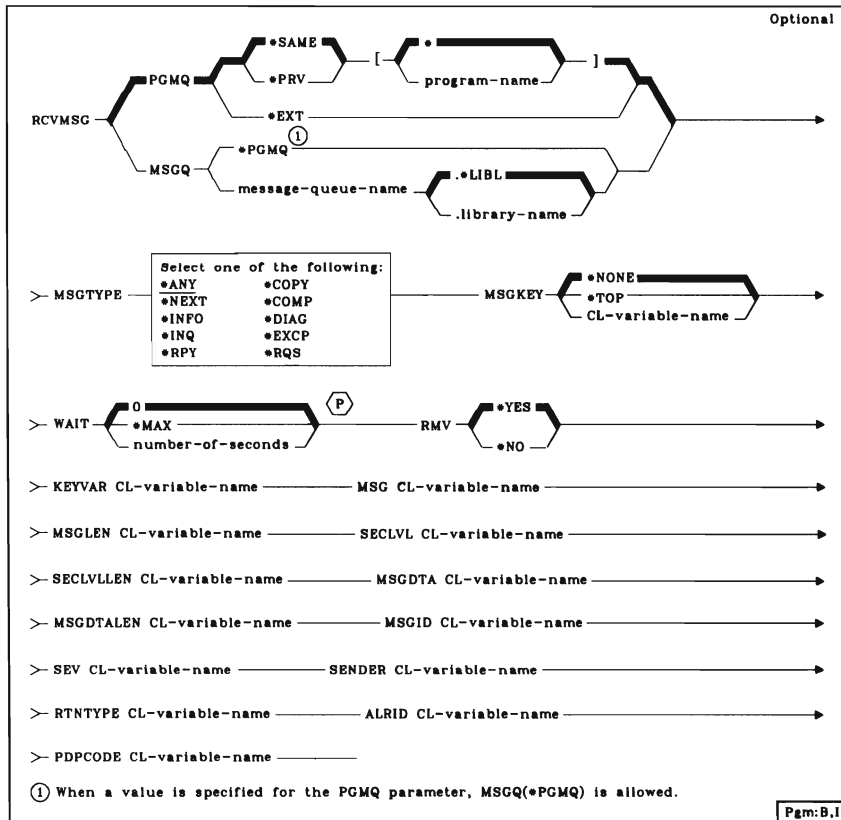

RCVNETF (Receive Network File)

Receives a network file and copies the records into a physical data base file or a save file. Once the file has been received, it will be removed from the queue of network files.

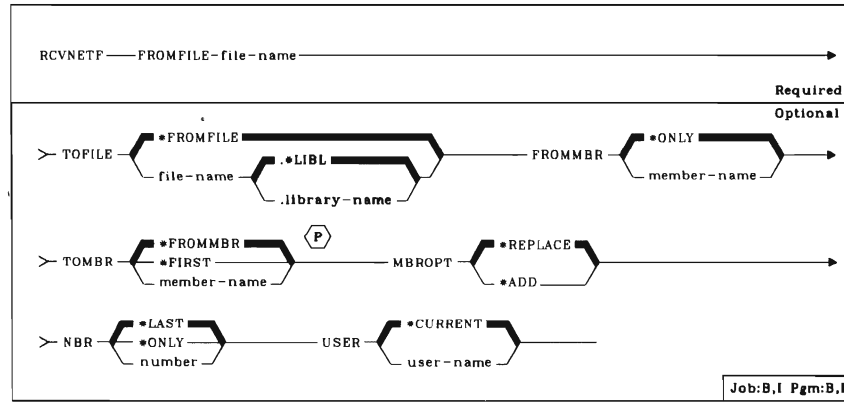

RETURN (Return)

If used in a CL program, returns control to the command after the one that causes the program to be executed. If entered in an interactive job, it performs the same function as the CF1 key.



RLSJOB (Release Job)

Makes a held job eligible for processing by the system. The job may be on a job queue, it may be active within a subsystem, or it may have already completed execution.

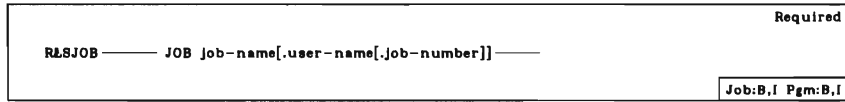

RLSJOBQ (Release Job Queue)

Allows processing of entries on a held job queue to begin or resume.

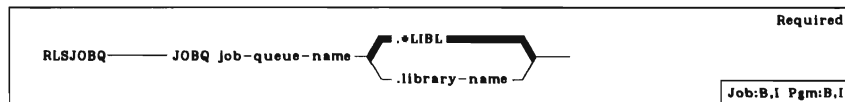

RLSOUTQ (Release Output Queue)

Allows processing of entries on a held output queue to begin or resume.

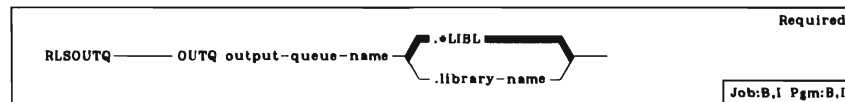

RLSRDR (Release Reader)

Resumes processing of a held spooling reader.

RLSRDR _____ RDR reader-name _____	Required
	Job:B,I Pgm:B,I

RLSSPLF (Release Spooled File)

Allows processing of a held spooled output file to begin or resume.

RLSSPLF _____ FILE spooled-file-name _____	Required
	Optional
> JOB { * _____ } { job-name[.user-name[.job-number]] }	
> SPLNBR { *ONLY _____ } { *LAST _____ } { spooled-file-number }	
	Job:B,I Pgm:B,I

RLSWTR (Release Writer)

Resumes processing of a held spooling writer.

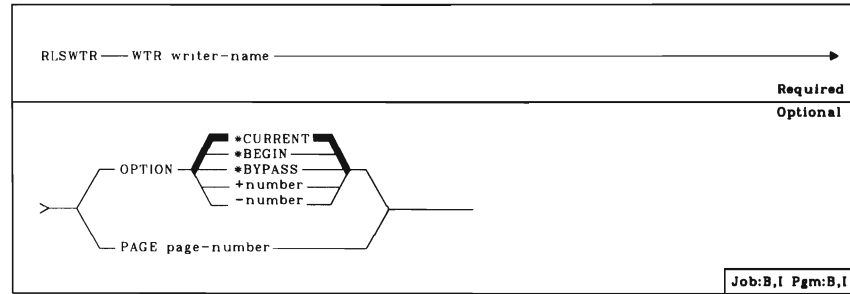

RMVACC (Remove Access Code)

Removes an access code from the system that was previously defined by the Add Access Code (ADDACC) command.

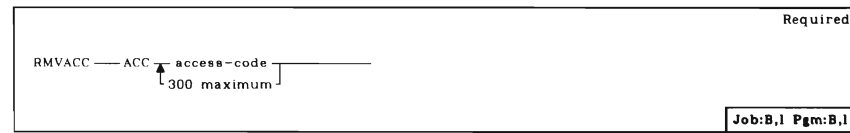

RMVAJE (Remove Autostart Job Entry)

Removes an autostart job entry from a subsystem description.

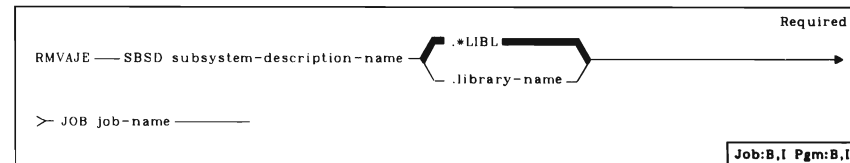

RMVBKP (Remove Breakpoint)

Removes breakpoints in a program being debugged (using the ENTDBG command).

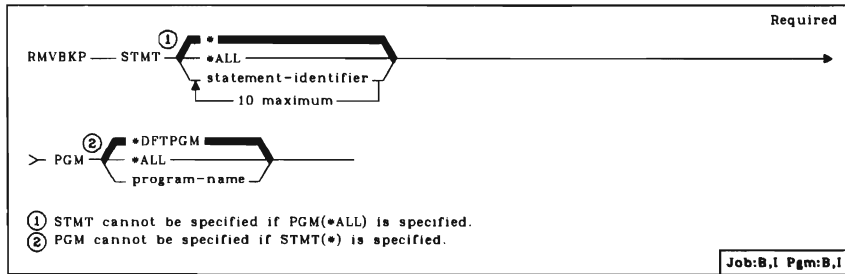

RMVBSCDEVE (Remove BSC Device Entry)

Removes one or more BSC program device entries from a mixed file.

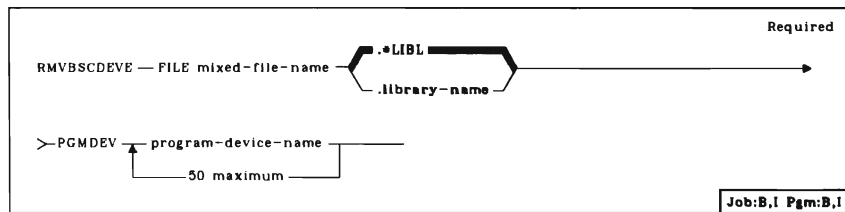

RMVCMNDEVE (Remove Communications Device Entry)

Removes one or more communications program device entries from a mixed file.

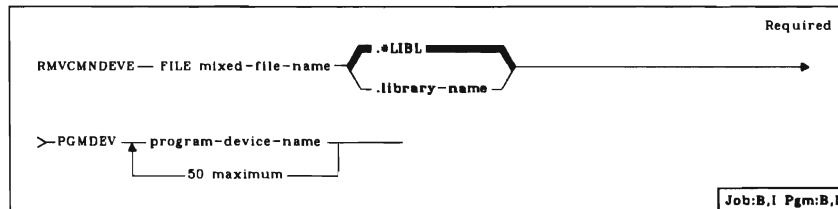

RMVCMNE (Remove Communications Entry)

Removes a communications entry from an existing subsystem description. The subsystem must not be active when this command is entered.

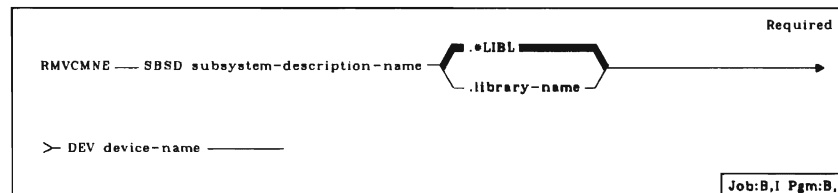

RMVDSPDEVE (Remove Display Device Entry)

Removes one or more display program device entries from a mixed file.

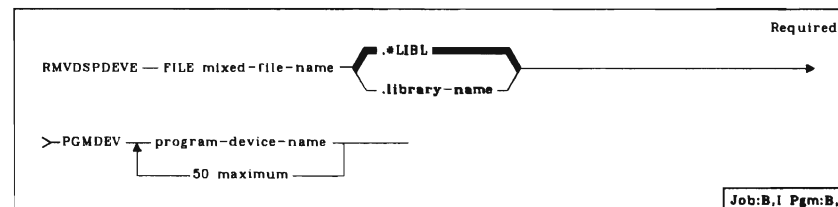

RMVFCTE (Remove Forms Control Table Entry)

Removes a forms entry from an existing RJE forms control table (FCT).

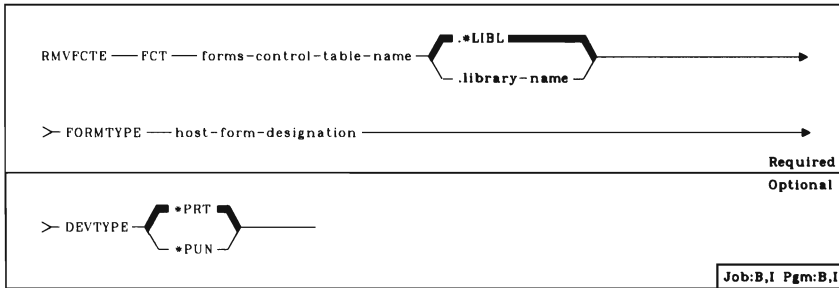

RMVJOBQE (Remove Job Queue Entry)

Removes a job queue entry from a subsystem description.

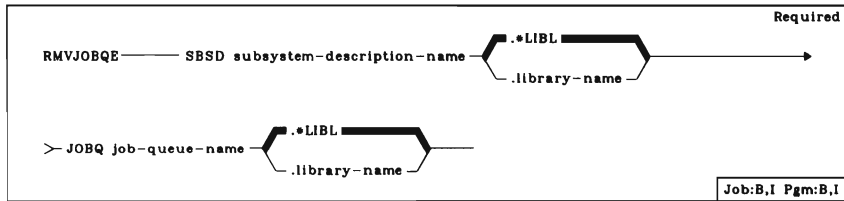

RMVJRNCHG (Remove Journalled Changes)

Removes the changes that have been journaled for a member of a data base file.

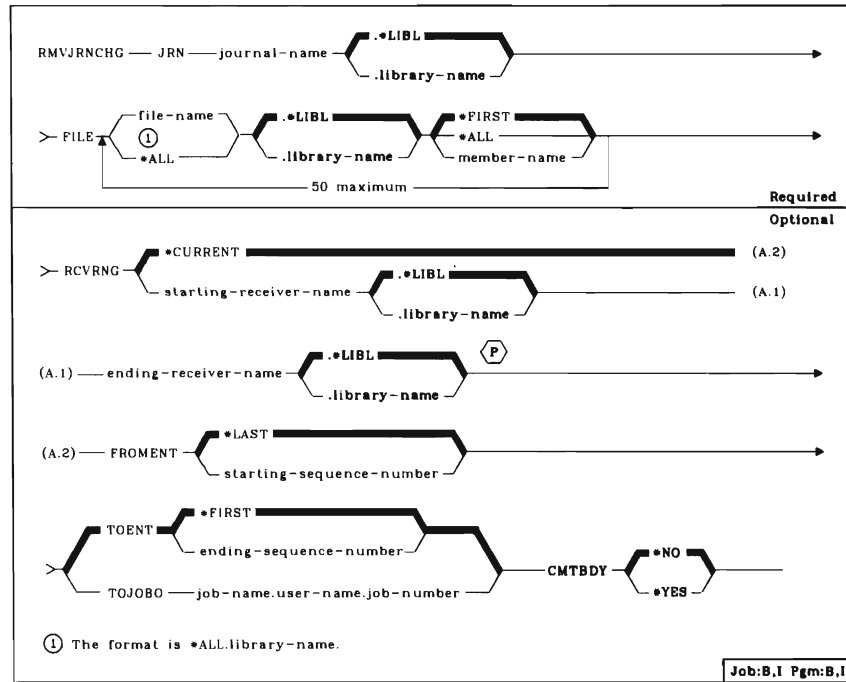

RMVLIBLE (Remove Library List Entry)

Removes a library name from the user portion of the library list.

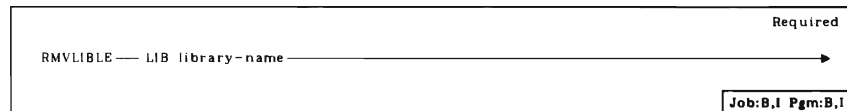

RMVM (Remove Member)

Removes a member from a logical or physical file.

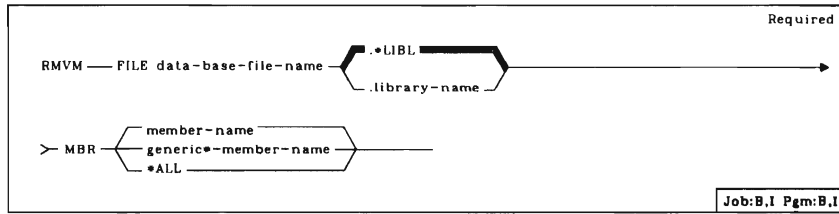

RMVMSG (Remove Message)

Removes a message from a message queue. Valid only in a CL program.

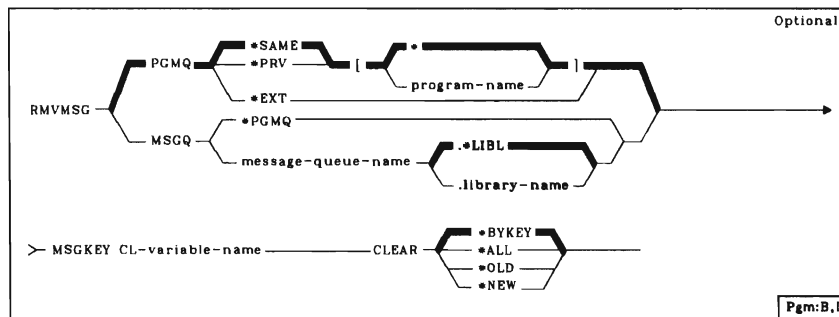

RMVMSGD (Remove Message Description)

Removes a message description from a message file.

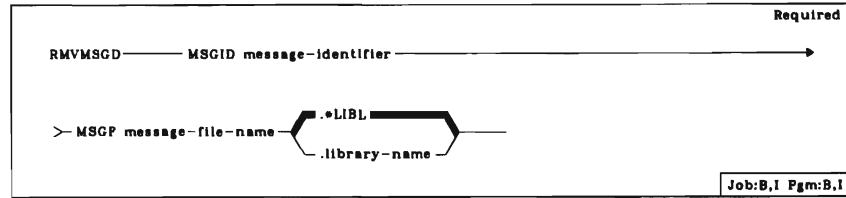

RMVNETJOBE (Remove Network Job Entry)

Removes a network job entry from the system.

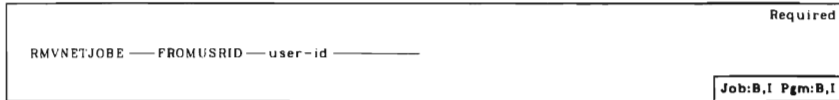

RMVPGM (Remove Program)

Removes program names from the list of programs being debugged (using the ENTDBG command).

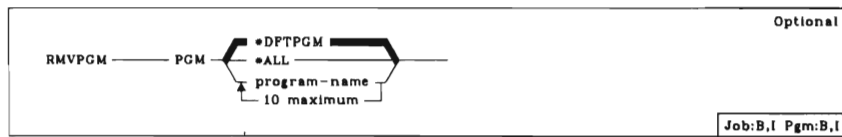

RMVPGMCHG (Remove Programming Change)

Changes the status of a temporary programming change to either temporary-inactive or permanent-inactive.

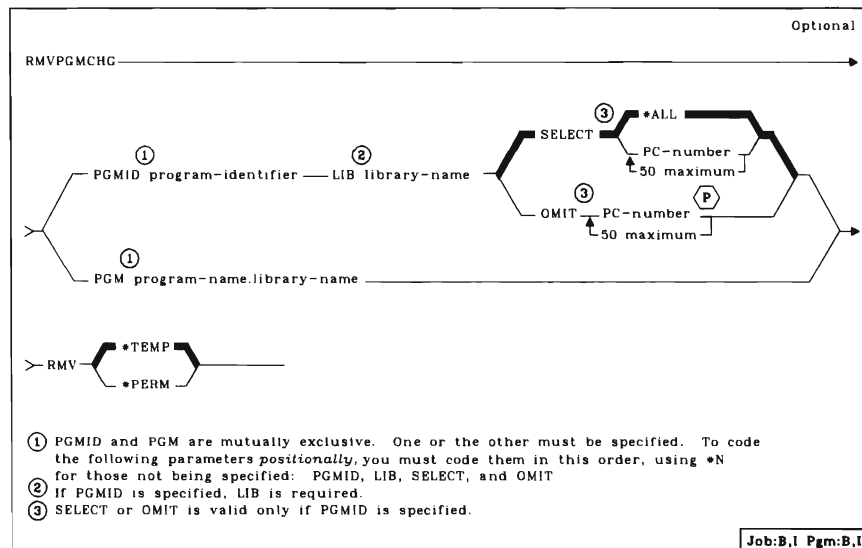

RMVRJECMNE (Remove RJE Communications Entry)

Removes an RJEF communications entry from an inactive session description.

RMVRJECMNE	SSND	session-description-name	.LIBL	Required
			.library-name	
> FILE		communications-device-file-name	.LIBL	
			.library-name	
				Job:B,I Pgm:B,I

RMVRJERDRE (Remove RJE Reader Entry)

Removes an RJEF reader entry from an inactive session description.

RMVRJERDRE	SSND	session-description-name	.LIBL	Required
			.library-name	
> RDR		Select one of the following: *AUTO RDI . . RD15		
				Job:B,I Pgm:B,I

RMVRJEWTRE (Remove RJE Writer Entry)

Removes an RJEF writer entry from an inactive session description.

RMVRJEWTRE	SSND	session-description-name	.LIBL	Required
			.library-name	
> WTR		Select one of the following: PRI . . PR15 PU1 . . PU15		
				Job:B,I Pgm:B,I

RMVRPYLE (Remove Reply List Entry)

Removes an entry from the system reply list.

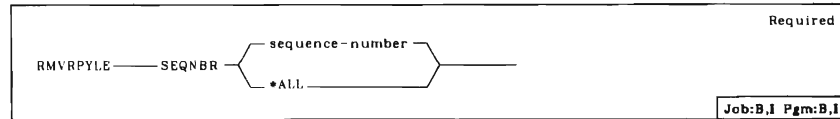

RMVRTGE (Remove Routing Entry)

Removes a routing entry from a subsystem description.

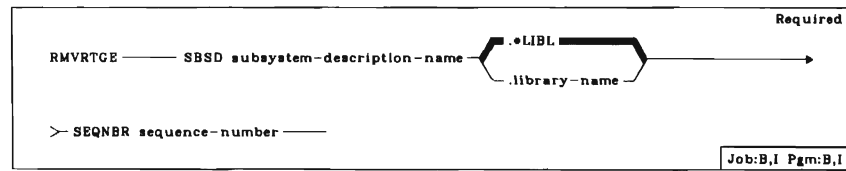

RMVTRC (Remove Trace)

Removes traces in a program being debugged (using the ENTDBG command).

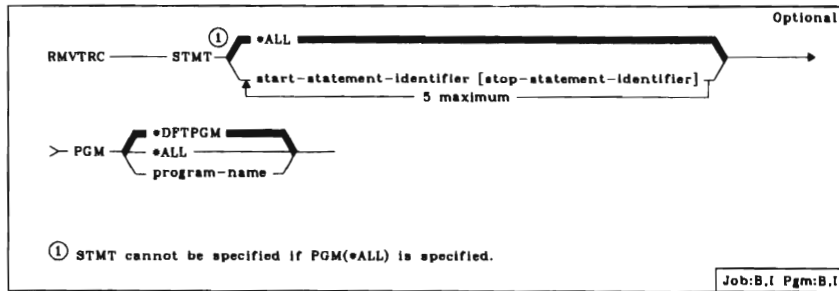

RMVWSE (Remove Work Station Entry)

Removes a work station entry from a subsystem description.

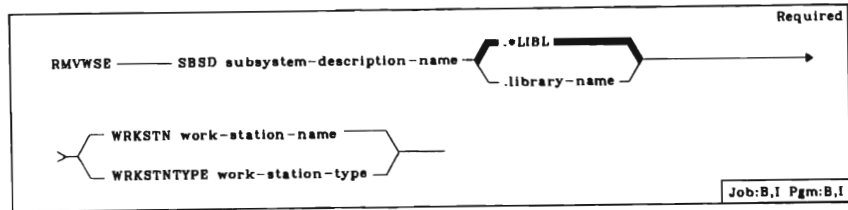

RNMDKT (Rename Diskette)

Changes the name of a diskette.

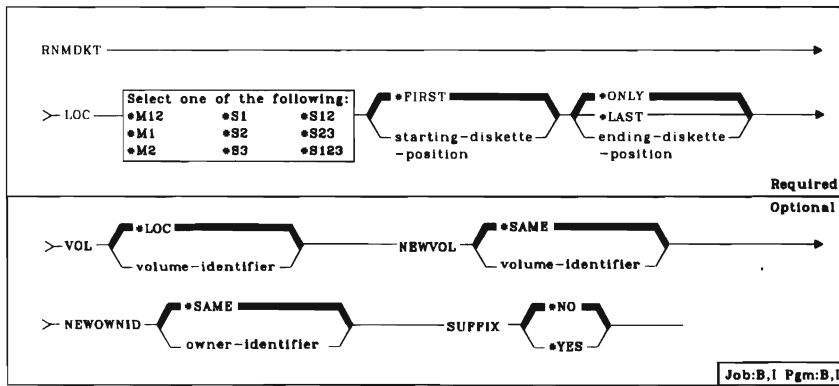

RNMM (Rename Member)

Changes the name of a specified file member. The member cannot be renamed while it is in use; other users can read but not update other members in the file that contains the member being renamed.

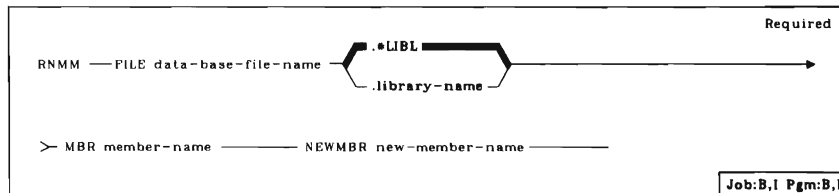

RNMOBJ (Rename Object)

Changes the name of an object in a library.

RNMOBJ	OBJ object-name	.LIBL	Required																					
		.library-name																						
>OBJTYPE	Select one of the following:		NEWOBJ new-object-name																					
	<table border="1"><tr><td>•CHTFMT</td><td>•FILE</td><td>•OUTQ</td></tr><tr><td>•CLS</td><td>•GSS</td><td>•PGM</td></tr><tr><td>•CMD</td><td>•JOBQ</td><td>•PRTIMG</td></tr><tr><td>•DTAARA</td><td>•JOBQ</td><td>•SBSD</td></tr><tr><td>•DTAQ</td><td>•LIB</td><td>•SPADCT</td></tr><tr><td>•EDTD</td><td>•MSGF</td><td>•SSND</td></tr><tr><td>•PCT</td><td>•MSGQ</td><td>•TBL</td></tr></table>		•CHTFMT	•FILE	•OUTQ	•CLS	•GSS	•PGM	•CMD	•JOBQ	•PRTIMG	•DTAARA	•JOBQ	•SBSD	•DTAQ	•LIB	•SPADCT	•EDTD	•MSGF	•SSND	•PCT	•MSGQ	•TBL	
•CHTFMT	•FILE	•OUTQ																						
•CLS	•GSS	•PGM																						
•CMD	•JOBQ	•PRTIMG																						
•DTAARA	•JOBQ	•SBSD																						
•DTAQ	•LIB	•SPADCT																						
•EDTD	•MSGF	•SSND																						
•PCT	•MSGQ	•TBL																						
			Job:B,I Pgm:B,I																					

ROLLBACK (Rollback)

Reestablishes the last commitment boundary as the current commitment boundary.

ROLLBACK	Optional
Job:B,I Pgm:B,I	

RPLLIBL (Replace Library List)

Replaces the names of libraries in the user library list for the current job.

RPLLIBL	LIBL	•NONE	Required
		library-name	
		25 maximum	
			Job:B,I Pgm:B,I

RRTJOB (Reroute Job)

Reroutes a job in the current subsystem.

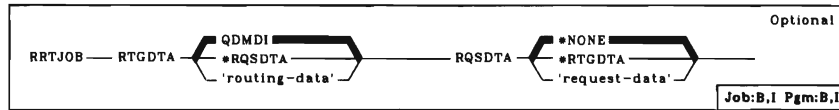

RSMBKP (Resume Breakpoint)

Causes execution of a program to be continued after it has been halted at a breakpoint.



RSMCTLRcy (Resume Control Unit Recovery)

Resumes error recovery procedures for a specific control unit, allowing the operator to resume automatic recovery after it has been stopped, and to continue using a control unit after it has been canceled ('C' response entered to a control unit failure inquiry message).

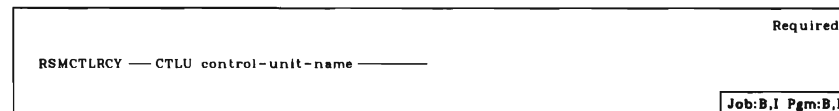

RSMDEVRCY (Resume Device Recovery)

Resumes error recovery procedures for a specific device, allowing the operator to resume automatic recovery after it has been stopped, and to continue using a device after it has been canceled ('C' response entered to a device failure inquiry message).

RSMDEVRCY — DEV device-name —	Required
	Job:B,I Pgm:B,I

RSMLINRCY (Resume Line Recovery)

Resumes error recovery procedures for a specific line, allowing the operator to resume automatic recovery after it has been stopped, and to continue using a line after it has been canceled ('C' response entered to a line failure inquiry message).

RSMLINRCY — LINE line-name —	Required
	Job:B,I Pgm:B,I

RSTAUT (Restore Authority)

Restores user profile authority to all objects on the system.

RSTAUT —	
	Job:B,I Pgm:B,I

RSTDOC (Restore Document)

Restores to the system documents that were saved on diskette or tape. When a document is restored, associated document control information is also restored and/or rebuilt.

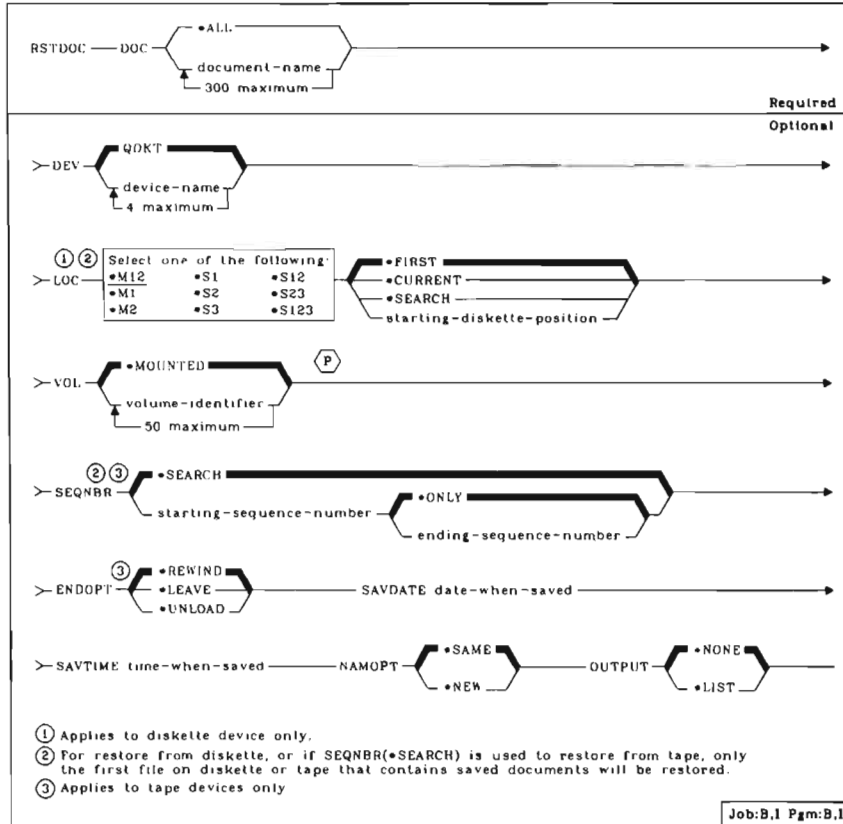

Printer file—QPRSTDOC

RSTLIB (Restore Library)

Restores libraries from diskette or tape to the system.

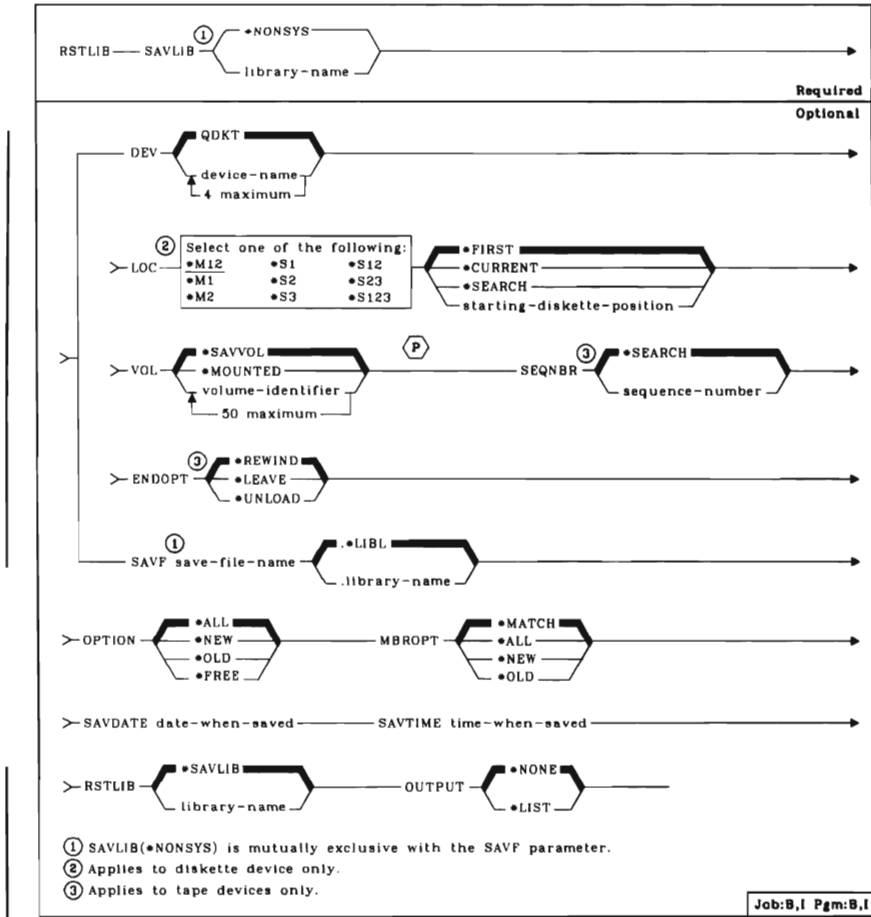

Diskette file—QSYSDKT
 Tape file—QSYSTAP
 Printer file—QPSRLDSP

RSTOBJ (Restore Object)

Restores objects from diskette or tape to the system.

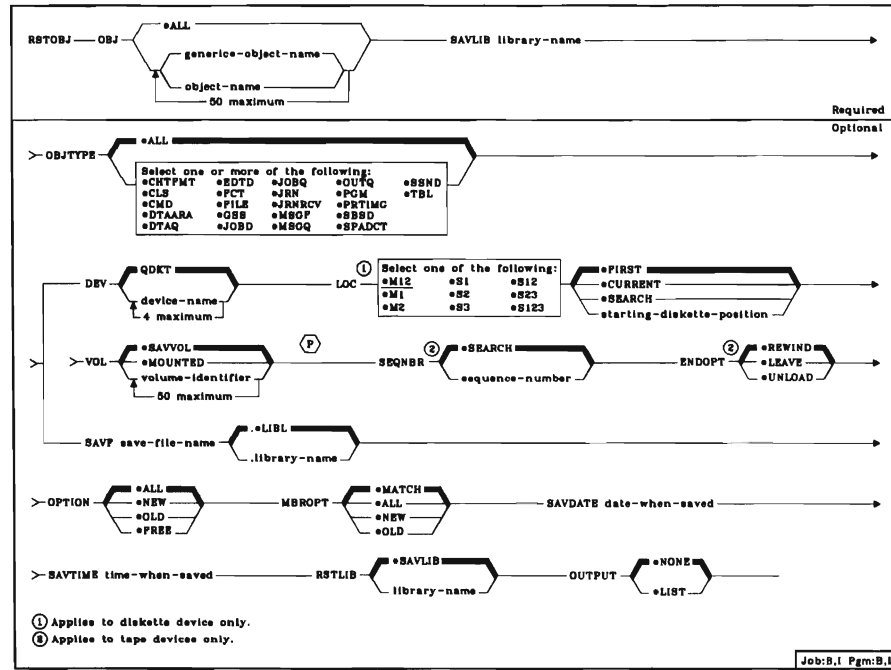

Diskette file—QSYSDKT
Tape file—QSYSTAP
Printer file—QPSRLDSP

RSTUSRPRF (Restore User Profiles)

Restores basic parts of user profiles that were saved by the SAVSYS command.

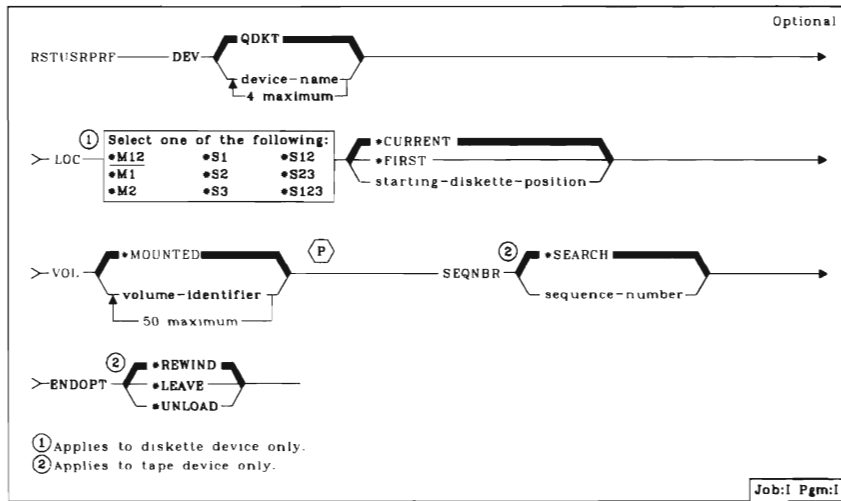

Diskette file—QSYSDKT

Tape file—QSYSTAP

RTVCLSRC (Retrieve CL Source)

Retrieves source statements used to compile a CL program.

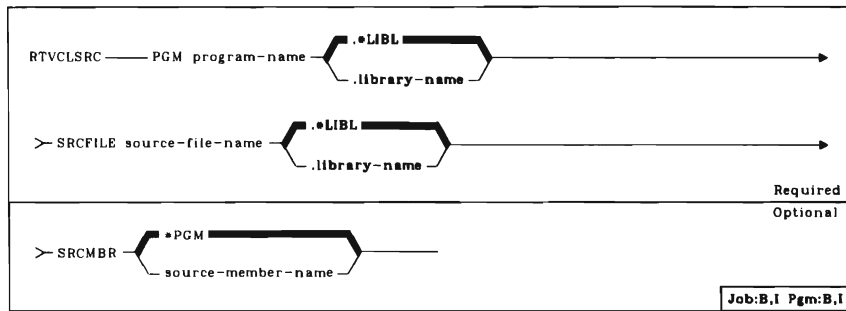

RTVDFUSRC (Retrieve DFU Source)

Retrieves utility definition source statements from a source member.

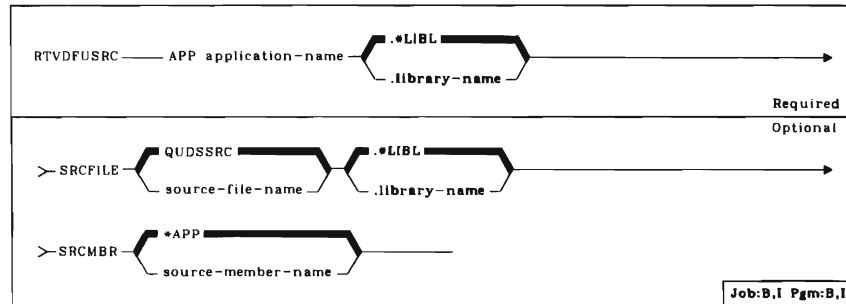

Data base source file—QUDSSRC

RTVDTAARA (Retrieve Data Area)

Retrieves the value of a data area and places it in a CL variable in the CL program in which this command is used. Valid only in a CL program.

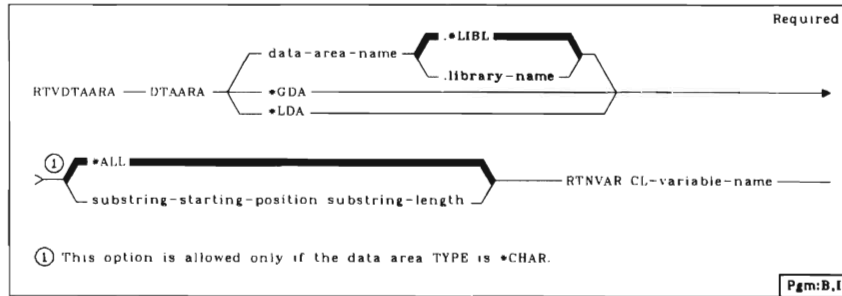

RTVGRPA (Retrieve Group Attributes)

Retrieves information about the group to which the job that issued the RTVGRPA command belongs.

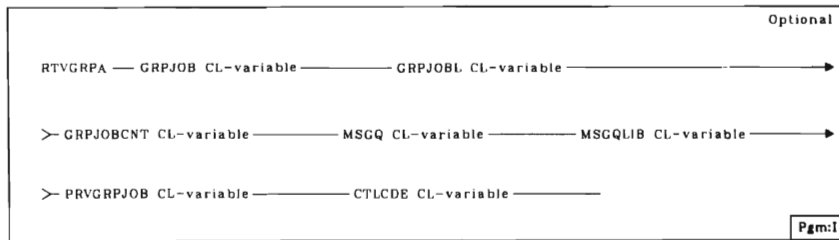

RTVJOBA (Retrieve Job Attributes)

Retrieves the values of job attributes and places them in CL variables in the CL program in which this command is used. The attributes retrieved are for the job in which the CL program is invoked. Valid only in a CL program.

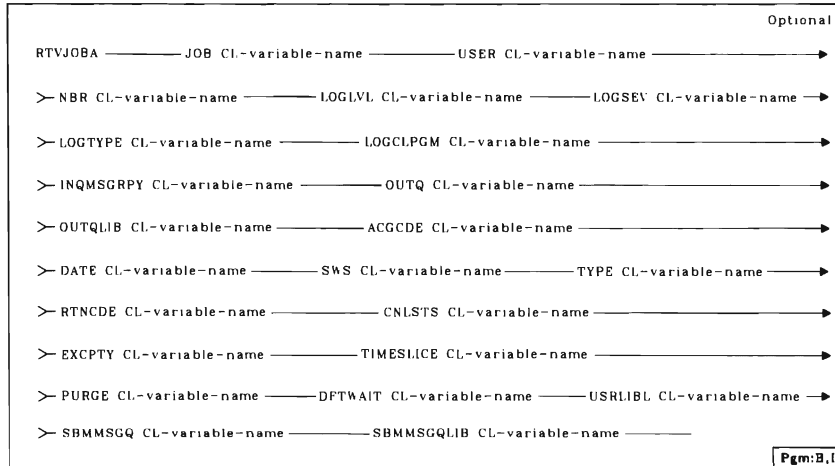

RTVJRNE (Retrieve Journal Entry)

Provides you with a means of retrieving a particular journal entry and placing the results in CL variables.

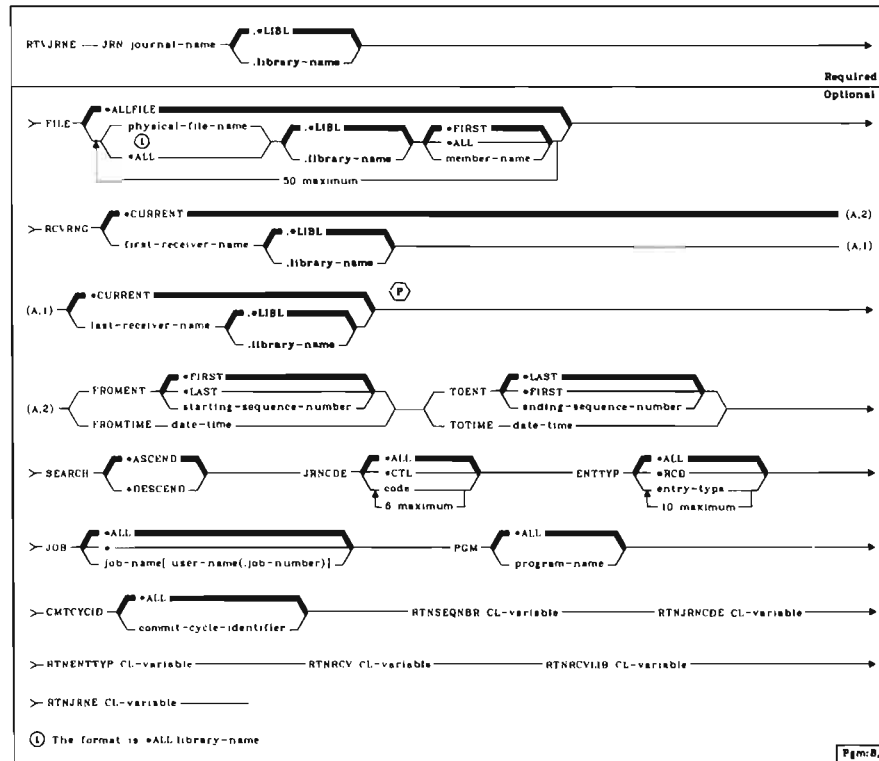

RTVMSG (Retrieve Message)

Retrieves a message from a message file and places it in CL variables in the CL program in which this command is used. Valid only in a CL program.

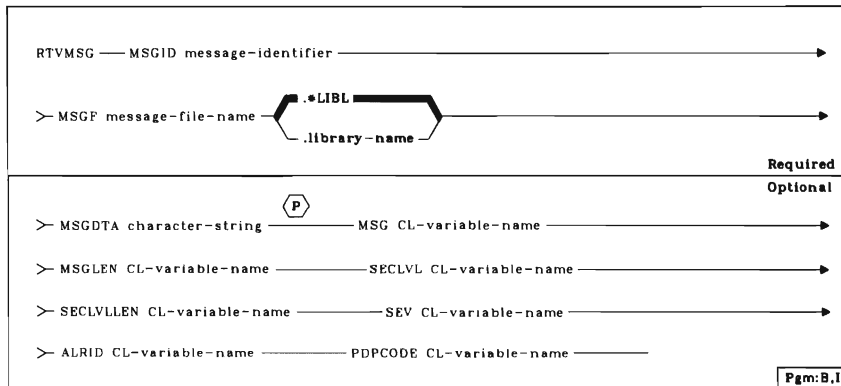

RTVQRYSRC (Retrieve Query Source)

Retrieves query application definition source statements from a source member.

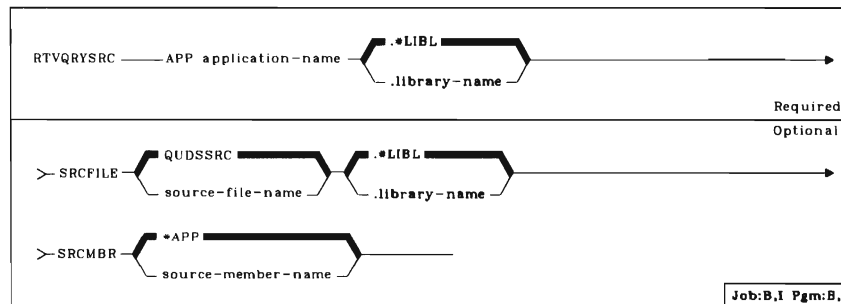

Data base source file—QUDSSRC

RTVSYSVAL (Retrieve System Value)

Retrieves the value of a system value and places it in a CL variable in the CL program in which this command is used. Valid only in a CL program.

RTVSYSVAL _____ SYSVAL system-value-name _____ RTNVAR CL-variable-name _____	Required
	Pgm:B,I

RTVUSRPRF (Retrieve User Profile)

Retrieves one or more of the values that are stored and associated with a user profile in a CL program.

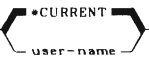
RTVUSRPRF _____ USRPRF _____  _____ RTNUSRPRF CL-variable _____	Optional
> SPCAUT CL-variable _____ MAXSTG CL-variable _____ PTYLMT CL-variable _____	
> INLPCM CL-variable _____ INLPGMLIB CL-variable _____ JOBD CL-variable _____	
> JOBDLIB CL-variable _____ GRPPRF CL-variable _____ OWNER CL-variable _____	
> GRPAUT CL-variable _____ ACGCDE CL-variable _____ MSGQ CL-variable _____	
> MSGQLIB CL-variable _____ OUTQ CL-variable _____ OUTQLIB CL-variable _____	
> TEXT CL-variable _____	
	Pgm:B,I

RVKACCAUT (Revoke Access Code Authority)

Revokes the access code authority for an individual user or a group of users.

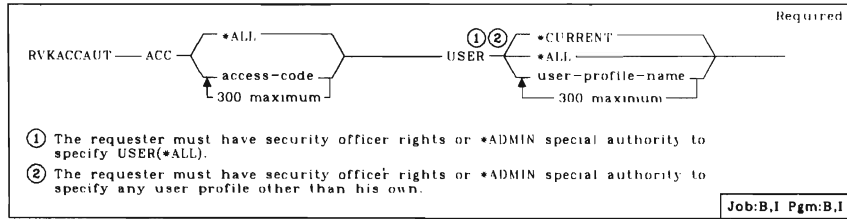

RVKDOCAUT (Revoke Document Authority)

Revokes document authority from one user (or all users) to access documents on behalf of another user.

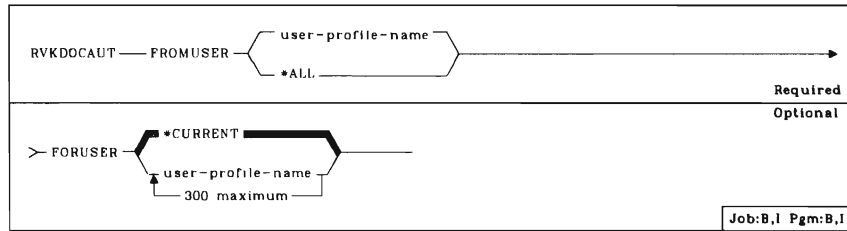

RVKOBJAUT (Revoke Object Authority)

Revokes authority for the use of objects.

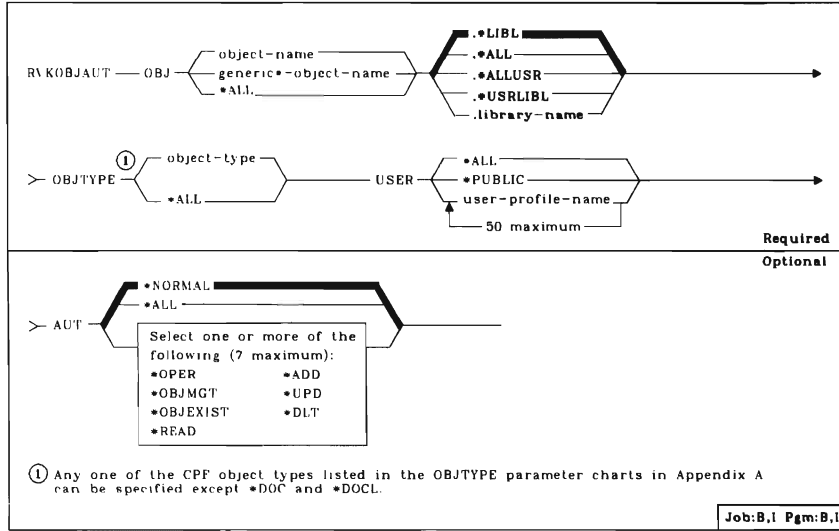

SAVCHGOBJ (Save Changed Object)

Saves a copy of each changed object (or group of objects in the same library) on diskette or tape.

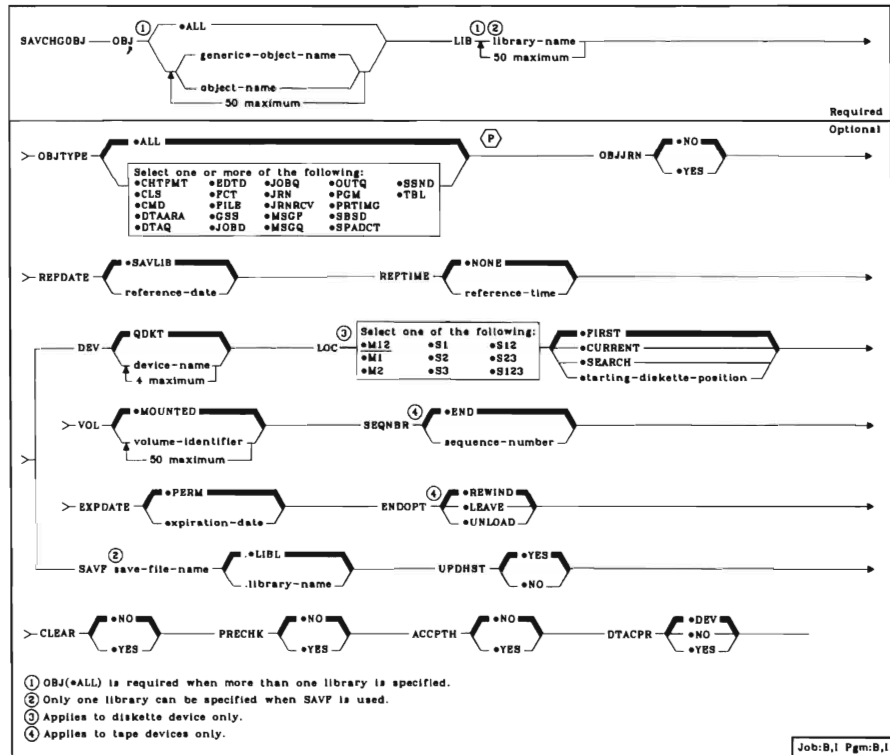

Diskette file—QSYSDKT
Tape file—QSYSTAP

SAVDOC (Save Document)

Saves a copy of the specified documents located in library QDOC.

SAVDOC	DOC	<div style="border: 1px solid black; padding: 2px;"> document-object-name 300 maximum *SEARCH ① *ALL </div>	(P)		Required			
> PERIOD	②	<div style="border: 1px solid black; padding: 2px;"> *AVAIL starting-time </div>	<div style="border: 1px solid black; padding: 2px;"> *BEGIN starting-date </div>	<div style="border: 1px solid black; padding: 2px;"> *AVAIL ending-time </div>	<div style="border: 1px solid black; padding: 2px;"> *END ending-date </div>	Optional		
> DOCCLS	①	<div style="border: 1px solid black; padding: 2px;"> *ALL document-class </div>	OWNER	<div style="border: 1px solid black; padding: 2px;"> *CURRENT user-profile-name </div>	DEV	<div style="border: 1px solid black; padding: 2px;"> QDKT device-name 4 maximum </div>		
> LOC	③	<div style="border: 1px solid black; padding: 2px;"> Select one of the following: *M12 *S1 *S12 *M1 *S2 *S23 *M2 *S3 *S123 </div>	<div style="border: 1px solid black; padding: 2px;"> *FIRST *CURRENT *SEARCH starting-diskette-position </div>	VOL	<div style="border: 1px solid black; padding: 2px;"> *MOUNTED volume-identifier 50 maximum </div>			
> SEQNBR	④	<div style="border: 1px solid black; padding: 2px;"> *END sequence-number </div>	EXPDATE	<div style="border: 1px solid black; padding: 2px;"> *PERM expiration-date </div>	ENDOPT	<div style="border: 1px solid black; padding: 2px;"> *REWIND *LEAVE *UNLOAD </div>		
> CLEAR		<div style="border: 1px solid black; padding: 2px;"> *NO *YES </div>	STG	<div style="border: 1px solid black; padding: 2px;"> *KEEP *DELETE *PRES </div>	DTACPR	<div style="border: 1px solid black; padding: 2px;"> *DEV *NO *YES </div>	OUTPUT	<div style="border: 1px solid black; padding: 2px;"> *NONE *LIST </div>
① PERIOD, DOCCLS, and OWNER are allowed only when DOC(*SEARCH) is specified. ② PERIOD contains 2 lists of 2 elements each. *N must be specified for any element that precedes the value(s) being specified to maintain its position in the parameter value sequence when previous elements are omitted. ③ Applies to diskette device only. ④ Applies to tape devices only.								
Job:B,1 Pgm:B,1								

Printer file-QPSAVDOC

SAVLIB (Save Library)

Saves libraries on diskette or tape.

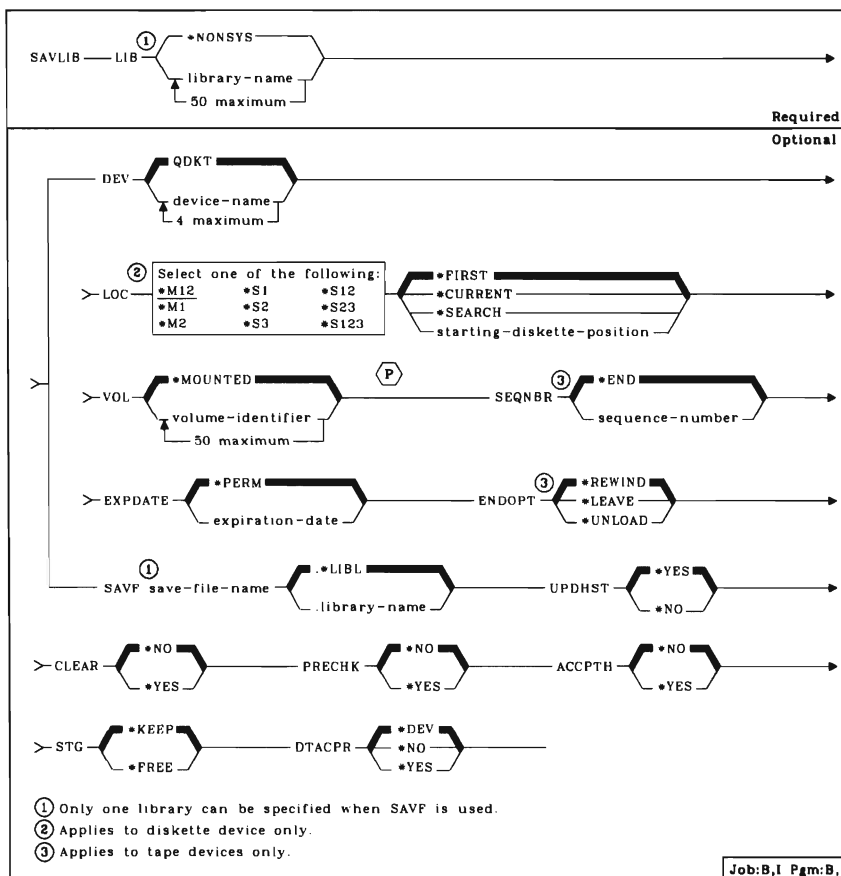

Diskette file—QSYSDKT

Tape file—QSYSTAP

SAVOBJ (Save Object)

Saves objects on diskette or tape.

SAVOBJ	OBJ	①	•ALL	generic-object-name	object-name	50 maximum	LIB	②	library-name	50 maximum	Required		
	OBJTYPE		•ALL	Select one or more of the following: •CHTFMT •EDTD •JOBQ •OUTQ •SSND •CLS •PCT •JRN •PGM •TBL •CMD •FILE •JRNVCV •PRTIMC •DTAARA •CSS •MSGF •SBSD •DTAQ •JOBQ •MSGQ •SPADCT							Optional		
	DEV	QDKT	device-name	4 maximum	LOC	③	Select one of the following: •M12 •S1 •S12 •M1 •S2 •S23 •M2 •S3 •S123	•FIRST	•CURRENT	•SEARCH	starting-diskette-position		
	VOL	•MOUNTED	volume-identifier	50 maximum	SEQNBR	④	•END	sequence-number					
	EXPDATE	•PERM	expiration-date		ENDOPT	④	•REWIND	•LEAVE	•UNLOAD				
	SAVP	②	save-file-name	•LIBL	library-name	UPDHST	•YES	•NO	CLEAR	•NO	•YES		
	PRECHK	•NO	•YES	ACCPH	•NO	•YES	STG	•KEEP	•FREE	DTACPR	•DEV	•NO	•YES

① OBJ(•ALL) is required when more than one library is specified.
 ② Only one library can be specified when SAVP is used.
 ③ Applies to diskette device only.
 ④ Applies to tape devices only.

Job:B,I Pgm:B,I

Diskette file—QSYSDKT

Tape file—QSYSTAP

SAVSAVFDTA (Safe Save File Data)

Saves the contents of a save file to either diskette or tape.

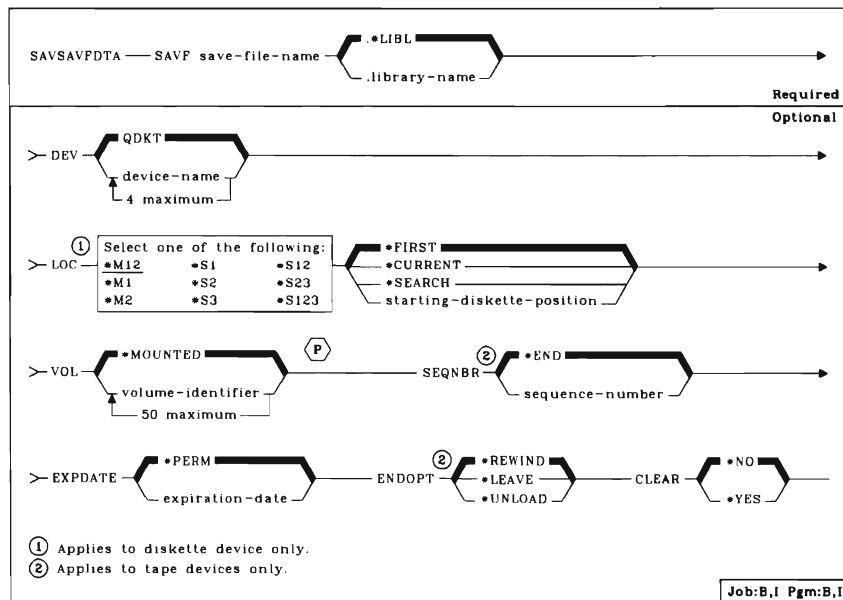

Diskette file—QSYSDKT

Tape file—QSYSTAP

SAVSYS (Save System)

Saves the IBM-supplied system libraries on diskette.

SAVSYS	DEV	①	QDKT	LOC	②	M12	Optional
			device-name			M1	
			4 maximum			M2	
> VOL.			MOUNTED	EXPDATE		PERM	
			volume-identifier			expiration-date	
			50 maximum				
> ENDOPT		③	REWIND	CLEAR		NO	DEV
			LEAVE			YES	NO
			UNLOAD			YES	YES

① When tape device(s) are specified, an installation diskette will also be written in location *S1 of the diskette device.
② Applies to diskette device only.
③ Applies to tape devices only.

Job:B.1 Pgm:B.1

Diskette file—QSYSDKT

Tape file—QSYSTAP

SBMCRDJOB (Submit Card Jobs)

Submits jobs to job queues to be executed as batch jobs. The job stream is read from cards.

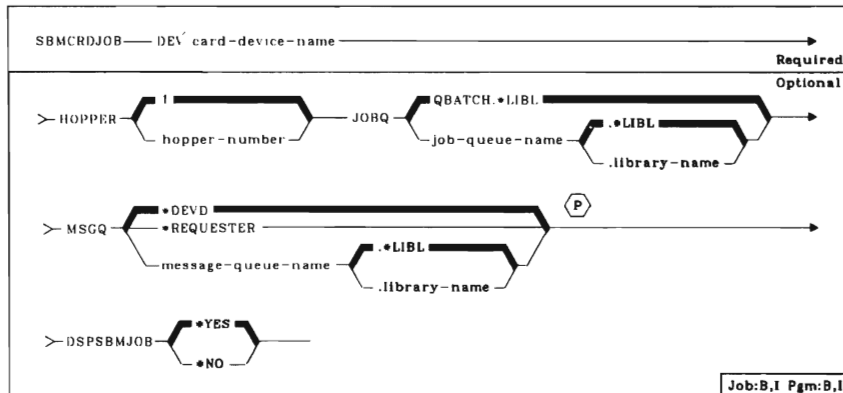

SBMDBJOB (Submit Data Base Jobs)

Submits jobs to job queues to be executed as batch jobs. The job stream is read either from a physical file or from a logical file in single-record format.

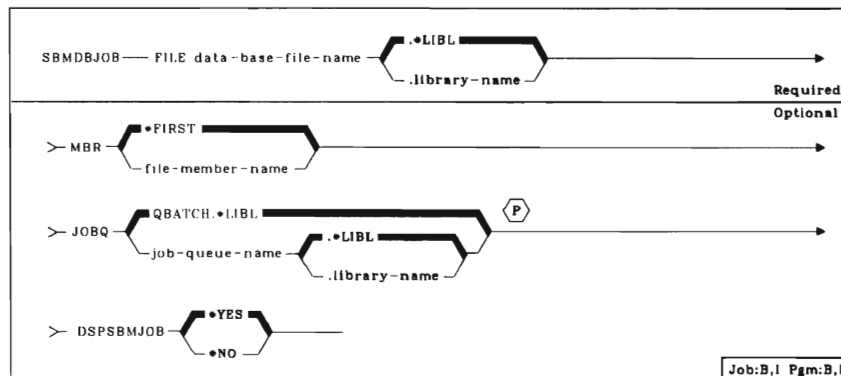

SBMDKTJOB (Submit Diskette Jobs)

Submits jobs to job queues to be executed as batch jobs. The job stream is read from diskette.

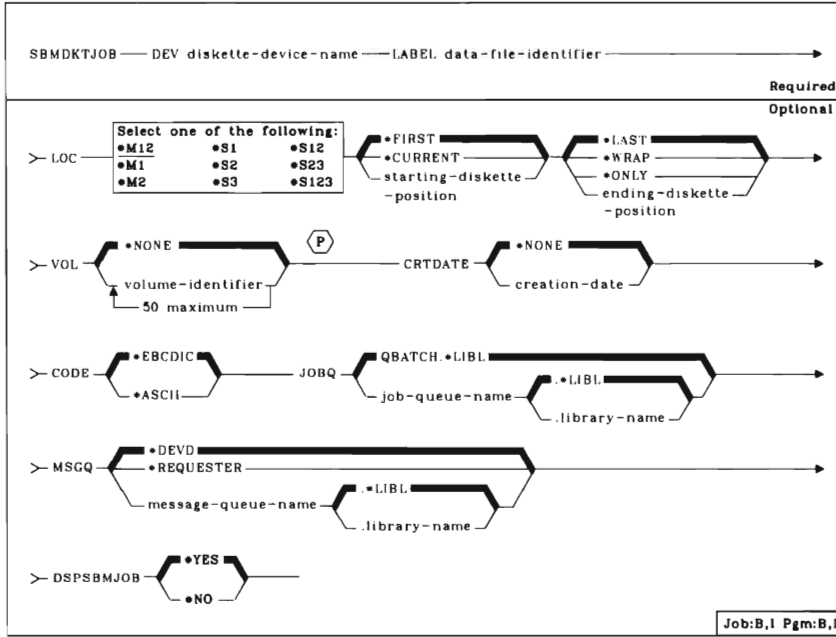

SBMFNCJOB (Submit Finance Job)

Submits a batch job that acts as the interface between your System/38 finance application programs and your 4701 control unit application programs.

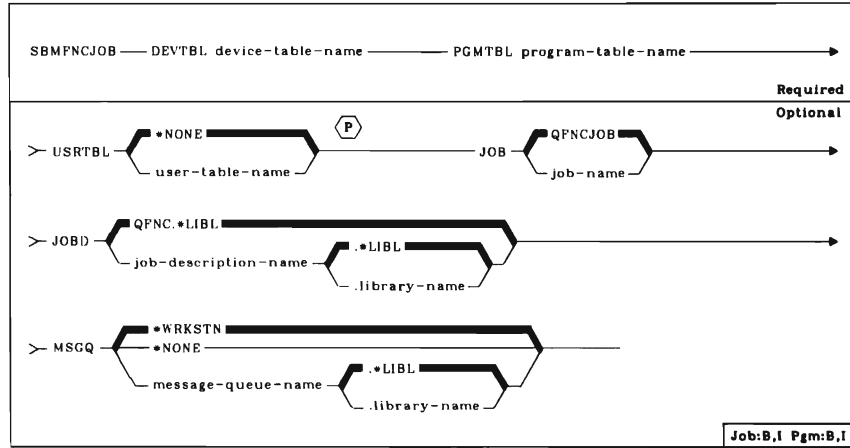

SBMJOB (Submit Job)

Submits a job to a job queue to be executed as a batch job.

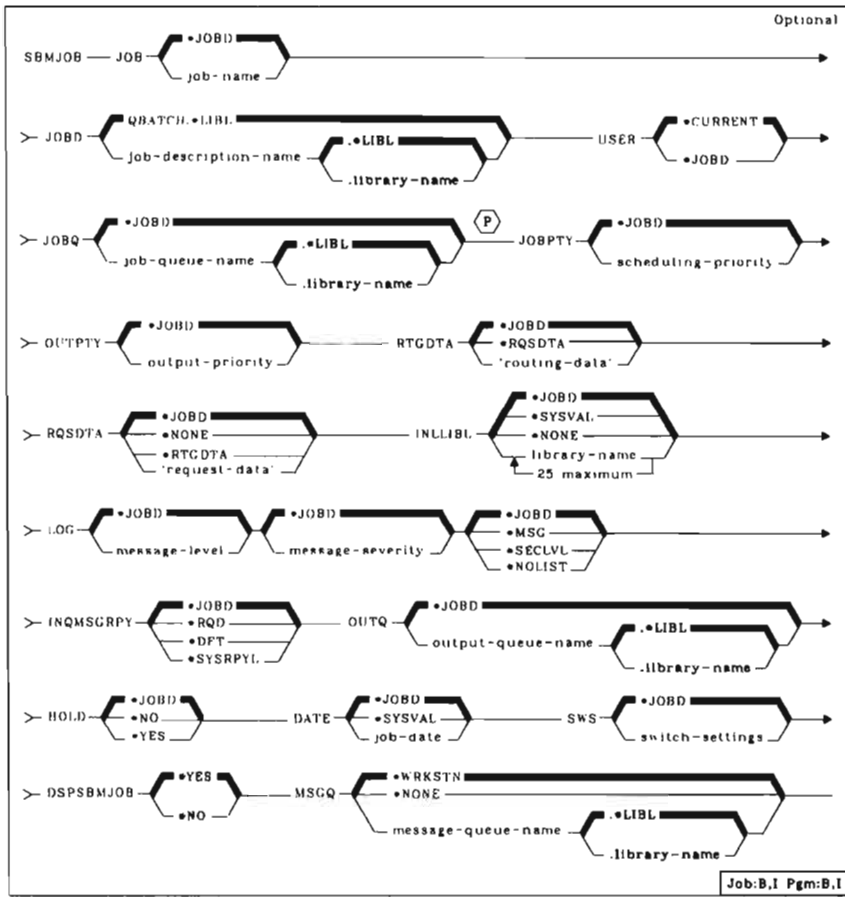

SBMNETJOB (Submit Network Job)

Sends a job stream to another System/38 user on the SNADS network.

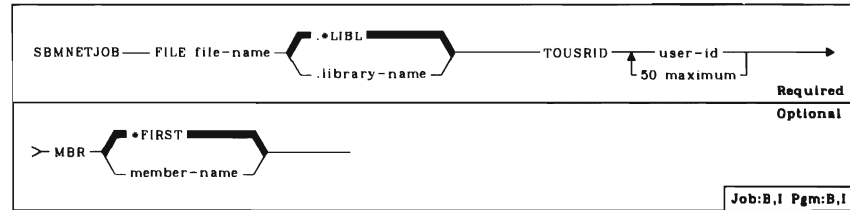

SBMRJEJOB (Submit RJE Job)

Requests that an RJE remote job input stream (System/38 data base file) be transmitted to the host system.

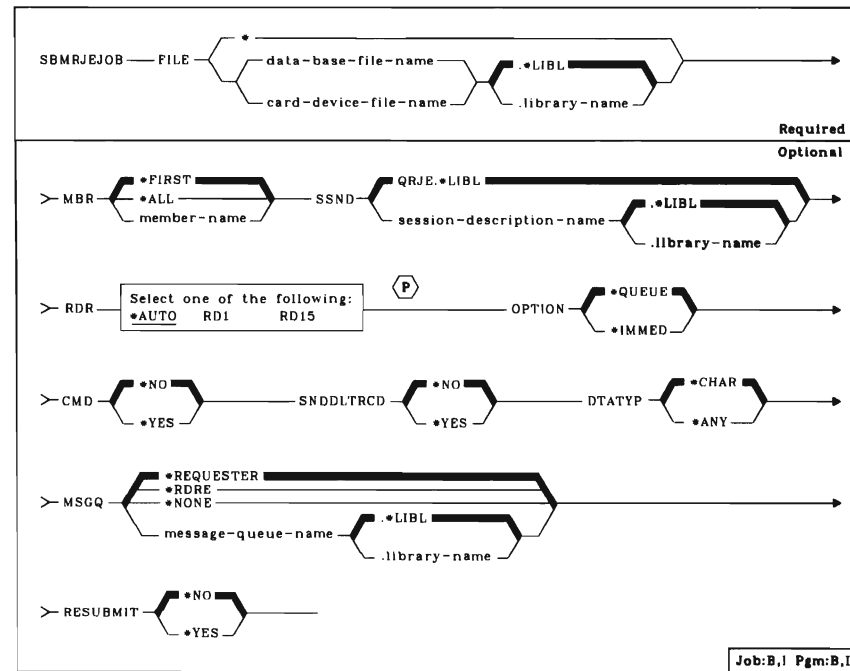

SETATNPGM (Set Attention Program)

Causes the specified program to become the attention key handler at the current invocation level in the job executing the command.

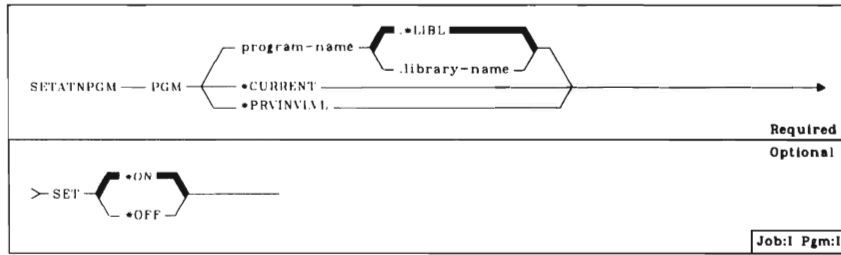

SIGNOFF (Sign Off)

Terminates an interactive job at a work station or at the system console.

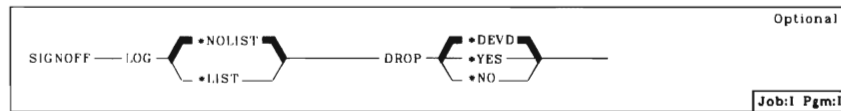

SNDBRKMSG (Send Break Message)

Sends an impromptu message to a message queue, forcing the message to be delivered in break mode.

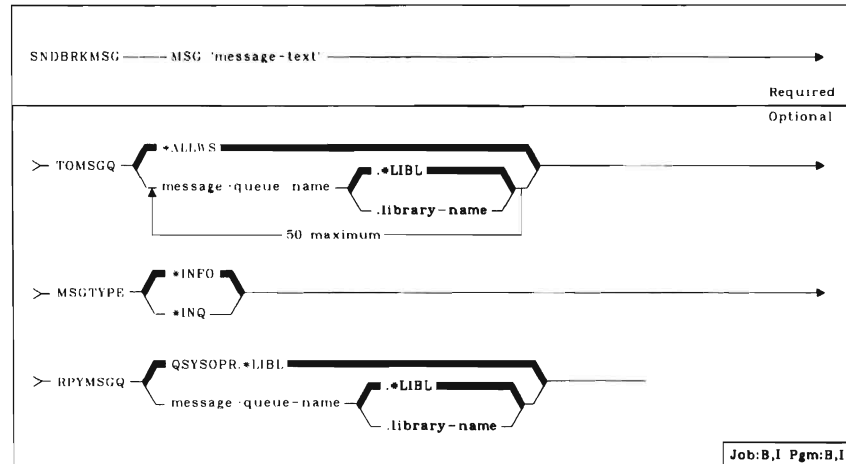

SNDDTAARA (Send Data Area)

Copies information from a CL variable to a data area. Valid only in a CL program.

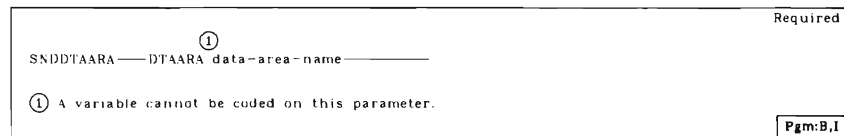

SNDF (Send File)

Writes a record to a display file. Valid only in a CL program.

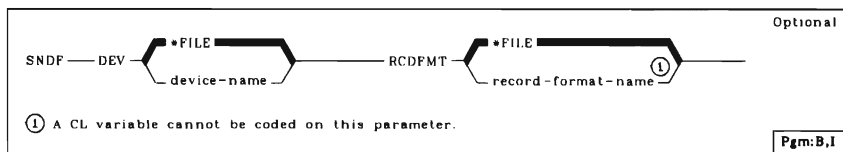

SNDJRNE (Send Journal Entry)

Places a single journal entry in a journal.

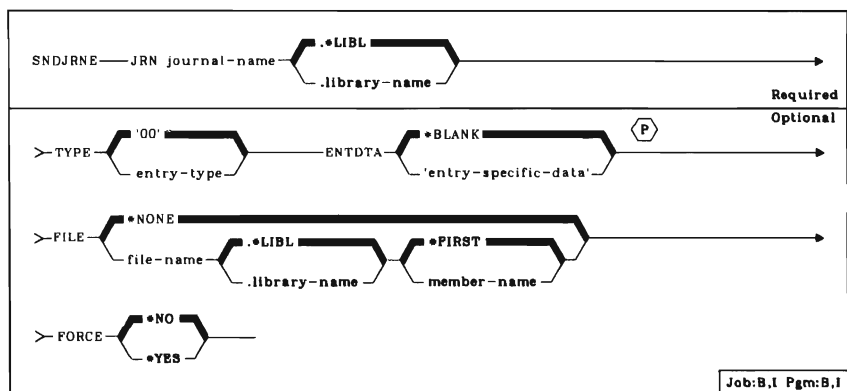

SNDMSG (Send Message)

Sends an impromptu message to a message queue.

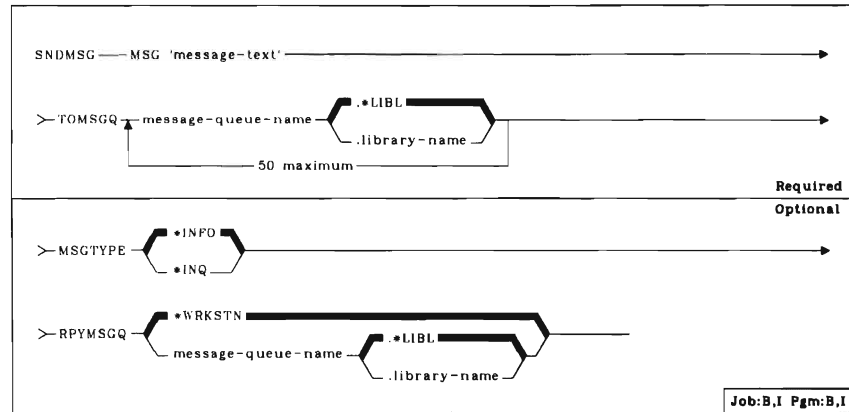

SNDNETF (Send Network File)

Sends a save file or a member of a physical data base file to another System/38 user through the SNADS network.

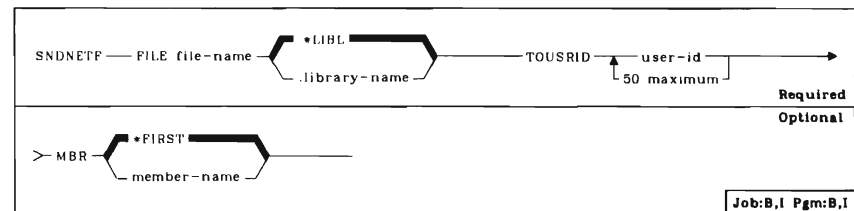

SNDNETMSG (Send Network Message)

Sends a message to another System/38 user through the SNADS network.



SNDNETSPLF (Send Network Spool File)

Sends a spooled file to another System/38 user on the SNADS network. The file is placed on an output queue that is specified in the user profile of the user to whom the spooled file was sent.

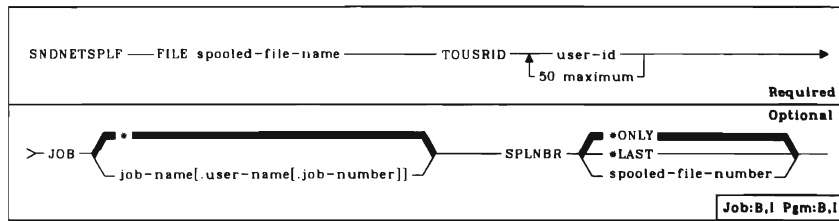

SNDPGMMSG (Send Program Message)

Sends a program message to a message queue. Valid only in a CL program.

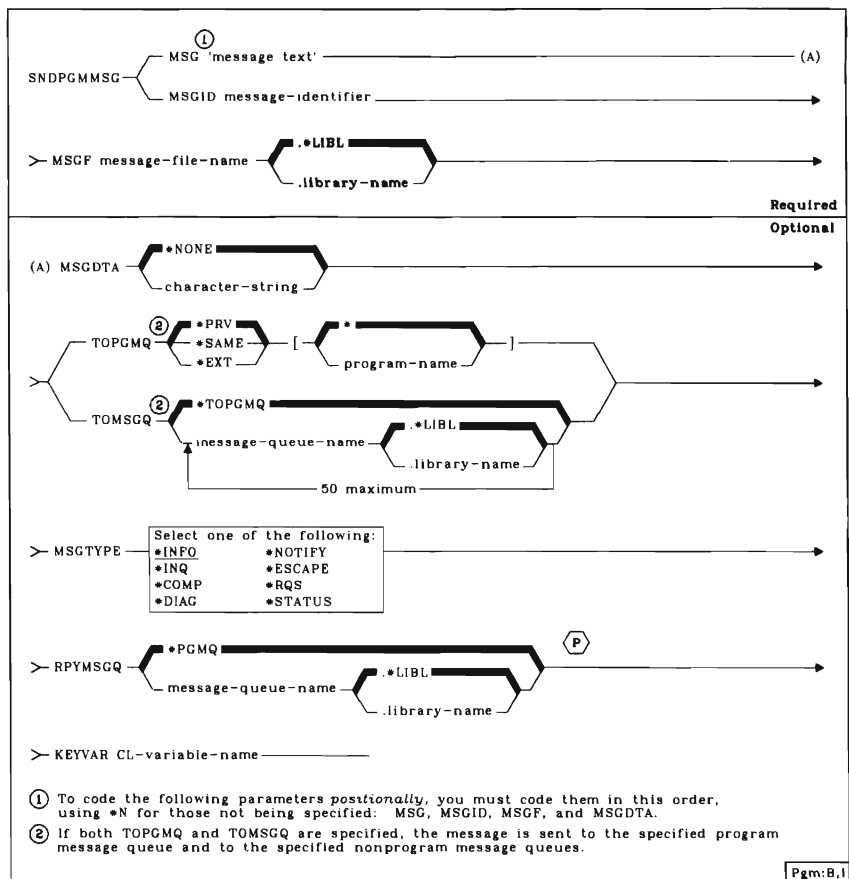

SNDRCVF (Send/Receive File)

Writes a record to a display file and receives a reply. Valid only in a CL program.

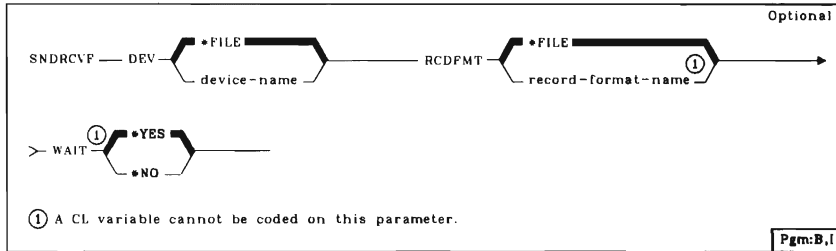

SNDRPY (Send Reply)

Sends a reply message to the sender of an inquiry message. Valid only in a CL program.

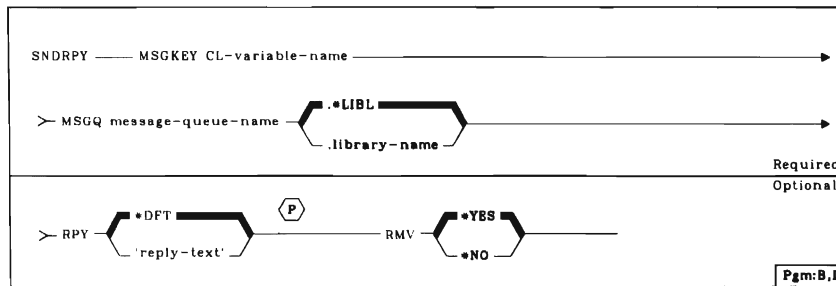

SENDUSRMSG (Send User Message)

Used by a program to send a message to a message queue and optionally receive a reply to that message.

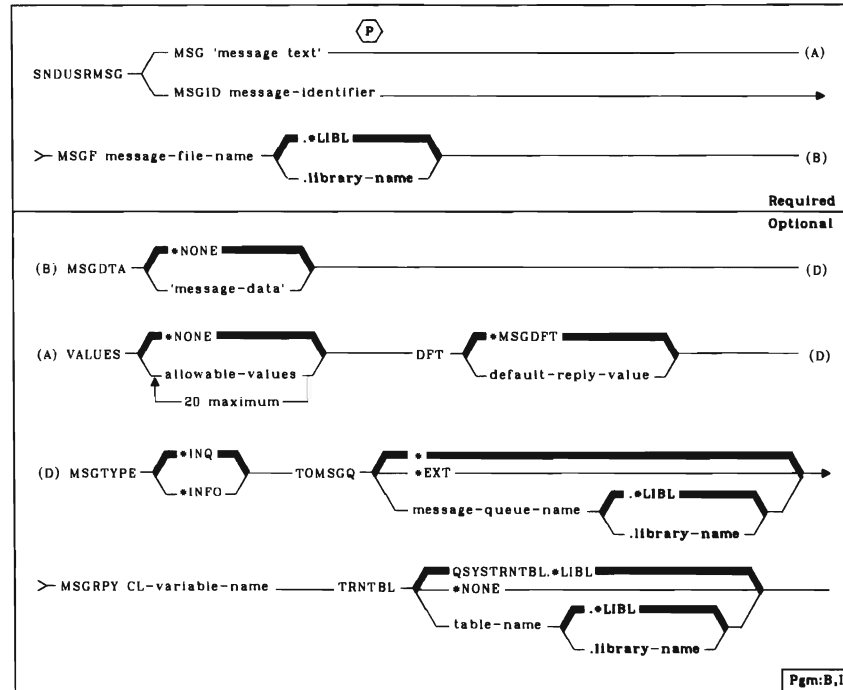

SRVJOB (Service Job)

Establishes service mode (allowing entry of other service commands) for a job.

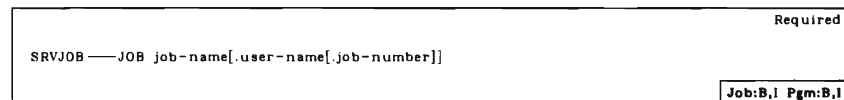

STPCTLR CY (Stop Control Unit Recovery)

Discontinues error recovery procedures for a specific control unit. If any type of failure occurs after this command is executed, an inquiry message is issued.

STPCTLR CY — CTLU control-unit-name _____	Required
	Job:B,I Pgm:B,I

STPDEVRCY (Stop Device Recovery)

Discontinues error recovery procedures for a specific device. If any type of failure occurs after this command is executed, an inquiry message is issued.

STPDEVRCY — DEV device-name _____	Required
	Job:B,I Pgm:B,I

STPLINRCY (Stop Line Recovery)

Discontinues error recovery procedures for a specific line. If any type of failure occurs after this command is executed, an inquiry message is issued.

STPLINRCY — LINE line-name _____	Required
	Job:B,I Pgm:B,I

STRCNFCHK (Start Confidence Check)

Ensures that the local I/O devices are functioning properly with the rest of the system.

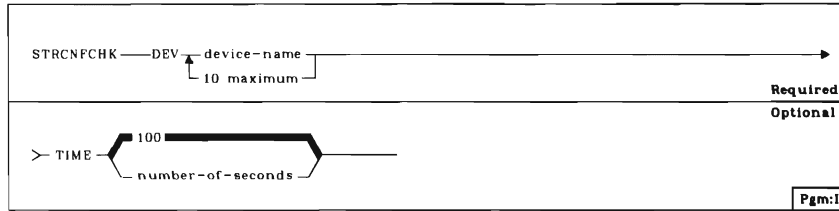

STRCRDRDR (Start Card Reader)

Starts a spooling reader to the specified card device to read a batch input stream into the system.

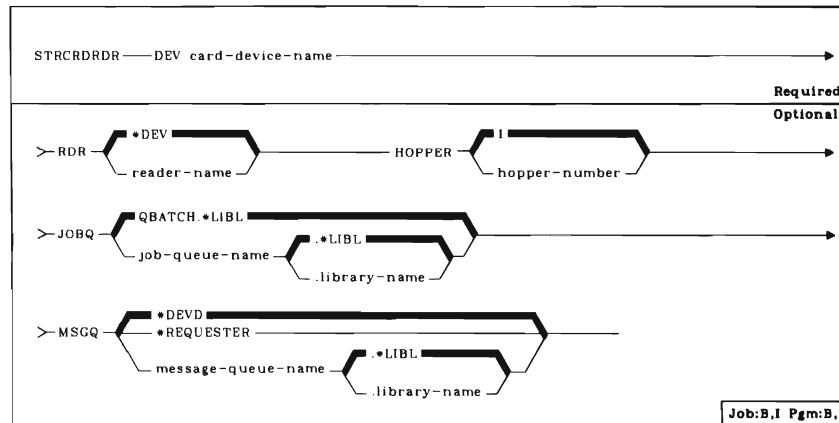

Card file-QCSPLCRD

STRCRDWTR (Start Card Writer)

Starts a spooling writer to the specified card device to write spooled output files from an output queue.

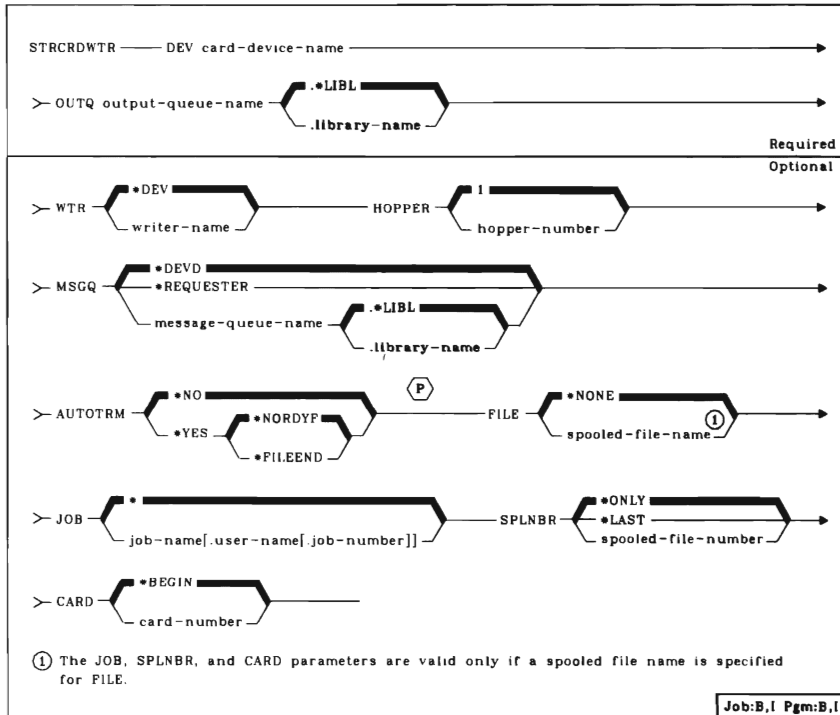

Card file-QCSPLCRD

STRDBRDR (Start Data Base Reader)

Starts a spooling reader to the specified data base file to read a batch input stream from the data base file.

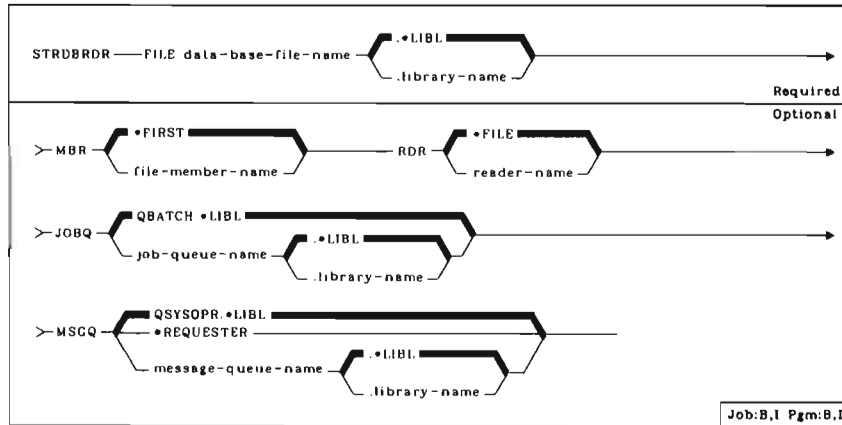

STRDKTRDR (Start Diskette Reader)

Starts a spooling reader to the specified diskette device to read a batch input stream into the system.

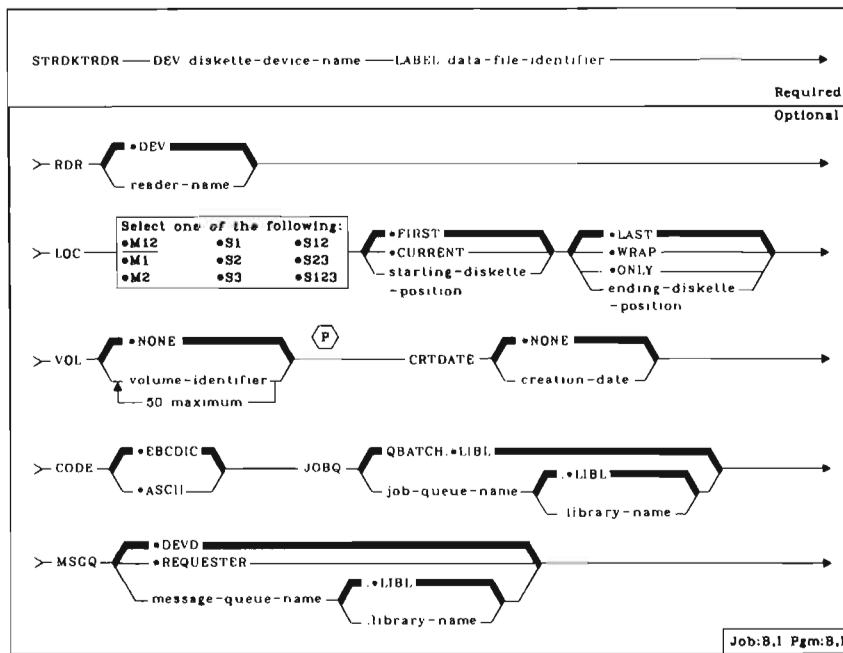

Diskette file—QKSPLDKT

STRDKTWTR (Start Diskette Writer)

Starts a spooling writer to the specified diskette device to write spooled output files from an output queue.

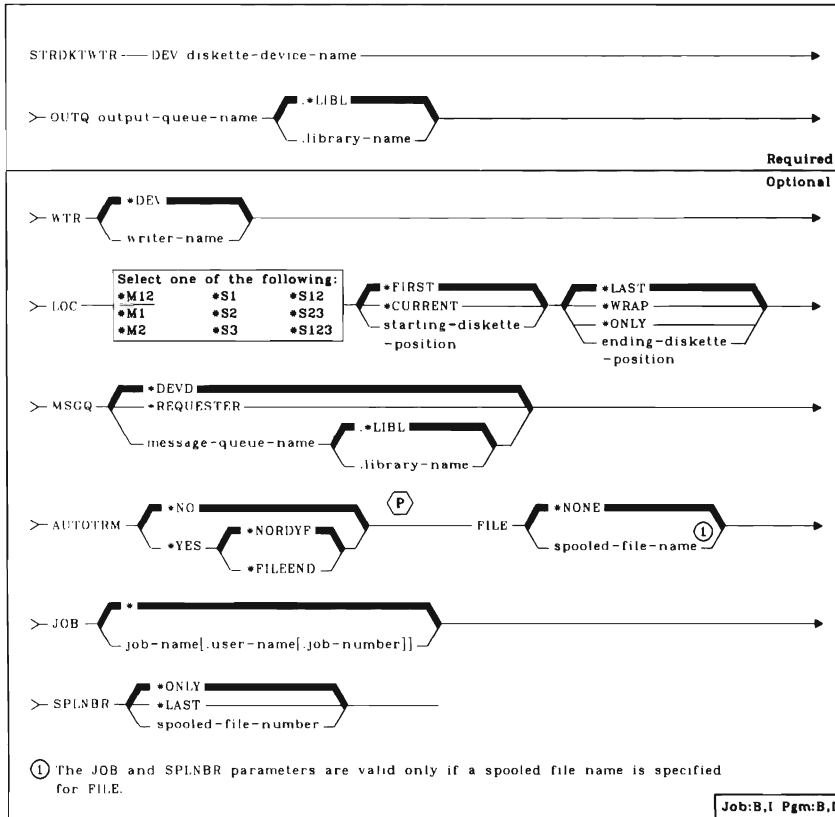

Diskette file-QKSPLDKT

STRPDP (Start Problem Determination Procedure)

Starts problem determination procedures.

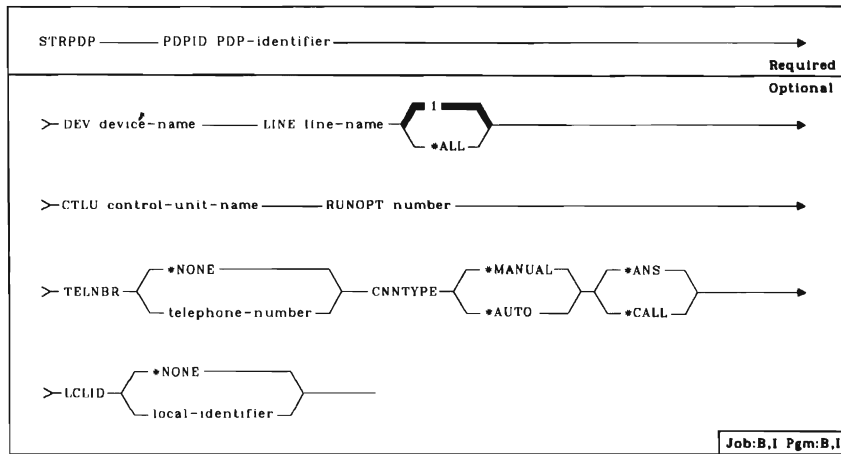

STRPRTEML (Start Printer Emulation)

Starts a batch job to emulate a 3270 printer using a BSC emulation printer device and a printer device file.

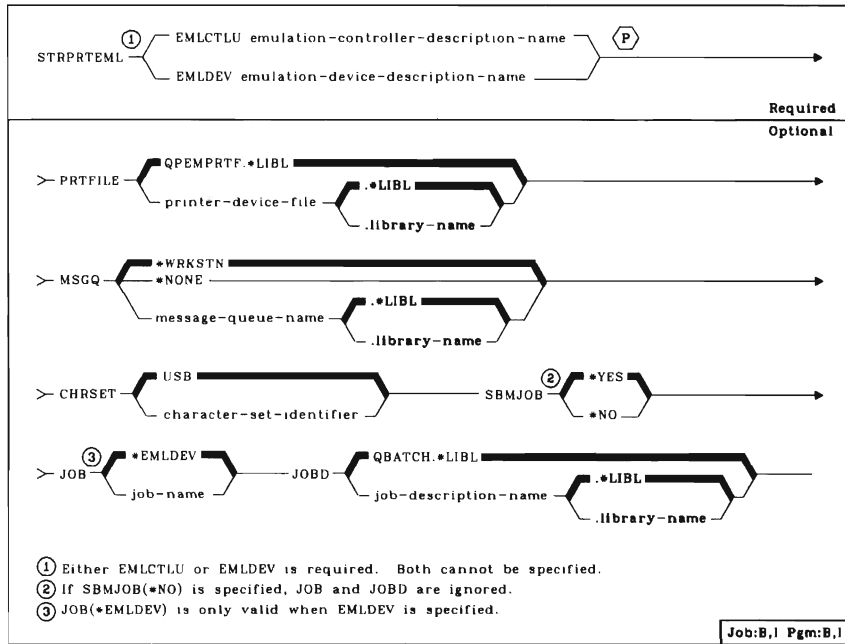

Printer file—QPEMPRTF

STRPRTWTR (Start Printer Writer)

Starts a spooling writer to the specified printer to write spooled output files from an output queue.

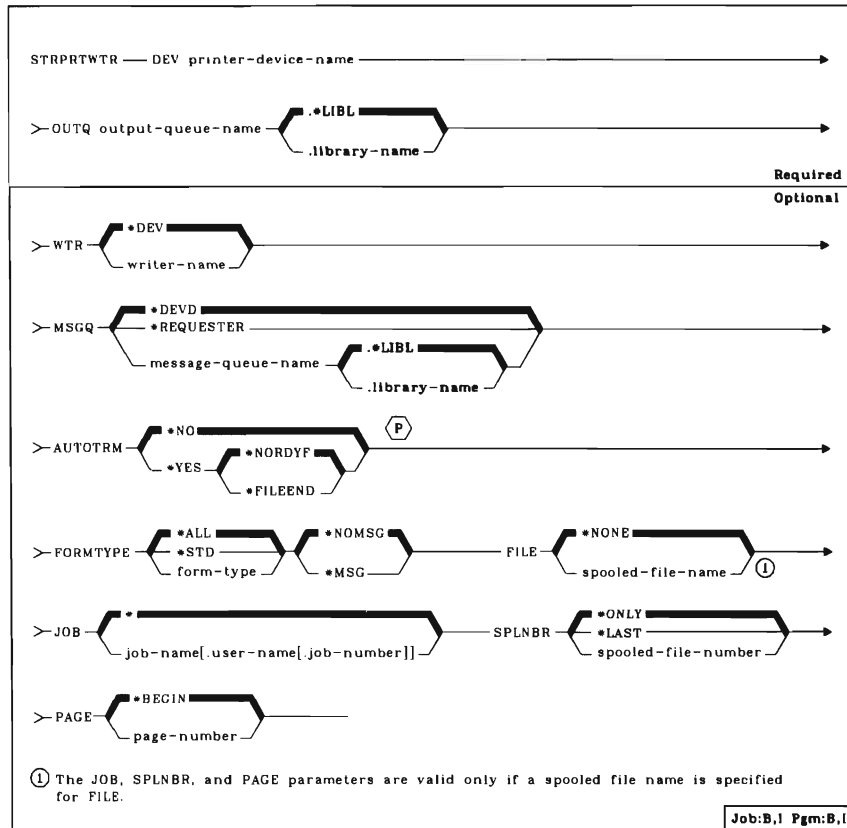

Printer file—QPSPLPRT

STRRJECSL (Start RJE Console)

Displays the RJEF console messages. This command can only be issued interactively.

STRRJECSL	SSND	session-description-name	<input type="checkbox"/> .LIBL <input type="checkbox"/>	Required
			<input type="checkbox"/> .library-name	
				Job:1 Pgm:1

STRRJRDR (Start RJE Reader)

Starts all RJEF readers or a specific RJEF reader (in order to send data to the host system).

STRRJRDR	RDR	Select one of the following: •ALL RD1 RD15	→	
>	SSN	remote-job-entry-session-name		
				Job:B,1 Pgm:B,1

STRRJEASN (Start RJE Session)

Starts an RJEF session.

STRRJEASN	SSND	session-description-name	<input type="checkbox"/> .LIBL <input type="checkbox"/>	<input type="checkbox"/> P	Required	
			<input type="checkbox"/> .library-name			
						Optional
>	RDRS	<input type="checkbox"/> YES <input type="checkbox"/> NO	WTRS	<input type="checkbox"/> YES <input type="checkbox"/> NO	→	
>	CLRMMSGQ	<input type="checkbox"/> YES <input type="checkbox"/> NO				
						Job:B,1 Pgm:B,1

STRRJEWTR (Start RJE Writer)

Starts all RJEF writers or a specific RJEF writer (in order to receive writer output from the host system). This command sends a start command to the host system to start the associated host writer.

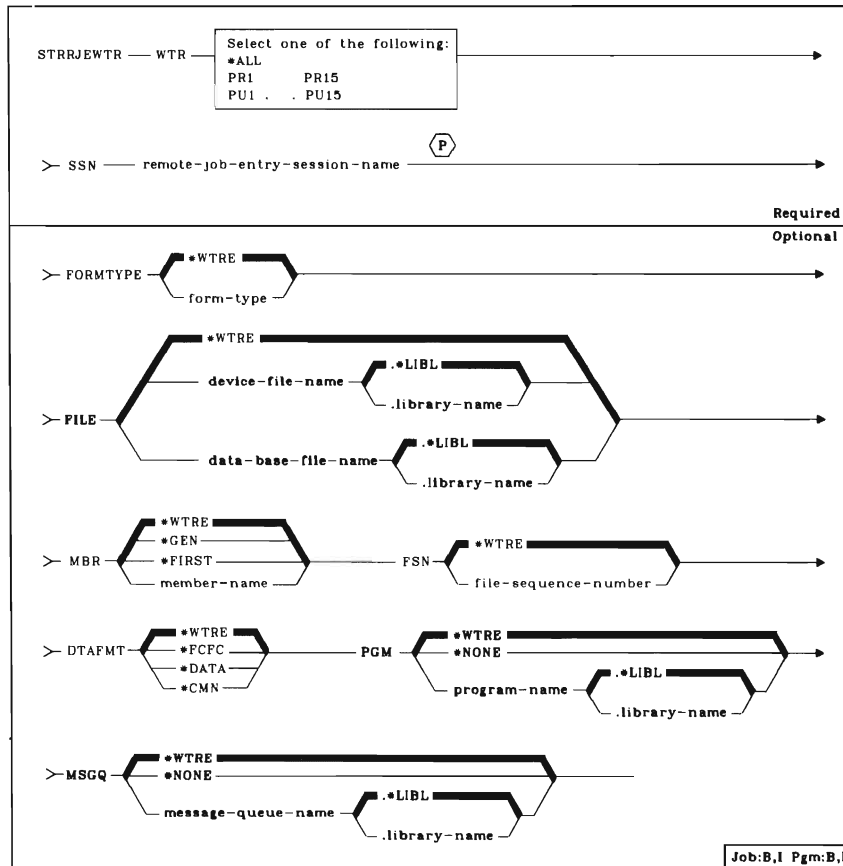

STRSBS (Start Subsystem)

Starts a subsystem.

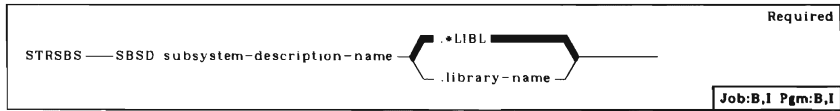

TFRBCHJOB (Transfer Batch Job)

Transfers a batch job to the specified job queue; routing data and request data can be specified for the batch job.

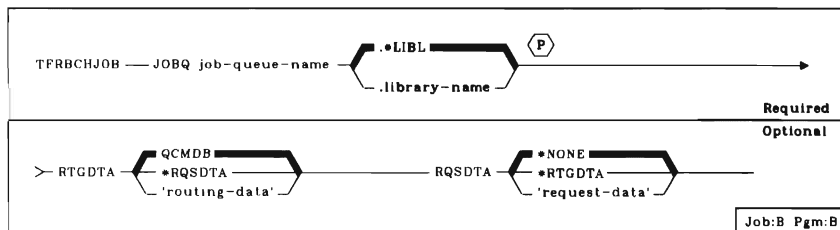

TFRCTL (Transfer Control)

Transfers control to a program. Valid only when specified in a CL program.

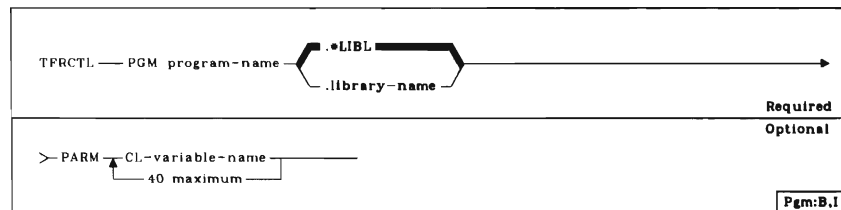

TFRGRPJOB (Transfer to Group Job)

Causes the job that issued the TFRGRPJOB command to be suspended and the group job specified by the GRPJOB parameter either to be resumed (if it already exists) or to be created (if it does not exist). In both cases, control is transferred to the job specified by the GRPJOB parameter.

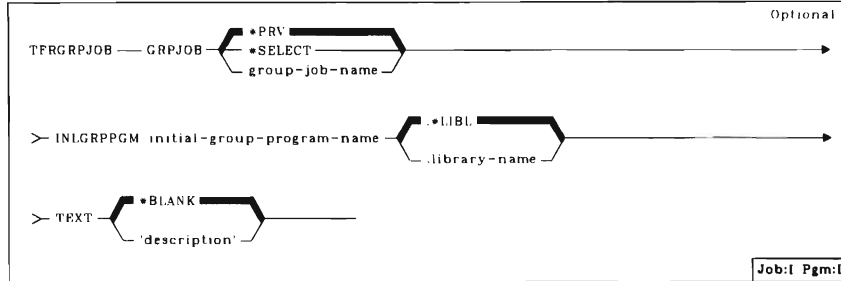

TFRJOB (Transfer Job)

Transfers a job to a different job queue.

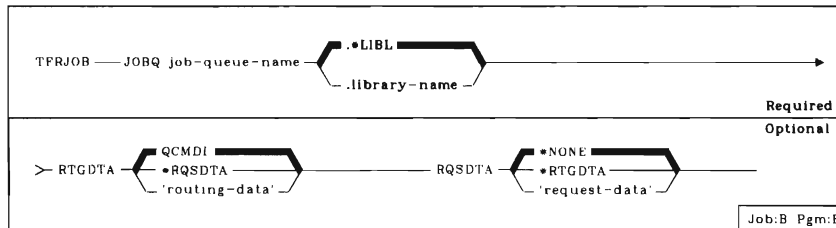

TFRSECJOB (Transfer Secondary Job)

Creates a secondary interactive job at your work station, then transfers control between the primary and secondary jobs.



TRCINT (Trace Internal)

Controls traces of internal events (associated with the current job) that occur below the machine interface.

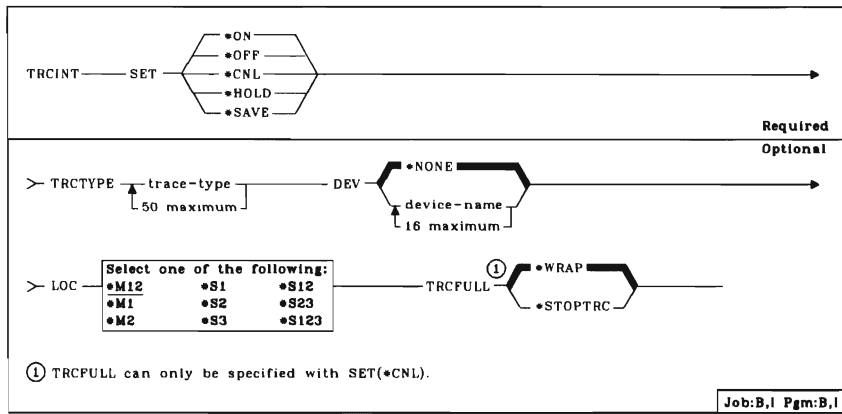

Printer file—QPCSMPT
Diskette file—QSYSDKT

TRCJOB (Trace Job)

Initiates or terminates program calls and returns in the current job (or in the job being serviced as a result of a previously issued SRVJOB command).

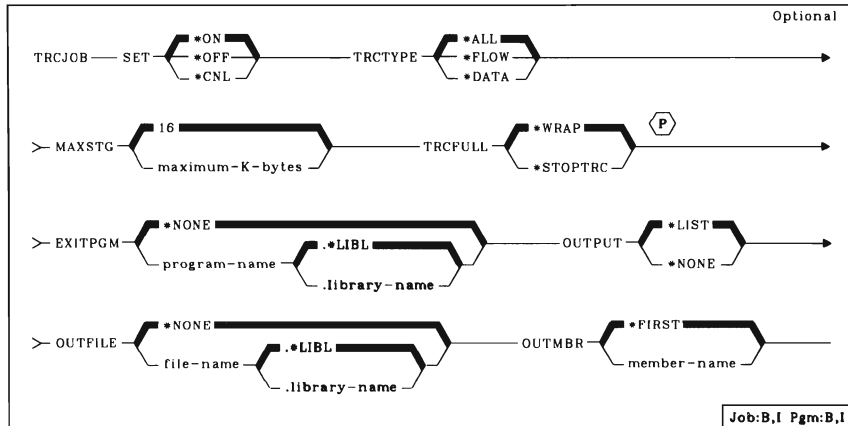

Printer file—QPSRVTRC
Out file—QATRCJOB
Format name—QSCTJTRC

TRMCPF (Terminate Control Program Facility)

Puts CPF in a service-only state (valid only in an interactive job in the controlling subsystem).

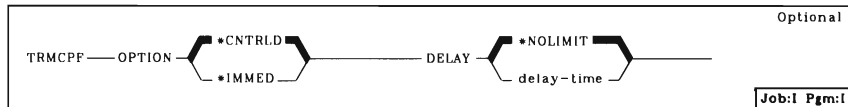

TRMGRPJOB (Terminate Group Job)

Causes a single job in a group to be terminated and another job in the group to be resumed.

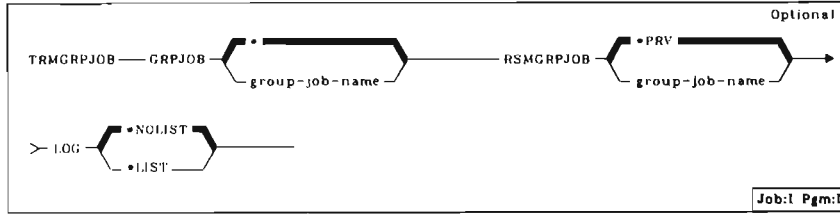

TRMPRTEML (Terminate Printer Emulation)

Ends a printer emulation without canceling the job. If there is another request in the job, that request is then processed.

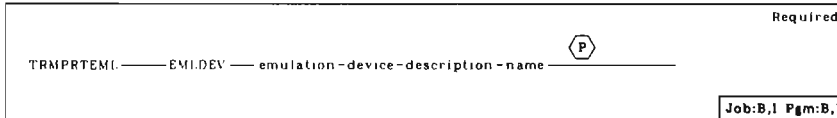

Printer file-QPEMPRTF

TRMRJESSN (Terminate RJE Session)

Terminates an RJEF session.

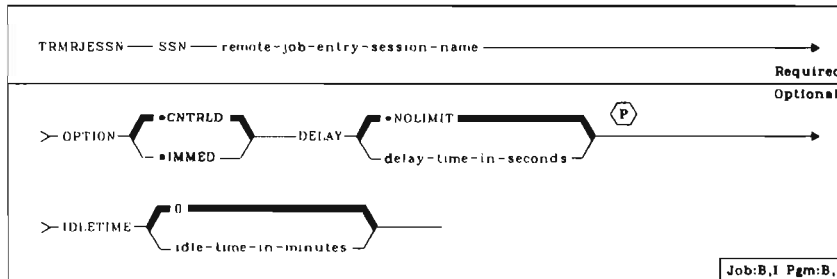

TRMSBS (Terminate Subsystem)

Terminates a specified subsystem or all subsystems (only valid in an interactive job in the controlling subsystem).

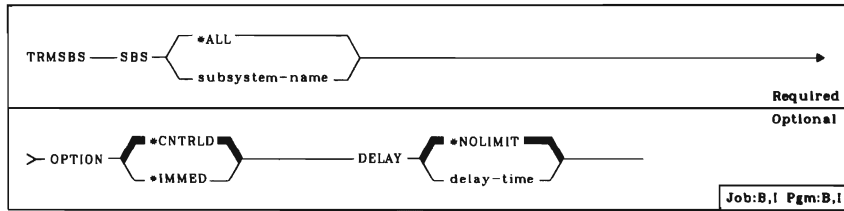

VFYPRT (Verify Printer)

Causes a test pattern to be printed on a 5219, 5224, 5225, or 5256 Printer the specified number of times.

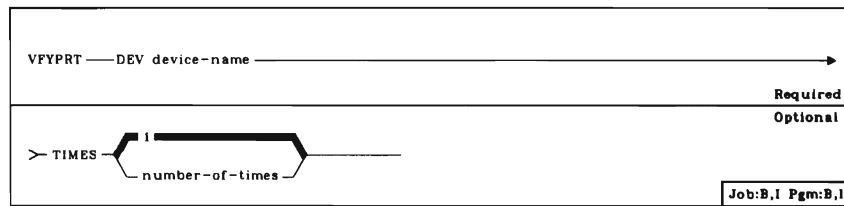

VRYCTLU (Vary Control Unit)

Places a control unit in an online or offline status.

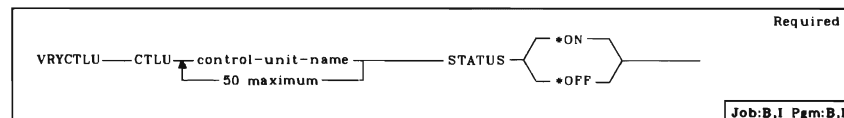

VRIDEV (Vary Device)

Places an external device in an online or offline status.

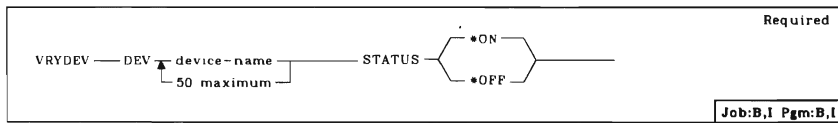

VRILIN (Vary Line)

Places a communications line in an online or offline status.

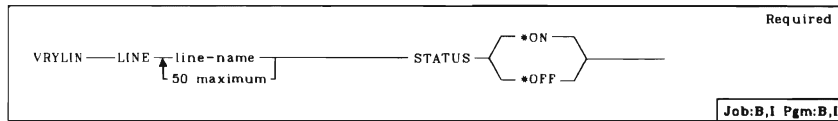

WAIT (Wait)

Causes the CL program in which it is used to wait for input from any display device to which a RCVF or SNDRCVF command specifying WAIT(*NO) has been issued. Valid only in a CL program.

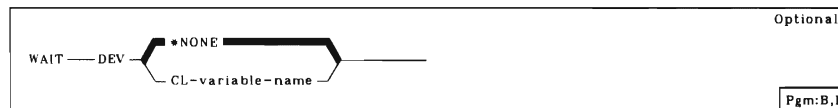

COMMAND DEFINITION STATEMENTS

CMD (Command)

The only required command definition statement. Optionally, specifies the prompt text for the command being defined.

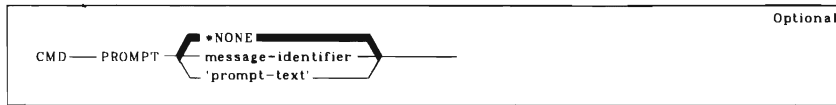

DEP (Dependent)

Defines a required relationship between parameters and parameter values used in a command being defined.

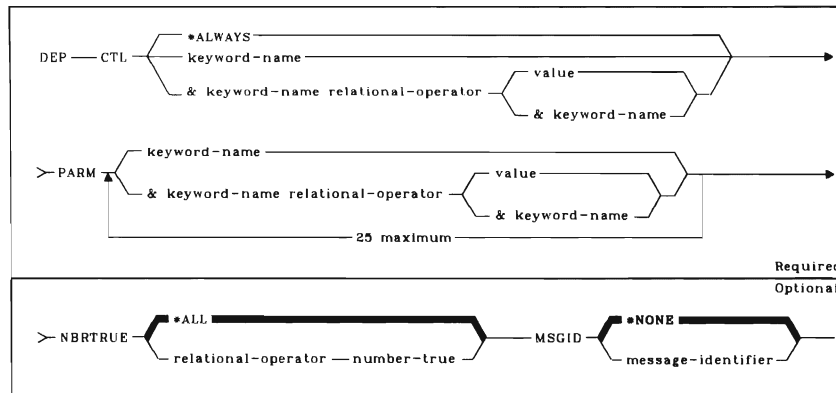

ELEM (Element)

Defines an element allowed in a mixed list for a parameter of a command being defined.

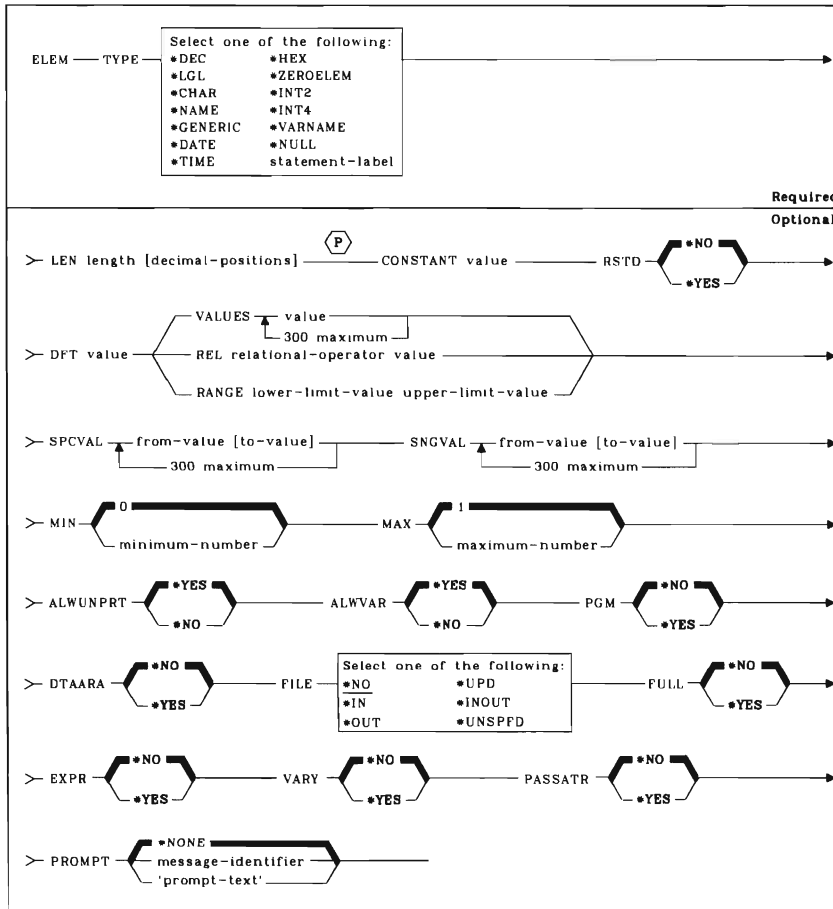

PARM (Parameter)

Defines a parameter of a command being defined.

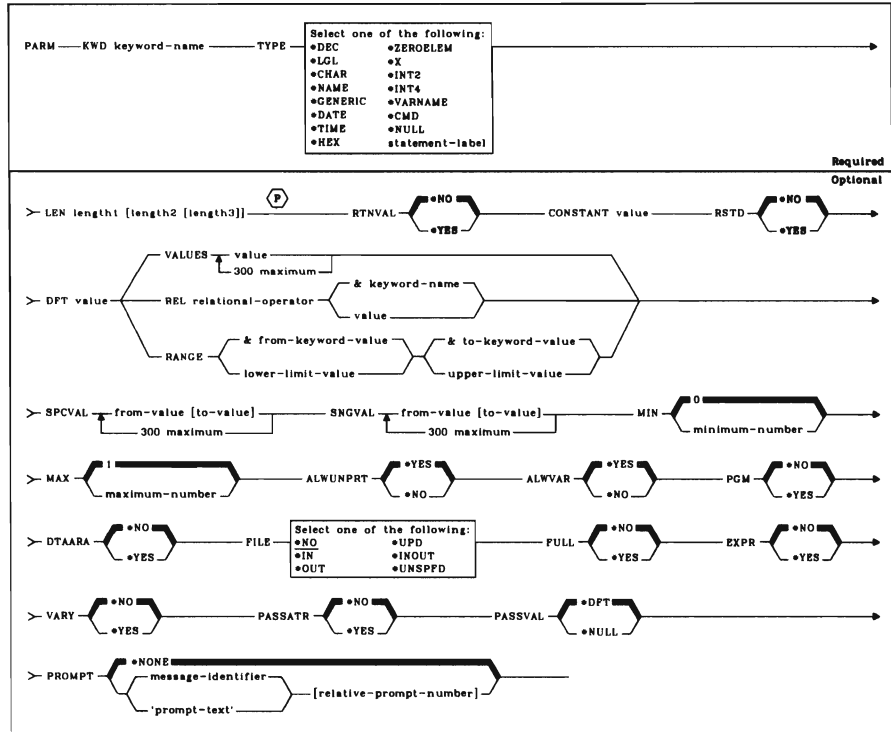

QUAL (Qualifier)

Defines one part of a qualified name allowed in a parameter value or list element being defined.

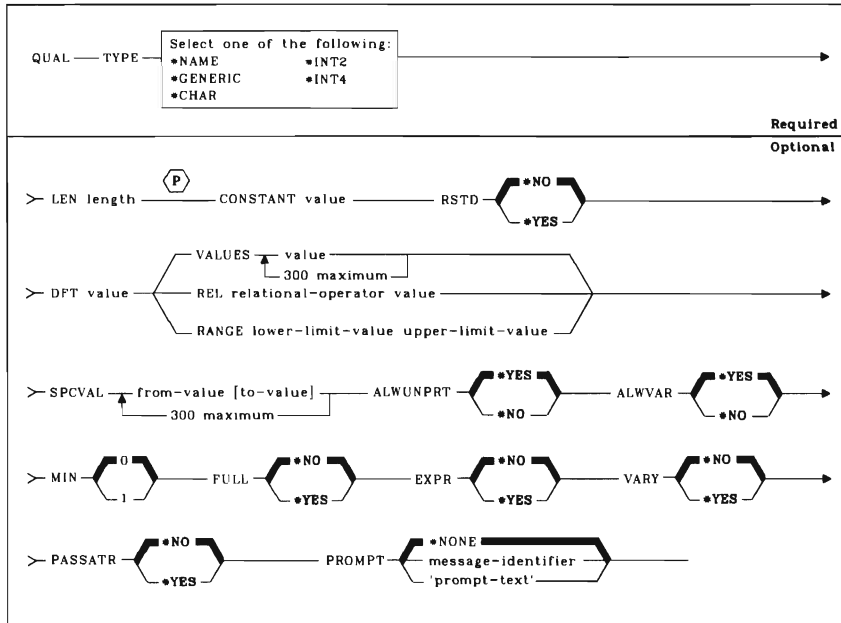

Chapter 3. Command Matrix

Items		Actions					
Items Affected	Item Abbrev.	Create/ Delete	Add/ Remove	Change/ Override	Display	Hold/ Release	Other Actions
Access code	ACC		ADD RMV		DSP		GRT RVK ENT
Access code authority	ACCAUT				DSP		
Accounting code	ACGCDE			CHG			
Active jobs	ACTJOB				DSP		
Administrative management	ADM						
Advanced printer function	APF						DSN
APAR	APAR						PRP
Attention program	ATNPGM						SET
Authority	AUT						RST
Authorized users	AUTUSR				DSP		
Auto report program	RPTPGM	CRT					DLT (see DLTPGM)
Autostart job entry	AJE		ADD RMV	CHG			
BASIC	BAS						BGN
BASIC procedure	BASPRC						EXC
BASIC program	BASPGM	CRT					DLT (see DLTPGM)
Batch job	BCHJOB						TFR
Break message	BRKMSG						SND
Breakpoint(s)	BKP		ADD RMV		DSP		RSM
BSC device entry	BSCDEVE		ADD RMV				
BSC file	BSCF	CRT		CHG OVR			DLT (see DLTF) DSP (see DSPFD)
Business graphics utility	BGU						ENT
Card file	CRDF	CRT		CHG OVR			DLT (see DLTF) DSP (see DSPFD)
Card jobs	CRDJOB						SBM
Card reader	CRDRDR						STR (see also Reader)
Card writer	CRDWTR						STR (see also Writer)

Items		Actions					
Items Affected	Item Abbrev.	Create/ Delete	Add/ Remove	Change/ Override	Display	Hold/ Release	Other Actions
Changed object	CHGOBJ						SAV
Channel status	CHLSTS				DSP		
Chart	CHT				DSP		
Chart format	CHTFMT	DLT					
Class	CLS	CRT DLT			DSP		
COBOL debug (mode)	CBLDBG						END ENT
COBOL program	CBLPGM	CRT					DLT (see DLTPGM)
Command	CMD	CRT DLT		CHG	DSP		
Command usage	CMDUSG						LST
Commitment control	CMTCTL						BGN END
Communications device	CMNDEV					HLD RLS	
Communications device entry	CMNDEVE		ADD RMV				
Communications entry	CMNE		ADD RMV	CHG			
Communications file	CMNF	CRT		CHG OVR			DLT (see DLTF) DSP (see DSPFD)
Communications Statistical Network Analysis Procedure Attributes	CNPA			CHG	DSP		LST (see LSTCNP) LSTCNP
Confidence check	CNFCHK						STR
Control	CTL						TFR
Control language program	CLPGM	CRT					DLT (see DLTPGM) DMP
Control language source	CLSRC						RTV
Control Program Facility	CPF						TRM
Control unit	CTLU						PWR VRY
Control unit description	CUD	CRT DLT		CHG	DSP		
Control unit recovery	CTLRCY						RSM STP
Control unit status	CTLSTS				DSP		
Data	DTA			CHG	DSP		FMT QRY

Items		Actions					
Items Affected	Item Abbrev.	Create/ Delete	Add/ Remove	Change/ Override	Display	Hold/ Release	Other Actions
Data area	DTAARA	CRT DLT		CHG	DSP		DCL SND RCV RTV
Data base file	DBF			OVR			CRT (see CRTLF/ CRTPF) DLT (see DLTF) LOG OPN STR
Data base reader	DBRDR						
Data base relations	DBR				DSP		
Data file utility application	DFUAPP	CRT DLT					DSN
Data file utility definition	DFUDEF	CRT		CHG			
Data file utility source	DFUSRC						RTV
Data queue	DTAQ	CRT DLT					
Date	DAT						CVT
Debug (mode)	DBG			CHG	DSP		ENT END
Device	DEV						PWR VRY MNGDEV
Device configuration	DEVCFG				DSP		
Device description	DEVD	CRT DLT		CHG	DSP		
Device mode entry	DEVMODE		ADD	CHG			
Device recovery	DEVRCY						RSM STP
Device status	DEVSTS				DSP		
Device table	DEVTBL						MNG
Diskette	DKT				DSP		CHK CLR CPYFRM CPYTO DUP INZ RNM
Diskette file	DKTF	CRT		CHG OVR			DLT (see DLTF) DSP (see DSPFD)
Diskette jobs	DKTJOB						SBM
Diskette label	DKTLBL	DLT					DSP (see DSPDKT) INZ (see INZDKT)

Items		Actions					
Items Affected	Item Abbrev.	Create/Delete	Add/Remove	Change/Override	Display	Hold/Release	Other Actions
Diskette reader	DKTRDR						STR (see also Reader)
Diskette writer	DKTWTR						STR (see also Writer)
Display device entry	DSPDEVE		ADD RMV				
Display file	DSPF	CRT		CHG OVR			DLT (see DLTf) DSP (see DSPFD)
Distribution list	DSTL						MNG
Distribution services	DSTSRV				DSP		CFG
Distribution status	DSTSTS				DSP		
Directory	DIR				DSP		MNG
Do	DO						END
Document	DOC	DLT					EDT PRT SAV RST
Document authority	DOCAUT				DSP		CRT RVK
Document list	DOCL	DLT					
Document owner	DOCOWN			CHG			
Duplicate object	DUPOBJ	CRT					
Edit description	EDTD	CRT DLT			DSP		
Emulation output	EMLOUT						EJT
Error log	ERRLOG						LST
File	F	DLT					CPY DCL SND RCV SNDRCV CLO
File description	FD				DSP		
File field description	FFD				DSP		
Finance help	FNCHLP				DSP		
Finance job	FNCJOB						SBM
Format	FMT						DSN
Form description	FORMD						MRG
Forms control table	FCT	CRT DLT		CHG	DSP		

Items		Actions					
Items Affected	Item Abbrev.	Create/ Delete	Add/ Remove	Change/ Override	Display	Hold/ Release	Other Actions
Forms control table entry	FCTE		ADD RMV	CHG			
Graphics symbol set	GSS	DLT					
Group attributes	GRPA				CHG		RTV
Group job	GRPJOB						TFR TRM
High-level language pointer	HLLPTR			CHG			
Input	INP						END BGN
Intelligent work station services	IWSSRV						
Internal	INT						TRC
Internal data	INTDTA						LST
Job	JOB			CHG	DSP	HLD RLS	CNL DLY DMP END RRT SBM SRV TFR TRC
Job attributes	JOBA						RTV
Job description	JOBDE	CRT DLT		CHG	DSP		
Job internal	JOBINT						DMP
Job log	JOBLOG				DSP		
Job queue	JOBQ	CRT DLT			DSP	HLD RLS	CLR
Job queue entry	JOBQE		ADD RMV	CHG			
Journal	JRN	CRT DLT		CHG	DSP		
Journal attributes	JRNA				DSP		
Journal entry	JRNE						SND RCV RTV CMP
Journal images	JRNIMG						
Journal menu	JRNMNU					DSP	
Journal receiver	JRNRCV	CRT DLT					DSP (see DSPJRN END
Journal physical file	JRNPF						APY RMV
Journalized changes	JRNCHG		RMV				
Keyboard map	KBDMAP			CHG	DSP		
Library	LIB	CRT DLT			DSP		CLR SAV RST RPL
Library list	LIBL				DSP		
Library list entry	LIBLE		ADD RMV				
Line	LIN						ANS VRY
Line description	LIND	CRT DLT		CHG	DSP		

Items		Actions					
Items Affected	Item Abbrev.	Create/ Delete	Add/ Remove	Change/ Override	Display	Hold/ Release	Other Actions
Line recovery	LINRCY	CRT ¹		CHG	DSP DSP DSP		RSM STP
Line status	LINSTS						
Link status	LNKSTS						
Log/logging	LOG						
Logical file	LF						
Logical file member	LFM		ADD	CHG			
Member	M		RMV				RNM
Menu	MNU		RMV		DSP DSP		MON
Message(s)	MSG						
Message description	MSGD						
Message file	MSGF	CRT DLT		OVR	DSP		DLT (see DLTf)
Message queue	MSGQ	CRT DLT		CHG	CHG OVR		DLT (see DLTf) DSP (see DSPFD)
Mixed file	MXDF	CRT					
Mode status	MODSTS				DSP		
Network attributes	NETA			CHG	DSP		
Object	OBJ						ALC CHK DLC DMP MOV RNM SAV SAVCHG RST SND CNL RCV SND SBM SND
Net spooled file	NETSPLF						
Network file	NETF				DSP		
Network job	NETJOB						
Network job entry	NETJOBE		ADD RMV		DSP		
Network message	NETMSG						

¹See also *data base file*.

Items		Actions					
Items Affected	Item Abbrev.	Create/ Delete	Add/ Remove	Change/ Override	Display	Hold/ Release	Other Actions
Object authority	OBJAUT				DSP		GRT RVK
Object description	OBJD				DSP		
Object lock	OBJLCK				DSP		
Object owner	OBJOWN			CHG			
Office	OFC						SND
Output queue	OUTQ	CRT DLT		CHG	DSP	HLD RLS	CLR
Override	OVR	DLT			DSP		
Pass-through	PASTHR						BGN END
Physical file	PF	CRT		CHG			DLT (see DLTF) DSP (see DSPFD), JRN OVR (see OVRDBF) BRW
Physical file member	PFM		ADD	CHG			CLR INZ RGZ BRW
PLI program	PLIPGM	CRT					DLT (see DLTPGM)
Pointer	PTR			CHG			
Print image	PRTIMG	CRT DLT					
Print key	PRTKEY						EML
Printer	PRT						CLN VFY
Printer emulation	PRTEML						STR TRM
Printer file	PRTF	CRT		CHG OVR			DLT (see DLTF) DSP (see DSPFD)
Printer writer	PRTWTR						STR (see also Writer)
Problem determination procedure	PDP						STR
Program	PGM	DLT	ADD RMV	CHG	DSP		END PCH SND
Program message	PGMMSG						
Program references	PGMREF				DSP		
Program table	PGMTBL						MNG

Items		Actions					
Items Affected	Item Abbrev.	Create/ Delete	Add/ Remove	Change/ Override	Display	Hold/ Release	Other Actions
Program variable	PGMVAR			CHG	DSP		
Programmer menu	PGMMNU				DSP		
Programming change	PGMCHG		RMV		DSP		APY LOD DSN
Query application	QRYAPP	CRT DLT					
Query definition	QRYDEF	CRT		CHG			
Query source	QRYSRC						
Reader	RDR				DSP	HLD RLS	RTV CNL
Receive	RCV						CNL
Record lock	RCDLCK				DSP		
Reply	RPY						SND
Reply list entry	RPYLE		ADD RMV	CHG			DSP (see DSPRPYL CNL RCL
Request	RQS						
Resources	RSC						
RJE communications entry	RJECMNE		ADD RMV	CHG			
RJE configuration	RJECFG	CRT DLT			DSP		
RJE console	RJESL						STR
RJE data	RJEDTA						FMT
RJE job	RJEJOB						SBM
RJE reader	RJERDR						STR CNL
RJE reader entry	RJERDRE		ADD RMV	CHG			
RJE session	RJESSN						STR TRM STR CNL
RJE writer	RJEWTR						
RJE writer entry	RJEWTRE		ADD RMV	CHG			
Routing entry	RTGE		ADD RMV	CHG			
RPG program	RPGPGM	CRT					DLT (see DLTPGM)
RPT program	RPTPGM	CRT					DLT (see DLTPGM)
Save file	SAVF	CRT		CHG OVR	DSP		CLR DLT (see DLTF)
Save file data	SAVEDTA						SAV
Secondary job	SECJOB						TFR
Service	SRV						END

Items		Actions					
Items Affected	Item Abbrev.	Create/ Delete	Add/ Remove	Change/ Override	Display	Hold/ Release	Other Actions
Service status	SRVSTS				DSP		
Session description	SSND	CRT DLT		CHG	DSP		
Session maximum	SSNMAX			CHG			
Source	SRC						EDT
Source file	SRCF						CPY
Source physical file	SRCPF	CRT		CHG			DLT (see DLTf) DSP (see DSPFD)
Spelling aid dictionary	SPADCT	CRT DLT					
Spoiled file	SPLF				DSP	HLD RLS	CNL CPY SNDNET
Spoiled file attributes	SPLFA			CHG	DSP		
Storage	STG						RCL
Submitted jobs	SBMJOB				DSP		
Subsystem	SBS				DSP		STR TRM
Subsystem description	SBSD	CRT DLT		CHG	DSP		
System	SYS				DSP		SAV PWRDW
System library list	SYSLIBL			CHG			
System object	SYSOBJ						DMP
System status	SYSSTS				DSP		
System value	SYSVAL			CHG	DSP		RTV

Items		Actions					
Items Affected	Item Abbrev.	Create/ Delete	Add/ Remove	Change/ Override	Display	Hold/ Release	Other Actions
Table	TBL	CRT DLT					CHK, CPYFRM, CPYTO, DMP, INZ
Tape	TAP				DSP		
Tape file	TAPF	CRT		CHG OVR			DLT (see DLTF) DSP (see DSPFD) EDT
Text	TXT						
Trace	TRC		ADD RMV		DSP		
Trace data	TRCDTA				DSP		CLR
User authority	USRAUT	CRT DLT					GRT SND RST RTV MNG
User message	USRMSG						
User profile(s)	USRPRF		CHG		DSP		
User table	USRTBL						
Variable	VAR			CHG			
Work station entry	WSE		ADD RMV	CHG			
Writer	WTR			CHG	DSP	HLD RLS	CNL
3270 device	3270						EML

Note: The following commands are all one-word commands that are also part of CL:

CALL	DCL	IF	ROLLBACK
CLOF	DO	JOB	SIGNOFF
COMMIT	PGM	PGM	WAIT
DATA	GOTO	RETURN	

Chapter 4. User Profile Matrix

P in the QUSER column indicates a command with public authorization. E in a column indicates a command with explicit authorization for a particular user. R in the QSECOFR column indicates a command authorized explicitly for use by the security officer.

Command Name	User Profile Names					
	QUSER (P)	QPGMR (E)	QSYSOPR (E)	QPSR (E)	QCE (E)	QSECOFR (R)
ADDACC						R
ADDAJE	P					
ADDBKP	P					
ADDBSCDEVE	P					
ADDCMNDEVE	P					
ADDCMNE	P					
ADDDEVMODE	P					
ADDDSPDEVE	P					
ADDFCTE	P					
ADDJOBQE	P					
APYJRNCHG		E		E	E	
ADDLFM	P					
ADDLIBLE	P					
ADDMSGD	P					
ADDNETJOBE						R
ADDPFM	P					
ADDPGM	P					
ADDRJECMNE	P					
ADDRJERDRE	P					
ADDRJEWTR	P					
ADDRPYLE		E				
ADDRTGE	P					
ADDTRC	P					
ADDWSE	P					
ALCOBJ	P					
ANSLIN	P					
APYPGMCHG		E	E	E	E	
BGNBAS	P					
BGNCMTCTL	P					
BGNPASTHR	P					

Command Name	User Profile Names					
	QUSER (P)	QPGMR (E)	QSYSOPR (E)	QPSR (E)	QCE (E)	QSECOFR (R)
BRWPFM	P					
CALL	P					
CFGDSTSRV						R
CHGACGCDE	P					
CHGAJE	P					
CHGBSCF	P					
CHGCMD	P					
CHGCMNE	P					
CHGCMNF	P					
CHGCNPA		E	E	E		
CHGCRDF	P					
CHGCUD	P					
CHGDBG	P					
CHGDEV D	P					
CHGDEV MODE	P					
CHGDFUDEF	P					
CHGDKTF	P					
CHGDOCOWN	P					
CHGDSPF	P					
CHGDTA	P					
CHGDTAARA	P					
CHGFCT	P					
CHGFCTE	P					
CHGGRPA	P					
CHGHLLPTR	P					
CHGJOB	P					
CHGJOB D	P					
CHGJOBQE	P					
CHGJRN		E	E	E	E	

Command Name	User Profile Names					
	QUSER (P)	QPGMR (E)	QSYSOPR (E)	QPSR (E)	QCE (E)	QSECOFR (R)
CHGKBDMAP	P					
CHGLF	P					
CHGLFM	P					
CHGLIND	P					
CHGMSGD	P					
CHGMSGQ	P					
CHGMXDF	P					
CHGNETA						R
CHGNETJOBE						R
CHGOBJOWN	P					
CHGOUTQ	P					
CHGPGM	P					
CHGPGMVAR	P					
CHGPF	P					
CHGPFM	P					
CHGPRTF	P					
CHGPTR				E	E	
CHGQRYDEF	P					
CHGRJECMNE	P					
CHGRJERDRE	P					
CHGRJEWTR	P					
CHGRPYLE		E				
CHGRTGE	P					
CHGSAVF	P					
CHGSBSD	P					
CHGSPLFA	P					
CHGSRCPF	P					
CHGSSND	P					
CHGSSNMAX	P					
CHGSYSLIBL		E		E	E	

Command Name	User Profile Names					
	QUSER (P)	QPGMR (E)	QSYSOPR (E)	QPSR (E)	QCE (E)	QSECOFR (R)
CHGSYSVAL		E	E	E	E	
CHGTAPF	P					
CHGUSRPRF						R
CHGVAR	P					
CHGWSE	P					
CHGWTR	P					
CHKDKT	P					
CHKOBJ	P					
CHKTAP	P					
CLNPRT		E	E	E	E	
CLOF	P					
CLRDKT		E	E	E	E	
CLRJOBQ	P					
CLRLIB	P					
CLROUTQ	P					
CLRPFM	P					
CLRSAVF	P					
CLRTRCDTA	P					
CMPJRNIMG	P					
CNLJOB	P					
CNLNETF	P					
CNLRVCV	P					
CNLRDR	P					
CNLRJERDR	P					
CNLRJEWTR	P					
CNLRQS	P					
CNLSPLF	P					
CNLWTR	P					
COMMIT	P					

Command Name	User Profile Names					
	QUSER (P)	QPGMR (E)	QSYSOPR (E)	QPSR (E)	QCE (E)	QSECOFR (R)
CPYF	P					
CPYFRMDKT	P					
CPYFRMTAP	P					
CPYSPLF	P					
CPYSRCF	P					
CPYTODKT	P					
CPYTOTAP	P					
CRTBASPGM		E		E	E	
CRTBSCF		E		E	E	
CRTCLPGM		E		E	E	
CRTCLS		E		E	E	
CRTCMD		E		E	E	
CRTC MNF		E		E	E	
CRTC RDF		E		E	E	
CRTCUD		E		E	E	
CRTDEVD		E		E	E	
CRTDFUAPP	P					
CRTDFUDEF	P					
CRTDKTF		E		E	E	
CRTDSPF		E		E	E	
CRTDTAARA		E		E	E	
CRTDTAQ	P					
CRTDUPOBJ	P					
CRTEDTD		E		E	E	
CRTFCT	P					
CRTJOBQ		E		E	E	
CRTJOBQ		E		E	E	
CRTJRN		E		E	E	
CRTJR NRCV		E		E	E	

Command Name	User Profile Names					
	QUSER (P)	QPGMR (E)	QSYSOPR (E)	QPSR (E)	QCE (E)	QSECOFR (R)
CRTLF	P					
CRTLIB		E		E	E	
CRTLIND		E		E	E	
CRTMSGF		E		E	E	
CRTMSGQ		E		E	E	
CRTMXDF		E		E	E	
CRTOUTQ		E		E	E	
CRTPF		E		E	E	
CRTPLIPGM	P					
CRTPRTF		E		E	E	
CRTPRTIMG		E		E	E	
CRTQRYAPP	P					
CRTQRYDEF	P					
CRTRJECFG		E		E	E	
CRTRPGPGM	P					
CRTRPTPGM	P					
CRTSAVF						R
CRTSBSD		E		E	E	
CRTSPADCT		E		E	E	
CRTSRCPF		E		E	E	
CRTSSND	P					
CRTTAPF		E		E	E	
CRTTBL		E		E	E	
CRTUSRPRF						R
CVTDAT	P					
DATA	P					
DCL	P					
DCLDTAARA	P					
DCLF	P					
DFNKBDMAP	P					

Command Name	User Profile Names					
	QUSER (P)	QPGMR (E)	QSYSOPR (E)	QPSR (E)	QCE (E)	QSECOFR (R)
DLCOBJ DLTCHTFMT DLTCLS DLTCMD DLTCUD	P P P P P					
DLTDEVD DLTDKTLBL DLTDOC DLTDOCL DLTDTAARA	P P P P P	E	E	E	E	
DLDTAQ DLTEDTD DLTDFUAPP DLTF DLTFCT	P P P P P					
DLTGSS DLTJOBQ DLTJOBQ DLTJRN DLTJRNRCV	P P P P P					
DLTLIB DLTLIND DLTMSGF DLTMSGQ DLTOUTQ	P P P P P					
DLTOVR DLTPGM DLTPRTIMG DLTQRYAPP DLTRJECFG	P P P P P	E		E	E	

Command Name	User Profile Names					
	QUSER (P)	QGMGR (E)	QSYSOPR (E)	QPSR (E)	QCE (E)	QSECOFR (R)
DLTSBSD DLTSPADCT DLTSSND DLTTBL DLTUSRPRF	P P P P P					R
DLYJOB DMPCLPGM DMPJOB DMPJOBINT DMPOBJ	P P P P P	E E E	E E E	E E E	E E E	
DMPYSOBY DMPTAP DO DSNAPF DSNDFUAPP	P P P P P	E	E	E	E	
DSNFMT DSNQRYPAPP DSPACC DSPACCAUT DSPACTJOB	P P P P P					
DSPAUTUSR DSPBKP DSPCHLSTS DSPCHT DSPCLS	P P P P P					R
DSPCMD DSPCNPA DSPCTLSTS DSPCUD DSPDBG	P P P P P	E E	E E	E E	E E	

Command Name	User Profile Names					
	QUSER (P)	QPGMR (E)	QSYSOPR (E)	QPSR (E)	QCE (E)	QSECOFR (R)
DSPDBR	P					
DSPDEVCFG	P					
DSPDEVD	P					
DSPDEVSTS		E	E	E	E	
DSPDIR	P					
DSPDKT	P					
DSPDOCAUT	P					
DSPDSTSRV	P					
DSPDSTSTS		E	E			
DSPDTA	P					
DSPDTAARA	P					
DSPEDTD	P					
DSPFCT	P					
DSPFD	P					
DSPFFD	P					
DSPFNCHLP	P					
DSPJOB	P					
DSPJOBBD	P					
DSPJOBLOG	P					
DSPJOBQ	P					
DSPJRN	P					
DSPJRNA	P					
DSPJRNMNU		E	E	E	E	
DSPJRNCVA	P					
DSPKBDMAP	P					
DSPLIB	P					
DSPLIBL	P					
DSPLIND	P					
DSPLINSTS		E	E	E	E	
DSPLOG		E	E	E	E	

Command Name	User Profile Names					
	QUSER (P)	QPGMR (E)	QSYSOPR (E)	QPSR (E)	QCE (E)	QSECOFR (R)
DSPSRVSTS		E	E	E	E	
DSPSSND	P					
DSPSYS	P					
DSPSYSSTS	P					
DSPSYSVAL	P					
DSPTAP	P					
DSPTRC	P					
DSPTRCDTA	P					
DSPUSRPRF	P					
DSPWTR	P					
DUPDKT		E	E	E	E	
EDTDOC	P					
EDTSRC	P					
EDTTXT	P					
EJTEMLOUT	P					
ELSE	P					
EML3270	P					
EMLPRTKEY	P					
ENDCBLDBG	P					
ENDCMTCTL	P					
ENDDBG	P					
ENDDO	P					
ENDINP	P					
ENDJOB	P					
ENDJRNPF	P					
ENDPASTHR	P					
ENDPGM	P					
ENDSRV		E	E	E	E	
ENTADM	P					
ENTBGU	P					

Command Name	User Profile Names					
	QUSER (P)	QPGMR (E)	QSYSOPR (E)	QPSR (E)	QCE (E)	QSECOFR (R)
ENTCBLDBG ENTDBG EXCBASPRC FMTDTA FMTRJEDTA	P P P	 E E		 E E	 E E	
GOTO GRTACCAUT GRDOCAUT GRTOBJAUT GRTUSRAUT	P P P P					R
HLDCMNDEV HLDJOB HLDJOBQ HLDOUTQ HLDRDR	 P P P P	E	E	E	E	
HLDSPLF HLDWTR IF INZDKT INZPFM	P P P P	 E	 E	 E	 E	
INZTAP JOB JRNPF LODPGMCHG LSTCMDUSG	 P P P	E E	E E	E E	E E	
LSTCNPDTA LSTCNPST LSTERRLOG LSTINTDTA MONMSG	 P	E E E E	E E E E	E E E E		

Command Name	User Profile Names					
	QUSER (P)	QPGMR (E)	QSYSOPR (E)	QPSR (E)	QCE (E)	QSECOFR (R)
MOV OBJ	P					
MNGDEVTBL						R
MNGDIR						R
MNGDSTL	P					
MNGPGMTBL						R
MNGUSRTBL						R
MRGFORMD	P					
OPNDBF	P					
OVRBSCF	P					
OVRCMNF	P					
OVRCRDF	P					
OVRDBF	P					
OVRDKTF	P					
OVRDSPF	P					
OVRMSGF	P					
OVRMXDF	P					
OVRPRTF	P					
OVRSAVF	P					
OVRTAPF	P					
PCHPGM				E	E	
PGM	P					
PRPAPAR		E	E	E	E	
PRTDOC	P					
PWRCTLU		E	E	E	E	
PWRDEV		E	E	E	E	
PWRDWN SYS	P					
QRYDTA	P					
RCLRSC	P					
RCLSTG		E	E	E	E	
RCVDTAARA	P					

Command Name	User Profile Names					
	QUSER (P)	QPGMR (E)	QSYSOPR (E)	QPSR (E)	QCE (E)	QSECOFR (R)
RCVF	P					
RCVJRNE	P					
RCVMSG	P					
RCVNETF	P					
RETURN	P					
RGZPFM	P					
RLSCMNDEV		E	E	E	E	
RLSJOB	P					
RLSJOBQ	P					
RLSOUTQ	P					
RLSRDR	P					
RLSSPLF	P					
RLSWTR	P					
RMVACC						R
RMVAJE	P					
RMVBKP	P					
RMVBSCDEVE	P					
RMVCMNDEVE	P					
RMVCMNE	P					
RMVDSPDEVE	P					
RMVFCTE	P					
RMVJOBQE	P					
RMVJRNCHG		E		E	E	
RMVLIBLE	P					
RMVM	P					
RMVMSG	P					
RMVMSGD	P					
RMVNETJOBE						R
RMVPGM	P					
RMVPGMCHG		E	E	E	E	

Command Name	User Profile Names					
	QUSER (P)	QPGMR (E)	QSYSOPR (E)	QPSR (E)	QCE (E)	QSECOFR (R)
RMVRJECMNE	P					
RMVRJERDRE	P					
RMVRJEWTR	P					
RMVRPYLE		E				
RMVRTGE	P					
RMVTRC	P					
RMVWSE	P					
RNMDKT		E	E	E	E	
RNMM	P					
RNMOBJ	P					
ROLLBACK	P					
RPLLIBL	P					
RRTJOB	P					
RSMBKP	P					
RSMCTLR	P					
RSMDEVR	P					
RSMLINR	P					
RSTAUT	P					
RSTDOC		E	E	E	E	
RSTLIB		E	E	E	E	
RSTOBJ		E	E	E	E	
RSTUSRPRF						R
RTVCLSRC	P					
RTVDFUSRC	P					
RTVDTAARA	P					
RTVGRPA	P					
RTVJOBA	P					
RTVJRNE	P					
RTVMSG	P					
RTVQRYSRC	P					

Command Name	User Profile Names					
	QUSER (P)	QPGMR (E)	QSYSOPR (E)	QPSR (E)	QCE (E)	QSECOFR (R)
RTVSYVAL	P					
RTVUSRPRF	P					
RVKACCAUT	P					
RVKDOCAUT	P					
RVKOBJAUT	P					
SAVCHGOBJ		E	E	E	E	
SAVDOC		E	E	E	E	
SAVLIB		E	E	E	E	
SAVOBJ		E	E	E	E	
SAVSAVFDTA		E	E	E	E	
SAVSYS	P					
SMBCRDJOB	P					
SBMDBJOB	P					
SBMDKTJOB	P					
SBMFNCJOB						R
SBMJOB	P					
SBMNETJOB	P					
SBMRJEJOB	P					
SETATNPGM	P					
SIGNOFF	P					
SNDBRKMSG		E	E	E	E	
SNDDTAARA	P					
SNDF	P					
SNDJRNE	P					
SNDMSG	P					
SNDNETF	P					
SNDNETMSG	P					
SNDNETSPLF	P					
SNDPGMMSG	P					

Command Name	User Profile Names					
	QUSER (P)	QPGMR (E)	QSYSOPR (E)	QPSR (E)	QCE (E)	QSECOFR (R)
SNDRCVF	P					
SNDRPY	P					
SNDUSRMSG	P					
SRVJOB		E	E	E	E	
STPCTLR CY	P					
STPDEVRCY	P					
STPLINRCY	P					
STRCNFCHK		E	E	E	E	
STRCRDRDR	P					
STRCRDWTR	P					
STRPRTEML	P					
STRDBRDR	P					
STRDKTRDR	P					
STRDKTWTR	P					
STRPDP		E	E	E		
STRPRTEML	P					
STRPRTWTR	P					
STRRJECSL	P					
STRRJERDR	P					
STRRJESSN	P					
STRRJEWTR	P					
STRSBS		E	E	E	E	
TFRBCHJOB	P					
TFRCTL	P					
TFRGRPJOB	P					
TFRJOB	P					
TFRSECJOB	P					
TRCINT		E		E		
TRCJOB		E	E	E	E	
TRMCPF	P					

Command Name	User Profile Names					
	QUSER (P)	QPGMR (E)	QSYSOPR (E)	QPSR (E)	QCE (E)	QSECOFR (R)
TRMGRPJOB	P					
TRMPRTEML	P					
TRMRJESSN	P					
TRMSBS	P					
VFYPRT		E	E	E	E	
VRYCTLU		E	E	E	E	
VRYDEV		E	E	E	E	
VRYLIN		E	E	E	E	
WAIT	P					

Notes:

4-20



Chapter 5. CPF Object Types

The predefined values for the CPF object types are listed below. When an object is created and a library qualifier can be specified and is not, the object is stored in the QGPL library, as shown in the last column. The other objects, identified by N/A in the last column, cannot be stored in user-provided libraries.

Value	Object Type	Default User Library
*CLS	Class	QGPL
*CHTFMT	Chart format	N/A
*CMD	Command	QGPL
*CUD	Control unit description	N/A
*DEVD	Device description	N/A
*DOC	Document	N/A
*DOCL	Document list	N/A
*DTAARA	Data area	QGPL
*DTAQ	Data queue	QGPL
*EDTD	Edit description	N/A
*FCT	Forms control table	QGPL
*FILE	File	QGPL
*GSS	Graphics symbol set	N/A
*JOBQ	Job description	QGPL
*JOBQ	Job queue	QGPL
*JRN	Journal	QGPL
*JRNRCV	Journal receiver	QGPL
*LIB	Library	N/A
*LIND	Line description	N/A
*MSGF	Message file	QGPL
*MSGQ	Message queue	QGPL
*OUTQ	Output queue	QGPL
*PGM	Program	QGPL
*PRTIMG	Print image	QGPL
*SBSD	Subsystem description	QGPL
*SPADCT	Spelling aid dictionary	QGPL
*SSND	Session description	QGPL
*TBL	Table	QGPL
*USRPRF	User profile	N/A

Notes:



**CHAPTER 6. OBJECT AUTHORITY REQUIRED FOR COMMANDS
AND OBJECTS**

Normal Authority by Object Type	6-3
Operational Authority by Object Type	6-5
Commands Common to All Objects	6-8
Applications	6-10
Chart Formats	6-10
Classes	6-11
Commands	6-11
Control Unit Descriptions	6-12
Data Areas	6-12
Data Queues	6-13
Device Descriptions	6-14
Device Emulation	6-15
Documents	6-16
Document Lists	6-16
Edit Descriptions	6-16
Files	6-17
Finance	6-24
Forms Control Tables	6-25
Graphic Symbol Sets	6-25
Job Descriptions	6-26
Job Queues	6-26
Jobs	6-27
Journals	6-30
Journal Receivers	6-32
Libraries	6-33
Lines Descriptions	6-34
Message Files	6-34
Message Queues	6-35
Output Queues	6-36
Print Images	6-36
Programs	6-37
Readers	6-39
Session Descriptions	6-40
Spelling Aid Dictionary	6-41
Spooled Files	6-42
Subsystem Descriptions	6-43
System Reply List	6-44
System Values	6-44
Tables	6-45
User Profiles	6-45
Writers	6-46

Notes:



Chapter 6. Object Authority Required for Commands and Objects

Normal Authority by Object Type

Normal authority varies according to object type. Normal authority includes operational rights and any data rights needed to perform common functions on an object. Object existence and object management rights are never granted as part of normal authority. In the following chart, N indicates that normal rights are granted to an object type in the following cases:

- When PUBAUT(*NORMAL) is specified or is the default when creating the object
- When AUT(*NORMAL) is specified or is the default when granting authority with the Grant Object Authority (GRTOBJAUT) command

Object Type	Object Rights		Data Rights		
	Operational	Read	Add	Update	Delete
Chart format	N	N		N	
Class	N	N	N	N	N
Command	N	N	N	N	N
Control unit description	N	N	N	N	N
Data area	N	N	N	N	N
Device description	N	N	N	N	N
Edit description	N	N	N	N	N
File (see note)	N	N	N	N	N
Forms control table	N	N	N	N	N
Graphics symbol set	N	N			
Job description	N	N	N	N	N
Job queue	N	N	N		
Journal	N	N	N	N	N
Journal receiver	N	N			
Library	N	N	N	N	N
Line description	N	N	N	N	N
Message file	N	N			
Message queue	N	N	N		N
Output queue	N	N	N		
Program	N	N	N	N	N
Print image	N	N	N	N	N
Session description	N	N	N	N	N
Spelling aid dictionary	N	N	N	N	N
Subsystem description	N	N	N	N	N
Table	N	N	N	N	N
User profile	N				

Note: Data rights cannot be specified for logical files.

Operational Authority by Object Type

The following chart shows what data rights are granted (indicated by O) when operational rights are granted for an object.

Object Type	Data Rights			
	Read	Add	Update	Delete
Chart format	O		O	
Class	O	O	O	O
Command	O	O	O	O
Control unit description	O	O	O	O
Data area	O	O		O
Device description	O	O	O	O
Edit description	O	O	O	O
File				
Forms control table	O	O	O	O
Graphics symbol set	O			
Job description	O	O	O	O
Job queue				
Journal				
Journal receiver				
Library	O			
Line description	O	O	O	O
Message file				
Message queue				

Operational Authority by Object Type (continued)

Object Type	Data Rights			
	Read	Add	Update	Delete
Output queue				
Program		0	0	0
Print image	0	0	0	0
Session description	0	0	0	0
Spelling aid dictionary	0	0	0	0
Subsystem description	0	0	0	0
Table	0	0	0	0
User profile				

The following charts show the object authority you need for using a command to perform a function on an object. The charts are organized alphabetically.

The charts in this section include all System/38 commands. In this way they differ from the charts in Appendix C of the *CPF Programmer's Guide*, which include only CPF commands.

The rights specified in the charts are those required on the primary object related to the command. Rights required on other objects are listed under *Additional Requirements*.

The following information is assumed—that is, it is not included in the charts.

- For all commands, command authority is required.
- For all commands with listed output, authority is required for the printer file used.
- For all display commands, operational rights are needed for the display or printer output file used by the command.
- To access any object, read rights are needed for the library containing the object.
- For create commands, add authority is required on the user profile and library.
- For delete commands, delete authority is required on the user profile and library.

COMMANDS COMMON TO ALL OBJECTS

Command	Object Rights			Data Rights				Additional Rights Required
	Operational	Object Management	Object Existence	Read	Add	Update	Delete	
ALCOBJ ¹	X							Read on library.
CHGOBJOWN ⁴			X					Read on library. Delete on old user profile. Add on new user profile. For files, subsystem descriptions, and libraries, operational rights to the object are required.
CHKOBJ								Read on library.
CRTDUPOBJ ¹	X	X		X				Operational and add on the to-library. Operational on the from-library.
DLCOBJ ¹	X							Read on library.
DMPOBJ	X							Read on library. Read on PGM, LIB and USRPRF.
DMPYSOBJ	X							Read on library. Read on PGM, LIB and USRPRF.
DSPOBJAUT ²								Read on library. Some authority required on object.
DSPOBJD ²								Read on library.
DSPOBJLCK								Read on library.
<p>¹ Only files, libraries, data areas, subsystem descriptions, message queues, and device descriptions can be allocated or deallocated.</p> <p>² If you have object management rights or you are the security officer, all owners and their rights are listed. If you do not have object management rights, only your rights are listed.</p> <p>³ Ownership or some authority to the object is required. For files, libraries, and subsystem descriptions, operational rights for the object are also required.</p> <p>⁴ Only the security officer can change the object owner for programs adopting their owner's user profile.</p> <p>⁵ For save files, user must be authorized to the CRTSAVF command.</p>								

COMMANDS COMMON TO ALL OBJECTS (continued)

Command	Object Rights			Data Rights				Additional Rights Required
	Operational	Object Management	Object Existence	Read	Add	Update	Delete	
GRTOBJAUT ²		X						Read on library. Owner or have object management rights and rights being granted. Must be owner or security officer to grant object management.
MOVOBJ		X						Delete and read on old library. Add and read on new library. For moving a file, operational to the object is required.
RNMOBJ		X						Update and read on library. For renaming a file or library, operational on the object is required.
RSTOBJ ¹			X					Add and read on library. Add on user profile for objects being created.
RVKOBJAUT ²		X						Read on library. Owner or have object management and rights being revoked. Must be owner or security officer to revoke object management.
SAVCHGJOB ¹			X					Read on library.
SAVOBJ ¹			X					Read on library.

¹ If you have the special save system rights (*SAVSYS), you can save and restore any object. You must have operational rights to the save/restore media device description and device file.

² For files, libraries, and subsystem descriptions, operational rights for the object are also required.

APPLICATIONS

Command	Object Rights			Data Rights				Additional Rights Required
	Operational	Object Management	Object Existence	Read	Add	Update	Delete	
CHGDTA ¹	X			X				
CRTDFUAPP								Read and add on library. Operational and read on source file.
CRTQRYAPP								Read and add on library. Operational and read on source file.
DLTDFUAPP			X					Read on library and user profile.
DLTQRYAPP			X					Read on library and user profile.
¹ Add, update, and delete rights are required for add, update, and delete operations on the file.								

CHART FORMATS

Command	Object Rights			Data Rights				Additional Rights Required
	Operational	Object Management	Object Existence	Read	Add	Update	Delete	
DLTCHTFMT			X					

CLASSES

Command	Object Rights			Data Rights				Additional Rights Required
	Operational	Object Management	Object Existence	Read	Add	Update	Delete	
CRTCLS								Read and add on library.
DLTCLS			X					Read on library.
DSPCLS	X							Read on library.

COMMANDS

Command	Object Rights			Data Rights				Additional Rights Required
	Operational	Object Management	Object Existence	Read	Add	Update	Delete	
CHGCMD		X						Read on library.
CRTCMD								Read and add on library. Operational and read on source file.
DLTCMD			X					Read on library.
DSPCMD				X				
LSTCMDUSG	X							Read on library.

CONTROL UNIT DESCRIPTIONS

Command	Object Rights			Data Rights				Additional Rights Required
	Operational	Object Management	Object Existence	Read	Add	Update	Delete	
CHGCUD	X							
CRTCUD								
DLTCUD	X		X					
DSPCUD	X							
DSPDEVCFG	X							
PWRCTLU								
RSMCTLCY	X							
STPCTLCY	X							
VRYCTLU								

DATA AREAS

Command	Object Rights			Data Rights				Additional Rights Required
	Operational	Object Management	Object Existence	Read	Add	Update	Delete	
CHGDTAARA 1	X					X		Read on library.
CRTDTAARA								Read and add on library.
DCLDTAARA 2	X			X				
DLTDTAARA			X					Read on library.
DSPDTAARA	X							Read on library. Operational on object if object is a file.
RCVDTAARA 3	X							
RTVDTAARA 3	X							Read on library.
SNDDTAARA 3	X					X		

1 If create and change data area are executed using high-level language functions, these authorities are still required although command authority is not.
2 Authority is checked at program compilation, not at execution.
3 Authority is not checked at program compilation but at execution.

DATA QUEUES

Command	Object Rights			Data Rights				Additional Rights Required
	Operational	Object Management	Object Existence	Read	Add	Update	Delete	
CRTDTAQ								Add and read on library.
DLTDTAQ			X					Read on library.

DEVICE DESCRIPTIONS

Command	Object Rights			Data Rights				Additional Rights Required
	Operational	Object Management	Object Existence	Read	Add	Update	Delete	
ADDDEVMODE	X							
CHGDEV	X							
CHGDEVMODE	X							
CHGSSNMAX	X							
CHKDKT				X				
CHKTAP				X				
CRTDEV								
DLTDEV	X		X					
DSPDEVCFG	X							
DSPDEV	X							
DSPDEVSTS	X							
DSPMODSTS	X							
HLDCNMDEV	X							Or *JOBCTL special authority.
MNGDEVTBL ■	X			X				
PWRDEV								
RLSCMNDEV	X							Or *JOBCTL special authority.
RMSDEVRCY	X							
STPDEVRCY	X							
VRYDEV								

■ As shipped, this command is authorized only to the security officer. To use it, other users must be explicitly granted authority to it.

DEVICE EMULATION

Command	Object Rights			Data Rights				Additional Rights Required
	Operational	Object Management	Object Existence	Read	Add	Update	Delete	
EJTEMLOUT								Operational on emulation device. Also, operational on control unit description when EMLCTLU is specified.
EMLPRTKEY								Operational on emulation device. Also, operational on control unit description when EMLCTLU is specified.
EML3270								Operational on emulation device. Also, operational on control unit description when EMLCTLU is specified. Operational authority to the System/38 work station being used.
STRPTEML								Operational on emulation device. Also, operational on control unit description when EMLCTLU is specified, and same authority as specified on the SBMJOB command.
TRMPTEML								Operational on emulation device. Also, operational on control unit description when EMLCTLU is specified.

DOCUMENTS

Command	Object Rights			Data Rights				Additional Rights Required
	Operational	Object Management	Object Existence	Read	Add	Update	Delete	
CHGDOCOWN			X					
DLTDOC			X					
GRTDOCAUT								No authority required.
RSTDOC 1			X					
SAVDOC 1			X					

1 If you have save system rights (*SAVSYS), you can save and restore any object. You must have operational rights to the device description and device file for the save/restore medium.

DOCUMENT LISTS

Command	Object Rights			Data Rights				Additional Rights Required
	Operational	Object Management	Object Existence	Read	Add	Update	Delete	
DLTDOCL			X					

EDIT DESCRIPTIONS

Command	Object Rights			Data Rights				Additional Rights Required
	Operational	Object Management	Object Existence	Read	Add	Update	Delete	
CRTEDTD								Operational and add on QSYS.
DLTEDTD			X					Read on QSYS.
DSPEDTD	X							Read on QSYS.

FILES

Command	Object Rights			Data Rights				Additional Rights Required
	Operational	Object Management	Object Existence	Read	Add	Update	Delete	
ADDBSCDEVE ¹	X	X						Read on library.
ADDCMNDEVE ¹	X	X						Read on library.
ADDDSPDEVE ¹	X	X						Read on library.
ADDLFM	X	X						Read and add on library. Object management and operational on files referenced in DTAMBR parameter and operational on files referenced in ACCPTHMBR parameter.
ADDPFM	X	X						Read and add on library.
BGNMCTCTL					X			Add on message queue. Update on data area. Read on libraries containing the file, message queue, and data area.
BRWPFM	X			X				Read on library.
CHGBSCF ¹	X	X						Read on library.
CHGCMNF ¹	X	X						Read on library.
CHGCRDF ¹	X	X						Read on library.
CHGDKTF ¹	X	X						Read on library.
CHGDSPF ¹	X	X						Read on library.
CHGLF ¹	X	X						Read on library.
CHGLFM ¹	X	X						Read on library.

¹ If device name is specified in the command, you must have operational rights to the device description.

FILES (continued)

Command	Object Rights			Data Rights				Additional Rights Required
	Operational	Object Management	Object Existence	Read	Add	Update	Delete	
CHGMXDF	X	X						Read and add on library.
CHGPF ¹	X	X						Read on library.
CHGPFM ¹	X	X						Read on library.
CHGPRTF ¹	X	X						Read on library.
CHGSRCPF	X	X						Read on library.
CHGTAPF ¹	X	X						Read on library.
CLOF	X							Read on library.
CLRPFM ¹	X	X					X	Read on library.
CLRSAVF	X	X						Read on library.
CNLNETF ³								
CPYF ²	X			From file	To file			Object management and delete required for *REPLACE.
CPYFRMDKT ²	X			X				Read on library. If the from-file is a logical file, read is required for each based-on physical file. If the to-file is a device file, operational is required for the device file.
CPYFRMTAP ²	X			X				Read on library. If the from-file is a logical file, read is required for each based-on physical file. If the to-file is a device file, operational is required for the device file.

¹ If device name is specified in the command, you must have operational rights to the device description.
² This information refers to physical files only.
³ The security officer can cancel, display, and receive network files sent to any user. Other users can only cancel, display, or receive files sent to themselves or their groups.

FILES (continued)

Command	Object Rights			Data Rights				Additional Rights Required
	Operational	Object Management	Object Existence	Read	Add	Update	Delete	
CPYTODKT ²	X			From file				Read on library. If the from-file is a logical file, read is required for each based-on physical file. If the to-file is a device file, operational is required for the device file.
CPYTOTAP ²	X			From file				Read on library. If the from-file is a logical file, read is required for each based-on physical file. If the to-file is a device file, operational is required for the device file.
CPYSRCF ²	From file			From file				Read on library. Operational and add on to-file if *MBROPR (*ADD) specified. Operational, add, delete, and object management on to-file if MBROPT (*REPLACE) specified.
CRTBSCF ¹								Read and add on library.
¹ If device name is specified in the command, you must have operational rights to the device description. ² This information refers to physical files only.								

FILES (continued)

Command	Object Rights			Data Rights				Additional Rights Required
	Operational	Object Management	Object Existence	Read	Add	Update	Delete	
CRTC MNF ¹								Read and add on library.
CRTMXDF ¹		X						Read and add on library.
CRTC RDF ¹								Read and add on library.
CRTDKTF ¹								Read and add on library.
CRTDSPF ¹								Read and add on library. Operational and read on source file.
CRTLF								Read and add on library. Object management and operational on files referenced in PFILE or JFILE keyword and operational on file referenced in ACCPTH keyword (if specified). Operational on files referenced in FORMAT keyword and on table referenced in ALTSEQ
CRTMXDF		X						Read and add on library.
CRTPF								Read and add on library. Operational on files referenced in FORMAT keyword and on table referenced in ALTSEQ keyword.
¹ If device name is specified in the command, you must have operational rights to the device description.								

FILES (continued)

Command	Object Rights			Data Rights				Additional Rights Required
	Operational	Object Management	Object Existence	Read	Add	Update	Delete	
CRTPRTF ¹								Read and add on library. Operational and read on source file.
CRTSAVF ⁴								Read and add on library.
CRTSRCPF								Read and add on library.
CRTTAPF ¹								Read and add on library.
DLTF	X		X					Read on library.
DLTOVR ²								
DSNDFUAPP	X							
DSNFMT	X							Object management and add on DDS source file.
DSNQRYAPP	X							
DSPDBR	X							
DSPDTA	X							Read on input file.
DSPFD ³	X							If TYPE (*ALL, *MBR, or *MBRLIST) is specified and the file is a physical file, one data right is required.
DSPFFD	X							
DSPFNCHLP								Read on library QHLPSYS.
DSPNETF ⁵								

¹ If device name is specified in the command, you must have operational rights to the device description.
² No authority is required when the override command is issued. Authority is checked when the file is opened.
³ Ownership or operational authority to the file is required.
⁴ As shipped, this command is authorized only to the security officer. To use it, other users must be explicitly granted authority to it.
⁵ The security officer can cancel, display, and receive network files sent to any user. Other users can only cancel, display, or receive files sent to themselves or their groups.

FILES (continued)

Command	Object Rights			Data Rights				Additional Rights Required
	Operational	Object Management	Object Existence	Read	Add	Update	Delete	
DSPOVR ²								
DSPRCDLCK								No authority required.
DSPSAVF	X			X				Read on library.
EDTSRC	X	X		X	X		X	
ENDCMCTL					X			Add on message queue. Update on data area. Read on libraries containing the file, message queue, and data area.
ENDJRNP	X	X						
FMTDTA	X							Read on sort input file.
INZPFM		X			X			Delete required to initialize with deleted records.
INZTAP		X						
JRNPF	X	X						
LOGDBF	X				X			Read on library.
OPNDBF ⁴	X							Read on library.
OVRBSCF ²								
OVRCMNF ²								
OVRCRDF ²								
OVRDBF ²								
OVRDKTF ²								
OVRDSPF ²								

¹ If device name is specified in the command, you must have operational rights to the device description.
² No authority is required when the override command is issued. Authority is checked when the file is opened.
³ Ownership or operational authority to the file is required.
⁴ Some data rights are required to perform any other operations on the subject.

FILES (continued)

Command	Object Rights			Data Rights				Additional Rights Required
	Operational	Object Management	Object Existence	Read	Add	Update	Delete	
OVRMXDF ²	X	X						Read on library.
OVRPRTF ²								
OVRSAVF ²								
OVRTAPF ²								Read and add on library.
QRYDTA	X							Read on the file to query.
RCVNETF	X				X			Read and add on library.
RGZPFM		X		X	X	X	X	
RMVBSCDEVE ¹	X	X						Read on library.
RMVCMNDEVE ¹	X	X						Read on library.
RMVDEVDEVE ¹	X	X						Read on library.
RMVM	X		X					Read on library.
RNMM	X	X						Read and update on library.
SAVSAVFDTA	X			X				Read on library. Operational on the device description and device file used for save/restore media.
SBMNETJOB	X			X				Read on library.
SNDNETF	X			X				Read on library.
¹ If the device name is specified in the command, you must have operational rights to the device description. ² No authority is required when the override command is issued. Authority is checked when the file is opened.								

FINANCE

Command	Object Rights			Data Rights				Additional Rights Required
	Operational	Object Management	Object Existence	Read	Add	Update	Delete	
DSPFNCHLP ¹								Read on library QHLPSYS.
MNGDEVTBL ¹								Read on library QUSRSYS. For Help key function, read on library QHLPSYS. At least one data right to device description.
MNGPGMTBL ¹								Read on library QUSRSYS. For Help key function, read on library QHLPSYS. Read on library containing program.
MNGUSRTBL ¹								Read on library QUSRSYS. For Help key function, read on library QHLPSYS.
SBMFNCJOB ¹								Operational on job description, and read on library containing job description. Operational and add on message queue, and read on library containing message queue.
¹ As shipped, these commands are authorized only to the security officer. To use them, other users must be explicitly granted authority to them.								

FORMS CONTROL TABLES

Command	Object Rights			Data Rights				Additional Rights Required
	Operational	Object Management	Object Existence	Read	Add	Update	Delete	
ADDFCTE	X							Read on library.
CHGFCT	X							Read on library.
CHGFCTE	X							Read on library.
CRTFCT								Read on library.
DLTFCT			X					Read on library.
DSPFCT				X				Read on library.
RMVFCTE	X							Read on library.

GRAPHIC SYMBOL SETS

Command	Object Rights			Data Rights				Additional Rights Required
	Operational	Object Management	Object Existence	Read	Add	Update	Delete	
DLTGSS			X					Read on library.

JOB DESCRIPTIONS

Command	Object Rights			Data Rights				Additional Rights Required
	Operational	Object Management	Object Existence	Read	Add	Update	Delete	
CHGJOB ¹	X	X						Read on library. Operational on the user profile specified on the USER parameter.
CRTJOB ¹								Read and add on library. Operational on the user profile specified on the USER parameter.
DLTJOB			X					Read on library.
DSPJOB	X							Read on library.

¹ Operational rights on the user profile on USER parameter.

JOB QUEUES

Command	Object Rights			Data Rights				Additional Rights Required
	Operational	Object Management	Object Existence	Read	Add	Update	Delete	
CLRJOB ¹				X	X		X	Read on library.
CRTJOB								Read and add on library.
DLTJOB			X	X	X		X	Read on library.
DSPJOB ¹ ²				X				Read on library.
HLDJOB ¹				X	X		X	Read on library.
RLSJOB ¹				X	X		X	Read on library.

¹ If you have the special authority of job control rights (*JOBCTL) and the queue has operator control rights (OPRCTL(*YES)), you do not need these rights.
² If JOBQ(*ALL) is specified, no authority is required.

JOBS

Command	Object Rights			Data Rights				Additional Rights Required
	Operational	Object Management	Object Existence	Read	Add	Update	Delete	
CHGACGCDE ¹								
CHGGRPA ⁴								Operational to message queue and read on library containing message queue if associating a message queue with the group.
CHGJOB ^{1 2} ³								Add and read to new job queue if changing a job queue. Add and read to new output queue if changing an output queue.
CNLJOB ¹								
DLYJOB ⁴								
DSPACTJOB ¹								
DSPJOB ¹								
DSPJOBLOG ^{1 2}								
DSPSBMJOB ¹								
HLDJOB ¹								
JOB ²	X							Operational on job description and subsystem description. Add and read on job queue. Operational and add on message queue.
RLSJOB ¹								
¹ Any user can execute these commands for a job running under his own user profile. A user with job control rights (*JOBCTL) can execute these commands for any job. ² You must have the authority (specified in your user profile) for the scheduling and output priority specified. ³ Certain job attributes require job control rights (*JOBCTL) to be changed even in the user's own job. These attributes are: EXCPTY, TIMESLICE, PURGE, and DFTWAIT. ⁴ This command must be executed in your own job. ⁵ To display the log for a job having security officer authority, you must also have security officer authority.								

JOBs (continued)

Command	Object Rights			Data Rights				Additional Rights Required
	Operational	Object Management	Object Existence	Read	Add	Update	Delete	
RRTJOB								Operational on subsystem description.
RTVJOBA								
SBMCRDJOB								Operational and add on the message STRJOB, SBMJOB, and SBMXXXJOB commands. Read and add on the job queue.
SBMDBJOB								Read on the library containing data base file. Operational and add on the message on the STRJOB, SBMJOB, and SBMXXXJOB commands. Read and add on the job queue.
SBMDKTJOB								Operational on job description. Operational and add on the message on the STRJOB, SBMJOB, and SBMXXXJOB commands. Read and add on the job queue.

JOBS (continued)

Command	Object Rights			Data Rights				Additional Rights Required
	Operational	Object Management	Object Existence	Read	Add	Update	Delete	
SBMJOB ¹								Operational on job description. Read on libraries specified in initial library list in the job description. Add and read on job queue. Operational on subsystem description. Operational and add on message queue.
SIGNON ¹								Operational on subsystem description, device description, and job description.
SRVJOB								Operational on user profile of job to be serviced. PSR can service any job from console.
TFRBCHJOB								
TFRJOB				X	X			Operational for subsystem job queue is allocated to.
TRCJOB								Read on the exit program and its library.
TFRGRPJOB								Operational on initial group program. Read on library containing initial group program.
TFRSECJOB								
TRMGRPJOB								
¹ You must have the authority (specified in your user profile) for the scheduling and output priority specified.								

JOURNALS

Command	Object Rights			Data Rights				Additional Rights Required
	Operational	Object Management	Object Existence	Read	Add	Update	Delete	
APYJRNCHG 1	X			X				Read on library.
CHGJRN	X	X				X		Read on library. Read on library containing message queue.
CMPJRNIMG	X			X				
CRTJRN								Add on library and read on library containing message queue.
DLTJRN	X		X					Read on library.
DSPJRN 2	X			X				Read on library.
DSPJRNA	X			X				Read on library.
DSPJRNMENU 2	X			X				Read on library.
ENDJRNPF	X	X						Read on library. Management, object, and operational on file.

1 For the file whose journaled changes are being applied or removed, operational, object management, read, update, add, and delete rights are required.

2 If entries for specific files are being displayed, received, or retrieved, operational and read rights on the files specified are required. If FILE(*ALLFILE) is specified or if the file specified has been deleted from the system, object existence rights are required on the journal. Operational and add rights are required on the output file.

2 Additional authorities are required for specific functions called during the operations selected. For example, to do a restore of an object, the user would need special authority. The user will also need the appropriate authority for any command that is called during a specific function.

JOURNALS (continued)

Command	Object Rights			Data Rights				Additional Rights Required
	Operational	Object Management	Object Existence	Read	Add	Update	Delete	
JRNPF	X	X						Read on library. Management, object, and operational on file.
RCVJRNE ²	X			X				Read on library.
RMVJRNCHG ¹	X			X				Read on library.
RTVJRNE ²	X			X				
SNDJRNE	X				X			Read on library. Operational rights on file.

¹ For the file whose journaled changes are being applied or removed, operational, object management, read, update, add, and delete rights are required.

² If entres for specific files are being displayed, received, or retrieved, operational and read rights on the files specified are required. If FILE(*ALLFILE) is specified or if the file specified has been deleted from the system, object existence rights are required on the journal. Operational and add rights are required on the output file.

³ Object existence authority is also required, if the required recovery involves deletion of the subject.

JOURNAL RECEIVERS

Command	Object Rights			Data Rights				Additional Rights Required
	Operational	Object Management	Object Existence	Read	Add	Update	Delete	
APYJRNCHG ¹	X			X				Read on library.
CHGJRN ²	X			X				Read on library.
CMPJRNIMG	X			X				
CRTJRN	X	X		X				Read on library.
CRTJRNRCV								Add on library.
DLTJRNRCV	X		X					Read on library and operational on journal.
DSPJRN ³	X			X				Read on library.
DSPJRNMMNU ⁴	X			X				Read on library.
DSPJRNRCVA	X							Or read on library and some data rights on journal receiver.
RMVJRNCHG ¹	X			X				Read on library.
RTVJRNE ³	X			X				

¹ For the file whose journaled changes are being applied or removed, operational, object management, read, update, add, and delete rights are required.

² Operational and read rights are not required for the journal receiver if JRNRCV(*SAME) is specified. If JRNRCV(*SAME) is not specified, operational and read rights are required for all the journal receivers involved in the operation.

³ If entries for specific files are being displayed, operational and read rights on the files specified are required. If FILE(*ALLFILE) is specified or if the file specific has been deleted from the system, object existence rights are required on the journal. Operational and add rights are required on the output file.

⁴ Additional authorities are required for specific functions called during the operation selected. For example, to do a restore of an object, the user would need special authority. The user will also need the appropriate authority for any command that is called during a specific function.

LIBRARIES

Command	Object Rights			Data Rights				Additional Rights Required
	Operational	Object Management	Object Existence	Read	Add	Update	Delete	
ADDLIB				X				
CHGSYSLIBL				X				
CLRLIB ¹				X			X	Object existence on every object to be deleted from library.
CRTLIB								
DLTLIB ¹			X	X				Object existence on every object in the library.
DSPLIB				X				
DSPLIBL ²								
RMVLIBLE								No authority is required, but read is required to have a library on the library list.
RPLLIB				X				Read required on every library to be placed in library list.
RSTLIB ³				X	X			Object existence on every object in the library.
SAVLIB ³				X				Object existence on every object in the library.

¹ If object existence authority is not held for every object in the library, those objects will not be deleted and the library will not be completely cleared or deleted. Only authorized objects will be deleted.

² No authority required.

³ If you have the special save system rights (*SAVSYS), you can save and restore any object. You must have operational rights to the diskette or tape device description and device file.

LINE DESCRIPTIONS

Command	Object Rights			Data Rights				Additional Rights Required
	Operational	Object Management	Object Existence	Read	Add	Update	Delete	
ANSLIN	X							
CHGLIND	X							
CRTLIND								
DLTLIND	X		X					
DSPDEVCFG	X							
DSPLIND	X							
DSPLINSTS	X							
RSMLINRCY	X							
STPLINRCY	X							
VRYLIN ¹								

¹ Once the line is varied on, no further authority is needed.

MESSAGE FILES

Command	Object Rights			Data Rights				Additional Rights Required
	Operational	Object Management	Object Existence	Read	Add	Update	Delete	
ADDMSGD	X				X			
CHGMSGD	X					X		
CRTMSGF								Read and add on library.
DLTMSGF			X					Read on library.
DSPMSG	X			X				Operational, read, and delete on message queue.
DSPMSGD								
DSPMSGF	X							Read on library.
OVRMSGF ¹								
RCVMSG	X			X				
RMVMSGD	X						X	
RTVMSG	X			X				
SNDPGMMSG ¹								

¹ No authority required.

MESSAGE QUEUES

Command	Object Rights			Data Rights				Additional Rights Required
	Operational	Object Management	Object Existence	Read	Add	Update	Delete	
CHGMSGQ	X			X			X	Read on library.
CRTMSGQ								Read and add on library.
DLTMSGQ	X		X	X			X	Read on library.
DSPMSG	X			X			X	Operational and read on message file.
RCVMSG	X			X			X	Operational and read on message file.
RMVMSG	X						X	
SNDBRKMSG	X				X			
SNDMSG	X				X			
SNDPGMMMSG	X				X			
SNDRPY	X			X			X	
SNDUSRMSG	X				X			Operational on message file. Read on libraries containing the message file and message queue.

OUTPUT QUEUES

Command	Object Rights			Data Rights				Additional Rights Required
	Operational	Object Management	Object Existence	Read	Add	Update	Delete	
CHGOUTQ		X		X	X		X	Read on library.
CLROUTQ ²				X	X		X	Read on library.
CRTOUTQ								Read and add on library.
DLTOUTQ			X	X	X		X	Read on library.
DSPOUTQ ² ³				X				Read on library.
HLDOUTQ ²				X	X		X	Read on library.
RLSOUTQ ²				X	X		X	Read on library.

¹ If you are changing the file to a different queue, you must have add rights to the new queue.
² If you have the special authority of job control rights (*JOBCTL) and the queue has operator control rights (OPRCTL(*YES) parameter), you do not need these rights.
³ If OUTQ(*ALL) is specified, no authority is required.

PRINT IMAGES

Command	Object Rights			Data Rights				Additional Rights Required
	Operational	Object Management	Object Existence	Read	Add	Update	Delete	
CRTPRTIMG								Read and add on library.
DLTPRTIMG			X					Read on library.
CRTPRTF (use in file)	X							

PROGRAMS

Command	Object Rights			Data Rights				Additional Rights Required
	Operational	Object Management	Object Existence	Read	Add	Update	Delete	
ADDPGM				X				
APYPGMCHG	X							Object management on library.
CALL ¹								Operational or one of data rights on program.
CHGPGM	X							Read on library. Add and delete on library if program re-creation is requested.
CRTCLPGM ¹ ²								Read and add on library. Operational and read on source file.
CRTCLPGM								Read and add on library. Operational and read on source file.
CRTRPGM ¹ ²								Read and add on library. Operational and read on source file.
CRTRPTGM								Read and add on library. Operational and read on source file.
DLTPGM			X					Read on library.
DMPCLPGM				X				Read on library.
DSPPGM				X				
DSPPGMCHG								Operational on library.
DSPPGMNU								
¹ For high-level language execution, several language functions (including program symbolic dump in case of failure) require read authority. If these functions are not used, read authority is not required. ² Operational authority is required on externally described device and data base files referenced in the source program.								

PROGRAMS (continued)

Command	Object Rights			Data Rights				Additional Rights Required
	Operational	Object Management	Object Existence	Read	Add	Update	Delete	
DSPPGMREF								Read on library. Some authority on program.
ENDCBLDBG								
ENTCBLDBG								
ENTDBG				X				
LODPGMCHG	X							Object management on library.
MNGPGMTBL ²								
PCHPGM				X				Object management on library.
RCLSRC								
RMVPGM								Some authority on program required.
RMVPGMCHG	X							Object management on library.
RTVCLSRC	X	X		X				Object management, operational, add and delete on data base source file. Read on library.
SETATNPGM								Operational or one of data rights on attention handling program. Read on library containing program.
TFRCTL ¹								Operational or one of data rights on program.
TFRGRPJOB								Operational on initial group program. Read on library.

¹ For high-level language execution, several language functions (including program symbolic dump in case of failure) require read authority. If these functions are not used, read authority is not required.

² As shipped, this command is authorized only to the security officer. To use it, other users must be explicitly granted authority to it.

READERS

Command	Object Rights			Data Rights				Additional Rights Required
	Operational	Object Management	Object Existence	Read	Add	Update	Delete	
CNLRDR 1								
DSPRDR								
HLDRDR 1								
RLSRDR 1								
STRCDRDR								Read on library containing data base file. Operational and add on message queue.
STRDBRDR								Operational and add on message queue.
STRDKTRDR								Operational and add on message queue.

1 You must have started the reader or have the special authority of job control rights (*JOBCTL).

SESSION DESCRIPTIONS

Command	Object Rights			Data Rights				Additional Rights Required
	Operational	Object Management	Object Existence	Read	Add	Update	Delete	
ADDRJECMNE	X							Read on library.
ADDRJERDRE	X							Read on library.
ADDRJEWTR	X							Read on library.
CHGRJECMNE	X							Read on library.
CHGRJERDRE	X							Read on library.
CHGRJEWTR	X							Read on library.
CHGSSND	X							Read on library.
CNLRJERDR	X							Read on library.
CNLRJEWTR	X							Read on library.
CRTSSND								Add on library.
DLTSSND			X					Read on library.
DSPRJESSN	X							Read on library.
DSPSSND								Read on library.
RMVRJECMNE	X							Read on library.
RMVRJERDRE	X							Read on library.
RMVRJEWTR	X							Read on library.
STRRERDR	X							Operational and read on data base file. Read on libraries. Operational on message queue.
STRRJESSN	X							Read on library.
STRJEWTR	X							Read on library.
TRMRJESSN	X							Read on library.

SPELLING AID DICTIONARY

Command	Object Rights			Data Rights				Additional Rights Required
	Operational	Object Management	Object Existence	Read	Add	Update	Delete	
CRTSPADCT								Operational and read on source file. Read and add on libraries.
DLTSPADCT			X					Read on library.

SPOOLED FILES

The rights indicated in this chart are for the output queue containing spooled files, not for the spooled files themselves. To use a spooled file, you must have add rights for the output queue to which the file is going.

Command	Object Rights			Data Rights				Additional Rights Required
	Operational	Object Management	Object Existence	Read	Add	Update	Delete	
CHGSPLFA ¹ ₂				X	X		X	
CNLSPLF ²				X	X		X	
CPYSPLF ³				X				Object management, operational, add, and delete on data base target file. Read on library.
DSPSPLF ³				X				
DSPSPLFA ²				X				
HLDSPLF ²				X	X		X	
RLSSPLF ²				X	X		X	
SNDNETSPLF ³				X				Read on library.

¹ If you are changing the file to a different queue, you must have add rights to the new queue and read rights to the library of the new queue.
² If you created the file or have job control rights (*JOBCTL) and the queue has operator control rights (OPRCTL), you do not need these rights.
³ A user can always display his own files in any job having his user name associated with it. If you have read rights to an output queue, you can display, copy, or send the files on that queue only if the queue has had DSPDTA(*YES) specified for it.

SUBSYSTEM DESCRIPTIONS

Command	Object Rights			Data Rights				Additional Rights Required
	Operational	Object Management	Object Existence	Read	Add	Update	Delete	
ADDAJE	X	X						Read on library.
ADDCMNE	X	X						Read on library.
ADDJOBQE	X	X						Read on library.
ADDRTGE	X	X						Read on library.
ADDWSE	X	X						Read on library.
CHGAJE	X	X						Read on library.
CHGCMNE	X	X						Read on library.
CHGJOBQE	X	X						Read on library.
CHGRTGE	X	X						Read on library.
CHGSBSD	X	X						Read on library.
CHGWSE	X	X						Read on library.
CRTSBSD								Read and add on library.
CRTSPADCT								Operational and read on source file. Read and add on library.
DLTGSS			X					Read on library.
DLTSBSD	X		X					Read on library.
DLTSPADCT			X					Read on library.
DSPSBSD	X							Read on library.
RMVAJE	X	X						Read on library.
RMVCMNE	X	X						Read on library.
RMVJOBQE	X	X						Read on library.
RMVRTGE	X	X						Read on library.
RMVWSE	X	X						Read on library.
STRSBS	X							Read on library.
TFR8CHJOB	X							Read and add on job queue.
TFRJOB	X							Read and add on job queue.
TRMSBS								Read on library.

SYSTEM REPLY LIST

Command	Object Rights			Data Rights				Additional Rights Required
	Operational	Object Management	Object Existence	Read	Add	Update	Delete	
CHGRPYLE								
DSPRPYL								
DSPRPYLE								
RMVRPYLE								

SYSTEM VALUES

Command	Object Rights			Data Rights				Additional Rights Required
	Operational	Object Management	Object Existence	Read	Add	Update	Delete	
CHGSYSVAL								
DSPSYSVAL								

TABLES

Command	Object Rights			Data Rights				Additional Rights Required
	Operational	Object Management	Object Existence	Read	Add	Update	Delete	
CRTTBL								Read and add on library.
DLTTBL			X					Read on library.

USER PROFILES

Command	Object Rights			Data Rights				Additional Rights Required
	Operational	Object Management	Object Existence	Read	Add	Update	Delete	
ADDNETJOBE	X							
CHGNETJOBE	X							
CHGPGM								Operational on new user profile if referenced user profile is to be changed.
CHGUSRPRF ¹								
CRTUSRPRF ¹								
DLTUSRPRF ¹			X					
DSPAUTUSR ¹								
DSPNETJOBE								
DSPUSRPRF				X				
GRTUSRAUT								Read on referenced user profile and same rights as GRTOBJAUT command for each object to be authorized.
MNGUSRTBL ²								
RSTUSRPRF								Save system rights in user profile.

¹ These commands are only authorized to the security officer user profile (QSECOFR).

² As shipped, this command is authorized only to the security officer. To use it, other users must be explicitly granted authority to it.

WRITERS

Command	Object Rights			Data Rights				Additional Rights Required
	Operational	Object Management	Object Existence	Read	Add	Update	Delete	
CHGWTR				X	X		X	1
CNLWTR				X	X		X	1
DSPWTR								
HLDWTR				X	X		X	1
RLSWTR				X	X		X	1
STRCRDWTR				X	X		X	1
STRDKTWTR				X	X		X	1
STRPRTWTR				X	X		X	1

1 The user must have read, add, and delete rights for the output queue or job control rights in the user profile and OPRCTL(*YES) is specified. The user must also have read rights on the library.

CHAPTER 7. IBM-SUPPLIED OBJECTS

Card Files	7-3
Classes	7-4
Control Unit Descriptions	7-4
Data Base Files	7-4
Device Descriptions	7-5
Diskette Files	7-5
Edit Descriptions	7-5
Graphic Symbol Sets	7-6
Job Descriptions	7-6
Job Queues	7-7
Libraries	7-7
Message Files	7-8
Message Queues	7-9
Output Queues	7-9
Printer Files	7-10
Programs	7-10
Subsystem Descriptions	7-10
Tables	7-11
Tape Files	7-11
User Profiles	7-11

Notes:



Chapter 7. IBM-Supplied Objects

This is a list of the names of IBM-supplied objects that are provided for your use. This does not include objects that are used only by the System/38 itself.

For detailed information on IBM-supplied objects, see the appropriate publication:

- *Control Program Facility Programmer's Guide*
- *RPG III Reference Manual and Programmer's Guide*
- *Data File Utility Reference Manual and User's Guide*
- *Source Entry Utility Reference Manual and User's Guide*
- *Query Utility Reference Manual and User's Guide*

Card Files

Name	Description
QCARD96	Card data device file
QCRDSRC	Card source device file
QPUNCH	Card punch device file

Classes

Name	Description
QBATCH	Default batch job class
QCTL	Controlling subsystem class
QFNC	Finance subsystem class
QINTER	Interactive subsystem class
QPGMR	Programmer subsystem class
QSNADS	SNADS class
QSPL	Spooling subsystem class
QSPL2	Spooling subsystem class

Control Unit Descriptions

Name	Description
QWSC1*	Standard work station controller description
QWSC2*	Optional work station controller description

*If created by service representative.

Data Base Files

Name	Description
QCBLSRC	COBOL source file
QCLSRC	CL source file
QCMDSRC	Command source file
QDDSSRC	DDS source file
QFMTSRC	Reformat source file
QIMGSRC	Print image source file
QPLISRC	PL/I source file
QRPGSRC	RPG source file
QTBLSRC	Table source file
QXTSRC	Text source file
QUOSSRC	UDS source file

Device Descriptions

Name	Description
QCARD96*	Card punch/reader device description (optional)
QCONSOLE	System console device description
QDKT	Diskette device description
QSYSPRT*	First attached printer device description
QSYSPRT2*	Second attached printer device description

*If device is ordered.

Diskette Files

Name	Description
QDKT	Diskette data device file
QDKTSRC	Diskette source device file

Edit Descriptions

Name	Edit Code	Description
QEDIT5	5	Edit code similar to B except DR = +
QEDIT6	6	Edit code similar to K except * prints as total indication
QEDIT7	7	Edit code similar to J except fixed \$ prints
QEDIT8	8	Edit code similar to J except floating \$ prints
QEDIT9	9	Edit code for date format

Graphic Symbol Sets

Name	Description
QGDDM	Symbol set library

Job Descriptions

Name	Description
QBATCH	Job description used by QBATCH subsystem
QCTL	Job description used by QCTL subsystem
QDIA	Document interchange transaction program job description
QFNC	Finance subsystem job description
QINTER	Job description used by QINTER subsystem
QNFTP	Object distribution job description
QPGMR	Job description used by QPGMR subsystem
QSNADS	SNADS job description
QOFCJOB	PS/38 batch job description
QOFALRMQ	PS/38 alarm job description
QSPLCRDR	Card reader spooling reader job description
QSPLCRDW	Card punch spooling writer job description
QSPLDBR	Data base spooling reader job description
QSPLDKTR	Diskette spooling reader job description
QSPLDKTW	Diskette spooling writer job description
QSPLERROR	Spooling error job description
QSPLPRTW	Printer spooling writer job description

Job Queues

Name	Description
QBATCH	Default job queue for batch jobs
QCTL	Job queue for controlling subsystem
QFNC	Finance subsystem job queue
QINTER	Interactive subsystem job queue
QPGMR	Programmer subsystem job queue
QSNADS	SNADS job queue
QSPL	Job queue for readers and writers

Libraries

Name	Description
QADM*	ADM Library (programs)
QADMFLS*	ADM Library (files for user data)
QBGU*	BGU library
QCBL*	COBOL library
QDOC	Document library
QGDDM	CPF Graphics library
QGPL	General-purpose library
QHLP SYS	System help library
QIDU*	Interactive Data Base Utilities library
QOFC*	PS/38 library
QOFCFLS*	PS/38 library (files for user data)
QPLI*	PL/I library
QRECOVERY	Recovery library
QRP G*	RPG library
QSPL	Spooling library
QSRV	Service library
QSYS	System library
QS3E*	Reformat library
QTX T*	Text Management Library
QUSRSYS	User system library

*If licensed program is ordered.

Message Files

Name	Description
QADMMSG	Message file for ADM titles and texts
QBGUMSG	Message file for BGU
QBGXMSG	Message file for BGU
QCBLMSGE	Message file for COBOL execution time
QCBLMSG	Message file for COBOL compiler and COBOL titles and texts
QCSCMSG	Message file for COBOL syntax checker
QCPFMSG	Message file for Control Program Facility (CPF), CPF informational messages, CPF titles and texts, keyboard messages, System/38 machine instruction interface
QEDTMSG	Message file for SEU titles and texts
QFMTMSG	Message file for Conversion Reformat Utility
QFMTTXT	Message file for reformat utility titles and texts
QIDUMSG	Message file for Interactive Data Base Utilities (IDU)
QIDXMSG	Message file for IDU titles and texts
QOFCMSG	Message file for PS/38
QPLIMSG	Message file for PL/I language compiler
QPLIMSGE	Message file for PL/I execution time
QRPMSG	Message file for RPG language compiler, RPG auto report, RPG syntax checker, RPG auto report titles and texts, and RPG relational diagnostic texts
QRPMSGGE	Message file for RPG execution time
QSDAMSG	Message file for screen design aid and screen design aid titles and texts
QTXMSG	Message file for Text Management

Message Queues

Name	Description
QCHG*	Message queue for system change log
QCONSOLE	System console message queue
QHST*	Message queue for system history log
QSRV*	Message queue for system service log
QSYSOPR	System operator message queue
Work station name	Work station message queue

*Accessed by the DSPLOG command rather than the DSPMSG command.

Output Queues

Name	Description
QDKT	Default diskette output queue
QPRINT	Default printer output queue
QPRINT2	Printer output queue intended for 2-part paper
QPRINTS	Printer output queue intended for special forms
QPUNCH	Default card output queue

Printer Files

Name	Description
QPRINT	Printer device file
QPRINT2	Printer two-copy device file
QPRINTS	Printer special forms device file

Programs

Name	Description
QCAEXEC	Command execution program
QCHECK	Command syntax check program
QCALLMENU	Program call menu program
QCL	Command processor program
QDCXLATE	Field translation program
QOFFCONV	PS/38 conversion program
QOPRMENU	System operator menu program
QPGMMENU	Programmer menu program
QRCVDTAQ	Receive from data queue
QSNDDTAQ	Send to data queue

Subsystem Descriptions

Name	Description
QBATCH	Batch subsystem description
QCTL	Controlling subsystem description
QFNC	Finance subsystem
QINTER	Interactive subsystem description
QPGMR	Programmer subsystem description
QSNADS	SNADS subsystem description
QSPL	Spooling subsystem description

Tables

Name	Description
QASCII	EBCDIC to ASCII translate table
QCASE256	Lowercase to uppercase translate table in code page 256
QEBCDIC	ASCII to EBCDIC translate table
QSYSTRNTBL	Lowercase to uppercase translate table

Tape Files

Name	Description
QTAPE	Tape data device file
QTAPSRC	Tape source device file

User Profiles

Name	Description
QCE	Customer engineer user profile
QPGMR	Programmer and batch user profile
QPSR	Program support representative user profile
QSECOFR	Security officer user profile
QSYSOPR	System operator user profile
QUSER	Work station user profile

Notes:

7-12



CHAPTER 8. SYSTEM VALUES

Date and Time	8-4
Editing	8-4
System Control	8-5
Library List	8-7
Allocation	8-7
Message and Logging	8-8
Storage	8-8

Notes:



Chapter 8. System Values

For each system value, this chart provides:

- The initial value specified for the system value when the system is shipped
- A brief description of the value
- The attributes of the value

Note: The *Length* column of this chart includes, for some values, a number that has a space between digits (for example, 5 0). The character(s) to the left of the space indicates the total number of positions the value contains; the character to the right of the space indicates how many of these positions are decimals.

Date and Time

Name	Initial Value	Description	Type	Length
QDATE ¹		System date	Character	5 ² or 6
QYEAR		Year	Character	2
QMONTH		Month of the year (not used for Julian dates)	Character	2
QDAY		Day of the month (day of the year if the system date format is Julian)	Character	2 or 3 ²
QLEAPADJ	0	Leap year adjustment	Decimal	5 0
QTIME ¹		Time of day	Character	6, 7, 8, or 9 ³
QHOURL		Hour of the day	Character	2
QMINUTE		Minute of the hour	Character	2
QSECOND		Second of the minute	Character	2

¹Because this value is set at start CPF time, no initial value is listed in this chart.
²For Julian dates.
³For tenths, hundredths, and thousandths of a second.

Editing

Name	Initial Value	Description	Type	Length
QCURSYM	'\$'	Currency symbol	Character	1
QDATFMT	MDY	Date format	Character	3
QDATSEP	'/'	Date separator	Character	1
QDECfmt	'b'	Decimal format	Character	1

System Control

Name	Initial Value	Description	Type	Length
QABNORMSW ¹	'0'	Previous termination of CPF indicator. ('0' means previous termination was normal. '1' means previous termination was abnormal.)	Character	1
QAUTOIMPL ¹	'0'	Start CPF IMPL indicator. ('0' specifies manual IMPL. '1' specifies auto-IMPL. '2' specifies restart IMPL.)	Character	1
QCHRID	'101 37'	Default graphic character set and code page used for displaying or printing data.	Character	20
QCMNRCYLMT	'0 0'	Provides recovery limits for system communications recovery.	Character	20
QCTLSBSD	'QCTL QSYS'	Controlling subsystem name.	Character	20
QDBRCVYWT	'0'	Data base recovery indicator. ('1' means wait. '0' means do not wait.)	Character	1
QIGC	'0'	Indicates whether the ideographic version of the system is installed. ('1' means the ideographic version is installed; '0' means the ideographic version is not installed.)	Character	1
QMAXSIGN	32767	Maximum number of invalid sign-on attempts allowed.	Decimal	(5 0)
QPWRDWNLMT	300	Maximum amount of time (in seconds) allowed for PWRDWN SYS *IMMED.	Decimal	(10 0)
¹ Because this value is set at start CPF time, no initial value is listed in this chart.				

System Control (continued)

Name	Initial Value	Description	Type	Length
QSCPFCONS	'1'	Start CPF console indicator. ('1' means to start system. '0' means terminate system.)	Character	1
QSCPFSIGN	15	Maximum number of invalid start CPF sign-on attempts allowed.	Decimal	(5 0)
QSRLNBR		System serial number.	Character	8
QSRVONLY	'0'	Service only indicator. ('0' means standard CPF. '1' means service only.)	Character	1
QUPSDLYTIM	*NONE	UPS (uninterruptible power supply) delay time.	Character	5
QUPSMMSGQ	*RESTART	Message queue for UPS (uninterruptible power supply) messages.	Character	20

Library List

Name	Initial Value	Description	Type	Length
QSYSLIBL	'QSYS'	System part of the library list.	Character	150
QUSRLIBL	'QGPL QTEMP'	User part of the library list.	Character	250

Allocation

Name	Initial Value	Description	Type	Length
QACTJOB	20	Initial number of active jobs to allocate storage for.	Decimal	(5 0)
QADLACTJ	10	Additional number of active jobs to allocate storage for.	Decimal	(5 0)
QADLSPLA	2048	Additional storage for extending spooling control block (bytes).	Decimal	(5 0)
QADLTOTJ	10	Additional total number of jobs to allocate storage for.	Decimal	(5 0)
QJOBMSGQSZ	16	Initial size of job message queue (K bytes).	Decimal	(5 0)
QJOBMSGQTL	24	Truncation level of job message queue (K bytes).	Decimal	(5 0)
QJOBSPLA	1536	Initial size of spooling control block for a job (bytes).	Decimal	(5 0)
QTOTJOB	30	Initial total number of jobs to allocate storage for.	Decimal	(5 0)

Message and Logging

Name	Initial Value	Description	Type	Length
QACGLVL	*NONE	Accounting level.	Character	80
QCHGLOGSI	1000	Maximum number of records for each version of the programming change log.	Decimal	(5 0)
QCSNAP	121500	Time of day to record statistics for communications lines.	Character	6
QHSTLOGSIZ	5000	Maximum number of records for each version of the history log.	Decimal	(5 0)
QSRVDMP	*DMPVSRJO	Control for requesting dumps, no jobs, system jobs, user jobs, or all jobs.	Character	10
QSRVLOGSIZ	1000	Maximum number of records for each version of the service log.	Decimal	(5 0)
QSYSOPRDE	QCONSOLE	Default device for the system operator.	Character	10

Storage

Name	Initial Value	Description	Type	Length
QAUXSTGTH	10	Unallocated auxiliary storage threshold (%).	Decimal	(9 6)
QBADPGFRM	5	Maximum number of bad page frames allowed before start CPF termination.	Decimal	(5 0)
QBASACTLVL	6	Activity level of base storage pool.	Decimal	(5 0)
QBASPOOL	150	Minimum size of base storage pool (K bytes).	Decimal	(5 0)
QMAXACTLVL	100	Maximum activity level of the system.	Decimal	(5 0)
QMCHPOOL	500	Machine storage pool size (K bytes).	Decimal	(5 0)

CHAPTER 9. DDS

Physical and Logical File	
Keywords–Group Listing	9-3
Physical and Logical File	
Keyword Descriptions	9-5
Display File Keywords–Group Listing	9-10
Display File Keyword Descriptions	9-13
Printer File Keywords–Group Listing	9-24
Printer File Keyword Descriptions	9-26
BSC File Keywords–Group Listing	9-29
BSC File Keyword Descriptions	9-30
Communications File Keywords–Group Listing	9-32
Communications File Keyword Descriptions	9-33
Mixed File Keyword Description	9-35
DDS Keyword and Value Abbreviations	9-36
DDS Edit Codes	9-40

Notes:



Chapter 9. DDS

PHYSICAL AND LOGICAL FILE KEYWORDS—GROUP LISTING

Access path keywords (PTH)

ABSVAL	NOALTSEQ
ACCPH	SIGNED
ALTSEQ	UNIQUE
DESCEND	UNSIGNED
DIGIT	ZONE
LIFO	

Editing keywords (EDT)

EDTCDE
EDTWRD

Join keywords (JOIN)

JDFTVAL
JDUPSEQ
JFILE
JFLD
JOIN
JREF

Miscellaneous keywords (MSC)

DFT
FLTPCN
TRNTBL

Naming and referencing keywords (REF)

ALIAS	REF
CONCAT	REFFLD
FORMAT	REFSHIFT
PFILE	RENAME

Select/omit keywords (S/O)

ALL	RANGE
CMP	VALUES
COMP	
DYNSLT	

Text definition keywords (TXT)

COLHDG
TEXT

Validity checking keywords (CHK)

CHECK	RANGE
CMP	VALUES
COMP	

PHYSICAL AND LOGICAL FILE KEYWORD DESCRIPTIONS

Keyword	Values	Function	Level	Groups
ABSVAl		Causes the sign of the key field to be ignored when sequencing values (use absolute values).	Physical file: Key field level Logical file: Key field level	Access path keywords
ACCPTh	{data-base-file-name [.library-name]}	Specifies that the keyed sequence access path of a previously created logical or physical file is to be shared by the file you are creating.	Logical file: File level	Access path keywords
ALIAS	{alternative-name}	Provides an alias name to be used for a field.	Physical file: Field level Logical file: Field level	Naming and referencing keywords
ALL		Select or omit all records not meeting the previously specified select/omit rules.	Logical file: Select/omit field level	Select/omit keywords
ALTSEQ	{alternate-sequence-table-name [.library-name]}	Use the specified alternative collating sequence for this key field.	Physical file: File level Logical file: File level	Access path keywords
CHECK	{AB, ME, MF, M10, M11, VN}	CHECK has no effect in physical or logical files. However, if the field you are defining is referenced at an input-capable field at display file creation, CHECK is duplicated into the display file. In the display file, CHECK tests the validity of data keyed into the input-capable field: <ul style="list-style-type: none"> • Allow blank (AB) • Mandatory enter (ME) or fill (MF) • IBM Modulus 10 (M10) or 11 (M11) self-check • Valid name (VN) CHECK does not request any action by data base data management, but can be specified in the data base file description so it can be duplicated into the device file descriptions when this field is referenced at device file creation.	Physical file: Field level Key file: Field level	Validity checking keywords
CMP	See COMP (the preferred spelling)			
COLHdG	{'label-1' ['label-2' ['label-3']]}	Specifies a column heading for a field (used by query and DFU).	Physical file: Field level Logical file: Field level	Text definition keywords

**PHYSICAL AND LOGICAL FILE KEYWORD DESCRIPTIONS
(continued)**

Keyword	Values	Function	Level	Groups
COMP	(AB, EQ, GE, GT, LE, LT, NE, NG, NL value/field name)	<i>At the field level in a physical file or logical file:</i> COMP has no effect. However, if the field you are defining is referenced by an input-capable field at display file creation, COMP is duplicated into the display file. In the display file, COMP tests the validity of data keyed into the input-capable field. <i>At the select/omit level in logical files only:</i> select or omit records retrieved from the based-on physical file(s) if they pass the specified test. For COMP, the test is a comparison between the value of the field and the specified value or field.	Physical file: Field level Logical file: Field level Logical file: Select/omit field level	Validity checking keywords
CONCAT	{field-1 field-2 [maximum]}	Concatenate fields from the based-on physical file into this logical file field.	Logical file: Field level	Naming and referencing keywords
DESCEND		Values in a key field are retrieved in descending sequence.	Physical file: Key field level Logical file: Key field level	Access path keywords
DFT	{'literal' X'hexadecimal-literal' numeric-literal}	Initializes the field to the literal value.	Physical file: Field level	Misc. keywords
DIGIT		Only the digit portion (low-order 4 bits) of each byte of the key field is used to build a key value.	Physical file: Key field level Logical file: Key field level	Access path keywords
DYNSLT		Specifies that dynamic select/omit is to be used.	Logical file: File level	Access path keywords
EDTCDE	{edit-code[* floating- currency-symbol]}	Names the edit code by which field values are to be displayed. EDTCDE has no effect on the physical or logical file you are defining, but can be duplicated into display or printer file descriptions when this field is referenced at display or printer file creation.	Physical file: Key field level Logical file: Key field level	Editing keywords

PHYSICAL AND LOGICAL FILE KEYWORD DESCRIPTIONS (continued)

Keyword	Values	Function	Level	Groups
EDTWRD	('word')	Specifies an edit word that describes the form in which field values are to be displayed. EDTWRD has no effect on the physical or logical file you are defining, but can be duplicated into display or printer descriptions when this field is referenced at display or printer file creation.	Physical file: Field level Logical file: Field level	EDT
FLTPCN	*SINGLE *DOUBLE	Specifies the precision of a floating-point field.	Physical file: Field level Logical file: Field level	Misc. keywords
FORMAT	(data-base-file-name [.library-name])	Use a previously described record format for this record format.	Physical file: Record level Logical file: Record level	Naming and referencing keywords
JDFTVAL		Specifies that the system is to provide default values for fields when a join to a secondary file produces no records.	Logical file: File level	Join keywords
JDUPSEQ	(sequencing-field-name) [*DESCEND])	Specifies the field to use for sequencing records when duplicates are found in secondary files.	Logical file: Field level	Join keywords
JFILE	(physical-file-name [.library-name][.32])	Identifies the physical files containing data to be accessed through the join logical file you are defining.	Logical file: Record level	Join keywords
JFLD	(from-field-name to-field-name)	Identifies the join fields in a join specification.	Logical file: Join level	Join keywords
JOIN	(from-file to-file)	Identifies the pair of files joined by a join specification.	Logical file: Join level	Join keywords
JREF	(file-name relative-file-number)	Identifies the file to use for a field name if the field name occurs in more than one based-on physical file.	Logical File: Field level	Join keywords
LIFO		Records with duplicate key values are processed in a last-in-first-out (LIFO) order.	Physical file: File level Logical file: File level	Access path keywords

PHYSICAL AND LOGICAL FILE KEYWORD DESCRIPTIONS (continued)

Keyword	Values	Function	Level	Groups
NOALTSEQ		The alternative collating sequence is not to be used for the key field.	Physical file: Key field level Logical file: Key field level	Naming and referencing keywords
PFILE	{data-base-file-name [.library-name][.32.]}	Names the physical file(s) on which the logical file and logical record format are to be based.	Logical file: Record level	Naming and referencing keywords
RANGE	{low high}	<i>At the field level in a physical file or logical file:</i> test the validity of data keyed into this field when this field is referenced by a display file. <i>At the select/omit level in logical files only:</i> select or omit records retrieved from the based-on physical file(s) if they pass the specified test. For RANGE, the test is that the value of the field must be greater than or equal to the lower value and less than or equal to the higher value.	Physical file: Field level Logical file: Field level Logical file: Select/omit keywords	Validity checking keywords Select/omit keywords
REF	{data-base-file-name [.library-name] [format-name]}	Refers to field specifications from the referenced file.	Physical file: File level	Naming and referencing keywords
REFFLD	{referenced-field-name [record-format-name] *SRC {data-base-file-name [.library-name]}	Refers to field specifications from the referenced field. Overrides REF for this field.	Physical file: Field level	Naming and referencing keywords
REFSHIFT	{reference-keyboard-shift}	Specifies a keyboard shift when the file is referenced by display file or DFU operation.	Physical file: Field level Logical file: Field level	Naming and referencing keywords
RENAME	{field-name}	Renames a physical file field name for a logical file record format.	Logical file: Field level	Naming and referencing keywords

PHYSICAL AND LOGICAL FILE KEYWORD DESCRIPTIONS (continued)

Keyword	Values	Function	Level	Groups
SIGNED		The sign of a field is considered when sequencing values.	Physical file: Key field level Logical file: Key field level	Access path keywords
TEXT	('description')	Specifies descriptive text for a record format or field.	Physical file: Record level Physical file: Field level Logical file: Record level Logical file: Field level	Text definition keywords
TRNTBL	(translate-table-name [.library-name])	On input to your program, the field is translated using the specified translate table.	Logical file: Field level	Misc. keywords
UNIQUE		Key values must be unique. (No duplicate key values are allowed.)	Physical file: File level Logical file: File level	Access path keywords
UNSIGNED	(unsigned)	The field is sequenced as unsigned binary data.	Physical file: Key field level Logical file: Key field level	Access path keywords
VALUES	(value-1 [value-2... [value-100]])	<i>At the field level in a physical file or logical file:</i> test the validity of data keyed into this field when this field is referenced by a display file. <i>At the select/omit level in logical files only:</i> select or omit records retrieved from the based-on physical file(s) if they pass the specified test. For VALUES, the test is that the value of the field must be equal to one of the specified values.	Physical file: Field level Logical file: Field level Logical file: Select/omit field level	Validity checking keywords Select/omit keywords
ZONE		Only the zone portion (high-order 4 bits) of each byte of the key field is used to build a key value.	Physical file: Key field level Logical file: Key field level	Access path keywords

DISPLAY FILE KEYWORDS—GROUP LISTING

Constant field keywords (CON)

DATE
DFT
MSGCON
TIME

Display control keywords (DSP)

ALARM	ERASEINP
ALWGPH	FRCDTA
ALWROL	GETRETAIN
BLINK	INZRCD
BLKFOLD	MDTOFF
CHECK (RL or RLTB only)	OVERLAY
CHGINPDFT	OVRATR
CLRL	OVRDTA
COLOR	PROTECT
CSRLOC	PUTOVR
DSPATR	PUTRETAIN
DSPSIZ	SLNO
ERASE	USRDFN

Editing keywords (EDT)

EDTCDE
EDTWRD
FLTFIXDEC

Keyboard control keywords (KBD)

CAnn	HOME
CFnn	LOCK
CHECK (ER, FE, LC, RB, RZ)	LOWER
CHGINPDFT (FE)	PRINT
CLEAR	ROLLDOWN
DUP	ROLLUP
HELP	UNLOCK
	VLDCMDKEY

Message handling keywords (MSG)

ERRMSG	SFLMSGID
ERRMSGID	SFLMSGKEY
MSGLOC	SFLMSGRCD
SFLMSG	

Miscellaneous keywords (MSC)

ASSUME	LOGINP
BLANKS	LOGOFF
CHRID	OPENPRT
FLTPCN	SETOF
INDARA	SETOFF
KEEP	

Naming and referencing keywords (REF)

ALIAS	REF
DLTCHK	REFFLD
DLT EDT	

Processing control keywords (CTL)

ALIAS
INVITE
PASSRCD
RTN DTA

Routing keywords (RTG)

RTGAID	RTGFIRST
RTGCON	RTGFLD
RTGDEV	RTGFMT
RTGDEVCLS	RTGPOS

Subfile control record (SFL(C))

SFLCLR	SFLIN
SFLCTL	SFLMSG
SFLDLT	SFLMSGID
SFLDROP	SFLPAG
SFLDSP	SFLPGMQ
SFLDSPCTL	SFLRCDNBR
SFLEND	SFLRNA
SFLENTER	SFLROLVAL
SFLINZ	SFLSIZ

Subfile record (SFL(R))

SFL	SFLNXTCHG
SFLMSGKEY	SFLPGMQ
SFLMSGRCD	

Text definition keywords (TXT)

INDTXT
TEXT

Validity checking keywords (CHK)

AUTO	CMP
CHANGE	COMP
CHECK (AB, ME, MF, M10, M11, VN)	RANGE VALUES
CHGINPDT (ME, MF)	

DISPLAY FILE KEYWORD DESCRIPTIONS

Keyword	Values	Function	Level	Option Indicator	Groups
ALARM		An audible alarm is set on when the record is displayed.	Record	Optional	Display control keywords
ALIAS	(alternative-name)	Provides an alias name to be used as a field.	Field		Naming and referencing keywords
ALWGPH		Allows concurrent display of graphics and alphameric characters.	File Record	Operational	Display control keywords
ALWROL		Allows program to roll data within a window when displaying this record format.	Record		Display control keywords
ASSUME		The system assumes that the record is currently on the display when the file is opened.	Record		Misc. keywords
AUTO		RA: See CHECK(ER). RAB: See CHECK(RB). RAZ: See CHECK(RZ).	Field	See note.	Validity checking keywords
BLANKS	(response-indicator ['text'])	Used for numeric, input-capable fields. Sets on the response indicator when the field is all blank on the display.	Field		Misc. keywords
BLINK		When the record is displayed, the cursor blinks.	Record	Optional	Display control keywords
BLKFOLD		CPF folds the field at the last blank before the end of the line instead of folding at the actual end of the line.	Field		Display control keywords
CAnn	[(response-indicator ['text'])]	The command key specified by nn is a command attention key.	File Record	Optional	Keyboard control keywords
CFnn	[(response-indicator ['text'])]	The command key specified by nn is a command function key.	File Record	Optional	Keyboard control keywords
CHANGE	(response-indicator ['text'])	The response indicator is set on when data is changed in the field or in the record.	Record Field		Validity checking keywords
CHECK	(AB)	Allows blank input data to satisfy validity checking requirements for the field.	File Record Field		Misc. keywords

Note: Option indicators valid for RA (record advance) only.

DISPLAY FILE KEYWORD DESCRIPTIONS (continued)

Keyword	Values	Function	Level	Option Indicator	Groups
CHECK	(ME, MF, M10, M11, VN)	A field value must meet one or more of the following check algorithms to be valid: <ul style="list-style-type: none"> • Mandatory enter (ME) or fill (MF) • IBM modulus 10 (M10) or 11 (M11) self-check • Valid name (VN) 	Field	See note.	Validity checking keywords
CHECK	(ER, FE, LC, RA, RZ)	On the 5250 work station, the following controls are placed on input keying: <ul style="list-style-type: none"> • End of record (ER) • Field exit check (FE) • Lowercase (LC) • Right-adjust, blank fill (RB) • Right-adjust, zero fill (RZ) 	Field		Keyboard control keywords
CHECK	(RL)	The cursor moves from right to left within a field.	File Record Field		Display control keywords
CHECK	(RLTB)	The cursor advances between input-capable fields in a right-to-left, top-to-bottom manner.	File		Display control keywords
CHGINPDT	[(input-default1 input-default2 ...)]	Without parameter values, input-capable fields are not underlined (as they are by default on System/38). With parameter values, specifies display attributes or check codes for fields in the file or record, or only for this field. Valid parameter values: <ul style="list-style-type: none"> • Blinking field (BL) • Column separators (CS) • High intensity (HI) • Reverse image (RI) • Underline (UL) • Field exit (FE) • Lowercase (LC) • Mandatory enter (ME) • Mandatory fill (MF) 	File Record Field		Display control keywords
CHRID		Character translation is done when field is processed.	File level		Misc. keywords

Note: ME (Mandatory entry) only.

DISPLAY FILE KEYWORD DESCRIPTIONS (continued)

Keyword	Values	Function	Level	Option Indicator	Groups
CLEAR ¹	[(response-indicator 'text')]	Your program receives control when the Clear key is pressed.	File Record	Optional Optional	Keyboard control keywords Keyboard control keywords
CLRL	(*NO nn)	Clears (erases) nn display lines. If *NO specified, no display lines are cleared.	Record		Display control keywords
CMP		See COMP (the preferred spelling).			
COLOR	(GRN WHT RED TRQ YLW PNK BLU)	On the 5292 Color Display Station, displays the field with the color you specify: <ul style="list-style-type: none"> • Green (GRN) • White (WHT) • Red (RED) • Turquoise (TRQ) • Yellow (YLW) • Pink (PNK) • Blue (BLU) 	Field	Optional	Display control keywords
COMP	(EQ, NE, LT, NL, GT, NG, LE, GE)	A field value must meet the specified comparison test such as <i>equal to</i> to be valid.	Field		Validity checking keywords
CSRLOC	(field-name-1 field-name-2)	Your program determines the cursor location by setting the contents of field-name-1 and field-name-2.	Record	Optional	Display control keywords
DATE		The job date is displayed in the specified location.	Field		Constant field keywords
DFT	('literal' 'literal')	The field is initialized to the literal value. (This keyword is also used to define constant fields.)	Field		Constant field keywords
DLTCHK		The field validity checking keywords are ignored (deleted) when referencing field specifications from a data base file.	Field		Naming and referencing keywords
DLTEDIT		The edit information is ignored (deleted) when referencing field specifications from a data base file.	Field		Naming and referencing keywords

¹A response indicator is required for this keyword to be used by RPG.

DISPLAY FILE KEYWORD DESCRIPTIONS (continued)

Keyword	Values	Function	Level	Option Indicator	Groups
DSPATR	{attribute[attribute [attribute[...]]]}	Displays the field with the attributes you specify: <ul style="list-style-type: none"> • Blinking field (BL) • Column separator (CS) • High intensity (HI) • Set modified data tag (MDT) • Nondisplay (ND) • Operator identification (OID) • Position cursor (PC) • Protect (PR) • Reverse image (RI) • Select by light pen (SP) • Underline (UL) 	Field level	Optional See note.	Display control keywords
DSPSIZ	{*DSx [*DSy [*DSz]] -or- (lines chars [condition-name-1] (lines chars [condition-name-2] (lines chars [condition-name-3]))}	Specifies the primary display size and any secondary display sizes. Valid entries for this parameter value are: *DS1 or 16 64 *DS2 or 12 80 *DS3 or 24 80 (x, y, or z = 1, 2, or 3 and x = y = z)	File		Display control keywords
DUP	{(response-indicator ['text'])}	Your program receives control when the Dup key is pressed.	Field	Optional	Keyboard control keywords
EDTCDE	{(edit-check-code[*] floating-currency-symbol)}	Names the edit code by which field values are to be displayed.	Field		Editing keywords
EDTWRD	{ 'word' }	Specifies an edit word that describes the form in which values are to be displayed.	Field		Editing keywords
ERASE	{(record-name-1 [record-name-2... [record-name-20]])}	Erases the specified records.	Record	Optional	Display control keywords.
ERASEINP	{*MDTON} {*ALL}	*MDTON: Input-capable fields with MDTs set on are returned to their initial values. *ALL: All input-capable fields are returned to their initial values.	Record level	Optional	Display control keywords
ERRMSG	{ 'message' [response-indicator] }	Specifies a message to be displayed on the message line.	Field	Optional	Message handling keywords
ERRMSGID	{(msg-ID msg-file [.library-name])}	Specifies the message identifier of a message to be displayed on the message line.	Field level	Optional	Message handling keywords
<p>Note: Option indicators not used for selector light pen or operator identification.</p>					

DISPLAY FILE KEYWORD DESCRIPTIONS (continued)

Keyword	Values	Function	Level	Option Indicator	Groups
FLTFIXDEC		Displays floating-point values in fixed decimal format.	Field		Editing keywords
FLTPCN	*SINGLE *DOUBLE	Specifies the precision of a floating-point field.	Field		Misc. keywords
FRCDTA		If DFTWRT(*YES) is specified for the file, causes a record to be displayed immediately when an output operation is issued (as if DFRWRT(*NO) were specified for the file).	Record level		Display control keywords
GETRETAIN		Leaves all input data on the screen.	Record		Display control keywords
HELP ¹	{ (response-indicator 'text') }	Your program receives control when the Help key is pressed.	File Record	Optional Optional	Keyboard control keywords Keyboard control keywords
HOME ¹	{ (response-indicator 'text') }	Your program receives control when the Home key is pressed and the cursor is already in the home position.	File Record	Optional Optional	Keyboard control keywords Keyboard control keywords
INDARA		Places option and response indicators in the separate indicator area.	File		Misc. keywords
INDTXT	(indicator 'indicator-usage-text')	Text is associated with the specified indicator for high-level language program documentation.	File Record Field		Text definition keywords Text definition keywords Text definition keywords
INVITE		Used to invite data from a device. Your program will receive the data on a later input operation.	File Record	Optional	Processing control keywords Processing control keywords

¹A response indicator is required for this keyword to be used by RPG.

DISPLAY FILE KEYWORD DESCRIPTIONS (continued)

Keyword	Values	Function	Level	Option Indicator	Groups
INZRCD		The record is written to the display before it is read.	Record		Display control keywords
KEEP		The display is not erased when the file closes.	Record		Misc. keywords
LOCK		The keyboard is locked on an output operation.	Record	Optional	Keyboard control keywords
LOGINP		The input record is copied (logged) to the job log.	Record		Misc. keywords
LOGOUT		The output record is copied (logged) to the job log.	Record	Optional	Misc. keywords
LOWER		See CHECK(LC) (the preferred spelling).	Field		Keyboard control keywords
MDTOFF	{*UNPR } {*ALL }	*UNPR: MDTs of fields without DSPATR(PR) are reset on an output operation. *ALL: MDTs of all fields are reset on an output operation.	Record	Optional	Display control keywords
MSGCON	(length message-ID message-file-name .library-name)	Specifies the message description that contains the text for a constant field.	Field		Constant field keywords
MSGLOC	(line-number)	Specifies the line on which messages are to be displayed.	File	See note.	Message handling keywords
OPENPRT		The printer file is to remain open until the display file is closed. (See the PRINT keyword.)	File		Misc. keywords
OVERLAY		The entire display is not erased before this record is written.	Record	Optional	Display control keywords
OVRATR		Display attributes of this field are changed on an output operation.	Field	Optional	Display control keywords
OVRDTA		Data contents of this field are changed on an output operation.	Field	Optional	Display control keywords
PASSRCD	(record-format)	Specifies the record format to be used when unformatted data is passed.	File		Processing control keywords
<p>Note: Screen size condition names can be used as indicators (*DS1, *DS2, *DS3).</p>					

DISPLAY FILE KEYWORD DESCRIPTIONS (continued)

Keyword	Values	Function	Level	Option Indicator	Groups
PRINT ^{1, 2}	{([response-indicator] ['text'] printer-file-name [.library-name])}	The Print key can be used to: <ul style="list-style-type: none"> • Print to the associated device. • Print to the specified printer file. • Pass control to your program. 	File	Optional	Keyboard control keywords
PROTECT		All input-capable fields on the display are changed to output-only fields.	Record	Optional	Display control keywords
PUTOVR		Permits the use of OVRATR and OVRDTA keywords.	Record	Optional	Display control keywords
PUTRETAIN		A record (at the record format level) or field (at the field level) is retained on the display.	Record Field	Optional Optional	Display control keywords Display control keywords
RANGE	(low high)	The field value must be within the range specified.	Field		Validity checking keywords
REF	{file-name [.library-name] [record-format-name]}	The system refers to the specified data base file for field specifications for this display file.	File		Naming and referencing keywords
REFFLD	{referenced-field-name [.record-format-name] *SRC {data-base-file-name [.library-name]}	The system refers to the specified data base file (other than the file specified in the REF keyword) for field specifications for this field.	Field		Naming and referencing keywords
ROLLDOWN ¹	{(response-indicator ['text'])}	Your program receives control when the Roll Down key is pressed.	File Record	Optional Optional	Keyboard control keywords Keyboard control keywords
ROLLUP ¹	{(response-indicator ['text'])}	Your program receives control when the Roll Up key is pressed.	File Record	Optional Optional	Keyboard control keywords Keyboard control keywords
RTGAID	(starting-feedback-location)	The AID byte (command key indication) is placed in the routing data as a 2-byte identifier.	Record level		Routing keywords
¹ A response indicator is required for this keyword to be used by RPG. ² A response indicator is required for this keyword to be used by COBOL.					

DISPLAY FILE KEYWORD DESCRIPTIONS (continued)

Keyword	Values	Function	Level	Option Indicator	Groups
RTGCON	(starting-feedback-location 'constant')	The specified literal is placed in the routing data at the specified location.	Record		Routing keywords
RTGDEV	(starting-feedback-location)	The 10-character device name is placed in the routing data.	Record		Routing keywords
RTGDEVCLS	(starting-feedback-location)	The 2-character device class is placed in the routing data.	Record		Routing keywords
RTGFIRST	(starting-feedback-location entry-length)	The length and location of the first field received is placed in the routing data.	Record		Routing keywords
RTGFLD	(starting-feedback-location)	The field data is placed in the routing data.	Field		Routing keywords
RTGFMT	(starting-feedback-location)	The record format name is placed in the routing data.	Record		Routing keywords
RTGPOS	(starting-feedback-locati starting-data-position ending-data-position)	Data received from a display device is placed in the routing data.	Record		Routing keywords
RTNDTA		CPF returns the same input data as on the last input operation.	Record		Processing control keywords
SETOF	{response-indicator ['text'] }	The specified response indicator is set off on an input operation.	Record		Misc. keywords
SFL		The record format is a subfile record format.	Record		Subfile record keywords
SFLCLR		Allows your program to clear a subfile (does not delete the subfile).	Record	Required	Subfile control record keywords
SFLCTL	(record-name)	Specifies that the record format is a subfile control record format.	Record		Subfile control record keywords
SFLDLT		Allows your program to delete a subfile.	Record	Required	Subfile control record keywords
SFLDROP	(CAAnn/CFnn)	Assigns a command key to be used to fold or truncate records in a subfile.	Record		Subfile control record keywords
SFLDSP		Allows your program to display a subfile.	Record	Optional	Subfile control record keywords

DISPLAY FILE KEYWORD DESCRIPTIONS (continued)

Keyword	Values	Function	Level	Option Indicator	Groups
SFLDSPCTL		Allows your program to display a subfile record format.	Record	Optional	Subfile control record keywords
SFLEND		Allows your program to display a plus sign (+) when there are more subfile records than fit on one page.	Record	Required	Subfile control record keywords
SFLENTER	(CAnn/CFnn)	Changes the Enter/Rec Adv key to a Roll Up key and assigns the specified command key to be the Enter/Rec Adv key.	Record		Subfile control record keywords
SFLINZ		Allows your program to initialize all records in a subfile with one output operation.	Record	Optional	Subfile control record keywords
SFLLIN	(spaces)	Specifies the number of spaces between columns of subfile records in a horizontal subfile.	Record	See note.	Subfile control record keywords
SFLMSG	{'message' [response-indicator]}	Specifies a subfile-related message to be displayed on the message line.	Record	Optional	Message handling keywords Subfile control record keywords
SFLMSGID	{msg-id msg-file [.library-name]}	Specifies the message identifier of a message to be displayed on the message line.	Record	Optional	Message handling keywords Subfile control record keywords
SFLMSGKEY		Must be specified on the first field in the subfile record format of a message subfile. The field contains the message reference key of a message to be placed in the message subfile.	Field		Subfile record keywords
<p>Note: Screen size condition names can be used as indicators (*DS1, *DS2, *DS3).</p>					

DISPLAY FILE KEYWORD DESCRIPTIONS (continued)

Keyword	Values	Function	Level	Option Indicator	Groups
SFLMSGRC	(line-number)	Defines a subfile as a message subfile (which contains messages from a program message queue).	Record	See note.	Subfile record keywords
SFLNXTCHG		Your program can require that the work station user rekey input fields correctly.	Record	Optional	Subfile record keywords
SFLPAG	(number-to-be-displaye	Specifies the number of subfile records that can be displayed at one time. If field selection is used in the subfile, specifies the number of display lines in the subfile page.	Record	See note.	Subfile control record keywords
SFLPGMQ		Must be specified on the second field in the subfile record format of a message subfile. Your program sets the value of this field to the name of the program message queue containing messages to be placed in a message subfile.	Field		Subfile control record keywords Subfile record keywords
SFLRCDNBR	[(CURSOR)]	Specifies that the first page of the subfile to be displayed is the page containing the record whose relative record number is in this field.	Field		Subfile control record keywords
SFLRNA		Allows your program to initialized the subfile with no active records.	Record		Subfile control record keywords
SFLROLVAL		Can be specified only on a field whose value determines the number subfile records to be rolled when the appropriate Roll key is pressed.	Field		Subfile control record keywords
SFLSIZ	(number-of-records-in-subfile)	Specifies the number of records in a subfile.	Record	See note.	Subfile control record keywords
TEXT	('description')	Specifies descriptive text for a record format or field.	Record Field		Text definition keywords Text definition keywords

DISPLAY FILE KEYWORD DESCRIPTIONS (continued)

Keyword	Values	Function	Level	Option Indicator	Groups
TIME		The system time is displayed in the specified location.	Field		Editing keywords
UNLOCK	[*ERASE *MDTOFF] [*ERASE *MDTOFF *MDTOFF *ERASE]	The keyboard is unlocked after a read operation so the next record can be entered.	Record		Keyboard control keywords
USRDFN		The data is a user-defined data stream.	Record		Display control keywords
VALUES	(value-1 [value-2. . . [value-100]])	The field value must be one of the values specified.	Field		Validity checking keywords
VLDCMDKEY	(response-indicator ['text'])	A response indicator is set on if any valid command key (a key associated with a keyword) is pressed.	File Record		Keyboard control keywords Keyboard control keywords
<p>Note: Screen size condition names can be used as indicators (*DS1, *DS2, *DS3).</p>					

PRINTER FILE KEYWORDS—GROUP LISTING

Constant field keywords (CON)

DATE PAGNBR
DFT TIME
MSGCON

Editing keywords (EDT)

EDTCDE
EDTWRD
FLTFIXDEC

Graphics keywords (GRA)

CPI DFT
CVTDTA TRNSPY
DFNCHR

Miscellaneous keywords (MSC)

CHRID
FLTPCN
INDARA

Naming and referencing keywords (REF)

ALIAS
DLT EDT
REF
REFFLD

Printer control keywords (PRT)

BLKFOLD	SKIPB
CPI	SPACEA
DRAWER	SPACEB
SKIPA	UNDERLINE

Text definition keywords (TXT)

INDTXT
TEXT

PRINTER FILE KEYWORD DESCRIPTIONS

Keyword	Values	Function	Level	Option Indicator	Groups
ALIAS	(alternative-name)	Provides an alias name to be used for a field.	Field		Naming and referencing keywords
BLKFOLD		Records are folded at the last blank before the end of the line instead of folding at the actual end of the line.	Field		Printer control
CHRID		Character translation is done when the field is processed.	Field level		Misc. keywords
CPI	(10 15)	Specifies the horizontal printing density for this record or field: <ul style="list-style-type: none"> • 10 (10 characters per inch) • 15 (15 characters per inch) 	Record Field	Optional	Graphics keywords Printer control keywords
CVTDTA		Converts character data placed in this field by your program to hexadecimal data.	Field	Optional	Graphics keywords
DATE		The job date is printed in the specified location.	Field		Constant field keywords
DFNCHR	X'code-point-1' X'dot-matrix-pattern-1' X'code-point-2' X'dot-matrix-pattern-2' X'code-point-50' X'dot-matrix-pattern-5	Defines up to 50 characters for use on the 5224 or 5225 printers only.	File Record	Optional	Graphics keywords
DFT	'literal' (X'hexadecimal-literal') 'literal' X'hexadecimal-literal'	When literal is specified, field has a constant value as specified. When hexadecimal literal is specified, dot matrixes (characters) corresponding to code points identified in the hexadecimal literal are printed. (Correspondences usually defined by DFNCHR keyword.)	Field		Constant field keywords Graphics keywords
DLTDT		The edit information is ignored when referencing field specifications.	Field		Naming and referencing keywords
DRAWER	(1 2 3)	Specifies the drawer from which forms will be selected on printers that print on non-continuous forms.	Record	Optional	Printer control keywords

PRINTER FILE KEYWORD DESCRIPTIONS (continued)

Keyword	Values	Function	Level	Option Indicator	Groups
EDTCDE	(edit-code [* floating-currency-symbol])	Names the edit code by which field values are to be printed.	Field		Editing keywords
EDTWRD	('word')	Specifies an edit word that describes the form in which values are to be printed.	Field		Editing keywords
FLTFIXDEC		Prints floating-point values in format.	Field		Editing keywords
FLTPCN	*SINGLE *DOUBLE	Specifies the precision of a floating-point field.	Field		Misc. keywords
INDARA		Places option indicators in the separate indicator area.	File		Misc. keywords
INDTXT	(indicator 'indicator-usage-text')	Text is associated with the specified indicator for high-level language program documentation.	File Record Field		Text definition keywords
MSGCON	(length message-ID message-file-name [.library-name])	Specifies the message description that contains the text for a constant field.	Field		Misc. keywords
PAGNBR		A system-supplied page number is printed in this field (a 4-digit zoned decimal field).	Field	Optional	Constant field keywords
REF	(data-base-file-name [.library-name] [format-name])	The system refers to field specifications from a referenced data base file.	File		Naming and referencing keywords
REFFLD	(referenced-field-name [.record-format-name] *SRC { data-base-file-name [.library-name] }	The system refers to field specifications from a data base file (other than the file specified in the REF keyword).	Field		Naming and referencing keywords
SKIPA	(skip-after-line-number)	Specifies a line to skip to after printing a line (file level), after printing an entire record (record level), or after printing the line containing the field associated with this keyword (field level).	File Record Field	Optional Optional Required	Printer control keywords
SKIPB	(skip-before-line-number)	Specifies the line to skip to before printing the next line of output (file level), or before printing the lines associated with a record (record level), or before printing the line containing the field associated with this keyword (field level).	File Record Field	Optional Optional Required	Printer control keywords

PRINTER FILE KEYWORD DESCRIPTIONS (continued)

Keyword	Values	Function	Level	Option Indicator	Groups
SPACEA	(space-after-value)	Specifies the number of lines to space after printing an entire record (record format level) or to space after printing the line containing the field associated with this keyword (field level).	Record Field	Optional Optional	Printer control keywords
SPACEB	(space-before-value)	Specifies the number of lines to space before printing the lines associated with a record (record format level) or before printing the line containing the field associated with this keyword (field level).	Record Field	Optional Optional	Printer control keywords
TEXT	('description')	Specifies descriptive text for the record format or field.	Record Field		Text definition keywords
TIME		The system time is printed in the specified location.	Field		Constant field keywords
TRNSPY		Prevents hexadecimal data being sent to the printer from being interpreted as SCS commands.	Field		Graphics keywords
UNDERLINE		The field is underlined.	Field	Optional	Printer control keywords

BSC FILE KEYWORDS—GROUP LISTING

Miscellaneous keywords (MSC)

FLTPCN
INDARA

Naming and referencing keywords (REF)

ALIAS
REF
REFFLD

Processing control keywords (CTL)

ALWWRT	RECID
ENDGRP	RQSWRT
FAIL	SUBDEV
FRCDTA	TRNRND
INVITE	TRNRND
RCVENDGRP	

Routing keywords (RTG)

RTGDEV
RTGDEVCLS
RTGFMT
RTGPOS

Text definition keywords (TXT)

INDTXT
TEXT

BSC FILE KEYWORD DESCRIPTIONS

Keyword	Values	Function	Level	Option Indicator	Groups
ALIAS	(alternative-name)	Provides an alias name to be used for a field.	Field		Naming and referencing keywords
ALWWRT		The record currently being written ends a transmission; the program is going to receive state.	File Record	Optional Optional	Processing control keywords
ENDGRP	(response-indicator 'indicator-usage-text')	Indicates the end of a user-defined group of records. Your program remains in a send state.	File Record	Required	Processing control keywords
FAIL		Discards the records being sent in the current transmission.	File Record	Optional Optional	Processing control keywords
FLTPCN	*SINGLE *DOUBLE	Specifies the precision of a floating-point field.	Field		Misc. keywords
INDARA		Places option and response indicators in the separate indicator area.	File		Misc. keywords
INDTXT	(indicator 'indicator-usage-text')	Text is associated with the specified indicator for high-level language program documentation.	File Record		Text definition keywords
INVITE		Used to invite data from a remote device. Your program will receive the data on a later input operation.	File Record	Optional	Processing control keywords
RCVENDGRP	(response-indicator ['text'])	Indicates the end of a user-defined group of records sent to the program.	File Record		Processing control keywords
RECID	(position value)	Used to allow the data content to identify the record format to use to receive the data.	Record		Processing control keywords
REF	(data-base-file-name [.library-name] [record-format-name])	The system refers to field specifications from a referenced data base file.	File		Naming and referencing keywords
REFFLD	(referenced-field-name [.record-format-name] *SRC { [data-base-file-name [.library-name] }	The system refers to field specifications from a data base file (other than the file specified in the REF keyword).	Field		Naming and referencing keywords

BSC FILE KEYWORD DESCRIPTIONS (continued)

Keyword	Values	Function	Level	Option Indicator	Groups
RQSWRT		Requests permission from the host system for the user to send data.	File Record	Optional Optional	Processing control keywords Processing control keywords
RTGDEV	(starting-routing-field-location)	The 10-character device name is placed in the routing data.	Record		Routing keywords
RTGDEVCLS	(starting-routing-field-location)	The 2-character device class is placed in the routing data.	Record		Routing keywords
RTGFMT	(starting-routing-field-location)	The record format name is placed in the routing data.	Record		Routing keywords
RTGPOS	(starting-routing-field-location starting-data-position ending-data-position)	Data received from a communications or BSC device is placed in the routing data.	Record		Routing keywords
SUBDEV	(*DC1 *DC2 *DC3 *DC4)	Request a BSC subdevice to which output should be directed.	File Record	Optional Optional	Processing control keywords
TEXT	('description')	Specifies descriptive text for the record format or field.	Record Field		Text definition keywords
TRNRND	(response-indicator ['text'])	Indicates to the program that it is now in the send state and has permission to write.	File Record		Processing control keywords

COMMUNICATIONS FILE KEYWORDS—GROUP LISTING

Miscellaneous keywords (MSC)

FLTPCN
INDARA

Naming and referencing keywords (REF)

ALIAS
REF
REFFLD

Processing control keywords (CTL)

ALWWRT	RCVDETACH
CONFIRM	RCVENDGRP
DETACH	RCVFAIL
ENDGRP	RECID
EVOKE	RQSWRT
FAIL	SECURITY
FRCDTA	SYNLVL
INVITE	TRNRND
RCVCFM	

Routing keywords (RTG)

RTGDEV
RTGDEVCLS
RTGFMT
RTGPOS

Text definition keywords (TXT)

INDTXT
TEXT

COMMUNICATIONS FILE KEYWORD DESCRIPTIONS

Keyword	Values	Function	Level	Option Indicator	Groups
ALIAS	(alternative-name)	Provides an alias name to be used for a field.	Field		Naming and referencing keywords
ALWWRT		The record currently being written ends a transmission; the program is going to receive state.	File Record	Optional Optional	Processing control keywords
CONFIRM (peer only)		Requests that the remote program confirm whether it has received the data.	File Record	Optional	Processing control keywords
DETACH (peer only)		Informs the remote program that your program is done sending data and is terminating the conversation.	File Record	Optional	Processing control keywords
ENDGRP	(response-indicator 'indicator-usage-text')	Indicates the end of a user-defined group of records. Your program remains in a send state.	File Record	Required	Processing control keywords
EVOKE (peer only)	(program-name [.library-name] [parameter-1... [parameter-255]])	Used to start a program on the remote system	File Record	Optional	Processing control keywords
FAIL		Discards the records being sent in the current transmission.	File Record	Optional Optional	Processing control keywords
FLTPCN	*SINGLE! *DOUBLE	Specifies the precision of a floating-point field.	Field		Misc. keywords
FRCDTA		Immediately sends communications data currently in the buffer, without waiting for the buffer to become full.	Record level		Processing control keywords
INDARA		Places option and response indicators in the separate indicator area.	File		Misc. keywords
INDTXT	(indicator 'indicator-usage-text')	Text is associated with the specified indicator for high-level language program documentation.	File Record		Text definition keywords
INVITE		Used to invite data from a remote device. Your program will receive the data on a later input operation.	File Record	Optional	Processing control keywords

COMMUNICATIONS FILE KEYWORD DESCRIPTIONS (continued)

Keyword	Values	Function	Level	Option Indicator	Groups
RCVCFM (peer only)	(response-indicator ['text'])	Indicates that the remote program is requesting a confirmation of conversation activity up to this point.	File Record	Optional	Processing control keywords
RCVDETACH (peer only)	(response-indicator ['text'])	Indicates to your program that the remote program has ended the conversation.	File Record		Processing control keywords
RCVENDGRP	(response-indicator ['text'])	Indicates the end of a user-defined group of records sent to the program.	File Record		Processing control keywords
RCVFAIL (peer only)	(response-indicator ['text'])	Indicates that the remote program has failed.	File Record		Processing control keywords
RECID	(position value)	Used to allow the data content to identify the record format to use to receive the data.	Record		Processing control keywords
REF	(data-base-file-name [.library-name] [record-format-name])	The system refers to field specifications from a referenced data base file.	File		Naming and referencing keywords
REFFLD	(referenced-field-name [.record-format-name] SRC { data-base-file-name [.library-name] })	The system refers to field specifications from a data base file (other than the file specified in the REF keyword).	Field level		Naming and referencing keywords
RQSWRT		Requests permission from the host system for the user to send data.	File Record	Optional Optional	Processing control keywords
RTGDEV	(starting-routing- field-location)	The 10-character device name is placed in the routing data.	Record		Routing keywords
RTGDEVCLS	(starting-routing- field-location)	The 2-character device class is placed in the routing data.	Record		Routing keywords
RTGFMT	(starting-routing- field-location)	The record format name is placed in the routing data.	Record level		Routing keywords
RTGPOS	(starting-routing- field-location starting- data-position ending- data-position)	Data received from a communications or BSC device is placed in the routing data.	Record		Routing keywords

COMMUNICATIONS FILE KEYWORD DESCRIPTIONS (continued)

Keyword	Values	Function	Level	Option Indicator	Groups
SECURITY (peer only)	(n reserved-word 'literal' field-name-1 + field-name-1 [.3])	Includes security information when your program starts on a remote system.	File Record	Optional	Processing control keywords
SUBDEV	(*DC1 *DC2 *DC3 *DC4)	Request a BSC subdevice to which output should be directed.	File Record	Optional Optional	Processing control keywords
SYNLVL (peer only)	(*NONE *CONFIRM)	Indicates the level of synchronization your program supports.	File Record	Optional	Processing control keywords
TEXT	('description')	Specifies descriptive text for the record format or field.	Record Field		Text definition keywords
TRNRND	(response-indicator ['text'])	Indicates to the program that it is now in the send state and has permission to write.	File Record		Processing control keywords

MIXED FILE KEYWORD DESCRIPTIONS

Keyword	Values	Function	Level	Option Indicator	Groups
INVITE		Used to invite data from a device. Your program will receive the data on a later input operation.	File Record	Optional	Processing control keywords

DDS KEYWORD AND VALUE ABBREVIATIONS

A	after
AB	allow blanks
ABS	absolute
ACC	access
ALT	alternative
ALW	allow
ATR	attributes
AUTO	automatic
B	before
BL	blinking field
BLANKS	blanks
BLINK	blinking cursor
BLK	blank
CA	command attention key
CDE	code
CF	command function key
CFM	confirm
CHG	change
CHK	check
CHR	character
CLR	clear
CLRL	clear line
CLS	class
CMD	command
CMP	comparison
COL	column
COMP	comparison
CON	constant
CONCAT	concatenate
CS	column separator
CSR	cursor
CTL	control

DEC	decimal
DEV	device
DFN	defined
DFT	default
DLT	delete
DS	display size
DSP	display
DTA	data
DUP	duplicate
DYN	dynamic
EDT	edit
END	end
EQ	equal to
ER	end of record
ERR	error
FAIL	fail
FE	field exit
FIX	fixed
FLD	field
FLT	floating-point
FMT	format
FRC	force
GE	greater than or equal to
GPH	graphics
GRP	group
GT	greater than
HDG	heading
HI	high intensity
ID	identifier
IND	indicator
INP	input
INZ	initialize

J	join
LC	lowercase
LE	less than or equal to
LIFO	last-in-first-out
LIN	line
LOC	location
LT	less than
LVL	level
MDT	modified data tag
ME	mandatory enter
MF	mandatory fill
MSG	message
NBR	number
ND	nondisplay
NE	not equal to
NG	not greater than
NL	not less than
NXT	next
OF	off
OID	operator identification
OUT	output
OVR	override
P	physical
PAG	page
PC	position cursor
PCN	precision
PFILE	physical file
PGM	program
POS	position
PR	protect
PRT	print or printer
PTH	path
Q	queue

RA	record advance
RAB	right-adjust with blank fill
RAZ	right-adjust with zero fill
RB	right-adjust with blank fill
RCD	record
RCV	receive
RECID	record identification
REF	reference
RI	reverse image
RL	right to left
RLTB	right to left, top to bottom
RNA	records not active
ROL	roll
RQS	request
RTG	routing
RTN	return
RZ	right-adjust with zero fill
SEQ	sequence
SFL	subfile
SIZ	size
SKIPA	skip after
SKIPB	skip before
SLNO	starting line number
SLT	select
SP	select by light pen
SPACEA	space after
SPACEB	space before
SYN	sync
TRNRND	turnaround
TRNTBL	translate table
TXT	text
UL	underline
USR	user
VAL	value(s)
VLD	valid
VN	valid name
WRD	word
WRT	write

DDS EDIT CODES

Edit Code	Commas ¹ Displayed (or printed)	Decimal Points ¹ Displayed (or printed)	Sign Displayed (or printed) When Negative Number			Zero Balance Displayed (or printed)	Leading Zero Suppressed
			No Sign	CR	- (Minus)		
1	Yes	Yes	No sign			Yes	Yes
2	Yes	Yes	No sign				Yes
3		Yes	No sign			Yes	Yes
4		Yes	No sign				Yes
A	Yes	Yes		CR		Yes	Yes
B	Yes	Yes		CR			Yes
C		Yes		CR		Yes	Yes
D		Yes		CR			Yes
J	Yes	Yes			-	Yes	Yes
K	Yes	Yes			-		Yes
L		Yes			-	Yes	Yes
M		Yes			-		Yes
Y ²							Yes
Z ³							Yes

¹The QDECFMT system value determines the decimal point character (period in U.S. usage), the character used to separate groups of three digits (comma in U.S. usage), and the type of zero suppression (depending on comma and period placement). See the *CPF Programmer's Guide* for detailed instructions.

²The Y edit code suppresses the leftmost zero of a date field that is three to six digits long, and it suppresses the two leftmost zeros of a field that is seven positions long. The Y edit code also inserts slashes (/) between the month, day, and year according to the following pattern:

nn/n
 nn/nn
 nn/nn/n
 nn/nn/nn
 nnn/nn/nn

If the DATE keyword is specified with EDTCDE(Y), the separator character (/) used depends on the contents of the system value, QDATSEP. The slash (/) is the default QDATSEP. If, at file creation time, QDATFMT is JUL (Julian), the date is normally formatted as nn/nnn and EDTCDE(Y) is not valid.

³The Z edit code removes the sign (plus or minus) from a numeric field. The sign of the units position is changed to a hexadecimal F before the field is written.

CHAPTER 10. RPG III

RPG Operation Codes	10-3
RPG Edit Codes	10-8

Notes:



Chapter 10. RPG III

RPG OPERATION CODES

Operation Code	Control Level Indicators ¹	Conditionin Indicators ²	Factor 1	Factor 2	Result Field	Resulting Indicators		
	Positions					Positions		
	7-8	9-17				54-55	56-57	58-59
ACQ	O	O	R	R			O: ER	
ADD ³	O	O	O	R	R	O: +	O: -	O: Z
ANDxx	O		R	R				
BEGSR	O		R					
BITOF	O	O		R	R			
BITON	O	O		R	R			
CABxx	O	O	R	R	O	O: HI	O: LO	O: EQ
CALL	O	O		R	O		O: ER	O
CASxx	O	O	O	O	R	O: HI	O: LO	O: EQ
CHAIN	O	O	R	R	O	R: NR	O: ER	
CLOSE	O	O		R			O: ER	
COMIT	O	O	O				O: ER	
COMP	O	O	R	R		O: HI ⁴	O: LO ⁴	O: EQ ⁴
DEBUG	O	O	O	O	O			
DEFN	O		R	O	R			
DELET	O	O	O	R		O: NR	O: ER	
DIV ³	O	O	O	R	R	O: +	O: -	O: Z

¹Control level indicators (L1 through L9) are valid on all operation codes except in a subroutine. On all subroutine lines, from BEGSR through ENDSR, the only valid entries in positions 7 and 8 are SR, AN, OR, or blanks.

²Conditioning indicators are valid only for executable operation codes.

³Half adjust (position 53) can be specified for this operation.

⁴At least one resulting indicator must be specified in positions 54 through 59.

⁵The END operation code can have a conditioning indicator if it is part of a DO, DOUxx, or DOWxx group, but not if it is part of CASxx or IFxx group.

⁶You must specify factor 2 or the result field. You may specify both.

RPG OPERATION CODES (continued)

Operation Code	Control Level Indicators ¹		Conditioning Indicators ²		Result Field	Resulting Indicators		
	Positions		Factor 1	Factor 2		Positions		
	7-8	9-17				54-55	56-57	58-59
DO	0	0	0	0	0			
DOUxx	0	0	R	R				
DOWxx	0	0	R	R				
DSPLY	0	0	0	0	0		O:ER	
DUMP	0	0	0					
ELSE	0							
END	0	0 ⁵		0				
ENDSR	0		0	0				
EXCPT	0	0		0				
EXFMT	0	0		R			O:ER	
EXSR	0	0		R				
FEOD	0	0		R			O:ER	
FORCE	0	0		R				
FREE	0	0		R			O:ER	
GOTO	0	0		R				
IFxx	0	0	R	R				

¹Control level indicators (L1 through L9) are valid on all operation codes except in a subroutine. On all subroutine lines, from BEGSR through ENDSR, the only valid entries in positions 7 and 8 are SR, AN, OR, or blanks.

²Conditioning indicators are valid only for executable operation codes.

³Half adjust (position 53) can be specified for this operation.

⁴At least one resulting indicator must be specified in positions 54 through 59.

⁵The END operation code can have a conditioning indicator if it is part of a DO, DOUxx, or DOWxx group, but not if it is part of CASxx or IFxx group.

⁶You must specify factor 2 or the result field. You may specify both.

RPG OPERATION CODES (continued)

Operation Code	Control Level Indicators ¹	Conditionin Indicators ²	Factor 1	Factor 2	Result Field	Resulting Indicators		
	Positions					Positions		
	7-8	9-17				54-55	56-57	58-59
IN	O	O	O	R			O: ER	
KFLD	O				R			
KLIST	O		R					
LOKUP (Array)	O	O	R	R		O: HI ⁴	O: LO ⁴	O: EQ ⁴
LOKUP (Table)	O	O	R	R	O	O: HI ⁴	O: LO ⁴	O: EQ ⁴
MHHZO	O	O		R	R			
MHLZO	O	O		R	R			
MLHZO	O	O		R	R			
MLLZO	O	O		R	R			
MOVE	O	O		R	R	O: +	O: -	O: ZB
MOVEA	O	O		R	R	O: +	O: -	O: ZB
MOVEL	O	O		R	R	O: +	O: -	O: ZB
MULT ³	O	O	O	R	R	O: +	O: -	O: Z
MVR	O	O			R	O: +	O: -	O: Z
NEXT	O	O	R	R			O: ER	
OCUR	O	O	O	R	O		O: ER	

¹Control level indicators (L1 through L9) are valid on all operation codes except in a subroutine. On all subroutine lines, from BEGSR through ENDSR, the only valid entries in positions 7 and 8 are SR, AN, OR, or blanks.

²Conditioning indicators are valid only for executable operation codes.

³Half adjust (position 53) can be specified for this operation.

⁴At least one resulting indicator must be specified in positions 54 through 59.

⁵The END operation code can have a conditioning indicator if it is part of a DO, DOUxx, or DOWxx group, but not if it is part of CASxx or IFxx group.

⁶You must specify factor 2 or the result field. You may specify both.

RPG OPERATION CODES (continued)

Operation Code	Control Level Indicators ¹	Conditionin Indicators ²	Factor 1	Factor 2	Result Field	Resulting Indicators		
	Positions					Positions		
	7-8	9-17				54-55	56-57	58-59
OPEN	O	O		R		O: ER		
ORxx	O		R	R				
OUT	O	O ³	O	R		O: ER		
PARM	O		O	O	R			
PLIST	O		R					
POST	O	O	O	O ⁶	O ⁶		O: ER	
READ	O	O		R	O		O: ER	R: EOF
READC	O	O		R			O: ER	R: EOF
READE	O	O	R	R	O		O: ER	R: EOF
READP	O	O		R	O		O: ER	R: BOF
REL	O	O	R	R			O	
RETRN	O	O						
ROLBK	O	O					O: ER	
SETGT	O	O	R	R		O: NR	O: ER	
SETLL	O	O	R	R		O: NR	O: ER	O: EQ
SETOF	O	O				O ⁴	O ⁴	O ⁴
SETON	O	O				O ⁴	O ⁴	O ⁴
SHTDN	O	O				R		

¹Control level indicators (L1 through L9) are valid on all operation codes except in a subroutine. On all subroutine lines, from BEGSR through ENDSR, the only valid entries in positions 7 and 8 are SR, AN, OR, or blanks.

²Conditioning indicators are valid only for executable operation codes.

³Half adjust (position 53) can be specified for this operation.

⁴At least one resulting indicator must be specified in positions 54 through 59.

⁵The END operation code can have a conditioning indicator if it is part of a DO, DOUxx, or DOWxx group, but not if it is part of CASxx or IFxx group.

⁶You must specify factor 2 or the result field. You may specify both.

RPG OPERATION CODES (continued)

Operation Code	Control Level Indicators ¹	Conditionin Indicators ²	Factor 1	Factor 2	Result Field	Resulting Indicators		
	Positions					Positions		
	7-8	9-17				54-55	56-57	58-59
SORTA	O	O		R				
SQRT ³	O	O		R	R			
SUB ³	O	O	O	R	R	O: +	O: -	O: Z
TAG	O		R					
TESTB	O	O		R	R	O ⁴	O ⁴	O ⁴
TESTN	O	O			R	O ⁴	O ⁴	O ⁴
TESTZ	O	O			R	O ⁴	O ⁴	O ⁴
TIME	O	O			R			
UNLCK	O	O		R			O: ER	
UPDAT	O	O		R	O		O: ER	
WRITE	O	O		R	O		O: ER	O: EOF
XFOOT ³	O	O		R	R	O: +	O: -	O: Z
Z-ADD ³	O	O		R	R	O: +	O: -	O: Z
Z-SUB ³	O	O		R	R	O: +	O: -	O: Z

¹Control level indicators (L1 through L9) are valid on all operation codes except in a subroutine. On all subroutine lines, from BEGSR through ENDSR, the only valid entries in positions 7 and 8 are SR, AN, OR, or blanks.

²Conditioning indicators are valid only for executable operation codes.

³Half adjust (position 53) can be specified for this operation.

⁴At least one resulting indicator must be specified in positions 54 through 59.

⁵The END operation code can have a conditioning indicator if it is part of a DO, DOUxx, or DOWxx group, but not if it is part of CASxx or IFxx group.

⁶You must specify factor 2 or the result field. You may specify both.

Fields without entries must be blank.

+ = Plus	EQ = Equal	R = Required
- = Minus	ER = Error	Z = Zero
BOF = Beginning of file	NR = No record found	ZB = Zero or blank
EOF = End of file	O = Optional	

RPG EDIT CODES

Edit Code	Commas	Decimal Point	Sign for Negative Balance			Entry in Position 21 of Control Specification			Zero Suppress
			No Sign	CR	- (Minus)	D or Blank	I	J	
1	Yes	Yes	No sign			.00 or 0	.00 or 0	0.00 or 0	Yes
2	Yes	Yes	No sign			Blanks	Blanks	Blanks	Yes
3		Yes	No sign			.00 or 0	.00 or 0	0.00 or 0	Yes
4		Yes	No sign			Blanks	Blanks	Blanks	Yes
5-9 ¹									
A	Yes	Yes		CR		.00 or 0	.00 or 0	0.00 or 0	Yes
B	Yes	Yes		CR		Blanks	Blanks	Blanks	Yes
C		Yes		CR		.00 or 0	.00 or 0	0.00 or 0	Yes
D		Yes		CR		Blanks	Blanks	Blanks	Yes
J	Yes	Yes			-	.00 or 0	.00 or 0	0.00 or 0	Yes
K	Yes	Yes			-	Blanks	Blanks	Blanks	Yes
L		Yes			-	.00 or 0	.00 or 0	0.00 or 0	Yes
M		Yes			-	Blanks	Blanks	Blanks	Yes
X ²									
Y ³									Yes
Z ⁴									Yes

¹These are the user-defined edit codes.

²The X edit code ensures a hex F sign for positive values. Because the system does this for you, normally you do not have to specify this code.

³The Y edit code suppresses the leftmost zero of a date field that is three to six digits long, and it suppresses the two leftmost zeros of a field that is seven positions long. The Y edit code also inserts slashes (/) between the month, day, and year according to the following pattern:

```
nn/n
nn/nn
nn/nn/n
nn/nn/nn
nnn/nn/nn
```

⁴The Z edit code removes the sign (plus or minus) from a numeric field and suppresses leading zeros of a numeric field.

CHAPTER 11. CPF GRAPHICS

CPF GRAPHICS 11-3
Data Types for Graphics Routine Parameters 11-3
 Data Types in GDDM 11-4
 Data Types in PGR 11-8

Notes:

11-2



Chapter 11. CPF Graphics

DATA TYPES FOR GRAPHICS ROUTINE PARAMETERS

CPF graphics is a part of CPF and is installed on your system when CPF is installed. The following tables show the routines you can call from high-level language programs for producing graphics. For more information about programs that use the CPF graphics routines, refer to the *CPF Graphics Programmer's Guide* and the *CPF Graphics Reference Manual*.

Data Types in GDDM

Name	1	2	3	4	5	6	7	8
ASREAD	in var	in var	in var					
DSCLS	in	in						
DSDROP	in	in						
DSOPEN	in	in	ch	in	in arr	in	ch arr	
DSQDEV	in	ch var	in var	in var	in	ch arr	in	ch arr
DSQUID	in var							
DSQUSE	in	in var						
DSRNIT	in	in						
DSUSE	in	in						
FSALRM								
FSEXIT	ch var	in						
FSFRCE								
FSINIT								
FSPCLR								
FSPCRT	in	in	in	in				
FSPDEL	in							
FSPQRY	in	in var	in var	in var				
FSPSEL	in							
FSQCPG	in							
FSQDEV	in	in arr						
FSQERR	in	ch var						
FSQUPG	in var							
FSREST	in							
FSRNIT								
FSTERM								
GSARC	fp	fp	fp					
GSAREA	in							
GSCA	fp	fp						
GSCB	fp	fp						
GSCD	in							
in = 4-byte binary integer fp = short floating-point number ch = character string arr = array var = variable (whose value is returned by GDDM)								

Data Types in GDDM (continued)

Name	1	2	3	4	5	6	7	8
GSCH	fp	fp						
GSCHAP	in	ch						
GSCHAR	fp	fp	in	ch				
GSCLP	in							
GSCLR								
GSCM	in							
GSCOL	in							
GSCS	in							
GSCT	in							
GSCTD	in	in	in	fp arr	fp arr	fp arr		
GSELPS	fp	fp	fp	fp	fp			
GSENDA								
GSFLD	in	in	in	in				
GSFLW	fp							
GSGET	in	ch var	in var					
GSGETE								
GSGETS								
GSIMG	in	in	in	in	ch			
GSIMGS	in	in	in	in	ch	fp	fp	
GSLINE	fp	fp						
GSLSS	in	ch	in					
GSLT	in							
GSLW	in							
GSMARK	fp	fp						
GSMIX	in							
GSMOVE	fp	fp						
GSMRKS	in	fp arr	fp arr					
GSMS	in							
GSMSC	fp							

in = 4-byte binary integer
fp = short floating-point number
ch = character string
arr = array
var = variable (whose value is returned by GDDM)

Data Types in GDDM (continued)

Name	1	2	3	4	5	6	7	8
GSPAT	in							
GSPFLT	in	fp arr	fp arr					
GSPLNE	in	fp arr	fp arr					
GSPS	fp	fp						
GSPUT	in	in	ch					
GSQCA	fp var	fp var						
GSQCB	fp var	fp var						
GSQCD	in var							
GSQCEL	fp var	fp var						
GSQCH	fp var	fp var						
GSQCLP	in var							
GSQCM	in var							
GSQCOL	in var							
GSQCP	fp var	fp var						
GSQCS	in							
GSQCT	in var							
GSQCTD	in	in	in	fp arr var	fp arr var	fp arr var		
GSQCUR	in var	fp var	fp var					
GSQFLW	fp var							
GSQLT	in var							
GSQLW	in var							
GSQMAX	in var	in var						
GSQMIX	in var							
GSQMS	in var							
GSQMSC	fp var							
GSQNSS	in var							
GSQPAT	in var							
GSQPS	fp var	fp var						

in = 4-byte binary integer
fp = short floating-point number
ch = character string
arr = array
var = variable (whose value is returned by GDDM)

Data Types in GDDM (continued)

Name	1	2	3	4	5	6	7	8
GSQSS	in var	in arr var	ch arr var	in arr var				
GSQTB	in	ch	in	fp arr var	fp arr var			
GSQVIE	fp var	fp var	fp var	fp var				
GSQWIN	fp var	fp var	fp var	fp var				
GSRSS	in	in						
GSSCLS								
GSSDEL	in							
GSSEG	in							
GSVECM	in	in arr						
GSVIEW	fp var	fp var	fp var	fp var				
GSWIN	fp var	fp var	fp var	fp var				

in = 4-byte binary integer
fp = short floating-point number
ch = character string
arr = array
var = variable (whose value is returned by GDDM)

Data Types in PGR

Name	1	2	3	4	5
CHAATT	in	in arr			
CHAREA		fp	fp	fp	fp
CHBAR	in	in	fp arr		
CHBATT	in	in arr			
CHCGRD	in	in			
CHCOL	in	in arr			
CHDATT		in	in arr		
CHDRAX					
CHFINE	in				
CHGAP	fp				
CHGATT	in	in arr			
CHGGAP	fp				
CHHATT	in	in arr			
CHHEAD	in	char			
CHHIST	in	in	fp arr	fp arr	fp arr
CHHMAR	in	in			
CHKATT	in	in arr			
CHKEY	in	in	ch		
CHKEYP	ch	ch	ch		
CHKMAX	in	in			
CHKOFF	fp	fp			
CHLATT	in	in arr			
CHLT	in	in arr			
CHLW	in	fp arr			
CHMARK	in	in arr			
CHNATT	in	in arr			
CHNOFF	fp	fp			
CHNOTE	ch	in	ch		
CHNUM	in				
CHPAT	in	in arr			

in = 4-byte binary integer
 fp = short floating-point number
 ch = character string
 arr = array
 var = variable (whose value is returned by GDDM)

Data Types in PGR (continued)

Name	1	2	3	4	5
CHPIE	in	in	fp arr		
CHPIER	in				
CHPLOT	in	in	fp arr	fp arr	
CHRNIT					
CHSET	ch				
CHSTRT					
CHSURF	in	in	fp arr	fp arr	
CHTATT	in	in arr			
CHTERM					
CHVATT	in	in arr			
CHVCHR	in				
CHVENN	fp	fp	fp		
CHVMAR	in	in			
CHXDAY	in				
CHYDAY	in				
CHXDTM	fp				
CHYDTM	fp				
CHXINT	fp				
CHYINT	fp				
CHXLAB	in	in	ch		
CHYLAB	in	in	ch		
CHXMTH	in				
CHYMTH	in				
in = 4-byte binary integer fp = short floating-point number ch = character string arr = array var = variable (whose value is returned by GDDM)					

Data Types in PGR (continued)

Name	1	2	3	4	5
CHXRNG	fp	fp	fp	fp	
CHYRNG	fp	fp	fp	fp	
CHXSCL	fp				
CHYSCL	fp				
CHXSEL	in				
CHYSEL	in				
CHXSET	ch				
CHYSET	ch				
CHXTIC	fp	fp			
CHYTIC	fp	fp			
CHXTTL	in	ch			
CHYTTL	in	ch			
in = 4-byte binary integer fp = short floating-point number ch = character string arr = array var = variable (whose value is returned by GDDM)					



CHAPTER 12. CHARACTER CODES

Decimal-to-Hexadecimal Chart: Printable Characters and Control Characters	12-3
Hexadecimal-to-Binary Character Conversion	12-12

Notes:



Chapter 12. Character Codes

DECIMAL-TO-HEXADECIMAL CHART: PRINTABLE CHARACTERS AND CONTROL CHARACTERS

Dec	Hex	Graphic/Control		
		EBCDIC ¹	EBCDIC ²	ASCII
0	00	NUL		NUL
1	01	SOH		SOH
2	02	STX		STX
3	03	ETX		ETX
4	04	PF		EOT
5	05	HT		ENQ
6	06	LC		ACK
7	07	DEL		BEL
8	08	GE		BS
9	09	RLF		HT
10	0A	SMM		LF
11	0B	VT		VT
12	0C	FF		FF
13	0D	CR		CR
14	0E	SO		SO
15	0F	SI		SI
16	10	DLE		DLE
17	11	DC1		DC1
18	12	DC2		DC2
19	13	TM		DC3
20	14	RES		DC4
21	15	NL		NAK
22	16	BS		SYN
23	17	IL		ETB
24	18	CAN		CAN

¹For English character set
²For Multinational character set

Dec	Hex	Graphic/Control		
		EBCDIC ¹	EBCDIC ²	ASCII
25	19	EM		EM
26	1A	CC		SUB
27	1B	CU1		ESC
28	1C	IFS		FS
29	1D	IGS		GS
30	1E	IRS		RS
31	1F	IUS		US
32	20	DS		SP
33	21	SOS		
34	22	FS		"
35	23			#
36	24	BYP		\$
37	25	LF		%
38	26	ETB		&
39	27	ESC		'
40	28			(
41	29)
42	2A	SM		*
43	2B	CU2		+
44	2C			,
45	2D	ENQ		
46	2E	ACK		.
47	2F	BEL		/
48	30			0
49	31			1
50	32	SYN		2
51	33			3
52	34	PN		4
53	35	RS		5
54	36	UC		6
55	37	EOT		7
56	38			8

¹For English character set
²For Multinational character set

Dec	Hex	Graphic/Control		
		EBCDIC	EBCDIC ²	ASCII
57	39			9
58	3A			:
59	3B	CU3		;
60	3C	DC4		<
61	3D	NAK		=
62	3E			>
63	3F	SUB		?
64	40	Sp		@
65	41			A
66	42			B
67	43			C
68	44			D
69	45			E
70	46			F
71	47			G
72	48			H
73	49			I
74	4A	¢		J
75	4B			K
76	4C	<	<	L
77	4D	((M
78	4E	+	+	N
79	4F			O
80	50	&	&	P
81	51			Q
82	52			R
83	53			S
84	54			T

¹For English character set
²For Multinational character set

Dec	Hex	Graphic/Control		
		EBCDIC ¹	EBCDIC ²	ASCII
85	55			U
86	56			V
87	57			W
88	58			X
89	59			Y
90	5A	!		Z
91	5B	\$	\$	[
92	5C	*		/
93	5D))]
94	5E	;	;	-
95	5F	-		—
96	60	-		
97	61	/		a
98	62			b
99	63			c
100	64			d
101	65			e
102	66			f
103	67			g
104	68			h
105	69			i
106	6A	!		j
107	6B	,	,	k
108	6C	%	%	l
109	6D	—	—	m
110	6E	>	>	n
111	6F	?	?	o
112	70			p

¹For English character sets
²For Multinational character sets

Dec	Hex	Graphic/Control		
		EBCDIC ¹	EBCDIC ²	ASCII
113	71			q
114	72			r
115	73			s
116	74			t
117	75			u
118	76			v
119	77			w
120	78			x
121	79	U		y
122	7A	:	:	z
123	7B	#	#	{
124	7C	@	@	!
125	7D	'	'	}
126	7E	=	=	~
127	7F	"	"	DEL
128	80		O	
129	81	a	a	
130	82	b	b	
131	83	c	c	
132	84	d	d	
133	85	e	e	
134	86	f	f	
135	87	g	g	
136	88	h	h	
137	89	i	i	
138	8A			
139	8B			
140	8C			
141	8D		≤	

¹For English character sets
²For Multinational character sets

Dec	Hex	Graphic/Control		
		EBCDIC ¹	EBCDIC ²	ASCII
142	8E			
143	8F			
144	90			
145	91	j	j	
146	92	k	k	
147	93	l	l	
148	94	m	m	
149	95	n	n	
150	96	o	o	
151	97	p	p	
152	98	q	q	
153	99	r	r	
154	9A			
155	9B			
156	9C			
157	9D			
158	9E			
159	9F			
160	A0			
161	A1			
162	A2	s	s	
163	A3	t	t	
164	A4	u	u	
165	A5	v	v	
166	A6	w	w	
167	A7	x	x	
168	A8	y	y	
169	A9	z	z	

¹For English character sets
²For Multinational character sets

Dec	Hex	Graphic/Control		
		EBCDIC ¹	EBCDIC ²	ASCII
170	AA			
171	AB			
172	AC			
173	AD			
174	AE			
175	AF		®	
176	B0		¢	
177	B1			
178	B2			
179	B3			
180	B4			
181	B5		§	
182	B6		¶	
183	B7			
184	B8			
185	B9			
186	BA		¬	
187	BB			
188	BC		≠	
189	BD		"	
190	BE		,	
191	BF		=	
192	C0	{	{	
193	C1	A	A	
194	C2	B	B	
195	C3	C	C	
196	C4	D	D	
197	C5	E	E	

¹For English character sets
²For Multinational character sets

Dec	Hex	Graphic/Control		
		EBCDIC ¹	EBCDIC ²	ASCII
198	C6	F	F	
199	C7	G	G	
200	C8	H	H	
201	C9	I	I	
202	CA			
203	CB			
204	CC			
205	CD			
206	CE			
207	CF			
208	D0	}	}	
209	D1	J	J	
210	D2	K	K	
211	D3	L	L	
212	D4	M	M	
213	D5	N	N	
214	D6	O	O	
215	D7	P	P	
216	D8	Q	Q	
217	D9	R	R	
218	DA		≥	
219	DB			
220	DC			
221	DD			
222	DE			
223	DF			
224	E0		/	
225	E1			

¹For English character sets
²For Multinational character sets

Dec	Hex	Graphic/Control		
		EBCDIC ¹	EBCDIC ²	ASCII
226	E2	S	S	
227	E3	T	T	
228	E4	U	U	
229	E5	V	V	
230	E6	W	W	
231	E7	X	X	
232	E8	Y	Y	
233	E9	Z	Z	
234	EA		²	
235	EB			
236	EC			
237	ED			
238	EE			
239	EF			
240	F0	0	0	
241	F1	1	1	
242	F2	2	2	
243	F3	3	3	
244	F4	4	4	
245	F5	5	5	
246	F6	6	6	
247	F7	7	7	
248	F8	8	8	
249	F9	9	9	
250	FA		³	
251	FB			
252	FC			
253	FD			
254	FE			
255	FF	EO		

¹For English character sets
²For Multinational character sets

HEXADECIMAL-TO-BINARY CHARACTER CONVERSION

Hex Digit	Bit Configuration
0	0000
1	0001
2	0010
3	0011
4	0100
5	0101
6	0110
7	0111
8	1000
9	1001
A	1010
B	1011
C	1100
D	1101
E	1110
F	1111

READER'S COMMENT FORM

Please use this form only to identify publication errors or to request changes in publications. Direct any requests for additional publications, technical questions about IBM systems, changes in IBM programming support, and so on, to your IBM representative or to your nearest IBM branch office. You may use this form to communicate your comments about this publication, its organization, or subject matter, with the understanding that IBM may use or distribute whatever information you supply in any way it believes appropriate without incurring any obligation to you.

If your comment does not need a reply (for example, pointing out a typing error) check this box and do not include your name and address below. If your comment is applicable, we will include it in the next revision of the manual.

If you would like a reply, check this box. Be sure to print your name and address below.

Please contact your nearest IBM branch office to request additional publications.

Name _____

Company or
Organization _____

Address _____

City	State	Zip Code
------	-------	----------

Phone Number _____
(Area Code)

Page number(s):

Comment(s):

No postage necessary if mailed in the U.S.A.

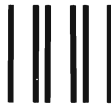

NO POSTAGE
NECESSARY IF
MAILED IN THE
UNITED STATES

BUSINESS REPLY MAIL
FIRST CLASS PERMIT NO. 40 ARMONK, N. Y.



POSTAGE WILL BE PAID BY ADDRESSEE:

International Business Machines Corporation
Information Development
Department 245
Rochester, Minnesota, U.S.A. 55901

Cut Along Line

Fold and tape Please do not staple Fold and tape



READER'S COMMENT FORM

Please use this form only to identify publication errors or to request changes in publications. Direct any requests for additional publications, technical questions about IBM systems, changes in IBM programming support, and so on, to your IBM representative or to your nearest IBM branch office. You may use this form to communicate your comments about this publication, its organization, or subject matter, with the understanding that IBM may use or distribute whatever information you supply in any way it believes appropriate without incurring any obligation to you.

If your comment does not need a reply (for example, pointing out a typing error) check this box and do not include your name and address below. If your comment is applicable, we will include it in the next revision of the manual.

If you would like a reply, check this box. Be sure to print your name and address below.

Please contact your nearest IBM branch office to request additional publications.

Name _____

Company or
Organization _____

Address _____

City	State	Zip Code
------	-------	----------

Phone Number _____
(Area Code)

Page number(s):

Comment(s):

No postage necessary if mailed in the U.S.A.

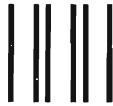

NO POSTAGE
NECESSARY IF
MAILED IN THE
UNITED STATES

BUSINESS REPLY MAIL
FIRST CLASS PERMIT NO. 40 ARMONK, N. Y.



POSTAGE WILL BE PAID BY ADDRESSEE:

International Business Machines Corporation
Information Development
Department 245
Rochester, Minnesota, U.S.A. 55901

— Cut Along Line —

Fold and tape Please do not staple Fold and tape





IBM System/38 Programming Reference Summary (File No. S38-20) Printed in U.S.A. SC21-7734-7

SC21-7734-7



SC21-7734-7