

IBM

Mavis Buckland

Guided Learning Center

**IBM System/38 Fundamentals
Student Materials Book**





ZR30-0780-5

**IBM System/38 Fundamentals
Student Materials Book**



Preface

This Student Materials Book is designed to be used in an IBM Guided Learning Center environment. It is intended to be kept by the student upon completion of the course.

This Student Materials Book is used with module texts that comprise the IBM System/38 Fundamentals course.

The module texts in this course are:

- Module 1. Introduction
- Module 2. Data Base Data Management
- Module 3. Work Station Data Management
- Module 4. Control Language
- Module 5. Programmer Services — Utilities
- Module 6. Programmer Services — Languages and Aids
- Module 7. Object Management and Work Management
- Module 8. System Service Facilities

Sixth Edition (November 1986)

This is a major revision of, and obsoletes, ZR30-0780-4. Changes are periodically made to the information herein; any such changes will be reported in subsequent editions.

References in this publication to IBM products, programs, or services do not imply that IBM intends to make these available in all countries in which IBM operates.

Publications are not stocked at the address given below. Requests for IBM publications should be made to your IBM representative or to the IBM branch office serving your locality.

You may communicate your comments about this publication, its organization or subject matter with the understanding that IBM may use or distribute whatever information you supply in any way it believes appropriate without incurring any obligation to you. Address your comments to IBM Corporation, Department 7TF, P.O. Box 2150, Atlanta, Georgia 30055.

©Copyright International Business Machines Corporation 1983, 1985, 1986

Contents

Course Overview	1	Display Station Familiarization	3-2
Course Purpose	1	Progress Check: Unit 1	3-11
Who Should Take This Course	1	Progress Check: Unit 1 Answers	3-12
What This Course Teaches	2	Progress Check: Unit 2	3-13
How This Course is Organized	3	Progress Check: Unit 2 Answers	3-14
Materials You Need for This Course	3	Notes	3-15
Summary	6	Module Summary	3-17
 		Module 3 Exercise	3-18
Module 1. Introduction	1-1	 	
Module Purpose	1-1	Module 4. Control Language	4-1
Time Estimate	1-1	Module Purpose	4-1
Module Objectives	1-1	Time Estimate	4-1
System/38 Hardware	1-2	Module Objectives	4-1
Progress Check: Unit 1	1-3	Notes	4-2
Progress Check: Unit 1 Answers	1-4	Progress Check: Module 4	4-3
Progress Check: Unit 2	1-5	Progress Check: Module 4 Answers	4-4
Progress Check: Unit 2 Answers	1-6	Module 4 Exercise	4-5
Notes	1-7	Module Summary	4-8
Module 2. Data Base Data Management	2-1	Module 5. Programmer Services — Utilities .	5-1
Module Purpose	2-1	Module Purpose	5-1
Time Estimate	2-1	Time Estimate	5-1
Module Objectives	2-1	Module Objective	5-1
Notes	2-2	Notes	5-2
Progress Check: Unit 1	2-5	DFU Machine Exercise	5-3
Progress Check: Unit 1 Answers	2-6	Purpose	5-3
Desk Exercise — Physical File DDS Coding	2-9	Requirements	5-3
Desk Exercise — Physical File DDS Coding		Module 5 Summary	5-25
Solution	2-10	Source Entry Utility	5-25
Desk Exercise — Logical File DDS Coding	2-11	Data File Utility	5-26
Desk Exercise — Logical File DDS Coding		Query	5-26
Solution	2-12	Screen Design Aid	5-26
Progress Check: Unit 2	2-13	Progress Check: Module 5	5-27
Progress Check: Unit 2 Answers	2-14	Progress Check: Module 5 Answers	5-28
Desk Exercise — SELECT/OMIT	2-17	 	
Desk Exercise — SELECT/OMIT Answers	2-18	Module 6. Programmer Services —	
Progress Check: Unit 3	2-19	Languages and Aids	6-1
Progress Check: Unit 3 Answers	2-20	Module Purpose	6-1
Module 2 Summary	2-21	Time Estimate	6-1
Module 2 Exercise	2-22	Module Objectives	6-1
 		COBOL Summary	6-2
Module 3. Work Station Data		RPG III Summary	6-3
Management	3-1	Progress Check: Unit 1 COBOL	6-4
Module Purpose	3-1	Progress Check: Unit 1 RPG III	6-5
Time Estimate	3-1	Progress Check: Unit 1 COBOL Answers ...	6-6
Module Objectives	3-1	Progress Check: Unit 1 RPG III Answers	6-7
 		Notes	6-8

Progress Check: Unit 2	6-9
Progress Check: Unit 2 Answers	6-10
Module Summary	6-11
Module Exercise	6-12

Module 7. Work Management and

Object Management	7-1
Module Purpose	7-1
Time Estimate	7-1
Module Objectives	7-1
Progress Check: Unit 1	7-3
Progress Check: Unit 1 Answers	7-4
Progress Check: Unit 2	7-5
Progress Check: Unit 2 Answers	7-6
Notes	7-7
Module Summary	7-8
Module 7 Exercise	7-10

Module 8. System Service Facilities

8-1	
Module Purpose	8-1
Time Estimate	8-1
Module Objectives	8-1
Notes	8-2
Progress Check: Unit 1	8-3
Progress Check: Unit 1 Answers	8-4
Progress Check: Unit 2	8-5
Progress Check: Unit 2 Answers	8-6
Module Summary	8-7

Course Summary

Appendix A

This flowchart is provided as a guide to the educational offerings for the System/38.

**System/38 Curriculum
Programmer/Implementer
(new to data processing)**

Legend

Self-Study or
Guided Learning
Center Course

Classroom
Course

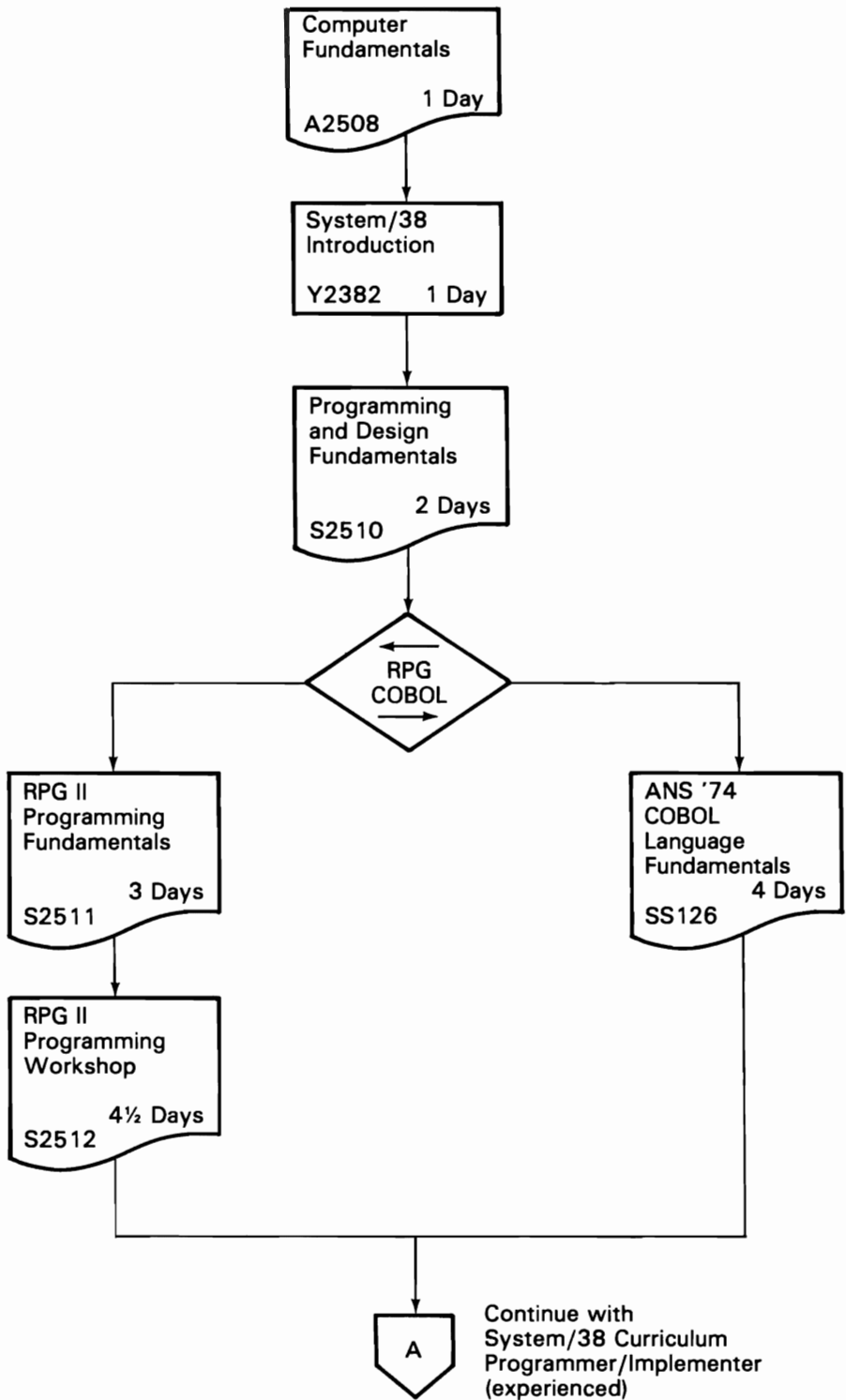

System/38 Curriculum Programmer/Implementer (experienced)

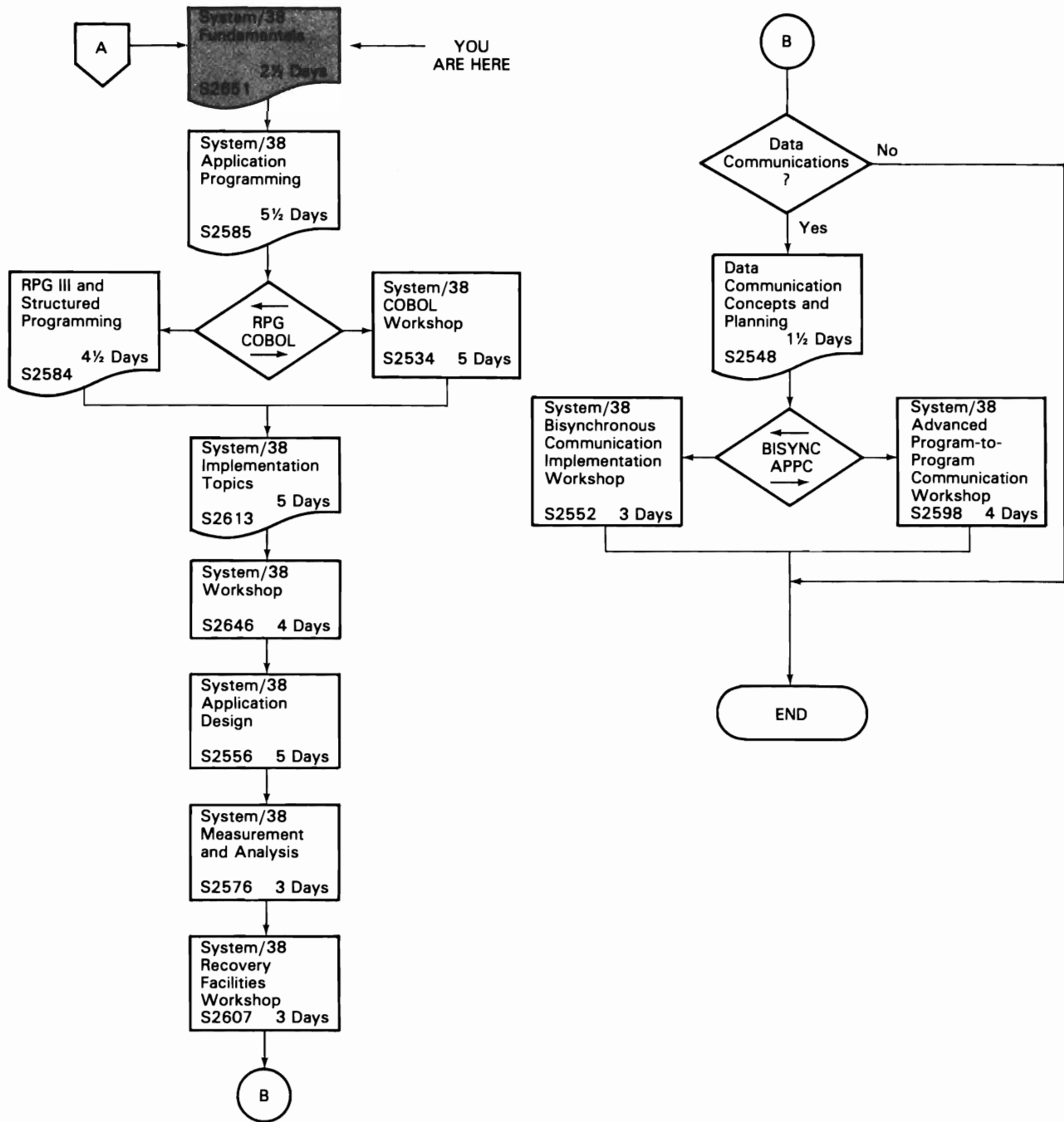



Course Overview

This is where you start the course.

COURSE PURPOSE

This course provides you with an overview of many System/38 functions and abilities. It introduces a number of topics without dwelling at length on any one. This course makes you aware of these topics for informational purposes and to prepare you for the complete System/38 curriculum. Topics introduced here are expanded and studied in much greater depth in following courses.



This course introduces and defines new terminology, ideas and concepts associated with the System/38. In some cases you see new definitions for some old words and new directions for what might be considered old ideas. In any case, you become aware of the impact of these items on productivity in application development, maintenance and enhancement.

WHO SHOULD TAKE THIS COURSE

This course is probably your first formal exposure to the System/38. It is a prerequisite for the in-depth System/38 technical education offered by IBM.

The course is intended for experienced data processing personnel — managers, analysts and programmers. You should be familiar with computer concepts, the concept of an operating system and have had experience with high level language programming. The material covered in this course is expanded greatly as you move on to subsequent courses in the System/38 curriculum.

WHAT THIS COURSE TEACHES

Upon completion of this course, using System/38 reference material, you should be able to:

- List the various components available on the System/38 to provide system growth.
- List the six major functional areas of the Control Program Facility (CPF).
- Define System/38 Data Base Data Management and list at least three advantages of using a data base.
- Define what "work station environment" means and list four ways work stations can be used with the System/38.
- Describe the structure of System/38 Control Language (CL) and list two ways to use it.
- List the Interactive Data Base Utilities (IDU) and state a use for each one.
- Identify (name) at least three programmer productivity or language facilities available to make application development more productive with the System/38.
- List three Object Management functions available with the System/38.
- List three facilities of Work Management available on the System/38.
- List two System Service facilities available for use with the System/38.
- Identify (name) two facilities available to aid in the installation of a System/38.

HOW THIS COURSE IS ORGANIZED

The primary course material consists of the following module texts:

Module 1. Course Introduction

Module 2. Data Base Data Management

Module 3. Work Station Data Management

Module 4. Control Language

Module 5. Programmer Services — Utilities

Module 6. Programmer Services — Languages and Aids

Module 7. Work Management and Object Management

Module 8. System Service Facilities.

Each module text has an estimated completion time. This estimated time is only a guide. You should take as much time as you need to understand the material presented. An advantage of a Guided Learning Center course is that it is self-paced.

MATERIALS YOU NEED FOR THIS COURSE

One of the features of the Guided Learning Center is its use of multimedia study materials. A list of these is shown below. Whenever you are to use one of the study materials, you will be directed to do so. The directions will be enclosed in a box and accompanied by the appropriate symbol.

Symbol

Meaning



Module Texts

This course has eight module texts which are the primary source of instruction. They guide you to other study materials such as videodisc presentations and reference manuals.

The module texts are used by other students. For this reason, you are asked not to write in them.

Symbol

Meaning

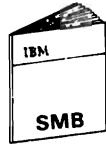

Student Materials Book

The Student Materials Book (SMB) is yours to keep. Each of its chapters corresponds to one of the module texts. Each chapter contains the introduction and summary of the corresponding module text. You may also find illustrations, exercises and summaries relevant to the module.

In addition, each chapter in the Student Materials Book contains blank pages for your notes. Use these pages so that your notes automatically become a part of the chapter for which they are written. The Student Materials Book also provides you with references to the material covered in the course.

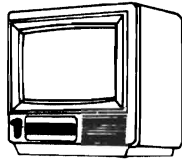

Video Instruction

Throughout the course you are asked to view video presentations. The videos are used either to present conceptual material to help you better understand the more detailed material given in the text or to reinforce textual material. In any event, you may find the video a welcome break, a time to get up and stretch, and do something different.

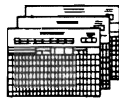

Exercises

This symbol indicates a coding exercise.

To reinforce some of the material presented in this course, there are exercises for you to perform. These exercises take the form of coding (paper and pencil) exercises and machine exercises. In either case, you are provided with full instructions in the module text as to when an exercise is to be done. The instructions for all exercises are in this Student Materials Book.

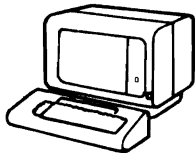

This symbol indicates a machine exercise.



Symbol

Meaning



Reference Material

The reference material is found in the Guided Learning Center Resource Library and you are directed to it by book title, topic and form number. Should you need help in locating any information, please ask your Administrator.

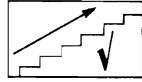

Progress Checks

A Progress Check is a series of questions about the material you have just covered. The questions, along with space to answer them, are found in your Student Materials Book. The answers, along with any appropriate discussion, are also in the Student Materials Book.



SUMMARY

This overview was intended to give you a better feeling for the course you are about to study. You are aware of the objectives of the course — the things you can expect to be able to do when you are finished. You are now aware of the materials you will use in the course, namely:

- Module texts
- Video presentations
- Student Materials Book
- Reference materials.



Start your study of the System/38 in the Module 1 text of this course.



Module 1. Introduction

MODULE PURPOSE

This module introduces you to the system unit components, input/output devices and program products of the System/38.

TIME ESTIMATE

1 hour

MODULE OBJECTIVES

After completing this module, you should be able to:

- List at least three components of the System/38 system unit.
 - List at least three kinds of input/output devices that can be attached to the System/38.
 - List the communication protocols supported by the System/38.
 - List the utilities of the Interactive Data Base Utilities program product.
 - List at least three languages available for the System/38.
- 

SYSTEM/38 HARDWARE

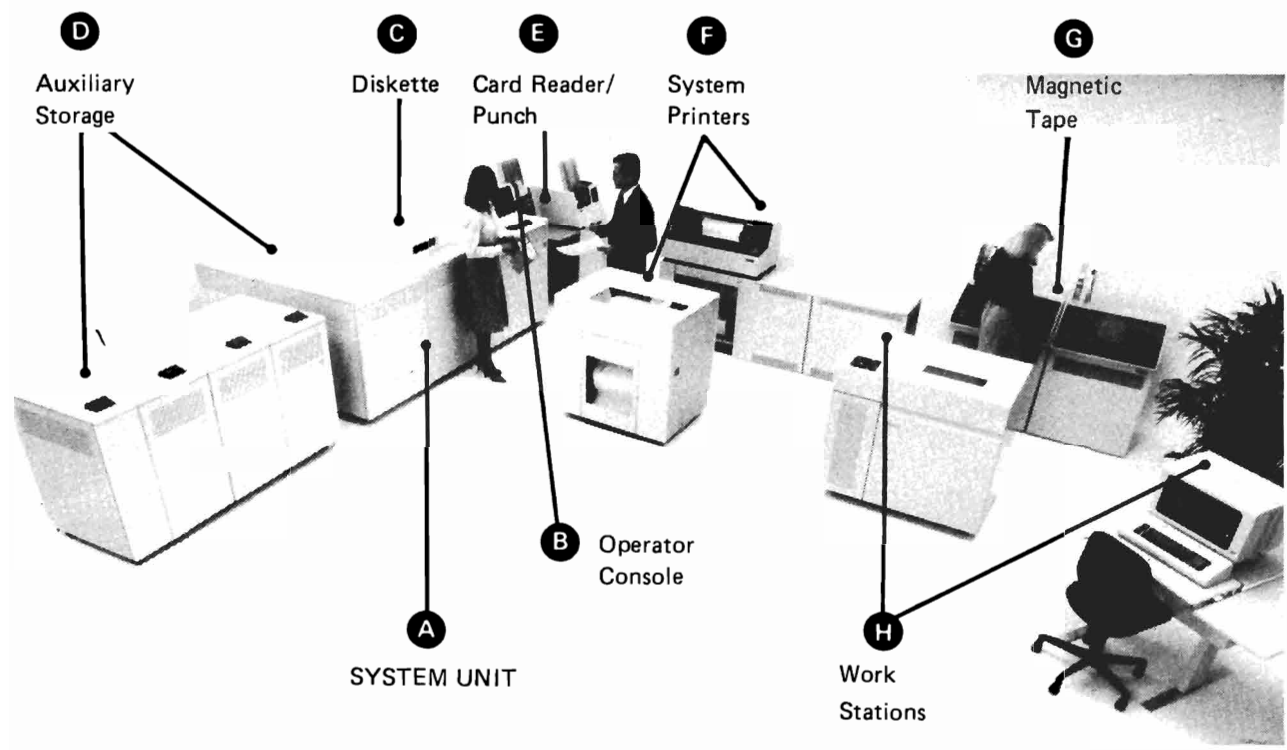

- A** System Unit
- B** Operator Console
- C** Diskette Drive
- D** Auxiliary Storage
- E** Card Reader/Punch
- F** System Printers
- G** Magnetic Tape
- H** Work Stations

Progress Check: Unit 1

You may record your answers in the space provided.

1. List at least three components of a System/38 system unit.

2. List at least three kinds of input/output devices that can be attached to the System/38.

3. List the two data communication protocols supported by the System/38.

You will find the answers on the next page.

Progress Check: Unit 1 Answers

1. List at least three components of a System/38 system unit.

Processing Unit (CPU)
Main Storage
System Operator Console
Diskette Magazine Drive
Disk Storage
Work Station Controller
I/O attachment features

2. List at least three kinds of input/output devices that can be attached to the System/38.

Display Stations
System Printers
Magnetic Tape
Work Station Printers

3. List the two data communication protocols supported by the System/38.

Binary Synchronous Communications (BSC)
Synchronous Data Link Control (SDLC)



When you feel you are ready, continue your study with Unit 2 of the Module 1 text.



Progress Check: Unit 2

Read each question carefully. Record your answers in the space provided.

1. Define the phrase "Work Station environment."

2. What is the name of the software that controls the System/38?

3. Name at least three of the six major functional areas of CPF.

When you have completed the questions, turn to the next page for a review of the answers.

Progress Check: Unit 2 Answers

1. Define the phrase "Work Station environment."

Putting access to the computer into the hands of the user. The user is becoming directly involved with the computer.

2. What is the name of the software that controls the System/38?

Control Program Facility, also known as CPF.

3. Name at least three of the six major functional areas of CPF.

Data Management (which includes Data Base and Work Station)

Work Management

Object Management

Programmer Services

Control Language

System Services



When you feel you are ready, return to the Module Summary in the Module 1 text.

CONTROL PROGRAM FACILITY FUNCTIONS

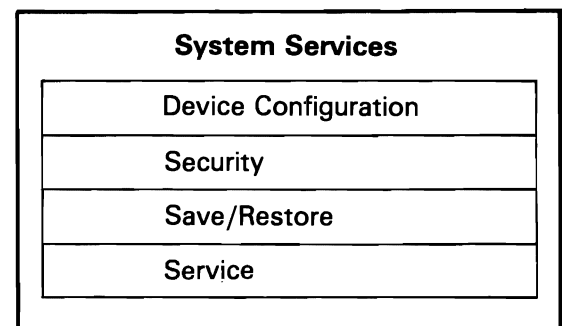
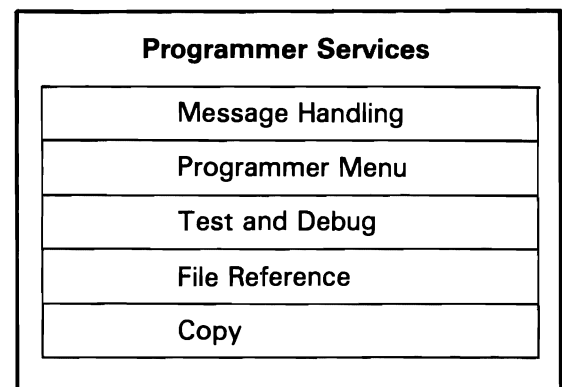
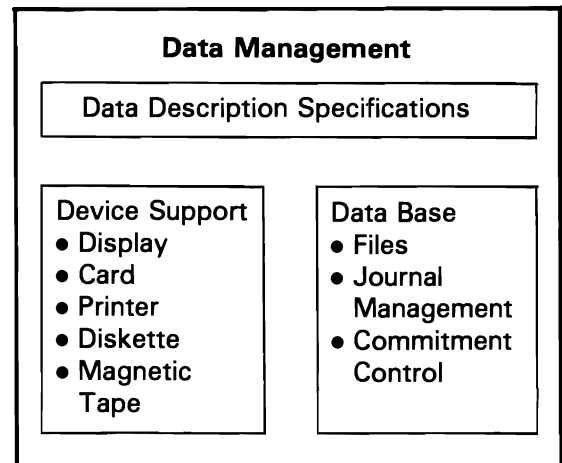
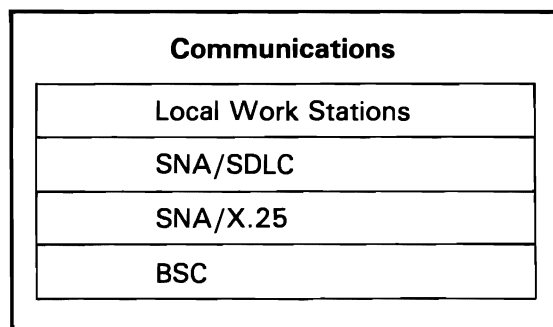
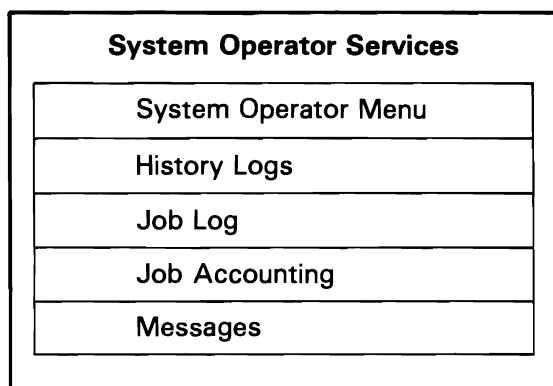
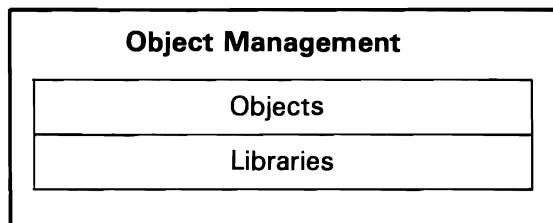
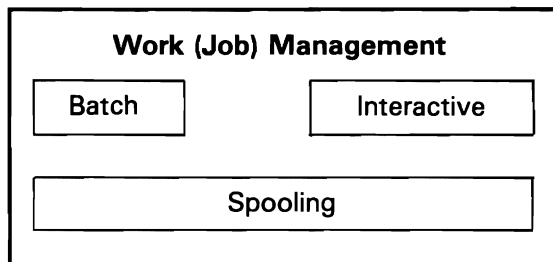
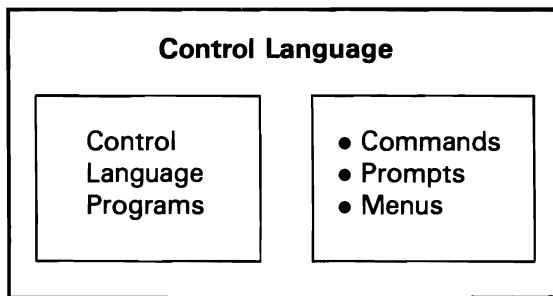



Module 2. Data Base Data Management

MODULE PURPOSE

In Module 1, you were introduced to the System/38 Control Program Facility. You became aware of the major functions of CPF. One of the major functions is Data Management. Data Management is subdivided into Data Base Data Management and Device Support Data Management.

Also in Module 1, you defined the concept of the Work Station Environment — putting access to the computer into the hands of the user. You became aware of some items to consider now that the user is directly involved. One of the considerations is the management of our information.

This module shows you how the System/38 CPF handles information (data) management. Specifically, you will study Data Base Data Management.



TIME ESTIMATE

2½ hours

MODULE OBJECTIVES

After completing this module, with the aid of applicable reference material, you should be able to:

- Define System/38 Data Base Data Management.
- List at least three advantages of using a Data Base.
- Identify (name) the two types of Data Base files used by the System/38.
- State how Data Base files are described to the System/38.

NOTES

- 2 length or size
- 3 Data type

This means a physical file can contain only 1 record type.

Progress Check: Unit 1

Read each question carefully. Record your answers in the space provided.

1. List three advantages of using a Data Base.

2. List the components of a physical file.

3. List the component of a logical file.

4. What makes up a File Description?

record format

access path

location

5. Is a logical file always associated with a physical file? *yes*

6. When is the access path updated when you add a record?

7. Can a program access a physical file without going through a logical file?

yes

After you have completed the questions, turn to the next page for a review of the answers.

Progress Check: Unit 1 Answers

1. List three advantages of using a Data Base.

Reduced data redundancy
Data described outside of programs
Multiple access paths or sequences
Immediate update capability
Data defined to system, one time
Anything else you may think of that is an advantage of using
Data Base

2. List the components of a physical file.

Data
File Description

If you listed such things as access path and record format, that's okay. Remember that those things make up the File Description.

3. List the component of a logical file.

File Description

Again, remember what makes up a File Description.

4. What makes up a File Description?

Record format, Access path, Location

5. Is a logical file always associated with a physical file?

Yes, a logical file provides an access path to a physical file. It
does not contain data.

6. When is the access path updated when adding a record?

Now or later. The access path is updated per your instructions given when the file was created. The update takes place immediately or the next time the access path is used.

7. Can a program access a physical file without using a logical file?

Yes. A logical file provides us with various access paths to a physical file. If the access path defined in the physical file is the sequence desired, no logical view is necessary. Keep in mind, however, that all data in the physical file would be available to the program.

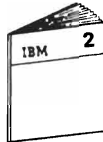

When you are ready, return to Unit 2 of the Module 2 text.



DESK EXERCISE – PHYSICAL FILE DDS CODING

If you have not already done so, ask your Administrator for some DDS coding sheets (GX21-7754).

Listed below is information about an Inventory Master file. You need to code this information on DDS sheets.

File name – INVMST
Record format name – INVFMT
Access path – part number

Field	Field Name and Type	
Part number	PARTNO	5.0
Part name	NAME	20A
Bin location	LOC	3.0
Quantity on hand	QTY	4.0
Quantity on order	ONORD	4.0
Selling price	PRICE	5.2
Unit cost	COST	5.2
Quantity sold this year	SOLDYR	4.0
Vendor number	VNDNR	3.0

When you have finished, compare your coding with the possible solution on the next page. Remember your solution may be slightly different. Be sure your solution has all required entries. If you need help, refer to the module example or any notes you have taken.

DESK EXERCISE — PHYSICAL FILE DDS CODING SOLUTION

IBM International Business Machine Corporation															DATA DESCRIPTION SPECIFICATIONS															GX21-7754-0 LIM (EO) Printed in U.S.A.														
File INVMST					Keying Instruction					Graphic					Description										Page of																			
Programmer SMITH					Date 8/1/-					Key																																		

Sequence Number	Conditioning				Name	Reference (R)	Length	Location		Functions
	Form Type Add'l Comment (A,C,T)	Indicator Not (N)	Indicator Not (N)	Indicator Not (N)				Line	Pos	
	A				R INVTM					
	A				PARTNO		5	0	TEXT('PART NUMBER')	
	A				NAME		20	0	TEXT('PART NAME')	
	A				LOC		3	0	TEXT('WAREHOUSE LOCATION')	
	A				QTY		4	0	TEXT('QUANTITY ONHAND')	
	A				ONORD		4	0	TEXT('QUANTITY ONORDER')	
	A				PRICE		5	2	TEXT('PRICE')	
	A				COST		5	2	TEXT('COST')	
	A				SOLDYR		4	0	TEXT('QUANTITY SOLD THIS YEAR')	
	A				VNDNR		3	0	TEXT('VENDOR NUMBER')	
	A				K PARTNO				TEXT('PARTNO IS THE KEY')	

*No. of sheets per pad may vary slightly.

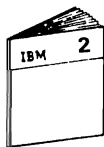

When you feel you are ready, return to "Logical File DDS Coding" in the Module 2 text and continue the course.

DESK EXERCISE – LOGICAL FILE DDS CODING

Ask your administrator for some blank DDS coding sheets if you need any.

A report is needed using data from your Inventory Master file, INVMST. The report is in vendor number sequence and must show the following data:

- Vendor number
- Part number
- Part name
- Quantity sold this year
- Unit cost

Code the DDS instructions necessary to define the logical file for this job. Review your INVMST code for any information you may need for this logical file. The logical file should be named VNDLST.

When you have finished, compare your coding with the possible solution on the next page. Remember your solution may be slightly different. Be sure your solution has all required entries. If you need help, refer to the module example or any notes you have taken.

Progress Check: Unit 2

Read each question carefully. Record your answers in the space provided.

1. List the steps required to build a file on the System/38.

2. What form is used to code physical or logical files? DDS sheets

3. What System/38 utility is used to key information into a source file?

4. What is the term used to distinguish between different entries, for example, different DDS entries, in a source file?

5. What are the CL commands to create a) physical and b) logical files?

a) _____ b) _____

6. Code the DDS necessary to describe a physical file called OPENAR. The file will be accessed in arrival sequence and contain the following data (use field names of your choice):

Customer number	5.0
Invoice number	6.0
Invoice date	6.0
Invoice amount	7.2

7. Code the DDS for a logical file called NUMLST. This file accesses the OPENAR file of Question 6 in invoice number sequence. All fields in OPENAR need to be available in NUMLST.

When you are ready check your answers with those on the next page.

Progress Check: Unit 2 Answers

1. List the steps required to build a file on the System/38.

Code Data Description Specifications

Enter DDS into source file

Create file using CL command

If a physical file, load with data

2. What form is used to code physical or logical files? DDS sheets

3. What System/38 utility is used to key information into a source file?

Source Entry Utility, SEU

4. What is the term used to distinguish between different entries, for example, different DDS entries, in a source file?

Member. A group of records that is a subset of a file.

5. What are the CL commands to create a) physical and b) logical files?

a) CRTPF b) CRTLFL

DESK EXERCISE – SELECT/OMIT ANSWERS

1. Select all records with an item number less than 6000.
2. Select all records with an item number of 1000, 2000, 3000, or 4000.
3. Select all records with an item number falling between 1000 and 10000.

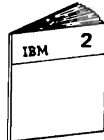

When you are ready, return to “Logical Files Referencing More Than One Physical File” in the module text and continue your study.



Progress Check: Unit 3

Read each question carefully. Record your answers in the space provided.

1. Define composite keys.

2. Where in DDS coding do you place select/omit logic?

3. How can two or more physical files be processed together in some sequence?



4. Why should field reference files be used?

5. How can you prevent a file from having duplicate keys?

When you are ready, check your answers with those on the next page.

Progress Check: Unit 3 Answers

1. Define composite keys.

An access path composed of more than one field in the record

2. Where in DDS coding do you place select/omit logic?

Following any key information describing the access path. The last entry for a record format

3. How can two or more physical files be processed together in some sequence?

By defining a logical file referencing both physical files.

4. Why should field reference files be used?

To aid in application design, programming, and documentation. All field names and definitions are stored in one place.

5. How can you prevent a file from having duplicate keys?

Specify UNIQUE on DDS defining the file.

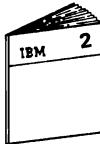

When you are ready, return to "Module Summary" in the module text.



MODULE 2 SUMMARY

This module introduced you to the concepts of System/38 Data Base Data Management. You became aware of some of the shortcomings of a non data base system:

- Redundant data
- Program description of data
- Constraints on data access.

You learned the basic elements of Data Base Data Management:

- Data independence — data is defined one time to the system
- Multiple access paths — more than one way to retrieve data
- Field oriented — referencing fields by name only.

You were introduced to the two kinds of Data Base files and the characteristics of each:

- Physical files, containing
 - Data
 - File description, which contains
 - Record format
 - Access path
 - Location of data
- Logical files, containing
 - File description
 - No data.



Unit 2 showed you how to define physical and logical files to the System/38 through the use of Data Description Specifications, DDS. You learned how to complete DDS sheets with coding exercises.

Unit 3 added additional topics to physical and logical file coding:

- Composite keys
- Select/Omit
- Logical file built over multiple physical files
- Field reference files
- Additional keywords of UNIQUE, DESCEND and ACCPTH.

Module 2 introduced you to the first component of System/38 Data Management — Data Base Data Management.

MODULE 2 EXERCISE

An employee master file is to be created for a payroll application. This physical file is to be called EMPMAST. The file contains the following data fields:

Field	Field Size and Type
Employee number	5.0
Employee name	15A
Pay Rate	6.2
Hourly/Salary (H = Hourly, S = Salary)	1A
Year-to-date Gross pay	7.2
Year-to-date withholding tax	6.2
Year-to-date FICA	6.2
Year-to-date state tax	6.2
Department number	3A

Employee number is the key field and no two employees should have the same number.

The accounting department wants a report listing:

- Department number
- Year-to-date gross
- Year-to-date withholding tax
- Year-to-date FICA
- Year-to-date state tax

This report is to include only Salary employees and be in departmental sequence. Please note that the logical file format you create for this report should include only the fields necessary for the report. One of these fields is the Hourly/Salary field which is needed for record selection, but is not printed in the report.

For this exercise:

1. Code the DDS required to define the physical file. Use record format and field names of your choosing.
2. Code the DDS required to define the logical file, named ACCTG, used by the accounting report.

Remember to use keywords as needed to define all necessary characteristics.



When you are done coding the Exercise, ask your Administrator for the solution.



When you feel you are ready, continue the Course by asking your Administrator for Module 3, Work Station Data Management.







Module 3. Work Station Data Management

MODULE PURPOSE

In Module 1, you were introduced to the System/38 Control Program Facility (CPF). As a result, you became aware of the major categories of the System/38 CPF. One of the major categories is Data Management. Data Management is subdivided into Data Base Data Management and Device Support Data Management.

Also in Module 1, you defined the concept of the work station environment — putting access to the computer into the hands of the user. You became aware of some items to consider now that the user is directly involved. One of the considerations is the use of work station devices.

This module shows you how the System/38 CPF handles work station data management.

TIME ESTIMATE



2½ hours

MODULE OBJECTIVES

After completing this module, with the aid of applicable reference material, you should be able to:

- List four ways work stations can be used with the System/38.
- List the steps necessary to create a display screen format.
- List two functions available at the work station as a result of work station data management that aid in work station design, coding and usage.

DISPLAY STATION FAMILIARIZATION

This exercise requires about 12 minutes at a display station.

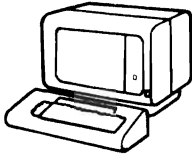

Read this list of things to be done before you start, so that you get a mental picture of what it is you will be doing at the display station. Here's the list.

1. Power On
 - a. Place the "Power" switch in the "On" position.

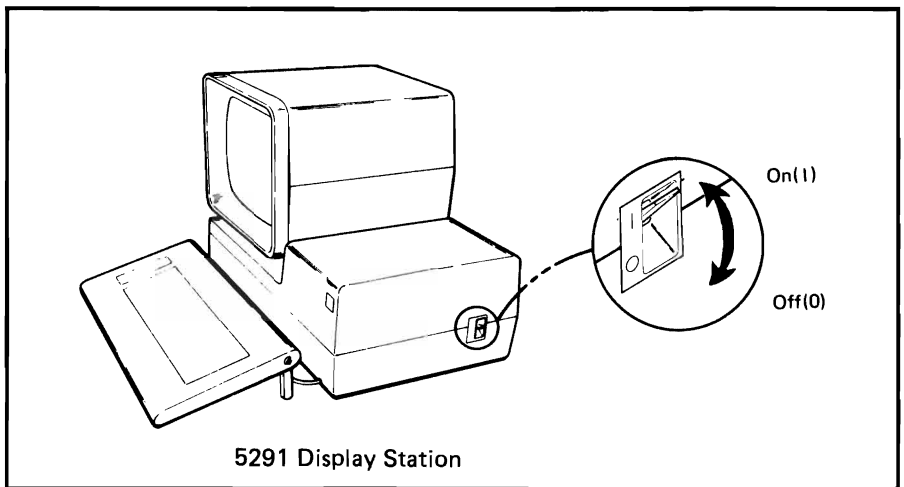
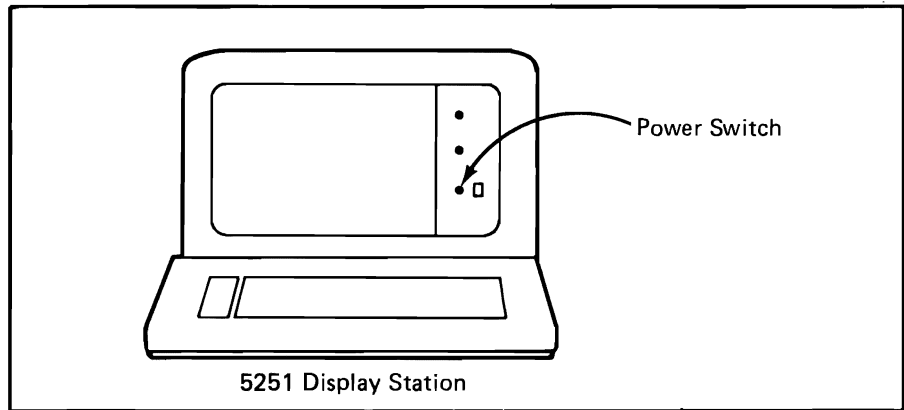

- b. When the "System Available Indicator" appears on the screen, the power-on step is complete.

If the system is not available, only a short horizontal line is seen. When the system is available, a square block of light replaces the line and a sign-on display appears on the display.

About 10 to 20 seconds of time are required after the power switch is turned on before the system available indicator comes on.

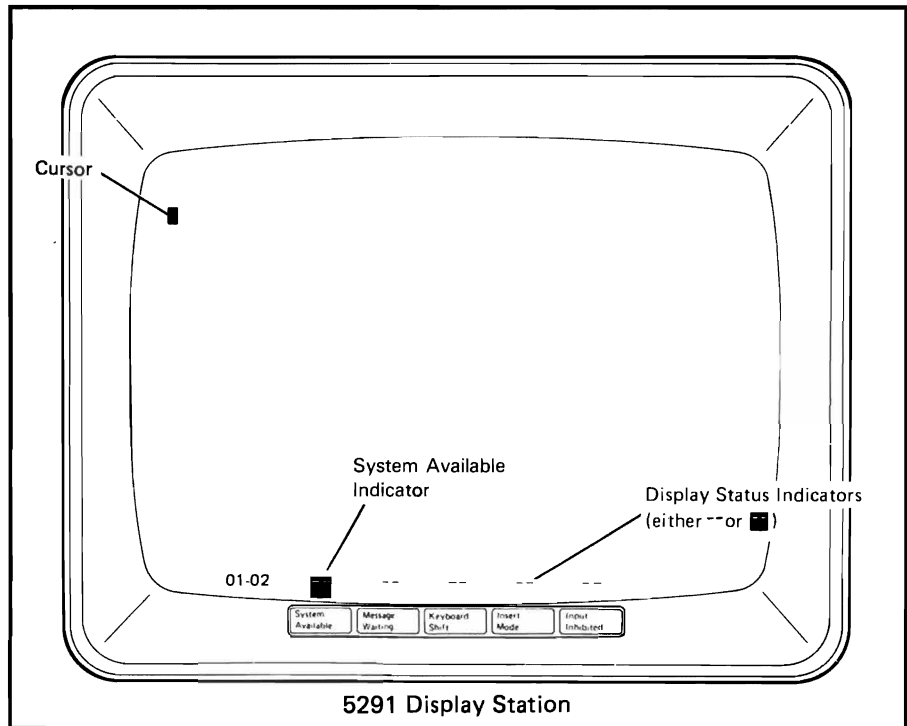
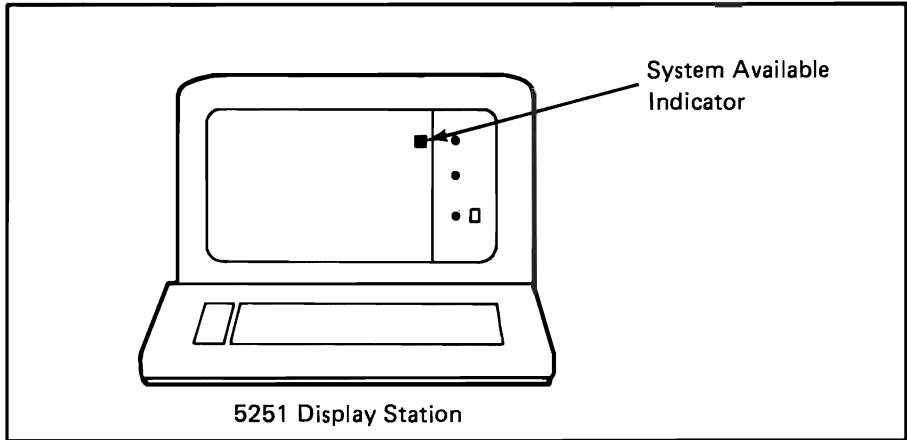

2. Sign On

You will see one of the two sign-on displays shown below. If you get the two-level sign-on display, enter the password for both the user ID and the password.

Single level sign-on display

```
Enter password to sign on:                System:  ATLEDDDEV
                                           Subsystem: QINTER
                                           Device:  XXXXXXXXX

Password:
```

Two-level sign-on display

```
Enter user ID and password to sign on:    System:  ATLEDDDEV
                                           Subsystem: QINTER
                                           Device:  XXXXXXXXX

User ID:
Password:
```

Type the password S38FUN.

Press the ENTER key to complete the sign on.

Note: You will not see the password as you type it because the password field is a non-display field.

3. Cursor Movement

When "sign on" is complete, you will see a screen display similar to this one.

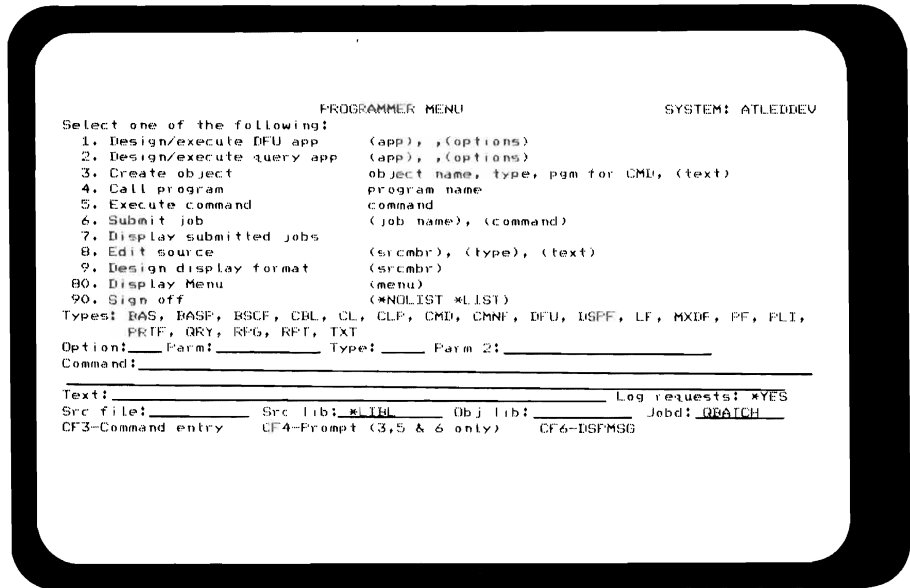

The "cursor" is a movable character on the display screen used to indicate where the next character to be typed will appear.

Four keys on the keyboard control the movement of the cursor from one position to the next: left-to-right, right-to-left, top-to-bottom, and bottom-to-top. These cursor movement control keys are identified in the illustration.

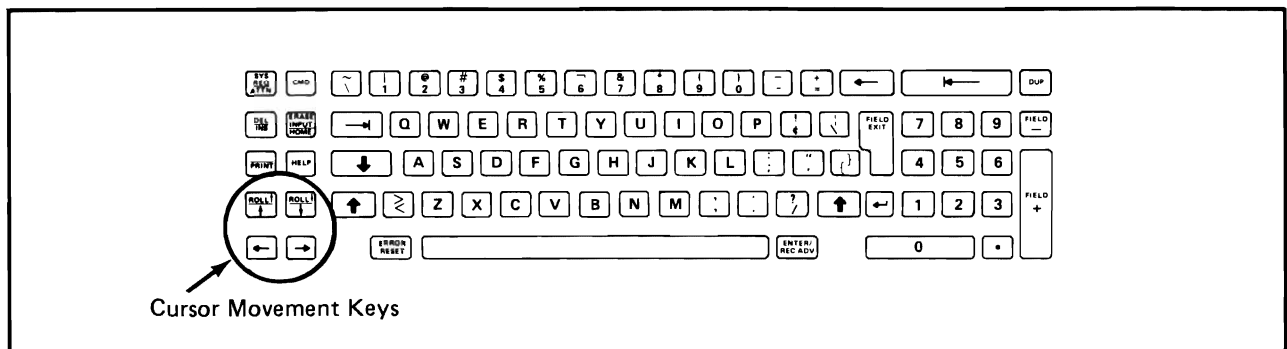

At this time, press each of these keys a few times and notice the direction in which the cursor moves.

These keys, like many others on the keyboard, are "typematic" keys. This means that when the key is held down, the function or character repeats until the key is released.

Press and hold each cursor movement key to become familiar with the "typematic" characteristic.

End this activity by signing off the work station. To "sign off", you do the following:

- a. If the cursor is not at "Option:" field, press the key marked "HOME" just once. This action will reposition the cursor as needed. Then, type the number 90 (Sign off) in the "Option:" field and press the ENTER key.

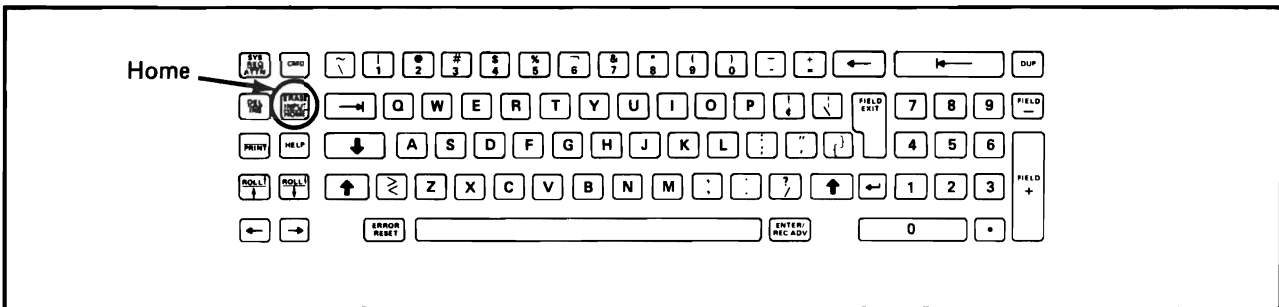

Note: If the "Home" key is pressed again after the cursor is already in its home position, an error message will be displayed and the "Input Inhibited Indicator" will come on. To eliminate the error message, press the "Error Reset" key.

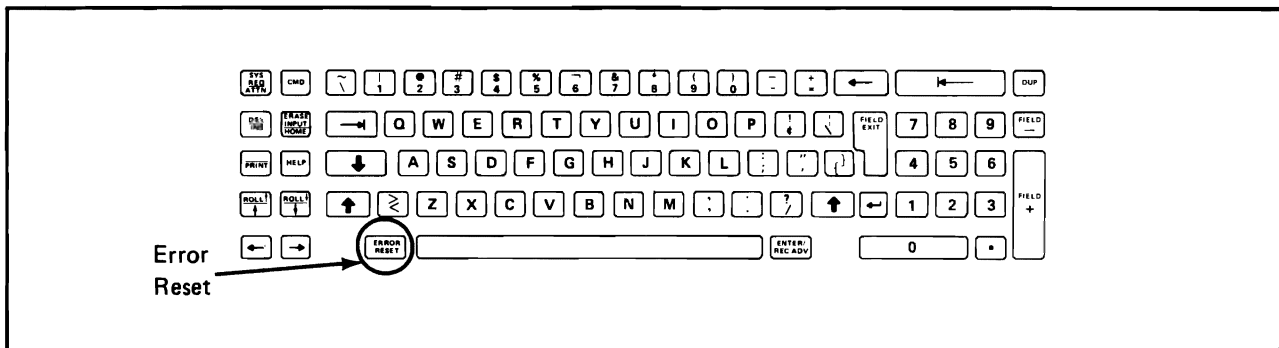

- b. If the cursor is at the "Option:" field, simply key in the number 90 and press the ENTER key.

Do not turn off power.

When you "sign off", the display station is made available to another user. The system automatically shows an "Enter password to sign on:" display at this time.

In addition to the keys just examined, there are four more keys that are used to move the cursor to locations that are predefined by a programmer. Locate the keys shown below on your keyboard.

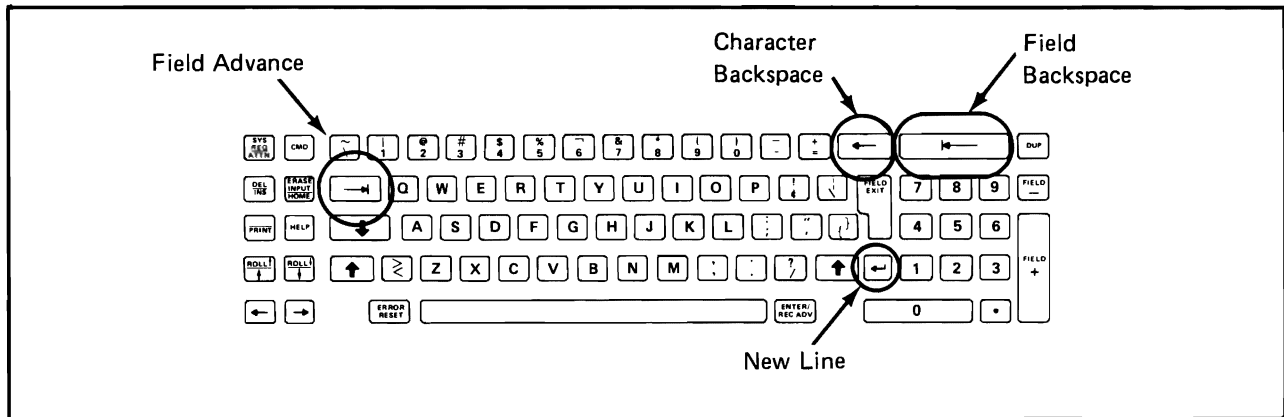

c. Sign on again exactly as you did in Step 2 using the password S38FUN.

d. With the "PROGRAMMER MENU" displayed, press the "Field Advance" key a few times. Notice that it moves the cursor to a predetermined position each time.

Press the "Field Backspace" key a few times and notice the cursor movement.

Press and hold the "Character Backspace" key. Notice that the cursor moves through every position in each of the fields.

Press the "New Line" key a few times and notice how the cursor moves.

Press the "Character Backspace" key a few times so that the cursor is not at the beginning of any of the fields. Then press the "New Line" key once and note the position of the cursor.

e. Position the cursor to the "Command:" line.

The next part of the exercise has to do with typing data and erasing data which is typed incorrectly.

All of the letter and number keys on the keyboard are typematic.

- Press and hold any letter or number key. Continue holding until the "Command:" lines are filled.
- To erase all of this typed data, press either "shift" key and the "Erase Input" key. Do so and then notice the position of the cursor.

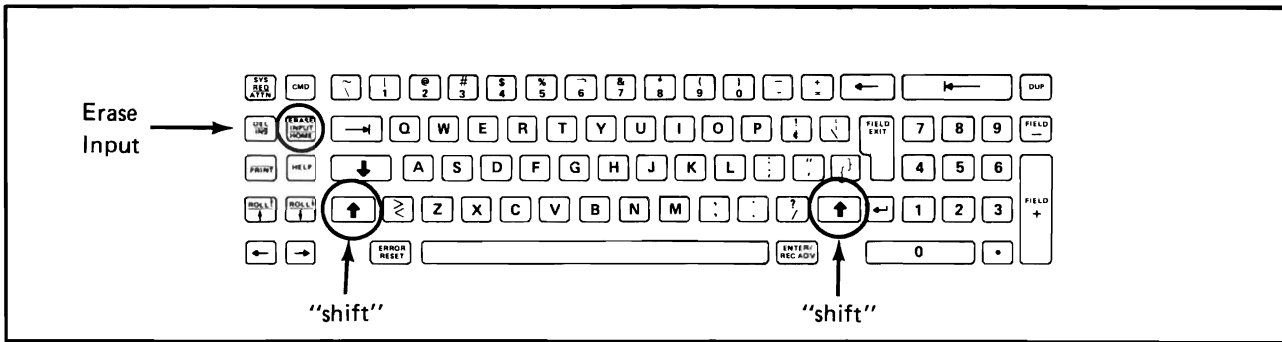

c. Now move the cursor to the "Command:" line and type in the following sentence:

This display station is signed on.

Note: If you make an error while typing, just use a cursor movement key to place the cursor at your error and press the correct key. The new letter or number will replace the error.

Note: When either "shift" key is pressed, the "Keyboard Shift" indicator on the screen is turned ON. Then, when the "shift" key is released, this indicator turns off.

Next, you will change a word in this sentence. When finished, it is to read:

This work station is signed on.

The steps to make this change follow.

- d. Position the cursor at the word display and replace it with the word work followed by three spaces. To create the spaces, use the "space bar".

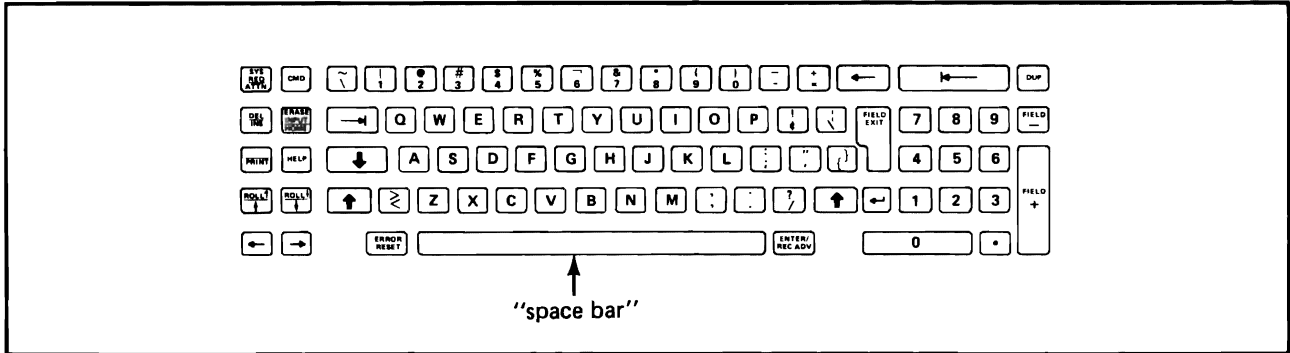

- e. You can eliminate the unwanted spaces following the word WORK in a number of ways. For instance, you could "erase input" and retype the entire sentence. Here's another way.
- f. Position the cursor at the first space immediately following the letter K in the word WORK.
- g. Locate the "DEL" key on your keyboard. DEL is an abbreviation for the word "delete". To use this key, you must also use a "shift" key.

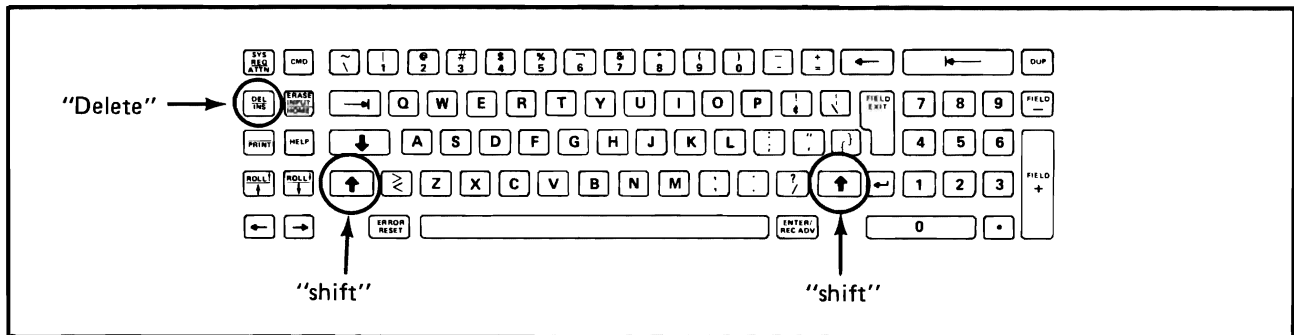

- h. Now, press and hold a "shift" key and then press the DEL key once. Notice what happens! All characters to the right of the cursor move to the left one position, because you have "deleted" one space.
- i. Delete the remaining unwanted spaces using the "shift" and "DEL" keys. Remember to leave one space between the words work and station.

- 
- j. When you are satisfied that you can type data, and if necessary, delete unwanted data or replace it, press and hold a "shift" key, then press the "Erase Input" key to blank all data.

To conclude this familiarization exercise, you are to "sign off" and "power off" your display station. Follow these steps.

- a. Position the cursor at the "Option:" field. If necessary, use the "shift" and "Erase Input" keys to do so.
- b. Type the number 90 and press ENTER. You have signed off. You must sign off before you power off.
- c. To "power off", place the power switch in the "Off" position.

The exercise is completed.

Note: You may repeat this exercise if you wish.

Now that you have read the list of steps to be done at the display station for this exercise, go to the display station and do the exercise.

When you have completed the exercise, return to your study carrel and continue in the text.



Progress Check: Unit 1 Answers

1. What are the two types of work station devices available on the System/38?

Display station

Printer

2. List four types of functions performed by work stations. Briefly describe each one you list.

Data Entry – the act of putting information into machine readable form

Source Entry – used by programmers to enter source code

Inquiry – answering a question about a single record in a file

Query – a complex inquiry asking question about multiple records

Online Update – a combination of inquiry and data entry, a net change to existing data

Online File Maintenance – addition, change, deletion of file data

Program Execution – initiation of a non-interactive program

3. In order to use a Display Device, what are the first two things you must do?

Turn the device on (Power On)

Sign On, using a password



When you are ready, return to the module text and continue your study with Unit 2.



Progress Check: Unit 2

Read each question carefully and write your answers in the space below each question.

1. What two methods can be used to initiate programs on the System/38?

2. List 2 menus supplied with the System/38.

3. Other than menus, list two capabilities available through Work Station Data Management that aid in work station design, coding and usage.

4. List the steps to create a display file.

When you are ready, check your answers with those on the next page.

Progress Check: Unit 2 Answers

1. What two methods can be used to initiate programs on the System/38?

Control Language

Menus, either predefined or defined by you

2. List 2 menus supplied with the System/38.

Program Call Menu for users

System Operator Menu for system console

Programmer Menu for programmers

3. Other than menus, list two capabilities available through Work Station Data Management that aid in work station design, coding and usage.

Display attributes

Validity checking

Subfiles

DDS and SDA, although not directly a part of Work Station Data Management, they function in conjunction with it; they work together to define, design and use displays

4. List the steps to create a display file.

Draw the Display Screen Layout

Code DDS, using the drawn layout

Key the DDS, using SEU

Create the display file with CRTDSPF

OR

Use Screen Design Aid

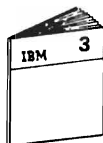

When you are ready, return to "Module Summary" in the Module 3 text and continue with the course.



MODULE SUMMARY

System/38 puts access to the computer into your hands. To use it effectively, you need to know how to manage the work station environment successfully. In this module you learned some of the functions available that support the work station environment. Device Support Data Management is the portion of CPF that provides the functions you studied in this module.

Work stations are used to send information to and receive information from the System/38. Work station devices include display stations and printers.

Work stations can be used in various ways, including:

- Data Entry — Entering data into the System/38 from display stations
- Source Entry — Entering source programs into the System/38 for future compilation
- Inquiry — Asking a question and receiving an answer at the display station
- Query — Complex inquiry, analysis of data records in the file
- Online Update — Combination of inquiry and data entry to change data
- Online File Maintenance — Add, change and delete records
- Program Execution — Initiate non-interactive tasks.



You learned how to run work station programs with menus and were shown some of the menus supplied with the System/38.

Device Support Data Management provides you with a number of functions to aid in work station design, coding and usage:

- Menus
- Display attributes
- Validity checking
- Subfiles.

You saw two methods of generating display files:

- Coding Data Description Specification (DDS)
- Using the Screen Design Aid (SDA) utility.

Device Support Data Management allows you to make efficient and productive use of the work station device.

MODULE 3 EXERCISE

On the facing page is a Display Screen Layout (GX21-9271) for a Payroll maintenance function. The user requested a program. The program, by showing a display, asked for the employee number of the employee record to be changed. The program took that number, retrieved the record for the employee, and presented the display you see on the facing page.

The headings and instructions are constants in the format. The data on Row 06 is variable information sent to the display by the program for user information and reference.

The user is to type any of the data on Row 14 that is changing. The data from Row 14, along with the Employee number from Row 06 is to be sent to the program from the display.

Code the Data Description Specifications (DDS) necessary for this display.

- Use any file, format, and field names you wish.
- Use the following display attributes and validity checks:
 1. Display the screen title in High Intensity.
 2. Display the employee name field in reverse image.
 3. The Hourly/Salary code entered must be either H or S.
 4. The Marital Status code entered must be either M or S.
 5. The entry for Exemptions must be between 0 and 20 and have column separators.
 6. The Home Phone entry must be numeric and have column separators.

Note: Ask your Administrator for DDS (GX21-7754) sheets if you need any.

		1-10		11-20		21-30		31-40		41-50		51-60		61-70		71-80					
		1	2	3	4	5	6	7	8	9	0	1	2	3	4	5	6	7	8	9	0
01		PAYROLL MASTER FILE MAINTENANCE																			
02																					
03																					
04		EMPLOYEE		NAME						HOURLY		MARITAL		EXEMPTIONS		HOME					
05		NUMBER								SALARY		STATUS		PHONE							
06		<u>XXXXX</u>		X-----X						X		X		XX		XXXXXX					
07																					
08																					
09																					
10		ENTER VALUES ONLY FOR FIELDS TO BE CHANGED																			
11																					
12		HOURLY		MARITAL		EXEMPTIONS		HOME													
13		SALARY		STATUS				PHONE													
14		<u>X</u>		<u>X</u>		<u>XX</u>		<u>XXXXXX</u>													
15																					
16																					
17																					
18																					
19																					
20		PRESS ENTER TO CONTINUE																			
21																					
22																					
23																					
24																					

When you are done with the exercise, ask your administrator for the solution. Compare your results to the possible solution.

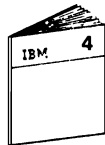

When you feel you are ready, ask your administrator for Module 4 to continue the course.





Module 4. Control Language

MODULE PURPOSE

As a user, you must have some means of telling a computer what you want it to do for you. With the System/38, the CPF expects instructions from you in the form of Control Language (CL) commands. Control Language is your means of communicating with the System/38. Control Language has been mentioned in prior modules. The purpose of this module is to show you how Control Language is used and what it can do.

TIME ESTIMATE

1 hour

MODULE OBJECTIVES



After completing this module, using applicable reference material, you should be able to:

- List two ways to use Control Language.
- Describe the structure of Control Language statements.
- Code a simple CL program using an example as a guide.



Progress Check – Module 4

Read each question carefully and record your answer(s) in the space provided for each question.

1. List two ways Control Language can be used.

2. Describe the structure of Control Language statements.

3. What two ways can be used to specify parameters for a Control Language command?

- 
4. A field named EMPNO is defined on DDS for a menu. How is the field referenced in a CL program?

5. List an advantage of using a CL program.

When you are finished with the questions, turn to the next page and review your answers.

Progress Check — Module 4 Answers

1. List two ways Control Language can be used.

Interactively — enter one statement at a time at the display station

Batch — statements read in from card or diskette

CL program — statements grouped together and compiled

2. Describe the structure of Control Language statements.

A command followed by parameters

The command consists of a verb/noun combination.

3. What two ways can be used to specify parameters for a Control Language command?

Keyword

Positional

4. A field named EMPNO is defined on DDS for a menu. How is the field referenced in a CL program?

&EMPNO

5. List an advantage of using a CL program.

Faster run time

Control application flow

Job control

When you are ready, continue with the Module Exercise for Module 4 on the next page.

MODULE 4 EXERCISE

The Display Screen Layout below describes a menu for a number of inquiry functions. Review it for a moment.

		COLUMN																																																																																Display Screen Layout Sheet
		1-10	11-20	21-30	31-40	41-50	51-60	61-70	71-80																																																																									
		1	2	3	4	5	6	7	8	9	0	1	2	3	4	5	6	7	8	9	0	1	2	3	4	5	6	7	8	9	0	1	2	3	4	5	6	7	8	9	0	1	2	3	4	5	6	7	8	9	0	1	2	3	4	5	6	7	8	9	0	1	2	3	4	5	6	7	8	9	0											
01		INQUIRY MENU																																																																																
02																																																																																		
03		SELECT ONE OF THE FOLLOWING:																																																																																
04																																																																																		
05		1. CUSTOMER INQUIRY																																																																																
06																																																																																		
07		2. ITEM FILE INQUIRY																																																																																
08																																																																																		
09		3. SUPPLIER FILE INQUIRY																																																																																
10																																																																																		
11		4. SIGN OFF DISPLAY																																																																																
12																																																																																		
13																																																																																		
14																																																																																		
15		ENTER OPTION AND NUMBER _____																																																																																
16																																																																																		
17																																																																																		
18																																																																																		
19																																																																																		
20																																																																																		
21																																																																																		
22																																																																																		
23																																																																																		
24																																																																																		

The user selects the inquiry option by keying 1, 2, or 3. The user also has the ability to enter the number for the first inquiry for each option. For example, if Option 2 is selected, the user can enter the first item number to appear on the display when the inquiry is performed. Once any of the inquiries are done, the Inquiry Menu should again appear on the screen.

The DDS for the Inquiry Menu is shown below. Note the two input capable fields – CHOICE and INQNUM. CHOICE is for the option number selected and INQNUM is the number for the first inquiry of any option.

Indicator	Type (R,K,S,O) Reserved	Name	Reference (R)	Length	Data Type (A,B,I,N,P,S,W,X,Y)	Decimal Positions	Usage (I,O,B,H,M)	Location		Functions
								Line	Pos	
		OF A MENU FORMAT								
		R INQMEN								TEXT('EXAMPLE OF A MENU FORMAT')
								1	31	'INQUIRY MENU'
								3	6	'SELECT ONE OF THE FOLLOWING:'
								5	21	'1 CUSTOMER INQUIRY'
								7	21	'2 ITEM FILE INQUIRY'
								9	21	'3 SUPPLIER FILE INQUIRY'
								11	21	'4 SIGN OFF DISPLAY'
								15	6	'ENTER OPTION'
		CHOICE		1	DI			15	19	
		INQNUM		6	DI			15	21	'AND NUMBER'

The display screen format name is INQMEN and is stored in a display file named MENUS.

Option 1 calls the program INQCUS.

Option 2 calls the program INQITM.

Option 3 calls the program INQSUP.

For this exercise, you need to write the Control Language statements necessary in a CL program for the Inquiry Menu described on the two previous pages. Use the CL program for the Payroll Menu as a guide. The screen display and CL program code for Payroll Menu are shown below.

```
PAYROLL MENU

1. ENTER HOURS (ENTER WEEK ENDING DATE)
2. PRINT PAYROLL REGISTER
3. PRINT 941'S
4. PRINT CHECKS (ENTER STARTING CHECK #)
5. SIGN OFF DISPLAY

OPTION: _____
WEEK ENDING DATE: _____
CHECK NO.: _____
```

```
PGM
DCLF FILE(PRFIL)
START: SNDRCVF RCDFMT(PRMENU)
      IF (&OPTS *EQ 1) CALL PGM(PRO01) PARM(&END)
      IF (&OPTS *EQ 2) CALL PGM(PRO02)
      IF (&OPTS *EQ 3) CALL PGM(PRO03)
      IF (&OPTS *EQ 4) CALL PGM(PRO04) PARM(&CHECK)
      IF (&OPTS *EQ 5) SIGNOFF
      GOTO START
      ENDPGM
```

When you are done, ask your administrator for the solution.

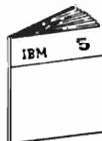

When you feel you are ready, ask your administrator for Module 5 to continue the course.

MODULE SUMMARY

Control Language (CL) is how you communicate with the System/38. Control Language is a single, consistent interface to all system functions. These functions are available to authorized users.

The structure of Control Language commands is uniform. Commands consist of a verb and a noun followed by parameters. Parameters may be required or optional and are used to further describe the function you want to do with a Control Language command. Parameters may be specified with keywords or, in some cases, positionally. Most parameters have default values to simplify entry and use.

You may enter Control Language commands interactively or in batch. If you do not know the proper parameters for a command, or even the proper command, extensive prompting is available.

Control Language statements can be compiled into CL programs that provide:

- Faster execution
- Logic capability
- Job control
- Control of application flow.

A CL program can handle variable data fields passed to it.

With all its abilities, Control Language is a high level language on the System/38, like RPG III and COBOL.



Module 5. Programmer Services — Utilities

MODULE PURPOSE

Today, the major costs associated with data processing lie with the software. As the computer hardware becomes more affordable and in wider use, the jobs being done with computers become more numerous and complex. The programming effort — creating and maintaining the software — has become more complex and time consuming, and therefore, more costly. The problem arising is a lack of time to effectively develop and maintain application programs. One solution is to increase programming productivity.

The System/38 offers a number of facilities to the designer, programmer, and implementer to increase their productivity. The purpose of this module is to discuss one of the tools available for application development.

TIME ESTIMATE

1½ hours



MODULE OBJECTIVE

After completing this module, using applicable reference material, you should be able to:

- List the Interactive Data Base Utility (IDU) programs available with the System/38 and state a use for each one.



DFU MACHINE EXERCISE

Purpose

The purpose of this exercise is to familiarize you with the steps used to create a DFU application. The DFU application will allow inquiries into a data file.

This exercise is simulated so that you may become familiar with the System/38 without worrying about making mistakes. You must make the entries indicated, and use the defaults when the instructions show them. Any incorrect entry will be edited and the display with the wrong entry will be shown again until the correct entry is made.

Please read all instructions and directions on each page before doing the exercise at the display station.

Requirements

Following are the requirements of the DFU application you will create in this exercise:

1. Name the DFU application DFUEXER.
2. The file name for the application is MASTERS.
3. During the actual problem definition you are to:
 - a. Review the fields for the record format.
 - b. Select specific fields to be used in the definition.
 - c. Give an Entry format identifier of "A".
 - d. Give an Entry format description of "DFU PRACTICE EXERCISE".
 - e. Accept all other DFU defaults.
 - f. Create the application.
4. Run the DFU inquiry application you have created.

The sequence of displays and the entries to be made are on the following pages.

If you have not been assigned a display station, ask the Administrator to assign you to a display station attached to the System/38.

In this exercise, entries you make are circled on the respective displays.

You will see one of the two sign-on displays shown below. If you get the two-level sign-on display, enter the password for both the user ID and the password.

Single level sign-on display

```
Enter password to sign on:                System:  ATLEDDDEV
                                           Subsystem: QINTER
                                           Device:  XXXXXXXXX

Password:
```

Two-level sign-on display

```
Enter user ID and password to sign on:    System:  ATLEDDDEV
                                           Subsystem: QINTER
                                           Device:  XXXXXXXXX

User ID:
Password:
```

Make the following entry:

1. Enter the password S38CLASS.
2. Press ENTER/REC ADV.

As you type the password, you will notice that the letters are not displayed.

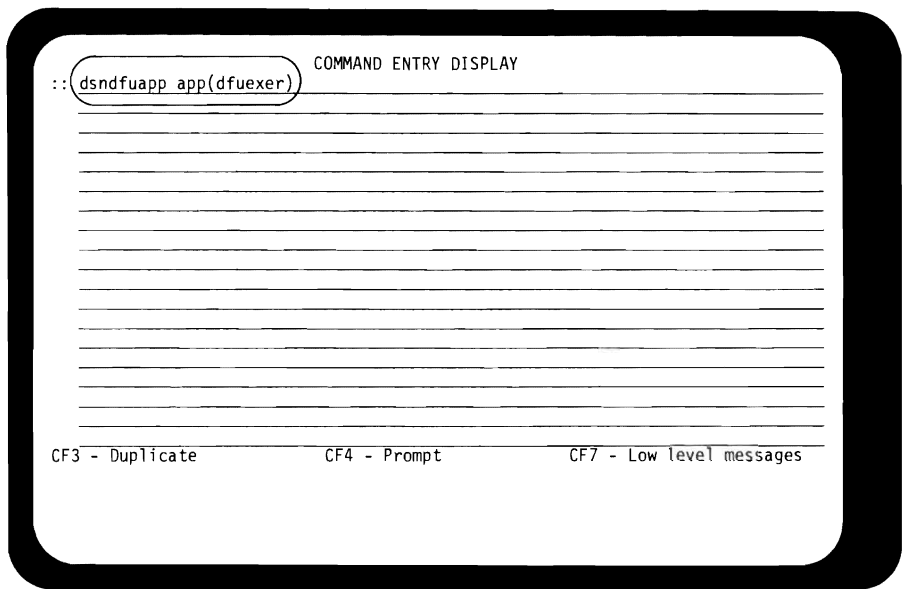

Initiate DFU by entering the proper System/38 command.

Make the following entry:

1. dsndfuapp app(dfuexer)
2. Press ENTER/REC ADV.

Note: Because this exercise is simulated, please observe the following:

- In Step 1, type only one space between dsndfuapp and app(dfuexer).
- Do not use Command Function (CFn) keys unless you are directed to do so, and do not use the HELP key. If you use these keys and an error message appears, press ERROR RESET to continue.

This is the DFU menu displayed after initiating the utility.

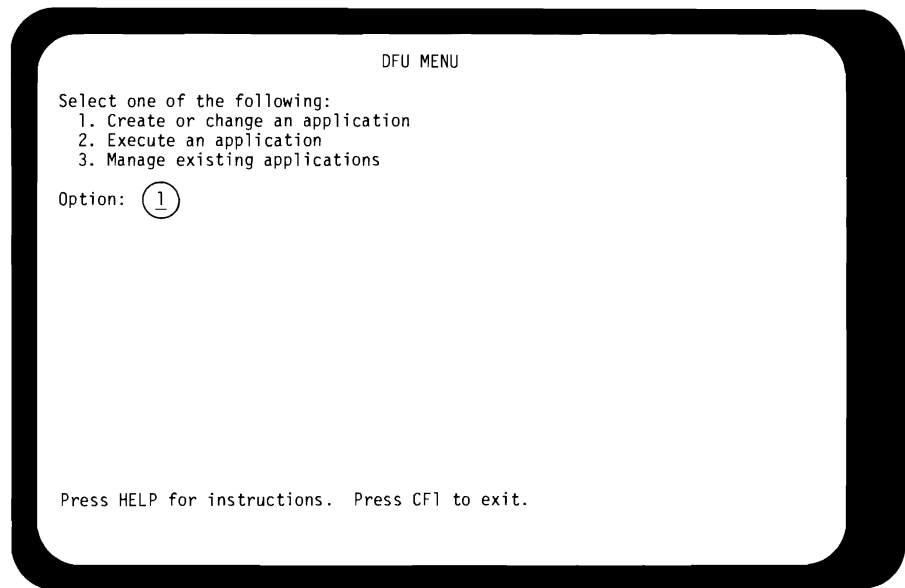

Do the following:

1. Type the number 1.
2. Press ENTER/REC ADV.

Indicate you will be creating the application named in the command, and tell which library to store it in.

```
DFU CREATE/CHANGE MENU

Select one of the following and enter values below:
 1. Display information about an application
 2. Create a new application
 3. Change an existing application
 4. Delete an existing application

Option:          2
Application name: DFUEXER  (*-Application selection list)
Library name:    S38DFU

HELP-Help  CF2-Previous display
```

Do the following:

1. Type the number 2.
2. Visually verify the application name.
3. Type the library name: S38DFU.
4. Press ENTER/REC ADV.

Name a file for this application to process and the file's location.

```
DFU CREATE PROMPT
Application name:  DFUEXER      Library:  S38DFU
Enter information for new application:
Description:      DFU PRACTICE EXERCISE
File name:       MASTERS      (*-file selection list)
Library name:    S38DFU

HELP-Help      CF2-Previous display      CF3-File information
```

Do the following:

1. For the description, type: DFU PRACTICE EXERCISE.
2. For the file name, type: MASTERS.
3. Verify that the library is S38DFU.
4. Press ENTER/REC ADV.

Select the display size this application is designed to use.

```

                                APPLICATION CONTROL PROMPT
Application name:  DFUEXER          Library:  S38DFU
File name:       MASTERS           Library:  S38DFU

Place an X next to display size:
Primary display size:  X 24x80      _ 12x80      _ 16x64

Take defaults after field selection:      N (Y-Yes  N-No)

HELP-Help  CF2-Previous display
```

Accept this display as shown.

1. Press ENTER/REC ADV.

In this exercise, the record format has the same name as the file.

```
FILE REVIEW PROMPT FOR FILE MASTERS
For each record format to be used, enter R to review the fields, A to select all
fields, or E to enter the fields later
RECORD FMT DESCRIPTION
  R MASTERS
```

Do the following:

1. Enter an R to review the fields.
2. Press ENTER/REC ADV.

The DFU field review prompt display is now shown.

```
FIELD REVIEW PROMPT FOR RECORD MASTERS

Place an X next to each field to be used or enter *ALL: _____
X  FIELD NAME  LENGTH  TYPE  DESCRIPTION
X  K ITNBR      5,0    S    ITEM NUMBER
X  ITDSC       24    A    ITEM DESCRIPTION
X  VNDNR       5,0    S    VENDOR NUMBER
X  LSTPC       5,2    S    LIST PRICE
X  CSTPC       5,2    S    COST PRICE
X  QTYOH       5,0    S    ON HAND QUANTITY
X  QTYOO       5,0    S    ON ORDER QUANTITY
  QTYRS       5,0    S    QUANTITY RESERVED
  SAQMO       5,0    S    QUANTITY SOLD THIS MONTH
  SAQYR       5,0    S    QUANTITY SOLD THIS YEAR
  SALMO       7,2    S    DOLLAR SALES THIS MONTH
  SALYR       7,2    S    DOLLAR SALES THIS YEAR
```

Do the following:

1. Enter X before the six fields as shown above.
2. Press ENTER/REC ADV.

The DFU entry format definition prompt is now shown.

```
ENTRY FORMAT DEFINITION PROMPT
For record format name MASTERS enter:
Entry format identifier:  A
Entry format description: DFU PRACTICE EXERCISE
Display one field per line: *NO
Display multiple records: *NO
Redisplay changes:      *NO
Chain to entry format ID: —
```

Do the following:

1. Type the entry format identifier — A.
2. Type the entry format description — DFU PRACTICE EXERCISE.
3. Leave the three defaults *NO on the display.
4. Press ENTER/REC ADV.

Define the fields and the sequence of the fields for the display format.

BASIC FIELD DEFINITION PROMPT FOR RECORD MASTERS						
Define format	ID A	-	DFU	PRACTICE	EXERCISE	
FIELD NAME	ORDER		INPUT	DISPLAY	VERIFY	XDEF XVAL
ITNBR	1.0		X	X	-	-
VNDNR	2.0		X	X	-	-
LSTPC	3.0		X	X	-	-
CSTPC	4.0		X	X	-	-
QTYOH	5.0		X	X	-	-
QTYOO	6.0		X	X	-	-
			-	-	-	-
			-	-	-	-
			-	-	-	-
			-	-	-	-

Accept all of the information as displayed.

1. Press ENTER/REC ADV.

The DFU entry format definition prompt is displayed again.

```

                                ENTRY FORMAT DEFINITION PROMPT
For record format name MASTERS   enter:
Entry format identifier:         _____
Entry format description:        _____
Display one field per line:      *NO
Display multiple records:        *NO
Redisplay changes:               *NO
Chain to entry format ID:        _____

```

It is possible to have multiple record formats and/or multiple display formats. This exercise uses only one.

Make no entries on this display.

1. Press ENTER/REC ADV.

If you make no entries on this display, you tell DFU there is only one display format for the MASTERS file.

The DFU audit control prompt is now displayed.

```
AUDIT CONTROL PROMPT
Enter the following:
Add/delete records allowed:  *YES
Change records allowed:    *YES
Key changes allowed:       *YES
Print additions:           *NO
Print changes:             *NO
Print deletions:          *NO
Data error option
(*NOTIFY *DISPLAY *CHANGE): *NOTIFY
```

Accept all of the defaults on this display.

1. Press ENTER/REC ADV.

You are ready to exit the definition part of DFU.

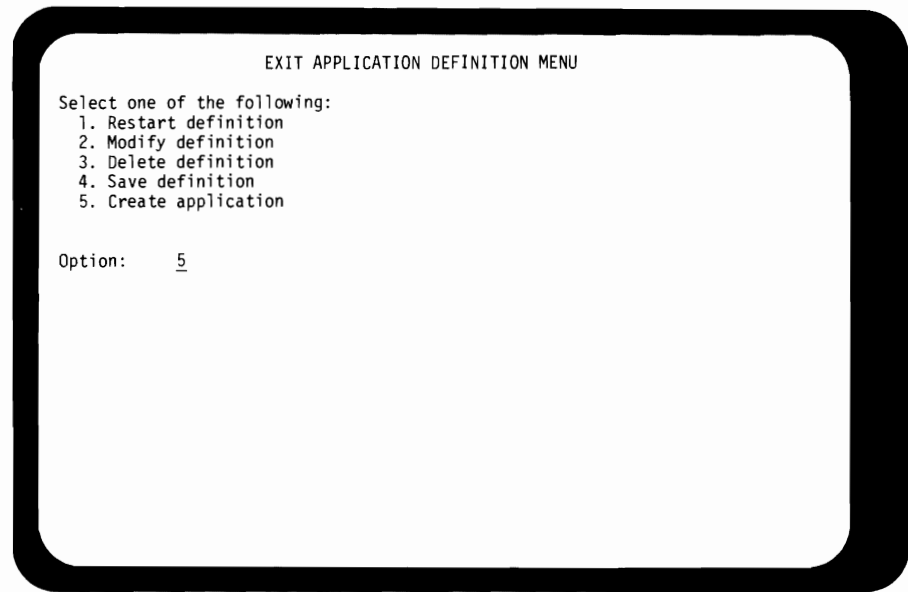

To create the application, accept the default option 5.

1. Press ENTER/REC ADV.

Using the definition, the application is ready to be created.

```
APPLICATION CREATION PROMPT

Enter the following:
Application name:          DFUEXER
Library name:             S38DFU
Public authority:         1 (1-Normal 2-None 3-All)
Adopt owner's user profile: N (Y-Yes N-No)
Source listing:           N (Y-Yes N-No)

Dump internal data areas: N (Y-Yes N-No)
Generate code listing:    N (Y-Yes N-No)
```

Accept the defaults for this display.

1. Press ENTER/REC ADV.

While the DFU application is being created, a message appears at the bottom of the display.

```
APPLICATION CREATION PROMPT

Enter the following:
Application name:      DFUEXER
Library name:         S38DFU
Public authority:     1 (1-Normal 2-None 3-All)
Adopt owner's user profile: N (Y-Yes N-No)
Source listing:       N (Y-Yes N-No)

Dump internal data areas: N (Y-Yes N-No)
Generate code listing:  N (Y-Yes N-No)

DFU Application creation in progress.
```

You make no entries at this time. The next display appears when the application is created.

After a successful application creation, the execution menu is displayed.

```
DFU EXECUTION MENU

Select one of the following and enter values below:
1. Display information about an application
2. Change data (add, delete, change, or verify records)
3. Display data (display data base records)

Option:          3
Application name: DFUEXER  (*-Application selection list)
Library name:    S38DFU

HELP-Help  CF2-Previous display
Application program DFUEXER.S38DFU successfully created.
```

Do the following:

1. Type the number 3.
2. Verify the application and library names.
3. Press ENTER/REC ADV.

The display data prompt appears.

```

                                DFU DISPLAY DATA PROMPT
Application name:  DFUEXER      Library:  S38LIB
Enter application execution information:
File name:       MASTERS      (*-File selection list)
Library name:    S38DFU
Member name:     _____ (*-List Blank-First member)

HELP-Help  CF2-Previous display  CF3-File information
```

Verify the file and library names.

1. Press ENTER/REC ADV.

The inquiry application is started.

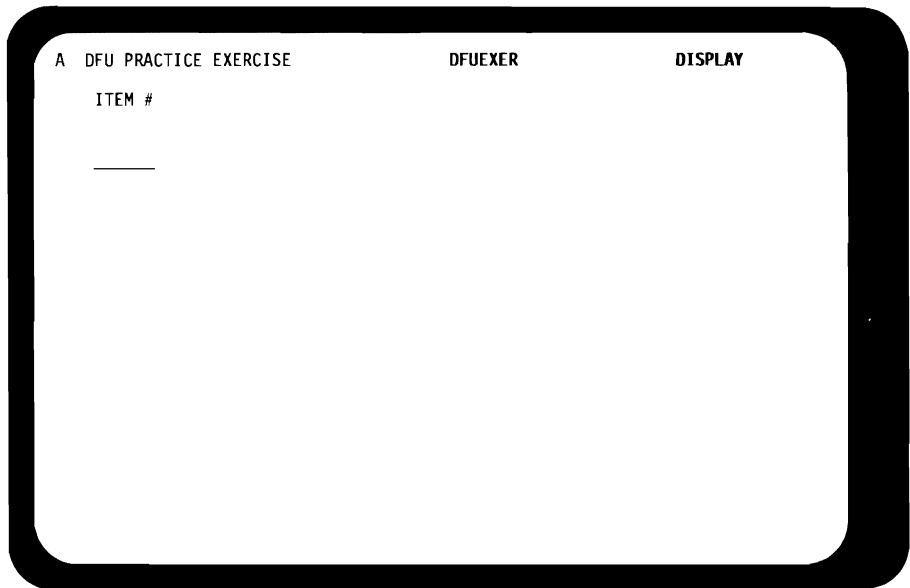

```
A DFU PRACTICE EXERCISE          DFUEXER          DISPLAY
ITEM #
_____
```

Notice the “Entry Format Identifier” at the top left of the display.

Make the following entries:

1. Type an item number — 2010.
2. Press the FIELD EXIT key. Your entry is right-adjusted, and the inquiry result display is presented automatically.

VALID ITEM NUMBERS

01080	20936
02010	20939
02030	33524
02070	33525
03060	33621
12940	33639
12960	33651
15001	33776
15003	33860
15057	33950
20832	40029
20933	40039

Inquiry information display for item number 2010.

A DFU PRACTICE EXERCISE			DFUEXER		DISPLAY
ITEM #	VENDOR	LIST PRICE	COST	QTY ON-HAND	QTY ON-ORDER
02010	2000	6.50	4.00	120	72

At this point, there are several options that you may do. Try several of the following, trying option 4 last.

1. Press ENTER/REC ADV to return to the initial inquiry display and enter another item number. Try item number 2030.
2. Use the ROLL UP and/or ROLL DOWN keys on this display or the initial inquiry display to scroll through the file.
3. Press ENTER/REC ADV to return to the initial inquiry display. Enter the invalid item number 55555.

The display will show headings without values. Do step 4 from this display—the Command Function key 1 is active only from this display.

4. Press Command Function key 1 to display the Exit Application Prompt and end the inquiry job.

You have indicated you are finished with the inquiry job.

```
EXIT APPLICATION PROMPT
Enter the following:
Exit application:  Y (Y-Yes  N-No)

                ADDED      DELETED      CHANGED      VERIFIED
                  0          0              0            0
```

Accept the yes default.

1. Press ENTER/REC ADV.

Sign off the simulated DFU exercise.

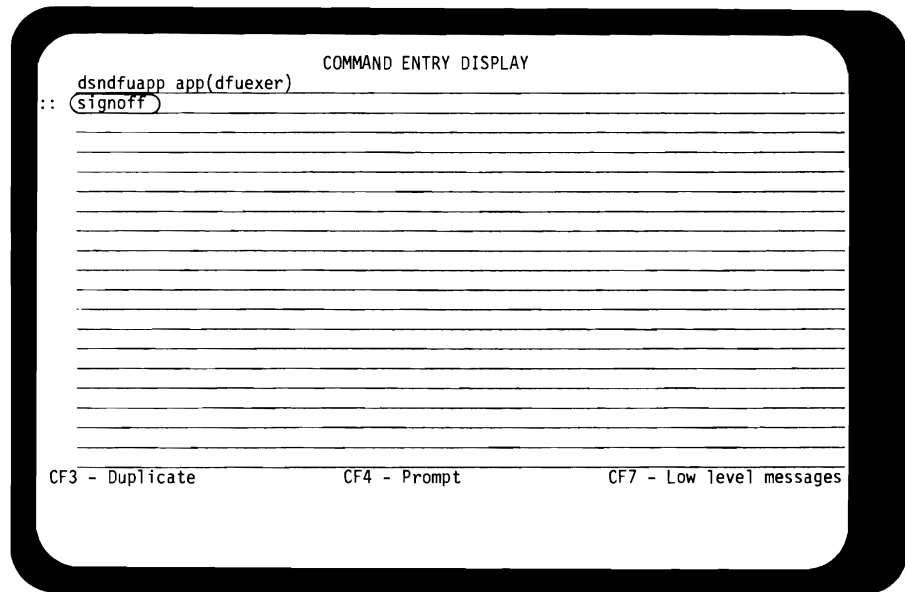

Do the following:

1. Type the command — signoff.
2. Press ENTER/REC ADV.

You have completed the DFU practice exercise. You may power off the display station.

If you have just read through the exercise, go to one of the display stations in the Guided Learning Center and try the exercise for yourself.

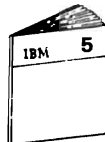

When you have finished, return to "Data File Utility Summary" in the Module 5 text.



MODULE 5 SUMMARY



This module introduced you to the first group of tools available with the System/38 to enhance productivity. The Interactive Data Base Utilities (IDU) save development and programming time and take advantage of System/38 data base and work station functions. Four programs make up the Interactive Data Base Utilities as described below.

Source Entry Utility

Source Entry Utility allows you to put source code and statements into machine readable form. The programmer can enter the following at the work station for storage in a source file:

- High level language programs like RPG III and COBOL
- DDS
- Control Language.

SEU provides data entry formats and syntax checking for each type of statement. SEU has other functions available, including:

- 
- Insert
 - Delete
 - Copy/Move
 - Prompting
 - Scan
 - Scan with substitution
 - Browse
 - Copy from one member to another.
- 

Data File Utility

Data File Utility is a tool you can use to develop data entry, update, and inquiry programs. It is prompt/response driven with a series of displays that ask questions about the application you are creating. Once the application is created, it can be used over and over again.

DFU is useful for:

- Rapid collection of data
- Data inquiry without you having to write, enter and compile a program
- File update and maintenance, again without requiring you to write a program to do it.

Query

Query is a very useful tool for producing reports without requiring you to write, enter, and compile a program.

Query supports:

- Record selection
- Field selection
- Record sequencing (sorting)
- Computations
- Output to a display or a printer.

Screen Design Aid

SDA is a productivity tool to aid you in creating and maintaining display formats and menus. It offers a much easier way to do these tasks without requiring separate steps for coding and entering the information used in creating the formats and menus.

Progress Check: Module 5

Read each question carefully. Record your answers in the space provided.

1. List the four Interactive Data Base Utility programs.

2. Which Interactive Data Base Utility would you use to:

Produce a report _____

Create an inquiry job _____

Create a menu interactively _____

Enter DDS for a logical file _____

3. Which, if any, of the following functions is not possible with DFU?
- a. Data entry
 - b. File update and maintenance
 - c. Inquiry

4. Which of the following functions is not available with Query?
- a. Record selection
 - b. Computation
 - c. Sorting
 - d. Data entry

5. Can SDA be used to interactively create a display screen format?

When you are finished with the questions, turn to the next page and review your answers.

Progress Check: Module 5 Answers

1. List the four Interactive Data Base Utility programs.

Source Entry Utility – SEU

Data File Utility – DFU

Query

Screen Design Aid – SDA

2. Which Interactive Data Base Utility would you use to:

Produce a report Query

Create an inquiry job DFU

Create a menu interactively SDA

Enter DDS for a logical file SEU

3. Which, if any, of the following functions is not possible with DFU?

a. Data entry

b. File update and maintenance

c. Inquiry

All are possible with DFU

4. Which of the following functions is not available with Query?

a. Record selection

b. Computation

c. Sorting

d. Data entry

Data Entry, which can be done with DFU. Query produces output reports

5. Can SDA be used to interactively create a display screen format?

Yes. SDA will prompt you for all required information then generate the DDS and create the display file.



When you feel you are ready, ask your administrator for Module 6 to continue the course.



Module 6. Programmer Services — Languages and Aids

MODULE PURPOSE

In the last module, you were introduced to one of the System/38 productivity tools, the Interface Data Base Utility programs. The IDU programs are readily usable by anyone, not necessarily just programmers or implementers. A user can work with DFU to create an inquiry program or Query to generate a report.

This module looks at the productivity tools available to the programmer directly. The purpose of this module is to address the primary tasks of the programmer/implementer.

- Programming, using a high level language
- Testing, getting a program to perform as it should once it is written.

This module looks at how the System/38 addresses these tasks.



TIME ESTIMATE

1 hour

MODULE OBJECTIVES

After completing this module, using applicable reference material, you should be able to:

- Name three programmer productivity facilities available to make application development more productive with the System/38.
- If you are a COBOL user, list three extensions to COBOL for the System/38.
- If you are an RPG user, list three new capabilities available with RPG III on the System/38.

COBOL Summary

System/38 COBOL supports:



- Physical and logical files
- Copying DDS definitions into the COBOL program for the Data Division
- Subfiles
- Indicators
- Remote and local work stations handled the same
- Linkage from and to all other System/38 high level languages.



RPG III Summary

RPG III is a major improvement on RPG of the past. It is more than additions to old RPG, but rather a powerful programming language built to take advantage of the System/38 and the work station environment.

RPG III supports:

- Externally described data base files
 - Physical and logical files
 - Full procedural file processing
 - Work station usage, both local and remote environments
 - Subfiles
 - Call a program from within a program, RPG III, COBOL or CL program
 - DO groups
 - A number of additional logic/processing operations such as
 - Compare and Branch
 - IF/ELSE
 - EXCPT to a name
 - TIME.
- 
- 

Progress Check: Unit 1 COBOL

Read each question carefully. Write your answers in the space provided.

1. From the list below, select three System/38 additions to COBOL. More than three additions may be listed below.

- _____ a. Remote and local work stations coded the same
- _____ b. Subfile handling
- _____ c. Call a CL program from within the COBOL program
- _____ d. Support for external described data files
- _____ e. Use of indicators for display files

2. What file organization method is used for a work station file?

3. Which COBOL statements are used to send information to a work station and input keyed information?

4. What are two other high level languages available on the System/38?

RPG III _____

Control Language _____

When you are ready, check your answers with those on the COBOL answer page.

Progress Check: Unit 1 RPG III

Read each question carefully. Write your answers in the space provided.

1. From the list below, select three functions supported by RPG III. The list may contain more than three functions.

- _____ a. Externally described data
- _____ b. Full procedural file processing
- _____ c. DO groups
- _____ d. Call a CL program from within an RPG III program
- _____ e. Subfile support

2. Are Input specifications always needed in RPG III?

3. Name 4 new operation codes in RPG III.

4. What are DO groups used for?

5. What are two other high level languages on the System/38?

COBOL _____
Control Language _____

When you are ready, check your answers with those on the RPG III answer page.

Progress Check: Unit 1 COBOL Answers

1. From the list below, select three System/38 additions to COBOL. More than three additions may be listed below.

- X a. Remote and local work stations coded the same
- X b. Subfile handling
- X c. Call a CL program from within the COBOL program
- X d. Support for external described data files
- X e. Use of indicators for display files

2. What file organization method is used for a work station file?

Transaction file

3. Which COBOL statements are used to send information to a work station and input keyed information?

WRITE to send a display format

READ to get data keyed by a user

4. What are two other high level languages available on the System/38?

RPG III

Control Language

PL/I

BASIC

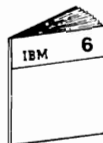

When you feel you are ready, return to Unit 2 in the module text and continue your study.

Progress Check: Unit 2

Read each question carefully. Write your answer in the space provided.

1. List two of the three programmer productivity aids available with the System/38.

2. When in Debug mode, can you specify whether production files will be updated?

3. How is the Debug facility controlled?

4. What is a "test library"?

5. What is a use for the System Request key?

When you are finished with the questions, turn to the next page for a review of the answers.

Progress Check: Unit 2 Answers

1. List two of the three programmer productivity aids available with the System/38.

Debug facility

Test libraries

Interactive programming

2. When in Debug mode, can you specify whether production files will be updated?

YES. The parameter default for the Control language command is NO, do not update files.

3. How is the Debug facility controlled?

With Control Language statements

4. What is a "test library"?

A means of testing and training in real environment without harming production files or programs. Test libraries are used to run in a "live" situation.

5. What is a use for the System Request key?

Interrupt an executing program to initiate another program at the work station. The interrupted program waits to be resumed.

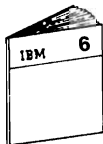

When you feel you are ready, return to "Module Summary" in the module text and continue your study.



MODULE SUMMARY

This module presented tools used by the programmer and the implementer to address their primary tasks of programming and testing.

If you are a COBOL user, you became aware of extensions to COBOL for the System/38.

If you are an RPG user, you learned of several new abilities available to you through RPG III.

Finally, you learned three programmer productivity facilities available to make application development more productive:

- Debug facility
- Test libraries
- Interactive programming.

These tools, along with the Interactive Data Base Utility programs, provide you with the Programmer Services needed to develop and implement your applications efficiently.

MODULE EXERCISE

Read each question carefully. Write your answers in the space provided.

1. If you are a COBOL user, list three extensions to COBOL for the System/38.

2. If you are an RPG user, list three new capabilities available with RPG III on the System/38.

3. Name three programmer productivity aids available to make application development more productive with the System/38.

When you have finished the questions, ask your Administrator for the answers.



You are now done with Module 6. When you feel you are ready, ask your Administrator for Module 7 to continue the course.



Module 7. Work Management and Object Management

MODULE PURPOSE

In earlier modules, you studied how System/38 and CPF provide control for the data base and work station environment. Data Base Data Management and Work Station Data Management are the CPF facilities that give you functions to easily use and control your information, whether it is stored or displayed.

You also need to control how things are stored and retrieved with the System/38. You want to know how activity is managed within the System/38 and how you can control the activity. This module introduces two more CPF facilities:

- Object Management
- Work Management.

Object Management provides the functions needed to place objects in storage and find stored objects when you want them.

Work Management provides facilities to enable work to flow through the System/38. It also controls the allocation of system resources to jobs running on the System/38.



TIME ESTIMATE

1 hour

MODULE OBJECTIVES

After completing this module, using applicable reference material, you should be able to:

- Define the words object and library as they apply to the System/38.
- List three Object Management functions available with the System/38.
- Define the terms interactive job and batch job as they apply to the System/38.
- List three facilities of Work Management available on the System/38.



Progress Check: Unit 1

Read each question carefully. Record your answers in the space provided.

1. Define the term object as it applies to the System/38.

2. Define the term library as it applies to the System/38.

3. List two types of objects.

4. From the list below, select three Object Management functions. The list may have more than three functions.

- a. Create a library
 b. Move an object from one library to another
 c. Save a library
 d. Power down the system
 e. Display the attributes of an object

5. What is a library list and how is it used?

When you have finished, check your answers with those on the next page.

Progress Check: Unit 1 Answers

1. Define the term object as it applies to the System/38.

An object is anything stored on the System/38 and given a name.

2. Define the term library as it applies to the System/38.

A library is a directory of objects. Libraries contain the location of objects in storage.

3. List two types of objects.

<u>Data files</u>	<u>Programs</u>
<u>Commands</u>	<u>Libraries</u>
<u>Display files</u>	<u>User profiles</u>

4. From the list below, select three Object Management functions. The list may have more than three functions.

a. Create a library
 b. Move an object from one library to another
 c. Save a library
 d. Power down the system
 e. Display the attributes of an object

5. What is a library list and how is it used?

The libraries to be searched to find an object. Libraries are searched in the order they are specified in list. Libraries are searched until the first occurrence of the object or all libraries have been searched unsuccessfully.

The operations can be broken into two categories
1. General Object Operations
2. Library Operations



When you feel you are ready, return to Unit 2 in the module text and continue your study.

Progress Check: Unit 2

Read each question carefully. Record your answers in the space provided.

1. List and briefly describe two facilities of Work Management on the System/38.

2. Define the term interactive job as it applies to the System/38.

3. List the two types of spooling available on the System/38.

4. Define the term batch job as it applies to the System/38.

When you are finished with the questions, turn to the next page to review your answers.

Progress Check: Unit 2 Answers

1. List and briefly describe two facilities of Work Management on the System/38.

Multiprogramming – handling more than one program request at one time

Multiple user programs – write all programs as if only one user at a time

Spooling – processing independent of input and output devices

Queues – list of items waiting to be serviced by some part of the system

Messages – means of communication between the user and the system

Subsystems – predefined operating environments to manage workflow and system resources.

2. Define the term interactive job as it applies to the System/38.

A dialog exists between the user and the system while the job is active

3. List the two types of spooling available on the System/38.

Input spooling

Output spooling

4. Define the term batch job as it applies to the System/38.

A series of steps that do not require any work station interaction with a user while executing



When you feel you are ready, return to "Module Summary" in the module text.

NOTES

Object Management provides the functions needed to place objects in storage and find stored objects when you need them.

Work Management provides facilities to enable work to flow through the System 38. It also controls the allocation of system resources to jobs running on the System/38.

An object is made up of a set of attributes and a value.

The attributes include

1. a name
2. a type of object
3. size of the object
4. date the object was created
5. optionally, a text description provided by the person who created the object

The value is the collection of information stored in the object

Several objects may have the same name as long as they are of different types or are assigned different storage locations. Two objects of the same name and type can only exist in different libraries

MODULE SUMMARY

This module introduced two more parts of CPF:

- Object Management
- Work Management.

Object Management keeps track of what is stored within the System/38.

- An object is anything stored within the System/38.
- A library is a directory of objects.

With Object Management, you can:

- Display or print the attributes of an object or group of objects. *General Object Operations*
- Limit the use of an object by other users — restrict what a user might do with an object.
- Change the ownership of an object.
- Move an object from one library to another.
- Rename an object.
- Save and restore an object or group of objects — provides backup copies for recovery purposes.
- Create or delete an object.
- Create or delete a library — when a library is deleted, any objects in it are also deleted. *LIBRARY OPERATIONS*
- Clear a library — deletes all the objects but leaves the library.
- Display the contents of a library.
- Save and restore a library — to create backup copies for recovery procedures.

Work Management provides facilities to manage the flow of work and control system resources.

The facilities provided by Work Management include:

- Multiprogramming — handling more than one program request at a time, using paging to overcommit main storage
- Multiple-user programs — programs written as if to be used by only one user at a time; program is divided into read only code and variable code
- Spooling — makes processing independent of input and output devices
- Subsystems — predefined operating environments used by System/38 to manage workflow and system resources
 - Available predefined subsystems include interactive, batch and spool
 - You can define your own for your operating requirements
- Queues — a list of items waiting to be serviced by some part of the system
- Messages — the means of communication between the user and the system.

MODULE 7 EXERCISE

Read each question carefully. Record your answers in the space provided.

1. Define the following terms:

a. Object _____

b. Library _____

c. Interactive job _____

d. Batch job _____

2. List three Object Management functions available with the System/38.

3. List three facilities of Work Management available on the System/38.

When you have finished the questions, ask your Administrator for the answers.



When you feel you are ready, ask your Administrator for Module 8 to continue the course.



Module 8. System Service Facilities

MODULE PURPOSE

Module 8 is the last module of this course. In the first module, you were introduced to the categories of programming that make up CPF. In each of the following modules, you looked at each of those categories in more detail. One category remains, System Service programs.

The primary purpose of this module is to look at the System Service facilities available with the System/38. In addition, Module 8 discusses some conversion and installation facilities for the System/38, and, because it is the last module, provides a Course Summary.

TIME ESTIMATE

1 hour



MODULE OBJECTIVES

After completing this module, using applicable reference material, you should be able to:

- List two System Service facilities available to use with the System/38.
- List two conversion and installation facilities available to aid in the installation of a System/38.

NOTES

File Reference Function

DSPFD Display File Description

DSPPGMREF Program File Reference

(what file a program uses)

DSPFFD Display File Field Description

(provides field-level information about a file)

The File Reference functions allow you to find out where and how files and fields are used, and how fields are defined. By placing the output from these functions in a data base file, you can analyze the information in whatever way you need.

eg use DSPFFD to place field data for several files in a file. Using a QUERY function, perform a where-used analysis on certain fields to research the impact of changes to a data base.

Progress Check: Unit 1

Read each question carefully. Record your answers in the space provided.

1. List two System Service facilities available with the System/38.

2. List the three basic components of System/38 security.

3. List three items that can be specified as part of a User Profile.

4. List the two major groups of rights you can assign for object authority.

5. From the list below, select all the facilities that can be used as part of a Save/Restore function.

- _____ a. Journal logging
- _____ b. System record of media used for save
- _____ c. System record of date of last save operation for an object
- _____ d. Save only objects changed since last save operation
- _____ e. Save and Restore from either diskette or tape

When you are ready check your answers with those on the next page.

Progress Check: Unit 1 Answers

1. List two System Service facilities available with the System/38.

File Reference Function
Security
Save/Restore

2. List the three basic components of System/38 security.

User Profiles
System Service Functions of CPF *module 2 514*
Object Authorization

3. List three items that can be specified as part of a User Profile.

<u>User ID, or Name</u>	<u>Password</u>
<u>Authorized Objects</u>	<u>Owned objects</u>
<u>Maximum Storage</u>	<u>Initial Program</u>
<u>Maximum Priority</u>	
<u>Special Authority</u>	

4. List the two major groups of rights you can assign for object authority.

Object rights Data rights

5. From the list below, select all the facilities that can be used as part of a Save/Restore function.

- X a. Journal logging
 X b. System record of media used for save
 X c. System record of date of last save operation for an object
 X d. Save only objects changed since last save operation
 X e. Save and Restore from either diskette or tape



When you feel you are ready, return to Unit 2 in the module text and continue your study.

Progress Check: Unit 2

Read the question carefully. Record your answer in the space provided.

1. List two Conversion and Installation facilities available to aid you in the installation of a System/38.

Feel free to list more than two, if you wish.

When you are ready, turn to the next page to review the answers.

Systems Services function of CPF provides the extensive security facilities as well as the SAVE/RESTORE facilities.

- Security requires each user to sign on using a valid password. The password allows the system to locate the user's Profile.

Progress Check: Unit 2 Answers

1. List two Conversion and Installation facilities available to aid you in the installation of a System/38.

Data Base Data Management

Work Station Data Management

Interactive Data Base Utilities

High level language capabilities

SPOOL functions

Security and Save/Restore

Conversion Reformat Utility

Batch Conversion Aid for System/3

COBOL Conversion Aids

System/34 Conversion Aid

System/36 Conversion Aid

Education (last but not least)

When you feel you are ready, go to the next page to continue the course.

MODULE SUMMARY

System Service programs provide the functions you need to control and administer your programs and data.

Field reference files and the file reference function allow you to maintain data base descriptions. They give you one place to look for data base information such as field definitions and to research the impact of changes to the data base.

With the System/38, all data is online and therefore must be protected from damage and unauthorized use. Security and Save/Restore provide functions necessary to maintain the integrity of your data and programs.

Security can be as simple as only a password, to as complex as complete control of who can do what with each individual object. The User Profile for each system user defines the range of each person's capabilities on the system.

Save/Restore facilities allow you to design and implement the recovery mechanism you need for your system. Functions such as date of last-save logging and journal logging help you to maintain accurate information.

This module discussed Conversion and Installation facilities available to you with the System/38. These facilities are designed to make your job of installing a System/38 simpler.

Some of the System/38 facilities discussed are:

- Data Base Data Management
- Work Station Data Management
- IDU programs
- High level languages
- SPOOL files
- Security and Save/Restore.

Other licensed programs available to help you convert to the System/38 are:

- Conversion Reformat Utility
- Batch Conversion Aid
- COBOL Conversion Aids
- System/34 Conversion Aid
- System/3 Data Base Techniques Conversion Aid.

Education is available to give you the skills you need to effectively and efficiently install your System/38.



Return to "Course Summary" in the module text.

Course Summary

This course provided you with an overview of many System/38 functions and facilities. The course introduced you to new terminology, ideas and concepts associated with the System/38.

Module 1 reviewed some of the System/38 hardware components and introduced the System/38 software.

The software running the System/38 is Control Program Facility, CPF. It is made up of six functional areas:

- Data Management, including Data Base Data Management and Work Station Data Management
- Control Language
- Programmer Services
- Work Management
- Object Management
- System Services.

These functional areas of CPF became the major topics of each module of the course.

Module 2 looked at Data Base Data Management. You learned about:

- Externally described data using DDS
- Physical and logical files and how they are defined.

Module 3 introduced you to Work Station Data Management. You became aware of:

- The types of jobs done with a work station
- Capabilities to aid in work station design coding and use, such as subfiles, validity checking, DDS and SDA.

Module 4 showed you how to communicate with the System/38 through Control Language. You learned that:

- Control Language is the single interface to all system functions.
- Control Language can be compiled into CL programs for faster execution and control of application flow.

Module 5 described the use of the Interactive Data Base Utility programs, which are:

- Source Entry Utility
- Data File Utility
- Query
- Screen Design Aid.

Module 6 looked at high level languages and test functions. You became aware of:

- COBOL extensions for the System/38, if you are a COBOL user
- RPG III functions, if you are an RPG user
- Productivity aids for application development including Debug, Test Libraries, and Interactive Programming.

Module 7 introduced two areas of CPF: Object Management and Work Management:

- Object Management keeps track of what is stored within the System/38.
- Work Management provides facilities to manage the flow of work through the System/38 and control system resources.

Finally, Module 8 discussed facilities available to help you administer the System/38, which are:

- File Reference Function to access and maintain accurate data base descriptions
- Security to protect your data and programs from unauthorized use
- Save/Restore functions to implement the recovery mechanisms you need.

Module 8 also touched on some Conversion and Installation considerations to be aware of for future reference and planning.

System/38 Curriculum Overview

Guided Learning Center Course Offerings

The following list shows the major topics of each module for the available System/38 Guided Learning Center courses.

System/38 Fundamentals

Module 1. Course Introduction

- Hardware Overview
- Software Overview

Module 2. Data Base Data Management

- Data Base Data Management Introduction
- Building the Data Base
- Additional Topics on Building Data Base

Module 3. Work Station Data Management

- Work Station Overview
- Work Station Implementation

Module 4. Control Language

- Control Language and CL Programs

Module 5. Programmer Services – Utilities

- Interactive Data Base Utilities

Module 6. Programmer Services – Languages and Aids

- High Level Languages
- Programmer Productivity Aids

Module 7. Object Management and Work Management

- Object Management
- Work Management

Module 8. System Service Facilities

- System Service Facilities (Security, Save/Restore)
- Conversion and Installation Facilities

System/38 Application Programming

- Module 1. Course Introduction
 - Course Overview
 - IBM System/38 Reference Library
 - Familiarization Exercise
- Module 2. System/38 Review
 - System/38 Review – CPF
 - Review Questions
- Module 3. System/38 Operation
 - The Command Entry Display
 - The Programmer Menu
- Module 4. Building the Data Base
 - Review of Data Base Concepts
 - Data Description Specifications
 - Transferring DDS to Machine Readable Media
- Module 5. Introduction to Interactive Processing
 - Fundamentals of Interactive Processing
- Module 6. Data File Utility
 - Introducing DFU
 - How to Design/Create a DFU Application
 - How to Execute a DFU Application
 - How to Change a DFU Application
 - How to Delete a DFU Application
- Module 7. Display Files
 - Concepts of Display Files
 - Creating Simple Display Files
 - Creating More Complex Display Files
- Module 8. RPG III Interactive Programs
 - RPG III for Simple Display Files
 - RPG III for More Complex Display Files
- Module 9. COBOL Interactive Programs
 - COBOL for Simple Display Files
 - COBOL for More Complex Display Files
- Module 10. Introduction to Batch Processing
 - Fundamentals of Batch Processing
 - How to Run a Batch Job
- Module 11. RPG III Batch Programming
 - RPG III for Batch Programming
- Module 12. COBOL Batch Programming
 - COBOL for Batch Programming



System/38 Application Programming

- Module 13. The Query Facility
 - Introducing Query
 - Application Creation and Execution
 - Modifying a Query Application
- Module 14. DEBUG Facilities
 - Purpose of Debug Mode
 - Operations in Debug Mode
- Module 15. Control Language Programs
 - Concepts of Control Language Programs
 - CL Programs for Menu Driven Applications
- Module 16. Screen Design Aid
 - Introducing SDA
 - SDA for Testing Display Files
 - SDA for Creating Menus
 - SDA for Creating Display Formats

System/38 RPG III and Structured Programming

- Module 1. Course Introduction
 - Course Overview
 - Prerequisite Review
- Module 2. Procedural File Operations
 - File Processing
 - File Processing Operation Codes
- Module 3. Structured Programming Concepts
 - Fundamentals of Structured Programming
- Module 4. Structured Programming Implementation
 - Structured Programming Operation Codes
 - Developing a Structured Program
- Module 5. Program Compilation and Testing
 - Compiling, Testing, and Debugging Programs
- Module 6. Subprograms
 - RPG III External Subroutines
- Module 7. Subfile Programming
 - Subfile Coding – Inquiry
 - Subfile Coding – Update
- Module 8. Data Areas
 - Use and Coding of Data Areas
- Module 9. Data Structures
 - Use and Coding of Data Structures
- Module 10. Handling Exception Errors
 - How to Handle Exception Errors in Programs
- Module 11. Additional RPG III Functions
 - RPG Enhancements
 - Multiple Device Files
 - Commitment Control
- Module 12. Program Described Work Station Files
 - How to Describe Work Station Files Within a Program
- Module 13. Printer Device Files
 - Externally Described Printer Files

System/38 Implementation Topics

Module 1. System Installation

- Pre-installation
- Installing Your System
- Post-installation

Module 2. Security

- Physical Security
- System Security
- System Security Implementation

Module 3. Work Management

- Concepts
- Interactive Job Processing
- Batch Job Processing
- Considerations

Module 4. Control Language Programming

- Using and Coding CL Programs
- Communicating Between Programs
- Creating Objects with CL Programs
- Character String Operations
- Data Areas
- Retrieving System Values and Job Status

Module 5. Source Entry Utility Additional Topics

- Services Display Operations
- Exit Display Options
- Insert Skeleton

Module 6. Message Handling

- Basic Message Handling
- Creating User Message Queues and Message Files
- Message Handling with CL Programs
- Problem Determination with Message Handling

Module 7. Data Base Topics

- File Sharing
- Copy Commands
- Journaling
- Commitment Control

Module 8. Save/Restore

- Save/Restore Concepts
- Saving Information
- Restoring Information
- Save/Restore Considerations

















ZR30-0780-05



Printed in U.S.A.