

MEMOREX

1377 Display Station Operation and Service Manual

1377.20-01

Publication Number 1377.20-01

March 1976 edition

The information in this publication is subject to periodic revisions and to updates by Publications Bulletins. A bulletin is identified as Publication Number 1377.20-01XX, where "XX" equals "01" for the first bulletin released.

To request copies of this publication or any bulletin, send a Supplies Requisition (form number 7020) using the publication number to: Memorex Corporation, Marketing Distribution Center, San Tomas at Central Expressway, Santa Clara, California 95052.

A readers' comments form is provided at the back of this publication. If the form has been removed, please send comments to Memorex Corporation, Department 6940, M/S 14-07, San Tomas at Central Expressway, Santa Clara, California 95052.

© 1976 MEMOREX CORPORATION

PREFACE

This manual provides information about the operation of and service requirements for the Memorex 1377 Display Station. The Introduction, Section 1, lists the advantages of the 1377 Display Station over other cathode-ray tube display stations. A description of the 1377 display, keyboards, and optional selector light pen operation is provided in Section 2.

Sections 3, 4, and 5 comprise installation procedures, maintenance instructions, and programming notes, respectively.

Because the Memorex 1377 is designed to interface specifically with the IBM 3271, 3272, or 3791 Control Unit, the reader should refer to the following IBM publications for system information:

- An Introduction to the IBM 3270 Information Display System, GA27-2739
- IBM 3270 Information Display System Component Description, GA27-2749
- Introduction to Programming the IBM 3270, GC27-6999
- A Guide to Using the Test Request Feature on IBM 3270 Information Display Systems, GA27-2774
- An Introduction to the IBM 3790 Communication System, GA27-2767

TABLE OF CONTENTS

Section		Page
1	INTRODUCTION	1-1
2	OPERATOR'S GUIDE	2-1
2.1	1377 DISPLAY	2-1
2.2	KEYBOARD OPERATION	2-2
2.3	1377 SELECTOR LIGHT PEN	2-13
3	INSTALLATION	3-1
3.1	SPECIFICATIONS	3-1
3.2	CABLE REQUIREMENTS	3-3
3.3	PROCEDURE	3-3
4	MAINTENANCE	4-1
4.1	DISASSEMBLY/ASSEMBLY	4-1
4.1.1	Monitor Disassembly	4-1
4.1.2	Keyboard Disassembly	4-7
4.2	MONITOR ALIGNMENT	4-10
4.2.1	Voltage Levels	4-11
4.2.2	Horizontal Size	4-13
4.2.3	Horizontal Frequency	4-14
4.2.4	Vertical Size	4-15
4.2.5	Vertical Linearity	4-16
4.2.6	Master Brightness	4-17
4.2.7	Centering	4-18
4.2.8	Tilted Raster	4-19
4.2.9	Focus	4-20
4.3	TROUBLESHOOTING	4-20
5	PROGRAMMING NOTES	5-1

SECTION 1

INTRODUCTION

The Memorex 1377 Display Station, shown in Figure 1-1, consists of a high-performance cathode-ray tube (CRT), a typewriter or operator console keyboard, and an optional selector light pen. These Display Stations are used in local or remote clusters to display alphanumeric data, and to enter data into and retrieve data from an IBM System/360 or System/370. Figure 1-2 illustrates compatible system configurations.



FIGURE 1-1. MEMOREX 1377 DISPLAY STATION

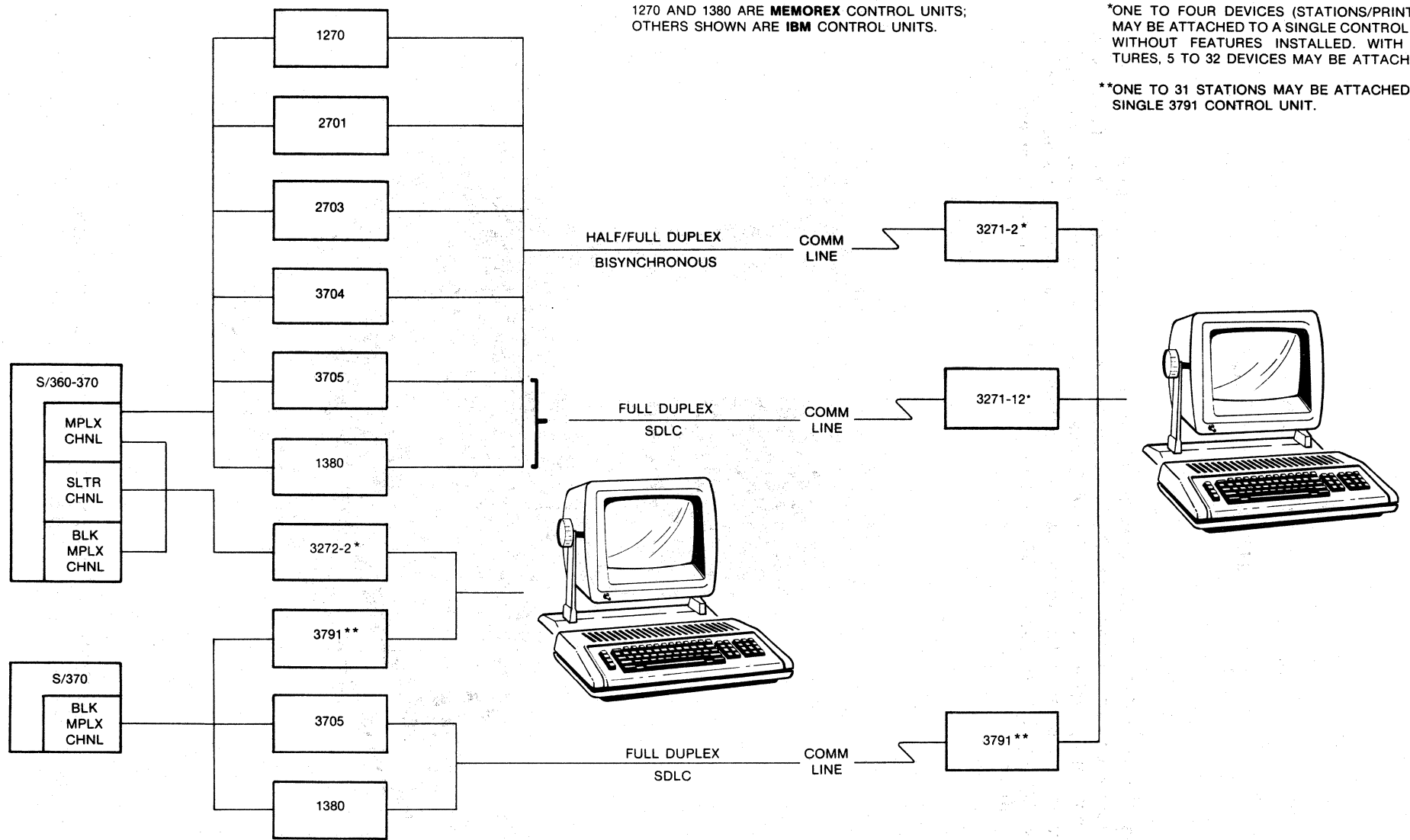

FIGURE 1-2. LOCAL AND REMOTE CLUSTERS OF 1377 DISPLAY STATIONS IN COMPATIBLE SYSTEM CONFIGURATIONS

The Memorex 1377 is a plug-compatible replacement for the IBM 3277-2 Display Station used in IBM 3270 Information Display Systems. Unique advantages of the 1377 are provided by the following **standard** features.

- Upper/lower case graphics.
- Keyboard shift lock — Permits full secretarial shift.
- Audible Alarm for source error detection — Alerts the operator that a keyboard entry was not accepted or that the screen is full. Additional utilization of the Audible Alarm may be provided by the application program.
- Horizontal frequency of approximately 19 KHz — Provides quiet operation.
- Non-glare screen — Reduces eye strain.
- Refresh cycle of 60 Hz — Eliminates eye fatigue caused by noticeable blinking of the display.
- Reverse video cursor (dark print on light background when remainder of screen displays light print on a dark background) — Indicates clearly where the next character typed on the keyboard will appear on the screen.
- Additional line (line 25) — Indicates line and column numbers of cursor and defines status (i.e., SYSTEM AVAILABLE, INPUT INHIBITED, and INSERT MODE).
- Keyboard Numeric Lock — Allows the programmer to set up fields that will accept only numeric entries from the keyboard.
- Tiltable screen — Flexible position adjustment allows the screen to be tilted for maximum operator convenience or unusual operating environments.
- Fewer components resulting in reduced power consumption and increased reliability.

SECTION 2

OPERATOR'S GUIDE

2.1 1377 DISPLAY

The 1377 display, shown in Figure 2-1, allows up to 1920 characters to be entered and/or displayed in an area 24 lines by 80 columns. An additional line is provided at the bottom of the screen to display the cursor line and column number positions and machine status as illustrated in Figure 2-1.

The display may be unformatted or formatted, depending on the application program. An unformatted display allows entering data in any line except the 25th line, which is reserved for cursor location and status information. A formatted screen provides display fields intended for certain types of information, such as customer name, date, model number, etc.

The keyboard Numeric Lock feature prevents entering any type of data except numeric data (numerals, minus sign, period, and DUP) into certain fields set up by the application program. If the operator attempts to enter an alphabetic character into a program-controlled numeric field, INPUT INHIBITED appears on the screen and the Audible Alarm sounds from the the station. The computer may also indicate to the operator erroneous data entry into other display fields, although the alarm and system status may not indicate the error unless directed to do so by the program.

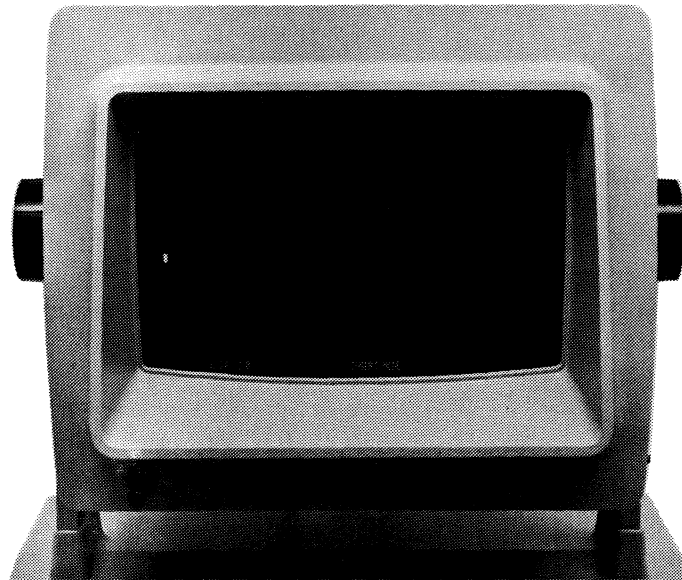

FIGURE 2-1. 1377 DISPLAY

Some of the fields on a formatted screen are protected by the program. Any attempt to enter data in a field that is protected is inhibited. A protected field is generally the title of the information to be entered by the operator (i.e., MODEL NO.). Data may or may not be displayed, depending on the program. In a personnel history, for example, SALARY display and/or modification would probably be inhibited to the operator.

Since the program knows what type of information to expect from the fields set up on a formatted screen, it can process the data much more rapidly than it can process data entered randomly on an unformatted screen.

The Power switch for operation of the 1377 Display Station is located in the lower lefthand corner of the display as shown in Figure 2-1. The switch is a push-pull switch which provides power to the Display Station when pulled out and removes power when pushed in. In addition, the operator can adjust the brightness of the display by turning the switch clockwise for a brighter image or counterclockwise to dim the image.

To accommodate a variety of viewing angles, the 1377 display may be adjusted to individual preference. This adjustment is made by turning the knobs located on each side of the display (reference Figure 2-1) in a counterclockwise motion to release the display, adjusting the screen as desired, and turning the knobs in a clockwise motion to tighten them, thus securing the desired viewing angle.

As noted in the Introduction, the 1377 display has several advantages for the operator that are provided as standard features of the Display Station. A non-glare screen and a rapid refresh cycle (60 Hz) eliminate eye fatigue caused by glare and blinking of the display. Features are also provided for quick reference and early error detection purposes. The reverse video cursor (light rectangular area on a dark background as shown in Figure 2-1) indicates clearly where the next character to be entered will appear on the screen. In addition to this quick reference aid, the 25th line continuously displays the cursor line number and column number and spells out the current status information for the operator.

2.2 KEYBOARD OPERATION

Two keyboards are available with the Memorex 1377 Display Station: a standard 78-key EBCDIC typewriter keyboard (Figure 2-2) and a 78-key EBCDIC operator console keyboard (Figure 2-3). In addition, six local function keys (F1 through F6) are available for future capabilities.

The unshaded keys in Figures 2-2 and 2-3 are those keys which have an automatic repeat capability as long as they are pressed down (i.e., the SPACE bar). All other keys must be pressed down once for each keystroke.

NOTE

Any character key can automatically repeat itself when the operator simultaneously presses the SPACE bar and the character to be repeated. A Space will occupy the first position on the screen, but the character will repeat from that point until the operator releases the keys.

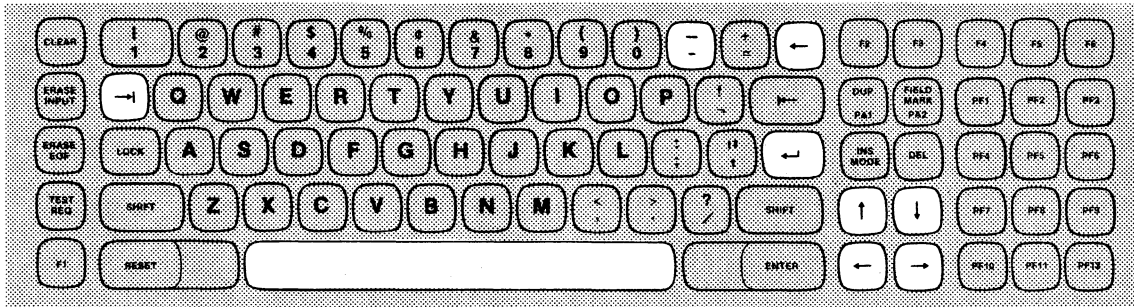

FIGURE 2-2. TYPEWRITER KEYBOARD

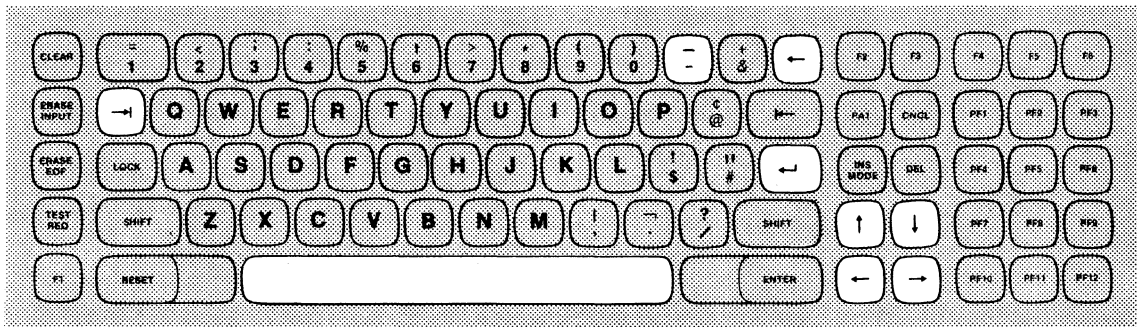

FIGURE 2-3. OPERATOR CONSOLE KEYBOARD

A Security Key Lock feature is provided as an optional feature to prevent unauthorized operation of either keyboard. Although the cursor appears on the screen when this feature is installed, the keyboard is inoperable unless the key is turned in the key lock where it must remain for the duration of keyboard operation. The Security Key Lock is located on the righthand side of the keyboard.

The operation of the Audible Alarm feature has been expanded to include these additional functions:

- Indicates that the operator has attempted to enter data while the system is in the INPUT INHIBITED mode.
- Indicates that the operator has attempted to tag a non-selectable field using the selector light pen.
- Indicates that the operator has attempted to enter non-numerical data into a program defined numerical field.

Although the status INPUT INHIBITED appears on the screen when a keyboard entry is not accepted, the sounding of the alarm alerts the operator to discontinue entry at the exact point where input is inhibited should the operator fail to see the status

indication appear on the screen. The Audible Alarm also indicates that the cursor is in the last character position on the screen. In addition, the Audible Alarm may be sounded by CPU control per the application program.

A description of the control, alphanumeric, symbol, and special purpose keys is provided below for each type of keyboard. The location of each key is shown as it is discussed. When keys are different or are in different locations on the two keyboards, illustrations of both keyboards are provided so that the differences may be compared easily. When the keys are identical on the two keyboards, only the typewriter keyboard is shown.

SHIFT/LOCK Keys

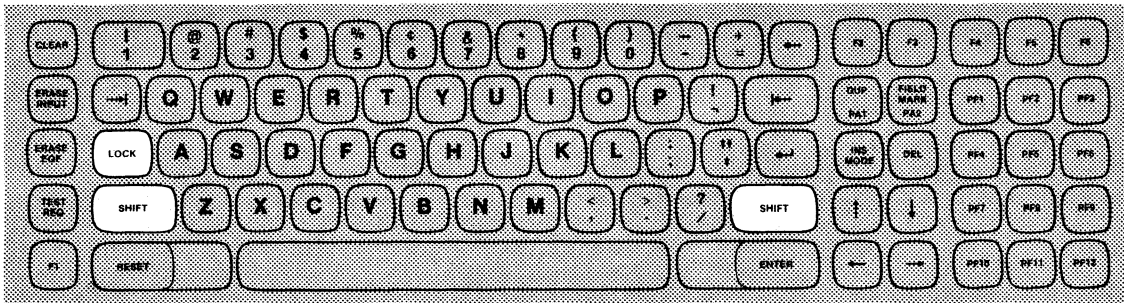

The SHIFT and LOCK keys are identical in function to those of a standard typewriter. When the SHIFT key is pressed in conjunction with a character key, the character shown on the upper half of the key is displayed. When the keyboard is shifted in conjunction with a dual-function control key, the function indicated on the upper half of that key is performed (i.e., DUP). Pressing a key without the SHIFT/LOCK key executes the character or function shown on the lower half of the key.

Pressing the LOCK key locks the keyboard in the shifted position until released by pressing either SHIFT key.

The 1377 keyboards provide a full secretarial shift. That is, when the LOCK key is pressed, the LOCK key remains down until released by pressing either SHIFT key. This provides the operator with a clear indication that the LOCK key is in the position desired before data is typed.

An advantage provided as a standard feature of the 1377 keyboard is the upper/lower case graphics display. When the SHIFT/LOCK keys are in an unshifted position, lower-case alphabetic characters are displayed on the screen; when shifted, upper-case letters are displayed.

SPACE Bar

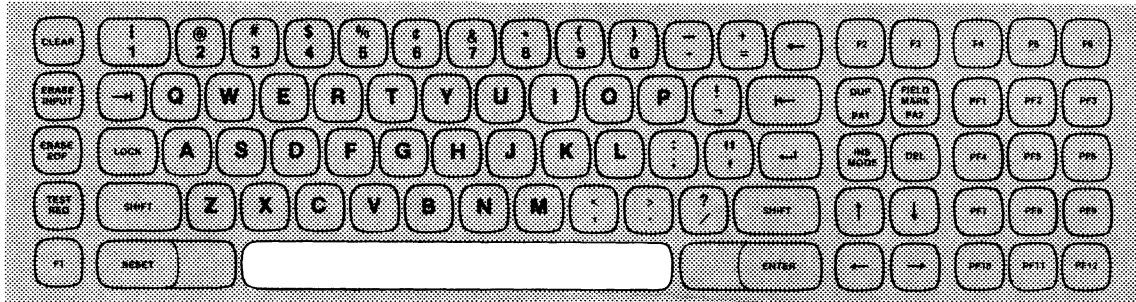

The keyboard SPACE bar is interpreted by the 1377 as any other character entry. When the SPACE bar is pressed, a space character replaces any character that appears in the position indicated by the cursor on the display. Therefore, caution should be taken not to use the SPACE bar to reposition the cursor.

The SPACE bar has an automatic repeat capability.

CURSOR CONTROL Keys

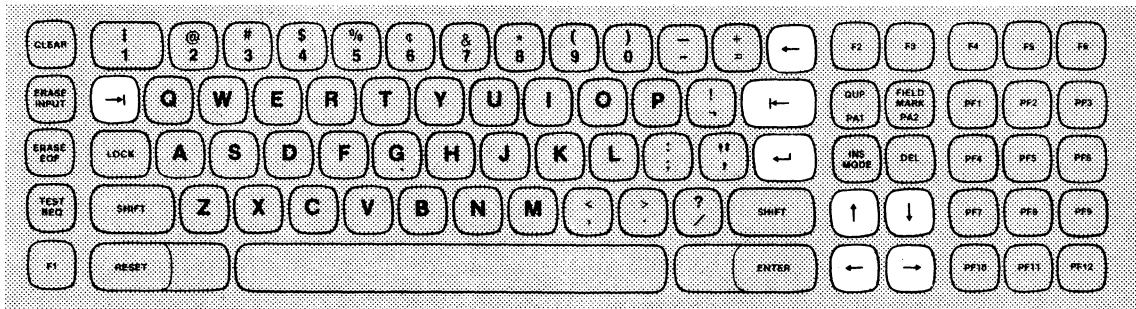

The cursor indicates to the operator where the next character entered will appear on the screen. Eight keys allow the operator to move the cursor quickly from one position to another. As noted in the individual key descriptions below, some of the CURSOR CONTROL keys move the cursor one character location at a time, while others move the cursor from one position on the screen to a position on a new line or at the beginning of a new field. The CURSOR CONTROL keys have automatic repeat capability with the exception of the backtab key. A brief description of each CURSOR CONTROL key function follows, with illustrations presented as required.

NEW LINE Key—

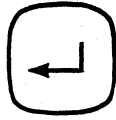

Moves the cursor to the first unprotected character position on the next line containing an unprotected data field. If no unprotected field exists, the cursor returns to line 1, column 1 of the screen.

TAB Key—

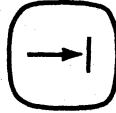

Moves the cursor to the beginning of the next unprotected data field. If the display is unformatted, the cursor moves to line 1, column 1.

BACKTAB Key—

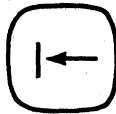

Moves the cursor back to the first unprotected character position in the field in which the cursor is located; if the entire field is protected or if the cursor is located at the beginning of the field, the cursor moves back to the first character location in the preceding unprotected input field.

HORIZONTAL and VERTICAL POSITIONING Keys—

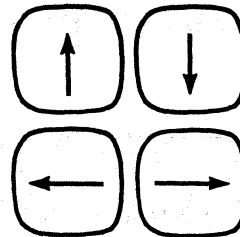

Moves the cursor one character position at a time in the direction indicated by the arrow. When located in the last character position in a line or column, the cursor moves to the opposite side of the screen (wraps around) if a positioning key is pressed. In the case of the horizontal keys, the cursor wraps around and appears on the righthand side of the line above if the arrow pointing to the left is pressed; the cursor wraps around and appears on the lefthand side of the line below if the key showing the arrow pointing to the right is pressed. When either vertical key is pressed, the cursor moves off the screen and reappears on the opposite end of the screen in the same column location.

BACKSPACE Key—

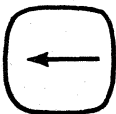

Moves the cursor one character position at a time to the left; operates the same as the left horizontal positioning key described above.

ALPHABETIC Keys

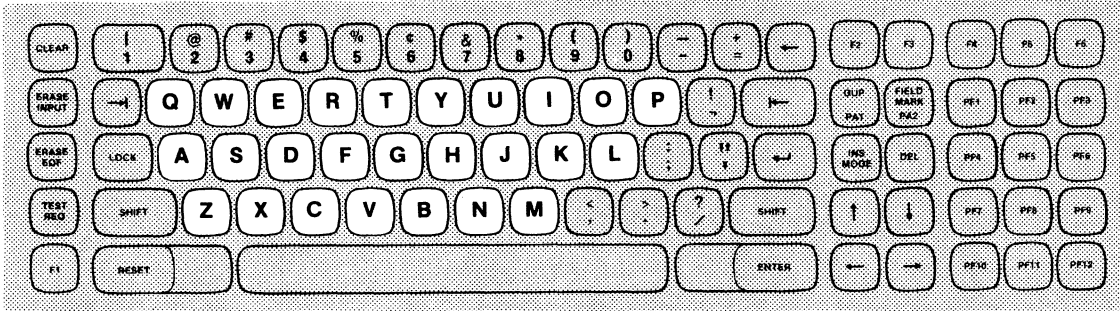

The ALPHABETIC keys on the 1377 are identical to those of a standard typewriter. Although only the upper-case letters appear on the keyboard, lower-case letters appear on the screen when the letters are typed and the SHIFT/LOCK keys are not pressed. The SHIFT/LOCK keys must be pressed in conjunction with an ALPHABETIC key to enter an upper-case alphabetic character.

NUMERIC Keys

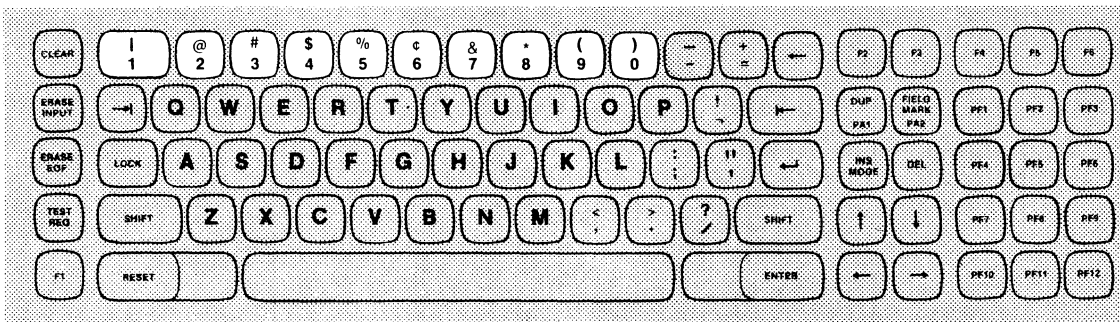

Numbers are entered and displayed on the screen by pressing the NUMERIC keys while the keyboard is in the unshifted position.

PUNCTUATION MARK and SYMBOL Keys

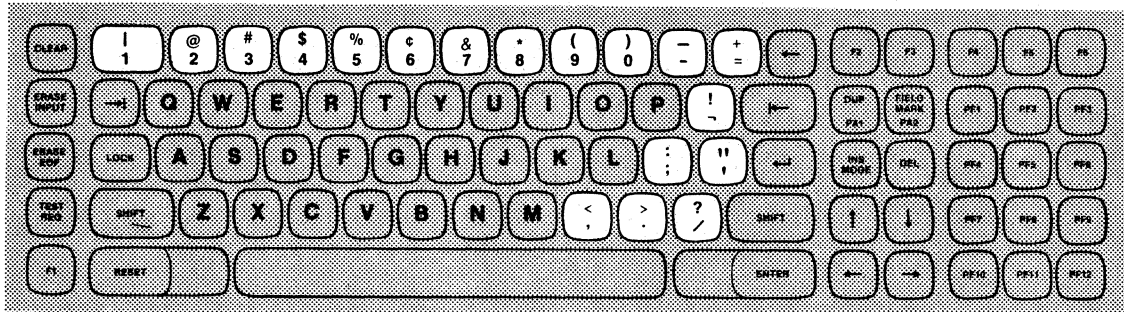

Typewriter Keyboard

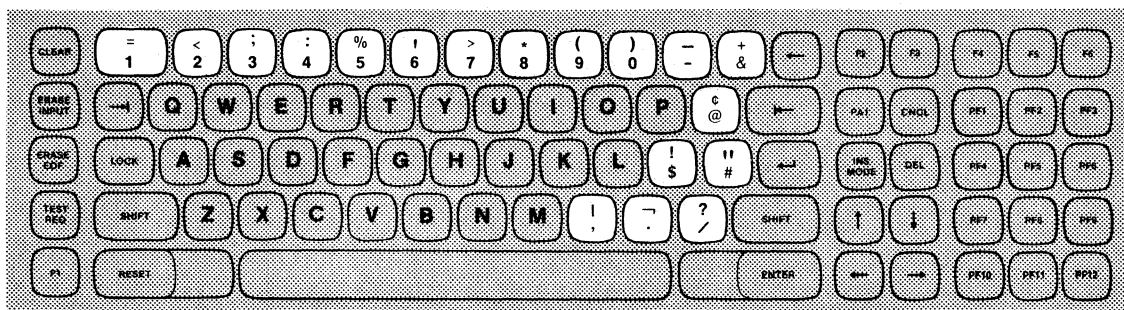

Operator Console Keyboard

PUNCTUATION MARKS and SYMBOLS are entered and displayed by pressing the appropriate key while the keyboard is in either the shifted (for characters appearing on the upper portion of the keys) or the unshifted (for characters appearing on the lower portion of the keys) position.

SYMBOLS and PUNCTUATION MARKS may be located in different keyboard positions and, in some cases, may be entirely different on the two types of 1377 keyboards. The names of the PUNCTUATION MARKS and SYMBOLS shown in the illustrations above are as follows:

UPPER HALF OF NUMERIC KEYS

TYPEWRITER KEYBOARD		OPERATOR CONSOLE KEYBOARD	
Key	Name	Key	Name
	Logical OR, Vertical Bar	=	Equals Sign
@	At Sign	<	Less Than Sign
#	Number Sign	;	Semicolon
\$	Dollar Sign	:	Colon
%	Percent Sign	%	Percent Sign
¢	Cent Sign	'	Apostrophe
&	Ampersand	>	Greater Than Sign
*	Asterisk	*	Asterisk
(Left Parenthesis	(Left Parenthesis
)	Right Parenthesis)	Right Parenthesis

UPPER/LOWER PUNCTUATION MARK AND SYMBOL KEYS

TYPEWRITER KEYBOARD		OPERATOR CONSOLE KEYBOARD	
Key	Name	Key	Name
—	Underscore } Automatic	—	Underscore } Automatic
-	Minus Sign } Repeat	-	Minus Sign } Repeat
			Capability
+	Plus Sign	+	Plus Sign
=	Equals Sign	&	Ampersand
!	Exclamation Point	¢	Cent Sign
¬	Logical NOT Sign	@	At Sign
:	Colon	!	Exclamation Point
;	Semicolon	\$	Dollar Sign
"	Quotation Mark	"	Quotation Mark
'	Apostrophe	#	Number Sign
<	Less Than Sign		Logical OR, Vertical Bar
,	Comma	,	Comma
>	Greater Than Sign	¬	Logical NOT Sign
.	Period	.	Period
?	Question Mark	?	Question Mark
/	Slash	/	Slash

CLEAR, ERASE INPUT, ERASE EOF, TEST REQ, and RESET Keys

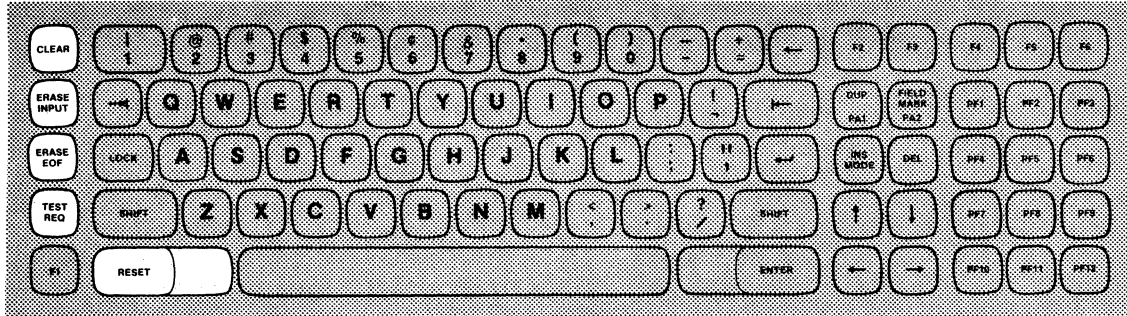

The CLEAR key erases the entire screen and returns it to an unformatted state. When the CLEAR key is pressed, INPUT INHIBITED appears in the status area on the 25th line of the display. Keyboard entry is then inhibited until released by the program or by pressing the RESET key.

The ERASE INPUT key erases all unprotected fields on the screen and moves the cursor to the first position where data may be entered. If the entire display is unformatted, the cursor moves to line 1, column 1 of the screen.

The ERASE EOF (End of Field) key erases all characters from the cursor position to the end of the unprotected field in which it is located. The cursor does not move when this key is pressed. The primary function of this key is to correct erroneous data entered by tabbing to the beginning of the data field, erasing data entered in that field by pressing ERASE EOF, and typing in the correct data.

The TEST REQ key signals the computer that a test message is on the screen and causes INPUT INHIBITED to display on the screen. Data entry is then inhibited until released by the program or by pressing the RESET key. After TEST REQ has been pressed, the computer should provide further instructions. For details regarding the use of this key, the reader should refer to the IBM manual *A Guide to Using the Test Request Feature on IBM 3270 Information Display Systems*, GA27-2774.

The RESET key resets the INSERT MODE and INPUT INHIBITED status indications, unless data is being transferred to or from the system. When these indications are not reset because of data being transferred, the RESET key must be pressed again after data transfer has been completed.

**DUP/PA1 and FIELD MARK/PA2 Keys (Typewriter Keyboard)
PA1 and CNCL Keys (Operator Console Keyboard)**

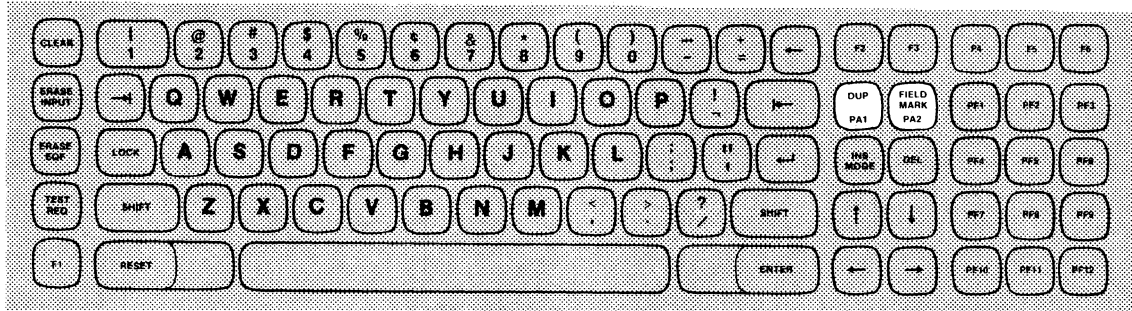

Typewriter Keyboard

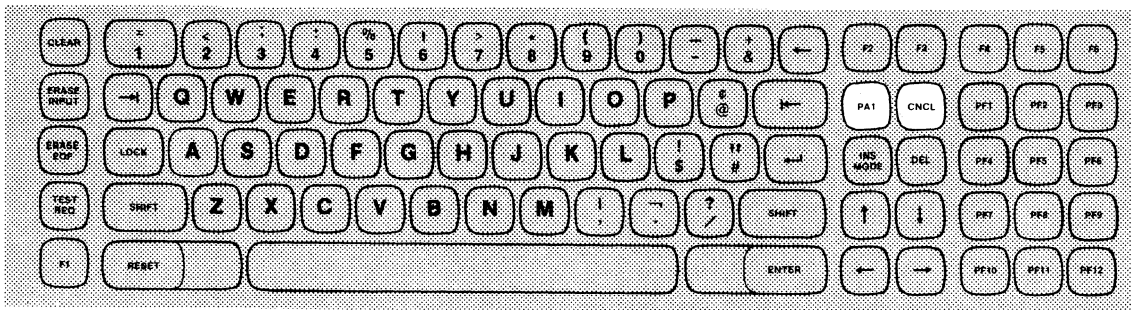

Operator Console Keyboard

The PA1 (for both keyboards) and PA2 (typewriter keyboard only) keys provide Program Access from the keyboard. The function of these keys is determined by the program being executed at the time one of the keys is pressed. After a PA key is pressed, INPUT INHIBITED is displayed on the screen until reset by the program or by pressing the RESET key.

The DUP key is unique to Display Stations having a typewriter keyboard. To use this key, the keyboard must be in the shifted position. When pressed, the DUP key enters a backward slash (\) in the cursor position on the display and moves the cursor to the beginning of the next unprotected data field. The DUP key signals the program that a duplication function is necessary. The program, however, determines the exact interpretation of this function.

The FIELD MARK key, also unique to typewriter keyboards, causes an arrow (→) to be displayed in the cursor position on the display. This code is normally used when the display is unformatted to indicate to the program that the end of a field has been reached.

The CNCL (Cancel) key normally signals the computer to erase all data entered in unprotected fields and moves the cursor to the beginning of the first unprotected data field on the screen. The program determines the exact function of this key.

INS MODE and DEL Keys

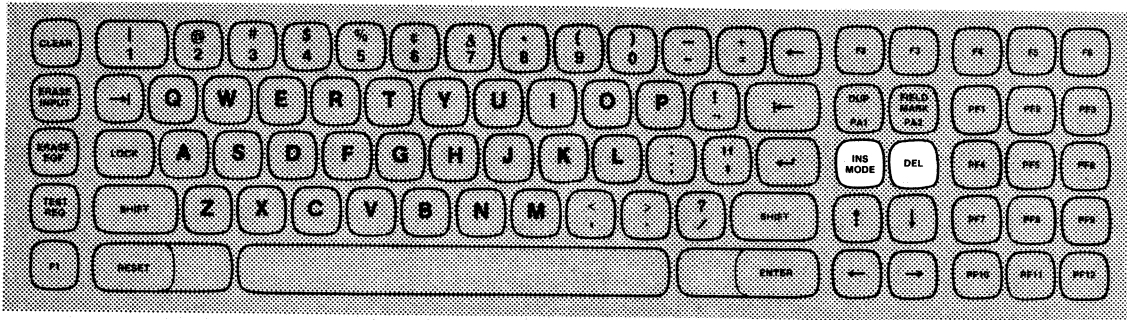

The INSERT MODE key allows the operator to enter or correct data in an unprotected field without changing the data following the insertion. When this key is pressed, the Display Station enters the Insert Mode. Keyboard operation is not inhibited unless the cursor is positioned in a protected field. Once the cursor has been moved to the location where an insertion is necessary, any key entry moves the character in the cursor location one space to the right and enters the new character in its place. Each character is inserted into the location originally occupied by the cursor, shifting the remaining letters to the right one character position. If necessary, and if the field is long enough, the characters may move to the line below to complete the insertion. The Audible Alarm sounds and the INPUT INHIBITED status appears if character insertion attempts to exceed the length of the field.

The keyboard is taken out of the Insert Mode by pressing the RESET key.

The DEL key allows the operator to delete data entered in the keyboard and displayed on the screen. This is accomplished by moving the cursor over the character to be deleted and pressing the DEL key. The character is removed and all characters following to the end of the field shift one character position to the left, thereby filling in the space left by the deleted character. The DEL key must be pressed once for each character deletion.

ENTER Key

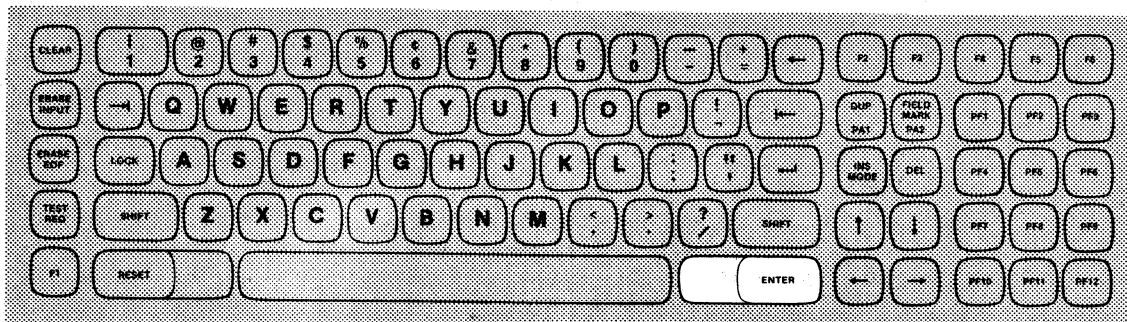

The ENTER key signals the computer that keyboard entry is complete and ready for transfer into the computer. When pressed, INPUT INHIBITED appears in the status area of the display and input is inhibited until released by the program or by pressing the RESET key.

PF1 Through PF12 Keys

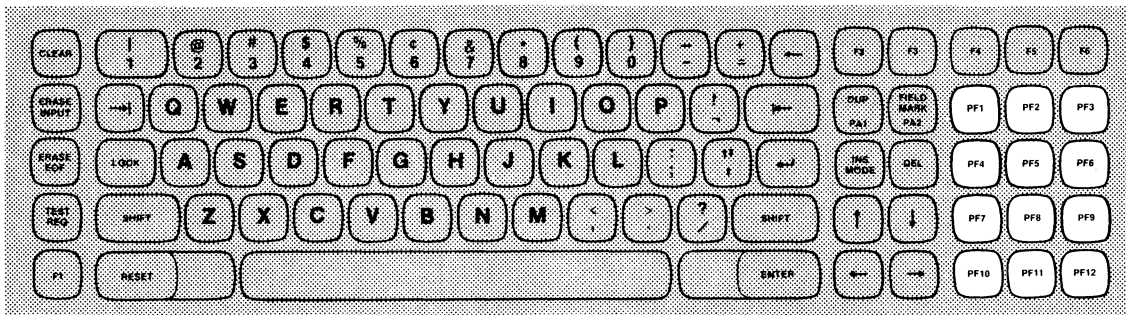

The function performed by pressing a PF (Program Function) key is determined by the application program being executed at the time the key is pressed. Under one program, pressing PF1 may signal the computer to send a specified form to the display. The function of PF1 may be entirely different under another application program.

2.3 1377 SELECTOR LIGHT PEN

A selector light pen is available as an optional feature of the 1377 Display Station. When used, the pen selects certain fields displayed on the screen. The addresses of these fields are then sent to the computer to be used as defined in the program.

A light pen field is denoted by a designator character located at the beginning of the field. These designators may be either a Greater Than Sign (>), a Question Mark (?), or a null or space character. Whenever a light-pen-detectable field showing a designator character is selected (tagged), the designator displayed changes (i.e., a Question Mark becomes a Greater Than Sign and vice versa). This indicates to the operator that the field has been tagged. Selectable fields without a Greater Than Sign or a Question Mark designator are attention fields and function like the ENTER key when selected.

To use the selector light pen, the operator presses the tip of the pen against the screen at a location within the field to be tagged (Figure 2-4). The electronic eye inside the pen reacts to the presence of light on the screen by changing the designator.

In operating the selector light pen, care should be taken to make sure that the tip of the pen is placed perpendicular to the screen. Slight tipping of the point may cause the field above or below the desired selection to be tagged. If this should happen, the operator simply presses the pen against the tagged field to deselect it and proceeds to reselect the proper field.

After all correct fields have been tagged, the field addresses are sent to the computer by pressing the light pen against a selectable field designated by a space or a null on the screen. These selectable fields are usually identified by the messages they spell out (i.e., ORDER COMPLETE).

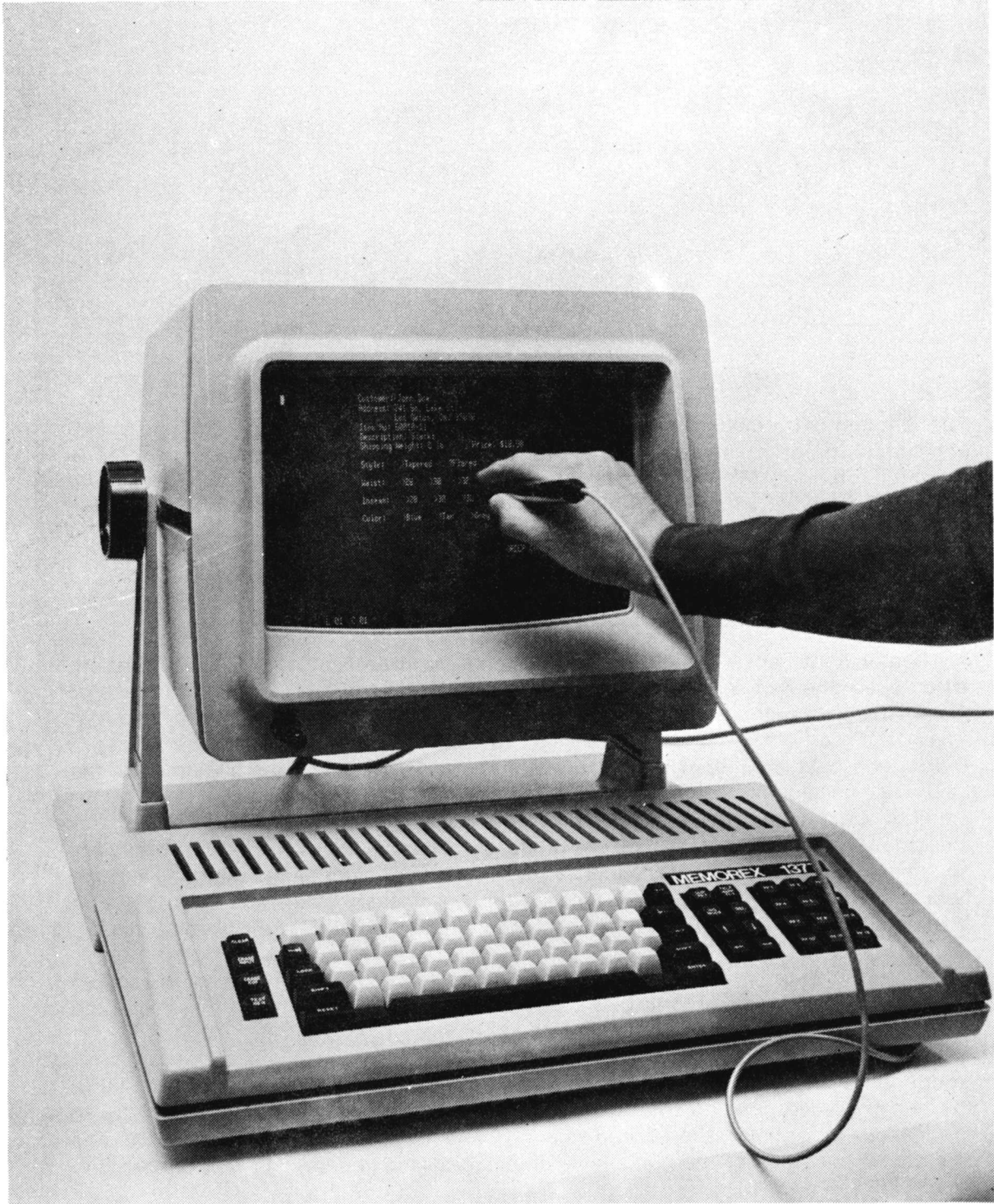

FIGURE 2-4. SELECTOR LIGHT PEN OPERATION

SECTION 3 INSTALLATION

3.1 SPECIFICATIONS

Dimensions	Refer to Figure 3-1*
Weight	22 kg (49 lb), including keyboard
Operating Clearances	
Top	15 cm (6 in.)
Bottom	No requirement
Sides	8 cm (3 in.)
Front	0 cm (0 in.)
Rear	3 cm (1 in.)
Airflow	Convection only
Power Requirements	
kVA	0.085
Phases	Single
Power Cord Length	2.43 m (8 ft)
Environment, Operating	
Temperature	10° to 43° C (50° to 110° F)
Relative Humidity	10% to 90%
Maximum Wet Bulb	27° C (80° F)
Environment, Nonoperating	
Temperature	10° to 49° C (50° to 120° F)
Relative Humidity	10% to 90%
Maximum Wet Bulb	27° C (80° F)

*The 1377 is designed for tabletop use. Recommended table height is 66 cm (26 in.). The keyboard can be physically located up to 60.9 cm (24 in.) from the front of the display stand.

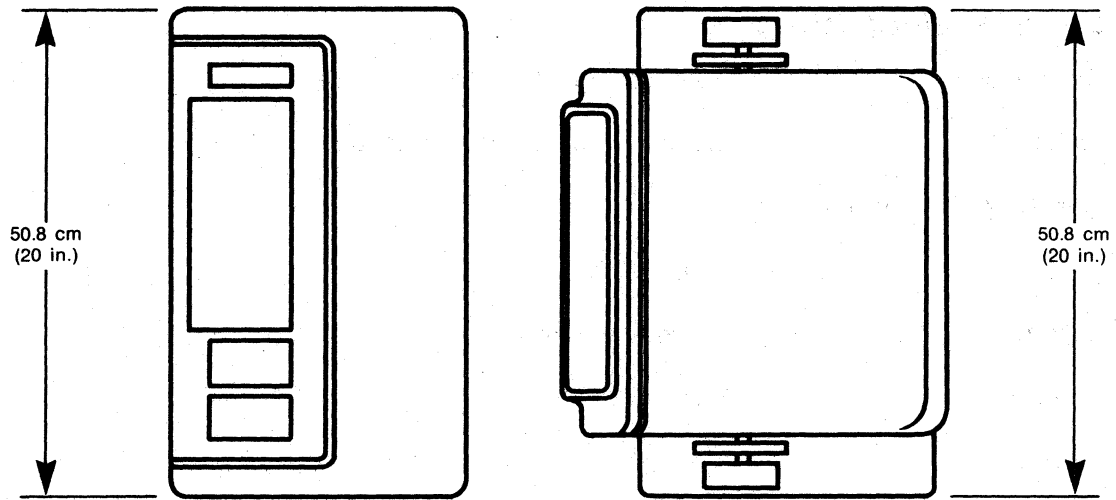

TOP VIEW

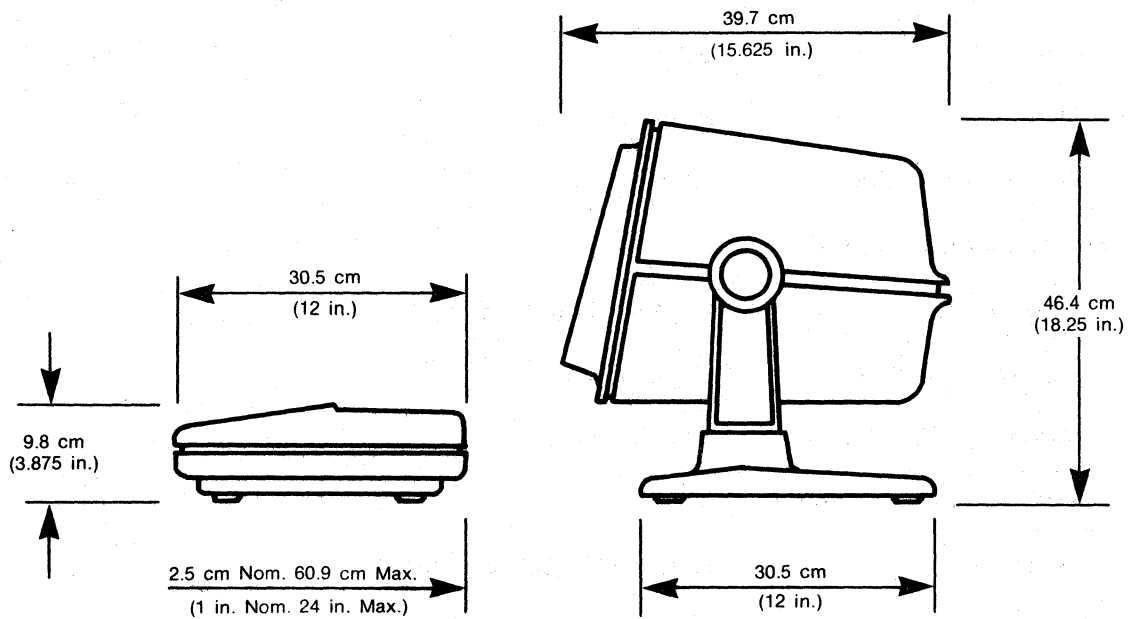

SIDE VIEW

FIGURE 3-1. DIMENSIONS OF 1377 DISPLAY STATION

3.2 CABLE REQUIREMENTS

The customer is responsible for the interconnect cable between the Display Station and the Control Unit. Cable length may not exceed 609 m (2000 ft).

Cable Type: Coax Commercial Type RG-62 A/U

Connector Type: Commercial Type BNC UG-260 B/U

3.3 PROCEDURE

1. Remove Display Station from packaging per instructions provided on the container.
2. Connect display to keyboard by attaching keyboard cable to back panel of display as illustrated in Figure 3-2.
3. Interconnect AC cord between connector at back of display (see Figure 3-2) and wall outlet.

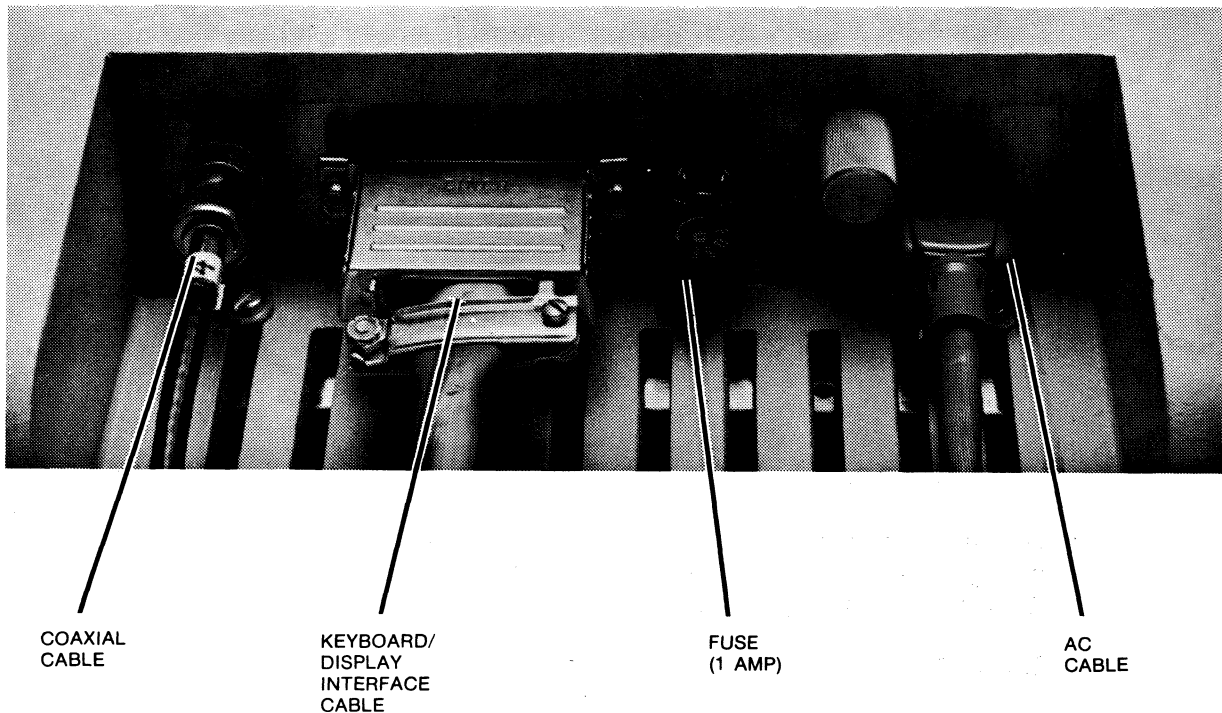

FIGURE 3-2. CABLE CONNECTIONS

4. Offline Check

- a. Pull power switch out to apply power to Display Station. Assure that Audible Alarm sounds and that cursor, line number, and column number appear on the screen (within 30 seconds) before proceeding. (If an error or malfunction occurs at this point, follow applicable steps in customer troubleshooting flowchart, Figure 4-11.) If INPUT INHIBITED appears, press RESET key.
- b. Enter several random characters from the keyboard to verify accuracy in character display.
- c. Test function of CURSOR CONTROL keys.
- d. Test INSERT MODE by pressing key. INSERT MODE should appear on 25th line of screen. Move the cursor to a location in the center of data displayed on the screen. Insert two or three characters to assure that INSERT MODE is functioning properly. Press Reset key.
- e. Test DEL key by moving cursor to location in the center of data displayed on the screen and pressing DEL two or three times to assure that characters are properly deleted from display.
- f. Test ERASE EOF key by moving cursor to a location in the center of data displayed on the screen and pressing the ERASE EOF key. All data from the cursor location to the last character typed on the screen should disappear.
- g. Test ERASE INPUT by pressing key and assuring that all data displayed on the screen is erased.
- h. Test the CLEAR key by entering data on the screen and then pressing CLEAR to assure that the screen is cleared. INPUT INHIBITED should appear. Press Reset key.

If an error should occur or the Display Station should malfunction during Offline Check (steps b. through h.), notify Memorex service. Otherwise, proceed to Step 5.

5. Connect coaxial cable from the Control Unit to the Display Station as shown in Figure 3-2. Identify Display Station Coaxial Cable by tagging it at the Control Unit connector and at the Display Station.

6. Online Check

If customer programs include IBM Online Tests (OLTs) or Requests for Tests (RFTs), these programs may be run to check the online functioning of the Display Station. If these programs are unavailable, the customer application program should be run for online testing. Should an error or malfunction occur during the test program, the customer should follow the troubleshooting guidelines set forth in Section 4.

SECTION 4 MAINTENANCE

This section describes the procedures to be taken for disassembly and assembly of the 1377 Display Station, the various procedures for monitor alignment, and the customer and Memorex field service troubleshooting procedures. Disassembly/assembly procedures are provided first since these procedures may be required for either monitor alignment or troubleshooting.

4.1 DISASSEMBLY/ASSEMBLY

The following disassembly procedures cover the two major components of the 1377 Display Station: the monitor and the keyboard. To assemble the 1377, reverse the procedures specified in paragraphs 4.1.1 and 4.1.2.

4.1.1 Monitor Disassembly

1. Disconnect the external AC, coaxial, and keyboard/monitor interface cables from the back of the monitor (Figure 4-1).
2. Remove the external fuse shown in Figure 4-1.
3. Loosen the top cover screw (Figure 4-1).

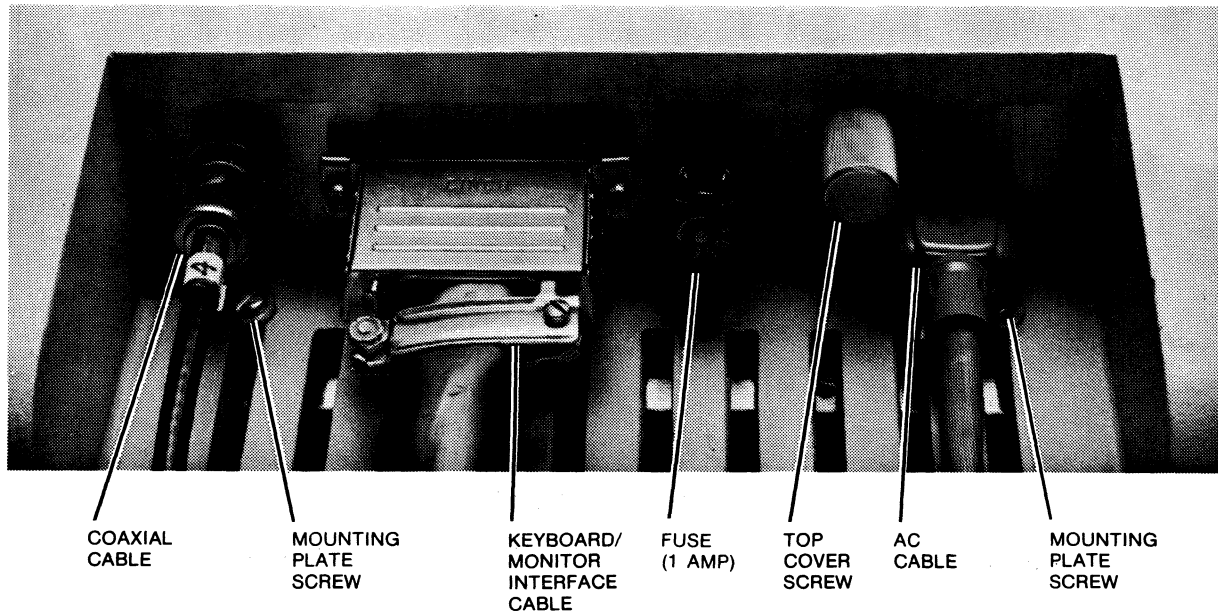

FIGURE 4-1. MONITOR CONNECTOR PANEL

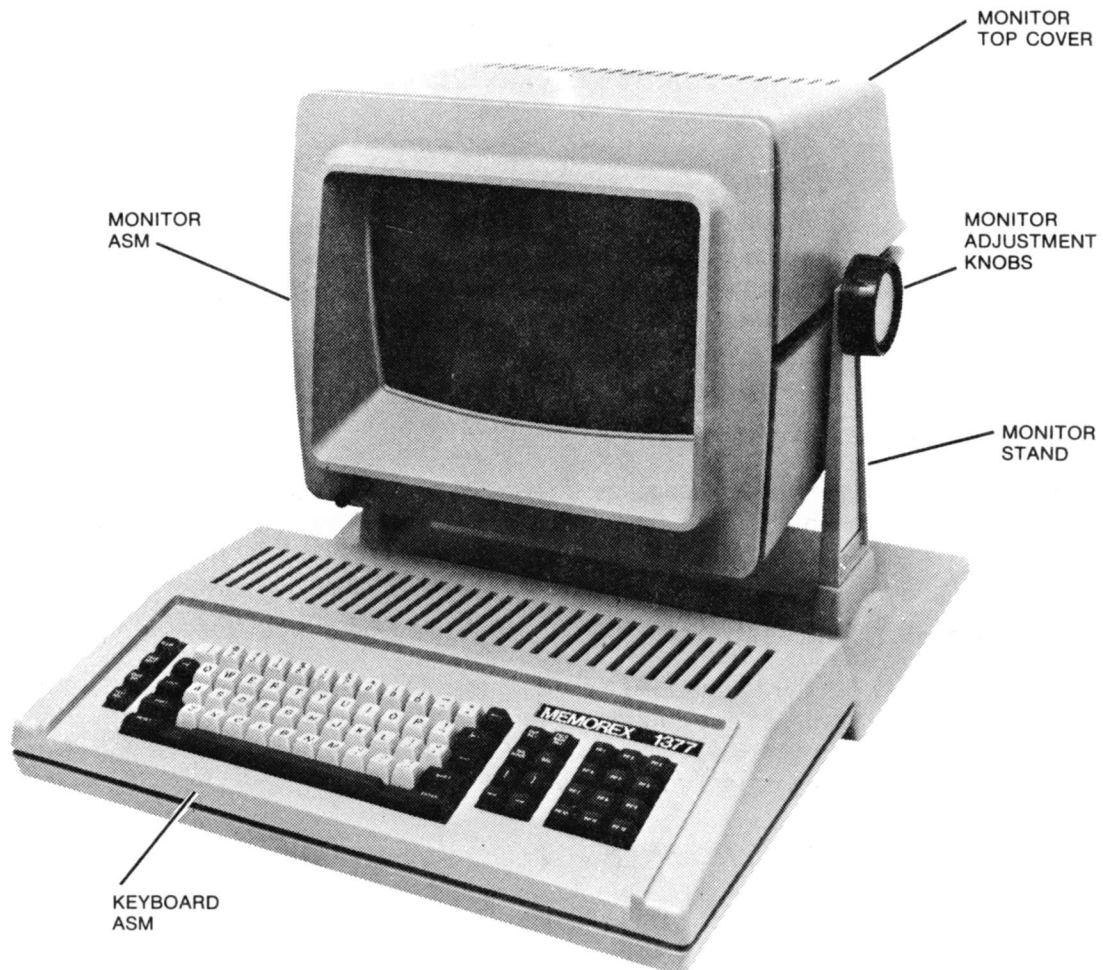

FIGURE 4-2. DISPLAY STATION MAJOR ASSEMBLIES

4. Remove the top cover of the monitor (Figure 4-2).
5. Loosen the monitor adjustment knobs until the housing rocks back and forth freely. (Figure 4-2)

CAUTION

Do not remove the adjustment knobs.

6. Position the monitor and monitor stand as shown in Figure 4-3.
7. Remove the adjustment knobs.
8. Remove the stand from the monitor.

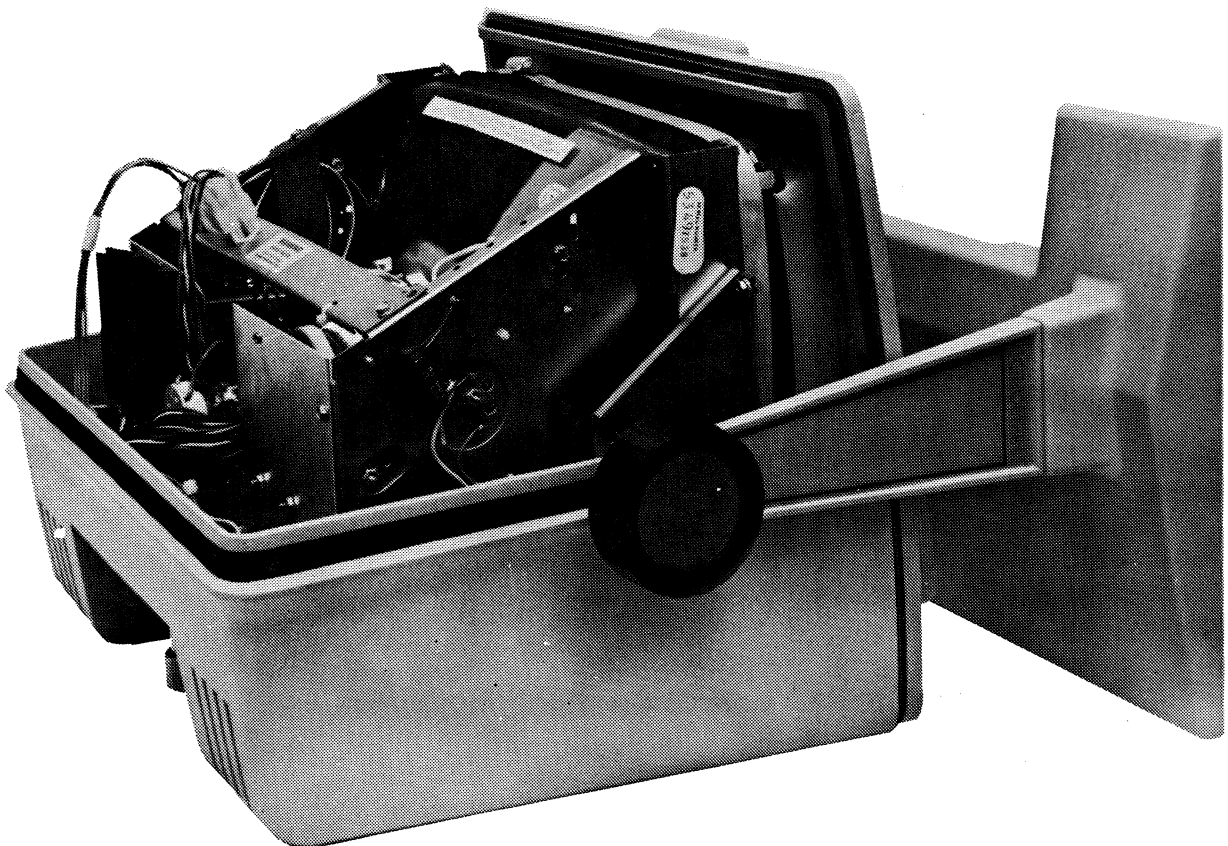

FIGURE 4-3. ADJUSTMENT KNOB AND STAND REMOVAL POSITION

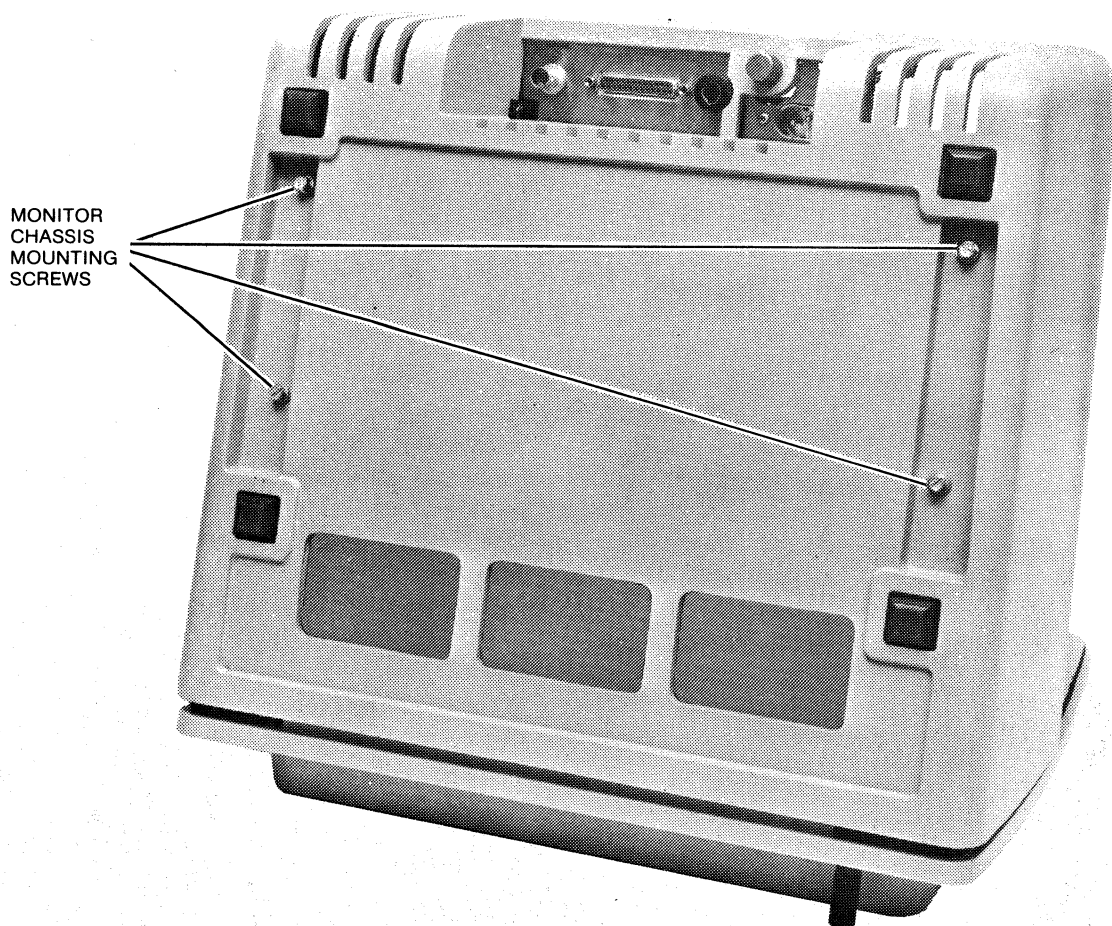

FIGURE 4-4. MONITOR HOUSING (BOTTOM VIEW)

9. Tilt the monitor so that the screen is facing down.
10. Using a $\frac{1}{4}$ " hex driver, remove the four monitor chassis mounting screws located on the bottom of the monitor housing (Figure 4-4).
11. Remove the connector cable mounting plate screws (Figure 4-1).
12. Tilt the monitor upright.
13. Disconnect the power/brightness plug (Figure 4-5).
14. Disconnect the coaxial wire connector (Figure 4-5).
15. Assure that the connector plate is loose (Figure 4-5).

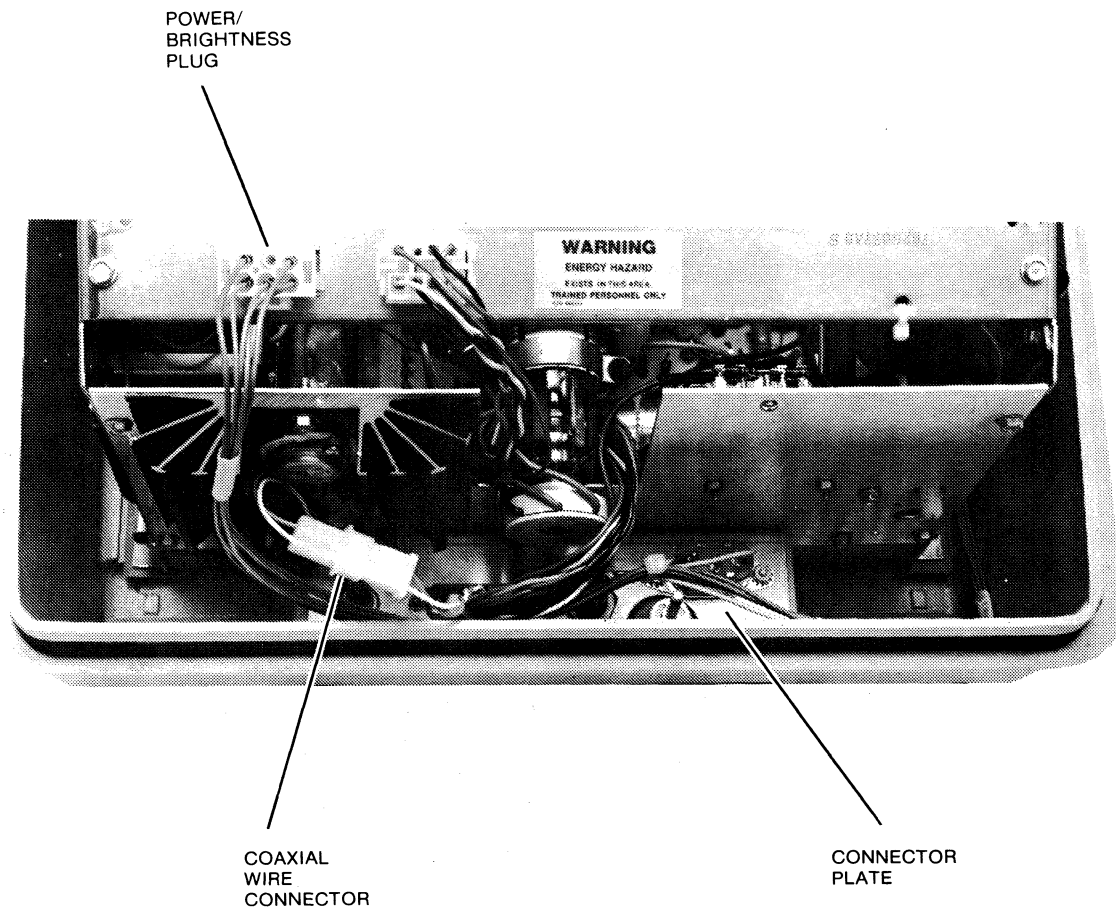
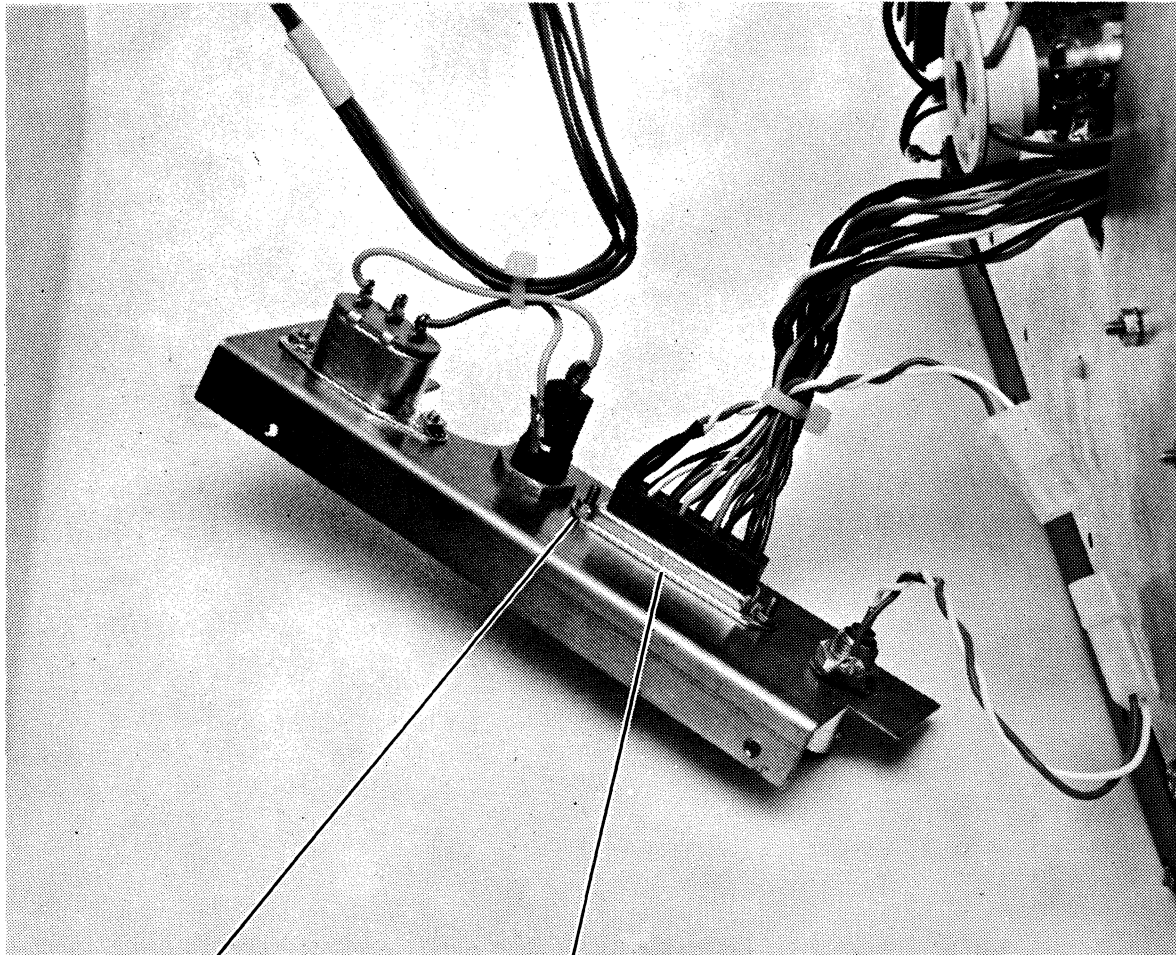

FIGURE 4-5. INTERNAL CABLE CONNECTIONS (MONITOR)

16. Facing the back of the monitor, lift the monitor chassis out of the housing by slightly rotating the chassis toward the rear and sliding it out of the housing.
17. Using a $\frac{3}{16}$ " hex driver, remove the internal keyboard/monitor interface cable connector from the connector plate by removing the two screws located on either side of the connector (Figure 4-6). This step completes monitor disassembly.



HARDWARE

INTERNAL
KEYBOARD/
MONITOR
INTERFACE
CABLE

FIGURE 4-6. CONNECTOR PLATE

4.1.2 Keyboard Disassembly

1. Tilt the keyboard as shown in Figure 4-7.
2. Remove the six keyboard housing cover mounting screws located on the bottom of the keyboard (Figure 4-7).
3. Set the keyboard in an upright position.
4. Remove the keyboard housing cover.

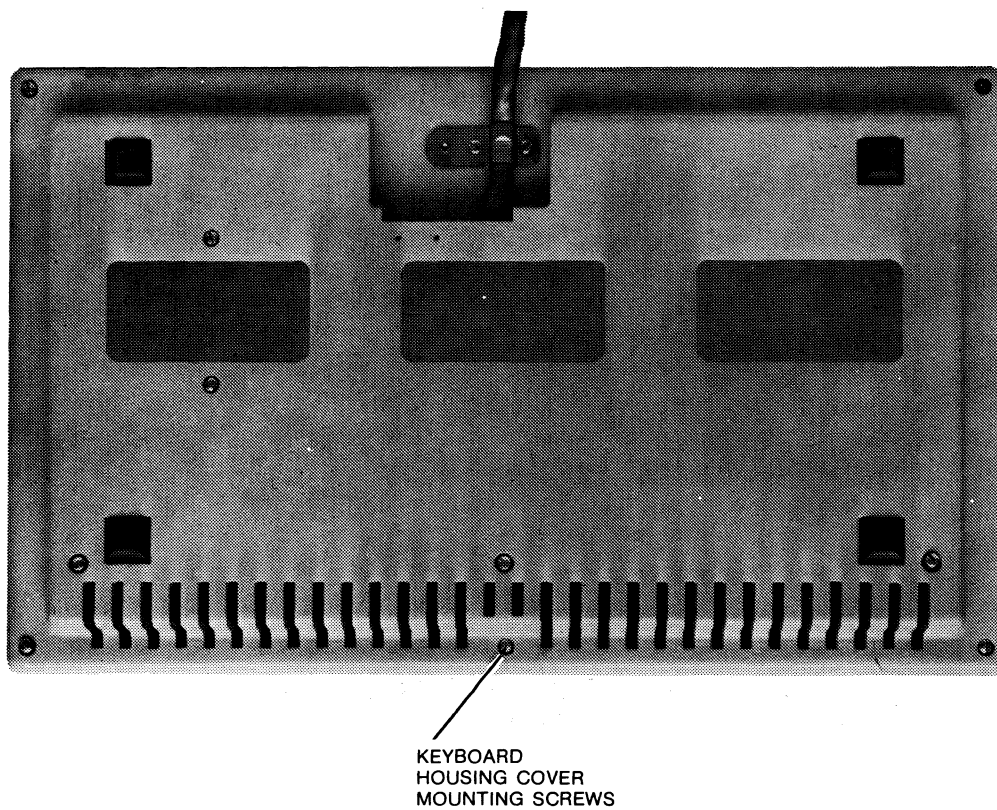

FIGURE 4-7. KEYBOARD (BOTTOM VIEW)

5. Disconnect the logic PCB/keyboard PCB interface cable (two places), the Audible Alarm cable, and the internal monitor/keyboard interface cable (Figure 4-8).
6. Using a 1/4" hex driver, remove the keyboard/PCB assembly from the keyboard brackets by removing the four mounting screws (Figure 4-8).
7. Remove the logic PCB by taking out the five screws and five keps nuts shown in Figure 4-9. This step completes keyboard disassembly.

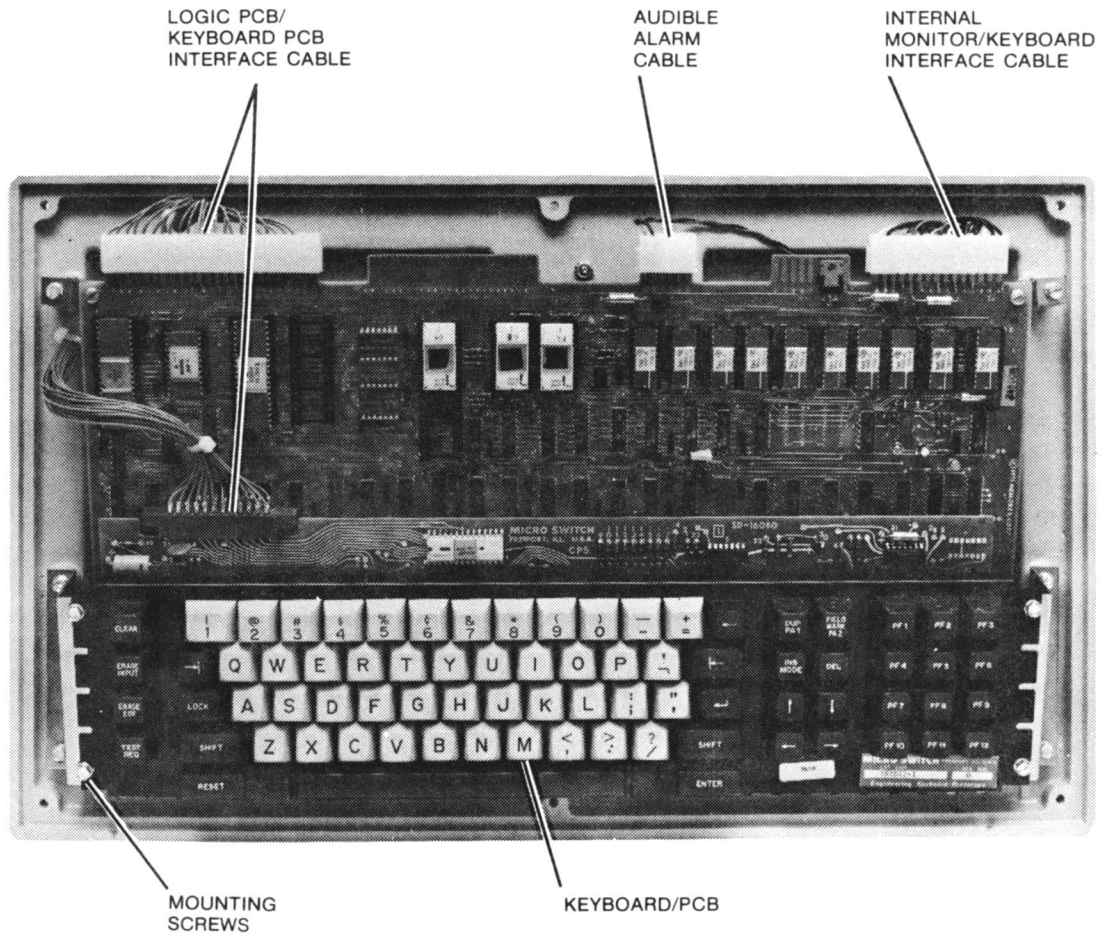
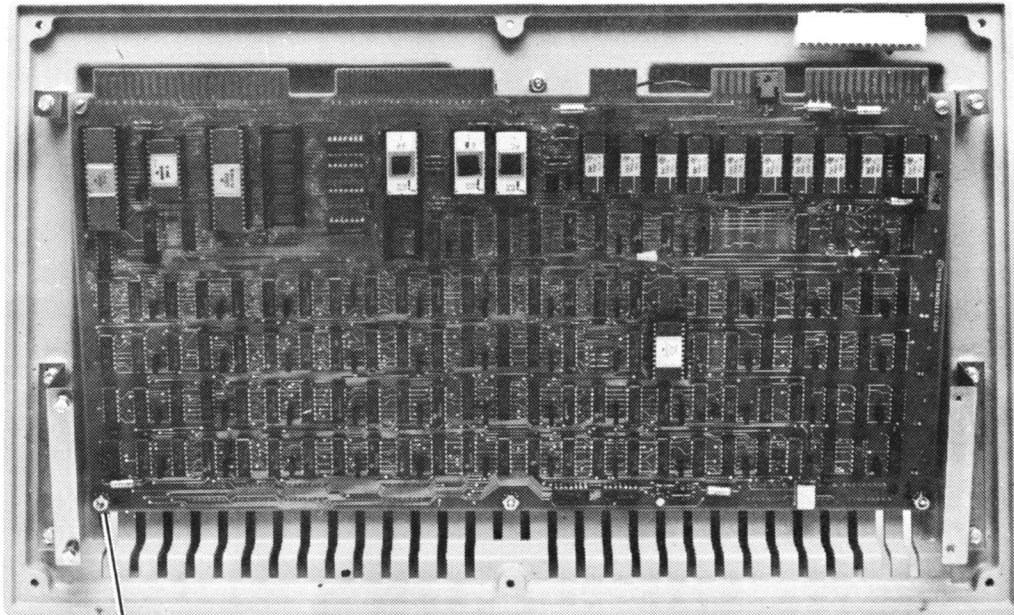

FIGURE 4-8. CABLE DISCONNECT AND PCB REMOVAL.



LOGIC PCB
MOUNTING
SCREWS

FIGURE 4-9. REMOVAL OF LOGIC PCB

4.2 MONITOR ALIGNMENT

Monitor alignment may be required in the maintenance of the 1377 Display Station. Most of the adjustments are made with a special tool that is provided with each Display Station.

The various monitor alignments, with accompanying illustrations, are covered in the following paragraphs. When performing an alignment procedure, observe the warning affixed to the monitor chassis. Areas of high voltage are shown in Figure 4-10.

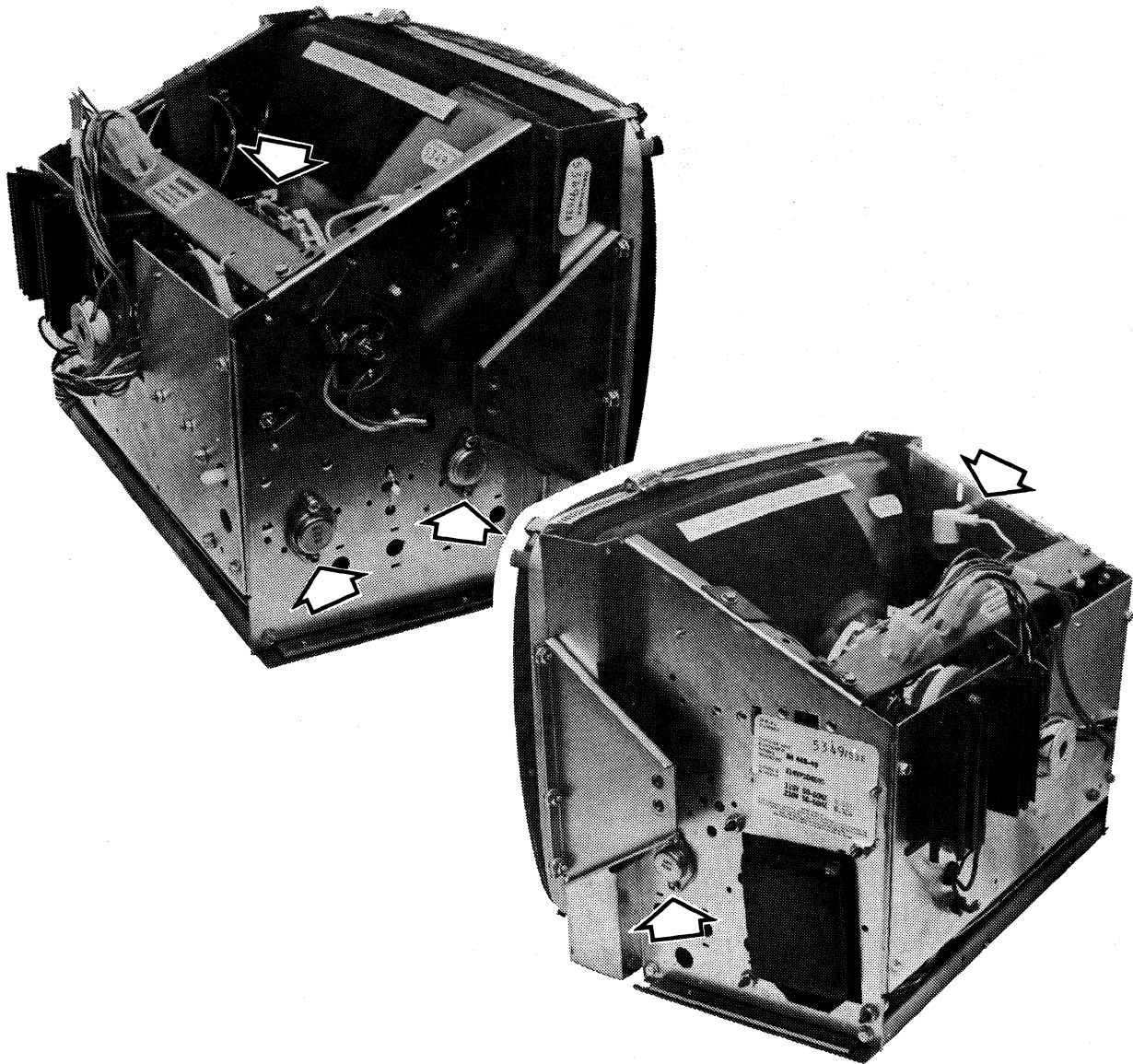
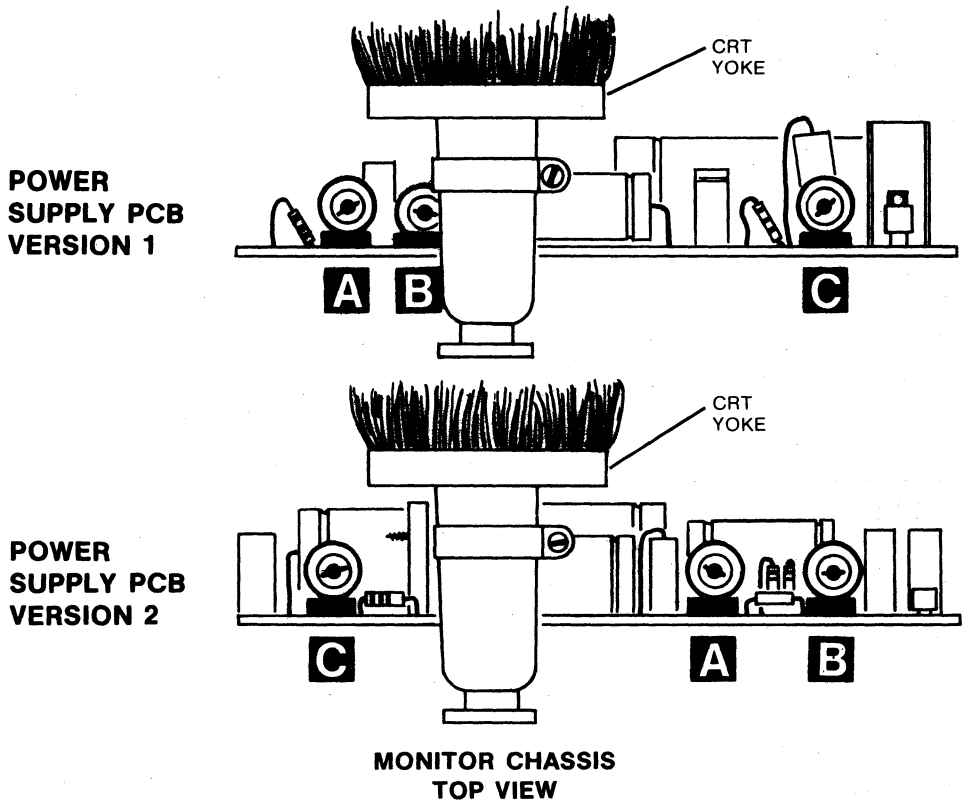

FIGURE 4-10. HIGH VOLTAGE AREAS

4.2.1 Voltage Levels

Potentiometer locations for +12, -12, and +5 VDC adjustments are shown below. Measure these voltages on P2 of the logic PCB with respect to Pin 6 (ground).



A	+12 VDC	B	-12 VDC	C	+5 VDC
ADJUST TO		ADJUST TO		ADJUST TO	
$+12.00 \pm .05$		$-12.00 \pm .05$		$+5.00 \pm .05$	

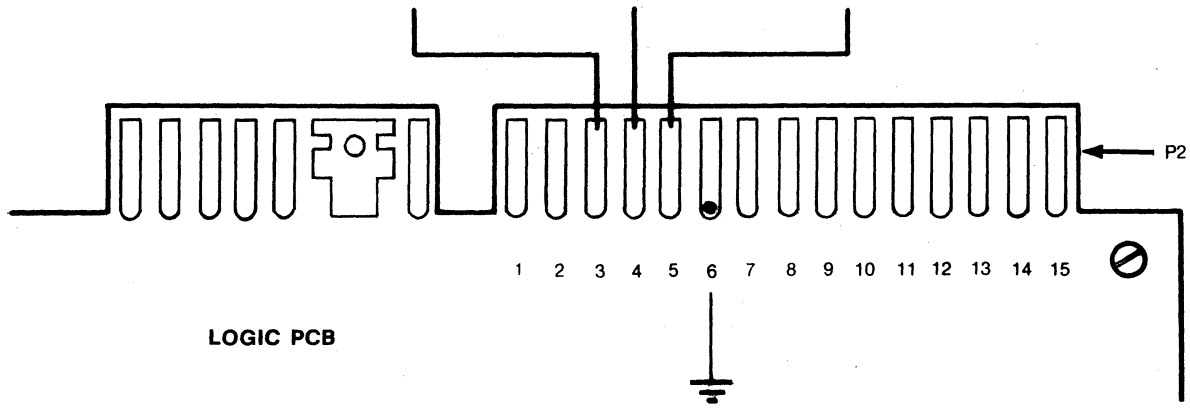

Measure +73 VDC at Pin 1 of the monitor PCB with respect to the chassis.

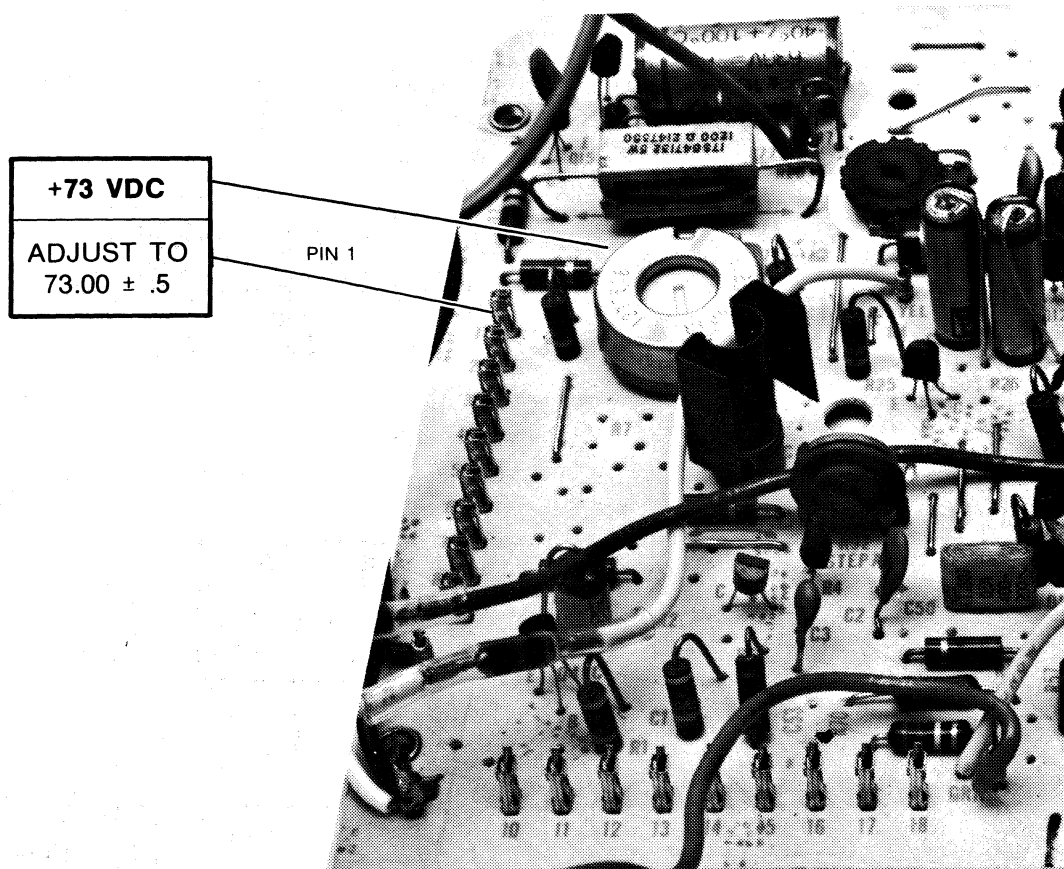

MONITOR PCB

4.2.2 Horizontal Size

Adjust the horizontal size by turning the knob located on the back of the monitor. An illustration of how this adjustment affects the monitor image is shown below.

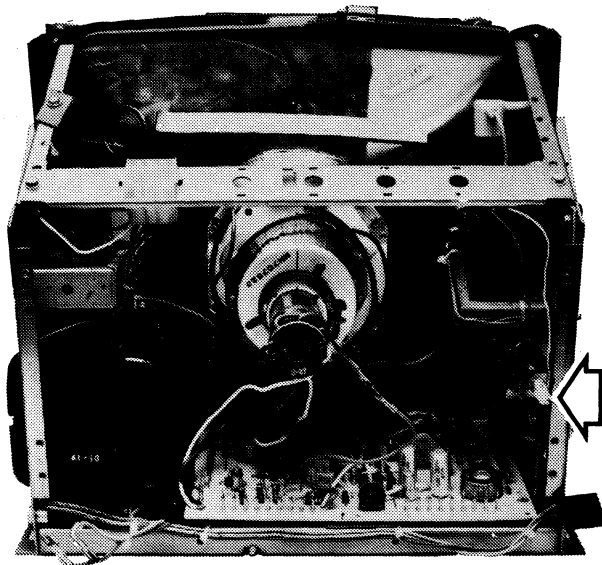

**MONITOR
(REAR VIEW)**

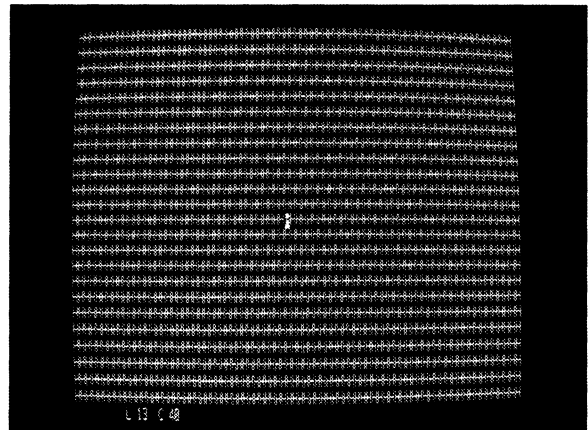

MAXIMUM ADJUSTMENT

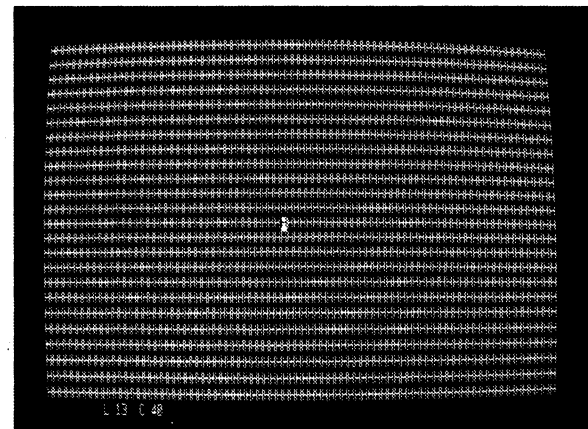

MINIMUM ADJUSTMENT

4.2.3 Horizontal Frequency

To center data within the monitor raster, adjust the horizontal frequency potentiometer located on the monitor PCB. The illustrations depict the ideal adjustment, along with two photographs showing how the monitor may appear before the adjustment is made.

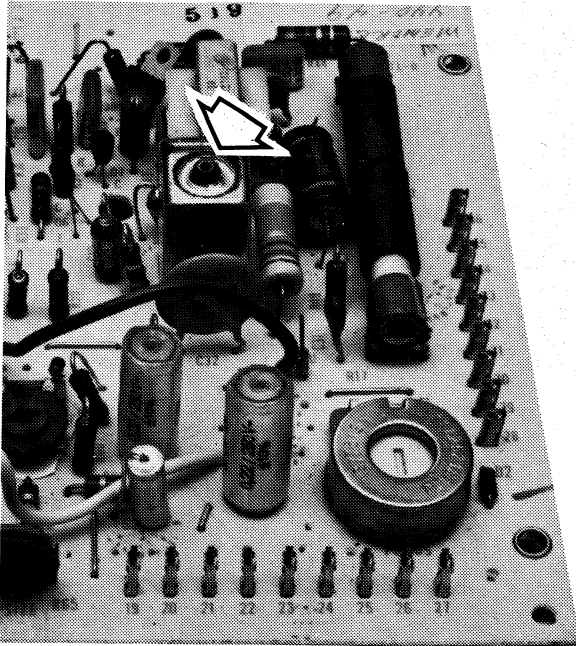

MONITOR PCB

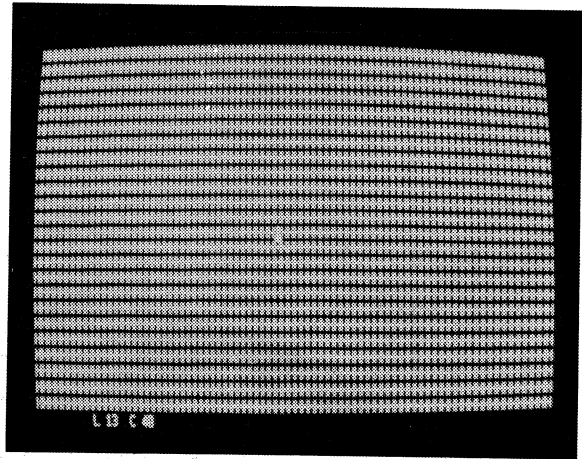

IDEAL HORIZONTAL FREQUENCY

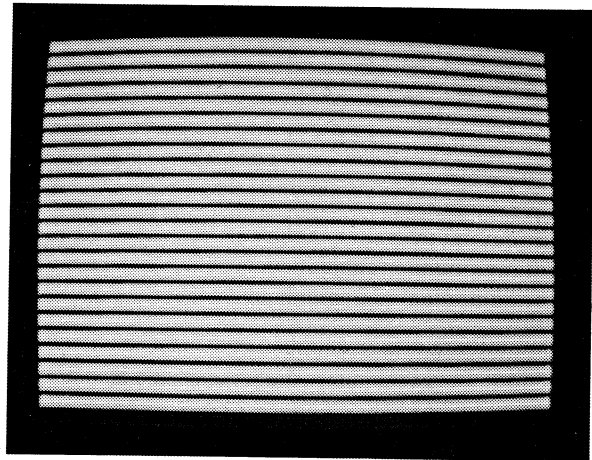
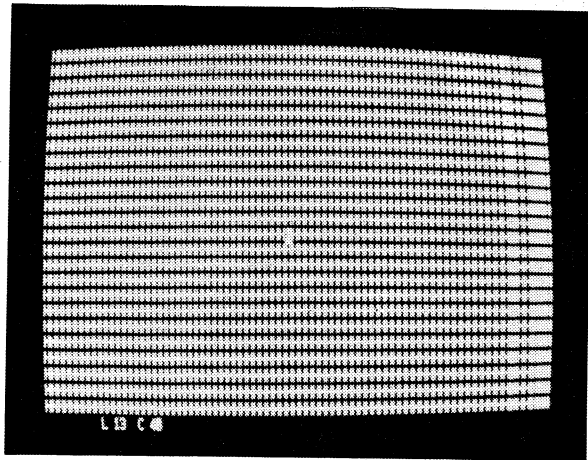

PARTIAL AND TOTAL MISADJUSTMENT

4.2.4 Vertical Size

The vertical size adjustment potentiometer is located on the monitor PCB. Illustrations of minimum and maximum adjustment are shown below.

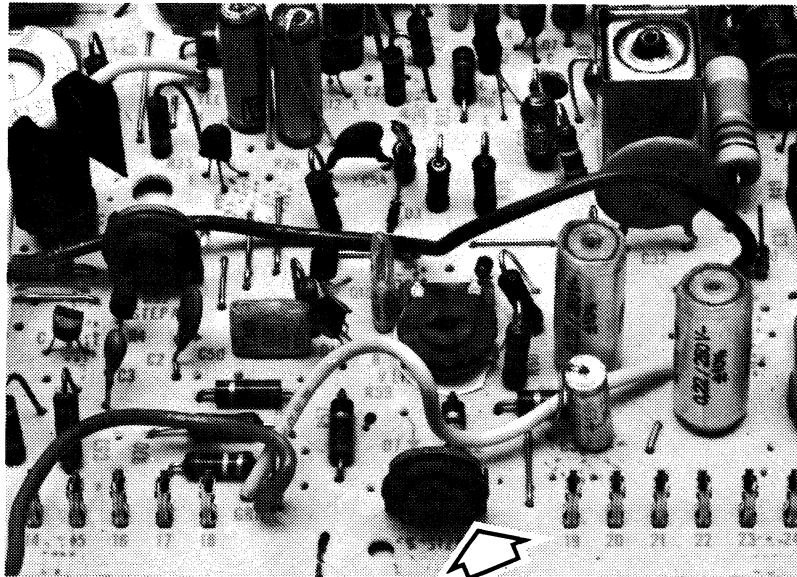

MONITOR PCB

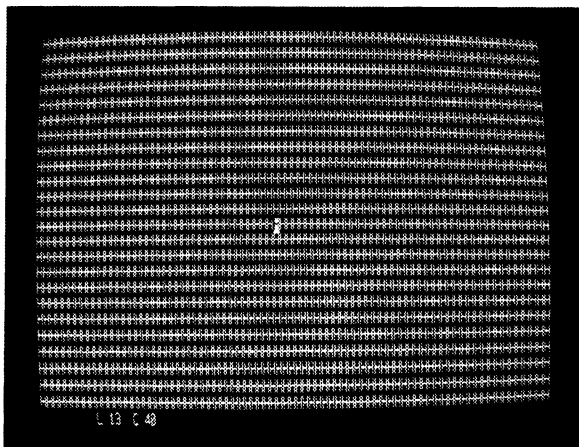

MINIMUM ADJUSTMENT

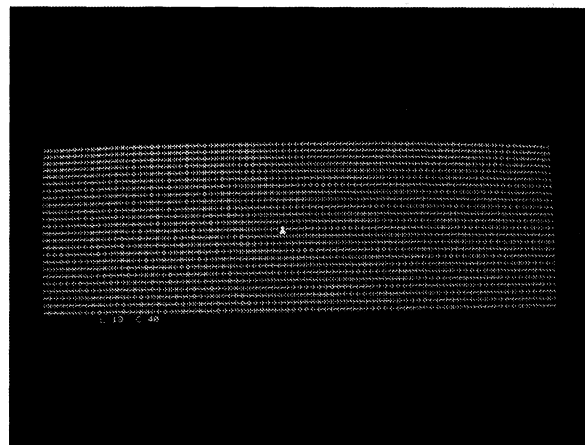

MAXIMUM ADJUSTMENT

4.2.5 Vertical Linearity

To provide equal spacing between lines of data, adjust the vertical linearity potentiometer located on the monitor PCB. An illustration shows a misaligned monitor requiring this type of adjustment.

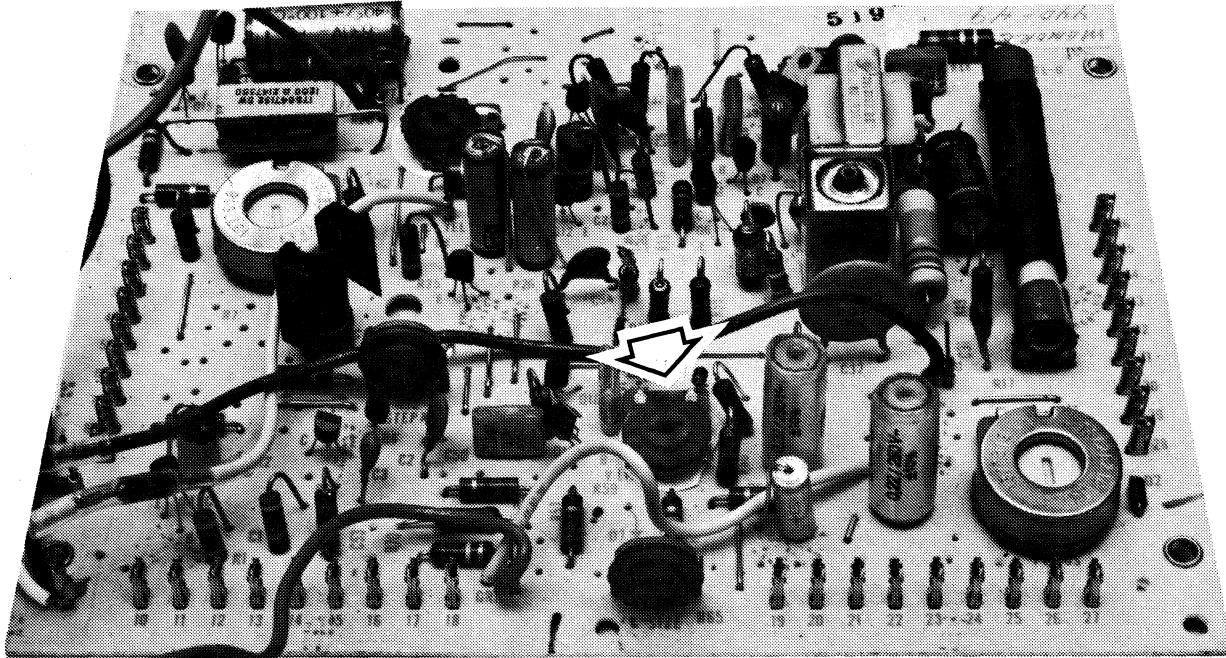

MONITOR PCB

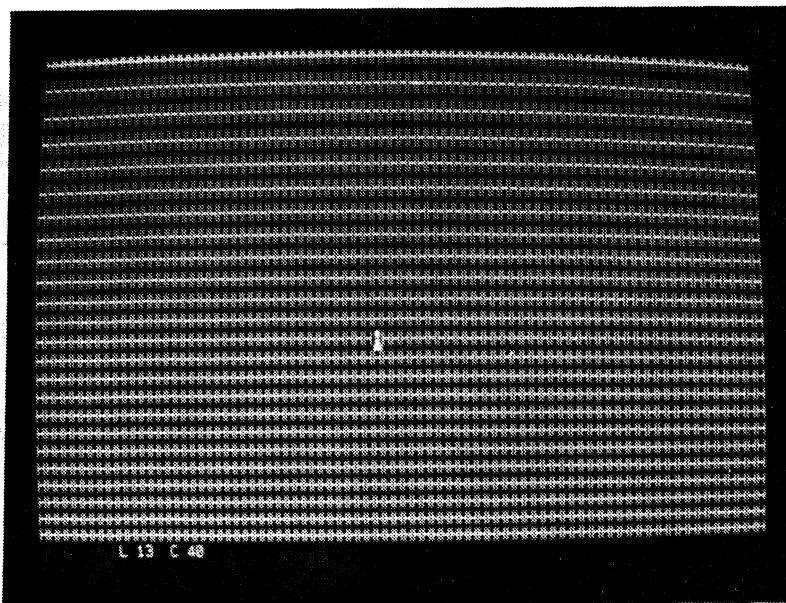

UNEVEN SPACING BETWEEN LINES

4.2.6 Master Brightness

The raster should be barely visible when the Contrast Control (ON/OFF pushbutton) is turned to its brightest intensity. Set this maximum brightness by adjusting the master brightness potentiometer located on the monitor PCB.

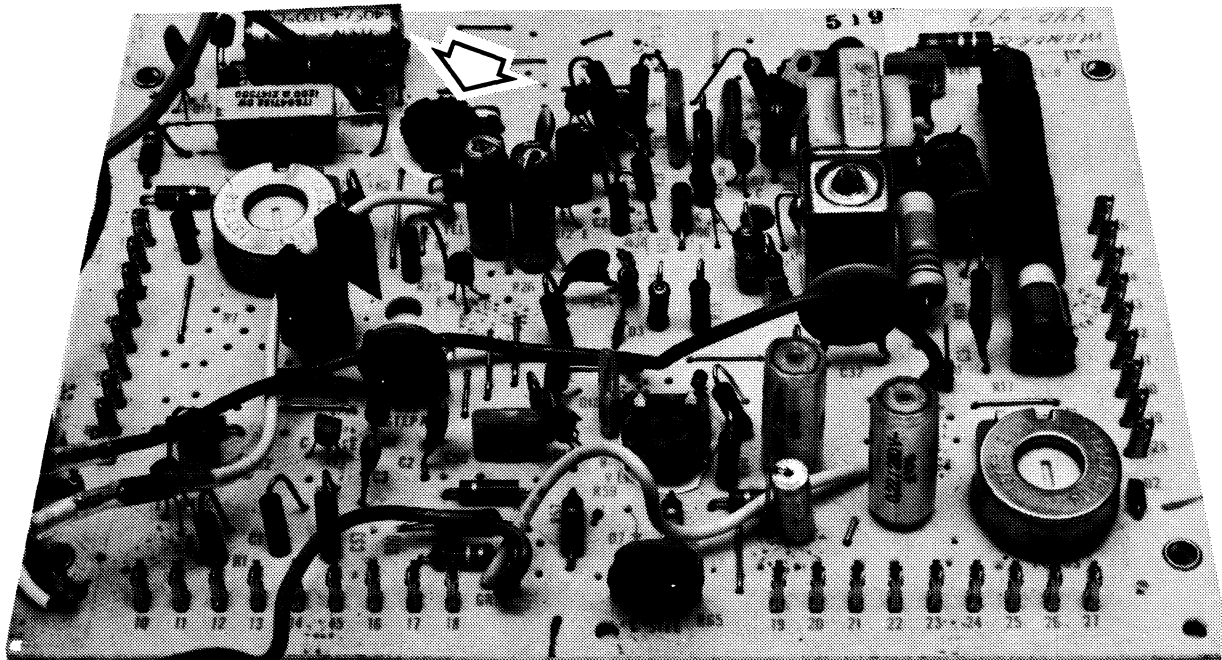

MONITOR PCB

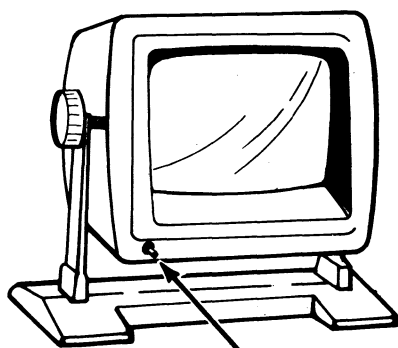

CONTRAST CONTROL
(ON/OFF PUSHBUTTON)

FRONT VIEW
(MONITOR)

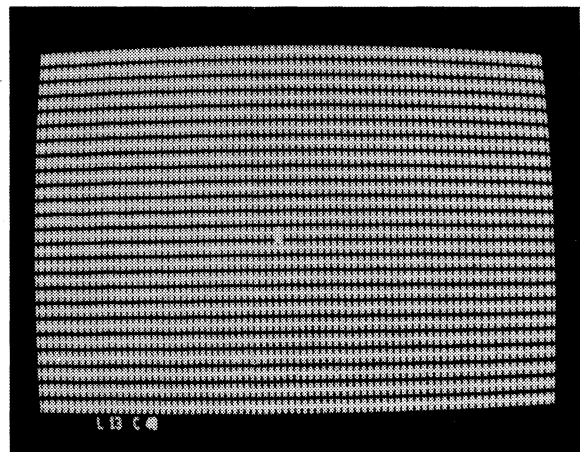

4.2.7 Centering

To center the image on the monitor, manually adjust the centering rings located on the monitor yoke. An off-center image is illustrated below.

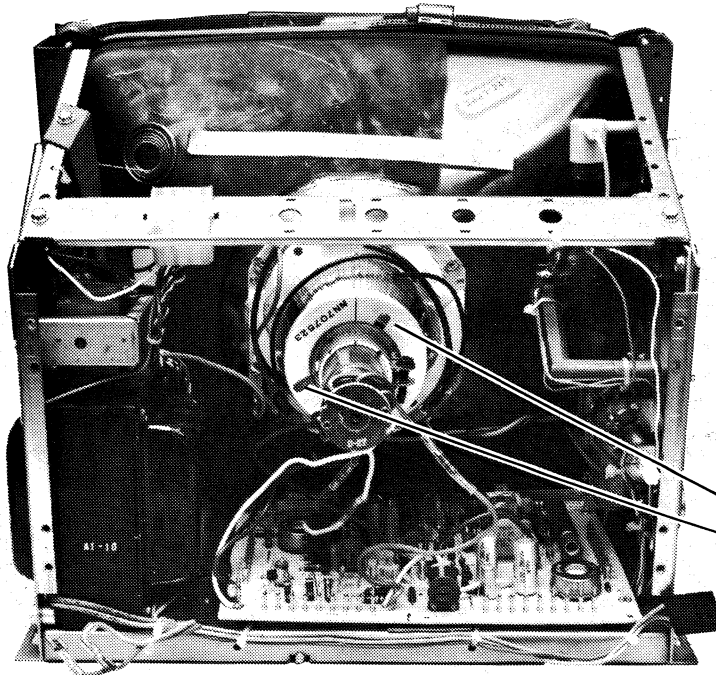

CENTERING
RINGS

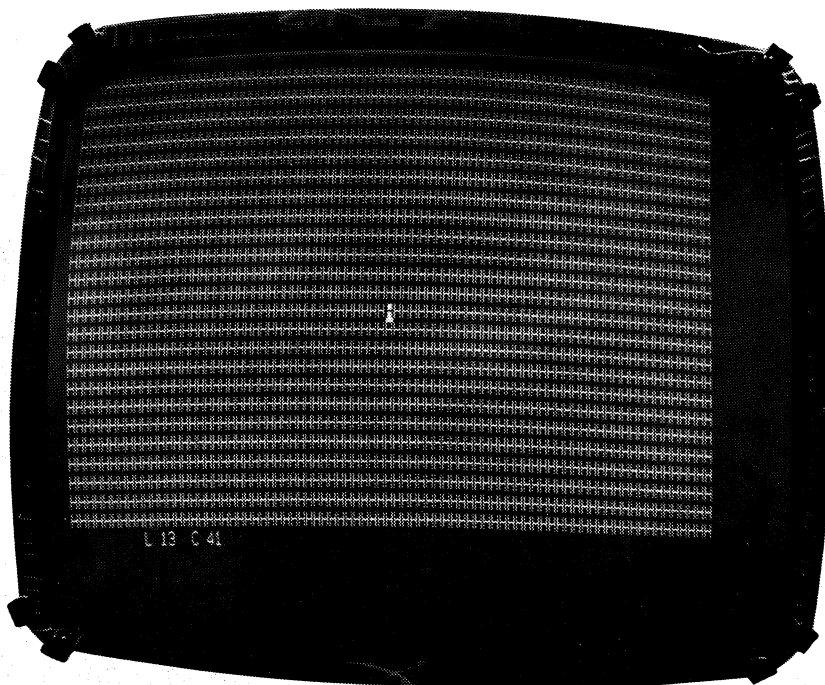

4.2.8 Tilted Raster

If the image on the monitor is rotated, adjust the yoke by loosening the screw on the right side of the yoke, adjusting the image, and securing the screws. Image rotation is illustrated below.

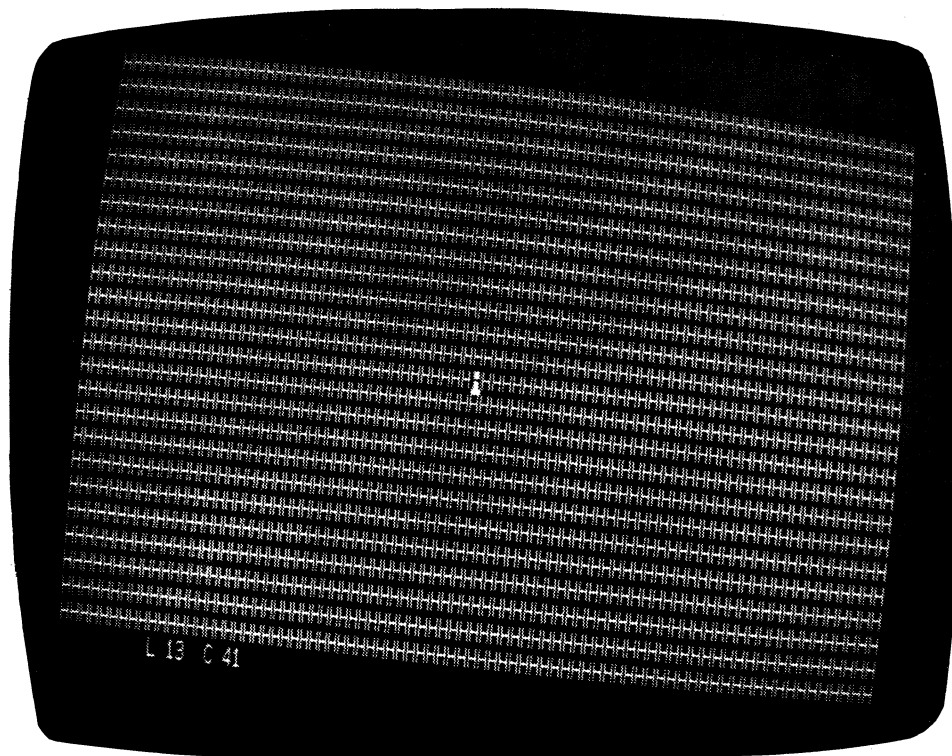
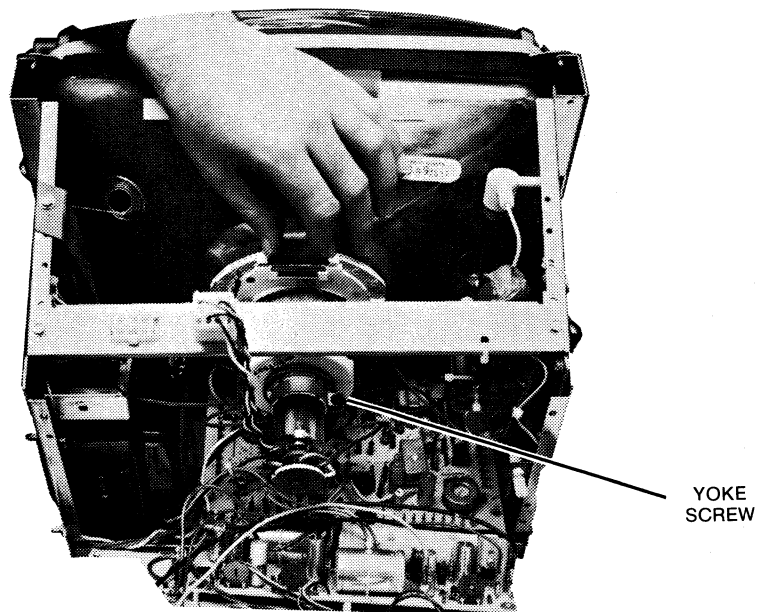

4.2.9 Focus

To focus the image on the monitor, adjust the potentiometer shown below.

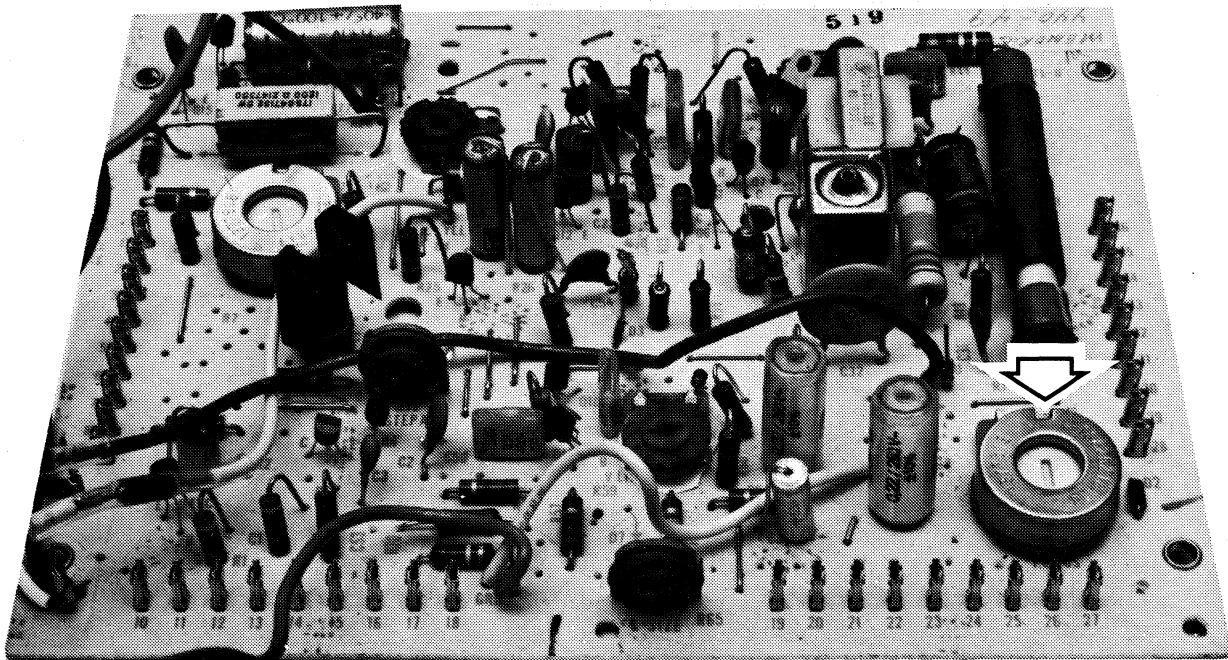

4.3 TROUBLESHOOTING

Figures 4-11 and 4-12 illustrate the steps to be taken by the customer and Memorex field service, respectively, should a malfunction occur during Display Station operation. Whenever the monitor housing must be removed to comply with procedure, make certain to observe the warning notice affixed to inside of chassis. For high-voltage locations, refer to the illustration presented in Figure 4-10.

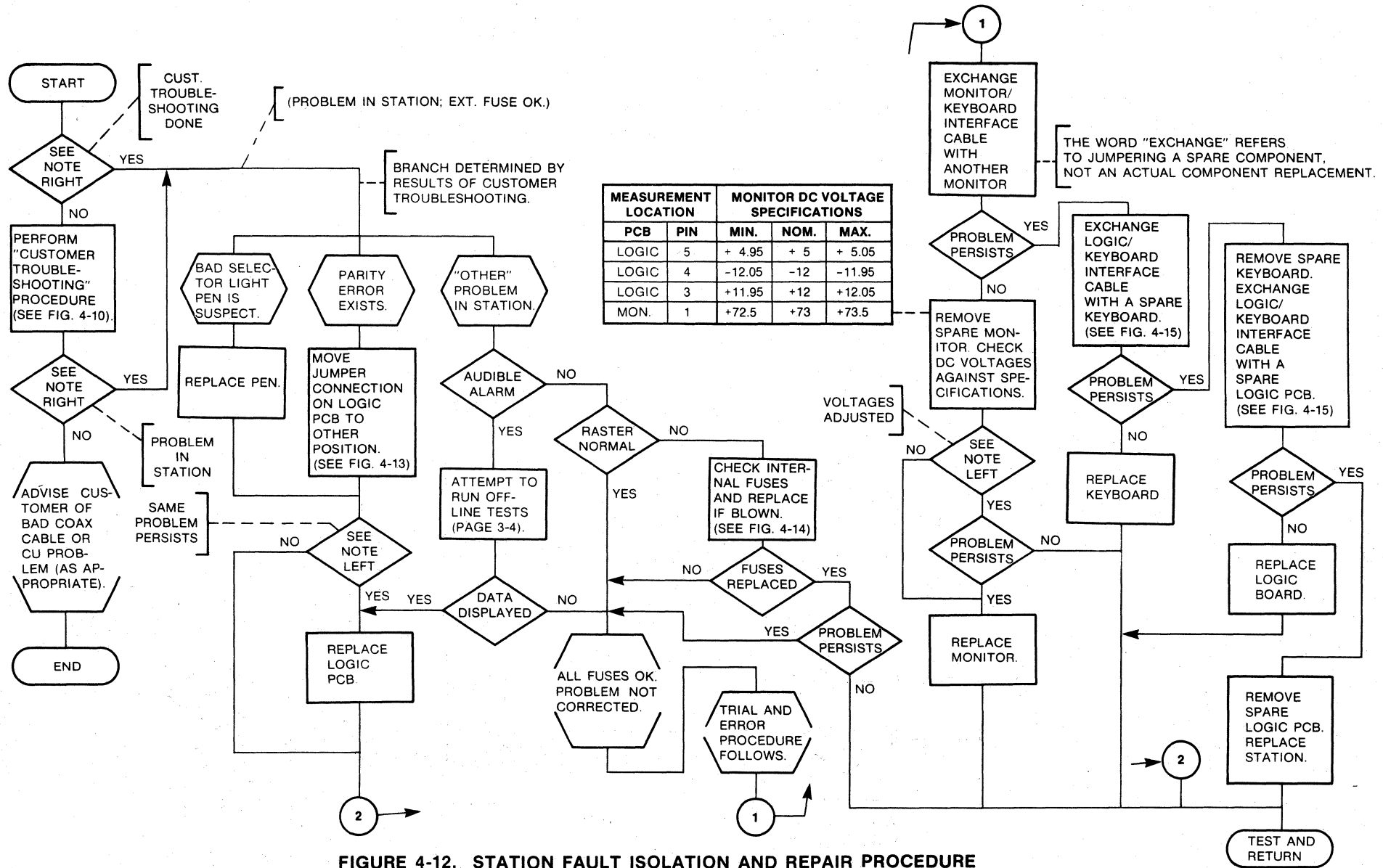

FIGURE 4-12. STATION FAULT ISOLATION AND REPAIR PROCEDURE

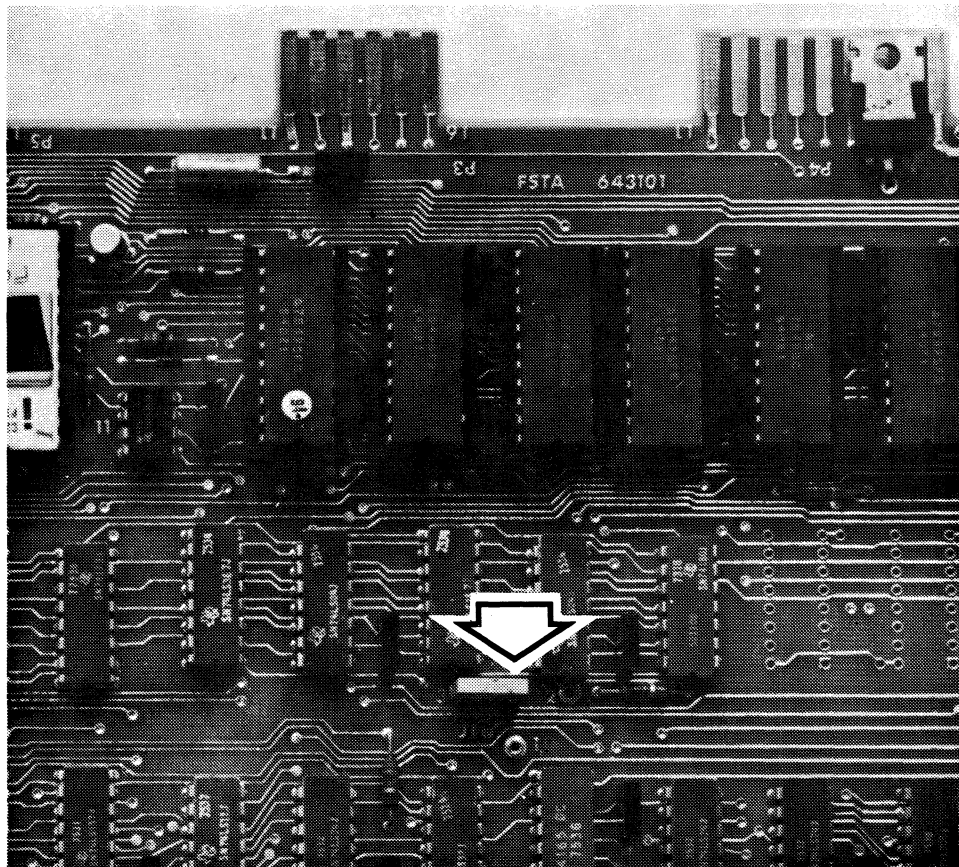
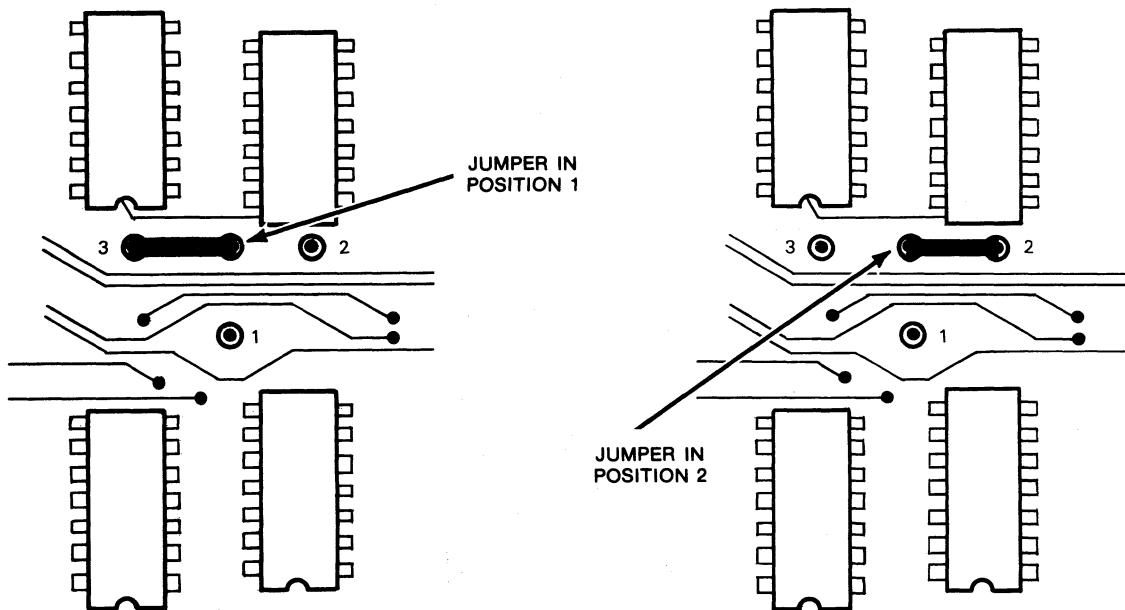

FIGURE 4-13. LOGIC PCB JUMPER POSITIONING

INTERNAL
FUSES
(0.8 AMP)

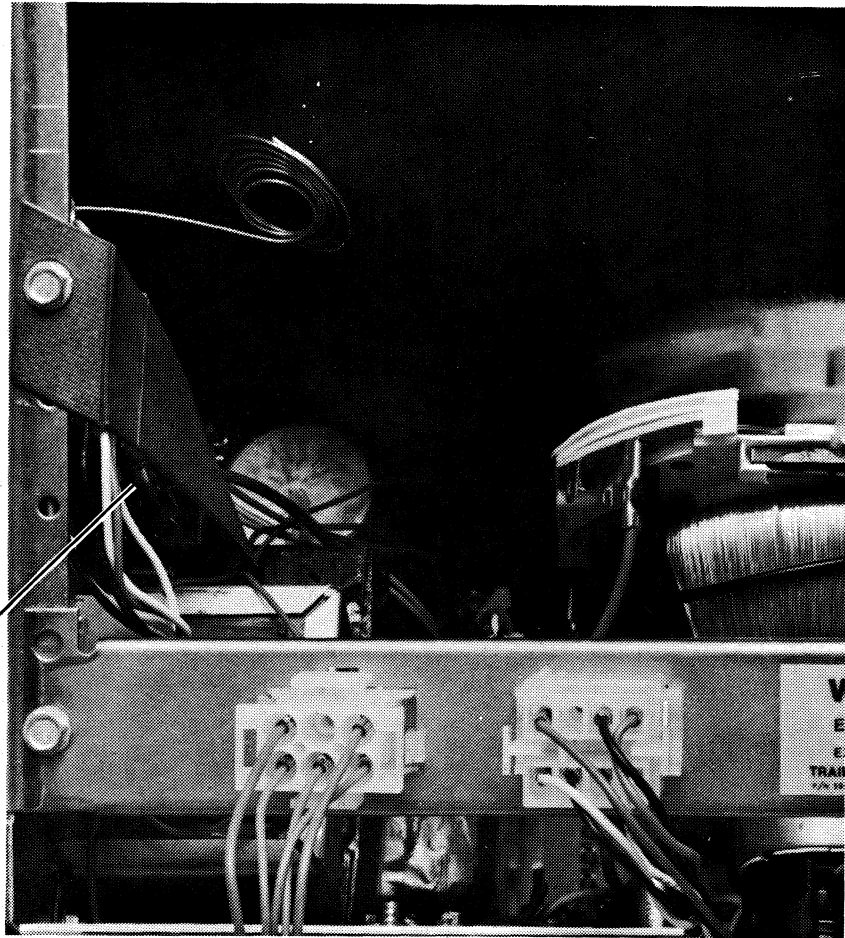

FIGURE 4-14. INTERNAL FUSES

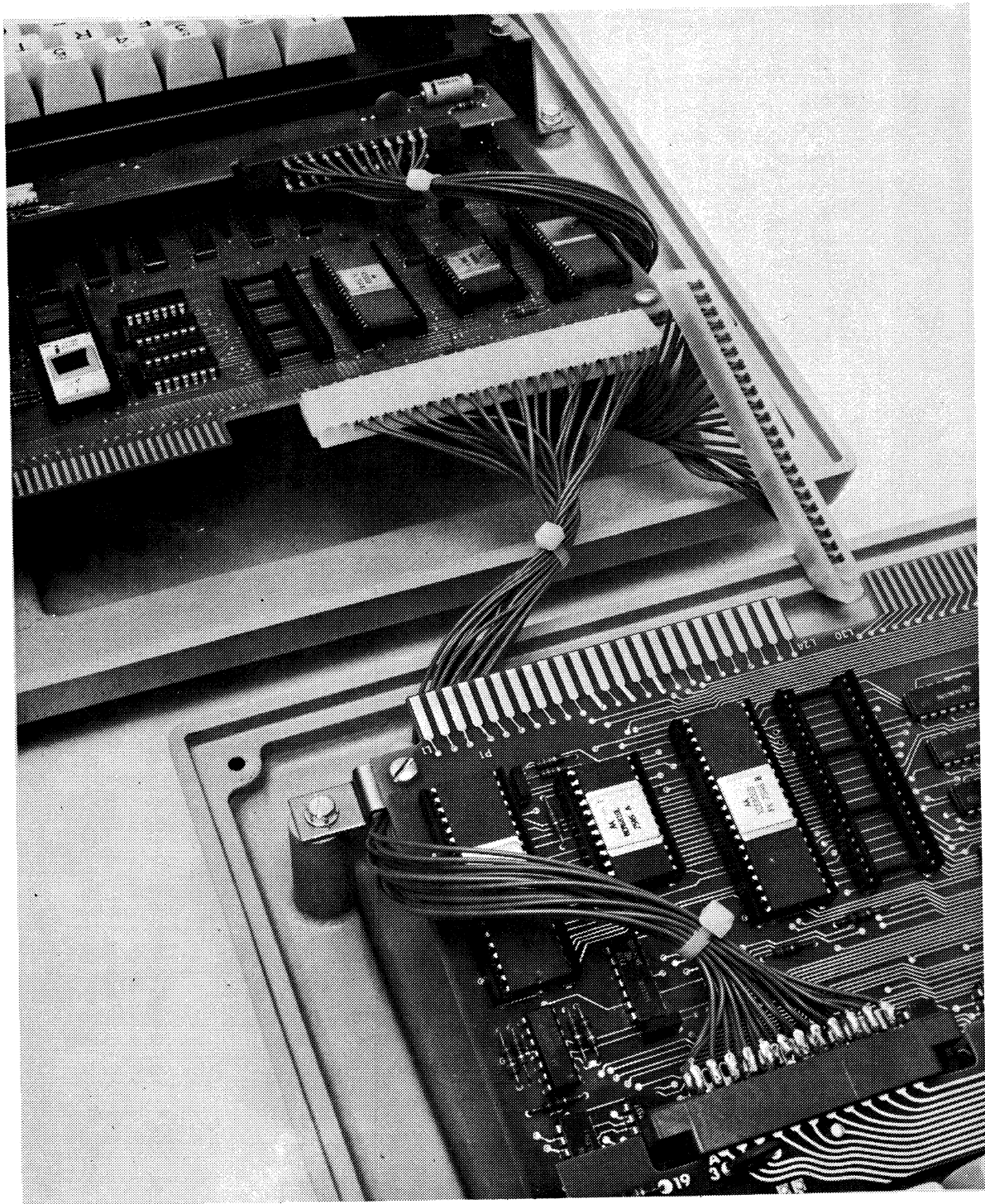

FIGURE 4-15. EXCHANGE OF LOGIC/KEYBOARD INTERFACE CABLE

SECTION 5 PROGRAMMING NOTES

The 1377 Display Station is plug and program compatible with the IBM 3270 Information Display System. Therefore, the reader should refer to the IBM manuals listed in Section 1 for programming details. The few enhancements of the Memorex 1377 are pointed out in this section.

Table 5-1 presents the EBCDIC Input/Output Interface Code used by the Control Unit and the Display Station. The characters that appear in bold typeface indicate those codes which are not identified for the 3277-2 but which have been specified for the 1377 Display Station. As shown, however, several codes remain unidentified. If an undefined code is transmitted, a random character may appear on the screen. Since the character is unspecified, another device may display a different character.

The control characters displayed for NL, EM, DUP, and FM are n, r, \ , and →, respectively.

The 1377 displays upper and lower case letters. Although the IBM 3277-2 displays only upper case letters, both upper and lower case letters are transmitted. Therefore, no software changes are required when using a Memorex 1377.

TABLE 5-1. EBCDIC INPUT/OUTPUT INTERFACE CODE

Hex Bits 4567	1 ↓	00				01				10				11				← Bits 0,1
		00	01	10	11	00	01	10	11	00	01	10	11	00	01	10	11	← 2,3
		0	1	2	3	4	5	6	7	8	9	A	B	C	D	E	F	← Hex 0
0000	0	NUL	DLE			SP	&	-		SP	∞	≈	0				0	
0001	1	SOH	SBA				/			a	j	Σ	1	A	J		1	
0010	2	STX	EUA		SYN					b	k	s	2	B	K	S	2	
0011	3	ETX	IC							c	l	t	3	C	L	T	3	
0100	4		EM							d	m	u	4	D	M	U	4	
0101	5	PT	NL							e	n	v	5	E	N	V	5	
0110	6			ETB						f	o	w	6	F	O	W	6	
0111	7			ESC	EOT					g	p	x	7	G	P	X	7	
1000	8									h	q	y	8	H	Q	Y	8	
1001	9		EM							i	r	z	9	I	R	Z	9	
1010	A				¢	!	 	:		μ	π	≤	T_M					
1011	B				.	\$,	#		{	[≥	R					
1100	C		DUP		RA	<	*	%	@	•	\	+	C					
1101	D		SF	ENQ	NAK	()	-	'	}]	-	•					
1110	E		FM			+	:	>	=	↑	→	±	~					
1111	F		ITB		SUB		⌋	?	"	↓	←	X	^					

COMMENTS FORM

1377 DISPLAY STATION OPERATION AND SERVICE MANUAL—1377.20-01

Please send us your comments; they will help us produce better publications. Whenever possible, please use specific page and paragraph references.

● Is the material:	Yes	No
Easy to understand?	<input type="checkbox"/>	<input type="checkbox"/>
Conveniently organized?	<input type="checkbox"/>	<input type="checkbox"/>
Complete?	<input type="checkbox"/>	<input type="checkbox"/>
Well illustrated?	<input type="checkbox"/>	<input type="checkbox"/>
Accurate?	<input type="checkbox"/>	<input type="checkbox"/>
Suitable for its intended audience?	<input type="checkbox"/>	<input type="checkbox"/>

● For what purpose did you use this publication (reference, general interest, etc.)?

● Please state your department's function:

Please use the space below for specific comments which you feel would improve any aspect of this publication. All comments become the property of Memorex Corporation.

MEMOREX

First Class
Permit No. 250
Santa Clara
California
95050

Business Reply Mail

No Postage Necessary if Mailed in the United States

Postage Will Be Paid By

Memorex Corporation

**Publications Department
Mail Stop 14-07
San Tomas at Central Expressway
Santa Clara, California 95052**

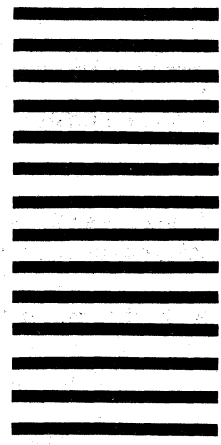

[Faint, illegible text area, possibly bleed-through from the reverse side of the page]