

\$3.00

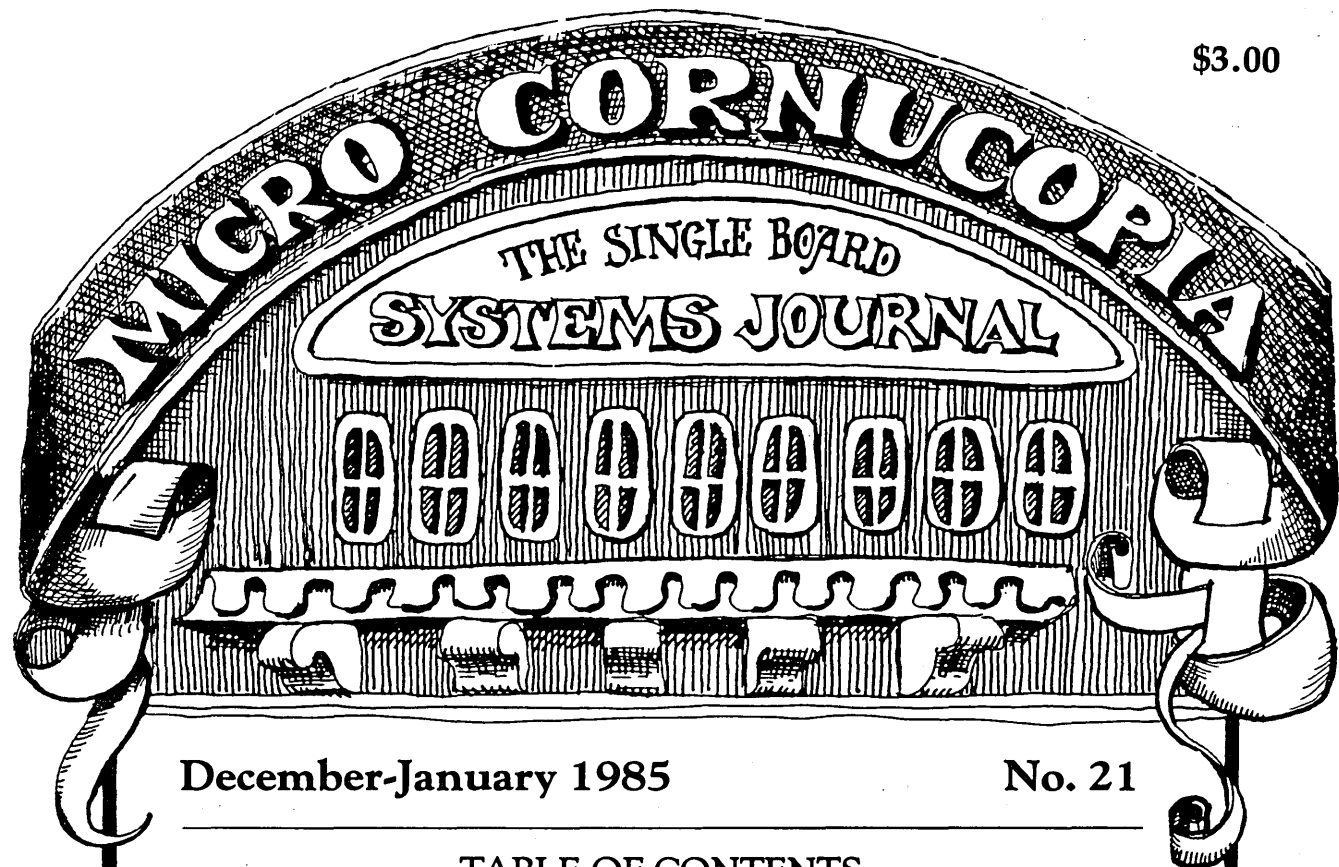

December-January 1985

No. 21

TABLE OF CONTENTS

Analog to Digital Interface ..... 4

Communication Between High-Level and Assembly Language ..... 10

Pascal Procedures ..... 14

Installing Turbo Pascal ..... 16

Xerox 820 Column ..... 20

C'ing Clearly ..... 24

Low Intensity BB I Video ..... 26

Slicer Column ..... 31

Saving Money on Quad Density Disks ..... 34

Three Keyboard Translators ..... 36

Kaypro Column ..... 40

KAMAS, An Outline Processor ..... 47

FORTHwords ..... 48

SBASIC Column ..... 52

Cooling a Hot Computer ..... 55

No Fault Power ..... 61

On Your Own: Turbo Pascal, the Early Days ..... 63

Technical Tips ..... 76

ALL SALES MADE SUBJECT TO THE TERMS OF OUR 90 DAY LIMITED WARRANTY. FREE COPY ON REQUEST.

**NEW LOWER PRICES**

# "THE ORIGINAL BIG BOARD" OEM - INDUSTRIAL - BUSINESS - SCIENTIFIC SINGLE BOARD COMPUTER KIT! Z-80 CPU! 64K RAM! (DO NOT CONFUSE WITH ANY OF OUR FLATTERING IMITATORS!)

**NEW!**

**PARTIALLY ASSEMBLED KITS**  
For All Sockets Installed  
And Soldered Add \$50.  
(Not For Blank PCB)

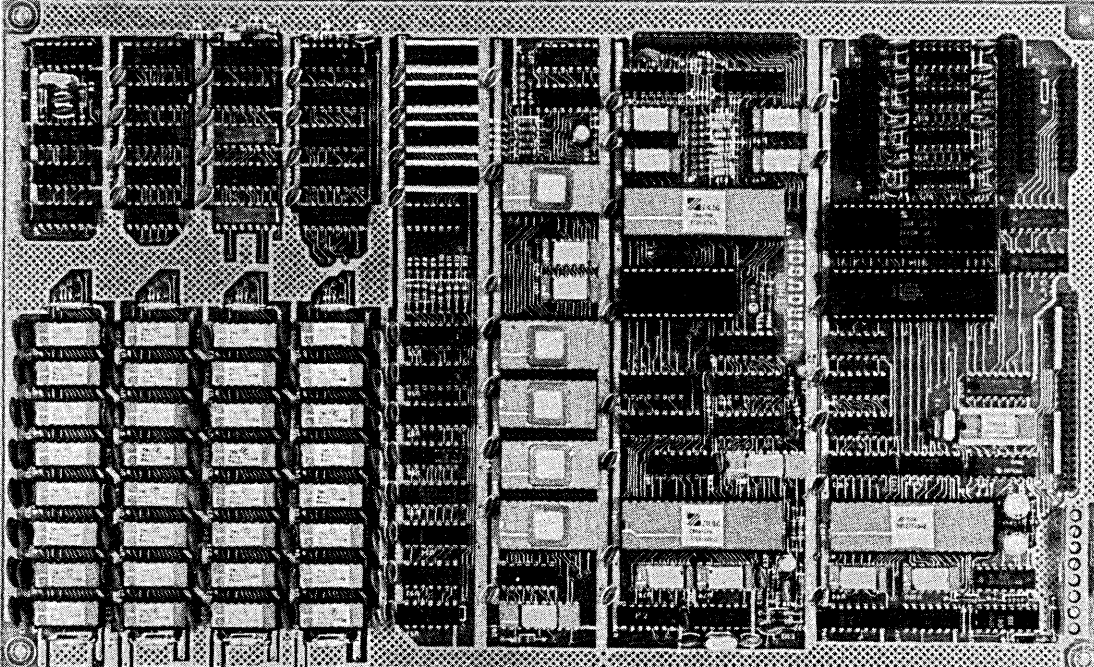

**WANT MORE INFO?**  
Full Documentation and  
Schematics — \$5.

**THE BIG BOARD PROJECT:** With thousands sold worldwide and over two years of field experience, the Big Board may just be one of the most reliable single board computers available today. This is the same design that was licensed by Xerox Corp. as the basis for their 820 computer.  
The Big Board gives you the right mix of most needed computing features all on one board. The Big Board was designed from scratch to run the latest version of CP/M\*. Just imagine all the off-the-shelf software that can be run on the Big Board without any modifications needed.

**\$219<sup>00</sup>\*\*** (64K KIT BASIC I/O)

SIZE: 8 1/2 x 13 3/4 IN.  
SAME AS AN 8 IN. DRIVE.  
REQUIRES: +5V @ 3 AMPS  
+ - 12V @ .5 AMPS.

**FULLY SOCKETED! FEATURES: (Remember, all this on one board!)**

**64K RAM**  
Uses industry standard 4116 RAM's. All 64K is available to the user, our VIDEO and EPROM sections do not make holes in system RAM. Also, very special care was taken in the RAM array PC layout to eliminate potential noise and glitches.

**Z-80 CPU**  
Running at 2.5 MHZ. Handles all 4116 RAM refresh and supports Mode 2 INTERRUPTS. Fully buffered and runs 8080 software.

**SERIAL I/O (OPTIONAL)**  
Full 2 channels using the Z80 SIO and the SMC 8116 Baud Rate Generator. FULL RS232I For synchronous or asynchronous communication. In synchronous mode, the clocks can be transmitted or received by a modem. Both channels can be set up for either data-communication or data-terminals. Supports mode 2 Int. Price for all parts and connectors: \$39.95

**BASIC I/O**  
Consists of separate parallel port (Z80 PIO) for use with an ASCII encoded keyboard for input. Output would be on the 80 x 24 Video Display.

**BLANK PC BOARD — \$89.95**  
The blank Big Board PC Board comes complete with full documentation (including schematics), the character ROM, the PFM 3.3 MONITOR ROM, and a diskette with the source of our BIOS, BOOT, and PFM 3.3 MONITOR.

**24 x 80 CHARACTER VIDEO**  
With a crisp, flicker-free display that looks extremely sharp even on small monitors. Hardware scroll and full cursor control. Composite video or split video and sync. Character set is supplied on a 2716 style ROM, making customized fonts easy. Sync pulses can be any desired length or polarity. Video may be inverted or true. 5 x 7 Matrix - Upper & Lower Case.

**FLOPPY DISC CONTROLLER**  
Uses WD1771 controller chip with a TTL Data Separator for enhanced reliability. IBM 3740 compatible. Supports up to four 8 inch disc drives. Directly compatible with standard Shugart drives such as the SA800 or SA801. Drives can be configured for remote AC off-on. Runs CP/M\* 2.2.

**TWO PORT PARALLEL I/O (OPTIONAL)**  
Uses Z-80 PIO. Full 16 bits, fully buffered, bi-directional. Uses selectable hand shake polarity. Set of all parts and connectors for parallel I/O: \$19.95

**REAL TIME CLOCK (OPTIONAL)**  
Uses Z-80 CTC. Can be configured as a Counter on Real Time Clock. Set of all parts: \$9.95

**CP/M\* 2.2 FOR BIG BOARD**  
The popular CP/M\* D.O.S. to run on Big Board is available for \$139.00.

**DOUBLE DENSITY ADAPTER BOARD — \$149.95 (A&T)**  
Requires no cuts or MODS to an existing Big Board. Gives up to 670K storage on a single sided 8 in. diskette. With software to patch your CP/M\* 2.2.

**PFM 3.3 2K SYSTEM MONITOR**  
The real power of the Big Board lies in its PFM 3.3 on board monitor. PFM commands include: Dump Memory, Boot CP/M\*, Copy, Examine, Fill Memory, Test Memory, Go To, Read and Write I/O Ports, Disc Read (Drive, Track, Sector), and Search PFM occupies one of the four 2716 EPROM locations provided. Z-80 is a Trademark of Zilog.

**Digital Research Computers**  
(OF TEXAS)  
P.O. BOX 461565 • GARLAND, TEXAS 75046 • (214) 225-2309

**TERMS:** Shipments will be made approximately 3 to 6 weeks after we receive your order. VISA, MC, cash accepted. We will accept COD's (for the Big Board only) with a \$75 deposit. Balance UPS COD. Add \$4.00 shipping.  
USA AND CANADA ONLY

\*TRADEMARK OF DIGITAL RESEARCH. NOT ASSOCIATED WITH DIGITAL RESEARCH OF CALIFORNIA, THE ORIGINATORS OF CPM SOFTWARE  
\*\*1 TO 4 PIECE DOMESTIC USA PRICE.

# MICRO CORNUCOPIA

December-January 1985

No. 21

MICRO CORNUCOPIA  
P. O. Box 223  
Bend, Oregon 97709  
503-382-8048

**Editor & Publisher**  
David J. Thompson

**Operations Manager**  
Myron Pogue

**Assistant Editor**  
Rebecca Ozrelc

**Graphic Design**  
Barbara Smiley

**Technical Department**  
Dana Cotant Eric Roby  
Tony Ozrelc Laine Stump

**Advertising Director**  
Alice Holbrow

**Staff Assistants**  
Dorcas Dsenis Tracey Braas  
Cary Gatton Carla Miller

**Secretary**  
Christina Donaldson

MICRO CORNUCOPIA is the systems journal supporting systems programming languages and builders of single board and S-100 systems.

MICRO CORNUCOPIA is published six times a year by Micro Cornucopia Inc. P.O. Box 223, Bend, Oregon 97709.

**SUBSCRIPTION RATES:**

1 yr. (bulk rate)	\$16.00
1 yr. (first class)	\$22.00
1 yr. (Canada & Mexico)	\$22.00
1 yr. (other foreign)	\$30.00

Make all orders payable in U.S. funds on a U.S. bank, please.

**ADVERTISING RATES:** Available on request (call Alice Holbrow).

**CHANGE OF ADDRESS:** Please send you old label and new address.

**SOFTWARE, HARDWARE, AND BOOK VENDORS:** We would very much like to review your software, Single Board, and S-100 products. Send materials to the Review Department, Micro Cornucopia.

CP/M is a trademark of Digital Research, Inc.  
Copyright © 1984 by Micro Cornucopia  
All rights reserved

## I See Spots



### Putting Ink On Paper

Those of you who have been with Micro C over the years and those of you who have waded through most of the back issues have followed the growth of Micro C from a 16-page light-weight to this 70+ page catalog. (At least they feel like catalogs when we're hauling more than 3,000 pounds of them to the post office.)

Well, we're still going and growing thanks to a strong core of contributors and a very responsive group of Kaypro owners who are just as excited about the technical details of their system as us "old" timers. Well, as you will see, there will soon be another new group of Micro C subscribers. Many of these, however, are already "old" hands.

### Microsystems

*Microsystems* magazine, begun in 1979 by Sol Libes, has had the same kind of supportive readership that we have had. Originally the magazine was called *S-100 Microsystems* and it helped guide the S-100 system through its infancy and toward its current maturity. In the process, S-100 Microsystems attracted a loyal following of very technical people.

As the computer market moved away from the S-100 bus, Sol dropped the S-100 prefix and began shifting the emphasis from hardware to operating systems (CP/M 80, CP/M 86, MSDOS, and UNIX) and systems software. He was hoping to expand the audience (there are only a limited number of really technical folks) and remain viable in this rapidly

changing marketplace.

During this period along came Ziff-Davis, a giant publisher looking for ways to make inroads into the burgeoning computer market. Microsystems seemed just the ticket, and Sol, well, he was much more interested in writing and teaching than in publishing, anyway, so he sold the magazine. (We magazine types don't need offspring; we have our publications which are just as ornery and spiteful and fun as kids ever dreamed of being.)

Ziff-Davis installed some new (expensive) talent and made Microsystems a real high-class operation complete with salesmen, bingo cards, and special subscription deals. Its goal was a total circulation of 100,000 (newsstands and subscribers).

It turns out that per-copy printing costs drop dramatically when you run 100,000 copies. At that number, a four-color, 120-page magazine costs about 60 cents per copy. That's less than it costs us per copy to print a 72-page black and white Micro C.

Anyway, Microsystems' circulation peaked at about 50,000 (which may be two copies for every S-100 system in the country), so the December issue will be the last. (Sol was devastated when they told him.)

The Wall Street Journal just reported that Ziff-Davis has put 25 of its business and consumer magazines up for sale—including: Car and Driver, Popular Photography, Travel Weekly and Stereo Review. The article indicated that Ziff was not selling any of its computer magazines (what's left of them).

So Ziff-Davis appears to be putting its corporate house in order and in the process the computer community is losing an institution. I'm very sorry to see it go. But:

### New Columns In Micro C

Just when you thought that Micro C was already chock-full of columns (nuts), we announce two new ones. Sol Libes has agreed to do a column for us. He will be writing about public domain software, and he should certainly know

(continued on page 70)

# LETTERS

Dear Editor,

We want to thank you for the mention in Issue 20, "On Your Own." We're sorry you don't approve of the name of our company (BEE.MOR Enterprises). Our name is our names: Linda Bee and Gary Morris, and fortunately we didn't shell out \$40,000 to name our company BEE.MOR. We have been marketing peripheral products and systems for Kaypros, and operate a disk drive service center. Fortunately, our business is MOR, not less, than last year because we ship a good product.

We are avid readers of Micro C and appreciate the wealth of knowledge you provide.

**Linda Bee  
Gary Morris  
BEE.MOR Enterprises  
22 182nd Ave. E.  
Sumner WA 98390**

*Editor's note:*

*Thanks for the letter, Linda and Gary. The response to that "On Your Own" column was immediate and very interesting. Some people loved it, some had mixed feelings, and others thought I was off base (I won't repeat how far off).*

*Picking on someone's business name is about as bad as picking on his personal name (perhaps worse since he didn't have any choice over his own name).*

*Before I wrote the column, I told the outfit that distributes Dulmonts what I thought about the name (to their face). The distributor indicated that it too had tried to get the name changed but that the Dulmont company insisted: "That's always been our name, we're successful, and we're not going to change it!!!!!!!!!" The Dulmont company was definitely not interested in a new name.*

*The Integrand folks responded immediately with a beautifully written reply. Their name was derived from the mathematical term "integration," and at the time, they thought it was appropriate for a small cabinet company (and from what I've heard they are not all that small any longer). And, to answer Integrand's question, "If you make pianos like you make your cabinets, yes, I'd definitely be interested in a piano."*

*Jim Tanner also called to say that according to his recollection, the name "Big Board" was his idea. One afternoon while going over prices for producing the Big Board circuit*

*board someone commented that the run would be expensive because it was such a "big board." No too long afterwards he was tuned to the stock market report while driving home. They announced the number of shares traded on the "Big Board" and bingo.*

Dear Editor,

I have enjoyed your magazine very much and I have found the articles to be very informative. I own a KayPro 10 and I would love to see more on what makes it tick and how to improve upon it.

I work for a KayPro dealer and I have had fun speeding up the II's and the 4's to run at 5mhz.

By the way, I have found that with a standard II or 4, I could only go up to 2400 baud when using MODEM7 between a slow Kaypro and a different brand 4 MHz machine. After speeding up the Kaypro, 9600 baud was no problem.

And now I have the same problem with my 10. I can only go up to 2400 baud before I start getting errors. I wrote a letter to KayPro about this and they called me back to get further information, but as of yet there has been no solution.

There is so much out there in the way of add-on's for the II and 4 but nothing for the 10. I would like to ask everybody out there if they have heard of any way to do the following.

1. Add a clock (with software) onto a 10.
2. How about a 6mhz upgrade? (I have the Z80-B's)
3. Adding an 8088 board and MSDOS and CP/M86.
4. RAM disk (might use 8088 board memory).
5. ZCPR type modifications to CCP.
6. Add an 8" drive. This I would like a lot. I already have UNIFORM for my 5"; with an 8" I wouldn't have to use MODEM7 to transfer my programs.
7. A 300/1200 modem card.
8. Screen dump routine, one that could dump the graphics as well would be nice. (I have Prowriter 8510).
9. I have just read the article on how to turn your KayPro II or 4 into an 8. How about this mod for the 10?

I want the world, but why not?

**David R. Meyers  
6390 Rancho Mission Rd. #208  
San Diego, CA 92108**

Dear Editor,

Back in August I sent a check for \$20 for your new Kaypro 4-84 schematics. My check hasn't been cashed yet, so I'm not angry, but I sure would like to have those schematics. Did the check get washed down the river when you were shooting the rapids? Just write a note on some toilet paper and let me know.

**Chuck Weingart  
2152 W. Iowa  
Chicago IL 60622**

*Staff reply:*

*You're right. It did get washed down the river but we finally fished it out. We decided to wait until it dried out before we sent it, though, so that's why it took so long. As for toilet paper, we ran out last week.*

*Actually, we finally got the darn things finished and shipped, so if you haven't received yours by now, please let us know.*

*Editor's note (to the staff):*

*A shortage of toilet paper could be disastrous (not even the software press releases work very well for this purpose).*

Dear Editor,

I could not let J. Wytsma's comments in Micro C issue 19 about the dearth of BBII articles go without rebuttal. One of things I enjoy most about Micro C is its informal approach coupled with varied information. I also enjoy the occasional minor errors. The whole format of Micro C makes it more personal and, for me, more readable than many of the "biggies" I no longer subscribe to. While Wytsma's point is well taken, I don't know how Micro C will continue to offer so much information on so many subjects for so little without changing a lot. It's a rotten shame that progress is a reality rather than just a theory.

**Dick Schaffer  
5138 W. Olive Ave.  
Glendale AZ 85302**

*Editor's note:*

*Thanks, Dick. I have really been struggling with idea of Micro C and change and it's been one of the most difficult parts of being editor. Other publications are facing the same changes and it doesn't look like very many have found any real direction. Some are just floundering better than others.*

# LETTERS

Dear Editor,

I see all of the interesting things that some people are doing with the Big Boards and start getting the urge to try some of them.

Would it be possible to get one of the Big Boards, and by using your improved PROM, generate a system that would use the Kaypro software and read the same disks in the same format?

The Big Boards might have the advantage that I would be able to have more I/O and the possibility of having an 8" disk to access some of the CP/M software.

Some time ago I put together a SWTP 6800 system and have had some limited experience in assembly language programming. I do not have much spare time and am somewhat afraid that I might be getting into a lot more than I can cope with.

Can the disk controller on the Digital Research Computers be changed to one that will control 5" floppies?

Would the BB II be a better choice as an answer to this problem?

**Albert P. Van der Klott**  
**Wahl-Henius Institute, Inc.**  
4206 N. Broadway  
Chicago IL 60613

*Editor's note:*

*We're working on that Kaypro/BB modification but it could be as much as six months down the road. Even then, you will need to perform some non-trivial details to use the software.*

*To date we haven't completed the modification that would allow the DRC controller to run 5" but SWP has a package. However this package will only allow you to run 8" or 5", not both.*

*The BB II will run both 5" and 8" with Andy Bakker's software but lack of support and documentation (as well as installed base) for that system make it a difficult project for all but heavy-weight engineering types.*

Dear Editor,

I received my blank PCB for the BB I about a year ago along with a sample page from Micro C. So I sent for a subscription and have enjoyed every issue.

After admiring my blank board for a couple of weeks, I finally started soldering sockets.

I could only go for about 2 hours at a sitting before those neat rows of pins turned into a sea of waving spears. But I finally got them all in.

The caps and resistors were added; the connectors, crystals, etc., were soldered in; and then the long careful job of inserting the IC's was done. I went over the board with a magnifying glass a million times it seems and everything looked good.

I built a box, a 24-volt power supply, bought a Shugart from Cascade and a solid state switch from Phenix, wired it all together, flipped the switch on, hit return on the keyboard, opened my eyes, and beheld a glorious spectacle of every character in the English and Greek character alphabets flashing on and off.

Going over the board I found 4 IC's with bent out pins and the display changed to alternate zero's and colons. So I got out my stack of Micro C's and found a good article which discussed a similar problem.

Trying everything the article suggested made things no better or worse, so I began to substitute IC's and found a flaky 74LS123.

The monitor went blank when I turned it on and PFM signed on, my wife thought I had been electrocuted from all the jumping and hollering that went on.

To make a long letter longer, I'd like to say it's all been fun and to thank you for a good magazine and thanks to the many suppliers that advertise in it. They have all been prompt and their products excellent.

I have three Kaypro II's at work and have ordered disks and ROM's for them from Micro C. Being at a government agency, I have been amazed at the speed in which you have delivered the items. I hope you have received payment at least in a reasonable time. Many companies will not accept a government purchase order at all.

Now stop laughing and get my subscription renewed.

**Stuart Eason**  
3 Cotswold Rd.  
Benton AR 72015

*Editor's note:*

*The tears weren't from laughing, they really weren't!*

Dear Editor,

Your magazine is full of ecstatic reports from people who apply power to their BB II and two seconds later hear the bleep which means all is okay.

Let the record show it is not always so fast. I first applied power to my BB II on 19 Dec., 1983, but the "two seconds" ended 24 Feb., 1984.

Only a fraction of those "two seconds" were used fixing solid errors; solder is quicker than the eye.

One short took a bit longer. It measured 0 ohms pin to pin on the IC's, but disappeared as soon as I turned the board over to check it. It came back again only under power. Eventually, this problem just went away.

But the real hassle was a poor IC socket contact. Evidently the pressure of ohm meter probe was enough to make it look good on the static test, but it wasn't making contact otherwise. I found that one only after borrowing a logic analyzer.

Before I could make any sense of that, however, I had to find someone to list out the EPROM and disassemble some of it by hand. Thus I got by with a lot of help from my friends, but the ecstatic items in Micro C were no help at all.

Couldn't you have a department "What to do while waiting for the bleep"? Among other things you could print listings of EPROM's.

Now I start scraping up money for a keyboard and disk drives. But looking ahead, I see things I don't understand.

CAL TEX sent me a disk which I hope I can still find, but I didn't (yet) buy CP/M.

Are the User Disks which you sell "stand alone," or do they assume CP/M? If the latter, is there no way to proceed without spending \$150? I mean legally, of course.

**R.W. Hartung**  
408 Orchard  
East Lansing MI 48823

*Editor's note:*

*All of our disks assume CP/M. I mean, either we have to spend the \$150 or you have to spend the \$150. At \$12 to \$15 per disk, it wouldn't make much sense for us to spend \$150 each to put CP/M on them.*

*(continued on page 72)*

# Analog To Digital Interface

By Don Fletcher

Rt 1 Box 216  
Pleasant Hill MO 64080  
816-869-3472

I developed an incubator data acquisition system this summer using my Big Board as a bed for testing different analog to digital convertors (ADCs). I'm the designer, technician, assembler, janitor, and everything else for a hatchery equipment company (called Egg-tronics, of course). (Editor's note: probably owned by a very gentle holding company.)

I hate to waste any effort, so I've taken the results of my design research and written this article. I've tried to include enough information on analog to digital conversion so you can come up with something which will work with your own system.

The circuit and driver provided should work on either the Big Board or the Xerox 820-I, since development work in our shop was done on both computers. (A slight change would, no doubt, make this work on a Kaypro or any other system with similar port hardware.)

## Background

Analog to digital conversion, as the name suggests, is a process of converting analog signals (from detectors or other instruments) into the digital 1s and 0s that computers can understand.

Some examples of things you could monitor include: voltage, current, heat, humidity, light, sound, velocity, force, etc. Since ADCs can only convert an electrical signal into its digital equivalent, all inputs must first be converted into voltages.

**Conversion Speed:** The time required to convert an analog input to a digital number. Faster is better but more expensive.

**Resolution:** The number of binary states an analog voltage range can be reduced to. For example, if an 8 bit ADC is used, there are 256 different binary numbers that it can output (00 to FF Hex). If the desired input range is 0 to 2.55 volts the voltage per step would be 2.55V/255 steps (zero doesn't count here), or 0.01 volt per step. The more bits you have, the smaller the steps will be.

**Accuracy:** A measure of how closely the calculated binary output of the ADC matches the voltage input. Usually measured as +/- some fraction of the least significant bit (LSB).

## SACs And DSICs

There are two major families of ADCs—the successive approximation convertor (SAC) and the dual slope integration convertor (DSIC), each suited to different applications. When speed is important, the choice is the SAC, which can complete a conversion in 100 microseconds. In contrast, the DSIC requires 100 milli-seconds, which is 1000 times longer. The SAC is sensitive to noise, requiring good bypassing and board layout. In contrast, the DSIC is virtually immune to noise. If you need a lot of steps (increased resolution) the DSIC is best because it can give you up to 4 1/2 digits (19999 steps) resolution. The SAC is limited to 12 bits (4096 steps). Both types of convertors are in the same price range.

I used the ADC0804 SAC from National Semiconductor. It has a conversion time of 100 micro-seconds and 8-bit (256 step) resolution.

ADCs differ in the available accuracy and cost; the higher the accuracy, the higher the cost. The ADC0804 has an accuracy of +/- 1 LSB. There are 10 and 12 bit convertors available that are pin for pin compatible with the ADC0804 (the extra bits are handled in software), but they are expensive and hard to get at this time.

If you would rather use an integrator ADC, Intersil has several types available

(best buy is the 12 bit ICL7109). Intersil data books and parts are available from JAMECO and several other suppliers. A good second choice is the Motorola MC14433 3 1/2 digit ADC.

## Theory Of Operation

**IC1-CA4051:** Eight channel analog MUX used for input scaling. (See Figure 2.) An analog voltage is supplied to the negative input (Vin-) of the ADC. PIO A bits 3-5 determine which input (0-7) on IC1 is passed through to Vin-. The 1K scaling resistors should be as close to the same value as possible. Use either a resistor pack, or 1% parts.

This circuit increases the resolution of the ADC, providing 256 steps for each of the 8 voltage ranges. This yields the equivalent of an 11-bit ADC. If you don't need this much resolution, leave this circuit off and connect the negative input of the ADC (pin 7) to ground or whatever minimum voltage you require.

Since under worst case conditions, 8 conversions must be made to develop the 11-bit binary output, the conversion time required will increase to 800 microseconds. If this is too slow, use an ADC with increased resolution.

**IC2-CA4051:** Eight channel analog MUX used to provide 8 analog input channels to the ADC. Each channel is selected the same way that reference volt-

Figure 1 - Display Routine In BASIC

```
05 REM          INIT-SETS UP THE PORTS  INPT-INPUTS DATA
10 INIT=&HFA80
20 INPT=&HFAAB
25 REM          FIRST SET UP PORTS, RESET CHANNEL COUNTER
30 CALL INIT
40 CHAN%=0
50 A%=CHAN%
55 REM          GET DATA FOR CHANNEL NUMBER A%
60 CALL INPT(A%)
65 REM          PRINT IT WITH SEPERATION SPACES
70 PRINT A%;" ";
75 REM          DO IT AGAIN WITH THE NEXT CHANNEL
80 CHAN%=CHAN%+1
85 REM          UNTIL THE 8TH, THEN GO TO NEXT LINE
90 IF CHAN%=8 THEN GOTO 200
100 GOTO 50
200 PRINT
205 Z=0
206 REM          DELAY, WAIT FOR A WHILE
210 FOR I=1 TO 300
220 Z=Z+1
230 NEXT I
240 GOTO 30
250 END
```

ages are passed through IC1. If you only need a single channel, leave out IC2.

Each input channel is tied high through a pull up resistor for noise reduction. Be sure to include these since CMOS ICs get strange when their inputs float.

**IC3-LM336-(2.5V):** This is a precision voltage reference, so don't use a Zener diode, a resistive voltage divider, two chipmunks in series or any other substitute. The accuracy of this reference determines the accuracy of the whole circuit.

**IC4-ADC0804:** An 8 bit ADC. The analog inputs are provided by IC1 and IC2 as described above. The binary outputs are connected to PIO Port B. The start conversion (WR-, pin 3) input is connected to Port A bit 6. The conversion starts on the rising edge of this input.

Since the ADC is isolated from the micro processor by the PIO, the read and chip select inputs (pins 2 and 1) are grounded. This means that data is immediately available at the end of the conversion cycle.

The end of conversion is signaled by a negative transition of INTR-. This line is connected to the B Strobe input, which triggers a processor interrupt. The INTR output is reset after a read. (A read occurs automatically at the end of each conversion cycle since the read input is grounded.)

R1 and C1 determine the clock frequency. Analog and digital grounds (pins 8 and 10) are connected to a common point.

Vref/2, developed from IC3, determines the voltage range of the ADC. This voltage should be adjusted to one half of the required voltage span.

Keep the analog inputs as far away from the digital outputs as possible. Connect the ADC bypass capacitor as close to the chip as possible. The ADC0804 is accurate only to the LSB so this bit may twitch randomly.

The resistor and capacitor on the input line are there to reduce noise. Additional noise reduction is possible by increasing the value of either part. If the parts get too large, it will take too long to charge or discharge the capacitor and you will lose information.

If you are sampling each input as rap-

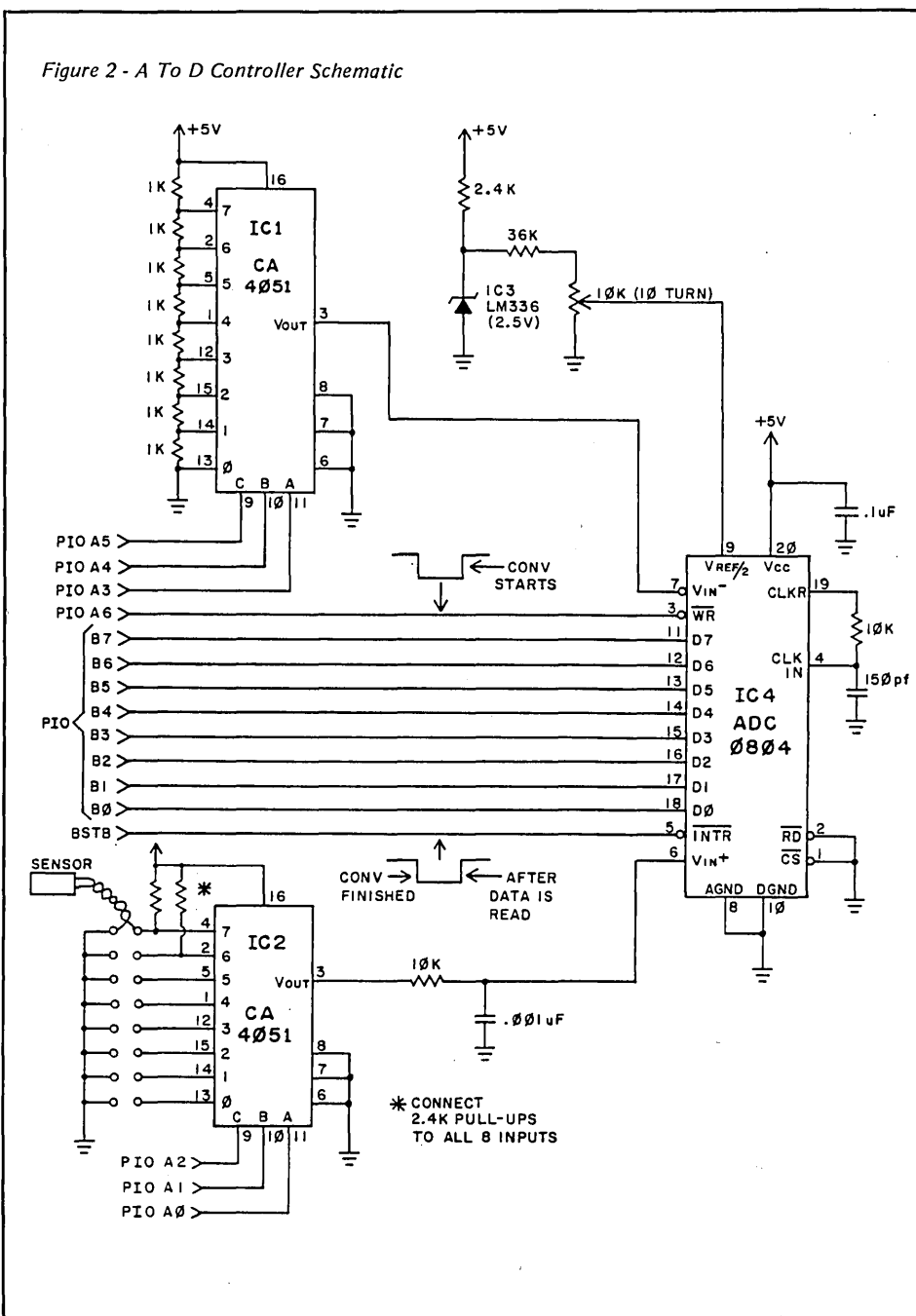

idly as possible, leave the values as they are. If you are sampling each channel at a slower rate, try increasing either R or C if you have a noise problem.

Connect input sensors with either shielded or twisted pair wire. If the sensor is high impedance, additional input filtering may be required. Sometimes this problem can be reduced by the choice of sensors. For example, if meas-

uring temperature, two sensor choices are:

- 1) A thermistor (high impedance)
- 2) An LM335 (low impedance)

The proper choice is the LM335.

*(continued next page)*

**Software**

I've provided an example driver for my ADC card, and a simple program in BASIC to print out the value of the 8 inputs on the console at periodic intervals. The driver must be loaded first since it resides in high memory. After loading the driver, load BASIC (or the language of your choice) and program away.

If you develop a good application for my ADC circuit, take a few moments and send it to Micro Cornucopia. It's fun—try it.



**HIGH PERFORMANCE VIDEO MONITOR**

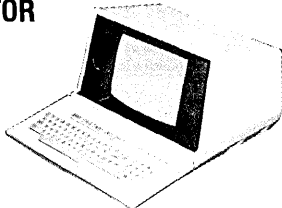

**BALL BCX-200 HP Monitor**

12", P31 Green, Non Composite, Separate Sync Required, 27 MHz Video Bandwidth, 12 VDC @ 1.5 A.

- Vertical Sync: 47-82 Hz
- Horizontal Sync (Jumper Selectable):
- PERFECT FOR BIG BOARD II

WHEN USING 9x11 CHARACTER SET

NEW with schematic shipping weight 10 lbs

**MONITOR ONLY . . . . . \$62.50**

**PLASTIC ENCLOSURE**

as pictured above. Size 17x14x12". Room inside for mounting above monitor, power supply, & S.B.C.

- PERFECT FIT FOR XEROX 820-1 BOARD!

NEW, SHIPPING WEIGHT 12 LBS

**ENCLOSURE ONLY . . . . . \$40.00**

**KEYBOARD & ENCLOSURE**

80-key X-Y scanned microprocessor controlled ASC II encoder kit. ROM source code supplied. 17x8.5x3".

New, with schematics, weight 8 lbs

**KEYBOARD, ENCODER KIT, ENCLOSURE . . . . . \$60.00**

Regulated power supply; 6 outputs: 5v @ 4 A, +/- 12 v @ 0.2 A, +24v @ 1.2 A, -24v @ 0.2A, +15v @ 2.6 A. 14x4x3", 10 lbs, New.

**REGULATED POWER SUPPLY . . . . . \$35.00**

**ARKON ENGINEERING**

PO Box 1390, Palm Bay, FL 32905  
(305) 676-5153

TERMS: Prepaid or UPS COD (CASH OR CERTIFIED CHECKS ONLY.)

*Figure 3 - ADC Driver Routine*

```

; Big Board - Xerox 820-I ADC0804 driver
;
; Board is connected to the General Purpose PIO, port A as output
; controlling the scaling MUX, the channel select MUX, and the
; start of conversion input into the ADC0804. Port B is set to
; read the binary data output from the ADC. Port B's strobe is
; also used as the end of conversion interrupt out of the ADC.
;
; Connect the following jumpers on JB3 on the Big Board (J11 on
; the Xerox) - (3-4), (9-10), and (17-18).
;
; This routine requires M80 to assemble.

.Z80

ADATA EQU 8
AOCNTRL EQU 9
BODATA EQU 10
BOCNTRL EQU 11
MODO0 EQU 0FH
MODO1 EQU 4FH
MODO3 EQU 0CFH
AOINTR EQU 1CH
BOINTR EQU 1EH
ITOCTL EQU 87H
LOAD EQU 0FA80H

BDOS EQU 5

ASEG
ORG 100H

LD DE,LOAD ;Load the program above the monitor
LD HL,ADC
LD BC,ADCEND-ADC-1
LDIR
RET ;Return to CPM

ADC: .PHASE LOAD

;FIRST SET UP INTERRUPT HANDLER

SETUP: LD HL,INTR
LD (OFF1CH),HL
LD (OFF1EH),HL
LD A,0
LD (LSTRDY),A ;SET LIST READY FLAG

;THEN SET UP PORTS

LD A,MODO0
OUT (AOCNTRL),A
LD A,0
OUT (AOCNTRL),A
LD A,07
OUT (AOCNTRL),A ;SET A TO OUTPUT MODE 3

LD A,MODO1
OUT (BOCNTRL),A
LD A,BOINTR
OUT (BOCNTRL),A
LD A,ITOCTL
OUT (BOCNTRL),A ;SET B TO INPUT MODE 1
    
```



**E Z PROMMER  
EPROM PROGRAMMER  
FOR THE BIG BOARD  
AND XEROX 820**

**FEATURES:**

- Supports 2716, 2732, 2732A, 2764, 27128, 27256
- Easily installed with only two connections
- No external supply needed, all power derived from +5 Volts
- All power controlled by software
- Extensive MENU driven software to Read, Program, Save, Load, Verify CRC check, Dump, Erase check complete with source code
- Over one year of troublefree use.

**EZPROMMER**

A&T w/Harness, Disk .... \$125  
Kit with Disk ..... \$90

**APL**

**CHARACTER GENERATOR  
FOR XEROX 820-II**

Upgrade kit allows the 820-II to display all the standard characters and attributes while permitting the display of all APL characters. Kit includes ROM and software.

APL UPGRADE KIT ... \$49.95

NY RES. ADD LOCAL TAX. POSTAGE  
AND HANDLING \$2.00  
VISA, MC, CHECK or COD

716-377-0369

**OPTRONICS  
TECHNOLOGY**

P.O. BOX 81  
PITTSFORD, NY 14534

```

LD      A,40H
OUT     (ADATA),A      ;SET STROBE HIGH

RET

;SUBROUTINE TO INPUT DATA FROM ADC, CHANNEL NUMBER IS POINTED TO
;BY HL. NUMBER IS RETURNED TO MEMORY POINTED TO BY HL AND HL+1
;(MSB IN HL+1)

ADCIN:  LD      A,(HL)      ;GET CHANNEL NUMBER
        PUSH   HL          ;SAVE POINTER FOR LATER STORAGE

        AND    07H
        LD     B,A
ADCIN3: OUT     (ADATA),A      ;OUTPUT CHANNEL NUMBER, STROBE LOW

        OR     40H
        OUT    (ADATA),A      ;STROBE HIGH

        CALL   ADCIN1
        CP    OFFH
        JP    NZ,ADCIN2

        LD     A,B
        ADD   A,08H      ;TRY NEXT SCALE
        LD     B,A
        AND   38H
        JP    Z,ADCIN2      ;CHECK FOR OUT OF RANGE
        LD     A,B
        JP    ADCIN3

ADCIN2: POP     HL          ;RECOVER POINTER
        LD     (HL),A      ;STORE LSB
        LD     A,B
        RRA
        RRA
        RRA
        RRA
        AND   07H      ;RECOVER MSB
        INC   HL
        LD     (HL),A      ;STORE MSB

RET

ADCIN1: LD     A,(LSTRDY)
        OR    A
        JP    Z,ADCIN1      ;WAIT FOR INTERRUPT

        LD     A,0
        LD     (LSTRDY),A      ;RESET READY FLAG

        IN    A,(BODATA)      ;GET DATA
        RET

;INTERRUPT HANDLER-SETS READY FLAG

INTR:   LD     A,OFFH
        LD     (LSTRDY),A
        EI
        RETI

;DATA STORAGE

LSTRDY: DB      0

        .DEPHASE
ADCEND: END

```

*End of Listing*

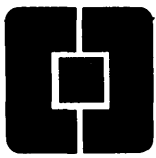

# Colonial Data **SB-80-II**

## The "Better Board" Gets BETTER!

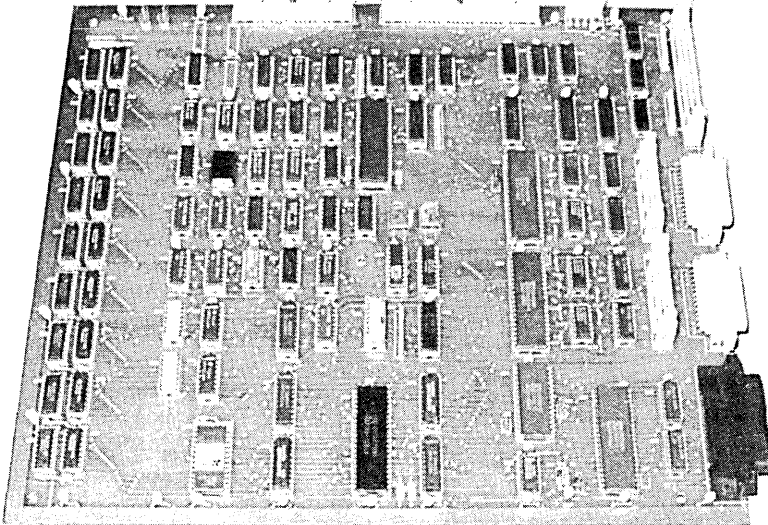

**\$298.00**  
ASSEMBLED & TESTED  
NOT A KIT!

For the past 4 years, Colonial Data has been supplying thousands of its original SB80 "Better Board" computers to the O.E.M. market. Now, the "Better Board" is even BETTER with the introduction of the **SB80-II**. More Standard Features at a NEW LOWER PRICE!

### Standard Features Include:

- 4MHz Z80A Processor
- 64K Memory (Expands to 128K)
- Supports 8" and 5¼" drives simultaneously
- Auto Density Selection (single/double/quad)
- 2 Serial Ports/1 Centronics Parallel Port

**SIZE:** 12" x 13"  
**POWER:** +12V, -12V, +5V  
**WARRANTY:** 90 days Parts and Labor

### ■ 4MHz Z80A CPU WITH NO WAIT STATES

Enhanced BIOS uses mode 2 interrupts.

### ■ 64K MEMORY STANDARD (EXPAND TO 128K)

Parity checked RAM utilizes 4164  
Up to 8K of EPROM (4K is standard)  
Accepts Pin-compatible EPROMS from 2716 thru 2764

### ■ NUMEROUS FLOPPY DISK STORAGE OPTIONS

Uses the advanced NEC765A controller chip  
Supports 8" and 5¼" drives simultaneously  
Automatic Density Selection (Single/Double/Quad)

### ■ 4 SERIAL I/O PORTS (2 STANDARD)

Software selectable baud rates to 19,200  
Uses Z80 SIO/0 and SMC 8116 baud rate generator.

### ■ Z80A PIO PARALLEL PRINTER INTERFACE

Centronics compatible printer interface is Standard!

### ■ SASI HARD DISK INTERFACE CIRCUITRY ON-BOARD!

SASI interface provides access to hard disk.  
Compatible with XEBEC and other controllers.  
Just populate with TTL and add connector.

### ■ 4 CHANNEL COUNTER TIMER-STANDARD!

Allows custom software applications.  
User accessible 125Hz interrupt.  
Provides system date/time clock.  
4th Channel used for the NEC 765 interrupt.

### ■ CP/M 2.2 BIOS ENHANCEMENTS

Allows flexible device assignments, baud rate selection, automatic density detection, a system date and time clock and hard disk support.

### ■ OPTIONAL CP/M 3.0 (CP/M PLUS)

Extensive disk buffering speeds system throughput.

Z80™ — ZILOG      CP/M™ — DIGITAL RESEARCH (Calif.)

### SB80-II SYSTEM OPTIONS:

### PRICE

ADDITIONAL 2 SERIAL PORT (INSTALLED)	\$ 60.00
ADDITIONAL 64K MEMORY (INSTALLED)	\$ 60.00
SASI INTERFACE OPTION (INSTALLED)	\$ 35.00
XEBEC HARD DISK CONTROLLER	\$290.00
CP/M 2.2 OPERATING SYS W/MANUAL	\$ 75.00
CP/M 3.0 OPERATING SYS W/MANUAL	\$275.00

### HOW TO ORDER:

Call or Write Colonial Data—Orders paid with bank card or cashier's check are shipped within 3 working days. Allow 3 weeks for Personal Checks.  
Shipping: Add \$5.00 for UPS Shipping (Brown) Within the United States.



## Colonial Data Services Corp.

80 Pickett District Road,  
New Milford, Conn. 06776  
Telephone (203) 355-3178

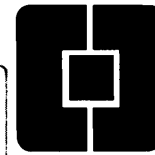
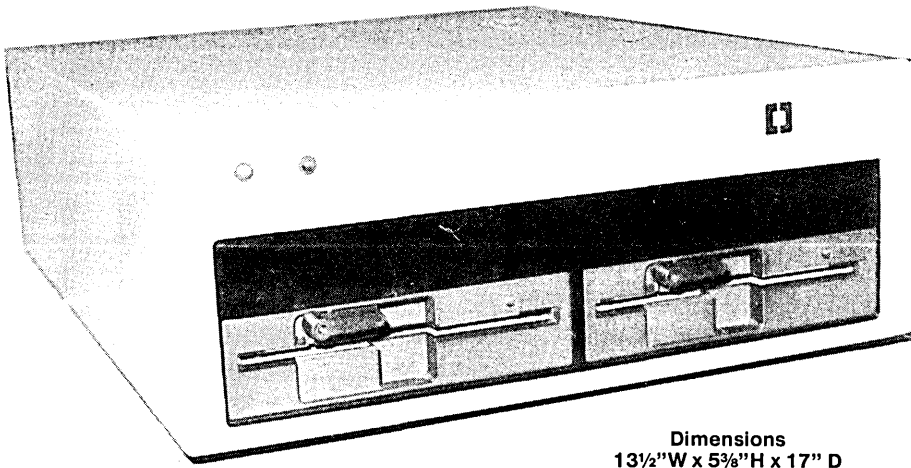

# Colonial Data SB-80-II

### COMPLETE SYSTEMS!

4 MHZ Z80A CPU  
64K RAM (EXPAND TO 128K)  
DUAL 5 1/4" DISK DRIVES  
2 SERIAL PORTS  
1 PARALLEL PORT

Dimensions  
13 1/2" W x 5 3/8" H x 17" D

FULL 90 DAY PARTS & LABOR WARRANTY

<b>MODEL IIA</b> - 2/380K DSDD DRIVES	<b>\$ 895.00</b>
<b>MODEL IIB</b> - 2/780K DSQD DRIVES	<b>\$ 995.00</b>
<b>MODEL IIC</b> - 10 Meg H/Disk w/380K Floppy	<b>\$1895.00</b>
<b>MODEL IID</b> - 10 Meg H/Disk w/780K Floppy	<b>\$1995.00</b>

\* **SB80-II** (Board Only) Wired and Tested **\$ 298.00**

SB80-II SYSTEM OPTIONS	PRICE
<b>All Models:</b>	
Additional 2 Serial Ports (installed)	<b>\$ 60.00</b>
Additional 64K Memory (installed)	<b>\$ 60.00</b>
CP/M 2.2 Operating System w/Manual	<b>\$ 75.00</b>
CP/M 3.0 Operating System w/Manual	<b>\$275.00</b>
<b>Models IIA and IIB only</b>	
SASI Interface Option (installed)	<b>\$ 35.00</b>
XEBEC Hard Disk Controller	<b>\$290.00</b>

## PICK YOUR SYSTEM! CHOOSE YOUR OPTIONS!

The Original "Better Board" SB80 from Colonial Data has just gotten BETTER YET! More on-board features like SASI interface circuitry, 4 Channel Counter Timer, Memory Expansion to 128K and MORE! All made to run the most popular programs under the CP/M Operating System.

Z80™ — ZILOG

CP/M™ — DIGITAL RESEARCH (Calif.)

## Colonial Data Cabinet Kits (Build Your Own Systems!)

### MODEL CKP1

Metal Cabinet will accept Single Boards up to 12"x16" complete with fan, RFI filter with power switch, front panel and mounting for two 5 1/4" half-height floppies. Pre-punched for 4 DB25 and 1-50 pin. Includes 60 watt power supply with ±12V, +5V.

**\$225.00**

### MODEL CKP2

Same as Model CKP1, but includes 90 Watt Power Supply to power half-height Winchester 5 1/4" hard disk and single 5 1/4" half-height floppy.

**\$425.00**

### MODEL CKX

Cabinet only with fan, RFI filter, power switch, prepunched connector holes. No Power Supply.

**\$139.00**

## Shugart 5 1/4" Disk Drives

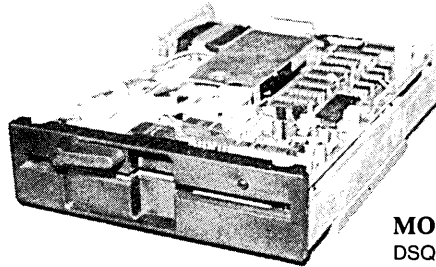

### MODEL 455

DSDD Floppy **\$195.00**  
Over 380K Capacity 2 For **\$370.00**

### MODEL 465

DSQD Floppy **\$225.00**  
Over 780K Capacity 2 For **\$430.00**

**O.E.M. Quantity Inquiries Invited!**  
Call or Write for Details!

### HOW TO ORDER:

Call or Write Colonial Data—Orders paid with bank card or cashier's check are shipped within 3 working days. Allow 3 weeks for Personal Checks.

Shipping: Add 2% (up to a maximum of \$20.00) for UPS (Brown) shipping within the United States.



## Colonial Data Services Corp.

80 Pickett District Road,  
New Milford, Conn. 06776  
Telephone (203) 355-3178

# Communication Between High-Level And Assembly Language

By Christian Phaneuf

P.O. Box 1107  
972 Guillaume Boisset  
Cap-Rouge Quebec Canada G1Y 3E4

How many times have you wished you could write complex assembly language programs as easily as you write programs in C, Pascal, or PL/I. After all, you need the control or speed of assembly language, but writing floating point (or even fixed point) routines in assembly language is a royal pain.

Perhaps, instead, you should be writing in a high level language and then, where necessary, calling assembly language subroutines.

This article includes two simple PL/I-80 programs, each with an assembly language subroutine. Both programs pass an ASCII character (\*) to a subroutine which outputs the character to the console using CP/M's CONOUT function. The subroutine then reads a character from the console (using CP/M's CONIN) and passes it back to the main program.

## High Level Languages Differ

Though there are differences at the detail level, the principles discussed here apply to most high level languages that let you include low-level routines.

However, no matter which compiler you use, the variables will always be passed through either the stack, the registers, the memory, or a combination of these. Therefore, the concepts illustrated in the PL/I-80 programs that follow can be adapted to any high level language compiler capable of generating relocatable code.

## Passing Data Back And Forth

In the first program (Figure 1), DEMO1 illustrates one way that parameters can be passed from the main program to the called routine. It also shows the implicit "returning" of values from the subroutine to the calling program.

Note that the assembly subroutine (CONSOLE1) is declared with entry and character(1). This tells the compiler that whenever the subroutine is called, a single ASCII parameter of length '1' will be passed to the called program. If several different parameters were to be passed, the type of each would be listed separately in the declaration of the procedure. For example:

```
dcl entry (char(3),fixed(15), . . .),
      1st par 2nd par etc...
```

The instruction "call CONSOLE1 (PARAM1);" tells the compiler that the variable PARAM1 is the actual parameter that will be passed. PARAM1 must be of the same data type (character(1)) as that declared in the entry procedure. Thus, an ASCII string of length 1 (the "\*" remember) will be passed to CONSOLE1.

## PL/I Details

PL/I-80 passes parameters to a subroutine by leaving the address of a pointer in register pair HL. The pointer contains the real address of the first parameter. If several parameters are passed, they must occupy successive memory locations.

The number of parameters and length of each parameter must be determined implicitly by agreement between the calling program and the called subroutine. Sound complicated? Well, if you can understand the man who saw the man who saw the bear, you should have no problem with this.

## Returning Data To PL/I

Since the locations of the passed variables are known, CONSOLE1 can alter the contents of these locations, thereby returning data to the calling program. Figure 1 demonstrates this.

CONSOLE1 first prints the "\*", then CONIN is used to read a character from the console. Finally, the subroutine places the new character into the memory location called PARAM1 (by PL/I) and returns control to the calling program. Figure 3 shows the results of running DEMO1.

An alternate method, used to return data to the calling program, is very useful for simple routines when there is no entry variable or when you don't want the subroutine tampering with the main program's data.

As shown in Figure 2, assembly language subroutine CONSOLE2 is declared with both entry() and return() attributes. This double declaration tells the compiler that instead of the general parameter passing protocol used in DEMO1, the alternate method will be used. Here, PL/I-80 stipulates that the subroutine must place data on top of the stack and the length of the data must be

left in the accumulator before control is returned to the calling program. Note in the execution of DEMO2 that the variable PARAM1 has not been altered by CONSOLE2.

The type of data to be returned will determine which method you use. For instance, fixed binary numbers with precision 1-7 are returned in the accumulator, while precision 8-15 are returned in HL. Bit string data is returned the same way but fixed decimal data is returned on the stack as a 16-decimal digit value in nine's complement form (8 bytes are used).

No matter which method you use, parameter passing can be an easy way to have the advantages of high-level language productivity and low-level language control and speed in the same program.



Figure 1 - Returning Data Via Globals

```
DEMO1:
procedure options (main);

declare
CONSOLE1  entry ( character (1) ),
PARAM1    character (1);

PARAM1 = '*';
put skip list ('Before calling: ');
put list ('PARAM1 =', PARAM1);
put skip;
call CONSOLE1 (PARAM1);
put skip list ('After calling: ');
put list ('PARAM1 =', PARAM1);
end DEMO1;

CONSOLE1:
.Z80 ;Z80 mnemonics used
PUBLIC CONSOLE1 ;Program will be recognised by LINK

BDOS EQU 05h
CONIN EQU 01h
CONOUT EQU 02h
PUSH HL ;Original HL saved
LD E,(HL) ;
INC HL ;Address of Parameter in
LD D,(HL) ;register pair DE
EX DE,HL ;Save parameter address
PUSH HL ;on stack
LD E,(HL) ;Parameter must be in E
LD C,CONOUT ;before calling CP/M
CALL BDOS ;console output funct.
;
LD C,CONIN ;Read a character using
CALL BDOS ;CP/M console input fn.
;
;The character read from the console
;will now replace the parameter from
;the calling procedure in memory
;
POP HL ;Parameter address in HL
LD (HL),A ;New parameter now in
;memory
POP HL ;Original HL restored
RET ;Return to calling
END ;procedure
```

# PROGRAMMER/4+

**NEW AND IMPROVED  
HOST SOFTWARE DISK**

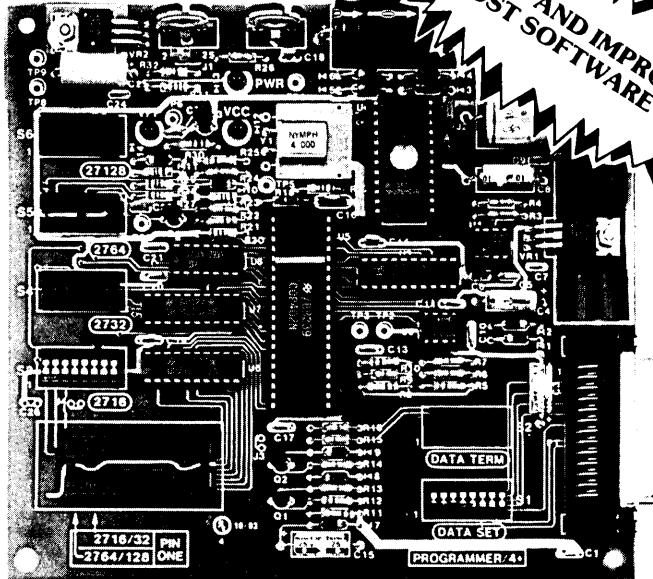

## A LOW COST ALTERNATIVE TO EPROM PROGRAMMING

- Reads and programs 2716, 2732, 2764, and 27128 EPROMS.
- Reads 2-16K ROMS.
- Direct connect to any RS232C terminal or computer.
- Plug selectable as either a data set or data terminal.
- All voltages made on board, (no power supplies needed).
- (User supplies power Xformer, 25.2 to 30 VAC C.T.1 Amp.)
- Power electronically switched, (can't damage EPROMS).
- Zero insertion force socket for EPROM.
- Programs, verifies, and dumps in both ASCII and hex.
- Edit buffer (like DDT).
- Saves hex and/or image files to and from disk.
- Saves or loads all or partial buffer.
- Completely menu driven for ease of operation.
- Commands of Test, Read, Display, Save, Load, Program and more.
- Check sum calculation.
- All software on disk including well commented source code.
- Detailed owners manual including schematic
- All chips socketed.
- Not a kit! Completely built and tested.
- 48 hour dynamic burn-in and test before shipment.
- 90 day limited warranty on parts and workmanship.
- 24 hour return policy on repairs.
- Delivery from stock.

NOTICE TO PREVIOUS CUSTOMERS: Send us your old disk and a suitable S.A.S.E. for your free copy of our new software, ver. 1.6.  
PROGRAMMER 4+ WITH OWNERS MANUAL AND DISK. \$199.95

Order from



1659 Scott Blvd., Suite 1  
Santa Clara, CA 95050  
(408) 244-5214

VISA and MASTERCARD telephone orders welcome.

Please specify Disk format  
CP/M 8" IBM format, KAYPRO II, XEROX 820, OSBORNE I, others.

Please specify method of shipment, UPS or Postal Service.  
California residents add 6% Sales Tax. Dealer Inquiries invited.

Figure 2 - Returning Data Via Stack

```

DEMO2:
  procedure options (main);

  declare
    CONSOLE2 entry ( character(1) )
      returns ( character(1) ),
    ( PARAM1, PARAM2 ) character(1);

    PARAM1 = '*';
    put skip list ('Before calling: ');
    put list ('PARAM1 =', PARAM1);
    put skip;
  /* here, subroutine is called by */
  /* invocation, "CALL" keyword not */
  /* required. */
    PARAM2 = CONSOLE2 (PARAM1);

    put skip list ('After calling: ');
    put list ('PARAM1 =', PARAM1);
    put list ('PARAM2 =', PARAM2);

end DEMO2;

CONSOLE2:
.Z80 ;Z80 mnemonics used
PUBLIC CONSOLE2 ;Program will be reco-
;gnised by LINK

BDOS EQU 05h
CONIN EQU 01h
CONOUT EQU 02h
PUSH HL ;Original HL saved
LD E,(HL) ;
INC HL ;Address of Parameter in
LD D,(HL) ;register pair DE
EX DE,HL ;exchange registers
LD E,(HL) ;Parameter must be in E
LD C,CONOUT ;before calling CP/M
CALL BDOS ;console output funct.
;
LD C,CONIN ;Read a character using
CALL BDOS ;CP/M console input fn.
;
POP HL ;Original HL restored
POP BC ;Return address in BC
;As per PL/I parameter
LD E,A ;passing convention
PUSH DE ;place char on stack
LD A,01h ;and string lenght in
;accumulator
PUSH BC ;Return adress back on
;top of stack
RET ;Return to calling
END ;procedure
  
```

Figure 3 - Results Of Running DEMO1

```

A>demo1

Before calling: PARAM1 = *
*o
After calling: PARAM1 = o
End of Execution

A>demo2

Before calling: PARAM1 = *
*9
After calling: PARAM1 = * PARAM2 = 9
End of Execution
  
```

# NEW from BORLAND! TURBO TOOLBOX & TURBO TUTOR

"TURBO is much better than the Pascal IBM sells."  
Jerry Pournelle. Byte. July 1984

"If you have the slightest interest in Pascal—buy it!"  
Bruce Webster. Softalk IBM. March 1984

## BORLAND INTERNATIONAL GIFT PACK

ONLY  
**\$99<sup>95</sup>**  
A SAVINGS OF \$30!

What a gift for you and your friends! The extraordinary TURBO PASCAL compiler, together with the exciting new TURBO TOOLBOX and new TURBO TUTOR. All 3 manuals with disks for \$99.95.

**TURBO PASCAL** Version 2.0 (reg. \$49.95). The now classic program development environment still includes the FREE MICROCALC SPREAD SHEET. Commented source code on disk

• Optional 8087 support available for a small additional charge

**NEW! TURBO TOOLBOX** (reg. \$49.95). A set of three fundamental utilities that work in conjunction with TURBO PASCAL.

- Includes:
- TURBO-ISAM FILES USING B+ TREES. Commented source code on disk
  - QUIKSORT ON DISK. Commented source code on disk
  - GINST (General Installation Program)

Provides those programs written in TURBO PASCAL with a terminal installation module just like TURBO'S!

• NOW INCLUDES FREE SAMPLE DATABASE

**NEW! TURBO TUTOR** (reg. \$29.95). Teaches step by step how to use the TURBO PASCAL development environment—an ideal introduction for basic programmers. Commented source code for all program examples on disk.

**30 DAY MONEY BACK GUARANTEE**  
These offers good through Feb. 1, 1985

For VISA and MASTERCARD order call toll free:

**1-(800)-255-8008 1-(800)-742-1133**

(Lines open 24 hrs., 7 days a week)

Dealer and Distributor inquiries welcome (408) 438-8400

**CHOOSE ONE** (please add \$5.00 for handling and shipping U.S. orders)

<input type="checkbox"/> All Three-Gift Pack	\$ 99.95 + 5.00 <b>SPECIAL!</b>
<input type="checkbox"/> All Three & 8087	139.95 + 5.00 <b>SPECIAL!</b>
<input type="checkbox"/> Turbo Pascal 2.0	49.95 + 5.00
<input type="checkbox"/> Turbo Toolbox	49.95 + 5.00
<input type="checkbox"/> Turbo Tutor	29.95 + 5.00
<input type="checkbox"/> Turbo 8087	89.95 + 5.00

Check  Money Order  VISA  MasterCard   
Card #: \_\_\_\_\_ Exp. date: \_\_\_\_\_ Shipped UPS

My system is: 8 bit  16 bit

Operating System: CP/M 80  CP/M 86  MS DOS  PC DOS

Computer: \_\_\_\_\_ Disk Format: \_\_\_\_\_

Please be sure model number & format are correct.

NAME: \_\_\_\_\_

ADDRESS: \_\_\_\_\_

CITY/STATE/ZIP: \_\_\_\_\_

TELEPHONE: \_\_\_\_\_

California residents add 6% sales tax. Outside U.S.A. add \$15.00 (if outside of U.S.A. payment must be by bank draft payable in the U.S. and in U.S. dollars). Sorry, no C.O.D. or Purchase Orders.

**BORLAND**  
INTERNATIONAL

4113 Scotts Valley Drive  
Scotts Valley, CA 95066  
TELEX: 172373



# THE LITTLE BOARD®

OEM — INDUSTRIAL — SCIENTIFIC

SECOND GENERATION SINGLE BOARD COMPUTER KIT!

4 MHZ Z80\* CPU! 64K RAM! DOUBLE DENSITY!

FREE CP/M\* 2.2!!!  
A \$139 VALUE! A FREE  
5-1/4 IN. CP/M 2.2  
DISKETTE IS INCLUDED  
WITH EACH KIT.

A. & T. UNITS  
\$319

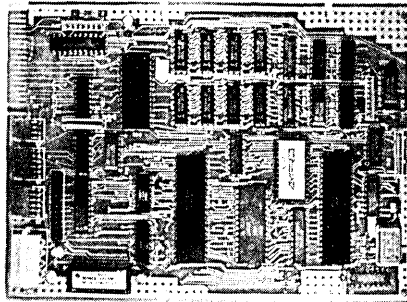

*New!*  
**\$259<sup>00</sup>**  
(COMPLETE KIT)

MINI-SIZE:  
ONLY  
5-3/4 x 7-3/4 INCHES

FULLY SOCKETED! PERFECT MATE TO OUR ZRT-80 TERMINAL BOARD. THROUGH SPECIAL ARRANGEMENT WITH AMPRO COMPUTERS, WE ARE PLEASED TO OFFER THEIR LITTLE BOARD® IN KIT FORM.

### FEATURES:

4 MHZ Z80 CPU!

DOUBLE DENSITY (5-1/4 IN.) FLOPPY CONTROLLER

64K DYNAMIC RAM!

CENTRONICS STYLE PARALLEL PRINTER PORT

USES +5VDC @ .75 A. AND +12VDC @ 50MA.

TWO RS232 SERIAL PORTS

SAME SIZE AS A MINI FLOPPY

2732 BOOT EPROM

## Digital Research Computers

(OF TEXAS)

P.O. BOX 461565 • GARLAND, TEXAS 75046 • (214) 225-2309

TERMS: Shipments will be made approximately 3 to 5 weeks after we receive your order. VISA, MC, cash accepted. We will accept COD's with a \$75 deposit. Balance UPS COD. Add \$4.00 shipping.

USA AND CANADA ONLY

LITTLE BOARD® — AMPRO Z80™ — ZILOG CP/M™ DIGITAL RESEARCH (CA.)

## Mini Z80B

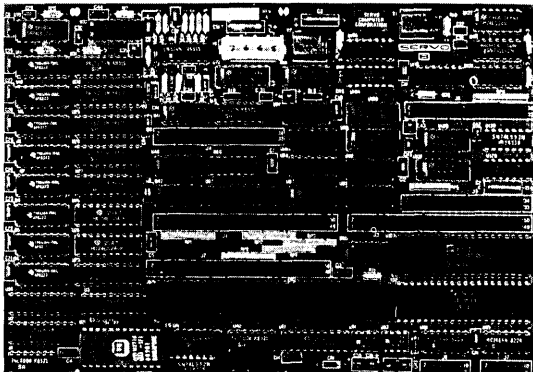

**SERVO 8  
HIGH PERFORMANCE  
SINGLE BOARD COMPUTER**

- 6 MEGAHERTZ Z80B CPU — No Wait States
- 5.75" x 8" mounts directly to Minifloppy
- 5 Volts only @ 1.4 Amps
- On Board Advanced Floppy Disc Controller Controls, four 5.25" or 3 1/2" & four 8" or 1.6 Megabyte Minifloppy Drives.
- Compatible with Kaypro II Format for Software Exchange
- 2K Eeprom Debugger/Monitor — Examine and change Memory I/O Ports, CPU Registers; Set Breakpoint, Control Disk Selection
- 64K 150 NS DRAM; Expandable
- SASI Bus Controls 10 Meg Winchester
- Expansion Bus-Z80 Terms Plus Additional Signals
- 2 RS232 Ports — 150 Baud to 153.6K Baud, Software Selectible
- Standard Centronics Parallel Port
- Disk I/O Buffers Timed for Flushing with Real Time Clock  
Clock Counts Available to Programmer
- CP/M V2.2 BIOS Sources Available — \$50; includes ROM Bootstrap & Automatic Disk Selection
- In Stock — \$495 CP/M add \$70 Visa M/C COD
- Piggy-Back Expansion Board Available;  
128K RAM, Two Serial Ports, Real/Time Clock Calendar with Battery Backup, \$384

# SERVO

SERVO COMPUTER CORPORATION  
360B N. ELLENSBURG ST. BOX 566  
GOLD BEACH, OREGON 97444  
(503) 247-2021

# Pascal Procedures

By John P. Jones

6245 Columbia Ave.  
St. Louis MO 63130  
314-645-1596

By the time you read this, advertisements for Borland's Turbo Toolbox should be in the magazines. The package consists of three utilities—an indexed file system, a sort utility, and a general installation program.

GINST.COM generates an installation program and the associated files necessary to customize a Turbo Pascal generated COM file to the end user's terminal. Without this utility, applications written in Turbo would either have to be written for each specific terminal or be distributed as source so the user could customize it. The Toolbox licensing agreement permits distribution of the generated installation files and even lets you include relevant sections of the Turbo Pascal manual with your programs without copyright problems.

The other portions of the package are of more general interest. Both the sort and indexed file routines are distributed as source for \$Inclusion in application programs.

## Turbosort

The sort utility, which uses the quicksort algorithm, can be used for most sorting applications. Because the routine is written to be general purpose, and sorts are extremely dependent on the structure of the data, the user must write three routines to interface to Turbosort. These are forward declared in the sort module and must match these declarations.

INP is called once by Turbosort and it must acquire successive data items. INP then calls SORTRELEASE (in the sort module) for each item. OUTP, which is also called only once, must call SORTRETURN to retrieve the sorted data items for output. The function SORTEOS is provided to let OUTP know when all records have been accessed. Since the user writes these routines, the data can be from any source.

Though it's most likely that you'd input from a file and output to another file, you might also, for instance, input from the keyboard and output to a file.

The third user-provided routine, which is called repeatedly by turbosort, is the boolean function LESS. It is in this routine that you determine sort order (ascending or descending), and whether

your program will check single or multiple fields. LESS receives two parameters, X and Y, which are the addresses of the variables to be compared. The routine must declare two variables of the type being sorted on top of the actual variables in memory by declaring them absolute at locations X and Y.

```
var variable1 : data_type absolute x;  
    variable2 : data_type absolute y;
```

Turbosort can be used to sort data files that are too large to fit into memory, since it can automatically set up temporary disk files as virtual memory. I tested the sort routines by generating a file of 1000 records, each 82 bytes long, with a 20 character random sort field. I sorted various parts of the file and output the results to the screen. Timing was from the Run command to the time the first sorted record was output to the screen. I used a 4 MHz Big Board with SWP dual density 8" disk controller using 1024 byte sectors.

# Records sorted	Time min:sec
100	00:05.6
200	00:10.9
250	00:38.8
300	02:30.8
400	03:59.2
1000	20:13.4

The times are quite respectable until you start using disk space. I did not have any other sorting utility for comparison but the results seem to be reasonable.

The sort is easy to use and flexible enough for any application.

## Turbo Access

Turbo Access is the B-tree indexed file handler. It is NOT a database manager like dBase II, but it provides the file interface to allow you to write your own database handler. Using Turbo Access is not a trivial task since you need to understand B-tree structured indexes. The manual contains enough information about B-trees for the intermediate or advanced programmer.

Turbo Access uses separate index and data files. The data file is a standard sequential file, with the first record reserved for Turbo Access use. The index

file(s) contains the B-tree structure along with pointers to records in the data file. Index and data files are updated by independent routines within the Turbo Access system. This makes the system flexible but you have to make sure that all the relevant files get updated as the data files are changed. Basically, however, the Turbo Access routines can maintain a data file and the index file or files associated with it.

First, a record is added to the data file. Then the index file is updated based on the contents of the key. Although the key does not need to be part of the data record, it is a lot easier to reconstruct a trashed index if it is.

Updates and deletions are performed in the opposite sequence. You access the index in order to locate the record. Then you can retrieve the data. It is never necessary to access the data file more than once to get a record. And depending on the memory available and the application, you might not have to access at all when you are searching the index.

I did not construct a large test database for performance testing but did set up a program for maintaining a club's membership records. I had been maintaining those records using the key-index facilities of JRT Pascal V 3.0. The Turbo Access system is slightly slower than the JRT system but significantly more flexible. Turbo Access allows for duplicate keys and multiple-index files.

This way, you can construct a very complex database. For instance, a magazine article database could be cross referenced using indexes for subject, author, source language, processor, and the like.

The example program BTREE is, by itself, worth the price of the package. If you are at all familiar with programming, I highly recommend that you take a close look at the source for this program.

The program is well written and you can learn a lot about Pascal programming by spending some time analyzing the techniques the Turbo folks used. I was able to set up the club database by making minor modifications to this program. (And it only took one evening.)

In a future column I'll spend some time on pointers, linked lists, and trees. After that we can take a closer look at



how Turbo Access works.

The Toolbox manual is of the same high quality as the Turbo Pascal manual. You get all the information you need to effectively use the utilities.

Turbo Toolbox is available from Borland International, 4113 Scotts Valley Dr., Scotts Valley, CA 95066. It is \$49.94.

**Turbo Tips**

Input filters are used to insure that input data falls within a specific range. The example program, included with Turbo Toolbox, uses a particularly good method to filter character input from the console. (See Figure 1.)

By defining a set type that includes the ASCII character set, it is then possible to pass a subset as a procedure or function parameter. So you can define exactly the range of values that can be returned by the procedure or function.

It is this type of capability which gives Pascal much of its power.

**Soap Box**

If you are familiar with Jerry Pournelle's column in Byte, you know his opinions about software prices and piracy. I agree with most of what he says, and would like to add a few thoughts.

In order to be successful, a software house has to have at least four factors working in its favor. First, there must be a large market. This means that the

product must have general appeal and run on a lot of machines. Next, the product has to be good. Poorly written, "buggy" software has little chance for success.

Third, the program has to be marketed at a reasonable price. The best word processor ever written for microcomputers would sell poorly at \$1000 a shot. What is a reasonable price? That, of course, depends on the product. Any software of direct utility in a business application will command a higher price than something like a game since the business can expect to profit from using the product.

Finally, the software publisher has to be able to fill orders. There are many cases in this young industry of companies with good products that have failed because they have been unable to keep up with demand.

As the number of small computers expands, the price of software should continue to fall. However, the software publisher can still expect to make a reasonable profit.

Borland International may be the first company to fit all of the above criteria. Their products are all well written, reasonably priced, promptly shipped and run on a broad base of computers. I expect Borland to be around for some time with a growing line of products.

Regarding piracy, quality software offered at a reasonable price should be

purchased, not stolen. Only through sales of its products can a company be successful, and every company that fails is a loss to us all. I won't strain my own credibility by telling you that I've never gotten an unauthorized copy of a program. On the other hand, anything I've looked at and have felt was necessary or useful, I've purchased. The copy of dBase II someone gave me has not been used since I tried it out. For what I'm doing, I can't justify the price.

For those of you on a tight budget, there are megabytes of public domain software available for minimal copying fees. Much of it is poor, but there are a lot of excellent programs available, some better than the equivalent commercial product.



**XEROX 820 USERS**

NEED MORE I/O??

2 PIO'S  
1 SIO

SASI INTERFACE  
SOUND GENERATOR  
REAL TIME CLOCK

USES THE NATIONAL 58167  
REAL TIME CLOCK

TI 76496 COMPLEX SOUND  
GENERATOR

BARE BOARD \$54.95

\*\*\*\*\*

COMPOSIT VIDEO INTERFACE  
BARE BOARD \$19.95

WE ACCEPT  
CHECK MONEY ORDER  
MASTER CHARGE VISA

**GRD TECHNIQUES**

PO BOX 6383  
BRIDGEPORT CT 06606  
203-374-3660

Figure 1 - Pascal Input Data Test Function

```
type
  charset = set of char;
.
.
function get_char (allowed : charset) : char;
var
  ch : char;
begin
  repeat
    read (kbd, ch);    { input from kbd needs no <CR> }
  until ch in allowed;
  get_char := ch;
end;
.
.
select := get_char ( ['A', 'a', 'z', '0'..'9'] );
.
select := get_char ( ['N', 'Y', 'n', 'y'] );
.
```

# Installing Turbo Pascal

By Laine Stump

Micro C Staff

**T**urbo Pascal is one of the most innovative packages to hit the market in a long time. With its built-in, full-screen editor and the ability to automatically find runtime errors in the source, you can have debugging sessions that rival the speed of an interpretive language like MBASIC (yuck!).

And, because it compiles to machine code, you can have execution speed that is as fast as C or any other 'systems' language and nearly as fast as the same program written in assembly language. However, the full potential of TURBO can only be realized if you use the internal editor for your debugging.

## Terminal Condition

Before using the TURBO editor, it is necessary to configure it for your terminal. This is trivial if your terminal is in the list given in TINST's (S) option; as a matter of fact, almost anybody reading this can choose 'ADM3A' and the editor will work.

However, if you want it to work as efficiently as possible, you should create your own definition. This is done by selecting the CREATE NEW DEFINITION option and answering approximately 20 questions about your terminal. This is covered in appendix K; I will briefly go over what is given there adding more detail on the subtle (but important!) points that aren't explained well enough in the manual.

## The Inquisition

There are three types of questions asked by TINST. The simplest asks for a Y/N response; just type a 'Y' for yes or 'N' for no and DO NOT follow it with a CR> carriage return. The second type of question asks for a single number. You can enter this number either as decimal by just typing the number, or as hexadecimal by preceding the number with '\$.'

When entering a number, you can edit your entry with the (BS) or (DEL) key. To end entry of the number, type (CR).

The third type of question asks for a command string to perform some function such as clearing the screen. TINST is more convenient than many other installation programs because you can enter the command string directly rather than having to enter a list of decimal or hexadecimal numbers.

If a command sequence is '(ESC)=,' you can type the escape key followed by the '=' key and a (CR) carriage return (0Dh) to indicate the end of the sequence. Any control characters typed this way are echoed as 'ctrl-cc' with the exception of (BS)—(ctrl-H), (DEL)—(7Fh), (CR)—(ctrl-M), and (ESC)—(ctrl-I), which are echoed as shown here. All other characters are echoed normally.

One of the most difficult things about entering command strings is that there is no such thing as backspace—once a key has been hit there is no return. If you forget and type a (BS) or (DEL) it will be taken as part of the command you are entering.

So, it is a very good idea to get out the reference guide for your terminal and go through the list of questions given on pp. 231-233 of the manual (for terminal installation) and pp. 11-13 (for editing command installation). Write down the answer to each question on a sheet of paper so that you will be ready and make no mistakes; if you slip up just once, you have to do the entire installation over again.

It is also helpful to STOP after each prompt and read the question. Some questions aren't asked if others are left blank, so you can't count on being able to type in your prepared answers exactly as you have written them down.

Some characters must be entered as strings of numbers (see p. 230 of the Turbo manual). The most obvious example of this is (CR). TINST interprets (CR) as its 'end of line' command, just like CP/M. To get around this, you must type '\$0D' (0D hex) or '13' (decimal) instead.

Note: if you enter part of a command in decimal, you must enter all of it the same way! For instance, the Kaypro 10 and the new II-84 and 4-84 have a bug in the terminal driver that causes the 'insert line' command to behave strangely. When the command is given, the current line is broken into two lines at the cursor position. TURBO expects the entire line to be moved down by one position and a new line to be inserted above it.

This difference of opinion means that the file and the screen won't necessarily agree. To cure this problem, you must tell TINST that the command to insert a line is '(CR)(ESC)E' instead of a simple '(ESC)E.' Since you can't directly type a

(CR), the way to do it is to reply to TINST's query for an insert line command with the following:

```
INSERT LINE command: $0D $1B  
$45(CR)
```

```
or 13 27 69(CR)
```

(Notice the spaces between the numbers.)

When entering numbers for commands, you are allowed a backspace of sorts. If you type a wrong digit you can start the current number over again by typing another '\$.' It doesn't work, however, if you have already typed the terminating space. Also, you can't enter a '-' (for 'none') after doing this.

One last thing about entering commands before we start talking about specific questions: you can change an existing definition by selecting its number and answering 'Y' when asked "Do you want to change this definition?" You are then asked the same questions used when creating a new definition, except the old answer to every question is displayed. If you just type (CR), the answer is left unchanged. If you want to change it, type in the new command as described before. If a command isn't supported by your terminal, type a '-' (minus sign) and the answer will be changed to 'Nothing.' This will only work if it is the first character on the line, so be careful what you type.

## Terminal Commands

The only command that must be defined for the editor to work properly is the CURSOR POSITIONING command. The screen lines and columns must also be defined, but the other commands simply make it run faster and more efficiently. The questions asked follow a general order of most to least important, with the exception of START/END HIGHLIGHTING. Without these commands, you cannot see what block of text the block commands are going to affect, most inconvenient but still passable.

If your terminal cannot highlight characters, then you can substitute the command for entering and leaving any other 'alternate video' mode, just be aware

that normal text is printed in 'highlighted' mode and special things (like marked blocks of text) are shown as 'normal.' This means that if you have a terminal with reverse video, you should give the command to return to 'normal' video for START HIGHLIGHTING and the command to enter reverse video as the END HIGHLIGHTING command. This seems a bit backwards, but if you do it the other way, the entire program you are working on will be displayed in reverse video, except for the marked block of text and any special characters that happen to be in the file. See Figure 1 for more help.

Figure 1 - What It Really Means

They Say	means
END HIGHLIGHTING	Set Alternate Video Mode
START HIGHLIGHTING	Return to Normal Video

The DELETE and INSERT LINE commands speed things up by making it possible to add and delete lines and scroll through the file without repainting the entire screen every time. The effect of adding these commands is especially obvious when scrolling toward the beginning of the file one line at a time. ERASE TO END OF LINE also cuts down the time needed to update the screen by eliminating the need to type spaces all the way out to the end of a line that doesn't fill the entire width of the screen.

#### Example

The following is a worksheet that has been filled in for a Kaypro II-84. If you have a Kaypro then you should use this definition rather than the one given in the terminal menu of TINST. If you have an older Kaypro, you should enter nothing (-) for the START HIGHLIGHTING command (the END HIGHLIGHTING command will then automatically be assumed to not exist). The definition supplied for Kaypros will not work totally correctly for any of the Kaypros, because it has highlighting commands not supported by the older models and it doesn't handle INSERT LINE correctly in the newer models, as mentioned before.

Figure 2 - Kaypro II-84 Video Command Worksheet

```
Terminal Type: Kaypro II-84 (4-84, 10)

Send Initialization String? N
Send a Reset String? N

CURSOR LEAD-IN command: <ESC> =
CURSOR POSITIONING COMMAND
  between row and column: Nothing
CURSOR POSITIONING COMMAND
  after line and column: Nothing
Column first? N
OFFSET to add to LINE: $20 (32)
OFFSET to add to COLUMN: $20 (32)
Binary address? Y

CLEAR SCREEN command: ctrl-Z
Does CLEAR SCREEN also HOME cursor? Y

DELETE LINE command: <ESC> R
INSERT LINE command: $OD $1B $45
  (<CR> <ESC> E)

ERASE TO END OF LINE command: ctrl-X

START HIGHLIGHTING command: <ESC> C 1
  < Nothing for older Kaypros
END HIGHLIGHTING command: <ESC> B 1

number of line on your screen: 24
number of columns on your screen: 80

Delay after CURSOR ADDRESS: 0
Delay after CLEAR, DELETE, and INSERT: 0
Delay after ERASE TO END OF LINE
and HIGHLIGHT On/Off: 0

Is this definition correct? Y
(I certainly hope so..)

Operating frequency of your
microprocessor in MHZ: 4
```

#### Editing Command Installation

If you happen to use WordStar, you can ignore this section. If you are used to some other set up of editing commands then you can save yourself a lot of grief by changing Turbo's editing commands to match the ones of your normal editor. To do this, select the C> option on the main menu of TINST and answer the 40 or so questions that follow. All these questions are of the same type as the 'command string' questions in the screen installation section and the same rules should be followed for entering them.

You should make up a work sheet for answers to these commands, too. If you want to, you can use the one on pp. 11-13 of the Turbo manual (along with the

update for vrs. 2.0 if you have it). The questions asked are sometimes confusing and inconsistent; for instance, did you know that Paging down takes you the same direction in the file as Scrolling up? To help overcome the confusion, see Figure 3.

Figure 3 - WordStar Worksheet

They Say	means
Scroll up ---->	to end
Scroll down -->	to beginning
Page up ----->	to beginning
Page down ----->	to end

Other than this, the only confusing part of installing editing commands is that you cannot have two commands that are the same (if you do, you have to do the ENTIRE installation procedure over again), and you cannot have ambiguous commands. For instance, if you have said that the Page up command will be '(ESC)F', you can't define the End Edit command as '(ESC)'.

#### The Bottom Line

Turbo Pascal is the greatest thing I have found since root beer floats. (Editor's note: Actually, root beer doesn't float, ice cream floats.) Its capabilities for addressing absolute memory and I/O ports directly make it indispensable for trying out new ideas. With a little work, its built-in editor can be customized to run efficiently and appear almost identical to your usual editor.



# ET COMPUTER SYSTEMS

MODEL 2000

## 4 MHz Z80-A COMPUTER WITH HARD DISK INTERFACE AND UP TO A MEGABYTE OF RAM

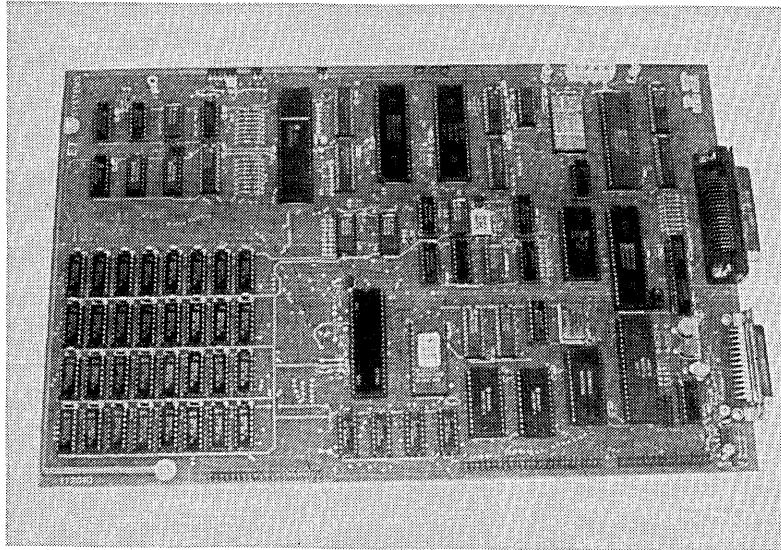

**ASSEMBLED AND TESTED BOARD WITH 64K of RAM**

**\$498<sup>00</sup>**

**• PROCESSOR:**

A Z80-A cpu running at 4 MHz with no added wait states and supporting mode 2 interrupts. Sockets are included for the optional DMA controller and a 9511 or 9512 arithmetic co-processor.

**• MEMORY:**

Up to 1 megabyte of main memory may be plugged in to give the Z80-A phenomenal performance (4 banks of 64K or 256K rams). Bank selecting is in 16K segments so that there is no wasted memory. Any 16K segment may be placed into any one or more of the four 16K banks that the Z80 directly addresses. A 65th segment contains the 4K video ram and 8K 2764 eprom. Any 16K segment may be write protected.

**• DISK DRIVE INTERFACE:**

The floppy disk controller is a WD 2797 and will run four 5.25" or 8" drives, single or double sided, single or double density and up to 255 tracks per side.

The HARD DISK port is designed to accept a Western Digital hard disk controller.

**• VIDEO:**

A high quality 80 x 24 character display is produced by an SMC 5037 and 8002A video chip set using 7 x 9 dot character in a 9 x 12 field. Video attributes include: reverse, blink, blank, underline and strike-thru. Two graphics modes are supported and may be displayed along with text. The final output is composite video for easy connection to most monitors.

**• KEYBOARD PORT:**

An interrupt driven serial port for the keyboard provides a true type ahead buffer and allows for a simple coiled cord connection to a detached keyboard.

**• INPUT-OUTPUT:**

The RS232-C serial port comes complete with a D-SUB connector and will communicate at 110 to 19.2K baud. The parallel printer port uses full handshaking and has a Centronics style connector. Optional ports include two additional RS232-C serial ports or a 800Kbit networking port and one RS232-C port.

**• POWER REQUIREMENTS:**

5V at 1.5 amp and +12V at 0.1 amp

**• SIZE:**

8.5" x 13"

**• SOFTWARE:**

ETOS II operating system (CP/M 2.2 compatible)  
BIOS for 5.25" drives (Kaypro II & 4 format) and a HARD DISK.

CP/M is a registered trademark of Digital Research

**TERMS:** We ship C.O.D. inside the U.S.A. Prepaid Orders: inside California add 6% sales tax, freight extra, company and personal checks, please allow 3 weeks to clear. Mastercard and Visa accepted.

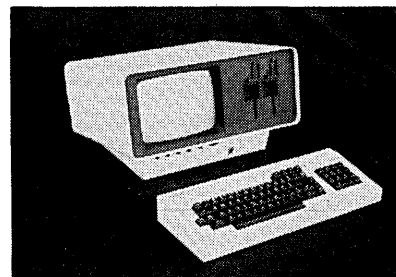

**PRICES**

Assembled and tested board with 64K ram .....	498.00
Keyboard .....	75.00
Main case .....	100.00
Keyboard case .....	25.00
Drives single sided .....	150.00
Drives double sided .....	175.00
Video display, green .....	100.00
5V 3 amp power supply .....	30.00
12V 2 amp power supply .....	30.00
Quiet fan .....	16.00
Cable—floppy disk 5.25" .....	16.00
Cable—5 & 12V power .....	8.00
10 MB half high drive .....	575.00
Hard disk controller .....	250.00
Hard disk cable kit .....	50.00
Networking port .....	100.00
2 extra serial ports .....	50.00

# ET COMPUTER SYSTEMS

8161 BROADWAY  
LEMON GROVE, CA 92045  
(619) 466-1671

# Single Board Computer Chassis & Power Supply

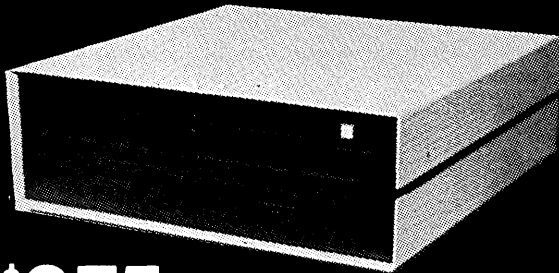

**\$275** (1 Piece) \*

2901 SBC Chassis & Power Supply

\* Call for quantity pricing.

Disk Drives not included.

- Assembled and Tested
- Heavy Duty All Metal Cabinet
- Fan & Dust Filter
- Hefty +5, +12, +24 Regulated Supply. Runs drives & computer board
- Accepts 2 ea 8" Floppy Drives, Half of Full
- 2 ea DB25, 1 ea Centronics, 1 ea 50 pin cutout on back
- Front panel reset switch
- Power Harness for Drives and Board
- Flexible Board Mounting
- Line Fuse, Filter, Line Cord, Power Switch
- Cabinet & Power Supply Available Separately

Write or call for our brochure which includes our application note:

"Making micros, better than any ol' box computer."

**INTEGRAND**

RESEARCH CORPORATION

8620 Roosevelt Ave./Visalia, CA 93291 209/651-1203

We accept BankAmericard/Visa and MasterCard

## **NEW** AMPRO "Little Board" MAIN/FRAME

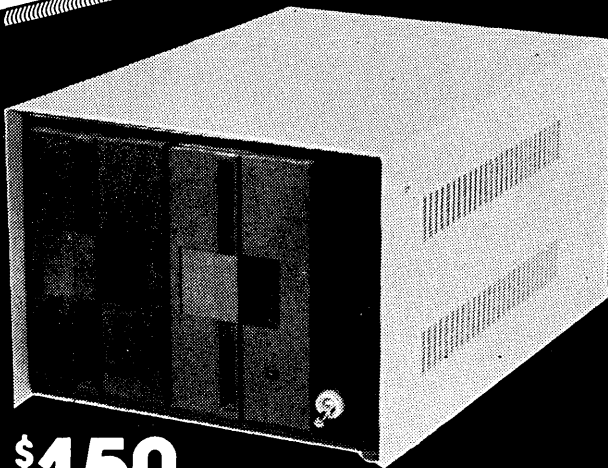

**\$150** (1 Piece) \*

2800 5 1/4 Drive & Little Board Enclosure  
(includes power supply & fan)

\* Call for quantity pricing.

(Disk Drives and Little Board not included)

- Assembled & Tested
- Heavy Duty All Metal Cabinet
- Fan & Dust Filter
- Hefty +5 & +12 Regulated Supply  
Runs Floppy Drives & Computer Boards
- Accepts 5 1/4 Drives, Full or Half
- 2 ea DB25, 1 ea Centronics Connector Cutouts
- Front Panel Reset & Power Switch
- Power Harness From Supply to Drives & Board
- Line Fuse, EMI Filter, Detachable Line Cord
- I/O & Drive Data Cables Available Separately
- Cabinet & Power Supply Available Separately

AMPRO & Little Board are TM AMPRO computers.

Write or call for our brochure which includes our application note:

"Making micros, better than any ol' box computer."

**INTEGRAND**

RESEARCH CORPORATION

8620 Roosevelt Ave./Visalia, CA 93291 209/651-1203

We accept BankAmericard/Visa and MasterCard

# Xerox 820 Column

By Mitchell Mlinar

1013 W. 210th St.  
Torrance CA 90502

Although most of my mail (2 out of the 3 letters) poses questions regarding the Xerox 820-I, there was some interest by the Xerox 820-II user. The last time an 820-II was even mentioned in Micro C was WAY back in December of 1982 (you do save your back issues, don't you?). At that time, John Marlin presented a cursory tour of the 820-II system (sort of a quick test drive). But being an engineer, instead of "driving" it, I tore it apart to see what makes it tick. (At the end of this column there is information on a very deluxe, but inexpensive operating system so that you don't need to purchase CP/M.)

## A Little History

The 820-II was born BEFORE the first 820-I was ever commercially sold (1980 timeframe) since Xerox knew that time, tide, and computer technology wait for no man (or company). When the 820-II was finally introduced to the public early in 1982, few eyebrows were raised; after all, it wasn't that different from the -I. Couple the ho-hum greeting with Xerox's public information policy (read: none) and the 820-II quickly entered obscurity.

Most of you -II owners know Xerox does not sell a technical manual for the 820-II, so I recommend purchasing the manual for the 820-I, as there are many characteristics which the -I and -II share.

## Contact:

Xerox Corporation  
1341 West Mockingbird Lane  
Dallas TX 75247

## Order:

820 Information Processor  
Software Development Guide  
Reorder # 9R80368  
Cost was \$35 in 1982

The only other source of information is the reference section in the CP/M 2.2 documentation that Xerox provides to buyers. However, since the 820-II is no longer made except for limited internal production, and bare boards do not have this documentation, I will assume many of you do not have that either. (Editor's note: I received a call from Xerox marketing about a month ago and they say that

the 820-II and the 16/8 are still being manufactured and actively marketed.)

## Hardware

I hate to use a cliché, but "where's the beef?" Oh sure, you now have a hot 4 MHz machine with 6k of ROM (up to 8k available) and a new fangled disk controller capable of double density. There is also a cute piezoelectric crystal which can produce a wide frequency range at one volume - annoying. But since one evening and \$100 will get you all of the above on a 820-I, there must be more. There is.

For a start, extra video hardware permits four screen attributes: flashing, inverse video, low-intensity and graphics. Although the graphics are nice, no commercial programs make use of them. The inverse video "sea of light" requires welding goggles, and flashing characters send my dog into convulsions.

I like the low intensity mode so I am currently modifying my 820-I to switch between flashing and low-intensity. (More on that in a later issue.) Besides the usual four ports on the back, there is a connector for the disk controller daughter board and a separate bus for future expansion (the 16/8 upgrade board plugs here).

A choice of disk controllers was available for the -II: floppy or hard. The floppy controller is a FD1793 capable of double density operation; the hard disk interface is merely another PIO which operates as a SASI interface. Although this seemed like a nice approach, it was limited. A floppy controller could run either 5.25 or 8 inch drives, but no hard disk. The hard disk interface worked with a SA1403 which only operates hard disks or 8 inch floppies. (Compare that to the BBII which offers all three capabilities.) Since I don't have a hard disk (yet), my discussion will focus on the floppy configured -II.

## Software

Compared to the -II, the -I software looks like the stuff I hand-coded for a PDP-8 ten years ago! All of the 820-II specific software (Monitor, BIOS, CONFIGUR.COM, SWAP.COM, INIT.COM, and SYSGEN.COM) was written by Balcones Computer during 1981 and

1982. The monitor code started with version 4.00 and is now up to 4.04. For only 6k of code, it is packed with features.

Upon startup, a RAM test and ROM CRC test are performed followed by the high memory monitor portion move from ROM to F000-FE5F. The upper monitor entry (at FC55H in v4.01) checks for the type of disk controller and, if floppy, the type of disk drives; this information is used to configure the disk I/O drivers.

The monitor in the -II offers 18 commands as shown in table 1 out of which three or four are truly useful. Unlike the -I monitor which loads itself into high memory never to return, the -II makes extensive use of the ROMs during normal execution. All of the 18 commands are located in ROM and overlaid into memory (at FC55H again) before execution. (In contrast, all of the user CALLable monitor routines are present in high memory with the exception of the video driver. It remains in ROM and is called directly.)

This approach saves space since only the command being executed needs to be moved into memory. Although most of the command routines were location independent (only JRs and CALLs to "fixed" routines from F000-FC54), some of them are self-modifying so they have to run in RAM. Of course, the overlay area can be used for disk I/O after system boot. See Figure 1 for monitor commands.

**BOOT SYSTEM:** This can be accomplished by A or L or LA for loading the system from drive A. To boot drive B, type LB etc.

**COPY MEMORY:** Copies memory block at (start address to end address) to destination address.

**DISPLAY COMMANDS:** Gives a quickie help menu.

**DISPLAY MEMORY:** Dumps memory in standard DDT format from start address to end address. Just like DDT, the start and end values are optional and successive segments can be dumped by just typing D.

**FILL MEMORY:** Same as DDT: start address, end address, and value all required.

**GOTO:** Calls subroutine at address; up to three values can follow the address

which are loaded into HL, DE, and BC in order. Any registers not set contain non-sense values.

**HOST TERMINAL:** Dumb terminal that stores screen lines into memory. These can be accessed by scrolling with the CTRL + up/down arrow keys. Other commands include:

Toggle local echo CTRL + DEL

Toggle local line feed CTRL + LINE FEED

Toggle remote echo CTRL + 1 (keypad)

Transmit break CTRL + . (keypad)

(Break will end when any char is pressed)

Abort CTRL + ESC

**INPUT:** Display value of input port. After display, press SPACE BAR to display same port again, RETURN to display the next port, or '-' to display the previous port. Any other key exits.

**MEMORY TEST:** Extended memory test with 256 possible patterns.

**MODIFY MEMORY:** Modify memory. After display, touching the RETURN will leave the contents alone and advance the address, '-' does the same except backs up the address, any hex value entered replaces the current value, and typing a quote '"' accepts the next char ASCII value as the location's new value. Any other key exits.

**OUTPUT PORT:** Same as input port except writing to it. Note that the Reference documentation errs here - the scroll register reads its data from the normal data lines, NOT the high address lines.

**PRINTER PROTOCOL:** Xon/Xoff is a flag: 1 = enabled, 0 = disabled. Status mask is mask to read register 0 of the printer (SIO-B). Status value is value after masking to see if printer is available for output (not busy). Next to useless unless you change printers as often as you change disks.

**SET BAUD RATE:** Sets the baud rate on channel B (unless channel is A) codes include: 05 = 300 baud, 07 = 1200 baud, and 0E = 9600 baud. Codes are sent to port 0 for channel A or port 0C for channel B. All values are in Hex.

**TYPEWRITER:** Worthless.

**READ SECTOR:** Disk drive is 0 through F (corresponding to drives A through P). Reads one physical sector re-

gardless of size.

**VERIFY MEMORY:** Gives a display of all locations that do not match.

**WRITE SECTOR:** The first time you execute this after turn-on or cold boot, just type W This will give you a nifty copyright message from Balcones. The next time (and thereafter), the write command will work normally. Use caution with this command!

Next time, I will discuss all the monitor entry points—especially those that Xerox told us to avoid.

### QP/M

QP/M, a replacement for CP/M 2.x, is now available. QP/M is fully compatible with CP/M but is much more powerful. Like ZCPR you can setup a common user area (where the system searches for un-found programs).

Overlay files (such as those used by Wordstar, SuperCalc, etc.) can be accessed from ANY user area, provided they exist in the common user area. QP/M uses Z-80 code and optimized disk routines for increased speed. Several utilities are supplied, including IN-

STQPM, PIPQ and STATQ. Also supplied is a compatible copy of ZCPR (a public domain program), complete with source code.

The primary benefit of QP/M is automatic time/date stamping of files. By using the built-in real-time clock in your 820, BB, or Kaypro, QP/M will stamp each file with the current date and time whenever written. The BACKUP utility backs up ONLY those files which have been modified or created since the last BACKUP. Also supplied is a 2k DIR program which can be toggled to display time/date information and .LBR directories.

The complete package, including documentation which describes all aspects of each QDOS call, is available for only \$40.00! Send a current address label from Micro C, and get a \$5.00 discount. Specify disk format when you contact:

**MicroCode Consulting**  
1013 W. 210th  
Torrance CA 90502



Figure 1 - 820-II Monitor Commands

Command	Format
Boot drive A	A
Boot system	L<disk drive>
Copy memory	C<start addr> <end addr> <dest addr>
Display commands	@
Display memory	D[<start addr>] [<end addr>]
Fill memory	F<start addr> <end addr> <value>
Goto location	G<addr> [HL DE BC registers]
Host terminal	H[channel]
Input port	I<port addr>
Memory test	X<start addr> <end addr>
Modify memory	M<addr>
Output port	O<port addr> <value>
Printer protocol	P<Xon/Xoff> [status mask] [status value]
Set baud rate	B<baud rate code> [channel]
Typewriter	T[baud rate code]
Read sector	R<disk drive> <track> <sector> <addr>
Verify memory	V<start addr> <end addr> <dest addr>
Write sector	W<disk drive> <track> <sector> <addr>

NOTE: Parameters within <> are necessary;  
parameters within [] are optional.  
All parameters and values are assumed to be hexadecimal.

# DOUBLE SIDED, DOUBLE DENSITY FOR YOUR XEROX 820-1!

NOW YOU CAN HAVE DOUBLE SIDED, DOUBLE DENSITY FOR YOUR XEROX 820-1 OR BIG BOARD I, AND RUN BOTH 8" AND 5 1/4" DISK DRIVES AT THE SAME TIME!

OUR STANDARD DISK FORMATS ARE COMPATIBLE WITH THE KAYPRO, XEROX, AND BIG BOARD II, WITH THE OPTION OF RUNNING UNIFORM BY MICRO SOLUTIONS, TO ACCESS OVER 70 OTHER DISK FORMATS.

### XPRO ROM SET BY MICRO CORNUCOPIA

COMES WITH ROMS, CUSTOM BIOS, INSTALLATION PROGRAMS, DISK FORMATTER, AND MANUAL

- RUNS 63K CPM FOR BIGGER AVAILABLE TPA
- USES PARALLEL KEYBOARD AND FAST VIDEO
- CENTRONICS AND SERIAL PRINTER SOFTWARE INCLUDED, SELECTABLE WITH IOBYTE
- 98% SOFTWARE COMPATIBLE WITH THE KAYPRO
- INCLUDES FIRMWARE MONITOR FOR DIRECT MEMORY AND PORT ACCESS
- BOOTS FROM 5 1/4" OR 8" DISKS
- FORMATS, READS, AND WRITES:

KAYPRO II - 191K, SSDD, 48 TPI, 5 1/4"

KAYPRO 4 - 390K, DSDD, 48 TPI, 5 1/4"

KAYPRO 8 - 784K, DSDD, 96 TPI, 5 1/4"

8" SSDD (IBM 3740 STANDARD) - 241K

8" SSDD (BB II) - 596K

8" DSDD - 1.212M

XEROX 820-1 SSDD 5 1/4" (W/R ONLY)

- AUTOMATICALLY DETECTS DISK FORMATS
- TRUE DOUBLE SIDED OPERATION
- SYSGEN & SOURCE FOR CBIOS INCLUDED

### X120 DOUBLE DENSITY CONTROLLER BOARD

DESIGNED FOR USE WITH THE XEROX 820-1 (CAN BE USED ON THE BBI) USING THE WD2791 DISK CONTROLLER CHIP

- RUNS ANY COMBINATION OF 5 1/4" AND 8" DRIVES, BOTH AT THE SAME TIME
- CAN USE ANY SHUGART COMPATIBLE DRIVE
- 50 AND 34 PIN SHUGART TYPE DRIVE INTERFACE CONNECTORS ON THE X120 BOARD
- CAN USE DRIVE CONNECTOR ON MAIN BOARD
- DRIVE SELECT LINES DECODED FOR FOUR DRIVES
- COMPOSITE VIDEO ADAPTOR ON X120
- PLUGS INTO 1771 (U109) AND U117 ON THE XEROX BOARD, WITH SIMPLE MODIFICATIONS

### UNIFORM BY MICRO SOLUTIONS

UNIVERSAL DISK COMPATIBILITY PROGRAM, RUNS ON THE MODIFIED XEROX 820, TO GIVE YOU ACCESS TO DISKS WRITTEN FOR OVER 70 OTHER COMPUTERS SUCH AS THE IBM-PC, MORROW, OSBORNE, AND MANY OTHERS.

### PRICING

XPRO ROM AND X120 BOARD A&T .....	\$180.00
XPRO ROM AND X120 BARE BOARD .....	\$ 72.00
XPRO ROM SET .....	\$ 49.95
X120 BARE BOARD .....	\$ 26.00
X120 BOARD ASSEMBLED & TESTED .....	\$140.00
X120 BARE BOARD AND KIT .....	\$115.00
XEROX DISK DRIVE CABLES .....	\$ 15.00
UNIFORM BY MICRO SOLUTIONS .....	\$ 64.95

ADD \$3.00 FOR SHIPPING AND HANDLING; \$6.00 FOR COD: VISA/MASTERCARD ADD 3% (INCLUDES S&H).



P.O. Box 6118 Aloha, OR 97007  
(503) 642-1860

## Powerful Single Board Computer Includes CP/M Plus™ on Disk

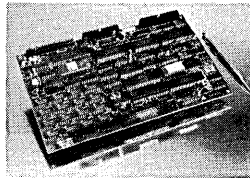

**\$599**  
Assembled, Tested  
Includes CP/M 3.0 on disk

- New Items:**
- MS-DOS Coprocessor
  - 68000 Coprocessor
  - BOX24 LCD Driver
  - Hard/DRAM Disk
  - 3 1/2" Single Board

### Mountain Side Computer

**MSC-100**

Video, 128Kb, CP/M Plus™, and more

#### Z80 CPU

MSC-100 uses the most popular microprocessor, the Z80, as its main CPU. MSC-100 runs at 4 MHz without any wait states. The whole system is incorporated into a high quality four layer PC board measuring only 145mm X 250mm (10" x 6"). The system requires only 1.2 Amps at + 5 Volts and 0.1 Amps at ±12 Volts.

**Banked CP/M Plus Included**  
CP/M Plus (3.0 banked) is included on disk with all manuals. CP/M Plus is upwardly compatible with CP/M 2.2 and includes the SID debugger, the MAC and RMAC macro assemblers and the LINK-80 loader. MSC-100's custom BIOS provides support for multiple disk formats and I/O device control. System specific software for disk formatting, disk copying, defining function keys and modifying screen attributes is also included.

#### 128Kb RAM

One 64K bank of memory is devoted to CP/M and its disk cache blocks, while the other 64K bank is devoted to applications programs. This arrangement not only provides more memory for programs, but it significantly increases the speed of disk I/O.

#### Internal Floppy Disk Controller

MSC-100 handles Shugart/ANSI standard floppy disk drives in a variety of sizes and formats:

- 8" SSDD, 243Kb
- 8" DSDD, 1.2Mb
- 5 1/4" DSDD, 320Kb
- 5 1/4" DSDD, 800Kb
- 5 1/4" QHD, 1.2Mb

Up to four drives of any density or size can be connected to MSC-100. Both 5 1/4" and 8" inch connectors are on-board to make disk drive connections easy.

#### High Speed CRT Controller

MSC-100 contains an 80 x 24 line memory mapped CRT controller. Video output is composite or separate to match any monitor. Attributes such as insert and delete line, reverse video, and semigraphics are supported. Cursor escape sequences are an extension of DEC's VT52 and can be easily reprogrammed to emulate most standard terminals.

CP/M Plus™ of Digital Research, Inc.

#### Two RS232C Ports

MSC-100 communicates with printers, modems, plotters, and other standard RS232C devices through its two serial ports. These ports are independently programmable for baud rates, stop bits, data format and parity. Synchronous communication on Port A is jumper selectable.

#### Centronics Parallel Port

A standard Centronics parallel port allows MSC-100 to communicate with printers and other parallel devices.

#### Parallel Keyboard Port

MSC-100 connects to any ASCII parallel keyboard of positive or negative polarity with a negative strobe. A type-ahead buffer and programmable function keys are provided by MSC-100's custom BIOS.

#### 16 Bit TTL I/O Port

This port allows you to access printers, relays, LEDs, DAC's, ADC's, switches, EPROM programmers and many other devices.

#### Clock Calendar

The battery backed up clock calendar provides time and date information to CP/M for file stamping. The clock can also be accessed from applications programs.

#### External Bus

MSC-100's 50 pin bus connector provides expansion for a hard disk controller, RAM disk, graphics or a 68000 system. Please call or write for more information on these options.

#### MSC-100 Saves Time and Money

With MSC-100's low cost and quality workmanship, why spend time, energy and money to design, debug and test your own system. Whether you require single units or large volume quantities we can meet your needs. Order your evaluation unit today!

Manufactured by  
**Southern Pacific Limited**  
1-3-18 Kurumicho Tsuzumi, Yokohama, JAPAN 230  
☎ 045-501-8842, Telex 3822320 SPACIF J  
USA Distributor  
**ARTISOFT, Inc.**  
P.O. Box 41436, Tucson, Arizona 85719 ☎ (602)327-4305

# CP/M EPROM PROGRAMMING SYSTEM

2708

2758

2716

2732

2764

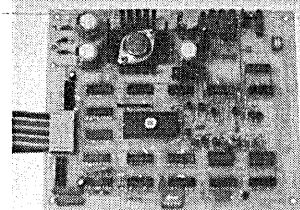

2516

2732A

27128

27256

27CXX

- STAND ALONE BOARD
- ELECTRONIC SWITCHING OF EPROM TYPES
- USES 24 VOLT XPMR FOR POWER
- ALL SUPPLIES/TIMING ON BOARD
- DESIGNED WITH EASY TO GET PARTS
- COMPREHENSIVE 30 PG MANUAL
- WORKS WITH ANY CP/M SYSTEM
- SOFTWARE INSTALL UTILITY

### \*\* INTERFACE TWO WAYS \*\*

- 1 - ONE 8 BIT INPUT PORT AND ONE 8 BIT OUTPUT PORT - 16 WIRES AND A GROUND - NO HANDSHAKE LINES REQUIRED
- 2 - CENTRONICS PRINTER PORT - 8 OUTPUT DATA BITS AND ONE INPUT DATA BIT (BUSY LINE) - 9 WIRES AND A GROUND

### \*\* CONTROL PROGRAM COMMANDS \*\*

- PROGRAM EPROM(S) FROM DISK
- READ DISK FILE INTO RAM
- READ EPROM(S) INTO RAM
- VERIFY EPROM IS ERASED
- DISPLAY/MODIFY RAM - (MONITOR MODE) WITH 11 SUB COMMANDS
- SAVE EPROM(S) TO DISK
- PROGRAM EPROM(S) FROM RAM
- COMPARE EPROM WITH RAM
- COPY EPROM
- DISPLAY-DUMP-XFER-EXAMINE-MODIFY-BIAS-PROGRAM-VERIFY, ETC.)

BARE P.C. BOARD WITH COMPLETE DOCUMENTATION AND SOFTWARE ON 8" SINGLE DENSITY DISKETTE

\$69

(ABOVE WITH COMPLETE PARTS KIT - \$169)(A&T - \$189)  
SOFTWARE AVAILABLE FOR OSBORNE, KAYPRO AND OTHER 5 1/4 FMT'S

TO ORDER SEND CHECK, MONEY ORDER, WRITE OR CALL

**ANDRATECH**  
P.O. BOX 222  
MILFORD, OHIO 45150  
(513) 752-7218

CALL OR WRITE FOR MORE INFORMATION --- ADD \$3.00 FOR SHIPPING  
OHIO RES. ADD 5.5% TAX --- VISA/MC. ACCEPTED --- \$3.00 FOR COD



## The Culture

Corner

Once upon a midnight dreary, while I pondered, weak and weary,  
O'er a quaint and curious program I had written long before;  
While I nodded, nearly sleeping, suddenly I heard a beeping  
From my Big Board; bugs a-creeping, creeping where I would deplore!  
T'was some misstroke I had entered, errant thumbstroke not well centered,  
Just a typo, nothing more.

Ah, distinctly I remember, it was in the bleak December  
When my hard disk files were listed; that was really quite a chore.  
Eagerly I wished the 'morrow. With the dawn I'd seek to borrow  
Program guides to ease my sorrow, from the dumps piled on the floor.  
My small glitch had thus created endless loops of cosines, fated  
To be rooted evermore.

Deep into my green screen peering, long I sat there wond'ring, fearing,  
Doubting, dreaming dreams of programs I had dreamt so oft before;  
That some subroutine, much needed, had my RAM space just exceeded,  
And was therefore rudely weeded, banished from the system's store;  
Exiled t'where none can forage, software limbo: federal storage.  
There to languish evermore.

Had I brought a curse upon me? More key pounding soon would tell me.  
Missing code, programmer's bain; I knew I must explore.  
CHESS and CHECKERS, BLKJACK, CARDDECK, even secret Fortran STARTREK,  
All these files I quickly queried. To the last they came up poor.  
One last hope, a final member: biorhythms for November,  
Only this and nothing more.

But I knew there was insurance for my toil and hard endurance.  
Nervously I sought assurance, hopefully I did implore.  
Daily, hourly, every second, when my Big Board II had reckoned,  
I had backed up all my labors safe on floppies, quite a chore.  
For eons it did cogitate, then printed out that fateful date:  
Quoth the green screen, "Nevermore."

**Tony Dowden**

780 El Solyo Heights Drive  
Felton, CA 95018

*you'll be*

## C'ing Clearly

*with our*

cheap  
c source code  
\$15.00

*gets you a disk*

*full of c code and*

*.com files from your*

*favorite column*

## C'ing Clearly

*graphics  
sorting  
software tools  
and more!!*

*send \$15 plus \$5  
postage & handling*

*to:*

tony ozrelic  
p.o. box 5246  
bend or 97708

*please specify*

*kaypro II or*

*8" sssd format*

*with apologies to e.e. cummings*

## THE ULTIMATE SOFTWARE IS IN . . .



### ORDER YOUR MICRO C T-SHIRT TODAY!

These user-friendly tan shirts are formatted in mahogany border with black enhanced mode design. The fully integrated system is compatible to size S, M, L and XL, for only \$6.95 ppd. (\$8.50 all foreign).

### MICRO CORNUCOPIA

P.O. Box 223  
Bend, Oregon 97709

# C'ing Clearly

By Tony Ozrelic

Micro C Staff

Philippe Kahn, father of Turbo Pascal, is quoted in the October 1984 issue of Dr. Dobbs' Journal as saying, "C is a disease." He goes on to say that "in Europe, C is seen as an American disease, and here people are trying to spread it."

That's a pretty strong statement, and I wonder how C'ing Clearly readers react to it. To me, such words as "disease" are nonsensical; this is a programming language, not herpes. But then I don't have a Computer Science background (oh, you didn't notice?). I came into software by necessity (so I could make the hardware work), and so I see programming languages as tools rather than religions. Get a hold of the DDJ article and send me a letter.

## L Is For Letters

Speaking of letters, I am finally beginning to get some feedback from you folks, most of which has to do with getting small-c to do something useful; my heart bleeds for you! Eric Sosman has figured out a way to compile small-c programs faster: you take out the comments in the .ASM files #included with your C code. Also, he found that CALL.ASM indents each line with eight spaces instead of a tab, making the file quite large. After stripping comments and replacing eight spaces with tabs, the compiles got two minutes faster and the ASM file was 20K smaller to boot.

Eric's comment-stripping program is shown in Fig. 1; he wrote it in MBASIC. Ok, now who's gonna send me a C version? The first one to send one in gets a Micro C T-shirt!

```
100 INPUT "Input file: ", F$
110 OPEN "I", #1, F$
120 INPUT "Output file: ", F$
130 OPEN "O", #2, F$
140 IF EOF(1) THEN 240
150 LINE INPUT #1, L$
160 I$ = INSTR(L$, ";")
170 IF I$ <= 0 THEN I$ = LEN(L$) + 1
180 I$ = I$ - 1
190 IF I$ <= 0 THEN 140
200 IF MID$(L$, I$, 1) = " " THEN 180
210 IF MID$(L$, I$, 1) = CHR$(9) THEN 180
220 PRINT #2, LEFT$(L$, I$)
230 GOTO 140
240 END
```

## H Is For Help

Scott Rich of 1640 E. 1140 N., Logan, Utah 84321, is confused. He is working

with the Manx Aztec C compiler, and, if my notes are correct, he is deaf. That makes it difficult for him to call someone up and ask enlightening (or any other) questions. The following are some of his more interesting questions.

## Q Is For Questions

1. What is a library?
2. How do I take a function and build a library out of it?
3. How do I call this library function?
4. When is the extern command used/required?
5. What defines a standard keyword? Is it in the compiler?
6. Can I redefine the standard keywords?
7. When and what do I #include in a \*.h file?
8. What do I stick into a library?

## A Is For Answers

1. A library is a set of pre-compiled routines that do something useful. An example of this is the runtime library, which is linked with your program after it is compiled.

2. To build a function library, you compile it without the main() program, but with whatever .h(ader) files you need. This gives you a .REL (sometimes called .OBJ) file, which you then link with your main program.

3. Functions are called when you use them. If you forget to include the library which has the function you called during linking, the linker usually complains that it can't find an address, or that it can't find some "name." (The "name" will be that of the missing function.)

4. Extern declarations tell the compiler that the variable you have declared is not in your program, but is in some library you will link to your program later. Functions are, by default, externs. That is, if the function you are calling isn't in your main program, the compiler does not complain—it just assumes it will appear when you link your program with the libraries.

5. Keywords are words like if, for, do, while, switch . . . and they are definitely built into the compiler! These words tell the compiler that you want to do a "for" loop, or a "switch" or an "if".

6. Obviously, if you could alter this

list, you would not have a C compiler anymore! No, you can't alter it (at least that I know of. You could use DDT I guess, but why would you want to do that?).

7. \*.h files are called header files, and they provide commonly used #defines, variables, and data structures for your program. For example, the stdio.h file contains C's standard input/output routines, and defines commonly used numbers like zero (NULL) or -1 (usually used as an ERROR indicator, as in if(x==ERROR) exit();). By defining constants, we alleviate much grief when it comes time to transport our code to another machine or compiler. It also makes life easier since we can attach a name to the number (pi = 3.14159, for instance).

8. Generally speaking, you put routines you'll be using in many programs into libraries. You can also split a large program into separately compiled segments to make the debug/compile process go faster.

## E Is For Example

For example, I was working on a C program to do PC layout on a hi-res video graphics interface. It has a mouse and (soon) a plotter for I/O. To make debugging faster, I split the program into three parts—the graphics I/O (GIO), which handles drawing lines, fetching coordinates from the mouse, and driving the plotter—the graphics package (GP), which did windowing, transformations, and scaling—and the actual drafting package, which did the menus and handled the database management necessary to add, delete, redraw lines, and move from component side to solder side.

Once I had the GIO running, I made it into a library. Then I got the GP working, which went quickly because I didn't have to re-compile the GIO every time I made a change—I just linked the GP with the GIO library. After the GP was done, I could concentrate on the actual drafting package. I had a bunch of functions to open and close windows, scale objects, send text to windows, etc. Real neat stuff. Needless to say, during the development process, I decided that some of the library functions could be ex-

(continued next page)

panded (gee, wouldn't it be nice if I could just . . .). A quick trip to the source of the library and a quick recompile and I was back on the air again.

#### T Is For Ta-ta

That's it for now. Next issue Bert Berlin will show us how to make our printers do spiffy things with a few simple characters and the printf() function.

P.S. Don't forget to write!



## "BMON"

### Software In-Circuit Emulator

Links your CP/M computer with any Z80 based computer or controller that you may develop. All that is needed is BMON, 12K of ROM space, and a handshakeable bi-directable I/O port (either RS232 or Parallel).

#### Features:

- Full program development debugger with Breakpoints, Snaps, Stops, & Waits.
- Single Step program execution.
- Download file from CP/M system to development Ram.
- Upload Memory from development RAM to CP/M disk.
- Two versions: Master BMON runs in your CP/M system, Slave BMON runs in your target system.

Note: Requires Microsoft's M80 & L80 assembler & linker to setup Slave BMON.

8" SSSD Disk containing Master BMON, Slave BMON, CONSOL, BMONIO, CONSOLIO, and Users Manual .....\$49.95

Shipped Via prepaid UPS  
—No COD or P.O. Box—  
Check or Money Order to:

**Barnes Research & Development**  
750 W. Ventura St.  
Altadena, CA 91101  
(818) 794-1244

CP/M is a trademark of Digital Research Inc.  
M80 & L80 are trademarks of Microsoft Inc.

## CP/M-80 C Programmers . . .

# Save time

. . . with the BDS C Compiler. Compile, link and execute *faster* than you ever thought possible!

If you're a C language programmer whose patience is wearing thin, who wants to spend your valuable time *programming* instead of twiddling your thumbs waiting for slow compilers, who just wants to work *fast*, then it's time you programmed with the BDS C Compiler.

BDS C is designed for CP/M-80 and provides users with quick, clean software development with emphasis on systems programming. BDS C features include:

- Ultra-fast compilation, linkage and execution that produce directly executable 8080/Z80 CP/M command files.
- A comprehensive debugger that traces program execution and interactively displays both local and external variables by name and proper type.
- Dynamic overlays that allow for run-time segmentation of programs too large to fit into memory.
- A 120-function library written in both C and assembly language with full source code.

#### Plus . . .

- A thorough, easy-to-read, 181-page user's manual complete with tutorials, hints, error messages and an easy-to-use index — it's the perfect manual for the beginner *and* the seasoned professional.
- An attractive selection of sample programs, including MODEM-compatible telecommunications, CP/M system utilities, games and more.
- A nationwide BDS C User's Group (\$10 membership fee — application included with package) that offers a newsletter, BDS C updates and access to public domain C utilities.

Reviewers everywhere have praised BDS C for its elegant operation and optimal use of CP/M resources. Above all, BDS C has been hailed for its remarkable *speed*.

"I recommend both the language and the implementation by BDS very highly."

Tim Pugh, Jr.  
in *Infoworld*

"Performance: *Excellent*.  
Documentation: *Excellent*.  
East of Use: *Excellent*."

*InfoWorld*  
Software Report Card

"... a superior buy . . ."

Van Court Hare  
in *Lifelines/The Software Magazine*

BYTE Magazine placed BDS C ahead of all other 8080/Z80 C compilers tested for fastest object-code execution with all available speed-up options in use. In addition, BDS C's speed of compilation was almost *twice* as fast as its closet competitor (benchmark for this test was the Sieve of Eratosthenes).

**Don't waste another minute on a slow language processor. Order your BDS C Compiler today!**

Complete Package (two 8" SSSD disks, 181-page manual): **\$150**  
Free shipping on prepaid orders inside USA.  
VISA/MC, COD's, rush orders accepted.  
Call for information on other disk formats.

## BDS Software

BDS C is designed for use with CP/M-80 operating systems, version 2.2, or higher. It is not currently available for CP/M-86 or MS-DOS.

BD Software, Inc.  
P.O. Box 2368  
Cambridge, MA 02238  
(617) 576-3828

# Low Intensity BBI Video

By John P. Jones

6245 Columbia Ave.  
St. Louis MO 63139

I have been using the SWP dual-density disk system for some time and both the hardware and software work extremely well. One of the functions added in the software is the ability to set/reset the attribute bit in the video memory. When I began using Borland's Turbo Pascal, which has built-in support for reduced intensity video, I decided to alter the BBI hardware to provide high/low intensity in the video display.

## Changes

1. Remove U37, bend out pin 11 and reinstall. This disconnects the blink clock from the video circuit.
2. Connect U25 pin 2 to U25 pin 7 (ground) to re-enable the normal scan line blanking.
3. Jumper U37 pin 12 to U74 pin 11. This latches the attribute bit and makes it available during the dot output portion of the video cycle.

4. Jumper U74 pin 10 to U94 pin 13. The latched attribute bit is now available on U94 pin 11.

5. If you want the attribute bit to cause reduced intensity, connect U94 pin 12 to U94 pin 14 (+5V), for high intensity connect to pin 7 (gnd).

At this point, the hardware changes are different for composite video and separate video.

## Separate video

6. Remove R21 to eliminate any effect of the composite video circuitry on the TTL level video.
  7. Cut trace from U94 pin 8 to J6 pin 2.
  8. Connect 47 ohm resistor between U94 pin 8 and J6 pin 2.
  9. Connect 220 ohm resistor between U94 pin 11 and J6 pin 2.
  10. CHECK YOUR WORK.
- Characters with bit 7 set will now be displayed with altered intensity. De-

pending on your CRT, you may need to adjust contrast and brightness and/or try different resistor values in steps 8 & 9 above.

## Composite video

6. Connect a 3K to 5K resistor between U94 pin 11 and the base of Q1.

7. CHECK YOUR WORK.

NOTE: I did not have a composite video monitor of high enough bandwidth to test the composite video mod. Results not guaranteed!

## Cursory Search

One additional problem remains. How do you find an altered intensity cursor character in an altered intensity video field?

Since there is no easy hardware fix, the solution is in software. Figure 1 is a routine to use interrupts from CTC channel 0 to toggle the high order bit of the cursor

Only \$95 with FULL SOURCE CODE!

# Q/C

"... an incredible learning tool." *Byte*

For only \$95, Q/C is a ready-to-use C compiler for CP/M with complete source code. Here's what *BYTE* (May 1984) said: "Q/C ... has a portable library and produces good code quality. If you want to learn compiler construction techniques or modify the standard language, Q/C is the obvious choice."

- Source code for compiler and over 75 library functions.
- Strong support for assembly language and ROMs.
- No license fees for object code.
- Z80 version takes advantage of Z80 instructions.
- Q/C is standard. Good portability to UNIX.

Q/C has casts, typedef, sizeof, structure initialization, and function typing. It is compatible with UNIX Version 7 C, but doesn't support long integers, float, parameterized #defines, or bit fields. Call about our new products: Q/C profiler, Z80 code optimizer, and Z80 assembler and virtual linker, all with full source code!

**THE CODE  
WORKS**

5266 Hollister, Suite 224  
Santa Barbara, CA 93111  
(805) 683-1585

Q/C, CP/M, Z80, and UNIX are trademarks of Quality Computer Systems, Digital Research, Zilog, Inc., and Bell Laboratories respectively.

Litek's  
**HackerSwitch**<sup>TM</sup>  
RS232 Configurable Interface Switch

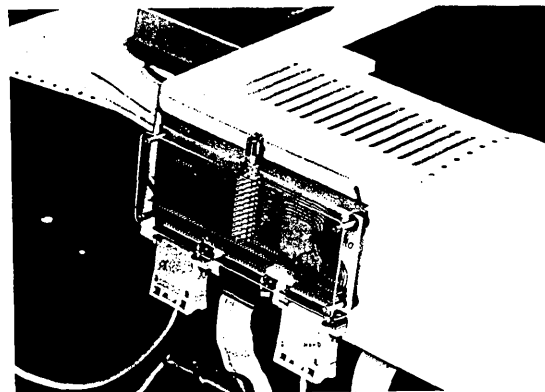

A sanitary alternative to dealing with cables

S2	switches between 2 devices	59.95
S3	switches between 3 devices	79.95
SX	swaps 2 x 2 devices	79.95

Other RS-232 (and parallel) interface accessories are available starting at 20.00

Write for brochure. Dealer inquiries invited

**LITEK**

4326 Fish Hatchery Road  
Grants Pass, OR 97527

character at about 4 Hz. The major disadvantage of doing blink this way is that the cursor blink rate drops significantly during periods of high disk activity. This is because interrupts are disabled during disk read/writes. It is set up to be run as a program which copies the interrupt routine to an empty area in PFM and initialize CTC channel 0 for blink timing.

On my system, I modified the PFM overlay that is loaded from disk to include the routine. It could also be included in the BIOS. For BIOS use, put the CTC 0 initialization in the cold boot routine and the interrupt routine anywhere.

If you are still using PFM, a simple patch allows you to send characters with the intensity bit set to the display. At location 0F523H is a RES 7,A instruction (2 bytes). Replace these bytes with NOPs and any char with bit 7 set will be displayed with altered intensity. If you have a PROM burner, patch locations 533H and 544H in the PROM. Alternatively, the patch can be made manually or in the CTC 0 init routine.

This works more than 99% of the time. The remaining problem is that if the final CTC 0 interrupt occurs after the character under the cursor has been replaced but before the cursor pointer (CURSOR) has been updated, the old cursor location can be left with incorrect intensity. This happens very rarely and PFM would be difficult to patch for the problem. If you are using the SWP monitor overlay the easiest fix is to reset the blink counter near the beginning of the CRT-OUT routine, just after the input char has been saved in register C. This gives CRTOUT about 250 mS. to do its thing.

#### Blink Counter Reset

```
ld c, a      ;existing
ld a, blnkval ;added
ld (blnk), a ;instructions
```

It's surprising how effective screen displays appear when areas can be emphasized or de-emphasized with high or low video.

Figure 1 - Blinking Cursor Routine

```
;
;
; software cursor blink routine (uses ctc0)
;
blnktim equ 15 ;for 4 MHz processor, about 250mS
ctcvec equ 0ff10h ;address for interrupt vector table
ctc0 equ 18h ;ctc0 address
cursor equ 0ff73h ;current absolute cursor address storage
bitdat equ 1ch ;bank bit port address
;
org 100h
;
; first move interrupt routine to final location
; and initialize vector
;
ld hl, blink ;vector address and destination of routine
ld (ctcvec),hl
ld de, source ;source of data to move
ex de,hl ;hl is source, de destination
ld bc, length ; number of bytes to move
ldir
;
ld b, 3 ;three bytes to output
ld c, ctc0 ; to ctc0
ld hl, initbl ; from initialization table
otir
;
jmp 0 ; back to CP/M
;
source equ $
;
org 0f800h ; if using M80, .phase 0f800h
;
blink: ld (blnksp),sp ;switch to local stack
ld sp,blnksp
push af ;modify no registers
push hl
ld hl,blnkclk ;update blink clock
dec (hl)
jr nz, noblnk ;not time to swap yet
ld (hl), blnktim ;reset timer
ld hl, (cursor) ;point to cursor absolute location
in a,(bitdat) ; get and save bank bit
push af
set 7,a ;enable crt bank
out (bitdat),a
ld a,(hl) ;toggle bit 7 @ cursor location
xor 80h
ld (hl),a
pop af ;restore bank bit
out (bitdat),a
noblnk: pop hl ;tidy up before exit
pop af
ld sp,(blnksp)
ei
reti
;
length equ $-blink
;
defs 10
blnksp: defs 2
blnkclk: defb blnktim
;
;
initbl: defb 0a7h ;timer mode, divide by 256 prescaler
defb 0 ; 256 counts before interrupt
defb ctcvec ; vector low order
;
end
;
```



# SWP's CO-POWER-88 makes Z80, CP/M microcomputers IBM-PC compatible!

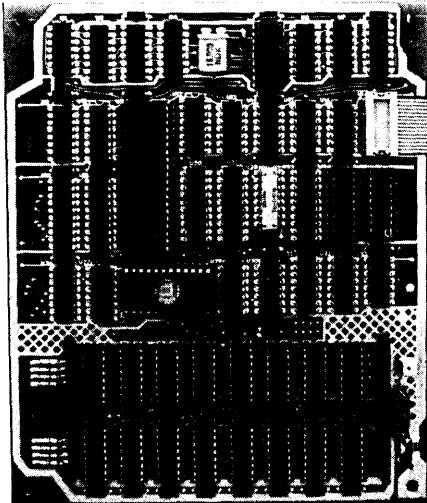

CO-POWER-88 is a 16-bit 8088 coprocessor for Z80 CP/M computers. Both versions of CO-POWER-88, 128k and 256k RAM, include both MSDOS, and RAM drive software, complete with MSDOS, IBM-PC compatibility.

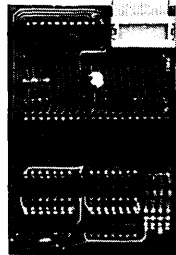

Simple commands move system control between the Z80 and 8088 processor. CO-POWER-88's RAM can be used in CP/M as a RAM drive! Currently available for Kaypro, Bigboard, Zorba, Xerox 820-II, Actrix, Osborne, and ATR8000 computers.

128k CO-POWER-88 w/MSDOS & RAM Drive..... \$400.00  
 256k CO-POWER-88 w/MSDOS & RAM Drive..... \$500.00  
 CP/M-86.....\$70.00

## ATR8000: SWP's \$499.95 CP/M Computer

SWP's ATR8000 is a 64k RAM, Z80A, 4 MHz computer that includes double density CP/M 2.2. The ATR-8000 runs up to four disk drives that are any mixture of size (5 1/4" and 8"), type (single-sided and double-sided), and density (single, double and quad). The ATR8000 has an RS-232 port for a modem or serial printer and includes software for both. There's also a parallel port with a parallel printer driver. The ATR8000 interfaces to an RS-232 terminal or to an ATARI home computer. Software includes a program that allows the ATR8000 to use CP/M disks from other computers. The ATR8000 can be upgraded to also run CP/M-86 and MSDOS by adding CO-POWER-88.

## Bigboard Dual Density

We've just released a new version!

### Hardware

- A daughter board that plugs into the 1771 socket. With this board the system employs automatic density select.
- Instructions tell how to run 5 1/4" drives. A 50-34 pin disk drive adapter board is included with 5 1/4" disk orders.

### Software V#061983

- One 8" version includes the code to make a 60k double density CP/M for:  
 8" SS 2.5 MHz      8" DS 2.5 MHz  
 8" SS 4 MHz        8" DS 4 MHz  
 5 1/4" SS 2.5 MHz
- Printer drivers are built-in, selectable in the IOBYTE.
- Easy to change port parameters.

- 8" SSDD disk storage is 674k; DS is twice as much! 5 1/4" is 183k.
- Includes DDINIT for SD and DD initializing and DDSYSGEN for DD sysgening.
- Special features have been added including a deluxe pause, screen print and clock.
- Source code is available for \$25 after you sign a disclosure agreement.

**For Orders:** We accept MasterCard, Visa, Money Orders or checks. Shipping charges and applicable taxes will be added. Call or write for delivery time. Prices and specifications subject to change without notice.

**Trademarks:** CO-POWER-88, ATR8000, SWP, Inc.; Z80, Zilog; CP/M, CP/M-86, Digital Research, Inc.; IBM-PC, IBM; MSDOS, Microsoft; Kaypro, Kaypro Corp.; Zorba, Mod Comp., Inc.; Xerox, Xerox Corp.; Actrix, Actrix Corp.; Osborne, Osborne Computer.

# SWP

MICROCOMPUTER PRODUCTS, INC.

2500 E Randol Mill Rd. - 125  
 Arlington, Texas 76011  
 817/469-1181  
 817/861-0421

## FORTRAN GRAPHICS For EPSON MX-80 on CP/M-80 Systems

MicroGlyph/SciPlot<sup>(TM)</sup> Graphics Library.  
A set of FORTRAN callable low-level  
graphics primitives for scientific and  
engineering applications.

- Presentation quality high resolution graphics with 120 by 216 dots/inch.
- Software generated text fonts, data centered symbols, uniform or proportional spacing, string plotting with rotation and size scaling capability, 14 sets.
- Linear or Log scaled axes.
- Vector graphics, point to point plotting with user selectable origin and data scaling.
- Multiple plot frame processing.

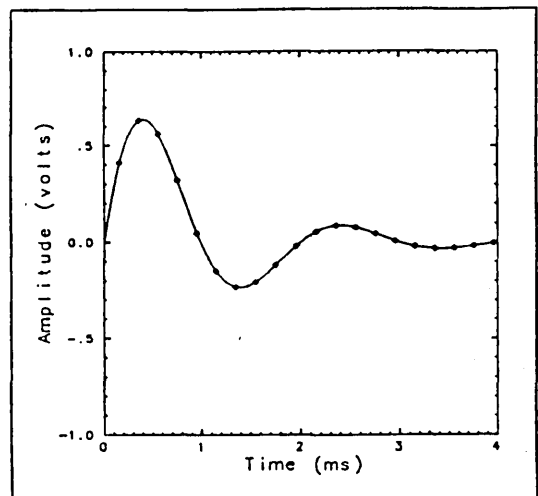
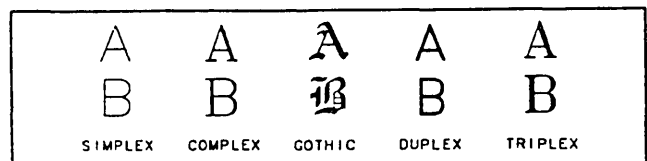
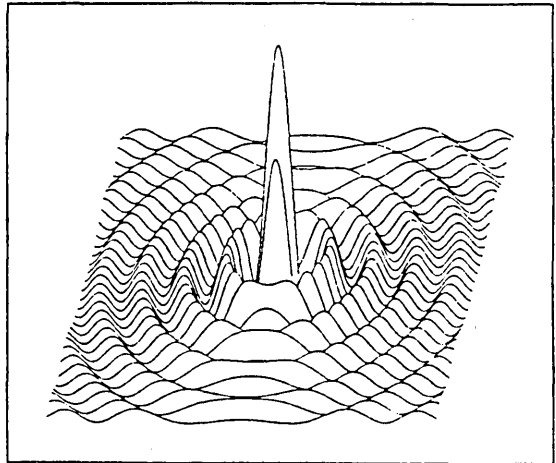

### SYSTEM REQUIREMENTS:

CP/M 8-bit system and MICROSOFT F80 FORTRAN with EPSON MX-80(GRAFTRAX PLUS) interfaced on 8-bit parallel port. 8" SS SD IBM format disks. 44K TPA (Transient Program Area) minimum.

### TERMS:

\$69.95 plus \$3.00 shipping. Mass residents add 5%. Allow 3 to 6 weeks for delivery. Check or M.O. USA and CANADA only.

MicroGlyph Systems  
P.O. Box 1066  
East Arlington, MA 02174

Trademarks are: EPSON of EPSON America, GRAFTRAX PLUS of EPSON America, CP/M of Digital Research, MICROSOFT of Microsoft, IBM of International Business Machines.

# SLICER . . . Growing to meet your needs!

## The Slicer

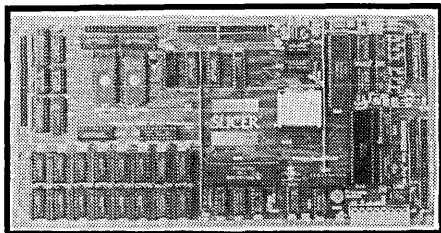

**REAL 16-BIT POWER ON A SINGLE BOARD**  
Featuring the Intel 80186

- Complete 8 MHz 16-bit microprocessor on 6"x12" board
- 256K RAM, plus up to 64K EPROM
- SASI port for hard disk controller
- Two full function RS232C serial ports with individually programmed transmission rates 50 to 38.4K baud
- Software compatibility with the 8086 and 8088
- 8K of EPROM contains drivers for peripherals, commands for hardware checkout and software testing
- Software supports most types and sizes of disk drives
- Source for monitor included on disk
- Bios supports Xebec 1410 and Western Digital WD 1002 SHD controller for hard disks

Fully assembled and tested only . . . . . \$995.00

## The Slicer System Expansion Board

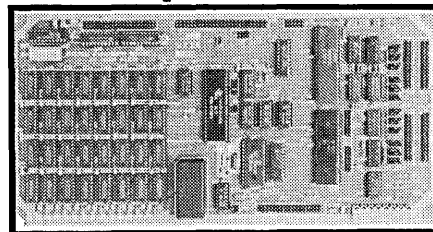

**FOR EXPANDED MEMORY, ADDITIONAL PORTS, AND REAL TIME CLOCK**

- Up to 256K additional dynamic RAM
- 2 RS232C asynchronous ports with baud rates to 38.4K for serial communication
- 2 additional serial ports for asynchronous RS232C or synchronous communication (Zilog 8530 SCC)
- Real Time Clock (with battery backup) for continuous timekeeping
- Centronics type parallel printer port

Fully assembled and tested only . . . . . \$750.00

## The Slicer PC Expansion Board

**New!!**

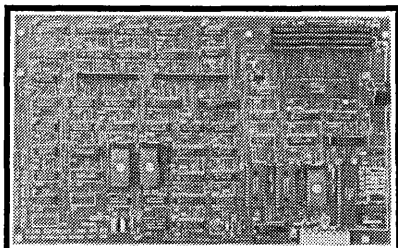

**GIVES YOUR SLICER HIGH PERFORMANCE VIDEO CAPABILITY**

- IBM compatible monochrome video
- Video memory provides 8 pages of text or special graphics capability
- 2 IBM type card slots for color video, I/O expansion, etc.
- IBM type keyboard port

Fully assembled and tested only . . . . . \$600.00

## The $\mu$ Slicer 188

**New!!**

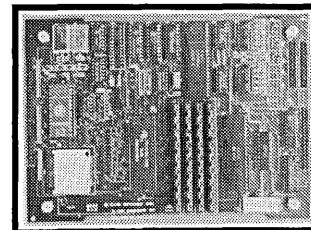

**REAL 8/16-BIT POWER ON A SINGLE BOARD**  
Featuring the Intel 80188

- Complete microcomputer on high quality 5-3/4"x7-1/2" multilayer board
- 256K RAM, plus up to 8K EPROM
- SASI port for hard disk controller
- Two full function RS232C serial ports with individually programmed transmission rates 50 to 38.4K baud
- Software compatibility with the 8086 and 8088
- 8K of EPROM contains drivers for peripherals, commands for hardware checkout and software testing
- Software supports 5-1/4" and 3-1/2" disk drives
- Source for monitor included on disk
- Bios supports Xebec 1410 and Western Digital WD 1002 SHD controller for hard disks

Fully assembled and tested only . . . . . Write or Call!



**SLICER COMPUTERS INC.**  
2543 Marshall Street N.E.  
Minneapolis, MN 55418  
(612) 788-9481

All products are available in several kit forms

Operating Systems are:

- CP/M-86 by Digital Research, Inc. . . . . \$85.00
- MS-DOS by Microsoft Corporation . . . . . \$175.00

MasterCard, Visa, Check, Money Order or C.O.D.  
Allow four weeks for delivery. Prices subject to change without notice.



# Slicer Column

By Laine Stump

Micro C Staff

I have undergone massive priority changes in the last two months. Hence, some of the products and projects I spoke of in the last column have been sidetracked momentarily.

But other interesting things have emerged, so this month I will give you a report on some of the Slicer related software and hardware. Then I will cover a few more useful software hints, and end with a description of a fast, cheap way of making one of your RS232 serial ports into a TTL serial port.

## CCP/M

Concurrent CP/M has yet to see the light of day. Although it is running, Earl and the others at Slicer want to make certain it is running correctly before they ship it (now that's an interesting policy. Maybe some other firms should try it . . . ). CCP/M was almost finished, but Earl had to spend some time working with Slicer's new model (description coming up), so CCP/M got to wait for a while.

CCP/M will sell for approximately \$200-\$250 and be available only from Slicer. I took a quick look through the "other" magazine and the lowest price I could find for CCP/M on the IBM was \$225. Slicer's version can also be reconfigured for a different number of physical and virtual consoles, while the IBM version is locked into a configuration of one physical and four virtual consoles. The Slicer implementation will not (yet) have CCP/M's PC DOS emulation mode, though.

## MSDOS

They've finally done it. Slicer Computers is now offering MSDOS for the Slicer; it should be in this issue's Slicer ad. This really opens up a lot of new possibilities for the Slicer since there are quite a few software publishers (notably Microsoft) that do not offer a CP/M-86 version of their 16 bit packages. Even Digital Research has some products that they only offer in MSDOS format. Now, for example, you can get a Fortran compiler that will run on the Slicer.

I have not yet received my copy of MSDOS, so I cannot even tell you which version it is (I'm hoping for 2.0 or better), but I will report on it in the next issue.

## PC Board

Of course, even if you have MSDOS you still can't run most of the popular PC software packages that directly access the PC's video memory. So Slicer is designing the "PC Board" (an add-on board that gives you IBM compatible video as well as some card slots for plugging in all those neat PC accessories). It is in the prototype stage right now, and the last time I talked to the folks at Slicer, they told me it was up and running (with Concurrent CP/M no less), so it should be on the market soon.

## Son of Slicer

Slicer has an interesting new model based on the 80188 (186 with 8 bit data bus). It has all the same features of the original Slicer, but through the use of AVLSI (Awesomely Very Large Scale Integration) the board has shrunk to the size of a 5" drive. This is also the size of a winchester controller card, so you can now stack the two boards on top of a winchester drive, add a terminal board and a flat panel display, and have a complete system that fits into a briefcase (my spare time project for 1985).

This system wasn't actually developed for the hobbyist market; it was designed for an overseas OEM who is going to base a portable computer on the board. Due to different design goals, the board will be somewhat more expensive than Papa. The problem is that all those new chips (that made it possible to fit all the features into such a small space) are very costly. This means that most people will probably still choose to go with the original, but at least we'll have a choice.

I haven't heard anything yet on pricing or availability. No word yet on the 8087 co-processor board that I talked about last issue, either, but you'll know as soon I find out anything.

## Software Workshop

One of the things I need for my Z-80 emulator program (which, by the way, has been stalled by my mandatory schoolwork) is the ability to make direct BIOS calls. In CP/M-80, this is simple; just look at memory location 6 to find the address of the bottom of BDOS and use that to compute the location of the BIOS jump table, then CALL that address.

Things get a lot more complicated when working with CP/M-86. Since your program may be executing anywhere in the 1 Mbyte address space, you must do a CALLF (CALL Far) to get to the BIOS, saving both the IP (Instruction Pointer) and CS (Code Segment) registers on the stack in the process. This would be just fine if BIOS routines ended with RETF (RETurn Far) instructions, but they all end with plain RETs (short returns, not even many happy returns) and RET assumes that only IP was pushed onto the stack when the routine was called.

Apparently the folks at DR knew that someone would want to bypass the operating system (a poor practice that should be avoided whenever possible) so they added a BDOS call to remedy the situation. This is done with Function #50 'Direct BIOS Call'.

When using this function, rather than loading the CPU registers with the arguments that will be passed to the BIOS routine, you must store the arguments (along with the number of the BIOS routine you wish to execute) in a 5 byte descriptor block in memory. Then you must place the offset address of the descriptor into register DX.

Figure 1 contains a subroutine which makes the currently selected drive seek track TRACKNO:

As I previously mentioned, using the BIOS directly is NOT recommended. DR wrote the specifications of the BIOS routines with very specific purposes in mind; if your purposes don't resemble theirs, you can get confused. For instance, the CP/M manual states that the BIOS SETTRK routine may be setup to delay the actual seek until a disk READ or WRITE operation occurs. That means that if you were using the preceding example in a drive test program and you wanted to just perform random seeks, you would have to SETTRK and then do a READ before the head would actually seek.

## Monitor Disk Copy

The following little routine showed up at Micro C during the SOG. It shows how to duplicate a SSSD 8 inch disk us-

*(continued next page)*

ing the Slicer's debug monitor. It is a really neat way of showing the power that was built into the monitor (thanks, Earl). To copy a disk with the monitor, you must first put the source and destination disks into their drives (say drive A and B) and type the following command:

```
+DNO D? DN1 D? DT0<cr>
```

This tells the monitor to reset both drives, establish the format of the disks, and set the track pointer to 0. Now that the system knows what it is working with, we can execute the copying loop:

```
+DNO DS1 DM80:0 DR1A DN1 DS1 DM80:
:0 DW1B,1A &
```

This command first reads a track (1Ah sectors) from drive 0 (A), then writes the same sectors to drive 1 (B). The DW command given here tells the monitor to write 27 (1Bh) sectors on a 26 (1Ah) sec-

tor track. This bumps the track pointer up to the next track. The '&' symbol is the monitor's REPEAT command, and tells the monitor to repeat the preceding command until a CTRLC is typed.

After all the tracks are copied, error messages will start appearing on the screen; just type CTRLC and you will be back to the monitor prompt. If you want to use this routine for copying other format disks, just substitute the number of sectors per track for the occurrences of '1A'. Then add one to that number and substitute it for the '1B'. Remember, though, that you cannot do a track-for-track copy between disks with different formats.

#### Fast MODEM7

The MODEM7SL program on Slicer disk S2 is set up to run at 300 baud. This is done by a routine way down in the middle of the source code near the statement IF SLICER. If you like, you can edit

that file and reassemble it to make a version of MODEM7 that runs at a different baud rate, but if you don't want to spend that much time on it, you can get the same results by making the patch in Figure 2 with DDT86.

See the baud rate table on page Monitor 16 of the Slicer manual for values needed for different baud rates. If the number at location 1755 isn't 44h then you don't have the same version of MODEM7SL so you can't make this patch.

#### TTL Serial Port

My system is a real hodge-podge of odds and ends picked up here and there. Since I don't have a serial terminal, I must, unfortunately, use my Bigboard as a terminal when I am running my Slicer. One of my roommates has a Zenith ZT1 terminal so I hooked it up to the Slicer.

The only problem was that the ZT1 is set up to connect directly to the phone lines through an internal modem and the

### DECEMBER SPECIALS:

~~64K DRAMs 200 NS max \$4 each or 8/\$28. Removed from new boards. Tested and guaranteed functional.~~

**AMBER SCREEN MONITORS!** These monitor assemblies work beautifully with a Xerox board with minor modifications (instructions included). Non-composite 20 MHz bandwidth. Require 12V DC only. May have slight scratches on screen. \$55 each postpaid.

**COMPONENTS BY THE YARD!** These components were taped for automatic insertion into computer PC boards. May include tantalum and monolithic capacitors, signal diodes resistors etc. \$3/yard or 10 yards/\$25. Please buy a few yards so we don't go "buggy" sorting through them and get a good mix of components.

**MONOLITHIC BYPASS CAPACITORS:** .1uF/50V. 8/\$1 or 100/\$10.  
.047uF/50V. Use instead of .1 and save! 10/\$1 or 120/\$10.  
6.8uF or 33uF or 39uF 35V tantalum capacitors. 5/\$1 or 60/\$10.

**FANS:** 3" \$6 5" \$7 (RFE). Asstd. Line filters \$3 (RFE).

We plan to develop hardware/software products for the 820 and BB. Users group inquiries welcome!

"Fine print": All items new unless removed from eqpmt (RFE) and subject to prior sale. Add \$3 for postage, handling and insurance. VISA M/C or check with order. \$20 minimum on credit card orders, please. We buy surplus electronics. Finders fees paid!

## SOUTHWEST COMPUTERS AND ELECTRONICS

3232 SAN MATEO NE SUITE 104 ALBUQUERQUE NM 87110 or (505) 293-8176/296-2738

only other connection is a TTL level serial port. After discovering there was hardware modification involved in hooking it up, I dropped the idea for awhile. Then last week when deadlines were looming and everyone wanted to use the computer, I finally decided to take action.

The modification I used involves making two little jumper boards that replace the terminal port RS232 drivers (U19, U20). There are no other modifications needed.

First, make two jumper boards using two 14 pin DIP headers or sockets. Simply connect pin 4 to pin 6 on both boards. This jumpers the data signal across the socket. Call one of the boards H19 and the other H20. Now jumper pin 3 of H19 to pin 2 of H20 and pin 11 of H19 to pin 9 of H20. These last two jumpers connect RTS (Request to Send) output to CTS (Clear to Send) input and DTR (Data Terminal Ready) output to DCD (Data Carrier Detect) input. You need these jumpers if the software you're running uses these signals.

When you have put the four jumpers on the two headers, just unplug U19 and U20, carefully store them somewhere on anti-static foam, and plug in the headers. Your serial port now operates at TTL voltages.

When you make the cable go to the device at the other end, remember that pin 1 is ground, pin 2 is transmit data, and pin 3 is receive data (on the DB25 connector, not the one on the Slicer board). If things don't seem to be working correctly, try switching the two jumpers on JB3 to switch the pinouts of transmit and receive. See page Connectors 4 of the Slicer manual for a diagram of these.

#### Other Serial Discussions

I recently discovered the use for one of the jumpers on JB2. If your terminal runs at 9600 baud, you can put a jumper between pin 1 and pin 2 on JB2 and the system will bypass the auto-baud code and simply assume 9600 baud. This eliminates the need to type a cr> before the system boots.

#### Later On

Wishing I had more I/O ports, but not quite having the money for an expansion

board, I have been thinking of some possibilities for other ways to chunk on another parallel or serial port—ways that involve small cash outlay. Next issue I will discuss some of these ideas (once I have had the chance to develop them). If anyone has any ideas on such things,

please get in touch with me SOON (I have to have the next column finished no later than two weeks after you read this one). Until then, happy trails.

■ ■ ■

Figure 1 - CSEG Seek Routine

```

CSEG
SEEK: LD    DX, offset SEEKDESC    ;BIOS call descriptor
      INT   224                    ;call BDOS
      RET

DSEG
SEEKDESC:DB 10    ;BIOS ftn 10 = SETTRK
           DW   TRACKNO ;reg CX = track to seek
           DW   0      ;reg DX = not used

```

Figure 2 - Modem 7 Baud Rate Patch

```

A>ddt86

-rmodem7sl.cmd
-s1755

xxxx:1755 44 66    ;for 1200 baud, BB for 9600, etc.
xxxx:1756 E6 .

-wmodem12.cmd    ;save 1200 baud version

```

## Out "keys" the competition!

Thinking about buying a "key" program? (You know, the names all start with words like "smart", "magic", "pro", etc.) Looking for a faster, easier way to calc? Process words or databases? Yes? Then you owe it to yourself (and your computer) to check out XtraKey. Quite frankly, we think it's the best. At any price! (And wait 'till you see our price.)

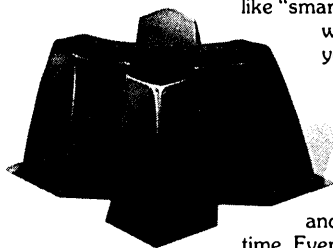

**Just like those other "keys",** XtraKey lets you redefine your regular keyboard keys to be anything you want. A word, a paragraph, a series of commands... whatever you hate to type over and over again! Change or make up new definitions any time. Even while running a favorite program like WordStar or dBASE II! Unlike other "keys", there's no limit on definition length.\* Plus our advanced XShift feature lets individual keys have up to 16 meanings.

**XtraKey can also talk to your printer or video display.** Change from pica to elite while working on a spreadsheet. Address an envelope while in a document. Or call up your own custom help or menu screens (almost like having windows!)

**There's more!** Built-in screen dump\*\*, keypad redefinition\*\*, clear screen, printer on/off, definition chaining, program chaining, input pause and batch processing. All in one, neat little package that uses less memory AND disk space than the leading program.

**Now, for \$39.95, aren't you ready for real key power?**

\* to available CP/M TPA \*\* XtraKey Custom versions for Kaypro (all models) & Gnat 10 only

# XtraKey

XtraKey will run on CP/M 2.2 based computers. To order, send check or money order for \$39.95 (\$49.95 for XtraKey Custom for Kaypro or Gnat 10) plus \$3.00 shipping (U.S. & Canada). California residents MUST also add 6% sales tax. Specify make and model of computer and disk format. VISA and MasterCard accepted.

CP/M, dBASE II, WordStar and Kaypro are trademarks of Digital Research, Ashton-Tate, Micropro and Kaypro respectively.

Xpert Software • 8865 Pollard Avenue • San Diego, CA 92123 • (619) 268-0112

# Saving Money on Quad Density Disks

By David Thompson

If you are planning to upgrade to a Kaypro 8 (or are just interested in getting the best possible disk for your dollar) then you're no doubt interested in locating double density (DD) 5" disks that will work dependably in a quad density (QD) drive.

## Good Disks vs Bad Disks

The difference between disks is primarily in the way their surfaces are coated, in the way they are polished (burnished) and in the way they are tested. Many different manufacturers use the same raw materials.

Manufacturers can make up for problems in manufacturing by rigorous testing (resulting in high rejection rates). However, when their disks are barely passing double density tests, they are not good candidates for quad density service (or for long term double density service for that matter).

## Manufacturing Problems

It is difficult to manufacture a good quality, high density disk. The thinner the magnetic coating, the better the disk records and keeps data. (The thinner the coating, the less the magnetic flux from one bit is able to spread out and effect an adjoining bit—called flux migration.) However, the thinner the coating, the greater the chance of having a dropout (a spot whether the media is missing or is defective).

Iron oxide is the material that stores the information, but iron oxide is very hard and abrasive. Manufacturers add a lubricant to the binder (the oxide particles are suspended in a binder), coat the base material with the oxide and binder and then they polish the surface of the disk. Some disk surfaces are so smooth that you can see your reflection in them, others like Maxell, are rough and abrasive.

## Testing

Disk manufacturers grade their disks by testing them. The highest grade is double sided quad density, the lowest grade is single sided, single density.

Just because a disk is only tested on one side (single sided) doesn't mean you can't use both sides. They just haven't checked the back side and they don't guarantee that the back side will work. Otherwise they are the same (single sided are polished on both sides just like the double sided).

Just because a disk has passed a double density test, doesn't mean that it wouldn't have passed a quad density test (again it depends a lot on the basic quality of the untested product).

We have had success formatting and using some standard double density disks in 96 tpi applications. When disks work perfectly in quad density it means they should work more than perfectly in double density (at least that seems reasonable to me).

## Enhance Your KAYPRO®

### CP/M 2.2E

Enhances any version of CP/M 2.2. Includes FASTCOPY, improved TYPE command, PUBLIC features, type-ahead buffer and more.

### Plu\*Perfect Writer

Enhancements for the Perfect Writer editor (versions 1.03 and 1.20). Set swap file size, change disks while editing, use keypad for one-touch commands, etc.

### The Backgrounder™

— with definable keys —

All keys fully definable in any program. Suspend any program to print the screen, write background notes, and use built-in CP/M commands. Now comes with Print Spooler.

(Requires CP/M 2.2E to run.)



### DateStamper

Software that automatically stamps a file with the dates it was created, last read or modified. If your Kaypro has a real-time clock, exact times will also be recorded. Brings big computer file organization to CP/M 2.2.

Includes utilities to:

- give directory showing when your files were created, last read and modified.
- initialize disks for date and time stamping
- mass transfer date-tagged (and other) files. Sophisticated display features.

Bring your Kaypro up-to-date! Only \$39.

(Currently requires CP/M 2.2E.  
General CP/M 2.2 version available soon.)

See Your Dealer or Purchase Direct  
Call or write for further information.

Please check which Kaypro(s) you own:

II  2-84  2X  4  4-84  10   
10-84  Robie  4X  12X



Trademarks: Kaypro (Kaypro Corporation), CP/M (Digital Research), Perfect Writer (Perfect Software).

K-1 Plu*Perfect Writer & CP/M 2.2E	\$39	_____
K-2 The Backgrounder	\$45	_____
K-3 CP/M 2.2E	\$32	_____
K-6 DateStamper	\$39	_____
Deduct \$5 if ordering 2 or more disks		_____
Subtotal		_____
California sales tax (6%)		_____
Shipping & handling		3.00
TOTAL		_____

(Orders outside N. America, \$5 shipping per disk.  
Any checks should be drawn on U.S. bank.)

**Plu\*Perfect Systems**

BOX 1494 • IDYLLWILD, CA 92349 • 714-659-4432

### DD Disks That Should Work in QD

The MAG MEDIA disks have been amazingly good. We've tested over 500 of them, both double sided double density and single sided double density, and they have all been absolutely solid despite continuous use.

I haven't tested any of the Dysan 5" disks (I can't afford them) but they have such an excellent reputation for reliability that I am comfortable recommending them in any application. Dysan is really the standard in the industry, both for polishing and testing.

Maxell disks have a very good reputation for data reliability but they are abrasive. Tektronix stopped using them because drive heads were being chewed up in less than a year. I cringe when someone sends me an article on a Maxell.

### DD Disks That Won't Work in QD

Elephants don't work, period. Their double density disks don't even work well in the standard double density Kaypros. I understand from the rumor mill that they are trying to upgrade their product, but the word, so far, is that "Elephants always forget." (Try to remember that.)

DD BASFs don't work very well QD. They usually format but the latest batch we've gotten don't hold data very long in

quad density. BASF, of course, only guarantees them to work double density and they work pretty well in that mode.

Scotch disks might work all right. They had some real problems with quality a year or so ago and I quit using them then. I understand that they are better now but I haven't tried any of the new ones to verify this.

### Finally

As far as the rest of the disks, try them for yourself. We test double density 5" disks by formatting them in quad density and then copying back and forth numerous times. Then we go back to double density and try to wear them out by using them as masters for many, many copies.

If you find some that work particularly well, send in a short letter to the editor; we'll pass the word along.



## LINK YOUR GANG TOGETHER

Control up to 4 AC devices at one time with your Kaypro\* computer.

- Without tying up either your RS232 or Centronics Port
- 7500v Isolation between computer and controlled devices
- No moving parts
- Simple plug in installation to your computer
- Requires no soldering or cutting in your Kaypro\*
- Software examples in Basic and Z80 Assembly Language
- Easy to create your own specialized programs

### INCLUDES:

- Fully assembled and tested printed circuit board
- 5 1/4" diskette with software examples and documentation
- plug in adapter and cable for the Kaypro\* II and IV (Ask about versions for Kaypro\* 10 or Kaypro\* 4/84)

**ONLY \$39.95 (plus \$2.00 shipping & handling)**  
**30 day Money Back Guarantee**

Send check, money orders, or inquiries for THE MASTER SWITCH to:

**ZIPPE SYSTEMS**  
6520 Selma Ave., Box 528  
Los Angeles, California 90028

\*Kaypro is a trademark of Kaypro Corporation

## "C/80 . . . the best software buy in America!"

—MICROSYSTEMS

Other technically respected publications like *Byte* and *Dr. Dobbs's* have similar praise for **The Software Toolworks' \$49.95 full featured 'C' compiler for CP/M® and HDOS with:**

- I/O redirection
- command line expansion
- execution trace and profile
- initializers
- Macro-80 compatibility
- ROMable code
- and much more!

**"We bought and evaluated over \$1500 worth of 'C' compilers . . . C/80 is the one we use."**

— Dr. Bruce E. Wampler  
Aspen Software  
author of "Grammatik"

In reviews published worldwide the amazing \$49.95 C/80 from **The Software Toolworks** has consistently scored at or near the top — even when compared with compilers costing ten times as much!

The optional **C/80 MATHPAK** adds 32-bit floats and longs to the C/80 3.0 compiler. Includes I/O and transcendental function library all for only \$29.95!

C/80 is only one of 41 great programs each **under sixty bucks**. Includes: LISP, Ratfor, assemblers and over 30 other CP/M® and MSDOS programs.

For your free catalog contact:

**The Software Toolworks**  
15233 Ventura Blvd., Suite 1118,  
Sherman Oaks, CA 91403 or call 818/986-4885 today!

CP/M is a registered trademark of Digital Research.

# Three Keyboard Translators

Review By Philip Bond

27 Sharon Dr  
Spring Valley NY 10977

In an effort to make my Kaypro easier to use, I have tried several translation programs which can redefine my keyboard characters. CONFIG, the freebie distributed with the Kaypro, was useful enough to convince me that keyboard translators could be very handy.

(For more on using CONFIG, see Pro-Files Magazine, Vol. 1 No. 2 or Vol. 1 No. 4.) I might add that KSTROKES on Micro C disk K24 was not available when I was trying out the three commercial programs described below. I still do not have a copy of KSTROKES, so I cannot make a relative judgement. However, it sounds like a good compromise between CONFIG and one of the more expensive commercial programs.

The three programs I will describe are The Backgrounder, WORDPAD, and XtraKey. Each cost between \$40 and \$50. All three of these translation programs do one job fairly well, and in about the same way.

All the programs contain a translation table and a small amount of code which accesses the table. The code and table are moved up to the top of the available memory (TPA) where they remain unmolested by programs or warm boots.

When the operator hits a key that is supposed to be translated, the program gets the replacement character or characters from the table and substitutes them for the keystroke.

## The Backgrounder

The Backgrounder is a product of Plu-Perfect Systems (PPS), which also sells the PluPerfect Writer enhancement for Perfect Writer. The Backgrounder must run under a special version of CP/M written by PPS called CP/M 2.2E. Therein lies The Backgrounder's greatest strength and weakness.

CP/M 2.2E is really a series of patches to standard Kaypro CP/M 2.2, in the CCP, BIOS, and BDOS. A complex (but completely documented and prompted) session copies your master CP/M disk onto a blank disk, then patches CP/M and certain utilities. Since some standard Kaypro utilities do not work correctly with 2.2E, new utilities are provided to replace FORMAT, COPY, BAUD and CONFIG. The replacement for CCP is based on ZCPR, but with some functions

removed to make room for an enhanced TYPE function.

Because the BIOS is altered, any program which makes direct BIOS calls may not work. Perhaps for this reason, a number of "old reliable" programs get flaky under CP/M 2.2E. Among these are such programs as MODEM7, WordStar, UNIFORM and PIP. The PPS manual also indicates that 2.2E will not work with hardware modifications such as ROMs, speedups, or graphics enhancements. This incompatibility is the main reason I am no longer using The Backgrounder.

Anyway, The Backgrounder does much more than key translation. In the background mode, it lets you run DIR, ERA or TYPE while in the middle of a program like PIP. You can also add other modules such as a screen dump, notepad (simple online editor for notes while in another program). I did not install these modules often, because of the erratic way WordStar worked when they were in memory.

The Backgrounder is easy to use but the setup is not for the casual operator.

## WORDPAD

My next attempt to find the best low priced translator program led me to WORDPAD by Wordtech Systems. For the capabilities, WORDPAD might seem a little overpriced, but the concept is beautifully simple and it is virtually immune to hardware and software conflicts. The only problems I had were with programs like UNIFORM and DDT, which also relocate themselves into high memory. Loading such programs can lead to strange halts or runaways.

There are several potential limitations, which may not be a problem for many people. Only the keypad and cursor keys may be programmed, but the keypad hyphen key is used as a shift so you can define up to 35 strings. Each string is limited to 15 characters and defined strings can contain only those characters which can be input from the keyboard. If your application needs special characters (for instance, with bit 7 set) this program will not handle it.

Each keyboard layout is a small independent .COM file, occupying 2K on a Kaypro 4. Calling up a layout displaces the one which was previously in effect, if

any. To remove the layouts entirely, you have to RESET the computer.

The master diskette contains versions for the model 10 as well as for 2 and 4. You get a master layout called WORDKEY.COM, sample layouts for WordStar and Perfect Writer (with a set of keytop labels), and SETKEY.COM. You use SETKEY to create your own layouts.

## XtraKey

XtraKey is the best translation program I've seen, and is the one I now use. XtraKey by Xpert Software, is apparently compatible with all the CP/M programs I have, and according to the manufacturer it should work properly with most hardware modifications (specifically 5MHz speedup kits, video attribute and graphics kits, and the Micro C Pro-Monitor ROM). They thought a RAM disk might have problems, depending on how it was implemented. (However, other key translation programs are likely to have problems with a RAM disk, too, so there is no real disadvantage here.)

XtraKey is also the only low cost program I've tried which is compatible with machines other than Kaypro. (Hear that, Big Board users?) In addition to versions for existing models of Kaypro, the master diskette contains a version for other CP/M machines. If you order the universal version only, the price is \$39.95. The Kaypro version for \$49.95 includes a screen dump routine and a special keypad and cursor key translation routine. (Editor's note: there is also supposed to be a Big Board version that adds the screen dump to the universal version for \$49.95.)

Strings of one or more bytes (any HEX value) can be assigned to ANY key, though it is easiest to use the keypad keys. There is no theoretical limit to the total number of bytes assigned to keys, but the practical limit is dictated by the amount of disk space and TPA you want to reserve for definitions.

XEDIT, the XtraKey editing program, has certain limits for individual strings, depending on how much memory you have, but longer strings may be created without XEDIT. The layout can be created directly using an editor, or an existing ASCII text file may become a long string.

Keys may also be temporarily redefined on the fly within any program.

Since the output from Kaypro keypad keys is distinctive, those keys do not require any special prefix key to have an assigned string sent to CP/M. If you are going to redefine the keys on the main keyboard, you must also define a special "shift" key if you also want to be able to use those keys to output their regular characters. You must enter your special shift key before a key will be translated. For this reason, I suspect Kaypro users will probably want to program keypad keys almost exclusively.

Both the Kaypro and general versions of XtraKey have some unique features. You can turn your printer on and off from within any program, you can clear the screen, you can prevent certain characters from going to the screen (nulls, for instance), and you can directly translate all keys on the keyboard to a different single character, with no shift key needed. This makes possible a complete keyboard rearrangement, such as the famed DVORAK layout, for which a definition file is included. Of course, you might want to use this feature only to change a few keys on the keyboard, which is possible by redefining only the keys you want to move.

### Summary

Figure 1 compares the three translation programs I have discussed. All three are good values, with only a few flaws here and there. Most differences are probably a matter of personal opinion. The price for The Backgrounder includes the CP/M 2.2E enhancement package.

### PluPerfect Systems

Box 1494  
Idyllwild, CA 92349

### Wordtech Systems

PO Box 1747  
Orinda, CA 94563

### Xpert Software

8865 Polland Avenue  
San Diego, CA 92123



Figure 1 - Translation Table

	# Backgrounder #	WORDPAD #	XtraKey #
Price (list)	\$50.00	\$40.00	\$39.95/\$49.95
Manual (pages)	96	12	78
Define Keypad?	yes	yes	yes
Other Keys?	yes	no	yes
Shift keys	1	1	7
String length	255	15	unlimited
Extras? (*)	yes	no	yes

(\*) "Extras" refers to features not directly connected with basic keyboard translation.

## A POWERFUL 68000 DEVELOPMENT ENVIRONMENT FOR YOUR Z80 SYSTEM

### CO1668 ATTACHED RESOURCE PROCESSOR

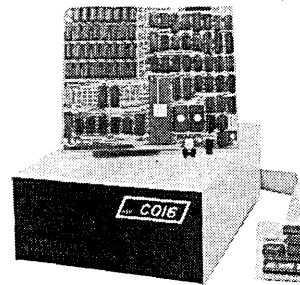

- 68000 Assembler
- C Compiler
- Forth
- Fortran 77

- Pascal
- BASIC-PLUS
- CBASIC
- APL 68000

6 MHZ 68000 CP/M-68K 768K RAM  
4 x 16081 MATH CO-PROCESSORS CPM80 RAM DISK

Develop exciting 68000 applications on your current Z80 based CPM system using powerful mini-frame like 32 bit programming languages. And then, execute them at speeds that will shame many \$100K plus minicomputer systems.

The CO1668 ATTACHED RESOURCE PROCESSOR offers a Z80 CPM system owner a very low cost and logical approach to 68000 development. You have already spent a small fortune on 8 bit diskette drives, terminals, printers, cards cages, power supplies, software, etc. The CO1668 will allow you to enjoy the vastly more powerful 68000 processing environment, while preserving that investment.

### CO1668 ATTACHED RESOURCE PROCESSOR SPECIAL FEATURES:

- 68000 running at 6 Mhz
- 256K to 768K RAM (user partitioned between CPU and RAM Disk usage)
- Up to four 16081 math co-processors
- Real time clock, 8 level interrupt controller & proprietary I/O bus
- Available in tabletop cabinet
- Delivered w/ sources, logics, & monolithic program development software
- Easily installed on ANY Z80 CPM system
- CP/M-68K and DRI's new UNIX V7 compatible C compiler (w/ floating point math) - standard feature
- Can be used as 768K CPM80 RAM Disk
- Optional Memory parity
- No programming or hardware design required for installation
- Optional 12 month warrantee

- PRICES START AS LOW AS \$899.00 for a CO1668 with 256K RAM, CPM68K, C Compiler, Sources, Prints, 200 page User Manual, Z80 Interface, and 68000 System Development Software.

For further information about this revolutionary product or our Intel 8086 Co-Processor, please send \$1 [no checks please] or call:



Hallock Systems Company, Inc.  
262 East Main Street  
Frankfort, New York 13340  
(315) 895-7426

RESELLER AND OEM  
INQUIRIES INVITED.

# NO MORE BDOS ERRORS

DIAGNOSE AND ADJUST ALL 5¼" FLOPPY DRIVES\*

OUR COMPLETE \$119 KIT INCLUDES:

- CERTIFIED DSDD® DYSAN DDD
- TEST PROGRAMS FOR ALL KAYPRO® PORTABLES PAST & PRESENT
- COMPLETE DOCUMENTATION FOR ALL TESTS AND DRIVE ADJUSTMENTS
- FLOPPY DRIVE SERVICE MANUAL WITH EASY-TO-USE DIAGRAMS

...IF YOU CAN READ THIS  
YOU CAN USE OUR DIAGNOSTIC SYSTEM

*Over 40% of all failures in transportable computers are caused by mechanical failure of the floppy drives. Does not need any additional equipment. You may test any Kaypro® portable as fast as you can make an omelette.*

**BE SAFE!!**

*Our kit will help you keep your drives in top shape!*

\*48 TPI or 96TPI, Full or Half Size



**SHEEPSHEAD SOFTWARE™**

P.O. Box 486  
Boonville, CA 95415  
(707) 463-1833 • (707) 468-8717

Phone orders Mon.-Sat., 9 a.m. to 9 p.m., Pacific Coast Time. Check, Money Order, MASTER/VISA Card or C.O.D., add \$2. Calif. add 6%, UPS Blue Label add \$5.



## A NEW TWIST

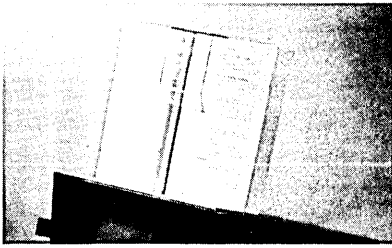

### FAT JACK READING RACK

- ★ SEE COPY-SCREEN/KEYBOARD AT THE SAME TIME.
- ★ EASILY ATTACHED TO ANY KAYPRO™
- ★ 16" WIDE - AND STRONG FULLY SUPPORTS - BOOKS MAGAZINES • REPORTS WITH UNIQUE PAGECLIP™

Dealer and group inquiries invited.

**ONLY \$17.95** + \$1.50 Shipping  
(Continental U.S.A.)

Washington Residents Add \$1.45 Sales Tax.  
Cashier Checks & Money Orders Shipped Promptly.  
(Personal Checks Must Clear - 2 Weeks.)  
(Price & Configuration subject to change without notice.)

**The Best Accessory  
You'll Ever Buy For Your  
Kaypro™**

ORDER FROM:  
**TWIST, INC.**  
P.O. Box 1406, Renton, WA 98057

# NETWORKING THE KAYPRO

Since December 1983, Adevco has been shipping the "WEB" networking system for Kaypro computers. We have thousands of satisfied users worldwide. Now Adevco introduces a new Kaypro local area network system that is 100% compatible with the Web —

**meet the LAN/ROVER!™**

#### SOME LAN/ROVER FEATURES:

- A complete, easy-to-install system, for any Kaypro model, including pre-configured software.
- Network can extend beyond 3000 feet without repeaters.
- Optimized for highest performance with Kaypro computers.
- Full security system with encoded passwords.
- Log on, run programs, save files to any disk drive on the network.
- Printout to any printer on the network from inside any applications program.
- Low cost per computer.

Write or phone for more information or the name of the nearest dealer. We will send article reprints describing an Adevco on-site installation of a 200 megabyte network system using more than 20 Kaypro 10 computers. Full technical specs included.



**ADEVCO, INC.**

3790 El Camino Real, Suite 329 • Palo Alto, CA 94306 • (415) 493-7466

\*Kaypro is a trademark of Kaypro Corporation.

## Look what only \$179.95 adds to your KAYPRO® 2 or 4! REVERSE VIDEO • REDUCED INTENSITY • BLINKING SCREEN GRAPHICS • REVERSE SCREEN SCREEN-TO-PRINTER DUMP

JFN Industries' new AT-1 VIDEO ATTRIBUTE BOARD adds badly needed REVERSE VIDEO • REDUCED INTENSITY • BLINKING • REVERSE SCREEN • and SCREEN-TO-PRINTER DUMP. The new GR-1 Graphics Upgrade adds Zenith Z-19 CELL SCREEN GRAPHICS and SCREEN DUMP CHARACTER TRANSLATION. Both install in minutes with no component desoldering and are compatible with the Kaypro's existing hardware and software.

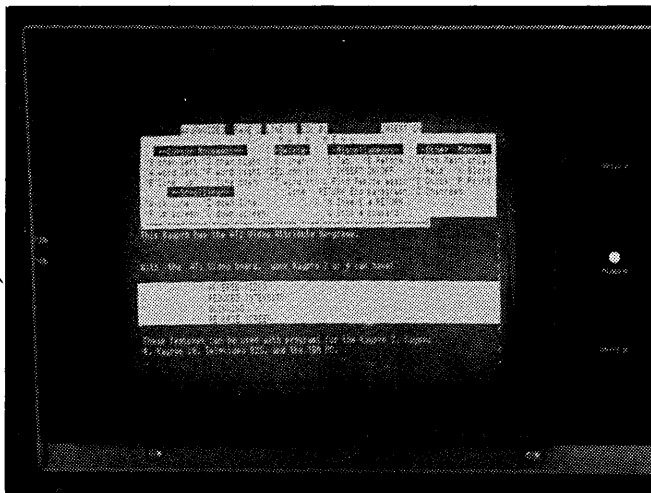

With the AT-1 installed, the video control codes are compatible with those of the Kaypro 2, 3, and 10 models, the popular Televideo 925 terminal and the IBM PC (Co Power 88). A patch program is also provided to automatically upgrade the standard software that comes with the Kaypro to use these new attributes.

The AT-1 comes ready to install, complete with connectors; programs to upgrade the operating system; demo, test, and configuration programs, plus a detailed instruction booklet. The AT-1 and GR-1 package is only \$179.95. The AT-1 alone is \$149.95 and the GR-1 alone only \$49.95. California residents add appropriate sales tax. Order yours today.

DEALER INQUIRIES INVITED.

**JFN Industries**

361 North Fuller Avenue, Los Angeles, California 90036  
(213) 939-4105

# The Kaypro Column

By Alan Barlow

6921 55th Ave. S  
Seattle WA 98118

So you've read the articles in Micro C about adding extra drives and souping up your CPU, and now you want to be the first kid on your block with a 5 MHz mill and double-sided quads growling under the hood. Here is a summary of the steps involved, including corrections, reader suggestions, and a few ideas of my own.

While you're at it, you can also make the drive select lamps do what they are supposed to do—light up only when a drive is (a) selected and (b) running.

The mods are independent. You can speed up your CPU or add disk drives or do both. To speed up an older Kaypro II from 2.5 MHz to 5 MHz will cut processing time in half—a remarkable improvement if you are recalculating spreadsheets, reformatting text files, or creating a program. (See "Benchmarks" in Micro C issue 19, p. 44.)

## Disk Drives

The older Kaypro IIs came with two full-height, single-sided, double-density, 40-track, 191K drives. Track spacing was 48 TPI (tracks per inch), so 40 tracks would occupy 5/6". There are three ways to increase total disk capacity.

You could use double-sided drives, which read and write both sides of each disk, giving you a total of 80 tracks per disk (40 on each side). This is the Kaypro 4 format.

Or, you could use 96 TPI drives (commonly called quad density). They pack 80 tracks per side into the same 5/6" of media, so a double-sided drive reads and writes 160 tracks. (Kaypro 8)

Third, you can use half-height drives, like the newer Kaypros. This allows you to stuff up to four drives into your machine. If the drives are also half-power models (most are), four will load your existing power supply no more than the two original drives.

Or you can do all three. If you plug in four half-height, double-sided, 96 TPI drives you get more than 3 Megabytes total usable capacity (for about \$540 if you purchase TEACs from California Digital, see the back of BYTE). I replaced just one of my Tandon drives with two half-wides so I have three units in my system.

You can do the speed-up and add the

extra drives yourself. All you need is information, tools, parts, and a little skill.

## Useful Back Issues

For background information, read the following issues of Micro Cornucopia. For the actual wiring, I suggest following the steps below.

Issue 12, page 24: "The Kaypro Column" (the original speed-up article);

Issue 15, page 14: "Great Eight Kaypro" (converting your Kaypro II to a 4, and the 4 to an 8);

Issue 18, page 3: Letter from Greg DeHoogh (2732 chip select), page 24: "The Kaypro Column" (cutting traces and soldering on the speed-up), and page 26: The "PRO-8 Plus-4" (MC's monitor ROM and 4-drive decoder).

You should also get a copy of the Kaypro schematic from Micro C (\$20.00).

In addition, a useful instruction booklet comes with Micro C's Pro-8 Monitor ROM. More about the ROM later.

## Not For Beginners

If a lot of monkeys on a lot of typewriters will eventually produce a "Hamlet," then it seems to follow that if you keep hooking up wires and parts, you could eventually wind up with a Cray 2. Sadly, this could require a great deal of time.

Although no technical wizardry is involved, you should not make this your first electronics project. Static electricity that you can't even feel will ruin MOS chips (the big ones). Excess heat from soldering will lift traces (foil strips) and make a hell of a mess to repair. Other things can also go wrong go wrong. (SIC)

You will need the right tools. A soldering gun and acid core solder won't do it. You should have the following:

## Recommended Tools

Soldering pencil: 15 to 25 watt, 3-wire grounded (to kill static)

Solder: 22-gauge rosin core (I insist on Ersin Multicore)

Desoldering tool: spring-loaded Solda-vac

Needle-nose pliers, 4½" to 5", smooth-jawed (to avoid nicking wire)

Diagonal cutters, semi-flush cutting, 4½" to 5"

Wire stripper: for 30-gauge wirewrap wire

Stripper/crimping tool: for stripping larger wire and crimping terminals

Allen wrench: 7/64" for disk drive mtg screws

Socket: 3/16" for serial connector mtg screws

Exacto knife for cutting traces

Screwdrivers, miscellaneous hand tools

Electric drill for mtg holes for new drives

Gooseneck lamp with magnifier

## Speed-up

This is the easiest mod you can make. You route the 2.5MHz and 5MHz taps from U86, pins 4 and 5 respectively, to a toggle switch on the back panel. A third line from the switch delivers the selected clock signal back to the CPU board. The switch is useful because a few programs run best (or run only) at 2.5MHz.

You'll need a faster CPU chip, a Z80B, in U63. The B means it will operate up to 6MHz.

You'll also need a faster Monitor ROM, U47. The selection you make depends on your intentions regarding disk drives. If you're sure you'll never be adding extra drives, or replacing the present ones with higher-capacity models, then you could scrimp by buying a blank 2716 rated at 350 nanoseconds or less, and having someone copy the code from the original ROM into the faster part. Or you could buy the Pro-Monitor II from Micro C (it is a 250 ns 2732 which is burned to look like a 2716).

However, if you plan to increase drive capacity, either now or later, I recommend replacing U47 with Micro C's Pro-8 ROM. It should satisfy all your present and future requirements. It will run at 5MHz, and it will allow your CPU to access up to four 5 1/4" drives, single- or double-sided, 48 or 96 TPI, in any combination. In addition, it contains some fancy features. The Pro-8 plugs right into the U47 socket; you'll merely have to cut two traces and add two wires (see below).

Also pick up a small connector to wire in-line between the switch and the CPU board (so you won't have to unsolder wires every time you decide to remove the CPU board in the future).

## Parts

1. Z80B CPU chip. Get a Zilog or Mos-tek part. Leave the chip in its anti-static foam until ready to use!
2. A faster Monitor ROM for U47
3. SPDT (3-terminal) toggle switch
4. Three-terminal connector (male and female pair)
5. 30-gauge wirewrap wire, to make the changes under the CPU board
6. 20-gauge stranded, tinned hookup wire, to connect between the CPU board and toggle switch (get red, white, black, and green if you plan to add extra drives later. These are the colors used in the drive power cable).

## Procedure

Unplug your computer from 120 VAC. Then decide where you want to mount the toggle switch. The back panel is recommended, because you won't be using it very often. (Also, if you try to shift gears during operation, the logic will hang up and you'll have to reset, losing everything in memory.) A convenient place is in a ventilation slot, near the reset switch. (I moved my reset switch up front and mounted my toggle switch in the hole it left.)

Remove 10 screws from the sides and top and remove the cover.

Unplug the four connectors on the board: J1 (video), J5 (power), J6 (drives), and J7 (reset switch and LED). Be careful not to bend the pins when removing the disk drive ribbon cable. Use a large flat-tip screwdriver to gently pry up each end of the connector, a little at a time.

On the back panel, use a 3/16" socket to remove the mounting bolts from the serial connector, J4. With a small phillips head screwdriver remove the mounting screws from the parallel connector, J2. Two more screws on the back panel secure the CPU board. Two remaining screws secure the board to the long spacers. After removing these two, put them back into the spacers to keep them apart from the others.

Remove the copper shield from the bottom of the CPU board. After removing the two screws, put them back into the brackets to keep them separated.

Glance at Figure 1 for a review of IC pin-numbering. Counting always starts at the notch. (On some ICs a dimple

marks pin 1.) When you're looking at the component side of the board, the pins are numbered counter-clockwise from the notch.

## Orientation

In the following directions let's assume you are holding the CPU board in your hands like a book, looking at the component side, with the keyboard connector upward. Locate the 20MHz crystal (in a silver-colored can) at the bottom of the board, near the center. Directly above the crystal is U67. Left of U67 is U66. Right of U67 is U86. Between U67 and U86, and slightly upward, are blank outlines for C6 and Q1 (Kaypro decided these two components were not necessary).

The C6 outline contains two plated-through holes. The bottom hole (nearest the edge of the board) makes a convenient tie-point for the switched clock signal returning to the board. Using your soldering pencil and solder sucker (on opposite sides of the board), open the hole.

Run a 4" 20-gauge stranded wire from this hole to the center pin of the female in-line connector. From the center pin of the male section, run a 12" wire of the same color to the common terminal of the toggle switch (usually the center terminal).

Temporarily remove U86 from its socket (use a small, flat-head screwdriver at one end and carefully pry it out). With your needle nose pliers bend pins 4 and 5 outward just enough so they won't go into the socket when you replace the chip. (We're talking about the bottom row of pins, 4th and 5th from the left end, viewed from the component side—right?) These are the 2.5MHz and 5MHz clock signals.

Solder 4" wires to these two pins and run them to the two outside terminals of the female connector. Now run two 12" wires from the male connector to the two remaining terminals of the toggle switch.

NOTE: These are the only two IC pins which you will have to bend out or solder to! All other wiring can be done quite neatly (and out of sight) on the foil side.

Turn the board over and look at the foil side. The keyboard connector is still up-

ward, as before. The disk drive ribbon cable connector, J6, is now on your left.

## Hints

When you cut a trace, use your exacto knife and make two cuts a fraction of an inch apart. Scrape away the foil in between. If you accidentally cut the wrong trace, don't try to drop a blob of solder between the broken ends. Instead, lay a short piece of 30-gauge wire across the break and tack-solder it to the foil.

Use the 30-gauge wirewrap wire to add jumpers on the foil side of the board. When adding a wire, strip little more than 1/16" insulation from each end, to avoid shorting to nearby terminals or traces. To connect to an IC pin, make a J-shaped hook with your needle nosed pliers. To connect to a foil solder pad, lay the wire flat and tack-solder to the pad.

Don't ever keep the iron on any trace, solder pad, or IC pin more than 5 seconds MAXIMUM. With good solder and clean, shiny surfaces you shouldn't need more than 2-3 seconds to do the job. Too much heat for too long will lift traces.

Remember—on the foil side, IC notches are on your right, and pins are numbered clockwise. U66-4 means pin 4 of U66.

Cut trace from U66-4 to solder pad near bottom end of C65.

Add wire from U66-3 to the previous solder pad.

Cut trace from U66-5 to solder pad below U49-2.

Add wire from U66-4 to the previous solder pad.

If you are replacing your 2716 Monitor ROM (U47) with a 2732 (like the Pro-8), then perform the following steps:

Cut trace from U59-2 to U60-1 (address line A11B).

Cut trace from U47-21 to U47-24.

Add wire from U59-2 to U47-21 (address line A11B).

Add wire from U60-1 to U60-8 (ground).

That's all the wiring for the speed-up. Now replace the Z80 CPU (U63) with the Z80B, and the 2716 Monitor ROM (U47) with the faster part—either the faster 2716 which you had burned with the old code, or the Pro-8 2732.

*(continued next page)*

**Caution**

Before handling the CPU or ROM chips, always discharge yourself by touching some bare metal on your machine. This puts you and your Kaypro at the same potential and helps prevent zapping gates on the MOS wafer (you need good eyes and tiny tools to repair a gate). All the larger chips (and memory) are MOS. Be especially careful in low humidity. Assembly line workers keep themselves grounded with a wrist strap to the chassis of whatever they are working on.

**More Disk Drives**

I bought two Mitsubishi M4853s for only \$175 each. They are half-height, half-power, double-sided, quad density (784K each), with DC brushless, direct-drive motors. They claim track-to-track access time of only 3ms. When these little hummers go out looking for data, they really rip-snort! The only complaint I have so far is that the disk does not always eject when I pop the door open. I just pull the upper latch down part way and let it snap up a second time.

**Adding Extra Drives Requires The Following:**

1. Drilling holes in the bracket and physically mounting the new drives
2. Installing address jumpers on all drives and terminators on the last drive
3. Adding connectors onto the ribbon cable for data and control lines
4. Extending the drive power cable and adding connectors
5. Installing a new Monitor ROM, such as the Pro-8 (the original 2716 can address only two single-sided, 48 TPI drives)
6. Adding a four drive decoder on or near the CPU board (the existing hardware can address only two drives)
7. Modifying your CP/M to a 63K system

**Parts**

1. The drives themselves
2. One 34-pin edge connector for each drive. (Examples: Ansley #609-3415M; Alpha #FCC-170-34; 3M #3463-0001.) If you add both connectors now, you can easily add up to four drives later. (For TEAC drives, see note in Micro C issue 17, p. 19.)

3. One 4-pin power connector for each new drive, AMP 1-480424-0. You also need pins, AMP 60619-1, four per connector. (The Mitsi's come with a connector and pins.) Get four extra pins, for daisy-chaining the wires (explained later).

4. One 3/16" (.188") female push-on connector for each new drive, for the ground wire (AMP 60972-1). Get one extra for daisy-chaining.

5. A new Monitor ROM to replace the 2716 in U47. See discussion under Speed-Up Parts, above. Recommended: Micro C's Pro-8.

6. One 74S04 to replace the 74LS04 in U73

7. 20-gauge and 30-gauge wire (see Speed-Up Parts)

8. Socket-head screws, 6-32 X 3/8", and flat washers. Four each to mount new drives.

9. Four-drive decoder. You can buy Micro C's Plus-4 Decoder Board or you can buy a 7445 chip and a 16-pin socket and make your own.

**Procedure**

Unplug your computer from 120 VAC. Decide how you want to configure your drives. I made my Mitsi's A: and B:, and my remaining original Tandon C:. This gives me room for all of my most-used programs on A:, lots of data storage on B:, and C: for backup. With A: and B: the same type, I can use fast COPY programs. However, I can no longer use my original version of UNIFORM, which was written for a single-sided, 48 TPI drive in B:. (A number of folks used Kaypro 4 drives in A and B and quad density drives in C and D so they can continue to run everything.)

Remove the CPU board. (Pretty soon you'll be able to do this in your sleep.)

Remove the ribbon cable from the drives.

Unplug the power cable from the drives. On the Tandons, it'll be as tight as a barnacle on a rock. Grab the connector by its little ears and rock it downward.

Remove the socket-head screws. Pull the drives out the front.

On the bottom of the computer remove the four screws that secure the drive mounting bracket. Note that the

bracket goes in only one way; keep this in mind when you measure and drill the new mounting holes. If there is a possibility of running four drives in the future, you may as well drill all the holes now. I had to notch my front diagonal brace to get one of the screws to fit.

See Figure 2 for mounting hole pattern. The Mitsi drives seem to be a hair wider than the Tandons. They wouldn't quite squeeze into the top of my mounting bracket, so I simply put the Tandon on top and the two Mitsi's on the bottom.

Be sure to remove all burrs and filings after drilling. (Disk drives are noisy enough as it is.)

**Jumpers**

Install the address jumpers in your drives according to the instructions that came with them. In your Tandon 100-1s, you have to cut out the jumpers you don't want. Locate the DIP (Dual In-line Package) with the jumpers, near the edge connector. Leave the first jumper (nearest the edge of the board) intact. The second jumper intact = A:; the third jumper intact = B:; etc. If you want your Tandon to be named C:, then you should have the first and fourth jumpers intact; no others. (You may have to bridge a previously cut jumper to set the address you want.)

Some manufacturers specify drive selection as DS0, DS1, DS2, DS3; this is equivalent to the Kaypro's A:, B:, C:, D:.

You have other jumper choices to make. The Mitsubishi drives, for example, have a head-loading solenoid. The heads load (contact the disk) only when the solenoid is energized. If you install a jumper in position HM (not HS), the heads will load whenever the motor runs, and unload when the motor stops. This is normal operation.

**Terminators**

The drive you decide to install at the bottom (farthest down the ribbon cable from the CPU board) must have terminators installed. No other drive should have them. Most new drives come with terminators installed—remove them from all but the last drive.

My Tandon terminators are contained in a single blue-colored DIP. The Mitsi's use a soldered-in DIP terminator, with 7 individual plug-in jumpers right next to it. To disconnect the terminators, simply remove the jumpers.

### Data/Control

To install your newly purchased 34-pin connector onto the ribbon cable, pull off the back and then press the back and front together with the cable in between. You can take your ribbon cable into the shop and have them do it with their special crimping tool, or you can do it yourself with a small vise. Be sure to align the connector carefully with the wires in the cable. The hardest part is getting the connector separated. It takes two people—one to probe with a small, pointy tool in the latch holes, and another to cuss (or discuss).

### Power

Note the double wires in the power connector for your uppermost existing drive. To daisy-chain power to your new drives, remove the last connector (with single wires), discard the pins, and install new pins with two wires crimped in each.

Be sure to get the right wires to the right pins. When you copy the existing wiring, note that the connector is keyed to mate only one way.

Daisy-chain the green ground wire in the same way. Cut off the last push-on connector and install a new one with two wires crimped in it.

### Circuit Board Wiring

Side Select: Locate the pad labeled E40 (on the component side, it's at right of U73). Now flip the board over to the foil side.

Cut trace from U73-5 to ground bus. Add wire from U73-5 to solder pad E40 (Side Select). Add wire from U73-6 to J6-32.

NOTE: J6 pins are even-numbered from bottom to top on the inside column. (Labeling is on component side.) J6-32, therefore, is the second pin from the top, inside column.

See directions under Speed-Up for installing a 2732 Monitor ROM. If you haven't done it, do it now.

Now you need to add a four-drive decoder. If you've bought one from Micro C, follow the instructions and install it.

If you're rolling your own decoder, this is your big chance to make the drive select lamps behave the way they always should have.

Locate the blank DIP outline labeled U75, near J6. It's made to order for this application.

Use your solder sucker to clean out the 16 holes. Install a 16-pin socket, orienting the notch like all the other ICs. Solder pins 5, 6, 7, 9, 10, 11 and 16 to hold it in place. Wire it according to Figure 3 and the following table:

### Wiring Table

Cut trace from U71-6 to J6-12 (Old Drive B Select)

Cut trace from U71-8 to J6-10 (Old Drive A Select)

Add wire from U71-6 to U75-14 (Drive Decode 0)

Add wire from U71-8 to U75-15 (Drive Decode 1)

Add wire from U81-2 to U75-13 (Motor On)

Add wire from U75-12 to U75-8 (Ground)

Add wire from U75-1 to J6-6 (Select D)

Add wire from U75-2 to J6-12 (Select B)

Add wire from U75-3 to J6-10 (Select A)

Add wire from U75-4 to J6-14 (Select C)

If you have already installed the Micro C decoder board, you can still make the drive select lamp modification. Simply remove the ground from pin 13 of the 7445 on the decoder board, and wire it instead to pin 16 of the ribbon cable connector. This will duplicate the circuit in Figure 3.

Plug the 7445 into U75. Replace U73 with the 74S04. Install your new Monitor ROM in U47, if you didn't do so already in the speed-up mod.

Put it all back together, and connect the power, ground and data cables to the drives. Don't forget the copper shield under the CPU board (copper side away from the board).

Read the instructions with your Pro-8 Monitor ROM for creating a 63K CP/M.

Plug it in, turn it on and stand back!

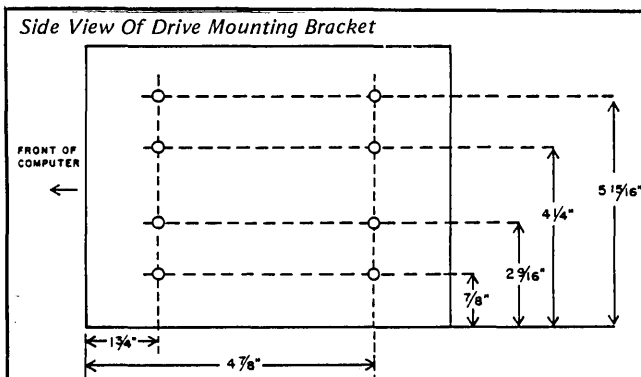
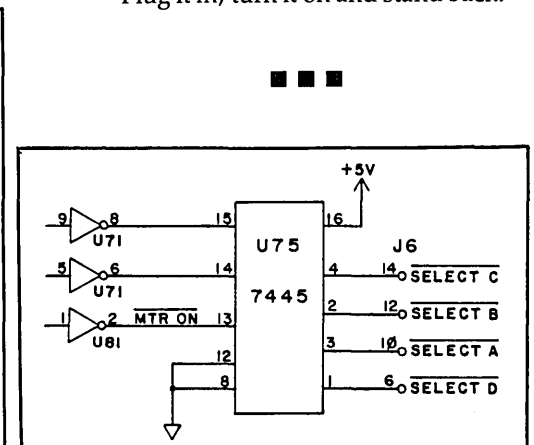
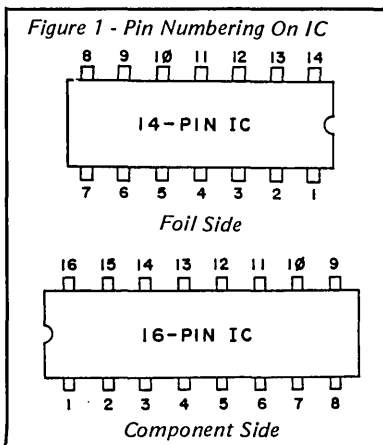

Figure 3 - Four-Drive Decoder With MOTOR ON Monitor

Figure 2 - Dimensions For Half-Height Drives

Create graphics masterpieces with...

# Rembrandt

Complete Business Graphics Toolkit™

**NEED GRAPHICS?** You don't need a new computer. You need **REMBRANDT**. The software package that unleashes all the graphics power built into your Kaypro Computer.

Until now, accessing Kaypro graphics required advanced programming efforts. Now the **REMBRANDT Business Graphics Toolkit** gives you three easy-to-use tools that allow even the most inexperienced user to quickly master Kaypro graphics.

**KGRAPH™** enables quick and easy creation of business graphics including horizontal and vertical bar charts, pie charts and xy plots (scatter-graphs) — KGRAPH uses hand entered data or reads numerical data from just about any source including dBase II, spreadsheet, Mbasic and Wordstar files.

**KBOARD™** is the full-screen graphics editor for your Kaypro computer. Create graphic screens, save and recall them to and from disk. Layout forms, design logos, draw pictures. It's easy and fun to use!

**KBRIEF™** produces electronic on-screen "slide shows" with absolutely no programming required! KGRAPH and KBOARD files are easily sequenced using nine special effects!

**REMBRANDT** is complete with printer routines so graphics can be reproduced on virtually every dot-matrix or daisy-wheel printer.

**REMBRANDT, the Complete Business Graphics Toolkit** costs just \$79.95.

A demonstration disk is just \$5.00 applicable to the purchase price.

See your **Kaypro** dealer for a demonstration.

For Kaypro 2-84, 2X, 4-84, 4E, 4X, 10, 12X and Roble.

## Make your KAYPRO computer IBM-PC compatible for \$29.95!

**READ, WRITE and FORMAT more than 25 different types of disks (including IBM PC-DOS/MS-DOS) with**

### Media Master™

Are you tired of trying to find your favorite software package in **Kaypro** format? Would you like to use your **Kaypro** generated Wordstar files, dBase II data and spreadsheet files on the IBM-PC at work (and vice-versa)? Do you want to trade public domain software with a friend who owns an Osborne?

**MEDIA MASTER** gives your **Kaypro** instant access to program and data files in over 25 disk formats including:

Osborne SD & DD	LNW-80	Cromemco w/Int'l Term	Xerox 820 I SD
IBM PC-DOS 1.0 & up	TRS-80 with Omikron CP/M	Cromemco CDOS SSDD	Xerox 820 II DD
IBM PC-DOS 2.0 & up	TRS-80 III w/Memory Merchant	Cromemco CDOS SSSD	Zenith Z90
IBM CP/M-86	TRS-80 IV with CP/M+	TI Professional CP/M-86	DEC VT180
Morrow MD2	Heath Z100	Actrix	NEC PC-8001A
System II	Heath w/Magnolia CP/M	Lobo Max-80	Kaypro II

Now available for Kaypro 2 (and II); All other models soon!

**ORDERING INFORMATION:** Include \$3 per order for postage/handling. Overseas airmail add \$10. California residents add 6% tax (LA County, add 6.5%). To place COD or credit card orders,



Call TOLL FREE 24 hours: **800-824-7888** (Ask for Operator 407)  
Alaska, Hawaii: **800-824-7919** (Ask for Operator 407)  
Technical questions: call (818) 716-1655

For more information, a free brochure (including sample printouts and reviews), or to order, contact:



**23145 Bigler Street  
Woodland Hills, CA 91364**

All programs also available for OSBORNE and DEC RAINBOW computers. Dealer inquiries invited.

# EEPROM PROGRAMMERS & UV ERASERS

## NOW AVAILABLE PAL PROGRAMMERS

See us at COMDEX SPRING, ATLANTA

PROMPRO-7™ - \$489.00  
PROMPRO-8™ - \$689.00



Money Back Guarantee

UV ERASERS  
QUV-T8/1  
**\$49.95**  
\*HOBBY

QUV-T8/2N  
**\$68.95**  
\*INDUSTRIAL

QUV-T8/2T  
**\$97.50**  
\*WITH TIMER  
& SAFETY SWITCH

GANGPRO-8™  
**\$995.00**  
(GANG PROGRAMMER)  
Add Shipping

## RS-232 serial, STAND ALONE, INTELLIGENT

\*EASY DUPLICATION \*USER FRIENDLY \*128K BUFFER

SUPPORTS: MOST 8K, 16K, 32K, 64K, 128K, 256K EPROMS  
PROMPRO-8: KEY PAD OPTION, EPROM SIMULATION MODE  
Microcomputer Chips: 8748 (H), 8749H, 8750, 8751, 8741, 8742, 8755A  
SOFTWARE DRIVERS: MDS ISIS, TEKTRONICS 8002, IBM PC, ATARI, APPLE II, CPM, FLEX, TRS-80  
DIRECT HOOK UP TO ANY DUMB TERMINAL OR COMPUTER.

AFFORDABLE ★ RELIABLE ★ AVAILABLE

DISTRIBUTOR INQUIRY WELCOME. TO ORDER 1-800-EE1-PROM

**LOGICAL DEVICES INC.**

1321 N.W. 65 Place, Ft. Lauderdale, FL 33309 For Info: (305) 974-0967

INTRODUCING



# THE CYPHER™



## A COMPLETE 68000 & Z 80 SINGLE BOARD COMPUTER SYSTEM WITH ULTRA-HIGH-RES GRAPHICS!!

NEW REDUCED PRICES!

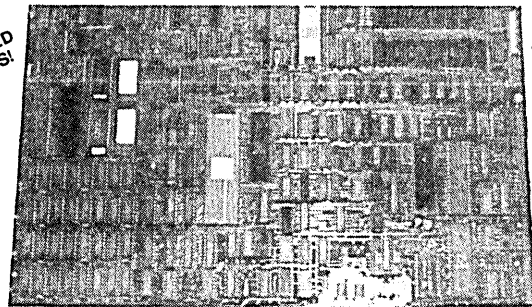

NEW REDUCED PRICES!

- 68000 & Z80 DUAL PROCESSORS (BEST OF BOTH WORLDS!).
- 256K TO 1 MEGABYTE MEMORY.
- DOUBLE DENSITY FLOPPY DISK CONTROLLER (8" OR 5 1/4", WD 2793)
- DMA CONTROLLER FOR FAST IMAGE TRANSFERS TO/FROM VIDEO MEMORY. (INT 8237)
- 2 RS232 SERIAL PORTS (ZSIO).
- 24 BIT ADDRESS MANAGEMENT FOR Z80.
- 4 LAYER P.C.B. (9 1/4 X 14 1/4")
- RUNS CP-M-80 AND CP-M-68K
- ULTRA HIGH RESOLUTION GRAPHICS, 128K, PROGRAMMABLE UP TO 1024 X 1024 RESOLUTION (NEC 7220, GREAT FOR CAD SYSTEMS!).
- REAL TIME CLOCK (MULTITASKING CAPABILITY!)
- TWO CHANNELS OF D/A AND A/D, 12 BIT RESOLUTION (MUSICI ROBOTICS).
- 16K TO 64K MONITOR EPROM
- 4K TO 64K STATIC RAM.
- PROGRAMMABLE BAUD RATE GENERATOR.
- PARALLEL ASCII KEYBOARD INPUT
- FULL 68000 EXPANSION BUS (60 PIN HEADER, BUFFERED)

(80286 CPU AND HARD DISC INTERFACE PLUG-IN CARD AVAILABLE SOON!)

MANUAL .....	\$ 20.00	COMPLETELY ASSEMBLED "CYPHER" WITH 256K DRAM, BARE BOARD, EPROMS, Z80 BIOS, 68000 BIOS, Z80 MONITOR, 128K VIDEO DRAM, NEC 7220, REAL TIME CLOCK, A/D D/A, 68000 MONITOR AND UTILITIES .....	\$ 399.95
BASIC ASSEMBLED SYSTEM TESTED WITH 68000/Z80, SERIAL I/O, 128K DRAM, 4K S RAM AND DISK CONTROLLER .....	\$ 94.95	KEYBOARD .....	\$ 154.95
SWITCHING POWER SUPPLY .....	\$ 94.95	CASE .....	\$ 94.95



ALL PRICES ARE IN U.S. DOLLARS  
SHIPPING: 8% SHIPPING, EXCESS WILL BE REFUNDED  
DELIVERY WILL BE MADE APPROXIMATELY 3 TO 5 WEEKS AFTER WE RECEIVE YOUR ORDER. VISA, MC, CASH.  
PRICES SUBJECT TO CHANGE WITHOUT NOTICE.  
CP-M IS A TRADEMARK OF DIGITAL RESEARCH.

MOTOROLA INTEL

MOTEL COMPUTERS LIMITED  
174 BETTY ANN DRIVE, WILLOWDALE,  
TORONTO, ONTARIO, CANADA M2N 1X6  
(416) 221-2340

## POWER SUPPLY

For the BIG BOARD and other SBC's  
Assembled, tested and burned-in 48 hours  
• +5V @ 4A + OVP. 24V @ 2.5A. ± 12V @ .2A  
• All supplies have over-current protection  
• Bell circuit and Piezo speaker for BB  
• Low line warning circuit - brown out  
• Input 105-120 VAC 50/60 Hz @ 1.0 A  
• 4.5" H. 3.8" D. 11" L - 5 lb.

\$110  
PLUS \$5  
S & H



## DOUBLE DENSITY HARDWARE

DAUGHTER BOARD FOR THE WD2795 DSDD CONTROLLER  
\$29 KIT without WD 2795  
\$59 WD 2795  
\$79 KIT with DRAWINGS  
AT LAST! DD SOFTWARE \$25  
SOLD WITH KIT ONLY

COMPATIBLE WITH ANY COMPUTER USING WD 1771 ONLY \$1.00 S & H

*cheap!*



## AMP CONNECTORS FOR YOUR DISK DRIVE

KIT OF 2 EACH WITH PINS  
\$5 Plus \$1 S & H

## The Big Mouth

CALL MORNINGS FOR DEMO

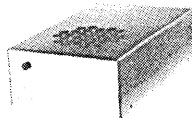

LISTEN! Your computer could be talking to you through the BIG MOUTH from ASTROTRONICS. True speech synthesis for ANY computer through your printer port. (parallel or serial). Using our BIG MOUTH speech synthesizer with its Z80 CPU and SSI-263 third generation phonetic speech synthesizer.

- Text to speech
- Will run on any computer
- Embed phonemes in text for those special words that don't fit the rules, names foreign words etc.
- Programmable: vocal-tract frequency, intonation rate, duration pitch, articulation amplitude...for all 64 phonemes
- Can be programmed to make sound effects and can even be programmed to SING!
- No software required
- 400 character buffer



• PCB & EPROM with Instruction	\$59	+ \$1	S & H
• Complete PCB Kit with Instruction	\$129	+ \$3	S & H
• Complete Kit Including Case Speaker & Power Supply	\$159	+ \$3	S & H
• Completed Unit A & T	\$199	+ \$5	S & H

Coming next month a 56K smart Printer Buffer, order your own 'son of a buffer' Kit for only \$99 plus + \$3 S & H

FOR THE

## BIG BOARD

and other SBC's

The "LA CAJA" Enclosure w/Power Supply

\$299 PLUS \$20 S & H

STANDARD FEATURES INCLUDE

- Power Supply 5V @ 4A + OVP, 24V @ 2.5A, ± 12V @ .2A
- All voltages are current protected
- Reset Switch
- Key-lock Power
- Bell Circuit and Piezo Speaker
- 2 AC Outlets, One Switched
- Color, Beige and Chocolate
- 6" H x 12" W x 16" D 24" W for 2 Drive Unit
- Fan
- Solid State AC Relay



IN STOCK!



"La Caja" can be supplied fully wired for the Big Board with all ports disk DC and timed AC for \$150.00

NAKED! Yes now you can buy the LA CAJA stripped for only \$119 fans, line fliers, etc. available. \$15 S & H.

California residents add 6% tax on all items

AstroTronics  
MICROSYSTEMS

(714) 734-6006

1137 TOPAZ ST  
CORONA, CA 91720

# WHAT IF THE TORTOISE COULD ALWAYS BEAT THE HARE?

## ELECTRONIC RAM DISK

Fired of spending so much of your computer time waiting for programs to load, compile, recalc or sort? Check these time comparisons!!! Now a lowly Kaypro II or 4 running at 2.5mhz alias Tortoise) can even out run a 4 mhz Kaypro 10 with Winchester Hard Disk (alias Hare).  
Benchmark test data (see below)

You'll find SUPERSPEED for all disk access action with this multiprocessing Electronic RAM Disk. Comes with memory space user selectable from 256K to 1 mb; has dual centronics connectors; optional external power supply design. This RAM disk can be configured as drive A or D; runs at 6mhz; operates as printer buffer while simultaneously storing and retrieving data to the RAM. This add-on will be a real time saving asset to your Kaypro 2, 4, 2-84, 4-84 jockeyed without RAM chips ..... \$199.00 Assembled & Tested 256K, 512K, 1mb ..... \$CALL for current price JS Add \$5.00 shipping International Add \$15 shipping

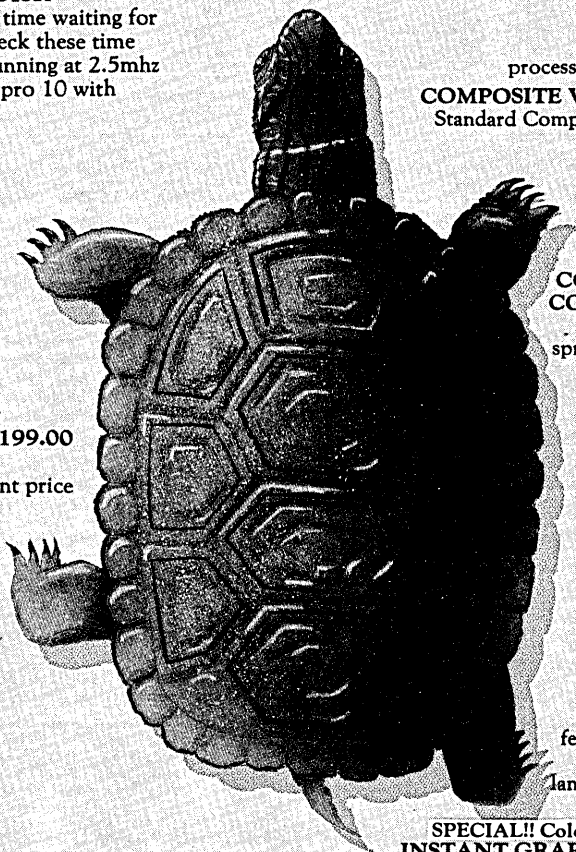
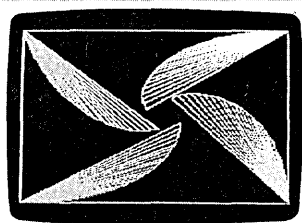

TLC® LOGO is also available for all Kaypros with internal graphics (2-84, 4-84, 10). No modifications required. This Standard Version uses the internal screen, has 16,000 pixel resolution, multiple turtles, multiprocessing, vectors and many LISP commands . . . \$99.95

**COMPOSITE VIDEO GENERATOR** — Allows connection of a Standard Composite Monitor. An absolute necessity for those who need a larger screen or bigger characters.

Kaypro II, 4 — \$59.95  
Kaypro 2-84, 4-84, 10 — \$89.95\*

\*Includes a new character set which generates a character cell size readable by a standard composite monitor. All graphics included.

**COLOR GRAPHICS SYSTEM FOR KAYPRO COLOR BOARD** — for Kaypro II, 4, 2-84, 4-84, 10 & Robie. 256x192 Pixel resolution, 16 colors, 32 sprites. Software includes three editors, drivers, screen dump to printer and disk, six-month subscription to Micro Cornucopia. Generates standard composite color. RF modulator is required for color TV operation. Plug in installation . . . \$245.00

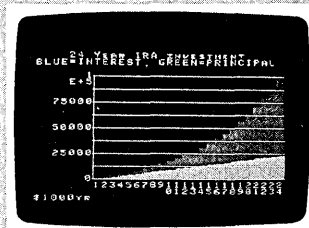

**COLOR BOARD SOFTWARE** — TLC LOGO featuring multiple turtles, multiprocessing mode, fast, easy to use and easy to learn. This is the graphics language the schools rave about. There are many facets to TLC LOGO including LISP commands. \$129.95

**SPECIAL!! Color Board and Deluxe Version of LOGO . . . \$299.95**  
**INSTANT GRAPHER 2.0:** allows bar charts, stacked bar charts and line graphs. Accepts up to 24x24 arrays or 180 points per plot. Reads numbers directly from Perfect Calc, CalcStar or other standard disk print files. Screen dump to printer program on color board disk also works . . . \$50.00

### SUPPLY STORE SPECIALS:

#### ECHO LIFETIME WARRANTY DISKETTES

10 Echo Disks w/Box  
10 Echo Disks w/Box

SSDD \$20.00/box  
DSDD \$24.00/box

#### SPECIAL SALE!!!!

100 GENERIC DISKS DSDD  
\$150.00/100 w/sleeves

#### INFOCOM ADVENTURE GAMES (Kaypro format)

ZORK I, ZORK II, or ZORK III \$45.00 ea.  
STAR CROSS \$45.00 ea.  
SEASTALKER (beginner ages 9 & up) \$45.00 ea.  
DEADLINE \$55.00 ea.  
SUSPENDED \$55.00 ea.  
WITNESS \$55.00 ea.  
PLANETFALL \$55.00 ea.

MicroSphere, Inc.  
PO Box 1221  
Bend, Oregon 97709  
503-388-1194  
9-5 Pacific Time

Dealer inquiries invited

Time in Seconds

	2.5 MHz Kaypro		4 MHz Kaypro		4 MHz Kaypro 10 Winchester Hard Disk
	Floppy Disk	Ram Disk	Floppy Disk	Ram Disk	
Load Perfect Writer	8.37	2.46	7.64	1.76	6.57
Load Perfect Calc	10.35	3.16	9.44	1.87	7.19
Load Perfect Calc + 14KFile	12:04.01	3:33.26	10.48.00	1:51.08	6:20.37
Recalc 14K PC File	10:19.00	2:27.36	9.31.25	1:17.78	5:30.53
Page down PC File	25.24	8.01	22.49	4.32	17.55
Load LADDER.COM	10.90	3.31	9.38	2.12	6.60
WARM BOOT	2.82	.64	2.22	.46	2.69
Load M BASIC	5.79	1.64	5.43	1.12	2.55

As you can easily see even a 2.5 mhz Kaypro with RAM disk is faster than a Kaypro 10 using a hard disk. A 4 mhz Kaypro with RAM disk is significantly faster.





# KAMAS, An Outline Processor

Review By Jack Rodenhi

1317 W. College Ave.  
Lompoc CA 93436

I have long been intrigued with the slightly mystical appearance of mind amplification ads, so at SOG III, I attended the KAMAS lecture. After hearing a straightforward talk by Adam Trent and his associate, Anne Hickman, I offered to do a review on KAMAS for Micro C.

## KAMAS Programming Language

One cannot review the KAMAS program without first discussing the KAMAS programming language.

A fully developed application development environment, the KAMAS language has some interesting variable types, several good control structures, and runs interpreted code quickly. But it is complex.

A detailed review of this language would require a whole series of articles. Compusophic Systems, developers of KAMAS, publish a newsletter that goes into considerable depth on this FORTH-like language. The language is also thoroughly covered in the two manuals that come with the program.

Also included in the package is a small book which serves as an introduction to outline processing, the major function of KAMAS.

## Outline Processing

Outline processors, which have recently become quite popular, basically help you create or work from an outline.

So what should the computer user expect from the KAMAS outline processor? It has a pretty decent text editor with commands similar to those of Perfect Writer. You can enter and edit text from the one or two line descriptions KAMAS uses for keys (for leaves, branches, and stems of the outline).

KAMAS helps you create an outline in two ways. First, it allows the outline to be compressed or expanded so you can zoom in for detail on a leaf or particular branch or back off to view the entire tree.

Second, KAMAS lets you reorganize the outline any way you wish. I believe this is the most important thing an outline processor can do. Word processors allow reorganization, but outline processors go even farther by letting units of text be linked together logically.

## The Bottom Line

So how did I like KAMAS? On the negative side, the flexibility and full blown language capabilities that KAMAS includes have been achieved at the cost of simplicity. You could spend a lot of time exploring parts of the package you won't really use.

On the other hand, if I spent as much time working with KAMAS as I do with Wordstar, I would feel very comfortable with its complexity, I'm sure. KAMAS has an excellent on-line help facility, and the best way to learn any program is to use it.

Another thing I didn't particularly like about the program was that the delete key is not handled consistently within the program. Within the outline editor, the delete key will back up and delete one character from the entered text. At the ROVE prompt, however, the delete key echoes the deleted key and the backspace key has the desired backup and

delete effect.

Owners of Kaypro 10s may not be jubilant with KAMAS. On my Kaypro 4, I get excellent scrolling speed, but my 10 reads a little data and prints it and reads a little more and prints it and so on. It only prints about four lines per second, whereas my 4 probably prints a screenful a second. When I asked Adam about this, he was at a loss to explain it. I suspect that the KAMAS files are spread around on my hard disk and the head is spending a lot of time seeking records. This inconvenience could be solved by unloading some of the clutter before loading KAMAS.

Other than these problems, I found the program dependable, and if you feel that an outline processor would help you in your work, you might want to give KAMAS a hard look.

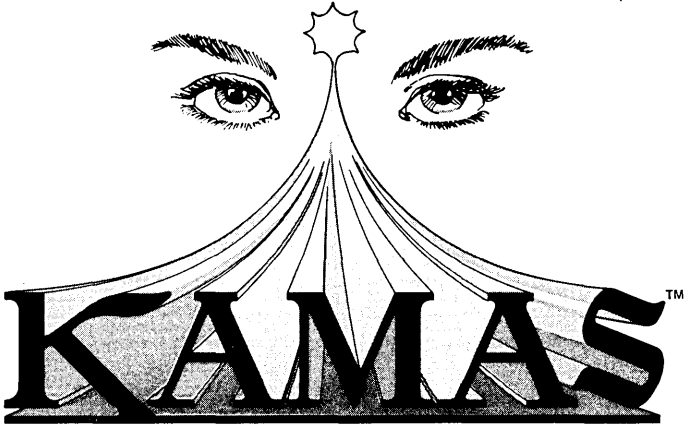

**KAMAS**<sup>TM</sup>  
Knowledge And Mind Amplification System.

A unique blend of familiar productivity tools with dynamic new ones:

- Outline Processing** lets you organize your ideas in a familiar outline form.
- Information Retrieval** keeps your thoughts at your fingertips with astonishing speed.
- Word Processing** fills out the structure of your ideas with text.
- Telecommunications** lets you set up a structured, electronic bulletin board.
- Programming Environment** lets you get under the hood and extend your horizons.

It all adds up to **awesome Knowledge Processing power**. Your chance to join the next wave of the integrated software revolution.

Available for CP/M, Z80 systems. Special introductory offer: \$147. Send now for your **free** copy of *The KAMAS Report*.

 **COMPUSOPHIC SYSTEMS** Dept. 112 • 2525 SW 224th Ave.  
Aloha, Oregon 97006 • (503) 649-3765

KAMAS is a trademark of Compusophic Systems. CP/M is a registered trademark of Digital Research, Inc. Z80 is a registered trademark of Zilog, Inc.

# FORTHwords

By Arne A. Henden

7415 Leahy Road  
New Carrollton MD 20784  
(301) 552-1295

EDN magazine is one of those engineer's freebies that I recommend getting. About once a month, EDN publishes a feature article on some aspect of microcomputers, such as floppy disk drives, laser printers, etc. The July 26, 1984, issue covered pointing devices (joysticks, mice, etc.). I thought it was a very succinct review and I learned a lot about what pointer I want in my next computer.

## Back At The Ranch

I bet you are wondering what all this has to do with FORTH! The above article mentioned that Microtouch Systems, Inc. produces a continuously conductive touch panel that uses the Rockwell 65F11 FORTH chip for its control. Many of these pointing devices are becoming "smart," and the use of FORTH as a controller sounds like a good marriage.

## Big Board II Graphics

I've always felt that BBII owners have gotten shortchanged. Since one of my friends finally bought a BBII, I've had a chance to customize UNIFORTH to support the special features of the BBII.

This column will discuss implementing a rudimentary graphics package for the BBII, interfacing with hardware using FORTH.

I approach hardware/software projects with a basic goal in mind, first familiarizing myself with the hardware, then designing the software package to support it. The steps taken in bringing such a project to fruition are listed below.

## Have A Goal In Mind

I know this is obvious, but when you sit down at your computer, you should have a goal. It directs your investigation and makes your time much more productive. For our example, the goal is to create a basic graphics package that makes optimum use of the BBII's built-in video.

## Look At The Hardware Architecture

Each chip manufacturer publishes a product data book detailing the chip specifications and programming considerations. If you own a Big Board, I highly recommend obtaining a copy of the Zilog and Standard Microsystems Corpora-

tion data books.

The BBII uses a CRT8002 Video Display/Attributes Controller (VDAC) to provide the actual dot data to the 6845 CRT controller. The CRT8002 has 4 modes of operation: an internal 7x11 dot character generator for the 128 ASCII characters; wide or block graphics; thin line graphics; and external input for an off-chip character generator.

I'm going to be using block graphics for this application. This mode divides each character cell into a 2x4 matrix, assigning each "pixel" to an input bit. A diagram of this assignment is shown below.

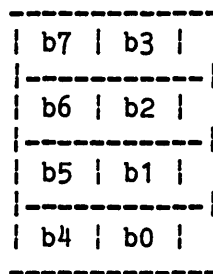

Note that block graphics gives you a 160x96 dot resolution, quite adequate for most situations. For all you non-BBII owners, block-mode graphics are not unique to the 8002. The TRS-80 and other computers and printers also use block graphics. And this particular graphics package should be usable for other systems, besides the BBII.

## Study The Hardware Interface

We now know not only how the CRT8002 works, but also how it is incorporated into the computer. This means looking at the schematics and reading the BBII documentation to find port addresses, supported functions, etc.

The CRT8002 uses two normal sources of data input: a RAM array of ASCII codes to display, and a RAM array of attributes for each displayed character. The BBII has bankswitched memory, switching the lower 32K between RAM—ROM and CRT—and the STD bus. In the ROM/CRT bank, addresses 6000-6800H are used for the display codes, and addresses 7000-7800H are for the attributes. You may access these di-

rectly by manually switching banks from a routine residing in the upper 32K, or you may use the monitor calls.

## Study The Software Interface

Software interface deals with how the monitor interfaces with the 8002, and what kind of function calls it makes available to the programmer. If you look at your scant documentation, you will find some single control-character and escape sequences that control the 8002. First, send a 26 code (CTRL-Z) to clear the screen. Control characters are sent by prefixing the code with a 31. Escape sequences provide cursor addressing, graphics mode selection, and character attribute control. You will find on screen 1 the FORTH words to provide these functions.

## Design The Graphics Package

By now we've read the documentation, played with programming and initializing the chip, and feel confident with this new knowledge. The next step is to decide what functions we want to implement, and to name routines to implement those functions. For most projects, the design phase ranges from 5 to 50 percent of the total development time. Because of the simplicity of this project, the lower percentage figure is more reasonable.

Write down the functions you want the package to perform. In this case, simplicity reigns: I just want to be able to enter an x,y pair and have a dot plotted on the screen. Then break up each of these functions into building blocks.

In our example, you must initialize the graphics generator (such as clearing the screen)—you must get the user to input the X,Y coordinates—you then break the X,Y pair into a character cell (and the position within that cell)—and you must actually display the points on the screen.

Your breakdown should continue until each block is one short FORTH word. Then carefully assign the name for each block so you can read the final program and understand it.

I tend to program "quick and dirty." While there may be an easy way to use the row/column offset to pick an 8-bit code that will plot that pixel, I decided to use the offsets as indices into a lookup

```

SCR # 1
0 ( BBII Graphics Package -- 1          100784AAH)
1 : BLOCK-MODE ( set graphics mode)
2   27 EMIT 77 EMIT 48 EMIT ;
3 : ASCII-MODE ( set ascii mode)
4   27 EMIT 77 EMIT 52 EMIT ;
5 : NORMAL-GRAPHICS ( set graphics attribute)
6   27 EMIT 71 EMIT 56 EMIT ;
7 : NORMAL-TEXT ( set normal ascii attribute)
8   27 EMIT 71 EMIT 48 EMIT ;
9 : NO-SCROLL ( turn off scroll function)
10  27 EMIT 46 EMIT 50 EMIT ;
11 : SCROLL ( turn on scroll function)
12  27 EMIT 46 EMIT 48 EMIT ;
13 : GOTO CR ( col row -- ..move cursor)
14  27 EMIT 61 EMIT 32 + EMIT 32 + EMIT ;
15 -->

```

```

SCR # 2
0 ( BBII Graphics Package -- 2          100784AAH)
1 : GRAPHICS ( enter graphics mode)
2   NO-SCROLL BLOCK-MODE NORMAL-GRAPHICS ;
3 : TEXT ( enter text mode)
4   SCROLL ASCII-MODE NORMAL-TEXT ;
5
6 : CMATRIX ( ncols nrows -- ..create byte matrix)
7   CREATE OVER , * ALLOT DOES>
8   DUP 2+ SWAP @ ROT * + + ;
9
10 80 24 CMATRIX SHADOW ( crt shadow array)
11 2 4 CMATRIX BITMAP ( character/dot bitmap)
12
13 HEX 0880 0 0 BITMAP !    0440 0 1 BITMAP !
14    0220 0 2 BITMAP !    0110 0 3 BITMAP !
15 DECIMAL -->

```

table to select the correct bit pattern. I added a byte matrix defining word because this new data type was needed, and might be useful later.

### Code And Test The Package

You can see what names I chose and how I broke the package down by looking at screens 1-3. The monitor commands are straightforward. The word PAGE provides the clear-screen function, and XYTRANS performs the x,y to character cell/offset form. But why is that SHADOW array there? And why do I precede each graphics character output with a 31 code?

When I first coded the routines, I started with the words in screens 1 and 2 and then played with outputting characters on the CRT. You can switch to graphics mode and then just send characters with EMIT. Patterns such as 1, 4, 20H, etc. each turn on one bit of a character cell.

This kind of rough experimentation is useful (not to mention crucial) before you do much planning. Such interactive testing is where FORTH excels. In our case, the testing demonstrated that the monitor masked off bit 7 of each character, preventing codes such as 80H from plotting correctly. In addition, all control codes (such as 1, 4, 9, etc.) are not plotted. However, preceding codes with a "31" will bypass the monitor's stripping function.

### Problems And Solutions

The SHADOW array also arose from this preliminary testing. The problem is this: what if you want to plot two dots, but both dots fall within the same character cell? The BBII monitor does not permit fetching a character from the CRT memory so that you can OR in a second

```

SCR # 3
0 ( BBII Graphics Package -- 3          100784AAH)
1 : PAGE ( clear screen and clear shadow array)
2   0 0 SHADOW 24 80 * ERASE 26 EMIT ;
3 : XYTRANS ( x y -- coloff rowoff col row)
4   4 /MOD >R SWAP 2 /MOD >R SWAP 2R> ;
5 : ADD-DOT ( coff roff col row -- ..dot to crt & shadow)
6   2DUP SWAP GOTO CR SHADOW ROT ROT BITMAP C@ OVER
7   C@ OR DUP 31 EMIT EMIT SWAP C! ;
8 : !DOT ( x y -- ..store dot on screen & shadow)
9   XYTRANS ADD-DOT ;
10 ;S

```

dot and re-output the character.

There are several solutions to the problem. You could bankswitch and directly access the video RAM, requiring a routine resident in the upper 32K of RAM so it is not also switched out. Second, you could keep a 1-line buffer in memory, set all bits in that line, and then output the entire line at once. This method requires some fancy footwork and prohibits real-time plotting of acquired A/D data, etc.

The solution I chose was a generalization of the second method. A 24x80 byte array is kept in RAM, exactly duplicating (shadowing) the CRT display. Each time you EMIT a character, you also store it in SHADOW. When you need to OR a bit, you fetch the shadow byte, OR the bit, EMIT and store it back. Did I invent shadow screening? Heavens, no. It is a common trick in track buffering schemes for disk controllers and is even found in RAM/EEROM chips. Shadow screening works quite well in this graphics application, but at the cost of 2K bytes.

If I were building this package for sale, I would probably directly access video memory as it is faster and does not require the 2K RAM array. However, us-

ing a shadow screen gives the package more portability, does not require any assembly language programming, and does not limit the physical location of the graphics package in memory.

### Follow-up

There you have it. The !DOT word is the only primitive you need to start building a full-blown graphics package. Line drawing algorithms can be found in many articles; the graphics primers now appearing in many bookstores give BASIC routines that can be adapted to implement lines, circles, filled boxes, pie and bar charts. The rest is up to you.

### One More Thing

Unfortunately, I wasn't able to attend the FORTH Interest Group annual meeting in November or the FORTH Modification Laboratory (FORML) meeting. I'm certain some of you attended, and hope that someone will send me a summary so I can pass it along to other Micro C readers.



# IN SEARCH OF THE PERFECT TERMINAL . . . . .

Refer to Micro Cornucopia Review; October 1983, Page 7.

**It took some probing, but we located the Falco TS-1 terminal as described by David Thompson last year in his article, "In Search Of The Perfect Terminal", and we have them in STOCK !**

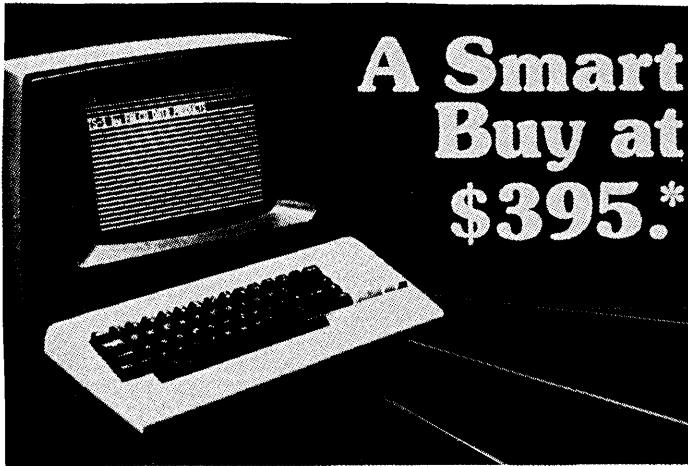

Why by a dumb CRT when you can buy a SMART CRT for the same money? ? ? Through an exceptional purchase, we have obtained a large (but limited) quantity of this fine terminal. The Falco TS-1 is the type of CRT which will allow you to GROW. Give us a call today to reserve your new CRT!

When you buy from CHA you can buy with Confidence. With years of experience in the peripheral marketplace we are proud of our two Guarantees: First, a 90-day product guarantee on parts and labor; and, second, a 10-day moneyback guarantee.

We also have a supply of seagate ST-412 Winchester Drives (IBM compatible for . . . \$275  
IBM Winchester sub-system; shugart 712 with controller and cables for only . . \$749

## COMPLETE REPAIR DEPOT

COMPUTERS	FLOPPY/WIN	PRINTERS	HARD DISC	TERMINALS
IBM PC,XT	Tandom	Printrnix	Perfec	Lear Siegler
Comp Auto	Shugart	Centronics	Diablo	Hazeltine
Kaypro	MPI	C.ltoh	CDC	GTC
Commodore	Seagate	Diablo	Century	Falco
Xerox II		NEC		Televideo

We are a full service Sales Organization      Call us with your peripheral requirements

(714) 850-9191

C. HOELZLE ASSOCIATES, INC.

1399 Logan Ave.  
Costa Mesa, California 92626



## HARDWARE SPOOLER and INTERFACE CONVERTER

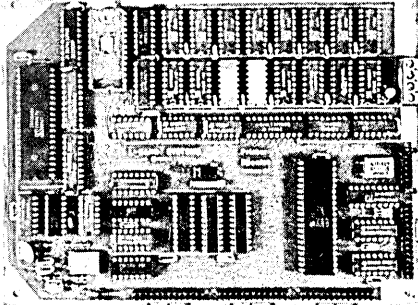

- 128 K PRINT BUFFER
- CENTRONICS OR SERIAL INPUT/OUTPUT
- MULTIPLE PROTOCOLS
- 5¾ X 7½ INCH BOARD
- + 5 Volts at .75 Amp  
± 12 Volts at .1 Amp

The L-BAND SYSTEMS hardware spooler is a Z80 based unit that provides a 128 K byte buffer and interface conversion between Centronics and serial. Input and output may be either parallel or serial at various baud rates and with several protocols. Multiple copy and single sheet feed are supported.

BARE BOARD with EPROM (2732) and program listings . . . . \$ 39.95  
 DISK with program source, 8-inch SSSD . . . . . 10.95  
 MINI KIT board, EPROM, headers, crystals (less disk) . . . . . 59.95  
 \*PARTIAL KIT all parts EXCEPT RAMS . . . . . 109.95  
 \*ASSEMBLED and TESTED BOARD (128 K) . . . . . 259.95  
 WALL MOUNT POWER SUPPLY . . . . . 39.95

California Orders Add 6.5% Sales Tax  
 Shipped via UPS — Check or Money Orders to:

### L-BAND SYSTEMS

1037 E. Lemon Ave.  
 Monrovia, CA 91016  
 (818) 357-0566

\*Not available for export.



COMING SOON!

KEEP AN EYE OUT

FOR DETAILS OF

SOG '85

Plan on visiting us  
 at the end of July

COMING SOON!

# GRAF 2.0 PRINTER GRAPHICS \$29.95

MSC is proud to announce an extensive upgrade of the public domain program GRAF 1.0 (available on Micro Cornucopia disks K5, K19, and B11). Unlike the original GRAF, however, GRAF 2.0 is a fully professional graphics program, allowing the user to plot floating point data on graphs with arbitrary horizontal and vertical scales. Features of GRAF 2.0 include:

- \* Simple interface allows GRAF 2.0 to plot data obtained from most spreadsheets or any CP/M programming language
- \* Examples showing how to do graphics from MBASIC and Turbo Pascal are included
- \* Graphs can be downloaded from MicroSphere's Color Graphics Board for the Kaypro and BigBoard I
- \* Point-plotting symbols include • + x and □
- \* Any number of graphs may be overlaid
- \* Written by Dr. Donald L. Brittain, author of the original GRAF program and all of the editors and utility programs included with MicroSphere's Color Graphics Board
- \* Extensive User's Manual with many examples
- \* Line, box, arc, and circle plotting functions
- \* Fast execution (much faster than GRAF 1.0!)
- \* 360 x 360 pixel resolution
- \* Vastly improved user interface
- \* Labels for both axes
- \* Graphs may be stored on disk
- \* GRAF 1.0 upward compatible
- \* Source code (in C) available for an additional fee

**System Requirements** Z80 CPU with 60k (or greater) CP/M 2.2 driving one of the following printers (or any printer fully compatible with one on this list): Epson MX-80 with GRAFTRAX, Epson RX-80, Epson FX-80, IBM Graphics Printer, Gemini 10X, C. Itoh ProWriter, or any OkiData dot-matrix printer having the OkiData Plug 'n' Play chips installed. (Unmodified OkiData printers are NOT supported!)

#### ORDER AT NO RISK:

When you receive GRAF 2.0, check out our extensive, illustrated User's Manual. If you don't think GRAF 2.0 satisfies your requirements, return the manual and the unopened disk to MSC within 21 days for a full refund of the purchase price.

#### MICROCOMPUTER SYSTEMS CONSULTANTS

301 North Harrison Street  
 CN 5279, Suite 228  
 Princeton, New Jersey 08540

**Terms:** Send check or money order for \$29.95 + \$5.00 shipping/handling per copy of GRAF 2.0 to MSC at the address above. Be sure to state what printer you own and what disk format you want (Kaypro SSSD 5 1/4" or standard SSSD 8"). NJ residents add 6% sales tax. Outside US and Canada, add additional \$5.00 for postage.

# SBASIC Column

By Jack Rodenhi

1317 W. College Ave.  
Lompoc CA 93436

This will be the last regular SBASIC column I will be writing. I have just opened my own CPA office and it seems things that were easily done a month ago take lots of extra attention this month. I have also become a fairly rabid (and rapid) Turbo Pascal user.

## Background

I bought my Kaypro in August of 1983. I had had a little experience programming in Microsoft BASIC, dBase II and Apple Pascal, and was convinced that compilers in general and Apple Pascal compilers in particular were a real drag. However, when I got my Kaypro, I discovered it came with a compiler that would let me write real CP/M .COM files. That compiler used words and concepts that were similar to MBASIC and dBase II.

Working with SBASIC, I discovered what a heady experience it was to create a subroutine and call it anything I wished. No GOSUB 25110 in my SBASIC programs. If I thought it was appropriate to repeat a process "Until Miller Time," then that's what I did. SBASIC introduced me to the joys of local variables and modular code. I also learned to appreciate "information hiding" (one of the main strengths of Modula-2).

SBASIC has given me much, but I think it is time to leave it behind. SBASIC is a good transitional language between BASIC and Pascal, but it's not portable. Also, you will have to learn many things about SBASIC that you won't be able to apply to other languages.

Compared to Turbo Pascal, which comes with its own application development environment, writing and debugging in SBASIC is tedious. In fact, I have written most of my recent SBASIC programs (for this column) in Turbo and then translated them into SBASIC after they were fully debugged.

## Creepy Crawly Thing

While putting together the program for this column, I ran across what I believe is a significant bug in the language.

The procedure ReadRecords ends by assigning the value 10 to the variable ListSize. ListSize is a variable global in the procedure ssort.

In the main routine of the procedure ssort, there is a call to procedure ReadRecords, the last line inside the procedure prints the value of ListSize (10). On returning to ssort, the value of ListSize is again printed: This time it is 0 even though ListSize is declared as a global variable. Apparently ReadRecords has set up its own undeclared local version of the variable ListSize. The compiler has mutinied!

This particular bug, quirk, aspect, or (depending on your point of view) feature of SBASIC seems to be undocumented. In the section on Scope of Recursion in the SBASIC manual, there is some talk of variables changing values randomly or not changing values when expected to.

But the manual seems to suggest that recursion would not occur in our program. In their example program on recursion, X2 seems equivalent to our variable ListSize. In the discussion on their program, they claim that X2 would not be duplicated when P3 is called from P4. Of course, although their program is executable, it does not contain enough code to reveal anything about recursion in SBASIC. I think our program illustrates the point.

This suggests that you should be VERY careful when using nested procedures in SBASIC.

This program is not fully debugged but a major clarification for it is to un-nest the procedures Order, LesserOf, ReadRecords, and WriteRecords. This means you will have to move them as a block to a point before the beginning of the procedure ssort. You will then have to pass variables to ReadRecords and WriteRecords.

I've tried this and found that the program works better but it still has a few problems. To use the module in one of your own programs, you would read the User Supplied Procedures into your program and follow the comments found there. I borrowed some of the ideas in this section from the Sort.Box approach used in Turbo Toolbox.

## Finally

I hate to leave you with an unfinished program but I believe this discovery belongs in the growing library of SBASIC

Figure 1 - Test Program

```
var i = integer
var a = char

files R(10)
create "UNSORTED.DAT"
open #0;"UNSORTED.DAT"
i = 100
write #0,0;i
for i = 1 to 100
  a = chr$(fix(rnd(i)*26)+65)
  print a
  write #0,i;a
next
```

unofficial documentation.

Speaking of this library, David tells me that Micro C receives more material on SBASIC than any other language. They have amassed a good deal of code and commentary on the language, and it seems that many people who have spent time on SBASIC see the need for a good tutorial. I would imagine that soon David will be putting much of it on users' disks.

## So long for now. See you at SOG IV!

*Editor's note: It's been great Jack, we'll miss having you in Micro C but we'll still look forward to seeing you and Wickie here in Bend next July.*

■ ■ ■

Figure 2 - User Supplied Procedure For Sort Routine

```

REM-----User Supplied Procedures For Sort Routine-----

$constant MaxSize = 10
REM **the higher the better but not more than 255**

dim string: 9; List(MaxSize + 1)
Comment
    Dimension an array for each record element such as:
        dim string:25; Name(MaxSize + 1)
        dim string:25; Address(MaxSize + 1)
        dim string:25; City(MaxSize + 2)
    and so on...
End

dim integer NextPtr(MaxSize + 1)
dim byte Vacancy(MaxSize + 1)
var InfilePtr,OutfilePtr = integer
REM Just include these three statements as is.

var ImpossiblyBig = string:9
ImpossiblyBig = 'z'
Comment
    ImpossiblyBig should be a variable of the same type as your comparison
    string and impossibly big.
end

procedure ReadFile(Infile, i = integer)
    read #Infile,InfilePtr; List(i)
    Comment Be sure to have this read each of your record elements such as this:
        read #Infile,InfilePtr; List(i), Name(i), Address(i), City(i)
    end
end

procedure WriteFile(Outfile,i = integer)
    write #Outfile,OutfilePtr;List(i)
    Rem Set this up like ReadFile
end

function Less(item1, item2 = integer) = byte
    var Less = byte
    if List(item1) < List(item2) then Less = "T" else Less = "F"
    Comment This is where you get to tell the program which element is bigger.
    If you don't your sort based on List, then use your own variable such
    as Name, City or whatever.
    end
end = Less

REM-----End of User Supplied Procedures-----

procedure sssort(Infile, Outfile, UnsortedMasses = integer)
    var Smallest, Current, LastOne, LastItem, RunSize;
    ListSize, RecordsIn, RecordsOut, RecordsToRead, i, j = integer

    procedure Order(NewItem = byte)
        procedure SearchAndInsert
            while Less(Current, NewItem) do begin
                LastOne = Current
                Current = NextPtr(Current)
            end
            NextPtr(NewItem) = NextPtr(LastOne)
            NextPtr(LastOne) = NewItem
            LastItem = NewItem
        end
        if Less(NewItem,LastItem) then begin
            if Less(NewItem,Smallest) then begin
                NextPtr(NewItem) = Smallest
                Smallest = NewItem
            end else begin
                Current = NextPtr(Smallest).
                LastOne = Smallest
                SearchAndInsert
            end
        end else begin
            Current = NextPtr(LastItem)
            LastOne = LastItem
            SearchAndInsert
        end
    end
end

function LesserOf(var1, var2 = integer) = integer
    var Lesser = integer
    if var1 < var2 then Lesser = var1 else Lesser = var2
end= Lesser

procedure ReadRecords
    for i = 1 to RecordsIn
        ReadFile Infile, Vacancy(i)
        InfilePtr = InfilePtr + 1
        Order Vacancy(i)
        print
        print "          *****Run number: ";i;*****"
        for j = 1 to i
            if j = Smallest then print "Smallest ----->";\
                else print "          ";
            print j,List(j),NextPtr(j)
        next j
    next i
    $TRACE
    ListSize = ListSize + RecordsIn
    print "ListSize per the procedure ReadRecords is ";ListSize
    rem ** ListSize contains 10 here **
end

procedure WriteRecords
    for i = 1 to RecordsOut
        WriteFile Outfile,Smallest
        OutfilePtr = OutfilePtr + 1
        Vacancy(i) = Smallest
        Smallest = NextPtr(Smallest)
    next i
    ListSize = ListSize - RecordsOut
end

Write #Outfile,0;ImpossiblyBig
RunSize = fix(MaxSize/2)
repeat begin
    for i = 1 to MaxSize
        Vacancy(i) = i
    next i
    Smallest = 0
    List(Smallest) = ImpossiblyBig
    LastItem = 0
    ListSize = 0
    InfilePtr = 15
    OutfilePtr = 1
    RecordsToRead = UnsortedMasses
    RecordsIn = LesserOf(MaxSize,RecordsToRead)
    ReadRecords
    rem ReadRecords sets ListSize to 10
    print "ListSize per the main procedure is ";ListSize
    rem **** ListSize contains 0 here! ****
    RecordsToRead = RecordsToRead - RecordsIn
    repeat begin
        print "ListSize = ";Listsize;" RunSize = ";RunSize
        RecordsOut = LesserOf(ListSize,ListSize - RunSize)
        print "RecordsOut = ";RecordsOut
        WriteRecords
        RecordsIn = LesserOf(RunSize,RecordsToRead)
        ReadRecords
        RecordsToRead = RecordsToRead - RecordsIn
    end until (RecordsToRead = 0)
    WriteRecords
    Infile = Outfile
    UnsortedMasses = UnsortedMasses - RunSize
    end until UnsortedMasses = 0
end

var i = integer
var a = string: 9

files r(10), r(10)
open #0;"UNSORTED.DAT"
open #1;"SORTED.DAT"
print "          Sorting the Data File"
sssort 0,1,100
print "          The Sorted File"
for i = 1 to 100
    read #1,i;a
    print a
next i

```

END OF LISTING

**NEW LOWER PRICES!**

**NEW LOWER PRICES!**

**NEW LOWER PRICES!**

## **"BIG BOARD II"**

### **4 MHz Z80-A SINGLE BOARD COMPUTER WITH "SASI" HARD-DISK INTERFACE**

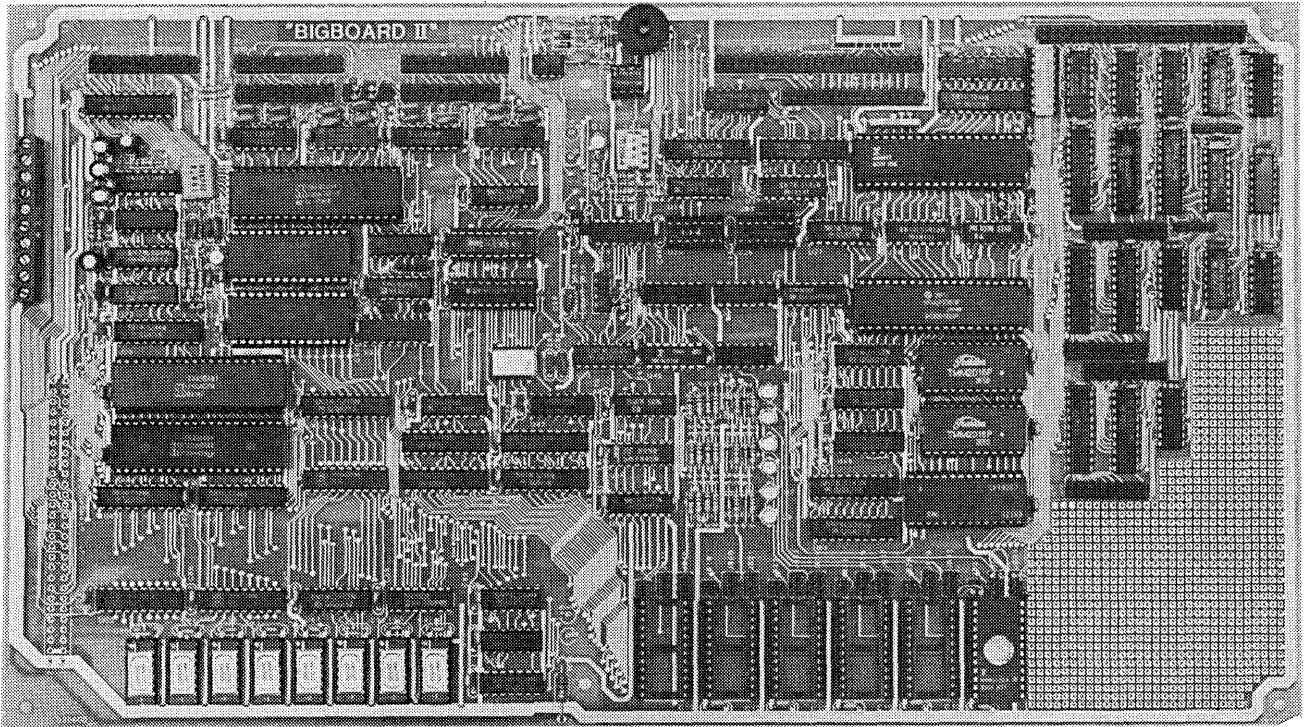

#### **\$545 ASSEMBLED & TESTED**

Jim Ferguson, the designer of the "Big Board" distributed by Digital Research Computers, has produced a stunning new computer that Cal-Tex Computers has been shipping for a year. Called "Big Board II", it has the following features:

##### ■ **4 MHz Z80-A CPU and Peripheral Chips**

The new Ferguson computer runs at 4 MHz. Its Monitor code is lean, uses Mode 2 interrupts, and makes good use of the Z80-A DMA chip.

##### ■ **64K Dynamic RAM + 4K Static CRT RAM + 24K E(E)PROM or Static RAM**

"Big Board II" has three memory banks. The first memory bank has eight 4164 DRAMs that provide 60K of user space and 4K of monitor space. The second memory bank has two 2Kx8 SRAMs for the memory-mapped CRT display and space for six 2732As, 2Kx8 static RAMs, or pin-compatible EEPROMs. The third memory bank is for RAM or ROM added to the board via the STD bus. Whether bought as a bare board or assembled and tested, it comes with a 2732 EPROM containing Russell Smith's superb Monitor.

##### ■ **Multiple-Density Controller for SS/DS Floppy Disks**

The new Cal-Tex single-board computer has a multiple-density disk controller. It can use 1793 or 8877 controller chips since it generates the side signal with TTL parts. The board has two connectors for disk signals, one with 34 pins for 5.25" drives, the other with 50 pins for 8" drives.

##### ■ **Vastly Improved CRT Display**

The new Ferguson SBC uses a 6845 CRT controller and SMC 8002 video attributes controller to produce a display rivaling the display of quality terminals. There are three display modes: Character, block-graphics, and line-graphics. The board emulates an ADM-31 with 24 lines of 80 characters formed by a 7x9 dot matrix.

##### ■ **STD Bus**

The new Ferguson computer has an STD Bus port for easy system expansion.

##### ■ **DMA**

The new Ferguson computer has a Z80-A DMA chip that will allow byte-wise data transfers at 500 KBytes per second and bit-serial transfers via the Z80-A SIO at 880 Kbits per second with minimal processor overhead. When a hard-disc subsystem is added, the DMA chip makes impressive disk performance possible.

#### **\$145 PC BOARD WITH 16 PARTS**

**SIZE:** 8.75" x 15.5"

**POWER:** +5V @ 3A, +-12V @ 0.1A

##### ■ **"SASI" Interface for Winchester Disks**

Our "Big Board II" implements the Host portion of the "Shugart Associates Systems Interface." Adding a Winchester disk drive is no harder than attaching a floppy-disk drive. A user simply 1) runs a fifty-conductor ribbon cable from a header on the board to a Xebec controller that costs only \$295 and implements the controller portion of the SASI interface, 2) cables the controller to a Seagate Technology ST-506 hard disk or one compatible with it, and 3) provides power for the controller-card and drive. Since our CBIOS contains code for communicating with hard-disks, that's all a user has to do to add a Winchester to a system!

##### ■ **Two Synchronous/Asynchronous Serial Ports**

With a Z80-A SIO/O and a Z80-A CTC as a baud-rate generator, the new Ferguson computer has two full RS232-C ports. It autobauds on both.

##### ■ **A Parallel Keyboard Port + Four Other Parallel Ports for User I/O**

The new Cal-Tex single-board computer has one parallel port for an ASCII keyboard and four others for user-defined I/O.

##### ■ **Two Z80-A CTCs = Eight Programmable Counters/Timers**

The new Ferguson computer has two Z80-A CTCs. One is used to clock data into and out of the Z80-A SIO/O, while the other is for systems and applications use.

##### ■ **PROM Programming Circuitry**

The new Cal-Tex SBC has circuitry for programming 2716s, 2732(A)s, or pin-compatible EEPROMs.

##### ■ **CP/M 2.2\*\***

CP/M with Russell Smith's CBIOS for the new Cal-Tex computer is available for \$150. The CBIOS is available separately for \$25.

\*\*CP/M is a registered trademark of Digital Research.

**CAL-TEX COMPUTERS, INC.**  
12788 HWY. 9 • BOULDER CREEK, CA 95006 • (408) 338-2572

**Terms:** Orders paid for with a cashier's check or bank card will be shipped within three working days. Orders paid for with a personal check will be shipped within three weeks. Add \$5 for packing & shipping in North America.



# Cooling A Hot Computer

By Kenneth J. Grymala

P.O. Box 2540  
Manassas VA 22110

In Issue 19 of Micro C, David Thompson discusses problems with the Morrow MD11. In that article he says, "MD11s are becoming famous for going to lunch before noon, reportedly due to the very critical timing between the TTL parts and the Z80 during data transfers." He also discusses power supply problems in the MD11, and I suspect these same problems are showing up in the Morrow MD16 and MD34.

## Heat—The Real Culprit?

I believe the problems are due to overheating. Excessive heat causes equipment to start acting strangely, go into a tighter and tighter tailspin, and finally crash. My MD11 began showing these classic symptoms when its internal temperature exceeded 140 F degrees.

Because of the heat, the clocks and timing circuits changed frequency—capacitors, regulators, rectifiers, and ICs began dying of heat exhaustion.

The power supply might fail repeatedly but the real culprit is probably heat. Obviously, this problem is not exclusive to the MD11. The following discussion is applicable to any system which is having heat problems.

As a designer of equipment for the government, military, and industry, I am all too familiar with the problems caused by heat. In government terms,

the MTBF (Mean Time Between Failures) takes a real nose dive as temperature rises. Power supplies, oscillators (timing clocks), and PC board traces are usually affected first.

## History

About two days after I got the MD11, an old-time hacker friend paid me a visit. While tinkering with the computer, he noticed that the floppies were coming out of the drive very warm. The next day I put a thermometer inside the MD11 and monitored the temperature between the hard disk and the power supply. After about four hours the internal temperature reached 140 degrees Fahrenheit in an office that was 68 degrees, and I'm sure the power supply components were much hotter.

Six months before I read Micro Cornucopia's description of the problem, I began to look for ways to cool my system. The most vulnerable component appeared to be the Shugart SA-455 disk drive with a maximum operating temperature of 115 degrees. With this plus a safety factor in mind, I set my target for a maximum internal operating temperature of 100 F, or 20 F above an 80-degree office temperature.

I dug out some test equipment and measured the power consumption with a calibrated meter (traceable to NBS). It

turned out that my MD11 was drawing (dissipating) approximately 85 watts (Morrow specification is 50 watts). This may not seem like much, but think about sticking even a 60 or 75 watt light bulb in a box the size of an MD11. It'll get darned hot!

Then I took an ALNOR air velocity meter and found that the small MD11 fan pulled only a little more than 3 Cubic Feet per Minute (CFM). An early brochure I have on the MD11 says it is supposed to have a 12 CFM fan. But I discovered that even a 12 CFM fan is really not big enough to adequately cool 85 watts.

## Thermal Analysis Formula

When doing thermal analysis, I use a common rule of thumb formula (converted to degrees Fahrenheit) that I learned many years ago in an engineering seminar:

$$(\text{CFM}) = \frac{1.76 \times \text{Watts}}{\text{Rise in Temp (deg C)}} + 25\%$$

At 85 watts, this results in a minimum airflow of approximately 17 CFM for 20 F above room temperature. At 12 CFM you could expect an approximate rise of 29 F. (Of course, that's assuming your 12 CFM fan is delivering 12 CFM once it's installed.)

(continued next page)

## PUT TIME OUT OF MIND, INTO MEMORY WITH... MICROCRON

Finally, a real time calendar/clock for the 820, 820II and Big Board. Time stamp files, document printouts. Your computer need never ask YOU the time again. We use an OKI clock chip with a lithium battery backup. Crystal controlled to time resolutions of one second. 12/24 hr. format, even keeps track of leap year. Board simply plugs into parallel port. It comes with software on disk and manual. Please state type of system and 5 1/4 or 8 inch disk. Let MICRONCRON put time out of mind, into memory.

MC - 1 with disk ..... \$69.

MC, VISA COD, CHECK,  
P & H \$2, NYS ADD TAX

716-377-0369  
PO BOX 81  
PITTSFORD, NY 14534

 **OPTRONICS**  
TECHNOLOGY

\* Xerox 820, 820 II trademark of Xerox

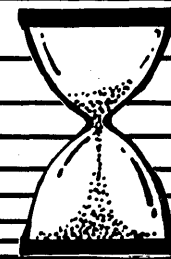

I pulled out the original fan and discovered it moved only a little more than 3 CFM. So I reversed the wiring and the impeller, and put the fan back in. That increased the air flow to almost 4 CFM, but after about an hour the temperature was up to 130 degrees, still much too high for dependable operation.

**Testing Your Own Machine For Airflow**

Before you cool your computer, make sure it needs it. To check, turn on your system and hold a facial tissue about 3 inches behind the air intake. If the tissue doesn't get pulled hard against the fan intake, you've got a problem!

When the tissue is directly against the front of the hard disk or the door opening to the floppy disk drive you should see about a 30-degree (off vertical) deflection of the tissue. This air flow is a little more subtle than the air intake because of all of the other holes in the case, but you definitely want air coming out through the disk drives (and the power supply).

**Cooling The Morrow**

There are ventilation holes on the back of MD11s (Morrow used standard MD series cabinets). As a consequence, even when enough air does go into the rear fan opening, it goes right back out the ventilation holes on the rear panel, taking very little heat with it.

To solve this problem cover the rear panel holes from the inside with a 1-1/2" X 9" thin sheet of plastic.

Now, if you don't have adequate air flow into the rear, I suggest you temporarily operate your MD11 (or other system) without its case until you can replace the fan.

**Choosing a Fan**

I first decided to replace the present fan with a higher velocity unit of the same size and voltage. It's a plastic 12 volt DC fan, 2 1/4 inches in diameter, and it looks like it belongs in a child's toy.

I scoured all my catalogs, fliers, and magazines for a suitable replacement that did not cost a fortune. It didn't exist. So I chose a standard 3.125", 25 CFM axial style 115 VAC fan in a 4" X 4" X 2" aluminum box chassis, mounted outside of the MD11 on the rear panel over the fan opening. The fan and the chassis are both available in most good electronic

supply houses and in ads in the back of electronic hobbyist magazines.

**MD11 Installation Instructions**

To get power to the fan I used the original MD11 power cord and ran it through the fan housing (you could also purchase a new power cord if you don't want to destroy the original—they're about \$5.00). I cut the cord about 8" from the end that normally would connect to the computer, and ran both pieces of the cord into the side of the chassis box through clamping grommets.

I also mounted a new toggle switch be-

low the air intake of the fan housing so I could control power to the fan and the computer. Now the power cord comes into the box to power the fan and it leaves the chassis box to power the MD11. The computer's power switch is always left on, and main power is controlled by the new toggle switch.

**The Chassis Box**

Make sure that one dimension on your new chassis box is no greater than 4", otherwise it will not fit between the top of the MD11 and the auxiliary RS-232 connector. Conversely, the box also

**CO1686 ATTACHED RESOURCE PROCESSOR**

<b>MS-DOS 2.11</b>	<b>CP/M-86</b>	<b>CP/M-80 RAM DISK</b>
<b>8086</b>	<b>8087</b>	<b>768K RAM</b>

**For ANY Z80 Based CPM System**

"THE 16 BIT CO-PROCESSOR TO BE MEASURED BY THE COMPANY IT KEEPS"

Kaypro 2, Osborn I, TRS-80/I, Bigboard, Max80, Heath H8, Altos Dynabyte, Xerox 820-I, Horizon, Heath H89, Systems, Multitech, Intersystem, Televideo 802, Teletex, Cromemco, Morrow MD3, Discovery, Exidy Sorcer, TRS-80/4, Xerox 820-II, Altos Series 5, Microengine, Magic, Superbrain, Morrow MD11, Davidge, Northstar and many other Z80 systems owners are all extremely satisfied with the CO1686

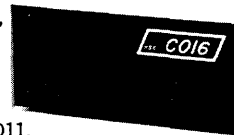
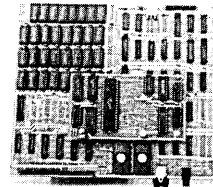

Televideo 803, Eagle 1, Epson QX10, Lobo 8000-10, Lanier EZ1, Zorba TRS-80/II, North Star TRS-80/III, Monolithic Convertable, BMC, Ithaca Kaypro 4, Osborn Exec, Compupro, Altos 8000-12, DEC VT180, Kaypro 10, Wave Mate Bullet, Portabrain, TRS-80/12, TRS-80/16A, Sierra, Vector, Advantage,

and many other Z80 systems owners are all extremely satisfied with the CO1686 ATTACHED RESOURCE PROCESSOR.

And why shouldn't they be. Look at these impressive features:

- A True 16 Bit 8086 Processor
- 256K to 768K RAM
- MS-DOS 2.11 & CPM86
- Emulation of 80% of "PC" ROM BIOS
- Thousands of CPM86, MS-DOS, & "PC" Applications will run
- MS-DOS & CPM disk files can be co-resident on the same device (including harddisk)
- Can be used as 768K of high speed CPM80 RAM Disk
- Easily installed on any Z80 based system
- Available in an external cabinet w/ power supply
- Optional 8087 Math Co-Processor, Real Time Clock, 8 Level Interrupt Controller, & Proprietary I/O Bus
- Delivered with Logics and Sources
- Optional 12 month warrantee
- Full money back guarantee that it will function on your Z80 system
- A Quarterly Newsletter

PRICES START AT A LOW \$495.00.

For additional information about this revolutionary product, or our Motorola 68000 Co-Processor, contact your favorite dealer, send \$1 (no checks please) or call:



Hallock Systems Company, Inc.  
262 East Main Street  
Frankfort, New York 13340  
(315) 895-7426

RESELLER AND OEM  
INQUIRIES INVITED.

must be at least 4" in two dimensions to allow room inside for the switch, power cord, and fan.

On a 4" X 4" X 2" box, such as an LMB #143, the air intake and outlet are not centered, but are offset to allow for proper mounting of internal parts and for mounting on the MD11. The air intake is cut for the fan mounting, and the air outlet from the chassis box is cut to exactly match the fan and fan mounting holes on the MD11.

After the holes are cut, and before you mount the fan inside the box, make a filter and impeller protector. I used some 1/4" hardware cloth and two layers of window screen mounted inside the fan housing on the air intake hole.

### Opening Up The MD11

First, remove the power and power cord. Then slide the case off the front of the MD11 after removing the four Phillips head screws that hold it in place.

Remove the four screws that hold the old fan, and, once the fan is loose, clip the power wires. Insulate the wires with tape, and mark them with a label or masking tape so a couple of years from

now when you have the MD11 disassembled for some other reason, you'll remember what they were for.

Next, install a 1-1/2" X 9" piece of cardboard or plastic over the MD11 rear panel ventilation holes. Place some foam rubber weather stripping on the exhaust side of the new fan housing to make a good seal.

With four #4 screws mount the new fan housing over the old fan hole.

Do not plug the short end of the power cord into the back of the MD11 yet, but plug the other end into an AC outlet. Turn on the switch on the fan housing to see if the fan works.

Using another tissue, make certain that the air is entering from the rear and blowing into the MD11. This slightly filtered air must blow out of the front of the disk drives rather than pull dust in.

Assuming this worked, turn the switch off and plug the short end of the cord into the back of the MD11. Turn on the switch. If everything was wired properly, you should be back in business. Replace the cover and operate a cool computer!

### Results

With this arrangement the temperature between the hard disk and the power supply reaches a maximum of 28 F degrees above room temperature—a far cry from the 70-degree rise before. And the rest of the computer stays at about 10 degrees above room temperature. The 25 CFM fan pulls about 22 CFM.

Since I added the fan six months ago, my MD11 has been used an average of 10 hours a day, and so far, I wouldn't trade it for twice the price.

If anyone out there knows of a direct replacement 20-30 CFM 12 VDC fan for the MD11 at a reasonable cost, please do the other MD11 owners a service and send the part number and supplier information to either me or Micro Cornucopia.

Below is a list of parts you will need to cool your system. And if you'd rather not search for everything yourself, I'll sell you the complete kit for \$52.95. Write to the address at the top of the article to order or for more information.



*Air Intake Panel*

*MD11 Top View With Fan Installed*

**Parts List**

Quantity	Item
1	3.125" axial style fan. 25 CFM, 115 VAC (Such as ETRI model 126LF or Rotron Sprite series)
1	4" X 4" X 2" box chassis. LMB #143 or equiv.
1	power cord. Belden 17742 or equiv.
1	SPST 3A 125 VAC toggle switch. (Radio Shack 275-602)
1	3.5" X 3.5" hardware cloth (1/4" heavy duty screen)
2	3.5" X 3.5" pieces of window screen
2	power cord grommets
16"	1/4" or 3/8" foam weather stripping
1	1-1/2" X 9" piece of stiff cardboard or thin plastic
4	6-32 X 3/4" fan mounting screws, washers, nuts
4	4-40 X 3/8" fan housing mounting screws, washers, nuts

# EXPAND YOUR BIG BOARD

GIVE YOUR BBI A PRESENT: EXPAND IT!

This versatile expansion system features a Z80 daughter board for direct "on the bus" expansion of memory and I/O. The main board allows you to add on the most popular Big Board accessories all on one board:

**BANK-SWITCHED MEMORY:** 64K to 1 Mbyte of dynamic RAM with "delay line" timing and 8K to 32K of EPROM or battery-backed STATIC RAM. Advanced "HOLE" memory mapping for ultra-fast RAMdisk operation.

**Z80 I/O:** One SIO, two PIOs, and one CTC. The SIO and PIOs are fully buffered with the same header connections as the BB I.

**OTHER I/O:** One ADC0808 8-input 8-bit A/D converter, two DAC 800 8-bit D/A converters, one AY-3-8910 programmable sound generator, and one MM58167 battery-backed real-time clock.

\* **SIMPLE PIGGYBACK INSTALLATION - NO MODIFICATIONS TO BB I NEEDED!** \*  
Main board is the same size as the BB I and runs at 2.5 or 4 MHz  
Versatile connection scheme allows for further expansion

RAMdisk software provided (.COM and .MAC) for SWP DD or standard DRC CBIOS  
It installs a 250K drive M: and patches the MM58167 as the clock display. The patch can be easily modified for other types of CBIOS. Also included are system checkout and utility software.

All parts (except delay line) are easily obtainable. We provide source lists. Pro-quality schematics on two large blueprints for easy reference.

\$99.95 Bare daughter and main boards (solder-masked and silk-screened), documentation, and 8-in. SSSD software disk

\$16.95 Delay line  
Shipping and handling, add: U.S.A., \$5.00; Canada, \$8.00. Sorry, no other exports.  
Check or money order only; no CODs. Delivery: stock to 6 weeks.

For free 5-page spec sheet, please write or call:  
Rivendell Audiocomp, P.O. Box 28937, San Diego, CA 92128

## Rivendell Audiocomp

Custom Audio and Computer Design 619-451-3424

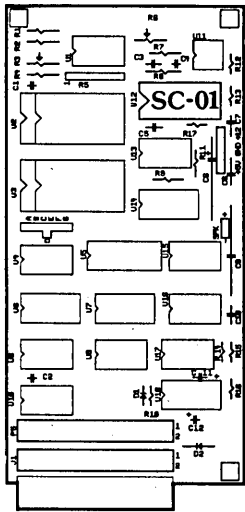

**SPEECH  
SYNTHESIZER  
FOR THE BIG BOARD  
AND XEROX 820**

**TCC** CONTROLS

## BIG VOICE KIT

- 1400 BUILT-IN WORDS PLUS UNLIMITED PHONETIC SPEECH CAPABILITY
- DATA RATE: 3.5 bytes/sec typical (2 bytes/word or phoneme)
- PLUGS DIRECTLY ONTO GPIO "A"

### BIG VOICE KIT INCLUDES:

- HIGH QUALITY BARE BOARD
- 1400 WORDS IN EPROM
- USER/ASSY MANUAL w/schem.
- SOFTWARE: WORD SOURCE, DEMO & SUPPORT PROGRAMS, ON 8" sssd FLOPPY DISK
- \$70. kit / \$150. ass'd & tested all ppd. (Texas res. add 6%) state whether B/B or XeroX
- \$130. complete kit

9910 LEAWOOD BLVD.  
HOUSTON, TEXAS 77099  
tel. (713) 495-6185

## ENGINEERING SOFTWARE

CPM-80 • MSDOS • TRSDOS • PCDOS\*

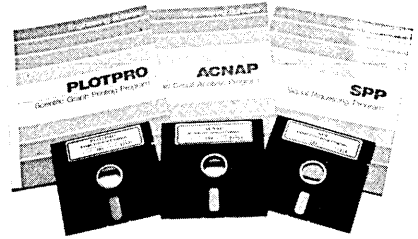

Free Catalog

Dealer Inquiries Welcome

### Professional — Affordable

PLOTPRO — Scientific Graph Printing Program \$49.95  
ACNAP — Electronic Circuit Analysis Program \$49.95  
SPP — Signal Processing Program \$59.95

\* 96 computers and formats including IBM look-alikes, 8087 co-processor (slightly more), and Apple with CP/M. Include \$3.00 (\$9.00 Foreign) shipping and handling with each program. California add 6%.

### BV Engineering

Box 3429 • Riverside, CA 92519 • (714) 781-0252

## NOW FOR XEROX 820 BB & BBII

### LOW COST DISK CONTROLLER

SAVE WEAR AND TEAR ON YOUR DISK DRIVES AND FLOPPIES WITH THE MODEL 3801 ALL SOLID STATE RELAY. SMALL ENOUGH TO FIT EASILY INSIDE YOUR DISK DRIVE, THE 3801 CAN BE INSTALLED IN MINUTES. YOUR BIG BOARD WILL THEN TURN YOUR DRIVES ON AND OFF AUTOMATICALLY AS THEY ARE NEEDED.

#### - FEATURES -

- \* SMALL SIZE - 1.75 X 1.40 X 0.35
- \* FAST INSTALLATION - DIAGRAM INCLUDED
- \* ZERO CROSSING - ELIMINATES ALL SWITCHING NOISE
- \* TRIAC OUTPUT - NO MECHANICAL PARTS
- \* DVDT FILTER - INCLUDED
- \* LOW COST - ONLY \$8.80 EACH
- \* 1 YEAR WARRANTY
- \* 30 DAY MONEY BACK GUARANTEE

**PHENIX**

COMPANY OF CALIFORNIA  
1619 SOUTH MINNIE STREET  
SANTA ANA, CALIFORNIA 92707

(714) 547-4316

CALIF. RES. ADD 6% SALES TAX  
ADD \$1.00 EA. POSTAGE & HANDLING  
PLEASE SPECIFY BBI, BBII OR XEROX

# FERGUSON ENGINEERING

817-640-0207

820-1 Schematics, 18" x 24" set of six, very legible .....	\$ 18.00
STD BUS connector for BBII .....	12.50
Crydom S312 solid state relay, 120 VAC, 2 A, 0 volt switch .....	10.00
Complete 820-1 Documentation package .....	15.00
820-1 CBIOS source, ROM monitor source, and 5.25"—or—8" formatter all in source code, M80* compatible, 8" SSSD .....	35.00
820-1 dual drive disk cable for two 5.25" drives w/power conn .....	20.00
820-1 dual drive disk cable kit for eight inch drives .....	45.00
Composite video adapter kit for 820-1, produces true RS-170 compatible video .....	25.00
Serial console monitor program for the 820-1, gives your 820-1 the PFM style serial console, M80 source, 8" SSSD .....	35.00
820-1 power connector w/pins .....	4.00
820-1 / BIGBOARD-1 ASCII keyboard, w/cable, NEW! .....	95.00
BIGBOARD-1/11 dual-drive 8" disk cable, 17" long .....	35.00
Assembled and tested Xerox 820-1 computer boards .....	100.00
Bigboard dual 8" drive cable .....	30.00
Bigboard serial I/O cable .....	15.00
AMP 8" drive AC connector w/pins .....	.75
AMP 8" drive DC power connector w/pins .....	1.50
AMP 5.25" drive DC power connector w/pins .....	1.10
CP/M Primer (Xerox CP/M handbook) .....	7.50

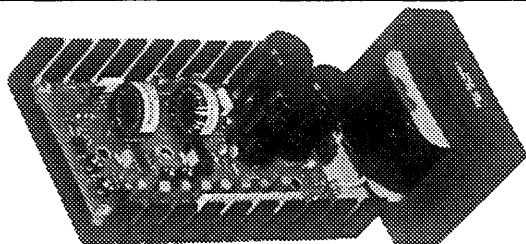

**IMPROVED!**

**UNINTERRUPTABLE POWER SUPPLY**

**UPS 5-200 \$195<sup>00</sup>**

+5V @ 8.5 AMPS, +12V @ 7.5 AMPS — 12V @ .5 AMP  
TWO +24 VOLT OUTPUTS @ 1.5 AMPS EACH (2A PEAK)

This supply is designed to power entire computer systems with Winchester and floppy disk subsystems. When the AC power fails, power can be maintained by a single 24V battery. The switchover time from AC to battery is zero, power is never interrupted.

24V 4.5 AH Panasonic LCR series battery ..... \$65.00

- High Reliability (1 year limited warranty)
- High Efficiency (75% typ)
- New design is very quiet.
- Quick response OVP
- Fold-Back current limiting
- Drop-out immunity for up to 250 mS (without battery)
- Uninterruptable (with addition of battery pack)
- Built-in battery charger
- Very Small 3.5"H, 10.0"L, 4.25"W

**FERGUSON ENGINEERING**

817-640-0207

P.O. BOX 30085 ARLINGTON, TEXAS 76010

## GENERAL PURPOSE INDUSTRIAL CONTROLLER

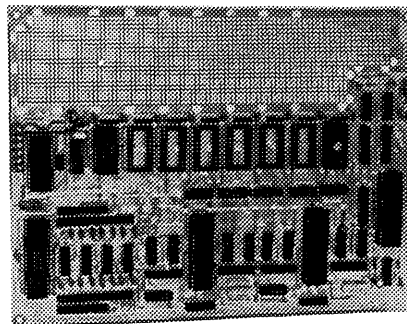

LB-1

**\$75<sup>00</sup>**

Bare Board & Doc

- Uses Z80, Z80A, or Z80B family of components
- Dual RS232 serial I/O W/Current loop option on the "A" channel (both strappable as terminal or modem in the RS-232 mode)
- 16 programmable Baud rates on each serial channel
- 32 bits of buffered parallel I/O assignable on 4 bit boundaries, W/Strappable Handshake Polarity (2xZ80-PIO)
- 4 Channels of counter-timer, 4 inputs, 3 outputs
- Accommodates 16K mix of RAM or ROM or EEPROM on 2K boundaries in 2716 or 2016 or Xicor EEPROM
- 2.3" x 10" sea of holes prototyping area on .1" grid
- All I/O is mode 2 interrupt compatible
- Watchdog timer for long-term unattended operation

ROM monitor and source listing ..... \$ 35.00

Assembled and tested 4 Mhz LB-1 ..... 250.00

**TERMS:** Master Card/VISA add 3%, money order, certified check, UPS cash COD. Allow 2 weeks for personal or company checks to clear. Shipping/handling extra. Texas order add 5% tax.



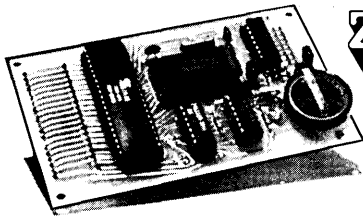

# Ztime-I

CALENDAR/CLOCK

**\$69 KIT**

- WORKS WITH ANY Z-80 BASED COMPUTER
- PIGGYBACKS IN Z80 SOCKET
- USES NATIONAL MM58167 CLOCK CHIP, AS FEATURED IN MAY '82 BYTE.
- BATTERY BACKUP KEEPS TIME WITH CPU POWER OFF!
- EASY TO USE SOFTWARE INCLUDED TO SET AND READ THE CLOCK IN BDS C, JRT PASCAL, TURBO PASCAL, AND MICROSOFT BASIC, WITH ALL SOURCE.
- SOFTWARE IS AVAILABLE ON 8" SSSD, 5" XEROX 820, KAYPRO 2, OSBORNE, NORTHSTAR, CROMEMCO, APPLE CP/M DISKS AND OVER A MODEM FOR OTHER COMPUTERS.
- PACKAGES AVAILABLE:
 

FULLY ASSEMBLED AND TESTED	<b>\$99</b>
COMPLETE KIT	<b>\$69</b>
BARE BOARD AND SOFTWARE	<b>\$29</b>

N.Y. STATE RESIDENTS ADD 7% SALES TAX.

PERSONAL CHECKS, MONEY ORDERS, PURCHASE ORDERS, AND C.O.D.'S ACCEPTED.



**KENMORE  
COMPUTER  
TECHNOLOGIES**

20 Landers Road - Kenmore, New York 14217 - (716) 877-0617

# CALL WREN! WORKSTATION



**Computerfone by Wren**

- Z-80 4MHZ
- 5 1/4, 8 or hard drives
- Uses BBII CPU
- CPM, CPM86, MS DOS
- Defineable keys

**\$1955.00**

## DISKS:

5 1/4 SSSD Dysan	<b>\$2.30</b>	Verbatim	<b>\$2.70</b>
5 1/4 DSDD Dysan	<b>2.95</b>	Verbatim	<b>3.75</b>
8 SSSD Dysan	<b>3.10</b>	Verbatim	<b>3.40</b>
8 DSDD Dysan	<b>3.50</b>	Verbatim	<b>3.80</b>

Disk Mailers 10 for **\$5.00**, 100 for **\$40.00**.

## PRINTERS:

82 A S & P	8.5 Carr.	120 CPS	<b>\$ 325.</b>
83 A S & P	13.6 Carr.	120 CPS	<b>575.</b>
84 P P	13.6 Carr.	200 CPS	<b>975.</b>
84 S S	13.6 Carr.	200 CPS	<b>1065.</b>
92 P P	8.5 Carr.	160 CPS	<b>440.</b>
92 S S	8.5 Carr.	160 CPS	<b>530.</b>
93 P P	13.2 Carr.	160 CPS	<b>715.</b>
93 S S	13.2 Carr.	160 CPS	<b>900.</b>

## DRIVES:

Shugart 810	<b>\$335.00</b>	Tandon 100-1	<b>\$175.00</b>
<b>SPECIAL</b> Shugart 860	<b>350.00</b>	Tandon 100-2	<b>199.00</b>
<b>PRICES:</b> Tandon 848-1	<b>270.00</b>	Tandon 100-4	<b>295.00</b>
		Tandon 848-2	<b>375.00</b>

# CALL TOLL FREE 1-800-543-WREN

except in Ohio, 513-931-7160

Minimum Order \$30.00



880 Reynard  
Cincinnati, Ohio 45231

## EPROM PROGRAMMER

interfaces to the BBI (XEROX 820) parallel port  
Requires +5v. @ .3A, +25v. @ .1A, interface cable

1. Software and schematic	24.95
2. Bareboard and schematic	29.95
3. Software and bareboard	49.95
4. Software and kit (less ZIFs)	84.95
5. Software and full kit	114.95
6. Programmer A + T	134.95
S/H	5.00

LOWER  
NEW PRICES  
TILL JANUARY 1985

Big Board II software and source  
(uses BB II sockets for programming) 24.95

- Program, Verify, Load and check for Erased Intel Eproms 2716, 2732(A), 2764, 27128 T.I. Eproms 2516, 2532, 2564 Xicor EEprom 2816A
- Uses 16k bytes of system memory as a buffer, allowing you to work with up to 8-2716 EPROMs at the same time
- Upload and Download Intel Hex Files
- Edit the data in the 16k byte memory buffer
- Define your own addresses for the memory buffer
- Complete screen error messages
- Software source included
- Menu driven
- Interfaces with most Z80 CP/M systems

SPECIFY 8" SSSD OR KAYPRO 5 1/4" SSSD  
KAYPRO INTERFACE (USES PADS ON P.C.B.)

### Utility Disk 1 includes

- PEG - Universal Object File Translator. Formats supported...
  - 8 and 16 bit Intel hex BHLF COM
  - 8 and 16 bit Motorola BPNF ASCII
 Merge and split of 16 bit data also supported.
- HEXED - A full screen hex file editor, allowing simultaneous edit of both the hex and ascii representations of a file.
- Full source and documentation on disk 24.95

## WADE-I

Universal Interface Expander

Use the WADE-I U.I.E. for Intelligent Communications

Printer Buffer	Parallel driven RAM disk
System multiplexer	P/S to S/P converter

AND as a BIG BOARD I or XEROX 820 PORT EXPANDER  
Power requirements +5 volts @3A, +/-12 volts @.1A

1. Bareboard	85.95
2. Printer buffer EPROM	14.00
3. Printer buffer source on 8" SSSD diskette	25.00
4. 4 MHz Kit (64k) with printer buffer EPROM	359.00
5. 4 MHz A + T (64k) with printer buffer EPROM	459.00
6. 64k byte bank of RAM (8-4164s 200nsec)	79.00
S/H	10.00

### BIG BOARD I (XEROX 820) PORT EXPANDER

- interfaces through the Z80 CPU socket and 1 jumper to connect the 'IEO-IEI' daisy chain
- adds 2-PIOs, SIO, CTC, and a DMA controller
- FULL MODE 2 INTERRUPT OPERATION
- Works with 2.5MHz and 4MHz systems
- Complete documentation

### STAND ALONE U.I.E.

- 256k bytes of RAM with DMA capability
- 4 fully buffered 8 bit parallel ports
- 4 Mhz - use Z80A parts and 200 nsec dynamic RAM
- 2.5 Mhz - use Z80 parts and 250 nsec dynamic RAM
- configurable EPROM socket (2716 thru 27256)
- 4 fully buffered 8 bit parallel ports
- 2 configurable RS232C serial ports
- Complete documentation

all prices shown are in US funds orders shipped within 10 days A.R.O.

# Biegun & Associates

P.O. Box 4071, Stn "B" Winnipeg, Manitoba Canada R2W 5K8

CP/M is a trademark of Digital Research, Inc.

# No Fault Power

By Al Paarmann

368 El Gaucho Rd.  
Santa Barbara CA 93111

## Editor's note:

This project involves the use of potentially lethal voltages. We do not recommend that you attempt to assemble this project if you do not have prior electrical/electronic experience.

After two power losses while using Perfect Writer, I designed a non-portable battery backup for use with my Kaypro II. After all, a little time spent up front can save a lot of time trying to reconstruct files later.

## Controller Circuit

The DPDT-center-off switch stays in the off-position when nothing is running. When it is set in the up position, the 120 V relay is activated.

The relay has a long lock-up path through the upper normally-open contact: normally closed pushbutton; the lower normally-open contact; and the 4.7K resistor.

With the switch moved to the bottom position:

- 1) The relay is holding on this lock-up circuit.
- 2) The DC-to-AC inverter is turned on.

Any loss of powerline voltage will drop the relay (permanently) and switch over to inverter power.

When it's time to shut down, I put the switch in center position and break the lock-up with the normally-closed pushbutton. The circuit breakers shown are regular house wiring types. The lamps show where the power is coming from (amber for backup; green for wall power).

## Battery Charger

Next, I built a small battery charger (fig 2) for the 12V battery (a discount store special). I set the battery inside a plastic washtub for safety.

I used a small 0.1 A regulator to provide the reference voltage for the 1.5 A regulator.

After charging the batter overnight (so I knew it was fully charged), I adjusted the current down almost to zero. This current, of course, increases steeply as the battery voltage drops.

The two diodes and 330-ohm resistor are intended to clamp the 1K resistor (between the diodes) for -left, +right volt-

age drop only. The 3-amp diode keeps the battery from discharging through the charger when the charger is off. The maximum charging rate is 1.2 amps.

## Fast-Demand Circuit

The inverter draws 2 amps when it is just sitting around buzzing (no load). That seemed like a losing situation since my supply was only 1.2 amps so I cooked up the fast-demand circuit in Figure 3.

The diodes isolate the small 4.7 uFd capacitor from the rest of circuit. When a power loss occurs, the voltage on this capacitor drops quickly, turning the transistor on.

Since the transistor is in series with inverter connect relay, the relay only applies 12V when needed. I've forced a switch-over with the pushbutton many times without loss of data, but have not yet had a real line-voltage drop.

The pushbutton is near the keyboard, and if the lights flicker, I'm sure my reflex will be to manually force a switch-over before something more exciting happens.

## Editor's Note:

Kaypro does not recommend that you power a system from any inverter that outputs square waves. You see, those little supplies inside the Kaypros are simply transistor switches driving a transformer.

Most switching supplies like the ones Kaypro has been shipping turn the AC into over 200VDC. They use a simple doubler for 110V and go straight if you have 220V in your wall. Then the 200V DC is used to drive a high-frequency switching transistor which in turn drives small high-frequency transformers. The outputs of these transformers become the +5V, -12V, and +12V supplies for your Kaypro.

Spikes on the incoming 110V, or square waves can be really fun for these little diode doublers and transistor switchers. So, to be on the safe side, I'd either get an inverter that is filtered (so it will output a sine-wave), or get a special filter for my inverter. That way, I'd feel a lot safer about my precious system.

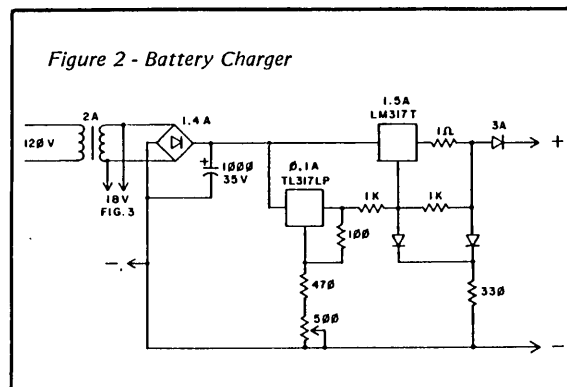
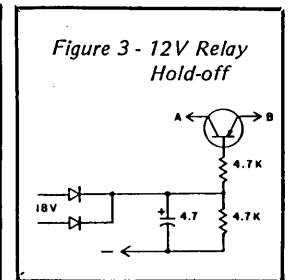
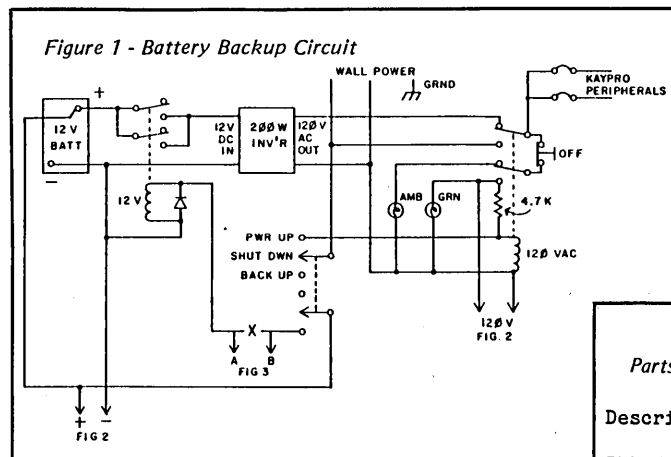

## Parts List For Battery Backup

Description	Radio Shack #
PNP Transistor	276-2032
12VDC Relay	275-218
120VAC Relay	275-217
LM317T	276-1778
TL317LP	276-1762
Bridge Rect.	276-1151
3A Diode	276-1141
Other Diodes	276-1120
DPDT Ctr-off Sw	275-664
N.C. Pushbutton	275-1548
Indicator Lamp	272-707
18V, 2A Trans	273-1515
200W 12VDC to 120 VAC Inverter from Sears.	
Montgomery Wards also has an equivalent inverter.	

# DSD 80

## ***The Dynamic Screen Debugger for CP/M***

DSD-80 is the most advanced debugging program available for CP/M-80 and compatible operating systems. Spend less time debugging and more time programming because DSD is the only utility to offer all of the most important features in one package.

**Satisfaction is guaranteed or a full refund!**

- Full screen display includes:
  - 2 memory displays
  - Register display
  - Stack display
  - Instruction display
- Fully upward compatible with DDT.
- Over 50 commands
- Full symbol support including:
  - Loading symbol files
  - Interactive symbol definitions
- Manipulate I/O ports
- String searching
- Free updates for one year
- 30 day money back guarantee
- Endorsed by Leor Zolman — author of BDS C
- Full featured simulator provides for:
  - Execution only within boundaries
  - Write protected memory
  - Stack overflow protection
  - Stack underflow protection
  - Real time subroutines
  - Breakpoint on specified memory or register values
- Single keystroke commands for:
  - Stepping instructions
  - Subroutine execution
  - Scrolling memory displays
- Uses less than 15k of memory
- On line help information
- Clearly written 50 page manual
- Requires CRT with cursor addressing

**Only \$195.00**

# SOFTADVANCES

**P.O. Box 49473 Austin, TX 78765 (512) 478-4763**

**Available on 8" SSSD & varlous 5.25" formats  
IBM PC verslon available soon!  
Visa & MC accepted**



# On Your Own: Turbo Pascal, The Early Days

By Philippe Kahn

President of Borland International  
4807 Scotts Valley Dr  
Scotts Valley CA 95066

*Editor's note: This is the story of the early days at Borland International, a once-small software startup headed by Philippe Kahn. He came to the United States with a Pascal compiler and the desire to start his own company, but, as you will see, the people with money to invest didn't believe a company could survive selling a compiler for \$49.95. The money people were obviously wrong, but then I'll let Philippe tell you in his own words. The following, excerpted from Philippe's keynote speech at SOG III, is this issue's "On Your Own." I think you'll enjoy it.*

In Silicon Valley there are people called finders who, for a fee (5% of the money they raise) will take your business plan to, say, Fred Adler, and he'll read it. So you say, "Great, but I don't have a business plan."

He says, "If you'll give me \$1000, I'll write you a business plan."

When I first got here, I didn't know enough English to write a business plan and, unfortunately, spelling checkers are not semantic checkers. However, we wrote a beautiful business plan, which basically said, "If you invest in my company, we will multiply your investment by 20 in two years." That's what any business plan should say (and we did it for a lot less than \$1000).

A business plan also has to list the members of the staff. That was a problem. I lined up a couple guys: one had a Japanese restaurant in Cupertino, and the other was a former telephone salesman for Campbell's Soup in Mexico. (It's absolutely true!) I was the "engineer."

We put together this 20-page business plan, but it still looked a little thin, so we told the printer to double space so it would weigh more. In spite of our skimpy business plan, some venture guys interviewed us. I remember one.

## A Venture

I met one of the investors of VisiCorp, Arthur Rot, in a restaurant in Palo Alto. I was completely broke so I was hoping he would pick up the tab. My trick was to say, "Oh, I forgot my wallet with my credit cards." I had to do that because those venture guys expected you to pay the bill. Don't hope to get anything out of the venture guys, especially not a meal. You're there because you need the money, so they expect you to pay.

Anyway, he asked me, "How do you

intend to do what VisiCorp is doing?"

I said, "I hope I won't do what they are doing, because they are in trouble." But, of course, he didn't understand.

## What Venture People Want

A venture guy has a problem: he doesn't know about software, hardware, or anything. He is a business person. He doesn't even own the money he invests. He manages a venture capital pool of 100 million dollars and he needs to find ways to invest it.

The people who put their money into the pool want high returns but they don't want to lose their cash. So venture capital is not risk capital. At least venture people think they don't take risks. What they want is the bottom line and the management team.

They want an MBA from Stanford or Harvard who has worked 5 years at Intel, 4 years at IBM, 6 years at Apple, 7 years at VisiCorp, and is 22 years old. Unfortunately, I was 30 and didn't have an MBA. They told me, "You're a dumb engineer; you don't know anything about management." "Software at \$50? You're crazy! You have to sell software at \$300 to make a profit."

After a while I found out that I was wasting my time. I got absolutely nowhere, and I was finally so broke that I had to do some consulting for the computer store next door. I rented a little office and I wrote little things for customers—an accounting package and other crazy stuff.

## Looking For The Wrong Thing

The problem with venture capitalists is that they think everything is in the marketing team and the management team: who is going to carry your product? how you are going to do your distribution? etc. Well, my idea was that it was very easy to find people who could do that. Just put an ad in any paper and you can find people who know about marketing, who know about distribution, and who know how to put an ad together.

Now put an ad in the paper and try to find a debugged software program that will be a best seller.

So the venture guys have got it all wrong. It's much more difficult to find

products and people who can write products than to find marketing teams. The venture guys give no value to the guys who can make something work.

Look at Osborne, for instance. They got themselves into real trouble and dumped \$25 million. Look at Eagle, Victor, VisiCorp, and all those guys. They were just marketing someone else's product. They didn't know how to do their own product.

## Changing Attitudes

Anyway, now the venture capital people are our friends, strangely enough. We get letters from underwriters, and fellows come and visit us and show us business plans, asking if we think they can make it. We charge them for that (including lunch). It's really strange how things have reversed.

Sorcim was recently sold for \$17 million just six months after an English group had purchased it for \$24 million. The English group lost a lot of money. You see, they had no product after SuperCalc.

Chances still are that you will go to the venture capital people with your product and you will waste your time—now more than ever. They are frightened by all the flubs in hardware and software.

## Making It Without Venture Capital

You have to be very creative to make it without venture capital. My case was even worse than for most people: I had no house for collateral, I was an illegal alien, I didn't have anything. In this situation you have to be very creative. And lucky.

We were lucky to have a debugged working product and we had good timing. JRT had made Pascal somewhat popular but had just gone bankrupt. We had used Europe for a beta test site for a year, and our challenge was to find a way to let the world know about our Pascal. Our big decision was whether to sell it for \$50 or \$600. (We're selling it right now for \$600 in Europe.) We now know we made the right choice, but we could have been totally wrong.

*(continued next page)*

### Pricing

One of our assumptions was that prices would go down as volume increased. The manuals cost us 80 cents, the disks cost \$1.00, and the whole package costs \$3.50 or \$4.00. If you multiply that by more than 10 you have a comfortable margin. Perhaps \$49.95 is too high, but sooner or later it probably won't be that price.

When you have 2 million PCs out there it's a big market. Turbo Pascal is a small market but we're shipping serial number 85,000 (end of July 1984). Plus we have Japanese translations, German translations—we have distributors world-wide now. In fact, most countries with more than 10 million people have a local translation of Turbo.

We shipped 10,000 copies of Sidekick in the first three weeks. We expect to ship between 300,000 and 400,000 copies in the first year. At \$49.95, it's a cheap product that fits the whole IBM market.

The most important question is: "Do I have the right product to make it?" Don't let people tell you that venture capital is the crucial factor.

### Quality

It's not enough to be adequate. I had a long controversy with Adam Osborne, who is currently starting a company called Paperback Software International. He wants to do what we are doing: sell low-cost software. But he contends (in Hypergrowth) that software only needs to be adequate and the rest is a marketing game.

I think software better be damned good if you want to sell it. If you are using software, you'll be using it every day, year after year. I've been using WordStar since 1979 so it's a reliable program. It was a good product then and it's still a good product, which explains why there are a million copies out there. Lotus is an excellent product. It's the fastest spreadsheet around, but it's successful primarily because the product is really good.

In fact, the more you advertise a bad product the sooner people find out that it is bad and stop buying it. That is what happened to JRT. It was a good price, the product was OK, but they just weren't shipping. People stopped buying be-

cause the word spread that they didn't ship.

### Marketing

We are marketing Turbo in an unusual way, mostly mail order and directly to dealers. We haven't had much luck with distributors.

You see, our discount stops at 45 percent and that's on 1000 quantity, COD. We tried Software Distributors on 30 days net, and they still owe us two-month-old bills. So when SoftSell called, we told them we'd only ship COD. They said, "We're SoftSell." We told them we didn't care. They told us they wanted a 70 percent discount and we told them no.

These guys are used to having people come begging to them. Why should SoftSell get 70 percent discount? That means that you could sell a product for \$200 and only get \$60 for it. Their contract is a joke: they want the big discount and 90 days to pay. You're financing SoftSell. And everybody is kneeling in front of them. When we sell mail order we get \$49.95 and we get the money immediately.

Of course the hackers will read Micro C or Byte and will buy mail order but there are a lot of people who won't buy mail order.

So how do you reach these guys? You start a dealer network, and our guy who used to sell Campbell's Soup now sells Turbo Pascal to dealers (on the phone). Believe it or not, he doesn't know what a computer is, but he knows how to talk to dealers. He tells them that it's a hot product. He's got six people on the phone all the time, and if you take his canned pitch and changed "Turbo Pascal" to "Campbell's Soup" he would be getting orders for soup.

### Getting Started

First, we got two rooms above an auto repair shop. Next we needed to advertise and we knew that Byte Magazine was the place we had to be. Unfortunately, we knew that Byte would insist on having its money up front for the first ad and we didn't have \$9,000. We weren't even close.

So we set a trap. We took a flip chart and we started writing "Personal Com-

puting—full page, Business Week—double spread, Byte—crossed out." We lined up the whole thing with several layers like it had been done over many days. We got some friends in (I was answering the phones at the time) and scrounged up some banquet tables (my desk was a banquet table). We bought some pictures and framed them, made up letters from big companies that we laid around—we really set the trap.

So Bill McCaffey (the Byte rep.) arrived. My flip chart was open to the right page and I "tried" to keep him from seeing it. I even acted embarrassed that it was open. We had also planned that the girl who was playing the secretary would tell me I had a call from Japan.

So I had to leave the room to take the phone. We had a little hole drilled in the wall, so I got to watch him really look over that flip chart. He was really staring at it. He couldn't believe it. (Bill now laughs about it.)

When I came back into the room, Bill said, "OK, you really have to advertise in Byte. We'll make a special effort and give you credit."

I said, "I don't know, our studies show we won't get a good response from Byte."

Bill countered: "Well, for the first run, we'll give you a special rate."

So we got the agency discount, guaranteed placement in the first 75 pages (normally 10 percent extra), and he gave us 60 days to pay. (We couldn't have paid for it if it hadn't worked.)

The ad broke in November, and that month we took in 1100 orders. So the ad was paid for. The second month we took in 2500 orders. The third month and after, we were running 4,000 to 5,000 orders per month. At that point we didn't need money.

Even though we were shipping 5,000 orders per month, we didn't have a computer. We were hand writing invoices, working nights. The writing on the labels was my wife's or mine, until we could program a computer to handle the orders.

In February we did \$350,000 and we had four people in the company. We were working 24 hours a day. We couldn't program anymore so suddenly we had to hire people. Now we have 50

**KAYPRO OWNERS**

Now, we have something for (almost) every one of you!

**4-84**

At last, the real time clock in the 4-84 IS good for something — the complete TIMEPRO system is available as single programs, or as a complete set:

**SEETIME.COM** continuously displays the time and date (in either standard or military time) on the 25th line of the screen — all the time you use your Kaypro.

**TD.COM** time and date stamps your disk files. Automatically detects which files have been added or modified since TD was last run and updates the time and date only for those files. Does automatic backup, too.

**APPT.COM** maintains your calendar of appointments and other reminders. Includes archiving capabilities and several utilities.

**2-84, 2X-84**

As you probably know, the main computer board of these two systems is identical to the 4-84, except that Kaypro left out the components for the real time clock and modem. We have the forgotten real time clock components, complete with instructions, ready to install.

**II, 4 ('83)**

Time and speed are yours with our easily installed SPEEDPRO-5RTC 5 megahertz speedup board with real time clock. Shipped complete with the full TIMEPRO series of 12 programs — a whole disk full (192K) of software.

All TIMEPRO programs are accompanied by programs for setting the time and date and by source code in several computer languages to demonstrate the use of the real time clock in your own programs.

**THE BOTTOM LINES**

SEETIME.COM .....	\$ 29.95
TD.COM .....	\$ 39.95
APPT.COM .....	\$39.95
ALL ABOVE, PLUS SEVERAL ADDITIONAL PROGRAMS ..	\$ 89.95
TIMEPRO DOCUMENTS ON DISK (credited toward complete TIMEPRO system) .....	\$ 14.95
2/2X REAL TIME CLOCK KIT ..	\$ 49.95
CLOCK KIT & TIMEPRO .....	\$109.95
SPEEDPRO-5RTC & TIMEPRO	\$129.95
SPEEDPRO-5+ SPEEDUP BOARD .....	\$ 89.95
(Prices exclusive of shipping.)	

**NOW IS THE TIME!**

**Digital Dynamics (206) 627-0797**  
P.O. Box 5653 Tacoma, WA 98405

people, a complete shipping department, and we have passed \$1 million per month.

If it hadn't worked with Bill McCaffey, we probably wouldn't be here (we certainly couldn't have run that four-color full-page ad in Byte which cost over \$9,000).

In the beginning we duplicated our own disks, printed our own labels, and took our mail to the post office. We weren't ready for the kind of response we got. We thought maybe we would sell 300 or 400.

**Start-up Costs**

A printer agreed to give us credit so when we placed the ad we already had 5,000 manuals in hand. I had two months to pay for them. Probably we could have started the company with about \$20,000 or \$30,000 without credit. But when you have too much money, you spend it. If we had had \$30,000 we would have bought a hard disk-based machine (instead of floppy-based), and we would have bought a copier instead of going next door for copies. If you don't have money you become creative.

It sounds stupid, but the problem most of those venture-funded companies have is they are spending someone else's money and they are spending it for dumb things. You know a company called DayFlo? Their ads say, "Garbage in, information out." They paid \$35,000 for a company to tell them that they should change their name from Gilchrist Software to Dayflo.

Ashton-Tate paid \$250,000 to produce the ad for dBASE III. (You know, "Turn the page, we're going to do a number on you.") That was just for the artwork.

**How To Do Ads**

Don't use ad agencies. First, when they place ads, they take 15 percent on top of what they pay the magazines. Second, they don't know what the hell software or hardware is. Then they'll hire a graphics person and charge you 25 percent more than they pay out.

So you should do what we do: handle everything in-house. We do the ads, layout and placement. We use friends who are good graphics people. They make more money, we lose less money and ev-

erybody's happy. You know what you want so you can do just as well as an agency.

There are two advertising routes for starting out. If there is one magazine you should advertise in, it is Byte. Their figures are true: it is really read by 400,000 people world-wide. When the ad breaks in Byte we can see our response go up like crazy and 10 days later we see the response going down. We're in 18 magazines now. Last month, AdTrack reported we were the software company advertising the most. The reason is that we are mostly direct mail.

The other magazines that pay to advertise in are the special interest group publications like Micro Cornucopia and the Boston Computer Society magazine. Readers of these magazines are usually knowledgeable people who recognize a reasonable product at a reasonable price.

**Products We're Looking For**

Since we work on compilers, there are areas that we don't have time to work on, or we don't have the right expertise. We'd love to have a dBASE 4 or a Framework for \$49.95. If we don't do it, someone else will. We'd be happy if someone wanted to do it and work with us. We'd love to do a big trick on Ashton-Tate or Lotus.



# FREE

## CATALOG

### KAYPRO USERS DISKS for Kaypro II, 4 and 10 \$12<sup>00</sup> each

**KayPro Disk K1**  
Modem software  
**KayPro Disk K2**  
Utilities

Really oodles of spiffy little (and big) programs to help you get full use of your KayPro.

**ZESOURCE.COM:** A true Zilog format disassembler for 8080 and Z80 object (.COM) files. Now you can turn .COM files into .MAC files.

**UNERA.COM:** Simply enter "UN-ERA" followed by the name of the file you just erased and presto, the erased file is back! A lifesaver.

**FINDBD54.COM:** Checks an entire disk, reports bad sectors, and then creates a special file containing those sectors. You save a bundle on disks.

**CATZ:** This a group of programs which create and maintain a single directory of all the programs you have on all your disks. Even keeps track of which programs are backed up and which aren't.

**UNSPPOOL.COM:** Use your KayPro II and print files at the same time. Doesn't slow down system response!

**DUMPIX, DU-77, COMPARE, SUPERSUB, FORM-FEED, DIR-DUMP, ...** and all have documentation on disk.

**KayPro Disk K3**  
Games

**KayPro Disk K4**  
Adventure

This disk contains one 191K game, Adventure. **ADV.COM:** This is the latest, greatest, most cussed adventure ever devised by half-mortals. This is the 550-point version so the cave is greatly expanded and the creatures are much smarter.

**KayPro Disk K5**  
MX-80 Graphics

**KayPro Disk K7**  
Small C Version 2 Compiler

**KayPro Disk K9**  
ZPCR

**KayPro Disk K11**

**Library & Checkbook Programs**

**CHECKS:** This has been a very popular group of programs. Categorizes checks so you can keep track which are tax deductible and which get charged to which projects. Includes source and excellent example check files. Very powerful.

**LIBR:** This is a complete set of library routines which let you group files into a single file called a library. Then CP/M sees them as a single program, but with the library routines, you can list them out separately, run them separately, or divide them up again. Almost like a unix environment.

**DISPLAY, VLIST, PGLST:** Additional screen and print utilities.

**KayPro Disk K12**  
FORTH

**KayPro Disk K13**  
Source of fig-FORTH

**KayPro Disk K14**  
Smartmodem Programs

**KayPro Disk K15**  
Hard Disk Utilities

**KayPro Disk K16**  
Pascal Compiler

**KayPro Disk K17**  
Z80 Tools

**KayPro Disk K18**  
System Diagnostics

Just as we finished editing the routines on this disk, we received a copy of KayPro's diagnostic disk. The memory test and drive exercise routines on this disk are more powerful than KayPro's versions. (Plus, it's only \$12!) Setup for KayPro II and 4.

**KayPro Disk K19**  
Prowriter Graphics

**KayPro Disk K20**  
Color Graphics Routines

**KayPro Disk K21**  
SBASIC Routines & Screen Dump  
**SBASIC:** Finally a disk of SBASIC software. There are some good examples of structured programming on this disk (including one program written both ways so you can see the difference).

**SCREEN DUMP:** This is a screen dump for all Kaypro new and old. You can buy a similar package elsewhere for \$60.

**KayPro Disk K22**  
ZPCR (Again)

This disk is filled with ZPCR files. You get ZPCR for the Kaypro II, Kaypro 4, and the Kaypro 10. This version is fixed so that you can pass control characters (such as cntl-P) to the system and you can choose to have it recognize the semi-colon for drive select (as well as the colon). So you can enter "B;" or "B:" to select drive B. Super neat! ZPCR, for those of you who don't know, makes CP/M a lot friendlier. It searches drive A for any .COM file it doesn't find on the current drive, the TYPE command scrolls text 24 lines at a time, and a new LIST command outputs a file to the printer.

**KayPro Disk K23**  
Fast Terminal Software & New BYE

**KayPro Disk K24**  
MBASIC Games & Keyboard Translator

We sifted through many, many games before coming up with these gems. All will work on any Kaypro and all come in MBASIC source.

**USOPEN** shows you the fairway on the screen. You select the club and direction for each stroke. After you reach the green the display shifts to show details of the green and flag. For one to four players.

**DUCK** is an offshoot of aliens (pardon the pun). Hunter tries to shoot down ducks while ducks try to bomb the hunter. [Much fairer than real life.]

**CASTLE** is an adventure in which you select your attributes (strength, dexterity, and intelligence) and you get to purchase arms and protection. Great documentation and very interesting game.

**KSTROKES** is a keyboard translator similar to Smartkey. Bill Forbes did an excellent job creating this program. You can create and save translation files on disk. The program even includes a table which generates WordStar commands from the Kaypro's keypad! You can define 8 keystrokes at up to 63 characters each.

**KayPro Disk K25**  
Z80 Macro Assembler

**KayPro Disk K26**  
EPROM Programmer & Character Editor

**KayPro Disk K27**  
Typing Tutor

A complete typing tutor for beginners and experts. Written in Australia, it comes complete with source. This was customized for Kaypro II, 4 and 10 by Barry Cole of WLAKUG.

The documentation says you can learn to touch type in 8 hours (probably a little longer for mortals).

**KayPro Users Disk K28**  
Modem 730

**DISK \$12.00 ea.**  
**postage paid**

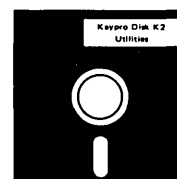

Write or call  
for a free catalog  
(also included with each order from)  
**MICRO CORNUCOPIA**

P.O. Box 223  
Bend, OR 97709  
503-382-8048



9-5 PST Monday-Friday

# PRICELESS

## UPGRADES

### Schematic Packages

Finally, a complete schematic for your portable Kaypro, logically laid out on a single 24" by 36" sheet, plus a very complete illustrated Theory of Operation that's keyed to the schematic. You'll get detail information on your processor board that's available nowhere else.

For instance, those of you with the 10 and new 84 systems get a thorough rundown on your video section complete with sample video control programs in assembly language and Pascal. Of course, all packages contain serial and parallel port details and programming examples as well as complete coverage of the processor, clock, I/O, and disk controller (information that is not even available in Kaypro's own Dealer Service Manual).

### Kaypro Schematic Packages

Kaypro II & 4 (pre-84) ..... \$20  
 Kaypro 10 (pre-84) ..... \$20  
 Kaypro 84 series (II & 4) ..... \$20

### Special Offer!

Your First Schematic Package (If you also order subscription) ..... \$10

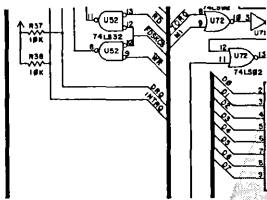

## ROM'S from Micro Cornucopia

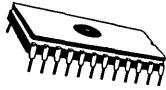

There are two ROMs in each Kaypro, a monitor ROM and a character ROM. The Monitor ROM supplies information for the Z80 processor on such things as how to get information from the disk drives, and which character to use as a cursor. The character ROM works entirely in the video circuit and it determines what the characters look like on the screen (for instance, does the "P" have a high, small cross bar, or a lower, longer one of the Micro C character ROM). When you speed up your Kaypro, you are speeding up the character ROM. Since the monitor ROM tells the processor how to do disk accesses you are going to have to change that ROM in order to upgrade to larger drives.

### Pro-Monitor II for Kaypro II

1. This ROM is a fast part so you can run 4 or 5 MHz with your Kaypro II.
2. It gives you a non-blinking block cursor (much less irritating), though you can specify a standard blinking cursor.
3. It does faster disk accesses (even if you don't speed up your system).
4. It throws away null characters (those little asterisks that sometimes garbage the screen during data communications).
5. Includes complete printed instructions for simple plug-in installation (takes 5 minutes).

### Pro-Monitor 4 for Kaypro 4

1. Non-blinking block cursor.
2. Faster disk accesses.
3. Throws away null characters.
4. Complete printed instructions for simple plug-in installation (takes 5 minutes).

### Pro-Monitor 8 package for Kaypro 4

1. You get 784K per disk with quad density (96 tpi, double sided) Tandon 100-4 (or equivalent) drives.
2. You can use any combination of Tandon 100-1 (Kaypro II), 100-2 (Kaypro 4), or 100-4 drives as drives A and B.
3. You can boot from any disk with normal system tracks (Kaypro II, Kaypro 4, or Kaypro 8). The disk needs no modification.
4. You can choose any character (including space) as a cursor and you can choose to make the character blink or not blink. Plus, you can change the cursor at will.
5. You get a disk which contains a new copy routine for copying and formatting 784K disks, and a drive diagnostic routine for checking out the quad density drives.
6. You get complete printed instructions for installation of ROM and drives (takes 10 to 15 minutes).
7. The installation requires no cuts or jumpers, everything simply plugs into a Kaypro 4. (If you have a Kaypro II, see the modification article in Micro C issue 15 to turn your II into a 4.)

### Pro-Character ROM (for Kaypro II and 4)

The character ROM gives you a nicer looking character set. Kaypros have come with two different character ROMs, the early character ROMs had a rotten g, y, q, f, and t as well as commas and semi-colons that were hard to tell from periods and colons. On the newer systems (manufactured since Sept 83) half of the characters (notably the g) have been improved, but they haven't gone all the way.

### The character ROM comes in two flavors:

1. The standard Greek Pro-Character has the nicer character set plus the standard Kaypro Greek characters.
2. The Clean Pro-Character has the nicer character set but no Greek characters. This is the ROM for people who get strange Greek characters on the screen when interfacing with Mainframe systems.
3. Complete printed instructions for simple plug-in installation (takes 5 minutes).

Note: These ROMs will not work in the Kaypro 10 or the latest Kaypro 4 with graphics (it contains the Kaypro 10 board). We are working on new ROMs for these systems.

### Prices:

Pro-Monitor II	29.95
Pro-Monitor 4	29.95
Pro-Monitor 8 (package)	49.95
Pro-Character (either Greek or Clean)	29.95
Pro-Set II (Pro-Monitor II & Pro-Character)	55.00
Pro-Set 4 (Pro-Monitor 4 & Pro-Character)	55.00
Pro-Set 8 (Pro-Monitor 8 package & Pro-Character)	70.00

### PLUS-4 Decoder Board

With this nifty little plug-in board, your Pro-8 ROM can access up to four 5 1/4" drives. You just plug a four-drive 34-pin cable into this board and you can add up to two additional drives.

Now you can run any mix of 191K, 390K, and 784K drives as drives A, B, C, and D. You can run your original drives as A and B then add 380K or 784K drives outboard as C and D. You can even run four half-wides inside your original Kaypro!

The Plus-4 Decoder Board for only \$39<sup>95</sup>  
 Watch for 4-84 and 10-84 compatible ROMs coming soon.

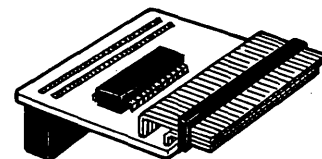

## Micro Cornucopia

P.O. Box 223

Bend, OR 97709

(503) 382-8048 9-5 PST • Mon-Fri.



# More Goodies From Micro Cornucopia

BB I, BB II, and XEROX 820 USERS DISKS

The following are full 8" disks of software. Each program has a .DOC (documentation) file and many come with source.

**8" Users Disks \$15.00 each**

## USERS DISK #1

- 1-Two fast disk copiers
- 2-The manual for Small C+
- 3-Crowe Z80 Assembler
- 4-Two disk formatters
- 5-Modem 7
- 6-Othello
- 7-Serial print routine-Port B

## USERS DISK #2

- 1-Two single disk drive copy programs, both with source
- 2-Crowe Z80 Assembler source
- 3-New Crowe.COM file, debugged version
- 4-New CBIOS with parallel print driver & other extensions for CP/M 1.4 & 2.2
- 5-Disk mapper with source

## USERS DISK #3

- 1-EPROM burning software for BB 1
- 2-Reset bit 7 (in WordStar a file)
- 3-Disk file CRC checker
- 4-New fast copy program & source
- 5-DU77, disk inspector/editor
- 6-FINDBAD, isolates bad disk sectors
- 7-Print fancy page headings

## USERS DISK #4

- 1-CBIOS, custom bios for Tandon drives
- 2-ZCPR, dynamite CCP checks drive A for missing .COM files; improved commands
- 3-ZCPRBLOC, identifies CCP location

## USERS DISK #5

- 1-CAT, disk cataloging routines
- 2-Modem 7 for Port A
- 3-Modem 7 for Port B
- 4-PACMAN, the arcade game
- 5-FAST, buffers the disk to speed up assemblies
- 6-NOLOCK, removes BB 1 shift lock
- 7-VERIFY, cleanup & verify a flaky disk
- 8-DUMPM, enhanced for BB 1
- 9-UNLOAD, create .HEX file from .COM file

## USERS DISK #6

- 1-REZ, 8080/Z80 disassembler, TDL mnemonics
- 2-PRINTPRN, prints Crowe listings
- 3-RUNPAC, run-time utility package for 8080 assembly language programs. Has 51 functions. Includes source which assembles under ASM.

## USERS DISK #7

- 1-CHNGPFM, PFM monitor mods
- 2-TERM, terminal routines let you set up BB as simple terminal, as a file receiver, or as a file sender
- 3-Checkbook balancing package
- 4-Disk Utilities - copy to memory, from memory, and dump.

## USERS DISK #8

- 1-BDSCIO, custom BDSC I/O for BB 1 (both .h and .c)
- 2-YAM, Yet Another Modem program in source & .COM form. Turns BB into paging intelligent terminal, complete with printer interface, baud rates to 9600.
- 3-ROFF, text formatter
- 4-SIGNS, prints large block letters

## USERS DISK #9

- 1-ADVENTURE, expanded 550 pt version
- 2-Keyboard translation program
- 3-CBIOS, serial & parallel printer interface
- 4-EPROM programming package for BBII, for 2732s only

## USERS DISK #10 - Lots of Disk Utilities

- 1-REBOOT, sets up the CP/M auto load
- 2-SWEEP, directory/file transfer routine
- 3-A, Lets BB I recognize a double sided drive as one drive with 494K of usable space
- 4-FIX, super disk utility, does everything, much easier to use than DU77
- 5-Compare files routine
- 6-UNERA, retrieve erased files
- 7-FIND, check all drives on system for a file
- 8-MENU, menu program for CP/M
- 9-NEWCAT, enhanced disk catalog program
- 10-Single drive copy program that does track by track copies rather than file by file

## USERS DISK #11 - Printer Utilities

- 1-Microline 92 printer routine
- 2-Graphics display package for MX-80 with Graftrax, very fancy
- 3-Epson MX80 setup for BB 1 with 59.5K CP/M
- 4-Epson MX8 setup for any CP/M, lets you set print modes.
- 5-Micro Tek print driver, Ports A & B

## USERS DISK #12 - Games for BB I

- 1-ALIENS, a fast, exciting arcade game
- 2-ZCHESS, chess with a 1-6 level look ahead
- 3-MASTERMIND, match wits with the computer
- 4-BIO, Biohythm charts complete with graphics on the BB I
- 5-LIFE, so fast it's real animation!
- 6-CRAPS, see how much you'd lose in Vegas
- 7-WUMPUS, a caver's delight, kill the Wumpus or be killed
- 8-PRESSUP, similar to Othello
- 9-Games, 7 games in one program, includes blackjack, maze and animal

## USERS DISK #13 - General Utilities, BB 1

- 1-ZZSOURCE, disassembles to real Zilog mnemonics
- 2-EX14, superset of submit or supersub
- 3-MOVPATCH, lets you use MOVECPM on other copies of CP/M
- 4-XMON, 3K expanded BB I monitor, use in ROM or as overlay
- 5-CURSOR, prompts you for cursor char you want
- 6-UMPIRE, very fancy RAM test
- 7-ZSIDFIX, display improvement for ZSID
- 8-PIPPAT, modify PIP so you can reset system from within PIP
- 9-@, Lets you use the BB as a calculator, including HEX
- 10-SORT, sort package written in C80.

## USERS DISK #14 - BB II Software

- 1-PRO32, latest 2732 reader & programmer
- 2-SMODEM2, lets BB II talk to Hayes Smartmodem
- 3-GRAFDEMO, demonstrates BB II graphics (in BASIC)
- 4-ATTRTEST, demonstrates BB II graphics (in JRT Pascal)
- 5-INITSIO, initializes port B for 300 or 1200 baud
- 6-MENU, displays menu of .COM files, enter number to run file
- 7-SETCLK, sets realtime clock built into BB II
- 8-PRINT2, modified print which accesses BB II clock
- 9-BOX, draws a thin line box on screen determined by HL and BC
- 10-ALIENS, space invaders arcade game
- 11-LISTSET, printer interface, auto-enables RTS, ignores DCD.

## USERS DISK #15 - Word Processing

- 1-EDIT, very fancy line editor similar to EX (Unix). Includes help menu, programmable key, and full manual on disk.
- 2-TED, simple minded line editor, easy to learn & use. Very fast.
- 3-TTYPE, typing training program written in BASIC
- 4-TINYPLAN, very simple-minded spreadsheet. Whets your appetite for a fancy one.
- 5-C80 Text Utilities
- 6-CHOP, cuts off file after N bytes
- 7-ENTAB, replace spaces with tabs where possible
- 8-MS, double or triple spaces a file to output
- 9-RTW, removes trailing spaces from file
- 10-TRUNC, truncates each line to specified length
- 11-WRAP, wraps at column 80, plus pretty pretty printing, page #s . . .

## USERS DISK #16 - BB I Modem Software

- 1-RCPM27, list of U.S. bulletin boards
- 2-SMODEM, interfaces BB I with Hayes Smartmodem
- 3-PLINK66, easy to use with non-CP/M host, for port A
- 4-BBPAT, menu selection of BAUD rate, bits/char, parity, & stop bits
- 5-MODEM 7+, Modem 7 plus BBPAT, lets you talk to anything from port A

## USERS DISK #17 - Small C version 2

SMALLC2, this substantially expanded version of Small C now includes for, goto, label, switch (case); external declarations; new preprocessor commands; expanded I/O includes redirection; initializers; plus 12 new expressions. The I/O and runtime libraries have been greatly expanded (including printf). Source & documentation on one full disk.

## USERS DISK #18 - FORTH

IFORTH, this is Idaho FORTH which can be burned into ROM or loaded from disk. It replaces the PFM monitor & handles all the monitor functions. See issue #11 FORTH column for more info about IFORTH and this disk.

## USERS DISK #19 - BB I Double Density

New BB I Monitor, BIOS, character ROM, Winchester Interface, ZCPR, and formatter from Trevor Marshall. See BB I expansion article in Issue #11.

## USERS DISK #20 - Assemblers

**CROWEASM:** This is the Crowe assembler modified so that it runs on any CP/M system (including the BB I, BB II, Xerox . . .). Includes .COM .Z80 and .DOC files.

**LASM:** This assembler is similar to the ASM that comes with CP/M except that it can link files at assembly time.

**PRINTPRN:** Print routine for CROWEASM.PRN files.

**LIBRARY:** Utilities which let you combine many files into one, then you can run, type, or extract any file within the larger system.

## USERS DISK #21 - Winchester Utilities

**BACKUP:** Helps you back-up the winchester onto multiple floppies. Creates a catalog of the files on each disk and includes the date of the latest backup. Will not back-up an unchanged file more than once. Plus many more super features.

**FLOPCOPY:** Lets you make floppy copies (with only one floppy drive) by using the winchester as a buffer.

**BIGBURST:** Backs up a very large winchester file onto multiple floppies. Joins the copies to recreate the original file.

**MULTCOPY:** Use this like PIP but it prompts you to change disks. Accepts ambiguous file names.

**MDIR:** Displays files in all user areas on selected drive. Many features.

**MAKE, MOVE:** PIP-like utilities that make it easy to move files between user areas.

**SWEEP:** The famous disk cleanup and transfer routine that does just about everything you can do with TYPE, ERA, DIR, and PIP.

**UNSQ:** This is the latest, greatest file unsqueezer. Enter UNSQ \*.\* and it will check every file on the disk. All squeezed files will be unsqueezed.

## USERS DISK #22 - Pascal Compiler

This is a real Pascal compiler. It supports only a subset of the language (no records, pointers, booleans, reals or complex) but it generates a real .COM file. Everything is on this disk: the compiler, its source, example programs and documentation.

## USERS DISK #23 - Xerox Utilities

This disk contains Xerox specific utilities including a screen dump from Wayne Sugai (with source); modifications for the SWP package including ZCPR, a new monitor, and a clock/calendar from Mitch Mlinar; and Jim Mayhugh's new monitor (see issue 19). A very special disk for Xeroxers.

## USERS DISK #24 - Prowriter Graphics

This is a complete Prowriter printer graphics package written by the same Micro C subscriber who wrote the MX-80 graphics package. Plot points, lines, circles, boxes, and more. Examples, documentation.

## USERS DISK #25 - Z80 Macro Assembler

This is a real Z80 macro assembler! Syntax closely follows RMAC and MAC. Also includes pseudo-ops to support conditional assembly etc. No phase or relocatable code.

## USERS DISK #26 - BBII CP/M 3.0 Banked BIOS/ Winchester Support

CP/M 3.0 Banked BIOS implementation for the BBII. Roy Epperson's software to support the Adaptec ACB-4000 SCSI and the Rodime R204 5" Winchester on the BBII (see issue #19). Plus more Winchester programs.

## USERS DISK #27 - BYE Remote CP/M System

BYE programs to run your BB I, BBII, or XEROX 820-1 as a remote CP/M system using a Hayes Smartmodem compatible modem. Includes programs to allow restricted access.

## USERS DISK #28 - VFILER and

### Extended Single Density

VFILER is a screen-oriented file manipulation utility, similar to SWEEP, CLEAN, and DISK. Also, Larry Blunk's documentation and software for implementing extended single density (334K) on eight inch disks.

# Fire In the Valley

Book Review By Charlie Berry

Rt. 8, Box 6A  
Chapel Hill NC 27514

The book *Fire in the Valley* is the story of the microcomputer and its development. This new book captures the excitement of the early 1970s when engineers were engineers and hobbyists were hobbyists and they worked together to create a computer revolution.

Authors Freiberger and Swaine have written a series of short vignettes, each a self-contained insight into the people and events that shaped (and are still shaping) this incredible field.

## Early Hardware

Two magazines, *Popular Electronics* and *Radio Electronics* were most instrumental in spreading the word on the new hardware. On July 1974, *Radio Electronics* published an article on the Mark-8 computer (based on the Intel 8008 chip) complete with plans. *Popular Electronics* made its entry into this field in its January 1975 issue with a cover story on the Altair computer (based on the newer Intel 8080 chip).

It turned out that the Altair on the cover of *Popular Electronics* was actually an empty box (sound familiar?). A shipping problem prevented the first Altair from arriving in New York on time.

The Altair was available in kit form from MITS, a struggling Albuquerque electronics company. (MITS had almost lost its shirt a year before when the bottom dropped out of the calculator market.)

Of course, once the article ran, MITS was deluged with orders. Their delivery was slow, their quality was poor, and their service was nonexistent. However, hobbyists were ecstatic. MITS lasted only a couple of years—it was killed by its undependable product and a gaggle of new competitors.

## Early Software

Alan Cooper and Keith Parsons wanted to write an accounting package to run on the early Altair computer. When they found Gordon Eubanks, the Navy man who had written BASIC-E (and released it to the public domain), they proposed that he and they get together and really upgrade the language.

The development of Eubanks' new BASIC was a crash project with sessions often running until 3 a.m. Alan Cooper

would say something like, "Why don't you put a WHILE loop in?" Gordon would answer, "Sounds good to me," and they'd put it in.

Then Cooper and Parsons set out to make \$50,000 a year (their goal) by founding Structured Systems Group, and writing business software (in CBASIC of course) for new Altairs. Their first ad was primarily for CBASIC but it contained a small mention of a \$995 general ledger package at the bottom.

They figured that the only response to the ledger package would be complaints that it cost three times as much as the Altair. When they got their first order for the business software, they made a copy of the ledger program, inserted it and the manual in a zip-lock bag and shipped it off. Before they knew it, back came a check for \$995. So Cooper and Parsons took the whole staff (what there was of it) out for pizza.

Three weeks later, another order arrived and there was another pizza. In fact, the pizza ritual continued for two months, but eventually, with people sending in checks for thousands of dollars, they had to quit the custom. They were getting tired of pizza for breakfast, lunch, and dinner.

Part of their success could have been the casual atmosphere at Structured Systems. For instance, Parsons' girlfriend made phone sales while sunbathing nude in the yard behind their "office." (And that's the true skinny.)

## Conclusion

*Fire in the Valley* captures the spirit and history of the microcomputer world as well, I believe, as *The Soul of a New Machine* described the world of Data General. It is fascinating reading.

## Fire In The Valley

By Paul Freiberger and Michael Swaine  
Published by Osborne/McGraw-Hill  
ISBN 0-88134-121-5  
\$9.95



# CP/M 86

8" CP/M-86 Disk \$15.00 each

## DISK 86-1 — Disk Utilities

D.CMD/A86, SD.CMD/A86, XDIR.CMD/A86: Three extended directory programs. Each does it differently, so we included all three.

FILE-EXT.CMD/A86: Disk status program with good display format.

PAGE.CMD/A86: A text paging program. Displays 24 lines at a time.

PRINT.CMD/A86: File printing routine. Puts a header at the top of each page along with page number and file name.

MUCHTEXT.CMD/A86: Counts words and lines in a text file.

ERQ.CMD/A86: Selective file erase program. Displays all selected files and then asks you one at a time for a Y/N.

INUSE.CMD/A86: Prints "In Use" on your terminal and asks for a password. It will not release the console until you enter the password.

FINDBAD.CMD/A86: Finds and collects bad sectors on a disk. If there are no bad sectors, information on the disk is unaltered.

## Disk 86-2 — DU and Modem Programs

DU-V75.CMD/A86/DOC: This is the popular disk utility from CP/M 80. It lets you read, write, and modify disk sectors.

MODEM4.CMD/A86: This is a modem program set up for the Slicer. This program includes a built-in help file.

MODEM7SL.CMD/A86/DOC: No modem disk would be complete without this standard. This is modem 7 set up for the Slicer. It displays a menu when it is called.

## Disk 86-3 — Small C

C86.CMD: This is the original Small C compiler which appeared in Dr Dobbs Journal in 1980. It runs under CPM-86 and generates 8086 source for the ASM86 assembler.

C86.COM: This is the C86 compiler which runs under CPM-80. This 8080 program produces 8086 assembly language.

C86LIB.A86: This is the C86 I/O library.

SMALLC86.DOC: Documentation on Small C.

C?????.C: Source of the C86 compiler.

## DISK 86-4 — IBM Mainframe Interchange/ RESOURCE 8086

XBIOS.A86: A new BIOS that supports a real time clock.

RES86.CMD: A disk management program for transferring files between CP/M-86 and IBM 374X mainframe environments.

SDI86.CMD: An 8086 version of the RESOURCE disassembler.

## DISK 86-5&6 — FIG Forth

Disks 5 and 6 are a complete two disk set of FIG Forth 83.

F83.CMD: The standard Fig Forth 83.

META86.CMD: The Forth compiler.

More ROMs: Fast monitor ROMs for speed freaks and our famous 'better than Texas' character ROM (V2.3) for screen freaks.

Fast Monitor ROM BB1 ..... \$29.95

Deluxe Character ROM BB1 ..... \$29.95

## BB II DRIVE INTERFACE

For 5¼" and 8" Drives

Andy Bakkers is making this special software package available through Micro C. Complete source, HEX, & documentation files on an 8" SS SD disk. Also outlines on disk the hardware changes needed.

\$29.95

## Micro Cornucopia

P.O. Box 223  
Bend, OR 97709  
503-382-8048

9-5 Pacific Time  
Monday-Friday

the subject. He is one of the founders of SIG/M, the largest, most active purveyor of public domain software in the world.

Dave Hardy, the S-100 columnist for Microsystems, will also be switching his column over to Micro C. Microsystems was the only magazine I am aware of which supported this very technical group of folks. It will be great to have Sol and Dave with us. Each brings a wealth of expertise to Micro C.

I have been calling Micro C the "Single Board Systems Journal" to let people know that we didn't support bus type systems like the S-100. After all, Microsystems was supporting them. Now that Microsystems is no more, I guess we'll have to be the "Single Board (and More) Systems Journal."

### Is The Computer Hobbyist Dead?

Initially, most micros were built by their owners. Now that percentage is very very small and getting smaller. Much smaller. Who is willing to build a system when it's cheaper simply to buy one? (I, for one, am certainly willing to build.)

Sol mentioned that great numbers of technical hobbyists used to build their own radios (I built my own two-transistor radio in 1959; the parts cost about \$15). He pointed out that very few people are building AM transistor radios nowadays.

He feels that computer hobbyists are heading in the same direction. In time, the Big Boards and Slicers will no longer be available as kits and people will no longer be interested in upgrading their Kaypros by modifying the hardware.

Over the long term, he may be right. I have no desire to dig into a \$3.95 Japanese AM radio. And if I had a \$29.95 lap computer that were as tightly packed with parts as a radio, I might not be willing to spend a week trying to add a second serial port.

However, there are those of us who are very interested in modifying and building our own systems. Perhaps we are a minority, but minorities have their rights, too, and I think the S-100 folks might make interesting compatriots.

### RIP More Magazines

Microsystems isn't the only publication to byte the dust this month. It's just

the most significant to me. Microcomputing and PC-Jr have also gotten thumbs down from their corporate fathers and everyone keeps saying we've only seen the tip of the iceberg. I won't miss Microcomputing (a Wayne Green mag) or PC-Jr (another Ziff-Davis piece).

Newsstand sales have dropped very significantly this year, with some newsstands dropping computer pubs altogether. I understand that even Byte's newsstand sales have dropped by 20 percent since spring.

We started nosing around to see if one of the regular distributors would be interested in distributing Micro C, but it doesn't look promising. A few computer stores are carrying Micro C and we have gotten reports that some of them have sign-up sheets so anxious customers can be guaranteed a copy. (You'd think they might subscribe, wouldn't you?)

For large magazines, even a slight drop in circulation is very important because large circulation woos advertisers, and magazines count on advertising revenue for their survival. (Most of the subscription money gets hijacked by their subscription services.)

Anyway, things are fine as long as those big magazines are growing, but if circulation declines, advertisers start dropping out (and those that stay insist on paying less). So the exponential growth in revenue can somersault into an exponential death curve.

### No Culture

I'm beginning to wonder if the demise of computer magazines (and a recent decline in computer sales) may be due to something no one has dealt with. It's possible that the general public is just getting tired of technical this and technical that. What they really want is some culture.

So I took a close look to see if there were any way we could add some culture to Micro C. (I know that we are too technical to appeal to everyone who buys a computer, but with a little culture we would appeal to many of those who refuse to buy a computer.)

How many computer magazines have even considered the needs of this audience? (Of course, a number of computer mags are doing their best to disinterest those who have already bought computers, but that is a different task.)

Anyway, I started nosing around to see if we could come up with some culture that would fit in Micro C. In the process I found out that: Culture is often dry and dull. Culture usually wears three-piece suits. Culture sometimes lives in petri dishes or on old bread. Culture is very old. Culture is hard to understand. Culture has no obvious value. However, I have also noticed that culture can be quite humorous (but only accidentally, of course).

So, I'm making a commitment to culture. There is a Culture Corner in this issue and I see it as an off-again, on-again, off-again sort of thing. (Does that mean it's an irregular feature?) Anything non-technical (especially anti-technical) is fine just as long as it has some culture.

### Renewals Fold

Actually there has been an increase in renewals (folks have been increasing them right before inserting them into the envelopes), but a few have complained about the size of the renewal form (very large) versus the size of our return envelope (very small).

After a number of folks wrote to us indicating that their most difficult design project was getting their completed renewal form into our envelope I decided to come up with a definitive procedure to handle this important task and I have tried to document it to military specs.

### Insertion Procedure:

1. Fold renewal form in half (reduces it from 8 1/2 by 11 to 8 1/2 by 5 1/2).
2. Fold the result in thirds (reduces the form to 2 5/6 by 5 1/2).
3. Insert folded piece into envelope.
4. Make sure payment is enclosed (the most important step).

### Uninsertion Procedure:

1. This procedure is classified.

### Cheap Hard Drives

Bill Siegmund is an expert on two subjects, the BBII and the winchester drives, so I called him after a Hamilton-Avnet salesman came through.

Xebec has announced the Owl, which is a 5 meg winchester with a built-in winchester controller. Xebec has not announced the price but Bill thinks it will be in the \$500 range. Well, that doesn't



sound too bad until you hear the rest.

First, standard Xebec controller cards are showing up on discounters' shelves for a little over \$100 each, 603S 10 meg drives are selling for about \$395, and 5 meg Seagate units are going for around \$200.

Now, don't call Bill and ask him where to get the drives. Different surplus shops have them at different times. The best way to locate these units would be to watch Computer Shopper or start asking around in your local CP/M user group for the names of the local surplus shops.

The surplus houses (such as Cascade Electronics or BG Micro) purchase overstocked materials from original manufacturers. For example, they have drives at incredible prices as long as they last, but when they run out, they may not have drives at all for a while.

A lot of computer manufacturers have gone out of business lately and those that are still going are dumping their 5 meg drives and going to 10 or 20 meg.

#### Caveat Emptor

Bill feels that Adaptec makes the best controller, but it sells for over \$200. The original Xebec S1410 controllers are generally available for \$140. The S1410 really set the interface standard for controller cards. Shugart came out with a copy of the S1410 called the SA1410 but the early Shugart units had some timing problems that made them less than compatible. Shugart later replaced these early units with truly compatible versions (but beware of super deals on early Shugart controllers).

#### Meanwhile

Everything is in an uproar in the winchester world. Dysan is trying just to keep its head above water and a lot of the little companies that depended on Dysan to purchase their little sub-assemblies have gone under.

The standard practice now is for drive manufacturers to design and prototype their new drives in the U.S. Once they are sure the design is sound and the units are manufacturable, they move production overseas. In a very short time they have boat-loads of new drives showing up on Pacific docks.

If the drives don't sell because of manufacturing problems or lack of market, then they get scrapped or sent to surplus dealers.

Bill is looking forward to getting some of the new 3.5" 10 meg Rodimes. He says Compaq and Televideo have been soaking up all the production so far, but Televideo has been doing very badly (manufacturing problems and poor acceptance) so its allocation may soon show up on the open market. He also said he's watching to see if Seagate is going to start manufacturing its 100 meg drives. The price should be around \$1600.

#### Technical Help

In small companies like Micro C, all technical help comes from the technical staff. If we were to answer the increasing number of technical calls all day long, we wouldn't finish any new designs and we wouldn't get a chance to write or edit technical articles.

So, we are taking technical calls between 9:00 a.m. and 12:00 noon Pacific Time, Monday through Friday. Alice, Tracey, Dorcas, and Cary do their best to answer questions you have about our products, but if you need a definitive answer about a burning question, try us in the mornings. (Please note that though our answers may be definitive, that's no guarantee they are correct.)

#### Another Single Board Computer

The Servo 8 is a new, very compact single board system, which, like the Little Board, fits onto the side of a 5 1/4" drive (just as the original BBI fit onto the side of an 8" unit).

The Servo 8 is a 64K, 6 MHz Z80 system with a 1793 floppy disk controller. It supports four 5 1/4" and four 8" drives simultaneously. It also has a SASI interface, a connector for Mitsubishi 1.6 M-byte drives, a real time clock, two serial ports (150 - 153.6K baud), one centronics port, and an expansion bus. The Servo 8 requires only +5V at 1.4 amps. Like the little board, you must use an external monitor with the Servo 8.

An expansion board with 128K and additional ports is also available.

Price for the computer is \$495 (in onesies) with CBIOS object file. CP/M is \$70 extra (their cost).

For more information, contact Servo Computer Company, Box 566, Gold Beach OR, 97444. 503-247-2021.



## EXPAND YOUR PRO-TENTIAL

### • HARD DISK ADAPTOR

Allows you to add megabytes of storage. Easy to install. Includes complete software and documentation.  
\$95.00 single unit quantity.

### • CP/M 3.0 BIOS UPGRADE

Allows installation of CP/M 3.0 giving you a faster more powerful system.  
\$50.00 single unit quantity.

### • ALAN\* NETWORK

—local network for Kaypro® computers.

OEM/DEALER INQUIRIES WELCOME  
Quantity Discount Available.

Call to order or for information



\*ALAN is a trademark of Huntington Data Systems, Inc.

*Solutions that work. For you.*

**307 SIXTH STREET  
HUNTINGTON BEACH, CA 92648  
(714) 960-7498**

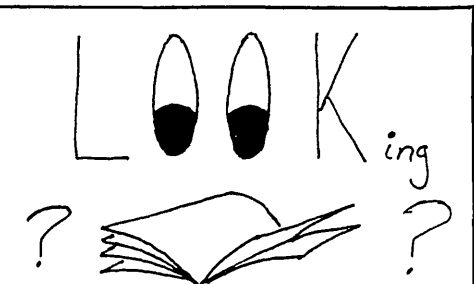

for an article in Micro Cornucopia  
... find it FAST with the Micro-C index!

\$29.95

(check or Money order)

gets you the Index, two games, a solar siting program, and a home heatloss audit program.

(Games, solar siting and heatloss audit program require MBASIC)

Formats: 8" SSSD or, 5" SSSD for Kaypro, Xerox, Osborne, Morrow, and Superbrain.

**SPECIAL!! HAYES COMPATIBLE 300-BAUD MODEMS  
\$155.00**

The Logical Connexion  
629 NW 10th  
Corvallis OR 97330  
(503) 754-8647  
5-10pm Pacific Time  
Monday - Friday

(MBASIC is trademark of Microsoft Inc.  
Kaypro is a trademark of Kaypro Corp.  
Hayes is a trademark of Hayes Corp.)

# LETTERS

(continued from page 3)

Dear Editor,

I just finished putting my system together and it works great. I am using the big board, a Power General switching power supply, an Electrohome monitor, a Jameco keyboard and two FD100-8 drives. It all worked the first time, without a single problem. I then added a solid state relay to the disk motors (Micro C #2) with no problem.

You may be thinking that I have been deprived of the debugging pleasure that is supposed to come with a big board project, but when I connected my H14 Heath kit printer, it did not work so which gave me several hours of pure joy.

I used E8BIOS.HEX on user disk #9 to set up serial port b for the heath printer. since I am a novice and don't really know what I'm doing, I just followed the instructions on user disk #2 to install it. It worked except that the printer uses an "XON XOFF" protocol and the bios on user disk #9 is using the CTS-RTS hardware protocol.

I created an "f.com" file just like the one on page 5 of micro-c #2. I set the baud rate at 300 which is slower than the mechanical speed of the printer that way the printer buffer never filled with characters. After using f.com for a few days, I decided to try changing the baud rate in the bios.

I used the PFM monitor and changed the baud rate byte from 07 (1200) to 05 (300). I then sysgened the code back onto drive A:

I also installed Wordstar so I could send you this letter. It works great too. I contribute the success of my project and this happy moment to Micro C. A novice would have a rough time without it.

**Dan Wise WA4BBU**

**RT 2 Box 914**

**Kings Mountain NC 28086**

Dear Editor,

I'd like to see someone come up with CPM 3 for the BB II (bank switched) I am quite sure I'm not the only one to think about this but I need help. Anyone want to help?

**Dr Andre Michel**

**Fac. Univ. N-D, Dept Chimie**

**Rue De Bauxelles, 61**

**B-5000 Namur Belgium**

Dear Editor,

As a deaf man with a BS in civil engineering, I consider a handicap something to be solved. I've come up with several ideas which could aid handicapped people, and I would appreciate feedback from Micro C readers.

First, someone might design a cursor controlled by the head or eyes. An old application of this is a special helmet worn by a weapons man on a plane or helicopter that points the weapon system in the same direction the helmet is pointing.

It would be even better if someone could develop something that could detect eye movement and eye blinks. Perhaps it could be a laser system of some sort.

While the idea above is especially applicable to quadriplegics, the second idea below, a computer terminal providing tactile feedback, is suited to the blind.

Sightless folks could stick their fingertips into a thimble-like solid state device which would provide braille feedback. I've considered several possibilities, including translating video into braille. If Micro C readers have questions about what I'm doing, or have any suggestions, I'd enjoy hearing from them.

**Scott Rich**

**1640 E. 1140 N.**

**Logan UT 84321**

Dear Editor,

Can you recommend any books for learning to use M80 and Mac? The manuals are impossible to understand.

**Reimar Goetzke**

**Box 543**

**Lynden WA 98264**

*Editor's Note:*

*Sorry! We don't know of anything specifically for M80. Since M80 is a Z80 or 8080 assembler, you might try some of the books on programming the Z80. This will give you a better perspective on how an assembler is used, making the job of learning M80 easier.*

Dear Editor,

My husband and I built a Xerox 820 and are interested in corresponding with others who have done the same. The system worked well for a while, but now we are having disk drive problems. We'd like to meet with other people from New York to compare problems and solutions.

**Robin and Louis Sommo**

**33 Bay 14th St.**

**Brooklyn NY 11214**

Dear Editor,

While my broken fingers are mending after trying to play "ALIENS" at 4 MHz, I'm writing to give a work of caution regarding CPU's.

I got an SGS Z80A in a "JimPack." With the cover off the Kaypro-II, it works fine at 4 MHz; but with cover on and the unit warm, it won't run with out bugging up the works even at 2.5 MHz.

Also at 4 MHz, my disk has seemingly unlimited capacity! Using D-COM to read the directory I find that no matter how much space I have used, I always have 195K left. Could this be my new PRO-MONITOR, or when I get a Z80B will the bytes left be correct?

A question for the "SLICER" guru's (oh, how I envy their smarts): will it be able to run programs for the Tandy 2000? It would be great to have a format supported by a major force in the field.

**Harvey DeGering**

**1245 E. Washington Blvd.**

**Pasadena CA 91104**

*Editor's note:*

*The problem is most likely with the Z80B. See the Issue 18 Letters Column. You might also need to replace the PIOs with PIO-As.*

Dear Editor,

Can I buy the debugger called SID and how about the price? If I use the LIST command will it show the Z80 mnemonics (DDT shows the 8080 code)?

**Michael Johansson**

**Tjadern 8**

**17562 Jarfalla**

**Sweden**

*Editor's note:*

*SID is available from Direct Software--see their ad in Byte magazine. You actually want ZSID for Z80 mnemonics but we're not sure where to get it. Try Digital Research of California.*

Dear Editor,

I have my BB mounted in an Ampex D80 terminal. It has an amber screen and looks really nice. I have been running the board at 4 MHz with UniFORTH for about 9 months and just got CP/M from Wilcox Enterprises. I've also ordered JRT Pascal. I'd like to hear from BB I users in the Grand Rapids area.

I have access to several D80 terminals in various stages of repair at reasonable prices.

**Kevin Tyrrell**

**1221 Colorado SE**

**Grand Rapids, MI 49506**

Dear Editor,

I enjoy Micro C very much although a good bit of it goes over my head.

I have a Kaypro II and I would like to make the great eight modification (issue #15). If I purchase your Pro-Monitor 8 package, would I still be able to add an 8" drive without having to kludge things together (keep in mind that I'm a relative beginner)?

**Clifford H. Taylor**  
1700 Leslie Ave.  
Las Vegas NV 89101

*Editor's note:*

*Dana's been doing a lot of work on the new versions of the PRO-8 package. First, there is the PRO-8+ disk which gives you the utilities you need when you add up to two additional 5" drives to the system.*

*Plus, we are working on another version that will allow you to add 8" drives. It will be compatible with the 8 upgrade.*

Dear Editor,

I would like to complement you on the Kaypro schematic which you are marketing. This week my Kaypro II failed at work. It had two problems.

First, I couldn't read data from the B drive, and second, my printer was losing characters, and sometimes whole words.

My dealer found a bad logic board on the B drive. That cost me \$135.

When I tried the Kaypro out at home, the print problem still existed. It was too late in the day to return it to the store, so I took it to work with me the next day to see what I could find out. I felt that this print problem might be software rather than hardware.

After exhaustively testing the software, I decided it was a hardware problem. Since I had access to test equipment and the dealer charged \$60 an hour for labor, I took a stab at doing my own repairs.

The minute I took the top off, I had five helpers; all technicians with the dreaded kibitz disease. We proceeded with a scope and your schematic and found that when the data was being output to the printer some of the signals weren't coming up to full voltage and then we lost sync. When this happened, the printer lost characters.

After 4 hours we located the problem. It was U73 the busy ret—from the printer. Apparently when the printer buffer was full, the busy was not properly halting the data flow. I replaced U73 with another 74LS04 that I purchased from a parts house for \$1 and the computer was back up.

There is no possible way that I could have attempted these repairs without your schematic and theory of operation. At the hourly rate the dealer was charging, I figure the net savings including the cost of the schematic was \$219.

Since I suspected that the cause was a power line spike, I built a line conditioner. It consists of three transient suppressors and a four-outlet power strip.

The parts can be purchased from Radio Shack for \$22. The suppressors are part #276-570 and are installed across all three leads of the power strip.

**R. F. Loftus**  
3156D Texas Ct.  
Great Lakes IL 60088

Dear Editor,

I really liked your lambastation (a shelter for young sheep) of the GTEK programmer. I bought a single EPROM programmer for my employer recently and avoided difficulties on the perfectly rational basis that the GTEK ad looked like it had been put together by kidnappers. I wound up purchasing the PROMPRO-7 for \$489 from Logical Devices, Inc., 1321-E N.W. 65th Pl., Ft. Lauderdale, FL 33309. It worked fine, had reasonable documentation, and had human beings to answer the phone.

**Gregor Owen**  
35 Admiral St.  
Port Jefferson Station  
New York NY 11776

Dear Editor,

My first issue of Micro C came today, and already you've moved me to take pen in hand. Issue 19, page 19, documented your woes with the GTEK gang programmer. I mused a bit, as I had received the same day a software upgrade for my trusty GTEK 7128. We seem to have different luck; perhaps different gnomes built our programmers, as mine is rugged and reliable.

Sounds like you got a GTEK lemon or two. And you didn't mention that their literature carries the repeated statement that "All GTEK products are fully warranted against defects in workmanship and materials." A \$200 restocking fee on defective equipment hardly sounds like a comprehensive warranty.

Unfortunate situation, but your special editorial treatment still doesn't seem consistent or fair. An editorial slam is bad enough; a facing full page ad for the competition (mentioned in the article) adds insult to injury.

As you said, there are advantages to

having a magazine of your own. Maybe one of them is getting to make up your own rules.

In spite of the nature of my letter, I like the magazine. You keep writing and I'll keep reading.

**Bob Jenner**  
110 Long Sands Rd.  
York Maine 03909

*Editor's note:*

*I received calls and letters supporting both sides of this fence. Most people who have had GTEK programmers for a while are really happy with them. Perhaps I was just unlucky, perhaps their quality has dropped recently—I don't know. My mind has reopened slightly.*

*Meanwhile, my new Southern Computer Corp (SCC) programmer died (it quit burning ROMs) and I had to send it back for repair (gang programmers and I don't seem to get along). Their service wasn't quite as fast as GTEK's but the unit programmed ROMs when I got it back. Later I discovered that the serial interface didn't work (the problem turned out to be a second-sourced part that wasn't compatible with the design) so it's going back a second time.*

*Oh well, the SCC is still much easier to use, much more powerful (CRCs and all), and it lets me edit data in its memory before burning the ROM (the GTEK I had didn't have any memory).*

*As for the ad and its placement (Issue 19, page 18), I have mixed feelings, too. I had Alice call them about advertising after I had written the review (blast). Whether they chose to advertise or not couldn't have changed the article.*

*I thought they should advertise in Micro C because I thought they offered the best value in a gang programmer and I felt that you folks should know about it. (In fact, if I had time, I'd review all products before letting manufacturers advertise in Micro C.)*

*I agree that the juxtaposition of the ad and the column (as well as the timing) does look suspicious, but we get calls, almost daily, from prospective advertisers wanting to know if their product will be reviewed in the next issue. They want to advertise in the issue with the review, and, of course, they want their ad opposite the review (even though they are only hoping that the review will be favorable).*

*A few manufacturers, when sending a review sample, have asked to have final edit on a review. I have returned those products without looking at them. Other times I have gotten word that a review I've received from a "reader" was written or edited by the manufacturer. Those reviews were canned.*

■ ■ ■

# WANT ADS

The following folks are reaching you for only 20 cents per word. If you would like to reach the same audience, send your words and 20 cents for each to Micro Cornucopia.

**Public Domain UG Library Software Rental:** CP/M UG Vol 1-92 on 46 8" Flippies \$45.00, SIG/M UG Vol 1-192 on 96 8" Flippies \$99.50, PICONET Vol 1-34 on 17 8" Flippies \$25.00, Pascal-Z UG Vol 1-28 14 8" Flippies \$25.00, UG Games 20 Vols of the best ones \$25.00, UG Modem 20 Vols of the best \$25.00, UG Business 20 Vols of the best \$25.00, UG Utilities 10 Vols of the best \$25.00. Rental is for 7 days after receipt with 3 more days grace for return. Credit cards accepted (preferred). Other 5" disk formats also available. Downloading-disk format conversions. Call. User Group Software Automatic Update Service - \$7.50 per 2 volume set PP. 619-727-1015 24 hrs. Recording 619-941-0925 info. National Public Domain Software Center, 1533 Avohill Drive, Vista, CA 92083.

**SUPERB MAILING LIST PROGRAM** stores and manages names and addresses that can be revised at any time. Its size is limited only by the disk storage available. The address labels may be code selected and printed in five different formats on your computer paper or on label rolls. In addition to the name and address fields there are four additional fields in each record for telephone number, date, and two amount fields if desired. At any time the entire roster may be printed out. For JCP/M 2.2 based systems with two disk drives and printer capable of 132 columns for maximum usage. Terminal installation program module included. Supplied on 8" SSSD, 5.25" Kaypro and many others (please write). Special introductory offer by ABLE DATA SOFTWARE INC. PO Box 86923, Station C, North Vancouver, BC V7L 4P6. Only USA \$19.95 postpaid check or money order.

**KAYPRO SOFTWARE**, hardware information, technical updates, and two RCP/M systems with 26Mb of on-line storage. The Tampa Bay Kaypro User's Group has the largest public domain library and more current Kaypro-specific programs than KUG. The TBKUG can be of benefit to members without modems, all TBKUG User Disk volumes and other public domain software available by mail. A very informative monthly newsletter with NO ADS, featuring articles on modifying your Kaypro and many offers from distributors for group discount purchases. TAMPA BAY KAYPRO USER'S GROUP, 14 CYPRESS DRIVE, PALM HARBOR FL 33563. One year membership with password ID# for accessing both RCP/M systems (300/1200 baud) \$25.00.

**BIG BOARD, XEROX 820'S 16/8; REAL TIME CLOCK:** MICROCRON is assembled, adjusted and comes with extensive software collection, time-stamp files, printouts, dBASEII-\$69. EPROM PROGRAMMER; EZPROMMER is by far the best value for versatility and convenience- A&T \$125. DRIVE CONTROL UNIT: Xerox chose our design for their 820's. We have a version for the 820 that doesn't require soldering from \$29.95 to \$65. WORDSTAR ENHANCEMENT: SPEEDSCREEN speeds up screen access and allows bright/dim with blinking cursor for the 820-II version-\$29. 820-I SUPER MONITOR: Prom set enhances standard monitor with terminal mode, soft boot, clock, features rich at \$29.95. Call or write for details and product support, VISA, MC. OPTRONICS TECHNOLOGY, PO BOX 81, Pittsford, NY 14534. 716-377-0369

**SAVE MONEY** on new microcomputer gear. Get Schultz's List, the bimonthly report of best current prices. We search for the great deals; you get top equipment cheaply. Why waste more money? Concisely covers thousands of products: systems, terminals, monitors, drives, cards, printers, modems, software, accessories, supplies. Single report only \$9.95; save 33% order year's service (six) for \$39.80. All postpaid and guaranteed from Owen Schultz, POSTROAD PRESS, INC. 635 Day Avenue 3SW, Roanoke VA 24016.

**SUMMER SALE** Morrow, Smith-Corona, Qantex printers, terminals, Alpha Micro, 3M telex, 5" winchester drives, Xebec, Cromemco, Otrona, Wicat. send for list. Polygon Industries, PO Box 24615, New Orleans, LA 70184, 504-282-5372.

**1200/300 auto-dial auto-answer modem.** Hayes compatible, \$249. 300-baud modem, \$89. DATASHEILD Backup Power Source, 200 Watts, \$259. B.W. Systems, Box 9791, Austin, TX 78766. (512) 225-8350.

**EPROMS 2716, 2732, 2732A** new & used. Send two 20 cent stamps for listing. NANFA, PO BOX 88703 Emeryville, CA 94662.

**ELECTRONIC PACKAGING DESIGN.** Printed circuit boards, cables and wiring, enclosures, documentation, assembly, prototypes. Send for information. Aerotronix Dept. MC, 45961 Private Shore, Mt. Clemens, MI 48045

**XEROX 820-II mother boards** brand new, \$269. 612-636-5103 after 5 p.m. 565 Redwood Lane, New Brighton MN 55112.

**Garage Sale:** Microswitch hall-effect Keyboards, \$20. 12" monitor w/enclosure, \$30. 8" drives, \$75. 820-II board, \$225. Everything works. Lots of S-100 boards, SBC's cheap. Ask for list! Noor Singh, 1059 E. New York Dr., Altadena, CA 91001 (818) 794-8730.

**8" Shugart-compatible drives,** \$70. Cherry PRO keyboard, case, \$40. Lots of good BB related stuff, cheap. List available on request. Noor Singh, 1059 E. New York Dr., Altadena, CA 91001. (818) 794-8730.

**Xerox 820-II disk drive adapter.** Allows connection of dual 8" and 5 1/4" drives at the same time. You choose any (2) one line to upload or download software. Free color photo. We are experts on the Xerox PC. We modify WordStar for your needs. Install ZCPR 2.2. Contact us for any special needs. Merit Computer, 1658 Westport Rd., Merritt Island, FL 32952

**Kaypro Software Memory Bugout.** Isolates defective memory chips for easy repair. Pays for itself with first failure. (Assembly Language). \$19.95. Mail List—Create and maintain your personal/business mailing list. Prints mailing labels, menu driven, easy to use. \$34.95. Abrams Consulting (custom Kaypro software), 9615 Cecilwood Dr., Santee, CA 92071. CA residents add 6%.

**Xebec S1410 Winchester controllers (2).** Tested to Seagate, Ampex and Rodine hard disks. \$160 for 1; \$300 for 2. Harry Siegmund, (808) 536-4624.

**Telex/TWX Communications Program** for Kaypro or Xerox. Also terminal program. 4/84 internal modem versions available. Specify computer and answer back when ordering. \$49.95. CA residents add 6% sales tax. Michael G. Veilleux, 1110 W. Winston Dr., Santa Maria, CA 93454 (805) 922-3318.

**Income Tax templates** for Kaypro with Perfect Calc. Updated for 1984. CPA designed, computes 1040, Schedules A thru W, depreciation, and more. Professionally used for tax planning and "what-if" tax calculations. Includes complete instructions and formula listings. Send \$29.95 (VA residents add 4% sales tax) to: Walker Financial Services, Inc., P.O. Box 161, Woodstock, VA 22664. (703) 459-5453.

**Keyboards for Computer Builders** 83 keys, full ASCII, upper/lower case, all control characters, numeric pad, CAPS-LOCK, Repeat, self test! Brand new, hundreds sold already to builders of Apples, BBs, Xerox 820s. Parallel output, positive TTL logic, strobe. Uses only 106ma of +5V. Custom case available. 90 day warranty unmodified. Keyboard \$35. Documentation (21 pages)/cable package \$5. Spare custom CPU/ROM \$4. UPS included. Call/SASE for detailed spec sheet. Electrovalue Industrial, Inc., Box 376-MC, Morris Plains, NJ 07950. (201) 267-1117.



## FREE EPROM!\*

When you purchase our EP-1 or EP-2 Eprom programmer for your Kapro II or IV. We feel that your programmer is the best in its price range. Introductory price for the EP-1 is just \$99.95 plus \$5.00 shipping and handling.

Here are just some of the features of our programmers:

- Easy to use menu driven software
- Programs 25/2716, 25/2732 and 2764 Eproms
- Once installed, programmers need not to be removed and do not interfere with Kaypro operation
- Store and retrieve files on drive A or B
- True Eprom burn verification
- Includes program disk and full documentation

Please write or call for additional information including our new flyer and voice synthesizer!

Write or call:

**Busch Computers**  
447 Blohm Street  
West Haven, Ct. 06516  
Phone: (203) 933-9383

\*2716 first 500 orders  
Conn. residents add 7 1/2% Sales Tax

# FLOWCHARTER

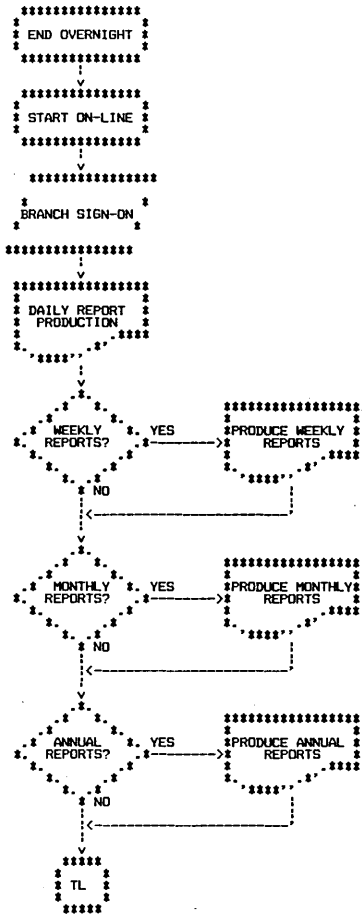

EasyFlow is a program which helps you to produce neat, accurate flowcharts. You describe the flowchart using a simple flowchart description language; EasyFlow then produces a complete flowchart. EasyFlow is excellent for describing procedures of all kinds - not just for programming.

- Fast: 12 seconds for a typical chart.
- Command language easy to learn.
- Easily adapts to all printers.
- Standard flowcharting shapes included.
- User defined shapes easily added.
- User selected line drawing characters.
- Charts up to 5 by 11 shapes in size.
- Explicit, meaningful error messages.
- Fully documented with many examples.
- Ten demonstration flowcharts included.
- Special printer drivers included for MX80 and u92 that produce small flowcharts directly on 8.5 x 11 inch paper.

\$49.95 (\$59.95 in Canada + 7% PST in Ontario)

Runs on Z80 CPM 2.2 machines with 38K TPA. Available on SSSD 8" and Kaypro 5" disks. Other 5" formats: call.

Available by check, money order or Visa:

**HavenTree Software Limited**  
R.R. #1,  
Seeley's Bay, Ontario,  
Canada, K0H 2N0  
(613) 542-7270



# FOR SALE

PRINTER BY OKIDATA MICROLINE 80  
80 CHARACTERS PER SECOND  
7X9 DOT MATRIX 10 CHARACTERS PER INCH  
6 OR 8 LINES PER INCH FRICTION FEED  
BUILT IN SELF TEST NEW RIBBON

REMOVED FROM SERVICE  
COMPLETE DOCUMENTATION  
PARALLEL INTERFACE  
SERIAL INTERFACE

\$119.00  
\$139.00

KEYBOARD BY MICROSWITCH  
113 HALL EFFECT KEYS  
8 BIT ASCII PARALLEL OUTPUT  
WITH CASE & DOCUMENTATION

\$40.00

SA800-2 GUARANTEED 60 DAYS

\$99.00

SA850 GUARANTEED 60 DAYS

\$199.00

CASCADE ELECTRONICS, INC.  
ROUTE 1 BOX 8  
RANDOLPH, MN 55065  
507-645-7997

FREE SHIPPING

MN ADD 6% Sales Tax Credit Card ADD 5% COD ADD \$2.00  
LIMITED TO STOCK ON HAND EVENING CALLS PREFERRED

# BIG BOARD COLOR GRAPHICS

\$29<sup>95</sup> Bare Board

**TMS 9918A Based Graphics System**  
**256H-192V ★ 16 Colors**

★ 32 Simultaneous Fast Moving Sprites

★ Composite Video Output

★ Highest Quality PC Construction

★ Software Includes Character & Sprite Editor

Demo Program In Pascal & Basic

★ Drivers Are Above The Monitor For Use

With High Level Languages

Requires 1 trace cut and 1 jumper (see adding 6K of Ram MicroC#7)  
Plugs Into U70 (U70 Still Available for Prom with Jumper)

TMS9918A Graphics Chip \$34<sup>95</sup>



Check ★ Money Order ★ COD



## GRAPHTECH

P.O. Box 1185, McPherson, KS 67460 — (316) 241-6330

Call for Availability & Price of Parts Kit

Kansas Residents Add 4% Tax/Include \$3 For Postage & Handling

Allow Four to Six Weeks for Delivery

# TECHNICAL TIPS

## Keep Your Kaypro

In Micro C Issue #19 in the Kaypro Column, you discussed Kaypro's going to lunch while auto-dialing. Your suggestion was to buy another microprocessor. I have another idea:

Buy two 40-pin wire-wrap sockets, three 14-pin sockets, three buffer ICs, and something to mount them all on.

First, remove the Z80 from its socket and place it in one of the sockets mounted on the prototype board. Cut the pins on that socket to half length. Then solder wires from the mP inputs to the corresponding pins on the longer socket. Now solder wires from the outputs of the mP to the inputs of the buffers and from the outputs of the buffers to the corresponding pins of the socket with the long legs. Finally, connect the supply pins of the buffers to the power supply rails in the computer and insert the pins of the uncut socket into the original Z80 socket (on the computer). That ought to work.

Also, in the SBASIC Column, someone mentioned that SBASIC has no EOF indicator. It does. Just test for ASCII character 26 (control Z).

I would like to know anyone knows how I can configure/modify any version of BYE to work with my 4-84 with the internal modem.

**Bill Tuck**  
Rt. 1 Box 222  
Alberta VA 23821

## DSDD/SSDD Compatibility

Here is a useful tip when installing a DSDD drive along with a SSDD drive.

After installing a Pro-8 ROM package, I placed the double sided drive in the A position. Then I placed a single sided disk with sysgen in A to boot the system. With a format2 and sysgen in B, I then tried to format and sysgen a new disk in A to double sided. Not realizing that one cannot boot in one format and then format in another, all my attempts to boot A in DSDD failed.

Finally, the light dawned! Initially the double sided drive must be in position B. Format the first double sided disk in B,

then move the DSDD drive to A, boot in double sided, and then format and sysgen. Moral: In drive A, boot up in whatever format you intend to work with in that drive.

Only one drawback remains: there is a 15-second pause when using both single and double-sided disks.

PIP lets you copy either way with no problem, but other programs like Wash 14 will sit and think about it for almost 15 seconds before acting. And my serial printer beeps, then waits 15 seconds before printing starts. With WORDSTAR and THE WORD PLUS on A, operation is normal except for that 15-second delay when paging with CTL C. Using the same format on both drives still works normally.

**Harvey DeGering**  
1245 E. Washington Blvd  
Pasadena CA 91104

## Speeding Up the Blinkin' 820

I found the slow blink of the CRT display of characters with bit 7 set to be extremely irritating, as well as rendering the display illegible. The blink attribute is more useful when it blinks faster. This is easily achieved by a minor hardware modification. Cut the trace going to pin 8 of U49 (74LS393) and connect it instead to pin 9, 10 or 11 according to whether you wish to multiply the blink rate by 2, 4, or 8. The last gives half-intensity characters with some flicker and is useful for providing contrasting characters, but it makes the cursor harder to locate over a small character such as a period.

**Richard Parsons**  
RR #1  
Mount Albert Ont. Canada L0G 1M0

## Quicker Fix For BBI Video

As pointed out by Wesley Ebisuzaki in Micro C Issue #18, Big Boards sometimes have a problem with their composite video output. Mine had the characteristic dim vertical and bright horizontal mentioned by Ebisuzaki, but his quick fix

wouldn't work on my board.

The fix I came up with is even quicker than Ebisuzaki's and completely cured the problem in my system.

Capacitor C 142 in the feedback circuit of XOR gate U 94 is critical because it has only 20% tolerance. Try exchanging C 142 with other capacitors having the same or slightly higher value until you find the rare bird. In my case, a 47 pF cap from the junk box did the trick perfectly well.

**Christian Phaneuf**  
P.O. Box 1107  
972 Guillaume Boisset  
Cap-Rouge Quebec Canada G1Y 3E4

## Free Samples From Texas Instruments

I have come across a good deal for those who have not yet gone to double density on their BBI. In recent issues of "Electronic Engineering Times," Texas Instruments has had ads offering free samples of their WD2797 floppy disk controller chip. You must fill out and send in the form in the ad.

This chip is identical to the WD2795 controller with the exception that it uses a true rather than an inverted data bus. Robert Carroll's article in Micro C Issue #16 details the conversion to the WD2795. The only additional modification required to use the WD2797 is to replace U99 and U100 with 74LS243s (non-inverting bus transceivers) instead of 74LS242s (inverting bus transceivers).

The free controller chip more than offsets the cost of replacing U99 and U100 (\$50 vs. 2x\$1.20).

**Ronald R. Swager**  
1515 N Lincoln Ave #17  
Springfield IL 62702

## Fast Boot From Slow ROMS

When increasing the speed of the BBI, it's really not necessary to change the PFM ROM(s) from the slower 2716 to the faster 2716-1. I have a system up at 5 MHz now which has never failed to boot from PFM in two 2716s. Simply drive the

# TECHNICAL TIPS

Z80 WAIT line from a 74121 or L121 one-shot as shown in the following figure. Since the intent of the WAIT line is to allow the Z80 to wait on slow I/O devices, this scheme works well.

By using Rint and a capacitor value around 120 Pf., approximately 200 NS<sup>2</sup> can be added to the ROM access time. For the purists in the crowd, the slower access time is only critical for the execution of the first 10H bytes since only they incur the faster instruction fetch cycle times on ROM access. Subsequent ROM accesses are at the slower fetch cycle times and probably would do fine without the wait states.

The scheme below requires only one trace cut and the addition of three wires plus Cext, +5V and ground. There is room on the BBI between U85 and U88 to locate the one-shot socket. I glued mine on a stand-off to the component side of

Fast Boot Scheme

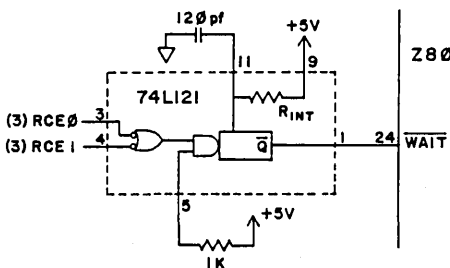

the board and drilled a small hole near it for wiring access to the bottom of the board. If a L121 were used instead of a 121, the wait would be longer because of Rint being larger in the L121, but you can hardly tell the difference.

D.L. Carlyle  
1107 Horseshoe Lane  
Blacksburg VA 24060

## Repairing BBI System Clock

When my BBI system clock quit for the fourth time, I bought a 20 MHz crystal oscillator from JAMECO. This is a single-component oscillator in a package compatible with DIP integrated circuits. The oscillator requires +5V and provides a TTL level output signal.

The +5V requirement and the shape

of the package cause minor difficulties when installing the oscillator in a BB. I

Oscillator Placement

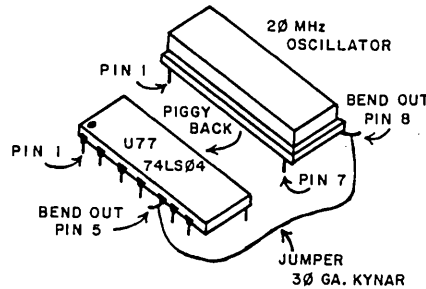

OSCILLATOR PINOUT

PIN 1 - N.C.  
PIN 7 - GROUND  
PIN 8 - 20 MHz OUTPUT  
PIN 14 - +5V

JAMECO P/N OSC 20.000

solved the problem by placing the oscillator on top of U77. First remove U77 and bend out what would be pin 8 on the oscillator, if the oscillator were a 14 pin DIP device. Place the oscillator on top of U77 and carefully solder pins 1,7 and 14 to the corresponding pins of U77. Install a jumper between pin 8 of the oscillator and pin 5 of the 74LS04 (U77). Then place U77 back in the socket, leaving pin 5 bent out. With this modification you may leave the old clock components in place in case you need to go back to the old crystal.

I still don't know why my old clock stopped, but since the modification, it's been running reliably.

Pat Coleman  
6529 Creekwood Ct.  
Mobile AL 36609

## THE BIGGEST & BEST SBC

# The Mega Super Computer

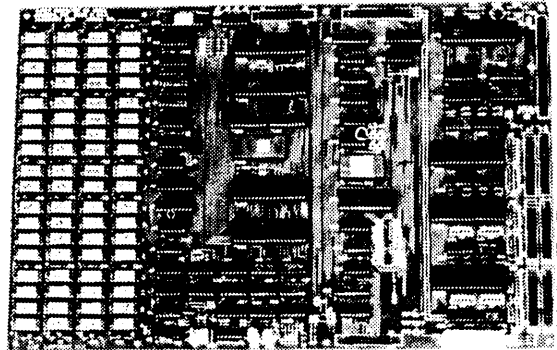

### The Maxi Computer System on Board

- ★ 512K of D-Ram with Parity-Configurable as 8 Banks of 64K or as a high speed Electronic Disk
- ★ Dual Density 1 or 2 sided Floppy Disk Controller (WD2797)-8" or 5" simultaneously - supports 3 drives for 4 MB's of DATA
- ★ Hard Disk Interface, ST506 or Priam
- ★ Six Serial Ports - with hand shaking
- ★ 48 Additional Ports on I/O expander BUS
- ★ Math Chip (9511 or 9512)
- ★ CTC & DMA
- ★ Two Parallel Ports
- ★ Z80B Runs at 4 or 5 MHz
- ★ ROMS/CPM/MPM and Turbodos

— CP/M 2.2 System 512K, RAM Disk (430K)

— CP/M 3.0 System 512K Bank

— MP/M 2.1 System 384K auto-boot for console (16 users)

— Turbodos 1.3, 128K (see Microsystem, Aug. 84)

Total price for above systems \$1099 — includes operating system and board  
Hard disk 20 megabyte package for all systems above

All this on a multi layer card - with accurate documentation.

Bare Board - with documentation & Firmware (PAL) — \$200

Users Manual — \$25

Wave soldered assembled board without IC's — \$375



# MEGACO.



2248 S. Park Street, Madison, WI 53713, (608) 255-7400

## ADVERTISER'S INDEX

Adevco, Inc. ....	39
Andratech .....	22
Arkon Engineering .....	6
Artisoft .....	22
Astrotronics .....	45
BD Software .....	25
BV Engineering .....	58
Barnes Research .....	25
Biegun & Assoc. ....	60
Borland International .....	12
Busch Computers .....	74
Cal-Tex Computers .....	54
Cascade Electronics .....	75
The Codeworks .....	26
Colonial Data .....	8,9
Compusophic Systems .....	47
DG Systems .....	44
Digital Dynamics .....	65
Digital Research .....	13
.....	Inside Front Cover
ET Computers .....	18
Emerald Microware .....	22
Ferguson Engineering .....	59
.....	Inside Back Cover
GRD .....	15
Graphtech .....	75
HSC, Inc. ....	37,56
Haventree Software .....	75
C. Hoelzle Assoc. ....	50
Huntington Data Systems .....	71
Integrand .....	19
JFN Industries .....	39
Kenmore Computer Technologies .....	60
L-Band .....	51
Litek .....	26
Logical Connexion .....	71
Logical Devices .....	45,78
Manx Software Systems .....	Back Cover
Mega Co. ....	77
Microcomputer Systems .....	51
Micro Cornucopia .....	66-69
MicroGlyph Systems .....	29
Microgroup .....	78
Microprocessors Unlimited .....	Back Cover
Microsphere .....	46
Motel Computers, Ltd. ....	45
Optronics Technology .....	7,55
Periphco .....	11
Phenix Co. ....	58
PluPerfect Systems .....	34
Rivendell Audiocomp .....	58
SWP, Inc. ....	28
Servo Computers .....	13
Sheepshead Software .....	38
Slicer Computer Corp. ....	30
Soft Advances .....	62
Software Toolworks .....	35
Southwest Computers .....	32
TC Controls .....	58
Tony Ozrelc .....	23
Twist, Inc. ....	39
Unified Software .....	Back Cover
Wren .....	60
Xpert Software .....	33
Zippe Systems .....	35

# The Personal EE/EPROM Programmer

FOR YOUR

IBM P.C., APPLE II,  
COMMODORE 64  
OR ANY OTHER PC

**\$395.00**

PLUS POSTAGE  
& HANDLING

*With Shooter  
You Aim Low  
in Price and High  
in Quality!*

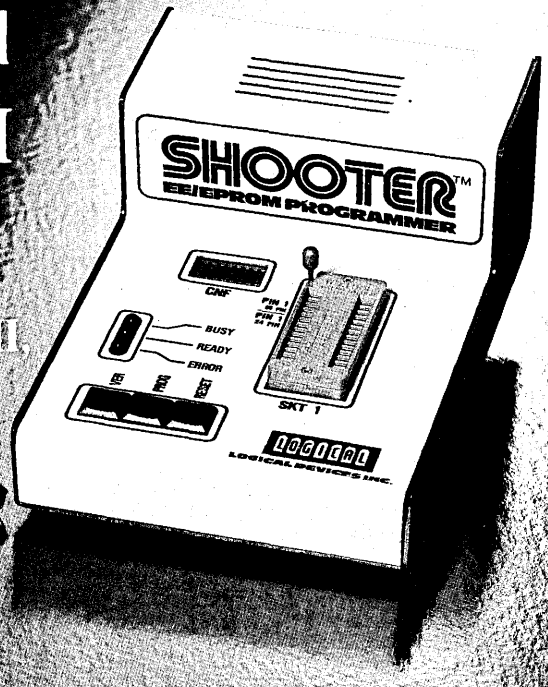

- RS-232 Port. Works with any computer or terminal.
- Stand-Alone. Copies & verifies.
- 32K/128K RAM Buffer.
- Upload/Download in Intel or Motorola Hex format.
- 90 Day Warranty

**LOGICAL**

**LOGICAL DEVICES, INC.**

1-800-EE1-PROM (331-7766)

FLA. (305) 974-0967 • TELEX: 383142 LOGICALTX  
1321 E N.W. 65th PLACE, FT. LAUDERDALE, FL 33309

# \$29.95 SpellSys

Are you signing your name with an X  
because spelling doesn't come easily?

Then you need SpellSys!

With this full-feature package, you can write prose with the pros. SpellSys features a 42,000 word dictionary and all the bells and whistles of those expensive checkers—including rhyming, crossword search, letter unscrambling, etc.

SpellSys is made up of a group of individual programs which you can use together or separately. With SpellSys you can setup and maintain your own custom dictionary (in addition to the main dictionary). These are real dictionaries, not hash tables, so you edit or remove words from your own dictionary at will.

IT'S EASY TO USE!

Just enter "SPELLSYS", select which disks you'll use, and file you're checking. Then SpellSys takes over. Everything is self-prompting—so sit back and relax.

Word Review Operations

- C .. show Context in file
- L .. Lookup word in dictionary
- M .. Misspelled (correct file to.....)
- D .. put in user Dictionary
- I .. Ignore
- N .. Next word
- P .. Previous word
- E .. Exit review
- ? .. (or any other key) displays menu

ORDER AT NO RISK!

Check out the manual and if you don't agree that SpellSys is a super bargain, just return the package with the disk unopened within 30 days and we'll refund your money.

**SPELLSYS** \$29.95 ppd. in US & Can  
Other Foreign add \$5.00  
Requires 32K CP/M\*  
Formats: 8" SS SD or  
5" SS DD for KayPro, Xerox,  
Osborne, Morrow, Superbrain.

\*CP/M is a trademark of Digital Research

microgroup

P.O. Box 65 Bend, OR 97709  
MC (503) 382-8048 Visa



# ORDER FORM

Micro C works because it is a central information exchange for the doers in this crazy industry. So we encourage you to share your trials and tribulations. That way we can invent new wheels rather than redoing the old ones over and over.

What kind of exciting adventure (misadventure) are you working on?

---

---

---

---

---

---

---

---

What information would you like to see in Micro C?

---

---

---

---

---

---

---

---

Quantity	Description	Price Each			Total
		U.S.	Can & Mex	Other Foreign	
	SUBSCRIPTION (1 year—6 issues) <input type="checkbox"/> New <input type="checkbox"/> Renewal	<input type="checkbox"/> \$16 (Bulk) <input type="checkbox"/> \$22 (1st Class)	<input type="checkbox"/> \$22 (Air Mail)	<input type="checkbox"/> \$30 (Air Mail)	
	USERS DISKS — 8" SSSD, CP/M #’s	\$15	\$15	\$15	
	CP/M 86 DISKS — 8" SSSD #’s	\$15	\$15	\$15	
	KAYPRO DISKS for the II, 4, & 10 — 5" SSDD #’s	\$12	\$12	\$12	
	BACK ISSUES #’s	\$3	\$3	\$5	
	T-SHIRT (specify S, M, L, XL)	\$6.95	\$8.50	\$8.50	
	OTHER ITEMS:				
	FREE KAYPRO CATALOG				

Prices include media, package, 1st Class postage (Air Mail for Other Foreign)

Check or money order enclosed  
(US funds only, payable on a US bank)

Make checks payable to:  
**MICRO CORNUCOPIA**

**TOTAL  
ENCLOSED**

Card No. _____ - _____ - _____ - _____	Exp. _____	Signature _____
<input type="checkbox"/> Visa <input type="checkbox"/> MasterCard		

NAME \_\_\_\_\_ PHONE (?) \_\_\_\_\_

ADDRESS \_\_\_\_\_

CITY \_\_\_\_\_ STATE \_\_\_\_\_ ZIP \_\_\_\_\_

MICRO CORNUCOPIA • P.O. Box 223 • Bend, Oregon • 97709  
(503) 382-8048

# BACK ISSUES

\$3.00 each  
US, CAN, MEX

\$5.00 each  
Other Foreign

## ISSUE NO. 1 (8/81)

Power Supply  
RAM Protection  
Video Wiggle  
½ PFM. PRN  
16 pages

## ISSUE NO. 2 (10/81)

Parallel Print Driver  
Drive Motor Control  
Shugart Jumpers  
Program Storage Above PFM  
½ PFM. PRN  
16 pages

## ISSUE NO. 3 (12/81)

4 MHz Mods  
Configuring Modem 7  
Safer Formatter  
Reverse Video Cursor  
FORTHwords begins  
16 pages

## ISSUE NO. 4 (2/82)

Keyboard Translation  
More 4 MHz Mods  
Modems, Lync, and SIOs  
Undoing CP/M ERASE  
Keyboard Encoder  
20 pages

## ISSUE NO. 5 (4/82)

Word Processing  
Two Great Spells  
Two Text Editors  
Double Density Review  
Scribble, A Formatter  
20 pages

## ISSUE NO. 6 (6/82)

BB I EPROM Programmer  
Customize Your Chars  
Double Density Update  
Self-Loading ROM  
Terminal in FORTH  
24 pages

## ISSUE NO. 7 (8/82)

6 Reviews of C  
Adding 6K of RAM  
Viewing 50 Hz  
On Your Own begins  
24 pages

## ISSUE NO. 8 (10/82)

Drive Maintenance  
Interfacing Drives  
Installing a New BIOS  
Flippy Floppies  
C'ing Clearly begins  
Xerox 820 begins  
28 pages

## ISSUE NO. 9 (12/82)

BB II EPROM Program  
Relocating Your CP/M  
Serial Print Driver  
Big Board I Fixes  
Bringing Up WordStar  
Cheap RAM Disk  
32 pages

## ISSUE NO. 10 (2/83)

Saving a Flaky Disk  
Hooking Wini to BB II  
The Disk Inspector  
JRT Fix  
Serial Keyboard Interface  
Pascal Procedures begins  
36 pages

## ISSUE NO. 11 (4/83)

BB I Expansions  
BB II Details  
Dyna, RAM Disk Review  
Easier Reverse Video Cursor  
PlannerCalc Review  
KayPro Column begins  
36 pages

## ISSUE NO. 12 (6/83)

256K for BB I  
Bringing Up BB II  
dBase II  
Look at WordStar  
Double Sided Drives for BB I  
Packet Radio  
5MHz Mod for KayPro  
40 pages

## ISSUE NO. 13 (8/83)

CP/M Disk Directory  
More 256K for BB I  
Mini Front Panel  
Cheap Fast Modem  
Nevada Cobol Review  
BB I Printer Interface  
KayPro Reverse Video Mod  
44 pages

## ISSUE NO. 14 (10/83)

BB II Installation  
The Perfect Terminal  
Interface to Electronic Typewriter  
BB I Video Size  
Video Jitter Fix  
Slicer Column starts  
KayPro Color Graphics Review  
48 pages

## ISSUE NO. 15 (12/83)

Screen Dump Listing  
Fixing Serial Ports  
Playing Adventure  
SBASIC Column Begins  
Upgrading KayPro II to 4  
Upgrading KayPro 4 to 8  
48 pages

## ISSUE NO. 16 (2/84)

Xerox 820 Column Restarts  
BB I Double Density  
BB II 5"/8" Interface Fix  
KayPro ZCPR Patch  
Adding Joystick to Color Graphics  
Recovering Text from Memory  
52 pages

## ISSUE NO. 17 (4/84)

Voice Synthesizer  
820 RAM Disk  
Kaypro Morse Code Interface  
68000-Based System Review  
Inside CP/M 86  
56 pages

## ISSUE NO. 18 (6/84)

Kaypro EPROM Programmer  
I/O Byte: A Primer  
Kaypro Joystick  
Serial to Parallel Interface  
Business COBOL  
60 pages

## ISSUE NO. 19 (8/84)

Adding Winchester to BBII  
6MHz on the BBI  
Bulletin Boards, Getting It Together  
Track Buffering on the Slicer  
4MHz for the 820-1  
64 pages

## ISSUE NO. 20 (10/84)

HSC 68000 Co-Processor  
DynaDisk for the BBII  
Serial Printer on BBI Sans SIO  
Cheap & Dirty Talker for Kaypro  
Extended 8" Single Density  
72 pages

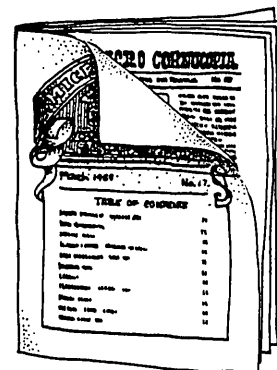

# BOOKS

**Your Fortune in the Microcomputer Business** ..... \$26.45 (US, Can, Mex)  
..... \$36.45 (Other foreign)  
This is the best, most complete collection of "working for yourself" information I've found (and I've heard nothing but good comments from those who have received it). This two-volume set is perfect for those times when you need a break from monitor watching.



**Inside CP/M** ..... \$27.95 (US, Can, Mex)  
..... \$37.95 (Other foreign)  
This is one of the best books on CP/M. It covers the whole spectrum of users from novice to guru. There are a few books that include more programming examples but none work better for the whole range of users and this book is perfect for reference use. Micro C's copy of Inside CP/M is showing definite signs of overuse.

MICRO CORNUCOPIA - P.O. Box 223 - Bend, Oregon - 97709

# FERGUSON ENGINEERING

817-640-0207

## Get CP/M+ power with PDQCache (without much cash)

PDQCache and the 820-256K RAM card are now linked to provide a dramatic difference in system throughput. PDQCache is a disk buffering applications program, designed especially for the Xerox 820-1 and the Bigboard-1 with the 820-256K RAM card. With PDQCache disk-intensive operations execute MUCH FASTER:

- up to 20X faster than single density 5 1/4",
- up to 10X faster than single density 8",
- and up to 5X faster than double density 8" (1024 x 9).

PDQCache significantly reduces delays associated with rotational latency, head-load, disk turn-on, and seek time. PDQCache enhances the life expectancy of your disks and your drives, as well as decreasing the frequency of disk errors.

A synopsis of PDQCache features:

- easy to install
- built-in printer spooler
- fully compatible with the newest version SWP double density
- functions are transparent to the operator
- TPA size is not affected

PDQCache is NOT a memory drive program. There is no need to transfer your files to some imaginary drive. There is also no need to configure your programs to operate on an alternate drive. As you operate your computer, PDQCache buffers the data for you automatically.

PDQCache - The most significant system enhancement since 4 Mhz.

### BIGBOARD-1 / 820-1 256K RAM EXPANSION MODULE

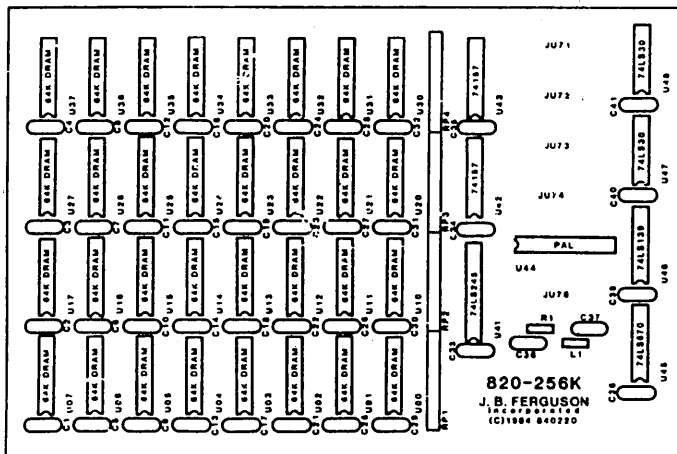

### BIGBOARD-1 / 820-1 256K RAM EXPANSION CARD

Give your Bigboard-1 or 820-1 a quarter-megabyte of RAM. This card can be used as a RAM disk, a spooler buffer, a disk cache or anything that requires more memory than the basic 64K. The flexible architecture will accommodate a wide variety of applications such as MP/M, CP/M+ and a host of high-speed data acquisition tasks. This card plugs in to five device sockets below the existing RAM array as a daughter board.

- Easy installation WITHOUT wires, cables or jumpers.
- Uses none of your precious I/O.
- This RAM upgrade works beyond 5 Mhz.
- Adds only 1/2 inch to the overall height.
- Interconnect hardware provided.
- Small (4.5" x 6.75").

This product comes with complete schematics and a full theory of operation. Assembly, installation and test procedures are thoroughly documented.

### XDRIVE: a Ram disk.

We have modified XDRIVE, a public-domain RAM disk software package, to run with the 820-256K, for the Bigboard 1 and the 820. Provides a 192K RAM disk for lightning speed operation. Can be run with almost any BIOS, with the exception of the SWP double density distribution BIOS. Source code is included.

BARE BOARD & DOCUMENTATION.....	\$ 67.50
KIT W/O RAM.....	95.00
Assembled and tested 820-256K (4 Mhz parts).....	295.00
PDQCache disk cache and spooler software.....	95.00
New monitor ROM source & XDRIVE software.....	45.00
64K DRAM (good at 4 Mhz).....	4.65
820-1 modified monitor ROM.....	10.00
Bigboard-1 modified monitor ROM.....	10.00

### FERGUSON ENGINEERING

817-640-0207

P.O. BOX 300085 ARLINGTON, TEXAS 76010

TERMS: Master Card/VISA add 3%, money order, certified check, UPS cash COD. Allow 2 weeks for personal or company checks to clear. Shipping/handling extra. Texas order add 5% tax.



LEAP INTO A NEW DIMENSION



WITH AZTEC CII

Full implementation of "C" with standard floating point, library, and I/O subroutines. UNIX VER 7 compatible. Produces relocatable 8080 (optional 0Z80) assembler code. Relocating assembler and linker supplied with package or use Microsoft M80 and L80, SID/ZSID debugger interface. FAST COMPILATION AND EXECUTION.

**AZTEC CII FOR CP/M \$199**  
(Special price for Micro C subscribers \$149)



**MANX**  
software systems



Box 55, Shrewsbury, N.J. 07701  
(201) 780-4004

Also available for Apple DOS, HDOS, CP/M-86, PC-DOS

**ICs PROMPT DELIVERY!!!**  
SAME DAY SHIPPING (USUALLY)

8087-3 Co-Processors \$149.97

**DYNAMIC RAM**

256K	256Kx1	150 ns	\$18.77
64K	64Kx1	120 ns	3.77
64K	64Kx1	150 ns	3.31
64K	64Kx1	200 ns	3.44

**EPROM**

27256	32Kx8	300 ns	\$45.97
27128	16Kx8	250 ns	13.67
27C64	8Kx8	200 ns	22.50
2764	8Kx8	250 ns	6.50
2732	4Kx8	250 ns	6.37
2716	2Kx8	450 ns	3.50

**STATIC RAM**

6264LP	8Kx8	150 ns	\$23.67
6116P	2Kx8	150 ns	4.37

QUANTITY ONE PRICES SHOWN

Open 6½ days: We can ship via Fed-Ex on Sat.

MasterCard/VISA or UPS CASH COD

**Factory New, Prime Parts**  $\mu P_{\infty}$

**MICROPROCESSORS UNLIMITED**

24,000 South Peoria Ave. (918) 267-4961  
BEGGS, OK. 74421

Prices shown above are for November 12, 1984

Please call for current prices & volume discount. Prices subject to change. Please expect higher or lower prices on some parts due to supply & demand and our changing costs. Shipping & insurance extra. Cash discount prices shown. Small orders received by 6 PM CST can usually be delivered to you by the next morning, via Fed. Exp. Standard Air @ \$6.75!

# uniforth

Tired of the slowness of BASIC? Find that the bugs in FORTRAN are bugging you? Step up to FORTH, the language that gives you total control over your computer! UNIFORTH is the only version of FORTH available either "captured" under an operating system (such as CP/M), or "standalone", acting as its own operating system. Our standalone versions are customized to your single board computer, providing serial and parallel port support, a real-time clock, formatting, fast disk copy, and disk access up to twice as fast as CP/M! All systems are FORTH-79, and include a video editor, macro assembler, debugger, decompiler, top-notch documentation, and much more. Write for our free brochure, or order direct from the special Micro-C reader prices listed below.

**UNIFORTH Version**

System	Integer	Floating Point	Multi-Tasking	Multi-User
Big Board	\$ 60	\$100	\$125	\$150
Big Board II	80	125	150	200
Slicer	100	150	200	250
Any CPM-80	60	100		

**Unified Software Systems**

P.O. Box 2644, New Carrollton, MD 20784, 301/552-9590

DEC, VAX, PDP, RT-11, RSX-11 (TM) Digital Equipment Corp; CP/M (TM) Digital Research; MSDOS (TM) Microsoft; VIC-20 (TM) Commodore.

## MICRO CORNUCOPIA

The Single Board Systems Journal

P.O. BOX 223  
BEND, OREGON 97709

FORWARDING POSTAGE GUARANTEED

BULK RATE  
U.S. POSTAGE  
PAID  
Forest Grove, OR  
Permit No. 36