

# MICROSOFT<sup>TM</sup> MULTIPLAN<sup>TM</sup>

Electronic  
Worksheet



For CP/M-80

# **Microsoft™ Multiplan™**

---

**Electronic Worksheet**

**for CP/M®-80**

**Microsoft Corporation**

Information in this document is subject to change without notice and does not represent a commitment on the part of Microsoft Corporation. The software described in this document is furnished under a license agreement or nondisclosure agreement. The software may be used or copied only in accordance with the terms of the agreement. It is against the law to copy Microsoft Multiplan on cassette tape, disk, or any other medium for any purpose other than the purchaser's personal use.

©Microsoft Corporation 1982

Microsoft Corporation  
10700 Northup Way  
C-97200  
Bellevue, WA 98004

Microsoft and Multiplan are trademarks of Microsoft Corporation.

VisiCalc is a trademark of VisiCorp, Inc.

CP/M is a registered trademark of Digital Research, Inc.

Catalog no. 3223

Part no. 32F23A

Document no. 8901-100-01b

# Preface

---

Microsoft™ Multiplan™ is a personal productivity tool that will help you analyze data. As an aid for both business and personal needs, Multiplan is one of the most powerful modeling and planning tools ever invented. With Multiplan you can do the capital budgeting for a small company; you can make major sales force decisions or analyze product planning; you can plan your personal investments and put together a budget for your family . . . and much more.

Multiplan is easy to learn, and its versatility is enhanced by the skill of its user. As you become more familiar with Multiplan, and better able to exercise its powers, you'll be surprised at how quickly and efficiently you'll accomplish various tasks.

The two parts of this manual are designed as a tutorial and a reference guide to Multiplan. Part 1 is the tutorial, which gives you an overview of the features of the system. Part 2 is a detailed reference guide to all Multiplan features. Parts 1 and 2 complement one another; together, they will teach you both the concepts and uses of Multiplan.

The design of Multiplan allows you to work intuitively; its capabilities allow you to accomplish a wide variety of tasks.

Welcome! We hope you enjoy working with your powerful new assistant: Microsoft Multiplan.



# Contents

---

Preface      iii

Introduction      xiii

Operating Information      xvii

## Part 1      Using Multiplan      1

### 1      Fundamentals      3

The Screen	5
The Direction Keys	7
Moving the Cell Pointer	8
The Status Line	9
Scrolling the Worksheet	11
The Goto (G) Command	14
Command Selection from Menus	17
Multiplan Proposed Responses	18
Filling in the Command Line: The TAB Key	19
Carrying Out a Command: The RETURN Key	20
Canceling a Command: The CANCEL Key	20
The Help (H) Command	20
The Quit (Q) Command	23
Summary	23

### 2      Building a Worksheet      25

The Worksheet Number Grid	28
Entering Text: The Alpha (A) Command	30
Correcting Typing Errors: The BACKSPACE Key	32
Entering Data with the Direction Keys	33
Column Width	37
The Format Width Command	38
Entering Numbers	40

The Format Default Cells Command	43	
Alignment	44	
Formats	45	
Saving Work: The Transfer Save Command	47	
The Quit (Q) Command	49	
Summary	49	
<b>3</b>	<b>Entering Formulas</b>	<b>51</b>
Loading a File: The Transfer Load Command	53	
The Insert Command	55	
Entering Additional Text	57	
Entering Additional Numbers	59	
Aligning Cell Contents	60	
Ranges: The Colon	62	
The Blank Command	65	
Formulas	66	
Building a Formula	67	
Reviewing or Changing a Formula	76	
The Status Line: Cell Contents	76	
Drawing Lines	78	
The Transfer Save Command (Review)	80	
Summary	81	
<b>4</b>	<b>Naming Cells and Copying</b>	<b>83</b>
The Transfer Load Command (Review)	85	
Titles	86	
Format: Align Center	89	
The Copy Right Command	91	
Formulas (Review)	98	
Naming Cells	99	
Building a Formula Using Names	103	
The Goto Name Command	107	
Calculating Functions: SUM	110	
Number Signs (#)	113	
Error Values	114	
Relative References and Absolute References	116	
Copying a Formula: The Copy From Command	121	
Summary	123	

<b>5</b>	<b>Windows, Copying Formulas, and Options</b>	<b>125</b>
	Fixing Titles: The Window Split Title Command	128
	Opening a Window: The Window Split Command	131
	Linking Windows: The Window Link Command	134
	Bordering Windows: The Window Border Command	136
	Building a Formula to Show Increasing Sales	138
	Copying a Formula to the Right: The Copy Right Command (Review)	142
	What If . . . ?	144
	Protecting the Worksheet: The Lock Formulas Command	145
	The NEXT UNLOCKED CELL Key	146
	Unlocking Cells	148
	The Options Command	148
	Summary	152
<b>6</b>	<b>Printing a Worksheet</b>	<b>153</b>
	The Print Command	155
	The Print Printer Command	156
	Other Print Subcommands	157
	Summary	158
<b>7</b>	<b>Using Multiple Worksheets</b>	<b>159</b>
	Relating Worksheets to Each Other	163
	The Transfer Clear Command	164
	Building a Supporting Sheet	165
	Naming Related Worksheets	170
	The eXternal Copy Command	171
	Revising a Supporting Sheet	179
	Dissolving Connections between Worksheets	182
	The eXternal List Command	185
	Summary	186
	Learning More about Multiplan	187



**Part 2      Reference to Multiplan      189**

**8      Elements of Multiplan      191**

The Microsoft Multiplan Worksheet      193

Entering Commands      196

    Select a Command      197

    Select Responses for the Command Fields      198

    Proposed Responses      199

Editing      200

Formulas      202

    Numbers      203

    Text      204

    References to Cells      205

        Absolute References      206

        Relative References      206

        Names      209

        Intersection Operator      210

        Range Operator      211

        Union Operator      212

    Logical Values      215

    Error Values      215

Files      217

    File Handling      217

    Problems with File Access      219

    External Relationships      220

Transforming the Worksheet      223

**9      Command Directory      225**

Alpha      230

Blank      232

Copy      233

    Copy Down      234

    Copy From      235

    Copy Right      238

Delete      239

    Delete Column      240

    Delete Row      241

Edit      242

Format	243	
Format Cells	245	
Format Default	249	
Format Default Cells	250	
Format Default Width	251	
Format Options	252	
Format Width	253	
Goto	255	
Goto Name	256	
Goto Row-col	257	
Goto Window	258	
Help	259	
Insert	261	
Insert Column	262	
Insert Row	263	
Lock	264	
Lock Cells	265	
Lock Formulas	266	
Move	267	
Move Column	269	
Move Row	270	
Name	271	
Options	273	
Print	274	
Print File	275	
Print Margins	276	
Print Options	277	
Print Printer	278	
Quit	279	
Sort	280	
Transfer	282	
Transfer Clear	283	
Transfer Delete	284	
Transfer Load	285	
Transfer Options	287	
Transfer Rename	288	
Transfer Save	289	
Value	291	
Window	293	
Window Border	294	
Window Close	295	
Window Link	296	
Window Split	298	
Window Split Horizontal	299	
Window Split Titles	300	
Window Split Vertical	301	

## Contents

eXternal	302
eXternal Copy	303
eXternal List	306
eXternal Use	307

## 10 Function Directory 309

ABS	312
AND	313
ATAN	314
AVERAGE	315
COLUMN	316
COS	317
COUNT	318
DOLLAR	319
EXP	320
FALSE	321
FIXED	322
IF	323
INDEX	324
INT	325
ISERROR	326
ISNA	327
LEN	328
LN	329
LOG10	330
LOOKUP	331
MAX	333
MID	334
MIN	335
MOD	336
NA	337
NOT	338
NPV	339
OR	340
PI	341
REPT	342
ROUND	343
ROW	344
SIGN	345
SIN	346
SQRT	347
STDEV	348

SUM	349
TAN	350
TRUE	351
VALUE	352

## **11 Message Directory 353**

### **Appendices 363**

- 1 Helpful Hints 365**
- 2 Glossary 369**
- 3 Notes for the VisiCalc™ User 377**
- 4 The SYLK (Symbolic Link) File Format 387**
- 5 Solving Extended Problems with the Iteration Option 395**

### **Index**



# Introduction

---

Microsoft Multiplan is an electronic worksheet—a large grid of entries, each of which can be words, numbers, or formulas. You can set up the Multiplan worksheet with titles and numbers. But more, Multiplan can replace your pen and paper and your calculator because Multiplan can perform the calculations for you.

Multiplan frees you from the limitations of more traditional methods of calculation. Because Multiplan remembers the relationships between entries on the worksheet, it can automatically perform calculations—and this is where the real power comes from. You get a chance to ask “What if?” to test out plans and to forecast. What if one number changes? What is the effect on the Worksheet?

For example:

What if costs rise by 10% for one item and 6.5% for another?

What if production increases?

What if sales of one item skyrocket?

What if home utility bills soar?

Is it worth it to pay express freight to get a product early?

Is it worth it to give a discount to marginal buyers?

Alter a critical number and watch the figures change across your worksheet; observe the effects over time of a small change here, an improvement there. You can run sensitivity analyses, do budget and resource planning, and schedule more efficiently. You'll soon agree that Multiplan is a vast improvement over “hand calculating” methods.

Multiplan overcomes the limitations of paper worksheets. Multiplan offers you a worksheet 255 rows long and 63 columns wide for words, numbers, and formulas. Multiplan allows you to

connect several worksheets so that you can build up a chain of sheets that provide information to each other. You can, as necessary, instantly move, insert, or erase data; widen or shrink columns; or insert or delete space; thereby eliminating the costly and tiresome work of typing or hand printing the worksheet over and over. The Multiplan worksheet is always very flexible.

Multiplan communicates with you as directly and naturally as possible, providing many aids to help you accomplish your objectives. You will soon learn how to manipulate data to obtain the answers you need.

### How to Proceed

An interactive program like Multiplan can be learned only by use. This manual is designed to be read and used as you use Multiplan. It's important that you try, test, and experiment as you learn. You'll be surprised at how quickly it all falls together. Nothing you type can damage the computer or Multiplan, so don't hesitate to experiment.

Part 1, "Using Multiplan," introduces Multiplan in a tutorial manner, in simple steps with many practical examples. You'll learn by using Multiplan to make a financial analysis of a model firm—Spencer Ceramics. The tutorial demonstrates the main Multiplan features as they are commonly used.

Begin by working through Part 1. Chapter 1, "Fundamentals," and Chapter 2, "Building a Worksheet," help you become familiar with the keyboard and screen display and introduce you to the Multiplan typing aids.

"Entering Formulas" and "Naming Cells and Copying," Chapters 3 and 4, lead you further into the use of Multiplan. When you complete these chapters you'll have used some of the most important Multiplan commands and features.

Chapter 5, “Windows, Copying Formulas, and Options,” introduces the finer points of the Multiplan screen display. After completing it, you’ll be ready to print some samples of your work. Chapter 6, “Printing a Worksheet,” tells you how. The final chapter in the tutorial, Chapter 7, “Using Multiple Worksheets,” takes you beyond working with a single sheet. You learn how to organize data on multiple sheets and to draw data from them for use on another sheet.

As you work through Part 1, you’ll find it helpful to refer to Part 2, “Reference to Multiplan.”

Part 2, “Reference to Multiplan,” begins with Chapter 8, “Elements of Multiplan,” which explains in depth the Multiplan worksheet, how to enter commands, how to edit, what formulas are, how access to files works, and what happens when the worksheet undergoes changes that move data.

Part 2 also contains detailed descriptions of all Multiplan commands in Chapter 9, “Command Directory,” of all mathematical and statistical functions in Chapter 10, “Function Directory,” and of all messages Multiplan displays in Chapter 11, “Message Directory.”

At the end of Part 2, you’ll find appendices that contain additional information you’ll find helpful. Appendix 1, entitled “Helpful Hints,” is the most important. These hints suggest ways to make your Multiplan sessions more efficient and effective; if you follow the hints, you’ll save time and space.

Included also is the Multiplan Quick Reference Guide, which summarizes Multiplan for quick, easy reference.

Begin applying Multiplan to simple tasks, making frequent use of Part 2. As you gain experience, use Multiplan for more complex tasks, such as organizing multiple worksheets. You’ll soon find that you have a firm grip on a powerful tool.





# Operating Information

---

The following sections explain how to start a Multiplan session and how Multiplan works with various memory configurations and input/output devices. This information will help you operate Multiplan under the CP/M-80 operating system.

## How to Start Multiplan

After the first time, start Multiplan by following these three steps:

1. Insert a Multiplan diskette that also contains a copy of the operating system in drive A.
2. Insert a data diskette in drive B.
3. Type *MP*, then press RETURN.

## How to Start Multiplan the First Time

The first time you use Multiplan, you must perform a few preliminary tasks.

To protect yourself from accidental errors and to make Multiplan easier to use, you will want to make a copy of Multiplan with CP/M-80 and the PIP utility. This copy has to be made on a formatted diskette. So you will want to format one diskette for your copy of Multiplan (see the section “How to Format a New Diskette”) then follow the procedure described in “How to Make a Copy of Multiplan.”

Multiplan worksheets must also be saved on formatted diskettes. You should format at least one diskette for worksheets. Once you’ve started formatting diskettes, you might as well format several data diskettes.

Before you can run Multiplan, you must tell Multiplan about the characteristics of your terminal. To do this, run the Install program, described in the section “How to Run the Install Program.”

These tasks may seem difficult at first, but formatting a diskette (a task you’ll perform many times as you use Multiplan) will soon be routine. You need to copy Multiplan only once, and, unless you change terminals, you need to run the Install program only once. In fact, once you’ve created a “bootable” copy of Multiplan, just follow the three easy steps, described at the beginning of this section, to start Multiplan.

## How to Start Multiplan for Mode Conversion

You can also start Multiplan with the names of worksheet files you want loaded at the same time:

MP file1 file2 ... filen

If you give only one filename with MP, the computer loads Multiplan, and Multiplan loads the worksheet file in Normal mode. (For details of worksheet modes, see the Transfer Options command in Chapter 9.)

If you give more than one filename, Multiplan processes the worksheet files in pairs, as follows:

For every pair of files you specify, Multiplan converts the first file of the pair from Symbolic format mode to Normal format mode and gives the Normal format file the second name of the pair. For example:

MP80 Model.SK Model.MP

converts the file named Model.SK (a worksheet in Symbolic Link format—SYLK) then sends the result to a file named Model.MP.

After Multiplan converts the first file to the second, it goes on to the next pair of files and converts those. Multiplan continues to process the files in pairs until the last file on the list is reached. Multiplan then loads the last file named in Normal mode for your work with Multiplan.

## Restarting the Operating System (“Warm Booting”)

In general, when you replace one diskette with another, you must inform the system you have done so by “warm booting.” The “warm booting” procedure involves pressing CTRL-C (pressing simultaneously the CTRL key and the C key). The diskette should spin, and a prompt should appear. If the system expects diskettes to be exchanged, as happens when Multiplan allows you to change data diskettes, you should not warm boot. In these cases, warm booting stops the program.

## How to Format a New Diskette

To format a new diskette, use a CP/M-80 initialization or format program. This program appears under many names (FORMAT, INIT, CREATE, FMT, etc.). See your CP/M-80 manual for the name and exact usage. A typical FORMAT program works like this:

1. With a system diskette in drive A, place a blank diskette in drive B.
2. Type *FORMAT*, then press RETURN.

The screen will display a message telling you that the contents of the diskette in drive B will be erased and asking you if that is what you want.

3. Press *Y* then RETURN.

The system will ask what drive to use.

4. Press *B* then RETURN.

If the system asks for the density, select an appropriate density. Usually this density will be the highest density available on your system. You will be asked to insert a diskette and to press RETURN. Make sure that the blank diskette is in drive B and that the drive door is closed.

5. Press RETURN.
6. When asked if you want to format more diskettes, press *N* then RETURN.
7. Press RETURN again. The computer returns to the system in drive A. The diskette in drive B is formatted.

## How to Make a Copy of Multiplan

Making a copy of Multiplan is a procedure accomplished in three phases. First, you copy CP/M-80 onto a formatted diskette. Second, you copy the PIP program onto that diskette. Third, you copy Multiplan onto that diskette.

1. Copy CP/M-80.

**Note** This procedure is different in each CP/M-80 system. You should also consult your CP/M-80 manual. The description of a typical copying procedure follows.

Insert a CP/M-80 system master diskette in drive A and a formatted, blank diskette in drive B.

Type *SYSGEN*, then press RETURN.

**Note** In some systems, *SYSGEN* may have another name. Consult your CP/M-80 manual.

When you are asked for the source drive, press *A*, but do not press RETURN. The screen should now display

SOURCE ON A

Now, press RETURN. The computer will display

COPY BIOS.SYS (Y/N)

Press *Y*, but not RETURN. The computer will display

DESTINATION DRIVE NAME:

Press *B* then RETURN.

The destination drive already has the diskette inserted, so simply press RETURN.

After the computer displays

FUNCTION COMPLETE

press RETURN again.

2. Copy the PIP program.

Type

PIP B: = A:PIP.COM

then press RETURN. This command copies only the PIP program. This procedure should work for all CP/M-80 systems.

3. Copy Multiplan onto the diskette that has the copy of CP/M-80 and PIP.

Move the diskette in drive B to drive A. Insert the Multiplan distribution diskette in drive B.

Warm boot (press CTRL-C).

Type

PIP A: = B:.\* [V]

When a drive prompt reappears, the diskette in drive A will contain a complete "bootable" copy of Multiplan with the PIP utility on the same diskette.

The copy of Multiplan is now on the diskette in drive A and is ready to use. Remove the Multiplan distribution diskette from drive B and store it in a safe place.

Follow the three steps listed under "How to Start Multiplan."

## Keyboard

In the rest of the Multiplan manual, the keyboard keys are referred to by a functional name (by what they do), rather than by what may be written on the key.

The following are the basic key assignments provided by the Install program. Depending on the terminal you use, you may have additional function keys or different key assignments. This chart is also listed in your *Multiplan Quick Reference Guide*. An extended chart, which lists terminal-specific keys, is available in Multiplan itself by pressing *H* then *K* (for *Help Keyboard*). (Press *N*, for *Next*, to view more of the chart.)

**Note** For some functions, several alternatives are listed, separated by commas. CTRL-(letter key) means press the CTRL key and the letter key simultaneously.

<b>Key</b>	<b>Function</b>
CTRL-E	(UP DIRECTION). Move the cell pointer up one row.
CTRL-X	(DOWN DIRECTION). Move the cell pointer down one row.
CTRL-S	(LEFT DIRECTION). Move the cell pointer left one column.
CTRL-D	(RIGHT DIRECTION). Move the cell pointer right one column.

Note that the direction keys form a diamond on the keyboard. Continue moving the cell pointer to scroll the contents of the window.

A direction key may be preceded by CTRL-R to scroll to the next window-size page of the worksheet in the direction of the key.

CTRL-R CTRL-E	(PAGE UP).
CTRL-R CTRL-X	(PAGE DOWN).
CTRL-R CTRL-S	(PAGE LEFT).
CTRL-R CTRL-D	(PAGE RIGHT).
CTRL-Q	(HOME). Moves the cell pointer to R1C1.
CTRL-Z	(END). Moves the cell pointer to the last cell down and right that has contents or has been formatted.
CTRL-W, ;	(NEXT WINDOW). Moves the cell pointer to the next window.
CTRL-F, LINE FEED	(NEXT UNLOCKED CELL). Moves the cell pointer to the next unlocked, nonblank cell.
CTRL-C	(CANCEL). Cancels the present operation and returns to the main command menu.
RETURN	(RETURN). Starts a command selected from a menu or carries out a completed command.
SPACE	Selects the next item on a menu.
BACKSPACE, CTRL-H	Selects the previous item on a menu. When editing responses in command fields, deletes selected characters. Replacement text may be typed.
TAB, CTRL-I, CTRL-A	(TAB). Moves to and selects the entire contents of the next field in the command line.



## Operating Information

?	(HELP). Requests information about the selected command or the command in progress at the time of the request.
!	(RECALCULATE). Recalculates the entire worksheet. If typed in a formula, the formula will be replaced by its result.
CTRL-Y, DELETE	(DELETE). Deletes selected characters. Replacement text may be typed.
CTRL-L	(CHARACTER RIGHT). Selects the character to the right of the current character.
CTRL-K	(CHARACTER LEFT). Selects the character to the left of the current character.
CTRL-P	(WORD RIGHT). Selects the word to the right of the current word.
CTRL-O	(WORD LEFT). Selects the word to the left of the current word.
@	(REFERENCE). Changes relative references to absolute. Also enters names in formulas.

## Memory Use

Multiplan requires at least 64K bytes of memory. With this much memory, the user's workspace is more than 13K bytes. To save workspace, use the suggestions in Appendix 1, "Helpful Hints." Only part of the Multiplan program is actually in memory at any given time. Other parts of Multiplan remain on diskette and are read into memory when they are needed, displacing other portions of the program. This process is called swapping.

## Filenames

Computer files, like files of paper documents, are collections of information. This information may be data (numbers, text, formulas, and so on), computer programs, or a combination of the two.

You will be using the Multiplan program file, named MP.COM, and any number of Multiplan worksheet files that you create yourself. Worksheet files are a permanent record of the information that you enter into the worksheet.

Files are stored on floppy diskettes. Because there may be many files on each diskette, files are identified by filenames. This makes it easy for you to find specific information.

Filenames may be up to 8 characters long. Filenames should begin with a letter, followed by any of the characters A-Z, 0-9,     (underline), or - (hyphen).

To further distinguish among files that may be named similarly, a period and up to 3 additional letters may be appended to a filename as an extension of the name. The most common use for filename extensions is to be able to distinguish the type of the file (types of data or the file format mode) at a glance.

Each diskette has a filename directory to help you and the computer keep track of what files are on the diskette.

To view the directory, use the direction keys with the Transfer Load command (explained in Chapter 9). Or, you can use the operating system DIR (for directory) command, which is described in the CP/M-80 manual.

## Use of Disk Drives

**Warning** Do not change diskettes in the diskette drives unless:

1. Multiplan specifically asks you to. Then, put the diskette into the correct drive, as explained below.
- or
2. Multiplan displays the main command menu.

In particular do not change diskettes while Multiplan shows Help text and the Help command menu.

Always handle diskettes carefully. Protect the diskette from dust, magnetism, extremes of temperature, and mechanical hazards (bending or writing on the label with a ballpoint pen or with a pencil).

You may include an explicit drive letter in a filename (for example, B:SPENCER.WRK, where *B:* is the drive designation).

While working with Multiplan, you might use several disk drives. Multiplan selects the drive to access to be the first of:

1. The drive designation given as part of a filename.
2. The “setup” field of the Transfer Options command.
3. The logged-in drive when you typed MP. The logged-in drive is indicated by the letter in the prompt when you started Multiplan. For example, A> or B>, and so on.

Multiplan assumes that you want to load and save your worksheets and printfiles on the diskette from which you booted the system. If you have more than one disk drive, you can direct Multiplan to store data on a different diskette by changing the default drive, as follows:

1. Press *T* then *O*.

You are now in the Transfer Options command.

2. Press *TAB*.

You are now in the "setup" field.

3. Type (drive letter):.

For example, if you want to change the default drive to drive B, type *B:*. At this point, you may want to switch diskettes in the designated drive. It is all right to do so.

4. Press RETURN.

Multiplan will now look on drive B for worksheets and any files you want to print. It will look on drive A for the parts of Multiplan needed for "swapping." Multiplan will "swap" in part of the program before it writes out a worksheet or file, so don't panic if you see drive A turn on when you direct Multiplan to access a file.

## Disk Errors

If a serious disk error occurs, the operating system may issue the error message:

Bdos Err on drive (letter): (message)

*message* is one of the following: SELECT, R/O, BAD SECTOR. Correct the problem as suggested below, then press RETURN to continue Multiplan.

A SELECT error message probably means that you entered the name of a drive that does not exist.

A R/O (read only) error message means that you tried to write to a protected file or diskette. Either remove write protection from the file or diskette (see your CP/M-80 manual) or write to another (unprotected) file.

A BAD SECTOR error message means one of several problems: your diskette may be improperly seated; the disk drive door may be open; the disk drive may be write protected. Check for these conditions and correct if found. Reboot the operating system and start Multiplan. If the BAD SECTOR error message reappears, your diskette may be bad. If the diskette is a data diskette, replace it with another unused, formatted diskette. If the bad diskette contains the bootable copy of Multiplan, make another bootable copy. Then reboot the operating system and start Multiplan.

If the diskette is full, a disk full error may occur. New diskettes must be formatted before they can be used to store Multiplan (or any other) files. This procedure is described in the "How to Format a New Diskette" section.

## Printer

CP/M-80 works with a wide variety of printers. Multiplan will work with most of them (the printer should expect ASCII characters and a carriage return and a line feed in that order at the end of each line). If the printer needs special characters sent to it to set special modes (for example, bold printing or 132 character width), Multiplan can send the necessary special characters.

1. From the Multiplan main command menu, press *P* then *O*.

This puts you in the Print Options command.

2. Press TAB.

This puts you in the "setup" field.

3. Type in the special characters.

These characters will be sent to the printer only at the start of printing a sheet.

To send a control character, press ^ then the uppercase character (for example, CTRL-L becomes ^L). To send an escape character, press ^ then press |. Your printer manual will tell you what modes are possible and what special characters to send to set the modes.

The “setup” field of the Print Options command is saved when you save the worksheet. Once the worksheet is formatted properly, it will always print out the way you direct.

## How to Run the Install Program

Install is a program used with Microsoft products that run under the CP/M-80 operating system. CP/M-80 supports many different types of terminals. For Multiplan to run correctly on a specific terminal, Multiplan needs to know the characteristics of the terminal. Install is a program that adds information about your terminal to the Multiplan file.

The Install program includes a file (INSTALL.DAT) that contains descriptions of many terminals. If the description of your terminal is in the INSTALL.DAT file, you can quickly modify Multiplan for your terminal.

If your terminal is not described in the INSTALL.DAT file, Install will display questions about terminal characteristics. You will need a manual that describes your terminal for answers to most of the questions. Your answers will be recorded in the INSTALL.DAT file. You can review and edit them later.

Throughout, Install displays explanatory text to help you complete the answer file.

To run Install, you need six files:

INSTALL.COM	The Install program file.
INSTALL.OVR INSTALL.SPC INSTALL.MSG	Data files needed by the Install program.
INSTALL.DAT	The file that contains descriptions of terminals. If Install lists your terminal, then this file contains a description of your terminal.
MP.COM	The Multiplan file to be modified by Install.

Install consists of five phases:

Phase 1	Starting Install and determining if a description of your terminal is included.
Phase 2	Answering questions about your terminal if it is not included in Install.
Phase 3	Reviewing and editing your answers to the questions in Phase 2.
Phase 4	Running terminal tests to verify your answers in Phase 2.
Phase 5	Running Multiplan.

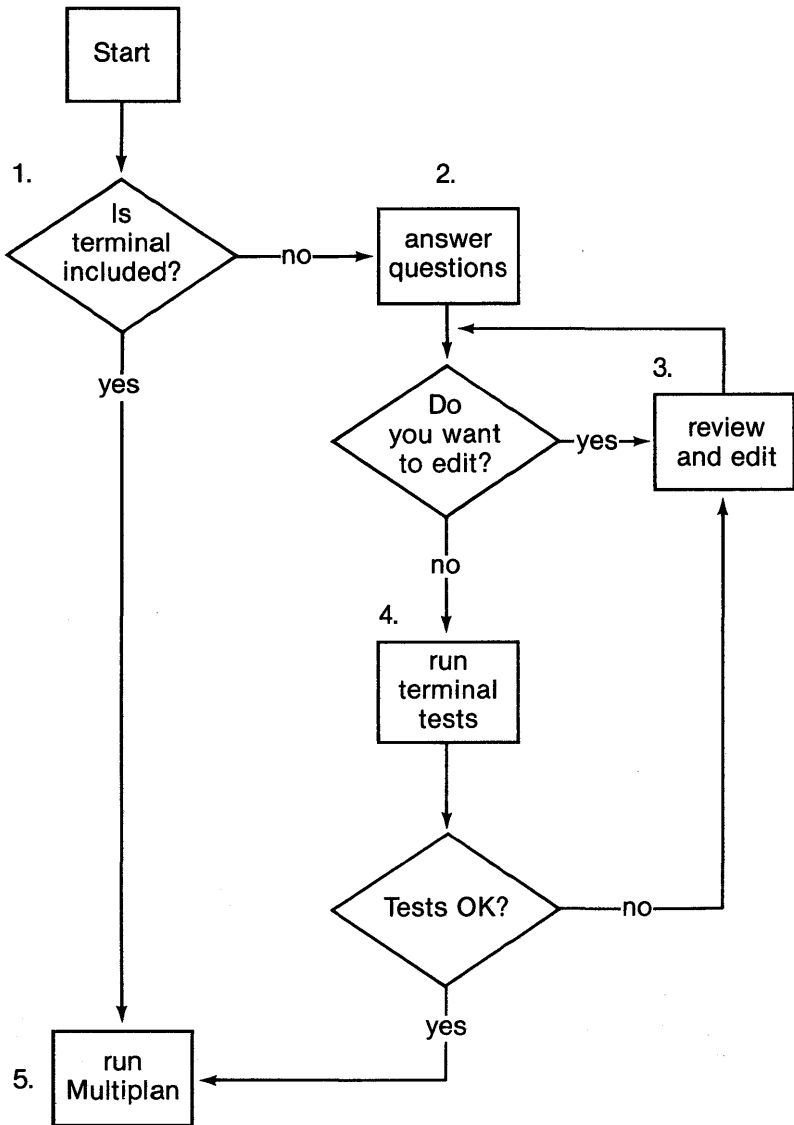

**Phases of the Install Program**



## Phase 1: Starting Install

The first phase of the Install program includes starting Install and determining if a description of your terminal is included in the INSTALL.DAT file.

To start the Install program, type:

INSTALL

then press RETURN. The Install program displays some text that describes the files you need and the basic keys you will need. The files were described above. The basic keys are:

CTRL-C            To abort the Install program at any time.

RETURN            Pressed after typing in each answer. To go on with the Install program at any time, whether or not you type an answer to a question, you press RETURN.

Next you are asked which program you want to modify with Install. When you have answered this question and Install has found the file on a diskette, you are shown a list of terminals. If your terminal is listed, type the number corresponding to your terminal and press RETURN. At this point, simply jump to Phase 5, "Running Multiplan." Phases 2 through 4 do not apply to your terminal and the portions of Install dealing with Phases 2 through 4 will not appear.

If your terminal is not listed, press *1* to define your own terminal. If you select 1, Install begins to ask you questions about your terminal (Phase 2—see the description below). Install then runs short terminal tests. After each test, press RETURN to continue with the next one. If any of the tests fail, press Control-C to exit the terminal tests.

If all terminal tests end successfully, Install finishes the program automatically, including adding the description of your terminal to Multiplan. When Install is finished, it displays the message "Install complete."

## Phase 2: Answer Questions

Install asks if you want to go through all the questions sequentially or if you want to see a menu of all the questions and proposed responses. Phase 3 describes how to select and change items on the menu. But if this is the first time you've run Install, press *Y* and RETURN. Install now displays questions about how screen functions are executed on your terminal.

You should try to answer all the questions as best you can. The questions on cursor positioning must be answered. If not answered or if answered incorrectly, Multiplan will not run. If you do not answer the other questions, the full features of the Multiplan display will not be used.

The answers may be either responses you type or proposed answers that are already a part of Install. To accept correct answers, simply press RETURN.

The questions display characters to prompt you for the type of answer you should enter. The prompts characters are:

- (I) for Integer. Use only number keys for this type of answer.
- (Y/N) for Yes or No. Answer with *Y*, *y*, *N*, or *n*.
- (S) for Character string. Enter a sequence of characters. Special keys can be coded with an escape character (there are two). For example, "What sequence of characters start highlighting?" If the answer is ESCAPE-P, then you type *&EP*. When you see the (S) prompt, typing *&M* causes Install to display a menu of the escape characters.

There are two escape characters; & and ^ . The ^ is for the coding of control characters. The & is for the following characters. The characters can be typed in lowercase or uppercase.

&E - escape  
&N - newline  
&F - forward-space  
&R - return  
&T - tab  
&B - backspace  
&X - rubout  
&^ - ^  
&& - &  
&, - ,  
&Dxxx - xxx, three digit decimal value (less than 256)  
&Oxxx - xxx, three digit octal value (less than 400 octal)  
&Hxx - xx, hex value  
&P&Hxx - pause xx (hex) milliseconds  
&Iy&Dxxx - send the pad character 'y', xxx times  
&Y - Y Used to code a Y after a control-C  
&M - print this menu

*Note*      The millisecond timing of a pause is for an 8 MHz clock. If you have a 4 MHz clock, divide the value by two. If you have a 2 MHz clock, divide the value by four.

You will also be asked questions about key assignments and about graphics characters (questions that have the (S) prompt). You can assign special keys on your terminal to Multiplan functions. For example, if you want the left arrow key to move a screen feature to the left in Multiplan, then you must assign this left movement to the left arrow key. You are not required to assign special keys because control characters provide most of the screen functions.

You can also tell Multiplan the sequence of characters it must output to display graphics characters needed by Multiplan. For example, Microsoft Multiplan needs to generate graphics characters to form borders and column indicators, as follows:

vertical bar	
upper right corner	┐
lower right corner	┌
lower left corner	└
upper left corner	┘
top half of a +	⊥
bottom half of a +	⊤
horizontal bar	—

Multiplan links these graphics characters together to form a box:

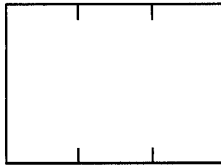

You can answer questions to tell Install the sequence of characters that generate these graphics.

When you have seen and answered all questions, you are ready to review and edit your answers: Phase 3.

### **Phase 3: Reviewing and Editing Answers**

You can review and edit all answers before installing the terminal characteristics in the Multiplan file. Install displays a menu listing questions and their current or proposed responses. To change a response, type the question number and press RETURN. Then answer any questions Install asks.

### **Phase 4: Running Terminal Tests**

Install runs eight terminal tests. During the tests, pressing Control-C returns control to the Install program.

The tests are:

1. Cursor position. No scrolling should occur during this test.
2. Clear to end of display.
3. Multiplan initialization.
4. Key assignment. Press any key except RETURN to test. If you assigned RETURN to another key, pressing this other key terminates the key assignment test.
5. Highlighting. If the terminal does not have "inverse" video (shows black characters on a white background), brackets are placed around highlighted fields.
6. Cursor on/off, key click on/off.
7. Bell.
8. Graphics characters.

### **Phase 5: Running Multiplan**

Multiplan is now ready to be run. Follow the instructions in "How to Start Multiplan."

If Multiplan does not run correctly, rerun Install to review and edit your answers.

## User Defined Routines

The install program will set up Multiplan for most terminals. However, in rare cases you may need to provide your own routines to read and write to the terminal.

You can define your own routines to allow Multiplan to interface with either a memory mapped or serial terminal.

The following is a list of routines that you may define:

OutChar	Output a character to the screen
ReadChar	Read a character from the screen
Setpos	Position the cursor on the screen
ReadXco	Read the x coordinate of the cursor
ReadYco	Read the y coordinate of the cursor
SetAttr	Set a screen attribute (i.e., reverse video)
AlterAttr	Alter the attribute of characters on the screen
Scroll	Scroll the screen in one of four directions
ClrScr	Clear the screen

If you need to write your own interface routines, phone:

(206)828-8080  
 Microsoft Corporation  
 Product Support Group

and ask for the "User Defined Routines for Install" manual.



# Part 1

## Using Multiplan

---

1	Fundamentals	3
2	Building a Worksheet	25
3	Entering Formulas	51
4	Naming Cells and Copying	83
5	Windows, Copying Formulas, and Options	125
6	Printing a Worksheet	153
7	Using Multiple Worksheets	159





# Chapter 1

## Fundamentals

---

The Screen	5
The Direction Keys	7
Moving the Cell Pointer	8
The Status Line	9
Scrolling the Worksheet	11
The Goto (G) Command	14
Command Selection from Menus	17
Multiplan Proposed Responses	18
Filling in the Command Line: The TAB Key	19
Carrying Out a Command: The RETURN Key	20
Canceling a Command: The CANCEL Key	20
The Help (H) Command	20
The Quit (Q) Command	23
Summary	23



# The Screen

To work with Microsoft Multiplan, you need the Multiplan diskette. Refer to the "Operating Information" section at the beginning of this volume for specific information about "How to Start Multiplan" and "How to Format a New Diskette."

When Multiplan is loaded and ready, your screen will show the following display:

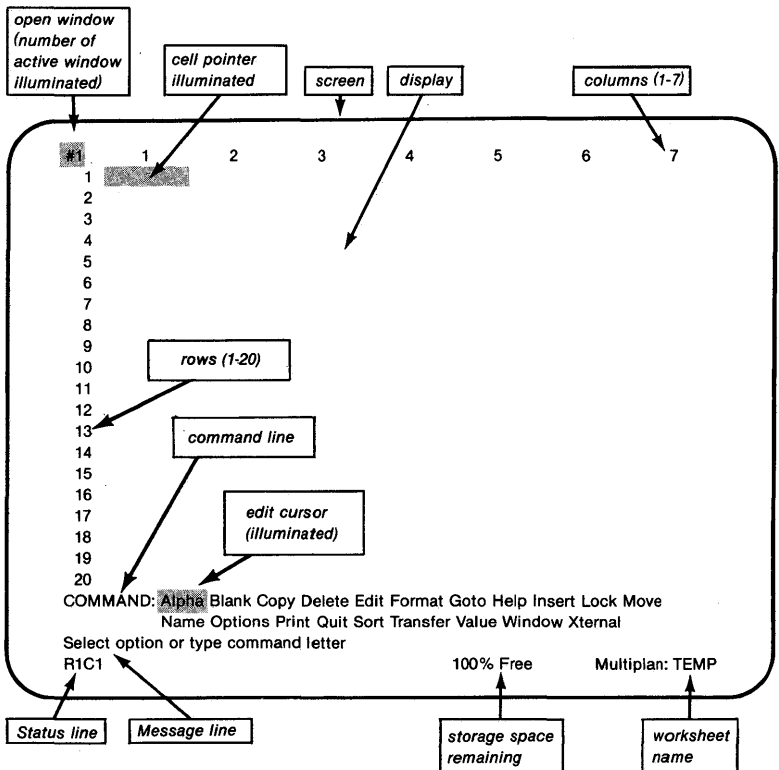

What you see now is the basic Multiplan screen. Notice the row and column numbers, command line, message line, and status

line, as well as three highlighted areas for window number, cell pointer, and command menu. You'll learn more about the parts as you progress through this manual.

Your screen displays only a small portion of the actual worksheet available to you. You can imagine the screen as a window to your worksheet:

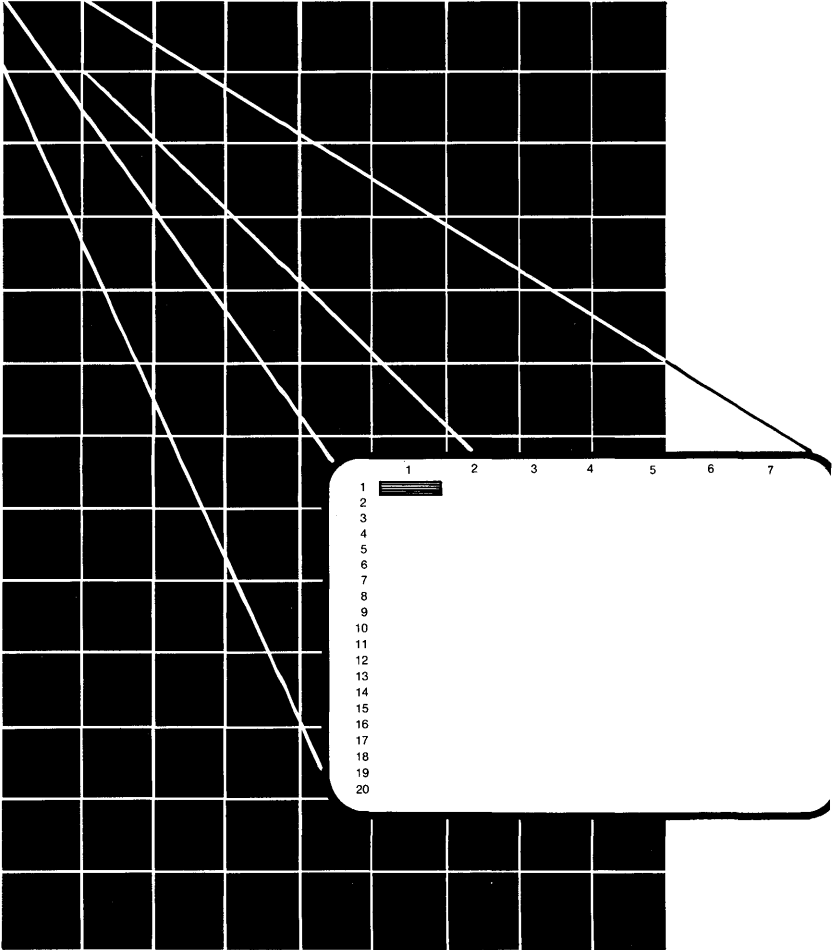

With Multiplan, it is possible to see information on different parts of the worksheet by viewing the sheet through more than one window at a time. You will learn how to do that in Chapter 5.

Columns are numbered across the top. The illustrated screen now shows you 7 of the 63 worksheet columns.

Rows are numbered down the left side of the display. The illustrated screen now shows you 20 of the 255 worksheet rows.

Imagine lines running vertically between the column numbers and horizontally between the row numbers to form boxes on the worksheet. Each box is called a “cell.” Cells hold the values of the worksheet.

The cell that is available for immediate use, the active cell, is illuminated by the cell pointer. The cell pointer is currently in the upper left corner of the display; in row 1, column 1. A cell is identified by its location; the row number is always given first. Cell “row 1, column 1” (R1C1) is the active cell now.

## The Direction Keys

Look at the Quick Reference Guide that came with Multiplan to find the direction keys (named UP, DOWN, LEFT, and RIGHT). Then, locate the keys on your keyboard. These keys are used to move the cell pointer around the worksheet (and for other functions you will learn about later).

## Moving the Cell Pointer

Press the RIGHT direction key once. Now look at the cell pointer. You moved it one cell to the right, to column 2. The pointer is now in row 1, column 2 (R1C2). That cell is now the active cell.

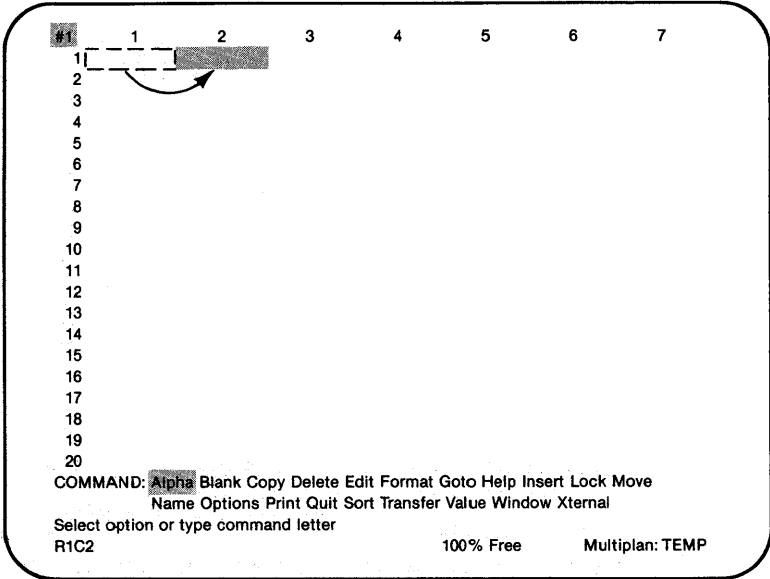

Try the other direction keys. Watch how the cell pointer moves.

Try to move the cell pointer to row 4, column 4 (R4C4). You can press the direction keys in any order you want.

## The Status Line

The bottom line of the screen is called the status line. It tells you the location of the active cell and what it contains. Right now the status line should read R4C4, which is a location. If any other location is shown, use the direction keys to move the cell pointer to row 4, column 4. The space next to R4C4 in the status line shows the contents of the cell; right now the cell is blank so the space is empty.

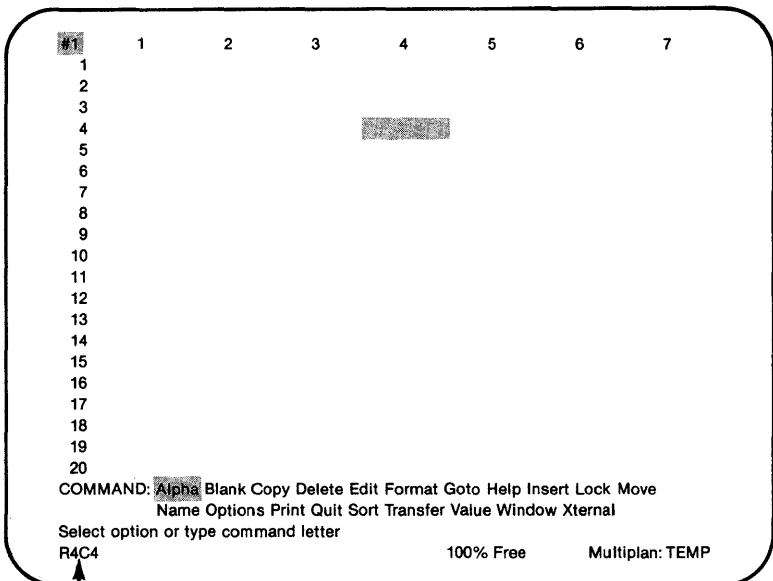

*status line:  
shows active  
cell row 4  
column 4*



# Multiplan

Look at the percent in the center of the status line. It tells you how much working memory is left.

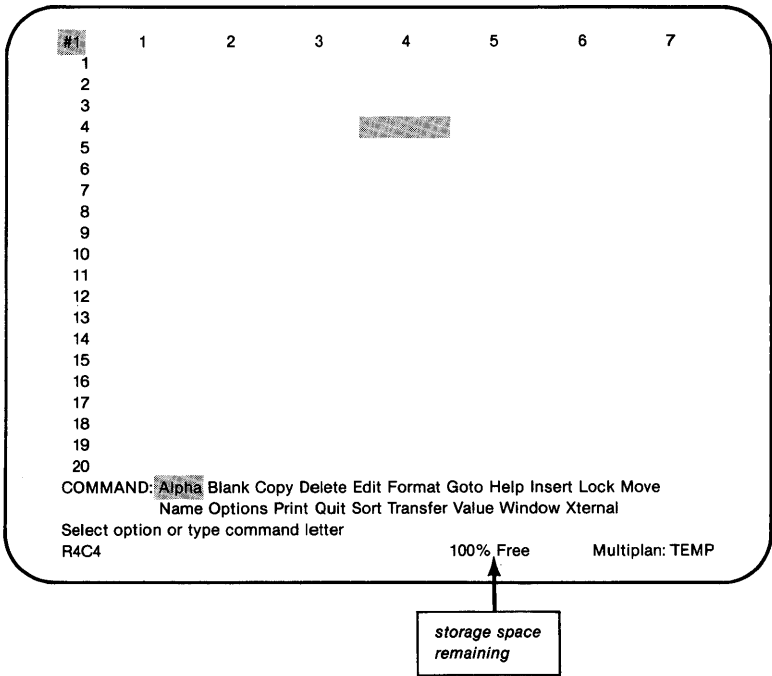

100% Free means that all of working memory is available for your use. Check this percent as you continue your work. The number shows how much room is left to continue your work.

You can name worksheets for ready reference. The status line will also tell you the name of the worksheet currently in use. Until you give your sheet a name of your own, Multiplan calls it *TEMP* (for temporary).

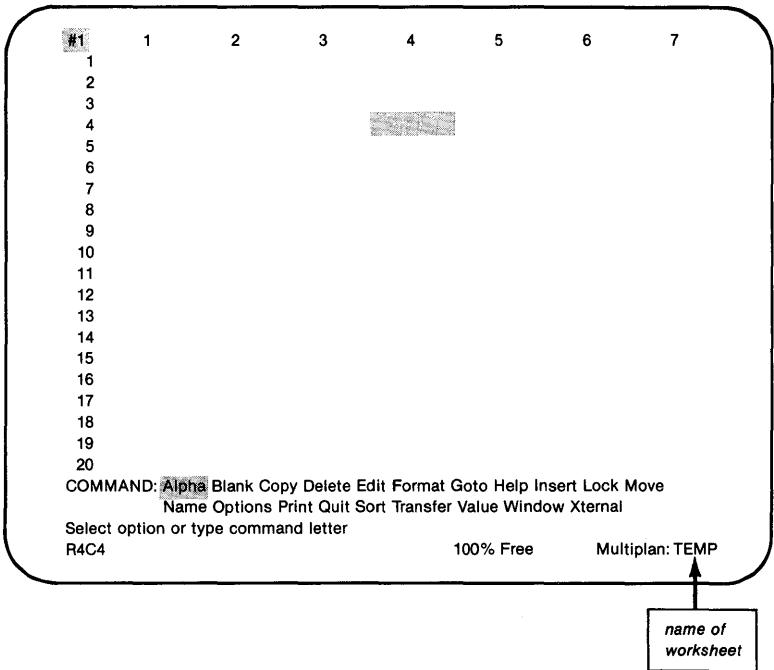

## Scrolling the Worksheet

The illustrated screen shows you only 7 columns. What if you want to see column 15? Press the RIGHT direction key until the cell pointer reaches the right edge of the display. As you continue to press the RIGHT direction key, the pointer remains still, but the columns move to the left beneath it. This is called scrolling.

# Multiplan

Press the RIGHT direction key until column 15 is reached. (Columns 1 through 8 are no longer visible on the left.) You are now in row 4, column 15 (R4C15).

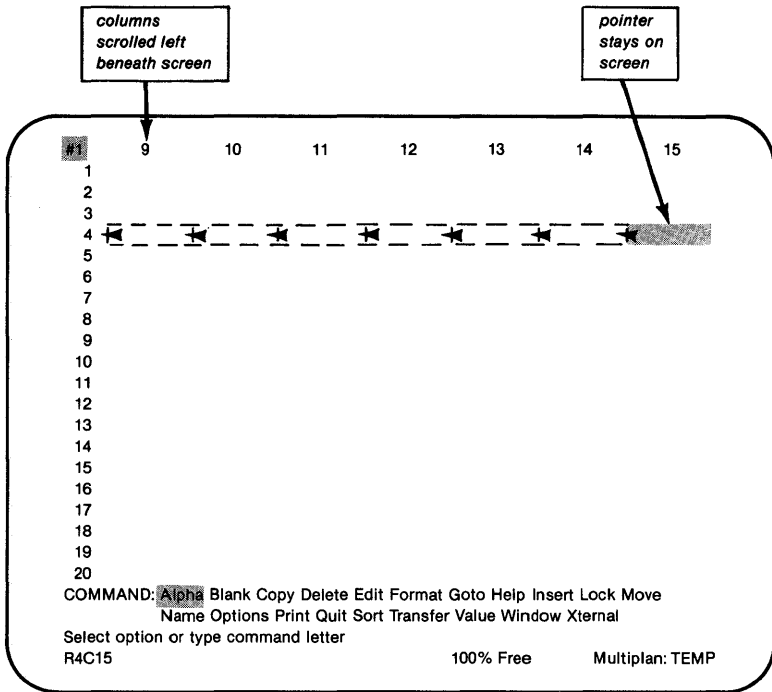

Now press the DOWN direction key until the cell pointer reaches row 43. You are now in row 43, column 15 (R43C15).

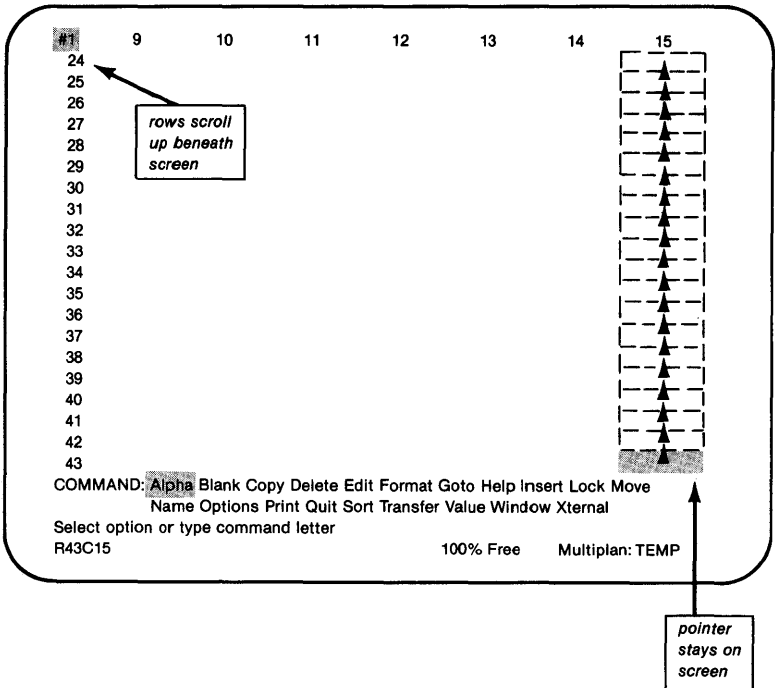

Notice that during all of these movements, the cell pointer always stays on the screen. When the cell pointer reaches the edge of the display, the row numbers or the column numbers scroll across the screen. You could visualize this as sliding the window around the worksheet.

You could return to the upper left corner of the worksheet (R1C1) by pressing the UP and LEFT direction keys until the cell pointer arrives there. But, there is another, faster way to move the cell pointer to R1C1.

Look at the Quick Reference Guide again. Find the HOME key and try it. The cell pointer returns in one movement to the upper left corner (R1C1).

## The Goto (G) Command

There is a way that is faster than using the direction keys to reach a cell on a different part of the worksheet. Press the *G* key. At the bottom of the screen on the command line (above the status line and message line), you should see the command:

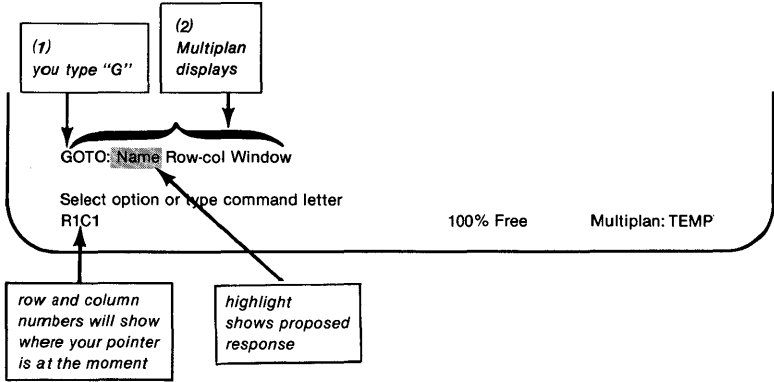

You can see that the Goto command now offers you a choice of subcommands: Name, Row-col(umn), or Window. (Names will be discussed in Chapter 4; Windows in Chapter 5.) For now, we'll consider the Row-col subcommand.

Look at the illuminated box on the command line. It shows which command is selected on a menu.

If you now press *R*, you will see:

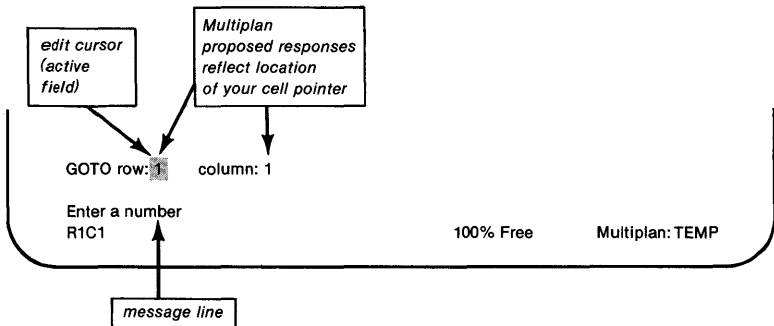

Multiplan is also displaying numbers in the command line in this example, one number by *row* and one number by *column*. The words *row* and *column* are the names of command “fields,” which are where you tell Multiplan how you want a command carried out. Entries in these command fields are called “responses.” When you first select a command, Multiplan proposes responses in the command fields; these responses are called “proposed responses.” Multiplan derives proposed responses from various aspects of the worksheet and your previous responses in command fields. In this case, the proposed responses in the command fields are based on the current position of the cell pointer.

Look at the message line below the command line. It reads, “Enter a number R1C1.” The highlight (called the edit cursor) is in the first field (“row”). Respond with the last row on the worksheet, row 255: type 255.

The command line should now look like this:

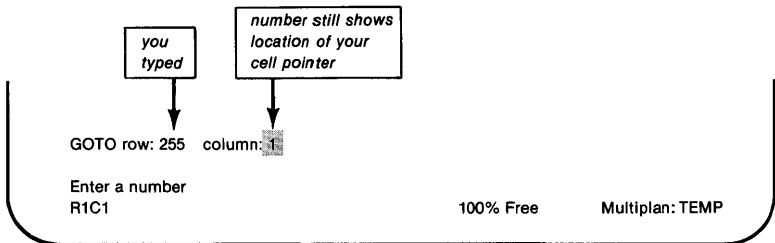

The edit cursor is now after the 255. Press TAB to move the cursor to the second field in the command line.

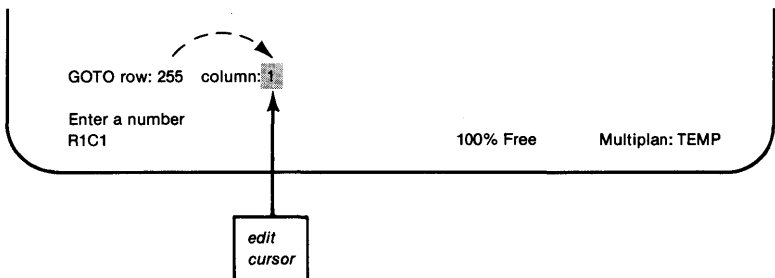

# Multiplan

With the edit cursor in the second field ("column"), pick the last column on the worksheet, column 63: type 63. The command line looks like this:

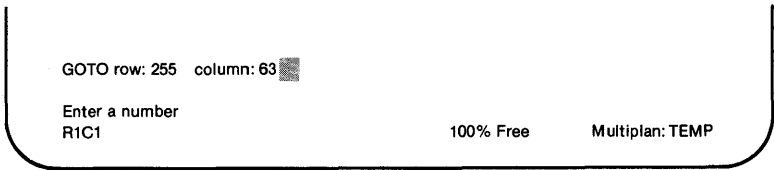

You have now selected the cell (by its row and column numbers) to which you want the cell pointer to go. But, Multiplan does not carry out the command until you tell it to do so. Press RETURN. Your screen should look like this:

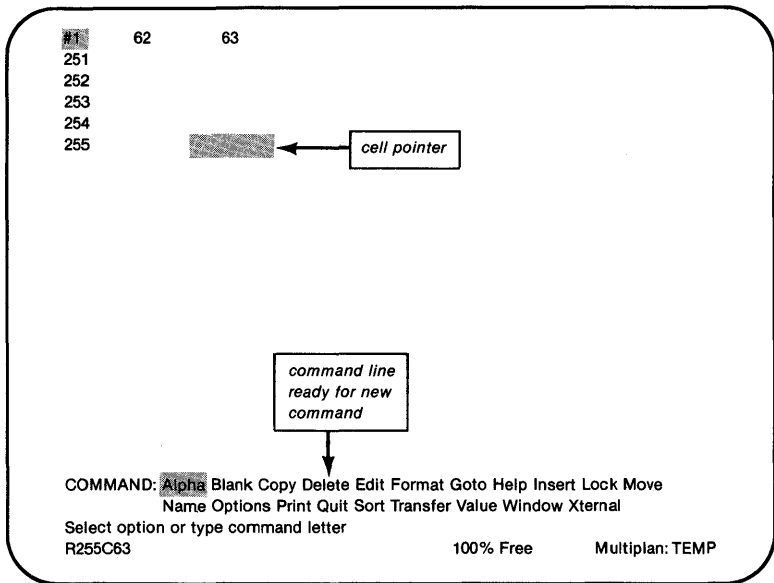

What if you change your mind? You have moved a different part of the worksheet into the screen by using the Goto command. Use this command to move quickly to any part of the worksheet.

Suppose you decide you want row 155 instead of row 255. Press *G* then *R* again. When the edit cursor is in the first field for row number, simply type *155*. If you want to change the last field for column number, use the TAB key to move the edit cursor to that field and type in the new number; for example, *3*. Notice that as you type the *3*, both digits of the *63* are replaced at once.

Press RETURN to carry out the command. The cell pointer is now on row 155, column 3.

## Command Selection from Menus

All Multiplan commands are selected as the Goto command was: you first select the initial letter of the command you want, then you choose one of several versions of the command (subcommands) with another letter.

**Note** If you pressed a key that does not work as a command (an invalid command), such as the letter *J*, the command line will not change, but you will see the message “Illegal option.”

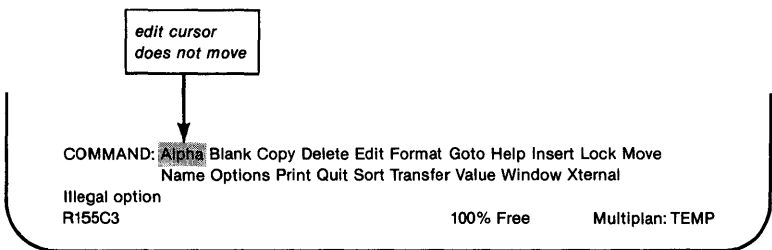

If you have pressed other keys while you were moving the cell pointer, or if you pressed the wrong command letter, look at your Quick Reference Guide to find the CANCEL key. Press it to clear the command line.



## Multiplan

The lists of commands (or subcommands) are called menus. In fact, any time you see choices on the command line, that's a menu. You can select an option from a menu, as the message in the message line will tell you to do ("Select an option"), by typing the first letter of the option you want.

There's another way to select commands and other options. Press the SPACE bar and watch the command line. The highlight moves left to right, stopping at each command name.

Press the SPACE bar until Goto is highlighted. Now press RETURN. The command line should look the same as it did when you typed *G* earlier.

Similarly, you can press SPACE to move between "Name," "Row-col," and "Window." When the highlight rests on "Row-col," press RETURN and you'll see the "row" and "column" fields, as before.

BACKSPACE can be used to back up (move right to left) through a menu.

To save you time, Multiplan presents the subcommands in the order you are most likely to use them. If several subcommands are equally as likely to be used, they are presented in alphabetical order.

You continue to select subcommands until the command line shows command fields. Command fields tell Multiplan how to perform the command.

## Multiplan Proposed Responses

When the command line shows fields (for the Goto Row-col command the fields were "row" and "column"), each field will show a proposed response. In some fields, the proposed response is a blank. In some fields, a proposed response is given which looks like a typed-in response. In fields that have a menu of possible responses, the proposed response is shown either by the highlight (when the edit cursor is in that field) or by parentheses (when the edit cursor is in another field).

Proposed responses often reflect the current settings, positions, and name of the worksheet that you are working with. If you agree with the proposed response, merely press the RETURN key to carry out the command or press TAB to move to the next command field. If you do not want the proposed response, you can change the command field to the response you want.

When you are selecting a command or subcommand, the first choice shown is highlighted. This is also called a proposed response. If you agree with the proposed response, merely press the RETURN key. Or, press SPACE or BACKSPACE to move to another choice. The command line will change to display your choice.

## Filling in the Command Line: The TAB Key

The command line will be divided into as many fields as there are choices to be made. The edit cursor shows you which field is active (available for immediate use).

The edit cursor is moved from field to field by the TAB key, and will return to the first field after the last field has been reached.

In commands with more than two fields, the TAB key moves the cursor like this:

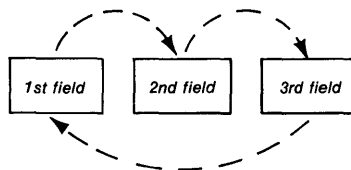

Look at the message line below the command line. Multiplan tells what kind of response you should make in each field. As you move from field to field, the message may change. For the Goto Row-col command it doesn't because both fields require the same type of response, but the message will change for other commands, as we'll see later.

## **Carrying Out a Command: The RETURN Key**

Multiplan does not carry out the command until you tell it to do so. The RETURN key is used to carry out commands.

Also, as shown earlier, the RETURN key is used after you use SPACE or BACKSPACE to move the highlight to a command or subcommand name.

You can press the RETURN key whenever the responses in all the command fields are correct; you are not required to move the edit cursor first.

When a command has been carried out, the command line reappears and waits for a new command from you.

## **Canceling a Command: The CANCEL Key**

At any time before you press RETURN to carry out a command, you may press the CANCEL key to cancel the command. When you press the CANCEL key, the main command menu will reappear and the worksheet will appear as it did before you began the command.

## **The Help (H) Command**

Microsoft Multiplan includes a special Help command to assist you while using Multiplan.

The help information is always available to you.

Let's use the Goto command to illustrate how the Help command works.

Select the Goto command by using SPACE; do not press RETURN. When the highlight rests on Goto, press the ? key. The Multiplan worksheet will be replaced by the help information for the Goto command.

GOTO  
Used to move cell pointer over sheet.  
GOTO ROW-COL  
Moves cell pointer directly to specified row and column. If cell requested is already visible through window, window is not moved. Otherwise window is shifted to show the specified cell.  
GOTO NAME  
Moves cell pointer directly to the upper left corner of named area. The arrow keys may be used to step through the directory of names.  
GOTO WINDOW  
Moves cell pointer and designated cell to upper left hand corner of designated window.

As you can see, the information given for “GOTO ROW-COL” describes what happened when you used the Goto Row-col command.

Notice also that there is a new menu in the command line that looks like:

HELP: **Resume** Start Next Previous  
Applications Commands Editing Formulas Keyboard  
Select option or type command letter  
R155C3 100% Free Multiplan: TEMP

These subcommands are used to view various parts of the help information.

For right now, press C (for Commands). The Goto information is replaced by the beginning of the COMMAND OVERVIEW, which describes how to select commands, as described earlier.

Now, press *N* (for Next). The rest of the COMMAND OVERVIEW is shown. You will often need to use the *N* subcommand because the information for many topics is longer than one screenful.

Now, press *R* (for Resume). The Multiplan worksheet display resumes exactly as you left it; no changes were made. As you can see, the Goto command is still highlighted.

If you try out the Help command, you'll begin to see how it adapts the information to your situation. Let's take Goto again.

Select Goto (if you use SPACE to do this, press RETURN). With the "Name" subcommand highlighted, press ?.

Now the screen shows only part of the Goto information, with GOTO NAME at the top.

Press *R* (for Resume). Move the highlight to Row-col and press ?. Now GOTO ROW-COL is at the top.

Whenever you request help information with the ? key, the information describing the command or subcommand you have selected is listed at the top of the screen.

Instead of the ? key, you can also use the Help command. (First, you need to return to the main command menu — press CANCEL.) When the main command menu is on display, press *H*. Multiplan replaces the worksheet display with the beginning of the Help information.

Now, you can use the Help subcommands in the menu to move through the help information.

From now on, whenever you need quick assistance, you know you can get help by pressing the ? key or by using the Help command.

One final bit of help: remember looking at your Quick Reference Guide earlier for some of the keys? Select the Help command then press *K* (for Keyboard). The beginning of the list of keys appears. Use "Next" (press *N*) to view the rest of the list.

## The Quit (Q) Command

In your next Multiplan lesson, you will learn how to place information on the worksheet. To leave Multiplan now, however, use the Quit command. Press *Q*. Your screen will show:

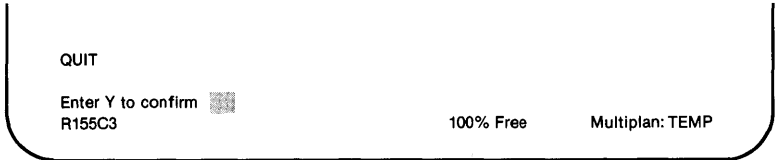

The command line asks you to confirm your decision to erase the screen by typing *Y* for Yes. Press *Y*.

After you've learned to place information on the worksheet, you'll learn how to save your work before you use the Quit command.

The screen is now blank.

## Summary

In this session you learned:

- What the different parts of the screen look like and what they mean.

- Where the the direction keys are located on the keyboard, and what they do.

- How to move the cell pointer using the direction keys and HOME key.

- Where the status line is located, and what it tells you.

- How to scroll the worksheet by using the direction keys.

## Multiplan

How to get to another cell quickly by using the Goto (G) command.

How commands are structured.

How Multiplan helps you by presenting proposed responses.

How to move the edit cursor between fields by using the TAB key.

How to carry out a command by using the RETURN key.

How to leave Multiplan by using the Quit (Q) command.

How to request help by using the ? key and the Help (H) command.

# Chapter 2

## Building a Worksheet

---

The Worksheet Number Grid	28
Entering Text: The Alpha (A) Command	30
Correcting Typing Errors: The BACKSPACE Key	32
Entering Data with the Direction Keys	33
Column Width	37
The Format Width Command	38
Entering Numbers	40
The Format Default Cells Command	43
Alignment	44
Formats	45
Saving Work: The Transfer Save Command	47
The Quit (Q) Command	49
Summary	49





In Chapter 1, you learned how to start Multiplan and how the rows and columns are used to identify the cells of the worksheet.

You also learned how to move the cell pointer to different parts of the worksheet by using the direction keys, and how to move the pointer quickly by using the Goto command.

In this session you will begin to build a worksheet. You will learn how to change cell entries and correct mistakes as you go along. You will also begin work on a financial analysis for a model company—Spencer Ceramics.

A large industrial firm is considering buying Spencer Ceramics and has requested a projected income statement; the firm has asked you for a summary operating budget, showing projected sales, costs, and gross profits. If, on the basis of this information, Spencer Ceramics looks like a good investment, the firm will send in its own accountants to do a more detailed survey.

## The Worksheet Number Grid

Load the Multiplan diskette according to the instructions given in the Multiplan Quick Reference Guide. In a moment you will see the row and column numbers, as well as the command, message, and status lines appear on the screen.

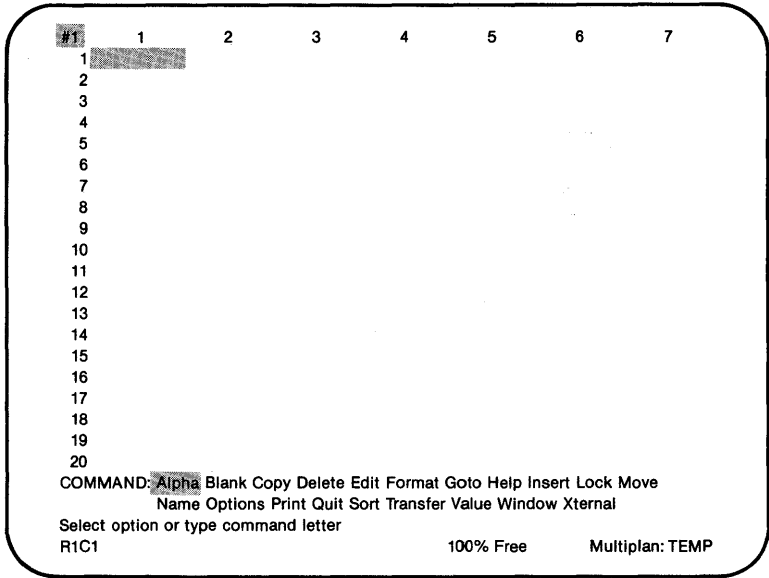

The row and column numbers are merely guides for entering data. The information on the command, message, and status lines is there only to help you enter the data on the worksheet and will not appear on the final printed form.

To plan what needs to be done in your analysis of Spencer Ceramics, let's sketch a brief outline with pencil and paper, showing how the table will be set up.

<i>Spencer Ceramics</i> <i>Projected Income Statement</i> <i>Period: 12 months</i>															
		<i>Jan.</i>	<i>Feb.</i>	<i>Mar.</i>	<i>Apr.</i>	<i>May</i>	<i>Jun.</i>	<i>Jul.</i>	<i>Aug.</i>	<i>Sept.</i>	<i>Oct.</i>	<i>Nov.</i>	<i>Dec.</i>	<i>Jan.</i>	<i>Sum</i>
		<i>Sales</i>													
<i>Cost</i>															
<i>Profit</i>															

With Multiplan, it is easy to expand the worksheet later to add more items; to insert rows or columns of space, or to delete unwanted items. It is even easy to change a figure, such as January sales; Multiplan will recalculate the entire table automatically.

## Entering Text: The Alpha (A) Command

To prepare the worksheet for Spencer Ceramics, begin by entering the headings for the rows and columns. You can add a title to the sheet later.

Text and numbers are entered in different ways. Since Multiplan is designed to deal primarily with numbers and formulas, it automatically recognizes numbers as soon as they are typed. However, when you want to enter text or a title, you must specifically tell Multiplan that you want to enter text, and not a formula, into the cell. You do this by using the Alpha (A) command.

Before you begin, look at the cell pointer on your screen. It should be in row 1, column 1 (R1C1). If it is not, use the direction keys or the HOME key to place it there.

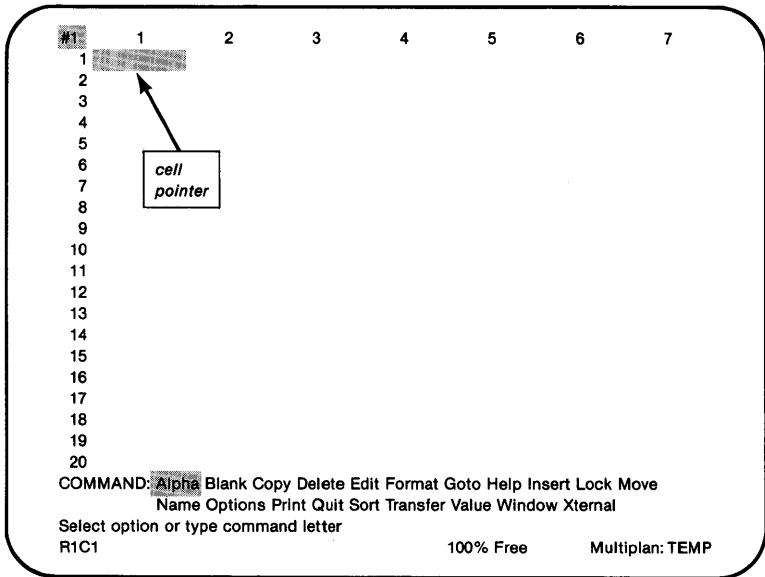

Since you will later need some room at the top of your table for the names of the months, move the cell pointer down two rows. The pointer is now in row 3, column 1 (R3C1).

#1	1	2	3	4	5	6	7
1							
2							
3							
4							
5							
6							
7							
8							
9							
10							
11							
12							
13							
14							
15							
16							
17							
18							
19							
20							

COMMAND: Alpha Blank Copy Delete Edit Format Goto Help Insert Lock Move  
Name Options Print Quit Sort Transfer Value Window Xternal

Select option or type command letter

R3C1 100% Free      Multiplan: TEMP

Now press A. You will see:

ALPHA:

Enter text (no double quotes)

R3C1 100% Free      Multiplan: TEMP

The command line indicates selection of the Alpha command, and the message line informs you that the next step is to enter text. Begin by entering *Sales* in column 1.

Type *Sales*.

Now you see:



## Correcting Typing Errors: The BACKSPACE Key

The edit cursor is located immediately after the text you have typed. Before you press RETURN to enter the text in the cell, try editing the word *Sales* by using the BACKSPACE key. Press BACKSPACE three times. You will see that the edit cursor deletes the character to its left as it moves. You now have:

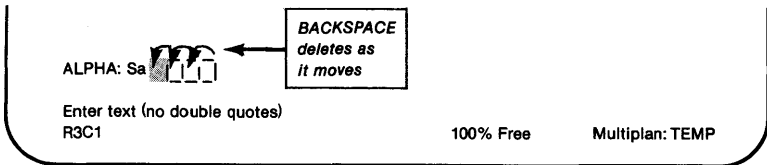

This time type the word incorrectly. Finish typing *Sakes*. Notice that the new characters appear just to the left of the edit cursor. When you've finished typing, you have:

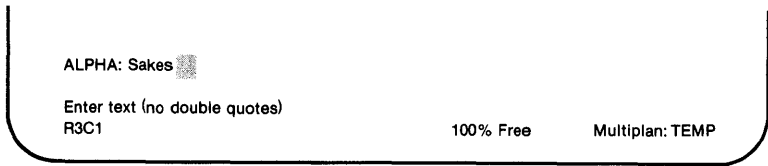

Now use BACKSPACE again and correct the text to *Sales* once again, so that the screen looks like:

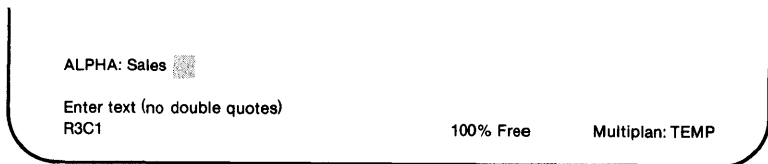

## Entering Data with the Direction Keys

Now that the word *Sales* is correct, you can enter it into the cell in two ways:

1. You could first press RETURN, and *Sales* would appear in the cell R3C1. Try it to see. You now need to press a direction key to move the pointer to the next cell. Before you press a direction key, consider the second way to enter data.



2. A faster way to enter text is to press the DOWN direction key (instead of RETURN), moving the pointer to the next cell in which you want to work. *Sales* will be entered automatically. Try it. Press *A* (for Alpha); *Sales* now appears next to ALPHA: in the command line. Now press the DOWN direction key. *Sales* reappears in cell R3C1, and the cell pointer moves down to R4C1. (You may, of course, use any direction key; your choice will depend on the cell you want to use next.) Notice the command line; it shows:



The next key you press selects either the Alpha command or the Value command, just as if you pressed *A* or *V*.

If you type any digit, 0-9, or press one of the characters = (equals), + (plus), - (minus), . (period), ( (left parenthesis), or " (quotation mark), you select the Value command. All other keys select the Alpha command.

This feature will save you many keystrokes as you continue to work with Multiplan, especially when entering a sequence of text and values in successive cells.

To enter *Cost*, move the cell pointer down to row 5 in column 1 (R5C1).

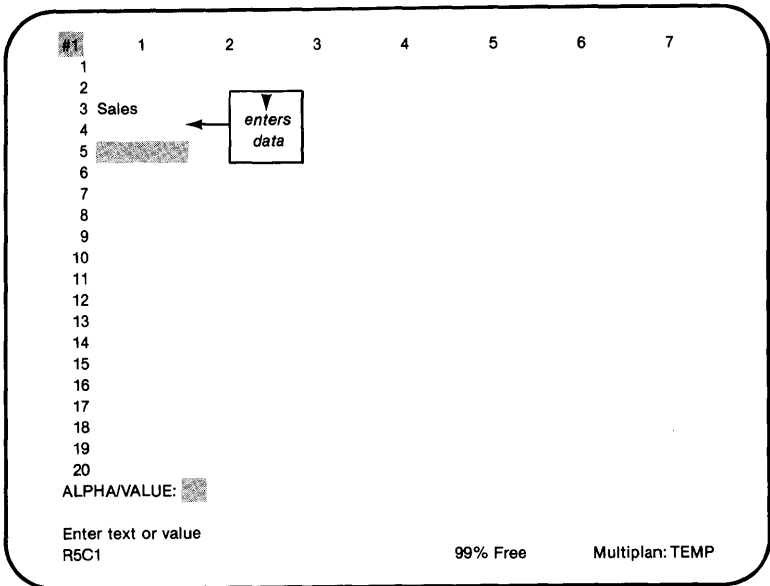

Multiplan is waiting for your next instruction. Tell it that you want to enter more text by beginning to type *Cost*. As soon as you press *C*, the command line changes from ALPHA/VALUE: to ALPHA:, and the message line changes from “Enter text or value” to “Enter text.”



Finish typing *Cost*.

# Multiplan

To enter *Cost* in row 5, column 1 (R5C1), press the DOWN direction key. Continue to press the DOWN direction key until the screen looks like this:

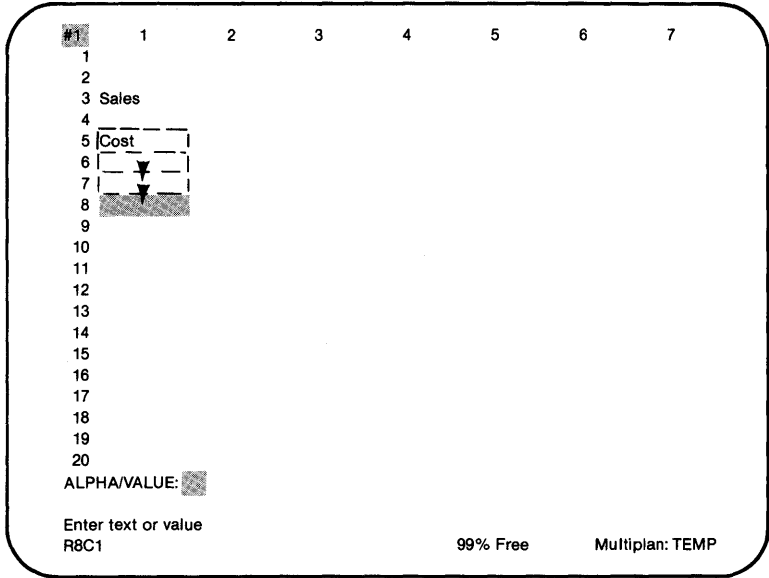

Now enter *Gross Profits* in cell R8C1 (your current position).

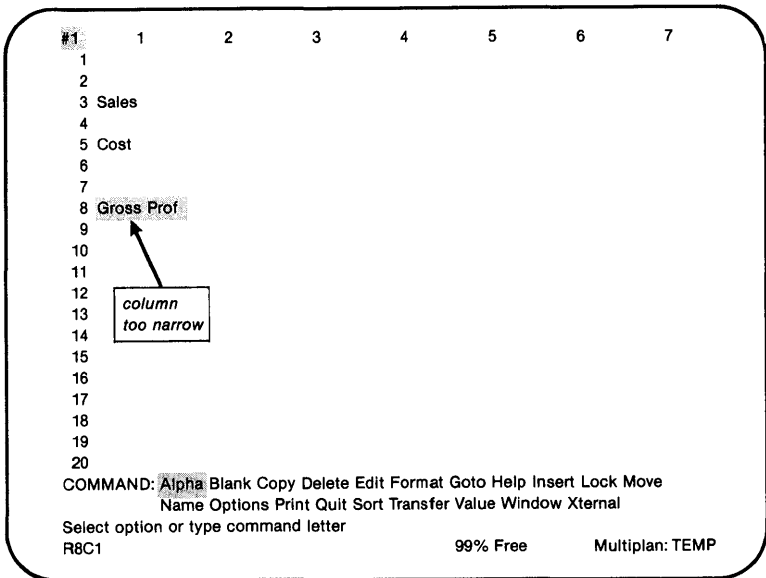

## Column Width

Look at row 8, column 1. You can see that the column is not wide enough to accommodate all the characters in *Gross Profits*. Multiplan has not lost any of the information you have entered. It displays as much of it as it can in the space it has. If you give it more space, it will display the remainder of the characters.

When you started Multiplan, the column width was set at 10 characters. Column width is easily changed using the Format Width command.

## The Format Width Command

Press *F*. On the command line you will see:

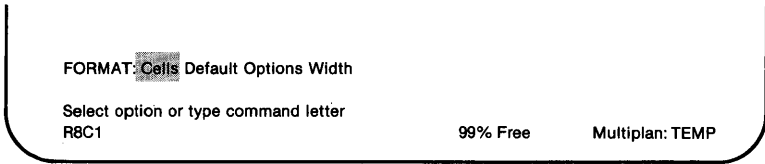

At this point you need the Format Width subcommand. The other subcommands will be explained later. For now, however, press *W*. You will see:

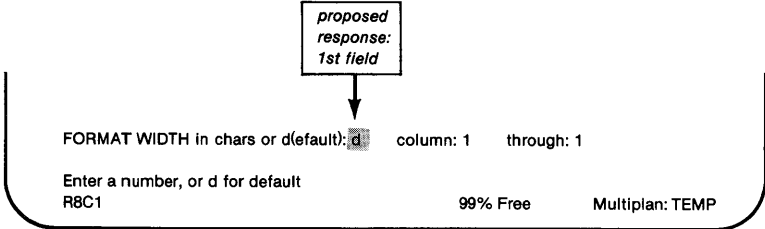

In the first field, Multiplan shows “d” (for default) as the proposed response, but you may specify the number of characters of width you want. Since 10 characters (which is what you now have) is not wide enough to show your heading completely, choose the width you will need. *Gross Profits* has 13 characters (12 letters and 1 space). Select 15 characters of width to give yourself enough room. Type *15*. Now you see:

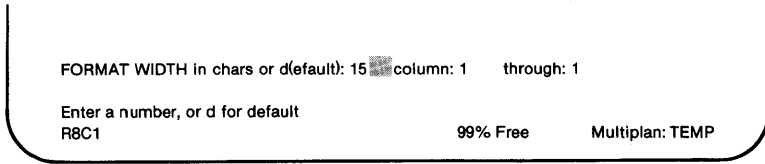

Multiplan lets you select the columns you want to widen. The proposed response is to widen column 1 through column 1. As you only want to widen column 1 at this time, accept the proposed responses; simply press RETURN (you don't need to TAB or change any responses).

The screenshot shows a spreadsheet grid with columns labeled 1 through 7 and rows labeled 1 through 20. The cell at row 8, column 1 (A8) is highlighted and contains the text "Gross Profits". A callout box with an arrow pointing to this cell contains the text "column width now accommodates cell entry". At the bottom of the window, a command menu is visible with "Alpha" selected. Other menu items include Blank, Copy, Delete, Edit, Format, Goto, Help, Insert, Lock, Move, Name, Options, Print, Quit, Sort, Transfer, Value, Window, and Xternal. Below the menu, it says "Select option or type command letter". In the bottom right corner, it displays "99% Free" and "Multiplan: TEMP".

*Gross Profits* may now be seen fully in column 1 because that column has been widened. Your sheet is now ready for the first numbers.

## Entering Numbers

The sales figures for Spencer Ceramics show that the average amount of monthly sales last year was \$20,000.

Move the cell pointer to row 3, column 2 (R3C2) opposite *Sales*. Type 20000. (Use the numbers at the top of the keyboard.)

**Note** Multiplan handles commas in a special way (using the Format Options command), so you do not use commas (20,000) or spaces (20 000) when entering numbers. Also, you do not have to tell Multiplan that you want to enter a number, as you do for text (to enter text, you use the Alpha command). As soon as you type a digit from 0 to 9, Multiplan treats it as if you had selected the Value command.

Do not type the \$ now. Fill in all the figures first. You'll learn how to change them to dollars later.

Look at the command line.

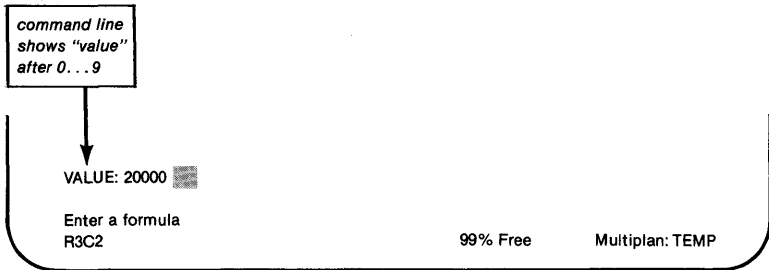

Press the DOWN direction key. Now you have:

#1	1	2	3	4	5	6	7
1							
2							
3	Sales	\$20000.00					
4							
5	Cost						
6							
7							
8	Gross Profits						
9							
10							
11							
12							
13							
14							
15							
16							
17							
18							
19							
20							

ALPHA/VALUE:  
Enter text or formula  
R4C2

99% Free      Multiplan: TEMP

Notice that the ALPHA/VALUE: command line appears again, just as it did when you pressed the DOWN direction key after entering the titles.

Spencer Ceramics' costs were \$15,000 per month. Enter 15000 in row 5, column 2, like this:

1. Move the pointer to the desired cell (row 5, column 2).
2. Type *15000*.
3. Press RETURN to enter the number in the cell.





## The Format Default Cells Command

Multiplan offers a wide selection of formats in which cell entries may be displayed. The command used for this purpose is Format.

Press *F*. You will see:

```

FORMAT: Cells Default Options Width
Select option or type command letter
R5C2                               99% Free      Multiplan: TEMP
  
```

This time you want to change the format of all cells, so choose Default.

The command line shows:

```

FORMAT DEFAULT: Cells Width
Select option or type command letter
R5C2                               99% Free      Multiplan: TEMP
  
```

Now select the proposed response "Cells." The command line now shows:

```

FORMAT DEFAULT CELLS alignment: Ctr Gen Left Right
format code: Cont Exp Fix(Gen)Int $ * % # of decimals: 0
Select option
R5C2                               99% Free      Multiplan: TEMP
  
```

In the first field you will choose the alignment setting.

## Alignment

Alignment means where text and numbers are placed in a cell; flush with the left edge, flush with the right edge, centered, or a mix of right and left (called General).

The "alignment" field offers you these choices:

Settings	Examples	Effect
Ctr	Sales \$1000.25 \$50.25	text and numbers centered
Gen	Sales \$1000.25 \$50.25	text flush left numbers flush right
Left	Sales \$1000.25 \$50.25	text and numbers flush left
Right	Sales \$1000.25 \$50.25	text and numbers flush right

Any alignment choice that sets the numbers to the right would be acceptable because you want the decimal points to be in line with each other. Therefore, you could choose Gen or Right with the same effect on the numbers. However, because this command can affect all cells, including column 1, all of your text would be moved to the right, too. Since the proposed response (Gen) is acceptable, press TAB to move to the next field where you'll choose the format of the display.

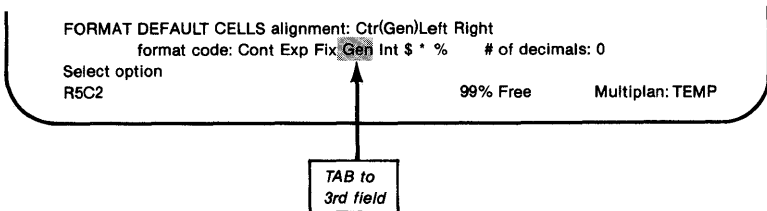

## Formats

The second field contains several choices for the format of the display. At this point, you know you want the format code for dollars. Some of the other choices are quite specialized. The following chart gives a brief summary of these formats; they are thoroughly explained in the “Command Directory” in Part 2.

<b>Settings</b>	<b>Meanings</b>	<b>Examples</b>
Cont	Continuous	Spencer Ceramics
Exp	Scientific	1.4301E-23 4.67E5
Fix	Fixed Point	4.513
Gen	General	text and numbers shown in standard format
Int	Integer	3.1416 shown as 3
\$	Dollars	\$20000.00 (\$150.00)
*	Bar Graph	3 shown as ***
%	Percent	.0513 shown as 5.13%
—	(Do not change format)	

# Multiplan

Choose the dollar format instead of the proposed response by typing a dollar sign (\$).

FORMAT DEFAULT CELLS alignment: Ctr(Gen)Left Right  
format code: Cont Exp Fix Gen Int \$ \* % # of decimals: 0  
Select option  
R5C2 99% Free Multiplan: TEMP

↑  
cursor moves to \$

Selecting the dollar format automatically gives you two decimal places, so you do not need to specify a number in the last field.

As soon as you have made certain that all your choices are correct, press RETURN to carry out your choices.

#1	1	2	3	4	5	6	7
1							
2							
3	Sales		\$20000.00				
4							
5	Cost		\$15000.00				
6							
7							
8	Gross Profits						
9							
10							
11							
12							
13							
14							
15							
16							
17							
18							
19							
20							

COMMAND: Alpha Blank Copy Delete Edit Format Goto Help Insert Lock Move  
Name Options Print Quit Sort Transfer Value Window Xternal  
Select option or type command letter  
R5C2 99% Free Multiplan: TEMP

You have made three choices in the Format command:

1. You selected Format Default Cells to choose settings for all cells.
2. You selected the proposed alignment of the contents of the cells.
3. You selected the display format for dollars (\$), which automatically gave you two decimal places.

**Note** You can change the way numbers are displayed any time you like without changing their values. For example, you could show the same value as 3, 3E0, \$3.00, or 300%, or even “\*\*\*”, depending on the format setting you select. See “Format” in Chapter 9, “Command Directory,” in Part 2.

You have learned about formatting in this session, and you will learn more in the next chapter. You will also use a more detailed breakdown of costs to make a more comprehensive forecast for Spencer Ceramics.

## Saving Work: The Transfer Save Command

Unless you save your worksheet, you will have to start over the next time you use Multiplan. To save your worksheet, use the Transfer Save command. Press *T*. The command line now shows:

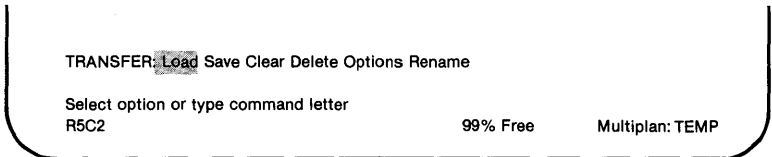

To save your work, choose "Save" by pressing S.

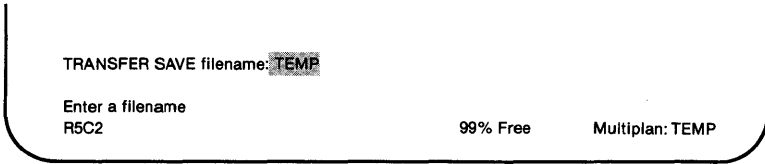

Give your worksheet a meaningful filename, so that it will be easy to remember when you load the sheet in the next session.

Type *SPENCER*.

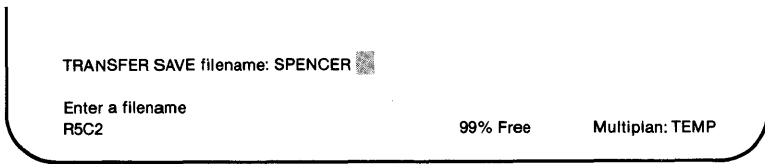

You have replaced the name *TEMP*, which Multiplan had given the sheet in the absence of another name. From now on, you must ask for this file by its exact name when you want to load it, or Multiplan will not be able to find it.

Press RETURN to complete the command. Notice that the sheet name on the status line has changed to reflect the new sheet name.

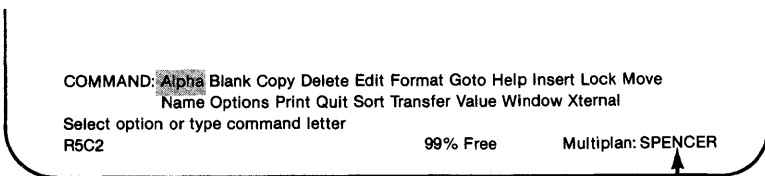

## The Quit (Q) Command

To leave Multiplan, press *Q* (for Quit), as you did at the end of the last session:

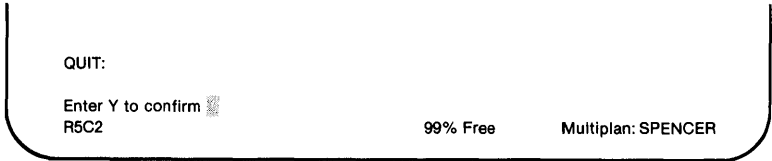

Be sure you have saved your work with the Transfer Save command before you press *Y*.

Press *Y*. The screen should now be blank.

When you begin the next session, you will use the Transfer Load command to pick up where you left off.

## Summary

In this session you learned:

How to use the Alpha (*A*) command to enter text.

How to use BACKSPACE to correct typing errors by deleting characters.

How to enter data using the direction keys.

How to change the width of columns using the Format Width command.

How to enter numbers in cells.



How to change cells to the dollar format using the Format Default Cells command.

What alignment settings are available.

What format settings are available.

How to save your work using the Transfer Save command.

# Chapter 3

## Entering Formulas

---

Loading a File: The Transfer Load Command	53
The Insert Command	55
Entering Additional Text	57
Entering Additional Numbers	59
Aligning Cell Contents	60
Ranges: The Colon	62
The Blank Command	65
Formulas	66
Building a Formula	67
Reviewing or Changing a Formula	76
The Status Line: Cell Contents	76
Drawing Lines	78
The Transfer Save Command (Review)	80
Summary	81



In the last session you learned to put text (using the Alpha command) and numbers into cells by pointing to them with the cell pointer, typing the information in the command line, then entering it into the cell by pressing either RETURN or one of the direction keys.

You also learned to use the Format command to display numbers in dollar format.

At the end of the session you saved your worksheet in a file that you named *SPENCER*.

In this session you will get more practice in entering words and numbers and in formatting cells. Most important, you will learn to enter formulas.

## Loading a File: The Transfer Load Command

When you start your Multiplan program, you will see that the row and column numbers appear on the screen, but not the information you typed in earlier. You have to load the file before that information will appear. Press *T* (for Transfer). The command line will show:

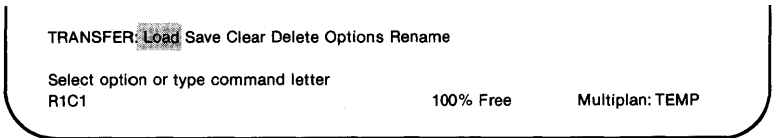

Multiplan has selected "Load" as its proposed response. Since you want to load your file into Multiplan, merely press RETURN (or press *L*). The command line will show:

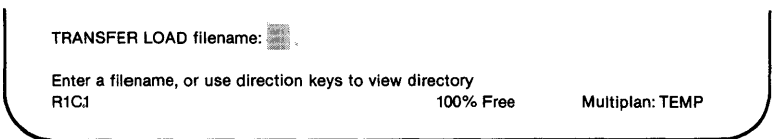

## Multiplan

Type the name of the file you wish to load, *SPENCER*. You should see:

TRANSFER LOAD filename: **SPENCER**

Enter a filename, or use direction keys to view directory  
R1C1 100% Free Multiplan: TEMP

Then, press RETURN. Your file looks like this when it is loaded:

#1	1	2	3	4	5	6	7
1							
2							
3	Sales	\$20000.00					
4							
5	Cost	\$15000.00					
6							
7							
8	Gross Profits						
9							
10							
11							
12							
13							
14							
15							
16							
17							
18							
19							
20							

COMMAND: **Alpha** Blank Copy Delete Edit Format Goto Help Insert Lock Move  
Name Options Print Quit Sort Transfer Value Window Xternal

Select option or type command letter  
R5C2 99% Free Multiplan: SPENCER

Notice that the cell pointer is at cell R5C2, just as it was when you saved this worksheet at the end of the last chapter.

## The Insert Command

Look at the following breakdown of Spencer Ceramics' monthly costs:

Material	= \$ 4,000.00
Labor	= \$ 7,000.00
Overhead	= <u>\$ 4,000.00</u>
 Total Costs	 = \$15,000.00

Your worksheet must be expanded to make room for this new information. You will need space for *Material*, *Labor*, and *Overhead*, as well as *Total Costs*. It would be logical to place this information between the *Cost* and the *Gross Profits* titles. To prepare for inserting this new information, move the cell pointer to R6C2.

To insert either empty rows or empty columns, use the Insert command. Press *I*.

INSERT: **Row** Column

Select option or type command letter

R6C2 99% Free      Multiplan: SPENCER

The proposed response, "Row," is what you want. (You need to add some extra rows of space.) Press RETURN to select "Row."

INSERT ROW # of rows: **1**      before row: 6

   between columns: 1      and: 63

Enter a number

R6C2 99% Free      Multiplan: SPENCER

Notice that the proposed responses are based on the position of the cell pointer. Because the cell pointer is at row 6, Multiplan proposes the insertion of 1 row of space before row 6, extending from column 1 through 63; in other words, across the whole worksheet.

The new figures will require at least 5 rows (4 for figures and 1 for the total costs). Allow yourself enough room by adding 7 rows. Press 7.

INSERT ROW # of rows: 7  before row: 6  
between columns: 1 and: 63  
Enter a number  
R6C2 99% Free Multiplan: SPENCER

Look at the second field. In the “before row” field, you tell Multiplan where to insert the new space by filling in which row the space should go in front of. You need the space between row 5 and row 8. You may put the new rows in front of row 6 or 7 or 8. Since the proposed response of row 6 is all right, we don’t need to change it.

Multiplan also proposes that you insert the new rows of space across all of the columns by saying, “between columns 1 and 63.” Since you want the space to extend across your worksheet, you also do not need to type any numbers in either the third or fourth fields. Just press RETURN to carry out the command as it stands.

Now you see:

#1	1	2	3	4	5	6	7
1							
2							
3	Sales				\$20000.00		
4							
5	Cost				\$15000.00		
6							
7							
8							
9							
10							
11							
12							
13							
14							
15	Gross Profits						
16							
17							
18							
19							
20							

7 new rows added

COMMAND: Alpha Blank Copy Delete Edit Format Goto Help Insert Lock Move  
 Name Options Print Quit Sort Transfer Value Window Xternal  
 Select option or type command letter  
 R6C2 99% Free Multiplan: SPENCER

## Entering Additional Text

You will be able to add the new information in the space you have created. Under *Cost* (row 5), you will type the subcategories of *Material* in row 6, *Labor* in row 7, and *Overhead* in row 8. Leave a row of space between *Overhead* and *Total Costs* for a line, and type *Total Costs* in row 10. The procedure is the same as given in Chapter 2, and is summarized here:

Move the cell pointer to row 6, column 1 (using either the direction keys or the Goto command). Use the Alpha command.

Press A (or RETURN).

Type *Material*. If you make a mistake in entering text, BACK-SPACE and type over the mistake.



Press the DOWN direction key to enter *Material*. Your screen now looks like this:

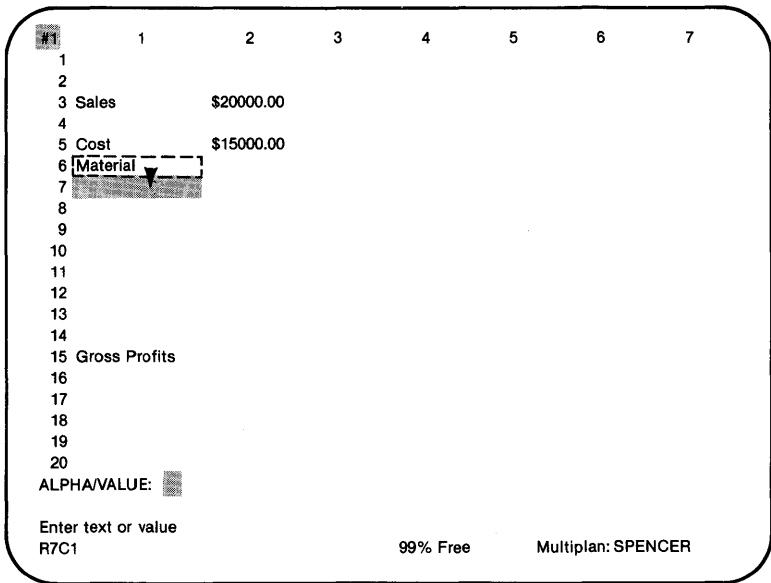

As in Chapter 2, the ALPHA/VALUE: command reappears after pressing a direction key, and the next character you type selects either the Alpha or the Value command.

Enter *Labor* in row 7 and *Overhead* in row 8 by simply typing the title then pressing the DOWN direction key.

Leave row 9 empty for now, and move the cell pointer to row 10. Enter *Total Costs*, as you entered *Labor* and *Overhead*. Your screen should now look like this:

#1	1	2	3	4	5	6	7
1							
2							
3	Sales		\$20000.00				
4							
5	Cost		\$15000.00				
6	Material						
7	Labor						
8	Overhead						
9							
10	Total Costs						
11							
12							
13							
14							
15	Gross Profits						
16							
17							
18							
19							
20							

ALPHA/VALUE:

Enter text or value  
R11C1

99% Free      Multiplan: SPENCER

## Entering Additional Numbers

Now you are ready to enter the numbers.

Move the cell pointer to row 6, column 2. Notice that the ALPHA/VALUE: command remains on the command line.

Type *4000*.

Press the DOWN direction key.

## Multiplan

Type *7000*, and press the DOWN direction key.

For the last number (by *Overhead*), type *4000*, and press RETURN. You will see:

#1	1	2	3	4	5	6	7
1							
2							
3	Sales		\$20000.00				
4							
5	Cost		\$15000.00				
6	Material		\$4000.00				
7	Labor		\$7000.00				
8	Overhead		\$4000.00				
9							
10	Total Costs						
11							
12							
13							
14							
15	Gross Profits						
16							
17							
18							
19							
20							

COMMAND: Alpha Blank Copy Delete Edit Format Goto Help Insert Lock Move  
Name Options Print Quit Sort Transfer Value Window Xternal  
Select option or type command letter  
R8C2 99% Free Multiplan: SPENCER

## Aligning Cell Contents

To make it clear that the four entries under *Cost* (*Material*, *Labor*, *Overhead*, and *Total Costs*), are subcategories, you will want to align them to the right side of column 1. First position the cell pointer on the first cell to be aligned (row 6, column 1).

To align cells, use the Format command. Press *F*.

```

FORMAT: Cells Default Options Width
Select option or type command letter
R6C1      "Material"                99% Free      Multiplan: SPENCER
    
```

From the command line choices, choose “Cells” (by pressing *C* or RETURN). The command line now shows:

```

FORMAT cells: R6C1                alignment: (Def)Ctr Gen Left Right -
                format code:(Def)Cont Exp Fix Gen Int $ * % - # of decimals: 0
Enter reference to cell or group of cells
R6C1      "Material"                99% Free      Multiplan: SPENCER
    
```

The first field (“cells”) shows the “active” cell (where the cell pointer is located, R6C1). We want first to align this single cell to the right to see how it looks. So, leave the proposed response as is.

TAB to the next field (“alignment”). To select an alignment here, use the same method you used for the Format Default Cells command in Chapter 2. Press *R* (for Right). The command line shows:

```

FORMAT cells: R6C1                alignment: Def Ctr Gen Left Right -
                format code:(Def)Cont Exp Fix Gen Int $ * % - # of decimals: 0
Select option
R6C1      "Material"                99% Free      Multiplan: SPENCER
    
```

The proposed response in the “format code” field is suitable and the “# of decimals” doesn’t concern us now, so press RETURN. You will see:

#	1	2	3	4	5	6	7
1							
2							
3	Sales		\$20000.00				
4							
5	Cost		\$15000.00				
6	Material		\$4000.00				
7	Labor		\$7000.00				
8	Overhead		\$4000.00				
9							
10	Total Costs						
11							
12							
13							
14							
15	Gross Profits						
16							
17							
18							
19							
20							

COMMAND: Alpha Blank Copy Delete Edit Format Goto Help Insert Lock Move  
 Name Options Print Quit Sort Transfer Value Window Xternal  
 Select option or type command letter  
 R6C1 "Material" 99% Free Multiplan: SPENCER

*text aligns right*

You also want to align rows 7 through 10 in column 1 to the right. You can align these four cells at once by using the symbol for “range,” as explained in the next section.

## Ranges: The Colon

With Microsoft Multiplan, you can perform tasks on more than one cell at a time by typing two cell locations separated by a colon. Let’s try this with *Labor*, *Overhead*, and *Total Costs* in column 1.

1. Move the cell pointer to *Labor* (R7C1).
2. Press *F* (for Format).

- Press **C** (for Cells). You can now see R7C1 in the “cells” field:

FORMAT cells: **R7C1** alignment: (Def)Ctr Gen Left Right -  
 format code:(Def)Cont Exp Fix Gen Int \$ \* % - # of decimals: 0  
 Enter reference to cell or group of cells  
 R7C1 "Labor" 99% Free Multiplan: SPENCER

- Press the colon (:). Notice that the response in the field is not deleted. Multiplan helps you with entering a range that starts at the active cell.
- Now let Multiplan do the work for you. Press the DOWN direction key until the cell pointer is in row 10 (R10C1). Notice the response in the “cells” field. It shows the range of cells you want to change.

#1	1	2	3	4	5	6	7
1							
2							
3	Sales		\$20000.00				
4							
5	Cost		\$15000.00				
6		Material	\$4000.00				
7	Labor		\$7000.00				
8	Overhead		\$4000.00				
9							
10	Total Costs						
11							
12							
13							
14							
15	Gross Profits						
16							
17							
18							
19							
20							

FORMAT cells: **R7C1:R10C1** alignment: (Def)Ctr Gen Left Right -  
 format code: (Def)Cont Exp Fix Gen Int \$ \* % - # of decimals: 0  
 Enter reference to cell or group of cells  
 R10C1 "Total Costs" 99% Free Multiplan: SPENCER

*shows range of cells*

6. TAB to the second field (“alignment”). In the second field, you again want to change the proposed response from “Def” (which aligns words to the left) to “Right.”
7. Press *R*.
8. As before, the proposed response in the other two fields are suitable, so press RETURN.

Your screen should now show you the new alignment for rows 6 through 10 in column 1:

#1	1	2	3	4	5	6	7
1							
2							
3	Sales		\$20000.00				
4							
5	Cost		\$15000.00				
6	Material		\$4000.00				
7	Labor		\$7000.00				
8	Overhead		\$4000.00				
9							
10	Total Costs						
11							
12							
13							
14							
15	Gross Profits						
16							
17							
18							
19							
20							

COMMAND: Alpha Blank Copy Delete Edit Format Goto Help Insert Lock Move  
Name Options Print Quit Sort Transfer Value Window Xternal  
Select option or type command letter  
R7C1 "Labor" 99% Free Multiplan: SPENCER

In Chapter 4, we will discuss “ranges” and other kinds of references to cells more fully.

## The Blank Command

Now you are ready to enter values for *Total Costs* in row 10.

When you do so, you will have two rows showing total costs. You started with *Cost* in row 5, and now you have another row for *Total Costs*. To correct this duplication, you will want to blank out the number \$15000.00 in row 5, column 2. The worksheet will be clearer if the heading *Cost* is left as a major category heading in column 1, but you want the number to appear next to *Total Costs*.

Use the Blank command to blank out the \$15000.00. First move the cell pointer to row 5, column 2.

Press *B* (for Blank). The command line shows:

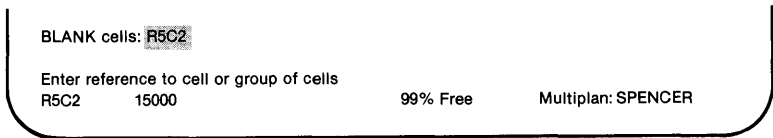

Look at the cell number highlighted by the edit cursor. It shows you that the cell pointer is in row 5, column 2. All you have to do is press RETURN to erase the contents of that cell. Watch R5C2 as you press RETURN.



# Multiplan

#1	1	2	3	4	5	6	7
1							
2							
3	Sales		\$20000.00				
4							
5	Cost						
6	Material	\$4000.00					
7	Labor	\$7000.00					
8	Overhead	\$4000.00					
9							
10	Total Costs						
11							
12							
13							
14							
15	Gross Profits						
16							
17							
18							
19							
20							

COMMAND: Alpha Blank Copy Delete Edit Format Goto Help Insert Lock Move  
Name Options Print Quit Sort Transfer Value Window Xternal  
Select option or type command letter  
R5C2 99% Free Multiplan: SPENCER

You can also use this command to blank out a group of cells. You can first press *B* (for Blank), then specify a range, as you did earlier for the Format Cells command. But we don't need to do this now.

## Formulas

Now you are ready to enter a formula for calculating the total costs. The total costs in row 10 will be figured by adding the three rows above it. Move the cell pointer down next to *Total Costs*, (row 10, column 2).

## Building a Formula

You might be tempted not to bother with a formula. After all, you could just enter \$15000.00 because you already know that number belongs there. You need a formula, however, because costs may change; you need something that will work for other months, too, so that you don't have to calculate costs yourself every time.

Without touching any keys for a moment, think about what you will be doing. Point with your fingers to row 10, column 2 (next to *Total Costs*) on your display screen.

Think:

“*Total Costs* (row 10, column 2) . . .

#1	1	2	3	4	5	6	7
1							
2							
3	Sales		\$20000.00				
4							
5	Cost						
6		Material	\$4000.00				
7		Labor	\$7000.00				
8		Overhead	\$4000.00				
9							
10		Total Costs					
11							
12							
13							
14							
15	Gross Profits						
16							
17							
18							
19							
20							

COMMAND: Alpha Blank Copy Delete Edit Format Goto Help Insert Lock Move  
 Name Options Print Quit Sort Transfer Value Window Xternal  
 Select option or type command letter  
 R10C2 99% Free Multiplan: SPENCER

“will be the sum of (now point to row 6, column 2) *Material* . . .

#1	1	2	3	4	5	6	7
1							
2							
3	Sales		\$20000.00				
4							
5	Cost						
6		Material	\$4000.00				
7		Labor	\$7000.00				
8		Overhead	\$4000.00				
9							
10		Total Costs	<input type="text"/>				
11							
12							
13							
14							
15	Gross Profits						
16							
17							
18							
19							
20							

COMMAND: Alpha Blank Copy Delete Edit Format Goto Help Insert Lock Move  
Name Options Print Quit Sort Transfer Value Window Xternal  
Select option or type command letter  
R6C2 4000 99% Free Multiplan: SPENCER

“plus (now point to row 7, column 2) *Labor* . . .

#1	1	2	3	4	5	6	7
1							
2							
3	Sales		\$20000.00				
4							
5	Cost						
6	Material		\$4000.00				
7	Labor		\$7000.00				
8	Overhead		\$4000.00				
9							
10	Total Costs						
11							
12							
13							
14							
15	Gross Profits						
16							
17							
18							
19							
20							

COMMAND: Alpha Blank Copy Delete Edit Format Goto Help Insert Lock Move  
 Name Options Print Quit Sort Transfer Value Window Xternal  
 Select option or type command letter  
 R7C2          7000                                  99% Free          Multiplan: SPENCER

# Multiplan

“plus (now point to row 8, column 2) *Overhead.*”

#1	1	2	3	4	5	6	7
1							
2							
3	Sales		\$20000.00				
4							
5	Cost						
6	Material		\$4000.00				
7	Labor		\$7000.00				
8	Overhead		\$4000.00				
9							
10	Total Costs						
11							
12							
13							
14							
15	Gross Profits						
16							
17							
18							
19							
20							

COMMAND: Alpha Blank Copy Delete Edit Format Goto Help Insert Lock Move  
Name Options Print Quit Sort Transfer Value Window Xternal  
Select option or type command letter  
R8C2 4000 99% Free Multiplan: SPENCER

You will follow the same procedure using your cell pointer.

**Say to yourself:**

**Do this:**

“Total Costs. . .

1. Place the cell pointer next to *Total Costs* (row 10, column 2).

1 2 3 4 5 6 7

1

2

3 Sales \$20000.00

4

5 Cost

6 Material \$4000.00

7 Labor \$7000.00

8 Overhead \$4000.00

9

10 Total Costs

11

12

13

14

15 Gross Profits

16

17

18

19

20

COMMAND: Alpha Blank Copy Delete Edit Format Goto Help Insert Lock Move  
Name Options Print Quit Sort Transfer Value Window Xternal  
Select option or type command letter

R10C2 99% Free Multiplan: SPENCER

“equals . . .

2. Press =. (To begin a formula in Multiplan, press either = or V for the Value command.) Look at the command line.

VALUE:

Enter a formula

R10C2

99% Free Multiplan: SPENCER

# Multiplan

“row 6 (*Material*) . . .

3. Move the cell pointer up 4 rows to row 6. (Watch the formula being built on the command line. The entry R[-4]C is a formula to tell Multiplan to go up 4 rows in this column to find a value).

The screenshot shows a spreadsheet with the following data:

#1	1	2	3	4	5	6	7
1							
2							
3	Sales	\$20000.00					
4							
5	Cost						
6	Material	\$4000.00					
7	Labor	\$7000.00					
8	Overhead	\$4000.00					
9							
10	Total Costs						
11							
12							
13							
14							
15	Gross Profits						
16							
17							
18							
19							
20							

At the bottom of the screen, the command line shows: VALUE: R[-4]C

Below the command line, the text "Enter a formula" is displayed, with "R6C2" and "4000" entered in the fields below it.

At the bottom right, the status bar shows "99% Free" and "Multiplan: SPENCER".

A box on the right side of the spreadsheet contains the text "3" and "...Material..", with an arrow pointing to the cell containing "\$4000.00" in row 6, column 2.

“plus . . .

4. Press +. Watch how the formula builds. Notice that the cell pointer moves back to its original position.

“row 7 (*Labor*) . . .

5. Move the cell pointer to row 7.

“plus . . .

6. Press +.

“row 8 (*Overhead*).”

7. Move the cell pointer next to *Overhead*.

#1	1	2	3	4	5	6	7
1							
2							
3	Sales	\$20000.00					
4							
5	Cost						
6	Material	\$4000.00					
7	Labor	\$7000.00					
8	Overhead	\$4000.00					
9							
10	Total Costs						
11							
12							
13							
14							
15	Gross Profits						
16							
17							
18							
19							
20							

VALUE: R[- 4]C + R[- 3]C + R[- 2]C

Enter a formula  
R8C2 4000

99% Free Multiplan: SPENCER



- Press RETURN. You will see \$15000.00 now appear next to *Total Costs*. Look at the status line to see the formula Multiplan used to calculate the total.

#1	1	2	3	4	5	6	7
1							
2							
3	Sales		\$20000.00				
4							
5	Cost						
6	Material	\$4000.00					
7	Labor	\$7000.00					
8	Overhead	\$4000.00					
9							
10	Total Costs		\$15000.00				
11							
12							
13							
14							
15	Gross Profits						
16							
17							
18							
19							
20							

COMMAND: Alpha Blank Copy Delete Edit Format Goto Help Insert Lock Move  
 Name Options Print Quit Sort Transfer Value Window Xternal

Select option or type command letter

R10C2    R[-4]C + R[-3]C + R[-2]C    99% Free    Multiplan: SPENCER

The dollar format you selected in Chapter 2 with the Format Default Cells command automatically gives you two decimal places. Because of this default setting, any numbers you enter will appear in dollars unless you specifically change them with the Format Cells command.

The formula you see on the status line is the way Multiplan states what you said as you built the formula. Multiplan states:

$$\begin{array}{ccccccc} 1 & 2 & 3 & 4 & 5 & 6 & 7 \\ \hline R10C2 & = & R[-4]C & + & R[-3]C & + & R[-2]C \end{array}$$

1. "This cell is the active cell.
2. It contains . . .
3. the cell 4 rows up from here (or 'this row minus 4') in this column . . .
4. plus . . .
5. the cell 3 rows up from here . . .
6. plus . . .
7. the cell 2 rows up from here."

**Note** When a formula in Multiplan does not give a row or column number, it means "this" row or "this" column.

## Reviewing or Changing a Formula

At some time later, you may forget exactly how you calculated the figure in a particular cell. You can see the contents of a cell by moving the cell pointer to it and looking at the status line.

If you wish to change the formula, place the cell pointer on that cell and use the Edit command (press *E*) to bring the formula onto the command line. Then use the CHARACTER RIGHT and CHARACTER LEFT keys with the BACKSPACE key to make the changes you want. (You can also use the DELETE key; refer to your Quick Reference Guide or Help information to find CHARACTER RIGHT, CHARACTER LEFT, and DELETE. CHARACTER RIGHT moves the edit cursor one character to the right; CHARACTER LEFT moves the edit cursor one character to the left; DELETE erases the character that is highlighted rather than the character to its left, as BACKSPACE does.)

These four keys are part of the editing keys that Multiplan provides you. All the editing keys are explained in Part 2, Chapter 8, in the “Editing” section. In a nutshell, with the editing keys you can move the highlight around the command line, insert new text, and delete or replace old text.

## The Status Line: Cell Contents

If a formula is too long to be shown in full on the status line, use Edit to place the formula in the command line so that you can review all of it.

The status line shows what is actually contained in the active cell. While the active cell may display the number \$15000.00, the status line will tell us what formula governs that cell. The value displayed for the cell may change, but the formula will remain constant. If, for example, the cost of materials were \$6000 instead \$4000, the figure displayed in the *Total Costs* cell would change to 17000.00. Yet, the status line would still show the same formula.

Try it. Move the cell pointer to R6C2 (\$4000.00). Type 6000. Press RETURN and watch the display change to the following:

#1	1	2	3	4	5	6	7
1							
2							
3	Sales		\$20000.00				
4							
5	Cost						
6	Material	\$6000.00					
7	Labor	\$7000.00					
8	Overhead	\$4000.00					
9							
10	Total Costs	\$17000.00					
11							
12							
13							
14							
15	Gross Profits						
16							
17							
18							
19							
20							

COMMAND: Alpha Blank Copy Delete Edit Format Goto Help Insert Lock Move  
 Name Options Print Quit Sort Transfer Value Window Xternal  
 Select option or type command letter  
 R6C2 6000 99% Free Multiplan: SPENCER

*Annotations:* An arrow points from a box labeled "you change value" to the cell containing \$6000.00. Another arrow points from a box labeled "Multiplan recalculates" to the cell containing \$17000.00.

*Total Costs* now shows \$17000.00. Now, change the cost of materials back to \$4000.00 and watch *Total Costs* change back to \$15000.00.

## Drawing Lines

To make the worksheet easier to read, draw a line in row 9, column 2, using dashes to separate the subcategories from *Total Costs*. Follow the same procedure you used earlier to enter text:

1. Move the cell pointer to row 9.
2. Press *A* (for Alpha).

**Note** If you missed this step and tried to enter the dash without the Alpha command, the command line would show *VALUE* and be ready for a negative number or a formula. If you did do this, press the *CANCEL* key, and start this step over again.

3. Type the dash 10 times to fill the spaces in the cell:

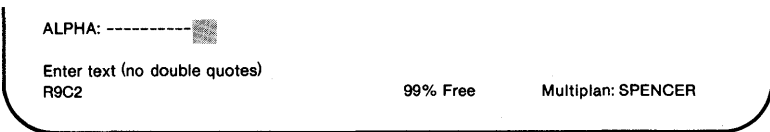

4. Press RETURN. You now see:

#1	1	2	3	4	5	6	7
1							
2							
3	Sales		\$20000.00				
4							
5	Cost						
6		Material	\$4000.00				
7		Labor	\$7000.00				
8		Overhead	\$4000.00				
9							
10		Total Costs	\$15000.00				
11							
12							
13							
14							
15	Gross Profits						
16							
17							
18							
19							
20							

COMMAND: Alpha Blank Copy Delete Edit Format Goto Help Insert Lock Move  
 Name Options Print Quit Sort Transfer Value Window Xternal

Select option or type command letter

R9C2 "-----" 99% Free Multiplan: SPENCER

You will learn later how to extend this line across the entire worksheet, or across as many columns as you wish. Later, you will also get more practice in entering formulas using the cell pointer.

## The Transfer Save Command (Review)

Save your work by using the Transfer Save command as you did before:

Press *T*. The command line shows:

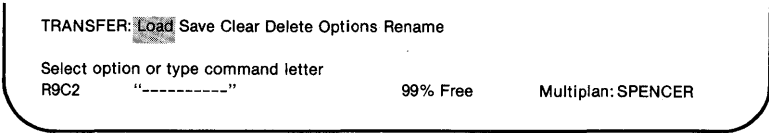

Choose Save by pressing *S*. Now the command line shows:

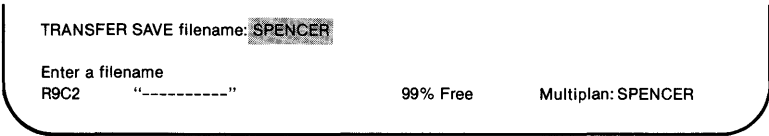

The proposed response is the last filename used, *SPENCER*. Since that is what you want, press RETURN.

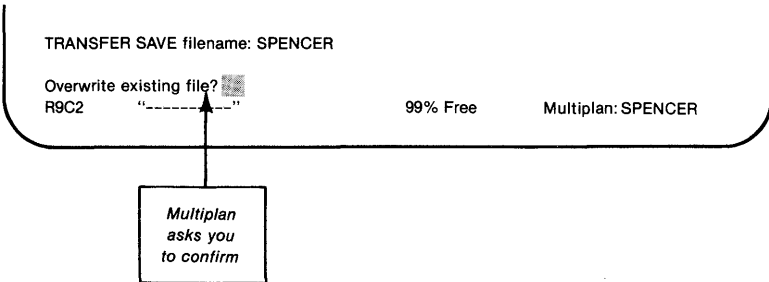

Multiplan is now asking you if you want the worksheet on the screen to replace the one in the file. Since you do want your new work saved, press *Y* (for Yes). The command line will now return to:

```
COMMAND: Alpha Blank Copy Delete Edit Format Goto Help Insert Lock Move
          Name Options Print Quit Sort Transfer Value Window Xternal
Select option or type command letter
R9C2    "-----"                99% Free      Multiplan: SPENCER
```

Any time you select a command that can affect a worksheet as a whole, Multiplan will ask you to confirm the action by pressing *Y*. This is true of worksheets on the screen and worksheets in a disk file. These actions include, for example, saving a file under a name previously used, or quitting a Multiplan session.

Your worksheet has been saved. Leave Multiplan for this session by typing *Q* (Quit) and *Y* (Yes) to confirm.

## Summary

In this session you learned:

- How to load your file.

- How to create more space by inserting empty rows using the Insert command (*I*).

- How to enter additional text using the Alpha command with the direction keys.

- How to enter additional numbers.

- How to align the contents of specific cells.

- How to specify a group of cells using the range symbol (colon).



How to erase the contents of specific cells using the Blank (*B*) command.

How to build formulas using the cell pointer and how to read the formula on the status line.

How to use the cell pointer and the status line to review a formula, and how to use the cell pointer and the Edit command (*E*) to change a formula.

How to draw a line using the dash (-).

How to save your new work with the Transfer Save command (writing over old work).

# Chapter 4

## Naming Cells and Copying

---

The Transfer Load Command (Review)	85
Titles	86
Format: Align Center	89
The Copy Right Command	91
Formulas (Review)	98
Naming Cells	99
Building a Formula Using Names	103
The Goto Name Command	107
Calculating Functions: SUM	110
Number Signs (#)	113
Error Values	114
Relative References and Absolute References	116
Copying a Formula: The Copy From Command	121
Summary	123



In the last session, you entered cost figures into the worksheet. You then built a formula for *Total Costs* using the cell pointer.

In this session you will practice building more formulas. You will also learn how to copy cells and how to name them.

## The Transfer Load Command (Review)

Load Multiplan. Now load your file. To review:

Press *T* (Transfer).

Press *L* or RETURN (to select Load).

Type *SPENCER*.

Press RETURN.

Your screen should show:

#1	1	2	3	4	5	6	7
1							
2							
3	Sales		\$20000.00				
4							
5	Cost						
6	Material	\$4000.00					
7	Labor	\$7000.00					
8	Overhead	\$4000.00					
9							
10	Total Costs		\$15000.00				
11							
12							
13							
14							
15	Gross Profits						
16							
17							
18							
19							
20							

COMMAND: Alpha Blank Copy Delete Edit Format Goto Help Insert Lock Move  
 Name Options Print Quit Sort Transfer Value Window Xternal  
 Select option or type command letter  
 R9C2 "-----" 99% Free Multiplan: SPENCER

# Titles

You need to be able to tell which month is which, so you will want to put the names of the months across the top of the worksheet. Move the cell pointer to row 1, column 2.

#1	1	2	3	4	5	6	7
1							
2							
3	Sales	\$20000.00					
4							
5	Cost						
6	Material	\$4000.00					
7	Labor	\$7000.00					
8	Overhead	\$4000.00					
9		-----					
10	Total Costs	\$15000.00					
11							
12							
13							
14							
15	Gross Profits						
16							
17							
18							
19							
20							

COMMAND: Alpha Blank Copy Delete Edit Format Goto Help Insert Lock Move  
Name Options Print Quit Sort Transfer Value Window Xternal  
Select option or type command letter

R1C2 99% Free Multiplan: SPENCER

You want to enter the months starting with January in row 1, column 2, so press A (for the Alpha command):

ALPHA: █

Enter text (no double quotes)

R1C2 99% Free Multiplan: SPENCER

Type *January*.

ALPHA: January

Enter text (no double quotes)  
R1C2

99% Free      Multiplan: SPENCER

Press the RIGHT direction key to move the cell pointer to the next cell, row 1, column 3. Remember that moving the cell pointer automatically enters the word and places you in the ALPHA/VALUE: command each time you press a direction key to enter data; there is no need to press RETURN or Alpha each time.

	1	2	3	4	5	6	7
1		January					
2							
3	Sales	\$20000.00					
4							
5	Cost						
6	Material	\$4000.00					
7	Labor	\$7000.00					
8	Overhead	\$4000.00					
9		-----					
10	Total Costs	\$15000.00					
11							
12							
13							
14							
15	Gross Profits						
16							
17							
18							
19							
20							

ALPHA/VALUE:

Enter text or value  
R1C3

99% Free      Multiplan: SPENCER

# Multiplan

Follow the same procedure until you have listed all twelve months. You will automatically scroll the screen as you move the cell pointer. Press RETURN after the last month to enter the final title and to return to the main command menu.

#1	8	9	10	11	12	13	14
1	July	August	September	October	November	December	
2							
3							
4							
5							
6							
7							
8							
9							
10							
11							
12							
13							
14							
15							
16							
17							
18							
19							
20							

COMMAND: Alpha Blank Copy Delete Edit Format Goto Help Insert Lock Move  
Name Options Print Quit Sort Transfer Value Window Xternal

Select option or type command letter

R1C13 95% Free Multiplan: SPENCER

Move the pointer back to January (row 1, column 2).

#1	1	2	3	4	5	6	7
1		January	February	March	April	May	June
2							
3	Sales	\$20000.00					
4							
5	Cost						
6	Material	\$4000.00					
7	Labor	\$7000.00					
8	Overhead	\$4000.00					
9		-----					
10	Total Costs	\$15000.00					
11							
12							
13							
14							
15	Gross Profits						
16							
17							
18							
19							
20							

COMMAND: Alpha Blank Copy Delete Edit Format Goto Help Insert Lock Move  
Name Options Print Quit Sort Transfer Value Window Xternal  
Select option or type command letter  
R1C2      "January"                      95% Free              Multiplan: SPENCER

## Format: Align Center

The names of the months, because they are text, are aligned left in the Multiplan "General" format (the format in which your worksheet began). The worksheet would look nicer and be easier to follow if the names of the months were centered over the columns. Use the Format Cells command with the "Center" alignment to accomplish this.



Press *F*.

```

FORMAT: Cells Default Options Width
Select option or type command letter
R1C2      "January"                95% Free      Multiplan: SPENCER
    
```

Press *C* or RETURN (for Cells).

```

FORMAT cells: R1C2                alignment: (Def)Ctr Gen Left Right -
                format code:(Def)Cont Exp Fix Gen Int $ * % - # of decimals: 0
Enter reference to cell or group of cells
R1C2      "January"                95% Free      Multiplan: SPENCER
    
```

You want to format all twelve months, so you could follow the same procedure you used earlier to format a range of cells (the subheadings for *Cost*). But it is much faster and more efficient to format the whole row at once.

Refer to your Quick Reference Guide or the Help Keyboard command for the CHARACTER RIGHT key. Press the CHARACTER RIGHT key to move the edit cursor to the end of the proposed response in the first field (R1C2).

Earlier, instead of pressing the RIGHT direction key a number of times to give the range, we typed colon and another cell reference. This time we want to format a whole row. You could type the column numbers yourself (1:63), but there's a more efficient way. Simply delete the C2 from the cell reference, using BACKSPACE.

```

FORMAT cells: R1  alignment: (Def)Ctr Gen Left Right -
                format code:(Def)Cont Exp Fix Gen Int $ * % - # of decimals: 0
Enter reference to cell or group of cells
R1C2      "January"                95% Free      Multiplan: SPENCER
    
```

This leaves the response as R1, which tells Multiplan to format the whole row. (Similarly, C1 would mean format all of column 1.)

Press TAB to move to the second field. Type C to choose "Center."

Press RETURN now because the proposed response in the "format code" field is correct and the "# of decimals" field does not apply.

The names of the months are now aligned in the center over the columns of numbers and are easier to read.

## The Copy Right Command

The figures you entered for Spencer Ceramics were for only one month. You will also want to show the rest of the year. Start by copying the figures you have for January into the remaining months of the year (the next 11 columns). You can later change some figures for costs or sales to see the effects of the changes on Spencer Ceramics' profits.

To copy the number for *Sales* (\$20000.00) into the next eleven cells, move the cell pointer to \$20000.00 (row 3, column 2). Press C (for Copy). Your command line shows:

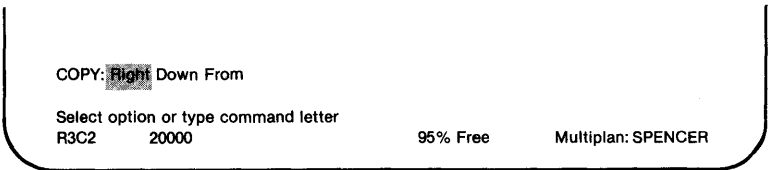

## Multiplan

Choose the Right subcommand to copy from one cell (for January) into the cells to its right. Press *R*. The command line shows:

```
COPY RIGHT number of cells:  starting at: R3C2
Enter a number
R3C2      20000                               95% Free      Multiplan: SPENCER
```

Where the edit cursor is located, type *11*, for the number of times you want the formula in R3C2 copied.

```
COPY RIGHT number of cells: 11  starting at: R3C2
Enter a number
R3C2      20000                               95% Free      Multiplan: SPENCER
```

Multiplan has proposed the cell you want to copy (the location of the cell pointer) as the starting point. You have already specified how many copies of that cell you want.

Press RETURN.

#1	1	2	3	4	5	6	7
1		January	February	March	April	May	June
2							
3	Sales	\$20000.00	\$20000.00	\$20000.00	\$20000.00	\$20000.00	\$20000.00
4							
5	Cost						
6	Material	\$4000.00					
7	Labor	\$7000.00					
8	Overhead	\$4000.00					
9		-----					
10	Total Costs	\$15000.00					
11							
12							
13							
14							
15	Gross Profits						
16							
17							
18							
19							
20							

COMMAND: Alpha Blank Copy Delete Edit Format Goto Help Insert Lock Move  
 Name Options Print Quit Sort Transfer Value Window Xternal  
 Select option or type command letter  
 R3C2      20000                                      94% Free                      Multiplan: SPENCER

The screen is too small to display the whole year at one time, but you can see the rest of the year by using the direction keys to scroll the sheet beneath the pointer. Scroll until both columns 13 and 14 are visible. The sales figures stop at column 13 (the last of the twelve months of the year).

# Multiplan

#1	8	9	10	11	12	13	14
1	July	August	September	October	November	December	
2							
3	\$20000.00	\$20000.00	\$20000.00	\$20000.00	\$20000.00	\$20000.00	
4							
5							
6							
7							
8							
9							
10							
11							
12							
13							
14							
15							
16							
17							
18							
19							
20							

COMMAND: Alpha Blank Copy Delete Edit Format Goto Help Insert Lock Move  
Name Options Print Quit Sort Transfer Value Window Xternal  
Select option or type command letter  
R3C14 94% Free Multiplan: SPENCER

Now, fill in the cost figures, again using the Copy command. Instead of copying one row at a time (as you did when you copied the \$20000.00 for *Sales*), use the Copy Right command to copy a group of cells.



Press *R* (for Right).

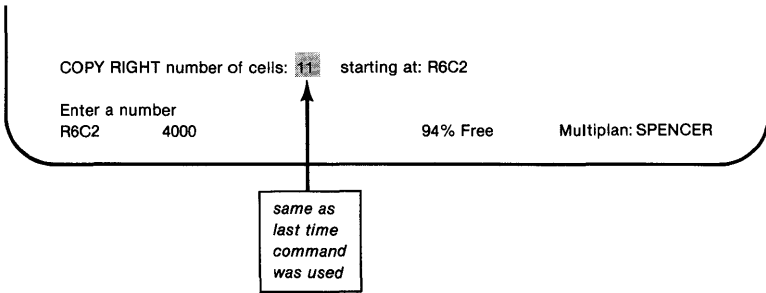

Notice that the “number of cells” field shows *11*, the same number you typed the last time you used the Copy Right command. Multiplan will always propose the number you used for the last Copy Right command. The number you want is the number *11* (this copying is just like the one for *Sales*).

Press TAB to move to the “starting at” field.

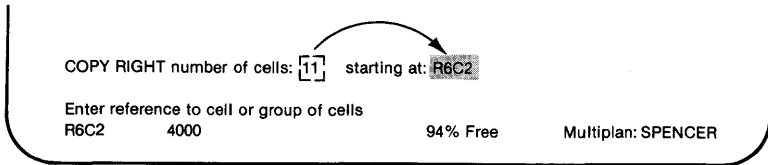

If you were copying only one row, the proposed response would be right. But you want to copy 5 rows of column 2 to the right, so you need to enter a range.

Press : (colon).

COPY RIGHT number of cells: 11 starting at: R6C2

Enter reference to cell or group of cells  
R6C2 4000 94% Free Multiplan: SPENCER

colon (:) to build a "range"

Press the DOWN direction key until the cell pointer is on \$15000.00 (next to *Total Costs*).

COPY RIGHT number of cells: 11 starting at: R6C2:R10C2

Enter reference to cell or group of cells  
R10C2 R[-4]C + R[-3]C + R[-2]C 94% Free Multiplan: SPENCER

use direction key for end cell



# Multiplan

Notice how easily the range has been built.

Press RETURN and watch the values appear across the screen. The values for *Total Costs* appear last because they involve copying a formula; Multiplan has to calculate the value after it finishes copying the formulas. You should now see:

#1	1	2	3	4	5	6	7
1		January	February	March	April	May	June
2							
3	Sales	\$20000.00	\$20000.00	\$20000.00	\$20000.00	\$20000.00	\$20000.00
4							
5	Cost						
6	Material	\$4000.00	\$4000.00	\$4000.00	\$4000.00	\$4000.00	\$4000.00
7	Labor	\$7000.00	\$7000.00	\$7000.00	\$7000.00	\$7000.00	\$7000.00
8	Overhead	\$4000.00	\$4000.00	\$4000.00	\$4000.00	\$4000.00	\$4000.00
9							
10	Total Costs	\$15000.00	\$15000.00	\$15000.00	\$15000.00	\$15000.00	\$15000.00
11							
12							
13							
14							
15	Gross Profits						
16							
17							
18							
19							
20							

COMMAND: Alpha Blank Copy Delete Edit Format Goto Help Insert Lock Move  
Name Options Print Quit Sort Transfer Value Window Xternal  
Select option or type command letter  
R8C2            4000                            90% Free                            Multiplan: SPENCER

## Formulas (Review)

A formula will do calculations for you, plus it allows you to change the numbers and have Multiplan recalculate the result. So you want to build formulas wherever you can.

In Chapter 3, you built a formula to calculate *Total Costs*. Now, you want to build a formula to calculate *Gross Profits*. Say to yourself, "*Gross Profits* is *Sales* minus *Total Costs*." A formula that uses these names is easily recognizable and as easy to build as the formulas you have built already. Before you can build such a formula, you must define the titles as names for some cells.

## Naming Cells

Multiplan has a way to name cells or groups of cells, so that you can refer to them easily. You can, for example, name a whole row, such as row 3; you can name it *Sales*, meaning the whole line of numbers showing sales. If you could see your whole screen at once, you could imagine the row named *Sales*. It would look like this:

The screenshot shows a spreadsheet grid with columns labeled 1 through 14 and rows labeled #1 through 20. Row 3 is highlighted and contains the text 'Sales' in column 1, and 'S', 'a', 'l', 'e', 's' in columns 2 through 6 respectively. A box with an arrow pointing to the 'Sales' cell contains the text: "Sales" (Row 3 col. 2:13). At the bottom of the screen, a command menu is visible with options: Alpha, Blank, Copy, Delete, Edit, Format, Goto, Help, Insert, Lock, Move, Name, Options, Print, Quit, Sort, Transfer, Value, Window, Xternal. The status bar at the bottom shows 'R3C2', '90% Free', and 'Multiplan: TEMP'.

#1	1	2	3	4	5	6	7	8	9	10	11	12	13	14
1		Jan	Feb	Mar	April	May	June	July	Aug	Sept	Oct	Nov	Dec	
2														
3	Sales	S	a	l	e	s								
4														
5														
6														
7														
8														
9														
10														
11														
12														
13														
14														
15														
16														
17														
18														
19														
20														

COMMAND: Alpha Blank Copy Delete Edit Format Goto Help Insert Lock Move  
 Name Options Print Quit Sort Transfer Value Window Xternal  
 Select option or type command letter  
 R3C2 90% Free Multiplan: TEMP

**Note** When you name a cell or group of cells, make the name one long word; do not use spaces or hyphens. (For more information, see the discussion of the Name command in Chapter 9.)

To build a formula for *Gross Profits*, you must first name the groups of cells that contain sales and total cost figures. Then these names can be used to build your formula.

Start by naming row 3 *Sales*.

Move the cell pointer to R3C1 (row 3, column 1).

Press *N* (for Name).

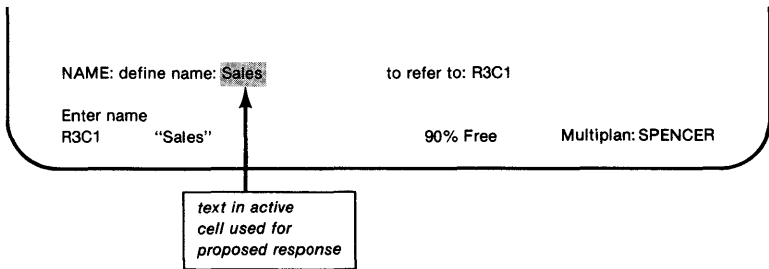

In the first field, Multiplan proposes *Sales* as the name to be defined. This is helpful for quickly turning titles on a worksheet into names. Titles are text that you place in a cell. Names are references to areas on the worksheet. A name may be the same as a title, as it is here. But, the area the name refers to may be different from the area that contains the title, again as it is here.

Press TAB to move to the next field.

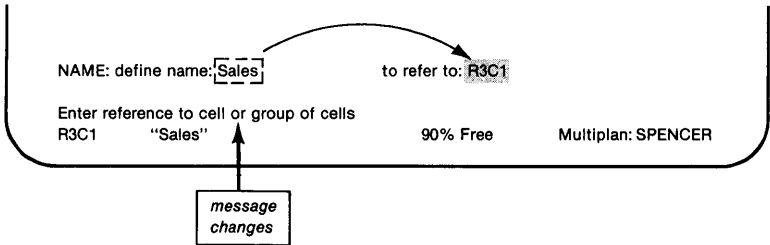

Notice that when you tabbed to the “to refer to” field, the message changed to “Enter reference to cell or group of cells.” Multiplan is asking you to specify which cells this name refers to.

You want *Sales* to refer to the cells in row 3, columns 2 through 13. Press the RIGHT direction key once; the response in the “to refer to” field is now R3C2. Press : (colon), then the RIGHT direction key to move the cell pointer to column 13 (December). You should see:

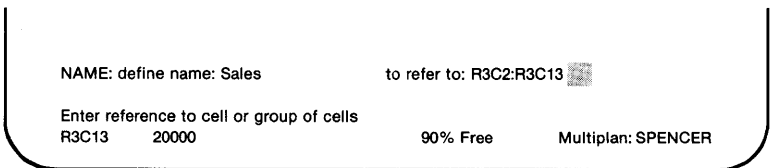

Press RETURN.

You could have typed *13* after the colon instead of using the cell pointer. This method is faster if you know which cells compose the group you are naming.

Now Name the group of cells that defines *Total Costs*.

## Multiplan

Move the cell pointer to *Total Costs* (R10C1).

Press *N* (for Name).

NAME: define name: Total\_Costs to refer to: R10C2:13

Enter name  
R10C1 "Total Costs" 90% Free Multiplan: SPENCER

same as  
for "Sales"

Notice *Total\_Costs* in the “define name” field and R10C2:13 in the “to refer to” field (the C2:13 part is the same as for *Sales*!). You need only press RETURN to define *Total\_Costs*.

**Note** Multiplan changes any spaces in titles to underlines and deletes any illegal characters when titles are defined as names. The titles themselves are unaffected.

The same procedure would work for *Material*, *Labor*, and *Overhead*, if you wanted to define these or any other names, too (it's not necessary for the Spencer Ceramics example):

1. Move the cell pointer to the title.
2. Press *N* (for Name).
3. Press RETURN.

By proposing responses, Multiplan makes it easy to define quickly names for groups of cells that have similar shapes. In other cases, the proposed responses may not be suitable. You should always check the definition proposed for a name before you press RETURN.

The names do not appear on the screen. Nevertheless, the name can be used later in a formula or any other way that cell references can be used. It can also be used to refer to data on this worksheet from other worksheets. You'll learn more about this later.

If you forget which cells a name refers to, you can use the Name command to find out. Press *N*, then use the RIGHT direction key to “step forward through” the list of names. Each time you press the RIGHT direction key, another name appears, and the group of cells it refers to appears in the second field. If you forget which name you used, follow the same procedure until the name you are searching for appears. (Press CANCEL to return to the regular command line.)

## Building a Formula Using Names

Move the cell pointer to row 15, column 2, next to *Gross Profits*.

#1	1	2	3	4	5	6	7
1		January	February	March	April	May	June
2							
3	Sales	\$20000.00	\$20000.00	\$20000.00	\$20000.00	\$20000.00	\$20000.00
4							
5	Cost						
6	Material	\$4000.00	\$4000.00	\$4000.00	\$4000.00	\$4000.00	\$4000.00
7	Labor	\$7000.00	\$7000.00	\$7000.00	\$7000.00	\$7000.00	\$7000.00
8	Overhead	\$4000.00	\$4000.00	\$4000.00	\$4000.00	\$4000.00	\$4000.00
9							
10	Total Costs	\$15000.00	\$15000.00	\$15000.00	\$15000.00	\$15000.00	\$15000.00
11							
12							
13							
14							
15	Gross Profits						
16							
17							
18							
19							
20							

15 Gross Profits [shaded cell] ← 1st step: position pointer

COMMAND: Alpha Blank Copy Delete Edit Format Goto Help Insert Lock Move  
Name Options Print Quit Sort Transfer Value Window Xternal  
Select option or type command letter  
R15C2 89% Free Multiplan: SPENCER

Again, say to yourself, “*Gross Profits* is *Sales* minus *Total Costs*.”

$$\text{Gross Profits} = \text{Sales} - \text{Total Costs}$$

# Multiplan

Now build the formula.

Press =.

2nd step:  
press =

VALUE: █

Enter a formula  
R15C2

89% Free

Multiplan: SPENCER

Type *Sales*.

3rd step:  
type *Sales*

VALUE: Sales █

Enter a formula  
R15C2

88% Free

Multiplan: SPENCER

Press - (minus).

4th step:  
press -

VALUE: Sales - █

Enter a formula  
R15C2

88% Free

Multiplan: SPENCER

Now type *Total\_Costs* (names must be typed exactly as defined; be sure to include the underline character between *Total* and *Costs*).

5th step:  
type *Total\_Costs*

VALUE: Sales - Total\_Costs

Enter a formula  
R15C2

88% Free      Multiplan: SPENCER

be sure to  
include  
underline  
character

Press RETURN.

#1	1	2	3	4	5	6	7
		January	February	March	April	May	June
2							
3	Sales	\$20000.00	\$20000.00	\$20000.00	\$20000.00	\$20000.00	\$20000.00
4							
5	Cost						
6	Material	\$4000.00	\$4000.00	\$4000.00	\$4000.00	\$4000.00	\$4000.00
7	Labor	\$7000.00	\$7000.00	\$7000.00	\$7000.00	\$7000.00	\$7000.00
8	Overhead	\$4000.00	\$4000.00	\$4000.00	\$4000.00	\$4000.00	\$4000.00
9		-----					
10	Total Costs	\$15000.00	\$15000.00	\$15000.00	\$15000.00	\$15000.00	\$15000.00
11							
12							
13							
14							
15	Gross Profits	\$5000.00					
16							
17							
18							
19							
20							

COMMAND: Alpha Blank Copy Delete Edit Format Goto Help Insert Lock Move  
Name Options Print Quit Sort Transfer Value Window Xternal

Select option or type command letter

R15C2      Sales - Total\_Costs                      88% Free              Multiplan: SPENCER

6th step:  
press RETURN

formula is  
complete



## Multiplan

Look at the cell for *Gross Profits* (row 15, column 2). When you pressed RETURN, Multiplan calculated your formula and placed the results in the cell. *Gross Profits* now shows \$5000.00, and the status line displays the *Gross Profits* formula (Sales—Total\_Costs).

Now copy this formula to the right 11 times (type C, R, 11, RETURN).

#1	1	2	3	4	5	6	7
1		January	February	March	April	May	June
2							
3	Sales	\$20000.00	\$20000.00	\$20000.00	\$20000.00	\$20000.00	\$20000.00
4							
5	Cost						
6	Material	\$4000.00	\$4000.00	\$4000.00	\$4000.00	\$4000.00	\$4000.00
7	Labor	\$7000.00	\$7000.00	\$7000.00	\$7000.00	\$7000.00	\$7000.00
8	Overhead	\$4000.00	\$4000.00	\$4000.00	\$4000.00	\$4000.00	\$4000.00
9							
10	Total Costs	\$15000.00	\$15000.00	\$15000.00	\$15000.00	\$15000.00	\$15000.00
11							
12							
13							
14							
15	Gross Profits	\$5000.00	\$5000.00	\$5000.00	\$5000.00	\$5000.00	\$5000.00
16							
17							
18							
19							
20							

COMMAND: Alpha Blank Copy Delete Edit Format Goto Help Insert Lock Move  
Name Options Print Quit Sort Transfer Value Window Xternal

Select option or type command letter

R15C2      Sales - Total\_Costs                      87% Free                      Multiplan: SPENCER

Remember that *Sales* is defined as a 12 cell area (January through December). And so is *Total\_Costs*. The \$5000.00 is, of course, the correct result for each month. But why does a formula that subtracts all of *Total\_Costs* from all of *Sales* give the correct result each month? (If you change either a sales figure or a cost figure for one month, the *Gross Profits* figure changes in that column only.)

Even though you specify part or all of a row, as you did here by using the names *Sales* and *Total\_Costs*, Multiplan calculates in only one column at a time when it needs only one value for the result. Multiplan works the same way if you specify all or part of a column; it calculates in only one row at a time when it needs only one value for the result. This topic is discussed thoroughly in the “Formulas” section of Chapter 8.

## The Goto Name Command

Named cells are easy to locate by using the Goto command.

Press *G* (for Goto).

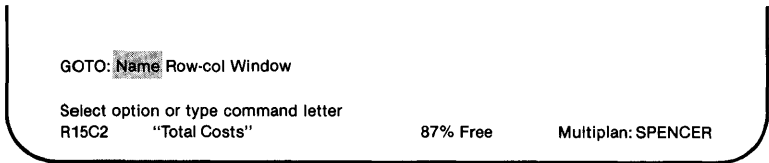

Choose Name by pressing *N* or RETURN.

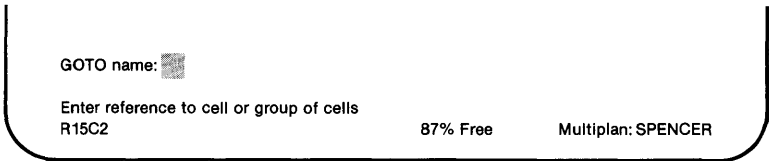



The cell pointer always goes to the first cell in the named area; the leftmost cell if the area is a row, the uppermost cell if it's a column, the upper leftmost cell if it's a block of cells.

**Note** When you name a cell, the name will stay the same no matter what is in the cell. For example, you named a group of cells *Sales*, and you can change the contents whenever you want. The cell will still be called *Sales*, and you can get to it by its name (that is, Goto Name, *Sales*.)

The only way you can remove a name is to define it as blank. For example, to remove the name *Sales*, press *N*, then the RIGHT direction key until *Sales* appears, then TAB. Now, simply press the DELETE key to erase the row and column numbers to which it refers:

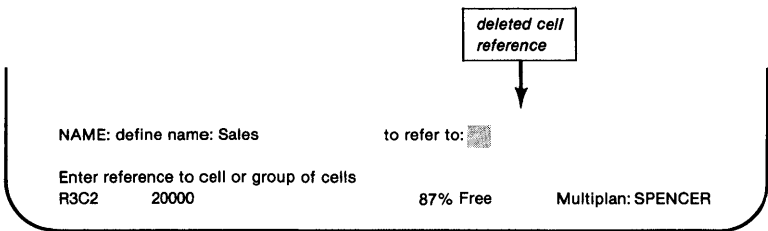

You should press the CANCEL key now because you don't want to remove *Sales* as a defined name. If you do remove the name *Sales*, you'll need to redefine *Sales* to refer to R3C2:13 before continuing.

## Calculating Functions: SUM

It looks like Spencer Ceramics has made a lot of money. Wouldn't you like to see how much? Then, let's add another column heading in column 14, row 1, for the sums. Use the Goto command to move the cell pointer to R1C14.

Press *G* (for Goto).

Press *R* (for Row).

Type *1*, press TAB, type *14*.

Press RETURN.

Enter the title *Sum* in column 14.

Press *A* (for Alpha).

Type *Sum*.

Press RETURN.

Now your screen should show:

#1	13	14	15	16	17	18	19
1	December	Sum					
2							
3	\$20000.00						
4							
5							
6	\$4000.00						
7	\$7000.00						
8	\$4000.00						
9	-----						
10	\$15000.00						
11							
12							
13							
14							
15							
16							
17							
18							
19							
20							

COMMAND: Alpha Blank Copy Delete Edit Format Goto Help Insert Lock Move  
Name Options Print Quit Sort Transfer Value Window Xternal  
Select option or type command letter  
R1C14 "Sum" 90% Free Multiplan: SPENCER

The word *Sum* is centered over column 14 because you used the Format Cells command earlier to “center” the whole row.

To calculate the sales total for Spencer Ceramics for the twelve months, use the Multiplan function SUM. Begin by moving the cell pointer to the cell where the result will appear, row 3, column 14.

#1	8	9	10	11	12	13	14
1	July	August	September	October	November	December	Sum
2							
3	\$20000.00	\$20000.00	\$20000.00	\$20000.00	\$20000.00	\$20000.00	
4							
5							
6	\$4000.00	\$4000.00	\$4000.00	\$4000.00	\$4000.00	\$4000.00	
7	\$7000.00	\$7000.00	\$7000.00	\$7000.00	\$7000.00	\$7000.00	
8	\$4000.00	\$4000.00	\$4000.00	\$4000.00	\$4000.00	\$4000.00	
9	-----						
10	\$15000.00	\$15000.00	\$15000.00	\$15000.00	\$15000.00	\$15000.00	
11							
12							
13							
14							
15							
16							
17							
18							
19							
20							

COMMAND: Alpha Blank Copy Delete Edit Format Goto Help Insert Lock Move  
 Name Options Print Quit Sort Transfer Value Window Xternal  
 Select option or type command letter  
 R3C14 87% Free Multiplan: SPENCER

Press =. The command line will show:

VALUE: 

Enter a formula  
 R3C14 87% Free Multiplan: SPENCER

# Multiplan

Type *SUM(Sales)*.

**Note** When using any of the Multiplan functions, type the function name followed immediately by an opening parenthesis, (. Do not leave any space between the function name and the opening parenthesis.

Press RETURN. You will see:

#1	8	9	10	11	12	13	14
1	July	August	September	October	November	December	Sum
2							
3	\$20000.00	\$20000.00	\$20000.00	\$20000.00	\$20000.00	\$20000.00	#####
4							
5							
6	\$4000.00	\$4000.00	\$4000.00	\$4000.00	\$4000.00	\$4000.00	
7	\$7000.00	\$7000.00	\$7000.00	\$7000.00	\$7000.00	\$7000.00	
8	\$4000.00	\$4000.00	\$4000.00	\$4000.00	\$4000.00	\$4000.00	
9	-----						
10	\$15000.00	\$15000.00	\$15000.00	\$15000.00	\$15000.00	\$15000.00	
11							
12							
13							
14							
15							
16							
17							
18							
19							
20							

COMMAND: Alpha Blank Copy Delete Edit Format Goto Help Insert Lock Move  
Name Options Print Quit Sort Transfer Value Window Xternal  
Select option or type command letter  
R3C14 SUM(Sales) 86% Free Multiplan: SPENCER

## Number Signs (#)

When numbers are too large to be shown in the current formatted column width, they are displayed as number signs (#) until the column is widened enough to accommodate the number.

Column 14 has not been widened so it is not wide enough to accommodate the sum-of-sales figure in the dollar format (remember: your whole sheet is formatted in dollars) because the dollar format adds a dollar sign, a decimal point, and two places after the decimal point. Look at the status line. It shows that cell R3C14 contains SUM(Sales). You would have to widen the column to display the dollar value as numbers instead of as number signs. Use the Format Width command to widen column 14. Press *F*. Press *W*. Type *15*, as you did when you widened column 1. Press RETURN. You'll see:

#1	8	9	10	11	12	13	14
1	July	August	September	October	November	December	Sum
2							
3	\$20000.00	\$20000.00	\$20000.00	\$20000.00	\$20000.00	\$20000.00	#240000.00
4							
5							
6	\$4000.00	\$4000.00	\$4000.00	\$4000.00	\$4000.00	\$4000.00	
7	\$7000.00	\$7000.00	\$7000.00	\$7000.00	\$7000.00	\$7000.00	
8	\$4000.00	\$4000.00	\$4000.00	\$4000.00	\$4000.00	\$4000.00	
9	-----						
10	\$15000.00	\$15000.00	\$15000.00	\$15000.00	\$15000.00	\$15000.00	
11							
12							
13							
14							
15							
16							
17							
18							
19							
20							

COMMAND: Alpha Blank Copy Delete Edit Format Goto Help Insert Lock Move  
 Name Options Print Quit Sort Transfer Value Window Xternal  
 Select option or type command letter  
 R3C14 SUM(Sales) 86% Free Multiplan: SPENCER



## Error Values

If you enter a formula that Multiplan cannot calculate to a number or text, Multiplan uses one of the special error values as the result. Error values start with a number sign (#). For example, look at the value in cell R3C14, which is the sum of sales. (If the cell pointer is not there already, move it to R3C14.) The formula is SUM(Sales). Let's "undefine" *Sales*. Press *N*. Press the RIGHT direction key until *Sales* appears in the "define name" field. Press TAB. Now press the DELETE key. The reference for *Sales* disappears. Press RETURN and the name *Sales* no longer exists.

Notice at the same time what happens in cell R3C14. The value changes from \$240000.00 to #NAME?.

#1	8	9	10	11	12	13	14
1	July	August	September	October	November	December	Sum
3	\$20000.00	\$20000.00	\$20000.00	\$20000.00	\$20000.00	\$20000.00	#NAME?
4							
5							
6	\$4000.00	\$4000.00	\$4000.00	\$4000.00	\$4000.00	\$4000.00	
7	\$7000.00	\$7000.00	\$7000.00	\$7000.00	\$7000.00	\$7000.00	
8	\$4000.00	\$4000.00	\$4000.00	\$4000.00	\$4000.00	\$4000.00	
9	-----						
10	\$15000.00	\$15000.00	\$15000.00	\$15000.00	\$15000.00	\$15000.00	
11							
12							
13							
14							
15							
16							
17							
18							
19							
20							

error value:  
name not defined

COMMAND: Alpha Blank Copy Delete Edit Format Goto Help Insert Lock Move  
 Name Options Print Quit Sort Transfer Value Window Xternal  
 Select option or type command letter  
 R3C14 SUM(Sales) 86% Free Multiplan: SPENCER

This means that Multiplan found a name you haven't defined yet.

Now, redefine *Sales* to refer to R3C2:13. Press *N*; the “define name” field is blank, but the “to refer to” field shows R3C2:13!

NAME: define name:  to refer to: R3C2:13

Enter name  
 R3C14 SUM(Sales) 86% Free Multiplan: SPENCER

Type *Sales*, then press RETURN. The value \$240000.00 reappears in cell R3C14.

#1	8	9	10	11	12	13	14
1	July	August	September	October	November	December	Sum
2							
3	\$20000.00	\$20000.00	\$20000.00	\$20000.00	\$20000.00	\$20000.00	\$240000.00
4							
5							
6	\$4000.00	\$4000.00	\$4000.00	\$4000.00	\$4000.00	\$4000.00	
7	\$7000.00	\$7000.00	\$7000.00	\$7000.00	\$7000.00	\$7000.00	
8	\$4000.00	\$4000.00	\$4000.00	\$4000.00	\$4000.00	\$4000.00	
9	-----						
10	\$15000.00	\$15000.00	\$15000.00	\$15000.00	\$15000.00	\$15000.00	
11							
12							
13							
14							
15							
16							
17							
18							
19							
20							

COMMAND: Alpha Blank Copy Delete Edit Format Goto Help Insert Lock Move  
 Name Options Print Quit Sort Transfer Value Window Xternal

Select option or type command letter

R3C14 SUM(Sales) 86% Free Multiplan: SPENCER

Remember, when you defined *Total\_Costs*, the “to refer to” field had a proposed response that fit. Because *Sales* will refer to a group of cells with the same shape as the group of cells of the last name defined (*Total\_Costs*), the proposed response is correct for redefining *Sales*, as long as the cell pointer is in the correct row before starting the Name command.

The other error values you might see as you build a worksheet are: #DIV/0!, #N/A, #NULL!, #NUM!, #REF!, #VALUE!. All of the error values are described fully under “Error Values” in the “Formulas” section of Chapter 8.

## Relative References and Absolute References

So far we’ve been using three different ways to refer to cells. Sometimes, we referred to a cell as R3C14 or a group of cells as R3C2:13. Sometimes, we referred to a group of cells by name, as when we built the formula SUM(Sales) or Sales—Total\_Costs. Sometimes, we referred to a cell by R[-4]C, as when we built the formula for *Total Costs*.

When you refer to cells by R3C14, R3C2:13, or similar references to specific row numbers and specific column numbers, you are using absolute references. When you refer to a cell by R[-4]C and similar references to the current row plus or minus a number of rows, you are using relative references (which can also be used for columns).

The major difference between absolute and relative references appears when copying formulas. When you copied the formula for *Total Costs* across all 12 months, the correct value appeared in each column. You wouldn’t see any difference between a formula with absolute references and one with relative references in this case because the values for *Material*, *Labor*, and *Overhead* are the same in each column. But, if one or more values were changed in one column, the value of *Total Costs* in that one column would differ.

On the other hand, if the formula contained absolute references, all copies of *Total Costs* would depend on the values in column 2 rather than on the values in each column.

If you had specified the exact row and column number for *Material*, *Labor*, and *Overhead* by making an absolute reference to their position, such as R6C2 + R7C2 + R8C2, you would have had to change each of the references for the *Total Costs* formula in each column for the formula to remain correct.

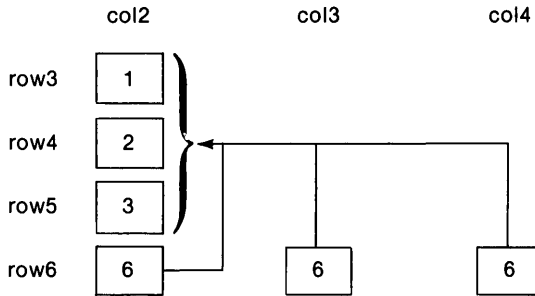

Absolute Formula in row6:  $R3C2 + R4C2 + R5C2$

**Figure 4.1. Copied Absolute Formulas Refer to the Same Cells**

If the 2 in col2 becomes a 3, then all 6's in row6 become 7's; if any value in row3, row4, or row5 of col3 or col4 changes, there is no affect in row6.

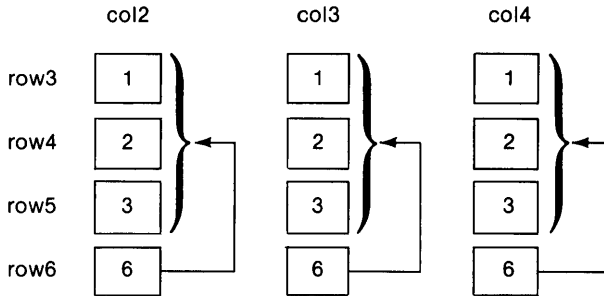

Relative Formula in row6:  $R[-3]C + R[-2]C + R[-1]C$

**Figure 4.2. Copied Relative Formulas Refer to Different Cells**

If one of the 2's in row4 becomes a 3, then the value in row6 in that one column becomes a 7.

For reasons of flexibility, you used a formula with relative references, built by using the cell pointer, to calculate *Total Costs*. Similarly, using a formula with relative references to calculate the sum of *Sales* allows you to copy a flexible formula for calculating the sums of *Total Costs* and *Gross Profits*.

First, you need to edit the formula in row 3, column 14 (R3C14). Right now it contains the formula SUM(Sales). Because names are defined by absolute references, *Sales* is handled the same as an absolute reference. You need to change *Sales* to relative references.

Move the cell pointer to R3C14.

Press *E* (for Edit). The command line now looks like:

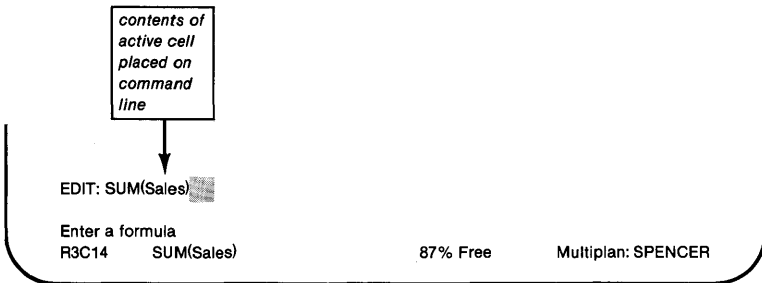

The formula in the active cell is now displayed on the command line.

Press BACKSPACE to erase *Sales*), but leave *SUM*(.

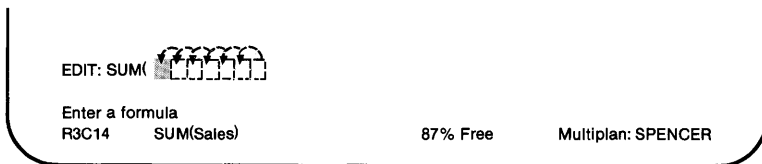

Press the LEFT direction key until the cell pointer reaches R3C2.

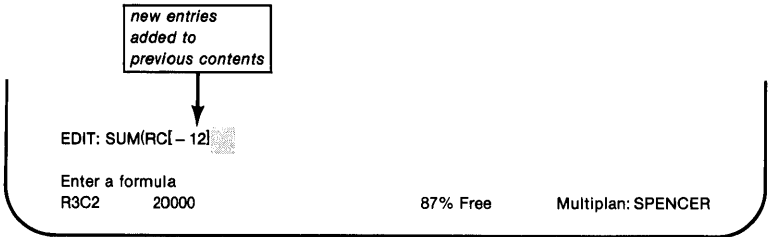

Multiplan inserts a relative reference into your formula. Press : (colon).

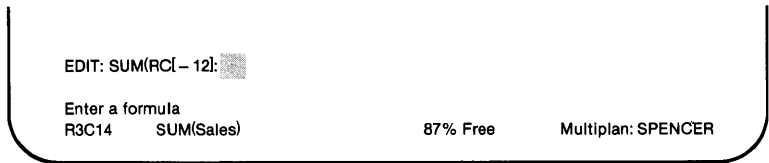

Press the LEFT direction key once (to R3C13).

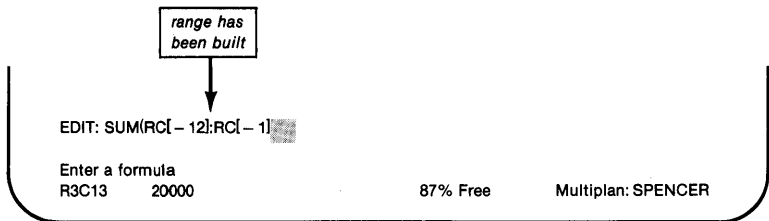

Press ) (right parenthesis).

remember  
closing  
parenthesis

EDIT: SUM(RC[ - 12:RC[ - 1])

Enter a formula  
R3C14      SUM(Sales)      87% Free      Multiplan: SPENCER

Press RETURN. Your screen now looks like:

#1	8	9	10	11	12	13	14
1	July	August	September	October	November	December	Sum
2							
3	\$20000.00	\$20000.00	\$20000.00	\$20000.00	\$20000.00	\$20000.00	\$240000.00
4							
5							
6	\$4000.00	\$4000.00	\$4000.00	\$4000.00	\$4000.00	\$4000.00	
7	\$7000.00	\$7000.00	\$7000.00	\$7000.00	\$7000.00	\$7000.00	
8	\$4000.00	\$4000.00	\$4000.00	\$4000.00	\$4000.00	\$4000.00	
9							
10	\$15000.00	\$15000.00	\$15000.00	\$15000.00	\$15000.00	\$15000.00	
11							
12							
13							
14							
15	\$5000.00	\$5000.00	\$5000.00	\$5000.00	\$5000.00	\$5000.00	
16							
17							
18							
19							
20							

COMMAND: Alpha Blank Copy Delete Edit Format Goto Help Insert Lock Move  
Name Options Print Quit Sort Transfer Value Window Xternal

Select option or type command letter

R3C14      SUM(RC[ - 12:RC[ - 1])      87% Free      Multiplan: SPENCER

Now, you can easily use this same formula to calculate the sums for *Total Costs* and *Gross Profits* by copying the formula into cells R10C14 and R15C14 using the Copy From command.

## Copying a Formula: The Copy From Command

Press *C* (for Copy), then *F* (for From).

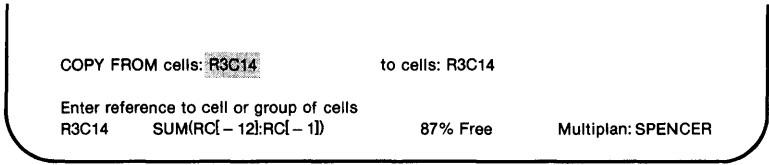

Multiplan proposes that you copy from the active cell, which is what you want to do. Press TAB. The proposed response in the “to cells” field is not correct. Press the DOWN direction key until the cell pointer reaches row 10.

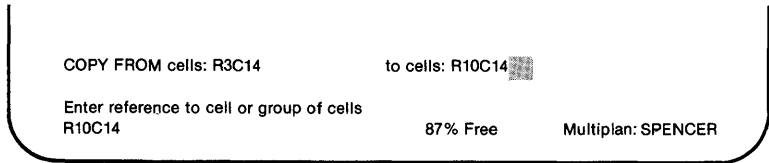

This is one of the cells to receive a copy of the formula. The other is in row 15. Because the cells are not next to each other, you can't use a range as you've done before with the colon. You need, instead, to make a list of cells. To make a list, use the comma.

Press , (comma).

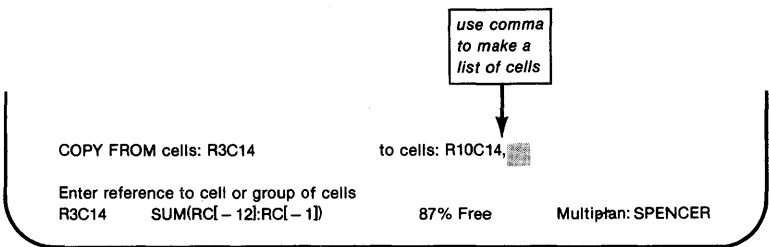



Now press the DOWN direction key until the cell pointer reaches row 15.

COPY FROM cells: R3C14 to cells: R10C14,R15C14

Enter reference to cell or group of cells  
R15C14

87% Free Multiplan: SPENCER

Press RETURN, and watch the values appear in rows 10 and 15 of column 14:

#1	8	9	10	11	12	13	14
1	July	August	September	October	November	December	Sum
2							
3	\$20000.00	\$20000.00	\$20000.00	\$20000.00	\$20000.00	\$20000.00	\$240000.00
4							
5							
6	\$4000.00	\$4000.00	\$4000.00	\$4000.00	\$4000.00	\$4000.00	
7	\$7000.00	\$7000.00	\$7000.00	\$7000.00	\$7000.00	\$7000.00	
8	\$4000.00	\$4000.00	\$4000.00	\$4000.00	\$4000.00	\$4000.00	
9							
10	\$15000.00	\$15000.00	\$15000.00	\$15000.00	\$15000.00	\$15000.00	\$180000.00
11							
12							
13							
14							
15	\$5000.00	\$5000.00	\$5000.00	\$5000.00	\$5000.00	\$5000.00	\$60000.00
16							
17							
18							
19							
20							

copied formula gives correct sums

COMMAND: Alpha Blank Copy Delete Edit Format Goto Help Insert Lock Move  
Name Options Print Quit Sort Transfer Value Window Xternal

Select option or type command letter  
R3C14 SUM(RC[-12]:RC[-1]) 86% Free Multiplan: SPENCER

It's time to take a break. To make it easier when you return, move the cell pointer back to the beginning of the worksheet. Multiplan always loads a worksheet exactly as it was when you saved it. Use Goto Row command to move the cell pointer to row 3, column 2.

In the next session, you will see how Spencer Ceramics' profits change as costs and sales change.

Save your work with the Transfer Save command. To review:

Press *T* (Transfer).

Press *S* (Save).

Press RETURN.

You will see the question:

Overwrite existing file?

Type *Y* (to update, or overwrite, the old file with the information you have added).

Your work has now been saved and will be available for you when you return. Press *Q* (for Quit), and *Y* (to confirm).

## Summary

In this session you learned:

How to load your worksheet with the Transfer Load command (review).

How to place titles on your worksheet.

How to center titles in columns (Format Cells command).

How to copy one cell to the right.

How to copy a group of cells to the right.

How to build formulas (review).

How to name cells and groups of cells.

How to build a formula using names.

How to go to the beginning of a named area using the Goto Name command.

How to calculate the sum of a named area.

How Multiplan indicates that a number is too large to be displayed within the present width of a column by displaying number signs (#).

How Multiplan displays error values for formulas that it cannot calculate.

How relative references and absolute references differ.

How to copy a formula using the Copy From command.

# Chapter 5

## Windows, Copying Formulas, and Options

---

Fixing Titles: The Window Split Title Command	128
Opening a Window: The Window Split Command	131
Linking Windows: The Window Link Command	134
Bordering Windows: The Window Border Command	136
Building a Formula to Show Increasing Sales	138
Copying a Formula to the Right: The Copy Right Command (Review)	142
What If . . . ?	144
Protecting the Worksheet: The Lock Formulas Command	145
The NEXT UNLOCKED CELL Key	146
Unlocking Cells	148
The Options Command	148
Summary	152



In the last session you reviewed the procedure for building formulas, and you learned how to copy cells into other cells on the worksheet. You also learned how to name cells, how to use the Goto command to move the pointer to the named area, and how to do a calculation using a name and a function.

In this session you will learn how to view several portions of the worksheet at once by "opening windows," as well as how to manipulate these windows quickly and easily.

Load the Multiplan disk. Then Transfer Load *SPENCER*. The screen should look just as it did when you left it last time:

#1	1	2	3	4	5	6	7
1		January	February	March	April	May	June
2							
3	Sales	\$20000.00	\$20000.00	\$20000.00	\$20000.00	\$20000.00	\$20000.00
4							
5	Cost						
6	Material	\$4000.00	\$4000.00	\$4000.00	\$4000.00	\$4000.00	\$4000.00
7	Labor	\$7000.00	\$7000.00	\$7000.00	\$7000.00	\$7000.00	\$7000.00
8	Overhead	\$4000.00	\$4000.00	\$4000.00	\$4000.00	\$4000.00	\$4000.00
9							
10	Total Costs	\$15000.00	\$15000.00	\$15000.00	\$15000.00	\$15000.00	\$15000.00
11							
12							
13							
14							
15	Gross Profits	\$5000.00	\$5000.00	\$5000.00	\$5000.00	\$5000.00	\$5000.00
16							
17							
18							
19							
20							

COMMAND: Alpha Blank Copy Delete Edit Format Goto Help Insert Lock Move  
 Name Options Print Quit Sort Transfer Value Window Xternal  
 Select option or type command letter  
 R3C2 20000 86% Free Multiplan: SPENCER

## Fixing Titles: The Window Split Title Command

It is possible to keep the headings for *Sales*, *Cost*, etc., in view while you look at the last half of the year. It can be difficult to tell what numbers you are looking at when you get past April if you can't see the headings.

You can "fix" the titles in place, so that they will remain visible as you scroll the columns by using the Window Split command.

Press *W* (for Window).

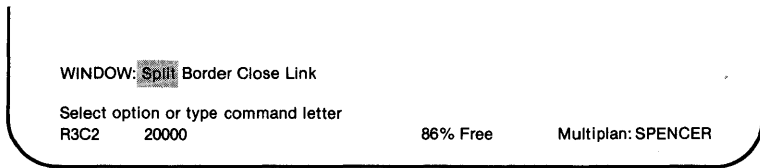

There are several subcommands to choose from. You want to split off the titles from the figures, so choose Split by pressing *S* or RETURN.

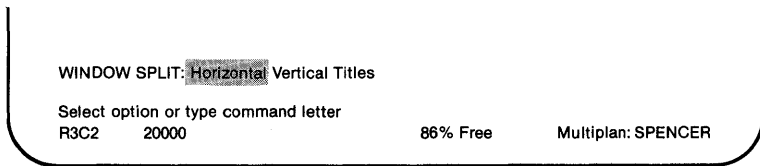

Of the subcommands you see, pick Titles because you want to fix the titles (or headings) in place down column 1.

Press *T*.

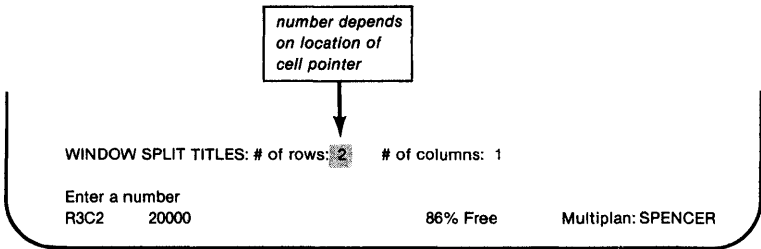

In the first field, type a zero (0) because you only want to split the the window vertically, by columns.

**Note** You cannot ask Multiplan to split more columns or rows than you can see on the screen. If you do, the “Window will not fit” message will appear.

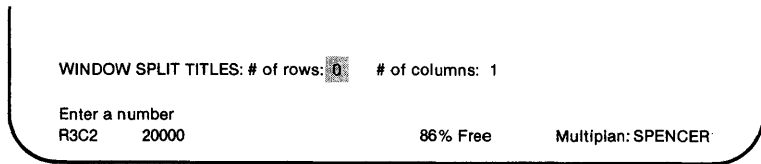

In the second field (“# of columns”), Multiplan is asking how many columns you would like to split. You want one column for the titles. As “1” is the proposed response, merely press RETURN.





## Opening a Window: The Window Split Command

You have actually opened a second window by splitting the one you were working on. Save your work at this stage by using the Transfer Save command (with *Y*, for Yes, to overwrite the existing file).

**Note** It is important that you save the worksheet, as you will be changing the worksheet in ways you probably won't want to save. After you practice opening and closing windows, you will reload the *SPENCER* worksheet, which will replace the active worksheet with the *SPENCER* worksheet as it stands now.

Now experiment with opening and closing windows by using the Window Split command.

Position the cell pointer on the row you want (for horizontal splits) or on the column you want (for vertical splits) before you start the Window command. For now, move the cell pointer to R11C2.

Now press *W*.

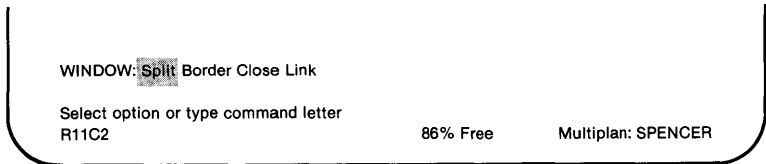

Now press *S*.

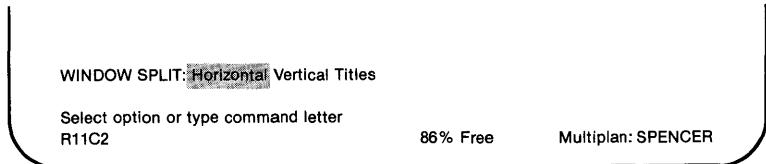

The Horizontal choice allows you to split a window across the screen at the row number you specify. The Vertical choice will let you split a window up and down at the column you choose.

Press *H* (for Horizontal).

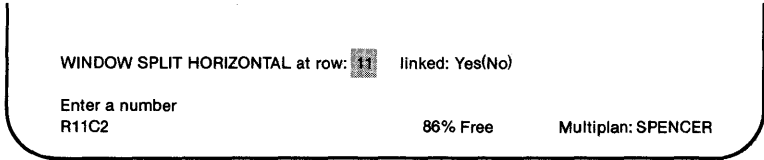

The first field (“at row”) asks at what row you want to split the window. Multiplan proposes row 11, which is what we’ll do for now. (Getting a correct proposed response is the reason you want to position the cell pointer before starting a command.)

The second field shows linking status: “linked: Yes(No)” When windows are linked, they scroll together. That means that as you move the cell pointer at the edge of one of the linked windows, the contents of both windows move across the screen at the same time.

For now, press RETURN. The screen should look like:

#1	1	#2	2	3	4	5	6
			January	February	March	April	May
3	Sales	new window number	\$20000.00	\$20000.00	\$20000.00	\$20000.00	\$20000.00
5	Cost						
6	Material		\$4000.00	\$4000.00	\$4000.00	\$4000.00	\$4000.00
7	Labor		\$7000.00	\$7000.00	\$7000.00	\$7000.00	\$7000.00
8	Overhead	\$4000.00	\$4000.00	\$4000.00	\$4000.00	\$4000.00	
10	Total Costs		\$15000.00	\$15000.00	\$15000.00	\$15000.00	\$15000.00
11		#3	2	3	4	5	6
15	Gross Profits		\$5000.00	\$5000.00	\$5000.00	\$5000.00	\$5000.00

COMMAND: Alpha Blank Copy Delete Edit Format Goto Help Insert Lock Move  
 Name Options Print Quit Sort Transfer Value Window Xternal  
 Select option or type command letter  
 R11C2 86% Free Multiplan: SPENCER

Notice the column numbers at the top of window #3. Scroll across to column 14, then scroll back to column 2. Window #2 is unaffected. When windows are not linked, you can scroll them separately to view different parts of the worksheet simultaneously. If you had specified "Yes" when splitting, windows #2 and #3 would scroll together.

## Linking Windows: The Window Link Command

Once windows are split, you can change their link status with the Window Link command. Press *W* (for Window), then press *L* (for Link).

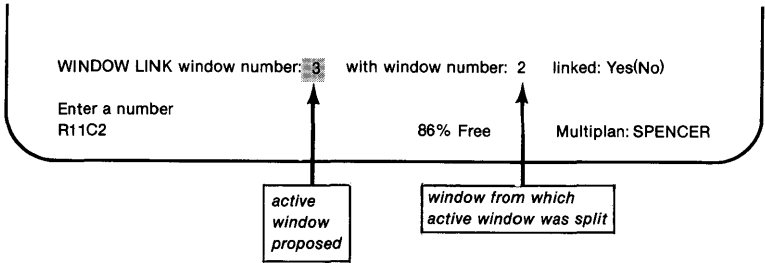

Multiplan proposes linking window #3 with window #2, which is what you want. Press *TAB* twice.

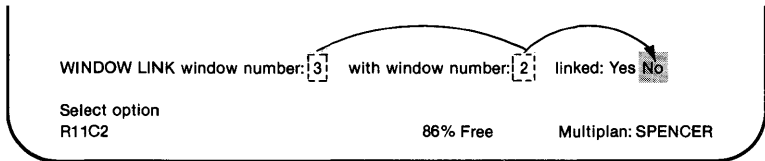

Press *Y* or *SPACE* to select "Yes."

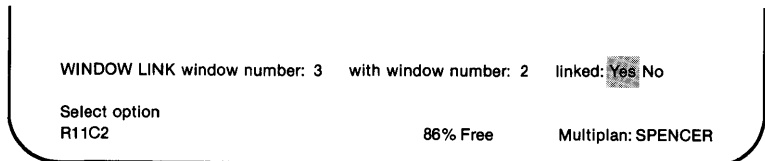

Press RETURN and watch the column numbers for window #3.

#1	1	#2	2	3	4	5	6
1			January	February	March	April	May
2							
3	Sales		\$20000.00	\$20000.00	\$20000.00	\$20000.00	\$20000.00
4							
5	Cost						
6	Material		\$4000.00	\$4000.00	\$4000.00	\$4000.00	\$4000.00
7	Labor		\$7000.00	\$7000.00	\$7000.00	\$7000.00	\$7000.00
8	Overhead		\$4000.00	\$4000.00	\$4000.00	\$4000.00	\$4000.00
9							
10	Total Costs		\$15000.00	\$15000.00	\$15000.00	\$15000.00	\$15000.00
11		#3					
12		11					
13		12					
14		13					
15	Gross Profits	14					
16		15	\$5000.00	\$5000.00	\$5000.00	\$5000.00	\$5000.00
17		16					
18		17					
19		18					
20		19					

COMMAND: Alpha Blank Copy Delete Edit Format Goto Help Insert Lock Move  
 Name Options Print Quit Sort Transfer Value Window Xternal  
 Select option or type command letter  
 R11C2 86% Free Multiplan: SPENCER

They've disappeared! This is an outward sign that windows are linked. The column numbers for window #2 now stand for both windows #2 and #3.

Scroll to column 14. The information in both windows scrolls. Scroll back to column 1; the information again moves together across the screen.

## Bordering Windows: The Window Border Command

If a window is bordered, it has a line drawn around it that sets it off from the surrounding worksheet. The sheet you now have is not bordered.

Try the Window Border command to see what a bordered window looks like. Press *W*, then *B*.

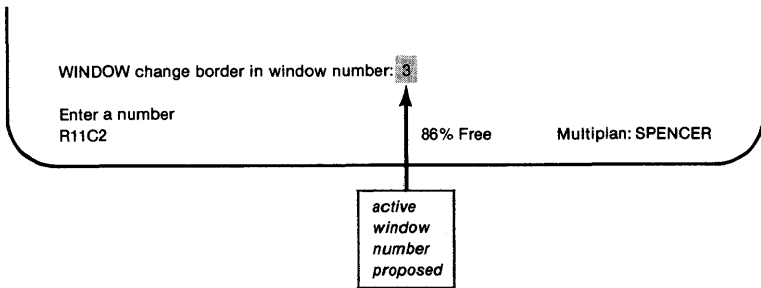

Multiplan proposes the active window, but you could give any open window number.

Simply press RETURN to place a border around window #3.





## Building a Formula to Show Increasing Sales

Your information on Spencer Ceramics indicates that sales have been increasing by about 1% a month. To see the effect of a 1% monthly increase in sales, first move the pointer to row 3, column 3, under February, which is the first month that will show an increase.

step 1:  
place pointer  
on 1st month  
of increase

#1	1	#2	2	3	4	5	6
1			January	February	March	April	May
2							
3	Sales		\$20000.00	\$20000.00	\$20000.00	\$20000.00	\$20000.00
4							
5	Cost						
6	Material		\$4000.00	\$4000.00	\$4000.00	\$4000.00	\$4000.00
7	Labor		\$7000.00	\$7000.00	\$7000.00	\$7000.00	\$7000.00
8	Overhead		\$4000.00	\$4000.00	\$4000.00	\$4000.00	\$4000.00
9							
10	Total Costs		\$15000.00	\$15000.00	\$15000.00	\$15000.00	\$15000.00
11							
12							
13							
14							
15	Gross Profits		\$5000.00	\$5000.00	\$5000.00	\$5000.00	\$5000.00
16							
17							
18							
19							
20							

COMMAND: Alpha Blank Copy Delete Edit Format Goto Help Insert Lock Move  
Name Options Print Quit Sort Transfer Value Window Xternal  
Select option or type command letter  
R3C3      20000      86% Free      Multiplan: SPENCER

Press =. Your command line shows:

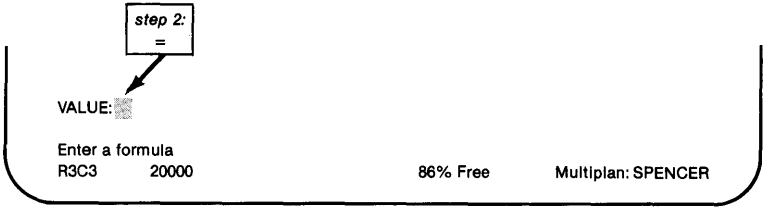

Using January sales as a base for the remaining months, type in a formula that will calculate each month's sales as a 1% increase over the preceding month's sales. Move the cell pointer back to row 3, column 2, under January.

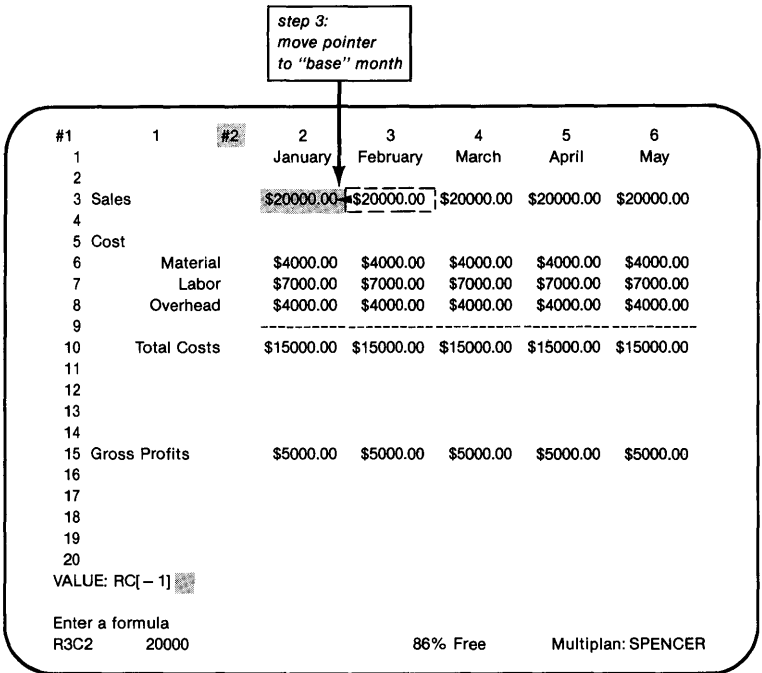

# Multiplan

To show February's sales as a 1% increase over January's, you need to multiply January's sales by 101% (that is, February sales are 101% of January's).

Press \* (the asterisk is the sign for multiplication).

cell pointer  
moves back

#1	1	#2	2	3	4	5	6
			January	February	March	April	May
3	Sales		\$20000.00	\$20000.00	\$20000.00	\$20000.00	\$20000.00
5	Cost						
6	Material		\$4000.00	\$4000.00	\$4000.00	\$4000.00	\$4000.00
7	Labor		\$7000.00	\$7000.00	\$7000.00	\$7000.00	\$7000.00
8	Overhead		\$4000.00	\$4000.00	\$4000.00	\$4000.00	\$4000.00
10	Total Costs		\$15000.00	\$15000.00	\$15000.00	\$15000.00	\$15000.00
15	Gross Profits		\$5000.00	\$5000.00	\$5000.00	\$5000.00	\$5000.00

step 4:  
type \*  
("times")

VALUE: RC[-1]\*

Enter a formula

R3C3      20000      86% Free      Multiplan: SPENCER

Now type 101% (use the number 1, not the lowercase letter l).

step 5:  
type 101%  
(1% increase)

VALUE: RC[-1]\*101%

Enter a formula

R3C3      20000      86% Free      Multiplan: SPENCER

Press RETURN. You should see the new cell value for February showing a 1% increase over the previous month, January.

*new value shows 1% increase*

#1	1	#2	2	3	4	5	6
			January	February	March	April	May
2							
3	Sales		\$20000.00	\$20200.00	\$20000.00	\$20000.00	\$20000.00
4							
5	Cost						
6	Material		\$4000.00	\$4000.00	\$4000.00	\$4000.00	\$4000.00
7	Labor		\$7000.00	\$7000.00	\$7000.00	\$7000.00	\$7000.00
8	Overhead		\$4000.00	\$4000.00	\$4000.00	\$4000.00	\$4000.00
9							
10	Total Costs		\$15000.00	\$15000.00	\$15000.00	\$15000.00	\$15000.00
11							
12							
13							
14							
15	Gross Profits		\$5000.00	\$5200.00	\$5000.00	\$5000.00	\$5000.00
16							
17							
18							
19							
20							

COMMAND: Alpha Blank Copy Delete Edit Format Goto Help Insert Lock Move  
 Name Options Print Quit Sort Transfer Value Window Xternal  
 Select option or type command letter  
 R3C3    RC[-1]\*101%                      86% Free                      Multiplan: SPENCER

*status line shows formula which replaces number for active cell*

## Copying a Formula to the Right: The Copy Right Command (Review)

Because January acts as the “base” month for the 1% increase, the cell for January Sales does not contain a formula. You will therefore be copying the formula for February Sales into the remaining 10 months of the year. To copy this formula to the right, be sure the cell pointer is on R3C3 (under February), and press *C*.

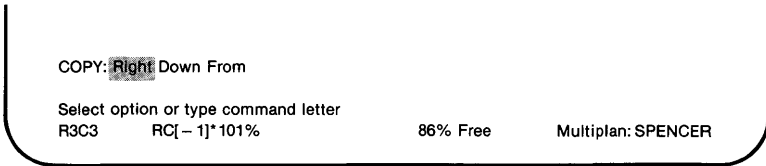

Press *R* or RETURN.

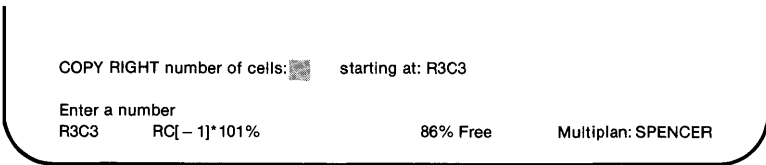

In the first field (“number of cells”), type *10*.

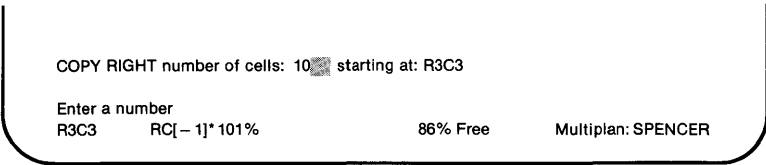

In the second field (“starting at”), you see that R3C3 (the active cell) is the proposed response. That is where you want to start because the other 10 cells are to be copies of this cell.

As you press RETURN, watch the results.

#1	1	#2	2	3	4	5	6
1			January	February	March	April	May
2							
3	Sales		\$20000.00	\$20200.00	\$20402.00	\$20606.02	\$20812.08
4							
5	Cost						
6	Material		\$4000.00	\$4000.00	\$4000.00	\$4000.00	\$4000.00
7	Labor		\$7000.00	\$7000.00	\$7000.00	\$7000.00	\$7000.00
8	Overhead		\$4000.00	\$4000.00	\$4000.00	\$4000.00	\$4000.00
9			-----				
10	Total Costs		\$15000.00	\$15000.00	\$15000.00	\$15000.00	\$15000.00
11							
12							
13							
14							
15	Gross Profits		\$5000.00	\$5200.00	\$5402.00	\$5606.02	\$5812.08
16							
17							
18							
19							
20							

COMMAND: Alpha Blank Copy Delete Edit Format Goto Help Insert Lock Move  
 Name Options Print Quit Sort Transfer Value Window Xternal  
 Select option or type command letter  
 R3C3 RC[-1]\*101% 86% Free Multiplan: SPENCER

Move the cell pointer to row 3, column 14, to see the sales figures resulting from a 1% monthly increase. The formula was copied to the remainder of the year, and the cells that depended on sales figures (*Gross Profits* and sum of *Sales*, for example) have been updated to include the new information.

# Multiplan

#1	1	#2	10	11	12	13	14
			September	October	November	December	Sum
3	Sales		\$21657.13	\$21873.71	\$22092.44	\$22313.37	\$253650.06
5	Cost						
6	Material		\$4000.00	\$4000.00	\$4000.00	\$4000.00	
7	Labor		\$7000.00	\$7000.00	\$7000.00	\$7000.00	
8	Overhead		\$4000.00	\$4000.00	\$4000.00	\$4000.00	
10	Total Costs		\$15000.00	\$15000.00	\$15000.00	\$15000.00	\$180000.00
15	Gross Profits		\$6657.13	\$6873.71	\$7092.44	\$7313.37	\$73650.06

COMMAND: Alpha Blank Copy Delete Edit Format Goto Help Insert Lock Move  
 Name Options Print Quit Sort Transfer Value Window Xternal  
 Select option or type command letter  
 R3C14 SUM(RC[- 12]: RC[- 1]) 84% Free Multiplan: SPENCER

Before you go on, save your work (Transfer Save, and Y to overwrite).

## What If . . . ?

The *SPENCER* worksheet is based on the assumption that the company will have \$20,000.00 in sales in the “base” month (January). The rest of the sales figures are calculated from a formula that assumes a sales increase of 1% per month. All the cost figures are the same for each month.

What if the actual “base” figures (figures you typed in rather than figures calculated from formulas) are different from the estimates you typed in? You would want to change the “base” figures, but would want to protect your formulas (especially those for calculating *Total Costs* and *Gross Profits*) from alteration. How do you protect your formulas from accidental alteration? And, how do you quickly find which cells contain the “base” figures?

Multiplan has a Lock command to protect formulas and text and a NEXT UNLOCKED CELL key to move quickly from one base figure to the next.

## Protecting the Worksheet: The Lock Formulas Command

Press *L* (for Lock), then *F* (for Formulas). The command line changes to:

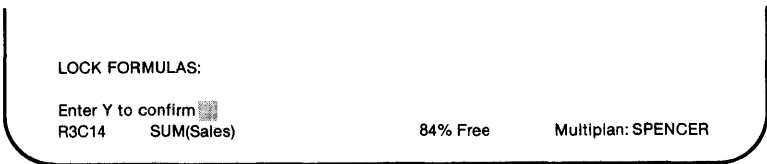

The message line shows the message “Enter *Y* to confirm.” Enter *Y* if you want to lock all cells with formulas or text. Press any other key to cancel the command.

Press *Y*. The command menu returns.



## The NEXT UNLOCKED CELL Key

To see the effect of the Lock Formulas command, press the HOME key to go to R1C1. Now press the NEXT UNLOCKED CELL key (refer to your Quick Reference Guide or the Help Keyboard command). Your screen should display:

#1	1	#2	1	2	3	4	5
1			January	February	March	April	
2							
3	Sales	Sales	\$20000.00	\$20200.00	\$20402.00	\$20606.02	
4							
5	Cost	Cost					
6	Material	Material	\$4000.00	\$4000.00	\$4000.00	\$4000.00	
7	Labor	Labor	\$7000.00	\$7000.00	\$7000.00	\$7000.00	
8	Overhead	Overhead	\$4000.00	\$4000.00	\$4000.00	\$4000.00	
9							
10	Total Costs	Total Costs	\$15000.00	\$15000.00	\$15000.00	\$15000.00	
11							
12							
13							
14							
15	Gross Profits	Gross Profits	\$5000.00	\$5200.00	\$5402.00	\$5606.02	
16							
17							
18							
19							
20							

COMMAND: Alpha Blank Copy Delete Edit Format Goto Help Insert Lock Move  
 Name Options Print Quit Sort Transfer Value Window Xternal  
 Select option or type command letter  
 R3C2      20000                                      84% Free                      Multiplan: SPENCER

The cell pointer moves to R3C2, which is the first cell from the beginning of the worksheet that contains typed in numbers rather than text or a formula. Notice that blank cells are also ignored.

Type *18000*, then press RETURN. Again, press the NEXT UNLOCKED CELL key.

#1	1	#2	1	2	3	4	5
				January	February	March	April
3	Sales	Sales		\$18000.00	\$18180.00	\$18361.80	\$18545.42
5	Cost	Cost					
6	Material	Material		\$4000.00	\$4000.00	\$4000.00	\$4000.00
7	Labor	Labor		\$7000.00	\$7000.00	\$7000.00	\$7000.00
8	Overhead	Overhead		\$4000.00	\$4000.00	\$4000.00	\$4000.00
10	Total Costs	Total Costs		\$15000.00	\$15000.00	\$15000.00	\$15000.00
15	Gross Profits	Gross Profits		\$3000.00	\$3180.00	\$3361.80	\$3545.42

COMMAND: Alpha Blank Copy Delete Edit Format Goto Help Insert Lock Move  
 Name Options Print Quit Sort Transfer Value Window Xternal  
 Select option or type command letter  
 R6C2      4000                                      84% Free                      Multiplan: SPENCER

The value in R3C2 (January Sales) changed, and Multiplan recalculated the figures in the *Sales* and *Gross Profits* rows. The cell pointer is now at R6C2, the next unlocked cell. If you want, you can alter the value in this cell, then watch the changes on the profit picture. Already you can see that gross profits dropped from \$5000 to \$3000 in January, with similar reductions in the following months.

You might want to press the NEXT UNLOCKED CELL key several more times to see which cells remain unlocked.

## Unlocking Cells

To unlock cells again, press *L* (for Lock), then *C* (for Cells). In the “cells” field, specify the whole active area of the worksheet, as follows:

Press the HOME key (for the upper left corner of the worksheet).

Press : (colon, to create a range).

Press the END key (for the most lower left cell that contains data or has been formatted).

Press RETURN.

All cells should now be unlocked. Press the NEXT UNLOCKED CELL key several times; the cell pointer should move from one cell to the next, just as if you were pressing the RIGHT direction key, except that blank cells are still skipped.

## The Options Command

As you have seen, if you change the contents of a cell, such as January Sales, Multiplan recalculates all of the cells that depend upon that cell.







## Summary

In this session you learned:

How to fix row and column titles to let you view the headings while you scroll the worksheet (Window Split Titles).

How to open a new window (Window Split).

How to link windows so that they scroll together, either by rows or by columns, or both (Window Link).

How to draw a border around a window (Window Border).

How to enter a formula to show an increasing sales percentage.

How to copy a formula into other cells to the right (Copy Right review).

How to lock cells that contain formulas or text so you can perform “what if” experiments.

How to use the NEXT UNLOCKED CELL key to find cells that contain typed in numbers.

How to unlock locked cells.

How to use the Options command to suspend the Multiplan automatic recalculation feature.

# Chapter 6

## Printing a Worksheet

---

The Print Command	155
The Print Printer Command	156
Other Print Subcommands	157
Summary	158





You have now become familiar with the basic command structure of Multiplan, using the keyboard and commands to build a worksheet that responds quickly and accurately to changes.

In this session you will learn to use the Multiplan Print command to print a copy of the summary operating budget that you developed to show Spencer Ceramics' projected sales and profits. You can print your work on paper or save it in a disk file.

## The Print Command

Start up Multiplan and load the *SPENCER* file. Next, use the Multiplan Print command to get a paper copy of your work. Press *P*.

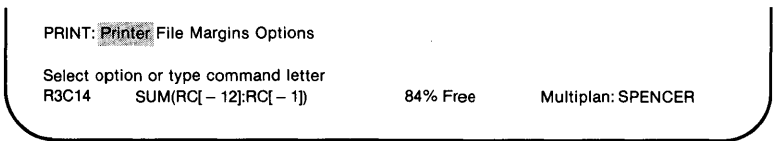

Multiplan's proposed response for the Print command is "Printer." You can press *P* or RETURN to have your worksheet printed.

Multiplan has set margins that it uses unless you specify different ones.

These margins are:

left	5 characters
top	6 lines
print width	70 characters
print length	54 lines
page length	66 lines

## Multiplan

Multiplan will print as many columns across the page as will fit within these margins. Any columns left over will be printed on a second page, with row and column numbers continued.

This method of printing permits you to cut and paste the printed pages to form a worksheet with the same dimensions you set up on the screen.

## The Print Printer Command

Before you print the worksheet, be sure the printer is connected properly, turned on, and ready to print. To produce a paper copy of your worksheet, press *P* or RETURN. Your worksheet should now be printing on your printer.

The printed pages should look something like the next three illustrations:

	January	February	March	April	May	
Sales	\$20000.00	\$20200.00	\$20402.00	\$20606.02	\$20812.08	
Cost						
Material	\$4000.00	\$4000.00	\$4000.00	\$4000.00	\$4000.00	
Labor	\$7000.00	\$7000.00	\$7000.00	\$7000.00	\$7000.00	
Overhead	\$4000.00	\$4000.00	\$4000.00	\$4000.00	\$4000.00	
Total Costs	\$15000.00	\$15000.00	\$15000.00	\$15000.00	\$15000.00	
Gross Profits	\$5000.00	\$5200.00	\$5402.00	\$5606.02	\$5812.08	
	June	July	August	September	October	November
	\$21020.20	\$21230.40	\$21442.71	\$21657.13	\$21873.71	\$22092.44
	\$4000.00	\$4000.00	\$4000.00	\$4000.00	\$4000.00	\$4000.00
	\$7000.00	\$7000.00	\$7000.00	\$7000.00	\$7000.00	\$7000.00
	\$4000.00	\$4000.00	\$4000.00	\$4000.00	\$4000.00	\$4000.00
	\$15000.00	\$15000.00	\$15000.00	\$15000.00	\$15000.00	\$15000.00
	\$6020.20	\$6230.40	\$6442.71	\$6657.13	\$6873.71	\$7092.44

December	Sum
\$22313.37	\$253650.06
\$4000.00	
\$7000.00	
\$4000.00	
-----	
\$15000.00	\$180000.00
\$7313.37	\$73650.06

## Other Print Subcommands

The Print command includes several other subcommands. These subcommands are summarized here. For descriptions of these subcommands, refer to Chapter 9, “Command Directory,” in Part 2.

### Print File

This subcommand lets you store a printable version of a worksheet on diskette. This printable “file” version of the worksheet has several uses:

You can print the worksheet at any time and repeatedly; If you do not have a printer available, you would need to have a disk copy to take to another computer for printing; You can call up the worksheet for editing with a word processing program you might have and include the worksheet in reports prepared by the word processing program.

## Print Margins

This subcommand lets you set the margins for printing a worksheet.

## Print Options

This subcommand lets you select what you want to print.

You may print:

Only the parts of the worksheet you specify. For example, you could specify just the column showing the sums for sales, costs, and gross profits (column 14).

The formulas in the cells instead of the values. For example, with the formulas option turned on, Multiplan would print *Sales—Total\_Costs* (the formula for *Gross Profits*) instead of \$5000.00.

The worksheet with row and column numbers included.

## Summary

In this session you learned:

How to start printing.

What other subcommands are part of the Print command.

# Chapter 7

## Using Multiple Worksheets

---

Relating Worksheets to Each Other	163
The Transfer Clear Command	164
Building a Supporting Sheet	165
Naming Related Worksheets	170
The eXternal Copy Command	171
Revising a Supporting Sheet	179
Dissolving Connections between Worksheets	182
The eXternal List Command	185
Summary	186
Learning More about Multiplan	187



In this session you will learn to use information from other worksheets in entries and formulas on your active sheet.

The worksheet you have been compiling for Spencer Ceramics is a summary worksheet showing sales, costs, and gross profits. It is based on information for one month, which was then projected into the remaining months of the year to show potential profits. Review the data you already have. Transfer Load the *SPENCER* worksheet. Your worksheet should look like this:

#1	1	#2	10	11	12	13	14
			September	October	November	December	Sum
2							
3	Sales		\$21657.13	\$21873.71	\$22092.44	\$22313.37	\$253650.06
4							
5	Cost						
6	Material		\$4000.00	\$4000.00	\$4000.00	\$4000.00	
7	Labor		\$7000.00	\$7000.00	\$7000.00	\$7000.00	
8	Overhead		\$4000.00	\$4000.00	\$4000.00	\$4000.00	
9			-----				
10	Total Costs		\$15000.00	\$15000.00	\$15000.00	\$15000.00	\$180000.00
11							
12							
13							
14							
15	Gross Profits		\$6657.13	\$6873.71	\$7092.44	\$7313.37	\$73650.06
16							
17							
18							
19							
20							
COMMAND: Alpha Blank Copy Delete Edit Format Goto Help Insert Lock Move							
Name Options Print Quit Sort Transfer Value Window Xternal							
Select option or type command letter							
R3C14	SUM(RC[-12]:RC[-1])		84% Free		Multiplan: SPENCER		

On this summary sheet, the costs of many types of items are added together to calculate the cost of materials and overhead for each month. You are now ready to use more detailed information about the company.

Look at the following breakdown of Spencer Ceramics' material and overhead costs for January.



**Material**

Clay	\$1500
Glaze	1500
Brushes	500
Sponges	200
Plaster	300
<b>Total</b>	<b>\$4000</b>

**Overhead**

Utilities	\$1100
Rent	2500
Telephone	200
Water	200
<b>Total</b>	<b>\$4000</b>

In the course of business, Spencer Ceramics would keep a record of each type of item that makes up *Material* and *Overhead* shown on the summary sheet. Your report on Spencer Ceramics would be more complete if you added these details. You can do this by setting up a worksheet for costs, which will supply totals for rows 6 and 8 of the summary sheet (we are assuming for the present that labor costs will remain the same).

supporting sheet  
will provide data  
for "material" (R6)  
and "overhead"(R8)

#1	1	#2	2	3	4	5	6
			January	February	March	April	May
3	Sales		\$20000.00	\$20200.00	\$20402.00	\$20606.02	\$20812.08
5	Cost						
6	Material		\$4000.00	\$4000.00	\$4000.00	\$4000.00	\$4000.00
7	Labor		\$7000.00	\$7000.00	\$7000.00	\$7000.00	\$7000.00
8	Overhead		\$4000.00	\$4000.00	\$4000.00	\$4000.00	\$4000.00
10	Total Costs		\$15000.00	\$15000.00	\$15000.00	\$15000.00	\$15000.00
15	Gross Profits		\$5000.00	\$5200.00	\$5402.00	\$5606.02	\$5812.08

COMMAND: Alpha Blank Copy Delete Edit Format Goto Help Insert Lock Move  
Name Options Print Quit Sort Transfer Value Window Xternal  
Select option or type command letter  
R6C2 4000 84% Free Multiplan: SPENCER

## Relating Worksheets to Each Other

With Multiplan, you can set up separate worksheets, which can draw information, as needed, from one another. The information on Spencer Ceramics could be set up to relate like this:

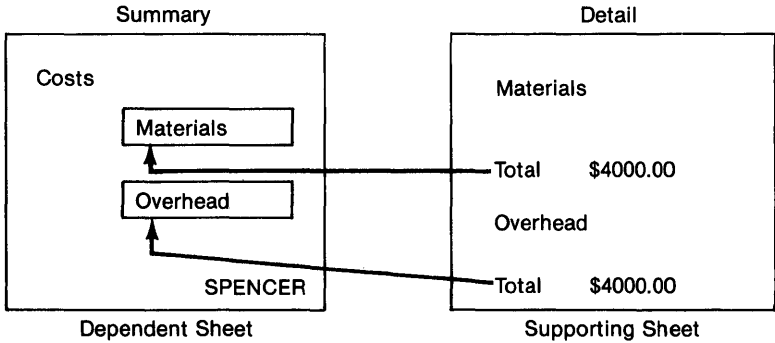

Sheets that provide data for another sheet are called supporting sheets: they support the calculations of the other sheet by providing data to it. Sheets that use data from other sheets are called dependent sheets: they depend on the data of other sheets for their calculations.

Once a supporting worksheet has been set up, named cells on the supporting sheet may be copied to the dependent sheet.

If, for example, a cost figure changes on the Costs supporting sheet, related numbers on the summary (dependent) worksheet will change as well, the next time the summary sheet is loaded.

## The Transfer Clear Command

Use the Transfer Clear command to clear the screen so that you can build a new worksheet.

**Note** The Transfer Clear command clears the sheet of all numbers, text, name definitions, and other information. It prepares a completely new sheet. The information on the screen is destroyed unless it has been saved. Therefore, if you have entered any new information you want saved since you loaded the sheet, be sure to save it first.

Your screen will look just as it does when you first start up Multiplan:

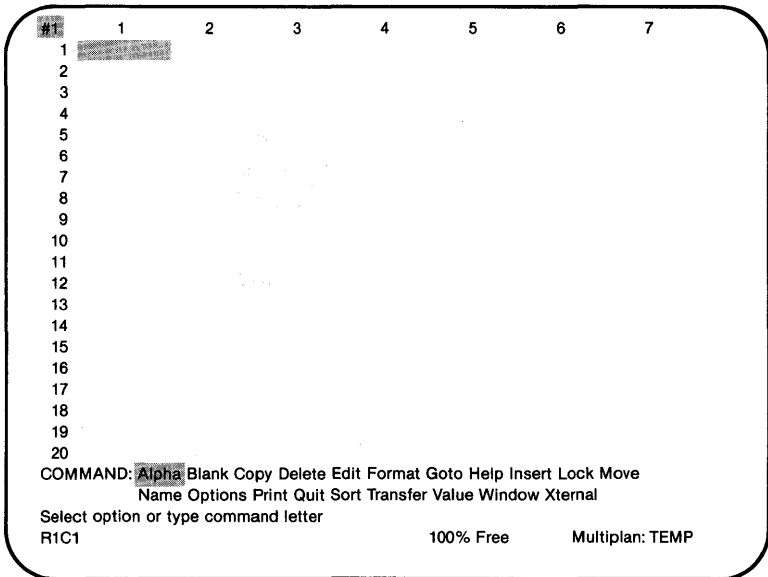

## Building a Supporting Sheet

It is not necessary to construct an elaborate supporting sheet to illustrate how Multiplan draws from other worksheets.

Before you continue with the new figures, a summary of the process of connecting worksheets will give you an idea of what's to come.

First, you will build a supporting sheet to calculate the values you want to use in your work on the summary (dependent) worksheet.

Second, Name the groups of cells that contain the values you want to use.

Third, Transfer Save the supporting sheet.

Fourth, Transfer Load the dependent sheet.

Fifth, eXternal Copy the named cells from the supporting sheet.

# Multiplan

Build the supporting sheet, using the following sample worksheet as a guide; enter on your supporting worksheet the data that is circled:

#1	1	2	3	4	5	6	7
1		January	February				
2	Material						
3	Clay	\$1500.00					
4	Glaze	\$1500.00					
5	Brushes	\$500.00					
6	Sponges	\$200.00					
7	Plaster	\$300.00					
8	Total	\$4000.00					
9							
10	Overhead						
11	Utilities	\$1100.00					
12	Rent	\$2500.00					
13	Telephone	\$200.00					
14	Water	\$200.00					
15	Total	\$4000.00					
16							
17							
18							
19							
20							

enter circled data

Row 8 = total material costs

Row 15 = total overhead costs

COMMAND: Alpha Blank Copy Delete Edit Format Goto Help Insert Lock Move  
Name Options Print Quit Sort Transfer Value Window Xternal  
Select option or type command letter  
R15C2 SUM(R[ - 4]C:R[ - 1]C) 97% Free Multiplan: TEMP



# Multiplan

#1	1	2	3	4	5	6	7
1		January	February				
2	Material						
3							
4							
5							
6							
7							
8	Total	\$4000.00	\$4032.00	\$4064.26	\$4096.77	\$4129.54	\$4162.58
9							
10	Overhead						
11							
12							
13							
14							
15	Total	\$4000.00	\$4032.00	\$4064.26	\$4096.77	\$4129.54	\$4162.58
16							
17							
18							
19							
20							

COMMAND: Alpha Blank Copy Delete Edit Format Goto Help Insert Lock Move  
 Name Options Print Quit Sort Transfer Value Window Xternal  
 Select option or type command letter  
 R15C3 RC[-1]\*1.008% 94% Free Multiplan: TEMP

You need to name two groups of cells before you connect this worksheet with the *SPENCER* summary worksheet. The connections between worksheets are made through defined names. You will recall that you already defined names on the *SPENCER* worksheet: *Sales*, *Material*, *Labor*, and *Overhead*.

Use the same process here to define names on the supporting sheet for the two groups of cells that you will copy to the *SPENCER* worksheet.

For now, define *Materialcosts* to refer to R8C2:13.

Move the cell pointer to R8C2.

Press *N*.

Type *Materialcosts*.

Press TAB.

Press : (colon).

Type 13.

NAME: define name: Materialcosts	to refer to: R8C2:R8C13	
Enter reference to cell or group of cells		
R8C13	RC[-1]*1.008%	94% Free Multiplan: TEMP

Press RETURN.

And, define *Overheadcosts* to refer to R15C2:13.

Move the cell pointer to R15C2.

Press *N*.

Type *Overheadcosts*.

NAME: define name: Overheadcosts	to refer to: R15C2:13	
Enter name		
R15C2	RC[-1]*1.008%	94% Free Multiplan: TEMP

↑

*proposed  
response  
is correct*



Press RETURN.

Now, you will want to save this worksheet with a name that indicates a relationship between the supporting (detail) sheet and the dependent (summary) sheet. The next section describes one way to name related worksheets.

## Naming Related Worksheets

Each supporting worksheet must be given a name and saved in a file. That filename is used with the eXternal command to make the data accessible to dependent sheets. Multiplan is able to find any worksheet on the diskette being used, but giving the sheets related names makes it easier to keep track of them and use them quickly and accurately.

You named the first worksheet *SPENCER*. Using a form of that name for related worksheets (which are also files once they have been saved) will help you to recognize later which sheets belong together. It is helpful to capitalize the names of the sheets to distinguish them from cell names, but it is not essential. If necessary, refer to the discussion of filenames in the "Operating Information" section at the beginning of this volume.

To name a supporting sheet, you could follow this procedure:

1. Use the general filename first (or some abbreviation of it).

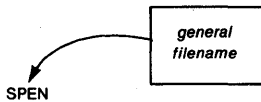

2. Next, append an additional name or abbreviation to create the supporting filename (a name that quickly identifies the worksheet to you as a supporting worksheet of the main (dependent) worksheet).

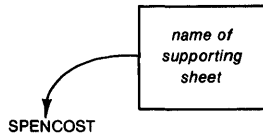

## The eXternal Copy Command

Transfer Load *SPENCER*. Your screen should look like:

#1	1	#2	10	11	12	13	14
			September	October	November	December	Sum
1							
2							
3	Sales		\$21657.13	\$21873.71	\$22092.44	\$22313.37	\$253650.06
4							
5	Cost						
6	Material		\$4000.00	\$4000.00	\$4000.00	\$4000.00	
7	Labor		\$7000.00	\$7000.00	\$7000.00	\$7000.00	
8	Overhead		\$4000.00	\$4000.00	\$4000.00	\$4000.00	
9							
10	Total Costs		\$15000.00	\$15000.00	\$15000.00	\$15000.00	\$180000.00
11							
12							
13							
14							
15	Gross Profits		\$6657.13	\$6873.71	\$7092.44	\$7313.37	\$73650.06
16							
17							
18							
19							
20							

COMMAND: Alpha Blank Copy Delete Edit Format Goto Help Insert Lock Move  
Name Options Print Quit Sort Transfer Value Window Xternal

Select option or type command letter

R3C14 SUM(RC[-12]:RC[-1]) 84% Free Multiplan: SPENCER

Move the cell pointer to R6C2.

The eXternal command is selected by pressing *X* (for “eXternal”). Press *X*.

```
EXTERNAL: Copy List Use
Select option or type command letter
R6C2      4000      84% Free      Multiplan: SPENCER
```

Press *C* or RETURN to select “Copy.” The command line should look like:

```
EXTERNAL COPY from sheet: to: R6C2      name:
Enter filename            linked:(Yes)No
R6C2      4000      84% Free      Multiplan: SPENCER
```

In the first field (“from sheet”), type the name of the supporting sheet from which you want to copy information. Type *SPENCOST*.

```
EXTERNAL COPY from sheet: SPENCOST to: R6C2      name:
Enter filename            linked:(Yes)No
R6C2      4000      84% Free      Multiplan: SPENCER
```

↑  
name of  
“supporting”  
external  
sheet

TAB to the second field (“name”). Type the name of the group of cells you want to copy to the active cell. Type *Materialcosts*.

EXTERNAL COPY from sheet: SPENCOST to: R6C2	name: Materialcosts	linked:(Yes)No	
Enter name on external sheet R6C2 [SPENCOST Materialcosts]	80% Free	Multiplan: SPENCER	

name defined  
on supporting sheet

Notice that the third field (“to”) proposes the active cell as the beginning of the area to receive the copied information. This is the correct response because you positioned the cell pointer before starting to use the eXternal command.

The proposed response in the “linked” field is “Yes.” This means that a permanent connection will be set between *SPENCER* and *SPENCOST*. You want a permanent connection between worksheets whenever you will put the current figures on one worksheet but want the summary to be on another, as you have been doing with *SPENCOST* (current figures) and *SPENCER* (summary).

Leave the “Yes” response as is; press RETURN.

Something’s wrong! In the message line you see:

COMMAND: Alpha Blank Copy Delete Edit Format Goto Help Insert Lock Move Name Options Print Quit Sort Transfer Value Window Xternal			
Cannot copy into non-blank cell	80% Free	Multiplan: SPENCER	
R6C2 4000			

error  
message  
on message  
line

The eXternal Copy command, unlike the regular Copy commands, only copies into blank cells to protect the information on the active sheet from inadvertent elimination. So, you must first blank out the cells in row 6.

Press *B* (for Blank). Press *:* (colon). Press the RIGHT direction key until the cell pointer reaches column 13. Press RETURN. The cells in row 6, columns 2 through 13 should be blank.

#1	1	#2	2	3	4	5	6
1			January	February	March	April	May
2							
3	Sales		\$20000.00	\$20200.00	\$20402.00	\$20606.02	\$20812.08
4							
5	Cost						
6	Material						
7	Labor		\$7000.00	\$7000.00	\$7000.00	\$7000.00	\$7000.00
8	Overhead		\$4000.00	\$4032.00	\$4064.26	\$4096.77	\$4129.54
9							
10	Total Costs		\$11000.00	\$11032.00	\$11064.26	\$11096.77	\$11129.54
11							
12							
13							
14							
15	Gross Profits		\$9000.00	\$9168.00	\$9337.74	\$9509.25	\$9682.54
16							
17							
18							
19							
20							

destination of external copy must be blank

COMMAND: Alpha Blank Copy Delete Edit Format Goto Help Insert Lock Move  
 Name Options Print Quit Sort Transfer Value Window Xternal  
 Select option or type command letter  
 R6C2 81% Free Multiplan: SPENCER

Now, use the eXternal Copy command again, as described above. Briefly:

1. Press *X*.
2. Press *C*.
3. Type *SPENCOST*.

4. Press TAB.
5. Type *Materialcosts*.
6. Press RETURN.

The values from *SPENCOST* should now appear on your screen:

#1	1	#2	2	3	4	5	6
			January	February	March	April	May
2							
3	Sales		\$20000.00	\$20200.00	\$20402.00	\$20606.02	\$20812.08
4							
5	Cost						
6	Material		\$4000.00	\$4032.00	\$4064.26	\$4096.77	\$4129.54
7	Labor		\$7000.00	\$7000.00	\$7000.00	\$7000.00	\$7000.00
8	Overhead		\$4000.00	\$4000.00	\$4000.00	\$4000.00	\$4000.00
9			-----				
10	Total Costs		\$15000.00	\$15032.00	\$15064.26	\$15096.77	\$15129.54
11							
12							
13							
14							
15	Gross Profits		\$5000.00	\$5168.00	\$5337.74	\$5509.25	\$5682.54
16							
17							
18							
19							
20							

COMMAND: Alpha Blank Copy Delete Edit Format Goto Help Insert Lock Move  
 Name Options Print Quit Sort Transfer Value Window Xternal  
 Select option or type command letter  
 R6C2 [SPENCOST Materialcosts] 80% Free Multiplan: SPENCER

active cell shows  
 sheet name and  
 defined name  
 of cells copied

Now, Name the area. Press *N*.

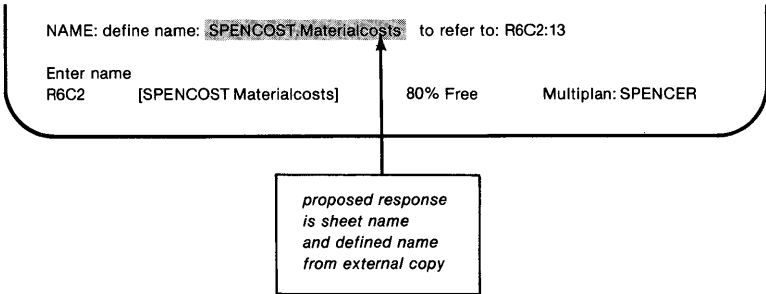

Multiplan proposes to define the name *SPENCOST.Materialcosts* to refer to R6C2:13, the area that received the values. To define the name, simply press RETURN.

When the Name command is used immediately after an eXternal Copy command, Multiplan proposes the response in the "name" field of the eXternal Copy command as the name to be defined. This makes it easy to define names for the cells that receive values from another worksheet. Simply press *N*, then RETURN as soon as you finish each eXternal Copy command. This is the only time the name on the supporting sheet is proposed as a name on the active sheet.

Now, let's copy information from *SPENCOST* for Overhead costs. Move the cell pointer to R8C2.

Remember: you must first blank out the cells that will receive the values from another sheet. Press *B*, then *:* (colon). Type *13*. Press RETURN. You should see:

#1	1	#2	2	3	4	5	6
1			January	February	March	April	May
2							
3	Sales		\$20000.00	\$20200.00	\$20402.00	\$20606.02	\$20812.08
4							
5	Cost						
6	Material		\$4000.00	\$4032.00	\$4064.26	\$4096.77	\$4129.54
7	Labor		\$7000.00	\$7000.00	\$7000.00	\$7000.00	\$7000.00
8	Overhead						
9							
10	Total Costs		\$11000.00	\$11032.00	\$11064.26	\$11096.77	\$11129.54
11							
12							
13							
14							
15	Gross Profits		\$9000.00	\$9168.00	\$9337.74	\$9509.25	\$9682.54
16							
17							
18							
19							
20							

COMMAND: Alpha Blank Copy Delete Edit Format Goto Help Insert Lock Move  
Name Options Print Quit Sort Transfer Value Window Xternal  
Select option or type command letter  
R8C2 82% Free Multiplan: SPENCER

Now, press *X* (for eXternal), then *C* (for Copy).

EXTERNAL COPY from sheet: SPENCOST name:  
to: R8C2 linked:(Yes)No  
Enter filename R8C2 82% Free Multiplan: SPENCER

proposed response is sheetname from last external copy

Notice that Multiplan proposes the name of the last worksheet named, *SPENCOST*.



# Multiplan

So all you have to do now is TAB to the "name" field. Press TAB.

Type *Overheadcosts*.

EXTERNAL COPY from sheet: SPENCOST	name: Overheadcosts
to: R8C2	linked:(Yes)No
Enter name on external sheet	
R8C2	82% Free Multiplan: SPENCER

As before, the responses in the "to" and "linked" fields are correct.

Simply press RETURN, and watch the values appear in row 8.

#1	1	#2	2	3	4	5	6
1			January	February	March	April	May
2							
3	Sales		\$20000.00	\$20200.00	\$20402.00	\$20606.02	\$20812.08
4							
5	Cost						
6	Material		\$4000.00	\$4032.00	\$4064.26	\$4096.77	\$4129.54
7	Labor		\$7000.00	\$7000.00	\$7000.00	\$7000.00	\$7000.00
8	Overhead		\$4000.00	\$4032.00	\$4064.26	\$4096.77	\$4129.54
9			-----				
10	Total Costs		\$15000.00	\$15064.00	\$15128.51	\$15193.54	\$15259.09
11							
12							
13							
14							
15	Gross Profits		\$5000.00	\$5136.00	\$5273.49	\$5412.48	\$5552.99
16							
17							
18							
19							
20							

COMMAND: Alpha Blank Copy Delete Edit Format Goto Help Insert Lock Move  
 Name Options Print Quit Sort Transfer Value Window Xternal  
 Select option or type command letter  
 R8C2 [SPENCOST Overheadcosts] 80% Free Multiplan: SPENCER

Once again take advantage of the proposed responses for the Name command just after an eXternal Copy command. Press *N*.

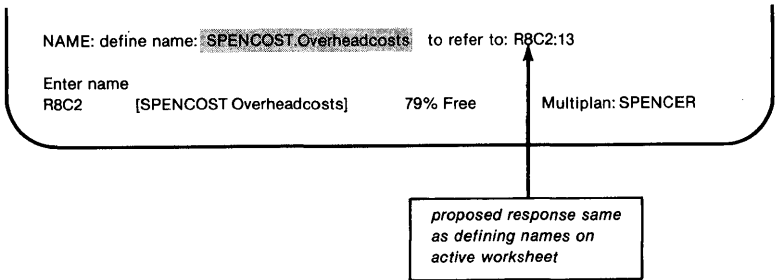

Press RETURN.

The relation between *SPENCER* and *SPENCOST* is not permanent until you save the active sheet (*SPENCER*). Multiplan will record the dependency—established with the eXternal Copy command—in both saved sheets. After you have saved *SPENCER*, *SPENCER* will always depend on *SPENCOST*, and *SPENCOST* will always support *SPENCER*. If you don't save *SPENCER* before you start work on another sheet or before you Quit Multiplan, you will have to redo the eXternal Copy commands when you next load *SPENCER*. Save the *SPENCER* worksheet now.

## Revising a Supporting Sheet

Now, you might like to experiment with the *SPENCOST* supporting sheet to see how revisions on it affect the *SPENCER* summary sheet.

Transfer Load *SPENCOST*.

Move the cell pointer to R15C2.

Type 5000.

# Multiplan

Press RETURN; the values for the total of overhead should change.

#f	1	2	3	4	5	6	7
1		January	February				
2	Material						
3							
4							
5							
6							
7							
8	Total	\$4000.00	\$4032.00	\$4064.26	\$4096.77	\$4129.54	\$4162.58
9							
10	Overhead						
11							
12							
13							
14							
15	Total	\$5000.00	\$5040.00	\$5080.32	\$5120.96	\$5161.93	\$5203.23
16							
17							
18							
19							
20							

COMMAND: Alpha Blank Copy Delete Edit Format Goto Help Insert Lock Move  
Name Options Print Quit Sort Transfer Value Window Xternal  
Select option or type command letter  
R15C2 5000 91% Free Multiplan: SPENCOST

Now Transfer Save *SPENCOST*, pressing *Y* to confirm overwriting the old file.

Transfer Load *SPENCER*. As *SPENCER* loads, you'll see "Copying..." messages in the message line:

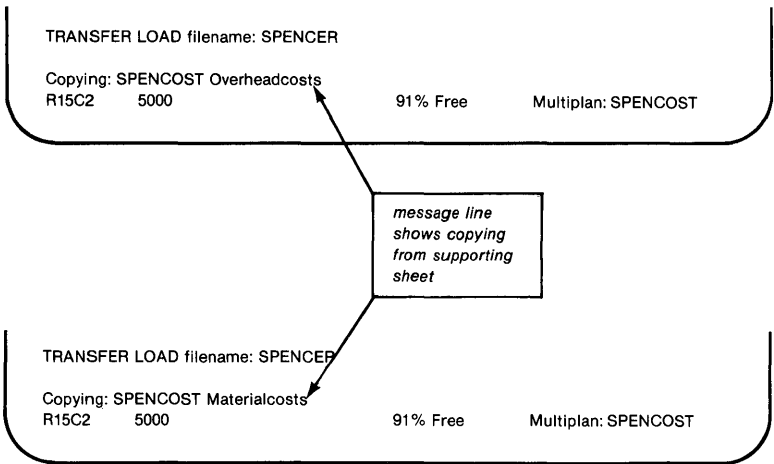

These messages tell you that Multiplan is copying the information from the supporting sheets onto the dependent sheet. When the *SPENCER* worksheet is displayed, you'll see that *Material* shows \$5000.00 for January, and the appropriate amounts for the other months.

If, when you used the eXternal Copy command, you had responded "No" in the "linked" field, the *SPENCER* worksheet would not have been affected by the revisions to *SPENCOST*. You will want to select "No" in the "linked" field whenever the data you copy will never change or, if it does change, you don't need the change reflected on the "dependent" worksheet.

For example, suppose you want to set up the *SPENCOST* worksheet with all the month titles across the top, not just January and February as it is now. *SPENCER* already has all the months entered. Instead of typing each month title again, simply use the eXternal Copy command without linking (select "No" in the "linked" field). The steps would be: Transfer Load *SPENCOST* and Blank January and February (R1C2:3).

Press *X* then *C*. Type *SPENCER*. Press *TAB*. Type *R1C2:13* (the range of cells that contain the titles you want). Press *TAB* twice (we're assuming the cell pointer is at the first destination cell). Press *N* then *RETURN*.

The month titles will appear across the top of the sheet.

If you do this example, Transfer Save *SPENCOST* then Transfer Load *SPENCER*.

## Dissolving Connections between Worksheets

At some time you may want to dissolve the connections between worksheets. This process is very similar to building the connections.

Select the eXternal Copy command; press *X*, then *C*. The "from sheet" field should show the name of the worksheet last copied; in this case, *SPENCOST*.

EXTERNAL COPY from sheet: <b>SPENCOST</b>	name:
to: R8C2	linked:(Yes)No
Enter filename	
R8C2	82% Free Multiplan: SPENCER

Press *TAB* to move the "name" field.

Type the name of the group of cells you want to delete. Let's delete the connection with *Materialcosts*. Type *Materialcosts*.

EXTERNAL COPY from sheet: SPENCOST	name: Materialcosts <input type="checkbox"/>
to: R6C2	linked:(Yes)No
Enter name on external sheet	
R6C2 [SPENCOST Materialcosts]	79% Free Multiplan: SPENCER

Press TAB to move to the “to” field. The entire proposed response is highlighted.

EXTERNAL COPY from sheet: SPENCOST      name: Materialcosts  
to: R6C2:13      linked:(Yes)No  
Enter reference to cell or group of cells  
R6C2      [SPENCOST Materialcosts]      79% Free      Multiplan: SPENCER

*proposed response changes to area of external copy*

Press the DELETE key; the response disappears.

EXTERNAL COPY from sheet: SPENCOST      name: Materialcosts  
to:      linked:(Yes)No  
Enter reference to cell or group of cells  
R6C2      [SPENCOST Materialcosts]      79% Free      Multiplan: SPENCER

*definition of external copy deleted*

Now, press RETURN, and watch the values disappear from row 6.

#1	1	#2	2	3	4	5	6
	1		January	February	March	April	May
	2						
	3	Sales	\$20000.00	\$20200.00	\$20402.00	\$20606.02	\$20812.08
	4						
	5	Cost					
	6	Material					
	7	Labor	\$7000.00	\$7000.00	\$7000.00	\$7000.00	\$7000.00
	8	Overhead	\$4000.00	\$4032.00	\$4064.26	\$4096.77	\$4129.54
	9		-----				
	10	Total Costs	\$11000.00	\$11032.00	\$11064.26	\$11096.77	\$11129.54
	11						
	12		area of external copy is now blank				
	13						
	14						
	15	Gross Profits	\$9000.00	\$9168.00	\$9337.74	\$9509.25	\$9682.54
	16						
	17						
	18						
	19						
	20						
COMMAND: Alpha Blank Copy Delete Edit Format Goto Help Insert Lock Move							
Name Options Print Quit Sort Transfer Value Window Xternal							
Select option or type command letter							
R6C2			80% Free		Multiplan: SPENCER		

The name you defined after using the eXternal Copy command to copy *Materialcosts* is still a defined name on the active worksheet. If you want to delete the definition for the sake of tidiness, use the Name command now. Press N.

NAME: define name: SPENCOST.Materialcosts	to refer to:
Enter name	
R6C2	80% Free Multiplan: SPENCER
deleted definition of name	

Multiplan proposes *SPENCOST.Materialcosts* as the name to be defined. Notice that the “to refer to” field is blank. All you have to do to delete the definition of *SPENCOST.Materialcosts* as a name is press RETURN.

## The eXternal List Command

You may review the connections between worksheets by using the eXternal List command. Press *X*, then *L*.

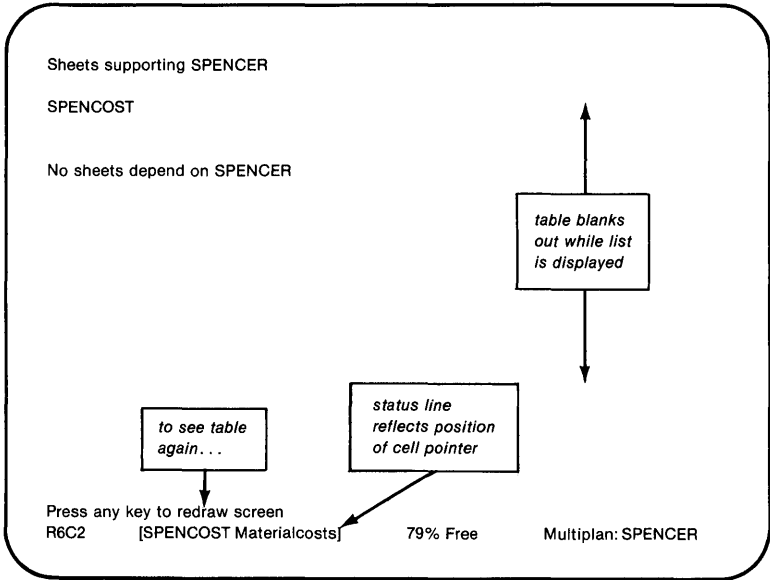

The eXternal List command displays what Multiplan knows about the relationship between the various sheets. The list of “sheets supporting” shows the names used in the present sheet that call for values from other, saved sheets. The list of “sheets depending on” shows the names of other, saved sheets that call for a value or values from the active sheet.

Notice that *SPENCOST* supports *SPENCER*, but not vice versa because the copy of the month titles was not a permanent link.

Press any key to redraw the active sheet on the screen.



Once you have entered all of the detail information in new worksheets, named the cells you will need, and saved the sheets, you will be able to use the eXternal Copy command to copy information from as many of these related sheets as you need to supply information to the active (dependent) sheet.

## Summary

In this session you learned:

How worksheets interrelate.

How worksheets provide data to and/or take data from other worksheets.

How to clear the screen, using the Transfer Clear command.

How to build supporting sheets.

How to define names on supporting sheets.

How to name related worksheets for easy identification.

How to use the eXternal Copy command.

How to revise supporting sheets.

How to dissolve connections between worksheets.

How to review the relationships between sheets, using the eXternal List command.

## Learning More about Multiplan

The example of Spencer Ceramics is completed.

There are other tasks and other problems to be solved that require additional commands and functions. Multiplan provides them.

Multiplan is described completely in Part 2, "Reference to Multiplan." In Part 2, you'll find descriptions of additional commands like:

Delete

Move

Sort

which weren't used at all for the *SPENCER* worksheet, plus additional options and uses for familiar commands like:

Copy

Format

Goto

Lock

Options

Print

Transfer

eXternal

Multiplan provides mathematical, financial, and statistical functions for calculations and problem solving. So far you've only seen SUM.

## Multiplan

In addition, in Part 2, you'll find descriptions of additional editing keys that make building a worksheet easier. And, you'll find an alphabetical list of all the messages Multiplan can display on the message line. An appendix of "Helpful Hints" suggests ways to save time and space while using Multiplan.

Now that you've learned how to use Multiplan in Part 1, you can use Part 2 to explore the full potential of Microsoft Multiplan.

## Part 2

# Reference to Multiplan

---

8	Elements of Multiplan	191
9	Command Directory	225
10	Function Directory	309
11	Message Directory	353



# Chapter 8

## Elements of Multiplan

---

The Microsoft Multiplan Worksheet	193
Entering Commands	196
Select a Command	197
Select Responses for the Command	
Fields	198
Proposed Responses	199
Editing	200
Formulas	202
Numbers	203
Text	204
References to Cells	205
Absolute References	206
Relative References	206
Names	209
Intersection Operator	210
Range Operator	211
Union Operator	212
Logical Values	215
Error Values	215
Files	217
File Handling	217
Problems with File Access	219
Problems When Reading	219
Problems When Writing	219
External Relationships	220
Transforming the Worksheet	223



This chapter is divided into six sections that describe Multiplan structure, features, and operation. Details of the commands, functions, and messages are described in separate chapters and are covered only generally in this chapter.

## The Microsoft Multiplan Worksheet

The worksheet is a rectangle with an arrangement of intersecting rows and columns. The sheet may be up to 63 columns wide and 255 rows long. An area one column wide by one row high is called a cell.

Each cell possesses both a value that may be displayed on the Multiplan screen and a formula for computing that value. This formula may be as simple as the number 19.95, or it may be more complex, containing functions and references to other cells; for example, “previous cell times growth rate.”

The potential dependence of the value of one cell on the values in other cells is the key idea behind the worksheet. When cells have been connected by references among them, a change in one cell (for example, changing 19.95 to 18.50), causes Multiplan to calculate the effect of the change on all other cells. This process is called “recalculating the worksheet.” Recalculation may be automatic after every change, or it may be turned off (see Options command, Chapter 9). When automatic recalculation is turned off, one-time recalculation may be caused by pressing the RECALC key(!).

The order of calculating the cells is automatically chosen by Multiplan so that the calculation of each cell precedes the calculation of other cells that depend on it. If such an order is impossible, the “Circular references unresolved” error message is displayed.

The Multiplan screen is a movable “window” through which to view part of the worksheet. When Multiplan starts, only one window is open. You may open up to eight windows to the worksheet. Each window opened is given a consecutive window number. For the following discussion, assume that only one window is open, just as when you start a Multiplan session.



Across the top of the window are column numbers. Down the left edge of the window are row numbers. The row and column numbers tell you what area of the worksheet you are viewing.

Somewhere within the window is a highlighted cell. The highlight is called the cell pointer, and it points to the “active cell.” Many operations do something with the active cell.

Across the bottom of the screen are four lines of text. The top two lines are called the command line. The actions you want Multiplan to perform are selected from these commands. The command line is discussed more in the “Entering Commands” section. The commands are described in Chapter 9, “Command Directory.”

Just below the command line is the message line. The message line shows either an error message or a prompt message. An error message indicates what the problem is. A prompt message indicates in general terms your next step in entering a command. The prompt message changes as you work your way through a command. See the “Entering Commands” section for more information about command entry and Chapter 11, “Message Directory” for explanations of message line messages.

The bottom line on the screen is called the status line. Here, Multiplan displays the position of the cell pointer, the current contents of the active cell, the percent of free memory, and the name of the active sheet.

The position (row number and column number) of the active cell is shown first on the status line. The formula used for calculating the value of the active cell is shown next to the coordinates. When the contents of the active cell are text or numbers, the status line shows the text in double quotes or the number itself.

The cell pointer can be moved around by using the direction keys.

UP moves the cell pointer towards the top of the window.

DOWN moves the cell pointer towards the bottom of the window.

LEFT moves the cell pointer towards the left edge of the window.

RIGHT moves the cell pointer towards the right edge of the window.

When the cell pointer reaches the edge of the window, the window begins to move across the worksheet one cell at a time. This is called scrolling. When the cell pointer reaches the edge of the worksheet, the cell pointer stops, and the Multiplan alarm sounds.

The page keys scroll across the worksheet a whole windowful at a time in the direction selected.

The HOME key may be used to go to row 1 column 1 quickly. The END key may be used to go to the last row and last column of the active area of the worksheet. The active area is the smallest rectangle that encompasses the cell in the upper left corner of the worksheet (row 1 column 1, referred to as R1C1) and the last cell to the right and down that has been given contents or formatting. When Multiplan starts, HOME and END are both at R1C1.

## Entering Commands

You direct Multiplan to perform the tasks you want done by entering commands. The commands are described individually in Chapter 9, "Command Directory." This section describes the methods of command entry.

You select a command when the main command menu is on the screen. The main command menu shows the choice of commands:

Alpha Blank Copy Delete Edit Format Goto Help Insert Lock Move  
Name Option Print Quit Sort Transfer Value Window Xternal

When this menu is on display, Multiplan is waiting for you to select a command. When Multiplan is computing, the main command menu is not visible and no message appears on the message line. When the main command menu reappears, Multiplan is ready for more commands.

Some of the main commands have subcommands. In these cases, when the main command has been chosen, the main command menu is replaced with a subcommand menu.

Remember: the message line shows a prompt message that indicates your next step in entering the command. See Chapter 11, "Message Directory," for descriptions of these messages.

To enter a command:

1. Select an active cell (move the cell pointer to the appropriate cell), if required by the command to be selected.
2. Select a command.
3. Select responses for the command fields. The responses are used to specify where to Goto, what to Format, where and how to split windows, and so forth.
4. Press RETURN to carry out the command. Or, press CANCEL during the first three steps to cancel the command.

Selecting the active cell is described in the section entitled “The Microsoft Multiplan Worksheet.” Steps 2 and 3 are described below.

## Select a Command

When you are prompted to select an option from a menu, select in one of two ways:

1. Type the first letter of the option you want.

or

2. Use SPACE and BACKSPACE to move the highlight to the appropriate command word. SPACE moves the highlight to the right, BACKSPACE to the left. Press RETURN.

When you have selected a command, Multiplan displays the main command name followed by either a subcommand menu or one or more command fields. Typically, a new subcommand menu will follow selection of a main command. Select a subcommand as you would a main command.

The command line will show the command and subcommands you have already selected in capital letters. For example:

WINDOW: Split Border Close Link

Now if “Split” is selected, the command line changes to:

WINDOW SPLIT: Horizontal Vertical Titles

Continue selecting subcommands until the command fields are displayed. The names of command fields are shown in lowercase letters followed by a colon. For example:

WINDOW SPLIT HORIZONTAL at row: 7 linked: Yes(No)

This command line has two fields: the “at row” field and the “linked” field. Note that the “linked” field contains a small menu.

## Select Responses for the Command Fields

The next step is to enter responses for the command field or fields. There may already be responses in the fields. These are responses proposed by Multiplan. If a proposed response suits your purpose, you need not enter a response in that field. In fact, if the proposed responses in all the fields are suitable, you can just press RETURN to carry out the command.

Entering responses proceeds field by field starting at the first one. A highlight indicates the “active” field (the field in which a response is being entered). Other fields will not contain a highlight.

To move the highlight from field to field, press the TAB key. Pressing the TAB key when the highlight is in the last field returns it to the first field.

The message line gives you messages prompting entries in the command fields. Whenever the message line starts with “Enter...,” the field must be filled in. To “fill in” the field, either accept the proposed response or simply type the characters. For example:

```
TRANSFER LOAD filename: INCOME
Enter filename
```

where *INCOME* was typed. In this case, there is only one field, and the TAB key is not needed. Simply press RETURN to carry out the command.

In certain fields, the direction keys may be used to view and select from a list of possible responses. The message line will indicate when the direction keys may be used. The RIGHT direction key will propose the next response on the list; the LEFT, the previous response. The UP direction key will propose the first response on the list; the DOWN, the last response.

When the message line shows “Select option,” the field contains a menu of options. Select the option you want by either of the two methods used for selecting commands: either type the initial letter or use SPACE and BACKSPACE to move the highlight to your choice. Note that when a command field with a menu is not active, the current option is shown enclosed in parentheses, as in the “linked” field in the example above.

## Proposed Responses

The proposed response depends on the specific command; thus proposed responses are described with the commands in Chapter 9, “Command Directory.” However, proposed responses follow a few general principles:

1. When a command field contains a menu, the “proposed” response is the current setting. For example, the Options command initially appears as:

OPTIONS recalc:(Yes)No    mute: Yes(No)

with the highlight on Yes showing the current setting in the “recalc” field and the parentheses showing the current setting in the “mute” field. Thus, the same menu may be used to inspect as well as select options in command fields.

2. In other fields, the proposed response will be the one entered the last time the command was used. This simplifies entering a series of related commands.
3. Yet other fields reflect the position or contents of the active cell. For this reason, positioning the cell pointer before selecting a command may be helpful.

All proposed responses may be edited by using Multiplan editing keys, described in the “Editing” section below.

## Editing

Microsoft Multiplan provides editing keys to edit responses in command fields. Multiplan editing can be used any time you are entering responses in command fields. To edit the contents of cells, move the cell pointer to the cell, then use the Alpha command for cells with text or the Edit command for cells with formulas, and edit the proposed responses in the command line.

Either just after a command is selected or just after pressing the TAB key, the whole field containing a proposed response is highlighted.

To *replace* the proposed response: Type the replacement. Multiplan automatically deletes the proposed response as you type the new one.

To *delete* the proposed response and leave the field empty: Press DELETE. All text that is highlighted is deleted.

To *append* to the proposed response: For cell references (when the message line shows "Enter reference to cell or group of cells"), type a colon (:) or other operator. For other responses, press either the CHARACTER RIGHT or the WORD RIGHT key, then type the additional text.

Once the proposed response is altered, one character or word in the field is highlighted. This highlight is the edit cursor. The edit cursor may be moved to designate where or what to edit.

Use CHARACTER LEFT, CHARACTER RIGHT, WORD LEFT, and WORD RIGHT keys to move the edit cursor.

The CHARACTER LEFT and CHARACTER RIGHT keys move the edit cursor left or right one character.

The WORD LEFT and WORD RIGHT keys move the edit cursor left or right highlighting words or the space or punctuation between words. In formulas, the values and the operators are highlighted alternately.

To *insert* new text: Type the text. It will be inserted in front of the edit cursor.

To *delete* text: Use BACKSPACE to delete characters on the left side of the cursor. Use DELETE to delete what is highlighted by the cursor.

To *replace* text: Delete the old text and type the new.

The following formula editing keys simplify the typing of formulas. These keys all insert text in front of the edit cursor:

1. As you begin to enter a formula or just after you enter an operator, the direction keys (as well as the HOME and END keys) can be used to enter a relative cell reference of the form:

$$R[\pm n]C[\pm m]$$

in the field by pointing to the cell you want (see the "Formulas" section for an explanation of cell references, relative references, absolute references, and Names). As you move the cell pointer, the reference will change accordingly. The cell pointer will return to its original position as soon as any key other than a direction key is pressed.

2. Similarly, the direction keys can be used to enter absolute references of the form:

$$RnCm$$

in fields that accept a cell reference (when the message line shows "Enter reference to cell or group of cells").

3. Relative references created with direction keys (described under item 1 above) may be changed to absolute references by pressing the REFERENCE key ( @ ) immediately after the direction keys.
4. Names may be entered easily by pressing the REFERENCE key first, then using the direction keys to step through the list of defined names.
5. Finally, a formula may be replaced with its resulting value by pressing the RECALC key ( ! ) after the formula is entered.



## Formulas

Formulas are “recipes” for calculating values. When these values are displayed on the computer screen or printed on a printer, they compose the results of a Multiplan worksheet.

Multiplan works with different types of values, which are appropriate in different circumstances:

Value	Use
numbers	used for financial, statistical, scientific, and other calculations.
text	characters treated as words, including numbers in special displays, such as \$10.00 or 6/14/81. Text is always shown in double quotes (“text”) in the status line.
references to cells	used to express dependency of a value in one cell on values in other cells on the worksheet. Groups of cells can be specified by “intersection,” “range,” and “union” operators.
logical values ( <i>true</i> and <i>false</i> )	used in making conditional, “either-or” decisions.
error values	used as substitutes for values that cannot be calculated because of a mistake in a formula. For example, the “result” of division by 0 is an error value.

New values may be calculated by combining other values with the operators, described below under the topics “Numbers,” “Text,” and “References to Cells”; or by using functions, such as MIN or MAX, described in Chapter 10.

The following sections describe each type of value.

## Numbers

Numbers may be written as integers (123), as decimal fractions (123.45), or in scientific notation. In the latter case, an integer or decimal fraction (mantissa) is followed by the letter *E* and a positive or negative integer exponent. This notation multiplies the mantissa of the number by 10 raised to the given power. For example:

12.1E2 means 1,210 ( $12.1 \times 10^2$ )  
(note: + sign may be omitted)

1E-5 means .00001 ( $1 \times 10^{-5}$ )

1.5E+6 means 1,500,000

Percentages may be written as numbers followed by % (same as division by 100):

15% means .15 (15/100)

Numbers are calculated with 14 digits of precision and a decimal exponent ranging from -63 to +63. This means that the smallest positive nonzero number is:

$.1 \times 10^{-63}$

and the largest one is:

$9.999999999999 \times 10^{+62}$

Mathematical operators are the following:

Operator	Meaning
^	exponentiation. Calculated by the rule: $a^b = \exp(\ln(a)*b)$ .
*	multiplication.
/	division.

## Multiplan

- % percent. Written after the value and has the same meaning as /100.
- + arithmetic addition.
- subtraction. May also be used in front of a value to denote “negative.”

Operator precedence is: — (negative value) is evaluated first, then %, then ^, followed by \* and /, then + and — (subtraction), and finally the logical operators described under “Logical Values” below. Parentheses may be used to alter the order in which Multiplan performs the calculation when more than one operator appears in a formula.

Chapter 10 describes Multiplan functions for performing mathematical, statistical, and financial calculations.

## Text

A text value may contain up to 255 characters. Text is written enclosed with double quotes (“”). Text may not include double quotes as a character. For example:

“salary =” is 8 characters of text

“1.0” is also text, not a number

Two text values may be concatenated using the & operator. The result is a text value that consists of the left text immediately followed by the right. For example:

“ \$ ” & “1.00” concatenates the text value “\$1.00”

Chapter 10 describes functions that operate on or return text values. In particular:

LEN(*T*) returns the number of characters in a text value.

MID(*T,s,c*) returns a specified part of a text value.

Functions are also provided for converting numbers into text and vice versa. For example:

`FIXED(1,2)` returns the text "1.00"

`VALUE("0.1")` returns the number .1

All the functions are described in detail in Chapter 10.

## References to Cells

References to cells describe the location of one or more cells on the worksheet. References are the means of access to the values in cells.

A cell reference consists of a row reference and of a column reference, in that order. (You can give cell references by entering the column reference followed by the row reference, but Multiplan stores the reference in row-column order.)

A cell reference indicates the place where a specific row and a specific column intersect.

For example, R4C3 is a reference to the cell at row 4, column 3. Assuming that that cell has the value 5, the result of the formula `R4C3 + 1` is 6.

	column					
	1	2	3	4	5	
1						
2						
3						
4			5			<code>R4C3 + 1 = 6</code>
5						

Figure 8.1. Cell Reference Gives Access to a Value

References may be written three ways:

as an absolute reference

as a relative reference

as a name reference

### Absolute References

An absolute reference consists of the letters *R* and *C* and the actual row number and column number (as illustrated above).

The forms are:

<b>Form</b>	<b>Meaning</b>
Rn	row number n (1–255)
Cn	column number n (1–63)
Rn:m	all rows from n through m
Cn:m	all columns from n through m

Placing an R form and a C form together denotes the rectangle formed by the intersection of the rows and columns:

<b>Form</b>	<b>Meaning</b>
RnCm	single cell at row n, column m
Rn:mCp:q	a rectangle of cells

### Relative References

A relative reference describes the location of another cell in terms of the location of the current cell. (“Current” means the cell that contains the cell reference.) A relative reference gives a direction by “+” for right or down or “–” for left or up and a number indicating how many rows or columns away from the current cell.

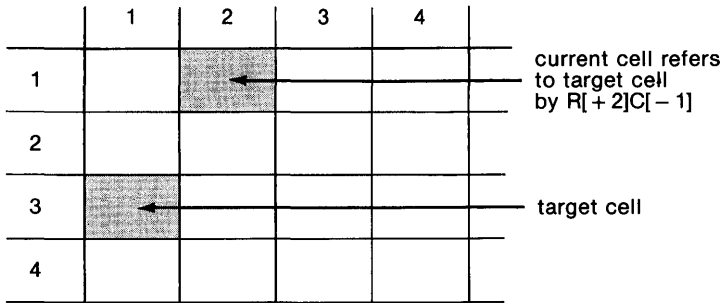

**Figure 8.2. Relative Cell Reference**

The “target” cell is 2 rows down from the current cell (+2) and 1 column left of the current cell (−1).

The forms of relative references are:

<b>Form</b>	<b>Meaning</b>
R	current row
C	current column
$R[+n]$	the row that is n rows below R (the + may be omitted)
$C[+n]$	the column that is n columns to the right of C (the + may be omitted)
$R[-n]$	the row that is n rows above R
$C[-n]$	the column that is n columns to the left of C

As for absolute references, placing a relative R form and C form together denotes the rectangle formed by the intersection of the rows and columns. For example:

Form	Meaning
RC[-1]	the single cell just to the left of the current cell

The difference between absolute and relative references becomes apparent only when a reference is copied (see Copy command, Chapter 9). Absolute references will refer to exactly the same cell or cells in all of the copies. The cells referred to by relative references, however, are different for each copy (see Figure 8.3):

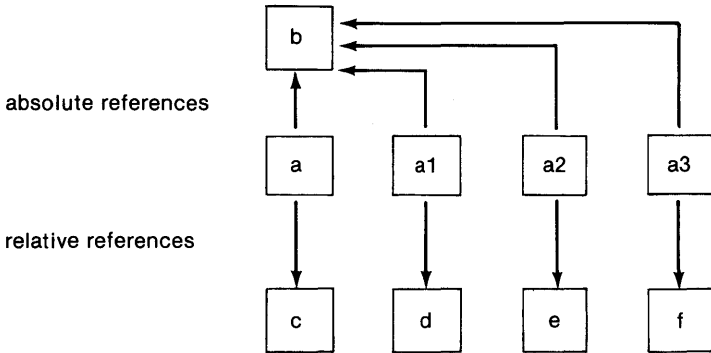

**Figure 8.3. Comparison of Absolute and Relative References**

If a reference in cell *a* is absolute and refers to cell *b*, the copied references in cells *a1*, *a2*, and *a3* will all refer to cell *b*.

If a reference in cell *a* is relative and refers to cell *c* as 3 rows down [+3], cell *a1* will refer to cell *d* (not cell *c*), cell *a2* will refer to cell *e*, and cell *a3* will refer to cell *f*.

## Names

Names are words used to identify a cell or group of cells. A Name may be defined as an absolute reference with the Name command (see Chapter 9). The spelling rules for names are:

Names must start with a letter,

followed by letters, digits, periods, and underline (   ) characters,

up to 31 characters maximum.

Words that are the same as absolute or relative references (for instance, R1C1 or R) must not be used for names.

Once defined, a Name may be used as you would use any absolute reference. For example, you might define the name *Sales* to refer to R3C2:8. The name of the reference suggests that the calculation involves sales figures. The absolute form, R3C2:8, is not mnemonically suggestive of sales figures. However, to the Multiplan program, the meanings are identical.

The name in the example above may be illustrated as:

	1	2	3	4	5	6	7	8
1								
2								
3		Sales						
4								
5								

Figure 8.4. Names as Cell References



Three operators may be used to combine references: intersection, range, and union.

### Intersection Operator (Space)

The intersection operator is used to combine two references to refer to all the cells that belong to both references.

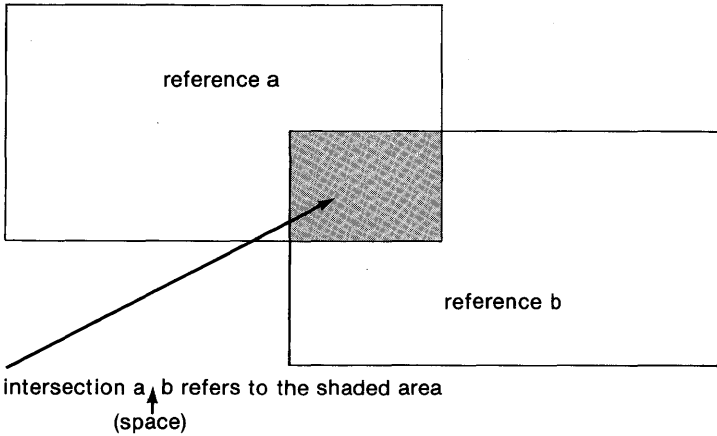
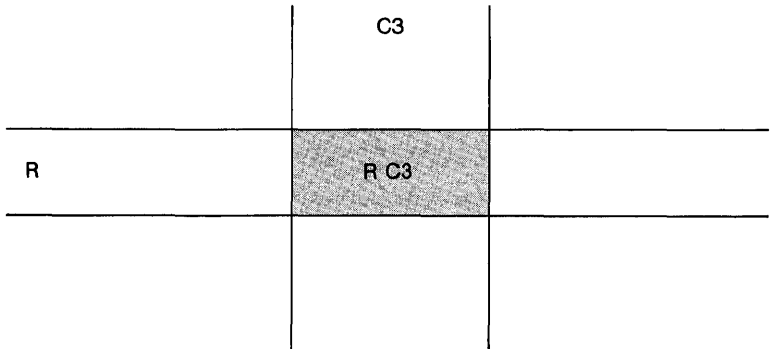

**Figure 8.5. Intersection Reference**

As a specific example,

R C3  
↑  
(space)

refers to the cell where the current row and column 3 intersect.



**Figure 8.6. Relative-Absolute Intersection Reference**

When reference forms are combined (that is, an absolute with a relative, an absolute with a name, a relative with a name, or a name with a name), the intersection operator must separate them to indicate access to the value or values where the two references intersect.

For example: RC3 is not permitted, write R C3 instead.

If the two references do not intersect, Multiplan returns a #NULL! error value.

### **Range Operator (Colon) (:)**

The range operator is used to combine two references so that the values in a group of contiguous cells may be used.

The area of a range is the smallest rectangle that includes both references.

Typically, in a reference written as a:b, the *a* reference is in the upper left corner and the *b* reference is in the lower right. For example:

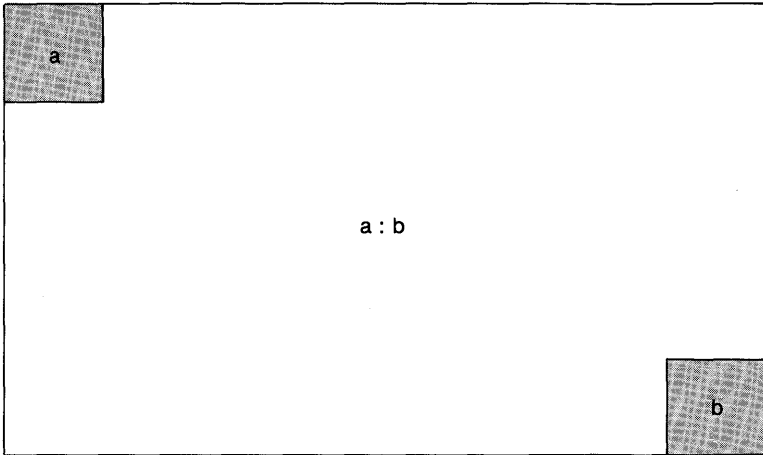
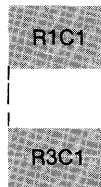

**Figure 8.7. Range Reference**

The range operator may be used to combine any of the reference forms (absolute, relative, or name) in any order.

**Union Operator (Comma) (,)**

The union operator is used to combine references to refer to all cells that belong to either reference. For example:



R1C1,R3C1

**Figure 8.8.**

Each reference in a union may be any form (absolute, relative, or name), an intersection, or a range.

A union usually refers to cells that are not contiguous. Where a union describes contiguous cells, it describes a rectangle as a range reference would. For example:

R1C1,R1C2 equals R1C1:2



Figure 8.9

but R1C1,R3C1 does not equal R1:3C1

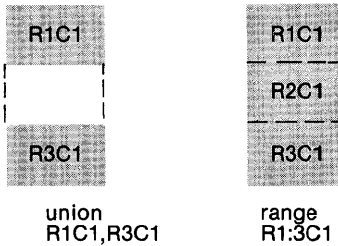
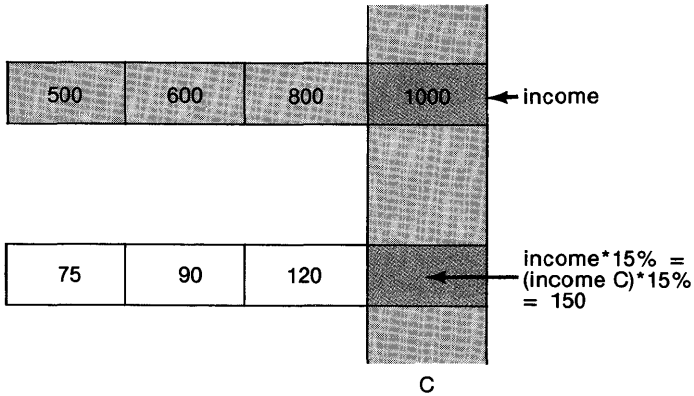

Figure 8.10

The range reference in the second example includes cells not specified by the union reference.

References may be used in formulas that require the value of a single cell. When the reference describes a single cell and a single value is required (for example, R1C1+1), the value meant is the value of the cell described plus the value 1. (Note that this value may be a number, text, logical, or error value, depending on the value in the cell referred to.)

When the reference describes a group of cells but a single value is required, Multiplan chooses the value to be used from the cell where the current row or column intersects the group of cells. In particular, for groups that are parts of rows, Multiplan chooses the value in the current column. Similarly, from parts of columns, the value in the current row is chosen. Figure 8.11 illustrates a use for this feature. Using a group of cells that is not either a row or a column (or a part of one of these) does not yield useful results.



**Figure 8.11. Single Value from a Reference to a Group of Cells**

Chapter 10 contains descriptions of the functions that can process a collection of values (SUM(...) for instance). Any type of reference may be given as an argument to such a function. The value of all the cells that are described, whether one or many, will be processed.

## Logical Values

The logical values true and false are returned by the comparison operators that compare two numbers:

Operator	Meaning
<	less than
< =	less than or equal
=	equal
> =	greater than or equal
>	greater than
<>	not equal

The functions AND(...), OR(...), NOT(...), TRUE(), and FALSE() also perform logical operations.

The purpose of logical values is to make “either-or” decisions using the IF(...) function. All of these functions are explained in Chapter 10.

Note that text values cannot be compared, except by the Sort command.

## Error Values

When a Multiplan function, operation, or reference is used incorrectly, an error value will result. There are different error values for different error conditions, as described below. Error values “propagate,” meaning that operations or functions that result in error values in one cell cause the same error values in all the cells that refer to the first cell. This also means that when one notices an error value in a cell, the propagation has to be unraveled step-by-step until the source of the error is found.

For example, we notice that cell R1C1 displays the #NAME? (undefined name) error value. The formula in R1C1 is  $a+1$ . We

check the definition of *a* using the Name command. We find that the name *a* is defined to refer to R1C2. That cell is the next step in the search. When we look in cell R1C2, we may find the cause there, but we may also find references to other quantities which will have to be inspected. We may have to look at more than one cell to find the source of the error.

The error values and their causes are:

<b>Value</b>	<b>Cause</b>
#DIV/0!	result of an attempt to divide by 0.
#NAME?	result of an undefined label reference.
#N/A	result when the value is not available. Also, #N/A is a special value that may be created using the NA() function and which will be propagated by arithmetic.
#NULL!	result of specifying an intersection of disjoint areas; e.g., R1 R2 (use union instead, R1,R2).
#NUM!	result of overflow (number is too large or too small) or of an illegal use of an arithmetic function; e.g., SQRT(-1).
#REF!	result of a relative reference reaching outside the sheet or of a reference to a deleted area.
#VALUE!	result of using text where a number is needed or vice versa or of using references when a value is needed.

## Files

This section describes how Multiplan uses files, when it reads and writes files and how links between files are handled.

This information will help better plan your use of Multiplan files.

### File Handling

Files are permanent repositories of information kept on diskettes. Files are identified by filenames, which are kept in a directory. Multiplan uses files mainly to store worksheets. For more information on diskettes, see the section entitled “Operating Information.”

Multiplan can read files, and it can write them. For both operations, Multiplan requires access to the file.

However, the machine may have more than one disk drive and different files may reside on different diskettes. It is important, then, to make sure that the proper diskette is mounted in the proper drive.

If the filename includes a drive specification, then that drive is the proper one. Otherwise, the “default” drive (assigned through the Transfer Options command) is used.

See also the section entitled “Operating Information” and the Transfer Options command in Chapter 9 for details.

Efficient operations with multiple diskettes may require some advance planning. Should the planning fail, however, Multiplan will simply display the message:

Enter Y to retry access to *filename*

When you see this message, check the diskette and replace it, if necessary.



The following lists describe when Multiplan reads files, when it writes files, and what problems Multiplan may have with reading and writing files. This information may help you anticipate file access by Multiplan.

Multiplan reads files:

1. When a sheet is loaded (Transfer Load command) in any mode (Normal, Symbolic, Other).
2. When a sheet is loaded that has supporting sheets, the supporting sheets are read one by one.
3. When the eXternal Copy command is executed, the source sheet is read.
4. When the eXternal Use command is executed, the affected copies are redone, and the source sheets are read. (See the eXternal Use command in Chapter 9.)
5. The Multiplan system diskette will be read for parts of the Multiplan program when commands are executed and for the Help file when Help is requested.

Multiplan writes the file to the diskette:

1. When a sheet is saved (Transfer Save command) in any mode.
2. When a sheet is renamed or deleted, the file directory is read or written. The file directory, by definition, shares the diskette with the worksheet files.
3. When the Print File command is executed.
4. When sheet linking relationships change, a Transfer Save or Transfer Rename command, in addition to normal duties, gains access to all supporting sheets to issue or to revoke receipts.

## Problems with File Access

You should be aware of problems to consider when trying to read or write a file. If problems with file access persist, check for possible causes from the following lists.

### Problems When Reading

1. The information may not be on the diskette. Use the Transfer Load command and the direction keys to display the directory of files on the diskette.
2. The information is not reliably readable or is unreadable. You should maintain backup copies of important files.
3. The information is not in the expected format. Check the “mode” setting of the Transfer Options command. Remember that the eXternal Copy command requires that sheets be saved in Normal mode.
4. The information is not up to date. This may happen if incorrect procedures are used for updating a collection of externally linked sheets. See the section, “External Relationships,” for details.

### Problems When Writing

1. The diskette may become filled. Diskettes can store only a limited amount of information. As more files are stored on them, they may fill up. See the section entitled “Operating Information” for procedures for determining the amount of storage used on a diskette.
2. Previous information stored in a file may be valuable. Multiplan will ask you:
 

Overwrite existing file?

Pause and reflect if this is what you want.
3. The diskette may be write-protected by a small piece of foil covering an indentation on the sleeve of the diskette. Consider the reason for write-protection before removing the foil.

4. Errors during writing, such as an interruption, may leave incorrect information on the diskette. Make sure that write operations are allowed to complete.

## External Relationships

The information in this section applies to the eXternal group of commands. Refer to the discussion of these commands in Chapter 9 for additional information.

External relationships between worksheets may be illustrated as follows:

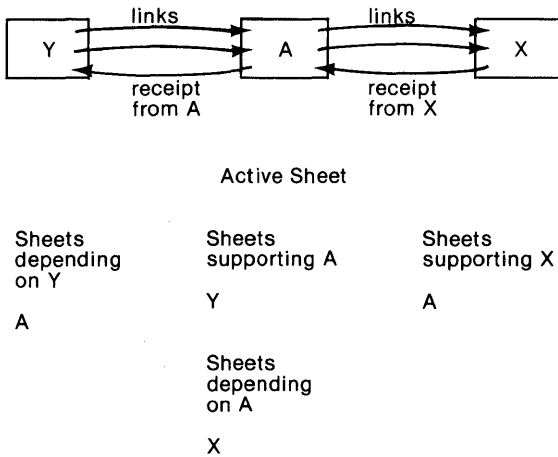

**Figure 8.12. External Relationships between Worksheets**

The set of external links can be reviewed by stepping through the supporting sheet names and the source and target areas in the eXternal Copy command.

Changing data on a supporting sheet has no immediate effect on its dependent sheets. Only when a dependent sheet is loaded is

the current information read from its supporting sheet. Thus, when changes are made to sheet Y, nothing changes on sheet A until sheet A is loaded. When sheet A is loaded, then sheet Y is read, and its data is copied to sheet A.

Similarly, when sheet A is changed (including changes from sheet Y), sheet X does not change until it is loaded. When sheet X is loaded, then sheet A is read, and its data is copied to sheet X. Note that for the information read from A to X to be current with the information on Y, A must have been loaded *and saved* at least once before X was loaded. Information is copied only one link at a time.

In a more complex set of worksheets, the relationships between the worksheets may be unraveled using the eXternal List command on each sheet and creating a dependency diagram similar to the one above.

Consistency of all data can be assured by starting with a set of sheets that are not supported by any sheets. Load and save a second set of sheets that depend on the set of unsupported sheets, then load and save sheets that depend on the second set of sheets, and so on until all sheets have been loaded and saved.

This process is illustrated in the following diagram:

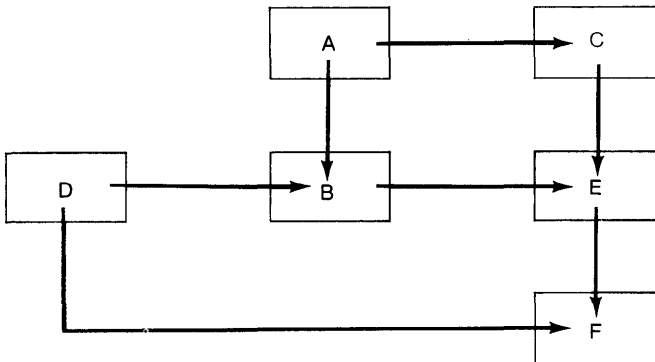

**Figure 8.13. Dependency Diagram**

Sheets A and D are not supported by any other sheets. If the information on them is current, then:

1. Load and save sheets C and B.
2. Load and save sheet E.
3. Load and save sheet F.

When preparing the dependency diagram, remember that the list of “depending sheets” on each sheet is not necessarily complete. For example, the listing of sheets depending on A is contingent on a “receipt” being issued when the link was established by B.

A “receipt” is an entry in the supporting file that says sheet B receives data from this sheet. When you give the eXternal List command, Multiplan looks at the receipts to build the list of “Sheets depending on.” The “receipt” must have been written correctly onto A just after B was saved. If, for any reason, Multiplan cannot enter the receipt onto sheet A, the “depending” list on A is not current. Even so, the data from the supporting sheets can be copied as specified by the eXternal Copy command.

The list of “supporting” sheets will always be correct.

## Transforming the Worksheet

The information in this section applies to the Delete, Insert, Move, and Sort commands. Refer to the discussions of these commands in Chapter 9 for additional information.

When rows or columns are inserted, deleted, moved, or sorted, sections of the worksheet may be displaced. For example:

1. One column is inserted before column 2. This moves the part of the worksheet that is to the right of column 2 one column farther to the right.
2. Row 2 is moved to before row 10. Besides moving the contents of row 2 to row 9, the former rows 3-9 are displaced one row toward the top of the sheet.

Because these commands may change the location of cells, Multiplan also automatically adjusts any references to the cells, whether they occur in formulas or in the definition of names. However, the adjustments to some references after the worksheet has been transformed may cause problems. The problems fall into the following general categories:

1. References to cells which have been deleted from the sheet are replaced by #REF! error values. All formulas that contained the references must be edited. These formulas are found by inspecting the cells that display the #REF! error value.
2. If the reference is to a group of cells and the transformation would distort a rectangular part of the group into a more complex shape (for example, if a corner cell is deleted from a rectangular area), the name definition is not changed.
3. If cells are inserted adjacent to a group of cells, references to the group are not updated to include the new cells. If the enlargement of the group is desired, the insertion must be made in the interior of the group rather than at the boundary. If necessary, the new cells may be inserted at an unambiguous place (e.g., in the interior of the group), then the cell contents copied as required.

4. Related problems may occur when rows or columns containing a boundary of a group are moved. Such moves will “drag” the boundary line of the definition of the group along. If this is not desired, the move can still be accomplished by an insert, copy, delete sequence.
5. If a formula is copied into a number of cells using the Copy Down, Copy Right, or Copy From commands, the relative references in all of the formulas are adjusted equally. The model formula for the adjustment is the first one encountered on the sheet. This means, for example, if the formula

$$RC[-1]*1.05$$

is copied from R1C2 to R1C14, and if column 5 is deleted, all formulas will be adjusted according to R1C2; no change in this case. However, if column 1 is deleted, the reference in R1C2 will become #REF! (see rule 1 above), and the other formulas will follow accordingly. To fix undesirable results, edit the model formula and recopy it.

Note that the Sort command may move many rows and, therefore, may cause any of these problems.

# Chapter 9

## Command Directory

---

Alpha	230
Blank	232
Copy	233
Copy Down	234
Copy From	235
Copy Right	238
Delete	239
Delete Column	240
Delete Row	241
Edit	242
Format	243
Format Cells	245
Format Default	249
Format Default Cells	250
Format Default Width	251
Format Options	252
Format Width	253
Goto	255
Goto Name	256
Goto Row-col	257
Goto Window	258
Help	259



Insert	261
Insert Column	262
Insert Row	263
Lock	264
Lock Cells	265
Lock Formulas	266
Move	267
Move Column	269
Move Row	270
Name	271
Options	273
Print	274
Print File	275
Print Margins	276
Print Options	277
Print Printer	278
Quit	279
Sort	280
Transfer	282
Transfer Clear	283
Transfer Delete	284
Transfer Load	285
Transfer Options	287
Transfer Rename	288
Transfer Save	289
Value	291

Window	293
Window Border	294
Window Close	295
Window Link	296
Window Split	298
Window Split Horizontal	299
Window Split Titles	300
Window Split Vertical	301
eXternal	302
eXternal Copy	303
eXternal List	306
eXternal Use	307



The following directory explains each Multiplan command.

At the beginning of each command description, the complete menu for the command or subcommand is shown with proposed responses. In most cases, the proposed response is derived from the position and contents of the active cell. For consistency of reference, a general notation is used for proposed responses, as follows:

- RC indicates the active cell
- R indicates the row number of the active cell
- C indicates the column number of the active cell
- W indicates the active window
- ( ) indicates a description of proposed response; for example, (contents of RC)

Other proposed responses, usually numbers, are shown as they appear when the command is used.

The examples provided are intended to give you a sample of the uses for the command. A short description of the action to be performed precedes a command format with proposed responses in the fields. To recreate the example yourself, use any of the methods for entering responses until your command line looks like the example.

All commands are terminated (carried out) by pressing the RETURN key.

Related and similar commands are listed under the heading "See Also." Commands that offer subcommands are described only generally under the main command heading. Refer to the subcommand descriptions for the details of performing a particular action.

## Alpha

ALPHA: (contents of RC)

Enter text (no double quotes)

### Description

Places text in the active cell. If the active cell already contains text, that text is the proposed response to the Alpha prompt.

The proposed response may be edited, but if you simply begin typing, the proposed response is replaced entirely.

The Alpha command is terminated by pressing the RETURN key or any action key that moves the cell pointer, such as the direction keys.

The contents of a cell containing text are displayed in double quotes in the status line. Multiplan supplies these double quotes automatically.

Alpha may not be used to blank a cell. Use the Blank command for this.

The Alpha command is highlighted in the command menu when Multiplan is idle. This means that (1) Alpha can be selected by pressing RETURN; and (2) if RETURN is pressed inadvertently, you may find yourself in the Alpha command.

Entering text or values in a sequence of cells is made easier because of the following feature:

If either the Alpha or Value command is terminated by an action key that moves the cell pointer, the cell pointer is moved appropriately, and Multiplan displays on the command line:

ALPHA/VALUE:

Enter text or value

The first character entered selects the standard Alpha or Value command. The Value command is selected if you press

one of the digits 0-9 or one of the characters = (equals), + (plus), - (minus), . (period), ( (left parenthesis), or " (quotation mark). The characters selecting the Value command have the same effect as when selecting from the main command menu. This effect is described under the Value command in this chapter. All other characters select the Alpha command.

This process can be repeated for entering text, numbers, and formulas in successive cells, until the RETURN or CANCEL key is pressed.

### Example

To enter the text *Net Profit* into the active cell:

ALPHA: Net Profit

To enter the text *Spencer*, the text *Sales* and the number *1000* in adjacent cells, press *A* (for Alpha), type *Spencer*, press the RIGHT direction key, type *Sales*, press the RIGHT direction key, type *1000*, and press RETURN.

### See Also

*Format Cells Continuous* to permit the display of cell contents to cross a cell boundary.

*Format Width* to accommodate text within a column.

*Name* to create names for cells.

*Value* to enter numbers or formulas.

## Blank

BLANK cells: RC

Enter reference to cell or group of cells

### Description

Replaces contents of specified cells with blanks. The proposed response permits quick blanking of the active cell.

The format of the cell is not changed. The cell is still available for storing values.

Names are not affected. If a cell was named before the Blank command was used, that name will still apply.

When a formula refers to a blank cell, its number value is taken as zero, or its text value is a blank.

### Examples

To blank the cell in row 3 column 2:

BLANK cells: R3C2

To blank all cells in the area named *Sales*:

BLANK cells: Sales

To blank an irregular area:

BLANK cells: R1:6C1,R7:8

### See Also

*Delete* to remove cells from the sheet entirely.

*Transfer Clear* to clear the entire sheet.

# Copy

COPY: Right Down From

Select option or type command letter

## Description

Presents a choice of ways to copy some cells into other cells. Both the contents and the formats of the source cells are copied. Source cells are not altered.

Copy Right copies one cell or a column of cells into cells to its right.

Copy Down copies one cell or a row of cells into cells below it.

Copy From is the general form and can be used for all copying on the active worksheet. Copy Right and Copy Down are included because they make a common copying task easier.

The subcommands are explained individually on the following pages.

## See Also

*Insert* to add new cells between existing ones.

*Move* to move cells to other locations.

*eXternal Copy* to copy cells from an inactive worksheet.



## Copy Down

COPY DOWN number of cells: 1      starting at: RC

Enter a number

### Description

Copies the specified cell the number of times specified in the “number of cells” field into the cells below it.

The proposed response for the “number of cells” field is the number used in the last Copy Down or Copy Right command. The total number of identical cells will be number specified plus one (for the original).

The command can also copy down a row of cells by specifying a row or part of a row in the “starting at” field.

### Examples

To copy the value and format of R1C1 into the 10 cells below it:

COPY DOWN number of cells: 10      starting at: R1C1

To copy the first five cells in row 1 into the next four rows below:

COPY DOWN number of cells: 4      starting at: R1C1:5

## Copy From

COPY FROM cells: RC      to cells: RC

Enter reference to cell or group of cells

### Description

Copies the contents of a cell or group of cells to another location on the sheet. Copy From is used, for example, when the source cells and the destination cells are not in the same row or column.

When there is only one source cell, the cell contents are copied into each destination cell.

When the source is a group of cells, the entire group is copied. When only one destination cell is given but the source is a group of cells, the destination cell marks the upper left corner of the destination area.

In general, either the source or the destination should consist of a single cell.

In special circumstances, copying vectors can be accomplished. (A vector is a line of two or more cells, either in a row or in a column.) Copying from a row to a row or from a column to a column is allowed if the source and the destination are the same size. If copying is done from a row vector to a column vector, or from a column to a row, the resulting copy is a rectangle in which the source vector is copied starting at each cell of the target vector.

The following diagrams illustrate the results of copying vectors, as described above:

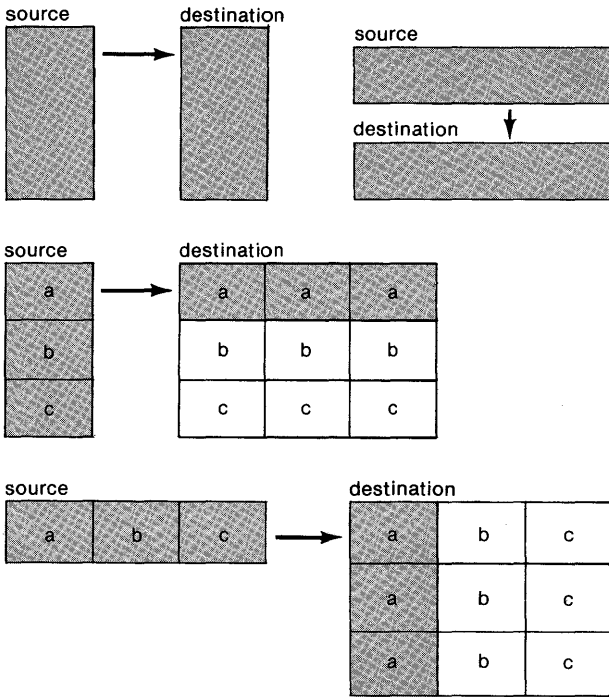

**Figure 9.1. Results of Copying Vectors**

If other forms of copies are attempted, the system cancels the Copy command and displays the "Illegal parameter" message.

**Examples**

To copy the contents of cell R1C1 into cell R5C3:

COPY FROM cells: R1C1 to cells: R5C3

To copy the contents of cell R1C1 into all cells in column 8:

COPY FROM cells: R1C1 to cells: C8

To copy a square patch of cells in the upper left corner of the worksheet into a square patch beginning at R8C1:

COPY FROM cells: R1:4C1:4      to cells: R8C1

The upper left cell of the new patch is R8C1. After the copying, R8C1 is a copy of R1C1, R8C2 is a copy of R1C2, and so on to R11C4, which is a copy of R4C4.

Likewise, the same copy can be made by also specifying a destination area that matches the source area:

COPY FROM cells: R1:4C1:4      to cells: R8:11C1:4

To copy the first four cells in column three into column six:

COPY FROM cells: R1:4C3      to cells: R1C6  
(upper left of area)

COPY FROM cells: R1:4C3      to cells: R1:4C6  
(matching area)

To copy the first four cells in column six three times:

COPY FROM cells: R1:4C6      to cells: R1C6:8

The source cells are part of a column while the destination area is part of a row. The source column is copied down beginning at each cell of the destination.

## Copy Right

COPY RIGHT number of cells: 1      starting at: RC

Enter a number

### Description

Copies the specified cell the specified number of times into the cells to the right of the specified cell.

The proposed response for the “number of cells” field is the number used in the last Copy Down or Copy Right command. The total number of identical cells will be the number specified plus one (for the original).

The command can also copy right a column of cells by specifying a column or part of a column in the “starting at” field.

### Examples

To copy the contents of the active cell (R1C1) into the 8 cells to the right of it:

COPY RIGHT number of cells: 8      starting at: R1C1

To copy the contents of the 5 cells in column 1 (R1:5C1) into column 2, giving two side by side columns with the same contents:

COPY RIGHT number of cells: 1      starting at: R1:5C1

## Delete

DELETE: Row Column

Select option or type command letter

### Description

Presents choices for deleting cells from the worksheet and closing up the space.

Delete Row deletes a row or rows and moves the rest up.

Delete Column deletes a column or columns and moves the rest to the left.

Multiplan adjusts all references affected by any deletion. See “Transforming the Worksheet” in Chapter 8 for the description of how the Delete command affects references.

The subcommands are explained individually on the following pages.

### See Also

*Blank* to make cells empty.







## Edit

EDIT: (contents of RC)

Enter a formula

### Description

Used to edit a formula or value in the active cell. If you edit text with the Edit command, remember to enclose the text in double quotes.

The current contents are shown in the command line. The edit cursor is placed at the end of the current contents.

After you have edited the cell's contents, press RETURN or one of the cursor movement keys, such as the direction keys, to put the contents into the cell. If you use a cursor movement key to place the contents in the cell, Multiplan changes to the ALPHA/VALUE: command rather than returning to the main command menu. Refer to the description under the Alpha command.

Press CANCEL before pressing either RETURN or one of the cursor movement keys to cancel your changes and to return to the main command menu.

If the cell contains a formula, Multiplan checks the formula for errors when RETURN is pressed. If the formula contains an error, the erroneous part is highlighted, and the Multiplan Edit command remains active.

See the "Editing" section in Chapter 8 for the description of the editing keys.

### See Also

*Alpha* for entering or editing text.

## Format

FORMAT: Cells Default Options Width

Select option or type command letter

### Description

Presents a choice of various display adjustments.

Format Cells alters the alignment and format of a cell or group of cells.

Format Default sets the default alignment, format, and width for all cells.

Format Options controls the display of formulas and of commas in numbers.

Format Width sets the width of a column or columns.

The display of cell contents is controlled by the settings in the “alignment” and “format” fields of the Format Cells command.

The setting in the “alignment” field controls the placement of the contents within the available spaces of the cell; whether the empty space is placed to the right of the contents, to the left, or on both sides.

The setting in the “format” field, together with the response in the “# of decimals” field, controls how the value is displayed, as a dollar amount, as a percentage, as a decimal value, and so on.

In both the “alignment” and “format” fields, there is a “Default” setting. The “Default” setting is defined by the Format Default Cells command. The settings selected in the “alignment” and “format” fields of the Format Default Cells command define the display of all cells with the “Default” setting.

All cells have the “Default” setting initially. (When Multiplan is first started, the display is controlled by “General” alignment and “General” format.) If you insert new rows or columns, the inserted cells receive the default setting.

The format given to the default settings can be changed at any time by using the Format Default command. This allows you to change easily the format of all cells that have the default code setting, which may be most of the cells.

We recommend that you define the most common format you will be using as the default, and alter a cell or some cells to display their contents differently from the default with the Format Cells command.

The subcommands are explained individually on the following pages.

### See Also

*Print Margins* to set the format of a printed copy of the sheet.

## Format Cells

FORMAT cells: RC alignment: Def Ctr Gen Left Right –  
 format code: Def Cont Exp Fix Gen Int \$ \* % – # of decimals:

Enter reference to cell or group of cells

### Description

Alters the alignment and format codes of one or more cells.

The proposed responses are the format codes of the active cell. This command may be used to review the settings for the active cell. The settings of the active cell may be given to a group of cells by changing the response in the “cells” field.

If you are changing the alignment code of a group of cells but not the format code, you must select the hyphen response in the “format code” field to keep the format codes as they are. Otherwise, all cells in the group will receive the format code of the menu setting.

Similarly, if you want to change the format code but not the alignment code of a group of cells, select the hyphen response in the “alignment field.”

The alignment codes are:

Def	Default	Align this cell by the default alignment.
Ctr	Center	Center the cell display in the column.
Gen	General	Align text left, numbers right.
Left	Left	Left-justify the cell display in the column.
Right	Right	Right-justify the cell display in the column.

- Leave all alignment codes as they are. Used when changing the format code of a group of cells but not the alignment codes.

Text is displayed only for the width of the cell unless the Continuous format code is selected.

The format codes are:

Def	Default	Display this cell with the default format.
Cont	Continuous	Text longer than the column width is displayed at its full width, crossing into the column on the right if necessary (the cell to the right must be blank and must have the Continuous format also). Numbers are displayed in the General format code. Typically, you will want to format an entire row when using the Continuous format code.
Exp	Scientific	Numbers are displayed as a decimal notation times a power of ten; for instance, 2.1E6 for 2100000. The number of decimal places used is set in the “# of decimals” field of the Format Cells command.
Fix	Fixed Point	Numbers are displayed rounded to a fixed number of digits of decimal fraction. The number of decimal places is set in the “# of decimals” field of the Format Cells command.
Gen	General	Numbers are displayed as precisely as possible in the available width of the cell, with scientific notation used automatically, as needed.

Int	Integer	Numbers with a decimal fraction are rounded to integers.
\$	Dollar	Money amounts are displayed with a leading dollar sign and two decimal places. Negative numbers are shown in parentheses.
*	Bar graph	<p>When the cell contains a number, it is rounded to an integer and that many asterisks are displayed. For example, all values between 2.5 and 3.5 are displayed as three asterisks.</p> <p>Use the Bar graph format code to build a bar graph. Negative numbers are shown in parentheses. Only as many asterisks as the width of the cell allows are shown. To see all asterisks, use the Format Width command to widen the cell. See also the REPT function for creating bar graphs composed of other characters.</p>
%	Percent	Numbers are displayed as a percentage. The number of decimals is set in the “# of decimals” field of the Format Cells command. For example, the value .1 will be displayed as 10% if the # of decimals is zero; or as 10.0% if the # of decimals is 1.
—		Leave all format codes as they are. Used when changing the alignment code of a group of cells but not the format codes.

The “# of decimals” field is used only for the Fix, Exp, and % format codes. If you enter a response to this prompt for the other format codes, your response is ignored. If you are not specifying one of these three format codes, you can simply press RETURN after specifying the format code.

## Examples

To align the contents of the active cell (R5C15) in the center of the available spaces:

FORMAT CELLS: R5C15 alignment: Def (Ctr) Gen Left Right –  
format code: (Def) Cont Exp Fix Gen Int \$ \* % – # of decimals: 0

To display the cells in column 2, rows 3 through 6 as money values preceded with a dollar sign and displayed with two decimal places:

FORMAT CELLS: R3:6C2 alignment: (Def) Ctr Gen Left Right –  
format code: Def Cont Exp Fix Gen Int (\$) \* % – # of decimals: 0

Notice that the alignment of all cells in this group is now “Default.” If any of the cells had an alignment setting other than “Default” and if you want to preserve the special alignment, select the hyphen response instead of the “Def” response in the “alignment code” field.

To display the values in rows 1 through 12 of column 10 as percentages with four decimal places accuracy:

FORMAT CELLS: R1:12C10 alignment: Def Ctr Gen Left Right (–)  
format code: Def Cont Exp Fix Gen Int \$ \* (%) – # of decimals: 4

Any alignment already specified for any of the cells in this group is retained.

## See Also

*Format Default* to set the default format.

*Format Width* to set the width of specific columns.

## Format Default

FORMAT DEFAULT: Cells Width

### Description

Presents a choice of two kinds of defaults to be changed.

Format Default Cells sets default alignment and format codes.

Format Default Width sets the default width of all columns.

### See Also

*Format Cells* to alter the format and alignment codes of specific cells.

*Format Width* to alter column widths of specific columns.



## Format Default Cells

FORMAT DEFAULT CELLS alignment: Ctr Gen Left Right  
format code: Cont Exp Fix Gen Int \$ \* % # of decimals: 0

### Description

Sets the alignment and format for all cells that have the default setting. The initial default alignment and format code is General.

The alignment and format codes are listed and described under the Format Cells command.

### Example

To set the default format code to money amounts (\$):

FORMAT DEFAULT CELLS alignment: Ctr (Gen) Left Right  
format code: Cont Exp Fix Gen Int (\$) \* % # of decimals: 0

## Format Default Width

FORMAT DEFAULT column width in chars: 10

Enter a number

### Description

Sets the width of all columns that have the “default” width setting. See “Format Width” for an explanation of default width.

The initial default width is 10 characters.

### Example

To set the default width to 12:

FORMAT DEFAULT column width in chars: 12

### See Also

*Format Width* to alter the width of some columns.

## Format Options

FORMAT OPTIONS commas: Yes No      formulas: Yes No

Select option or type command letter

### Description

The proposed responses are the current settings of the options.

For cells that have “Fix,” “Int,” “\$,” or “%” format settings, the comma option groups a number into thousands and separates the groups with commas. For example, a number such as 12345678 under the comma option would be displayed as 12,345,678.

The formulas option permits you to see what generates the value in every cell. A cell normally displays the value of a formula placed in it. Selecting “Yes” for the formulas option causes cells that contain formulas to display their formulas instead of their values. The width of all columns is doubled. Cells that contain text display their contents in double quotes.

When the “formulas” option is off (No), check the formula in a cell by using the Edit command or by moving the cell pointer to the cell; the formula will appear in the status line.

### Example

To display formulas in the cells that contain them:

FORMAT OPTIONS commas: Yes(No)      formulas: (Yes)No

## Format Width

FORMAT WIDTH in chars or d(default): d    column: C    through: C

Enter a number or d for default

### Description

Alters the width of one or more columns to the number of characters specified.

The proposed response for the “in chars or d(default)” field is always d. “d” is a special “default” setting, similar to the default setting for format and alignment codes. When the width setting is “d”, the column width is controlled by the Format Default Width command.

All columns have the default setting initially. The width of all columns with the default setting can be changed easily using the Format Default Width command. You can set the most convenient width as the default with the Format Default Width command, and alter specific columns to other widths with the Format Width command.

If a cell contains text longer than the column is wide, Multiplan cuts off the display at the right edge of the column. Use this command to widen the column or the “Continuous” cell format.

If a cell contains a number that cannot be displayed in the column width, Multiplan displays a series of number signs (#) instead. This can be fixed by widening the column, or sometimes by using a different format code.

### Examples

To change the width of column 1:

FORMAT WIDTH in chars or d(default): 12    column: 1    through: 1

## Multiplan

To change the width of columns 4 through 8 to 20 characters:

FORMAT WIDTH in chars or d(efault): 20 column: 4 through: 8

### See Also

*Format Cells* to set Continuous format code.

*Format Default Width* to set the default column width.

# Goto

GOTO: Name Row-col Window

Select option or type command letter

## Description

Presents a choice of ways to move the cell pointer to a new position.

Goto Name makes the first cell of a named area the active cell.

Goto Row-col makes the specified cell the active cell.

If a requested cell is already visible through the active window, only the cell pointer is moved.

If the requested cell is not visible through the active window, the active window is shifted so that the named area appears in the specified window.

Goto Window makes the specified cell the active cell and places it at the upper left corner of the specified window.

The subcommands are explained individually on the following pages.

## Goto Name

GOTO name:

Enter reference to cell or group of cells

### Description

Places the cell pointer on the upper left corner cell of the named area, making that cell the active cell.

Use the direction keys to step through the list of names.

### Example

To move the cell pointer to the upper left corner of the area named *SumCosts*:

GOTO name: SumCosts

## Goto Row-col

GOTO row: R    column: C

Enter a number

### Description

Places the cell pointer on the specified cell, making that cell the active cell.

### Examples

To move to row 25 in the active column (column 1):

GOTO row: 25    column: 1

The proposed response in the “column” field was not changed.

If rows 1 through 20 are visible through the window when you enter this command, the window will be shifted so that cell R25C1 is visible in the upper left quarter of the active window.

To make row 37, column 9 (R37C9) visible:

GOTO row: 37    column: 9



## Goto Window

GOTO WINDOW window number: W    row: R    column: C

Enter a number

### Description

Places the specified cell in the upper left corner of the window specified.

If you use this command with the proposed responses, which are the active window and active cell, Multiplan redraws the active window, placing the active cell in the upper left corner.

### Examples

To set the active cell as the upper leftmost cell of window number 3:

GOTO WINDOW window number: 3    row: 5    column: 15

To set cell R100C45 as the upper leftmost cell of window number 5:

GOTO WINDOW window number: 5    row: 100    column: 45

### See Also

*Window Split* to open windows.

# Help

HELP: Resume Start Next Previous  
Applications Commands Editing Formulas Keyboard

Select option or type command letter

## Description

Provides helpful information about Multiplan.

Help information is read from a diskette file. Information in the Help file is requested two ways: either (1) selecting Help from the main command menu, or (2) pressing the HELP action key, except when using the Alpha command (this places a question mark as a response to Alpha). When you request Help, the worksheet is replaced by text from the Help file, and the Help command menu appears.

The worksheet display resumes when you either select the "Resume" subcommand (press *R* or RETURN) or press CANCEL. "Resume" returns to the exact place where Help was requested. CANCEL returns to the main command menu.

The information displayed depends on when Help is requested. In particular:

If you use SPACE or BACKSPACE to highlight a command word in a menu, a description of that command is shown when you request Help.

If the edit cursor is in a command field, a description of that field is shown.

If the message line shows an error message, either a description of the previous command or a description of the error is shown.

Once in the Help command, you can request Help information by selecting one of the following options on the Help menu:

<b>Option</b>	<b>Result</b>
Resume	Return to the menu where you requested Help.
Start or HOME	Show the beginning of the Help file.
Next or PAGE DOWN	Show the next screenful of Help information. Typically, not all the relevant information is shown, and Next (press the letter <i>N</i> ) should be used.
Previous or PAGE UP	Show the previous screenful of Help information.
Applications	Show a list of common problems paired with the names of the commands that offer solutions.
Commands	Show the description of the first command (Alpha).
Editing	Show the description of Multiplan editing.
Formulas	Show a list of all functions and the rules about formulas.
Keyboard	Show the keytop labels corresponding to Multiplan action keys.

## Insert

INSERT Row Column

Select option or type command letter

### Description

Presents a choice of ways to insert new cells into the worksheet.

Insert Row inserts new rows, moving the rest down.

Insert Column inserts new columns, moving the rest to the right.

Multiplan adjusts all references affected by the insertion. See “Transforming the Worksheet” in Chapter 8 for the description of how the Insert command affects references.

The Insert command will not be carried out if the insertion would push data off the edge of the sheet. If, for example, you have data in column 63, an attempt to insert even one column will receive the message “Illegal parameter.” Similarly, if you have data in column 50 and attempt to insert 14 columns, you will receive the “Illegal parameter” message.

The subcommands are explained individually on the following pages.

### See Also

*Move* to move rows or columns on the sheet.

*Delete* to remove rows or columns.



## Insert Row

```
INSERT ROW # of rows: 1      before row: R
           between columns: 1  and: 63
```

### Description

Inserts all or part of a row or rows of blank cells. This command is most commonly used to insert complete rows above the active row by accepting the proposed responses of the active cell and columns 1 and 63.

The command can be used to insert parts of rows. Insertion takes place between the specified columns; other columns are not affected.

Cells below the ones added move down.

### Examples

To insert a new row above row 7:

```
INSERT ROW # of rows: 1      before row: 7
           between columns: 1  and: 63
```

To insert a rectangular area in rows 4 and 5 between columns 1 and 8, causing the lower parts of columns 1-8 to move down to make room:

```
INSERT ROW # of rows: 2      before row: 4
           between columns: 1  and: 8
```

## Lock

LOCK: Cells Formulas

Select option or type command letter

### Description

Provides two ways to lock cells to protect them from accidental change.

Lock Cells locks and unlocks selected cells.

Lock Formulas locks all cells that contain text or formulas.

The values of locked cells cannot be changed by the commands Alpha, Blank, Copy, Edit, Value, or eXternal.

Locked cells are still affected by the commands Delete, Format Cells, Insert, Move, and Sort.

When some cells are locked, the NEXT UNLOCKED CELL key positions the cell pointer on the next unlocked cell that is not blank. Using Lock and this action key, you can quickly locate variable quantities on a complex worksheet and perform “what if” experiments.

The subcommands are explained individually on the following pages.

## Lock Cells

LOCK cells: RC      status: Locked Unlocked

Enter reference to cell or group of cells

### Description

Displays and changes the protection status of cells.

The proposed responses show the status of the active cell.

Lock or unlock selected cells by selecting the appropriate response in the “status” field.

Cells locked by eXternal Copy may not be unlocked with this command.

### Examples

To lock an unlocked active cell (R1C1):

LOCK cells: R1C1      status: (Locked) Unlocked

To unlock the whole worksheet:

LOCK cells: R1:R255      status: Locked (Unlocked)



## Lock Formulas

LOCK FORMULAS:

Enter Y to confirm

### Description

Entering Y locks all cells that contain text or formulas. Cells that contain numbers are not affected by the Lock Formulas command.

The Lock Formulas command protects all values generated by formulas. Numbers and any entries made after locking are the exception, and you must decide which unlocked cells you want to lock.

### See Also

*Lock Cells* to lock cells with numbers and to unlock cells.

# Move

MOVE: Row Column

Select option or type command letter

## Description

Presents a choice of ways to move cells from one place to another on the sheet.

Move Row moves whole rows.

Move Column moves whole columns.

More complex moves can be made by inserting blank cells at the destination, copying the source cells into the destination cells, then deleting the source cells.

The destination of a move is identified by the row or column that will follow the moved cells. That row may or may not be displaced, depending on the direction of the move.

For example:

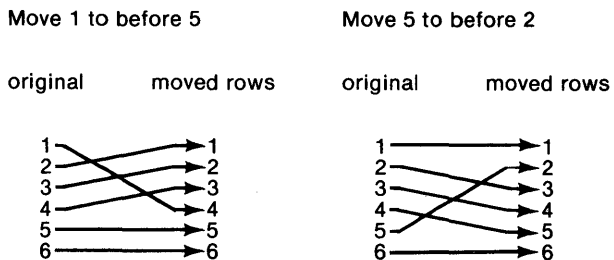

Figure 9.2

Moving cells causes the worksheet arrangement and all references to be adjusted. See “Transforming the Worksheet” in Chapter 8 for the description of how the Move command affects the worksheet.

The subcommands are explained individually on the following pages.

**See Also**

*Copy* to duplicate cells.

*Delete* to delete rows or columns.

*Insert* to add rows or columns.

## Move Column

MOVE COLUMN from column: C      to left of column: C  
# of columns: 1

Enter a number

### Description

Moves a group of columns to a new position on the worksheet.

### Example

To move the active column (column 9) to the left edge of the sheet, moving all columns now between the active column and the leftmost column right one column to make room:

MOVE COLUMN from column: 9      to left of column: 1  
# of columns: 1

## Move Row

MOVE ROW from row: R      to before row: R      # of rows: 1

Enter a number

### Description

Moves a row or group of rows to a new position on the worksheet.

### Example

To move the active row (row 5) to the top of the sheet, moving all rows now between the active row and the top row down one row to make room:

MOVE ROW from row: 5      to before row: 1      # of rows: 1

## Name

NAME: define name:      to refer to:

Enter name

## Description

Assigns a name to a cell or area of cells. The name may then be used to refer to that cell or area in a command or formula.

The proposed response for the “define name” field is either a blank or text. If the active cell contains text, Multiplan proposes that text, with any illegal characters removed, as the name to be defined. This makes it easy to convert a title already given to a row or column into a name.

If cell R5C1 contains the text *Costs* as a title, then the Name command can be used to define the name *Costs* as R5C2:15. Text used as titles and names are very different and should not be confused. However, it will be easier to read your formulas if the names in them correspond to the visible titles on your worksheet.

If you want the name to be something besides the proposed response, simply type the new response.

The proposed response for the “to refer to” field is either the active cell or, if the last name defined was a vector (portion of a row or column), the same vector shifted to the active row or column. This feature makes defining parallel groups a simple task.

If the name you enter is already defined, after you hit TAB the proposed response in the “to refer to” field will show the current definition.

Names must begin with a letter. The rest of the characters of a name may be any combination of letters, numbers, the period (.), and the underscore (\_). (These rules are the same ones used in the BASIC programming language.) Proposed responses are automatically made to conform to these rules. Illegal characters are ignored and underscores are substituted for blanks embedded in text strings.

Names may be up to 31 characters long.

Names may not be a combination of characters that could be confused with a reference. See the descriptions of references in the “Formulas” section of Chapter 8.

To see the names that have been defined, select the Name command. Use the direction keys to display each defined name and its definition in the command fields.

To change the definition of a name after viewing it, use the edit keys to alter the response in the “to refer to” field and press RETURN.

Names are deleted by making them refer to no area. Enter the name in the “define name” field, delete the response in the “to refer to” field, and press RETURN.

### **Example**

To define row 10, columns 3 through 15 as Sales:

NAME: define name: Sales    to refer to: R10C3:15

### **See Also**

*eXternal Copy* for names associated with external links.

## Options

OPTIONS recalc: Yes No      mute: Yes No  
                  iteration: Yes No      completion test at:

Select option

### Description

The proposed responses show the current settings.

The “recalc” option controls when Multiplan performs formula calculations. If the “recalc” option is set to “Yes,” Multiplan recalculates all formulas whenever a cell is changed. If the “recalc” option is set to “No,” recalculation is done only when the RECALC control key is pressed or during Transfer Save.

The length of time Multiplan takes to recalculate a sheet depends on how many cells are in use, and on the complexity of the formulas in them. When you want to make many entries on a busy worksheet, set the “recalc” option to “No” for quicker response. Set “recalc” to “Yes” again when you want to see the effect of each change.

The “mute” option controls the Multiplan audible alarm. The initial setting is “No,” which means the alarm sounds when an error is made. Select “Yes” when you want to mute the alarm.

The “iteration” option, and the accompanying completion test, allows for the use of numerical approximation methods that involve circular dependencies. Such methods are applicable to a wide range of problems, which includes solving simultaneous equations, calculating internal rate of return, and finding roots of equations. Appendix 5, “Solving Extended Problems with the Iteration Option,” contains a detailed discussion of this powerful feature.

After you press the RETURN key, Multiplan will display in the message line its version number and the total bytes of storage (corresponding to 100% Free) that are available to Multiplan.



## Print

PRINT: Printer File Margins Options

Select option or type command letter

### Description

Presents a choice of four actions related to printing the active worksheet.

Print Printer begins printing.

Print File stores printable output in a disk file.

Print Margins sets the margins for the printed output.

Print Options specifies the part of the worksheet to be printed and controls part of the printed format and printer setup.

The subcommands are explained individually on the following pages.

## Print File

PRINT on file:

Enter a filename

### Description

Stores printed output in a disk file rather than sending it to the printer. Such files have several uses. The file might be printed at a later time. You might use a text editor to alter the file before printing it, or you could include the file as an illustration in another text file.

If a file of the same name exists, Multiplan will display the message "Overwrite existing file?". Press *Y* to start printing. Pressing any other key cancels the Print File command.

### Example

To write a print formatted version of a file to the name *BUDGET*:

PRINT on file: BUDGET

## Print Margins

PRINT MARGINS: left: 5    top: 6    print width: 70  
                  print length: 54    page length: 66

Enter a number

### Description

Alters the margins and page length for printed output. The left margin and the print width are given as a number of characters. The top margin, print length, and page length are given as a number of lines.

The “print width” field sets the maximum number of characters to be printed on each line. The “print length” field sets the maximum number of lines of print on each page. The “page length” field sets the length of the paper so that a form feed advances the paper the correct number of lines to begin printing on the next page. The proposed responses are the ones created by the last Print Margins command. In addition, margins are saved with the sheet.

When the Print Margins command is complete, the Print command is displayed again.

### Example

A sheet of letter-size paper is 8-1/2" x 11". Assuming the printer prints 10 characters per inch across a page and 6 lines per inch down a page, the page length is 66 lines and the page width is 85 characters. To fill these dimensions, you might want a top margin of 3 and a print length of 60 for a bottom margin of 3. A print width of 65 characters leaves 20 characters total for the right and left margins. To center lines on the page, you need a left margin of 10.

PRINT MARGINS: left: 10    top: 3    print width: 65  
                  print length: 60    page length: 66



## Print Printer

PRINT on printer:

### Description

Starts printing the sheet under the conditions set up by the Print Margins and Print Options commands.

The time it takes to print depends on the size of the sheet and the speed of the printer.

Empty columns at the right of, and empty rows at the bottom of the sheet are not printed. Multiplan prints as many columns across the page as will fit in the print margins. If there are rows left over, it prints a second page, repeating the same columns. When all the rows have been displayed, Multiplan starts the next set of columns on a new page. Thus, if the area to be printed is wider than the paper, you can assemble the complete width by cutting and pasting later.

Press CANCEL to interrupt printing.

If a printer error occurs during printing, Multiplan will display the "Printer error" message.

### See Also

*Print File* to direct output to a disk file.

*Print Margins* to set the dimensions of a page.

*Print Options* to print part of a sheet, to print formulas, or to print row and column numbers.

## Quit

QUIT:

Enter Y to confirm

### Description

Ends the Multiplan session. The active sheet is not automatically saved. If you wish to save the worksheet, use the Transfer Save command before using the Quit command.

Multiplan will display the message "Enter Y to confirm." If you press Y, Multiplan terminates, returning control to the operating system. Pressing any other key cancels the command.

### See Also

*Transfer Save* to save the active sheet.

## Sort

SORT by column: C    between rows: 1    and: 255    order: (>)<

Enter a number

### Description

Reorders the rows on the worksheet within the specified column so that the values will be sorted.

The proposed response for the column field is the active column. The proposed response for the rows is the whole column. The proposed sorting order is ascending order, from least to greatest.

The column to be sorted may contain numbers, text, or other values. Sorting collects the different types into the following groups:

1st	Numbers
2nd	Text
3rd	Logical and error values
4th	Blank cells

Numbers and text are further sorted into either ascending (>) or descending (<) order. Text is arranged according to the ASCII standard character sequence, which is, from “least” to “greatest”:

! " # \$ % & ' ( ) \* + , - . / 0-9 ; ;

< = > ? @ A-Z [ ] ^ \_ ` a-z { ! }

Within each type, equal values are left in the order Multiplan encounters them.

The worksheet can be sorted on multiple columns. To do this, sort the least significant column first. Then, sort the other columns one at a time, from the least significant to the most significant. The example below illustrates this method.

References on the worksheet are adjusted as described in the “Transforming the Worksheet” section of Chapter 8.

To generate a sorted report without the effects of the adjusted formulas, turn off automatic recalculation. Multiplan then displays the values calculated before the sort was performed. You can print the sorted sheet, but do not save it.

Note also that numbers intermixed with text in a cell or dates represented as text are sorted by the rules of standard alphabetization. For example, “A10” is sorted as *less than* “A9.”

### Example

To sort a list of checks into categories (in column 1) by amount (in column 2) with the largest amount at the top of each category, first sort all checks by amount in descending order:

SORT by column: 2    between rows: 1    and: 255    order: >(<)

The checks are listed from largest to smallest, but with the categories unsorted. To sort the categories alphabetically:

SORT by column: 1    between rows: 1    and: 255    order: (><

The checks are now sorted into categories. The checks within each category are arranged from largest to smallest. Because Multiplan leaves equal items in the order it finds them in the column it is sorting, any previous sorting in other columns is retained.



## Transfer

TRANSFER: Load Save Clear Delete Options Rename

Select option or type command letter

### Description

Offers a choice of six subcommands which affect an entire sheet.

Transfer Load loads a saved sheet, replacing the active sheet.

Transfer Save saves the active sheet in a disk file.

Transfer Clear clears the active sheet, deleting all its contents.

Transfer Delete deletes a file on the diskette.

Transfer Options specifies which disk drive to use, or which file format.

Transfer Rename saves the active sheet under a new name and updates external links.

The subcommands are explained individually on the following pages.

## Transfer Clear

TRANSFER CLEAR:

Enter Y to confirm

### Description

Clears the active sheet after you type *Y* to confirm the command. Typing any other key cancels the command.

Using the Transfer Clear command is almost the same as starting up Multiplan; that is, all cells are deleted; all columns are set to the default width; the default alignment and format are set to General; all names and all links to external sheets are cleared; and the sheet name is set to *TEMP*. The exceptions are that options set with the Options, Format Options, Transfer Options, and Print Options commands are preserved.

If a copy of the active sheet has previously been saved with Transfer Save, that copy is not affected.

### See Also

*Blank* to replace the contents of specified cells with blanks.

*Delete* to delete specified cells.

*Transfer Save* to save the active sheet as a disk file.

## Transfer Delete

TRANSFER DELETE filename:

Enter a filename, or use direction keys to view directory

### Description

Deletes a saved worksheet from a diskette.

Pressing one of the direction keys causes Multiplan to display a directory of files on the diskette. To use the direction keys, see the directory display explanation under the Transfer Load command. Press the RETURN key to select the filename that is highlighted.

When you press the RETURN key, Multiplan displays the message "Enter Y to confirm." Press Y to delete the file. Pressing any other key cancels the Transfer Delete command.

Use Transfer Delete to clear your diskette of unwanted files.

## Transfer Load

TRANSFER LOAD filename:

Enter a filename, or use direction keys to view directory

### Description

Loads a sheet from a disk file. The disk file's name must be spelled and punctuated exactly as it was when the sheet was saved with the Transfer Save command.

Pressing any one of the direction keys causes Multiplan to display a directory of files on the diskette. The direction keys may be used whether the "filename" field is empty or has a filename filled in.

When the "filename" field is empty, the whole directory is displayed.

When you enter a filename in the "filename" field then press a direction key, Multiplan uses the filename you enter as a pattern and displays only those filenames on the default diskette that match the pattern. The rules of pattern matching are described in the section entitled "Operating Information."

Once the directory is on the screen, use the direction keys to move the highlight among the filenames. As you do, the highlighted filename also appears as a proposed response in the "filename" field in the command line. Press the RETURN key to load the highlighted file.

While the directory is visible, pressing any other key besides a direction key causes the worksheet previously on the screen to reappear. This other key has the same effect as it does while editing responses in command fields that need to be filled in, as described in the "Editing" section of Chapter 8.

When a "Normal" mode Multiplan worksheet diskette file is loaded, it replaces the sheet on display and becomes the active sheet.

As a special feature, the Transfer Load command can also load worksheets from files written by other systems in an acceptable interchange format (described under Transfer Options and Appendix 4, "The SYLK (Symbolic Link) File Format). Data read from one of these files will be merged with the active worksheet, rather than replacing it. To avoid this merging, first use the Transfer Clear command.

### **Example**

To load a sheet saved in a file named *INCOME*:

TRANSFER LOAD filename: INCOME

### **See Also**

*Transfer Save* to save the active sheet as a disk file.

## Transfer Options

TRANSFER OPTIONS mode: Normal Symbolic Other    setup:

Select option

### Description

The “mode” field specifies the file format for all subsequent Transfer Load and Transfer Save commands.

The format choices are:

Normal	Multiplan binary format. External references require that the referenced worksheet be saved in Normal format. This format is also the most efficient use of disk space and requires the least transfer time.
Symbolic	The format for data interchange with other programs. This format is described in Appendix 4, “The (SYLK) Symbolic Link File Format.”
Other	VisiCalc™ file format. Multiplan can load files in this format. The loaded file is merged with the active sheet. See Transfer Load and Appendix 3. Worksheets cannot be saved in Other mode. If you try to do so, Multiplan displays an “Illegal parameter” error message.

The “setup” field changes the default disk drive from the drive currently being used to the drive specified. This affects all subsequent Transfer commands.

The proposed responses show the current settings.

### Example

Multiplan was started on drive B:. To simplify use of a data diskette in drive A:

```
TRANSFER OPTIONS mode: (Normal)Symbolic Other
                    setup: A:
```

## Transfer Rename

TRANSFER RENAME filename: (name of active sheet)

Enter a filename

### Description

Saves the active sheet under a new name and adjusts external links to supporting and dependent sheets. Deletes the file with the previous sheet name. (See the “Files” section of Chapter 8 for a description of external links.)

### Example

To rename the active sheet *JUNE82*:

TRANSFER RENAME filename: JUNE82

### See Also

*Transfer Load* to load a saved sheet.

*Transfer Save* to save the active sheet as a disk file.

## Transfer Save

TRANSFER SAVE filename: (name of active sheet)

Enter a filename

### Description

Saves the active sheet as a disk file, which can later be loaded with Transfer Load. The proposed name for the disk file is the name last given with Transfer Save or Transfer Rename, or the name last loaded with Transfer Load, or *TEMP* if the sheet is clear or was not previously named.

If the filename is a duplicate of one that exists on the diskette already, the message “Overwrite existing file?” appears when you press RETURN. Press Y to replace the file on diskette with the worksheet on the screen. Pressing any other key cancels the Transfer Save command.

If you want to rename the sheet, we recommend using the Transfer Rename command if you have any external links to supporting sheets. Transfer Save will not update the “receipts” on the supporting sheets if you rename the active sheet using the Transfer Save command. Refer to “Files” in Chapter 8 for a discussion of external links and “receipts.”

You can save your Multiplan files in either Normal or Symbolic mode.

### Examples

To save the active sheet under the proposed name, simply press RETURN.

To save the active worksheet under the name *PRACTICE*:

TRANSFER SAVE filename: PRACTICE



**See Also**

*Print File* to put the displayed form of the sheet in a disk file.

*Transfer Load* to load a sheet saved previously.

*Transfer Options* to set the mode.

*Transfer Rename* to save the worksheet under a new name and to update “receipts.”

## Value

VALUE:

Enter a formula

### Description

Used to enter a formula or a number into the active cell.

Besides selecting Value from the command menu by highlighting Value and pressing RETURN or by typing V, the Value command can be selected by:

1. typing any digit, 0-9
2. typing one of the characters =, +, -, ., ", and (. (Except for the equal sign (=), these characters are also entered as the first character of the formula.

Inside formulas the direction keys enter relative references into the formula. See the "Editing" section of Chapter 8 for more information about editing responses to a command.

Terminate the Value command by:

1. pressing RETURN

or

2. pressing an action key that moves the cell pointer, such as a direction key or the NEXT UNLOCKED CELL key at the end of a number or complete formula. The formula or number is stored in the active cell, and the cell pointer is moved as directed.

Multiplan then displays

ALPHA/VALUE:

and awaits the entry of text or another value. This feature is described in detail under the Alpha command.

Text may be entered if enclosed in double quotes.

### Example

The simple method of entering a list of numbers, using a direction key:

*31 right 28 right 31 right 30 right 31 right*

is a series of Value commands.

Note that dates of the form 1/27/82 can be interpreted as formulas. Be sure to enter dates as text, using the Alpha command, or enclose them in double quotes.

### See Also

*Alpha* for entering text and titles or a sequence of text and values.

*Edit* for editing formulas.

## Window

WINDOW: Split Border Close Link

Select option or type command letter

### Description

Presents a choice of window operations.

Window Split opens a new window by splitting the active window horizontally or vertically, or opens a window used for titles.

Window Border adds or removes a border around a window.

Window Close closes a window by removing it from the screen.

Window Link links two windows so that their contents scroll together.

The NEXT WINDOW key moves the cell pointer from one window to another.

The subcommands are explained individually on the following pages.

## Window Border

WINDOW change border in window number: W

Enter a number

### Description

Changes the border of the specified window. If the window presently has a border, it is removed. If it lacks a border, one is added.

A border takes up one screen position on each side of the window, reducing the area for the display of data by two screen lines and two screen columns.

## Window Close

WINDOW CLOSE window number: W

Enter a number

### Description

Removes the specified window from the screen. The active window is the proposed response.

The size of the remaining windows is increased to occupy the screen area used by the closed window. Windows are renumbered. Cells contents are not affected by closing a window.

If there is only one window open, the Window Close command is ignored.

### See Also

*Window Split* to open windows.

## Window Link

WINDOW LINK window number: W      with window number: W  
linked: Yes No

Enter a number

### Description

Reviews and revises the links between two windows. The links may have been established under the Window Split command, or they may not exist yet, in which case you may establish links between windows split from a common window so that the two windows scroll together.

The proposed responses specify the active window and either a window split from the active window or the window from which the active window was split. If no window splitting has occurred, both proposed window responses will be the active window.

You may enter any two window numbers as responses. But, only those pairs that share the split relationship can be linked. Attempts to link other pairs receive the "Cannot link those windows" message in the message line.

When windows are linked, the contents of the two windows scroll together. If the window split was horizontal, the synchronized scrolling is horizontal. If the window split was vertical, the synchronized scrolling is vertical.

When two previously unlinked windows are linked, one set of row or column numbers disappears from the screen. If the pairs are related by a horizontal split, the column numbers disappear. Columns are identified by the numbers in the window above.

If the pairs are related by a vertical split, the row numbers disappear. Rows are identified by the numbers in the window to the left.

This command is also used to unlink windows, but you cannot unlink windows split by the Window Split Titles command.

**Example**

Window #4 was split from window #1. To link them so that they scroll together:

```
WINDOW LINK window number: 4    with window number: 1  
                linked:(Yes)No
```

**See Also**

*Window Split* for a description of window links.



## Window Split

WINDOW SPLIT: Horizontal Vertical Titles

Select option or type command letter

### Description

Presents a choice of three ways to open a window by splitting the active window.

**Window Split Horizontal** splits the active window across the screen, giving two windows, one above the other.

**Window Split Vertical** splits the active window between columns.

**Window Split Titles** splits the screen both vertically and horizontally to display titles in separate windows.

Up to eight windows may be opened using the Window Split commands.

The Window Split commands retain window borders, giving both windows a border if the original window has one.

### See Also

*Window Close* to close a window.

*Window Link* to link or unlink existing windows.

## Window Split Horizontal

WINDOW SPLIT HORIZONTAL at row: R      linked: Yes No

Enter a number

### Description

The active window is split horizontally. The display space used by the given row and the rows below it becomes the new window. The space above the given row remains part of the original window.

The new window is given the next unused window number and is made the active window.

The original window and the new window may be linked. If you select “Yes” in the “linked” field, whenever you scroll one of the windows horizontally, both windows scroll together. Notice also that the column numbers of the lower window do not appear on the screen. Rather, the column numbers of the window above are used to identify columns in the linked window.

### Examples

To split the active window at the active row, just press RETURN.

To split the active window at the display line presently showing row 34, and to link the windows:

WINDOW SPLIT HORIZONTAL at row: 34      linked:(Yes)No

### See Also

*Window Link* to review or revise links between windows.

## Window Split Titles

WINDOW SPLIT TITLES: # of rows:      # of columns:

Enter a number

### Description

The active window is split to form two or four windows. The windows formed are linked so that they scroll together. Windows linked by this command cannot be unlinked.

The specified number of rows becomes a window at the top of the display space occupied by the original window, unless the number is 0.

The specified number of columns becomes a window at the left of the display space occupied by the original window, unless the number is 0.

The remaining display space becomes the active window. It is linked for horizontal movement with the window above it, and for vertical movement with the window to its left, if any.

The proposed responses split the window so that the active cell becomes the upper left corner cell of the active window.

### Example

Suppose that column 1 contains descriptive titles for the rows of the worksheet, and that columns 2-25 contain data matching those titles. You would like to scroll the data columns horizontally while holding the titles fixed on the screen. If you scroll vertically, both titles and data should move so that the titles will remain aligned with the matching data. Move the cell pointer to R1C2, then the proposed response will be:

WINDOW SPLIT TITLES: # of rows: 0      # of columns: 1

### See Also

*Window Border* to draw a border around any of the windows.

## Window Split Vertical

WINDOW SPLIT VERTICAL at column: C      linked: Yes No

Enter a number

### Description

The active window is split vertically. The display space used for the given column and the columns to its right is used for the new window. The space used for columns to the left of the active column remains part of the original window.

The new window is given the next unused window number and becomes the active window.

The original window and the new window may be linked. If you select “Yes” in the “linked” field, whenever you scroll one of the windows vertically, both windows scroll together. Notice also that the row numbers of the right window do not appear on the screen. Rather, the row numbers of the window to the left are used to identify rows in the linked window.

### Examples

To split the window at the active column, just press RETURN.

To split the window at the column presently displaying column 3:

WINDOW SPLIT VERTICAL at column: 3      Linked:(Yes)No

### See Also

*Window Link* to review or revise links between windows.

## eXternal

EXTERNAL: Copy List Use

Select option or type command letter

### Description

Presents a choice of actions relating to the use of data on inactive (external) sheets.

eXternal Copy copies data from an inactive worksheet to the active worksheet. This command can also establish an external link, a permanent relationship that automatically causes data to be copied from a source, or supporting sheet, to the active, or dependent, sheet every time the latter is loaded into Multiplan.

eXternal List displays the lists of supporting and dependent worksheets.

eXternal Use assigns a substitute name for a specified sheet.

See the “Files” section in Chapter 8 for more information on external links and file accesses.

The subcommands are explained individually on the following pages.



This value alone does not show the dependence of the result on changes to the *rate* cell on an external sheet. The external link facility is provided to express permanently the relationship between the value on the “dependent” sheet and the source of the value (the formula on the “supporting” sheet).

External links are controlled by the options in the “link” field of the eXternal Copy command. If “No” link is selected, the command has no other effect than copying the values as described above. Information on possible dependencies is not recorded at all. If the source data is not expected to change, this option would be the most convenient.

Selecting “Yes” in the “link” field establishes an external link between the source data and the destination. The source sheet supports the active, or dependent, sheet. Of course, the same sheet may be in supporting and dependent roles in different external links.

After an external link is established, every time the dependent sheet is loaded (using the Transfer Load command), all the data described in the external links is automatically copied from the source sheets to the specified destinations. Any change in the source data is reflected on the dependent sheet.

The “formulas” associated with the destination cells—as seen on the status line or using the “formulas” Format Option—also show the data in the cells as dependent on a link, in the form:

[*sheetname sourcename*]

Destination cells are protected from changes just as if they were locked. They can be “unlocked” only by removing or redefining the external link in which the cells participate.

To remove a link, specify the source sheet, source name, empty destination, and “Yes” for linking in the eXternal Copy command.

To redefine a link so that it has a different destination on the active sheet, redefine the link with a new destination on the active sheet. Because a source area on an inactive sheet may be copied only once by each active sheet, the new destination replaces the former one in the link.

Both the removing and redefining of links, as well as the review of the existing links, is simplified by the use of the direction keys to step through the source (supporting) sheet names or the names of source cells in a given sheet. The “to” field is filled in by Multiplan to show the destination of the external link, as currently defined.

The Name command, when used immediately after an eXternal Copy, proposes to define the name

*sheetname.sourcename*

to refer to the destination of the copy. When defined (by pressing RETURN), this name can be used in other formulas on the active sheet to refer to the copied data.

The automatic copying process from supporting sheets requires that the files that contain the sheets be available to Multiplan. This topic is discussed in the “Files” section in Chapter 8.

Before copying the data in each link, the definition of the name for the source cells is checked. If the shape (size) of the named area has been changed, an error message is displayed, and the copy does not take place. Otherwise, the cells are copied to the destination cells, even if the destination cells are not blank but contain the results of the previous external copy.

## Example

To copy the value of the area named *Sales* from the worksheet named *INCOME* to the area starting at cell R5C5 on the active worksheet, and to set a permanent link:

```
EXTERNAL COPY from sheet: INCOME    name: Sales
                to: R5C5              linked: (Yes)No
```

Assuming that the area named *Sales* is a 12 cell wide part of a row, the destination for the copy will be R5C5:16. The Name command will propose:

```
NAME define name: INCOME.Sales    to refer to R5C5:16
```



## eXternal List

EXTERNAL LIST:

### Description

Produces a display of the names of worksheets supporting the active sheet and those dependent on the active sheet. The “supporting” and “dependent” relationships are explained in detail under eXternal Copy and in the “Files” section in Chapter 8.

The list of supporting sheets includes the “alias” names defined by eXternal Use.

### Example

Sheets supporting Department:  
Year81      instead of Year  
Labor

Sheets depending on Department:  
Consolidated

## eXternal Use

EXTERNAL USE filename:            instead of:

Enter filename

### Description

Sets a substitute name (alias) for a sheet.

The proposed response in the second field is the previous response, if any; otherwise, blank.

All references to the name in the “instead of” field will be directed to the name in the “filename” field. Copies from the affected file, if any, will be redone.

The name in the “instead of” field need not be the name of an actual file. However, it must not be a substitute name. The example shows how the substitution is used.

### Example

Assume that an active sheet has links to the supporting file *BUDGET82*. To view the figures that result from using the data on *BUDGET83* instead (which must be identical in format to *BUDGET82*):

EXTERNAL USE filename: BUDGET83    instead of: BUDGET82

This saves removing the links from *BUDGET82* then redefining links to *BUDGET83*. Also, you can return to *BUDGET82* easily by specifying *BUDGET82* in both fields of this command.

As an alternative, you could use a “logical name” when referring to supporting sheets. (A “logical name” is not the name of an actual file, but a name used only for setting up external links.)

Under this method, a substitution must be made through the eXternal Use command before setting up links between sheets:

EXTERNAL USE filename: BUDGET82      instead of: BUDGET

Then, the name *BUDGET*, which is not a file but a “logical name” used for defining links, may be used to set up the links in the eXternal Copy command and as a response in the “instead of” field in the eXternal Use command in future substitutions. For example, when you want to see the results of your budget for 1983:

EXTERNAL USE filename: BUDGET83      instead of: BUDGET

and all links will now be changed to refer to *BUDGET83*.

This method permits you to refer to whatever file you choose in the eXternal Use command without having to remember which file is the pattern for the substitutions.

# Chapter 10

## Function Directory

---

ABS	312
AND	313
ATAN	314
AVERAGE	315
COLUMN	316
COS	317
COUNT	318
DOLLAR	319
EXP	320
FALSE	321
FIXED	322
IF	323
INDEX	324
INT	325
ISERROR	326
ISNA	327
LEN	328
LN	329
LOG10	330
LOOKUP	331

MAX	333
MID	334
MIN	335
MOD	336
NA	337
NOT	338
NPV	339
OR	340
PI	341
REPT	342
ROUND	343
ROW	344
SIGN	345
SIN	346
SQRT	347
STDEV	348
SUM	349
TAN	350
TRUE	351
VALUE	352

This chapter describes the functions that can be used in Multiplan formulas. Each entry describes the operation of a function and any special requirements for its argument.

Use one of the methods described under the Value command in Chapter 9 to enter a formula. The functions are entered as part of a formula.

The argument to a function, enclosed in parentheses, follows the function name. No space is permitted between the function name and the left parenthesis.

Entries within the parentheses describe the argument to the function. The following abbreviations are used in argument descriptions:

*N* represents a number; a formula that yields a number. Wherever *N* is shown, only one entry is allowed. When more than one is allowed, *List* is shown.

*T* represents text; a formula that yields text.

*Logical* represents a logical value, which must be a reference to a single cell, a formula expressing a relation (=, <, >, <=, >=, <>), or a function that returns a logical value. Otherwise, a #VALUE! error value is returned.

*List* represents a list of items, separated by commas. An “item” may be either a value that represents itself or a reference to a group of cells that represent the collection of values in those cells. For example, the list

1,B

where *B* is defined as R1C2:3 and R1C2 contains the value 2 and R1C3 contains the value 3. The list then represents the collection of values 1,2,3. Lists may be up to five items long, but they may represent any number of values through references.

See the “Formulas” section in Chapter 8 to review the descriptions of numbers, formulas, and text.

Related functions are listed under the heading “See Also.”

## **ABS(N)**

### **Description**

Returns the absolute value of the argument *N*.

### **Examples**

"Difference:"&DOLLAR(ABS(first-second))

ABS(AVERAGE(R1C1:10)-R1C1)

Yields how far the first item is from the average.

### **See Also**

*SIGN* for the sign of a number; ABS is equivalent to number\*SIGN(number).

*MAX* for the maximum of two or more values.

*MIN* for the minimum of two or more values.

## AND(List)

### Description

Returns the logical value true if all of the specified argument values are true. Otherwise, returns false.

### Requirements

The argument entries must be logical values. If not, the #VALUE! error value is returned.

### Example

```
IF(AND(SUM(Homework)>82,Final>50)),credit,"not qualified")
```

### See Also

*OR* and *NOT* to operate on logical values.

*IF* to test a logical value.



## ATAN(N)

### Description

Calculates the Arctangent (inverse Tangent) function of the argument, yielding an angle in radians in the range  $(-\pi/2$  to  $+\pi/2)$ . ATAN can be used to calculate Arcsin and Arccos (see Appendix 3, Table 1).

### Example

ATAN(thetarow C)

### See Also

*TAN* for the Tangent function.

## **AVERAGE(List)**

### **Description**

Calculates the average of the specified argument values.  
Yields the same result as entering the formula

$\text{SUM}(\text{list})/\text{COUNT}(\text{list})$ .

### **Examples**

$\text{AVERAGE}(\text{Balance})$

$\text{AVERAGE}(1,5,6,5,5)$

### **See Also**

*STDEV* for the standard deviation of the number values.

*SUM* for the sum of number values.

*COUNT* for a count of number values.

## COLUMN()

### Description

Returns the number of the column in which the formula containing this function appears.

### Example

$1981 + \text{COLUMN()} - 4$

can produce the sequence of years 1981, 1982, . . . , starting in column 4. (Place this formula in column 4, then Copy Right from column 4 as many cells as the number of years you want in the series.)

## **COS(N)**

### **Description**

Calculates the Cosine of the argument, an angle in radians.

### **Example**

$\text{COS}(\theta)$

### **See Also**

*SIN* and *TAN* for the other trigonometric functions.

## COUNT(List)

### Description

Returns the count of number values represented by the List. Cells are counted only if they contain number values.

### Example

DOLLAR(COUNT(checks)\*0.15+1.00)&" is service charge"

### See Also

*AVERAGE* for the average value.

*SUM* for the sum of the number values.

## DOLLAR(N)

### Description

Converts the argument to text showing a dollar amount, just like the “\$” format code under the Format Cells command in Chapter 9.

The argument is rounded to two decimal places. If the argument is less than 1, a zero appears in the units position. A dollar sign is added before the leftmost digit. If the argument is less than zero, the result is enclosed in parentheses (the standard way of showing a negative balance in bookkeeping).

### Examples

DOLLAR(2.715)	produces \$2.72
DOLLAR(.15)	produces \$0.15
DOLLAR(0)	produces \$0.00
DOLLAR(-1)	produces (\$1.00)

### See Also

*FIXED* to format a number without the dollar sign.

*VALUE* to change text back to a number.

## EXP(N)

### Description

Calculates  $e$  (2.7182818..., the base of the natural logarithm) to the power of the argument. This is the inverse function of LN.

Powers of other bases are calculated using the exponentiation operator (^).

### Examples

"'e' is"&FIXED(EXP(1),14)

"SINH ="&FIXED((EXP(theta)-EXP(-theta))/2,8)

### See Also

*LN* for the natural logarithm of a number.

## **FALSE()**

### **Description**

Returns the logical value false.

### **Example**

If you are planning on putting a complicated condition into a cell, you can use **FALSE()** to put a logical value in for testing before you construct the more complicated expression.

### **See Also**

*AND*, *OR*, and *NOT* to operate on logical values.

*IF* to test a logical value.



## **FIXED(N,Digits)**

### **Description**

Converts the specified value to text showing a fixed-decimal number with the number of decimal digits specified, just like the “Fix” format code under the Format Cells command in Chapter 9.

If the value is negative, a minus sign is placed before the leftmost digit. If digits is negative, rounding is done to the left of the decimal point.

### **Requirements**

Digits must be an integer between 0 and 30.

### **Example**

`FIXED((first/second)*100,2)&“percent”`

### **See Also**

*DOLLAR* to format money amounts.

*VALUE* to convert text back to a number.

*ROUND* to return the number value of rounding.

## IF(Logical,Then Value,Else Value)

### Description

If the Logical is true, returns the Then value. Otherwise, returns the Else value. These values may be numeric, text, or logical values.

### Example

```
IF(grade>80,"excellent",grade)
```

### See Also

*AND*, *OR*, and *NOT* to operate on logical values.

*ISNA* and *ISERROR* to check for error values.

## **INDEX(Area,Subscripts)**

### **Description**

Returns the value of a cell selected by Subscripts from the rectangular area.

One or two subscripts may be given. With one subscript, the area must be part of one row or one column. Subscript value 1 selects the first cell in the row or column, value 2 the second cell, and so on.

If two subscripts (separated by commas) are given, the area may be rectangular. The subscripts select the row and column in the area, starting at 1 in each case.

If any index exceeds the limits of the area, the #N/A (not available) error value is returned.

### **Examples**

To repeat the first column in the first row, copy the formula

```
INDEX(C1,COLUMN())
```

throughout the first row.

If the area Score is a table giving adjusted composite scores for raw scores on two components in a test, then:

```
INDEX(Score,Raw1 C,Raw2 C)
```

will give the appropriate composite score, based on the two raw scores.

## INT(N)

### Description

Returns the largest integer less than or equal to *N*.

### Examples

"fraction="&FIXED(number-INT(number),4)

INT(6) is 6

INT(8.9) is 8

INT(-123.999) is -124

### See Also

*ROUND* to round a number to a certain decimal place.

## **ISERROR(Value)**

### **Description**

Returns the logical value true if the argument is any of the error values (#N/A, #VALUE!, #REF!, #DIV/0!, #NUM!, #NAME?, #NULL!). Otherwise, returns false.

### **Example**

```
IF(ISERROR(ratio),"check your numbers","")
```

### **See Also**

*IF* to test a logical value.

## ISNA(Value)

### Description

Returns the logical value true if the argument is #N/A (not available). Otherwise, returns false.

### Example

IF(ISNA(balance),"0",balance)

### See Also

*NA* to produce #N/A value.

*IF* to test a logical value.

*ISERROR* to test for all error values.

## **LEN(T)**

### **Description**

Returns the number of characters in the text value.

### **Example**

$MID(T,LEN(T),1)$  is the last character of the text *T*.

### **See Also**

*MID* to return specified characters from a text value.

## LN(N)

### Description

Calculates the natural logarithm of the argument.

### Requirements

*N* must be positive. A #NUM! error value is returned if *N* is less than or equal to zero.

### Example

```
"log2="&FIXED(LN(value)/LN(2),8)
```

### See Also

*ABS* to ensure that the argument is positive.

*EXP* for the inverse of LN.

*LOG10* for logarithms to the base 10.



## LOG10(N)

### Description

Calculates the base 10 logarithm of the argument.

### Requirements

*N* must be positive. A #NUM! error value is returned if *N* is negative.

### Example

“Order of Magnitude:   ”&FIXED(LOG10(value),0)

### See Also

*ABS* to ensure that the argument is positive.

*LN* for logarithms to the base e, and other bases.

## LOOKUP(*N*,*Table*)

### Description

Searches for *N* in the first row or column of *Table*. Returns the contents of a cell from the last row or column of *Table*. *Table* is a group of cells on the worksheet.

The dimensions of *Table* determine the direction of the search.

If *Table* is square, or higher than it is wide, Multiplan searches in the first column of *Table* until it finds the cell that has the largest value that is less than or equal to *N*. The value in the last cell in that row of *Table* is returned as the result of the function. If the values in all cells in the first column are less than *N*, the last row of *Table* is used. If the values in all cells in the first column are greater than *N*, a #N/A value is returned.

If *Table* is wider than it is high (has more columns than it has rows), then Multiplan searches for *N* in the first row of *Table*. The value in the last cell in that column of *Table* is returned as the result of the function. If the values in all cells in the first row are less than *N*, the last column of *Table* is used. If the values in all cells in the first row are greater than *N*, a #N/A value is returned.

### Requirements

*Table* should be a cell reference to a rectangular area in the active worksheet. The result returned may be either a number value, a text value, or a logical value.

**Example**

Assume that column 1 (C1) lists base salaries, column 2 (C2) lists minimum tax, and column 3 (C3) lists marginal tax rates as percents:

C1	C2	C3
0	0	0%
2300	0	14%
3400	154	16%
4400	314	18%
6500	692	19%
8500	1072	21%
...	...	...

Also assume that a name *Salary* has been defined and that it contains a value *N*.

The tax on a salary in one of the brackets in Table can be expressed as:

$$\text{LOOKUP}(\text{Salary}, \text{C1:C2}) + (\text{Salary} - \text{LOOKUP}(\text{Salary}, \text{C1})) * \text{LOOKUP}(\text{Salary}, \text{C1:C3})$$

Notice that in the first lookup, we find the tax on the “base” amount (using C1 to find a value in C2). In the second lookup, we find the actual base amount (using C1 to find a value in itself; in fact, Table can be one column wide or one row high). And in the third lookup, we find the marginal tax rate for the amount of the salary that exceeds the base amount (using C1 to find a value in C3).

## MAX(List)

### Description

Returns the largest number value from List. Returns zero if List represents no number values.

### Example

```
"Best of"&FIXED(COUNT(scores),0)&  
"is"&FIXED(MAX(scores),2)
```

### See Also

*MIN* for the minimum of two or more values.

## **MID(T,Start,Count)**

### **Description**

Returns specified characters from *T*.

*Start* specifies the position of the first character of *T* to be taken, counted from the left end of *T*. The first character is position 1.

*Count* specifies the number of characters to be taken.

If *Count* is zero, or if *start* is greater than the length of the result of *T*, no characters are returned.

If *Count* is negative, a #VALUE! error value is returned.

### **Requirements**

*Start* and *Count* must be *N* values. If either *Start* or *Count* has a fraction, the fraction part is truncated before the integer part is used.

### **Example**

```
MID("FFFFFFDCBAA",INT(grade/10),1)
```

### **See Also**

*LEN* for the length of the text value.

## **MIN(List)**

### **Description**

Returns the smallest number value from List.

### **Example**

"Lowest of"&FIXED(COUNT(times),0)&  
"is"&FIXED(MIN(times),0)

### **See Also**

*MAX* for the maximum of two or more values.

## MOD(Dividend,Divisor)

### Description

Returns the remainder of Dividend divided by Divisor. The result has the same sign as Divisor.

### Requirements

Both parts of the argument must be an *N* value. If Divisor is zero, a #DIV/0! error value is returned.

### Examples

$$\text{MOD}(3,2) = 1$$

$$\text{MOD}(-3,2) = -1$$

$$\text{MOD}(-3,-2) = -1$$

$$\text{MOD}(3,-2) = -1$$

In general:  $\text{MOD}(x,y) = x - \text{INT}(x/y) * y$

## NA()

### Description

Returns the #N/A (not available) special value. This value may be used to mark data points that are yet to be defined.

### Example

By assigning NA() to the interest rate, all values on the worksheet that depend on the interest rate will change to #N/A.



## NOT(Logical)

### Description

Returns the opposite of the logical value argument (false if the argument is true; true if the argument is false).

### Example

```
IF(OR(credit>limit,NOT(AND(conditions))),  
"not qualified","")
```

where "conditions" is a group of cells and each cell contains one necessary condition of credit worthiness.

### See Also

*AND* and *OR* to operate on logical values.

*IF* to test a logical value.

## NPV(Rate,List)

### Description

Net Present Value (NPV) calculates the amount of money required now to produce a specified cash flow in the future, given some interest rate.

The formula used is:

$$\sum_{i=1}^n \frac{\text{list}_i}{(1+\text{rate})^i}$$

### Requirements

Rate is an interest rate, expressed as a decimal fraction (0.11 is a rate of 11%). It must be an *N* value.

The first value represented by List is income required at the end of the first period, the second the income required at the end of the next period, and so on.

### Example

You are given the opportunity to lease a parking lot for five years for an \$80,000 one time payment. The lot currently generates \$15,000 net operating income annually. Based on research and profit studies you have done, you expect the income to increase 30% annually.

Place \$15,000 in cell R1C1. Place R[-1]C\*1.3 in cell R1C2 and copy it right to the next three cells. Name the area *Flow*. Now, you can figure the net present value of the cash flow.

If your opportunity rate is 15%, then NPV(15%,Flow) gives you the present value of \$84,598.24. Since this is greater than the cost of the lease, you conclude that it is a worthwhile investment.

## OR(List)

### Description

Returns the logical value true if any value in List is true. Otherwise, returns false.

### Requirements

The argument entries must be logical values. If not, the #VALUE! error value is returned.

### Example

`IF(OR(grade>80,final>=150),"good work","")`

### See Also

*AND* and *NOT* to operate on logical values.

*IF* to test a logical value.

# PI()

## Description

Returns the value 3.1415926535898, an approximation of the mathematical constant  $\pi$ .

## Example

```
SIN(PI()/4)
```

## **REPT(*T*,Count)**

### **Description**

Returns a text value consisting of Count repetitions of *T*. If Count is zero or negative, #VALUE! is returned. Otherwise, the length of the result will be the length of *T* multiplied by Count.

This function may be used to create bar graphs, or repeating patterns (such as printer's rules) to separate areas of the worksheet.

### **Requirements**

*T* is usually a single character, but it may be any number of characters.

Count must be an *N* value, which will be truncated to an integer.

### **Example**

REPT("+",Score/3)

## ROUND(N,Digits)

### Description

Returns a value, rounded to the number of decimal places specified by Digits.

Digits specifies the rounding as follows:

If Digits is greater than zero, then the result will be rounded to that many decimal places. For example, ROUND(3.1416,3) produces 3.142.

If Digits is zero, the result is rounded to an integer.

If Digits is negative, rounding is carried into the integer. For example, ROUND(21,-1) produces 20 while ROUND(991,-2) produces 1000.

### Requirements

Digits must be an *N* value.

### Example

Balance+ROUND(Balance\*Interest/12,2)

### See Also

*INT* to return the integer part of a number.

## ROW()

### Description

Returns the number of the row in which the formula containing this function appears.

### Example

Copying the expression `ROW()*10` throughout the first column creates the sequence of numbers:

10  
20  
30  
...

### See Also

*COLUMN* for the current column number.

## SIGN(N)

### Description

Returns a number representing the algebraic sign of the argument.

If the sign of the argument is positive, the function returns 1.

If the argument value is zero, the function returns 0.

If the sign of the argument is negative, the function returns  $-1$ .

### Example

To display the magnitude of a number in bar chart form and its sign:

```
REPT(MID(' - +',SIGN(num)+2,1),ABS(num))
```

### See Also

*ABS* to return the absolute value of a number.



Multiplan

## **SIN(N)**

### **Description**

Calculates the sine of the argument, an angle in radians.

### **Example**

SIN(thetarow C)

### **See Also**

*COS* and *TAN* for the other trigonometric functions.

# SQRT(N)

## Description

Returns the square root of the argument.

## Requirements

*N* must be positive. If *N* is negative, a #NUM! error value is returned.

## Example

SQRT(x\*x+y\*y)

## STDEV(List)

### Description

Calculates the sample standard deviation of the number values represented by List according to the formula:

$$s = \sqrt{\frac{\sum x^2 - \frac{(\sum x)^2}{n}}{n-1}}$$

### Example

STDEV(grades)

### See Also

*AVERAGE* for the average value.

## **SUM(List)**

### **Description**

Returns sum of number values represented by List.

### **Example**

$(1 + \text{rate}) * \text{SUM}(\text{deposits January})$

### **See Also**

*MAX* for the maximum of two or more values.

*MIN* for the minimum of two or more values.

*AVERAGE* for the average value.

*COUNT* for the count of the number values.

## TAN(N)

### Description

Calculates the tangent of the argument, an angle in radians.

### Example

TAN(thetarow C)

### See Also

*COS* and *SIN* for the other trigonometric functions.

*ATAN* for the inverse tangent function.

# TRUE()

## Description

Returns the logical value true.

## Example

If you are planning on putting a complicated condition into a cell, you can use TRUE() to put a logical value in for testing before you construct the more complicated expression.

## See Also

*AND*, *OR*, and *NOT* to operate on logical values.

*IF* to test a logical value.

## VALUE(T)

### Description

Returns the number in the argument, represented as text. The argument must be the text form of a number, similar to those produced by the formatting codes used by Multiplan. It may contain a leading dollar sign or a leading minus sign. It may be written in scientific notation.

For example, all the following text forms yield the value 10: 10, \$10.00, 1E1. The following text forms yield negative 10: -10, -1E1.

### Requirements

If the contents of *T* do not describe a number—if they include letters, for instance, or two decimal points—a #VALUE! error value is returned. You can avoid this problem by first isolating numbers mixed with nonnumeric characters, as the example below shows.

### Example

Suppose that the cell named *date* contains the text "6/14/83." Then,

```
VALUE(MID(date,3,2))
```

returns the number 14.

# Chapter 11

## Message Directory

---

The following directory lists in alphabetical order all the possible messages that Multiplan may display, along with descriptions of possible causes and what actions you may take in response to them.

### **Cannot copy into non-blank cell**

*Cause.* The destination area of an eXternal Copy contains a nonblank cell.

*Action.* Review the response to the eXternal Copy command. Make sure that the destination area you specify is not used for any other purpose. If appropriate, blank the cells that are not blank.

### **Cannot link those windows**

*Cause.* An attempt was made to link two windows that were not split from each other. Also occurs on unlinking, especially unlinking a Title split.

*Action.* Refer to the Window Link command in Chapter 9.

### **Cannot read file**

*Cause.* Confirms a negative response to the “Enter Y to retry access to filename” message. Also may appear when directory display is requested, but an unknown file is named.

*Action.* No special action is necessary. See the “Files” section in Chapter 8 for more information.



### Cannot write file

*Cause.* The file last named is available but cannot be written to disk; either because (1) the diskette is full, or (2) the diskette is write-protected.

*Action.* First, save your work on a different diskette. Check the available space and write protection of the diskette that caused the error message. See the “Files” section in Chapter 8 and the section at the beginning of this volume entitled “Operating Information” for more information.

### Cell locked by eXternal Copy

*Cause.* Either an attempt was made to unlock a cell that is the destination of a linked eXternal Copy, or an attempt was made to copy from an area of the worksheet that is the destination of a linked eXternal Copy.

*Action.* Such cells must not be changed, for any change would be erased the next time the sheets were loaded and the external copies executed. To regain access to the cell, exclude it from copying. Redefine the eXternal Copy command accordingly.

### Cells to recalculate: *number*

*Cause.* You entered a new value into the worksheet while Multiplan was in automatic recalculation mode, or you pressed the RECALC key (!) after entering a new value while Multiplan was not in automatic recalculation mode. This message appears only if there are more than 32 cells to be recalculated.

*Action.* Simply watch the *number* count down to zero. The number tells you where Multiplan is in the recalculation. When the number reaches zero, you can continue your Multiplan session.

### Circular references unresolved

*Cause.* Cells refer to each other in a chain so that the last refers back to the first. (The simplest case is a cell containing a reference to itself—RC—but the chain may be many steps long.) Multiplan has calculated all the cells of the chain once and found itself starting over. It stops calculating, leaving the cells in the circular chain in an undefined state.

*Action.* Alter the logic of the sheet so that there is no circularity. Use the same methods described in the “Formulas” section of Chapter 8 for finding the source of error values.

**Command is too long**

*Cause.* The command, formula, or text on the command line is too long to be displayed there.

*Action.* The command, formula, or text must be shortened.

**Confirm change: *sheet name***

*Cause.* The name of an area, which is the source of a linked eXternal Copy, has been changed on the supporting sheet. Copying will not take place. The system will wait for a character to be typed.

*Action.* Type any character. The rest of the specified files, if any, will be loaded. Review the eXternal Copy command in light of the change on the supporting sheet. Redefine the eXternal Copy command as appropriate.

**Disk error**

*Cause.* While attempting to read or write a file, Multiplan was told of a serious error by the operating system.

*Action.* See the “Files” section in Chapter 8 for possible problems with reading or writing files.

**Disk full**

*Cause.* There is no more room on the diskette.

*Action.* Use the Transfer Delete command to look at the file directory on the diskette, and delete unneeded files. As an alternative, use a different diskette.

**Enter a filename**

*Cause.* The active field of the command takes the name of a file to be written.

*Action.* Enter a filename, or press CANCEL to cancel the command.

### **Enter a filename, or use direction keys to view directory**

*Cause.* The active field of the command takes a filename existing on a disk.

*Action.* If you know the name of the file desired, enter it. If you want to examine the names of all saved sheets, use the direction keys as described under the Transfer Load command. Or, press CANCEL to cancel the command.

### **Enter a formula**

*Cause.* Multiplan awaits a formula. The direction keys can be used to put a reference into the formula.

*Action.* Enter a formula, a number, or text (enclosed in quotes), or press CANCEL to cancel the command.

### **Enter a number**

*Cause.* The active field of the command takes a single number: a row or column number, or a quantity, such as margin spacing.

*Action.* Enter a number or press CANCEL to cancel the command. Note that it is possible to enter a formula, though it must result in a small integer.

### **Enter a number, or d for default**

*Cause.* In the Format Width command, the width of a column can be set to a specific width in characters, or to the width set by the Format Default Width command.

*Action.* Enter a number from 3 to 32, or the letter *d*, or press CANCEL to cancel the command.

### **Enter name**

*Cause.* The active field of the command takes a name. See the Name command in Chapter 9 for the rules governing names.

*Action.* Enter a name, or press CANCEL to cancel the command.

**Enter reference to cell or group of cells**

*Cause.* The active field of the command takes a reference of any kind, including a range, intersection, or a list (a union) of references.

*Action.* Enter a reference to a cell (or cells), or press CANCEL to cancel the command. The direction keys may be used to enter references to particular cells.

**Enter sheet name**

*Cause.* In eXternal Use command, prompts for the sheet name for which a substitution will be made.

*Action.* Supply the sheet name, or press CANCEL to cancel the command.

**Enter text (no double quotes)**

*Cause.* The active field of the command takes text. Double quotes are not permitted because they are used to delimit text in formulas.

*Action.* Enter text, or press CANCEL to cancel the command.

**Enter text or value**

*Cause.* You press a cursor movement key (such as a direction key), following either the Alpha command or Value command or Edit command.

*Action.* If you want to enter additional data, simply type what you want entered. Multiplan automatically selects the appropriate command (Alpha or Value). If you want to return to the main command menu, press CANCEL. If you press RETURN instead of a cursor movement key following these three commands, Multiplan returns to the main command menu as soon as the command is carried out.

**Enter Y to confirm**

*Cause.* You have asked Multiplan to make a major change in the active sheet. Please carefully consider whether this action is correct.

*Action.* If it is safe for the command to proceed, type a Y. If it is not safe, press any other character, and Multiplan will return to the main command menu without changing the worksheet.

**Enter Y to retry access to *filename***

*Cause.* The file named is not accessible to Multiplan.

*Action.* Enter *N* if the file is not appropriate. Make sure that the correct diskette is mounted in the correct drive. Change the “default drive” if necessary. See the “Files” section in Chapter 8 and the section at the beginning of this volume entitled “Operating Information” for more information. Then try *Y* again. If you still get this message, *N* cancels the command and returns the main command menu and worksheet display. If Multiplan is asking for the system disk, entering *N* will terminate the session immediately.

**Error in formula**

*Cause.* See the rules for formulas in the “Formulas” section in Chapter 8. The highlighted area begins at the point an error was noted.

*Action.* Check all punctuation, especially parentheses, quotes, and brackets. Check the spelling of function names. Check for a mismatch of data types, as in concatenating text to a number.

**Field has too many words**

*Cause.* The formula or text being edited has more numbers or words than Multiplan can handle for purposes of moving from word to word with the WORD LEFT and WORD RIGHT keys.

*Action.* None needed; the formula or text is valid and may be used. However, the WORD LEFT and WORD RIGHT keys cannot be used while editing it.

**File format error: line *number***

File being read is in the incorrect format. The file read stopped at the line *number* displayed.

*Action.* Check the mode setting of the Transfer Options command. Be sure that the mode setting is the same as the format of the file being read.

### **File is not a saved worksheet**

*Cause.* The file you are trying to load or link to was not saved with the Transfer Save command.

*Action.* Check the spelling of the filename. Make sure the “mode” of the transfer is correct if you are trying to load other than Normal format files.

### **Help file not available**

*Cause.* The disk file containing the on-line reference information can't be found.

*Action.* See the “Files” section in Chapter 8.

### **Illegal option**

*Cause.* A menu is displayed, and a character is typed that does not appear as a starting letter of any of the menu options.

*Action.* Check the menu for the option that you wish to select, and type the first letter of the menu item, or press CANCEL to cancel the command.

### **Illegal parameter**

*Cause.* One field of the command last entered had a numeric response that was illegal. For instance, if the “number of cells” field of Copy Down was given the response 299, this message would appear when RETURN was pressed. There are only 255 rows, so 299 copies could never be made.

*Action.* The command had no effect, so reenter it correctly.

### **Illegal width of column**

*Cause.* The column width you requested was out of range.

*Action.* Reenter the command. Make sure you specify the width as a number between 3 and 32 inclusive.

### **Insufficient memory**

*Cause.* Multiplan has run out of storage space; it has no space left for new cell contents.

*Action.* Save the sheet at once. Then consider ways to simplify it. Blank cells take little space, so blank any unwanted cells. If you have large areas of blanks between areas in use, make the sheet more compact. The Delete commands remove cells from your sheet. Beyond that, you may have to break the application into additional sheets to fit in all the information.

### **Locked cells may not be changed**

*Cause.* An attempt was made to modify the value of a locked cell. Note that the lock may have been set by eXternal Copy.

*Action.* If you need to change the cell, unlock it first, using the Lock Cells command.

### **Name not defined: *sheet name***

*Cause.* An eXternal Copy was attempted from a named area that is not defined on the source sheet.

*Action.* Check the source sheet for the correct name. Redefine the external link if necessary.

### **Name too long**

*Cause.* Names may not exceed 31 characters. The name you have entered exceeds this.

*Action.* Use a shorter name.

### **Overwrite existing file?**

*Cause.* The disk file Multiplan is about to create—either a saved worksheet or a file of printer lines from the Print File command— has the same name as an existing file. If Multiplan continues, it will replace the existing file with the new one.

*Action.* Think carefully! If you agree that the existing file is of no importance, reply *Y* to let the command proceed. If the file might be important, reply *N* and re-enter the command giving a different, unique filename.

### **Press any key to redraw screen**

*Cause.* The eXternal List command has put an information display on the screen in place of the usual display.

*Action.* When you have seen enough of the information display press any key to return to the normal display.

### **Printer error**

*Cause.* The printer is not responding to a request from Multiplan.

*Action.* Check if the printer is connected properly and ready to print.

### **Reading line *number***

*Cause.* You command Multiplan to read a symbolic file.

*Action.* None. The line *number* increases as Multiplan reads through the file. When the file has been read completely, you can continue your Multiplan session.

### **Select option**

*Cause.* Multiplan is waiting for your choice among a short list of options.

*Action.* Selection in this case is similar to command selection. Move the edit cursor to the desired option using the space bar and BACKSPACE key (as necessary). Or type the initial letter of the option.

### **Select option or type command letter**

*Cause.* Multiplan awaits your choice from a list of options.

*Action.* Select one of the items shown by moving the edit cursor to it with the SPACE and BACKSPACE key, then pressing RETURN. Or, just type the initial letter of the item you want.



### **Shapes of areas do not match**

*Cause.* The destination area of an eXternal Copy command does not have the same “shape” (size) as the source area.

*Action.* Specifying a single cell as the upper left corner of the destination will suppress the shape check. However, the mismatch suggests a review of the names on the supporting sheet and on the active sheet.

### **Too many depending sheets**

*Cause.* Multiplan can keep track of at most eight dependent sheets. The message signals that there are more than eight dependent sheets.

*Action.* No action is necessary, but you cannot rely on the accuracy of the eXternal List command. See also the discussion of eXternal Relationships in the “Files” section in Chapter 8.

### **Too many windows**

*Cause.* There is a limit of eight windows and the Window Split command has been used in an attempt to open a ninth.

*Action.* Review the existing windows; use the Window Close command to delete some of them.

### **Window will not fit**

*Cause.* The window you are trying to Border or Split is too small.

*Action.* Close an adjacent window to get more room on the screen, or rethink your screen layout.

# Appendices

---

- 1 Helpful Hints 365
- 2 Glossary 369
- 3 Notes for the VisiCalc™ User 377
- 4 The SYLK (Symbolic Link) File Format 387
- 5 Solving Extended Problems with the Iteration  
Option 395

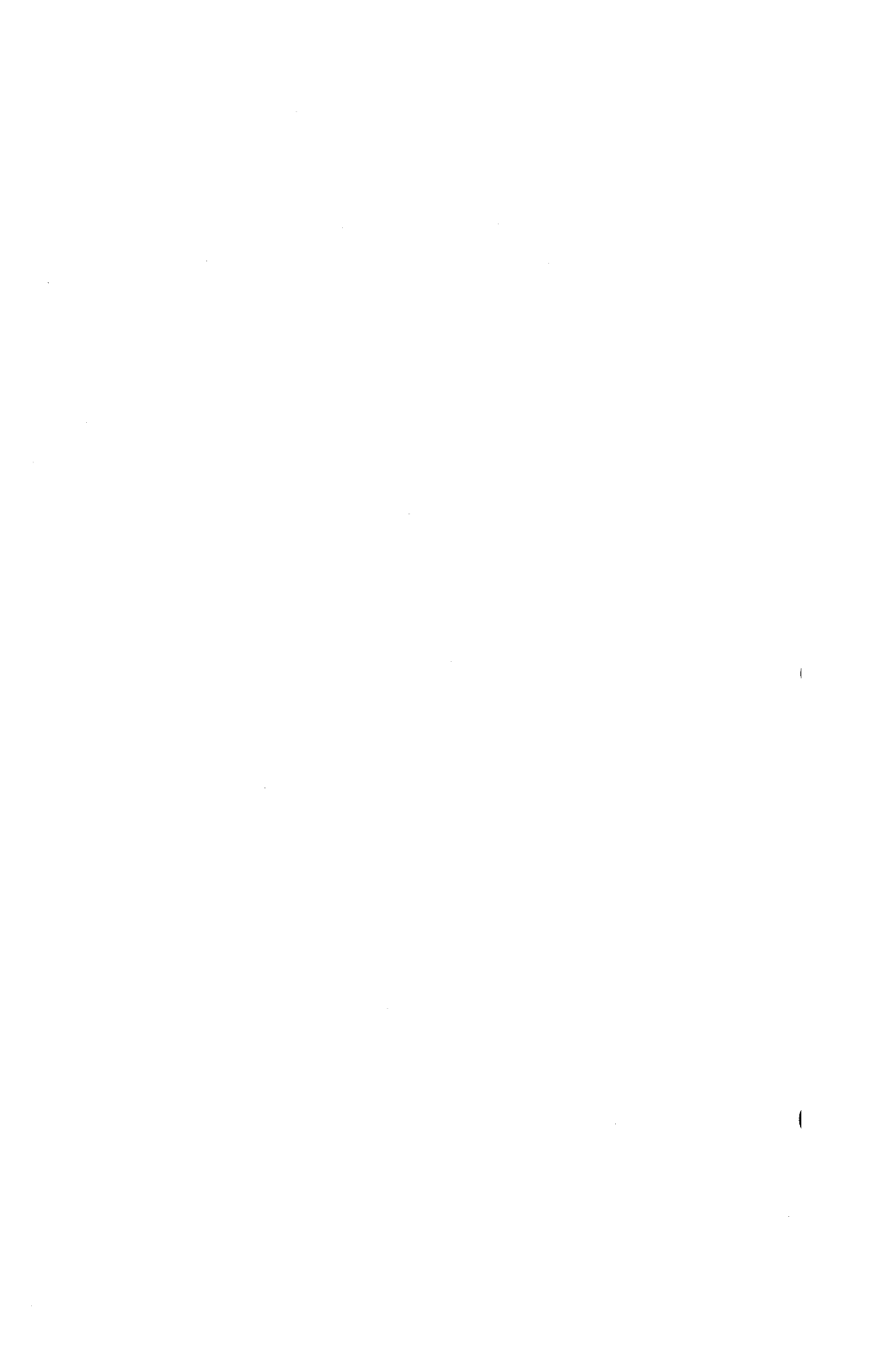

# Appendix 1

## Helpful Hints

---

This appendix offers hints for saving space in memory and on your diskettes, for saving time during your Multiplan sessions, and for making Multiplan easier to use.

1. Use the eXternal commands to split sheets at logical places. The method of splitting up your work should follow the natural breaks in your tasks. By splitting up your task into smaller tasks, you can keep your worksheets smaller and faster to work with.
2. Keep the worksheet compact. Keep the amount of blank space within the worksheet to a minimum. Also, avoid extending the worksheet size unnecessarily.

Placing any number outside the general work area, even formatting a cell unintentionally, can use more memory and diskette storage than necessary.

If you suspect that too much memory is being used (check the % Free indicator at the bottom of the screen), try deleting all columns to the right and all rows below your work area on the sheet. This ensures the minimum size for your worksheet.

3. Place common subexpressions in an intermediate cell, then refer to that cell when the subexpression is needed in a formula in another cell. This saves retyping and recomputing the same information. For example, if SUM(Sales) appears in several formulas:

```
MIN(1000,SUM(Sales))  
SUM(Sales)*commission%  
AVERAGE(Sales) (this example has it hidden)
```

it is more efficient to compute SUM(Sales) once in a cell, then refer to that cell from the formulas. Having the intermediate result visible also helps with tracing problems in the setup of the formulas.

4. Define names for the common areas on your worksheet. By defining names, you speed up references to a group of cells. For example, it is much easier and faster to type *Sales* than R2C3:15, or *Hotspots* than R3C4,R5C6,R5C8. Use the REFERENCE key (@) to enter names directly from the name table.
5. Use the Copy commands for filling in cells with identical values, especially formulas, but also numbers and text. Copying is simpler, less error prone, and more space efficient than manually entering repeated values into cells individually.
6. To copy quickly the format of a group of cells into another part of the worksheet, first copy the group of cells as they are. Then, blank the cells in the new area.
7. Use primitive forms of references wherever possible. For example, it is more efficient to use R2C2 than R2 C2; or R1:2C1 than R1C1:R2C1.
8. Turn off automatic recalculation, and use the RECALC key (!). This way you can enter new values and edit current values without waiting for each recalculation. Recalculation also occurs when you change text.
9. Use "Continuous" cell format code sparingly, Formatting whole rows with "Continuous" format or specifying "Continuous" as the default setting is expensive.
10. Format entire rows or columns at one time, except for "Continuous" format. Formatting entire rows or columns does not extend your worksheet.

11. Avoid functions or operations over unnecessarily large ranges. For example, instead of `SUM(R2)`, specify only the range of columns that contain values, for instance `SUM(R2C1:5)`. Or, try to restructure the function or operation so that large ranges are not necessary.
12. Avoid extensive use of forward references because they are slower to recalculate. For example, a reference to cell `R10C10` from cell `R5C5` is slower than a reference to `R5C5` from `R10C10`.
13. Use the `PAGE`, `HOME`, and `END` keys to scroll rapidly across and down the worksheet.
14. Perform similar operations together. Try to define all names at once. Copy all cells at once. Many Multiplan commands offer you proposed responses. By performing similar operations together, you can make maximum use of the proposed responses, which saves considerable time.
15. Simply press the `RETURN` key to select the Alpha command whenever the main command menu is displayed.
16. Position the cell pointer before selecting a command. This also makes it easier to use proposed responses.
17. Use the Normal mode for saving and loading files, whenever possible (see Transfer Options command). If you load a file that is in Symbolic or Other mode, save it in Normal mode when you are finished with it. Files in Normal mode load much faster than files in the other modes.



# Appendix 2

## Glossary

---

### Absolute reference

A reference to a cell that uses specific row and column numbers; for instance, R17C12. Opposed to relative reference, as R[+1]C[-2].

### Action keys

Keys that cause Multiplan to carry out an action at once. The action keys include the CANCEL key, NEXT WINDOW key, and RETURN key. *See also* Direction keys, Edit keys.

### Active

Something in use right now and immediately accessible, such as the active window, active cell, or active field of a command.

### Active cell

The cell indicated by the cell pointer. The contents of the active window can be seen on the status line and may be edited with the Edit command.

### Active window

The window containing the active cell, marked on the screen by a highlighted window number.

### Alignment

The rule for the horizontal positioning of the display of a cell's value. Values may be left justified or right justified or centered.

### CANCEL key

Action key that causes Multiplan to abandon the current command and return to command choice.



# Multiplan

## Cell

One position on the worksheet, a place where data or a formula may be stored. A cell has a location and may be referred to by one or more names. The contents of a cell determine its value; the cell's format determines how its value is displayed.

## Cell pointer

A highlighted pointer that selects one cell from all the cells in the worksheet. That cell becomes the active cell. The cell pointer is moved from cell to cell with the direction keys, or directly with the Goto command.

## Character

A symbol that can be displayed on the screen; includes letters, digits, punctuation, and special characters like \$, +, and %.

## Column

A vertical line of cells down the worksheet. There are 63 columns, designated by the numbers 1 through 63.

## Command

An instruction to Multiplan to do something. A command may have one or more fields in which to specify how the command should be carried out.

## Command line

The screen lines just under the worksheet area, beginning with the word COMMAND:, and showing the main command menu. Here is where commands are built.

## Contents (of a cell)

That which has been put into a cell. If nothing has been put in, the cell is empty and its contents are blank. Otherwise the cell contains either data (text or a number) or a formula. If a cell contains a formula, the cell's value, which is the result of the formula, is usually displayed.

## Cursor

*See* Edit cursor.

**Dependent sheet**

A sheet that uses values from another sheet. The dependent sheet depends on information calculated on another, saved, sheet to which it is linked by the eXternal Copy command. *See also* Link.

**Direction keys**

Keys that move the cell pointer. The UP, DOWN, LEFT, and RIGHT keys move the pointer one cell at a time. The HOME key moves it to the cell in the upper left corner of the active window.

**Directory**

The table of file names kept on each diskette by the operating system. The directory lists each file on the diskette.

**Edit**

Altering a response in a field of a command. The edit keys are used to move the edit cursor over the response, and the character keys are used to replace or insert characters.

**Edit cursor**

The highlighted part of a command on the command line, which may be as small as one character or as large as an entire field. The edit cursor is moved with edit keys. It shows where alterations can be made to the command.

**Edit keys**

Keys that move the edit cursor within the command line. Includes, for example, WORD RIGHT and WORD LEFT and CHARACTER RIGHT and CHARACTER LEFT keys.

**Field**

A portion of a command in which you type a response to instruct Multiplan in some detail of the command's work. When Multiplan first shows a field, it fills it with a proposed response; you can replace or edit that response if it isn't what you want.

## Multiplan

### **File**

A named unit of data stored on disk or diskette. When a worksheet is saved it is written into a file. Not all files represent saved worksheets, but those that are can be loaded or linked to other worksheets.

### **Filename**

The name used to refer to a worksheet when it is saved, loaded, or linked to another sheet.

### **Format**

How a cell's formula is displayed. The format controls numeric punctuation and the alignment of the displayed value. A format can be specified for a cell or cells with the Format Cells command; cells without a specific format are displayed according to a default format set with the Format Default command.

### **Formula**

A recipe for how a value is to be calculated. Whenever the contents of a cell are changed, Multiplan recalculates all the formulas on the worksheet (unless automatic recalculation is turned off).

### **Function**

A built-in mathematical or statistical operation that Multiplan can perform on one or more values; e.g., SUM or AVERAGE.

### **Group of cells**

A collection of one or more cells on the worksheet that may be named; e.g., *Sales*.

### **Highlight**

An area on the display that appears emphasized. Highlights are used to indicate the edit cursor, active cell, active window number, and current menu item.

**Link**

In Multiplan, the use of data from an inactive sheet in calculations on the active sheet. The inactive sheet is called the supporting sheet. The data to be copied must have been marked with the Name command or must be specified by an absolute reference. Then data from the supporting sheet may be used in formulas on the active sheet. Link is also used to express connection between windows for synchronized scrolling.

**Load**

To make a saved sheet active again. The sheet to be loaded must have been saved. The Transfer Load command is used to copy the saved sheet from its file to working storage, where it becomes the active sheet.

**Lock**

Protection of cells that contain formulas or text from inadvertent alteration.

**Menu**

A list of alternatives. A choice from a menu is selected in one of two ways: by moving through the list with the space bar (a highlight will move along the menu indicating the current selection) and selecting the highlighted choice with the RETURN key, or by typing the initial letter of the desired item.

**Message**

A notice posted by Multiplan on the message line to explain a problem or suggest what kind of input the system is waiting for.

**Message line**

The next to the last line on the display.

**Name (of a cell or group of cells)**

A tag, associated with a group of cells by the Name command. The name can be used to refer to the cell or cells in formulas.

### **NEXT UNLOCKED CELL key**

Action key that moves the cell pointer to the next cell that is not blank and is not locked. Used to find cells that contain numbers (rather than a formula or text) so you can perform “what if” experiments.

### **Proposed response**

Response supplied by Multiplan. It is usually based on the most recent responses by the user or on the current status of Multiplan.

### **Range**

The smallest rectangle of cells containing two references. A range is designated by the colon (:). The range R3:R8 defines the rectangular area containing all of rows 3 and 8, namely rows 3, 4, 5, 6, 7, and 8. *See also* Reference.

### **Reference**

The designation of a cell or an area of cells. The simplest reference is to a single cell: R9C2. A reference may be relative to the cell containing the reference, as in R[-1]C. A reference may be to a single cell, as the prior two, or to an area of cells: R6 refers to all of row 6. A reference may be composed of intersections of references, ranges of references, or unions of references. A reference may be a name defined to refer to one or more cells. *See also* Name and Range.

### **Relative reference**

A reference to a cell relative to the cell containing the reference, as R[-1]C meaning “the row above, in this column.” Opposed to absolute reference, in which the actual column and row numbers are stated.

### **Response**

What the user types in a field of command. May be a row or column number, a count, a name, or the contents to be put in a cell. When Multiplan displays a command on the command line, it usually supplies a proposed response in every field of the command; the user may replace the proposed response, edit it, or leave it as proposed.

**Row**

A horizontal line of cells across the worksheet. There are 255 possible rows, designated by the numbers 1 through 255.

**Save**

The operation of making a permanent copy of the active worksheet in a file.

**Scroll**

To move one or more windows across the worksheet one row or column at a time. Scrolling is done with the direction keys. For example, if the RIGHT DIRECTION key is pressed until the cell pointer reaches the right edge of the screen, and then pressed again, Multiplan scrolls the worksheet display one column to the left.

**Status line**

Bottom line of the screen, where Multiplan presents status information such as the location of the active cell and its contents.

**Supporting sheet**

A sheet providing values to another sheet. The sheet supports the other sheet (the dependent sheet) with data that has been designated with the eXternal Copy command. Data on the supporting sheet must have been named with the Name command. *See also* Link.

**Text**

String of characters that may be used for titles in the worksheet. Multiplan formulas can perform operations on text also.

**Value**

The information content of a cell: its numeric value if it contains a number; its text if it contains text; or, if it contains a formula, the result of calculating that formula.

## Multiplan

### **Window**

A rectangular portion of the display area within which Multiplan displays a part of the worksheet. As many as eight windows may be open at once; they are opened or closed with the Window command. Each window has a window number from 1 through 8 shown in its upper left corner. The window number of the active window is highlighted; that window contains the active cell, which is highlighted by the cell pointer.

### **Worksheet**

A grid of cells displayed by Multiplan to store formulas and values.

# Appendix 3

## Notes for the VisiCalc™ User

---

If you have used VisiCalc previously, you are probably curious about how that product differs from Multiplan. This appendix compares the operations and features of the two. Described first are the operations the two programs have in common, roughly in the order they are presented on the VisiCalc reference card. The features unique to Multiplan are described second.

### The Multiplan Screen

Multiplan divides the screen into a display area, command lines, a message line, and a status line. Parts of the worksheet are shown in the display area. Unlike VisiCalc, which allows you to create just two windows, Multiplan allows you to create as many as eight windows within the display area. You have control over the size and placement of each window, you can have windows with or without borders, and you can freeze title columns and rows. All these functions are controlled by the Window commands (see Chapter 9).

The message line displays Multiplan's comments on the progress of any command. The status line at the bottom of the screen displays the coordinates of the active cell, its actual contents, and the percent of storage that remains.

### Moving the Cell Pointer

The four direction keys move the cell pointer around the active window. The HOME key sends the cell pointer to the upper left corner of the worksheet. The END key sends the cell pointer to the lower right corner. You may also move the cell pointer to a specific cell with the Goto command, which lets you move to a



particular row and column or to a particular cell by name (see “Names” below). The NEXT WINDOW key moves the cell pointer to the next window in sequence.

## **Correcting Errors, Canceling Commands**

In Multiplan the CANCEL key cancels any command you have begun. The BACKSPACE key erases the last character typed. There are several other editing keys used to correct typing errors (see Chapter 8).

## **Entering Titles and Text**

In Multiplan, a cell may contain a title or simple text made of characters documenting a row or column on the worksheet. To enter text, choose the Alpha command, type the title, and press RETURN or any direction key.

Unlike VisiCalc, Multiplan can use text in formulas. To include text as part of a formula, enter it in double quotes. You can use the titles on your worksheet in formulas (as references to parts of the worksheet) if the titles are also defined with the Name command.

## **Entering Numbers**

A cell may contain a number. To enter one, just start typing it. Put the finished number in the active cell by pressing RETURN or any direction key. Numbers may be in decimal form or in scientific notation.

## Entering Formulas

A formula is composed of text, numbers, cell references, operators (+ - \* /), and function names (SUM, MIN, etc.). Unlike VisiCalc, but like most programming languages, Multiplan evaluates formulas according to the precedence of operators: - (negative value) is evaluated first, then %, then exponentiation (^), then multiplication (\*) and division (/), then addition (+) and subtraction (-), and finally text concatenation (&). You may use parentheses to change the order of calculation.

Values can be compared using the operators less than (<), greater than (>), less than or equal (<=), greater than or equal (>=), equal (=), and not equal (<>).

The & (concatenate) and % (percent) operators are unique to Multiplan.

To enter a formula, first type = or +, then the formula. Within a formula, you may enter a reference to another cell by pointing to that cell with the direction keys. All the editing keys are available to you while entering a formula; the WORD RIGHT and WORD LEFT keys are especially helpful.

## References

Note that Rows and Columns are both numbered, the Row indication given first. Thus, the VisiCalc reference B3 can be written in Multiplan as R3C2.

In a formula, you may refer to the value of a cell or a group of cells in any of several ways. You may give an absolute reference to a row and column (R3C5) or to a range along a row or column (R3:6 C9, R5, C1:8). You may give a reference relative to the cell holding the formula (R[-1] C for “this column, one row up”). Most important, you can give a name to any cell or group of cells. For instance, the name *Sales* might refer to R9C2:9 (row 9, columns 2 through 9). The formula SUM(Sales) produces the sum of all numbers in those cells.

References of any of those three kinds may be combined by intersection or union to make other references (see Chapter 8 for details and examples).

## Multiplan Names

In Multiplan, the Name command allows you to define a name as a reference to a single cell, or to any group of cells. Once you've done so, you may use that name as an argument of a function or, in many cases, as a response in a command. A name must start with a letter, and it may contain letters, numbers, periods (.), and underline (\_) characters, up to 31 characters maximum.

This naming ability can make a big difference in the clarity of your sheets. Consider this formula (as VisiCalc presents it):

$$B1 * B2 * (1-B3)$$

Notice the improvement if you write it using names:

$$\text{Quantity} * \text{Price} * (1 - \text{Discount})$$

The Name command also allows you to review your name definitions using the direction keys.

## Functions

Multiplan supports all of the functions familiar to you from VisiCalc, and others unique to Multiplan. Table 1 compares the Multiplan functions with their VisiCalc counterparts. See Chapter 10 for details on each Multiplan function. Note that Multiplan function names do not begin with “@”.

Multiplan also provides several unique functions. See Table 2.

**Table 1****Multiplan Functions and Their VisiCalc Counterparts**

---

<b>Multiplan</b>	<b>VisiCalc</b>
ABS( <i>N</i> )	@ABS( <i>N</i> )
use PI()/2 - ATAN( <i>N</i> /SQRT(1 - <i>N</i> * <i>N</i> ))	@ACOS( <i>N</i> )
AND(list)	@AND(list)
use ATAN( <i>N</i> /SQRT(1 - <i>N</i> * <i>N</i> ))	@ASIN( <i>N</i> )
ATAN( <i>N</i> )	@ATAN( <i>N</i> )
AVERAGE(list)	@AVERAGE(list)
INDEX (area,subscripts)	@CHOOSE
COS( <i>N</i> )	@COS( <i>N</i> )
COUNT(list)	@COUNT(list)
use undefined name	@ERROR
EXP( <i>N</i> )	@EXP( <i>N</i> )
FALSE()	@FALSE
IF( <i>l</i> , <i>v1</i> , <i>v2</i> )	@IF( <i>l</i> , <i>v1</i> , <i>v2</i> )
INT( <i>N</i> )	@INT( <i>N</i> )
ISERROR( <i>N</i> )	@ISERROR( <i>N</i> )
ISNA( <i>N</i> )	@ISNA( <i>N</i> )
LN( <i>N</i> )	@LN( <i>N</i> )
LOG10( <i>N</i> )	@LOG10( <i>N</i> )
LOOKUP( <i>N</i> , area)	@LOOKUP( <i>N</i> ,range)
MAX(list)	@MAX(list)
MIN(list)	@MIN(list)
NA()	@NA
NOT( <i>l</i> )	@NOT( <i>l</i> )
NPV( <i>dr</i> , list)	@NPV( <i>dr</i> ,range)
OR(list)	@OR(list)
PI()	@PI
SIN( <i>N</i> )	@SIN( <i>N</i> )
SQRT( <i>N</i> )	@SQRT( <i>N</i> )
SUM(list)	@SUM(list)
TAN( <i>N</i> )	@TAN( <i>N</i> )
TRUE()	@TRUE

---

**Table 2**  
**Functions Unique to Multiplan**

<b>Function</b>	<b>Description</b>
COLUMN()	Current column number
DOLLAR( <i>N</i> )	Text form of <i>N</i> formatted as dollar amount; negative <i>N</i> shown in parentheses
FIXED( <i>N</i> , <i>d</i> )	Text form of <i>N</i> formatted with <i>d</i> decimal places
LEN( <i>T</i> )	Length of text <i>T</i> in characters
MID( <i>T</i> , <i>s</i> , <i>c</i> )	The <i>c</i> characters of text value <i>T</i> starting at <i>s</i>
MOD( <i>N</i> <sub>1</sub> , <i>N</i> <sub>2</sub> )	Remainder of <i>N</i> <sub>1</sub> / <i>N</i> <sub>2</sub>
REPT( <i>T</i> , <i>N</i> )	Text made of <i>N</i> repetitions text <i>T</i>
ROUND( <i>N</i> , <i>d</i> )	Value of <i>N</i> rounded to <i>d</i> decimal places
ROW()	Current row number
SIGN( <i>N</i> )	-1, 0, or +1 depending on <i>N</i>
STDEV(List)	Standard deviation
VALUE( <i>T</i> )	Number value of text <i>T</i>

## Commands

Multiplan commands are chosen from the menu by highlighting a command word or by typing the first letter of a menu item. Table 3 shows the Multiplan commands and their VisiCalc counterparts (for complete details on the Multiplan commands see Chapter 9). Remember as you scan Table 3 that you type only the capitalized letters when choosing a Multiplan command.

If a command has more than one argument "field," they are separated by TAB instead of RETURN, as in VisiCalc. In Multiplan, RETURN executes the command.

It's worth noting that Multiplan's Insert, Delete, and Move commands can operate on more than one row or column at a time. You can Insert several blank rows, or Delete several rows. Move allows you to move any rectangular area; you aren't restricted to moving entire rows or columns. Multiplan adjusts all references (absolute or relative) and name definitions to account for the changes.

The Multiplan Format command can set the format of one cell, or of a group of cells.

Multiplan automatically recalculates cells until all have reached the correct values (or until Multiplan finds an endless chain of references) so the VisiCalc “/GO” (order of calculation) command isn’t needed. You don’t have to be concerned with the order of calculation in Multiplan, or worry about forward references.

Multiplan provides several unique commands which VisiCalc does not have. See Table 4.

**Table 3**

**Multiplan Commands and Their VisiCalc Counterparts**

---

<b>Multiplan</b>	<b>VisiCalc</b>
Blank	/B
Transfer Clear	/C
Delete Columns, Delete Rows	/D
Edit, Alpha	/E
Format Cells	/F
Format Width	/GC
Format Default	/GF
not needed; see text	/GO
Option	/GR
Insert Columns, Insert Rows	/I
Move Columns, Move Rows	/M
Print	/P
Copy	/R
Transfer Load	/SL
Quit	/SQ
Transfer Save	/SS
Window Split Titles	/T
Option	/V
Window Open, Window Split, etc.	/W
Window Link	/WS, /WU
Goto Row-col	>
Next Window key	;
Recalc key	!
use references	#
see Table 2, REPT function	/-

---

NOTE: You type only the capitalized characters of the Multiplan command names.

**Table 4**

**Commands Unique to Multiplan**

---

Format Options  
Help  
Lock  
Name  
Sort  
Window  
eXternal

---

## Printing

Multiplan has a full set of printing operations, invoked by the Print command. You may print all or any rectangular area of the worksheet; an area can be specified by name or specific references. Multiplan can send the printed representation of the worksheet to a file on disk. You may then use that file with operating system commands and other programs: you could, for instance, incorporate a worksheet listing into another document. Multiplan also gives you the option to print the formulas in cells instead of their resulting values.

## Copying Cells

Multiplan's Copy command performs the operations that, in VisiCalc, are done with "/R". Copy Down and Copy Right provide especially easy ways to duplicate one cell down a column or across a row. The general Copy From operation will duplicate a single cell into an area of any shape or duplicate an area of any shape in another area of the same shape. Multiplan doesn't ask whether references should be adjusted or not; if you build your formulas with relative references and names, they will be position-independent.

## Worksheet Transfers

The Transfer command handles operations on the whole worksheet.

The DIF™ format is not directly supported by Multiplan. However, DIF™ files can be readily converted into the Multiplan SYLK format described in Appendix 4.

By the proper choice of Transfer Options (see Transfer Options command in Chapter 9), Multiplan can load saved VisiCalc files directly. Simply select the Transfer Options command and set the “mode” to Other. Then use the Transfer Load command as you would for any Multiplan file. Just as in VisiCalc, the loaded sheet will be merged with the active sheet. This feature automatically compensates for the following differences:

- arithmetic operator precedence

- names of functions and the order of arguments

- format of cell references (all cell references are converted to relative references)

## Linking Sheets

The Multiplan eXternal Copy command may be used to copy data from a named area in a saved worksheet to the active sheet. The data sharing relationship between the sheets may be made permanent, in which case Multiplan will automatically copy the data from the “supporting” sheet every time the “dependent” sheet is loaded. You can find the details of this important Multiplan feature in Chapter 9.



## Sorting

The Multiplan Sort command (described in Chapter 9) may be used to sort the worksheet on any column or columns containing numbers or text, in ascending or descending order.

## Lock

The Multiplan Lock command can be used to lock individual cells or to lock all cells that contain formulas or text. This command makes it safe to test “What if...?” situations without disrupting or destroying your valuable worksheet structure.

# Appendix 4

## The SYLK (Symbolic Link) File Format

---

The purpose of the SYLK (SYmbolic LinK) file format is to exchange information between Multi-Tools and application programs. The format is designed with extensibility, ease of generation, ease of parsing, and storage efficiency in mind. The worksheet can be completely represented by SYLK files. This means that a program can generate a Multiplan worksheet, such as a program to build a cash-flow forecasting worksheet from a general ledger chart of accounts. It is useful to subdivide the definition of SYLK into the following “layers”:

1. SYLK record and field formats: this layer provides for the identification of the files, a degree of data compression, and an easy way for a program to separate information that is important for its purpose from information that the program is not interested in handling.
2. The “C” or cell or data point record. This is probably the record type of the most universal interest.
3. Other Multiplan-specific records and fields. This collection of formats affords complete control or complete overview for a communicating program of the state of a Multiplan session, including the worksheet, windows, options, etc.

The first layer is defined as follows. The contents of a SYLK file—encoded in ASCII—are divided into records by either CR or LF characters. Empty records are ignored. Nonempty records are further subdivided into an RTD (record-type descriptor) optionally followed by a list of fields. Each field in the list is preceded by an FTD (field-type descriptor). The contents of the

fields is determined by the RTD and the FTD, as described below:

RTDs consist of up to two letters. They determine the meaning of the record according to the standards described below.

FTDs consist of a semicolon and a single letter that determines the meaning of the field. The meanings of FTDs ;U, ;V, ;W, ;X, ;Y, and ;Z will be the same for all records. The meanings of other FTDs will depend on the record type.

The field contents can be arbitrary except for the following: CRs or LFs may not be included, and semicolons must be doubled.

A degree of data compression is achieved by the following rule: for certain fields, the last field value will be automatically substituted if the field contents are empty. Such fields are said to be differentially encoded and will be marked by (diff) in their description.

The FTDs ;X and ;Y determine x and y coordinates in a worksheet or other two-dimensional space containing data points. Coordinates of the first cell are 1,1. ;X and ;Y are differentially encoded, and they may be altogether omitted from records if the last defined value is to be used.

In general, programs that process SYLK files cannot be expected to handle all RTDs, all FTDs, or even the full range of field contents for two reasons. First, their interest may be limited to some aspect of the available data. Second, SYLK may very well be expanded after the release of the program in question. This means that programs must be prepared to ignore records and fields that they do not understand. Data with coordinates that lie outside of the space that the program can process should also be ignored.

The following sections describe data records and fields that are currently defined.

**Record Type: C**

These records describe a data point that exists in a two-dimensional space with coordinates ;X and ;Y. The Multiplan concept of cell is one example of a data point. Besides its coordinates, data points may also possess a number or text value, an expression, a protection state (locked or unlocked), and several Multiplan-specific properties. Formatting properties for data points may be specified in a separate record type (F, see below).

Fields are:

;X, ;Y	(diff) cell coordinates.
;K	Value of the data point. Numerical values are given in decimal or exponential form (see Multiplan "Gen" format code). Text values are enclosed in double quotes. The logical values TRUE and FALSE are given this way. Error values are preceded by # and appear as in Multiplan.
;P	Protection state. If ;P appears, the data is locked; otherwise, it is not locked.
;E	An expression that computes the value of the data point. The field contents appear exactly as a Multiplan formula.
;R,;C	(diff) Used by ;S.
;S	Expression for the data point is given at another coordinate. X is given by ;C (column), y is given by ;R (row). The field contents are decimal coordinates. Note that ;E must not appear together with ;S. Moreover, the data point at (;R, ;C) must be marked with either ;D or ;G. In the latter case, the value of the data point is taken to be the (constant) expression.

## Multiplan

- ;D** ;E expression is shared by some other data point.
- ;G** ;K value is shared by some other data point. ;E must not appear.

### Record Type: B

Defines the bounds of the two-dimensional space of data points. This record should appear at the beginning of a SYLK file.

### Record Type: E

Defines the end of the SYLK file.

### Record Type: F

Describes the Multiplan formatting properties of individual cells or of the whole worksheet. (See also the descriptions of the Format group of commands in Chapter 9.)

Fields are:

- ;X, ;Y** (diff) Cell coordinates.
- ;Fc1nc2** (diff) Cell formatting properties are defined by the contents where c1 is a one-character formatting code (D, C, E, F, G, \$, or \*), n is the “# of digits” argument, and c2 is a one-character alignment code (D, C, G, L, or R).
- ;R, ;C** ;F properties are to be applied to a whole whole row or whole column of the Multiplan worksheet. Contents are decimal row or column numbers, respectively.

;Dc1nc2n3	“Default” format properties are defined as in ;F (except that the “D” codes may not be used). n3 is the “default” width of columns (see also the Format Default Width command, Chapter 9).
;K,;E	Appear if the commas and formulas Format Options are set, respectively.
;Wn1 n2 n3	Defines the widths of a group of columns in the worksheet where n1 is the first column (x), n2 is the last column in the group, and n3 is the width of the columns in the group expressed as number of characters (cf. Format Width command). Columns that are not mentioned in any format record will have the “default” width setting.

**Record Type: ID**

The first record in the SYLK file must be an ID record. This convention helps with the identification of the file as a SYLK file.

Field is:

;Pname	The name of the program that produced the file (for example, MP).
--------	---

**Record Type: NN**

This record defines a Multiplan name as a union of rectangular areas expressed with absolute references (see also the Name command, Chapter 9).

Fields are:

;Nname	The name to be defined.
;Ee	Expression describing the area. Its general form is:

Rn11:n12Cn13:n14,Rn21:n22Cn23:n24,...

Ranges over single values may be written without the “:” operator. Ranges R1:255 or C1:63 (but not both) may be omitted.

**Record Type: NE**

The record describes a link to an inactive sheet. See also the eXternal group of commands in Chapter 9.

Fields are:

- ;F                   Filename (or logical filename) for source sheet.
- ;S                   Description of the source area, typically a name of a group of cells.
- ;E                   Expression defining target area, as in NN.

**Record Type: NU**

Describes an external filename substitution. See eXternal Use command, Chapter 9.

Fields are:

- ;L                   Filename (or logical filename).
- ;F                   Filename to be used instead of ;L.

**Record Type: W**

The window structure of a Multiplan screen is described in part by the states of the windows and in part by the operations that create the windows. To discover the correct description for a particular screen fenestration, the best approach is to use Multiplan to set up the windows and then to inspect SYLK output from Multiplan.

Fields are:

;N	Window number, as shown by Multiplan.
;Ay x	Coordinates of the cell shown in the upper left corner of window ;N
;B	Window ;N is bordered if (and only if) ;B appears.
;STcy cx ;SHlcy ;SVLcx	Split window ;N to create new window. The window number of the new window will be one greater than the largest number previously in use. The letters T, H, or V define Title, Horizontal, or Vertical splits, respectively. The symbol l stands for the letter L if the windows are to be linked for scrolling, otherwise it is omitted. Cx is the number of character positions in the new window, cy is the number of screen lines, also in the new window.

### Order of Records

There are only a few restrictions on the order of records in SYLK files.

1. ID must be the first record.
2. B should be used (although not required) for Multiplan input.
3. For Multiplan C records: ;D or ;G must appear before another C record that refers to it (with ;S, ;R, ;C).
4. Name definition should precede name use for efficiency, although this is not required.
5. Window splits and window properties must be in strict logical order.
6. NU records must precede NE records.
7. E must be the last record.





# Appendix 5

## Solving Extended Problems with the Iteration Option

---

The Microsoft Multiplan electronic worksheet includes an option that extends the number of solvable problems.

Consider this example. Spencer Ceramics must pay a bonus that is equal to 10% of its profits. The bonus is calculated then subtracted from the profits to yield the net profit.

Set up this simple calculation in Multiplan as follows (the “Suggested Steps” column is just one way to enter data on the worksheet).

---

<b>Entries</b>	<b>Suggested Steps</b>
Move cell pointer to R1C1	Press the HOME key
Enter <i>Gross P</i> in R1C1	Press <i>A</i> , type <i>Gross P</i> , press DOWN
Enter <i>Bonus</i> in R2C1	Type <i>Bonus</i> , press DOWN
Enter <i>Net P</i> in R3C1	Type <i>Net P</i> , press RETURN
Name R3C2 as <i>Net_P</i>	Press <i>N</i> , TAB, RIGHT, RETURN
Name R2C2 as <i>Bonus</i>	Press UP, <i>N</i> , TAB, RIGHT, RETURN
Name R1C2 as <i>Gross_P</i>	Press UP, <i>N</i> , TAB, RIGHT, RETURN
Enter <i>1000</i> in R1C2	Press RIGHT, type <i>1000</i> , press DOWN
Enter <i>Gross_P*10%</i> in R2C2	Type = <i>Gross_P*10%</i> , press DOWN
Enter <i>Gross_P-Bonus</i>	Type = <i>Gross_P-Bonus</i> , press RETURN
Format column 2 to \$	Press <i>F</i> , <i>C</i> , type <i>C2</i> Press TAB, TAB, \$, RETURN

---

At this point, your screen looks like:

Gross P	\$1000.00
Bonus	\$100.00
Net P	\$900.00

## Multiplan

This bonus is calculated on the gross profits. But, the contract calls for the bonus to be calculated on the net profit instead of the gross. You may try to change the worksheet:

Enter *Net\_P\*10%* in R2C2      Press UP, *V*  
Type *Net\_P\*10%*  
Press RETURN

Multiplan displays the error message:

Circular references unresolved

The error message indicates a more complicated calculation that requires a different approach. The bonus calculation depends on the net profit. The net profit, in turn, depends on the size of the bonus, which must be subtracted from gross profit to get net profit; a seemingly endless circle. To solve the problem on paper, we would set up an equation and use algebra to find the bonus from the gross profit. Once the equation is set up, the bonus can be calculated manually or using any calculator.

Instead of spending time setting up complex algebraic formulas, you can let Multiplan automatically solve this extended problem without algebra, as follows:

Press *O* (for Options)

Make sure "Yes" is selected in the "recalc" field

Press TAB twice to move to the "iteration" field

Press *Y* (for "Yes")

Press RETURN

The numbers on the screen change in rapid succession until they become \$90.91 for Bonus and \$909.09 for Net P. These are the solutions. If you change the gross profit to \$1100, Multiplan quickly recalculates the new bonus as \$100 and the net profit as \$1000. The "Circular references unresolved" error message does not reappear.

What happened? Multiplan used iteration to calculate the solution. To iterate means to repeat a calculation using the results of the previous calculation instead of an unknown quantity. Of course, previous results do not solve the problem exactly, but each iteration produces results that fit better. In the Spencer Ceramics example, the solution was produced as follows.

Just before the first iteration, we had the initial values:

Bonus        \$90.00

Net P        \$900.00

The calculations then progressed as follows:

90			
900	$900 \cdot .1 = 90$		
	$1000 - 90 = 910$	$910 \cdot .1 = 91$	
		$1000 - 91 = 909$	$909 \cdot .1 = 90.9$
			$1000 - 90.9 = 909.1$

... and so on.

When iteration causes values to become more precise, the process is called “convergence.” Not all models converge. Some models converge only partially. Convergence may also depend on the initial values as well as on the model. Unless you specify otherwise, however, Multiplan stops iterating when the maximum change in all cell values on the worksheet is less than 0.001. This limit assures that the results are precise at least to the penny or percent without jeopardizing the chances for normal termination.

If, for some reason, a model fails to converge within the limit, pressing the CANCEL key interrupts the recalculation at the end of the iteration that is in progress (see the description of the Options command below).

In the next section, you’ll find descriptions of the Multiplan command and functions for controlling iteration: the Options command and the ITERCNT and DELTA functions.

Following that, you'll find examples of some useful iterative worksheets; one for an Income Statement and Balance Sheet, one for calculating the Internal Rate of Return (IRR), and one for finding roots of equations using the binary search technique.

Finally, you'll find a summary of hints for creating iterative models.

For more information on the mathematical theories of iterative methods, consult any handbook on numerical analysis.

## **The Iteration Option and Supporting Functions**

Multiplan enters an iteration phase at the end of any normal worksheet recalculation if the following conditions exist:

1. The worksheet contains at least one circular chain of references.
2. The "iteration" field of the Options command is set "Yes."
3. The completion test (see below) is not TRUE at the end of the first recalculation.

The Options command and two functions (DELTA and ITERCNT) support the iteration option.

## Options

OPTIONS      recalc: Yes No      mute: Yes No  
                  iteration: Yes No      completion test at:

Select option

### Description

See the Options command in Chapter 9 for details of the “recalc” and “mute” fields.

Select “Yes” in the “iteration” field if you want to calculate values from formulas that form a circle of references. Select “No” in the “recalc” field while making new entries to the worksheet. This saves time when entering or changing values. Also, selecting “No” in the “recalc” field instead of in the “iteration” field prevents Multiplan from displaying the “Circular references unresolved” error message.

In the “completion test at” field, you enter an absolute or name reference to the cell that contains a completion test. A completion test is a formula in the cell that returns a logical value (TRUE or FALSE). Multiplan tests the value of the cell after each iteration. If the value is TRUE, Multiplan stops iteration. If the value is FALSE, Multiplan continues iteration. See the DELTA and ITCNT functions for more details about completion tests.

Storing the test formula in a cell lets you store and display a complex test as a part of the worksheet. If you leave the “completion test at” field blank, Multiplan applies the formula

$$\text{DELTA()} < 0.001$$

as the convergence test (see the DELTA function below for details).

Stepping through an iteration model one iteration at a time permits debugging and illustrating an iterative solution. To set this up, enter as a response in the “completion test at” field an absolute or name reference of a cell that contains the TRUE()

function. This means that Multiplan calculates the model only once. And, repeatedly pressing the RECALC key produces a step-by-step solution.

Pressing the CANCEL key stops iteration. Other keys are ignored during iteration. Multiplan checks for the CANCEL key at the beginning of each iteration. If you press the CANCEL key during an iteration, Multiplan completes that iteration, checks the completion test, and finally (if the completion test is not TRUE) stops iteration and displays the "Circular references unresolved" error message.

The responses in the Options command "iteration" and "completion test at" fields are saved with the worksheet in Normal mode (see the Transfer Options command in Chapter 9). When you load a worksheet that contains an iterating model, the fields of the Options command receive the responses saved with the worksheet. If you later start another sheet, you may want to reset "iteration" to "No" and delete the response in the "completion test at" field.

### Example

To cause Multiplan to recalculate the worksheet using iteration and to place a completion or convergence test in R20C5, which you have named "Done":

```
OPTIONS      recalc:(Yes)No      mute: Yes(No)
              iteration:(Yes)No  completion test at: Done
```

See "Creating Iteration Models" for actual models that include iteration.

## DELTA()

### Description

Returns the maximum absolute value of the changes in values from one iteration to the next. Returns #N/A if “No” is selected in the “iteration” field. Multiplan counts only the values in the cells that it evaluates between two successive DELTA functions. The DELTA function returns the #N/A error value when ITERCNT() $\leq$ 1 or when ISNA(ITERCNT()) returns TRUE (that is, during the first calculation of a circular model) because no previous values exist from which to calculate changes.

You can enter the DELTA function in a convergence test formula to calculate the results of an iteration to any desired precision. For example:

DELTA(<0.000001

returns TRUE when convergence results are less than 0.000001.

Each time Multiplan encounters a DELTA function, it resets the internal DELTA value to 0. By entering more than one DELTA function, you can isolate the maximum change in a particular part of the worksheet. To create a DELTA() that only applies to the differences of a part of the worksheet, bracket the cells with cells that contain the DELTA function. Each DELTA() resets the DELTA value to 0. To avoid problems with order of evaluation, enter the first DELTA function in the cell immediately above the block of cells for which you want a local DELTA value. Then, enter the test DELTA formula in the cell immediately below the block of cells to return a local DELTA value.



The following sketches illustrate these guidelines:

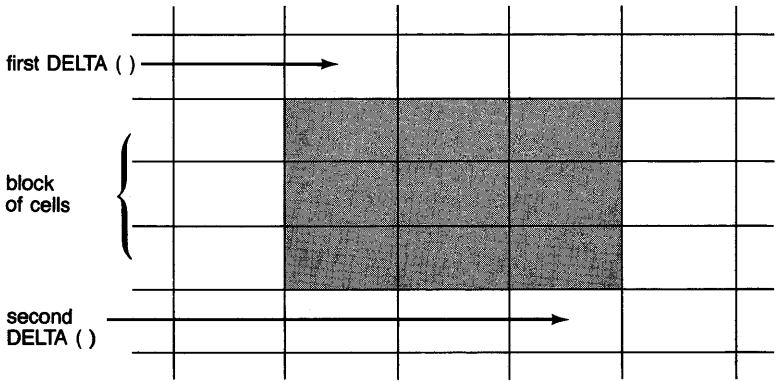

Multiplan recalculates the block of cells column by column. This model provides local values of DELTA only if these columns contain no other circular references. The next sketch illustrates a better model design:

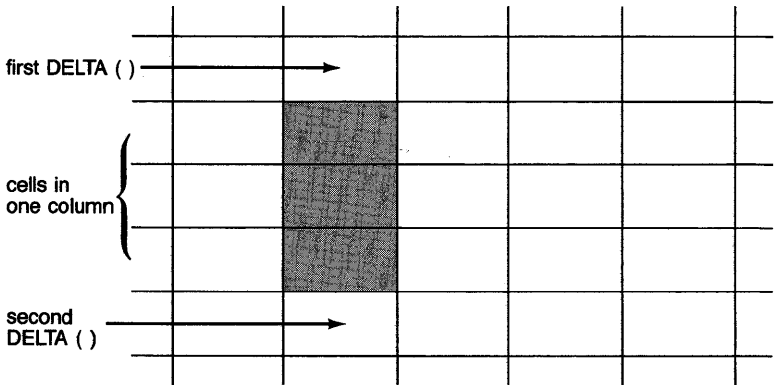

Note that subsequent evaluations of the second DELTA function normally include changes to the cell with the first DELTA function. The simple formula DELTA() is usually not sufficient to isolate local values of DELTA. Instead, enter a formula such as:

IF(TRUE(),"",DELTA())

which clears the maximum DELTA value while appearing blank on the screen and presenting no value for the following DELTA to evaluate.

Note that if you enter the DELTA function as a completion test and the ITERCNT function by itself in a model (see the ITERCNT function), you may create divergence. The DELTA function also reads the cell that contains the ITERCNT function. Because ITERCNT changes by 1 during each iteration, DELTA will always return at least 1 unless you set up the worksheet model to return local values of DELTA or you eliminate the ITERCNT formula. Note that the formula ITERCNT() $>$ 20 returns TRUE or FALSE after each iteration and therefore would not affect convergence.

### Example

Take the simple example of Spencer Ceramics given at the beginning of this appendix, but now calculate the results to the nearest dollar instead of to the nearest penny:

1. Enter  $DELTA() < 1$  in R4C2.

This gives a TRUE value when the difference between the previous and the current result is less than one dollar.

2. Select the Options command and enter R4C2 in the “completion test at” field.

## Multiplan

3. Now, enter 1000 in R1C2, the gross profit cell.

The results that Multiplan returns are not the same as before, but are now within one dollar of *the more accurate (to-the-penny) result*; that is, Bonus is now \$90.90 instead of \$90.91 (\$90.90 is the first result that had less than \$1 change from the previous result—\$91). (Refer to the series of calculations that iteration produced in the Spencer Ceramics example.)

See “Creating Iteration Models” for actual models that include the DELTA function.

## ITERCNT()

### Description

Returns the current iteration count, starting with 1 for the first iteration. During the first recalculation after each change to the worksheet, ITERCNT returns the #N/A error value.

The ITERCNT function is especially helpful for providing initial values for iterative models, for creating a table of iteration results, and for providing a completion test.

### *Initial Values*

Many worksheet models require an explicit initial value. Yet, during subsequent iterations, the model requires a formula. To arrange this, substitute a conditional formula (with the IF function) in place of the formula that requires an initial value.

For example, as in the Spencer Ceramics example, to start with an initial value of Initial\_Net\_Profit, then switch to the formula Gross\_Profit–Bonus, enter the formula:

```
IF(ISNA(ITERCNT()),Initial_Net_Profit,
Gross_Profit–Bonus)
```

IF selects Initial\_Net\_Profit when the condition is TRUE; that is, when ITERCNT() returns the #N/A error value (which it does during the first recalculation after each change to the worksheet), the ISNA() function returns TRUE. After that, ITERCNT returns a number, making ISNA return FALSE; then, IF selects the formula Gross\_Profit–Bonus.

### *Table of Iteration Results*

You can create a table of partial results from an iteration by copying the formula:

`IF(ITERCNT(=ROW()-9,Net_Profit,RC)`

into successive rows starting at row 10. Note that each row receives the value of Net\_Profit during a particular iteration and stays unchanged (RC) for all other iterations, before and after.

### *Completion Test*

Enter a formula that includes ITERCNT to limit the number of iterations. For example, enter the formula:

`ITERCNT(>20`

Enter the absolute or name reference to the cell that contains this formula in the “completion test at” field of the Options command. During subsequent recalculations, Multiplan completes 20 iterations then stops.

## Creating Iteration Models

Iteration is a powerful problem-solving tool. To illustrate using iteration, we provide three examples. Before you begin to study the examples, you should be aware of the order of evaluation Multiplan follows during iteration.

Unlike Multiplan worksheet models without iteration, models with iteration must take into account the order of evaluation of each cell. During iteration the current value of cells referred to in the formulas affects the iteration. Fortunately for the worksheet builder, the order of evaluation of cells participating in circular references is strictly defined when `ITERCNT()>=1`. Multiplan always calculates these cells one column at a time, top to bottom, starting with the first cell of the first column.

A general guideline that helps avoid problems is to place all the circular references in a single column. Care must also be taken that the ordering is correct for iterative methods such as Newton's method (see Example 2) and binary search (see Example 3). In some situations, the order of evaluation determines whether the solution converges or diverges. If the original order of evaluation does not converge, reconsider the order to get convergence.

**Example 1**  
**Financial Gap Model**

*Integrated Income Statement and Balance Sheet*

We based the discussion of this example on the following model. If you want to recreate the model, the formulas, text, and data appear following the discussion.

1	2	3	4	5	6
1 sales	\$100.00	\$300.00	\$800.00		
2 costs	\$50.00	\$420.00	\$620.00		
3 profit	\$50.00	(\$120.00)	\$180.00		
4 int income		\$3.89	\$23.21		
5 int expense		\$0.00	\$0.00		
6 net profit	\$50.00	(\$116.11)	\$203.21	delta	0.000415
7 beg ret earns	\$75.00	\$125.00	\$8.89	itercnt	13
8 end ret earns	\$125.00	\$8.89	\$212.10		
9 cash	\$10.00	\$10.00	\$10.00		
10 funds surplus	\$155.00	\$38.89	\$232.10	done	TRUE
11 total assets	\$165.00	\$48.89	\$242.10	max i	50
12				max d	0.001
13 liabilities	\$40.00	\$40.00	\$30.00		
14 funds deficit	\$0.00	\$0.00	\$0.00		
15 tot liab	\$40.00	\$40.00	\$30.00		
16 tot liab + re	\$165.00	\$48.89	\$242.10		
17 difference	\$0.00	\$0.00	\$0.00		
18 funds		\$38.89	\$232.10		

This model shows a common business application of iteration. Throughout, this model contains examples of one result depending on the result of another calculation in a circular pattern. That is the situation that iteration handles.

Entries and calculations on a balance sheet must satisfy the condition:

$$\begin{array}{r} \text{total} \\ \text{assets} \end{array} = \begin{array}{r} \text{total} \\ \text{liabilities} \end{array} + \begin{array}{r} \text{retained} \\ \text{earnings} \end{array}$$

To achieve this balance, you vary the funds surplus and the funds deficit. This is an iterative process because varying the funds alters the interest, which affects the profit, which changes the retained earnings. This circle of calculation throws the sheet back out of balance.

Funds surplus and funds deficit both refer to the value in the “funds” line (R18). Either funds surplus or funds deficit will always equal 0. If the value in the “funds” line (R18) is positive, you have funds surplus. If this value is negative, you have funds deficit.

Notice the formulas (in the next section) for funds surplus and funds deficit. For funds surplus, the formula  $\text{MAX}(0,\text{funds})$  returns the value of funds only if funds is positive; otherwise, it returns 0. For funds deficit, the formula  $-\text{MIN}(0,\text{funds})$  returns the absolute value of funds when funds is negative.

Notice also the formula  $\text{IF}(\text{TRUE}(),\text{“”},\text{DELTA}())$  in R8C6. This formula keeps the  $\text{ITERCNT}()$  function in R7C6 from interfering with the  $\text{DELTA}()$  function in R6C6.

The completion test is in R10C6. It checks both the  $\text{DELTA}$  value and the  $\text{ITERCNT}$  value. When one of the two returns  $\text{TRUE}$  (that is, either a maximum  $\text{DELTA}$  of 0.001 or an  $\text{ITERCNT}$  of 50), iteration stops.

Columns 3 and 4 show two new time periods. Column 3 shows a large increase in capital outlay and an increase in sales that is not large enough to offset it. Thus, the profit line (R3) shows a loss. In column 4, however, sales have grown enough to offset the capital outlay. The profit line (R3) shows a profit. This is a typical situation in which the effect of a capital outlay on sales is delayed. You can apply these same formulas to analyze how much increase in sales you need to offset a particular capital outlay.

This model can also help you analyze how much money you must borrow at any specific interest rate to receive as much usable funds as you need.

See the listing of the formulas in the next section.



## Multiplan

### *Formulas for Integrated Income and Balance Sheet Model*

To show the formulas without breaking them across several lines, the worksheet appears in two parts, in a manner similar to the Multiplan method of printing. Columns 1 and 2 appear first, then columns 3 and 4, then columns 5 and 6. Note that the row numbers are the same for each part; that is, enter the six columns side-by-side.

	1	2
1	"sales"	100
2	"costs"	$0.5 * R[-1]C$
3	"profit"	$R[-2]C - R[-1]C$
4	"int income"	
5	"int expense"	
6	"net profit"	$R[-3]C + R[-2]C - R[-1]C$
7	"beg ret earns"	75
8	"end ret earns"	$R[-2]C + R[-1]C$
9	"cash"	10
10	"funds surplus"	155
11	"total assets"	$R[-2]C + R[-1]C$
12		
13	"liabilities"	40
14	"funds deficit"	0
15	"tot liab"	$R[-2]C + R[-1]C$
16	"tot liab + re"	$R[-1]C + R[-8]C$
17	"difference"	$R[-6]C - R[-1]C$
18	"funds"	
19		

Solving Extended Problems with the Iteration Option

3	4
1 300	800
2 300+(0.4*R[-1]C)	300+(0.4*R[-1]C)
3 R[-2]C-R[-1]C	R[-2]C-R[-1]C
4 0.1*R[+6]C	0.1*R[+6]C
5 0.1*R[+9]C	0.1*R[+9]C
6 R[-3]C+R[-2]C-R[-1]C	R[-3]C+R[-2]C-R[-1]C
7 R[+1]C[-1]	R[+1]C[-1]
8 R[-2]C+R[-1]C	R[-2]C+R[-1]C
9 10	10
10 MAX(0,R[+8]C)	MAX(0,R[+8]C)
11 R[-2]C+R[-1]C	R[-2]C+R[-1]C
12	
13 40	30
14 -MIN(0,R[+4]C)	-MIN(0,R[+4]C)
15 R[-2]C+R[-1]C	R[-2]C+R[-1]C
16 R[-1]C+R[-8]C	R[-1]C+R[-8]C
17 R[-6]C-R[-1]C	R[-6]C-R[-1]C
18 IF(ISNA(ITERCNT()),0, RC-diff)	IF(ISNA(ITERCNT()),0, RC-diff)
19	

5	6
1	
2	
3	
4	
5	
6 "delta" DELTA()	
7 "itercnt" ITERCNT()	
8 IF(TRUE(),"",DELTA())	
9	
10 "done" OR(R[-4]C<R[+2]C,R[-3]C>R[+1]C)	
11 "max i" 50	
12 "max d" 0.001	
13	
14	
15	
16	
17	
18	
19	

**Example 2**  
**IRR Model**

*Internal Rate of Return Calculation*

In Multiplan, the Internal Rate of Return (IRR) of a group of cash flows is the Rate for which

$$\text{NPV}(\text{Rate}, \text{Cash\_Flow}) = 0$$

The name `Cash_Flow` refers to the part of the worksheet that contains the cash flows. There may be many solutions to the IRR equation. The one found by this method will typically be the one closest to the initial estimate.

The following set of formulas automatically searches for the correct Rate. You can include these formulas in any worksheet under the following conditions:

1. Enter each of these formulas in a single row.
2. When other parts of the model include iteration and the completion test refers to the IRR convergence, also include the method for returning local values of DELTA (see the DELTA function).

*Formulas for IRR Model*

	1	2	3	4
1				"Cash Flow"
2	"IRR"	IF(ISNA(ITERCNT()), R[+4]C, IF(ABS(RC)>R[+8]C, -(R[+4]C+ITERCNT()/100), IF(R[+2]C=0, RC+SIGN(R[+1]C*0.000001, RC-R[+1]C/R[+2]C)))		"-----"
3	"NPV"	NPV(IRR,Cash_Flow)		-1000
4	"NPV "	IF(IRR=0, (NPV(0.001, Cash_Flow) -R[-1]C)/0.0001, (NPV(IRR*1.01,Cash_Flow) -R[-1]C)/IRR*0.01))		300
5				400
6	"EST. IRR"	0.01		300
7				-200
8	"STATUS"	DELTA(<0.01		1000
9				-1000
10	"LIMIT"	500		2000
11				"-----"

For this model, the following names are defined:

$$\text{IRR} = \text{R2C2}$$

$$\text{Cash\_Flow} = \text{R3:10C4}$$

The labels represent:

- IRR is the Internal Rate of Return.
- NPV is the Net Present Value.
- NPV' is the first derivative of NPV (used for Newton's method).
- EST. IRR is the initial IRR entered by you. An IRR close to 0, such as 1%, usually gives the first positive IRR, which is the one you seek.
- STATUS indicates when the calculation is done.
- LIMIT is the largest positive IRR to try before trying negative roots.

These formulas yield the following results:

1	2	3	4
1			Cash Flow
2	IRR	27%	
3	NPV	0.0	-1000
4	NPV'	-2226.3	300
5			400
6	EST. IRR	1%	300
7			-200
8	STATUS	TRUE	1000
9			-1000
10	LIMIT	50000%	2000
11			

The following paragraphs explain briefly the mathematical basis of IRR calculation.

Solving the equation

$$NPV(IRR, Cash\_Flow) = 0$$

for IRR employs the numerical method known as Newton's method. (This method was first published by Sir Isaac Newton in *Principia* (1686) as a solution for a cubic polynomial.) Newton's method solves for an initial estimate that is close to a root of the equation then extrapolates along the tangent of this root to find its intersection with the x-axis as the next root to try. Iteration continues until either successive x values converge or the value of the function converges on 0.

The tangent of a given equation  $f(x)$  is the first derivative  $f'(x)$ . Therefore, Newton's method for successive approximations is:

$$x_{(n+1)} = x_n - (f(x_n) / f'(x_n))$$

Applying this equation to the solution of the IRR equation produces:

$$\text{IRR}_{(n+1)} = \text{IRR}_n - \frac{(\text{NPV}(\text{IRR}_n, \text{Cash\_Flow}) / \text{NPV}'(\text{IRR}_n, \text{Cash\_Flow}))}{\text{IRR}_n}$$

Now,  $f'(x)$  becomes:

$$f'(x) = \lim_{\text{delta}(x) \rightarrow 0} \frac{(f(x + \text{delta}(x)) - f(x)) / \text{delta}(x)}{\text{delta}(x)}$$

In our case, with a  $\text{delta}(x)$  of 0.01 of  $x$ , the equation becomes:

$$\text{NPV}'(\text{IRR}_n, \text{Cash\_Flow}) = \frac{(\text{NPV}(\text{IRR}_n + (\text{IRR}_n * 0.01), \text{Cash\_Flow}) - \text{NPV}(\text{IRR}_n)) / (\text{IRR}_n * 0.01)}{\text{IRR}_n}$$

This general method solves many equations that have more than one root, although you must realize that this method may converge to a root different from the expected root or may even diverge if the starting value is not close enough to the root. In the case of IRR, the first root found that is greater than zero is normally the correct answer.

**Example 3**  
**Binary Search Model**

*Binary Search to Find Roots of Equations*

The IRR formulas in the last section readily adapt to finding the roots of arbitrary equations using the binary search technique.

Assume that you have a polynomial

$$x^3 + 4x^2 + 5$$

Further suppose that you want to solve for a value of x that yields a result of 30. The following model solves for one root of the polynomial using the binary search technique.

	1	2	3
1	"f(x)"	"c_low"	"c_high"
2	$x^3 + 4x^2 + 5$	IF(ISNA (ITERCNT()), low,IF(fx>res, RC,x))	IF(ISNA (ITERCNT()), high,IF(fx<res, RC,x))
3			
4			
5	"result"		
6	30		
	4	5	6
1	"x"	"low"	"high"
2	(c_low+c_high)/2	0	100

For this model, the following names are defined:

- c\_low = R2C2 (current low value)
- c\_high = R2C3 (current high value)
- x = R2C4
- low = R2C5 (low value entered by you)
- high = R2C6 (high value entered by you)
- fx = R2C1
- res = R6C1 (your desired result; you enter)

The calculation proceeds as follows:

1. In cell R2C2, Multiplan evaluates the IF function. During the first iteration, the ITERCNT function returns the #N/A error value, making the ISNA function return TRUE. Thus, IF selects the value of “low,” which in this model is 0.
2. For all other iterations, ITERCNT returns an integer, making ISNA return FALSE. Thus, IF selects the “Else” value, which is another conditional formula.
3. The second IF formula in R2C2 compares the result of using the value of “x,” (calculated in R2C4) in the polynomial  $f(x)$  in R2C1 with the desired result, 30, in R6C1. If the value of  $f(x)$  is more than 30, IF selects the current value of the cell (for the second iteration, 0). If the value of  $f(x)$  is less than 30, IF selects the value of “x” calculated in R2C4.
4. The same steps apply to the conditional formula in R2C3, except this formula selects the “high” value during the first iteration. During subsequent iterations, IF selects the current value of the cell if  $f(x)$  is less than 30 or the value of “x” in R2C4 if  $f(x)$  is more than 30.

Once Multiplan begins iteration, the calculations proceed rapidly, and it is difficult to see the numbers clearly before they change.



# Multiplan

The following list of values for each cell describes, in part, what happens as Multiplan iterates toward a result:

	1	2	3
1			
2		0	100
3		0	50
4		0	25
5		0	12.5
6		0	6.25
7		0	3.125
8		1.5625	3.125
...			
16	29.999762	2.0352602	2.035284
	4	5	6
50	0		100
25	0		100
12.5	0		100
6.25	0		100
3.125	0		100
1.5625	0		100
2.34375	0		100
2.0352721	0		100

At this point, iteration stops because the maximum change in any value is less than 0.001, the internal DELTA value of Multiplan. The root Multiplan calculated is 2.0352721. (The changing values for  $f(x)$  in column one are left to you to find.)

For more precision, enter a DELTA formula in a cell that sets a limit smaller than 0.001. Or, enter an ITERCNT formula that sets a limit higher than 16. Then, enter either an absolute reference to that cell or the name of the cell in the “completion test at” field of the Options command.

## Summary of Hints for Creating Iteration Models

### 1. Order of Evaluation

Unlike Multiplan worksheet models without iteration, models with iteration must take into account the order of evaluation of each cell. During iteration the current value of cells referred to in the formulas affects the iteration. Fortunately for the worksheet builder, the order of evaluation of circular references is strictly defined when  $\text{ITERCNT}() \geq 1$ . Multiplan always calculates the circular references one column at a time, top to bottom, starting with the first cell of the first column.

A general guideline that helps avoid problems is to place all the circular references in a single column. Care must also be taken that the ordering is correct for iterative methods such as Newton's method (see Example 2) and binary search (see Example 3).

For solving simultaneous equations, order is less critical because Multiplan assumes that each iteration converges on the solution. However, in some situations the order of evaluation determines whether the solution converges or diverges. If the original order produces divergence, rearranging the order may bring about convergence.

## 2. Providing for Initial Values

As discussed in the section on the ITERCNT function, you may enter a conditional formula to provide an initial value for formulas on the worksheet. For example, because ITERCNT() returns #N/A the first time it is called, a simple IF statement such as:

```
IF(ISNA(ITERCNT()),initial_value,formula)
```

provides initial\_value for the first calculation, then the formula in subsequent iterations.

## 3. Obtaining Local Values of DELTA

To obtain a DELTA() that applies only to the differences of a part of the worksheet, bracket the cells with cells that contain the DELTA function. Each DELTA() resets the DELTA value to 0. To avoid problems with order of evaluation, enter the first DELTA function in the cell immediately above the block of cells for which you want a local DELTA value. Enter a formula such as:

```
IF(TRUE(),"",DELTA())
```

which clears the maximum DELTA value while appearing blank on the screen. Then, enter the test DELTA formula in the cell immediately below the block of cells to return a local DELTA value. See the section on the DELTA function for further details.

## 4. ITERCNT() and DELTA() Interaction

If you enter both the DELTA function with a specific limit and the ITERCNT function as a formula by itself in a model, you may create divergence. The DELTA function also reads the cell that contains the ITERCNT function. Because ITERCNT changes by 1 during each iteration, DELTA will always return at least 1 unless you set up the worksheet model to return local values of DELTA or you eliminate the ITERCNT formula. Note that the formula ITERCNT(>20) returns TRUE or FALSE after each iteration and therefore would not affect convergence.

## 5. Single Stepping Iteration Models

Stepping through an iteration model one iteration at a time permits debugging and illustrating an iterative solution. To set this up, enter as a response in the “completion test at” field an absolute or name reference of a cell that contains the TRUE() function. This means that Multiplan calculates the model only once. And, repeatedly pressing the RECALC key produces a step-by-step solution.

## 6. General Information

Turn off iteration and/or automatic recalculation when building models to save time.

The responses in the Options command “iteration” and “completion test at” fields are saved with the worksheet in Normal mode (see the Transfer Options command in Chapter 9). Thus, when you load a worksheet that contains an iterating model, the fields of the Options command receive the responses saved with the worksheet. If you later start another sheet, you may want to reset “iteration” to “No” and delete the response in the “completion test at” field.

Pressing the CANCEL key stops iteration. Only the CANCEL key has an affect during iteration because all other keys would be entries and are therefore ignored. This also means that any characters you type during iteration are not saved, so the type-ahead feature does not work.

Multiplan checks for the CANCEL key at the beginning of each iteration. Thus, if you press the CANCEL key during an iteration, then Multiplan completes that iteration, checks the completion or convergence test, and finally (if the completion or convergence test is not TRUE) stops iteration and displays the “Circular references unresolved” error message. (If the completion or convergence test is TRUE, Multiplan ends iteration as if you had not pressed the CANCEL key.)



# Index

---

- ABS, 312
- Absolute references, 116, 206
- Active cell, 194
- Addition (+) operator, 72, 203
- Aligning cell contents, 60
- Alignment, 44
- Alpha, 30, 230
- AND, 313
- ATAN, 314
- AVERAGE, 315
  
- BACKSPACE key, 19, 32, 76, 201
- Blank, 65, 232
- Building a formula, 67
  
- Calculating functions, 110
- CANCEL key, 17
- Canceling a command, 20
- Carrying out a command, 20
- Cell contents, 60, 76
- Cell pointer, 6, 8
- Cell references, 205
- Cells, 7, 60, 99, 148
- Center alignment, *see* Alignment
- Changing a formula, 76
- CHARACTER LEFT key, 76, 200
- CHARACTER RIGHT key, 76, 200
- Colon (:) (range operator), 62
- COLUMN, 316
- Column width, 37, 113
- Comma (,) (union operator), 121
- Command
  - field, 198
  - line, 194
  - selection, 17, 196
- Commands, 14, 196, 229
  - Alpha, 30, 230
  - Blank, 65, 232
  - Copy, 91, 233
  - Copy Down, 234
  - Commands (*continued*)
    - Copy From, 121, 235
    - Copy Right, 91, 142, 238
    - Delete, 239
    - Delete Column, 240
    - Delete Row, 241
    - Edit, 76, 242
    - eXternal, 172, 302
    - eXternal Copy, 172, 303
    - eXternal List, 185, 306
    - eXternal Use, 307
    - Format, 43, 243
    - Format Cells, 89, 245
    - Format Default, 249
    - Format Default Cells, 43, 250
    - Format Default Width, 250
    - Format Options, 40, 252
    - Format Width, 38, 113, 253
    - Goto, 14, 255
    - Goto Name, 107, 256
    - Goto Row-col, 14, 257
    - Goto Window, 258
    - Help, 20, 259
    - Insert, 55, 261
    - Insert Column, 262
    - Insert Row, 263
    - Lock, 145, 264
    - Lock Cells, 148, 265
    - Lock Formulas, 145, 266
    - Move, 267
    - Move Column, 269
    - Move Row, 270
    - Name, 176, 271
    - Options, 148, 273
    - Print, 155, 274
    - Print File, 157, 275
    - Print Margins, 158, 276
    - Print Options, 158, 277
    - Print Printer, 156, 278
    - Quit, 23, 49, 279
    - Sort, 280
    - Transfer, 282

## Index

### Commands (*continued*)

- Transfer Clear, 164, 283
- Transfer Delete, 284
- Transfer Load, 53, 85, 285
- Transfer Options, 287
- Transfer Rename, 288
- Transfer Save, 47, 80, 289
- Value, 34, 291
- Window, 128, 293
- Window Border, 136, 294
- Window Close, 295
- Window Link, 134, 296
- Window Split, 128, 131, 298
- Window Split Horizontal, 132, 299
- Window Split Titles, 128, 300
- Window Split Vertical, 132, 301

Concatenation operator (&), 204

Copy, 91, 233

Copy Down, 234

Copy From, 121, 235

Copy Right, 91, 142, 238

Correcting typing errors, 32

COS, 317

COUNT, 318

Delete, 239

DELETE key, 76, 201

Delete Column, 240

Delete Row, 241

Dependent sheets, 163

Direction keys, 7, 33

Division operator (/), 203

#DIV/O! error value, 216

DOLLAR, 319

Drawing lines, 78

Edit, 76, 242

Edit cursor, 371

Editing, 200

END key, 148

Entering data, 33

- numbers, 40, 59
- text, 30, 57

Equal (=), 34, 71

Error values, 114, 215

EXP, 320

Exponentiation (^), 203

eXternal, 172, 302

eXternal Copy, 172, 303

eXternal List, 185, 306

External relationships, 220

eXternal Use, 307

FALSE, 321

False, 321

File access, problems of, 217, 219

File handling, 53

File mode, 287

- Normal mode, 287
- Other mode, 287
- Symbolic mode, 287

Filenames, 48, 217

FIXED, 322

Format, 43, 243

Format Cells, 89, 245

Format Default, 249

Format Default Cells, 43, 250

Format Default Width, 250

Format Options, 40, 252

Format Width, 38, 113, 253

Formats, 45, 89

Formulas, 67, 98, 103

- changing, 76
- copying, 121, 142
- reviewing, 76
- using names, 103

Functions, 311

ABS, 312

AND, 313

ATAN, 314

AVERAGE, 315

COLUMN, 316

COS, 317

COUNT, 318

DOLLAR, 319

EXP, 319

FALSE, 321

FIXED, 322

IF, 323

INDEX, 324

INT, 325

ISERROR, 326

Functions (*continued*)

ISNA, 327  
 LEN, 328  
 LN, 329  
 LOG10, 330  
 LOOKUP, 331  
 MAX, 333  
 MID, 334  
 MIN, 335  
 MOD, 336  
 NA, 337  
 NOT, 338  
 NPV, 339  
 OR, 340  
 PI, 341  
 REPT, 342  
 ROUND, 343  
 ROW, 344  
 SIGN, 345  
 SIN, 346  
 SQRT, 347  
 STDEV, 348  
 SUM, 110, 349  
 TAN, 350  
 TRUE, 351  
 VALUE, 352

Goto, 14, 255  
 Goto Name, 107, 256  
 Goto Row-col, 14, 257  
 Goto Window, 258  
 Greater than (>), 215  
 Greater than or equal (>=), 215

Help, 20, 259  
 HOME key, 13

IF, 323  
 Increasing formula, 76  
 INDEX, 324  
 Insert, 55, 261  
 Insert Column, 262  
 Insert Row, 263  
 INT, 325

Intersection operator, 210

ISERROR, 326  
 ISNA, 327

LEN, 328  
 Less than (<), 215  
 Less than or equal (<=), 215  
 Lines, drawing, 78  
 LN, 329  
 Lock, 145, 264  
 Lock Cells, 148, 265  
 Lock Formulas, 145, 266  
 LOG10, 330  
 Logical values, 215  
 LOOKUP, 331

MAX, 333  
 Message line, 194  
 MID, 334  
 MIN, 335  
 MOD, 336  
 Mode of file, 287  
     Normal mode, 287  
     Other mode, 287  
     Symbolic mode, 287  
 Move, 267  
 Move Column, 269  
 Move Row, 270  
 Multiplication operator (\*), 140, 203

NA, 337  
 #N/A error value, 216  
 Name, 176, 271  
 #NAME? error value, 216  
 Names  
     as cell references, 209  
     building formulas using, 103  
     defining, 168, 271  
     of cells, 99, 100  
     of files, 48, 217  
     of worksheets, 170  
 NEXT UNLOCKED CELL key, 146  
 NEXT WINDOW key, 137



## Index

- Normal mode, 287
- NOT, 338
- Not equal (<>), 215
- NPV, 339
- #NULL! error value, 216
- #NUM! error value, 216
- Numbers, entering, 40, 59, 203
- Number signs (#), 113
  
- Operators, 203
  - Addition (+), 72, 203
  - Concatenation (&), 204
  - Division (/), 203
  - Equal (=), 34, 71
  - Exponentiation (^), 203
  - Greater than (>), 215
  - Greater than or equal (>=), 215
  - Intersection (space), 210
  - Less than (<), 215
  - Less than or equal (<=), 215
  - Multiplication (\*), 140, 203
  - Not equal (<>), 215
  - Percent (%), 203
  - Range (:), 62, 211
  - Subtraction (-), 203
  - Union (comma), 212
- Options, 148, 273
- OR, 340
- Other mode, 287
  
- Percent operator (%), 203
- PI, 341
- Print, 155, 274
- Print File, 157, 275
- Print Margins, 158, 276
- Print Options, 158, 277
- Print Printer, 156, 278
- Problems with file access, 217, 219
- Proposed responses, 17, 199, 229
  
- Quit, 23, 49, 279
  
- Range operator (:), 62, 211
- RECALC key, 151, 201
- #REF error value, 216
- References, 206
- REFERENCE key, 201
- References to cells, 205
- Relative references, 116, 206
- REPT, 342
- RETURN key, 20
- Reviewing a formula, 76
- ROUND, 343
- ROW, 344
  
- Saving space, 365
  - time, 365
  - work, 47
- Screen, 5
- Scrolling the worksheet, 11
- SIGN, 345
- SIN, 346
- Sort, 280
- SPACE bar, 18
- Space (intersection operator), 210
- SQRT, 347
- Status line, 9, 76, 194
- STDEV, 348
- Subtraction operator (-), 203
- SUM, 110, 349
- Supporting sheets, 163, 165, 179
- Symbolic mode, 287
  
- TAB key, 19
- TAN, 350
- Text, entering, 30, 57, 204
- Titles, 86, 100, 128
- Transfer, 282
- Transfer Clear, 164, 283
- Transfer Delete, 284
- Transfer Load, 53, 85, 285
- Transfer Options, 287
- Transfer Rename, 288
- Transfer Save, 47, 80, 289
- Transforming the worksheet, 223
- TRUE, 351
- True, 321
- Typing errors, 32

Union operator (,), 212

Unlocking cells, 148

VALUE, 78, 352

Value, 34, 205, 291

#VALUE! error value, 216

Width, column, 37

Window, 128, 131, 293

Window Border, 136, 294

Window Close, 295

Window Link, 134, 296

Window Split, 128, 131, 298

Window Split Horizontal, 132, 299

Window Split Titles, 128, 300

Window Split Vertical, 132, 301

WORD LEFT key, 200

WORD RIGHT key, 200

Worksheet

naming, 170

number grid, 28, 193

protecting, 145

Worksheet (*continued*)

relating, 163, 165, 182

transforming, 223

<= (less than or equal), 215

<> (not equal), 215

> (greater than), 215

>= (greater than or equal), 215

= (equal), 34

< (less than), 215

, (union operator), 121

: (range operator), 62, 211

& (concatenation operator), 204

− (subtraction operator), 34

+ (addition operator), 34

% (percent operator), 203

/ (division operator), 203

\* (multiplication operator), 140, 203

^ (exponentiation operator), 203

( (left parenthesis), 34

“ (quotation mark), 34

. (period), 34



