

LH1605 Switching Regulator

National Semiconductor
Application Note 343
September 1983



LH1605 Switching Regulator

INTRODUCTION

The LH1605 is the first in a family of high-efficiency switching regulators designed to simplify power conversion while minimizing power losses. It can deliver 5 amps continuous output current and operate over a wide range of input and output voltages. In classic step-down voltage regulator applications it requires only 4 external parts: a resistor, 2 capacitors and an inductor. The device is housed in a standard 8-pin TO-3 power package containing a temperature compensated voltage reference, an error amplifier, a pulse-width modulator with programmable operating frequency and a high current output switch and steering diode. Typical performance of the LH1605 is summarized in Table I.

This discussion details LH1605 operating theory and analyzes device power considerations. It also explains DC/DC conversion using the LH1605 and presents design criteria and examples. A section suggesting other typical LH1605 applications is included, as in an appendix listing suppliers of capacitors, magnetic components and heat sinks suitable for use with the LH1605.

TABLE I. LH1605 Typical Performance Characteristics

	Parameter	Value
I_O	Continuous Output Current	5A
V_{IN}	Input Voltage	10V–35V
V_O	Output Voltage	3V–30V
V_S	Switch Saturation Voltage, $I_{OUT} = 4A$	1.4V
ΔV_R	Line Regulation of Reference Voltage	20 mV
η	Efficiency	70%
θ_{JC}	Thermal Resistance	5°C/W

THEORY OF OPERATION

Unlike linear regulators, which rely on a linear series element to control the flow of power to a load, switching regulators utilize a series switch which is either open or closed (Figure 1). Average output voltage is proportional to the ratio of switch closed time to switch open time, expressed as the switch duty cycle.

$$D = \frac{t_{ON}}{t_{ON} + t_{OFF}} \quad (1)$$

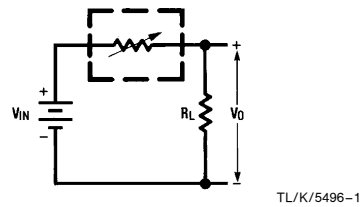

FIGURE 1a. Linear Regulator

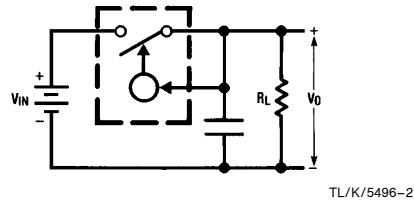

FIGURE 1b. Switching Regulator

A switching regulator achieves a constant average output by varying the switch duty cycle according to output feedback.

In the LH1605 (Figure 2), a pulse-width modulator operating at a frequency determined by an external capacitor, C_T , varies the duty cycle of a Darlington transistor switch according to the feedback voltage applied to pin 3.

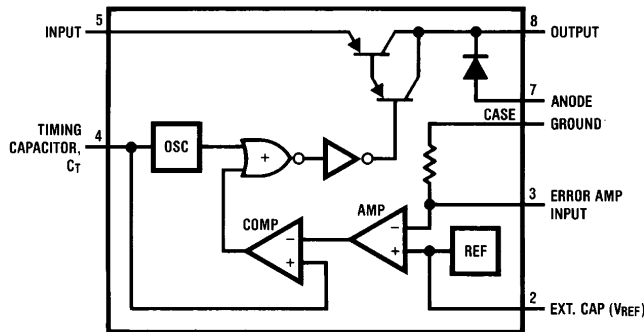

FIGURE 2. Block Diagram of the LH1605

TL/K/5496-3

AN-343

To achieve precise regulation, the difference between the feedback voltage and the internal reference is amplified, creating an error voltage which varies inversely with the feedback signal. This error voltage is compared to a periodic ramp voltage created across C_T by a constant current source within the oscillator. Comparator output is low until the ramp voltage exceeds the error voltage. *Figure 3* illustrates how fluctuations in error voltage alter the duty cycle of the comparator's output.

The comparator output is logically combined with a blanking pulse created by the oscillator while discharging C_T . This produces a constant frequency switch drive signal whose leading edge coincides with the falling edge of the blanking pulse. Note that, because the oscillator blanking pulse is shorter than the combined delay time of the drive signal buffer and the switch transistors, the LH1605 can run at 100% duty cycle for sufficiently low feedback voltage on pin 3.

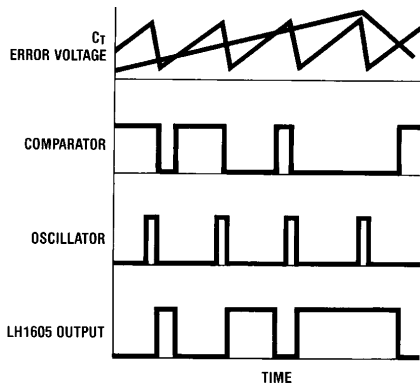

FIGURE 3. LH1605 Timing Diagram

TL/K/5496-4

EFFICIENCY CALCULATIONS

Because high-efficiency is the principle advantage of switched-mode power conversion, switching regulator losses are an important design concern. Losses and efficiency of the LH1605 can be calculated with the following equations. (Note: pin 7 is grounded; I_O = average current output at pin 8.)

Switching Period (T) =

$$\frac{1}{f_O} = t_{ON} + t_{OFF} \quad (2)$$

Duty Cycle (D) =

$$\frac{t_{ON}}{t_{ON} + t_{OFF}} = \frac{V_O + V_F}{V_{IN} - V_S + V_F} \quad (3)$$

Transistor DC Losses (P_T) =

$$V_S \times I_O \times D \quad (4)$$

Transistor Switching Losses (P_S) =

$$(V_{IN} + V_F) \times I_O \times \frac{(t_r + t_f + 2t_s) f_O}{2} \quad (5)$$

Diode DC Losses (P_D) =

$$V_F \times I_O \times (1 - D) \quad (6)$$

Drive Circuit Losses (D_L) =

$$\frac{V_{IN}^2}{300} \times D \quad (7)$$

Power Output (P_O) =

$$\frac{(V_{IN} - V_S) t_{ON} - (V_F) t_{OFF}}{t_{ON} + t_{OFF}} \times I_O \quad (8)$$

Efficiency (η) =

$$\frac{P_O}{P_{IN}} = \frac{P_O}{P_O + P_T + P_S + P_D + D_L} \quad (9)$$

As with all switching regulators, the LH1605 requires some external filter to achieve a non-pulsating output. The overall circuit efficiency, therefore, must include power losses in the filter section (discussed later) as well as losses in the LH1605.

From equation 5, it follows that LH1605 efficiency is improved as the operating frequency is reduced. Efficiency can also be improved by adding an external Schottky diode with the LH1605's as shown in *Figure 4*. Schottky diodes exhibit almost no storage time and have a very low forward voltage drop. When using an external Schottky diode, the steering diode at pin 7 should be left open to insure that it contributes no storage delay losses.

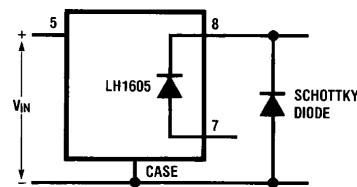

TL/K/5496-5

FIGURE 4. LH1605 with External Schottky Diode

HEAT SINKING CONSIDERATIONS

Even at moderate output power, there is significant self-heating of the LH1605 due to internal power dissipation. To prevent thermal damage, the junction temperature, T_j , must remain below 150°C under all operating conditions. Some useful expressions for steady state thermal design are given below:

$$P_{DISS} = \frac{P_O - \eta P_O}{\eta} < \frac{T_{J(MAX)} - T_{A(MAX)}}{\theta_{JC} + \theta_{CS} + \theta_{SA}} \quad (10)$$

$$\theta_{CS} + \theta_{SA} < \frac{T_{J(MAX)} - T_{A(MAX)}}{P_{DISS}} - \theta_{JC} \quad (11)$$

Where:

$T_{J(MAX)}$ = maximum allowable junction temperature, 150°C.

$T_{A(MAX)}$ = Maximum ambient operating temperature in °C.

θ_{JC} = device junction-to-case thermal resistance, typically 5°C/W.

θ_{CS} = case-to-heat sink thermal resistance in °C/W.

θ_{SA} = heat sink-to-ambient thermal resistance in °C/W.

The case-to-heat sink thermal resistance depends on the interface materials used. The following list gives the expected values for various materials.

0.002" thick insulating mica	
without thermal grease	1.20°C/W
with thermal grease	0.35°C/W

0.003" thick insulating mica
 without thermal grease 1.30°C/W
 with thermal grease 0.38°C/W

Bare joint
 without thermal grease 0.50°C/W
 with thermal grease 0.15°C/W

Most heat sink manufacturers provide the heat sink-to-ambient thermal resistance under convection as well as forced-air cooling. Appendix A gives a partial list of hardware and manufacturers.

DC/DC CONVERSION

The LH1605 operates only in Buck-type DC/DC converters. A Buck converter produces a positive DC output voltage which is less than its input voltage. It consists of a switching regulator, a steering diode, an inductor and a capacitor (Figure 5). During the switch ON time, inductor current, i_L , builds, flowing to both the capacitor and the load. During t_{OFF} , the magnetic energy stored in the inductor draws current through the diode. The capacitor serves to filter the output voltage by sourcing current while i_L is low and sinking current when i_L is high.

Figure 6 illustrates the current waveforms of the paths labeled in Figure 5.

As the load increases, more current must be supplied to maintain a given output voltage. The switching regulator senses the drop in V_O and increases switch duty cycle to raise the average i_L . Likewise, a reduction in loading causes a reduction in switch duty cycle.

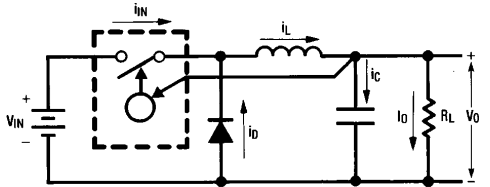

TL/K/5496-6

FIGURE 5. Buck-Type Step-Down Voltage Converter

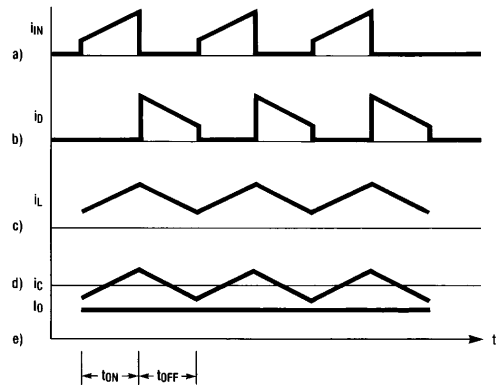

TL/K/5496-7

FIGURE 6. Buck Converter Current Waveforms

INDUCTOR DESIGN

The primary function of the inductor in a switching converter is to reduce the ripple current flowing to the output node. Inductor current, Figure 6c, consists of a DC value equal to the average converter output current, I_O , and a ripple current whose peak-to-peak value is:

$$\Delta I_L = \frac{(V_{IN} - V_O)}{L} \times t_{ON} \quad (12)$$

If ΔI_L is greater than $2I_O$, i_L will become zero for a portion of each switching cycle (Figure 7), which may result in an unstable output voltage.

To maintain $i_L > 0$, L must be made large enough so that:

$$I_{O(MIN)} > \frac{[V_{IN(MAX)} - V_O]}{2L} \times t_{ON} \quad (13)$$

Equation 14 conveniently expresses the minimum required inductance as a function of $I_{O(MIN)}$ and the operating frequency, f_O .

$$L > [V_{IN(MAX)} - V_O] \left(\frac{V_O}{V_{IN(MAX)}} \right) \times \frac{1}{2f_O} \times \frac{1}{I_{O(MIN)}} \quad (14)$$

The graph in Figure 8 plots L vs $I_{O(MIN)}$ for some common converter parameters.

The next consideration for inductor design is the choice of an appropriate magnetic core. The core must provide the desired inductance without saturating under maximum output conditions. Magnetic core saturation leads to excessive inductor current which jeopardizes output stability and may damage both the switching regulator and the load circuitry it supplies.



TL/K/5496-8

FIGURE 7. Inductor Current with $\Delta I_L > 2I_O$

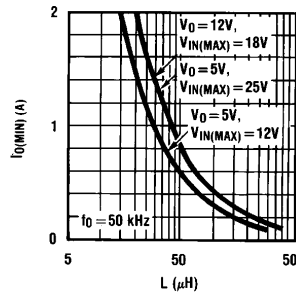

TL/K/5496-9

FIGURE 8. Inductance vs Minimum Output Current

Switching converter inductor cores are normally made of ferrite or molypermalloy powder to minimize core loss at high switching frequencies. The core should provide a closed flux path to minimize radiated noise due to flux leakage. Toroidal and fully enclosed pot cores are popular for this reason.

To further reduce flux leakage, the core winding should be a single layer covering a maximum amount of the winding surface. The number of winding turns necessary for an inductance, L , is:

$$N = 1000 \times \sqrt{\frac{L}{L_{1000}}} \quad (15)$$

Core manufacturers specify the nominal inductance, L_{1000} mH per 1000 turns, for a given core as well as the maximum magnetic energy, LI^2 , that a core can sustain without saturation. LI^2 is calculated using L as determined by equation 14 and I equal to the maximum anticipated output current plus $I_{O(MIN)}$.

When using a core with optimum magnetic performance at the desired switching frequency, the I^2R loss in the winding will dominate inductor power losses. This loss,

$$P_L = I_O^2 \times R_L \text{ (DC winding resistance)} \quad (16)$$

can be reduced by using large diameter copper wire for the core winding.

Many magnetic core manufacturers offer further information on inductor design. Some companies now specialize in supplying pre-wound inductors to meet specific switching converter needs. A partial list of core manufacturers and inductor suppliers is included in Appendix A.

CHOOSING AN OUTPUT CAPACITOR

The output filter capacitor reduces the peak-to-peak output ripple voltage, e_O , by integrating the inductor ripple current at the output node. To do this, the capacitor may have to source and sink currents as high as 2A. At these current levels, the drop across the capacitor's effective series resistance, ESR, could dominate e_O . Figure 9 shows an example where no amount of capacitance could achieve less than 50 mV output ripple.

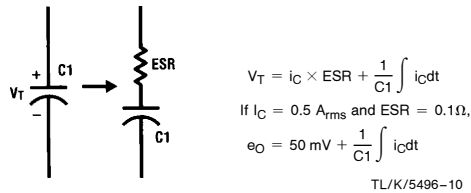

FIGURE 9. Effect of ESR on e_O

Because the ESR of a large capacitor is generally less than that of a small capacitor of similar construction, the easiest way to reduce ESR is to use a large capacitor. ESR can also be reduced by using 2 or more capacitors in parallel. Capacitor leads and the PC board traces connecting them contrib-

ute to the ESR and should be made as short as possible. To reduce output voltage spikes due to switching transients, a 0.1 μ F ceramic capacitor should be used in parallel with an electrolytic capacitor. A partial list of manufacturers of low ESR capacitors is included in Appendix A.

Equation 17 is a convenient expression for determining the minimum required capacitance as a function of e_O , f_O , ESR, and the inductor ripple current.

$$C > \frac{I_{O(MIN)}}{4f_O} \times \frac{1}{e_O - (I_{O(MIN)} \times ESR)} \quad (17)$$

Figure 10 plots C vs e_O for some common converter parameters.

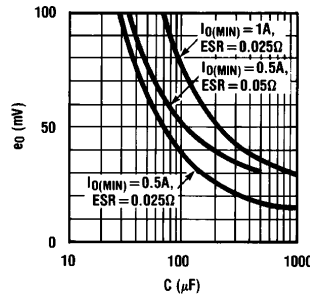

FIGURE 10. Capacitance vs Output Ripple Voltage

Power loss in a filter capacitor is almost entirely due to ESR. This loss is given by:

$$P_C = \left(\frac{I_{O(MIN)}}{2}\right)^2 \times ESR \quad (18)$$

FEEDBACK

The LH1605 regulates output voltage using a single feedback resistor. The resistor, R_f , forms a voltage divider with a 2 k Ω internal resistor from pin 3 of the LH1605 to ground (Figure 11). A steady state output voltage is reached when the voltage on pin 3 is approximately equal to the reference voltage on pin 2, about 2.5V.

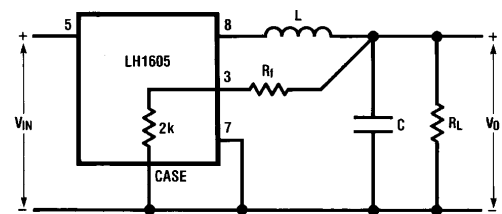
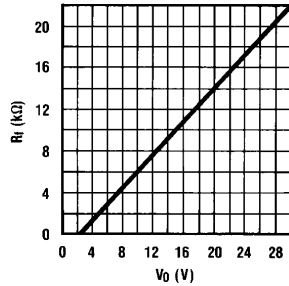

FIGURE 11. Output Voltage Feedback with LH1605

The output voltage can be programmed by selecting a feedback resistor as follows:

$$R_f = 2 \text{ k}\Omega \frac{V_{OUT} - 2.5V}{2.5V} \quad (19)$$

Figure 12 shows the linear relationship between R_f and V_O .



TL/K/5496-13

FIGURE 12. Feedback Resistance vs Output Voltage

CURRENT LIMITING

LH1605 current limiting is best done by pulling down the reference voltage at pin 2. This reduces the output pulsewidth on a cycle-to-cycle basis. Clamping the reference to ground inhibits the output switch and can be done with any general purpose transistor.

A 10 μF capacitor from pin 2 to ground will allow the LH1605 to recover with a soft start from an over-current condition. Figure 13 illustrates a typical current limit circuit for the LH1605 requiring only two transistors and three resistors.

Although this circuit is effective, it has several shortcomings. The $-2.2 \text{ mV}/^\circ\text{C}$ TC of Q1 can cause a 34% drift in the current limit set point over the -25°C to $+85^\circ\text{C}$ temperature range, and the relatively large R_S can decrease overall converter efficiency by as much as 10%. Furthermore, a short circuit condition draws significant power from the input supply. Superior performance can be obtained from a foldback current limit with only a slightly higher parts count.

FOLDBACK CURRENT LIMITING

A foldback current limit reduces the current limit threshold as the converter's load increases from an initial overcurrent condition to a complete short circuit. Because short circuit current, I_{SC} , is much less than the initial current limit set point, I_{CL} , a prolonged short circuit draws very little power from the input supply.

In the circuit of Figure 14, initial current limit is reached when the output of Q2 reaches 0.6V, $V_{BE(ON)}$ of Q1.

This corresponds to $V_{CL} = \frac{0.6V}{A_V}$ where

$$A_V = \frac{R_2}{R_1}, R_1 = R_3, R_2 = R_4. \quad (20)$$

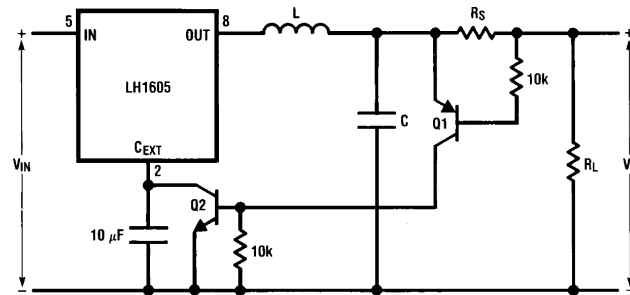

$$I_{CL} = \frac{0.6V}{R_S}$$

$$I_{SC} = \frac{0.75V}{R_S}$$

TL/K/5496-14

FIGURE 13. Hard Limiting Circuit for LH1605

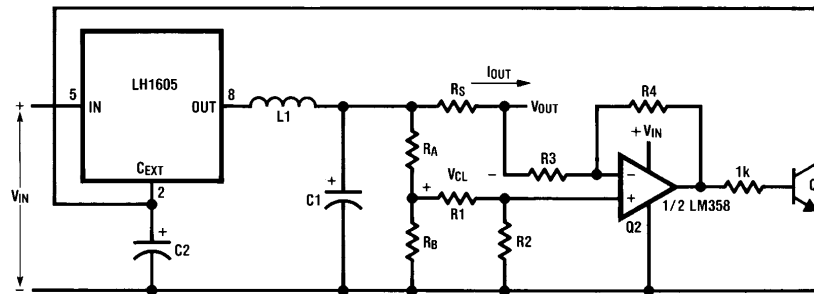

TL/K/5496-15

FIGURE 14. Foldback Limiting for LH1605

V_{CL} is the sum of the voltage drop across R_S and the opposing drop across R_A . As current limit is reached, V_O is reduced, lowering the voltage across R_A . It then requires less current through R_S to create a V_{CL} sufficient to cause further current limiting. This action produces the I-V characteristics shown in Figure 15. As the overload is removed, the converter output recovers along the same curve.

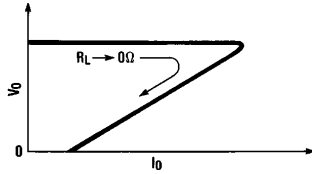

TL/K/5496-16

FIGURE 15. V_O vs I_O with Foldback Limiting

Because the gain of Q2 can be quite large, generally 10 to 20, the sense resistor, R_S , can be made very small, 0.02Ω to 0.06Ω . This significantly improves overall converter efficiency. Another advantage of amplifier gain is increased temperature stability. A gain of 10 reduces I_{CL} drift to about $-3.3 \text{ mA}/^\circ\text{C}$ with $R_S = 0.06\Omega$.

The first step in designing a foldback current limit for the LH1605 is to choose a readily available value for R_S . Then the amplifier gain can be determined as a function of R_S and the desired short circuit current.

$$A_V = \frac{0.6}{I_{SC} \times R_S} \quad (21)$$

The relationship between A_V , I_{SC} , and R_S is shown in Figure 16. A small capacitor in parallel with R2 and/or R4 may be necessary with high amplifier gains to filter switching noise.

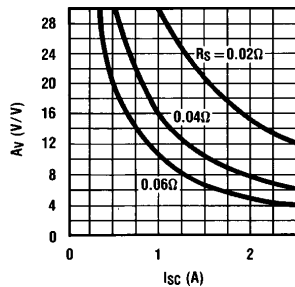

TL/K/5496-17

FIGURE 16. Amplifier Gain vs Short Circuit Current and R_S

The resistors R_A and R_B can be found in terms of V_O , R_S , and the amount of current foldback desired.

$$R_A = \frac{R_B \times R_S}{V_O} (I_{CL} - I_{SC}) \quad (22)$$

The condition $R_B \ll R_1$ should be maintained to insure accuracy in setting I_{CL} . Typical values for these resistors are:

$$1 \text{ k}\Omega < R_B < 5 \text{ k}\Omega$$

$$20 \text{ k}\Omega < R_1 < 100 \text{ k}\Omega$$

Power loss due to the current limit circuit under normal converter operation is:

$$P_{CL} = I_O^2 \times R_S \quad (23)$$

Power drained from the input supply with the converter output short circuited cannot be easily expressed due to the nature of the LH1605's control loop while in current limit. The drain, however, can be minimized by using a foldback current limit with a low I_{SC} .

Design Example

Design requirements:

$$V_{IN(MAX)} = 20\text{V}$$

$$V_{IN(MIN)} = 10\text{V}$$

$$V_{IN(NOM)} = 14\text{V}$$

$$V_O = 5\text{V}$$

$$e_O = 50 \text{ mV}$$

$$I_{CL} = 5\text{A}$$

$$I_{O(MIN)} = 0.5\text{A}$$

$$I_{SC} = 1\text{A}$$

$$f_O = 25 \text{ kHz}$$

Inductor

From equation 14:

$$L_{MIN} = (20\text{V} - 5\text{V}) \left(\frac{5\text{V}}{(20\text{V})} \right) \left(\frac{1}{2} \right) \left(\frac{1}{25 \text{ kHz}} \right) \left(\frac{1}{0.5\text{A}} \right) = 150 \mu\text{H}$$

The maximum magnetic energy will be:

$$E_L = (150 \mu\text{H}) (5\text{A} + 0.5\text{A})^2 = 4.54 \text{ mJ}$$

A toroidal powdered-iron core from Arnold Engineering, part #SG-0800-0320-T, was chosen for this example because of its high flux density capability. At only 25 kHz switching frequency, a powdered-iron core has very little hysteresis power loss and costs far less than a molypermalloy powder core of comparable flux density capability.

The nominal inductance of this core is 32 mH per 1000 turns. The number of turns required for this design is found using equation 15:

$$N = 1000 \times \sqrt{\frac{150 \mu\text{H}}{32 \text{ mH}}} = 69 \text{ turns}$$

A single layer winding of this core requires about 5.1 feet of #24 wire which would yield a DC winding resistance of 0.13Ω . In this case, efficiency can be improved significantly by using a double layer winding of #20 wire with only 0.050Ω .

Capacitor

From equation 17:

$$C_{MIN} = \left(\frac{0.5\text{A}}{4} \right) \left(\frac{1}{25 \text{ kHz}} \right) \left(\frac{1}{0.05\text{V} - (0.5\text{A} \times \text{ESR}) \text{V}} \right) = \frac{5}{0.05 - 0.5 \text{ ESR}} \mu\text{F}$$

Since no capacitor will meet the needs of this application with $\text{ESR} > 0.1\Omega$ at 25 kHz, it is easier in this case to search for a capacitor on the basis of ESR rather than capacitance. Mepco/Electra part #3475GD681M6P3JMBS has a typical ESR at 25 kHz of about 0.06Ω .

For $\text{ESR} = 0.06\Omega$,

$$C_{MIN} = 250 \mu\text{F}$$

This part, rated at $680 \mu\text{F}$, 6.3 WV_{DC} , is more than adequate for this application.

Feedback

From equation 19:

$$R_f = 2 \text{ k}\Omega \frac{5V - 2.5V}{2.5V} = 2 \text{ k}\Omega.$$

Current Limit

$R_S = 0.05\Omega$, 1.5W will be used in this application.

From equations 21 and 22:

$$A_V = \frac{0.6V}{1A \times 0.05\Omega} = 12,$$

$$R_A = R_B \left(\frac{0.05\Omega}{5V} \right) (5A - 1A) = 0.04 R_B.$$

If $R_B = 2 \text{ k}\Omega$ and $R1 = 100 \text{ k}\Omega$, then,

$$R_A = 80\Omega,$$

$$R2 = R4 = 1.2 \text{ M}\Omega,$$

$$R3 = 100 \text{ k}\Omega.$$

Operating Frequency

From the LH1605 data sheet graph of C_T vs f_O , the desired timing capacitor is,

$$C_T = 0.001 \mu\text{F}.$$

Input Capacitor

The choice of this capacitor depends upon the source impedance and ripple voltage requirements of the input supply. In most applications,

$$C_{IN} > 50 \mu\text{F}$$

The complete circuit is shown in Figure 17.

Using LH1605 data sheet information and equations 2-9 of this note, LH1605 efficiency in this design with $V_{IN} = 14V$ and $I_O = 3A$ is,

$$\eta = \frac{15}{15 + 1.66 + 2.34 + 2.59 + 0.30} = 0.69$$

Equation 11 gives the maximum allowable thermal resistance of heat sink bolted directly to the LH1605 with thermal grease at 50°C ambient temperature:

$$\theta_{SA} = \frac{(150^\circ\text{C} - 50^\circ\text{C})}{6.89W} - 5^\circ\text{C/W} - 0.15^\circ\text{C/W} = 9.4^\circ\text{C/W}$$

By including the power losses found in equations 16, 18 and 23, equation 9 yields the overall converter efficiency:

$$\eta = \frac{15}{21.89 + 0.45 + 0.004 + 0.45} = 0.66$$

So, in this design example, the converter dissipates only 7.8W, whereas a linear regulator under identical input/output conditions would dissipate 27W.

TYPICAL APPLICATIONS

Figure 18 shows a typical LH1605 Buck regulator application powered from the rectified output of a step-down transformer. Because LH1605 regulation is more efficient than equivalent linear regulation, the size and power rating of the transformer and bridge rectifier can be much smaller. Table II contains component values for several converters with this topology.

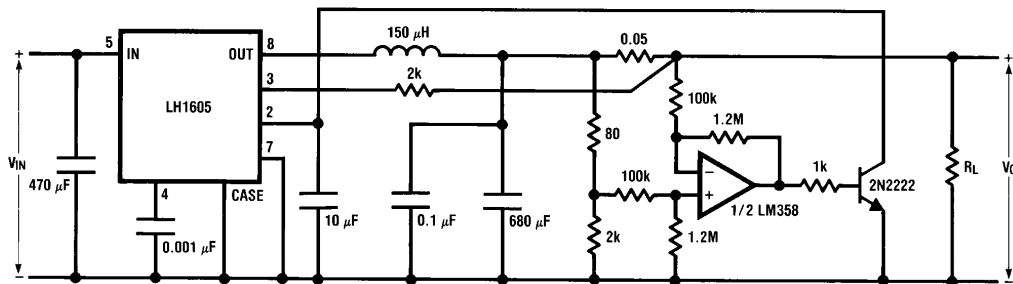

FIGURE 17. Complete Buck Converter Using LH1605

TL/K/5496-18

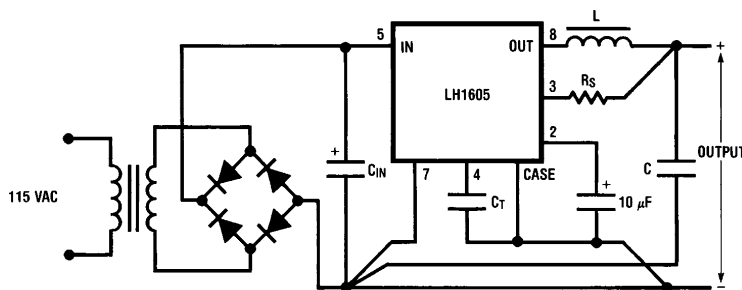

FIGURE 18. Typical Power Supply System

TL/K/5496-19

TABLE II. Typical Component Values for Buck Regulators

$f_o = \text{kHz}$ $e_o = 50 \text{ mV}$			$I_o (\text{MIN})$				R_f (Ω)
			1.0A		0.5A		
ESR_C (Ω)	$V_{IN} (\text{MAX})$ (V)	V_O (V)	L_{MIN} (μH)	C_{MIN} (μF)	L_{MIN} (μH)	C_{MIN} (μF)	
0.02	12	5	59	334	117	125	
0.03	15	5	67	500	134	143	
0.04	25	12	125	1000	250	167	
0.05	35	24	151	—	302	200	

Power Distribution Pre-Regulator

In applications requiring very low output ripple voltage, the LH1605 can be used as a pre-regulator to improve system performance and efficiency (Figure 19). By pre-regulating the input to the linear regulators to 5.8V, line frequency ripple is virtually eliminated from the 5V output. The 25 kHz switching ripple is attenuated 70 dB by the LM2931's giving less than 1 mV total output noise voltage.

DC Motor Speed Controller

Figure 20 shows how an LH1605 can be connected as a fractional-horsepower, DC motor speed controller. The constant average output voltage of the LH1605 is set with a single resistor, R_f , as it is in Buck converter applications. Current limiting may be required to protect the LH1605 during start-up of motors with low armature resistance.

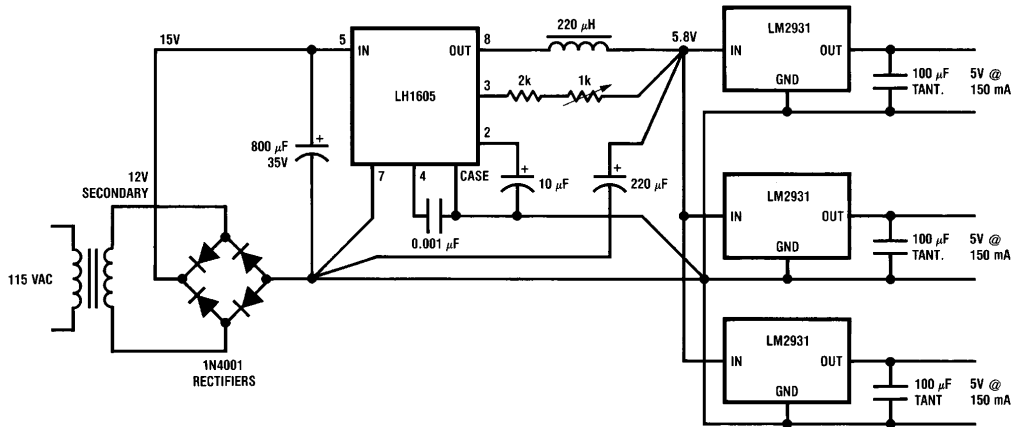

TL/K/5496-20

FIGURE 19. Pre-Regulator Power Distribution System

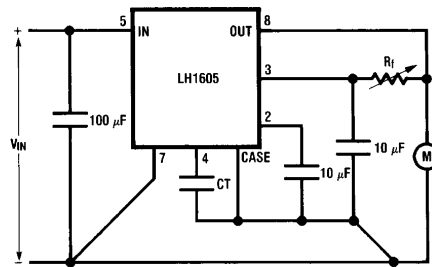

TL/K/5496-21

FIGURE 20. DC Motor Speed Regulation

Multiple Outputs

It is possible, as *Figure 21* suggests, to obtain any number of outputs from a single LH1605 provided there is one primary output in a Buck configuration drawing sufficient output current. During t_{OFF} , the voltage across the primary inductance is $(V_O + V_f)$. The voltage across any secondary windings wound on the same core is $N_S/N_P (V_O + V_f)$. Because V_O is regulated and V_f is nearly constant, the voltages on the secondaries are also constant.

During t_{ON} , the diodes in the secondaries are reverse biased so all secondary power comes from the filter capacitors, C1 and C2. During t_{OFF} , the diodes conduct, and the capacitors are recharged. To ensure stable output voltages,

the Buck converter's output power must be greater than that of the secondaries. In the circuit of *Figure 21*, $I_O \geq 0.8A$ in the 5V primary is necessary in order to have 100 mA capability in the $\pm 12V$ secondaries.

REFERENCES

1. National Semiconductor, 1982 Hybrid Products Data-book.
2. National Semiconductor, "LH1605 5 Amp, High Efficiency Switching Regulator" datasheet.
3. Abraham I. Pressman, "Switching and Linear Power Supply, Power Converter Design", Hyden Book Company, 1977.

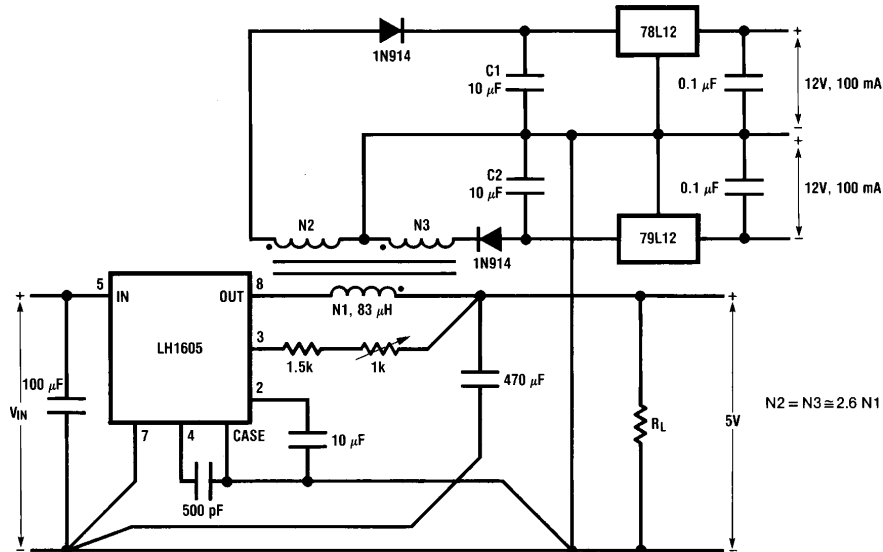

FIGURE 21. Multiple Output Voltages from a Single LH1605

TL/K/5496-22

APPENDIX A

Following is a partial list of sockets, heat dissipators, magnetic components and low ESR-type capacitors for use with the LH1605. National Semiconductor Corporation assumes no responsibility for their quality or availability.

8-LEAD TO-3 HARDWARE

Sockets

Robinson Nugent 0002011
Azimuth 6028 (test socket)

AAVID ENGINEERING

30 Cook Court
Laconia, New Hampshire 03246

AZIMUTH ELECTRONICS

2377 S. El Camino Real
San Clemente, CA 92672

Heat Sinks

Thermalloy 2266B (35°C/W)
IERC LAIC 3B4CB
IERC HP1-TO3-33CB (7°C/W)
AAVID 5791B

IERC

135 W. Magnolia Blvd.
Burbank, CA 91502

KEYSTONE ELECTRONICS CORP.

49 Bleecker St.
New York, N.Y. 10012

Mica Washers

Keystone 4658

ROBINSON NUGENT INC.

800 E. 8th St.
New Albany, IN 47150

THERMALLOY

P. O. Box 34829
Dallas, Texas 75234

MAGNETIC COMPONENTS MANUFACTURERS

Cores

ARNOLD ENGINEERING CO.

300 West St.
Marengo, ILL. 60152

FERROXCUBE

5038 Kings Highway
Saugerties, N.Y. 12477

MAGNETICS

P. O. Box 391
Butler, PA 16001

FERRONICS, INC.

60 N. Lincoln Rd.
E. Rochester, N.Y. 14445

Pre-Wound Inductors

GFS MANUFACTURING CO., INC.

6 Progress Drive
Dover, N.H. 03820

RENCO ELECTRONICS

60 Jefryn Boulevard
East Deer Park, N.Y. 11729

LOW ESR-TYPE CAPACITORS

SPRAGUE

Type 672D Aluminum Electrolytics
Type 32DR Aluminum Electrolytics
Type 622D Aluminum Electrolytics

MEPCO/ELECTRA INC.

Series 3428 Aluminum Electrolytics
Series 3191 Aluminum Electrolytics
Series 3120 Aluminum Electrolytics

MALLORY

Type TT Aluminum Electrolytics
Types CG/CGS/TCG Aluminum Electrolytics

SANGAMO

Type 301 Aluminum Electrolytics

SPRAGUE

481 Marshall St.
North Adams, MA 01247

MEPCO/ELECTRA INC.

265 Industrial Dr.
Roxboro, NC 27573

SANGAMO

P. O. Box 128
Pickens, SC 29671

MALLORY

P. O. Box 1284
Indianapolis, IN 46206

LIFE SUPPORT POLICY

NATIONAL'S PRODUCTS ARE NOT AUTHORIZED FOR USE AS CRITICAL COMPONENTS IN LIFE SUPPORT DEVICES OR SYSTEMS WITHOUT THE EXPRESS WRITTEN APPROVAL OF THE PRESIDENT OF NATIONAL SEMICONDUCTOR CORPORATION. As used herein:

1. Life support devices or systems are devices or systems which, (a) are intended for surgical implant into the body, or (b) support or sustain life, and whose failure to perform, when properly used in accordance with instructions for use provided in the labeling, can be reasonably expected to result in a significant injury to the user.
2. A critical component is any component of a life support device or system whose failure to perform can be reasonably expected to cause the failure of the life support device or system, or to affect its safety or effectiveness.



National Semiconductor Corporation
1111 West Bardin Road
Arlington, TX 76017
Tel: 1(800) 272-9959
Fax: 1(800) 737-7018

National Semiconductor Europe

Fax: (+49) 0-180-530 85 86
Email: cnjwge@tevm2.nsc.com
Deutsch Tel: (+49) 0-180-530 85 85
English Tel: (+49) 0-180-532 78 32
Français Tel: (+49) 0-180-532 93 58
Italiano Tel: (+49) 0-180-534 16 80

National Semiconductor Hong Kong Ltd.

19th Floor, Straight Block,
Ocean Centre, 5 Canton Rd.
Tsimshatsui, Kowloon
Hong Kong
Tel: (852) 2737-1600
Fax: (852) 2736-9960

National Semiconductor Japan Ltd.

Tel: 81-043-299-2309
Fax: 81-043-299-2408

National does not assume any responsibility for use of any circuitry described, no circuit patent licenses are implied and National reserves the right at any time without notice to change said circuitry and specifications.