



Manual

QumeTrak 242 Product Description

August 1982



Reorder Number 36053

© 1982 Qume Corporation
Qume, Q, QPW, QumeTrak, Sprint, Sprint Micro, SpeedFeed, Twintellect, TwinTrack, WideTrack, and MicroDrive are Trademarks of Qume Corporation.

Contents of this publication may be preliminary and/or may be changed at any time without notice and shall not be regarded as a warranty.

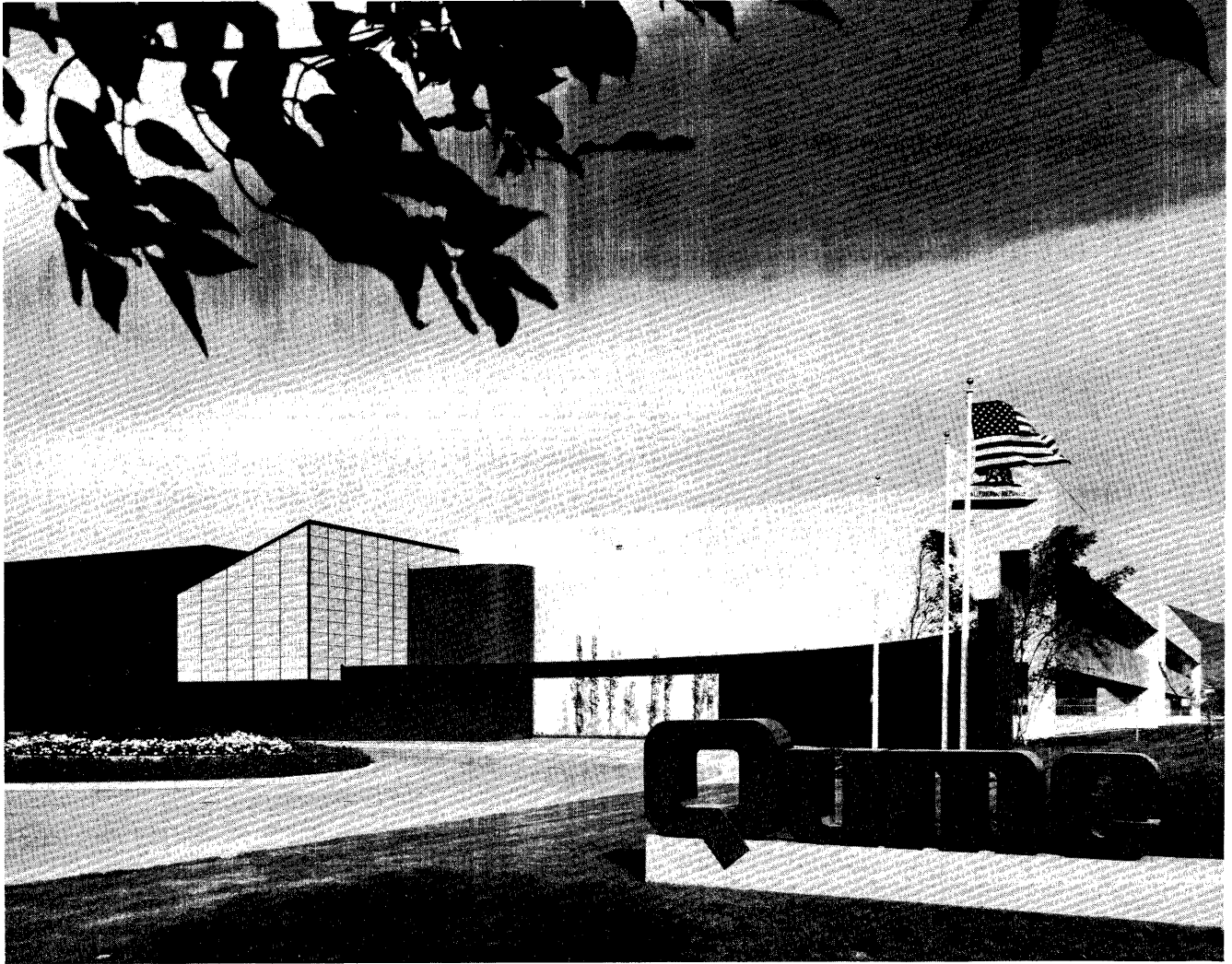

FOREWORD

This Qume manual presents the product description of the QumeTrak 242 flexible disk drive. For more detailed information consult your authorized Qume representative or the associated Qume publications listed below.

Title	Publication Number
QumeTrak 242 Maintenance Manual	36057

TABLE OF CONTENTS

	PAGE
GENERAL	1
SPECIFICATIONS SUMMARY	1
MOUNTING	3
Mechanical Dimensions	3
Recommendations	3
COMPATIBILITY	3
Track Positioning	3
Read/Write/Erase Head	3
Read Output Level	3
Write Current	3
Switch Filter	3
INDEX POSITIONING	3
ELECTRICAL INTERFACE	5
I/O SIGNAL INTERFACE	5
INPUT LINES	5
Drive Select 1-4	5
Direction	5
Step	7
Write Data	7
Write Gate	7
Side Select	7
Low Current/Switch Filter	7
Head Load	7
In Use	7
OUTPUT LINES	7
Index	8
Ready	9
Track 00	9
Write Protect	9
Read Data	9
Disk Change	9
Two-Sided	9
ALTERNATE I/O PINS	9

TABLE OF CONTENTS (Continued)

	PAGE
CUSTOMER STRAPPABLE OPTIONS	11
PROGRAMMABLE SHUNT	13
DRIVE SELECT OPTIONS	13
Option 1	13
Option 2	13
HEAD LOAD OPTIONS	14
Option 1	14
Option 2	14
Option 3	14
SIDE SELECT OPTIONS	14
Option 1	14
Option 2	14
RADIAL READY OPTION	15
RADIAL INDEX OPTION	15
IN USE OPTIONS	15
Option 1	15
Option 2	15
Option 3	15
DOOR LOCK LATCH OPTION	15
WRITE PROTECT OPTION	15
DISK CHANGE (Alternate Output)	15
TWO-SIDED (Alternate Output)	16
PHYSICAL INTERFACE	17
CONNECTORS AND CABLES	17
I/O Signals (P1/J1)	17
DC Power P5/J5)	18
TERMINATORS	18

LIST OF TABLES

TABLE		PAGE
1	Performance Specifications	1
2	Installation Requirements	2
3	Reliability and Maintenance	2
4	Minimum Read Output Level Requirements	3
5	Drive Selection	5
6	Factory Configuration of the Customer Strappable Options	11
7	Programmable Shunt Trace Functions	13
8	Drive Select Options	14
9	Side Select Options	14
10	I/O Signal Connector P1 Requirements for a Flat Cable	17
11	I/O Signal Connector P1 Requirements for Twisted Wire Pairs . .	17
12	I/O Signal Connector P1/J1 Pin Assignments	18
13	DC Power Connector P5/J5 Requirements	18
14	DC Power Connector P5/J5 Pin Assignments	18

LIST OF FIGURES

FIGURE		PAGE
1	QumeTrak 242 – Top View	3
2	QumeTrak 242 – Side View	3
3	Disk Drive Mounting	3
4	Recommended Controller Interface Circuit	5
5	Interface Connections	6
6	Step Timing	7
7	Write Data Timing for Frequency Modulation (FM)	7
8	Write Data Timing for Modified Frequency Modulation (MFM) . .	7
9	Track Access Timing	8
10	Read Timing	8
11	Write Timing	8
12	Index Timing	9
13	Read Data Timing for Frequency Modulation (FM)	9
14	Read Data Timing for Modified Frequency Modulation (MFM) . .	9
15	PCB Option Features	12
16	Disk Change Timing	16
17	Interface Connection	17
18	Connector J1 Dimensions (Component Side)	17

GENERAL

The QumeTrak 242 flexible disk drive offers low cost, direct access data storage, utilizing a removable eight-inch IBM diskette or equivalent as storage medium.

NOTE

In this manual the medium will be referred to as simply a **disk**.

It is compatible with the following IBM disk drives and systems:

- Single sided IBM 3740 and System 32 drives: 33FD.
- Two sided IBM 3600 and 4964 drives: 43FD.
- Two sided double density IBM System 34 drives: 53FD.

The QumeTrak 242 provides a storage capacity of 0.56M bytes on a two-sided single density flexible disk (IBM DISKETTE 2 or equivalent), and 1.2M

bytes on a two-sided double density flexible disk (IBM DISKETTE 2D or equivalent).

The QumeTrak 242 uses a two-sided head carriage assembly containing two ceramic read/write tunnel erase heads, and a flexured mounting arrangement for extremely high reliability.

Fast access time (3ms track-to-track) is accomplished by a precision steel belt drive mechanism that affords minimal wear with low power dissipation.

Standard features include:

- Positive DC power only required (no negative DC or AC)
- Four drive daisy chain capability
- ISO write protect
- Program controlled door lock
- In Use LED activity indicator on the front panel

SPECIFICATIONS SUMMARY

Table 1. Performance Specifications

SPECIFICATION	SINGLE DENSITY	DOUBLE DENSITY
CAPACITY PER DISK UNFORMATTED	0.8M bytes	1.6M bytes
IBM FORMAT	0.56M bytes	1.2M bytes
RECORDING DENSITY (TRACK NO. 76)	3408 BPI	6816 BPI
TRACK DENSITY	48 TPI	48 TPI
NUMBER OF CYLINDERS	77	77
NUMBER OF TRACKS	154	154
RECORDING METHOD	FM	MFM
ROTATIONAL SPEED	360 RPM	360 RPM
TRANSFER RATE	250K bits/sec	500K bits/sec
LATENCY (AVERAGE)	83 ms	83 ms
ACCESS TIME AVERAGE	91 ms	91 ms
TRACK-TO-TRACK	3 ms	3 ms
SETTLING	15 ms	15 ms
HEAD LOAD TIME	50 ms	50 ms
MOTOR START TIME	2 sec	2 sec

Table 2. Installation Requirements

DC POWER REQUIREMENTS	VOLTAGE	MAX. RIPPLE	CURRENT (AMPS)				
	+ 24 V ± 10%	0.1 V (P-P)		1 DRIVE	2 DRIVES	3 DRIVES	4 DRIVES
			TYP.	0.5	1.0	1.5	2.0
			MAX. RUN. START- UP	1.0 1.0	1.7 2.0	2.4 3.0	3.1 4.0
+ 5 V ± 5%	0.05 V (P-P)	TYP.	0.9	1.6	2.3	3.0	
		MAX.	1.3	2.2	3.1	4.0	
POWER DISSIPATION	LESS THAN 30W, 17W TYP.						
ENVIRONMENTAL	TEMPERATURE		OPERATING		STORAGE		
			+ 5°C TO + 43°C (41°F TO 110°F)		-10°C TO + 45°C (14°F TO 113°F)		
	RELATIVE HUMIDITY		20 TO 80%		8 TO 80%		
MAX. WET BULB		+ 29°C (84°F)		NO CONDENSATION			
MECHANICAL DIMENSIONS	HEIGHT	WIDTH	DEPTH		WEIGHT		
	57mm (2.25in)	217mm (8.55in)	320mm (12.6in)		3.5Kg (7.7lbs)		
NOTES:							
<p>1. DC power voltage as specified is at the DC power connector (J5) on the PCB.</p> <p>2 DC supply current is for drives that are normally installed without customer options.</p> <p>3. If the stepper motor and door solenoid are energized on all drives continuously, the maximum current requirement for the +24 V supply is 1.0 A times the number of drives on the daisy chain.</p>							

Table 3. Reliability and Maintenance

ERROR RATE	RECOVERABLE READ ERROR RATE	ONE ERROR PER 10 ⁹ BITS READ	MTTR	30 MINUTES
	NON-RECOVERABLE READ ERROR RATE	ONE ERROR PER 10 ¹² BITS READ	PREVENTATIVE MAINTENANCE	6000 POWER ON HOURS OR 2 YEARS
	SEEK ERROR RATE	ONE ERROR PER 10 ⁶ SEEKS	DESIGN LIFE	15000 POWER ON HOURS OR 5 YEARS
MTBF	8500 HOURS AT 100% DUTY CYCLE 13000 HOURS AT 50% DUTY CYCLE		MEDIA LIFE*	3.5 x 10 ⁶ PASSES/TRACK

*USEFUL MEDIA LIFE IS EXCEEDED WHEN "HEAD OUTPUT" DROPS TO BELOW 80% OF INITIAL VALUE, AS MEASURED BY USING IBM DISKETTE (IBM P/N 1766872).

MOUNTING

MECHANICAL DIMENSIONS

The mounting and clearance dimensions for the QumeTrak 242 are shown below.

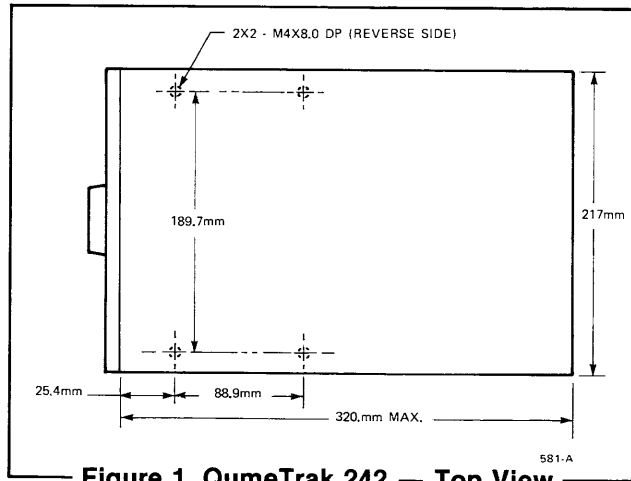

Figure 1. QumeTrak 242 — Top View

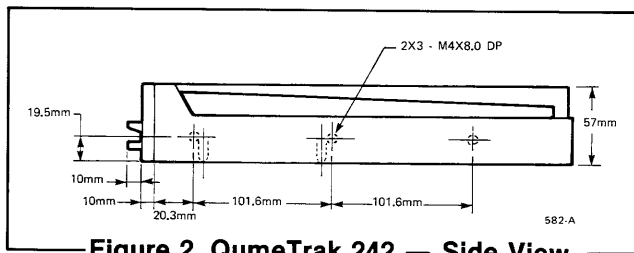

Figure 2. QumeTrak 242 — Side View

RECOMMENDATIONS

The QumeTrak 242 can be mounted in any one of three positions to allow horizontal front loading, vertical front loading, or vertical top loading.

When the QumeTrak 242 is mounted in a horizontal front loading position, the In Use LED on the front bezel must be under the front door as shown below.

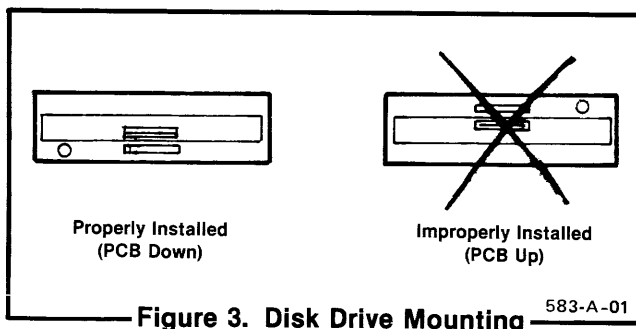

Figure 3. Disk Drive Mounting

COMPATIBILITY

The QumeTrak 242 uses a standard 8-inch flexible disk (IBM Diskette, P/N 1766872 or equivalent) as the recording medium.

The QumeTrak 242 complies with the physical and electrical characteristics described below for full compatibility with an IBM system.

TRACK POSITIONING

The QumeTrak 242 positions the R/W head to the center line of track 40 to within ± 0.04 mm (± 0.0016 of an inch). Track 40 positioning accuracy can be checked by using a Qume CE disk (Q.P.N. 50152-02).

READ/WRITE/ERASE HEAD

The geometry of the QumeTrak 242 Read/Write/Erase head is equivalent to the IBM Read/Write/Erase head.

Read Output Level

The QumeTrak 242 read output level, as measured by the following procedure, satisfies the requirements listed in the table below.

1. Data is written by the QumeTrak 242 on a standard disk (IBM Diskette P/N 1766872).
2. The read output level from the standard disk is checked between test points TP1A and TP1B (the integrated outputs of the head preamplifier.)

Table 4.
Minimum Read Output Level Requirements

Track	Output (all '1')	Resolution = $\frac{\text{all '1' output}}{\text{all '0' output}} \times 100$
76	150 mV p-p MIN.	50% MIN.

WRITE CURRENT

IBM compatibility requires a 20% reduction in write current on tracks 44 through 76.

SWITCH FILTER

IBM compatibility requires an increase in the read output resolution on tracks 60 through 76.

INDEX POSITIONING

The QumeTrak 242 Index Sensor allows precise positioning in relation to the read/write head gap.

The dynamic positional difference of the QumeTrak 242 is $500\mu\text{s} \pm 500\mu\text{s}$, which can be checked by using a Qume CE disk (Q.P.N. 50152-02).

ELECTRICAL INTERFACE

The QumeTrak 242 has two interface connectors: connector P1/J1 interfaces digital I/O signals, and connector P5/J5 interfaces the +5V and +24V DC power source. Refer to the Interface Connections illustration.

I/O SIGNAL INTERFACE

All I/O signal interface lines are TTL compatible and are active (true) when low.

The QumeTrak 242 uses 7438 NAND buffers (open collector) as line drivers and 7414 Schmitt trigger inverters as line receivers. The input of all receiver lines in a single drive, and those in the last drive of a daisy chain, must be terminated in 150 ohms pulled up to +5V.

The illustration below shows the recommended controller interface circuit.

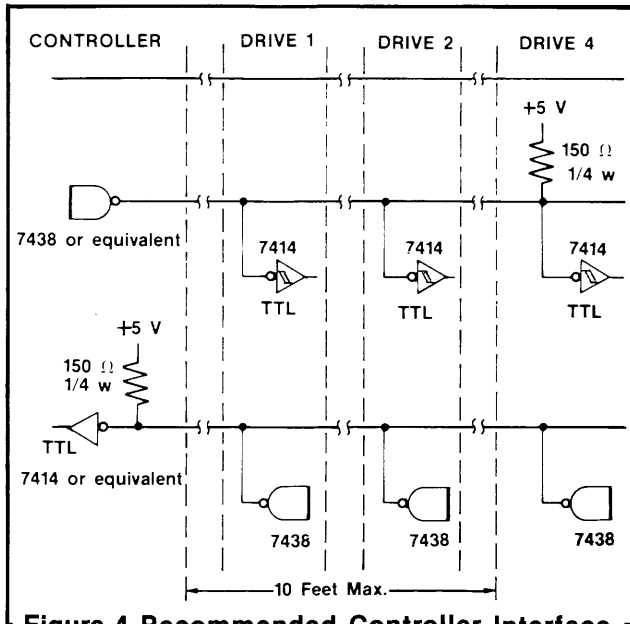

Figure 4. Recommended Controller Interface Circuit.

INPUT LINES

There are twelve (12) active low TTL input lines to the QumeTrak 242. Ten (10) are standard and two (2) are user installable options. Individual signal line characteristics are described below.

High Level:	Logical False	2.4 to 5.25 V
Low Level:	Logical True	0 to 0.4 V
Impedance:	150 ohms to 5 V	

DRIVE SELECT 1-4

An active low level on the appropriate line (pin 26, 28, 30, or 32) enables communication between the individual drive and the controller.

When two or more (up to 4) drives are daisy chained, each drive must have a unique DRIVE SELECT address. The DRIVE SELECT address is controlled by jumpers DS1 through DS4. When the two pins of jumper DS1 are connected, that drive will be activated by an active low signal on the DRIVE SELECT number one line. If the two pins of jumper DS2 are connected, that drive will be activated when DRIVE SELECT line number two is low active. The same system applies to jumpers DS3 and DS4.

Table 5. Drive Selection

Drive Number	Drive Select Input				Jumper Pins			
	1	2	3	4	DS1	DS2	DS3	DS4
1	L	H	H	H	S	O	O	O
2	H	L	H	H	O	S	O	O
3	H	H	L	H	O	O	S	O
4	H	H	H	L	O	O	O	S

L = low level, H = high level, S = short, O = open

NOTE

Only one jumper can be connected within a single drive. Each drive within a daisy chain must have a unique DRIVE SELECT number.

DIRECTION

DIRECTION (pin 34) defines the direction of read/write head movement. A low level on this line causes the head positioning mechanism to move the read/write head toward the center of the disk when the STEP Line is pulsed. With the DIRECTION line at a high level, a pulse on the STEP line causes the head positioning mechanism to move the read/write head away from the center of the disk. The logic state of DIRECTION can be changed at any time after the trailing (positive going) edge of the STEP pulse, and to within 1 microsecond before the trailing edge of a following STEP pulse. The logic state of DIRECTION cannot be changed during the positive going transition of STEP, or within the preceding 1 microsecond of the positive going transition of STEP.

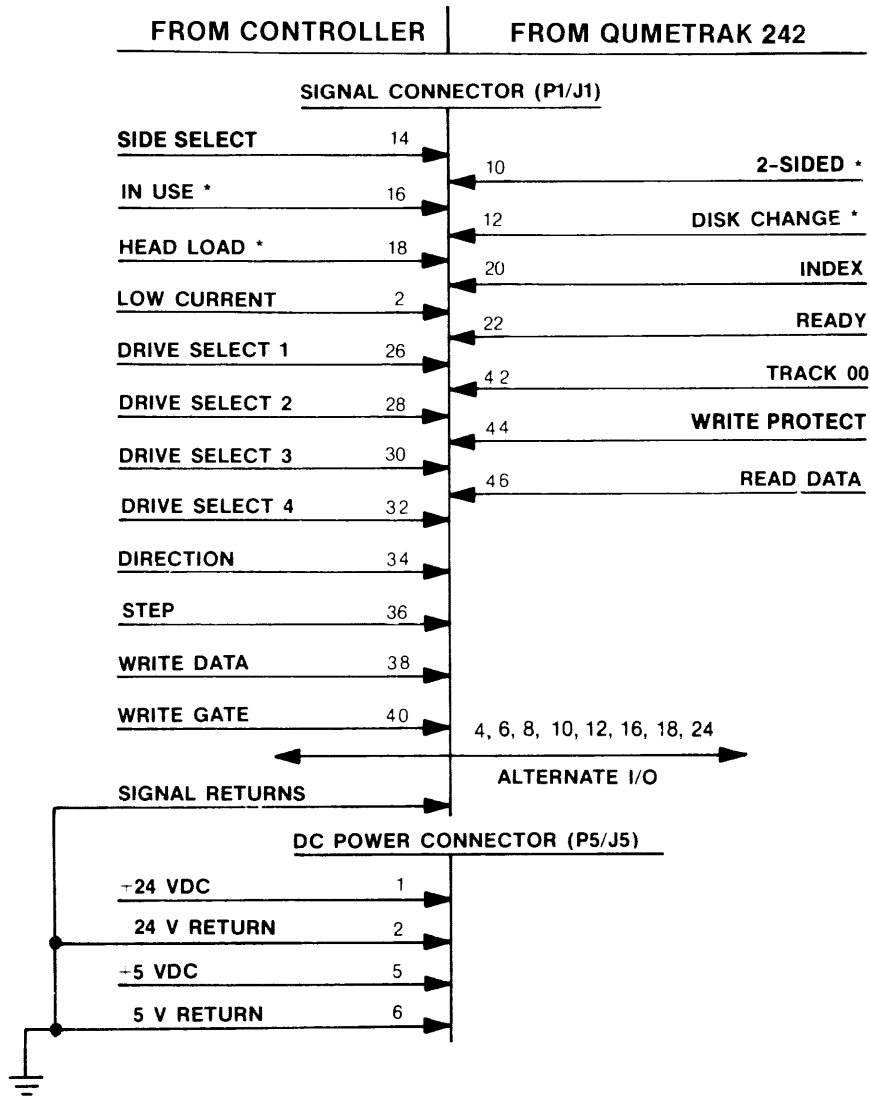

NOTES:

1. *Optional.
2. Signal returns (all odd numbered pins on P1/J1), +24 V return, +5 V return, and frame ground must be connected together at the controller.
3. Pins 48 and 50 on P1/J1 and Pins 3 and 4 on P5/J5 are reserved.

Figure 5. Interface Connections

STEP

The negative going edge of a STEP pulse applied to this line (pin 36) will cause the read/write head to be moved one track. The direction of movement is controlled by the DIRECTION line. STEP pulses have the timing characteristics shown below.

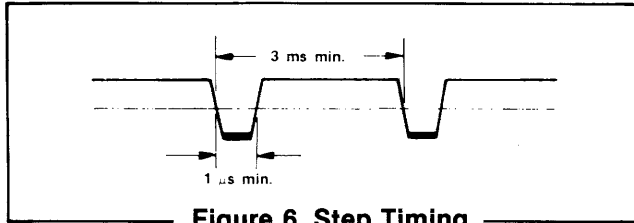
**WRITE DATA**

This interface line (pin 38) provides the data to be written on the disk. Each transition from high level to an active low level causes the write current polarity through the head to be reversed. The WRITE DATA timing characteristics for Frequency Modulation (FM) and Modified Frequency Modulation (MFM) formats are shown below.

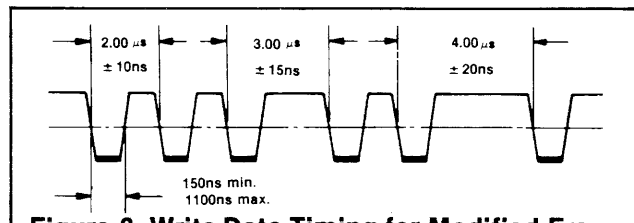
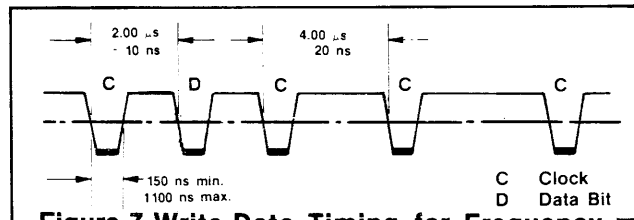
**WRITE GATE**

An active low level on this line (pin 40) enables the write current source and disables the stepping (head movement) circuitry. A high level on this line enables the read circuitry.

Deactivation of DRIVE SELECT and/or changing SIDE SELECT must be delayed at least 590 μ s following a write operation, to assure that the track is fully tunnel erased.

Refer to the READ TIMING and WRITE TIMING diagrams for the timing relationships.

SIDE SELECT

Side Select (pin 14) defines which surface of a two-sided disk is used for data recording or retrieval. An active low level on this line selects the R/W head for side 1 (the disk surface that faces the carrier assembly). A high level on this line selects the R/W head for side 0 of the disk (the disk surface that faces the PCB). When switching from side 0 to side 1 and conversely, a 100 μ s delay is required before any read or write operation can be initiated. Refer to CUSTOMER STRAPPABLE OPTIONS for alternate operation.

LOW CURRENT/SWITCH FILTER

When WRITE GATE is low, this signal line (pin 2) should be high on tracks 0 through 43, and active low on tracks 44 through 76 (low current). When data is read, this line should be high on tracks 0 through 59, and active low on tracks 60 through 76, in order to improve read output resolution on the inner tracks (switch filter).

HEAD LOAD

An active low level on this optional input line (pin 18), when READY is active low, causes the R/W head to be loaded against the disk.

Refer to CUSTOMER STRAPPABLE OPTIONS for uses and method of installation.

IN USE

An active low level on this optional input line (pin 16) will energize the In Use LED. Refer to CUSTOMER STRAPPABLE OPTIONS for uses and method of installation.

OUTPUT LINES

There are seven (7) output lines from the QumeTrak 242; five (5) are standard and two (2) are optional. Each line has the following properties.

High Level:	Logical False	2.4 to 5.25 V, MAX. leakage current 250 μ A when 7438 NAND buffers are at cutoff.
Low Level:	Logical True	0 to 0.4 V, MAX. sink current 48 mA when the 7438 NAND buffers draw current.

INDEX

This interface signal (pin 20) is provided by the drive once each revolution. The leading (negative going) edge of an INDEX pulse indicates to the

controller the beginning of the next track. The timing characteristics for INDEX are shown below.

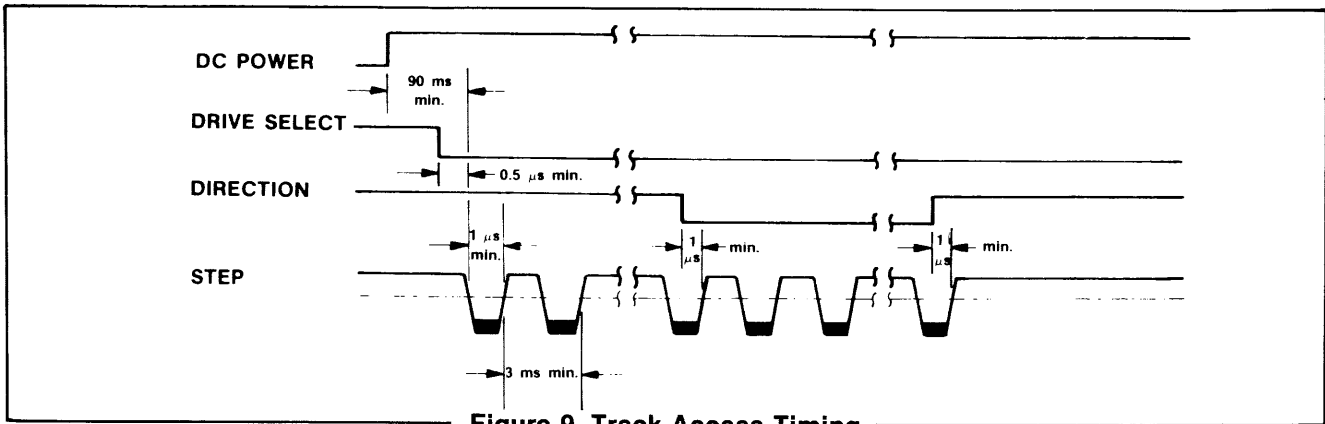

Figure 9. Track Access Timing

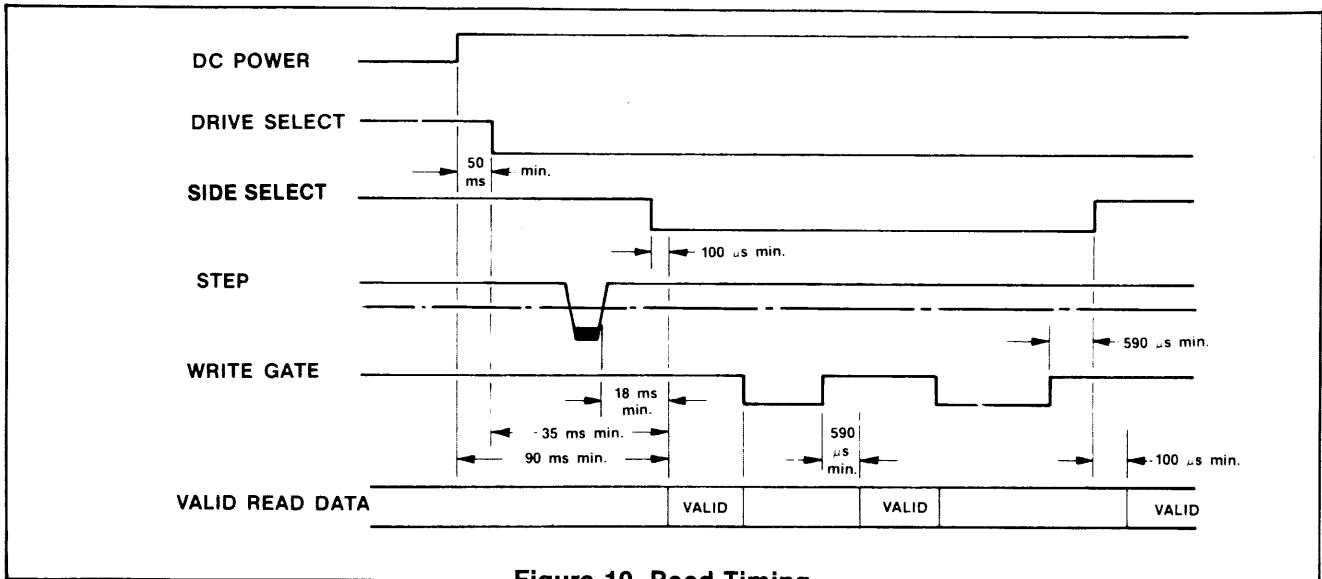

Figure 10. Read Timing

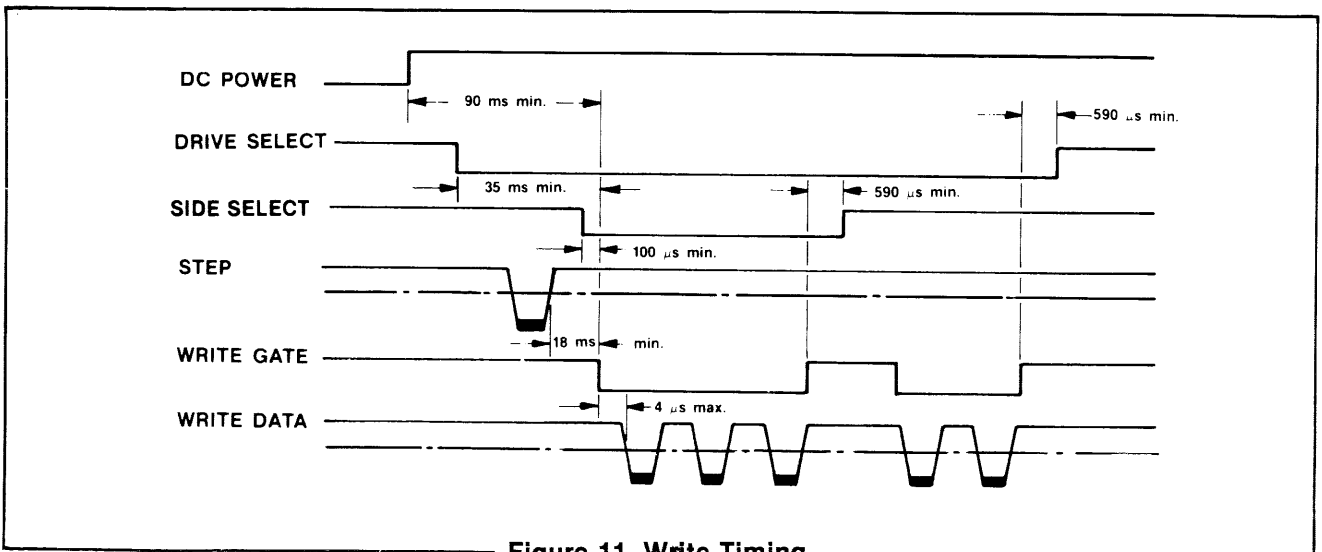
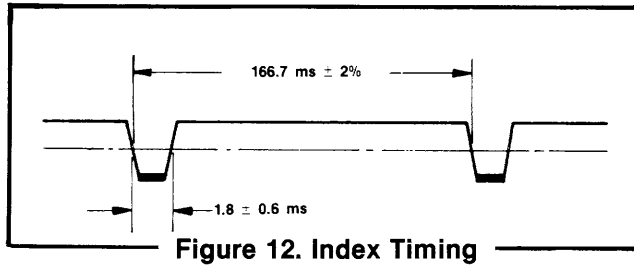

Figure 11. Write Timing



READY

An active low level on this line (pin 22) indicates that at least three index pulses have been sensed (two complete disk revolutions by a properly inserted disk with the door closed). When using a single-sided disk, READY will go true only when side 0 is selected.

TRACK 00

An active low level on this line (pin 42) indicates that the R/W head is positioned at Track 00.

WRITE PROTECT

An active low level on this line (pin 44) indicates that a disk with an ISO write protect notch is loaded. Under normal operation, the drive will inhibit writing when a protected disk is installed in addition to notifying the controller.

Refer to CUSTOMER STRAPPABLE OPTIONS for alternate operation.

READ DATA

Data from the disk is output to the host system in the same form as it was received on the WRITE DATA line. Each flux reversal that is sensed on the disk produces a transition to an active low level on the READ DATA line (pin 46).

DISK CHANGE

An active low level on this optional output line (pin 12) indicates that the disk drive door has been opened and the disk removed after the DRIVE SELECT signal has gone false. The DISK CHANGE circuit is reset on the true to false transition of DRIVE SELECT provided that READY

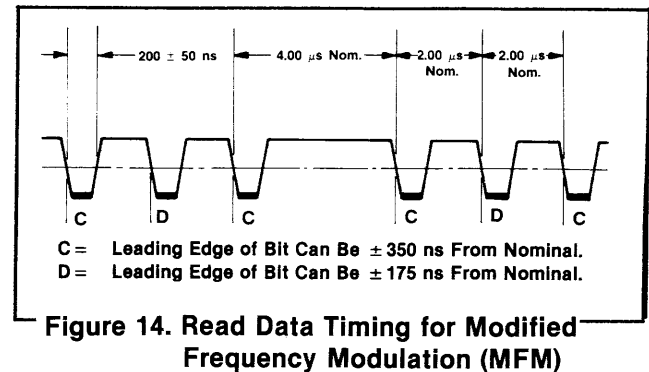
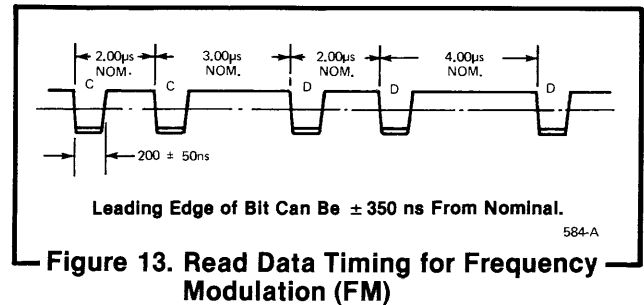

is true. Refer to the section on CUSTOMER STRAPPABLE OPTIONS for method of installation.

TWO-SIDED

With a disk installed and the drive selected, an active low level on this optional output line (pin 10) indicates that a two-sided disk is in use. A high level indicates that a single-sided disk is in use. Refer to the section on CUSTOMER STRAPPABLE OPTIONS for method of installation.

ALTERNATE I/O PINS

Eight alternate I/O pins are provided on connector J1 for interfacing the disk drive with additional control signals. These eight alternate I/O pins (4, 6, 8, 10, 12, 16, 18 and 24) connect to PCB pads for customer installable optional jumpers. Two factory designated input and two factory designated output lines of the drive internal circuits are selectable by installing jumpers to I/O pins 10, 12, 16, and 18.

CUSTOMER STRAPPABLE OPTIONS

The QumeTrak 242 can be modified by the user to alter functions that were described previously. These modifications are made by adding or deleting traces and by using the Alternate I/O

pins. The following table shows the configuration of the option traces and jumpers as shipped from the factory.

Table 6. Factory Configuration of the Customer Strappable Options

DESIGNATOR	DESCRIPTION	FROM FACTORY	
		OPEN	SHORT
DS1 - DS4	DRIVE SELECT ADDRESS PINS (UP TO 4 DRIVES)	DS2, DS3 DS4	DS1
A,B,X	RADIAL HEAD LOAD		X
Z	IN USE FROM DRIVE SELECT		X
HL	STEPPER POWER FROM HEAD LOAD		X
R	ALTERNATE OUTPUT READY PAD		X
I	ALTERNATE OUTPUT INDEX PAD		X
C	ALTERNATE INPUT HEAD LOAD	X	
D	ALTERNATE INPUT IN USE	X	
DC	ALTERNATE OUTPUT DISK CHANGE	X	
2S	ALTERNATE OUTPUT TWO SIDED DISK	X	
Y	IN USE FROM HEAD LOAD	X	
DL	DOOR LOCK LATCH	X	
RR	RADIAL READY		X
RI	RADIAL INDEX		X
WP	INHIBIT WRITE WHEN WRITE PROTECT		X
NP	ALLOW WRITE WHEN WRITE PROTECT	X	
D1,D2,D4,DDS	DRIVE ADDRESS SELECT (UP TO 8 DRIVES)	X	
B1 - B4	TWO, DOUBLE-SIDED DRIVE SELECT	X	
S1 - S3	HEAD SELECT OPTION	S1,S3	S2
T40	TEST TRACK 40	X	
HA	TEST ACTUATE HEAD LOAD	X	
4,6,8,10, 12,16,18,24	ALTERNATE I/O PINS	X	
SF	SWITCH FILTER		X
SP	STEPPER POWER (USED WITH HL)	X	

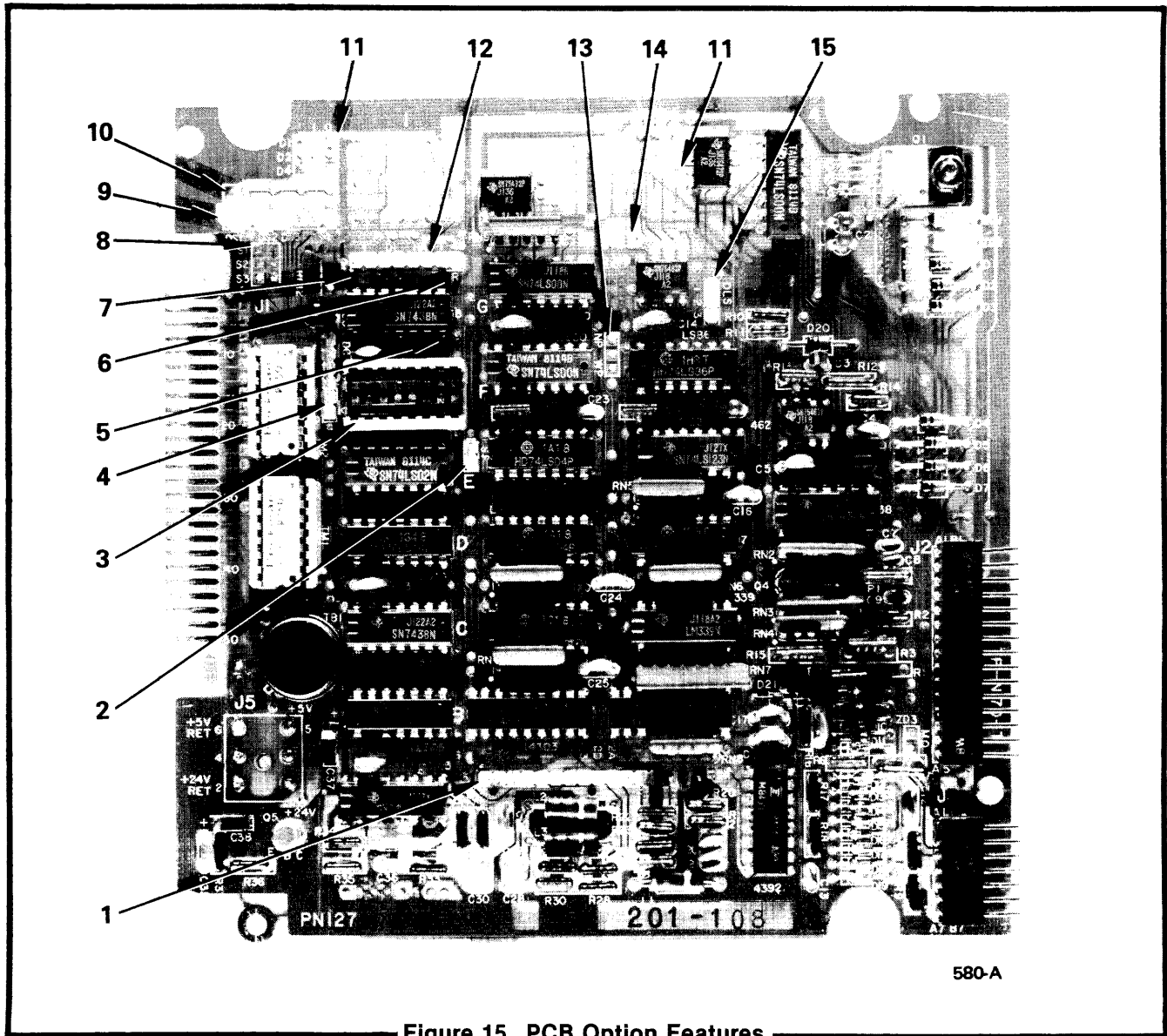

Figure 15. PCB Option Features

LEGEND

1. Test Pins
2. Switch Filter Option Pins - SF
3. Programmable Shunt Trace/Cut Options - A, B, X, R, I, Z, HL
4. Optional I/O Pins - 2S, DC, D, C
5. Alternate Output Index Pad - I
6. Alternate Output Ready Pad - R
7. Radial Ready/Index Option Pads - RR, RI
8. Side Select Option Pads - S1, S2, S3
9. Drive Select Address Pins - DS1, DS2, DS3, DS4
10. 2-Double Sided Drive Side Select Option Pads - B1, B2, B3, B4
11. 8-Drive Multiplex Option Pads - D1, D2, D4, DDS
12. Optional I/O Pins - Y, DL, HA, T40
13. Enable/Disable Write Protect Option Pads - WP, NP
14. Stepper Power Enable (used with HL) - SP
15. Door Lock Solenoid Power Configuration Pins - DLS 1, 2, 3

PROGRAMMABLE SHUNT

A 16-pin programmable shunt is provided for the seven commonly used trace/cut options. All of these traces are usually shorted when shipped

from the factory. The shorted and open functions of the programmable trace/cut options are shown in the following table.

Table 7. Programmable Shunt Trace Functions

TRACE	FUNCTION - SHORTED (STD.)	FUNCTION - OPEN (OPTION)
A	DRIVE SELECT ACTIVE	DRIVE SELECT ACTIVE, HEAD LOAD ACTIVE FROM DRIVE SELECT
B	DRIVE SELECT ACTIVE	DRIVE SELECT ACTIVE HEAD LOAD ACTIVE
X	HEAD LOAD ACTIVE FROM DRIVE SELECT	HEAD LOAD ACTIVE, DRIVE SELECT ACTIVE FROM HEAD LOAD
Z	IN USE ACTIVE FROM DRIVE SELECT	IN USE ACTIVE FROM HEAD LOAD OR OPTIONAL IN USE I/O
HL	STEPPER MOTOR POWER ACTIVE FROM HEAD LOAD	STEPPER MOTOR POWER IS ALWAYS ACTIVE
R	READY IN MULTIPLEX MODE (REFER TO NOTE 1)	READY IN RADIAL MODE (REFER TO NOTE 2)
I	INDEX IN MULTIPLEX MODE (REFER TO NOTE 1)	INDEX IN RADIAL MODE (REFER TO NOTE 2)

NOTES:

1. Multiplex mode requires DRIVE SELECT to check that the READY and/or INDEX lines are active on any drive.
2. Radial mode allows the controller to check that the READY and/or INDEX lines are active on any drive without DRIVE SELECT.

DRIVE SELECT OPTIONS

Factory configuration of the Drive Select circuit allows for up to four drives to be addressed in a daisy chain arrangement. Normally, a jumper is factory installed in location DS1, designating the drive as number one. Moving this jumper to any one of the three remaining locations (DS2-4), designates the drive for the corresponding position number. Two other options are available.

OPTION 1

This option allows direct selection of a particular disk side from among two daisy chained double-sided drives. The four disk sides are addressed as if they were separate drives on the existing four DRIVE SELECT input lines. Detailed instructions on input configuration and jumper status are presented below under Side Select Options.

OPTION 2

This option allows up to eight drives to be multiplexed together. The four DRIVE SELECT lines are used for addressing the drive. DRIVE

SELECT 1 is used to enable the DRIVE SELECT 2 (binary 1), DRIVE SELECT 3 (binary 2), and DRIVE SELECT 4 (binary 4) address lines. The logical drive assignment is accomplished by properly jumpering traces D1, D2, and D4, where D1 = (binary 1), D2 = (binary 2), D4 = (binary 4). The jumper pads are arranged to appear as a 3 X 3 matrix. Within each column, the center pad must be jumpered to an adjacent logical 1 or logical 0 pad. The proper jumpers for each drive select number are shown in the table below.

Installation (refer to the PCB Option Features illustration):

1. Add a 74L85, 4-bit comparator IC in PCB location 1K.
2. Jumper trace DDS.
3. Unplug trace DS1-DS4.
4. Properly jumper traces D1, D2, and D4.

Table 8. Drive Select Options

DRIVE NUMBER	DRIVE SELECT INPUT				JUMPER CENTER PAD TO:		
	1	2	3	4	D1	D2	D4
0	L	H	H	H	0	0	0
1	L	L	H	H	1	0	0
2	L	H	L	H	0	1	0
3	L	L	L	H	1	1	0
4	L	H	H	L	0	0	1
5	L	L	H	L	1	0	1
6	L	H	L	L	0	1	1
7	L	L	L	L	1	1	1

L = LOW LEVEL, H = HIGH LEVEL

HEAD LOAD OPTIONS

When a factory configured drive is selected, its heads are loaded and the stepper motor is energized. Three other options are available.

OPTION 1

This option allows a drive to be selected without loading the heads or enabling the stepper motor. The advantage is that the output status signals can be monitored while the head is unloaded, thereby extending the media life.

Installation (refer to the PCB Option Features illustration):

1. Open trace X on the programmable shunt with a small screwdriver.
2. Plug pins C on the optional I/O pins near connector J1.

OPTION 2

This option allows a drive to be selected and the stepper motor to be enabled without loading the heads. As an example of this option, initial reset to Track 00 at power-up can be performed without the READY condition.

Installation (refer to the PCB Option Features illustration):

1. Open traces B and HL on the programmable shunt with a small screwdriver.
2. Plug pins C on the optional I/O pins.
3. Open pads SP.

OPTION 3

This option (RADIAL READY) allows a drive to load the heads without selecting the drive or enabling

the stepper motor. The advantage is that the heads can be kept loaded on all the drives, thereby eliminating the head load time when the drive is performing a disk copy operation.

Installation (refer to the PCB Option Features illustration):

1. Open traces A and HL on the programmable shunt with a small screwdriver.
2. Plug pins C on the optional I/O pins.
3. Open pads SP.

SIDE SELECT OPTIONS

Normally, a R/W head is selected by the SIDE SELECT interface line in a daisy chain system of up to four drives. Two options are available.

OPTION 1.

This option allows both SIDE SELECT and DIRECTION to be multiplexed on the same DIRECTION line. DIRECTION can be used in this way because it is not being used during reading or writing (STEP must accompany DIRECTION to initiate head movement).

Installation (refer to the PCB Option Features illustration):

Open pads S2 and jumper pads S1.

OPTION 2.

This option uses the existing DRIVE SELECT lines to address up to two double-sided drives. It selects up to four sides as if the sides were separate drives.

Installation (refer to the PCB Option Features illustration):

Open pads S2 and jumper pads S3. Disk sides are then selected according to the table below.

Table 9. Side Select Options

DRIVE NUMBER	HEAD SELECT	DRIVE SELECT INPUT				TRACES
		1	2	3	4	
1	0	L	H	H	H	PLUG DS1 JUMPER B2 PLUG DS3 JUMPER B4
1	1	H	L	H	H	
2	0	H	H	L	H	
2	1	H	H	H	L	

L = LOW LEVEL, H = HIGH LEVEL

RADIAL READY OPTION

Normally, the READY line from a factory configured drive is only available to the interface when it is selected. This option enables the user to monitor the READY line of each drive on the interface continuously.

Installation (refer to the PCB Option Features illustration):

1. Open pads RR.
2. Open trace R on the programmable shunt with a small screwdriver.
3. Jumper pad R to one of the available Alternate I/O pins (4, 6, 8, or 24). READY will then appear on the chosen Alternate I/O pin.

RADIAL INDEX OPTION

Normally, the INDEX line from a factory configured drive is only available to the interface when the drive is selected. This option enables the user to monitor the INDEX line of each drive on the interface at all times.

Installation (refer to the PCB Option Features illustration):

1. Open pads RI.
2. Open trace I on the programmable shunt with a small screwdriver.
3. Jumper pad I to one of the available Alternate I/O pins (4, 6, 8, or 24). INDEX will then appear on the chosen Alternate I/O pin.

IN USE OPTIONS

Normally, the In Use LED indicator will be energized when DRIVE SELECT is active. The door solenoid will be activated when DRIVE SELECT and READY are active. The three options listed below will energize the IN Use LED when activated to a low level.

OPTION 1

The option will energize the In Use LED when the DRIVE SELECT or IN USE line is active.

Installation (refer to the PCB Option Features illustration):

Plug pins D on the optional I/O pins.

OPTION 2

This option will energize the In Use LED when the HEAD LOAD or IN USE line is active.

Installation (refer to the PCB Option Features illustration):

1. Open trace Z on the programmable shunt with a small screwdriver.
2. Plug pins D on the optional I/O pins.
3. Plug pins Y on the optional I/O pins.

OPTION 3

This option will energize the In Use LED only when the IN USE line is active.

Installation (refer to the PCB Option Features illustration):

1. Open trace Z on the programmable shunt with a small screwdriver.
2. Plug pins D on the optional I/O pins.

DOOR LOCK LATCH OPTION

With this option, the door lock actuator can be attached without maintaining the IN USE signal throughout the door lock interval. IN USE may be activated by DRIVE SELECT.

Installation (refer to the PCB Option Features illustration):

1. Plug pins D on the optional I/O.
2. Plug pins DL on the optional I/O pins.

WRITE PROTECT OPTION

With this option installed, a Write Protected disk will not inhibit writing but it will be reported to the controller.

Installation (refer to the PCB Option Features illustration):

Open pads WP and jumper pads NP (located near the center of the PCB).

DISK CHANGE (ALTERNATE OUTPUT)

An active low level on this option line indicates that the READY signal has gone false (door opened) after DRIVE SELECT went false. The DISK

CUSTOMER STRAPPABLE OPTIONS

CHANGE circuit is reset on the true to false (low/high) transition of DRIVE SELECT provided that the drive is READY. Refer to the following illustration.

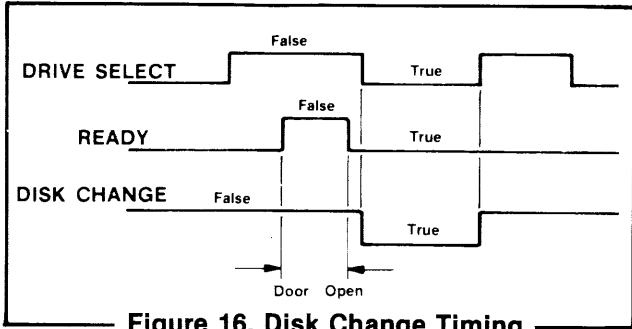

Figure 16. Disk Change Timing

Installation (refer to the PCB Options Features illustration):

Plug pins DC on the optional I/O pins.

TWO-SIDED (ALTERNATE OUTPUT)

A low level on this line indicates that a two-sided disk is in use, and a high level indicates that a single-sided disk is in use.

Installation (refer to the PCB Option Features illustration):

Plug pins 2S on the optional I/O pins.

PHYSICAL INTERFACE

The interface between the QumeTrak 242 and the host system is via two (2) connectors: I/O Signals (P1/J1), and DC power (P5/J5).

Refer to the CONNECTORS AND CABLES paragraph for specific pin assignments.

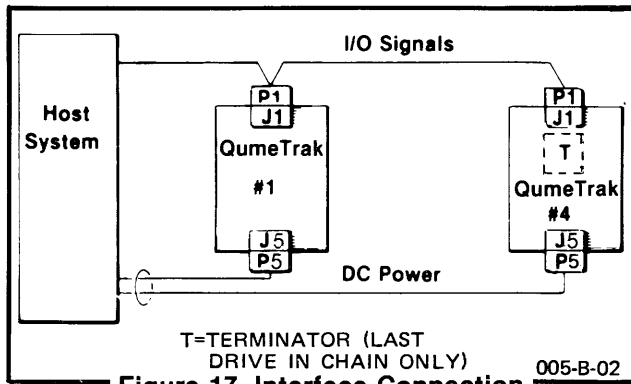

Figure 17. Interface Connection

CONNECTORS AND CABLES

I/O SIGNALS (P1/J1)

Connection to J1 is through a 50 pin PCB edge card connector. The dimensions for this connector are shown in the figure below.

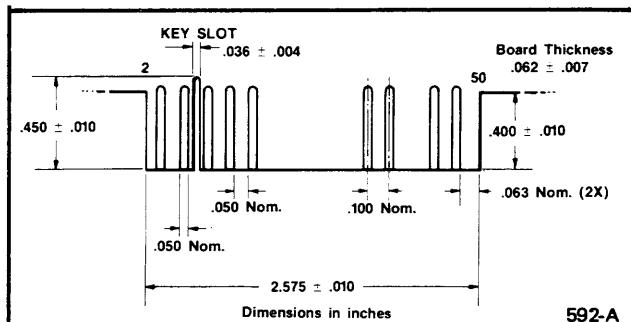

Figure 18. Connector J1 Dimensions (component side)

Table 10
I/O Signal Connector P1 Requirements
for a Flat Cable

PARTS		3M P/N
CONNECTOR		3415-0001
POLARIZING KEY		3439-0000
CRIMP TOOL	PRESS	3440
	LOCATOR PLATE	3443-11
	PLATEN	3442-1
FLAT CABLE (10 FEET MAX.)		3365-50

Table 11
I/O Signal Connector P1 Requirements
for Twisted Wire Pairs

PARTS	CRIMP TYPE	SOLDER TYPE	
		AMP P/N	VIKING P/N
HOUSING	1-583717-1	1-583717-1	3VH25/1JN-5
CONTACT	583616-5	583854-3	—
POLARIZING KEY	583274-1	583274-1	091-0071-000
CRIMP TOOL	90268-1	—	—
EXTRACTOR TOOL	91073-1	91073-1	—
TWISTED PAIRS (20 FEET MAX.)	AWG 26	AWG 26	AWG 26

Table 12.
I/O Signal Connector P1/J1 Pin Assignments

SIGNAL RETURN	SIGNAL	SIGNAL NAME	
PIN NO.	PIN NO.	STANDARD	OPTION
1	2	LOW CURRENT/ SWITCH FILTER	
3,5,7	4,6,8	ALTERNATE I/O	
9	10	ALTERNATE I/O	TWO-SIDED
11	12	ALTERNATE I/O	DISK CHANGE
13	14	SIDE SELECT I/O	ALTERNATE I/O
15	16	ALTERNATE I/O	IN USE
17	18	ALTERNATE I/O	HEAD LOAD
19	20	INDEX	
21	22	READY	
23	24	ALTERNATE I/O	
25	26	DRIVE SELECT 1	
27	28	DRIVE SELECT 2	
29	30	DRIVE SELECT 3	
31	32	DRIVE SELECT 4	
33	34	DIRECTION	
35	36	STEP	
37	38	WRITE DATA	
39	40	WRITE GATE	
41	42	TRACK 00	
43	44	WRITE PROTECT	
45	46	READ DATA	
47	48	RESERVED	
49	50	RESERVED	

NOTE

Also check Factory Configuration of Option Traces and Program Shunt Trace Functions table when interfacing.

DC POWER (P5/J5)

Table 13.
DC Power Connector P5/J5 Requirements

	P5 (CABLE SIDE)	J5 (DRIVE SIDE)
PARTS	AMP P/N	AMP P/N
HOUSING	1-480270-0	1-380999-0
CONTACT (6 PINS)	60619-1	—
CRIMP TOOL	90124-2	—
EXTRACTOR TOOL	1-305183-2	—
CABLE (10 FEET MAX.)	AWG 16 OR 18	—

Table 14.
DC Power Connector P5/J5 Pin Assignments

PIN NO.	SIGNAL NAME
1	+ 24 VDC
2	+ 24 V RETURN (GND)
3	NOT USED (GND)
4	NOT USED
5	+ 5 VDC
6	+ 5 V RETURN (GND)

TERMINATORS

The QumeTrak 242 requires that two DIP resistor terminator modules be installed in the DIP sockets on the PCB of a single drive or in those of the last drive in a daisy chain. No other drives in a daisy chain should have terminators installed.

QumeTrak 242

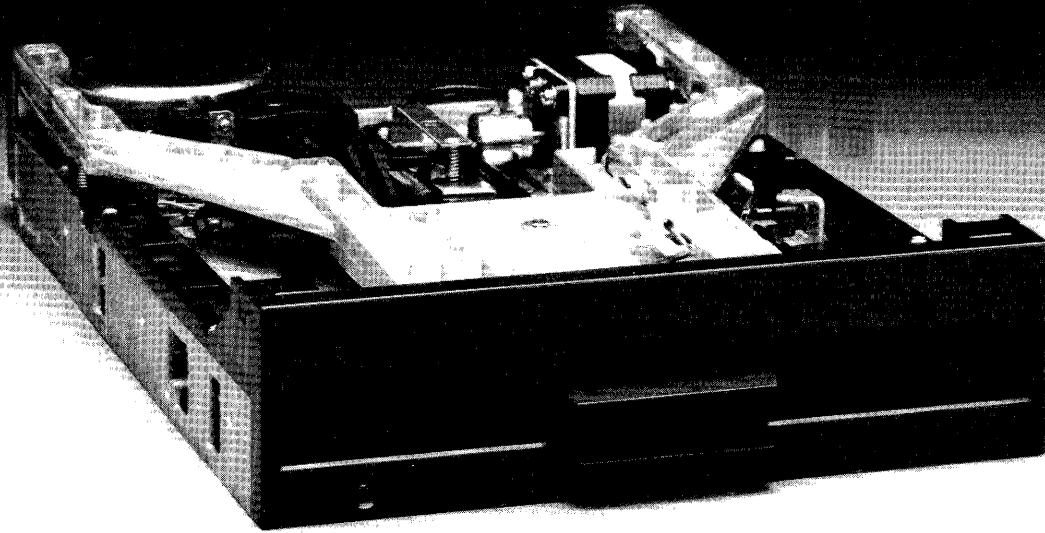

Half-Height, Double-Sided 8 Inch Floppy Disk Drive From Qume

The QumeTrak 242 delivers 1.6M Bytes of unformatted storage in a half height floppy disk drive. It is designed for the user requiring high capacity while maintaining compatibility with double-sided 8 inch media. The QumeTrak 242 is a remarkably well engineered advancement in 8 inch floppy disk drives.

Floppy Disk Drives by Qume offer the quality, reliability, performance and human engineering that users have come to depend on for their word processing and small computer applications. Data reliability is enhanced through two independently flexured trigimball-ed head assemblies loaded by an electronically dampened head load solenoid.

Additionally highlighted features include a highly reliable

DC drive motor and a bezel designed to facilitate operator loading and unloading of diskettes.

Best of all, it is a Qume drive from the recognized leader in quality.

KEY FEATURES

- Double-sided, 8 inch media with capacity of 1.6M Bytes
- Half-height size
- DC motor
- Operator-oriented bezel
- Qume quality

Qume[®]
A Subsidiary of ITT

Design Benefits

8 Inch Double-Sided Media

- 1.6M Bytes capacity
- Backward compatibility in both media and software

Half Height 8 Inch Size

- Two double sided 8 inch drives can be located in the same space as one full size 8 inch drive
- Reduced shipping weight and volume

DC Motor

- Simplified power requirements
- No requirement to adjust to different country AC power sources

Superior Media Wear Reduction

- Dual independently flexured trigim-balled head assemblies
- Dampened head load solenoid
- Contoured ceramic high resolution read/write tunnel erase heads

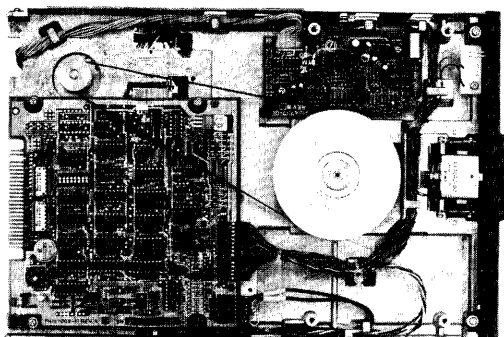
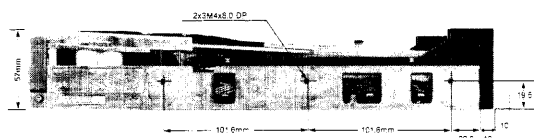
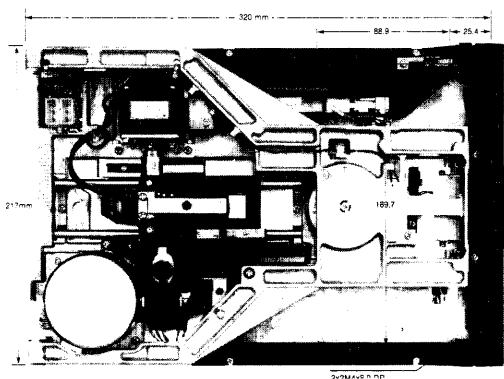

Product Specifications

Performance Specifications

	Single Density	Double Density
Capacity		
Unformatted	0.8M Bytes	1.6M Bytes
Qume formatted	0.56M Bytes	1.2M Bytes
Recording density	3408 BPI	6816 BPI
Track density	48 TPI	48 TPI
Cylinders	77	77
Tracks	154	154
Recording method	FM	MFM
Rotational speed	360 RPM	360 RPM
Transfer rate	250K Bits/sec	500K Bits/sec
Latency (avg.)	83 ms	83 ms
Access Time		
Average	91 ms	91 ms
Track-to-track	3 ms	3 ms
Settling	15 ms	15 ms
Head Load Time	50 ms	50 ms
Motor Start Time	2 sec	2 sec

Installation Requirements

DC Power	+ 24 VDC \pm 10%, 1.0A MAX. 0.5A TYP.
Requirements	+ 5 VDC \pm 5%, 1.3A MAX. 0.9A TYP.
Power dis- sipation	30W below, 17W TYP.
Temperature	Operating Environment 5°C to 43° (41°F to 110°F)
Relative humidity	20% to 80%RH
Max. wet bulb	29°C (84°F)
Mechanical dimensions	
Width	217 mm (8.55 in.)
Height	57 mm (2.25 in.)
Depth	320 mm (12.60 in.)
Weight	3.5 Kg (7.7 lbs.)
Maintenance and Reliability	
MTBF	10000 POH
MTTR	.5H
PM	2 year
Error rate	
Soft read error	1/10 ⁹ bits read
Hard read error	1/10 ¹² bits read
Seek error	1/10 ⁶ seeks
Design life	15000H or 5 years



Qume[®]
A Subsidiary of ITT

2350 Qume Drive
San Jose, CA 95131
Tel: (408) 942-4000, TWX 910-338-0232

REQUEST FOR READER'S COMMENTS

Qume Corporation attempts to provide documents that meet the needs of all Qume product users. This form lets you participate directly in the documentation process.

Please restrict your comments to the usability, accuracy, readability, organization, and completeness of this document.

1. Please specify by page any errors you found in this manual.

2. Does the document cover the information you expected or required? Please make suggestions for improvement.

3. Is this the right type of document for your needs? Is it at the right level? What other types of documents are needed?

4. Did you have any difficulty understanding descriptions or wording? Where?

5. Please rate this document on a scale of 1 to 10 with 10 being the best rating _____

6. Dealer/Distributor where product purchased: _____

NAME _____ DATE _____

TITLE _____

COMPANY NAME/DEPARTMENT _____

ADDRESS _____

CITY _____ STATE _____ ZIP CODE _____

Please check here if you require a written reply.

WE'D LIKE YOUR COMMENTS . . .

This document is one of a series describing Qume products. Your comments on the back of this form will help us produce better manuals. Each reply will be carefully reviewed by the responsible person. All comments and suggestions become the property of Qume Corporation.

PLACE
POSTAGE
HERE

Qume Corporation
Attn: Technical Publications
2350 Qume Drive
San Jose, CA 95131