

High Performance Motion Control for Disk Drive Computer Peripherals

by
Richard K. Oswald, OMAC Corporation

Disk drives currently in production achieve random average positioning times between any two track locations in a 1.2 inch stroke, including following within 50 microinches of the target track, in less than 18 milliseconds. The motion control components and systems design which have permitted this level of performance in a highly reliable mass produced product are somewhat unique. However, the design techniques used can have many other applications. The particular areas covered in this presentation include the actuator, position transducer, velocity measuring system, and controller.

INTRODUCTION Disk files use a thin magnetic layer on the surface of a rotating disk for the storage of data in computer systems. The transducer which writes and reads this data is supported just above the surface of disk by a self-generated air bearing so as to maintain the required 10 to 15 x 10⁻⁶ inch spacing without any wear producing contact. Any location on the disk can be reached by moving the recording transducer ("head") to its radial coordinate ("track") and allowing disk rotation to bring the desired information under the head. Since the access time to data at any arbitrary location on a disk is determined by the time required to move the head to the required disk radius, minimum positioning time is the objective for the access motor control system. However, the head must be very accurately held at the required radius after arrival, so a transient response which minimizes settling to final value as well as steady state accuracy are also extremely important.

MECHANICAL SYSTEM CONFIGURATION A typical layout for the mechanical components of a disk drive is shown in Figure 1.

Several 14 inch diameter aluminum substrate recording disks are mounted on a precision spindle rotated at a

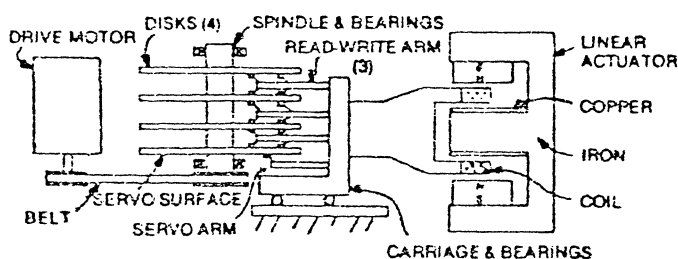

FIGURE 1. Disk Drive Mechanical Layout

constant 3600 RPM by means of a belt and drive motor. In order to reduce the required radial motion distance, two heads are used on each disk recording surface and four headed arm assemblies are the payload of the positioning system. The necessary number of read-write arm assemblies plus a single "servo" arm and head are supported by a linear motion carriage and bearing assembly and driven by a moving coil-permanent magnet actuator.

THE POSITION TRANSDUCER There are actually two position axes whose coordinates determine the storage location of a particular data record on a disk: radial and circumferential. Both are measured by the same servo head by reading the specially prerecorded information contained on the dedicated servo disk surface. A format for the servo surface which provides this information is shown in Figure 2.

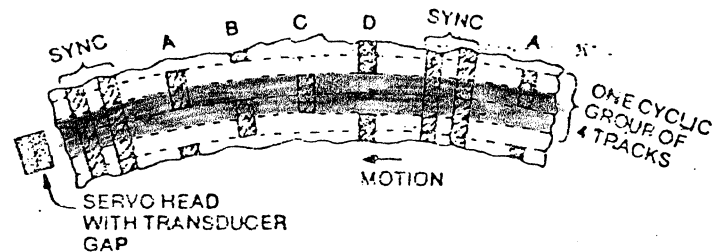

FIGURE 2. Servo Disk Format

The magnetic surface of the servo disk is prerecorded during manufacturing with magnetization areas of either N to S or S to N polarities which are represented in Figure 2 by clear and shaded areas. The servo head electrical read signal is a pulse as the boundary between areas is crossed. The pulse polarity is determined by the type of boundary, light to dark or dark to light; and the amplitude is determined by the percentage of the gap length covered by the transition. Thus the servo head signal for the location shown in Figure 2 would be as shown in Figure 3.

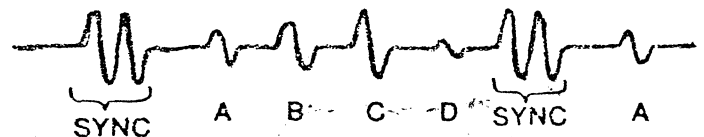

FIGURE 3. Servo Head Read Signal

For a circumferential index reference, one transition of a sync character is deleted. Thus circumferential position is determined by the number of syncs counted since index for the current disk revolution. For a continuous measure of radial position the analog pulse height differences A-B and C-D are determined. In one cyclic group of 4 tracks there are two nulls in both A-B and C-D, so each of these 4 null locations defines a track center as shown in Figure 2.

The similarity of this transducer system to the combination of an incremental shaft encoder for rotary position and a two phase linear position transducer such as an Inductosyn® should now be apparent. However, the performance levels routinely achieved are far better. 20,000 pulses per revolution, each accurate to better than ±5% of a period from its true location, is typical for the shaft encoder function. The two phase linear position transducer has typical cycle distance of 0.004 inch (1000 nulls per inch), worst case absolute accuracy of 100 x 10⁻⁶ inch over a 1.2 inch stroke and incremental accuracy of 25 x 10⁻⁶ inch with an equivalent carrier frequency of greater than one megahertz.

• Feed Controls

(continued on following page)

High Performance Motion

(continued from preceding page)

THE ACTUATOR The electromechanical linear actuators used in disk files are usually constructed with ironless moving coil armatures and permanent magnet stators. The actuator configuration so closely resembles that of the conventional dynamic loud speaker used for audio that it is often referred to as a voice coil motor. Total stroke length for use with a 14 inch disk is usually about 1.2 inches; and total moving mass for the system is between 0.2 and 0.7 pounds, depending upon the number of disks and details of the carriage design.

In order to achieve 16 millisecond average access time and include 2 milliseconds to verify settling to final position, the available motion time for an average length seek of about 0.4 inch is 14 milliseconds. This requires acceleration levels of about 20 times *g* (the acceleration of gravity). However, a very demanding requirement for the actuator is a fast force rise time so that the motion times for the short seeks can be kept small. For a one track seek distance of one milli-inch (1000 tracks per inch) the required motion time is about 800 microseconds, during which the current (and thus force) must rise from zero to a reasonable fraction of final value, reverse to the same magnitude with opposite polarity, and return to zero. Therefore, the current rise time to 60% of final value is usually less than 100 microseconds, an acceleration rate of 120*g* per millisecond. To achieve this armature time constant, a copper shorted turn is placed on the stator magnet assembly coaxial with the moving coil, and it often reduces the effective inductance of the actuator below that of the coil in air.

THE CONTROLLER Nearly time optimal control for all length seeks in the presence of parameter variations is obtained by using a predetermined deceleration trajectory and closed loop velocity controller within the position control loop as shown in Figure 4.

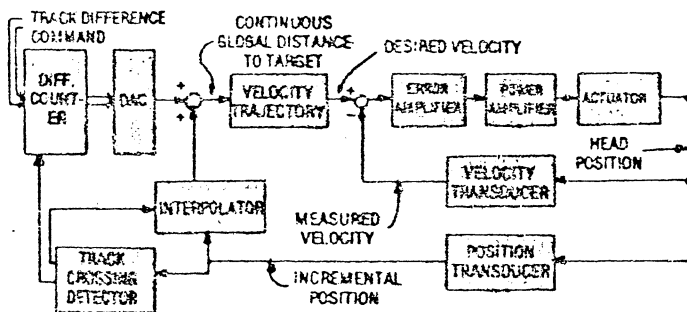

FIGURE 4. Access Control System

Employing this type of controller to achieve not only minimum motion time, but also maintain the required steady state position, is not unique. However, the configuration used to obtain a continuous global position signal from an incremental position transducer is somewhat unusual. Its operation is described in Figure 5.

This signal processing method uses digital logic and quantization of the incremental transducer to achieve accuracy with wide dynamic range at low cost. In addition it provides the same continuous resolution, step-free output throughout the entire displacement range that would otherwise be available only over one half cycle of the incremental transducer.

Achieving not only short motion times, but also fast

settling to a very small steady state error, requires high bandwidth mechanical components. Present disk files often utilize a unity gain bandwidth of 2 to 3 kilohertz in the velocity transducer minor loop of Figure 4. Conventional mechanical velocity transducers which have sufficiently high structural resonant frequencies, as well as the required accuracy, are not only inherently very expensive, but also add mass and structural complexity to the payload. Therefore, the required velocity information is obtained by signal processing without a separate transducer.

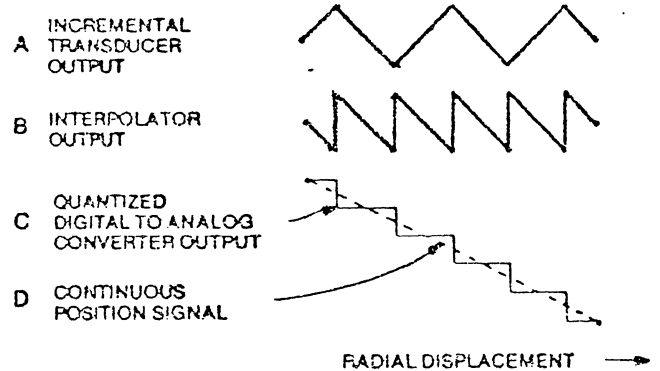
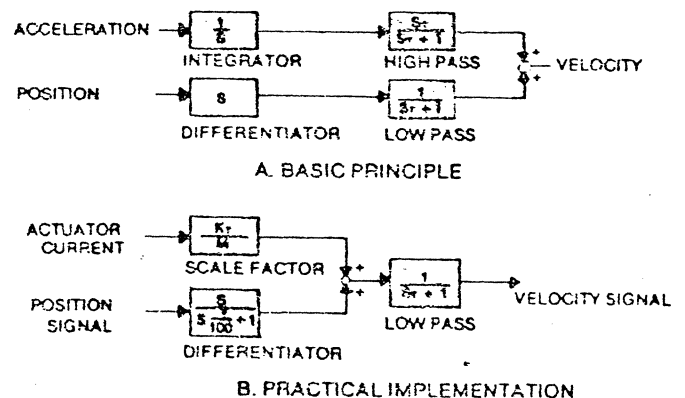

FIGURE 5. Position transducer operation

THE VELOCITY MEASURING SYSTEM The positioning system already utilizes two electromechanical devices, the actuator and position transducer, which can at least potentially be sources of velocity information. To provide the required high accuracy positioning capability, the carriage system inherently has very low friction. Thus the only forces acting to accelerate the moving mass are provided by the actuator. Actuator force is directly proportional to armature current, so measuring this current and applying the proper scale factor yields acceleration. The time integral of acceleration then provides accurate wideband velocity except for the problem of DC drift in the integrator. The global position signal obtained from the incremental position transducer can be differentiated to provide velocity, but it is severely contaminated with high frequency noise. However, combining these two signals after processing them through appropriate high pass and low pass filters gives the accurate wideband phase linear velocity information for the motor control system and is described in Figure 6.



$K =$ ACTUATOR CONSTANT $M =$ MOVING MASS $\tau =$ FILTER TIME CONSTANT

FIGURE 6. Velocity signal processing

CONCLUSION The position transducer and velocity measuring systems described are not only key to the performance of disk file positioning systems but may also be applicable in the design of motion controls for other applications.

(continued on page 51)

High Performance Motion

(continued from page 34)

REFERENCES

Engineering Design of a Disk Storage Facility with Data Modules; R.B. Mulvary, IBM Journal of Research and Development, November 1974, page 489.

Track Following Servo System; R.K. Oswald, IBM Technical Disclosure Bulletin, March 1976, page 3424.

An Electronic Tachometer for Disk File Motion Control; R.K. Oswald, IEEE Transactions on Magnetics, September 1975, page 1245. 

4/17/83



22-141 50 SHEETS
22-142 100 SHEETS
22-144 200 SHEETS

560
1000

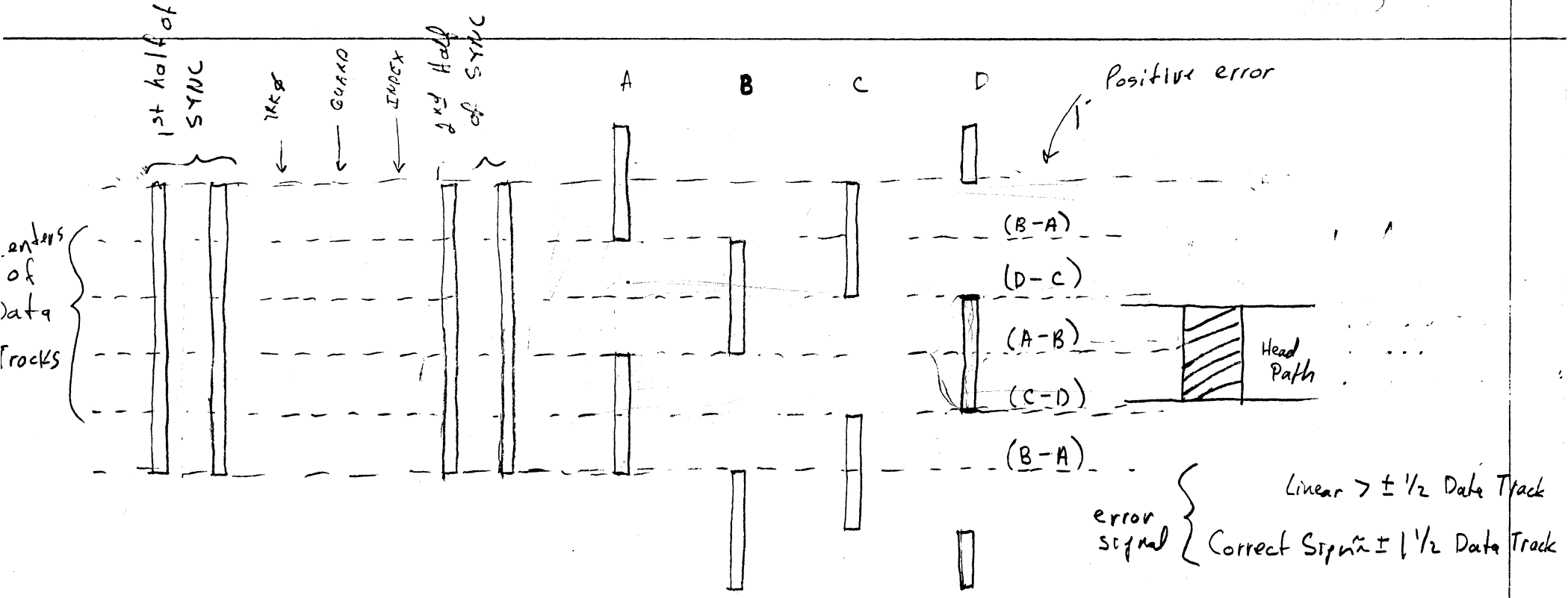

Read Signal

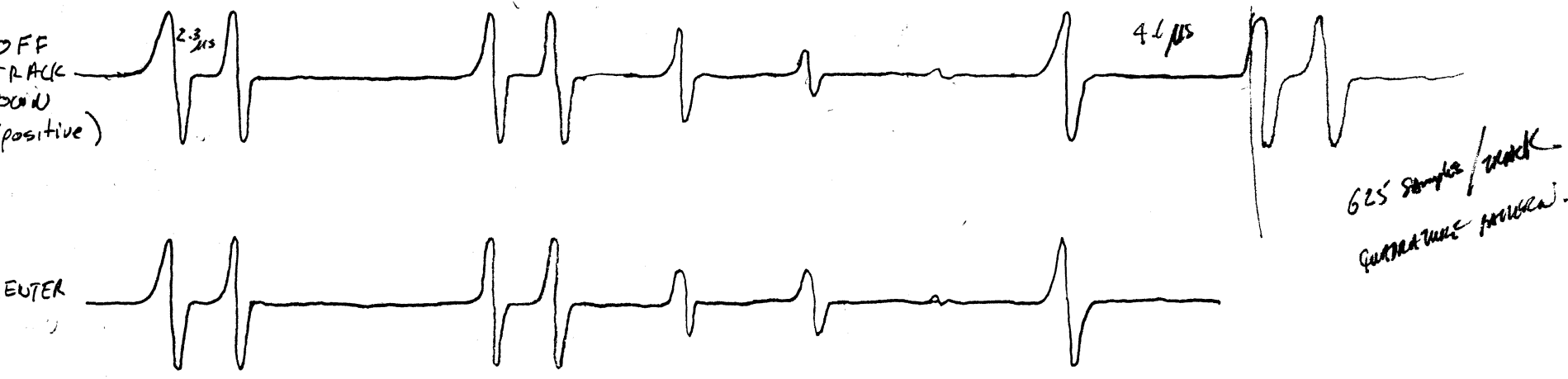

625 samples/track
guard time included.