

TEAC[®]

**TEAC FD-55BV-06
MINI FLEXIBLE DISK DRIVE
SPECIFICATION**

TABLE OF CONTENTS

	Title	Page
1-1	APPLICATION	101
1-2	DISK	101
1-3	PHYSICAL SPECIFICATION	101
1-4	REQUIRED POWER	104
1-5	ENVIRONMENTAL CONDITIONS	105
1-6	OPERATIONAL CHARACTERISTICS	107
1-7	RELIABILITY	110
1-8	SIGNAL INTERFACE	111
1-8-1	Electrical Characteristics	111
1-8-2	Signal Connector and Cable	113
1-8-3	Input/Output Signals	115
1-9	POWER INTERFACE	124
1-10	FRAME GROUNDING	126
1-11	STRAPS	127
1-12	OPERATIONAL CONDITION	131
1-12-1	Front Bezel Indicator	131
1-12-2	Spindle Motor	133

1-1. APPLICATION

This SPECIFICATION provides a description for the TEAC FD-55BV-06, double sided 48tpi mini flexible disk drive (hereinafter referred to as the FDD) of CSS model without head load solenoid.

1-2. DISK

5.25 inch, soft or hard sectored flexible disks which comply with ISO, ANSI, or ECMA standard.

1-3. PHYSICAL SPECIFICATION

- (1) Width: 146mm (5.75 in), Nom.
- (2) Height: 41.3mm (1.63 in), Nom.
- (3) Depth: 203mm (7.99 in), Nom. (excludes projections of interface connectors)
- (4) Weight: 1.2Kg (2.65 lbs), Nom., 1.3Kg (2.87 lbs), Max.
- (5) External view: See Fig.101
- (6) Cooling: Natural air cooling
- (7) Mounting: Mounting for the following directions are acceptable.
 - (a) Front loading, mounted vertically with front lever up.
 - (b) Front loading, mounted horizontally with indicator up. Do not mount horizontally with spindle motor up.
 - (c) Mounting angle in items (a) and (b) should be less than 30° with front bezel up.Note: As to the other mounting directions than the above will be considered separately.

(8) Installation: With installation holes on the side frame or on the
bottom frame of the FDD (see Fig.101)

(9) Material of frame : Aluminum diecast

(10) Material of front bezel : PPHOX (Xyron) or ABS
Standard color : Black

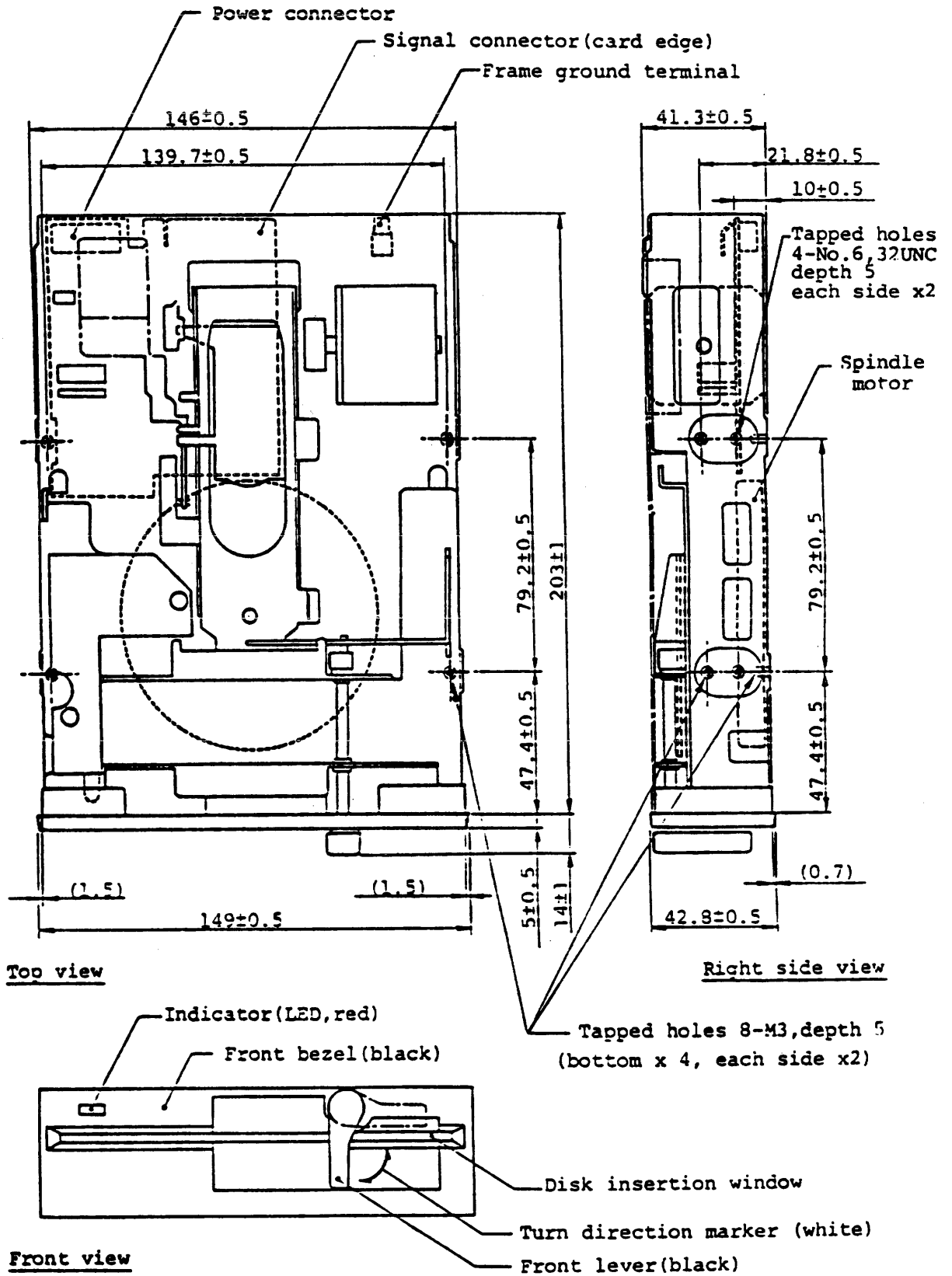

(Fig.101) External view

(Units:mm)

1-4. REQUIRED POWER

The following specifications are applicable at the power connector of the FDD.

(1) DC+12V

(a) Voltage tolerance

Read/write operation: Less than $\pm 5\%$

Others : Less than $\pm 10\%$

(b) Allowable ripple voltage: Less than 200mVp-p (including noise)

(c) Operating current consumption

Typical average: 0.22A

(using a disk of typical running torque)

Maximum average: Less than 0.54A

(using a disk of maximum running torque)

Peak: Less than 0.9A (400msec, Max. at spindle motor start)

(d) Waiting current consumption (spindle motor off)

Typical: 0.03A

Maximum: 0.04A

(2) DC+5V

(a) Voltage tolerance: $\pm 5\%$

(b) Allowable ripple voltage: Less than 100mVp-p (including noise)

(c) Operating current consumption

Typical average: 0.3A

Maximum average: Less than 0.38A

Peak: Less than 0.46A

(d) Waiting current consumption

Typical: 0.23A

Maximum: Less than 0.28A

(3) Power consumption

- (a) Typical at operating: 4.1W
- (b) Typical at waiting: 1.5W

(4) Power on sequence

Not specified. Since the FDD is equipped with power reset circuit, disk and data on the disk will not be damaged by power on or off.

1-5. ENVIRONMENTAL CONDITIONS

(1) Ambient temperature

- (a) Operating: 4°C ~ 46°C (40°F ~ 115°F)
- (b) Storage: -22°C ~ 60°C (-8°F ~ 140°F)
- (c) Transportation: -40°C ~ 65°C (-40°F ~ 149°F)

(2) Temperature gradient

- (a) Operating: Less than 15°C (27°F) per hour
- (b) Transportation and storage: Less than 30°C (54°F) per hour

(3) Relative humidity

- (a) Operating: 20% ~ 80% (no condensation)
Maximum wet bulb temperature shall be 29°C (84°F)
- (b) Storage: 10% ~ 90% (no condensation)
Maximum wet bulb temperature shall be 40°C (104°F)
- (c) Transportation: 5% ~ 95% (no condensation)
Maximum wet bulb temperature shall be 45°C (113°F)

(4) Vibration

- (a) Operating: Less than 0.5G (less than 55Hz)
Less than 0.25G (55 ~ 500Hz)

(b) Transportation: Less than 2G (less than 100Hz)

(5) Shock

(a) Operating: Less than 10G (less than 10msec)

(b) Transportation: Less than 40G (less than 10msec)

(6) Altitude

(a) Operating: Less than 5,000m (16,500 feet)

(b) Transportation: Less than 12,000m (40,000 feet)

Note: The above requirements are applied for the FDD without shipping box.
When a long period is required for transportation such as by ship,
the storage environmental conditions shall be applied.

1-6. OPERATIONAL CHARACTERISTICS

(1) Data capacity

Recording method		FM	MFM	
Data transfer rate (K bits/sec)		125	250	
Tracks/disk		80	80	
Innermost track bit density (bpi)		2,938(Side 1)	5,876(Side 1)	
Innermost track flux density (frpi)		5,876(Side 1)	5,876(Side 1)	
Data capacity	Unformatted	K bytes/track	3.125	6.25
		K bytes/disk	250	500
	Formatted (16 sectors /track)	K bytes/sector	0.128	0.256
		K bytes/track	2.048	4.096
		K bytes/disk	163.84	327.68

(Table 101) Data capacity

(2) Disk rotation mechanism

- (a) Spindle motor: Direct DC brushless motor
- (b) Spindle motor speed: 300rpm
- (c) Motor servo method: PLL servo or frequency servo by AC tachometer
- (d) Motor/spindle connection: Motor shaft direct
- (e) Disk speed: 300rpm
 - Long term speed variation (LSV): Less than $\pm 1.5\%$
 - Instantaneous speed variation (ISV): Less than $\pm 1.5\%$
- (f) Start time: Less than 400msec
- (g) Average latency: 100msec

(3) Index

- (a) Number of index: 1 per disk revolution
- (b) Detection method: LED and photo-transistor
- (c) Detection cycle: 200msec $\pm 1.5\%$

(d) Index burst detection timing error: Less than $\pm 200\mu\text{sec}$ with specified test disk.

(4) Track construction

(a) Track density: 48tpi

(b) Number of cylinders: 40 cylinders

(c) Number of tracks: 40 tracks/surface, 80 tracks/disk

(d) Outermost track radius (track 00): Side 0 57.150mm (2.2500 in)
Side 1 55.033mm (2.1667 in)

(e) Innermost track radius (track 39): Side 0 36.513mm (1.4375 in)
Side 1 34.396mm (1.3542 in)

(f) Positioning accuracy: Less than $\pm 30\mu\text{m}$, with specified test disk.
(Track 16, $23\pm 2^\circ\text{C}$, 40 ~ 60%RH)

(5) Magnetic head

(a) Magnetic head: Flexure supported read/write head with tunnel erase,
2 sets

(b) Effective track width: $0.300 \pm 0.025\text{mm}$ (0.0118 ± 0.0010 in)

(c) Read/write-erase gap spacing: 0.35mm (0.0135 in), Nom.

(d) Read/write gap azimuth: $0^\circ \pm 18'$, with specified test disk.

(6) Track seek mechanism

(a) Head positioning mechanism: Band positioner

(b) Stepping motor: 4-phase, 200 steps per revolution

(c) Stepping motor drive: 2 steps per track

(d) Outermost and innermost stopper: Mechanical moving stopper of head
carriage

(e) Track 00 detection method: LED and photo-transistor

(f) Track to track time: Use 6msec, Min.

(g) Settling time: Less than 15msec (excludes track to track time)

(h) Average track access time: 93msec (includes settling time).

(7) Head load mechanism: Not used.

(When a disk is inserted and the door is closed,
the FDD becomes head load condition).

(8) File protect mechanism: Detection of write enable notch by LED and
photo transistor

(9) Window margin (shipping): More than 600nsec, with specified test disk,
MFM method, PLO separator, and zero write
pre-compensation.

1-7. RELIABILITY

- (1) MTBF: 10,000 power on hours or more (for typical usage)
- (2) MTTR: 30 minutes
- (3) Design component life: 5 years
- (4) Preventive maintenance: Not required (for typical usage)
- (5) Error rates
 - (a) Soft read error: 1 per 10^9 bits (up to 2 retries)
 - (b) Hard read error: 1 per 10^{12} bits
 - (c) Seek error: 1 per 10^6 seeks
- (6) Security standard: Complying with UL, CSA

1-8. SIGNAL INTERFACE

Four FDDs, Max. can be connected to one FDD controller by daisy chaining.

1-8-1. Electrical Characteristics

(1) Interface driver/receiver: See Fig.102.

(2) Electrical characteristics

The following specifications are applicable at the signal connector of the FDD.

(a) Input signal

LOW level (TRUE): 0V ~ 0.5V

Terminator current: 18mA, Max.

Receiver current: 3.2mA, Max.

HIGH level (FALSE): 2.5V ~ 5.25V

(b) Output signal

LOW level (TRUE): 0V ~ 0.4V

Driver sink current capability: 48mA, Max.

HIGH level (FALSE): 5.25V, Max.

(depending on controller terminator)

(3) Terminator

(a) Resistance value: $330\Omega \pm 5\%$

(b) Terminator for DRIVE SELECT 0 ~ 3 input signals:

A terminator resistor is mounted on the PCB with soldering joint.

(c) Terminator for other input signals:

A resistor network is mounted on IC socket on the PCB.

(d) Shipping condition

All of the terminator resistors are mounted.

(e) Multiplex connection:

For the multiplex connection of the FDDs by daisy chaining, the resistor network explained in item (c) shall be removed from all the FDDs except for the final FDD of the interface cable.

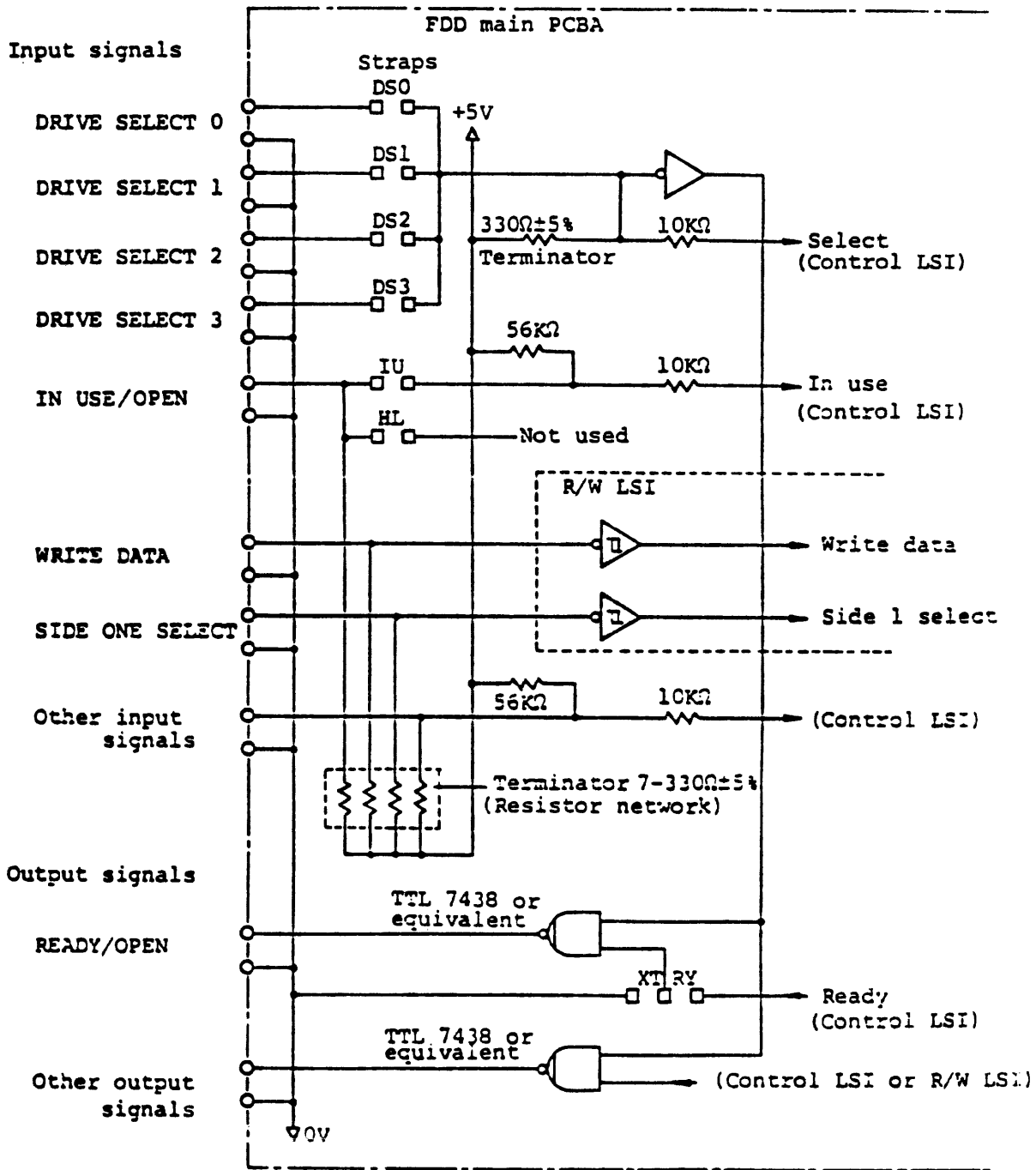

(Fig.102) Signal interface circuit

1-8-2. Signal Connector and Cable

(1) Signal connector

- (a) FDD side connector: Card edge of the main PCBA (gold plated)
- (b) Pin numbers & pin pitch: 34 pins, 2.54mm (0.1 in) pitch
(17 pins on both sides, even number pins are bottom side of the FDD)
- (c) Polarizing key location: Between pins 4 and 6
- (d) Card edge dimensions: See Fig.103
- (e) Interface connections: See Table 102
- (f) Cable side matched connector: 3M, Scotchflex ribbon connector, P/N 3463-0001
or AMP, thin leaf connector, P/N 583717-5
and contactor P/N 1-583616-1
or equivalent

(2) Maximum interface cable length: 3m, Max.

For the multiplex connection by daisy chaining, the total cable length shall be less than 3m.

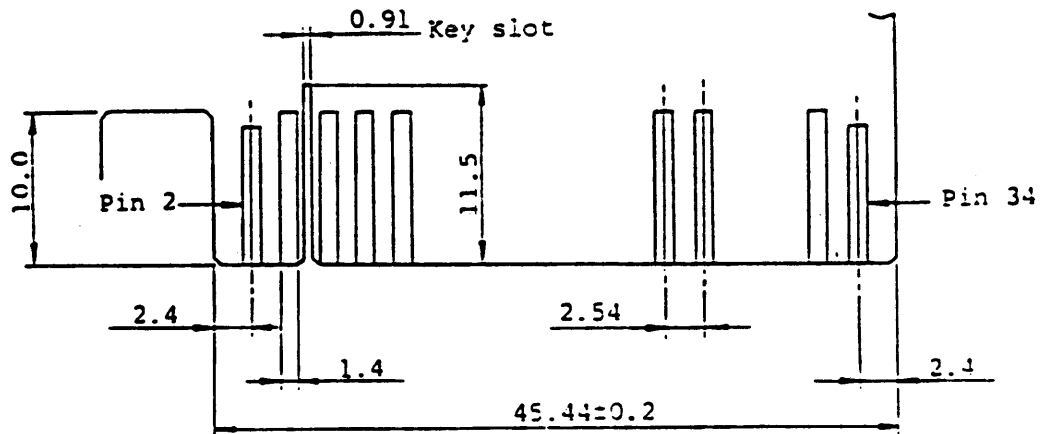

- Notes: 1. PCB thickness: 1.6mm, Nom.
- 2. The figure shows bottom view of the FDD.

(Fig.103) Card edge dimensions of signal connector

Signals	Directions	Terminal Nos.	
		Signals	0V
RESERVED		2	1
IN USE/OPEN	INPUT	4	3
DRIVE SELECT 3	INPUT	6	5
INDEX/SECTOR	OUTPUT	8	7
DRIVE SELECT 0	INPUT	10	9
DRIVE SELECT 1	INPUT	12	11
DRIVE SELECT 2	INPUT	14	13
MOTOR ON	INPUT	16	15
DIRECTION SELECT	INPUT	18	17
STEP	INPUT	20	19
WRITE DATA	INPUT	22	21
WRITE GATE	INPUT	24	23
TRACK 00	OUTPUT	26	25
WRITE PROTECT	OUTPUT	28	27
READ DATA	OUTPUT	30	29
SIDE ONE SELECT	INPUT	32	31
READY/OPEN	OUTPUT	34	33

Note: RESERVED terminal is open condition.

(Table 102) Signal interface connection

1-8-3. Input/Output Signals

In the following, input signals are those transmitted to the FDD while output signals are those transmitted from the FDD.

Refer to item 1-12 as to the relation between input signals and operating conditions of the front bezel indicator and spindle motor. LOW level of the signals is TRUE.

(1) DRIVE SELECT 0 ~ 3 input signals

- (a) Signals of four lines to select a specific FDD for operating in multiplex control by daisy chaining.
- (b) Only the DRIVE SELECT signal of the same number as of on-state strap among DS0 ~ 3 straps is effective.
- (c) All the input/output signals except for the MOTOR ON and IN USE are effective when this signal is effectively received.
- (d) The time required to make each input or output signal effective after the transmission of this signal is 0.5μsec, Max. including delay time through the interface cable.

(2) MOTOR ON input signal

- (a) Level signal to rotate the spindle motor.
- (b) The spindle motor reaches to the rated rotational speed within 400msec after this signal becomes TRUE.

(3) DIRECTION SELECT input signal

- (a) Level signal to define the moving direction of the head when the STEP line is pulsed.
- (b) Step-out (moving away from the center of the disk) is defined as HIGH level of this signal. Conversely, step-in (moving toward the center of the disk) is defined as LOW level of this signal.

(4) STEP input signal

- (a) Pulse signal to move the head. The pulse width shall be more than 0.8µsec and the head moves one track space per one pulse.
- (b) The access motion (head seek operation) is initiated at the trailing edge of the pulse and completes within 21msec after starting the access including the settling time. For the successive access motion in the same direction, the pulses shall be input with the space of more than 6msec, while the pulses shall be input with the space of more than 21msec for the access motion in a different direction.
- (c) This signal becomes ineffective when the WRITE PROTECT signal is FALSE and the WRITE GATE signal is TRUE.
Also this signal becomes ineffective when the TRACK 00 signal is TRUE and the DIRECTION SELECT signal is HIGH level (step-out).
- (d) This signal shall be input according to the timing in Fig.104.

(5) WRITE GATE input signal

- (a) Level signal to erase the written data and to enable the writing of new data.
- (b) The FDD is set to write mode when the following logical expression is satisfied.

$$\text{WRITE GATE} * \text{DRIVE SELECT} * \overline{\text{WRITE PROTECT}}$$

- (c) This signal should be made TRUE after satisfying all of the following three conditions.
 - i) The FDD is in ready state (refer to item (13)).
However, the host controller can ignore this item since the INDEX and the READ DATA pulses are output only when the FDD is in ready state.
 - ii) More than 21msec after the effective receipt of the final STEP pulse.
Practical write operation, however, can be executed without error more than 10msec after the final STEP pulse.
 - iii) More than 100µsec after the level change of the SIDE ONE SELECT

signal.

- (d) None of the following operations shall be done for at least 1msec after this signal is changed to FALSE.
 - i) Make a motor-on command FALSE.
 - ii) Make the DRIVE SELECT signal FALSE.
 - iii) Start the head access motion by the STEP pulse.
 - iv) Change the level of the SIDE ONE SELECT signal.

(6) WRITE DATA input signal

- (a) Pulse signal to designate the contents of the data to be written on the disk. The pulse width shall be 0.10µsec through 2.5µsec and the leading edge of the pulse is used.
- (b) This signal becomes ineffective when one of the following conditions is satisfied.
 - i) WRITE GATE signal is FALSE.
 - ii) WRITE PROTECT signal is TRUE.
- (c) This signal shall be input according to the timing in Fig.105.

(7) SIDE ONE SELECT input signal

- (a) Level signal to define which side of a double sided disk is used for reading or writing.
- (b) When this signal is HIGH level, the magnetic head on the side 0 surface of the disk is selected, while the magnetic head on the side 1 surface is selected when this signal is LOW level.
- (c) The READ DATA signal on a selected surface becomes valid more than 100µsec after the change of this signal level.
- (d) Write operation (the WRITE GATE signal is TRUE) on a selected surface shall be started more than 100µsec after the change of this signal level.
- (e) When the other side of the disk is selected after the completion of a write operation, the level of this signal shall be switched more than 1msec after making the WRITE GATE signal FALSE.

(8) IN USE/OPEN input signal

This signal is effective only when the IU strap is on-state (refer to item 1-11).

- (a) Level signal to indicate that all of the daisy chained FDDs are in use condition under the control of the host system. Refer to item 1-12.
- (b) When the IU strap is off-state, only the terminator is connected to pin 4 of the signal interface connector and the input circuit becomes open condition (refer to Fig.102).

(9) TRACK 00 output signal

- (a) Level signal to indicate that the head is on track 00 (the outermost track).
- (b) This signal becomes valid more than 5.8msec after the effective receipt of the STEP pulse.

(10) INDEX/SECTOR output signal

- (a) Pulse signal for the detection of the index hole or the sector holes.
- (b) INDEX pulse is output when the following logical expression is satisfied.

Hole detection * DRIVE SELECT * READY

Note: For a hard sectored disk, strap setting shall be changed according to item 1-11 (9) and the ready state has no relation to the INDEX/SECTOR output condition.

- (c) When using a soft sectored disk, there will be one index pulse on this line per one revolution of the disk. When using a hard sectored disk, sector pulses and index pulse are output together.
- (d) Fig.106 shows the timing for this signal. Leading edge of the pulse shall be used as the reference.

(11) READ DATA output signal

- (a) Pulse signal for the read data from the disk composing clock bits and data bits together.
- (b) Fig.107 shows the timing for this signal. Leading edge of the pulse shall be used as the reference.
- (c) This signal becomes valid when all of the following four conditions are satisfied.

i) FDD is in ready state (refer to item (13)).

ii) More than 21msec after the effective receipt of the final STEP pulse.

However, practical read operation can be executed without error

more than 10msec after the final STEP pulse.

iii) More than 1msec after the WRITE GATE signal becomes FALSE.

iv) More than 100µsec after the level change of the SIDE ONE SELECT signal.

(d) READ DATA pulse is output when the following logical expression is satisfied.

READ DATA detection * DRIVE SELECT * READY * WRITE OPERATION

Notes: 1. WRITE OPERATION is the state when the WRITE GATE input signal is FALSE and more than 1msec has been passed after the WRITE GATE signal changed to FALSE.

2. For a hard sectored disk, strap setting shall be changed according to item 1-11 (9) and the ready state has no relation to the READ DATA output condition.

(12) WRITE PROTECT output signal

(a) Level signal to indicate that the write enable notch of the disk is masked.

(b) When this signal is TRUE, the data on the disk are protected from erasing and writing of new data is inhibited.

(13) READY/OPEN output signal

(a) Level signal to indicate that the FDD is in ready state.

(b) The FDD becomes ready state when all of the following four conditions are satisfied.

i) The FDD is powered on.

ii) A disk is installed and a motor-on command from the host side is TRUE.

iii) The disk rotates at more than 50% of the rated speed and two INDEX pulses have been counted after the 50% speed is satisfied.

iv) INDEX pulse interval is within the range of $\pm 6\%$ for the rated value.

(c) The FDD becomes ready state within 800msec (550msec, approx. in

average) after making a motor-on command TRUE.

- (d) The ready state is reset within 0.3msec after changing the level of a motor-on command to FALSE.
- (e) The READY output signal is effective only for the condition that the RY strap is on-state (refer to item 1-11) and that an installed disk is soft sectored type.

For a hard sectored disk, ready condition cannot be detected due to the conditions in item (b)-iii) and (b)-iv).

- (f) When the XT strap is on-state with the RY strap being off, the output of the signal interface terminal 34 maintains open condition (FALSE state of open collector driver). Refer to Fig.102.

Even if a signal having other function is daisy chained to terminal 34, its function will not be disturbed.

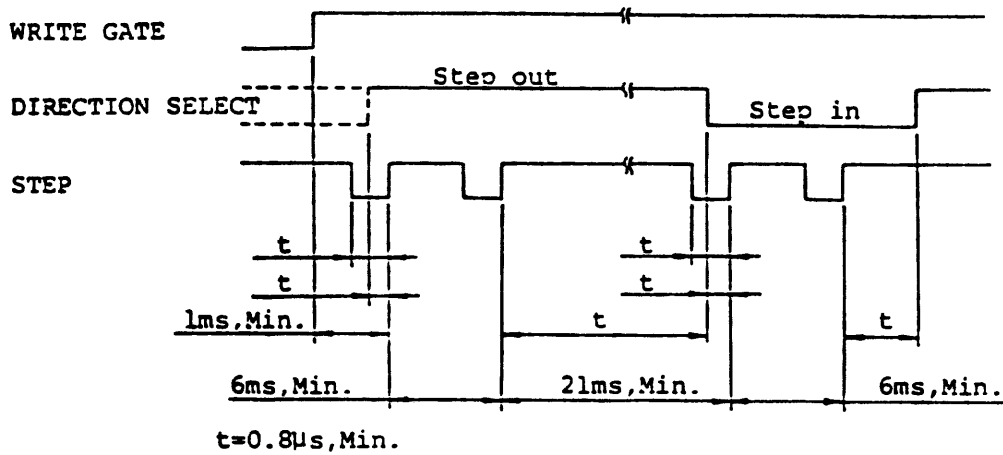

(Fig.104) STEP timing

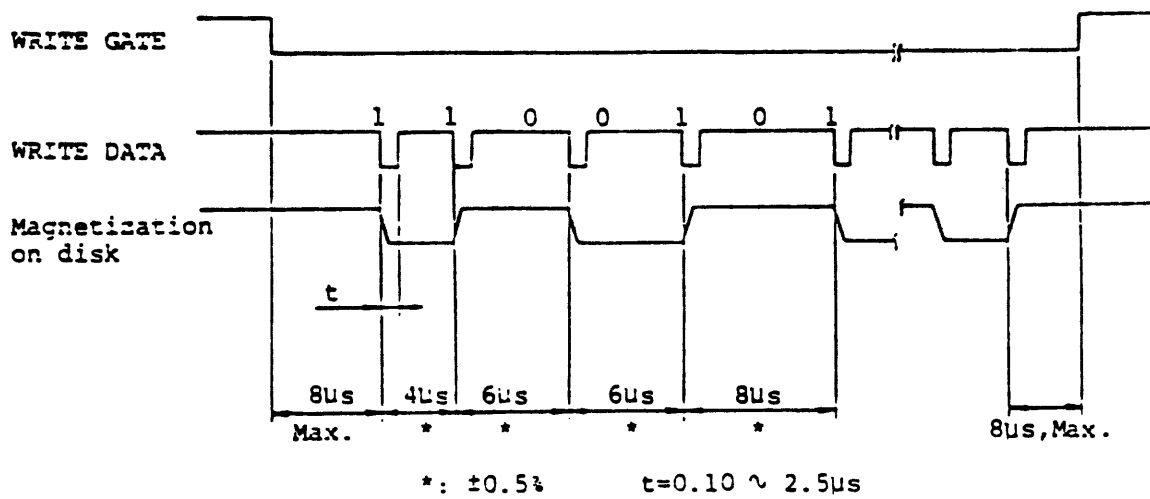

(Fig.105) WRITE DATA timing (MFM method)

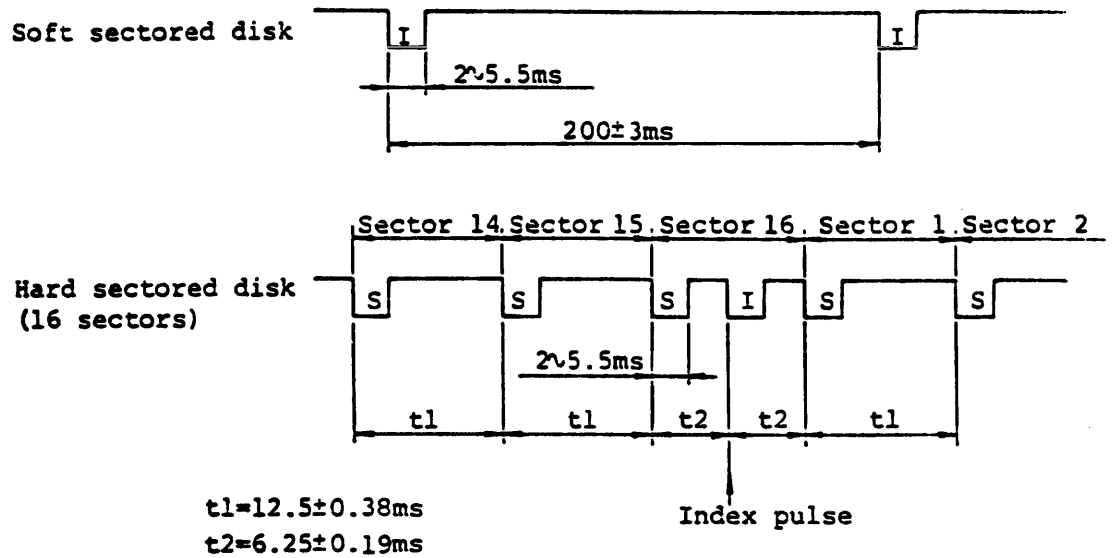

(Fig.106) INDEX/SECTOR timing

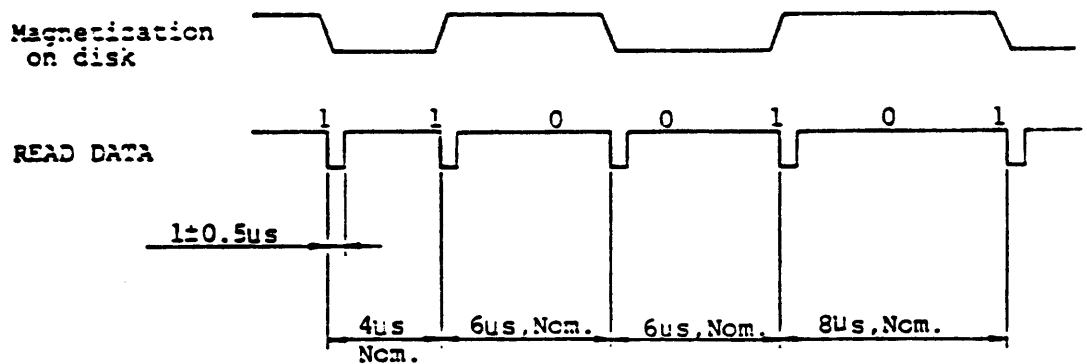

Note: The displacement of any bit position does not exceed ±700nsec from its nominal position. (When PLO separator is used with zero write pre-compensation.)

(Fig.107) READ DATA timing (MFM method)

1-9. POWER INTERFACE

Refer to item 1-4 for power requirements.

(1) Power connector

- (a) FDD side connector: AMP, Mate-N-Lock connector, P/N 172349-1
or equivalent
- (b) Pin numbers: 4 pins
- (c) Protection method for mis-connection: Mechanical protection by the
shape of the connector housing.
- (d) Pin location: See Fig.108
- (e) Power interface connections: See Table 103
- (f) Cable side matched connector: AMP, P/N 1-480424-0 and pins 60617-1,
or 60619-1,
or equivalent

(2) Power cable

Any appropriate cables taking the maximum power consumption of the FDD and the power voltage at the connector into consideration will be acceptable.

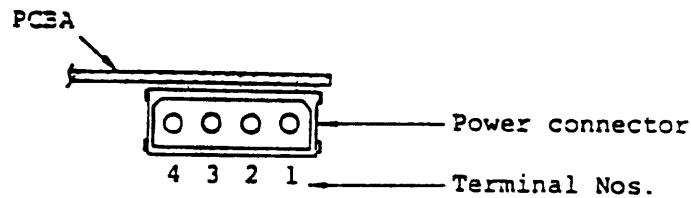

(Fig.108) Power connector pin location (rear view)

Voltage	Terminal Nos.
DC+12V	1
0V	2
0V	3
DC+5V	4

(Table 103) Power interface connections

1-10. FRAME GROUNDING

(1) Frame grounding

- (a) The FDD frame is electrically connected to DC 0V by FG strap on the main PCBA. (See Fig.109).
- (b) The FDD is shipped with the FG strap set to on-state.
- (c) Insulation resistance between the frame and DC 0V is more than $150K\Omega$ at DC 150V, if the FG strap is set to off-state.

(2) Frame ground terminal (back side of the FDD)

- (a) FDD side terminal: AMP Faston 187 tab P/N 61761-2
or equivalent
- (b) Cable side matched terminal: AMP P/N 60972-2 or 61697-1
or equivalent

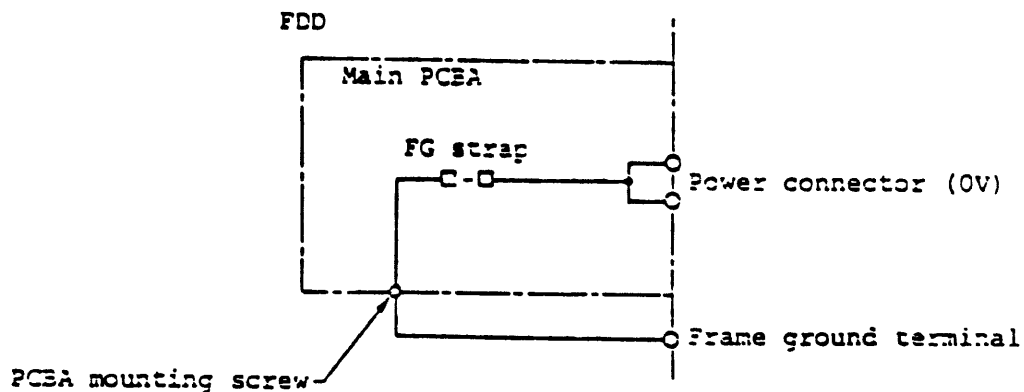

(Fig.109) Frame ground internal connection

1-11. STRAPS

All the straps are mounted on the main PCBA of the FDD. Insertion of a short bar onto the post pin is defined as the on-state of the strap. Fig.110 shows the assignment of the straps on the PCBA.

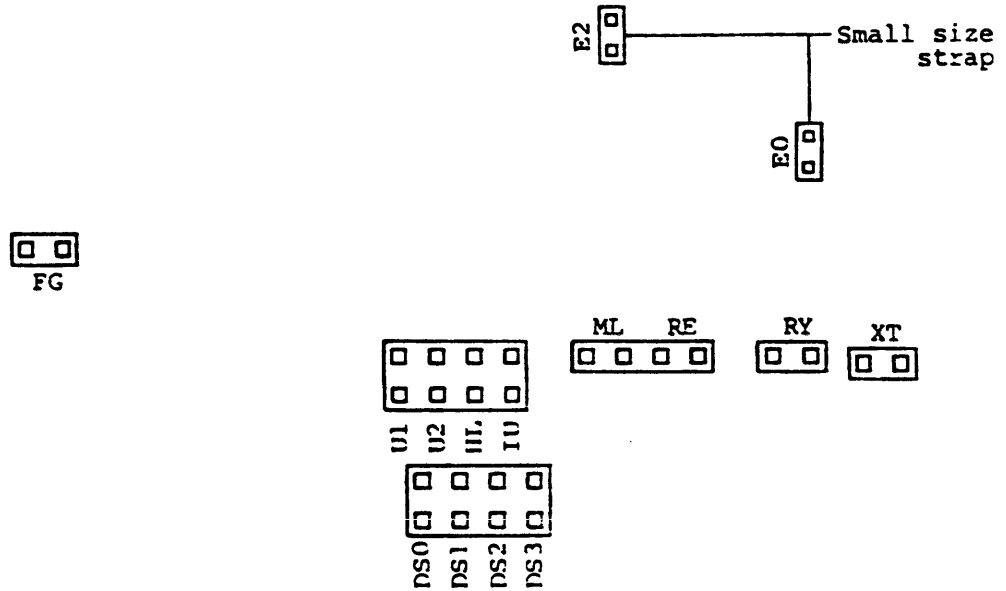

(Fig.110) Assignment of straps

(1) Straps setting at shipment

The FDD is shipped with the following straps set to on-state:

DS1, XT, FG, E2

(2) DS0 ~ DS3 straps

- (a) In the multiplex control by daisy chaining, these straps designate the address of the FDD.
- (b) By the combination with the DRIVE SELECT 0 ~ 3 signals (refer to Fig.102 and item 1-8-3 (1)), four addresses of 0 through 3 can be designated. Never designate more than 2 FDDs to a same address.

(3) IU strap

- (a) Strap to make the signal interface terminal 4 be used for the IN USE input signal. In such application, this strap should be on-state.
- (b) If this strap is off-state, the input circuit becomes open and the IN USE signal becomes ineffective.

(4) U1 and U2 straps

- (a) Straps to determine the turn-on condition of the front bezel indicator.
- (b) Five turn-on conditions can be selected including the IU strap in item (3). Refer to item 1-12-1.

(5) RY and XT straps

- (a) Straps to select the function of the signal interface terminal 34. It is used for either function of READY output signal or maintaining open condition.
- (b) When the RY strap is on-state, the READY signal is output from the terminal 34.
- (c) When the XT strap is on-state, the terminal 34 will maintain open condition (FALSE state of open collector driver).

Caution: Never set both of the RY and the XT straps on-state. Be sure to set either of them on.

(6) FG strap

- (a) Strap to connect the FDD frame electrically to DC 0V.
- (b) Refer to item 1-10 as to the details.

(7) ML strap

- (a) Strap to determine the rotational condition of the spindle motor by

an external command.

- (b) When this strap is off-state, the spindle motor rotates only by the MOTOR ON input signal.
- (c) When this strap is on-state, the spindle motor rotates by either of the following conditions. (Refer to item 1-12-2).
 - i) While the MOTOR ON input signal is TRUE.
 - ii) While the front bezel indicator turns on.

(8) RE strap

- (a) Strap to make the head recalibrate automatically to track 00 immediately after the power on.
- (b) When this strap is off-state, no auto-recalibration is executed.
- (c) When this strap is on-state, auto-recalibration starts immediately after the power on. It will be completed within 255msec (if the head was on the innermost track) and the FDD maintains not-ready condition during the operation.

(9) E0 and E2 straps

- (a) Straps to select the output condition of INDEX/SECTOR pulse and READ DATA pulse.
- (b) When the E0 strap is off-state, INDEX/SECTOR pulse is output during the ready state of the FDD, while it is output independently of the ready state when the E0 strap is on.
- (c) When the E2 strap is on-state, READ DATA pulse is output during the ready state of the FDD, while it is output independently of the ready state when the E2 strap is off.
- (d) The FDD is shipped with the strap setting of E0 off and E2 on usually. It is required to change the strap setting for a hard sectored disk so that E0 becomes on and E2 becomes off.

(10) HL strap

HL strap is not used on this FDD. Set it to off-state.

1-12. OPERATIONAL CONDITIONS

1-12-1. Front Bezel Indicator

Five turn-on conditions of the front bezel indicator are offered for selection using three straps IU, U1, and U2 as shown in Table 104.

Selection No.	Strap-combinations			Indicator turn-on conditions
	IU	U1	U2	
1	-	-	-	DRIVE SELECT
2	ON	-	-	DRIVE SELECT + IN USE
3	ON	ON	-	IN USE
4	-	ON	ON	DRIVE SELECT * READY
5	ON	ON	ON	IN USE + (DRIVE SELECT * READY)

Notes: 1. "-" mark indicates the off-state of the strap.

2. Other combinations not specified in table are not used practically.

(Table 104) Indicator turn-on conditions

(1) Selection No.1

The indicator turns on while the DRIVE SELECT signal (selected by DSO ~ 3 straps) is TRUE.

(2) Selection No.2

The indicator turns on while the DRIVE SELECT signal is TRUE or while the IN USE signal is TRUE.

(3) Selection No.3

The indicator turns on while the IN USE signal is TRUE.

(4) Selection No.4

The indicator turns on while the DRIVE SELECT signal is TRUE and the FDD is in ready state (refer to item 1-8-3 (13))

(5) Selection No.5

The indicator turns on in the condition of item (3) or (4).

1-12-2. Spindle Motor

The spindle motor starts rotation in either of the following conditions (1) and (2). The motor reaches to the rated rotational speed within 400msec after the start.

(1) Rotation by a command from the host side

Either one of the conditions can be selected by the ML strap.

(a) Selection 1: Off-state of ML strap

While the MOTOR ON signal is TRUE, the spindle motor rotates.

(b) Selection 2: On-state of ML strap

While the MOTOR ON signal is TRUE, or while the front bezel indicator is on, the spindle motor rotates.

Note that the Selection Nos.4 and 5 of the turn-on conditions of the front bezel indicator (refer to item 1-12-1) cannot be used for this purpose.

(2) Automatic rotation by the internal circuit of the FDD

(a) Automatic rotation by the internal circuit will start under either of the following conditions.

- i) When a disk is inserted into the front bezel.
- ii) When the disk is removed.

Note that the automatic rotation will not start when a write protected disk is removed.

(b) Automatic rotation will stop under one of the following conditions.

- i) When the front lever is closed, disk starts rotation, and the FDD becomes ready state. The READY signal maintains FALSE.
- ii) Approximately 10 seconds after the removal of a disk from the FDD.
- iii) The front lever is not closed for 10 seconds, approx.