

**UNISYS**

**U 5000/20, U 5000/30,  
U 5000/35, U 5000/40,  
U 5000/50, and U 5000/55  
Systems**

**U 5000 Series  
Operating System**

**Installation  
Guide**

April 1988

Priced Item

Printed in U S America  
UP-12693 Rev. 1

# **UNISYS**

**U 5000/20, U 5000/30,  
U 5000/35, U 5000/40,  
U 5000/50, and U 5000/55  
Systems**

**U 5000 Series  
Operating System**

**Installation  
Guide**

Copyright © 1988 Unisys Corporation.  
Unisys is a trademark of Unisys Corporation.  
Previous Title: SPERRY 5000/20, 5000/30, 5000/40,  
and 5000/50 Hardware Installation Guide

April 1988

Priced Item

Printed in U S America  
UP-12693 Rev. 1

**NO WARRANTIES OF ANY NATURE ARE EXTENDED BY THE DOCUMENT.**

Any product and related material disclosed herein are only furnished pursuant and subject to the terms and conditions of a duly executed Program Product License or Agreement to purchase or lease equipment. The only warranties made by Unisys, if any, with respect to the products described in this document are set forth in such License or Agreement. Unisys cannot accept any financial or other responsibility that may be the result of your use of the information in this document or software material, including direct, indirect, special or consequential damages.

You should be very careful to ensure that the use of this information and/or software material complies with the laws, rules, and regulations of the jurisdictions with respect to which it is used.

The information contained herein is subject to change without notice. Revisions may be issued to advise of such changes and/or additions.

**WARNING:** This equipment generates, uses, and can radiate radio frequency energy and if not installed and used in accordance with the instructions manual, may cause interference to radio communications. It has been tested and found to comply with the limits for a Class A computing device pursuant to Subpart J of Part 15 of FCC Rules, which are designed to provide reasonable protection against such interference when operated in a commercial environment. Operation of this equipment in a residential area is likely to cause interference in which case the user at his own expense will be required to take whatever measure may be required to correct the interference.

Ethernet is a trademark of Xerox Corporation.

Centronics is a trademark of Centronics Data Computer Corporation.

VT 100 is a trademark of Digital Equipment Corporation.

TTY is a trademark of AT&T Teletype Corporation.

UNISCOPE is a registered trademark of Unisys Corporation.

Copyright © 1985 by NCR Corporation.

# Contents

1.	Installing the Unisys 5000/20 .....	1-1
2.	Installing the Unisys 5000/30 .....	2-1
3.	Installing the Unisys 5000/35 .....	3-1
4.	Installing the Unisys 5000/40 .....	4-1
5.	Installing the Unisys 5000/50 .....	5-1
6.	Installing the Unisys 5000/55 .....	6-1
7.	Using the Hardware System .....	7-1
	Overview .....	7-1
	System Control Panels .....	7-1
	On/Off Switch .....	7-1
	Power Indicator .....	7-2
	Disk Indicator .....	7-3
	Communications Indicator .....	7-3
	Fault Indicator .....	7-3
	Battery Indicator .....	7-3
	Floppy Disk Indicator .....	7-4
	Streaming Tape Indicator .....	7-4
	Turning On the System .....	7-5
	Inserting a Streaming Tape .....	7-7

# Contents

---

## Figures

1-1. 5000/20 System and Peripherals .....	1-1
1-2. 5000/20 Component Connectors .....	1-3
1-3. Back of the 5000/20 Unit .....	1-6
1-4. 5000/20 Battery Back-Up Fuse .....	1-7
2-1. 5000/30 System and Peripherals .....	2-1
2-2. Rear View of 5000/30 Component Connectors .....	2-3
2-3. Back of the 5000/30 Unit .....	2-6
2-4. Rear View of 5000/30 Battery Back-Up Fuse .....	2-7
3-1. 5000/35 System and Peripherals .....	3-1
3-2. Rear View of 5000/35 Component Connectors (Less Than or Equal to 16 Users) .....	3-3
3-3. Rear View of 5000/35 Component Connectors (Greater than 16 Users) .....	3-4
3-4. Back of the 5000/35 Unit (Less than or Equal to 16 Users) .....	3-7
3-5. Back of the 5000/35 Unit (Greater Than 16 Users) .....	3-8
3-6. 5000/35 Battery Back-Up Fuse .....	3-9
4-1. 5000/40 System and Peripherals .....	4-1
4-2. 5000/40 Component Connectors .....	4-3
4-3. Back of the 5000/40 Unit .....	4-6
4-4. 5000/40 Battery Back-Up Fuse .....	4-7
5-1. 5000/50 System and Peripherals .....	5-1
5-2. 5000/50 Component Connectors .....	5-3
5-3. Back of the 5000/50 Unit .....	5-6
5-4. 5000/50 Battery Back-Up Fuse .....	5-7
6-1. 5000/55 System and Peripherals .....	6-1
6-2. 5000/55 Component Connectors .....	6-3
6-3. Back of the 5000/55 Unit .....	6-6
6-4. 5000/55 Battery Back-Up Fuse .....	6-7
7-1. Main Unit Indicators .....	7-5
7-2. Installing a Tape .....	7-7

# Preface

The Unisys 5000/20, 5000/30, 5000/35, 5000/40, 5000/50, or 5000/55 system is designed for simple installation, upgrading, and maintenance. The purpose of this guide is to show you how to install the hardware.

The following devices can be connected to your system:

Unisys Video Terminals (SVT-1210, SVT-1220, UVT-1224)

Unisys Personal Computers (PC/HT, PC/IT, PC/MicroIT, Personal Workstation<sup>2</sup> Series 300, 500, and 800)

Disk/Tape Expansion Cabinet

(for the 5000/30, 5000/35, 5000/40, 5000/50, or 5000/55 system)

5000/35 Disk Expansion Cabinet

5000/55 Disk Expansion Cabinet

Standalone 1/2-Inch Tape Drive Cabinet

<u>Model</u>	<u>Format</u>	<u>Type</u>
25C	dot matrix printer	Serial/Parallel
31	letter quality printer	Serial
35	dot matrix printer	Serial/Parallel
37	laser printer	Serial/Parallel
47	laser printer	Serial
0789	line printer	Serial
AP1307	daisywheel printer	Serial
AP1327	dot matrix printer	Serial/Parallel
AP1329	dot matrix printer	Serial/Parallel
AP9215-1	laser printer	Serial/Parallel
B9246-7	line printer	Serial/Parallel

## Before You Begin

You should already have the necessary cables and the separate installation instructions for each terminal and printer. You should know where you will place each device, and how your system will be configured. Before beginning the procedures described in this guide, unpack and install each of your printers and terminals according to the installation instructions provided with each device.

As part of the system installation you will connect one of your terminals to a console port and use it for start-up procedures. You should know which terminal you will use for this purpose.

If your site has not been prepared for installation, refer to the *5000/20*, *5000/30*, *5000/35*, *5000/40*, *5000/50*, and *5000/55 Planning Guide*, before beginning.

## Tools

The following tools should be available before the installation is started:

- Combination pliers

- Needlenose pliers

- Small, medium, and large screwdrivers, both standard and phillips

## How to Use This Book

The installation procedures of each system are discussed in a chapter specifically about that system, i.e., Chapter 1 contains information detailing the 5000/20, Chapter 2 treats the 5000/30, Chapter 3 discusses the 5000/35, Chapter 4 concerns the 5000/40, Chapter 5 describes the 5000/50, and Chapter 6 handles the 5000/55. Chapter 7 deals with information common to all systems such as the front panel indicators, how to turn on the system, and how to load a cartridge tape.





# Chapter 1. Installing the Unisys 5000/20

Figure 1-1 shows the various peripherals that can be connected to the 5000/20 system. This chapter provides instructions for connecting these devices to the main unit.

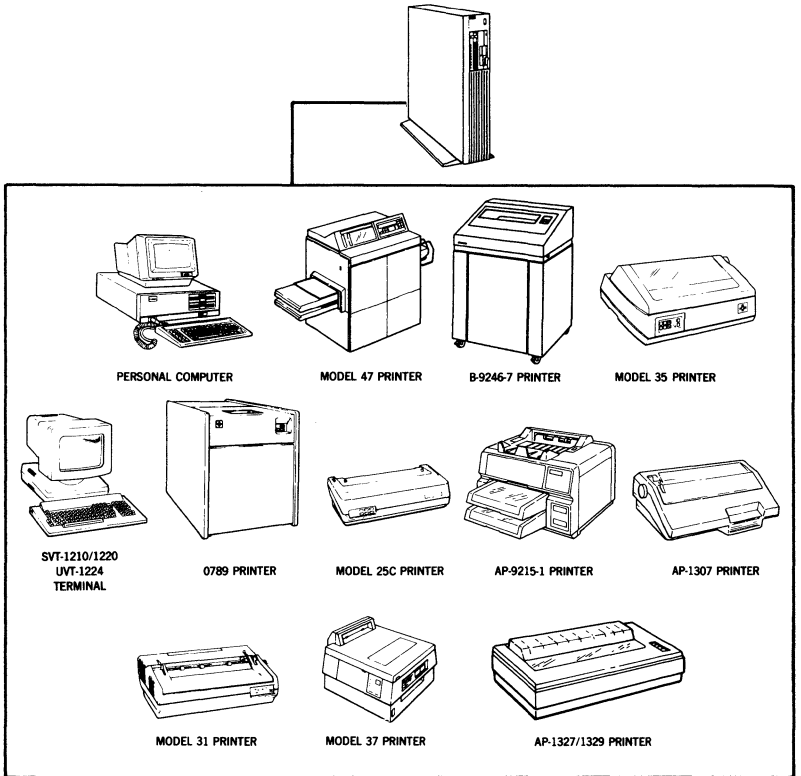

12693-1

**Figure 1-1. 5000/20 System and Peripherals**

# Chapter 1

---

Before installing the 5000/20 system, you should know where you are going to place each component of the system. You should know which printers will be connected as serial printers and which will be connected as parallel printers.

Your system requires a control console terminal. The control console is used to install and maintain the system. Any of the terminals you ordered with your system can be connected as a control console. Before beginning these procedures, you should know which terminal is designated for this purpose. If your site is not prepared for installation, refer to the *5000/20, 5000/30, 5000/35, 5000/40, 5000/50, and 5000/55 Planning Guide*.

# Installing the Unisys 5000/20

Figure 1-2 shows the connectors that are used for the components of the Unisys 5000/20.

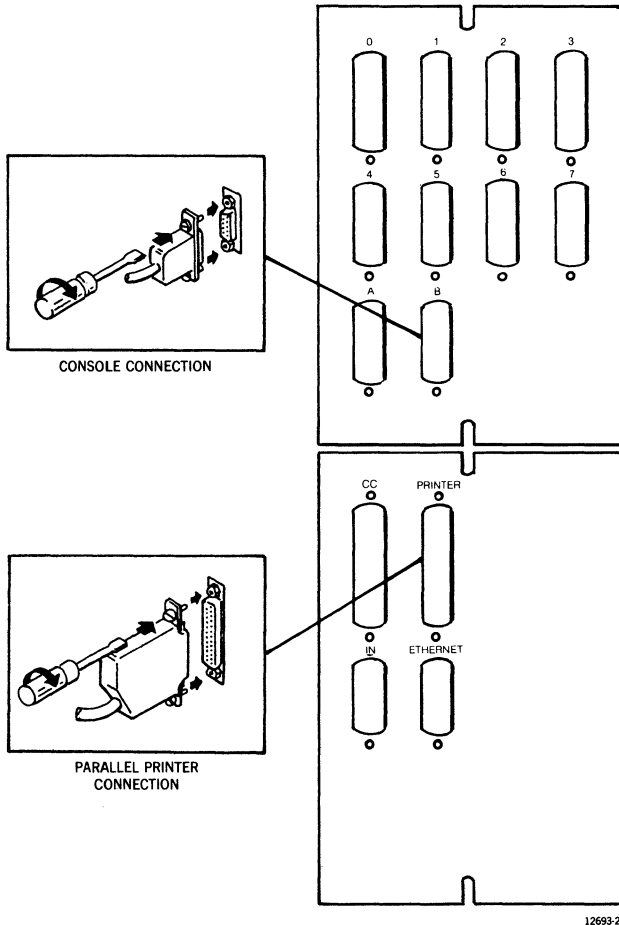

Figure 1-2. 5000/20 Component Connectors

# Chapter 1

---

The 5000/20 has a maximum of 8 asynchronous ports available for any combination of terminals and serial printers. These ports have female, 15-pin connectors that use an RS-232-C cable.

Processor Channel A is a dial-in port.

Processor Channel B is initialized by the firmware as the system console port.

One female 25-pin connector is available for a parallel printer (Centronics cable). Two synchronous ports with female 25-pin connectors are available for high speed communication if a synchronous/asynchronous board is installed in the system. A position on the bulkhead is available for the addition of Ethernet.

**CAUTION:**

Attach cables carefully. Damage to the connector pins causes the system to malfunction.

# Installing the Unisys 5000/20

---

Follow these steps to install your system:

1. Unpack and install the terminal that is designated as the console according to the instructions supplied with the terminal.

Configure the console terminal with the following characteristics (Refer to the documentation accompanying your particular terminal.):

<u>SVT/UVT Series</u>	<u>Other</u>
Xon/Xoff	Xon/Xoff
New Line Off	New Line Off
7 bits/character	7 bits/character
Parity on, even	Parity on, even
Reverse Video	Reverse Video
Attribute	Attribute
9600 Baud	9600 Baud
1 stop bit	1 stop bit

If possible, configure all terminals with the following characteristics:

Mode: VT100 (ANSI)  
Scroll: Jump  
Auto Repeat: On  
Background: Dark  
Cursor: Underline  
Wrap Around: On  
Margin Bell: Off

2. Unpack the main unit of the 5000/20.
3. Connect the console to Channel B of the main unit.
4. Unpack and install the printers and terminals according to the instructions provided with each unit.

# Chapter 1

---

5. Attach the terminals and serial printers to the connectors indicated in Figure 1-3. (These should be in an order that is suited to the configuration of your system).

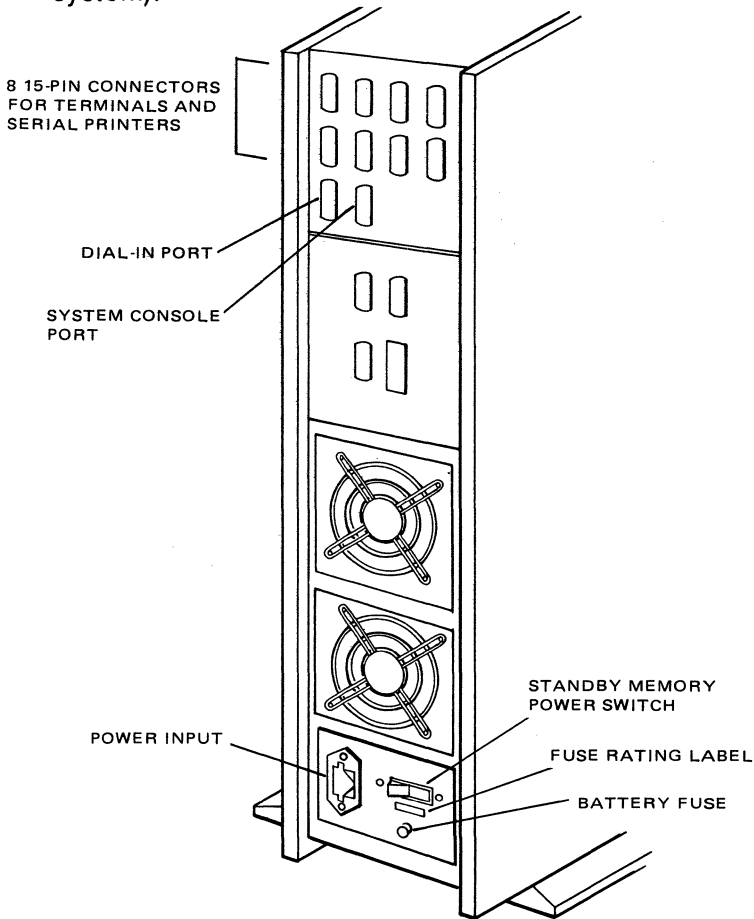
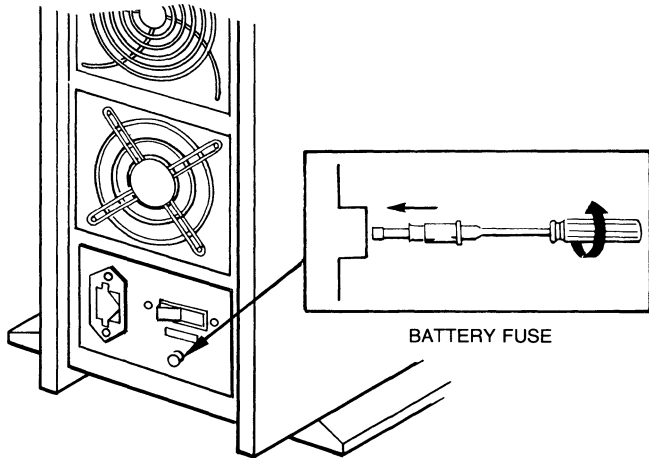

Figure 1-3. Back of the 5000/20 Unit

6. Attach the parallel printer to the connector indicated in Figure 1-3.
7. Locate the battery back-up fuse in the package containing the power cord. Install the fuse and turn on the standby memory power switch. (Refer to Figure 1-4.)



12693-3

**Figure 1-4. 5000/20 Battery Back-Up Fuse**

8. Attach the AC power cord to the unit and then connect it to the AC power source. Proceed to Chapter 7, "Using the Hardware System". To install the software follow the procedures in the *5000/20, 5000/30, 5000/35, 5000/40, 5000/50, and 5000/55 Installation and Implementation Guide*.



## NOTE:

This Unisys product contains a battery which automatically provides emergency current for retention of memory data in the event of a short AC power interruption. To prolong battery life and assure its satisfactory operation when needed, please observe these precautions:

1. Do not unplug or disconnect external power to this unit after it is installed. Battery life is significantly reduced if external AC power is regularly disconnected during working hours or overnight.
2. If you want to disconnect this unit for an extended period of time, disconnect the battery to prevent total battery discharge. To accomplish this, shut down the operating system (described in the "Operator Duties" chapter in your *5000/20, 5000/30, 5000/35, 5000/40, 5000/50, and 5000/55 Operators Guide*), move the STANDBY MEMORY POWER switch to the OFF position, move the POWER switch to the OFF position, and remove the battery back-up fuse from the unit.
3. Have a new battery installed periodically in accordance with the replacement schedule shown on the label attached to the 5000/20 system near the battery.
4. Only Unisys-trained personnel should attempt battery replacement. Electrical shock, damage, or loss of memory data may result if improper procedures are used.

# Chapter 2. Installing the Unisys 5000/30

Figure 2-1 shows the various peripherals that can be connected to the 5000/30 system. This chapter provides instructions for connecting these devices to the main unit.

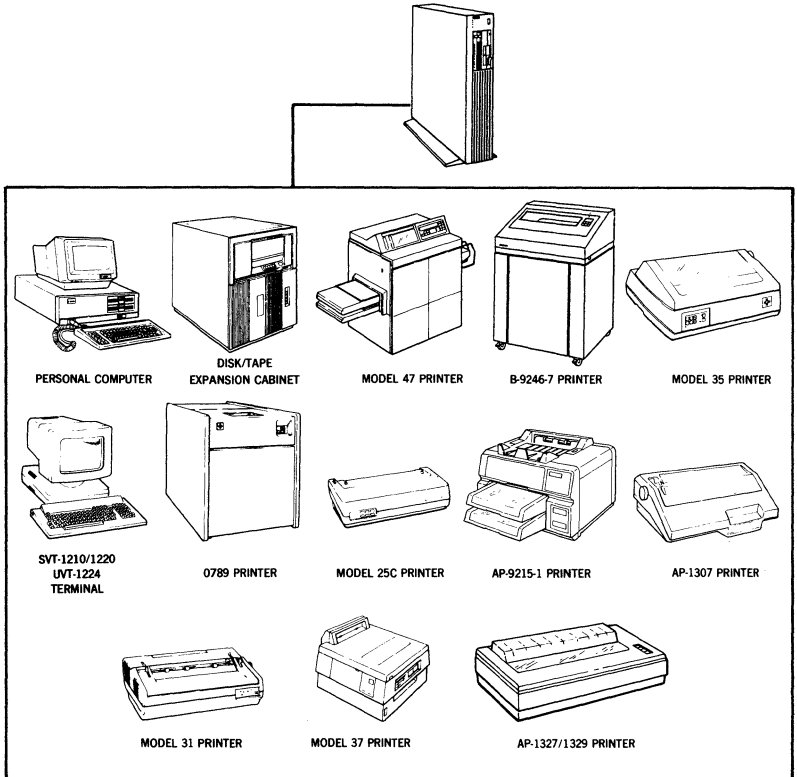

12693-4

Figure 2-1. 5000/30 System and Peripherals

## Chapter 2

---

Before installing the 5000/30 system, you should know which printers will be connected as serial printers and which will be connected as parallel printers.

Your system requires a control console terminal. The control console is used to install and maintain the system. Any of the terminals that you ordered with your system can be connected as a control console. Before beginning these procedures, you should know which terminal is designated for this purpose.

If your site has not been prepared for the 5000/30, refer to the *5000/20, 5000/30, 5000/35, 5000/40, 5000/50, and 5000/55 Planning Guide*.

Figure 2-2 shows the connectors that are used for the components of the Unisys 5000/30.

# Installing the Unisys 5000/30

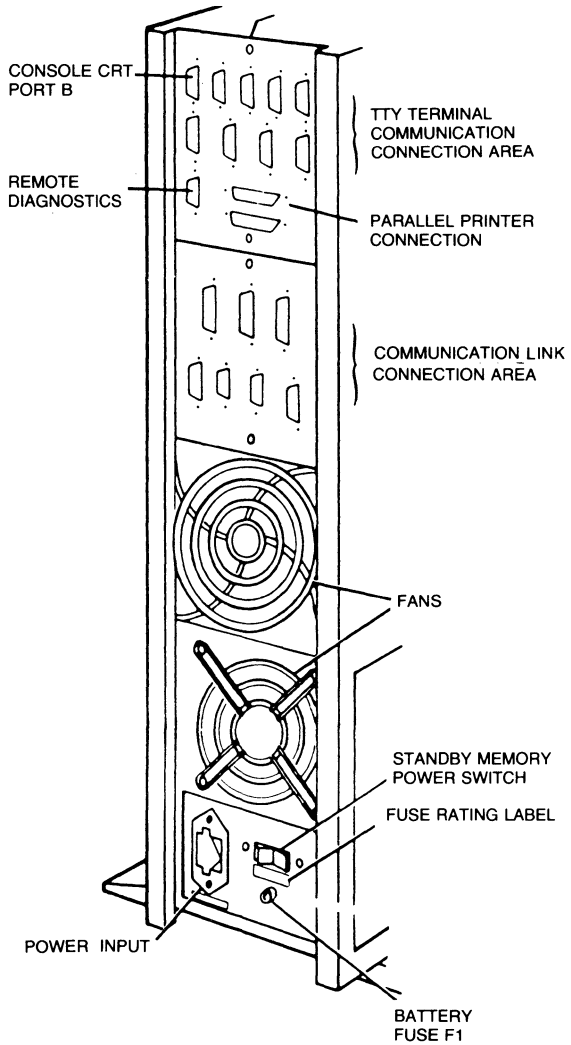

12693-5

Figure 2-2. Rear View of 5000/30 Component Connectors

## Chapter 2

---

The 5000/30 has a minimum of 6 and a maximum of 16 asynchronous ports for connecting any combination of TTY terminals or serial printers. These ports have female 15-pin connectors that use the RS-232-C cable. Eight additional ports are available by adding another asynchronous controller card and by using distribution boxes.

Processor Channel A is a dial-in port.

Processor Channel B is initialized by the firmware as the system control console port.

Two female 25-pin connectors are available for parallel printers (Centronics cable.)

Two synchronous ports with female 25-pin connectors are available for high speed communication if a synchronous/asynchronous board is installed in the system. A position on the bulkhead is available for the addition of Ethernet.

### **CAUTION:**

Attach cables carefully. Damage to the connector pins causes the system to malfunction.

# Installing the Unisys 5000/30

---

Follow these steps to install your system:

1. Unpack and install the terminal designated as the console. Installation instructions are included with the terminal.

Configure the console terminal with the following characteristics (Refer to the documentation accompanying your particular terminal.):

## SVT/UVT Series

Xon/Xoff  
New Line Off  
7 bits/character  
Parity on, even  
Reverse Video  
Attribute  
9600 Baud  
1 stop bit

## Other

Xon/Xoff  
New Line Off  
7 bits/character  
Parity on, even  
Reverse Video  
Attribute  
9600 Baud  
1 stop bit

If possible, configure all terminals with the following characteristics:

Mode: VT100 (ANSI)  
Scroll: Jump  
Auto Repeat: On  
Background: Dark  
Cursor: Underline  
Wrap Around: On  
Margin Bell: On

2. Unpack the main unit of the 5000/30.
3. Connect the control console to Channel B of the main unit.
4. Unpack and install the printers and terminals according to the instructions provided with each unit.

# Chapter 2

5. Attach the terminals and printers to the connectors indicated in Figure 2-3. Make the connections in an order that is suited to the configuration of your system.

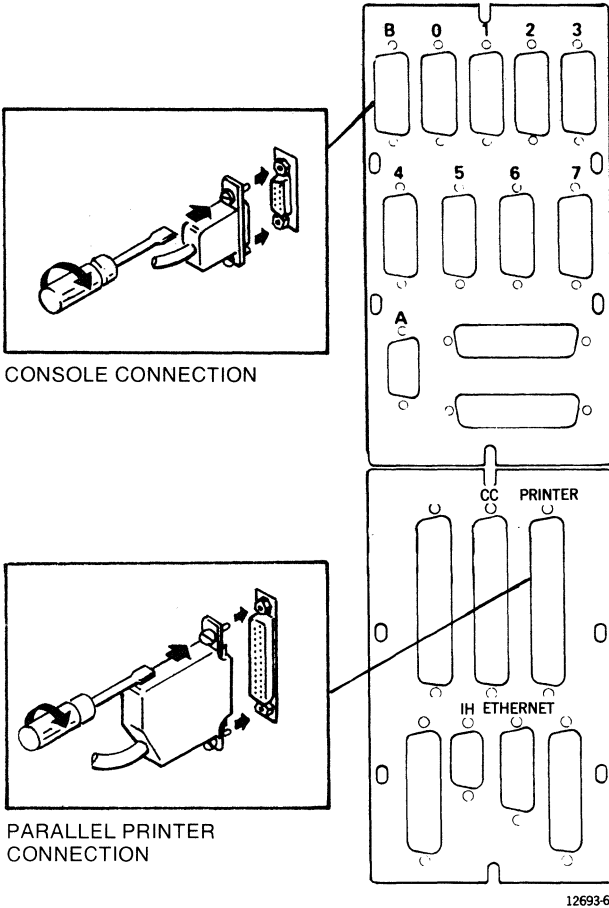
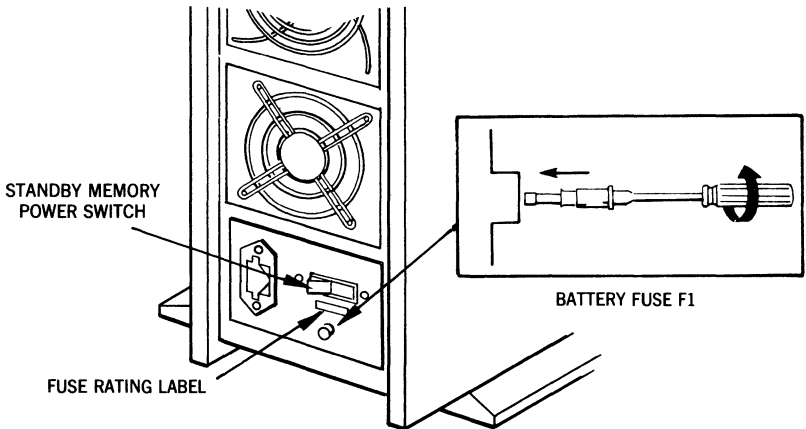

Figure 2-3. Back of the 5000/30 Unit

## Installing the Unisys 5000/30

6. Attach the parallel printer to the connector indicated in Figure 2-3.
7. Locate the battery back-up fuse in the package containing the power cord. Install the fuse and turn on the standby memory power switch. (Refer to Figure 2-4.)



12693-7

**Figure 2-4. Rear View of 5000/30 Battery Back-Up Fuse**

8. Attach the AC power cord to the unit and a power outlet and proceed to Chapter 7, "Using the Hardware System". Install the software following the procedures in the *5000/20, 5000/30, 5000/35, 5000/40, 5000/50, and 5000/55 Installation and Implementation Guide*.



### NOTE:

This Unisys product contains a battery which automatically provides emergency current for retention of memory data in the event of a short AC power interruption. To prolong battery life and assure its satisfactory operation when needed, please observe these precautions:

1. Do not unplug or disconnect external power to this unit after it is installed. Battery life is significantly reduced if external AC power is regularly disconnected during working hours or overnight.
2. If you want to disconnect this unit for an extended period of time, disconnect the battery to prevent total battery discharge. To accomplish this, shut down the operating system (described in the "Operator Duties" chapter in your *5000/20*, *5000/30*, *5000/35*, *5000/40*, *5000/50*, and *5000/55*, *Operators Guide*), move the STANDBY MEMORY POWER switch to the OFF position, move the POWER switch to the OFF position, and remove the battery back-up fuse from the unit.
3. Have a new battery installed periodically in accordance with the replacement schedule shown on the label attached to the 5000/30 system near the battery.
4. Only Unisys-trained personnel should attempt battery replacement. Electrical shock, damage, or loss of memory data may result if improper procedures are used.

# Chapter 3. Installing the Unisys 5000/35

Figure 3-1 shows the various peripherals that can be connected to the 5000/35 system. This chapter provides instructions for connecting these devices to the main unit.

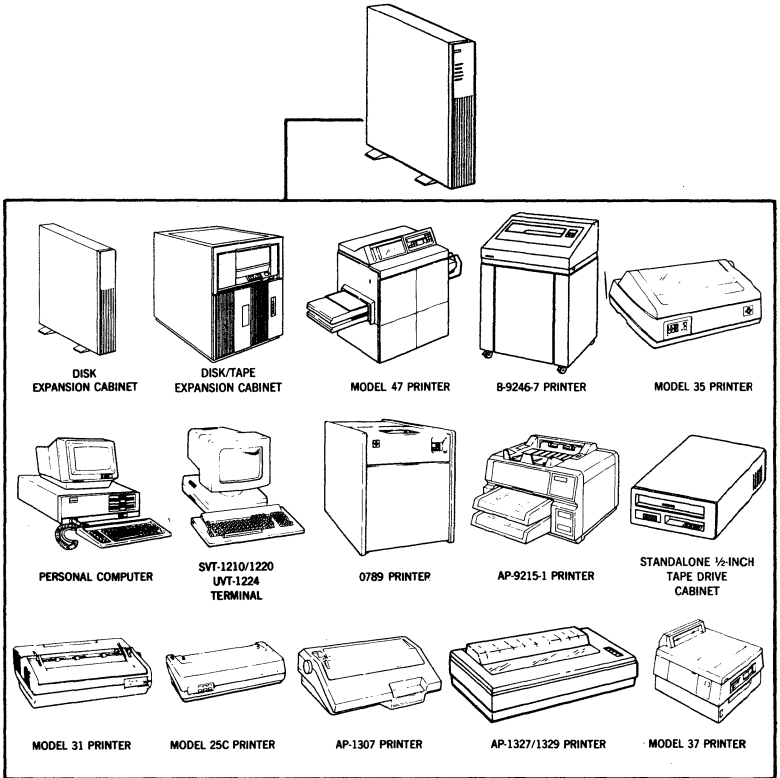

12693-8

Figure 3-1. 5000/35 System and Peripherals

## Chapter 3

---

Before installing the 5000/35, you should know which printers will be connected as serial printers and which will be connected as parallel printers.

Your system requires a control console terminal. The control console is used to install and maintain the system. Any of the terminals that are ordered with your system can be connected as a control console. Before beginning these procedures, you should know which terminal is designated for this purpose.

If your site is not prepared for the 5000/35 system, refer to the *5000/20, 5000/30, 5000/35, 5000/40, 5000/50, and 5000/55 Planning Guide*.

Figure 3-2 and Figure 3-3 show the connectors that are used for the components of the Unisys 5000/35.

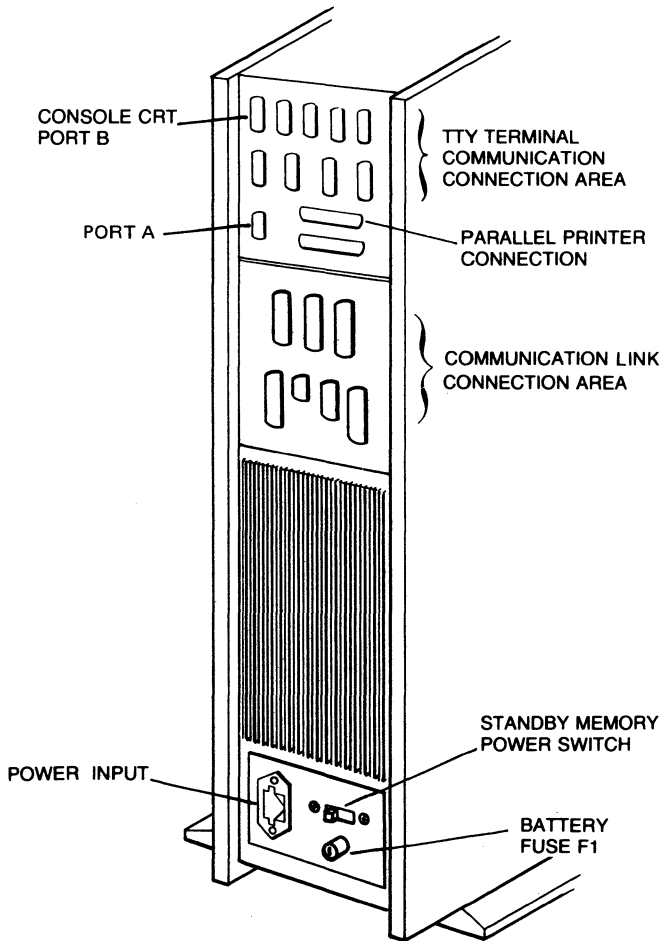

12693-9

**Figure 3-2. Rear View of 5000/35 Component Connectors  
(Less Than or Equal to 16 Users)**

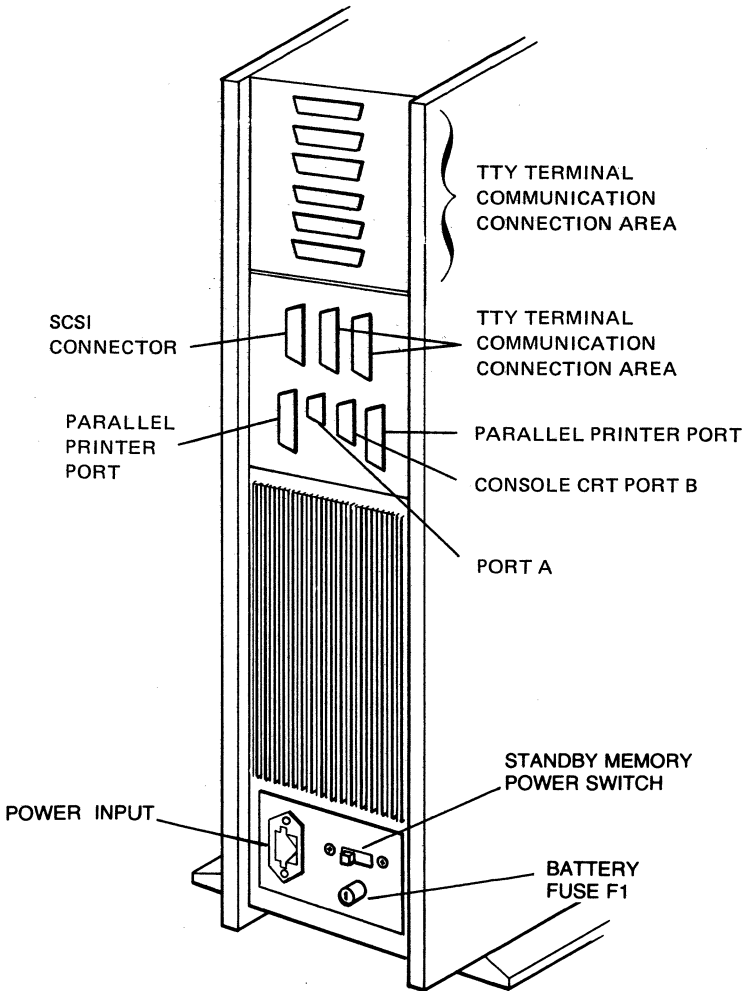

12693-10

**Figure 3-3. Rear View of 5000/35 Component Connectors (Greater than 16 Users)**

## Installing the Unisys 5000/35

---

The 5000/35 has a minimum of 6 and a maximum of 32 asynchronous ports for connecting any combination of TTY terminals or serial printers. These ports use the RS-232-C cable. Additional ports are available by adding asynchronous controller cards and may require changing bulkheads. The use of more than 8 ports requires distribution boxes.

Processor Channel A is a dial-in port for remote diagnostics.

Processor Channel B is initialized by the firmware as the system control console port.

One or two female 25-pin connectors are available for parallel printers (Centronics cable).

Two synchronous ports with female 25-pin connectors are available for high speed communication, if a synchronous/asynchronous board is installed in the system. A position on the bulkhead is available for the addition of Ethernet.

### **CAUTION:**

Attach cables carefully. Damage to the connector pins causes the system to malfunction.

## Chapter 3

---

Follow these steps to install your system:

1. Unpack and install the terminal that is designated as the console. Installation instructions are included with the terminal.

Configure the console terminal with the following characteristics (Refer to the documentation accompanying your particular terminal.):

SVT/UVT Series

Other

Xon/Xoff

Xon/Xoff

New Line Off

New Line Off

7 bits/character

7 bits/character

Parity on, even

Parity on, even

Reverse Video

Reverse Video

Attribute

Attribute

9600 Baud

9600 Baud

1 stop bit

1 stop bit

If possible, configure all terminals with the following characteristics:

Mode: VT100 (ANSI)

Scroll: Jump

Auto Repeat: On

Background: Dark

Cursor: Underline

Wrap Around: On

Margin Bell: On

2. Unpack the main unit of the 5000/35 system.
3. Connect the control console to Channel B of the main unit.
4. Unpack and install the printers and terminals according to the instructions provided with each unit.

# Installing the Unisys 5000/35

5. Attach the terminals and printers to the connectors indicated in Figure 3-4 and Figure 3-5. Make the connections in an order that is suited to the configuration of your system.

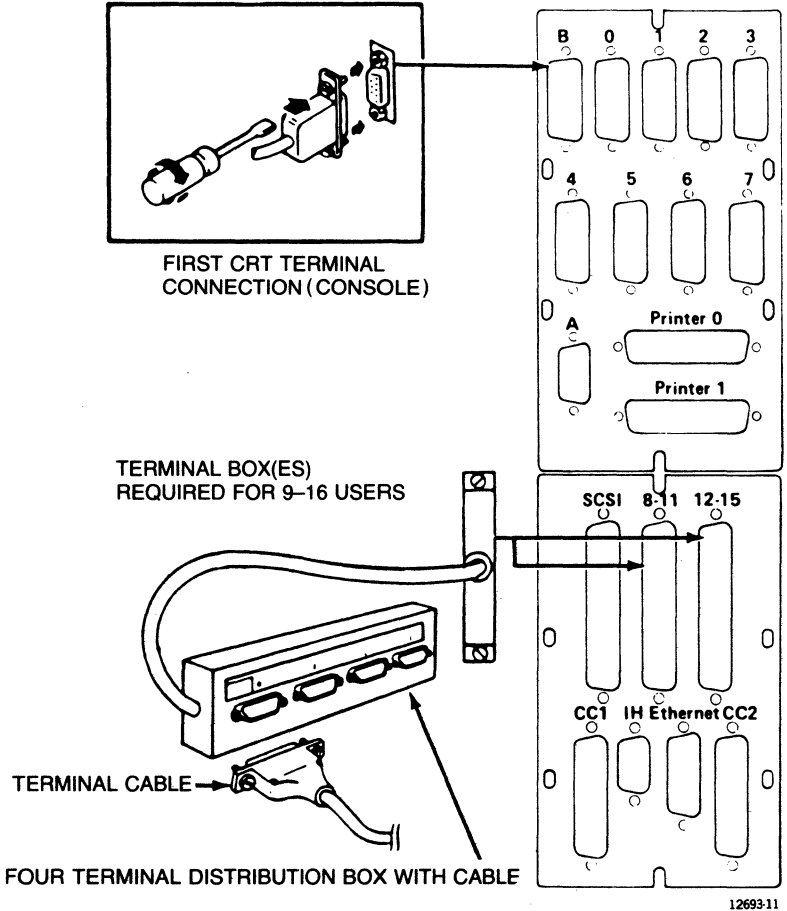
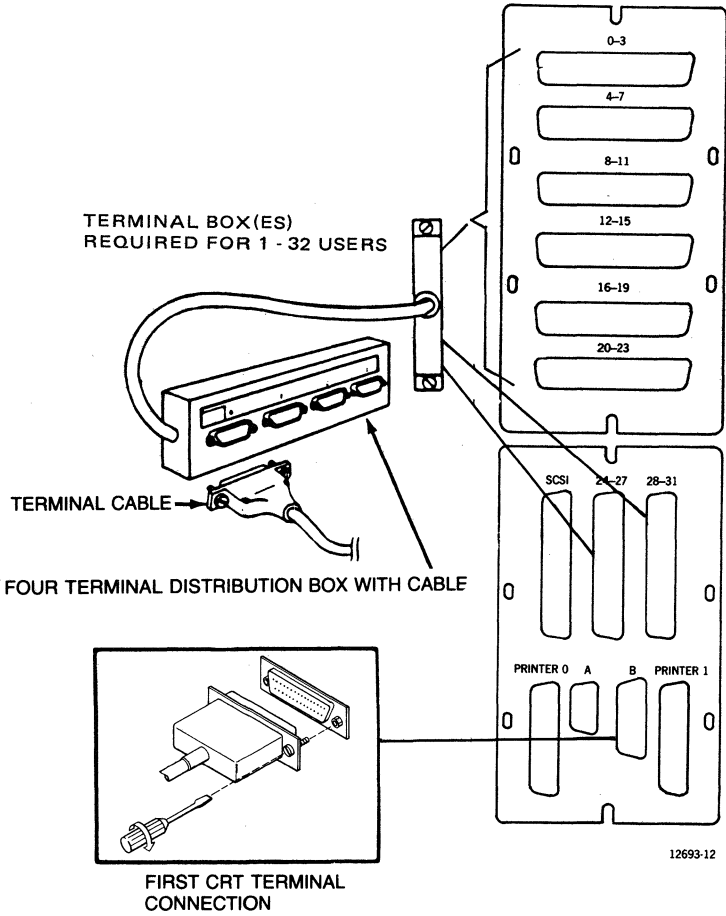

Figure 3-4. Back of the 5000/35 Unit  
(Less Than or Equal to 16 Users)



# Chapter 3



**Figure 3-5. Back of the 5000/35 Unit  
(Greater Than 16 Users)**

6. Attach the parallel printer to the connector indicated in Figure 3-5 and Figure 3-6.
7. Locate the battery back-up fuse in the package containing the power cord. Install the fuse and turn on the standby memory power switch. (Refer to Figure 3-6.)

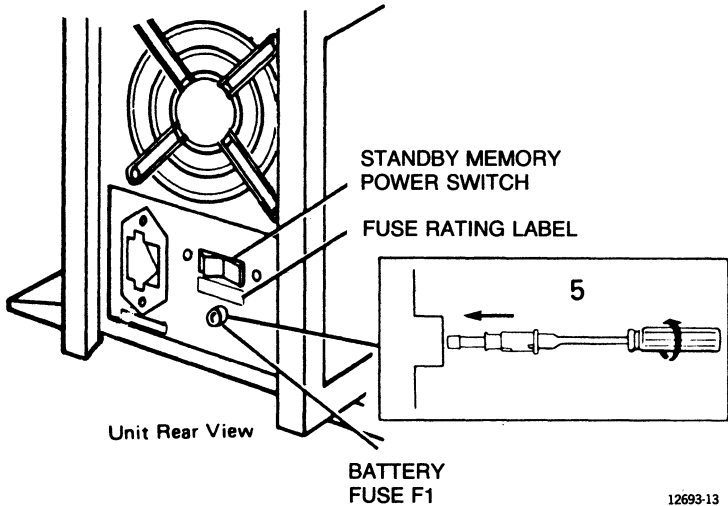

**Figure 3-6. 5000/35 Battery Back-Up Fuse**

8. Attach the AC power cord to the unit and a power outlet and proceed to Chapter 7, "Using the Hardware System". Install the software following the procedures in the *5000/20, 5000/30, 5000/35, 5000/40, 5000/50, and 5000/55 Installation and Implementation Guide*.

### NOTE:

This Unisys product contains a battery which automatically provides emergency current for retention of memory data in the event of a short AC power interruption. To prolong battery life and assure its satisfactory operation when needed, please observe these precautions:

1. Do not unplug or disconnect external power to this unit after it is installed. Battery life is significantly reduced if external AC power is regularly disconnected during working hours or overnight.
2. If you want to disconnect this unit for an extended period of time, disconnect the battery to prevent total battery discharge. To accomplish this, shut down the operating system (described in the "Operator Duties" chapter in your *5000/20*, *5000/30*, *5000/35*, *5000/40*, *5000/50*, and *5000/55 Operators Guide*.), move the STANDBY MEMORY POWER switch to the OFF position, move the POWER switch to the OFF position, and remove the battery back-up fuse from the unit.
3. Have a new battery installed periodically in accordance with the replacement schedule shown on the label attached to the 5000/35 system near the battery.
4. Only Unisys-trained personnel should attempt battery replacement. Electrical shock, damage, or loss of memory data may result if improper procedures are used.

# Chapter 4. Installing the Unisys 5000/40

Figure 4-1 shows the various peripherals that can be connected to the 5000/40 system. This chapter provides instructions for connecting these devices to the main unit.

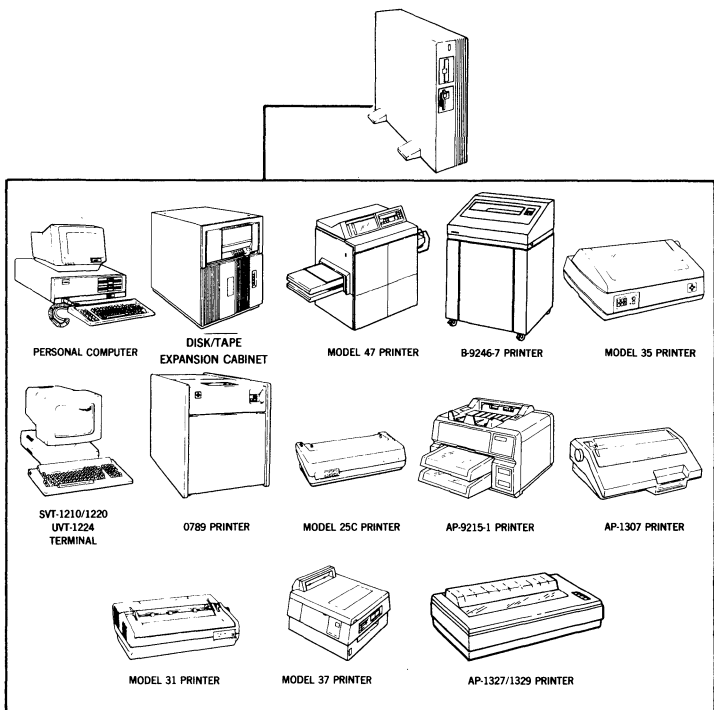

Figure 4-1. 5000/40 System and Peripherals

## Chapter 4

---

Before installing the 5000/40, you should know where you are going to place each component of the system. You should know which printers will be connected as serial printers and which will be connected as parallel printers.

Your system requires a control console terminal. The control console is used to install and maintain the system. Any of the terminals you ordered with your system can be connected as a control console. Before beginning these procedures, you should know which terminal is designated for this purpose.

If your site is not prepared for the 5000/40 system, refer to the *5000/20, 5000/30, 5000/35, 5000/40, 5000/50, and 5000/55 Planning Guide*.

# Installing the Unisys 5000/40

Figure 4-2 shows the connectors that are used for the components of the Unisys 5000/40.

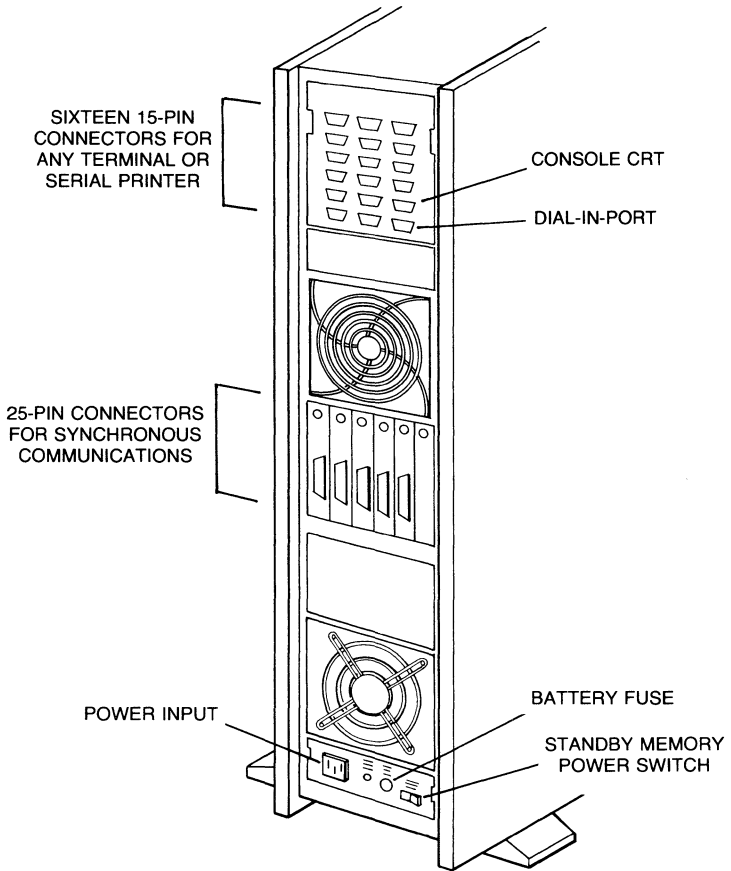

12693-15

**Figure 4-2. 5000/40 Component Connectors**

# Chapter 4

---

The 5000/40 has a maximum of 16 asynchronous ports available for any combination of terminals and printers. These ports have female 15-pin connectors that use the RS-232-C cable.

Processor Channel A is a dial-in port for remote diagnostics.

Processor Channel B is initialized by the firmware as the system control console port.

One of two female 25-pin connectors is available for a parallel printer (Centronics cable). Two synchronous ports with female 25-pin connectors are available for high speed communication if a synchronous/asynchronous board is installed in the system.

# Installing the Unisys 5000/40

---

Follow these steps to install your system:

1. Unpack and install the terminal that is designated as the console according to the instructions supplied with the terminal.

Configure the console terminal with the following characteristics (Refer to the documentation accompanying your particular terminal.):

<u>SVT/UVT Series</u>	<u>Other</u>
Xon/Xoff	Xon/Xoff
New Line Off	New Line Off
7 bits/character	7 bits/character
Parity on, even	Parity on, even
Reverse Video Attribute	Reverse Video Attribute
9600 Baud	9600 Baud
1 stop bit	1 stop bit

If possible, configure all terminals with the following characteristics:

Mode: VT100 (ANSI)  
Scroll: Jump  
Auto Repeat: On  
Background: Dark  
Cursor: Underline  
Wrap Around: On  
Margin Bell: Off

2. Unpack the main unit of the 5000/40 system.
3. Connect the console to Channel B of the main unit.
4. Unpack and install the printers and terminals according to the instructions provided with each unit.



## CAUTION:

Attach cables carefully. Damage to the connector pins causes the system to malfunction.

5. Attach the terminals and serial printers to the connectors indicated in Figure 4-3. Make the connections in an order that is suited to the configuration of your system.

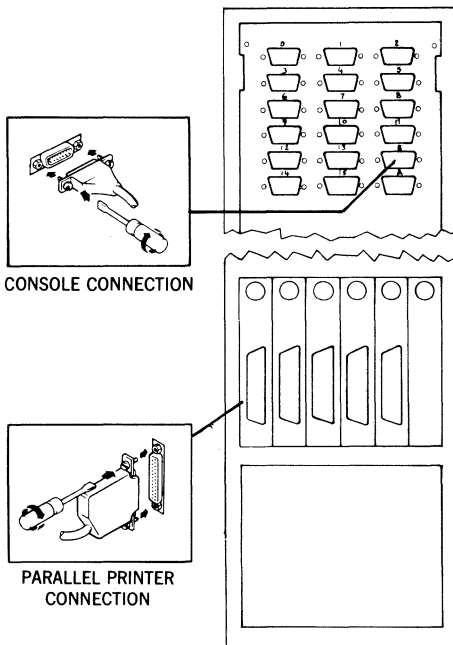

12693-16

Figure 4-3. Back of the 5000/40 Unit

6. Attach the parallel printer as indicated in Figure 4-3.
7. Locate the battery back-up fuse in the package containing the power cord. Install the fuse and turn on the standby memory power switch. (Refer to Figure 4-4.)

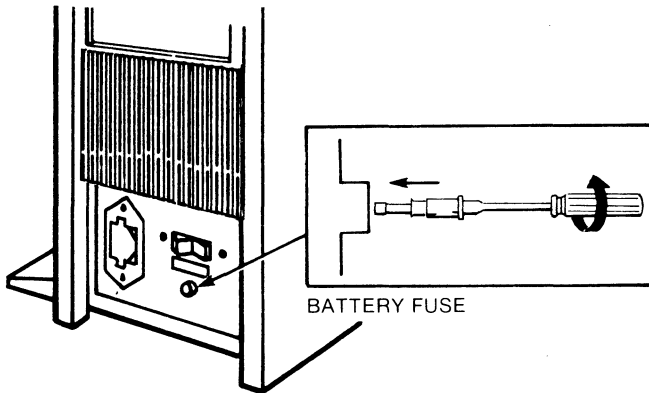

**Figure 4-4. 5000/40 Battery Back-Up Fuse**

8. Attach the AC power cord to the unit and a power outlet and proceed to Chapter 7, "Using the Hardware System". Install the software following the procedures in the *5000/20, 5000/30, 5000/35, 5000/40, 5000/50, and 5000/55 Installation and Implementation Guide*.

**NOTE:**

This Unisys product contains a battery which automatically provides emergency current for retention of memory data in the event of a short AC power interruption. To prolong battery life and assure its satisfactory operation when needed, please observe these precautions:

1. Do not unplug or disconnect external power to this unit after it is installed. Battery life is significantly reduced if external AC power is regularly disconnected during working hours or overnight.
2. If you want to disconnect this unit for an extended period of time, disconnect the battery to prevent total battery discharge. To accomplish this, shut down the operating system (described in the "Operator Duties" chapter in your *5000/20, 5000/30, 5000/35, 5000/40, 5000/50, and 5000/55 Operators Guide*), move the STANDBY MEMORY POWER switch to the OFF position, move the POWER switch to the OFF position, and remove the battery back-up fuse from the unit.
3. Have a new battery installed periodically in accordance with the replacement schedule shown on the label attached to the 5000/40 system near the battery.
4. Only Unisys-trained personnel should attempt battery replacement. Electrical shock, damage, or loss of memory data may result if improper procedures are used.

# Chapter 5. Installing the Unisys 5000/50

Figure 5-1 shows the various peripherals that can be connected to the 5000/50 system. This chapter provides instructions for connecting these devices to the main unit.

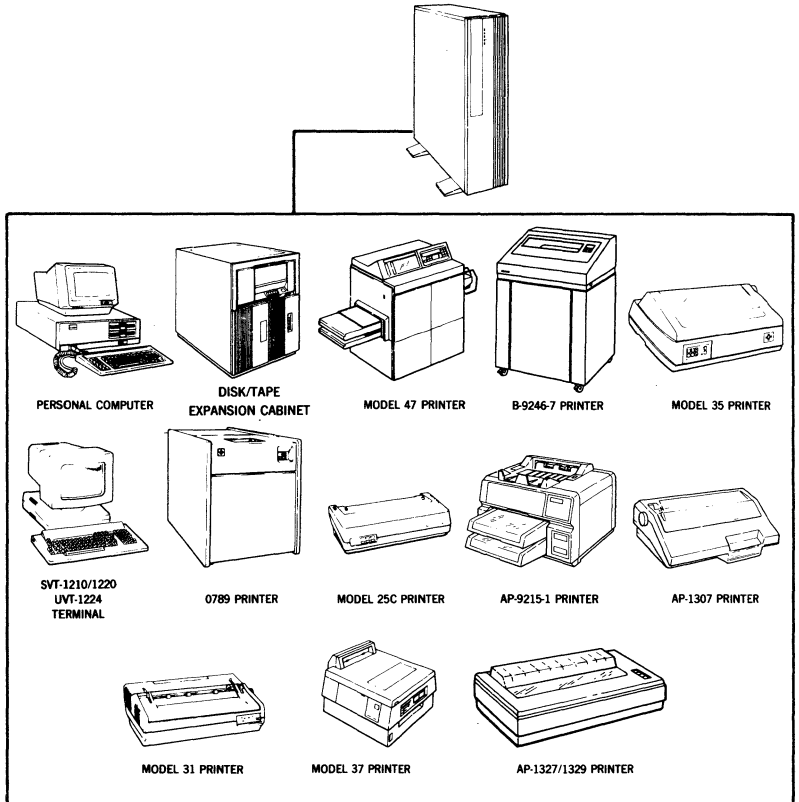

12693-18

Figure 5-1. 5000/50 System and Peripherals

# Chapter 5

---

Before installing the 5000/50 system, you should know which printers will be connected as serial printers and which will be connected as parallel printers.

Your system requires a control console terminal. The control console is used to install and maintain the system. Any of the terminals you ordered with your system can be connected as a control console. Before beginning these procedures, you should know which terminal is designated for this purpose.

If your site is not prepared for the 5000/50 system, refer to the *5000/20*, *5000/30*, *5000/35*, *5000/40*, *5000/50*, and *5000/55 Planning Guide*.

# Installing the UNISYS 5000/50

Figure 5-2 shows the connectors that are used for the components of the Unisys 5000/50 system.

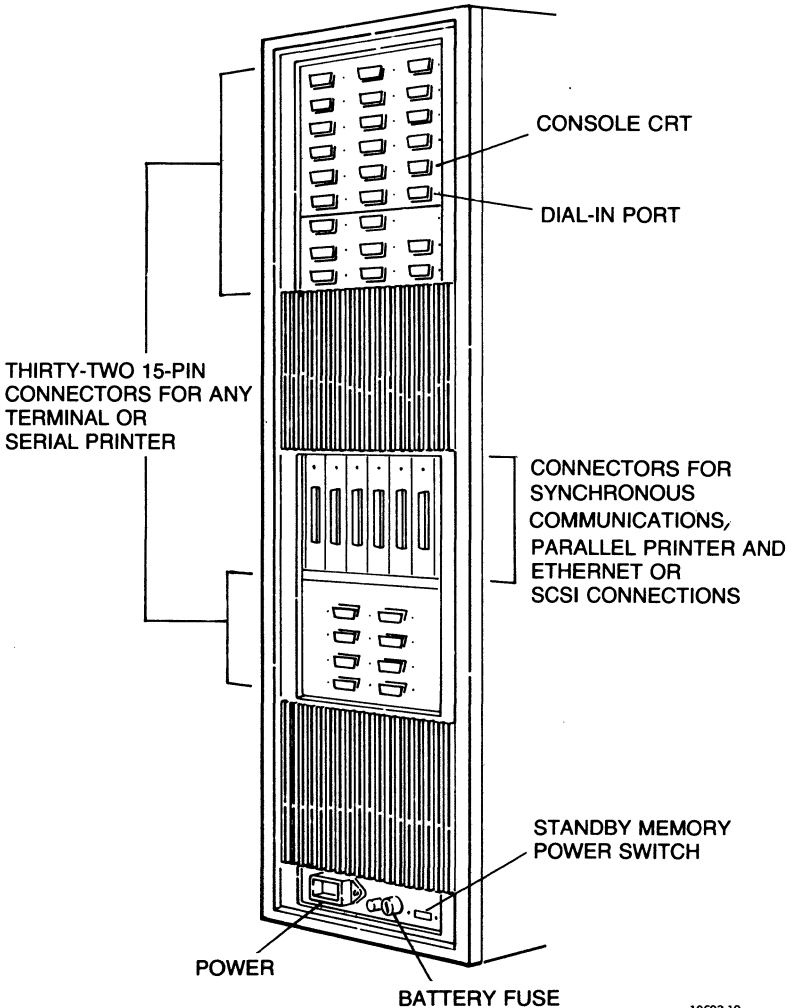

12693-19

Figure 5-2. 5000/50 Component Connectors

## Chapter 5

---

The 5000/50 system has a minimum of 6 and a maximum of 32 asynchronous ports available for any combination of terminals and serial printers. These ports have female 15-pin connectors that use an RS-232-C cable.

Processor Channel A is a dial-in port for remote diagnostics.

Processor Channel B is initialized by the firmware as the system console port.

On a fully configured system there are six available mini-bulkhead positions for:

- 1 to 2 parallel printers,
- 1 Ethernet connection,
- 1 UNISCOPE connector,
- 1 SCSI connection,
- 1 to 2 synchronous connections, and
- MUX-5000

# Installing the UNISYS 5000/50

---

Follow these steps to install your system:

1. Unpack and install the terminal that is designated as the console. Installation instructions are included with the terminal.

Configure the console terminal with the following characteristics (Refer to the documentation accompanying your particular terminal.):

## SVT/UVT Series

Xon/Xoff  
New Line Off  
7 bits/character  
Parity on, even  
Reverse Video  
Attribute  
9600 Baud  
1 stop bit

## Other

Xon/Xoff  
New Line Off  
7 bits/character  
Parity on, even  
Reverse Video  
Attribute  
9600 Baud  
1 stop bit

If possible, configure all terminals with the following characteristics:

Mode: VT100 (ANSI)  
Scroll: Jump  
Auto Repeat: On  
Background: Dark  
Cursor: Underline  
Wrap Around: On  
Margin Bell: Off

2. Unpack the main unit of the 5000/50 system.
3. Connect the control console to Channel B of the main unit.



# Chapter 5

4. Unpack and install the printers and terminals according to the instructions provided with each unit.

**CAUTION:**

Attach cables carefully. Damage to the connector pins causes the system to malfunction.

5. Attach the terminals and serial printers to the connectors indicated in Figure 5-3. Make the connections in an order that is suited to the configuration of your system.

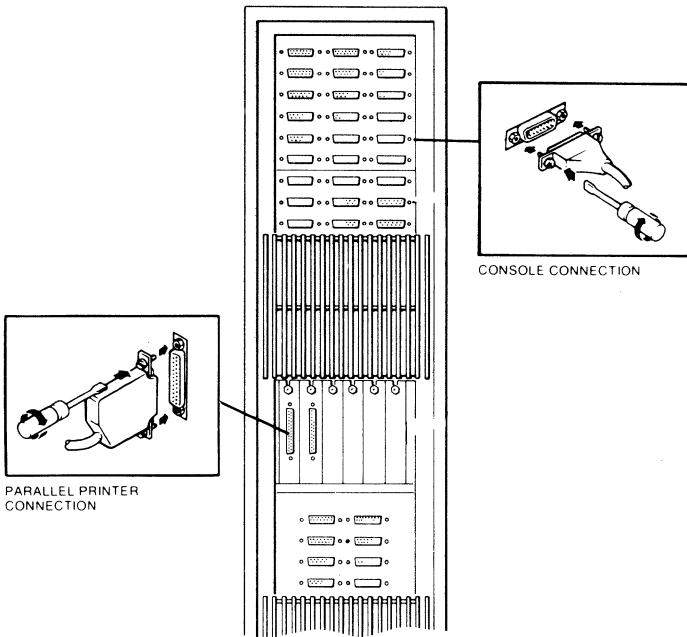

**Figure 5-3. Back of the 5000/50 Unit**

6. Attach the parallel printer to the connector indicated in Figure 5-3.
7. Locate the battery back-up fuse in the package containing the power cord. Install the fuse and turn on the standby memory power switch.

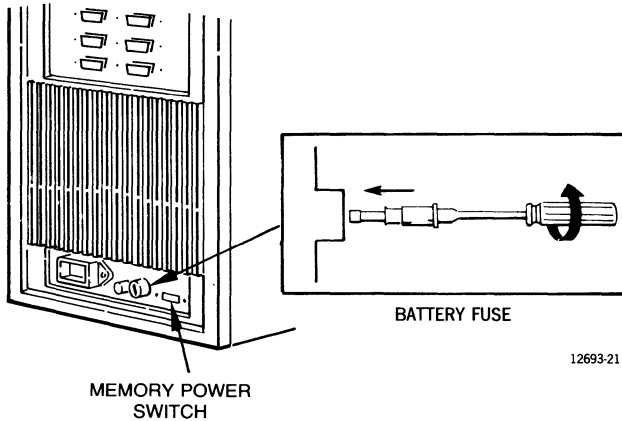

**Figure 5-4. 5000/50 Battery Back-Up Fuse**

8. Attach the AC power cord to the unit and a power outlet and proceed to Chapter 7, "Using the Hardware System". Install the software following the procedures in the *5000/20, 5000/30, 5000/35, 5000/40, 5000/50, and 5000/55 Installation and Implementation Guide*.

### NOTE:

This Unisys product contains a battery which automatically provides emergency current for retention of memory data in the event of a short AC power interruption. To prolong battery life and assure its satisfactory operation when needed, please observe these precautions:

1. Do not unplug or disconnect external power to this unit after it is installed. Battery life is significantly reduced if external AC power is regularly disconnected during working hours or overnight.
2. If you want to disconnect this unit for an extended period of time, disconnect the battery to prevent total battery discharge. To accomplish this, shut down the operating system (described in the "Operator Duties" chapter in your *5000/20*, *5000/30*, *5000/35*, *5000/40*, *5000/50*, and *5000/55 Operators Guide*), move the STANDBY MEMORY POWER switch to the OFF position, move the POWER switch to the OFF position, and remove the battery back-up fuse from the unit.
3. Have a new battery installed periodically in accordance with the replacement schedule shown on the label attached to the 5000/50 system near the battery.
4. Only Unisys-trained personnel should attempt battery replacement. Electrical shock, damage, or loss of memory data may result if improper procedures are used.

# Chapter 6. Installing the Unisys 5000/55

Figure 6-1 shows the various peripherals that can be connected to the 5000/55 system. This chapter provides instructions for connecting these devices to the main unit.

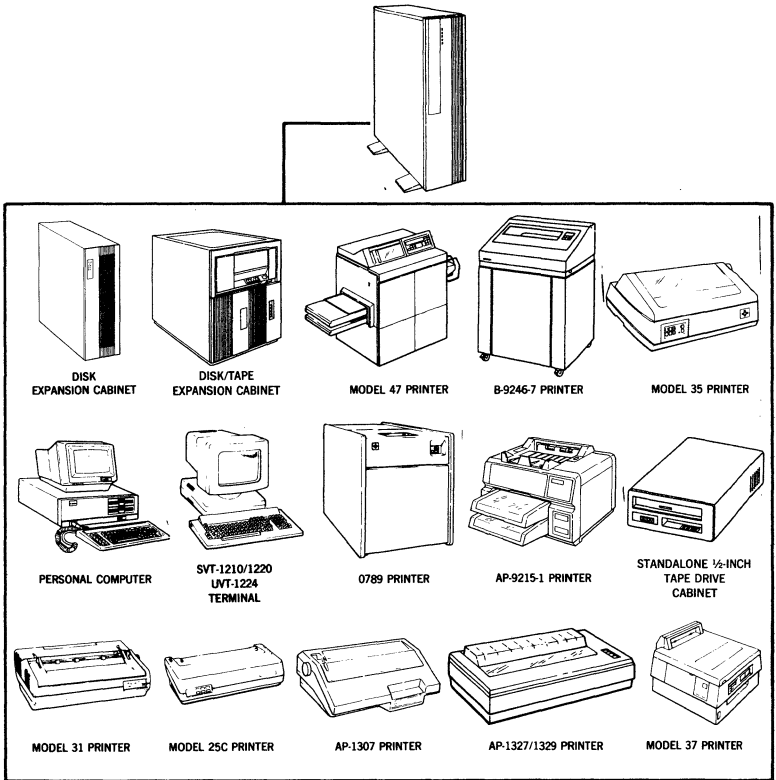

12693-22

**Figure 6-1. 5000/55 System and Peripherals**

## Chapter 6

---

Before installing the 5000/55 system, you should know which printers will be connected as serial printers and which will be connected as parallel printers.

Your system requires a control console terminal. The control console is used to install and maintain the system. Any of the terminals you ordered with your system can be connected as a control console. Before beginning these procedures, you should know which terminal is designated for this purpose.

If your site is not prepared for the 5000/55 system, refer to the *5000/20*, *5000/30*, *5000/35*, *5000/40*, *5000/50*, and *5000/55 Planning Guide*.

# Installing the Unisys 5000/55

The following figure shows the connectors that are used for the components of the Unisys 5000/55.

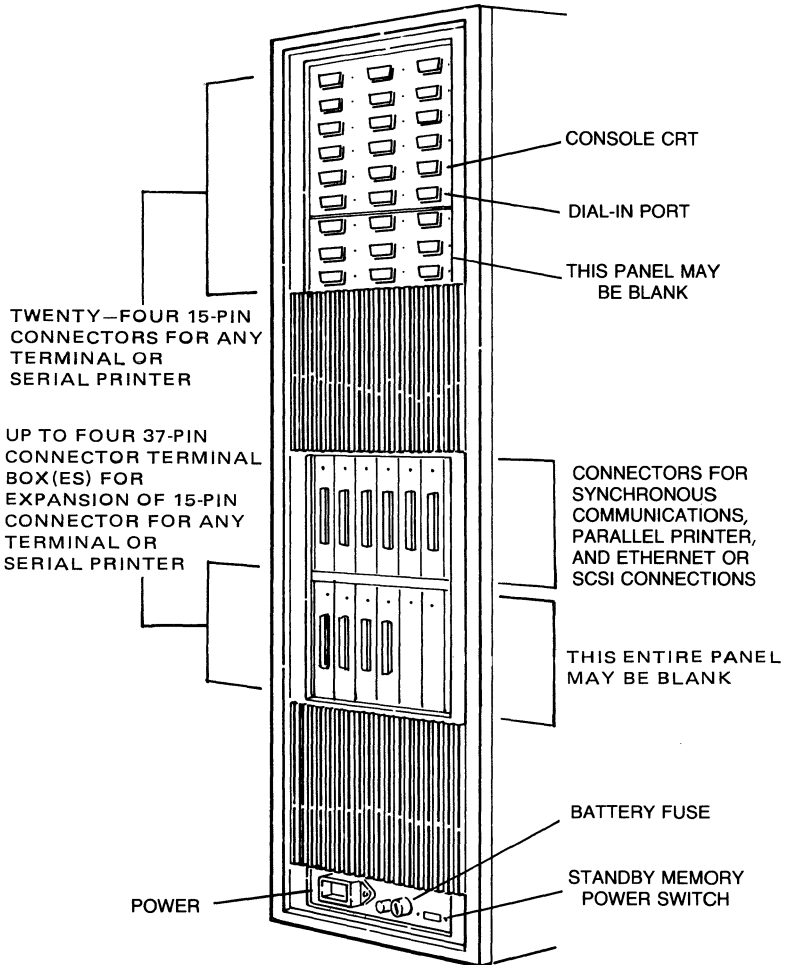

**Figure 6-2. 5000/55 Component Connectors**

## Chapter 6

---

There are a minimum of 16 and a maximum of 40 asynchronous ports available for any combination of terminals and serial printers on the rear bulkhead. These ports have female 15-pin connectors that use the RS-232-C cable. Up to 64 total users can be configured using MUX-5000. The MUX-5000 ports use a female 25-pin connector for the RS-232-C cable.

Processor Channel A is a dial-in port.

Processor Channel B is initialized by the firmware as the system console port.

On a fully configured system there are 12 mini-panel positions available for:

- 1 to 2 parallel printers,
- 1 Ethernet connection,
- 1 UNISCOPE connector,
- 1 SCSI connection,
- 2 synchronous connectors,
- 2 MUX-5000 connections (coaxial), and
- 4 DB 37 asynchronous RS-232-C connectors (these require DB15 breakout boxes).

# Installing the Unisys 5000/55

---

Follow these steps to install your system:

1. Unpack and install the terminal that is designated as the console. Installation instructions are included with the terminal.

Configure the console terminal with the following characteristics (Refer to the documentation accompanying your particular terminal.):

<u>SVT/UVT Series</u>	<u>Other</u>
Xon/Xoff	Xon/Xoff
New Line Off	New Line Off
7 bits/character	7 bits/character
Parity on, even	Parity on, even
Reverse Video Attribute	Reverse Video Attribute
9600 Baud	9600 Baud
1 stop bit	1 stop bit

If possible, configure all terminals with the following characteristics:

Mode: VT100 (ANSI)  
Scroll: Jump  
Auto Repeat: On  
Background: Dark  
Cursor: Underline  
Wrap Around: On  
Margin Bell: Off

2. Unpack the main unit of the 5000/55 system.
3. Connect the console to Channel B of the main unit.
4. Unpack and install the printers and terminals according to the instructions provided with each unit.



**CAUTION:**

Attach cables carefully. Damage to the connector pins causes the system to malfunction.

5. Attach the terminals and printers to the connectors indicated in Figure 6-3. Make the connections in an order that is suited to the configuration of your system.

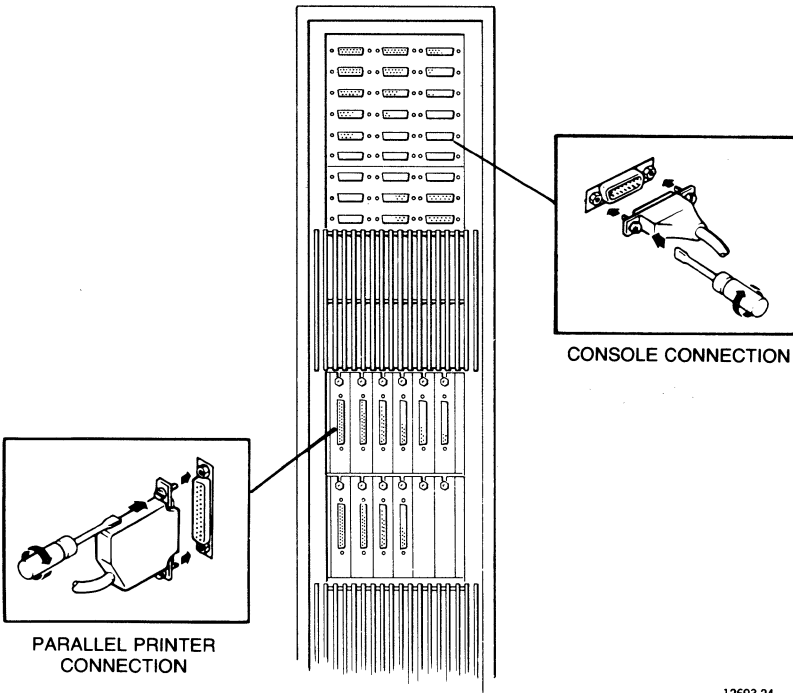

12693-24

**Figure 6-3. Back of the 5000/55 Unit**

6. Attach the parallel printer to the connector indicated in Figure 6-3.
7. Locate the battery back-up fuse in the package containing the power cord. Install the fuse and turn on the standby memory power switch. (Refer to Figure 6-4.)

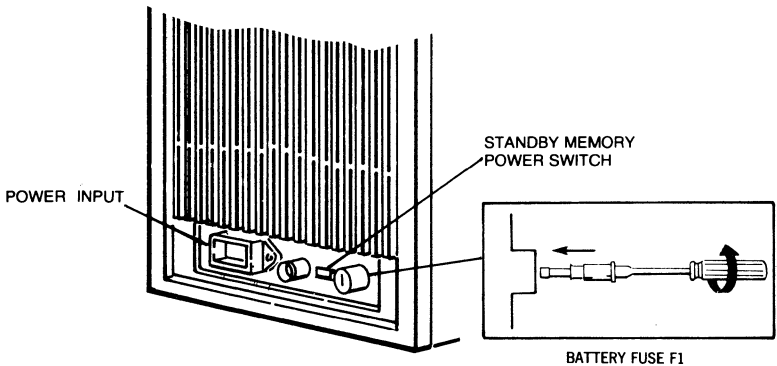

**Figure 6-4. 5000/55 Battery Back-Up Fuse**

8. Attach the AC power cord to the unit and a power outlet. Proceed to Chapter 7, "Using the Hardware System". Install the software following the procedures in the *5000/20, 5000/30, 5000/35, 5000/40, 5000/50, and 5000/55 Installation and Implementation Guide*.

### NOTE:

This Unisys product contains a battery which automatically provides emergency current for retention of memory data in the event of a short AC power interruption. To prolong battery life and assure its satisfactory operation when needed, please observe these precautions:

1. Do not unplug or disconnect external power to this unit after it is installed. Battery life is significantly reduced if external AC power is regularly disconnected during working hours or overnight.
2. If you want to disconnect this unit for an extended period of time, disconnect the battery to prevent total battery discharge. To accomplish this, shut down the operating system (described in the "Operator Duties" chapter in your *5000/20, 5000/30, 5000/35, 5000/40, 5000/50, and 5000/55 Operators Guide*), move the STANDBY MEMORY POWER switch to the OFF position, move the POWER switch to the OFF position, and remove the battery back-up fuse from the unit.
3. Have a new battery installed periodically in accordance with the replacement schedule shown on the label attached to the 5000/55 system near the battery.
4. Only Unisys-trained personnel should attempt battery replacement. Electrical shock, damage, or loss of memory data may result if improper procedures are used.

# Chapter 7. Using the Hardware System

## Overview

This chapter describes the control panel and explains how to turn on the system and load a tape cartridge. Before you install your system software, you should familiarize yourself with these front panel controls and procedures.

## System Control Panels

Although your primary interface with the system is through a terminal screen and keyboard, the system control panels provide the power ON/OFF switch and several status indicators. The operator interface for the main unit consists of a single ON/OFF switch and five status indicators, located on the control panel. The ON/OFF switch is used to remove operating voltage from the units when they are not in use. The status indicators provide hardware integrity information and hardware activity information.

These are the functions of the main unit control panel elements:

### ON/OFF Switch

- ON - turns on the main unit. Moving the switch from OFF to ON causes the main unit logic element to perform a predefined start-up sequence consisting of

basic integrity testing, loading system software into memory if installed and not previously loaded, and enabling system software.

- OFF - turns off the main unit. Before powering off the system, shut down the operating system (described in the "Operator Duties" chapter of your *5000/20, 5000/30, 5000/35, 5000/40, 5000/50, and 5000/55 Operators Guide*). With the switch in the "OFF" position, the memory support system remains enabled, which preserves the contents of system memory. The time-of-day clock records the shut-down time.

### Power Indicator

The power indicator for the 5000/20, 5000/30, 5000/35, 5000/40, 5000/50, and 5000/55 systems displays a red or green light according to the following descriptions:

- Green - indicates that the power system logic operating voltages, including the memory support system voltages, are enabled and operating within their specified ranges. This is the normal operating mode.
- Red - indicates that the power system logic operating voltage, including the memory support system voltage, is not within its specified operating range. The system is not operational if this condition exists.
- Off - indicates that except for the memory support system, the unit power system is off.

## Disk Indicator

- On - a green light indicates that a main unit hard disk is selected and operating. Depending on the duration of disk activity, the light may only flicker.
- Off - indicates the absence of system unit hard disk activity.

## Communications Indicator

- On - a green light indicates that one or more of the unit's remote communication channels is requesting a line connection.
- Off - indicates that no remote communication channel in the unit is requesting a line connection.

## Fault Indicator

- On - a red light indicates that a critical system failure exists or that the file system is 90% full. If a critical system failure exists, the system is not operational.
- Off - indicates that the system is operational.

## Battery Indicator

- On - a red light indicates that a fault exists in the memory support system. When this condition occurs, the system also turns on the fault indicator to identify a critical system failure. The system is not operational.

## Chapter 7

---

- Flashing red light - indicates that the battery is being charged. The battery may or may not preserve the contents of memory if AC power is lost.
- Off - indicates that the battery is fully charged and will preserve the contents of memory during an AC power failure.

### **Floppy Disk Indicator**

If your system has one or more floppy disk drives, each drive has an indicator.

- On - a red light indicates that the floppy disk drive is selected and ready for disk activity, or that the drive is selected and a disk operation is in progress.
- Off - Indicates the absence of floppy disk activity.

### **Streaming Tape Indicator**

If your system has one or more streaming tape drives, each drive has an indicator.

- On - a red light indicates that the streaming tape drive is selected and ready for tape activity, or that the drive is selected and a tape operation is in progress.
- Off - no light indicates the absence of streaming tape activity.

## Turning On the System

To turn on the system:

1. Turn on the terminal that is connected to Port B (control console). If a terminal is connected to Port 0, make sure that it is turned off.
2. Remove the top cover of the main unit by lifting it up.
3. Move the MANUAL/AUTO LOAD toggle switch to the MANUAL position.
4. Turn on the POWER switch on the main unit.

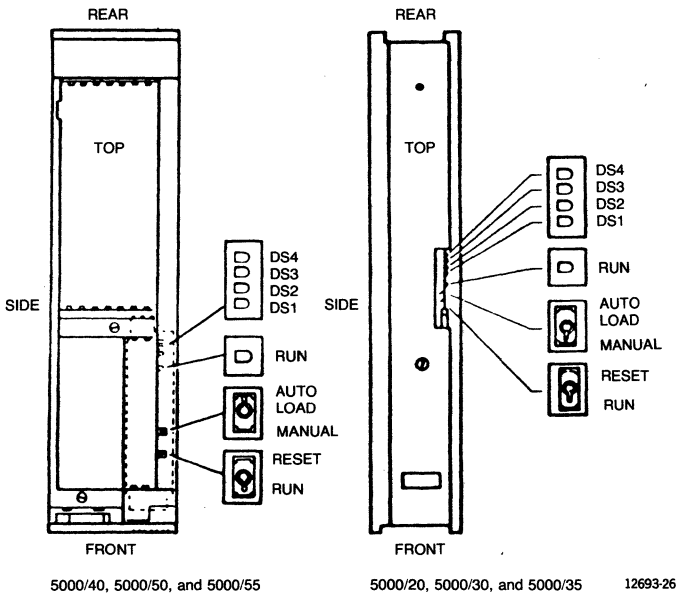

Figure 7-1. Main Unit Indicators



## Chapter 7

---

The terminal connected to Channel B displays the Select Startup Function menu as follows:

SELECT STARTUP FUNCTION

- 1 QUERY
- 2 INSTALL SYSTEM
- 3 LOAD
- 4 SWITCH INPUT
- 5 TEST
- 6 SUSBUG

ENTER ITEM NUMBER

If any message other than the Select Startup Function menu is displayed refer to "The Startup Diagnostics" chapter in the *5000/30, 5000/35, 5000/50, and 5000/55 Diagnostics Guide*. When the Select Startup Function menu is displayed, continue the system software installation following the procedures in the *Installation and Implementation Guide*. If any error message is displayed during the system software installation procedure, refer to the "Error Messages" chapter in the *Installation and Implementation Guide*.

## Inserting a Streaming Tape

Before inserting a streaming tape, decide whether you want it to be write-protected or write-enabled. The write-protect lock is in the upper left corner of the transparent side of the tape. When the pointed side of the lock is turned to the word **SAFE**, the tape is write-protected. To write-enable the tape, use a flat bladed screwdriver and turn the lock 180 degrees, so the pointed side of the lock faces directly away from the word **SAFE**.

On most systems the tape drive is located near the top of the main unit, but on the 5000/50, the drives are behind the small door in the upper left hand corner. At the upper edge of the drive opening is a sliding switch that moves up or down to unlock or lock the cartridge. Use the following procedure to install a tape cartridge in the drive:

1. Move the sliding switch to the up position to unblock the drive unit slot.

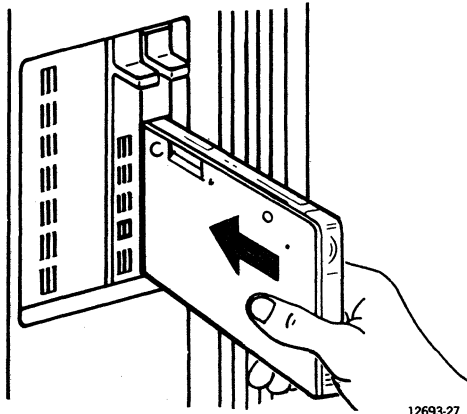

12693-27

**Figure 7-2. Installing a Tape**

## Chapter 7

---

2. Remove the tape cartridge from its container and close the container.
3. With the label edge down and the aluminum plate to your left, slide the cartridge into the drive until it stops.
4. Move the slide switch down to lock the cartridge in position. Make sure the slide switch clicks into position.

To remove the tape cartridge, be sure that the drive light is off. Move the slide switch up; the drive partially ejects the cartridge. Pull the cartridge out and put it in the container.