

SM-ZVM-122/123

Video Monitors

Service Manual



PRODUCT SAFETY SERVICING GUIDELINES

CAUTION: Do not attempt to modify any circuit. Perform service work only after you are thoroughly familiar with all of the following safety checks and servicing guidelines. To do otherwise increases the risk of potential hazards and injury to the user. **CAUTION: Never attempt to service a chassis that is connected directly to an AC line. Make sure it is connected through an isolation transformer. No matter which way the AC plug is inserted, a potential shock hazard is present at chassis ground unless you use an isolation transformer during servicing.** Since one side of the AC input is fused; there's a 50% chance you'll blow a fuse, or a 50% chance

you'll destroy components and/or test equipment without an isolation transformer. The chassis consists of a single circuit board mounted horizontally in the bottom of the cabinet. All circuit parts are mounted on the board except the CRT and deflection yoke. The horizontal sweep transformer is also mounted on the chassis circuit board. You can slide the board out of the cabinet without disconnecting it, and the Monitor will operate with the board exposed. Screws are not required to hold the board in place. It slides into slots which are molded into the cabinet, and the cabinet back holds it in place.

SAFETY CHECK

After the original service problem has been corrected, check for the following:

FIRE & SHOCK HAZARD

1. Be sure that all components are positioned in such a way to avoid the possibility of adjacent component shorts. This is especially important on those chassis which are transported to and from the repair shop.
2. Never release a repair unless all protective devices such as insulators, barriers, cover shields, strain reliefs, and other hardware have been reinstalled per the original design.
3. Inspect the soldering for possible cold solder joints, frayed leads, damaged insulation (including AC cord), solder splashes or sharp solder points. Remove all loose foreign particles.
4. Check "across-the-line" capacitors and other components for physical evidence of damage or deterioration, and replace them if necessary. Follow the original layout, lead length, and dress.
5. No lead or component should touch a receiving tube or a resistor rated at 1 watt or more. Avoid lead tension around protruding metal surfaces.
6. Always replace critical components (shaded on the Schematic Diagram and parts lists) such as: fuses, flameproof resistors, capacitors, etc. with exact Zenith types. Do not use replacement components other than those specified or make unrecommended circuit modifications.

7. After you reassemble the set, always perform an AC leakage test on all exposed metallic parts of the cabinet to be sure the set is safe to operate without danger of electrical shock. **DO NOT USE A LINE ISOLATION TRANSFORMER DURING THIS TEST.** Use an AC voltmeter with a 5000 ohms per volt or more sensitivity in the following manner: Connect a 1500 ohm, 10-watt resistor (63-10401-76), paralleled by a 0.15 μ F, 150 VAC type capacitor (22-4384), between a known good

earth ground (water pipe, conduit, etc.) and the exposed metallic parts, one at a time. Measure the AC voltage across the combination 1500 ohm resistor and 0.15 μ F capacitor. Reverse the AC plug and repeat AC voltage measurements for each exposed metallic part. Voltage measured must not exceed 0.75 volts rms. This corresponds to 0.5 milliamps AC. Any value exceeding this limit constitutes a potential shock hazard and must be corrected immediately.

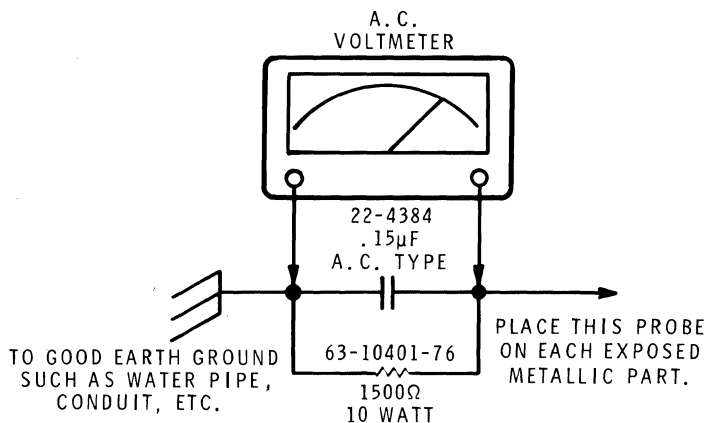

Figure 1-1

IMPLOSION PROTECTION

1. All Zenith picture tubes are equipped with an integral implosion protection system, but be careful to avoid damage during installation. Avoid scratching the tube.
2. Use only Zenith replacement tubes.

X-RADIATION

1. Be sure procedures and instructions to all service personnel cover the subject of X-radiation. The only potential source of X-rays in the current Monitor is the picture tube. However, this tube does not emit X-rays when the

HV is at the factory-specified level. It is only when the HV is excessive that X-radiation can be generated. The basic precaution which must be exercised is to keep the HV at the factory-recommended level. Refer to the X-Ray Precaution Label which is located inside each Monitor for the correct high voltage. The proper value is also given in the applicable service manual. Operation at higher voltages may cause a failure of the CRT or high voltage supply and, under certain circumstances, may produce radiation in excess of desirable levels.

2. Use only Zenith specified CRT anode connectors.

3. It is essential that the serviceman have an accurate high voltage meter available at all times. Check the calibration of this meter periodically against a reference standard, such as the one available at your distributor.
4. When the high voltage circuitry is operating properly, there is no possibility of an X-radiation problem. Every time you service a monochrome chassis, run the brightness up and down while you monitor the high voltage with a meter to be certain that the high voltage does not exceed the specified value and that it is regulating correctly. We suggest that you and your service organization review test procedures so that voltage regulation is always checked as a standard servicing procedure, and that the reason for this prudent routine be clearly understood by everyone. It is important to record an accurate high voltage reading on each customer's invoice.
5. When you are troubleshooting and making test measurements in a Monitor with a problem of excessive high voltage, avoid being unnecessarily close to the picture tube and the high voltage compartment. Do not operate the chassis longer than is necessary to locate the cause of excessive voltage.
6. Models which use a high voltage rectifier vacuum tube should have that tube replaced only with a Zenith recommended replacement type or a Zenith recommended solid-state rectifier replacement. The high voltage compartment and all metal shields, where used, must be kept in place whenever the chassis is operating. If a shield is missing, it should be replaced at once as a standard servicing procedure.

TIPS ON PROPER INSTALLATION

1. Never install a Monitor in a closed-in recess, cubbyhole, or closely fitting shelf space.
2. Never install a Monitor over or close to a heat duct, or in the path of heated air flow.
3. Avoid conditions of high humidity such as: outdoor patio installations where dew is a factor, or near steam radiators where steam leakage is a factor.
4. Avoid placement where draperies may obstruct rear venting. Customers should also avoid the use of decorative scarves or other coverings which might obstruct ventilation.
5. Wall and shelf-mounted installations must use the factory approved mounting kit and mounting instructions.
6. A Monitor mounted to a shelf or platform must retain its original feet or the equivalent thickness in spacers for adequate air flow from the bottom. Bolts or screws used for fasteners must not touch any parts or wiring. Perform leakage tests on customized installations.
7. Caution customers against the use of a Monitor on a sloping shelf or in a tilted position, unless it is properly secured.

DISCHARGING THE CRT

Discharge the high voltage lead going to the anode of the CRT. One method of discharging it is to use a screwdriver and a 12" jumper wire with an alligator clip on each end. Clip one alligator clip to chassis or DAG ground, and place the other one on your screwdriver. Then slide the end of the screwdriver under the high voltage cap at the anode of the CRT.

TABLE OF CONTENTS

Introduction	1-1	Service Procedures	6-1
Specifications	2-1	Replacement Parts List	7-1
Installation and Set-Up	3-1	Semiconductor Identification	8-1
Theory of Operation	4-1	Circuit Board X-Ray Views	9-1
Disassembly	5-1	Schematic Diagram	fold-out

INTRODUCTION

The ZVM-122 has a 12-inch CRT with amber phosphor. The ZVM-123 is identical to the ZVM-122 except it uses a green phosphor CRT.

Both Monitors accept NTSC composite sync inputs, display twenty-five 40 or 80-character lines, and have an 18 MHz bandwidth with a 50 ns rise time.

Front panel controls include Brightness, Contrast, Vertical Hold, Horizontal Hold, and Vertical Height.

These Monitors are certified to comply with the limits for class B computing devices pursuant to subpart J of part 15 of the FCC rules.

Service of these monitors is to board level. When you have determined that a circuit board is at fault, it must be replaced. Return the defective board to your Zenith Data Systems Distributor.

You will need the following tools and test equipment to service the ZVM-122 and ZVM-123 monitor:

- 1/4" nut driver
- 1/4" flat screwdriver
- Needle-nose pliers
- Digital voltmeter
- Oscilloscope
- Software – ZDOS with VMENTEST
ZBASIC

SPECIFICATIONS

Operating Voltage	120 VAC 60Hz.
Operating Current	0.3 Amps.
Nominal Power	28 Watts.
Nominal High Voltage	13.0 kV.
Fuse Protection	4.0 Amp, type FX3201.
Power Transformer	Standard.
Bandwidth	15 MHz.
Rise Time	50 nanoseconds.
CRT	12" diagonal.
Phosphor	ZVM-122 – Amber ZVM-123 – Green.
Character Type	8 × 10 matrix.
Character Width	40 or 80 per line.

Zenith Data Systems reserves the right to discontinue products and to change specifications at any time without incurring any obligation to incorporate new features in products previously sold.

INSTALLATION AND SET UP

Control adjustments are covered in Service Procedure, section 6.

LOCATION

The ZVM-122 and ZVM-123 Monitors should be located near an AC power source, and in an area which will provide proper ventilation. There are vents on the back and bottom of the cabinet permitting air flow through the cabinet. Be sure these vents are not blocked.

CABLE DESCRIPTION

The video output cable from the computer to the Video In jack on the Monitors is a single conductor cable (HE 134-1319). Refer to Figure 3-1 for cable connection to the Monitor.

WIDTH CONTROL

The Width control is soldered to the input board and is accessible from the rear panel. Refer to Figure 3-1.

40/80 CHARACTER SWITCH

The 40/80 Character switch is an SPST slide switch located on the rear panel. Refer to Figure 3-1.

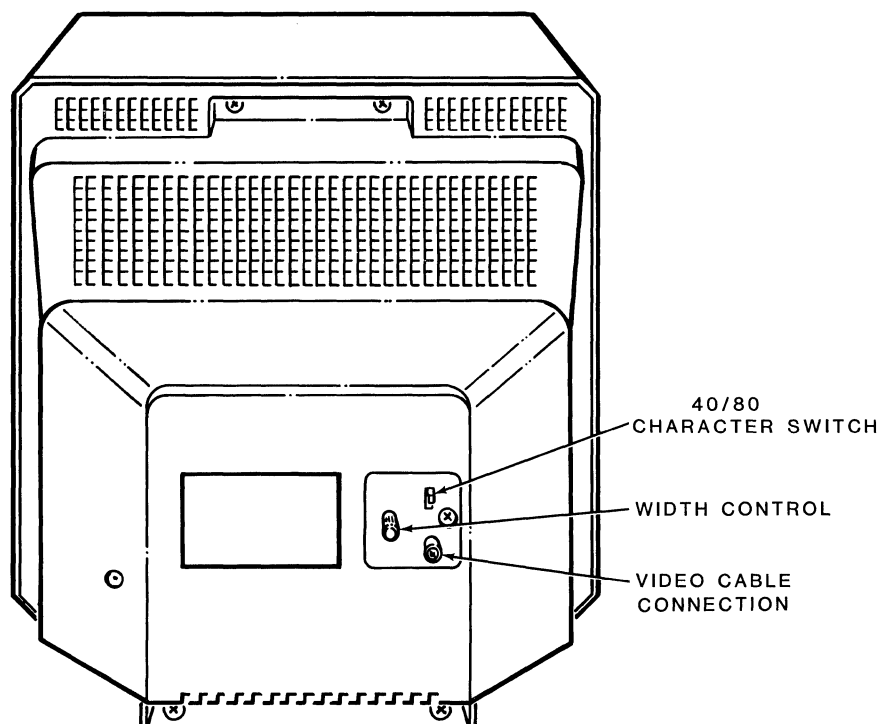

Figure 3-1
Rear panel.

CONTRAST CONTROL

The Contrast control is located on the front of the Monitor behind the access door. Refer to Figure 3-2.

BLACK LEVEL CONTROL

The Black Level control is located on the front of the Monitor behind the access door. Refer to Figure 3-2.

VERTICAL SIZE CONTROL

The Vertical Size control is located on the front of the Monitor behind the access door. Refer to Figure 3-2.

VERTICAL HOLD CONTROL

The Vertical Hold control is located on the front of the Monitor behind the access door. Refer to Figure 3-2.

HORIZONTAL HOLD CONTROL

The horizontal hold control is located in front of the monitor behind the access door. Refer to Figure 3-2.

ON/OFF SWITCH

The ON/OFF switch is located on the front of the monitor.

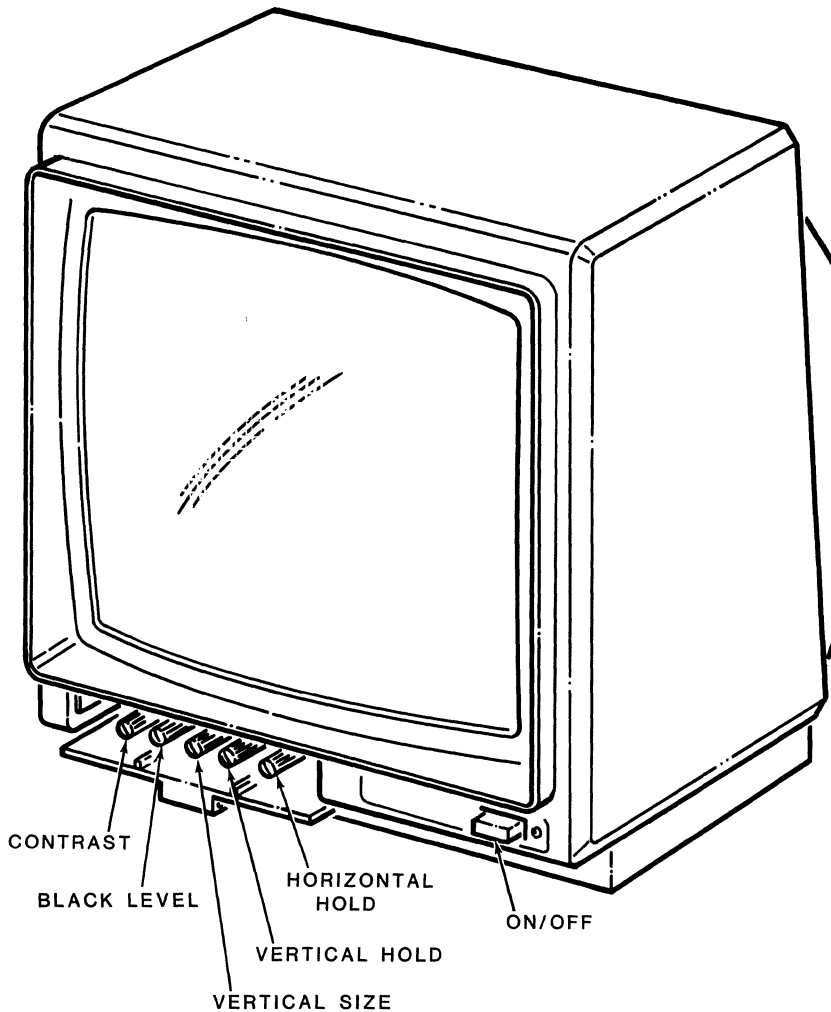

Figure 3-2
Front panel controls.

THEORY OF OPERATION

Refer to the fold-out schematic diagram (page 6-7) and the block diagram in Figure 4-1 (fold out from Page 4-3) as you read the following information.

POWER SUPPLY

Power transformer TX201 and bridge diodes CRX701, CRX702, CRX703, and CRX704 develop approximately 17.5 volts DC on capacitor CX707, with 1.7 volts of ripple present. QX703 acts as a variable series element, dropping more or less voltage across it in order to maintain the output voltage at a constant 12.7 volts.

When the output voltage increases or decreases due to line voltage fluctuations or load variations, this voltage change appears at the base of Q701. The voltage divider network that feeds this voltage to the base is made up of R704, R706, R707, R708, RX709, and C709. The potentiometer is configured to minimize voltage drift caused by tolerances or temperature variations. The AC ripple is coupled to the base by C709. This voltage is compared against the reference of CR706 (4.7-volt zener) and C708. Any difference causes the collector current to increase or decrease proportionally. This current is amplified by Q702 and fed to control transistor QX703. If the output voltage tries to rise, Q701 will try to turn off, causing Q702 and Q703 to turn off. Conversely, when the output voltage drops, Q701 turns on harder, turning on Q702 and Q703 and raising the output voltage back to normal.

A unique feature of this circuit is its ability to switch from a regulator to an active filter at low line voltages. The voltage at the collector of Q702 is proportional to the available input voltage to the regulator. When the input is too low to maintain 12.7 volts, the voltage at the collector of Q702 drops below the reference zener voltage, causing CR705 to conduct.

This additional current sinking through R701 disables the zener reference, causing the DC output voltage to drop and no longer be regulated for DC variations. However, the AC reference remains in control; so AC ripple regulation continues – in effect – producing an active filter.

VIDEO PREAMP

The video input is configured to accept a standard RS170 composite video with a 75-ohm terminating input. The video is coupled to the emitter of Q806 through C814 and R835. Q806 is a common-base amplifier which amplifies the one-volt peak-to-peak video to three volts without a phase inversion. The output of Q806 is coupled through C808 to the base of the video driver (Q805). In the base circuit of Q805, a sync tip clamp; consisting of CR804, R814, R815, and R820; is used to clamp the video signal so there are no black level shifts with variation in input signal.

SYNC AMP

The video signal at the emitter of video driver Q805 is sent to the video output through the Contrast control. It is also sent to the base of the sync amplifier Q801. The sync amplifier is used to stretch the sync portion of the video signal before the signal is sent to the sync separator, Q802. Q802 is a standard dual-time-constant sync separator. Its output is sent to the horizontal and vertical oscillators to keep the deflection in sync.

VIDEO OUTPUT

The video is DC-coupled from video driver Q805 and Contrast control R815 to the base of video output transistor Q201.

The beam limiter current is used to control the amount of DC coupling. Beam current limiter transistor Q807 and its associated components sense the anode current in the tertiary of the horizontal output transformer. As the beam current increases, so does the collector current at Q807. This collector current is fed to the emitter of Q201, which increases the collector voltage of the video output transistor. Increasing the collector voltage decreases the beam current.

This circuit allows for a maximum of 90% DC coupling. Because this circuit will not limit the maximum beam current at a sufficiently low value, diode CR802 is required. This diode is biased off until the beam current reaches 210 microamps. At this point, the diode is allowed to conduct. The emitter impedance is lowered considerably, which increases the collector current. This limits the maximum beam current.

SPOT BURN PROTECTION

When the Monitor is turned off, CR803 and C809 keep the collector voltage high. This keeps the CRT biased off, preventing spot burn.

VERTICAL SWEEP CIRCUIT

The vertical sweep circuit is a self-oscillating DC-coupled ramp-generating circuit that uses complimentary push-pull class B output transistors, a driver transistor, a differential amplifier transistor, and an oscillator transistor.

The emitters of the output stage are fed back to the input through C613, R618, R617, and Q601. The differentiated, positive-going fly back pulse from the emitter charges C606 and C608 through Q601. The capacitors discharge through their respective resistor networks. Capacitor C606 discharges during the trace interval to 0.6 volts below the emitter voltage of Q601. At this point, Q601 conducts and turns off the amplifier stages. This causes the yoke voltage to fly up and repeat the cycle.

The presence of a sync signal causes Q601 to conduct slightly before the voltage on C606 decreases to 0.6 volts below the Q601 emitter voltage, bringing the circuit timing into sync with the sync signal. Capacitor C608 discharges linearly through its resistor network because this network is returned to yoke current sensing resistor R624, where a ramp voltage appears of the same amplitude as the ramp voltage across C608. A constant voltage appears across the discharge resistor and maintains the constant discharge current from C608. Capacitor C608 provides a linear, negative-going ramp voltage of average DC value, established by R608 and R609, to the base of Q602. The signal to the emitter of the differential amplifier comes from the yoke return circuit.

The ramp voltage across R624 has S-correction in its waveform as required in the yoke current to produce linear pictures on the CRT. Across C609 is an inverse S-correction signal, which is derived through the shaping network of R620, R621, and C615. This adds to the ramp-plus-S-correction signal appearing across R624 to produce a linear ramp at the emitter of Q602. This linear ramp is compared by Q602 with the linear ramp across C608. The difference between the two is coupled to the succeeding amplifier stages. This returns the yoke current to the desired current for producing a linear picture.

HORIZONTAL PROCESSOR

The operation of the horizontal processor (IC501), 221-141, is the same as the 221-86. The 221-141 can be replaced by 221-86. However, 221-86 cannot be replaced by 221-141.

Integrated circuit 221-141 is divided into four sections:

- Phase detector
- Oscillator
- Regulator
- Predriver

Phase Detector

The phase detector is comprised of a differential amplifier and a gated current source.

The current source is strobed on by a negative sync that is AC coupled to pin 3.

The current division between the two transistors of the differential amplifier is determined by the phase relationship of the sync and sawtooth waveform on pin 4. This sawtooth is derived from a negative horizontal flyback pulse. When the sync and sawtooth are in phase, the current division between the two transistors in the differential amplifier will be equal. When there is a phase difference, current will either flow into or out of pin 5, which is connected by way of a low-pass filter to pin 7 of the oscillator. This current controls the oscillator.

Oscillator

The oscillator is an RC type, with pin 7 being the control point. The timing capacitor is charge up by an external resistor to a trip voltage set in the integrated circuit. When this trip voltage is reached, the capacitor is discharged to a new trip value. This process is repeated, producing a sawtooth waveform.

The output of the phase detector controls the oscillator through resistive coupling from pin 5 to pin 7. The Horizontal Hold control is also connected at pin 7. The two 100 k Ω resistors in the horizontal hold circuit are used to center the hold control range. The diode in series with the Hold control is used to temperature compensate the oscillator.

Regulator

Pin 6 on the regulator is temperature-compensated and consists of two high-current diodes in series with a zener diode. The zener current is determined by an external resistor connected to the 12.7-volt power supply. The voltage set by the regulator is between 8 and 9 volts.

Predriver

The predriver is a four-transistor circuit which takes the sawtooth formed at pin 7 and produces a variable duty cycle waveform at pin 1. This output is used to drive the horizontal driver. The "on" time of the output waveform is determined by the bias voltage on pin 8. This voltage is determined by a series of clip resistors that match the integrated circuit to the Monitor.

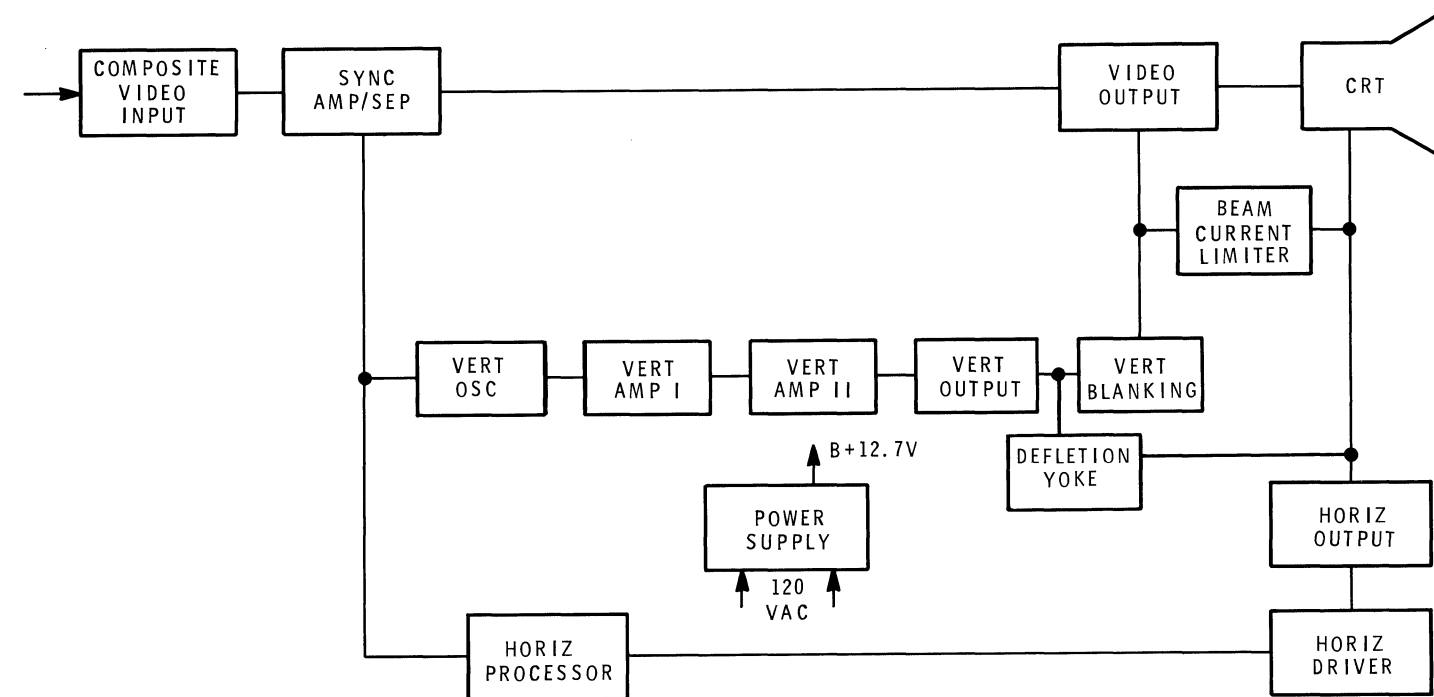

Figure 4-1
Block diagram.

DISASSEMBLY

BACK COVER

Refer to Figure 5-1.

The back cover is secured to the main cabinet with six screws across the rear of the cabinet. To remove the back cover:

- Remove the power cord from the power source.
- Disconnect the video cable.
- Remove the three screws (A).
- Remove the two screws (B) across the bottom.
- Remove the one screw (C) on the rear panel.
- Slide rear panel through its opening to remove it from the back cover.
- Remove the back cover.

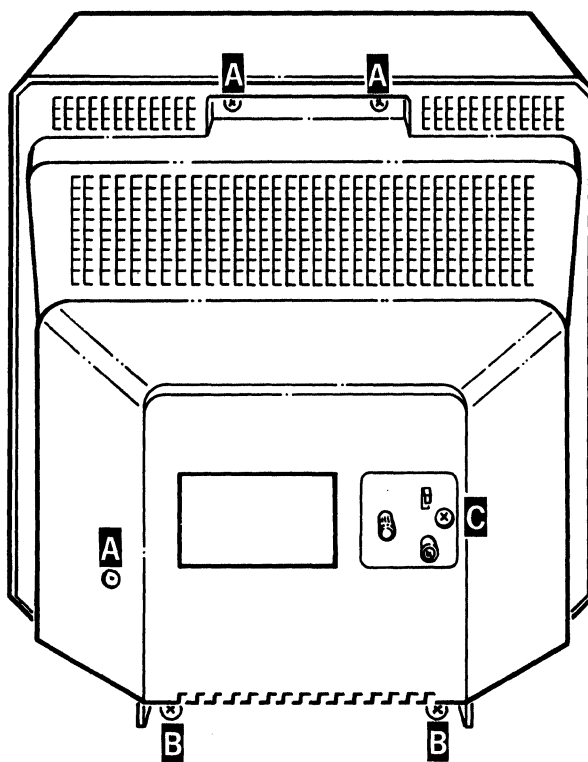

Figure 5-1
Back cover removal.

INPUT TRANSFORMER ASSEMBLY

Refer to Figure 5-2.

The input transformer assembly is connected to main cabinet by two screws. To remove this assembly:

- Remove the back cover.
- Remove the two screws (D) on the bottom of the cabinet holding the assembly in place.

MAIN BOARD

Refer to Figure 5-2.

The main board sets in place with two guide rails. To remove the main board:

- Remove the back cover.
- Remove the input transformer assembly.
- Slide out the main board.

CRT SOCKET BOARD

Refer to Figure 5-2.

- Remove the back cover.
- Remove the CRT socket board by carefully pulling the board off the socket.

CONTROL PANEL BOARD

Refer to Figure 5-2.

The Video controls are mounted to circuit board which is secured to the front of the main chassis. To remove this board:

- Remove the back cover.
- Remove the input transformer assembly.
- Remove the main board.
- Remove the three screws (E) that secure the board to the front panel.
- Remove the board.

ON/OFF SWITCH

Refer to Figure 5-2.

The On/Off switch is located on the front panel. To remove this switch:

- Remove the back cover.
- Remove the input transformer assembly.
- Remove the main board.
- Remove the two screws (F) holding the switch to the switch bracket.

CRT

Refer to Figure 5-2.

NOTE: Before you remove the CRT, discharge the anode lead. Refer to the Caution/Warnings on Page II.

The CRT is fastened to the front panel with four screws. To remove the CRT:

- Remove the CRT socket board.
- Remove the CRT high voltage lead.
- Remove the four screws (G) that hold the CRT to the front panel.

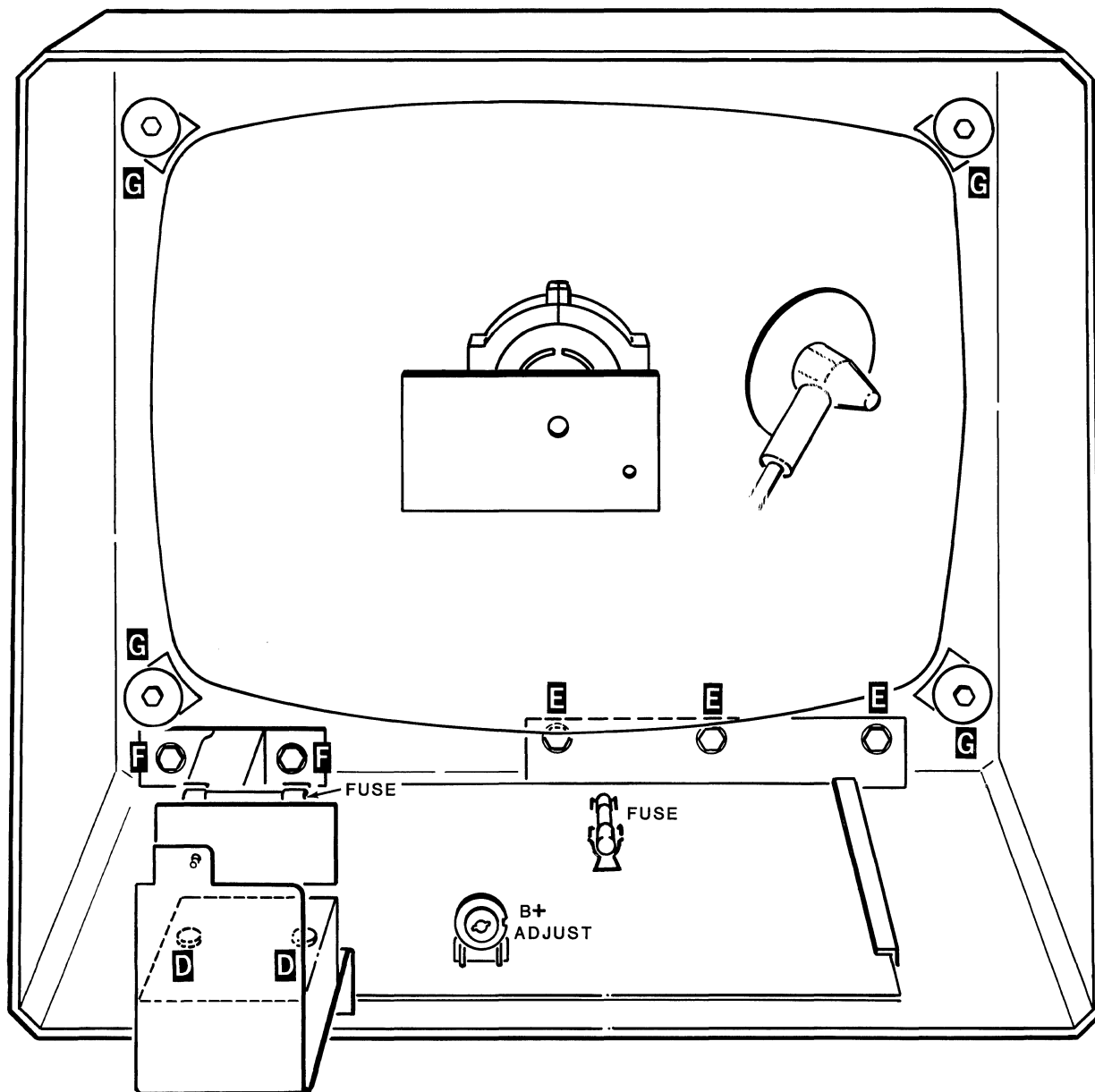

Figure 5-2
Component removal.

SERVICE PROCEDURES

SYMPTOMS AND CHECKS

The following list of symptoms and checks provides you with some problems you may encounter, and the most probable areas to check.

This list is not intended to be inclusive of all the problems you may encounter, but rather to provide you with a systematic approach to diagnosing the problem. If you encounter a problem not listed in this chart, analyze where the problem is located by the way the circuits relate to each other.

SYMPTOM	AREA TO CHECK
Monitor completely dead. (no power to LED)	<ul style="list-style-type: none"> ● Line cord and power source. ● Fuse FX201 or FX701. ● Transformer TX201. ● Switch SX201 or wiring at switch. ● Shorted diode, CR701-CR704. ● Q701-Q703, or associated circuitry. ● LED open.
Hum bars in display.	<ul style="list-style-type: none"> ● CX707. ● R707 and R706 interchanged. ● CR701-CR704, one open. ● CR706.
No raster.	<ul style="list-style-type: none"> ● Black Level or Contrast control turned down. ● CRT or CRT socket. ● Q201, Q807. ● RX711 open.
No high voltage.	<ul style="list-style-type: none"> ● Q501 or Q502. ● Horizontal yoke winding. ● TX502. ● CR507, CR508, CR502, CR503. ● IC501.
No horizontal sync.	<ul style="list-style-type: none"> ● R502, R503. ● Horizontal Hold control.
No vertical sync.	<ul style="list-style-type: none"> ● C601, R602, R603. ● Adjust Vertical Hold control.

SYMPTOM	AREA TO CHECK
Only top or bottom of vertical deflection present.	<ul style="list-style-type: none"> • Q601, Q602, Q603, Q604, Q606. • Yoke, TX202A, open.
Horizontal scans right to left instead of left to right.	<ul style="list-style-type: none"> • Yellow and black wires on yoke interchanged.
Vertical scans bottom to top instead of top to bottom.	<ul style="list-style-type: none"> • Red and blue wires on yoke interchanged.
No horizontal or vertical sync.	<ul style="list-style-type: none"> • Q801, Q802.
No characters on screen. (High and low voltage OK)	<ul style="list-style-type: none"> • C801 open • Q806, Q805. • Wiring between boards.

ADJUSTMENTS

Video adjustments are located behind the front panel access door and on the rear panel. The B+ Voltage adjustment is located on the main board. Refer to Figures 6-1, 6-2, and 6-3.

To adjust the Video controls, use the Display/Keyboard Test, or the ZBASIC Program to fill the screen.

DISPLAY/KEYBOARD TEST

If your Z-100 Computer has the diagnostic ROM (HE 444-87-5) at location U190, you may use the Display/Keyboard Test to fill the screen.

- When the prompt appears, type T.
- Select the Keyboard Test.
- Type any character and it will fill the screen.
- Press the DELETE key to exit.

ZBASIC PROGRAM

- Boot up ZBASIC.
- Enter the following program:

```

KEY ON
10 FOR Z=1 TO 2000
20 PRINT "Z";
30 NEXT Z
40 GOTO 40
    
```

- TYPE RUN and press the RETURN key. The screen will be filled with Z's.

BLACK LEVEL CONTROL

The Black Level control is located behind the front access panel. Refer to Figure 6-1. Adjust this control counterclockwise until the raster is visible. Then back it down until the raster just disappears. This adjustment works best in a darkened room.

CONTRAST CONTROL

The Contrast control is located behind the front access panel. Refer to Figure 6-1. Adjust this control until the display is comfortable to the eye.

HORIZONTAL HOLD

The Horizontal Hold control is located behind the front access panel. Refer to Figure 6-1. Adjust this control as required for a stable display.

VERTICAL HOLD

The Vertical Hold control is located behind the front access panel. Refer to Figure 6-1. Adjust this control as required for a stable display.

VERTICAL SIZE

The Vertical Size control is located behind the front access panel. Refer to Figure 6-1. Adjust this control so the display is equal on top and bottom.

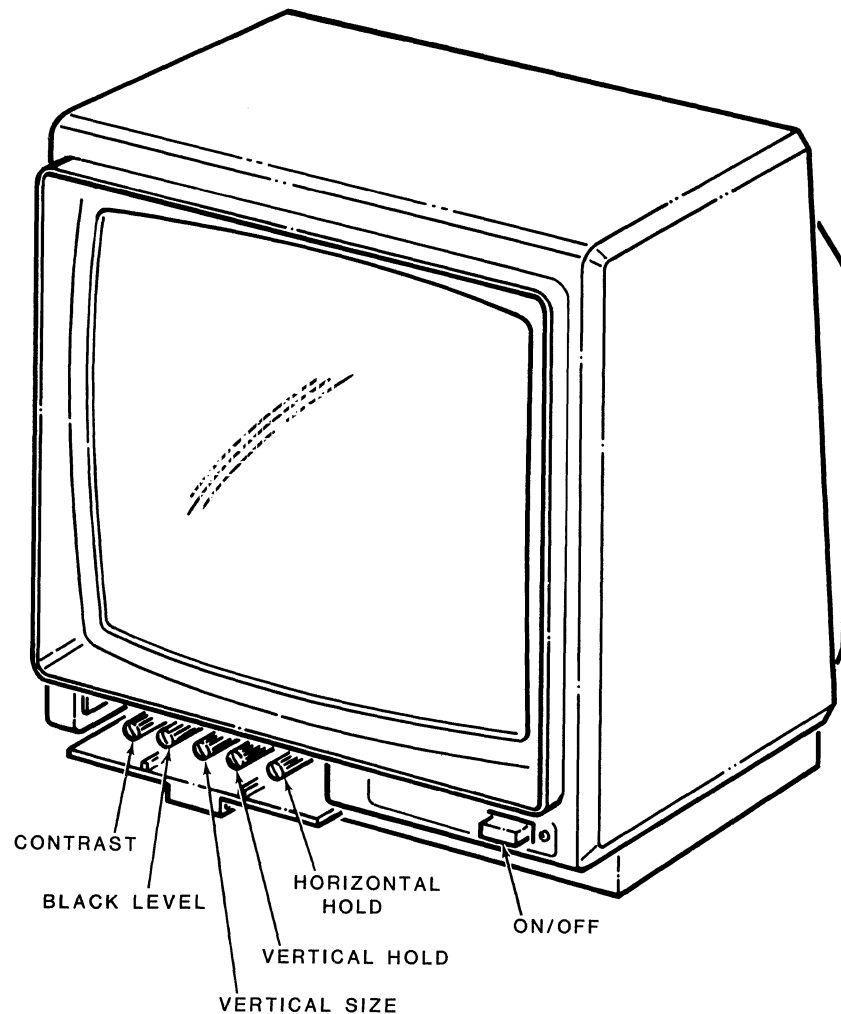

Figure 6-1
Front panel controls.

WIDTH CONTROL

The Width control is located on the rear panel. Refer to Figure 6-2. Adjust this control so the display is equal on both sides.

40/80 CHARACTER SWITCH

The Character switch is located on the rear panel. Refer to Figure 6- 2. Set the character switch for 40 or 80 characters per line.

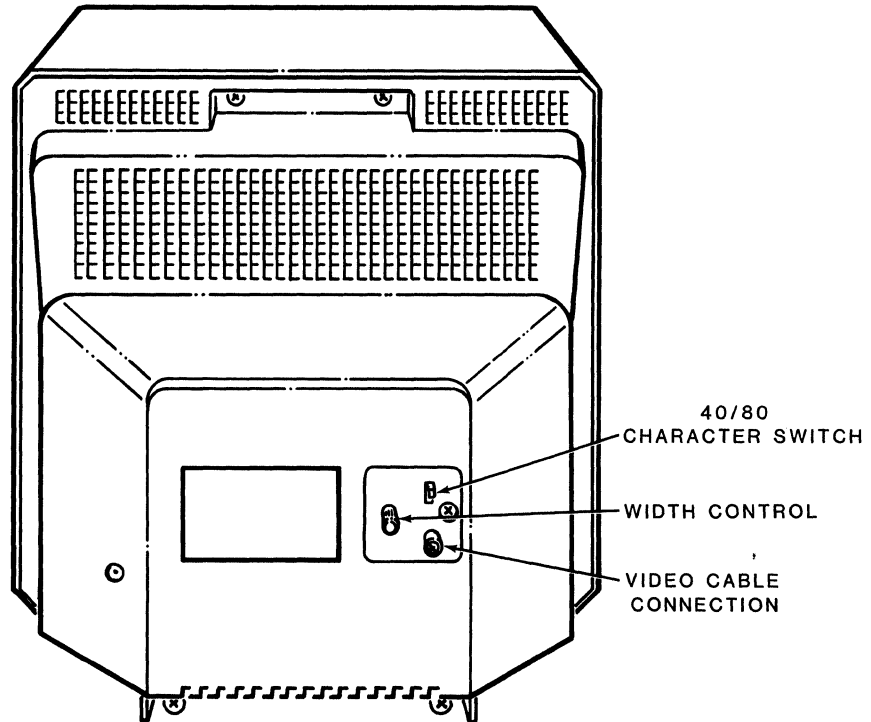

Figure 6-2
Rear panel.

FOCUS CONTROL

The Focus control is located at R215 on the CRT socket circuit board. It is adjustable through a hole in the circuit board. Refer to Figure 6-3. You will have to remove the rear cover to make this adjustment. With the screen full of characters, adjust the Focus control for best all around focus.

B+ ADJUSTMENT

The B+ adjustment is located on the main board

at RX709. To adjust B+ voltage, remove the rear cover. Then connect your voltmeter to ground and the positive lead to the B+ side of RX709. Refer to Figure 6-3. Adjust the control for +12.7 VDC.

CRT CENTERING MAGNETS

The CRT Centering magnets are located in front of the yoke on the neck of the CRT. Refer to Figure 6-3. Adjust the centering magnets to center the display.

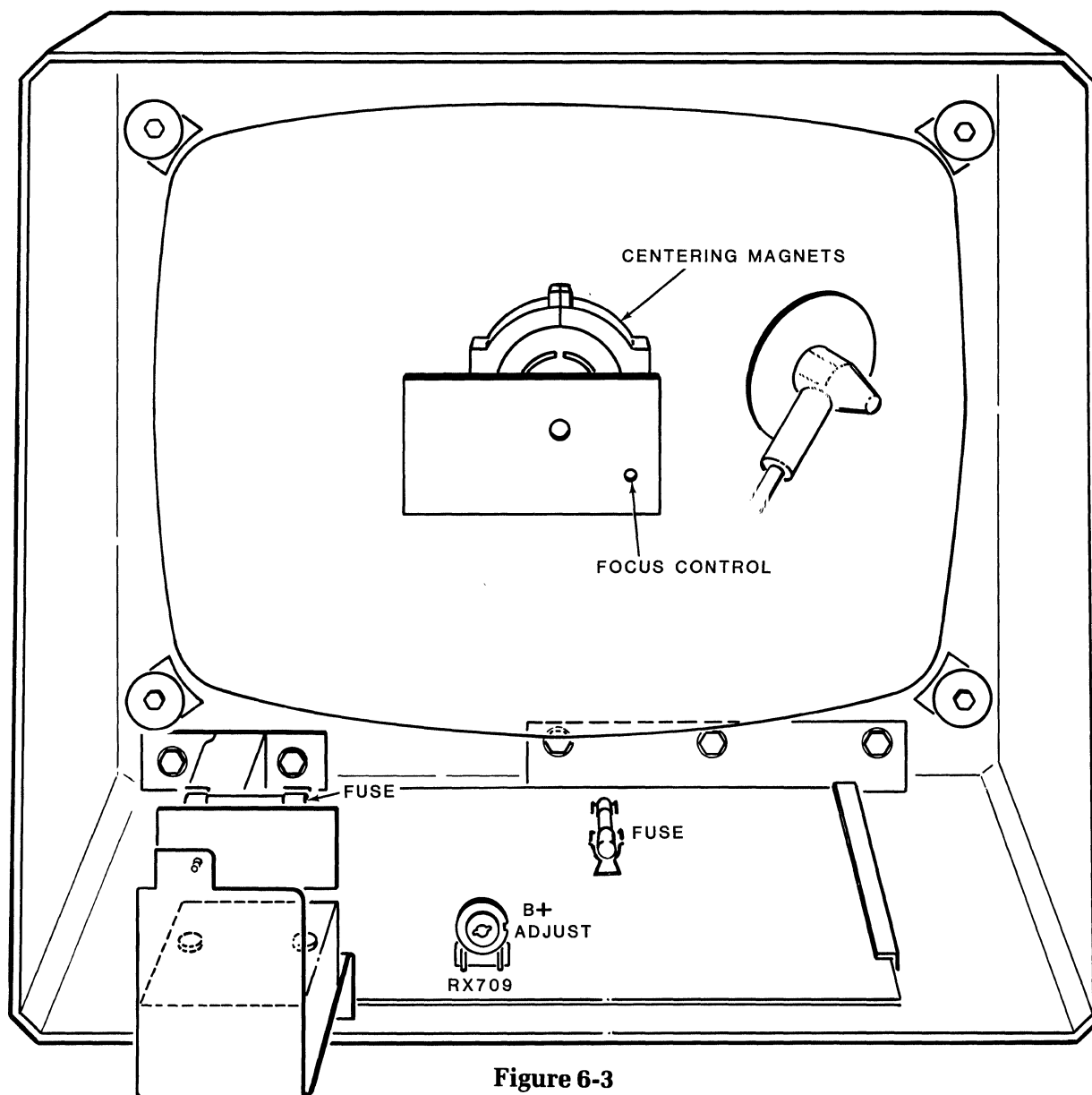

Figure 6-3
Monitor adjustment.

MEASUREMENTS

The main board has several test points that provide excellent reference for sync and video signals.

Video Input

.5 v/div
5 ms/div

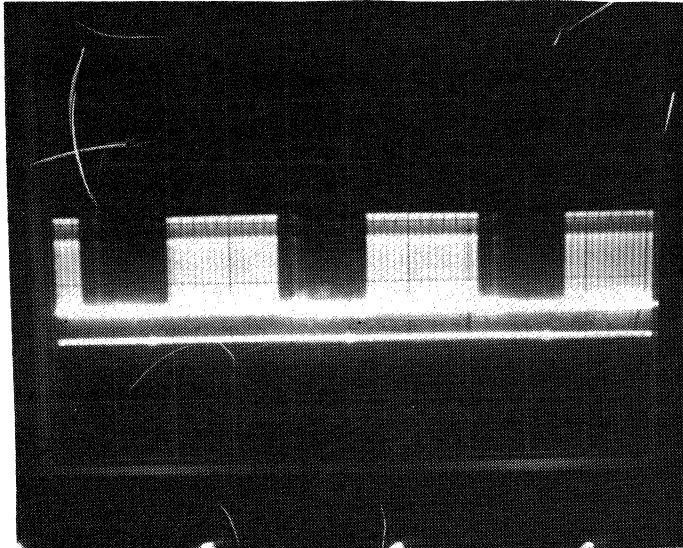

Figure 6-4
Video input.

Video Driver – Q805

1 v/div
5 ms/div

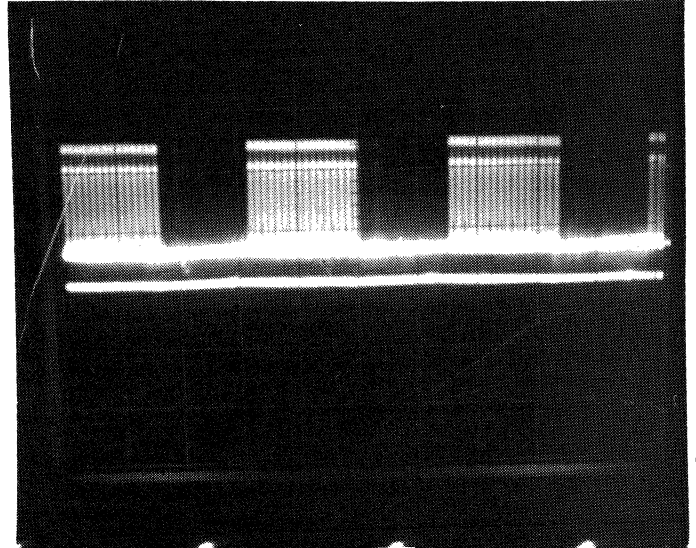

Figure 6-5
Video driver.

Video Output – Q201

10 v/div
5 ms/div

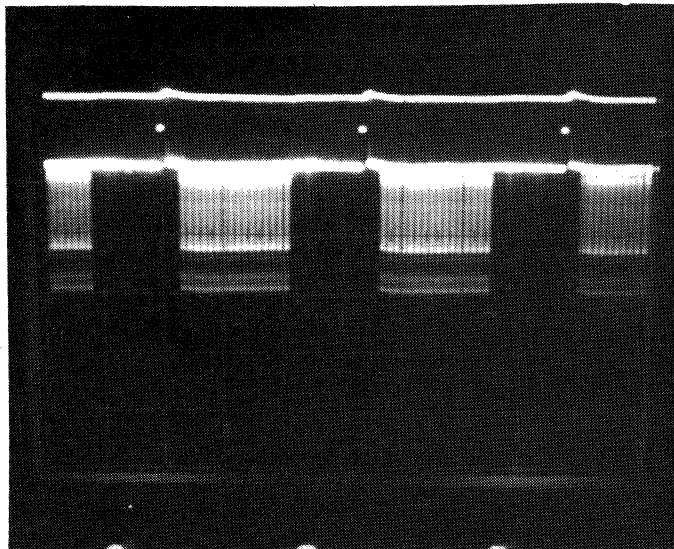

Figure 6-6
Video output.

Vertical Oscillator – Q601

2 v/div
5 ms/div

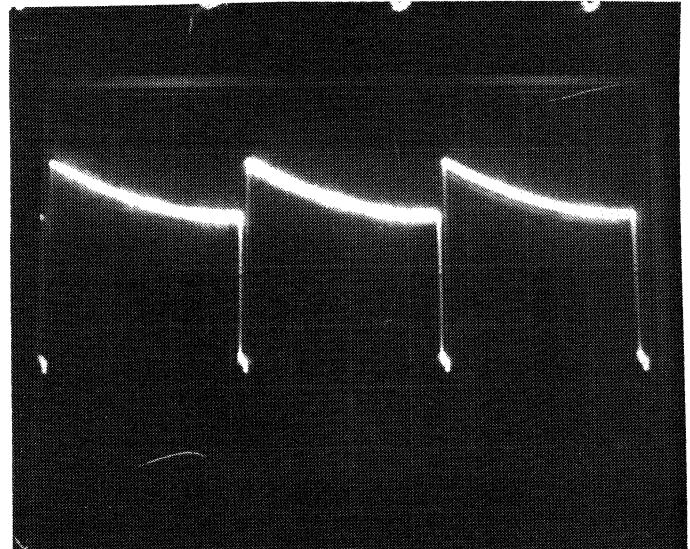

Figure 6-7
Vertical oscillator.

Vertical Output – Q606
10 v/div
5 ms/div

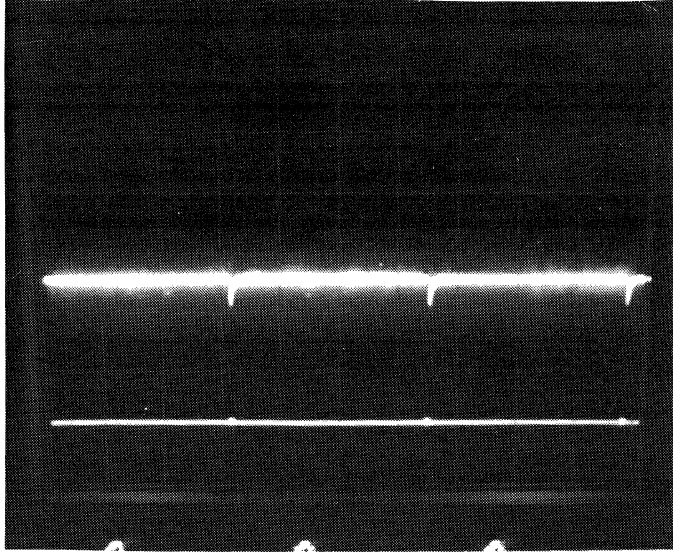

Figure 6-8
Vertical output.

Sync Separator – Q802
5 v/div
5 ms/div

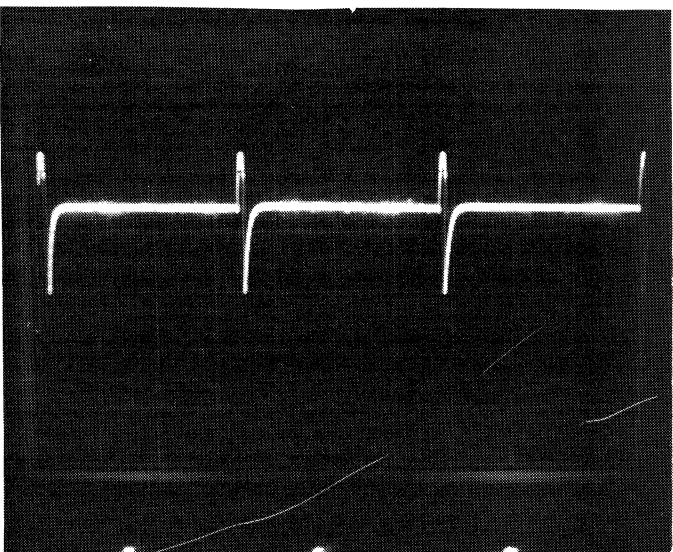

Figure 6-9
Sync separator.

Horizontal Output – QX502
50 v/div
20 micro sec/div

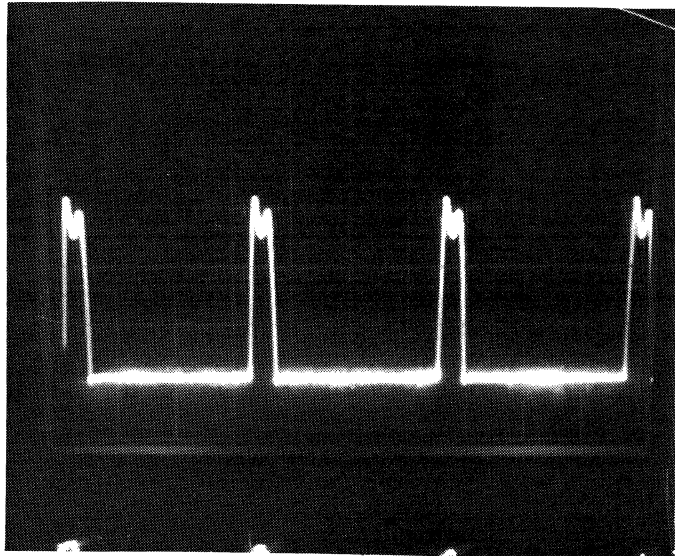

Figure 6-10
Horizontal output.

NOTES:

1. ALL RESISTOR VALUES ARE IN OHMS (k = 1,000, M = 1,000,000) ALL RESISTORS ARE 1/4-WATT, 5% UNLESS OTHERWISE SPECIFIED.
2. ALL CAPACITOR VALUES ARE IN μ F (MICROFARADS), UNLESS OTHERWISE SPECIFIED.
3. REFER TO THE CIRCUIT BOARD X-RAY VIEWS FOR THE PHYSICAL LOCATION OF PARTS.

LEGEND:

1. CHASSIS GROUND
2. CIRCUIT BOARD GROUND
3. DIRECTION
4. SIGNAL FROM S-100 BUS
5. SIGNAL TO S-100 BUS
6. MECHANICAL CONNECTION
7. MALE CONNECTION
8. FEMALE CONNECTION
9. NO CONNECTION
10. CONNECTION
11. CALIBRATION OR A TEST POINT

PARTS ORDERING INFORMATION:

If you order a part from Zenith Data Systems, use the (HE) prefix. Example:
HE 443-730

If you order a part from Heath Company, DO NOT use the (HE) prefix. Example:
443-730

For semiconductor type numbers (Example: 74LS153), refer to the "Semiconductor Identification Chart."

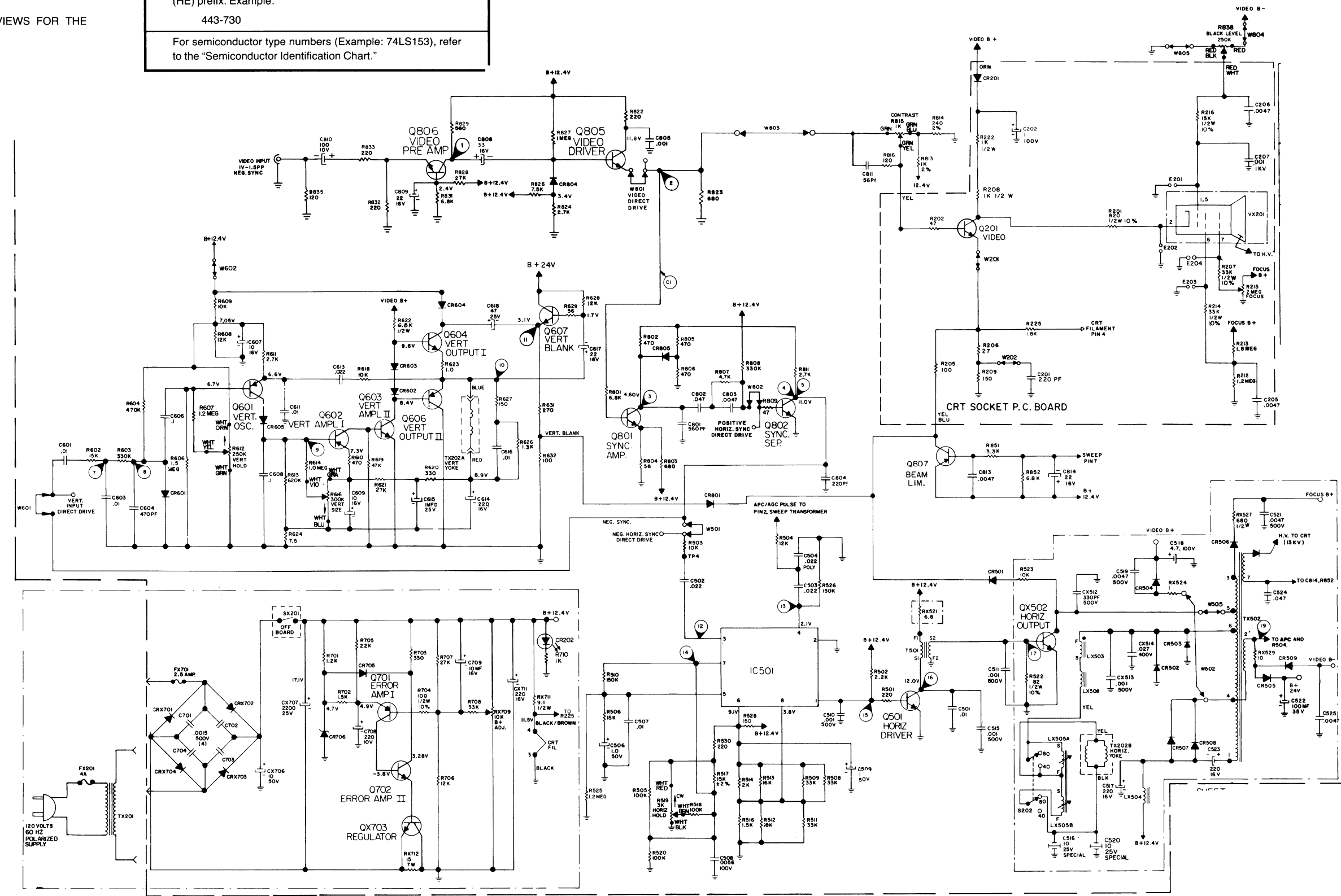

REPLACEMENT PARTS LIST

Electronic Parts

CIRCUIT COMP. NO.	ZDS PART NO.	DESCRIPTION	CIRCUIT COMP. NO.	ZDS PART NO.	DESCRIPTION
RESISTORS					
NOTE: All resistors are 1/4-watt, 5% unless specified otherwise.					
R201	HE 6-821	820Ω, 1/2 watt, 10%	R525	HE 6-125-12	1.2 MΩ
R202	HE 6-470-12	47Ω	R526	HE 6-154-12	150 kΩ
R205	HE 6-101-12	100Ω	RX527	HE 6-681	680 Ω, 1/2 watt
R206	HE 6-270-12	27Ω	R528	HE 6-151-12	150 Ω
R207	HE 6-333	33kΩ	RX529	HE 6-100-12	10 Ω
R208	HE 6-102	1000Ω, 1/2 watt	R530	HE 6-221-12	220 Ω
R209	HE 6-151-12	150Ω	R602	HE 6-153-12	15 kΩ
RX212	HE 6-125-12	1.2 MΩ	R603	HE 6-334-12	330 kΩ
R213	HE 6-185-12	1.8 MΩ	R604	HE 6-474-12	470 kΩ
R214	HE 6-333	33 kΩ	R606	HE 6-105-12	1 MΩ
R215	HE 6-205-12	2 MΩ	R607	HE 6-275-12	2.7 MΩ
R216	HE 6-153	15 kΩ, 1/2 watt, 10%	R608	HE 6-123-12	12 kΩ
R222	HE 6-102	1000Ω, 1/2 watt	R609	HE 6-103-12	10 kΩ
R225	HE 6-182-12	1800Ω	R610	HE 6-471-12	470 kΩ
R501	HE 6-221-12	220Ω	R611	HE 6-272-12	2700 Ω
R502	HE 6-222-12	2200Ω	R612	HE 234-332	250 kΩ vertical hold control
R503	HE 6-103-12	10 kΩ	R613	HE 6-624-12	620 kΩ
R504	HE 6-123-12	12 kΩ	R614	HE 6-125-12	1.2 MΩ
R505	HE 6-105-12	100 kΩ	R616	HE 234-333	300 kΩ vertical size control
R506	HE 6-153-12	15 kΩ	R618	HE 6-103-12	10 kΩ
R507	HE 6-270-12	27 Ω	R619	HE 6-473-12	47 kΩ
R508	HE 6-333-12	33 kΩ	R620	HE 6-331-12	330 Ω
R509	HE 6-333-12	33 kΩ	R621	HE 6-273-12	27 kΩ
R510	HE 6-154-12	150 kΩ	R622	HE 6-243	24 kΩ
R511	HE 6-333-12	33 kΩ	R623	HE 6-100-12	1 Ω
R512	HE 6-163-12	16 kΩ	R624	HE 6-689-12	6.8 Ω
R513	HE 6-163-12	16 kΩ	R626	HE 6-132-12	1.3 kΩ
R514	HE 6-202-12	2 kΩ	R627	HE 6-151-12	150 Ω
R515	HE 6-121-12	120 Ω	R628	HE 6-123-12	12 kΩ
R516	HE 6-152-12	1500 Ω	R629	HE 6-560-12	56 Ω
R517	HE 6-153-12	15 kΩ, 2%	R631	HE 6-271-12	270 Ω
R518	HE 6-104-12	100 kΩ	R632	HE 6-101-12	100 Ω
R519	HE 234-330	3 kΩ horizontal hold control	R701	HE 6-122-12	1200 Ω
R520	HE 6-104-12	100 kΩ	R702	HE 6-152-12	1500 Ω
RX521	HE 6-689-12	6.8 Ω	R703	HE 6-331-12	330 Ω
R522	HE 6-820	82 Ω, 10%, 1/2 watt	R704	HE 6-101	100 Ω, 10%, 1/2 watt
R523	HE 6-104-12	10 kΩ	R705	HE 6-223-12	22 kΩ
RX524	HE 6-100-12	1 Ω	R706	HE 6-123-12	12 kΩ
			R707	HE 6-273-12	27 kΩ
			R708	HE 6-333-12	33 kΩ
			RX709	63-10521-01	10 kΩ, B+ adjust control
			RX711	HE 234-414	9.1 Ω
			RX712	HE 234-348	15 Ω, 7 watt

<u>CIRCUIT COMP. NO.</u>	<u>ZDS PART NO.</u>	<u>DESCRIPTION</u>	<u>CIRCUIT COMP. NO.</u>	<u>ZDS PART NO.</u>	<u>DESCRIPTION</u>
R801	HE 234-346	6.8 Ω	CAPACITORS		
R802	HE 6-471-12	470 Ω	C201	HE 21-22	27 pF ceramic
R803	HE 6-681-12	680 Ω	C202	HE 21-140	1 μ F ceramic
R804	HE 6-560-12	56 Ω	C205	HE 21-182	.0047 μ F
R805	HE 6-471-12	470 Ω	C206	HE 21-182	.0047 μ F
R806	HE 6-471-12	470 Ω	C207	HE 21-140	.001
R807	HE 6-472-12	4700 Ω	C501	HE 21-185	.01 μ F
R808	HE 6-334-12	330 k Ω	C502	HE 234-402	.022 μ F
R809	HE 6-470-12	47 Ω	C503	HE 234-402	.022 μ F
R810	HE 6-332-12	3300 Ω	C504	HE 234-401	.022 μ F
R811	HE 6-272-12	2700 Ω	C505	HE 25-900	10 μ F
R812	HE 6-561-12	560 Ω	C506	HE 21-185	1 μ F
R813	HE 6-102-12	1 k Ω	C507	HE 21-750	.01 μ F
R814	HE 6-241-12	240 Ω	C508	HE 25-900	.0056 μ F
R815	HE-234-331	1 k Ω Contrast control	C509	HE 21-140	.01 μ F
R816	HE 6-121-12	120 Ω	C510	HE 21-140	1000 pF
R817	HE 6-241-12	240 Ω , 2%	C511	HE 21-140	1000 pF
R818	HE 6-184-12	180 k Ω	CX512	HE 21-722	330 pF
R819	HE 6-183-12	18 k Ω	CX513	HE 21-140	1000 pF
R820	HE 6-752-12	7500 Ω	CX514	HE 234-403	.027 μ F
R821	HE 6-682-12	6800 Ω	C515	HE 21-140	.001 μ F
R822	HE 6-221-12	220 Ω	C516	HE 234-401	10 μ F
R823	HE 6-681-12	680 Ω	C517	HE 25-861	220 μ F
R824	HE 6-272-12	2700 Ω	C518	HE 234-408	4.7 μ F
R825	HE 6-273-12	27 k Ω	C519	HE 21-56	4700 pF
R826	HE 6-752-12	7500 k Ω	C520	HE 234-401	10 μ F
R827	HE 6-105-12	1 M Ω , 10%	C521	HE 21-56	4700 pF
R828	HE 6-273-12	27 k Ω	C522	HE 25-918	100 μ F
R829	HE 6-511-12	510 Ω	C523	HE 25-942	220 μ F
R830	HE 6-333	33 k Ω , 10%, 1/2 watt	C524	HE 234-418	.0047 μ F
R831	HE 6-682-12	6800 Ω , 1/2 watt	C525	HE 21-182	.047 μ F
R832	HE 6-221-12	220 Ω	C601	HE 21-185	.01 μ F
R833	HE 6-221-12	220 Ω	C602	HE 21-185	.01 μ F
R834	HE 6-221-12	220 Ω	C603	HE 21-185	.01 μ F
R835	HE 6-121-12	120 Ω	C604	HE 21-56	470 pF
R836	HE 234-347	10 Ω	C606	HE 234-404	.1 μ F
R837	HE 6-271-12	270 Ω , 2%	C607	HE 25-917	10 μ F
R838	HE 234-332	250 k Ω Black Level control	C608	HE 234-404	.1 μ F
R839	HE 6-153-12	15 k Ω	C609	HE 25-917	10 μ F
R840	HE 6-121-12	120 Ω	C611	HE 21-185	.01 μ F
R841	HE 6-275-12	2.7 M Ω	C613	HE 234-402	.022 μ F
R842	HE 6-335-12	3.3 M Ω	C614	HE 21-22	220 μ F
R843	HE 6-106-12	10 M Ω	C615	HE 25-900	1 μ F
R844	HE 6-106-12	10 M Ω	C616	HE 21-185	.01 μ F
R846	HE 6-106-12	10 M Ω	C617	HE 25-884	22 μ F
R852	HE 234-346	6.8 Ω	C618	HE 25-884	47 μ F

<u>CIRCUIT COMP. NO.</u>	<u>ZDS PART NO.</u>	<u>DESCRIPTION</u>
------------------------------	-------------------------	--------------------

C701	HE 21-164	1500 pF
C702	HE 21-164	1500 pF
C703	HE 21-164	1500 pF
C704	HE 21-164	1500 pF
CX706	HE 234-401	10 μ F
CX707	HE 25-861	2200 μ F
C708	HE 25-861	220 μ F
C709	HE 25-917	10 μ F
CX711	HE 25-942	220 μ F

C801	HE 234-405	560 pF
C802	HE 21-182	.047 μ F
C803	HE 21-182	.047 μ F
C804	HE 21-22	220 pF
C805	HE 21-140	.001 μ F
C806	HE 21-56	4700 pF
C807	HE 25-917	10 μ F
C809	HE 25-927	22 μ F
C810	HE 25-918	100 μ F
C811	HE 21-750	56 pF
C812	HE 234-402	22 μ F
C813	HE 234-418	.0047 μ F
C814	HE 25-927	22 μ F

INDUCTORS – TRANSFORMERS

L503	HE 234-344	Coil RCF linearity
LX504	HE 234-343	Coil RCF parasitic suppressor
LX505	HE 234-387	Width coil
LX508	HE 234-342	Choke coil
TX201	HE 234-385	Power transformer
TX202	HE 234-386	Deflection yoke
T501	HE 234-350	Transformer horizontal driver
TX502	HE 234-398	Sweep transformer

MISCELLANEOUS

IC 501	HE 234-368	Horizontal processor (IC)
E201	HE 234-336	Spark gap
E202	HE 234-336	Spark gap
E203	HE 234-336	Spark gap
E204	HE 234-336	Spark gap
FX701	HE 234-366	Fuse normal lag 2.25 amp, 32V
FX201	HE 421-5	Fuse 4.0 amp
VX201	HE 234-422	CRT amber
-	HE 234-421	CRT green
XS201	HE 234-382	On/off switch
-	HE 234-377	Knob
S202	HE 234-383	40/80 switch
J1	HE 234-380	Video input jack
-	HE 89-22	Line cord
-	HE 234-411	LED

CIRCUIT BOARD ASSEMBLIES

-	12ZM2ZX	Main board
-	Not Available*	Control panel board
-	Not Available*	CRT socket board
-	Not Available*	Input board

*These part numbers will be issued in a Service Bulletin when they become available.

Mechanical Parts

ZDS
PART NO. DESCRIPTION

CABINET PARTS

HE 234-374	Cabinet front
HE 234-373	Cabinet rear
HE 234-370	Plastic rail – left
HE 234-371	Plastic rail – right
HE 234-372	Power supply bracket
HE 234-375	Control cover

CABLE

HE 134-1319	One conductor, video input
HE 89-22	Line cord

HARDWARE

HE 234-390	4-24 × .312 screw
HE 234-391	6-20 × .312 screw
HE 234-393	6-20 × .375 screw
HE 234-388	6-20 × .5 screw
HE 234-389	8-18 × .625 screw
HE 234-392	8-18 × .75 screw
HE 234-394	8-18 × .625 screw

SEMICONDUCTORS

See "semiconductor identification".

SEMICONDUCTOR IDENTIFICATION CHART

The "Component Number Index" provides a cross-reference between semiconductor numbers and their respective Part Numbers. The component numbers are listed in numerical order.

COMPONENT NUMBER INDEX

<u>CIRCUIT</u>	<u>ZDS</u>
<u>COMP. NO.</u>	<u>PART NO.</u>

Diodes

CR201	103-261-02
CR202	103-325
CR501	HE 234-353
CR502	103-261-02
CR503	103-261-02
CR504	103-295-02
CR506	103-261-04
CR507	HE 234-299
CR508	103-263
CR509	103-295
CR601	103-142-01
CR602	103-142-01
CR603	HE 234-299
CR604	HE 234-299
CR605	HE 234-299
CRX701	HE 57-42
CRX702	HE 57-42
CRX703	HE 57-42
CRX704	HE 57-42
CR705	HE 234-299
CR706	103-279-09
CR801	103-142-01
CR804	103-142-01
CR805	103-142-01

<u>CIRCUIT</u>	<u>ZDS</u>
<u>COMP. NO.</u>	<u>PART NO.</u>

Transistors

Q501	HE 234-270
QX502	121-1039
Q601	HE 234-274
Q602	HE 234-274
Q603	HE 234-275
Q604	HE 234-270
Q606	HE 234-272
Q607	HE 234-270
Q701	HE 234-274
Q702	HE 234-275
QX703	121-992-01
Q807	121-669-01

CIRCUIT BOARD X-RAY VIEWS

NOTE: To find the PART NUMBER of a component for the purpose of ordering a replacement part:

A. Find the circuit component number (C101, R104, etc.) on the proper X-ray View.

B. Refer to the Replacement Parts List. Then locate this same number in the Circuit Component Number column.

C. Adjacent to this circuit component number, you will find the ZDS PART NUMBER.

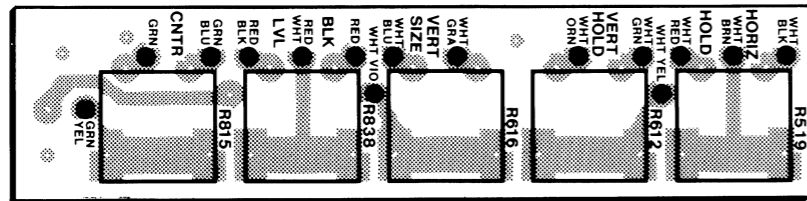

CONTROL PANEL BOARD
(Shown from the component side.)

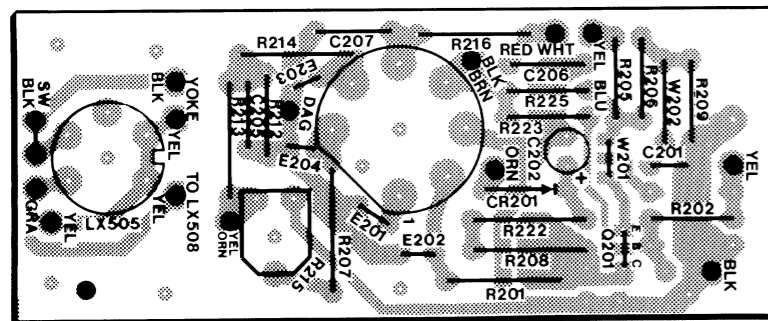

CRT SOCKET BOARD
(Shown from the component side.)

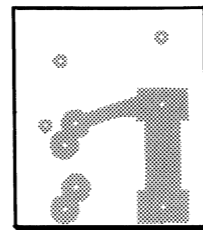

INPUT BOARD
(Shown from the component side.)

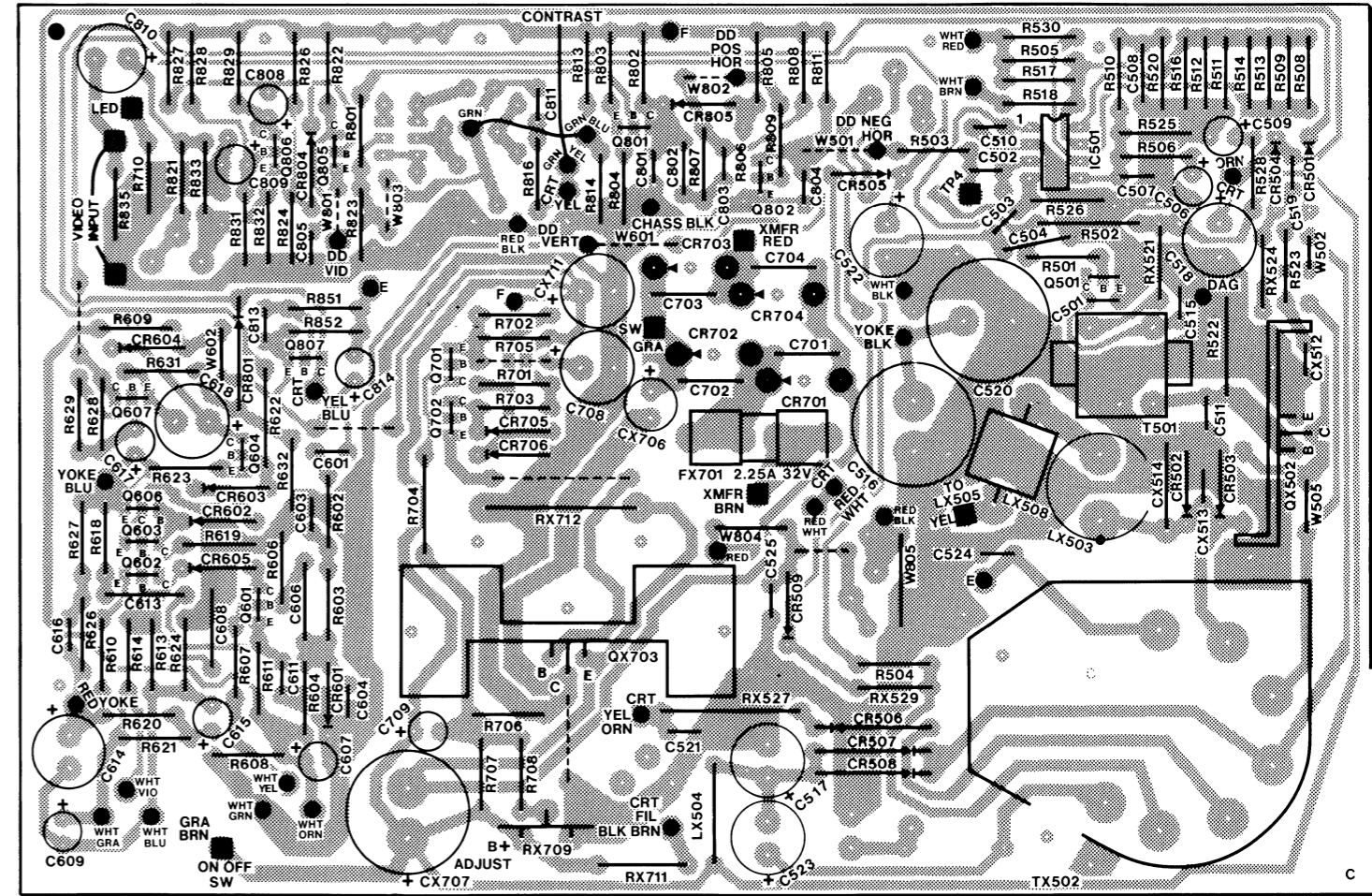

MAIN BOARD
(Shown from the component side.)