



OPERATOR'S MANUAL

**9002B**

MICROCOMPUTER TERMINAL SYSTEM

*Zentec Corporation*

**OPERATOR'S MANUAL**  
**9002B**  
**MICROCOMPUTER TERMINAL SYSTEM**

*Zentec Corporation*  
2390 Walsh Avenue  
Santa Clara, California 95050

# T A B L E O F C O N T E N T S

		PAGE
CHAPTER I	WELCOME TO THE ZENTEC 9002B	1-1
CHAPTER II	FEATURES OF YOUR ZENTEC 9002B	2-1
	2-1. THE MICROCOMPUTER	2-1
	2-2. THE 9002B DISPLAY	2-1
	2-3. THE ALL IMPORTANT 25th LINE	2-2
	2-4. CONVENIENT CONTROL PANEL	2-2
	2-5. TELECOMMUNICATIONS - BOTH CHARACTER MODE OR BLOCK MODE WITH STANDARD RS-232C COMPATIBILITY AT UP TO 9600 BAUD	2-3
	2-6. BUILT IN MODULARITY AND UPGRADABILITY	2-4
	2-7. STANDARD FULL EDIT CAPABILITIES	2-5
	2-8. COMPLETE PROGRAMMABILITY	2-5
	2-9. FUNCTIONAL MULTI-TASK KEYBOARD	2-6
	2-10. ALPHANUMERIC GROUP	2-6
	2-11. CURSOR CONTROL AND PROGRAM CONTROL GROUP	2-7
	2-12. NUMERIC PAD GROUP	2-7
	2-13. SPECIAL FUNCTIONS KEYS	2-7
	2-14. GENERAL KEYBOARD FEATURES	2-7
CHAPTER III	INSTALLING AND TURNING ON YOUR 9002B	3-1
	3-1. UNPACKING THE 9002B	3-1
	3-2. INSTALLATION OF THE 9002B	3-2
	3-3. TURNING THE 9002B ON AND OFF	3-3
CHAPTER IV	OPERATION OF THE 9002B STANDARD FEATURES	4-1
	4-1. INTRODUCTION	4-1
	4-2. EDIT MODE - KEYBOARD OPERATION	4-5
	4-2-1. PROGRAM SELECT FUNCTIONS	4-5
	4-2-2. ALPHANUMERIC FUNCTIONS	4-5
	4-2-3. CURSOR CONTROL FUNCTIONS	4-6
	4-2-4. TAB FUNCTIONS	4-7
	4-2-5. NUMERIC PAD FUNCTIONS	4-7
	4-2-6. SPECIAL FUNCTIONS	4-7
	4-2-7. INSERT/REPLACE SUB MODES OF BOTH THE EDIT AND FORM MODE	4-8

	PAGE
4-3. FORM MODE - KEYBOARD OPERATION	4-9
4-3-1. PROGRAM SELECT FUNCTIONS	4-9
4-3-2. FORM MODE SPECIAL KEY FUNCTIONS	4-9
4-3-3. SETTING TABS AND ERASING TABS	4-10
4-4. FORM GENERATION MODE - KEYBOARD OPERATION	4-11
4-4-1. PROTECTED AND UNPROTECTED CHARACTER	4-11
4-4-2. VIDEO FIELD ENHANCE CHARACTERS	4-11
 CHAPTER V	
OPERATION OF THE 9002B WITH EXTENDED FEATURES	5-1
5-1. INTRODUCTION TO TTY (CHARACTER) MODE STANDARD RS-232C	5-1
5-1-1. TTY MODE - KEYBOARD OPERATION	5-2
5-1-2. TO SET VIDEO FIELD ENHANCE CHARACTER FROM A REMOTE DEVICE	5-5
5-1-3. KEY FUNCTIONS WHICH ARE TRANSMITTED IN TTY MODE	5-6
5-1-4. KEY FUNCTIONS WHICH ARE NOT TRANSMITTED BUT HAVE EFFECT WITHIN THE 9002B	5-6
5-1-5. RECEIVED CONTROL CODES	5-6
5-2. BLOCK TRANSMIT MODE - KEYBOARD OPERATION	5-7
5-2-1. DATA COMPRESSION IN BLOCK XMIT      FORM/DATA MODE:	5-8
5-2-2. DATA COMPRESSION IN BLOCK XMIT      ALL      MODE:	5-9
5-3. SYMBOL DISPLAY MODE - KEYBOARD OPERATION	5-9
5-3-1. SYMBOL DISPLAY RECEIVE - KEYBOARD OPERATION	5-10
5-4. HOST "WAKE UP" MESSAGE	5-10
5-5. SPECIAL CUSTOMER PROGRAM MODES - USING YOUR 9002B'S PROGRAMMABILITY FEATURE	5-11
 CHAPTER VI	
OPTIONS ON 9002B	6-1
6-1. PRINTER SUBSYSTEM OPTION	6-1
6-1-1. PRINT ON-LINE	6-1
6-1-2. PRINT OFF-LINE	6-1
6-2. SPECIAL RECEIVE MODE	6-2
6-3. BAUD RATE OPTION	6-2
6-4. POWER OPTION - 230 V. 50 HZ.	6-2
6-5. POWER OPTION - 110 V. 50/60 HZ.	6-3
6-6. GENERAL PURPOSE 2K MEMORY OPTION	6-3
6-7. ADDITIONAL RAM MEMORY	6-3
6-8. DUAL RS-232C CARD	6-3
 APPENDIX	
	7-1



Figure 1-1. The 9002 Microcomputer Terminal System.

## CHAPTER I

### WELCOME TO THE ZENTEC 9002B

You have chosen ZENTEC's new 9002B Programmable MICROCOMPUTER Terminal System a new generation data handling and processing terminal that can function either as a standalone computer system or an interactive intelligent data terminal. The 9002B has been specially built and tested for you to provide a reliable and flexible service with extensive features which can save you valuable dollars in fulfilling a wide range of computer applications.

This manual will acquaint you with the 9002B MICROCOMPUTER and its ease of operation. It should cover any questions you have on the actual use of the 9002B, and cover installation notes and an introduction to programmability. The ZENTEC Programmer's Language Manual PN 88-403-01 and the ZENTEC System Description and Maintenance Manual PN 88-401-01 are available to cover detailed programming instruction, trouble shooting and repair.

### THE 9002 MICROCOMPUTER/TERMINAL SYSTEM

The Zentec 9002 Microcomputer/Terminal System is a new generation data handling device that can function either as a complete standalone computer system, or as an interactive intelligent data terminal. The basic 9002 system consists of a keyboard, a CRT display, and telecommunications interface electronics, all functionally organized around a microcomputer that controls data communications and data processing operations in the system.

The 9002 system is housed in a desktop console and can be interconnected to a telecommunications line via a modem, or to any of a number of peripheral devices, such as a hard copy printer, auxiliary memory devices (disc, cassette, reel-to-reel tape drives, etc.), or directly to a larger computer.

### THE 9002 SYSTEM MICROCOMPUTER

The microcomputer consists of the basic microprocessor chips, PROM, ROM, and RAM memory, and system timing circuits, all mounted on three circuit boards within the console. Because all functions of the 9002 system are under the control of the microcomputer, the program operating the microcomputer determines the functions of the 9002 system. This software oriented organization of the system is the fundamental reason for its application versatility.

INS EDIT

CURSOR  
(MOVABLE)

FIGURE 1-2. Typical Text Display on the 9002 Terminal System.

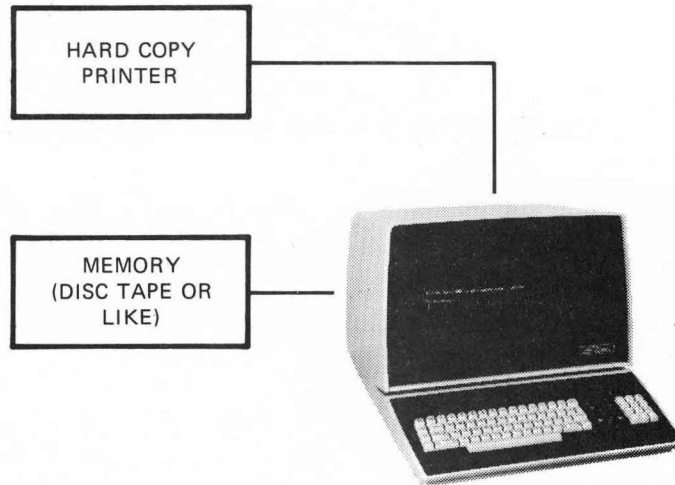

*(9002 system functions as a standalone computer)*

Figure 1-3. The 9002 System Installation for Typical Standalone Computing Purposes.

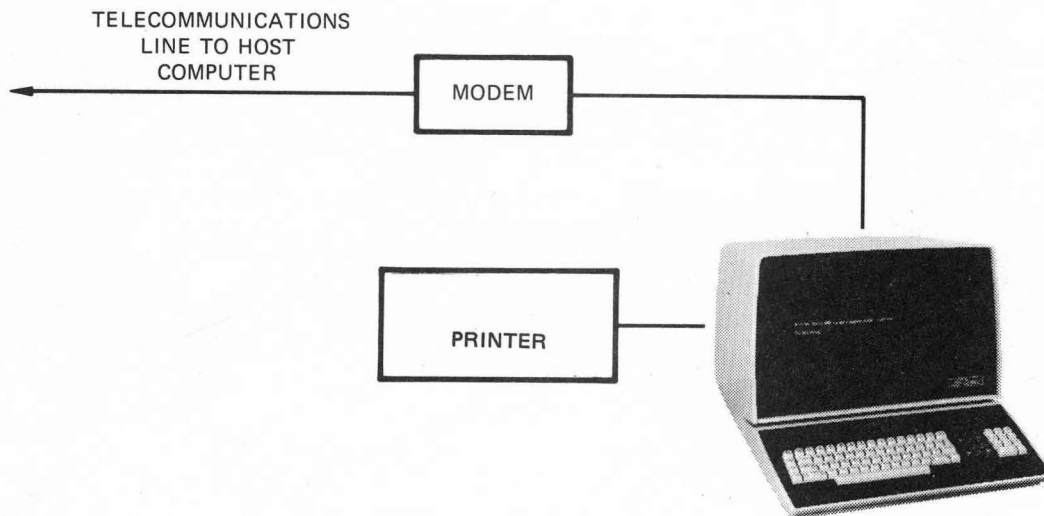

*(9002 system functions as a data terminal)*

Figure 1-4. Typical 9002 System Telecommunications Installation.





## CHAPTER II

### FEATURES OF YOUR ZENTEC 9002B

#### 2-1. THE MICROCOMPUTER

The operating characteristics of the ZENTEC 9002B are controlled by both firmware and software. This feature enables the 9002B to be used in a wide range of applications. The microprocessor manages memory refresh, keyboard and display control, data communication and peripherals on a unique data bus architecture which allows wide flexibility for system upgrade whenever a new application comes along.

#### 2-2. THE 9002B DISPLAY

The large 15" diagonal display gives the mandatory high resolution necessary when viewing your 1920 character capacity screen. The 9002B provides 24 lines of 80 characters per line. The characters are formed by a 7x9 dot matrix generated in a 10x10 character space. A special character generator provides a high resolution uniform character which is easy to read.

### 2-3. THE ALL IMPORTANT 25th LINE

Your 9002B has an additional 25th line which provides convenient operator communication. This line will at all times tell the operator which program has control of the ZENTEC 9002B. In addition it can display messages from a host computer or another terminal. It provides a direct easy communication to the operator and simplifies the use of the 9002B.

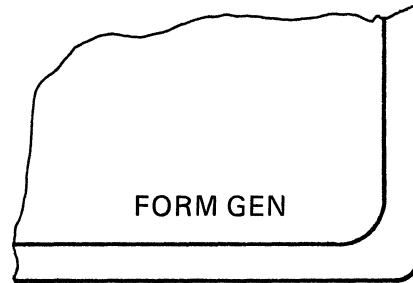

### 2-4. CONVENIENT CONTROL PANEL

For convenience, all initial "set up" controls are located on the rear control panel.

- \* Brightness Control - This control adjusts the overall brightness of the display. It should be used in conjunction with the contrast control to adjust the displayed image for the desired visibility. Normally adjust so that the raster is just not visible.
- \* Contrast Control - This control is used in conjunction with the brightness control and varies the ratio between the darker and lighter positions of the screen.
- \* Volume Control - This control varies the sound level of the speaker. The speaker is used to provide an audible feedback when a key is depressed on the keyboard. The speaker is also used as a warning on power up and when error conditions are programmed.

- \* Baud Rate Switch - A four position switch which selects data transmission rate. Rates of 110, 300 and 1200 baud are standard. The SEL position is used to provide an additional baud speed which can be specified at time of order by the customer. Typical SEL speeds are 4800 baud or 9600 baud.
- \* Parity Switch - Select ODD, EVEN or NONE. Parity transmission for each character when selected.

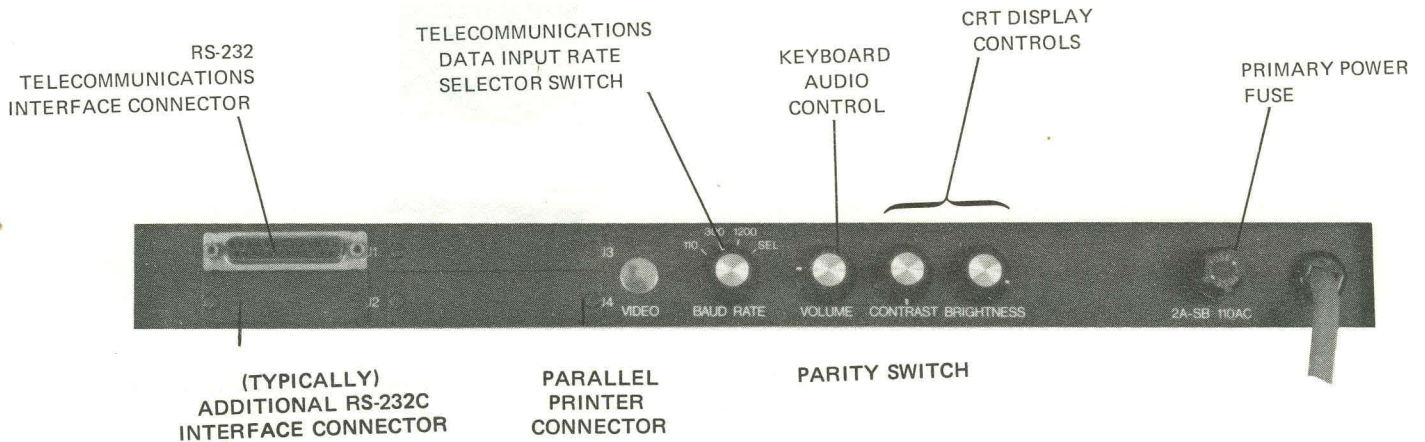

FIGURE 2-1 Rear Control Panel.

2-5. TELECOMMUNICATIONS - BOTH CHARACTER MODE OR BLOCK MODE WITH STANDARD RS-232 COMPATIBILITY AT UP TO 9600 BAUD

The 9002B will operate character by character on-line as a completely interactive terminal or is capable of operating on a block of data at one time. The BLOCK MODE allows information to be composed and edited off-line, thus permitting the terminal user to verify and correct data before transmission to a computer over the telecommunication lines. Data transfer between the 9002B and another computer is by the EIA RS-232C interface, a communications industry standard with serial asynchronous operation and using ASCII code. Connection to another computer can be direct or via a 103 or 202 Modem. Transmission can be FULL or HALF DUPLEX.

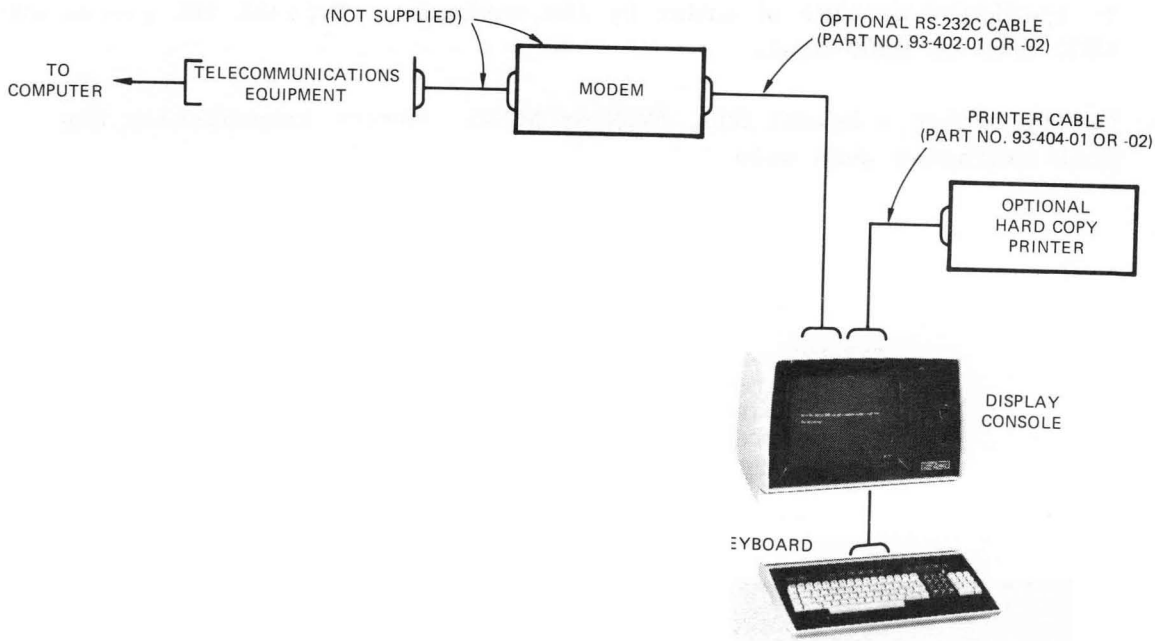

Figure 2-2. Typical System Cabling Diagram (showing a Telecommunications Interconnection).

FIGURE 2-2 Typical System Cabling Diagram (showing a Telecommunications Interconnection).

## 2-6. BUILT IN MODULARITY AND UPGRADABILITY

Your ZENTEC 9002B is designed for ease of servicing and modular addition of upgrading features. Digital electronics are all packaged on easy pluggable printed circuit cards that can be exchanged within the terminal. Additional capabilities can be readily added by simply plugging in more printed circuit cards.

## 2-7. STANDARD FULL EDIT CAPABILITIES

Editing and computer time requirements can be significantly reduced by such features as:

- \* Programmable protected fields in any combination, and Enhanced Display features in any combinations such as HALF BRIGHT, UNDERLINE, REVERSE VIDEO, BLINKING, etc. are provided in a unique FORMS GENERATION MODE.
- \* 32 function keys which will allow up to 171 different keyboard codes to be produced.
- \* SCROLL UP, SCROLL DOWN
- \* CURSOR SENSING, ADDRESSABILITY, TABULATION and POSITIONING.
- \* 8 Specific Functions keys which allow ALL CAPITAL SELECTION, a MICROPROCESSOR RESET, DELETE CHARACTER, ERASE FIELD, DELETE and INSERT LINE, ERASE END LINE, ERASE END DISPLAY and ERASE DISPLAY.

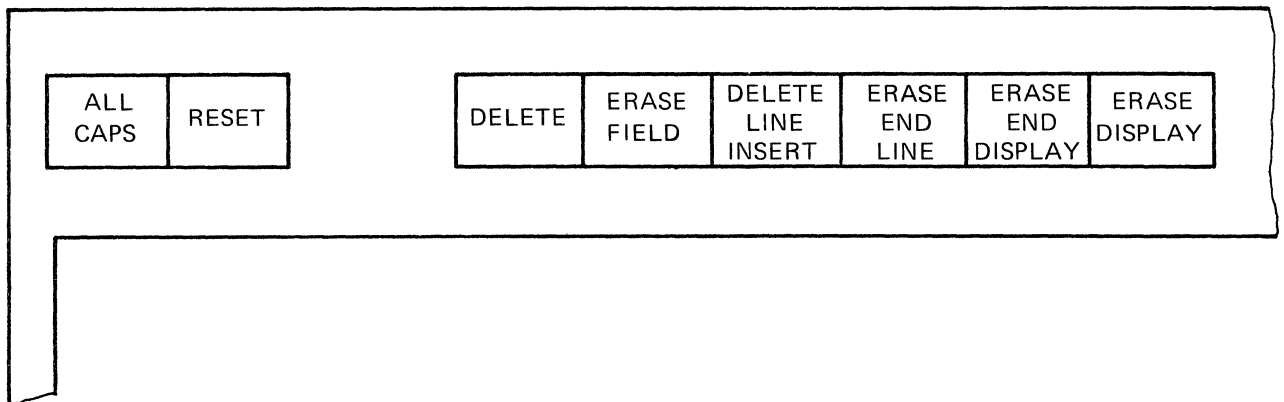

## 2-8. COMPLETE PROGRAMMABILITY

Your ZENTEC 9002B comes with a standard set of firmware (ROM/PROM) subroutines which handle all keyboard control and display functions. A table look up subroutine list is provided so that these subroutines can be used in any customer application programs you may write, thus simplifying the application programming task.

## 2-9. FUNCTIONAL MULTI-TASK KEYBOARD

The 9002B has a detachable sculptured expanded ASCII type keyboard which has been designed for ease of use and to handle the flexibility of a programmable terminal. Keys are provided for entering data (Alphanumeric characters, symbols and punctuation) and performing a variety of operations.

- \* Editing text
- \* Preparing and Correcting Forms
- \* Selecting Programs for Controlling the Terminal
- \* Telecommunicating to a Host Computer
- \* Operating Peripherals

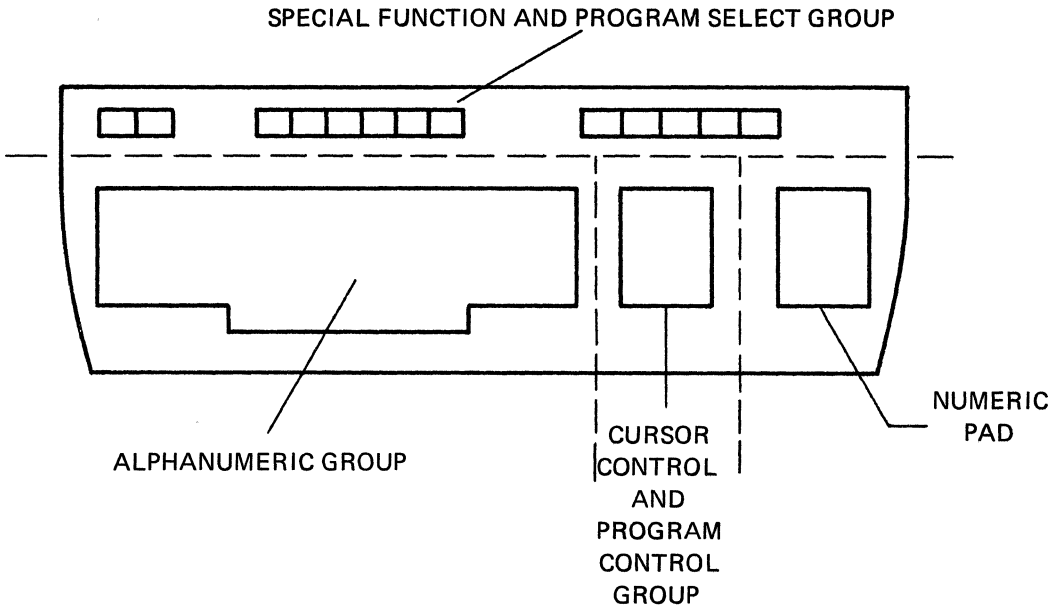

## 2-10. ALPHANUMERIC GROUP

This group of keys provides the expanded ASCII functions. Upper and lower case are provided through a familiar SHIFT Key.

## 2-11. CURSOR CONTROL AND PROGRAM CONTROL GROUP

The Cursor Control keys allow the cursor to be indexed to any screen position, the screen to be paged and the data to be scrolled.

The Program Control keys provide the local off-line program selection controls. The MODE key being the basic key used when selecting the many different program modes potentially available.

## 2-12. NUMERIC PAD GROUP

This group provides a standard adding machine like keypad for entry of numeric data. These keys are separate from the numeric keys in the main keyboard group, consequently not affected by the SHIFT or ALL CAPS keys. Key "5" has a locating nipple which facilitates touch entry of data.

## 2-13. SPECIAL FUNCTION KEYS

This group of Special Function keys can have different meanings dependent upon the program selected. In the basic off-line modes the keys provide the functions as labelled. While some keys provide special editing capabilities, others can be defined by the user to implement unique application oriented capabilities.

## 2-14. GENERAL KEYBOARD FEATURES

- \* Key Repeat Feature - those keys which cause the entry of a character or move the cursor are provided with a repeat feature. If the key is depressed for longer than 1/2 second, the key will repeat until the key is released.
- \* N-Key Rollover - this feature allows the operator of the 9002 keyboard to depress several keys at the same time without losing any characters. This is necessary for very fast operators.



- \* Audible Key Click - an audible "CLICK" will be heard every time a key is depressed. The loudness of this click can be adjusted on the rear control panel.
- \* ALL CAPS Key - this is a two position key which allows selection of all upper case alpha characters. Only alpha characters are affected by this key.
- \* RESET Key - this key is used to reset the microprocessor. If for any reason during software debug or new operator training, a processor hang up is effected; the RESET key can be used to reset the system. RESET will return the terminal to the REP FORM mode without erasing the screen or losing data, the cursor will go to home and the 25th line will display REP FORM.

Note: Your 9002B is pre-configured to include the options and accessories which you ordered. These are recorded for history control purposes by SERIAL NUMBER specified on the IDENTIFICATION LABEL FOUND ON THE REAR PANEL.

When communicating with ZENTEC CORPORATION regarding your 9002B please use the SERIAL NUMBER to insure quick and correct identification by ZENTEC personnel.

TABLE 2-1  
Performance Specifications 9002B

CHARACTERISTIC	VALUE
SYSTEM	
DIMENSIONS	
CRT Display Console	21 in. W. * 16 in. H * 18 in. D
Keyboard	20 in. W. * 3.5 in. H * 13 in. D
FINISH	textured vinyl, beige color
POWER REQUIREMENTS	115 V ac +/- 10%, 60 Hz; 220 V, 50 Hz optional
MICROPROCESSOR	
TYPE	13 microsecond general purpose parallel processor with interrupt capability; inputs and outputs TTL compatible.
WORD SIZE	8-bits
INSTRUCTION SET	48
MEMORY ADDRESSING	Can address up to 16K bytes directly.
MEMORY	
ROM/PROM	
Capacity	Up to 10,250 bytes (2560 bytes are used by Basic Program).
Type	ROM: 2048 x 8; PROM: 256 x 8, Intel 1702, 1702A, or equivalent.
RAM	
Capacity	Up to 16,384 bytes
Type	2048 x 1 dynamic

TABLE 2-1 (Continued)  
Performance Specifications 9002B

CHARACTERISTIC	VALUE
KEYBOARD	
OUTPUT CODE	128 ASCII and 43 special codes.
Alphanumeric	96 ASCII characters, upper and lower case.
Control	32 ASCII basic, 32 special, as modified by CTRL and SHIFT keys.
Numeric	10 special coded numbers and one special code for decimal point.
CRT DISPLAY	
CRT	
Size	8 in. x 11 in.. 15 in. diagonal
Phosphor	P4 (white); P39 optional.
SCAN METHOD	Non-interlaced, RS-230, 525 line compatible.
SCAN RATE	60 fields per second.
CHARACTER FORMAT	
Display Matrix	10 x 10 dot matrix of which a 7 x 9 matrix is used for character formation.
Size	0.2 in. high by 0.09 in. wide
PAGE FORMAT	80 characters on each line, 25 lines on full screen (defined as one page). Note: of the 25 lines, 24 are operator accessible, the 25th is used only by the microprocessor.
TELECOMMUNICATIONS INTERFACE	
TYPE	RS-232C, asynchronous, full or half duplex.
TRANSMISSION RATE	Selectable at 110, 300, 1200 or 2400 baud; the 2400 baud rate can optionally be changed to 4800 or 9600 baud.
CHARACTER SIZE	8 data bits, with one start and 1 or 2 stop bits.
PARITY	Odd, even, or none switch selectable.

## CHAPTER III

### INSTALLING AND TURNING ON YOUR 9002B

#### 3-1. UNPACKING THE 9002B

The 9002B system is shipped in a special carton that provides protection during shipping. The display console and detachable keyboard are shipped in the same enclosure with the inter-connecting cable installed.

**W A R N I N G:** Be careful when unpacking the terminal not to overstress the keyboard cable and do not disconnect the keyboard cable.

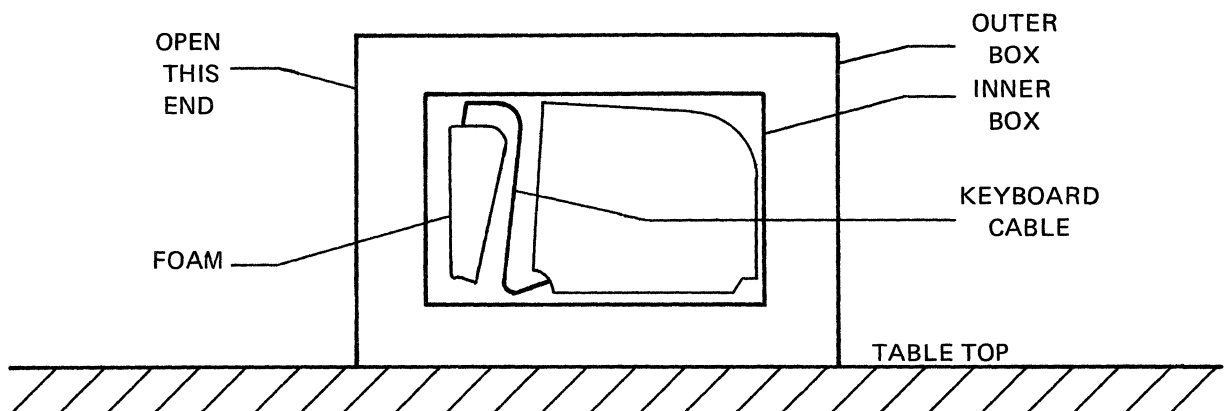

- \* First open both outer and inner boxes.
- \* Then carefully pull out the keyboard to the length of the inter-connecting cable.
- \* Now pull out the terminal by grabbing underneath front bezel.

### 3-2. INSTALLATION OF THE 9002B

The ZENTEC 9002B is designed to operate in a wide variety of environments. It is totally self contained and therefore installation does not require opening up the terminal.

(Note: Should you later desire to open the terminal for option/accessory additions please refer to the ZENTEC 9002B System Description and Maintenance Manual PN 88-401-01)

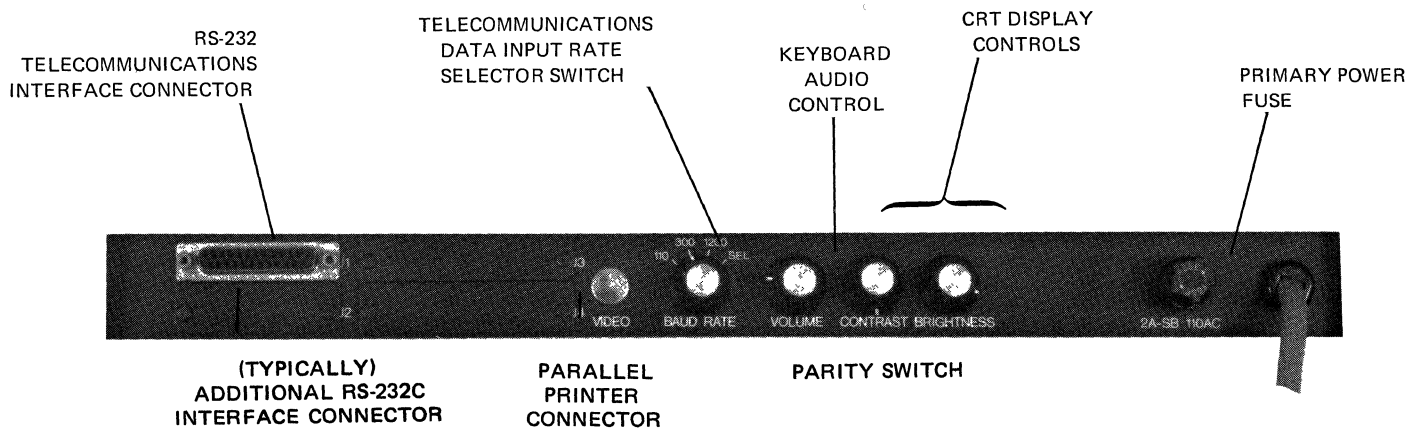

FIGURE 3-1 Rear Control Panel.

Simply complete the following steps to insure proper installation.

- \* Place the terminal on any table free from dust and lint, making sure the air flow vents on the bottom are not restricted.
- \* Plug and secure the printer, disk or telecommunications cable as indicated on the rear panel. (See Pin Assignment Chart for Telecommunications Appendix VII)
- \* Connect the other end of each cable to the appropriate device.
- \* Put the AC POWER SWITCH in the OFF position; connect the power cord to the correct 100V, 110V or 220 volt outlet. Be sure to check on the rear panel identification label.
- \* Set the BAUD RATE SWITCH to the desired transmission rate.
- \* Set the PARITY SELECT to ODD/EVEN/NONE as required by the application.

### 3-3. TURNING THE 9002B ON AND OFF

ON: After proper installation and the AC Power Voltage has been checked to be correct.

- \* Simply switch on the rocker type ON/OFF switch. Pressing the top of the switch causes power to be turned on. Pressing the bottom turns power off. After a 20 second warm-up period the terminal will be initialized, the display and memory are clear, the cursor will be at the HOME position (upper left corner) and the 25th line will display REP FORM.

Note: If the cursor does not appear and REP FORM is not displayed on the 25th line (bottom line), depress RESET. If the cursor still does not appear after approximately 20 seconds, turn off the AC POWER ON/OFF switch and do not attempt to operate the terminal until the malfunction has been corrected by a qualified service representative.

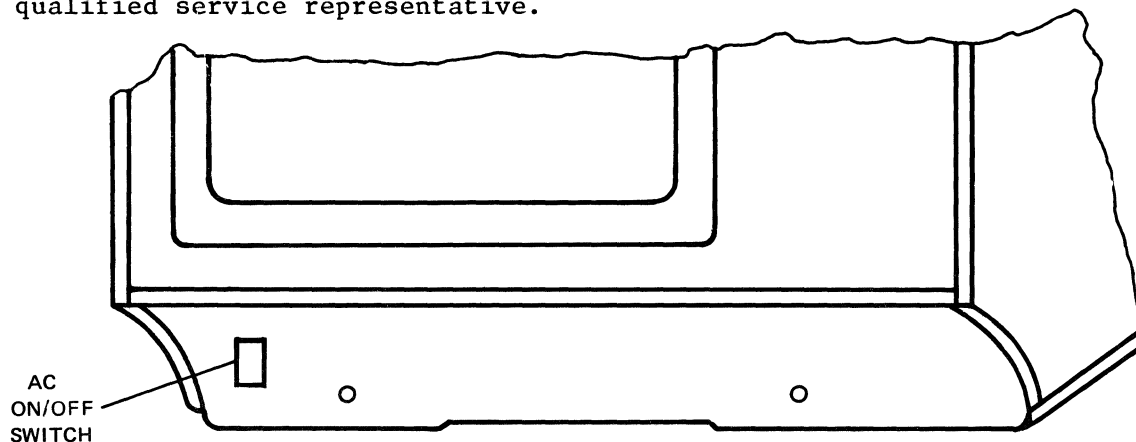



CHAPTER IV  
OPERATION OF THE 9002B  
STANDARD FEATURES

4-1. INTRODUCTION

The ZENTEC 9002B has been designed for ease of use and for the flexibility necessary to take advantage of its programmability features. All keys, indicators and switches necessary for normal operation (after initial installation) are located on the keyboard and the 25th line.

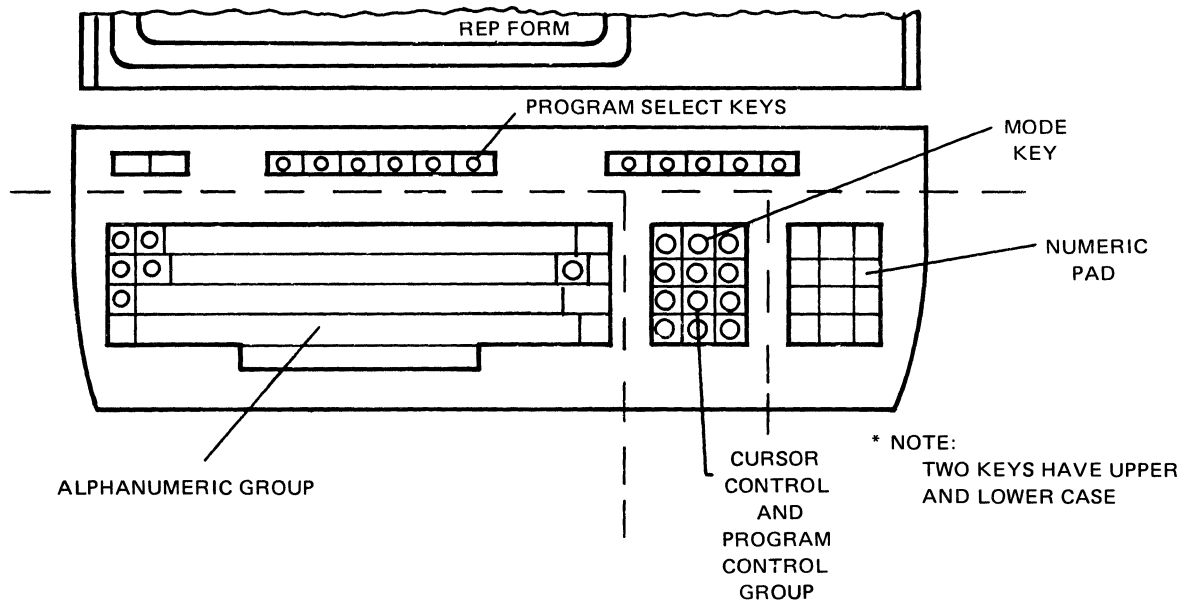



Note: Any of the 30 function keys may be used as a PROGRAM SELECT key. They have been circled for your convenience.

Note: Two keys have both upper and lower case operation giving 32 selections.

MODE Key - the MODE key is the most important key on your ZENTEC 9002B. It provides the way to change the terminal from one program mode to another, and therefore the means by which the programmability feature of the terminal is used. Depressing the MODE key causes the CONTROL MODE to be selected.

Once in the CONTROL MODE any other program mode may be entered by depressing a PROGRAM SELECT key. The 25th line provides a feedback to the operator by displaying at all time the MODE (PROGRAM) that is in control of the terminal. For example, when the MODE key is depressed and the terminal is in the CONTROL MODE, the 25th line will display CONTROL.

The ZENTEC 9002B can operate in many MODES. There are, however, nine standard modes:

- \* CONTROL MODE
- \* EDIT MODE
- \* FORM MODE
- \* FORM GENERATION MODE
- \* TTY (Character) MODE - HALF DUPLEX
- \* TTY (Character) MODE - FULL DUPLEX
- \* BLOCK TRANSMIT MODE
- \* SYMBOL DISPLAY MODE
- \* SPECIAL CUSTOMER PROGRAM MODES

**IMPORTANT:**

The 32 Program Select keys can have different meanings and functions in different modes.

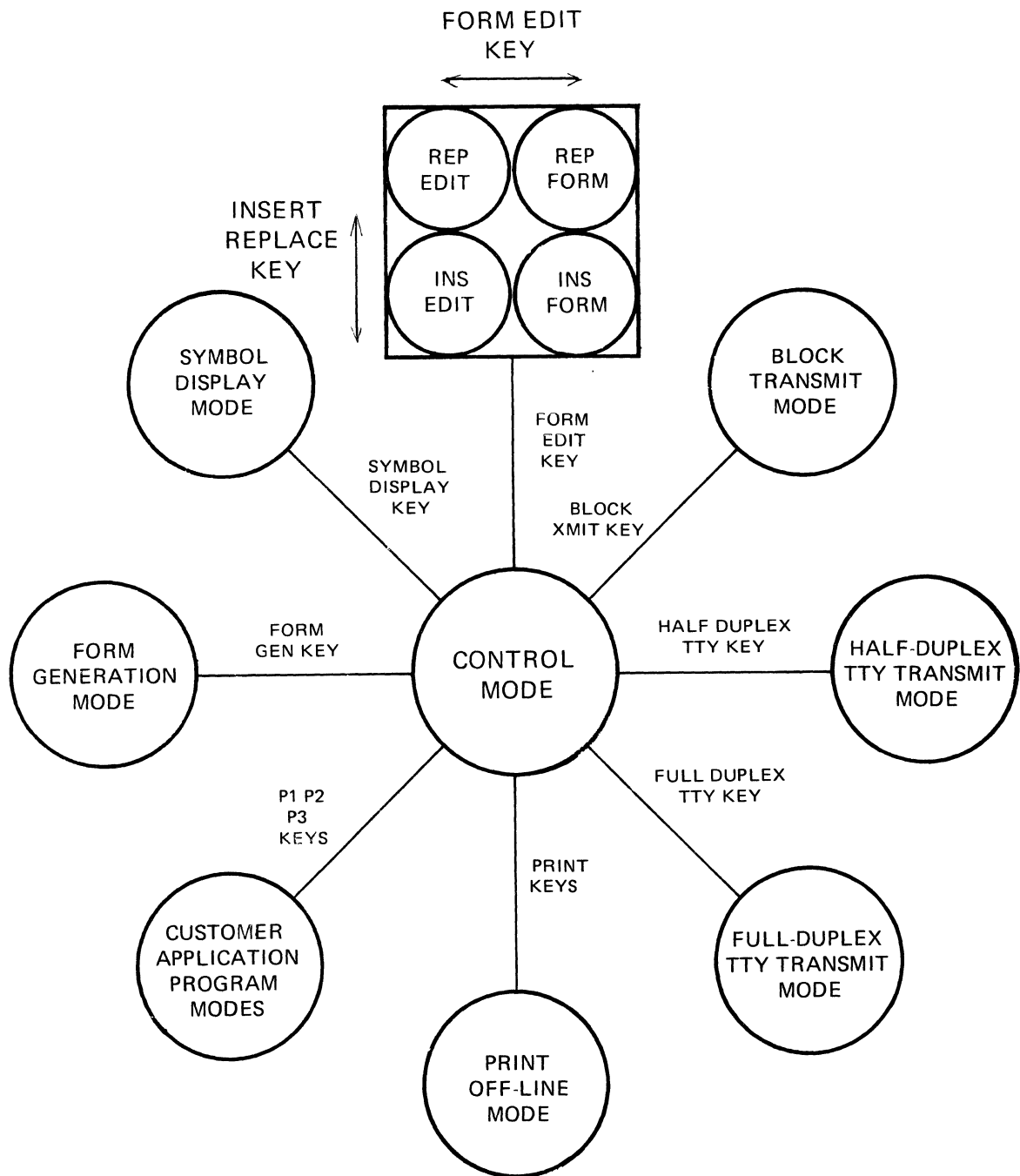

Note:

- \* Operation of the Program Select Keys switches the 9002B MODE from CONTROL to the desired mode.
- \* For convenience when operating off-line the FORM/EDIT/INSERT/REPLACE are grouped together. You select this grouping of modes by depressing the FORM/EDIT key. Once in this MODE, operating the FORM/EDIT key will toggle between the FORM and EDIT MODES. Operating the INSERT/REPLACE key will toggle between the INSERT and REPLACE SUB MODES.

CONTROL MODE	SYMBOL DISPLAY MODE	XMIT SYMBOL DATA	ZIM MODE PROG 1	PROG 2	PROG 3	FORM GEN MODE
--------------	---------------------	------------------	--------------------	--------	--------	---------------

FORM GEN MODE	PRINT ON	PRINT OFF	SPECIAL RECEIVE PERMIT	BREAK	ENHANCE CHARACTER
TTY MODE					SYMBOL RECEIVE ON/OFF
CONTROL MODE	PRINT → DATA ←	PRINT SCREEN	BLOCK XMIT → ALL ←	BLOCK XMIT → FORM DATA ←	TTY MODE FD HD

ALL CAPS	RESET
----------	-------

START	ENTER	CLEAR FORM	EOS	EOL	DELETE
-------	-------	------------	-----	-----	--------

1	2	3	4	5
---	---	---	---	---

\*

\*

AUTO BACK TAB	BACK TAB	!	"	#	\$	%	&	'	(	)	∅	DEL	=	~	BACK SPACE
AUTO TAB	TAB	Q	W	E	R	T	Y	U	I	O	P	}	{	LINE FEED	
ESC	LOCK	A	S	D	F	G	H	J	K	L	+	*	:	\	RETURN
CTRL	SHIFT	Z	X	C	V	B	N	M	<	>	?	/	SHIFT	@	,
(SPACE)															

PAGE ↑	MODE	SCROL ↑	7	8	9
PAGE ↓	↑	SCROL ↓	4	5	6
←	HOME	→	1	2	3
INSERT REPLACE	↓	FORM EDIT	∅	.	

\*NOTE: Two keys have upper and lower case meaning

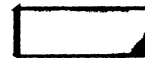

Program select keys (function keys)

## 4-2. EDIT MODE - KEYBOARD OPERATION

### 4-2-1. PROGRAM SELECT FUNCTIONS

This mode is intended to be used for off-line editing and correcting of text material in a word processing type environment. As described earlier the EDIT, FORM, INSERT and REPLACE SUB MODES are grouped together for convenience of operation since they are all local modes. By grouping these modes it is possible to toggle between these modes without going to the CONTROL MODE.

- \* FORM/EDIT Key - this key toggles the mode between FORM and EDIT MODES.
- \* INSERT/REPLACE Key - this key toggles the mode between INSERT and REPLACE sub modes of the FORM and EDIT modes.

Note: The 25th line will display one of the four statements: REP FORM, REP EDIT, INS FORM or INS EDIT.

### 4-2-2. ALPHANUMERIC FUNCTIONS

- \* Alphabetical, Numerical and Symbol Keys - this group of keys functions similar to a standard typewriter keyboard. ASCII character codes are generated for upper and lower case letters, numbers and symbols (Optional display fonts when installed will also be displayed).
- \* SHIFT and SHIFT LOCK Keys - these operate similar to a normal typewriter.
- \* ALL CAPS Key - this key is a two position key which allows selection of only upper case alpha characters on the keyboard. Only alpha characters are affected by this key.
- \* DEL Key - this key generates a code usually used for error notification. The character displayed will be a reverse video rectangle "█".

### 4-2-3. CURSOR CONTROL FUNCTIONS

- \* Cursor Control Keys - these keys control the position of the "Blinking" cursor. The cursor position indicates the current entry point of keyboard input data and can be positioned in any position on the screen using the cursor control keys. Depressing an arrow key causes the cursor to move in that direction.

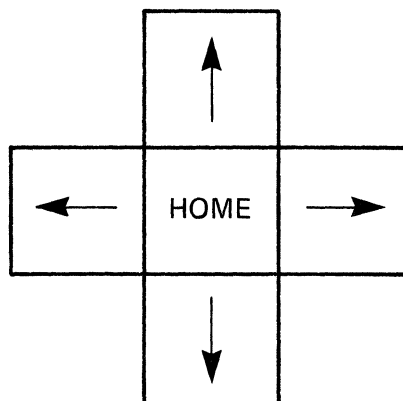

- \* HOME Key - depressing the HOME key causes the cursor to move to the HOME position which is the upper left hand corner of the display on the currently displayed page.
- \* RETURN Key - this key, when depressed, effects a carriage return line feed.
- \* LINE FEED Key - this key operates like a RETURN key. It causes a carriage return line feed, plus places a " ↓ " symbol on the display at the current cursor location. This symbol is used for data compression when in transmission mode.
- \* BACK SPACE Key - this key operates like a standard typewriter. It causes the cursor to move back one space.

PAGE AND SCROL KEYS ONLY  
OPERATE ON TERMINALS  
HAVING TWO PAGES

- \* PAGE ↑ Key - this key causes the second page to be displayed. The cursor remains in its position in the text.
- \* PAGE ↓ Key - this key causes the first page to be displayed.
- \* SCROL ↑ - a depression of this key will cause the text to move upwards until the end of memory is reached.
- \* SCROL ↓ - a depression of this key will cause the text to move downwards until the beginning of memory is reached.

#### 4-2-4. TAB FUNCTIONS

- \* TAB Key - this key effects a typewriter-tab function. The cursor will jump from tab position to tab position across the screen and then go to the next tab on the next line.
- \* BACK TAB Key - performs a typewriter BACK TAB function.

#### 4-2-5. NUMERIC PAD FUNCTIONS

- \* The numeric pad keys are a duplication of the numeric and period keys in the main CHARACTER SET GROUP section of the keyboard. They are provided for convenience. In addition the "5" key has a nipple at its center. This feature assists you to easily locate the "5" key by touch.

#### 4-2-6. SPECIAL FUNCTIONS

- \* RESET Key - this key effects a RESET of the microprocessor and allows a restart in the event of a "hang up". When depressed, RESET will return the terminal to REP FORM MODE without erasing the screen or losing data, the cursor will go to HOME and the 25th line will display REP FORM.

- \* DELETE Key - depressing the DELETE key will cause the character over the cursor to be deleted and all characters following it up to the end of the line to be shifted one position to the left.
- \* ERASE FIELD Key - erases the line and places the cursor at the start of that line.
- \* DELETE LINE Key (Upper Case) - depressing this key will completely delete the line on which the cursor is located and the lower lines will move up filling the line space deleted. The cursor will be located at the left-most position of the current line location upon completion of this command.
- \* INSERT LINE Key (Lower Case) - operation of this key will insert a blank line at the current cursor position and push all lines of text below down one line. The cursor will be located at the left-most position of the new line upon completion of this command.
- \* ERASE END LINE Key - this key when depressed will erase all unprotected information from the current cursor position to the end of the line.
- \* ERASE END DISPLAY Key - this key when depressed will erase all information from the current cursor position to the end of display.
- \* ERASE DISPLAY Key - this key will erase all unprotected information on the display when depressed once and will erase all information if depressed twice.

#### 4-2-7. INSERT/REPLACE SUB MODES OF BOTH THE EDIT AND FORM MODE

- \* INSERT/REPLACE Key - this switch toggles the MODE between the INSERT and REPLACE SUB MODES of both the EDIT and FORM modes. The 25th line will display INS EDIT, REP EDIT, INS FORM or REP FORM as appropriate.

These sub modes are provided for convenience during off-line Editing or Forms Data Entry. They allow you to modify the way characters and spaces are inserted. In the REPLACE sub mode, the character being keyed will simply replace the character over the current cursor position. If the space bar is operated, a space character will simply replace the character over the current cursor position. In the INSERT sub mode, the character being keyed will be inserted in the character position over the current cursor location and all characters to the right will be moved one space to the right to make room for the inserted character.

#### 4-3. FORM MODE - KEYBOARD OPERATION

##### 4-3-1. PROGRAM SELECT FUNCTIONS

In this mode either REP FORM or INS FORM will be displayed on the 25th line. This mode is intended to be used when entering data into a FORM; the FORM formats being previously generated in the FORMS GENERATION MODE (to be described later) or transmitted to the 9002B from a local disk store or over the telecommunications line.

- \* FORMS/EDIT Key - this key toggles the mode between EDIT and FORM MODES and also switches the 9002B from CONTROL MODE to FORM MODE.
- \* INSERT/REPLACE Key - toggles the mode between INS FORM and REP FORM.
- \* MODE Key - returns the 9002B to the CONTROL MODE.

NOTE: ALL OTHER KEYS OPERATE THE SAME AS IN TEXT EDIT EXCEPT: AUTO TAB, AUTO BACK TAB, AND ERASE FIELD AND LINE FEED KEYS.

##### 4-3-2. FORM MODE SPECIAL KEY FUNCTIONS

In the FORMS MODE the form formats appear as protected fields. The cursor cannot be positioned in a protected field, therefore, no data can be entered into the protected area. This prevents the operator from inadvertently destroying or altering the form itself. In this mode, it is possible to tab from one unprotected field to another automatically by the use of some special function keys; AUTO TAB and AUTO BACK TAB. Data can be entered into these unprotected areas of the form.

NOTE: If for any reason a program does not function, first check the SHIFT and ALL CAPS key status. If these keys are set correctly, pressing RESET will allow a restart. The 9002B will return to REP FORM with the cursor in the home position without erasing the display.

- \* AUTO TAB Key - depressing the AUTO TAB key will move the cursor to the first unprotected position following the next protected field. If there is no unprotected position following the next protected field before refresh RAM, the cursor will appear at HOME.



- \* AUTO BACK TAB Key - depressing the AUTO BACK TAB key will move the cursor to the first unprotected position of this field if the cursor is not already at the first unprotected location. If it is already at the first position, the cursor will be moved to the first unprotected location of the next preceding field. In no case will the cursor be moved back past HOME.
- \* LINE FEED Key - this key operates like the AUTO TAB key plus it places a " ↓ " symbol on the display. This symbol is used for data compression in telecommunications.
- \* ERASE FIELD Key - depressing the ERASE FIELD key will erase or blank all unprotected locations in that field. For example:
  - a. If cursor is between two protected fields on a line, the unprotected characters will be changed to blanks, and then the cursor will move to the left-most unprotected location within the field.
  - b. If there is no protected field between the cursor and the right end of the line, data will be replaced by blanks from the first unprotected character in the field to the end of the line, and the cursor will appear at left-most unprotected location in the field.
  - c. If no protected fields are on a line, the whole line is set to blanks and cursor will be set at left-most location on the line.

#### 4-3-3. SETTING TABS AND ERASING TABS

Setting tabs and erasing tabs is a simple two key sequence from either the EDIT or FORM MODES. The tabs set are the normal columnar type tabs used on a typewriter.

**TAB SETTING:** Place the cursor at the position where the tab is desired. Then simply depress the MODE key followed by the TAB key. You have now set vertical tab mark on each line down the display. Repeating this process will provide a series of tabs across the display.

**ERASING TABS:** Place the cursor at the tab position you wish to erase. Then depress the MODE key followed by the BACK TAB key. You have now erased a vertical tab.

#### 4-4. FORM GENERATION MODE - KEYBOARD OPERATION

Using the FORM GEN MODE is one way a form format can be generated within the terminal and displayed on the screen. Once generated the form can be stored on disk, tape or sent to the host for storage and be recalled when required. (APPLICATION SOFTWARE). This mode allows protected characters and fields to be generated on the screen. In order to facilitate the generation of formats, provision is made to allow video field enhancement UNDERLINE, REVERSE VIDEO, BLINKING etc. The 9002B will display FORM GEN when switched to this mode. The FORM GEN MODE is entered by depressing the FORM GEN key from the CONTROL MODE. Depressing the MODE key will cause the unit to switch back to REP FORM MODE.

##### 4-4-1. PROTECTED AND UNPROTECTED CHARACTER - HOW TO GENERATE

- \* Protected Characters - in the FORM GEN MODE the cursor can be moved anywhere on the screen and all characters entered on the display, including the SPACE BAR which generates a space, are PROTECTED.
- \* Unprotected Character - in the FORM GEN MODE the cursor move controls ↑ , ← , ↓ , → , and HOME must be used to generate UNPROTECTED fields.
- \* In this mode the DELETE, ERASE END LINE, ERASE END DISPLAY and ERASE DISPLAY keys are used to correct any form format errors.
- \* The RETURN and BACKSPACE keys operate normally.
- \* The alphanumeric keys operate like a typewriter by overstriking.

##### 4-4-2. VIDEO FIELD ENHANCE CHARACTERS

The video field enhance character is achieved in the FORMS GEN MODE by depressing the ENHANCE CHARACTER key followed by one of the following alphanumeric keys. (0, 1, 2, 3, 4, 6) and (a, b, ----, f) (and the lower case @ key).

SEE TABLE BELOW - Depressing the ENHANCE CHARACTER key followed by depressing one of the keys in the table will cause a protected video field enhancement character, appearing as a blank to be placed at the current cursor position. This will cause every character location from the cursor position to the end of the display or to the next video field enhancement character to appear as indicated. Depressing ENHANCE CHARACTER, then the "0" key will cause a normal video display. This can be used to end an enhanced field. The enhance feature can be used in a wide variety of applications to accentuate the difference between fields. The BLINK can be used as a warning.

Normal Video	0	1	2	3	4	6	Lower case @	a	b	c	d	f
Normal Video	X		X			X	X		X			X
Half Video Intensity		X		X				X		X		
Blinking			X	X		X			X	X		X
Reverse Video					X	X					X	X
Underscore							X	X	X	X	X	X

Note: X indicates the feature is on. For example pressing the ENHANCE CHARACTER key followed by depressing the lower case "@" key will give an underline with normal video character display.

CHAPTER V  
OPERATION OF THE 9002B WITH  
EXTENDED FEATURES

5-1. INTRODUCTION TO TTY (CHARACTER) MODE STANDARD RS-232C

The 9002B may be operated on-line or off-line. In the ON-LINE CHARACTER MODE there are two modes of communications. The 9002B can be used in a TTY MODE in either FULL-DUPLEX or HALF-DUPLEX at 110, 300, 1200, 2400, 4800 and 9600 baud via a standard EIA RS-232C interface. FULL-DUPLEX MODE allows data to be transmitted with each key stroke wherein the receive side of the terminal is enabled to allow the host to echo the transmitted data which is then displayed on the screen to enable verification. In HALF-DUPLEX MODE each keystroke is interpreted by the processor, transmitted, and at the same time displayed directly on the screen. In these TTY asynchronous transmission modes the word structure consists of a start bit, seven data bits, a parity bit and one or two stop bits. (One stop bit except when the baud rate switch is at 110 baud.)

During character by character transmission the terminal must be on-line. Received alphanumeric characters are stored in refresh memory and displayed. Received CTRL codes or ESC sequence codes cause the unit to perform the appropriate function and are not stored in memory or displayed. Keyboard-generated alphanumeric characters are transmitted to the host. In FULL-DUPLEX MODE, CTRL codes and ESC sequence codes are transmitted but not acted upon until/unless echoplexed back to the terminal. For hard copy the 9002B allows direct interface to the ZENTEC printer.

#### 5-1-1. TTY MODE - KEYBOARD OPERATION

- \* The HALF-DUPLEX TTY MODE is entered from the CONTROL MODE by depressing the lower case TTY-HD key. When in this mode the 25th line will display TTY-HD.
- \* The FULL-DUPLEX TTY MODE is entered from the CONTROL MODE by depressing the upper case TTY-FD key. When in this mode the 25th line will display TTY-FD.
- \* Exit from the TTY MODE is accomplished by depressing the MODE key which will switch the 9002B into the CONTROL MODE.
- \* Alphabetical, Numerical and Symbol keys - this group of keys function similar to a standard typewriter keyboard. ASCII character codes are generated and transmitted for the upper and lower case letters, numbers and symbols.
- \* ESCAPE Key (ESC) - this key is only used on the on-line interactive character transmit mode. The key generates the ASCII ESCAPE character when depressed. It is used to generate escape code sequences (for example, depressing the ESC key followed by a B key generates an ESC B sequence, which produces a LOCK KEYBOARD command to be transmitted). See TABLE 5-1 for definition of ESCAPE codes which, when received, cause the ZENTEC 9002B to react.

TABLE 5-1

ESCAPE SEQUENCES RECEIVED AND ACTED UPON			
@	CLEAR FORM	P	CLEAR
A	TAB SET	Q	TAB CLEAR
B	LOCK KEYBOARD	R	UNLOCK KEYBOARD
C	CURSOR SET	S	CURSOR READ
D	START PROTECT	T	CURSOR READ RESPONSE
E	END PROTECT	U	
F	SET ENHANCEMENT CHARACTER	V	
G	EOS	W	
H	TURN PRINT ON	X	
I	TURN PRINT OFF	Y	BACK TAB
J		Z	SYMBOL DATA RECIEVE
K	HOME	[	
L	HOST MESSAGE ON 25th LINE	\	CLEAR HOST MESSAGE ON 25th LINE
M	AUTO TAB	]	AUTO BACK TAB
N	JUMP	^	
O	EOL		

## NOTE:

- \* Jump is defined as an ESC N sequence; i.e. it is actually ESC N "XY", X and Y being HEX in ASCII, X being most significant part of the jump count number. The combination of X and Y make up the jump count allowing a maximum of 255 byte jump. The jump command causes the terminal to jump ahead the specified number of spaces. The ESC N sequence is used in place of an AUTO TAB by the Host in order to speed up data transmission.
- \* CURSOR SET: The receipt of an ESCAPE C, "L", "C" sequence sets the 9002B cursor to the location defined by the "L" and "C". The "L" and "C" form the LINE number and COLUMN number as shown on the following table. (Example: If you wish to send the cursor of a 9002B to line number #24 and character column number #25, then the ESC C, 18, 19 is required.) See Table 5-2.
- \* CURSOR READ: The receipt of a cursor read (Escape S) will generate numbers which define the LINE and COLUMN value of the current cursor position. The response from the 9002B will be in the form ESCAPE T, "L", "C".

Sequence is ESCAPE, C, "wx", "yz"

L = Line Number = WX

C = Column Number = YZ

L,C	Transmitted Characters wx,yz	L,C	Transmitted Characters wx,yz	L,C	Transmitted Characters wx,yz	L,C	Transmitted Characters wx,yz
00	00	20	14	40	28	60	3<
01	01	21	15	41	29	61	3=
02	02	22	16	42	2:	62	3>
03	03	23	17	43	2;	63	3?
04	04	24	18	44	2<	64	40
05	05	25	19	45	2=	65	41
06	06	26	1:	46	2>	66	42
07	07	27	1;	47	2?	67	43
08	08	28	1<	48	30	68	44
09	09	29	1=	49	31	69	45
10	0:	30	1>	50	32	70	46
11	0;	31	1?	51	33	71	47
12	0<	32	20	52	34	72	48
13	0=	33	21	53	35	73	49
14	0>	34	22	54	36	74	4:
/5	0?	35	23	55	37	75	4;
16	10	36	24	56	38	76	4<
17	11	37	25	57	39	77	4=
18	12	38	26	58	3A	78	4>
19	13	39	27	59	3B	79	4?

Table 5-2

CURSOR POSITION DIRECTIVE CHARACTERS

5-1-2. TO SET VIDEO FIELD ENHANCE CHARACTER FROM A REMOTE DEVICE

The receipt of an ESCAPE F "X" sequence will set the special video field enhance characters. The following list defines the video enhance codes.

ESC F	0	sets normal
"	1	sets half video intensity
"	2	sets blinking character
"	3	sets half video blinking
"	4	sets reverse video
"	6	sets reverse video plus blinking
"	Lower case @	sets underscore
"	a	sets underscore plus half video intensity
"	b	sets underscore plus blinking
"	c	sets underscore plus blinking half intensity
"	d	sets underscore plus reverse video
"	f	sets underscore plus blinking reverse video

\* CONTROL Key (CTRL) - this key is only used in on-line interactive transmit mode. The key generates the ASCII CONTROL SHIFT when depressed in conjunction (AT THE SAME TIME) with an appropriate alphanumeric or symbol key. The CTRL key converts the character code for that particular key into an ASCII control code. SEE TABLE 5-3.

TABLE 5-3 ASCII CONTROL CODES WHICH CAN BE TRANSMITTED

Bits 765		000	001	
Bits 4321	CTRL KEY	ASCII	CTRL KEY	ASCII
0000	@	NUL	P	DLE
0001	A	SOH	Q	DC1
0010	B	STX	R	DC2
0011	C	ETX	S	DC3
0100	D	EOT	T	DC4
0101	E	ENQ	U	NAK
0110	F	ACK	V	SYN
0111	G	BEL	W	ETB
1000	H	BS	X	CAN
1001	I	HT	Y	EM
1010	J	LF	Z	SUB
1011	K	VT	[	ESC
1100	L	FF	\	FS
1101	M	CR	]	GS
1110	N	SO	^	RS
1111	O	SO	_	US



5-1-3. KEY FUNCTIONS WHICH ARE TRANSMITTED IN TTY MODE

KEY	TRANSMISSION	ACTION
RETURN	CR (CTRL M)	Carriage Return
LINE FEED	LF (CTRL J)	Line Feed
BACK SPACE	BS (CTRL H)	Back Space
TAB	HT (CTRL I)	Tab
ESC	ESC (CTRL [)	None
←	BS (CTRL H)	←

5-1-4. KEY FUNCTIONS WHICH ARE NOT TRANSMITTED BUT HAVE EFFECT WITHIN THE 9002B

KEY	ACTION
MODE	Switch to control mode
HOME	Cursor move to home
DELETE	Deletes a character
ERASE END LINE	Erase end line
ERASE END DISPLAY	Erase end display
ERASE FIELD	Erase field or line
ERASE DISPLAY	Erase data (depress once)
	Erase protected field (depress twice)
PRINT ON	Turns printer on
PRINT OFF	Turns printer off
BACK TAB	Back tab
↑ → ↓	Move cursor

5-1-5. RECEIVED CONTROL CODES

CTRL codes received will have the following effect. All other CTRL codes have no effect.

RECEIVED CONTROL CODE	ACTION
CTRL H	Back space
CTRL G	Sound beep tone
CTRL I	Tab
CTRL J	Line Feed
CTRL M	Carriage return
CTRL [	Escape sequence
CTRL A	Special batch receive

- \* BREAK Key - pressing this key causes a 200 millisecond BREAK signal to be transmitted via the primary RS-232C communications line. This is sometimes referred to as an "interrupt" or "attention" key.
- \* INFINITE SCROLL FEATURE - in the TTY MODE the ZENTEC 9002 provides an infinite scrolling capability to facilitate teletype operation. So if data is received with the cursor on the bottom line of display memory, the entire data being displayed moves upwards one line providing a new blank line at the bottom. Information that was located on the top line is lost.

## 5-2. BLOCK TRANSMIT MODE - KEYBOARD OPERATION

Block transmission is used to allow the operator to prepare text and data in an off-line mode and then transmit the data as a unit block at up to 9600 baud. (A screen full for example.) Once the editing of text or form preparation is complete in the OFF-LINE (FORM or EDIT) MODE, a BLOCK TRANSMISSION (TRANSMIT) MODE can be entered from the CONTROL MODE by depressing one of the two BLOCK XMIT keys: BLOCK XMIT → ALL ← or BLOCK XMIT → FORM/DATA ← . In these modes the 25th line will display TRANSMIT. Upon completion of the transmission the 9002B program automatically returns to the EDIT or FORM MODE ready for you to prepare another page of text or another form.

The following sequence is followed when preparing and then transmitting in BLOCK MODE. (Start in FORM or EDIT MODE)

- \* The operator enters the START OF MESSAGE character → , by depressing the MODE key followed by depressing the → key. If no → symbol is found on the display, transmission begins from the HOME position.
- \* The operator constructs the message by typing in the data via the keyboard in the FORM or EDIT modes off-line.
- \* The operator then enters the END OF MESSAGE character ← , by depressing the MODE key followed by depressing the ← key. During transmission a CR-LF is transmitted and the 9002B performs a RETURN. If no ← symbol is found during transmission a ← symbol is assumed at the end of visible display. A CARRIAGE RETURN LINE FEED is transmitted and the 9002B performs a RETURN.

- \* The operator then depresses the MODE key, which moves the 9002B into CONTROL MODE.
- \* The operator then depresses the (i) BLOCK XMIT → ALL ← key or (ii) BLOCK XMIT → FORM/DATA ← key.
- \* The 9002B then goes into BLOCK TRANSMIT MODE with the word TRANSMIT displayed on the 25th line and with the keyboard locked (with the standard firmware). Transmission ends with a CR-LF. Upon successful transmission the 9002B will automatically switch back to the local mode (EDIT or FORM).
- \* BLOCK XMIT → FORM/DATA ← Key - depressing this key will cause a block transmission of Data Only.

Typically this will be used when transmitting FORM INFORMATION from the display where the FORM itself will be protected and the data will be the information entered into the form and you only wish to transmit the variable data. TRANSMISSION will start at the → symbol and end at the ← symbol.

#### 5-2-1. DATA COMPRESSION IN BLOCK XMIT → FORM/DATA ← MODE:

Data compression can be achieved by inserting " ↓ " symbols at the end of the data. If a " ↓ " symbol is found, an ESC N Sequence is transmitted (ESC N "x" "y"). This causes the receiving terminal to jump the defined (xy) number of spaces.

If a protected character is found, the cursor is auto-tabbed and an ESC N sequence is transmitted.

- \* BLOCK XMIT → ALL ← Key - depressing this key will cause a block transmission of all information between the → and ← symbols on the screen. Typically this will be used for transmitting text material or the complete form (both data and format).

### 5-2-2. DATA COMPRESSION IN BLOCK XMIT → ALL ← MODE:

Data compression can be achieved by inserting a " ↓ " symbol on the end of a line for example. The " ↓ " symbol causes the insertion of a CR-LF in the transmission and moves the cursor to the first position on the next line.

#### NOTE:

Care should be taken not to place the " ↓ " symbol on the same line as the " ← " symbol otherwise the second symbol will be neglected.

### 5-3. SYMBOL DISPLAY MODE - KEYBOARD OPERATION

This mode simply enables all 128 ASCII characters to be displayed on the screen. Control characters are not acted upon in this mode. It is a useful tool for diagnosing line protocol problems. This mode allows the operator to prepare off-line special text with all 128 ASCII characters and symbols displayed, and then transmit the text as a unit block transmission. The 9002B operates just like it does in INSERT EDIT MODE except the 32 control keys are activated and their respective characters and symbols are displayed.

- \* SYMBOL DISPLAY MODE Key - depressing this key in the CONTROL MODE will switch the 9002B into SYMBOL DISPLAY MODE, and the 25th line will display SYM DATA. The only control code which has any effect is LF which puts a " ↓ " symbol on the screen and causes a carriage return line feed. Depressing the MODE key will switch the 9002B out of SYMBOL DISPLAY MODE back to CONTROL MODE.
- \* SYMBOL DISPLAY XMIT Key - depressing this key from the CONTROL MODE will switch the 9002B into the SYMBOL DISPLAY TRANSMIT MODE, and the 25th line will display TRANSMIT. If the special text has been prepared off-line, then a BLOCK transmission is initiated starting at the HOME position and ending at the current cursor location. If the cursor is at HOME, then all information on the visible screen is transmitted. At the end of transmission the 9002B automatically switches to REP FORM.

### 5-3-1. SYMBOL DISPLAY RECEIVE - KEYBOARD OPERATION

The SYMBOL DISPLAY RECEIVE may be selected by a remote host when the 9002 is in the TTY MODE. The receipt of an ESCAPE Z sequence will turn the SYMBOL DISPLAY RECEIVE on. All 128 ASCII characters received will be displayed. Only the CR-LF character will have a cursor effect. To turn this mode off, an ESCAPE ESCAPE sequence is required.

#### KEYBOARD OPERATION

- \* ON SYMBOL DISPLAY RECEIVE Key - this will allow the 9002B to receive SYMBOL DATA.
- \* OFF SYMBOL DISPLAY RECEIVE Key - this inhibits the 9002B from receiving SYMBOL DATA.

### 5-4. HOST "WAKE UP" MESSAGE

Your ZENTEC 9002 is provided with a unique "WAKE UP" sequence. Whenever the 9002B is off-line, the host is prevented from blasting through and wiping out text or forms data being prepared off-line, however, a special "WAKE UP" sequence is provided. An ESCAPE "L" XXXXXXXXXXXXXXXXXXXX allows a special message to be displayed on the 25th line to call the attention of the operator. Care must be taken to transmit from the host all 16 characters. The 16 characters must be printable. Any CTRL codes will abort the process and be ignored. The receipt of an ESCAPE "\" will clear the message from the 25th line. Depressing the LINE FEED key will clear the 25th line from the terminal keyboard when in CONTROL MODE.

(Example the host can send:

ESCAPE L CALL 21504767767

The operator would then call the phone number indicated.)

## 5-5. SPECIAL CUSTOMER PROGRAM MODES - USING YOUR 9002B'S PROGRAMMABILITY FEATURE

The ZENTEC 9002B is a fully intelligent programmable terminal. A standard set firmware (ROM) subroutines enable the microprocessor to handle all keyboard commands and display functions. This set of subroutines can be addressed and used in any custom application program. This is achieved by means of a table "look up" subroutine list, thus simplifying the application programming task.

For entering programs into ZENTEC 9002B.

- \* TELECOMMUNICATIONS ENTRY - using the BATCH TRANSMISSION MODE program object code can be transmitted via the telecommunication port from a host into the ZENTEC 9002B RAM storage area.

Once the program code is in RAM, the ZENTEC 9002B can be instructed via the keyboard to branch to the program (typically we use the P1, P2, P3 etc. keys) and execute the program. These allow the entry into special CUSTOMER PROGRAM MODES.

These special application programs are entered by depressing the P1, P2 or P3 keys from the CONTROL MODE. The 25th line will display any suitable description selected by the application programmer.

The P1, P2 and P3 keys are provided as special branch keys. In actual operation, the NUMERIC PAD can be programmed with special system control software to give additional branch points. If there is nothing located at these branch points the 9002B will go to REP FORM.

NOTE: P1, P2 and P3 keys are built in branch points to locations X'1FFD', X'2000' and X'1FFA' respectively and thus can be used to branch to CUSTOMER PROGRAM MODES.



## CHAPTER VI

### OPTIONS ON 9002B

#### 6-1. PRINTER SUBSYSTEM OPTION

The printer subsystem option enables the 9002B system to communicate with and print out data on a peripheral hard copy printer. The subsystem consists of a free-standing impact printer, a cable inter-connecting the printer to the 9002B system display console, a printer interface card inside the display console, and software required to operate the printer as a 9002B system peripheral device. The printer operates at up to 30 characters per second. In the PRINT MODE, all keyboard functions are disabled. There are two modes of operation with the printer.

##### 6-1-1. PRINT ON-LINE

- \* Print in HALF DUPLEX TTY MODE. When the 9002B is in TTY HALF DUPLEX MODE, depressing the PRINT ON key enters a mode which allows printing of the telecommunication line information in both directions.
- \* Print in FULL DUPLEX TTY MODE. When the 9002B is in TTY FULL DUPLEX MODE, depressing the PRINT ON key enters a mode which allows printing of the information coming down the line from the host.

##### 6-1-2. PRINT OFF-LINE

- \* When in the CONTROL MODE depressing the PRINT → DATA ← key will print all the information on the display between the arrows ( → ← ).



- \* When the PRINT SCREEN key is depressed in the CONTROL MODE, all the information on the display will be printed. The program will return the 9002 to CONTROL MODE upon completion.

In the ON-LINE MODE, depressing the PRINT ON key or the receipt of an ESC H code will initiate the print command. In this mode the 25th line will display PRINT. Depressing the PRINT OFF key or the receipt of an ESC I code will inhibit the printer. In the PRINTER ON-LINE MODE the I/O baud rate must be slaved to the selected printer baud rate and turn the printer OFF.

NOTE: When the 9002B is on-line, with the printer off-line, it is possible to use the 9002B as a print buffer at up to 9600 baud.

## 6-2. SPECIAL RECEIVE MODE

The SPECIAL RECEIVE PERMIT key in the TTY MODE allows the 9002B to respond to a CTL A code from the host and thus enables the 9002B to be switched to a SPECIAL RECEIVE MODE in which Program Code can be received over the RS-232C interface and loaded into memory. The 25th line will display RTTY-HD. This allows your 9002B to be loaded with software programs over telecommunication lines. This condition is reset by depressing the SPECIAL RECEIVE PERMIT key again. (See Appendix II for format of message required from the host to switch the 9002B into the BATCH RECEIVE MODE.)

## 6-3. BAUD RATE OPTIONS

This option modifies the RS-232C telecommunications interface circuits so that the system can communicate data to and from the telecommunications line at 4800 baud or 9600 baud rate. The option involves a strapping change on the timing card and affects the operation of the BAUD RATE witch on the rear connector panel of the display console. If no baud rate option is installed in the system, placing the BAUD RATE switches in the SEL position enables the system to receive and transmit data at 2400 baud. If the option is installed, the corresponding rate is 4800 or 9600 instead.

## 6.4. POWER OPTION - 230 V. 50 Hz.

This option changes the operating input power requirements of the 9002B system to 230 volts and 50 Hz. It cannot be installed in any system that has the full interlace.

#### 6-5. POWER OPTION - 100 V. 50/60 Hz.

This option changes the operating input power requirements of the 9002B system to 100 volts 50/60 Hz. The 50 Hz. version cannot be installed in any system that has the full interlace.

#### 6-6. GENERAL PURPOSE 2K MEMORY OPTION

This option adds 2048 bytes of memory to the system. The 2048 bytes of memory can be used as general purpose memory for the microprocessor.

#### 6-7. ADDITIONAL RAM MEMORY

This option provides space for up to 8192 bytes of RAM memory in addition to the ROM, PROM and RAM memory provided in the standard 9002 system. It is located on one circuit card, which is installed in the display console circuit card chassis. Any number of bytes of memory in increments of 2048 can be installed in this card. The added memory space is under direct microprocessor control and can be used for additional program, video display, RS-232C interface, or keyboard data storage.

#### 6-8. DUAL RS-232C CARD

This option provides two RS-232C telecommunication interface circuits, in addition to the one provided in the standard 9002 system. The two added interfaces are located on a single circuit card that is installed in the display console circuit card chassis. Along with this circuit card, the page two video option or the general purpose 2K memory option must be installed in the system.

If the dual RS-232C option is installed, there are three interfaces available for connecting to telecommunications lines or external equipment. The dual RS-232 circuits operate in such a manner that either can be receiving or transmitting data at any one time, but not both simultaneously. Switching between the two circuits must be done under software control. No supporting software is normally provided with this option.



## APPENDIX

### CONTENTS

- I. KEYBOARD LAYOUT WITH OPTIONS
- II. SPECIAL BATCH RECEIVE MODE MESSAGE FORMAT
- III. HOW TO USE NCSS, INC. TIMESHARE WITH THE 9002
- IV. HEXADECIMAL AND DECIMAL CONVERSION CHART
- V. TELECOMMUNICATIONS CONNECTOR PIN ASSIGNMENTS
- VI. BATCH OPTION RECEIVE MODE
  - 1. WAKE UP SEQUENCE
  - 2. DATA MESSAGE INPUT
  - 3. DATA MESSAGE EXAMPLE 1 ASCII (PROTECTED AND UNPROTECTED DATA)
- VII. ADDITIONAL OPTIONS FOR 9002A
  - 1. TELECOMMUNICATIONS TTY MODE STANDARD RS-232 INTERFACE
  - 2. 2 MICROSECOND PROCESSOR
  - 3. BATCH TELECOMMUNICATIONS OPTION
  - 4. THE BATCH MODE OPERATES SIMNILAR TO THE BLOCK MODE (START IN EDIT OR FORM MODE)
  - 5. TRANSMIT DATA TYPES
  - 6. RECEIVE DATA TYPES
  - 7. BATCH RECEIVE CAPABILITY
  - 8. APPLICATION OF THE BATCH TRANSMISSION OPTION
  - 9. ZIM (ZENTEC INTERROGATION MODEULE) PROGRAM
  - 10. PAGE TWO VIDEO DISPLAY OPTION
  - 11. DUAL DISK DRIVE SUBSYSTEM
  - 12. EXTENDED TEXT EDITOR PROGRAM
- VIII. TYPICAL 9002A PROGRAM WHICH CAN BE ENTERED FROM THE KEYBOARD

CONTROL MODE	SYMBOL DISPLAY MODE	XMIT SYMBOL DATA	ZIM MODE PROG 1	PROG 2	PROG 3	FORM GEN MODE
--------------	---------------------	------------------	--------------------	--------	--------	---------------

FORM GEN MODE	PRINT ON	PRINT OFF	SPECIAL RECEIVE PERMIT	BREAK	ENHANCE CHARACTER
TTY MODE					SYMBOL ON RECEIVE OFF
CONTROL MODE	PRINT → DATA ←	PRINT SCREEN	BLOCK XMIT → ALL ←	BLOCK XMIT → FORM DATA ←	TTY MODE FD HD

ALL CAPS	RESET
----------	-------

START	ENTER	CLEAR FORM	EOS	EOL	DELETE
-------	-------	------------	-----	-----	--------

1	2	3	4	5
---	---	---	---	---

\*

\*

AUTO BACK TAB	BACK TAB	!	"	#	\$	%	&	'	(	)	∅	DEL	=	~	BACK SPACE
AUTO TAB	TAB	Q	W	E	R	T	Y	U	I	O	P	}	{	LINE FEED	
ESC	LOCK	A	S	D	F	G	H	J	K	L	+	*	;	:	RETURN
CTRL	SHIFT	Z	X	C	V	B	N	M	<	>	?	/	SHIFT	@	,
(SPACE)															

PAGE ↑	MODE	SCROL ↑	7	8	9
PAGE ↓	↑	SCROL ↓	4	5	6
←	HOME	→	1	2	3
INSERT REPLACE	↓	FORM EDIT	∅	•	

\*NOTE: Two keys have upper and lower case meaning

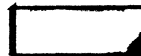

Program select keys (function keys)

## APPENDIX I

## APPENDIX II

### SPECIAL RECEIVE MODE

FORMAT OF MESSAGE REQUIRED FROM THE HOST TO SWITCH THE 9002 INTO THE SPECIAL RECEIVE MODE FROM THE TTY MODE

01	CTRL A (SOH)
L	
L	MSG LENGTH, HEX IN ASCII
L	MAX 4095, MOST SIGNIFICANT FIRST
S	
S	
S	
S	
TEXT	HEX IN ASCII, EVEN COUNT
03	CTRL C (EOT)

NOTE: LRC is vertical Modulo 2 sum of all seven bit positions. Upon receipt of LRC, terminal return to TTY-HD or TTY-FD MODE from which RECEIVE MODE occurred. If LRC does not check, 25th line says FAILED.

## APPENDIX III

### HOW TO USE NCSS, INC. TIMESHARE WITH THE 9002

#### INTRODUCTION

Program Development is done in the INTERACTIVE/CHARACTER MODE (H.D. GT1 MODE on the ZENITEC 9002) with National CSS, Inc. timeshare service. In this mode the programmer will enter program statements and thus develop a file within the NCSS system of his raw program. He will, of course, be required to provide a file identification and upon completing his program statements, he must make an order to assemble on the NCSS mainframe computer. The method used will follow the standard NCSS INTEL assembler operating procedures.

NCSS will then proceed to assemble the program and will inform the ZENITEC 9002 via the display when the task is complete. (See National CSS Inc. publication on the INTEL 8008 MICRO ASSEMBLER dated August 1974.)

The host will then switch the ZENITEC 9002 from the TTY-HD into the SPECIAL TIMESHARE RECEIVE MODE using the SOH character. The object code will then be transmitted to the 9002 RAM storage location selected by the programmer.

## APPENDIX IV

### HEXADECIMAL AND DECIMAL CONVERSION CHART

To find the decimal number, locate the hexadecimal number and its decimal equivalent for each position. Add these to obtain the decimal number. To find the hexadecimal number, locate the next lower decimal number and its hexadecimal equivalent. Each difference is used to obtain the next hexadecimal number until the entire number is developed.

HEXADECIMAL COLUMNS					
6	5	4	3	2	1
HEX = DEC	HEX = DEC	HEX = DEC	HEX = DEC	HEX = DEC	HEX = DEC
0	0	0	0	0	0
1	1,048,576	1	4,096	1	16
2	2,097,152	2	8,192	2	32
3	3,145,728	3	12,288	3	48
4	4,194,304	4	16,384	4	64
5	5,242,880	5	20,480	5	80
6	6,291,456	6	24,576	6	96
7	7,340,032	7	28,672	7	112
8	8,388,608	8	32,768	8	128
9	9,437,184	9	36,864	9	144
A	10,485,760	A	40,960	A	160
B	11,534,336	B	45,056	B	176
C	12,582,912	C	49,152	C	192
D	13,631,488	D	53,248	D	208
E	14,680,064	E	57,344	E	224
F	15,728,640	F	61,440	F	240
0 1 2 3	4 5 6 7	0 1 2 3	4 5 6 7	0 1 2 3	4 5 6 7
BYTE		BYTE		BYTE	

#### POWERS OF 2

$2^n$	n
256	8
512	9
1 024	10
2 048	11
4 096	12
8 192	13
16 384	14
32 768	15
65 536	16
131 072	17
262 144	18
524 288	19
1 048 576	20
2 097 152	21
4 194 304	22
8 388 608	23
16 777 216	24

#### POWERS OF 16

$16^n$	n
1	0
16	1
256	2
4 096	3
65 536	4
1 048 576	5
16 777 216	6
268 435 456	7
4 294 967 296	8
68 719 476 736	9
1 099 511 627 776	10
17 592 186 044 416	11
281 474 976 710 656	12
4 503 599 627 370 496	13
72 057 594 037 927 936	14
1 152 921 504 606 846 976	15





APPENDIX VI

BATCH OPTION RECEIVE MODE

1. WAKE UP SEQUENCE

The "Wake Up" sequence as shown must be used to bring the terminal out of the "Local" state to the RECEIVE state. In the RECEIVE state, the keyboard is locked out. All messages must be preceded by the "Wake Up" sequence.

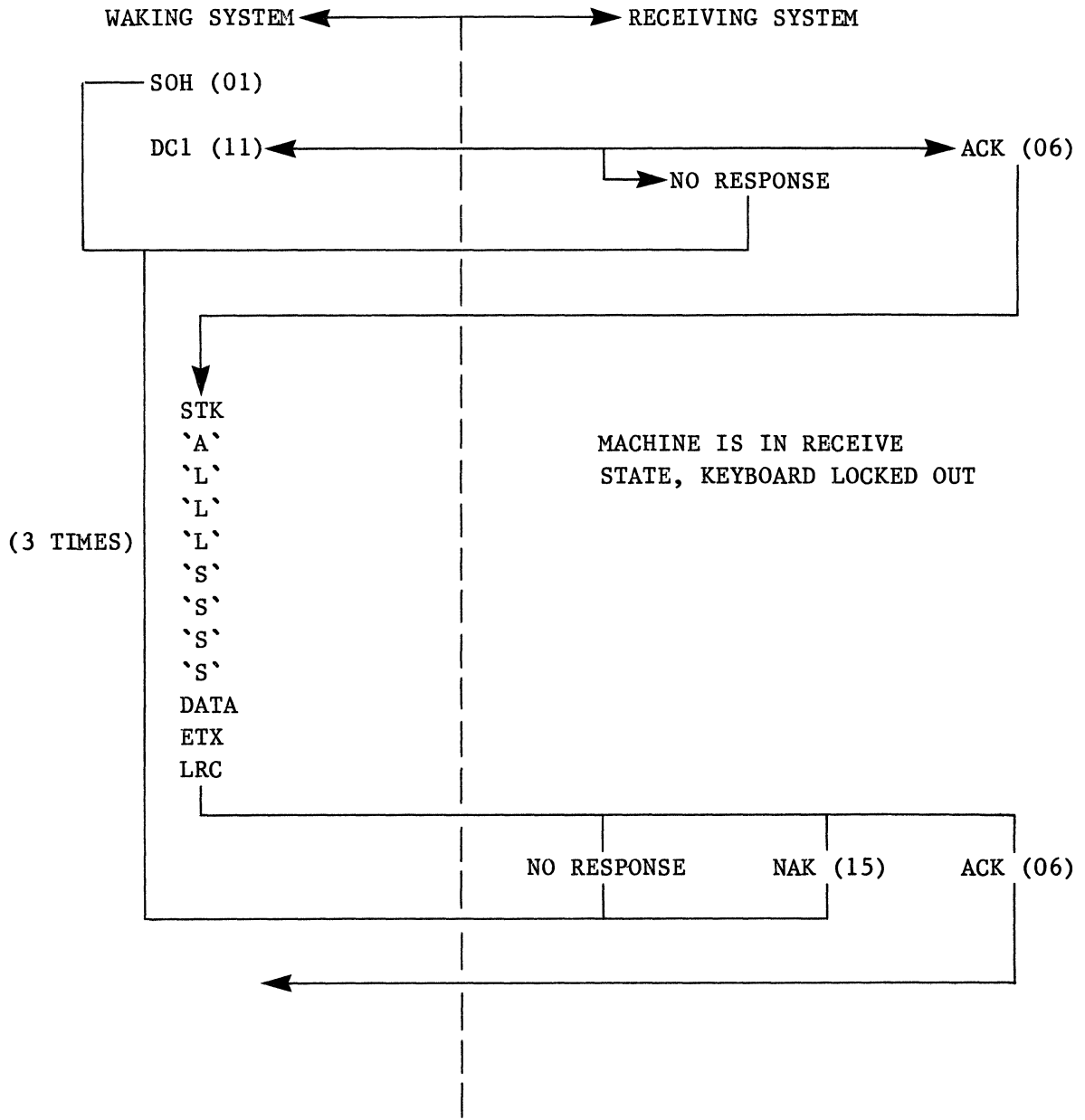

## 2. DATA MESSAGE INPUT

After "Wake Up" all input data from the CPU will have the following format:

STX

HEADER

TEXT

ETX

LRC

This terminal will respond with an ACK, a NAK, or no response.

### Header Format

- `A` Type of Data Code \*
- `L` Length of Message - HEX in ASCII Form. From the first data byte up to, but not including ETX character.
- `L` The count is equal to the number of the text bytes being transferred with Type of Data Code "31". The count must
- `L` be one half the number of text bytes with type of Data Code "30". Used with Type of Data Codes: 30, 31, 35
- `S` only.
- `S` Starting address in memory for data inserting. HEX in ASCII form. Used with Type of Data Code: 30, 31, 32 and
- `S` 33. NOTE: Data will be transferred into any byte space specified by the starting address. Type of Data Code
- `S` 32 and 33 should not be used for data being loaded outside screen boundaries.

SEE EXAMPLES OF BATCH  
PROTOCOL SEQUENCES  
ON FOLLOWING  
PAGES

Example 1 - ASCII (Protected and Unprotected)

After Host Wake-up sequence

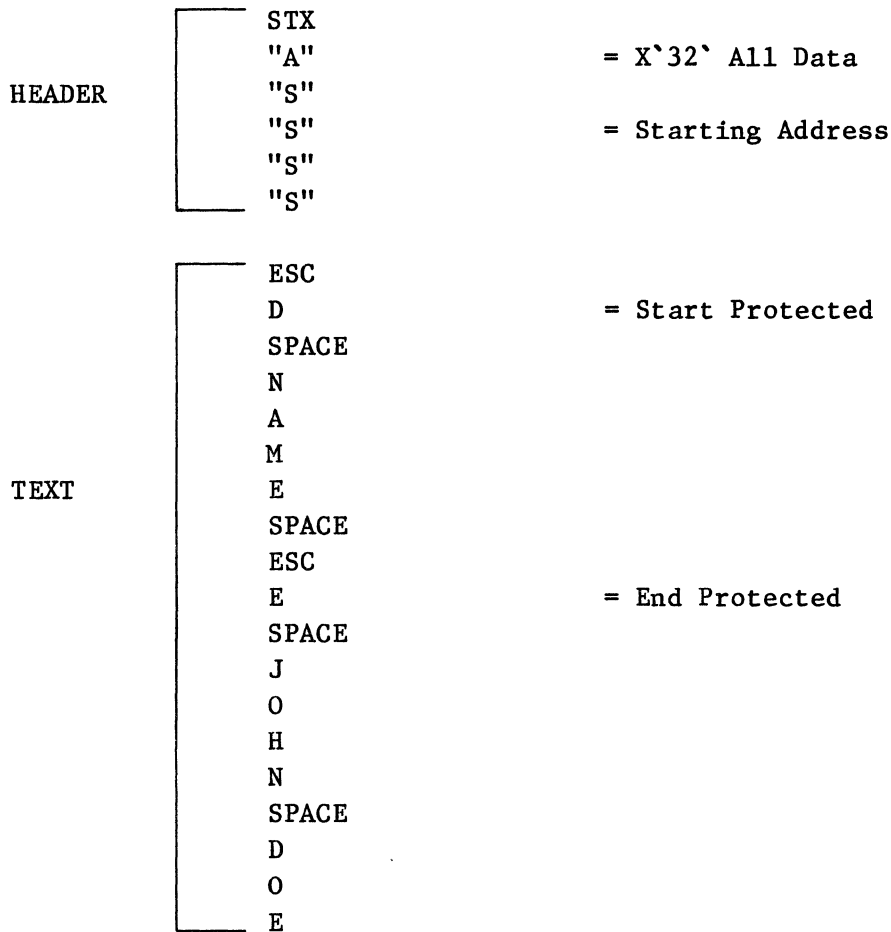

Everything on screen from home or from start code to end of screen or end code.

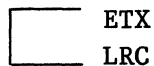

The ZENTEC 9002 expects an ACK '60' from the Host after the LRC is transferred and checked. Otherwise the 9002 will time out and try again, for a maximum of three attempts.

The only escape sequence expected or allowed in the ASCII (Protected and Unprotected) MODE are those which start protected data, i.e., data following the sequence X'1B', X'44' are placed into screen RAM as protected bytes; and end protected data, i.e., data following the sequence X'1B', X'45' are placed into screen RAM as unprotected bytes.

## Example 2 - ASCII (Unprotected Data)

After Host Wake-up sequence

STX

A = X`33` all unprotected data, compressed

"S"

"S"

= Starting Address

"S"

"S"

J

O

H

N

SPACE

D

O

E

Everything on screen from home or from start code to end of screen or end code

etc

ETX

LRC

The only ESCAPE sequence expected or allowed in the ASCII (Unprotected Data) MODE is the one which allows the skipping over of protected areas and spaces adjacent to protected data. The sequence is X`1B`, followed by two HEX in ASCII bytes whose low order four bits when brought together become a one byte count field of minimum value X`01` and maximum value X`FF`. This value is used to tell the receiving system to skip over the number of bytes represented by the count.

## APPENDIX VII

### ADDITIONAL OPTIONS FOR 9002A

(Note the 9002A can have the 9002B options plus the following.)

#### I. TELECOMMUNICATIONS TTY MODE STANDARD RS-232C INTERFACE.

The 9002A can be provided with a telecommunications option which provides both Full-Duplex and Half Duplex at 110, 300, 2400, 4800 and 9600 baud via a standard EIA RS-232C interface. This ASYNCHRONOUS TRANSMISSION MODE provides both character by character and block mode operation. (See the 9002B TTY [Character] MODE standard RS-232C description.)

#### 2. 2.6 MICROSECOND PROCESSOR

The 2.6 microsecond processor can be added to your 9002A in place of the standard 13 microsecond processor. This option basically gives the 9002A the ability to run six to ten times faster, allow a significantly more powerful instruction set (78 codes) to be used, and up to 64,000 bytes of directly addressable memory. In addition, there is no program call level limitations.

#### 3. BATCH TELECOMMUNICATIONS OPTION

This option provides a block-type transmission capability with a true pseudo polling feature, i.e., block transmission with a special telecommunications protocol. The special protocol provides complete handshaking sequences, data checking (LRC generated for each data byte) to insure data transmission integrity.

NOTE: Data Checking is achieved by the automatic generation of a LRC character. Starting with a zeroed accumulator and successively performing exclusive OR's for each data byte within the text. The LRC character does not include the Header or the ETX. The result of the accumulator after all data has been OR'd is the LRC character. This character is transmitted and checked.

In the BATCH MODE, off-line editing of text program code and/or forms updating can be performed. Once this is complete the BATCH TRANSMISSION MODE is entered which will allow all 127 ASCII codes to be transmitted at line rates up to 9600 baud. (NOTE: 03 code is reserved for End of Transmission.)

#### 4. THE BATCH MODE OPERATES SIMILAR TO THE BLOCK MODE (START IN EDIT OR FORM MODE)

- \* The operator enters the Start of Message character → by depressing the MODE key followed by the → key. If no → character is found on the display, transmission begins at the Home position.
- \* The operator constructs the program or edits the text using the keyboard in the FORM or EDIT OFF-LINE MODE.
- \* Then the operator enters the End of Message character ← by depressing the MODE key followed by depressing the ← key. If no ← symbol is found during transmission, a ← symbol is assumed at the end of visible memory.
- \* To transmit the information, depress the MODE key which moves the ZENTEC 9002A into CONTROL MODE. Then depress BATCH XMIT → ALL ← MODE key or BATCH XMIT → DATA ← MODE key.
- \* The ZENTEC 9002 then goes into BATCH TRANSMIT MODE with the word TRANSMIT displayed on the 25th line. Three tries will be made to transmit the message. If it is unsuccessful, the word FAILED will appear on the 25th line. In this event, a check should be made of the modem, the connectors and/or the baud rate switch selection. Upon successful transmission, the 9002A will automatically return to the previous off-line mode used.

The only significant difference between RECEIVING and TRANSMITTING MODES is that two types of ASCII data can be transmitted and five different types of data can be received.

#### 5. TRANSMIT DATA TYPES

- \* Protected and Unprotected ASCII
- \* Compressed Unprotected ASCII

## 6. RECEIVE DATA TYPES

ASCII 0	Hex 30	Hexadecimal in ASCII using two eight bit characters to make one byte.
ASCII 1	Hex 31	BINARY where all eight bits are the same as the character to be transferred.
ASCII 2	Hex 32	ASCII Protected and Unprotected.
ASCII 3	Hex 33	ASCII Compressed unprotected with trailing blank suppression.
ASCII 4	Hex 34	Reserved for user generated telecom routines.
ASCII 5	Hex 35	ASCII to the 9002A CONTROL LINE (25th line). Must be less than 73 bytes in length. Data appears on 25th line only.

## 7. BATCH RECEIVE CAPABILITY

The BATCH TRANSMISSION OPTION also includes a capability to allow the host to "awaken" the 9002A from the local modes (EDIT or FORMS). If the host sends a SOH DCI code, then the 9002A will switch automatically to a RECEIVE MODE. It will display RECEIVE on the 25th line and receive data in a BATCH MODE. While in this state, the keyboard will be locked out.

## 8. APPLICATION OF THE BATCH TRANSMISSION OPTION

The BATCH TRANSMISSION MODE can be used in conjunction with timeshare services (like NCSS, Inc. which have a ZENTEC DRIVER and an INTEL CROSS ASSEMBLER) for program development. Typically program statements can be transmitted, assembly of the program can be initiated (using the INTEL CROSS ASSEMBLER) and the object code can be retransmitted back to added RAM storage within the ZENTEC 9002A. Once the application code is in RAM, the ZENTEC 9002A can be instructed via the keyboard to branch to the application program (typically we use the P1 and P2 keys) and execute the program. (See Appendix IV - How To Use NCSS, Inc. Timeshare System with the ZENTEC 9002.)



## 9. ZIM (ZENTEC INTERROGATION MODULE) PROGRAM

The ZIM provides means for visual access to the contents of ROM, PROM, and RAM memories in the system. The contents of each location in the memory is displayed on the screen in hexadecimal-coded form and various sections of the memory can be moved on or off the screen with the cursor controls. In addition, contents of any memory location in the RAM segment can be altered from the keyboard when operating under the control of ZIM program. Consequently, ZIM program is useful for programming, program debugging, as well as maintenance purposes.

Installation of the ZIM program requires that the page two video display option is present in the system.

The ZIM program is entered from the CONTROL MODE by depressing the ZIM key. The 25th line will display CONTROL. A segment of the memory content will be displayed in hexadecimal in rows across the screen with their address appearing in the left hand column.

```
0F80    C2 0A 0A 0A 0A 24 0F B1 2E 10 36 24 F8 07 46 00
0F90    08 2E 10 36 01 C4 97 40 9B 0F 19 E0 46 0C 08 16
0FA0    50 46 99 09 46 7A 09 46 59 08 09 0B EB F4 16 50
0FB0    C7 3C 20 48 9F 0F 46 34 08 11 48 B0 0F 07 CA 2E
0FC0    10 36 14 F9 44 C5 0D 00 46 8D 0A 1E 10 26 00 2E
0FD0    0F 36 DE 16 22 46 27 09 46 D3 0B 44 16 00 01 00
0FE0    FF 00 00 01 00 00 44 00 00 00 00 00 00 02 19
```

CONTROL

- \* The cursor move keys will allow indexing through the memory. The cursor appears as a reverse video character.
- \* Indexing through memory can also be achieved by keying in the four digit memory address number and then depressing the lower case "L" key. This will cause the cursor to jump to the specified memory address.
- \* The SPACE BAR can be used to enter hexadecimal code into the RAM memory locations. This is achieved by depressing the appropriate alpha-numeric key (two key sequence) and then depressing the SPACE BAR. The hexadecimal characters will be inserted at the cursor location.

- \* Depressing the RESET key or branching using the "g" key to location X'0008' will return the 9002A to the normal operating program.
- \* The 9002A program can be made to branch to a specific memory location by keying in the four digit memory address number and then depressing the "g" key. This will cause the 9002A to branch to the specific memory location and execute the program residing at that location. Depressing the RESET key or branching using the "g" key to location X'0008' will return the 9002A to the normal operating program.

NOTE: The most significant number is entered first when keying in the hexadecimal memory address (i.e., X'1FF2' is address 8178. (See Appendix V for HEXADECIMAL TO DECIMAL CONVERSION CHART.)

#### 10. PAGE TWO VIDEO DISPLAY OPTION

This option provides 2048 bytes of additional memory and supporting software for one full page (24 lines) of video display information. Thus, when the option is installed, the operator can choose to display on the CRT display screen either of two full pages of video. With the paging and scrolling controls on the keyboard, the operator can also choose to either scroll line by line through the two pages (always displaying 24 lines), or switch from one page to the other. Scrolling is defined as moving the display material across the screen two lines at a time (with the SCROL control(s). Paging is defined as switching from one page to another (with the PAGE control(s) on the keyboard).

#### 11. DUAL DISK DRIVE SUBSYSTEM

This option is a disk memory peripheral device, complete with interfacing hardware and supporting system software. The subsystem consists of a free-standing disk memory, a cable that connects the disk memory to the CRT display console, a disk memory interface card inside the display console, and a disk handler program (IPL only).

The disk memory consists of two separate disk drives and a controller; all housed in a common enclosure. The disk memory has a total capacity of 500,000 bytes, uses removable flexible (floppy) diskettes, and records in IBM compatible format. It connects to the system bus through the interface card and communicates both directly with the microprocessor and reads and writes into the system memory.

The 9002A contains software to perform an initial program load from the diskette. This is achieved by depressing the PAGE ↑ key from the CONTROL MODE.

## 12. EXTENDED TEXT EDITOR PROGRAM

The Extended Text Editor program enhances the text mode capabilities of the Program. Its purpose is to give added capabilities for the editing of text displayed on the screen. For example, the Extended Text Editor enables the operator to insert or delete words or sentences, and have the line(s) of text, or entire paragraphs, reformatted. Thus, the Extended Text Editor program is useful for composing original copy of manuscript editing on the screen, in a more convenient manner than possible either on a typewriter or manually with paper and pencil.

The Extended Text Editor option adds the following capabilities to the INSERT TEXT MODE of operation (INS TEXT on 25th line).

- \* Erase a Word - by simply positioning the cursor under any part of the word and depressing the ERASE WORD key.
- \* Erase Sentence - by simply positioning the cursor under any part of the sentence and depressing ERASE SENTENCE key.
- \* Erase a Paragraph - by simply positioning the cursor under any part of the paragraph and depressing the ERASE PARAGRAPH key.
- \* Word Wrap Around - is automatic with this option. The option allows the operator to type and not worry about overfilling the line. If a word overfills a line, the program will automatically move the word to the next line.

- \* Reformating of Text in Paragraphs - can be accomplished by the use of a PARAGRAPH MARK ( Γ ) symbol. First position the cursor at the beginning of the desired paragraph. Now depress the lower case SET PM key. A Γ symbol will be entered on the display. Now locate the cursor at the end of the paragraph. Again depress the lower case SET PM key. NOTE: If the paragraph starts at the HOME position, no paragraph mark is needed at the beginning of the paragraph. Now position the cursor inside the paragraph and depress the REFORMAT key. The text on the display will be reformatted with the beginning of the paragraph indented and all spaces cleared. You are now ready to perform another paragraph reformat sequence on the following paragraph. NOTE: The cursor will automatically position itself under the next paragraph mark.
  
- \* A Paragraph Mark - can be removed by use of the upper case ERASE PM key. Simply place the cursor under the paragraph mark and depress the upper case ERASE PM key.
  
- \* Tab On Character - To set a character for tabbing, depress the MODE key which moves you to CONTROL MODE. Then depress the AUTO BACK TAB followed by the character on which you want to tab. Depressing the AUTO TAB key will cause a tab on the selected character. Depressing the AUTO BACK TAB key will back tab on the character. To remove the character tab setting, depress the RESET key.

## APPENDIX VIII

### TYPICAL 9002A PROGRAM WHICH CAN BE ENTERED FROM THE KEYBOARD

This routine moves a block of data, characters or bytes if you wish, from one part of memory (RAM) to another part of memory. For demonstration purposes in this example, we'll move the data from the top of Page One to the top of Page Two. This is so you can visibly observe the results for yourself or demonstrate.

Bear in mind that we are going to "write" a software move. Also we are going to use (Call) a special subroutine known as RMOVE. (See page 20 of ZENTEC's Programmer's Language Manual (PN 88-403-01) for further details on the RMOVE subroutine.) RMOVE resides in the Executive Program of all 9002's. The maximum characters or bytes that can be accommodated with RMOVE is 256.

Pictorially what this routine does is illustrated below:

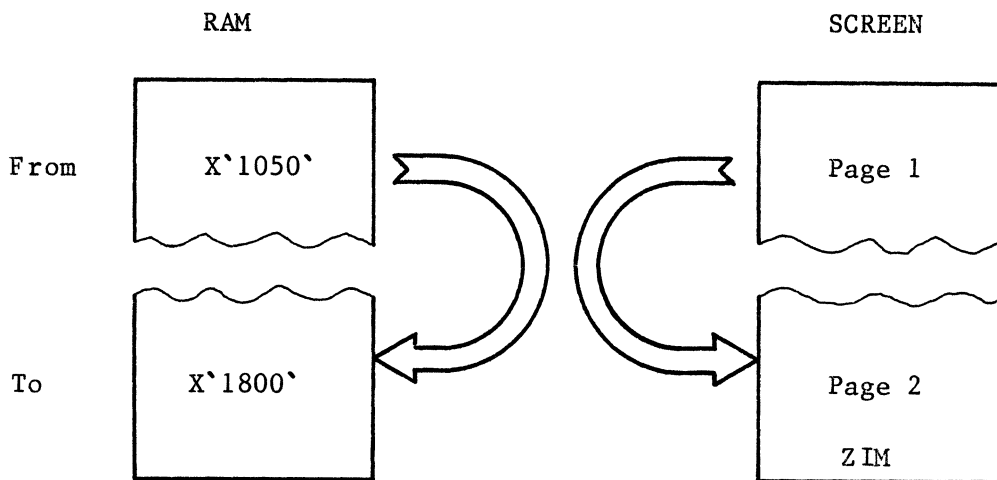

#### TYPICAL USES OF THIS ROUTINE

There are many uses for this type of program. They range all the way from what we are going to do, i.e. demonstrating to Text Editing to Manipulating Elements in a Matrix Array. Move routines are also commonly employed in I/O Buffering. For instance, moving data from one part of memory to another known as an Output Buffer. This Output Buffer could then be that area of memory that is written to a Disk, Mag Tape, Printer, etc...

## NMENONIC LISTING

```
START          = X`1A30`

X`1A30`        LBI RD,18          Set up registers D and E with
                LBI RE,00          "TO" Address
                LBI RH,10          Set up registers H and L with
                LBI RL,80          "FROM" Address
                LBI RC,00          Set up count 00 = 256 Bytes
                CALL RMOVE         Execute the move routine
                B ZIM              Branch back to ZIM
```

## HOW TO ENTER AND EXECUTE THIS PROGRAM

- Step 1. Turn Power On
- Step 2. Type in three lines of text. Either Alpha, Numeric or any combination.
- Step 3. Depress the ZIM MODE key. Note that you have automatically switched to Page 2 and that ZIM appears on the screen.
- Step 4. Verify that the ALL CAPS key is off (not down).
- Step 5. With the keyboard enter: 1a301. Note that this will locate (move) reverse video cursor to X`1A30`.
- Step 6. Enter 1e and then depress SPACE BAR.
- Step 7. Enter 18 and then depress SPACE BAR.
- Step 8. Enter 26 and then depress SPACE BAR.
- Step 9. Enter 00 and then depress SPACE BAR.
- Step 10. Enter 2e and then depress SPACE BAR.
- Step 11. Enter 10 and then depress SPACE BAR.

- Step 12. Enter 36 and then depress SPACE BAR.
- Step 13. Enter 80 and then depress SPACE BAR.
- Step 14. Enter 16 and then depress SPACE BAR.
- Step 15. Enter 00 and then depress SPACE BAR.
- Step 16. Enter 46 and then depress SPACE BAR.
- Step 17. Enter 27 and then depress SPACE BAR.
- Step 18. Enter 09 and then depress SPACE BAR.
- Step 19. Enter 44 and then depress SPACE BAR.
- Step 20. Enter 00 and then depress SPACE BAR.
- Step 21. Enter 3d and then depress SPACE BAR.
- Step 22. You have now entered in Machine Language the demonstration program. Enter la30 and then depress lower case L. This will locate (move) the cursor to X`1A30`. That`s the Starting Address of your program.
- Step 23. Depress g. (Lower case G means "go", or start executing the program.)
- Step 24. Note that whatever you typed on the screen in Step 2 now appears at the top of Page 2.
- Step 25. Depress RESET.
- Step 26. Now! Change the text that you entered in Step 2.
- Step 27. Re-enter ZIM by depressing ZIM MODE Key. Repeat Steps 22 and 23 and note the results!!!

Congratulations!!!

#### QUICK DEMO PROCEDURE

1. Power On, Type Text
2. ZIM MOED, ALL CAPS off, Enter 1a30 and lower case L.
3. 1e SPACE 18 SPACE
4. 26 SPACE 00 SPACE
5. 2e SPACE 10 SPACE
6. 36 SPACE 80 SPACE
7. 16 SPACE 00 SPACE
8. 46 SPACE 27 SPACE
9. 09 SPACE 44 SPACE
10. 00 SPACE 3d SPACE
11. 1a30 and lower case L and then depress g
12. RESET and Type New Text
13. ZIM MODE Key
14. Repeat Step 11



FLOW CHART

