

Contents

HP E1326B/E1411B 5 1/2 Digit Multimeter User's Manual

Edition 4

[Click here to Return to the HP TS-5400 Systems On-Line Manuals Main Contents](#)

Warranty	7
WARNINGS	8
Safety Symbols	8
Declaration of Conformity	9
Declaration of Conformity	10
Reader Comment Sheet	11
Chapter 1. Getting Started with the HP E1326B/E1411B Multimeter	13
About This Chapter	13
Multimeter Overview	13
Functional Description	14
Electrical Description	14
Physical Description	15
Introduction to Operation	16
Multimeter Self-Test	16
Resetting the Multimeter	17
Making a Measurement	20
Chapter 2. Configuring the HP E1326B/E1411B Multimeter	21
About This Chapter	21
Installation Overview	21
Setting the Logical Address Switch	22
VXIbus Interrupt Lines	24
HP E1326B Internal Installation	25
Installing the HP E1411B in a Mainframe	26
The Reference Frequency	27
Input Characteristics	28
Input Terminals	29
Connecting Multiplexers	30
Connecting Input Signals	32
Wiring Considerations	32
Measurement Connections	33
Carrier Cable Assemblies	37
Additional Configurations	39
Selecting VME RAM	39
Disabling Front-panel for Stand-alone Applications	39
Chapter 3. Using the HP E1326B/E1411B Multimeter	41
About This Chapter	41
Using the Programs	41

Making a Single Measurement	42
Making a Burst of Measurements	43
Making an Externally Triggered Burst of Measurements	44
Making Multiple Burst Measurements	45
Scanning a Channel List	46
Making Multiple Scans	47
Making Multiple Paced Scans	48
Making an Externally Triggered Scan	49
Scanning Switchbox Channels (E1326B/E1351A)	50
Scanning Switchbox Channels (E1411B/E1460A)	52
Multiple High-Speed Scans	54
Maximizing Measurement Speed	56
Changing the Data Format	58
Using a PC, C Language, and the HP 82335 HP-IB Interface Card	60
Maximizing Measurement Accuracy	63
Storing Readings in Shared Memory	64
Checking for Errors	66
Synchronizing the Multimeter with a Computer	68
Additional Measurement Functions	69

Chapter 4. Understanding the HP E1326B/E1411B Multimeter 75

About This Chapter	75
Using MEASure and CONFigure Commands	76
How to Make Measurements	78
Using MEASure	78
Using CONFigure	78
Data Formats and Destinations	80
Data Formats	80
Reading Destinations	81
Reading Destination Summary	85
Measurement Functions	86
DC Voltage Measurements	86
RMS AC Voltage Measurements	86
Resistance Measurements	87
Temperature Measurements	88
Specifying a Function	90
Multimeter Parameters	91
Range	93
Autorange	94
Resolution	95
Aperture and Integration Time	97
Autozero	99
Offset Compensation	100
Triggering the Multimeter	101
The Trigger Source	103
The Trigger Count	104
The Trigger Delay	106
The Sample Count	108
The Sample Period	109

The Wait-For-Trigger State	111
Using a Single Trigger	112
Aborting a Measurement	112
Saving Multimeter Configurations	114
How to Save and Recall a Configuration	114

Chapter 5. HP E1326B/E1411B Multimeter Command Reference 117

Using This Chapter	117
Command Types	117
Common Command Format	117
SCPI Command Format	117
Linking Commands	119
SCPI Command Reference	121
ABORt	122
CALibration	123
:LFRequency	123
:LFRequency?	123
:ZERO:AUTO	124
:ZERO:AUTO?	124
CONFigure	126
:FRESistance	127
:RESistance	128
:TEMPerature	129
:VOLTage:AC	130
:VOLTage[:DC]	132
CONFigure?	134
DIAGnostic	135
:FETS	135
:FETS?	135
DISPlay	136
:MONitor:CHANnel	136
:MONitor:CHANnel?	137
:MONitor[:STATe]	137
:MONitor[:STATe]?	138
FETCh?	139
FORMat	140
[:DATA]	140
FORMat?	141
INITiate	142
[:IMMEDIATE]	142
MEASure	143
:FRESistance?	144
:RESistance?	145
:TEMPerature?	146
:VOLTage:AC?	147
:VOLTage[:DC]?	148
MEMory	150
:VME:ADDRess	150

:VME:ADDRESS?	150
:VME:SIZE	151
:VME:SIZE?	151
:VME:STATE	152
:VME:STATE?	152
OUTPut	153
:TTLTrg <i>H</i> [:STATE]	153
:TTLTrg <i>H</i> [:STATE]?	154
READ?	155
SAMPlE	157
:COUNT	157
:COUNT?	158
:SOURce	158
:SOURce?	159
:TIMer	159
:TIMer?	160
[SENSe:]	161
FUNction	162
FUNction?	162
RESistance:APERture	163
RESistance:APERture?	164
RESistance:NPLC	164
RESistance:NPLC?	165
RESistance:OCOMpensated	165
RESistance: OCOMpensated?	165
RESistance:RANGe	166
RESistance:RANGe?	167
RESistance:RANGe :AUTO	167
RESistance:RANGe:AUTO?	168
RESistance:RESolution	168
RESistance:RESolution?	169
VOLTagE:AC:RANGe	169
VOLTagE:AC: RANGe?	170
VOLTagE:APERture	171
VOLTagE:APERture?	171
VOLTagE[:DC]:RANGe	172
VOLTagE[:DC]:RANGe?	173
VOLTagE:NPLC	173
VOLTagE:NPLC?	174
VOLTagE:RANGe:AUTO	174
VOLTagE:RANGe:AUTO?	175
VOLTagE:RESolution	175
VOLTagE:RESolution?	176
SYSTem	177
:CDEscription?	177
:CTYPe?	177

:ERRor?	178
TRIGger	179
:COUNT	179
:COUNT?	180
:DELay	181
:DELay?	181
:DELay:AUTO	182
:DELay:AUTO?	182
[:IMMediate]	183
:SOURce	183
:SOURce?	184
IEEE 488.2 Common Command Reference	186
Command Quick Reference	187
Appendix A. HP E1326B/E1411B Multimeter Specifications	189
General Specifications	189
Appendix B. HP E1326B/E1411B Multimeter Error Messages	197
Appendix C. HP E1326B/E1411B Multimeter Register-Based Programming	199
About This Appendix	199
Register Addressing	199
The Base Address	200
Register Offset	202
Accessing the Registers	202
Register Descriptions	203
The WRITE Registers	203
The Control Register	203
The Command and Parameter Registers	204
The READ Registers	205
The ID Register	205
The Device Type Register	206
The Status Register	206
The Query Response Register	207
The Data Buffer	208
Program Timing and Execution	210
Resetting the Multimeter	210
Configuring the Multimeter	211
Retrieving Measurements	213
Checking for Errors	214
Querying Parameters	215
Using a Multiplexer with the Multimeter	216
Register Triggering	217
The Trigger System	217
Multimeter Triggering Model	218
Control Register Sampling	219
Programming Examples	220

System Configuration	220
Resetting the Multimeter	221
Reading the ID Register	223
Reading the Device Type Register	224
Reading the Query Response Register	226
Reading an Error Code	230
Stand-Alone Multimeter Measurements	234
Scanning Multimeter Measurements	246
Useful Tables	262
Command and Parameter Opcodes	262
Register-Based Programming Error Codes	264
Multimeter Power-On Settings	265
Function and Aperture Change Times	266
VME Interrupts	267
Appendix D. Measurement Speed and Accuracy Tradeoffs	269
Index	279

Certification

Hewlett-Packard Company certifies that this product met its published specifications at the time of shipment from the factory. Hewlett-Packard further certifies that its calibration measurements are traceable to the United States National Institute of Standards and Technology (formerly National Bureau of Standards), to the extent allowed by that organization's calibration facility, and to the calibration facilities of other International Standards Organization members.

Warranty

This Hewlett-Packard product is warranted against defects in materials and workmanship for a period of three years from date of shipment. Duration and conditions of warranty for this product may be superseded when the product is integrated into (becomes a part of) other HP products. During the warranty period, Hewlett-Packard Company will, at its option, either repair or replace products which prove to be defective.

For warranty service or repair, this product must be returned to a service facility designated by Hewlett-Packard (HP). Buyer shall prepay shipping charges to HP and HP shall pay shipping charges to return the product to Buyer. However, Buyer shall pay all shipping charges, duties, and taxes for products returned to HP from another country.

HP warrants that its software and firmware designated by HP for use with a product will execute its programming instructions when properly installed on that product. HP does not warrant that the operation of the product, or software, or firmware will be uninterrupted or error free.

Limitation Of Warranty

The foregoing warranty shall not apply to defects resulting from improper or inadequate maintenance by Buyer, Buyer-supplied products or interfacing, unauthorized modification or misuse, operation outside of the environmental specifications for the product, or improper site preparation or maintenance.

The design and implementation of any circuit on this product is the sole responsibility of the Buyer. HP does not warrant the Buyer's circuitry or malfunctions of HP products that result from the Buyer's circuitry. In addition, HP does not warrant any damage that occurs as a result of the Buyer's circuit or any defects that result from Buyer-supplied products.

NO OTHER WARRANTY IS EXPRESSED OR IMPLIED. HP SPECIFICALLY DISCLAIMS THE IMPLIED WARRANTIES OF MERCHANTABILITY AND FITNESS FOR A PARTICULAR PURPOSE.

Exclusive Remedies

THE REMEDIES PROVIDED HEREIN ARE BUYER'S SOLE AND EXCLUSIVE REMEDIES. HP SHALL NOT BE LIABLE FOR ANY DIRECT, INDIRECT, SPECIAL, INCIDENTAL, OR CONSEQUENTIAL DAMAGES, WHETHER BASED ON CONTRACT, TORT, OR ANY OTHER LEGAL THEORY.

Notice

The information contained in this document is subject to change without notice. HEWLETT-PACKARD (HP) MAKES NO WARRANTY OF ANY KIND WITH REGARD TO THIS MATERIAL, INCLUDING, BUT NOT LIMITED TO, THE IMPLIED WARRANTIES OF MERCHANTABILITY AND FITNESS FOR A PARTICULAR PURPOSE. HP shall not be liable for errors contained herein or for incidental or consequential damages in connection with the furnishing, performance or use of this material. This document contains proprietary information which is protected by copyright. All rights are reserved. No part of this document may be photocopied, reproduced, or translated to another language without the prior written consent of Hewlett-Packard Company. HP assumes no responsibility for the use or reliability of its software on equipment that is not furnished by HP.

U.S. Government Restricted Rights

The Software and Documentation have been developed entirely at private expense. They are delivered and licensed as "commercial computer software" as defined in DFARS 252.227-7013 (October 1988), DFARS 252.211.7015 (May 1991) or DFARS 252.227-7014 (June 1995), as a "commercial item" as defined in FAR 2.101(a), or as "Restricted computer software" as defined in FAR 52.227-19 (June 1987) (or any equivalent agency regulation or contract clause), whichever is applicable. You have only those rights provided for such Software and Documentation by the applicable FAR or DFARS clause or the HP standard software agreement for the product involved.



HP E1326B/E1411B 5 1/2-Digit Multimeter User's Manual
Edition 4

Copyright © 1996 Hewlett-Packard Company. All Rights Reserved.

Documentation History

All Editions and Updates of this manual and their creation date are listed below. The first Edition of the manual is Edition 1. The Edition number increments by 1 whenever the manual is revised. Updates, which are issued between Editions, contain replacement pages to correct or add additional information to the current Edition of the manual. Whenever a new Edition is created, it will contain all of the Update information for the previous Edition. Each new Edition or Update also includes a revised copy of this documentation history page.

Edition 1 August 1990
Edition 2 March 1994
Edition 3 April 1995
Edition 4 February 1996

Safety Symbols



Instruction manual symbol affixed to product. Indicates that the user must refer to the manual for specific WARNING or CAUTION information to avoid personal injury or damage to the product.



Alternating current (AC).



Direct current (DC).

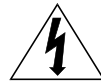

Indicates hazardous voltages.



Indicates the field wiring terminal that must be connected to earth ground before operating the equipment—protects against electrical shock in case of fault.

WARNING

Calls attention to a procedure, practice, or condition that could cause bodily injury or death.

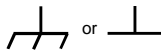

Frame or chassis ground terminal—typically connects to the equipment's metal frame.

CAUTION

Calls attention to a procedure, practice, or condition that could possibly cause damage to equipment or permanent loss of data.

WARNINGS

The following general safety precautions must be observed during all phases of operation, service, and repair of this product. Failure to comply with these precautions or with specific warnings elsewhere in this manual violates safety standards of design, manufacture, and intended use of the product. Hewlett-Packard Company assumes no liability for the customer's failure to comply with these requirements.

Ground the equipment: For Safety Class 1 equipment (equipment having a protective earth terminal), an uninterruptible safety earth ground must be provided from the mains power source to the product input wiring terminals or supplied power cable.

DO NOT operate the product in an explosive atmosphere or in the presence of flammable gases or fumes.

For continued protection against fire, replace the line fuse(s) only with fuse(s) of the same voltage and current rating and type. DO NOT use repaired fuses or short-circuited fuse holders.

Keep away from live circuits: Operating personnel must not remove equipment covers or shields. Procedures involving the removal of covers or shields are for use by service-trained personnel only. Under certain conditions, dangerous voltages may exist even with the equipment switched off. To avoid dangerous electrical shock, DO NOT perform procedures involving cover or shield removal unless you are qualified to do so.

DO NOT operate damaged equipment: Whenever it is possible that the safety protection features built into this product have been impaired, either through physical damage, excessive moisture, or any other reason, REMOVE POWER and do not use the product until safe operation can be verified by service-trained personnel. If necessary, return the product to a Hewlett-Packard Sales and Service Office for service and repair to ensure that safety features are maintained.

DO NOT service or adjust alone: Do not attempt internal service or adjustment unless another person, capable of rendering first aid and resuscitation, is present.

DO NOT substitute parts or modify equipment: Because of the danger of introducing additional hazards, do not install substitute parts or perform any unauthorized modification to the product. Return the product to a Hewlett-Packard Sales and Service Office for service and repair to ensure that safety features are maintained.

Declaration of Conformity
according to ISO/IEC Guide 22 and EN 45014

Manufacturer's Name: Hewlett-Packard Company
Loveland Manufacturing Center

Manufacturer's Address: 815 14th Street S.W.
Loveland, Colorado 80537

declares, that the product:

Product Name: 5 1/2 Digit Multimeter

Model Number: HP E1326B

Product Options: All

conforms to the following Product Specifications:

Safety: HD 401/IEC 348
CSA 231
UL 1244

EMC: EN55011 (1991)
/CISPR11 Group 1 Class A
EN50082-1 (1991)
/IEC 801-2
/IEC 801-3
/IEC 801-4

Tested in a typical configuration in an HP B-Size VXI mainframe.

December 18, 1991

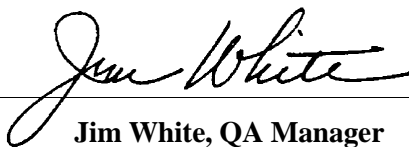

Jim White, QA Manager

European contact: Your local Hewlett-Packard Sales and Service Office or Hewlett-Packard GmbH, Department HQ-TRE, Herrenberger Straße 130, D-71034 Böblingen, Germany (FAX +49-7031-14-3143).

Declaration of Conformity
according to ISO/IEC Guide 22 and EN 45014

Manufacturer's Name: Hewlett-Packard Company
Loveland Manufacturing Center

Manufacturer's Address: 815 14th Street S.W.
Loveland, Colorado 80537

declares, that the product:

Product Name: 5 1/2 Digit Multimeter

Model Number: HP E1411B

Product Options: All

conforms to the following Product Specifications:

Safety: IEC 1010-1 (1990) Incl. Amend 1 (1992)/EN61010-1 (1993)
CSA C22.2 #1010.1 (1992)
UL 3111

EMC: CISPR 11:1990/EN55011 (1991): Group1 Class A
IEC1000-4-2:1995/prEN50082-1 (1995): 4 kV CD, 8 kV AD
ENV50140:1993/prEN50082-1 (1995): 3 V/m
IEC1000-4-4:1995/prEN50082-1 (1995): 1 kV Power Line
ENV50141:1993/prEN50082-1 (1995): 3 Vrms
ENV50142:1994/prEN50082-1 (1995): 1 kV CM, 0.5 kV DM
IEC1000-4-8:1993/prEN50082-1 (1995): 3 A/m
EN61000-4-11:1994/prEN50082-1 (1995): 30%, 10 ms 60%, 100 ms

Supplementary Information: The product herewith complies with the requirements of the Low Voltage Directive 73/23/EEC and the EMC Directive 89/336/EEC (inclusive 93/68/EEC) and carries the "CE" mark accordingly.

Tested in a typical configuration in an HP C-Size VXI mainframe.

February 15, 1995

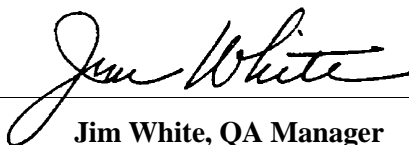

Jim White, QA Manager

European contact: Your local Hewlett-Packard Sales and Service Office or Hewlett-Packard GmbH, Department HQ-TRE, Herrenberger Straße 130, D-71034 Böblingen, Germany (FAX +49-7031-14-3143).

Please fold and tape for mailing

Reader Comment Sheet

HP E1326B/E1411B 5 1/2-Digit Multimeter User's Manual
Edition 4

You can help us improve our manuals by sharing your comments and suggestions. **In appreciation of your time, we will enter you in a quarterly drawing for a Hewlett-Packard Palmtop Personal Computer** (U.S. government employees cannot participate in the drawing).

_____ Your Name	_____ City, State/Province
_____ Company Name	_____ Country
_____ Job Title	_____ Zip/Postal Code
_____ Address	_____ Telephone Number with Area Code

Please list the system controller, operating system, programming language, and plug-in modules you are using.

fold here

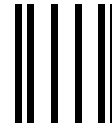

NO POSTAGE
NECESSARY
IF MAILED
IN THE
UNITED STATES



POSTAGE WILL BE PAID BY ADDRESSEE

HEWLETT-PACKARD COMPANY
Measurement Systems Division
Learning Products Department
P.O. Box 301
Loveland, CO 80539-9984

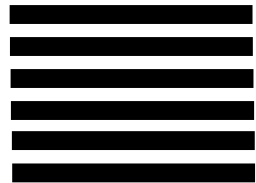

cut along this line



fold here

Please pencil-in one circle for each statement below:

Disagree ←————→ Agree

- | | | | | | |
|--|-----------------------|-----------------------|-----------------------|-----------------------|-----------------------|
| • The documentation is well organized. | <input type="radio"/> | <input type="radio"/> | <input type="radio"/> | <input type="radio"/> | <input type="radio"/> |
| • Instructions are easy to understand. | <input type="radio"/> | <input type="radio"/> | <input type="radio"/> | <input type="radio"/> | <input type="radio"/> |
| • The documentation is clearly written. | <input type="radio"/> | <input type="radio"/> | <input type="radio"/> | <input type="radio"/> | <input type="radio"/> |
| • Examples are clear and useful. | <input type="radio"/> | <input type="radio"/> | <input type="radio"/> | <input type="radio"/> | <input type="radio"/> |
| • Illustrations are clear and helpful. | <input type="radio"/> | <input type="radio"/> | <input type="radio"/> | <input type="radio"/> | <input type="radio"/> |
| • The documentation meets my overall expectations. | <input type="radio"/> | <input type="radio"/> | <input type="radio"/> | <input type="radio"/> | <input type="radio"/> |

Please write any comments or suggestions below--be specific.

Chapter 1 Getting Started with the HP E1326B/E1411B Multimeter

About This Chapter

This chapter introduces you the B-size HP E1326B and C-size HP E1411B 5½ - Digit Multimeters. The main sections of the chapter are:

- Multimeter Overview Page 13
- Introduction to Operation. Page 16

Note This manual is to be used with the HP E1326B or HP E1411B installed in the HP 75000 Series B or Series C mainframe, and when the multimeter is programmed using Standard Commands for Programmable Instruments (SCPI) language or when it is programmed at the register level.

Multimeter Overview

The HP E1326B/E1411B multimeter is a register-based VXI instrument. There are two different methods of programming the multimeter based on the system configuration that it is used in.

If the HP E1326B is used in an HP E1300/E1301/E1302 B-size VXI mainframe, or if the HP E1326B/E1411B is used in a C-size VXI mainframe with an HP E1405/E1406 Command Module or with a computer which has HP Compiled SCPI software, then it may be programmed using SCPI language. This is the method described in Chapters 1 through 5.

If the HP E1326B is in a VME mainframe or the E1326B/E1411B is in a C-size VXI mainframe and no HP Command Module or computer with Compiled SCPI is present, then the multimeter must be programmed at the register level. Appendix C covers register level programming.

The HP SCPI driver provides an error queue, input and output buffers, status registers, and is allocated a portion of mainframe memory for reading storage. This "instrument" may consist of the multimeter, or it can also include multiplexers such as the HP E1345A/46A/47A/51A/53A and the HP E1460A/76A. The instrument is operated from the mainframe front panel or from a computer using the SCPI language.

Instruments are based on the logical addresses of the plug-in modules. The *HP VXIbus Systems Installation and Getting Started Guide* explains how to

set the addresses in order to create an instrument. The guide should be your starting point toward using the multimeter. The functions and features of the multimeter are presented in the following functional, electrical, and physical descriptions.

Functional Description

The 5½ - digit multimeter can be used stand-alone, or combined with multiplexers (for example, HP E1345A/46A/47A/51A/52A/55A/56A/57A/58A or HP E1460A/76A) to form a scanning multimeter.

In stand-alone operation, input signals are connected to the multimeter's external (faceplate) terminals. In scanning operation, input signals are connected to the multiplexer channels. The multimeter is linked to relay multiplexer(s) via an analog bus cable. The multimeter is linked to FET multiplexers via an analog cable and a digital bus cable.

Measurement Functions

The multimeter's measurement functions are shown below. These functions are typical of those required for many data acquisition and computer aided test applications.

- DC Voltage
- RMS AC voltage
- 2-Wire Resistance (scanning multimeter only)
- 4-Wire Resistance
- Temperature (thermistors, RTDs, thermocouples)

Configuring the Multimeter

With MEASure or CONFigure, the multimeter is configured for measurements using a single command. When necessary, low-level commands are available to set configurations for unique applications. Such commands, for example, allow you to enable autozero or offset compensation, or change various analog-to-digital (A/D) converter parameters.

Triggering the Multimeter

The multimeter's trigger system allows it to be internally or externally triggered. The system enables you to scan a multiplexer channel list multiple times, or in the stand-alone configuration, take multiple readings per trigger. An on-board timer allows you to pace measurements.

Reading Storage

Readings are returned directly to the multimeter's output buffer or are stored in mainframe memory. The total number of readings which can be stored (all multimeters combined) depends on the amount of memory available. Each reading stored will consume four bytes of memory.

Saving Configurations

To minimize repeated programming, up to 10 stand-alone multimeter configurations can be saved and recalled. The configurations remain in memory until a new configuration is saved or until power is cycled.

Electrical Description

The electrical performance of the multimeter is summarized in Table 1-1. Refer to Appendix A for a complete table of specifications.

Table 1-1. HP E1326B/E1411B Operating Characteristics

DC Voltage	
Ranges	0.125V, 1.0V, 8.0V, 64.0V, 300V full scale.
Resolution	120nV on 0.125V range with 20/16.7 msec aperture time.
Accuracy (90 days)	0.01%
Max Rdgs/sec	13,150
AC RMS Voltage	
Ranges	0.0875V, 0.7V, 5.6V, 44.8V, 300V full scale.
Resolution	29.8nV on 0.0875V range with 320/267 msec aperture time.
Accuracy (90 days)	0.625%
Frequency Range	20 Hz to 10 kHz
2-Wire and 4-Wire Resistance	
Ranges	256Ω, 2048Ω, 16384Ω, 131072Ω, 1048576Ω full scale.
Resolution	250mΩ on 256Ω range with 20/16.7 msec aperture time.
Accuracy (90 days)	0.025%

Physical Description

The 5¹/₂ - digit multimeter occupies one B-Size or one C-Size mainframe slot. However, the faceplate of the B-size multimeter covers up an additional slot in the B-Size mainframe. This prevents another B-size card from being installed in the slot directly above the multimeter. An internal installation kit, discussed in Chapter 2, enables you to install the multimeter internal to the HP 75000 Series B mainframe. This saves two externally accessed slots.

Input Terminals

There are four input terminals on the faceplate of the multimeter (see Figure 2-7 on page 29). The terminals, which are isolated from chassis ground, are used to connect input signals when the multimeter is used stand-alone.

A high-to-low TTL pulse applied to the External Trigger port externally triggers the multimeter. The Analog Bus and Digital Bus ports allow relay and FET multiplexers to be connected to the multimeter.

Introduction to Operation

This section contains information on checking communication between the multimeter, mainframe, and computer. It includes information on returning the multimeter to a known operating state should programming errors occur or if you simply want to start over. It also shows how to send a command to configure the multimeter and make a measurement.

Note The HP E1411B has a "Failed" annunciator and an "Access" annunciator on the faceplate. The "Failed" annunciator turns on if the multimeter does not properly respond during the mainframe's power-on sequence. If this occurs, return the multimeter to Hewlett-Packard for service. The "Access" annunciator turns on each time the multimeter receives a command.

Multimeter Self-Test

Once the mainframe completes its power-on sequence, the multimeter is ready for use. Sending the self-test command is an easy way to verify that you are properly addressing the multimeter. Also, the self-test is useful in locating intermittent problems that might occur during operation. The command used to execute the self-test is:

*TST?

You can also run the self-test by selecting "TEST" from the multimeter's front panel menu on the HP E1301A mainframe. Upon execution, the self-test resets the multimeter, performs the test, and returns one of the codes listed in Table 1-2.

The following program executes the self-test. The program assumes the mainframe (command module for C-size systems) is at primary HP-IB address of 09 and the multimeter is at secondary address 03. The program also assumes an HP 9000 Series 200/300 computer is used.

```
10  !Send the self-test command to the multimeter.
20  OUTPUT 70903;"*TST?"
30  !Enter and display the self-test code.
40  ENTER 70903;A
50  PRINT A
60  !Reset the multimeter.
70  OUTPUT 70903;"*RST"
80  END
```

After the test passes, always reset the multimeter to return it to a known state.

Table 1-2. HP E1326/E1411 Self-Test Codes

Self-Test Code	Description
0	Test passed.
1	Multimeter does not respond to the self-test.
2	Invalid communication between the multimeter's two on-board processors.
3	Data line test between the multimeter and the mainframe command module failed.
4	Invalid communication between the multimeter and mainframe command module.

If self-test code 1, 2, 3, or 4 occurs, return the multimeter to Hewlett-Packard for repair.

Note If the multimeter did not respond to the self-test, the address you specified may be incorrect. Refer to Chapter 2 in this manual and the *HP VXibus Systems Installation and Getting Started Guide*.

Resetting the Multimeter

During operation, programming errors and other conditions may occur making it necessary to reset the multimeter. This section shows you how to reset and clear the multimeter, and read its error queue.

The multimeter is reset with the command:

```
*RST
```

which can be sent from an HP 9000 Series 200/300 computer as:

```
OUTPUT 70903;"*RST"
```

The multimeter can also be reset by pressing the green “**Reset Instr**” key on the HP E1301A mainframe front panel. Note that the multimeter must first be selected from the mainframe menu.

When resetting the multimeter:

- A front panel reset (“**Reset Instr**” key on the HP E1301A mainframe) returns the multimeter to the idle state from the busy state and sets the multimeter’s power-on configuration (Table 1-3). A front panel reset is equivalent to clearing the multimeter followed by a reset.
- A reset from the computer (*RST) returns the multimeter to the idle state from the busy state if the multimeter is busy due to a command entered from the front panel. If the multimeter is busy due to a command sent from the computer, you must clear the multimeter before sending the reset. The reset sets the multimeter’s power-on configuration.

Table 1-3. HP E1326/E1411 Power-on Settings

Parameter	Setting
FUNCtion	VOLT:DC
VOLTage:RANGe	8V
RESistance:RANGe	16384 Ω
VOLTage:RANGe:AUTO	ON
RESistance:RANGe:AUTO	ON
VOLTage:RESolution	7.629 μ V
RESistance:RESolution	15.6 m Ω
VOLTage:APERture	16.7 ms or 20 ms (based on line frequency)
RESistance:APERture	16.7 ms or 20 ms (based on line frequency)
CALibration:LFRequency	Unchanged (factory setting = 60 Hz)
VOLTage:NPLC	1
RESistance:NPLC	1
RESistance:OCOMPensated	OFF
CALibration:ZERO:AUTO	ON
TRIGger:COUNt	1
TRIGger:DELay:AUTO	ON
TRIGger:SOURce	IMM
SAMPle:COUNt	1
SAMPle:SOURce	IMM

Clearing the Multimeter

When the multimeter is selected from the HP E1301A mainframe menu, the multimeter is cleared by pressing the “**Clear Instr**” key on the front panel. The multimeter is also cleared by sending the following command from an HP 9000 Series 200 or Series 300 controller:

```
CLEAR 70903
```

Clearing the multimeter:

- allows you to regain control without cycling power and without setting the power-on configuration.
- with the HP E1301A “**Clear Instr**” key terminates any command entered from the front panel. A command sent from the computer will still continue to execute.
- from the computer (CLEAR 70903) terminates any command sent from the computer. A command entered from the HP E1301A front panel will still continue to execute.
- erases any pending commands. For example, if commands are sent from the computer to the multimeter while the multimeter is waiting for an external trigger, the commands are buffered until they can execute after the trigger is received. Clearing the multimeter (from the computer) erases those commands. Similarly, clearing the multimeter from the HP E1301A front panel erases any pending front panel commands.
- if cleared from the HP E1301A front panel, the display buffer is cleared. If cleared over HP-IB, the data in the output buffer is erased.

The Error Queue

When an error occurs during operation, an error code and corresponding message are stored in the multimeter’s error queue. If the Series B mainframe has a display (HP E1301A) and the multimeter is being monitored, the "err" annunciator will turn on.

Since many mainframes may not have a front panel display, the other way to determine if an error has occurred is to read the error queue. This is done with the command:

```
SYSTEM:ERR?
```

The following program shows how the command is used to read and clear the error queue.

```
10 !Declare a string variable in the computer to store the error message.
20 DIM Message$[256]
30 !Read the error queue until no errors remain.
40 !Print the error codes and messages.
50 REPEAT
60   OUTPUT 70903;"SYST:ERR?"
70   ENTER 70903;Code,Message$
80   PRINT Code,Message$
90 UNTIL Code=0
100 END
```

The error queue can store up to 30 error messages which are retrieved in a first in, first out (FIFO) manner. When there are no error messages in the queue, a code of 0 and the message "No Error" are returned. Errors generated during front panel operation are displayed but are not stored in the error queue.

Note Appendix B contains a list of error messages associated with the multimeter and their causes.

Making a Measurement

The HP E1326B/E1411B multimeter can be configured and make measurements using the MEASure command. The following examples show how it is used with the stand-alone and scanning multimeters.

Example: Making a Measurement (Stand-Alone Multimeter)

This example uses the MEASure command to make a DC voltage measurement on the terminals connected to the multimeter's faceplate. The reading is then entered into the computer and displayed.

```
10  OUTPUT 70903;"MEAS:VOLT:DC?"
20  ENTER 70903;Rdg
30  PRINT Rdg
40  END
```

Example: Making a Measurement (Scanning Multimeter)

This example uses the MEASure command to scan a list of multiplexer channels and make a DC voltage measurement on each channel. The readings are then entered into the computer and displayed.

```
10  DIM Rdgs(1:5)
20  OUTPUT 70903;"MEAS:VOLT:DC? (@100:104)"
30  ENTER 70903;Rdgs(*)
40  PRINT Rdgs(*)
50  END
```

Chapter 2

Configuring the HP E1326B/E1411B

Multimeter

About This Chapter

This chapter contains information on connecting input signals to the multimeter using multiplexers and using the terminals on the multimeter's faceplate. The main sections of the chapter are:

- Installation Overview Page 21
- Input Characteristics Page 28
- Connecting Input Signals Page 32
- Carrier Cable Assemblies Page 37
- Additional Configurations Page 39

WARNING **SHOCK HAZARD. Only service-trained personnel who are aware of the hazards involved should install or configure the multimeter. Remove all sources of power to the multimeter and mainframe before removing the multimeter.**

The maximum allowable input on the multimeter terminals is 300 V dc (450 V ac peak). Since the terminals are isolated from the multimeter chassis, the potential between the terminals and the chassis is equal to the value of the input signal.

Installation Overview

As mentioned in the *HP VXibus Systems Installation and Getting Started Guide*, each plug-in module has a row of switches which set the module's logical address. Based on this address, the system instrument within the HP 75000 Series B mainframe and HP E1406A command module combines the modules into virtual instruments. The instruments are programmed by a computer using SCPI language or from a computer by writing commands directly to the multimeter registers (see Appendix C).

This section shows the location of the multimeter's logical address switch and shows how it is set. It also mentions considerations when installing the multimeter in the mainframe.

Setting the Logical Address Switch

Figure 2-1 shows the location and settings of the multimeter’s logical address switch.

The switch has a factory setting of 24 which is equivalent to a secondary HP-IB address of 03. If you have more than one multimeter, you must change the logical address to some other multiple of 8 (for example, 32, 40, 48...), as there can only be one instrument per secondary address.

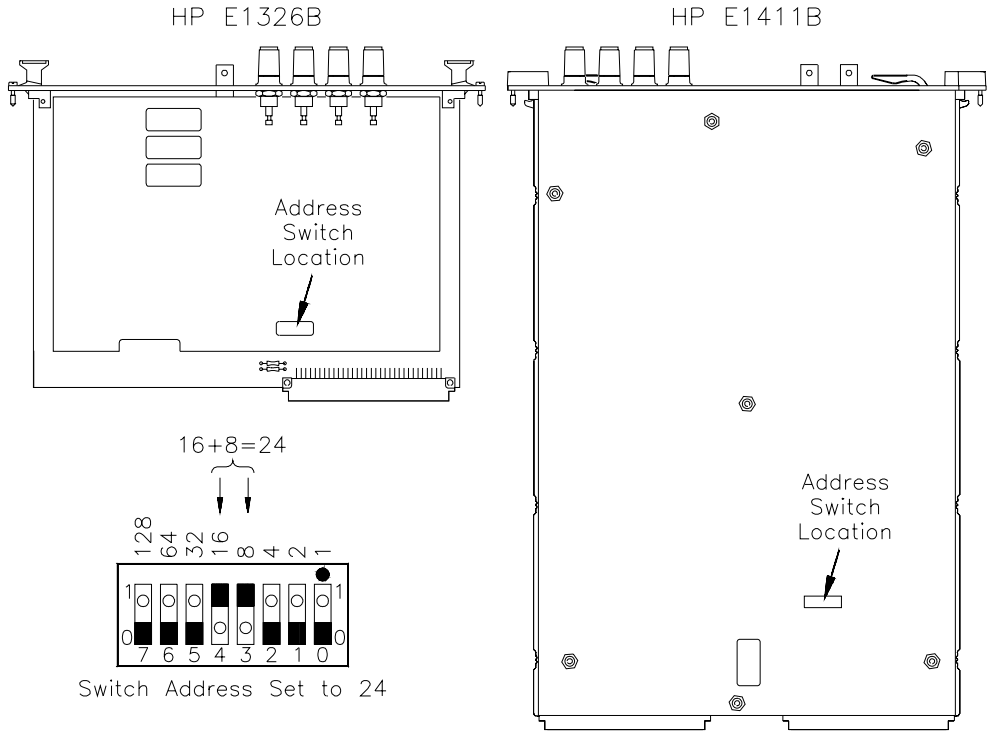

Figure 2-1. HP E1326/1411 Logical Address Switch Settings

Forming a Scanning Multimeter

If multiplexers are used to form a scanning multimeter, they must be assigned successive logical addresses beginning with the address immediately following that of the multimeter. An example is shown in Figure 2-2.

The scanning multimeter can consist of relay multiplexers, FET multiplexers, or a combination of both. See “Connecting Multiplexers” on page 30 for information on physically connecting the multiplexers to the multimeter.

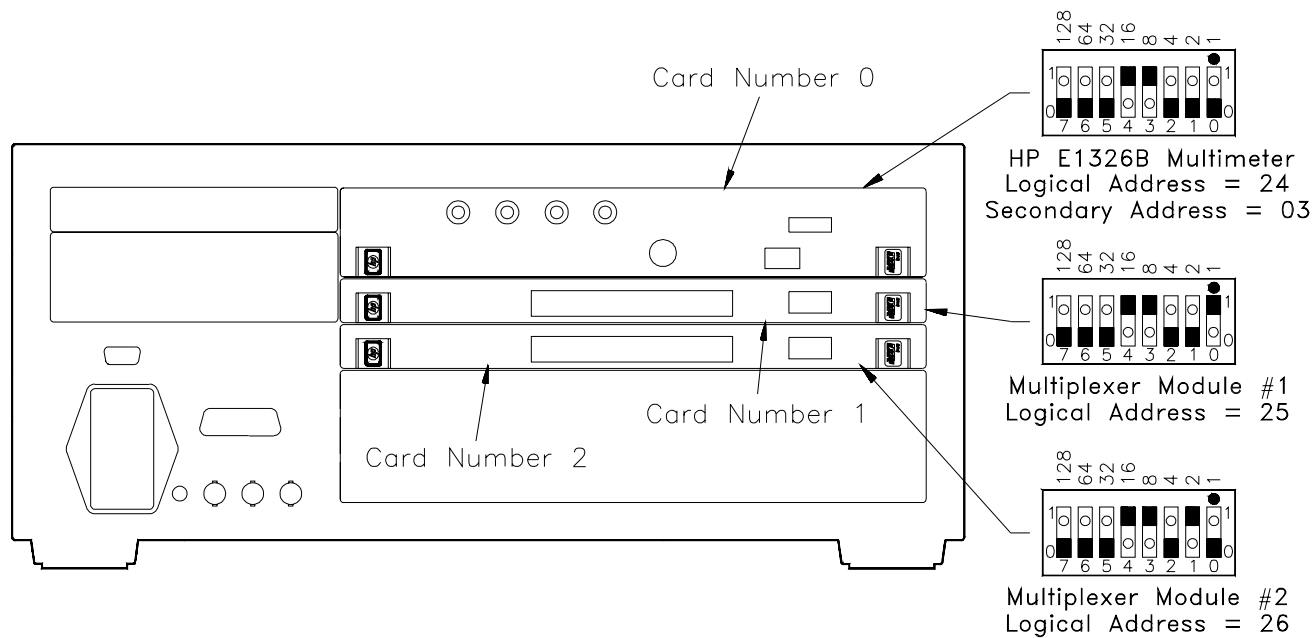

Figure 2-2. Setting Successive Logical Addresses to Form an Instrument

VXIbus Interrupt Lines

The multimeter sends interrupts to, and receives acknowledgements from the slot 0 module via the VXIbus backplane interrupt lines. Since the multimeter is a nonprogrammable interrupter, the interrupt line is selected with the multimeter's IRQ jumper.

There are seven backplane interrupt lines. At the factory, the IRQ jumper is set to line 1. The system instrument in the Series B mainframe is assigned to each line, and the system instrument in the HP E1406A command module is assigned to line 1 by default. Therefore, in Series B systems it is not necessary to change the IRQ jumper setting. If the command module in Series C systems is assigned another line and the multimeter is to use that line, the IRQ jumper must be set accordingly. Figure 2-3 shows the location of the jumpers used to select an interrupt line. For most applications where the multimeter is installed in an HP 75000 Series B or Series C mainframe, the jumpers do not have to be moved.

Note IRQ OFF is set when the multimeter is installed in systems without a Series B mainframe or HP E1406A command module.

Interrupt Priority In the HP 75000 Series B and Series C mainframes, the VXIbus interrupt lines have the same priority; therefore, interrupt priority is established by installing modules in slots numerically closest to the slot 0 module. Thus, slot 1 (internal on the Series B mainframe) has a higher priority than slot 2 (also internal), slot 2 has a higher priority than slot 3, and so on.

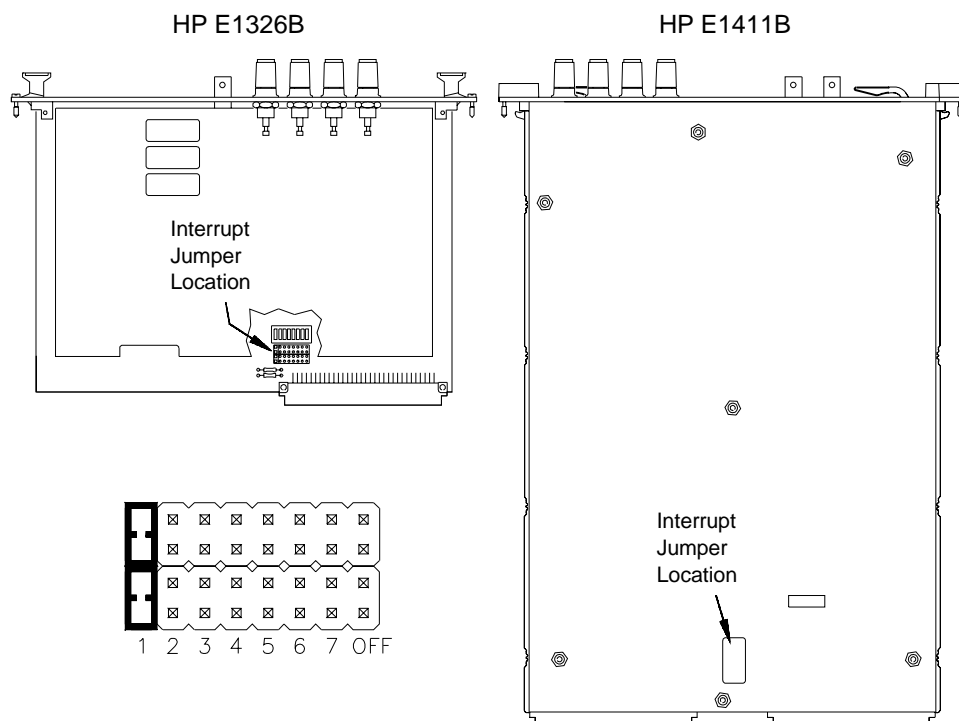

Figure 2-3. Interrupt Jumper Locations

HP E1326B Internal Installation

When the HP E1326B is installed in an HP E1300A/E1301A/E1302A mainframe, it occupies one slot. However, the faceplate to which the input terminals are connected covers up an additional slot. This prevents another module from being installed in the slot directly above the multimeter.

To make the two slots available to other modules, the HP E1326B can be installed internal to the mainframe (in slot 2) using an internal installation kit (HP P/N E1326-80004).

Multimeter installation into the external slots is covered in the *Installation and Getting Started Guide*. Instructions for installing the multimeter internally are included in the installation kit.

Connecting the HP E1326B Adapter

If the HP E1326B multimeter is installed internal to the HP E1300A/E1301A mainframe, the HP E1326-80005 adapter can be used to provide HI, LO, COM, and HI banana plug terminals for the multimeter. When the adapter is connected as shown in Figure 2-4, the terminals, rather than the multiplexer, are the input to the multimeter.

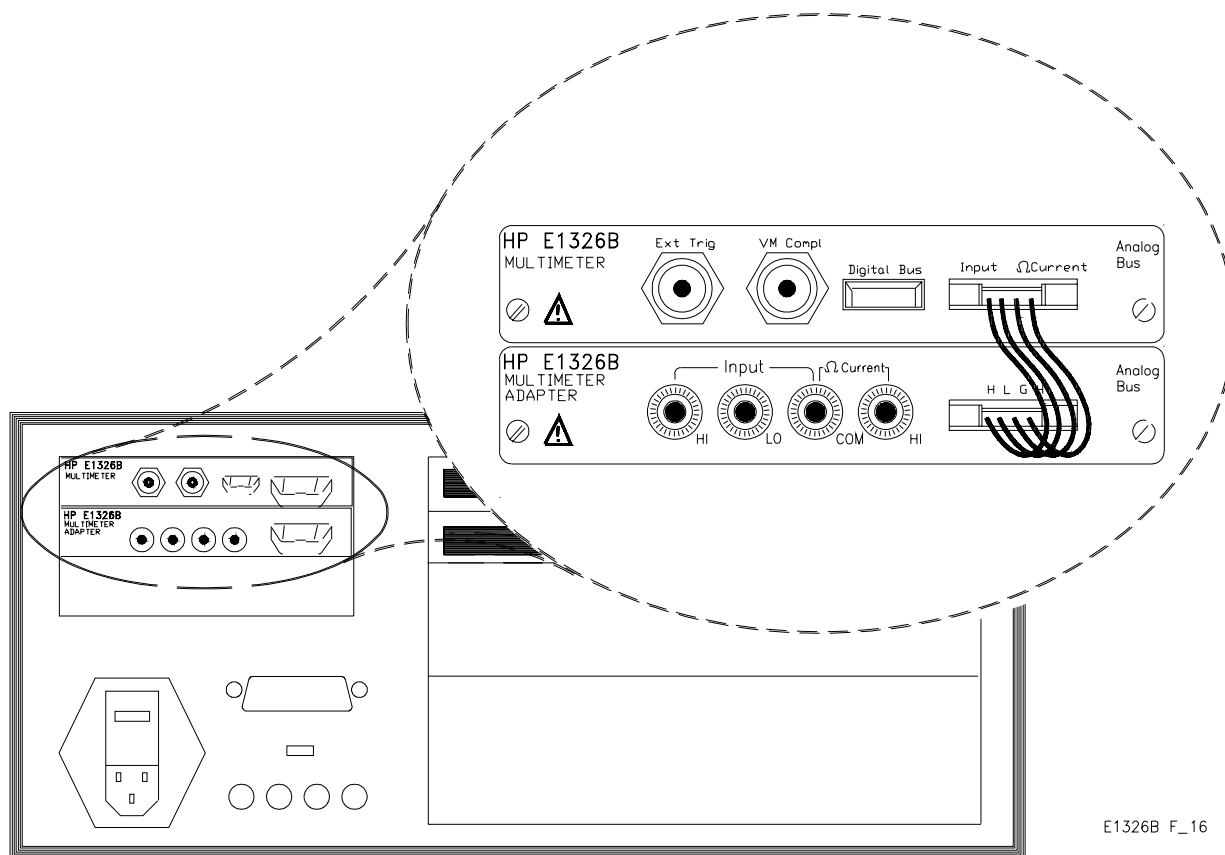

E1326B F_16

Figure 2-4. Connecting the HP E1326B Adapter

Installing the HP E1411B in a Mainframe

The HP E1411B multimeter can be installed in any slot (except slot 0) in a C-size VXIbus mainframe. Refer to Figure 2-5 to install the E1411B in a mainframe.

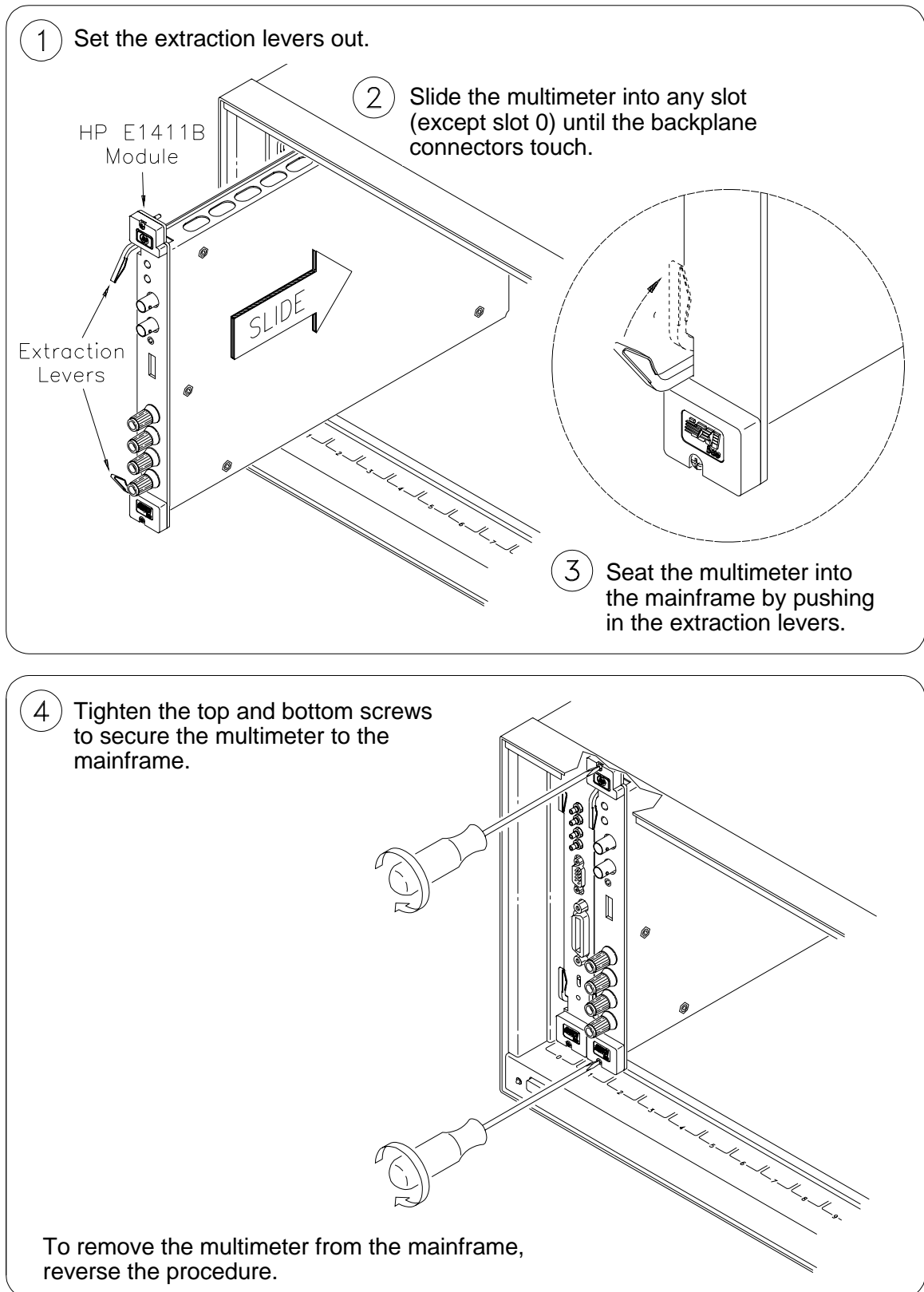

Figure 2-5. Installing the HP E1411B Multimeter in a VXIbus Mainframe

The Reference Frequency

In many data acquisition applications, DC voltage and resistance measurements are often made in the presence of normal mode noise. This type of noise emanates from the surrounding environment, primarily from 50 Hz and 60 Hz power lines. The HP E1326B/E1411B multimeter is able to reject normal mode noise by using an integrating analog-to-digital (A/D) converter. The integration process averages out the power line related noise over an integer number of power line cycles (PLCs) during the A/D conversion. The multimeter's ability to reject noise at the power line frequency is expressed in terms of normal mode rejection (NMR).

Setting the Reference Frequency

In certain applications, the multimeter's power line frequency may be different from the line frequency of the device being measured. Assume, for example, the multimeter has a power line frequency of 60 Hz and the device being measured has a line frequency of 400 Hz. Normal mode rejection can be achieved by setting the reference frequency to 50 Hz. This is done with the command:

```
CALibration:LFrequency frequency | MIN | MAX
frequency is power line frequency. Settings are 50 or 60.
MIN sets the minimum power line frequency (50 Hz).
MAX sets the maximum power line frequency (60 Hz).
```

The reference frequency is set to 60 Hz at the factory. The setting is stored in non-volatile memory and is changed only when CALibration:LFrequency is executed.

Querying the Reference Frequency

The reference frequency is queried with the following commands. See Chapter 5 for additional information about these commands.

```
CALibration:LFrequency?
CALibration:LFrequency? MIN | MAX
```

Input Terminals

The multimeter input terminals are shown in Figure 2-7. The maximum input on the HI and LO terminals is 300 V dc (450 V ac peak). The maximum amount of common mode voltage developed between LO and COM and HI (current) and COM cannot exceed 15 V peak.

CAUTION

A maximum voltage of 300 V dc (450 V ac peak) is allowed on the multimeter's rear terminals. Multiplexers connected to the multimeter reduce the voltage that can be applied between the multiplexer's High (H), Low (L), and Guard terminals, to the level specified for the multiplexer. For example,

HP E1343A/44A 250 V dc or 354 V ac peak
 HP E1345A/47A 120 V dc or 170 V ac peak
 HP E1351A 14 V dc or ac peak

Mixing of multiplexer types reduces all voltage ratings to that of the lowest rated multiplexer. For example, if an HP E1343A and E1351A are connected to the same multimeter, then the system rating is that of the E1351A, which is 14 V.

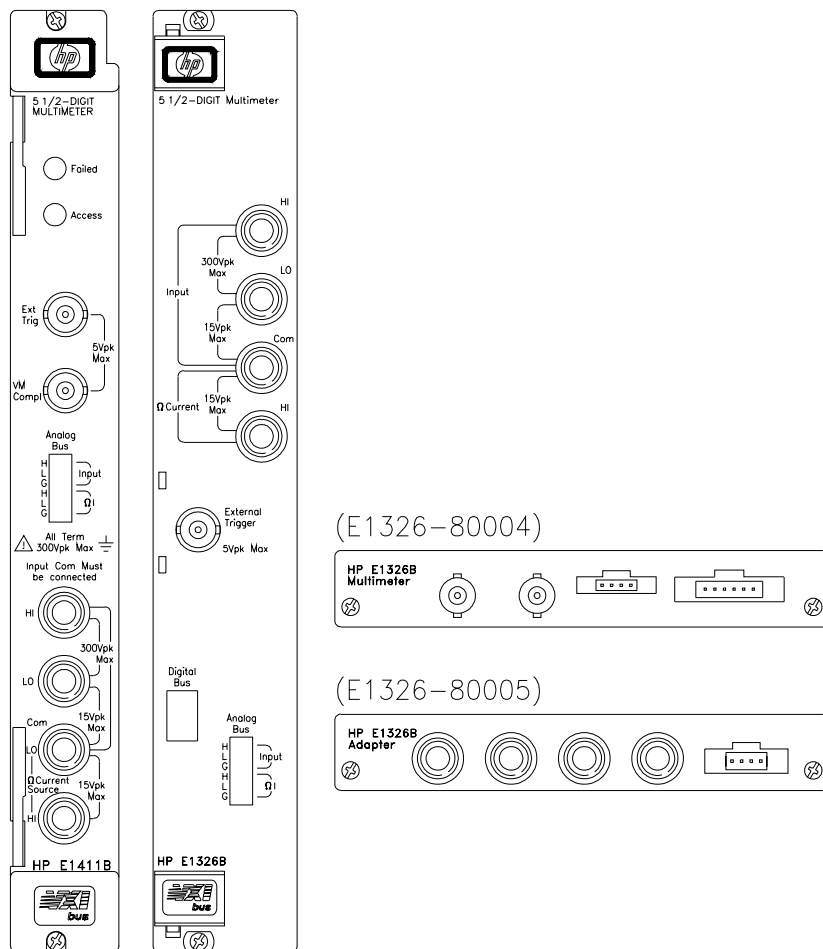

Figure 2-7. HP E1326B/E1411B Input Terminals

Connecting Multiplexers

In a scanning multimeter configuration, the multimeter is connected to the multiplexers with an analog bus cable, or with the analog bus cable and a digital bus cable. The cable(s) used is determined as follows:

1. If the scanning multimeter uses **relay multiplexers only**, the **analog bus cable** is used.
2. If the scanning multimeter uses **FET multiplexers only**, the **analog bus cable** and the **digital bus cable** are used.
3. If the scanning multimeter uses a **combination of relay and FET multiplexers**, only the **analog bus cable** is used.

Figure 2-8 shows how the analog and digital bus cables are connected.

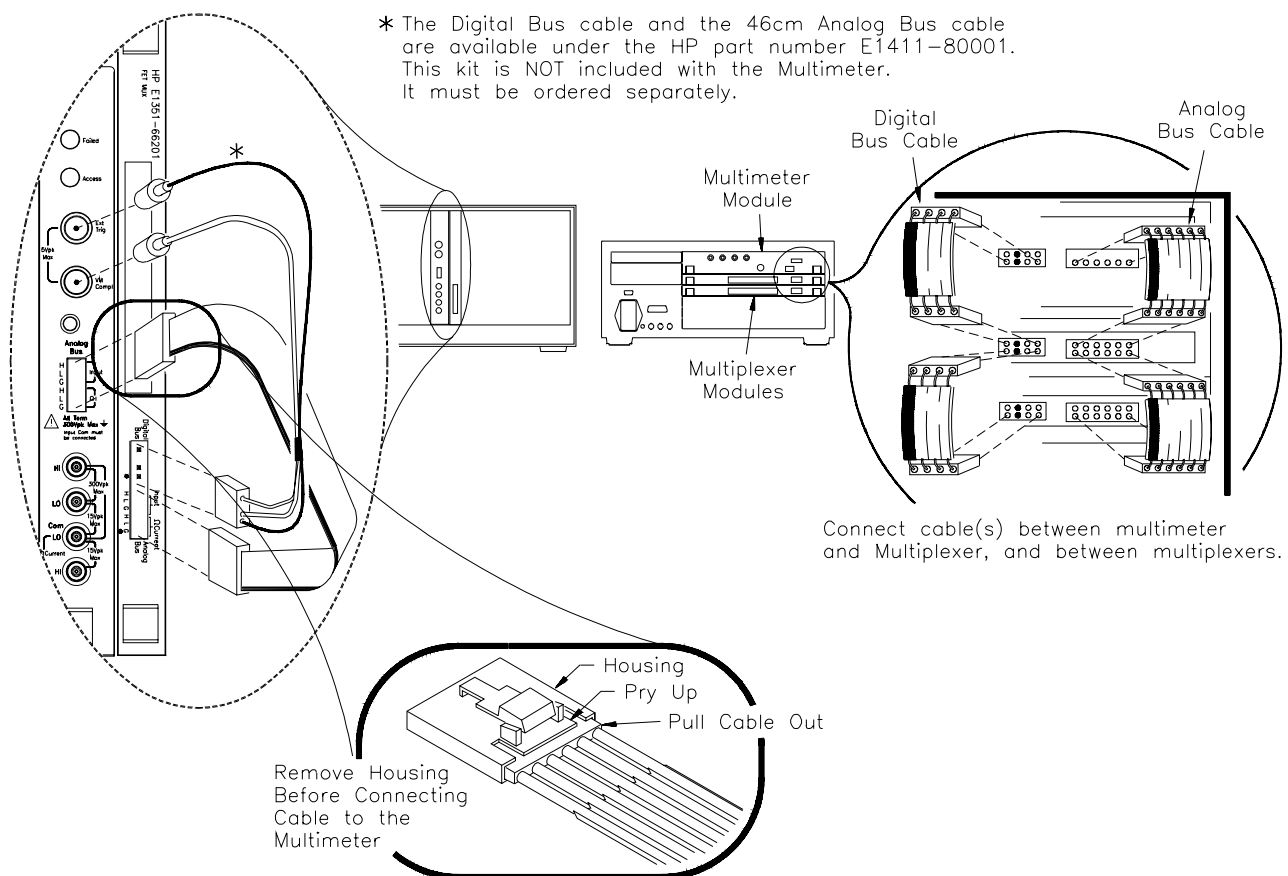

Figure 2-8. Connecting the Analog and Digital Bus Cables

Analog Bus Connections at the Multimeter

The analog bus coming from the multiplexer consists of six lines. On the multiplexer terminal block these lines are labeled:

H L G I+ I- IG

Where the ribbon cable connects the multiplexer to the multimeter the lines are labeled:

H L G H L G

The lines are then connected to the multimeter's HI LO COM HI lines as shown in Figure 2-9.

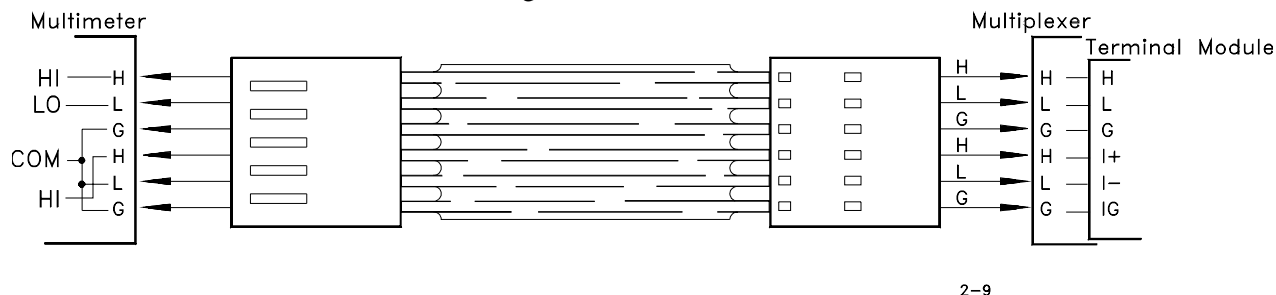

Figure 2-9. Analog Bus Connections

Digital Bus Overview

The digital bus cable coordinates the operation (handshaking) between the multimeter and FET multiplexers without involvement from the system instrument. This enables the multimeter to scan the FET channels at a rate of approximately 13,150 channels/sec.

The digital bus consists of a Voltmeter Complete line, an (external) Trigger line, and ground. The handshake sequence is described in the following steps and in Figure 2-10.

1. When a FET channel is closed, a "channel closed" signal is sent over the Trigger line. This triggers the multimeter which, in turn, makes a measurement.
2. When the measurement is finished, a "voltmeter complete" signal is sent from the multimeter to the multiplexer on the Voltmeter Complete line. This signal advances the scan to the next channel in the list. When the channel is closed, the channel closed signal triggers the multimeter and the process repeats.

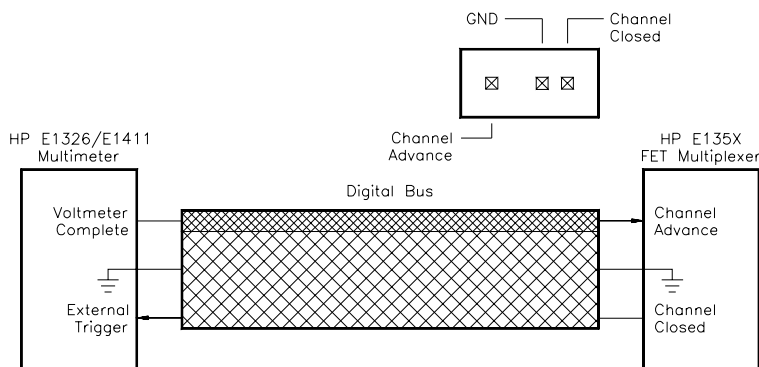

Figure 2-10. Digital Bus Overview

Connecting Input Signals

This section contains guidelines on connecting input signals to the multimeter and shows the connections required to make the following measurements:

- DC and AC RMS Voltage
- 2-Wire Resistance (including thermistors and RTDs)
- 4-Wire Resistance (including thermistors and RTDs)
- Thermocouples

Note Refer to the *HP E1355A - E1358A Strain Gage Multiplexers User's Manual* for information on connecting strain gages.

Wiring Considerations

To ensure accurate measurements, input signals should be connected to the multimeter (via its rear terminals or a multiplexer) using a shielded twisted-pair cable. Twisted-pair cables reduce magnetic (inductive) noise in the measurement circuit. The shield reduces electrical (capacitive) noise.

Connecting the COM Lead

To prevent the HI and LO terminals from floating from the COM terminal and causing erratic overload readings, the COM terminal must be connected to the signal source. If a shielded cable is used, connect one end of the cable shield to the LO lead at the signal source, and connect the other end of the cable shield to the COM (or guard) terminal. If a shielded cable is not used, connect a COM (guard) lead with the LO lead AT THE SIGNAL SOURCE. These connections (Figure 2-11), apply to measurement using the rear terminals or multiplexers.

WARNING The HI, LO, COM, HI terminals on the multimeter faceplate are internally connected to the analog bus port. Thus, signals on the analog bus (from a multiplexer) appear on the faceplate terminals and vice versa.

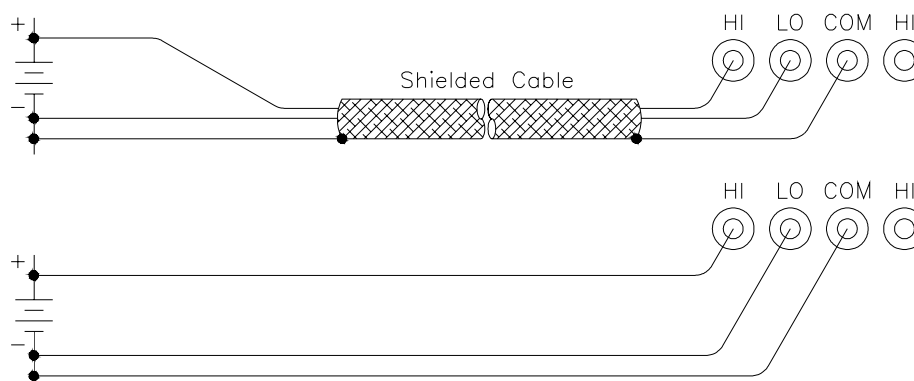

Figure 2-11. Connecting the COM Lead

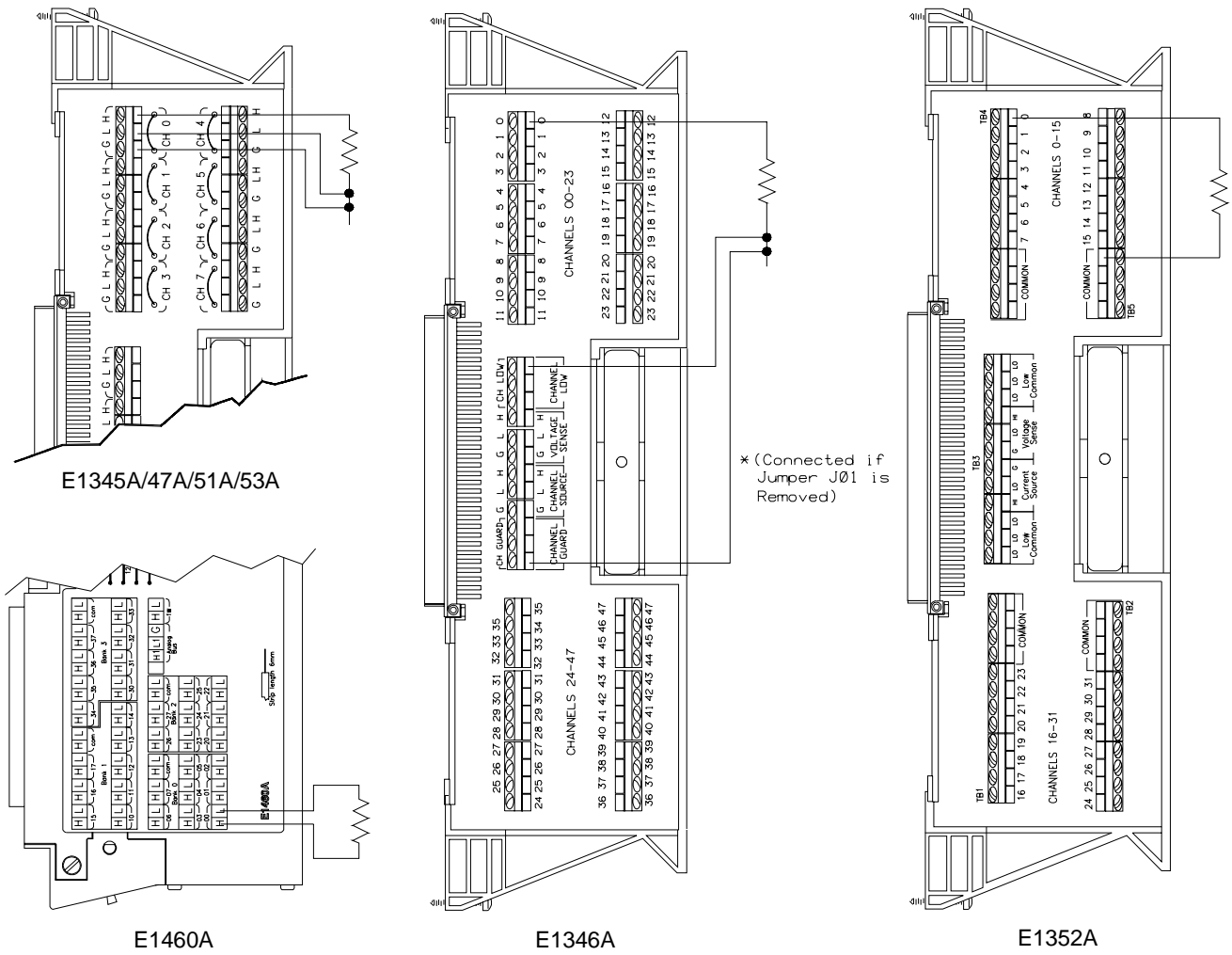
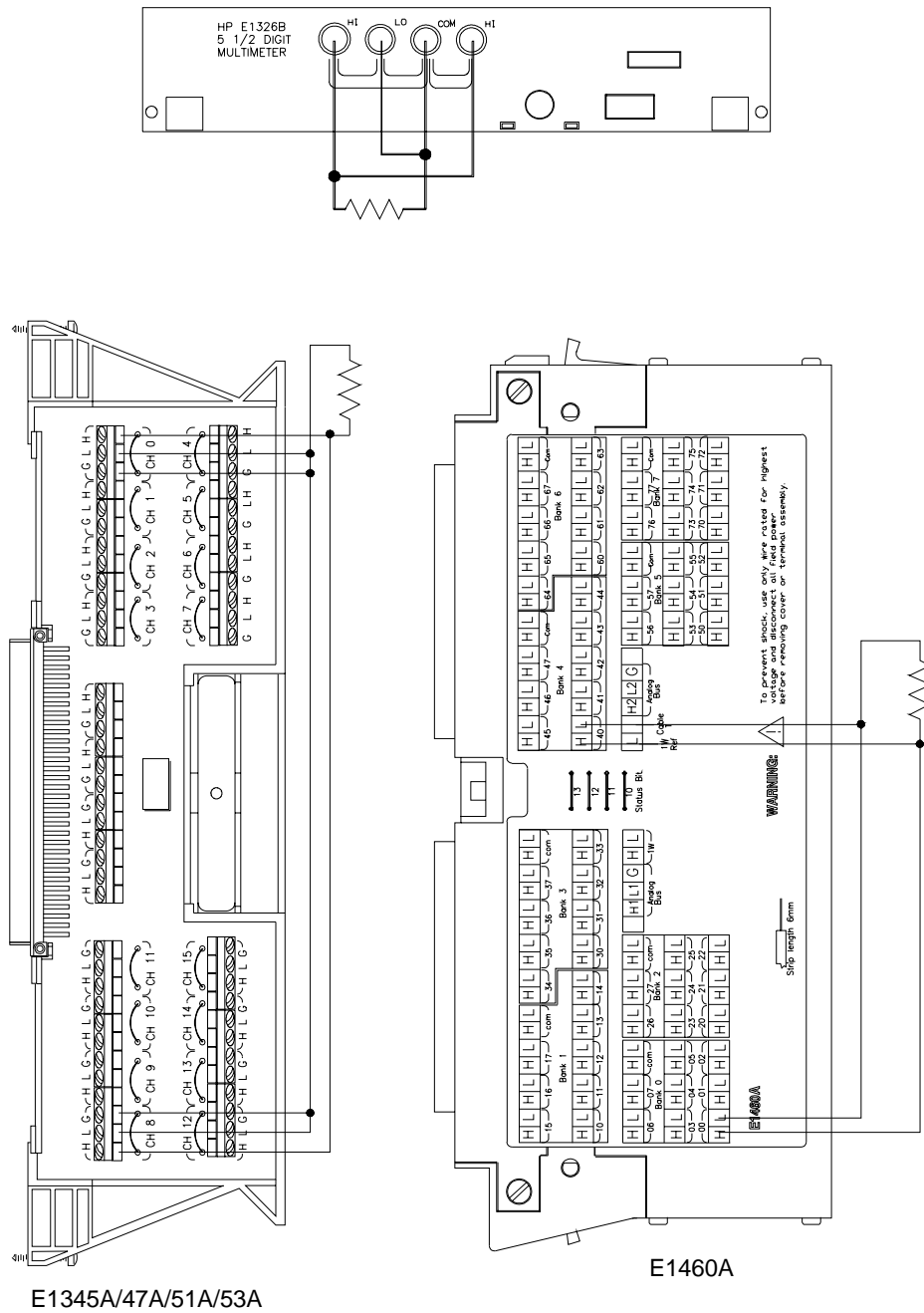
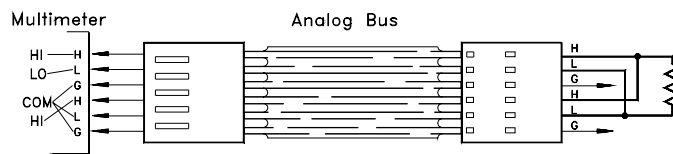

Figure 2-13. Connections for 2-Wire Resistance Measurements (Including Thermistors and RTDs)

Note 2-wire resistance measurements require the multiplexer modules shown above. Resistance measurements using the multimeter terminals or directly through the analog bus must be configured as 4-wire measurements.



NOTE: Channel Pairs are banks 0/4, 1/5, 2/6, and 3/7.
See Chapter 2 of the *HP E1460A User's Manual*.



**Figure 2-14. Connections for 4-Wire Resistance Measurements
(Including Thermistors and RTDs)**

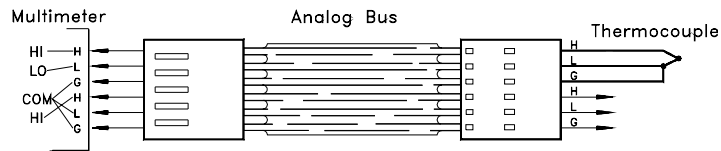
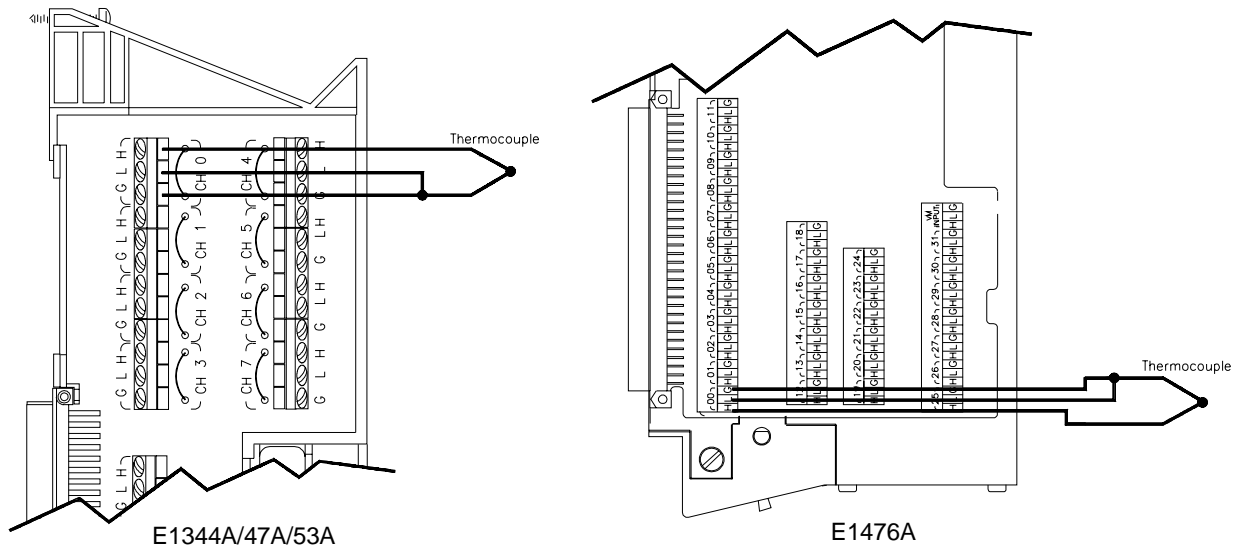

Figure 2-15. Connections for Thermocouples

Carrier Cable Assemblies

The following table and figures show the cables used to connect relay and FET multiplexers to the HP E1411B multimeter. These cables are required when the (B-Size) multiplexers are installed in the Series C mainframe using the HP E1403B A/B-to-C-size module adapter.

Table 2-1. Cable Assemblies

Configuration 1: HP E1345A/46A/47A/55A or 56A (relay multiplexer) in HP E1403B module adapter. Configuration 2: HP E1351A/52A/53A/57A or 58A (FET multiplexer) in HP E1403B module adapter.		
Cable assemblies for HP E1411B multimeter-to-multiplexer connections		
	Configuration 1	Configuration 2
Connecting the HP E1411B to:	E1326-61611 (analog bus)	E1326-61611 (analog bus) E1411-61601 (digital bus)
Cable assemblies for multiplexer-to-multiplexer connections		
	Configuration 1	Configuration 2
Connecting Configuration 1 to:	E1400-61605 (analog bus)	E1400-61605 (analog bus)
Connecting Configuration 2 to:	E1400-61605 (analog bus)	E1400-61605 (analog bus) and E1400-61601 (digital bus)
Examples:		
1. To connect the HP E1411B multimeter to a FET multiplexer in the HP E1403B module adapter (configuration 2), the analog and digital bus cables in kit E1400-80001 are required.		
2. To connect a FET multiplexer in the HP E1403B module adapter (configuration 2) to a relay multiplexer in the E1403B adapter (configuration 1), the E1400-61605 analog bus cable is required.		
Notes:		
1. The HP E1326-61611 analog bus cable and HP E1411-61601 digital bus cable are available under kit part number E1411-80001. This kit is not included with the multimeter or multiplexers. It must be ordered separately.		
2. The HP E1400-61605 analog bus cable ships with the HP E1345A/46A/47A/55A and 56A relay multiplexers. The HP E1400-61605 analog bus cable and HP E1400-61601 digital bus cable ship with the HP E1351A/52A/53A/57A/58A FET multiplexers.		

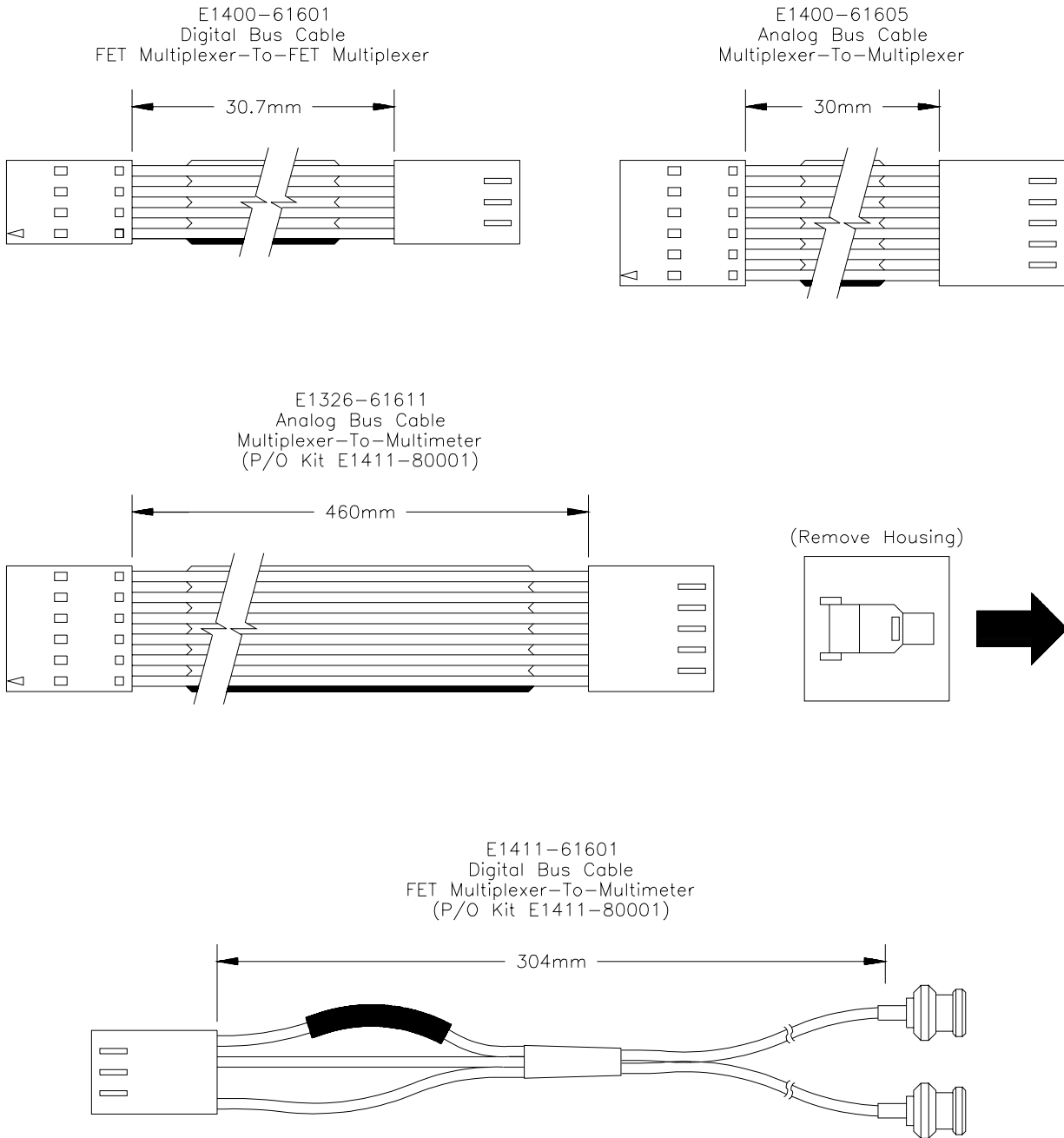

Figure 2-16. Cables for B-Size Multiplexers in HP E1403B Adapter

Additional Configurations

This section contains information on two additional configurations for the multimeter:

- selecting VME RAM, and
- disabling front-panel for stand-alone applications.

Selecting VME RAM

Up to 12 Mbytes of VME RAM can be added to the B-size mainframe to be used for multimeter reading storage. The following lists guidelines for using VME RAM with the multimeter:

- Dynamic RAM must handle its own refresh, and not require any command module activity.
- VME cards can never be a bus master.
 - B-size mainframe does not have bus arbitration.
- VME cards must exclude the first and last 2 Mbytes of A24 space.
 - B-size mainframe's system ROM is located in the lower 2 Mbytes.
 - B-size mainframe's system RAM is located in the upper 2 Mbytes.
- VME RAM may not be used for IBASIC program memory.

The following lists guidelines in selecting a VME card:

A24	A24 address space
D16	16 bits of data at a time
3U	A size slot
6U	B size slot

Disabling Front-panel for Stand-alone Applications

When using the HP E1326B Multimeter as a stand-alone instrument, the HP E1301A front-panel keyboard can be disabled without disabling the display. To disable the front-panel keyboard, use the following guidelines:

- send a "REMOTE" command to each instrument, and
- send a "LOCAL LOCKOUT" to the HP-IB interface.

This should allow the display to still work, but disable the keyboard and the softkeys.

Chapter 3

Using the HP E1326B/E1411B Multimeter

About This Chapter

This chapter is a collection of example programs which show you how to make measurements with various multimeter configurations. The examples in this chapter include:

- Making a Single Measurement Page 42
- Making a Burst of Measurements Page 43
- Making an Externally Triggered Burst of Measurements Page 44
- Making Multiple Burst Measurements Page 45
- Scanning a Channel List Page 46
- Making Multiple Scans Page 47
- Making Multiple Paced Scans Page 48
- Making an Externally Triggered Scan Page 49
- Scanning Switchbox Channels (E1326B/1351A) Page 50
- Scanning Switchbox Channels (E1411B/1460A) Page 52
- Multiple High-Speed Scans Page 54
- Maximizing Measurement Speed Page 56
- Changing the Data Format Page 58
- Using a PC, C Language, and the HP 82335 HP-IB Interface Card Page 60
- Maximizing Measurement Accuracy Page 63
- Storing Readings in Shared Memory Page 64
- Checking for Errors Page 66
- Synchronizing the Multimeter with a Computer Page 68
- Additional Measurement Functions Page 69

Using the Programs

The purpose of the chapter is to provide example programs that show you how to operate the multimeter. With minor modifications, these programs can also be used for many of your applications.

Programming Language

The example programs are shown in the Hewlett-Packard BASIC language and assume the multimeter is controlled from an HP 9000 Series 200/300 computer over the HP-IB. When using HP BASIC, a command is sent to the multimeter with the OUTPUT statement:

```
OUTPUT 70903;"MEAS:VOLT:DC? (@100)"
```

The destination specified (70903) is the interface select code of the computer (7), plus the HP-IB addresses of the HP 75000 Series B mainframe or Series C command module (09), and the multimeter (03). The multimeter command is enclosed between quotation marks. Use ENTER to enter data from the multimeter is entered into the computer:

```
ENTER 70903;variable
```

Multimeter Connections

Chapter 2 contains information on connecting input signals for the measurements described in this chapter.

The MEASure and CONFigure Commands

All of the example programs use the MEASure or CONFigure commands. These commands configure the multimeter, and are equivalent to executing several other multimeter commands. The CONFigure command is used in place of MEASure when changes to the configuration set by either command are required.

Recall from Chapter 1 that the HP E1326B/E1411B can function stand-alone, or with multiplexers as a scanning multimeter instrument. When programming, the stand-alone multimeter and scanning multimeter are distinguished by the absence or presence of the (@channel_list) parameter in the MEASure or CONFigure command. Chapter 4 provides details on these commands and the multimeter configurations they set.

Measurement Functions other than DC Voltage

In each of the programs, the measurement function specified is DC voltage. The function can be changed by changing the MEASure or CONFigure command. The different functions available are shown following the last example program.

Making a Single Measurement

This program makes a single DC voltage measurement on the terminals connected to the multimeter's faceplate using the configuration set by the MEASure command.

```
10  !Clear and reset the multimeter.
20  CLEAR 70903
30  OUTPUT 70903;"*RST"
40  !Configure the multimeter and make a DC voltage measurement.
50  OUTPUT 70903;"MEAS:VOLT:DC?"
60  !Enter and display the reading on the computer.
70  ENTER 70903;A
80  PRINT A
90  END
```

Comments

- The scanning multimeter (multimeter plus multiplexers) is required to make 2-wire measurements (resistance, thermistors, RTDs) or thermocouple measurements.

Making a Burst of Measurements

This program makes 100 DC voltage measurements on the terminals connected to the multimeter's faceplate.

```
10  !Dimension a computer array to store the readings.
20  DIM Rdgs(1:100)
30  !Clear and reset the multimeter.
40  CLEAR 70903
50  OUTPUT 70903;"*RST"
60  !Configure the multimeter for DC voltage measurements. Take a burst of 100
70  !readings, store the readings in mainframe memory until all readings are
80  !taken. Fetch the readings from memory and place them in the output buffer.
90  OUTPUT 70903;"CONF:VOLT:DC"
100 OUTPUT 70903;" SAMP:COUN 100"
110 OUTPUT 70903;"INIT"
120 OUTPUT 70903;"FETCH?"
130 !Enter the readings into the computer. Display selected measurements.
140 ENTER 70903;Rdgs(*)
150 PRINT Rdgs(1),Rdgs(50),Rdgs(100)
160 END
```

Comments

- CONFigure sets a burst consisting of one measurement. The SAMPlE:COUNT command is used to set a burst of measurements greater than one. Up to 16,777,215 measurements can be specified with SAMPlE:COUNT.
- When INIT follows CONFigure, the readings are stored in mainframe memory. FETCH? retrieves the readings and places them in the output buffer once all measurements are taken. Replacing INIT and FETCH? with READ? returns the readings directly to the output buffer. Readings should be stored in memory first, rather than returned directly to the output buffer, when measurement speed is critical.
- Readings are returned directly to the multimeter's output buffer, or are stored in mainframe memory on in memory shared by the VXIbus system. The total number of readings which can be stored depends on the amount of memory available. Each reading stored will consume four bytes of memory.
- A burst of measurements (set by SAMPlE:COUNT) can also be made when scanning a single channel.

Making an Externally Triggered Burst of Measurements

This program makes a burst of 10 measurements on the faceplate terminals when the multimeter receives an external trigger.

```
10  !Dimension a computer array to store the readings.
20  DIM Rdgs(1:10)
30  !Clear and reset the multimeter.
40  CLEAR 70903
50  OUTPUT 70903;"*RST"
60  !Configure the multimeter for DC voltage measurements. Set the trigger
70  !source to an external trigger. Take a burst of 10 readings when the trigger
80  !occurs. Wait for the trigger then return the readings to the output buffer.
90  OUTPUT 70903;"CONF:VOLT:DC"
100 OUTPUT 70903;"  TRIG:SOUR EXT"
110 OUTPUT 70903;"  SAMP:COUN 10"
120 OUTPUT 70903;"READ?"
130 !Enter and display the readings on the computer.
140 ENTER 70903;Rdgs(*)
150 FOR I=1 TO 10
160   PRINT Rdgs(I)
170 NEXT I
180 END
```

Comments

- The multimeter is triggered when a high-to-low TTL signal is applied to the "External Trigger" port.
- CONFigure sets the trigger source to the multimeter's internal trigger. The trigger source is changed with the TRIGger:SOURce command. The sources available are:
 - IMM - immediate (internal) trigger
 - EXT - external trigger
 - BUS - triggered by *TRG or HP-IB group execute trigger
 - HOLD - suspend trigger
- CONFigure sets a burst consisting of one measurement. The SAMPlE:COUNT command is used to set a burst of measurements greater than one. Up to 16,777,215 measurements can be specified with SAMPlE:COUNT.
- The multimeter output buffer can hold eight readings. When the buffer fills, measurements are suspended until readings are read from the buffer (by the computer) to make space available.

Making Multiple Burst Measurements

This program makes multiple burst measurements with a 5 second delay between bursts. There are three bursts, each consisting of 100 readings, occurring 1 ms apart.

```
10  !Dimension a computer array to store the readings.
20  DIM Rdgs(1:300)
30  !Clear and reset the multimeter.
40  CLEAR 70903
50  OUTPUT 70903;"*RST"
60  !Configure the multimeter for DC voltage measurements (7.27V range). Set
70  !the aperture time for 100 ms and turn autozero off. Make a total of 3 bursts,
80  !with a 5 second delay between them. Set each burst to 100 readings, with
90  !each reading 1 ms apart. Store the readings in mainframe memory until all
100 !bursts have occurred.
110 OUTPUT 70903;"CONF:VOLT:DC 7.27"
120 OUTPUT 70903;"    VOLT:APER 100E-6"
130 OUTPUT 70903;"    CAL:ZERO:AUTO OFF"
140 OUTPUT 70903;"    TRIG:COUN 3"
150 OUTPUT 70903;"    TRIG:DEL 5"
160 OUTPUT 70903;"    SAMP:SOUR TIM"
170 OUTPUT 70903;"    SAMP:TIM 0.001"
180 OUTPUT 70903;"    SAMP:COUN 100"
190 OUTPUT 70903;"INIT"
200 OUTPUT 70903;"FETCH?"
210 !Enter the readings and display selected measurements.
220 ENTER 70903;Rdgs(*)
230 PRINT Rdgs(100),Rdgs(200),Rdgs(300)
240 END
```

Comments

- CONFigure sets an aperture time of 16.7 ms or 20 ms depending on the line frequency. The VOLTage:APERture command is used to set aperture times of 10 μ s, 100 μ s, 2.5 ms, 16.7 ms, 20 ms, 267 ms, and 320 ms. For this program, the 100 μ s aperture time is the maximum that allows the multimeter to sample the readings every 1 ms (see Chapter 4).
- CONFigure turns autozero on. The command CALibration:ZERO:AUTO is used to turn it off. Turning autozero off allows the readings in the burst to occur at more precise, and smaller intervals.
- The trigger count is the number of triggers the multimeter is to respond to before it returns to an idle state. In this program, the multimeter responds to three internal triggers. CONFigure sets the trigger count to 1. The command TRIGger:COUNt is used to set up to 16,777,215 counts.

- The trigger delay is the period between the trigger signal and the start of the measurement (burst). The trigger delay set by CONFigure is 0 seconds for the DC voltage function. The TRIGger:DELAy command is used to set delays up to 16.7 seconds.
- CONFigure sets the sample source such that there is a minimum delay (sample rate) between measurements in a burst, and a burst size of 1. The sample rate and burst size are changed with the SAMPlE:SOURce, SAMPlE:TIMer, and SAMPlE:COUNt commands. SAMPlE:SOURce selects the source which sets the sample rate. SAMPlE:TIMer sets the rate, and SAMPlE:COUNt sets the number of readings in the burst.

Scanning a Channel List

This program scans a channel list one time using the multimeter configuration set by the MEASure command.

```

10  !Dimension a computer array to store the readings.
20  DIM Rdgs(1:16)
30  !Clear and reset the multimeter.
40  CLEAR 70903
50  OUTPUT 70903;"*RST"
60  !Configure the multimeter and make DC voltage measurements on
70  !channels 100 through 115.
80  OUTPUT 70903;"MEAS:VOLT:DC? (@100:115)"
90  !Enter and display the readings on the computer.
100 ENTER 70903;Rdgs(*)
110 FOR I=1 TO 16
120   PRINT Rdgs(I)
130 NEXT I
140 END

```

Comments

- The multimeter output buffer can hold eight readings. When the buffer fills, measurements are suspended until readings are read from the buffer (by the computer) to make space available.

Making Multiple Scans

This program scans a channel list multiple times.

```
10 !Dimension a computer array to store the readings.
20 DIM Rdgs(1:20)
30 !Clear and reset the multimeter.
40 CLEAR 70903
50 OUTPUT 70903;"*RST"
60 !Configure the multimeter for DC voltage measurements. Scan the
70 !channel list five times.
80 OUTPUT 70903;"CONF:VOLT:DC (@100:103)"
90 OUTPUT 70903;" TRIG:COUN 5"
100 OUTPUT 70903;"READ?"
110 !Enter and display the readings on the computer.
120 ENTER 70903;Rdgs(*)
130 FOR I=1 TO 20 STEP 4
140 PRINT Rdgs(I),Rdgs(I+1),Rdgs(I+2),Rdgs(I+3)
150 NEXT I
160 END
```

Comments

- For the scanning multimeter, CONFigure sets one scan (pass) through the channel list. The TRIGger:COUNT command can specify up to 16,777,215 scans.
- The multimeter makes one measurement per channel per scan. However, multiple measurements per channel (per scan) can be made when scanning a single channel. The number of measurements taken during a single channel scan is set with the SAMPlE:COUNT command.
- The multimeter output buffer can hold eight readings. When the buffer fills, measurements are suspended until readings are read from the buffer (by the computer) to make space available.

Making Multiple Paced Scans

This program makes multiple scans through a channel list with the scans occurring at specified intervals.

```
10  !Dimension a computer array to store the readings.
20  DIM Rdgs(1:20)
30  !Clear and reset the multimeter.
40  CLEAR 70903
50  OUTPUT 70903;"*RST"
60  !Configure the multimeter for DC voltage measurements. Scan the
70  !channel list five times, with a two second delay between scans.
80  !Store the readings in mainframe memory.
90  OUTPUT 70903;"CONF:VOLT:DC (@100:103)"
100 OUTPUT 70903;" TRIG:COUN 5"
110 OUTPUT 70903;" TRIG:DEL 2"
120 OUTPUT 70903;"INIT"
130 OUTPUT 70903;"FETCH?"
140 !Enter and display the readings on the computer.
150 ENTER 70903;Rdgs(*)
160 FOR I=1 TO 20 STEP 4
170   PRINT Rdgs(I),Rdgs(I+1),Rdgs(I+2),Rdgs(I+3)
180 NEXT I
190 END
```

Comments

- For the scanning multimeter, CONFigure sets one scan (pass) through the channel list. The TRIGger:COUNT command can specify up to 16,777,215 scans.
- The delay between scans is the delay between the trigger signal and the first channel in the list. There is no programmable delay between subsequent channels in the list. The trigger delay set by CONFigure is 0 seconds for the DC voltage function. The TRIGger:DELAy command is used to set delays up to 16.7 seconds.
- When scanning with the FET multiplexers, the sample period for each channel can be specified with the SAMPlE:TIMER command. This feature is available with the FET multiplexers only.
- When INIT follows CONFigure, the readings are stored in mainframe memory. FETCH? retrieves the readings and places them in the output buffer once all measurements are taken. Replacing INIT and FETCH? with READ? returns the readings directly to the output buffer.

Making an Externally Triggered Scan

This example makes one scan through a channel list when the multimeter receives an external trigger.

```
10  !Dimension a computer array to store the readings.
20  DIM Rdgs(1:16)
30  !Clear and reset the multimeter.
40  CLEAR 70903
50  OUTPUT 70903;"*RST"
60  !Configure the multimeter for DC voltage measurements. Set the
70  !trigger source to an external trigger. Scan the channel list one time
80  !when the trigger is received.
90  OUTPUT 70903;"CONF:VOLT:DC (@100:115)"
100 OUTPUT 70903;" TRIG:SOUR EXT"
110 OUTPUT 70903;"READ?"
120 !Enter and display the readings on the computer.
130 ENTER 70903;Rdgs(*)
140 FOR I=1 TO 16
150   PRINT Rdgs(I)
160 NEXT I
170 END
```

Comments

- The multimeter is triggered when a high-to-low TTL signal is applied to the "External Trigger" port.
- CONFigure sets the trigger source to the multimeter's internal trigger. The trigger source is changed with the TRIGger:SOURce command. The sources available are:
 - IMM - immediate (internal) trigger
 - EXT - external trigger
 - BUS - triggered by *TRG or HP-IB group execute trigger
 - HOLD - suspend trigger
- If programmed for multiple scans, multiple external triggers must occur since each scan requires a trigger.

Scanning Switchbox Channels (E1326B/E1351A)

In this example, the stand-alone multimeter (HP E1326B) scans 5 channels of an HP E1351A FET multiplexer switchbox 100 times. The scanning sequence is controlled with the digital bus.

```
10  !Dimension a controller array to store the readings.
20  DIM Rdgs(1:500)
30  !Reset the E1326B multimeter and the E1351A FET switchbox. Turn the
40  !multimeter monitor mode off to increase throughput.
50  OUTPUT 70903;"*RST"
60  OUTPUT 70903;"*OPC?"
70  ENTER 70903;Rst_done
80  OUTPUT 70914;"*RST"
90  OUTPUT 70914;"*OPC?"
100 ENTER 70914;Rst_done
110 OUTPUT 70903;"DISP:MON OFF"
120 !Configure the multimeter for measurements at its fastest rate. This
130 !includes a fixed range (7.27), a 10  $\mu$ s aperture time (MAX), autozero
140 !off, and a sample period of 76  $\mu$ s (SAMP:TIM MIN). Set the multimeter
150 !to make 500 measurements (5 channels/100 scans). Wait for the
160 !configuration to complete.
170 OUTPUT 70903;"CONF:VOLT:DC 7.27,MAX"
180 OUTPUT 70903;"    CAL:ZERO:AUTO OFF"
190 OUTPUT 70903;"    SAMP:COUN 500"
200 OUTPUT 70903;"    SAMP:SOUR TIM"
210 OUTPUT 70903;"    SAMP:TIM MIN"
220 OUTPUT 70903;"*OPC?"
230 ENTER 70903;Complete
240 !Configure the switchbox so that it receives its triggers over the digital bus.
250 !Route the signals on the multiplexer channels to the multimeter via the
260 !analog bus. Specify the scan list. Wait for the configuration to complete.
270 OUTPUT 70914;"TRIG:SOUR DBUS"
280 OUTPUT 70914;"SCAN:PORT ABUS"
290 OUTPUT 70914;"SCAN (@100:104)"
300 OUTPUT 70914;"*OPC?"
310 ENTER 70914;Complete
320 !Place the switchbox in the continuous scanning mode. Start the scan by
330 !closing the first multiplexer channel in the channel list. Wait for the
340 !command to complete and then trigger the multimeter.
350 OUTPUT 70914;"INIT:CONT ON"
360 OUTPUT 70914;"INIT"
370 WAIT .1
```

Continued on Next Page

```
380 OUTPUT 70903;"INIT"  
390 !Retrieve the readings from multimeter memory and enter them into the  
400 !controller. Clear the switchbox to exit the continuous scanning mode.  
410 OUTPUT 70903;"FETC?"  
420 ENTER 70903;Rdgs(*)  
430 CLEAR 70914  
440 END
```

Comments

- The multimeter at secondary address 03 (logical address 24) is connected to the switchbox at secondary address 14 (logical address 112) with an analog bus cable and a digital bus cable.
- The analog bus carries the input signals to the multimeter. The digital bus is used to carry a "multimeter complete" signal to the switchbox to trigger the next channel closing.
- Because of the fast rate at which the FET channels close, the multimeter is triggered once (INIT) and then samples continuously (SAMP:COUN 500). Thus, the multimeter ignores the multiplexer "channel closed" signal on the digital bus.
- Using this configuration, the multimeter is able to continuously scan the switchbox and store readings in its memory at a 76 μ s (13 kHz) rate.

Scanning Switchbox Channels (E1411B/E1460A)

In this example, the stand-alone multimeter (HP E1411B) scans 64 channels on an HP E1460A relay multiplexer switchbox. The scanning sequence is controlled with the VXibus TTLTrg trigger lines.

```
10  !Dimension a computer array to store the readings.
20  DIM Rdgs(1:64)
30  !Reset the E1411B multimeter and the E1460 switchbox. Wait for the
40  !resets to complete before continuing.
50  OUTPUT 70903;"*RST"
60  OUTPUT 70903;"*OPC?"
70  ENTER 70903;Rst_done
80  OUTPUT 70914;"*RST"
90  OUTPUT 70914;"*OPC?"
100 ENTER 70914;Rst_done
110 !Configure the multimeter for DC voltage measurements. Set its trigger
120 !source to TTL trigger line 0, set it to receive 64 triggers (one to measure
130 !each channel). Set the multimeter to output its channel closed pulse on
140 !TTL trigger line 1. Wait for the configuration to complete. Place the
150 !multimeter in the wait-for-trigger state.
160 OUTPUT 70903;"CONF:VOLT:DC"
170 OUTPUT 70903;"   TRIG:SOUR TTL0"
180 OUTPUT 70903;"   TRIG:COUN 64"
190 OUTPUT 70903;"   OUTP:TTL1:STAT ON"
200 OUTPUT 70903;"*OPC?"
210 ENTER 70903;Complete
220 OUTPUT 70903;"INIT"
230 !Configure the switchbox so that it receives its "channel advance" trigger
240 !on TTL trigger line 1, and that it outputs its "channel closed" pulse on
250 !TTL trigger line 0. Route the signals on the multiplexer channels to the
260 !multimeter via the analog bus. Specify the scan list. Wait for the
270 !configuration to complete before proceeding.
280 OUTPUT 70914;"TRIG:SOUR TTL1"
290 OUTPUT 70914;"OUTP:TTL0:STAT ON"
300 OUTPUT 70914;"SCAN:PORT ABUS"
310 OUTPUT 70914;"SCAN (@100:177)"
320 OUTPUT 70914;"*OPC?"
330 ENTER 70914;Complete
340 !Start the scan and the measurements by closing the first multiplexer
350 !channel in the channel list.
360 OUTPUT 70914;"INIT"
```

Continued on Next Page

```
370 !Retrieve the readings from multimeter memory, enter and display them
380 !on the computer.
390 OUTPUT 70903;"FETC?"
400 ENTER 70903;Rdgs(*)
410 PRINT Rdgs(*)
420 END
```

Comments

- The multimeter and (multiplexer) switchbox have unique secondary HP-IB addresses and as such, are two separate instruments. Input signals from the switchbox are routed to the multimeter via the analog bus. The scanning sequence is controlled with selected TTLTrg trigger bus lines.
- The HP E1460A multiplexer has eight banks of channels with eight channels in each bank. Channel numbers are 00 through 07 on bank 0, up to 70 through 77 on bank 7. Since the switchbox consists of only one multiplexer, the channel list for scanning 64 channels is (@100:177).
- Additional information on triggering the multimeter is found in Chapters 4 and 5. Information on the multimeter's OUTPUT subsystem is contained in Chapter 5.

Multiple High-Speed Scans

This example shows how a scanning multimeter consisting of the HP E1326B multimeter and HP E1351A FET multiplexer is programmed for multiple scans at a 13 kHz rate. The program scans 16 channels 100 times.

```
10  !Dimension a controller array to store the readings.
20  DIM Rdgs(1:1600)
30  !Reset the multimeter, turn monitor mode off, and then download the
40  !channel list to the FET multiplexer.
50  OUTPUT 70903;"*RST"
60  OUTPUT 70903;"*OPC?"
70  OUTPUT 70903;"DIAG:FETS 1"
80  ENTER 70903;Rst_done
90  OUTPUT 70903;"DISP:MON OFF"
100 OUTPUT 70903;"CONF:VOLT:DC 7.27,MAX,(@100:115)"
110 !Configure the multimeter for a burst of measurements. Specify a fixed
120 !range (7.27), a 10  $\mu$ s aperture time (MAX), turn autozero off, and set a
130 !76  $\mu$ s sample period (SAMP:TIM MIN). The number of measurements
140 !(sample count) is determined by multiplying the number of channels times
150 !the number of scans. In this example, 16 channels are scanned 100 times.
160 !Wait for the configuration to complete.
170 OUTPUT 70903;"CONF:VOLT:DC 7.27,MAX"
180 OUTPUT 70903;"    CAL:ZERO:AUTO OFF"
190 OUTPUT 70903;"    SAMP:COUN 1600"
200 OUTPUT 70903;"    SAMP:SOUR TIM"
210 OUTPUT 70903;"    SAMP:TIM MIN"
220 OUTPUT 70903;"*OPC?"
230 ENTER 70903;Complete
240 !The following commands set the FET multiplexer scanning configuration
250 !by writing directly to the multiplexer registers. Specifically, the first
260 !command transfers control of the scan from the multimeter to the user.
270 !The second command enables digital bus triggering, continuous scanning,
280 !and sets the pointer to the beginning of the scan list. The third command
290 !transfers control back to the multimeter. The fourth command closes the
300 !first channel in the list.
310 OUTPUT 70900;"VXI:WRITE 25,4,8"
320 OUTPUT 70900;"VXI:WRITE 25,6,26"
330 OUTPUT 70900;"VXI:WRITE 25,4,0"
340 OUTPUT 70900;"VXI:WRITE 25,4,16"
350 OUTPUT 70900;"*OPC?"
360 ENTER 70900;Complete
```

Continued on Next Page

```

370 !Trigger the multimeter to start the measurements. Retrieve the readings
380 !from multimeter memory and enter them into the controller. Since the
390 !first channel in the scan list remains closed after the last multimeter
400 !complete signal is received, transfer control to the user, open the channel,
410 !and then transfer control to the multimeter.
420 OUTPUT 70903;"INIT"
430 OUTPUT 70903;"FETC?"
440 ENTER 70903;Rdgs(*)
450 OUTPUT 70900;"VXI:WRITE 25,4,8"
460 OUTPUT 70900;"VXI:WRITE 25,6,16"
470 OUTPUT 70900;"VXI:WRITE 25,4,0"
480 END

```

Comments

- The multimeter is connected to the multiplexer using the analog bus cable and the digital bus cable.
- The analog bus carries the input signals to the multimeter. The digital bus is used to carry a "multimeter complete" signal to the multiplexer to trigger the next channel closing.

Because of the fast rate at which the FET channels close, the multimeter is triggered once (INIT) and then samples continuously (SAMP:COUN 1600). Thus, the multimeter ignores the multiplexer "channel closed" signal on the digital bus.

Using this scanning multimeter configuration, the multimeter is able to continuously scan the multiplexer channels and store readings in its memory at a 76 μ s (13 kHz) rate.

- The maximum number of continuous scans and measurements depends on the amount of multimeter memory available.
- Detailed information on the FET multiplexer registers can be found in the register-based programming section of the multiplexer user's manual.

Maximizing Measurement Speed

This program shows the multimeter configuration required to make measurements at the fastest possible rate (13150 readings/sec).

```
10  !Dimension a computer array to store the readings.
20  DIM Rdgs(1:500)
30  !Clear and reset the multimeter. For mainframes with a display and
40  !keyboard, turn off monitor mode so the measurements are not displayed.
50  CLEAR 70903
60  OUTPUT 70903;"*RST"
70  OUTPUT 70903;"DISP:MON OFF"
80  !Configure the multimeter for DC voltage measurements. Increase
90  !measurement speed by specifying a fixed range (7.27), the worst
100 !resolution (MAX), and turning autozero off. Specify the number of
110 !readings in the burst and set the fastest sample rate. Store the
120 !readings in mainframe memory.
130 OUTPUT 70903;"CONF:VOLT:DC 7.27,MAX"
140 OUTPUT 70903;" CAL:ZERO:AUTO OFF"
150 OUTPUT 70903;" SAMP:COUN 500"
160 OUTPUT 70903;" SAMP:SOUR TIM"
170 OUTPUT 70903;" SAMP:TIM MIN"
180 OUTPUT 70903;"INIT"
190 OUTPUT 70903;"FETC?"
200 !Enter the readings and display selected measurements.
210 ENTER 70903;Rdgs(*)
220 PRINT Rdgs(1),Rdgs(250),Rdgs(500)
230 END
```

Comments

- The 13 kHz reading rate is achieved under the following conditions:

function	= DC voltage
range	= fixed
resolution	= least
aperture time	= 10 μ s
autozero	= off
sample rate	= 76 μ s (MINimum)
reading storage	= mainframe (or shared) memory

In addition, there should be no activity by other instruments in the mainframe.

- The terms MIN and MAX often appear as parameter choices in a command's syntax. MIN selects the minimum numeric value for that parameter. MAX selects the maximum numeric value. This eliminates the need to look up specific numbers in the manual.
- In this program, note that MAX in the CONFigure command selects the least resolution and sets the aperture time to 10 μ s (see Table 4-5 on page 92). When measurement speed is critical, readings should be stored in mainframe memory first, rather than returned directly to the output buffer.
- The total number of readings which can be stored depends on the amount of memory available. Each reading stored will consume four bytes of memory.
- To increase the (throughput) speed at which measurement data is transferred from the multimeter to the computer by the FETCh? command, the multimeter's output data format should be set to REAL,64 or REAL,32 (see "Changing the Data Format" on page 58).
- The 13 kHz reading rate must be reduced to 12.82 kHz when the sample count is greater than 32 k. Setting the SAMP:TIM to 78 μ s gives a reading rate of 12.82 kHz and allows the sample count to be greater than 32 k.

```

CONF:VOLT:DC 7.27,MAX
CAL:ZERO:AUTO OFF
SAMP:SOUR TIM
SAMP:TIM 0.078
INIT

```

Changing the Data Format

Throughput speed between the multimeter and computer is increased when binary (rather than ASCII) data formats are used. The following program changes the data format to REAL 64, and then makes a burst of 1,000 measurements on a single multiplexer channel.

```
10 !Dimension computer variables to store the data header and readings.
20 !Assign an input/output path between the multimeter and computer.
30 !This is a path for data in the REAL 64 format. Clear the path and
40 !reset the multimeter.

50 DIM Ndig$[1],Count$[9],Rdgs(1:1000)
60 ASSIGN @Dmm TO 70903;FORMAT OFF
70 CLEAR @Dmm
80 OUTPUT 70903;"*RST"

90 !Set the data format to REAL 64. Configure the multimeter for DC
100 !voltage measurements on multiplexer channel 0. Increase
110 !measurement speed by specifying a fixed range (58.1), turning
120 !autozero off, and setting the minimum aperture time. Specify the
130 !number of readings in the burst and set the fastest sample period.
140 !Store the readings in mainframe memory.

150 OUTPUT 70903;"FORM REAL,64"
160 OUTPUT 70903;"CONF:VOLT:DC 58.1,(@100)"
170 OUTPUT 70903;" CAL:ZERO:AUTO OFF"
180 OUTPUT 70903;" VOLT:APER MIN"
190 OUTPUT 70903;" SAMP:COUN 1E3"
200 OUTPUT 70903;" SAMP:SOUR TIM"
210 OUTPUT 70903;" SAMP:TIM MIN"
220 OUTPUT 70903;"INIT"
230 OUTPUT 70903;"FETC?"
240 !Enter and display readings.
250 ENTER 70903 USING "#,X,K,K";Ndig$;Count$[1;VAL(Ndig$)]
260 ENTER @Dmm;Rdgs(*)
270 ENTER 70903;Lf$
280 PRINT Rdgs(*)
290 END
```

Comments

- The REAL,64 format is selected because the HP 9000 Series 200/300 computer stores readings in that format.
- REAL,64 data is transferred to the computer in the IEEE 488.2-1987 Definite Length Arbitrary Block format. Data in this format is preceded by a header consisting of: # <non-zero digit> <block length>. In this program, the header preceding the measurement data is #48000. The 4 represents the number of digits indicating the block length (8000), and 8000 is the block length (1,000 readings * 8 bytes/reading).

- When HP BASIC is used, the program's ENTER @Dmm USING ... statement is used to remove the Arbitrary Block header:

- tells the computer to terminate the ENTER when all ENTER statements have completed.

X - tells the computer to skip the first character of the Arbitrary Block header (#).

K,K - stores the <non-zero digit> and <block length> portions of the header in the Ndig\$ and Count\$ variables respectively.

More information on the Definite Length Arbitrary Block format is located in Chapter 4.

- The ENTER @Dmm;Rdgs(*) statement enters the readings into the computer. Since a Line Feed (LF) follows the last reading, ENTER 70903;Lf\$ removes the LF character from the multimeter output buffer. If the LF character is not removed, Error -410 "Query Interrupted" occurs the next time data is sent to the buffer. This (third) ENTER statement is only required when using the REAL data formats.

Using a PC, C Language, and the HP 82335 HP-IB Interface Card

The following benchmark program scans 50 channels, 40 times, and compares each reading to upper and lower limits. The benchmarks varied from 1.5 to 1.75 sec. The variation is caused by the time function in the computer reporting back time with only 1 second increments.

The loop is repeated four times, thus: $6/4=1.5$ and $7/4=1.75$.

The line:

```
IOOUTPUTS(ADDR, "FORMAT REAL,32",14 );
```

programs the E1326B to output its data in a 32-bit real format.

The line:

```
IOENTERAB(ADDR, rdgs, &bytes, swap);
```

/ enter readings and remove block header */*
enters the 32-bit numbers sent out by the DMM directly into a "float" type C variable which is also 32-bits. Doing binary transfers this way is the fastest method of moving data.

The program was Compiled in Borland© TurboC, and was run on an HP Vectra 25 MHz, 386 PC with an HP 82335 HP-IB card connected to an HP E1301A mainframe with an HP E1326B multimeter and four HP E1351A FET multiplexers.

```
/* BENCHMK.C - This is a benchmark program for the E1326B. The program */
/* scans 50 FET multiplexer channels 40 times, and repeats the sequence */
/* 4 times. The readings are compared to a set of limits after each scan. */
/* Results: 1.5000 to 1.75000 seconds for 40 scans of 50 channels */

/* Include the following header files */
#include <studio.h>
#include <stdlib.h>
#include <string.h>
#include <time.h>
#include <malloc.h>
#include <func.h>

/* This file is from the HP-IB Command Library Disk */
#define ADDR 70903L

/* I/O path from PC to the E1326 scanning multimeter */
/* Function Prototypes */

void rst_clr(void);
void scan_mult(void);
void check_error(char *func_tion);

/*****
```

Continued on Next Page

```

void main(void)          /* run the program */
{
    clrscr();            /* clears screen (turbo C only) */
    rst_clr();           /* reset the scanning multimeter */
    scan_mult();        /* function to configure multimeter and take readings */
}
/*****

void scan_mult(void)
{
    time_t T1, T2;
    int  c = 0, i = 0, j = 0, length = 0, swap = 0, bytes = 0;
    float *rdgs, rdy;
    char lf_remove[1];

    /* dynamically allocate memory for readings */
    rdgs = malloc(8000 * sizeof(float)); /* float = 32-bit real number */
    /* set number of bytes placed in memory, and number of bytes read */
    swap = size of (float);             /* place 4 bytes/reading in memory */
    bytes = 8000 * swap;                 /* read 32,000 bytes */
    /* configure the scanning multimeter and wait for configuration to complete */
    IOOUTPUTS(ADDR, "CONF:VOLT:DC
(@1(00:15),2(00:15),3(00:15),4(00:01)", 51);
    IOOUTPUTS(ADDR, "VOLT:RANGE 10;;CAL:ZERO:AUTO
OFF;;VOLT:APERMIN", 47 );
    IOOUTPUTS(ADDR, "FORMAT REAL,32", 14 );
    IOOUTPUTS(ADDR, "*OPC?", 5); /* wait for configuration to complete */
    IOENTER(ADDR, &rdy); /* enter *OPC? response from multimeter */
    /* function call to check for multimeter configuration errors */
    check_error("scan_mult");
    T1 = time(NULL); /* get start time */
    /* program loop which set 4, 40 scan measurements */
    for (c = 0; c < 4; c++)
    {
        /* program loop which scans the 50 multiplexer channels 40 times */
        for (i = 0; i < 40; i++)
        {
            IOOUTPUTS(ADDR, "INIT", 4); /* trigger multimeter */
            IOOUTPUTS(ADDR, "FETCH?", 6); /* fetch the readings */
            IOENTERAB(ADDR, rdgs, &bytes, swap); /* enter readings and remove
block header*/

            /* remove line feed which trails the last data byte */
            length = 1;
            IOENTERS(ADDR, lf_remove, &length);
            /* compare each reading to a set of limits */
            for (j = 0; j < 50; j++)
            {

```

Continued on Next Page

```

        if (rdgs[j] < -5 || rdgs[j] > .5)
            printf("\n%f", rdgs[j]);
    }
}
}
T2 = time(NULL);          /* get stop time */
/* calculate time for measurements */
printf("\nTime = %f seconds", (difftime(T2,T1)/4));
free(rdgs);
}
/*****/
void rst_clr(void)
{
/* Reset and clear the scanning multimeter */
    IOOUTPUTS(ADDR, "RST;CLS", 9);    /* Send (9) characters */
}
/*****/
void check_error(char *func_tion)
{
    char    into[161];
    int    length = 160;

    IOOUTPUTS(ADDR, "SYST:ERR?", 9);    /* Query error register */
    IOENTERS(ADDR, into, &length);    /* Enter error message */
    if (atoi(into) != 0)                /* Determine if error is present
                                         If errors present, print and exit */
    {
        while (atoi(into) != 0)
        {
            printf("Error %s in function %s\n\n", into, func_tion);
            IOOUTPUTS(ADDR, "SYST:ERR?", 9);
            IOENTERS(ADDR, into, &length);
        }
        exit(1);
    }
}
}

```

Maximizing Measurement Accuracy

This program makes DC voltage measurements on three channels using the multimeter configuration which makes the most accurate measurements. Note that measurement accuracy also depends on wiring practices and the surrounding environment.

```
10  !Dimension a computer array to store the readings.
20  DIM Rdgs(1:3)
30  !Clear and reset the multimeter.
40  CLEAR 70903
50  OUTPUT 70903;"*RST"
60  !Configure the multimeter for DC voltage measurements.
70  !Set autorange and select the minimum (best) resolution.
80  OUTPUT 70903;"CONF:VOLT:DC AUTO,MIN,(@101:103)"
90  OUTPUT 70903;"READ?"
100 !Enter and display the readings on the computer.
110 ENTER 70903;Rdgs(*)
120 PRINT Rdgs(*)
130 END
```

Comments

- MIN sets the minimum (best) resolution for the range set by autorange. MIN also indirectly selects the aperture time for the most accurate measurements.
- The terms MIN and MAX often appear as parameter choices in a command's syntax. MIN selects the minimum numeric value for that parameter. MAX selects the maximum numeric value for the parameter. This eliminates the need to look up specific numbers in the manual.
- CONFigure turns autozero on.
- When making resistance measurements (including thermistors and RTDs), accuracy can often be increased by turning on offset compensation (for example, RESistance:OCOMPensated).

Storing Readings in Shared Memory

The following program stores the multimeter readings on a VME memory card.

```
10  !Dimension computer variables to store the data header and readings.
20  !Assign an input/output path between the multimeter and computer.
30  !Clear the path and reset the multimeter.

40  DIM Ndig$[1],Count$[9],Rdgs(1:200,1:1000)
50  ASSIGN @Dmm TO 70903;FORMAT OFF
60  CLEAR @Dmm
70  OUTPUT 70903;"*RST"

80  !Specify the starting memory location in shared memory (800000h),
90  !specify the amount of memory to use (1 MByte), direct the readings to the
100 !memory card.
110 OUTPUT 70903;"MEM:VME:ADDR #H800000"
120 OUTPUT 70903;"MEM:VME:SIZE #H100000"
130 OUTPUT 70903;"MEM:VME:STAT ON"

140 !Set the data format to REAL,64. Configure the multimeter to take 200,000
150 !readings at its fastest possible rate.
160 OUTPUT 70903;"FORMAT REAL,64"
170 OUTPUT 70903;"CONF:VOLT:DC 58.1"
180 OUTPUT 70903;"    CAL:ZERO:AUTO OFF"
190 OUTPUT 70903;"    VOLT:APER MIN"
200 OUTPUT 70903;"    SAMP:COUN 200000"
210 OUTPUT 70903;"    SAMP:SOUR TIM"
220 OUTPUT 70903;"    SAMP:TIM MIN"
230 OUTPUT 70903;"INIT"
240 OUTPUT 70903;"FETC?"
250 !Enter the readings.
260 ENTER 70903 USING "#,X,K,K";Ndig$;Count$[1;VAL(Ndig$)]
270 ENTER @Dmm;Rdgs(*)
280 ENTER 70903;Lf$
290 END
```

Comments

- Once the INIT command completes, the readings in shared memory are available to any device. The readings at this time are in 32-bit REAL format.
- When the shared memory state is on (MEM:VME:STAT ON), **all** readings are stored in VME memory regardless of the number of readings taken.
- The VME memory location and memory size can be specified in decimal or hexadecimal. Configuration of the VME memory card should be covered in the manual which came with the card.
- In this program, the readings retrieved from shared memory are 64-bit REAL numbers in the IEEE 488.2-1987 Definite Length Arbitrary Block format. Page 58 contains an example which describes the Arbitrary Block format and additional format information is located in Chapter 4.
- When running HP BASIC, an array dimension can have no more than 32767 elements. Thus, to store 200,000 readings, a two-dimensional array is declared.

Checking for Errors

The following program is a method of checking for errors as you program the multimeter. The program monitors the multimeter's Standard Event Status Register for an error condition. If no errors occur, the multimeter functions as programmed. If errors do occur, the multimeter interrupts the computer and the error codes and messages are read from the multimeter error queue.

The computer commands shown are for an HP 9000 Series 200/300 computer running HP BASIC and controlling the multimeter over HP-IB.

```
10 !Call computer subprogram "Errmsg" if a multimeter programming error
20 !occurs. Enable the computer to respond to an interrupt from the multimeter.
30 ON INTR 7 CALL Errmsg
40 ENABLE INTR 7;2
50 !Unmask the Event Status bit in the multimeter's Status Byte register.
60 !Unmask the multimeter error conditions in its Standard Event Status
70 !register.
80 OUTPUT 70903;"*SRE 32"
90 OUTPUT 70903;"*ESE 60"
100 !At this point, the multimeter is programmed for the intended application.
110 OUTPUT 70903;"...
120 OUTPUT 70903;"...
130 !Allow the computer time to respond if an error occurs during the
140 !multimeter configuration or measurement. Process the measurement
150 !data if no error occurs.
160 WAIT 2
170 ENTER 70903;...
180 PRINT ...
190 END
200 !When an error occurs, clear the multimeter to regain control. Execute a
210 !Serial Poll to clear the service request bit in the Status Byte register.
220 !Read all error messages in the multimeter error queue. Clear all bits in
230 !the multimeter Standard Event Status Register.
240 SUB Errmsg
250 DIM Message$(256)
260 CLEAR 70903
270 B=SPOLL(70903)
280 REPEAT
290 OUTPUT 70903;"SYST:ERR?"
300 ENTER 70903;Code,Message$
310 PRINT Code,Message$
320 UNTIL Code=0
330 OUTPUT 70903;"*CLS"
340 STOP
350 SUBEND
```

Comments

- If you have an HP 75000 Series B mainframe with a keyboard, errors can be monitored by selecting "Monitor" from the multimeter menu. If errors occur when the program executes, the "err" annunciator will appear. Entering SYST:ERR? repeatedly from the keyboard reads all of the messages in the error queue.
- An overload condition (for example, reading = +9.900000E+037) sets the Device Dependent Error bit in the Standard Event Status Register. In this program, this condition interrupts the computer which then calls the subprogram. However, an overload does not generate an error message so 0 "No Error" is displayed.
- The *B-size VXibus Mainframe User's Manual* contains detailed information on the Status and Standard Event Status Registers.

Synchronizing the Multimeter with a Computer

This is an example of how an HP 9000 Series 200/300 computer can monitor the multimeter to determine when data is available. This allows the computer to perform other functions while the multimeter is making measurements. When the readings are available, the computer stops its current function and enters the data.

```
10  !Dimension a computer array to store the readings.
20  DIM Rdgs(1:15)
30  !Clear and reset the multimeter.  Unmask the Message Available (MAV)
40  !bit (4) in the Status Byte Register.
50  OUTPUT 70903;"*CLS"
60  OUTPUT 70903;"*RST"
70  OUTPUT 70903;"*SRE 16"
80  !Configure the multimeter for DC voltage measurements.  Make 5 scans
90  !through the channel list with each scan 5 seconds apart.  Store the
100 !readings in mainframe memory.
110 OUTPUT 70903;"CONF:VOLT:DC (@104:106)"
120 OUTPUT 70903;"  TRIG:COUN 5"
130 OUTPUT 70903;"  TRIG:DEL 5"
140 OUTPUT 70903;"INIT"
150 OUTPUT 70903;"FETC?"
160 !Monitor the message available bit.  Have the computer perform another
170 !function (e.g. display a message) until the bit indicating a reading is
180 !available is set.  Enter and display the readings.
190 WHILE NOT BIT (SPOLL(70903),4)
200     DISP "WAITING FOR DATA"
210     WAIT 1
220     DISP ""
230     WAIT 1
240 END WHILE
250 ENTER 70903;Rdgs(*)
260 FOR I=1 TO 15 STEP 3
270     PRINT Rdgs(I),Rdgs(I+1),Rdgs(I+2)
280 NEXT I
290 END
```

Comments

- Readings are not fetched from memory until all scans and all measurements have completed.
- The message available bit (MAV) is set when the first reading retrieved from memory enters the output buffer.
- Only the data from one command can be in the output buffer or in mainframe memory. Synchronizing the computer with the multimeter in this manner ensures the data is entered into the computer before it is overwritten by data from another command.

Additional Measurement Functions

The following MEASure and CONFigure statements can be substituted into the example programs to make measurements other than DC voltage.

Additional Stand-Alone Multimeter Functions

The following statements can be substituted into the program “Making a Single Measurement” on page 42.

```
!AC voltage.  
OUTPUT 70903;"MEAS:VOLT:AC?"
```

```
!4-wire resistance.  
OUTPUT 70903;"MEAS:FRES?"
```

```
!4-wire thermistor (type = 2252, 5000, 10000).  
OUTPUT 70903;"MEAS:TEMP? FTH,type"
```

```
!4-wire RTD (type = 85, 92).  
OUTPUT 70903;"MEAS:TEMP? FRTD,type"
```

The following statements can be substituted into the programs where the faceplate terminals are used to make multiple reading bursts or multiple burst measurements.

```
!AC voltage.  
OUTPUT 70903;"CONF:VOLT:AC"
```

```
!4-wire resistance.  
OUTPUT 70903;"CONF:FRES"
```

```
!4-wire thermistor (type = 2252, 5000, 10000).  
OUTPUT 70903;"CONF:TEMP FTH,type"
```

```
!4-wire RTD (type = 85, 92).  
OUTPUT 70903;"CONF:TEMP FRTD,type"
```

Additional Scanning Multimeter Functions

The following statements can be substituted into the program “Scanning a Channel List” on page 46.

```
!AC voltage.  
OUTPUT 70903;"MEAS:VOLT:AC? (@channel_list)"
```

```
!2-wire resistance.  
OUTPUT 70903;"MEAS:RES? (@channel_list)"
```

```
!4-wire resistance (channels available are 00 through 07).  
OUTPUT 70903;"MEAS:FRES? (@channel_list)"
```

```
!Thermocouple (type = B, E, J, K, N14, N28, R, S, T).  
OUTPUT 70903;"MEAS:TEMP? TC,type,(@channel_list)"
```

!2-wire thermistor (type = 2252, 5000, 10000).
OUTPUT 70903;"MEAS:TEMP? THER,type,(@channel_list)"

!4-wire thermistor (type = 2252, 5000, 10000)
!Channels available are 00 through 07.
OUTPUT 70903;"MEAS:TEMP? FTH,type,(@channel_list)"

!2-wire RTD (type = 85, 92).
OUTPUT 70903;"MEAS:TEMP? RTD,type,(@channel_list)"

!4-wire RTD (type = 85, 92)
!Channels available are 00 through 07.
OUTPUT 70903;"MEAS:TEMP? FRTD,type,(@channel_list)"

The following statements can be substituted into the programs where the multimeter configuration is set by CONFigure (and low-level commands).

!AC voltage.
OUTPUT 70903;"CONF:VOLT:AC (@channel_list)"

!2-wire resistance.
OUTPUT 70903;"CONF:RES (@channel_list)"

!4-wire resistance (channels available are 00 through 07).
OUTPUT 70903;"CONF:FRES (@channel_list)"

!Thermocouple (type = B, E, J, K, N14, N28, R, S, T).
OUTPUT 70903;"CONF:TEMP TC,type,(@channel_list)"

!2-wire thermistor (type = 2252, 5000, 10000).
OUTPUT 70903;"CONF:TEMP THER,type,(@channel_list)"

!4-wire thermistor (type = 2252, 5000, 10000)
!Channels available are 00 through 07.
OUTPUT 70903;"CONF:TEMP FTH,type,(@channel_list)"

!2-wire RTD (type = 85, 92).
OUTPUT 70903;"CONF:TEMP RTD,type,(@channel_list)"

!4-wire RTD (type = 85, 92).
!Channels available are 00 through 07.
OUTPUT 70903;"CONF:TEMP FRTD,type,(@channel_list)"

Note The HP E1326B/E1411B multimeter also makes strain gage measurements. Refer to the *HP E1355A - E1358A Strain Gage Multiplexers User's Manual* for example programs.

Additional Function Using the HP E1345A Multiplexer

This is an example of how to setup scanning when using an HP E1345A multiplexer configured as a switchbox and the HP E1326B multimeter used with no multiplexers assigned to it. The two subprograms used in this example are Scan_100 μ sec and Scan_10 μ sec. Configuration for this example is as follows:

Connect two cables as:

- Multimeter's "Ext Trig" to "Trig Out" on the E1406 or E1300/E1301.
- Multimeter's "VM Compl" to "Trig In" on the E1406 or E1300/E1301.

The two different subprograms are used to demonstrate a more effective method of scanning (Scan_100 μ s) and a less effective method of scanning (Scan_10 μ s). Comments follow the program and subprograms providing information about the instruments execution.

Scan_100 μ s demonstrates the multimeter set for an aperture of 100 μ s and achieves a scan rate of 123/sec in the E1300 B-size mainframe. Whereas, Scan_10 μ s demonstrates the multimeter set for an aperture of 10 μ s and achieves a decrease in scanning speed.

```
10  !Define I/O paths.
20  !
30  ASSIGN @Sys TO 70900
40  ASSIGN @Dvm TO 70903
50  ASSIGN @Sw TO 70916
60  !
70  !Setup for timeouts and errors.
80  !
90  ON TIMEOUT 7,5 GOTO End
100 ON ERROR RECOVER Kaboom
105 !
110 !Supply your own application code for Main.
120 !
130 Main
140 PRINT "Checking for E13xx_errors at the end of the program"
150 E13xx_errors
160 !
170 !Subprogram Kaboom.
180 !
190 Kaboom:PRINT ""
200   PRINT ERRM$
210   PRINT "Checking for E13xx Errors as a BASIC Error has occurred"
220   E13xx_errors
230 End:END
240 !
250 !Subprogram to read all errors from E13xx instruments.
260 !
270 SUB E13xx_errors
280   .
   .
   .
300 SUBEND
```

Continued on Next Page

```

310 !
320 !Subprogram Scan_100µs.
330 !
340 SUB Scan_100us
350 COM @Sys,@Dvm,@Sw
360 DIM Readings(0:15)
370 !
380 !Clear and reset multimeter.
390 !
400 CLEAR @Dvm
410 OUTPUT @Dvm;"*RST;*CLS;*OPC?"
420 ENTER @Dvm;A
430 !
440 !Clear and reset switch.
450 !
460 CLEAR @Sw
470 OUTPUT @Sw;"*RST;*CLS;*OPC?"
480 ENTER @Sw;A
490 !
500 !Send commands to multimeter.
510 !
520 OUTPUT @Dvm;"CONF:VOLT:DC 11"
530 OUTPUT @Dvm;"VOLT:APER 100E-6"
540 OUTPUT @Dvm;"CAL:ZERO:AUTO ONCE"
550 OUTPUT @Dvm;"TRIG:SOUR EXT;COUNT 16"
560 OUTPUT @Dvm;"*OPC?"
570 ENTER @Dvm;A
580 OUTPUT @Dvm;"INIT"
590 !
600 !Send commands to switch.
610 !
620 OUTPUT @Sw;"OUTP ON"
630 OUTPUT @Sw;"TRIG:SOUR EXT"
640 OUTPUT @Sw;"SCAN:MODE VOLT"
650 OUTPUT @Sw;"SCAN:PORT ABUS"
660 OUTPUT @Sw;"SCAN (@100:115)"
670 OUTPUT @Sw;"*OPC?"
680 ENTER @Sw;A
690 !
700 !Get readings.
710 !
720 Start=TIMEDATE
730 OUTPUT @Sw;"INIT"
740 OUTPUT @Dvm;"FETCH?"
750 ENTER @Dvm;Readings(*)
760 Stop=TIMEDATE
765 PRINT "Scan Rate with Multimeter Aperture at 100us ";16/(Stop-Start)
770 SUBEND
780 !
790 !Subprogram Scan_10µs.
800 !
810 SUB Scan_10us
820 COM @Sys,@Dvm,@Sw
830 DIM Readings(0:15)
840 !

```

Continued on Next Page

```

850  !Clear and reset multimeter.
860  !
870  CLEAR @Dvm
880  OUTPUT @Dvm;"*RST;*CLS;*OPC?"
890  ENTER @Dvm;A
900  !
910  !Clear and reset switch.
920  !
930  CLEAR @Sw
940  OUTPUT @Sw;"*RST;*CLS;*OPC?"
950  ENTER @Sw;A
960  !
970  !Send commands to multimeter.
980  !
990  OUTPUT @Dvm;"CONF:VOLT:DC 11"
1000 OUTPUT @Dvm;"VOLT:APER 10E-6"
1010 OUTPUT @Dvm;"CAL:ZERO:AUTO ONCE"
1020 OUTPUT @Dvm;"TRIG:SOUR EXT;COUNT 16"
1030 OUTPUT @Dvm;"*OPC?"
1040 ENTER @Dvm;A
1050 OUTPUT @Dvm;"INIT"
1060 !
1070 !Send commands to switch.
1080 !
1090 OUTPUT @Sw;"OUTP ON"
1100 OUTPUT @Sw;"TRIG:SOUR EXT"
1110 OUTPUT @Sw;"SCAN:MODE VOLT"
1120 OUTPUT @Sw;"SCAN:PORT ABUS"
1130 OUTPUT @Sw;"SCAN (@100:115)"
1140 OUTPUT @Sw;"*OPC?"
1150 ENTER @Sw;A
1160 !
1170 !Get readings.
1180 !
1190 Start=TIMEDATE
1200 OUTPUT @Sw;"INIT"
1210 OUTPUT @Dvm;"FETCH?"
1220 ENTER @Dvm;Readings(*)
1230 Stop=TIMEDATE
1240 PRINT "Scan Rate with Multimeter Aperture at 10us ";16/(Stop-Start)
1250 SUBEND

```

Results of this program are as follows:

Scan Rate with Multimeter Aperture at 100 μ s: 123.072300469

Scan Rate with Multimeter Aperture at 10 μ s: 4.48178352225

Checking for E13xx Errors at the end of the program:

DVM ERROR: "No error"

SYSTEM ERROR: "No error"

SWITCH ERROR: "No error"

Chapter 4

Understanding the HP E1326B/E1411B

Multimeter

About This Chapter

This chapter describes the parameters which configure the multimeter and helps you determine settings to optimize performance. Information on triggering the multimeter and on saving multimeter configurations in memory is also included.

The chapter is divided into the following sections:

- Using MEASure and CONFigure Commands Page 76
- How to Make Measurements Page 78
- Data Formats and Destinations Page 80
- Measurement Functions Page 86
- Multimeter Parameters Page 91
- Triggering the Multimeter Page 101
- Saving Multimeter Configurations Page 114

Note Throughout this chapter, the HP E1326B/E1411B multimeter is referred to as a "scanning multimeter" or a "stand-alone multimeter".

"Scanning" implies that one or more multiplexers are used with the multimeter and are part of the same instrument (i.e. same HP-IB secondary address).

"Stand-alone" means the multimeter is the only device at that secondary address.

Using MEASure and CONFigure Commands

Each time the multimeter makes a measurement, it does so from a configuration based on several parameters. The easiest way to set these parameters is with the MEASure and CONFigure commands:

```
MEASure:measurement?  
[range|AUTO|DEF|MIN|MAX[,resolution|DEF|MIN|MAX]][,(@channel_list)]
```

```
CONFigure:measurement  
[range|AUTO|DEF|MIN|MAX[,resolution|DEF|MIN|MAX]][,(@channel_list)]
```

```
MEASure:TEMPerature? transducer,type[,(@channel_list)]
```

```
CONFigure:TEMPerature transducer,type[,(@channel_list)]
```

Executing these high-level commands is equivalent to setting up the multimeter with the commands shown in Table 4-1 on page 77. Note that specifying a channel list identifies a scanning multimeter. No channel list identifies a stand-alone multimeter.

Note If a channel list is the only parameter specified in the MEASure or CONFigure command, it must be separated from the command header by a space, rather than a comma (e.g. MEAS:VOLT:DC? (@100)).

Table 4-1. Configurations Using MEASure and CONFigure

Parameter	Command	Setting
Function	_____	As specified.
Range	VOLTage:RANGe RESistance:RANGe	As specified or autorange.
Resolution	VOLTage:RESolution RESistance:RESolution	As specified or a function of range and aperture or integration time.
Aperture Time	VOLTage:APERture RESistance:APERture	16.7 ms (60 Hz), 20 ms (50 Hz), or based on the specified resolution.
Integration Time	VOLTage:NPLC RESistance:NPLC	1 power line cycle (PLC) or based on the specified resolution.
Autozero	CALibration:ZERO:AUTO	ON; autozero is performed after every measurement.
Offset Compensation	RESistance:OCOMPensated	OFF; resistance measurements only.
Trigger Source	TRIGger:SOURce	IMM; trigger signal is always true. Measurement is taken when multimeter goes to Trigger State.
Number of Triggers or Number of Scans	TRIGger:COUNT	1; number of triggers issued or number of scans through channel list before multimeter returns to Idle State.
Trigger Delay	TRIGger:DELay	AUTO - delays are 0 seconds for DC voltage and resistance, 0.5 seconds for AC voltage.
Readings per Trigger	SAMPle:COUNT	1; number of measurements taken when trigger is received.
Sample Period	SAMPle:SOURce	IMM; period between measurements or the period between FET multiplexer scans.

How to Make Measurements

This section explains when you should use MEASure or CONFigure to configure the multimeter. It also shows you how to make measurements once the configuration is set.

Using MEASure

When MEASure is used, the measurement is taken automatically after the configuration is set. For example, executing MEASure as:

```
MEAS:VOLT:DC? 0.91,0.953E-6,(@100:104)
```

makes measurements on channels 100 through 104 after setting the function to DC voltage, the range to 0.91 V, the resolution to 0.953 μV , and the remainder of the parameters as shown in Table 4-1 on page 77.

Because the measurement is taken immediately, variations to the multimeter configuration are limited to the parameters within the MEASure command (range, resolution, channel list).

Using CONFigure

Use CONFigure for applications requiring a configuration different from that available with MEASure. CONFigure *does not* make a measurement after setting the configuration. Any of the low-level commands (see Table 4-1 on page 77) can be used to change selected parameters before a measurement is made.

Assume an application requires the following configuration:

- 4-wire resistance measurements
- 1861 ohm range
- Maximum (best) resolution
- Measure four multiplexer channels
- Offset compensated measurements
- Three scans (passes) through the channel list

MEASure cannot be used since it turns offset compensation off (RES:OCOM OFF). MEASure also sets the multimeter to make one scan (TRIGger:COUNt 1), while the application requires three scans.

By setting the configuration with CONFigure, the low-level commands RESistance:OCOMpensated and TRIGger:COUNt can be used to turn offset compensation ON and set the desired number of scans:

```
CONF:FRES 1861,MAX,(@100:103)
RES:OCOM ON
TRIG:COUN 3
```

Making Measurements When Using CONFigure

To make a measurement the multimeter must be in the wait-for-trigger state when a trigger signal occurs. The MEASure command automatically places the multimeter in the "wait state" after setting the configuration. When CONFigure is used, the multimeter must be placed in the wait state with the command:

READ? (readings are sent to the output buffer)

or

INIT[:IMMEDIATE] (readings are stored in memory)

These commands follow CONFigure as shown below:

```
CONF:FRES 1861,MAX,(@100:103)
```

```
RES:OCOM ON
```

```
TRIG:COUN 3
```

```
READ?
```

```
CONF:FRES 1861,MAX,(@100:103)
```

```
RES:OCOM ON
```

```
TRIG:COUN 3
```

```
INIT
```

Note

READ? and INIT will make measurements upon execution if TRIG:SOUR IMM (trigger signal always true) remains set. If the trigger source is changed following the CONFigure command, execution of the READ? or INIT commands will place the multimeter in the wait-for-trigger state; however, a measurement will not be made until a trigger from the specified source occurs.

Data Formats and Destinations

The HP E1326B/E1411B multimeter allows you to specify the measurement (data) format and reading destination parameters which affect throughput speed. This section identifies the formats available and shows you how to display and store measurements.

Data Formats The multimeter data formats are selected with the command:

```
FORMat[:DATA] <type> [,<length>]
```

The formats (and lengths) are shown in Table 4-2.

Table 4-2. Multimeter Data Formats

Type	Representation	Bytes/Reading
ASCII	+ -1.234567E+ -123	15
REAL 64	# <non-zero digit> <block length> <8-bit data bytes>	8
REAL 32	# <non-zero digit> <block length> <8-bit data bytes>	4
<p>REAL 64 and REAL 32 numbers are transferred to the computer in the IEEE 488.2-1987 Definite Length Arbitrary Block format. Data in this format is preceded by a header consisting of # <non-zero digit> <block length>. <non-zero digit> indicates the number of digits representing <block length>. <block length> indicates the number of 8-bit data bytes which follow. The following examples show how to interpret the Arbitrary block header.</p>		
REAL, 32	#14 <4 bytes> 1 reading	
	#240 <40 bytes> 10 readings	
	#44000 <4000 bytes> 1,000 readings	
REAL, 64	#18 <8 bytes> 1 reading	
	#280 <80 bytes> 10 readings	
	#48000 <8000 bytes> 1,000 readings	

The default format is ASCII. Readings in ASCII are followed by a comma (.). A line feed (LF) and End-Or-Identify (EOI) follow the last reading in all formats.

Specifying a Format The following program segment shows you how to select a data format. Chapter 3 contains an example on selecting a format and entering data with the definite length arbitrary block header into an HP Series 200/300 computer.

```
FORM REAL,64
CONF:FRES 1861,MAX,(@100:103)
RES:OCOM ON
TRIG:COUN 3
READ?
```

Overload Indications

The multimeter indicates an overload condition (input greater than the selected range can measure) by displaying or storing:

$\pm 9.900000E+037$

for the measurement. For temperature measurements:

$9.910000E+037$

indicates an overload condition.

An overload sets the Device Dependent Error bit in the Standard Event Status Register. However, the overload does not generate an error message.

Reading Destinations

Measurements can be displayed on the HP E1301A mainframe, returned to the output buffer and entered into a computer, or stored in memory. This section explains how a reading destination is selected.

Reading Destination vs. Data Format

The data formats available depend on the reading destination. Table 4-3 shows the data formats available for each reading destination.

Table 4-3. Reading Destination vs. Data Format

Destination	Formats
Display	ASCII / REAL 64-bit / REAL 32-bit
Output Buffer	ASCII / REAL 64-bit / REAL 32-bit
Mainframe Memory/ VME Memory Card	REAL 32-bit

Destination = Mainframe Display

When a measurement is made by entering commands from the HP E1301A mainframe front panel, the reading is displayed on the front panel. Readings are also displayed when commands are sent from a computer and the multimeter's monitor mode is on.

Although REAL,64 and REAL,32 are accepted formats, readings displayed in those formats will not resemble the measured values.

Destination = Computer

When multimeter measurements are made using:

`MEASure:measurement? ...`

or

`READ?`

the readings are available to the computer via the output buffer. The following examples show how data (ASCII format) is entered into an HP 9000 Series 200/300 computer using HP BASIC.

**Example: Entering
Data into the Computer
(measurements using
MEASure)**

```
10 !Declare computer array to store 5 readings.
20 REAL Dc_rdgs(1:5)
30 !Configure multimeter and take the measurements.
40 OUTPUT 70903;"MEAS:VOLT:DC? (@100:104)"
50 !Enter readings into the computer.
60 ENTER 70903;Dc_rdgs(*)
70 !Display readings on computer.
80 PRINT Dc_rdgs(*)
90 END
```

**Example: Entering
Data into the Computer
(measurements using
READ?)**

```
10 !Declare computer array to store 12 readings.
20 REAL Ohm_rdgs(1:12)
30 !Configure the multimeter.
40 OUTPUT 70903;"CONF:FRES 1861,MAX,(@100:103)"
50 OUTPUT 70903;" RES:OCOM ON"
60 OUTPUT 70903;" TRIG:COUN 3"
70 !Put multimeter in wait-for-trigger state; take readings.
80 OUTPUT 70903;"READ?"
90 !Enter readings into the computer.
100 ENTER 70903;Ohm_rdgs(*)
110 !Display readings on the computer.
120 PRINT Ohm_rdgs (*)
130 END
```

The data returned by commands such as MEASure or READ? must be entered into the computer before another command is executed. Otherwise, Error -410, "Query Interrupted" occurs and the data will be overwritten if data is generated by the next command.

**Destination =
Mainframe Memory**

A few words about mainframe memory:

1. The E1301A memory is built into the mainframe whereas the E1405A/E1406A memory is **not** built-in.
2. Data is stored in mainframe and shared memory by executing the INIT command.
3. Reading rates are increased when the readings are stored in mainframe memory. Storing readings in memory also ensures that the sample rate is maintained at a constant value.

4. Data stored in memory overwrites the data from a previous command.
5. Each reading stored in memory is four bytes (REAL 32-bit). This format cannot be changed.
6. Each multimeter instrument within the HP 75000 Series B or Series C mainframe is allocated enough memory to store a minimum of 100 readings.

If greater than 100 readings are requested, the mainframe multiplies the TRIGger:COUNT setting by the SAMPlE:COUNT setting to determine the exact number. If enough memory is available, an additional amount is allocated to the multimeter and the readings are stored. If enough memory is not available, an error message occurs and the command is aborted.

The number of additional readings which can be stored in memory depends on the amount of memory in your system and on the number of instruments which use the memory.

7. The memory allocated to the multimeter above the amount required to store 100 readings remains dedicated to that multimeter until *RST is executed or until power is cycled. Once de-allocated, the memory is available to any instrument.

Example: Storing Readings in Mainframe Memory

To store measurements in mainframe memory, execute:

```
INIT[:IMMEDIATE]
```

following the CONFigure command (or any applicable low-level commands).

```

10 !Configure the multimeter.
20 OUTPUT 70903;"CONF:FRES 1861,MAX,(@100:103)"
30 OUTPUT 70903;" RES:OCOM ON"
40 OUTPUT 70903;" TRIG:COUN 3"
50 !Place the multimeter in the wait-for-trigger state, store the readings
60 !in memory.
70 OUTPUT 70903;"INIT"

```

Retrieving Data From Mainframe Memory

Data stored in mainframe memory is retrieved using:

```
FETCH?
```

Once the data is fetched, it is available to the computer via the output buffer. Refer to the next example.

Example: Retrieving Data from Memory

```
10  !Declare computer array to store 12 readings.
20  REAL Ohm_rdgs(1:12)
30  !Configure the multimeter.
40  OUTPUT 70903;"CONF:FRES 1861,MAX,(@100:103)"
50  OUTPUT 70903;" RES:OCOM ON"
60  OUTPUT 70903;" TRIG:COUN 3"
70  !Place the multimeter in the trigger state, store the readings in
80  !mainframe memory.
90  OUTPUT 70903;"INIT"
100 !Retrieve readings from mainframe memory.
110 OUTPUT 70903;"FETCh?"
120 !Enter readings into computer.
130 ENTER 70903;Ohm_rdgs(*)
140 !Display readings on computer.
150 PRINT Ohm_rdgs (*)
160 END
```

Destination = Shared Memory

Multimeter measurements can also be stored in memory shared by the VXibus system (VME Memory Card). The commands used to specify the memory location and direct the readings to shared memory are:

MEMory:VME:ADDRess <address>

MEMory:VME:SIZE <bytes>

MEMory:VME:STATe <mode>

Chapter 3 contains an example on storing readings in shared memory. The MEMory command is covered in Chapter 5.

Reading Destination Summary

The reading destination you select will depend on your application. However, consider the following when selecting a destination:

1. Use READ? or MEASure? to return readings to the output buffer when throughput speed is not important or when the number of measurements is too large to store in mainframe memory.
2. Use INIT to store readings in mainframe memory when speed is important. Use FETCh? to retrieve the readings.
3. Use the MEMory commands and INIT to store readings in shared memory (VME memory card) when speed is important and when the readings will not fit in mainframe memory. Use FETCh? to retrieve the readings.

In addition to selecting a destination, you may want to determine beforehand the number of readings that can be saved in the B-size mainframe RAM. Consider the following when determining the number of readings that can be saved:

- Select your System Instrument.
- Send "DIAG:RDIS:CRE? MAX".
- Divide the number returned by four (4)
(this determines the approximate number of readings that can be saved).

You can also determine if a certain number of readings can be stored in the B-size mainframe RAM by doing the following:

- Select the E1326B multimeter.
- Send "SAMP:COUNt *nnn*" command
(where *nnn* is the number of readings).
- Look for an "OUT OF MEMORY" error message
(if the message is **NOT** generated, then *nnn* readings can be stored).

Measurement Functions

The HP E1326B/E1411B multimeter can make the following measurements:

- DC Voltage
- RMS AC Voltage
- 2-Wire Resistance
- 4-Wire Resistance
- Temperature

Note

The HP E1326B/E1411B multimeter also makes $\frac{1}{4}$ bridge, $\frac{1}{2}$ bridge, and full bridge strain measurements. Refer to the *HP E1355A - E1358A Strain Gage Multiplexer User's Manual* for descriptions of these functions.

DC Voltage Measurements

The multimeter can measure DC voltages up to 300 V (170 V with multiplexers), with resolution down to approximately 30 nV depending on the range and aperture or integration time. Selectable integration times of 1 or 16 power line cycles (PLC) provide normal mode rejection for measurements in the presence of noise.

The DC voltage function is specified as:

VOLTage:DC

and generally appears in the MEASure and CONFigure commands as:

MEAS:VOLT:DC? ...

CONF:VOLT:DC ...

RMS AC Voltage Measurements

The multimeter can measure RMS AC voltages up to 450 V_{peak} (170 V_{peak} with multiplexers, 15 V_{peak} with FET multiplexers), at frequencies from 20 Hz to 10 kHz. Measurement resolution down to approximately 30 nV is achieved with the appropriate range and aperture or integration time settings. The AC measurements are AC-coupled. This means that for an AC signal with a DC offset, only the AC amplitude is measured. The DC offset is prevented (blocked) from reaching the measurement circuitry of the multimeter.

The multimeter uses a true RMS converter for AC voltage measurements. This allows accurate measurement of voltages that are noisy, distorted, or non-sinusoidal such as square waves, triangle waves, sawtooths, and so on.

The AC voltage function is specified as:

VOLTage:AC

and generally appears in the MEASure and CONFIgure commands as:

MEAS:VOLT:AC? ... [(@channel_list)]

CONF:VOLT:AC ... [(@channel_list)]

Resistance Measurements

The multimeter can measure resistance up to 1.048 M Ω . Measurement resolution down to 60 $\mu\Omega$ is achieved with the appropriate range and aperture or integration time settings. Measurements can be made using a 2-wire or 4-wire configuration.

How Resistance is Measured

The multimeter measures resistance by turning on an internal current source which induces a voltage across the unknown resistance. The induced voltage is measured and is divided by the amount of current applied. The result is the "measured" resistance (resistance = voltage/current).

Table 4-4 shows the amount of current applied to the unknown resistance for a given range. Consider that the current flowing through the resistance will cause a certain amount of self-heating, thus changing the resistance. The effects of self-heating can be minimized by selecting a higher range since less current is applied. However, measurement resolution is also decreased.

Table 4-4. Current Source Values

Range	Current
256 Ω	488 mA
2048 Ω	488 μA
16384 Ω	61 μA
131072 Ω	61 μA
1048576 Ω	7.6 μA

Two-Wire vs. Four-Wire Measurements

The multimeter uses separate "sense" and "source" terminals when making resistance measurements. The sense terminals measure (sense) the input signal. The source terminals route current from the current source through the unknown resistance. When the scanning multimeter makes a 2-wire resistance measurement, the multiplexer connects these terminals together. Thus, the input is sensed and the current is sourced through essentially the same terminals. When the stand-alone multimeter is used, you must connect the sense and source terminals to the resistance being measured. This is a 4-wire configuration and the measurement must be specified accordingly. Only 4-wire measurements can be made with the stand-alone multimeter. Two-wire and 4-wire measurements can be made with the scanning multimeter.

Two-Wire Measurements

Two-wire measurements are useful in applications where test lead resistance is not critical. Because the multimeter measures the total resistance between its terminals, lead resistance that is large relative to the unknown resistance will cause inaccurate measurements. Thus, for all resistance measurements and especially those on the lower ranges, the leads should be as short as possible.

Two-wire measurements are specified as:

RESistance

This function appears in the MEASure and CONFigure commands as:

MEAS:RES? ...(@channel_list)

CONF:RES ...(@channel_list)

Four-Wire Measurements

For applications which require accurate resistance measurements or where long test leads are used, the 4-wire configuration should be used. In the 4-wire configuration, errors due to test lead resistance are eliminated since only the voltage induced across the unknown resistance is measured.

Four-wire measurements are specified as:

FRESistance

This function appears in the MEASure and CONFigure commands as:

MEAS:FRES?...[(@channel_list)]

CONF:FRES ...[(@channel_list)]

Channel Pairs

Four-wire measurements with multiplexers use channel pairs. Channel pairs on the HP E1345A 16-channel multiplexer, for example, are channels 00 and 08, 01 and 09, 02 and 10, ... 07 and 15. The lower channel in the channel pair (00, 01, 02) is the sense channel. The higher channel (08, 09, 10) is the source channel. When specifying a channel list, the lower "sense" channels are specified.

Temperature Measurements

The multimeter can make temperature measurements using specific thermistors, thermocouples, and RTDs.

Thermistor Measurements

The thermistor *types* supported are 2252 Ω , 5000 Ω , and 10000 Ω . Use thermistors that match the Omega 440xx series temperature response curves. Thermistor measurements can be made in either a 2-wire or 4-wire configuration. Two-wire measurements require the scanning multimeter.

Two-wire thermistor measurements are specified as:

TEMP THERmistor,*type*

This function appears in the MEASure and CONFigure commands as:

```
MEAS:TEMP? THER,type,(@channel_list)
CONF:TEMP THER,type,(@channel_list)
```

Four-wire measurements are specified as:

```
TEMP FTHermistor,type
```

This function appears in the MEASure and CONFigure commands as:

```
MEAS:TEMP? FTH,type,(@channel_list)
CONF:TEMP FTH,type,(@channel_list)
```

Thermocouple Measurements

Thermocouple measurements require the HP E1344A, E1347A, E1353A, or HP E1476A multiplexers which are thermocouple compensated. The thermocouple *types* supported are B, E, J, K, N14, N28, R, S, and T.

Thermocouple measurements are specified as:

```
TEMP TCouple,type
```

and appear in the MEASure and CONFigure commands as:

```
MEAS:TEMP? TC,type,(@channel_list)
CONF:TEMP TC,type,(@channel_list)
```

You can also measure the temperature of the reference thermistor on the HP E1344A, E1347A, E1353A, or E1476A multiplexers as shown below:

```
MEAS:TEMP? THER,5000,(@nn93)
```

where *nn* is the multiplexer card number.

RTD Measurements

The RTD types supported are 85 (alpha = 0.00385) and 92 (alpha = 0.00392). RTD measurements can be made in either a 2-wire or 4-wire configuration. Two-wire measurements require the scanning multimeter.

Two-wire RTD measurements are specified as:

```
TEMP RTD,type
```

The function appears in the MEASure and CONFigure commands as:

```
MEAS:TEMP? RTD,type,(@channel_list)
CONF:TEMP RTD,type,(@channel_list)
```

Four-wire measurements are specified as:

```
TEMP FRTD,type
```

The function appears in the MEASure and CONFigure commands as:

```
MEAS:TEMP? FRTD,type[(@channel_list)]
```

```
CONF:TEMP FRTD,type[(@channel_list)]
```

Note

When making temperature measurements with the MEASure command, the question mark (?) must be inserted between TEMP and the temperature transducer used. Also, if a channel list immediately follows the transducer, it must be separated by a comma (,) (e.g. MEAS:TEMP? THER,5000,(*@100*)).

Specifying a Function

The measurement functions described previously are represented by the "measurement" parameter in the MEASure and CONFigure commands:

```
MEASure:measurement?  
[range|AUTO|DEF|MIN|MAX[,resolution|DEF|MIN|MAX]][,(@channel_list)]
```

```
CONFigure:measurement  
[range|AUTO|DEF|MIN|MAX[,resolution|DEF|MIN|MAX]][,(@channel_list)]
```

When using the stand-alone multimeter, the low-level command:

```
FUNCtion:function
```

can be used to change the measurement function without causing a complete reconfiguration of the multimeter. The stand-alone multimeter *functions* which can be changed are:

```
VOLT:DC
```

```
VOLT:AC
```

```
FRESistance
```

The next example shows you how to change from a DC voltage measurement to a 4-wire resistance measurement.

Example: Changing Measurement Functions with FUNCTION

```
10  !Configure for DC voltage measurement.
20  CONF:VOLT:DC
30  !Put multimeter in wait-for-trigger state, take reading.
40  READ?
50  !Enter reading into computer.
60  !Change function to 4-wire resistance.
70  FUNC:FRES
80  !Put multimeter in wait-for-trigger state, take reading.
90  READ?
100 !Enter reading into computer.
```

In addition to the function change the range, resolution, aperture time, and integration time for the second measurement are set to either their reset or last programmed values. The triggering parameters remain as set by CONFigure.

Multimeter Parameters

Many of the parameters set by MEASure, CONFigure, and low-level commands configure the multimeter's analog-to-digital (A/D) converter and other portions of its measurement circuitry. These parameters include:

- range
- resolution
- aperture and integration time
- autozero
- offset compensation

This section describes these parameters. The settings are summarized in Table 4-5 on page 92.

Table 4-5. Aperture Time, Range, and Resolution Settings

Aperture Time Integration Time (PLCs)			10 μ s* 0.0005	100 μ s 0.005	2.5 ms 0.125	16.7 ms 1	20 ms 1	267 ms 16	320 ms 16
DC & AC Voltage (Using CONFIGure/MEASure)									
Range DC	Range AC	Percent Overrange	Resolution						
0.113 V 0.91 V 7.27 V 58.1 V 300 V	0.0795 V 0.63 V 5.09 V 40.7 V 300 V	10% 10% 10% 10% 0%	7.629 μ V 61.035 μ V 488.281 μ V 3.906 mV 31.25 mV	3.814 μ V 30.517 μ V 244.14 μ V 1.953 mV 15.625 mV	0.476 μ V 3.814 μ V 30.517 μ V 244.14 μ V 1.953 mV	0.119 μ V 0.953 μ V 7.629 μ V 61.035 μ V 488.28 μ V	0.119 μ V 0.953 μ V 7.629 μ V 61.035 μ V 488.28 μ V	28.9 nV 0.238 μ V 1.907 μ V 15.258 μ V 122.07 μ V	28.9 nV 0.238 μ V 1.907 μ V 15.258 μ V 122.07 μ V
DC & AC Voltage (Using RANGE)									
Range DC	Range AC	Percent Overrange	Resolution						
0.125 V 1.0 V 8.0 V 64.0 V 300 V	0.0875 V 0.7 V 5.6 V 44.8 V 300 V	0% 0% 0% 0% 0%	7.629 μ V 61.035 μ V 488.281 μ V 3.906 mV 31.25 mV	3.814 μ V 30.517 μ V 244.14 μ V 1.953 mV 15.625 mV	0.476 μ V 3.814 μ V 30.517 μ V 244.14 μ V 1.953 mV	0.119 μ V 0.953 μ V 7.629 μ V 61.035 μ V 488.28 μ V	0.119 μ V 0.953 μ V 7.629 μ V 61.035 μ V 488.28 μ V	28.9 nV 0.238 μ V 1.907 μ V 15.258 μ V 122.07 μ V	28.9 nV 0.238 μ V 1.907 μ V 15.258 μ V 122.07 μ V
2-Wire & 4-Wire Resistance (Using CONFIGure/MEASure)									
Range		Percent Overrange	Resolution						
232 Ω 1861 Ω 14894 Ω 119156 Ω 1048576 Ω		10% 10% 10% 10% 10%	15.625 m Ω 125 m Ω 1 Ω 8 Ω 64 Ω	7.812 m Ω 62.5 m Ω 0.5 Ω 4 Ω 32 Ω	0.976 m Ω 7.812 m Ω 62.5 m Ω 0.5 Ω 4 Ω	244 μ Ω 1.95 m Ω 15.6 m Ω 125 m Ω 1 Ω	244 μ Ω 1.95 m Ω 15.6 m Ω 125 m Ω 1 Ω	61 μ Ω 488 μ Ω 3.9 m Ω 31.2 m Ω 250 m Ω	61 μ Ω 488 μ Ω 3.9 m Ω 31.2 m Ω 250 m Ω
2-Wire & 4-Wire Resistance (Using RANGE)									
Range		Percent Overrange	Resolution						
256 Ω 2048 Ω 16384 Ω 131072 Ω 1048576 Ω		0% 0% 0% 0% 0%	15.625 m Ω 125 m Ω 1 Ω 8 Ω 64 Ω	7.812 m Ω 62.5 m Ω 0.5 Ω 4 Ω 32 Ω	0.976 m Ω 7.812 m Ω 62.5 m Ω 0.5 Ω 4 Ω	244 μ Ω 1.95 m Ω 15.6 m Ω 125 m Ω 1 Ω	244 μ Ω 1.95 m Ω 15.6 m Ω 125 m Ω 1 Ω	61 μ Ω 488 μ Ω 3.9 m Ω 31.2 m Ω 250 m Ω	61 μ Ω 488 μ Ω 3.9 m Ω 31.2 m Ω 250 m Ω
Max. Readings/Second **			13,150	3,000	350	58	49	2	1.9
Line Frequency Rejected			---	---	400 Hz	60 Hz	50/400 Hz	60 Hz	50/400 Hz
Normal Mode Rejection			0 dB	0 dB	60 dB	60 dB	60 dB	84 dB	84 dB
Bits of Resolution			14	15	18	20	20	22	22
* 10 μ s aperture time is only available when a fixed range is specified.									
** Reading rates are approximate and are achieved using a stand-alone multimeter, DC voltage function, fixed range, autozero off, offset compensation off, reading stored in mainframe/command module memory. See Table 4-6 on page 110 for the necessary sample rates.									

Range The range parameter sets the range of input signal levels the multimeter is to accept and measure. Consider the following when determining a range:

1. Measurement speed is increased when a fixed range is specified.
2. The selected range should include all of the input signal levels you expect to measure. For the best resolution, select the lowest possible range.
3. Setting an AC voltage range changes the DC voltage range to a corresponding value and vice versa.
4. The range must be specified before specifying a resolution. You must also set a fixed range in order to specify an aperture time of 10 μ s.

Setting the Range The DC voltage, AC voltage, and resistance ranges are given in Table 4-5 on page 92.

The percentage (%) of overrange is the amount the input can exceed the range value shown and still be measured on that range.

The commands used to specify a range are:

MEASure:*measurement?*
[*range*|AUTO|DEF|MIN|MAX[,resolution|DEF|MIN|MAX]][,(@channel_list)]

CONFigure:*measurement*
[*range*|AUTO|DEF|MIN|MAX[,resolution|DEF|MIN|MAX]][,(@channel_list)]

VOLTage:RANGe *range* | MIN | MAX

RESistance:RANGe *range* | MIN | MAX

VOLTage:AC:RANGe *range* | MIN | MAX

where:

range = measurement range from Table 4-5.

AUTO = sets autorange.

DEF = sets autorange.

MIN = sets the minimum range of 0.113 Vdc / 0.0795 Vac / 232 Ω if MEASure or CONFigure is used. Sets the minimum range of 0.125 Vdc / 0.0875 Vac / 256 Ω if range is used.

MAX = sets the maximum range of 300 V / 1048576 Ω .

If no range parameter is specified in the MEASure or CONFigure command, autorange is set. However, to specify a MIN or MAX resolution while autoranging, AUTO or DEF must be explicitly specified. This prevents the MIN or MAX resolution from being interpreted as a range setting.

Autorange The default range is autorange. Autorange is the process where the multimeter samples the input signal, and then automatically selects the correct (lowest valid) range. Consider the following when using autorange:

1. Autoranging typically adds 150 μs to the fixed range measurement time if it ranges up one range, or ranges down any number of ranges. Each reading takes an additional 50 μs for each additional range-up step. If autoranging is enabled but does not occur, approximately 100 μs is added to the fixed range measurement time. The E1326B/E1411B automatically switches to the 10 μs aperture time when making measurements to determine the correct range.
2. For maximum speed, group channels together which use the same range. When the aperture time is 10 μs and autoranging is enabled but does not occur, the measurement rate is 2380 readings/second.
3. Use autorange to simplify thermocouple, thermistor, and RTD measurements.

Setting Autorange Autorange is set when AUTO, DEF, or no range parameter is specified in the MEASure or CONFigure command. Autorange is also enabled and disabled with the low-level commands:

VOLTage:RANGe:AUTO *mode*

RESistance:RANGe:AUTO *mode*

where:

mode = ON (turns autorange on) or OFF (turns autorange off).

Querying the Range The measurement range is queried with the following commands:

VOLTage:RANGe?
VOLTage:RANGe? MIN | MAX

VOLTage:AC:RANGe?
VOLTage:AC:RANGe? MIN | MAX

RESistance:RANGe?
RESistance:RANGe? MIN | MAX

Executing CONFigure? returns the range, resolution, and measurement function set by the CONFigure command.

Note When querying the range, the ranges available with the range command (Table 4-5) are returned. For example, if a range of 0.113 V is set with the MEASure or CONFigure command, 0.125 is returned if the range is queried. If 0.91 V is set, 1.0 is returned, and so on.

Querying the Autorange Setting

The autorange setting is queried with the `VOLTage:RANGe:AUTO?` and `RESistance:RANGe:AUTO?` commands. See Chapter 5 for additional information.

Resolution

Resolution is the smallest change in voltage or resistance that can be discerned. Assume, for example, a nominal resistance of $10\ \Omega$ is measured. The reading might appear as:

1.084540E+001

If the multimeter is set for $0.976\ \text{m}\Omega$ resolution, resistance changes as small as $0.976\ \text{m}\Omega$ will appear in the measurements.

When setting a resolution, consider the following:

1. Specify a resolution only when making measurements on a fixed range. Otherwise, the resolution will be changed to correspond to the range selected during autorange.
2. Resolution affects the reading rate. The better the resolution, the lower the reading rate.
3. Setting the resolution also sets the aperture time and integration time. Of these three parameters, the settings of the other two are based on the one most recently set.

Setting the Resolution

The resolutions for DC/AC voltage and resistance measurements are given in Table 4-5 on page 92. Note that the resolution is specified in the units of the measurement (volts, ohms), and not as a percentage of the measurement.

When a resolution is specified the aperture time and integration time are set accordingly. For example, specifying a range of 232 Ω and a resolution of 0.976 m Ω sets a 2.5 ms aperture time and 0.125 PLC of integration time.

The commands used to specify *resolution* are:

```
MEASure:measurement?  
[range|AUTO|DEF|MIN|MAX[,resolution|DEF|MIN|MAX]][,(@channel_list)]
```

```
CONFigure:measurement  
[range|AUTO|DEF|MIN|MAX[,resolution|DEF|MIN|MAX]][,(@channel_list)]
```

```
VOLTage:RESolution resolution | MIN | MAX
```

```
RESistance:RESolution resolution | MIN | MAX
```

where:

resolution = value from Table 4-5 on page 92 (for the corresponding range).

DEF = defaults the resolution. This sets 1 PLC of integration time.

MIN = sets the smallest resolution number in the table (best resolution) for the specified range.

MAX = sets the largest resolution number in the table (worst resolution) for the specified range.

Note

When autoranging, MIN or MAX are the only resolution settings which can be specified.

Querying the Resolution

The resolution is queried with the following commands. See Chapter 5 for additional information.

```
VOLTage:RESolution?  
VOLTage:RESolution? MIN | MAX
```

```
RESistance:RESolution?  
RESistance:RESolution? MIN | MAX
```

Executing CONFigure? returns the resolution, range, and measurement function set by the CONFigure command.

Aperture and Integration Time

The aperture time or integration time is the time which the multimeter samples the input signal. Aperture time is expressed in seconds and integration time is expressed in power line cycles. Integrating multimeters, like the E1326B, may be programmed to integrate an integer number of power line cycles (PLC). These have a common mode rejection ratio. The common mode rejection ratio is increased by the normal mode rejection ratio. This is known as the effective common mode and is shown as follows:

$$[\text{AC common mode rejection ratio}] + [\text{Normal mode rejection ratio}]$$

The effective common mode rejection is only for power line frequencies. However, this is the most common noise that needs to be rejected. Therefore, the effective common mode rejection for DC and resistance measurements is as follows:

$$110 \text{ db} + 60 \text{ db} = 170 \text{ db}$$

when the voltmeter aperture is set for one power line cycle (PLC).

When setting an aperture or integration time, consider the following:

1. Normal mode rejection of 50 Hz or 60 Hz noise is only achieved with aperture times ≥ 16.7 ms (60 Hz) (≥ 20 ms (50 Hz)), or with integration times ≥ 1 power line cycle.
2. The longer the aperture or integration time, the greater the normal mode noise rejection, but the lower the reading rate.
3. Setting the aperture time or integration time sets the other and the resolution. Of these three parameters, the settings of the other two are based on the one most recently set.

Setting the Aperture and Integration Time

The multimeter aperture times, integration times, line frequency rejected, and the amount of normal mode rejection (NMR) are given in Table 4-5 on page 92.

When an aperture or integration time is specified, the time not specified and the resolution are set accordingly. For example, an aperture time of 16.7 ms (line frequency = 60 Hz) sets an integration time of 1 PLC. The corresponding resolution depends on the function and range.

The MEASure and CONFigure commands set an aperture time of 16.7 ms (60 Hz) or 20 ms (50 Hz) and an integration time of 1 PLC. These values can be changed with the commands:

```
VOLTage:APERTure time | MIN | MAX  
RESistance:APERture time | MIN | MAX  
VOLTage:NPLC value | MIN | MAX  
RESistance:NPLC value | MIN | MAX
```

where:

time = aperture time (in seconds) from Table 4-5 on page 92.

value = number of PLCs from Table 4-5 on page 92.

MIN = sets an aperture time of 10 ms (fixed ranges only). This setting offers no NMR; however, the reading rate is increased.

MIN = sets 0.0005 PLC. This setting offers no NMR; however, the reading rate is increased. This setting is only available for measurements on a fixed range.

MAX = sets an aperture time of 267 ms or 320 ms depending on the power line frequency. This setting offers the greatest amount of NMR at the lowest reading rate.

MAX = sets 16 PLC. This setting offers the greatest amount of NMR at the lowest reading rate.

Querying the Aperture and Integration Time

The aperture and integration times are queried with the following commands. See Chapter 5 for additional information.

```
VOLTage:APERture?  
VOLTage:APERture? MIN | MAX
```

```
RESistance:APERture?  
RESistance:APERture? MIN | MAX
```

```
VOLTage:NPLC?  
VOLTage:NPLC? MIN | MAX
```

```
RESistance:NPLC?  
RESistance:NPLC? MIN | MAX
```

Autozero

Autozero is the process of cancelling out the offset voltage from DC voltage and resistance measurements. When the multimeter is triggered and autozero is enabled, the signal or induced voltage (resistance measurements) is measured. The multimeter then internally disconnects the signal or turns off the current source and measures the offset voltage. The difference between these readings is the measurement, or the value used to calculate the resistance.

When using autozero, consider the following:

1. Autozero ensures the most accurate DC voltage measurements; however, measurement speed is half of that obtained with autozero off.
2. If the temperature of the measurement environment is constant and the measurements are taken on the same range, autozero can be turned off with few adverse affects on measurement accuracy.
3. Autozero *does not* occur following a range change whether it is on or off.
4. When on, an autozero will occur when changing the measurement function to or from AC voltage.
5. Since autozero shorts the input internally, only the internal DC offset to the A/D is measured.

Enabling Autozero

The MEASure and CONFigure commands turn the autozero function on. The command used to turn autozero on and off is:

```
CALibration:ZERO:AUTO mode | ONCE
```

where:

mode = ON (an offset voltage measurement is made after every measurement of the input signal) or OFF (turns the autozero function off).

ONCE - performs an offset voltage measurement after one measurement of the input signal. The offset is then subtracted from all subsequent measurements.

Querying the Autozero Mode

The autozero mode is queried with the CALibration:ZERO:AUTO? command. See Chapter 5 for additional information.

Offset Compensation

Anytime a resistance measurement is made, offset voltages internal and external to the multimeter can be present. When these offsets are added to the voltage induced (by the multimeter) across the resistance, measurement accuracy is affected. Offset compensation cancels the offset voltage by:

1. Turning on the current source and measuring the induced voltage.
2. Turning off the current source and measuring the offset voltage.
3. Taking the difference between the induced and offset voltages and dividing that number by the amount of current applied.

The result is the resistance measurement output from the multimeter.

Note

The multimeter can compensate for offset voltages that are 10% of the maximum voltage induced across the resistor.

When using offset compensation, consider the following:

1. Offset compensation allows you to make the most accurate 2-wire and 4-wire resistance measurements; however, measurement speed is decreased.
2. Offset compensation can be used on any measurement range; however, on the highest range, the induced voltage is likely to be much greater than the offset voltage. Thus, the offset voltage's affect on measurement accuracy is negligible.
3. The external circuit remains connected thus allowing an offset measurement to be made for the SUM of BOTH internal and external offsets.
4. With the external circuit connected, any induced voltage in your external wiring is compensated for. Induced voltage in your external wiring could be due to thermal heating, noise pickup, or other battery effects (thermocouple junctions at wiring points, for example).
5. Offset compensation (OCOM) overrides autozero; however, if both are on, the reading rate reflects the autozero state.

Enabling Offset Compensation

The MEASure and CONFigure commands turn offset compensation off. The command used to turn offset compensation on is:

```
RESistance:OCOMpensated mode
```

where:

mode = ON (offset compensation is enabled) or OFF (offset compensation is disabled).

Querying the Offset Compensation Mode

The offset compensation mode is queried with:

```
RESistance:OCOMpensated?
```

See Chapter 5 for additional information.

Triggering the Multimeter

The E1326B/E1411B multimeter operates in an idle state, a wait-for-trigger state, and a triggered state. Configuration of the multimeter and its trigger system occurs while the multimeter is in the idle state. When the multimeter is ready to make a measurement, it is placed in the wait-for-trigger state. When the trigger is received, the multimeter is placed in the triggered state and a measurement is made. If the multimeter is programmed to make one measurement per trigger, it returns to the idle state once the measurement completes. If the multimeter is programmed for multiple measurements per trigger or is programmed to receive multiple triggers, those conditions must be satisfied before it returns to the idle state.

Additionally, the multimeter's trigger system consists of two loops - the trigger count loop and the sample count loop. The sample count loop is the faster of the two and can sustain 13 K samples per second as indicated in Table 4-6 on page 110. The trigger count loop is slower due to the following:

- The multimeter has a 512 by 16 bit buffer.
- In 10 μ s aperture mode, the buffer holds 512 readings.
- For other aperture modes, the buffer holds 256 readings.
 - for less than 512 readings, limitations by the multimeter occur
 - for greater than 512 readings, limitations by the command module occur

Figure 4-1 summarizes the multimeter's trigger system. The trigger system commands in the figure are covered on the following pages.

NOTE:
Multimeter is configured using MEASure, CONFigure and low-level commands.

NOTE:
MEASure and READ? execute INIT implicitly which puts the multimeter in the wait-for-trigger state.

NOTE:
MEASure and CONFigure set TRIG:SOUR IMM which causes an immediate measurement when the multimeter is placed in the wait-for-trigger state.

NOTE:
MEASure and CONFigure set a trigger delay of 0s.

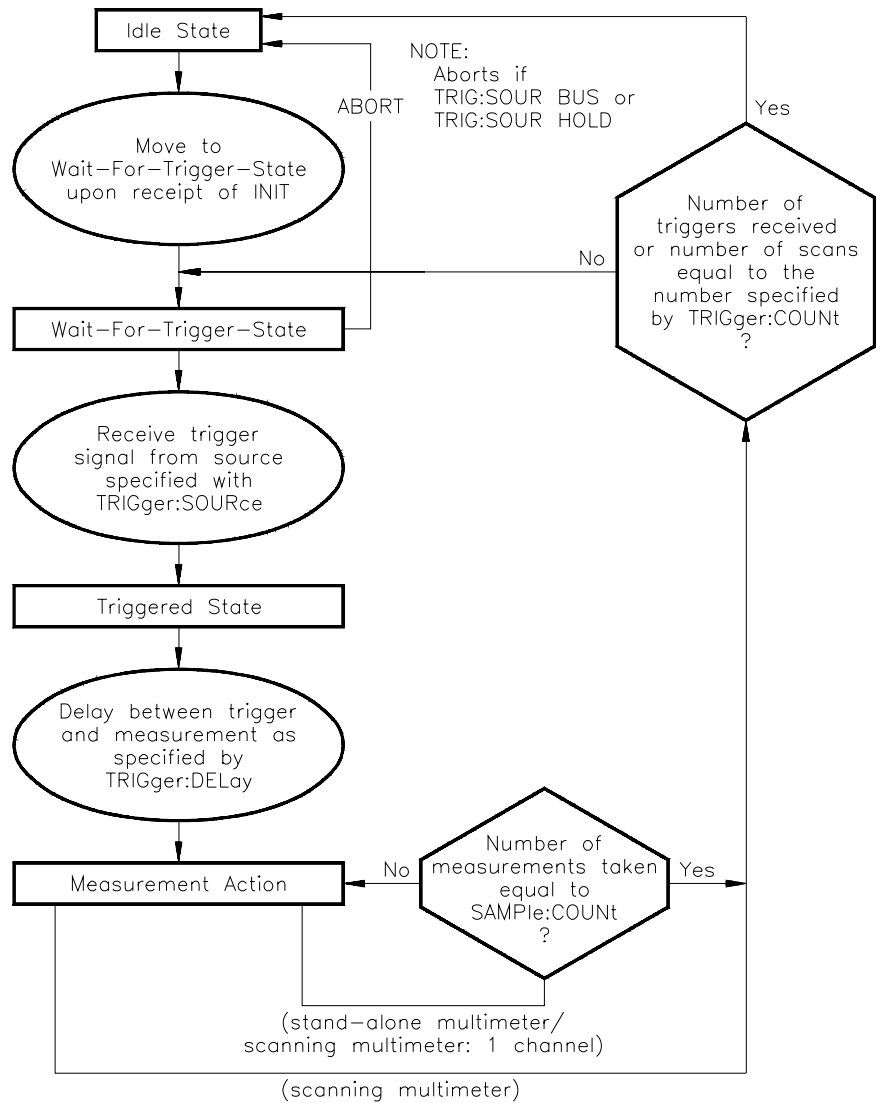

Figure 4-1. The Multimeter Trigger System

The Trigger Source

The trigger source parameter specifies the signal which triggers the multimeter. The trigger source is set with the following command:

```
TRIGger:SOURce source
```

The *source* settings are:

BUS = trigger source is the HP-IB group execute trigger (GET) or the system *TRG command. Within the HP 75000 Series B mainframe, the instrument whose trigger source is set to BUS and was the last instrument addressed to listen will respond to the HP-IB group execute trigger. The system trigger (*TRG) is sent to a specific instrument (i.e. OUTPUT 70903;"*TRG").

EXT = trigger source is an external trigger applied to the multimeter's "External Trigger" BNC connector. The multimeter triggers on the falling (negative-going) edge of a TTL signal.

When scanning with a FET multiplexer "switchbox" (multiplexers at a different secondary HP-IB address), TRIGger:SOURce EXT must be selected in order to trigger the multimeter with the Channel Closed/External Trigger line on the digital bus.

HOLD = suspends triggering. Once set, the multimeter can only be triggered with the TRIGger[:IMMEDIATE] command.

IMMEDIATE = an internal trigger signal is always present. Placing the multimeter in the wait-for-trigger state (INIT) causes it to be triggered. MEASure and CONFigure set TRIGger:SOURce IMM. (MEASure also executes INIT.)

TTLTrg0 - TTLTrg7 = trigger source is VXIbus TTL trigger line 0 through 7. These trigger sources are available with the HP E1411B multimeter only.

Querying the Trigger Source

The trigger source is queried with the TRIGger:SOURce? command. See Chapter 5 for additional information.

The Trigger Count

The function of the trigger count parameter depends on whether the stand-alone multimeter or scanning multimeter is used.

Stand-alone Multimeter

The trigger count specifies the number of triggers the multimeter is to receive before it returns to the idle state.

Scanning Multimeter

The trigger count specifies the number of scans (passes) through the channel list. When making multiple scans through the channel list, a trigger signal starts each scan. To take multiple readings on a particular channel, the multimeter must scan only one channel, or make multiple scans through the list.

The command used to set the trigger count is the same for the stand-alone and scanning multimeter:

```
TRIGger:COUNT number | MIN | MAX
```

where:

number = number of triggers received before the multimeter returns to the idle state, or the number of scans through the channel list. The minimum number is 1, the maximum number is 16,777,215. MEASure and CONFigure set TRIGger:COUNT 1.

MIN = sets 1 trigger before returning to the idle state or 1 scan through the channel list.

MAX = sets 16,777,215 triggers before returning to the idle state or 16,777,215 scans through the channel list. If MAX or 16,777,215 is specified, Error +1000 “Out of memory” occurs indicating that many readings cannot be stored in memory. However, READ? can be executed to return the readings to the output buffer.

The next two examples show how TRIGger:COUNT is used in the stand-alone and scanning multimeter configurations.

Example 1: Setting the Trigger Count (stand-alone multimeter)

In this example, one DC voltage measurement is taken each time an external trigger occurs. After 10 external triggers (and measurements), the multimeter returns to the idle state.

```
10 !Configure the stand-alone multimeter for DC voltage measurements
20 !on its terminals. Set the multimeter to receive 10 external triggers.
30 !Place the multimeter in the wait-for-trigger state.
40 CONF:VOLT:DC
50 TRIG:SOUR EXT
60 TRIG:COUN 10
70 READ?
```

Example 2: Setting the Trigger Count (scanning multimeter)

In this example, the multimeter scans the channel list five times making a total of 25 measurements. The multimeter is internally triggered as the trigger source is not changed from that set by CONFigure (TRIG:SOUR IMM).

```
10 !Configure the scanning multimeter for DC voltage measurements on
20 !multiplexer channels 100 through 104. Make 5 scans through the channel list.
30 !Place the multimeter in the wait-for-trigger state.
40 CONF:VOLT:DC (@100:104)
50 TRIG:COUN 5
60 READ?
```

Querying the Trigger Count

The trigger count setting is queried with the TRIGger:COUNt? and TRIGger:COUNt? MIN | MAX commands. See Chapter 5 for additional information.

The Trigger Delay

The trigger delay parameter allows you to specify the period between the trigger signal and the measurement. For the stand-alone multimeter, this is the delay between the trigger and the first measurement of each burst. For the scanning multimeter, it's the delay between the trigger and the first channel in each scan (Figure 4-2).

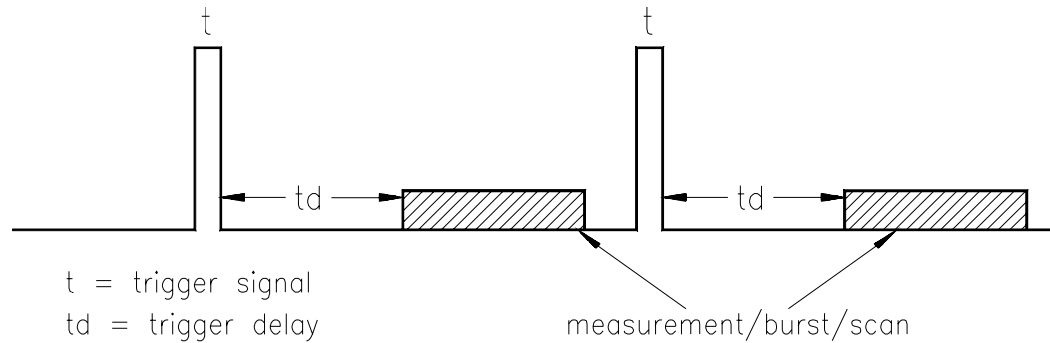

Figure 4-2. Multimeter Trigger Delays

Note that you can set the sample period between measurements in a burst and the sample period between FET multiplexer channels with the `SAMPLE:TIMer` command.

The trigger delay is set with the commands:

```
TRIGger:DElay period | MIN | MAX
```

```
TRIGger:DElay:AUTO mode
```

where:

period = period between the trigger signal and the measurement. The range for period is 0 to 16.7772150 seconds.

MIN = sets the minimum trigger delay of 0 seconds for DC voltage and resistance measurements. Sets a delay of 0.5 seconds for AC voltage measurements.

MAX = sets the maximum trigger delay of 16.7772150 seconds.

mode = ON; delay is 0 seconds for the DC voltage and resistance measurements, 0.5 seconds for the AC voltage measurements. To reduce the delay for AC voltage measurements, change the function to AC voltage first, and then set the delay. MEASure and CONFigure set TRIGger:DElay:AUTO ON.

OFF turns TRIGger:DElay:AUTO off. Specifying a trigger delay automatically turns TRIG:DEL:AUTO off.

The following program segment shows the context in which TRIGger:DELay is used.

Example: Setting a Trigger Delay

```
10  !Configure the scanning multimeter for DC voltage measurements on  
20  !channels 100 through 104. Make 5 scans through the channel list.  
30  !Make a scan every 10 seconds.  
40  CONF:VOLT:DC (@100:104)  
50   TRIG:COUN 5  
60   TRIG:DEL 10  
70  READ?
```

Querying the Trigger Delay

The trigger delay setting is queried with the TRIGger:DELay? and TRIGger:DELay? MIN | MAX commands. See Chapter 5 for additional information.

The Sample Count

The sample count specifies the number of measurements made for each trigger signal received. For the stand-alone multimeter, it is the number of measurements in a burst of readings. For the scanning multimeter, it is the number of measurements made when scanning a single multiplexer channel. The sample count is set with the command:

```
SAMPlE:COUNT number | MIN | MAX
```

where:

number = number of readings (measurements) per trigger. The minimum number is 1, the maximum number is 16,777,215. MEASure and CONFigure set a sample count of 1.

MIN = sets 1 reading per trigger.

MAX = sets 16,777,215 readings per trigger. If MAX or 16,777,215 is specified, Error +1000 “Out of memory” occurs indicating that many samples (measurements) cannot be stored in memory. However, READ? can be executed to return the readings to the output buffer.

The following program segment shows the context in which SAMPlE:COUNT is used.

Example: Setting Sample Count

In this segment, 10 DC voltage measurements are taken when a single external trigger is received.

```
10 !Configure the stand-alone multimeter for DC voltage measurements.
20 !Externally trigger the multimeter and take 10 readings when triggered.
30 CONF:VOLT:DC
40 TRIG:SOUR EXT
50 SAMP:COUNT 10
60 READ?
```

Querying the Sample Count

The sample count setting is queried with the SAMPlE:COUNT? and SAMPlE:COUNT? MIN | MAX commands. See Chapter 5 for more information.

The Sample Period

Sample period is the time between measurements in a multiple-reading burst, or the time between channels when scanning a FET multiplexer channel list.

Note The sample period between channels can be specified for the FET multiplexers only.

The source which sets the sample period is specified with the commands:

SAMPlE:SOURce *source*

SAMPlE:TIMer *period* | MIN | MAX

The *source* settings are:

IMM = the measurement is taken as soon as the previous measurement completes. MEASure and CONFIgure set SAMPlE:SOURce IMM.

TIMer = the sample period is set with the SAMPlE:TIMer command.

The *period* settings are:

period = period between measurements (sample rate). The period range is 76 ms to 65.534 ms.

MIN = sets the sample period to 76 ms.

MAX = sets the sample period to 65.534 ms.

The sample period must be longer than the aperture time. Table 4-6 on page 110 shows the minimum sample period for each available aperture time setting.

Note If the aperture time is longer than the sample period, Error 2602 “Timer too fast” is stored in the error queue when the multimeter begins to make the measurement.

Table 4-6. Aperture Times and Minimum Sample Period

Aperture Time	Minimum Sample Rate (SAMPLE:TIMer)	Maximum Reading Rate (Readings/second)
10 μ s	76 μ s	13,150
100 μ s	0.32 ms	3,000
2.5 ms	2.8 ms	350
16.7 ms	16.9 ms	58
20 ms	20.3 ms	49
267 ms	IMM*	2
320 ms	IMM*	1.9

Aperture times and sample rates assume a fixed range and autozero off. Reading rates are for the DC Voltage function. Times and number of readings are approximate.

* IMM is set with SAMPLE:SOURce IMM.

Example: Setting the Aperture Time and Sample Period

This program segment shows the context in which SAMPLE:SOURce and SAMPLE:TIMer are used, and their relationship to the aperture time.

```

10  !Configure the stand-alone multimeter for DC voltage measurements on
20  !the 7.27 V range. Turn off autozero. Set the aperture time to allow a
30  !sample period of 5 ms. Make a burst of 5 readings, sampled every 5 ms.
40  !Place the multimeter in the wait-for-trigger state and take the readings.
50  CONF:VOLT:DC 7.27
60  CAL:ZERO:AUTO OFF
70  VOLT:APER 0.0025
80  SAMP:COUN 5
90  SAMP:SOUR TIM
100 SAMP:TIM 0.005
110 READ?

```

Querying the Sample Source and Sample Period Settings

The sample source and sample period settings are queried with the following commands. See Chapter 5 for more information.

```

SAMPLE:SOURce?
SAMPLE:TIMer?
SAMPLE:TIMer? MIN | MAX

```

The Wait-For-Trigger State

For the multimeter to respond to a trigger signal, the multimeter must be placed in the wait-for-trigger state. This is done with the INIT[:IMMEDIATE] command. INIT is also executed by the READ? and MEASURE? commands. The following examples show INIT implicitly and explicitly specified.

In this segment, INIT is executed by the MEASURE command after configuring the multimeter for DC voltage measurements. Since MEASURE sets TRIGGER:SOURCE IMM, placing the multimeter in the wait-for-trigger state causes the measurements to be taken and sent to the output buffer. The measurements overwrite any data currently in the buffer.

```
!INIT specified implicitly.  
MEAS:VOLT:DC? (@100:104)
```

In this segment, INIT is executed by READ? after the multimeter is configured with CONFIGURE and the low-level command VOLT:APER. Because CONFIGURE sets TRIGGER:SOURCE IMM, placing the multimeter in the wait-for-trigger state causes the measurements to be taken and sent to the output buffer. Again, the measurements overwrite any data in the buffer.

```
!INIT specified implicitly.  
CONF:VOLT:DC (@100:104)  
VOLT:APER 267E-3  
READ?
```

This segment shows that the multimeter is configured with the CONFIGURE command and is externally triggered with TRIGGER:SOUR EXT. INIT puts the multimeter in the wait-for-trigger state. When the external trigger occurs, the measurements are taken and stored in memory - overwriting any readings currently in memory.

```
!INIT specified explicitly.  
CONF:VOLT:DC (@100:104)  
TRIGGER:SOUR EXT  
INIT  
FETCH?
```

Recall that the stand-alone multimeter returns to the idle state following each trigger, or after the number of triggers specified by TRIGGER:COUNT have occurred. The scanning multimeter returns to the idle state after the number of scans specified by TRIGGER:COUNT have occurred.

Using a Single Trigger

The multimeter can be internally triggered with a single trigger signal. This signal is issued with the TRIGger[:IMMediate] command:

Before a single trigger can be sent, however, the trigger source must be set to HOLD and the multimeter must be in the wait-for-trigger state. These conditions are shown in the following program which shows how a single trigger can be used.

Example: Measurements with a Single Trigger

When TRIG is executed, the multimeter makes 10 DC voltage measurements and stores them in mainframe memory. The FETCH? command retrieves the readings.

```
10  !Configure the stand-alone multimeter for DC voltage measurements.
20  !Suspend triggering and set 10 measurements to be taken when the single
30  !trigger is received.
40  CONF:VOLT:DC
50   TRIG:SOUR HOLD
60   SAMP:COUN 10
70  !Place the multimeter in the wait-for-trigger state and issue a single trigger.
80  !Fetch the readings from memory.
90  INIT
100 TRIG
110 FETCH?
```

Aborting a Measurement

When the multimeter is in the wait-for-trigger state it can be returned to the idle state before the trigger signal is received. This is done with the ABORt command.

Trigger sources which allow the ABORt command to return the multimeter to the idle state are TRIGger:SOURce BUS and TRIGger:SOURce HOLD.

The next two examples show how ABORt works.

Example: Aborting a Measurement (Trigger Source = BUS)

After the multimeter is configured it is placed in the wait-for-trigger state. ABORt returns the multimeter to the idle state, and when *TRG is executed, the “Trigger Ignored” message is stored in the error queue.

```
10 !Configure the scanning multimeter for DC voltage measurements on
20 !channels 100 through 104. Set the trigger source to BUS (system or
30 !group execute trigger). Place the multimeter in the wait-for trigger state.
40 CONF:VOLT:DC (@100:104)
50 TRIG:SOUR BUS
60 INIT
70 !Abort the measurement before the trigger is received.
80 ABORt
90 *TRG
100 FETCH?
```

Example: Aborting a Measurement (Trigger Source = HOLD)

Again, the multimeter is configured and placed in the wait-for-trigger state. Aborting the measurement causes the subsequent single trigger (TRIG) to be ignored.

```
10 !Configure the scanning multimeter for DC voltage measurements on
20 !channels 100 through 104. Suspend triggering. Place the multimeter in
30 !the wait-for-trigger state.
40 CONF:VOLT:DC (@100:104)
50 TRIG:SOUR HOLD
60 INIT
70 !Abort the measurement before the trigger is received.
80 ABORt
90 TRIG
100 FETCH?
```

Note

If the multimeter is in the wait-for-trigger state and is waiting for an external trigger (TRIG:SOUR EXT), clearing the multimeter returns it to the idle state. This is done by pressing the “Clear Instr” key on the HP E1301A mainframe front panel when the multimeter instrument is selected. Sending CLEAR 70903 over the HP-IB also returns the multimeter to the idle state.

Saving Multimeter Configurations

To minimize repeated programming, up to 10 stand-alone multimeter configurations can be saved in mainframe/command module memory. The information saved includes:

Measurement System Parameters

- Measurement function
- Range
- Resolution
- Aperture time
- Integration time
- Autozero
- Offset compensation

Trigger System Parameters

- Trigger source
- Trigger count
- Trigger delay
- Sample count
- Sample source
- Sample timer

Because channel lists are not included, only stand-alone multimeter configurations are saved. A configuration is identified by a number from 0 to 9. The configuration(s) remains in memory until power is cycled.

How to Save and Recall a Configuration

Multimeter configurations are saved and recalled with the commands:

- *SAV register
- *RCL register

where register is a number from 0 to 9. The following program shows how a configuration can be saved and recalled.

Example: Saving and Recalling a Configuration

This program saves a configuration in register 0. The multimeter is then reset in order to change the current configuration to the power-on configuration. The configuration in register 0 is recalled which also places the multimeter in the idle state. By placing the multimeter in the wait-for-trigger state, the measurements are taken as soon as the internal trigger signal is received.

```
10  !Configure the stand-alone multimeter for DC voltage measurements
20  !on the 7.27 V range. Set an aperture time of 267 ms.
30  CONF:VOLT:DC 7.27
40   VOLT:APER 267E-3
50  !Issue 10 triggers (10 measurements) before returning to the idle state.
60  !Set a one second delay between the trigger and the measurement.
70   TRIG:COUN 10
80   TRIG:DEL 1
90  !Save the configuration in register 0.
100 *SAV 0
110 !Reset the multimeter to its power-on configuration.
120 *RST
130 !Recall the configuration in register 0. Place the multimeter in the
140 !wait-for-trigger state, enter and display the readings.
150 *RCL 0
160 READ?
```

Notes

Chapter 5

HP E1326B/E1411B Multimeter Command Reference

Using This Chapter

This chapter describes the Standard Commands for Programmable Instruments (SCPI) and IEEE 488.2 Common (*) commands applicable to the HP E1326B and HP E1411B 5½-Digit Multimeters.

- Command Types Page 117
- SCPI Command Reference Page 121
- IEEE 488.2 Common Command Reference Page 186
- Command Quick Reference. Page 187

Command Types

Commands are separated into two types: IEEE 488.2 Common Commands and SCPI Commands.

Common Command Format

The IEEE 488.2 standard defines the common commands that perform functions such as reset, self-test, status byte query, and so on. Common commands are four or five characters in length, always begin with the asterisk character (*), and may include one or more parameters. The command keyword is separated from the first parameter by a space character. Some examples of common commands are shown below:

*RST *ESR 32 *STB?

SCPI Command Format

The SCPI commands perform functions such as making measurements, querying instrument states, or retrieving data. A command subsystem structure is a hierarchical structure that usually consists of a top level (or root) command, one or more low-level commands, and their parameters. The following example shows a typical subsystem:

```
CALibration
:LFrequency <frequency>
:LFrequency? [MIN | MAX]
:ZERO:AUTO <mode>
:ZERO:AUTO?
```

CALibration is the root command, LFrequency, LFrequency?, and ZERO are second level commands, and AUTO and AUTO? are third level commands.

Command Separator

A colon (:) always separates one command from the next lower level command as shown below:

CALibration:ZERO:AUTO?

Colons separate the root command from the second level command (CALibration:ZERO) and the second level from the third level (ZERO:AUTO?).

Abbreviated Commands

The command syntax shows most commands as a mixture of upper and lower case letters. The upper case letters indicate the abbreviated spelling for the command. For shorter program lines, send the abbreviated form. For better program readability, you may send the entire command. The instrument will accept either the abbreviated form or the entire command.

For example, if the command syntax shows MEASure, then MEAS and MEASURE are both acceptable forms. Other forms of MEASure, such as MEASU or MEASUR will generate an error. You may use upper or lower case letters. Therefore, MEASURE, measure, and MeAsUrE are all acceptable.

Implied Commands

Implied commands are those which appear in square brackets ([]) in the command syntax. (Note that the brackets are not part of the command and are not sent to the instrument.) Suppose you send a second level command but do not send the preceding implied command. In this case, the instrument assumes you intend to use the implied command and it responds as if you had sent it. Examine the partial [SENSe:] subsystem shown below:

```
[SENSe:]  
  FUNCtion[:<function>]  
  FUNCtion?  
  RESistance  
    :APERTure <time>  
    :APERTure? [MIN | MAX]  
    :NPLC <number>  
    :NPLC? [MIN | MAX]
```

The root command [SENSe:] is an implied command. To set the multimeter's function to AC volts, for example, you can send either of the following command statements:

SENS:FUNC:VOLT:AC *or* FUNC:VOLT:AC

Parameters **Parameter Types.** The following table contains explanations and examples of parameter types you might see later in this chapter.

Parameter Type	Explanations and Examples
Numeric	Accepts all commonly used decimal representations of number including optional signs, decimal points, and scientific notation. 123, 123E2, -123, -1.23E2, .123, 1.23E-2, 1.23000E-01. Special cases include MINimum, MAXimum, and DEFault.
Boolean	Represents a single binary condition that is either true or false. ON, OFF, 1, 0
Discrete	Selects from a finite number of values. These parameters use mnemonics to represent each valid setting. An example is the TRIGger:SOURce <source> command where <i>source</i> can be BUS, EXT, HOLD, or IMM.

Optional Parameters. Parameters shown within square brackets ([]) are optional parameters. (Note that the brackets are not part of the command and are not sent to the instrument.) If you do not specify a value for an optional parameter, the instrument chooses a default value. For example, consider the TRIGger:COUNT? [MIN | MAX] command. If you send the command without specifying a MINimum or MAXimum parameter, the present TRIGger:COUNT value is returned. If you send the MIN parameter, the command returns the minimum trigger count available. If you send the MAX parameter, the command returns the maximum trigger count available. Be sure to place a space between the command and the parameter.

Linking Commands **Linking IEEE 488.2 Common Commands with SCPI Commands.** Use a semicolon between the commands. For example:

*RST;RES:OCOM ON *or* SAMP:SOUR TIM;*TRG

Linking Multiple SCPI Commands. Use both a semicolon and a colon between the commands. For example:

SAMP:COUN 10;;SAMP:TIM 0.065

Table 5-1 lists the voltage and resistance ranges available for the multimeter. Also shown are the associated resolution values, aperture times, and integration times. You will be asked to refer to this table throughout this chapter.

Table 5-1. Voltage and Ohms Ranges vs. Resolution, Aperture, and Integration Time

Aperture Time Integration Time (PLCs)			10 μ s* 0.0005	100 μ s 0.005	2.5 ms 0.125	16.7 ms 1	20 ms 1	267 ms 16	320 ms 16
DC & AC Voltage (Using CONFIGure/MEASure)									
Range DC	Range AC	Percent Overrange	Resolution						
0.113 V 0.91 V 7.27 V 58.1 V 300 V	0.0795 V 0.63 V 5.09 V 40.7 V 300 V	10% 10% 10% 10% 0%	7.629 μ V 61.035 μ V 488.281 μ V 3.906 mV 31.25 mV	3.814 μ V 30.517 μ V 244.14 μ V 1.953 mV 15.625 mV	0.476 μ V 3.814 μ V 30.517 μ V 244.14 μ V 1.953 mV	0.119 μ V 0.953 μ V 7.629 μ V 61.035 μ V 488.28 μ V	0.119 μ V 0.953 μ V 7.629 μ V 61.035 μ V 488.28 μ V	28.9 nV 0.238 μ V 1.907 μ V 15.258 μ V 122.07 μ V	28.9 nV 0.238 μ V 1.907 μ V 15.258 μ V 122.07 μ V
DC & AC Voltage (Using RANGE)									
Range DC	Range AC	Percent Overrange	Resolution						
0.125 V 1.0 V 8.0 V 64.0 V 300 V	0.0875 V 0.7 V 5.6 V 44.8 V 300 V	0% 0% 0% 0% 0%	7.629 μ V 61.035 μ V 488.281 μ V 3.906 mV 31.25 mV	3.814 μ V 30.517 μ V 244.14 μ V 1.953 mV 15.625 mV	0.476 μ V 3.814 μ V 30.517 μ V 244.14 μ V 1.953 mV	0.119 μ V 0.953 μ V 7.629 μ V 61.035 μ V 488.28 μ V	0.119 μ V 0.953 μ V 7.629 μ V 61.035 μ V 488.28 μ V	28.9 nV 0.238 μ V 1.907 μ V 15.258 μ V 122.07 μ V	28.9 nV 0.238 μ V 1.907 μ V 15.258 μ V 122.07 μ V
2-Wire & 4-Wire Resistance (Using CONFIGure/MEASure)									
Range		Percent Overrange	Resolution						
232 Ω 1861 Ω 14894 Ω 119156 Ω 1048576 Ω		10% 10% 10% 10% 10%	15.625 m Ω 125 m Ω 1 Ω 8 Ω 64 Ω	7.812 m Ω 62.5 m Ω 0.5 Ω 4 Ω 32 Ω	0.976 m Ω 7.812 m Ω 62.5 m Ω 0.5 Ω 4 Ω	244 μ Ω 1.95 m Ω 15.6 m Ω 125 m Ω 1 Ω	244 μ Ω 1.95 m Ω 15.6 m Ω 125 m Ω 1 Ω	61 μ Ω 488 μ Ω 3.9 m Ω 31.2 m Ω 250 m Ω	61 μ Ω 488 μ Ω 3.9 m Ω 31.2 m Ω 250 m Ω
2-Wire & 4-Wire Resistance (Using RANGE)									
Range		Percent Overrange	Resolution						
256 Ω 2048 Ω 16384 Ω 131072 Ω 1048576 Ω		0% 0% 0% 0% 0%	15.625 m Ω 125 m Ω 1 Ω 8 Ω 64 Ω	7.812 m Ω 62.5 m Ω 0.5 Ω 4 Ω 32 Ω	0.976 m Ω 7.812 m Ω 62.5 m Ω 0.5 Ω 4 Ω	244 μ Ω 1.95 m Ω 15.6 m Ω 125 m Ω 1 Ω	244 μ Ω 1.95 m Ω 15.6 m Ω 125 m Ω 1 Ω	61 μ Ω 488 μ Ω 3.9 m Ω 31.2 m Ω 250 m Ω	61 μ Ω 488 μ Ω 3.9 m Ω 31.2 m Ω 250 m Ω
Max. Readings/Second **			13,150	3,000	350	58	49	2	1.9
Line Frequency Rejected			---	---	400 Hz	60 Hz	50/400 Hz	60 Hz	50/400 Hz
Normal Mode Rejection			0 dB	0 dB	60 dB	60 dB	60 dB	84 dB	84 dB
Bits of Resolution			14	15	18	20	20	22	22
* 10 μ s aperture time is only available when a fixed range is specified.									
** Reading rates are approximate and are achieved using a stand-alone multimeter, DC voltage function, fixed range, autozero off, offset compensation off, reading stored in mainframe/command module memory. See Table 4-6 on page 110 for the necessary sample rates.									

SCPI Command Reference

This section describes the Standard Commands for Programmable Instruments (SCPI) for the HP E1326B and HP E1411B 5¹/₂-Digit Multimeters. Commands are listed alphabetically by subsystem and also within each subsystem.

The ABORt command subsystem removes the multimeter from the wait-for-trigger state and places it in the idle state. ABORt can only be used with the following trigger sources: TRIGger:SOURce BUS and TRIGger:SOURce HOLD.

Subsystem Syntax ABORt

- Comments**
- ABORt does not affect any other settings of the trigger system. When the INITiate command is sent, the trigger system will respond as it did before ABORt was executed.
 - When TRIGger:SOURce BUS is selected, ABORt returns the multimeter to the idle state. When a Group Execute Trigger (GET) bus command or *TRG common command is executed, the "Trigger ignored" error is generated.
 - When TRIGger:SOURce HOLD is selected, ABORt returns the multimeter to the idle state. All subsequent single triggers sent using TRIGger:IMMEDIATE are ignored and the "Trigger ignored" error is generated.
 - When the trigger system is initiated from the HP-IB interface, execute the HP-IB CLEAR command or press the HP E1301A front panel “Clear Instr” or “Reset Instr” key to return to the idle state.
 - When the trigger system is initiated from the HP E1301A front panel, execute *RST over the HP-IB interface or press the HP E1301A front panel “Clear Instr” or “Reset Instr” key to return to the idle state.
 - **Related Commands:** INITiate, TRIGger:SOURce
 - ***RST Condition:** After a *RST, the multimeter acts as though an ABORt has occurred.

Example Aborting a Measurement

CONF:VOLT:DC (@100:104)	<i>!Function: DC voltage on specified channels.</i>
TRIG:SOUR HOLD	<i>!Suspend triggering; wait for TRIG:IMM command.</i>
INIT	<i>!Place multimeter in wait-for-trigger state.</i>
ABOR	<i>!Place multimeter in the idle state.</i>

The CALibration command subsystem selects the multimeter's line reference frequency (CALibration:LFRrequency) and enables/disables the autozero mode (CALibration:ZERO:AUTO).

Subsystem Syntax CALibration
:LFRrequency <frequency>
:LFRrequency? [MIN | MAX]
:ZERO:AUTO <mode>
:ZERO:AUTO?

:LFRrequency

CALibration:LFRrequency <frequency> selects the line reference frequency used by the multimeter's analog-to-digital converter.

Parameters

Parameter Name	Parameter Type	Range of Values	Default Units
<frequency>	numeric	50 60 MIN MAX	hertz

- Comments**
- MIN selects the minimum line reference frequency (50 Hz). MAX selects the maximum line reference frequency (60 Hz).
 - The line reference frequency is set to 60 Hz at the factory. The setting is stored in non-volatile mainframe memory and is changed only when CAL:LFR is executed.
 - For a line frequency of 400 Hz, the 50 Hz reference frequency is used; however, since 50 Hz is a subharmonic of 400 Hz, it provides normal mode rejection of power line related noise.
 - ***RST Condition:** The selected line reference frequency remains unchanged since it is stored in non-volatile mainframe memory.

Example Selecting the Line Frequency Reference

CAL:LFR 50 *!Reference frequency is 50 Hz.*

:LFRrequency?

CALibration:LFRrequency? [MIN | MAX] returns one of the following numbers to the output buffer:

- The present line reference frequency ("50" or "60") if MINimum or MAXimum is not specified.
- The minimum line reference frequency ("50") if MIN is specified.
- The maximum line reference frequency ("60") if MAX is specified.

Example Querying the Line Reference Frequency

```
CAL:LFR 50                                !Reference frequency is 50 Hz.
CAL:LFR?                                   !Query for reference frequency.
enter statement                             !Enter value into computer.
```

:ZERO:AUTO

CALibration:ZERO:AUTO <mode> enables or disables the autozero mode for DC voltage and resistance measurements.

Parameters

Parameter Name	Parameter Type	Range of Values	Default Units
<mode>	boolean	OFF 0 ON 1 ONCE	none

- Comments**
- You can substitute decimal values for the OFF ("0") and ON ("1") parameters.
 - When autozero is ON, the multimeter makes a zero measurement (measurement with input disabled) following every measured reading and subtracts the zero measurement from the reading. This doubles the time required per reading.
 - When autozero is OFF, the multimeter makes one zero measurement and subtracts this from all subsequent measurements. A new zero measurement is made whenever the function is changed. Notice that the mode parameters OFF and ONCE have the same effect.
 - An autozero measurement *is not* made following a range change whether autozero is ON or OFF.
 - Autozero cannot be used when a 10 μ s aperture time is specified.
 - The CONFigure and MEASure commands turn autozero ON.
 - ***RST Condition:** CAL:ZERO:AUTO ON

Example Turning Autozero OFF

```
CAL:ZERO:AUTO OFF                          !Disable autozero.
```

:ZERO:AUTO?

CALibration:ZERO:AUTO? returns a number to show whether the autozero mode is enabled or disabled: "1" = ON, "0" = OFF or ONCE. The number is sent to the output buffer.

Example Querying the Autozero Mode

CAL:ZERO:AUTO OFF

!Disable autozero.

CAL:ZERO:AUTO?

!Query multimeter to return autozero mode ("0").

enter statement

!Enter value into computer.

The CONFigure command subsystem configures the multimeter to perform the specified measurement with the given range and resolution. CONFigure *does not* make the measurement after setting the configuration. Use the INITiate command to place the multimeter in the wait-for-trigger state and store readings in mainframe or command module memory. Or, use the READ? command to make the measurement and send the readings to the output buffer when the trigger is received.

Executing CONFigure is equivalent to configuring the multimeter with the low-level commands shown in the following table.

Command	Setting
VOLTage:RANGe RESistance:RANGe	As specified, or autorange.
VOLTage:RESolution RESistance:RESolution	As specified, or as a function of range, integration time, or aperture time.
VOLTage:APERture RESistance:APERture	16.7 ms (60 Hz) or 20 ms (50 Hz), or based on specified resolution.
VOLTage:NPLC RESistance:NPLC	1 PLC, or based on specified resolution.
CALibration:ZERO:AUTO	ON (autozero is performed after every measurement).
RESistance:OCOMPensated	OFF (applies to resistance measurements only).
TRIGger:SOURce TRIGger:COUNt TRIGger:DELay	IMM (trigger signal is always true). 1 AUTO (DC volts/resistance: 0 s, AC volts: 0.5 s).
SAMPle:COUNt SAMPle:SOURce	1 IMM

Subsystem Syntax CONFigure

```
:FRESistance [<range>,<resolution>] [,<channel_list>]
:RESistance [<range>,<resolution>] ,<channel_list>
:TEMPerature <transducer>,<type> ,<channel_list>
:VOLTage:AC [<range> [,<resolution>]] [,<channel_list>]
:VOLTage[:DC] [<range> [,<resolution>]] [,<channel_list>]
```

NOTE: If *range* and *resolution* are not specified (that is, if you use the default values), use a space rather than a comma before the *channel_list* parameter.

CONF:RESistance [<range>,<resolution>] [<channel_list>] selects the 4-wire ohms function and allows you to specify the measurement *range* and *resolution*. If you specify a *channel list*, those multiplexer channels are scanned.

For a complete listing of range and resolution values available, see Table 5-1 on page 120.

Parameters

Parameter Name	Parameter Type	Range of Values	Default Units
<range>	numeric	232 Ω 1861 Ω 14894 Ω 119156 Ω 1048576 Ω AUTO DEF MIN MAX	ohms
<resolution>	numeric	resolution (see Table 5-1) DEF MIN MAX	ohms
<channel_list>	numeric	cc00-cc15 (E1345A/E1347A)	none

- Comments**
- To select a standard measurement range, specify range as the input signal's maximum expected resistance. The multimeter then selects the correct range.
 - The AUTO and DEFault options for the *range* parameter have the same effect (enable autorange). The DEF option for the *resolution* parameter defaults the integration time to 1 PLC.
 - The MIN and MAX parameters select the minimum or maximum values for range and resolution:

For *range*: MIN = 232 Ω; MAX = 1048576 Ω

For *resolution*: MIN selects the best resolution (the smallest value from Table 5-1) for the selected range. MAX selects the worst resolution (the largest value from Table 5-1) for the selected range.

- The *channel list* is of the form (@ccnn), (@ccnn,ccnn), or (@ccnn:ccnn), where cc = card number and nn = channel number (105 is channel 05 of card number 1, for example).
- Four-wire resistance measurements use channel pairs. For example, on the HP E1345A multiplexer, channels 0 and 8, 1 and 9, 2 and 10, etc. are paired. The lower channel in each pair (0, 1, 2, ...7) is the sense channel. Use *channel_list* to specify the "sense" channels.
- To select autorange, specify AUTO (or DEF) for *range* or do not specify a value for the parameter. In the autorange mode, the multimeter samples the input signal before each measurement and selects the appropriate range.
- To specify a MIN or MAX resolution while autoranging, you must specify CONF:FRES AUTO or CONF:FRES DEF (you cannot omit the *range* parameter). This prevents the MIN or MAX resolution from being interpreted as a range setting.
- The fastest aperture time available when autoranging is 100 μs. In order to specify an aperture time of 10 μs, you must select a fixed range.

- **Related Commands:** FETCh?, INITiate, READ?

Example Making 4-Wire Ohms Measurements

```

CONF:FRES 1560,MAX,(@100:103)  !Function: 4-wire ohms;
                                range selected: 1861Ω;
                                MAX resolution: 125 mΩ;
                                specify sense channel list.

TRIG:COUN 3                    !Scan channel list 3 times (take 4 readings
                                per trigger); trigger source is IMMEDIATE by
                                default.

READ?                          !Place multimeter in wait-for-trigger state and
                                make measurements;
                                send readings to output buffer.

enter statement                !Enter readings into computer.

```

:RESistance

CONFigure:RESistance [*<range>* [, *<resolution>*]] , *<channel_list>*

selects the 2-wire ohms function and allows you to specify the *range* and *resolution*. Two-wire resistance measurements can only be made using the scanning multimeter (a *channel list* is required).

For a complete listing of range and resolution values available, see Table 5-1 on page 120.

Parameters

Parameter Name	Parameter Type	Range of Values	Default Units
<i><range></i>	numeric	232 Ω 1861 Ω 14894 Ω 119156 Ω 1048576 Ω AUTO DEF MIN MAX	ohms
<i><resolution></i>	numeric	resolution (see Table 5-1) DEF MIN MAX	ohms
<i><channel_list></i>	numeric	Refer to the multiplexer user's manual for a list of channels available.	none

Comments

- To select a standard measurement range, specify range as the input signal's maximum expected resistance. The multimeter then selects the correct range.
- The AUTO and DEFault options for the *range* parameter have the same effect (enable autorange). The DEF option for the *resolution* parameter defaults the integration time to 1 PLC.
- The MIN and MAX parameters select the minimum or maximum values for range and resolution:

For *range*: MIN = 232 Ω; MAX = 1048576 Ω

For *resolution*: MIN selects the best resolution (the smallest value from Table 5-1) for the selected range. MAX selects the worst resolution (the largest value from Table 5-1) for the selected range.

- The *channel list* is of the form (@ccnn), (@ccnn,ccnn), or (@ccnn:ccnn), where cc = card number and nn = channel number (105 is channel 05 of card number 1, for example).
- To select autorange, specify AUTO (or DEF) for *range* or do not specify a value for the parameter. In the autorange mode, the multimeter samples the input signal before each measurement and selects the appropriate range.
- To specify a MIN or MAX resolution while autoranging, you must specify CONF:RES AUTO or CONF:RES DEF (you cannot omit the *range* parameter). This prevents the MIN or MAX resolution from being interpreted as a range setting.
- The fastest aperture time available when autoranging is 100 μ s. In order to specify an aperture time of 10 μ s, you must select a fixed range.
- **Related Commands:** FETCh?, INITiate, READ?

Example Making 2-Wire Ohms Measurements

```

CONF:RES 1320,MAX,(@105:109)      !Function: 2-wire ohms;
                                   range selected: 1861  $\Omega$ ;
                                   MAX resolution: 125 m $\Omega$ ;
                                   specify channel list.

TRIG:COUN 3                        !Scan channel list 3 times
                                   (take 4 readings per trigger).

INIT                               !Place multimeter in wait-for-trigger state;
                                   store readings in mainframe memory; trigger
                                   source is IMMEDIATE by default.

FETC?                              !Place readings in output buffer.

enter statement                    !Enter readings into computer.

```

:TEMPerature

CONFigure:TEMPerature <transducer>,<type> ,<channel_list>

selects the temperature function. All measurements are returned in degrees celsius. The following transducers can be measurements using the multimeter:

Thermocouples

Thermistors (2-wire or 4-wire measurement)

RTDs (2-wire or 4-wire measurement)

Two-wire temperature measurements can only be made using the scanning multimeter (a *channel list* is required).

Parameters

Parameter Name	Parameter Type	Range of Values	Default Units
<transducer>	discrete	TCouple THERmistor FTHERmistor RTD FRTD	none

<i><type></i>	discrete numeric numeric	TC: B, E, J, K, N14, N28, R, S, or T THER/FTH:2252 5000 10000 RTD/FRTD: 85 92	none ohms alpha
<i><channel_list></i>	numeric	Refer to the multiplexer user's manual for a list of channels available.	none

- Comments**
- The HP E1344A, E1347A, E1353A, or E1476A multiplexer is required for thermocouple measurements. These module's have built-in thermocouple compensation circuitry on the terminal module.
 - The *channel list* is of the form (@ccnn), (@ccnn,ccnn), or (@ccnn:ccnn), where cc = card number and nn = channel number (105 is channel 05 of card number 1, for example).
 - Four-wire temperature measurements use channel pairs. For example, on the HP E1345A multiplexer, channels 0 and 8, 1 and 9, 2 and 10, etc. are paired. The lower channel in each pair (0, 1, 2, ...7) is the sense channel. Use *channel_list* to specify the "sense" channels.
 - You can measure RTD *types* 85 (alpha = 0.00385 Ω/Ω/°C) and 92 (alpha = 0.00392 Ω/Ω/°C). The values 385, 0.00385, 392, 0.00392 are also accepted for the *type* parameter.
 - Thermistor *types* are 2252, 5000, and 10000. Use thermistors that match the Omega 440xx series temperature response curves.
 - **Related Commands:** FETCh?, INITiate, READ?

Example Making Thermocouple Measurements

```
CONF:TEMP TC,J,(@100:107)      !Measure J-type thermocouples (scan the 8
                                channels once); trigger source is IMMEDIATE
                                by default.

READ?                            !Place multimeter in wait-for-trigger state and
                                make measurements; send readings to output
                                buffer.

enter statement                  !Enter readings into computer.
```

:VOLTage:AC

CONFigure:VOLTage:AC [*<range>* [,*<resolution>*]] [,*<channel_list>*] selects the AC-coupled RMS voltage function and allows you to specify the *range* and *resolution*. If you specify a *channel list*, those multiplexer channels are scanned.

For a complete listing of range and resolution values available, see Table 5-1 on page 120.

Parameters

Parameter Name	Parameter Type	Range of Values	Default Units
<i><range></i>	numeric	0.0795 V 0.63V 5.09 V 40.7 V 300 V AUTO DEF MIN MAX	volts

<i><resolution></i>	numeric	<i>resolution</i> (see Table 5-1) DEF MIN MAX	volts
<i><channel_list></i>	numeric	Refer to the multiplexer user's manual for a list of channels available.	none

- Comments**
- To select a standard measurement range, specify *range* as the input signal's maximum expected voltage. The multimeter then selects the correct range.
 - The AUTO and DEFault options for the *range* parameter have the same effect (enable autorange). The DEF option for the *resolution* parameter defaults the integration time to 1 PLC.
 - The MIN and MAX parameters select the minimum or maximum values for range and resolution:

For *range*: MIN = 0.0795 V; MAX = 300 V.

For *resolution*: MIN selects the best resolution (the smallest value from Table 5-1) for the selected range. MAX selects the worst resolution (the largest value from Table 5-1) for the selected range.

- The *channel list* is of the form (@ccnn), (@ccnn,ccnn), or (@ccnn:ccnn), where cc = card number and nn = channel number (105 is channel 05 of card number 1, for example).
- To select autorange, specify AUTO (or DEF) for *range* or do not specify a value for the parameter. In the autorange mode, the multimeter samples the input signal before each measurement and selects the appropriate range.
- To specify a MIN or MAX resolution while autoranging, you must specify CONF:VOLT:AC AUTO or CONF:VOLT:AC DEF (you cannot omit the *range* parameter). This prevents the MIN or MAX resolution from being interpreted as a range setting.
- The fastest aperture time available when autoranging is 100 μ s. In order to specify an aperture time of 10 μ s, you must select a fixed range.

Example Making AC Voltage Measurements

```

CONF:VOLT:AC 0.54,MAX,(@100:103) !Function: AC volts;
range selected: 0.63V;
MAX resolution: 61.035  $\mu$ V; specify
channel list.

TRIG:COUN 3 !Scan channel list 3 times (take 4 readings
per trigger); trigger source is IMMEDIATE by
default.

READ? !Place multimeter in wait-for-trigger state and
make measurements; send readings to output
buffer.

enter statement !Enter readings into computer.

```

:VOLTage[:DC]

CONF:VOLTage[:DC] [<range>[,<resolution>]] [,<channel_list>] selects the DC voltage function and allows you to specify the *range* and *resolution*. If you specify a *channel list*, those multiplexer channels are scanned.

For a complete listing of range and resolution values available, see Table 5-1 on page 120.

Parameter Name	Parameter Type	Range of Values	Default Units
<range>	numeric	0.113 V 0.91 V 7.27 V 58.1 V 300 V AUTO DEF MIN MAX	volts
<resolution>	numeric	<i>resolution</i> (see Table 5-1) DEF MIN MAX	volts
<channel_list>	numeric	Refer to the multiplexer user's manual for a list of channels available.	none

- Comments**
- The :DC parameter is optional. Both of the following command statements select the DC voltage function:

CONF:VOLT:DC *or* CONF:VOLT

- To select a standard measurement range, specify *range* as the input signal's maximum expected voltage. The multimeter then selects the correct range.
- The AUTO and DEFault options for the *range* parameter have the same effect (enable autorange). The DEF option for the *resolution* parameter defaults the integration time to 1 PLC.
- The MIN and MAX parameters select the minimum or maximum values for range and resolution:

For *range*: MIN = 0.113 V; MAX = 300 V.

For *resolution*: MIN selects the best resolution (the smallest value from Table 5-1) for the selected range. MAX selects the worst resolution (the largest value from Table 5-1) for the selected range.

- The *channel list* is of the form (@ccnn), (@ccnn,ccnn), or (@ccnn:ccnn), where cc = card number and nn = channel number (105 is channel 05 of card number 1, for example).
- To select autorange, specify AUTO (or DEFault) for *range* or do not specify a value for the parameter. In the autorange mode, the multimeter samples the input signal before each measurement and selects the appropriate range.
- To specify a MIN or MAX resolution while autoranging, you must specify CONF:VOLT:DC AUTO or CONF:VOLT:DC DEF (you cannot omit the *range*

parameter). This prevents the MIN or MAX resolution from being interpreted as a range setting.

- The fastest aperture time available when autoranging is 100 μs . In order to specify an aperture time of 10 μs , you must select a fixed range.
- **Related Commands:** FETCh?, INITiate, READ?

Example Making DC Voltage Measurements

CONF:VOLT 0.825,MAX,(@100:103)	<i>!Function: DC voltage; range selected: 0.91 V; MAX resolution: 61.035 μV; specify channel list.</i>
TRIG:COUN 3	<i>!Scan channel list 3 times (take 4 readings per trigger).</i>
INIT	<i>!Place multimeter in wait-for-trigger state; store readings in mainframe memory; trigger source is IMMEDIATE by default.</i>
FETC?	<i>!Place readings in output buffer.</i>
enter statement	<i>!Enter readings into computer.</i>

The CONFigure? command queries the multimeter to return the configuration set by the most recent CONFigure or MEASure command.

It returns a quoted string to the output buffer in the following format:

```
"<function> <parameter>,<parameter>"
```

Subsystem Syntax CONFigure?

- Comments**
- When the multimeter is configured for voltage or resistance measurements, CONFigure? returns the function followed by the selected range and resolution. For example:

```
"FRES 2.320000E+002,6.103516E-005"  
"RES 1.489400E+004,1.562500E-002"  
"VOLT:AC 5.090000E+000,7.629395E-006"  
"VOLT 7.270000E+000,7.629395E-006"
```

- Since you cannot set the range or resolution for temperature measurements, CONFigure? returns "TEMP" followed by the specified transducer and type. For example:

```
"TEMP FRTD,385"  
"TEMP THER,2252"
```

- If you specify AUTO, DEF, MIN, or MAX for the *range* or *resolution* parameters in CONFigure or MEASure, the CONFigure? command returns the selected value.

- **Related Commands:** CONFigure, MEASure

Example Querying the Multimeter Configuration

dimension string array	<i>!Dimension computer array to store string.</i>
CONF:FRES 1560,MAX,(@100:103)	<i>!Function: 4-wire ohms; range selected: 1861 Ω; MAX resolution: 125 mΩ.</i>
CONF?	<i>!Query configuration.</i>
enter statement	<i>!Enter string into computer.</i>

String Returned:

```
"FRES 1.861000E+003,1.250000E-001"
```

The DIAGnostic command subsystem provides control of the FET multiplexers.

Subsystem Syntax DIAGnostic
:FETS <mode>
:FETS?

:FETS

DIAGnostic:FETS <mode> selects either external digital bus or backplane control of the FET multiplexers.

Parameters

Parameter Name	Parameter Type	Range of Values	Default Units
<mode>	boolean	OFF 0 ON 1	none

- Comments**
- 0 or OFF = backplane control; 1 or ON = digital bus control.
 - The channels on FET multiplexers (HP E1351A, E1352A, E1353A, E1357A, and E1358A) that are part of the voltmeter virtual instrument can be closed using either the VXI backplane or by the external digital bus connected to the modules. The digital bus should be used when maximum scanning speed is required.
 - When only FET multiplexers are present in a system, the digital bus is automatically used. When a relay multiplexer is present, then the digital bus to the FET multiplexers is not used. Instead, all switching of channels is done using backplane control.
 - When the digital bus is used to communicate with FET multiplexers, a scan list is downloaded to the FET multiplexer and then the digital bus routes the "Voltmeter Complete" signal from the voltmeter to the FET multiplexer. The falling edge on the Voltmeter Complete signal causes the FET multiplexer to advance to the next channel.
 - The command DIAG:FETS 0 sets the mode to be backplane control. This mode must be used if both FET and relay multiplexers are in a scan list.
 - The command DIAG:FETS 1 sets the mode to be digital bus control. This mode must be used to obtain the maximum speed from FET multiplexers. This mode can not be used if any relay multiplexer channels are in the scan list.

:FETS?

DIAGnostic:FETS? is used to query which mode of operation is in effect. The returned number has the following meaning:

0 = backplane control

1 = digital bus control

The DISPlay command subsystem monitors the state of the selected multiplexer channel within the scanning multimeter. This command is useful only with mainframes that have a front panel display, such as the HP 75000 Series B Mainframe (Model HP E1301A).

Subsystem Syntax DISPlay
 :MONitor
 :CHANnel <channel>
 :CHANnel?
 [:STATe] <mode>
 [:STATe]?

:MONitor:CHANnel

DISPlay:MONitor:CHANnel <channel> selects a single multiplexer channel to be monitored. Use the DISPlay:MONitor:STATe command to enable and disable the monitor mode.

Parameters

Parameter Name	Parameter Type	Range of Values	Default Units
<channel>	numeric	Refer to the multiplexer user's manual for a list of channels available.	none

Comments

- Use the *channel* parameter to specify a single multiplexer channel within the scanning multimeter. The channel list is of the form (@ccnn), where cc = card number and nn = channel number (105 is channel 05 of card number 1, for example).
- Use AUTO in place of *channel* to display measurements from the most recent channel to receive a CONFIGure or MEASure command. The channel number and measurement are updated as the scan progresses. You may want to add a small delay to the scan or use a slow, externally paced scan in order to view each channel from the mainframe's front panel.
- The following example shows the multimeter's monitor mode display on the HP E1301A front panel.

```
VOLTMTR_8:          Chan:  101      +1.465302E-01
mon                  volt
```

- **Related Commands:** DISPlay:MONitor:STATe
- ***RST Condition:** DISP:MON:CHAN AUTO

Example Monitoring a Channel

```
DISP:MON:CHAN (@101)      !Select channel 101 for monitor mode.  
DISP:MON ON                !Enable monitor mode.
```

:MONitor:CHANnel?

DISPlay:MONitor:CHANnel? returns one of the following strings to the output buffer:

The multiplexer channel number selected to be monitored using DISP:MON:CHAN. For example, (@100).

If DISP:MON:CHAN AUTO is specified, (@0) is returned.

Example Querying the Monitor Mode Channel

```
DISP:MON:CHAN (@101)      !Select channel 101 for monitor mode.  
DISP:MON ON                !Enable monitor mode.  
DISP:MON:CHAN?            !Query monitor mode channel.  
enter statement           !Enter string into computer.
```

:MONitor[::STATe]

DISPlay:MONitor[::STATe] <mode> enables or disables the monitor mode.

Parameters

Parameter Name	Parameter Type	Range of Values	Default Units
<mode>	boolean	OFF 0 ON 1	none

- Comments**
- The [::STATe] parameter is optional; therefore, either of the following command statements is valid:

DISP:MON:STAT ON *or* DISP:MON ON

- You can substitute decimal values for the OFF ("0") and ON ("1") parameters.
- When the monitor mode is ON, the status of the multiplexer channel selected by DISPlay:MONitor:CHANnel is displayed. When the monitor mode is OFF, the instrument menu for the multimeter is displayed.
- ***RST Condition:** DISP:MON:STAT OFF

Example Turning Monitor Mode ON

```
DISP:MON:CHAN (@101)      !Select channel 101 for monitor mode.  
DISP:MON ON                !Enable monitor mode.
```

:MONitor[:STATe]?

DISPlay:MONitor[:STATe]? returns a number to show whether the monitor mode is enabled or disabled: "1" = ON, "0" = OFF. The number is sent to the output buffer.

- Comments**
- This command is valid only when executed from your computer over the interface bus. The monitor mode is automatically disabled, if you attempt to execute the command from the mainframe's front panel.
 - The [:STATe] parameter is optional; therefore, either of the following command statements is valid:

DISP:MON:STAT? *or* DISP:MON?

Example Querying the Monitor Mode

DISP:MON:CHAN (@101)	<i>!Select channel 101 for monitor mode.</i>
DISP:MON ON	<i>!Enable monitor mode.</i>
DISP:MON?	<i>!Query monitor mode.</i>
enter statement	<i>!Enter value into computer.</i>

The FETCh? command retrieves measurements stored in mainframe/ command module memory by the most recent INITiate command and places them in the output buffer. This command is most commonly used with CONFigure.

Subsystem Syntax FETCh?

Comments

- Execute INITiate before sending the FETCh? command to place the multimeter in the wait-for-trigger state. If the multimeter is in the idle state (that is, if INITiate has not been executed), FETCh? will generate the “Data corrupt or stale” error.

- Each reading sent to the output buffer consists of 15 bytes (characters) in Real ASCII format:

±1.234567E±123 LF

- Each measurement is terminated with a Line Feed (LF). The HP-IB End-or-Identify (EOI) signal is sent with the last byte transferred. If multiple readings are returned, the readings are separated by commas and EOI is sent only with the last byte.
- The output buffer capacity is 128 bytes. Therefore, eight readings (15 bytes each) can be transferred to the output buffer at a time. The mainframe remains "busy" until you begin removing readings from the output buffer using your computer's enter statement.
- This command causes the stored readings in the mainframe RAM to be retrieved and sent over the HP-IB bus. Readings are not output until all readings are taken and stored in RAM.
- Readings can be received and placed into RAM at any reading rate up to 13K. The maximum number of readings is limited by the amount of RAM in the mainframe (HP E1300, for example). Each reading is four bytes long.
- **Related Commands:** CONFigure, INITiate, READ?
- ***RST Condition:** Since *RST places the multimeter in the idle state, executing FETCh? after a *RST generates the “Data corrupt or stale” error.

Example Transferring Stored Readings to Output Buffer

dimension array	<i>!Dimension computer array to store 100 readings.</i>
CONF:VOLT:DC	<i>!Function: DC voltage; stand-alone multimeter.</i>
SAMP:COUN 100	<i>!100 readings per trigger (stand-alone multimeter only).</i>
INIT	<i>!Store readings in mainframe memory; trigger source is IMMEDIATE by default.</i>
FETCh?	<i>!Place readings in output buffer.</i>
enter statement	<i>!Enter readings into computer.</i>

The FORMat subsystem sets the format for data transferred from the multimeter to the computer using the MEASure?, READ?, and FETCh? commands.

Subsystem Syntax FORMat
[:DATA] <type>[,<length>]

[:DATA]

FORMat[:DATA] <type>[,<length>] selects the data format and length.

Parameters

Parameter Name	Parameter Type	Range of Values	Default Units
<type>	discrete	ASCii REAL	none
<length>	numeric	32 64	none

- Comments**
- ASCII readings are transferred in the form $\pm 1.234567E \pm 123$. Each reading is followed by a comma(.). A line feed (LF) and End-Or-Identify (EOI) follow the last reading. Each reading is 15 bytes.
 - REAL reading lengths are 32- and 64-bits. The readings are transferred in the IEEE 488.2-1987 Definite Length Arbitrary Block format. The readings are preceded by an Arbitrary Block header which consists of:

<non-zero digit> <block length>

<non-zero digit> indicates the number of digits representing <block length>, and <block length> indicates the number of 8-bit data bytes which follow the header. Examples of the header are shown below:

```
REAL,32 #240 <40 bytes> 10 readings
REAL,64 #18 <8 bytes> 1 reading
```

- ***RST Condition:** ASCii

Example Setting the Data Format

```
FORMAT REAL,64           !Format is set to REAL 64.
CONF:VOLT:DC 58.1
```

FORMat? returns one of the following to the output buffer:

- ASC,+7 seven significant digits
- REAL,+32 REAL 32 format
- REAL,+64 REAL 64 format

The INITiate command subsystem places the multimeter in the wait-for-trigger state. This command is most commonly used with CONFigure.

Subsystem Syntax INITiate
[:IMMediate]

[:IMMediate]

INITiate[:IMMediate] places the multimeter in the wait-for-trigger state. When a trigger is received, readings are placed in mainframe/command module memory.

- Comments**
- After the trigger system is initiated using INITiate, use the TRIGger command subsystem to control the behavior of the trigger system.
 - If TRIGger:SOURce is IMMediate, the measurement starts and readings are stored in mainframe/command module memory as soon as INITiate is executed. Readings stored in memory from previous commands are replaced by the new readings.
 - To transfer readings from memory to the output buffer, use the FETCh? command.
 - If the multimeter is in the wait-for-trigger state, the ABORt command places the multimeter in its idle state and terminates any measurement in progress.
 - Each multimeter module is allocated enough mainframe memory to store 100 readings. Each reading stored is four bytes long. Since readings are stored in a four-byte format, INITiate is faster than sending readings directly to the output buffer using the READ? command. If more than 100 readings are requested, and memory is available, the mainframe allocates additional memory to the multimeter.
 - The READ? command executes INITiate implicitly. The MEASure command executes READ? implicitly.
 - **Related Commands:** ABORt, CONFigure, FETCh?, READ?
 - ***RST Condition:** *RST places the multimeter in the idle state.

Example Placing Multimeter in Wait-For-Trigger State

CONF:VOLT:DC (@100:104)	<i>!Function: DC voltage; specify channel list.</i>
TRIG:SOUR EXT	<i>!Trigger source is external BNC on multimeter front panel.</i>
INIT	<i>!Place multimeter in wait-for-trigger state; store readings in memory when trigger is received.</i>
FETC?	<i>!Place readings in output buffer.</i>
INIT	<i>!You must reinitiate the wait-for-trigger state after each trigger cycle.</i>

The MEASure command subsystem configures the multimeter to perform the specified measurement with the given range and resolution. When the multimeter is triggered, MEASure makes the measurement and sends the readings to the output buffer.

Executing MEASure is equivalent to configuring the multimeter with the low-level commands shown in the following table.

Command	Setting
VOLTage:RANGe RESistance:RANGe	As specified, or autorange.
VOLTage:RESolution RESistance:RESolution	As specified, or as a function of range, integration time, or aperture time.
VOLTage:APERture RESistance:APERture	16.7 ms (60 Hz) or 20 ms (50 Hz), or based on specified resolution.
VOLTage:NPLC RESistance:NPLC	1 PLC, or based on specified resolution.
CALibration:ZERO:AUTO	ON (autozero is performed after every measurement).
RESistance:OCOMPensated	OFF (applies to resistance measurements only).
TRIGger:SOURce TRIGger:COUNt TRIGger:DELay	IMM (trigger signal is always true). 1 AUTO (DC volts/resistance: 0 s, AC volts: 0.5 s).
SAMPlE:COUNt SAMPlE:SOURce	1 IMM

Subsystem Syntax MEASure

```
:FRESistance? [<range>[,<resolution>]] [,<channel_list>]
:RESistance? [<range>[,<resolution>]] ,<channel_list>
:TEMPerature? <transducer>,<type> [,<channel_list>]
:VOLTage:AC? [<range>[,<resolution>]] [,<channel_list>]
:VOLTage[:DC]? [<range>[,<resolution>]] [,<channel_list>]
```

NOTE: If *range* and *resolution* are not specified (that is, if you use the default values), use a space rather than a comma before the *channel_list* parameter.

:FRESistance?

MEASure:FRESistance? [*<range>* [,*<resolution>*]] [,*<channel_list>*] selects the 4-wire ohms function and allows you to specify the *range* and *resolution*. If you specify a *channel list*, those multiplexer channels are scanned.

For a complete listing of range and resolution values available, see Table 5-1 on page 120.

Parameters

Parameter Name	Parameter Type	Range of Values	Default Units
<i><range></i>	numeric	232 Ω 1861 Ω 14894 Ω 119156 Ω 1048576 Ω AUTO DEF MIN MAX	ohms
<i><resolution></i>	numeric	<i>resolution</i> (see Table 5-1) DEF MIN MAX	ohms
<i><channel_list></i>	numeric	cc00-cc15 (E1345A/E1347A)	none

- Comments**
- To select a standard measurement range, specify *range* as the input signal's maximum expected resistance. The multimeter then selects the correct range.
 - The AUTO and DEFault options for the *range* parameter have the same effect (enable autorange). The DEF option for the *resolution* parameter defaults the integration time to 1 PLC.
 - The MIN and MAX parameters select the minimum or maximum values for range and resolution:

For *range*: MIN = 232 Ω ; MAX = 1048576 Ω

For *resolution*: MIN selects the best resolution (the smallest value from Table 5-1) for the selected range. MAX selects the worst resolution (the largest value from Table 5-1) for the selected range.

- The *channel list* is of the form (@ccnn), (@ccnn,ccnn), or (@ccnn:ccnn), where cc = card number and nn = channel number (105 is channel 05 of card number 1, for example).
- Four-wire resistance measurements use channel pairs. For example, on the HP E1345A multiplexer, channels 0 and 8, 1 and 9, 2 and 10, etc. are paired. The lower channel in each pair (0, 1, 2, ...7) is the "sense" channel. Use *channel_list* to specify the sense channels.
- To select autorange, specify AUTO (or DEF) for *range* or do not specify a value for the parameter. In the autorange mode, the multimeter samples the input signal before each measurement and selects the appropriate range.
- To specify a MIN or MAX resolution while autoranging, you must specify MEAS:FRES? AUTO or MEAS:FRES? DEF must be specified (you cannot omit the *range* parameter). This prevents the MIN or MAX resolution from being interpreted as a range setting.
- The fastest aperture time available when autoranging is 100 μ s. In order to specify an aperture time of 10 μ s, you must select a fixed range.

Example Making 4-Wire Ohms Measurements

MEAS:FRES? 1560,MAX,(@100:103)

*!Function: 4-wire ohms;
range selected: 1861 Ω;
MAX resolution: 125 mΩ;
specify sense channel list (scan 4 channels
once); trigger source is IMMEDIATE by
default.*

enter statement

!Enter readings into computer.

:RESistance?

MEASure:RESistance? [<range>[,<resolution>]] , <channel_list>

selects the 2-wire ohms function and allows you to specify the *range* and *resolution*. Two-wire ohms measurements can only be made using the scanning multimeter (a *channel list* is required).

For a complete listing of range and resolution values available, see Table 5-1 on page 120.

Parameters

Parameter Name	Parameter Type	Range of Values	Default Units
<range>	numeric	232 Ω 1861 Ω 14894 Ω 119156 Ω 1048576 Ω AUTO DEF MIN MAX	ohms
<resolution>	numeric	<i>resolution</i> (see Table 5-1) DEF MIN MAX	ohms
<channel_list>	numeric	Refer to the multiplexer user's manual for a list of channels available.	none

- Comments**
- To select a standard measurement range, specify *range* as the input signal's maximum expected resistance. The multimeter then selects the correct range.
 - The AUTO and DEFault options for the *range* parameter have the same effect (enable autorange). The DEF option for the *resolution* parameter defaults the integration time to 1 PLC.
 - The MIN and MAX parameters select the minimum or maximum values for range and resolution:

For *range*: MIN = 232 Ω; MAX = 1048576 Ω

For *resolution*: MIN selects the best resolution (the smallest value from Table 5-1) for the selected range. MAX selects the worst resolution (the largest value from Table 5-1) for the selected range.

- The *channel list* is of the form (@ccnn), (@ccnn,ccnn), or (@ccnn:ccnn), where cc = card number and nn = channel number (105 is channel 05 of card number 1, for example).
- To select autorange, specify AUTO (or DEF) for *range* or do not specify a value for the parameter. In the autorange mode, the multimeter samples the input signal before each measurement and selects the appropriate range.

- To specify a MIN or MAX resolution while autoranging, you must specify MEAS:RES? AUTO or MEAS:RES? DEF must be specified (you cannot omit the *range* parameter). This prevents the MIN or MAX resolution from being interpreted as a range setting.
- The fastest aperture time available when autoranging is 100 μ s. In order to specify an aperture time of 10 μ s, you must select a fixed range.

Example Making 2-Wire Ohms Measurements

MEAS:RES? 1320,MAX,(@105:109)

*!Function: 2-wire ohms;
range selected: 1861 Ω ;
MAX resolution: 125 m Ω ;
specify channel list (scan the 5 channels
once); trigger source is IMMEDIATE by
default.*

enter statement

!Enter readings into computer.

:TEMPerature?

MEASure:TEMPerature? <transducer>,<type> [,<channel_list>]

selects the temperature function. All measurements are returned in Degrees Celsius. The following transducers can be measured using the multimeter:

Thermocouples

Thermistors (2-wire or 4-wire measurement)

RTDs (2-wire or 4-wire measurement)

Two-wire temperature measurements can only be made using the scanning multimeter (a *channel list* is required).

Parameters

Parameter Name	Parameter Type	Range of Values	Default Units
<transducer>	discrete	TCouple THERmistor FTHermistor RTD FRTD	none
<type>	discrete numeric numeric	TC: B, E, J, K, N14, N28, R, S, or T THER/FTH:2252 5000 10000 RTD/FRTD: 85 92	none ohms alpha
<channel_list>	numeric	Refer to the multiplexer user's manual for a list of channels available.	none

Comments

- The HP E1344A, E1347A, E1353A, or E1476A multiplexer is required for thermocouple measurements. These modules have built-in thermocouple compensation circuitry on the terminal module.
- To measure the temperature of the reference thermistor on the HP E1347A, send:

MEAS:TEMP? THER,5000,(@cc93)

where “cc” is the multiplexer (card) number.

- The *channel list* is of the form (@ccnn), (@ccnn,ccnn), or (@ccnn:ccnn), where cc = card number and nn = channel number (105 is channel 05 of card number 1, for example).
- Four-wire temperature measurements use channel pairs. On the HP E1345A multiplexer, for example, channels 0 and 8, 1 and 9, 2 and 10, etc. are paired. The lower channel in each pair (0, 1, 2, ...7) is the "sense" channel. Use *channel_list* to specify the sense channels.
- You can measure RTD *types* 85 (alpha=0.00385 Ω/Ω/°C) and 92 (alpha=0.00392 Ω/Ω/°C). The values 385, 0.00385, 392, 0.00392 are also accepted for the *type* parameter.
- Thermistor *types* are 2252, 5000, and 10000. Use thermistors that match the Omega 440xx series temperature response curves.

Example Making Thermocouple Measurements

MEAS:TEMP? TC,J,(@100:107)

!Measure J-type thermocouples (scan the 8 channels once); trigger source is IMMEDIATE by default.

enter statement

!Enter readings into computer.

:VOLTage:AC?

MEASure:VOLTage:AC? [<range>,<resolution>] [<channel_list>] selects the AC-coupled RMS voltage function and allows you to specify the *range* and *resolution*. If you specify a *channel list*, those multiplexer channels are scanned.

For a complete listing of range and resolution values available, see Table 5-1 on page 120.

Parameters

Parameter Name	Parameter Type	Range of Values	Default Units
<range>	numeric	0.0795 V 0.63V 5.09 V 40.7 V 300 V AUTO DEF MIN MAX	volts
<resolution>	numeric	<i>resolution</i> (see Table 5-1) DEF MIN MAX	volts
<channel_list>	numeric	Refer to the multiplexer user's manual for a list of channels available.	none

Comments

- To select a standard measurement range, specify *range* as the input signal's maximum expected voltage. The multimeter then selects the correct range.
- The AUTO and DEFault options for the *range* parameter have the same effect (enable autorange). The DEF option for the *resolution* parameter defaults the integration time to 1 PLC.

- The MIN and MAX parameters select the minimum or maximum values for range and resolution:

For *range*: MIN = 0.0795 V; MAX = 300 V.

For *resolution*: MIN selects the best resolution (the smallest value from Table 5-1) for the selected range. MAX selects the worst resolution (the largest value from Table 5-1) for the selected range.

- The *channel list* is of the form (@ccnn), (@ccnn,ccnn), or (@ccnn:ccnn), where cc = card number and nn = channel number (105 is channel 05 of card number 1, for example).
- To select autorange, specify AUTO (or DEF) for *range* or do not specify a value for the parameter. In the autorange mode, the multimeter samples the input signal before each measurement and selects the appropriate range.
- To specify a MIN or MAX resolution while autoranging, you must specify MEAS:VOLT:AC? AUTO or MEAS:VOLT:AC? DEF (you cannot omit the *range* parameter). This prevents the MIN or MAX resolution from being interpreted as a range setting.
- The fastest aperture time available when autoranging is 100 μ s. In order to specify an aperture time of 10 μ s, you must select a fixed range.

Example Making AC Voltage Measurements

MEAS:VOLT:AC? 0.54,MAX,(@100)

*!Function: AC volts;
range selected: 0.63 V;
MAX resolution: 61.035 μ V; specify single
channel; trigger source is IMMEDIATE by
default.*

enter statement

!Enter reading into computer.

:VOLTage[:DC]?

MEASure:VOLTage[:DC]? [**<range>** [,**<resolution>**]] [,**<channel_list>**] selects the DC voltage function and allows you to specify the *range* and *resolution*. If you specify a *channel list*, those multiplexer channels are scanned.

For a complete listing of range and resolution values available, see Table 5-1 on page 120.

Parameters

Parameter Name	Parameter Type	Range of Values	Default Units
<range>	numeric	0.113 V 0.91 V 7.27 V 58.1 V 300 V AUTO DEF MIN MAX	volts
<resolution>	numeric	<i>resolution</i> (see Table 5-1) DEF MIN MAX	volts
<channel_list>	numeric	Refer to the multiplexer user's manual for a list of channels available.	none

- Comments**
- The [:DC] parameter is optional. Both of the following command statements select the DC voltage function:

MEAS:VOLT:DC? *or* MEAS:VOLT?

- To select a standard measurement range, specify *range* as the input signal's maximum expected voltage. The multimeter then selects the correct range.
- The AUTO and DEFault options for the *range* parameter have the same effect (enable autorange). The DEF option for the *resolution* parameter defaults the integration time to 1 PLC.
- The MIN and MAX parameters select the minimum or maximum values for range and resolution:

For *range*: MIN = 0.113 V; MAX = 300 V.

For *resolution*: MIN selects the best resolution (the smallest value from Table 5-1) for the selected range. MAX selects the worst resolution (the largest value from Table 5-1) for the selected range.

- The *channel list* is of the form (@ccnn), (@ccnn,ccnn), or (@ccnn:ccnn), where cc = card number and nn = channel number (105 is channel 05 of card number 1, for example).
- To select autorange, specify AUTO (or DEF) for *range* or do not specify a value for the parameter. In the autorange mode, the multimeter samples the input signal before each measurement and selects the appropriate range.
- To specify a MIN or MAX resolution while autoranging, you must specify MEAS:VOLT:DC? AUTO or MEAS:VOLT:DC? DEF (you cannot omit the *range* parameter). This prevents the MIN or MAX resolution from being interpreted as a range setting.
- The fastest aperture time available when autoranging is 100 μ s. In order to specify an aperture time of 10 μ s, you must select a fixed range.

Example Making DC Voltage Measurements

MEAS:VOLT:DC? 0.825,MAX,(@100)

*!Function: DC voltage;
range selected: 0.91 V;
MAX resolution: 61.035 μ V; specify single
channel; trigger source is IMMEDIATE by
default.*

enter statement

!Enter reading into computer.

The MEMory command subsystem enables you to store multimeter readings in shared memory (an external VME memory card).

Subsystem Syntax MEMory

```
:VME:ADDRess <address>
:VME:ADDRess? [MIN | MAX]
:VME:SIZE <bytes>
:VME:SIZE? [MIN | MAX]
:VME:STATe <mode>
:VME:STATe?
```

MEMory SubsystemData Format The multimeter sends readings to an external VME memory card in IEEE-754 32-bit notation (this is the IEEE standard for binary floating-point representation).

:VME:ADDRess

MEMory:VME:ADDRess <address> sets the address of the external memory board in A24 memory address space.

Parameters

Parameter Name	Parameter Type	Range of Values	Default Units
<address>	numeric	2097152 - 14680060 #H200000 - #HDFFFFC	none

- Comments**
- You can specify the address location in decimal or hexadecimal (#H....).
 - MIN sets the address to 2097152 (#H200000). MAX sets the address to 14680060 (#HDFFFFC) - to store one reading.
 - The VME address specified is based on the memory card configuration. Refer to the memory card manual for configuration information.
 - *RST Condition:** MEM:VME:ADDR #H200000

Example Setting the VME Memory Address

```
MEM:VME:ADDR #H800000           !Set memory address location.
```

:VME:ADDRess?

MEMory:VME:ADDRess? [MIN | MAX] returns one of the following numbers to the output buffer:

The present decimal address selected if MINimum or MAXimum are not specified.

The lowest decimal address available (2097152) if MIN is specified.

The highest decimal address available (14680060) if MAX is specified.

Example Querying the VME Memory Address

```
MEM:VME:ADDR #H800000      !Set memory address location.  
MEM:VME:ADDR?             !Query multimeter to return memory  
                           address (in decimal).  
enter statement           !Enter into computer.
```

:VME:SIZE

MEMory:VME:SIZE <bytes> sets the size, in bytes, of the external VME memory card.

Parameters

Parameter Name	Parameter Type	Range of Values	Default Units
<bytes>	numeric	0 - 12582912 0 - #HC00000	bytes

- Comments**
- You can specify the memory size in decimal or hexadecimal (#H...).
 - MINimum sets the memory size to 0 bytes. MAXimum sets the memory size to 12582912 (#HC00000) bytes.
 - The memory address (MEM:VME:ADDR) plus memory size (MEM:VME:SIZE) must not exceed 14680064 (#HE00000).
 - Since each reading requires 4 bytes of memory, the sample count multiplied by the trigger count must be less than or equal to MEM:VME:SIZE/4.
 - ***RST Condition:** MEM:VME:SIZE 0

Example Setting the VME Memory Size

```
MEM:VME:SIZE 100000      !Set memory size to 100 kBytes.
```

:VME:SIZE?

MEMory:VME:SIZE? [MIN | MAX] returns one of the following numbers to the output buffer:

The present memory size (in decimal) selected if MINimum or MAXimum are not specified.

The smallest memory size available (0) if MIN is specified.

The largest memory size available (12582912) if MAX is specified.

Example Querying the VME Memory Size

```
MEM:VME:SIZE 100000           !Set memory size to 100 kBytes.  
MEM:VME:SIZE?              !Query multimeter to return memory size.  
enter statement               !Enter string into computer.
```

:VME:STATe

MEMory:VME:STATe *<mode>* enables or disables use of an external VME memory card for reading storage.

Parameters

Parameter Name	Parameter Type	Range of Values	Default Units
<i><mode></i>	boolean	OFF 0 ON 1	none

- Comments**
- You can substitute decimal values for the OFF ("0") and ON ("1") parameters.
 - ***RST Condition:** MEM:VME:STAT OFF

Example Enabling VME Memory

```
MEM:VME:ADDR #H800000        !Set memory address location.  
MEM:VME:SIZE #H100000       !Set memory size to 100 kBytes.  
MEM:VME:STAT ON           !Direct readings to memory card.  
CONF:VOLT:DC 58.1           !Configure the multimeter.  
SAMP:COUN 10000             !Set a burst of 10,000 readings.  
INIT                         !Place multimeter in wait-for-trigger state;  
                             !store readings on memory card; trigger  
                             !source is IMMEDIATE by default.
```

:VME:STATe?

MEMory:VME:STATe? returns a number to show whether use of the external VME memory card is enabled or disabled: "1" = ON, "0" = OFF. The number is sent to the output buffer.

Example Querying the VME Memory State

```
MEM:VME:STAT ON              !Direct readings to external memory card.  
MEM:VME:STAT?            !Query multimeter to return external  
                             !memory state ("1").  
enter statement              !Enter value into computer.
```

The OUTPut command subsystem enables you to route the multimeter's *voltmeter complete* signal to the VXIbus TTL trigger lines.

Subsystem Syntax OUTPut
 :TTLTrgn[:STATe] <mode>
 :TTLTrgn[:STATe]?

:TTLTrgn[:STATe]

OUTPut:TTLTrgn[:STATe] <mode> enables or disables routing of the *voltmeter complete* signal to the specified VXIbus trigger line (TTLTrg0 through TTLTrg7) on the backplane P2 connector.

Parameters

Parameter Name	Parameter Type	Range of Values	Default Units
<i>n</i>	discrete	0 1 2 3 4 5 6 7	none
<mode>	boolean	OFF 0 ON 1	none

- Comments**
- The OUTPut subsystem applies to the HP E1411B multimeter only.
 - You can substitute decimal values for the OFF ("0") and ON ("1") parameters.
 - The *voltmeter complete* signal is always routed to the E1411B multimeter's front panel "VM Complete" BNC connector. When enabled (ON), the OUTPut command also routes *voltmeter complete* to the specified trigger line on connector P2. When disabled (OFF), *voltmeter complete* is routed only to the multimeter's front panel connector.
 - The multimeter generates the *voltmeter complete* signal after it has sampled the input for each reading. The length of time this low-going TTL signal is true (low) depends on the aperture time and on the autozero mode as shown below.

Aperture Time	Voltmeter Complete low	
	Autozero ON	Autozero OFF
320 ms (50 Hz)	350 ms	350 μs
267 ms (60 Hz)	370 μs	370 μs
20 ms (50 Hz)	20.5 ms	370 μs
16.7 ms (60 Hz)	17.2 ms	390 μs
2.5 ms (400 Hz)	3.1 ms	430 μs
100 μs	520 μs	250 μs
10 μs	NA	70 μs

- The VXIbus trigger lines are open-collector TTL lines that remain in a non-asserted (high) state until the *voltmeter complete* signal is sent.
- ***RST Condition:** OUTP:TTL*n* OFF

Example Routing Voltmeter Complete to Trigger Line

OUTP:TTLT7 ON

!Route signal to trigger line 7.

:TTLTrgn[:STATe]?

OUTPut:TTLTrgn[:STATe]? returns a number to show whether VXibus trigger line routing of the *voltmeter complete* signal is enabled or disabled: "1" = ON, "0" = OFF. The number is sent to the output buffer.

Example Querying Voltmeter Complete Destination

OUTP:TTLT7 ON

!Route signal to trigger line 7.

OUTP:TTLT7?

!Query multimeter to return trigger line mode.

enter statement

!Enter value into computer.

The READ? command is most commonly used with CONFigure to:

Place the multimeter in the wait-for-trigger state (executes the INITiate command).

Transfer the readings directly to the output buffer when the trigger is received (same action as FETCh? but the readings are not stored in memory).

Subsystem Syntax READ?

- Comments**
- The READ? command is slower than the INITiate command since readings are formatted and sent to the output buffer as they are taken. However, the sample count and trigger count are not limited with READ? since memory is not used.
 - This command causes the multimeter to start taking readings as soon as its trigger requirements are met (this is the same as the INIT command).
 - Each reading sent to the output buffer is terminated with a Line Feed (LF). The HP-IB End-of-Identify (EOI) signal is sent with the last byte transferred. If multiple readings are returned, the readings are separated by commas and EOI is sent only with the last byte.
 - The output buffer capacity is 128 bytes. When the buffer fills, the multimeter remains "busy" until you begin removing readings from the buffer.
 - Readings are placed directly in the output buffer; therefore, mainframe RAM is not allocated for the readings. You may want to use this mode of operation when readings need to be taken at a continuous rate.
 - The rate the controller removes the readings need to match the multimeter to keep from causing an overflow condition.

controller output buffer 128 characters

multimeter FIFO 512 words

for example, 10 μ s aperture equals 1 word per reading; all other apertures equals 2 words per reading.

- **Related Commands:** CONFigure, FETCh?, INITiate

Example Transferring Readings Directly to Output Buffer

dimension array	<i>!Dimension computer array to store 100 readings.</i>
CONF:VOLT:DC	<i>!Function: DC voltage; stand-alone multimeter.</i>
SAMP:COUN 100	<i>!Specify 100 readings per trigger (stand-alone multimeter only).</i>

READ?

!Place multimeter in wait-for-trigger state and make measurements; send readings to output buffer; trigger source is IMMEDIATE by default.

enter statement

!Enter readings into computer.

The SAMPlE command subsystem operates with the TRIGger command subsystem.
The SAMPlE subsystem:

Designates the number of readings made for each trigger signal received (SAMPlE:COUnT).

Selects the pacing source for the sample period (SAMPlE:SOURce).

Sets the sample period when the sample count is greater than one (SAMPlE:TIMer).

Subsystem Syntax SAMPlE
 :COUnT <number>
 :COUnT? [MIN | MAX]
 :SOURce <source>
 :SOURce?
 :TIMer <period>
 :TIMer? [MIN | MAX]

:COUnT

SAMPlE:COUnT <number> designates the number of readings per trigger.

Parameters

Parameter Name	Parameter Type	Range of Values	Default Units
<number>	numeric	1 - 16,777,215 MIN MAX	none

- Comments**
- MINimum sets 1 reading per trigger. MAXimum sets 16,777,215 readings per trigger.
 - If MAX or 16,777,215 is specified for *number*, an “Out of memory” error is generated to show that memory is exceeded. However, you can execute READ? to return the readings to the output buffer.
 - CONFigure and MEASure set the sample count to 1.
 - ***RST Condition:** SAMP:COUn 1

Example Setting the Sample Count

```
CONF:VOLT:DC !Function: DC voltage; stand-alone multimeter.
TRIG:SOUR EXT !Trigger source is external BNC on multimeter front panel.
SAMP:COUn 10 !Specify 10 readings per trigger.
```

READ?

!Place multimeter in wait-for-trigger state; make measurement when external trigger is received; send readings to output buffer.

enter statement

!Enter readings into computer.

:COUNT?

SAMPle:COUNT? [MIN | MAX] returns one of the following numbers to the output buffer:

The present sample count (1 through 16,777,215) if MINimum or MAXimum is not specified.

The minimum sample count (1) if MIN is specified.

The maximum sample count (16,777,215) if MAX is specified.

Example Querying the Sample Count

SAMP:COUN 10

!Specify 10 readings per trigger.

SAMP:COUNT?

!Query multimeter to return sample count.

enter statement

!Enter value into computer.

:SOURCE

SAMPle:SOURce <source> selects the pacing source for the sample period when SAMPle:COUNT is greater than 1. The sources available are:

IMM: initiate reading whenever multimeter is not busy.

TIMer: specify sample period using the SAMPle:TIMer command.

Parameters

Parameter Name	Parameter Type	Range of Values	Default Units
<source>	discrete	IMM TIMer	none

Comments • CONFigure and MEASure set the sample source to IMM.

• **Related Commands:** SAMPle:COUNT

• ***RST Condition:** SAMP:SOUR IMM

Example Setting the Pacing Source

CONF:VOLT:DC

!Function: DC voltage; stand-alone multimeter.

SAMP:COUN 10

!Specify 10 readings per trigger.

SAMP:SOUR TIM

!Sample source is SAMPle:TIMer command.

SAMP:TIM 0.065

!Set 65 ms sample period.

READ? *!Place multimeter in wait-for-trigger state and make measurements; send readings to output buffer.*

enter statement *!Enter readings into computer.*

:SOURce?

SAMPle:SOURce? returns "IMM" or "TIM" to show the present pacing source. The quoted string is sent to the output buffer.

Example Querying the Pacing Source

SAMP:SOUR TIM *!Sample source is SAMPle:TIMer command.*

SAMP:SOUR? *!Query multimeter to return pacing source setting.*

enter statement *!Enter string into computer.*

:TIMer

SAMPle:TIMer <period> defines the period between readings in a burst (stand-alone multimeter) or defines the period between FET multiplexer channels in the scan list (scanning multimeter).

Parameters

Parameter Name	Parameter Type	Range of Values	Default Units
<period>	numeric	76 μ s - 65.534 ms MIN MAX	seconds

Comments

- MIN sets the time to 76 μ s. MAX sets the time to 65.534 ms.
- When using SAMP:TIM, the first measurement occurs without the specified period. However, you can insert a time interval before the first measurement using the TRIGger:DELAy command.
- To achieve specific sample periods, the aperture time must be set accordingly (see the [SENSe:] subsystem). The following table shows the minimum sample period for each available aperture time setting. The aperture times and sample periods shown assume a fixed range and autozero off. Reading rates are for the DC voltage function with readings stored mainframe/command module memory.

Aperture Time	Minimum Sample Period (SAMPle:TIMer)	Maximum Reading Rate (Readings/second)
10 μ s	76 μ s	13,150
100 μ s	0.32 ms	3,000
2.5 ms	2.8 ms	350
16.7 ms	16.9 ms	58
20 ms	20.3 ms	49
267 ms	IMM	2
320 ms	IMM	1.9

- The sample period must be longer than the specified aperture time.

- **Related Commands:** SAMPlE:COUNT, SAMPlE:SOURce, SENSE
- ***RST Condition:** SAMPlE:TIMer 50E-3 seconds

Example Setting the Sample Period

CONF:VOLT:DC	<i>!Function: DC voltage; stand-alone multimeter.</i>
SAMP:COUN 10	<i>!Specify 10 readings per trigger.</i>
SAMP:SOUR TIM	<i>!Sample source is SAMPlE:TIMer command.</i>
SAMP:TIM 0.065	<i>!Set 65 ms sample period.</i>
READ?	<i>!Place multimeter in wait-for-trigger state and make measurements; send readings to output buffer.</i>
enter statement	<i>!Enter readings into computer.</i>

:TIMer?

SAMPle:TIMer? [MIN | MAX] returns one of the following numbers to the output buffer:

The present sample period (76 μ s through 65.534 ms) if MINimum or MAXimum is not specified.

The minimum sample period available (76 μ s) if MIN is specified.

The maximum sample period available (65.534 ms) if MAX is specified.

Example Querying the Sample Period

SAMP:SOUR TIM	<i>!Sample source is SAMPlE:TIMer command.</i>
SAMP:TIM MAX	<i>!Set sample period to maximum.</i>
SAMP:TIM?	<i>!Query multimeter to return sample period.</i>
enter statement	<i>!Enter value into computer.</i>

The [SENSe:] command subsystem is most commonly used with CONFigure to change specific "low-level" measurement parameters. Normally when you execute CONFigure, the multimeter operates using predefined settings. [SENSe:] enables you to change the following measurement parameters without completely reconfiguring the multimeter:

Function

Range

Resolution

Aperture and Integration Time

Autozero

Offset Compensation

Subsystem Syntax [SENSe:]

```
FUNCTION[:<function>]
FUNCTION?
RESistance
    :APERture <time>
    :APERture? [MIN | MAX]
    :NPLC <number>
    :NPLC? [MIN | MAX]
    :OCOMpensated <mode>
    :OCOMpensated?
    :RANGe:AUTO <mode>
    :RANGe:AUTO?
    :RANGe <range>
    :RANGe? [MIN | MAX]
    :RESolution <resolution>
    :RESolution? [MIN | MAX]
VOLTage
    :AC:RANGe <range>
    :AC:RANGe? [MIN | MAX]
    :APERture <time>
    :APERture? [MIN | MAX]
    [:DC]:RANGe <range>
    [:DC]:RANGe? [MIN | MAX]
    :NPLC <number>
    :NPLC? [MIN | MAX]
    :RANGe:AUTO <mode>
    :RANGe:AUTO?
```

:RESolution <resolution>
:RESolution? [MIN | MAX]

Note The root command [SENSe:] is an implied command and can be omitted.

FUNCTION

[SENSe:]FUNCTION[:<function>] selects the measurement function. You can select 4-wire resistance, AC voltage, or DC voltage.

Parameters

Parameter Name	Parameter Type	Range of Values	Default Units
<function>	discrete	:FRESistance :VOLTage:AC :VOLTage[:DC]	none

Comments

- The :DC parameter is optional. Both of the following command statements select the DC voltage function:

FUNC:VOLT:DC *or* FUNC:VOLT

- ***RST Condition:** SENS:FUNC:VOLT:DC

Example Changing Measurement Function

```
CONF:VOLT:DC !Function: DC voltage; stand-alone multimeter.
FUNC:FRES !Change function to 4-wire resistance.
READ? !Place multimeter in wait-for-trigger state and make measurement; send reading to output buffer.
enter statement !Enter reading into computer.
```

FUNCTION?

[SENSe:]FUNCTION? returns one of the following quoted strings to the output buffer: "FRES", "VOLT:AC", or "VOLT".

Example Querying the Measurement Function

```
FUNC:FRES !Function: 4-wire ohms; stand-alone multimeter.
FUNC? !Query multimeter to return selected function.
enter statement !Enter quoted string into computer.
```

RESistance:APERture

[SENSe:]RESistance:APERture <time> sets the aperture (integration time) in seconds. Values are rounded up to the nearest aperture time shown in the following table.

Parameters

Parameter Name	Parameter Type	Range of Values	Default Units
<time>	numeric	10 μ s 100 μ s 2.5 ms 16.7 ms 20 ms 267 ms 320 ms MIN MAX	seconds

Comments

- MINimum sets the aperture time to 10 ms. MAXimum sets the aperture time to 320 ms.
- The fastest aperture time available when autoranging is 100 μ s. In order to specify an aperture time of 10 μ s, you must select a fixed range.
- Setting the aperture time also sets the integration time in power line cycles (PLCs) and the resolution. For example, an aperture time of 16.7 ms (60 Hz line frequency) sets an integration time of 1 PLC. The corresponding resolution depends on the function and range you select.
- The RES:APER command overrides the results of previously executed RESistance:NPLC and RESistance:RESolution commands (the last command executed has priority).
- The greater the aperture time, the greater the normal mode rejection (and the lower the reading rate).
- For a 50 Hz line frequency, only the 20 ms and 320 ms settings provide normal mode rejection of power line related noise. For a 60 Hz line frequency, only the 16.7 ms and 267 ms settings provide normal mode rejection of power line related noise.
- ***RST Condition:** 16.7 ms (60 Hz) or 20 ms (50 Hz)

Example Setting the Aperture Time

RES:APER 2.67E-01

!Aperture time is 267 ms.

RESistance:APERture?

[SENSe:]RESistance:APERture? [MIN | MAX] returns one of the following numbers to the output buffer:

The present aperture time in seconds if MIN or MAX is not specified.

The minimum aperture time available (10 μ s) if MIN is specified.

The maximum aperture time available (320 ms) if MAX is specified.

Example Querying the Aperture Time

```
RES:APER 2.67E-01           !Aperture time is 267 ms.
RES:APER?                   !Query multimeter to return aperture time.
enter statement              !Enter value into computer.
```

RESistance:NPLC

[SENSe:]RESistance:NPLC <number> sets the integration time in power line cycles (PLCs). Values are rounded up to the nearest number of PLCs shown in the following table.

Parameters

Parameter Name	Parameter Type	Range of Values	Default Units
<number>	numeric	0.0005 0.005 0.125 1 16 MIN MAX	PLCs

- ### Comments
- MINimum selects 0.0005 PLCs. MAXimum selects 16 PLCs. Setting the integration time in power line cycles (PLCs) also sets the aperture time and the resolution. For example, 16 PLCs (60 Hz line frequency) sets an aperture time of 267 ms. The corresponding resolution depends on the function and range you select.
 - The RES:NPLC command overrides the results of previously executed RESistance:APERture and RESistance:RESolution commands (the last command executed has priority).
 - The greater the number of PLCs, the greater the normal mode rejection (and the lower the reading rate).
 - Only the 1 PLC and 16 PLC settings provide normal mode rejection of 50 Hz or 60 Hz power line related noise.
 - ***RST Condition:** 1 PLC

Example Setting the Integration Time in PLCs

```
RES:NPLC 16                 !Integration time is 16 PLCs.
```

RESistance:NPLC?

[SENSe:]RESistance:NPLC? [MIN | MAX] returns one of the following numbers to the output buffer:

The present integration time in PLCs if MINimum or MAXimum is not specified.

The minimum integration time available (0.0005) if MIN is specified.

The maximum integration time available (16) if MAX is specified.

Example Querying the Integration Time

```
RES:NPLC 16                                !Integration time is 16 PLCs.
RES:NPLC?                                   !Query multimeter to return integration time.
enter statement                             !Enter value into computer.
```

RESistance:OCOMpensated

[SENSe:]RESistance:OCOMpensated <mode> enables or disables the offset compensated ohms function.

Parameters

Parameter Name	Parameter Type	Range of Values	Default Units
<mode>	boolean	OFF 0 ON 1	none

- Comments**
- You can substitute decimal values for the OFF ("0") and ON ("1") parameters.
 - You can use offset compensation for 2-wire or 4-wire resistance measurements on any measurement range.
 - With offset compensation enabled, the multimeter measures the offset voltage before each resistance measurement and subtracts it from the following reading. This prevents the offset voltage from affecting the resistance but doubles the time required per reading.
 - ***RST Condition:** RES:OCOM OFF

Example Enabling Offset Compensation

```
RES:OCOM ON                                !Enable offset compensation.
```

RESistance: OCOMpensated?

[SENSe:]RESistance:OCOMpensated? returns a number to show whether offset compensation is enabled or disabled: "1" = ON, "0" = OFF. The number is sent to the output buffer.

Example Querying the Offset Compensation Mode

```
RES:OCOM ON           !Enable offset compensation.
RES:OCOM?             !Query multimeter to return offset
                       compensation mode.
enter statement       !Enter value into computer.
```

RESistance:RANGe

[SENSE:]RESistance:RANGe <range> selects the range for 2-wire and 4-wire resistance measurements.

For a complete listing of range and resolution values available, see Table 5-1 on page 120.

Parameters

Parameter Name	Parameter Type	Range of Values	Default Units
<range>	numeric	256 Ω 2048 Ω 16384 Ω 131072 Ω 1048576 Ω MIN MAX	ohms

- Comments**
- To select a standard measurement range, specify *range* as the input signal's maximum expected resistance. The multimeter then selects the correct range.
 - MIN selects the minimum range available with the RESistance:RANGe command (256 Ω). MAX selects the maximum range available (1048576 Ω).
 - You must select a range using RESistance:RANGe *before* specifying resolution. Also, in order to specify an aperture time of 10 μ s, you must select a fixed range.
 - Specifying a fixed range disables the autorange mode set by the RES:RANG:AUTO command.
 - The RES:RANG command overrides the range setting from a previous CONFigure command on the same function. The multimeter uses the same aperture time to set the resolution on the new range as was selected by CONFigure.
 - ***RST Condition:** RES:RANG 16384 Ω

Example Changing the Range

```
CONF:RES 1320,MAX,(@105:109) !Function: 2-wire ohms;
                               range selected: 1861  $\Omega$ ;
                               MAX resolution: 125  $\Omega$ ;
                               specify channel list.

RES:RANG 220                 !Range selected: 256  $\Omega$ ;
                               MAX resolution: 15.625 m $\Omega$ .

READ?                        !Place multimeter in wait-for-trigger state and
                               make measurements; send readings to output
                               buffer.

enter statement              !Enter readings into computer.
```

RESistance:RANGe?

[SENSe:]RESistance:RANGe? [MIN | MAX] returns one of the following numbers to the output buffer:

The present resistance range is selected if MIN or MAX is not specified. Only the ranges available with the RANGe command are returned. For example, if CONFigure selects the 232 Ω range, 256 Ω is the range returned.

The minimum resistance range available (256 Ω) if MIN is specified.

The maximum resistance range available (1048576 Ω) if MAX is specified.

Example Querying the Measurement Range

```
RES:RANG 256           !Select 256  $\Omega$  range.
RES:RANG?             !Query multimeter to return the present
                      range.
enter statement       !Enter value into computer.
```

RESistance:RANGe :AUTO

[SENSe:]RESistance:RANGe:AUTO <mode> enables or disables the autorange function for resistance measurements.

Parameters

Parameter Name	Parameter Type	Range of Values	Default Units
<mode>	boolean	OFF 0 ON 1	none

- ### Comments
- You can substitute decimal values for the OFF ("0") and ON ("1") parameters.
 - When autoranging is ON, the multimeter samples the input before each measurement and selects the appropriate range.
 - If you explicitly select a range using RESistance:RANGe, autoranging is turned OFF.
 - In order to specify an aperture time of 10 μ s, you must select a fixed range (RESistance:RANGe:AUTO OFF, for example).
 - **Related Commands:** CONFigure, RESistance:RANGe
 - ***RST Condition:** RES:RANG:AUTO ON

Example Disabling Autoranging

```
RES:RANG:AUTO OFF     !Disable autorange.
```

RESistance:RANGe:AUTO?

[SENSe:]RESistance:RANGe:AUTO? returns a number to show whether the autorange mode is enabled or disabled: "1" = ON, "0" = OFF. The number is sent to the output buffer.

Example Querying the Autorange Mode

```
RES:RANG:AUTO OFF           !Disable autorange.
RES:RANG:AUTO?             !Query multimeter to return autorange
                             mode.
enter statement            !Enter value into computer.
```

RESistance:RESolution

[SENSe:]RESistance:RESolution <resolution> selects the *resolution* for 2-wire and 4-wire resistance measurements.

For a complete listing of range and resolution values available, see Table 5-1 on page 120.

Parameters

Parameter Name	Parameter Type	Range of Values	Default Units
<resolution>	numeric	resolution (see Table 5-1) MIN MAX	ohms

- ### Comments
- **MINimum** selects the best resolution (the smallest value from Table 5-1) for the selected range. **MAXimum** selects the worst resolution (the largest value from Table 5-1) for the selected range.
 - You must select a range using **RESistance:RANGe** *before* specifying *resolution*. Also, only specify a resolution when making measurements on a fixed range. Otherwise, the resolution will change to correspond with the range selected during autoranging.
 - If autoranging is required, set the resolution using the **MIN** or **MAX** parameters or select a specific aperture time using **RESistance:APERture**.
 - If necessary to achieve the specified resolution, the multimeter will increase the integration time as needed. This command overrides the results of previously executed **RESistance:APERture** and **RESistance:NPLC** commands (the last command executed has priority).
 - The **RES:RES** command overrides the resolution setting from a previous **CONFigure** command on the same function.
 - **Related Commands:** **CONFigure**, **RESistance:APERture**, **RESistance:NPLC**
 - ***RST Condition:** Based on the ***RST** values for the **RESistance:APERture** and **RESistance:NPLC** commands.

Example Changing the Resolution

```
CONF:FRES 1560,MAX,(@100:103) !Function: 4-wire ohms;  
range selected: 1861 Ω;  
MAX resolution: 125 mΩ;  
specify sense channel list.  
  
RES:RANG 220 !Range selected: 256 Ω;  
MAX resolution: 15.626 mΩ.  
  
RES:RES 2.44E-04 !Set resolution to 244 μΩ;  
selects 16.7 ms aperture time  
(60 Hz line frequency).  
  
READ? !Place multimeter in wait-for-trigger state and  
make measurements;  
send readings to output buffer.  
  
enter statement !Enter readings into computer.
```

RESistance:RESolution?

[SENSe:]RESistance:RESolution? [MIN | MAX] returns one of the following numbers to the output buffer.

The present resolution selected if MIN or MAX are not specified. Only the resolution values available on ranges set by the RANGE command are returned.

The resolution with the smallest value (the best resolution) for the selected range if MIN is specified.

The resolution with the largest value (the worst resolution) for the selected range if MAX is specified.

Example Querying the Resolution

```
RES:RES 2.44E-04 !Set resolution to 244 μΩ.  
RES:RES? !Query multimeter to return the present  
resolution.  
  
enter statement !Enter value into computer.
```

VOLTage:AC:RANGE

[SENSe:]VOLTage:AC:RANGE <range> selects the range for AC-coupled RMS voltage measurements.

Parameters

Parameter Name	Parameter Type	Range of Values	Default Units
<range>	numeric	0.0875 V 0.7 V 5.6 V 44.8 V 300 V MIN MAX	volts

- Comments**
- To select a standard measurement range, specify *range* as the input signal's maximum expected voltage. The multimeter then selects the correct range.

- MIN selects the minimum *range* available with the VOLTage:AC:RANGe command: 0.0875V. MAX selects the maximum *range* available: 300 V.
- You must select a range using VOLTage:AC:RANGe **before** specifying resolution. Also, in order to specify an aperture time of 10 μ s, you must select a fixed range.
- Specifying a fixed range disables the autorange mode set by the VOLT:RANG:AUTO command.
- The VOLT:AC:RANG command overrides the range setting from a previous CONFigure command specifying the same function. With the new range, a new resolution is also selected. However, this resolution is based on the aperture time set by CONFigure.
- Changing the AC range changes the DC voltage range to a corresponding value (the AC range is $\frac{7}{10}$ of the DC range).
- ***RST Condition:** VOLT:AC:RANG 5.6V

Example Changing the Range

```

CONF:VOLT:AC 0.54,MAX,(@100:103)  !Function: AC volts;
                                   range selected: 0.63 V;
                                   MAX resolution: 61.035  $\mu$ V;
                                   specify channel list.

VOLT:AC:RANG 0.5                    !Range selected: 0.7 V;
                                   MAX resolution: 61.035  $\mu$ V.

READ?                               !Place multimeter in wait-for-trigger state and
                                   make measurement;
                                   send readings to the output buffer.

enter statement                     !Enter readings into computer.

```

VOLTage:AC: RANGe?

[SENSe:]VOLTage:AC:RANGe? [MIN | MAX] returns one of the following numbers to the output buffer.

The present voltage range selected if MIN or MAX is not specified. Only the ranges available with the RANGe command are returned. For example, if CONFigure selects the 0.63 V range, 0.7 V is the range returned.

The minimum voltage range available with the VOLTage:AC:RANGe command (0.0875 V) if MIN is specified.

The maximum voltage range available with the VOLTage:AC:RANGe command (300 V) if MAX is specified.

Example Querying the Measurement Range

```

VOLT:AC:RANG 0.7                    !Select 0.7 V range.

```

VOLT:AC:RANG?

!Query multimeter to return the present range.

enter statement

!Enter value into computer.

VOLTage:APERture

[SENSe:]VOLTage:APERture <time> sets the aperture (integration time) in seconds. Values are rounded up to the nearest aperture time shown in the following table.

Parameters

Parameter Name	Parameter Type	Range of Values	Default Units
<time>	numeric	10 μ s 100 μ s 2.5 ms 16.7 ms 20 ms 267 ms 320 ms MIN MAX	seconds

Comments

- MIN sets the aperture time to 10 μ s. MAX sets the aperture time to 320 ms.
- The fastest aperture time available when autoranging is 100 ms. In order to specify an aperture time of 10 ms, you must select a fixed range.
- Setting the aperture time also sets the integration time in power line cycles (PLCs) and the resolution. For example, an aperture time of 16.7 ms (60 Hz line frequency) sets an integration time of 1 PLC. The corresponding resolution depends on the function and range you select.
- The VOLT:APER command overrides the results of previously executed VOLTage:NPLC and VOLTage:RESolution commands (the last command executed has priority).
- The greater the aperture time, the greater the normal mode rejection (and the lower the reading rate).
- For a 50 Hz line frequency, only the 20 ms and 320 ms settings provide normal mode rejection of power line related noise. For a 60 Hz line frequency, only the 16.7 ms and 267 ms settings provide normal mode rejection of power line related noise.
- ***RST Condition:** 16.7 ms (60 Hz) or 20 ms (50 Hz)

Example Setting the Aperture Time

VOLT:APER 2.67E-01

!Aperture time is 267 ms.

VOLTage:APERture?

[SENSe:]VOLTage:APERture? [MIN | MAX] returns one of the following numbers to the output buffer:

The present aperture time in seconds if MIN or MAX is not specified.

The minimum aperture time available (10 μ s) if MIN is specified.

The maximum aperture time available (320 ms) if MAX is specified.

Example Querying the Aperture Time

VOLT:APER 2.67E-01

!Aperture time is 267 ms.

VOLT:APER?

!Query multimeter to return aperture time.

enter statement

!Enter value into computer.

VOLTage[:DC]:RANGe

[SENSE:]VOLTage[:DC]:RANGe <range> selects the range for DC voltage measurements.

For a complete listing of range and resolution values available, see Table 5-1 on page 120.

Parameters

Parameter Name	Parameter Type	Range of Values	Default Units
<range>	numeric	0.125 V 1.0 V 8.0 V 64.0 V 300 V MIN MAX	volts

- Comments**
- The [:DC] parameter is optional. Both of the following command statements select a DC voltage range:

VOLT:DC:RANG <range> or VOLT:RANG <range>

- To select a standard measurement range, specify *range* as the input signal's maximum expected voltage. The multimeter then selects the correct range.
- MIN selects the minimum range available with the VOLTage[:DC]:RANGe command: 0.125 V. MAX selects the maximum DC voltage range available: 300 V.
- You must select a range using VOLTage[:DC]:RANGe *before* specifying resolution. Also, in order to specify an aperture time of 10 μ s, you must select a fixed range.
- Specifying a fixed range disables the autorange mode set by the VOLT:RANG:AUTO command.
- The VOLT[:DC]:RANG command overrides the range setting from a previous CONFIGure command on the same function. With the new range, a new resolution is also selected. However, this resolution is based on the aperture time set by CONFIGure.
- Changing the DC range changes the AC voltage range to a corresponding value (the AC range is $\frac{7}{10}$ of the DC range).
- ***RST Condition:** VOLT:RANG:DC 8.0V

Example Changing the Range

CONF:VOLT:DC 0.85,MAX,(@100:103)

*!Function: DC volts;
range selected: 0.91 V;
MAX resolution: 61.035 μ V; specify
channel list.*

VOLT:DC:RANG 0.9

*!Range selected 1 V;
MAX resolution: 61.035 µV.*

READ?

*!Place multimeter in wait-for-trigger state and
make measurements;
send readings to output buffer.*

enter statement

!Enter readings into computer.

VOLTage[:DC]:RANGe?

[SENSe:]VOLTage[:DC]:RANGe? [MIN | MAX] returns one of the following numbers to the output buffer.

The present voltage range selected if MIN or MAX are not specified. Only the ranges available with the RANGE command are returned. For example, if CONFIGure selects the 0.91 V range, 1.0 V is the range returned.

The minimum voltage range available with the VOLTage:DC:RANGe command (0.125 V) if MIN is specified.

The maximum voltage range available with the VOLTage:DC:RANGe command (300 V) if MAX is specified.

Example Querying the Measurement Range

VOLT:DC:RANG 1.0

!Select 1 V range.

VOLT:DC:RANG?

*!Query multimeter to return the present
range.*

enter statement

!Enter value into computer.

VOLTage:NPLC

[SENSe:]VOLTage:NPLC <number> sets the integration time in power line cycles (PLCs). Values are rounded up to the nearest number of PLCs shown in the following table.

Parameters

Parameter Name	Parameter Type	Range of Values	Default Units
<number>	numeric	0.0005 0.005 0.125 1 16 MIN MAX	PLCs

- Comments**
- MIN selects 0.0005 PLCs. MAX selects 16 PLCs. Setting the integration time in PLCs also sets the aperture time and the resolution. For example, 16 PLCs (60 Hz line frequency) sets an aperture time of 267 ms. The corresponding resolution depends on the function and range you select.
 - The VOLT:NPLC command overrides the results of previously executed VOLTage:APERture and VOLTage:RESolution commands (the last command executed has priority).

- The greater the number of PLCs, the greater the normal mode rejection (and the lower the reading rate).
- Only the 1 PLC and 16 PLC settings provide normal mode rejection of 50 Hz or 60 Hz power line related noise.
- ***RST Condition:** 1 PLC

Example Setting the Integration Time in PLCs

VOLT:NPLC 16

!Integration time is 16 PLCs.

VOLTage:NPLC?

[SENSe:]VOLTage:NPLC? [MIN | MAX] returns one of the following numbers to the output buffer:

The present integration time in PLCs if MIN or MAX is not specified.

The minimum integration time available (0.0005) if MIN is specified.

The maximum integration time available (16) if MAX is specified.

Example Querying the Integration Time

VOLT:NPLC 16

!Integration time is 16 PLCs.

VOLT:NPLC?

!Query multimeter to return integration time.

enter statement

!Enter value into computer.

VOLTage:RANGe:AUTO

[SENSe:]VOLTage:RANGe:AUTO <mode> enables or disables the autorange function for voltage measurements.

Parameters

Parameter Name	Parameter Type	Range of Values	Default Units
<mode>	boolean	OFF 0 ON 1	none

- Comments**
- You can substitute decimal values for the OFF ("0") and ON ("1") parameters.
 - When autoranging is ON, the multimeter samples the input before each measurement and selects the appropriate range.
 - If you explicitly select a range using VOLTage:AC:RANGe or VOLTage:DC:RANGe, autoranging is turned OFF.
 - In order to specify an aperture time of 10 μ s, you must select a fixed range (VOLT:RANG:AUTO OFF, for example).

- **Related Commands:** CONFigure, VOLTage:RANGe
- ***RST Condition:** VOLT:RANG:AUTO ON

Example Disabling Autoranging

VOLT:RANG:AUTO OFF *!Disable autorange.*

VOLTage:RANGe:AUTO?

[SENSe:]VOLTage:RANGe:AUTO? returns a number to show whether the autorange mode is enabled or disabled: "1" = ON, "0" = OFF. The value is sent to the output buffer.

Example Querying the Autorange Mode

VOLT:RANG:AUTO OFF *!Disable autorange.*
VOLT:RANG:AUTO? *!Query multimeter to return autorange mode.*
 enter statement *!Enter value into computer.*

VOLTage:RESolution

[SENSe:]VOLTage:RESolution <resolution> selects the resolution for AC and DC voltage measurements.

For a complete listing of range and resolution values available, see Table 5-1 on page 120.

Parameters

Parameter Name	Parameter Type	Range of Values	Default Units
<resolution>	numeric	resolution (see Table 5-1) MIN MAX	volts

Comments

- MINimum selects the best resolution (the smallest value from Table 5-1) for the selected range. MAXimum selects the worst resolution (the largest value from Table 5-1) for the selected range.
- You must select a range using VOLTage:RANGe *before* specifying resolution. Also, only specify a resolution when making measurements on a fixed range. Otherwise, the resolution will change to correspond with the range selected during autoranging.
- If autoranging is required, set the resolution using the MIN or MAX parameters or select a specific aperture time using VOLT:APERTure.
- To achieve the specified resolution, the multimeter will increase the integration time as needed. This command overrides the results of previously executed VOLTage:APERTure and VOLTage:NPLC commands (the last command executed has priority).

- The VOLT:RANG command overrides the range setting from a previous CONFigure command on the same function. The multimeter uses the same aperture time to set the resolution on the new range as was selected by CONFigure.
- **Related Commands:** CONFigure, VOLTage:APERture, VOLTage:NPLC
- ***RST Condition:** Based on the *RST values for the VOLTage:APERture and VOLTage:NPLC commands.

Example Changing the Resolution

```

CONF:VOLT:DC 6.25,MAX,(@100:103)  !Function: DC volts;
                                     range selected: 7.27 V;
                                     MAX resolution: 488.281  $\mu$ V; specify
                                     channel list.

VOLT:DC:RANG 0.95                    !Range selected: 0.125 V;
                                     MAX resolution: 7.629  $\mu$ V.

VOLT:RES 1.19E-07                 !Set resolution to 0.119  $\mu$ V;
                                     selects 16.7 ms aperture time
                                     (60 Hz line frequency).

READ?                                 !Place multimeter in wait-for-trigger state and
                                     make measurements;
                                     send readings to output buffer.

enter statement                       !Enter readings into computer.

```

VOLTage:RESolution?

[SENSe:]VOLTage:RESolution? [MIN | MAX] returns one of the following numbers to the output buffer.

The present resolution selected if MIN or MAX is not specified. Only the resolution values available on ranges set by the RANGE command are returned.

The resolution with the smallest value (the best resolution) for the selected range if MIN is specified.

The resolution with the largest value (the worst resolution) for the selected range if MAX is specified.

Example Querying the Resolution

```

VOLT:RES 1.19E-07                    !Set resolution to 0.119  $\mu$ V.

VOLT:RES?                         !Query multimeter to return the present
                                     resolution.

enter statement                       !Enter value into computer.

```

The SYSTem command subsystem returns error numbers and messages in the error queue. For the scanning multimeter configuration only, SYSTem can also return the module type and description.

Subsystem Syntax SYSTem
 :CDEscription? <card_number>
 :CTYPe? <card_number>
 :ERRor?

:CDEscription?

SYSTem:CDEscription? <card_number> returns a description of the selected multiplexer module within the scanning multimeter. The command returns one of the following strings to the output buffer:

- “16 Channel Relay Mux” (HP E1345A)
- “48 Channel Single-Ended Relay Mux” (HP E1346A)
- “16 Channel Relay Mux with T/C” (HP E1347A)
- “64 Channel Relay Mux” (HP E1460A)
- “No Card”

Parameters

Parameter Name	Parameter Type	Range of Values	Default Units
<card_number>	numeric	1 - 99	none

The *card number* relates only to the multiplexer modules within the scanning multimeter. The multiplexer with the lowest logical address is always card number 1. The multiplexer with the next successive logical address is card number 2, and so on.

Example Reading Description of Card 1

SYST:CDES? 1 *!Query module description.*

:CTYPe?

SYSTem:CTYPe? <card_number> returns the card type of the selected multiplexer module within the scanning multimeter. The command returns one of the following strings to the output buffer:

- HEWLETT-PACKARD,E1345A,0,A.01.00
- HEWLETT-PACKARD,E1346A,0,A.01.00

- HEWLETT-PACKARD, E1347A, 0, A.01.00
- HEWLETT-PACKARD, E1460A, 0, A.01.00
- NONE, NONE, 0, 0

Parameters

Parameter Name	Parameter Type	Range of Values	Default Units
<card_number>	numeric	1 - 99	none

The *card number* relates only to the multiplexer modules within the scanning multimeter. The multiplexer with the lowest logical address is always card number 1. The multiplexer with the next successive logical address is card number 2, and so on.

Example Reading Card Type of Card 1

```
SYST:CTYP? 1                !Query card type.
```

:ERRor?

SYSTEM:ERRor? returns the error numbers and corresponding error messages in the error queue. Errors generated from the HP E1301A front panel are not stored in the error queue. See Appendix B in this manual for a listing of the error numbers and messages.

- Comments**
- When an error is generated by the multimeter, it stores an error number and corresponding message in the error queue.
 - One error is removed from the error queue each time the **SYSTEM:ERRor?** command is executed. The errors are cleared in a first-in, first-out order. This means that if several errors are waiting in the queue, each **SYSTEM:ERRor?** query returns the oldest (not the most recent) error. That error is then removed from the queue.
 - When the error queue is empty, subsequent **SYSTEM:ERRor?** queries return +0, "No error". To clear all errors from the queue, execute the ***CLS** command.
 - The error queue has a maximum capacity of 30 errors. If the queue overflows, the last error is replaced with -350, "Too many errors". No additional errors are accepted by the queue until space becomes available.

Example Reading the Error Queue

```
SYST:ERR?                  !Query the error queue.
```

The TRIGger command subsystem controls the behavior of the trigger system. The subsystem can control:

The number of triggers to occur before the multimeter returns to the idle state (TRIGger:COUNT).

The delay between trigger and measurement (TRIGger:DELAy).

An immediate internal trigger (TRIGger:IMMEDIATE).

The source of the trigger (TRIGger:SOURce).

Subsystem Syntax TRIGger

```
:COUNT <number>
:COUNT? [MIN | MAX]
:DELAy <period>
:DELAy? [MIN | MAX]
:DELAy:AUTO <mode>
:DELAy:AUTO?
[:IMMEDIATE]
:SOURce <source>
:SOURce?
```

:COUNT

TRIGger:COUNT <number> sets the number of triggers issued or the number of scans through the channel list.

Parameters

Parameter Name	Parameter Type	Range of Values	Default Units
<number>	numeric	1 - 16,777,215 MIN MAX	none

- Comments**
- MIN selects 1 trigger (stand-alone multimeter) or 1 scan through the channel list (scanning multimeter). MAX selects 16,777,215 triggers or scans through the channel list.
 - If MAX or 16,777,215 is specified for the *number* parameter, an “Out of memory” error occurs to show that this generates too many readings to store in memory. However, you can use the READ? command to return the readings to the output buffer.
 - In the scanning multimeter configuration, TRIGger:COUNT specifies the number of scans through the channel list. To take several readings on a particular channel, the multimeter must be programmed to scan only one channel (see SAMPLE:COUNT), or scan the channel list multiple times.

- CONFigure and MEASure set the trigger count to 1.
- ***RST Condition:** TRIG:COUN 1

Examples Setting the Trigger Count (Scanning Multimeter)

CONF:VOLT:DC (@100:104)	<i>!Function: DC voltage; specify channel list.</i>
TRIG:SOUR EXT	<i>!Trigger source is external BNC on multimeter front panel.</i>
TRIG:COUN 10	<i>!Multimeter will accept 10 external triggers (5 channels will be scanned with each trigger).</i>
READ?	<i>!Place multimeter in wait-for-trigger state; make measurement when external trigger is received; send readings to output buffer.</i>
enter statement	<i>!Enter readings into computer.</i>

Setting the Trigger Count (Stand-Alone Multimeter)

CONF:VOLT:DC	<i>!Function: DC voltage; stand-alone multimeter.</i>
TRIG:SOUR EXT	<i>!Trigger source is external BNC on multimeter front panel.</i>
TRIG:COUN 10	<i>!Multimeter will accept 10 external triggers (one measurement is taken with each trigger).</i>
READ?	<i>!Place multimeter in wait-for-trigger state; make measurement when external trigger is received; send readings to output buffer.</i>
enter statement	<i>!Enter readings into computer.</i>

:COUNT?

TRIGger:COUNt? [MIN | MAX] returns one of the following numbers to the output buffer:

The present trigger count (1 through 16,777,215) if MIN or MAX are not specified.

The minimum trigger count available (1) if MIN is specified.

The maximum trigger count available (16,777,215) if MAX is specified.

Example Querying the Trigger Count

TRIG:COUN 10	<i>!Multimeter will accept 10 external triggers.</i>
TRIG:COUN?	<i>!Query multimeter to return trigger count.</i>
enter statement	<i>!Enter value into computer.</i>

:DElay

TRIGger:DElay *<period>* sets the delay period between receipt of the trigger and the start of the measurement.

Parameters

Parameter Name	Parameter Type	Range of Values	Default Units
<i><period></i>	numeric	0 - 16.777215 MIN MAX	seconds

- Comments**
- MIN selects the minimum delay of 0 seconds for DC voltage and resistance measurements or 0.5 seconds for AC voltage measurements. MAX selects the maximum delay of 16.777215 seconds for all functions.
 - For the stand-alone multimeter, the trigger delay is inserted between the trigger and the first measurement of a burst. For the scanning multimeter, the trigger delay is inserted between the trigger and the first channel in each scan.
 - If a trigger delay is specified using the TRIG:DEL *<period>*, TRIGger:DElay:AUTO is turned OFF.
 - You can set a delay between measurements in a burst using the SAMPlE:TIMer command.
 - ***RST Condition:** DC volts/resistance: 0 seconds;
AC volts: 0.5 seconds.

Example Setting the Trigger Delay

TRIG:DEL 2

!Wait 2 seconds between trigger and start of scan.

:DElay?

TRIGger:DElay? [MIN | MAX] returns one of the following numbers to the output buffer:

The present trigger delay (0 through 16.777215 seconds) if MIN or MAX is not specified.

The minimum trigger delay available (0 seconds for DC volts/resistance; 0.5 seconds for AC volts) if MIN is specified.

The maximum trigger delay available (16.777215 seconds) if MAX is specified.

Example Querying the Trigger Delay

TRIG:DEL 2

!Wait 2 seconds between trigger and start of measurement.

TRIG:DEL?

!Query multimeter to return trigger count.

enter statement

!Enter value into computer.

:DElay:AUTO

TRIGger:DElay:AUTO *<mode>* enables or disables a trigger delay based on the present function, range, and integration time. The trigger delay specifies the period between the trigger signal and the start of the measurement.

Parameters

Parameter Name	Parameter Type	Range of Values	Default Units
<i><mode></i>	boolean	OFF 0 ON 1	none

- Comments**
- You can substitute decimal values for the OFF ("0") and ON ("1") parameters.
 - When TRIG:DEL:AUTO is ON, the trigger delay is 0 seconds for DC voltage and resistance measurements or 0.5 seconds for AC voltage measurements.
 - For the stand-alone multimeter, the trigger delay is inserted between the trigger and the first measurement of a burst. For the scanning multimeter, the trigger delay is inserted between the trigger and the first channel in each scan.
 - If a trigger delay is specified using the TRIGger:DElay *<period>* command, TRIG:DEL:AUTO is turned OFF.
 - You can set a delay between measurements in a burst using the SAMPlE:TIMer command.
 - ***RST Condition:** TRIG:DEL:AUTO ON

Example Disabling Automatic Trigger Delay

```
TRIG:DEL:AUTO OFF !Disable automatic trigger delay.
```

:DElay:AUTO?

TRIGger:DElay:AUTO? returns a number to show whether the automatic trigger delay mode is on or off: "1" = ON, "0" = OFF. The number is sent to the output buffer.

Example Querying the Trigger Delay Mode

```
TRIG:DEL:AUTO OFF !Disable automatic trigger delay.  
TRIG:DEL:AUTO? !Query multimeter to return trigger delay mode.  
enter statement !Enter value into computer.
```

[:IMMediate]

TRIGger[:IMMediate] causes a trigger to occur immediately provided the multimeter is in the wait-for-trigger state (see the INITiate subsystem). The trigger source must be TRIGger:SOURce BUS or TRIGger:SOURce HOLD.

- Comments**
- The [:IMMediate] parameter is optional. Both of the following command statements are valid:

TRIG:IMM *or* TRIG

- When the TRIG:IMM command is executed, the readings are stored in mainframe/command module memory. Use FETCh? to place the readings in the output buffer.
- The TRIGger:SOURce BUS or TRIGger:SOURce HOLD commands remain in effect after the TRIG:IMM command is executed.
- **Related Commands:** FETCh?, INITiate, TRIGger:SOURce

Example Sending an Immediate Trigger

CONF:VOLT:DC	<i>!Function: DC voltage; stand-alone multimeter.</i>
TRIG:SOUR HOLD	<i>!Suspend triggering.</i>
INIT	<i>!Place multimeter in wait-for-trigger state; store reading in memory when trigger is received.</i>
TRIG	<i>!Trigger the multimeter.</i>
FETC?	<i>!Place reading in output buffer.</i>
enter statement	<i>!Enter reading into computer.</i>

:SOURce

TRIGger:SOURce <source> configures the trigger system to respond to the specified source. The following *sources* are available:

BUS: Group Execute Trigger (GET) bus command or *TRG common command.

EXT: The multimeter's External Trigger BNC connector.

HOLD: Suspend triggering. Only the TRIGger:IMMediate command will trigger the multimeter.

IMMediate: The trigger system is always true (continuous triggering). The only valid trigger sources with IMMediate are TRIGger:SOURce BUS and TRIGger:SOURce HOLD.

TTLTrg0 - TTLTrg7: Trigger source is VXIbus trigger line 0 through 7. These trigger sources are available with the HP E1411B multimeter only.

Parameters

Parameter Name	Parameter Type	Range of Values	Default Units
<source>	discrete	BUS EXT HOLD IMMEDIATE TTLTrg0 - TTLTrg7	none

- Comments**
- The TRIGger:SOURce command only selects the trigger source. You must use the INITiate command to place the multimeter in the wait-for-trigger state. (The MEASure command automatically executes an INITiate command.)
 - TRIGger:SOURce EXT uses the multimeter’s External Trigger BNC connector as the trigger source. The multimeter triggers on the falling (negative-going) edge of a TTL input signal.
 - TRIGger:IMMEDIATE causes a trigger to occur immediately provided the multimeter is placed in the wait-for-trigger state using INITiate.
 - When TRIGger:SOURce BUS is selected, ABORt returns the multimeter to the idle state. When a Group Execute Trigger (GET) bus command or *TRG common command is executed, the “Trigger ignored” error is generated.
 - When TRIGger:SOURce HOLD is selected, ABORt returns the multimeter to the idle state. All subsequent single triggers sent using TRIGger:IMMEDIATE are ignored and the “Trigger ignored” error is generated.
 - The CONFigure and MEASure command subsystems automatically set the trigger source to TRIG:SOUR IMM.
 - The READ? command cannot be used if the trigger source is TRIG:SOUR BUS or TRIG:SOUR HOLD.
 - **Related Commands:** ABORt, INITiate, TRIGger:IMMEDIATE
 - ***RST Condition:** TRIG:SOUR IMM

Example Setting the Sample Source

```
CONF:VOLT:DC (@100:104)           !Function: DC voltage;  
                                   specify channel list.  
TRIG:SOUR EXT                     !Trigger source is external BNC on  
                                   multimeter front panel.  
TRIG:COUN 10                      !Multimeter will accept 10 external triggers  
                                   (5 channels will be scanned with each  
                                   trigger).  
READ?                              !Place multimeter in wait-for-trigger state;  
                                   make measurements when external trigger is  
                                   received; send readings to output buffer.  
enter statement                   !Enter readings into computer.
```

:SOURce?

TRIGger:SOURce? returns “BUS”, “EXT”, “HOLD”, or “IMM” to show the present trigger source. The quoted string is sent to the output buffer.

Example Querying the Trigger Source

TRIG:SOUR EXT

*!Trigger source is external BNC on
multimeter front panel.*

TRIG:SOUR?

*!Query multimeter to return trigger source
setting.*

enter statement

!Enter quoted string into computer.

IEEE 488.2 Common Command Reference

The following table lists the IEEE 488.2 Common (*) Commands that can be executed by the HP E1326B and HP E1411B 5¹/₂-Digit Multimeters.

Category	Command	Title	Description
System Data	*IDN?	Identification	Returns the identification string of multimeter.
Internal Operations	*RST	Reset	Resets the multimeter and associated multiplexers to: FUNC:VOLT:DC VOLT:RANG 8 V RES:RANG 16384 Ω RANGE:AUTO ON VOLT:RES 7.629 μV RES:RES 15.6 mΩ APER 16.7 ms 20 ms NPLC 1 RES:COMP OFF CAL:ZERO:AUTO ON TRIG:COUN 1 TRIG:DELAY:AUTO ON TRIG:SOUR IMM SAMP:COUN 1 SAMP:SOUR IMM SAMP:TIM 200 μs
	*TST?	Self-Test	Should return 0. If code 1, 2, 3, or 4 occurs, return multimeter to Hewlett-Packard for repair.
Synchronization	*OPC	Operation Complete	Operation complete command
	*OPC?	Operation Complete Query	Operation complete query
	*WAI	Wait to Complete	Wait-to-continue command
Status & Event	*CLS	Clear Status	Clear status command
	*ESE	Event Status Enable	Standard event status enable command
	*ESE?	Event Status Enable Query	Standard event status enable query
	*ESR?	Event Status Register Query	Standard event status register query
	*SRE	Service Request Enable	Service request enable command
	*SRE?	Service Request Enable Query	Service request enable query
	*STB?	Read Status Byte Query	Read status byte query
Bus Operation	*TRG	Bus Trigger	When the multimeter is in the wait-for-trigger state and the trigger source is TRIGger:SOURce BUS, use *TRG to trigger the multimeter.
Instrument	*RCL	Recall Instrument State	Recall instrument state command
	*SAV	Store Instrument State	Store (save) instrument state command
Macros	*DMC	Define Macro	Define macro command
	*EMC	Enable Macro	Enable macro command
	*EMC?	Enable Macro Query	Enable macro query
	*GMC?	Get Macro Contents Query	Get macro contents query
	*LMC?	Learn Macro Query	Learn macro query
	*PMC	Purge Macros	Purge all macros command
	*RMC	Remove Individual Macro	Remove individual macro command

NOTE: These commands apply to many instruments and are not documented here in detail. See your command module or controller manual, and the *ANSI/IEEE Standard 488.2-1987* for more information.

Command Quick Reference

The following tables summarize SCPI commands for the HP E1326B and HP E1411B 5½-Digit Multimeters.

Command	Description
ABORt	Place multimeter in idle state.
CALibration :LFRequency 50 60 MIN MAX :LFRequency? [MIN MAX] :ZERO:AUTO OFF 0 ON 1 :ZERO:AUTO?	Change line reference frequency. Query line reference frequency. Enable/disable autozero mode. Query autozero mode.
CONFigure :FRESistance [<range>,<resolution>] [,<channel_list>] :RESistance [<range>,<resolution>] [, <channel_list>] :TEMPerature <transducer>,<type>,<channel_list> :VOLTage:AC [<range> [,<resolution>]] [,<channel_list>] :VOLTage[:DC] [<range> [,<resolution>]] [,<channel_list>]	Configure multimeter for 4-wire ohms. Configure multimeter for 2-wire ohms. Configure multimeter for temperature. Configure multimeter for AC voltage. Configure multimeter for DC voltage.
CONFigure?	Query multimeter configuration.
DIAGnostic :FETS <mode> :FETS?	Selects control of FET multiplexers. Query mode of operation.
DISPlay :MONitor:CHANnel <channel> AUTO :MONitor:CHANnel? :MONitor[:STATe] OFF 0 ON 1 :MONitor[:STATe]?	Monitor multiplexer channel. Query monitor channel. Enable/disable monitor mode. Query monitor mode.
FETCh?	Place stored readings in output buffer.
FORMat [:DATA] <type>[,<length>]	Select output data format and length.
FORMat?	Query format.
INITiate [:IMMediate]	Place multimeter in wait-for trigger state.
MEASure :FRESistance? [<range>,<resolution>] [,<channel_list>] :RESistance? [<range>,<resolution>] [, <channel_list>] :TEMPerature? <transducer>,<type> [,<channel_list>] :VOLTage:AC? [<range> [,<resolution>]] [,<channel_list>] :VOLTage[:DC]? [<range> [,<resolution>]] [,<channel_list>]	Make 4-wire ohms measurements. Make 2-wire ohms measurements. Make temperature measurements. Make AC voltage measurements. Make DC voltage measurements.
MEMory :VME:ADDRess <address> :VME:ADDRess? [MIN MAX] :VME:SIZE <bytes> :VME:SIZE? [MIN MAX] :VME:STATe <mode> :VME:STATe?	Set address of memory on VME card. Query VME memory location (address). Amount of memory used on VME card. Query amount of VME memory used. Direct readings to VME memory card. Query VME memory mode.
OUTPut :TTLTrg0 1 2 3 4 5 6 7 [:STATe] OFF 0 ON 1 :TTLTrg0 1 2 3 4 5 6 7 [:STATe]?	Send voltmeter complete to VXIbus trigger lines. Query voltmeter complete destination.
READ?	Place multimeter in wait-for trigger state; place readings in output buffer.

Command	Description
SAMPl e :COUNT 1-16777215 MIN MAX :COUNT? [MIN MAX] :SOURce IMM TIM :SOURce? :TIMER 76 μ s-65.534 ms MIN MAX :TIMER? [MIN MAX]	Set number of readings per trigger. Query number of readings per trigger. Set pacing source. Query pacing source. Define period between readings. Query period between readings.
[SENSe:] FUNctio[n]:<function> FUNctio[n]? RESistance:APERture <time> MIN MAX RESistance:APERture? [MIN MAX] RESistance:NPLC <number> MIN MAX RESistance:NPLC? [MIN MAX] RESistance:OCOMpensated OFF 0 ON 1 RESistance:OCOMpensated? RESistance:RANGe <range> MIN MAX RESistance:RANGe? [MIN MAX] RESistance:RANGe:AUTO OFF 0 ON 1 RESistance:RANGe:AUTO? RESistance:RESolution <resolution> MIN MAX RESistance:RESolution? [MIN MAX] VOLTage:AC:RANGe <range> MIN MAX VOLTage:AC:RANGe? [MIN MAX] VOLTage:APERture <time> MIN MAX VOLTage:APERture? [MIN MAX] VOLTage[:DC]:RANGe <range> MIN MAX VOLTage[:DC]:RANGe? [MIN MAX] VOLTage:NPLC <number> MIN MAX VOLTage:NPLC? [MIN MAX] VOLTage:RANGe:AUTO OFF 0 ON 1 VOLTage:RANGe:AUTO? VOLTage:RESolution <resolution> VOLTage:RESolution? [MIN MAX]	Select measurement function. Query measurement function. Set aperture (integration) time in seconds. Query aperture (integration) time. Set integration time in PLCs. Query integration time. Enable/disable offset compensation. Query offset compensation mode. Select range. Query range. Enable/disable autorange function. Query autorange mode. Specify resolution. Query resolution. Select measurement range. Query range. Set aperture (integration) time in seconds. Query aperture (integration) time. Select range. Query range. Set integration time in PLCs. Query integration time. Enable/disable autoranging. Query autorange mode. Specify resolution. Query resolution.
SYSTem :CDEscription? <card_number> :CTYPe? <card_number> :ERRor?	Return description of multiplexer in scanning multimeter. Return card type of multiplexer in scanning multimeter. Return error number/message from error queue.
TRIGger :COUNT 1-16777215 MIN MAX :COUNT? [MIN MAX] :DELay 0-16.777215 MIN MAX :DELay? [MIN MAX] :DELay:AUTO OFF 0 ON 1 :DELay:AUTO? [:IMMEDIATE] :SOURce BUS EXT HOLD IMM TTLTrg0-TTLTrg7 :SOURce?	Set number of triggers or scans. Query trigger count. Set delay between trigger and start of measurement. Query trigger delay. Enable/disable automatic trigger delay. Query automatic trigger delay mode. Trigger immediately. Specify trigger source. Query trigger source.

Appendix A

HP E1326B/E1411B Multimeter Specifications

General Specifications

Reading Rate Conditions: Autozero off, fixed range, default trigger delay, offset comp off, Sample Source 'TIMER' for rates >15 readings/second.

Noise Rejection Conditions: CMR measured with 1k Ω in both HIGH and LOW leads with a 10% imbalance, LOW connected to COMMON at source, measured with respect to earth ground. NMR is for specified frequencies $\pm 0.1\%$.

	320 ms	267 ms	Aperture		2.5 ms	100 μ s	10 μ s
			20 ms	16.7 ms			
Typical Reading Rates (rdgs/sec)							
DC voltage	3	3.5	49	59	365	3125	13000
Four-wire resistance	3	3.5	49	59	365	3125	13000
AC voltage	1.3	1.4	1.9	1.9	1.9	1.9	1.9
Resolution (bits/digits)							
Binary bits	± 22	± 22	± 20	± 20	± 18	± 15	± 14
Decimal digits	6.5	6.5	6	6	5.5	4.5	4
Noise Rejection (dB)							
DC Voltage & Resistance							
DC Common mode rejection	150 dB	150 dB	150 dB	150 dB	150 dB	150 dB	150 dB
50Hz Power line cycles (NPLCs)	16	---	1	---	---	---	---
Normal mode (50 Hz) rejection	84 dB	0 dB	60 dB	0 dB	0 dB	0 dB	0 dB
60Hz Power line cycles (NPLCs)	---	16	---	1	---	---	---
Normal mode (60 Hz) rejection	0 dB	84 dB	0 dB	60 dB	0 dB	0 dB	0 dB
400Hz Power line cycles (NPLCs)	128	---	8	---	1	---	---
Normal mode (400 Hz) rejection	84 dB	0 dB	84 dB	0 dB	60 dB	0 dB	0 dB
AC Voltage: DC to 400 Hz							
Common mode rejection	110 dB	110 dB	110 dB	110 dB	110 dB	110 dB	110 dB

Input Characteristics: Maximum Nondestructive Input (volts)

Terminals	DC	AC RMS	AC Peak
Hi to lo	300	300	450
Hi to common	300	300	450
Hi to chassis	300	300	450
Lo to common	15	10	15
Lo to chassis	300	300	450
Common to chassis	300	300	450

Input amplifier bandwidth: 80 kHz

Autorange settling time:

The multimeter autoranges and settles faster than its minimum (fastest) sample rate.

DC Voltage

Accuracy conditions for table below: Autozero on, one hour warmup. Temperature within $\pm 5^{\circ}\text{C}$ of calibration temperature (module calibrated at 18°C to 28°C).

Resolution vs. Aperture (volts)						
Range	Input Resistance	267/320 ms	16.7/20 ms	2.5 ms	100 μs	10 μs
125 mV	>100 M Ω	.03 μV	.12 μV	0.5 μV	4.0 μV	7.6 μV
1 V	>100 M Ω	.24 μV	1.0 μV	4.0 μV	30 μV	61 μV
8 V	>100 M Ω	2.0 μV	7.6 μV	30 μV	250 μV	488 μV
64 V	10 M Ω \pm 5%	15 μV	61 μV	250 μV	2.0 mV	3.9 mV
300 V	10 M Ω \pm 5%	122 μV	488 μV	2.0 mV	16 mV	31 mV

Accuracy conditions for table below: Autozero on, one hour warmup. Within 24 hours and $\pm 1^{\circ}\text{C}$ of calibration temperature (module calibrated at 18°C to 28°C).

24-Hour Accuracy vs. Aperture \pm (% of reading + volts)					
Range	267/320 ms	16.7/20 ms	2.5 ms	100 μs	10 μs
125 mV	.008% + 5.0 μV	.008% + 5.0 μV	.008% + 10 μV	.05% + 30 μV	.05% + 60 μV
1 V	.008% + 10 μV	.008% + 15 μV	.008% + 15 μV	.05% + 100 μV	.05% + 200 μV
8 V	.005% + 50 μV	.005% + 50 μV	.005% + 80 μV	.05% + 750 μV	.05% + 1.5 mV
64 V	.01% + 1.0 mV	.01% + 1.0 mV	.01% + 1.0 mV	.05% + 5.0 mV	.05% + 20 mV
300 V	.01% + 5.0 mV	.01% + 5.0 mV	.01% + 5.0 mV	.05% + 30 mV	.05% + 80 mV

Accuracy conditions for table below: Autozero on, one hour warmup. Within 90 days and $\pm 5^{\circ}\text{C}$ of calibration temperature (module calibrated at 18°C to 28°C).

90-Day Accuracy vs. Aperture \pm (% of reading + volts)					
Range	267/320 ms	16.7/20 ms	2.5 ms	100 μs	10 μs
125 mV	.023% + 5.0 μV	.023% + 5.0 μV	.023% + 10 μV	.065% + 30 μV	.115% + 60 μV
1 V	.013% + 10 μV	.013% + 15 μV	.013% + 15 μV	.055% + 100 μV	.1% + 200 μV
8 V	.010% + 50 μV , .01% + 50 μV	.01% + 50 μV	.01% + 80 μV	.055% + 750 μV	.1% + 1.5 mV
64 V	.015% + 1.0 mV	.015% + 1.0 mV	.015% + 1.0 mV	.055% + 5.0 mV	.1% + 20 mV
300 V	.015% + 5.0 mV	.015% + 5.0 mV	.015% + 5.0 mV	.055% + 30 mV	.1% + 80 mV

Accuracy conditions for table below: Autozero on, one hour warmup. Within 1 year and $\pm 5^{\circ}\text{C}$ of calibration temperature(module calibrated at 18°C to 28°C).

1-Year Accuracy vs. Aperture \pm (% of reading + volts)					
Range	267/320 ms	16.7/20 ms	2.5 ms	100 μs	10 μs
125 mV	.033% + 5.0 μV	.033% + 5.0 μV	.033% + 10 μV	.075% + 30 μV	.125% + 60 μV
1 V	.023% + 10 μV	.023% + 15 μV	.023% + 15 μV	.065% + 100 μV	.110% + 200 μV
8 V	.020% + 50 μV	.020% + 50 μV	.020% + 80 μV	.065% + 750 μV	.110% + 1.5 mV
64 V	.025% + 1.0 mV	.025% + 1 mV	.025% + 1.0 mV	.065% + 5.0 mV	.110% + 20 mV
300 V	.025% + 5.0 mV	.025% + 5 mV	.025% + 5.0 mV	.065% + 30 mV	.110% + 80 mV

Temperature Coefficient \pm (% of reading)/$^{\circ}\text{C}$		
Range	Temperature Coefficient	10 μs Aperture
125 mV	0.003	0.013
1 V	0.001	0.01
8 V	0.001	0.01
64 V	0.001	0.01
300 V	0.001	0.01

Conditions: 0°C to (cal temp -5°C),
(cal temp $+5^{\circ}\text{C}$) to 55°C .

Autozero Off Offset Error (volts)	
Range	Additional Offset Error
125 mV	10 μV
1 V	10 μV
8 V	10 μV
64 V	1 mV
300 V	1 mV

Conditions: Stable environment,
24 hours, $\pm 1^{\circ}\text{C}$.

Four-Wire Resistance

Input Characteristics

Measurement Characteristics vs. Range

Range	Source Current	Maximum Open Circuit Voltage	Maximum Allowable Current Source Lead Resistance	Maximum Allowable Offset Volts For Offset Compensated Ohms	Default Measurement Settling Time	Default Range/Function Change Settling Time
256 Ω	488 μ A	11.5 V	20 k Ω	12 mV	0	0
2 k Ω	488 μ A	11.5 V	15 k Ω	100 mV	0	0
16 k Ω	61 μ A	11.5 V	100 k Ω	100 mV	0	0
131 k Ω	61 μ A	11.5 V	30 k Ω	0.8 V	0	2 ms
1 M Ω	7.6 μ A	11.5 V	200 k Ω	0.8 V	0	11 ms

Conditions: Settling times may need to be increased (programmably) if load capacitance is greater than 200 pF.

Resolution vs. Aperture (ohms)					
Range	267/320 ms	16.7/20 ms	2.5 ms	100 μ s	10 μ s
256 Ω	.06 m Ω	0.25 m Ω	1.0 m Ω	8.0 m Ω	15 m Ω
2 k Ω	.5 m Ω	2.0 m Ω	8.0 m Ω	60 m Ω	125 m Ω
16 k Ω	4.0 m Ω	15 m Ω	60 m Ω	500 m Ω	1.0 Ω
131 k Ω	30.0 m Ω	125 m Ω	500 m Ω	4.0 Ω	8.0 Ω
1 M Ω	.25 m Ω	1.0 Ω	4.0 Ω	30 Ω	64 Ω

Accuracy Conditions for table below: Autozero on, one hour warmup. Within 24 hours and $\pm 1^\circ\text{C}$ of calibration temperature (module calibrated at 18°C to 28°C).

24-Hour Accuracy vs. Aperture \pm (% of reading + ohms)					
Range	267/320 ms	16.7/20 ms	2.5 ms	100 μ s	10 μ s
256 Ω	.015% + 10 m Ω	.015% + 10 m Ω	.015% + 10 m Ω	.05% + 50 m Ω	.05% + 50 m Ω
2 k Ω	.015% + 20 m Ω	.015% + 20 m Ω	.015% + 20 m Ω	.05% + 150 m Ω	.05% + 200 m Ω
16 k Ω	.015% + 200 m Ω	.015% + 200 m Ω	.015% + 200 m Ω	.05% + 1 Ω	.05% + 2 Ω
131 k Ω	.015% + 1 Ω	.015% + 1 Ω	.015% + 1 Ω	.05% + 8 Ω	.05% + 16 Ω
1 M Ω	.015% + 10 Ω	.015% + 10 Ω	.015% + 10 Ω	.05% + 60 Ω	.05% + 120 Ω

Accuracy conditions for table below: Autozero on,, one hour warmup. Within 90 days and $\pm 5^{\circ}\text{C}$ of calibration temperature (module calibrated at 18°C to 28°C).

90-Day Accuracy vs. Aperture \pm (% of reading + ohms)					
Range	267/320 ms	16.7/20 ms	2.5 ms	100 μs	10 μs
256 Ω	.035% + 10 m Ω	.035% + 10 m Ω	.035% + 10 m Ω	.07% + 50 m Ω	.12% + 50 m Ω
2 k Ω	.025% + 20 m Ω	.025% + 20 m Ω	.025% + 20 m Ω	.06% + 150 m Ω	.10% + 200 m Ω
16 k Ω	.025% + 200 m Ω	.025% + 200 m Ω	.025% + 200 m Ω	.06% + 1 Ω	.1% + 2 Ω
131 k Ω	.025% + 1 Ω	.025% + 1 Ω	.025% + 1 Ω	.06% + 8 Ω	.1% + 16 Ω
1 M Ω	.025% + 10 Ω	.025% + 10 Ω	.025% + 10 Ω	.06% + 60 Ω	.1% + 120 Ω

Accuracy conditions for table below: Autozero on,, one hour warmup. Within 1 year and $\pm 5^{\circ}\text{C}$ of calibration temperature (module calibrated at 18°C to 28°C).

1-Year Accuracy vs. Aperture \pm (% of reading + ohms)					
Range	267/320 ms	16.7/20 ms	2.5 ms	100 μs	10 μs
256 Ω	.05% + 10 m Ω	.05% + 10 m Ω	.05% + 10 m Ω	.085% + 50 m Ω	.135% + 50 m Ω
2 k Ω	.04% + 20 m Ω	.04% + 20 m Ω	.04% + 20 m Ω	.075% + 150 m Ω	.115% + 200 m Ω
16 k Ω	.04% + 200 m Ω	.04% + 200 m Ω	.04% + 200 m Ω	.075% + 1 Ω	.115% + 2 Ω
131 k Ω	.04% + 1 Ω	.04% + 1 Ω	.04% + 1 Ω	.075% + 8 Ω	.115% + 16 Ω
1 M Ω	.04% + 10 Ω	.04% + 10 Ω	.04% + 10 Ω	.075% + 60 Ω	.115% + 120 Ω

Temperature Coefficient \pm (% of reading)/$^{\circ}\text{C}$		
Range	Temperature Coefficient	10 μs Aperture
256 Ω	0.004	0.014
2 k Ω	0.002	0.01
16 k Ω	0.002	0.01
131 k Ω	0.002	0.01
1 M Ω	0.002	0.01

Conditions: 0°C cal temp - 5°C (cal temp $+5^{\circ}\text{C}$) to 55°C .

Autozero Off Offset Error (ohms)	
Range	Additional Offset Error
256 Ω	20 m Ω
2 k Ω	20 m Ω
16 k Ω	60 m Ω
131 k Ω	160 m Ω
1 M Ω	1.25 Ω

Conditions: Stable environment, 24 hours, $\pm 1^{\circ}\text{C}$.

True RMS AC Voltage (AC coupled)
Crest Factor: 7 at 10% full scale; 1.5 at full scale.

Noise Rejection (dB)

Noise	Rejection
DC to 60 Hz common mode rejection (CMR)	150 dB
DC to 400 Hz common mode rejection (CMR)	150 dB

Conditions: CMRR and ECMR measured with 1k Ω in each of HIGH and LOW leads, 10% imbalance. LOW connected to COMMON at source. Measured with respect to earth ground.

Resolution vs. Aperture (volts)						
Range	Input Impedance	267/320 ms	16.7/20 ms	2.5 ms	100 μ s	10 μ s
87.5 mV	>100 m Ω , <100 pF	.03 μ V	.12 μ V	0.5 μ V	4 μ V	7.6 μ V
700 mV	>100 m Ω , <100 pF	.24 μ V	1 μ V	4 μ V	30 μ V	61 μ V
5.6 V	>100 m Ω , <100 pF	2 μ V	7.6 μ V	30 μ V	250 μ V	488 μ V
44.8 V	10 M Ω \pm 5%, <100 pF	15 μ V	61 μ V	250 μ V	2 mV	3.9 mV
300 V	10 M Ω \pm 5%, <100 pF	122 μ V	488 μ V	2 mV	16 mV	31 mV

Accuracy conditons for table below: Autozero on; 1 hr. warmup. Within 24 hours and \pm 1 $^{\circ}$ C of calibration temperature (module calibrated at 18 $^{\circ}$ C to 28 $^{\circ}$ C). Sine wave inputs >10% full scale; DC component <10% AC component.

24-Hour Accuracy vs. Aperture \pm (% of reading + volts)			
Range	Frequency	267/320 ms	all other apertures
87.5 mV	20 - 50 Hz	2% + 200 μ V	N/A
	50 Hz - 1 kHz	.5% + 200 μ V	.5% + 200 μ V
	1 - 5 kHz	.5% + 200 μ V	.5% + 200 μ V
	5 - 10 kHz	3% + 200 μ V	3% + 200 μ V
700 mV	20 - 50 Hz	2% + 1.5 mV	N/A
	50 Hz - 1 kHz	.5% + 1.5 mV	.5% + 1.5 mV
	1 - 5 kHz	.5% + 1.5 mV	.5% + 1.5 mV
	5 - 10 kHz	3% + 1.5 mV	3% + 1.5 mV
5.6 V	20 - 50 Hz	2% + 15 mV	N/A
	50 Hz - 1 kHz	.5% + 15 mV	.5% + 15 mV
	1 - 5 kHz	1% + 15 mV	1% + 15 mV
	5 - 10 kHz	10% + 15 mV	10% + 15 mV
44.8 V	20 - 50 Hz	2% + 100 mV	N/A
	50 Hz - 1 kHz	.5% + 100 mV	.5% + 100 mV
	1 - 5 kHz	1% + 100 mV	1% + 100 mV
	5 - 10 kHz	10% + 100 mV	10% + 100 mV
300 V	20 - 50 Hz	2% + 500 mV	N/A
	50 Hz - 1 kHz	.5% + 500 mV	.5% + 500 mV
	1 - 5 kHz	1% + 500 mV	1% + 500 mV
	5 - 10 kHz	10% + 500 mV	10% + 500 mV

Accuracy conditons for table below: Autozero on; 1 hr. warmup. Within 90 days and $\pm 5^{\circ}\text{C}$ of calibration temperature (module calibrated at 18° to 28°C). Sine wave inputs $>10\%$ of full scale; DC component $<10\%$ of AC component.

90-Day Accuracy vs. Aperture \pm (% of reading + volts)			
Range	Frequency	267/320 ms	all other apertures
87.5 mV	20 - 50 Hz	2.175% + 200 μV	2.175% + 1mV
	50 Hz - 1 kHz	.675% + 200 μV	.675% + 200 μV
	1 - 5 kHz	.675% + 200 μV	.675% + 200 μV
	5 - 10 kHz	3.175% + 200 μV	3.175% + 200 μV
700 mV	20 - 50 Hz	2.125% + 1.5 mV	2.125% + 8 mV
	50 Hz - 1 kHz	.625% + 1.5 mV	.625% + 1.5 mV
	1 - 5 kHz	.625% + 1.5 mV	.625% + 1.5 mV
	5 - 10 kHz	3.125% + 1.5 mV	3.125% + 1.5 mV
5.6 V	20 - 50 Hz	2.125% + 15 mV	2.125% + 80 mV
	50 Hz - 1 kHz	.625% + 15 mV	.625% + 15 mV
	1 - 5 kHz	1.125% + 15 mV	1.125% + 15 mV
	5 - 10 kHz	10.125% + 15 mV	10.125% + 15 mV
44.8 V	20 - 50 Hz	2.125% + 100 mV	2.125% + 500 mV
	50 Hz - 1 kHz	.625% + 100 mV	.625% + 100 mV
	1 - 5 kHz	1.125% + 100 mV	1.125% + 100 mV
	5 - 10 kHz	10.125% + 100 mV	10.125% + 100 mV
300 V	20 - 50 Hz	2.125% + 500 mV	2.125% + 2.5 V
	50 Hz - 1 kHz	.625% + 500 mV	.625% + 500 mV
	1 - 5 kHz	1.125% + 500 mV	1.125% + 500 mV
	5 - 10 kHz	10.125% + 500 mV	10.125% + 500 mV

Accuracy conditons for table below: Autozero on; 1 hr. warmup. Within 1 year and $\pm 5^{\circ}\text{C}$ of calibration temperature (module calibrated at 18°C to 28°C). Sine wave inputs $>10\%$ of full scale; DC component $<10\%$ of AC component.

1-Year Accuracy vs. Aperture \pm (% of reading + volts)				Temp. Coefficient: \pm (% of reading)/$^{\circ}\text{C}$		
Range	Frequency	267/320 ms	all other apertures	Range	Frequency	Temp. Coefficient
87.5 mV	20 - 50 Hz	2.195% + 200 μV	N/A	87.5 mV	20 - 50 Hz	0.035
	50 Hz - 1 kHz	.695% + 200 μV	.695% + 200 μV		50 Hz - 1 kHz	0.035
	1 - 5 kHz	.695% + 200 μV	.695% + 200 μV		1 - 5 kHz	0.035
	5 - 10 kHz	3.195% + 200 μV	3.195% + 200 μV		5 - 10 kHz	0.035
700 mV	20 - 50 Hz	2.145% + 1.5 mV	N/A	700 mV	20 - 50 Hz	0.025
	50 Hz - 1 kHz	.645% + 1.5 mV	.645% + 1.5 mV		50 Hz - 1 kHz	0.025
	1 - 5 kHz	.645% + 1.5 mV	.645% + 1.5 mV		1 - 5 kHz	0.025
	5 - 10 kHz	3.145% + 1.5 mV	3.145% + 1.5 mV		5 - 10 kHz	0.025
5.6 V	20 - 50 Hz	2.145% + 15 mV	N/A	5.6 V	20 - 50 Hz	0.025
	50 Hz - 1 kHz	.645% + 15 mV	.645% + 15 mV		50 Hz - 1 kHz	0.025
	1 - 5 kHz	1.145% + 15 mV	1.145% + 15 mV		1 - 5 kHz	0.025
	5 - 10 kHz	10.140% + 15 mV	10.140% + 15 mV		5 - 10 kHz	0.025
44.8 V	20 - 50 Hz	2.145% + 100 mV	N/A	44.8 V	20 - 50 Hz	0.025
	50 Hz - 1 kHz	.645% + 100 mV	.645% + 100 mV		50 Hz - 1 kHz	0.025
	1 - 5 kHz	1.145% + 100 mV	1.145% + 100 mV		1 - 5 kHz	0.025
	5 - 10 kHz	10.140% + 100 mV	10.140% + 100 mV		5 - 10 kHz	0.025
300 V	20 - 50 Hz	2.145% + 500 mV	N/A	300 V	20 - 50 Hz	0.025
	50 Hz - 1 kHz	.645% + 500 mV	.645% + 500 mV		50 Hz - 1 kHz	0.025
	1 - 5 kHz	1.145% + 500 mV	1.145% + 500 mV		1 - 5 kHz	0.025
	5 - 10 kHz	10.140% + 500 mV	10.140% + 500 mV		5 - 10 kHz	0.025

Timer/Pacer

Timer Range: 76 µsec to 65.5 msec

Resolution: 2 µs

Accuracy: 0.01%

Programmable Delay

Delay Range: 40 µsec to 16 sec

Resolution: 2 µsec

Accuracy: 0.01%

External Trigger

Trigger Condition: negative edge

Minimum Pulse Width: 100 nsec

Maximum Trigger Rate: 5 kHz

(fixed range, 10 µsec aperture)

Typical Reading Storage**HP 75000****Mainframe****Number of****Readings**Series B with
standard memory

50,000

Series B with
512 kB memory
(HP E1300/01A Opt. 010)

100,000

Series B with
1 MB memory
(HP E1300/01A Opt. 011)

200,000

Series C with
Command Module
(HP E1406A)

100,000

Series C plus E1406A
with Opt. 010

200,000

Module Size/Device Type:

B, register-based (E1326B)

C, register-based (E1411B)

Connectors Used: P1**No. Slots: 1** (standard terminal panel takes 2 slots)**VXIbus Interface Capability:**

Slave, interrupter, A16, D16

Interrupt Level: 1-7, selectable**Power Requirements:****Voltage** **+5** **+12**

Peak module

current, IPM (A): 0.20 0.55

Dyanmic module

current, IDM (A): 0.01 0.01

Watts/Slot: 8.5 (E1411B) 4.2 (E1326B)**Cooling/Slot:**0.14 mm H₂O @ 0.71 liter/sec (E1411B)0.07 mm H₂O@ 0.35 liter/sec (E1326B)**Humidity:** 65% 0° to 40°C**Operating Temperature:** 0° to 55°C**Storage Temperature:** -40° to 75°C**EMC, RFI, Safety:**

meets FTZ 1046/1984, CSA 556B.

IEC 348, UL 1244

Appendix B

HP E1326B/E1411B Multimeter Error Messages

The error messages associated with the HP E1326B/HP E1411B multimeter are shown in this appendix.

Code	Message	Cause
- 101	Invalid character	Unrecognized character in specified parameter.
- 102	Syntax error	Command is missing a space or comma between parameters.
- 103	Invalid separator	Command parameter is separated by a space rather than a comma.
- 104	Data type error	The wrong data type (i.e., number, character, string, expression) was used when specifying a parameter.
- 108	Parameter not allowed	Parameter specified in a command which has only a command header.
- 109	Missing parameter	No parameter specified in the command in which a parameter is required.
- 113	Undefined header	Command header was incorrectly specified.
- 124	Too many digits	257 digits were specified for a parameter.
- 128	Numeric data not allowed	A number was specified for a parameter when a letter is required.
- 131	Invalid suffix	Parameter suffix incorrectly specified (e.g., 5 K rather than 5 KOHM).
- 138	Suffix not allowed	Parameter suffix is specified when one is not allowed.
- 141	Invalid character data	The parameter type specified is not allowed (e.g., MEAS:TEMP? TC,O - O is not a choice).
- 178	Expression data not allowed	A parameter other than the channel list is enclosed in parentheses.
- 211	Trigger ignored	Trigger occurred while the multimeter is in the idle state, or a trigger occurred from a source other than the specified source.
- 213	INIT ignored	An INIT command is received when the multimeter is already in the wait-for-trigger state following TRIG:SOUR HOLD.
- 214	Trigger deadlock	The multimeter is triggered from another source (e.g., READ?) after the trigger source has been set to TRIG:SOUR BUS.
- 221	Settings conflict	Multimeter parameters are set such that a measurement cannot be made (e.g., specifying a fixed resolution while autoranging).
- 222	Data out of range	The parameter value specified is too large or too small.
- 224	Illegal parameter value	The numeric value specified is not allowed (e.g., MEAS:TEMP? RTD).

Code	Message	Cause
- 230	Data corrupt or stale	Data in mainframe memory is fetched after a command (e.g., MEASure, READ?) has returned data to the output buffer.
- 231	Data questionable	Resolution is too great for specified range. Measurement is still taken.
- 240	Hardware error	Hardware error detected during power-on cycle. Return multimeter to Hewlett-Packard for repair.
- 270	Macro error	Deleting a macro that does not exist.
- 273	Illegal macro label	Macro name begins with a character other than a letter.
- 276	Macro recursion error	The macro called is nested too deep within other macro calls.
- 277	Macro redefinition not allowed	A macro with that label already exists.
- 300	Device specific error	Severe overload, protection relay is opening (caused by fixed range and severe overload or COM not connected to Lo). To fix, use autorange, higher range, or connect COM to Lo.
- 310	System error	Out of macro memory.
- 350	Too many errors	The error queue is full as more than 30 errors have occurred.
- 410	Query interrupted	Data is not read from the output buffer before another command is executed.
- 420	Query unterminated	Command which generates data not able to finish executing due to a multimeter configuration error.
- 430	Query deadlocked	Command execution cannot continue since the mainframe's command input
+ 1000	Out of memory	Not enough memory to store the number of measurements requested.
+ 2000	Invalid card number	There is no multiplexer which corresponds to the card number specified in the channel list.
+ 2001	Invalid channel number	The channel or range of channels specified for the (@channel list) parameter does not exist.
+ 2008	Scan list not initialized	Occurs when INIT is executed after error 2000 or 2001 occurred.
+ 2009	Too many channels in channel list	The number of channels in the specified channel list is larger than the number of channels on the multiplexer(s).
+ 2012	Invalid channel range	Specifying a channel range such as (@115:100).
+ 2600	Function not supported on this card	Function specified cannot be measured (specifying a 2-wire resistance measurement without a multiplexer, for example).
+ 2601	Channel list required	Measurement function specified requires a channel list (specifying a thermocouple measurement without a multiplexer, for example).
+ 2602	Timer too fast	Aperture time is longer than sample rate.

Appendix C

HP E1326B/E1411B Multimeter Register-Based Programming

About This Appendix

The HP E1326B and HP E1411B 5¹/₂-Digit Multimeters are register-based modules which do not support the VXIbus word serial protocol. When a SCPI command is sent to the multimeter, the HP E1406A Command Module (Series C) or HP E1300/01 Mainframe (Series B) parses the command and programs the multimeter at the register level.

Register-based programming is a series of **reads** and **writes** directly to the multimeter registers. This increases throughput speed since it eliminates command parsing and allows the use of an embedded controller. Also, if slot 0 and resource manager functionality are provided by the embedded controller, use of the command module is not required.

This appendix contains the information you need for register-based programming. The contents include:

- Register Addressing Page 199
- Register Descriptions Page 203
- Program Timing and Execution Page 210
- Register Triggering Page 217
- Programming Examples Page 220
- Useful Tables Page 262

Register Addressing

Register addresses for register-based devices are located in the upper 25% of VXI A16 address space. Every VXI device (up to 256) is allocated a 64 byte block of addresses. With seven registers, the HP E1326B/E1411B Multimeters use seven of the 64 addresses allocated.

Figure C-1 shows the register address location within A16. Figure C-2 shows the location of A16 address space in the HP E1406A Command Module and HP E1300A/01A Mainframe.

The Base Address

When you are reading or writing to a multimeter register, a hexadecimal or decimal register address is specified. This address consists of a base address plus a register offset.

The base address used in register programming depends on whether the A16 address space is outside or inside the HP E1406A Command Module or HP E1300A/01A Mainframe.

A16 Address Space Outside the Command Module or Mainframe

When the command module or mainframe is **not** part of your VXIbus system (Figure C-1), the multimeter's base address is computed as:

$$C000_{16} + (LADDR * 64)_{16}$$

or

$$49,152 + (LADDR * 64)$$

where $C000_{16}$ (49,152) is the starting location of the register addresses, LADDR is the multimeter's logical address, and 64 is the number of address bytes per VXI device. For example, the multimeter's factory set logical address is 24. If this address is not changed, the multimeter will have a base address of:

$$C000_{16} + (24 * 64)_{16} \quad C000_{16} + 600_{16} = \mathbf{C600_{16}}$$

or (decimal)

$$49,152 + (24 * 64) = 49,152 + 1536 = \mathbf{50,688}$$

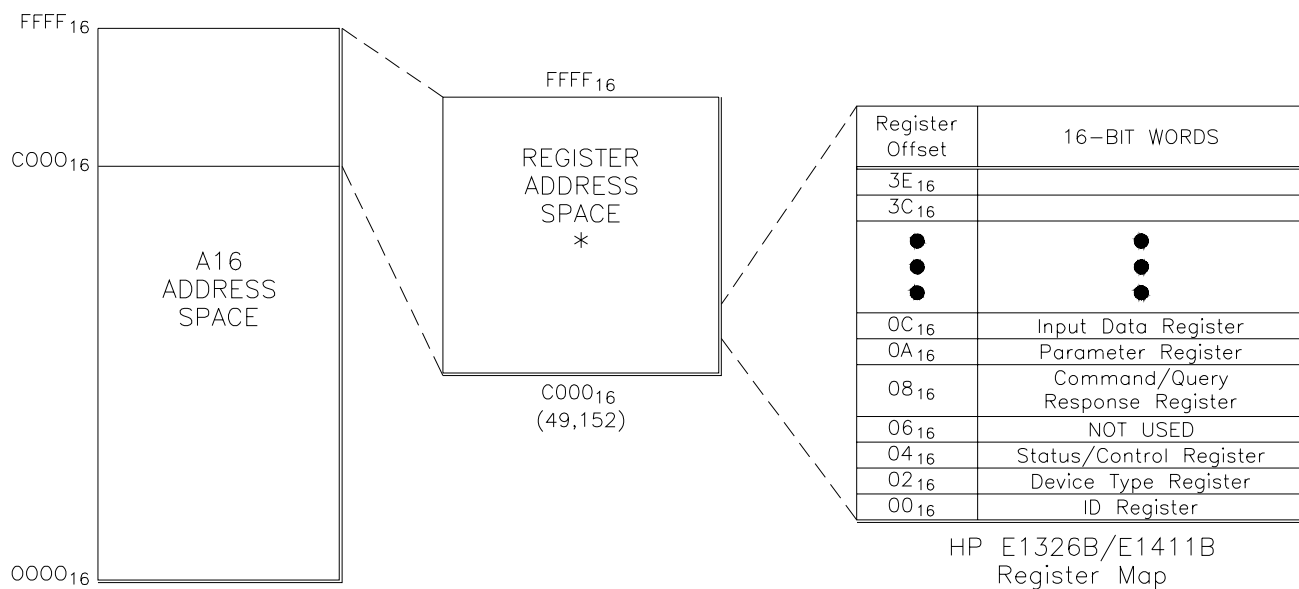

$$* \text{Base Address} = C000_{16} + (\text{Logical Address} * 64)_{16}$$

or

$$49,152 + (\text{Logical Address} * 64)_{10}$$

$$\text{Register Address} = \text{Base address} + \text{Register Offset}$$

Figure C-1. Multimeter Registers within A16 Address Space

Finding the Base Address in an Embedded Controller

When using an embedded controller such as the HP RAD-EPC7 with the Standard Instrument Command Library (SICL) for DOS, the A16 base address is obtained using the `imap` function:

```
imap(INST id, int mapspace, unsigned int pagestart, unsigned int pagecnt, char *suggestedaddress);
```

and using `I_MAP_VXIDEV` as the constant for `mapspace`. The C language example programs at the end of this appendix use `imap` to get the E1411B/E1326B base address.

A16 Address Space Inside the Command Module or Mainframe

When the A16 address space is inside the command module or mainframe (Figure C-2), the multimeter's base address is computed as:

$$1FC000_{16} + (LADDR * 64)_{16}$$

or

$$2,080,768 + (LADDR * 64)$$

where $1FC000_{16}$ (2,080,768) is the starting location of the VXI A16 addresses, `LADDR` is the multimeter's logical address, and 64 is the number of address bytes per register-based device. Again, the multimeter's factory set logical address is 24. If this address is not changed, the multimeter will have a base address of:

$$1FC000_{16} + (24 * 64)_{16} = 1FC000_{16} + 600_{16} = \mathbf{1FC600_{16}}$$

or

$$2,080,768 + (24 * 64) = 2,080,768 + 1536 = \mathbf{2,082,304}$$

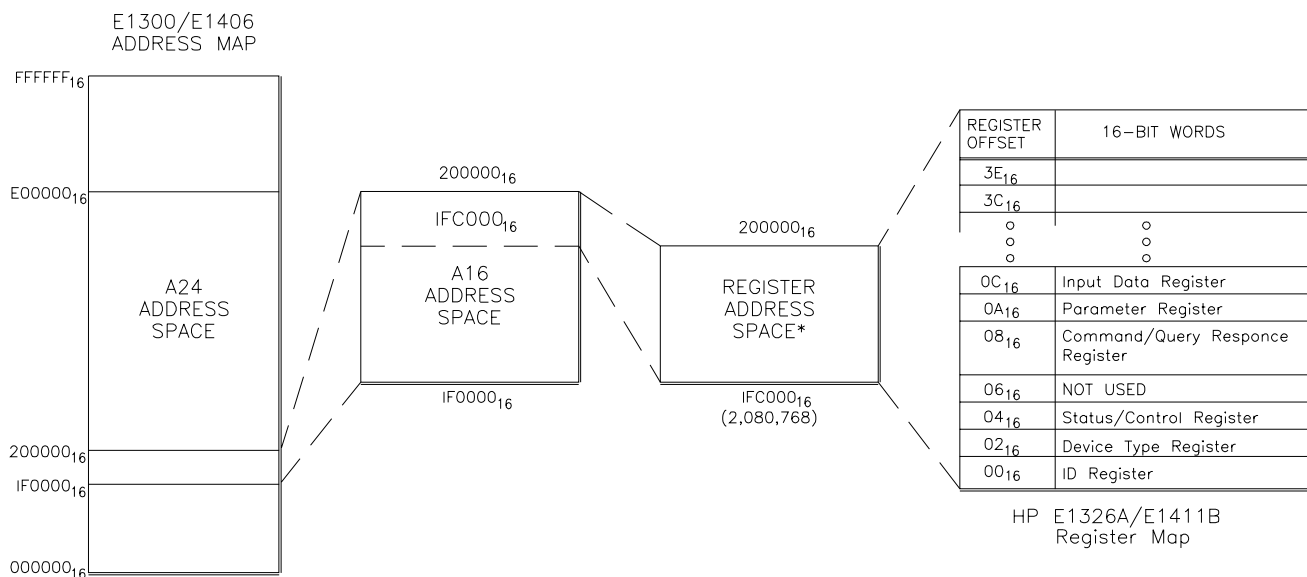

$$* \text{ Base Address} = 1FC000_{16} + (\text{logical address} * 64)_{16}$$

$$\text{or}$$

$$2,080,768 + (\text{logical address} * 64)_{10}$$

$$\text{Register Address} = \text{Base Address} + \text{Register Offset}$$

E1326A F_C_2

Figure C-2. Mainframe/Command Module A16 Address Space

Register Offset

The register offset is the register's location in the block of 64 address bytes. For example, the multimeter's Command Register has an offset of 08₁₆. When you write a command to this register, the offset is added to the base address to form the register address:

$$C600_{16} + 08_{16} = \mathbf{C608}_{16}$$

$$1FC600_{16} + 08_{16} = \mathbf{1FC608}_{16}$$

or

$$50,688 + 8 = \mathbf{50,696}$$

$$2,082,304 + 8 = \mathbf{2,082,312}$$

Accessing the Registers

Table C-1 summarizes several of the programming methods used to access the E1326B/E1411B multimeter registers.

Table C-1. Accessing the Multimeter Registers

Computer	Programming Method	Base Address
E1300/01 IBASIC (Absolute Addressing) (Select Code 8)	READIO (-9826, Base_addr + offset) WRITEIO -9826, Base_addr + offset; data (positive select code = byte read or write negative select code = word read or write) READIO (8, Base_addr + reg number) WRITEIO 8, Base_addr + reg number; data	Base_addr = 1FC000 ₁₆ + (LADDR * 64) ₁₆ or = 2,080,768 + (LADDR * 64) offset = register offset (Figure C-2) Base_addr = LADDR * 256 reg number = register offset (Figure C-2)/2
External Computer (over HP-IB to E1300A/E1301A Mainframe or E1406A Command Module)	VXI:READ? logical_address, offset VXI:WRITE logical_address, offset, data DIAG:PEEK? Base_addr + offset, width DIAG:POKE Base_addr + offset, width, data	module logical address setting (LADDR) offset = register offset (Figure C-2) Base_addr = 1FC000 ₁₆ + (LADDR * 64) ₁₆ or = 2,080,768 + (LADDR * 64) offset = register offset (Figure C-2)
V/382 Embedded Computer (C-Size system)	READIO (-16, Base_addr + offset) WRITEIO -16, Base_addr + offset; data (positive select code = byte read or write negative select code = word read or write)	Base_addr = C000 ₁₆ + (LADDR * 64) ₁₆ or = 49,152 + (LADDR * 64) offset = register offset (Figure C-1)
HP RADI-EPC7 Embedded Computer with SICL	iwpeek((unsigned short*)(base_addr + offset)) iwpoke((unsigned short *) (base_addr + offset),data)	INST device_name; device_name = iopen ("vxi, logical address"); base_addr = imap (device_name, I_MAP_VXIDEV,0,1,NULL);
LADDR: E1326B/E1411B logical address = 24 (LADDR * 64) ₁₆ : Multiply quantity then convert to a hexadecimal number (e.g. (24 * 64) ₁₆ = 600 ₁₆) When using DIAG:PEEK? and DIAG:POKE, the width (number of bits) is either 8 or 16.		

Register Descriptions

There are three WRITE and five READ registers on the multimeter. This section contains a description and a bit map of each register.

The WRITE Registers

The following WRITE registers are located on the multimeter.

- Control Register (base + 04₁₆)
- Command Register (base + 08₁₆)
- Parameter Register (base + 0A₁₆)

The Control Register

The Control Register is used to reset the multimeter, to disable the multimeter from driving the SYSFAIL line, and to initiate multimeter measurements.

Address	15 - 8	7	6	5	4	3	2	1	0
base + 04 ₁₆	Not Used	X	X	X	X	X	MM Samp	SYS FAIL	Reset

Resetting the Multimeter. Writing a one (1) to bit 0 resets the multimeter. Writing a zero (0) turns the reset function off. While bit 0 is 1, the multimeter continually resets.

De-asserting SYSFAIL. Writing a one (1) to bit 1 prevents the multimeter from driving the SYSFAIL line. Writing a zero (0) allows the multimeter to drive SYSFAIL.

The multimeter drives the SYSFAIL line during a self-test, and the line remains asserted if the self-test fails. If the multimeter fails its power on self-test, the Resource Manager de-asserts SYSFAIL and resets the multimeter to take the device off-line. If a self-test fails during register-based programming, you must write a "1" to bit 1 to de-assert SYSFAIL and then reset the multimeter to take it off-line.

The "Programming Examples" section beginning on page 220 shows how to reset the multimeter.

Control Register Sampling. When the multimeter is in the wait-for-trigger state and the sample source is set to "Control Register", the multimeter will make a measurement when a one (1) is written to Control register bit 2.

Note

This sampling method is available on the HP E1326B/E1411B multimeters only. Refer to the "Control Register Sampling" section on page 219 for information on setting up the multimeter to take samples using this method.

The Command and Parameter Registers

Commands and their parameters are opcodes written to the Command and Parameter Registers.

Address	15 - 8	7	6	5	4	3	2	1	0
base + 08 ₁₆	Not Used	Command Opcode							

Address	15 - 8	7	6	5	4	3	2	1	0
base + 0A ₁₆	Not Used	Parameter Opcode							

Command Structure. Multimeter commands consist of a command opcode and a parameter opcode (which may be optional). The opcodes must be in 2's complement binary format when written to the registers.

An example of how to write to the Command and Parameter Registers is shown in the following statements. The statements set the multimeter function (command opcode 4) to DC voltage (parameter opcode 0):

!Write command

```
iwpoke((unsigned short*)(base_addr_dmm + 0x08),4)
```

!Write parameter

```
iwpoke((unsigned short*)(base_addr_dmm + 0x0A),0)
```

When the command and parameter are received, the multimeter processor checks for the proper syntax and range. If an error is found, the NOERR bit in the Status Register is cleared (0), and operation continues (if it is possible).

Note

When you are writing (sending) commands and parameters, the multimeter needs time to process the current command before the next command is sent.

The READ Registers

The following READ registers are located on the multimeter.

- ID Register (base + 00₁₆)
- Device Type Register (base + 02₁₆)
- Status Register (base + 04₁₆)
- Query Response Register (base + 08₁₆)
- Data Buffer (base + 0C₁₆)

The ID Register

The multimeter's ID Register indicates the classification, addressing mode, and the manufacturer of the device.

Address	15	14	13	12	11 - 0
base + 00 ₁₆	Device Class		Address Mode		Manufacturer ID

Device Classification. Bits 15 and 14 classify the device:

- 0 0** memory device
- 0 1** extended device
- 1 0** message-based device
- 1 1** register-based device

The HP E1326B/E1411B multimeter is a register-based device.

Addressing Mode. Bits 13 and 12 indicate the addressing mode:

- 0 0** A16/A24 address mode
- 0 1** A16/A32 address mode
- 1 0** RESERVED
- 1 1** A16 address mode

The HP E1326B/E1411B multimeter uses the A16 address mode.

Manufacturer ID. Bits 11 through 0 identify the manufacturer of the device. Hewlett-Packard's ID number is 4095, which corresponds to bits 11 - 0 being set to "1".

Given the device classification, addressing space, and manufacturer of the HP E1326AB/E1411B multimeters, reading the ID Register returns FFFF₁₆.

The "Programming Examples" section on beginning on page 220 shows how to read the ID Register.

The Device Type Register

The Device Type Register contains a model code which identifies the device.

Address	15	14	13	12	11	10	9	8	7	6	5	4	3	2	1	0
base + 02 ₁₆	Model Code															

Model Code. The following model codes identify the HP E1326B and E1411B multimeters:

FF38₁₆ - HP E1411B 5½ Digit Multimeter

FF40₁₆ - HP E1326B 5½ Digit Multimeter

The “Programming Examples” section on beginning on page 220 shows how to read the Device Type Register.

The Status Register

Register-based programs are regulated by the Status Register. This register is continually monitored to determine when to send a command, when a measurement is complete, when data is available, etc.

Address	15 - 8	7	6	5	4	3	2	1	0
base + 04 ₁₆	FF ₁₆	DONE	NOERR	MM Comp	Data Ready	Extended	Passed	Q.Resp Ready	Cmd/ Parm Ready

DONE. A zero (0) in bit 7 indicates the multimeter is processing a command and its parameters. Bit 7 is set to one (1) by the multimeter when it is finished. The validity of this bit is determined by bit 0, and in turn, bit 7 determines the validity of bits 6, 5, 4, and 1. See “Status Bit Precedence” on page 207 for more information.

NOERR. A zero (0) in bit 6 indicates a programming error has occurred. Bit 6 is set to one (1) when the next command opcode is received. The error code, however, is stored until it is read from the Query Response Register or until it is overwritten by another error.

MULTIMETER COMPLETE. A one (1) in bit 5 indicates the analog-to-digital conversion is in progress. Bit 5 stays set to “1” for approximately 400 μs. If autozero is on, the bit is set for the specified aperture time (except for the 267/320 ms aperture time in which the bit is set for 400 μs). It is often necessary to turn autozero on to detect when the bit is set.

Data Ready. A one (1) in bit 4 indicates that a reading is available in the multimeter’s Data Buffer. The bit is cleared (0) when the data is read from the buffer. The bit is also cleared when the data is no longer valid (that is, following a command which changes the measurement function).

Extended. A zero (0) in bit 3 and a one (1) in bit 2 indicates the multimeter is performing an extended self-test.

Passed. A zero (0) in bit 2 indicates the multimeter is executing a reset, or is executing or failed its self-test. A one (1) indicates the reset is finished or the self-test passed.

Q.Resp Ready. A one (1) in bit 1 indicates data returned by a query is in the Query Response Register. The bit is cleared (0) when the response is read from the register.

Cmd/Parm Ready. A one (1) in bit 0 indicates a command or parameter can be written to the Command or Parameter Registers. The bit is cleared (0) when the command or parameter is received. Bit 0 also determines the validity of bit 7. See “Status Bit Precedence” for more information.

Status Bit Precedence

In addition to the conditions the bits monitor, certain status bits indicate the validity of other bits in the Status Register. This solves race situations between selected bits.

When **bit 0** is zero (0), **bit 7** is **invalid**. This allows the multimeter to clear bit 7 (set it to zero (0)) to indicate that a command or parameter is being processed.

When **Bit 7** is zero (0), **bits 6, 5, 4, and 1** are **invalid**. This allows the multimeter time to set those bits to the correct states based on the conditions they represent.

The Query Response Register

When the multimeter is queried as to its configuration (that is, function, range, aperture time) or when an error code is requested, the reply is sent to the Query Response Register.

Address	15 - 8	7	6	5	4	3	2	1	0
base + 08 ₁₆	FF ₁₆	Query Response							

Query Response. The response returned to the register is an error code or a parameter opcode. For example, if the measurement function is AC voltage, 01₁₆ is returned when the function is queried.

When multimeter parameters such as the trigger count, trigger delay, sample count, and sample rate are queried, a 16-bit or 24-bit **unsigned** number is returned. Thus, the Query Response Register must be read two or three consecutive times in order to retrieve the upper byte and lower byte or to retrieve the high byte, middle byte, and low byte.

The Data Buffer

Measurements are returned to the Data Buffer. The buffer is a first-in-first-out (FIFO) buffer capable of storing 256 four-byte readings, or up to 512 two-byte readings.

Address	15	14	13	12	11	10	9	8	7	6	5	4	3	2	1	0
base + 0C ₁₆	16-bit word															

Four-Byte Reading Mode

For aperture times of:

- 100 μ s (opcode 05₁₆)
- 2.5 ms (opcode 04₁₆)
- 16.7 ms (opcode 01₁₆)
- 20 ms (opcode 03₁₆)
- 267 ms (opcode 00₁₆)
- 320 ms (opcode 02₁₆)

Each reading is a four-byte number arranged as follows:

Reading = effoprrr dddddddd dddddddd dddddddd

e = error bit. Set if an overrange, input overload, or sample rate error occurs.

ff = function code (DCV, ACV, OHMS)

o = input overload bit. Set in conjunction with the error (e) bit. The bit is cleared when a new range is set. (This also clears the NOERR bit in the Status Register.)

p = sample rate overrun bit. Set in conjunction with the error (e) bit when the sample rate is too fast for the specified aperture time. (This also clears the NOERR bit in the Status Register.)

rrr = range code (power of 8 multiplier for reading).

dd = multimeter measurement in **2's complement binary**.

Readings are returned as two 16-bit words, with the upper word returned first. Thus, for each reading, the data buffer must be read twice. The "Programming Examples" section contains examples on retrieving four-byte readings.

Two-Byte Reading Mode

For the aperture time of:

- 10 μ s (opcode 06₁₆)

Each reading is a two-byte number arranged as follows:

Reading = dddddddd ddddde

e = error bit. Set if an overrange, input overload, or sample rate error occurs.

dd ... = multimeter measurement in **2's complement binary**.

Readings are returned as one 16-bit word. Thus, for each reading, the data buffer is read once. The "Programming Examples" section contains examples on retrieving two-byte readings.

Converting Four-Byte and Two-Byte Readings

Four-byte readings and two-byte readings are converted to voltages and resistances as follows.

Four-Byte Readings

1. The four-byte reading should be arranged into a single 32-bit variable. The upper two bytes from the first Data Register read must be the most significant word, the lower two bytes from the second Data Register read must be the least significant word.
2. The 32-bit quantity is then shifted 8 bits to the left to remove the eight reading header bits (effoprrr). Note that this header is used to determine overrange conditions, and contains the function and range opcodes.
3. The reading is calculated as:

$$\text{converted_reading} = (\text{range} * \text{shifted_reading}) / 0x7FFFFFF0$$

where range is the multimeter's voltage or resistance range and 0x7FFFFFF0 is the full scale reading for the given range in hexadecimal.

The "Programming Examples" section contains examples for converting four-byte readings.

Two-Byte Readings

1. After the two-byte reading is retrieved from the Data Register, the reading is shifted one bit to the right to remove the error bit. Note that this bit is used to determine overrange conditions.
2. The reading is calculated as:

$$\text{converted_reading} = (\text{range} * \text{shifted_reading}) / 0x3FFF$$

where range is the multimeter's voltage or resistance range and 0x3FFF is the full scale reading for the given range in hexadecimal.

The "Programming Examples" section contains examples for converting two-byte readings.

Program Timing and Execution

When programming the multimeter at the register level, the structure of the program will generally be as follows:

- resetting the multimeter
- configuring the multimeter
- retrieving the measurements

This section contains generalized flowcharts and comments for performing these and other procedures. The flowcharts identify the registers used and the status bits monitored to ensure execution of the program.

Resetting the Multimeter

The multimeter is reset as indicated in Figure C-3.

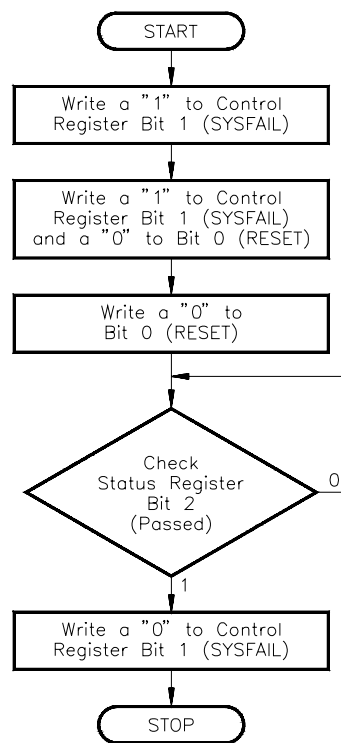

Figure C-3. Resetting the Multimeter

Comments

- The registers used are:
 - Control Register (base + 04₁₆)
 - Status Register (base + 04₁₆)
- Writing a "1" to bit 1 prevents the multimeter from asserting the SYSFAIL line when the multimeter is reset. (If SYSFAIL is enabled when a reset occurs, the multimeter is taken off-line by the system Resource Manager.)
- Writing a "1" to bits 1 and 0 keeps SYSFAIL disabled and resets the multimeter. This condition must remain for at least 2 μ s for the reset to complete. Writing a "0" to bit 0 turns the reset function off.

- Bit 2 of the Status Register is monitored to determine when the reset is finished.
- Writing a "0" to bit 1 re-enables SYSFAIL.

Configuring the Multimeter

Configuring the multimeter consists of:

- Setting the multimeter's analog-to-digital A/D parameters
 - function
 - range
 - aperture time
 - autozero mode
 - offset compensation mode
- Setting up the multimeter trigger system
 - trigger source
 - trigger count
 - trigger delay
 - sample count
 - sample source
 - sample rate
 - wait-for-trigger state

This process is accomplished as indicated by the flowchart in Figure C-4.

Comments

- The registers used are:
 - Status Register (base + 04₁₆)
 - Command Register (base + 08₁₆)
 - Parameter Register (base + 0A₁₆)
- Status Register bit 0 is monitored to determine when a command and parameters can be written to the Command and Parameter Registers.
- Status Register bit 7 is monitored to determine when the multimeter has finished processing the current command and parameter(s).
- Repeated passes through the flowchart are made until the desired configuration is set.

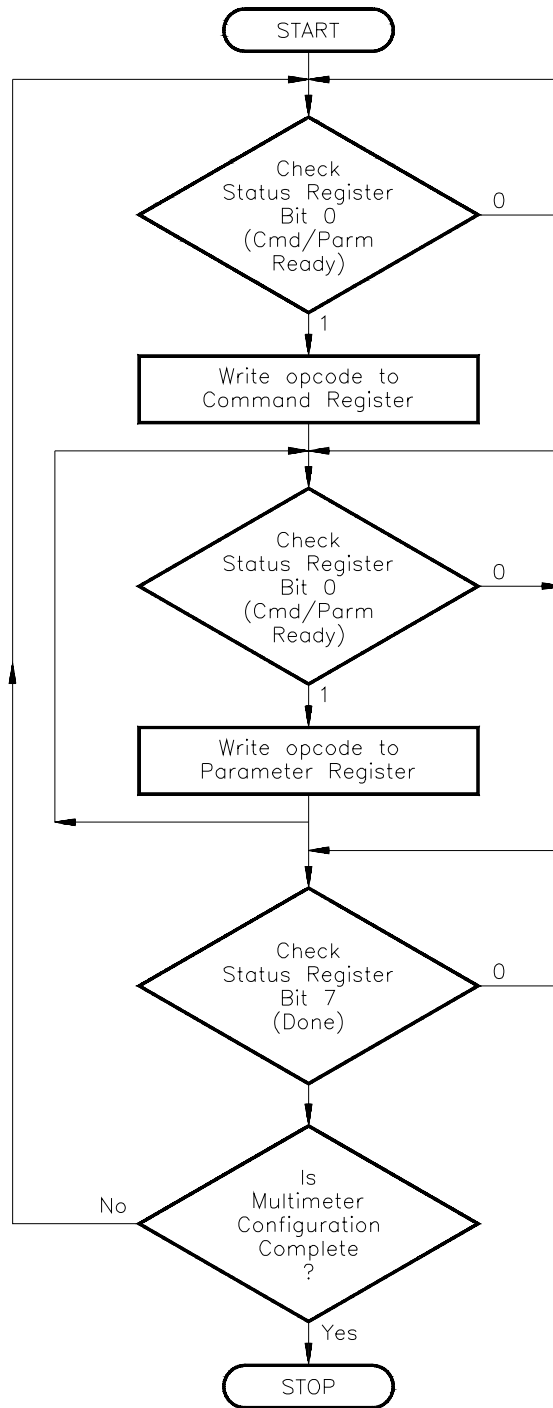

Figure C-4. Configuring the Multimeter

Retrieving Measurements

Figure C-5 shows the conditions monitored to determine when measurements are available in the data buffer.

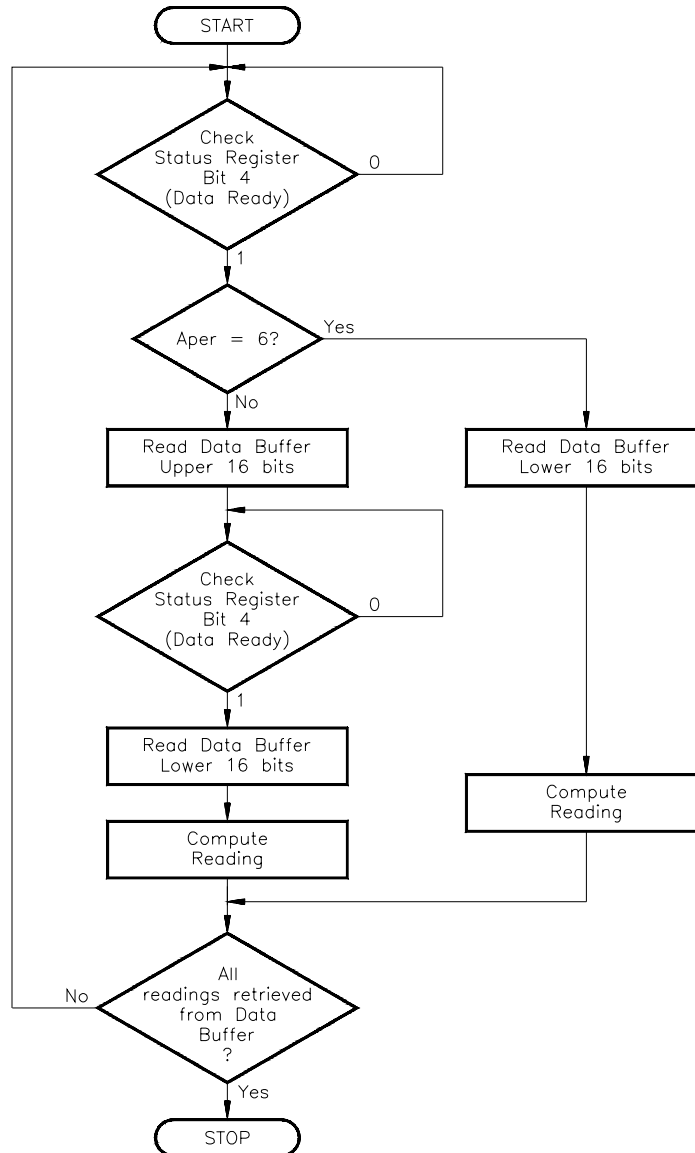

Figure C-5. Retrieving Measurements

Comments

- The registers used are:
 - Status Register (base + 04₁₆)
 - Data Buffer (base + 0C₁₆)
- Bit 4 is monitored to determine when a reading is in the Data Buffer.
- In the four-byte reading mode, the Data Buffer must be read **two times** for **each reading**. The first time the buffer is read, the upper 16 bits are retrieved. The second time the buffer is read, the lower 16 bits are retrieved.
- In the two-byte reading mode (10 μs aperture time), the Data Buffer is read **one time** for **each reading**.
- The process is repeated until all readings have been read from the buffer.

Checking for Errors

Error conditions are monitored and error codes are returned as indicated in figure C-6.

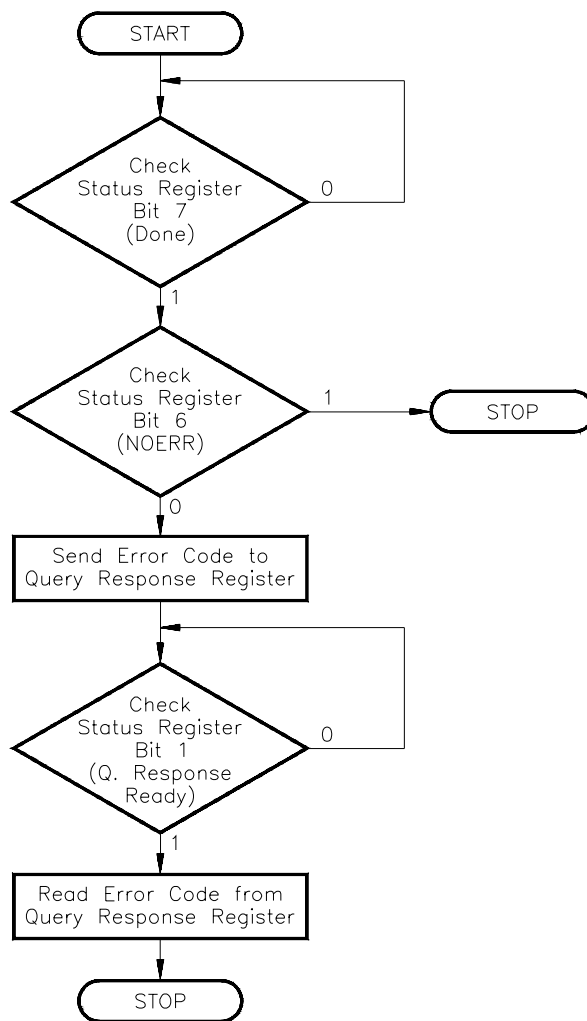

Figure C-6. Checking for Errors

Comments

- The registers used are:
 - Status Register (base + 04₁₆)
 - Command Register (base + 08₁₆)
 - Query Response Register (base + 08₁₆)
- Status Register bit 7 is monitored to determine when the previous command has finished. Bit 6 is monitored to determine when a configuration error has occurred.
- Once an error is detected, the error code is written to the Query Response Register with the Send Error command (opcode 15).
- Status Register bit 1 is monitored to determine when the error code can be read from the Query Response Register.

Querying Parameters

Multimeter parameters are queried as shown in Figure C-7.

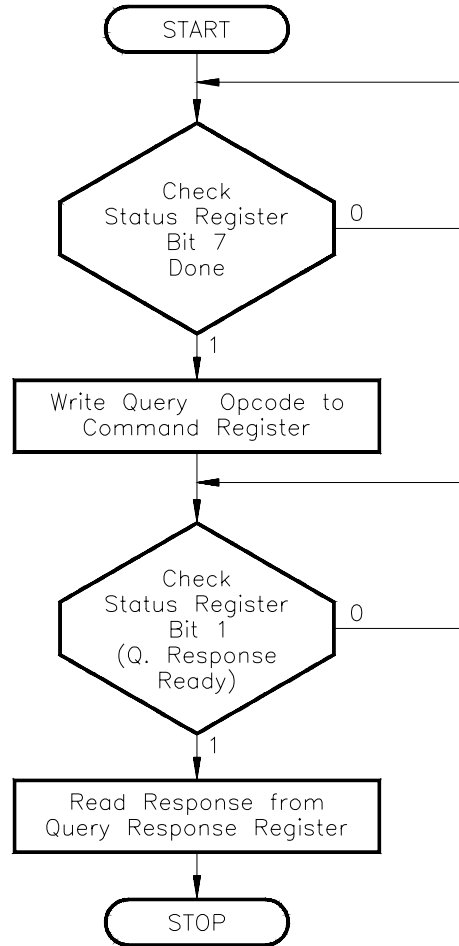

Figure C-7. Querying Multimeter Parameters

Comments

- The registers used are:
 - Status Register (base + 04₁₆)
 - Command Register (base + 08₁₆)
 - Query Response Register (base + 08₁₆)
- Status bit 7 is monitored to determine when a query opcode (command) can be written to the Command Register.
- Status bit 1 is monitored to determine when the response to the query is in the Query Response Register.

Using a Multiplexer with the Multimeter

Figure C-8 shows an example timing sequence between closing a multiplexer channel and triggering the multimeter.

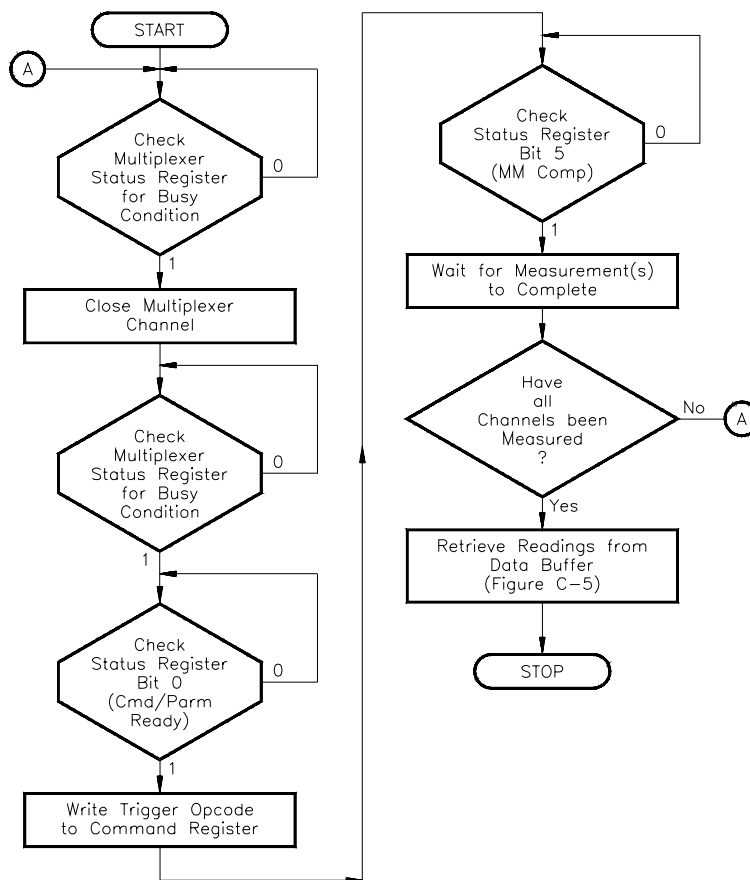

Figure C-8. Using a Multiplexer with the Multimeter

Comments

- The registers used are:
 - multiplexer Status Register (base + 01₆)
 - multimeter Status Register (base + 04₁₆)
 - multiplexer/multimeter Command Register (base + 08₁₆)
- The multiplexer Status Register is monitored to determine when a channel can be closed (or opened), and when a channel has finished closing (or opening).
- Multimeter status bit 0 is monitored to determine when a trigger opcode can be written to the Command Register (the flowchart assumes the multimeter is already configured).
- Multimeter status bit 5 is monitored to determine when the analog-to-digital (A/D) conversion is in progress, and thus, when to advance the channel. This enables each channel to be measured before the readings are read from the buffer.

The channel can also be advanced by monitoring bit 4 (Data Ready). However, before measuring the next channel, readings from the previous channel must be read from the buffer in order to clear the bit.

- Autozero is often turned on in order to detect when bit 5 is active (see “The Status Register” on page 206).

Register Triggering

This section reviews the multimeter's trigger system from the register-based standpoint. The section shows the triggering models used by the burst and scanning measurement examples in the "Programming Examples" section. Also shown is the triggering model used for Control Register sampling.

The Trigger System The operation of the multimeter trigger system is shown in Figure C-9.

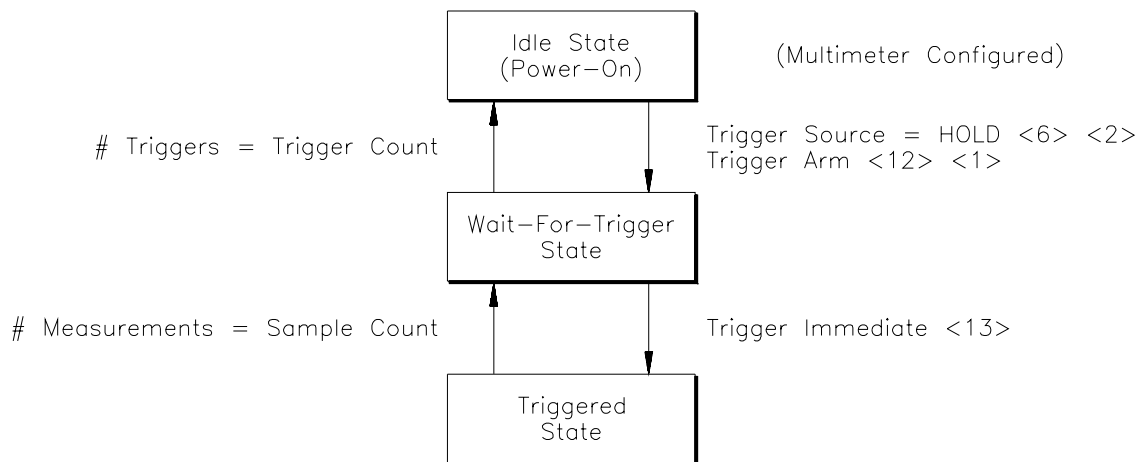

Figure C-9. Multimeter Trigger System

Comments

- The multimeter is configured while it is in the Idle state.
- When the Trigger Source is Hold, Trigger Arm moves the multimeter from the Idle state to the Wait-for-trigger state. Trigger Immediate or a trigger from another source moves the multimeter to the Triggered state. The measurement that is taken is appended to the other readings in the buffer.
- When the Trigger Source is Immediate, Trigger Arm moves the multimeter directly to the Triggered State. The measurement overwrites any data currently in the data buffer.
- The multimeter returns to the Wait-for-trigger state once the number of measurements equals the specified sample count.
- The multimeter returns to the Idle state when any of the following occurs:
 - the number of triggers received equals the specified trigger count
 - the multimeter is disarmed
 - the multimeter configuration is changed
 - there is a reading overrun (the buffer fills)

Multimeter Triggering Model

The following models suggest one method of triggering the multimeter when it is used to make stand-alone or scanning measurements.

Burst Measurements

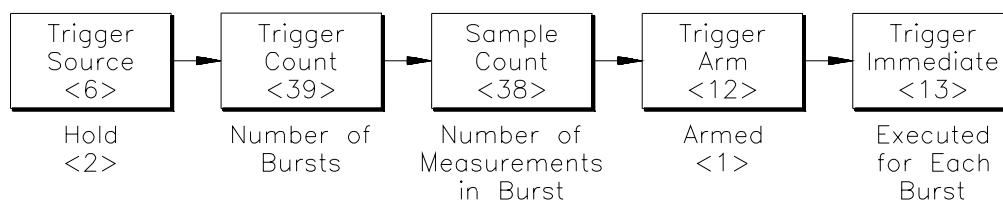

Scanning Measurements

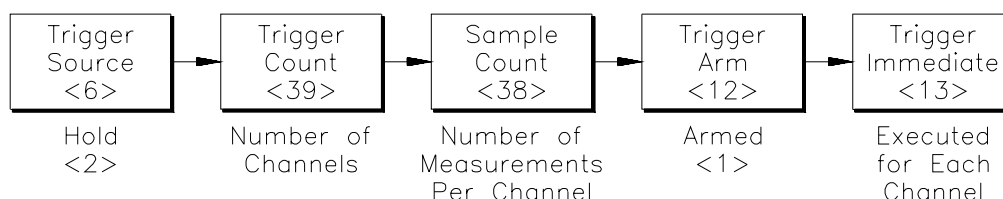

Figure C-10. Multimeter Triggering Model

Comments

- For burst measurements, the number of times Trigger Immediate is executed is equal to the number of bursts (trigger count) specified.
- For scanning measurements, the number of times Trigger Immediate is executed is equal to the number of channels (trigger count) specified.
- When the Trigger Source is Hold and the multimeter is placed in the Wait-for-trigger state (Trigger Arm), triggering the multimeter (Trigger Immediate) causes the readings to be appended (rather than overwritten) in the buffer.
- When making burst or scanning measurements, a waiting period (not shown) is usually inserted between each burst/scan trigger (Trigger Immediate). This allows each measurement (in the burst or on the channel) to complete before the next trigger is issued. The period is determined by the number of readings and the aperture time.

For burst measurements, the waiting period enables all bursts to occur before the readings are read from the data buffer. Status bit 4 (Data Ready) can be monitored between bursts; however, the data must be read from the buffer before the next trigger is issued. This clears the bit so that data from the next burst can be detected.

- For burst and scanning measurements, the sample source and sample rates can be set as required.

Control Register Sampling

The following model shows how to make a measurement by writing to the Control Register. This method of sampling is available with the HP E1326B or E1411B multimeter only.

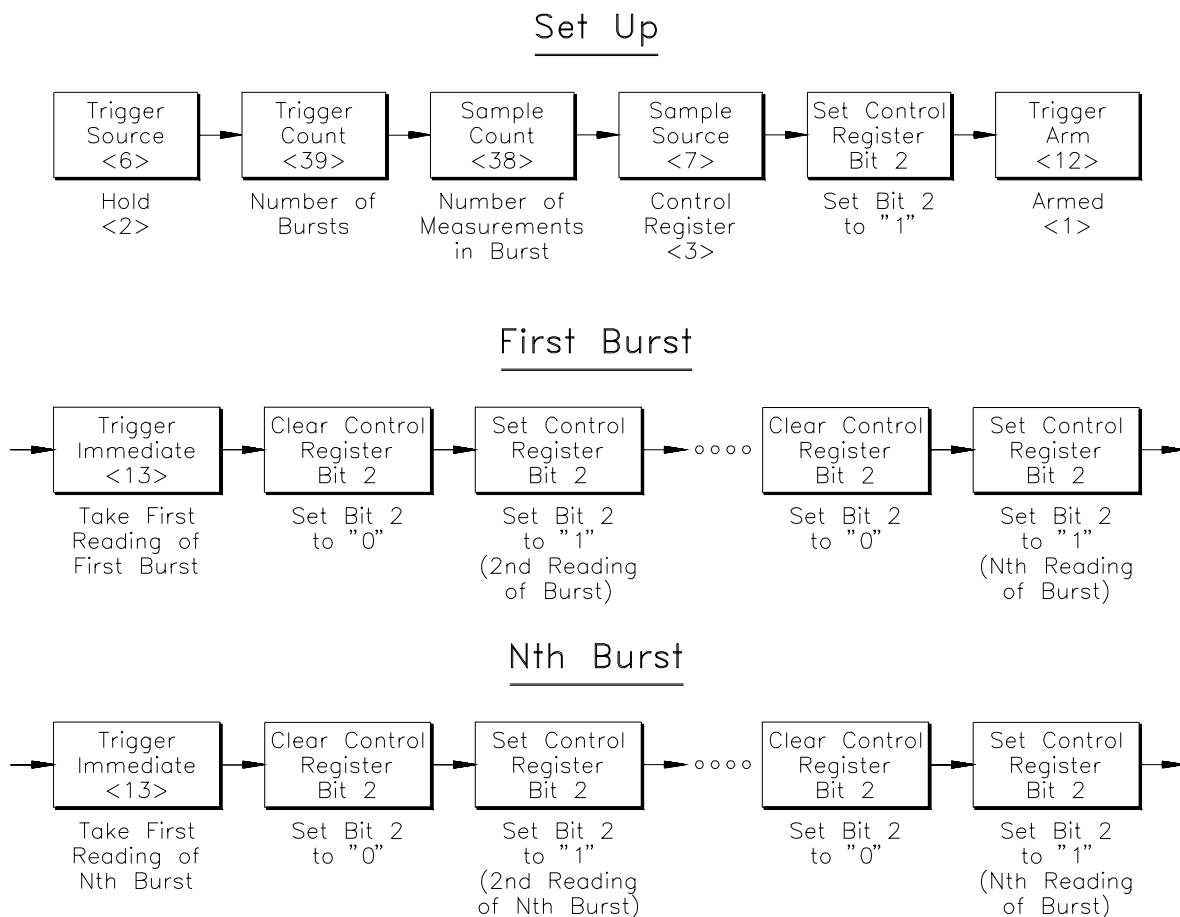

Figure C-11. Control Register Sampling

Comments

- The first measurement of each burst occurs when the trigger signal (Trigger Immediate) is received. Subsequent measurements in the burst occur when Control Register bit 2 is cleared (0), and then set to one (1).

Programming Examples

The examples in this section demonstrate how to program the multimeter at the register level. The programs follow the execution and timing models covered in the previous section. The examples in this section include:

- Resetting the Multimeter
- Reading the ID Register
- Reading the Device Type Register
- Reading the Query Response Register
- Reading an Error Code
- Stand-Alone Multimeter Measurements
- Scanning Multimeter Measurements

System Configuration

The HP BASIC/WS and C language example programs were developed using the following system configurations:

HP BASIC/WS Programs

Mainframe: HP 75000 Series C (HP E1401A)
Controller: HP V/382 (HP E1499B) w/HP E1481A drivers and E1481L License to Use
Programming Language: HP BASIC/WS
Multimeter: HP E1411B (Logical address = 24)
Multiplexer: HP E1460A (Logical address = 25)

C Language Programs

Mainframe: HP 75000 Series C (HP E1401A)
Controller: HP RADI-EPC7 486 Embedded Controller w/Standard Instrument Control Library (SICL) for DOS
Programming Language: C
Multimeter: HP E1411B (Logical address = 24)
Multiplexer: HP E1351A (Logical address = 25) w/HP E1403B Adapter

Resetting the Multimeter

HP BASIC/WS

The following program resets the multimeter.

```
10  !Map the A16 address space in the HP V/382 and store the multimeter base
20  !address in a variable.
30  CONTROL 16,25;2
40  COM Base_addr
50  Base_addr=DVAL("C600",16)
60  !Call the subprogram which resets the multimeter.
70  CALL Mm_rst
80  END
90  !This subprogram checks each bit in the multimeter Status register.
100 !The subprogram is called by subprogram Mm_rst to monitor status bit 2.
110 SUB Read_status(Status,Rdy,Done,Indardy,Qryrdy,Noerr,Pass_fail)
120   COM Base_addr
130   Status=READIO(-16,Base_addr+4)
140   Rdy=BIT(Status,0)
150   Done=BIT(Status,7) AND Rdy
160   Indardy=BIT(Status,4) AND Done
170   Qryrdy=BIT(Status,1) AND Done
180   Noerr=NOT (NOT (BIT(Status,6)) AND Done)
190   Pass_fail=BIT(Status,2)
200   SUBEND
210   !This subprogram resets the multimeter by disabling the SYSFAIL bit,
220   !then writing a '1' to Control Register bit 0, and then writing a '0' to
230   !Control Register bit 0. Once the reset completes, SYSFAIL is re-enabled.
240   SUB Mm_rst
250     COM Base_addr
260     WRITEIO -16,Base_addr+4;
270     WRITEIO -16,Base_addr+4;3
280     WRITEIO -16,Base_addr+4;2
290     REPEAT
300       CALL Read_status(Status,Rdy,Done,Indardy,
310         Qryrdy,Noerr,Pass_fail)
310     UNTIL Pass_fail
320     WRITEIO -16,Base_addr+4;0
330   SUBEND
```

C Version

```
/* E1411_RS.CPP - This program resets the multimeter. */
#include <sicl.h>
#include <stdio.h>
#include <stdlib.h>
#include <conio.h>
#define PASS_FAIL (iwpeek((unsigned short*)(base_addr + 0X04)) & 0x04)
/* Function prototypes */
void reset_mm(char *base_addr);

void main(void)
{
    char *base_addr;

    /* create and open a device session */
    INST e1411b;
    e1411b = iopen("vxi,24");

    /* map the E1411B registers into user memory space */
    base_addr = imap(e1411b, I_MAP_VXIDEV, 0, 1, NULL);

    /* function call to reset the multimeter */
    reset_mm(base_addr);

    /* close session */
    iclose(e1411b);
}
/*****
void reset_mm(char *base_addr)
{
    /* This function resets the multimeter by disabling the Control register */
    /* 'SYSFAIL' bit (bit 1), and then by writing a '1' to bit 0 and then by */
    /* writing a '0' to bit 0. After the reset, the 'SYSFAIL' bit is re-enabled. */

    iwpoke((unsigned short*)(base_addr + 0x04),2); /* disable 'SYSFAIL' */

    iwpoke((unsigned short*)(base_addr + 0x04),3);
    iwpoke((unsigned short*)(base_addr + 0x04),3); /* bit must be set for 2 us */
    iwpoke((unsigned short*)(base_addr + 0x04),3);

    iwpoke((unsigned short*)(base_addr + 0x04),2); /* turn off reset */
    while (!PASS_FAIL); /* wait for the reset to complete */
    iwpoke((unsigned short*)(base_addr + 0x04),0); /* enable 'SYSFAIL' */
}
*****/
```

Reading the ID Register

As mentioned previously, the ID Register indicates the classification, addressing mode, and manufacturer of the device. This program reads the ID Register and returns FFFF₁₆.

HP BASIC/WS Version

```
10  !Map the A16 address space in the HP V/382 and store the multimeter
20  !base address in a variable.
30  CONTROL 16,25;2
40  COM Base_addr
50  Base_addr=DVAL("C600",16)
60  !Call the subprogram which reads the ID register.
70  CALL Id_read
80  END
90  !This subprogram reads the ID register and displays the result in hexadecimal.
100 SUB Id_read
110   COM Base_addr
120   Register=READIO(-16,Base_addr+0)
130   Hex$=IVAL$(Register,16)
140   PRINT Hex$
150 SUBEND
```

Reading the Device Type Register

The Device Type Register contains the model code of the device. The HP E1326B model code is FF40₁₆ and the HP E1411B model code is FF38₁₆.

HP BASIC/WS Version

```
10  !Map the A16 address space in the HP V/382 and store the multimeter
20  !base address in a variable.
30  CONTROL 16,25;2
40  COM Base_addr
50  Base_addr=DVAL("C600",16)
60  !Call the subprogram which reads the Device Type register.
70  CALL Dt_read
80  END
90  !This subprogram reads the Device type register and displays the result
100 !in hexadecimal.
110 SUB Dt_read
120   COM Base_addr
130   Register=READIO(-16,Base_addr+2)
140   Hex$=IVAL$(Register,16)
150   PRINT Hex$
160 SUBEND
```

C Version

```
/* E1411_ID.CPP - This program reads the multimeter's ID and Device Type */
/* registers. */

#include <fcntl.h>
#include <stdio.h>
#include <stdlib.h>
#include <conio.h>

/* Function prototypes */
void read_registers(char *base_addr);

void main(void)
{
    char *base_addr;

    /* create and open a device session */
    INST e1411b;
    e1411b = iopen("vxi,24");
    /* map the E1411B registers into user memory space */
    base_addr = imap(e1411b, I_MAP_VXIDEV, 0, 1, NULL);
    /* function call to read the ID and Device Type registers */
    read_registers(base_addr);

    /* close session */
    iclose(e1411b);
}
/*****
void read_registers(char *base_addr)
{
    /* This function reads the multimeter's ID and Device Type registers. */
    unsigned short id_reg, dt_reg;
    /* clear the user screen */
    clrscr( );
    /* read the E1411B ID and Device Type registers */
    id_reg = iwpeek((unsigned short *) (base_addr + 0x00));
    dt_reg = iwpeek((unsigned short *) (base_addr + 0x02));
    printf("ID register = 0x%4X\nDevice Type register = 0x%4X", id_reg, dt_reg);
    exit(0);
}
```

Reading the Query Response Register

The following program sets the multimeter function to (2-wire) OHMS, and then queries the function and reads it from the Query Response Register. The number "2" is returned.

HP BASIC/WS Version

```
10 !Map the A16 address space in the HP V/382 and store the multimeter base
20 !address in a variable.
30 CONTROL 16,25;2
40 COM Base_addr
50 Base_addr=DVAL("C600",16)
60 !Call the subprogram which sets and queries the multimeter function.
70 CALL Func_qry
80 END
90 !This subprogram checks each bit in the multimeter Status register.
100 !The subprogram is called by subprograms Wait_not_bsy and Qry_ready
110 !to determine when a command and parameter can be written to the
120 !Command and Parameter registers, and when data is in the Query
130 !Response register.
140 SUB Read_status(Status,Rdy,Done,Indardy,Qryrdy,Noerr,Pass_fail)
150   COM Base_addr
160   Status=READIO(-16,Base_addr+4)
170   Rdy=BIT(Status,0)
180   Done=BIT(Status,7) AND Rdy
190   Indardy=BIT(Status,4) AND Done
200   Qryrdy=BIT(Status,1) AND Done
210   Noerr=NOT (NOT (BIT(Status,6)) AND Done)
220   Pass_fail=BIT(Status,2)
230 SUBEND
240 !This subprogram calls Read_status to check status bit 0 to determine
250 !when a command or parameter can be sent.
260 SUB Wait_not_bsy
270   REPEAT
280     CALL Read_status(Status,Rdy,Done,Indardy,Qryrdy,Noerr,Pass_fail)
290     UNTIL Rdy
300 SUBEND
310 !This subprogram calls Read_status to check status bit 1 to determine
320 !when data is in the Query Response register.
330 SUB Qry_ready
340   REPEAT
350     CALL Read_status(Status,Rdy,Done,Indardy,Qryrdy,Noerr,Pass_fail)
360     UNTIL Qryrdy
370 SUBEND
```

Continued on Next Page

```
380  !This subprogram sets and queries the multimeter function.
390  SUB Func_qry
400    COM Base_addr
410      WRITEIO -16,Base_addr+8;4
420    CALL Wait_not_bsy
430    WRITEIO -16,Base_addr+10;2
440      CALL Wait_not_bsy
450    WRITEIO -16,Base_addr+8;5
460    CALL Qry_ready
470      Register=READIO(-16,Base_addr+8)
480      Rslt=BINAND(Register,255)
490      PRINT Rslt
500  SUBEND
```

C Version

```
/* E1411_QY.CPP - This program sets the multimeter function to (4-wire) */
/* OHMS and then queries the function setting and reads it from the Query */
/* Response register. */

#include <sicl.h>
#include <stdio.h>
#include <stdlib.h>
#include <conio.h>

#define READY ((iwpeek((unsigned short*)(base_addr + 0x04)) & 0x01)
#define DONE ((iwpeek((unsigned short*)(base_addr + 0x04)) & 0x81) == 0x81)
#define QRYRDY ((iwpeek((unsigned short*)(base_addr + 0x04)) & 0x83) == 0x83)

/* Function prototypes */
void set_function(char *base_addr);

void main(void)
{
    char *base_addr;

    /* clear the user screen */
    clrscr();

    /* create and open a device session */
    INST e1411b;
    e1411b = iopen("vxi,24");

    /* map the E1411B registers into user memory space */
    base_addr = imap(e1411b, I_MAP_VXIDEV, 0, 1, NULL);

    /* function call to set the multimeter function */
    set_function(base_addr);

    /* close session */
    iclose(e1411b);
}

/*****
void set_function(char *base_addr)
{
```

Continued on Next Page

```

/* this function sets the multimeter function to ohms */

unsigned short query; /* variable for data from query response reg */
/* write 'measurement function' to command register, wait for */
/* ready bit = 1 */
while(!READY);
iwpoke((unsigned short*)(base_addr + 0x08),4);

/* write 'OHMS' to parameter register, wait for ready bit = 1 */
while (!READY);
iwpoke((unsigned short*)(base_addr + 0x0A),2);
while (!DONE);

/* write 'measurement function query' to command register, wait for */
/* qyrdy bit = 1 */
iwpoke((unsigned short*)(base_addr + 0x08),5);
while (!QRYRDY);

query = iwpeek((unsigned short*)(base_addr + 0x08));

printf("Query register contents = %x", (query & 0xFF));

}

```

Reading an Error Code

This program generates an error and then reads the error code from the Query Response Register.

HP BASIC/WS Version

```
10  !Map the A16 address space in the HP V/382 and store the multimeter base
20  !address in a variable.
30  CONTROL 16,25;2
40  COM Base_addr
50  Base_addr=DVAL("C600",16)
60  !Call the subprogram which sets an invalid parameter, thus generating an error.
70  CALL Error_gen
80  END
90  !This subprogram checks each bit in the multimeter Status register.
100 !The subprogram is called by subprograms Wait_not_bsy, Wait_done, and
110 !Qry_ready to determine when a command and parameter can be written to
120 !Command and Parameter registers, and when an error code is in the Query
130 !Response register.
140 SUB Read_status(Status,Rdy,Done,Indardy,Qryrdy,Noerr,Pass_fail)
150   COM Base_addr
160   Status=READIO(-16,Base_addr+4)
170   Rdy=BIT(Status,0)
180   Done=BIT(Status,7) AND Rdy
190   Indardy=BIT(Status,4) AND Done
200   Qryrdy=BIT(Status,1) AND Done
210   Noerr=NOT (NOT (BIT(Status,6)) AND Done)
220   Pass_fail=BIT(Status,2)
230 SUBEND
240 !This subprogram calls Read_status to check status bit 0 to determine
250 !when a parameter can be sent.
260 SUB Wait_not_bsy
270   REPEAT
280     CALL Read_status(Status,Rdy,Done,Indardy,Qryrdy,Noerr,Pass_fail)
290   UNTIL Rdy
300 SUBEND
310 !This subprogram calls Read_status to check status bit 7. This bit determines
320 !the validity of bits 6 and 1, and determines when a command is finished.
330 SUB Wait_done
340   REPEAT
350     CALL Read_status(Status,Rdy,Done,Indardy,Qryrdy,Noerr,Pass_fail)
360   UNTIL Done
370 SUBEND
```

Continued on Next Page

```

380  !This subprogram calls Read_status to check status bit 1 to determine
390  !when an error code is in the Query Response register.
400  SUB Qry_ready
410    REPEAT
420      CALL Read_status(Status,Rdy,Done,Indardy,Qryrdy,Noerr,Pass_fail)
430    UNTIL Qryrdy
440  SUBEND

450  !This subprogram calls Read_status to check status bit 6 to determine
460  !if an error has occurred. If there is an error, the code is written to the
470  !Query Response register and then is read from the register.
480  SUB Err_chk(Noerr)
490    COM Base_addr
500    CALL Read_status(Status,Rdy,Done,Indardy,Qryrdy,Noerr,Pass_fail)
510    IF Noerr THEN Ok
520    WRITEIO -16,Base_addr+8;15
530    CALL Qry_ready
540    Errcode=READIO(-16,Base_addr+8)
550    Errcode=BINAND(Errcode,255)
560    PRINT "Error Code:";Errcode
570  Ok:SUBEND

580  !This subprogram generates an error by specifying a parameter opcode of 7
590  !for the function parameter. (This is a parameter out of range.)
600  SUB Error_gen
610    COM Base_addr
620    WRITEIO -16,Base_addr+8;4
630    CALL Wait_not_bsy
640    WRITEIO -16,Base_addr+10;7
650    CALL Wait_done
660    CALL Err_chk(Noerr)
670  SUBEND

```

C Version

```
/* E1411_EC.CPP - This program generates an error and then reads the */
/* error code from the Query Response Register. */

#include <si1.h>
#include <stdio.h>
#include <stdlib.h>
#include <conio.h>

#define READY ((ipeek((unsigned short*)(base_addr + 0x04)) & 0x01)
#define DONE ((ipeek((unsigned short*)(base_addr + 0x04)) & 0x81) == 0x81)
#define QRYRDY ((ipeek((unsigned short*)(base_addr + 0x04)) & 0x83) == 0x83)
#define NOERR ((ipeek((unsigned short*)(base_addr + 0x04)) & 0xC1) == 0xC1)

/* Function prototypes */
void cause_error(char *base_addr);
void check_for_error(char *base_addr);

void main(void)
{
    char *base_addr;

    /* clear the user screen */
    clrscr();
    /* create and open a device session */
    INST e1411b;
    e1411b = iopen("vxi,24");

    /* map the E1411B registers into user memory space */
    base_addr = imap(e1411b, I_MAP_VXIDEV, 0, 1, NULL);

    /* function call to cause a multimeter error */
    cause_error(base_addr);
    /* close session */
    iclose(e1411b);
}

/*****/
void cause_error(char *base_addr)
{

```

Continued on Next Page

```

/* this function specifies a parameter opcode of 7 for the function */
/* parameter. This is a parameter out of range. */

/* write 'measurement function' to command register, wait for */
/* ready bit = 1 */
while(!READY);
iwpoke((unsigned short*)(base_addr + 0x08),4);

/* write an opcode of 7 to parameter register, wait for ready bit = 1 */
while (!READY);
iwpoke((unsigned short*)(base_addr + 0x0A),7);
while (!DONE);

/* call function which reads the error if an error has occurred */
if(!NOERR) check_for_error(base_addr);
}

/*****
void check_for_error(char *base_addr)
{
    unsigned short error_code; /* variable for error code from the */
                               /* query response register */

    /* write 'send error' to command register, wait for */
    /* qryrdy bit = 1 */
    iwpoke((unsigned short*)(base_addr + 0x08),15);
    while (!QRYRDY);

    error_code = iwpeek((unsigned short*)(base_addr + 0x08));
    printf("Error code = %x", (error_code & 0xFF));
}

```

Stand-Alone Multimeter Measurements

HP BASIC/WS Version

The following program makes measurements using the stand-alone multimeter. The configuration shown makes five bursts of five measurements each, and displays the readings on a terminal.

```
10  !Initialize program variables.
20  CONTROL 16,25;2
30  Base_addr=DVAL("C600",16)           !logical address 24
40  Aper=0
50  Func=0
60  Rng=0
70  COM Base_addr,Aper,Func,Rng
80  !Initialize (reset) the multimeter.
90  CALL Mm_reset
100 !Configure the multimeter's A/D converter.
110 !Set the function                      (DCV)
120 CALL Peek_meas(4,0)
130 !Set the range                        (8V)
140 CALL Peek_meas(2,2)
150  !Set the aperture time                (16.7 ms)
160 CALL Peek_meas(0,1)
170 !Set the autozero mode                (OFF)
180 CALL Peek_meas(8,1)
190  !Set the offset compensation mode      (OFF)
200 CALL Peek_meas(36,0)
210 !Configure multimeter trigger system
220 !Set the trigger source                (HOLD)
230 CALL Peek_meas(6,2)
240 !Set the trigger count (number of bursts) (5)
250 CALL Peek_meas(39,0,0,5)
260  !Set the trigger delay                 (0s)
270 CALL Peek_meas(23,0,0,0)
280  !Set the sample count (number of readings/burst) (5)
290 CALL Peek_meas(38,0,0,5)
300 !Set sample source                     (IMMEDIATE)
310 CALL Peek_meas(7,0)
320  !Set the sample rate (set if sample source is Timer) (1)
330 !CALL Peek_meas(10,0,70)
340 !Place (arm) the multimeter in the wait-for-trigger state
350 CALL Peek_meas(12,1)
```

Continued on Next Page

```

360  !Dimension a computer variable to store the measurements.
370  !(size = number of bursts * number of readings per burst.)
380  REAL Readings(1:25)
390  !Trigger the multimeter one time for each burst specified by the
400  !Trigger Count parameter. A wait period equal to the number of readings
410  !in the burst times the aperture time is inserted to allow the measurement
420  !computation(s) to complete. All bursts occur before the readings are read
430  !from the buffer.
440  FOR I=1 TO 5
450    CALL Peek_meas(13)
460    WAIT 5*.0167
470  NEXT I
480  !Retrieve the measurement(s) and convert the measured signal to volts,
490  !ohms, etc.
500  CALL Read_data(Readings(*))
510  END
520  !The timing of events within a register-based program is controlled by
530  !monitoring the Status register for conditions which indicate when an
540  !event is in progress or has finished. The following subprogram reads
550  !the Status register and is called by other subprograms to determine when
560  !an action can be performed.
570  SUB Read_status(Status,Rdy,Done,Indardy,Qryrdy,Noerr,Pass_fail)
580    Read_status: !
590    COM Base_addr,Aper,Func,Rng
600    Status=READIO(-16,Base_addr+4)
610    Rdy=BIT(Status,0)
620    Done=BIT(Status,7) AND Rdy
630    Indardy=BIT(Status,4) AND Done
640    Qryrdy=BIT(Status,1) AND Done
650    Noerr=NOT (NOT (BIT(Status,6)) AND Done)
660    Pass_fail=BIT(Status,2)
670  SUBEND
680  !This subprogram calls the Read_status subprogram to check status bit 0
690  !(Cmd/Parm Rdy) to determine when a command or parameter can be sent.
700  SUB Wait_not_bsy
710    Wait_not_bsy: !
720    COM Base_addr,Aper,Func,Rng
730    REPEAT
740    CALL Read_status(Status,Rdy,Done,Indardy,Qryrdy,Noerr,Pass_fail)
750    UNTIL Rdy
760  SUBEND

```

Continued on Next Page

```

770 !This subprogram calls Read_status to check the validity of status bit 7
780 !(DONE). This ensures the validity of status bits 6,5,4, and 1.
790 SUB Wait_done
800   Wait_done: !
810   COM Base_addr,Aper,Func,Rng
820   REPEAT
830   CALL Read_status(Status,Rdy,Done,Indardy,Qryrdy,Noerr,Pass_fail)
840   UNTIL Done
850 SUBEND
860 !This subprogram calls Read_status to determine if an error has occurred
870 !(status bit 6). If an error has occurred, the error code is displayed.
880 SUB Err_chk(Noerr)
890   Err_chk: !
900   COM Base_addr,Aper,Func,Rng
910   CALL Read_status(Status,Rdy,Done,Indardy,Qryrdy,Noerr,Pass_fail)
920   IF Noerr THEN Ok
930   WRITEIO -16,Base_addr+8;15
940   CALL Qry_ready
950   Errcode=READIO(-16,Base_addr+8)
960   Errcode=BINAND(Errcode,255)
970   PRINT "Error Code: ";Errcode
980   STOP
990 Ok:SUBEND
1000 !This subprogram calls Read_status to determine when an error code or
1010 !a response to an instrument query is in the Query Response register
1020 !(status bit 1).
1030 SUB Qry_ready
1040   Qry_ready: !
1050   COM Base_addr,Aper,Func,Rng
1060 REPEAT
1070   CALL Read_status(Status,Rdy,Done,Indardy,Qryrdy,Noerr,Pass_fail)
1080 UNTIL Qryrdy
1090 SUBEND
1100 !This subprogram calls Read_status to determine when measurement data
1110 !is available in the multimeter data buffer (status bit 4).
1120 SUB Data_ready
1130   Data_ready: !
1140   COM Base_addr,Aper,Func,Rng
1150 REPEAT
1160   CALL Read_status(Status,Rdy,Done,Indardy,Qryrdy,Noerr,Pass_fail)
1170 UNTIL Indardy
1180 SUBEND

```

Continued on Next Page

```

1190 !This subprogram writes commands and parameters to the Command
1200 !and Parameter registers. It calls Wait_not_bsy prior to writing the next
1210 !command or parameter. Once a command and its parameter(s) are written,
1220 !it calls Wait_done and Err_chk to check for any errors.
1230 !The subprogram also stores the measurement function, range, and aperture
1240 !time so that the right routine (in subprogram Read_data) is used to
1250 !convert the measured signal to the appropriate quantity.
1260 SUB Peek_meas(Cmd,OPTIONAL INTEGER Parm1,Parm2,Parm3)
1270 Peek_meas: !
1280 COM Base_addr,Aper,Func,Rng
1290 CALL Wait_not_bsy
1300 WRITEIO -16,Base_addr+8;Cmd
1310 IF NPAR>1 THEN
1320 CALL Wait_not_bsy
1330 WRITEIO -16,Base_addr+10;Parm1
1340 END IF
1350 IF NPAR>2 THEN
1360 CALL Wait_not_bsy
1370 WRITEIO -16,Base_addr+10;Parm2
1380 END IF
1390 IF NPAR>3 THEN
1400 CALL Wait_not_bsy
1410 WRITEIO -16,Base_addr+10;Parm3
1420 END IF
1430 IF Cmd=0 THEN Aper=Parm1
1440 IF Cmd=2 THEN Rng=Parm1
1450 IF Cmd=4 THEN Func=Parm1
1460 CALL Wait_done
1470 CALL Err_chk(Noerr)
1480 SUBEND
1490 !This subprogram retrieves the reading(s) from the multimeter's data
1500 !buffer and converts it to the appropriate quantity (i.e. voltage,
1510 !resistance) based on the measurement function, range, and aperture time.
1520 !The subprogram calls Data_ready to determine when the readings are
1530 !in the data buffer.
1540 SUB Read_data(Readings(*))
1550 Read_data: !
1560 COM Base_addr,Aper,Func,Rng
1570 CALL Data_ready
1580 FOR I=1 TO 25 !Number of bursts * number of readings/burst
1590 IF Aper=6 THEN
1600 Lower_word=READIO(-16,Base_addr+12)
1610 Count=Lower_word/32768

```

Continued on Next Page

```

1620     Header=BIT(Lower_word,0)*128+Rng
1630     Exp=BINAND(Header,7)
1640     ELSE
1650     Upper_word=READIO(-16,Base_addr+12)
1660     CALL Data_ready
1670     Lower_word=READIO(-16,Base_addr+12)
1680     Header=SHIFT(Upper_word,8)
1690     Count=65536.*BINAND(Upper_word,255)+2.*
        SHIFT(Lower_word,1)
1700     Exp=BINAND(Header,7)
1710     IF Count>=8388608 THEN
1720     Count=(Count-16777216.)/8388608
1730     ELSE
1740     Count=Count/8388608
1750     END IF
1760     END IF
1770     IF Func=2 THEN
1780     Readings(l)=Count*256*8^(Exp)
1790     ELSE
1800     Readings(l)=Count*8^(Exp-1)
1810     END IF
1820 NEXT I
1830 PRINT Readings(*)
1840 SUBEND
1850 !This subprogram resets the multimeter by disabling the SYSFAIL bit,
1860 !then writing a '1' to Control register bit 0, and then writing a '0' to
1870 !Control register bit 0. Once the reset completes, SYSFAIL is re-enabled.
1880 SUB Mm_reset
1890 Mm_reset: !
1900     COM Base_addr,Aper,Func,Rng
1910     WRITEIO -16,Base_addr+4;2
1920     WRITEIO -16,Base_addr+4;3
1930     WRITEIO -16,Base_addr+4;2
1940     REPEAT
1950     CALL Read_status(Status,Rdy,Done,Indardy,Qryrdy,Noerr,Pass_fail)
1960     UNTIL Pass_fail
1970     WRITEIO -16,Base_addr+4;0
1980 SUBEND

```

C Version

```
/* E1411_M.CPP - This program takes measurements on the front */
/* terminals of the E1411B multimeter. */

#include <si1.h>
#include <stdio.h>
#include <stdlib.h>
#include <conio.h>

/* define macros to monitor status register conditions */

#define READY (iwritek((unsigned short*)(base_addr_dmm + 0x04)) & 0x01)
#define DONE ((iwritek((unsigned short*)(base_addr_dmm + 0x04)) & 0x81) ==
0x81)
#define DATARDY ((iwritek((unsigned short*)(base_addr_dmm + 0x04)) & 0x91)
== 0x91)
#define QRYRDY ((iwritek((unsigned short*)(base_addr_dmm + 0x04)) & 0x83)
== 0x83)
#define NOERR ((iwritek((unsigned short*)(base_addr_dmm + 0x04)) & 0xC1)
== 0xC1)
#define PASS_FAIL (iwritek((unsigned short*)(base_addr_dmm + 0x04)) & 0x04)

/* Function prototypes */

void configure_dmm(char *base_addr_dmm, int command, int parameter);
void set_sample_period(char *base_addr_dmm, int command, unsigned short
parameter);
void set_dmm_counts(char *base_addr_dmm, int command, long parameter);
void no_dmm_parameters(char *base_addr_dmm, int command);
void trigger_dmm(char *base_addr_dmm);
void check_for_error(char *base_addr_dmm);
void reset_mm(char *base_addr_dmm);

int aper, rng, func; /* global variables to contain the multimeter */
/* aperture time, range, and function; which are */
/* used to calculate the reading */

void main(void)
{
    char *base_addr_dmm; /* pointer to multimeter base address */

    clrscr(); /* clear the user screen */
    /* create and open the device session */
    INST e1411b;
    e1411b = iopen("vxi,24");
}
```

Continued on Next Page

```

/* map the E1411B registers into user memory space */
base_addr_dmm = imap(e1411b, I_MAP_VXIDEV, 0, 1, NULL);

/* function call to reset the multimeter */
reset_mm(base_addr_dmm);

/* function calls to configure the multimeter; the parameters */
/* are the multimeter's A16 base address, the command opcode, */
/* and the parameter opcode or value */

configure_dmm(base_addr_dmm,4,0); /* function = DCV */

configure_dmm(base_addr_dmm,2,2); /* range = 8V */

configure_dmm(base_addr_dmm,0,1); /* aperture time = 16.7 ms */

configure_dmm(base_addr_dmm,8,1); /* autozero = off */

configure_dmm(base_addr_dmm,36,0); /* offset compensation = off */

/* trigger system */
configure_dmm(base_addr_dmm,6,2); /* trigger source = HOLD */

configure_dmm(base_addr_dmm,7,0); /* sample source = IMMEDIATE */

/*set_sample_period(base_addr_dmm,10,76); sample rate = set when
source is TIMER */

set_dmm_counts(base_addr_dmm,39,5); /* trigger count = 5 */

set_dmm_counts(base_addr_dmm,23,0); /* trigger delay = 0 */

set_dmm_counts(base_addr_dmm,38,5); /* sample count = 5 */

configure_dmm(base_addr_dmm,12,1); /* arm the multimeter */

/* trigger the multimeter */
trigger_dmm(base_addr_dmm);

/* close the device session */
iclose(e1411b);
}

/*****/
void configure_dmm(char *base_addr_dmm, int command, int parameter)
{
/* this function sets the multimeter measurement function, range, aperture */
/* time, autozero mode, offset compensation mode, trigger source, sample */
/* source, and trigger arm */

```

Continued on Next Page

```

/* write command to command register */
/* wait for mm ready bit = 1 */

while(!READY);
iwpoke((unsigned short*)(base_addr_dmm + 0x08),command);

/* write parameter to parameter register */
/* wait for mm ready bit = 1 */
while (!READY);
iwpoke((unsigned short*)(base_addr_dmm + 0x0A),parameter);

/* save aperture time, range, and function for reading conversion */
if (command == 0)
    aper = parameter;
else if (command == 2)
    rng = parameter;
else if (command == 4)
    func = parameter;

while(!DONE); /* wait until mm is done before sending the */
               /* next command and parameters */

if(!NOERR) check_for_error(base_addr_dmm);
/* check for configuration errors */
}
/*****/
void set_sample_period(char *base_addr_dmm, int  command, unsigned
short parameter)
{
/* this function sets the multimeter sample period */
/* parameter variables */
unsigned short parm1 = 0, parm2 = 0;

/* convert parameter (sample period) to two bytes */
parm1 = parameter >> 8; /* upper byte */
parm2 = parameter & 0xFF; /* lower byte */

/* write command to command register */
/* wait for mm ready bit = 1 */
while(!READY);
iwpoke((unsigned short*)(base_addr_dmm + 0x08),command);

/* write upper byte to parameter register */
/* wait for mm ready bit = 1 */
while (!READY);
iwpoke((unsigned short*)(base_addr_dmm + 0x0A),parm1);

/* write lower byte to parameter register */
/* wait for mm ready bit = 1 */
while (!READY);

```

Continued on Next Page

```

iwpoke((unsigned short*)(base_addr_dmm + 0x0A),parm2);

while(!DONE); /* wait until mm is done before sending the */
               /* next command and parameters */

if(!NOERR) check_for_error(base_addr_dmm);
/* check for configuration errors */
}

/*****/
void set_dmm_counts(char *base_addr_dmm, int  command, long
parameter)
{
/* this function sets the multimeter trigger count, trigger delay, and */
/* sample count */

/* parameter variables */
unsigned short parm1 = 0, parm2 = 0, parm3 = 0;

/* convert count or delay to three bytes */
parm1 = parameter >> 16; /* upper byte */
parm2 = parameter >> 8;  /* middle byte */
parm3 = parameter;      /* lower byte */

/* write command to command register */
/* wait for mm ready bit = 1 */
while(!READY);
iwpoke((unsigned short*)(base_addr_dmm + 0x08),command);

/* write upper byte to parameter register */
/* wait for mm ready bit = 1 */
while (!READY);
iwpoke((unsigned short*)(base_addr_dmm + 0x0A),parm1);

/* write middle byte to parameter register */
/* wait for mm ready bit = 1 */
while (!READY);
iwpoke((unsigned short*)(base_addr_dmm + 0x0A),parm2);

/* write lower byte to parameter register */
/* wait for mm ready bit = 1 */
while (!READY);
iwpoke((unsigned short*)(base_addr_dmm + 0x0A),parm3);

while(!DONE); /* wait until mm is done before sending the */
               /* next command and parameters */

if(!NOERR) check_for_error(base_addr_dmm);
/* check for configuration errors */
}

```

Continued on Next Page

```

/*****/
void no_dmm_parameters(char *base_addr_dmm, int  command)
{
/* this function sends those multimeter commands which do not have */
/* parameters; this includes trigger immediate and software sample. */

/* write command to command register */
/* wait for mm ready bit = 1 */
while(!READY);
iwpoke((unsigned short*)(base_addr_dmm + 0x08),command);

while(!DONE); /* wait until mm is done before sending the */
/* next command and parameters */

if(!NOERR) check_for_error(base_addr_dmm);
/* check for configuration errors */

}

/*****/
void trigger_dmm(char *base_addr_dmm)
{
/* this function triggers the multimeter and retrieves and prints the readings */
/* from the data register */

int  i, range_code;
short dmm_2byte = 0; /* 2-byte reading variable */
long dmm_4byte = 0, temp_4byte = 0; /* 4-byte reading variable */
float range, reading;

/* voltage range and resistance range tables */
float volt_range[5] = {0.125, 1.0, 8.0, 64.0, 300.0};
float ohm_range[5] = {256.0, 2048.0, 16384.0, 131000.0, 1048000.0};
for (i=0; i<25; i++) /* loop for 5 bursts of 5 readings */
{
no_dmm_parameters(base_addr_dmm,13);/* trigger the multimeter */
while(!DATARDY);

if (aper != 6)/* aperture time is NOT 10 us (4-byte readings) */
{
/* get upper word of reading from the data register, shift the */
/* word 16-bits to the left */
temp_4byte = (long) iwpeek((unsigned short *)
(base_addr_dmm + 0x0C));
dmm_4byte = (temp_4byte << 16);

while(!DATARDY); /* wait for lower word of reading */

```

Continued on Next Page

```

/* get lower word of reading from the data register, add the */
/* word to the reading upper word in the variable dmm_4byte, */
/* ensure upper word of temp_4byte is 00h */

temp_4byte = (long) iwpeek((unsigned short *)
(base_addr_dmm + 0x0C));
dmm_4byte = dmm_4byte + (temp_4byte & 0xFFFF);

/* check for reading overrange */

if (dmm_4byte & 0x80000000)
{
    printf("\nReading Overrange");
}

else
{
    /* get range code from reading, get range from */
    /* the appropriate range table */

    range_code = ((dmm_4byte >> 24) & 7);

    if (func == 2)
        range = ohm_range[range_code];
    else
        range = volt_range[range_code];

    /* compute and print reading */
    dmm_4byte = (dmm_4byte << 8);
    reading = (range * dmm_4byte) / 0x7FFFFFF0;
    printf("\n%.5E", reading);
}
}
else /* aperture time is 10 us (2-byte readings) */
{
    dmm_2byte = (short) iwpeek((unsigned short *)
(base_addr_dmm + 0x0C));

    /* check for reading overrange */

    if (dmm_2byte & 0x1)
    {
        printf("\nReading Overrange");
    }

    else
    {
        /* remove error bit from reading */

```

Continued on Next Page

Scanning Multimeter Measurements

The following program makes measurements using the multimeter and the HP E1460A 64-Channel Relay Module. The configuration makes one scan through eight channels, and takes one measurement on each channel.

HP BASIC/WS Version

```
10  !Initialize program variables.
20  CONTROL 16,25;2
30  Base_addr=DVAL("C600",16)      !logical address 24
40  Base_addrm=DVAL("C640",16)    !logical address 25
50  I=0
60  Aper=0
70  Func=0
80  Rng=0
90  !Number of channels being measured.
100 Nchan=8
110 COM I,Base_addr,Base_addrm,Aper,Func,Rng,Nchan,Chan_closed
120 !Initialize (reset) the multimeter.
130 CALL Mm_reset
140 !Open all multiplexer channels.
150 CALL Mux_reset
160 !Configure the multimeter's A/D converter.
170 !Set the function                (DCV)
180 CALL Peek_meas(4,0)
190 !Set the range(Autorange)
200 CALL Peek_meas(2,5)
210 !Set the aperture time          (16.7 ms)
220 CALL Peek_meas(0,1)
230 !Set the autozero mode - to detect bit 5      (ON)
240 CALL Peek_meas(8,0)
250 !Set the offset compensation mode(OFF)
260 CALL Peek_meas(36,0)
270 !Configure multimeter trigger system
280 !Set the trigger source          (HOLD)
290 CALL Peek_meas(6,2)
300 !Set the trigger count (number of channels to scan)  (8)
310 CALL Peek_meas(39,0,0,8)
320 !Set the trigger delay(0s)
330 CALL Peek_meas(23,0,0,0)
340 !Set the readings per trigger (per channel)      (1)
350 CALL Peek_meas(38,0,0,1)
```

Continued on Next Page

```

360  !Set the sample source(IMMEDIATE)
370    CALL Peek_meas(7,0)
380  !Set the sample rate (Set if sample source is Timer (1))
390  !CALL Peek_meas(10,0,70)
400  !Place (arm) the multimeter in the wait-for-trigger state
410  CALL Peek_meas(12,1)
420  !Dimension a computer variable to store the measurements.
430  !(size = number of channels * number of readings per channel*
440  !number of scans.)
450  REAL Readings(1:8)
460  !Step through the scan list; close the multiplexer channel, check that the
470  !channel is closed, trigger the multimeter, wait for the multimeter to
480  !complete the measurement(s), close the next channel ...
490  FOR I=1 TO 8           !One trigger for each channel
500    CALL Close_chan
510    CALL Peek_meas(13)
520  NEXT I
530  !Retrieve the measurement(s) and convert the measured signal to volts,
540  !ohms, etc.
550  CALL Read_data(Readings(*))
560  END
570  !The following subprogram reads the Status register and is called by
580  !other subprograms to determine when a particular action can be performed.
590  SUB Read_status(Status,Rdy,Done,Indardy,Qryrdy,Noerr,Mmcomp, Pass_fail)
600  Read_status: !
610    COM I,Base_addr,Base_addrm,Aper,Func,Rng,Nchan,Chan_closed
620    Status=READIO(-16,Base_addr+4)
630    Rdy=BIT(Status,0)
640    Mmcomp=BIT(Status,5)
650    Done=BIT(Status,7) AND Rdy
660    Indardy=BIT(Status,4) AND Done
670    Qryrdy=BIT(Status,1) AND Done
680    Noerr=NOT (NOT (BIT(Status,6)) AND Done)
690    Pass_fail=BIT(Status,2)
700  SUBEND
710  !This subprogram calls the Read_status subprogram to check status bit 0
720  !(Cmd/Parm Rdy) to determine when a command or parameter can be sent.
730  SUB Wait_not_bsy
740  Wait_not_bsy: !
750    COM I,Base_addr,Base_addrm,Aper,Func,Rng,Nchan,Chan_closed
760    REPEAT
770      CALL Read_status(Status,Rdy,Done,Indardy,Qryrdy,Noerr,Mmcomp, Pass_fail)
780    UNTIL Rdy

```

Continued on Next Page

```

790 SUBEND
800 !This subprogram calls Read_status to check the validity of bit 7 (DONE).
810 !This ensures the validity of bits 6,5,4, and 1.
820 SUB Wait_done
830 Wait_done: !
840   COM I,Base_addr,Base_addrm,Aper,Func,Rng,Nchan,Chan_closed
850   REPEAT
860     CALL Read_status(Status,Rdy,Done,Indardy,Qryrdy,Noerr,Mmcomp, Pass_fail)
870   UNTIL Done
880 SUBEND
890 !This subprogram calls Read_status to determine if an error has occurred
900 !(status bit 6). This subprogram is called after Wait_done to ensure the
910 !validity of the Noerr bit. If an error has occurred, the error code is
920 !displayed.
930 SUB Err_chk(Noerr)
940 Err_chk: !
950   COM I,Base_addr,Base_addrm,Aper,Func,Rng,Nchan,Chan_closed
960   CALL Read_status(Status,Rdy,Done,Indardy,Qryrdy,Noerr,Mmcomp, Pass_fail)
970   IF Noerr THEN Ok
980   WRITEIO -16,Base_addr+8;15
990   CALL Qry_ready
1000  Errcode=READIO(-16,Base_addr+8)
1010  Errcode=BINAND(Errcode,255)
1020  PRINT "Error Code: ";Errcode
1030  STOP
1040 Ok:SUBEND
1050 !This subprogram calls Read_status to determine when an error code or
1060 !a response to an instrument query is in the Query Response register
1070 !(status bit 1).
1080 SUB Qry_ready
1090 Qry_ready: !
1100  COM I,Base_addr,Base_addrm,Aper,Func,Rng,Nchan,Chan_closed
1110  REPEAT
1120    CALL Read_status(Status,Rdy,Done,Indardy,Qryrdy,Noerr,Mmcomp, Pass_fail)
1130  UNTIL Qryrdy
1140 SUBEND
1150 !This subprogram calls Read_status to determine when measurement data
1160 !is available in the multimeter data buffer (status bit 4).
1170 SUB Data_ready
1180 Data_ready: !
1190  COM I,Base_addr,Base_addrm,Aper,Func,Rng,Nchan,Chan_closed
1200  REPEAT

```

Continued on Next Page

```

1210    CALL Read_status(Status,Rdy,Done,Indardy,Qryrdy,Noerr,Mmcomp, Pass_fail)
1220    UNTIL Indardy
1230 SUBEND
1240 !This subprogram monitors bit 5 (MULTIMETER COMPLETE) in the
1250 !status register. When the bit is set, the A/D portion of the measurement is
1260 !in progress and the multiplexer channel is advanced. By advancing the
1270 !channel during this condition, each channel can be scanned
1280 !before the readings are read from the buffer.
1290 SUB Mm_comp
1300 Mm_comp: !
1310    COM I,Base_addr,Base_addrm,Aper,Func,Rng,Nchan,Chan_closed
1320    REPEAT
1330        CALL Read_status(Status,Rdy,Done,Indardy,Qryrdy,Noerr,Mmcomp, Pass_fail)
1340    UNTIL Mmcomp
1350 SUBEND
1360 !This subprogram monitors the multiplexer Status register. It is called
1370 !by subprogram Chan_rdy to determine when a channel can be closed
1380 !(or opened), and to determine when a channel has finished closing (or
1390 !opening).
1400 SUB Mux_status
1410 Mux_status: !
1420    COM I,Base_addr,Base_addrm,Aper,Func,Rng,Nchan,Chan_closed
1430    M_status=READIO(-16,Base_addrm+4)
1440    Chan_closed=BIT(M_status,7)
1450 SUBEND
1460 !This subprogram closes the multiplexer channels.
1470 SUB Close_chan
1480 Close_chan: !
1490    COM I,Base_addr,Base_addrm,Aper,Func,Rng,Nchan,Chan_closed
1500    CALL Chan_rdy
1510    WRITEIO -16,Base_addrm+32;2^(I-1)
1520    CALL Chan_rdy
1530 SUBEND
1540 !This subprogram calls Mux_status to determine when a channel can be
1550 !closed and when a channel has finished closing.
1560 SUB Chan_rdy
1570 Chan_rdy: !
1580    COM I,Base_addr,Base_addrm,Aper,Func,Rng,Nchan,Chan_closed
1590    REPEAT
1600        CALL Mux_status
1610    UNTIL Chan_closed
1620 SUBEND

```

Continued on Next Page

```

1630 !This subprogram writes commands and parameters to the Command and
1640 !Parameter registers. When a command is written, it calls Wait_not_bsy
1650 !before writing the parameter(s). Once a command and parameter are
1660 !written it calls Wait_done, and Err_chk to check for configuration
1670 !errors. The subprogram also stores the function, range, and aperture
1680 !time so that the right routine is used to convert the measured signal
1690 !to the appropriate quantity. When the trigger command is sent, subprogram
1700 !Mm_comp is called to monitor status bit 5 before the channel is
1710 !advanced. The waiting period allows multiple measurements to complete.
1720 SUB Peek_meas(Cmd,OPTIONAL INTEGER Parm1,Parm2,Parm3)
1730 Peek_meas: !
1740   COM I,Base_addr,Base_addrm,Aper,Func,Rng,Nchan,Chan_closed
1750   CALL Wait_not_bsy
1760   WRITEIO -16,Base_addr+8;Cmd
1770   IF NPAR>1 THEN
1780     CALL Wait_not_bsy
1790     WRITEIO -16,Base_addr+10;Parm1
1800   END IF
1810   IF NPAR>2 THEN
1820     CALL Wait_not_bsy
1830     WRITEIO -16,Base_addr+10;Parm2
1840   END IF
1850   IF NPAR>3 THEN
1860     CALL Wait_not_bsy
1870     WRITEIO -16,Base_addr+10;Parm3
1880   END IF
1890   IF Cmd=0 THEN Aper=Parm1
1900   IF Cmd=2 THEN Rng=Parm1
1910   IF Cmd=4 THEN Func=Parm1
1920   IF Cmd=13 THEN
1930     CALL Mm_comp
1940     WAIT 1*.0334           !Number of readings per channel
1950   ELSE
1960     CALL Wait_done
1970     CALL Err_chk(Noerr)
1980   END IF
1990 SUBEND

```

Continued on Next Page

```

2000 !This subprogram reads the measurements (all channels) from the
2010 !data buffer. It converts the measured quantities to volts, ohms, etc.,
2020 !and displays them.
2030 SUB Read_data(Readings(*))
2040 Read_data: !
2050 COM I,Base_addr,Base_addrm,Aper,Func,Rng,Nchan,Chan_closed
2060 CALL Data_ready
2070 FOR R=1 TO 8 !# of channels * # of readings/channel * # of scans
2080 IF Aper=6 THEN
2090 Lower_word=READIO(-16,Base_addr+12)
2100 Count=Lower_word/32768
2110 Header=BIT(Lower_word,0)*128+Rng
2120 Exp=BINAND(Header,7)
2130 ELSE
2140 Upper_word=READIO(-16,Base_addr+12)
2150 CALL Data_ready
2160 Lower_word=READIO(-16,Base_addr+12)
2170 Header=SHIFT(Upper_word,8)
2180 Count=65536.*BINAND(Upper_word,255)+2.* SHIFT(Lower_word,1)
2190 Exp=BINAND(Header,7)
2200 IF Count>=8388608 THEN
2210 Count=(Count-16777216.)/8388608
2220 ELSE
2230 Count=Count/8388608
2240 END IF
2250 END IF
2260 IF Func=2 THEN
2270 Readings(R)=Count*256*8^(Exp)
2280 ELSE
2290 Readings(R)=Count*8^(Exp-1)
2300 END IF
2310 NEXT R
2320 PRINT Readings(*)
2330 SUBEND

```

Continued on Next Page

```

2340 !This subprogram resets the multimeter by disabling the SYSFAIL bit,
2350 !then writing a "1" to Control register bit 0, and then writing a "0" to
2360 !Control register bit 0. Once the reset completes, SYSFAIL is re-enabled.
2370 SUB Mm_reset
2380 Mm_reset: !
2390 COM I,Base_addr,Base_addrm,Aper,Func,Rng,Nchan,Chan_closed
2400 WRITEIO -16,Base_addr+4;2
2410 WRITEIO -16,Base_addr+4;3
2420 WRITEIO -16,Base_addr+4;2
2430 REPEAT
2440 CALL Read_status(Status,Rdy,Done,Indardy,Qryrdy,Noerr,Mmcomp, Pass_fail)
2450 UNTIL Pass_fail
2460 WRITEIO -16,Base_addr+4;0
2470 SUBEND
2480 !This subprogram opens all multiplexer channels and then closes the bank
2490 !99 relay on the HP E1460A multiplexer.
2500 SUB Mux_reset
2510 Mux_reset: !
2520 COM I,Base_addr,Base_addrm,Aper,Func,Rng,Nchan,Chan_closed
2530 WRITEIO -16,Base_addrm+32;0
2540 REPEAT
2550 CALL Mux_status
2560 UNTIL Chan_closed
2570 WRITEIO -16,Base_addrm+48;4
2580 REPEAT
2590 CALL Mux_status
2600 UNTIL Chan_closed
2610 SUBEND

```

C Version

This program uses the E1411B multimeter and the E1351A FET multiplexer to perform high-speed scanning. The program configures the multimeter for high-speed measurements and downloads a scan list to the FET multiplexer. The program requires that the analog bus and digital bus cables be connected between the multimeter and the multiplexer.

```
/* E1411_SC.CPP - This program uses the E1411B to scan five E1351A FET */
/* multiplexer channels five times. */

#include <si1.h>
#include <stdio.h>
#include <stdlib.h>
#include <conio.h>
#include <dos.h>

/* define macros to monitor status register conditions */

#define READY ((iwpeek((unsigned short*)(base_addr_dmm + 0x04)) & 0x01)
#define DONE ((iwpeek((unsigned short*)(base_addr_dmm + 0x04)) & 0x81) ==
0x81)
#define DATARDY ((iwpeek((unsigned short*)(base_addr_dmm + 0x04)) & 0x91)
== 0x91)
#define QRYRDY ((iwpeek((unsigned short*)(base_addr_dmm + 0x04)) & 0x83)
== 0x83)
#define NOERR ((iwpeek((unsigned short*)(base_addr_dmm + 0x04)) & 0xC1)
== 0xC1)
#define PASS_FAIL ((iwpeek((unsigned short*)(base_addr_dmm + 0x04)) & 0x04)

/* Function prototypes */

void configure_dmm(char *base_addr_dmm, int command, int parameter);
void set_sample_period(char *base_addr_dmm, int command, unsigned
short parameter);
void set_dmm_counts(char *base_addr_dmm, int command, long parameter);
void no_dmm_parameters(char *base_addr_dmm, int command);
void set_scanlist(char *base_addr_fet);
void trigger_dmm(char *base_addr_dmm);
void check_for_error(char *base_addr_dmm);
void reset_mm(char *base_addr_dmm);
void reset_fet(char *base_addr_fet);

int aper, rng, func; /* global variables to contain the multimeter */
/* aperture time, range, and function; which are */
/* used to calculate the reading */

void main(void)
{
```

Continued on Next Page

```

char *base_addr_dmm;    /* pointer to multimeter base address */
char *base_addr_fet;    /* pointer to multiplexer base address */

clrscr( );    /* clear the user screen */
/* create and open device sessions */
INST e1411b;
e1411b = iopen("vxi,24");

INST e1351a;
e1351a = iopen("vxi,25");

/* map the E1411B and E1351A registers into user memory space */
base_addr_dmm = imap(e1411b, I_MAP_VXIDEV, 0, 1, NULL);

base_addr_fet = imap(e1351a, I_MAP_VXIDEV, 0, 1, NULL);

/* function calls to reset the multimeter and the multiplexer */
reset_mm(base_addr_dmm);

reset_fet(base_addr_fet);

/* function calls to configure the multimeter; the parameters */
/* are the multimeter's A16 base address, the command opcode, */
/* and the parameter opcode or value */

configure_dmm(base_addr_dmm,4,0); /* function = DCV */

configure_dmm(base_addr_dmm,2,2); /* range = 8V */

configure_dmm(base_addr_dmm,0,6); /* aperture time = 10 us */

configure_dmm(base_addr_dmm,8,1); /* autozero = off */

configure_dmm(base_addr_dmm,36,0); /* offset compensation = off */

/* trigger system */

configure_dmm(base_addr_dmm,6,2); /* trigger source = HOLD */

configure_dmm(base_addr_dmm,7,1); /* sample source = TIMER */

set_sample_period(base_addr_dmm,10,76);/* sample rate = 76 us */

set_dmm_counts(base_addr_dmm,39,25);/* trigger count = 25 */

set_dmm_counts(base_addr_dmm,23,0);/* trigger delay = 0 */

set_dmm_counts(base_addr_dmm,38,1);/* sample count = 1 */

configure_dmm(base_addr_dmm,12,1); /* arm the multimeter */

```

Continued on Next Page

```

/* Download FET multiplexer scan list */
set_scanlist(base_addr_fet);
/* trigger the multimeter */
trigger_dmm(base_addr_dmm);

/* close the device sessions */
fclose(e1411b);
fclose(e1351a);
}

/*****
void configure_dmm(char *base_addr_dmm, int  command, int  parameter)
{
/* this function sets the multimeter measurement function, range, aperture */
/* time, autozero mode, offset compensation mode, trigger source, sample */
/* source, and trigger arm */

/* write command to command register */
/* wait for mm ready bit = 1 */
while(!READY);
iwpoke((unsigned short *)(base_addr_dmm + 0x08),command);

/* write parameter to parameter register */
/* wait for mm ready bit = 1 */
while (!READY);
iwpoke((unsigned short *)(base_addr_dmm + 0x0A),parameter);

/* save aperture time, range, and function for reading conversion */
if (command == 0)
    aper = parameter;
else if (command == 2)
    rng = parameter;
else if (command == 4)
    func = parameter;

while(!DONE); /* wait until mm is done before sending the */
/* next command and parameters */

if(!NOERR) check_for_error(base_addr_dmm);
/* check for configuration errors */
}

```

Continued on Next Page

```

/*****/
void set_sample_period(char *base_addr_dmm, int  command, unsigned
short parameter)
{
/* this function sets the multimeter sample period */

/* parameter variables */
unsigned short parm1 = 0, parm2 = 0;

/* convert parameter (sample period) to two bytes */
parm1 = parameter >> 8; /* upper byte */
parm2 = parameter & 0xFF; /* lower byte */

/* write command to command register */

/* wait for mm ready bit = 1 */
while(!READY);
iwpoke((unsigned short *)(base_addr_dmm + 0x08),command);

/* write upper byte to parameter register */

/* wait for mm ready bit = 1 */
while (!READY);
iwpoke((unsigned short *)(base_addr_dmm + 0x0A),parm1);

/* write lower byte to parameter register */
/* wait for mm ready bit = 1 */
while (!READY);
iwpoke((unsigned short *)(base_addr_dmm + 0x0A),parm2);

while(!DONE); /* wait until mm is done before sending the */
/* next command and parameters */

if(!NOERR) check_for_error(base_addr_dmm);
/* check for configuration errors */

}

```

Continued on Next Page

```

/*****/
void set_dmm_counts(char *base_addr_dmm, int  command, long parameter)
{
/* this function sets the multimeter trigger count, trigger delay, and */
/* sample count */

/* parameter variables */
unsigned short parm1 = 0, parm2 = 0, parm3 = 0;

/* convert count or delay to three bytes */
parm1 = parameter >> 16; /* upper byte */
parm2 = parameter >> 8; /* middle byte */
parm3 = parameter; /* lower byte */

/* write command to command register */
/* wait for mm ready bit = 1 */
while(!READY);
iwpoke((unsigned short *)(base_addr_dmm + 0x08),command);

/* write upper byte to parameter register */
/* wait for mm ready bit = 1 */
while (!READY);
iwpoke((unsigned short *)(base_addr_dmm + 0x0A),parm1);

/* write middle byte to parameter register */
/* wait for mm ready bit = 1 */
while (!READY);
iwpoke((unsigned short *)(base_addr_dmm + 0x0A),parm2);

/* write lower byte to parameter register */
/* wait for mm ready bit = 1 */
while (!READY);
iwpoke((unsigned short *)(base_addr_dmm + 0x0A),parm3);

while(!DONE); /* wait until mm is done before sending the */
/* next command and parameters */

if(!NOERR) check_for_error(base_addr_dmm);
/* check for configuration errors */
}

```

Continued on Next Page

```

/*****/
void no_dmm_parameters(char *base_addr_dmm, int  command)
{
/* this function sends those multimeter commands which do not have parameters; */
/* this includes trigger immediate and software sample. */
/* write command to command register */
/* wait for mm ready bit = 1 */
while(!READY);
iwpoke((unsigned short *)(base_addr_dmm + 0x08),command);

while(!DONE); /* wait until mm is done before sending the */
/* next command and parameters */

if(!NOERR) check_for_error(base_addr_dmm);
/* check for configuration errors */
}
/*****/
void set_scanlist(char *base_addr_fet)
{
/* this function downloads the scan list to the FET multiplexer */

/* clear old scan list and set up scan control register */
iwpoke((unsigned short *)(base_addr_fet + 0x06),1);
iwpoke((unsigned short *)(base_addr_fet + 0x06),0);

/* Download the scan list (channels 0 through 4), configure for */
/* DC voltage measurements */
iwpoke((unsigned short *)(base_addr_fet + 0x0A),0x6000);
iwpoke((unsigned short *)(base_addr_fet + 0x0A),0x6001);

iwpoke((unsigned short *)(base_addr_fet + 0x0A),0x6002);
iwpoke((unsigned short *)(base_addr_fet + 0x0A),0x6003);
iwpoke((unsigned short *)(base_addr_fet + 0x0A),0x6004);

/* set up multiplexer scanning */
/* set direct control of scan list */
iwpoke((unsigned short *)(base_addr_fet + 0x04),0x08);
/* enable digital bus triggering, continuous scanning, reset pointer */
iwpoke((unsigned short *)(base_addr_fet + 0x06),0x1A);
/* set control of scan list to dmm */
iwpoke((unsigned short *)(base_addr_fet + 0x04),0x00);
/* close first channel */
iwpoke((unsigned short *)(base_addr_fet + 0x04),0x10);
}

```

Continued on Next Page

```

/*****/
void trigger_dmm(char *base_addr_dmm)
{
/* this function triggers the multimeter and retrieves and prints the */
/* readings from the data register */

    int i, range_code;
    short dmm_2byte = 0;          /* 2-byte reading variable */
    long dmm_4byte = 0, temp_4byte = 0; /* 4-byte reading variable */
    float range, reading;

/* voltage range and resistance range tables */
    float volt_range[5] = {0.125, 1.0, 8.0, 64.0, 300.0};
    float ohm_range[5] = {256.0, 2048.0, 16384.0, 131000.0, 1048000.0};

    for (i=0; i<25; i++) /* loop for 5 scans of 5 readings */
    {
        no_dmm_parameters(base_addr_dmm,13);/* trigger the multimeter */
        while(!DATARDY);

        if (aper != 6)/* aperture time is NOT 10 us (4-byte readings) */
        {
            /* get upper word of reading from the data register, shift the */
            /* word 16-bits to the left */

            temp_4byte = (long) iwpeek((unsigned short*)(base_addr_dmm + 0x0C));
            dmm_4byte = (temp_4byte << 16);

            while(!DATARDY); /* wait for lower word of reading */

            /* get lower word of reading from the data register, add the */
            /* word to the reading upper word in the variable dmm_4byte, */
            /* ensure upper word of temp_4byte is 00h */

            temp_4byte = (long) iwpeek((unsigned short*)(base_addr_dmm + 0x0C));
            dmm_4byte = dmm_4byte + (temp_4byte & 0xFFFF);

            /* check for reading overrange */

            if (dmm_4byte & 0x80000000)
            {
                printf("\nReading Overrange");
            }
            else
            {

```

Continued on Next Page

```

        /* get range code from reading, get range from */
        /* the appropriate range table */
        range_code = ((dmm_4byte >> 24) & 7);

        if (func == 2)
            range = ohm_range[range_code];
        else
            range = volt_range[range_code];

        /* compute and print reading */
        dmm_4byte = (dmm_4byte << 8);
        reading = (range * dmm_4byte) / 0x7FFFFFF0;
        printf("\n%.5E", reading);
    }
}

else /* aperture time is 10 us (2-byte readings) */
{
    dmm_2byte = (short) iwpeek((unsigned short *)
        (base_addr_dmm + 0x0C));

    /* check for reading overrange */

    if (dmm_2byte & 0x1)
    {
        printf("\nReading Overrange");
    }

    else
    {
        /* remove error bit from reading */
        dmm_2byte = (dmm_2byte >> 1);

        /* get range code from rng variable, get range from */
        /* the appropriate range table */
        if (func == 2)
            range = ohm_range[rng]; /* resistance ranges */
        else
            range = volt_range[rng]; /* voltage ranges */

        /* compute and print reading */
        reading = (range * dmm_2byte) / 0x3FFF;
        printf("\n%.5E", reading);
    }
}
}
}

```

Continued on Next Page

```

/*****/
void check_for_error(char *base_addr_dmm)
{
    unsigned short error_code; /* variable for error code from the */
                                /* query response register */

    /* write 'send error' to command register, wait for */
    /* Qryrdy bit = 1 */
    iwpoke((unsigned short *)(base_addr_dmm + 0x08),15);
    while (!QRYRDY);

    error_code = iwpeek((unsigned short *)(base_addr_dmm + 0x08));

    printf("Error code = %x", (error_code & 0xFF));

    exit(EXIT_FAILURE); /* exit program */
}
/*****/
void reset_mm(char *base_addr_dmm)
{
    /* This function resets the multimeter by disabling the Control Register */
    /* 'SYSFAIL' bit (bit 1), and then by writing a '1' to bit 0 and then by */
    /* writing a '0' to bit 0. After the reset, the 'SYSFAIL' bit is re-enabled. */

    iwpoke((unsigned short *)(base_addr_dmm + 0x04),2);/*disable 'SYSFAIL' */

    iwpoke((unsigned short *)(base_addr_dmm + 0x04),3);
    iwpoke((unsigned short *)(base_addr_dmm + 0x04),3);/*set bit for 2us*/
    iwpoke((unsigned short *)(base_addr_dmm + 0x04),3);

    iwpoke((unsigned short *)(base_addr_dmm + 0x04),2);/* turn off reset */

    while (!PASS_FAIL); /* wait for the reset to complete */

    iwpoke((unsigned short *)(base_addr_dmm + 0x04),0);/* enable 'SYSFAIL' */
}
/*****/
void reset_fet(char *base_addr_fet)
{
    /* This function resets the FET multiplexer by writing a '1' to Control */
    /* register bit 0, waiting 100 ms, and then writing a '0' to bit 0. */
    iwpoke((unsigned short *)(base_addr_fet + 0x04),1);/* set bit 0 to 1 */
    delay (100); /* wait 100 ms (Borland C++ function) */
    iwpoke((unsigned short *)(base_addr_fet + 0x04),0);/* set bit 0 to 0 */
}

```

Useful Tables

The tables contained in this section are:

- Command and Parameter Opcodes
- Register-Based Programming Error Codes
- Multimeter Power-On Settings
- Aperture and Function Change Times
- VME Interrupt Conditions

Command and Parameter Opcodes

Table C-2 contains the command and parameter opcodes. The opcodes used to query the parameter settings are also included. Additional information on the relationship between commands can be found in Chapter 4.

Table C-2. Command and Parameter Opcodes

Multimeter Parameter	Command Opcode	Parameter Opcode	Value	Query Opcode	Query Response
Measurement Function	04	00 01 02	DCV ACV (4-wire) OHMS	05	parameter opcode
Range	02	00 01 02 03 04 05	125 mV / 256 Ω 1V / 2.048 kΩ 8V / 16.384 kΩ 64V / 131 kΩ 300V / 1.048 MΩ Autorange	03	parameter opcode
Aperture Time	00	00 01 02 03 04 05 06	267 ms 16.7 ms 320 ms 20 ms 2.5 ms 100 μs 10 μs	01	parameter opcode
Autozero	08	00 01 02	On Off Once	09	parameter opcode
Offset Compensation	36	00 01	Off On	37	parameter opcode
Trigger Source	06	00 01 02 03 - 0A	Immediate External Hold TTL trigger lines 0 - 7	29	parameter opcode
Trigger Count	39	<upper byte> <middle byte> <lower byte>	1 - 16,777,215 (1),(3)	33	24-bit unsigned number (2)
Trigger Delay	23	<upper byte> <middle byte> <lower byte>	0 - 16.777215s (1)	31	24-bit unsigned number (2)

Table C-2 Continued on Next Page

Table C-2. Command and Parameter Opcodes (continued)

Multimeter Parameter	Command Opcode	Parameter Opcode	Value	Query Opcode	Query Response
Voltmeter Complete Signal Destination	40	8-bit binary number (7)	0 - 7 (TTL trigger lines)	41	8-bit binary number
Sample Count	38	<upper byte> <middle byte> <lower byte>	1 - 16,777,215 (1),(4)	32	24-bit unsigned number (2)
Sample Source	07	00 01 02 03	Immediate Timer Software Control Register	30	parameter opcode
Sample Period (5)	10	<upper byte> <lower byte>	76 μ s - 65.534ms (1)	11	16-bit unsigned number (2)
Software Sample (6)	35	---	---	---	...
Trigger Arm	12	00 01	Un-armed Armed	---	---
Trigger Immediate	13	---	---	---	...
Send Error	15	---	---	---	---

(1) Specified as a 2's complement binary number. For three byte parameters <upper byte> = value shifted 16 bits to the right (>>16), <middle byte> = value shifted 8 bits to the right (>>8), <lower byte> = value. For two byte parameters <upper byte> = value shifted 8 bits to the right (>>8), <lower byte> = value & 0xFF.

(2) Reading the Query Response Register two times (16-bit number) or three times (24-bit number) returns in order; the high byte, middle byte, and low byte.

(3) A parameter value of 0 sets infinite triggers per trigger arm.

(4) A parameter value of 0 sets infinite samples per trigger.

(5) Set when Sample Source is Timer.

(6) Used when Sample Source is Software. The first measurement of each burst occurs when the trigger signal is received (e.g. Trigger Immediate). Subsequent measurements in the burst occur when Software Sample is written to the Command Register.

(7) Up to seven VXIbus TTLTrg trigger lines can be selected. 01 selects line 0, FF selects all lines.

Register-Based Programming Error Codes

The error codes related to register-based programming are listed in Table C-3.

Note When an error occurs, bit 6 in the Status Register is cleared and an error code is stored. The error code is placed in the Query Response Register with the Send Error command. The “Programming Examples” section shows you how to check for errors and display error codes.

Table C-3. Register-Based Programming Error Codes

Error Code	Cause
00 ₁₆	No error has occurred since the last error code was read.
01 ₁₆	Unrecognized command opcode.
02 ₁₆	A parameter was required but a command was received.
03 ₁₆	A parameter is invalid or out of range for the specified command.
04 ₁₆	Reading overrun. The data buffer is full and another measurement is taken. This error also occurs when a new command (opcode) is received while the multimeter is placing a reading in the data buffer. Trigger Arm is disabled.
05 ₁₆	The command or parameter received is not allowed in the two byte reading mode (10 μs aperture time).
0C ₁₆	Command is terminated by another command.
0E ₁₆	The aperture time is longer than the sample rate.
0F ₁₆	Input overload. A potentially damaging voltage has been applied to the multimeter: > +- 40V between HI and LO or HI and COMMON with the range <= 8V > +- 40V between LO and COMMON on any range Under this condition, the multimeter disconnects itself from the input. A new range must be specified to restore operation.

Multimeter Power-On Settings

The multimeter's power-on settings are shown in Table C-4.

Table C-4. Multimeter Power-On Settings

Parameter	Value	Opcode
Function	DCV	00 ₁₆
Range	8V	02 ₁₆
Aperture time	16.7 ms	01 ₁₆
Autozero	ON	00 ₁₆
Offset Compensation	OFF	00 ₁₆
Trigger Source	IMMEDIATE	00 ₁₆
Trigger Count	1	—
Trigger Delay	set by function	—
Sample Count	1	—
Sample Source	IMMEDIATE	00 ₁₆
Sample Rate	50 ms	—
Trigger Arm	OFF	00 ₁₆

Function and Aperture Change Times

Table C-5 lists the times required for the multimeter to change its function and aperture time. The times pertain to both SCPI and register-based programming.

Table C-5. Function and Aperture Change Times

To Function	From Function	
	DCV/OHMS*	ACV
ACV**	530 ms (autozero = ON) 15 ms (autozero = OFF)	---
DCV	750 μ s (from OHMS)	12 ms
OHMS	750 μ s (from DCV)	12 ms
Aperture Time	Function	
	DCV/OHMS*	ACV
320 ms	123 ms	1.0 s
267 ms	106 ms	1.0 s
20 ms	123 ms	1.0 s
16.7 ms	106 ms	1.0 s
2.5 ms	36 ms	1.0 s
100 μ s	24 ms	1.0 s
10 μ s	23 ms	1.0 s
* Including offset compensated OHMS. ** Changing the function to ACV automatically sets a 250 ms trigger delay. This delay can be changed with the Trigger Delay command. Note - range changes are approximately 200 μ s.		

Reading the Table

For example, it takes the multimeter **12 ms** to change its function from ACV to DCV. It takes **23 ms** to set the 10 μ s aperture time for DCV. Thus, to change from ACV/16.7 ms aperture time to DCV/10 μ s aperture time would require:

$$12 \text{ ms (function change)} + 23 \text{ ms (aperture time change)} = 35 \text{ ms.}$$

VME Interrupts

The HP E1326B/E1411B generates interrupt signals on the conditions indicated in Table C-6. These signals are available to the computer (controller) via the VXIbus backplane.

Table C-6. VME Interrupt Conditions

Bit	Decimal Value	Interrupt
0	1	Interrupt on reading available.
1	2	Interrupt on Status Register bit 7 (DONE) = 1.
2	4	Interrupt on an error (Status Register bit 6 = 0.
3	8	Interrupt on Multimeter Complete (Status Register bit 5 = 1).
4	16	Interrupt when data buffer is half full.
<p>A VME interrupt is enabled by sending the following command opcode and the decimal value of the bit representing the interrupt condition: <26> <decimal value></p> <p>The interrupt condition enabled is queried with the opcode: <34></p>		

Appendix D

Measurement Speed and Accuracy Tradeoffs

The HP E1326B SCPI driver was designed so that its default mode of operation will deliver high accuracy readings with a minimum of programming effort. However, many applications require high-speed measurements and reduced reading accuracy is acceptable.

The following guidelines show how to increase measurement speed. Be aware that these guidelines also increase the complexity of the program.

1. Avoid function changes.
2. Avoid aperture changes.
3. Minimize the number of command/response sessions.
4. Do binary transfers to the computer:
 - REAL 32 is fastest and is compatible with compiled languages.
 - REAL 64 is fast and is compatible with HP BASIC.
5. Use macros to minimize command parsing time.
6. Set autozeroing to ONCE or OFF.
7. Turn auto ranging OFF.
8. Decrease aperture time:
 - to reach 10 μ s aperture time you must be on a fixed range.
9. Store the readings in command module RAM instead of sending them directly to the computer.
10. Post process strain and temperature measurements.

Note Only items 7 and 8 may reduce the accuracy of a measurement. The rest of the guidelines involve increased work for the system programmers.

Avoid Function Changes

The E1326B multimeter (DMM) takes time to switch between its various functions because the hardware is reconfigured and calibration constants for the new function are retrieved. Organize your program so all measurements on a function are done at the same time. This is best accomplished with a scan list. For example:

```
10 OUTPUT @Dmm;"MEAS:VOLT:DC? (@100:103)"
20 ENTER @Dmm;Dc_readings(*)
30 OUTPUT @Dmm;"MEAS:RES? (@105,107)"
40 ENTER @Dmm;Res_readings(*)
```

Avoid Aperture Changes

Changing apertures takes a significant amount of time because the multimeter retrieves new calibration constants from its calibration memory and prepares to use them. The easiest way to avoid aperture changes is to directly specify the aperture time. This requires that you not use the MEASure command and that you not specify the optional *<resolution>* parameter in a CONFigure command. For example:

```
10 OUTPUT @Dmm;"CONF:VOLT:DC (@100:103);:VOLT:APER 100e-6;;READ?"
20 ENTER @Dmm;Dc_readings(*)
```

Minimize the Number of Command/Response Sessions

Minimizing the number of command/response sessions involves programming the multimeter to pace itself, rather than the computer pacing the multimeter. The SAMPlE TIMer should be used for single channel pacing or for multiple channel scanning with the FET multiplexers (see page 58). The SAMPlE TIMer will generate an error message if the multimeter cannot keep up. For example:

```
10 OUTPUT @Dmm;"CONF:VOLT:DC;:VOLT:APER 100e-6;"
20 OUTPUT @Dmm;"SAMP:SOUR TIM;SAMP:TIM .02;SAMP:COUNT 200;;READ?"
30 DIM Reading(1:200)
40 ENTER @Dmm;Reading(*)
```

The EXTeRnal TRIGger input can be used to start a scan based on an external signal. In the HP E1300/E1301 mainframe the built-in pacer is a convenient source for an external signal. A potential problem is that if an external trigger arrives before the multimeter is ready to start a new scan, the trigger will be missed and no error message is generated. For example:

```
10 OUTPUT @Dmm;"CONF:VOLT:DC (@100:109);:VOLT:APER 100e-6;"
20 OUTPUT @Dmm;"TRIG:SOUR EXT;TRIG:COUNT 200;;READ?"
30 OUTPUT @Sys;"PULSE:PER .02;PULSE:COUN 200;;INIT"
40 DIM Reading(1:200)
50 ENTER @Dmm;Reading(*)
```

Do Binary Transfers to the Computer

REAL 32 is fastest and is compatible with compiled languages.
REAL 64 is fast and is compatible with HP BASIC.

The default data format between the multimeter and the computer is ASCII. This format is not efficient because the multimeter's internal format is 32-bit REAL. Thus, the multimeter must convert its 32-bit REAL number to ASCII, and then the computer must convert the ASCII number to its internal format which is either 32- or 64-bit REAL.

A REAL number in HP BASIC is a 64-bit REAL. In the C language, variable type "float" is a 32-bit REAL number, and variable type "double" is a 64-bit REAL number.

When an instrument has been programmed to output its readings in either REAL 32 or REAL 64 format, an ANSI/IEEE Standard 488.2-1987 definite length arbitrary block header precedes the binary data. In the header format #, <*non-zero digit*>, <*digits*>, and <*8-bit data byte*> :

- # indicates the data is in an arbitrary block
- <*non-zero digit*> is a single digit number which shows the number of digits contained in "*digits*". For example, if the "*digits*" value is 100 or 2000, the "*non-zero digit*" value is 3 or 4, respectively.
- <*digits*> is the number of 8-bit data bytes which follow the header.
- <*8-bit data byte*> are the multimeter readings. For the PACKED format, each reading is two bytes. For the REAL 64 format, each reading is eight bytes.

Following the last reading in each block is the line feed (LF) character. The line feed must be read from the buffer to prevent Error -410 "Query Interrupted" occurs the next time data is read from the multimeter.

Here is a program which demonstrates the speed differences.\$ISpeed;differences This program was run on a BASIC language co-processor. Note the actual program output at the end.

```
10 !re-save "DMM_FMTS"
20 !This main line code is reserved as a error handling shell.
30 !All application code must be at lower level context.
40 !Define I/O paths.

50 ASSIGN @Sys TO 70900
60 ASSIGN @Dmm TO 70903
70 ASSIGN @Dmm_bin TO 70903;FORMAT OFF
80 COM @Sys,@Dmm,@Dmm_bin
90 !Turn TIMEOUTS to errors--this branch never taken.
100 ON TIMEOUT 7,3 GOTO End
110 !This handles timeouts and errors not handled at lower level contexts.
120 ON ERROR RECOVER Kaboom
130 !Put application code in this sub.
140 Main
```

Continued on Next Page

```

150 GOTO End
160 Kaboom: PRINT ""
170 PRINT ERRM$
180 PRINT "HERE IS THE E13XX ERROR STATUS"
190 E13xx_errors
200 End: END
210 !This sub reads all errors from E13xx instruments.
220 SUB E13xx_errors
230 COM @Sys,@Dmm,@Dmm_bin
240 DIM A$[128]
250 ABORT 7
260 CLEAR @Dmm
270 REPEAT
280 OUTPUT @Dmm;"SYST:ERR?"
290 ENTER @Dmm;A,A$
300 PRINT "DMM ERROR ";A$
310 UNTIL A=0
320 !
330 CLEAR @Sys
340 REPEAT
350 OUTPUT @Sys;"SYST:ERR?"
360 ENTER @Sys;A,A$
370 PRINT "SYSTEM ERROR ";A$
380 UNTIL A=0
390 SUBEND
400 !This subroutine is treated as the main line.
410 SUB Main
420 COM @Sys,@Dmm,@Dmm_bin
430 !Put application code here.
440 !Program the DMM to take 10000 readings FAST.
450 OUTPUT @Dmm;"CONF:VOLT:DC;;VOLT:RANGE:AUTO
OFF;;CAL:ZERO:AUTO OFF;;VOLT:APER MIN"
460 OUTPUT @Dmm;"SAMP:SOUR TIM;SAMP:TIM 76E-6;SAMP:COUNT 10000"
470 !Take the readings now
480 OUTPUT @Dmm;"INIT;*OPC?"
490 ENTER @Dmm;A
500 !Now time taking the 10000 readings out in ASCII
510 OUTPUT @Dmm;"FORMAT ASCII"
520 DIM Readings(1:10000)
530 OUTPUT @Dmm;"FETCH?"
540 Start=TIMEDATE

```

Continued on Next Page

```

550 ENTER @Dmm;Readings(*)
560 Stop=TIMEDATE
570 PRINT "TIME TO READ 10000 READINGS IN ASCII=";(Stop-Start)
580 !Now transfer the same data in BASIC internal format REAL 64.
590 OUTPUT @Dmm;"FORMAT REAL,64"
600 DIM Ndig$[1],Count$[9]
610 OUTPUT @Dmm;"FETCH?"
620 Start=TIMEDATE
630 !Read the header.
640 ENTER @Dmm USING "#,X,K,K";Ndig$,Count$[1;VAL(Ndig$)]
650 !Read the data.
660 ENTER @Dmm_bin;Readings(*)
670 !Read the LF.
680 ENTER @Dmm;Lf$
690 Stop=TIMEDATE
700 PRINT "TIME TO READ 10000 READINGS IN REAL 64= ";(Stop-Start)
710 !Now transfer the same date in REAL 32 format.
720 !If this is going to BASIC it would later need to be converted.
730 OUTPUT @Dmm;"FORMAT REAL,32"
740 !It take two integers per reading.
750 INTEGER I_readings(1:20000)
760 OUTPUT @Dmm;"FETCH?"
770 Start=TIMEDATE
780 !Read the header.
790 ENTER @Dmm USING "#,X,K,K";Ndig$,Count$[1;VAL(Ndig$)]
800 !Read the data.
810 ENTER @Dmm_bin;I_readings(*)
820 !Read the LF.
830 ENTER @Dmm;Lf$
840 Stop=TIMEDATE
850 PRINT "TIME TO READ 10000 READINGS IN REAL 32=";(Stop-Start)
860 SUBEND
870 !

```

TIME TO READ 10000 READINGS IN ASCII = 34.75

TIME TO READ 10000 READINGS IN REAL 64 = 8.14999389648

TIME TO READ 10000 READINGS IN REAL 32 = 1.82000732422

Use Macros to Minimize Command Parsing Time

Macros provide the fastest programming method when it is necessary to change functions from one measurement to the next. If you are not changing functions, then it is just as fast to repeat a measurement using INIT;:FETCH? or READ?.

Program with macros if more than one scan list or function is needed. The firmware has allocated space for approximately 50 macros.

```
OUTPUT @Dmm;"*PMC;*EMC 1" !To initialize Purge old macros.  
!Enable macros.
```

```
!Define the MACRO. Choose a short name such as M1.
```

```
!The #225 is an IEEE 488.2 arbitrary block header in the form #ndd
```

```
! # means block specifier
```

```
 n is the number of dd to follow
```

```
 dd is the number of characters
```

```
!
```

```
OUTPUT @Dmm;"*DMC ""M1"",#234MEAS:VOLT:DC?,300,1000, (@100:115)"
```

```
!To use the Macros.
```

```
OUTPUT @Dmm;"M1"
```

```
ENTER @Dmm;Reading(*) !This example is doing ASCII transfer.
```

Set Autozeroing to ONCE or OFF

Autozeroing causes the A/D to alternately measure its internal zero and the external signal. Autozeroing improves reading accuracy; however, it reduces reading speed by $\frac{1}{2}$.

```
CAL:ZERO:AUTO ON      ----The zero will be measured before each  
                        measurement.
```

```
CAL:ZERO:AUTO OFF     ---- No new zero readings will be made.
```

```
CAL:ZERO:AUTO ONCE    ---- Does one Autozeroing operation when the  
                        command is received and also sets the mode  
                        to autozeroing OFF.
```

The zero may vary over time, especially as the room temperature varies. Noticeable changes can be expected over many minutes or hours. However, over a few seconds the changes should be very small.

When a scan list is used the readings occur as a burst, thus little is gained by auto zeroing each reading.

Turn Auto Ranging OFF

Turning auto ranging OFF makes the E1326B take all of its measurements on a fixed range which results in fast and predictable measurement times. Also, auto ranging must be turned OFF in order to set a 10 μ s aperture time.

Auto ranging is turned OFF when a numeric value or MIN | MAX is specified for the *<range>* parameter of the CONFIGure, MEASure, [SENSe:]RESistance:RANGe, [SENSe:]VOLTage:RANGe, or [SENSe:]VOLTage:AC:RANGe command. Auto ranging is directly controlled by the [SENSe:]VOLTage:RANGe:AUTO ON | OFF, [SENSe:]VOLTage:AC:RANGe:AUTO ON | OFF, or [SENSe:]RESistance:RANGe:AUTO ON | OFF command.

You can verify the auto range mode by querying the E1326B as to its auto range status using the following commands:

```
[SENSe:]VOLTage:RANGe:AUTO?
```

```
[SENSe:]VOLTage:AC:RANGe:AUTO?
```

```
[SENSe:]RESistance:RANGe:AUTO?
```

Decrease Aperture Time

The aperture time is the amount of time that the input signal is integrated. The available choices are 10 μ s, 100 μ s, 2.5 ms, 16.7 ms, 20 ms, 267 ms, and 320 ms. The smaller the aperture time, the faster the readings are taken.

The 10 μ s aperture time can only be entered if auto ranging is first turned OFF.

A disadvantage to faster aperture times is that increased noise will be present in the measured values. The most common source of noise is from AC power sources.

The magnitude of noise from AC power sources is commonly many milli-volts. If the signal being measured is large enough, then the noise may not be significant. However, if the signal being measured is in the micro-volt range, then noise becomes a factor.

The E1326B default aperture time is 16.7 ms in countries with 60 Hz power, or 20 ms in countries with 50 Hz power. Integrating for one or sixteen power line cycles causes the E1326B to reject power line frequencies that are coupled into the measured signal. For example, the specification of 60 db of normal mode rejection will cause 1 mV of noise to be reduced to 1 μ V of noise.

Setting the Resolution

The aperture time is set as a result of specifying the *<resolution>* parameter in the MEASure or CONFigure command, or by directly setting it with the VOLTage:APERture or RESistance:APERture command.

Table 4-5 on page 92 can be used to pick a value for the *<resolution>* parameter in a MEASure or CONFigure command when you want to set the aperture time. Select the range and aperture, and then look up the resolution from the table. Round the resolution up to one less significant digit and use it in the CONFigure or MEASure command.

A less complicated method used to set the aperture time is to specify it directly. This requires that you use the VOLTage:APERture command. For example:

```
10 OUTPUT @Dmm;"CONF:VOLT:DC (@100:103);:VOLT:APER 100e-6;:READ?"
20 ENTER @Dmm;Dc_readings(*)
```

Temperature Measurements

Thermocouple temperature measurements are actually a computation following both a voltage and a resistance measurement. Thermistor or RTD temperature measurements are actually a computation following a resistance measurement. To change the aperture for temperature, you need to change the RESistance:APERture for thermistor measurements and the RESistance:APERture and VOLTage:APERture for thermocouple measurements. For example:

```
10 OUTPUT 70903;"CONF:TEMP TC,J,(@100:115)"
20 OUTPUT 70903;"VOLT:APER MIN;:RES:APER MIN"
30 OUTPUT 70903;"READ?"
40 ENTER 70903;Reading(*)
```

Store the Readings in Command Module RAM Instead of Sending them Directly to the Computer

There is a major difference between INIT::FETCH? and READ? after a CONFIGure command.

INIT::FETCH?

When the INITiate command is sent to the HP E1326B, the multimeter will reserve four bytes per reading of command module RAM to hold the total number of readings that the E1326B multimeter has been configured to take. For example:

```
CONF:VOLT:DC?
```

```
SAMP:COUNT 1000
```

```
INIT
```

!Reserves room for 1000 four byte readings

```
FETCH?
```

The HP E1326B then takes the readings as soon as its trigger conditions have been satisfied. For example, if the trigger source is IMMEDIATE, the readings are started once INITiate is executed. If the trigger source is BUS, then the readings are started when a group execute trigger is received.

The FETCH? command causes the readings that have been stored in the HP E1300/E1301 RAM (or command module RAM) to be retrieved and sent over the HP-IB bus. No readings are output until all readings have been taken and stored in RAM. This results in a burst-then-transfer mode of operation.

This mode of operation has been designed so that readings from the E1326B multimeter can be received and placed into RAM at any reading rate up to 13 kHz. The 13 kHz rate is achieved with auto zeroing and auto ranging OFF, and the 10 μ s aperture time selected. In this mode, the E1326 does a two-pass process on the data. In response to the INIT command, the multimeter readings are placed into RAM in the multimeter's internal format as they are taken. When the first pass ends, the readings in RAM are converted to 32-bit REAL numbers. The FETCH? command outputs the readings in the format that has been selected.

The maximum number of readings is limited by the amount of RAM in the HP E1300/E1301 mainframe or command module. The RAM is used up at the rate of four bytes per reading.

READ? The READ? command causes the E1326B multimeter to start taking readings as soon as the trigger requirements have been met (see INIT;:FETCh).

The READ? command, however, causes NO RAM in the command module (or E1300/E1301 mainframe) to be allocated for E1326B reading storage. Instead, E1326B readings are placed directly in the HP-IB output buffer.

This is the mode of operation that should be used when readings need to be taken at a continuous rate.

The controller needs to remove the readings at a rate such that the HP-IB output buffer (128 characters) and the 512 word multimeter Data Register (used when SAMPlE:SOURce TIM is used) does not overflow.

The readings in the multimeter's Data Register are in the multimeter internal format. For example:

- 10 μ s aperture == one word per reading
- all other apertures == two words per reading

The readings in the output buffer are in the format specified by the FORMat command. For example, FORMat ASCII, FORMat REAL 32, FORMat REAL 64.

Post Process Strain and Temperature Measurements

The temperature and strain measurements are computations done on voltage and resistance measurements. The computations are done at the end of each pass through a scan list. This computation limits the maximum speed.

With thermocouple temperature measurements, function changing times are also involved in the measurements as the RESistance function is used to measure a 5000 Ω thermistor on the isothermal terminal block, and then the voltage function is used to measure each thermocouple.

The method used to make fast temperature and strain measurements is to make the measurements using the voltage and resistance functions. After all measurements have been completed the computer can convert the readings to the desired final units (i.e., temperature, strain). This maximizes measurement speed, but also increases program complexity.

- *CLS, 178, 186
- *DMC, 186
- *EMC, 186
- *EMC?, 186
- *ESE, 186
- *ESE?, 186
- *ESR?, 186
- *GMC?, 186
- *IDN?, 186
- *LMC?, 186
- *OPC, 186
- *OPC?, 186
- *PMC, 186
- *RCL, 114, 186
- *RMC, 186
- *RST, 17, 186
- *SAV, 114, 186
- *SRE, 186
- *SRE?, 186
- *STB?, 186
- *TRG, 103, 122, 186
- *TST?, 16, 186
- *WAI, 186

A

- A16 Address Space, 199 - 200
 - inside command module, 201
 - inside embedded controller, 201
 - inside mainframe, 201
 - outside command module, 200
 - outside mainframe, 200
- Abbreviated SCPI Commands, 118
- ABORt, 112 - 113, 122
- Aborting Measurements, 112 - 113, 122
- AC Voltage Measurements
 - AC-coupled, 86, 130, 147
 - CONFigure:VOLTage:AC, 130
 - connecting for, 33
 - MEASure:VOLTage:AC?, 147
 - percent overrange, 92, 120
 - range, 92, 120, 169
 - resolution, 92, 120, 175
 - RMS, 86, 130, 147
 - specifications, 194 - 195
 - VOLTage:AC:RANGe, 169
- Access Annunciator (E1411B only), 16
- Accessing the Registers, 202
- Adapter
 - A/B to C-size, 37
 - HP E1326B, 25
- Address
 - A16 address space, 199
 - base address, 200 - 201
 - bytes per register-based device, 201
 - bytes per VXI device, 200
 - external memory board, 150
 - logical, 22 - 23, 200 - 201
 - registers, 199, 201 - 202
 - secondary, 22
- Analog Bus
 - cables, 30 - 31, 37 - 38
 - connections, 31
 - connections at multimeter, 31
 - port, 15
- Aperture Time
 - changes, 266
 - changing, 270
 - decreasing, 275
 - description, 97
 - four-byte reading mode, 208
 - See also* Integration Time (PLC)
 - minimum sample period, 110
 - parameters, 91, 97
 - querying, 98, 164, 171
 - RESistance:APERture, 98, 163
 - sample period (minimum), 159
 - saved in memory, 114
 - setting, 98, 110, 163, 171
 - table listing, 92, 120
 - two-byte reading mode, 208
 - VOLTage:APERture, 98, 171
- Arbitrary Block Header, 140, 271
- ASCII Data Format, 140, 271
- Assemblies, carrier cable, 37
- Autorange
 - description, 94

- enabling, 167, 174
- parameters, 94
- querying setting, 95, 168, 175
- RESistance:RANGe:AUTO, 94, 167
- setting, 94
- VOLTage:RANGe:AUTO, 94, 174

Autozero

- CALibration:ZERO:AUTO, 99, 124
- description, 99, 124
- disabling, 124, 275
- enabling, 99, 124, 274
- parameters, 91, 99, 124
- querying, 99
- querying mode, 124
- saved in memory, 114

B

Backplane

- closing channels, 135
- FET multiplexer control, 135
- interrupt line, 24

Base Address, 200

- inside embedded controller, 201

BASIC Example Programs

- See* HP BASIC/WS Example Programs

Binary

- data format, 58
- transfers to computer, 271

Bits

- device dependent error, 67, 81
- message available, 68
- status, 207

Block Length, 80

Boolean Parameters, 119

Burst Measurements, making, 43 - 46

C

C Language Example Programs

- high-speed scanning, 253 - 261
- reading error codes, 232 - 233
- reading the device type register, 225
- reading the query response register, 228 - 229
- resetting the multimeter, 222
- scanning multimeter measurements, 253 - 261
- stand-alone multimeter measurements, 239 - 245

Cables

- analog bus, 30 - 31, 37 - 38
- digital bus, 30 - 31, 37 - 38
- for B-size multiplexers, 38
- list of connecting, 37 - 38
- shielded, 32

- shielded twisted-pair, 32
- CALibration Subsystem, 123 - 124
- CALibration:LFRequency, 123
- CALibration:LFRequency?, 123
- CALibration:ZERO:AUTO, 99, 124
- CALibration:ZERO:AUTO?, 99, 124
- Carrier Cable Assemblies, 37
- Certification, 7

Changing

- AC voltage range, 170
- aperture time, 270
- data format, 58 - 59
- DC voltage range, 172
- DC voltage resolution, 176
- function, 270
- range, 166
- resolution, 169

Channel

- closing via backplane, 135
- closing via digital bus, 135
- list scanning, 46 - 49
- monitoring single, 136 - 137
- pairs, 88
- query monitor mode, 137
- sense, 88, 130, 147
- source, 88

Checking for Errors, 66 - 67, 214

CLEAR Command, 19, 113, 122

Clearing the Multimeter, 19

- error queue, 19 - 20, 178

*CLS, 178, 186

Codes for Self-test, 17

COM Lead, connecting, 32

Command Module

- A16 address space, 199 - 201
- default IRQ line, 24
- memory, 114

Command Reference, 117 - 121

- SCPI commands, 121

Command Register, 204

Commands

- ABORt, 112, 122
- alphabetical listing, 117 - 121
- CALibration, 123 - 124
- CLEAR, 19, 113, 122
- common (*) command format, 117
- CONFigure, 42, 76 - 79, 126 - 130, 132 - 133
- CONFigure?, 134
- DIAGnostic, 135
- DISPlay, 136 - 138
- FETCh?, 83, 139, 277
- FORMat, 140
- FORMat?, 141

- INITiate, 142
- linking, 119
- MEASure, 42, 76 - 78, 82, 143 - 149
- MEMory, 150 - 152
- opcodes, 262 - 263
- OUTPut, 153 - 154
- parsing time, 274
- quick reference, 187 - 188
- READ?, 82, 155, 278
- SAMple, 157 - 160
- SCPI format, 117
- [SENSe:], 161 - 176
- SYSTem, 177 - 178
- TRIGger, 179 - 184
- types, 117
- Comment sheet, reader, 11
- Common (*) Commands
 - *CLS, 178, 186
 - *DMC, 186
 - *EMC, 186
 - *EMC?, 186
 - *ESE, 186
 - *ESE?, 186
 - *ESR?, 186
 - format, 117
 - *GMC?, 186
 - *IDN?, 186
 - linking with SCPI, 119
 - *LMC?, 186
 - *OPC, 186
 - *OPC?, 186
 - *PMC, 186
 - *RCL, 114, 186
 - reference, 186
 - *RMC, 186
 - *RST, 17, 186
 - *SAV, 114, 186
 - *SRE, 186
 - *SRE?, 186
 - *STB?, 186
 - *TRG, 103, 122, 186
 - *TST?, 16, 186
 - *WAI, 186
- Common Mode Rejection
 - effective, 97
 - ratio, 97
- Computer
 - binary transfers to, 271
 - reading destinations, 81
 - resetting from, 17
 - synchronizing multimeter with, 68
- Configurations
 - recalling, 114 - 115
 - saving, 14, 114 - 115
 - setting with CONFigure, 78
 - using MEASure and CONFigure, 77
- CONFigure
 - commands, 126 - 130, 132 - 133
 - making measurements with, 78 - 79
 - parameters, 91
 - subsystem, 126 - 130, 132 - 133
 - used in example programs, 42
 - used in place of MEASure, 42
- CONFigure and MEASure
 - commands, 76 - 77
 - equivalent commands, 77
 - used as a single command, 14
 - used in example programs, 42
- CONFigure:FRESistance, 127
- CONFigure:RESistance, 128 - 129
- CONFigure:TEMPerature, 129
- CONFigure:VOLTage:AC, 130
- CONFigure:VOLTage[:DC], 132 - 133
- CONFigure? Command, 134
- Configuring the Multimeter, 14, 21 - 40, 211 - 212
- Conformity, declaration, 9 - 10
- Connecting
 - analog bus cables, 30
 - analog bus to multimeter, 31
 - COM lead, 32
 - digital bus cables, 30
 - for 4-wire measurements, 35
 - for measurements, 33 - 35
 - HP E1326B Adapter, 25
 - input signals, 32
 - multiplexers to multimeter, 30 - 31, 33 - 38
 - thermocouples, 36
- Control Register, 203
 - sampling, 219
- Converting Readings, 209

D

- Data
 - buffer register, 208
 - retrieving from memory, 83 - 84
 - storing in memory, 82 - 83
- Data Format, 80
 - ASCII, 80, 140, 271
 - binary, 58
 - changing, 58 - 59
 - default format, 80, 271
 - definite length arbitrary block, 58, 80
 - external VME, 150
 - length, 140
 - query, 141

- REAL-32, 80, 140, 271
- REAL-64, 58, 80, 140, 271
- selecting, 80
- specifying, 80, 140
- vs. reading destination, 81
- DC Voltage Measurements, 42
 - accuracy conditions, 190
 - changing to 4-wire measurement, 91
 - CONFigure:VOLTage[:DC], 132 - 133
 - connecting for, 33
 - description, 86
 - MEASure:VOLTage[:DC]?, 148 - 149
 - percent overrange, 92, 120
 - range, 92, 120, 172
 - resolution, 92, 120, 175
 - specifications, 190
 - specifying, 86
 - using autozero, 99
 - VOLTage[:DC]:RANGe, 172
- Declaration of Conformity, 9 - 10
- Default Data Format, 271
- Definite Length Arbitrary Block, 58, 80
- Description, 13
- Device Dependent Error Bit, 67
 - setting in overload, 81
- Device Type Register, 206, 224 - 225
- DIAGnostic Subsystem, 135
- DIAGnostic:FETS, 135
- DIAGnostic:FETS?, 135
- Digital Bus
 - cables, 30 - 31, 37 - 38
 - closing channels, 135
 - connecting, 30
 - FET multiplexer control, 135
 - overview, 31
 - port, 15
- Disabling
 - autozero, 124, 275
 - front-panel mainframe keyboard, 39
 - offset compensation, 165
 - trigger delay, 182
 - VME memory card, 152
- Discrete Parameters, 119
- DISPlay Subsystem, 136 - 138
- DISPlay:MONitor:CHANnel, 136
- DISPlay:MONitor:CHANnel?, 137
- DISPlay:MONitor[:STATe], 137
- DISPlay:MONitor[:STATe]?, 138
- *DMC, 186
- Documentation History, 8

E

- Effective Common Mode, 97
- Electrical Description, 14
- Embedded Controller
 - base address, 201
- *EMC, 186
- *EMC?, 186
- Enabling
 - autorange, 167, 174
 - autozero, 99, 124, 274
 - offset compensation, 101, 165
 - trigger delay, 182
 - VME memory card, 152
- Error
 - checking for, 66 - 67, 214
 - codes, 264
 - codes, list of, 264
 - codes, reading, 230 - 233
 - messages, 197 - 198
 - queue, 19 - 20, 178
- *ESE, 186
- *ESE?, 186
- *ESR?, 186
- Example Programs
 - aborting a measurement, 113
 - burst measurements, 43 - 46
 - changing measurement functions, 91
 - changing the data format, 58 - 59
 - channel list scanning, 46 - 49
 - checking for errors, 66 - 67
 - data format, selecting, 80
 - entering data into computer, 82
 - externally triggered burst of measurements, 44
 - externally triggered scan, 49
 - maximizing measurement accuracy, 63
 - maximizing measurement speed, 56 - 57
 - measurements using single trigger, 112
 - multimeter self-test, 16
 - multiple burst measurements, 45
 - multiple high-speed scans, 54 - 55
 - multiple paced scans, 48
 - multiple scans, 47
 - read/clear error queue, 19
 - reading an error code, 230 - 233
 - reading the device type register, 224 - 225
 - reading the ID register, 223
 - reading the query response register, 226 - 229
 - register-based programming, 220 - 261
 - resetting the multimeter, 221 - 222
 - retrieving data from memory, 84
 - saving/recalling configurations, 115
 - scanning a channel list, 46 - 49
 - scanning B-size switchbox channels, 50 - 51
 - scanning C-size switchbox channels, 52 - 53

- scanning multimeter measurements, 20, 246 - 261
- setting aperture time and sample period, 110
- setting sample count, 108
- setting trigger count, 105
- setting trigger delay, 107
- single measurements, 42
- speed differences, 271
- stand-alone multimeter measurements, 20, 234 - 245
- storing readings in mainframe memory, 83
- storing readings in shared memory, 64 - 65
- synchronizing multimeter with a computer, 68
- using a PC, C language, and HP-IB card, 60 - 62
- using E1345A configured as a switchbox, 71 - 73

External Trigger

- burst of measurements, 44
- port, 15, 103
- scan, making, 49

External VME Memory Board, 150 - 152

F

Failed Annunciator (E1411B only), 16

FET Multiplexer Control, 135

FEtCh? Command, 83, 139, 277

FORMat Subsystem, 140

FORMat[:DATA], 140

FORMat? Command, 141

Four-byte Readings, 208 - 209

Four-wire

- resistance measurements, 35, 127, 144, 192 - 193
- resistance measurements, channel pairs, 88
- resistance measurements, CONFigure:FRESistance, 127
- resistance measurements, description, 88
- resistance measurements, MEASure:FRESistance?, 144
- resistance measurements, range, 166
- resistance measurements, resolution, 168
- resistance measurements, scanning multimeter, 87
- resistance measurements, stand-alone multimeter, 87
- resistance measurements, table listing, 92, 120
- resistance measurements, using offset compensation, 100, 165
- RTD measurements, 35, 90
- temperature measurements, 129 - 130, 146 - 147
- thermistor measurements, 35, 89
- vs. two-wire measurements, 87

Front Panel

- keyboard disabling, 39
- resetting from, 17

Function

- change times, 266
- changing, 270

- measurement, 14, 162
- specifying, 90

Functional Description, 14

G

Getting Started, 13 - 20

*GMC?, 186

Group Execute Trigger (GET), 103, 122

H

High-speed Scanning, 269 - 278

- example program, 253
- multiple scans, 54 - 55

How To Make Measurements, 78

HP BASIC/WS Example Programs

- reading error codes, 230 - 231
- reading the device type register, 224
- reading the ID register, 223
- reading the query response register, 226 - 227
- resetting the multimeter, 221
- scanning multimeter measurements, 246 - 252
- speed differences, 271
- stand-alone multimeter measurements, 234 - 238

HP E1326B

- connecting the adapter, 25
- input terminals, 29
- installing in the mainframe, 25
- scanning switchbox channels with, 50 - 51
- SCPI driver, 269
- stand-alone instrument, 39

HP E1344A

- reference thermistor, 89
- terminal module connections, 36
- thermocouple measurements, 130, 146
- thermocouple types, 89

HP E1345A

- configured as switchbox, 71 - 73
- terminal module connections, 33 - 35

HP E1346A

- terminal module connections, 33 - 34

HP E1347A

- reference thermistor, 89
- terminal module connections, 33 - 36
- thermocouple measurements, 130, 146
- thermocouple types, 89

HP E1351A

- high-speed scanning, 253
- terminal module connections, 33 - 35

HP E1352A

- terminal module connections, 33 - 34

HP E1353A

- reference thermistor, 89
- terminal module connections, 33 - 36
- thermocouple measurements, 130, 146
- thermocouple types, 89
- HP E1403B Adapter, 37
 - cables, 38
- HP E1411B
 - high-speed scanning, 253
 - input terminals, 29
 - installing in mainframe, 26
 - scanning switchbox channels with, 52 - 53
 - TTLTrg line, 153
- HP E1460A
 - making measurements, 246
 - scanning switchbox channels with, 52 - 53
 - terminal module connections, 33 - 35
- HP E1476A
 - reference thermistor, 89
 - terminal module connections, 36
 - thermocouple measurements, 130, 146
 - thermocouple types, 89
- HP-IB
 - CLEAR command, 113, 122
 - group execute trigger (GET), 103, 122
 - interface card, 60 - 62
 - secondary address, 22

I

- ID Register, 205, 223
- *IDN?, 186
- IEEE 488.2 Commands
 - See* Common (*) Commands
- Implied SCPI Commands, 118
- Increasing
 - measurement speed, 269 - 278
 - reading rates, 82
 - throughput speed, 58
- Induced Voltage, 100
- INITiate Subsystem, 142
- INITiate:FETCh?, 277
- INITiate[:IMMediate], 111, 142
- Input
 - characteristics, 28, 189
 - signals, connecting, 32
 - terminals, 15, 29
- Installation Overview, 21
- Instrument, definition of, 13
- Integration Time (PLC)
 - See also* Aperture Time
 - description, 97
 - parameters, 91, 97
 - querying, 98, 165, 174

- RESistance:NPLC, 98, 164, 173
 - saved in memory, 114
 - setting, 98, 163 - 164, 171, 173
 - table listing, 92, 120
 - VOLTage:NPLC, 98, 173
- Interface Card, HP-IB, 60 - 62
- Internal Installation, HP E1326B, 25
- Interrupt
 - lines, 24
 - priority, 24
 - VME, list of, 267
- Introduction to Operation, 16
- IRQ Jumper Setting, 24

J

- Jumper, IRQ, 24

L

- LADDR, 22 - 23, 200 - 201
- Language Used In Programming, 41
- Line Reference Frequency, 123
- Linking Commands, 119
- *LMC?, 186
- Logical Address
 - factory setting, 22 - 23, 200 - 201
 - register-based, 200 - 201
 - setting, 22 - 23, 200 - 201

M

- Macros, 274
- Mainframe
 - A16 address space, 199 - 201
 - disabling keyboard, 39
 - E1411B installation, 26
 - HP E1326B internal installation, 25
 - installing the E1326B adapter, 25
 - memory, 82, 114
 - reading destinations, 81 - 82
 - retrieving data from memory, 83 - 84
- Making
 - a measurement, 78
 - externally triggered scan, 49
 - measurements, 20
 - measurements using CONFigure, 78 - 79
 - measurements using MEASure, 78, 82
 - measurements using READ?, 82
 - multiple paced scans, 48
 - multiple scans, 47 - 48
- Maximizing
 - measurement accuracy, 63

- measurement speed, 56 - 57
- MEASure
 - commands, 143 - 149
 - making measurements with, 78, 82
 - parameters, 91
 - subsystem, 143 - 149
 - used as a single command, 20
 - used in example programs, 42
- MEASure and CONFigure
 - commands, 76 - 77
 - equivalent commands, 77
 - used as a single command, 14
 - used in example programs, 42
- MEASure:FRESistance?, 144
- MEASure:RESistance?, 145 - 146
- MEASure:TEMPerature?, 146
- MEASure:VOLTage:AC?, 147
- MEASure:VOLTage[:DC]?, 148 - 149
- Measurement Function
 - of multimeter, 14, 86
 - other than DC voltage, 42
 - querying, 162
 - saved in memory, 114
 - selecting, 162
- Measurements
 - AC voltage, 33, 86, 130, 147, 169
 - burst, 43 - 46
 - connections, 33 - 36
 - DC voltage, 20, 33, 86, 132 - 133, 148 - 149, 172
 - externally triggered burst, 44
 - externally triggered scan, 49
 - four-wire resistance, 35, 88, 127, 144
 - full bridge strain, 86
 - half bridge strain, 86
 - how to make, 78
 - in output buffer, 139
 - making, 20
 - maximizing accuracy, 63
 - maximizing speed, 56 - 57
 - multiple burst, 45
 - multiple high-speed scans, 54 - 55
 - multiple paced scans, 48
 - multiple scans, 47 - 48
 - overload indications, 81
 - quarter bridge strain, 86
 - resistance, 34 - 35, 87 - 88
 - retrieving, 213
 - RMS AC voltage, 86, 130, 147
 - RTD resistance, 35, 89 - 90, 276
 - scanning a channel list, 46 - 49
 - scanning B-size switchbox channels, 50 - 51
 - scanning C-size switchbox channels, 52 - 53
 - single, 42
 - speed tradeoffs, 269 - 278
 - temperature, 88, 129, 146, 276
 - thermistor, 88, 276
 - thermistor resistance, 35, 89
 - thermocouple, 89, 276
 - two-wire resistance, 34, 88, 128 - 129, 145 - 146
 - two-wire vs. four-wire, 87
 - using CONFigure commands, 78 - 79
 - using MEASure commands, 78, 82
 - using READ? commands, 82
 - using single trigger, 112
- Memory
 - amount used for readings, 14
 - command module, 114
 - mainframe, 82, 114
 - parameters stored, 114
 - reading capacity, 83
 - retrieving data from, 83 - 84
 - saving configurations in, 14
 - shared, 64 - 65, 84, 150
 - storing readings in, 64 - 65, 83
 - subsystem, 150 - 152
 - VME memory card, 150 - 152
- MEMory:VME:ADDRess, 150
- MEMory:VME:ADDRess?, 150
- MEMory:VME:SIZE, 151
- MEMory:VME:SIZE?, 151
- MEMory:VME:STATe, 152
- MEMory:VME:STATe?, 152
- Message Available Bit
 - setting, 68
- Multimeter
 - analog bus connections, 31
 - command reference, 117 - 121
 - configuring, 14, 21 - 40, 211 - 212
 - description, 13
 - error messages, 197 - 198
 - installation overview, 21
 - logical address, 22 - 23, 200 - 201
 - maximum voltage allowed, 29
 - measurement functions, 14, 86
 - overview, 13
 - parameters, 91
 - power-on settings, 18, 265
 - resetting, 17, 210, 221 - 222
 - self-test, 16
 - specifications, 189 - 196
 - synchronizing with a computer, 68
 - triggering, 14, 101 - 113, 179 - 184, 217 - 219
 - understanding the, 75 - 116
 - using with a multiplexer, 29 - 38, 216
 - wait-for-trigger state, 142
- Multiple

- burst measurements, 45
- high-speed scans, 54 - 55
- scans, making, 47 - 48

Multiplexer

- AC voltage measurement, 130, 147
- connected to multimeter, 14, 29 - 31, 33 - 35
- DC voltage measurement, 132 - 133, 148 - 149
- FET control, 135
- four-wire resistance measurement, 127, 144
- monitor single channel, 136 - 137
- temperature measurements, 130, 146
- two-wire resistance measurement, 128, 145 - 146
- using with multimeter, 29 - 38, 216
- voltage ratings, 29

N

- Noise Rejection Conditions, 189
- Non-Zero Digit, 80
- Normal Mode Rejection (NMR), 27
 - increasing, 97
 - ratio, 97
- Numeric Parameters, 119

O

Offset

- register, 202
- voltage, 100

Offset Compensation

- 2-wire resistance measurements, 100
- 4-wire resistance measurements, 100
- autozero override, 100
- description, 100 - 101
- disabling, 165
- enabling, 101, 165
- four-wire resistance measurements, 165
- parameters, 91, 100 - 101
- querying, 101, 165
- RESistance:OCOMpensated, 101, 165
- saved in memory, 114
- two-wire resistance measurements, 165

Ohms Ranges, 92, 120

- *OPC, 186
- *OPC?, 186

Opcodes, 262 - 263

Operating Characteristics, 15

Operation, introduction to, 16

Optional SCPI Command Parameters, 119

Output Buffer

- capacity, 139, 155
- measurement storage, 139

OUTPut Subsystem, 153 - 154

OUTPut:TTLTrgn[:STATe], 153

OUTPut:TTLTrgn[:STATe]?, 154

Overload Indications, 81

Overrange, 92, 120

Overview

- digital bus, 31
- installation, 21
- multimeter, 13

P

Pacing

- multiple paced scans, 48
- source, 158 - 159

Parameter Register, 204

Parameters

- aperture time, 91, 97
- autorange, 94
- autozero, 91, 99, 124
- boolean, 119
- discrete, 119
- integration time, 91, 97
- numeric, 119
- offset compensation, 91, 100 - 101
- opcodes, 262 - 263
- optional SCPI, 119
- querying, 215
- range, 91, 93
- resolution, 91, 95 - 96
- saved in memory, 114
- SCPI commands, 119
- trigger count, 104
- trigger delay, 106
- trigger source, 103

Percent Overrange, 92, 120

Physical Description, 15

- *PMC, 186

Ports

- analog bus, 15
- digital bus, 15
- external trigger, 103
- external trigger, 15

Power Line

- cycles (PLC), integration time, 164, 173
- cycles (PLCs), 27, 97
- frequency, 27
- noise, 27

Power-on

- configuration, 17
- settings, 18, 265

Programming

- language, 41

- register-based, 199 - 268
- timing and execution, 210

Q

- Query Response Register, 207, 226 - 229
 - reading an error code, 230 - 233
- Querying
 - AC voltage range, 170
 - aperture time, 98, 164, 171
 - autorange mode, 168, 175
 - autorange setting, 95
 - autozero, 124
 - autozero mode, 99
 - data format, 141
 - DC voltage range, 173
 - FET multiplexer mode, 135
 - integration time, 98, 165, 174
 - line reference frequency, 123
 - measurement function, 162
 - monitor mode channel, 137
 - monitor mode state, 138
 - multimeter parameters, 215
 - multiplexer configuration, 134
 - offset compensation, 165
 - offset compensation mode, 101
 - pacing source, 159
 - range, 94, 167
 - reference frequency, 27
 - resolution, 96, 169
 - sample count, 108, 158
 - sample period, 110, 160
 - sample source, 110
 - trigger count, 105, 180
 - trigger delay, 107, 181 - 182
 - trigger source, 103, 185
 - VME memory address, 150 - 151
 - VME memory size, 151
 - VME memory state, 152
 - voltage resolution, 176
- Quick Reference SCPI Commands, 187 - 188

R

Range

- AC voltage, 92, 120, 169
- changing, 166
- DC voltage, 92, 120, 172
- default, 94
- description, 93
- four-wire resistance, 166
- parameters, 91, 93
- querying, 94, 167, 170, 173

- RESistance:RANGe, 93, 166
 - saved in memory, 114
 - setting, 93, 166
 - two-wire resistance, 166
 - VOLTage:AC:RANGe, 93
 - VOLTage:RANGe, 93
- *RCL, 114, 186
- READ Registers, 205 - 208
 - data buffer, 208
 - device type, 206, 224 - 225
 - ID, 205, 223
 - query response, 207, 226 - 233
 - status, 206
- READ? Command, 82, 155, 278
 - entering data with, 82
- Reader comment sheet, 11
- Reading
 - card description, 177
 - card type, 178
 - destinations, 80 - 85
 - device type register, 224 - 225
 - error codes, 230 - 233
 - error queue, 19 - 20, 178
 - four-byte, 209
 - ID register, 223
 - number per trigger, 157
 - placed in RAM, 139
 - query response register, 226 - 229
 - rate, conditions, 189
 - rates, 159
 - rates, increasing, 82
 - registers, 200
 - storage, 14, 83, 150
 - two-byte, 209
- REAL 32 Data Format, 80, 140, 271
- REAL 64 Data Format, 80, 140, 271
 - changing to, 58
- Recalling Multimeter Configurations, 114 - 115
- Reference Frequency
 - description, 27
 - querying, 27
 - setting, 27
- Register-based Programming, 199 - 268
 - aperture change times, 266
 - base address, 200 - 201
 - checking for errors, 214
 - command opcodes, 262 - 263
 - command register, 204
 - configuring the multimeter, 211 - 212
 - control register, 203, 219
 - data buffer register, 208
 - description, 199
 - device type register, 206, 224 - 225

- error codes, 264
- examples, 220 - 261
- function change times, 266
- ID register, 205, 223
- parameter register, 204
- parameters opcodes, 262 - 263
- power-on settings, 265
- program timing and execution, 210
- query response register, 207, 226 - 233
- querying parameters, 215
- READ registers, 205 - 208
- reading an error code, 230 - 233
- reading the device type register, 224 - 225
- reading the ID register, 223
- reading the query response register, 226 - 229
- register addressing, 199, 201 - 202
- register descriptions, 203
- register offset, 202
- register triggering, 217 - 219
- resetting the multimeter, 210, 221 - 222
- retrieving measurements, 213
- status register, 206
- useful tables, 262
- using multiplexers, 216
- VME interrupts, 267
- WRITE registers, 203 - 204

Registers

- accessing, 202
- addressing, 199, 201 - 202
- base address, 200 - 201
- command register, 204
- control register, 203, 219
- data buffer register, 208
- descriptions, 203
- device type register, 206, 224 - 225
- ID register, 205, 223
- offset, 202
- parameter register, 204
- query response register, 207, 226 - 233
- READ, 205 - 208
- reading registers, 200
- standard event status, 66
- status register, 206
- triggering, 217 - 219
- WRITE, 203 - 204
- writing to registers, 200

Resetting

- computer, 17
- from E1301A front panel, 17
- multimeter, 17, 210, 221 - 222

Resistance Measurements, 87

- autorange function, 167
- converting to, 209

- current source values, 87
- four-wire, 35, 88, 127, 144, 166, 168
- offset compensated ohms, 165
- output from multimeter, 100
- range, 166
- resolution, 168
- two-wire, 34, 88, 128 - 129, 145 - 146, 166, 168
- two-wire vs. four-wire, 87

Resolution

- AC voltage, 175
- changing, 169
- DC voltage, 175
- description, 95 - 96
- four-wire resistance, 168
- parameters, 91, 95 - 96
- querying, 96, 169, 176
- RESistance:RESolution, 96, 168
- saved in memory, 114
- setting, 95 - 96, 168, 276
- table listing, 92, 120
- two-wire resistance, 168
- VOLTage:RESolution, 96, 175

Retrieving

- data from memory, 83 - 84
- measurements, 213

*RMC, 186

RMS AC Voltage Measurements, 86

- AC-coupled, 86, 130, 147
- CONFigure:VOLTage:AC, 130
- MEASure:VOLTage:AC?, 147

*RST, 17, 186

RTD Measurements

- CONFigure:TEMPerature RTD, 129
- description, 276
- four-wire resistance, 35, 90
- MEASure:TEMPerature? RTD, 146
- two-wire resistance, 89

S

Safety Warnings, 8, 21

Sample

- count, 108, 157 - 158
- period, 109 - 110, 159 - 160
- source, 110, 158 - 159

SAMPlE Subsystem, 157 - 160

- SAMPlE:COUNt, 108, 157
- SAMPlE:COUNt?, 158
- SAMPlE:SOURce, 109 - 110, 158
- SAMPlE:SOURce?, 159
- SAMPlE:TIMer, 109 - 110, 159
- SAMPlE:TIMer?, 160
- *SAV, 114, 186

- Saving Multimeter Configurations, 114
 - *SAV, 114
 - example program, 115
 - how to, 114
 - in memory, 14
- Scanning
 - B-size switchbox channels, 50 - 51
 - C-size switchbox channels, 52 - 53
 - channel list, 46 - 49
 - high-speed example program, 253
 - multiple high-speed scans, 54 - 55
- Scanning Multimeter
 - 2-wire measurements, 87
 - 4-wire measurements, 87
 - additional functions, 69
 - command parameter, 42
 - definition of, 75
 - forming, 14, 23
 - logical address, 23
 - making a measurement, 20
 - measurements example program, 246 - 261
 - sample count, 108
 - trigger count, 104 - 105, 180
 - trigger delay, 106, 182
 - two-wire temperature measurements, 129, 146
- SCPI Commands
 - abbreviated, 118
 - ABORt, 122
 - CALibration subsystem, 123 - 124
 - CONFigure subsystem, 126 - 130, 132 - 133
 - CONFigure? subsystem, 134
 - DIAGnostic subsystem, 135
 - DISPlay subsystem, 136 - 138
 - FETCh? subsystem, 139, 277
 - format, 117
 - FORMat subsystem, 140
 - FORMat? subsystem, 141
 - implied, 118
 - INITiate subsystem, 142
 - linking with common (*) commands, 119
 - MEASure subsystem, 143 - 149
 - MEMory subsystem, 150 - 152
 - OUTPut subsystem, 153 - 154
 - parameters, 119
 - quick reference, 187 - 188
 - READ?, 155, 278
 - reference, 121
 - SAMPlE subsystem, 157 - 160
 - [SENSe:] subsystem, 161 - 176
 - separator, 117
 - SYSTem subsystem, 177 - 178
 - TRIGger subsystem, 179 - 184
 - upper case vs. lower case, 118
- SCPI Driver, description of, 13
- Secondary HP-IB Address, 22
- Selecting
 - data format, 80
 - measurement function, 162
 - reading destinations, 81 - 85
 - VME RAM, 39
- Self-test
 - codes, 17
 - example program, 16
 - multimeter, 16
- Sense
 - channels, 88, 130, 147
 - terminals, 87
- [SENSe:] Subsystem, 161 - 176
- [SENSe:]FUNcTION, 162
- [SENSe:]FUNcTION:RESistance, 162
- [SENSe:]FUNcTION:VOLTAge:AC, 162
- [SENSe:]FUNcTION:VOLTAge[:DC], 162
- [SENSe:]FUNcTION?, 162
- [SENSe:]RESistance:APERture, 163
- [SENSe:]RESistance:APERture?, 164
- [SENSe:]RESistance:NPLC, 164
- [SENSe:]RESistance:NPLC?, 165
- [SENSe:]RESistance:OCOMpensated, 165
- [SENSe:]RESistance:OCOMpensated?, 165
- [SENSe:]RESistance:RANGe, 166, 275
- [SENSe:]RESistance:RANGe:AUTO, 167, 275
- [SENSe:]RESistance:RANGe:AUTO?, 168, 275
- [SENSe:]RESistance:RANGe?, 167
- [SENSe:]RESistance:RESolution, 168
- [SENSe:]RESistance:RESolution?, 169
- [SENSe:]VOLTAge:AC:RANGe, 169, 275
- [SENSe:]VOLTAge:AC:RANGe?, 170
- [SENSe:]VOLTAge:APERture, 171
- [SENSe:]VOLTAge:APERture?, 171
- [SENSe:]VOLTAge[:DC]:RANGe, 172
- [SENSe:]VOLTAge[:DC]:RANGe?, 173
- [SENSe:]VOLTAge:NPLC, 173
- [SENSe:]VOLTAge:NPLC?, 174
- [SENSe:]VOLTAge:RANGe:AUTO, 174, 275
- [SENSe:]VOLTAge:RANGe:AUTO?, 175, 275
- [SENSe:]VOLTAge:RESolution, 175
- [SENSe:]VOLTAge:RESolution?, 176

- Setting
- AC voltage range, 169
- AC voltage resolution, 175
- aperture time, 98, 110, 163, 171
- autorange, 94
- autozero, 99, 124
- data format, 140
- DC voltage range, 172
- DC voltage resolution, 175

- integration time, 98, 163 - 164, 171, 173
- IRQ jumper, 24
- line reference frequency, 123
- logical address switch, 22 - 23
- pacing source, 158
- range, 93, 166
- readings per trigger, 157
- reference frequency, 27
- resolution, 95 - 96, 168, 276
- sample count, 108
- sample period, 109 - 110
- trigger count, 104 - 105, 179 - 180
- trigger delay, 106 - 107, 181 - 182
- trigger source, 103
- VME memory address, 150
- VME memory size, 151
- wait-for-trigger state, 111
- Shared Memory
 - reading destinations, 84
- Shielded Cables, 32
- Shielded Twisted-pair Cables, 32
- Shock Hazard, 21
- Single
 - measurements, 42
 - trigger, 112
- Source
 - channels, 88
 - terminals, 87
- Specifications, 189 - 196
- Specifying
 - data format, 80
 - function, 90
- Speed
 - increasing, 269 - 278
 - increasing throughput, 58
 - maximizing, 56 - 57
 - multiple high-speed scans, 54 - 55
- *SRE, 186
- *SRE?, 186
- Stand-alone Multimeter
 - 4-wire measurements, 87
 - additional functions, 69
 - command parameter, 42
 - configurations saved in memory, 114
 - definition of, 75
 - making a measurement, 20
 - measurements example program, 234 - 245
 - sample count, 108
 - scanning switchbox channels, 50, 52
 - trigger count, 104 - 105, 180
 - trigger delay, 106, 182
- Standard Commands for Programmable Instruments
 - See* SCPI Commands

- Standard Event Status Register
 - device dependent error bit, 67, 81
 - monitor for errors, 66
- Status
 - bit precedence, 207
 - register, 206
- *STB?, 186
- Storing Readings
 - in mainframe memory, 83
 - in memory, 83
 - in shared memory, 64 - 65
 - on VME memory card, 64 - 65, 150
- Switchbox
 - HP E1345A configured as, 71 - 73
- Switches, logical address, 22 - 23
- Synchronizing Multimeter with a Computer, 68
- SYSTem Subsystem, 177 - 178
- SYSTem:CDEscription?, 177
- SYSTem:CTYPe?, 177
- SYSTem:ERRor?, 19, 178

T

- Temperature Measurements
 - CONFigure:TEMPerature, 129
 - description, 88, 276
 - MEASure:TEMPerature?, 146
 - overload indications, 81
 - RTD resistance, 35, 89 - 90, 129, 146
 - specifying, 88
 - thermistor, 88, 129, 146
 - thermocouple, 89, 129 - 130, 146 - 147
- Terminal Module Connections, 33 - 36
- Terminals
 - input, 15, 29
 - sense, 87
 - source, 87
- Thermistor Measurements, 88
 - CONFigure:TEMPerature THER, 129
 - description, 276
 - four-wire resistance, 35, 89
 - MEASure:TEMPerature? THER, 146
 - two-wire, 88
- Thermocouple Measurements, 89
 - CONFigure:TEMPerature TCouple, 129 - 130
 - connections for, 36
 - description, 276
 - MEASure:TEMPerature? TCouple, 146 - 147
 - multiplexers needed, 89
- *TRG, 103, 122, 186
- Trigger
 - count, 104 - 105, 179 - 180
 - count loop, 101

- delay, 106 - 107, 181 - 182
- group execute (GET), 103, 122
- immediately, 183
- lines (TTL), 153 - 154
- model, 218
- readings per, 157
- registers, 217 - 219
- sample count loop, 101
- source, 103, 183 - 184
- system, 217
- TRIGger Subsystem, 179 - 184
- TRIGger:COUNT, 104 - 105, 179
- TRIGger:COUNT?, 180
- TRIGger:DELAy, 106 - 107, 181
- TRIGger:DELAy:AUTO, 106, 182
- TRIGger:DELAy:AUTO?, 182
- TRIGger:DELAy?, 181
- TRIGger[:IMMediate], 183
- TRIGger:SOURce, 103, 183 - 184
 - BUS, 103, 113, 183 - 184
 - EXTernal, 103, 183
 - HOLD, 103, 113, 183 - 184
 - IMMediate, 103, 183 - 184
 - TTLTrg, 103, 183
- TRIGger:SOURce?, 103, 184
- Triggering the Multimeter, 14, 101 - 113, 179 - 184
- *TST?, 16, 186
- TTL Trigger Lines, 153 - 154
- Two-byte Readings, 208 - 209
- Two-wire
 - resistance measurements, 34, 128 - 129, 145 - 146
 - resistance measurements, CONFIgure:RESistance, 128 - 129
 - resistance measurements, description, 88
 - resistance measurements, MEASure:RESistance?, 145 - 146
 - resistance measurements, range, 166
 - resistance measurements, resolution, 168
 - resistance measurements, scanning multimeter, 87
 - resistance measurements, table listing, 92, 120
 - resistance measurements, using offset compensation, 100, 165
 - RTD measurements, 89
 - temperature measurements, 129, 146
 - thermistor measurements, 88
 - vs. four-wire measurements, 87

U

- Understanding the Multimeter, 75 - 116
- Useful Tables, 262
 - command and parameter opcodes, 262 - 263
 - function and aperture change times, 266

- multimeter power-on settings, 265
- register error codes, 264
- VME interrupts, 267

Using

- a PC, C language, and HP-IB card, 60 - 62
- CONFIgure commands, 76 - 79
- HP E1345A configured as a switchbox, 71 - 73
- macros, 274
- MEASure commands, 76 - 78, 82
- READ? commands, 82
- single trigger signal, 112
- the multimeter, 41 - 74

V

- VME Interrupts, 267
- VME Memory Card
 - enabling/disabling, 152
 - query address, 150
 - querying memory size, 151
 - querying state, 152
 - setting size (bytes), 151
 - storing readings, 64 - 65, 84, 150
- VME RAM, selecting, 39
- Voltage
 - aperture time, 171
 - autorange function, 174
 - converting to, 209
 - induced, 100
 - maximum allowed, 21, 29
 - measure AC, 33, 130, 147, 169
 - measure DC, 20, 33, 42, 132 - 133, 148 - 149, 172
 - offset, 100
 - ranges, 92, 120
 - resolution, 175
- VXIbus
 - interrupt lines, 24
 - TTL trigger lines, 153 - 154

W

- *WAI, 186
- Wait-for-Trigger State, 111
 - command used, 142
- WARNINGS, 8
- Warranty, 7
- Wiring Considerations, 32
- WRITE Registers, 203 - 204
 - command, 204
 - control, 203, 219
 - parameter, 204
- Writing to Registers, 200

Notes
