

---

# Minimizing Intrusion Effects When Probing With a Logic Analyzer

**Application Note 1244-1**

---

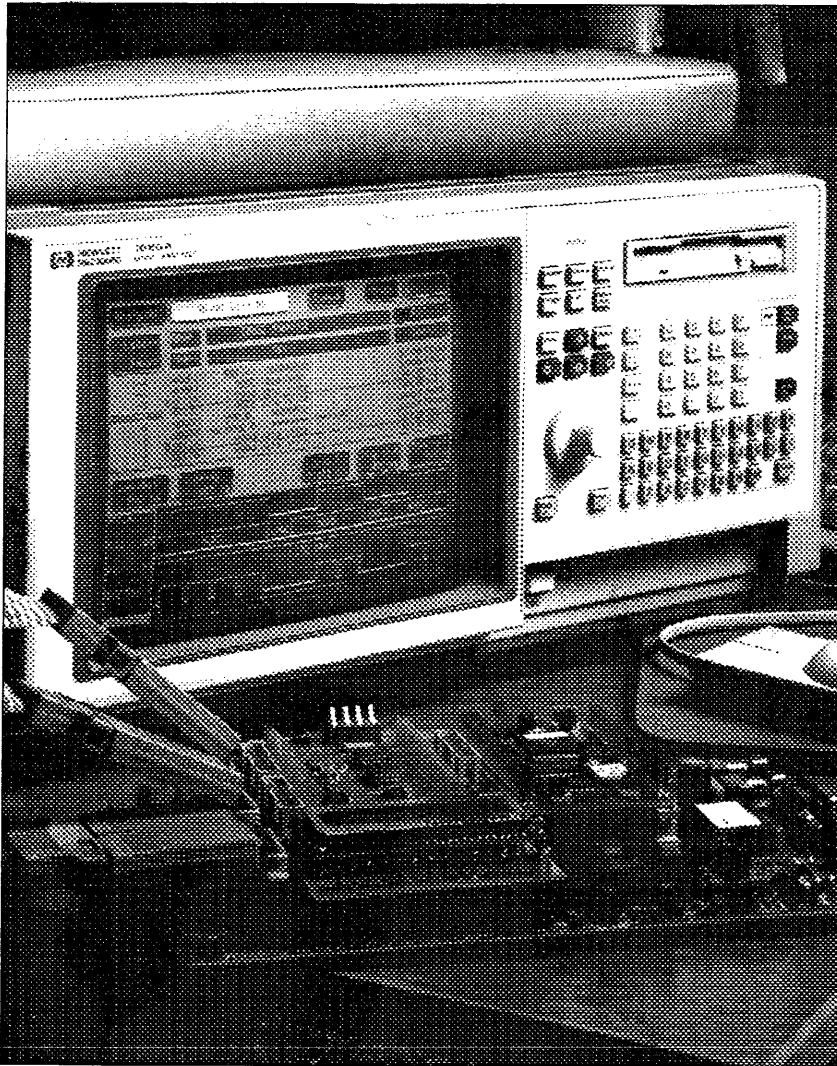

Engineers and technicians frequently need to probe target systems with a logic analyzer to locate problems and verify performance. This application note discusses four methods of probing, which minimize probing effects on these target systems. These four methods are:

1. General-purpose probing with 16-channel lead sets.
2. Direct connection through termination adapters into standard, 20-pin connectors mounted on the target system boards.
3. Direct connection through standard, 40-pin connectors and termination ICs mounted directly on the target system boards.
4. Direct connection through the high density cable termination system (HDCTS).

These four probing methods are designed for use with the Hewlett-Packard logic analyzers and logic analyzer cards shown in table 1.

HP Portable Logic Analyzers	HP 16500 Logic Analyzer Cards
1650A, 1651A	16510A
1650B, 1651B, 1652B, 1653B, 1654B	16510B, 16511B
1660A/AS, 1661A/AS, 1662A/AS, 1663A/AS	16540A, 16541A, 16542A 16540D, 16541D
	16550A

**Table 1. Hewlett-Packard logic analyzers**

**General-Purpose Probing** General-purpose probing requires connecting probe leads to individual signal lines. This method is generally the most cumbersome, especially when connecting large numbers of channels, but it is also the most flexible, and can be used in conjunction with other probing techniques.

**The Standard Probing System** The standard probing system consists of grabbers, probe leads, pods, and a probe cable. Because it is passive, the standard probing system is smaller, lighter, and much easier to use than previous active probing systems. This passive probing system is similar to a probing system used on a high-frequency oscilloscope. It consists of a series RC network (90.9 k $\Omega$  in parallel with 8 pF) at the probe tip (see figure 1), and a shielded resistive transmission line. The advantages of this system are:

- 2-ns rise time with  $\pm 5\%$  perturbations.
- Low 8-pF capacitive loading at the probe tip.
- Signal ground at the probe tip for high-speed timing signals.
- Inexpensive, removable probe tip assemblies.

Probe leads are configured into lead sets, which can probe 16 data channels, 1 clock channel, and a common pod ground. A 16-channel probe lead set (HP part number 01650-61608) is shown in figure 2, along with the replacement part numbers for individual components.

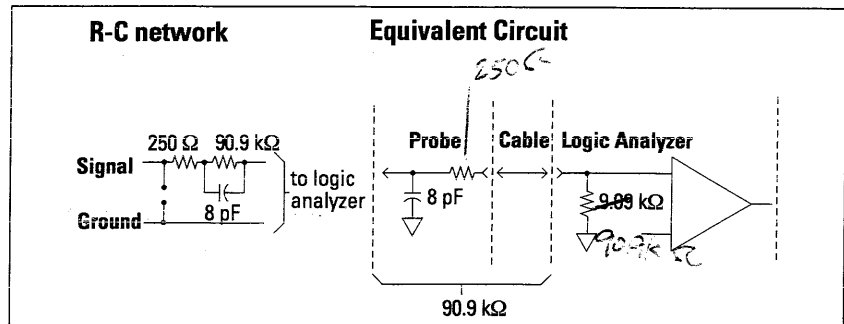

**Figure 1. Probe input circuit**

Each probe lead is a 12-inch, twisted-pair cable connected to the probe cable at the probe housing (see figure 2). The probe tip includes a signal lead, a connector for a ground lead, and the housing for the RC network shown in figure 1. The input system impedance is 100 kΩ in parallel with approximately 8 pF.

The signal and ground leads can be connected directly to the target system. This requires installing 0.63 mm (0.025 in) square pins, or round pins with a diameter of between 0.66 mm (0.026 in) and 0.84 mm (0.033 in) directly on the board. An IC test clip can also be used. The same specifications apply for the pin dimensions of the test clip.

The through-hole grabbers (HP part number 5959-0288, containing 20 grabbers) have hooks that fit around IC pins and component leads. They are small enough to fit around adjacent IC pins. There is also a surface-mount grabber (HP part number 5090-4356, containing 20 grabbers) designed for fine surface-mounted component leads.

The probe cable (figure 4) contains 17 or 18 (availability of CLK2 signal is dependent on the logic analyzer) signal lines as shown in figure 5A, two +5 volt power lines, and ground lines for each of the signal and power lines. All of these lines are woven into a 4.5-foot cable. The cable grounds are chassis (earth) grounds, not “floating” grounds. The two +5 volt power lines can be used to power active probing systems. Please consult the specifications for the individual logic analyzers or logic analyzer cards for the maximum allowable current through each cable.

## Grounding

There are three methods of grounding the probe system. First, the entire probe lead set can be grounded through the pod ground. This requires only one connection, but the ground path will not be the same length as the signal paths. The second method is to individually ground each probe lead. This yields a grounding path equal to the signal path. This is required for high-speed signals. A third method is a mixture of the first two. Grounding the main pod along with every fourth lead will provide improved signal fidelity.

## Signal Line Loading

Any probed signal line must be able to supply a minimum of 600 mV to the probe tip, and must be able to handle an input impedance of 100 kΩ shunted by 8 pF. If the signal lines are incapable of this, there may be a significant measurement error, or the system under test may malfunction. The maximum input voltage of each probe is  $\pm 40$  volts peak.

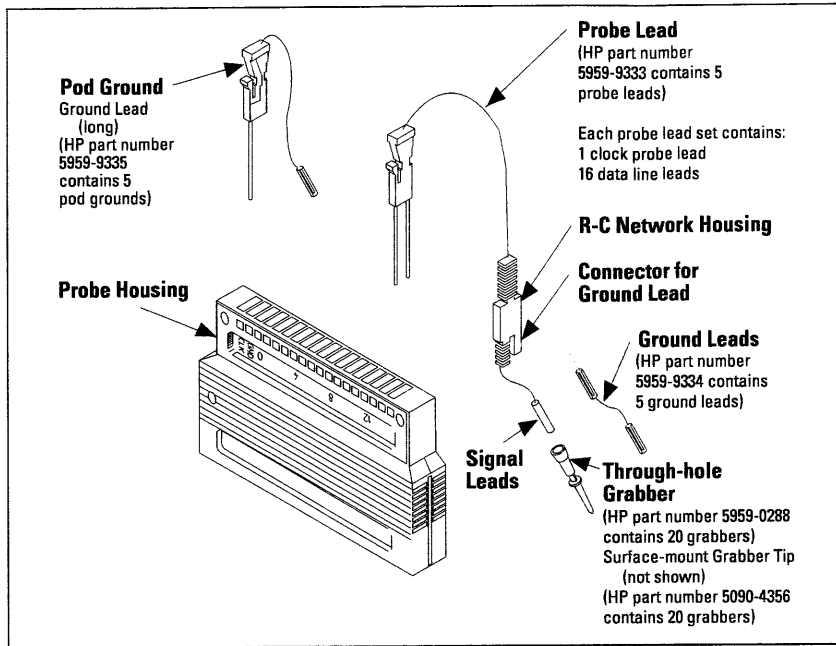

**Figure 2. 16-channel probe lead set (HP part number 01650-61608)**

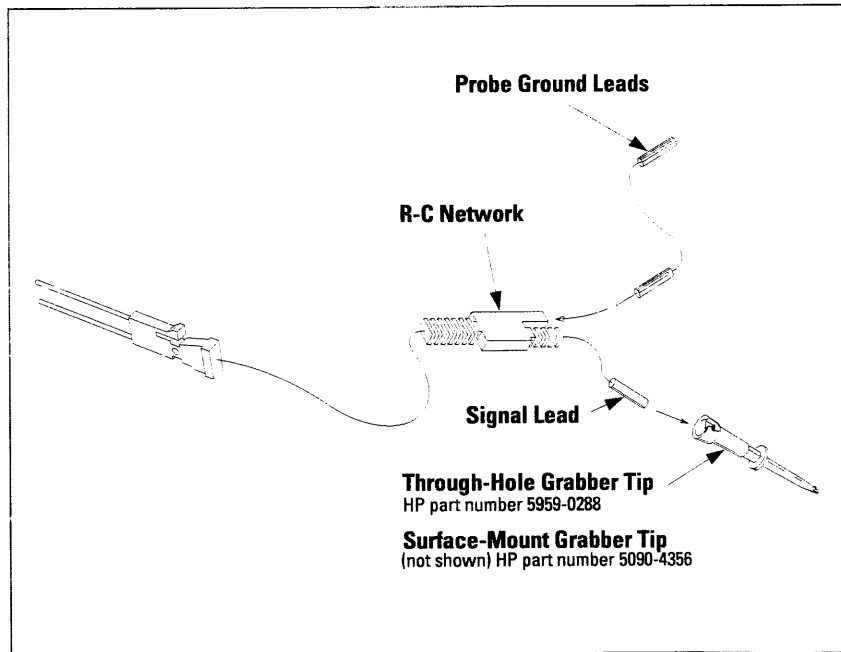

**Figure 3. Connecting grabbers and ground leads to probes**

## Direct Connection Through Termination Adapters

A fixed configuration provides fast access to test ports on target system boards without using the cumbersome, general-purpose lead sets. Connectors are installed directly onto the target system boards, resulting in quick hook-ups. There are two basic methods used for fixed configuration probing, termination adapters and 40-pin connectors.

Termination adapters (HP part number 01650-63203) that fasten to the end of the probe cable are designed to perform two functions. The first is to reduce the number of pins required for the header on the target board from 40 pins to 20 pins. This process reduces the board area dedicated to the probing connection. The second function is to properly terminate the probing system in a very convenient package. Figure 4 illustrates how the termination adapter physically connects to the target system. Figures 5A and 5B show the pinout diagrams for the probe cable, the termination adapter, and the 20-pin connector, respectively. There are two 20-pin connectors, along with their Hewlett-Packard and 3M part numbers, listed in table 2 below.

HP Part Number	3M Part Number	Connector Description
1251-8106	2520-6002	20-Pin, Low Profile (Straight)
1252-2321	2520-5002	20-Pin, Low Profile (Right Angle)
1251-8828	2540-6002	40-Pin, Low Profile (Straight)
1251-8158	2540-5002	40-Pin, Low Profile (Right Angle)
1251-8831	3432-6302	40-Pin, With Long Latches (Straight)
1251-8931	3432-5302	40-Pin, With Long Latches (Right Angle)

**Table 2. Connectors for fixed configuration probing**

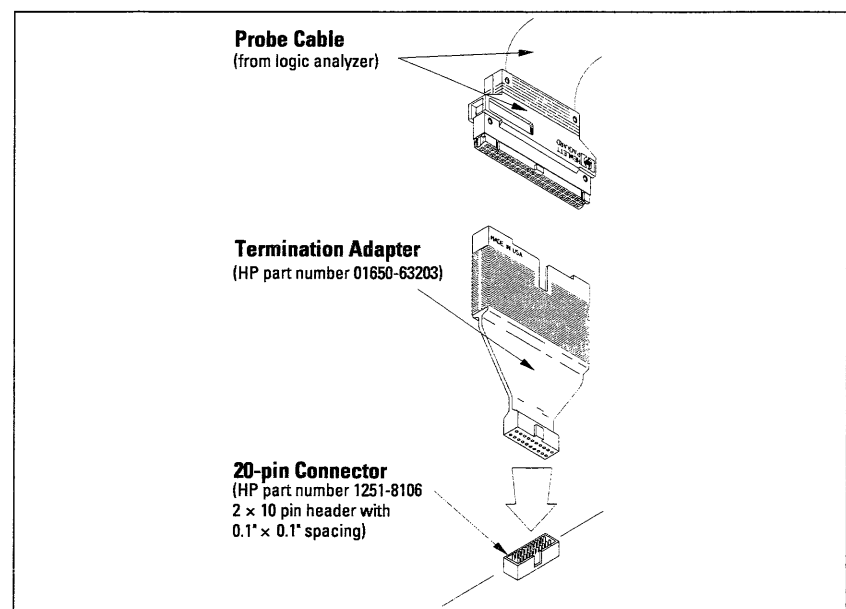

**Figure 4. Connecting a termination adapter to a target system board**

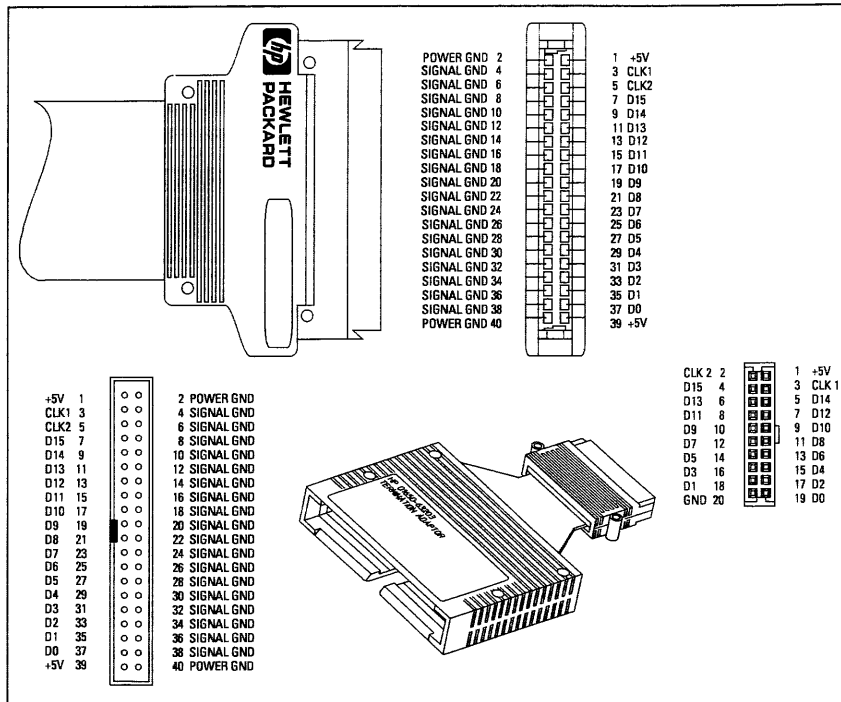

Figure 5A. Pinout for probe cable and 100-kΩ termination adapter (HP part number 01650-63203)

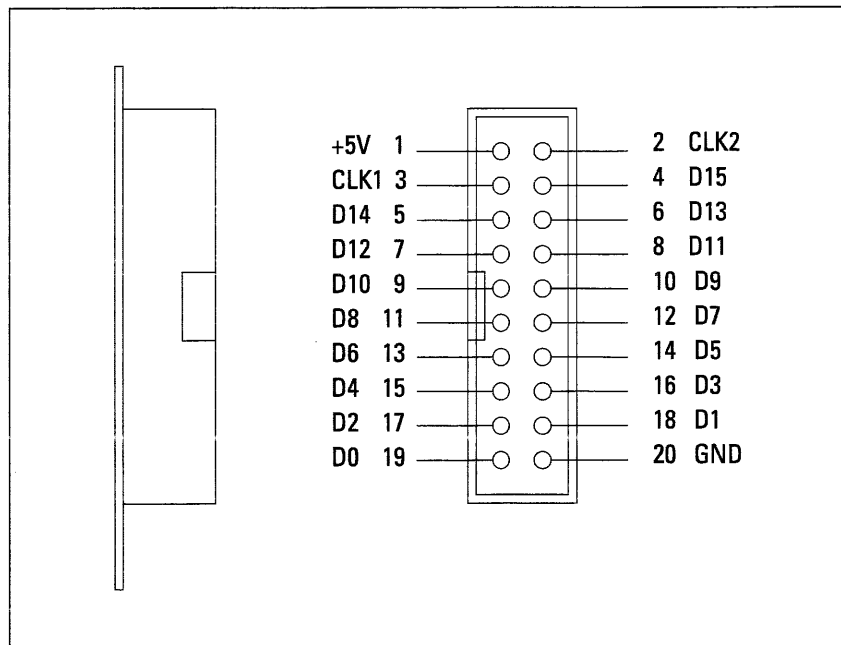

Figure 5B. Pinout for 20 pin connector (HP part number 1251-8106)

## Direct Connection Through 40-pin Connectors

The probe cable can also be plugged directly into the various 40-pin connectors shown in table 2, but proper termination must be installed directly onto the target system board. Hewlett-Packard provides two types of termination ICs for this purpose. The first is an 18-pin termination DIP (HP part number 1810-1278), which provides nine terminations as shown in figure 6A. Two of these DIPs are required for each probe cable as shown in figure 6B. The second is a 10-pin termination SIP that provides five terminations as shown in figure 7A. Four of these SIPs are required for each probe cable as shown in figure 7B. The 4 SIPs occupy less space on the target boards than the 2 DIPs, and should be used when space is restricted and when use of termination adapters is not practical. These SIPs may be ordered as part number 1810-1588 from Skyline Electronics (see page 12).

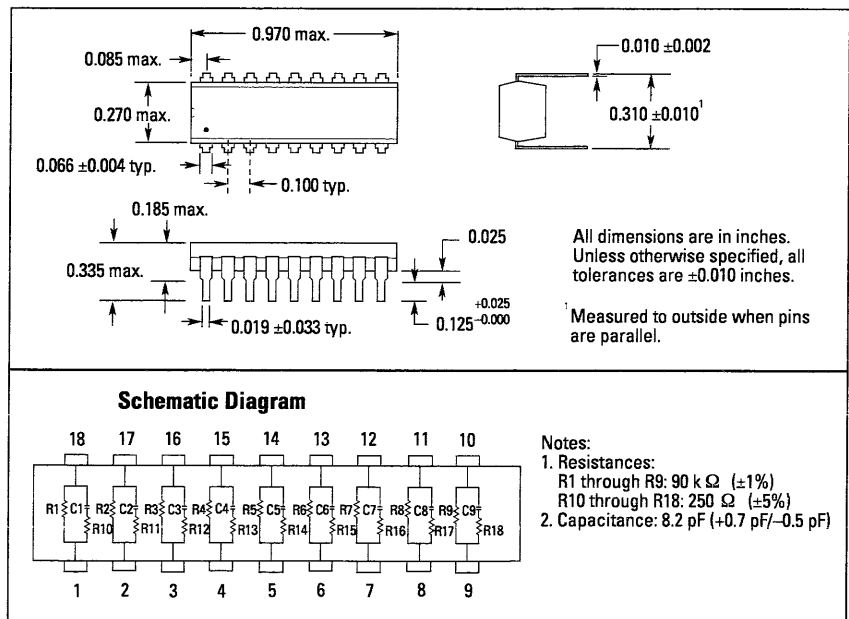

Figure 6A. 9-channel termination IC (HP part number 1810-1278)

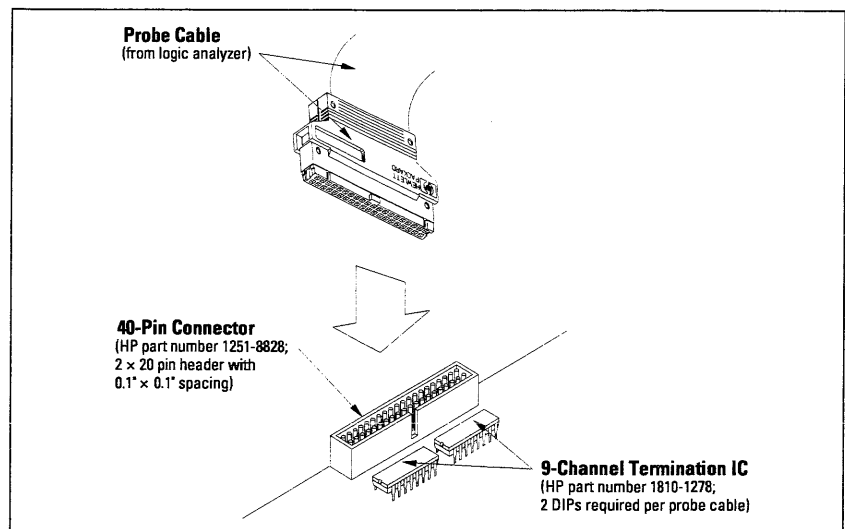
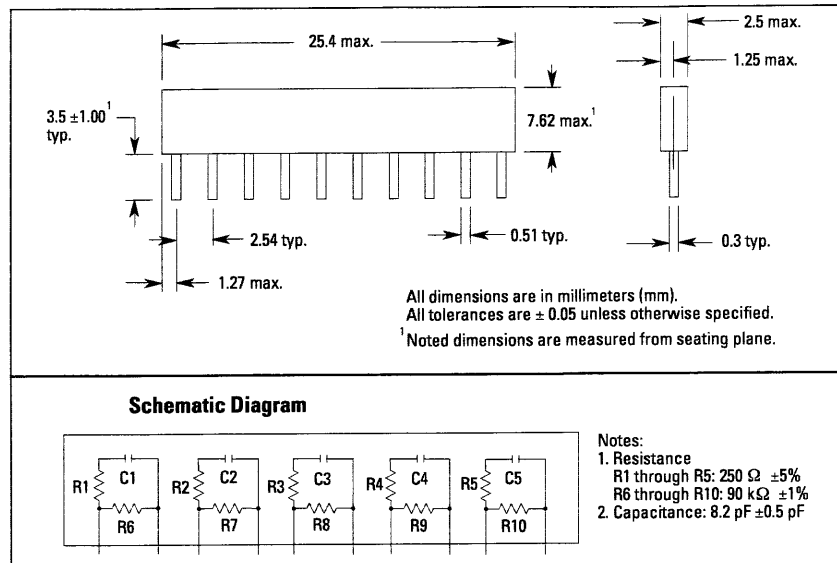
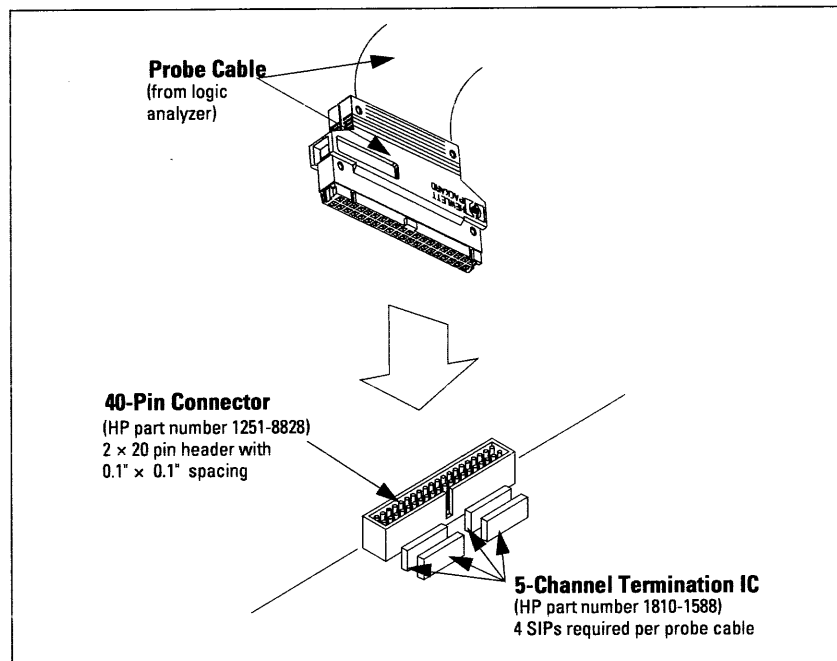

Figure 6B. Connecting probe cable to 40-pin connector with termination DIPs



**Figure 7A. 5-channel termination IC (HP part number 1810-1588)**



**Figure 7B. Connecting probe cable to 40-pin connector with termination SIPs**

An optional, high-density probe cable is available for situations where target board space is restricted. The cable, HP part number 16550-61605, is supported by the HP 16550A and HP 1660-series logic analyzers. The pinout of the cable is shown in figure 8. The signals must still be terminated on the target board by one of the techniques discussed in this application note. The following are two styles of mating connector that this cable will plug into:

Right angle – Fujitsu part number FCN-215Q050-G/0  
Straight – Fujitsu part number FCN-214Q050-G/0



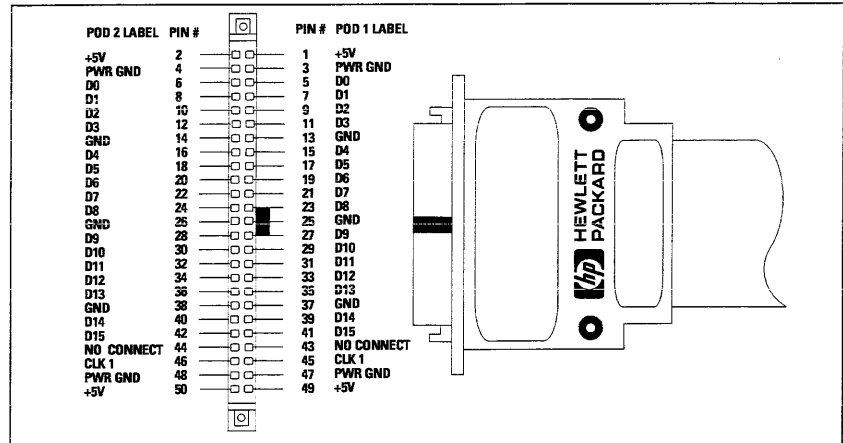

Figure 8. High-density cable pinout

Hewlett-Packard offers a wide array of preprocessors, adapters, extenders, and chip rotators, either directly or via third parties, to support standard industry microprocessors and buses. An up-to-date list may be obtained from your nearest HP sales office. If the processor or bus you are using is not directly supported, the HP E2445A User Definable Interface is available. It consists of a wire-wrap board, a standard probe interface board, and instructions for designing and building a custom interface.

## Double Probing

There will be occasions when an engineer or technician will need to passively probe with two different analyzers. For example, they may need to capture both state and timing data simultaneously, in order to quickly isolate problems. They can easily double probe, without imposing additional loading on the target system, with the simple "Y" connector shown in figure 9 (HP part number 16542-61607).

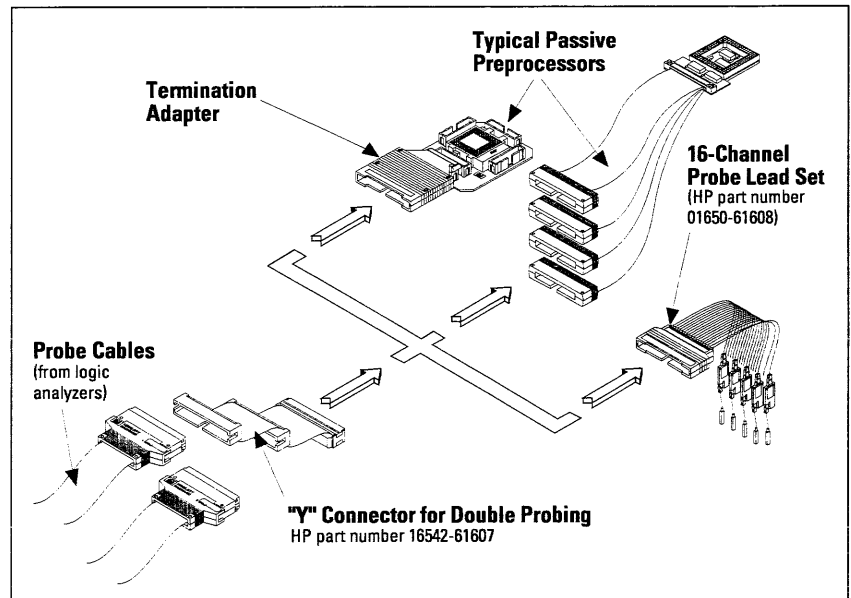

Figure 9. Double probing

## Direct Connection Through the HDCTS

The fourth method of probing is the Hewlett-Packard High Density Cable Termination System (HDCTS), a technique that can be used to provide electrical and mechanical connection to Hewlett-Packard (HP) logic analyzers from printed circuit boards incorporating embedded microprocessors or buses. The cable connection density, including grounds on the printed circuit board, is approximately 180 per square inch, and the termination technique has been qualified to clock speeds in excess of 350 MHz. This section provides technical information and part numbers to allow you to design an HDCTS into a unique application.

### Features

**Low Capacitive Loading:** 10–20 pF.

**Low Profile:** About 0.5-inch thick is possible. This allows probing a chip between boards in a card cage.

### Typical Applications

**Passive HDCTS:** No active circuitry; RC termination networks are used for all target signals. An existing target signal is used for the logic analyzer clock.

**Passive HDCTS With Active Clocking:** Signal channels flow straight through RC termination networks, and logic analyzer clocking is generated with active circuitry, such as a PAL.

**Active Latching HDCTS:** Active circuitry (such as flip-flops) precaptures the target signals to meet the setup and hold requirements of the logic analyzer. The signals are then terminated by RC networks before being routed to the logic analyzer.

**Active Buffering HDCTS:** Active circuitry buffers the target signals and may also generate logic analyzer clocking. The signals are then terminated by RC networks before being routed to the logic analyzer.

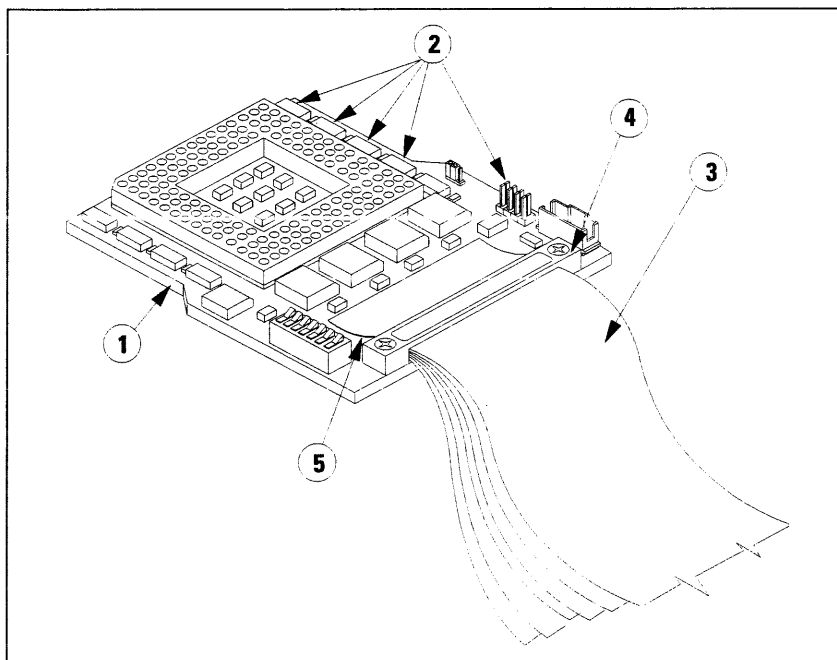

Figure 10. Typical HDCTS application (see page 11 for component names)

## System Components

The HDCTS components consist of the following as shown in figure 10:

- ① **Printed circuit board**
- ② **Various connectors and logic circuits on the PC board**
- ③ **40 conductor ribbon cable assembly**—This cable provides connections for 16 data lines, two clock lines, and two +5 Volt lines. The remainder of the lines are grounds.
- ④ **Ribbon cable strain relief**—This provides strain relief at the printed circuit board for the ribbon cables. Various sizes are available.
- ⑤ **Ribbon cable termination network**—Two types of RC networks are available—Single In Line (SIP), which are mounted on top of the board, or Surface Mount Technology (SMT), which are mounted on the bottom of the board.
- ⑥ **ESD shield and label (not shown)**—Custom ESD (electrostatic discharge) shields can be designed that will protect the circuitry on the printed circuit board from damage caused by electrostatic discharge.
- ⑦ **Pod identification label (not shown)**—This part has generic pod numbers; you can document a matrix in your user documentation that shows how to connect to different logic analyzers.

## Typical Vendors for Components

### Printed Circuit Board

The following vendor has the capability of manufacturing the required type of PC board. You may elect to choose other suppliers that meet the specifications listed below.

Sigma Circuits  
2950 Airway Avenue  
Costa Mesa, CA 92626

#### Specifications:

- SMT pad spacing requires 0.005 inch spaces and traces
- Cable termination area of board is defined at the end of this application note.

### PGA Sockets

McKenzie Technology  
910 Page Avenue  
Fremont, CA 94538  
Phone: 510 651-2700  
FAX: 510 651-1020

#### Specifications:

##### Pin

	Very Low Force	Ultralow Force Pin:
Long Tail	101B	120B
Pin Protector	004B	010B

(for pin count > 150 use the Ultra Low Force pins)

**Insulator**

Ryton preferred for high temperature, durability, and aesthetics; FR4 acceptable if Ryton not available. Hollow center option used if parts are loaded under the PGA; otherwise, solid center preferred for keyed foot-prints.

A thin FR4 insulator should be used between the PC board and the first PGA pin protector. This will prevent trace damage if the pin protector is pried off.

**Cable Assembly, Termination Networks, and Strain Reliefs are available from the following vendor:**

Skyline Electronics, Inc.  
2845 Delta Drive  
Colorado Springs, CO 80910-1012  
Phone: 719 390-4200  
FAX: 719 390-9425

**Cable Assembly**

Skyline Electronics; see above  
Part Number E2406-61601

**Cable Termination Components**

Skyline Electronics; see above  
Single Inline Package (SIP) Network: Part Number 5062-7351  
Surface Mount Termination (SMT) Network: Part Number 5062-7396

**Strain Relief**

Skyline Electronics; see above

No. of Cables	HP Part Number	Assembly Screw Length
5	E2406-41201	0.438 in
6	E2426-41201	0.438 in
7	E2420-41201	0.438 in
9	E2412-41201	0.500 in
10	E2443-41202	0.562 in

**ESD Shield**

(Typical vendor; you may substitute if appropriate.)  
United Foam Plastics  
1 Johnson Drive  
Raritan, NJ 08869-1651  
Phone 908 707-4444  
FAX: 908 707-0655

**Pod ID Labels**

HP Part Number E2406-94301

## Notes on Using the SMT Part in a Design

The ground on the 40th pin of even numbered cables is not picked up with the via/trace scheme. This needs to be connected (using via or trace) to the nearest ground.

HP currently uses a two-step process in soldering the SMT part to the board. The first pass places solder paste on those pads with vias. Application of heat allows the via to fill with solder. (If only one solder step was used, the solder would wick away from the part into the via and a solid connection would not be made with the part.) The next pass places solder paste on all of the pads.

## Special Considerations for a Design With an Odd Number of Cables

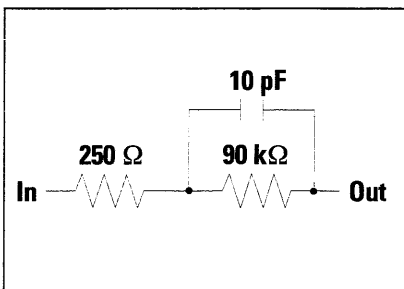

Figure 11. Hybrid network schematic diagram

Each SMT RC network is used with two cables. If you have an odd number of cables, you don't have to place an extra cable on the board. You do have to have pads for the unused halves of the SMT parts. Leaving the extra cable off the board gives you 0.100 inches more room or reduces the size of the board by the same amount.

The pattern below is for a single 6-channel part. However, the size of the part is such that the above pattern can be repeated to accommodate multiple parts stacked end to end. The process for termination of the hybrid is similar to an LCC package. Due to the small size of the part, however, there would not be any TCE problems during solder reflow. The hybrid's ceramic substrate has an NPO temperature characteristic. The schematic diagram on the left shows an equivalent circuit for the hybrid network.

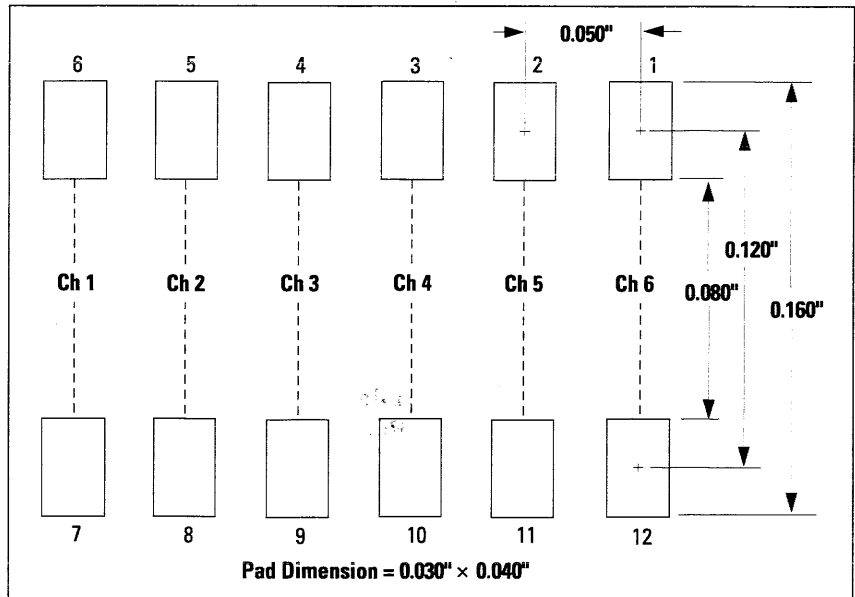
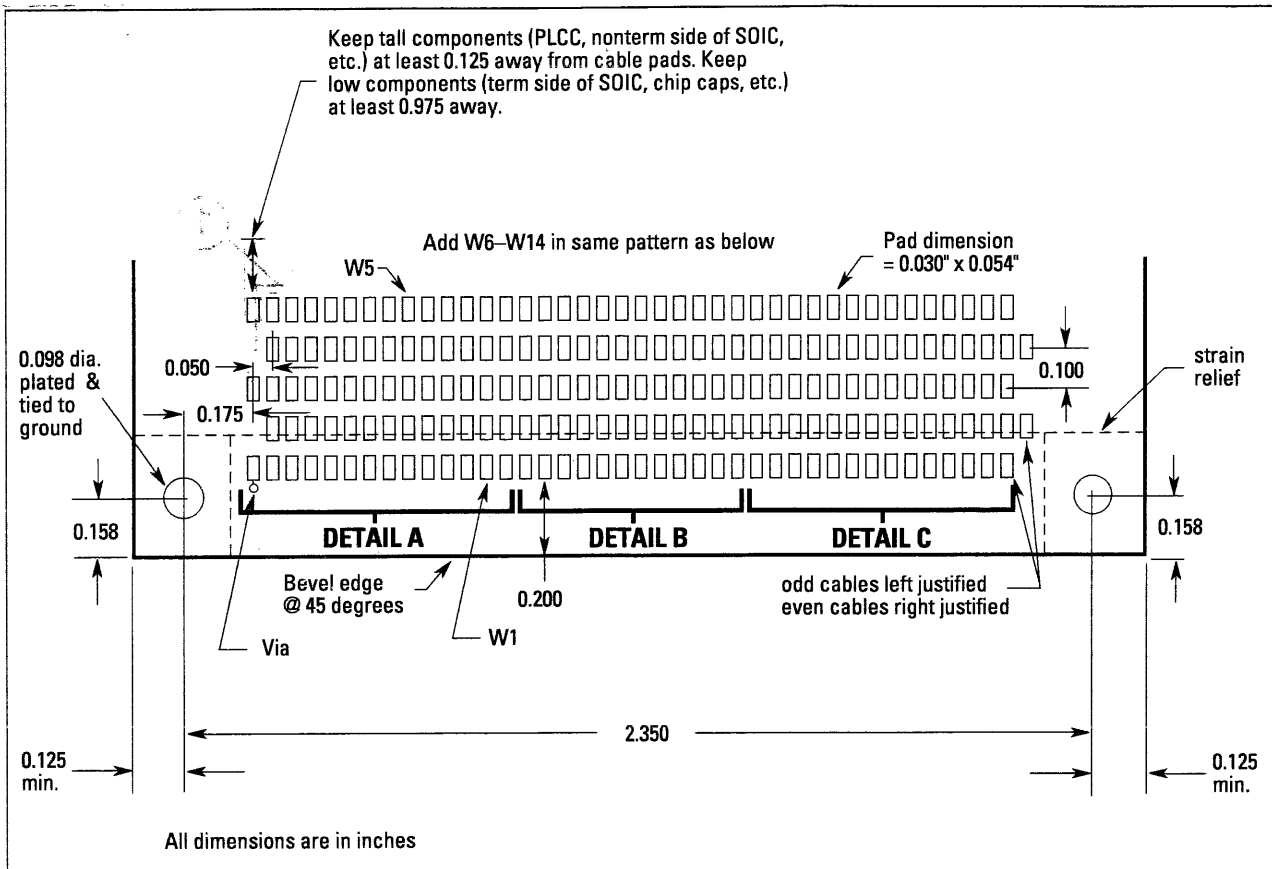

Figure 12. Recommended PC board pattern for surface mount termination RC network



**Figure 13a. Recommended PC board pattern for ribbon cable termination. See Details A, B, and C when using the SMT network.**

Figure 11b is a top side view of the pads, ground traces, and vias of the circuitry needed when using the SMT termination network. The "W" numbers are cable reference designators with corresponding pin numbers. The "Z" numbers are SMT network reference designators with corresponding pin numbers. The solid line pads are on the top side and are for cable wire connections. Note that pads 1 and 39 are +5 V, and all even pads are ground connections (see Figure 5A). The dotted line pads are for the SMT networks mounted on the bottom side. The large rectangular dotted line area defines a given SMT network. The solid filled-in circles are vias with traces connected to the even numbered wires of the cables and to ground. The solid open circles are vias that carry a signal from the output of the SMT network on the bottom side to the cable wire connected to the pad on the top side.

For example, a given signal would enter the SMT on the bottom side at Z1.1, go through the network and exit at Z1.12, go through the via to the W1.3 pad on the top side, and then into the logic analyzer through the cable connection. The next signal would enter the network at Z1.11, exit the network at Z1.2, go through the via to the W2.3 pad, and then into the logic analyzer. Notice that three of the networks within a given SMT part terminate signals on an odd-numbered cable, and the other three terminate signals on an even-numbered cable.

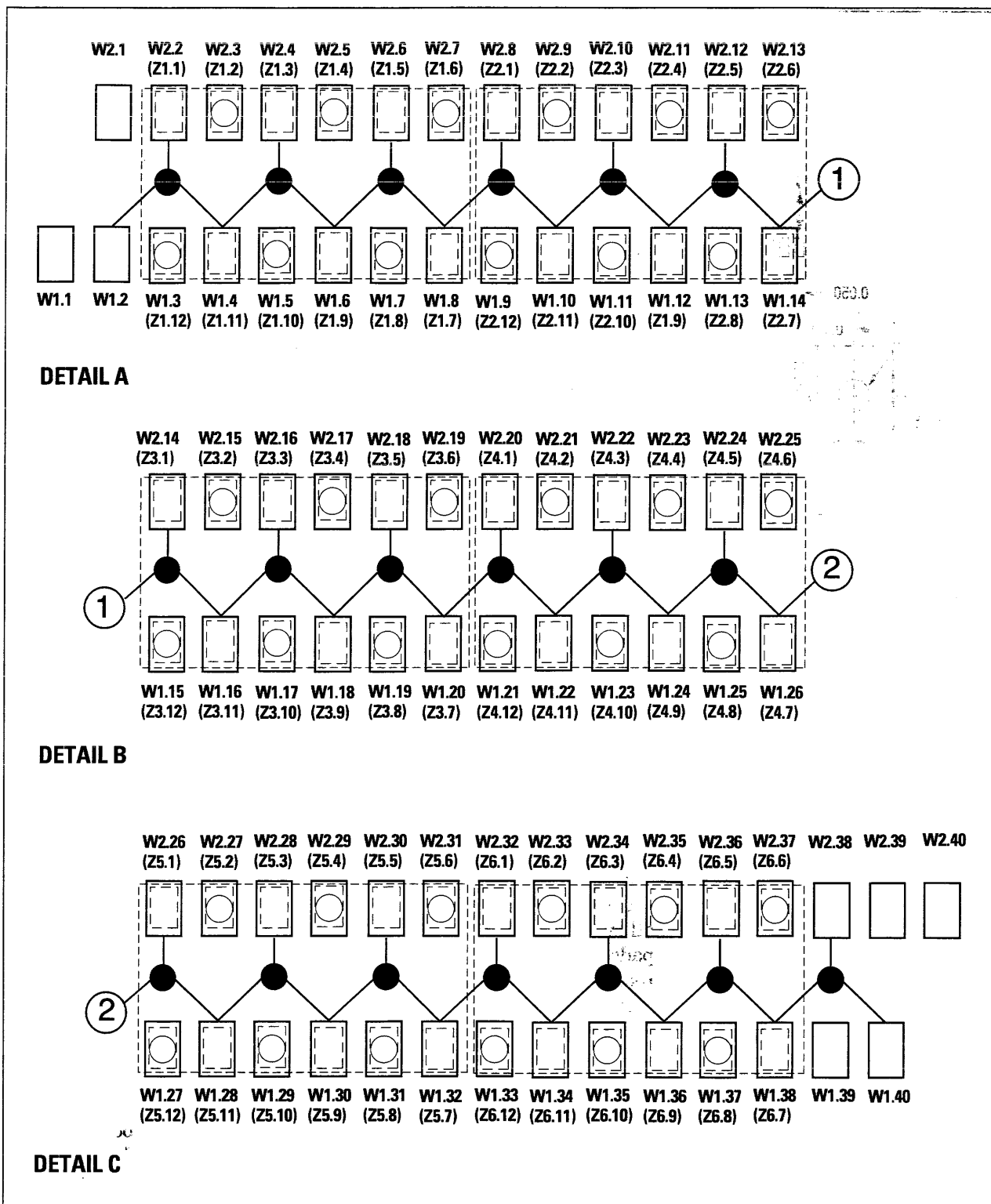

Figure 13b. Recommended PC board pattern for ribbon cable termination (when using the SMT network)

## Summary

This application note has discussed four probing methods which minimize probing effects on target systems. They include probing to individual signal lines using 16-channel lead sets, and connecting directly to microprocessors and buses via termination adapters, 40-pin connectors and HP's High Density Cable Termination System. These methods enable digital designers to choose the best probing alternative for their specific application.

**For more information on Hewlett-Packard Test & Measurement products, applications or services please call your local Hewlett-Packard sales offices. A current listing is available via Web through Access HP at <http://www.hp.com>. If you do not have access to the internet, please contact one of the HP centers listed below and they will direct you to your nearest HP representative.**

**United States:**  
Hewlett-Packard Company  
Test and Measurement Organization  
5301 Stevens Creek Blvd.  
Bldg. 51L-SC  
Santa Clara, CA 95052-8059  
1 800 452 4844

**Canada:**  
Hewlett-Packard Canada Ltd.  
5150 Spectrum Way  
Mississauga, Ontario  
L4W 5G1  
(905) 206 4725

**Europe:**  
Hewlett-Packard  
European Marketing Centre  
P.O. Box 999  
1180 AZ Amstelveen  
The Netherlands

**Japan:**  
Yokogawa-Hewlett-Packard Ltd.  
Measurement Assistance Center  
9-1, Takakura-Cho, Hachioji-Shi,  
Tokyo 192, Japan  
(81) 426 48 3860

**Latin America:**  
Hewlett-Packard  
Latin American Region Headquarters  
5200 Blue Lagoon Drive  
9th Floor  
Miami, Florida 33126  
U.S.A.  
(305) 267 4245/4220

**Australia/New Zealand:**  
Hewlett-Packard Australia Ltd.  
31-41 Joseph Street  
Blackburn, Victoria 3130  
Australia  
131 347 ext. 2902

**Asia Pacific:**  
Hewlett-Packard Asia Pacific Ltd  
17-21/F Shell Tower, Time Square,  
1 Matheson Street, Causeway Bay,  
Hong Kong  
(852) 2599 7070

**Technical information in this document is subject to change without notice**

**Printed in U.S.A 7/95  
5962-8620E**

