



Agilent 89600 Series

Installation and VXI Service Guide

Notices

© Agilent Technologies, Inc. 2010

No part of this manual may be reproduced in any form or by any means (including electronic storage and retrieval or translation into a foreign language) without prior agreement and written consent from Agilent Technologies, Inc. as governed by United States and international copyright laws.

Acknowledgments

Microsoft® and Windows® are U.S. registered trademarks of Microsoft Corporation.

Pentium® is a U.S. registered trademark of Intel Corporation

FireWire® is a registered trademark of Apple Computer, Inc.

Adobe®, the Adobe Logo, Acrobat® and the Acrobat Logo are trademarks of Adobe Systems Incorporated.

Manual Part Number

89600-90163
Supersedes: 89600-90159

Edition

March 2010
Printed in USA

Agilent Technologies, Inc.
5301 Stevens Creek Blvd.
Santa Clara, CA 95052 USA

Warranty

The material contained in this document is provided “as is,” and is subject to being changed, without notice, in future editions. Further, to the maximum extent permitted by applicable law, Agilent disclaims all warranties, either express or implied, with regard to this manual and any information contained herein, including but not limited to the implied warranties of merchantability and fitness for a particular purpose. Agilent shall not be liable for errors or for incidental or consequential damages in connection with the furnishing, use, or performance of this document or of any information contained herein. Should Agilent and the user have a separate written agreement with warranty terms covering the material in this document that conflict with these terms, the warranty terms in the separate agreement shall control.

Technology Licenses

The hardware and/or software described in this document are furnished under a license and may be used or copied only in accordance with the terms of such license.

Restricted Rights Legend

If software is for use in the performance of a U.S. Government prime contract or subcontract, Software is delivered and licensed as “Commercial computer soft-

ware” as defined in DFAR 252.227-7014 (June 1995), or as a “commercial item” as defined in FAR 2.101(a) or as “Restricted computer software” as defined in FAR 52.227-19 (June 1987) or any equivalent agency regulation or contract clause. Use, duplication or disclosure of Software is subject to Agilent Technologies’ standard commercial license terms, and non-DOD Departments and Agencies of the U.S. Government will receive no greater than Restricted Rights as defined in FAR 52.227-19(c)(1-2) (June 1987). U.S. Government users will receive no greater than Limited Rights as defined in FAR 52.227-14 (June 1987) or DFAR 252.227-7015 (b)(2) (November 1995), as applicable in any technical data.

Safety Notices

CAUTION

A CAUTION notice denotes a hazard. It calls attention to an operating procedure, practice, or the like that, if not correctly performed or adhered to, could result in damage to the product or loss of important data. Do not proceed beyond a CAUTION notice until the indicated conditions are fully understood and met.

WARNING

A WARNING notice denotes a hazard. It calls attention to an operating procedure, practice, or the like that, if not correctly performed or adhered to, could result in personal injury or death. Do not proceed beyond a WARNING notice until the indicated conditions are fully understood and met.

In this book

Other documentation	9
Safety Summary	10
Front and Rear Panel Symbols	11
Warranty	12

1. Installation Overview

89600 Series Software	14
Before you start installation	15
To prepare for installation:	15
89600-Series Analyzer Installation and Setup	18

2. Installing 89600 Software

Installing 89600 Software	24
New Installation	24
Modify Installation	26
Repair Installation	28
Remove	29
Update Installation	30

3. Setting Up VXI Hardware

Introduction	32
Inspecting Agilent 89600-series VXI modules	33
Setting up Agilent 89600 series VXI mainframe and modules	34
Set logical addresses	34
Installing modules in the mainframe	39
To install modules in the mainframe:	39
Configuring your VXI hardware	40
Connecting front panel cables	51
Cable connections, 89610	52
Cable connections, two-channel 89610	53
Cable connections, 89610 with external down converter	54
Cable connections, 89611	55
Cable connections, 89611 with PSA Option H70	56
Cable connections, 89611 with ESA Option H70	57
Cable connections, two-channel 89611	59
Cable connections, 89640	61
Cable connections, 89640 with second IF/baseband channel	62
Cable connections, 89640 with second RF channel	64
Cable connections, 89640 with external down converter	66
Cable connections, 89641	67
Cable connections, 89641 with second IF/baseband channel	68
Cable connections, 89641 with second RF channel	70
Cable connections, 89641 with external down converter	72
Connecting EMC grounding cable	74

4. Installing IEEE 1394 Interfaces in Computers

Introduction to installing IEEE 1394 interfaces	78
---	----

Installing the IEEE 1394 host adapter in your computer	79
To install the IEEE 1394 host adapter in your computer:	79
Installing the IEEE 1394 PCMCIA cardbus	82
To install IEEE 1394 PCMCIA cardbus in your computer:	82
Installing drivers for IEEE 1394 and E8491	83
To install drivers for IEEE 1394 and E8491:	83
5. Installing GPIB, LAN, and USB Interface Cards	
Introduction	86
Configuring GPIB on a desktop PC	87
Configuring GPIB on a laptop PC	88
Installing a LAN Interface	89
Installing a USB interface	90
Configuring a LAN-to-GPIB gateway	91
To make the LAN-to-GPIB gateway connection:	91
6. Configuring IO Interfaces	
Introduction	94
Configuring the VXI interface	95
To configure the VXI interface:	95
Configuring the LAN interface	97
To configure your LAN interface:	97
Instrument IP address for a Local Area Network configuration	97
Instrument IP address for a crossover cable configuration	98
Run Connection Expert.	100
Configuring the Agilent E5810 LAN/GPIB Gateway interface.	102
To configure the Agilent E5810 LAN/GPIB Gateway interface:	102
Run Connection Expert.	103
Configuring the USB/GPIB Interface	105
To configure the USB/GPIB interface:	105
Run Connection Expert.	105
Configuring the GPIB interface	107
To configure the GPIB interface:	107
Run Connection Expert.	107
Configuring the USB Interface.	109
To configure the USB interface:	109
Run Connection Expert.	109
7. Configuring Infiniium Windows XP Scopes	
Introduction	112
Configuring Windows XP Infiniium Networking for non-DHCP Network	114
To configure Windows XP Infiniium networking for a non-DHCP network:	114
Configuring Windows Infiniium Networking for DHCP Network	115
Configuring Windows XP Infiniium Networking for a Crossover Cable Network	116
To configure Windows XP Infiniium networking for a crossover cable:	116
Configuring PC Networking for a Crossover Cable Configuration	117
To configure PC networking for a crossover cable configuration:	117
Configuring PC Agilent IO Config for GPIB connection	118

To configure PC Agilent IP Config for a GPIB connection:	118
Configuring PC Agilent IO Config for LAN connection	119
To configure PC Agilent IO Config for a LAN connection:	119
Configuring the Agilent E5810 LAN/GPIB Gateway Interface	121
To configure the E5810 LAN/GPIB Gateway interface:	121
Configuring the USB/GPIB Interface	123
To configure the USB/GPIB interface:	123
8. Installing 89601 Software in Agilent Infiniium XP Scopes	
Introduction	126
Installing the 89600 software	127
To install the 89600 software embedded in your scope:	127
Verifying correct operation	129
To verify correct operation:	129
9. Installing Agilent 89600 Software in Agilent X-Series Signal Analyzers	
Introduction	132
Installing the 89600 software in an Agilent X-Series Signal Analyzer	133
Verifying correct operation	135
To verify correct operation:	135
10. Linking Logic Analyzers to the Agilent 89600 VSA	
Introduction	138
Configurations	139
16900 Series Logic Analyzers	139
1680 and 16800 Series Logic Analyzers	141
1690 Series Logic Analyzers	141
Software Installation	143
Logic Analyzer Software Installation	143
89600 Vector Signal Analyzer Software Installation	143
Connecting to a Network	145
89600 I/O Connections	146
Overview	146
Adding an Instrument	146
Logic Analyzer Link Examples	148
Logic Analyzer application and 89600 VSA application running on the same PC	148
Logic Analyzer application and 89600 VSA application running on the Logic Analyzer mainframe	152
Logic Analyzer application running on the Logic Analyzer mainframe and 89600 VSA application running on a separate PC	156
11. Linking a Synthetic Instrument (SI) Spectrum Analyzer to the Agilent 89600 VSA	
Introduction	162
Linking an SI Spectrum Analyzer	163
12. Connecting Acqiris Waveform Digitizers to the Agilent 89600 VSA	
Introduction	170
Overview	170

Configurations	171
Agilent Acqiris High-Speed Digitizers	171
Installation for Standard Operation	172
Installation for Embedded Operation	180
13. Installing a Node-Locked License	
Introduction	188
Starting the analyzer	189
Licensing your software	190
Obtaining a site key (license)	191
Installing a site key	194
Transferring a license from another computer	195
14. Setting Up a Floating License Server	
Introduction	198
Floating License Overview	199
Redundant license servers	200
Setting up client PCs	200
Adding license files	200
Installing Floating License Support	201
To install floating license support:	201
Obtaining your Floating License File	204
Find the materials and information you need:	204
To complete the License File Request Form:	205
Installing your Floating License File	206
To install your floating license file:	206
Starting Your License Server	207
To start your license server:	207
Setting up Redundant License Servers	209
To setup redundant license servers:	209
Adding License (.lic) Files	211
To add license (.lic) files:	211
To stop and restart the license servers:	211
Managing Multiple Application License Servers on One Computer	212
To manage multiple application license servers on one computer:	212
Removing 89600 License Support	213
To uninstall and remove 89600 license support:	213
Tools and Batch Files	214
15. Setting Up a Floating License Client	
Introduction	216
Floating License Overview	217
Setting the System Environment Variables	218
To set the system environment variables:	218
Starting the 89600 software	220
16. Diagnostics	
Introduction to Diagnostics	222

Recommended Test Equipment	224
Troubleshooting a VXI mainframe failure	225
Troubleshooting a VXI installation problem	226
To troubleshoot a VXI installation problem:	226
Troubleshooting a VXI IO configuration problem	227
To troubleshoot a VXI IO configuration problem:	227
Troubleshooting an IEEE-1394 interface failure	228
To troubleshoot an IEEE-1394 interface failure:	228
Troubleshooting a LAN interface problem	230
To verify the correct ADC.	230
To troubleshoot the LAN interface:	230
LAN interface problem with an Infiniium Oscilloscope:	231
Troubleshooting interference with other devices or instruments	233
Troubleshooting licensing errors	234
License Initialization Errors	234
Lost License Error.	235
Troubleshooting a lost connection to the network license server	236
Troubleshooting an E1438 ADC module	237
To verify the E1438 module using the self test:	237
Troubleshooting an E1439 ADC module	238
To verify the E1439 module using the self test:	238
Troubleshooting the E2730/E2731 module	239
To troubleshoot the E2730/E2731 module:	239
Troubleshooting the 2.7 GHz RF signal path	240
To troubleshoot the 2.7 GHz RF signal path:	240
Troubleshooting the 6.0 GHz RF signal path	243
To troubleshoot the 6.0 GHz RF signal path:	243
Troubleshooting the 0 to 36 MHz baseband signal path	246
Troubleshooting the 70 MHz IF signal path	247
Troubleshooting the 0-to-40 MHz baseband signal path	248
To troubleshoot the 0-to-40MHz baseband signal path:	248
Verifying Channel 1 LO outputs in a 2-channel RF system	250
To verify Channel 1 LO outputs in a 2-channel RF system, 1st LO:	250
To verify Channel 1 LO outputs in a 2-channel RF system, 2nd LO	251
Troubleshooting the Display Driver	252
Problem	252
Possible Cause	252
Solution	252

17. Circuit Descriptions

Introduction	254
Agilent 89610 circuit description	255
E8491 PC Link to VXI	255
89606/B Input Module	255
E1438 ADC Module	257
Agilent 89640/89641 circuit description	259
E8491 PC Link to VXI	259
89605 Input Module	261
E2730/E2731 RF Tuner module	261

E1439 ADC module	261
Agilent 89611 70 MHz IF Analyzer circuit description	263
E8491 PC Link to VXI	263
89605 Input Module	265
E1439 ADC Module	265

18. Replacing VXI Hardware

Replaceable parts for VXI hardware	268
Ordering Information	268
System cables and connectors	268
Modules	268
Agilent 89610A parts	269
Agilent 89611A parts	269
Agilent 89640A parts	270
Agilent 89641A parts	271
89605 parts	272
89606 parts	272
E1438 parts	272
E1439 parts	272
E2730 parts	273
E2731 parts	273
E8491B parts	273
Transporting VXI modules	274
Storing VXI modules	275

In this book

This book documents the Agilent 89600-Series installation and service procedures. It provides the following:

- software installation instructions
- hardware installation instructions
- PCI card and PCMCIA cardbus installation instructions
- hardware configuration information
- licensing information
- diagnostics, troubleshooting, and replaceable parts information for VXI hardware

This book does not contain operating information. All operating information is contained in the 89600 online help.

Other documentation

In addition to the Installation Guide (this book), the following documentation also comes with your software:

- 89600 Online Help is available after you install the software on your computer. The help includes reference information, tutorials on making several kinds of measurements, and a video overview of the analyzer. Separate online help is available for the 89600 WLAN Test and 89604 Distortion Suite applications.
- An online version of this Installation Guide (install.pdf) is available at C:\Program Files\Agilent\89600 VSA\Help after you install the software on your computer.
- If the analyzer includes VXI measurement hardware, the printed VXI mainframe User and Service Manual is shipped with your analyzer. (You can put the mainframe manual in the 89600-series binder.)
- The complete documentation (PDF files) for the Agilent IO libraries is located in C:\Program Files\Agilent\IO Libraries Suite\Manuals (if you install the IO libraries).
- Agilent E1438 and Agilent E1439 operating information is documented in PDF files located in C:\Program Files\Visa\Winnt\age1438\help and C:\Program Files\Visa\Winnt\age1439\help (only for VXI measurement hardware).
- Technical Specifications are available from the 89600 web page: <http://www.agilent.com/find/89600>.

Independent operation of the Agilent 89605, 89606, E2730, and E2731 modules is not supported at this time.

To read the PDF files, you must have Acrobat® Reader installed on your computer. You can install this application from the 89600 Installation CD.

We have provided room in this binder so that you can put the VXI mainframe documentation in this binder. This way all the documentation you may need for troubleshooting or replacing parts will be in one location.

Safety Summary

IMPORTANT

Note that this manual contains only the safety information pertaining to installing VXI modules in the VXI mainframe and for installing the IEEE 1394 PCI interface card in your computer. For information on operating your VXI hardware and your computer safely, please refer to the user or service manuals for your VXI mainframe and computer.

The following general safety precautions must be observed during all phases of operation of this instrument. Failure to comply with these precautions or with specific warnings elsewhere in this manual violates safety standards of design, manufacture, and intended use of the instrument. Agilent Technologies Inc. assumes no liability for the customer's failure to comply with these requirements.

GENERAL

This product is a Safety Class 1 instrument (provided with a protective earth terminal). The protective features of this product may be impaired if it is used in a manner not specified in the operation instructions.

BEFORE APPLYING POWER

Verify that the product is set to match the available line voltage, the correct fuse is installed, and all safety precautions are taken. Note the instrument's external markings described under Safety Symbols.

GROUND THE PRODUCT

To minimize shock hazard, the instrument chassis and cover must be connected to an electrical protective earth ground. The instrument must be connected to the ac power mains through a grounded power cable, with the ground wire firmly connected to an electrical ground (safety ground) at the power outlet. Any interruption of the protective (grounding) conductor or disconnection of the protective earth terminal will cause a potential shock hazard that could result in personal injury.

FUSES

Only fuses with the required rated current, voltage, and specified type (normal

blow, time delay, etc.) should be used. Do not use repaired fuses or short-circuited fuse holders. To do so could cause a shock or fire hazard.







DO NOT OPERATE IN AN EXPLOSIVE ATMOSPHERE

Do not operate the instrument in the presence of flammable gases or fumes.

DO NOT REMOVE THE PRODUCT COVER

Operating personnel must not remove instrument covers. Component replacement and internal adjustments must be made only by qualified service personnel.

Instruments that appear damaged or defective should be made inoperative and secured against unintended operation until they can be repaired by qualified service personnel.

	Caution, refer to accompanying documents		Alternating current
	Earth (ground) terminal		Direct current
	Frame or chassis terminal		Warning, risk of electric shock
	Terminal is at earth potential. Used for measurement and control circuits designed to be operated with one terminal at earth potential.		

Front and Rear Panel Symbols

 The CE mark is a registered trademark of the European Community.

 **N10149** The C-Tick mark is a registered trademark of the Australian Spectrum Management Agency.

 This is a marking of an Industrial Scientific and Medical Group 1 Class A product, and to indicate product compliance with the Canadian Interference-Causing Equipment Standard (ICES-001).

 The CSA mark is a registered trademark of the Canadian Standards Association.



This is a marking of the WEEE Directive (2002/96/EC) requirements. The affixed label indicates that you must not discard this electrical/ electronic product in domestic household waste.

Do not dispose in domestic household waste.

To return unwanted products, contact your local Agilent office or for more information, see <http://www.agilent.com/environment/product/>.

Warranty

This Agilent Technologies instrument product is warranted against defects in material and workmanship for a period of one year from date of shipment. During the warranty period, Agilent Technologies will, at its option, either repair or replace products that prove to be defective.

For warranty service or repair, this product must be returned to a service facility designated by Agilent Technologies. Buyer shall prepay shipping charges to Agilent Technologies and Agilent Technologies shall pay shipping charges to return the product to Buyer. However, Buyer shall pay all shipping charges, duties, and taxes for products returned to Agilent Technologies from another country.

Agilent Technologies warrants its software and firmware designated by Agilent Technologies for use with an instrument will execute its programming instructions when properly installed on that instrument. Agilent Technologies does not warrant that the operation of the instrument, or software, or firmware will be uninterrupted or error-free.

1 **Installation Overview**

89600 Series Software

The 89600 Series Software CD-ROM includes software for the following applications:

- 89600 Vector Signal Analyzer (89601 VSA software)
- 89600 Spectrum Analyzer (89601 VSA software)
- 89604 Distortion Suite
- 89607 WLAN Test

Before you start installation

The information in this section prepares you for installation.

IMPORTANT

If you are installing only a floating license server, skip the rest of this chapter and go directly to [Chapter 14](#), “Setting Up a Floating License Server,” on page 197

To prepare for installation:

1. Be sure you have the documentation and media listed below:
 - Agilent 89600 Series Software installation CD.
 - *Installation and Service Guide* for Agilent 89600 Series.
 - If your analyzer requires LAN, GPIB, or IEEE 1394 interfaces, you need your computer’s documentation for installation of PCI adapters, PCMCIA cards, or GPIB cards.
 - VXI Measurement Hardware - If the VXI measurement hardware includes an 89605, E2730, or E2731 module, you may need the Calibration disks for the module.
 - Installation and setup information for a source or non-VXI measurement hardware you will be using with 89600 software.
2. Be sure your desktop or laptop PC satisfies the following minimum requirements.

Characteristic	Microsoft® Windows® XP Professional	Microsoft Windows Vista Business, Enterprise, or Ultimate	Microsoft Windows 7 Professional, Enterprise, or Ultimate
CPU	600 MHz Pentium or AMD-K6 (≥ 2 GHz recommended)	1 GHz 32-bit (x86) (≥ 2 GHz recommended)	1 GHz or faster 32-bit (x286) or 64-bit (x64) processor
Empty slots (desktop)	1PCI-bus slot (2 recommended- VXI hardware only)	1PCI-bus slot (2 recommended- VXI hardware only)	1PCI-bus slot (2 recommended- VXI hardware only)
Empty slots (laptop)	1 CardBus TypeII slot (integrated FireWire® recommended - XI hardware only)	1 CardBus TypeII slot (integrated FireWire recommended - XI hardware only)	1 CardBus TypeII slot (integrated FireWire recommended - XI hardware only)
RAM	512 MB (1 GB recommended)	1 GB Rcmd'd	2 GB Rcmd'd (32bit) / 4 GB Rcmd'd (64-bit)
Video RAM	4MB (16 MB recommended)	128 MB (512 MB recommended)	128 MB (512 MB recommended)

Installation Overview
Before you start installation

Characteristic	Microsoft® Windows® XP Professional	Microsoft Windows Vista Business, Enterprise, or Ultimate	Microsoft Windows 7 Professional, Enterprise, or Ultimate
Hard disk	1 GB available	1 GB available	1 GB available
Additional drives	CD-ROM to load software; license transfer requires a 3.5 inch floppy disk drive, network access, or USB memory stick	CD-ROM to load software; license transfer requires a 3.5 inch floppy disk drive, network access, or USB memory stick	CD-ROM to load software; license transfer requires a 3.5 inch floppy disk drive, network access, or USB memory stick
Interface support	LAN, GPIB, USB or FireWire ^a interface (VXI HW only)	LAN, GPIB, USB or FireWire interface (VXI HW only)	LAN, GPIB, USB or FireWire interface (VXI HW only)

- a. For a list of supported IEEE 1394 (FireWire) interfaces, visit www.agilent.com/find/89600 and search the FAQs for information on “What type of IEEE-1394 interface can I use in my computer to connect to the 89600S VXI hardware?”

3. Setup your computer and connect peripherals if required.
4. Determine what kind of interface is required for your measurement hardware, using the following table. Note that you may need to install and configure more than one interface. For example, if your measurement hardware includes VXI measurement hardware and an Agilent ESG source, you must configure both an IEEE-1394 interface and a GPIB interface.

Measurement Hardware	Computer Type	Interface
VXI (Agilent 89610, 89611, 89640, 89641)	Laptop or desktop PC	IEEE-1394 VXI to PC
Agilent ESA	Laptop or desktop PC	GPIB, LAN/GPIB Gateway (portal), USB/GPIB adapter
Agilent ESA-E Series Analyzer	Laptop or desktop PC	GPIB or LAN/GPIB Gateway (portal), USB/GPIB
Agilent InfiniiVision 6000/7000 Series Oscilloscope	Laptop or desktop PC	LAN, GPIB, LAN/GPIB Gateway (portal), USB/GPIB
Agilent Infiniium Oscilloscope	Laptop or desktop PC or embedded Windows XP scope	LAN, GPIB, LAN/GPIB Gateway (portal), USB/GPIB, or internal
Agilent Logic Analyzer	Laptop, desktop PC, or embedded PC	LAN or internal
Agilent X-Series Signal Analyzer	Laptop or desktop PC or embedded PC	LAN or internal**

Measurement Hardware	Computer Type	Interface
Agilent N4010 Wireless Connectivity Test Set	Laptop or desktop PC	USB, LAN, GPIB, LAN/GPIB, USB/GPIB
Agilent PSA (used as ADC)*	Laptop or desktop PC	LAN, GPIB, USB, LAN/GPIB Gateway (portal), USB/GPIB*
Agilent PSA (used as a down-converter with 89611)*	Laptop, desktop, or VXI embedded PC	LAN, GPIB, USB, LAN/GPIB Gateway (portal), USB/GPIB
Agilent SI Spectrum Analyzer (N8201, N8221)	Laptop or desktop PC	LAN
Agilent Acqiris Waveform Digitizer	Laptop, desktop, or embedded Acqiris PC	LAN
Agilent Sources: ESG-D, ESG-DP, E4438C, PSG, and MXG sources	Laptop, desktop, measurement hardware with embedded PC, or embedded VXI PC	LAN, GPIB, LAN/GPIB Gateway (portal), USB/GPIB**

* To use GPIB with the PSA, your PSA firmware must be version A.4.0 or later. With earlier firmware versions, you must use the LAN connection.

** The Agilent X-Series Signal Analyzer embedded PC configuration (89600 analyzer running in the analyzer) only supports a LAN interface between the analyzer and an Agilent Source; GPIB is not supported.

89600-Series Analyzer Installation and Setup

IMPORTANT

If you are installing only a floating license server, skip the rest of this chapter and go directly to [Chapter 14](#), “Setting Up a Floating License Server,” on page 197.

This chapter provides the instructions necessary to install and configure all the various 89600-series analyzer system configurations. It is very important to begin with this procedure and use it as the primary procedure unless noted or directed otherwise. This general procedure will direct you to other chapters and procedures for software and hardware specific installation and setup information.

The 89600-series analyzer installation and setup process consists of 6 basic steps:

1. Install the software
2. Set up the measurement hardware
3. Install I/O cards in your computer
4. Configure I/O interfaces
5. License the software.
6. Calibrate the analyzer

Not all 89600-series analyzer system configurations require all steps to be performed. The details for each of these steps vary, depending on what kind of computer you are using, what type of interface connects your measurement hardware to the computer, and what operating system your computer uses. System hardware and configuration specific procedures are provided in various chapters in this book. You will not need to read and use every chapter, instead you will be directed to the appropriate chapter and procedure when required.

NOTE

Read all steps completely before doing the task. Most steps contain exceptions.

Perform each step in sequence unless specifically directly otherwise:

- **Pre-installed systems:**
VXI measurement hardware with embedded VXI computer or laptop PC configuration: If your 89600 system includes VXI measurement hardware with either an embedded VXI computer or a laptop PC, all installation and licensing may have been completed at the factory. If this is true, you only need to connect the VXI hardware to the computer and start the analyzer.
- **Software only installations:**
For 89600-series analyzer configurations that do not include measurement hardware, you only need to install and license the software. Do the “Install 89600-series software” [Step 1](#). and “License the software” [Step 5](#).

Step 1. Install 89600-series software

For all PC based hardware except the following, go to [“Installing 89600 Software” on page 24](#) and install the 89600-software:

- **Agilent Infiniium scope:** If you are installing 89600 software in an Agilent Infiniium scope with a Windows XP operating system, go directly to [Chapter 8](#), [“Installing 89601 Software in Agilent Infiniium XP Scopes,” on page 125](#).
- **Agilent X-Series Signal Analyzer:** If you are installing 89600 software in an Agilent X-Series Signal Analyzer, go directly to [Chapter 9](#), [“Installing Agilent 89600 Software in Agilent X-Series Signal Analyzers,” on page 131](#)
- **Agilent Logic Analyzer:** If you are installing the 89600 software in an Agilent Logic Analyzer, go directly to Logic Analyzer ["Software Installation" \(page 143\)](#).

If your analyzer is a software only installation that does not include measurement hardware, go to [“License the software” Step 5](#).

Step 2. Set up your measurement hardware

- a. For VXI measurement hardware, see: [“Introduction” on page 32](#). If the VXI modules are already installed in the mainframe and you are not using a laptop PC, skip this step and continue with step b.
- b. Set up and configure the LAN, USB, and/or GPIB interface in the instruments you plan to connect to the computer, referring to the instrument’s user’s guide for documentation on configuring I/O. (Look in the instrument user guide index under “GPIB” or “I/O configuration.”)

You probably can use the instrument default settings. Make sure that each instrument on the GPIB has a unique GPIB address; two instruments cannot use the same address.

Step 3. Install the necessary I/O interface cards in the computer

- a. For VXI measurement hardware, install the Agilent IEEE 1394 Host Adapter in your computer.

For desktop computer details, see: [“Installing the IEEE 1394 host adapter in your computer” on page 79](#). Use the instructions in this book rather than any installation instructions that came with the adapter. For laptop computer details, see: [“Installing the IEEE 1394 PCMCIA cardbus” on page 82](#).

- b. If you require communication via GPIB, LAN, or USB and the interface has not been installed in your computer, install the interface card, following the instructions that came with the card. For details, see: [“Introduction” on page 86](#).
- c. Connect all measurement hardware to the appropriate interface on your computer or to the LAN. Plug in and turn on all measurement hardware and your computer (if they are not already on).

Step 4. Configure the I/O hardware interfaces

Find your measurement hardware or interface type from the following list and go to the referred procedure.

- a. Infiniium scope: If your measurement hardware is an Infiniium scope, see: [Chapter 7 , “Configuring Infiniium Windows XP Scopes,” on page 111.](#)
- b. Agilent Logic Analyzer: If your measurement hardware is an Agilent Logic Analyzer follow the instructions in the ["Connecting to a Network" \(page 145\)](#) and ["89600 I/O Connections" \(page 146\)](#) in Chapter 10 , [“Linking Logic Analyzers to the Agilent 89600 VSA,” on page 137.](#)
- c. VXI: If your analyzer includes VXI measurement hardware, configure IEEE-1394. See: [“Configuring the VXI interface” on page 95](#) for details.
- d. LAN interface: If you will be communicating with hardware via LAN, configure LAN. See: [“Configuring the LAN interface” on page 97](#) for details.
- e. LAN/GPIB Gateway interface: If you will be communicating with hardware via a LAN/GPIB Gateway, configure LAN-to-GPIB. See: [“Configuring the Agilent E5810 LAN/GPIB Gateway interface” on page 102](#) for details.
- f. USB/GPIB interface: If you will be communicating with hardware via a USB/GPIB interface, configure USB-to-GPIB. See: [“Configuring the USB/GPIB Interface” on page 105](#) for details.
- g. GPIB interface: If you will be communicating with hardware via GPIB, configure GPIB. See: [“Configuring the GPIB interface” on page 107](#) for details.
- h. USB interface: If you will be communicating with hardware via USB, configure USB. See: [“Configuring the USB Interface” on page 109](#) for details.

Step 5. License the software (obtain authorization to use the software). There are four types of licenses: trial (step a.), node-locked (step b.), floating (step c.), or demo (step d.).

- a. Trial license:
A trial license lets you to run the software for 14 days. During this 14-day period, all options are enabled. This lets you to try all the optional software and to use your analyzer while you obtain and install permanent authorization (license). To use the trial license, start the 89600 software. When you are asked if you want to obtain authorization, click **Yes**, then click the **Trial** tab and click **Accept Trial**.
- b. Node-locked license:
For a node-locked license, follow these instructions:
 1. Start the software as follows:

For an 89600 analyzer, double click the appropriate icon, or click **Start > (All) Programs > Agilent 89600 VSA > Vector Signal Analyzer or Spectrum Analyzer**.
 2. Follow the instructions for obtaining and installing a site key. If you

encounter problems or need more information, see “Installing a Node-Locked License,” [page 187](#).

NOTE

A site key will have to be obtained for each installed software application: 89600 VSA, 89604 Distortion Suite and/or 89607 WLAN Test.

3. Continue with Calibrate your analyzer, [Step 6](#).
- c. Floating or Network license:
For a floating or network license, perform these steps:
 1. Set up the license server as instructed in [Chapter 14](#) , “[Setting Up a Floating License Server](#),” on [page 197](#).
 2. Set up the license client as instructed in [Chapter 15](#) , “[Setting Up a Floating License Client](#),” on [page 215](#).
- d. Demo:
For a demo license, perform these steps:
 1. Start the analyzer by double clicking the Vector Signal Analyzer icon, or clicking **Start > (All) Programs > Agilent 89600 VSA > Vector Signal Analyzer**.
 2. Follow the instructions for accepting a Demo License.

NOTE

Unlike other licenses, you must accept a Demo License each time you start the software. There is no limit to the number of times you can use a Demo License, but analyzer functionality is limited.

Step 6. Calibrate your analyzer

Before making measurements, you should calibrate (or align) your analyzer to optimize measurement accuracy. Refer to the 89600 online help for details on calibration for your analyzer configuration.

- In the Agilent 89600 VSA (or Spectrum Analyzer) window, click **Utilities**. Position the pointer on **Calibration**, and press F1 on the keyboard.
- In 89604 Distortion Suite, open help and look for Calibration in the Utilities menu or in the index.
- In 89607 WLAN Test, open help and look for Calibration in the Utilities menu or in the index.

NOTE

For 2-RF-channel VXI measurement hardware, you can use the fixed equalization feature to better match the channels. See fixed equalization in the 89600 online help index.

Installation Overview
89600-Series Analyzer Installation and Setup

2 **Installing 89600 Software**

Installing 89600 Software

The Agilent 89600 Installation Manager program guides you through software installation. If you have problems installing your software, see [Chapter 16](#), “Diagnostics,” on [page 221](#) for assistance.

There are several types of Agilent 89600 software installation (each described in the following sections):

- **New installation** is a first-time installation. (No previous versions of the Agilent 89600 software have been installed.)
- **Modify installation** adds or removes features or adds hardware support components to an existing version of Agilent 89600 software.
- **Repair installation** repairs corrupted files on the hard drive for an existing version of Agilent 89600 software.
- **Remove** will removed the existing version of the Agilent 89600 software.
- **Update installation** replaces an existing version of Agilent 89600 software with a newer version.

New Installation

If you are installing the Agilent 89600 software for the first time:

1. Turn on the computer. If the computer is already on, close any applications you have open.

NOTE

To install the Agilent 89600 VSA software, you must have administrator privileges on the computer you are installing the Agilent 89600 VSA software on.

2. Insert the Agilent 89600 Series Vector Signal Analysis Software installation CD-ROM.
3. If the installation utility does not start automatically, click **Start > Run**, and type:

drive:\autoplay.exe

...where *drive* represents the drive containing the installation CD-ROM. Click **OK**.

- When the Agilent 89600 Installation Manager window opens, please read the Readme information.

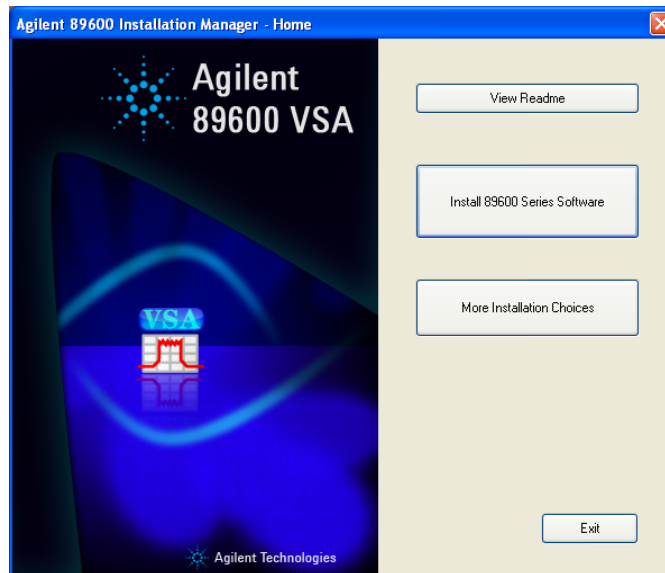

- After you read the ReadMe file, close it and click **Install 89600 Series Software**. Continue through the InstallShield Wizard to complete the installation.
- After the 89600 Series software is installed, you will have the choice to install hardware support. If you do not choose to install any hardware support at this time, all hardware support components are available for installation at a later time. See [“Add Hardware Support” on page 27](#).
- The installation program preconfigures your system environment for 89600. The installation process may ask you to reboot your computer. Click **OK**.

IMPORTANT

After rebooting you will need to be logged on with administrative privileges to complete the installation.

NOTE

If you are installing from a remotely mounted CD-ROM drive, the remote drive must be configured to reconnect at logon so that the installation files can be found after the reboot.

Modify Installation

If you want to add or remove a feature or add hardware support to an existing version of 89600 software:

Add or remove a feature

1. Turn on the computer. If the computer is already on, close any applications you have open.

NOTE

To modify the Agilent 89600 VSA software installation, you must have administrator privileges on the computer you are modifying the Agilent 89600 VSA software installation on.

2. Insert the Agilent 89600 Series Vector Signal Analysis Software installation CD-ROM.
3. If the installation utility does not start automatically, click **Start > Run**, and type:
drive:\autoplay.exe
...where *drive* represents the drive containing the installation CD-ROM. Click **OK**.
4. When the Agilent 89600 Installation Manager window opens, click **Install 89600 Series Software**.

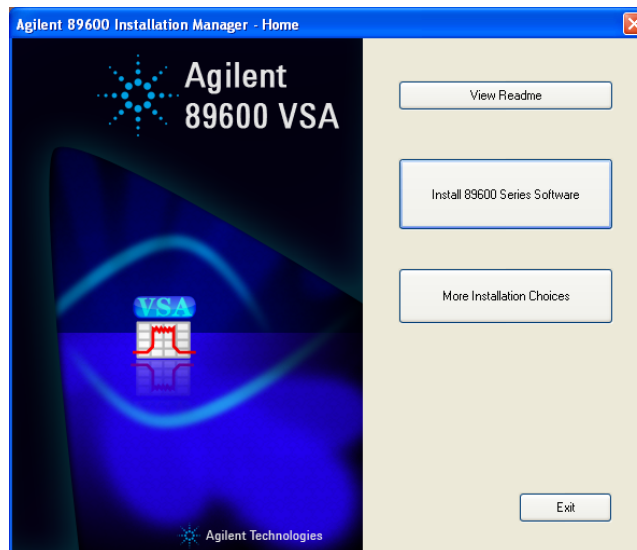

5. The Modify, Repair or Remove window will open. Select **Modify** and continue through the InstallShield Wizard.

Add Hardware Support

1. Turn on the computer. If the computer is already on, close any applications you have open.

NOTE

To install the Agilent 89600 VSA software, you must have administrator privileges on the computer you are installing the Agilent 89600 VSA software on.

2. Insert the Agilent 89600 Series Software installation CD-ROM.
3. If the installation utility does not start automatically, click **Start > Run**, and type:

drive:\autoplay.exe

...where *drive* represents the drive containing the installation CD-ROM. Click **OK**.

4. When the Agilent 89600 Installation Manager window opens, click **More Installation Choices**.

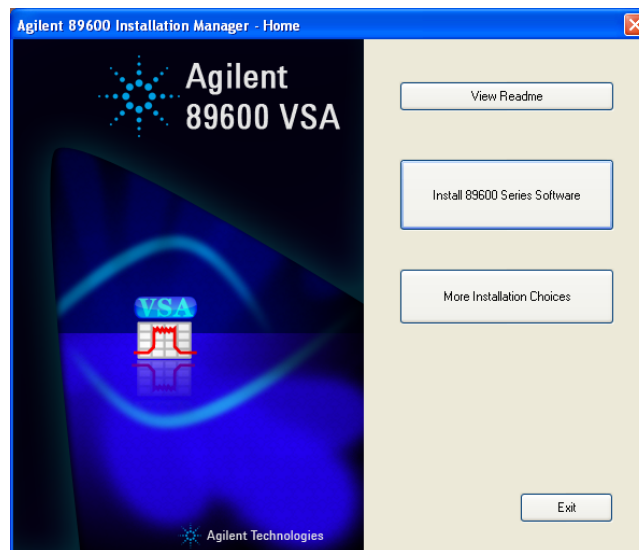

5. In the More Installation Choices window, click **Hardware Support Menu**.
6. The Hardware Support window will open. Select the components to add and continue through the Installation Manager.

Repair Installation

If you need to repair corrupt files on your hard drive affecting an existing version of 89600 Software:

1. Turn on the computer. If the computer is already on, close any applications you have open.

NOTE

To install the Agilent 89600 VSA software, you must have administrator privileges on the computer you are repairing the Agilent 89600 VSA software on.

2. Insert the Agilent 89600 Series Vector Signal Analysis Software installation CD-ROM.

3. If the installation utility does not start automatically, click **Start > Run**, and type:

drive:\autoplay.exe

...where *drive* represents the drive containing the installation CD-ROM. Click **OK**.

4. When the Agilent 89600 Installation Manager window opens, click **Install 89600 Series Software**.

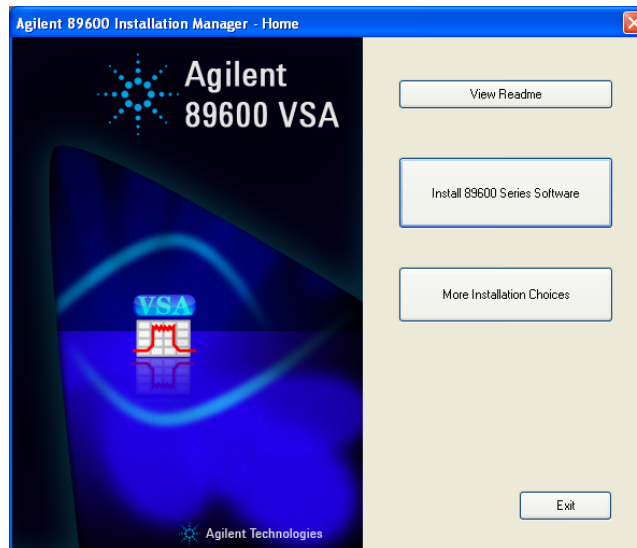

5. The Modify, Repair or Remove window will open. Select **Repair** and continue through the InstallShield Wizard.

Remove

If you need to remove an existing version of 89600 Software:

1. Turn on the computer. If the computer is already on, close any applications you have open.

NOTE

To uninstall the Agilent 89600 VSA software, you must have administrator privileges on the computer you are uninstalling the Agilent 89600 VSA software from.

2. For Windows XP: Click **Start > Control Panel > Add or Remove Programs**.
For Windows Vista: Click **Start > Control Panel > Programs and Features**
3. Scroll down and select *Agilent 89600 Series Software*.
4. For Windows XP: Click **Remove**.
For Windows Vista: Click **Uninstall**.
5. A dialog named *Remove All Agilent 89600 Series Software* will pop up. Click **Yes** to uninstall the software.

Update Installation

IMPORTANT

You must uninstall any 89600 Software that is Version 7.2 or less before you install Version 8.0 or greater. For a Windows XP system, click **Start > Control Panel > Add or Remove Programs**. For a Windows Vista system, click **Start > Control Panel > Programs and Features**.

Each new version of the 89600 Software is shipped with an Update Installation Note. Use the Update Installation Note for the current version being installed.

3 Setting Up VXI Hardware

Introduction

This chapter includes instructions on configuring your VXI measurement hardware, installing the VXI hardware modules into the VXI mainframe, connecting front-panel cables, and connecting the EMC grounding cable to the VXI chassis and laptop PC. See: [Chapter 1](#), “[Installation Overview](#),” on [page 13](#) to learn which procedures you must perform to install your Agilent 89600-series product.

NOTE

If you purchased an Agilent 89610, 89611, 89640, or 89641, everything in this chapter was done at the factory except connecting the cables for an external down converter or EMC grounding cable. If your analyzer uses an external down converter, see the appropriate illustration at the end of the chapter. If your system includes a laptop PC, see “[Connecting EMC grounding cable](#)” on [page 74](#). Otherwise, continue with [Step 2.](#), [part b](#), in “[Set up your measurement hardware](#)” on [page 19](#).

For information on configuring other measurement hardware, see 89600 online help under **Installation and Licensing > Hardware Setup**.

Inspecting Agilent 89600-series VXI modules

The Agilent 89600-series VXI modules were carefully inspected both mechanically and electrically before shipment. They should be free of marks or scratches upon receipt.

If a module was damaged in transit, do the following:

- Save all packing materials.
- File a claim with the carrier
- Call your Agilent Technologies sales and service office (phone numbers available at www.agilent.com/find/89600).

NOTE

If you ordered a 2-channel analyzer, the two E1438 or E1439 modules must have the same amount of memory.

Setting up Agilent 89600 series VXI mainframe and modules

CAUTION To protect circuits from static discharge, observe anti-static techniques whenever handling the Agilent 89600-series VXI modules.

IMPORTANT For safety, environment, regulatory, and mains power specifications, see the user or service manual for your VXI mainframe.

Set logical addresses

This section includes information on setting logical addresses.

To set logical addresses:

1. Check the logical address switches for each VXI module. (See [Figure 3-1](#) through [Figure 3-5](#) on the following pages.) Except for the E2730 and E2731 modules, each module in the system must have a unique logical address. The following table lists the factory default settings (the addresses for second-channel 89605, E1438, and E1439 modules must be different).

For 2-channel systems, the addresses must be different for the two modules

VXI module	Default address	Figure showing address switch location
Agilent 89605	14 (0000 1110)	Figure 3-1 on page 35
Agilent E2730 or E2731	255 (1111 1111)	Figure 3-2 on page 35
Agilent E1439	194 (1100 0010)	Figure 3-3 on page 36
Agilent 89606	15 (0000 1111)	Figure 3-4 on page 37
Agilent E1438	192 (1100 0000)	Figure 3-5 on page 38

2. If you need to change the address setting for a module, use a small screwdriver or similar tool to move the switches to the correct position. The figures on the following pages show the location and default setting of the logical address switches for each module.

Figure 3-1 89605 Input module -- address 14 (000 1110)

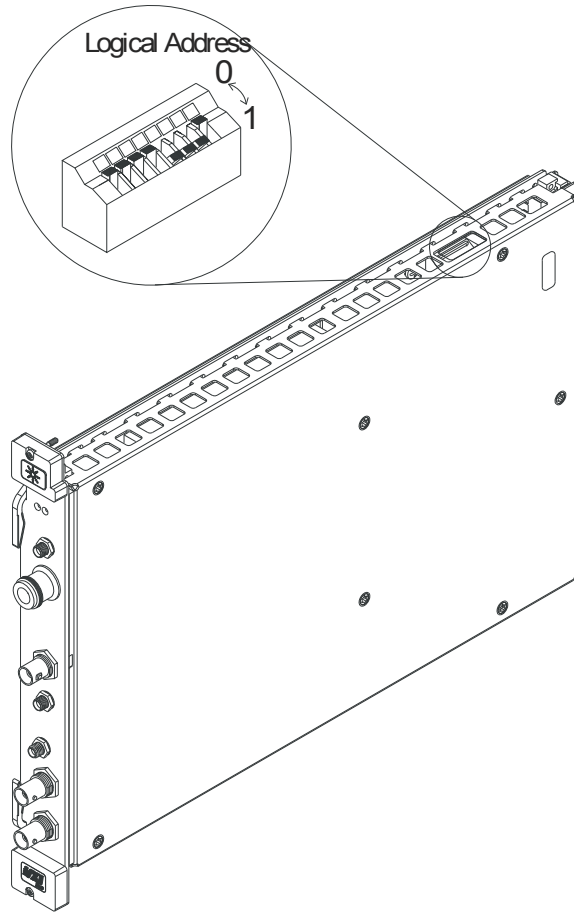
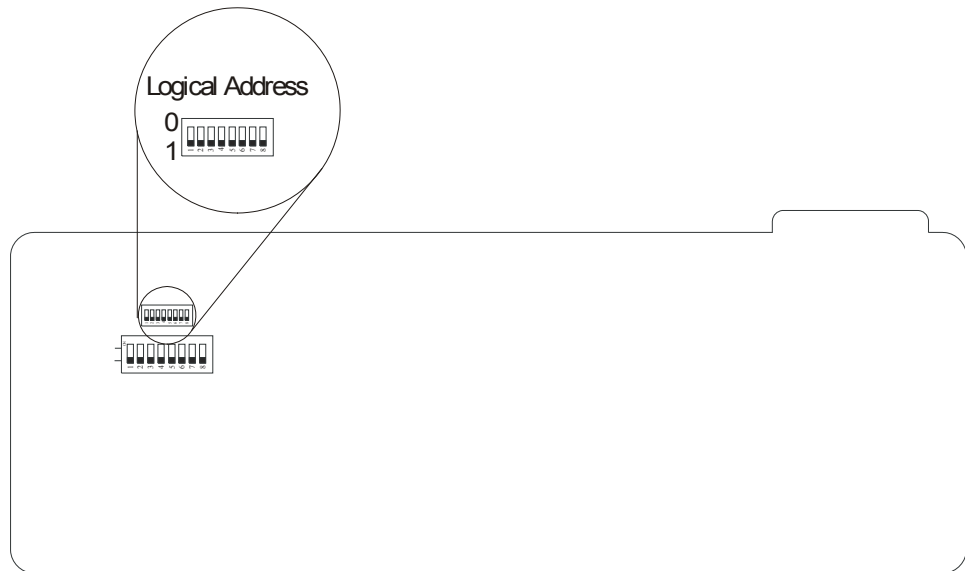

Figure 3-2 E2730 or E2731 RF Tuner module -- address 255 (1111 1111) (This setting enables dynamic addressing, so that the address is automatically assigned.)



For 2-channel systems, the addresses must be different for the two E1439 modules.

Figure 3-3 E1439 ADC module -- address 194 (1100 0010)

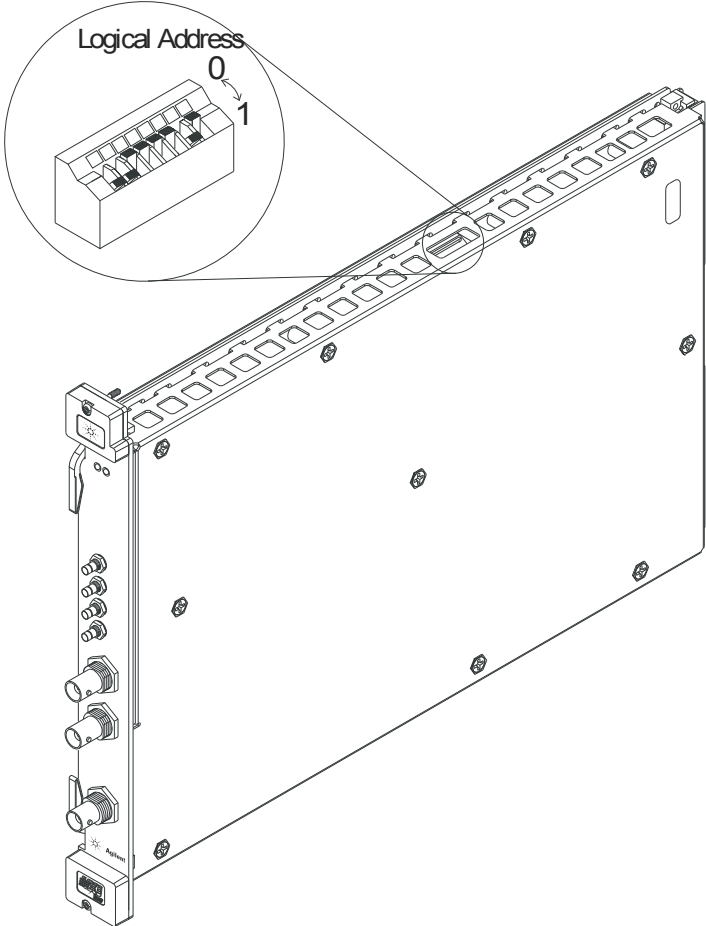
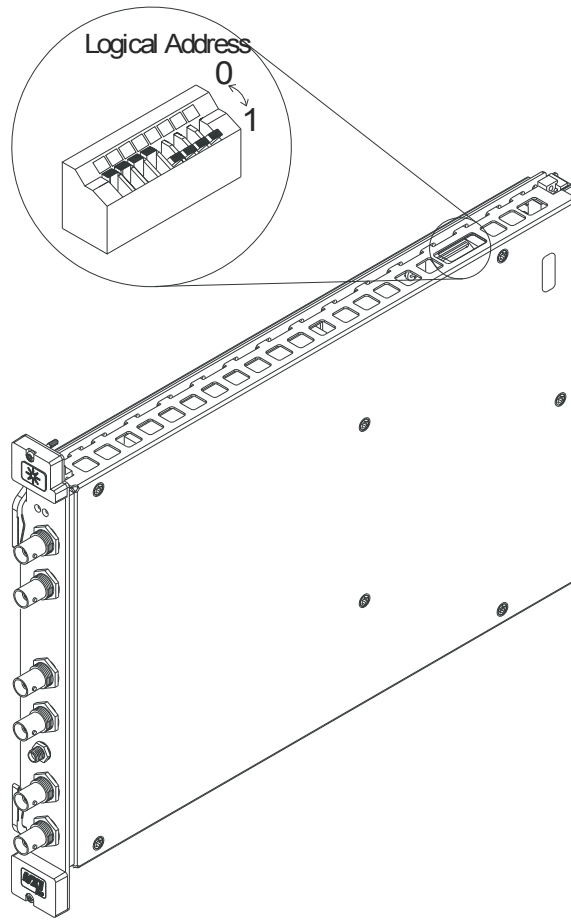
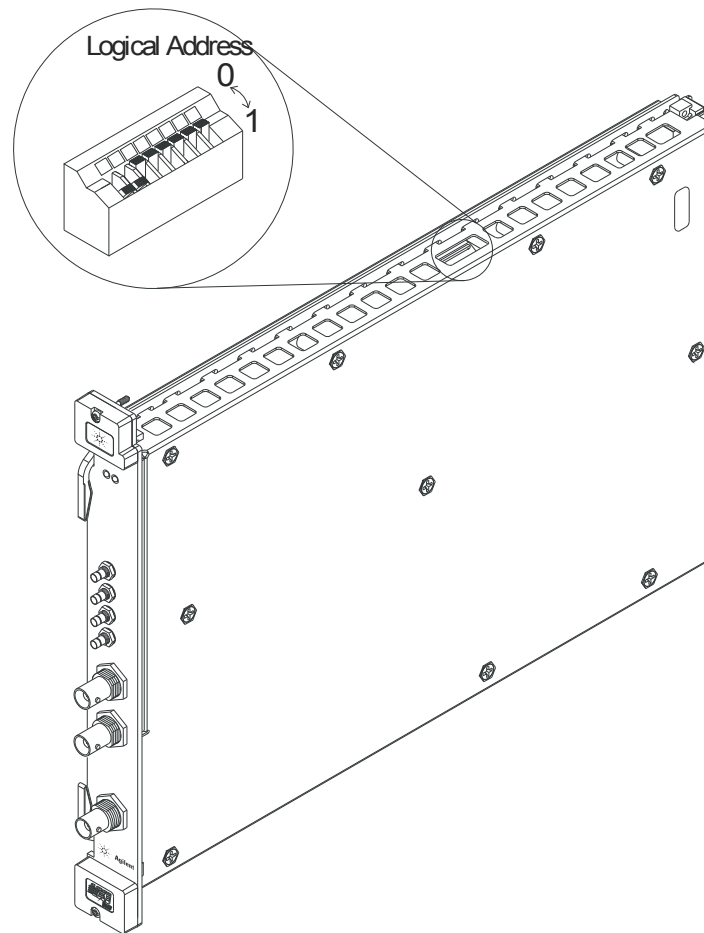

Figure 3-4 89606 module -- address 15 (0000 1111)



For 2-channel systems, the addresses must be different for the two E1438 modules.

Figure 3-5 E1438 ADC module -- address 192 (1100 0000)



Installing modules in the mainframe

Refer to [Figure 3-6](#) for installing modules in the mainframe.

To install modules in the mainframe:

1. Unpack your VXI mainframe.

IMPORTANT

For safety, environment, regulatory, and mains power specifications, see the user or service manual for your VXI mainframe.

2. Set the mainframe's power switch to off (0).

CAUTION

Be sure the power is off before installing modules in the mainframe. Installing or removing a module with power on may damage components in the module.

3. Be sure to put each module in the correct slot, see "[Configuring your VXI hardware](#)" (page 40).
4. Place the module's card edges (top and bottom) into the module guides in the slot.
5. Install the module into the mainframe. (Note: the E2730 module does not have insertion/extraction levers.)

Figure 3-6

Installing a VXI module in the mainframe

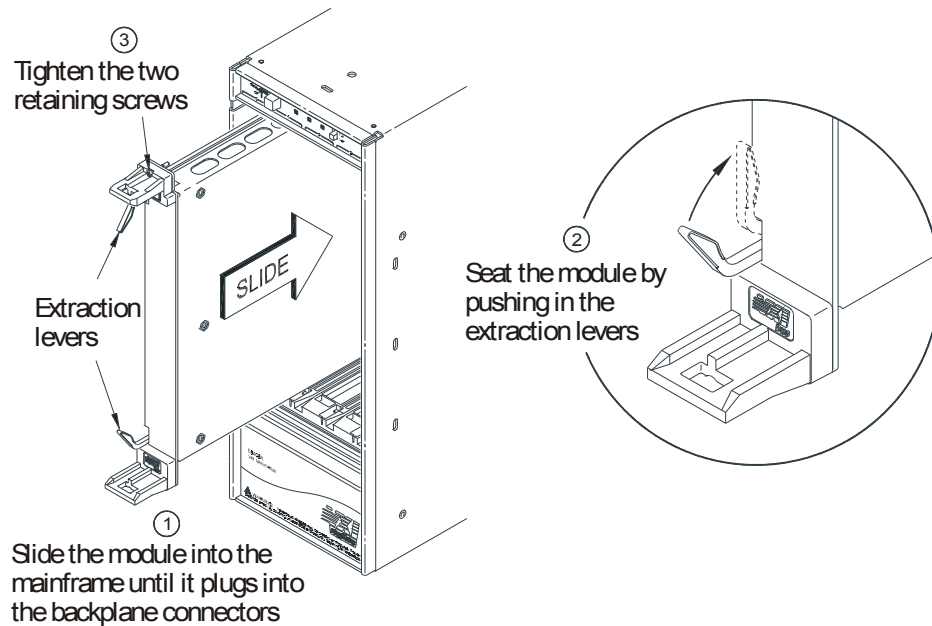

Configuring your VXI hardware

Your Agilent 89600 series VXI modules must be installed in a specified order in the VXI mainframe. There are eight possible configurations:

- Agilent 89610 Single-channel DC-40 MHz analyzer ([page 41](#))
- Agilent 89610 Two-channel DC-40 MHz analyzer ([page 42](#))
- Agilent 89611 70 MHz IF analyzer ([page 43](#))
- Agilent 89611 Two-channel 70 MHz IF analyzer ([page 44](#))
- Agilent 89640 DC-2.7 GHz analyzer ([page 45](#))
- Agilent 89640 DC-2.7 GHz analyzer with second IF/baseband channel ([page 46](#))
- Agilent 89640 DC-2.7 GHz analyzer with second RF channel ([page 47](#))
- Agilent 89641 DC-6 GHz analyzer ([page 48](#))
- Agilent 89641 DC-6 GHz analyzer with second IF/baseband channel ([page 49](#))
- Agilent 89641 DC-6 GHz analyzer with second RF channel ([page 50](#))

NOTE

If you are using a VXI mainframe with more than 4 slots, the Agilent E8491 module or VXI imbedded PC must be installed in slot 0. The other 89600 series modules are not required to be installed in slots 1 through 3. However, the modules must be installed relative to each other in the order described in [Figure 3-7](#) through [Figure 3-16](#).

89610 Single-channel DC-40 MHz analyzer

This configuration includes 3 modules (Figure 3-7), which must be installed in this order:

Mainframe slot	VXI module
0	Agilent E8491 Interconnect
1	Agilent 89606 Baseband Input
2	Agilent E1438 ADC

Note that this illustration shows an 89606B input module. Your analyzer might include an 89606A input; the configuration is the same for both modules.

Figure 3-7

89610 DC-40 MHz analyzer

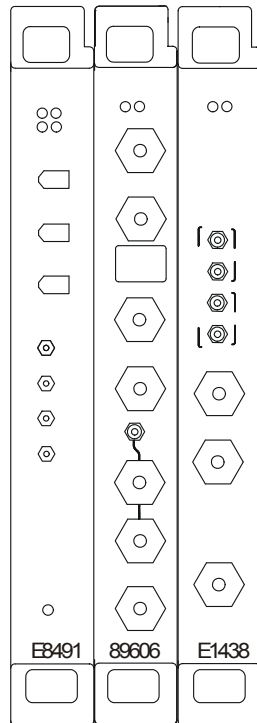

Setting Up VXI Hardware
Installing modules in the mainframe

89610 Two-channel DC-40 MHz analyzer

This configuration includes 4 modules (Figure 3-8), which must be installed in this order:

Mainframe slot	VXI module
0	Agilent E8491 Interconnect
1	Agilent 89606 Baseband Input
2	Agilent E1438 ADC
3	Agilent E1438 ADC

Note that this illustration shows an 89606B input module. Your analyzer might include an 89606A input module. The configuration is the same for both modules.

Figure 3-8

89610 Two-channel DC-40 MHz analyzer

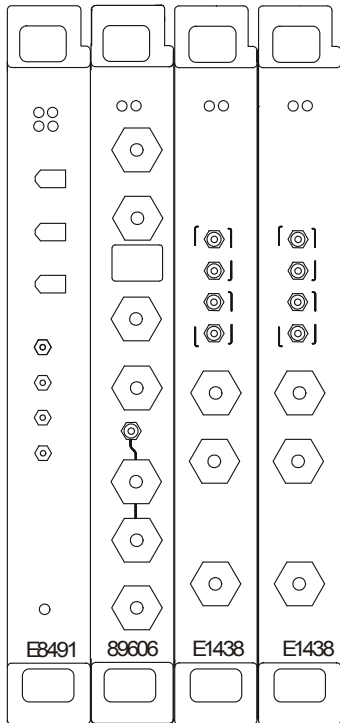

89611 70 MHz IF analyzer

This configuration includes 3 modules ([Figure 3-9](#)), which must be installed in this order:

Mainframe slot	VXI module
0	Agilent E8491 Interconnect
1	Agilent 89605 RF Input
2	Agilent E1439 RF ADC

Note that this illustration shows an 89605B input module. Your analyzer might include an 89605A input. The configuration is the same for both modules.

Figure 3-9

89611 analyzer

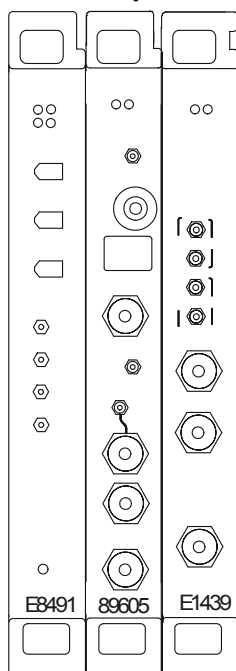

89611 Two-channel 70 MHz IF analyzer

This configuration includes 5 modules ([Figure 3-10](#)), which must be installed in this order:

Mainframe slot	VXI module
0	Agilent E8491 Interconnect
1	Agilent 89605 RF Input
2	Agilent E1439 RF ADC
3	Agilent 89605B RF Input
4	Agilent E1439 RF ADC

NOTE The 2-channel 89611 requires an 89605B module for the second channel (slot 3 in [Figure 3-10](#)). The module for channel 1 can be either an 89605B or A.

Figure 3-10 2-channel 89611 analyzer

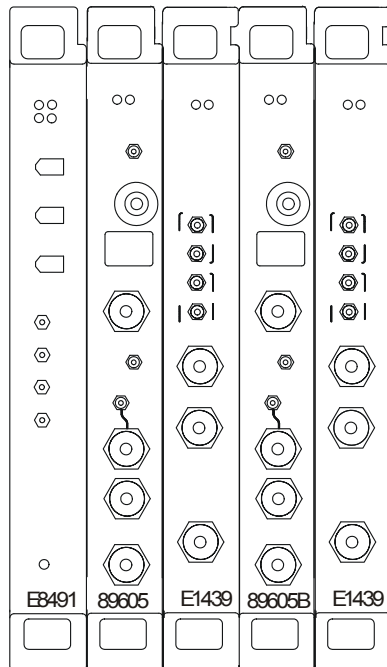

89640 DC-2.7 GHz analyzer

This configuration includes 4 modules (Figure 3-11), which must be installed in this order:

Mainframe slot	VXI module
0	Agilent E8491 Interconnect
1	Agilent 89605 RF Input
2	Agilent E2730 RF Tuner
3	Agilent E1439 RF ADC

Figure 3-11

89640 DC-2.7 GHz analyzer

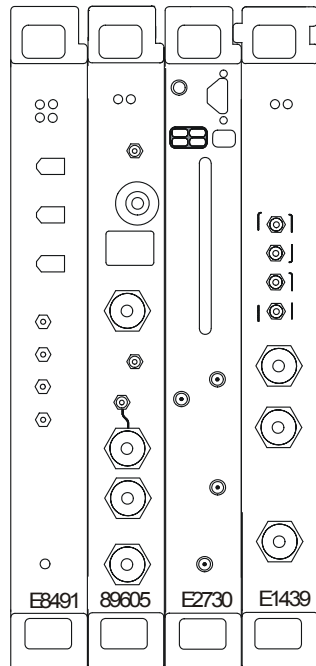

89640 DC-2.7 GHz analyzer with second IF/baseband channel

This configuration includes 6 modules (Figure 3-12), which must be installed in this order:

Mainframe slot	VXI module
0	Agilent E8491 Interconnect
1	Agilent 89605 RF Input
2	Agilent E2730 RF Tuner
3	Agilent E1439 RF ADC
4	Agilent 89605B RF Input
5	Agilent E1439 RF ADC

NOTE The 2-channel 89640 requires an 89605B module for the second channel (slot 4 in Figure 3-12). The module for channel 1 can be either an 89605B or A.

Figure 3-12 89640 DC-2.7 GHz analyzer with second IF/baseband channel

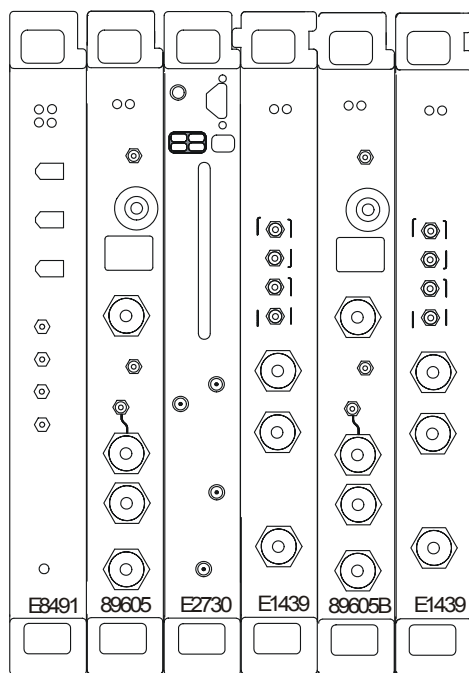

89640 DC-2.7 GHz analyzer with second RF channel

This configuration includes 7 modules (Figure 3-13), which must be installed in this order:

Mainframe slot	VXI module
0	Agilent E8491 Interconnect
1	Agilent 89605 RF Input
2	Agilent E2730 RF Tuner
3	Agilent E1439 RF ADC
4	Agilent 89605B RF Input
5	Agilent E2730 RF Tuner
6	Agilent E1439 RF ADC

NOTE

The 2-channel 89640 requires E2730B modules for both channels and an 89605B module for the second channel (slot 4 in Figure 3-13). The module for channel 1 can be either an 89605B or A.

Figure 3-13

89640 DC-2.7 GHz analyzer with second RF channel

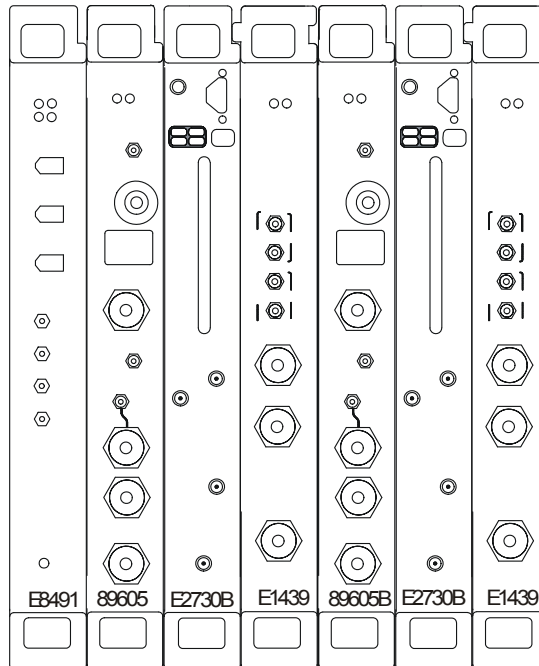

Setting Up VXI Hardware
Installing modules in the mainframe

89641 DC-6 GHz analyzer

This configuration includes 4 modules (Figure 3-14), which must be installed in this order:

Mainframe slot	VXI module
0	Agilent E8491 Interconnect
1	Agilent 89605 RF Input
2	Agilent E2731 RF Tuner
3	Agilent E1439 RF ADC

Figure 3-14

89641 DC-6 GHz analyzer

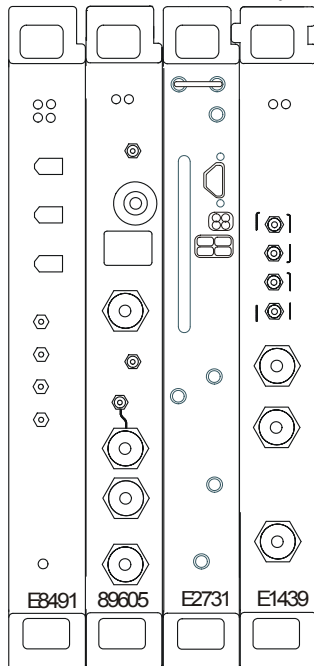

89641 DC-6 GHz analyzer with second IF/baseband channel

This configuration includes 6 modules (Figure 3-15), which must be installed in this order:

Mainframe slot	VXI module
0	Agilent E8491 Interconnect
1	Agilent 89605 RF Input
2	Agilent E2731 RF Tuner
3	Agilent E1439 RF ADC
4	Agilent 89605B RF Input
5	Agilent E1439 RF ADC

NOTE The 2-channel 89641 requires an 89605B module for the second channel (slot 4 in Figure 3-15). The module for channel 1 can be either an 89605 B or A.

Figure 3-15 89641 DC-6 GHz analyzer with second IF/baseband channel

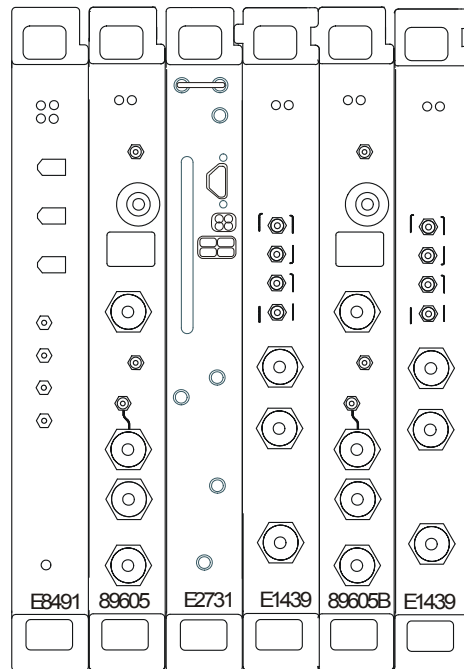

89641 DC-6 GHz analyzer with second RF channel

This configuration includes 7 modules (Figure 3-16), which must be installed in this order:

Mainframe slot	VXI module
0	Agilent E8491 Interconnect
1	Agilent 89605 RF Input
2	Agilent E2731 RF Tuner
3	Agilent E1439 RF ADC
4	Agilent 89605B RF Input
5	Agilent E2731 RF Tuner
6	Agilent E1439 RF ADC

NOTE

The 2-channel 89641 requires E2731B modules for both channels and an 89605B module for the second channel (slot 4 in Figure 3-16). The module for channel 1 can be either an 89605B or A.

Figure 3-16

89641 DC-6 GHz analyzer with second RF channel

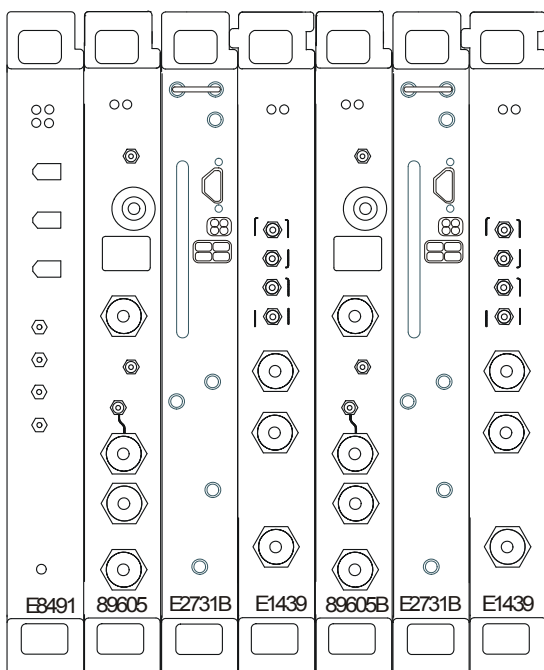

Connecting front panel cables

The illustrations on the following pages show the cable connections for 11 configurations of Agilent 89600 series analyzers. Below each illustration is a table listing each cable, termination, and adapter with a description and part number.

For a single-channel 89610A, see [page 52](#).

For a two-channel 89610A, see [page 53](#).

For an 89610A with external down converter, see [page 54](#).

For a single-channel 89611A, see [page 55](#).

For an 89611A with PSA option H70, see [page 56](#).

For a two-channel 89611A, see [page 59](#).

For a single-channel 89640A, see [page 61](#).

For an 89640A with second IF/baseband channel, see [page 62](#).

For an 89640A with second RF channel, see [page 64](#).

For an 89640A with external down converter, see [page 66](#).

For a single-channel 89641A, see [page 67](#).

For an 89641A with second IF/baseband channel, see [page 68](#).

For an 89641A with second RF channel, see [page 70](#).

For an 89641A with external down converter, see [page 72](#).

NOTE

If you change or replace any cables, be sure to do a calibration to compensate for variance in cable characteristics before you make measurements.

Cable connections, 89610

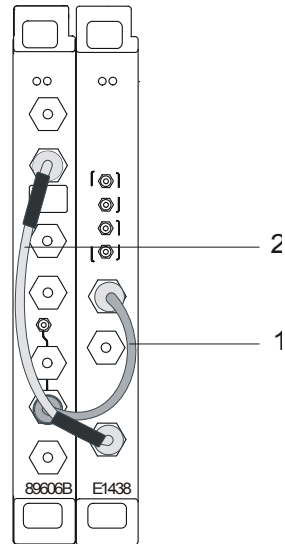

Description	Connection	Part number
1 black BNC-BNC cable (172 mm)	89606 10 MHz Ref Out to E1438A Ext Clock/Ref	8120-6237
2 black BNC-BNC cable (267mm)	89606 To ADC Analog In to E1438 Analog In	8121-0133

After you have installed and configured the IEEE-1394 interface in your PC, you must connect the IEEE 1394 interface cable between the PC and one of the E8491 module IEEE ports. If you are using a laptop PC, you must also connect the EMC grounding cable. See [“Connecting EMC grounding cable” on page 74](#).

Continue with [Step 2., part b](#), in [“Set up your measurement hardware” on page 19](#).

Cable connections, two-channel 89610

The following cable connections for the 2-channel 89610 are especially important:

- You must connect one set of Clock connectors and one set of Sync connectors between the two E1438 modules. The two cables used for these connections must be exactly the same length to avoid timing and synchronization problems.
- You must connect the 10 MHz Ref Out from the 89606 module to the Ext Clock/Ref connector on the E1438 module adjacent to the 89606 module.
- If you use external trigger, you must connect the trigger signal to the channel 1 ADC (E1438) trigger input.

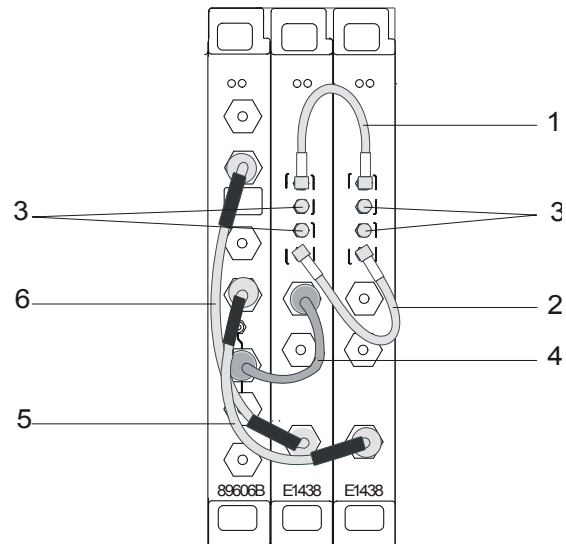

Description	Connection	Part number
1 orange SMB-SMB cable (100 mm)	E1438 #1 <i>Clock</i> to E1438 #2 <i>Clock</i>	03585-61603
2 orange SMB-SMB cable (100 mm)	E1438 #1 <i>Sync</i> to E1438 #2 <i>Sync</i>	03585-61603
3 50 ohm SMB term (Qty 4)	Unused E1438 <i>Clock</i> & <i>Sync</i> connectors	1250-0676
4 black BNC-BNC cable (172 mm)	89606 <i>10 MHz Ref Out</i> to E1438A #1 <i>Ext Clock/Ref</i>	8120-6237
5 black BNC-BNC cable (215 mm)	89606 <i>To ADC 2 Analog In</i> to E1438A #2 <i>Analog In</i>	8121-0132
6 black BNC-BNC cable (267 mm)	89606 <i>To ADC 1 Analog In</i> to E1438A #1 <i>Analog In</i>	8121-0133

After you have installed and configured the IEEE-1394 interface in your PC, you must connect the IEEE 1394 interface cable between the PC and one of the E8491 module IEEE ports. If you are using a laptop PC, you must also connect the EMC grounding cable. See “Connecting EMC grounding cable” on page 74.

Continue with [Step 2.](#), part b, in “Set up your measurement hardware” on page 19.

Cable connections, 89610 with external down converter

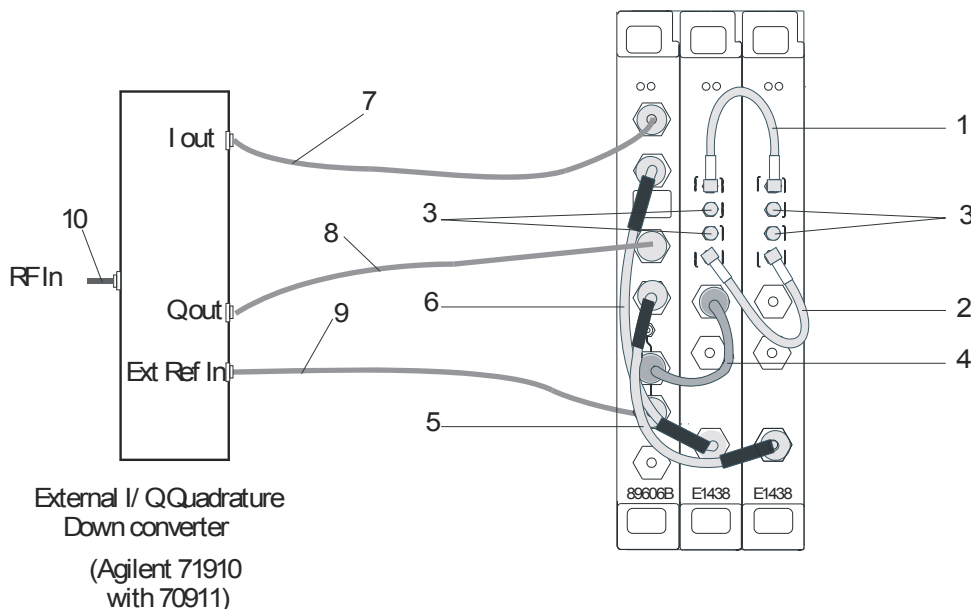

Description	Connection	Part number
1 orange SMB-SMB cable (100 mm)	E1438 #1 to E1438 #2 Clock	03585-61603
2 orange SMB-SMB cable (100 mm)	E1438 #1 to E1438 #2 Sync	03585-61603
3 50 ohm SMB term (Qty 4)	Unused E1438 Clock & Sync connectors	1250-0676
4 black BNC-BNC cable (172 mm)	89606 to E1438 Ext Clock/Ref	8120-6237
5 black BNC-BNC cable (215 mm)	89606 to E1438 #2 Analog In	8121-0132
6 black BNC-BNC cable (267mm)	89606 to E1438 #1 Analog In	8121-0133
7 varies	down converter I Out to 89606 Ch1 In	user supplied
8 varies	down converter Q Out to 89606 Ch2 In	user supplied
9 BNC	89606 10 MHz Ref Out to down converter Ext Ref In	user supplied
10 varies	down converter RF input	user supplied

After you have installed and configured the IEEE-1394 interface in your PC, you must connect the IEEE 1394 interface cable between the PC and one of the E8491 module IEEE ports. If you are using a laptop PC, you must also connect the EMC grounding cable. See [“Connecting EMC grounding cable” on page 74](#).

Continue with [Step 2., part b](#), in [“Set up your measurement hardware” on page 19](#).

Cable connections, 89611

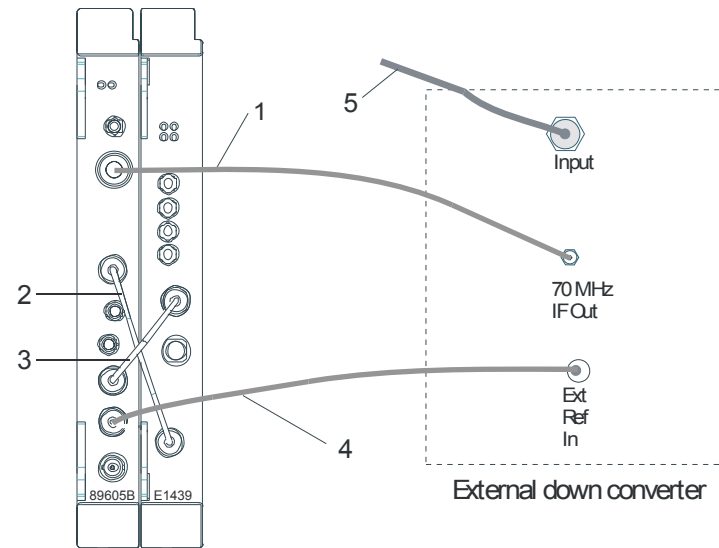

	Description	Connection	Part number
1	SMA-SMA cable (requires a type N-SMA adapter)	from external tuner IF output to 89605 <i>Ch 1 Input</i>	8121-0790 (cable) 1250-1250 (adapter)
2	black BNC-BNC cable (215 mm)	from 89605 <i>To ADC Analog In</i> to E1439 <i>Analog In</i>	8121-0132
3	black BNC-BNC cable (215 mm)	from 89605 <i>10 MHz Ref Out</i> to E1439 <i>Ext Clock/Ref</i>	8121-0132
4	BNC-BNC cable	from 89605 <i>10 MHz Ref Out</i> to external tuner <i>Ext Ref In</i> (or from external tuner <i>10 MHz Ref Out</i> to 89605 <i>Ext Ref In</i>)	user supplied
5	varied	input to down converter	user supplied

After you have installed and configured the IEEE-1394 interface in your PC, you must connect the IEEE 1394 interface cable between the PC and one of the E8491 module IEEE ports. If you are using a laptop PC, you must also connect the EMC grounding cable. See “Connecting EMC grounding cable” on page 74.

Continue with [Step 2., part b](#), in “Set up your measurement hardware” on page 19.

Cable connections, 89611 with PSA Option H70

This configuration replaces the VXI tuner module with an Agilent PSA option H70.

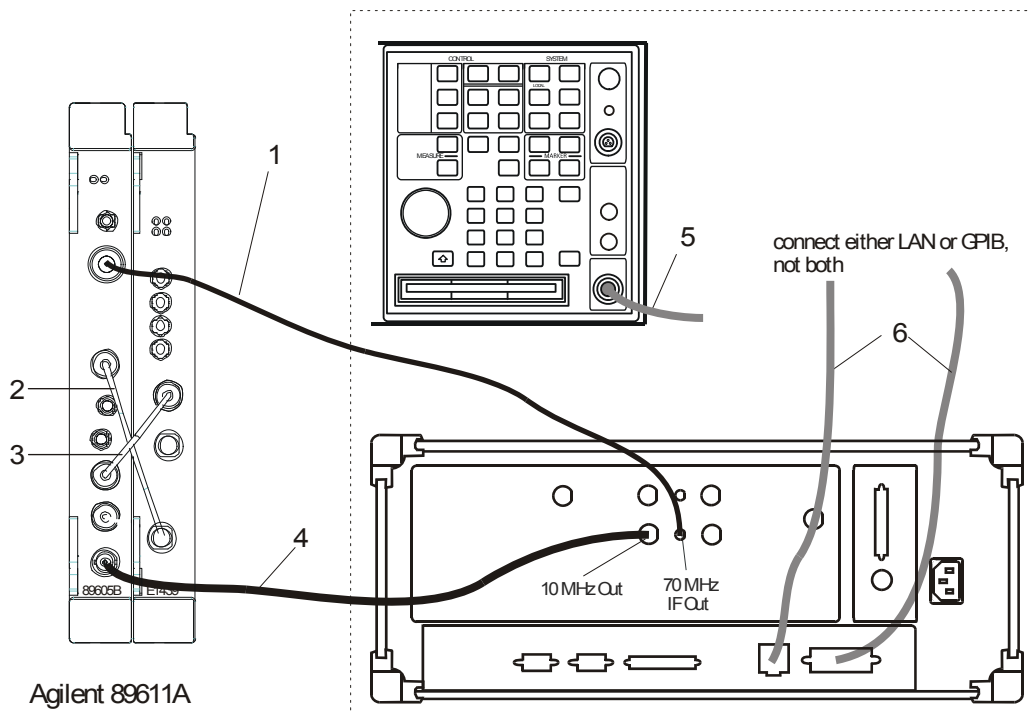

Agilent 89611A

Agilent PSA option H70

Description	Connection	Part number
1 SMA-SMA cable with a type N-SMA adapter	from PSA 70 MHz IF output to 89605 <i>Ch 1 Input</i>	8121-0790 (cable) 1250-1250 (adapter)
2 black BNC-BNC cable (215 mm)	from 89605 <i>To ADC Analog In</i> to E1439 <i>Analog In</i>	8121-0132
3 black BNC-BNC cable (215 mm)	from 89605 <i>10 MHz Ref Out</i> to E1439 <i>Ext Clock/Ref</i>	8121-0132
4 BNC-BNC cable	from 89605 <i>10 MHz Ref Out</i> to PSA <i>Ext Ref In</i> (or from PSA <i>10 MHz Ref Out</i> to 89605 <i>Ext Ref In</i>)	user supplied
5 varies	PSA RF input	user supplied
6 LAN or GPIB cable	LAN or GPIB connector to PC (not both)	varies

After you have installed and configured the IEEE-1394 interface in your PC, you must connect the IEEE 1394 interface cable between the PC and one of the E8491 module IEEE ports. If you are using a laptop PC, you must also connect the EMC grounding cable. See [“Connecting EMC grounding cable” on page 74](#).

Continue with [Step 2., part b](#), in [“Set up your measurement hardware” on page 19](#).

Cable connections, 89611 with ESA Option H70

This configuration replaces the VXI tuner module with an Agilent ESA option H70.

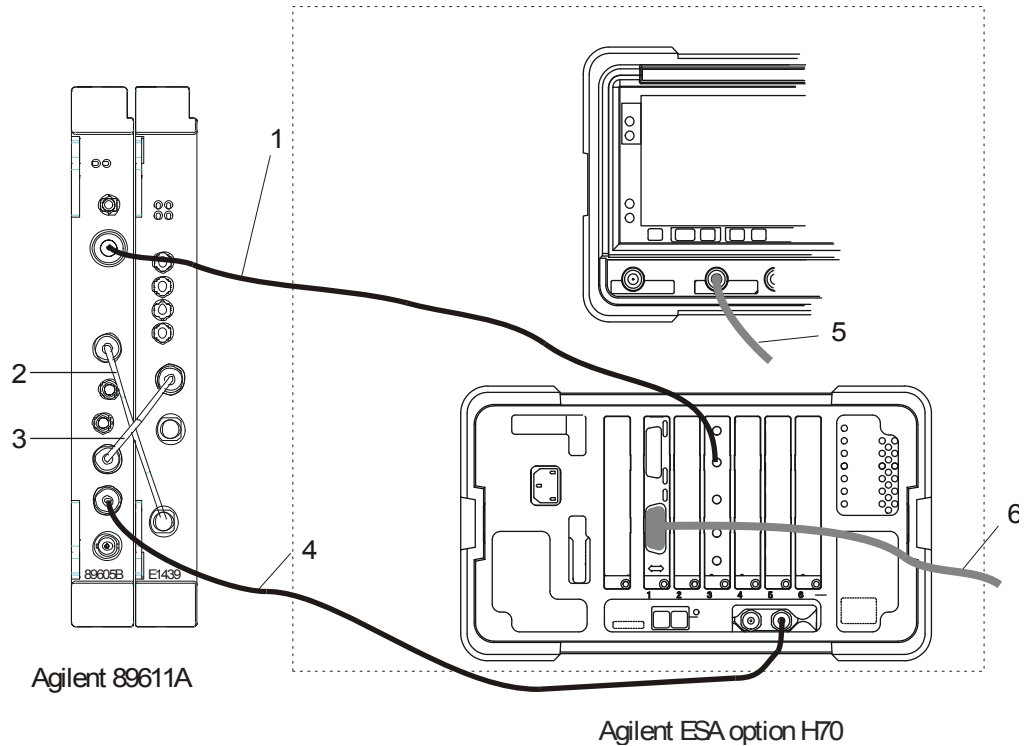

Note that the cards may be installed in a different order in the slots, so the GPIB connector and the 70 MHz Out connector may be in different locations on the rear panel.

Description	Connection	Part number
1 SMA-SMA cable with a type N-SMA adapter	from ESA 70 MHz IF output to 89605 <i>Ch 1 Input</i>	8121-0790 (cable) 1250-1250 (adapter)
2 black BNC-BNC cable (215 mm)	from 89605 <i>To ADC Analog In</i> to E1439 <i>Analog In</i>	8121-0132
3 black BNC-BNC cable (215 mm)	from 89605 <i>10 MHz Ref Out</i> to E1439 <i>Ext Clock/Ref</i>	8121-0132
4 BNC-BNC cable	from 89605 <i>10 MHz Ref Out</i> to ESA <i>Ext Ref In</i> (or from ESA <i>10 MHz Ref Out</i> to 89605 <i>Ext Ref In</i>)	user supplied
5 varies	ESA RF input	user supplied
6 GPIB cable	ESA GPIB connector to PC	varies

After you have installed and configured the IEEE-1394 interface in your PC, you must connect the IEEE 1394 interface cable between the PC and one of the E8491 module IEEE ports. If you are using a laptop PC, you must also connect the EMC

Setting Up VXI Hardware
Connecting front panel cables

grounding cable. See “Connecting EMC grounding cable” on page 74.

Continue with [Step 2.](#), part b, in “Set up your measurement hardware” on page 19.

Cable connections, two-channel 89611

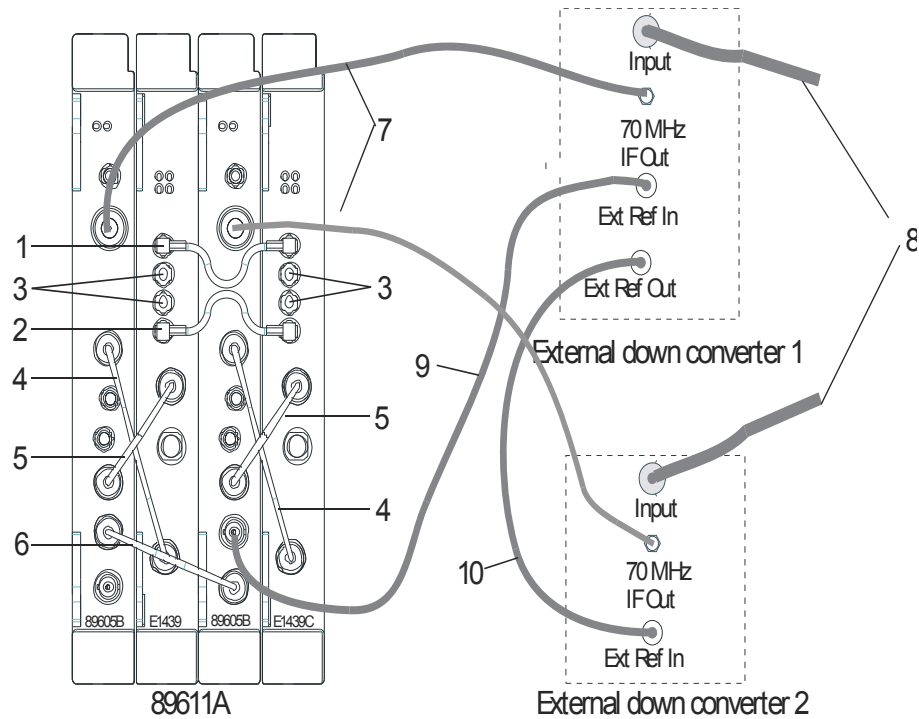

NOTE

If you use external trigger, you must connect the trigger signal to the channel 1 ADC (E1439) trigger input.

The interconnections for the 10 MHz reference signals can be different, but you must ensure that all the hardware is referenced to one signal.

	Description	Connection	Part number
1	orange SMB-SMB cable (100 mm)	E1439 #1 <i>Clock</i> to E1439 #2 <i>Clock</i>	03585-61603
2	orange SMB-SMB cable (100 mm)	E1439 #1 <i>Sync</i> to E1439 #2 <i>Sync</i>	03585-61603
3	50 ohm SMB term (Qty 4)	Unused E1438 <i>Clock</i> & <i>Sync</i> connectors	1250-0676
4	black BNC-BNC cable (215 mm)	89605 <i>To ADC Analog In</i> to E1439 <i>Analog In</i>	8121-0132
5	black BNC-BNC cable (215 mm)	from 89605 <i>10 MHz Ref Out</i> to E1439 <i>Ext Clock/Ref</i>	8121-0132
6	black BNC-BNC cable (215 mm)	from 89605 <i>1 10 MHz Ref Out</i> to 89605 <i>2 Ext Ref In</i>	8121-0132
7	varies	external down converter <i>70 MHz IF Out</i> to 89605 <i>Ch 1 Input</i>	user supplied
8	varies	input to down converter	user supplied
9	varies	from 89605 #2 <i>10 MHz Ref Out</i> to external down converter #1 <i>Ext Ref In</i>	user supplied

Setting Up VXI Hardware

Connecting front panel cables

Description	Connection	Part number
10 varies	from external down converter #1 <i>10 MHz Ref Out</i> to external down converter #2 <i>Ext Ref In</i>	user supplied

After you have installed and configured the IEEE-1394 interface in your PC, you must connect the IEEE 1394 interface cable between the PC and one of the E8491 module IEEE ports. If you are using a laptop PC, you must also connect the EMC grounding cable. See [“Connecting EMC grounding cable” on page 74](#).

Continue with [Step 2., part b](#), in [“Set up your measurement hardware” on page 19](#).

Cable connections, 89640

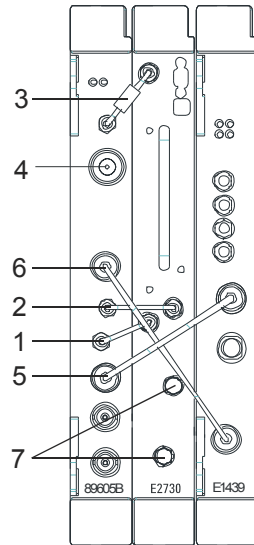

	Description	Connection	Part number
1	semi-rigid SMA cable	89605 10 MHz Ext Ref Out to E2730 10 MHz Ext Ref	for 89605B, 89605-61693 for 89605A, 89605-61691
2	semi-rigid SMA cable	E2730 70 MHz IF Out to 89605 From 70 MHz IF Out	89605-61691
3	semi-rigid SMA cable	89605 To RF In to E2730 RF In	89605-61692
4	N-to-BNC adapter	89605 Ch 1 Input (user signal)	1250-0780
5	black BNC-BNC cable (215 mm)	89605 10 MHz Ref Out to E1439 Ext Clock/Ref	8121-0132
6	black BNC-BNC cable (215 mm)	89605 To ADC Analog In to E1439 Analog In	8121-0132
7	coax SMA cap	E2730 1st LO In/Out and 2nd LO In/Out	1250-0590

NOTE

It is important that you use the semi-rigid SMA cables shipped with the analyzer. Using other cables could degrade measurement accuracy.

After you have installed and configured the IEEE-1394 interface in your PC, you must connect the IEEE 1394 interface cable between the PC and one of the E8491 module IEEE ports. If you are using a laptop PC, you must also connect the EMC grounding cable. See “Connecting EMC grounding cable” on page 74.

Continue with [Step 2., part b](#), in “Set up your measurement hardware” on page 19.

Cable connections, 89640 with second IF/baseband channel

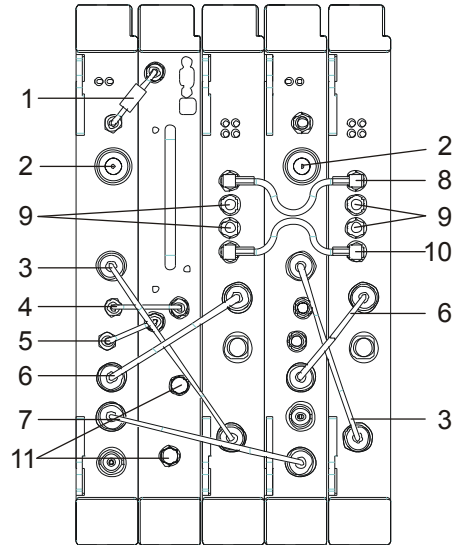

NOTE

If you use external trigger, you must connect the trigger signal to the channel 1 ADC (E1439) trigger input.

It is important that you use the semi-rigid SMA cables shipped with the analyzer. Using other cables could degrade measurement accuracy.

	Description	Connection	Part number
1	semi-rigid SMA cable	89605 <i>To RF In</i> to E2730 <i>RF In</i>	89605-61692
2	N-to-BNC adapter	89605 <i>Ch 1 Input</i> (user signal)	1250-0780
3	black BNC-BNC cable (215 mm)	89605 <i>To ADC Analog In</i> to E1439 <i>Analog In</i>	8121-0132
4	semi-rigid SMA cable	E2730 <i>70 MHz IF Out</i> to 89605 <i>From 70 MHz IF Out</i>	89605-61691
5	semi-rigid SMA cable	89605 <i>10 MHz Ext Ref Out</i> to E2730 <i>10 MHz Ext Ref</i>	for 89605B, 89605-61693 for 89605A, 89605-61691
6	black BNC-BNC cable (215 mm)	89605 <i>10 MHz Ref Out</i> to E1439 <i>Ext Clock/Ref</i>	8121-0132
7	black BNC-BNC cable (215 mm)	89605-1 <i>10 MHz Ext Ref Out</i> to 89605-2 <i>Ext Ref In</i>	8121-0132
8	orange SMB-SMB cable (100 mm)	E1439 #1 <i>Clock</i> to E1439 #2 <i>Clock</i>	03585-61603
9	50 ohm SMB term (Qty 4)	Unused E1438 <i>Clock & Sync</i> connectors	1250-0676
10	orange SMB-SMB cable (100 mm)	E1439 #1 <i>Sync</i> to E1439 #2 <i>Sync</i>	03585-61603
11	coax SMA cap	E2730 <i>1st LO In/Out</i> and <i>2nd LO In/Out</i>	1250-0590

After you have installed and configured the IEEE-1394 interface in your PC, you must connect the IEEE 1394 interface cable between the PC and one of the E8491 module IEEE ports. If you are using a laptop PC, you must also connect the EMC grounding cable. See “[Connecting EMC grounding cable](#)” on page 74.

Continue with [Step 2.](#), part b, in “[Set up your measurement hardware](#)” on page 19.

Cable connections, 89640 with second RF channel

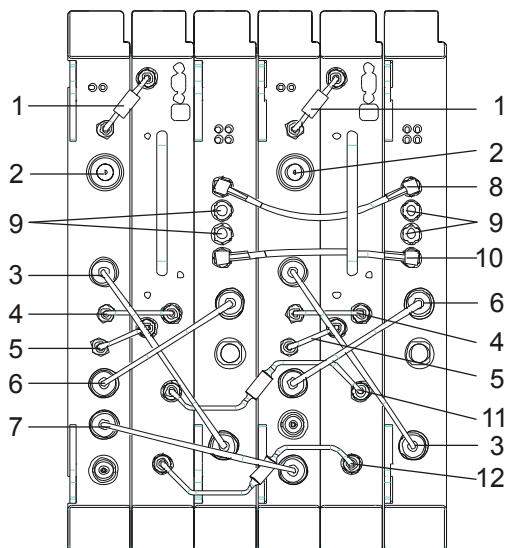

NOTE

If you use external trigger, you must connect the trigger signal to the channel 1 ADC (E1439) trigger input. It is important that you use the semi-rigid SMA cables shipped with the analyzer; using other cables could degrade measurement accuracy.

	Description	Connection	Part number
1	semi-rigid SMA cable	89605 To RF In to E2730 RF In	89605-61692
2	N-to-BNC adapter	89605 Ch 1 Input (user signal)	1250-0780
3	black BNC-BNC cable (215 mm)	89605 To ADC Analog In to E1439 Analog In	8121-0132
4	semi-rigid SMA cable	E2730 70 MHz IF Out to 89605 From 70 MHz IF Out	89605-61691
5	semi-rigid SMA cable	89605 10 MHz Ext Ref Out to E2730 10 MHz Ext Ref	for 89605B, 89605-61693 for 89605A, 89605-61691
6	black BNC-BNC cable (215 mm)	89605 10 MHz Ref Out to E1439 Ext Clock/Ref	8121-0132
7	black BNC-BNC cable (215 mm)	89605-1 10 MHz Ext Ref Out to 89605-2 Ext Ref In	8121-0132
8	orange SMB-SMB cable (100 mm)	E1439 #1 Clock to E1439 #2 Clock	03585-61603
9	50 ohm SMB term (Qty 4)	Unused E1438 Clock & Sync connectors	1250-0676
10	orange SMB-SMB cable (100 mm)	E1439 #1 Sync to E1439 #2 Sync	03585-61603
11	semi-rigid SMA cable	E2730 #1 2nd LO In/Out to E2730 #2 2nd LO In/Out	89605-61696
12	semi-rigid SMA cable	E2730 #1 1st LO In/Out to E2730 #2 1st LO In/Out	89605-61696

After you install and configure the IEEE-1394 interface in your PC, you must connect an IEEE 1394 cable between the PC and an E8491 module IEEE ports. If you are using a laptop PC, you must also connect the EMC grounding cable. See [“Connecting EMC grounding cable” on page 74](#).

CAUTION

If you reconfigure a 2-RF-channel 89640 to a single-channel, you must connect coax SMA caps (Agilent part number 1250-0590) to the LO connectors on the E7230 module.

Continue with [Step 2., part b](#), in [“Set up your measurement hardware” on page 19](#).

Cable connections, 89640 with external down converter

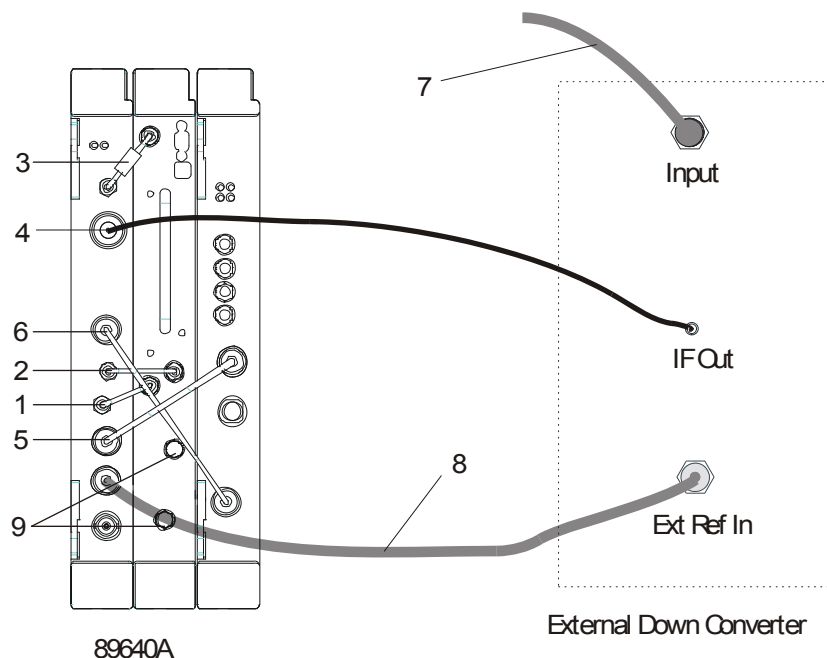

Description	Connection	Part number
1 semi-rigid SMA cable	89605 10 MHz Ext Ref Out to E2730 10 MHz Ext Ref	for 89605A, 89605-61691 for 89605B, 89605-61693
2 semi-rigid SMA cable	E2730 70 MHz IF Out to 89605 From 70 MHz IF Out	89605-61691
3 semi-rigid SMA cable	89605 To RF In to E2730 RF In	89605-61692
4 varies	external down converter IF Out to 89605 Ch1 Input	varies
5 black BNC-BNC cable (215 mm)	89605 10 MHz Ref Out to E1439 Ext Clock/Ref	8121-0132
6 black BNC-BNC cable (215 mm)	89605 To ADC Analog In to E1439 Analog In	8121-0132
7 varies	input to external down converter	varies
8 BNC-BNC cable	89605 10 MHz Ext Ref Out to external down converter Ext Ref In	varies
9 coax SMA cap	E2730 1st LO In/Out and 2nd LO In/Out	1250-0590

NOTE

It is important that you use the semi-rigid SMA cables shipped with the analyzer. Using other cables could degrade measurement accuracy.

After you have installed and configured the IEEE-1394 interface in your PC, you must connect the IEEE 1394 interface cable between the PC and one of the E8491 module IEEE ports. If you are using a laptop PC, you must also connect the EMC grounding cable. See “Connecting EMC grounding cable” on page 74.

Continue with [Step 2., part b](#), in “Set up your measurement hardware” on page 19.

Cable connections, 89641

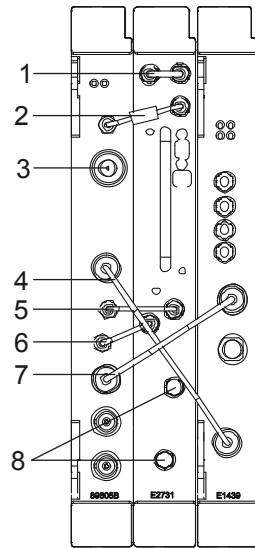

NOTE

It is important that you use the semi-rigid SMA cables shipped with the analyzer. Using other cables could degrade measurement accuracy.

	Description	Connection	Part number
1	semi-rigid SMA cable	E2731 <i>FE RF Out</i> to E2731 <i>2.7GHz RF In</i>	E2731-61601
2	semi-rigid SMA cable	89605 <i>To RF In</i> to E2731 <i>6 GHz In</i>	89605-61694
3	N-to-BNC adapter	89605 <i>Ch 1 Input</i> (user signal)	1250-0780
4	black BNC-BNC cable (215 mm)	89605 <i>To ADC Analog In</i> to E1439 <i>Analog In</i>	8121-0132
5	semi-rigid SMA cable	E2731 <i>70 MHz IF Out</i> to 89605 <i>From 70 MHz IF Out</i>	89605-61691
6	semi-rigid SMA cable	89605B <i>10 MHz Ext Ref Out</i> to E2731 <i>10 MHz Ext Ref</i>	for 89605B, 89605-61693 for 89605A, 89605-61691
7	black BNC-BNC cable (215 mm)	89605 <i>10 MHz Ref Out</i> to E1439 <i>Ext Clock/Ref</i>	8121-0132
8	coax SMA cap	E2731 <i>1st LO In/Out</i> and <i>2nd LO In/Out</i>	1250-0590

After you have installed and configured the IEEE-1394 interface in your PC, you must connect the IEEE 1394 interface cable between the PC and one of the E8491 module IEEE ports. If you are using a laptop PC, you must also connect the EMC grounding cable. See [“Connecting EMC grounding cable”](#) on page 74.

Continue with [Step 2., part b](#), in [“Set up your measurement hardware”](#) on page 19.

Cable connections, 89641 with second IF/baseband channel

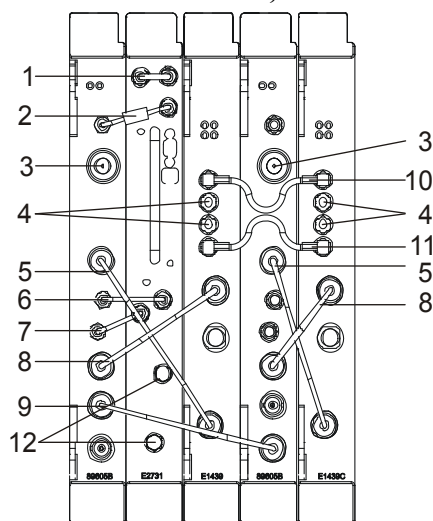

NOTE

If you use external trigger, you must connect the trigger signal to the channel 1 ADC (E1439) trigger input.

It is important that you use the semi-rigid SMA cables shipped with the analyzer. Using other cables could degrade measurement accuracy.

	Description	Connection	Part number
1	semi-rigid SMA cable	E2731 <i>FE RF Out</i> to E2731 <i>2.7GHz RF In</i>	E2731-61601
2	semi-rigid SMA cable	89605 <i>To RF In</i> to E2731 <i>6 GHz In</i>	89605-61694
3	N-to-BNC adapter	89605 <i>Ch 1 Input</i> (user signal)	1250-0780
4	50 ohm SMB term (Qty 4)	Unused E1439 <i>Clock & Sync</i> connectors	1250-0676
5	black BNC-BNC cable (215 mm)	89605 <i>To ADC Analog In</i> to E1439 <i>Analog In</i>	8121-0132
6	semi-rigid SMA cable	E2731 <i>70 MHz IF Out</i> to 89605 <i>From 70 MHz IF Out</i>	89605-61691
7	semi-rigid SMA cable	89605 <i>10 MHz Ext Ref Out</i> to E2731 <i>10 MHz Ext Ref</i>	for 89605B, 89605-61693 for 89605A, 89605-61691
8	black BNC-BNC cable (215 mm)	89605 <i>10 MHz Ref Out</i> to E1439 <i>Ext Clock/Ref</i>	8121-0132
9	black BNC-BNC cable (215 mm)	89605 #1 <i>10 MHz Ref Out</i> to 89605 #2 <i>Ext Ref In</i>	8121-0132
10	orange SMB-SMB cable (100 mm)	E1438 #1 <i>Clock</i> to E1438 #2 <i>Clock</i>	03585-61603
11	orange SMB-SMB cable (100 mm)	E1438 #1 <i>Sync</i> to E1438 #2 <i>Sync</i>	03585-61603
12	coax SMA cap	E2731 <i>1st LO In/Out</i> and <i>2nd LO In/Out</i>	1250-0590

After you have installed and configured the IEEE-1394 interface in your PC, you

must connect the IEEE 1394 interface cable between the PC and one of the E8491 module IEEE ports. If you are using a laptop PC, you must also connect the EMC grounding cable. See “[Connecting EMC grounding cable](#)” on page 74.

Continue with [Step 2.](#), part b, in “[Set up your measurement hardware](#)” on page 19.

Cable connections, 89641 with second RF channel

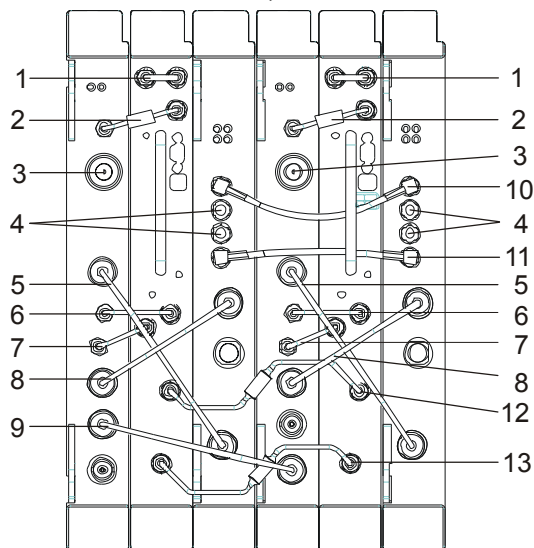

NOTE

If you use external trigger, you must connect the trigger signal to the channel 1 ADC (E1439) trigger input.

It is important that you use the semi-rigid SMA cables shipped with the analyzer. Using other cables could degrade measurement accuracy.

Description	Connection	Part number
1 semi-rigid SMA cable	E2731 <i>FE RF Out</i> to E2731 <i>2.7GHz RF In</i>	E2731-61601
2 semi-rigid SMA cable	89605 <i>To RF In</i> to E2731 <i>6 GHz In</i>	89605-61694
3 N-to-BNC adapter	89605 <i>Ch 1 Input</i> (user signal)	1250-0780
4 50 ohm SMB term (Qty 4)	Unused E1439 <i>Clock & Sync</i> connectors	1250-0676
5 black BNC-BNC cable (215 mm)	89605 <i>To ADC Analog In</i> to E1439 <i>Analog In</i>	8121-0132
6 semi-rigid SMA cable	E2731 <i>70 MHz IF Out</i> to 89605 <i>From 70 MHz IF Out</i>	89605-61691
7 semi-rigid SMA cable	89605 <i>10 MHz Ext Ref Out</i> to E2731 <i>10 MHz Ext Ref</i>	for 89605B, 89605-61693 for 89605A, 89605-61691
8 black BNC-BNC cable (215 mm)	89605 <i>10 MHz Ref Out</i> to E1439 <i>Ext Clock/Ref</i>	8121-0132
9 black BNC-BNC cable (215 mm)	89605 #1 <i>10 MHz Ref Out</i> to 89605 #2 <i>Ext Ref In</i>	8121-0132
10 orange SMB-SMB cable (100 mm)	E1438 #1 <i>Clock</i> to E1438 #2 <i>Clock</i>	03585-61603
11 orange SMB-SMB cable (100 mm)	E1438 #1 <i>Sync</i> to E1438 #2 <i>Sync</i>	03585-61603
12 semi-rigid SMA cable	E2731 #1 <i>2nd LO In/Out</i> to E2731 #2 <i>2nd LO In/Out</i>	89605-61696

Description	Connection	Part number
13 semi-rigid SMA cable	E2731 #1 1st LO In/Out to E2731 #2 1st LO In/Out	89605-61696

After you have installed and configured the IEEE-1394 interface in your PC, you must connect the IEEE 1394 interface cable between the PC and one of the E8491 module IEEE ports. If you are using a laptop PC, you must also connect the EMC grounding cable. See [“Connecting EMC grounding cable” on page 74](#).

CAUTION

If you reconfigure a 2-RF-channel 89641 to a single-channel configuration, you must connect coax SMA caps (Agilent part number 1250-0590) to the LO connectors on the E7231 module.

Continue with [Step 2., part b](#), in [“Set up your measurement hardware” on page 19](#).

Cable connections, 89641 with external down converter

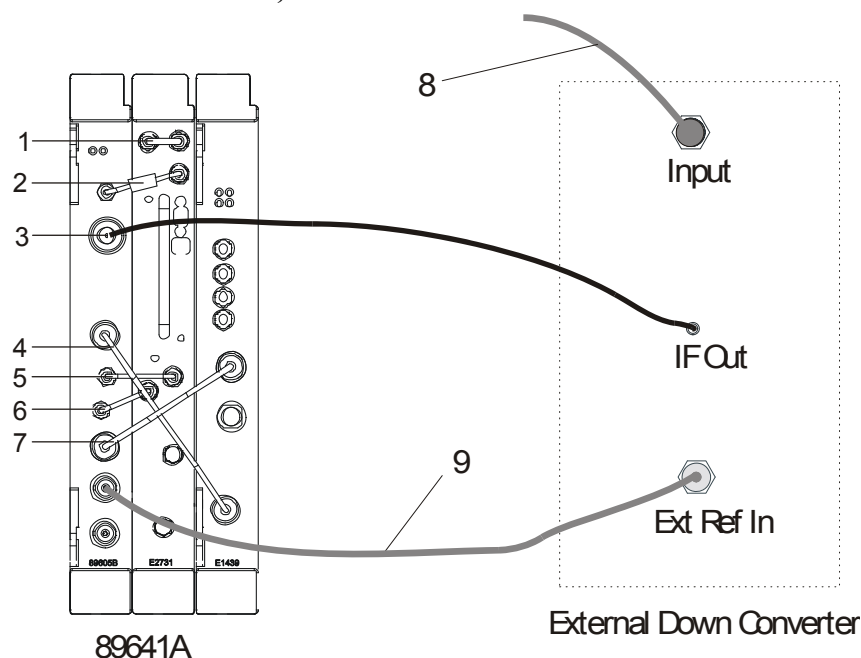

Description	Connection	Part number
1 semi-rigid SMA cable	E2731 FE RF Out to E2731 2.7 GHz In	E2731-61601
2 semi-rigid SMA cable	89605 To RF In to E2731 RF In	89605-61692
3 varies	external down converter IF Out to 89605 Ch1 Input	varies
4 black BNC-BNC cable (215 mm)	89605 To ADC Analog In to E1439 Analog In	8121-0132
5 semi-rigid SMA cable	E2731 70 MHz IF Out to 89605 From 70 MHz IF Out	89605-61691
6 semi-rigid SMA cable	89605 10 MHz Ext Ref Out to E2731 10 MHz Ext Ref	for 89605A, 89605-61691 for 89605B, 89605-61693
7 black BNC-BNC cable (215 mm)	89605 10 MHz Ref Out to E1439 Ext Clock/Ref	8121-0132
8 varies	input to external down converter	varies
9 BNC-BNC cable	89605 10 MHz Ext Ref Out to external down converter Ext Ref In	varies
9 coax SMA cap	E2731 1st LO In/Out and 2nd LO In/Out	1250-0590

NOTE

It is important that you use the semi-rigid SMA cables shipped with the analyzer. Using other cables could degrade measurement accuracy.

After you have installed and configured the IEEE-1394 interface in your PC, you must connect the IEEE 1394 interface cable between the PC and one of the E8491 module IEEE ports. If you are using a laptop PC, you must also connect the EMC grounding cable. See “Connecting EMC grounding cable” on page 74.

Continue with [Step 2., part b](#), in “Set up your measurement hardware” on page 19.

Connecting EMC grounding cable

When the 89600S is operating and configured with a laptop PC, the EMC grounding cable (Agilent part number 89600-60006) must be installed as described below. This cable is necessary to ensure conformity to European EMC immunity requirements according to IEC 61326-1. The EMC grounding cable is used in addition to the IEEE-1394 (Firewire) cable (Agilent part number 8121-1944).

The EMC grounding cable is provided with the 89600S when option 201 (IEEE-1394 cable and VXI interface for use with user-supplied laptop PC) or option 204 (Laptop PC w/VSA SW, IEEE-1394 I/F; 90 day warranty only) are purchased.

1. Attach the terminal lug of the EMC grounding cable (Agilent part number 89600-60006) to chassis grounding location on rear panel of VXI main frame with a M4 x 10mm screw as shown below.

Figure 3-17 EMC grounding cable attached to VXI main frame chassis



2. Insert the USB connector of the EMC grounding cable into any available USB port on the laptop computer as shown in the following figure.

NOTE

The EMC grounding cable establishes an electrical connection to the shield of the laptop computer's USB connector. That is, it makes no connection to the USB signal or voltage terminals.

Figure 3-18 IEEE-1394 cable connected to laptop PC (left side of image). EMC grounding cable connected to laptop PC (right side of image).



Setting Up VXI Hardware
Connecting EMC grounding cable

Introduction to installing IEEE 1394 interfaces

This chapter includes instructions on installing the IEEE 1394 to VXI interface card in your computer. See: “[89600-Series Analyzer Installation and Setup](#)” on [page 18](#) to learn which procedures you must perform to install your Agilent 89600-series product.

For instructions on installing the IEEE 1394 Host Adapter in your desktop computer, go to “[Installing the IEEE 1394 host adapter in your computer](#)” (page 79).

For instructions on installing the IEEE 1394 PCMCIA Cardbus in your laptop computer, go to “[Installing the IEEE 1394 PCMCIA cardbus](#)” (page 82).

Otherwise, continue with [Step 3.](#), part b, in “[Set up your measurement hardware](#)” on [page 19](#).

Installing the IEEE 1394 host adapter in your computer

The IEEE 1394 adapter shipped as Option 001 to the E8491 is an OHCI-compatible PCI-to-IEEE 1394 Host Adapter. You must install the following components:

- Host adapter card ([step 1.](#) through [step 6.](#) starting on [page 79](#)).
- Gray 4.5 meter interface cable between the computer and the VXI mainframe.

CAUTION Refer to your computer's documentation for specific instructions about the installation of PCI adapters.

NOTE If your personal computer (PC) currently has a PCI-to-IEEE 1394 host adapter or a built-in IEEE 1394 port, continue with [Step 3., part b](#), in “[Install the necessary I/O interface cards in the computer](#)” on [page 19](#).

WARNING **Shut down, turn off and disconnect the power to your computer and to any peripheral devices before installing the host adapter.**

CAUTION To protect circuits from static discharge, observe anti-static techniques whenever handling the Agilent 89600-series VXI modules.

To install the IEEE 1394 host adapter in your computer:

1. Remove the computer chassis cover to expose the expansion slots and external access covers.
2. Locate an unused, unobstructed PCI bus expansion slot ([Figure 4-1](#)) that supports bus mastering. (PCI slots are usually white or ivory.) See your computer documentation to determine if the PCI slot supports bus mastering.

CAUTION It is very important that the slot supports bus mastering. If it does not, you will be unable to install the IO libraries that are necessary for communication between the computer and the VXI hardware.

Figure 4-1 Locating a PCI bus Expansion Slot.

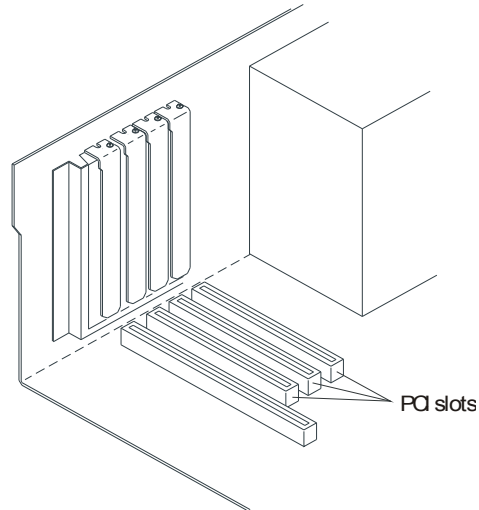

NOTE

Many computer PCI systems have one pair of ISA and PCI slots close to each other. This saves space and enables you to install either an ISA card or a PCI card in the slot pair.

3. Remove the corresponding expansion slot cover (Figure 4-2) from the computer chassis.

Figure 4-2 Removing the PC Expansion Slot Cover.

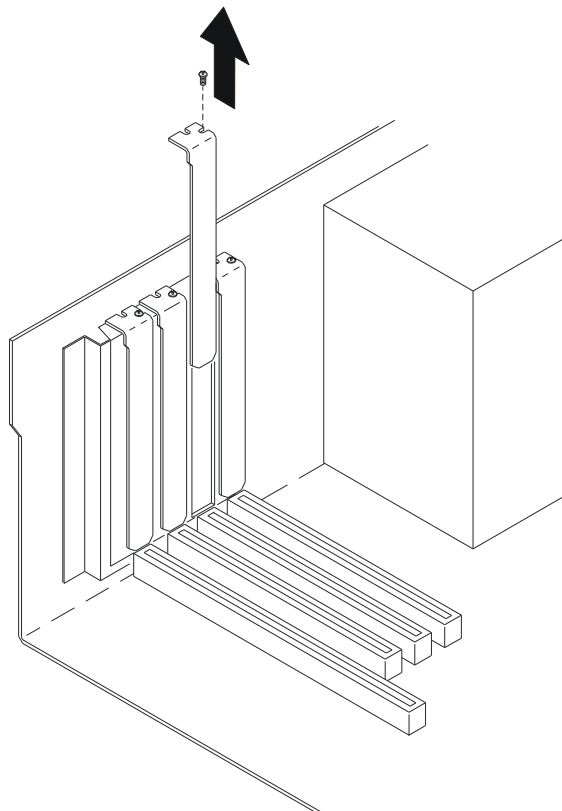

- Align the bus contacts on the bottom of the host adapter with the PCI bus slot. Carefully, but firmly, press the adapter into the slot ([Figure 4-3](#)).

Figure 4-3

Installing the Host Adapter.

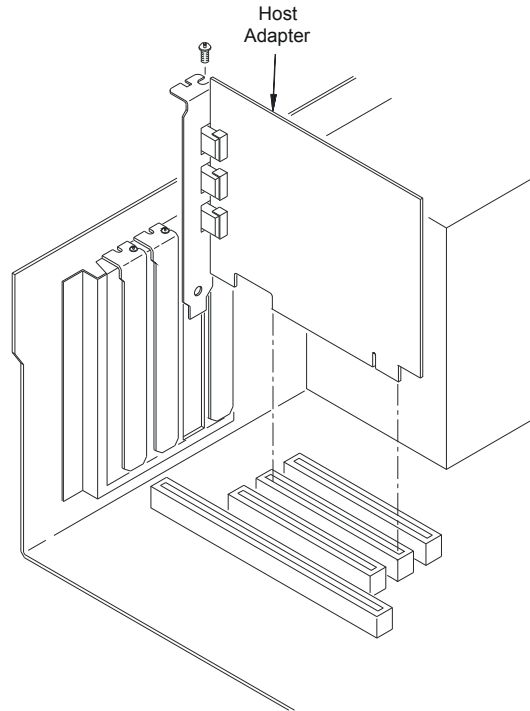

- Secure the host adapter bracket to the computer chassis with the screw from the expansion slot cover removed in [step 4](#).
- If you need to install a GPIB or LAN interface in your PC, continue with [Step 3](#), [part b](#), in “[Set up your measurement hardware](#)” on [page 19](#).

Otherwise, replace the computer cover. Reconnect the power cord and any other accessories you disconnected, then continue with [Step 3](#), [part b](#), in “[Set up your measurement hardware](#)” on [page 19](#).

If you encounter problems installing the driver, examine the files on the Installation CD-ROM in the `iolibs\readme` directory for troubleshooting information.

Installing the IEEE 1394 PCMCIA cardbus

NOTE

For a list of supported IEEE 1394 interfaces, see the Frequently Asked Question “What type of IEEE-1394 interface can I use in my computer to connect to the 89600S VXI hardware” at: <http://www.agilent.com/find/89600> or contact your local Test and Measurement Call Center or sales office.

You must have installed the 89600 VSA application software (“[Installing 89600 Software](#)” on page 24), and setup your VXI measurement hardware (“[Introduction](#)” on page 32) before installing the IEEE 1394 card.

To install IEEE 1394 PCMCIA cardbus in your computer:

1. Shut down or turn off the computer.
2. Plug in the IEEE 1394 card, following the instructions that came with the card.
3. Continue to the next page.

Installing drivers for IEEE 1394 and E8491

Before following these steps, be sure that your VXI hardware is installed, the mainframe is connected to your computer, and the mainframe is on.

To install drivers for IEEE 1394 and E8491:

1. If the Found New Hardware Wizard appears and prompts you to install the driver for an *OHCI Compliant IEEE 1394 Host Controller*, you must get and install the drivers for this card from the Windows XP CD that came with your computer (or from the CD that came with the IEEE Host Controller).

NOTE

These drivers may already be installed on your computer, and in that case, the Found New Hardware Wizard for this device will not appear.

2. If the Found New Hardware Wizard does not prompt you to install a driver for the E8491, click **Start > Settings > Control Panel > Add/Remove Programs**. If the E8491 is listed, the driver has already been installed.
3. If the Found New Hardware Wizard prompts you to install a driver for the E8491, you can install this driver from the 89600 Installation CD. Click **Next**.
4. In the next dialog box, select **Search** for suitable driver. Click **Next**.
5. In the next dialog box, select **CD-ROM**. Insert the 89600 Installation CD in the CD drive. Click **Next**. The wizard searches for the driver and configures the hardware.
6. If the 89600 Installation Manager window appears, close it. Return to the Found New Hardware Wizard and Click **Finish**.

If you encounter problems installing the driver, examine the files on the Installation CD-ROM in the `iolibs\readme` directory for troubleshooting information.

Continue with [Step 3., part b](#), in “Install the necessary I/O interface cards in the computer” on page 19.

5 **Installing GPIB, LAN, and USB
Interface Cards**

Introduction

This chapter includes general instructions for installing GPIB and LAN interface cards in your computer and connecting instruments to your computer.

Desktop computers require a PCI High-Performance GPIB card. Laptop computers require a GPIB Interface for PCMCIA. For a list of supported IEEE 1394 interfaces, see the Frequently Asked Question “What type of IEEE-1394 interface can I use in my computer to connect to the 89600S VXI hardware” at: <http://www.agilent.com/find/89600> or contact your local Test and Measurement Call Center or sales office.

For a GPIB interface on a desktop computer, see to "[Configuring GPIB on a desktop PC](#)" (page 87).

For a GPIB interface on a laptop computer, see to "[Configuring GPIB on a laptop PC](#)" (page 88).

For a LAN interface, see to "[Installing a LAN Interface](#)" (page 89).

For a USB interface, see to "[Installing a USB interface](#)" (page 90).

For a LAN-to-GPIB gateway, see to "[Configuring a LAN-to-GPIB gateway](#)" (page 91).

Configuring GPIB on a desktop PC

If the GPIB interface card has not been installed in your PC, install it now, following the instructions that came with the card. If you need to install other interface cards, do not put the cover back on your computer until you have installed those cards.

NOTE

If you control other GPIB instruments or devices from this computer, see [“Troubleshooting interference with other devices or instruments”](#) on page 233 for information on excluding those devices from the 89600 identification process.

If you will also be communicating with instruments via LAN, continue to [“Installing a LAN Interface”](#) (page 89). Otherwise, continue with [Step 3., part c](#), in [“Install the necessary I/O interface cards in the computer”](#) on page 19.

Configuring GPIB on a laptop PC

If the GPIB PCMCIA interface card has not been installed in your PC, install it now, following the instructions that came with the card. For a National Instruments GPIB card, be sure to install the NI 488.2 software first, then reboot your computer and install the interface card.

NOTE

After a National Instruments GPIB card installation is complete, you must reinstall the Agilent IO libraries. Insert the Agilent 89600 Series Software installation CD-ROM. When the Agilent 89600 Installation Manager window opens, click Install Agilent 89600 VSA. Select Custom Installation and select and install IO libraries.

If you control other GPIB instruments or devices from this computer, see [page 233](#) for information on excluding those devices from the 89600 identification process.

If you will also be communicating with instruments via LAN, continue on [page 89](#). Otherwise, continue with [Step 3., part c](#), in “[Install the necessary I/O interface cards in the computer](#)” on [page 19](#).

Installing a LAN Interface

If the LAN interface is not already installed in your computer, install it now, following the instructions that came with the interface.

NOTE

If your computer and the instrument are connected to a building LAN, you may need to check with your network administrator to verify that the IP addresses for your computer and the instrument satisfy requirements.

Continue with [Step 3., part c](#), in “[Install the necessary I/O interface cards in the computer](#)” on page 19.

Installing a USB interface

If the USB interface is not already installed in your computer, install it now, following the instructions that came with the interface.

Continue with [Step 3., part c](#), in “[Install the necessary I/O interface cards in the computer](#)” on page 19.

Configuring a LAN-to-GPIB gateway

This section provides information on the LAN-to-GPIB gateway.

To make the LAN-to-GPIB gateway connection:

1. Connect the LAN cable to the E5810A LAN/GPIB Gateway and a GPIB cable from the E5810A LAN/GPIB Gateway to your GPIB instrument. Connect power to the E5810A LAN/GPIB Gateway.
2. Do not configure the E5810. You will be instructed to do this later.

Continue with [Step 3., part c](#), in “Install the necessary I/O interface cards in the computer” on page 19

Installing GPIB, LAN, and USB Interface Cards
Configuring a LAN-to-GPIB gateway

6 **Configuring IO Interfaces**

Introduction

This chapter provides instructions for configuring your computer to communicate with hardware via IEEE-1394, LAN, or GPIB interfaces. See [“89600-Series Analyzer Installation and Setup” on page 18](#) to learn which procedures you must perform to install your Agilent 89600 series product.

NOTE

Do not configure more than one interface to point to a single instrument, either from a single computer or from multiple computers. For example, if your instrument is on a LAN, do not point to it from two computers simultaneously.

Perform the procedures for each interface type as directed below:

- **Agilent Infiniium oscilloscope:** If your measurement hardware is an Agilent Infiniium oscilloscope, skip this chapter and follow the instructions in [“Configuring Infiniium Windows XP Scopes” on page 111](#).
- **Agilent Logic Analyzer:** If your measurement hardware is an Agilent Logic Analyzer, skip this chapter and follow the instructions in the ["Connecting to a Network" \(page 145\)](#) and ["89600 I/O Connections" \(page 146\)](#).
- **IEEE-1394 to VXI interface:** For IEEE-1394 to VXI interface, start on ["Configuring the VXI interface" \(page 95\)](#).
- **LAN:** For LAN interface, start on ["Configuring the LAN interface" \(page 97\)](#).
- **LAN/GPIB:** For LAN/GPIB gateway (portal) interface, start on ["Configuring the Agilent E5810 LAN/GPIB Gateway interface" \(page 102\)](#).
- **USB/GPIB:** For USB/GPIB interface, start on ["Configuring the USB/GPIB Interface" \(page 105\)](#).
- **GPIB:** For GPIB interface, start on ["Configuring the GPIB interface" \(page 107\)](#).
- **USB:** For USB interface, start on ["Configuring the USB Interface" \(page 109\)](#).

Configuring the VXI interface

To configure the VXI interface:

1. Connect the IEEE 1394 interface card from the computer to the E8491 VXI module in the mainframe.
2. If using a laptop PC, connect the EMC grounding cable from the VXI mainframe chassis to a USB port on the laptop. See [“Connecting EMC grounding cable” on page 74](#).
3. Power on the computer and the VXI mainframe.

NOTE

If the Found New Hardware Wizard opens, click **Next** and when it is finished, click **Finish**.

4. Run Connection Expert:

Click the IO Control icon in the task bar, then click **Agilent Connection Expert**. (Or click **Start > (All) Programs > Agilent IO Libraries Suite > Agilent Connection Expert**.)

Connection Expert will automatically detect and configure most interfaces and instruments and will assign names and other default configuration settings.

If the VXIO interface does not show up, check cable connections and power cord connections. Also, check another port on the E8491 VXI Interconnect Module. Click **Refresh All** to update.

Interfaces or instruments can also be added manually to the test system configuration. See Agilent IO Libraries Suite Online Help for more information.

5. To verify that the computer recognized all the modules in your VXI mainframe, expand **VXIO** in the *Instrument I/O on this PC* section. Connection Expert will list all the modules and their addresses. A green checkmark is shown to verify the VXI mainframe and modules are on and connected properly.

Configuring IO Interfaces
Configuring the VXI interface

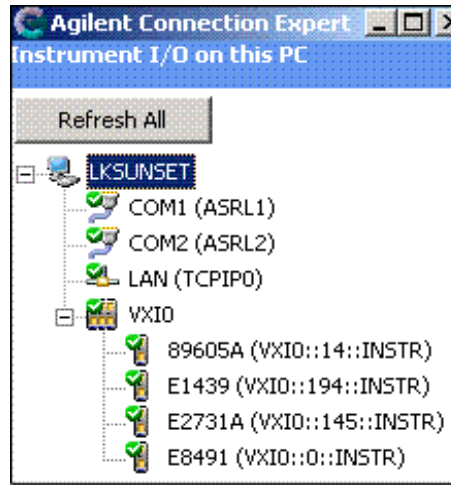

Agilent IO Libraries Suite also provides a VXI Resource Manager, that initializes and prepares a VXI system for use. The VXI Resource Manager runs when any of the following conditions occur:

- You start it from the Connection Expert's Tools menu (select **Tools > VXI Resource Manager > Edit Resources**, then click **Run** in the resulting Resource Manager dialog box)
- You start it from the Agilent IO Control
- You apply or cycle VXI mainframe power
- You press the E8491 Reset button
- You reboot your PC

In VXI systems with multiple E8491 interfaces, you can turn off individual VXI mainframes without affecting other mainframes in the system. When a mainframe is turned on, the VXI Resource Manager reconfigures that mainframe.

For more information about VXI interfaces, see Connectivity in the Agilent IO Libraries Suite Documentation. Click on the **IO Control** icon in the task bar and then select **Documentation**. (Or click **Start > (All) Programs > Agilent IO Libraries Suite > Documentation**.)

If you will also be communicating with measurement hardware via LAN, continue to ["Configuring the LAN interface" \(page 97\)](#).

If you will also be communicating with measurement hardware via a LAN-to-GPIB portal, continue to ["Configuring the Agilent E5810 LAN/GPIB Gateway interface" \(page 102\)](#).

If you will also be communicating with measurement hardware via GPIB, continue to ["Configuring the GPIB interface" \(page 107\)](#).

If you will not be using any other measurement hardware, continue with [Step 5 \(Page 20\)](#).

Configuring the LAN interface

This procedure is used to configure the LAN interface except as directed for the following measurement hardware:

- **Agilent Infiniium oscilloscope:** If your measurement hardware is an Agilent Infiniium oscilloscope, skip this chapter and follow the instructions in [Chapter 7](#), “Configuring Infiniium Windows XP Scopes,” on page 111.
- **Agilent Synthetic Instrument (SI) Spectrum Analyzer:** If your measurement hardware is an Agilent Synthetic Instrument (SI) Spectrum Analyzer, skip this chapter and follow the instructions in [Chapter 11](#), “Linking a Synthetic Instrument (SI) Spectrum Analyzer to the Agilent 89600 VSA,” on page 161.

For more information about LAN interfaces, see Connectivity in the Documentation section of the Agilent IO Libraries Suite. You can find this when you click on the **IO Control** icon in the task bar and then select **Documentation**. (Or click **Start > (All) Programs > Agilent IO Libraries Suite > Documentation**.)

You must ensure that the IP addresses for your computer and measurement hardware are compatible, then configure the LAN interface. The IP address consists of 4 groups of numbers separated by periods (for example, 192.192.192.25).

To configure your LAN interface:

1. Set the IP address on the instrument, using the appropriate set of instructions:
 - instrument IP address for a computer on Local Area network or IP address for computer cable (see: "[Instrument IP address for a Local Area Network configuration](#)" (page 97)).
 - or
 - instrument IP address for a computer with a crossover cable (see: "[Instrument IP address for a crossover cable configuration](#)" (page 98)).
2. Run Connection Expert ("[Run Connection Expert](#)" (page 100)).

Instrument IP address for a Local Area Network configuration

This section provides information on setting the instrument IP address when your computer is on a Local Area Network.

To set the instrument IP address for a LAN configuration:

1. If your computer is connected to a Local Area Network, have your network administrator assign an IP address for your instrument hardware that will work with your computer. (The network administrator can also tell you if you need to set Subnet Masks.)

Configuring the LAN interface

- a. Set the IP address on the measurement hardware.
 - **E4406**: On the E4406, press **System > Config IO > IP address**, type the new address using the number keypad, and press **Enter**.
 - **PSA**: On the PSA, press **System > Config IO > IP address**, type the new address using the number keypad, and press **Enter**.
 - **X-Series Signal Analyzer**: On the analyzer, press **System > Show > System** to find the IP address. To change the IP address, refer to the LAN Interface configuration documentation provided with the analyzer.
 - **Series 6000/7000 Oscilloscopes**: On the **Series 6000A/7000A** Oscilloscopes, verify the I/O Controller is set to LAN. If it is not set to LAN, press **Utility > I/O > Controller XX** (where XX is either GPIB, LAN or USB), use the Entry knob labelled with a circular arrow to point the screen arrow to LAN, and press the Controller button. For the **Series 6000L** Oscilloscopes, see scope documentation.

- b. Click in the Subnet Mask box.

For the E4406 only, if the IP address begins with “10.”, set the subnet mask to “255.0.0.0.” If the E4406 IP address begins with anything other than “10.”, set the subnet mask to “255.255.0.0.” (Press **System > Config I/O > Subnet Mask**, type the new address using the number keypad, and press **Enter**.)

For all other instruments, accept the default numbers that appear for the subnet mask.

Click **OK** and close all dialog boxes.

- c. If you are prompted to reboot your computer, do so now.
2. Be sure that both the instrument and your computer are connected to the LAN.
3. Cycle power on the measurement hardware (such as the E4406 or PSA).
4. Continue with ["Run Connection Expert" \(page 100\)](#).

Instrument IP address for a crossover cable configuration

This section provides information on setting the instrument IP address when your computer is connected to the instrument using a crossover cable.

To set the instrument IP address for a crossover cable configuration:

1. If your computer is connected to a Local Area Network and you will be connecting directly to the hardware using a crossover cable, perform these steps:
 - a. Determine the IP address for your computer. Click **Start > Run**. Type `cmd` and click **OK**. At the DOS prompt, type `ipconfig` and press **Enter**. If an IP address is not listed, or if the address is 0.0.0.0, go to [step d](#). If a non-zero IP address is listed, leave it and continue with [step b](#).

- b. Set the IP address on the instrument so that the first 3 sections of the IP address are the same as the computer's IP address and the last section is different than the computer's. (For example, if the computer IP address is 192.192.192.25, set the hardware IP address to 192.192.192.26.)

To change the E4406A or PSA IP address, press **System > Config I/O > IP address**, type the new address using the number keypad, and press **Enter**.

- c. Continue with [step e](#).
- d. Find the IP address for the hardware (for the E4406 or PSA, press **System > Config I/O > IP address**). Set the IP address for the computer so that the first 3 sections are the same as the instrument and the last section is different than the instrument. (For example, if the hardware IP address is 10.10.10.10, set the computer address to 10.10.10.9.)

For Windows XP, click **Start > right click My Network Places > Properties > right click Local Area Connection > Properties > Internet Protocol (TCP/IP) > Properties > Use the following IP address**.

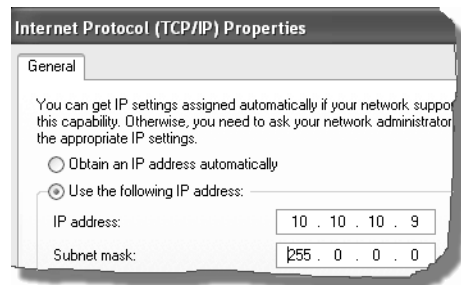

-or-

For Windows Vista, click **Start > right click Network > Properties > View Status in Local Area Connection > Properties > Internet Protocol Ver. 4 > Properties > Use the following IP address**.

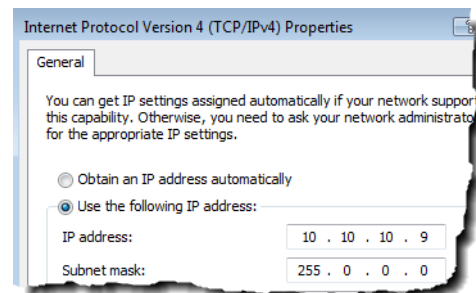

Enter the IP address in the box, using the periods (.) to separate the sections.

- e. Click in the Subnet Mask box.

For the E4406 only, if the IP address begins with “10.”, set the subnet mask to “255.0.0.0”. If the E4406 IP address begins with anything other than “10.”, set the subnet mask to “255.255.0.0”. (Press **System > Config I/O > Subnet Mask**, type the new address using the number keypad, and press **Enter**.)

For all other instruments, accept the default numbers that appear for the subnet mask.

Click **OK** and close all dialog boxes.

- f. If you are prompted to reboot your computer, do so now.
2. Connect the crossover cable between the computer and the instrument.

Configuring IO Interfaces
Configuring the LAN interface

3. Cycle power on the measurement hardware (such as the E4406 or PSA).
4. Continue with Run Connection Expert below.

Run Connection Expert

1. Run the Agilent IO Libraries Suite Connection Expert tool.

Click the **IO Control** icon in the Windows application task bar, then click **Agilent Connection Expert**. (Or click **Start > (All) Programs > Agilent IO Libraries Suite > Agilent Connection Expert**.)

2. Add an instrument.

Auto discover cannot be done on LAN devices so you must manually add the instrument.

- a. Click on **LAN** in the *Instrument I/O on this PC* section.
- b. Click **Add an instrument** in the *Task Guide* section. The Add LAN Instrument window will open.

You can browse for the instrument to be added and select the check box.

If the instrument is not listed, click Add Address. Enter the hostname or select **IP address** and enter the IP address of the instrument.

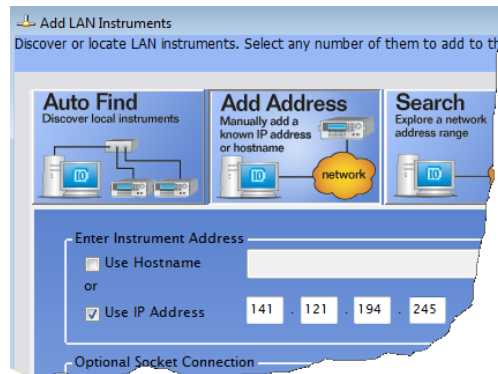

- c. Click **OK**.

Connection Expert will automatically configure the interface and instruments and will assign names and other default configuration settings.

3. To verify that the computer recognized the instrument, expand **LAN** in the *Instrument I/O on this PC* section. Connection Expert will list all instruments and their addresses. A green checkmark is shown to verify the instrument is on

and connected properly.

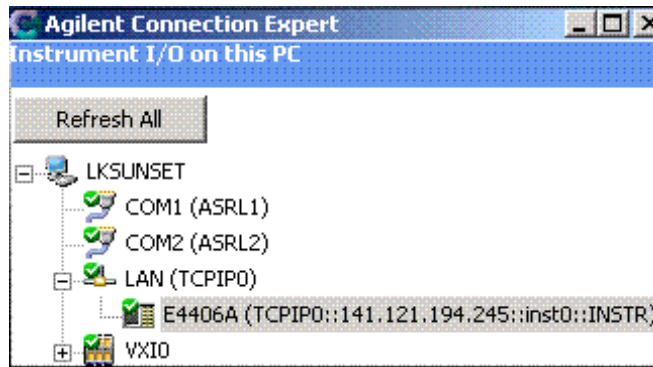

NOTE If you setup a LAN connection, then turn off or disconnect the hardware, the 89600 looks for the hardware when started. This slows down startup. To speed up startup, use Connection Expert to remove the LAN setup or choose to ignore the instrument.

NOTE When the 89601 software locates an instrument, it locks onto the instrument so only the 89601 software can communicate with it. This will prevent Agilent IO Libraries from any communication with these instruments and cause the green checkmark to become a red X in Connection Expert. You can disconnect the instrument by selecting **Control > Disconnect** in the 89601 software. Select Refresh in Connection Expert and the green checkmark will be shown.

If you will also be communicating with measurement hardware via a LAN-to-GPIB portal, continue on "[Configuring the Agilent E5810 LAN/GPIB Gateway interface](#)" (page 102).

If you will also be communicating with measurement hardware via GPIB, continue on "[Configuring the GPIB interface](#)" (page 107).

If you will not be using any other measurement hardware, continue with [Step 5](#) (Page 20).

Configuring the Agilent E5810 LAN/GPIB Gateway interface

This procedure is used to configure the E5810 LAN/GPIB interface except as directed for the following measurement hardware:

- **Agilent Infiniium oscilloscope:** If your measurement hardware is an Agilent Infiniium oscilloscope, skip this chapter and follow the instructions in [Chapter 7](#), “Configuring Infiniium Windows XP Scopes,” on page 111.

To setup and use the E5810 with Microsoft Windows, you must have Internet Explorer 4.0 or higher or Netscape 4.7 or higher.

For details on setting up the E5810, see the E5810 Users Guide in the Agilent IO Libraries Suite Documentation. Click the **Agilent IO Control** icon in the task bar. Click **Documentation** and then select **E5810 LAN GPIB Users Guide**. (Or click **Start > (All) Programs > Agilent IO Libraries Suite > Documentation > E5810 LAN GPIB Users Guide**.)

IMPORTANT

Before making network connections, contact your Information Technology (IT) department for policies concerning user connections, IP address, etc.

To configure the Agilent E5810 LAN/GPIB Gateway interface:

1. Connect the E5810 to the network and to instruments.
2. Plug in and power on the E5810 and any GPIB instruments.
 - E5810: The IP address should be displayed in the display of the E5810. If the address does not appear, see Troubleshooting Information in the *E5810 Getting Started Guide*.
 - Series 6000/7000 Oscilloscopes: On the **Series 6000A/7000A** Oscilloscopes, verify the I/O Controller is set to GPIB. If it is not set to GPIB, press Utility > I/O > Controller XX (where XX is either GPIB, LAN, or USB), use the Entry knob labelled with a circular arrow to point the screen arrow to LAN, and press the Controller button. For the **Series 6000L** Oscilloscopes, see scope documentation.
3. Configure the E5810
 - a. Display the E5810 Welcome Page. In your Web browser, type ‘http://<IP address>’ where <IP address> is the current E5830A IP address (such as 169.254.58.10) shown on the E5810 display. Press **Enter**.
 - b. Take note of the GPIB SICL Interface Name (something like *gpiB0*). You will need to use this name in a later step.
 - c. If you need to change any configuration information, such as the IP address, click *View & Modify Configuration*. (The default password is E5810.) After

making changes, click **Save** and then **Reboot E5810** to make changes effective.

4. Verify communication from the E5810.
 - a. From the E5810 Welcome page, click **Find & Query Instruments**. (The default password is E5810.)
 - b. Click **Find**.
 - c. In the list of SICL Addresses, highlight the instrument you want to query.
 - d. Click **IDN?** The identification information for the instrument appears in the right pane.

Run Connection Expert

1. Run the Agilent IO Libraries Suite Connection Expert tool.

Click the **IO Control** icon in the Windows application task bar, then click **Agilent Connection Expert**. (Or click **Start > (All) Programs > Agilent IO Libraries Suite > Agilent Connection Expert**.)

2. Add an interface.

For more information about LAN Client interfaces, see Connectivity in the Documentation section of the Agilent IO Libraries Suite. You can find this when you click on the **IO Control** icon in the task bar and then select **Documentation**. (Or click **Start > (All) Programs > Agilent IO Libraries Suite > Documentation > Connectivity**.)

- a. Click **Add an interface** on the Connection Expert task bar.
- b. Select **Remote GPIB interface** and click **Add**.
- c. Select **IP address** and enter IP address from the E5810A (see step 3B).
- d. Click **OK**.

Connection Expert will automatically configure the interface and instruments and will assign names and other default configuration settings.

3. To verify that the computer recognized the instrument, expand **Remote (GPIB1)** in the *Instrument I/O on this PC* section. Connection Expert will list all instruments and their addresses. A green checkmark is shown to verify that

the instrument is on and connected properly.

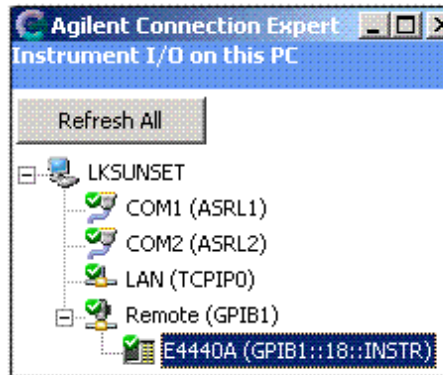

NOTE

When the 89601 software locates an instrument, it locks onto the instrument so only the 89601 software can communicate with it. This will prevent Agilent IO Libraries from any communication with these instruments and cause the green checkmark to become a red X in Connection Expert. You can disconnect the instrument by selecting **Control > Disconnect** in the 89601 software. Select Refresh in Connection Expert and the green checkmark will be shown.

If you will not be using any other measurement hardware, continue with [Step 5 \(Page 20\)](#).

Configuring the USB/GPIB Interface

This procedure is used to configure the USB/GPIB interface except as directed for the following measurement hardware:

- **Agilent Infiniium oscilloscope:** If your measurement hardware is an Agilent Infiniium oscilloscope, skip this chapter and follow the instructions in [Chapter 7](#), “Configuring Infiniium Windows XP Scopes,” on page 111.

For details on setting up the 82357 USB/GPIB Interface, see the 82357 USB/GPIB User’s Guide in the Agilent IO Libraries Suite Documentation. Click the **Agilent IO Control** icon in the task bar. Click **Documentation** and then select **82357 USB GPIB Users Guide**. (Or click **Start > (All) Programs > Agilent IO Libraries Suite > Documentation > 82357 USB GPIB Users Guide**.)

To configure the USB/GPIB interface:

1. Plug the 82357 USB cable into a USB port on your PC. Do not connect to your GPIB instrument at this time.
2. Observe the 3 LEDs on the E8237A. Initially, only the red FAIL LED should be on. After the Found New Hardware Wizard runs, all 3 LEDs should be ON. If any LED is off after 20 seconds, stop and refer to the *82357 USB/GPIB User’s Guide* in the Agilent IO Libraries Suite Documentation for information.
3. If the **Agilent 82357 USB/GPIB Interface Detected** dialog box appears, click **OK** or **Accept**. (If you want to change any of the settings, refer to the 82357 documentation for instructions.) (The graphic below is a sample from a Windows XP system.)
4. Connect one or more instruments to the GPIB connector on the 82357.
 - **Series 6000/7000 Oscilloscopes:** On the **Series 6000A/7000A** Oscilloscopes, verify the I/O Controller is set to GPIB. If it is not set to GPIB, press **Utility > I/O > Controller XX** (where XX is either GPIB, LAN, or USB), use the Entry knob labelled with a circular arrow to point the screen arrow to LAN, and press the Controller button. For the **Series 6000L** Oscilloscopes, see scope documentation.

Run Connection Expert

1. Run Connection Expert.
 - a. Click the **IO Control** icon in the task bar or click **Start > (All) Programs > Agilent IO Libraries Suite > Agilent Connection Expert**.

Connection Expert will automatically detect and configure the interface and instruments. It will also assign names and other default configuration settings.
2. To verify that the computer recognized the instrument, expand **USB/GPIB**

(GPIB1) in the *Instrument I/O on this PC* section. Connection Expert lists all instruments and their addresses. A green checkmark is shown to verify the instruments are on and connected properly. To troubleshoot problems, refer to the Troubleshooting chapter in the 82357 User's Guide.

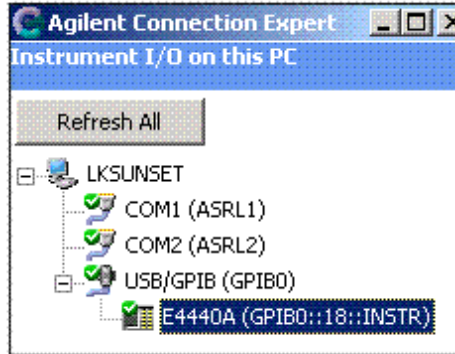

NOTE

When the 89601 software locates an instrument, it locks onto the instrument so only the 89601 software can communicate with it. This will prevent Agilent IO Libraries from any communication with these instruments and cause the green checkmark to become a red X in Connection Expert. You can disconnect the instrument by selecting **Control > Disconnect** in the 89601 software. Select Refresh in Connection Expert and the green checkmark will be shown.

If you will not be using any other measurement hardware, continue with [Step 5 \(Page 20\)](#).

Configuring the GPIB interface

This procedure is used to configure the GPIB interface except as directed for the following measurement hardware:

- **Agilent Infiniium oscilloscope:** If your measurement hardware is an Agilent Infiniium oscilloscope, skip this chapter and follow the instructions in [Chapter 7](#), “Configuring Infiniium Windows XP Scopes,” on page 111.

NOTE

The purpose of this chapter is to guide you through the specific setup required to get your computer and instrument configured properly. For more detailed information on IO configuration, refer to the documentation for the IO Libraries Suite (click the **IO Control** icon, then select **Documentation**).

For more information about GPIB interfaces, see Connectivity in the Documentation section of the Agilent IO Libraries Suite. You can find this when you click on the **IO Control** icon in the task bar and then select **Documentation**. (Or click **Start > (All) Programs > Agilent IO Libraries Suite > Documentation**.)

To configure the GPIB interface:

1. If you are configuring a GPIB connection for measurement hardware that is currently configured as a LAN connection on this computer, you must first remove the LAN configuration. Then cycle power on the hardware before continuing with the GPIB configuration.
2. Connect your GPIB instruments to the computer’s GPIB interface. Power on the PC and the instruments.
 - **Series 6000/7000 Oscilloscopes:** On the **Series 6000A/7000A** Oscilloscopes, verify the I/O Controller is set to GPIB. If it is not set to GPIB, press **Utility > I/O > Controller XX** (where XX is either GPIB, LAN, or USB), use the Entry knob labelled with a circular arrow to point the screen arrow to LAN, and press the Controller button. For the **Series 6000L** Oscilloscopes, see scope documentation.

Run Connection Expert

1. Run Connection Expert.

Click the **IO Control** icon in the task bar, then click **Agilent Connection Expert**, or click **Start > (All) Programs > Agilent IO Libraries Suite > Agilent Connection Expert**.

Connection Expert will automatically detect and configure the interface and instruments and will assign names and other default configuration settings.

2. To verify that the computer recognized the instrument, expand **GPIB0** in the *Instrument I/O on this PC* section. Connection Expert will list all instruments

and their addresses. A green checkmark will be shown to verify that the instrument is on and connected properly.

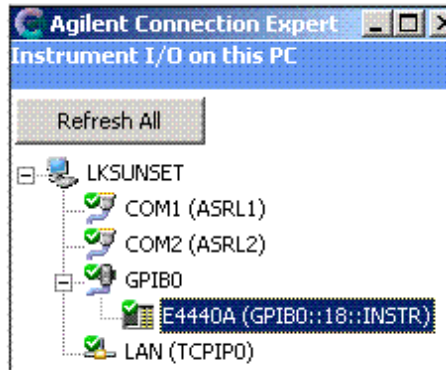

NOTE

When the 89601 software locates an instrument, it locks onto the instrument so only the 89601 software can communicate with it. This will prevent Agilent IO Libraries from any communication with these instruments and cause the green checkmark to become a red X in Connection Expert. You can disconnect the instrument by selecting **Control > Disconnect** in the 89601 software. Select Refresh in Connection Expert and the green checkmark will be shown.

If you will not be using any other measurement hardware, continue with [Step 5 \(Page 20\)](#).

Configuring the USB Interface

This procedure is used to configure the USB interface except as directed for the following measurement hardware:

- **Agilent 82357 USB/GPIB Interface:** If you are using a Agilent 82357 USB/GPIB Interface, go to "[Configuring the USB/GPIB Interface](#)" (page 105). The instructions in this chapter assume that the USB interface is installed in your PC and is working.

NOTE

The purpose of this chapter is to guide you through the specific setup required to get your computer and instrument configured properly. For more detailed information on GPIB IO configuration, refer to the documentation for the IO Libraries Suite (click the **IO Control** icon, then select **Documentation > Connectivity**).

To configure the USB interface:

Connect your USB instruments to the USB interface in the computer. Power on the PC and the instruments.

On the **Series 6000A/7000A** Oscilloscopes, verify the I/O Controller is set to USB. If it is not set to USB, press Utility > I/O > Controller XX (where XX is either GPIB, LAN or USB), use the Entry knob labelled with a circular arrow to point the screen arrow to USB and press the Controller button. For the **Series 6000L** Oscilloscopes, see scope documentation.

Run Connection Expert

1. Run Connection Expert.

Click the **IO Control** icon in the task bar, then click **Agilent Connection Expert**, or click **Start > (All) Programs > Agilent IO Libraries Suite > Agilent Connection Expert**.

Connection Expert will automatically detect and configure the interface and instruments and will assign names and other default configuration settings

2. To verify that the computer recognized the instrument, expand **USB0** in the *Instrument I/O on this PC* section. Connection Expert will list all instruments and their addresses. A green checkmark will be shown to verify that the instrument is on and connected properly.

Configuring IO Interfaces
Configuring the USB Interface

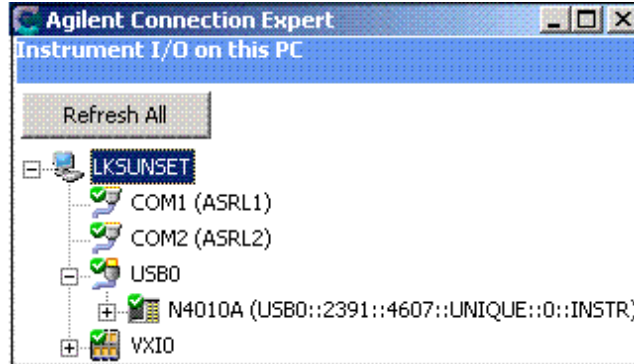

NOTE

When the 89601 software locates an instrument, it locks onto the instrument so only the 89601 software can communicate with it. This will prevent Agilent IO Libraries from any communication with these instruments and cause the green checkmark to become a red X in Connection Expert. You can disconnect the instrument by selecting **Control > Disconnect** in the 89601 software. Select Refresh in Connection Expert and the green checkmark will be shown.

If you will not be using any other measurement hardware, continue with [Step 5 \(Page 20\)](#).

7

**Configuring Infinium Windows XP
Scopes**

Introduction

This chapter includes networking information for configuring Agilent Infiniium scopes, running the Windows XP operating system, and a corresponding PC running the 89601 software.

The table below lists the supported Agilent Infiniium scopes.

Model #	Bandwidth	Model #	Bandwidth
8064	600 MHz	9104	1 GHz
8104	1 GHz	9254	2.5 GHz
80204	2 GHz	9404	4 GHz
80304	3 GHz	90254	2.5 GHz
80404	4 GHz	90404	4 GHz
80604	6 GHz	90604	6 GHz
80804	8 GHz	90804	8 GHz
81004	10 GHz	91204	12 GHz
81204	12 GHz	91304	13 GHz
81304	13 GHz		

NOTE

Refer to Application Note 5988-4096EN (Agilent Infiniium Oscilloscopes Performance Guide Using the 89601A VSA Software) for the required infinium firmware revisions.

NOTE

If you are installing the 89601 software directly in the Agilent Infiniium scope (Windows XP only), see: [Chapter 8](#), “Installing 89601 Software in Agilent Infiniium XP Scopes,” on page 125.

Before configuring your Infiniium scope, be sure you have installed the 89601 software on the PC you are using with the scope.

For any connection type, there are up to three possible steps:

1. Configure Infiniium Networking
 - ["Configuring Windows XP Infiniium Networking for non-DHCP Network" \(page 114\)](#)
 - ["Configuring Windows Infiniium Networking for DHCP Network" \(page 115\)](#)
 - ["Configuring Windows XP Infiniium Networking for a Crossover Cable Network" \(page 116\)](#)
2. Configure PC Networking

- "Configuring PC Networking for a Crossover Cable Configuration" (page 117)
- 3. Configure Agilent IO Config Software for GPIB and LAN
 - "Configuring PC Agilent IO Config for GPIB connection" (page 118)
 - "Configuring PC Agilent IO Config for LAN connection" (page 119)

See table below for additional information in determining the sections you need to complete based on your connection type. Check with your network administrator to determine your network type.

Table 7-1 Summary of Connection Types

Connection Type	Infiniium Networking	PC Networking	PC Agilent IO Config Software
GPIB to GPIB	N/A	N/A	"Configuring PC Agilent IO Config for GPIB connection" on page 118
USB to GPIB	N/A	N/A	"Configuring the USB/GPIB Interface" on page 123
LAN/GPIB Gateway	N/A	N/A	"Configuring the Agilent E5810 LAN/GPIB Gateway Interface" on page 121
LAN using a crossover cable	"Configuring Windows XP Infiniium Networking for a Crossover Cable Network" on page 116	"Configuring PC Networking for a Crossover Cable Configuration" on page 117	"Configuring PC Agilent IO Config for LAN connection" on page 119
LAN with DHCP	"Configuring Windows Infiniium Networking for DHCP Network" on page 115	N/A	"Configuring PC Agilent IO Config for LAN connection" on page 119
LAN without DHCP	"Configuring Windows XP Infiniium Networking for non-DHCP Network" on page 114	N/A	"Configuring PC Agilent IO Config for LAN connection" on page 119

Configuring Windows XP Infiniium Networking for non-DHCP Network

Complete the following procedure to configure your Windows XP Infiniium scope for networking via a non-DHCP (Dynamic Host Configuration Protocol) network.

To configure Windows XP Infiniium networking for a non-DHCP network:

1. You will need an IP Address, Gateway Address and a Subnet Mask from your Network Administrator.
2. On your Infiniium, quit the Scope application if it is running.
3. Open the **Control Panel (Start > Control Panel)**. Open **Network Connections**. (If you are in Category view, click Network and Internet Connections and then select Network Connections.)
4. Click **Local Area Connection** and then **Properties** to display the Local Area Connection Properties dialog box.
5. Select **Internet Protocol (TCP/IP)** on the connection list and click **Properties** to display the Internet Protocol (TCP/IP) Properties dialog box.
6. Select **Use the following IP address** and enter the IP Address, Subnet mask, and Default gateway address provided by your Network Administrator.
7. Click **OK** in the Internet Protocol (TCP/IP) Properties dialog box.
8. Click **OK** in the Local Area Connection Properties dialog box. If Windows prompts you to reboot your Infiniium, click **Yes**. If not, close all open dialog boxes.
9. After the Infiniium reboots, the instrument is ready for LAN control over the LAN interface. Go to [“Configuring PC Agilent IO Config for LAN connection” on page 119](#).

Configuring Windows Infiniium Networking for DHCP Network

If your network provider uses DHCP, Windows XP will automatically retrieve a dynamic IP Address from the DHCP server. No configuration for the Infiniium is necessary. Continue to "[Configuring PC Agilent IO Config for LAN connection](#)" (page 119).

Configuring Windows XP Infiniium Networking for a Crossover Cable Network

Complete the following procedure to configure Windows XP Infiniium Networking for a Crossover Cable.

To configure Windows XP Infiniium networking for a crossover cable:

1. You need to create IP Addresses for both the Infiniium and your PC. Both addresses must have the first 3 sections the same and the last one different. For example, the PC IP address can be 192.168.0.2 and the Infiniium IP address 192.168.0.1.
2. On your Infiniium, quit the Scope application if it is running.
3. Open the **Control Panel (Start > Control Panel)**. Open **Network Connections**. (If you are in Category view, click **Network and Internet Connections** and then select **Network Connection**.)
4. Click **Local Area Connection** and then **Properties** to display the Local Area Connection Properties dialog box.
5. Select **Internet Protocol (TCP/IP)** from the connection list and click **Properties** to display the Internet Protocol (TCP/IP) Properties dialog screen.
6. Select **Use the following IP address** and enter the IP Address for the Infiniium you created in step 1 (192.168.0.1 in this example), and type a subnet mask of 255.255.255.0.
7. Click **OK** in the Internet Protocol (TCP/IP) Properties dialog box.
8. Click **OK** in the Local Area Connection Properties dialog box. If Windows prompts you to reboot your Infiniium, click **Yes**. If not, close all open dialog boxes.
9. After the Infiniium reboots, the instrument is ready for LAN control over the LAN interface. Continue to "[Configuring PC Networking for a Crossover Cable Configuration](#)" (page 117).

Configuring PC Networking for a Crossover Cable Configuration

Complete the following procedure to configure a PC for a Crossover Cable configuration.

To configure PC networking for a crossover cable configuration:

1. On your PC, open the **Control Panel (Start > Control Panel)**.
2. For Windows XP, click **Network Connections > Local Area Connections > Properties**.
For Windows Vista, click **View network status and tasks in Network and Internet > View status in Local Area Connection > Properties**.
This will display the Local Area Connection Properties dialog box.
3. For Windows XP, select **Internet Protocol (TCP/IP)** and click **Properties**.
For Windows Vista, select **Internet Protocol Version 4** and click **Properties**.
This will display the Internet Protocol (TCP/IP or Version 4) Properties dialog screen.
4. Select **Use the following IP address** and enter the IP Address for the PC you created in step 1 of "[Configuring Windows XP Infiniium Networking for a Crossover Cable Network](#)" (page 116) (this example uses 192.168.0.2.), and enter a subnet mask of 255.255.255.0.
5. Click **OK** in the Internet Protocol (TCP/IP or Version 4) Properties dialog box.
6. Click **OK** or **Close** in the Local Area Connection Properties dialog box. If Windows prompts you to reboot your PC, click **Yes**. If not, close any open dialog boxes.
7. After your PC reboots, the PC is ready for setting up the Agilent IO Config software. Go to "[Configuring PC Agilent IO Config for LAN connection](#)" (page 119).

Configuring PC Agilent IO Config for GPIB connection

The 89601A Software will automatically install the Agilent IO Libraries Suite on your PC if they are not already installed. These instructions assume that your computer has a GPIB card installed and operable.

To configure PC Agilent IP Config for a GPIB connection:

1. On the PC with the 89600A software, select: **Start > Programs > Agilent IO Libraries Suite > Agilent Connection Expert**

Connection Expert will automatically detect and configure the interface and instruments. It will also assign names and other default configuration settings.

2. To verify that the computer recognized the instrument, expand **GPIB0** in the *Instrument I/O on this PC* section. Connection Expert will list all instruments and their addresses.

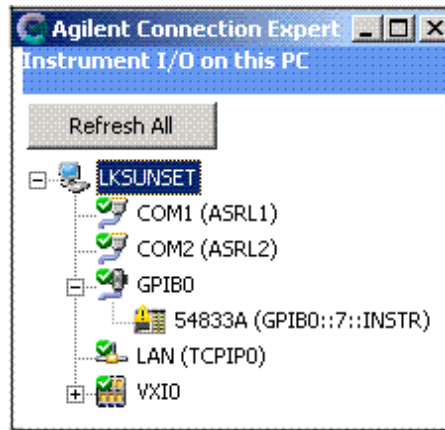

NOTE Agilent Connection Expert will not find the Infiniium scope if the scope application is not running.

NOTE When the 89601 software locates an instrument, it locks onto the instrument so only the 89601 software can communicate with it. This will prevent Agilent IO Libraries from any communication with these instruments and cause the green checkmark to become a red X in Connection Expert. You can disconnect the instrument by selecting **Control > Disconnect** in the 89601 software. Select Refresh in Connection Expert and the green checkmark will be shown.

Configuring PC Agilent IO Config for LAN connection

The 89601A Software automatically installs the Agilent IO Libraries Suite on your PC if they are not already installed.

To configure PC Agilent IO Config for a LAN connection:

1. On the PC with the 89601A software, select: **Start > Programs > Agilent IO Libraries Suite > Agilent Connection Expert**.
2. Add an instrument.

Auto discover cannot be done on LAN devices so you must manually add the instrument.

 - a. Click on **LAN** in the *Instrument I/O on this PC* section.
 - b. Click **Add an instrument** in the *Task Guide* section. The LAN selection should be highlighted but if not, highlight it.
 - c. Click **OK**.
 - d. Select **IP address** in the LAN instrument dialog box and enter the IP address of the instrument. You can also use Hostname if it is known.
 - e. Click **OK**.
3. To verify that the computer recognized the instrument, expand **LAN** in the *Instrument I/O on this PC* section. Connection Expert lists all instruments and their addresses.

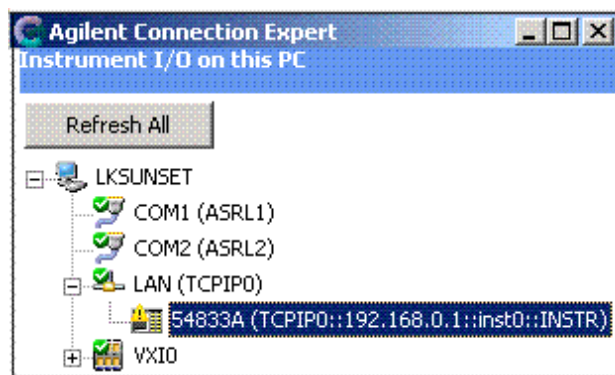

NOTE

Agilent Connection Expert can not find the Infiniium scope if the scope application is not running.

NOTE

When the 89601 software locates an instrument, it locks onto the instrument so only the 89600 software can communicate with it. This will prevent Agilent IO Libraries from any communication with these instruments and cause the green checkmark to become a red X in Connection Expert. You can disconnect the

Configuring Infiniium Windows XP Scopes
Configuring PC Agilent IO Config for LAN connection

instrument by selecting **Control > Disconnect** in the 89601 software. Select Refresh in Connection Expert and the green checkmark will be shown.

Configuring the Agilent E5810 LAN/GPIB Gateway Interface

To setup and use the E5810 with Microsoft Windows, you must have Internet Explorer 4.0 or higher or Netscape 4.7 or higher.

For details on setting up the E5810, see the E5810 User's Guide in the Agilent IO Libraries Suite Documentation. Click the **Agilent IO Control** icon in the task bar. Click **Documentation > Interface Manuals > E5810 LAN GPIB Users Guide**. (Or click **Start > (All) Programs > Agilent IO Libraries Suite > Documentation > E5810 LAN GPIB Users Guide**.)

IMPORTANT

Before making network connections, contact your Information Technology (IT) department for policies concerning user connections, IP address, etc.

To configure the E5810 LAN/GPIB Gateway interface:

1. Connect the E5810 to the network and to instruments.
2. Plug in and power on the E5810 and any GPIB instruments. The IP address should be displayed in the display. If the address does not appear, see Troubleshooting Information in the *E5810 Getting Started Guide*.
3. Configure the E5810
 - a. Display the E5810 Welcome Page. In your Web browser, type `'http://<IP address>'` where `<IP address>` is the current E5830A IP address (such as 169.254.58.10) shown on the E5810 display. Press **Enter**.
 - b. Take note of the GPIB SICL Interface Name (something like *gpib0*). You will need to use this name in a later step.
 - c. If you need to change any configuration information, such as the IP address, click **View & Modify Configuration**. (The default password is E5810.) After making changes, click **Save** and then **Reboot E5810** to make changes effective.
4. Verify communication from the E5810.
 - a. From the E5810 Welcome page, click **Find & Query Instruments**. (The default password is E5810.)
 - b. Click **Find**.
 - c. In the list of SICL Addresses, highlight the instrument you want to query.
 - d. Click **IDN?** The identification information for the information appears in the right pane.
5. Run the Agilent IO Libraries Suite Connection Expert tool.

Click the **IO Control** icon in the task bar, then click **Agilent Connection Expert**, or click **Start > (All) Programs > Agilent IO Libraries Suite > Agilent Connection Expert**.

6. Add an interface.

For more information about LAN Client interfaces, see *Connectivity Guide* in the Documentation section of the Agilent IO Libraries Suite. You can find this when you click on the **IO Control** icon in the task bar and then select **Documentation > Connectivity Guide**. (Or click **Start > (All) Programs > Agilent IO Libraries Suite > Documentation > Connectivity Guide**.)

- a. Click **Add an interface** on the Connection Expert *Task Guide* panel.
- b. Select **Remote GPIB interface** and click **Add**.
- c. Select **IP address** and enter IP address from the E5810A (see step 3b).
- d. Click **OK**.

Connection Expert will automatically configure the interface and instruments and will assign names and other default configuration settings.

7. To verify that the computer recognized the instrument, expand **Remote (GPIB1)** in the *Instrument I/O on this PC* section. Connection Expert will list all instruments and their addresses.

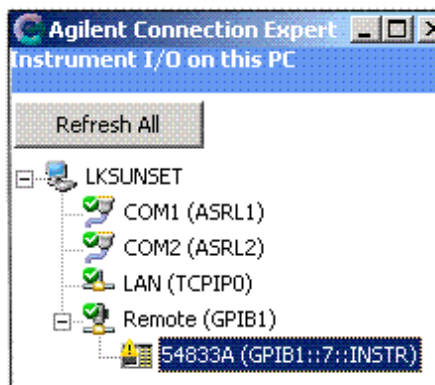

NOTE

Agilent Connection Expert will not find the Infiniium scope if the scope application is not running.

NOTE

When the 89601 software locates an instrument, it locks onto the instrument so only the 89601 software can communicate with it. This will prevent Agilent IO Libraries from any communication with these instruments and cause the green checkmark to become a red X in Connection Expert. You can disconnect the instrument by selecting **Control > Disconnect** in the 89601 software. Select Refresh in Connection Expert and the green checkmark will be shown.

Configuring the USB/GPIB Interface

For details on setting up the 82357 USB/GPIB Interface, see the *82357 USB/GPIB User's Guide* in the Agilent IO Libraries Suite Documentation. Click the **Agilent IO Control** icon in the task bar and select **Documentation > Interface Manuals > 82357 USB GPIB Users Guide**. (Or click **Start > (All) Programs > Agilent IO Libraries Suite > Documentation > 82357 USB GPIB Users Guide**.)

To configure the USB/GPIB interface:

1. Plug the 82357 USB cable into a USB port on your PC. Do not connect to your GPIB instrument at this time.
2. Observe the 3 LEDs on the E8237A. Initially, only the red FAIL LED should be on. After the Found New Hardware Wizard runs, all 3 LEDs should be ON. If any LED is off after 20 seconds, stop and refer to the *82357 USB/GPIB User's Guide* in the Agilent IO Libraries Suite Documentation for information.
3. If the *Agilent 82357A USB/GPIB Interface Detected* dialog box appears, click **OK** or **Accept**. (If you want to change any of the settings, refer to the 82357 documentation for instructions.)

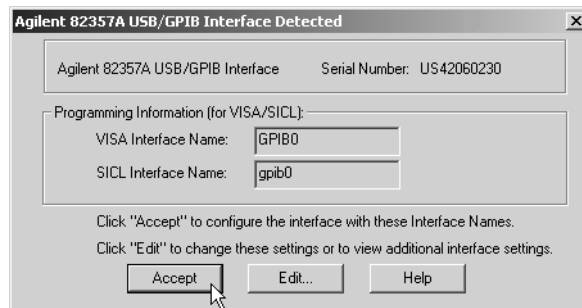

4. Connect one or more instruments to the GPIB connector on the 82357.
5. Run Connection Expert.
 - a. Click the **IO Control** icon in the task bar or click **Start > (All) Programs > Agilent IO Libraries Suite > Agilent Connection Expert**.

Connection Expert will automatically detect and configure the interface and instruments. It will also assign names and other default configuration settings.

6. To verify that the computer recognized the instrument, expand **USB/GPIB (GPIB1)** in the *Instrument I/O on this PC* section. Connection Expert will list all instruments and their addresses. To troubleshoot problems, refer to the

Configuring Infiniium Windows XP Scopes
Configuring the USB/GPIB Interface

Troubleshooting chapter in the 82357A User's Guide.

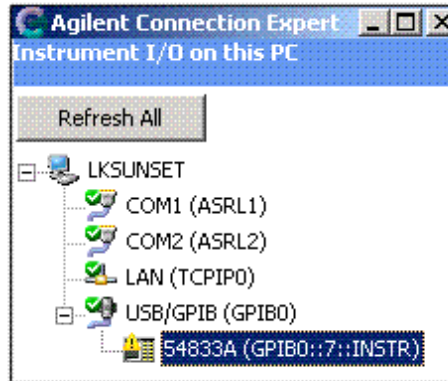

NOTE Agilent Connection Expert will not find the Infiniium scope if the scope application is not running.

NOTE When the 89601 software locates an instrument, it locks onto the instrument so only the 89601 software can communicate with it. This will prevent Agilent IO Libraries from any communication with these instruments and cause the green checkmark to become a red X in Connection Expert. You can disconnect the instrument by selecting **Control > Disconnect** in the 89601 software. Select Refresh in Connection Expert and the green checkmark will be shown.

Introduction

This chapter includes information for installing 89601 software in Agilent Infiniium scopes running Windows XP.

Many Infiniium oscilloscopes provide an open Microsoft Windows XP Pro operating system that enables you to install other applications. You can install and operate the 89601A Vector Signal Analyzer software on these scopes.

If you are installing 89600 software on a PC connected to your Infiniium scope, skip this chapter and see: [Chapter 7](#), “[Configuring Infiniium Windows XP Scopes](#),” on page 111

Installing the 89600 software

This section provides information on installing the 89600 software in your scope.

To install the 89600 software embedded in your scope:

1. Increase the scope's virtual memory to at least 1 GByte as follows:
 - a. Minimize the scope application.
 - b. Navigate to: **Start > Control Panel > Administrative Tools (double-click) > Computer Management (double-click) > Computer Management (Local) (right-click) > Properties > Advanced (tab) > Performance Settings (button) > Virtual Memory - Change (button)** to display the Virtual Memory dialog screen.
 - c. Set **Initial Size (MB)** and **Maximum Size (MB)** to 1000 MB (or more if you have sufficient Space Available), then click **Set > OK > OK (reboot message) > OK (reboot message - no) > OK** and close remaining screens. Remember, this change does not take effect until you reboot.
2. Install the 89600 VSA software as follows:
 - a. Insert the Agilent Technologies 89600 Series Software CD into the scope's CD drive. If your scope does not have a CD drive, use the USB procedure described in steps 1 - 7 of [Chapter 9](#), "Installing Agilent 89600 Software in Agilent X-Series Signal Analyzers," on page 131.
 - b. When the Agilent 89600 Installation Manager window opens, select **Install 89600 Series Software**. Continue through the InstallShield Wizard to complete the installation.
 - c. In the Select Products and Features window, select Agilent 89600 VSA. Click **Next**.

NOTE Only the 89600 VSA software is currently supported in your Infiniium scope.

- d. When the installation is complete, exit the Installation Manager.

NOTE When installing the 89600 VSA in an Infiniium scope, **Hardware support** is disabled. This prevents using disk space for unnecessary components that are not needed when the 89600 VSA software is installed in a logic analyzer.

Installing the 89600 software

3. Start the 89600 VSA. Click **Start > Programs > Agilent 89600 VSA > Vector Signal Analyzer**.

Verifying correct operation

If a *Simulated Hardware* watermark does *not* appear in the trace area of the VSA, the installation is complete and the VSA is operating properly. If the watermark **Simulated Hardware** does appear in the 89600 display, follow these steps to solve the problem.

To verify correct operation:

1. Exit the 89600 VSA application.
2. If the Infiniium application is not running, start the Infiniium application and restart the 89600 VSA application (click **Start > Programs > Agilent 89600 VSA > Vector Signal Analyzer**).
3. If the *Simulated Hardware* water mark still appears, check the hardware configuration as follows:
 - a. in the 89600 VSA window click **Utilities > Hardware**.
 - b. Check the **Default Hardware** check box and click **OK**.
4. If the Infiniium application is running, then there is a VISA configuration problem, which you can fix as follows:
 - a. Stop the VSA application.
 - b. Minimize the Infiniium application.
 - c. Start the Connection Expert application by clicking **Start > All Programs > Agilent IO Libraries > Agilent Connection Expert**.
 - d. Make sure that the GPIB0 (VISA Name), hipb7 (SICL Name) interface appears in the Configured Interfaces list.
 - e. If it does not appear then highlight *Internal Instrument* in the Available Interface Type list and click **Configure** then **OK** until the configuration is complete.
 - f. Restart the VSA application.

Continue with [Step 5 \(Page 20\)](#).

Installing 89601 Software in Agilent Infiniium XP Scopes
Verifying correct operation

9

**Installing Agilent 89600 Software in
Agilent X-Series Signal Analyzers**

Introduction

This chapter contains information for installing the Agilent 89600 VSA software into an Agilent X-Series Signal Analyzer.

NOTE

Verify that the Instrument software revision (**System** hardkey > **Show** softkey > **System** softkey) is A.01.40 or greater.

If you have an Internet connection to the X-series analyzer, you can download the Agilent 89600 VSA software from the Agilent 89600 VSA Analysis software home page (www.agilent.com/find/89600).

You can also install the software from the Agilent 89600 software product CD. Since the Agilent X-Series Signal Analyzers do not have a CD drive you can use a USB Flash drive. The first step is to copy the contents of the Agilent 89600 VSA Software CD onto the USB Flash Drive. The Agilent 89600 VSA software CD is not protected or encrypted. The copy will be identical to the original CD.

NOTE

This procedure assumes that a USB Flash Drive is being used. Other USB storage devices, such as a USB hard drive or USB CD/DVD drive, could also be used.

Installing the 89600 software in an Agilent X-Series Signal Analyzer

This section provides the instructions for installing the 89600 software in an Agilent X-Series Signal Analyzer using a USB Flash drive.

1. Insert the Agilent 89600 VSA Software CD into a PC's CD drive. If the Agilent 89600 Installation Manager window opens, close the installer program (click Exit).

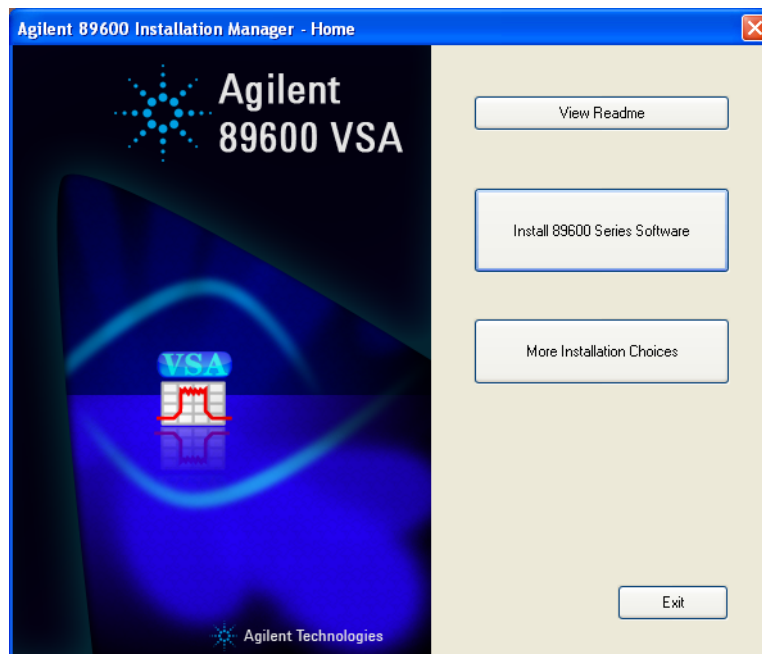

2. Insert a USB Flash Drive into a USB port on the same PC that the Agilent 89600 VSA Software CD is in.
3. Copy the contents of the Agilent 89600 VSA Software CD onto the USB Flash Drive.
4. Connect a USB keyboard and mouse to the analyzer.

NOTE

To install the Agilent 89600 VSA software on the analyzer, you need to have administrator privileges. Press **Ctrl - Alt - Delete**, then click **Log Off...** Log back in as the Administrator. The default password is `agilent4u`.

5. Insert the USB Flash Drive into an available USB port.
6. Open Windows Explorer and navigate to the USB drive.
7. Double-click **autoplay.EXE** to bring up the Agilent 89600 Installation Manager.
8. When the Agilent Installation Manager window opens, click **Install 89600**

Series Software. Continue through the InstallShield Wizard to complete the installation.

NOTE

In the Select Products and Features window of the InstallShield Wizard, select Agilent 89600 VSA. Only the 89600 VSA software is currently supported in your Agilent X-Series Signal Analyzer.

9. When the installation is complete, exit the Installation Manager.

NOTE

When installing the 89600 VSA in a logic analyzer mainframe, **Hardware support** is disabled. This prevents using disk space for unnecessary components that are not needed when the 89600 VSA software is installed in a logic analyzer.

Verifying correct operation

To verify correct operation:

1. Start the X-Series analyzer application: Double-click the **LaunchXSA** icon on the Windows desktop.
2. After the X-Series analyzer finishes booting up, start the Agilent 89600 VSA analyzer (press the **Mode** hardkey and the **89601 VSA** softkey to launch the 89600 VSA software).

Continue with [Step 5 \(Page 20\)](#).

Introduction

This chapter includes information related to the Agilent 89600 series Vector Signal Analyzer's link to selected Agilent Logic Analyzers. This capability is available with 89601A VSA software revision 6.00 and higher.

The 89600 VSA can capture and analyze time series data on a digital bus using either an Agilent 1680, 1690, 16800, or 16900 series Logic Analyzer as a data source. The Agilent 1680, 1690, 16800, and 16900 series Logic Analyzers all use the same Logic Analyzer software. The Logic Analyzer link to the 89600 VSA is available with Logic Analyzer software revision 3.20 and higher.

The Distortion Suite application (89604A) supports the Logic Analyzer as acquisition hardware as long as **Use 89600 VSA Application** and **Show 89600 VSA** are selected. To select **Use 89600 VSA Application** and **Show 89600 VSA**, start the Distortion Suite application and click **MeasSetup > Connection** and select **Use 89600 VSA Application** and select **Show 89600 VSA**.

The 89607A Wireless LAN Test application does not support the Logic Analyzer as acquisition hardware.

The 89601A software's Swept Spectrum Analyzer application does not support the Logic Analyzer Link.

Configurations

16900 Series Logic Analyzers

The 16900 series Logic Analyzer application runs on any PC running Windows XP Professional. The PC can be embedded in the 16900 series Logic Analyzer mainframe, or the PC can be connected to the Logic Analyzer mainframe via a LAN.

NOTE

The Logic Analyzer application version 3.20 or higher supports both Windows XP Professional Service Pack 1 and Windows XP Professional Service Pack 2.

The 16900 series Logic Analyzer application can be configured to run online or offline. The online configuration acquires data from a digital device using the measurement hardware in the Logic Analyzer mainframe. The offline configuration uses data previously recorded and saved by the Logic Analyzer. Offline analysis does not require a connection to the Logic Analyzer mainframe.

The 89600 VSA application runs on any PC running Window Vista or Windows XP Professional. The 89600 VSA application runs on either the 16900 series Logic Analyzer mainframe or on a separate PC. The 89600 VSA works with the 16900 series Logic Analyzer whether the 16900 series Logic Analyzer is online or offline.

Configurations for linking the Agilent 16900 series Logic Analyzer to the Agilent 89600 VSA are:

- Logic Analyzer application and VSA application both running on the Logic Analyzer mainframe. From a speed standpoint, this is generally the highest performance configuration.
- Logic Analyzer application running on the Logic Analyzer mainframe. VSA application running on a separate PC. The VSA application communicates with the Logic Analyzer via the LAN interface.

NOTE

The PC and the Logic Analyzer mainframe must both be members of the same domain or workgroup. If the PC and the Logic Analyzer are members of the same workgroup, you must log on to both the PC and the Logic Analyzer using the same user name. If the Logic Analyzer is a member of a workgroup, and uses Windows XP Professional, make sure that it does not use simple file sharing. Click **Start > My Computer > Tools > Folder Options > View** and clear **Use simple file sharing (Recommended)** if currently selected.

- Logic Analyzer application and VSA application both running on the same PC. The Logic Analyzer application communicates with the Logic Analyzer mainframe via the LAN interface.

Logic Analyzer Measurement Module Support

The 89600 VSA application supports the 16900 series Logic Analyzer mainframes and the following Logic Analyzer measurement modules. See table below.

Table 10-1 Supported Logic Analyzer Measurement Modules

State/Timing Cards	Maximum Clock Speed (MHz)	Maximum State Acquisition Rate (Mb/s)	Maximum Memory (MB)
16950A	600	800	64
16910A/11A	450	500	32
16740A/41A/42A	200	200	2/8/32
16750B/51B/52B	400	400	2/8/32/128
16753A/54A/55A/56A	600	600	2/8/32/128
16760A	800	1500	128

In addition to the measurement modules listed above, the 89600 VSA application supports 16900 series Logic Analyzer integrated software tools. Examples of Logic Analyzer software tools include tools that provide flexible de-serialization of serial data, and tools that serialize several parallel busses into one bus. The software tools are integrated with the Logic Analyzer application, and the output of these software tools look like parallel bus data to the 89600 VSA.

The 89600 VSA reads the collection of tools, identifies those that can be used as input, and adds them to the collection of module names available for analysis.

1680 and 16800 Series Logic Analyzers

The 1680 and 16800 series Logic Analyzer application runs on any PC running Windows XP Professional. The PC can be embedded in the 1680 or 16800 series Logic Analyzer mainframe, or the PC can be connected to the Logic Analyzer mainframe via a LAN.

NOTE

The Logic Analyzer application version 3.20 or higher supports both Windows XP Professional Service Pack 1 and Windows XP Professional Service Pack 2.

The 1680 and 16800 series Logic Analyzer application can be configured to run online or offline. The online configuration acquires data from a digital device using the measurement hardware in the Logic Analyzer mainframe. The offline configuration uses data previously recorded and saved by the Logic Analyzer. Offline analysis does not require a connection to the Logic Analyzer mainframe.

The 89600 VSA application runs on any PC running Windows Vista or Windows XP Professional. The 89600 VSA application runs on either the 1680 or 16800 series Logic Analyzer mainframe or on a separate PC. The 89600 VSA works with the 1680 or 16800 series Logic Analyzer whether the 1680 or 16800 series Logic Analyzer is online or offline.

Configurations for linking the Agilent 1680 or 16800 series Logic Analyzer to the Agilent 89600 VSA are:

- Logic Analyzer application and VSA application both running on the Logic Analyzer mainframe. From a speed standpoint, this is generally the highest performance configuration.
- Logic Analyzer application running on the Logic Analyzer mainframe. VSA application running on a separate PC. The VSA application communicates with the Logic Analyzer via a LAN interface.

NOTE

The PC and the Logic Analyzer mainframe must both be members of the same domain or workgroup. If the PC and the Logic Analyzer are members of the same workgroup, you must log on to both the PC and the Logic Analyzer using the same user name. If the Logic Analyzer is a member of a workgroup, and uses Windows XP Professional, make sure that it does not use simple file sharing. Click **Start > My Computer > Tools > Folder Options > View** and clear **Use simple file sharing (Recommended)** if currently selected.

- Logic Analyzer application and VSA application both running on the same PC. The Logic Analyzer application communicates with the Logic Analyzer mainframe via a LAN interface.

1690 Series Logic Analyzers

The 1690 series Logic Analyzer application runs on any PC running Windows XP Professional.

NOTE The Logic Analyzer application version 3.20 or higher supports both Windows XP Professional Service Pack 1 and Windows XP Professional Service Pack 2.

NOTE Unlike the 1680, 16800, and 16900 series Logic Analyzers, the 1690 series Logic Analyzer does not have an embedded PC in the Logic Analyzer mainframe.

The 1690 series Logic Analyzer mainframe must be connected to a PC via an IEEE 1394 Firewire interface. Refer to the instructions that came with the IEEE 1394 Connection Kit for IEEE 1394 installation help.

The 1690 series Logic Analyzer application can be configured to run online or offline. The online configuration acquires data from a digital device using the measurement hardware in the Logic Analyzer mainframe. The offline configuration uses data previously recorded and saved by the Logic Analyzer. Offline analysis does not require a connection to the Logic Analyzer mainframe.

The 89600 VSA application runs on any PC running Windows Vista or Windows XP Professional. The 89600 VSA application works with the 1690 series Logic Analyzer whether it is online or offline.

Configurations for linking an Agilent 1690 series Logic Analyzer to an Agilent 89600 VSA are:

- Logic Analyzer application and VSA application both running on the same PC. The Logic Analyzer application communicates with the Logic Analyzer mainframe via the IEEE 1394 interface. From a speed standpoint, this is generally the highest performance configuration.
- Logic Analyzer application and VSA application running on separate PCs. The Logic Analyzer application communicates with the Logic Analyzer mainframe via the IEEE 1394 interface. The VSA application communicates with the Logic Analyzer application via the LAN interface.

NOTE The two PC's must be members of the same domain or workgroup. If the PC's are members of the same workgroup, you must log on to both PC's using the same user name.

Software Installation

The first step is to decide where you want to install the Logic Analyzer software and the 89600 Vector Signal Analyzer software. See “Configurations” on page 139 for information on configurations.

Logic Analyzer Software Installation

The Logic Analyzer software comes installed on the Agilent 1680, 16800, and 16900 series Logic Analyzer mainframes. The 1690 series Logic Analyzers require the Logic Analyzer software to be installed on a PC. The Logic Analyzer software is available as a free download at <http://www.agilent.com/find/logic>. For Logic Analyzer software installation assistance, refer to the *Logic Analyzer Installation Guide*.

89600 Vector Signal Analyzer Software Installation

NOTE

It is useful to have an external keyboard and mouse connected to the Logic Analyzer mainframe on which you intend to install and run the VSA software.

To install the 89600 Vector Signal Analyzer software on a PC, follow the instructions in “Installing 89600 Software” on page 24.

To install the 89600 Vector Signal Analyzer software in an Agilent 1680 or 16900 series Logic Analyzer mainframe with a built in CD drive, be sure to log on with administrator privileges.

To install the 89600 software:

- a. Insert the Agilent Technologies 89600 Series Software CD into the logic analyzer’s CD drive.

NOTE

The 16901 and the 16800 Series Logic Analyzers do not have built in CD drives. To install the 89600 VSA software in a Logic Analyzer mainframe without a built in CD drive, copy the contents of the 89600 VSA software onto a USB device, such as a USB Flash Drive. Log on to the Logic Analyzer with administrator privileges, insert the USB Flash Drive with the Agilent 89600 VSA software on it, browse to and double-click on `autoplay.exe`.

- b. When the Agilent 89600 Installation Manager window opens, select **Install 89600 Series Software**. Continue through the InstallShield Wizard to complete the installation.

- c. In the Select Products and Features window, select Agilent 89600 VSA.

NOTE

Only the 89600 VSA software is currently supported in your Logic Analyzer.

- d. When the installation is complete, exit the Installation Manager.

NOTE

When installing the 89600 VSA in a logic analyzer mainframe, **Hardware support** is disabled. This prevents using disk space for unnecessary components that are not needed when the 89600 VSA software is installed in a logic analyzer.

Connecting to a Network

If either the Logic Analyzer application or the Vector Signal Analyzer application requires access to the Logic Analyzer mainframe via a LAN, you must:

- Configure the Logic Analyzer mainframe firewall to enable applications to access it.
- Set up a direct LAN connection between the host computer and the Logic Analyzer mainframe using a CAT5 crossover LAN cable or set up the Logic Analyzer mainframe to communicate via your intranet using a standard CAT5 LAN cable.
- Install the Logic Analyzer COM Automation client software on your remote computer.

NOTE

The PC and the Logic Analyzer mainframe must both be members of the same domain or workgroup. If the PC and the Logic Analyzer are members of the same workgroup, you must log on to both the PC and the Logic Analyzer using the same user name. If the Logic Analyzer is a member of a workgroup and uses Windows XP Professional, make sure that it does not use simple file sharing. Click **Start > My Computer > Tools > Folder Options > View** and clear **Use simple file sharing (Recommended)** if currently selected

Follow the instructions in the Logic Analyzer help topic **Setting Up for COM Automation** to properly set up your network connection and configure the firewall. To access the **Setting Up for COM Automation** information, start the Logic Analyzer application and click **Help > Help Topics > COM Automation > Setting Up for COM Automation**.

The preferred method for installing the Logic Analyzer COM Automation client software is to install the Logic Analyzer software on the remote computer. Installing the Logic Analyzer software automatically installs the COM Automation client. This gives you the benefit of having Logic Analyzer offline analysis capability and the COM Automation client set up on each computer you use to link to the Logic Analyzer. For a free copy of the latest Logic Analyzer software, go to <http://www.agilent.com/find/logic>.

If you would prefer to not install the Logic Analyzer software on your remote computer, you can install just the Logic Analyzer COM Automation client software. The Logic Analyzer COM Automation client software is available on any system that has the Logic Analyzer software installed. The file name is SetupLACOM.exe. The file is located at **C:\Program Files\Agilent Technologies\Logic Analyzer\SetupLACOM.exe**. For additional information on installing the Logic Analyzer COM Automation client software, refer to **Setting Up for COM Automation** in the Logic Analyzer online help.

For information on configuring the 89600 VSA LAN interface, see [“Configuring the LAN interface” on page 97](#).

89600 I/O Connections

Overview

Agilent 89600 I/O Connections is a software utility that helps you to quickly connect and configure your LAN-connected Logic Analyzer instruments, verify operation, and troubleshoot connectivity problems. The 89600 I/O Connections software is installed with the 89600 Vector Signal Analyzer software. To start the 89600 I/O Connections utility, click **Start > (All) Programs > Agilent 89600 VSA > Logic Analyzer > IO Connections**.

An explorer pane appears when you start the 89600 I/O Connections utility. The explorer pane is a graphical representation of your test system and its status. The following screen shot is of an 89600 I/O Connections explorer pane.

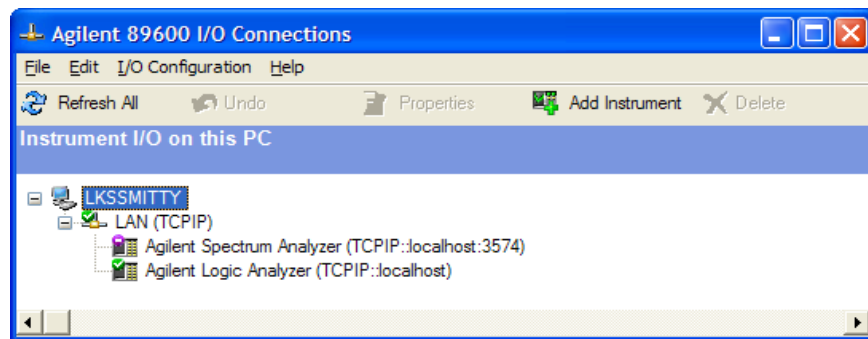

Adding an Instrument

You can use the Agilent 89600 I/O Connections utility to add an instrument in any of the following ways.

- Click **Add Instrument** on the toolbar.
- Right-click anywhere in the Explorer Pane, then click **Add Instrument**.
- From the menu bar, click **I/O Configuration > Add Instrument**.

When the *Add Instrument* dialog box appears, select **Agilent Logic Analyzer** and click **OK**.

When the *Add LAN Instrument* dialog box appears, configure your Logic Analyzer in one of the following ways.

- If you know the hostname of the Logic Analyzer, select **Hostname** and enter the Logic Analyzer hostname.
- If you know the IP address of the Logic analyzer, select **IP address** and enter the IP address of the Logic analyzer.

Click **Test Connection**, verify the connection works and click **OK**.

For additional information on the Agilent 89600 I/O Connections utility, refer to

the 89600 Vector Signal Analyzer online help. To get access to the online help, start the 89600 VSA application, then click **Help > Contents**. Information about the Agilent 89600 IO Connections is located under **Product Overview > Measurement Hardware > Agilent 89600 IO Connections**.

Logic Analyzer Link Examples

Logic Analyzer application and 89600 VSA application running on the same PC

This example guides you through the 89600 VSA and Logic Analyzer setups required to display a North American Digital Cellular (NADC) signal acquired by the Logic Analyzer. This example is valid when both the Logic Analyzer application and the VSA application are running on the same PC.

- Step 1.** Close the 89600 Vector Signal Analyzer application.
- Step 2.** Start the Logic Analyzer application.
- Step 3.** Select **Open File** when the following dialog box appears.

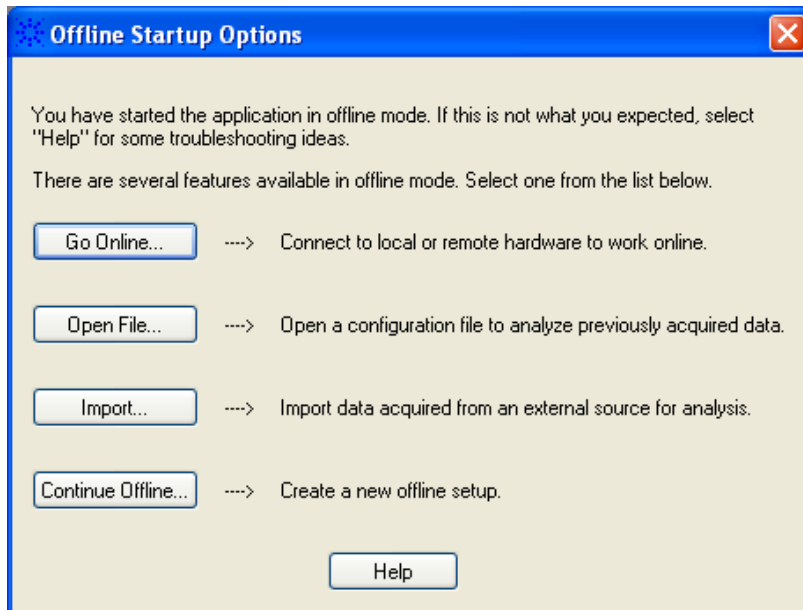

- Step 4.** When the *Open* dialog box appears, click the *Look in* drop down menu and open *C:\Program Files\Agilent\89600 VSA\LogicAnalyzer\demo nadc statedata.ala*. The file *demo nadc statedata.ala* is a configuration and data file of an NADC signal that was installed with the 89601A software.
- Step 5.** Click **Start > (All) Programs > Agilent 89600 VSA > Logic Analyzer > IO Connections**. When the *Agilent 89600 I/O Connections* dialog box appears, click **Add Instrument**. When the *Add Instrument* dialog box appears, select **Agilent Logic Analyzer** and click **OK**. Type **localhost** in the *Hostname* text box. Click **Test Connection** to make sure the connection works. Click **OK**.
- Step 6.** Start the 89600 Vector Signal Analyzer application.
- Step 7.** Click **Utilities > Hardware**. Clear **Default Hardware** if currently selected. Clear **Simulate Hardware** if currently selected. Select **TCPIP::localhost** as ADC 1 and

click **OK**.

NOTE

Selecting **TCPIP::localhost** as ADC 1 can create a hardware configuration that is not supported. A *red X* on a hardware tab in the *Select Hardware* dialog box indicates a hardware configuration that is not supported. Click hardware tabs that have a *red X* and clear the current hardware selection. Refer to the *ADC Tab* section of the 89600 VSA online help for more information on hardware configurations.

- Step 8.** Click **Input > Digital**. Type **97.2 kSa/Sec** in the *Frequency Sample Rate* text box. Your Input Properties dialog box *Digital* settings should now be the same as the settings in the following Input Properties dialog box.

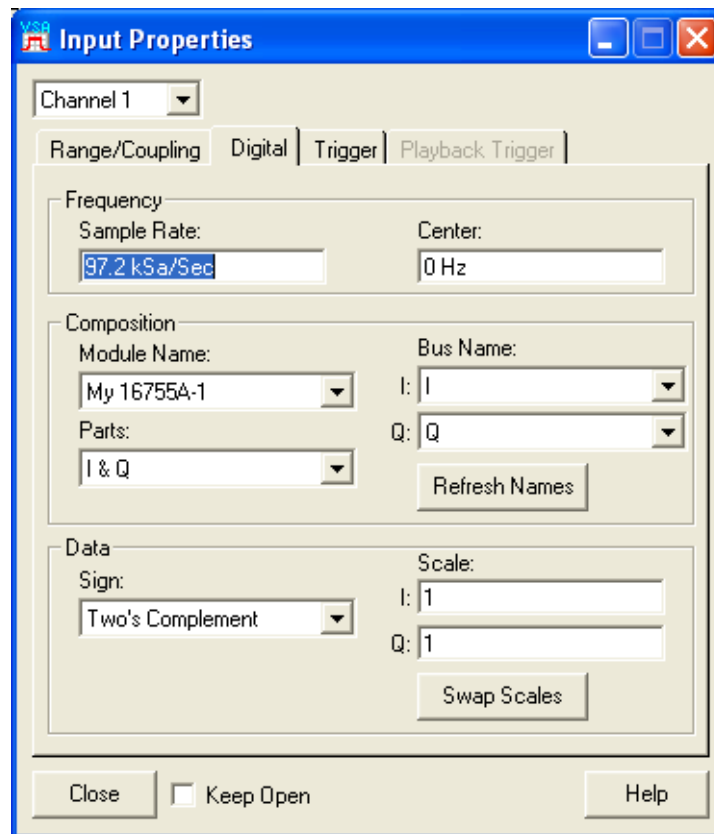

- Step 9.** Click **Close**.

- Step 10.** If the 89600 VSA is paused, click the **Restart** button.

Linking Logic Analyzers to the Agilent 89600 VSA Logic Analyzer Link Examples

Your 89600 VSA display should look similar to the following screenshot.

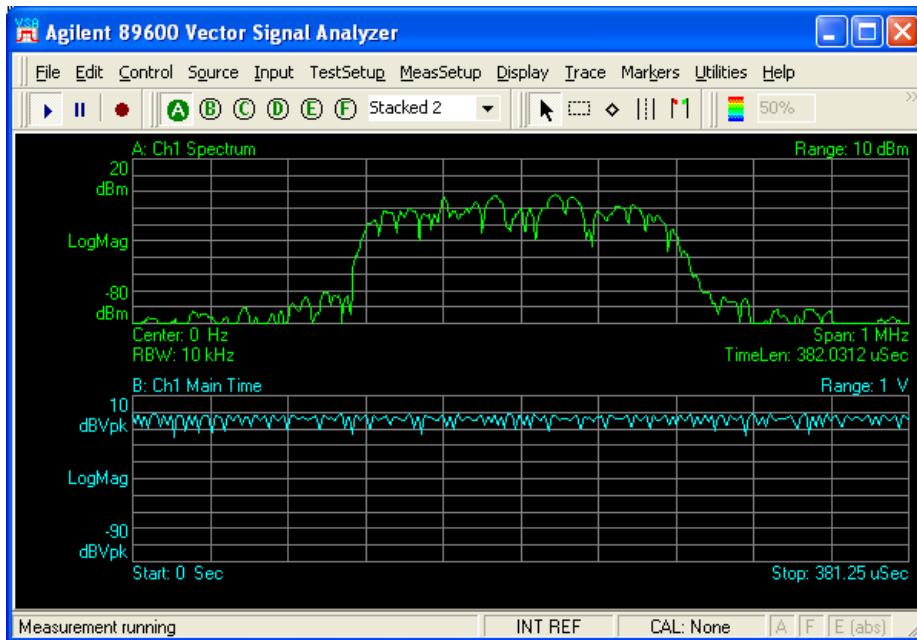

NOTE

If your 89600 VSA does not have option AYA, Vector Modulation Analysis, this is the end of the example. If your 89600 VSA does have option AYA, you can now digitally demodulate this signal.

Step 11. Click **MeasSetup > Demodulator > Digital Demod.**

Step 12. Click **MeasSetup > Demod Properties.** In the *Format Tab* dialog box, click **Preset to Standard > Cellular > NADC.** In the *Search Tab* dialog box, clear the **Pulse Search** selection. Click **Close.**

Your 89600 VSA display should now look similar to the following screenshot.

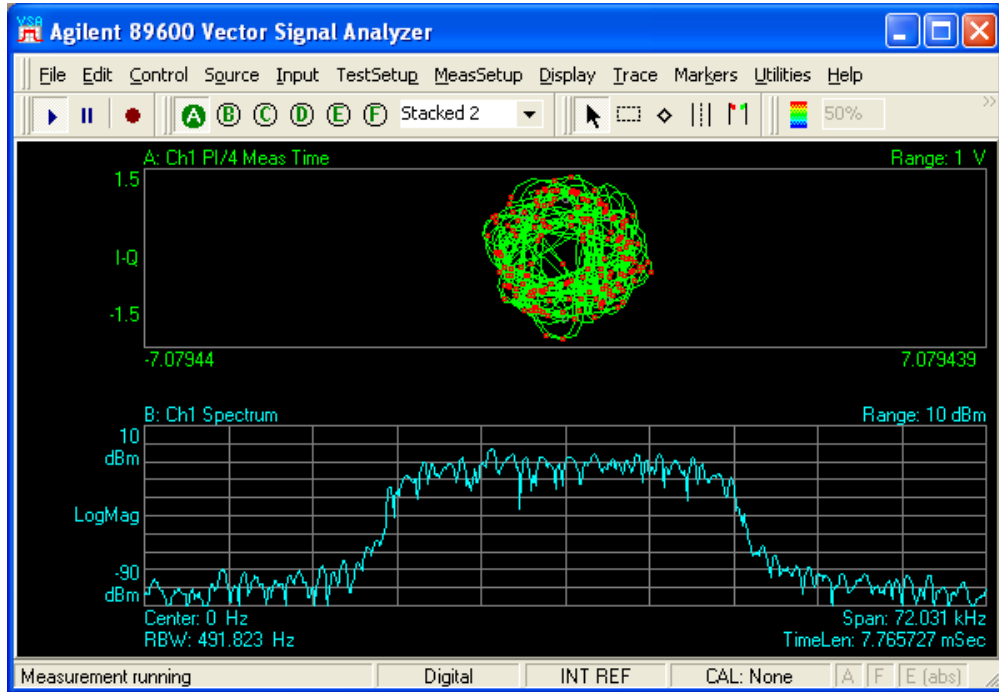

Logic Analyzer application and 89600 VSA application running on the Logic Analyzer mainframe

This example guides you through the 89600 VSA and Logic Analyzer setups required to display a North American Digital Cellular (NADC) signal acquired by the Logic Analyzer. This example is valid when both the Logic Analyzer application and the VSA application are running on the Logic Analyzer mainframe.

- Step 1.** Close the 89600 Vector Signal Analyzer application.
- Step 2.** Start the Logic Analyzer application.
- Step 3.** Click **File > Open**.
- Step 4.** When the *Open* dialog box appears, click the *Look in* drop down menu and open *C:\Program Files\Agilent\89600 VSA\LogicAnalyzer\demo nadc statedata.ala*. The file *demo nadc statedata.ala* is a configuration and data file of an NADC signal that was installed with the 89601A software.
- Step 5.** If the Module Mapping dialog box appears, select **Switch to ‘Offline’ mode and load the configuration as-is**.

If the dialog box does not appear, click **File > Go Offline**. Click **Ok** in the Information dialog box.

- Step 6.** Click **Start > (All) Programs > Agilent 89600 VSA > Logic Analyzer > IO Connections**. When the *Agilent 89600 I/O Connections* dialog box appears, click **Add Instrument**. When the *Add Instrument* dialog box appears, select **Agilent Logic Analyzer** and click **OK**. Type **localhost** in the *Hostname* text box. Click **Test Connection** to make sure the connection works. Click **OK**.
- Step 7.** Start the 89600 Vector Signal Analyzer application.
- Step 8.** Click **Utilities > Hardware**. Clear **Default Configuration** if currently selected. Clear **Simulate Hardware** if currently selected. Select **TCPIP::localhost** as ADC 1 and click **OK**.

NOTE

Selecting **TCPIP::localhost** as ADC 1 can create a hardware configuration that is not supported. A *red X* on a hardware tab in the *Select Hardware* dialog box indicates a hardware configuration that is not supported. Click hardware tabs that have a *red X* and clear the current hardware selection. Refer to the *ADC Tab* section of the 89600 VSA online help for more information on hardware configurations.

- Step 9.** Click **Input > Digital**. Type **97.2 kSa/Sec** in the *Frequency Sample Rate* text box. Your Input Properties dialog box *Digital* settings should now be the same as the

settings in the following Input Properties dialog box.

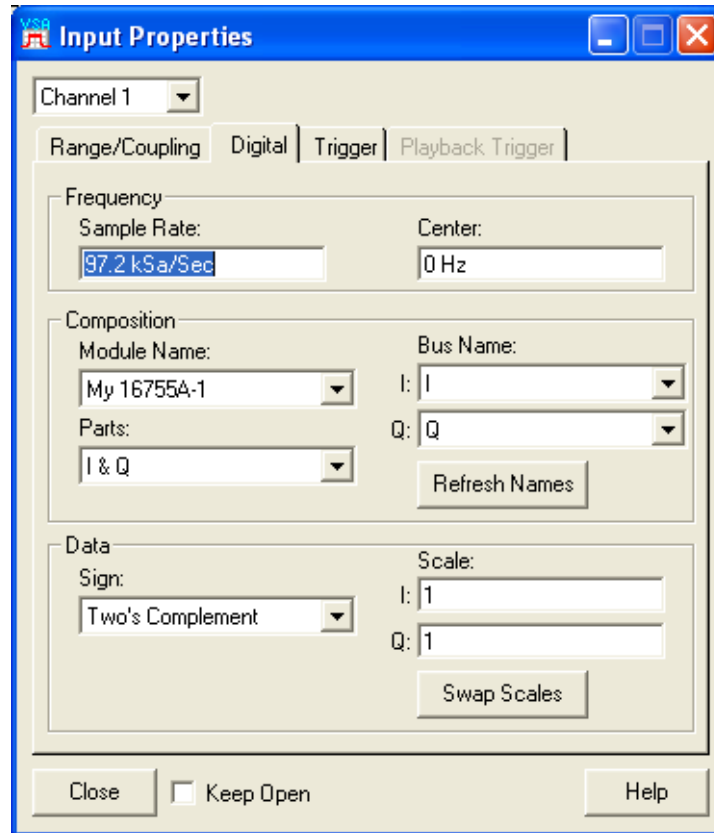

Step 10. Click **Close**.

Step 11. Click the **Play** button on the 89600 VSA.

Linking Logic Analyzers to the Agilent 89600 VSA Logic Analyzer Link Examples

The 89600 VSA display on the Logic Analyzer should look similar to the following screen shot.

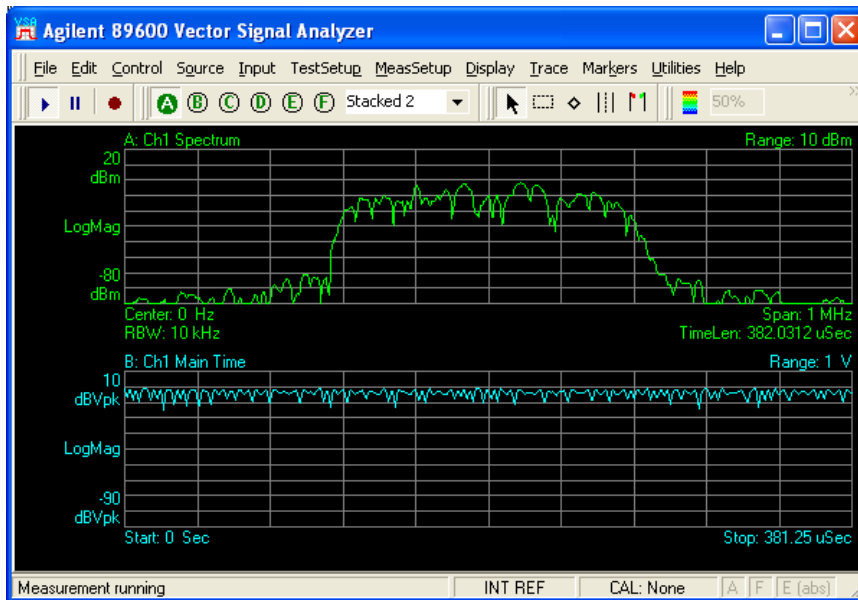

NOTE

If your 89600 VSA does not have option AYA, Vector Modulation Analysis, this is the end of the example. If your 89600 VSA does have option AYA, you can now digitally demodulate this signal.

Step 12. Click **MeasSetup > Demodulator > Digital Demod.**

Step 13. Click **MeasSetup > Demod Properties.** In the *Format Tab* dialog box, click **Preset to Standard > Cellular > NADC.** In the *Search Tab* dialog box, clear the **Pulse Search** selection. Click **Close.**

Your 89600 VSA display should now look similar to the following screen shot.

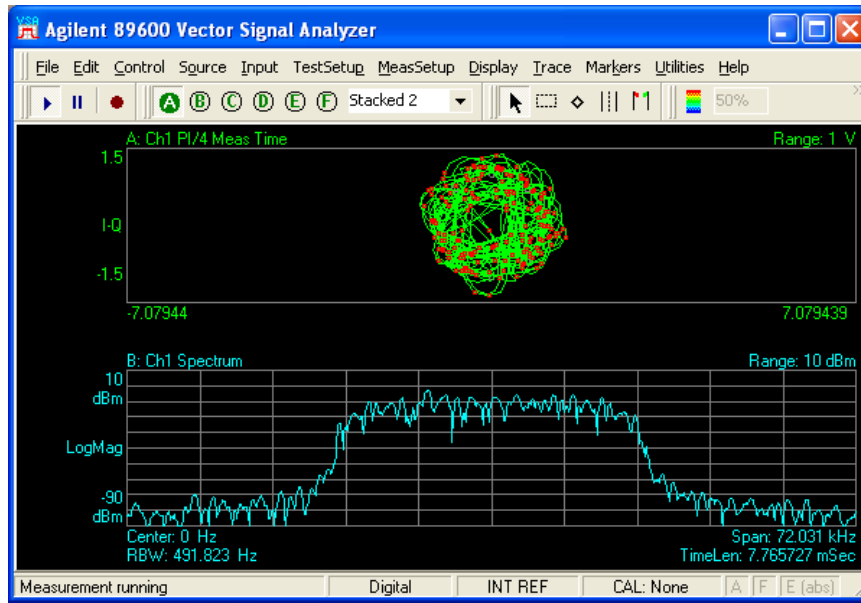

Logic Analyzer application running on the Logic Analyzer mainframe and 89600 VSA application running on a separate PC

This example guides you through the 89600 VSA and Logic Analyzer setups required to display a North American Digital Cellular (NADC) signal acquired by the Logic Analyzer. This example is valid when the Logic Analyzer application is running in the Logic Analyzer mainframe and the VSA application is running on a separate PC.

The connection from the PC to the Logic Analyzer mainframe is made with a LAN cable. The PC and the Logic Analyzer mainframe can be connected to your intranet, or you can connect a crossover LAN cable directly between the PC and the Logic Analyzer mainframe.

NOTE

The PC and the Logic Analyzer mainframe must both be members of the same domain or workgroup. If the PC and the Logic Analyzer are members of the same workgroup, you must log on to both the PC and the Logic Analyzer using the same user name. If the Logic Analyzer is a member of a workgroup, and uses Windows XP Professional, make sure that it does not use simple file sharing. Click **start > My Computer > Tools > Folder Options > View** and clear **Use simple file sharing (Recommended)** if currently selected.

- Step 1.** Locate the file *demo nadc statedata.ala* on the PC that has the 89600 Vector Signal Analyzer application installed on it. The file is located at *C:\Program Files\Agilent\89600 VSA\LogicAnalyzer\demo nadc statedata.ala*. The file *demo nadc statedata.ala* is a configuration and data file of an NADC signal that was installed with the 89601A software. You need to copy this file onto your Logic Analyzer mainframe.
- Step 2.** Close the 89600 Vector Signal Analyzer application.
- Step 3.** Start the Logic Analyzer application on the Logic Analyzer mainframe.
- Step 4.** Click **File > Open**.
- Step 5.** When the *Open* dialog box appears, click the *Look in* drop down menu and browse to the location where you copied the *demo nadc statedata.ala* file in step 1 and open the file.
- Step 6.** If the Module Mapping dialog box appears, select **Switch to 'Offline' mode and load the configuration as-is**.

If the dialog box does not appear, click **File > Go Offline**. Click **Ok** in the Information dialog box.

NOTE

The remaining steps are performed on the PC that has the 89600 Vector Signal Analyzer application installed on it.

- Step 7.** Click **Start > (All) Programs > Agilent 89600 VSA > Logic Analyzer > IO Connections**. When the *Agilent 89600 I/O Connections* dialog box appears, click **Add Instrument**. When the *Add Instrument* dialog box appears, select **Agilent**

Logic Analyzer and click **OK**. Type **localhost** in the *Hostname* text box. Click **Test Connection** to make sure the connection works. Click **OK**.

NOTE

The *Host Name* of your Logic Analyzer mainframe can be found by clicking **Start > My Computer > View System Information > Computer Name**. The *Full computer name* is the *Host Name*.

Step 8. Start the 89600 Vector Signal Analyzer application.

Step 9. Click **Utilities > Hardware**. Clear **Default Configuration** if currently selected. Clear **Simulate Hardware** if currently selected. Select **TCPIP:: or **TCPIP:: as ADC 1 and click **OK**.****

NOTE

Selecting **TCPIP:: or **TCPIP:: as ADC 1 can create a hardware configuration that is not supported. A *red X* on a hardware tab in the *Select Hardware* dialog box indicates a hardware configuration that is not supported. Click hardware tabs that have a *red X* and clear the current hardware selection. Refer to the *ADC Tab* section of the 89600 VSA online help for more information on hardware configurations.****

- Step 10.** Click **Input > Digital**. Type **97.2 kSa/Sec** in the *Frequency Sample Rate* text box. Your Input Properties dialog box *Digital* settings should now be the same as the settings in the following Input Properties dialog box.

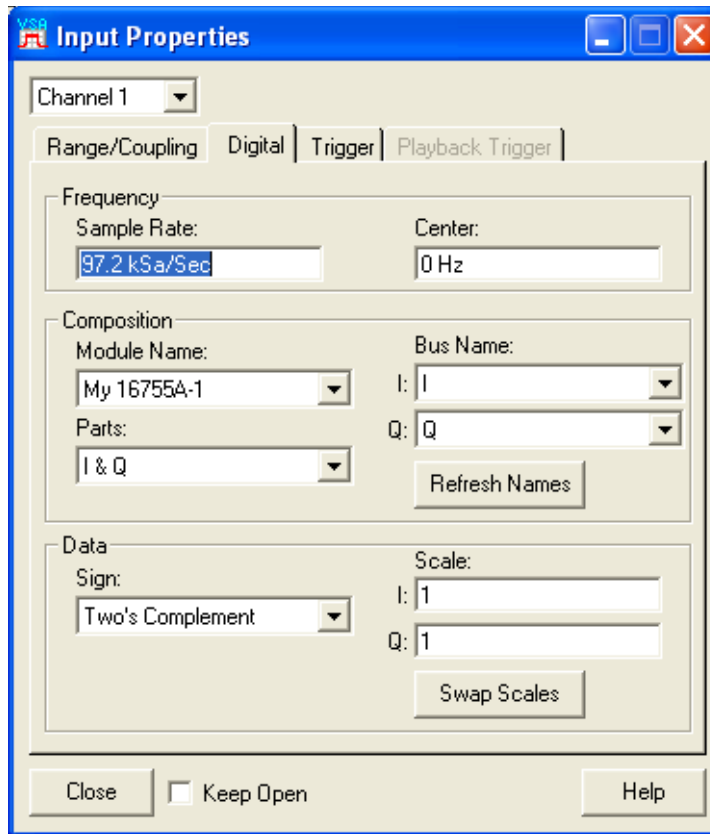

- Step 11.** Click **Close**.

- Step 12.** Click the **Play** button on the 89600 VSA.

Your 89600 VSA display should now look similar to the following screenshot.

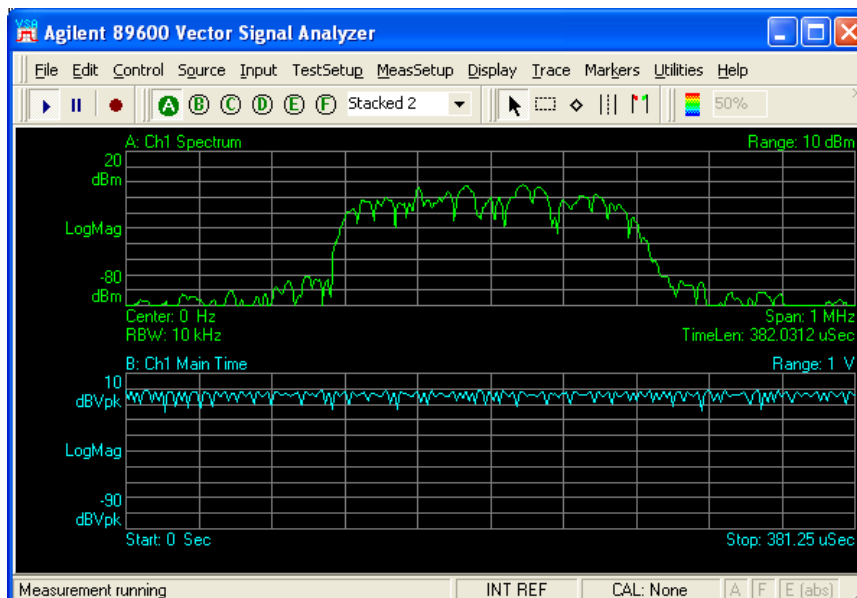

NOTE

If your 89600 VSA does not have option AYA, Vector Modulation Analysis, this is the end of the example. If your 89600 VSA does have option AYA, you can now digitally demodulate this signal.

Step 13. Click **MeasSetup > Demodulator > Digital Demod.**

Step 14. Click **MeasSetup > Demod Properties.** In the *Format Tab* dialog box, click **Preset to Standard > Cellular > NADC.** In the *Search Tab* dialog box, clear the **Pulse Search** selection. Click **Close.**

Your 89600 VSA display should now look similar to the following screenshot.

Linking Logic Analyzers to the Agilent 89600 VSA Logic Analyzer Link Examples

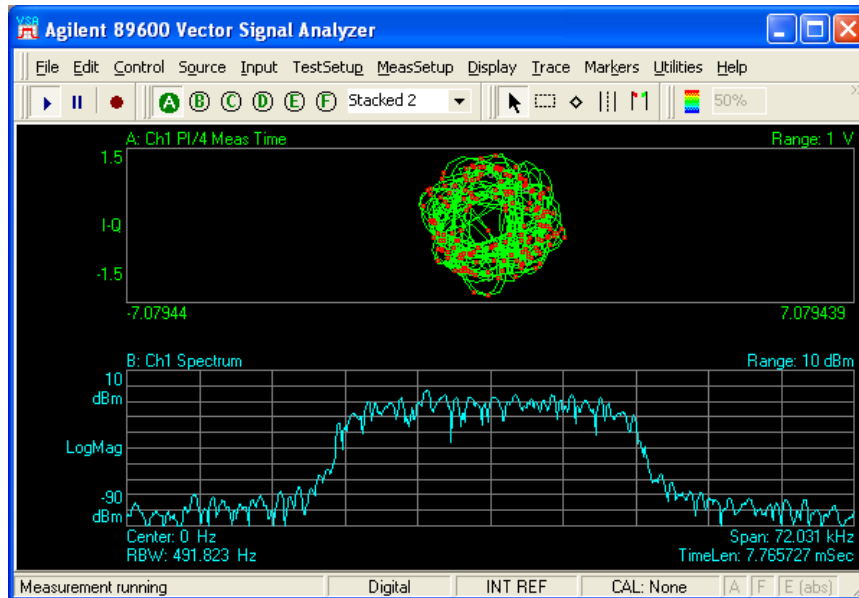

Introduction

This chapter includes information related to the Agilent 89600 series Vector Signal Analyzer's link to the Synthetic Instrument (SI) Spectrum Analyzer. This capability is available with 89600 VSA software revision 6.20 and higher.

The following Agilent Technologies LXI (LAN eXtensions for Instrumentation) models are supported by the 89600 VSA software.

- N8201 26.5 GHz Performance Downconverter Synthetic Instrument Module
- N8221 30 MS/s IF Digitizer Synthetic Instrument Module

The 89600 VSA Software supports the N8201 and the N8221 when they are used together to make a Synthetic Instrument (SI) Spectrum Analyzer.

The 89600 VSA Software also supports the N8201 with option 526 (frequency range from 3 Hz to 26.5 GHz), option B7J (1 dB step attenuator from 3 Hz to 3 GHz), and option H01 or H02 (30 MSa/s internal digitizer) as a stand alone spectrum analyzer. All three options, 526, B7J, and H01 or H02 must be installed. In this configuration, the N8201 operates exactly like an E4440 PSA in narrowband mode. Refer to the 89600 VSA Software Agilent PSA online help for stand alone N8201 hardware specific information.

89600 VSA software control of the Agilent SI Spectrum Analyzer requires the use of an underlying application program interface (API) called an SI Physics Server. You must install and create the SI Physics Server. After the SI Physics Server is created, you must configure it to connect to the N8221 and N8201 to create the Agilent Synthetic Instrument (SI) Spectrum Analyzer. Only after this process has been completed can you proceed to connect the 89600 VSA software to the Agilent SI Spectrum Analyzer. Refer to the documentation that came with your N8221 and N8201 for information on installing and configuring the SI Physics Server.

After the SI Physics Server has successfully established the link to the SI Spectrum Analyzer, the Agilent 89600 IO Connections software utility will be used to connect the SI Spectrum Analyzer to the 89600 VSA software. The Agilent 89600 IO Connections software is installed when you install the 89600 VSA software. The information in this chapter is intended to step you through the process of using the 89600 IO Connections utility to link an SI Spectrum Analyzer to the Agilent 89600 VSA software. Detailed information on the 89600 IO Connections utility is located in the 89600 VSA online help.

The Distortion Suite application (89604A) enables the SI Spectrum Analyzer as acquisition hardware. Performance is unspecified.

The Wireless LAN test application (option B7R or 89607A) does not support the SI Spectrum Analyzer as acquisition hardware.

The 89600 software's Swept Spectrum Analyzer application does not support the SI Spectrum Analyzer Link.

Linking an SI Spectrum Analyzer

89600 VSA software control of the Agilent SI Spectrum Analyzer requires that the SI Physics Server has been installed and is connected to the SI Spectrum Analyzer. Only after this process has been completed can you proceed to connect the 89600 VSA software to the Agilent SI Spectrum Analyzer. Please refer to the documentation that came with your N8201 and N8221 for information on configuring the SI Physics server and connecting the SI Physics Server to the SI Spectrum Analyzer.

After the SI Physics Server has been configured and successfully connected to the Agilent SI Spectrum Analyzer, follow these steps to connect the 89600 VSA software to the Agilent SI Spectrum Analyzer.

NOTE

The SI Physics Server can operate in a computer other than the computer the 89600 VSA software is operating in, however, the SI Physics Server software must also be installed in the computer that the 89600 VSA software is operating in. If the SI Physics Server is not installed in the same computer that the 89600 VSA software is installed in, start with Step 1. If the SI Physics Server is already installed in the same computer that the 89600 VSA software is installed in, start with Step 6.

- Step 1.** On the computer that the 89600 VSA software is installed in, insert the SI Physics Server software CD and begin the SI Physics software installation process. This will bring up the SI Physics Setup Wizard as shown below. Click **Next**.

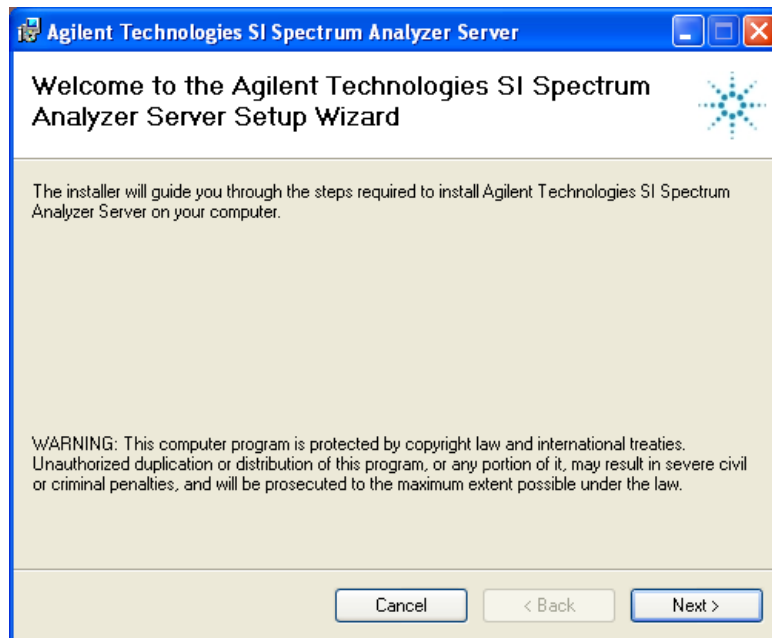

- Step 2.** Select **I agree** in the License Agreement window and click **Next**.

- Step 3.** Select an installation folder and select who can access the SI Physics Server. Click

Next.

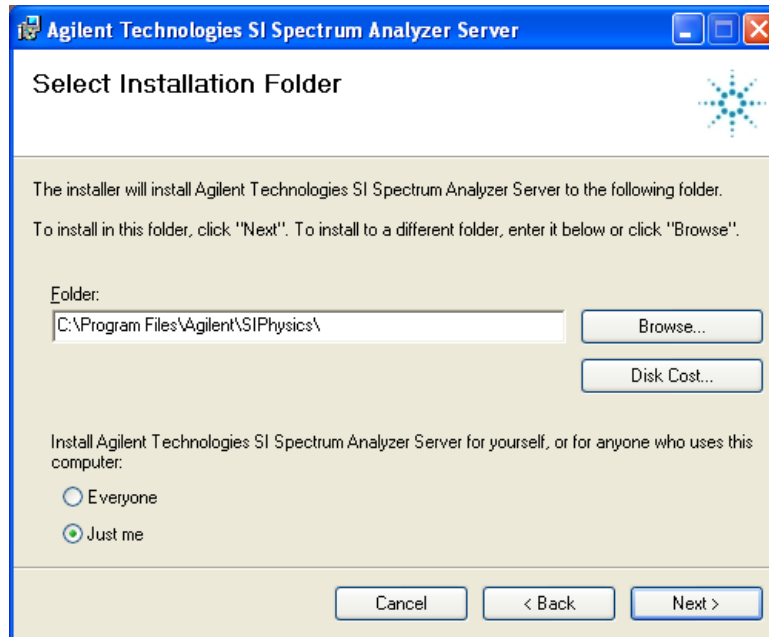

Step 4. Click **Next** to start the installation.

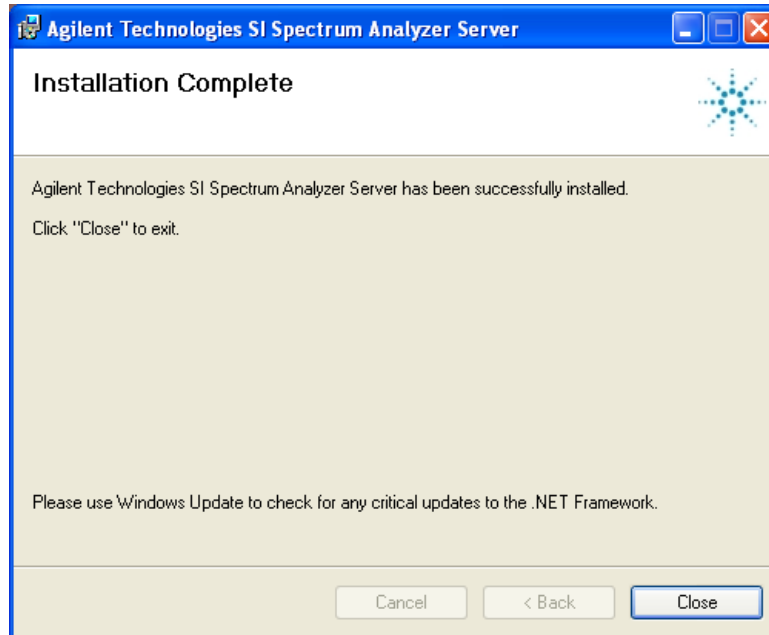

- Step 5.** Click Close after the following Installation Complete window comes up. The SI Physics Server software is now installed in the same computer that the 89600 VSA software is installed in.

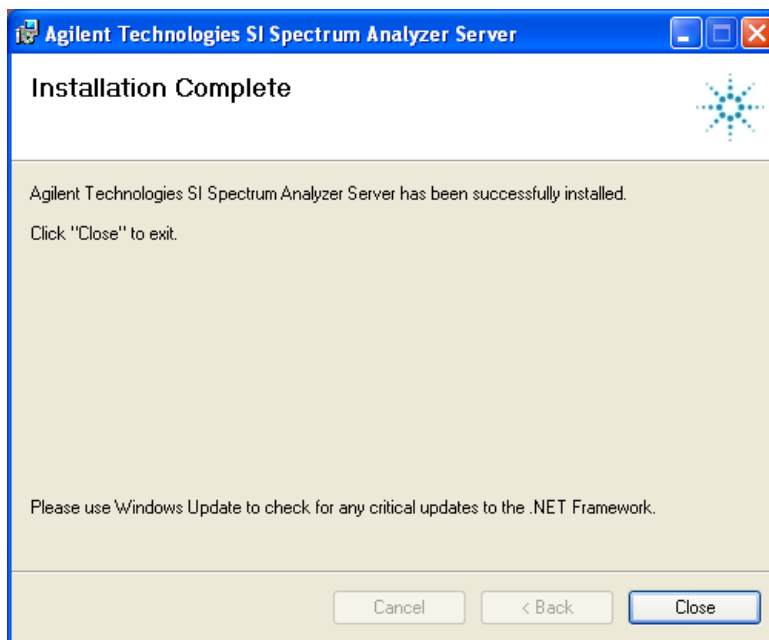

- Step 6.** Click **Start > All Programs > Agilent 89600 VSA > SI Spectrum Analyzer > IO Connections**. The Agilent 89600 I/O Connections explorer pane will come up. Click **LAN (TCPIP)** then click **Add instrument** in the toolbar.

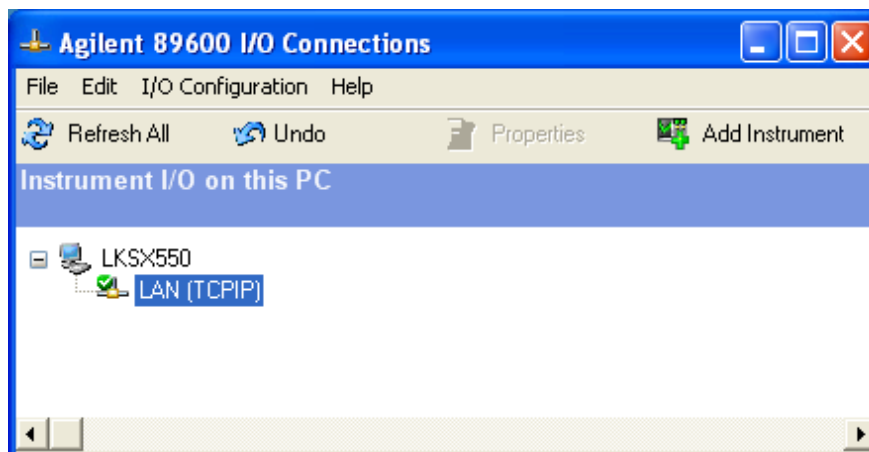

Step 7. The *Add Instrument* dialog box will come up. Select **Agilent Spectrum Analyzer** and click **OK**

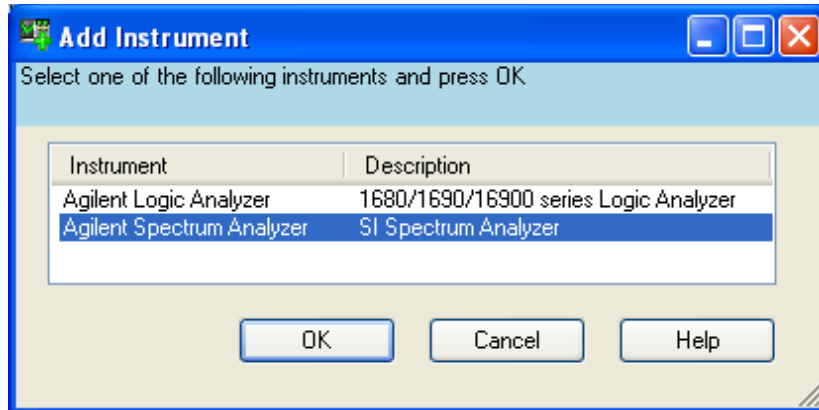

Step 8. The *Configurable Properties* dialog box will come up. If the SI Physics Server and the 89600 VSA software are running on the same PC, type **localhost** as the Hostname. Type the Physics Server Port number that is shown in the Physics Server Settings of the *Agilent SI Profile Editor* dialog box. If the SI Physics server and the 89600 VSA software are running on different computers, enter the IP address and Port number where the SI Physics server operates. Click **Test Connection** and verify that the instrument is connected. Click **OK** to close this window after verifying the connection

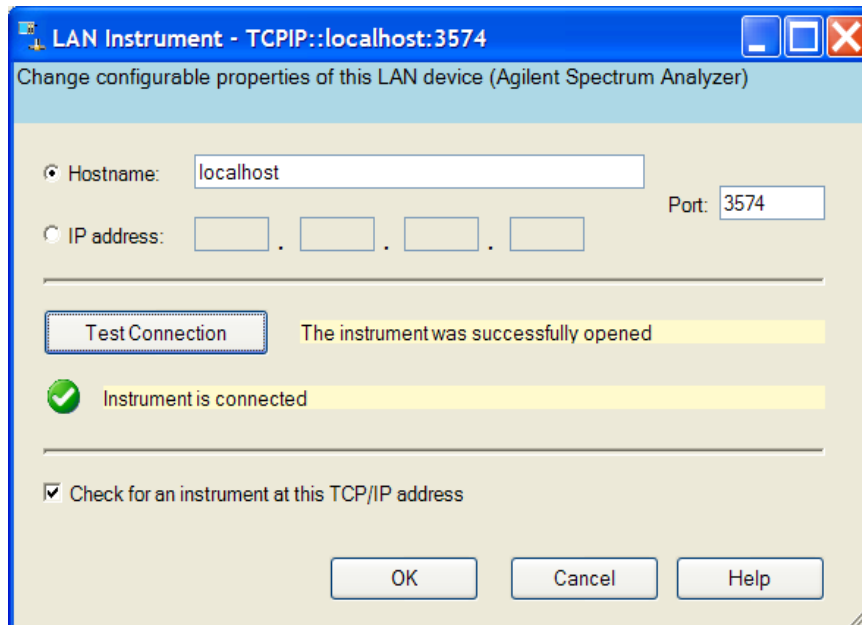

Step 9. Click **Start > All Programs > Agilent 89600 VSA > Vector Signal Analyzer** to start the 89600 VSA. In the 89600 VSA application, click **Utilities > Hardware** to bring up the Select Hardware window. Clear **Simulate Hardware** or **Default Configuration** if selected. Select the **Agilent SI Spectrum Analyzer for ADC 1**. The Agilent SI Spectrum Analyzer has the address you entered in the previous step. Click **OK**. The 89600 VSA is now controlling the Agilent SI Spectrum Analyzer configured from the N8221 Digitizer and the N8201 Down Converter.

For additional information about the SI Spectrum Analyzer, such as hardware configuration parameters and measurement setup parameters, refer to the 89600 VSA online help. To get access to the online help, start the 89600 VSA application, then click **Help > Contents**. Information about the SI Spectrum Analyzer is located under **Product Overview > Measurement Hardware > Agilent SI Spectrum Analyzer**. Additional information about the Agilent 89600 IO Connections is located under **Product Overview > Measurement Hardware > Agilent 89600 IO Connections**.

Introduction

Overview

This chapter includes information related to the Agilent 89600 Vector Signal Analyzer's link to selected Agilent U1065A and U1066A Acqiris Broadband High-Speed Digitizers. This capability is available with 89601A VSA software revision 8.00 and higher.

The 89600 VSA can be used to capture and analyze time series data on a digital bus by using either an Agilent Acqiris DC222, DC252, DC282, DC438 or DC440 as a data source. The Acqiris digitizers can be configured with the 89600 VSA Software in two different modes:

- Standard Operation - Acqiris Waveform Digitizers are linked to the 89601A VSA software running on a PC using the IC414 interface.
- Embedded Operation - Acqiris Waveform Digitizers are linked to the 89601A VSA software running on an embedded controller (PC505).

For additional information see the “Acqiris Broadband High-Speed Digitizers Using 89601A Vector Signal Analyzer Software” Application Note which can be found in the Library > Application Notes section of the Agilent 89600 Series VSA website (<http://www.agilent.com/find/89600>).

Configurations

Agilent Acqiris High-Speed Digitizers

The Agilent Acqiris High-Speed Digitizer application runs on any PC running Windows XP Professional.

NOTE

This application requires the following versions:

- Version 3.2 or later of the Acqiris Digitizer.
- Version 8.00 or later of the 89600 VSA Software (version 9.00 or later for the DC440 HF Input).

Configurations for linking the Agilent Acqiris Digitizers to the Agilent 89600 VSA Software are:

- Standard Operation - Acqiris Waveform Digitizers are linked to the 89600 VSA Software running on a PC using the U1056A-101 interface.
- Embedded Operation - Acqiris Waveform Digitizers are linked to the 89600 VSA Software running on an embedded controller (U1056A-300 Embedded CompactPCI Processor).

Acqiris Digitizers Supported

The 89600 VSA application supports the Agilent U1065A and U1066A Acqiris Digitizers consisting of the following options:

Table 12-1 Supported Acqiris Digitizers

Model Name	1 Channel Bandwidth	2 Channel Bandwidth
U1066A - 001 (DC440)	100 MHz	100 MHz
U1066A-001 (DC440) HF Input	164 MHz	164 MHz
U1066A - 002 (DC438)	78.125 MHz	78.125 MHz
U1065A - 001 (DC222)	2 GHz	n/a
U1065A - 002 (DC252)	2 GHz	1.5625 GHz
U1065A - 004 (DC282)*	2 GHz	1.5625 GHz

* only supported in 1 channel or 2 channel mode

Installation for Standard Operation

In Standard Operation mode, the Acqiris Waveform Digitizers are linked to the 89600 VSA Software running on a PC using the U1056A-101 interface.

The procedure for installing this mode is:

1. Install and configure the ADLINK PCI/PXI-8570 Extension Card in your PC using the instructions provided with the card.
2. Setup and configure the crate with the ADLINK PXI 8570 module and Agilent Acqiris Digitizers following the instructions provided with the equipment. Connect the U1056A-101 interface cable.
3. The installation process may ask you to reboot your computer. Click **OK** for a reboot.

NOTE

The digitizer crate must be turned on before the computer reboot for the new hardware to be found. Also, whenever the digitizer crate is powered down, your computer will need to be rebooted to find the new hardware again.

4. Install the Agilent 89600 VSA Software:
 - a. Turn on the computer. If the computer is already on, close any applications you have open.

NOTE

To install the Agilent 89600 VSA Software, you must have administrator privileges on the computer you are installing the Agilent 89600 VSA Software on.

- b. Insert the Agilent 89600 Series Software installation CD-ROM.
- c. If the installation utility does not start automatically, click **Start > Run** and type:

drive:\autoplay.exe

...where *drive* represents the drive containing the installation CD-ROM.

Click **OK**.

- d. When the Agilent 89600 Installation Manager window opens, it is recommended that you read the Readme information.

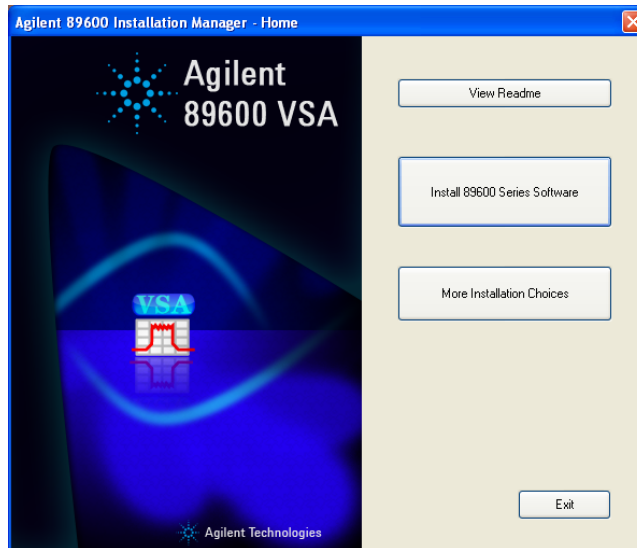

- e. To start the 89600 VSA Software installation, click **Install 89600 Series Software**. The Agilent 89600 Series Software - InstallShield Wizard window opens. Click **Next**.

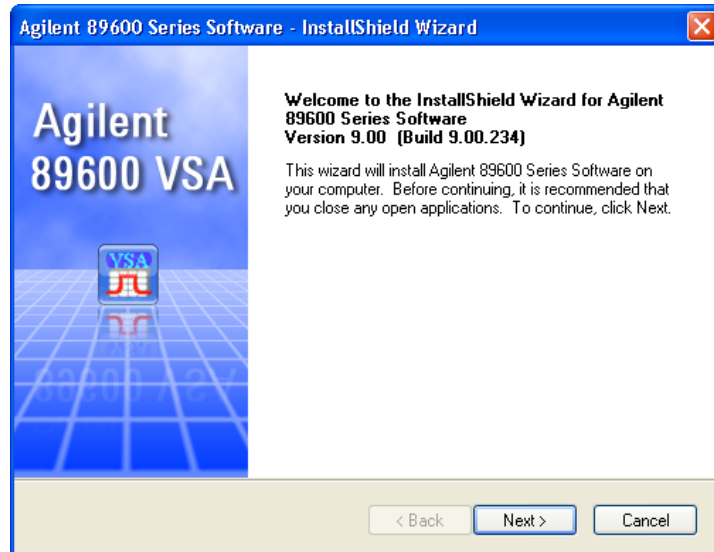

- f. Read the license agreement and warranty terms. Click to accept the terms and continue installation. If you do not accept the terms, you will not be able to install the software. Click **Next**.

Connecting Acqiris Waveform Digitizers to the Agilent 89600 VSA Installation for Standard Operation

- g. In the *Choose Destination Location* window of the InstallShield Wizard, verify where you want the 89600 Series Software to install. The default, a folder named Program Files located off the root of the drive where Windows is installed, is recommended. If you want to install the software in a different directory, click **Change**, enter the new directory, and click **OK**. Click **Next**.

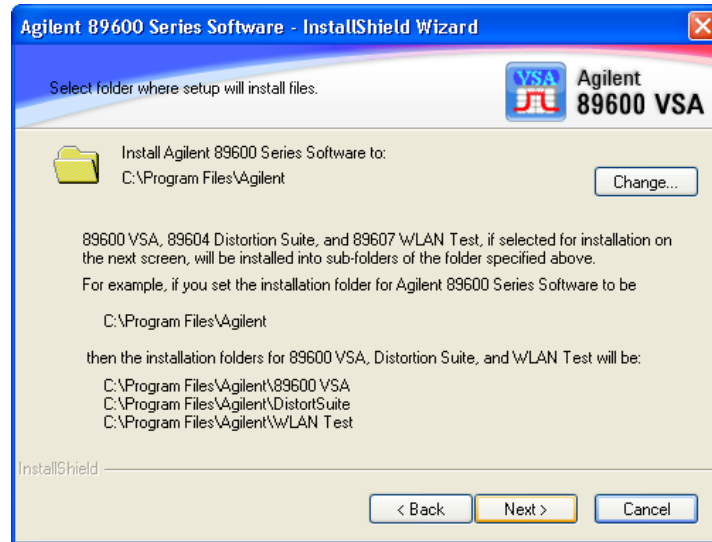

- h. In the *Select Products and Features* window of the InstallShield Wizard, select the products and features you want to install. Clear any selections you do not want. For example, if you do not want desktop shortcuts (icons) created, clear the check box to disable that option.

NOTE

Selecting a check box will install that product or feature and clearing a check box will uninstall the product or feature.

If you want the Floating License Support, see [Chapter 14](#), “Setting Up a Floating License Server,” on page 197 and [Chapter 15](#), “Setting Up a Floating License Client,” on page 215.

NOTE

Do not select Floating License Support unless you have a product with a Floating License.

Click **Next**.

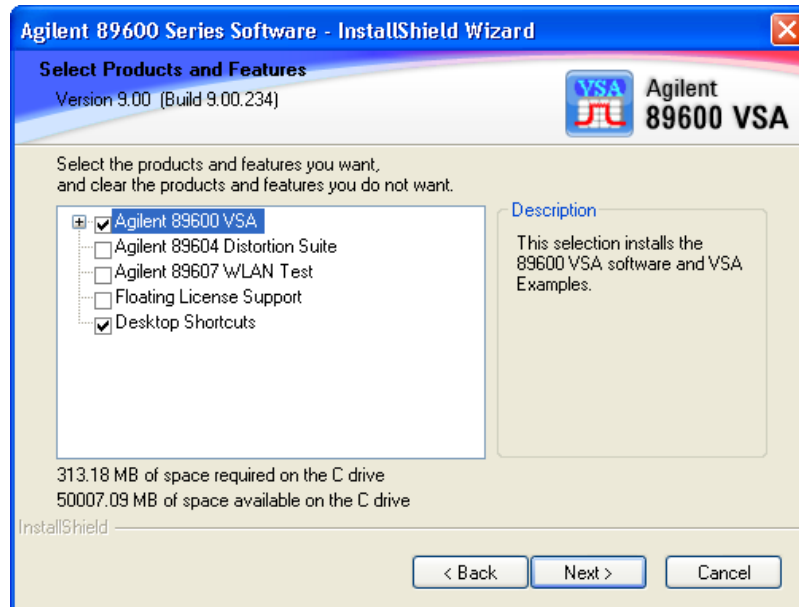

- i. If Floating License Support is selected in the Select Products and Features window, a warning message opens verifying that you do want to install floating license support. If you do not, click **No**.
- j. In the Setup Status window of the InstallShield Wizard, click **Install**.
- k. After the software has installed, you will get an attention message explaining the 14-day trial license and reminding you to install a permanent license prior to the expiration of the 14-day trial license. Click **OK**.

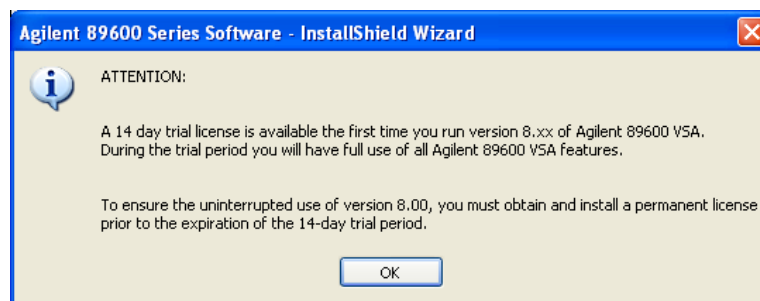

- l. In the InstallShield Wizard Complete window, click **Finish**.

Connecting Acqiris Waveform Digitizers to the Agilent 89600 VSA Installation for Standard Operation

- m. After the 89600 Series software is installed, the *Select Hardware Support* window opens. To install the Acqiris software, select **Hardware Support Menu** and click **Next**.

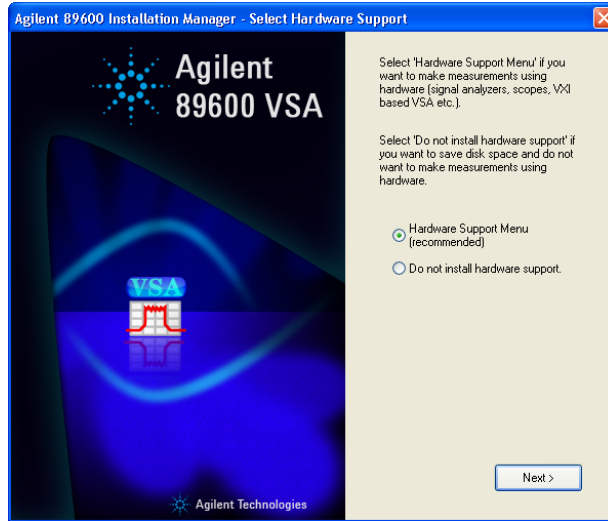

5. Install the Acqiris VSA Server Software:

- a. To start the Acqiris software installation, select **Acqiris VSA Server** and click **Install Hardware Support**.

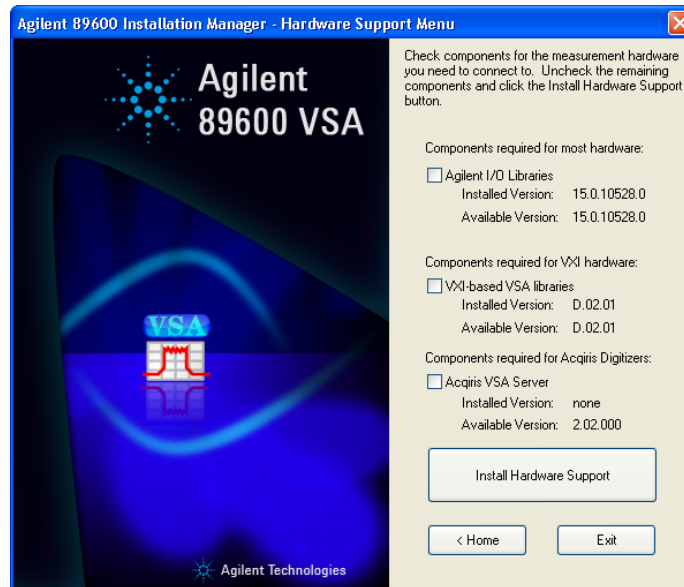

NOTE

If you do not want to install the Agilent IO Libraries or the VXI-based VSA libraries, you will need to clear these check boxes.

- b. When the *Agilent Acqiris VSA Server Welcome* window opens, click **Next**.

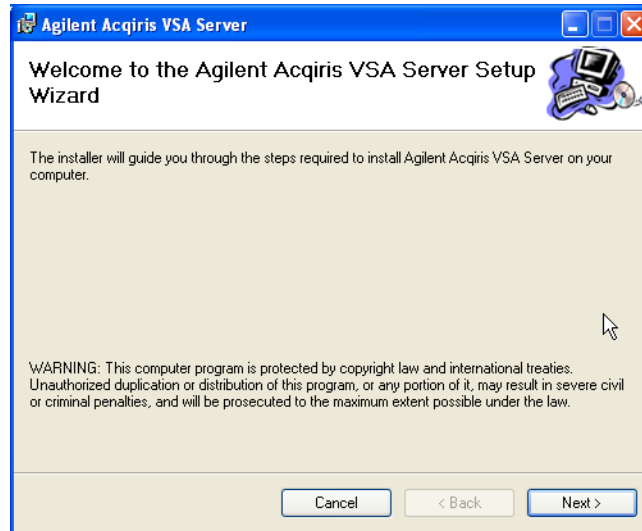

- c. In the *Select Installation Folder* window, select where you want the Agilent Acqiris VSA Server to install. The default folder of *C:\Program Files\Agilent\Agilent Acqiris VSA Server* is recommended. Click **Next**.

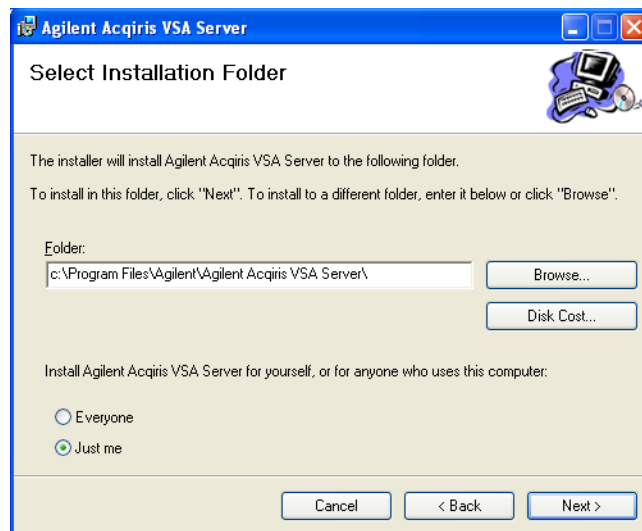

- d. In the *Confirm Installation* window, click **Next**.
- e. When the software has installed, the *Installation Complete* window will open. Click **Close**.
- f. The installation process may ask you to reboot your computer. Click **OK** for a reboot.
6. Run and configure the Acqiris VSA Server.
- a. Click **Start > All Programs > Agilent Acqiris VSA > Acqiris VSA Server**. The Agilent Acqiris VSA Configuration window will open. Click

Connecting Acqiris Waveform Digitizers to the Agilent 89600 VSA Installation for Standard Operation

New to configure the Acqiris Digitizer.

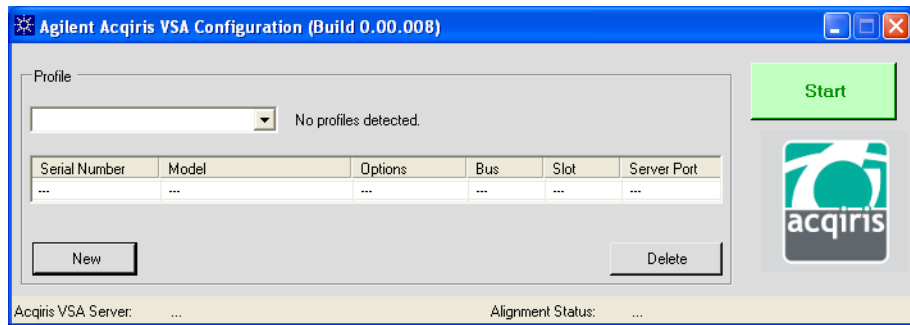

- b. In the Agilent Acqiris VSA Profile Editor window, after you name and configure your digitizer, click **Save**. If you have more than one digitizer, continue to configure and save each one.

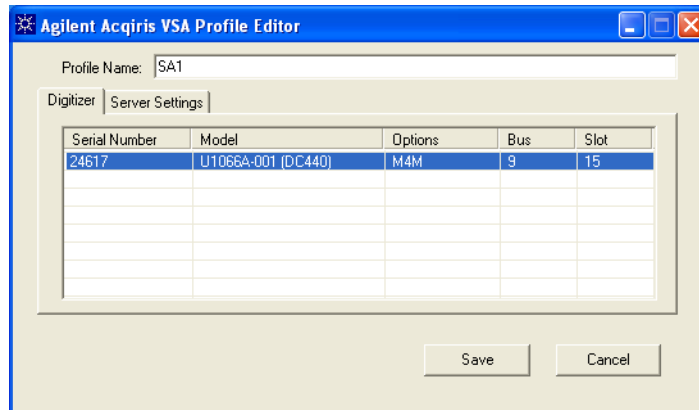

NOTE

You can configure several server profiles but only one server can be launched at a time.

- c. Click **Start** in the *Agilent Acqiris VSA Configuration* window to run the server. The digitizer software will run its alignment. When it is complete, the status will say OK. You may set an appropriate name for each digitizer profile.

IMPORTANT

The *Agilent Acqiris VSA Server* window must stay open for the Acqiris digitizer to remain connected to the 89600 VSA Software.

7. Run the 89600 VSA Software.
 - a. Click on the Vector Signal Analyzer icon on your computer or click **Start > All Programs > Agilent 89600 VSA > Vector Signal Analyzer**.
 - b. Verify the 89600 VSA Software is connected to the digitizer by clicking **Utilities > Hardware > ADC 1**.

Installation for Embedded Operation

In the Embedded Operation mode, the Acqiris Waveform Digitizers are linked to the 89600 VSA Software running on an embedded controller (U1056A-300 Embedded CompactPCI Processor).

1. Setup and configure the crate with the U1056A-300 controller module and Agilent Acqiris Digitizers following the instructions provided with the equipment. Connect to the monitor.
2. Install the Agilent 89600 VSA Software:

Since the U1056A-300 Embedded Controller does not have a CD driver, the first step is to copy the contents of the Agilent 89600 Series Software installation CD-ROM onto a USB Flash Drive. The Agilent 89600 VSA Software is not protected or encrypted. The copy you make will be identical to the original CD.

NOTE

This procedure assumes that a USB Flash Drive is being used. Other USB storage devices, such as a USB hard drive or USB CD/DVD drive, could also be used.

- a. Insert the Agilent 89600 Series Software installation CD-ROM into a PC's CD drive. If the Agilent 89600 Installation Manager window opens, click **Exit**.

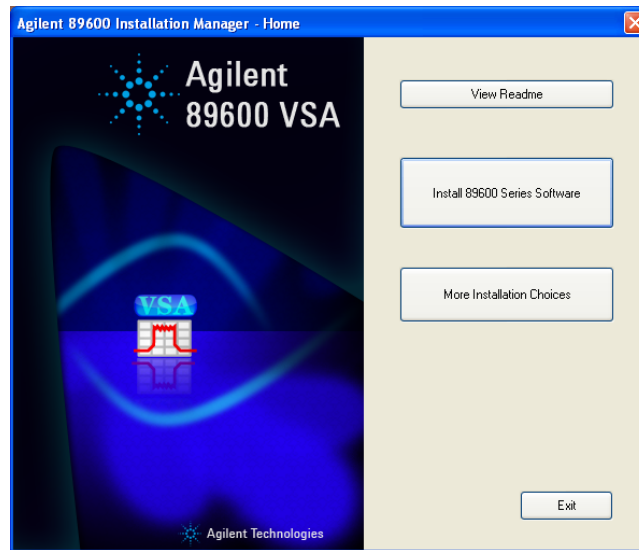

- b. Insert a USB Flash Drive into a USB port on the same PC that the Agilent 89600 Series Software CD-ROM is in.
- c. Copy the contents of the Agilent 89600 Series Software CD-ROM into the USB Flash Drive.

- d. Insert the USB Flash Drive into the USB port in the U1056A-300 Embedded Controller.

NOTE

To install the Agilent 89600 VSA Software on the controller, you need to have administrator privileges. If not, press **Ctrl - Alt - Delete**, then click **Log Off...** Log back in as the Administrator.

- e. Open Windows Explorer and navigate to the USB drive.
- f. Double-click **autoplay.EXE** to bring up the Agilent 89600 Installation Manager.
- g. When the Agilent Installation Manager window opens, click **Install 89600 Series Software**. The *Agilent 89600 Series Software - InstallShield Wizard* window will open. Click **Next**.

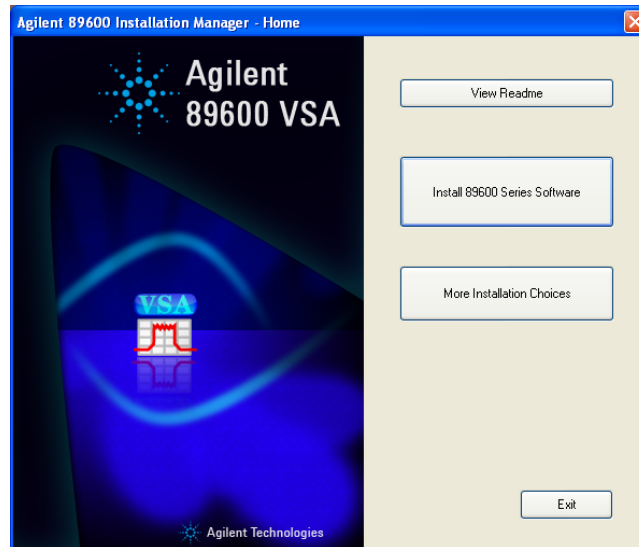

- h. Read the licensing information in the *Software License and Warranty* message window. Click to accept the terms and continue installation. Click **Next**.
- i. In the *Choose Destination Location* window of the InstallShield Wizard, verify where you want the 89600 Series Software to install. The default, a folder named Program Files located off the root of the drive where Windows is installed, is recommended. If you want to install the software in a different directory, click **Change**, enter the new directory, and click **OK**.

Connecting Acqiris Waveform Digitizers to the Agilent 89600 VSA Installation for Embedded Operation

Click **Next**.

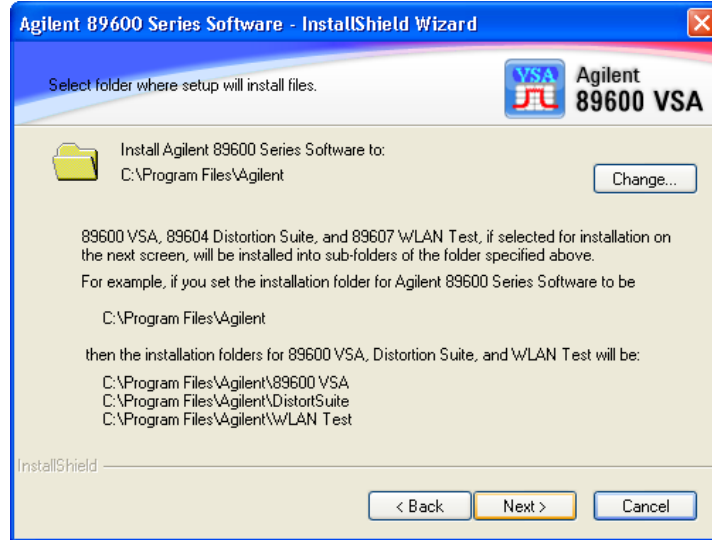

- j. In the *Select Products and Features* window of the InstallShield Wizard, select Agilent 89600 VSA.

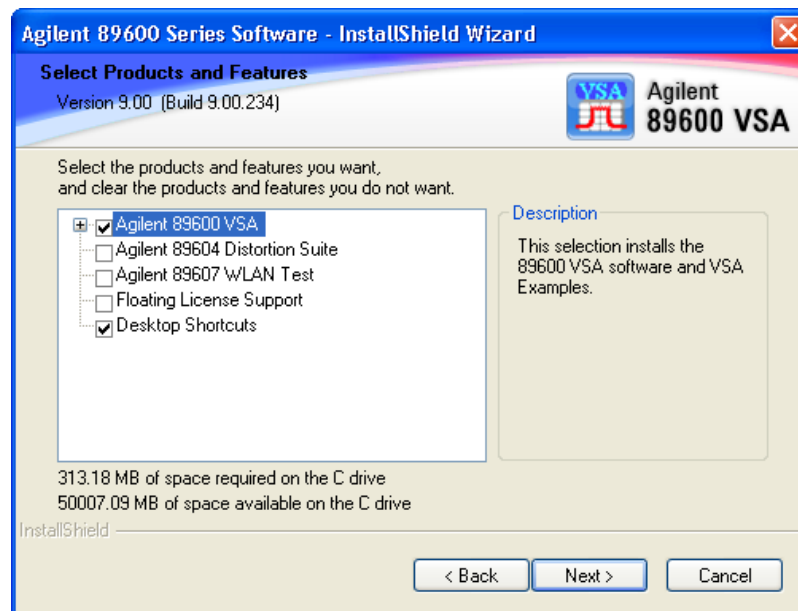

- k. In the *Setup Status* window of the InstallShield Wizard, click **Install**.
- l. After the software has installed, you will get an attention message explaining the 14-day trial license and reminding you to install a permanent

license prior to the expiration of the 14-day trial license. Click **OK**.



- m. In the *InstallShield Wizard Complete* window, click **Finish**.
- n. After the 89600 Series software is installed, the *Select Hardware Support* window opens. To install the Acqiris software, select **Hardware Support Menu** and click **Next**.

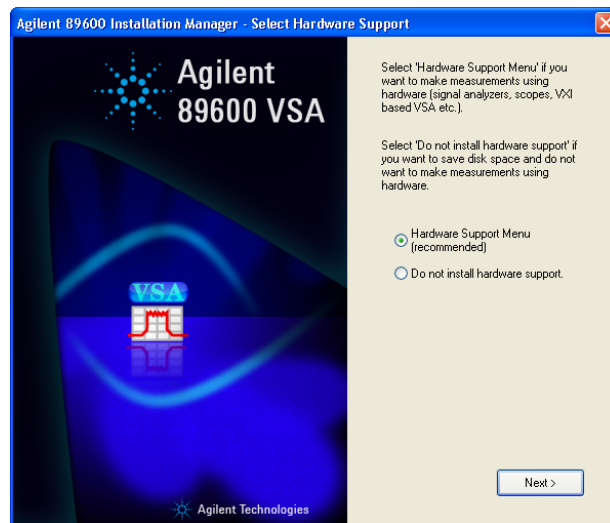

- 3. Install the Acqiris VSA Server Software:
 - a. To start the Acqiris software installation, select **Acqiris VSA Server** and click **Install Hardware Support**.

NOTE

If you do not want to install the Agilent IO Libraries or the VXI-based VSA libraries, you will need to clear these check boxes.

Connecting Acqiris Waveform Digitizers to the Agilent 89600 VSA Installation for Embedded Operation

- b. When the *Agilent Acqiris VSA Server Welcome* window opens, click **Next**.

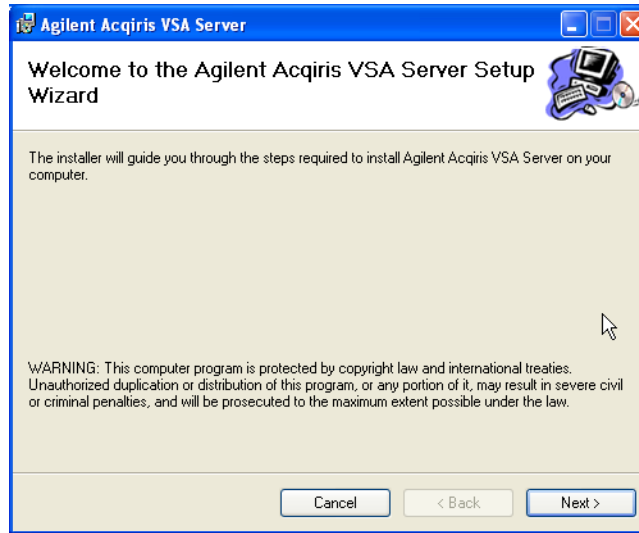

- c. In the *Select Installation Folder* window, select where you want the Agilent Acqiris VSA Server to install. The default folder of *C:\Program Files\Agilent\Agilent Acqiris VSA Server* is recommended. Click **Next**.

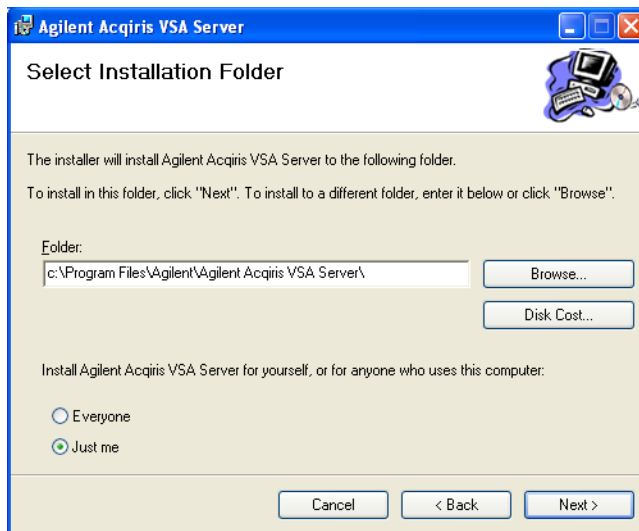

- d. In the *Confirm Installation* window, click **Next**.
- e. When the software has installed, the *Installation Complete* window will open. Click **Close**.
- f. The installation process may ask you to reboot your computer. Click **OK** for a reboot.
4. Run and configure the Acqiris VSA Server.
- a. Click **Start > All Programs > Agilent Acqiris VSA > Acqiris VSA Server**. The *Agilent Acqiris VSA Configuration* window will open. Click

New to configure the Acqiris Digitizer.

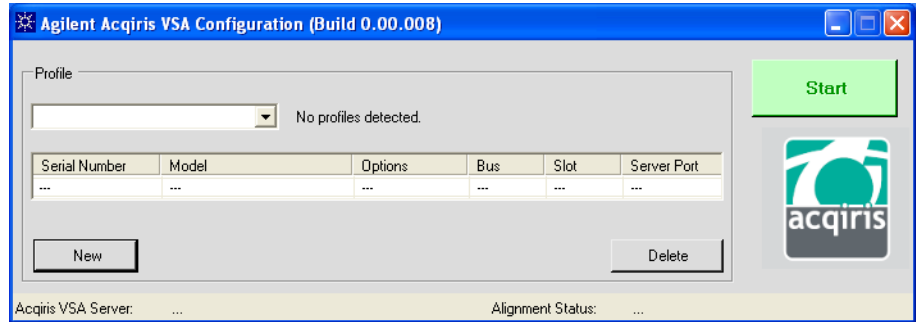

- b. In the *Agilent Acqiris VSA Profile Editor* window, after you name and configure your digitizer, click **Save**. If you have more than one digitizer, continue to configure and save each one.

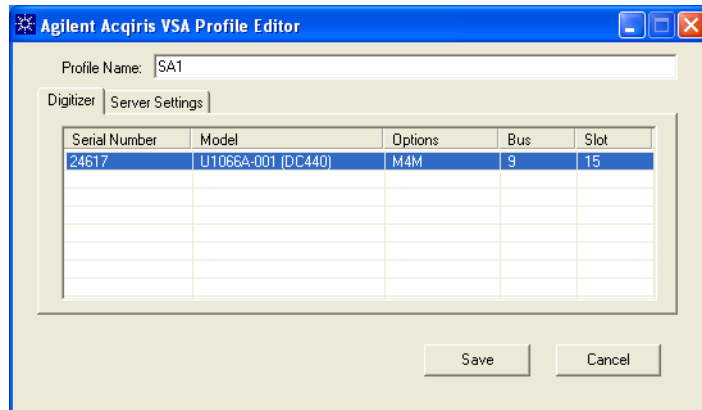

NOTE

You can configure several server profiles but only one server can be launched at a time.

Connecting Acqiris Waveform Digitizers to the Agilent 89600 VSA
Installation for Embedded Operation

- c. Click **Start** in the *Agilent Acqiris VSA Configuration* window to run the server. The digitizer software will run its alignment. When it is complete, the status will say *OK*. You may set an appropriate name for each digitizer profile.

IMPORTANT

The Agilent Acqiris VSA Server window must stay open for the Acqiris digitizer to remain connected to the 89600 VSA Software.

5. Run the 89600 VSA Software.
 - a. Click on the Vector Signal Analyzer icon on your computer or click **Start > All Programs > Agilent 89600 VSA > Vector Signal Analyzer**.
 - b. Verify the 89600 VSA Software is connected to the digitizer by clicking **Utilities > Hardware > ADC 1**.

Introduction

This chapter documents installing and setting up a node-locked license for your 89601 analyzer. This enables you to run the 89600 VSA software only on this PC. You can move the license to another PC, but then you cannot run the software on the PC you removed the license from.

NOTE

The term PC also refers to products such as analyzers and oscilloscopes running the 89600 VSA software.

If you purchased a floating license for your 89600 software, see installation instructions in [Chapter 14](#), “Setting Up a Floating License Server,” on page 197 and [Chapter 15](#), “Setting Up a Floating License Client,” on page 215.

If you are using a demo license, start the 89600 software and follow the instructions for accepting a demo license.

Starting the analyzer

Start the analyzer by double-clicking the appropriate icon on your desktop or by clicking:

Start > Programs > Agilent 89600 VSA > Spectrum Analyzer

Start > Programs > Agilent 89600 VSA > Vector Signal Analyzer,

Start > Programs > Agilent Distortion Suite > Distortion Suite

Start > Programs > Agilent WLAN Test > WLAN Test

You must accept a trial or demo license, or install a permanent license (authorization) before you can run the applications. See instructions that follow. You can also transfer a license from another computer ("[Transferring a license from another computer](#)" (page 195)).

NOTE

If your analyzer includes measurement hardware and the analyzer does not find it, see: "[Troubleshooting a VXI IO configuration problem](#)" on page 227.

Licensing your software

When you first run your application, you are prompted to license (or authorize) your software. You must obtain and install a valid software Site Key (a unique hexadecimal code) to permanently enable the 89600-series software on your computer. The licenses required depends on the applications that were purchased:

- The license for the 89600 software enables both the Vector Signal Analyzer and the Spectrum Analyzer applications.
- The 89604 Distortion Suite application must be licensed separately. The license for the 89604 only enables the Distortion Suite application. If you did not purchase the 89600 software, you cannot access the Vector Signal Analyzer or Spectrum Analyzer applications independent of Distortion Suite.
- The 89607 WLAN Test application must be licensed separately *unless the 89600 Option B7R was purchased*. The license for 89607 only enables the WLAN Test application. If you did not purchase the 89600 software, you cannot access the Vector Signal Analyzer or Spectrum Analyzer applications independent of WLAN Test.

The Trial License enables all software options for the analyzer for fourteen days. When you install the permanent Site Key (license), only the options you purchased will be enabled.

The Demo License lets you run the software with limited functionality. You cannot use measurement hardware, and you can analyze only the recordings provided with the software. You must accept a demo license each time you start the 89600 software, but there is no limit to the number of times you can use a demo license.

NOTE

When you accept the trial license, you can run your analyzer without the Site Key for fourteen days. You must install the Site Key before the trial license expires, or you will have to obtain a new Site Key and the analyzer will stop working.

You do not need to accept the trial license if you will be transferring in a license from another computer rather than obtaining a new license. For instructions on transferring in a license, see "[Transferring a license from another computer](#)" (page 195).

Continue with "[Obtaining a site key \(license\)](#)" (page 191).

Obtaining a site key (license)

Follow these steps to obtain your software Site Key:

To find the materials and information you need:

1. Locate the Site Key Request Form in one of these ways:
 - a. (*Preferred*) Go to the 89600 webpage at www.agilent.com/find/89600 and click **Request Site Key**. You can paste or type in your Site Code, complete the rest of the form, and submit your request.
 - b. Locate the printed Site Key Request Form. This sheet of paper is in the Installation Materials envelope shipped with your analyzer. You can fill in the requested information and return the form by fax to (707) 577-5043.
2. Collect the *License Certificates* for all copies of the 89600 software and each software option that you purchased. The License Certificates are printed on gray parchment and are shipped in the Installation Materials envelope.

NOTE

If you are installing a software update, you need an Update Certificate rather than a License Certificate. One Upgrade Certificate covers all the software and options installed on one computer.

3. Obtain the site code for your computer. The site code is a 30-character hexadecimal code created by the 89600 installation process to identify your computer. Each computer has a different site code. There are two ways to find the site code:

If you are starting the analyzer for the first time and have not already accepted a trial license, follow these steps:

- a. Start the application by double clicking the icon or by clicking:

**Start > (All) Programs > Agilent 89600 VSA > Spectrum Analyzer |
Vector Signal Analyzer**

-or-

Start > (All) Programs > Agilent Distortion Suite > Distortion Suite

-or-

Start > (All) Programs > Agilent WLAN Test > WLAN Test

If you get an error message saying that the analyzer *cannot find VXI hardware*, see: [Chapter 16](#), “Diagnostics,” on page 221.

- b. When a dialog box asks if you want to obtain authorization, click **Yes**.
- c. Click the **New License** tab in the Authorization dialog box.
- d. Click **Generate Site Code**. The Site Code appears in the Site Code box. This also accepts a trial license, so that you can operate the analyzer for 14 days while you obtain and install your permanent license.

Installing a Node-Locked License

Licensing your software

Be sure to obtain and install your Site Key within 14 days. At the end of the 14-day trial period, the trial license expires, and your Site Code changes. If you have not installed your Site Key before this happens, you must obtain a new Site Key.

If you previously accepted a trial license, follow these steps:

- a. Start the analyzer by double clicking the icon or by clicking **Start > (All) Programs > Agilent 89600 VSA > Spectrum Analyzer** or **Vector Signal Analyzer** or **Start > (All) Programs > Agilent Distortion Suite > Distortion Suite** or **Start > (All) Programs > Agilent WLAN Test > WLAN Test**.
- b. Click **Utilities > License > Modify**.
The Site Code is displayed in the Site Code box.

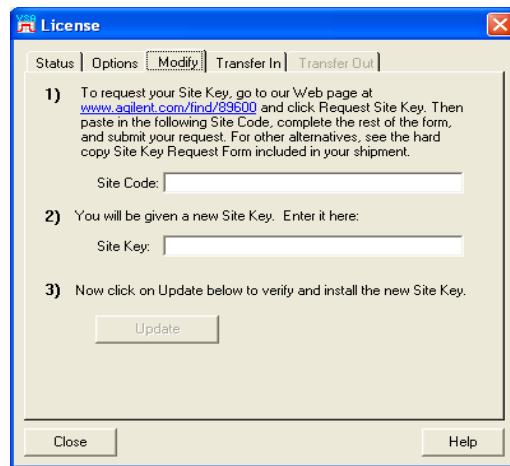

CAUTION

Be sure to obtain and install your Site Key within 14 days. At the end of the 14-day trial period, the trial license expires, and your Site Code changes. If you have not installed your Site Key before this happens, you must obtain a new Site Key. When the trial license expires, you cannot run the software until you install the correct Site Key.

To complete the Site Key Request Form:

1. Copy the site code onto the *Site Key Request Form*. The site code contains 30 hexadecimal characters (digits 0 through 9 and letters A through F). The code is not case sensitive, and spaces are optional. (You can copy and paste the site code into the Web or ASCII text version of the Site Key Request Form.)
2. (optional) Fill in the Customer's Computer ID. This is the name or code that you use to identify the computer. It might be the name of the person who uses the computer (such as *John Doe's PC*), or it might be an identifier that your company has assigned to the computer (such as *lab214*).

The Customer's Computer Name is optional and is included for your convenience. If you provide the information, we include it in any correspondence we send to you. This is useful for you if you are installing licenses on more than one computer, so you can identify which license file goes on which computer.

3. Below the Site Code, list the License Certificate Number for each piece of software and software option you installed on that computer. You can get this number from the gray parchment *License Certificate* that was shipped with the analyzer.

If you are installing a software update, list one Update Certificate Number. It covers all software options enabled on the computer.

4. If you ordered software for more than one computer, use separate tables to list the site code and license certificate numbers for each computer. You can photocopy the form or copy the e-mail form.
5. Fill in the customer name and address information on the *Site Key Request Form*. The fields marked with an asterisk (*) must be completed.
6. Return the *Site Key Request Form* to Agilent Technologies using one of these methods:
 - a. Submit the form from the Web page.
 - b. Send the Site Key Request Form via fax to (707) 577-5043. Your Site Key will be returned by fax to the number you provided on the form.
7. Close the Authorization or License window.

Installing a site key

When you receive your Site Key, install it on the computer.

CAUTION

Be sure to install your Site Key before your trial license expires. If the trial license expires, the Site Code for your computer changes and you must obtain a new Site Key.

To install a site key (if your Trial License is still active):

1. Start the analyzer by double-clicking the desktop icon or by clicking:
Start > (All) Programs > Agilent 89600 VSA > Spectrum Analyzer | Vector Signal Analyzer
-or-
Start > (All) Programs > Agilent Distortion Suite > Distortion Suite.
-or-
Start > (All) Programs > Agilent WLAN Test > WLAN Test
2. Click **Utilities > License > Modify**.
3. Copy and paste the Site Key in the space provided and click **Update**. (The Site Key is a hexadecimal number, containing only the numerals 0 through 9 and letters A through F. The Site Key is not case sensitive, and spaces are optional.) If you received your Site Key via fax, you must type the 26-character Site Key in the space.

CAUTION

If your trial license has expired, the Site Code for your computer has changed and you must obtain a new Site Key. The Site Key you just received will not work.

You can now run your Agilent 89600-series software permanently on this computer only. If you want to move the software to another computer, see [“Transferring a license from another computer” on page 195](#).

When you install the Site Key, the site code for your computer changes. In addition to identifying your computer, the site code also identifies which Agilent 89600-series software is installed and enabled on your computer.

Transferring a license from another computer

The Transfer In and Transfer Out tabs of the License dialog box provide the mechanism to transfer a single license from one computer to another using a license imprint file. To begin such a transfer, the software must be installed on two different computers, and there must be at least one valid license installed. Once these preconditions exist, take the following steps to transfer the license.

To transfer a license from another computer:

1. Perform the following steps on the target computer (the computer to which you want to move the license):
 - a. Start the analyzer by double clicking on the icon or by clicking **Start > (All) Programs > Agilent 89600 VSA > Spectrum Analyzer** or **Vector Signal Analyzer** or **Start > (All) Programs > Agilent Distortion Suite > Distortion Suite** or **Start > (All) Programs > Agilent WLAN Test > WLAN Test**.
 - b. During startup, no license is detected, so the software asks if you wish to obtain a license. Click **Yes**.
 - c. In the Authorization dialog box, click **Transfer In** and **Register Transfer**.
 - d. Enter the path where you want the license imprint file stored and click **OK**.
2. Transfer the license request file to the source computer (the computer that currently has the license) using an available transfer medium such as a floppy disk, flash drive, or network location.
3. Perform the following steps at the source computer:
 - a. Start the analyzer.
 - b. Click **Utilities > License > Transfer Out**.
 - c. Provide the path to the location of the license request file, and click **OK**. The licensing software moves the license to the specified location. At this time, the license on the source computer is discontinued, or decremented by one in the case of multiple licenses.

CAUTION

Do not lose the license file--it is now your license for the 89600 analyzer. If you lose it, you lose your license.

4. Perform the following steps at the target computer:
 - a. If the Authorization dialog box is still open, go to the next step. Otherwise, start the analyzer. In the Invalid Authorization question box, click **Yes**.
 - b. In the Authorization dialog box, click the **Transfer In** tab, then the **Transfer In** button.
 - c. Provide the path to the location of the license file, and click **OK**.
5. The software is now enabled on the target computer.

Via network drive

A license can never be shared - that is, it must always be assigned to a particular computer. In those rare cases when two computers on the same network need to run the software sequentially or alternately, the Direct Out license transfer can provide a kind of sharing without the need to carry a portable drive from one system to another.

To share a license:

1. Install the software on both computers
2. Obtain a license for one of the computers in the usual way and install the license.
3. When you want to run the application on the other computer, click **Utilities > License** on the licensed (source) computer and click **Direct Out**.
4. A dialog box will open asking you for the path to the license destination directory on shared network drive. Type or browse to it and click OK. This transfers the license to the destination computer and disables the license on the source computer.

Now when you open the application on the destination computer, the licensing software recognizes that the license has been transferred. The application will no longer open on the source computer.

Introduction

This chapter documents installing and setting up a floating license server for your 89600 analyzer. If you purchased a node-locked license for your 89600 software, installation instructions are in [Chapter 13](#), “[Installing a Node-Locked License](#),” on [page 187](#). If you are using a demo license, start the software and follow the instructions for accepting a demo license.

Floating License Overview

Use the information in this chapter to set up a floating license server for the 89600 software. You must set up the license server and your 89600 license (.lic) file before you can run any of the 89600 Series Software that require floating licenses. FLEXnet Licensing (floating licenses) require a server computer (to manage license control) and client computers (to obtain a license from the server computer) for running the 89600-series software. Note that the server computer and client computer can be the same PC.

The following operating systems are supported for use as 89600 license servers.

- Windows 2000
- Windows XP Professional
- Windows Vista Business, Enterprise, or Ultimate (32 bit only)
- Windows 2000 Server
- Windows Server 2003
- Windows Server 2008

NOTE

If you are currently using Sun Solaris 8.0 as a FlexLM license server for other products and are familiar with configuring the license server, the *agilevs* and *agilevs2* vendor daemons are available on the 89600 installation CD in `\unsupported\LicenseDaemon\SunSolaris`

NOTE

If you will not be running 89600 application software on this PC, install only the 89600 License Support and no other part of the 89600 software.

These are the basic steps for setting up your FLEXnet Licensing server, which are described in the rest of this chapter.

1. ["Installing Floating License Support" \(page 201\)](#).
2. ["Obtaining your Floating License File" \(page 204\)](#)
 - a. Read Host ID
 - b. Submit request form
3. ["Installing your Floating License File" \(page 206\)](#)
 - a. Place Floating License File
 - b. Enter hostname (optional)
4. ["Starting Your License Server" \(page 207\)](#)

Redundant license servers

If you will be setting up redundant license servers, see: "[Setting up Redundant License Servers](#)" (page 209).

Setting up client PCs

To set up FLEXnet Licensing on your client PC (the computer where you will run the 89600 software), see: [Chapter 15](#) , "Setting Up a Floating License Client," on page 215.

Adding license files

If you are adding licenses to an existing server, see: "[Adding License \(.lic\) Files](#)" (page 211).

Installing Floating License Support

The 89600 Series Software uses Macrovision's Flexible License Manager (FLEXnet Licensing) software for all floating software security configurations. The 89600 setup program installs the FLEXnet Licensing software at *%SystemRoot%\vsa\licenses\bin*, where *%SystemRoot%* is typically C:\WINDOWS.

Installing floating license support does the following:

- Creates the *%SystemRoot%\vsa\licenses* folder to contain your License File(s).
- Installs the FLEXnet Licensing libraries in the *%SystemRoot%\vsa\licenses\bin* folder.
- Installs the license daemons in the *%SystemRoot%\vsa\licenses\vendors* folder.

NOTE

Agilent 89600 Version 7.0 and greater installs 2 daemons: *agilevsa* for versions less than 7.0 and *agilevsa2* for Version 7.0 and greater.

- Installs help files in the *<TARGETDIR>\89600 VSA\Help* where *<TARGETDIR>* is typically C:\Program Files\Agilent
- Installs tools and batch files in the *%SystemRoot%\vsa\licenses\help* folder

To install floating license support:

NOTE

If the 89600 License Support software currently installed on your server computer is from an Agilent 89600 CD with version lower than Version 7.0, you will need to uninstall and remove the current license support.

If the 89600 License Support software currently installed on your server computer is from an Agilent 89600 CD with Version 7.0 or higher, skip to step 3.

1. If you need to uninstall the current license *server*, click **Start > (All) Programs > Agilent 89600 License Support > Server > License Server Uninstall**. This will not remove your current licenses.
2. To remove the current license *support*, click **Start > Control Panel > Add or Remove Programs > Agilent 89600 License Support > Remove**. This will not remove your current licenses.
3. If you have not installed the 89600 Series Software, insert the Agilent 89600 Series Software CD into the PC's CD drive and click **autoplay.EXE**.

If you have installed the 89600 Series Software:

For a Windows XP system, click **Start > Control Panel > Add or Remove Programs > Agilent 89600 Series Software > Change**.

For a Windows Vista system, click **Start > Control Panel > Uninstall a**

Setting Up a Floating License Server

Installing Floating License Support

program in Programs > highlight Agilent 89600 Series Software > Change in the toolbar.

The Agilent 89600 Series Software InstallShield Wizard opens. Select **Modify** and click **Next**.

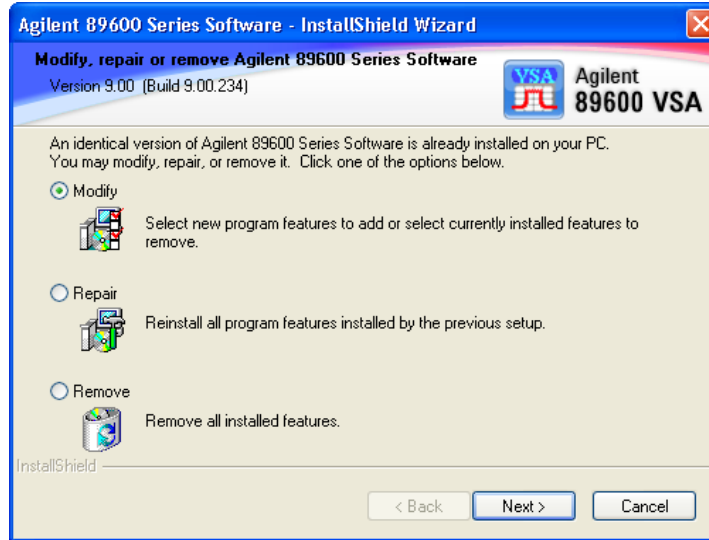

4. In the Select Products and Features window, select **Floating License Support**.

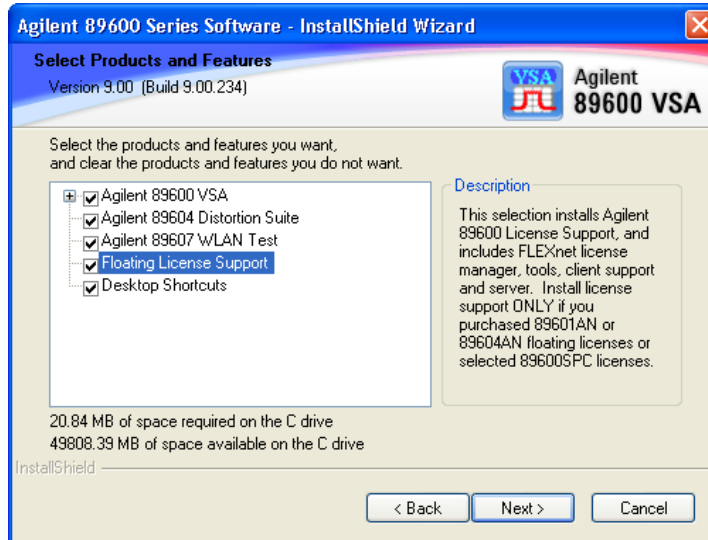

NOTE

Do not clear any of the selected products. Clearing any selected check boxes will uninstall that product.

Click **Next**

5. A warning message opens verifying that you do want to install floating license support. Click **Yes**.



6. Click **Finish** in the Maintenance Complete window.
7. If you see any errors in the command window, you may need to refresh the license support. Click **Start > All Programs > Agilent 89600 License Support > Server > License Server Refresh**.
8. Continue to: "[Obtaining your Floating License File](#)" (page 204).

Obtaining your Floating License File

Before performing these steps, you must have installed the 89600 License Support as described in "Installing Floating License Support" (page 201).

CAUTION

The new floating license file will NOT support client PCs with less than Version 7.0 versions of the 89600 VSA Software.

Find the materials and information you need:

1. Locate the *Floating License File Request Form* in one of these ways:
 - a. (*Preferred*) Go to the 89600 Web page at www.agilent.com/find/89600 and click **Request Floating License File**. You can paste or type in your Host ID, complete the rest of the form, and submit your request.
 - b. Locate the printed *Floating License File Request Form*. This sheet of paper is in the Read Me First envelope shipped with your software. You can fill in the requested information and return the form by fax to (707) 577-5043.
2. Collect the *License Certificates* for all copies of the 89600 software and each software option that you purchased. The License Certificates are printed on gray parchment and are shipped in the Read Me First envelope.

NOTE

If you are installing a software update, you need Update Certificates rather than License Certificates.

3. Obtain the Host ID for your computer.
 - a. Click **Start > (All) Programs > Agilent 89600 License Support > Server > Host ID**.

NOTE

If more than one Host ID is listed, use the first one from the list.

- b. Copy the line displayed in the Notepad window or print the file. This is the Host ID that you will need to obtain a License File.
- c. Paste or write the Host ID in the space provided in the License File Request Form.
- d. Close the Notepad window.

To complete the License File Request Form:

1. Copy the Host ID (from [step 3](#) on the previous page) onto the *Floating License File Request Form*. (You can copy and paste the Host ID into the Web version of the License File Request Form.)
2. (optional) Fill in the Customer's Computer Name. This is the name or code that you use to identify the computer. It might be the name of the person who uses the computer (such as *John Doe's PC*), or it might be an identifier that your company has assigned to the computer (such as *lab214*).

The Customer's Computer Name is optional and is included for your convenience. If you provide the information, we include it in any correspondence we send to you. This is useful for you if you are installing licenses on more than one computer, so you can identify which license file goes on which computer.

3. Below the Host ID, list the License Certificate Number for each piece of software you installed on that computer. You can get this number from the gray parchment *License Certificate* that was shipped with the software.

If you are installing a software update, list your Update Certificate Numbers rather than your License Certificate Numbers.

NOTE

If you are running 89600 software using several independent license servers, submit a separate License File Request for each license server. Each License Certificate can only be used once, and is intended to provide a license file for a single server. If you need to allocate the licenses within a License Certificate across multiple servers, please make a special note of this in your request.

4. Fill in the customer name and address information on the *Floating License File Request Form*.
5. Return the *Floating License File Request Form* to Agilent Technologies using one of the following methods. Your License File will be sent to you by e-mail or fax, depending on whether you provided a fax number or e-mail address on the request form.
 - a. Submit the form from the Web page (www.agilent.com/find/89600).
 - b. Send the *Floating License File Request Form* via fax to (707) 577-5043.

NOTE

The floating license files issued for 89601AN and 89604AN contain license keys (codewords) that Agilent will automatically renew every 18 months. To facilitate this, please keep the contact information you send to us current. If your software notifies you that a renewal is needed, and you have not received a renewal from Agilent Technologies, please contact us immediately using one of the methods outlined above. Failure to do so will lead to loss of access to the software until the license keys are renewed.

Installing your Floating License File

When you receive your license (.lic) file, you must install it on the server PC. If your licenses will be served by a central server, have your system administrator install the license (.lic) file on the license server computer.

To install your floating license file:

1. If you receive your license file via e-mail, open the message in e-mail.
 - a. Click **Start > (All) Programs > Agilent 89600 License Support > Server > License Files Directory**. This opens an Explorer window in the *%SystemRoot%\vsa\licenses* directory.
 - b. Drag the license file from the e-mail message and drop it in the licenses directory.
2. If you receive your license file via fax, you must type the file and save it under the name specified in the fax. The file must go in the directory described in the previous step.
3. If you are adding a license file to a previously-installed license server, go to: ["Adding License \(.lic\) Files" \(page 211\)](#).

If you are setting up a redundant license server, go to: ["Setting up Redundant License Servers" \(page 209\)](#).

Otherwise, continue to: ["Starting Your License Server" \(page 207\)](#).

Starting Your License Server

The information in this section shows you how to start your license server.

To start your license server:

1. Start FLEXnet Licensing by clicking **Start > (All) Programs > Agilent 89600 License Support > Server > License Server Install**.

- a. When the Install License Server window appears, press any key on the keyboard.

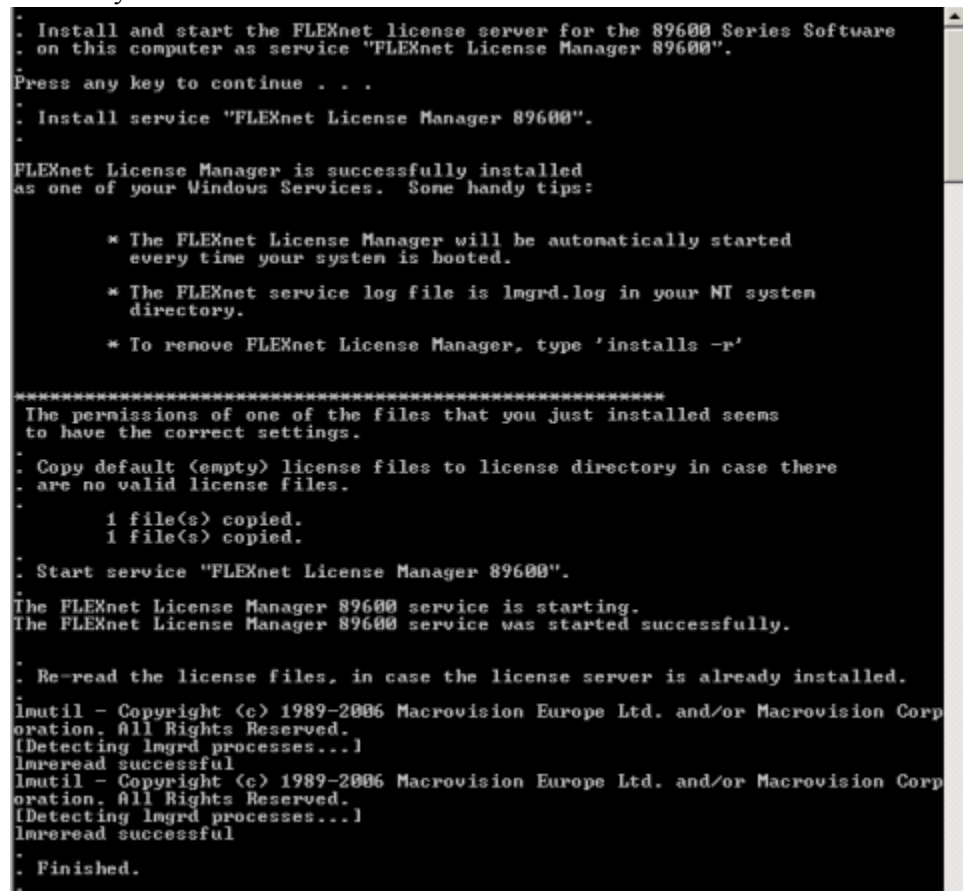

```
. Install and start the FLEXnet license server for the 89600 Series Software
. on this computer as service "FLEXnet License Manager 89600".
.
Press any key to continue . . .
.
. Install service "FLEXnet License Manager 89600".
.
FLEXnet License Manager is successfully installed
as one of your Windows Services. Some handy tips:

* The FLEXnet License Manager will be automatically started
every time your system is booted.
* The FLEXnet service log file is lmgrd.log in your NT system
directory.
* To remove FLEXnet License Manager, type 'installs -r'

*****
The permissions of one of the files that you just installed seems
to have the correct settings.
. Copy default (empty) license files to license directory in case there
are no valid license files.
.
1 file(s) copied.
1 file(s) copied.
.
. Start service "FLEXnet License Manager 89600".
.
The FLEXnet License Manager 89600 service is starting.
The FLEXnet License Manager 89600 service was started successfully.
.
. Re-read the license files, in case the license server is already installed.
lmutil - Copyright (c) 1989-2006 Macrovision Europe Ltd. and/or Macrovision Corp
oration. All Rights Reserved.
[Detecting lmgrd processes...]
lmreread successful
lmutil - Copyright (c) 1989-2006 Macrovision Europe Ltd. and/or Macrovision Corp
oration. All Rights Reserved.
[Detecting lmgrd processes...]
lmreread successful
.
. Finished.
```

- b. When the installation is finished and reads *Finished*. Press any key to *continue . . .*, press any key on the keyboard.

2. Verify that the license server is working. Click **Start > (All) Programs > Agilent 89600 License Support > Server > License Server Status**.

When you install the server for Version 7.0 and greater, two files are installed (empty_license_file_for_agilevsa2.lic and empty_license_file_for_agilevsa.lic) to ensure that the licenses directory has at least one license for each of the two daemon names.

3. Inform your clients of the computer name or names and port number (if

Setting Up a Floating License Server
Starting Your License Server

required) for the server PC.

To find the computer name, click **Start > (All) Programs > Agilent 89600 License Support > LMTOOLS > System Settings**. The computer name is listed in the Computer/Hostname box.

Clients must add an environment variable called `AGILEVSA2_LICENSE_FILE`. The value for the variable is the computer name and, optionally, the port number in this form:

`@mike` (if the computer name is *mike* and no port number is required).

`2110@mike` (if the computer name is *mike* and a port number of 2110 is required).

You need to specify a port only if it is specified on the SERVER line of the license file or files and it is not in the range of 27000 to 27009. The following table shows the possible formats for the variable value.

Single server - no port number assigned	@mike
Single server - port number assigned	2100@mike
Redundant server - no port number assigned	@mike;@mike2;@mike3
Redundant server - port number assigned	2100@mike2110;@mike2;2120@mike3

NOTE

You must install the 89600 Series Software on each client PC. Rather than installing the software from individual CDs, you can copy the CD to a shared drive. Then clients can run `autoplay.exe` from the shared drive to install the software on their PCs.

Setting up Redundant License Servers

FLEXnet lets you set up a redundant license server configuration. This involves configuring three license servers with one of the three servers functioning as the master server. If the master server goes down, one of the other two servers becomes the new master server, and the licenses remain available on the network.

NOTE

Setting up redundant servers requires extra system administration and is not recommended unless you absolutely need it.

To set up redundant license servers, use the same FLEXnet procedures on all three servers. All three servers must be up and running before your licenses are available.

To setup redundant license servers:

1. Install the 89600 License Support on all three computers (see: "[Installing Floating License Support](#)" (page 201)).
2. Obtain your floating license file (see: "[Obtaining your Floating License File](#)" (page 204)). You must provide the host ID for all three computers.
3. Install your license file (see: "[Installing your Floating License File](#)" (page 206)) with the following exceptions:
 - a. Using an ASCII editor, change the default hostname settings in your license (.lic) file to the actual hostnames of your license servers. The license servers are the machines that will serve the licenses on the network, and whose ethernet addresses appear on the SERVER lines:

```
SERVER <hostname1> <hostid1> <tcp_port>  
SERVER <hostname2> <hostid2> <tcp_port>  
SERVER <hostname3> <hostid3> <tcp_port>
```

To find the hostname and hostid, click **Start > (All) Programs > Agilent 89600 License Support > LMTOOLS > System Settings**. The computer name is listed in the Computer/Hostname box. The hostid is listed in the Ethernet Address box.

<tcp_port> is the port number for the server, such as 2100

For these examples, one SERVER line would read:

```
SERVER mike1 0060b05768ee 2100
```

IMPORTANT

Be sure the hostname and hostid in the same line (such as “hostname1” and “hostid1”) are for the same computer.

You must also specify a TCP port number for license requests. The license file includes a default port number. If this conflicts with other FLEXnet licenses on your server, change the port number.

- b. Save the license file to `<windir>\VSA\licenses`.
 - c. Copy empty license files from `<windir>\VSA\licenses\util` to `<windir>\VSA\licenses`.
 - d. Replace the SERVER line in the empty license files with the 3 lines created in step a and save to `<windir>\VSA\licenses`.
 - e. Copy the 3 license files to the licenses directory on each of the other two server PCs.
4. Start the license server on each of the PCs. See: "[Starting Your License Server](#)" (page 207).
 5. Verify that the license servers are installed properly. Click **Start > (All) Programs > Agilent 89600 License Support > LMTOOLS > Server Status > Perform Status Enquiry**.

The status should include 3 lines similar to these:

```
vsa: license server UP v8.3
vsa2: license server UP (MASTER) v8.3
vsaxp: license server UP v8.3
```

In this example, the hostnames of the three servers are vsa, vsa2, and vsaxp. All three servers should be listed as UP, and only one server should be indicated as MASTER.

Adding License (.lic) Files

If you have been running Flexlm and receive updated License Files from Agilent, you can add the new licenses to the FLEXnet Licensing environment as below.

To add license (.lic) files:

1. Install the new file from Agilent to the License Files Directory, following the instructions in "[Installing your Floating License File](#)" (page 206).
2. On the server, click **Start > (All) Programs > Agilent 89600 License Support > Server > License Server Refresh**. This causes the *lmgrd* on the primary server to re-read the license (.lic) files and update all of the other *lmgrd* processes on the network.

IMPORTANT

If you are using the LM_LICENSE_FILE for other products, you may see an invalid error on the old daemon name when you refresh. You may safely ignore the error as the refresh was successful. To verify this, run the status in the next step.

3. After you have done this, you can verify that the license servers have received the new license information by clicking **Start > (All) Programs > Agilent 89600 License Support > Server > License Server Status**.

If this does not work, you may need to stop and restart the license servers on your network.

To stop and restart the license servers:

IMPORTANT

This can cause a disruption to your clients using this license server. A warning will show on the client computers and after 15 minutes the clients will be terminated if the license server is not restarted.

1. Click **Start > (All) Programs > Agilent 89600 License Support > Server > License Server Uninstall**.
2. When instructed to *Press any key to continue*, do so.
3. Click **Start > (All) Programs > Agilent 89600 License Support > Server > License Server Install**.
4. When instructed to *Press any key to continue*, do so.

Managing Multiple Application License Servers on One Computer

When you are running multiple FLEXnet Licensing applications, the recommended configuration is to run multiple license servers, each running one *lmgrd* and accessing one or more license (.lic) files. This enables you to keep the other application's licensing separate from the 89600 licensing.

To manage multiple application license servers on one computer:

1. Each *lmgrd* uses a different TCP/IP port. If you specify port numbers in your License File(s), then each license server (*lmgrd*) must use a different port number as specified on the SERVER lines of the license (.lic) files. You can use a standard text editor to change the port number in each license (.lic) file.
2. You must make sure that you are using a compatible version of *lmgrd* when you start it up for a particular license (.lic) file.

When you have license (.lic) files for two different FLEXnet-licensed products, the products may ship with the different versions of FLEXnet Licensing. FLEXnet Licensing is designed to handle this situation.

If you install an application that provides a newer version of FLEXnet Licensing than was installed for your 89600 program, the easiest way to ensure compatibility is to copy three files from the newer version into the directory `%SystemRoot%\vsa\licenses\bin`. The files you should copy are *lmgrd.exe*, *lmtools.exe*, and *lmutil.exe*.

To determine the version of FLEXnet currently in use by the 89600 license, click **Start > (All) Programs > Agilent 89600 License Support > Server > FLEXnet Version**.

If the version of FLEXnet Licensing you install with your 89600 program is newer than FLEXnet Licensing versions installed for other applications, see the documentation for those applications to determine what you need to do.

Removing 89600 License Support

If you have a node-locked 89600 license installed or have accepted a trial 89600 license, then you install 89600 License Support on that PC, you *hide* the other licenses. To use either the trial license or node-locked license, you must uninstall and remove 89600 License Support.

To uninstall and remove 89600 license support:

1. Click **Start > (All) Programs > Agilent 89600 License Support > Server > License Server Uninstall**. This will not remove your current licenses.
2. Click **Start > Control Panel > Add or Remove Programs**.
3. Select **Agilent 89600 Series Software** and click **Change**.
4. Select **Modify** in the *Modify, repair or remove Agilent 89600 Series Software* dialog box and click **Next**. Clear the **Floating License Support** checkbox and click **Next**. This will not remove your current licenses.
5. Click **Finish**.
6. When the removal is finished, close all the Control Panel dialog boxes and windows.

You can now run your 89600 software with the node-locked or trial license. When your trial license expires, you must reinstall 89600 License Support and install your license file before you can run the 89600 software.

Tools and Batch Files

The FLEXnet support includes several batch files to simplify setting up and checking your licenses. You can run these batch files by clicking **Start > (All) Programs > Agilent 89600 License Support** and either **Server** or **LMTOOLS**.

FLEXnet Version	Run this file to check which versions of FLEXnet and 89600 License Support are used for the 89600 license manager.
Host ID	<p>Run this file to display the host ID of this computer. If the list includes more than one line, use the host ID from the first line.</p> <p>If you are setting up redundant servers (see page 209), you must provide the host ID of all three servers. If more than one host ID is listed for a server, use the first host ID listed.</p>
License Files Directory	Run this file to open an explorer window in the licenses directory.
License Server Install	Run this file to install FLEXnet Licensing as a service and start FLEXnet Licensing.
License Server Refresh	Run this file after you have installed a new license file or modified an existing license file. This forces a currently running FLEXnet Licensing server to reread the license files.
License Server Status	Run this file to display the number of licenses available and used.
License Server Uninstall	Run this file to shut down FLEXnet Licensing and remove FLEXnet Licensing as a service.
LMTOOLS	This file provides a shortcut to the LMTOOLS utility. LMTOOLS is a graphical user interface to the FLEXnet license manager tools. For details on using the tools, see the FLEXnet end user document, click Start > (All) Programs > Agilent 89600 License Support > Help > FLEXnet End User Guide .

Introduction

This chapter documents installing and setting up a floating license client for your 89600 analyzer. If you purchased a node-locked license for your 89600 software, see: [Chapter 13](#) , “[Installing a Node-Locked License](#),” on page 187. If you are using a demo license, start the software and follow the instructions for accepting a demo license.

Floating License Overview

The 89600 Series Software uses Macrovision's FLEXnet Licensing software for floating (network) software security configurations. When you run the 89600 Series Software setup program, the FLEXnet Licensing software is installed at *%SystemRoot%\vsa\licenses\bin* where *%SystemRoot%* is typically C:\WINDOWS.

The FLEXnet Licensing floating licenses require a server computer, to manage license control, and client computers, those on which you obtain a license from the server and run the 89600 series software.

These are the basic steps to set up FLEXnet Licensing on a client PC:

1. Install 89600 Series Software on your client PC as instructed in [Chapter 2](#), "Installing 89600 Software," on page 23.
2. Install 89600 license support on your client PC as instructed in [Chapter 14](#), "Setting Up a Floating License Server," on page 197
3. Set system environment variables: "[Setting the System Environment Variables](#)" (page 218).
4. Start the 89600 software: "[Starting the 89600 software](#)" (page 220).

NOTE

If you install 89600 License Support on a PC that also has a node-locked or trial license, you will not be able to use the node-locked or trial license unless you use Add/Remove Programs to remove 89600 License Support.

Setting the System Environment Variables

To run 89600 Series Software and check out a license from the license server, you must set the `AGILEVSA2_LICENSE_FILE` environment variable.

The environment variable specifies the name of the license server computer (or computers) from which you will get a license to run 89600 software. You specify a name for the environment variable (`AGILEVSA2_LICENSE_FILE`) and assign a value. The value is the license computer name and, optionally, the TCP port number assigned. Your license administrator will provide you with the computer name and, if required, the port number.

To set the system environment variables:

1. Get the name of the server computer (or computers) from your license administrator.
2. For Windows XP, click **Start > Control Panel > System > Advanced > Environment Variables**.

For Windows Vista, click **Start > Control Panel > System and Maintenance > System > Advanced system settings in the side panel > Environment Variables**.

3. Add a new variable named `AGILEVSA2_LICENSE_FILE` that points to the license server computer.
 - a. Click **New** under the User variables or System variables list.

NOTE

You can enter the `AGILEVSA2_LICENSE_FILE` environment variable either as a user variable or as a system variable. The user variable affects only the currently logged-in user; the system variable affects all users.

- b. In the Variable name box, type `AGILEVSA2_LICENSE_FILE`
- c. In the Variable value box, type `@` and the name of the server computer (mike, in this example). Your license administrator can provide you with this information.

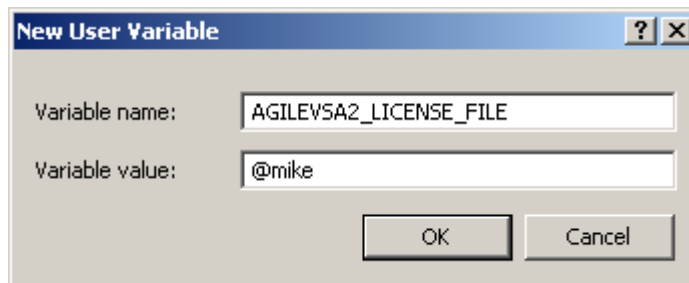

- d. Click **OK, OK, OK**, and close the Control Panel window.

IMPORTANT

The AGILEVSA2_LICENSE_FILE environment variable takes precedence over any LM_LICENSE_FILE settings you might have set up for other applications that use FLEXnet Licensing. AGILEVSA2_LICENSE_FILE is searched first for a valid license before LM_LICENSE_FILE. As a result, using the AGILEVSA2_LICENSE_FILE variable will isolate your 89600 Series Software license configurations from other applications that use the LM_LICENSE_FILE variable.

Starting the 89600 software

Start the application by double-clicking the appropriate icon on your desktop or by using the Start menu:

Start > (All) Programs > Agilent 89600 VSA > Spectrum Analyzer | Vector Signal Analyzer

Start > (All) Programs > Agilent Distortion Suite > Distortion Suite

Start > (All) Programs > Agilent WLAN Test > WLAN Test.

NOTE

If two to three minutes after starting the 89600 VSA software, a License Warning message window appears that says *Lost connection to network license server for the following*, you may have a firewall incompatibility. Every two to three minutes, the 89600 VSA software will connect to the license server to check the floating license status. Some third party firewall applications treat this as a port scan attack and will lock out the client. This problem can be fixed by turning off any third party firewall software that resides on the server. This is not an issue with the Windows firewall.

16 **Diagnostics**

Introduction to Diagnostics

This chapter includes procedures for troubleshooting and isolating hardware problems.

NOTE

For additional troubleshooting information, in the Agilent 89600 window, click **Help > Roadmap > Troubleshooting**.

Before you run diagnostics on VXI analyzers, check the front-panel cable connections described in [Chapter 3](#) (see table below).

Table 16-1 Front-Panel Cable Connections for VXI Analyzers

Analyzer configuration	Cable connections
1-channel 89610A	"Cable connections, 89610" (page 52)
2-channel 89610A	"Cable connections, two-channel 89610" (page 53)
1-channel 89611A	"Cable connections, 89611" (page 55)
2-channel 89611A	"Cable connections, two-channel 89611" (page 59)
1-channel 89640A	"Cable connections, 89640" (page 61)
89640A, second IF/BB channel	"Cable connections, 89640 with second IF/baseband channel" (page 62)
2-RF-channel 89640A	"Cable connections, 89640 with second RF channel" (page 64)
1-channel 89641A	"Cable connections, 89641" (page 67)
89641A second IF/BB channel	"Cable connections, 89641 with second IF/baseband channel" (page 68)
2-RF-channel 89641A	"Cable connections, 89641 with second RF channel" (page 70)

Refer to table below for a summary of diagnostic procedures in this chapter.

Table 16-2 Summary of Diagnostic Issues and Procedures

Issue	Discussion
Your analyzer includes VXI hardware and when you start the 89600 software you get a message saying the hardware wasn't found (or <i>Simulated Hardware</i> is displayed on the trace grid)	Troubleshoot Installation problems: "Troubleshooting a VXI installation problem" (page 226) .
	Troubleshoot a VXI IO problem: "Troubleshooting a VXI IO configuration problem" (page 227) .
	Troubleshoot an IEEE-1394 interface problem: "Troubleshooting an IEEE-1394 interface failure" (page 228) .
Problem is VXI hardware and you suspect a defective module	E1438 ADC module: "Troubleshooting an E1438 ADC module" (page 237)
	E1439 ADC module: "Troubleshooting an E1439 ADC module" (page 238)
	E2730 or E2731 RF Tuner module: "Troubleshooting the E2730/E2731 module" (page 239)

Table 16-2 Summary of Diagnostic Issues and Procedures

Issue	Discussion
Problem is in signal path and you suspect a defective module	2.7 GHz RF signal path: " Troubleshooting the 2.7 GHz RF signal path " (page 240)
	6.0 GHz RF signal path: " Troubleshooting the 6.0 GHz RF signal path " (page 243)
	0 to 36 MHz baseband signal path: " Troubleshooting the 0 to 36 MHz baseband signal path " (page 246)
	70 MHz IF signal path: " Troubleshooting the 70 MHz IF signal path " (page 247)
	0 to 40 MHz signal path: " Troubleshooting the 0-to-40 MHz baseband signal path " (page 248)
Your analyzer uses non-VXI measurement hardware and when you start the 89600 software you get a message saying the hardware wasn't found (or <i>Simulated Hardware</i> appears on the trace grid)	" Troubleshooting a LAN interface problem " (page 230)
Other instruments or devices connected to the same computer reset or experience errors when you start an 89600 analyzer	" Troubleshooting interference with other devices or instruments " (page 233)
The trace data constellation symbol location shape, such as dots, is not properly displayed.	" Troubleshooting the Display Driver " (page 252)

Recommended Test Equipment

The table below shows you the recommended test equipment.

Table 16-3 Recommended Test Equipment

Instrument	Specifications (50 Ω In/Out Impedance)	Model
Digital Signal Generator	Frequency: 500 kHz to 3 GHz Amplitude range: -40 to +16 dBm Amplitude resolution: 0.1 dB Harmonic level: <-30 dBc Spurious: <-90 dBc, <40 MHz Spurious: <-78 dBc, <2.56 GHz SWR: <1.5 Frequency Reference Out: 10 MHz Amplitude: ~7 dBm SSB Phase Noise: <-140 dBc/Hz at 100,1 k, 10MHz offsets RF: 1 GHz SSB Phase Noise: ≤-109 dBc/Hz at 20 kHz ≤-122 dBc/Hz at 100 kHz offset External Reference Input	E4433B
Spectrum Analyzer	Frequency 3 to 7 GHz Amplitude Range -20 to +15 dBm	E4407B
Power Meter	Dual Channel Absolute Accuracy: ±0.5% Power Reference Accuracy: ±0.9%	E4419B Alternate: E4419A
Power Sensor (2)	Frequency Range: 10 MHz to 6 GHz Amplitude Range: -30 to +20 dBm SWR (varies): ≤1.1 10 MHz to 2 GHz ≤1.15 2GHz to 6 GHz	E9301A

Troubleshooting a VXI mainframe failure

Using the mainframe service guide, verify that all power supplies and fan(s) are operational.

Troubleshooting a VXI installation problem

If you get a message saying that the analyzer cannot find VXI hardware when you start either the Vector Signal Analyzer or the Spectrum Analyzer application, there may have been a problem during the installation of the PCI card in your computer.

To troubleshoot a VXI installation problem:

1. It is very important that you upgrade the PC BIOS to the latest version your PC manufacturer provides whether your PC is new or old. Upgrading to the latest version of BIOS will eliminate those bugs fixed by the new BIOS. A BIOS upgrade and a video driver upgrade may be required to fix PCI-related problems even on a new PC.
2. You may also need to upgrade the drivers for other PCI devices in the PC (video, IDE, LAN, SCSI, sound, modem, etc.).
3. Verify that the power supply splitter cable is connected between the PC power supply and the PCI card.
4. The E8491B requires installation of the PCI-to-IEEE 1394 host adapter in a bus-mastering PCI slot. Consult your PC's user manual to determine which slots are bus-mastering (it is possible that all slots are bus-mastering).
5. In addition to the above, you may need to move the PCI-to-IEEE 1394 host adapter to a separate IRQ line in the PC. PCI enables up to four devices sharing an IRQ line. However, this doesn't always work, and you may need to have one IRQ per card. Moving the IRQ is not easy, and whether it can be done will depend on the details of the BIOS implementation of your PC.
6. Go to Control Panel, Devices and change the Startup mode for the wn1394 to *System*. This starts the 1394 PCI card driver sooner and prevent problems.

If you suspect such a problem, refer to PDF: *Agilent E8491B IEEE 1394 PC Link to VXI Configuration and User's Guide* located at http://www.home.agilent.com/upload/cmc_upload/All/E8491-90001_users.pdf

Troubleshooting a VXI IO configuration problem

The information in this section shows you how to troubleshoot a VXI IO configuration problem when the 89600 software cannot find VXI measurement hardware.

If you replace the E8491 card in the mainframe or connect a different VXI mainframe to your computer, the 89600 software will not be able to find the hardware. The PCI interface in the computer looks for the specific E8491 card that was previously connected and cannot find it.

To troubleshoot a VXI IO configuration problem:

1. If you are running Vector Signal Analyzer or Spectrum Analyzer, close the application.
2. Click **Start > (All) Programs > Agilent IO Libraries Suite > Agilent Connection Expert**.
3. In the right column, select **VXI** in list and click **Delete**.
4. Click **Add Interface** and then select **VXI: Agilent E8491 IEEE 1394 to VXI Controller**, then click **Add**.
5. If E8491 IEEE to VXI is not listed, you may need to install a driver for the E8491. See instructions on the next page. The 89600 software should find the hardware. If not, you can find E8491 troubleshooting information in *E8491B Configuration and User's Guide* located at http://www.home.agilent.com/upload/cmc_upload/All/EP5G084330.pdf.

You can also find *E8491B Configuration and User's Guide* by searching: Go to <http://www.agilent.com>. Click on **Technical Support > Manuals** and Search for E8491B.

Troubleshooting an IEEE-1394 interface failure

If you are running Vector Signal Analyzer or Spectrum Analyzer, close the application before troubleshooting this problem.

To troubleshoot an IEEE-1394 interface failure:

1. Verify that Agilent IO Libraries Suite Control is running.

If this program is running, the icon shown to the right will appear in the task bar. If the icon is there, go to step 2.



If the icon is not there, reinstall the IO Libraries Suite from the 89600 Installation CD as follows:

- a. Insert the 89600 Installation CD ROM.
 - b. If the installation utility does not start automatically, click **Start > Run**, and type:
`drive:\setup.exe`
...where *drive* represents the drive containing the setup CD-ROM.
 - c. When the Installation Manager window opens, select **Install Agilent 89600 VSA**.
 - d. Click **Next** in the Welcome window and **Yes** in the Software License and Warranty window.
 - e. In the Installation Options window, select **Custom Installation** and click **Next**.
 - f. In the Custom Installation window, select **IO Libraries Suite 14.0** from the list. Click **Next**.
 - g. In the Installation Settings window, click **Install**.
2. If the Agilent IO Libraries Suite Control is running, verify that the version is 14.0 or greater.
 - a. Click the IO Control icon (shown above).
 - b. Click **About Agilent IO Control**.
If the version is lower than 14.0, reinstall the IO Libraries Suite 14.0 as instructed in [step 1](#).
 3. Verify that the IEEE-1394 drivers are loaded and running.
 - a. Click **Start > Settings > Control Panel > System > Hardware > Device Manager**.
 - b. If *IEEE 1394 Bus host controllers* is not present then the IEEE-1394 drivers were not loaded properly. Reload the IO Libraries Suite as instructed in [step](#)

1.

If *IEEE 1394 Bus host controllers* is on the list, then the PCI interface card is most likely faulty.

4. Verify the E8491B slot zero VXI controller card.

- a. Click on the Agilent IO Control icon and click **VXI Resource Manager > Edit Resources**, then click the **Run** button.
- b. If an error is reported, click **Start > (All) Programs > Agilent IO Libraries Suite > Agilent Connection Expert**.

If Connection Expert is unable to find the E8491B, then the E8491B is most likely faulty.

Troubleshooting a LAN interface problem

If the 89600 software cannot find your measurement hardware, the problem may be in the LAN interface.

To verify the correct ADC.

1. Click **Utilities > Hardware**.
2. If your measurement hardware is not included in the list for ADC1, continue with “To troubleshoot the LAN interface.”
3. If your measurement hardware is included in the list for ADC1, click to highlight it.
4. Make sure that the *Default Hardware* and *Simulate Hardware* checkboxes are cleared.
5. Click **OK**.
6. If the analyzer still does not use your hardware, continue with “To troubleshoot the LAN interface.”

To troubleshoot the LAN interface:

1. Close all 89600 applications. To verify that all applications are closed, run Task Manager.
 - a. Right click an empty space in the task bar or press Alt-Ctrl-Delete.
 - b. Click **Task Manager ... > Applications**.
 - c. If there are any *AgtVSAVector* or *AgtVSAScalar* applications listed, highlight them and click **End Task**.
 - d. Click the **Processes** tab.
 - e. If there are any *VSAVEC*.EXE* or *VSASCA*.EXE* processes in the list, highlight them and click **End Task**.
2. Confirm that your PC can communicate with the instrument.
 - a. Open a Command Prompt window: for Windows XP, click **Start > All Programs > Accessories > Command Prompt**.
 - b. Type **ping hostname** and press Enter, where hostname is the IP address or hostname for the instrument. (For instructions on finding the IP address or hostname, see “[Instrument IP address for a crossover cable configuration](#)” on page 98.)

If you are successful, continue with [step 3](#). If you are not successful, continue with the next sub-step.
 - c. Make sure that the PC is on and the LAN cable is connected to the PC and

the instrument.

- d. If you are connecting directly from the PC to the instrument, verify that you are using a crossover LAN cable.
 - e. Cycle power on the instrument.
 - f. Verify that the subnet mask is set appropriately. For detailed instructions, see: [“Instrument IP address for a crossover cable configuration” on page 98](#).
3. Confirm that VISA Assistant can find and communicate with the LAN instrument. Follow the instructions in: [step 3](#), in [“Configuring the Agilent E5810 LAN/GPIB Gateway interface” on page 102](#).
 4. After you have confirmed that Interactive IO can find the instrument, verify that Interactive IO can send a SCPI query (if the instrument supports SCPI).
 - a. Restart Interactive IO if necessary.
 - b. Click **Connect** and check the resource name.
 - c. Click **Send & Read**.
 - d. If there is an error or an incorrect response, try sending a device clear first. Click **Device Clear**. If this does not help, cycle power on the instrument and try [step c](#), again.
 5. Start an 89600 application. Look for any error dialog boxes at startup stating that the instrument does not have the proper options or firmware.
 6. Verify that the instrument is in the ADC 1 list under **Utilities > Hardware**.

LAN interface problem with an Infiniium Oscilloscope:

If you are having trouble communicating directly over the LAN with an Infiniium Oscilloscope, check that the M libraries on the scope are configured correctly (Click Start > All Programs > Agilent IO Libraries > Connection Expert).

Table 16-4 M libraries configuration

VISA Name	SICL Name
GPIB0	hpib7
GPIB1	inst0
TCPIP0	lan

To configure the M libraries (Win XP firewall must be off):

1. On the Infiniium scope, minimize the scope application. Click Start > All Programs > Agilent I/O Libraries > Connection Expert.
2. Select Internal Instrument in the Available Interfaces and click the Configure button. Set the following parameters: SICL Interface Name - hpib7, VISA Interface Name - GPIB0, and Logical Unit - 7. Press OK.
3. Select Internal Instrument in the Available Interfaces and click the Configure button again. Set the following parameters: SICL Interface Name - inst0, VISA Interface Name - GPIB1, and Logical Unit - 8. Press OK.
4. Select TCPIP in the Available Interfaces and click the Configure button. Set the following parameters: SICL Interface Name - lan, VISA Interface Name - TCPIP0, Logical Unit - 30 and Default Protocol - Auto. Press OK.
5. Select n/a LAN Server in the Available Interfaces and click the Configure button. Click the Defaults button and press OK.
6. Close the Connection Expert dialog box.

You must reboot the scope after closing the Connection Expert dialog box.

Troubleshooting interference with other devices or instruments

When you start an 89600 analyzer, the software attempts to identify other instruments and devices connected to the computer. This can cause the following problems:

- Instruments and devices get reset when you start the 89600 analyzer even if the instrument/device is not controlled by 89600.
- Errors occur on instruments or devices not controlled by 89600 when you start the 89600 analyzer.

To eliminate these problems, you can instruct the 89600 software to exclude specific devices from the identification process. To do this, edit the file:

C:/Program Files/Agilent/89600 VSA/VsaVisaTemplate.txt

List the addresses of the devices you want to exclude, then save the file as:

C:/Program Files/Agilent/89600 VSA/VsaVisaConfig.txt

Troubleshooting licensing errors

The licensing errors include:

- license initialization errors
- lost licenses

License Initialization Errors

When starting up any 89600 software application, the following error messages may be generated by the Crypkey licensing software.

89600 software Version 7.20 or lower:

License initialization error
Reply from network driver is bad
Re-install product

License initialization error
Network driver appears to not be serving this directory
Re-install product

Use this procedure to uninstall and re-install the licensing software.

1. Stop the CrypKey service via the Windows Services tool.
For Windows 2000, click **Start > Settings > Control Panel > Administrative > Services**.
For Windows XP, click **Start > Control Panel > Performance and Maintenance > Administrative Tools > Services**.
2. Delete the following files in <WINNT>/system32:
 - Ckldrv.sys
 - Crypserv.exe
 - esnecil.ind
3. Execute <WINNT>/vsa/setupex.exe.
4. Start 89600 software. Once the software is able to start, you may need to request a new site key.

89600 software Version 8.00 or greater:

*Update NOT successful
Reply from network driver is bad
Re-install product*

*License initialization error
Could not start ngn.
Re-install product*

Use this procedure to uninstall and re-install the licensing software.

1. Start a command prompt window. Click **Start > Run > cmd > OK**.
2. Enter the command “ **\Documents and Settings\All Users\Application Data\Agilent\Vsa\8.0\setupex /U** ” and then press **Enter**.
3. Delete the file **\system32\esnecil.ind**.
4. Reboot your PC.
5. Run **\Documents and Settings\All Users\Application Data\Agilent\Vsa\8.0\setupex**.

Lost License Error

If you have antivirus software on your PC, it can cause your 89600 software license to be lost. To avoid this problem, configure your antivirus software to exclude the following files:

- *.rst
- *.ent
- *.key
- *.41s
- *.ind
- cks*.tmp

Troubleshooting a lost connection to the network license server

This information only applies to systems that use a floating license server and a floating license client.

If two to three minutes after starting the 89600 VSA software, a License Warning message window appears that says *Lost connection to network license server for the following*, you may have a firewall incompatibility. Every two to three minutes, the 89600 VSA software will connect to the license server to check the floating license status. Some third party firewall applications treat this as a port scan attack and will lock out the client. This problem can be fixed by turning off any third party firewall software that resides on the server. This is not an issue with the Windows firewall.

Troubleshooting an E1438 ADC module

This section provides information on troubleshooting an E1438 ADC module.

To verify the E1438 module using the self test:

1. If you have either the Vector Signal Analyzer or Spectrum Analyzer running, close the application.
2. Click **Start > (All) Programs > Vxipnp > Age1438 > E1438 Front Panel**.
3. If the factory default address has been changed you must enter it into the dialog box that will be presented.

There are two ways to find the E1438 address:

- a. Click on the Agilent IO Libraries Suite Control icon and click **VXI Resource Manager > Edit Resources**, highlight Add/delete symbolic names of VXI devices, and click **RM Output**. The LADD column in the VXI device table lists the logical address for each module.
 - b. Open the Vector Signal Analyzer or Spectrum Analyzer, click **Utilities > Hardware** and the ADC tab for the module. The logical address is listed in the first column with the VXI mainframe number.
4. On the menu bar of the front panel program select **Control > Self Test**.
If errors are reported, then the E1438 module is faulty.
 5. Repeat this procedure for a second E1438 if necessary.

The E1438 front panel test always looks for a module at logical address 192. If it finds one, it automatically opens the soft front panel for that module. To test another E1438 module, power-off the mainframe and pull the module with address 192 out of the mainframe (you don't have to remove the module completely--just slide it forward an inch or so). Repeat steps 1-4 above.

Troubleshooting an E1439 ADC module

This section provides troubleshooting information for an E1439 ADC module.

To verify the E1439 module using the self test:

1. If you have either the Vector Signal Analyzer or Spectrum Analyzer running, close the application.
2. Click **Start > (All) Programs > Vxipnp > Age1439 > E1439 Front Panel**.
3. If the factory default address has been changed you must enter it into the dialog box that will be presented.

There are two ways to find the E1439 address:

- a. Click on the Agilent IO Libraries Suite Control icon and click **VXI Resource Manager > Edit Resources**, highlight Add/delete symbolic names of VXI devices, and click **RM Output**. The LADD column in the VXI device table lists the logical address for each module.
 - b. Open the Vector Signal Analyzer or Spectrum Analyzer, click **Utilities, Hardware** and the ADC tab for the module. The logical address is listed in the first column with the VXI mainframe number.
4. On the menu bar of the front panel program select **Control > Self Test**.
If errors are reported, then the E1439 module is faulty.
 5. Repeat this procedure for a second E1439 if necessary.

The E1439 front panel test always looks for a module at logical address 194. If it finds one, it automatically opens the soft front panel for that module. To test another E1439 module, power-off the mainframe and pull the module with address 194 out of the mainframe (you don't have to remove the module completely--just slide it forward an inch or so). Repeat steps 1-4 above.

Troubleshooting the E2730/E2731 module

You can use VISA Assistant to isolate problems to the E2730/E2731 module.

To troubleshoot the E2730/E2731 module:

1. Start Agilent Connection Expert by clicking **Start > (All) Programs > Agilent IO Libraries Suite > Agilent Connection Expert**.
2. Under VXIO, highlight the E273xA module.
3. Click **Interactive IO**.
 - a. If the red LED on the E273xA front panel is lit, type **CDE?** in the command box and click **Send & Read**. (CDE? reads the module's current device Error Register contents.) If the response ends in 32768, the 10 MHz Reference signal is probably not connected properly. Check the semi-rigid cable from the 10 MHz Ref Out connector on the 89605 module to the 10 MHz Ext Ref connector on the E273xA module. Tighten the connectors, and the red LED should turn off. If the query returns any number other than 32768 or 00000, the E273xA module is most likely faulty.
 - b. If the red LED on the E273xA front panel flickers or turns on and off, type **DDE?** in the command box and click **Send & Read**. (DDE? reads the module's latched error status. Reading this register clears it until the fault reoccurs.) If the query returns 32768, check the 10 MHz Ref connections as described in the previous paragraph. If the query returns any number other than 32768 or 00000, the E273xA module is most likely faulty.
4. Repeat for a second E2730/E2731 module if necessary.

Troubleshooting the 2.7 GHz RF signal path

The following procedures direct you through inserting a signal at various points in the analyzer's signal path to isolate problems to a specific module. Perform the steps in the order listed.

This test requires a signal generator. See, "[Recommended Test Equipment](#)" (page 224).

To troubleshoot the 2.7 GHz RF signal path:

1. Set up the analyzer as follows:
 - a. If it is not already running, start the Vector Signal Analyzer by double clicking the icon or clicking **Start > (All) Programs > Agilent 89600 VSA > Vector Signal Analyzer**.
 - b. Click **File > Preset > Preset Setup**.
 - c. Click **Utilities > Calibration**, and clear the **Apply Corrections to Data** checkbox.
 - d. Click **MeasSetup > Frequency Bands > 36 MHz – 2.7 GHz**.
 - e. Disconnect the BNC cable from the E1439 *Analog In* connector and connect a signal generator to E1439 Analog Input.
 - f. Set the signal generator for 70 MHz, –10 dBm output.
 - g. Set the analyzer's marker to peak by right clicking on the spectrum trace and clicking **↑Peak**.

The marker reading should be 20 dBm ± 1.5 dB.
 - h. Verify the other settings in the following table.

Input Range	Signal Generator Level	Marker Level
+20 dBm	–10 dBm	+20 dBm ± 1.5 dB
–35 dBm	–20 dBm	–40 dBm ± 1.5 dB
–40 dBm	–20 dBm	–40 dBm ± 1.5 dB
–45 dBm	–20 dBm	–40 dBm ± 1.5 dB

If any of the readings are incorrect, the E1439 module is most likely faulty.

2. Reconnect the BNC cable to the E1439 *Analog In* and disconnect the SMA cable from the 89605 *From 70 MHz IF Out* connector. Connect the signal generator output to 89605 *From 70 MHz IF Out*.
 - a. Set the marker to peak by right clicking on the spectrum trace and clicking **↑Peak**.

- b. The marker reading should be $-40 \text{ dBm} \pm 1.5 \text{ dB}$. If this reading is incorrect, the 89605 module is most likely faulty.
 3. Set the signal generator to 1 GHz, -40 dBm .
 - a. Reconnect the SMA cable to the 89605 *From 70 MHz IF Out* connector. Disconnect the SMA cable from the E2730 *RF IN* connector. Connect the signal generator output to the E2730 *RF In* connector.
 - b. Set the marker to peak by right clicking on the spectrum trace and clicking **↑Peak**.
 - c. The marker reading should be $-40 \text{ dBm} \pm 3.5 \text{ dB}$
 - d. Change the signal generator and 89600 center frequency to 950 MHz.
 - e. Set the marker to peak by right clicking on the spectrum trace and clicking **↑Peak**.
 - f. The marker reading should be $-40 \text{ dBm} \pm 3.5 \text{ dB}$.

If either reading is incorrect, the E2730 module is most likely faulty. If this module is channel 2 in a 2-channel analyzer, see [“Verifying Channel 1 LO outputs in a 2-channel RF system”](#) on page 250.
 4. Set the signal generator to 1 GHz, -30 dBm . Set the 89600 center frequency to 16 Hz.
 - a. Reconnect the SMA cable to E2730 *RF In* connector. Connect the signal generator output to the 89605 Ch1 Input connector.
 - b. Set the marker to peak by right clicking on the spectrum trace and clicking **↑Peak**.

Troubleshooting the 2.7 GHz RF signal path

- c. Change the analyzer input range and the signal generator output level in 5 dB steps, verifying the marker readings in the following table.

Input Range	Signal Generator Level	Marker Level
-30 dBm	-30 dBm	-30 dBm \pm 3.5 dB
-25 dBm	-25 dBm	-25 dBm \pm 3.5 dB
-20 dBm	-20 dBm	-20 dBm \pm 3.5 dB
-15 dBm	-15 dBm	-15 dBm \pm 3.5 dB
-10 dBm	-10 dBm	-10 dBm \pm 3.5 dB
-5 dBm	-5 dBm	-5 dBm \pm 3.5 dB
0 dBm	0 dBm	0 dBm \pm 3.5 dB
+5 dBm	+5 dBm	+5 dBm \pm 3.5 dB
+10 dBm	+10 dBm	+10 dBm \pm 3.5 dB
+15 dBm	+15 dBm	+15 dBm \pm 3.5 dB
+20 dBm	+20 dBm	+20 dBm \pm 3.5 dB

If any of these readings are incorrect, the 89605 module is most likely faulty.

5. Repeat steps 1 through 4 for a second channel if required.

Troubleshooting the 6.0 GHz RF signal path

The following procedures direct you through inserting a signal at various points in the analyzer's signal path to isolate problems to a specific module. Perform the steps in the order listed. This test requires a signal generator. See "[Recommended Test Equipment](#)" (page 224).

To troubleshoot the 6.0 GHz RF signal path:

1. Set up the analyzer as follows:
 - a. If it is not already running, start the Vector Signal Analyzer by double clicking the icon or clicking **Start > (All) Programs > Agilent 89600 VSA > Vector Signal Analyzer**.
 - b. Click **File > Preset > Preset Setup**.
 - c. Click **Utilities > Calibration**, and clear the **Apply Corrections to Data** checkbox.
 - d. Click **MeasSetup > Frequency Bands > 36 MHz – 6 GHz**.
 - e. Disconnect the BNC cable from the E1439 *Analog In* connector and connect a signal generator to E1439 Analog Input.
 - f. Set the signal generator for 70 MHz, –10 dBm output.
 - g. Set the analyzer's marker to peak by right clicking on the spectrum trace and clicking **↑Peak**. The marker reading should be 20 dBm ± 1.5 dB
 - h. Verify the other settings in the following table.

Input Range	Signal Generator Level	Marker Level
+20 dBm	–10 dBm	+20 dBm ± 1.5 dB
–35 dBm	–20 dBm	–40 dBm ± 1.5 dB
–40 dBm	–20 dBm	–40 dBm ± 1.5 dB
–45 dBm	–20 dBm	–40 dBm ± 1.5 dB

If any of the readings are incorrect, the E1439 module is most likely faulty.

2. Reconnect the BNC cable to the E1439 *Analog In* and disconnect the SMA cable from the 89605 *From 70 MHz IF Out* connector. Connect the signal generator output to 89605 *From 70 MHz IF Out*.
 - a. Set the marker to peak by right clicking on the spectrum trace and clicking **↑Peak**.
 - b. The marker reading should be –40 dBm ± 1.5 dB.

If this reading is incorrect, the 89605 module is most likely faulty.

Troubleshooting the 6.0 GHz RF signal path

3. Set the signal generator to 1 GHz, -40 dBm.
 - a. Reconnect the SMA cable to the 89605 *From 70 MHz IF Out* connector. Disconnect the SMA cable from the E2731 *6 GHz IN* connector. Connect the signal generator output to the E2731 *6 GHz IN* connector.
 - b. Set the marker to peak by right clicking on the spectrum trace and clicking **↑Peak**.
 - c. The marker reading should be -40 dBm ± 4.5 dB
 - d. Change the signal generator and 89600 center frequency to the frequencies in the table and repeat steps b and c.

Frequency
950 MHz
3.5 GHz
4.0 Ghz
4.5 Ghz
5.5 Ghz

If any of these readings are incorrect, the E2731 module is most likely faulty. If this module is channel 2 in a 2-channel analyzer, see [“Verifying Channel 1 LO outputs in a 2-channel RF system”](#) on page 250.

4. Set the signal generator to 1 GHz, -30 dBm. Set the 89600 center frequency to 16 Hz.
 - a. Reconnect the SMA cable to E2731 *6 GHz In* connector. Connect the signal generator output to the 89605 Ch1 Input connector.
 - b. Set the marker to peak by right clicking on the spectrum trace and clicking **↑Peak**.
 - c. Change the analyzer input range and the signal generator output level in 5 dB steps, verifying the marker readings in the following table.

Input Range	Signal Generator Level	Marker Level
-30 dBm	-30 dBm	-30 dBm ± 5 dB
-25 dBm	-25 dBm	-25 dBm ± 5 dB
-20 dBm	-20 dBm	-20 dBm ± 5 dB
-15 dBm	-15 dBm	-15 dBm ± 5 dB
-10 dBm	-10 dBm	-10 dBm ± 5 dB
-5 dBm	-5 dBm	-5 dBm ± 5 dB
0 dBm	0 dBm	0 dBm ± 5 dB
+5 dBm	+5 dBm	+5 dBm ± 5 dB
+10 dBm	+10 dBm	+10 dBm ± 5 dB

Input Range	Signal Generator Level	Marker Level
+15 dBm	+15 dBm	+15 dBm \pm 5 dB
+20 dBm	+20 dBm	+20 dBm \pm 5 dB

If any of these readings are incorrect, the 89605 module is most likely faulty.

5. Repeat steps 1-4 for channel 2 if required.

Troubleshooting the 0 to 36 MHz baseband signal path

Perform the following procedures in the order listed to troubleshoot the 89640 baseband signal path.

This test requires a signal generator. See "[Recommended Test Equipment](#)" (page 224).

1. Set up the 896xxA as follows:
 - a. If it is not already running, start the Vector Signal Analyzer by double clicking the icon or clicking **Start > (All) Programs > Agilent 89600 VSA > Vector Signal Analyzer**.
 - b. Click **File > Preset > Preset Setup**.
 - c. Click **Utilities > Calibration**, and clear the *Apply Corrections to Data* checkbox.
 - d. Click **MeasSetup > Frequency Bands > 0 - 36 MHz**.
 - e. Disconnect the BNC cable from the E1439 *Analog In* connector and connect a signal generator to E1439 *Analog In*.
 - f. Set the signal generator for 20 MHz, -30 dBm output.
 - g. Set the marker to peak by right clicking on the spectrum trace and clicking **↑Peak**.
 - h. The marker reading should be 20 dBm ± 1.7 dB.
If this reading is incorrect, the E1439 module is most likely faulty.
2. Connect the signal generator output to 89605 *Ch 1 Input*.
 - a. Reconnect the BNC cable from 89605 *To ADC* to E1439 *Analog In*.
 - b. Set the center frequency to 20 MHz and the frequency span to 100 kHz.
 - c. Set the marker to peak by right clicking on the spectrum trace and clicking **↑Peak**.
 - d. The marker reading should be -30 dBm ± 3.5 dB.
 - e. Change the 89640A input range in 5 dB steps while verifying that the marker reading at each step is -30 dBm ± 3.5 dB.
If any of these readings are incorrect, the 89605 module is most likely faulty.
3. Repeat steps 1 and 2 for a second channel if required.

Troubleshooting the 70 MHz IF signal path

The following procedures direct you through inserting a signal at various points in the analyzer's signal path to isolate problems to a specific module. Perform the steps in the order listed. This test requires a signal generator. See "[Recommended Test Equipment](#)" (page 224).

1. Set up the analyzer as follows:
 - a. If it is not already running, start the Vector Signal Analyzer by double clicking the icon or clicking **Start > (All) Programs > Agilent 89600 VSA > Vector Signal Analyzer**.
 - b. Click **File > Preset > Preset Setup**.
 - c. Click **Utilities > Calibration**, and clear the *Apply Corrections to Data* checkbox.
 - d. Click **MeasSetup > Frequency Bands > 52 MHz – 88 MHz**.
 - e. Click **MeasSetup > Freq > Span**, and enter 100 kHz.
 - f. Click **Input > Range**, and enter -45 dBm.
 - g. Click **Control > Restart**.
 - h. Disconnect the BNC cable from the E1439 *Analog In* connector and connect a signal generator to E1439 Analog Input.
 - i. Set the signal generator for 70 MHz, -45 dBm output.
 - j. Set the 89600 marker to peak: right click on the spectrum trace and click **↑Peak**. The marker reading should be -39 dBm ± 1.5 dB
 - k. Click **Markers > Copy Marker to > Move Offset to Mkr**.
 - l. Change the Input Range in 5 dB increments from -45 dBm to -25 dBm. The Marker Level for all ranges should read 0 dB ± 0.5 dB.

If any of the readings are incorrect, the E1439 module is most likely faulty.
2. Reconnect the BNC cable to the E1439 *Analog In*. Connect the signal generator output to 89605 *Ch 1 Input*.
 - a. Set the marker to peak: right click on the spectrum trace and click **↑Peak**.
 - b. Click **Input > Range**, and enter -25 dBm.
 - c. Click **Markers > Copy Marker to > Move Offset to Mkr**.
 - d. Change the Input Range in 5 dB increments from -25 dBm to +20 dBm. The Marker Level for all ranges should read 0 dB ± 0.5 dB.

If any of these readings is incorrect, the 89605 module is most likely faulty.
3. For a two-channel IF analyzer, repeat this procedure for the second channel.

Troubleshooting the 0-to-40 MHz baseband signal path

Perform the following procedures in the order listed to troubleshoot the 89610A signal path. This test requires a signal generator. See "[Recommended Test Equipment](#)" (page 224).

To troubleshoot the 0-to-40MHz baseband signal path:

1. Set up the analyzer as follows:
 - a. If it is not already running, start the Vector Signal Analyzer by double clicking the icon or clicking **Start > (All) Programs > Agilent 89600 VSA > Vector Signal Analyzer**.
 - b. Click **File > Preset > Preset Setup**.
 - c. Click **Utilities > Calibration**, and clear the *Apply Corrections to Data* checkbox.
 - d. Disconnect the BNC cable from the E1438 *Analog In* connector and connect a signal generator to E1438 *Analog In*.
 - e. Set the signal generator for 20 MHz, -31 dBm output.
 - f. Set the analyzer input range to -31 dBm.
 - g. Set the marker to peak by right clicking on the spectrum trace and clicking **↑Peak**.
 - h. The marker reading should be -31 dBm ± 1.7 dB.
If this reading is incorrect, the E1438 module is most likely faulty.

- i. Change the analyzer input range and the signal generator output level in 3 dB steps, verifying the marker readings in the following table.

Input Range	Signal Generator Level	Marker Level
-31 dBm	-31 dBm	-31 dBm \pm 1.7 dB
-28 dBm	-28 dBm	-28 dBm \pm 1.7 dB
-25 dBm	-25 dBm	-25 dBm \pm 1.7 dB
-22 dBm	-22 dBm	-22 dBm \pm 1.7 dB
-19 dBm	-19 dBm	-19 dBm \pm 1.7 dB
-16 dBm	-16 dBm	-16 dBm \pm 1.7 dB
-13 dBm	-13 dBm	-13 dBm \pm 1.7 dB
-10 dBm	-10 dBm	-10 dBm \pm 1.7 dB
-7 dBm	-7 dBm	-7 dBm \pm 1.7 dB
-4 dBm	-4 dBm	-4 dBm \pm 1.7 dB
-1 dBm	-1 dBm	-1 dBm \pm 1.7 dB
+ 2 dBm	+ 2 dBm	+ 2 dBm \pm 1.7 dB
+5 dBm	+5 dBm	+5 dBm \pm 1.7 dB
+8 dBm	+8 dBm	+8 dBm \pm 1.7 dB
+11 dBm	+11 dBm	+11 dBm \pm 1.7 dB
+14 dBm	+14 dBm	+14 dBm \pm 1.7 dB
+17 dBm	+17 dBm	+17 dBm \pm 1.7 dB
+20 dBm	+20 dBm	+20 dBm \pm 1.7 dB

If any readings are incorrect, the E1438 module is most likely faulty.

2. For a two-channel 89610A, repeat this procedure for the second E1438.
3. Connect the signal generator output to 89606/B *Ch 1 Input*.
 - a. Reconnect the BNC cable from 89606/B *To ADC* to E1438 *Analog In*.
 - b. Set the signal generator to -31 dBm output level.
 - c. Set the analyzer center frequency to 20 MHz, frequency span to 100 kHz, and input range to -31 dBm.
 - d. Set the marker to peak by right clicking on the spectrum trace and clicking **↑Peak**.
 - e. The marker reading should be -31 dBm \pm 1.7 dB.
 - f. Change the analyzer input range and the signal generator output level in 3 dB steps, verifying the marker readings in the table in above.

If any of these readings are incorrect the 89606/B module is most likely faulty.

Verifying Channel 1 LO outputs in a 2-channel RF system

Perform the following procedures to verify the channel 1 LO output on an E2730 or E2731 module in a 2-channel analyzer. This test requires a spectrum analyzer and a power meter. See "[Recommended Test Equipment](#)" (page 224).

To verify Channel 1 LO outputs in a 2-channel RF system, 1st LO:

1. Disconnect the cable connected to E273x 1st LO In/Out.
2. Connect Channel 1 1st LO In/Out to the spectrum analyzer RF Input.
3. If it is not already running, start the Vector Signal Analyzer by double clicking the icon or clicking **Start > (All) Programs > Agilent 89600 VSA > Vector Signal Analyzer**.
4. Set up the 89600 Vector Signal Analyzer:
 - a. Click **File > Preset > Preset Setup**.
 - b. Click **Input > Channels > 2 Channels**.
5. Set up the spectrum analyzer:
 - a. Preset.
 - b. Set the reference level to 12 dBm.
 - c. Set the span to 100 MHz.
6. For each frequency listed below verify that the amplitude is < 6.5 dBm. If the signal level is marginal, verify with a power meter.

89600 center frequency	Spectrum analyzer center frequency
36 MHz	3.8175 GHz
1 GHz	4.7825 GHz
2.7 GHz	6.4825 GHz

If any reading is incorrect then the E273x is most likely faulty.

To verify Channel 1 LO outputs in a 2-channel RF system, 2nd LO

1. Disconnect the cable connected to E273x 2nd LO In/Out.
2. Connect Channel 1 2nd LO In/Out to the spectrum analyzer RF Input.
3. If it is not already running, start the Vector Signal Analyzer by double clicking the icon or clicking **Start > (All) Programs > Agilent 89600 VSA > Vector Signal Analyzer**.
4. Set up the 89600 Vector Signal Analyzer:
 - a. Click **File > Preset > Preset Setup**.
 - b. Click **Input > Channels > 2 Channels**.
5. Set up the spectrum analyzer:
 - a. Preset.
 - b. Set the reference level to 15 dBm.
 - c. Set the center frequency to 3.711 GHz.
 - d. Set the span to 5 MHz.
6. For each frequency listed below verify that the amplitude is < 10.0 dBm. If the signal level is marginal, verify with a power meter.

89600 center frequency	Spectrum analyzer center frequency
252.4 MHz	3710 MHz
252.5 MHz	3712.5 MHz
254 MHz	3711 MHz

If any reading is incorrect then the E273x is most likely faulty.

Troubleshooting the Display Driver

This section provides display driver troubleshooting information.

Problem

The symbol location shape, such as the dots, on the constellation trace displays do not show properly.

Possible Cause

The display driver may not be functioning properly.

Solution

Use this procedure to correct the display driver:

1. Update the display driver:
Contact your PC manufacturer to see if a newer version of the display driver is available. If there is, update the driver and verify if the problem is fixed.
2. Reconfigure the display driver settings:
If the latest display driver does not fix the problem, try decreasing the hardware acceleration.
 - (Windows XP Instructions) Click **Start > Control Panel > Display > Settings > Advanced > Troubleshoot**, then decrease the hardware acceleration value, click **OK > OK**.

17 **Circuit Descriptions**

Introduction

This chapter contains block diagrams and circuit descriptions of the 89600 series VXI measurement hardware. This information is provided to help you understand system operation and identify and isolate problems to a specific module.

These products consist of VXI measurement hardware and Vector Signal Analysis (VSA) software running on a standard Windows XP workstation. The 89600 series includes three analyzer configurations with VXI measurement hardware:

- 89611 70 MHz IF Analyzer, see: "[Agilent 89611 70 MHz IF Analyzer circuit description](#)" (page 263)
- 89610 DC - 40 MHz Analyzer (with optional second input channel), see: "[Agilent 89610 circuit description](#)" (page 255)
- 89640 DC - 2.7 GHz Analyzer and 89641 DC - 6.0GHz Analyzer, see: "[Agilent 89640/89641 circuit description](#)" (page 259)

Agilent 89610 circuit description

The Agilent 89610 Vector Signal Analyzer VXI hardware includes the following VXI modules:

- Agilent E8491 Option 001 IEEE 1394 PC Link to VXI (Firewire)
- Agilent 89606 Input module
- Agilent E1438 ADC module
- Option 002, 102, 145, and 289 include a second E1438 module

For module descriptions in this section, refer to [Figure 17-1 on page 256](#).

E8491 PC Link to VXI

The E8491 module provides the link between the computer and the VXI measurement hardware. No signal acquisition or processing happens in this module. For detailed information on this module and the IEEE 1394 interface, refer to the PDF document *Agilent E8491B IEEE 1394 PC Link to VXI Configuration and User's Guide* located at http://www.home.agilent.com/upload/cmc_upload/All/E8491-90001_users.pdf.

89606/B Input Module

The 89606 Input module accepts the input signal and passes it to the E1438 ADC module. During calibration, the input signal path is interrupted. The calibrator in the 89606 module inserts a calibration signal into the signal path to the E1438 ADC module. The calibration signal is taken from the 10 MHz reference and multiplied by 10 to match the E1438 sampling rate of 100 MSa per second. The E1438 ADC uses the same 10 MHz reference, so the calibration source is phase locked to the sample clock.

The 89606 also provides a 10 MHz reference signal to the Agilent E1438 module. An additional 10 MHz Ref output is available on the module front panel to connect to other instruments in your measurement setup. For the 89606B only, you can connect a 10 MHz or 13 MHz reference signal to the Ext Reference In connector.

Use of this module outside the 89600-series of analyzers is not supported.

Figure 17-1

89610 block diagram

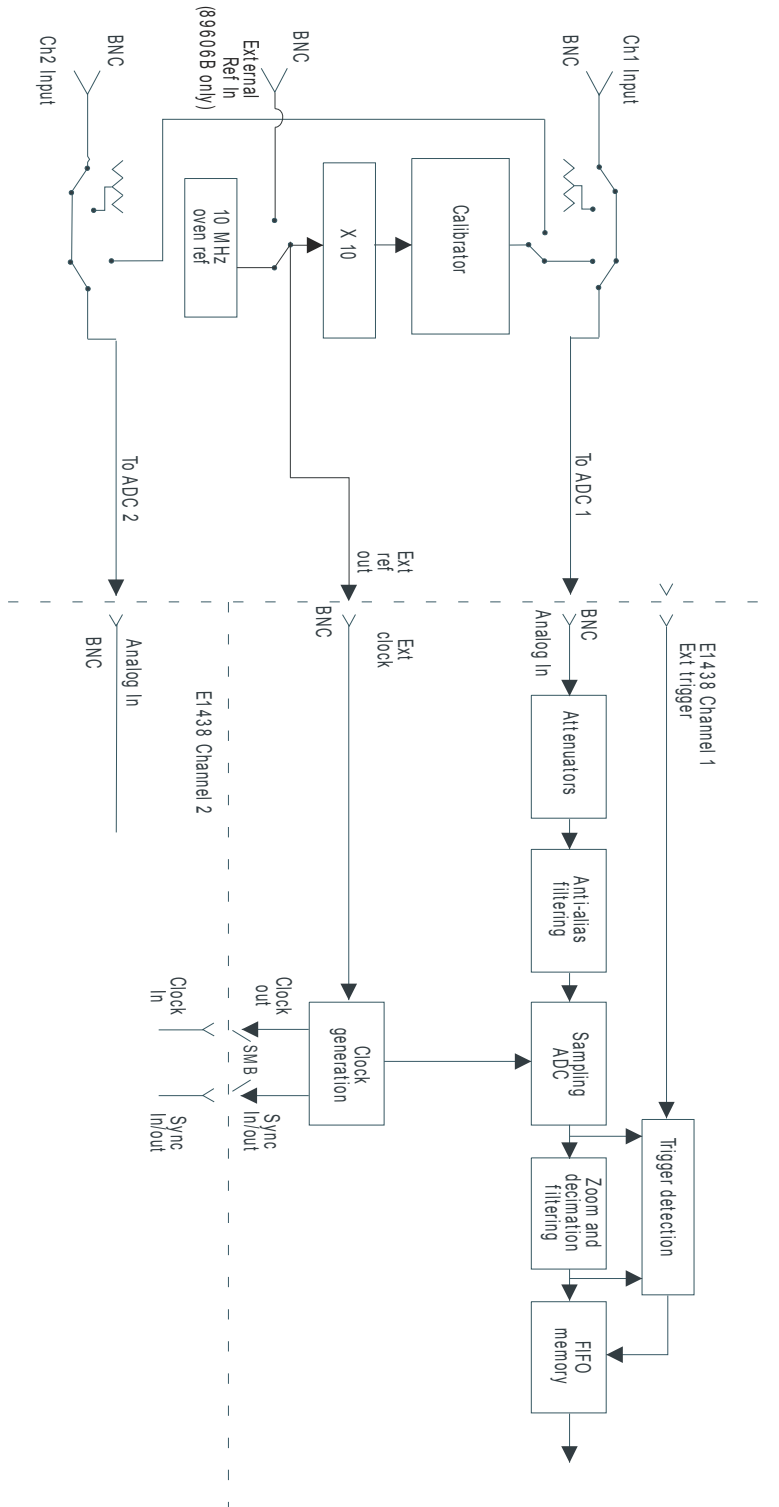

E1438 ADC Module

All signal processing happens in the Agilent E1438A 100 MSa/s ADC + Filter + FIFO (attenuation, anti-alias filtering, etc.). Detailed information about this module is available in a PDF file: *Agilent E1438 VXI 100 MSa/s ADC with filters and memory User's Guide*. This guide is installed on your computer, however, you may have to use the Search function to find the exact location. Typical locations include the following:

C:/Vxi/Vxipnp/Winnt/age1438/help/e1438_Users_Guide.pdf

C:/Program Files/Visa/Winnt/age1438/help/e1438_Users_Guide.pdf

Triggering

For external trigger mode, a trigger signal must be supplied at the *Ext Trigger* connector on the front panel. This input is AC coupled with an impedance of 1 K ohm so any signal with a sharp rising or falling transition greater than 100 mV (for example, TTL or ECL logic) can be used as an external trigger source. Minimum pulse width is 300 ns.

If your system includes two E1438 modules, you can use the external trigger connector on either module. The bi-directional Intermodule Sync connectors on the module front panels connect the trigger signal between the modules. This synchronizes the two modules so that they receive the trigger signal simultaneously.

Coupling

The input can be either AC or DC coupled. AC coupling enables the system to measure low level AC signals in the presence of a large DC offset.

Ranging

Attenuation is the first step in the E1438 module. The module provides 0 to 51 dB of attenuation in 3 dB steps, resulting in analyzer input ranges between -31 dBm and 20 dBm in 3 dB steps.

Anti-alias filtering

Since the normal ADC sample rate is 100 MHz, a complete representation of the input signal can be achieved only for bandwidths up to 50 MHz. Frequency components above 50 MHz can cause ambiguous results (aliasing).

The anti-alias filter attenuates these high frequency components to reduce aliasing. The anti-alias filter in the Agilent E1438 is flat to 40 MHz and rejects signals above 60 MHz by at least 90 dB. Thus the 0-40 MHz frequency range of the sampled signal is -90 dB alias free. The filter's transition band from 40 MHz to 60 MHz affects flatness and enable some aliasing in the sampled signal frequency range of 40 MHz to 50 MHz.

Analog-to-digital (ADC) signal conversion

The central part of the E1438 is a precision sampling ADC. The ADC samples the

signal at a rates up to 100 MSa/sec and converts the analog signal to a digital signal.

Zoom and decimation filtering

This section uses digital circuitry to enable programmable changes in the center frequency and signal bandwidth of the 89610 analyzer (zoom). Bandwidth is controlled by a chain of digital low-pass filters. Each of the filters reduces the bandwidth by a factor of 2 (decimation).

Memory

Digitized data is stored in memory in the E1438 module and read out after a block of data has been taken. The digitized data passes through the E8491 interface to the measurement software in the computer.

For information on how the signal is processed by the measurement software, see the 89600 online help for “System Block Diagram” under Tutorial, Theory of Operation. Typically, this help file is in location:

C:/Program Files/Agilent/89600 VSA/Help/tasks.hlp

Agilent 89640/89641 circuit description

The Agilent 89640 Vector Signal Analyzer VXI hardware includes the following VXI modules:

- Agilent E8491 Option 001 IEEE 1394 PC Link to VXI
- Agilent 89605 Input module
- Agilent E1439 ADC module
- Agilent E2730 RF Tuner module
- optional second IF/baseband channel, including an additional E1439 and E2730 modules

The Agilent 89641 Vector Signal Analyzer VXI hardware includes the following VXI modules:

- Agilent E8491 Option 001 IEEE 1394 PC Link to VXI
- Agilent 89605 Input module
- Agilent E1439 ADC module
- Agilent E2731 RF Tuner module
- optional second IF/baseband channel, including an additional E1439 and E2731 modules

The module descriptions in this section apply to the 89640/89641 block diagram: "[89640/89641 block diagram](#)" (page 260). Your analyzer may include a second IF/baseband channel, which is not shown in the block diagram.

E8491 PC Link to VXI

The E8491 module provides the link between the computer and the VXI measurement hardware. No signal acquisition or processing happens in this module. For detailed information on this module and the IEEE 1394 interface, refer to the PDF document *Agilent E8491B IEEE 1394 PC Link to VXI Configuration and User's Guide* located at http://www.home.agilent.com/upload/cmc_upload/All/E8491-90001_users.pdf.

Figure 17-2

89640/89641 block diagram

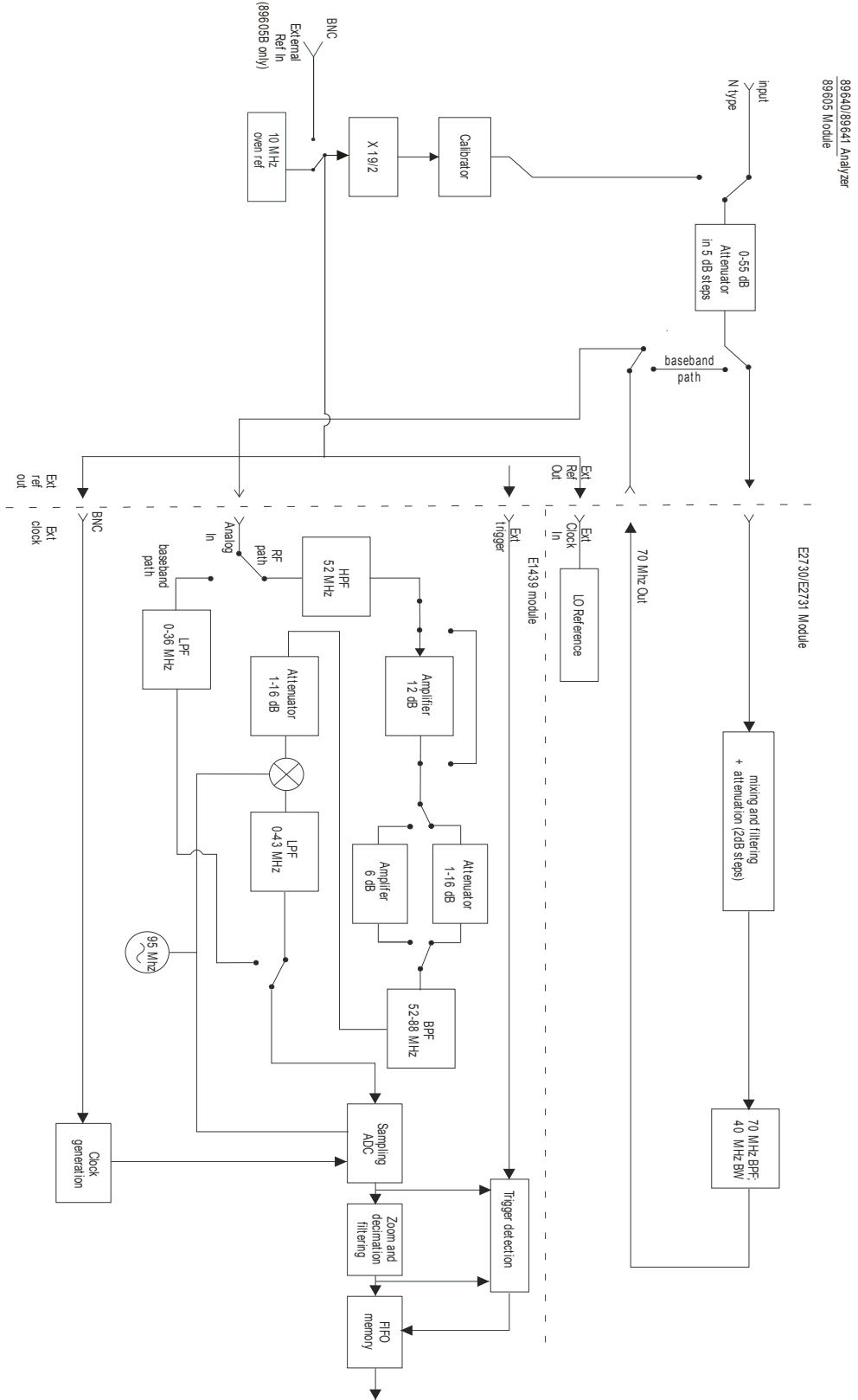

89605 Input Module

The 89605 Input module accepts the input signal and passes it through a 0-to-50 dB attenuator (5 dB steps). In baseband mode (0 to 36 MHz), the signal is routed directly to the E1439 module, by-passing the E2730/E2731 module. In RF mode (36 MHz to 2.7 GHz or 6 GHz), the signal is routed to the E2730/E2731 RF Tuner. The down-converted signal from the E2730/E2731 comes back to the 89605 and is routed to the E1439 module.

During calibration, the input signal path is interrupted. The calibrator in the 89605 module inserts a calibration signal into the signal path to the E1439 ADC module. The calibration signal is taken from the 10 MHz reference and multiplied by 19/2 to match the E1439 sampling rate of 95 MSa per second. The E1439 ADC uses the same 10 MHz reference, so the calibration source is phase locked to the sample clock.

The 89605 also provides a 10 MHz reference signal to the E2730/E2731 and E1439 modules. An additional 10 MHz Ref output is available on the module front panel to connect to other instruments in your measurement setup. For the 89605B only, you can connect a 10MHz or 13 MHz reference signal to the Ext Reference In connector.

Use of this module outside the 89600-series of analyzers is not supported.

E2730/E2731 RF Tuner module

The E2730 RF Tuner has a frequency tuning range of 20 to 2700 MHz in 1 kHz steps. The E2731 RF Tuner has a frequency tuning range of 20 to 6000 MHz. Each tuner converts the input signal in multiple stages of local oscillators, amplifiers, attenuators, and filters. The 70 MHz output has a bandwidth of 36 MHz, resulting in an output signal to the ADC between 52 MHz and 88 MHz.

Use of this module outside the 89600-series of analyzers is not supported.

E1439 ADC module

The input signal passes to the E1439 ADC module in one of two ways. If the input frequency band is 0 Hz to 36 MHz, the signal goes directly to the E1439 module. If the input frequency band is 36 MHz to 2.7 GHz or 6 GHz, the signal goes to the RF Tuner module to be down converted. From the RF Tuner module, the signal goes back through the 89605 module to the Agilent E1439 95 MSa/s ADC + Filter + FIFO + 70 MHz IF Input module.

Detailed information about this module is available in a PDF file: *Agilent E1439 VXI 70 MHz IF ADC with filters and memory User's Guide*. This guide is installed on your computer, however, you may have to use the Search function to find the exact location. Typical locations include the following:

C:/Vxi/Vxipnp/Winnt/age1439/help/e1439_Users_Guide.pdf

C:/Program Files/Visa/Winnt/age1439/help/e1439_Users_Guide.pdf

Triggering

For external trigger mode, a trigger signal must be supplied at the *Ext Trigger* connector on the front panel. This input is AC-coupled with an impedance of 1K ohm so any signal with a sharp rising or falling transition greater than 100 mV (for example, TTL or ECL logic) can be used as an external trigger source. Minimum pulse width is 300 ns.

Coupling

The input can be either AC or DC coupled. AC coupling enables the system to measure low level AC signals in the presence of a large DC offset.

Signal conditioning

In 0-36 MHz mode, the input signal goes through the lower path in the block diagram. In this mode, no attenuation occurs in the E1439 module.

In 36 MHz-2.7 GHz (or 6 GHz) mode, the input signal goes through the upper path in the block diagram. This path includes 0 to 32 dB of attenuation in 1 dB steps. The signal is band-pass filtered, mixed with 95 MHz, and low-pass filtered. This inverts and translates the frequency spectrum from 52-88 MHz at the input to 43-7 MHz at the ADC. The ADC samples the signal at a 95 MHz sample rate.

Analog-to-digital (ADC) signal conversion

The central part of the E1439 is a precision sampling ADC. The ADC samples the signal at a rate of up to 95 MSa/sec and converts the analog signal to a digital signal.

Memory

Digitized data is stored in memory in the E1439 module and read out after a block of data has been taken. The digitized data passes through the E8491 interface to the measurement software in the computer.

For information on how the signal is processed by the measurement software, see the 89600 online help for “System Block Diagram” under Tutorial, Theory of Operation. Typically, this help file is in location:

C:/Program Files/Agilent/89600 VSA/Help/tasks.hlp

Agilent 89611 70 MHz IF Analyzer circuit description

The Agilent 89610 Vector Signal Analyzer VXI hardware includes the following VXI modules:

- Agilent E8491 Option 001 IEEE 1394 PC Link to VXI
- Agilent 89605 Input module
- Agilent E1439 ADC module
- an optional second channel, including an additional 89605 and E1439 module

In addition, the 89611 requires an external down converter that provides a 70 MHz IF out signal. If you use an Agilent PSA option H70 as the down converter, the 89600 software controls the down converter. Otherwise, you must control the down converter separately from the 89600 interface.

The module descriptions in this section apply to: "[89611 block diagram](#)" ([page 264](#)). This block diagram does not include the optional second channel.

E8491 PC Link to VXI

The E8491 module provides the link between the computer and the VXI measurement hardware. No signal acquisition or processing happens in this module. For detailed information on this module and the IEEE 1394 interface, refer to the PDF document *Agilent E8491B IEEE 1394 PC Link to VXI Configuration and User's Guide* located at http://www.home.agilent.com/upload/cmc_upload/All/E8491-90001_users.pdf.

Figure 17-3

89611 block diagram

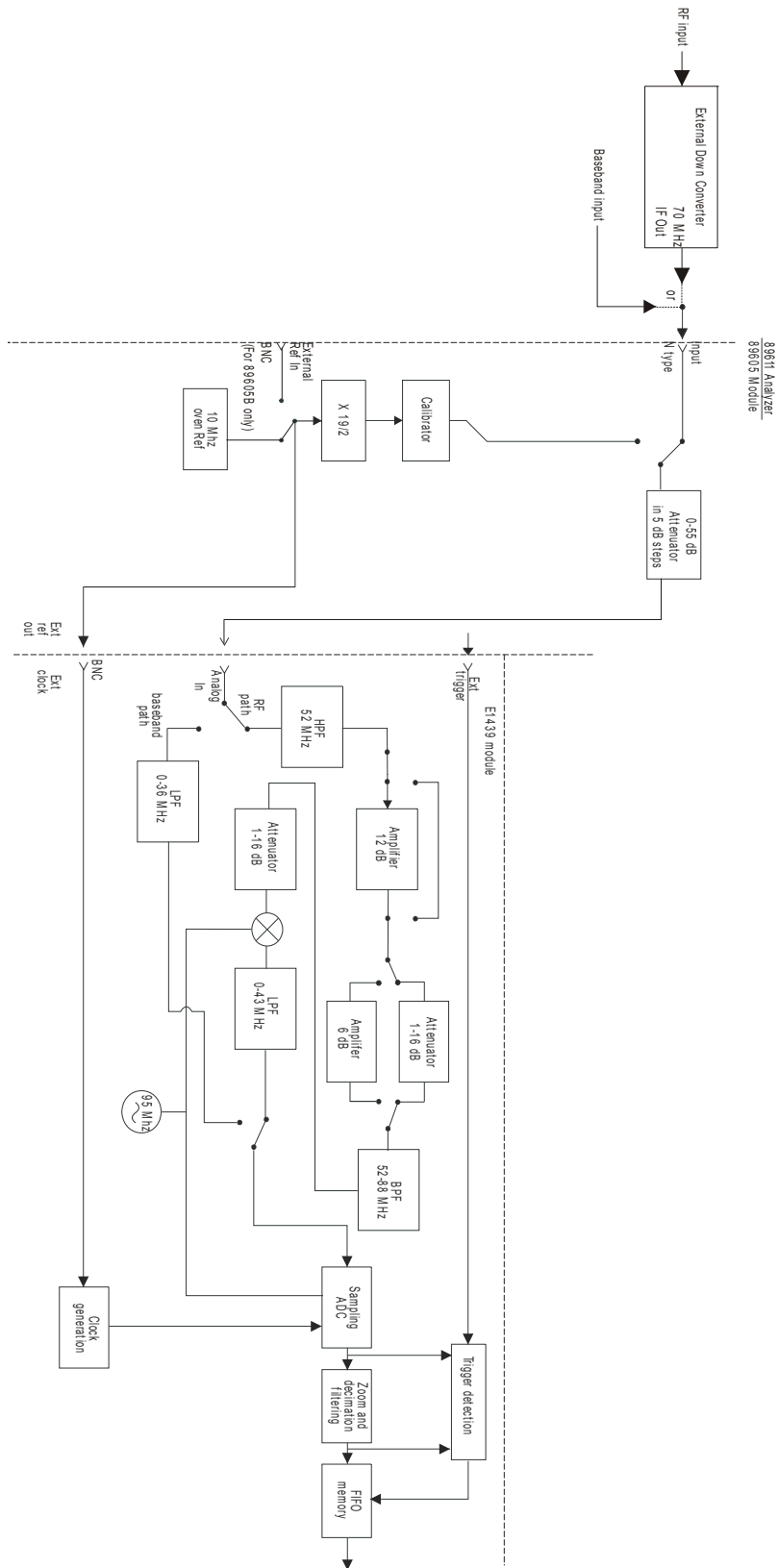

89605 Input Module

The 89605 Input module accepts the baseband input signal and passes it through a 0-to-50 dB attenuator (5 dB steps). In baseband mode (0 to 36 MHz), the signal from the Ch 1 Input connector is routed to the E1439 module. For the upper frequency band (frequencies determined by the down converter used), the signal is routed from the *From 70 MHz IF Out* connector to the E1439 module (via the *To ADC Analog In* connector).

During calibration, the input signal path is interrupted. The calibrator in the 89605 module inserts a calibration signal into the signal path to the E1439 ADC module. The calibration signal is taken from the 10 MHz reference and multiplied by 19/2 to match the E1439 sampling rate of 95 MSa per second. The E1439 ADC uses the same 10 MHz reference, so the calibration source is phase locked to the sample clock.

The 89605 also provides a 10 MHz reference signal to the E1439 module. An additional 10 MHz Ref output is available on the module front panel to connect to other instruments in your measurement setup. For the 89605B only, you can connect a 10 MHz or 13 MHz reference signal to the Ext Reference In connector.

Use of this module outside the 89600 series analyzers is not supported.

E1439 ADC Module

The input signal passes to the E1439 ADC module in one of two ways. If the input frequency band is 0 Hz to 36 MHz, the signal at the 89605 input is passed directly to the E1439 module. If the input frequency band is 20 MHz to 2.7 GHz, the signal comes from the external down converter through the 89605 module to the E1439 95 MSa/s ADC + Filter + FIFO + 70 MHz IF Input module.

Detailed information about this module is available in a PDF file: *Agilent E1439 VXI 70 MHz IF ADC with filters and memory User's Guide*. This guide is installed on your computer, however, you may have to use the Search function to find the exact location. Typical locations include the following:

C:/Vxi/Vxipnp/Winnt/age1439/help/e1439_Users_Guide.pdf

C:/Program Files/Visa/Winnt/age1439/help/e1439_Users_Guide.pdf

Triggering

For external trigger mode, a trigger signal must be supplied at the *Ext Trigger* connector on the front panel. This input is AC coupled with an impedance of 1 K ohm so any signal with a sharp rising or falling transition greater than 100 mV (for example, TTL or ECL logic) can be used as an external trigger source. Minimum pulse width is 300 ns.

Coupling

The input can be either AC or DC coupled. AC coupling enables the system to measure low level AC signals in the presence of a large DC offset.

Signal conditioning

In 0-36 MHz mode, the input signal goes through the lower path in the block diagram. In this mode, no attenuation occurs in the E1439 module.

In 36 MHz-2.7 GHz mode, the input signal goes through the upper path in the block diagram. This path includes 0 to 32 dB of attenuation in 1 dB steps. The signal is band-pass filtered, mixed with 95 MHz, and low-pass filtered. This inverts and translates the frequency spectrum from 52-88 MHz at the input to 43-7 MHz at the ADC. The ADC samples the signal at a 95 MHz sample rate.

Analog-to-digital (ADC) signal conversion

The central part of the E1439 is a precision sampling ADC. The ADC samples the signal at a rate of up to 95 MSa/sec and converts the analog signal to a digital signal.

Memory

Digitized data is stored in memory in the E1439 module and read out after a block of data has been taken. The digitized data passes through the E8491 interface to the measurement software in the computer.

For information on how the signal is processed by the measurement software, see the 89600 online help for “System Block Diagram” under Tutorial, Theory of Operation. Typically, this help file is in location:

C:/Program Files/Agilent/89600 VSA/Help/tasks.hlp

Replaceable parts for VXI hardware

NOTE

This chapter contains information only for VXI measurement hardware modules. If your analyzer uses other measurement hardware, such as an Agilent E4406 or Agilent E4440, refer to the service document shipped with that product.

For VXI mainframes, refer to the mainframe documentation on replaceable parts.

For information on upgrading your analyzer or replacing parts, contact your local Agilent Technologies sales and service office. See the list of office locations and addresses in the back of this manual.

Ordering Information

To order Agilent parts in the U.S., call Agilent Technologies Support Parts at (877) 447-7278. Outside the U.S., please contact your local Agilent Technologies parts center.

See the following pages for replaceable parts lists:

System cables and connectors

- ["Agilent 89610A parts" \(page 269\)](#)
- ["Agilent 89611A parts" \(page 269\)](#)
- ["Agilent 89640A parts" \(page 270\)](#)
- ["Agilent 89641A parts" \(page 271\)](#)

Modules

- ["89605 parts" \(page 272\)](#)
- ["89606 parts" \(page 272\)](#)
- ["E1438 parts" \(page 272\)](#)
- ["E1439 parts" \(page 272\)](#)
- ["E2730 parts" \(page 273\)](#)
- ["E2731 parts" \(page 273\)](#)
- ["E8491B parts" \(page 273\)](#)

Agilent 89610A parts

Cables, connectors, and terminations. References for illustrations showing cable connections:

- [“Cable connections, 89610” on page 52](#)
- [“Cable connections, two-channel 89610” on page 53](#)

Part Number	Description	Qty
8121-0133	flex BNC (m) to BNC (m) cable 267 mm, black	1
8120-6237	flex BNC (m) to BNC (m) cable 172 mm, black	1

Additional cables and connectors for second input channel

Part Number	Description	Qty
8121-0132	BNC (m) to BNC (m) cable 215 mm, black	1
03585-61603	SMB (f) to SMB (f) cable, 100 mm, orange	2
1250-0676	50 ohm SMB termination	4

Agilent 89611A parts

Cables, connectors, and terminations (double the quantities for 2-channel configurations). References for illustrations showing cable connections:

- [“Cable connections, 89611” on page 55](#)
- [“Cable connections, 89611 with PSA Option H70” on page 56](#)
- [“Cable connections, two-channel 89611” on page 59](#)

Part Number	Description	Qty
8121-0132	flex BNC (m) to BNC (m) cable 215 mm, black	2
1250-0780	N (m) to BNC (f) Adapter	1
8121-0790	SMA(m) to SMA(m) cable 1,219 mm	1
1250-1250	Type N(m) to SMA(f) adapter	1
1250-1700	BNC(m) to SMA(f) adapter	1
1250-0590	coax SMA cap	2

Additional cables and connectors for second input channel:

Part Number	Description	Qty
03585-61603	SMB (f) to SMB (f) cable, 100 mm, orange	2
8121-0132	flex BNC (m) to BNC (m) cable 215 mm, black	1
1250-0676	50 ohm SMB termination	4

Replacing VXI Hardware
Replaceable parts for VXI hardware

Part Number	Description	Qty
1250-0590	coax SMA cap	2

Agilent 89640A parts

Cables, connectors, and terminations. (Double the quantities for 2-channel configurations.) References for illustrations showing cable connections:

- [“Cable connections, 89640” on page 61](#)
- [“Cable connections, 89640 with second IF/baseband channel” on page 62](#)
- [“Cable connections, 89640 with second RF channel” on page 64](#)
- [“Cable connections, 89640 with external down converter” on page 66](#)

Part Number	Description	Qty
8121-0132	flex BNC (m) to BNC (m) cable 215 mm, black	2
1250-0780	N (m) to BNC (f) Adapter	1
89605-61691	SMA (m) to SMA (m) Semi-rigid cable	1-2*
89605-61692	SMA (m) to SMA (m) Semi-rigid cable with toroid	1
89605-61693	SMA (m) to SMA (m) Semi-rigid cable	0-1*
1250-0590	coax SMA cap	2

* With an 89605A, you need two 89605-61691 cables. With an 89605B, you need one 89605-61691 cable and one 89605-61693 cable.

Additional cables and connectors for second IF channel:

Part Number	Description	Qty
03585-61603	SMB (f) to SMB (f) cable, 100 mm, orange	2
1250-0676	50 ohm SMB termination	4
8121-0132	flex BNC (m) to BNC (m) cable 215 mm, black	1

Additional cables and connectors for second RF channel:

Part Number	Description	Qty
03585-61603	SMB (f) to SMB (f) cable, 100 mm, orange	2
1250-0676	50 ohm SMB termination	4
8121-0132	flex BNC (m) to BNC (m) cable 215 mm, black	1
89605-61696	semi-rigid SMA cable	2
1250-0590	coax SMA cap	2

Agilent 89641A parts

Cables, connectors, and terminations. References for illustrations showing cable connections:

- [“Cable connections, 89641” on page 67](#)
- [“Cable connections, 89641 with second IF/baseband channel” on page 68](#)
- [“Cable connections, 89641 with second RF channel” on page 70](#)
- [“Cable connections, 89641 with external down converter” on page 72](#)

Part Number	Description	Qty
8121-0132	flex BNC (m) to BNC (m) cable 215 mm, black	2
1250-0780	N (m) to BNC (f) Adapter	1
89605-61691	SMA (m) to SMA (m) Semi-rigid cable	1-2*
89605-61694	SMA (m) to SMA (m) Semi-rigid cable with toroid	1
89605-61693	SMA (m) to SMA (m) Semi-rigid cable	0-1*
1250-0590	coax SMA cap	2

* With an 89605A, you need two 89605-61691 cables; with an 89605B, you need one 89605-61691 cable and one 89605-61693 cable.

Additional cables and connectors for second IF channel:

Part Number	Description	Qty
03585-61603	SMB (f) to SMB (f) cable, 100 mm, orange	2
1250-0676	50 ohm SMB termination	4
8121-0132	flex BNC (m) to BNC (m) cable 215 mm, black	1

Additional cables and connectors for second RF channel:

Part Number	Description	Qty
03585-61603	SMB (f) to SMB (f) cable, 100 mm, orange	2
1250-0676	50 ohm SMB termination	4
8121-0132	flex BNC (m) to BNC (m) cable 215 mm, black	1
89605-61696	semi-rigid SMA cable	2
1250-0590	coax SMA cap	2

89605 parts

The following lists 89605 parts.

Part Number	Description	Qty
89605-69201	Exchange 89605A module	1
89605-69211	Exchange 89605B module	1

89606 parts

The following lists 89606 parts.

Part Number	Description	Qty
89606-69201	Exchange 89606A module	1
89606-69211	Exchange 89606B module	1

E1438 parts

For information in installing SDRAM, see the Replacing Assemblies chapter in the Agilent E1438 VXI 100 MSa/s ADC with filters and memory User's Guide. This guide is installed in your computer, however, you may have to use the Search function to find the exact location. Typical locations include the following:

C:/Vxi/Vxipnp/Winnt/age1438/help/e1438_Users_Guide.pdf

C:/Program Files/Visa/Winnt/age1438/help/e1438_Users_Guide.pdf

Part Number	Description	Qty
E1438-69202	Exchange E1438 module	1-2
1818-7901	ICM SDRAM 128 MB	0-2
1818-7889	ICM SDIMM 16 MB	0-2
1818-8606	IC SDRAM 64MX7	0-2

E1439 parts

For information in installing SDRAM, see the Replacing Assemblies chapter in the Agilent E1439 VXI 70 MHz IF ADC with filters and memory User's Guide. This guide is installed in your computer, however, you may have to use the Search function to find the exact location. Typical locations include the following:

C:/Vxi/Vxipnp/Winnt/age1439/help/e1439_Users_Guide.pdf

C:/Program Files/Visa/Winnt/age1439/help/e1439_Users_Guide.pdf

Part Number	Description	Qty
E1439-69202	Exchange E1439 module	1-2

Part Number	Description	Qty
1818-7901	ICM SDRAM 128 MB	0-2
1818-8606	IC SDRAM 64MX7	0-2
1818-7889	IC SDIMM 16 MB	0-2

E2730 parts

The following lists E2730 parts.

Part Number	Description	Qty
E2730-69201	Exchange E2730A module	1
E2730-69211	Exchange E2730B module	1-2
1250-0590	coax SMA cap	2

E2731 parts

The followings lists E2731 parts.

Part Number	Description	Qty
E2731-69201	Exchange E2731A module	1
E2731-69211	Exchange E2731B module	1
E2731-61601	SMA (m) to SMA (m) Semi-rigid cable	1
1250-0590	coax SMA cap	2

E8491B parts

See E8941B service manual for installation instructions. You can also find this PDF guide using: <http://www.agilent.com>. Click on Technical Support and Search for E8491B. Select E8491B Configuration and User's Guide from the results. You can also view this guide as a PDF using the link:

http://www.home.agilent.com/upload/cmc_upload/All/EP5G084330.pdf

Part Number	Description	Qty
E8491-66202	Module, Service Replaceable E8491B	1
8121-0078	E8491B to IEEE-1394/PCI card cable	1
E8491-61613	IEEE-1394/PCI card power adapter cable	1
E8491-66204	IEEE-1394/PCI Card	1

Transporting VXI modules

CAUTION

The VXI modules are static sensitive; use appropriate precautions when removing, handling, and installing to avoid damage.

- Package the module using the original factory packaging or packaging identical to the factory packaging.
- If returning the module to Agilent Technologies for service, attach a tag describing the following:
 - Type of service required
 - Return address
 - Model number
 - Full serial number

In any correspondence, refer to the module by model number and full serial number.

- Mark the container FRAGILE to ensure careful handling.
- If necessary to package the module in a container other than original packaging, observe the following (use of other packaging is not recommended):
 - Wrap the module in heavy paper or anti-static plastic.
 - Protect the front panel with cardboard.
 - Use a double-wall carton made of at least 200-pound test (32 ECT) material.
 - Cushion the module to prevent damage. For example, several layers of plastic bubble wrap is usually sufficient.

CAUTION

Do not use pellets in any shape as packing material for the module. The pellets do not adequately cushion the module and do not prevent the module from shifting in the carton. In addition, some pellets create static electricity which can damage electronic components.

Storing VXI modules

Store modules in a clean, dry, and static free environment.

Replacing VXI Hardware
Storing VXI modules

Numerics

1680 Series Logic Analyzers, [141](#)
1690 Series Logic Analyzer, [141](#)
16900 Series Logic Analyzers, [139](#)
89600 I/O Connections, [146](#)
89600 software, starting, [220](#)
89600 software, verify operation in
 Infiniium scope, [129](#), [135](#)
89601 software, installing in Infiniium
 scope, [125](#), [127](#), [131](#), [133](#)
89604
 licensing, [190](#)
89605 Input Module, [261](#), [265](#)
89606/B Input Module, [255](#)
89610 2-channel
 cable connections, [53](#)
 configuring, [42](#)
89610 signal path
 troubleshooting, [248](#)
89610 single channel
 cable connections, [52](#)
 configuring, [41](#)
89610 with external downconverter
 cable connections, [54](#)
89610, Block Diagram, [256](#)
89610, circuit description, [255](#)
89611 2-channel
 cable connections, [59](#)
 configuring, [44](#)
89611 70MHz IF Analyzer, [263](#)
89611 Block Diagram, [264](#)
89611 single channel
 cable connections, [55](#)
 configuring, [43](#)
89611 with ESA Option H70
 cable connections, [57](#)
89611 with PSA Option H70
 cable connections, [56](#)
89640 Block Diagram, [260](#)
89640 single channel
 cable connections, [61](#)
 configuring, [45](#)
89640 with external down converter
 cable connections, [66](#)
89640 with second BB channel
 cable connections, [62](#)
 configuring, [46](#)
89640 with second RF channel
 cable connections, [64](#)
 configuring, [47](#)
89640, circuit description, [259](#)
89640A baseband signal path
 troubleshooting, [246](#)
89640A RF signal path
 troubleshooting, [240](#), [243](#), [247](#)
89641 Block Diagram, [260](#)
89641 single channel

 cable connections, [67](#)
 configuring, [48](#)
89641 with second BB channel
 cable connections, [68](#)
 configuring, [49](#)
89641 with second RF channel
 cable connections, [70](#)
 configuring, [50](#)
89641, circuit description, [259](#)

A

adding license files, [211](#)
address, module, [34](#)
alignment, of analyzer for accuracy, [21](#)
authorizing software, [190](#)

C

cable connections
 89610 2-channel, [53](#)
 89610 single channel, [52](#)
 89610 with external downconverter,
 [54](#)
 89611 single channel, [55](#)
 89611 with ESA Option H70, [57](#)
 89611 with PSA Option H70, [56](#)
 896112-channel, [59](#)
 89640 single channel, [61](#)
 89640 with external down converter,
 [66](#)
 89640 with second BB channel, [62](#)
 89640 with second RF channel, [64](#)
 89641 single channel, [67](#)
 89641 with second BB channel, [68](#)
 89641 with second RF channel, [70](#)
calibration, of analyzer, [21](#)
circuit descriptions, [253](#)
computer name, finding, [208](#)
computer, name, [208](#)
configure
 I/O for GPIB, [107](#)
 I/O for LAN, [97](#)
 I/O for LAN-to-GPIB Gateway, [102](#),
 [121](#)
 I/O for VXI, [95](#)
configuring your system
 89610 2-channel, [42](#)
 89610 single channel, [41](#)
 89611, [43](#)
 89611 2-channel, [44](#)
 89640, [45](#)
 89640 with second BB channel, [46](#)
 89640 with second RF channel, [47](#)
 89641, [48](#)
 89641 with second BB channel, [49](#)
 89641 with second RF channel, [50](#)

D

default logical address, [34](#)
demo license, [21](#), [190](#)
descriptions, circuit, [253](#)
DHCP-non, Infiniium networking, [114](#)

E

E1438 ADC Module, [257](#)
E1438 ADC module
 troubleshooting, [237](#)
E1438 PDF guide, [257](#)
E1439 ADC Module, [261](#), [265](#)
 troubleshooting, [238](#)
E1439 PDF guide, [261](#)
E2730 module
 troubleshooting, [239](#)
E2730 RF Tuner Module, [261](#)
E2731 RF Tuner Module, [261](#)
E4438C, [17](#)
E5810, [102](#), [121](#)
E8491 PC Link to VXI, [255](#), [259](#), [263](#)
E8491B, PDF manual, [226](#)
environment variables, when setting up
 a license, [218](#)
ESA, [16](#)
ESG, [17](#)

F

floating license client, setting up, [215](#)
floating license support, installing, [201](#)
floating license support, removing, [213](#)
floating license, overview, [217](#)
floating licenser server, starting, [207](#)

G

GPIB interface, configuring, [105](#), [107](#),
 [123](#)
GPIB, for PC IO Config connection,
 [118](#)
GPIB, installing on a laptop PC, [88](#)
GPIB, installing on desktop PC, [87](#)
GPIP, installing, [85](#)
grounding cable, [74](#)

H

Host ID, finding, [204](#)

I

I/O for GPIB
 configuring, [107](#)
I/O for LAN
 configuring, [97](#)
I/O for LAN-to-GPIB Gateway
 configuring, [102](#), [121](#)
I/O for VXI

- configuring, 95
- IEEE 1394 card
 - installation in laptop, 82
- IEEE 1394 host adapter
 - installation, 79
- IEEE-1394 interface failure
 - troubleshooting, 228
- Infiniium networking
 - Crossover cable network, Windows XP, 116
 - DHCP network, Windows 98/XP, 115
 - non-DHCP, Windows XP, 114
 - Windows XP, non-DHCP, 114
- Infiniium scope, 16
- Infiniium Windows 98, configuring, 111
- Infiniium Windows XP, configuring, 111
- Infiniium, installing 89601 software in, 125, 127, 131, 133
- installing
 - floating license support, 201
 - IEEE 1394 host adapter, 79
 - IEEE 1394I card in laptop, 82
 - license file, 206
 - modules, 39
 - site key, 194
 - VXI modules, 39
- IO Config, running, 100
- IO Libraries, IO Config, 100
- IP address, for computer on LAN, 97
- IP address, for computer with crossover cable, 98

L

- LAN interface problems, 230
- LAN interface, installing, 89
- LAN, for PC IO Config connection, 119
- LAN, installing, 85
- LAN/GPIB gateway interface, 102, 121
- LAN-to-GPIB gateway, installing, 91
- license
 - demo, 21, 190
- License Certificate, 191
- license file
 - installing, 206
 - obtaining, 204
- license servers, redundant, 209
- license, floating, overview, 217
- license, floating, setting up a client, 215
- license, setting up environment variables, 218
- license, to share a license, 196

- license, transfer from another computer, 195
- license.lic file
 - adding, 211
- licensing software, 190
- Logic Analyzer, 137, 161, 169
- Logic Analyzer Link Examples, 148
- Logic Analyzer Measurement Module Support, 140
- Logic Analyzer Software Installation, 143
- logical address
 - defaults, 34
 - setting, 34

M

- mainframe, 39
- module address
 - setting, 34
- modules
 - installing, 39

O

- obtaining a license file, 204

P

- packaging a module, 274
- parts, ordering or replacing, 268
- PC Agilent IO Config for GPIB connection, 118
- PC Agilent IO Config for LAN connection, 119
- PC Networking, for Crossover cable network, 117
- PCMCIA cardbus, 82
- PSA, 17
- PSG, 17

R

- redundant license servers, 209
- redundant license servers, setting up, 209
- removing floating license support, 213

S

- setting the logical address, 34
- shipping a module, 274
- Simulated Hardware, discussion of watermark, 129, 135
- site code
 - definition, 191
 - locating, 191
- site key
 - definition, 190
 - installing, 194

- obtaining, 191
- Site Key Request Form, 191
- source, 17
- system configuration
 - 89610 2-channel, 42
 - 89610 single channel, 41
 - 89611, 43
 - 89611 2-channel, 44
 - 89640, 45
 - 89640 with second BB channel, 46
 - 89640 with second RF channel, 47
 - 89641, 48
 - 89641 with second BB channel, 49
 - 89641 with second RF channel, 50

T

- Test equipment, recommended, 224
- transporting a module, 274
- trial license, 190
- Troubleshooting
 - LAN interface problems, 230
- troubleshooting
 - 89610 signal path, 248
 - 89640A baseband signal path, 246
 - 89640A RF signal path, 240, 243, 247
 - E1438 ADC module, 237
 - E1439 ADC Module, 238
 - E2730 module, 239
 - IEEE-1394 interface failure, 228
 - VXI I/O configuration, 227
 - VXI installation, 226
 - VXI mainframe failure, 225

U

- USB installing, 85
- USB interface, configuring, 105, 109, 123
- USB interface, installing, 90
- USB/GPIB interface, configuring, 105, 123

V

- VsaVisaConfig.txt, 233
- vsaVisaTemplate.txt, 233
- VXI hardware, block diagrams, 254
- VXI I/O configuration
 - troubleshooting, 227
- VXI installation
 - troubleshooting, 226
- VXI mainframe, 39
- VXI mainframe failure
 - troubleshooting, 225
- VXI modules
 - installing, 39
 - setting logical addresses, 34

W

watermark, Simulated Hardware, [129](#),
[135](#)

Windows 2000, environment variables,
[218](#)

Windows 98 Infinium, networking for
DHCP, [115](#)

Windows XP Infinium, networking for
DHCP, [115](#)

Windows XP Infinium, networking for
non-DHCP, [114](#)

Windows XP, environment variables,
[218](#)

Contacting Agilent

By internet, phone, or fax, get assistance with all your test and measurement needs

Online assistance: www.agilent.com/find/assist

United States

(tel) 1 800 452 4844

Latin America

(tel) (305) 269 7500

(fax) (305) 269 7599

Canada

(tel) 1 877 894 4414

(fax) (905) 282-6495

Europe

(tel) (+31) 20 547 2323

(fax) (+31) 20 547 2390

New Zealand

(tel) 0 800 738 378

(fax) (+64) 4 495 8950

Japan

(tel) (+81) 426 56 7832

(fax) (+81) 426 56 7840

Australia

(tel) 1 800 629 485

(fax) (+61) 3 9210 5947

Asia Call Center Numbers		
Country	Telephone Number	FAX Number
Singapore	1-800-375-8100	(65) 836-0252
Malaysia	1-800-828-848	1-800-801664
Philippines	(632) 8426802 1-800-16510170 (PLDT Subscriber Only)	(632) 8426809 1-800-16510288 (PLDT Subscriber Only)
Thailand	(088) 226-008 (outside Bangkok) (662) 661-3999 (within Bangkok)	(66) 1-661-3714
Hong Kong	800-930-871	(852) 2506 9233
Taiwan	0800-047-866	(886) 2 25456723
People's Republic of China	800-810-0189 (preferred) 10800-650-0021	10800-650-0121
India	1-600-11-2929	000-800-650-1101