

SERIES 90 PROM PROGRAMMER featuring the M900 CONTROL UNIT



PL PRO-LOG
CORPORATION

PRO-LOG
CORPORATION
PM9051A
PROM GANG
SERIAL NO.

M980 for quality when you program PROMs

Pro-Log's M980 is a portable, microprocessor-based control unit in our Series-90 family of PROM programmers. With the M980 and plug-in personality modules, you can program, copy, and test PROMs and other programmable devices. The M980 can use any of our field-proven personality modules, including individual, generic, and gang modules. Its software enables you to implement a host of optional plug-in interfaces—to terminals, computers, development systems, and other equipment.

Whether a design engineer, manufacturer, or field-service engineer, you'll find that the M980 meets your current needs—as well as your future needs—now.

As a company manager, you'll welcome the M980 as a cost-effective ally in your fight to keep the lid on your engineering, production, and field-service costs.

Using the M980 and Pro-Log's plug-in personality modules, you can:

- Program, compare, read, and duplicate more than 450 different devices, including PROMs, PALs, and microprocessors containing programmable memory.
- Perform blank checks, six-digit checksums, and illegal-bit checks.
- Edit data in the CMOS RAM buffer memory, including move, insert, delete, and nibble swap.
- Retain data in the CMOS RAM buffer for 7 days with power off.
- Interface with computers, development systems, paper-tape readers, and TTYs.
- Utilize visible and audible prompting to ensure proper programming operations.
- Use the manufacturing mode for single keystroke duplicating.
- Select built-in, self-test functions.
- Operate with a safe, UL-listed, product.

Contents

M980 for:

Engineering	2
Manufacturing	4
Field-Service	5
Management	6
Pro-Log for Support	7
M980 Features	8-23
Development System Interfaces	13
Personality Module Selection	24-30
Accessories	31
General Information	32
Pricing	33

M980 for engineering— powerful, versatile, flexible

Using the M980 control unit, and Pro-Log's plug-in personality modules, you can program, compare, read, and duplicate any one of over 450 devices available today: PROMs, PALs, microprocessors, and other devices that include PROMs. And tomorrow? The M980 is ready to handle virtually any programmable device now being conceived—PROMs and PROM arrays as large as 64K words x 16 bits.

Here's what else you can do with the M980/Series-90:

Calculate and display a six-digit checksum on a PROM in either the master or the copy socket of the personality module, or on the buffer memory. You can perform this checksum on all or any part of a PROM or the buffer memory.

Your checksum feature reassures you that your master PROM is valid and properly inserted in the master socket. It also gives you a high-confidence verification of the data pattern stored in any area of buffer memory or in a copy PROM, without comparing the pattern directly against a master.

Perform an illegal-bit check on the copy PROM, as compared to a master PROM or the buffer memory.



Blank check either a master PROM or copy PROM to see if your specific address field is in the unprogrammed state. Through its blank check function, the M980

automatically sequences through the specified address field. It then indicates with a tone and display whether the field is unprogrammed or not.

Edit data in the CMOS RAM buffer. You can write data into the CMOS RAM buffer from the keyboard, from a master PROM, or from an interface: paper-tape reader, TTY, or any device or system having an RS-232 interface

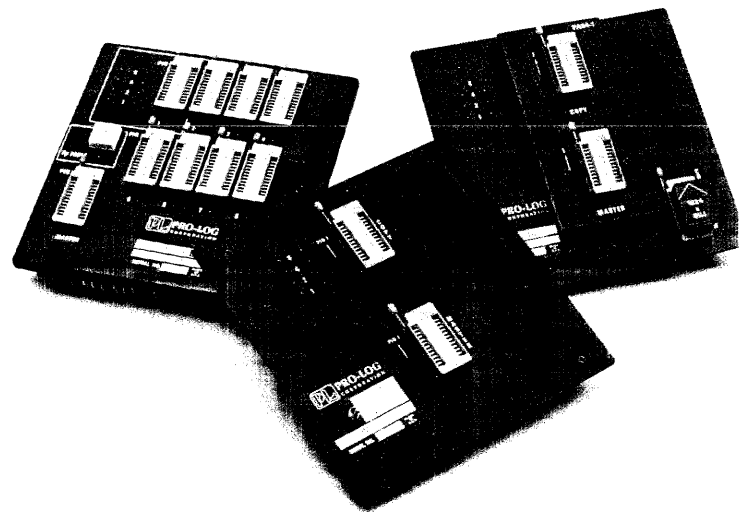

and one of the M980's many compatible data formats. Once the data is in memory, you can edit it in many ways: nibble swap, insert, delete, and block move.

Standard size of the buffer memory is 4,096 words with 8 bits in each word. Also, the memory is available in 8Kx8 and 16Kx8 sizes.

The rechargeable backup battery retains data for seven days in buffer memory when power is off. It becomes completely recharged in less than 15 hours. With this feature, you can move programs from one kind of PROM to another. Also, you can load the memory with data at one location, travel, and have the data ready to use at your destination.

Interface with a wide range of external sources: computers, development systems, paper-tape readers, and TTYs, all in multiple formats. Standard formats are Pro-Log's Standard Hex, Intel Hex, Intel Hex with Control Z for MDS, Intel Hex with ACK/NAK for communications, MOS Technology, and Tek Hex. Other formats are available as options, and new formats are being continuously developed by Pro-Log for your interface use.

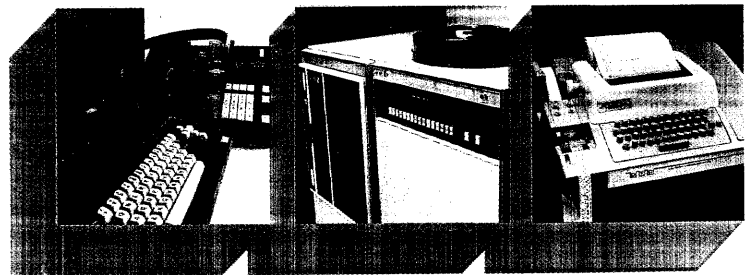
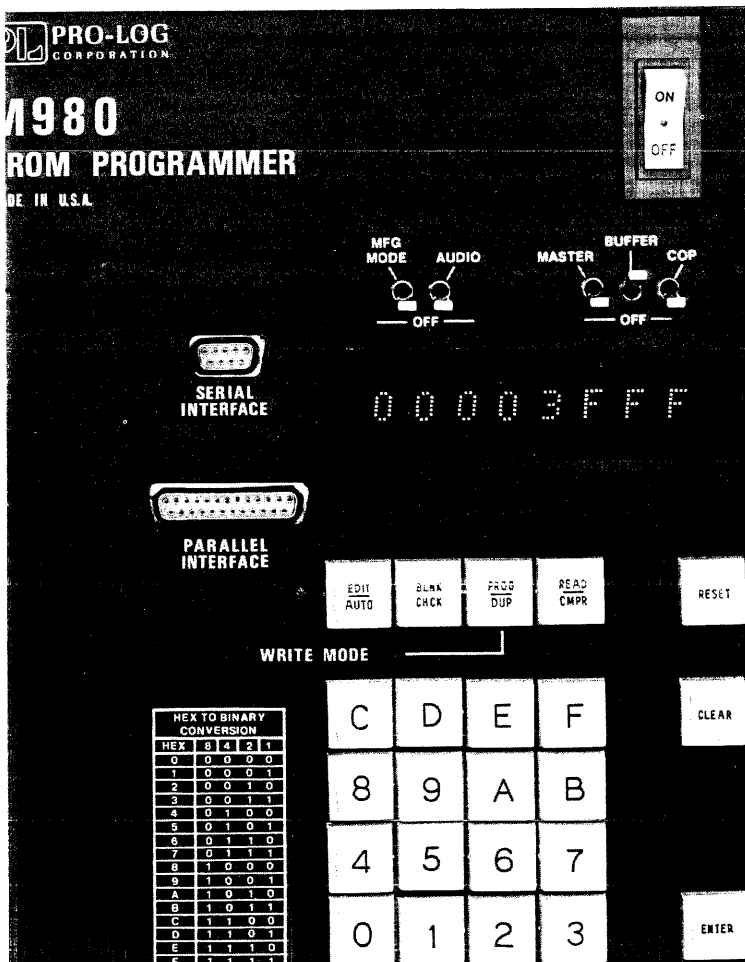

Self-test the keyboard, displays, RAM buffer memory, and switches. You can select whichever self-test you want, using the keyboard.

Pro-Log keeps in constant touch with PROM manufacturers. We know what changes to expect in the industry, which is to your advantage. We'll be able to provide you with a new plug-in module (or modify an existing one) for almost any new or altered PROM.

M980 for manufacturing— simple, fast, reliable

If you are looking for a speedy, straightforward solution to increasing your production, the M980 helps you with a flip of its Manufacturing Mode switch.

In the manufacturing mode, you can blank check a



PROM in the copy socket, duplicate it from the master, compare it to the master, or perform all three functions in automatic sequence. You simply hit the ENTER key to activate the selected function. The M980 then performs the operation, giving both visible and audible signals of pass or fail. You can repeat the function as many times as you like with a single stroke of the ENTER key. The audio features are particularly helpful when you want to know that an operation is complete, without watching the display. But you can disable the speaker if you wish.

This mode is ideally suited for your manufacturing environment. Its single keystroke operation makes it easy and simple to implement, requiring no skilled labor. You can never accidentally program your master PROM, because it's never exposed to programming voltages. Nor can you accidentally change data, since the hexadecimal keyboard is automatically disabled in this mode.

You can self-test the M980. You can test the keyboard, the control switches, the display, the buffer memory, and the connection of the personality module or mating optional hardware.

Pro-Log secures vendor approval for every type of personality module we produce. Our modules meet the PROM vendors' programming and testing specifications to the letter. This assures you of reliable devices after programming and maximum yield during programming. If a device vendor changes his process and his programming algorithms, we notify you and provide an update service. Also, through our Field Assurance Confidence Tests (FACTS), you can check whether your personality modules are programming to current specifications. Pro-Log's programmers and personality modules are designed to protect devices and equipment from common operator problems. For example, they include cold sockets and current-limiting features to prevent damage during insertion or removal of a PROM, even if it's plugged in backwards.

M980 for field-service— rugged, compact, portable

When troubleshooting in the field, you can examine and compare data by utilizing the read and compare modes of the M980. If you want to manipulate data for on-site modification or updating, the program and duplicate modes allow you to do it.

For remote control of diagnostics and pattern updates in the field, you can use the M980's RS-232 interface, or parallel interface, to connect to a computer, terminal, or modem. The M980 can be remotely controlled via instruction codes sent through the interface.

The M980 is modular in construction. It contains a limited number of functional high-density parts and a limited number of interconnects, to ensure reliability.

Like other components of the Series-90 system, we designed the M980 for strength, using reliable industry-standard hardware. We built it to last.

Weighing less than 22 pounds, and small enough to fit under an airline seat, you'll find the M980 easy to carry in its attaché case; or you can check it through as airline baggage, if you wish.



M980 for management— cost-effective, universal, safe

Company managers know that Pro-Log's Series-90 programmers are cost-effective and reliable. With the M980 control unit, the Series-90 programmer yields even more tangible benefits for the money you spend.

As a company manager, you'll discover the M980 equally suited for applications in your engineering, manufacturing, and field-service departments. The singular use of the M980 as a control unit for all departments spells out practical efficiency: one vendor to deal with, one piece of gear to learn, and common spares. Also, since the M980 embodies Pro-Log's design concepts of modularity, standardization, and advanced technology,

you are not buying obsolescence. The M980 carries a full, two-year parts and labor warranty. Each personality module carries a one-year parts and labor warranty.

We strive for high quality, top reliability, and complete customer satisfaction in designing and making our products. And the M980 is no exception. Each M980 includes the best industrial-grade parts. It's inspected and tested to rigid standards, including 48 hours of power-on burn-in, before shipment. The M980 is UL-listed—just one aspect of Pro-Log's commitment to provide you with a safe unit.



Pro-Log: For well-documented, up-to-date product support from an industry leader

Pro-Log introduced its first PROM programmer in 1973. Our Series-90 PROM programmers entered the marketplace in 1975. Now, more than 9,000 Series-90 PROM programmers and more than 20,000 of Pro-Log's personality modules are operating worldwide. We are a recognized leader in the PROM programming and microprocessor industry.

Pro-Log supports the M980/Series 90 with complete and thorough support documentation, including comprehensive manuals, PROM cross-references, and a *PROM User's Guide*. For example, we ship two sets of user's manuals with the M980.

Pro-Log works closely with PROM manufacturers. We keep ourselves informed and up to date on any changes in every aspect of PROM technology. We keep our customers promptly informed too. In meeting the complex changes of the the PROM industry, we service our customers' programmers rapidly and efficiently.

If you need service or technical support, contact your local representative, or call Pro-Log direct and ask for the Customer Service Department. Pro-Log sells and supports the M980 through trained sales representatives and international distributors. We service all programmers in the United States. International distributors service Pro-Log's products in their own countries.

If you find it necessary to return equipment to Pro-Log for repair, our service desk will give you a return number and instructions to expedite Pro-Log's handling of your equipment. Our repair policy is an in-plant, maximum 5-day turnaround time.

Pro-Log has gained its customers' respect through the depth and scope of its thorough support documentation, responsive customer service, and prompt hardware service—qualities that mean dependability for you.



M980 Features

Cooling-Fan Hood

Plug-in Personality Module
pp. 22-30

Contains:
—CMOS RAM Buffer Memory
—Speaker

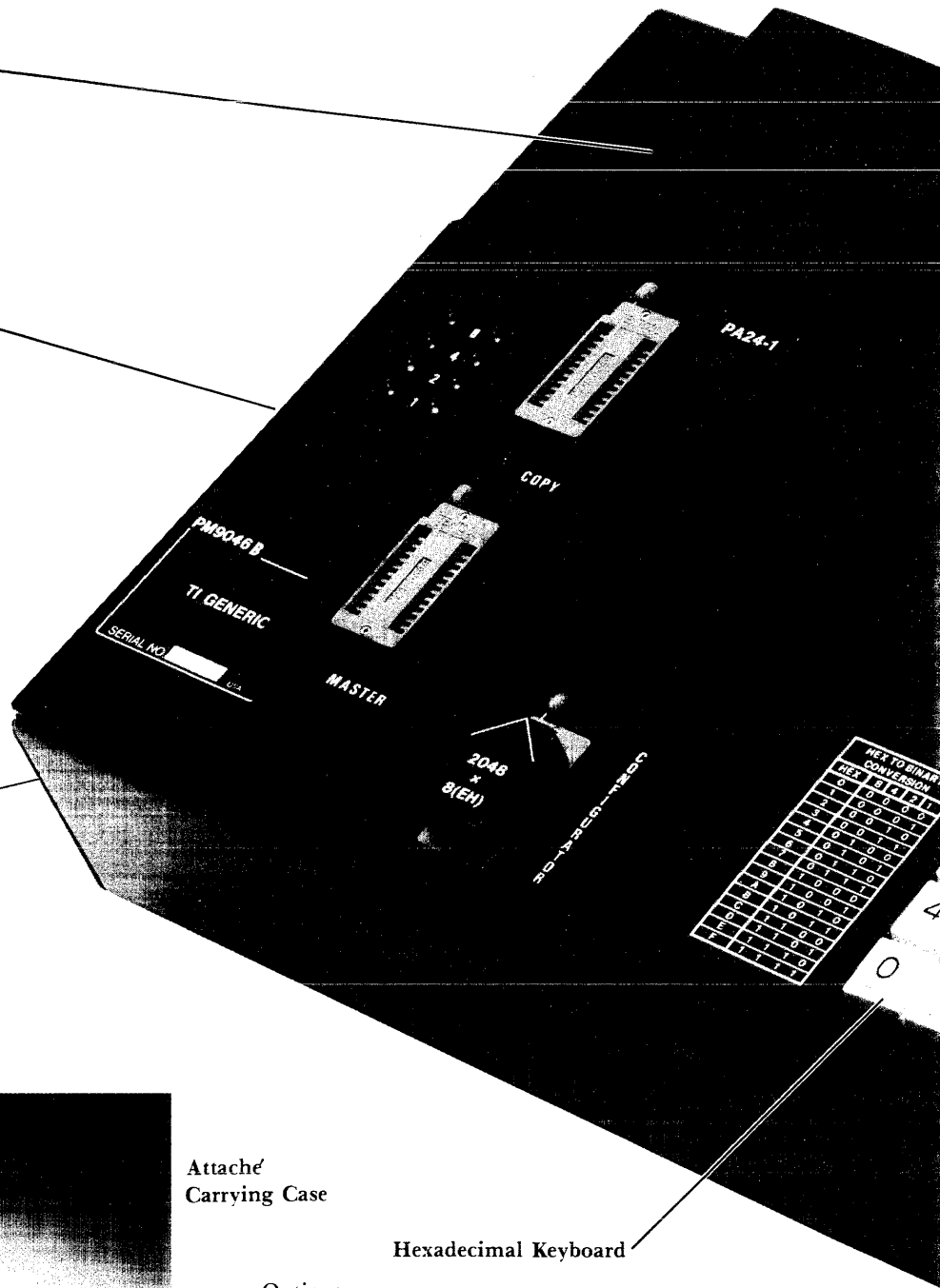

Attache' Carrying Case

Hexadecimal Keyboard



Options:

9103A U.V. Erase Light
p. 31

M301 Paper-Tape Reader
p. 18

M304 Communications Adapter
p. 15

RC12, TTY Cable
p. 19

RC18, RS-232C Cable
p. 15

9203 Personality Module Carrying Case
p. 31

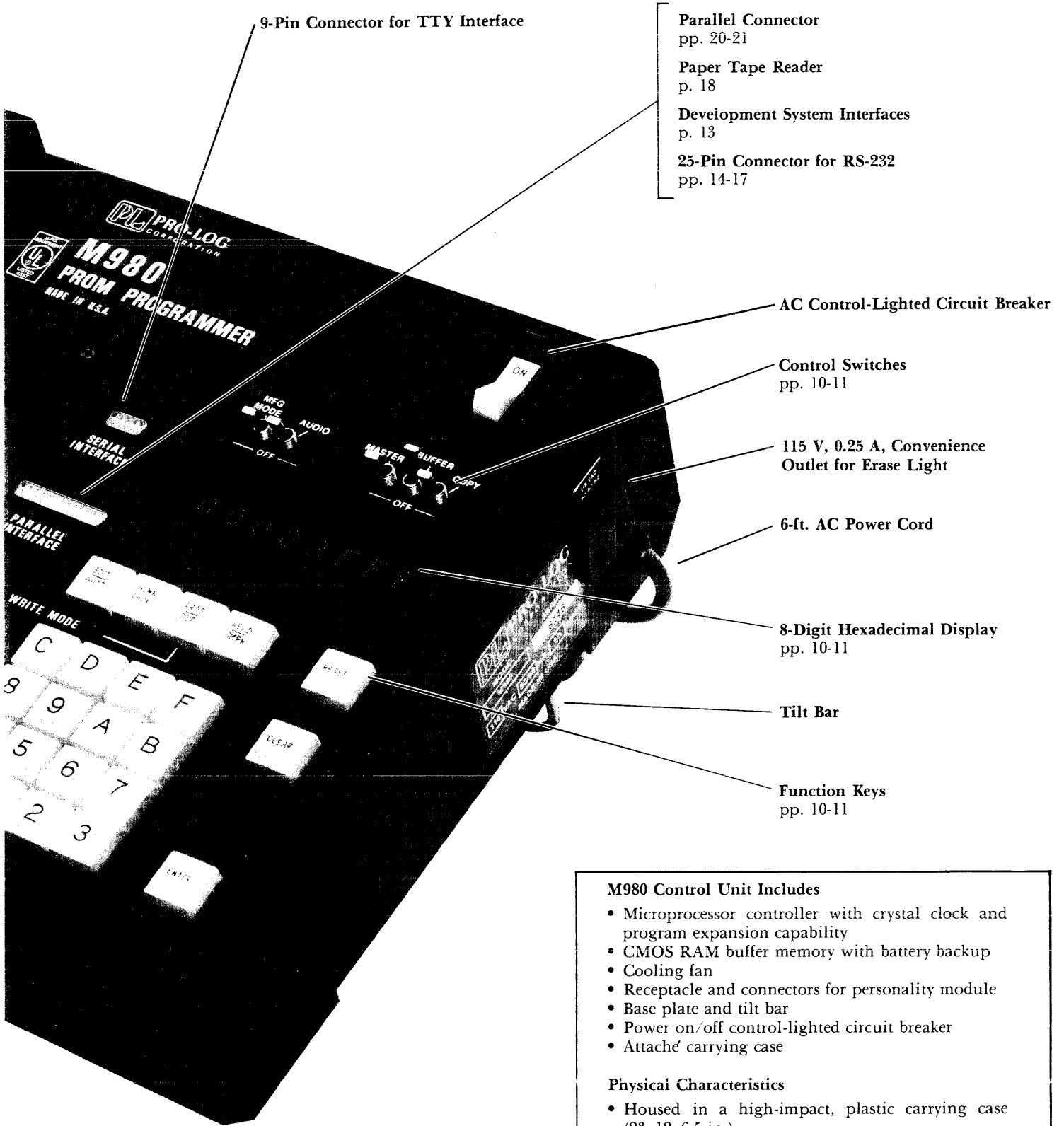

9-Pin Connector for TTY Interface

Parallel Connector
pp. 20-21

Paper Tape Reader
p. 18

Development System Interfaces
p. 13

25-Pin Connector for RS-232
pp. 14-17

AC Control-Lighted Circuit Breaker

Control Switches
pp. 10-11

115 V, 0.25 A, Convenience
Outlet for Erase Light

6-ft. AC Power Cord

8-Digit Hexadecimal Display
pp. 10-11

Tilt Bar

Function Keys
pp. 10-11

M980 Control Unit Includes

- Microprocessor controller with crystal clock and program expansion capability
- CMOS RAM buffer memory with battery backup
- Cooling fan
- Receptacle and connectors for personality module
- Base plate and tilt bar
- Power on/off control-lighted circuit breaker
- Attaché carrying case

Physical Characteristics

- Housed in a high-impact, plastic carrying case (23x12x6.5 in.)
- Maximum weight with personality module and erase light: 24 lbs.

Power Requirements

- Factory wired for either 117-V 50-60 Hz, or 220-V 50-60 Hz (100-V 50 Hz optional)
- Maximum power: 100 W

Master and Copy Socket Operations

Easy to Operate. The M980, despite its power, features, and options, is simple to operate. First, set up the five control switches—they visually indicate what elements (master, buffer memory, copy) of the programmer you intend to work with. Then, select an operating function by hitting one of the clearly labeled function keys—the display indicates your chosen function.

Next, define the limitations you place on the function, again shown by the display. Then, start your function. If it's an automatic one like checksum, blank check, duplicate, compare, or read, simply hit the ENTER key as the last step. If it's a manual function like program, key in the data, and then depress the ENTER key. The display and the audio prompter both assure you of a successful operation. An alarm tone indicates possible problems in the cockpit, hardware, or PROM.

When you duplicate or compare data between the buffer memory and either the copy socket or the master socket, the data can be in different address fields in the two devices. With this feature, you can assemble the contents of several small PROMs (e.g., 1702As) in the buffer memory, change personality modules, and copy the assembled data into one larger PROM (e.g., a 2716).

Built-in Speaker. A speaker in the M980 indicates the conclusion of a particular operation. It generates several sounds—a warm tone to indicate a successful operation, and two alarm tones to indicate problems. You can disable the speaker with the AUDIO control switch. The audible indication is not a required function, since the visible display also indicates the above conditions. The speaker is particularly useful when you don't care to watch the display, to see if an operation is complete.

Six-digit Checksum. The M980 calculates and displays a 6-digit checksum of a PROM in either the master socket or the copy socket of the personality module, or on the buffer memory. It can perform this checksum operation on the entire PROM, or on buffer memory, or on any key-selected defined address field. This feature can reassure you that your master PROM is valid and properly inserted in the master socket, that data sorted in any area of buffer memory is correct, or that data in a copy PROM is correct without having to compare it directly to a master.

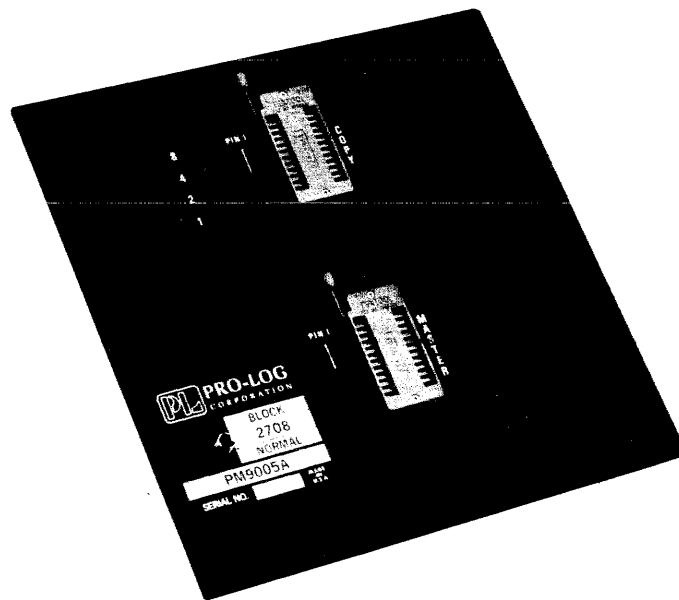

Dedicated Personality Module

Blank Check. This function allows you to check that all bits in a defined address field are in the unprogrammed state, when you insert a PROM in the master socket or in the copy socket. The M980 indicates pass or fail for the check.

Illegal-bit Check. When you hit the BLNK CHK with either the BUFFER and COPY toggle switches ON, or the MASTER and COPY switches ON, the M980 automatically selects the illegal-bit check function. Note that if either the MASTER or COPY switch is ON by itself, the M980 performs a blank check when you hit the BLNK CHK key. The M980 performs no illegal-bit check in the manufacturing mode. The M980 checks the PROM in the copy socket against the contents of either the buffer memory or the master PROM. An error signal indicates if any bit in the copy PROM is in the programmed state when the data in the other memory is in the PROM's unprogrammed state. This feature gives you a quick check of a partially programmed PROM, to see if it can be successfully programmed to match the source data.

Self-tests Included. With the M980, you can self-test the keyboard and control switches, the display, the buffer memory, and the proper connection of the personality module or mating optional hardware. The standard checksum feature, which in the M980 can checksum the master PROM, the copy PROM, or the buffer memory over any defined address field, assures you that PROM or memory data is being read properly.

Manufacturing Mode. The MFG MODE switch implements the simplest and fastest operation—one ideally suited to the manufacturing environment.

In this mode, all operations occur between the master socket and the copy socket. A PROM in the copy socket may be blank checked, duplicated from the master, and compared to the master. You can key-select any of the three modes, or all three, in an automatic sequence. Then, you hit the ENTER key once to implement your choice. The M980 performs the operation and gives both visible and audible indications of pass or fail. Thereafter, you can repeat the operation as many times as you like by hitting the ENTER key each time. Thus, PROM programming in the manufacturing environment is reduced to a single keystroke operation.

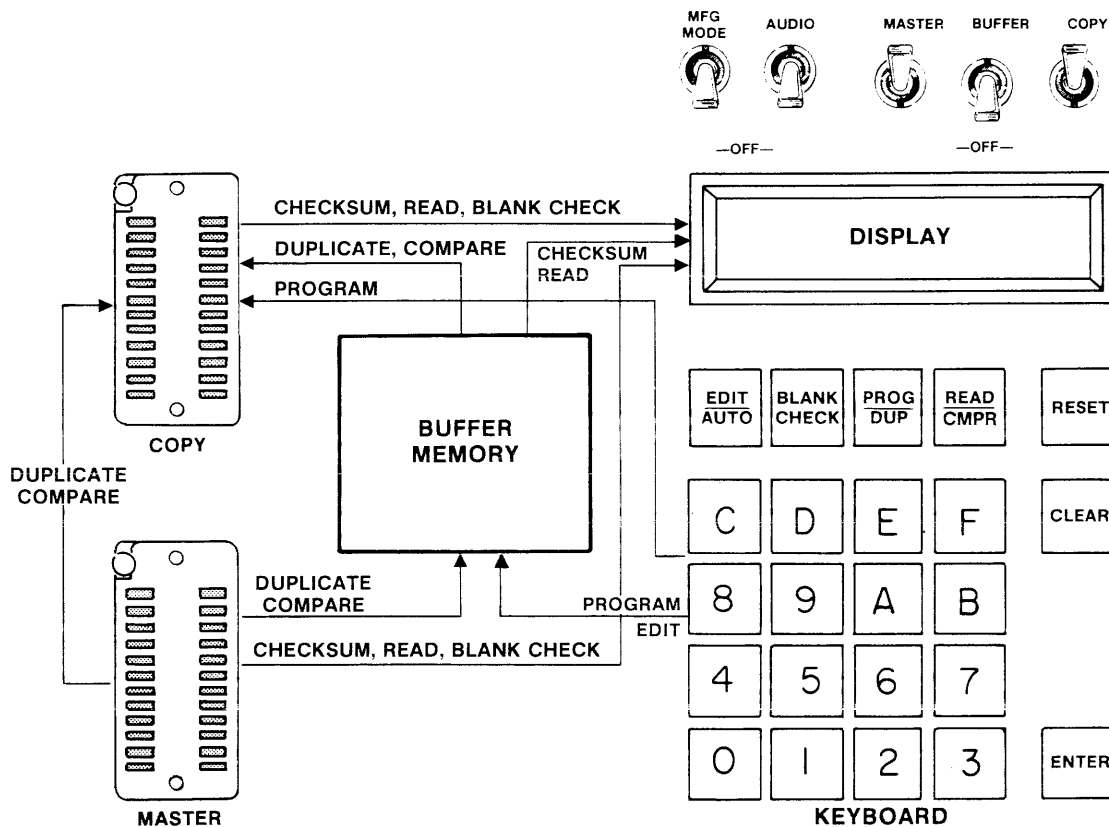

Buffer Memory

Buffer Memory Retains Data for Seven Days. The M980's CMOS RAM buffer memory provides operating features unique to the programming industry. The basic memory size is 4,096 words of 8 bits, but it is also available in 8Kx8 or 16Kx8 sizes. The memory is backed up with a rechargeable battery so that it holds data for a minimum of 7 days.

The battery recharges whenever power is on and is completely recharged in under 15 hours.

The buffer memory can be redefined by a personality module, or from the keyboard, to function as a 4-bit, 8-bit, or 16-bit memory.

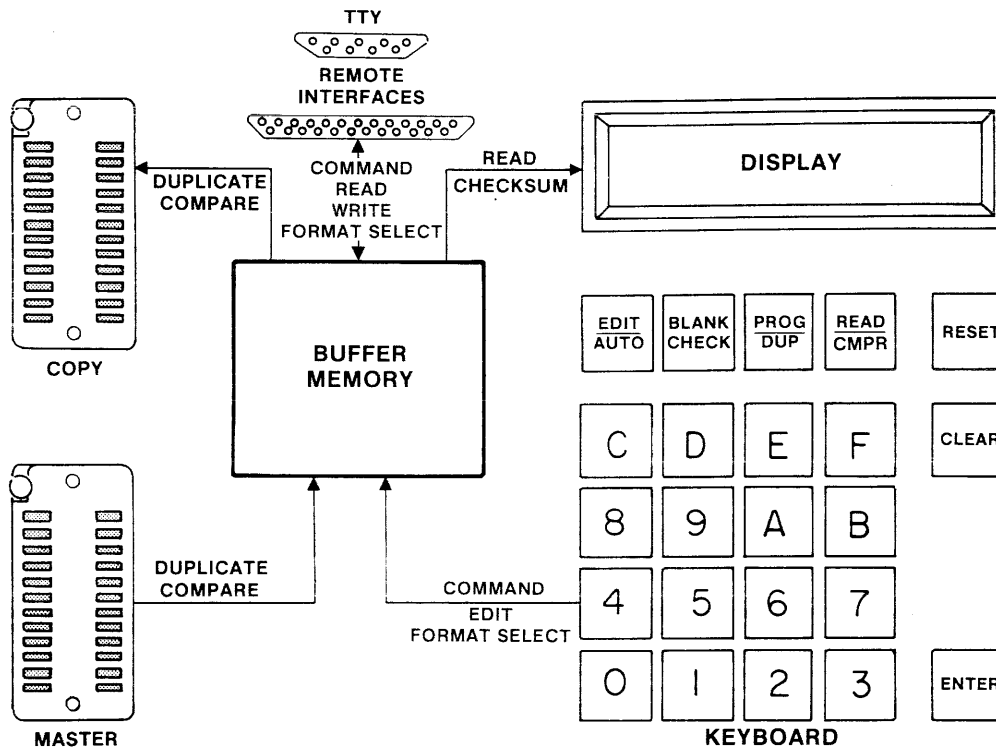

Buffer Memory Operations. Using the buffer memory in the M980, you can manipulate data before PROM programming.

The buffer can be loaded from the keyboard, master, or remote interface by various options. It can be read to the display one location at a time and can be automatically compared with the master or the copy. An automatic checksum can be performed on the buffer.

You can manipulate the buffer by a series of edit operations such as: character fill, data invert, nibble swap, insert, delete, and others.

All buffer operations can be implemented over either a full address field or a partial address field.

Keyboard Operations on Buffer Memory. You may perform all the operations described below over any desired field of data in the buffer memory. The unselected fields are left unaltered.

Program: Addresses are sequentially displayed without data. Data may be entered from the keyboard to the display for verification, and then to the indicated location in the buffer memory.

Read/Write: Data is sequentially read to the display, a character at a time, along with the data's address. Dis-

played data may be altered from the keyboard and is automatically written into the buffer.

Checksum: A 6-digit checksum is computed and displayed.

Edit Functions

Invert (Complement): Data is logically inverted.

Fill: A specific 8-bit character of data entered from the keyboard is loaded into an address field of buffer memory.

Insert: Up to thirty-two 8-bit characters of data may be inserted into a data field, starting at a specified address. The previous data in the starting address and higher addresses is automatically moved upward, to make room for the inserted data.

Delete: A block of data may be deleted from a data field. Data in higher addresses of the field is moved down to replace the deleted data. Locations vacated by the move are filled with FFs.

Block Move: A block of data may be moved from one address field in buffer to any other address field.

Nibble Swap: The most significant 4 bits of each 8-bit character in memory are exchanged with the least significant 4 bits.

Development System Interface to M980

You can interface the M980 with various development systems for direct downloading of programs to the M980's CMOS buffer. The following table includes some of the more widely used development systems that can be interfaced with the M980, along with the corresponding options that effect the interface capability for each system.

This list is a partial compilation of the more popular development systems. It does not imply that the M980 interface is limited to these systems; nor does it constitute an endorsement of any particular development system.

MANUFACTURER	MODEL	M980 INTERFACE	COMMENTS
Advanced Micro Computer	System 8 System 29	9818-12, 18 9818-12, 18	Interfaces require no system modification.
Futuredata	GenRad 230 Network 2301	9818-01, 05 9818-01, 05	Interfaces require no system modification.
Intel	MDS 210 MDS 220 MDS 230	9818-11, 12 9818-11, 12 9818-11, 12	A jumper is required on M304 adapter or Intel IOC board.
Motorola	EXORciser M68SDT	9818-16 9814	Requires no modification of EXORciser Requires Motorola system M68SDT modification. Contact: Motorola Microsystems, Box 20906, Phoenix, AZ 85036 (602) 962-3561.
RCA	COSMAC	9814	Requires RCA system modification. (See RCA Microprocessor Products Application Note ICAN-6622.)
Tektronix	8002A MDA 8550 MDL	9818-14 9818-14	Interfaces require no system modification.
Zilog	ZDS 1/25 ZDS 1/40	9814 9814	Requires no system modification. Uses Zilog Centronics Interface Board (CIB). For interfacing details, contact Zilog Technical Support Center in California (408) 446-4666.
Digital Research CP/M	—	9818-10	Use TYPE UFN.HEX ↑P or PIP via available RS-232 port.

9818 Selectable Baud-Rate Interface with the RS-232C

The interface allows an RS-232C connection between the M980 and development systems, computers, and terminals or peripherals. Many popular data formats are supported by the M980 software. Main features are:

- Numerous key-selectable data formats
- Switch-selectable baud rate from 50 to 9600 baud
- Terminal interface and modem/computer interface
- Transfer of data to or from the M980 buffer
- Remote control of duplicate and compare operations between buffer and copy

The 9818 interface is implemented through the optional M304 adapter, the keyboard-selectable format software, and the RC-18 interconnect cables. The M304 adapter plugs into the M980 parallel interface and

converts the TTL port levels of the M980 to the RS-232C levels. It also provides switching for baud-rate selection and on-line/off-line operation.

The M304 is a "T" connection that allows you to tap the M980 into existing terminal-to-computer connections. Also, the connections can be utilized independently, so that you can use the M980 separately with a terminal or a computer. The computer link can be made directly or through a modem.

Typical applications are:

- Terminal to computer and M980
- Terminal to M980 and computer
- Computer to terminal and M980 (on-line)

TERMINAL TO COMPUTER (M980 OFF-LINE)

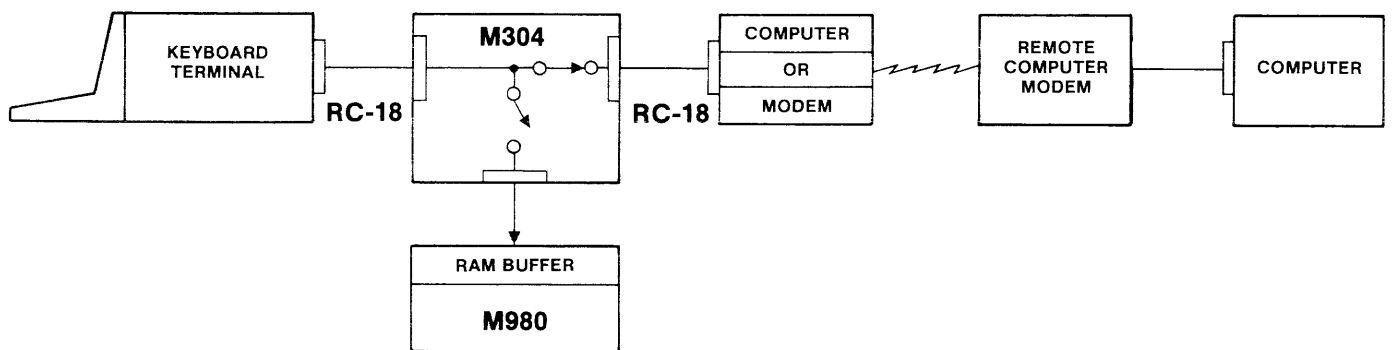

TERMINAL TO M980 RAM BUFFER

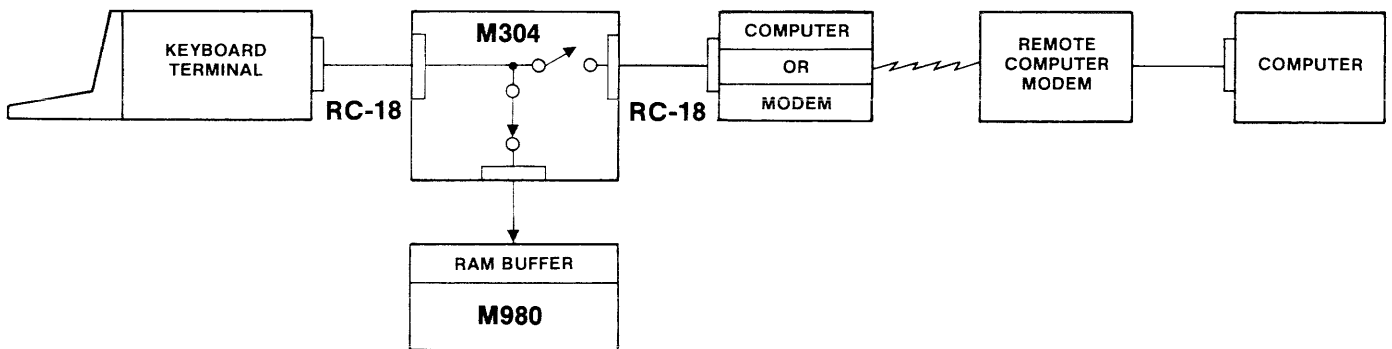

COMPUTER TO TERMINAL AND M980 (M980 ON-LINE)

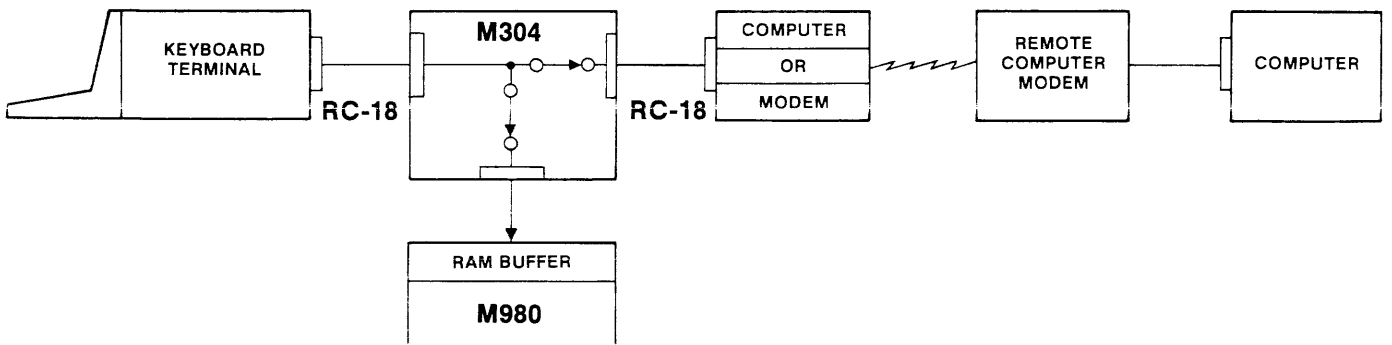

RS-232C Physical Compatibility. A 25-pin D male connector connects the M304 adapter to a terminal, and a 25-pin D female connector connects it to a modem. When

the M304 connects to a terminal, the M980 acts as a modem. When it connects to a modem, the M980 acts as a terminal.



M304, RS-232C Adapter

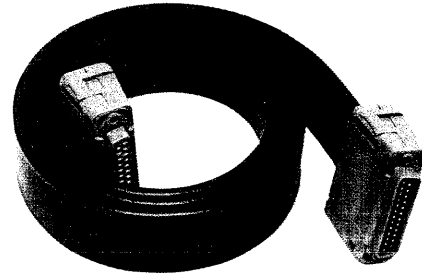

RC18, RS-232C Cable

Male connector on one end, female on the other end.

RS-232C Electrical Compatibility. The M304 works with a high input level of from +3V to +25V, and with a low input level of from -3V to -25V. Output levels are approximately +4V for a high level and -4V for a low level. Signals and pin assignments for the terminal and modem connectors are given in the pin list. Signal lines not listed are wired directly from the terminal connector to the modem connector by the M304 adapter.

Signal Discipline. The RS-232C signals provided by the M304 are used by the 9818 interface as follows:

TRANSMIT DATA, when used by the terminal, sends address, control, and data characters to the M980 and/or modem. When used by the M980, it sends data to the modem.

RECEIVE DATA, when used by the M980, sends control and data characters to the terminal. When used by the modem, it sends data to the terminal.

REQUEST TO SEND is held high by the M980 for the modem, if required.

CLEAR TO SEND, when used by the M980, indicates to the terminal that it is ready to receive characters. It indicates that the M980 is in the receive mode. This line is also used by the modem.

M304 ADAPTER		RS-232C INTERFACE CONNECTORS	
PIN NUMBER		PIN NUMBER	
SIGNAL			SIGNAL
	1	14	
TRANSMIT DATA*	2	15	
RECEIVE DATA*	3	16	
REQUEST TO SEND	4	17	
CLEAR TO SEND	5	18	
DATA SET READY	6	19	
SIGNAL GROUND	7	20	DATA TERMINAL RDY
CARRIER DETECT	8	21	
	9	22	
	10	23	
	11	24	
	12	25	
	13		

*Designates Low Level Logic

DATA TERMINAL READY, when used by the M980, determines that the M304 adapter option is installed and ready to operate. It should be held continuously high. Dropping this signal low aborts operation with the M980. CARRIER DETECT is not used, but it is held high by the M980.

Information Coding. Information is coded on the transmit and receive data lines in serial start/stop format. The code set is 7-level ASCII, plus parity, with each character sent as one start bit, seven data bits even parity, and at least one stop bit. The M980 does not check parity; however, it must be sent odd, even, or fixed.

Operation of the transmit and receive data is half-duplex. Characters received by the M980 on the transmit data line are not "echoed" back to the remote controller on the receive data line.

Data Formats. A variety of key-selectable data formats are available for the numerous communication modes that the M980 offers through its 9818 interface. They include Pro-Log formats as well as industry-compatible formats.

Pro-Log Formats. The M980 offers you seven RS-232C compatible communication modes, with minimum formatting. These simple formats interface with CRTs, printers, and terminals of limited intelligence, or with terminals and computers that have no format of their own.

You can individually select and execute the Pro-Log formats from the M980 keyboard. Hit the ENTER key to initiate the selected operation.

Also, all these formats, except the 9818-06, can be remotely executed via the interface. Remote operation is enabled by key-selecting any Pro-Log format to activate the interface. When the RS-232C link is established, the remote terminal or computer may take control by sending an 8-character starting and ending address, followed by the appropriate remote command code as given in the facing table.

Industry-Compatible Formats. The 9818 can send and receive data in a variety of industry-compatible formats that allow direct interfacing with most development systems and computers having these resident formats. It

can be used as a format converter by receiving data in one format, storing it in the buffer, then listing it out in a different format. The formats described on the following page are standard in the M980.

Each format allows you to send data to the M980 buffer from a remote terminal or computer. Also, you can send data from the M980 buffer to the remote unit in a LIST mode. The LIST mode can be initiated locally at the M980 or from the remote unit.

To initiate a local operation, key-select the desired format code. Then, hit the ENTER key twice to initiate the local LIST operation.

To enable a remote operation, key-select the desired format code, which activates the interface. When the RS-232C link is established, the remote terminal or computer may take control by sending the character "L" to initiate the LIST operation, or it may begin sending the properly formatted data block to be written to the M980 buffer.

Remote Control Via the Interface (QX). Any of the remote formats can either send data to the buffer or list the buffer back through the interface. The QX remote feature allows master-to-buffer, buffer-to-copy, and copy-to-buffer operations to be commanded via the interface. If a QX character sequence is received when any format is active, the M980 waits for additional control commands as follows:

Remote Control Command	Operation Description
DMX	Duplicate master to buffer
DBX	Duplicate buffer to copy
DC	Duplicate copy to buffer

The first eight hexadecimal characters following the remote command can be used to define the address field of operation. If a nonhexadecimal character is received immediately after the command, the full field of the PROM will be operated on.

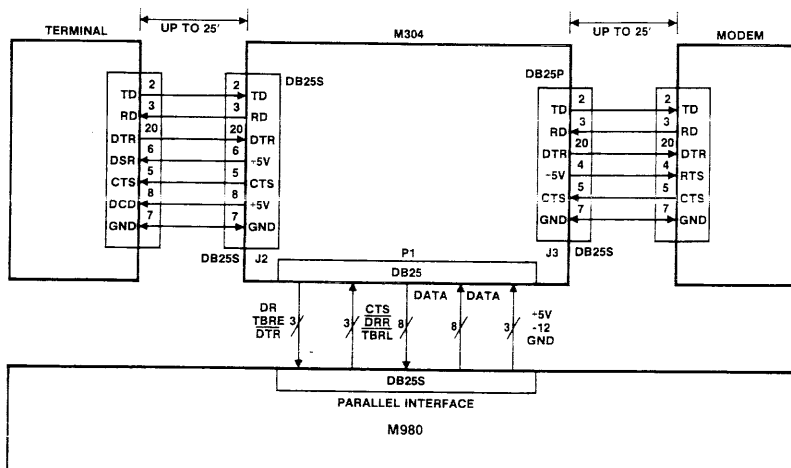

KEY SELECT	REMOTE CODE	PRO-LOG FORMAT DESCRIPTION
9818-00	P	M980 accepts ASCII hexadecimal characters as data to be written to the buffer. Each ASCII character represents 4 bits of data. Nonhexadecimal characters sent between characters are discarded.
9818-01	S	M980 lists selected buffer field in ASCII hexadecimal characters formatted in 256-byte data blocks. Each data block is preceded by a header to separate columns, and each data line is preceded by the line-starting address. Each line consists of 16 data bytes separated by spaces. Output operation halts after each block. A "SPACE" received via the interface or the ENTER key on the M980 causes the next block to be sent. Operation terminates when the end address is reached, when the M980 is reset, or when any character other than "SPACE" is received via the interface.
9818-02	L	M980 lists selected buffer field in ASCII hexadecimal characters formatted in 16-byte lines. Each line consists of 16 data bytes separated by spaces. Each line is followed by a carriage return and line feed. Output operation runs continuously until the end address is reached.
9818-03	M	M980 lists selected buffer field in ASCII hexadecimal characters formatted in 256-byte data blocks. Format and operation are identical to those of the 9818-01, except that output operation does not stop with each block but runs until the end address is reached.
9818-04	N	M980 lists selected buffer field in ASCII hexadecimal characters. Data is output in a continuous stream, without any control characters, from the start address to the end address.
9818-05	X	M980 lists selected buffer field in ASCII hexadecimal characters formatted in 16-byte lines. Each line consists of 16 data bytes separated by spaces. Each line is followed by a carriage return and a line feed. M980 outputs one line each time an XON character is received. Operation terminates when the end address is received.
9818-06	—	M980 sends a carriage return to initiate data transfer and then waits to receive ASCII hexadecimal characters as data to be written to the buffer.

INDUSTRY FORMATS

9818-10		Intel HEX basic—M980 sends or receives data in the Intel HEX block format, without any special control operations. This version is compatible with Intel HEX files based by systems other than MDS. For example, CPM-based systems can write UFN-HEX files to the M980 buffer, via TYPE UFN.HEX 1P, or read and write HEX files using the peripheral interchange program (PIP).
9818-11		Intel HEX with "ACK" or "NAK" response to checksum—M980 sends or receives data in the Intel HEX block format. In the receive mode, the M980 sends an "ACK" to acknowledge a correct checksum, and a "NAK" to acknowledge an incorrect checksum. This feature is intended to assist communication over a remote link, e.g., through a modem.
9818-12		Intel-Hex with "CONTROL Z" end-of-file terminator—M980 sends or receives data in the Intel HEX block format. In the local LIST operation, a "CONTROL Z" character is sent after the end-of-file record is sent; this is required by the Intel MDS to terminate the copy mode.
9818-14		TEK-HEX — can be used with the Tektronix 8001, and 8002 systems via the built-in commands of RHEX and WHEX.
9818-16		Motorola
9818-18		MOS Technology

9811 Interface with the M301 Paper-Tape Reader

The M980 inputs data from paper tape to its buffer memory at more than 100 characters per second, using the M301 paper-tape reader. You can load this data into the buffer memory (duplicate function) or compare it against data already in the buffer memory (compare function). The data on the tape can be in any one of four formats: ASCII-HEX, ASCII BNPF, Binary, or Intel MDS. The M301 connects directly to the 25-pin D connector on the M980. It contains its own power supply and comes in 115V and 230V AC versions.

M301 Controls and Indicators. The M301 controls consist of two rocker switches, an interface selection key, and an indicator.

The **READER POWER** switch, on top of the reader's chassis, controls the power supply for the reader's stepping motor. The **READER ENABLE** switch, on the front of the reader mechanism, enables the light source for the photoreader when the switch is ON. When the reader is in a ready condition, a red light on the reader mechanism comes on.

Selecting **KEY 1** on the M980 keyboard places the system in the operating sequence for the paper-tape reader. The four formats for the tape data are as follows:

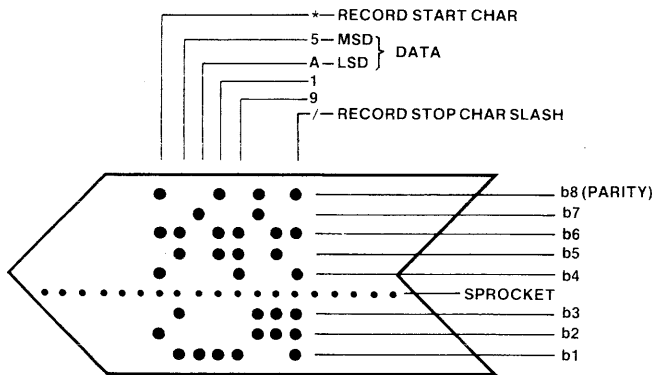

ASCII Hexadecimal Format (9811-00/01) requires 8-level, ASCII data coding, where only the hexadecimal characters represent data to be operated on.

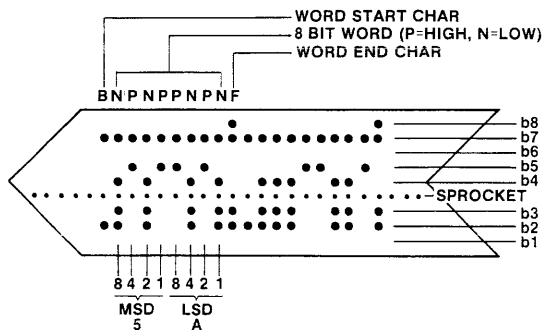

ASCII BNPF Format (9811-02/03) requires 8-level, ASCII data coding, where the characters B, N, P, and F are used to encode and control binary data words. Other characters are allowed on the tape, but they must not occur within the data word.

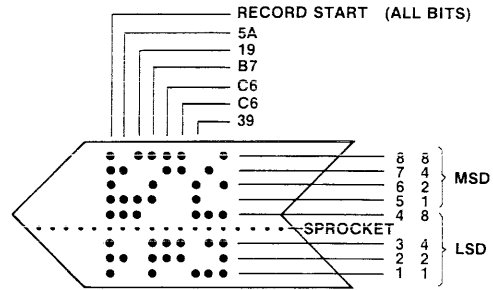

Binary Format (9811-04/05) uses all 8 punches to represent 8 bits of data. When this data is represented hexadecimally, the most significant digit (MSD) is to the wide side of the sprocket track. When 4 bits are being operated on, only the least significant digit (LSD) is used by the M980.

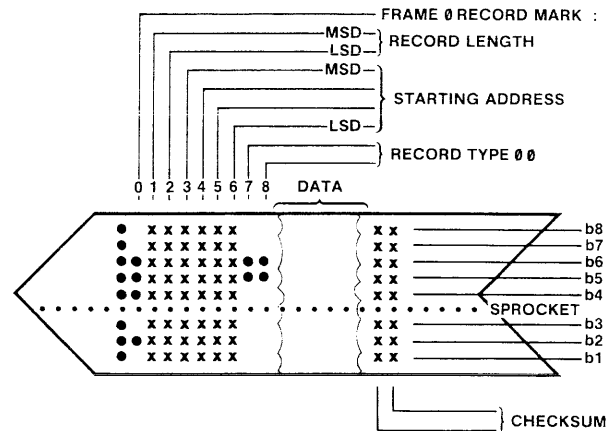

Intel MDS Format (9811-06/06) provides an interface with the M301 for reading MDS formatted paper tapes.



M301 Paper-Tape Reader

9812-02 Interface with the TTY

The M980 connects to the TTY via an optional RC12 cable. The cable provides three circuit connections, using six wires, to allow:

- Data to TTY, 20mA neutral loop receive
- Data from TTY, 20mA neutral loop send
- Reader control to TTY, 15V DC neutral loop

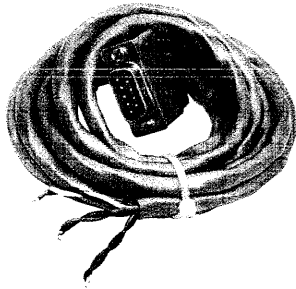

RC-12 4-ft. TTY Cable

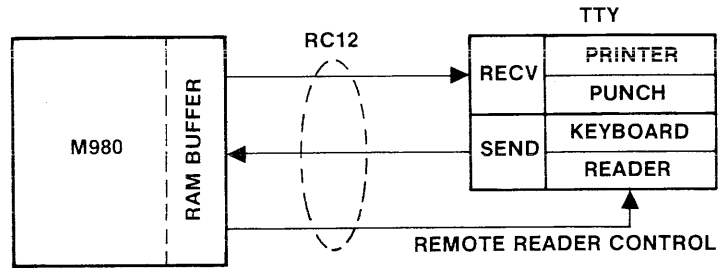

This interface allows full-duplex send and receive functions, and remote reader control, at any data rate up to 300 baud. The M980 can edit input data before printing and/or punching the output data. It can also print error information on the TTY during the compare mode, under remote reader control.

With the TTY interface, you can list, program, duplicate, and compare buffer operations from the TTY.

To utilize the interface, select key 2 on the M980, which then displays 9812-01. Depress ENTER on the M980, which then displays "A 02 AAA" for autobaud. To set the baud rate, type RETURN on the TTY. The TTY prints carriage return, line feed, and *. Type in the starting and ending addresses of the buffer field to be operated on. For the desired mode of operation, type a single letter code on the TTY as given in the following table.

TTY KEY	MODE	9812-02 OPERATION
L	LIST	Prints the content of the buffer from the start address to the end address. Sixteen buffer locations are printed on each line, with the contents of each location separated by a space. Leading spaces are inserted on the first line to maintain the hexadecimal address orientation of the printout. Buffer memory pages are separated by a blank line.
P	PROGRAM	Loads the buffer from the start address to the end address, with hexadecimal data typed from the TTY keyboard. The M980 prints the current buffer address, followed by a space. Then the user types the hexadecimal data to be loaded into the buffer. The M980 responds with carriage return-line feed and goes on to the next address.
D	DUPLICATE	Loads the buffer with ASCII-HEX data from a paper tape. The M980 recognizes all ASCII-HEX characters as data and stores them sequentially, beginning at the start address and finishing when end address or a / (slash) is reached. Nonhexadecimal characters are ignored.
C	COMPARE	Compares buffer contents against paper tape ASCII-HEX data. The tape data is compared, address by address, against the data in the buffer, beginning at the start address and finishing when the end address or a / (slash) is reached.
T	TAPE PUNCH	This mode is similar to List, but it is used with the tape punch turned ON. A 64-character leader and a second * (Asterisk) precedes the data printout, which is followed by an additional leader. Tape memory pages are separated by 16 null characters to improve readability of the paper tape.

9814 Computer Interface

The 9814 computer interface acts as an 8-bit parallel data path for transferring data to or from a computer and to or from the M980 RAM buffer. Through its parallel interface, the M980 can be configured as a master controller, or as a slave unit to a remote computer. The configuration is controlled by the cable interconnection and the keyboard-selected formats of the M980.

9814-00, M980 Slave Unit Configuration. The default format 9814-00 configures the M980 as a slave unit. It allows a remote master controller (computer) to either write data to the M980 buffer or read data from the M980 buffer. In this configuration, the remote computer commands the M980.

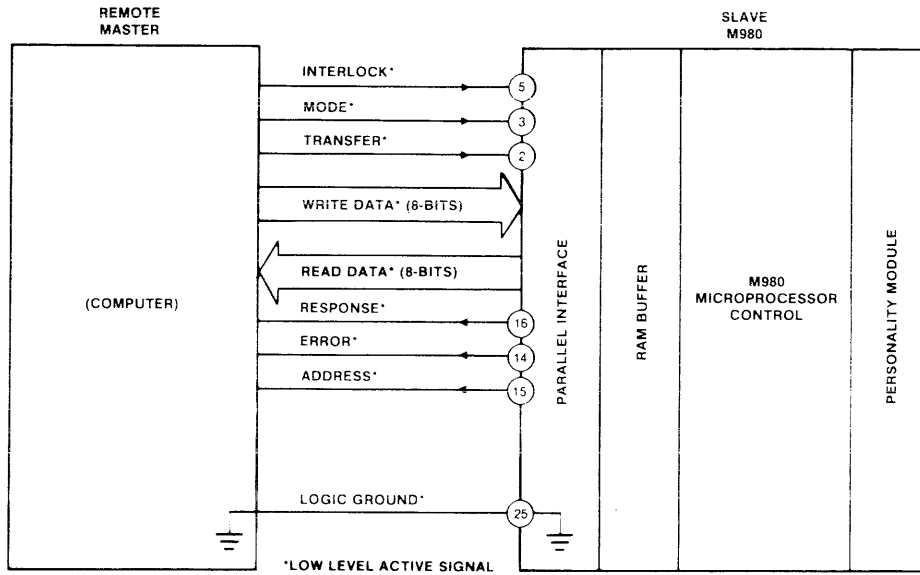

M980 Configured as a Slave Unit

9814-01 and 9814-02, M980 Master Controller Configuration. Master formats 9814-01 and 9814-02 configure the M980 as a master controller. The M980 either sends data from its buffer to a remote slave unit

(format 9814-01) or receives data into its buffer from a remote slave unit (format 9814-02). In this configuration, the M980 commands the remote computer.

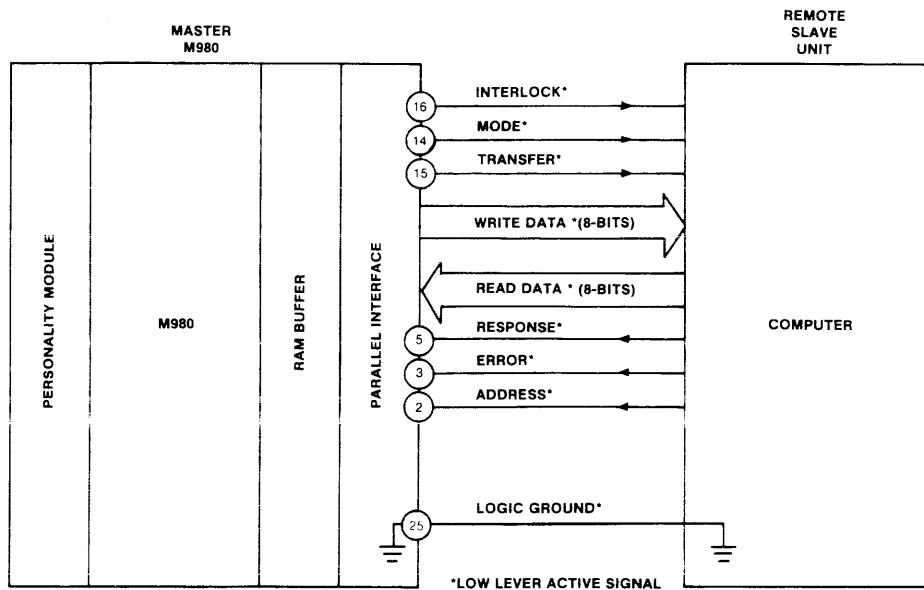

M980 Configured as a Master Controller

Transfer Operation. The master controller (computer or M980) sends the start and end addresses to the slave unit (computer or M980), to define the field size. Then, the master controller selects either the write or read mode and starts transferring data between the M980 buffer and the slave unit. Eight bits of data are transferred from each address location. After data transfer, the slave unit resets to the address field definition for the next operation. Then,

the master controller returns to select another format or to repeat the same format.

Address Field Definition. The master controller must define the address field of the M980 buffer, with start and end addresses, for each operation. The address field is sent as eight hexadecimal characters, in which each character represents four bits of the binary address. In the 8-bit character sent to the M980 for field definition, the low-order 4 bits contain the hexadecimal address character.

PARALLEL I/O WRITE DATA SIGNALS FOR ADDRESS FIELD DEFINITION AND DATA TO BE PROGRAMMED

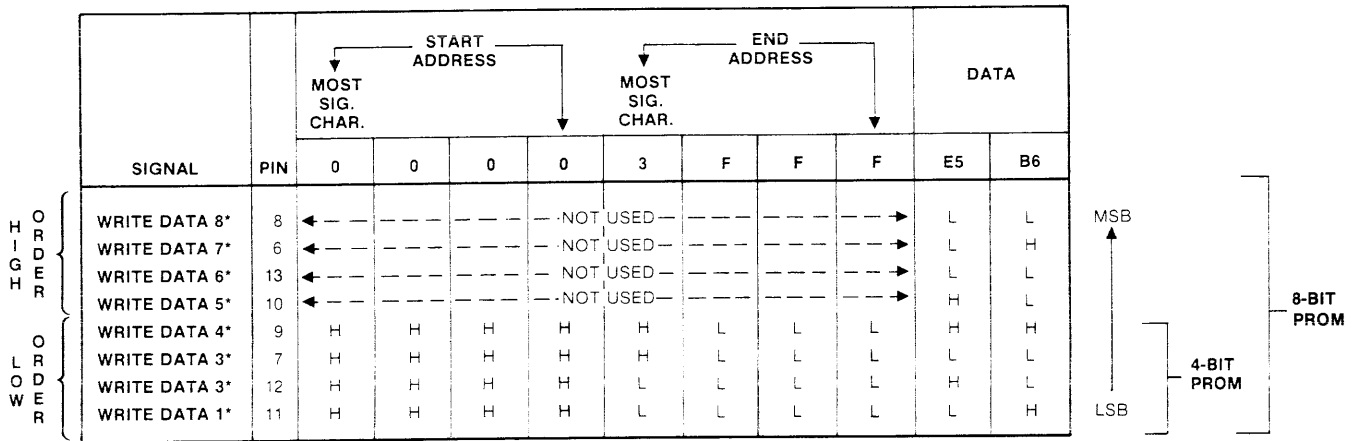

ABBREVIATIONS:
 HHIGH LEVEL TTL SIGNAL
 LLOW LEVEL TTL SIGNAL
 MSBMOST SIGNIFICANT (DATA) BIT
 LSBLEAST SIGNIFICANT (DATA) BIT

Signal Definitions:

INTERLOCK, a signal line from the master controller, that causes the slave unit to recognize the remote interface. The master controller acquires control of the slave unit by holding INTERLOCK low. It can then use the INTERLOCK to reset the slave unit to the address-field definition phase, if any error is detected.

MODE, a signal line from the master controller, indicates to the slave unit the direction of data transfer. It must be held low during address field definition and in the write mode. It must be held high in the read mode.

TRANSFER, a signal line from the master controller, indicates to the slave unit that the remote controller is ready to effect a data transfer either to or from the slave unit, as indicated by the MODE line. The TRANSFER line must not change from high to low unless RESPONSE is high; it should be held low until the master controller detects a low RESPONSE signal. If the master controller is sending data to the slave unit, the WRITE DATA lines must be stable before TRANSFER occurs. If data is being requested by the master controller, the READ DATA lines should be read after the RESPONSE signal goes low and before TRANSFER is removed (high signal).

RESPONSE is a signal sent by the slave unit as a response to the TRANSFER line. During address field definition, it indicates that the address character has been accepted. RESPONSE remains low until the last address character has been accepted. In the write mode, RESPONSE indicates that data has been accepted and stored by the

slave unit. In the read mode, RESPONSE indicates that data is available on the READ DATA lines.

ADDRESS is a signal sent by the slave unit to indicate that address field definition is required. It occurs in response to detection of the INTERLOCK signal, whenever the 9814 is selected. ADDRESS remains active until all field definition characters have been transferred to the slave unit. It terminates prematurely if the MODE line is in the incorrect state (high).

ERROR is a signal sent by the slave unit to indicate an error condition. ERROR occurs in combination with RESPONSE and ADDRESS, to indicate error mode during address field definition. It may also occur in combination with RESPONSE, to indicate error during transfer.

WRITE DATA, consisting of eight data lines from the master controller, transfers address information and data information to the slave unit. Address information is sent as a series of hexadecimal characters. The low-order data lines send the hexadecimal address characters. Data that is to be written is sent as binary data. All 8 data lines are used for 8-bit words, and the low-order 4 lines are used for 4-bit data. The most significant character is sent first, when defining the address.

READ DATA, consisting of eight data lines to the master controller, transfers data from the slave unit. Data is sent as binary data. All 8 data lines are used for 8-bit words, and the low-order 4 lines are used for 4-bit data.

Personality Modules

The PM9000 series of plug-in modules offer you a cost-effective means of programming an ever expanding range of bipolar and MOS PROMs.

Each personality module includes the circuitry for timing, voltages, and currents needed to program a PROM, when you couple the module with any of the Series-90 control units. This feature eliminates expensive periodic calibration.

Pro-Log maintains a close, but independent, relationship with PROM manufacturers. We keep you up to date on programming technology. Our ongoing program of vendor approval for all personality modules assures you of correct programming specifications. Contact Pro-Log for specific vendor approvals.

Pro-Log's four categories of modules—dedicated, generic, gang, and generic gang—offer you alternatives for specific programming applications. Each module includes self-guiding connectors for easy coupling with the Series-90 control units. See page 24 for the selection guide.

Dedicated modules include the required circuitry for programming individual nongeneric bipolar and MOS PROMs. Main features are:

- Master and copy sockets for master data protection
- Binary data display for copy PROM
- Zero-insertion-force sockets
- Usable with all Series-90 control units
- Cold sockets with the newer modules

Generic modules offer a cost-effective solution to the problems of programming a family of PROMs that have identical programming parameters, but different pin arrangements, PROM sizes, and bit structures.

Pro-Log's personality modules include electronics for controlling a PROM's voltage, current, and timing parameters. An entire generic family of PROMs can be programmed by simply accommodating the pin requirements and bit structures of a given PROM in the generic family.

Our generic module accepts one of a series of pinout adapters, to accommodate the various PROM pinout configurations. The PROM bit structures are selected by a plug-in configurator that adapts the system to the appropriate PROM configuration. A zero-insertion-force socket on the generic module accepts the configurator.

The various pinout adapters for the generic modules, and the required configurators for programming, are listed on page 24. Note that several PROMs utilize the same pinout adapter and configurator—another cost-saving factor when you use the generic family of PROMs. Main features are:

- All pinout adapters contain master and copy sockets
- Binary data display for the copy PROM
- Zero-insertion-force sockets
- Usable with all Series-90 control units
- Cold sockets with the newer modules
- Protected against devices being plugged in backwards

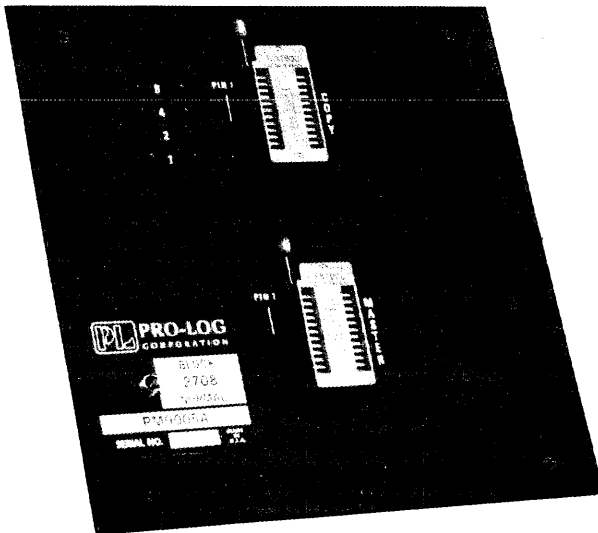

Dedicated Personality Module

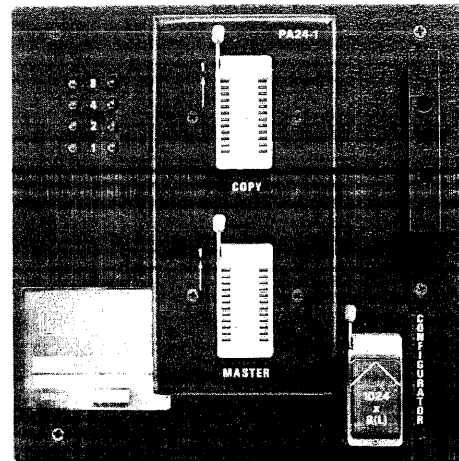

Generic Module

Gang modules provide a cost-effective alternative to expensive, cumbersome, automated high-production programming. Each module can automatically program and verify up to 8 PROMs at the same time. It takes 2 minutes to program a typical 2708 individually, but only 2-1/2 minutes to duplicate 8 of them on Pro-Log's PM9051A gang module. Main features are:

- Separate master with 8 copy sockets
- Zero-insertion-force sockets
- Automatic, self-check verify for all 8 copy PROMs
- Capability to list or verify single copy sockets
- Binary display for single copy socket
- Usable with all Series-90 control units
- Cold sockets with the newer modules

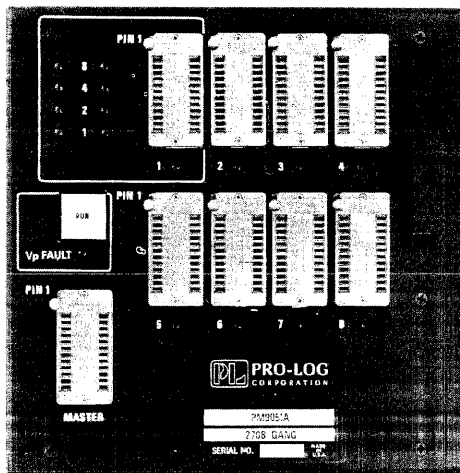

Gang Personality Module

Generic gang modules are capable of programming, simultaneously, eight PROMs from any family of 5V MOS devices available at the time of printing. Programming algorithms and PROM pinouts are reconfigured by simply plugging in the appropriate 40-pin gang configurator (GC).

The generic gang personality modules program and bulk-erase the latest E² PROMs. When used with E² PROMs, two gang configurators are needed: one for programming and one for bulk-erasing the parts. Both gang configurators are provided under one part number (GC-2X). Refer to the PM Selection Guide (page 24) for appropriate part numbers.

Pro-Log's generic gang modules are presently available in 24- and 28-pin versions. **Note:** Generic gang modules will function only in the M980 and M910A master control units.

Features

- Cold sockets (power off) during PROM insertion or removal
- Built-in self-test algorithm enables programming waveform verification with simple test equipment
- High/low Vcc verification of PROMs after programming
- Will easily accommodate future algorithm changes
- LED identification of passed and failed devices
- Vpp and Vcc overload test and indicator LED
- Tests for shorted address lines and inverted PROMs

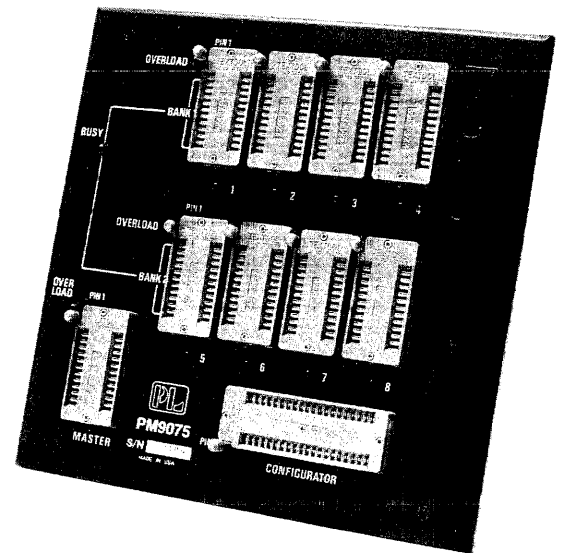

Generic Gang Module And Gang Configurators

Personality Module Selection Guide

The following selection guide lists all PROM manufacturers in alphabetical order (column 1). Manufacturers' part numbers of the PROMs are given in column 2. Appropriate personality modules for specific PROMs are listed in column 3.

The last two columns apply to generic modules only. They identify the appropriate pinout adapter (PA) and configurator (CA) or (GC) for use in conjunction with the generic module, when programming a specific PROM. As you proceed through the table,

note that a given personality module may accommodate various PROMs, through the use of different pinout adapters and configurations.

As indicated in the list, certain PROMs can be programmed by more than one personality module. In such cases, all personality modules that apply are listed. Note too that we list only commercial part numbers; however, each module will program the corresponding military equivalent and/or speed range.

PROM MANUFACTURER	PROM PART NUMBER	PERSONALITY MODULE	PINOUT ADAPTER	CONFIGURATOR
ADVANCED MICRO DEVICES (AMD)	Bipolar			
	Am27S20/21, 29760A/61A	PM9058	PA16-5	256x4(L)
	Am27S12/13, 29770/71	PM9058	PA16-5	512x4(L)
	Am27S32/33, 29780/81	PM9058	PA18-6	1Kx4(L)
	Am27S184/185	PM9058	PA18-8	2Kx4(L)
	Am27S40/41/40A/41A/PS41	PM9058	PA20-9**	4Kx4(L)
	Am27S09/LS09	PM9058	PA16-6	32x8(H)
	Am27S18/19, LS18/19	PM9058	PA16-6	32x8(L)
	Am29750A/51	PM9058	PA16-6	32x8(L)
	Am27LS18/19	PM9058	PA16-6	32x8(L)
	Am27S28/29, 29772/73	PM9058	PA20-4	512x8(L)
	Am27S26/27, 29774/75	PM9058	PA22-4	512x8(L)
	Am27S15	PM9058	PA24-14	512x8(L)
	Am27S30/31	PM9058	PA24-13	512x8(L)
	Am27S24/25	PM9058	PA24-16	512x8(L)
	Am27S180/181	PM9058	PA24-13	1Kx8(L)
	Am27S35/37	PM9058	PA24-18	1025x8(L)
	Am27S190/191/PS191	PM9058	PA24-17	2Kx8(L)
	Am27S290/291/290A/291A/PS291	PM9058	PA24-28**	2Kx8(L)
	MOS UV			
	Am1702A/Am9702A	PM9001A	—	—
	Am2708/Am9708	PM9005A	—	—
		PM9053A	—	—
		PM9051A (GANG)	—	—
	Am2716	PM9052A	—	—
		PM9064C	PA24-1	2Kx8(EH)
		PM9061A (GANG)	—	—
	Am2732	PM9075A (GEN. GANG)	—	GC-03
		PM9064C	PA24-10	4Kx8(EH)
		PM9075A (GEN. GANG)	—	GC-05
	Am2764**#	PM9074	PA28-2	8Kx8 (EH)
		PM9076 (GEN. GANG)	—	GC-08
	AMERICAN MICROSYSTEMS INC. (AMI)	MOS UV		
S5204A		PM9057	PA24-7	512x8(L)
S6834		PM9057	PA24-5	512x8(L)
FAIRCHILD	Bipolar			
	93417/427	PM9045	PA16-1	256x4(H)
	93436/446	PM9045	PA16-1	512x4(H)
	93452/453	PM9045	PA18-2	1Kx4(H)
	93438/448	PM9045	PA24-1 or -8	512x8(H)
	93450/451, L450/L451	PM9045	PA24-1 or -8	1Kx8(H)
	93460/461	PM9045	PA24-1 or -8	1Kx8(H)
	93465/466	PM9045	PA24-1 or -8	1Kx8(H)
	93510/511	PM9045	PA24-8	2Kx8(H)
	MOS UV			
	F2708	PM9005A	—	—
		PM9053A	—	—
		PM9051A (GANG)	—	—

** Under development.

An 8K byte buffer is recommended for programming convenience with M980.

PROM MANUFACTURER	PROM PART NUMBER	PERSONALITY MODULE	PINOUT ADAPTER	CONFIGURATOR		
FAIRCHILD (continued)	F2716	PM9052A	—	—		
		PM9064C	PA24-1	2Kx8(EH)		
		PM9061A (GANG)	—	—		
	F2532	PM9075A (GEN. GANG)	—	GC-03		
		PM9064C	PA24-12	4Kx8(EH)		
	F2732	PM9075A (GEN. GANG)	—	GC-04		
		PM9064C	PA24-10	4Kx8(EH)		
	F2564**#	PM9075A (GEN. GANG)	—	GC-05		
		PM9064C	PA28-3	8Kx8 (EH)		
	F2764**#	PM9076 (GEN. GANG)	—	GC-07		
		PM9074	PA28-2	8Kx8 (EH)		
		PM9076 (GEN. GANG)	—	GC-08		
		Microprocessor				
	F38E70	—	—	—		
FUJITSU	Bipolar	MB7052/57	PM9007C	—		
		MB7053/58	PM9007C	—		
	MOS UV	MB8518H	PM9005A	—	—	
			PM9053A	—	—	
			PM9051A (GANG)	—	—	
	MBM2716	PM9052A	—	—		
		PM9064C	PA24-1	2Kx8(EH)		
		PM9061A (GANG)	—	—		
	MBM2732	PM9075A (GEN. GANG)	—	GC-03		
		PM9064C	PA24-10	4Kx8(EH)		
		PM9075A (GEN. GANG)	—	GC-05		
	HARRIS SEMICONDUCTOR	Bipolar	HM7610/10A/11/11A	PM9039A	PA16-1	256x4(H)
HM7620/20A/21/21A			PM9039A	PA16-1	512x4(H)	
HM7644/44A			PM9039A	PA16-3	1Kx4(H)	
HM7642/42A/42P/43/43A/43P			PM9039A	PA18-2	1Kx4(H)	
HM7684/84P/85/85P			PM9039A	PA18-2	2Kx4(H)	
HM7602/03			PM9039A	PA16-2 or -4	32x8(H)	
HM7625R			PM9039A	PA24-9	256x8(H)	
HM7629			PM9039A	PA24-1 or -8	256x8(S2)	
HM7648/49			PM9039A	PA20-1	512x8(H)	
HM7640/40A**/41/41A			PM9039A	PA24-1 or -8	512x8(H)	
HM7647R			PM9039A	PA24-19	512x8(H)	
HM7608			PM9039A	PA24-1 or -8	1Kx8(H)	
HM7680/A/P/R/RP			PM9039A	PA24-1 or -8	1Kx8(H)	
HM7681/A/P/R/RP			PM9039A	PA24-1 or -8	1Kx8(H)	
HM7616			PM9039A	PA24-20	2Kx8(H)	
HM76160/161			PM9039A	PA24-8	2Kx8(H)	
JAN-0512			PM9055A	—	—	
			CMOS Fusible Link			
			HM6611	PM9056	—	—
HITACHI			MOS UV	HN462716	PM9052A	—
		PM9064C		PA24-1	2Kx8(EH)	
		PM9061A (GANG)		—	—	
	HN462532	PM9075A (GEN. GANG)	—	GC-03		
		PM9064C	PA24-12	4Kx8(EH)		
	HN462732	PM9075A (GEN. GANG)	—	GC-04		
		PM9064C	PA24-10	4Kx8(EH)		
		PM9075A (GEN. GANG)	—	GC-05		
		MOS E²				
	HN48016	PM9064C	PA24-26**	CP-2Kx8(S3)		
	PM9075A (GEN. GANG)	—	GC-23			

** Under development.

An 8K byte buffer is recommended for programming convenience with M980.

PROM MANUFACTURER	PROM PART NUMBER	PERSONALITY MODULE	PINOUT ADAPTER	CONFIGURATOR	
INTEL	Bipolar				
	3625/25-2	PM9048	PA18-2	1Kx4(H)	
	3625A/25A-1	PM9048	PA18-3	1Kx4(H)	
	3624A/24A-2	PM9048	PA24-2	512x8(H)	
	3628/28-4	PM9048	PA24-1 or -8	1Kx8(H)	
	3632**	—	—	—	
	3636/36-1	PM9048	PA24-8	2Kx8(H)	
	MOS UV				
	4702A*, 1702A* (All Versions)	PM9001A	—	—	
	2708, 8708 (All Versions)	PM9005A	—	—	
		PM9053A	—	—	
		PM9051A (GANG)	—	—	
	2758	PM9052A	—	—	
		PM9064C	PA24-1	1Kx8(EH)	
		PM9075A (GEN. GANG)	—	GC-01	
	2716 (All Versions)	PM9052A	—	—	
		PM9064C	PA24-1	2Kx8(EH)	
		PM9061A (GANG)	—	—	
		PM9075A (GEN. GANG)	—	GC-03	
	2732 (NMOS All Versions)	PM9064C	PA24-10	4Kx8(EH)	
		PM9075A (GEN. GANG)	—	GC-05	
	2732A	PM9074	PA24-10	4Kx8(EH)	
		PM9075A (GEN. GANG)	—	GC-06	
	2764# (All Versions)	PM9074	PA28-2	8Kx8(EH)	
		PM9076 (GEN. GANG)	—	GC-08	
	Microprocessor				
	8741A/48	PM9054	PA40-1	1Kx8(EL)	
	8749	**	**	**	
	8751	**	**	**	
	8755A	PM9054	PA40-2	2Kx8(EH)	
	MOS E²				
	2808	PM9064C	PA24-24**	1Kx8(S1)	
	PM9075A (GEN. GANG)	—	GC-21**		
2816	PM9064C	PA24-24**	2Kx8(S1)		
	PM9075A (GEN. GANG)	—	GC-22**		
INTERSIL	Bipolar				
	IM5603/23	PM9007C	—	—	
	IM5604/24	PM9007C	—	—	
	IM5600/10	PM9016C	—	—	
	IM5605/25	PM9028C	—	—	
	CMOS UV				
IM6653	PM9065	PA24-11	1Kx4(EH)		
IM6654	PM9065	PA24-1	512x8(EH)		
MARUMAN INTEGRATED CIRCUITS	MOS UV				
	2716	PM9052A	—	—	
		PM9064C	PA24-1	2Kx8(EH)	
		PM9061A (GANG)	—	—	
	PM9075A (GEN. GANG)	—	GC-03		
MITSUBISHI	MOS UV				
	M5L1702S*	PM9001A	—	—	
	M5L2708K	PM9005A	—	—	
		PM9053A	—	—	
		PM9051A (GANG)	—	—	
	M5L2716K	PM9052A	—	—	
		PM9064C	PA24-1	2Kx8(EH)	
		PM9061A (GANG)	—	—	
		PM9075A (GEN. GANG)	—	GC-03	
	M5L2732K	PM9064C	PA24-10	4Kx8(EH)	
	PM9075A (GEN. GANG)	—	GC-05		

* Obsolete device

** Under development.

An 8K byte buffer is recommended for programming convenience with M980.

PROM MANUFACTURER	PROM PART NUMBER	PERSONALITY MODULE	PINOUT ADAPTER	CONFIGURATOR	
MONOLITHIC MEMORIES (MMI)	Bipolar Type 1				
	6300-1/01-1	PM9037	PA16-1	256x4(H)	
	6305-1/06-1	PM9037	PA16-1	512x4(H)	
	6350-1/51-1	PM9037	PA18-1	1Kx4(H)	
	6352-1/53-1	PM9037	PA18-2	1Kx4(H)	
	6388/89	PM9037	PA18-2	2Kx4(H)	
	6330-1/31-1	PM9037	PA16-2	32x8(H)	
	6308-1/09-1	PM9037	PA20-2	256x8(H)	
	6335-1/36-1	PM9037	PA24-1 or -8	256x8(H)	
	6348-1/49-1	PM9037	PA20-1	512x8(H)	
	6340-1/41-1	PM9037	PA24-1	512x8(H)	
	6386-1/87-1	PM9037	PA22-1	1Kx8(H)	
	6380-1/81-1JO	PM9037	PA24-1 or -8	1Kx8(H)	
	6380-1/81-1JS	PM9037	PA24-23	1Kx8(H)	
	6384-1/85-1	PM9037	PA24-1 or -8	1Kx8(H)	
	Bipolar Type 2				
	63S140/S141	PM9066	PA16-1	256x4(L)	
	63S240/S241	PM9066	PA16-1	512x4(L)	
	63S440/S441	PM9066	PA18-2	1Kx4(L)	
	63RA441/RS441	PM9066	PA18-5	1Kx4(L)	
	63S840/S841	PM9066	PA18-2	2Kx4(L)	
	63RS840/S841	PM9066	PA20-6	2Kx4(L)	
	63RA840/A841	PM9066	PA20-6	2Kx4(L)	
	63S1640/S1641	PM9066	PA20-11**	4Kx4(L)	
	PAL				
	PAL10H8	PM9068	—	512x4(S1)	
	PAL12H6	PM9068	—	512x4(S1)	
	PAL14H4	PM9068	—	512x4(S1)	
	PAL16H2	PM9068	—	512x4(S1)	
	PAL10L8	PM9068	—	512x4(S2)	
	PAL12L6	PM9068	—	512x4(S2)	
	PAL14L4	PM9068	—	512x4(S2)	
	PAL16L2	PM9068	—	512x4(S2)	
	PAL16L8	PM9068	—	512x4(S2)	
	PAL16R8	PM9068	—	512x4(S2)	
	PAL16R6	PM9068	—	512x4(S2)	
	PAL16R4	PM9068	—	512x4(S2)	
	PAL16A4	PM9068	—	512x4(S2)	
	PAL16X4	PM9068	—	512x4(S2)	
PAL16C1	PM9068	—	512x4(S3)		
MOSTEK	MOS UV				
	MK3702-1* (All Versions)	PM9001A	—	—	
	MK2708	PM9005A	—	—	
		PM9053A	—	—	
		PM9051A (GANG)	—	—	
	MK2716 (All Versions)	PM9052A	—	—	
		PM9064C	PA24-1	2Kx8(EH)	
		PM9061A (GANG)	—	—	
		PM9075A (GEN. GANG)	—	GC-03	
	MK2764#	PM9064C	PA28-4**	8Kx8(S2)**	
		PM9076 (GEN. GANG)	—	GC-09**	
	MOTOROLA	Bipolar			
		5003*/04*	PM9055A	—	—
7620/21		PM9039A	PA16-1	512x4(H)	
7642/43		PM9039A	PA18-2	1Kx4(H)	
7684/85		PM9039A	PA18-2	2Kx4(H)	
7640/41		PM9039A	PA24-1	512x8(H)	
7680**/81**		PM9039A	PA24-1 or -8	1Kx8(H)	
82707**/08**		PM9039A	PA24-1 or -8	1Kx8(H)	
MOS UV					
MCM68708, 2708		PM9005A	—	—	
MCM68A708, 27A08		PM9053A	—	—	
		PM9051A (GANG)	—	—	

* Obsolete device.

** Under development.

An 8K byte buffer is recommended for programming convenience with M980.

PROM MANUFACTURER	PROM PART NUMBER	PERSONALITY MODULE	PINOUT ADAPTER	CONFIGURATOR
MOTOROLA (continued)	TMS2716	PM9053A	—	—
		PM9060A (GANG)	—	—
	MCM2716/L16	PM9052A	—	—
		PM9064C	PA24-1	2Kx8(EH)
		PM9061A (GANG)	—	—
		PM9075A (GEN. GANG)	—	GC-03
		PM9077 (GEN. GANG)	—	GC-03
	MCM2532/L32	PM9064C	PA24-12	4Kx8(EH)
		PM9075A (GEN. GANG)	—	GC-04
		PM9077 (GEN. GANG)	—	GC-04
	MCM68764/L764#†	PM9064C	PA24-15	8Kx8(S1)
		PM9077 (GEN. GANG)	—	GC-11
	MCM68766#†	PM9064C	PA24-15	8Kx8(S1)
		PM9077 (GEN. GANG)	—	GC-11
NATIONAL SEMICONDUCTOR	Bipolar			
	74S287/387	PM9047	PA16-1	256x4(L)
	74S570/571	PM9047	PA16-1	512x4(L)
	74S572/573	PM9047	PA18-2	1Kx4(L)
	74S574	PM9047	PA18-4	1Kx4(L)
	74S184/185	PM9047	PA18-2	2Kx4(L)
	74S188/288	PM9047	PA16-2 or -4	32x8(L)
	74S470*/471*	PM9047	PA20-2	256x8(L)
	74S472/473	PM9047	PA20-1	512x8(L)
	74S474/475	PM9047	PA24-1 or -8	512x8(L)
	87S180/181	PM9047	PA24-1 or -8	1Kx8(L)
	87S190/191	PM9047	PA24-8	2Kx8(L)
	PAL			
	DMPAL10H8	PM9068	—	512x4(S1)
	DMPAL12H6	PM9068	—	512x4(S1)
	DMPAL14H4	PM9068	—	512x4(S1)
	DMPAL16H2	PM9068	—	512x4(S1)
	DMPAL10L8	PM9068	—	512x4(S2)
	DMPAL12L6	PM9068	—	512x4(S2)
	DMPAL14L4	PM9068	—	512x4(S2)
	DMPAL16L2	PM9068	—	512x4(S2)
	DMPAL16L8	PM9068	—	512x4(S2)
	DMPAL16R8	PM9068	—	512x4(S2)
	DMPAL16R6	PM9068	—	512x4(S2)
	DMPAL16R4	PM9068	—	512x4(S2)
	DMPAL16A4	PM9068	—	512x4(S2)
	DMPAL16X4	PM9068	—	512x4(S2)
	DMPAL16C1	PM9068	—	512x4(S3)
	MOS UV			
	MM1702AQ*	PM9001A	—	—
	MM5203Q	PM9002A	—	—
	MM5204Q/Q-1	PM9006A	—	—
	MM2708Q/Q-1	PM9005A	—	—
		PM9053A	—	—
		PM9051A (GANG)	—	—
	MM2758Q-A	PM9052A	—	—
		PM9064C	PA24-1	1Kx8(EH)
		PM9075A (GEN. GANG)	—	GC-01
	MM2758Q-B	PM9052A	—	—
		PM9064C	PA24-1	1Kx8(S1)
		PM9075A (GEN. GANG)	—	GC-02
	MM2716	PM9052A	—	—
	PM9064C	PA24-1	2Kx8(EH)	
	PM9061A (GANG)	—	—	
	PM9075A (GEN. GANG)	—	GC-03	
NMC2532**	PM9064C	PA24-12	4Kx8(EH)	
	PM9075A (GEN. GANG)	—	GC-04	
NMC2732**/L32**	PM9064C	PA24-10	4Kx8(EH)	
	PM9075A (GEN. GANG)	—	GC-05	
NMC2732A**/L32A**	PM9074	PA24-10	4Kx8(EH)	
	PM9075A (GEN. GANG)	—	GC-06	

* Obsolete device. ** Under development.

An 8K byte buffer is recommended for programming convenience with M980.

† Cannot manually program on M900 or M900B as 8K word buffer is required to implement.

PROM MANUFACTURER	PROM PART NUMBER	PERSONALITY MODULE	PINOUT ADAPTER	CONFIGURATOR	
NATIONAL SEMICONDUCTOR (continued)	NMC2564***#	PM9064C	PA28-3	8Kx8(EH)	
		PM9076 (GEN. GANG)	—	GC-07	
	NMC2764***#	PM9074	PA28-2	8Kx8(EH)	
		PM9076 (GEN. GANG)	—	GC-08	
	CMOS UV 27C16	PM9052A	—	—	
	PM9064C	PA24-1	2Kx8(EH)		
	PM9061A (GANG)	—	—		
NIPPON ELECTRIC (NEC)	Bipolar μ PB403D, μ PB423D	PM9007C	—	—	
	μ PB405E, μ PB425E	PM9028C	—	—	
	MOS UV 2716	PM9052A	—	—	
		PM9064C	PA24-1	2Kx8(EL)	
		PM9075A (GEN. GANG)	—	GC-03	
	Microprocessor 8741A, 8748	PM9054	PA40-1	1Kx8(EL)	
OKI SEMICONDUCTOR	MOS UV MSM2708	PM9005A	—	—	
		PM9053A	—	—	
		PM9051A (GANG)	—	—	
	MSM2758	PM9052A	—	—	
		PM9064C	PA24-1	1Kx8(EH)	
		PM9075A (GEN. GANG)	—	GC-01	
	MSM2716	PM9052A	—	—	
		PM9064C	PA24-1	2Kx8(EH)	
		PM9061A (GANG)	—	—	
		PM9075A (GEN. GANG)	—	GC-03	
	MSM2532AS**	PM9064C	PA24-12	4Kx8(EH)	
		PM9075A (GEN. GANG)	—	GC-04	
RAYTHEON	Bipolar 29611/13	PM9037	PA16-1	512x4(H)	
	29651/53	PM9037	PA18-2	2Kx4(H)	
	29601/03	PM9037	PA20-2	256x8(H)	
	29621/23	PM9037	PA20-1	512x8(H)	
	29625/27	PM9037	PA24-1 or -8	512x8(H)	
	29631/33	PM9037	PA24-1 or -8	1Kx8(H)	
	29635/37	PM9037	PA24-1 or -8	1Kx8(H)	
	29681D/83D	PM9037	PA24-8	2Kx8(H)	
	29681S/83S	PM9037	PA24-27**	2Kx8(H)	
	SIGNETICS	Bipolar 82S126/129	PM9059	PA16-1	256x4(L)
		82S130/131	PM9059	PA16-1	512x4(H)
82S137		PM9059	PA18-2	1Kx4(L)	
82S185/HS185		PM9059	PA18-2	2Kx4(L)	
82S195		PM9059	PA20-11	4Kx4(L)	
82S23/123		PM9059	PA16-2 or -4	32x8(L)	
82S114		PM9059	PA24-9	256x8(S1)	
82S146/147		PM9059	PA20-1	512x8(L)	
82S115		PM9059	PA24-9	512x8(S1)	
82S141		PM9059	PA24-1 or -8	512x8(L)	
82S180, 82S2708		PM9059	PA24-1 or -8	1Kx8(L)	
82S181/LS181/S183		PM9059	PA24-1 or -8	1Kx8(L)	
82HS181/PS181		PM9059	PA24-1 or -8	1Kx8(L)	
82S191/HS191		PM9059	PA24-8	2Kx8(L)	
82S321		PM9059	PA24-25**	4Kx8(L)	
ECL 10149		PM9072	PA16-7	256x4(L)	
10139		PM9072	PA16-4	32x8(S1)	

** Under development.

An 8K byte buffer is recommended for programming convenience with M980.

PROM MANUFACTURER	PROM PART NUMBER	PERSONALITY MODULE	PINOUT ADAPTER	CONFIGURATOR	
SYNERTEK	MOS UV SY2716	PM9052A	—	—	
		PM9064C	PA24-1	2Kx8(EH)	
		PM9061A (GANG)	—	—	
		PM9075A (GEN. GANG)	—	GC-03	
TEXAS INSTRUMENTS (TI)	Bipolar Type 1	TBP14S10/SA10**	PM9046B	PA16-1	256x4(H)
		TBP18S030/SA030	PM9046B	PA16-4	32x8(L)
		TBP18S22/SA22	PM9046B	PA20-2	256x8(L)
		TBP18S42/SA42	PM9046B	PA20-1	512x8(L)
		TBP18S46/SA46	PM9046B	PA24-1 or -8	512x8(L)
	Bipolar Type 2	TBP24S10/SA10	PM9067	PA16-8**	256x4(H)
		TBP24S41/SA41	PM9067	PA18-7	1Kx4(H)
		TBP24SA81/SA81	PM9067	PA18-9**	2Kx4(H)
		TBP28L22	PM9067	PA20-10**	256x8(H)
		TBP28S42/L42/P42**	PM9067	PA20-1	512x8(H)
		TBP28S45/L45/P45**	PM9067	PA24-23**	512x8(H)
		TBP28S46	PM9067	PA24-1 or -8	512x8(H)
		TBP28S85/L85/P85**	PM9067	PA24-23**	1Kx8(H)
		TBP28S86/L86/SA86	PM9067	PA24-1	1Kx8(H)
		TBPS2708*	PM9067	PA24-1 or -8	1Kx8(H)
		TBP28P166**/S166**/L166**	PM9067	PA24-22**	2Kx8(H)
		TBP28R45**	—	—	—
		TBP28R85**	—	—	—
		TBP28R166**	—	—	—
		MOS UV	TMS2508 (All Versions)	PM9052A	—
	PM9064C			PA24-1	1Kx8(EH)
	PM9075A (GEN. GANG)			—	GC-01
	TMS2758-JL0		PM9052A	—	—
			PM9064C	PA24-1	1Kx8(S1)
			PM9075A (GEN. GANG)	—	GC-02
	TMS2758-JL1		PM9052A	—	—
			PM9064C	PA24-1	1Kx8(EH)
			PM9075A (GEN. GANG)	—	GC-01
	TMS2708 (All Versions)		PM9005A	—	—
			PM9053A	—	—
			PM9051A (GANG)	—	—
	TMS2516 (All Versions)		PM9052A	—	—
			PM9064C	PA24-1	2Kx8(EH)
			PM9061A (GANG)	—	—
			PM9075A (GEN. GANG)	—	GC-03
			PM9053A	—	—
	TMS2716		PM9053A	—	—
			PM9060A (GANG)	—	—
			PM9064C	PA24-12	4Kx8(EH)
	TMS2532 (All Versions)		PM9075A (GEN. GANG)	—	GC-04
			PM9064C	PA28-3	8Kx8(EH)
	TMS2564#	PM9076 (GEN. GANG)	—	GC-07	
	Microprocessor	9940E	—	—	—
—			—	—	
TOSHIBA	MOS UV TMM322	PM9005A	—	—	
		PM9053A	—	—	
		PM9051A (GANG)	—	—	
	TMM323	PM9052A	—	—	
		PM9064C	PA24-1	2Kx8(EH)	
		PM9061A (GANG)	—	—	
		PM9075A (GEN. GANG)	—	GC-03	

* Obsolete device.

** Under development

An 8K byte buffer is recommended for programming convenience with M980.

Accessories

Personality Module Storage/Carrying Case

Pro-Log offers a convenient storage/carrying case for either generic or individual personality modules. The case houses a complete generic family or up to four individual modules. It is made of high-impact resistant PVC. Dimensions are 8½x11¼x8½ in. Foam plastic inserts protect the personality modules.

- 9203 Dedicated Personality Module Carrying Case**
Will house maximum of 4 personality modules.
- 9204 Generic Personality Module Carrying Case**
Will house maximum of 10 pinout adapters, 7 configurators, and 2 personality modules.

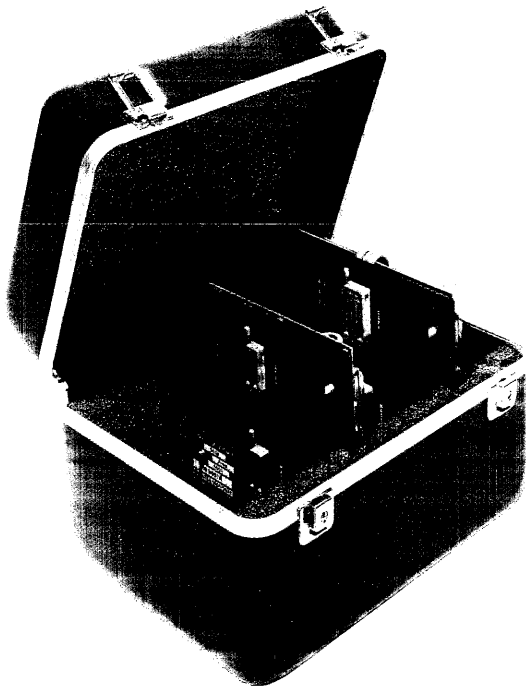

9203
Personality Module Carrying Case

9103A UV Erase-Light Option

Model 9103A is an ultraviolet (UV) erase light that accommodates a quantity of UV erasable PROMs. It consists of two high-intensity UV lamps mounted in an enclosed case with hinged lid and safety interlock, a pre-settable 0-60 minute timer, ON and OFF controls, and AC power connector. The 9103A is an accessory to the Series-90 PROM programmer's attaché case. Model 9103A-1 is a stand-alone unit with a 6-ft. power line cord. Main features are:

- Automatic shutoff with presettable timer
- Programmer-mountable
- Interlock, to prevent eye exposure to UV
- Safety-view hole to check lamp
- Conductive foam pad that holds ten 24-pin DIPs
- UL-listed

- 9103A Erase Light for M980 Convenience Outlet**
- 9103A-1 Erase Light (115VAC) with 6-ft. Cable**
- 9103A-2 Erase Light (230VAC) with 6-ft. Cable**

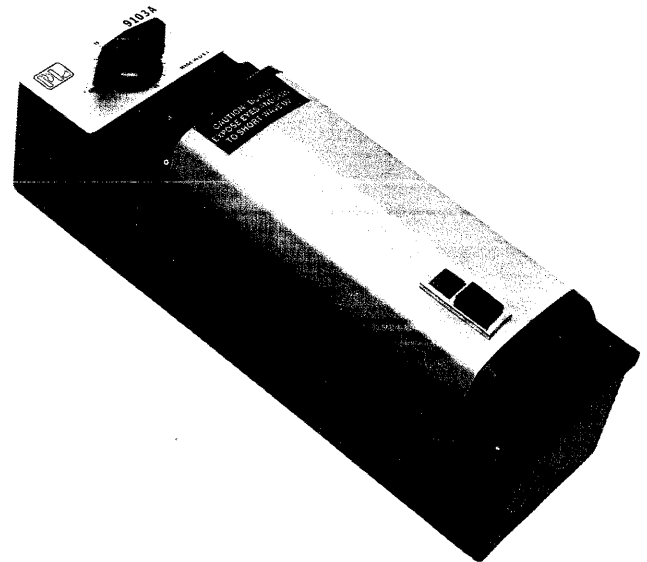

9103A
UV Erase Light

General Information

Placing An Order

Place orders through your local Pro-Log representative or directly with the factory. We accept telephone orders pending credit verification and confirming paperwork. When telephoning an order to Pro-Log, ask for the Order Desk. We have specially-trained personnel to handle your order promptly.

Product Availability

Pro-Log's normal shipment time is 2-4 weeks ARO on programmer products. If you require faster delivery, Pro-Log will try to accommodate you.

Functions and Limitations of Pro-Log Representatives

Pro-Log is represented domestically by a network of sales representatives. These people are ready to answer most of your questions about Pro-Log and its products. They can assist you in getting the support and information you need to solve your problems. Our representatives are not authorized to quote prices other than those listed in our published price list, nor can they commit Pro-Log to any contractual arrangements. Such pricing and arrangements can be made only in writing by an officer of Pro-Log Corporation.

Terms

1. 2%-10 Days, Net 30 Days; FOB Monterey, California. Pro-Log reserves the right to deny this discount under certain conditions.

2. A charge of 2% per month will be added to past due accounts.
3. Future orders from a customer who takes over 60 days will be accepted only on a C.O. D. or cash-with-order basis until credit is re-established to Pro-Log's satisfaction.
4. Cancellation charges on orders for standard products will be charged at the rate of 10 percent of the amount of the purchase order covering standard products. This will apply in all instances where orders for standard products are cancelled after Pro-Log acceptance of purchase order.
5. Minimum Order: \$100.00; all orders subject to credit verification.

International Ordering Information

We require a confirmed irrevocable letter of credit for all sales not handled by one of our international distributors. Our normal delivery time on initial orders is 4 to 6 weeks after receiving the order, pending completion of export licensing.

In order for us to obtain an export license, we must have a purchase order number and the necessary documents required for importation (i.e., import certificate, DIB 629). After receiving these documents, we can then apply for the export license, which takes approximately 3 to 4 weeks to process. ALL SALES ARE FOB MONTEREY, CALIFORNIA.

Warranty

WARRANTY: Seller warrants that the articles furnished hereunder are free from defects in material and workmanship and perform to applicable, published Pro-Log specifications for one year from date of shipment (two years for M980 and M910A Control Units). This warranty is in lieu of any other warranty expressed or implied. In no event will Seller be liable for special or consequential damages as a result of any alleged breach of this warranty provision. The liability of Seller hereunder shall be limited to replacing or repairing, at its option, any defective units which are returned F.O.B. Seller's plant. Equipment or parts which have been subject to abuse, misuse, accident, alteration, neglect, unauthorized repair or installation are not covered by warranty. Seller shall have the right of final determination as to the existence and cause of defect. As to items repaired or replaced, the warranty shall continue in effect for the remainder of the warranty period, or for ninety (90) days following date of shipment by Seller or the repaired or replaced part whichever period is longer. No liability is assumed for expendable items such as lamps and fuses. No warranty is made with respect to custom equipment or products produced, to Buyer's specifications except as specifically stated in writing by Seller and contained in the contract.

Pricing

List prices for domestic units are shown on this page. GSA prices are listed separately and can be obtained on request. Pro-Log quotes quantity prices on all products.

M980 Control Units

All control units are available in 115V AC, 230V AC, and 100V AC versions.

M980-041*	Control Unit with 4Kx8 RAM Buffer	\$2,450
M980-081*	Control Unit with 8Kx8 RAM Buffer	2,750
M980-161*	Control Unit with 16Kx8 RAM Buffer	3,450

Options and Accessories. Options or accessories may be ordered with control units, or separately, since parts are completely interchangeable.

M301-1	Paper-Tape Reader for 115V M980 \$1,050
M301-2	Paper-Tape Reader for 230V M980 1,050
M304	RS-232C Adapter 250
RC 12	TTY Cable 30
RC 18	RS-232C Cable 60
9103A	UV Erase Light 210
9103A-1	UV Erase Light 210
9103A-2	UV Erase Light 210
9203	Carrying Case 95
9204	Carrying Case 110
M980 User's Manual	 25
	(2 copies included free with each M980)	

Pinout Adapters:

PA16-XX through PA24-XX \$120
	(exceptions noted below)
PA24-16, 18, 23, 24, 27, 28 175
PA28-XX 175
PA40-1, 2 175

Configurators:

CA-X 35
CP-2Kx8(S3) 70
GC-0X through -1X 150
GC-2X 200
FACT-XX 50

* Part numbers shown are for operation on 115VAC line voltage. The 230VAC and 100VAC versions are also available. To order the 230VAC version, change the last digit in the part number from 1 to 2. To order the 100VAC version, change the last digit in the part number from 1 to 0. Prices also apply to the 100VAC and 230VAC versions purchased in the USA.

Personality Modules and Accessories. Personality modules may be ordered at any time, since any module works with any M980 control unit. To select the correct modules, configurators, and pinout adapters to meet device programming needs, see the PM Selection Guide (page 24).

PM9001A	1702A \$600
PM9002A	5203 625
PM9005A	2708 500
PM9006A ¹	National 5204 750
PM9007C	5603, 5604 650
PM9016C	5600 650
PM9018 ¹	Harris 1024/A 950
PM9028C	5605 950
PM9037	Generic	MMI, Raytheon
PM9039A	Generic	Harris, Motorola
PM9045	Generic	Fairchild
PM9046B	Generic	TI-Type 1
PM9047	Generic	National
PM9048	Generic	Intel
PM9051A	Gang	2708
PM9052A		2716, 2758
PM9053A		2708, TMS 2716
PM9054	Generic	8741A, 8748, 8755
PM9055A ¹		74186
PM9056 ¹		HM6611
PM9057 ¹	Generic	AMI
PM9058	Generic	AMD
PM9059	Generic	Signetics
PM9060A	Gang	TMS 2716
PM9061A	Gang	2716, TMS 2516
PM9064C	Generic	5V NMOS EPROMs
PM9065	Generic	Intersil EPROMs
PM9066	Generic	MMI
PM9067A	Generic	TI-Type 2
PM9068 ²	Generic	MMI, National PAL
PM9072	Generic	Signetics ECL
PM9074	Generic	5V HMOS EPROMs
PM9075 ³	Gang/Gen.	24-pin, 5V MOS
PM9076 ³	Gang/Gen.	28-pin, 5V MOS
PM9077 ³	Gang/Gen.	Motorola EPROMs

¹ Special order only.

² Includes configurators 512x4 (S1), (S2), and (S3).

³ Can only be used with the M980 and M910A Control Units.

U.S. domestic prices are effective April 5, 1981, and are subject to change without notice.



2411 Garden Road
Monterey, California 93940
Telephone (408) 372-4593
TWX: 910-360-7082