

**Tektronix®**

**577-177-D1 OR D2**  
**OPERATORS**

**INSTRUCTION MANUAL**



**PLEASE CHECK FOR CHANGE INFORMATION  
AT THE REAR OF THIS MANUAL.**

**577-177-D1 OR D2**

**OPERATORS**

**INSTRUCTION MANUAL**

**Tektronix, Inc.  
P.O. Box 500  
Beaverton, Oregon 97077**

**070-1436-00  
Product Group 48**

Serial Number \_\_\_\_\_

**First Printing NOV 1972  
Revised DEC 1983**

Copyright © 1972 Tektronix, Inc. All rights reserved.  
Contents of this publication may not be reproduced in  
any form without the written permission of Tektronix, Inc.

Products of Tektronix, Inc. and its subsidiaries are  
covered by U.S. and foreign patents and/or pending  
patents.

TEKTRONIX, TEK, SCOPE-MOBILE, and  are  
registered trademarks of Tektronix, Inc. TELEQUIP-  
MENT is a registered trademark of Tektronix U.K.  
Limited.

Printed in U.S.A. Specification and price change  
privileges are reserved.

### **INSTRUMENT SERIAL NUMBERS**

Each instrument has a serial number on a panel insert, tag,  
or stamped on the chassis. The first number or letter  
designates the country of manufacture. The last five digits  
of the serial number are assigned sequentially and are  
unique to each instrument. Those manufactured in the  
United States have six unique digits. The country of  
manufacture is identified as follows:

B000000	Tektronix, Inc., Beaverton, Oregon, USA
100000	Tektronix Guernsey, Ltd., Channel Islands
200000	Tektronix United Kingdom, Ltd., London
300000	Sony/Tektronix, Japan
700000	Tektronix Holland, NV, Heerenveen, The Netherlands

# TABLE OF CONTENTS

(OPERATING INSTRUCTIONS, Pages 1 to 14)

(APPLICATIONS, Pages 18 to 53)

	Page		Page
<b>OPERATING INSTRUCTIONS</b>	<b>1</b>	<b>APPLICATIONS (cont)</b>	
Introduction	1	Reverse Blocking Voltage	31
Power Source Requirements	2	SCR Forward Voltage Drop	31
Function of Controls and Connectors	2	SCR Holding Current	31
Display Units	2	Triac Characteristics	32
577 Curve Tracer		Signal and Rectifying Diods	33
Collector Sweep	2	Characteristics	33
Step Generator	5	Common Measurements	33
Horizontal	6	$I_f$ and $V_f$	33
Display	6	$I_r$ and $V_r$	33
Vertical	7	Diode Forward Voltage Drop	33
177 Test Fixture	7	Diode Characteristics, $I_f$ vs. $V_f$	34
Test Fixture Adapters	8	Zener Diodes	35
Kelvin Sensing	9	Characteristics	35
First-Time Operation and Familiarization	10	Common Measurements	35
Preliminary	10	$V_z$ and $I_r$	35
Positioning	11	$I_f$ and $V_f$	35
Collector Supply	11	Zener Characteristics at Low Current	35
Step Generator	14	Zero Temperature Coefficient	35
		Zener Tolerance Limits	37
<b>APPLICATIONS</b>	<b>18</b>	Tunnel Diodes and Back Diodes	38
Bipolar Transistors	19	Characteristics	38
Common-Emitter Characteristics	19	Common Measurements	38
Common Measurements	20	$I_f$ and $V_f$	38
Beta	20	$I_r$ and $V_r$	38
Saturation	20	Optical Semiconductor Devices	39
Leakage and Breakdown	21	Light-Emitting Diodes	39
Low Base-Drive Voltage	23	Photo Transistors	39
$I_c$ vs. $V_{be}$	23	Optically Coupled Isolators	39
Common-Base Characteristics	24	Miscellaneous Measurements	40
Field Effect Transistors	25	Relay Characteristics	40
Characteristics	25	Power Supply Load Current	42
Common Measurements	26	In-Circuit Location of Short Circuits	43
$g_m$	26	Leakage Resistance	43
$I_{DSS}$	26	General Resistance Measurements	43
Measuring Small-Signal $g_m$	26	Gas Discharge Devices	43
Pinch-off Voltage	26	Batteries	44
Finding Zero Temperature Coefficient, $T_c$	27	Measuring Capacitance (up to 1000 pF)	44
Unijunction Transistors	28	Measuring Semiconductor Capacitance	44
Characteristics	28	Measuring Capacitance (1000 pF and up)	45
Common Measurements	28	Polarized Capacitors	46
$n$	28	Incandescent Lamp Characteristics	47
$R_{B_2B_1}$	28	Induction Motors	47
$V_{EB_1(SAT)}$	29	In-circuit Testing	47
$I_{EB_2O}$	29	Integrated Circuits	49
$I_{B_2(MOD)}$	29	Digital Circuits	49
Measuring Negative Resistance	29	Evaluating TTL	50
Silicon Controlled Rectifiers	30	$V_{cc}$ Characteristics	51
Characteristics	30	Linear Circuits	53
Common Measurements	30	Input Current vs. Input voltage	53
Turn-on Voltage	30	Supply Current vs. Supply Voltage	53
Forward Blocking Voltage	31	Output Current vs. Output Voltage	53



The 577-177-D1 Curve Tracer.

# OPERATING INSTRUCTIONS

## INTRODUCTION

The 577-177-D1 (Storage) or D2 (Non-Storage) Curve Tracer system is a dynamic component tester that permits display of characteristic curves of many types of devices, including: bipolar transistors, field effect transistors, silicon-controlled rectifiers, uni-junction transistors, MOSFETS, integrated circuits, light coupled devices, capacitors, and relays.

The D1 Display Unit features split-screen storage, 6 1/2-inch CRT, variable stored brightness, and a beam finder.

The D2 Display Unit features a 6 1/2-inch CRT and a beam finder.

The features of the 577 Curve Tracer are:

A collector supply variable from 0 to 1600 volts in several operating modes, including AC. The current available varies from 10 A (20 A Pulsed) on the lowest voltage range to 40 mA (80 mA Pulsed) on the highest voltage range. The collector supply power is set using a switch that changes series resistance to maintain the same peak power setting as the voltage range is changed. The collector supply is automatically disabled when the vertical display exceeds 2.5 screen dimensions, helping to protect the device under test from destructive currents.



*When enabling the collector supply, changing polarity, or peak voltage range, always set the Left/Right device selector to center as transients may appear which exceed the indicated maximum peak voltage.*

Switching the collector supply polarity automatically changes the polarity of the step generator and re-positions the display start to the appropriate position on the CRT screen.

A step generator having current steps from 5 nA/Step (using STEP X.1) to 200 mA/Step, and voltage steps from

5 mV/Step (using STEP X.1) to 2 V/Step. When STEP X.1 is used, up to 95 steps are produced such that the Step Generator signal to the device under test is of the nature of a ramp, rather than discrete steps.

Calibrated step offset permits steps to be offset up to 10 steps (or 100 steps when using STEP X.1).

A 300  $\mu$ s pulsed step is also available.

The amplitude per step is indicated by a back-lighted knob skirt that automatically changes the indication when STEP X.1 is used.

The horizontal display may be either collector or base voltage.

A 10X horizontal magnifier is provided and the back-lighted knob skirt automatically indicates the change in horizontal deflection factor.

The features of the 177 Test Fixture are:

Vertical deflection factors from .2 nA/DIV (with magnifier on) to 2 A/DIV.

Correct deflection factor is indicated by a back-lighted knob skirt.

The vertical system monitors collector current even on the most sensitive ranges, such that three-terminal measurements can be made on all ranges.

A mode switch that provides for grounded base or grounded emitter operation, and includes a mode for emitter-base breakdown or leakage.

A bias supply that is adjustable from -12 volts to +12 volts. Output impedance  $\leq$  10K ohms.

Looping compensation that permits comparison of capacitance values down to  $1 \times 10^{-12}$  F.

"Device under test" connectors that accept a wide range of adapters, including those with Kelvin connections for high current measurements.

### POWER SOURCE REQUIREMENTS

The 577-177-D1 or D2 Curve Tracer system operates within two ranges of nominal line voltage: 100 V, 110 V, 120 V, or 200 V, 220 V, 240 V.

Fig. 1 shows the fuse locations and fuse size information. Fuse sizes are shown on the panel near the line fuse.

Fig. 2 shows the method of changing power transformer taps to match the transformer to the line voltage available. Fig. 2 also shows the location of the alternate line fuse.

### FUNCTIONS OF CONTROLS AND CONNECTORS

#### Display Units

##### D1-D2

INTENSITY	Controls non-stored display brightness.
FOCUS	Provides adjustment to obtain a well-defined display.
POWER	Used to turn instrument power on and off.
BEAM FINDER	Brings beam on-screen; limits display to the area inside the graticule.
TRACE ROTATION (rear panel)	Permits alignment of the trace to the horizontal graticule lines.

##### D1 Only (Storage)

UPPER and LOWER STORE	Selects storage or non-storage operation.
UPPER and LOWER ERASE	Complementary cancelling switches select the screen to be erased. Both buttons pushed selects both screens.
BRIGHTNESS	Provides continuously variable flood-gun current duty cycle from about 10% to 100% (when the collector sweep is turned down or disabled), permitting extended retention of displayed information. Also controls the degree of spot dimming when the collector sweep is turned down or disabled.

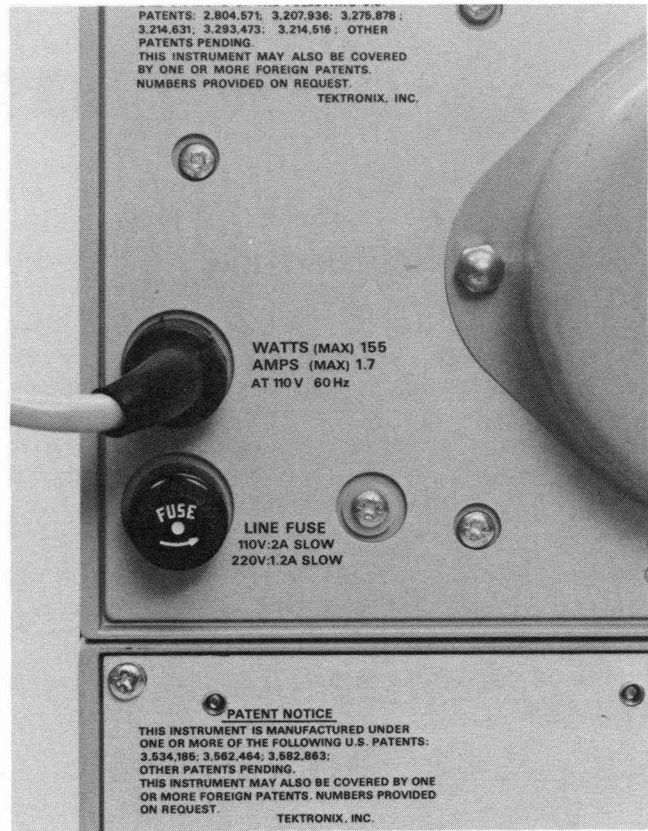

Fig. 1. Fuse location and fuse size information. See Electrical Parts List for part numbers and ordering information.

### 577 Curve Tracer

#### Collector Sweep

##### COLLECTOR SUPPLY POLARITY<sup>1</sup>

+DC	Applies positive DC to the collector terminals of the test fixture. Useful when the device under test exhibits excessive looping in sweep modes or when a DC supply is desired.
+	Applies positive sweeping voltage at 2X line rate to collector terminals of the test fixture. When the step generator is in PULSED mode, the supply is automatically switched to DC unless the operator desires to maintain the sweep voltage (see PULSED 300 $\mu$ s).
AC	Applies AC at power line frequency to the test fixture collector terminals (use SLOW step rate).

<sup>1</sup> Automatic trace position with polarity change is maintained in all switch positions.

**WARNING**

Dangerous voltages exist in this instrument. All servicing to the interior circuitry must be done by qualified personnel.

**LINE-VOLTAGE SELECTOR ACCESS**

Remove four machine screws from the corners of power-supply chassis. Swing right-end of chassis away from instrument. Chassis hinges on interconnecting wires.



**SELECTING LINE VOLTAGE**

Use brown connector for 110-volt nominal line (red for 220-volt line). To select voltage within nominal range, place connector on appropriate set of pins for high (H), medium (M), or low (L) line voltage. See table below. See fuse size information on rear panel, near fuseholder.

**LINE VOLTAGE SELECTOR**

	BROWN CONNECTOR	RED CONNECTOR
H	120 V	240 V
M	110 V	220 V
L	100 V	200 V

1436-3

Fig. 2. Power transformer line-voltage taps.



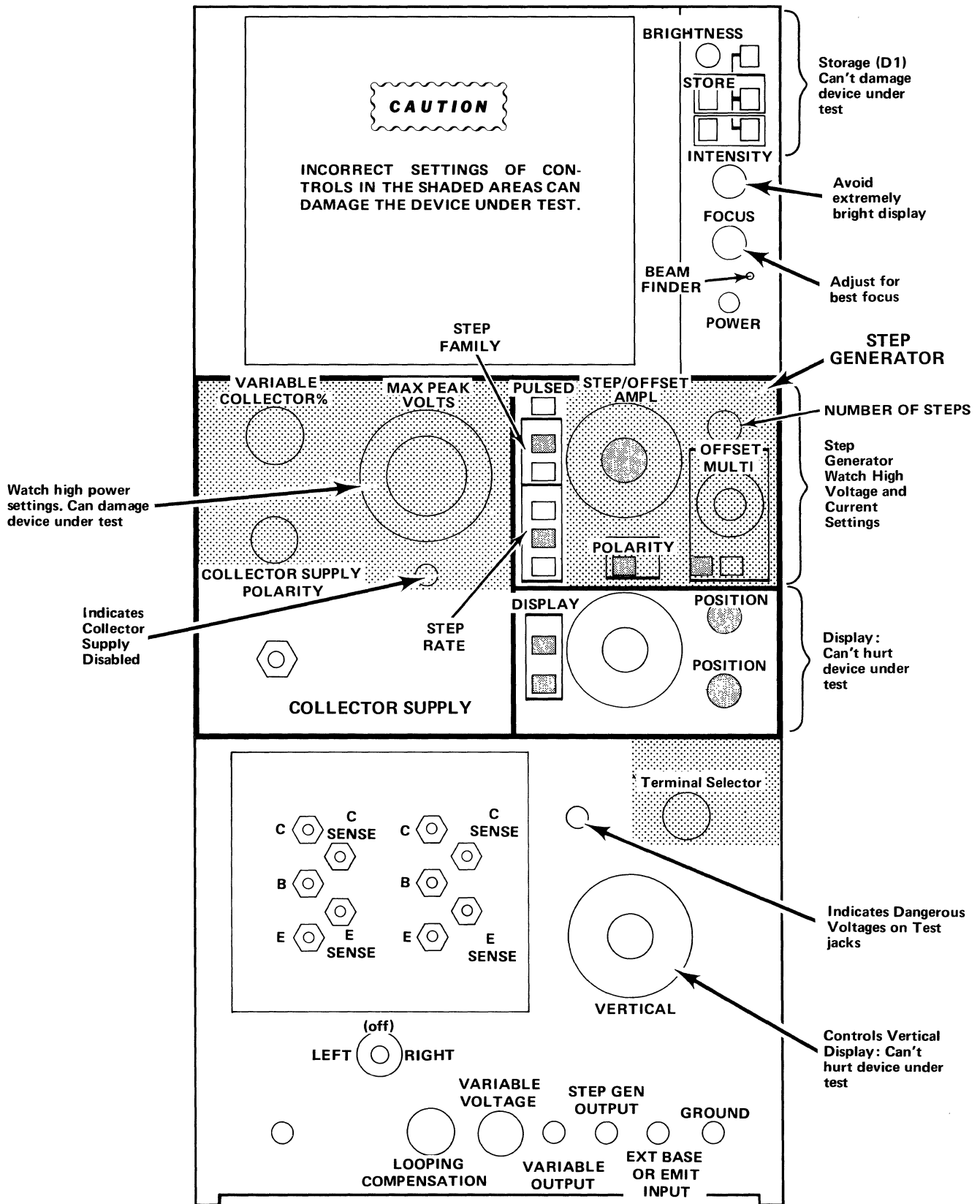

Fig. 3. Location of controls and connectors, 577 and 177.

- Applies negative sweeping voltage at 2X line rate to the test fixture collector terminals. When the step generator is in PULSED mode, the supply is automatically switched to DC unless the operator desires to maintain the sweep voltage (see PULSED 300  $\mu$ s).
- DC Applies negative DC to the test fixture collector terminals. Useful when the device under test exhibits excessive looping in sweep mode, or when a DC supply is desired.

**NOTE**

*The normal step generator polarity is positive-going in +DC, +, and AC, and negative-going in — and —DC. Step generator polarity can be inverted by either the STEP/OFFSET POLARITY switch or the test fixture Terminal Selector switching.*

- VARIABLE COLLECTOR % Provides uncalibrated, continuously variable control of collector supply amplitude from 0% to 100% of the voltage selected with the MAX PEAK VOLTS switch.
- MAX PEAK VOLTS Switch Selects one of five collector supply voltages.
- SERIES RESISTORS and PEAK POWER WATTS Switches Fourteen resistor values coupled to the MAX PEAK VOLTS switch to maintain one of six labeled peak-power limits. The SERIES RESISTORS and PEAK POWER WATTS switch pulls out to unlock from the MAX PEAK VOLTS switch to change the power setting. Lower power settings are available on all except the highest voltage range.  
  
The maximum peak power indicated by the MAX PEAK POWER WATTS can be delivered only if the VARIABLE COLLECTOR % control is set to 100 and the impedance of the “device under test” exactly matches the series resistor selected with the SERIES RESISTORS switch.  
  
The MAX PEAK POWER WATTS switch usually can be safely set above the maximum power rating of the device under test.

- COLLECTOR SUPPLY DISABLED (Indicator lamp) The yellow lamp is lighted when the test fixture protective lid is not closed over the test terminals (unless modified by a wiring option in the test fixture) whenever the MAX PEAK VOLTS switch is in the 100 V, 400 V, or 1600 V position. The yellow lamp pulses (on and off) if the vertical current limiting circuit disables the collector sweep (when the device under test current causes 2.5 times full-screen deflection for a short time).
- COLLECTOR SUPPLY CIRCUIT BREAKER Protects the collector supply from excessive power dissipation. Push to reset breaker after circuit interruption.

**Step Generator**

- PULSED 300  $\mu$ s (Pushbutton) With the 300  $\mu$ s pushbutton in the “in” position (Pulsed mode), the step generator produces 300  $\mu$ s wide pulses at 1 or 2 times line frequency, depending on the Step Rate selected. For these two step rates (SLOW and NORM) the collector supply is automatically switched to DC unless the COLLECTOR SUPPLY POLARITY is in AC. If the FAST Step Rate is selected, the generator step rate is twice the line frequency, but the collector supply is not switched.
- STEP FAMILY
  - REP With this pushbutton in the “in” position, up to ten steps per family are generated, depending on the position of the NUMBER OF STEPS control. When the push-push button, STEP X.1, concentric with the STEP/OFFSET AMPL switch, is in the “out” position, the NUMBER OF STEPS control provides from about 1 to 95 steps.
  - SINGLE Each time the SINGLE button is pressed, a single family is generated. Upon release, the step generator is turned off. Single family is useful for low-current, two terminal measurements.
  - SLOW (1X LINE Frequency) When the SLOW pushbutton is in the “in” position, the generator stepping rate is at power line frequency.

## 577-177-D1 or D2 Operators

**NORM (2X LINE Frequency)** When the NORM pushbutton is in the "in" position, the generator stepping rate is twice the power line frequency.

**FAST (4X LINE Frequency)** When the FAST pushbutton is in the "in" position, the generator stepping rate is four times the power line frequency.

### NOTE

*Step transitions occur at the start of the collector supply sweep in SLOW and NORM modes. Transitions occur at both the start and the peak of the collector supply sweep in the FAST mode.*

**FAST and SLOW** When FAST and SLOW buttons are in the "in" position simultaneously, the generator stepping rate is twice the power line frequency, (NORM), but the step transitions occur at the peaks of the collector supply sweeps.

**NUMBER OF STEPS** Continuously variable control selects the number of steps per display.

**STEP/OFFSET AMPL** Selects from 21 current steps, from 50 nA/Step to 200 mA/Step, or six voltage steps, from .05 V/Step to 2 V/Step, in a 1-2-5 sequence.

**STEP X.1** Push-push knob concentric with STEP/OFFSET AMPL knob. When this knob is released ("out" position), the Step Amplitude is reduced to .1X the previous amplitude and is indicated by the illuminated area of the STEP/OFFSET AMPL knob skirt. The OFFSET MULT range is not affected, resulting in small steps on large offset capability. The number of steps available changes (from the 1 to 10 range to approximately 1 to 95 steps), making the display appear as a ramp rather than discrete steps at the high rate.

**STEP/OFFSET POLARITY** When the NORM pushbutton is in the "in" position, the step voltage is the same polarity as the collector sweep unless inverted by the test fixture. When the NORM button is in the "out" position, the step voltage is opposite the collector sweep polarity unless inverted by

the test fixture. The Offset polarity is determined by the position of the OFFSET/AID/OPPOSE button.

**OFFSET MULT** Multiturn control providing DC offset from 0 to 10 times the STEP/OFFSET AMPL switch setting with the STEP X.1 knob in the "in" position, or 0 to 100 times the STEP/OFFSET AMPL setting with the STEP X.1 knob in the "out" position.

**OFFSET** In the "out" position, the offset voltage is determined by the OFFSET MULT control. When the ZERO button is in the "in" position, offset is disabled.

**OPPOSE** In the "in" position, the offset voltage aids the step generator signal. When the OPPOSE button is in the "out" position, the offset voltage opposes the step generator signal.

### Horizontal

**HORIZ VOLTS/DIV (knob)** Selects from 12 calibrated collector deflection factors from .05 V/DIV to 200 V/DIV or from 6 calibrated base deflection factors from 50 mV/DIV to 2 V/DIV with X10 HORIZ MAG PULL in the "in" position. With the X10 HORIZ MAG PULL in the "out" position, the deflection factors are 5 mV/DIV to 20 V/DIV or 5 mV/DIV to .2 V/DIV. All steps follow a 1-2-5 sequence.

**Horiz POSITION (knob)** Provides uncalibrated horizontal positioning over at least  $\pm 10$  graticule divisions.

**X10 HORIZ MAG PULL** Pulling the Horiz POSITION knob to the "out" position provides ten times magnification of the horizontal display, extending the horizontal positioning to  $\pm 100$  divisions. Sensitivity change is indicated by a change in the area of illumination of the HORIZ VOLTS/DIV knob skirt.

### Display

**DISPLAY INVERT** When the NORM pushbutton is in the "in" position, a normal display is presented. When the NORM button is in the "out" position, the display is inverted, both horizontally and vertically.

DISPLAY FILTER	Full vertical bandwidth is obtained with the NORM pushbutton in the "in" position. When the NORM pushbutton is in the "out" position, vertical bandwidth is limited to reduce noise on the trace. Bandwidth limit is useful in the most sensitive CURRENT/DIV positions, DC positions of the collector sweep, and with base steps turned off. When sweeping manually with filter in use, sweep very slowly.	front-panel EXT BASE OR EMIT INPUT terminal.
	<b>Vertical</b>	<b>NOTE</b>
Vertical POSITION (knob)	Provides uncalibrated vertical positioning over at least $\pm 8$ divisions.	<i>In BASE-GROUNDED mode, the step generator signal at the front-panel STEP GEN OUT is inverted.</i>
X10 VERT MAG PULL	Pulling the Vert POSITION knob to the "out" position provides ten times magnification of the vertical display, extending the vertical positioning to $\pm 80$ divisions. Sensitivity change is indicated by a change in the area of illumination of the VERTICAL SENSITIVITY (Test Fixture) knob skirt.	EMITTER-BASE BREAKDOWN Grounds the test fixture base terminal and applies collector sweep voltage (only those supply voltages that are not interlocked) to the emitter terminal. The collector terminal is open in this mode.
<b>177 Test Fixture</b>		VERTICAL SENSITIVITY (CURRENT/DIV) Selects from 28 calibrated vertical deflection factors from 2 nA/DIV to 2 A/DIV with mainframe X10 VERT MAG PULL in the "in" position and .2 nA/DIV to 200 mA/DIV with the VERT MAG PULL in the "out" position. All steps follow a 1-2-5 sequence.
Terminal Selector		LEFT-RIGHT Three-position toggle switch for applying test signal to either the left or right set of terminal connectors (center position disconnects the terminal connectors). The emitter terminals are connected together and to either ground, step generator, or collector, depending on the position of the Terminal Selector switch.
EMITTER GROUNDED		Interlock Defeat In normal operation, collector sweep voltages that are controlled by the interlock are removed from the device under test if the protective cover is open. Pushing the Interlock Defeat button applies sweep voltage with the protective cover open, as long as the button is pressed.
BASE TERM		LOOPING COMPENSATION Permits compensation of the internal and adapter stray capacitance and for some "device under test" capacitance.
STEP GEN	Applies step generator output to the test fixture base connections.	VARIABLE VOLTAGE, VARIABLE OUTPUT Provides +12, 0 –12 continuously variable voltage (referred to ground) to the VARIABLE OUTPUT connector. Impedance is approximately 10 k $\Omega$ .
OPEN (OR EXT)	Disconnects the test fixture base terminal from the step generator output and connects the base terminal to the front-panel EXT BASE OR EMIT INPUT connector.	STEP GEN OUTPUT Connector Provides external access to the step generator output.
SHORT	Disconnects the test fixture base terminal from the step generator output and grounds the base terminal.	
BASE GROUNDED		
EMITTER TERM		
STEP GEN	Applies step generator output to the test fixture emitter terminal and inverts the step generator polarity.	
OPEN (OR EXT)	Disconnects the emitter terminal from the step generator and connects the emitter terminal to the	

**577-177-D1 or D2 Operators**

**EXT BASE OR  
EMIT INPUT** Provides external access to the base or emitter terminals, depending on the position of the Terminal Selector switch. Also provides a means of connecting an external resistor between the step generator output and base of the device under test.

**GROUND** External ground connection.

**Test Fixture Adapters**

Devices to be tested are connected to the 577 through the ten banana jacks provided on the test fixture. These jacks permit two adapters to be used alternately to make comparison tests.

The ten test fixture jacks accept standard banana plugs so that a device under test may be connected to the 577-177 without using a specific adapting accessory.

The LEFT-RIGHT switch position determines which device is under test.

The adapters listed in Table 1 provide sockets into which semiconductors with diverse lead configurations can be placed for testing.

**TABLE 1  
Test Fixture Adapters<sup>2</sup>**

<b>Devices Tested</b>	<b>Case Types</b>	<b>TEKTRONIX Part Number</b>
Diodes	Axial Lead Provides Kelvin sensing <sup>3</sup> .	103-0111-00
Bipolar Transistors and FETs based like bipolar devices	TO-5, TO-18, and related sizes.	013-0098-01 <sup>5</sup>
Standard FET basing	TO-5, TO-18, and related sizes.	013-0099-01 <sup>4-5</sup>
Bipolar Transistors and SCRs	TO-3; Provides Kelvin sensing <sup>3</sup> .	013-0100-00 <sup>4</sup>
Bipolar Transistors and SCRs	TO-66; Provides Kelvin sensing <sup>3</sup> .	013-0101-00 <sup>4</sup>

<sup>2</sup>Some of the accessories listed are made of plastic and are susceptible to damage from excessive heat. If a device is likely to heat excessively, use a heat sink or switch to the PULSED mode of operation.

<sup>3</sup>See the paragraph titled Kelvin Sensing.

**TABLE 1 (cont)**

<b>Devices Tested</b>	<b>Case Type</b>	<b>TEKTRONIX Part Number</b>
Bipolar Transistors and FETs based like bipolar devices.	Long-lead devices.	013-0102-00 <sup>4</sup>
Standard FET basing	Long-lead devices.	013-0103-00 <sup>4</sup>
Diodes	Stud leads; DO-4 and DO-5. Provides Kelvin sensing <sup>3</sup> .	013-0110-00 <sup>4</sup>
Bipolar Transistors and SCRs	TO-36; Provides Kelvin sensing <sup>3</sup> .	013-0112-00 <sup>4</sup>
Bipolar Transistors, FETs, and SCRs	TO-5, TO-18, and related sizes, short or long leads. Kelvin sensing <sup>3</sup> . Furnished with standard bipolar configuration, but may be rewired to non-standard configurations.	013-0127-00 <sup>4</sup>
Bipolar Transistors	Small in-line plastic power transistors. Kelvin sensing <sup>3</sup> . Furnished with B-C-E configuration, but may be rewired to C-B-E configuration.	013-0139-00 <sup>4</sup>
Bipolar Transistors	Large in-line plastic. Kelvin sensing <sup>3</sup> . Furnished with B-C-E configuration but may be rewired to C-B-E configuration.	013-0138-00 <sup>4</sup>

<sup>4</sup>Optional accessory.

<sup>5</sup>The transistor adapter (TEKTRONIX Part Number 013-0098-01) and the FET adapter (TEKTRONIX Part Number 013-0099-01) have a fourth terminal (on each single test socket) marked with a yellow dot. This fourth terminal is connected to a terminal (also identified with a yellow dot) near the bottom edge of the adapter.

The fourth terminal is normally connected by a removable wire link to the E (emitter) or S (source) terminal of the device under test.

The fourth terminal may be used to bias the substrate of the device under test. The VARIABLE ±12 volts available on the 177 Test Fixture front panel can be patched (using a banana-to-pin patch cord) to the fourth terminal connector. Remove the wire link between the yellow dot and the E (or S) terminal and insert the patch cord pin end into the "yellow" terminal. To insert the pin (or wire link) into the connector(s), press the square, light gray button(s) while inserting the pin or link.

TABLE 1 (cont)

Devices Tested	Case Type	TEKTRONIX Part Number
Integrated Circuits	When used with the correct Barnes Corporation adapters, accepts most ICs with up to 16 leads.	013-0124-00 <sup>4</sup>
Diodes	Magnetic holder for axial lead diodes, providing rapid insertion and removal for production applications.	013-0079-00 <sup>4</sup>
Bipolar Transistors	Power transistors with hook leads.	013-0074-00 <sup>4</sup>
Other	Blank adapter box to mount your choice of socket.	013-0104-00 <sup>4</sup>

**Kelvin Sensing**

Since each contact in the test fixture has finite resistance, a potential is developed across this resistance during any test.

The potential developed across this contact resistance is of little consequence in low current measurements. Contact resistance can be an important consideration in high current measurements, since the potential developed across this contact resistance may be an appreciable part of the total potential measured.

Providing a separate path, through a separate set of contacts through which very little current flows (Kelvin Sensing) provides an accurate measurement of the voltage across only the device under test. See Fig. 4.

Kelvin sensing is designed into many of the test adapters available as accessories to the TEKTRONIX Curve Tracer systems, as shown in Table 1.

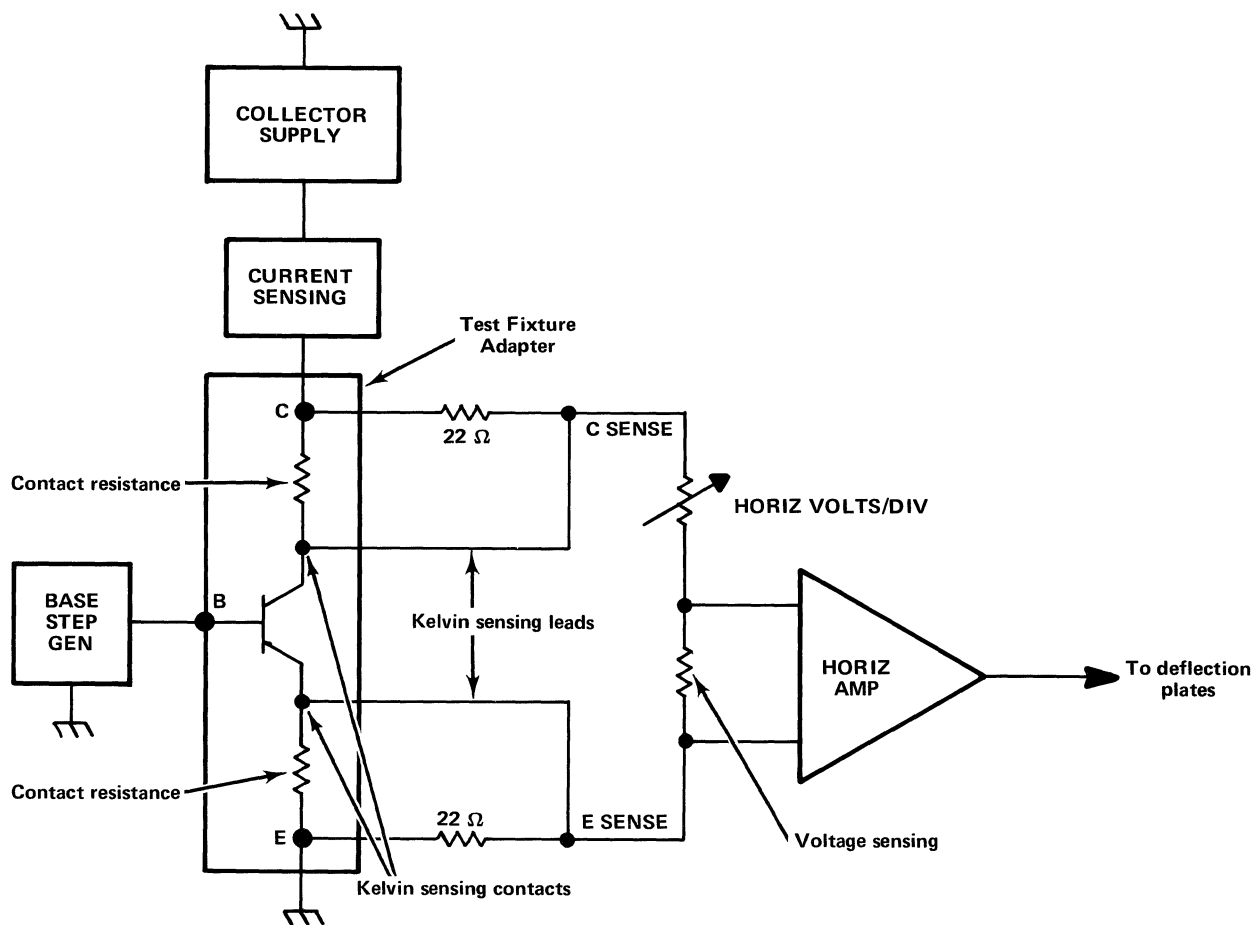

Fig. 4. Kelvin Sensing.

## FIRST-TIME OPERATION AND FAMILIARIZATION

The 577-177-D1 or D2 Curve Tracer system, as received, should perform within the specification given in Section 1 of the 577-D1 or D2 Service Manual and the 177 Service Manual.

This procedure permits the operator to become familiar with the front-panel controls and their functions.

This procedure can also be used as a general check of instrument performance. To check performance with respect to instrument specifications, use the Performance Check Procedure in Section 5 of the Service manuals.

### Preliminary

Set the Display Unit (D1 or D2) controls as follows:

#### NOTE

*When first receiving the instrument or when it has been turned off for two weeks or more: turn the BRIGHTNESS control fully clockwise, place the push-push STORE switches (UPPER and LOWER) in the depressed position. Turn the INTENSITY control fully counterclockwise. Turn the power on and note that after a short delay the screen will become fully illuminated. Leave the instrument in this mode for 5 minutes before erasing or going to non-store mode.*

#### D1, D2

INTENSITY	Counterclockwise
FOCUS	Centered

#### D1

BRIGHTNESS	Counterclockwise
STORE	
UPPER	"out" position
LOWER	"out" position
ERASE	
UPPER	Either position
LOWER	Either position

1. Apply power to the 577-177-D1 or D2 system. Pull the POWER switch to the ON position.

2. Allow about one minute for instrument warmup.

Set the 577 Mainframe controls as follows:

STEP FAMILY	
REP	Pushed in <sup>6</sup>
STEP RATE	
NORM	Pushed in <sup>6</sup>
STEP/OFFSET POLARITY	
,NORM	Pushed in <sup>6</sup>
OFFSET	
ZERO	Pushed in <sup>6</sup>
OPPOSE	
AID	As is
STEP X.1	Pushed in <sup>6</sup>
STEP/OFFSET AMPL	1 mA/DIV
NUMBER OF STEPS	1 (ccw)
OFFSET MULT	As is
MAX PEAK VOLTS	25
MAX PEAK POWER WATTS	.15
SERIES RESISTOR	2 k
COLLECTOR SUPPLY	
POLARITY	AC
VARIABLE COLLECTOR	
%	0
Horiz POSITION control	Centered
X10 HORIZ MAG PULL	Pushed in <sup>6</sup>
HORIZ VOLTS/DIV	200 COLLECTOR VOLTS
DISPLAY INVERT	
NORM	Pushed in <sup>6</sup>
DISPLAY FILTER	
NORM	Pushed in <sup>6</sup>

3. Turn the INTENSITY control clockwise, while pressing the BEAM FINDER button, until a spot appears on the graticule. To avoid burning the CRT phosphor, adjust the INTENSITY until the spot is easily visible, but not exceptionally bright. Position the spot to graticule center and release the BEAM FINDER.

4. Adjust the FOCUS control for a sharp, well-defined spot.

Vertical POSITION control	Center the display
VERTICAL SENSITIVITY	1 mA/DIV
X10 VERT MAG PULL	Pushed in

Set the remaining Test Fixture controls as follows:

#### Terminal Selector

EMITTER GROUNDED	
BASE TERM	STEP GEN
LOOPING COMPENSATION	As is
LEFT-RIGHT	Off (center position)

<sup>6</sup> For normal operation all dark gray buttons and knobs are in the "in" position.

## Positioning

1. Turn the Vertical POSITION control throughout its range. The control range should position the spot well off-screen in both directions. Vertically position the spot to graticule center.

2. Turn the Horizontal POSITION control throughout its range. The control range should position the spot well off-screen in both directions. Push the BEAM FINDER and note that the spot can not be positioned off screen. Release BEAM FINDER button and return the spot to graticule center.

3. Set the COLLECTOR SUPPLY POLARITY to +. Note that the spot moves to the lower left corner of the graticule.

4. Set the COLLECTOR SUPPLY POLARITY to -. Note that the spot moves to the upper right corner of the CRT graticule. Return the COLLECTOR SUPPLY POLARITY to +.

5. Install the Diode Test Adapter (TEKTRONIX Part Number 013-0111-00) into the right-hand set of accessory connectors located on the 177 Test Fixture.

6. Place a 1 k $\Omega$  resistor in the diode adapter clips.

7. Set the LEFT-RIGHT switch to the RIGHT position. Set the HORIZ VOLTS/DIV to 1 COLLECTOR VOLT.

8. Turn the VARIABLE COLLECTOR % control clockwise until a diagonal trace appears on the graticule, as shown in Fig. 5. Note that the trace intensifies when the Collector sweep level is turned up from the zero position. This feature helps to keep the intensity at the correct level, helping to prevent burning the CRT phosphor when the collector sweep is turned down or disabled. The amount of intensity change (D1) is controlled by the BRIGHTNESS control. The D2 Display Unit has a fixed amount of change.

9. Turn the VERTICAL SENSITIVITY switch clockwise and note that as the vertical deflection factor decreases, the slope of the diagonal trace increases. Set MAX PEAK POWER WATTS to 2.5. Turn the VERTICAL SENSITIVITY further clockwise (more sensitive) and note that the collector sweep disables (yellow light flashes). Increase the value of SERIES RESISTOR and note that the diagonal trace shortens, indicating that the higher value of SERIES RESISTOR limits the collector supply current. Reset the VERTICAL SENSITIVITY to 1 mA/DIV and the SERIES RESISTOR to 2 k.

10. Turn the HORIZ VOLTS/DIV switch and note that the slope change is the inverse of the vertical relationship noted in step 9. Return HORIZ VOLTS/DIV switch to 1 V/DIV COLLECTOR VOLTS.

11. Press the DISPLAY INVERT button to release the button to its "out" position. Turn the VARIABLE COLLECTOR % control counterclockwise. Note that the display has been inverted and is now originating at the upper right corner of the CRT graticule. Push the DISPLAY button to the "in" position. Return the VARIABLE COLLECTOR % to 0.

## Collector Supply

1. Turn the MAX PEAK VOLTS switch through its five positions. Note that when the switch is in the 100 V, 400 V, and 1600 V positions, the yellow lamp is lighted.

2. While the yellow light is on, turn the VARIABLE COLLECTOR % control clockwise. Note that the diagonal line obtained previously does not appear. The yellow lamp indicates that the collector supply is disabled.

3. Reset the 577-177 controls as follows:

MAX PEAK VOLTS	25
VARIABLE COLLECTOR	
%	0
LEFT-RIGHT	Off (center)

4. Set the MAX PEAK VOLTS to 100. Note that the yellow lamp is lighted.

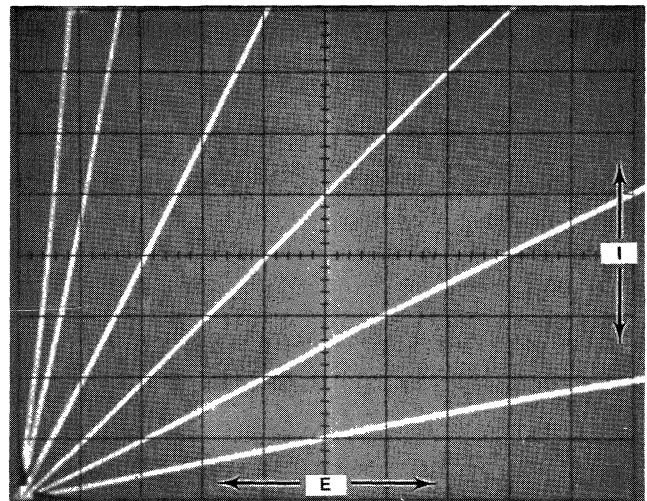

Fig. 5. Change in slope of resistance, VERTICAL SENSITIVITY or HORIZ VOLTS/DIV change.



## 577-177-D1 or D2 Operators

5. Install the protection box on the 177 Test Fixture as shown in Fig. 6, with the lid open.

6. Close the lid on the protective box and note that the yellow lamp extinguishes and the red lamp (on the test fixture) is lighted.

### WARNING

*The red lamp indicates that lethal voltage may exist at the test fixture collector terminals.*

7. Open the lid on the protective box and press the red Interlock Defeat button (left front of the test fixture) and note that the yellow lamp extinguishes and the red lamp lights.

8. Set the LEFT-RIGHT switch to the RIGHT position and turn the VARIABLE COLLECTOR % clockwise, while holding the Interlock Defeat button in. Note that the diagonal trace appears, indicating that the collector supply is enabled.

9. Reset MAX PEAK VOLTS to 25 and turn the VARIABLE COLLECTOR % to 0. The protective box may be removed, if desired.

10. Turn the VARIABLE COLLECTOR % control until the diagonal trace reaches center screen. Pull out the MAX PEAK POWER WATTS and set the switch to .6 watts. Note that the diagonal trace lengthens as the switch is turned through the higher wattage positions. Note that the SERIES RESISTORS values decrease as the maximum peak power increases.

11. Allow the MAX PEAK VOLTS switch and the MAX PEAK POWER WATTS switches to become locked together at 6.5 volts and .15 watts. Switch the MAX PEAK VOLTS to 25 and note that the MAX PEAK POWER WATTS remains at .15 watts and that the SERIES RESISTOR value changes to maintain this power level.

12. Set the 577-177 controls as follows:

HORIZ VOLTS/DIV	.1 V/DIV COLLECTOR VOLTS
VARIABLE COLLECTOR %	0
MAX PEAK VOLTS	25
MAX PEAK POWER WATTS	.15
LEFT-RIGHT	Off (center)

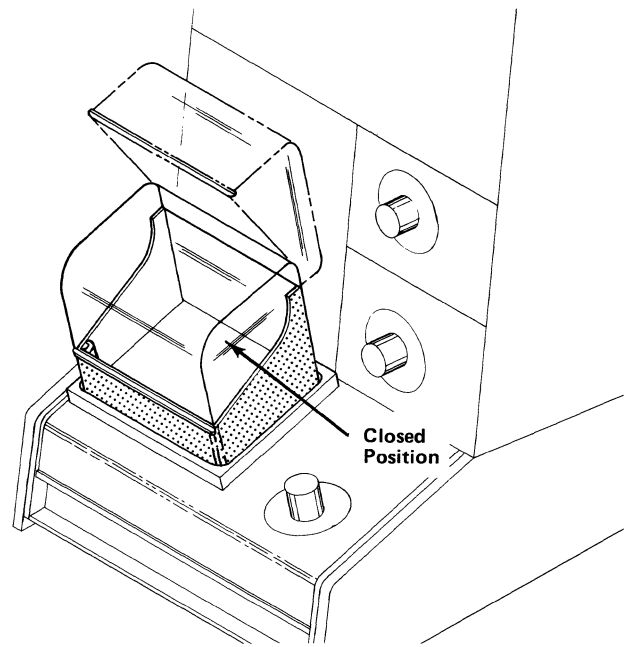

Fig. 6. Protective plastic box for 177 Test Fixture.

13. Remove the resistor from the diode test adapter and replace the resistor with a silicon diode. Connect the diode cathode to the test fixture emitter terminal.

14. Set the LEFT-RIGHT switch to RIGHT and turn the VARIABLE COLLECTOR % control clockwise until the diode forward voltage characteristic is displayed (see Fig. 7).

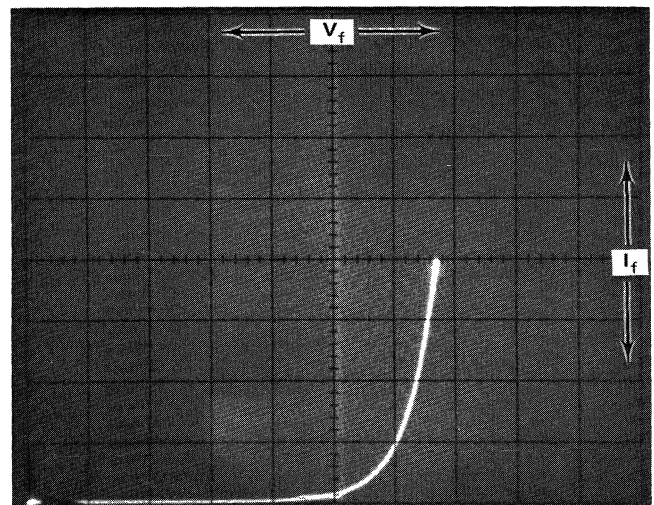

Fig. 7. Typical diode forward voltage characteristic.

15. Set the COLLECTOR SWEEP POLARITY to +DC. Note that the forward voltage characteristic is a spot. The spot position indicates diode voltage (horizontal) and current (vertical).

16. Turn the VARIABLE COLLECTOR % counterclockwise and note that the spot traces the diode characteristics.

#### NOTE

*If the display unit of the Curve Tracer system is a D1 (Storage) Unit, press the UPPER and LOWER STORE and UPPER and LOWER Erase buttons to the "in" position. Turn the INTENSITY control counterclockwise, press the ERASE button to prepare the target for storage, and turn the VARIABLE COLLECTOR % to 0. Turn the INTENSITY control clockwise far enough to produce a spot of normal viewing intensity (in lower left corner). Turn the VARIABLE COLLECTOR % control clockwise and note the diode characteristic on the screen. Return the VARIABLE COLLECTOR % counterclockwise to 0 and note that the trace has been stored on the screen. With the VARIABLE COLLECTOR % at 0, turn the BRIGHTNESS control throughout its range and note that the brightness of the stored image changes. Turn the BRIGHTNESS control fully counterclockwise. Now, turn the VARIABLE COLLECTOR % clockwise until the stored image again appears. Turn the BRIGHTNESS control throughout its range and note that the stored display brightness is not affected. Return the BRIGHTNESS control to the clockwise position. To remove the stored image, press the ERASE button. Storage mode can be returned to non-store by releasing UPPER and LOWER STORE buttons.*

17. Remove the diode from the adapter and switch the LEFT-RIGHT switch of Off.

Set the 577-177 controls as follows:

VERTICAL SENSITIVITY	1 $\mu$ A/DIV
HORIZ VOLTS/DIV	2 V/DIV COLLECTOR VOLTS
LEFT-RIGHT	RIGHT
COLLECTOR SWEEP POLARITY	AC

18. Turn the VARIABLE COLLECTOR % clockwise to give 10 horizontal divisions of display.

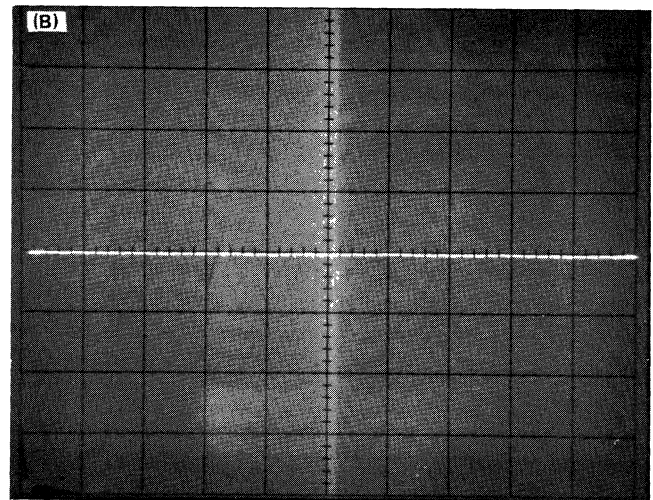
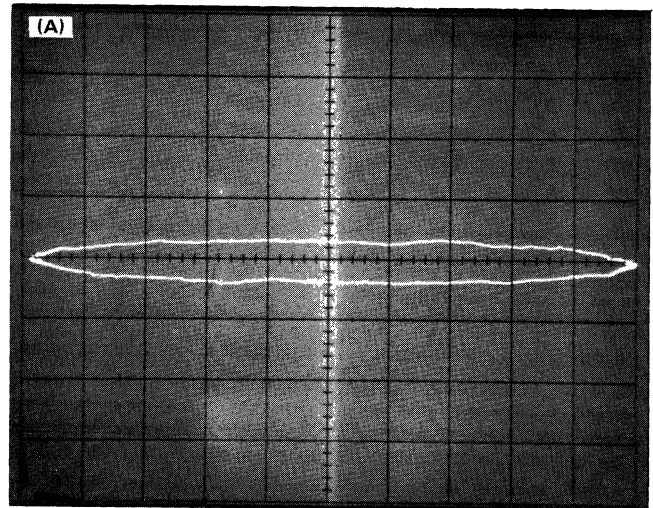

Fig. 8. Typical displays of (A) uncompensated looping and (B) looping compensated.

19. Adjust the 177 LOOPING COMPENSATION for minimum looping as shown in Fig. 8.

20. Set the 577-177 controls as follows:

VERTICAL SENSITIVITY	.2 mA/DIV
VARIABLE COLLECTOR %	0
COLLECTOR SWEEP POLARITY	AC
LEFT-RIGHT	Off
HORIZ VOLTS/DIV	5 V/DIV COLLECTOR VOLTS

21. Replace the test diode with a Zener (about 12 volts). Connect the Zener cathode to the test fixture emitter terminal.

22. Set the LEFT-RIGHT switch to RIGHT and turn the VARIABLE COLLECTOR % control to obtain a display similar to that in Fig. 9. Note that both forward and reverse characteristics are displayed.

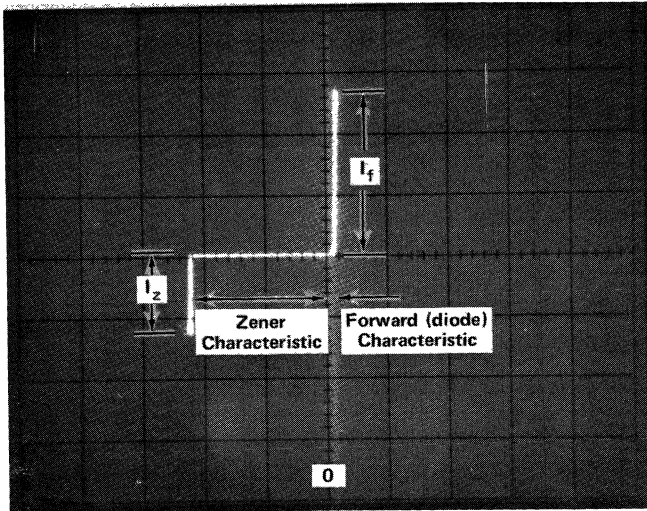

Fig. 9. Display of Zener diode characteristics (AC mode).

23. Set the COLLECTOR SWEEP POLARITY to - and note the display of only the Zener characteristics of the diode.

**Step Generator**

1. Set the 577-177 controls as follows:

LEFT-RIGHT	Off
OFFSET MULT	0 (ccw)
OFFSET	ZERO (pushed in)
HORIZ VOLTS/DIV	1 V/DIV COLLECTOR VOLTS
COLLECTOR SWEEP POLARITY	+
VARIABLE COLLECTOR %	0
VERTICAL SENSITIVITY	1 mA/DIV
MAX PEAK VOLTS	25
MAX PEAK POWER WATTS	.15
NUMBER OF STEPS	1 (ccw)
STEP/OFFSET AMPL	.5 μA/DIV

2. Remove the diode adapter and replace it with a TEKTRONIX 013-0098-01 Transistor Adapter.

3. Place an NPN silicon transistor into one of the right transistor sockets of the adapter.

4. Turn the VARIABLE COLLECTOR % control until the peak collector voltage is about 10 volts (10 horizontal divisions of display). Set the LEFT-RIGHT switch to RIGHT. Turn the STEP/OFFSET AMPL switch clockwise until a step appears on the display (see Fig. 10A). Set the STEP/OFFSET AMPL for the minimum step that produces about a 0.5 division step in the display.

5. Set the MAX PEAK POWER WATTS at or below the power dissipation rating of the transistor under test. Turn the NUMBER OF STEPS control clockwise until ten steps are displayed (see Fig. 10B).

6. Set the HORIZ VOLTS/DIV to .1 V/DIV, BASE VOLTS. Note the display (Fig. 11A) of collector current vs. base-emitter voltage. Push the STEP X.1 button to release to the "out" position and note that the trace is now a

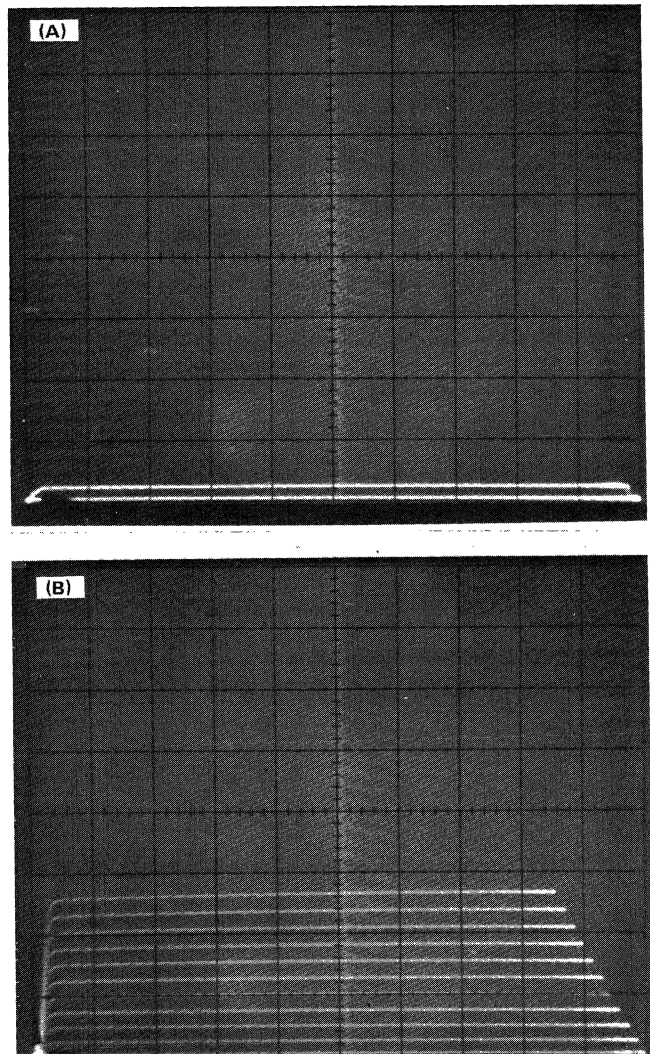

Fig. 10. (A) Illustration of step 4 (NUMBER OF STEPS at 1) and (B) Illustration of step 5 (NUMBER OF STEPS at 20).

repetition of approximately 100 steps, giving the appearance of a ramp rather than steps. Press the STEP X.1 button to the "in" position.

7. Set the HORIZ VOLTS/DIV to STEP GEN. Note the display of collector current vs. base current, one step per horizontal division (see Fig. 11B).

8. Set the HORIZ VOLTS/DIV to 1 V/DIV COLLECTOR VOLTS, and STEP RATE to SLOW. Note that the step rate is slower than the normal mode.

9. Press the STEP RATE NORM button and then the FAST. Note that the FAST step rate is faster than the normal step rate.

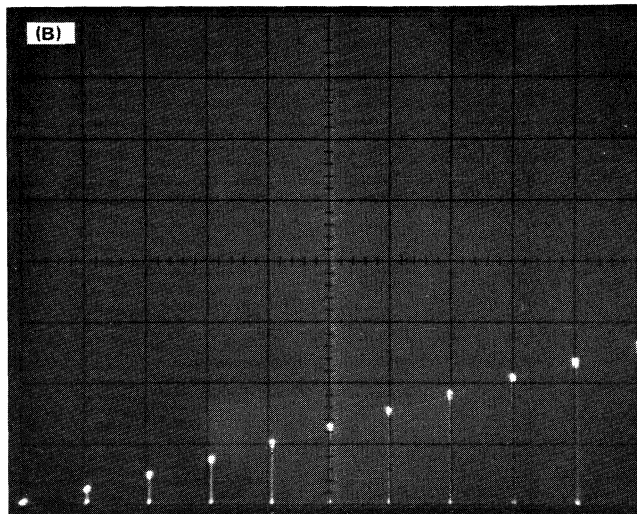
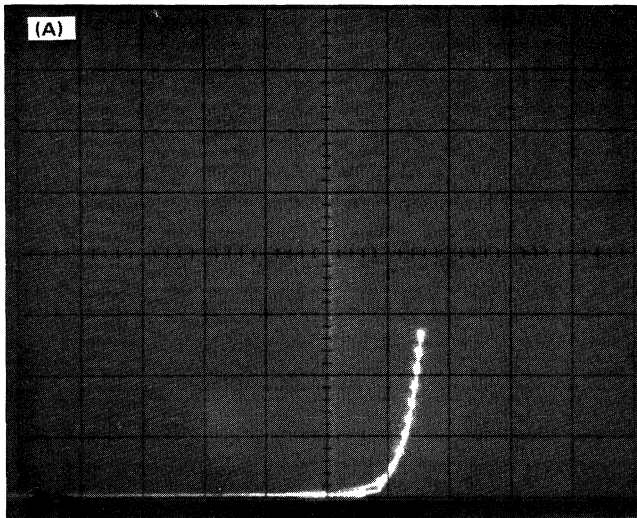

Fig. 11. (A) Illustration of steps 6 (Collector current vs. base-emitter voltage) and (B) illustration of step 7 (collector current vs. base current).

10. Press the STEP FAMILY SINGLE button several times, and note that each time the SINGLE button is pressed a single family of characteristics is displayed. Set the D1 Display Unit to store, press the ERASE button, press the SINGLE button, and note the stored family display.

11. Set the 577 controls as follows:

STEP FAMILY	REP
RATE	NORM
PULSED	Pushed in

12. Note that the collector supply has switched to DC and each step is a short duration (300  $\mu$ s) pulse (see Fig. 12). Turn the VARIABLE COLLECTOR % control slowly counterclockwise and note that the curve is traced and stored (with D1 Display Unit).

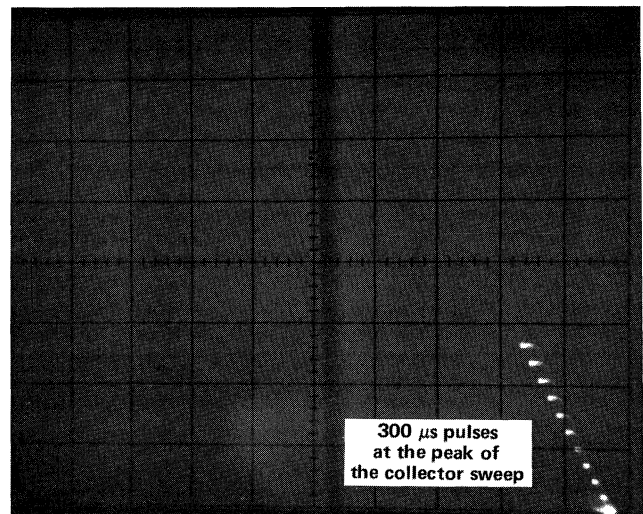

Fig. 12. Illustration of step 14 (300  $\mu$ s PULSED)

13. Set the 577 controls as follows:

PULSED 300 $\mu$ s	"out" position
VARIABLE COLLECTOR	
%	20%
NUMBER OF STEPS	5 displayed (6 lines)

14. Set the STEP/OFFSET AMPL switch and VARIABLE COLLECTOR % control for a family of curves similar to that in Fig. 13A.

15. Position the fifth curve to the graticule center. Pull the VERT X10 MAG (POSITION control) knob and position the display to a convenient area of the graticule (see Fig. 13B).

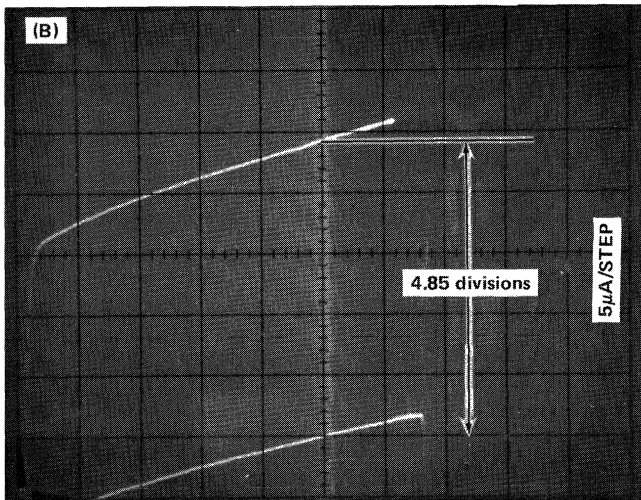
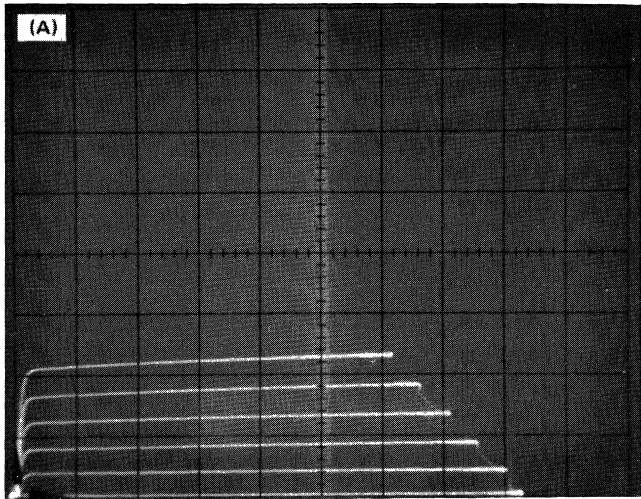

Fig. 13. Illustration of steps 14 and 15,  $\beta$  calculation.

Calculate  $\beta$ /Div as follows:

a. Divide the collector current/division (setting of VERTICAL SENSITIVITY switch) by the base current/step (setting of STEP/OFFSET AMPL switch).

b. Determine the change in collector current per base step (amplitude in vertical divisions for 1 base step).

c. Multiply the  $\beta$ /Div (a) by the collector current change in divisions (b). The example in Fig. 13 shows a base current step of  $5 \mu\text{A}$ . The collector current per division equals  $.2 \text{ mA}$ .

$$\beta \text{ per division} = \frac{.2 \text{ mA/DIV}}{5 \mu\text{A}} = \frac{.2 \times 10^{-3}}{5 \times 10^{-6}} = 0.4 \times 10^2 = 40$$

Since the collector current change between the fourth and fifth steps is 4.85 divisions, the  $\beta$  of the transistor under these operating conditions is 40 times 4.85 = 194.

16. Set the LEFT-RIGHT switch to Off. Place an N-channel junction FET into the LEFT test socket of the FET adapter.

17. Set the 577 controls as follows:

VERTICAL SENSITIVITY 1 mA/DIV

VARIABLE COLLECTOR

% 0  
STEP/OFFSET AMPL .05 V/DIV  
HORIZ VOLTS/DIV 1 V/DIV COLLECTOR  
VOLTS

300  $\mu\text{s}$  PULSED "out" position

18. Set the LEFT-RIGHT switch to LEFT. Turn the VARIABLE COLLECTOR % slowly clockwise. Note the display of drain current vs. drain-source voltage. Since the steps applied to the gate are positive-going, the curves represent the enhancement mode of operation of the FET (see Fig. 14A). Press the STEP FAMILY SINGLE button to locate the curve obtained with zero volts on the gate.

19. Position the zero gate volts curve to graticule center as shown in Fig. 14B. Pull the VERT 10X MAG (POSITION) knob and position the display to a convenient area of the graticule as shown in Fig. 14C. Press the STEP FAMILY REP button and reposition the display as necessary.

20. Calculate  $g_m$ /DIV from the following formula:

$$\frac{\text{Vert Current/Div}}{\text{Gate Volts/Div}}$$

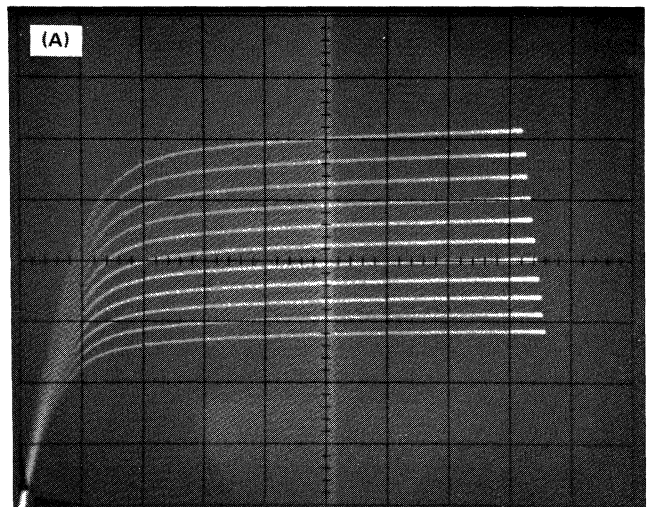

Fig. 14A. Illustration of step 19,  $g_m$  calculation.

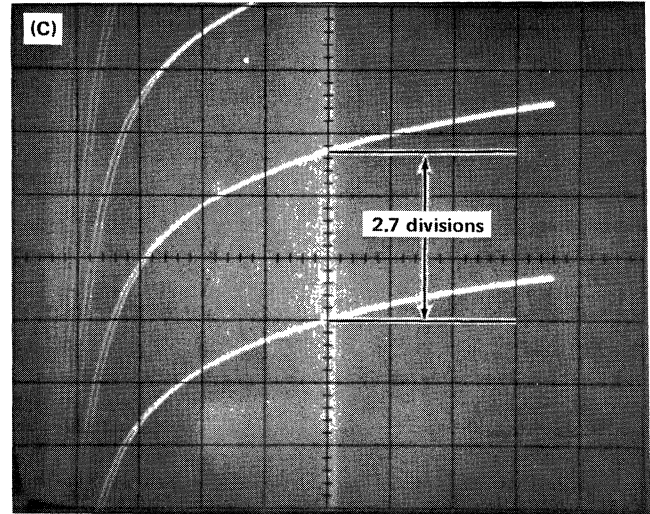
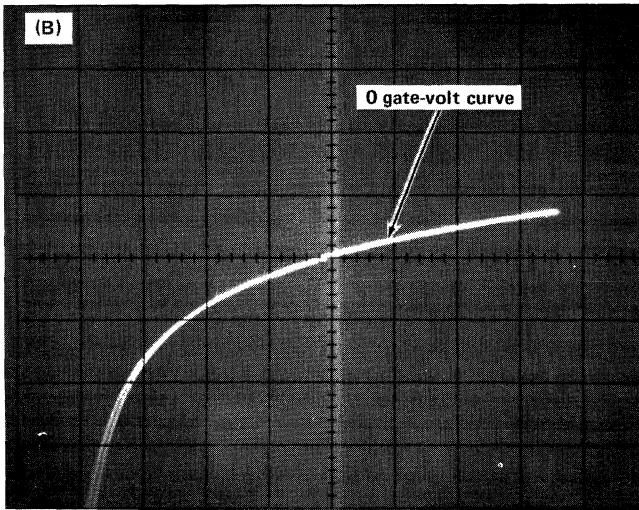

Fig. 14B, C. Illustration of step 19,  $g_m$  calculation (cont).

For the example in Fig. 14C:

$$\frac{50 \mu\text{A}/\text{DIV}}{.05 \text{ V}/\text{DIV}} = \frac{50 \times 10^{-6}}{5 \times 10^{-2}} = 1 \times 10^{-3} = 1000 \mu\text{hos}/\text{Div}.$$

$g_m$ , then is the  $g_m/\text{Div}$  times the number of displayed divisions between curves, and is equal to the  $1000 \mu\text{hos}/\text{Div}$  times 2.7 divisions, or  $2700 \mu\text{hos}$ .

# APPLICATIONS

The 577-177-D1 or D2 Curve Tracer system can be used to measure the basic parameters of a wide variety of devices.

These devices include: bipolar, field effect, and uni-junction transistors; signal, rectifying, Zener, light-emitting, tunnel, and back diodes; silicon-controlled rectifiers; relays; power supplies; and a wide range of resistances.

For each of the devices, the section includes a table of basic control settings required to make the test accurately, without damaging the device under test.

Where necessary for clarification, a diagram of connections to the test fixture and a photograph of a typical characteristic are provided.

A list of common measurements for most devices is also included.

This section was written assuming that the reader is familiar with the operation of the 577 Curve Tracer system and the parameters being considered.

Storage (using the D1 Display Unit) was used for many of the illustrations in this manual. Most of the tests can be performed without storage.

The photos were taken with a C5 Camera; most were stored images.

Storage tends to reduce difference in intensity such that waveform photos are easy to make, practically eliminating any waste of film, even on the first photo.

# BIPOLAR TRANSISTORS

## 577-177 Control Settings

Control	Settings
HORIZ VOLTS/DIV	COLLECTOR VOLTS (1 V/DIV).
COLLECTOR SWEEP POLARITY	+ (NPN) or - (PNP) depending on the transistor type.
VARIABLE COLLECTOR %	100
MAX PEAK VOLTS	6.5
MAX PEAK POWER WATTS	Set to a safe level.
NUMBER OF STEPS	10
STEP/OFFSET AMPL	Current Steps ( $\mu A$ ).
All Dark Gray buttons	Pushed in.
STEP X.1	Pushed in.
PULSED	300 $\mu s$ button pushed in when using high power levels.
Terminal Selector	
Common-Emitter Family	EMITTER GROUNDED, BASE TERM, STEP GEN.
Common-Base Family	BASE GROUNDED, EMITTER TERM, STEP GEN.

## COMMON EMITTER CHARACTERISTICS

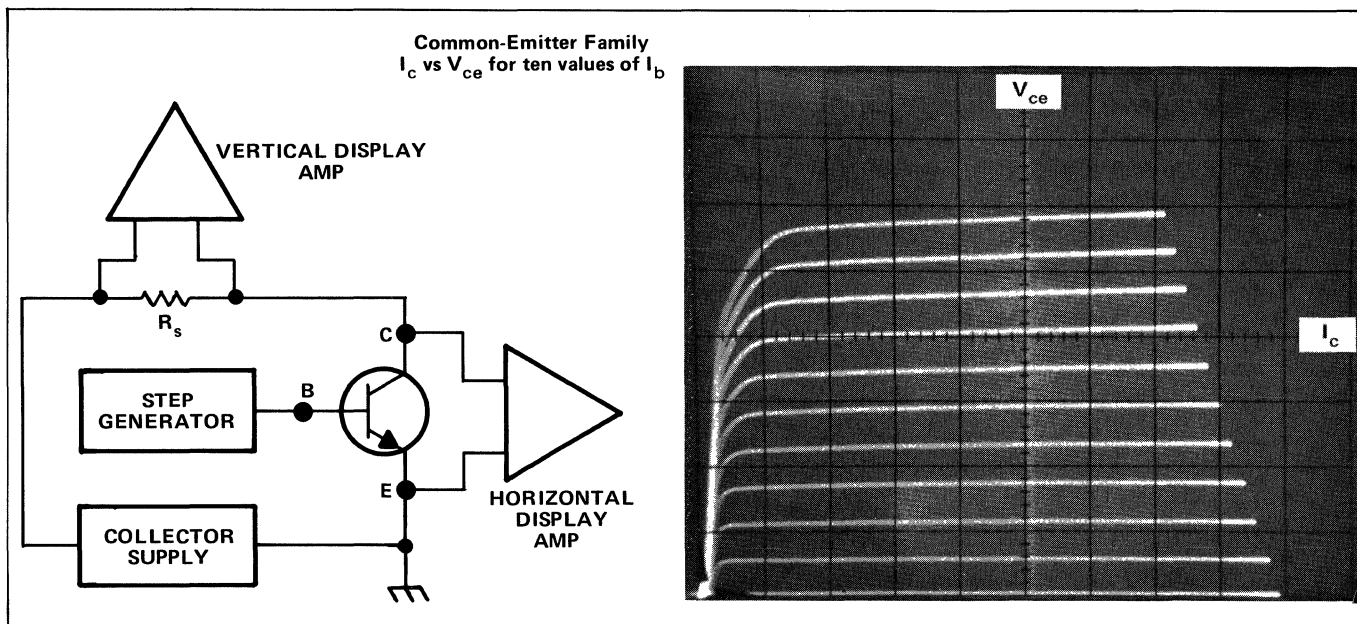



## COMMON MEASUREMENTS

## Beta

$\beta$  (Static) The static forward current transfer ratio (emitter grounded),  $h_{FE}$ , is  $I_C/I_B$ .

$\beta$  (Small Signal) The small-signal short-circuit forward current transfer ratio (emitter grounded),  $h_{fe}$ , is  $\Delta I_C/\Delta I_B$ . To determine  $h_{fe}$  at various points in a family of curves, multiply the vertical separation of two adjacent curves by  $I_C/I_B$ . To make a more accurate measurement of small-signal  $\beta$ , adjust the VERTICAL SENSITIVITY to limit the distance between curves, in the area of interest, to 0.8 divisions. Reduce the NUMBER OF STEPS to 1. Set OFFSET to AID and use the OFFSET MULT to set the display to the desired collector current level. Pull VERT X10 MAG to expand the display vertically. Use Vertical POSITION to re-position the display on the screen.

$\beta$  (High Current) High current  $\beta$  measurements should be made in the manner detailed for small-signal  $\beta$ , but the pulsed mode should be utilized. Use PULSED 300  $\mu s$  and SLOW STEP RATE.

Kelvin sensing is not necessary for high current, medium voltage,  $\beta$  measurements.

$\beta$  (Low Current) When measuring  $\beta$  at lower currents, base steps as low as 5 nA/DIV may be obtained by utilizing the STEP X.1 (in the "out" position). DC mode is necessary to prevent looping. If display noise is objectionable, the noise may be minimized in the following manner: Turn off the STEP FAMILY (press SINGLE button), use DISPLAY FILTER (button "out") and OFF-SET AID.

Curves can be traced manually for each desired level of base drive. Storage (using the D1 Display Unit) is useful for this kind of measurement.

## Saturation

 $V_{CE(SAT)}$ 

Saturation characteristics of many devices can be measured without being tested with pulses. But, usually saturation is specified as a pulsed measurement at 2%, or less, duty cycle. For making measurements to specifications, use the PULSED 300  $\mu s$  and SLOW STEP RATE features of the 577 Curve Tracer system to obtain 2% duty cycle. VARIABLE COLLECTOR % could be adjusted to obtain only the required current level.

At higher current levels (100 mA or above for small-signal devices and somewhat higher for power devices) Kelvin sensing should be utilized for most accurate measurements. See Fig. 15 for a typical display of saturation characteristics.

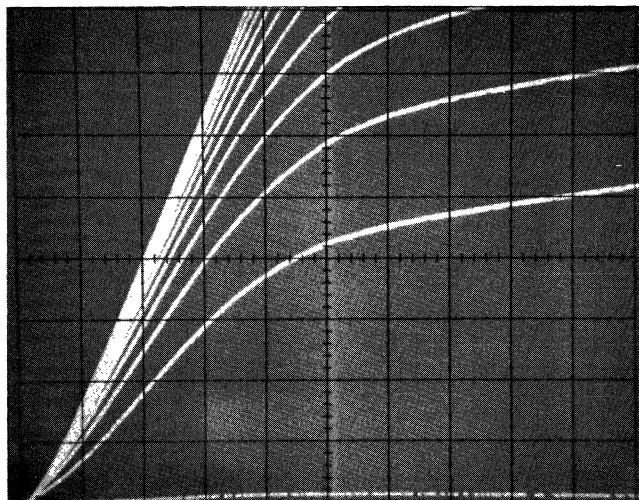

Fig. 15. Typical display of saturation Region characteristics.

 $V_{BE(SAT)}$ 

Set up the test as for  $V_{CE(SAT)}$  and switch the HORIZ VOLTS/DIV to BASE VOLTS.

**WARNING**

*For the leakage and breakdown tests that follow, lethal voltages may exist at the test terminals. USE THE PROTECTION OF THE PLASTIC GUARD BOX. If the plastic box cannot be used, exercise extreme caution.*

**CAUTION**

*Keep MAX PEAK POWER WATTS well below the rating of the device under test, since in the breakdown mode, the device under test can be destroyed at power levels well below the normal operating power. Set the VERTICAL SENSITIVITY consistent with leakage specifications.*

**Leakage and Breakdown** $I_{CEO}$ 

Collector-emitter leakage current with base open. Set the Terminal Selector to BASE TERM OPEN (OR EXT) and the HORIZ VOLTS/DIV and MAX PEAK VOLTS set as desired to make the measurement (consistent with breakdown voltage specifications).

Use DC mode to avoid looping. It is often advantageous to use the DISPLAY FILTER. For a cleaner display, turn off the steps (push SINGLE). Current measurements below 2 nA/DIV may be made by using vertical magnification (pull VERT X10 MAG). Whether using vertical magnification or not, the device under test should be removed from the socket so a zero current reference may be established. With Vertical magnification, the display may go off screen. Vertically reposition to establish zero with the device under test out of the socket.

 $I_{CES}$ 

Collector-emitter leakage current with the base shorted to emitter. Same test as  $I_{CEO}$  except that the Terminal Selector is set to BASE TERM SHORT.

 $V_{(BR)CEO}$ 

Collector-emitter breakdown voltage with the base open. Set the Terminal Selector to BASE TERM OPEN (OR EXT). When checking to breakdown specifications, set the HORIZ VOLTS/DIV to a setting consistent with the specification, and turn the VARIABLE COLLECTOR % until the display indicates breakdown (see Fig. 16).

**Measuring  $V_{(BR)CEO}$  and  $V_{(BR)CES}$  At Currents in Excess of 1 mA**

Tests for  $V_{(BR)CEO}$  and  $V_{(BR)CES}$  at test currents in excess of 1 mA can often be made with the 577 Curve Tracer system using a 300  $\mu$ s pulse.

Since junction heating at high current might damage the device under test, the 577 test is set up to use the step generator offset to hold the device in saturation, then using one 300  $\mu$ s step to obtain zero base current for the  $V_{(BR)CEO}$  test, or zero base volts for the  $V_{(BR)CES}$  test.

Some oscillations may occur at some current level as most devices exhibit a negative resistance region in the breakdown curve. The current level specified for most  $V_{(BR)CEO}$  sustaining tests is usually above the negative resistance region. Because of these oscillations, this test may not be usable for all devices.

Step generator polarity must be in the INVERT mode to turn off the device under test and offset in the OPPOSE mode to turn on the device under test.

Step/Offset amplitude should be no higher than necessary, since the open or shorted condition of the base is more closely approximated when the amplitude is low. For  $V_{(BR)CEO}$  tests, the amplitude is normally between 1 mA and 10 mA.

Settings above 10 mA will not turn on the device under test any harder, since the opposing offset current is limited to about 15 mA.

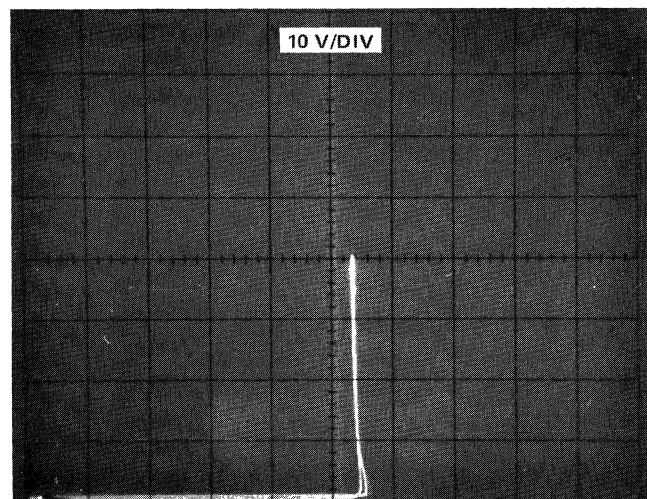

**Fig. 16. Display of collector-emitter breakdown voltage  $V_{(BR)CEO}$**

Select a value of SERIES RESISTOR (in the collector supply) that limits the peak saturation current to a reasonable value (not to exceed 2.5 times the vertical screen dimension, or the collector shutdown circuit will be activated).

#### Setup For Measuring $V_{(BR)CEO}$ (Example)

1. Obtain a normal display (10 steps of  $I_c$  vs.  $V_{ce}$ ).
2. Reduce the number of steps to 1 step above the zero collector current level.
3. Switch the LEFT-RIGHT switch to Off.
4. Turn the VERTICAL SENSITIVITY to 5 mA/DIV.
5. Set MAX PEAK VOLTS to 400, SERIES RESISTOR to 8 k, VARIABLE COLLECTOR % to 0, and COLLECTOR SUPPLY POLARITY to +DC.
6. Set HORIZ VOLTS/DIV to 20 V/DIV.
7. Set OFFSET "out", OPPOSE "out", OFFSET MULT to 1.00, and STEP GENERATOR POLARITY to INVERT.
8. Set the STEP RATE to SLOW and PULSED to 300  $\mu$ s.
9. Turn the VARIABLE COLLECTOR % clockwise and observe the display as the collector voltage is increased. Starting at zero volts, the collector-emitter voltage increases (horizontally) until breakdown is reached (horizontal increase stops).

As the collector supply voltage increases, the collector voltage no longer increases but the current through the device continues to increase, resulting in a display similar to Fig. 17.

Be certain that the device saturates in order to keep the power dissipation to a minimum. If any sign of oscillations occur, the voltage should be reduced or it is quite likely the device will be destroyed.

#### Measuring $V_{(BR)CES}$

Set up the test as for  $V_{(BR)CEO}$ , except that OFFSET AMPLITUDE is set at 1 V/DIV.

$I_{CER}$  and  $V_{(BR)CER}$  Collector-emitter leakage current and collector-emitter breakdown voltage (with a specified resistance between the base terminal and the emitter terminal) are measured the same as  $I_{CEO}$  and  $V_{(BR)CEO}$  except that a resistance is connected between the base terminal and the emitter terminal (R can be connected to terminals on the 177 front panel).

$I_{CBO}$  and  $V_{(BR)CBO}$  Collector-base leakage current and collector-base breakdown voltage (Emitter open) is measured the same as  $I_{CEO}$  and  $V_{(BR)CEO}$  except that the Terminal Selector switch is set to EMITTER TERM OPEN (OR EXT).

$I_{EBO}$  and  $V_{(BR)EBO}$  Emitter-base leakage current and emitter-base breakdown voltage (collector open) are measured the same as  $I_{CBO}$  and  $V_{(BR)CBO}$  except that the Terminal Selector is set to EMITTER-BASE BREAKDOWN.

Limit breakdown current to that specified as the small amount of power dissipated in the emitter-base junction can alter the  $\beta$  of the device. Maximum voltage available in this Selector position is 25 volts, unless the 177 has been modified to remove the 100 V and 400 V from the safety interlock circuit.

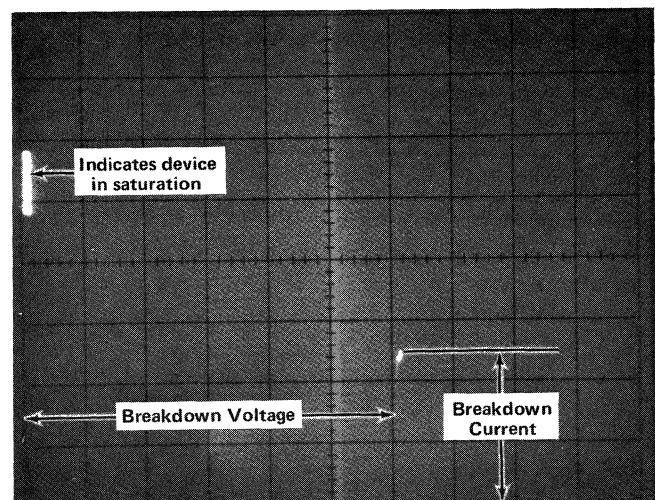

Fig. 17. Typical display of  $V_{(BR)CEO}$  for current values in excess of 1 mA.

**Low Base-Drive Voltage**

Fig. 18 shows the characteristics of a transistor driven with low base-voltage drive. The drive voltage (350 mV to 390 mV in 5 mV increments) was varied using AIDing Offset and the OFFSET MULT.

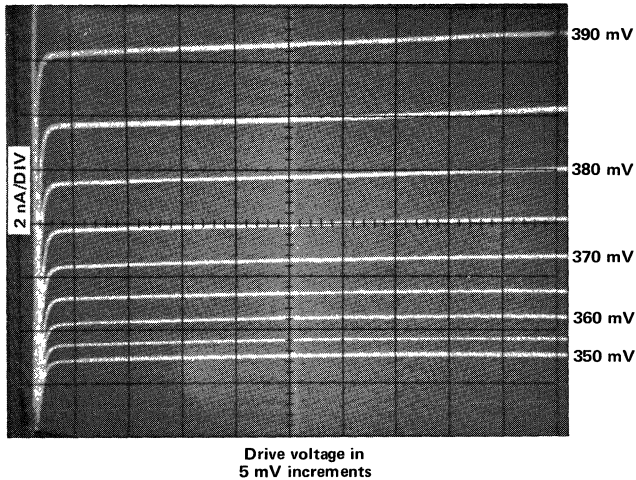

Fig. 18. Characteristics of transistor driven with low base-drive voltage.

Collector current (vertical) was 2 nA/DIV.

The photograph was made using the storage feature of the D1 Storage Display Unit. The collector voltage was swept manually with STEP FAMILY set to SINGLE, COLLECTOR SWEEP POLARITY set to DC, and the DISPLAY FILTER button in the "out" position.

**$I_c$  vs.  $V_{be}$**

The test results displayed in Fig. 19 show deviation from linearity at the highest current (20 mA/DIV) level.

The example (a 2N3905) was made with the Curve Tracer controls set as follows: MAX PEAK VOLTS, 6.5; VARIABLE COLLECTOR %, about 30; COLLECTOR SUPPLY POLARITY, +DC; MAX PEAK POWER WATTS, 2.3; and HORIZ VOLTS/DIV, .1 BASE VOLTS.

The curve at the left represents 200 pA/DIV and each successive curve is one decade higher, i.e., 2 nA, 20 nA, 200 nA, etc., to 20 mA/DIV at the ninth curve. Each curve was traced manually (using the D1 Display Unit storage feature) with base drive provided by the step generator and OFFSET MULT (using AIDing Offset). The base drive voltage can be measured on the horizontal axis.

From 200 pA/DIV to 200 nA/DIV the Display Filter was used.

At 2 mA/DIV and 20 mA/DIV, a 1-volt, 300  $\mu$ s Pulse, and Opposing Offset were used.

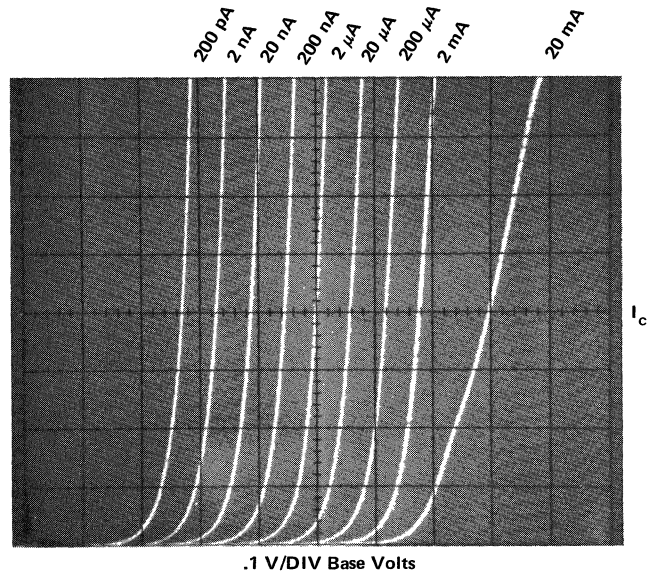
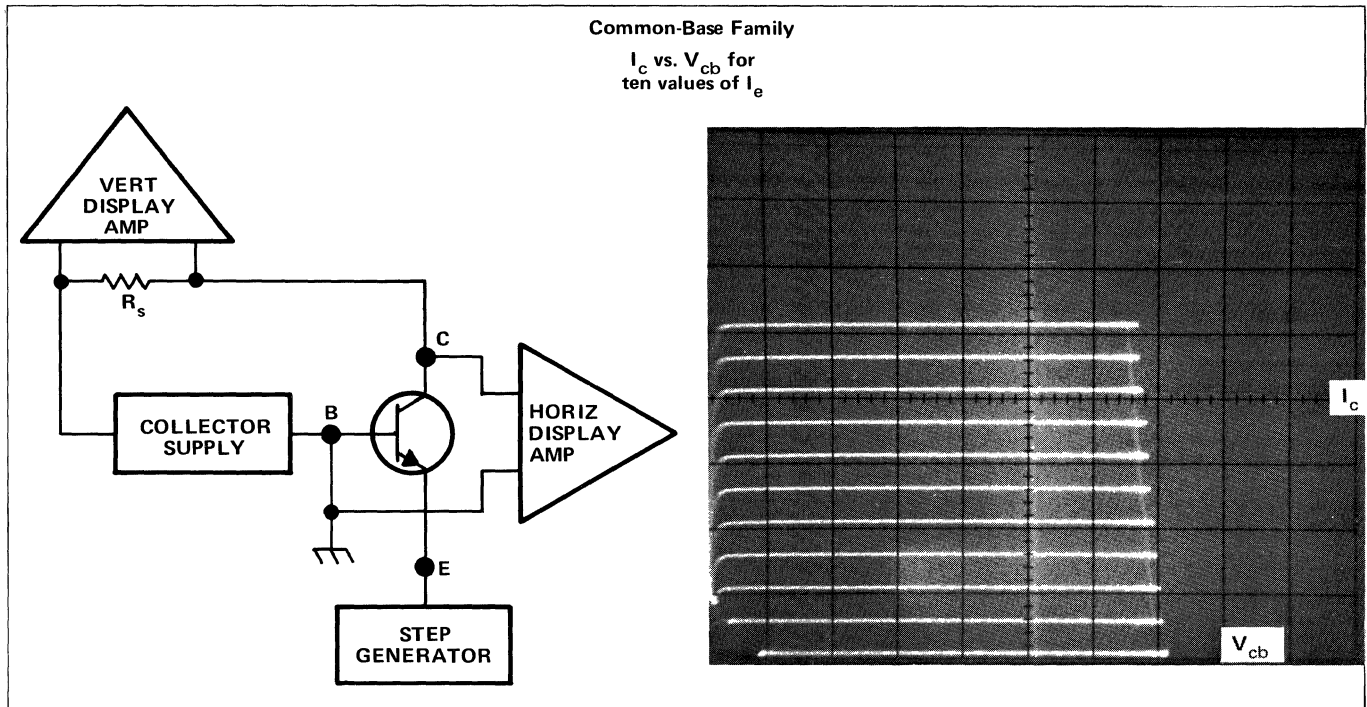

Fig. 19.  $I_c$  vs.  $V_{be}$  for a 2N3509.

## COMMON BASE CHARACTERISTICS



## COMMON MEASUREMENTS

$\alpha$  (Small Signal)

The small-signal short-circuit forward current transfer ratio (base-grounded),  $h_{fb}$ , can be measured from the common-base family displays, but is determined most easily by calculation from the equation:

$$\alpha = \beta / (\beta + 1).$$

# FIELD EFFECT TRANSISTORS

NOTE

Some MOS FETs may be tested in the double transistor adapter, since the basing configuration is the same as that of bipolar transistors. However, the majority of FETs have different basing than bipolar transistors and can be most easily tested in the FET adapter (TEKTRONIX Part Number 013-0099-01).

### 577-177 Control Settings

Control	Settings	
HORIZ VOLTS/DIV	COLLECTOR VOLTS	
COLLECTOR SWEEP POLARITY	+ (NPN) for N-channel device and - (PNP) for P-channel device.	
MAX PEAK POWER WATTS	Set to a safe level.	
MAX PEAK VOLTS	6.5	
VARIABLE COLLECTOR %	100%	
STEP/OFFSET AMPL	VOLTAGE Steps.	
All dark gray buttons	Pushed in.	
300 $\mu$ s PULSED	"out" position.	
Terminal Selector	EMITTER GROUNDED, BASE TERM, STEP GEN.	
STEP/OFFSET POLARITY	Mode <sup>7</sup>	
	Enhancement	Depletion
INVERT	Pushed in	"out" position

<sup>7</sup>STEP/OFFSET POLARITY depends on whether the device is operated in the enhancement or depletion mode. Most junction FETs can operate in the depletion mode and MOS-FETs operate in either the enhancement or depletion modes.

To operate in both modes simultaneously, the POLARITY may be in either position. Set OFFSET to 5, Opposing. This setup gives 5 steps in either direction from zero.

### CHARACTERISTICS

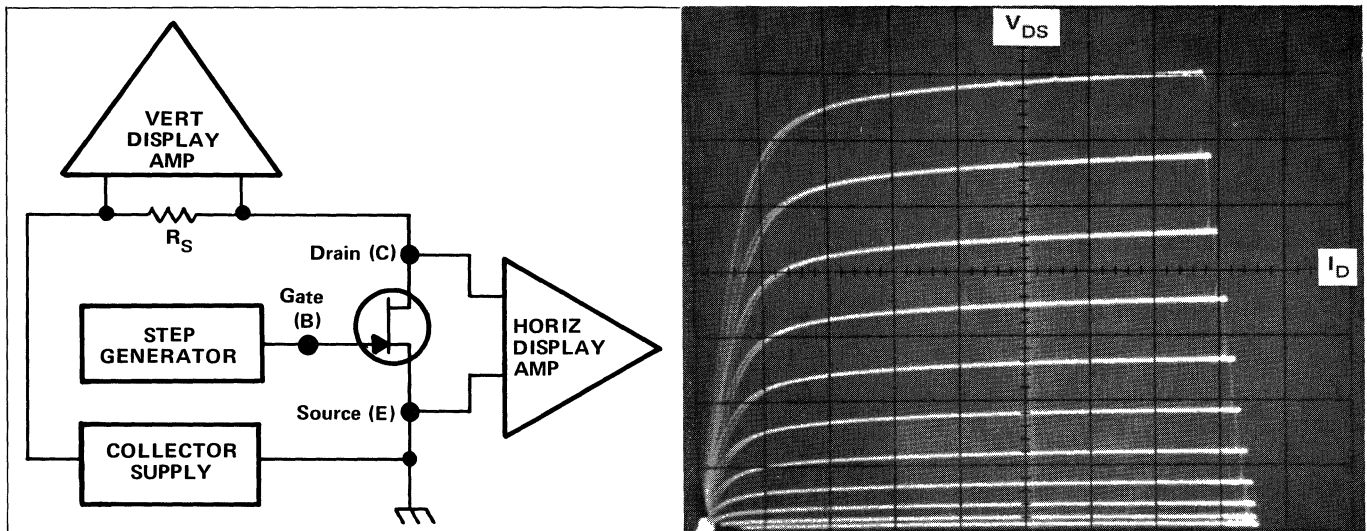

## COMMON MEASUREMENTS

 $g_m$ 

$g_m$  (Static) The static transconductance (source grounded) is  $I_D/V_{GS}$ .

$g_m$  (Small Signal) The small-signal transconductance (source grounded) is  $\Delta I_D/\Delta V_{GS}$ .

 $I_{DSS}$ 

Drain-source current with zero  $V_{GS}$  is measured from the common source family with the Terminal Selector set to BASE TERM SHORT.  $I_{DSS}$  should be measured above the knee of the curve.

Measuring Small-Signal  $g_m$ 

If the FET gate-source voltage is specified at zero, the zero-volt operating point may be set precisely, as follows:

Display a normal common-source family of characteristics.

Adjust the MAX PEAK VOLTS and VARIABLE COLLECTOR % to set the  $V_{DS}$  to that specified.

Vertically position the zero volt curve to a reference line on the graticule.

Reduce the NUMBER OF STEPS to 1.

Using the OFFSET OPPOSE and OFFSET MULT, position the displayed traces to be equidistant from the reference line. Pull the VERT X10 MAG and measure the distance between the two traces.

Calculate  $g_m/\text{Div}$  from the formula:

$$\frac{I_D/\text{Div}}{V_{GS}/\text{Div}}$$

and multiply the  $g_m/\text{Div}$  by the number of divisions of display at the current of interest. See Fig. 20 for typical displays.

## Pinch-Off Voltage

Pinch-off Voltage ( $V_p$ ) Pinch-off voltage,  $V_p$ , can be measured by increasing the depletion voltage with the OFFSET MULT control and the STEP/OFFSET AMPL switch until the specified pinch-off current is reached.

Example of the procedure for a typical FET:

Observe a family of characteristics. Set the MAX PEAK VOLTS and VARIABLE COLLECTOR % to display (horizontally) the  $V_{DS}$  specified. Set OFFSET to AID, OFFSET MULT to 0, and STEP FAMILY to SINGLE. Turn the OFFSET MULT control to reduce the drain current toward zero (STEP/OFFSET AMPL may need resetting).

Increase the VERTICAL SENSITIVITY toward the specified pinch-off current (STEP/OFFSET AMPL and OFFSET MULT may need resetting to keep the display on-screen).

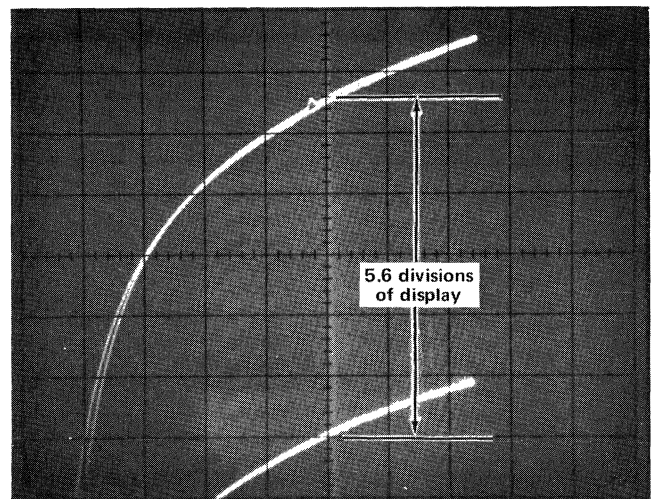
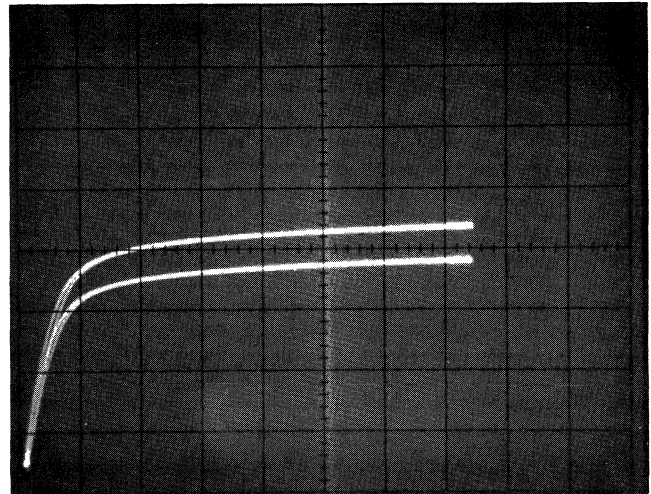

Fig. 20. Display illustrating method of measuring small-signal  $g_m$ .

## 577-177-D1 or D2 Operators

Set the trace to indicate the desired current (vertical).

Calculate the pinch-off voltage from the product of the STEP/OFFSET AMPL and the OFFSET MULT controls.

### Finding Zero Temperature Coefficient, $T_c$

To provide the best display of the results of this test method, the storage feature should be used.

Display a normal family of curves..

Push the STORE buttons on the D1 Display Unit and then push the ERASE button to prepare the target for storage.

Heat (or cool) the device under test and look for the level at which the least change occurs. See Fig. 21 for a typical display. The Offset may be used to change the

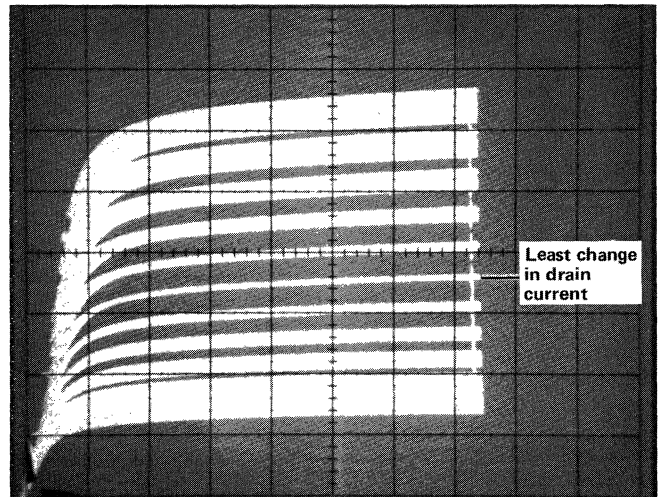

Fig. 21. Display of changes in drain current characteristics with temperature changes. Stored display clearly shows level of least change in drain current.

position of the steps such that the zero temperature point may be found more accurately.



# UNIUNCTION TRANSISTORS

## 577/177 Control Settings

Control	Setting
HORIZ VOLTS/DIV	COLLECTOR VOLTS
COLLECTOR SWEEP POLARITY	+
MAX PEAK POWER WATTS	Set to a safe level.
STEP/OFFSET AMPL	Voltage steps.
OFFSET	"out" position.
OPPOSE	"in" position.
STEP FAMILY	SINGLE (dial in desired offset).
Terminal Selector	BASE TERM STEP GEN.

## CHARACTERISTICS

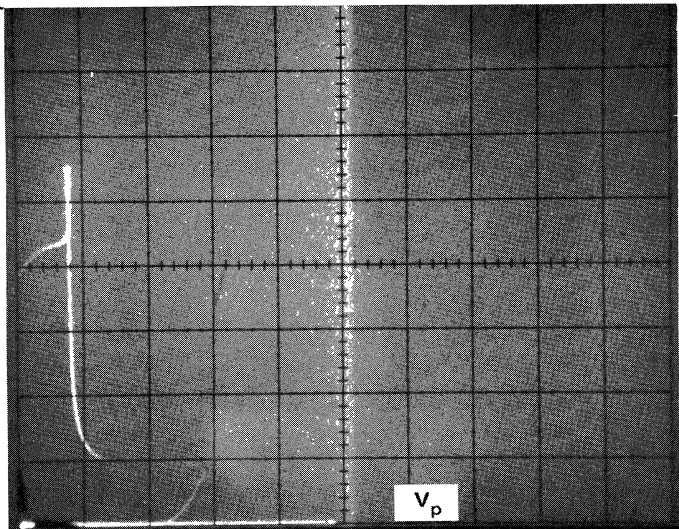
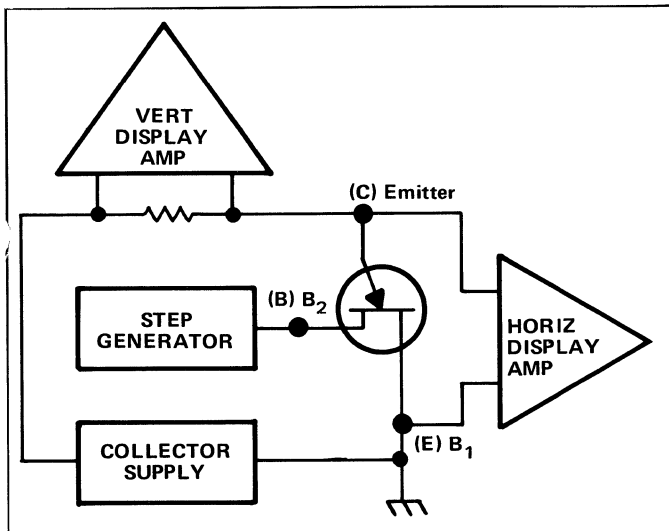

## COMMON MEASUREMENTS

n

The intrinsic standoff ratio is as shown in the formula:

$$\frac{V_p - V_{EB_1}}{V_{B_2B_1}}$$

where  $V_{B_2B_1}$  is the voltage between bases.  $V_{B_1B_2}$  is determined by the OFFSET MULT and the STEP/OFFSET AMPL controls.  $V_{B_1B_2}$  may be measured by setting the HORIZ VOLTS/DIV to BASE VOLTS.  $V_p$  is determined by applying voltage between the emitter and the base<sub>1</sub> terminals

$R_{B_2B_1}$

using the VARIABLE COLLECTOR % control.  $V_p$  is the voltage at which the emitter-base<sub>1</sub> junction becomes forward biased.  $V_{EB_1}$ , the turn on voltage of the emitter-base<sub>1</sub> junction is determined by setting the Terminal Selector to BASE TERM OPEN.  $V_{EB_1}$  is typically 0.5 V at 10  $\mu$ A.

The interbase resistance can be measured by placing the base<sub>2</sub> lead in the collector terminal of the test socket and the base<sub>1</sub> lead in the emitter terminal. Leave the emitter lead of the device open and apply voltage across the two bases with

the VARIABLE COLLECTOR % control and measure R from the slope of the display.

$V_{EB_1(SAT)}$

Emitter saturation voltage. Set up this test as shown in the block diagram. Use the step generator to provide voltage to base<sub>2</sub>. Measure the voltage at saturation (as shown in Fig. 22) at the current specified. Typical figures for this device are: Base<sub>2</sub>, 10 volts; Current at which saturation is measured, 50 mA.

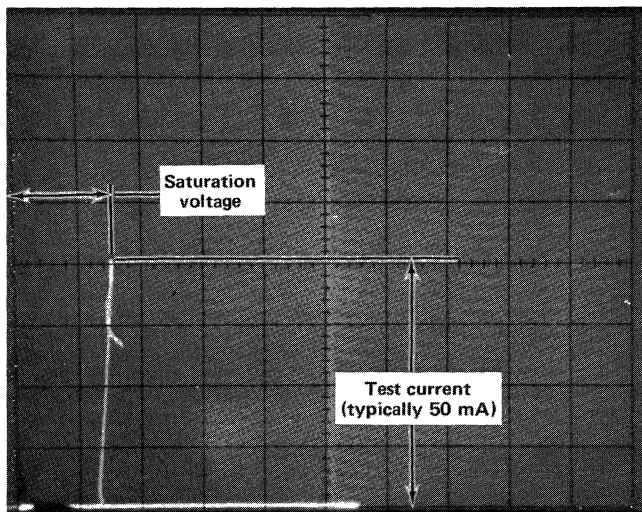

Fig. 22. Typical display of Emitter Saturation Voltage  $V_{EB_1(SAT)}$ .

$I_{EB_20}$

Emitter Reverse Current with B<sub>1</sub> open. Use specified voltage on B<sub>2</sub> and measure as with any leakage current.

$I_{B_2(MOD)}$

Modulated Interbase Current.  $I_{B_2(MOD)}$  is the current flowing in base<sub>2</sub> with the specified current in the emitter circuit, using the specified interbase voltage. Set up the test as shown in Fig. 23A. Set NUMBER OF STEPS to 1, STEP/OFFSET AMPL to 50 mA/DIV, HORIZ VOLTS/DIV to 2 V/DIV, and measure current as in Fig. 23B.

### Measuring Negative Resistance of the Unijunction Transistor

Connect the unijunction to the test fixture as for measuring emitter saturation characteristics, with one exception: Connect a variable resistance in series with the unijunction emitter and the Collector (C) terminal of the test adapter.

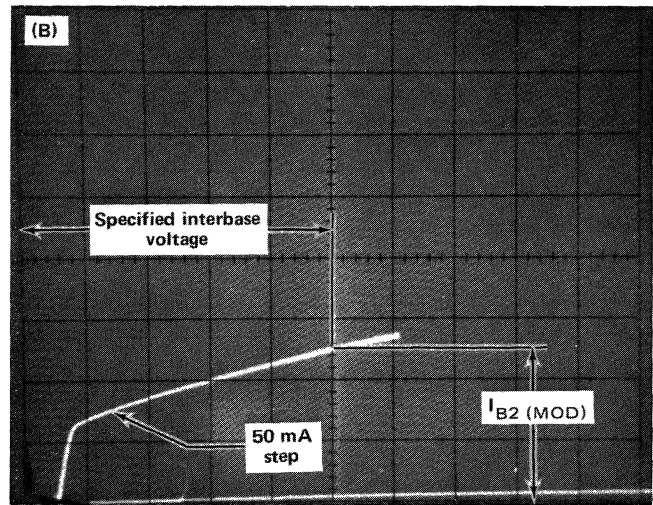
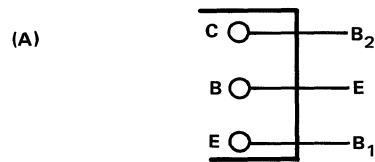

Fig. 23. (A) Connecting unijunction transistor to test fixture (B) Typical display of Modulated Interbase Current.

Set the resistance to zero and set up the test to observe emitter saturation voltage.

Increase the value of resistance to the point at which the display is vertical at the current level of interest. See Fig. 24.

The value of resistance required to produce the vertical display is equal to the negative resistance of the device.

Since the display has some curvature, the measurement should be made at the point at which the curve is tangent to the vertical.

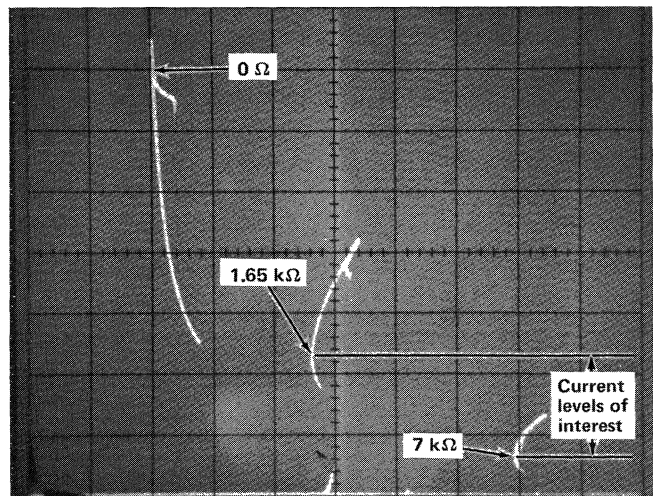

Fig. 24. Stored display of the effect of resistance in series with the unijunction emitter.

# SILICON CONTROLLED RECTIFIERS (SCRs)

## 577/177 Control Settings

Control	Settings
HORIZ VOLTS/DIV	COLLECTOR VOLTS or BASE VOLTS.
MAX PEAK POWER WATTS	Set to a safe level.
COLLECTOR SWEEP POLARITY	+
STEP FAMILY, REP	Pushed in when using low gate voltage or current.
PULSED 300 $\mu$ s	Pushed in.
Terminal Selector	EMITTER GROUNDED, BASE TERM, STEP GEN.

## CHARACTERISTICS

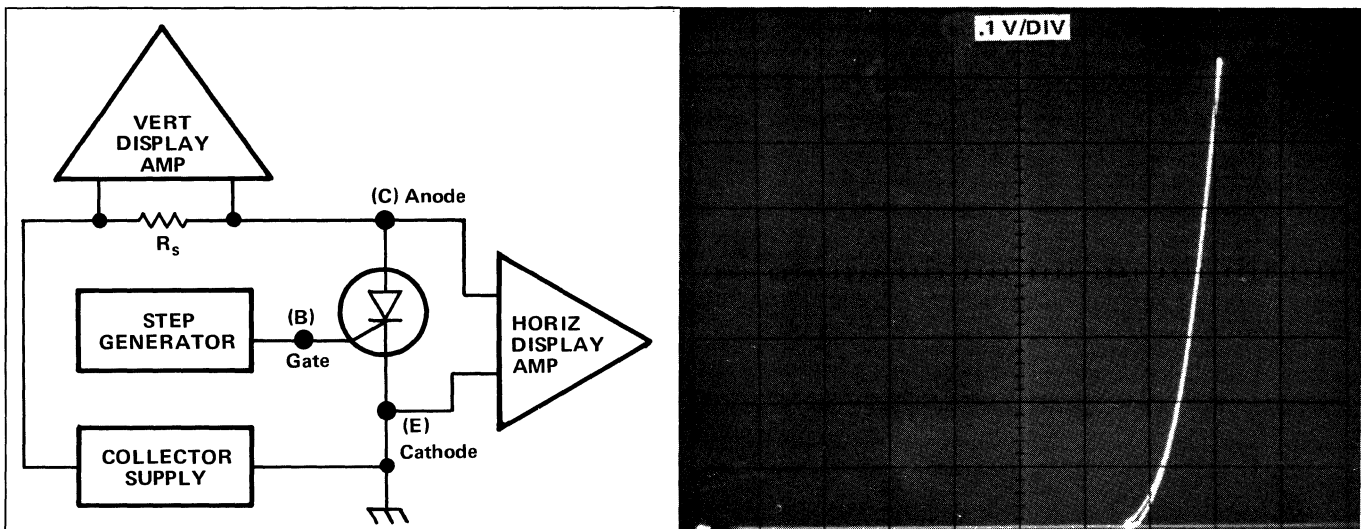

## COMMON MEASUREMENTS

### Turn-On Voltage

Fig. 25 is a display of the turn-on characteristics of a 2N3669 SCR with the turn-on voltage indicated. Set up the test for the device as follows: Set HORIZ VOLTS/DIV to .1 BASE VOLTS; STEP/OFFSET AMPL to .1 V/Step; STEP X.1 to "out" position; NUMBER OF STEPS clockwise; MAX PEAK VOLTS to 6.5; and SERIES RESISTORS switch to minimum resistance.

Set the VERTICAL SENSITIVITY to .1 A/DIV and push all dark gray buttons to the "in" position.

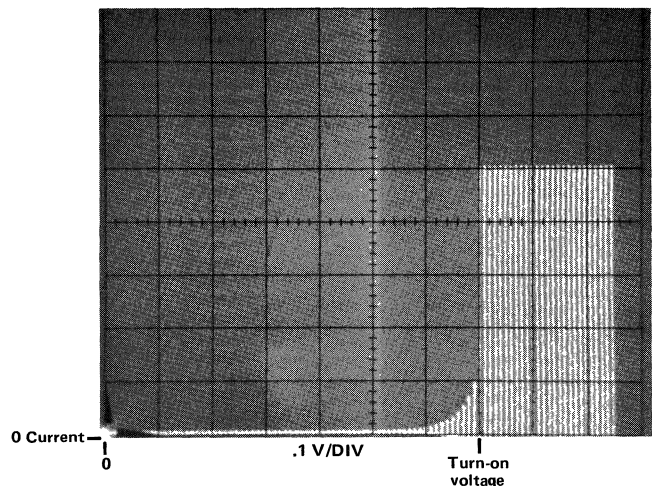

Fig. 25. Display of 2N3669 SCR turn-on voltage.

Adjust the VARIABLE COLLECTOR % for the current level desired (vertical) and measure the turn-on voltage on the horizontal axis.

**Forward Blocking Voltage**

To measure forward blocking voltage, set the Terminal Selector switch to BASE TERM OPEN (OR EXT). If a value of R is specified between gate and cathode, connect a resistor between GROUND and the EXT BASE OR EMIT connector on the test fixture front panel.

**CAUTION**

*Set the SERIES RESISTORS switch to a large enough value to prevent damage to the device if break-over should occur.*

Turn the VARIABLE COLLECTOR % control clockwise only until the forward current reaches the specified level. The voltage at which the specified current is reached is the forward blocking voltage.

**Reverse Blocking Voltage**

Reverse blocking voltage is measured in the same way as the forward blocking voltage except that the COLLECTOR SUPPLY POLARITY is set to -(PNP).

**SCR Forward Voltage Drop**

Fig. 26 is a typical display of the characteristics of an SCR (2N3669) with the Forward Voltage Drop indicated.

Set up the test for this device as follows:

Set the VERTICAL SENSITIVITY to 2 A/DIV, HORIZ VOLTS/DIV to .2 COLLECTOR VOLTS, MAX PEAK VOLTS to 6.5, SERIES RESISTORS to minimum, and all dark gray buttons (plus 300 μs PULSED) pushed to the "in" position except STEP RATE to FAST.

Set NUMBER OF STEPS to 10 and STEP/OFFSET AMPL to 50 mV/Step.

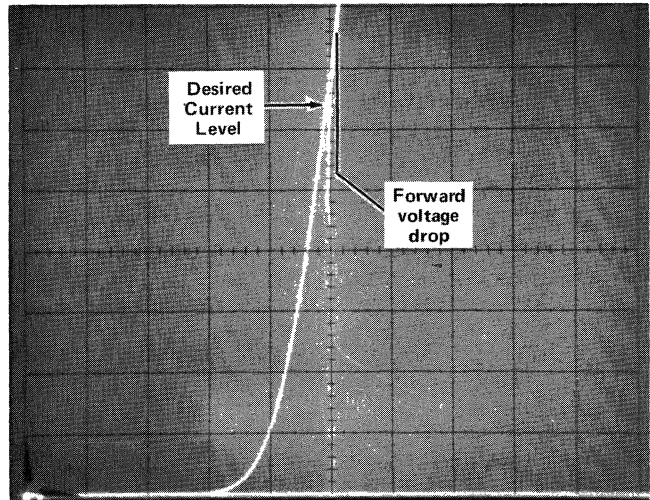

Fig. 26. SCR Forward voltage drop.

Set VARIABLE COLLECTOR % to produce a 10 division horizontal trace.

Increase the STEP/OFFSET AMPL until the display indicates the device has turned on. Reduce the number of steps to the point at which only the last step triggers the device (lowest number of steps which causes conduction). This method reduces the test duty cycle to about 10% to 25%.

To further reduce the test duty cycle, push the STEP X.1 button to release the button to the "out" position and readjust the NUMBER OF STEPS control to the lowest setting that causes conduction.

Adjust the VARIABLE COLLECTOR % control to obtain the desired current, and measure the forward drop on the horizontal axis at the specified current level.

**SCR Holding Current**

To measure holding current (minimum anode current that holds the device in the conducting state), push all dark gray buttons to the "in" position except, STEP RATE to FAST.

Fig. 27 shows the SCR characteristics with the holding current indicated.

Curve Tracer control settings for this device were: VERTICAL SENSITIVITY, 5 mA/DIV; HORIZ VOLTS/DIV, .2 COLLECTOR VOLTS; and STEP/OFFSET AMPL, 2 VOLTS/STEP. VARIABLE COLLECTOR % was increased until the device turned on.

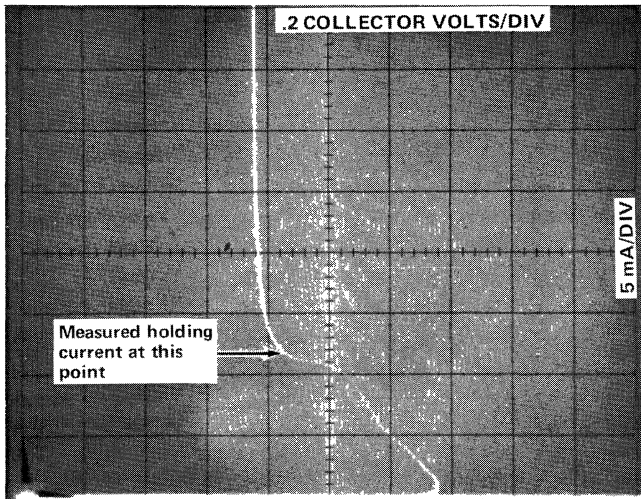

Fig. 27. Display of SCR holding current.

### Triac Characteristics

Triac characteristic measurements can be made in much the same manner as SCRs. Use the AC mode to view conduction in both directions.

Fig. 28 shows a typical display of a General Electric SC141B Triac.

To set up this test, set the COLLECTOR SUPPLY POLARITY to AC, MAX PEAK VOLTS to 6.5, MAX

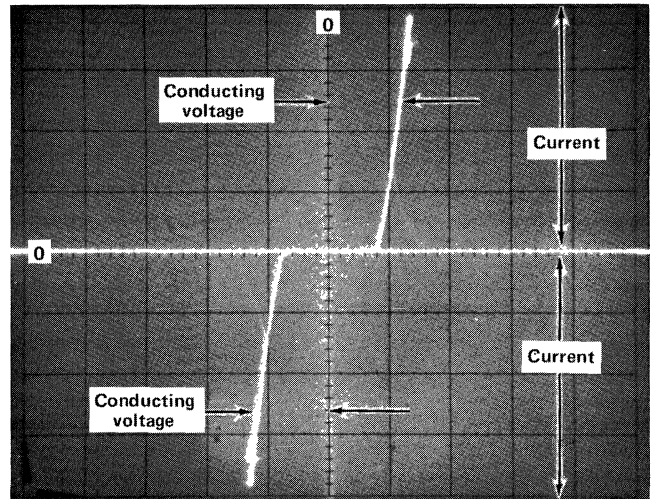

Fig. 28. Display of GE SC141B Triac characteristics measured in AC mode to show conduction in both directions.

PEAK POWER WATTS to maximum, and all dark gray buttons (plus 300  $\mu$ s PULSED) pushed to the "in" position except STEP RATE to FAST.

Set HORIZ VOLTS/DIV to 1 V/DIV, VERTICAL SENSITIVITY to 2 A/DIV, STEP/OFFSET AMPL to .2 V/Step and NUMBER OF STEPS set high enough to cause conduction in both directions.

Adjust VARIABLE COLLECTOR % to display approximately 8 A in each direction.

# SIGNAL AND RECTIFYING DIODES

## 577/177 Control Settings

Control	Settings
HORIZ VOLTS/DIV	COLLECTOR VOLTS
MAX PEAK POWER WATTS	Set to a safe level.
COLLECTOR SWEEP POLARITY	+
Terminal Selector	EMITTER GROUNDED.

## CHARACTERISTICS

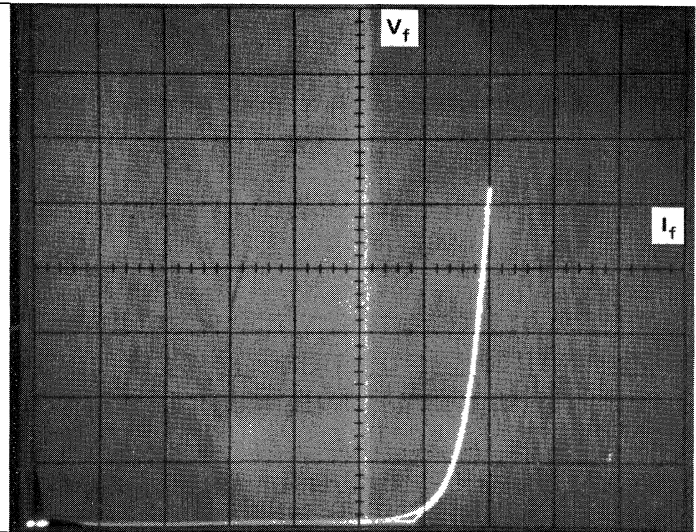
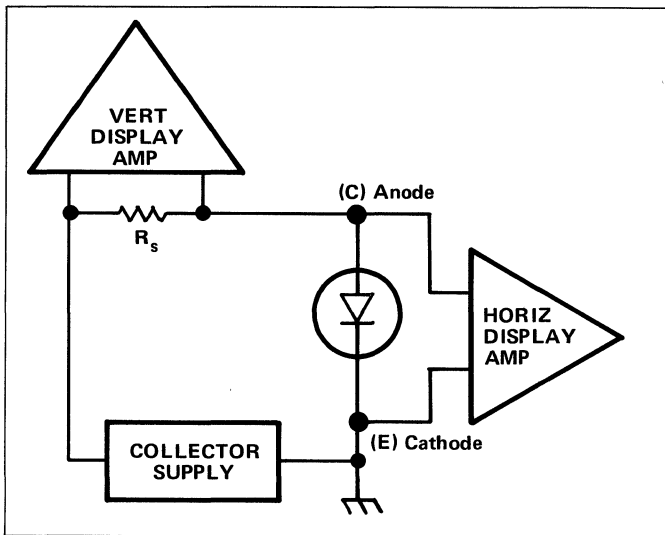

### COMMON MEASUREMENTS

$I_f$  and  $V_f$

To measure forward current and voltage, place the diode in the adapter with the cathode in the adapter emitter terminal and the anode in the adapter collector terminal. Apply voltage to the diode with the VARIABLE COLLECTOR %.

$I_r$  and  $V_r$

Current and voltage in the reverse direction are measured in the same manner as in the forward direction, except that the COLLECTOR SWEEP POLARITY is set to -.

### Diode Forward Voltage Drop

This test method permits current levels that would ordinarily destroy the device if tested at the same levels using the Collector Sweep. The diode is pulsed ( $300 \mu s$

pulses) at current levels from 100 mA to 1 A in ten steps. See Fig. 29.

Connect the diode to the transistor adapter with its anode in the adapter Base terminal and its cathode in the adapter Emitter terminal.

Push all dark gray buttons and the  $300 \mu s$  PULSED button to the "in" position.

Set the HORIZ VOLTS/DIV switch to .1 BASE VOLTS/DIV, the STEP/OFFSET AMPL switch to 100 mA, and the NUMBER OF STEPS to 10.

To establish a zero reference voltage, short circuit the test fixture B to E terminals and position the spot to the first graticule line.

Read the forward voltage drop from the horizontal display.

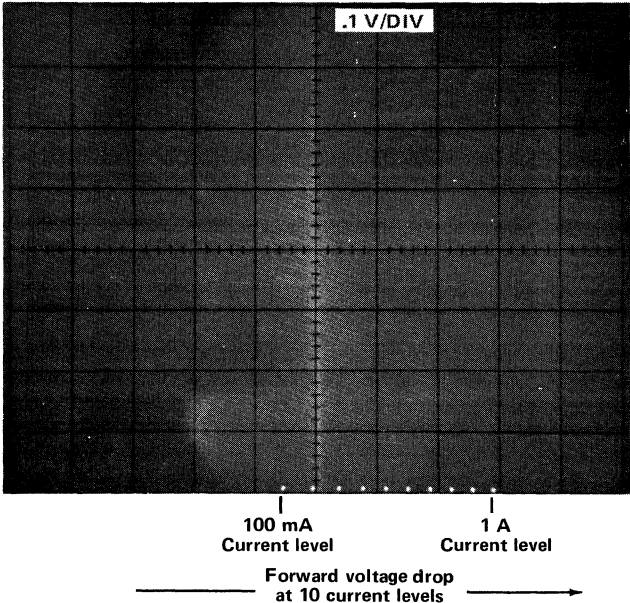

Fig. 29. Display of diode forward drop at high current levels using 300  $\mu$ s PULSED mode.

**Diode Characteristics  $I_f$  vs.  $V_f$**

This test method shows departure from ideal diode characteristics at low and high current levels. See Fig. 30.

Looking across any horizontal line on the display, the change in  $V_f$  is shown for each decade change in  $I_f$ .

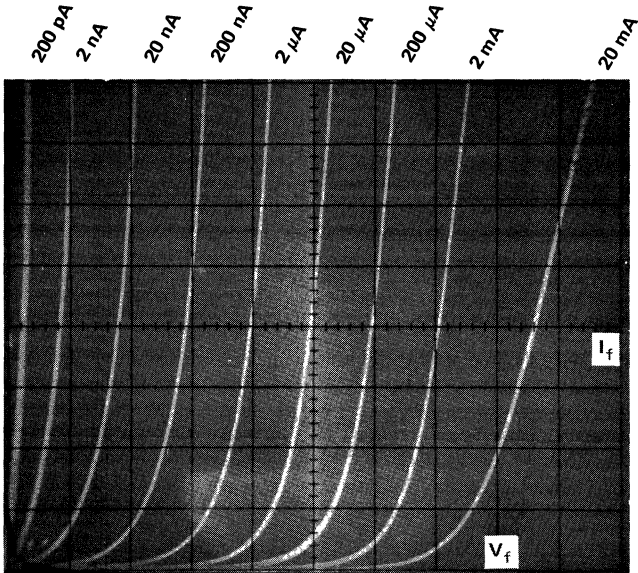

Fig. 30. Display of  $I_f$  vs.  $V_f$  for a typical diode. Each curve was traced by sweeping collector voltage manually at each current level. Photo from stored display.

The photo was made from a stored display. Each curve was traced by sweeping manually in the DC mode at each current level. The VERT X10 MAG and DISPLAY FILTER were used for the lowest current curve. With filter in, manual sweep must be made very slowly.

The first (left) curve is 200 pA, while the last curve is 20 mA. HORIZ VOLTS/DIV set to .1 V/DIV.

# ZENER DIODES

## 577/177 Control Settings

Control	Settings
HORIZ VOLTS/DIV	COLLECTOR VOLTS
MAX PEAK POWER WATTS	Set to a safe level.
COLLECTOR SWEEP POLARITY	AC
Terminal Selector	EMITTER GROUNDED.

## CHARACTERISTICS

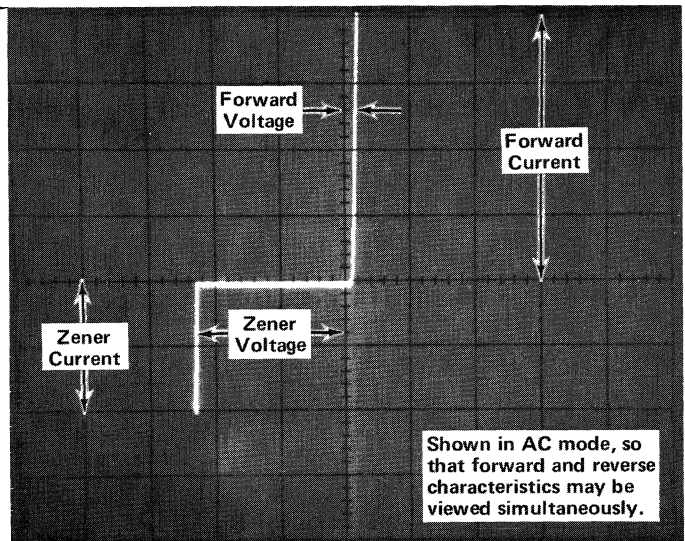
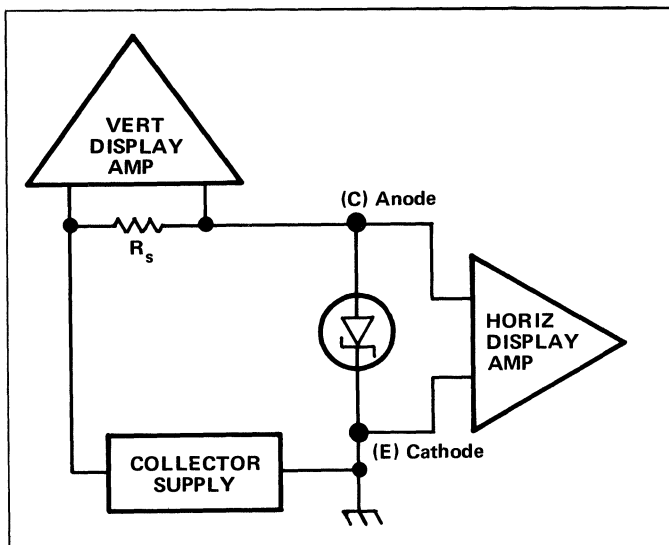

## COMMON MEASUREMENTS

$V_z$  and  $I_r$

To measure Zener voltage or reverse current, place the diode in the adapter with the cathode in the adapter emitter terminal and the anode in the adapter collector terminal. Apply voltage to the device with the VARIABLE COLLECTOR %. Set COLLECTOR SUPPLY POLARITY to -.

$I_f$  and  $V_f$

Current and voltage in the forward direction are measured in the same manner as in the reverse direction except that the COLLECTOR SUPPLY POLARITY is set to +. For a display of current and voltage in both directions, set the COLLECTOR SWEEP POLARITY to AC.

## Zener Characteristics at Low Current

Fig. 31 shows the characteristics of the Zener knee at current values from 2 nA/DIV to 20  $\mu$ A/DIV in decade steps.

The test was made using + COLLECTOR SUPPLY POLARITY with HORIZ VOLTS/DIV at 2 V/DIV COLLECTOR VOLTS.

## Zero Temperature Coefficient

Zero temperature coefficient of a temperature compensated Zener may be quite easily found using the storage feature of the D1 Display Unit.

If a calibrated temperature source is available, the temperature coefficient at any current is easily determined.

Fig. 32 shows a stored display at the current level at which the coefficient is zero.



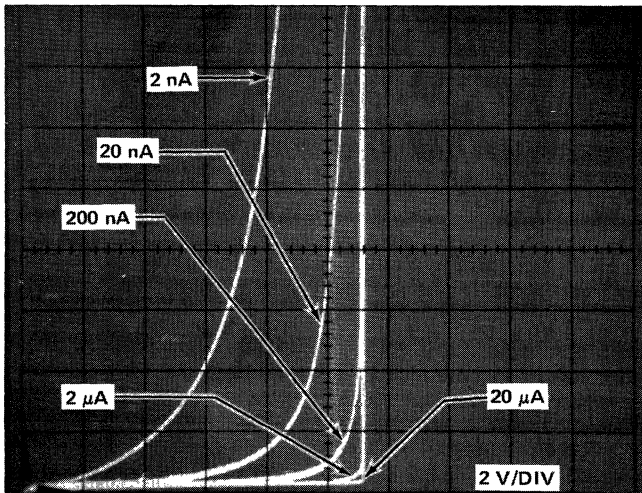

Fig. 31. Display of Zener characteristics for five low values of Zener current.

Use the X10 HORIZ MAG and horizontally position the Zener breakdown to graticule center.

Store one display at a low temperature (Zener cooled) and the other at a high temperature (Zener heated). The crossover on the display is the zero temperature coefficient point.

Fig. 33 shows a stored display of the change in voltage as the Zener is heated (or cooled).

Fig. 34 shows a stored display magnified, and at a more sensitive HORIZ VOLTS/DIV setting using step generator opposing offset voltage to position the display to graticule center (see Fig. 34B). This display shows the device at room temperature (center trace) and the traces caused by cooling and heating.

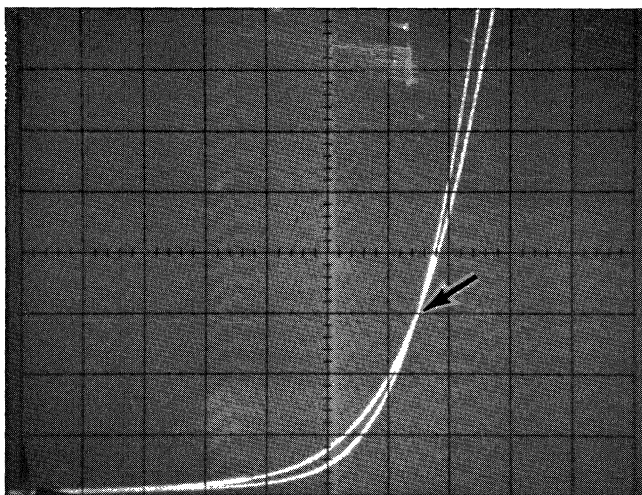

Fig. 32. Display of temperature compensated Zener characteristics showing current (magnified) level at which the temperature coefficient is zero.

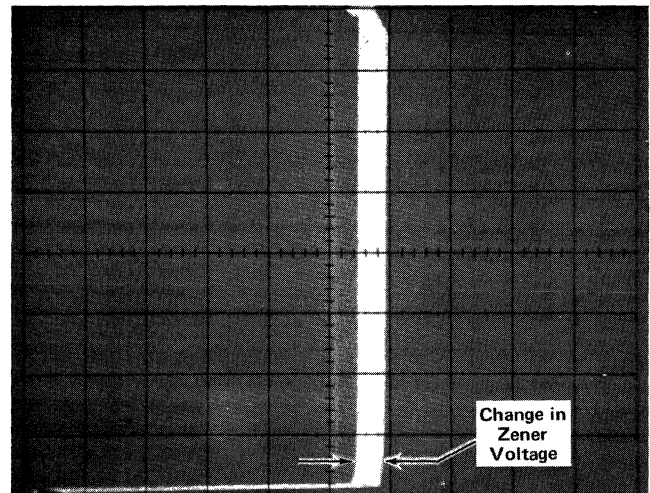

Fig. 33. Stored display of change in Zener voltage with temperature change.

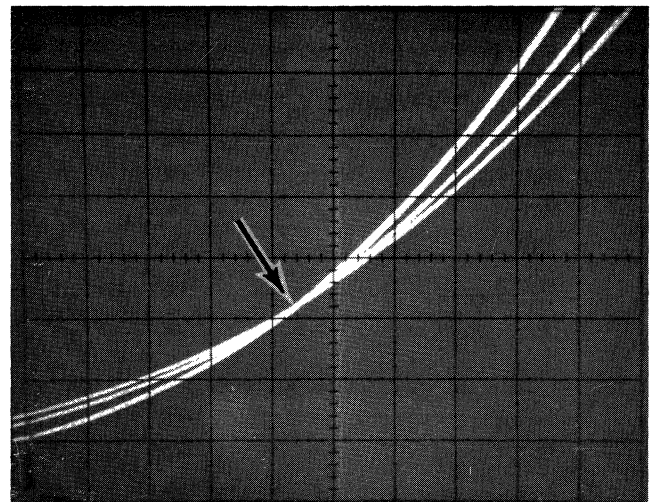

Fig. 34A. Stored display of Zener zero temperature coefficient. See text.

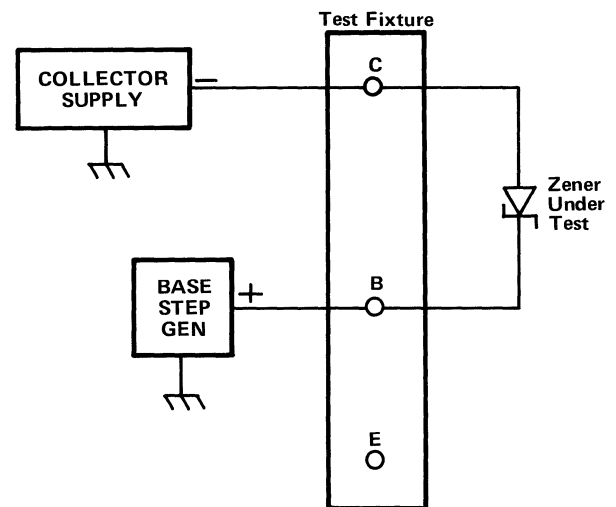

Fig. 34B. Method of connecting the Zener and Base Step Generators.

**Zener Tolerance Limits**

Connect a patch cord between the B and C terminals of one set of test fixture terminals.

Set a voltage limit on the STEP/OFFSET AMPL and OFFSET MULT controls.

Set the HORIZ VOLTS/DIV control to obtain an on-screen display. Turn on X10 HORIZ MAG and use the Vertical POSITION control to trace a vertical line on the storage screen (lower half).

Set the next voltage limit by adjusting the OFFSET MULT to the voltage desired. Again trace a vertical line. If desired, high limit, low limit, and nominal values can be stored for comparison.

Connect the Zener being tested to the remaining set of test fixture terminals (with adapter) and vertically position the display to the upper half of the screen (either stored or not) and compare the Zener to the stored limits set on the lower screen, as shown in Fig. 35.

A high degree of accuracy may be obtained by measuring each limit voltage using a DVM.

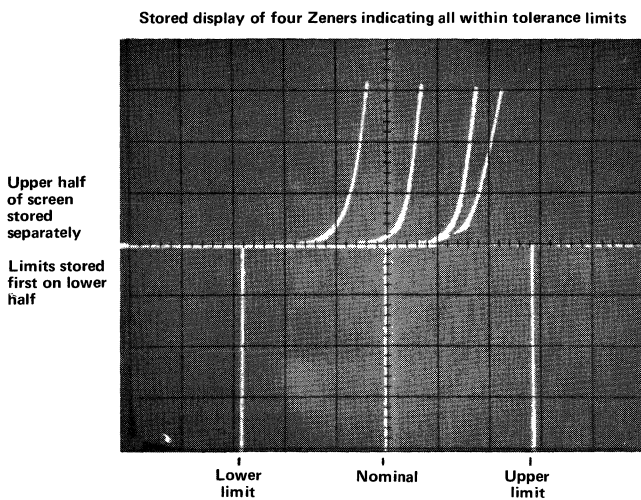

Fig. 35. Display of tolerance limits stored on lower screen and Zener characteristics stored in upper screen.

If storage is not available, a reference voltage can be set on one set of test fixture terminals, using the STEP/OFFSET AMPL and OFFSET MULT controls as above. The Zener being tested is placed in the remaining test fixture terminals and the LEFT-RIGHT switch alternately switched between the two "on" positions. If the LEFT-RIGHT switch is switched rapidly, between LEFT and RIGHT positions, the display is similar to that of Fig. 36.

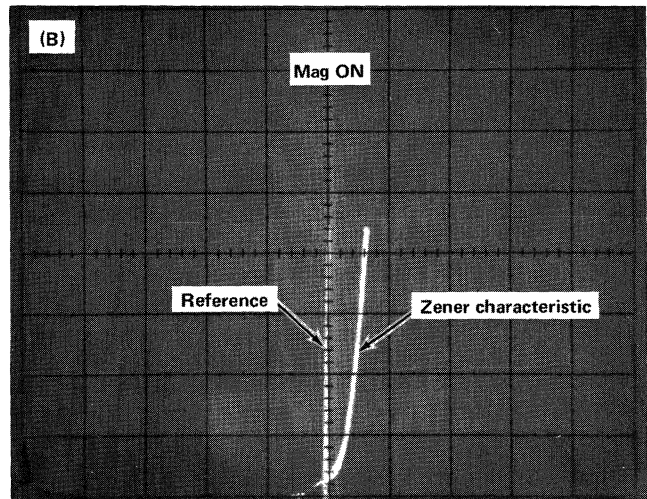
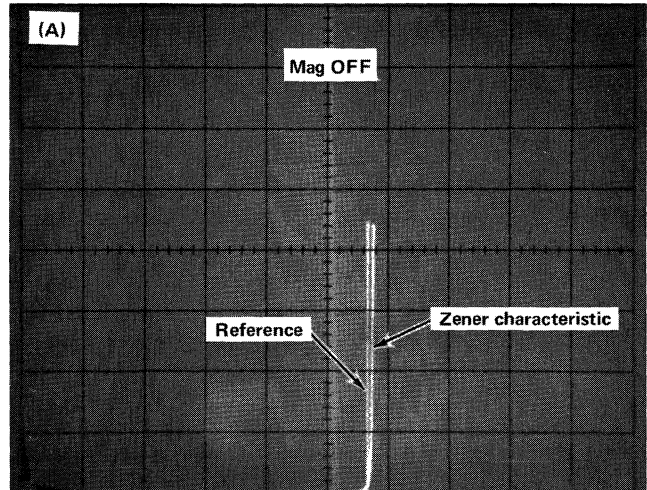

Fig. 36. (A) Display of comparison of Zener curve to a limit by switching between LEFT and RIGHT sets of test fixture terminals (B) Same as A except Horizontal magnified 10X.

# TUNNEL DIODES AND BACK DIODES

## 577/177 Control Settings

Control	Settings
HORIZ VOLTS/DIV	COLLECTOR VOLTS
MAX PEAK POWER WATTS	Set to a safe level.
COLLECTOR SWEEP POLARITY	+
Terminal Selector	EMITTER GROUNDED.

## CHARACTERISTICS

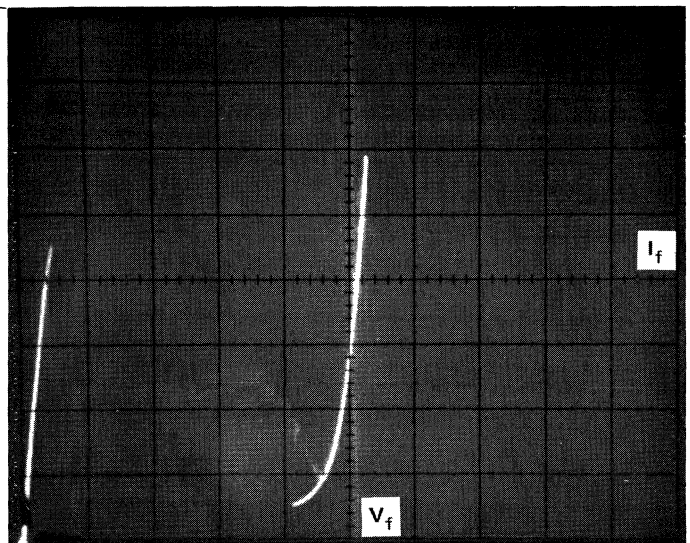
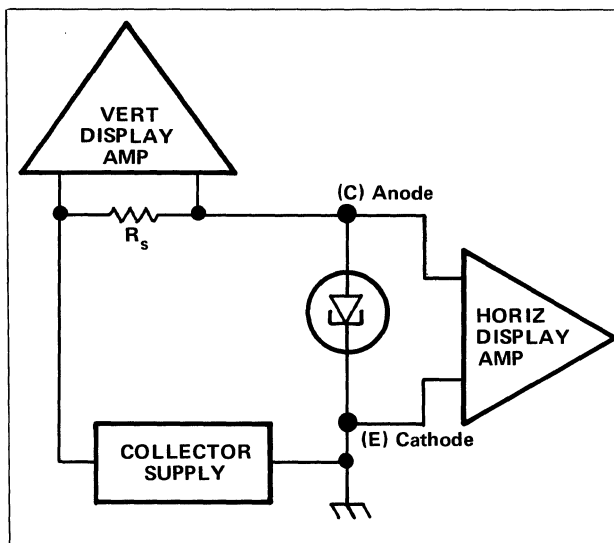

## COMMON MEASUREMENTS

$I_f$  and  $V_f$

To measure forward current and voltage characteristics of a tunnel or back diode, place the cathode in the test adapter emitter terminal and the anode in the adapter collector terminal.

### CAUTION

*Use extreme care on high-current, low-capacitance diodes. Do not exceed the peak current ratings.*

Apply voltage to the device with the VARIABLE COLLECTOR %

control. Some tunnel diodes may switch before reaching the peak current due to noise on the collector supply. A  $0.001 \mu\text{F}$  capacitor in parallel with the diode eliminates this switching problem.

$I_r$  and  $V_r$

Current and voltage in the reverse direction are measured in the same manner as in the forward direction except that the COLLECTOR SUPPLY POLARITY switch is set to  $-$ . For a display of current and voltage in both directions, set the COLLECTOR SUPPLY POLARITY to AC.

## OPTICAL SEMICONDUCTOR DEVICES

### LIGHT-EMITTING DIODES

$V_f$ —Measure as with any diode. Use the curve tracer to power the LED and measure light characteristics with a light meter, such as the TEKTRONIX J16 Photometer.

### PHOTO TRANSISTORS

Use a light source specified by the manufacturer of the transistor and measure the parameters as with other light-coupled devices.

#### NOTE

*The TEKTRONIX IC Adapter (TEKTRONIX Part Number 012-0310-00) is useful for many devices having more than four leads.*

### OPTICALLY COUPLED ISOLATORS

$V_{(BR)CBO}$ —Collector-base breakdown voltage, with the emitter open. Use the same test method as for  $BV_{CBO}$ , that is, ground the base, open the emitter, and check breakdown voltage.

$V_{(BR)CEO}$ —Collector-emitter breakdown voltage with base open. Use the same test method as for  $V_{(BR)CBO}$  or  $BV_{CBO}$ . Ground the emitter, open the base, and check breakdown voltage.

$V_{(BR)EBO}$ —Emitter-base breakdown voltage with collector open. Use the same test method as for  $BV_{EBO}$ . Ground the base, open the collector, and check breakdown voltage.

$I_C$  (on)—Drive the photo diode section as if driving a transistor base. The display will be that of a conventional transistor. The photo transistor may be operated open base or with appropriate R between base and emitter.

$I_C$  (off)—As above,  $I_C$  (on), but don't drive the photo diode.

$h_{fe}$  (phototransistor)—Same as any  $h_{fe}$ .

$V_f$  (photodiode)—Same as any diode.

$V_{ce}$  (sat)—Same as any transistor saturation test. Breakdown and leakage between the transistor and the photo-diode may be checked by connecting all of the transistor leads to the C terminal of the test fixture and the photo-diode leads to the E terminal. Measure as leakage or breakdown of a diode.

## MISCELLANEOUS MEASUREMENTS

### RELAY CHARACTERISTICS

Set the voltage (HORIZ VOLTS/DIV) and current (VERTICAL SENSITIVITY) to values appropriate to view the values specified.

Connect the coil to the E and C terminals on the Curve Tracer.

Set the Curve Tracer to store the display.

#### NOTE

*While the opening and closing points may be seen on the non-storage Curve Tracer, evaluation of the results is easier with the storage feature.*

Adjust the VARIABLE COLLECTOR % to draw a diagonal trace on the CRT. At pull-in voltage, a minor change in voltage (increase) and current (decrease) will occur momentarily as the magnetic field is disturbed by the movement of the armature (or reed).

When the coil voltage is reduced to the drop-out level, a minor change will be seen as the armature again disturbs the magnetic field. The drop-out will be seen as a double excursion for Form A contact configurations and as a single excursion for Form C contact configurations. From the same display (see Fig. 37) the coil resistance can be

measured. The slope of the diagonal line indicates the resistance of the coil. Calculate R from E and I.

In some reed type relays, in which the moving arm is small and the contacts closely spaced, the excursion of the display at switching may be quite small. For these types, use the test methods described in the following paragraphs.

Energize the coil from the STEP GEN OUTPUT on the 177 Test Fixture front panel. See Fig. 38.

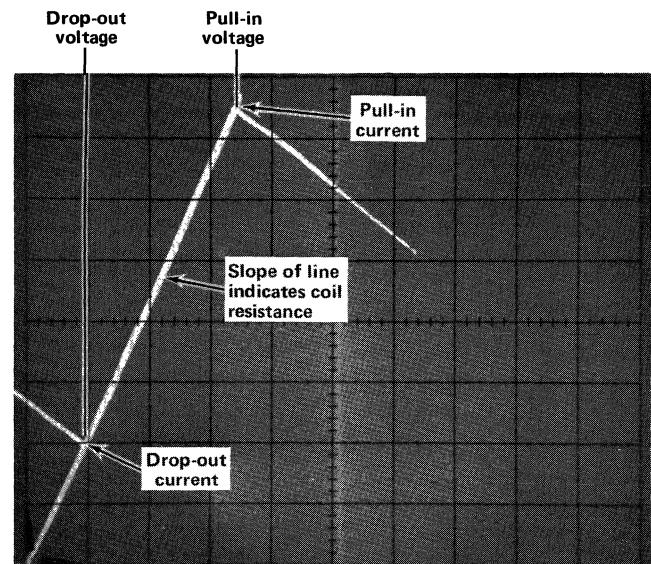

Fig. 37. Typical display of coil characteristics of relay at pull-in and drop-out voltage and current levels.

**577-177-D1 or D2 Operators**

Set the STEP/OFFSET AMPL to 1 V/Step and OFFSET MULT to 0.

Set the HORIZ VOLTS/DIV switch to BASE VOLTS consistent with the specified operating and pull-in voltages.

Connect the relay contacts to the C and E terminals of the test fixture as shown in Fig. 38.

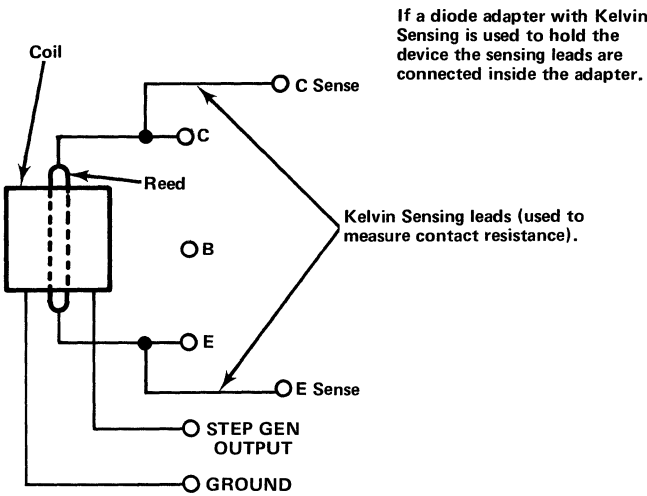

Fig. 38. Method of connecting the relay to the 177 Test Fixture.

Push the STEP X.1 (concentric with the STEP/OFFSET AMPL switch) to release to the "out" position.

Check for closure of the contacts as indicated by the display in Fig. 39.

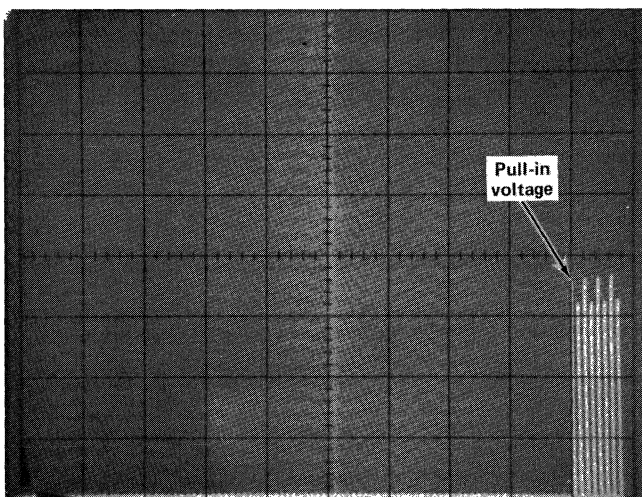

Fig. 39. Display of relay pull-in.

If the display does not indicate closure, push the OFFSET ZERO button to release to the "out" position and the AID button to the "in" position. Rotate the OFFSET MULT control clockwise until contact closure is indicated.

Measure pull-in voltage on the horizontal axis as shown in Fig. 39.

To measure contact resistance, switch HORIZ VOLTS/DIV to COLLECTOR mV. If the display is unstable, increase the coil drive voltage until the display indicates no erratic closure. Adjust VARIABLE COLLECTOR % and HORIZ VOLTS/DIV to display a diagonal line and from this line, calculate the contact resistance from the following equation (see Fig. 40):

$$R = \frac{E}{I}$$

To observe both pull-in and drop-out voltage and current, switch the COLLECTOR SUPPLY POLARITY to +DC, push the DISPLAY FILTER NORM button to release button to the "out" position. Set the STEP FAMILY to SINGLE and OFFSET to AID.

Set the display unit to store the display. Trace the pull-in by turning the OFFSET MULT control until the contacts close, as indicated by a positive step.

Slope of display indicates contact resistance. Change in slope indicates a range of contact resistance, rather than a single value of R.

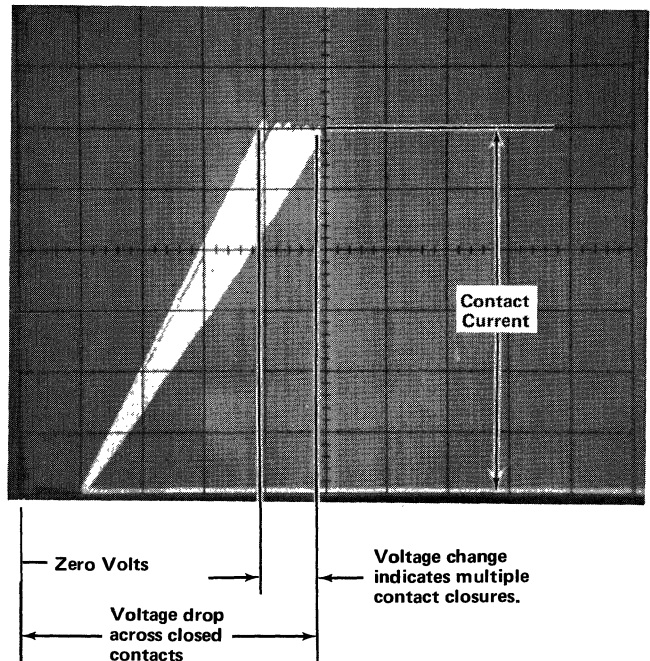

Fig. 40. Relay contact resistance.

Turn the OFFSET MULT control in the opposite direction until the contacts open, as indicated by a negative step.

The stored display of contact opening and closing should appear similar to that shown in Fig. 41.

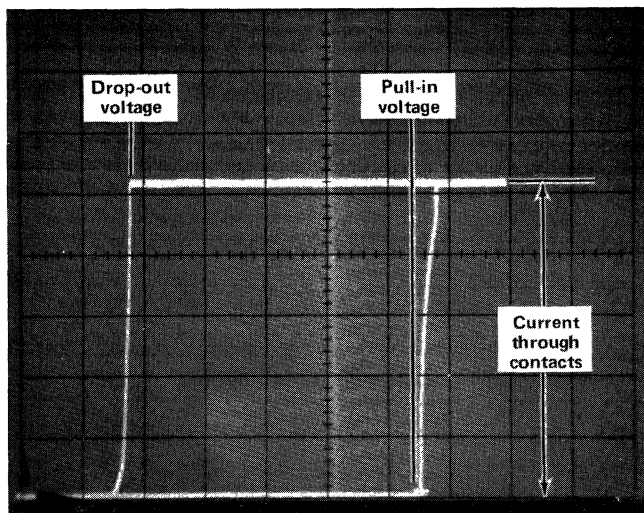

Fig. 41. Stored display showing relay pull-in and drop-out voltages.

### POWER SUPPLY LOAD CURRENT (not suitable for Shunt-Regulator type power supplies)

The following method permits the measurement of power supply load current without putting a current measuring device in series with the power supply, or changing the load on the supply.

If the power supply being tested is positive with respect to ground, use a positive collector sweep. See Fig. 42A.

Set the 577 COLLECTOR SUPPLY POLARITY to +DC and turn the VARIABLE COLLECTOR % clockwise until the power supply output voltage starts to rise. See Fig. 42B.

When the power supply output voltage starts to rise, the current provided by the 577 collector supply is equal to the current being supplied to the power supply load plus any current provided by shunt resistors. Be careful not to increase the supply voltage excessively as damage may be done to the devices powered by the supply.

Impedance is determined by noting the change in output voltage relative to the change in output current. Calculate Z from the formula:

$$\frac{\Delta E}{\Delta I}$$

Power supply short circuit current can be determined by driving the collector sweep with polarity opposite that of the power supply under test. Use a limiting resistor (SERIES RESISTOR in the 577) large enough to permit the supply under test to operate at rated value until the collector supply is increased.

As the collector supply voltage is increased, the power supply voltage will decrease. When the power supply voltage reaches zero volts, the collector supply current (vertical axis on the 577) is equal to the short-circuit current of the supply.

If there is a load current from the power supply under test to a higher voltage, the measured current will be higher by the amount of the extra load current. If there is a load current from the power supply under test to a voltage of the opposite polarity, the measured current will be lower by the amount of that load.

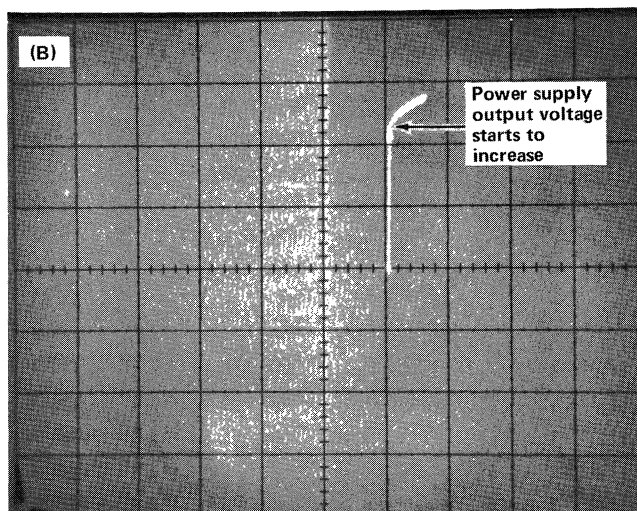
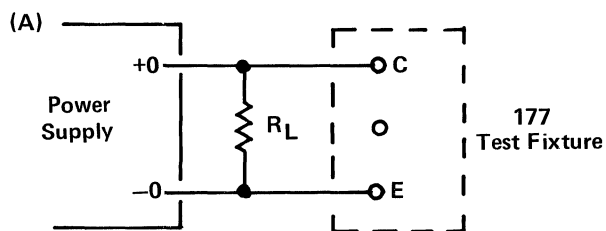

Fig. 42. (A) Connecting power supply to curve tracer and (B) Display of power supply current delivered to load.

## IN-CIRCUIT LOCATION OF SHORT CIRCUIT

Use C-Sense lead as a probe as shown in Fig 43. As R goes down (slope of the display increases) the probe is getting closer to the short circuit.

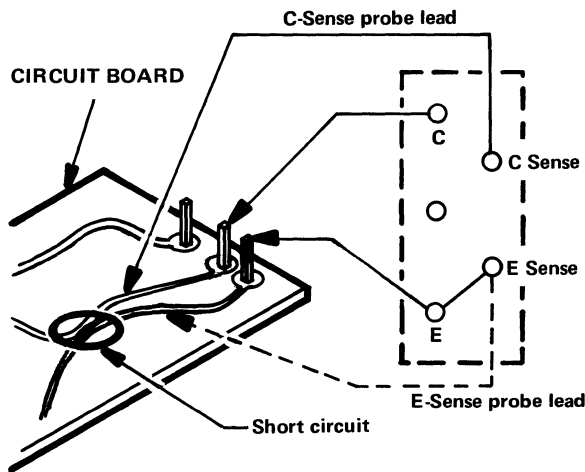

Fig. 43. Connecting the C-sense lead for short-circuit location.

As the short is approached, better resolution can be obtained by moving the E-Sense probe toward the suspected area.

The R being measured is the R between the C-Sense and E-Sense, not between E and C.

Resistances down to  $500 \mu\Omega$  can be measured if the circuit being measured can safely pass 10 amperes.

For circuit boards, the resistance is more on the order of  $50 \text{ m}\Omega$ , with currents of up to 100 mA.

A short circuit caused by defective etching on a new circuit board may be cleared by increasing the collector current to a high enough level to burn out the short circuit. Use the 6.5 volt range and minimum series resistance so that the voltage will not increase too much when the short circuit is cleared. Be certain that the current is applied only to the immediate area of the short circuit, since the current can also destroy proper conductors in series with the short circuit.

## LEAKAGE RESISTANCE

Leakage resistance measurements as large as  $8 \times 10^{12}$  ohms can be measured if the circuit can tolerate the 1600 volts required to make the measurement.

If the circuit can tolerate only 1.6 volts, then the maximum resistance that can be measured is  $8 \times 10^9$  ohms.

When measuring leakage or high resistance, use DC collector supply. Shut off the base steps and set DISPLAY FILTER to the "out" position. First set zero, with the device under test out of the fixture. Then measure the device.

## GENERAL RESISTANCE MEASUREMENTS

Resistance of switch contacts and connectors can be measured using the technique for measuring any low resistance (using Kelvin sensing terminals) as detailed for measuring short-circuit faults, reed-relay contact resistance, etc.

Power cords may also be checked by measuring the resistance while flexing the cord. Broken strands may be detected as the R changes as the broken strands become disconnected and reconnected.

## GAS DISCHARGE DEVICES

The 577 Curve Tracer system can be used to measure gas discharge devices such as neon lamps, readout devices, voltage protection devices, etc.

Common measurements that can be made are:

**Firing or Breakdown Voltage.** Measure in the same manner as that of diode breakdown voltage. Select the SERIES RESISTOR value cautiously, (start with a high value) since the devices have negative resistance.

**Voltage Drop (conducting).** Measure in the same manner as Zener diodes.

**Resistance (conducting).** Measure in the same manner as any small resistance value (magnify horizontally) and calculate the resistance from the slope of the vertical trace.

**Leakage Current.** Measure as with any diode leakage.

See Fig. 44 for a typical display of neon lamp characteristics, measured in the AC mode to display the conduction in both directions.



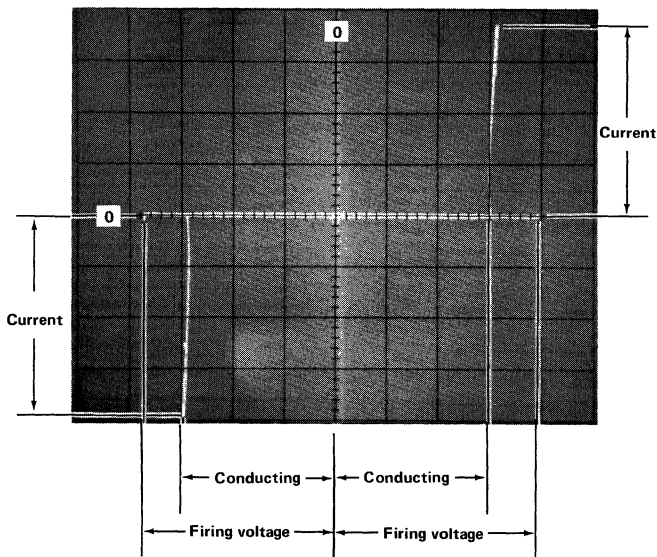

Fig. 44. Typical display of neon lamp characteristics using AC mode.

## BATTERIES

Battery output voltage and output impedance can be measured on the curve tracer.

Connect the battery between the test fixture C and E terminals with the COLLECTOR SUPPLY POLARITY opposite that of the battery (– if the battery positive is connected to C). Adjust the collector supply output voltage and SERIES RESISTORS to set the desired current level.

Use the X10 HORIZ MAG to measure output impedance. Calculate the impedance from the slope of the current (vertical) and voltage (horizontal) display.

If characteristics in both directions are to be viewed, switch the COLLECTOR SUPPLY POLARITY to AC.

Batteries up to 6 volts can be charged using the step generator and Offset output. Set the charge current range with the STEP/OFFSET AMPL and set the desired current with the OFFSET MULT control.

Batteries over 6 volts can be charged using the collector supply. The higher the supply voltage, relative to the battery voltage, the more constant the charging current.

Batteries up to 20 volts can also be charged, with automatic voltage shutoff (current limited between 100 mA and 200 mA) by using step generator (in the voltage mode) and Offset.

## MEASURING CAPACITANCE (up to 1000 pF)

### NOTE

*When the Collector Sweep voltage is applied to the test fixture, the capacitance of the device under test, the test adapter capacitance, and stray capacitance must be charged and discharged. The result of the charge and discharge can appear (at higher deflection sensitivities) as looping.*

Looping can be put to use in measuring capacitance.

Set the HORIZ VOLTS/DIV to a COLLECTOR VOLTS range, COLLECTOR SUPPLY POLARITY to AC, and VERTICAL SENSITIVITY to display a loop on the screen.

Place the adapter in the test fixture and adjust the LOOPING COMPENSATION to close the loop (ignore the tilt). See Fig. 45A.

Place the known (or standard) value of capacitance in the test adapter and measure the loop opening (vertically). See Fig. 45B.

Calculate the current/pF for the reference capacitor.

Replace the reference capacitor with the unit to be measured.

Measure the loop opening, adjusting the VERTICAL SENSITIVITY (in decade steps) if necessary, and calculate the capacitance. (See Fig. 45C.)

### NOTE

*For VERTICAL SENSITIVITY setting below 10 nA/DIV the effects of looping compensation are different than for higher settings. Since adequate resolution is provided at settings of 10 nA/DIV and above, using 25 volts Collector Sweep, there is little need to use the lower settings. Capacitance values as small as  $1 \times 10^{12}$  F can be easily measured.*

## MEASURING SEMICONDUCTOR CAPACITANCE

Set the COLLECTOR SWEEP POLARITY to the polarity indicated by the transistor type (NPN or PNP).

Vertically position the display to center screen.

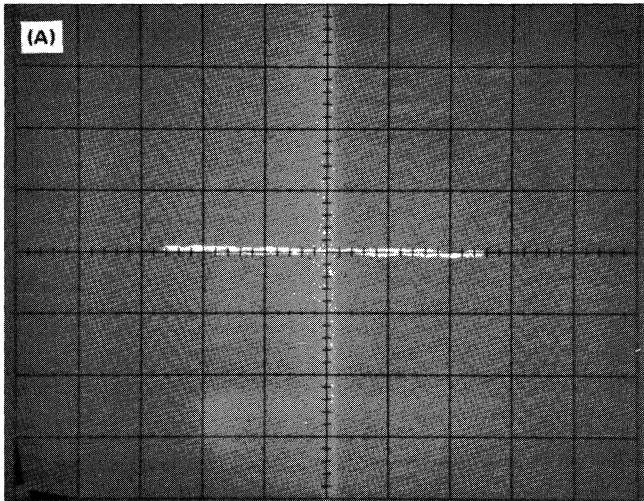

Set the Collector Sweep voltage range no higher than the breakdown voltage of the device being tested.

Set the VERTICAL SENSITIVITY to 2 nA/DIV.

Install the transistor adapter and adjust the LOOPING COMPENSATION for zero slope of the display (see Fig. 46A).

Place a capacitor of known value in the test adapter between the C and E terminals of the test fixture adapter. Adjust the VARIABLE COLLECTOR % for a convenient deflection (for example, 4.7 divisions of tilt for a 4.7 pF capacitor). See Fig. 46B.

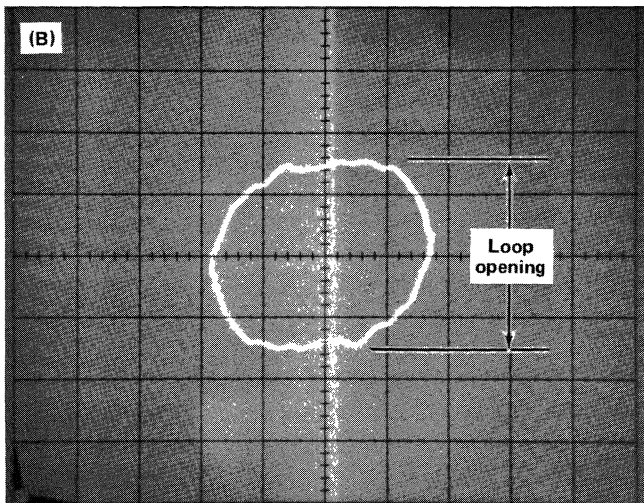

Replace the capacitor with the semiconductor to be tested.

Compare the tilt of the semiconductor display to that of the reference capacitor.

Calculate the semiconductor capacitance from the ratio of tilt of the two devices. See Fig. 46C.

This test does not measure absolute capacitance at some specific value of bias, and since the capacitance changes as the applied voltage changes, this method is only a close approximation.

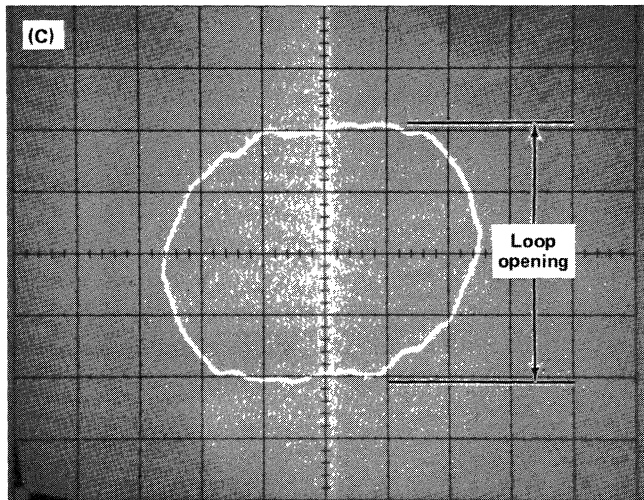

### MEASURING CAPACITANCE (1000 pF and up)

#### NOTE

*See the section titled Polarized Capacitors.*

Connect a reference (or standard) capacitor in the test adapter between test fixture terminals C and E.

Set the COLLECTOR SWEEP POLARITY to AC, SERIES RESISTORS to minimum, MAX PEAK VOLTS to 25, VARIABLE COLLECTOR % to a setting consistent with the maximum voltage rating of the capacitor being tested. Set HORIZ VOLTS/DIV to 200. For capacitors of 10  $\mu$ F and over, set MAX PEAK VOLTS to 6.5 to get the benefit of the lower value of SERIES RESISTOR.

Fig. 45. Measuring capacitance at test current levels of 10 nA/DIV, and up.

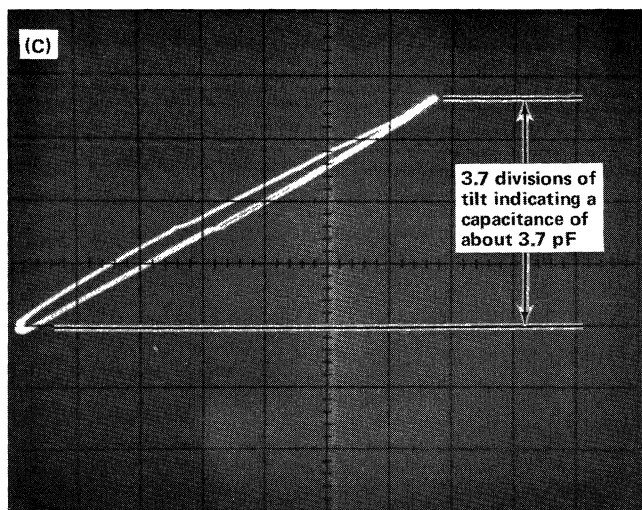
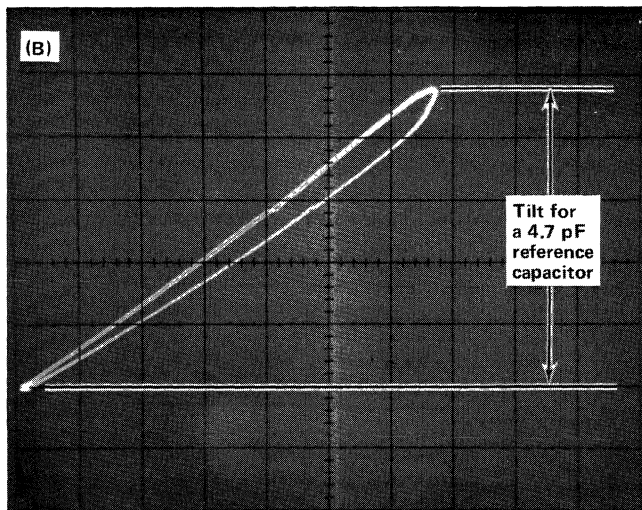
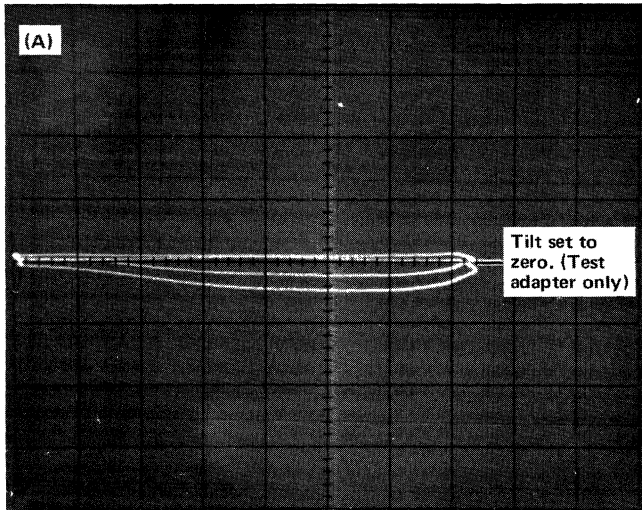

Fig. 46. Typical display of capacitance comparison measurement technique.

Set the VERTICAL SENSITIVITY for an off-screen deflection and reduce the voltage to the capacitor to a convenient display amplitude (5 divisions most convenient for calculations but 6 or 7 divisions give better resolution) using the VARIABLE COLLECTOR % control (see Fig. 47).

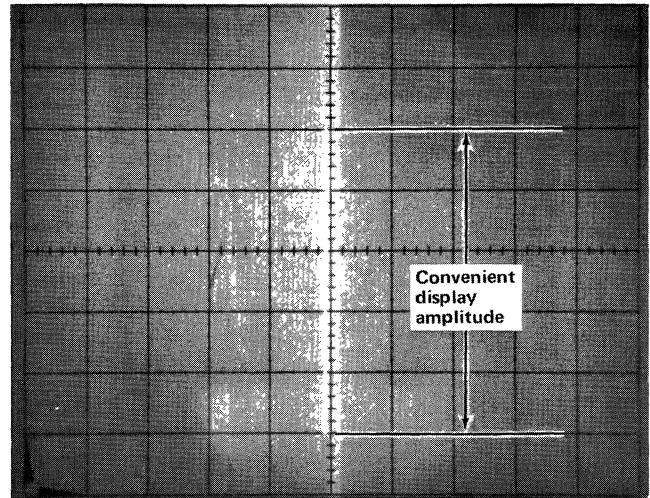

Fig. 47. Typical display of vertical deflection for capacitance measurement.

Calculate the current per unit of capacitance from the display and VERTICAL SENSITIVITY setting.

Remove the reference, or standard, capacitor and replace with the capacitor to be checked, and switch the VERTICAL SENSITIVITY (in decade steps) if necessary, and measure the deflection.

The deflection times the current per division, corrected by the Vertical Deflection factor change (if any) gives the capacitance of the device being tested.

**NOTE**

*Line voltage fluctuations affect the accuracy of these tests. For maximum accuracy the line voltage source should be regulated.*

**POLARIZED CAPACITORS**

Since the reverse voltage that can be applied to a polarized capacitor is limited, the tests for measuring capacitance with the 577 Curve Tracer system must be used cautiously.

## 577-177-D1 or D2 Operators

Capacitance can be measured if the reverse voltage characteristics are accurately known. Limit the voltage excursion in the reverse direction to a value that is known to be safe. Since the value of SERIES RESISTOR must be as small as possible, for best accuracy, there is no current limit. If the voltage limit should be exceeded, the device under test could be destroyed. Tantalum and electrolytic capacitors typically explode under high reverse voltage and current conditions.

Polarized capacitors can be made non-polarized by connecting two like-value capacitors in series, opposing each other. The unknown capacitor value can then be calculated.

## INCANDESCENT LAMP CHARACTERISTICS

Incandescent lamp characteristics can be displayed, as in Fig. 48, to show voltage, current, and cold and hot resistance.

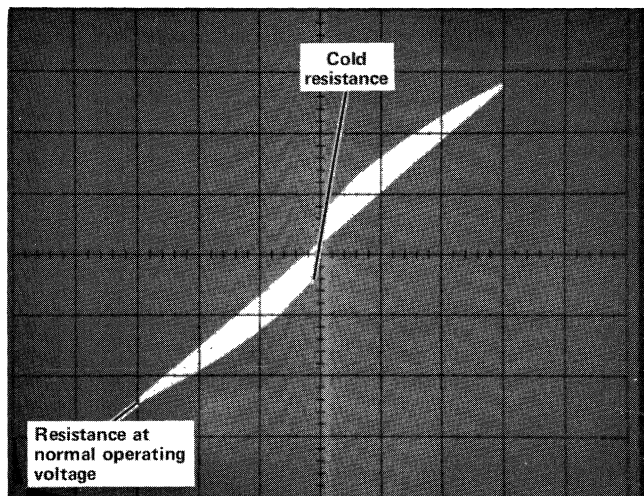

Fig. 48. Stored display of incandescent lamp characteristics from cold to normal hot resistance.

Light output can be measured, with a suitable light meter, at the same time that the other tests are made.

The photo was made from the image stored on the D1 Display Unit.

Use AC Collector Supply.

## INDUCTION MOTORS

Fig. 49 shows the characteristics of a small induction motor.

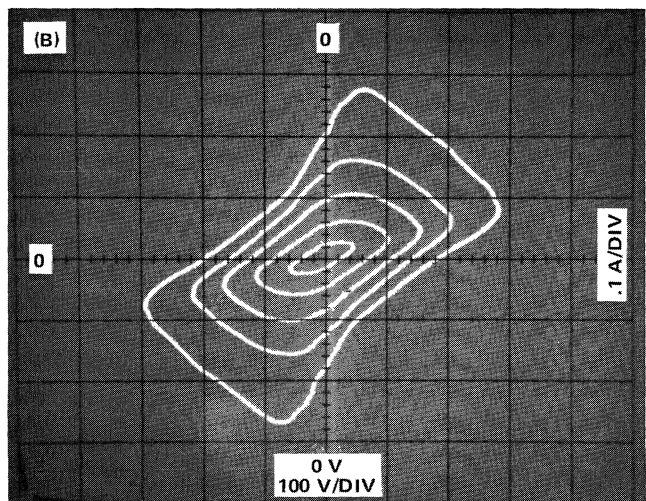
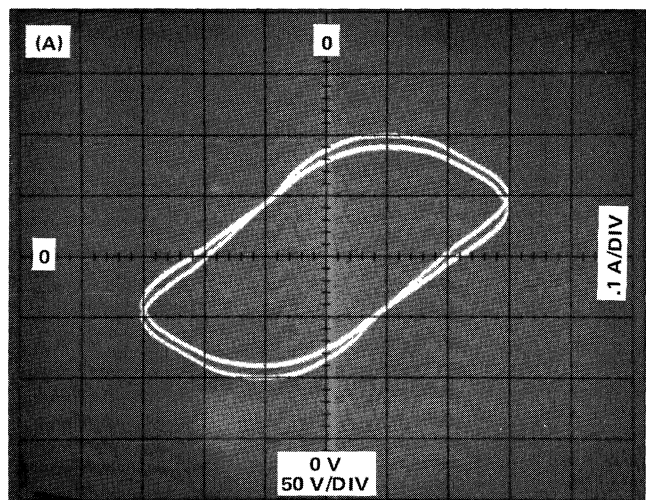

Fig. 49. Stored display of small motor characteristics. See text.

Photo A shows the motor characteristics with no load and with locked rotor.

Photo B shows the motor characteristics with five increments of applied voltage.

Both tests were made with the 577 Curve Tracer system operating in AC mode with MAX PEAK VOLTS at 400 and MAX PEAK POWER WATTS set at 100. Voltage and current levels are indicated on the photos.

## IN-CIRCUIT TESTING

Many in-circuit tests can be made with the 577 Curve Tracer system using the test methods described in this manual.

Keep the curve tracer power setting to a level consistent not only with a particular device in the circuit under test, but with the devices around the device under test.

AC collector sweep is ideal for making impedance comparison tests (especially in balanced circuits) of a suspected circuit against a like circuit known to be good. Using sufficient test voltage to turn on nearby junctions can indicate such troubles as open or shorted semiconductor junctions.

Any substantial difference in impedance of the circuit under test from that of the good circuit indicates a possible trouble.

The storage feature of the D1 Display Unit is especially helpful in making these comparison tests, e.g., store the good unit display on the lower screen and compare with the suspected unit display on the upper screen.

Complete functions of devices such as amplifiers can be verified with the 577 Curve Tracer system. Drive the amplifier input with the curve tracer step generator and view the output using the curve tracer collector sweep (usually in the AC mode). The SERIES RESISTORS can be used as loads for the devices (usually with the VARIABLE COLLECTOR % set to 0).

## INTEGRATED CIRCUITS

Specific instructions for testing all integrated circuit types are beyond the scope of this manual because of the large variety of IC types available.

However, several measurement examples are included. The techniques used may be applied to other ICs.

Connecting the integrated circuit to the 177 Test Fixture is greatly simplified by using the TEKTRONIX Integrated Circuit Adapter (TEKTRONIX Part Number 013-0124-01).

The adapter plugs into the 177 Test Fixture. Barnes Corporation Series RD-86 sockets and contactors plug into this adapter. Sockets are available for dual-in-line, 6-through 14-lead round-pin-pattern TO packages, and flat pack. Connections to the 577 are made by patch cords from the pin terminal to the 577 terminals on the adapter.



*Watch pin numbers on any device that has less pins than that of the adapter being used.*

The pins on the Barnes Corporation sockets are so arranged that the integrated circuit pin numbers agree with the pin terminal numbering around the adapter. Some of the earlier Barnes Corporation Series RD-86 sockets and contactors were not pin-compatible. Dual-in-line 14-pin and flat pack are all compatible, as are other sockets and contactors having a yellow base. The units that are now purchased from either Tektronix, Inc. or Barnes Corporation are all pin-compatible.

The 577 Collector Supply may be used to drive the input, load the output, or drive the  $V_{cc}$  terminal. When driving the inputs or loading the outputs of an IC, the AC polarity position of the collector supply permits viewing of both current sourcing and current sinking on the same display. When displaying supply current as a function of supply voltage, usually the + polarity is used instead of AC.

The 577 step generator may be used as a signal source, a power supply, or a combination of both. As a signal source it will output a voltage (or current) staircase or a square wave (by turning the NUMBER OF STEPS control to 1) or a ramp by using the 100 steps (STEP X.1). To use the step generator as a power supply, the STEP FAMILY SINGLE button is pushed in and the OFFSET MULT control is adjusted to obtain the desired voltage or current. The current is limited to 100 mA when in the voltage mode.

The Variable Voltage supply on the 177 Test Fixture front panel may be used to drive IC inputs. Since the supply has a 10 k $\Omega$  impedance, it is not usually suitable as a power supply.

For many IC tests such as  $I_{in}(0)$ ,  $I_{in}(1)$ ,  $I_{os}$ ,  $I_{cc}(0)$ , and  $I_{cc}(1)$ , the only connections needed are to the collector supply (C), the step generator (B), and ground (E). Some tests require external power supplies.

## DIGITAL CIRCUITS

The 577-177 Curve Tracer system is well suited to observe input, output, and power supply requirements of most digital ICs.

Some ICs require a series of logic inputs to put the device being tested into the desired logic state.

Charge coupled devices are especially difficult to test because of the need for continuous clocking.

**Evaluating TTL**

Following are some examples of measurements on a Texas Instruments SN7402N IC. The SN7402N is a typical example of a digital integrated circuit. Fig. 50 shows one of the four identical sections of this circuit. The measurement techniques used here can be applied to other families of circuits as well.

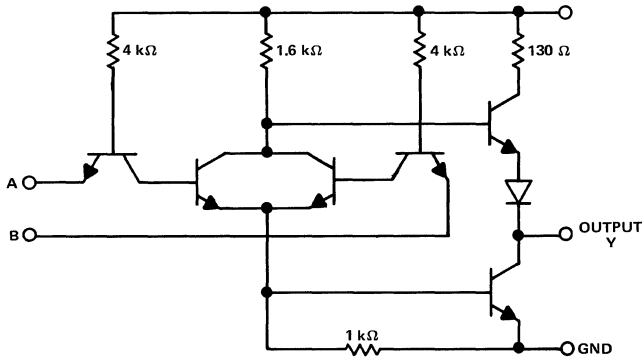
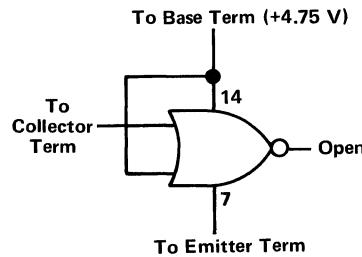
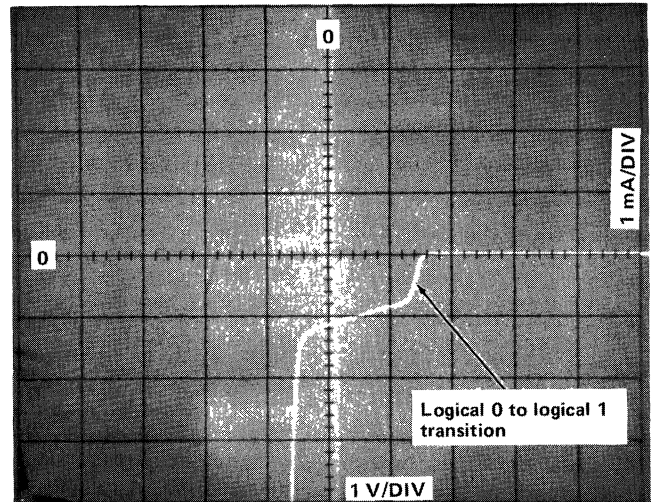

Fig. 50. One of four identical sections of the SN7402N IC.

Input current of this circuit can be displayed over the full range of input voltages of interest. The step generator offset of the 577 is used as the  $V_{CC}$  supply. The collector supply is used to drive the input that is being evaluated. AC collector sweep is used to permit observation of both sourcing and sinking of the input. Fig. 51 shows the  $I_{in}(0)$  condition. The specified value of  $I_{in}(0)$  may be measured on this display.  $I_{in}(0)$  measures about  $-1$  mA at the specified value of 0.4 volts, well within the specification of  $-1.6$  mA maximum. The point at which the input voltage changes from a logical 0 to a logical 1 can be determined by observing the sharp transition in the input current. This transition occurs at about +1.4 volts.  $I_{in}(1)$  can also be measured by increasing the vertical sensitivity until a reading is obtained, as shown in Fig. 52. To perform the measurement as specified by the manufacturer, it is necessary to move the input not being tested from the  $V_{CC}$  supply to ground (which will usually not affect the measurement).

The ability of the output to source or sink current can also be evaluated. The step generator offset is used to bias the output for the  $V_{out}(0)$  condition. The collector supply is used to load the output. AC collector sweep is used to permit observation of both current sourcing and sinking. An external voltage supply is used for  $V_{CC}$ .



Step generator offset is used as  $V_{CC}$  supply. AC collector sweep (set at 6.5 V) drives the input being evaluated, to observe both current sourcing and sinking.

Fig. 51. TTL evaluation,  $I_{in}(0)$  condition.

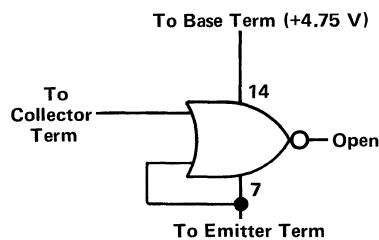
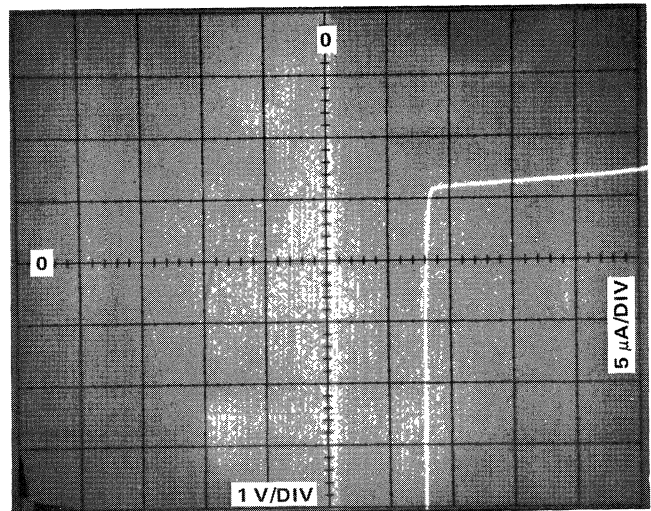

Same setup as in Fig. 51, with vertical sensitivity increased to permit reading input current.

Fig. 52. TTL evaluation,  $I_{in}(1)$  condition.

## 577-177-D1 or D2 Operators

Fig. 53 shows the  $V_{out}(0)$  condition. The manufacturer's specification can be verified and actual performance measured. The specification for the device indicates the ability to sink 16 mA at no more than 0.4 V. From this display it is apparent that the device will actually sink 40 mA at 0.4 volts and will have a voltage drop of 0.2 volts at the 16 mA specified. The normal fan out is specified at 10, but this particular gate could drive 25 gates, at least as far as DC characteristics are concerned.

In addition, the display indicates how much current is available to drive shunt capacitance, and knowing the amount of C, the time required to discharge this C to the logical 0 state can be determined.

Fig. 54 shows  $V_{out}(1)$  of one of the SN7402N outputs along the horizontal axis as a function of output current along the vertical axis. The specification indicates the ability to source at least 400  $\mu$ A at 2.4 volts. From the curve it is apparent that the device will source 4 mA at 2.4 volts and has a logical 1 voltage of 2.6 volts at 400  $\mu$ A. Because the maximum input current,  $I_{in}(1)$ , is specified at 40  $\mu$ A, this output could drive almost 100 other worst-case inputs for a fan out of almost 100 instead of the specified 10. However, this measurement was performed at 25°C and when the device is operated at lower ambient temperatures, the performance for this characteristic decreases.

Short-circuit output current ( $I_{os}$ ) can be measured using the same test setup as for  $V_{out}(1)$  by decreasing the vertical deflection factor. The deflection factor is decreased until the curve crosses the zero-volt line, as shown in Fig. 55. The manufacturer specifies the current to be at least -18 mA, and not more than -55 mA. This device measures -29 mA, well within the specification.

## $V_{cc}$ Characteristics

The current required for the  $V_{cc}$  supply as a function of supply voltage and input levels can be displayed. The collector supply is used to drive the  $V_{cc}$  terminal. Use + Collector Supply Polarity since only a current source is required. The step generator can be used to voltage drive the inputs from zero volts to +5 volts by setting the STEP/OFFSET AMPL control to 1 V/Step and using 5 steps. No offset is used. Fig. 56 shows the characteristics.

Only two curves are displayed in Fig. 56, since the zero- and one-volt steps are below the level at which transition from the logical 0 to logical 1 takes place.  $I_{cc}(0)$  measures 17.5 mA, and  $I_{cc}(1)$  measures 15 mA, well within the manufacturer's specification.

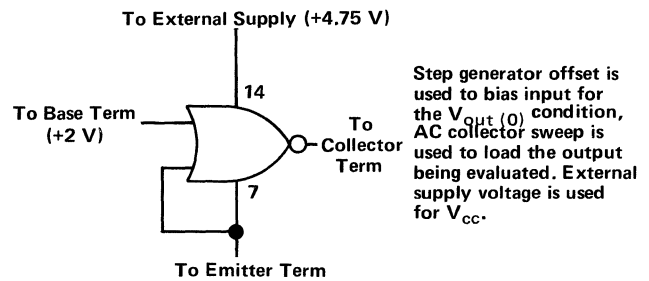
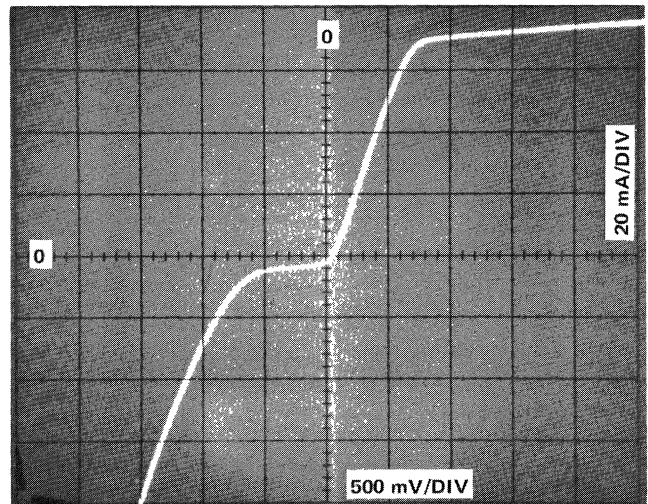

Fig. 53. TTL evaluation,  $V_{out}(0)$  condition.

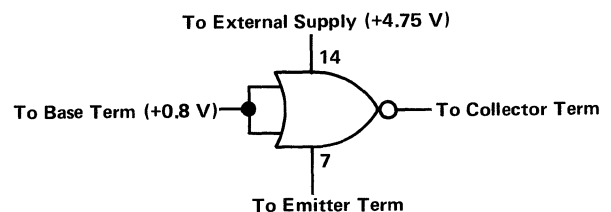
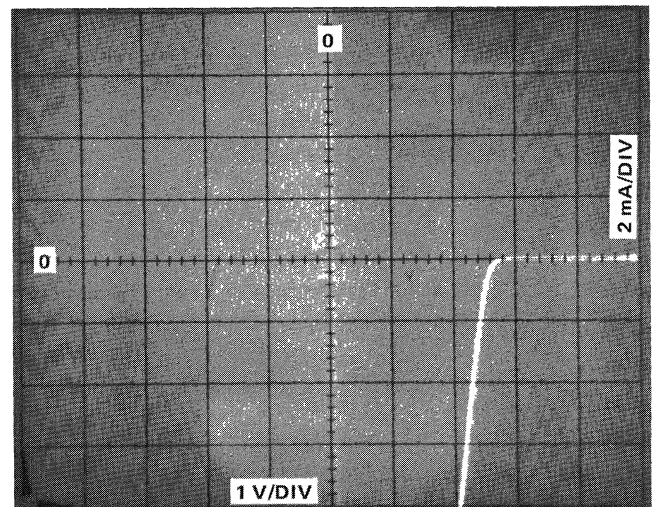
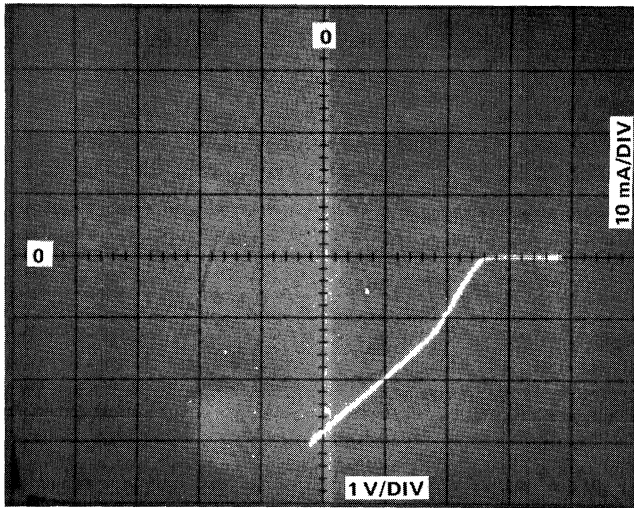

Fig. 54. TTL evaluation,  $V_{out}(1)$  condition.





From the same display the effect on  $V_{cc}$  current can be determined as  $V_{cc}$  or the input voltage is changed. Changing the input voltage has little effect, except in the logical 0 to logical 1 transition zone. However, a small change in  $V_{cc}$  produces a relatively large change in  $V_{cc}$  current.

### LINEAR CIRCUITS

Linear circuits are most easily tested using the 178 Linear Test Fixture.

However, some tests can be made using the 177. Following are some examples.

### Input Current vs. Input Voltage

Fig. 57 is a display of the input current and voltage characteristics of a type 741 Linear Integrated circuit.

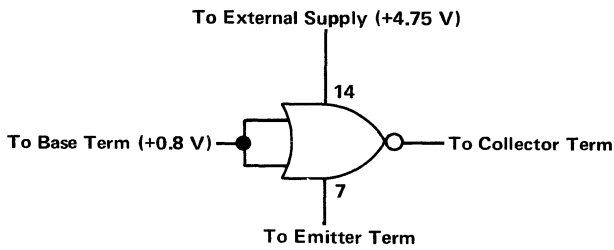

Fig. 55. TTL evaluation, Short-Circuit Output Current  $I_{OS}$ .

The input current rise is directly proportional to the input voltage up to approximately +14.2 volts. Beyond +14.2 volts the current rises rapidly with increase in input voltage, indicating that the output voltage can no longer follow the input.

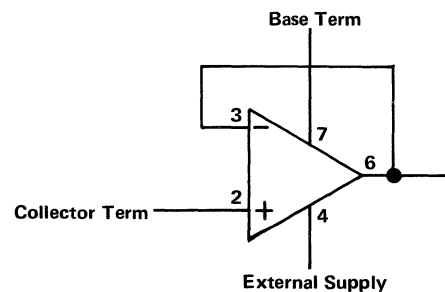
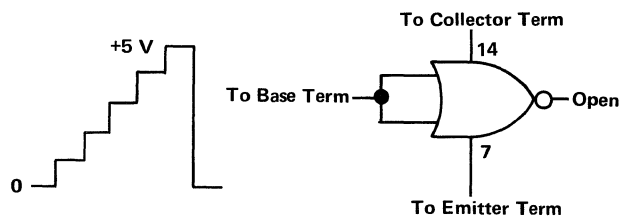
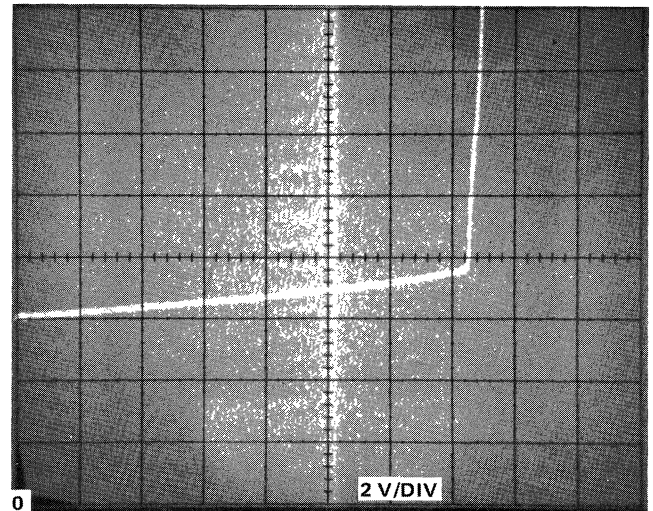
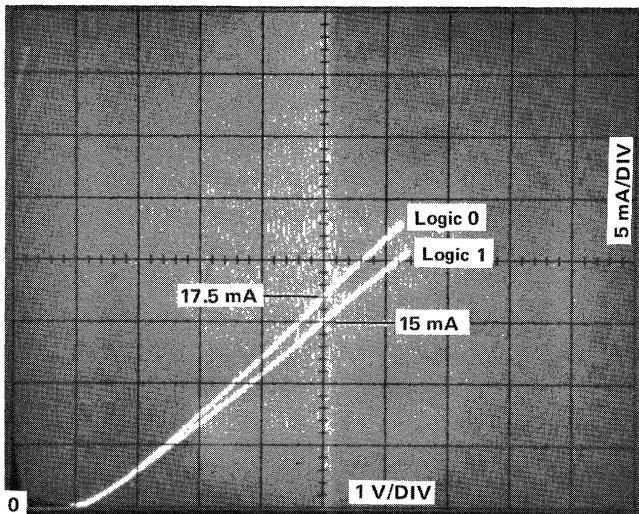

Fig. 56. TTL evaluation,  $V_{cc}$  characteristics.

Fig. 57. 741 Linear IC, Input I vs. Input E.

## 577-177-D1 or D2 Operators

The test was made with IC terminal 4 connected to an external DC supply set to  $-15$  volts. The step generator (Base Terminal) was set for 2 V/Step, STEP FAMILY SINGLE, AIDing Offset, and OFFSET MULT set to 7.5 (+15 volts, DC).

Input voltage drive was supplied by the collector supply.

Vertical and horizontal deflection factors are shown on the illustration.

### NOTE

*Many devices require power supply bypass capacitors close to the device under test to prevent oscillations.*

## Supply Current vs. Supply Voltage

Fig. 58 shows a display of the supply current relative to the supply voltage of a 741 Linear Integrated circuit.

As the collector supply voltage is increased linearly on terminal 7 of the IC, the current rise is linear.

The test was made with the IC connected as shown, with the step generator set at 2 V/Step, AIDing Offset, OFFSET MULT at 7.5 (15 volts) with the step generator polarity inverted, and STEP FAMILY SINGLE.

## Output Current vs. Output Voltage

Fig. 59 is a display of output current and voltage characteristics of a 741 Linear Integrated circuit.

The display indicates the current limits of the device in both directions.

The test was set up as shown, with the step generator furnishing +15 volts to IC terminal 7 and an external supply providing the specified voltage at terminal 4.

The step generator was set for 2 V/Step, Offset AIDing, STEP FAMILY SINGLE, and OFFSET MULT at 7.5.

MAX PEAK VOLTS control was set to 25, MAX PEAK POWER WATTS to .6, COLLECTOR SUPPLY POLARITY to AC, HORIZ VOLTS/DIV to 5 COLLECTOR VOLTS, and VERTICAL SENSITIVITY to 10 mA/DIV.

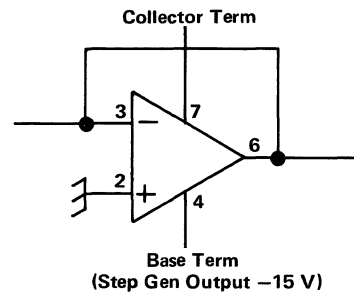
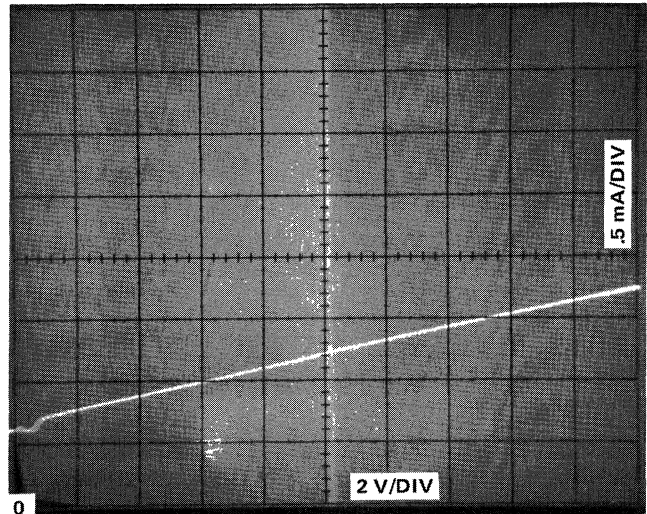

Fig. 58. 741 Linear IC, Supply Current vs. Supply Voltage.

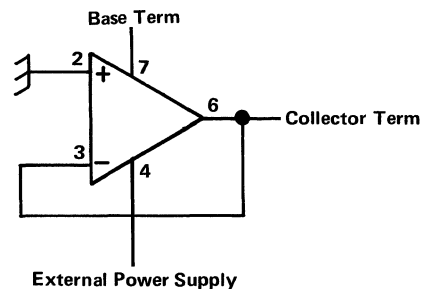
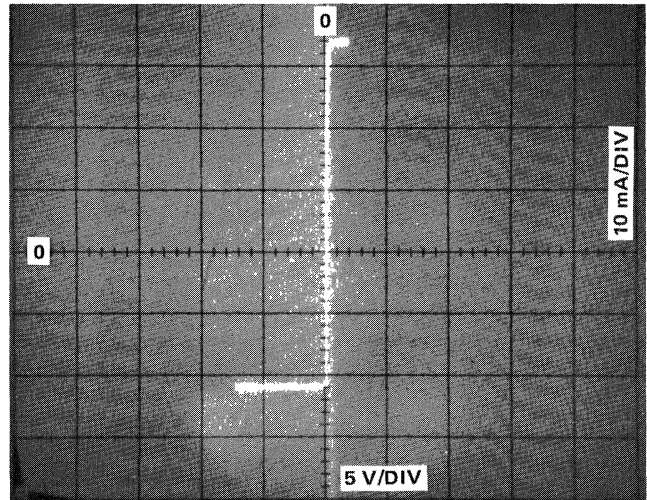

Fig. 59. 741 Linear IC, Output characteristics.