

See for yourself

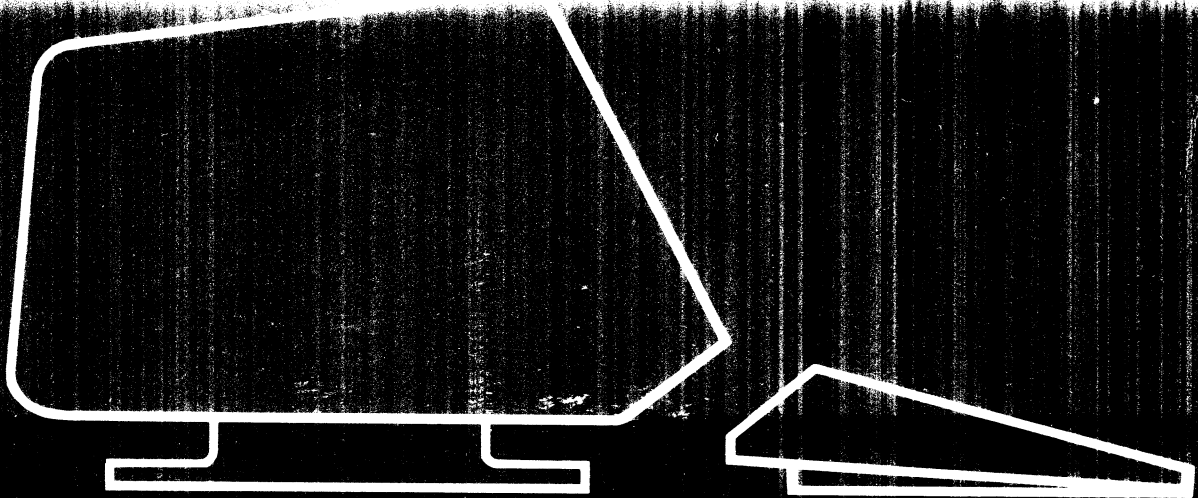

WARNING

This equipment generates, uses, and can radiate radio frequency energy and if not installed and used in accordance with the instruction manual may cause interference to communications. It has been tested and found to comply with the limits for Class A computing devices pursuant to Subpart J of Part 15 of FCC rules which are designed to provide reasonable protection against such interference when operated in a commercial environment. Operation of this equipment in a residential area is likely to cause interference in which case the user at his own expense will be required to take whatever measures may be required to correct the interference.

Class A Label

DC 010-002 Rev A

VISUAL 102
REFERENCE MANUAL

NOVEMBER 1983

SAFETY WARNING

Hazardous voltages 115, 220 VAC and 15 KV DC are present when the terminal is on, and may remain after power is removed. Use caution when working on internal circuits, and do not work alone.

When handling the cathode ray tube caution is required as the internal phosphor is toxic. Safety goggles and gloves must be used whenever the CRT tube is handled. Should the tube break, skin or eyes exposed to the phosphor, rinse the affected area with cold water and consult a physician.

This terminal is supplied with a cord set which includes a safety ground. Do not use this terminal with an ungrounded outlet, missing ground pin, or use any adaptor which will defeat the safety ground.

Insure that power is turned off before connecting or disconnecting the keyboard cable.

This manual is published and distributed by Visual Technology Inc. Every effort has been exercised to insure its accuracy and completeness. The contents are subject to change without notice and this manual may not reflect the latest changes. Consult the sales department for latest changes.

WARRANTY STATEMENT

The information contained in this manual is believed to be accurate and reliable. However, Visual Technology, Incorporated assumes no responsibility for any errors, omissions, or inaccuracies whatsoever. Without limiting the foregoing, VISUAL TECHNOLOGY, INCORPORATED DISCLAIMS ANY AND ALL WARRANTIES, EXPRESS OR IMPLIED, INCLUDING THE WARRANTY OF MERCHANTABILITY AND FITNESS FOR A PARTICULAR PURPOSE, WITH RESPECT TO THE INFORMATION CONTAINED IN THIS MANUAL AND THE HARDWARE AND FIRMWARE DESCRIBED HEREIN. The entire risk as to the quality and performance of such information and equipment is upon the buyer or user. Visual Technology, Incorporated shall not be liable for any damages, including special or consequential damages, arising out of the use of such information or equipment even if Visual Technology, Incorporated has been advised in advance of the possibility of such damages. The use of the information contained in this manual and the equipment described herein is subject to Visual Technology, Incorporated's standard license agreement, which must be executed by the buyer or user before the use of such information or software.

This warranty gives you specific legal rights, and you may also have other rights which vary from state to state.

Some states do not allow the exclusion or limitation of incidental or consequential damages or limitations on how long an implied warranty lasts, so the above limitations or exclusion may not apply to you.

TABLE OF CONTENTS

		Page
1.	INTRODUCTION	1-1
	1.1 PRODUCT INTRODUCTION	1-1
	1.2 HOW TO USE THIS MANUAL	1-1
	1.3 COMMONLY USED GENERAL TERMS	1-2
	1.4 COMMONLY USED GRAPHIC TERMS	1-3
2.	SPECIFICATIONS AND CHARACTERISTICS	2-1
	2.1 KEYBOARD	2-1
	2.2 VIDEO MONITOR AND COMPOSITE VIDEO	2-1
	2.3 PRINTED CIRCUIT BOARD (P.C.B.)	2-1
	2.4 GENERAL SPECIFICATION	2-1
	2.4.1 Terminal Type	2-1
	2.4.2 Communication Interface	2-1
	2.4.3 Screen Presentation	2-2
	2.4.4 Overview Specifications	2-2
	2.4.5 Field Installable Options	2-3
	2.4.5.1 Current Loop Interface	2-3
	2.4.5.2 Tektronix 4010/4014 Graphic Upgrade	2-3
3.	START-UP PROCEDURES	3-1
	3.1 GENERAL	3-1
	3.2 UNPACKING INSTRUCTIONS	3-1
	3.3 INSTALLATION	3-1
	3.4 SET-UP MODE	3-2
	3.5 HOW TO ENTER BASIC SET-UP MODE	3-2
	3.6 HOW TO CHANGE BASIC SET-UP FEATURES	3-3
	3.6.1 Line/Local	3-3
	3.6.2 80 Column/132 Column Mode	3-3
	3.6.3 Click/Silent Mode	3-4
	3.6.4 Normal/Reverse Mode	3-4
	3.6.5 Jump/Smooth Scrolling Mode	3-4
	3.6.6 Reset	3-4
	3.6.7 Menus	3-4
	3.6.8 Tabs	3-4
	3.6.9 Firmware Revision	3-5
	3.6.10 Answerback	3-5
	3.7 HOW TO ENTER MENU SET-UP MODE	3-7
	3.8 HOW TO CHANGE MENU SET-UP FEATURES	3-7
	3.8.1 Menu #1	3-7
	3.8.1.1 Auto Line Wrap Mode	3-7
	3.8.1.2 Auto New Line Mode	3-8
	3.8.1.3 Control Representation Mode	3-8
	3.8.1.4 Auto Repeat Mode	3-8
	3.8.1.5 Margin Bell	3-8

TABLE OF CONTENTS — Continued

	Page
3.8.2 Menu #2	3-9
3.8.2.1 Refresh Rate	3-9
3.8.2.2 Cursor Type	3-9
3.8.2.3 Cursor Blink	3-9
3.8.2.4 Screen Saver	3-10
3.8.2.5 Status Line	3-10
3.8.2.6 English Set	3-10
3.8.2.7 Language	3-10
3.8.2.8 Emulation	3-10
3.8.3 Menu #3	3-11
3.8.3.1 Duplex Mode	3-11
3.8.3.2 Local Echo	3-11
3.8.3.3 Disconnect Character	3-12
3.8.3.4 Disconnect Delay	3-12
3.8.3.5 Turnaround/Disconnect Character	3-12
3.8.3.6 Auto Turnaround	3-13
3.8.3.7 Auto Answerback	3-14
3.8.3.8 Initial Direction	3-14
3.8.4 Menu #4	3-15
3.8.4.1 Transmitter Baud Rate	3-15
3.8.4.2 Receiver Baud Rate	3-15
3.8.4.3 Data/Parity Bits	3-16
3.8.4.4 Stop Bits	3-16
3.8.4.5 Break	3-16
3.8.4.6 Flow Control	3-16
3.8.4.7 Receiver Parity Check	3-17
3.8.4.8 Identify Response	3-17
3.8.5 Menu #5	3-17
3.8.5.1 Copy Mode	3-18
3.8.5.2 Printer Controller Mode	3-18
3.8.5.3 Auto Print Mode	3-18
3.8.5.4 Underline Sequence	3-18
3.8.5.5 Line Feed Suppression	3-18
3.8.5.6 Buffered Print	3-19
3.8.5.7 Cancel Select	3-19
3.8.6 Menu #6	3-20
3.8.6.1 Printer Rate	3-20
3.8.6.2 Printer Data/Parity Rates	3-21
3.8.6.3 Stop Bits	3-21
3.8.6.4 Printer Busy	3-21
3.8.6.5 Busy Polarity	3-21
3.8.6.6 Print Extent	3-21
3.8.6.7 Printer Termination Character	3-22

TABLE OF CONTENTS — Continued

	Page
3.9 HOW TO ENTER PROGRAM	
FUNCTION KEY SET-UP MODE	3-23
3.10 FUNCTION KEY DEFINITION	3-24
3.11 HOW TO PROGRAM FUNCTION KEYS	3-24
3.11.1 Selecting the Function Key for Programming	3-24
3.11.2 Programmable Function Key Links	3-25
3.11.3 Programmable Function Key Example	3-25
3.11.4 Explanation of Programmable Function Key Example ...	3-26
3.12 PERFORMING A SAVE OPERATION	3-26
3.13 PERFORMING A RECALL OPERATION	3-27
3.14 PERFORMING A DEFAULT OPERATION	3-27
3.15 SCREEN BRIGHTNESS	3-27
4. KEYBOARD OPERATION	4-1
4.1 KEYBOARD LAYOUT	4-1
4.2 STANDARD KEY CODES	4-2
4.3 SPECIAL FUNCTION KEY CODES	4-2
4.4 NUMERIC KEY PAD	4-8
4.4.1 Alternate Key Pad Mode	4-8
5. TERMINAL PROGRAMMING	5-1
5.1 GENERAL	5-1
5.2 CONTROL CODES	5-1
5.3 CONTROL SEQUENCES RECOGNIZED IN ANSI MODE	5-2
5.3.1 General	5-2
5.3.2 Control Sequence Format — ANSI Mode	5-2
5.3.3 Control Sequence Functions — ANSI Mode	5-3
5.3.3.1 Scrolling Region Command ESC [x;y r (private)	5-3
5.3.3.2 Cursor Movement	5-4
5.3.3.3 Cursor Positioning Commands	5-4
5.3.3.4 Erasure Modes	5-6
5.3.3.5 Tabbing Commands	5-6
5.3.3.6 Screen Alignment Command ESC #8	5-7
5.3.3.7 Program Function Key Command	5-7
5.3.3.8 Character Set Commands	5-8
5.3.3.9 Report Commands and Sequences	5-9
5.3.3.10 Invoke Self Test	5-11
5.3.3.11 Video Attribute Command	5-12
5.3.3.12 Programmable L.E.D. Commands	5-13
5.3.3.13 Character Size Commands	5-13
5.3.3.14 Reset Command	5-14
5.3.3.15 Alternate Keypad Mode	5-14
5.3.3.16 Editing Commands	5-15

TABLE OF CONTENTS — Continued

	Page	
5.4	MODES (SET/RESET)	5-15
5.4.1	General	5-15
5.4.2	Set/Reset Mode Format	5-16
5.4.3	Set/Reset Mode Commands	5-17
5.4.3.1	Keyboard Action Mode	5-17
5.4.3.2	Control Representation Mode	5-17
5.4.3.3	Insert Replace Mode	5-17
5.4.3.4	Local Echo Mode	5-18
5.4.3.5	Auto New Line	5-18
5.4.3.6	Cursor Key Mode	5-18
5.4.3.7	80/132 Column Mode	5-18
5.4.3.8	Jump/Smooth Scroll Mode	5-18
5.4.3.9	Normal/Reverse Video Mode	5-18
5.4.3.10	Origin Mode	5-19
5.4.3.11	Auto Line Wrap Mode	5-19
5.4.3.12	Auto Repeat Mode	5-19
5.4.3.13	Enter VT52 Mode	5-19
5.5	CONTROL SEQUENCES RECOGNIZED	
	IN DEC VT-52 MODE	5-19
5.5.1	Cursor Movement	5-19
5.5.1.1	Cursor Up	5-19
5.5.1.2	Cursor Down	5-19
5.5.1.3	Cursor Right	5-19
5.5.1.4	Cursor Left	5-20
5.5.2	Line Graphics Mode	5-20
5.5.2.1	Enter Line Graphics Mode	5-20
5.5.2.2	Exit Line Graphic Mode	5-20
5.5.3	Cursor Home	5-20
5.5.4	Reverse Line Feed	5-20
5.5.5	Erasure Mode	5-20
5.5.5.1	Erase to End of Screen	5-20
5.5.5.2	Erase to End of Line	5-20
5.5.6	Cursor Addressing	5-20
5.5.7	Identify	5-20
5.5.8	Alternate Keypad	5-23
5.5.8.1	Enter Alternate Keypad Mode	5-23
5.5.8.2	Exit Alternate Keypad Mode	5-23
5.5.9	Enter ANSI Mode	5-23
6.	GRAPHICS OPTION OPERATION	6-1
6.1	GENERAL	6-1
6.2	PHYSICAL DESCRIPTION	6-1
6.3	GRAPHICS SCREEN FORMAT	6-1
6.3.1	Direct Scale Screen Format	6-1
6.3.2	Proportional Screen Format	6-2

TABLE OF CONTENTS — Continued

		Page
6.4	DISPLAY COORDINATE FORMAT	6-2
6.5	SET-UP — GRAPHICS	6-3
6.5.1	Status Line Set-Up	6-3
6.5.1.1	Auto Video Mode	6-3
6.5.1.2	Graphics Video Mode	6-3
6.5.1.3	Alphanumeric Video Mode	6-3
6.5.1.4	Both Video Modes	6-3
6.5.2	Revision Menu	6-3
6.5.3	Menu #7	6-4
6.5.3.1	Cell Size	6-4
6.5.3.2	Space Code Operation	6-4
6.5.3.3	Scale Factor	6-4
6.5.3.4	Extended Diagnostics	6-5
6.5.3.5	Start of Message Code	6-5
6.5.3.6	End of Line	6-5
6.5.4	Menu #8	6-5
6.5.4.1	Auxiliary Port Receiver Data Use	6-6
6.5.4.2	Graphics Printer Type	6-6
6.5.4.3	Print Image Rotation	6-6
6.5.4.4	Bit Pad Type	6-6
6.5.4.5	Bit Pad Tip Switch	6-6
6.5.4.6	Trailer Code #1	6-7
6.5.4.7	Trailer Code #2	6-7
6.6	GRAPHICS COMMANDS — CONTROL CODES	6-7
6.6.1	Sound Bell	6-8
6.6.2	Cursor Left	6-8
6.6.3	Cursor Right	6-8
6.6.4	Cursor Down	6-8
6.6.5	Cursor Up	6-8
6.6.6	Alphagraphics Mode	6-8
6.6.6.1	Enter Alphagraphics Mode	6-8
6.6.6.2	Enter Alphagraphics Mode	6-8
6.6.6.3	Enter Alphagraphics Mode	6-9
6.6.6.4	Set Alphagraphics Cursor	6-9
6.6.6.5	Set Alphagraphics Character Size	6-9
6.6.6.6	Set Alphagraphics Font Size	6-10
6.6.6.7	Set Alphagraphics Margins	6-10
6.6.7	Alphanumeric Mode	6-10
6.6.7.1	Enter Alphanumeric Mode	6-11
6.6.7.2	Alphanumeric Cursor	6-11
6.6.8	Point Plot Mode	6-11
6.6.8.1	Enter Point Plot Mode	6-11
6.6.9	Incremental Point Plot Mode	6-12

TABLE OF CONTENTS — Continued

		Page
	6.6.9.1 Enter Incremental Point Plot Mode	6-12
	6.6.10 Clear Bypass Condition	6-13
	6.6.11 Vector Mode	6-14
	6.6.11.1 Enter Vector Mode	6-14
	6.6.11.2 Vector Mode Example	6-16
6.7	GRAPHICS ESCAPE SEQUENCES	6-17
	6.7.1 Select Line Style	6-17
	6.7.2 Define User Line Styles	6-17
	6.7.3 Figure Draw and Fill	6-18
	6.7.3.1 Filling Type Commands	6-18
	6.7.3.2 Define User Fill Pattern	6-18
	6.7.3.3 Rectangle Draw	6-19
	6.7.3.4 Rectangle Draw and Fill	6-19
	6.7.3.5 Circle/Arc Draw	6-20
	6.7.3.6 Circle/Arc Draw and Fill	6-20
	6.7.4 Direction Commands	6-20
	6.7.4.1 Characters Direction Commands	6-21
	6.7.5 Data Level	6-21
	6.7.5.1 Set Data Level	6-21
	6.7.6 Crosshair Mode	6-22
	6.7.6.1 Enter Crosshair Mode	6-22
	6.7.6.2 Load Crosshair	6-23
6.8	INQUIRY	6-23
	6.8.1 Response Byte Format	6-24
	6.8.2 Graphics Inquiry Command	6-24
	6.8.2.1 Status Response Word	6-24
6.9	SCALING	6-24
6.10	BLOCK TRANSFER	6-24
	6.10.1 Address Load	6-25
	6.10.2 Data Load	6-25
	6.10.3 Memory Read	6-26
6.11	GRAPHICS COMMUNICATIONS	6-26
	6.11.1 Handshaking	6-26
	6.11.1.1 XON/XOFF	6-26
	6.11.1.2 Status Readback Control	6-26
6.12	REMOTE PARAMETER SELECTION	6-27
	6.12.1 Set Parameters Remote Command	6-27
	6.12.2 Reset Parameters Remote Command	6-27
	6.12.3 Set Auxiliary Port Mode	6-27
6.13	ADDITIONAL ESCAPE SEQUENCES	6-28
	6.13.1 Pre-Plot 10 Compatibility	6-28
	6.13.2 Remote Graphics Print Command	6-28
	6.13.3 Alternate Character Sequence for Rubout	6-28
	6.13.4 Clear Screen	6-28

TABLE OF CONTENTS — Continued

	Page
7. COMMUNICATION AND INTERFACING	7-1
7.1 WORD LENGTH AND PARITY	7-1
7.2 DATA INTERFACE CONNECTIONS	7-2
7.2.1 EIA Interface	7-2
7.2.2 Optional Current Loop Interface	7-3
7.3 COMMUNICATION MODES	7-3
7.3.1 Full Duplex	7-4
7.3.1.1 FDX A	7-4
7.3.1.2 FDX B	7-4
7.3.1.3 FDX C	7-4
7.3.2 Half Duplex	7-4
7.3.2.1 HDX A	7-4
7.3.2.2 HDX B	7-5
7.4 COMMUNICATION DIP SWITCH SETTINGS	7-5
7.5 FLOW CONTROL PROTOCOLS	7-5
7.5.1 XON/XOFF Protocol	7-5
7.5.2 Data Terminal Ready	7-7
8. BUFFERED PRINTER INTERFACE	8-1
8.1 GENERAL	8-1
8.2 PRINTER COMMANDS AND MODES	8-2
8.2.1 Printer Command Sequences — ANSI Mode	8-2
8.2.1.1 Print Page	8-2
8.2.1.2 Print Cursor Line	8-2
8.2.1.3 Print Line “P”	8-2
8.2.1.4 Print Lines “P” Through “Q”	8-2
8.2.1.5 Enter Copy Mode	8-3
8.2.1.6 Exit Copy Mode	8-3
8.2.1.7 Enter Printer Controller Mode	8-3
8.2.1.8 Exit Printer Controller Mode	8-3
8.2.1.9 Enter Auto Print Mode	8-3
8.2.1.10 Exit Auto Print Mode	8-3
8.2.1.11 Printer Status Reports	8-3
8.2.2 Set and Reset Printer Modes	8-3
8.2.2.1 Printer Form Feed	8-4
8.2.2.2 Printer Extent	8-4
8.3 PRINTER COMMAND SEQUENCES — DEC VT-52 MODE	8-5
8.3.1 Print Page	8-5
8.3.2 Print Line	8-5
8.3.3 Enter Printer Controller Mode	8-5
8.3.4 Exit Printer Controller Mode	8-5
8.3.5 Enter Auto Print Mode	8-5
8.3.6 Exit Auto Print Mode	8-5

TABLE OF CONTENTS — Continued

		Page
9.	FIRST LEVEL MAINTENANCE	9-1
9.1	GENERAL	9-1
9.2	TOP COVER	9-1
9.2.1	Top Cover Removal	9-1
9.3	PRINTED CIRCUIT BOARD REMOVAL AND INSTALLATION	9-2
9.3.1	Main PCB	9-3
9.3.2	Power Supply PCB	9-3
9.4	TV MONITOR PCB REMOVAL	9-4
9.5	CRT REMOVAL AND INSTALLATION	9-4
9.6	TV MONITOR ADJUSTMENTS	9-4
9.7	110/220 VOLT SELECTION	9-5
9.8	TROUBLESHOOTING THE V102	9-6
9.9	SELF TEST	9-7
9.10	V102 RAM FAILURE MESSAGE CODE	9-7
APPENDIX I	— VISUAL 100 ANSI MODE ESCAPE SEQUENCES	A1-1
APPENDIX II	— VISUAL 102 VT-52 MODE ESCAPE SEQUENCES	A2-1
APPENDIX III	— GRAPHIC RENDITION OF CONTROL CODES	A3-1
APPENDIX IV	— NUMERIC EQUIVALENT OF ASCII CHART	A4-1
APPENDIX V	— LOOP BACK CONNECTOR FOR INTERFACE TESTS	A5-1
APPENDIX VI	— U.S. AND FOREIGN LANGUAGE CODE CHARTS	A6-1
APPENDIX VII	— VT-52 GRAPHICS FONT	A7-1
APPENDIX VIII	— GRAPHICS UPGRADE INSTALLATION	A8-1
APPENDIX IX	— GRAPHICS PERIPHERALS	A9-1
APPENDIX X	— GRAPHICS PROGRAMMING	A10-1

LIST OF FIGURES

		Page
Figure 3-1	Basic Set-Up Mode	3-3
Figure 3-2	Basic Tab Stop Menu	3-5
Figure 3-3	Basic Answerback Menu	3-6
Figure 3-4	Set-Up Menu #1	3-9
Figure 3-5	Set-Up Menu #2	3-9
Figure 3-6	Set-Up Menu #3	3-11
Figure 3-7	Set-Up Menu #4	3-15
Figure 3-8	Set-Up Menu #5	3-17
Figure 3-9	Set-Up Menu #6	3-20
Figure 3-10	Program Function Key Menu	3-23
Figure 3-11	Programmed Function Key Menu Example	3-26
Figure 4-1	The VISUAL 102 Keyboard	4-1
Figure 4-2	Standard Key Codes	4-2
Figure 4-3	Control Codes Generated by Keys When Holding Down the Control Key	4-5
Figure 5-1	Control Sequence Format	5-2
Figure 5-2	Control Sequence Examples	5-3
Figure 5-3	Set Mode Control Sequence	5-16
Figure 5-4	Reset Mode Control Sequence	5-16
Figure 6-1	Screen Format	6-2
Figure 6-2	Set-Up Menu #7	6-4
Figure 6-3	Set-Up Menu #8	6-5
Figure 6-4	Data Sequence Point Plot Mode	6-12
Figure 6-5	Incremental Point Plot Directional Characteristics	6-14
Figure 6-6	Data Sequence Vector Mode	6-15
Figure 6-7	Sample Triangle	6-16
Figure 6-8	Rectangle Draw	6-19
Figure 6-9	Load Crosshair Example	6-23
Figure 7-1	Character Word Configuration	7-1
Figure 7-2	Current Loop Connections	7-3
Figure 9-1	Top Cover Removal	9-1
Figure 9-2	PCB Mounting	9-2
Figure 9-3	PS/TV PCB Mounting	9-3
Figure 9-4	TV Monitor	9-5

LIST OF TABLES

Table 3-1	Control Representation Characters	3-8
Table 3-2	Turnaround/Disconnect Character Choices	3-12
Table 3-3	Data/Parity Rates	3-16
Table 3-4	Printer Data/Parity Rates	3-21
Table 4-1	Transmittable Control Codes	4-6
Table 4-2	Codes Transmitted by Function Keys	4-7

LIST OF TABLES — Continued

	Page
Table 4-3	Codes Transmitted by Cursor Positioning Keys 4-7
Table 4-4	Codes Transmitted in Alternate Keypad Mode 4-8
Table 5-1	Alphanumeric Control Codes 5-1
Table 5-2	Page Erase Values 5-6
Table 5-3	Line Erase Values 5-6
Table 5-4	Clear Tab Values 5-7
Table 5-5	Character Set Commands 5-8
Table 5-6	Terminal ID Response 5-9
Table 5-7	Terminal Status Response 5-9
Table 5-8	Cursor Location Response 5-9
Table 5-9	Terminal Parameter Values 5-10
Table 5-10	Terminal Self Test Parameter Values 5-11
Table 5-11	Summary of Video Attributes and Selective Parameters 5-12
Table 5-12	L.E.D. Commands 5-13
Table 5-13	Codes Transmitted in Alternate Keypad Mode 5-14
Table 5-14	Selective Parameters Associated with Set/Reset Mode Control Sequences 5-17
Table 5-15	Cursor Key Mode Escape Sequences 5-18
Table 5-16	Graphic Character Set 5-21
Table 5-17	Cursor Addressing Code Chart (VT-52 Mode) 5-22
Table 5-18	Codes Transmitted in Alternate Keypad Mode 5-23
Table 6-1	Graphics Control Codes 6-7
Table 6-2	Alphagraphics Character Size 6-9
Table 6-3	Margin Location 6-10
Table 6-4	Incremental Point Plot Operations 6-13
Table 6-5	Incremental Point Plot Directional Characteristics 6-13
Table 6-6	Line Styles 6-17
Table 6-7	Fill Type Commands 6-18
Table 6-8	Direction Commands 6-20
Table 6-9	Characters Direction Commands 6-21
Table 6-10	Data Level Settings 6-22
Table 6-11	Remote Graphics Parameter Selection 6-27
Table 6-12	Auxiliary Port Mode Commands 6-28
Table 7-1	EIA RS232-C Signal Definitions and Connector Pins, and 20 MA Current Loop Pin Polarity 7-2
Table 7-2	Communication DIP Switch Settings 7-6
Table 8-1	Printer Port Pin Designations 8-1
Table 8-2	Printer Status Responses 8-4

1. INTRODUCTION

1.1 PRODUCT INTRODUCTION

The Visual 102 is code compatible with the DEC VT102*, while offering many enhanced features, including a tilt and swivel base, 16 programmable, non-volatile function keys, and a graphics upgrade capability.

The Visual 102 contains a unique user friendly menu-style set-up mode for ease of configuration.

The printer port is buffered and standard equipment.

1.2 HOW TO USE THIS MANUAL

This user guide is divided into numbered sections. The section number is the prefix for each page number. For example, Section 5 is located on pages 5-1 through 5-23.

This numbering allows easy referencing to a section when a given function is to be performed. The following is a summary of each chapter contained in this manual.

Section 1 contains an introduction of the Visual 102 and a list of frequently used terms in the manual.

Section 2 lists the characteristics and specifications in detail of the Visual 102.

Section 3 describes the menu style set-up mode and how to set the terminal's parameters for proper operation.

Section 4 contains detailed information about the Visual 102 keyboard and its functionality. This section also explains the different codes generated by each key.

Section 5 lists the programming commands recognized by the Visual 102. It describes the control functions used to alter the operation of the terminal. This chapter is strictly for alpha-numeric commands (not graphic).

Section 6 lists all the programming commands for the Tektronix 4010/4014 graphic upgrade option. This section of commands is for graphic control only once in graphic mode.

Section 7 describes the different types of communication available and explains the different modes in which the terminal communicates with the host computer.

Section 8 explains the operation of the printer port (aux port). It lists commands used by the terminal to interface with a printer.

Section 9 explains methods of troubleshooting the terminal if a failure occurs. Consulting this section may save a service call.

*VT102 is a trademark of Digital Equipment Corporation.

**Tektronix 4010 and 4014 are trademarks of Tektronix, Inc.

- Appendix I contains a summary of all ANSI mode escape sequences.
- Appendix II contains a summary of all DEC VT-52 mode escape sequences.
- Appendix III contains a summary of the graphic rendition of control codes.
- Appendix IV details the numeric equivalents of the ASCII code chart in decimal, octal, and hexadecimal values.
- Appendix V defines the loopback interface.
- Appendix VI shows the foreign language keyboards available, and details the codes and characters generated.
- Appendix VII Details the block graphics codes available.
- Appendix VIII Describes the process of installing the optional graphics upgrade board.
- Appendix IX Lists the graphics peripherals supported by the V102.
- Appendix X Details the graphics display coordinates for the programmer.
- Appendix XI Contains a summary of all graphics option commands.
- Appendix XII Lists all values of all screen routed characters for your convenience.

1.3 COMMONLY USED GENERAL TERMS

Monitor

The video display tube of the terminal.

Host

The computer with which the terminal is communicating.

Modem Port

Main communication port on the terminal.

Aux Port

The secondary port provided for interface with an auxiliary device, a printer for example.

Attribute

The type of visual display mode given to each alpha-numeric character.

Mode

A condition in which to set terminal for different results.

Escape Sequence

A string of ASCII characters received by the terminal to perform a certain duty. The string begins with an escape code (033 octal). Sometimes known as a control sequence.

Parameter, Numeric (Pn) and Selective (Ps)

A symbol defining a certain operation or number of operations found in an escape sequence.

Menu

A list of selections available to the operator in set-up mode.

Set-Up Mode

A mode unique to the Visual 102 that allows operator modifications to the terminal.

25th Status Line

A visible display on the 25th line offering information to the operator for instant updating.

Default State

(1) the electrical condition in which the terminal is shipped from the factory, i.e. set-up mode parameters; (2) the assumed value of a selective or numeric parameter if not defined.

1.4 COMMONLY USED GRAPHIC TERMS

Attribute

Property of a display entity. For example, on a graphics display a line may have the following attribute — line type.

Glossary of Common Computer Graphic Terms

Absolute Point

An individually addressable position on the display screen, identified by specified X and Y coordinate positions (e.g., X=23, Y=32).

Absolute Vector

A line segment drawn from the current beam position to an absolute point. The end coordinates are defined in Absolute Units relative to the origin of the IMAGE DEFINITION AREA. This is contrasted with relative vector.

Addressability

The smallest discrete unit at which a display element can be defined and to which the hardware responds. The addressability of the V102 image definition area is one part in 1024 and of the viewing area is one part in 768. The smallest addressable display element is sometimes called a Raster Unit (R.U.).

Addressable Point

Any position in the Viewing Area to which the CRT beam may be directed. These positions are specified by COORDINATES. Such addressable positions are finite in number, and form a discrete grid over the VIEWING AREA. In a matrix display such as the PLASMA PANEL, Addressable Point and Resolution are identical.

Basic Vector

In V102, a vector in one of the eight major directions (horizontal, vertical and 45° to these directions).

Blink

A hardware mode where the displayed information “blinks”, i.e., turn on and off, typically twice a second; usually to attract the attention of the operator as with a warning message (also known as FLASH).

Character Generator

A hardware or firmware option which takes character data stored in ASCII character format and causes the appropriate deflections and/or intensifications on the CRT to cause the corresponding character images to appear on the screen.

Contrast

The ratio of the brightness of a display image to the screen background.

Monitor

Usually refers to the physical CRT unit and housing used in graphic display systems.

Phosphor

The chemical coating on the inside face of a CRT which emits visible light when energized by an electron beam.

Pixel

A single picture element, a dot.

Primitive

One of the fundamental graphics entities. A primitive is *one* vector (relative, absolute, etc.) a *point*, a *text string*. Primitives are the smallest definable objects in a display processor’s instruction set.

Raster Scan

A technique for generating or recording an image with an intensity controlled, line-by-line sweep across the Display Surface.

Raster Unit

The horizontal or vertical distance between two adjacent addressable points on a CRT Display. Analogous to Plotter Step Size.

Refresh Rate

The rate at which a Display is Regenerated.

Relative Vector

A vector whose end points are defined with respect to a relative origin.

Resolution

The smallest distance between two display elements which can be perceived as two distinct elements by the viewer.

Scaling

A Transformation Function that alters one or more Display Elements by multiplying their Coordinates by constant values. The effect of Scaling is to change their size or shape in a graphics system, either in the Display Image, in the graphics data base or in both.

Scale Factor

A number which multiplies the vector end point coordinates to produce scaling.

Coordinate

A positional reference on the display image relative to an origin. In a display system the hardware interprets coordinates in the raster units, whereas in a program user defined coordinates may be used.

Cursor

A flashing underscore or symbol displayed on a screen. It is usually positioned where the next alphanumeric character will be displayed, or other data entry may take place. May be moved by the driving computer, or the operator through key-press, or other operator input devices.

Data Tablet

A graphic input device which encodes X-Y data from a hand held stylus. The portion of the stylus on the tablet surface may be interrogated under program control or may be continuously input. Most writing tablets provide the coordinate information by sensing signals from parallel sets of X and Y wires under the surface. Another form of writing tablet is the sonic variety which the sound from sparks is received by microphones at the edge of the tablet.

Function Keypad

A portion of an alphanumeric keyboard, typically with 8 keys, used to invoke control functions, e.g., move cursor left, right, up, down. Sometimes called Function Keyboard, and may be separate from alphanumeric keyboard.

Graphic

Adjective. Synonymous with Display (adj.) and Graphical. Usually refers to those devices that draw lines and points.

Hard Copy

A permanent copy of a DISPLAY IMAGE.

Intensity

Strictly, the absolute luminosity of brightness of an image on the display screen.

Line Type

The type of line used to display vectors on the screen.

Mode

The current mode of a display processor determines how it will interpret data values accessed from a display file. For example, in vector mode data values are interpreted as vector coordinates. Other modes are incremental Plot Mode, Point Plot Mode, Alphanumeric Mode.

Screen Size

The size of a cathode ray tube is the diameter of the tube outside of its housing, or for a non-round tube the length of the maximum diagonal. The screen size sometimes refers to the dimensions — length and breadth — after the CRT has been mounted in its housing. Because of tube mounting and deflection limits, the VIEWING AREA may be less than the Screen Size.

Scrolling

Conventional scrolling is the movement of an image, usually a block of text up the screen to allow the display of a new line at the bottom.

Selective Erase

Removal of one or more specified Display Elements, Display Entities, or Display Groups without affecting the remainder of the Display Image.

Subpicture

An entity defined by grouping together several primitive definitions. A subpicture is analogous to a computer subroutine and is used for the same reasons — primarily modularity and efficiency. By referencing a subpicture, images can be repeated without having to respecify the primitives included in the subpicture definition.

Text Mode

The manner in which text is displayed, e.g., normal, italics, subscript, superscript, etc.

Vector

As in the classical definition of vectors, graphic vectors possess the attributes of magnitude and direction and are generally defined relative to the “current beam positions.”

Vector Generator

A function generator which in hardware takes vector definition data, typically X and Y beam displacements or end point coordinates, and draws a line directly on the screen.

Vector Type

The specification of the vector appearance. For example, V102 has vector types: solid, dashed, short dashed, dot-dash.

Viewing Area

That portion of the screen on which images can be displayed. Typically the boundaries of the viewing area are set by hardware limiting amplifiers to be within the bounds of the SCREEN SIZE.

Windowing

The visual effect achieved by the apparent movement of a Viewing Area across a larger image area.

Window

A bounded area within a display image that contains a scissored subset of the display data.

Writing Tablet — See Data Tablet and Digitizer

Zooming

The visual effect achieved by the apparent movement of a picture such that it seems to move closer to (Zoom-in) or move away from (Zoom-out) an observer in a smooth fashion. It is equivalent to continuous scaling, i.e., repeatedly scaling by using slightly different scale factors for each frame.

The Visual 102 is not capable of zooming.

2. SPECIFICATIONS AND CHARACTERISTICS

The VISUAL 102 is a video terminal that allows interfacing with a host computer. The keyboard is used to input data to the computer, and the video monitor displays characters being received from the computer. The printed circuit board (P.C.B.) controls the communication lines to the computer.

2.1 KEYBOARD

The Visual 102 has a field proven solid-state DIN standard, low profile keyboard using capacitively coupled, scanned keys for high reliability and long life.

The keyboard is detached from the terminal for operator comfort and optimal space utilization. A single coil cord connects the keyboard to the terminal.

2.2 VIDEO MONITOR AND COMPOSITE VIDEO

The video monitor employed by the VISUAL 102 is a high quality 14" green (P31) Cathode Ray Tube (C.R.T.). The tube comes standard with a non-glare, brushed finish ensuring eye comfort and minimal glare.

The VISUAL 102 offers a composite video output jack (connector). An external composite video monitor with a video band width of 18 MHz and a horizontal frequency of 19.2 kHz is required to display the composite video output properly.

2.3 PRINTED CIRCUIT BOARD (P.C.B.)

A single, vertically mounted P.C.B. is located in the back of the VISUAL 102 terminal. The main communication port (modem port), auxiliary port, keyboard port and composite video output jack are located on the P.C.B. The P.C.B. contains the intelligence required to process data from the keyboard, display data to the screen and maintain communication with the computer simultaneously.

2.4 GENERAL SPECIFICATION

2.4.1 Terminal Type:	DEC VT102 compatible, VT52 compatible, TTY compatible, Z-80 microprocessor based
2.4.2 Communication Interface:	
Code:	128 characters ASCII
Type:	Serial asynchronous
Speed (baud):	Independent transmit and receive rates; 50, 75, 110, 134.5, 150, 200, 300, 600, 1200, 1800, 2000, 2400, 3600, 4800, 9600 and 19,200 bits per second
Method:	Character by character (conversational)
Mode:	Full duplex A, B or C; or half duplex A or B

Parity: Odd, even, mark, space, none
Interface: EIA RS232-C, 20 milli-amp current loop is optional
Stop Bits: 1 or 2, selectable

2.4.3 Screen Presentation

Display Unit: 14" non-glare P31 (green)
Format: Working 24 lines by 80 columns or 24 lines by 132 columns
25th Status Line: Terminal information of: Line/Local, L1, Insert, Keyboard Lock, CTS, DSR, Cursor Position, Alternate Keypad, Alternate Cursor Key, Alternate Character Set, Origin, Scroll Region, Graphics, ANSI/VT52
Cursor: Block or underline, blink or solid, selectable
Character Resolution: 7×9 font in a 10×12 cell in 80 column or a 5×9 font in a 6×12 cell in 132 column mode
CRT Refresh Rate: 50 Hz or 60 Hz, selectable
Band Width: 18 MHz
Composite Video Jack: Coaxial coupled, standard phono plug
Video Attributes: Bold, blink.reverse, underscore and blank
Video Attribute Selection: Any combination on a per character basis
Character Presentation: Single high-single width, single high-double width, double high-double width, line selectable
Character Set: 95 ASCII U.S./U.K. plus 32 special character and line drawing set
C.R.T. Brightness: Up and down cursor control keys in set-up mode
C.R.T. Image: Raster scan

2.4.4 Overview Specifications

Data Entry: Scroll, page, smooth scroll or jump scroll, split screen scrolling
Audible Indicators: Completion of self test sounds bell, key click selectable, and bell at column 72 or 124 selectable, power on error indicator
Answer Back: User programmable in non-volatile memory
External Operator Controls: Power on/off
Diagnostics: Power up self test, induced self test
LED indicators: Caps lock

Keyboard:	Solid state, capacitive scan, auto repeat, N-key roll over, sculptured cut, matte finish keys.
Alpha Cursor Control:	Up, down, left, right, home
Function Keys:	16 user-programmable, non-volatile, linkable each able to contain 24 characters (F1-F8 and shifted F1-F8); 4 pre-set function keys; PF1-PF4
Keypad:	14-key numeric pad, graphic cursor controls
Printer Port:	Buffered, limited bidirectional protocol, RS232C interface; independent baud rate selection
Parameter Selections:	Configurable in set-up menu via keyboard; non-volatile
Editing:	Insert and delete character and line
Power:	110/120 volts AC
Physical Components:	Keyboard assembly; monitor assembly
Operating Range:	10° to 40° C
Storage Range:	-20° to 60° C

2.4.5 Field Installable Options

2.4.5.1 Current Loop Interface

20 milliamp current loop interface. A unique customized hybrid 24 pin integrated circuit.

2.4.5.2 Tektronix 4010/4014 Graphic Upgrade

A graphic upgrade kit containing P.C.B. allowing code compatibility with Tektronix 4010 and 4014 storage tube terminal.

Also offering:

- 768 × 293 pixel resolution
- fully bidirectional auxiliary port
- 5-way graphic control modes:
 1. alpha graphics; 128 ASCII character
 2. vector mode
 3. point plot mode
 4. incremental point plot mode
 5. cross hair mode
 - 8 way cursor direction positioning keys
 - 8 pixel cursor fast move operation
 - full interface with approved data-tablets
- full page print capabilities on line and in local with approved printers

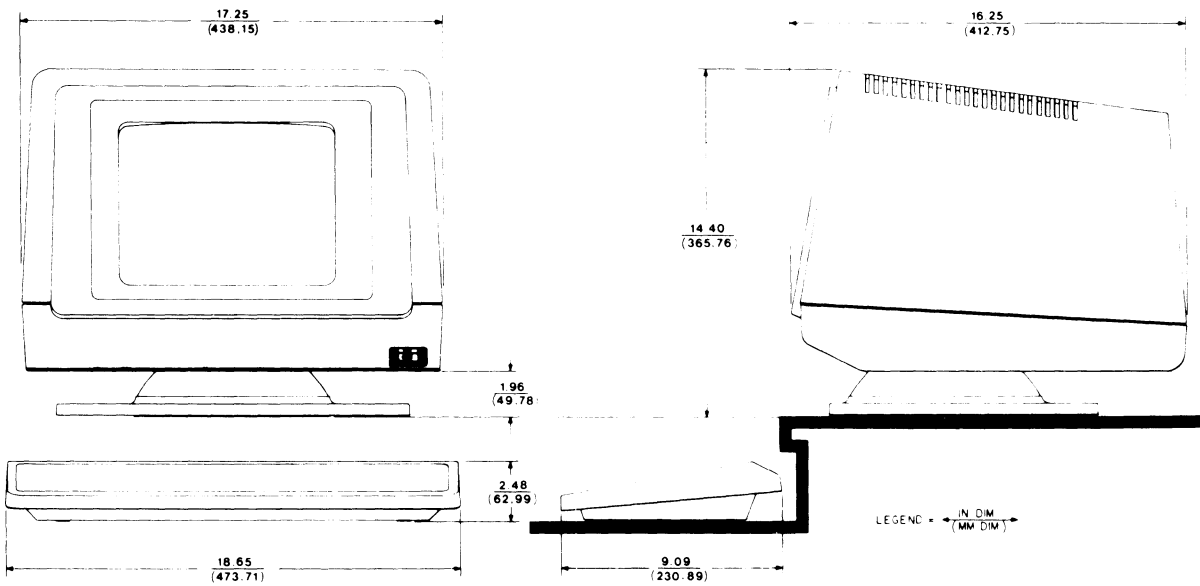

3. START-UP PROCEDURES

3.1 GENERAL

This chapter contains the information necessary to install and set up the VISUAL 102 terminal. It describes the various set-up modes, menus, and options available to configure your VISUAL 102 terminal to your exact needs.

3.2 UNPACKING INSTRUCTIONS

The VISUAL 102 is packed in a reinforced carton containing the following items:

- Monitor
- Keyboard
- AC Power Cord
- Keyboard Cable
- Reference Manual
- Terminal Set-Up Guide

The Terminal Set-Up Guide shows the packing used with the VISUAL 102. To unpack the terminal from the shipping container, follow the procedure outlined in the Terminal Set-Up Guide.

NOTE

Repack empty containers in reverse order and save the reusable shipping container.

3.3 INSTALLATION

When installing the VISUAL 102 for the first time, or when moving the terminal to a new location or new communications trunk, the following steps should be followed:

- a. Unpack the terminal and place it in the desired work area. A desk or table is satisfactory.
- b. Connect the keyboard to the monitor using the coiled cable provided.
- c. Plug the Interface cable and Printer cable (if used) into the corresponding connectors.
- d. Plug the power cord into the back of the panel and then plug the terminal into an acceptable AC power source.
- e. Power on the terminal. The Switch is in the front right corner under the screen.
- f. The terminal performs tests on initial power up. A successful power up test is indicated by a short audible tone. If the power up tests are unsuccessful, refer to the first level maintenance Section 9.

- g. If more than one audible tone is sounded, a SAVE operation must be performed to clear the error. See Section 3.12.
- h. If the intensity is too low or the cursor is not visible, press SETUP key once; then press the  key until the screen presentation is visible.

3.4 SET-UP MODE

The VISUAL 102 employs a sophisticated, easy to use MENU-STYLE parameter selection method that allows the user to define the terminal's characteristics from the keyboard in single keystrokes. The terminal's features and modes are selected and stored in a special mode called SET-UP MODE.

Terminal features and modes are stored (remembered) in a non-volatile RAM memory. Once the desired parameters have been selected, the terminal functions per the new configuration. The new configuration is considered temporary, unless a SAVE operation is performed. A subsequent RECALL or power on operation returns the terminal to the previously saved characteristics. If the SAVE operation is performed, the new configuration is considered permanent and is recalled on subsequent RECALL or power up operations. A RESET operation sets the terminal parameters to the previously saved state, and a DEFAULT operation returns the terminal parameters to the factory defined Default values. (For a more complete discussion of SAVE, RECALL, and DEFAULT operations, see Section 3.12 to 3.14).

SET-UP mode is divided into three groups: BASIC, MENU, and FUNCTION KEY, Set-Up Modes.

In the BASIC Set-Up mode, the user selects status line modes, columnar tab stops, answer back message, reset function or menu mode. Each BASIC Set-Up mode is described in Section 3.6.

In the MENU Set-Up mode the user selects up to six (6) programming menus. The menus are numbered One through Six (1-6) or, with the Graphic Option, One through Eight (1-8) for easy referencing.

Each MENU Set-Up mode is described in Section 3.8.

In FUNCTION KEY Set-Up mode the user programs the sixteen (16) function keys. The FUNCTION KEY Set-Up mode is described in Section 3.10.

3.5 HOW TO ENTER BASIC SET-UP MODE

BASIC Set-Up mode is entered by depressing the  key on the keyboard. When BASIC Set-Up mode is entered, the screen displays a presentation as shown in Figure 3-1. Subsequent depressions of the SET-UP key causes the VISUAL 102 to alternately exit and enter BASIC Set-Up mode.

F1=LOCAL F2=80 COL F3=CLICK F4=NORMAL F5=JUMP F7=RESET → =MENUS

Figure 3-1. Basic Set-Up Mode Menu

3.6 HOW TO CHANGE BASIC SET-UP FEATURES

Once BASIC Set-Up mode has been entered, any BASIC Set-Up feature may be changed from the keyboard by depressing a single key. Some BASIC set-up features may also be changed by the host computer using a control sequence (remotely).

3.6.1 Line/Local (F1)

Depressing key **F1** alternately selects between ON LINE and LOCAL operation.

When ON LINE, the terminal may send or receive data from the host computer. When in LOCAL (Off Line), the terminal is electronically disconnected from the host computer. Any data entered at the keyboard is looped back through the terminal receiver and displayed on the screen.

3.6.2 80 Column/132 Column Mode (F2)

Depressing key **F2** alternately selects between 80 and 132 columns per line displayed on the screen.

This feature determines whether the display on the screen is 80 (for most operations) or 132 columns (for spreadsheet and other operations).

NOTE

Changing the number of columns per line destroys the data on the screen.

3.6.3 Click/Silent Mode (F3)

Depressing key **F3** alternately selects between CLICK and SILENT mode of keyboard operation.

When Click is selected, an audible key click tone is generated by the VISUAL 102 keyboard for each key depression generating a code.

3.6.4 Normal/Reverse Mode (F4)

Depressing key **F4** alternately selects between NORMAL and REVERSE Screen Mode.

NORMAL mode characters are formed by white dots on a black background. REVERSE mode characters are formed by black dots on a white background.

3.6.5 Jump/Smooth Scrolling Mode (F5)

Depressing key **F5** causes SCROLLING mode to alternate between JUMP and SMOOTH mode.

JUMP SCROLL is the traditional scrolling method whereby lines of data move one line at a time to make room for new lines of data entering the screen.

SMOOTH SCROLL is a method whereby new lines of data move a scan line at a time to make room for new lines of data entering the screen.

3.6.6 Reset (F7)

Depressing key **F7** causes the VISUAL 102 to execute a RESET command.

The RESET operation has the same effect as powering-down and then powering-up the terminal, and is used to run the self test. The Reset command, however, returns the terminal's parameters to their "saved" state. This operation clears the screen of all data.

3.6.7 Menu

Depressing the  key causes the terminal to enter the first of six full screen set-up menus.

CAUTION

Entering MENU Set-Up mode clears the screen of all alphanumeric data.

3.6.8 Tabs (Shift T)

Holding down the **SHIFT** key and depressing the **T** key in BASIC Set-Up mode causes the screen presentation shown in Figure 3-2 to be displayed.

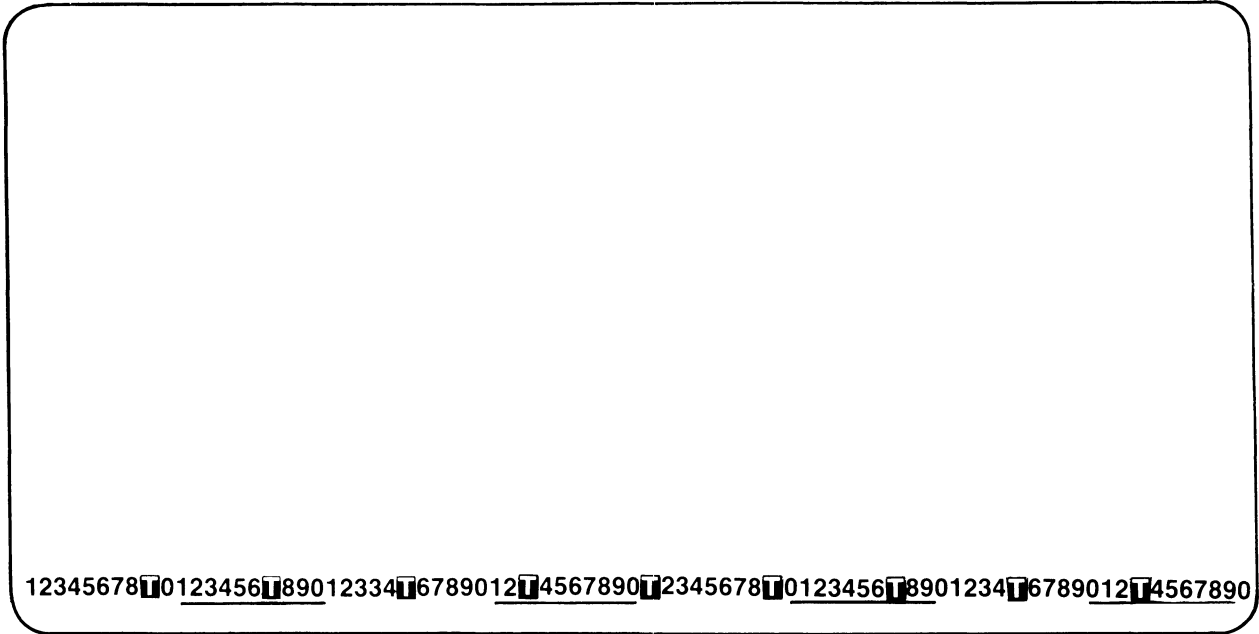

Figure 3-2. Basic Tab Stop Menu

The location of each columnar tab stop is indicated by a high intensity “T” in Figure 3-2.

All tab stops may be cleared by holding down the **SHIFT** key and depressing the **TAB** key. All tab stops may be set to their default positions by depressing the **FUNCT** , **SHIFT** , and **TAB** keys together. To set or clear tab stops on an individual basis, the following procedure is used:

1. Position the cursor by using the **←** , **→** , **TAB** , **SPACE BAR** , or **RETURN** key to the tab stop to be set or cleared.
2. Depress the **T** key to set or clear the tab stop at the cursor location.

Subsequent depressions of the **T** key alternately clears and sets the tab at the cursor location.

Tab set-up mode is exited by depressing the **SET-UP** or the **SHIFT** and **T** key combination on the keyboard.

3.6.9 Firmware Revision Level (Shift V)

Holding down the **SHIFT** key and depressing the **V** key in BASIC Set-up mode causes the firmware revision message to be displayed. To exit, depress any other key. However, if the exit keystroke is a valid set-up command, it will be acted upon.

3.6.10 Answerback (Shift A)

Holding down the **SHIFT** key and depressing the **A** key in BASIC Set-Up mode causes the screen presentation shown in Figure 3-3 to be displayed.



ANSWERBACK=

Figure 3-3. Basic Answerback Menu

The ANSWERBACK message of up to 32 characters can be programmed at the cursor location by first typing a user-defined delimiter character, followed by the text of the message, and ending with the defined delimiter.

NOTE

The delimiter may be any ASCII character (except NULL or a legal set-up command) not used in the message. If any control codes are used as part of the message, the code is displayed as in control representation mode. Delimiters are not counted in the 32 character limit.

When the ending delimiter is typed or upon exceeding 32 characters, the terminal exits Answerback mode and returns to the BASIC Set-Up mode automatically. The Answerback message is considered temporary unless a save operation is performed.



EXAMPLE:

```
ANSWERBACK = *VISUAL 102*
```

EXPLANATION:

The asterisk (*) is the delimiting character. Upon typing the second asterisk (*), the terminal automatically exits Answerback Message Menu. The message between the delimiters is sent upon request of the computer, but the delimiters are not transmitted.

3.7 HOW TO ENTER MENU SET-UP MODE

The MENU Set-Up mode is entered by first being in BASIC Set-Up Mode and then depressing the  key. When the MENU Set-Up mode is entered, the screen displays the first of the SET-UP menus (Figure 3-4). Subsequent depressions of the  key causes the terminal to step through the six (eight with the graphics option) available menus. MENU Set-Up mode is exited by depressing the SET-UP key on the keyboard.

CAUTION

Entering menu set-up mode clears the screen of all data.

3.8 HOW TO CHANGE MENU SET-UP FEATURES

3.8.1 Menu #1

Menu #1 screen presentation is shown in Figure 3-4.

DISPLAY MENU [1]		
AUTO LINE WRAP:	DISABLED	F1
AUTO NEW LINE:	DISABLED	F2
CONTROL REPRESENTATION:	DISABLED	F3
AUTO REPEAT:	ENABLED	F4
MARGIN BELL:	DISABLED	F5
PREVIOUS MENU		←
NEXT MENU		→

Figure 3-4. Set-Up Menu #1

3.8.1.1 Auto Line Wrap Mode (F1)

Depressing key  on the keyboard alternately enables or disables the AUTO LINE WRAP mode.

The AUTO LINE WRAP feature determines whether the cursor will automatically advance to the first position of the next line upon entering a character into the last position of the current line.

When enabled, the cursor wraps around automatically and enters the character on the first position of the new line.

When disabled, the cursor remains in the last column and any successive characters entered overlay the last character.

3.8.1.2 Auto New Line Mode (F2)

Depressing key **F2** on the keyboard alternately enables or disables the AUTO NEW LINE mode.

When enabled, the AUTO NEW LINE feature causes the RETURN key to generate the Carriage Return and Line Feed codes, and a received LF causes a new line function to be performed.

When disabled, the RETURN key generates only the CR code, and a received LF causes only a line feed to be performed.

3.8.1.3 Control Representation Mode (F3)

Depressing key **F3** on the keyboard alternately enables or disables the CONTROL REPRESENTATION mode.

When CONTROL REPRESENTATION is enabled, the terminal only displays control code characters and does not perform them. This is primarily a debugging mode.

Control characters are displayed by an underlined alphanumeric character.

FOR EXAMPLE:

**Table 3-1
CONTROL REPRESENTATION CHARACTERS**

Code	Symbol	Value
Bell	<u>G</u>	Octal 007
CR	<u>M</u>	Octal 015
LF	<u>J</u>	Octal 012

3.8.1.4 Auto Repeat Mode (F4)

Depressing key **F4** on the keyboard alternately enables and disables the AUTO REPEAT mode.

When AUTO REPEAT is enabled, the selected keys on the keyboard automatically repeat when held down. This mode does not apply to all keys.

When disabled, only single keystroke operation is allowed.

3.8.1.5 Margin Bell (F5)

Depressing key **F5** on the keyboard alternately enables and disables the terminal from sounding a warning bell when the cursor is eight characters from the end of the current line.

Depressing the  key causes the terminal to advance to the #2 menu presentation.

Depressing the  key causes the terminal to step back to the #6 menu presentation (#8 menu if the graphic upgrade is installed).

3.8.2 Menu #2

Menu #2 screen presentation is shown in Figure 3-5.

TERMINAL STATUS MENU [2]		
REFRESH RATE:	60 Hz	F1
CURSOR TYPE:	BLOCK	F2
CURSOR BLINK:	ENABLED	F3
SCREEN SAVER:	ENABLED	F4
STATUS LINE:	VISIBLE	F5
LANGUAGE:	ENGLISH	F6
ENGLISH SET:	U.S.	F7
EMULATION:	ANSI	F8
PREVIOUS MENU		←
NEXT MENU		→

Figure 3-5. Set-Up Menu #2

3.8.2.1 Refresh Rate (F1)

Depressing key  alternately selects 50 Hz or 60 Hz.

The REFRESH RATE must match the frequency of the terminal's power supply or screen distortion will occur. 60 Hz is standard in the U.S.A.

3.8.2.2 Cursor Type (F2)

Depressing key  alternately selects the cursor style to be either a block or an underline.

3.8.2.3 Cursor Blink (F3)

Depressing key  alternately selects either a blinking or a solid cursor.

3.8.2.4 Screen Saver (F4)

Depressing key **F4** alternately enables or disables the SCREEN SAVER FEATURE.

When enabled, the SCREEN SAVER dims the screen after no data has been received or typed for approximately 10 minutes. Any received data or keyboard input returns the screen to its normal brightness.

When disabled, the screen remains at the selected brightness level indefinitely.

3.8.2.5 Status Line (F5)

Depressing key **F5** alternately switches between displaying or blanking the information on the 25th line. When BLANKED is selected, the status line is not visible to the operator.

3.8.2.6 Language (F6)

Depressing key **F6** switches alternately between English and one of the six available foreign language character sets. Refer to Appendix VI for available languages. If a language other than English is chosen, the optional character generator must be installed.

3.8.2.7 English Set (F7)

Depressing key **F7** alternately chooses between U.S. or U.K. when English has been chosen as the default language.

3.8.2.8 Emulation (F8)

Depressing key **F8** alternately causes the terminal to switch between its two different programming standards — American National Standards Institute (ANSI) and VT52. In ANSI mode, the VISUAL 102 generates and responds to control codes and control sequences as defined in ANSI standard X3.64, 1977. In VT52 mode, the VISUAL 102 is compatible with the DEC VT52.

Depressing the  key causes the terminal to advance to the #3 menu presentation.

Depressing the  key causes the terminal to step back to the #1 menu presentation.

3.8.3 Menu #3

Menu #3 screen presentation is shown in Figure 3-6.

MODEM CONTROL MENU [3]		
DUPLEX MODE:	FDXA	F1
LOCAL ECHO:	DISABLED	F2
DISCONNECT CHARACTER:	DISABLED	F3
DISCONNECT DELAY:	2.0 SEC	F4
TURNAROUND/DISCONNECT CHARACTER:	ETX EOT	F5
AUTO TURNAROUND:	DISABLED	F6
AUTO ANSWERBACK:	DISABLED	F7
INITIAL DIRECTION:	TRANSMIT	F8
PREVIOUS MENU		←
NEXT MENU		→

Figure 3-6. Set-Up Menu #3

3.8.3.1 Duplex Mode (F1)

Depressing the **F1** key switches between Half-Duplex A and B and Full-Duplex A, B, and C communications with the computer. Set the feature to match the host's communication type. Refer to Section 7 for a full explanation of the modem control features.

3.8.3.2 Local Echo (F2)

Depressing key **F2** on the keyboard alternately enables and disables LOCAL ECHO mode.

The LOCAL ECHO feature provides for the automatic "echoing" of transmitted data back to the screen. If an echoing of transmitted data is not desired, if the terminal is set for half-duplex, or if the host computer or modem provides an echo, this feature should be disabled.

3.8.3.3 Disconnect Character (F3)

Depressing key **F3** on the keyboard alternately enables and disables the DISCONNECT CHARACTER mode.

When enabled, the terminal disconnects from the computer after receiving a disconnect character. The terminal also automatically transmits a disconnect character after a long break disconnect.

3.8.3.4 Disconnect Delay (F4)

Depressing key **F4** on the keyboard alternately switches the disconnect time between 2 seconds (US) and 0.06 seconds (UK).

The DISCONNECT DELAY is the time delay between RLSD (Receive Line Signal Detection) going off and the terminal disconnecting. This selection is only valid in full-duplex with modem control selections FDX B or FDX C.

3.8.3.5 Turnaround/Disconnect Character (F5)

Depressing key **F5** on the keyboard selects one of the five turnaround/disconnect character choices for the terminal.

The TURNAROUND/DISCONNECT CHARACTER is used with all half- or full-duplex modem control feature selections. Turnaround characters are only necessary for half-duplex modem control selection HDX B. The Turnaround/Disconnect character choices are as follows:

**TABLE 3-2
TURNAROUND/DISCONNECT CHARACTER CHOICES**

TACC	DCC	TACC	DCC
FF	EOT	Form Feed	End of Transmission
EXT	EOT	End of Text	End of Transmission
EOT	DLE EOT	End of Transmission	Data Link Escape End of Transmission
CR	EOT	Carriage Return	End of Transmission
DC3	EOT	Device Control 3	End of Transmission

3.8.3.6 Auto Turnaround (F6)

Depressing key **F6** on the keyboard alternately enables and disables the AUTO TURNAROUND feature.

The AUTO TURNAROUND feature is used only when the modem control feature is set to half-duplex coded control (HDX B).

When enabled, this feature causes the terminal to transmit the turnaround character (selected by the Turnaround/Disconnect feature) automatically after:

- The characters transmitted by RETURN.
- The end of the answerback message.
- The end of function key messages.
- All terminal report sequences.

When disabled, a control key combination must be used to generate the turnaround character.

NOTE

If the turnaround character is CR, **RETURN** will generate only one carriage return, regardless of the setting of AUTO NEW-LINE mode.

3.8.3.7 Auto Answerback (F7)

Depressing key **F7** on the keyboard alternately enables and disables the AUTO ANSWERBACK mode.

When AUTO ANSWERBACK is enabled, the terminal automatically transmits the Answerback message after a communication line connection. In half-duplex communication, with the initial direction feature set to receive, the terminal cannot transmit the answerback message until the line turns around.

3.8.3.8 Initial Direction (F8)

Depressing key **F8** on the keyboard alternately selects Transmit or Receive as the condition the terminal is to start at when in half-duplex mode.

Depressing the  key causes the terminal to advance to the #4 menu presentation.

Depressing the  key causes the terminal to step back to the #2 menu presentation.

3.8.4 Menu #4

Menu #4 screen presentation is shown in Figure 3-7.

COMMUNICATIONS MENU [4]		
TRANSMITTER RATE:	9600	F1
RECEIVER RATE:	9600	F2
DATA/PARITY BITS:	7 SPACE	F3
STOP BITS:	1	F4
BREAK:	ENABLED	F5
FLOW CONTROL:	XON/XOFF	F6
RECEIVER PARITY CHECK:	ENABLED	F7
IDENTIFY RESPONSE:	VT102	F8
PREVIOUS MENU		←
NEXT MENU		→

Figure 3-7. Set-Up Menu #4

3.8.4.1 Transmitter Baud Rate (F1)

Depressing key **F1** on the keyboard causes the terminal to step up through the selectable transmitter baud rates.

Holding down the **SHIFT** key and depressing key **F1** causes the terminal to step down through the selectable baud rates.

The possible baud rates are: 50, 75, 110, 134.5, 150, 200, 300, 600, 1200, 1800, 2000, 2400, 3600, 4800, 9600, and 19200 baud.

3.8.4.2 Receiver Baud Rate (F2)

Depressing key **F2** on the keyboard causes the terminal to step up through the selectable receiver baud rates.

Holding down the **SHIFT** key and depressing key **F2** causes the terminal to step down through the selectable baud rates.

The possible baud rates are: 50, 75, 110, 134.5, 150, 200, 300, 600, 1200, 1800, 2000, 2400, 3600, 4800, 9600, and 19200 baud.

3.8.4.3 Data/Parity Bits (F3)

Depressing key **F3** on the keyboard causes the terminal to step through the various data and parity bits per character.

**TABLE 3-3
DATA/PARITY RATES**

Data Bits per Char	Parity
7	Mark
7	Space
7	Odd
7	Even
7	No Parity Bit
8	Odd
8	Even
8	No Parity Bit

3.8.4.4 Stop Bits (F4)

Depressing key **F4** on the keyboard alternately selects 1 or 2 stop bits for the modem interface. Two stop bits are generally used only at baud rates at or below 110 baud.

3.8.4.5 Break: (F5)

Depressing key **F5** on the keyboard alternately enables and disables the **BREAK** key.

NOTE

This only affects **BREAK**, not **SHIFT** - **BREAK**
 (Long Disconnect) or **CTRL** - **BREAK** (Answerback)
 described in Section 4.

3.8.4.6 Flow Control (F6)

Depressing key **F6** on the keyboard alternately enables AUTO XON/XOFF protocol or DTR Busy. For detailed information, refer to Section 7.5.

3.8.4.7 Receiver Parity Check (F7)

Depressing key **F7** on the keyboard alternately enables and disables the RECEIVER PARITY CHECK.

When RECEIVER PARITY CHECK is enabled and a receive parity error occurs, the terminal displays the parity error character (P_E) in place of the character in error.

3.8.4.8 Identify Response (F8)

Depressing key **F8** alternately selects the terminal identification response between V102 and V100 with PRINTER.

Depressing the  key causes the terminal to advance to the #5 menu presentation.

Depressing the  key causes the terminal to step back to the #3 menu presentation.

3.8.5 Menu #5

Menu #5 screen presentation is shown in Figure 3-8.

PRINTER CONTROL MENU [5]		
COPY MODE:	DISABLED	F1
CONTROLLER MODE:	DISABLED	F2
AUTO PRINT:	DISABLED	F3
UNDERLINE SEQUENCE:	DISABLED	F4
LINEFEED SUPPRESSION:	DISABLED	F5
BUFFERED PRINT:	DISABLED	F6
CANCEL SELECT:	CANCEL	F7
PREVIOUS MENU		←
NEXT MENU		→

Figure 3-8. Set-Up Menu #5

NOTE

For detailed Printer Port Controls, refer to Section 8 of this Manual.

3.8.5.1 Copy Mode (F1)

Depressing key **F1** on the keyboard alternately enables and disables COPY MODE.

When enabled, COPY MODE sends all the data to the printer as well as to the screen.

NOTE

Resetting COPY MODE also resets PRINTER CONTROLLER MODE.

3.8.5.2 Printer Controller Mode (F2)

Depressing key **F2** on the keyboard alternately enables and disables PRINTER CONTROLLER MODE.

When PRINTER CONTROLLER MODE is enabled, all the data from the host is routed to the printer and not to the terminal. This means the printer speed controls the host in terms of XON/XOFF protocol.

NOTE

Resetting PRINTER CONTROLLER MODE also resets COPY MODE.

3.8.5.3 Auto Print Mode (F3)

Depressing key **F3** on the keyboard alternately enables and disables AUTO PRINT MODE.

When enabled, AUTO PRINT MODE sends a line to the printer whenever the cursor is moved off that line. This can be done in any of the following ways:

- a. AUTO LINE WRAP. The line is transmitted, followed by a CR and LF.
- b. LINE FEED. The line is transmitted, followed by a CR and LF.
- c. VERTICAL TAB. The line is transmitted, followed by a CR and VT.
- d. FORM FEED. The line is transmitted, followed by a CR and FF.

3.8.5.4 Underline Sequence (F4)

Depressing key **F4** on the keyboard alternately enables and disables the UNDERLINE SEQUENCE feature.

The UNDERLINE SEQUENCE feature, only valid in the Print Page Command, allows what is underlined on the screen to be underlined on the printer when enabled.

3.8.5.5 Line Feed Suppression (F5)

Depressing key **F5** on the keyboard alternately enables and disables the LINE FEED SUPPRESSION feature.

When LINE FEED SUPPRESSION is enabled, no Line Feed codes are sent to the printer.

3.8.5.6 Buffered Print (F6)

Depressing key **F6** on the keyboard alternately enables and disables the BUFFERED PRINT feature.

The BUFFERED PRINT feature, which applies to Printer Controller Mode and Copy Mode, determines whether or not the terminal passes the code sequences for exiting these modes on to the attached printer.

When the BUFFERED PRINT feature is enabled, the ESC code sequences for exiting Printer Controller Mode and Copy Mode are transmitted to the printer. The CANCEL SELECT feature then appends the CANCEL or DELETE code to cancel the ESC code to the printer.

When disabled, no codes in the sequence are transmitted to the printer. The setting of the CANCEL SELECT feature is disregarded.

NOTE

The BUFFERED PRINT feature should be set to the DISABLED position for full-line buffered printers, and should be set to the ENABLED position for FIFO buffered printers or printers with no buffers at all.

3.8.5.7 Cancel Select (F7)

Depressing key **F7** on the keyboard alternately enables and disables the CANCEL SELECT feature.

The CANCEL SELECT feature, which applies to the Printer Controller Mode and Copy Mode, determines whether the terminal automatically appends and transmits to the printer the CANCEL or DELETE code immediately following the control sequence to exit Printer Controller Mode or exit Copy Mode.

Select the CANCEL code if the printer interprets CANCEL as the Cancel Function, and select the DELETE code if the printer interprets DELETE as the Cancel Function. The Cancel Function causes the printer to erase its buffer.

Depressing the  key causes the terminal to advance to the #6 menu presentation.

Depressing the  key causes the terminal to step back to the #4 menu presentation.

3.8.6 Menu #6

Menu #6 screen presentation is shown in Figure 3-9.

PRINTER COMMUNICATION MENU [6]		
PRINTER RATE:	300	F1
DATA/PARITY BITS:	7 SPACE	F2
STOP BITS:	1	F3
PRINTER BUSY:	CTL LINE	F4
BUSY POLARITY:	HIGH	F5
PRINT EXTANT:	REGION	F6
TERMINATION CHARACTER:	FF	F7
PREVIOUS MENU		←
NEXT MENU		→

Figure 3-9. Set-Up Menu #6

3.8.6.1 Printer Rate (F1)

Depressing key **F1** on the keyboard causes the terminal to step up through the selectable printer baud rates.

Holding down the **SHIFT** key and depressing key **F1** causes the terminal to step down through the selectable baud rates.

The possible baud rates are: 50, 75, 110, 134.5, 150, 200, 300, 600, 1200, 1800, 2000, 2400, 3600, 4800, 9600, and 19200 baud.

3.8.6.2 Printer Data/Parity Bits (F2)

Depressing key **F2** on the keyboard causes the terminal to step through the various data and parity bits per character for the printer.

**TABLE 3-4
PRINTER DATA/PARITY RATES**

Data Bits per Char	Parity
7	Mark
7	Space
7	Odd
7	Even
7	No Parity Bit
8	Odd
8	Even
8	No Parity Bit

3.8.6.3 Stop Bits (F3)

Depressing key **F3** on the keyboard alternately selects 1 or 2 stop bits for the printer interface. Two stop bits are generally used only at baud rates at or below 110 baud.

3.8.6.4 Printer Busy (F4)

Depressing key **F4** on the keyboard alternately selects either CTL LINE or XON/XOFF protocol.

When CTL LINE protocol is selected, the terminal monitors the Control Line to determine if the printer is ready to receive characters.

When XON/XOFF protocol is selected, the terminal monitors the data stream to determine if the printer has sent these codes.

3.8.6.5 Busy Polarity (F5)

Depressing key **F5** alternately selects whether the Control Line is High or Low to determine if the printer is busy.

3.8.6.6 Print Extent (F6)

Depressing the **F6** alternately selects between Full Screen and Region Scrolling for the PRINT EXTENT.

If Scrolling REGION is chosen, only the scrolling region is printed when a print command is issued.

If Full SCREEN is chosen, the full screen contents is printed.

3.8.6.7 Printer Termination Character (F7)

Depressing key  alternately selects the PRINTER TERMINATION CHARACTER between FF and NONE.

If FF is selected, the terminal transmits a Form Feed code at the end of a print operation.

A Carriage Return/Line Feed is always transmitted when printing ends, regardless of the choice selected here.

Depressing the  key causes the terminal to advance to the #1 menu presentation (#7 menu if the graphic upgrade is installed).

Depressing the  key causes the terminal to step back to the #5 menu presentation.

NOTE

If the graphic upgrade is installed, and Menu #7 and Menu #8 are present, refer to Section 6 of this manual for detailed information about the menus and graphic operation.

3.9 HOW TO ENTER PROGRAM FUNCTION KEY SET-UP MODE

The FUNCTION KEY SET-UP mode allows the user to program the function keys from the keyboard. FUNCTION KEY SET-UP mode is entered by holding down the **FUNC** key and depressing the **SET-UP** key.

When the FUNCTION KEY SET-UP mode is entered, the VISUAL 102 displays the program function keys presentation shown in Figure 3-10. This presentation is the Default state of the Function keys.

PROGRAM FUNCTION KEYS		
01	[_A[\	F1
02	[_B[\	F2
03	[_C[\	F3
04	[_D[\	F4
05	[_E[\	F5
06	[_F[\	F6
07	[_G[\	F7
08	[_H[\	F8
09	[_I[\	S F1
10	[_J[\	S F2
11	[_K[\	S F3
12	[_L[\	S F4
13	[_M[\	S F5
14	[_N[\	S F6
15	[_O[\	S F7
16	[_P[\	S F8

Figure 3-10. Program Function Key Menu

FUNCTION KEY SET-UP mode is exited by depressing the SET-UP key on the keyboard.

3.10 FUNCTION KEY DEFINITION

The 16 user programmable function keys (F1-F8 and Shifted F1-F8) may contain up to 24 characters each.

- All ASCII codes except NULL may be programmed into the function keys.
- Each function key may be independently linked to any other function key.
- A function key definition cannot start with a link.
- Control Functions may be entered and are displayed as defined by Control Representation mode. Section 3.8.1.3.
- Function key data may be stored in non-volatile RAM by executing a SAVE command.

Function keys may be routed directly to the screen, transmitted to the computer, or both.

- Data entered while the **FUNC** key is depressed (like a SHIFT key) is routed to the terminal screen. The screen routed data appears in reverse video.
- Data entered without the **FUNC** key depressed is sent to the computer when transmitted. This data is displayed in normal video.
- One function key may have both types of data programmed into it.

Function keys may be locally programmed or loaded remotely via a command as described in Section 5.3.3.7.

Function key transmissions are described in Section 7.

3.11 HOW TO PROGRAM FUNCTION KEYS

First, enter FUNCTION KEY SET-UP mode as described in Section 3.9.

3.11.1 Selecting the Function Key for Programming

Select the function key to be programmed by depressing the corresponding function key (F1-F8 and Shifted F1-F8) on the keyboard. The selected line on the Program Function Key screen presentation is erased and the cursor moves to the first character position and waits for data input. Up to 24 characters may then be entered by typing the message on the keyboard. The function key string is terminated by depressing the selected function key on the keyboard again. The cursor then disappears.

3.11.2 Programmable Function Key Links

FUNCTION KEY LINKS are used when a message longer than 24 characters is desired. A Link is performed by holding down the **FUNC** key next to the Space Bar and then depressing the Function key desired to be linked to. This must be done before terminating the function key that contains the link. A successful link to another function key is considered the terminator of the function key containing the link.

Each function key can contain only one link.

It is possible to link any function key to any other function key, in any sequence. For example, F1 can link to F4; F4 can then link to F8, etc.

3.11.3 Programmable Function Key Example

Operation	Action
1. Enter FUNCTION KEY Set-Up Menu.	(Section 3.9)
2. Depress F1 key.	Clears previous message; places cursor on screen at F1 location.
3. Depress H O S T keys.	Places "Host" in normal video on F1 line.
4. Hold down the FUNC key and depress S C R E E N keys.	Places "Screen" in reverse video next to the word "Host" in normal video.
5. Hold down FUNC key and depress F2 key.	Places "02" in normal video at end of programmed message. F1 is now linked to F2. Cursor disappears as F1 message is terminated by the link to F2.
6. Depress key F2 .	Clears F2 message and places cursor on screen.
7. Hold down FUNC key, hold down CTRL key, and depress the G key.	Reverse video, underline "G" appears on F2 message line. This is a screen routed control code. The reverse video indicates a screen route, and the underline signifies a control code.
8. Depress key F2 .	Terminates F2 message; cursor disappears.
9. Depress SET-UP key.	Exits Set-Up mode.

NOTE

When programmed like the example given, Figure 3-11 displays the programmed Function Key menu.

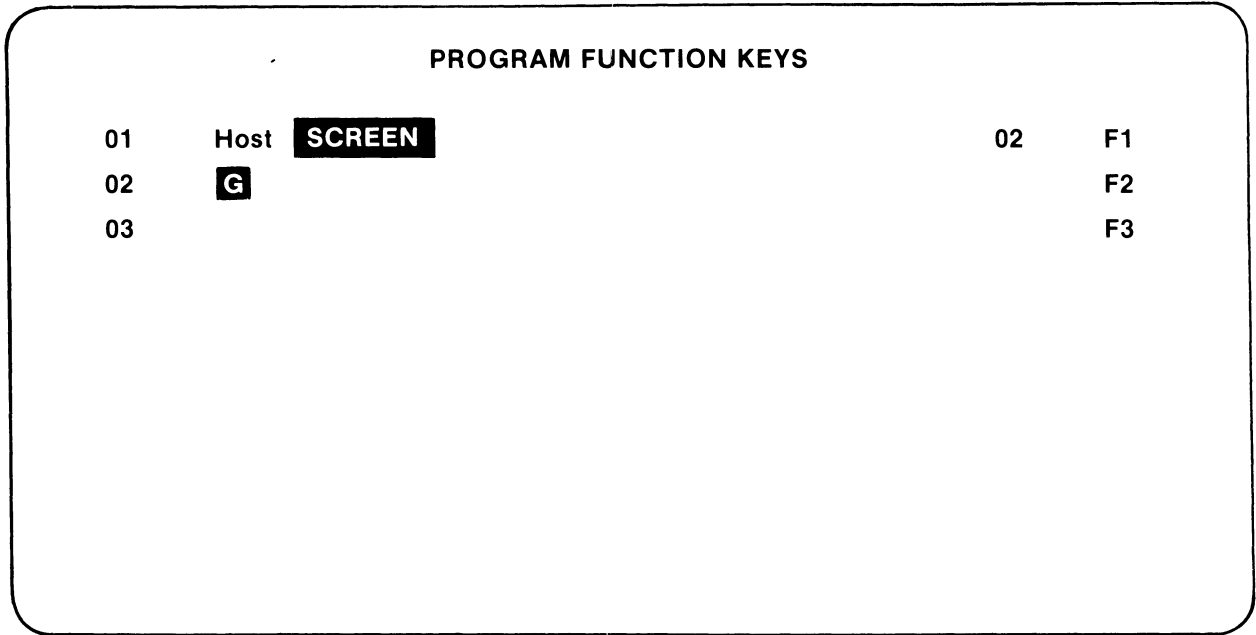

Figure 3-11. Programmed Function Key Menu Example

3.11.4 Explanation of Programmable Function Key Example

Upon depression to the **F1** key, the following happens:

1. The word "Host" is sent down line to the computer.
2. The word "Screen" is sent to the screen at the cursor location.
3. F1 links to F2 automatically and the F2 message is sent.
4. The F2 message of a Control G (Bell code-octal 007) is sent to the terminal, and the bell tone sounds.

3.12 PERFORMING A SAVE OPERATION

The SAVE operation is used to store all current SET-UP features, and is performed as follows:

1. Enter SET-UP Mode.
2. Hold down the **SHIFT** key and depress the **S** key. After a few seconds, the VISUAL 102 returns to SET-UP mode.

After performing the SAVE Operation, the current SET-UP features are stored. Upon the next cycling of power or a RECALL Operation, the saved parameters are valid.

To select the SET-UP features temporarily, do not use the SAVE Operation; simply exit SET-UP Mode.

3.13 PERFORMING A RECALL OPERATION

The stored Set-Up features may vary from the Set-Up features currently selected. If it is desired to return to those stored features, the RECALL Operation should be followed as follows:



1. Enter SET-UP Mode.
2. Hold down the **SHIFT** key and depress the **R** key. After a few seconds, the VISUAL 102 returns to SET-UP Mode.

3.14 PERFORMING A DEFAULT OPERATION

The Default Set-Up features may vary from the Set-Up features currently selected. If it is desired to return to those factory-installed features, the DEFAULT Operation should be performed as follows:

1. Enter SET-UP Mode.
2. Hold down the **SHIFT** key and depress the **D** key. After a few seconds, the VISUAL 102 returns to SET-UP Mode.

3.15 SCREEN BRIGHTNESS

Screen brightness may be adjusted up or down in SET-UP mode. Screen brightness is increased by depressing the  key, and decreased by depressing the  key.

4. KEYBOARD OPERATION

4.1 KEYBOARD LAYOUT

The keyboard on the VISUAL 102 is a standard typewriter configuration. The keys generate 128 ASCII characters. This section covers the standard keys (Section 4.2), the special function keys (Section 4.3) and the numeric key pad (Section 4.4).

NOTE

The actions taken by the various key depressions listed in this section, assume the transmitted code(s) are "echoed" back to the terminal. The transmitted codes can have no effect on the terminal unless echoed.

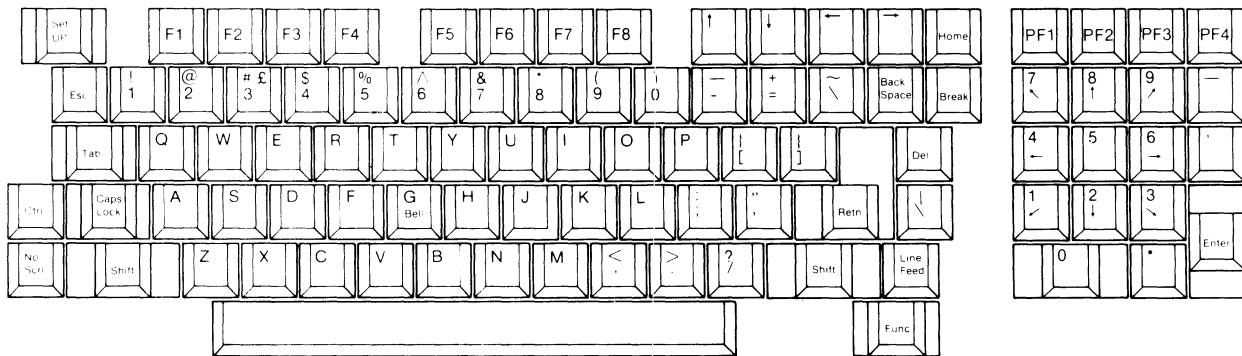

Figure 4-1. The VISUAL 102 Keyboard

4.2 STANDARD KEY CODES

Figure 4-2 contains the standard key codes generated by the VISUAL 102 keyboard. The upper case character codes are generated by depressing the SHIFT key or enabling the CAPS LOCK key and then depressing the desired key. Lower case is generated by depressing the desired key alone without the CAPS LOCK key enabled.

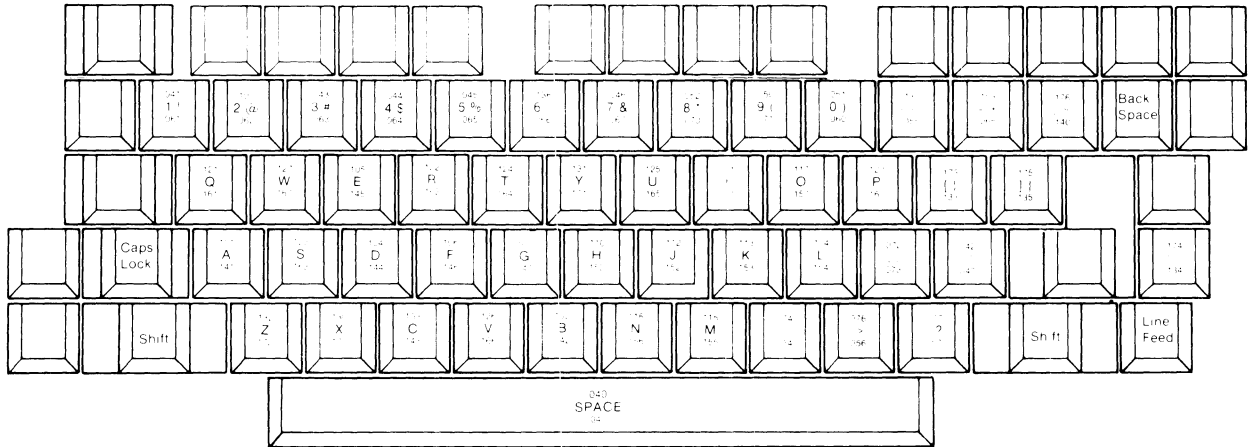

Figure 4-2. Standard Key Codes

The top number is the shifted value of the key and the bottom number is the unshifted value. The numeric system displayed is octal.

4.3 SPECIAL KEY FUNCTIONS

The VISUAL 102 keyboard contains special keys that perform specific operations. Listed below are the particular keys and their special functions.

SET UP

SET-UP — no code transmitted

This key is used to alternately enter and exit SET-UP mode. If the Auto XON/XOFF feature is enabled, this key causes the buffer to transmit an XOFF code (DC3) when nearly full, and to transmit the XON code (DC1) as the buffer empties after SET-UP mode is exited. If the Auto XON/XOFF feature is disabled, the SET-UP key transmits no codes when entering and exiting SET-UP mode. Refer to Section 7.5 for a full explanation of XON/XOFF.

CAPS LOCK

CAPS LOCK — no code transmitted

This key enables the transmission of only upper case alpha characters. The numeric keypad and special keys are not affected by the CAPS LOCK key.

SHIFT

SHIFT — no code transmitted

When depressed in conjunction with alpha-numeric keys, this key causes transmission of the corresponding upper case alpha code or the code whose symbol appears on the upper part of the key. Two SHIFT keys are on the keyboard for operator convenience.

**NO
SCRL**

NO SCROLL — alternate DC3, Control-Q (OCTAL 021) and DC1, Control-S (OCTAL 023)

The NO SCROLL key alternately stops and starts data flow from the buffer. As the buffer becomes empty or full, it transmits the XOFF (DC3) and XON (DC1) Control codes, if the Auto XON/XOFF SET-UP feature is enabled. These codes are used to stop and start transmissions from the host computer, provided the host recognizes these codes. If the Auto XON/XOFF feature is disabled, the NO SCROLL key will transmit no codes.

NOTE

When the Auto XON/XOFF feature is enabled, the NO SCROLL key will be synchronized with the use of XON/XOFF codes generated by the terminal.

EXAMPLE:

- Host's transmission causes terminal's FIFO buffer to become almost full causing terminal to automatically transmit XOFF.
- If the operator now depresses the NO SCROLL key, no XOFF code is sent.
- Buffer empties, no XON is sent.
- Operator depresses NO SCROLL, XON is sent.

**BACK
SPACE**

BS BACKSPACE — Control-H (OCTAL 010)

Depressing the **BACKSPACE** key causes transmission of the BS Control code, and causes the cursor to move one position to the left.

TAB

HT HORIZONTAL TAB — Control-I (OCTAL 011)

Depressing the **TAB** key causes transmission of the HT Control code, and causes the cursor to advance to the next tab stop.

**LINE
FEED**

LF LINE FEED — Control-J (OCTAL 012)

Depressing the **LINEFEED** key causes transmission of the LF Control Code, and causes the cursor to move down one line.

RETURN

CR CARRIAGE RETURN — Control-M (OCTAL 015) or CR LF (OCTAL 015, 012)

Depressing the **RETURN** key causes transmission of the CR Control code, and causes the cursor to move to the first column of the present line. If the NEW LINE feature is enabled, the **RETURN** key transmits the CR and LF control codes, and causes the cursor to move to the first column of the next line.

ESC

ESC ESCAPE — Control-[(OCTAL 33)

Depressing the **ESC** key causes the terminal to transmit the ESC Control code. This code is used to initiate multi-code sequences. Section 5 details all multi-code sequences and their effects on the terminal.

**(SPACE
BAR)**

SP SPACE BAR — (OCTAL 040)

Depressing the **Space Bar** causes the SP code to be transmitted, and causes the character at the cursor location to be erased and the cursor to advance one position.

DEL

DEL DELETE — (OCTAL 177)

Depressing the **DELETE** key causes the DEL code to be transmitted.

BREAK

BREAK — space condition

Depressing **Break** causes TXD to go low for 275 milliseconds. When in HDXA, depressing **BREAK** causes secondary request to send (SRTS) to go off for 275 milliseconds.

SHIFT

and

BREAK

SHIFT BREAK — space condition

Depressing **SHIFT** and **BREAK** simultaneously causes the terminal to turn off Data Terminal Ready (DTR) and Request To Send (RTS). The Transmit Data line (TXD) is held low. After 22 milliseconds, the terminal tests the condition of Data Set Ready (DSR). When DSR turns off or after 1.8 seconds, the disconnect is complete. When the disconnect character enable SET-UP feature is on, the terminal transmits the disconnect character before the DTR and RTS signals turn off.

CTRL

and

BREAK

CONTROL BREAK — Answerback transmission

Depressing **CONTROL** and **BREAK** simultaneously causes the Answerback message to be transmitted.

ENTER

CR or CR LF — ENTER (OCTAL 015 or 015, 012)

Depressing the **ENTER** key causes a CR code to be transmitted. If AUTO NEW LINE feature is enabled, a LF and CR are transmitted upon depression.

FUNC

FUNCTION — no code transmitted

The **FUNCTION** key is unique to the VISUAL 102. Its use is described throughout this manual for special applications. Its main use is in SET-UP mode, print capabilities, and in some graphic applications.

CTRL

CONTROL — no code transmitted

The **CTRL** key does not produce a code by itself. It is depressed in conjunction with other keys to produce the Control codes as displayed in Figure 4-3.

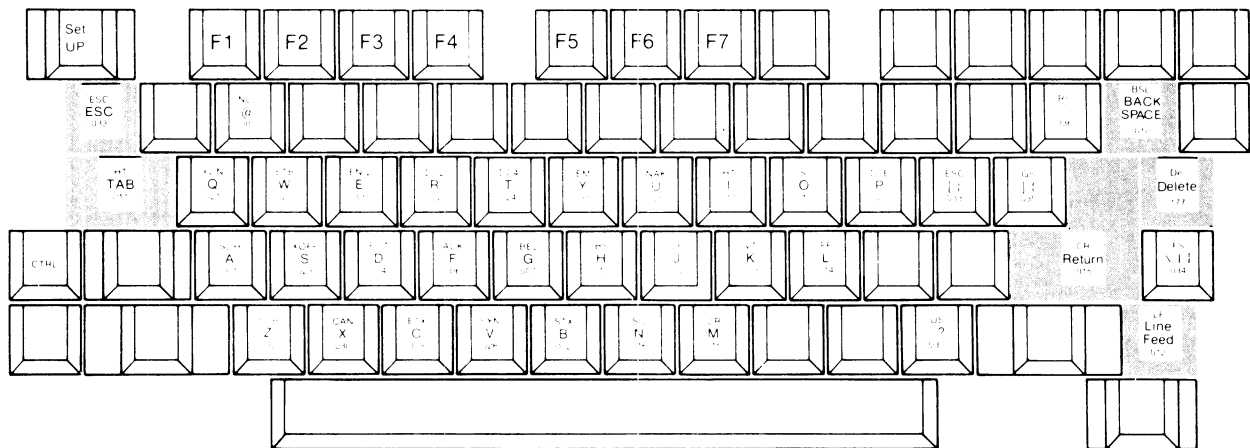

Figure 4-3. Control Codes Generated by Keys When Holding Down the Control Key

NOTE

Shaded keys perform a single keystroke control function for operator convenience.

Table 4-1 lists the Control codes that the VISUAL 102 can transmit.

**TABLE 4-1
TRANSMITTABLE CONTROL CODES**

Control Character	Mnemonic	Octal Value	Key Depressed with Control	Single Key
Null	NUL	000	@	—
Start of heading	SOH	001	A	—
Start of text	STX	002	B	—
End of text	ETX	003	C	—
End of transmission	EOT	004	D	—
Enquire	ENQ	005	E	—
Acknowledge	ACK	006	F	—
Bell	BEL	007	G	—
Back space	BS	010	H	BACK SPACE
Horizontal tabulation	HT	011	I	TAB
Linefeed	LF	012	J	LINE FEED
Vertical tabulation	VT	013	K	—
Form feed	FF	014	L	—
Carriage return	CR	015	M	RETURN*
Shift out	SO	016	N	—
Shift in	SI	017	O	—
Data link escape	DLE	020	P	—
Device control 1	DC1 (XON)	021	Q	NO SCROLL
Device control 2	DC2	022	R	—
Device control 3	DC3 (XOFF)	023	S	NO SCROLL
Device control 4	DC4	024	T	—
Negative acknowledge	NAK	025	U	—
Synchronous idle	SYN	026	V	—
End of transmission block	ETB	027	W	—
Cancel previous word or character	CAN	030	X	—
End of medium	EM	031	Y	—
Substitute	SUB	032	Z	—
Escape	ESC	033	[ESCAPE
Field separator	FS	034	/	—
Group separator	GS	035]	—
Record separator	RS	036	^	—
Unit separator	US	037	—	—
Delete	DEL	177		DELETE

PF1
PF2
PF3
PF4

The four preset function keys labeled PF1 through PF4 send multicode sequences. By using these keys, the number of key-strokes necessary by an operator to access commonly used functions is reduced to one.

The code sequences generated by PF1 through PF4 varies depending on whether VT-52 or ANSI Mode is selected. (See Table 4-2.)

**TABLE 4-2
CODES TRANSMITTED BY FUNCTION KEYS**

Key Depressed	Codes Transmitted	
	VT-52 Mode	ANSI Mode
PF1	ESC P	ESC O P
PF2	ESC Q	ESC O Q
PF3	ESC R	ESC O R
PF4	ESC S	ESC O S

HOME

Depressing the **HOME** key sends the cursor to line one, column one. This is known as "Home" position.

↑ ↓
← →

Depressing a cursor positioning key will cause the cursor to move one position in the direction indicated on the key. The codes transmitted by these keys varies depending on whether ANSI or VT-52 mode is selected. Table 4-3 summarizes the codes transmitted for each key in both ANSI and VT-52 modes.

**TABLE 4-3
CODES TRANSMITTED BY CURSOR POSITIONING KEYS**

Key Depressed	Codes Transmitted		
	VT-52 Mode	ANSI Mode	ANSI Mode and Cursor Key Mode Set*
↑	ESC A	ESC [A	ESC O A
↓	ESC B	ESC [B	ESC O B
←	ESC C	ESC [C	ESC O C
→	ESC D	ESC [D	ESC O D
HOME	ESC H	ESC [H	ESC O H

*See Section 5.3 3.3 for Cursor Key Mode definition.

NOTE

Alternate keypad mode must be set for cursor key mode to operate properly.

F1
through
F8

Function keys F1 through F8 are user programmable. Once programmed, the message can be saved in non-volatile memory. The function keys have a default value set by the factory. For detailed information, refer to Section 3 in this manual.

4.4 NUMERIC KEY PAD

A numeric key pad is added to the VISUAL 102 for applications requiring high volume numeric input. Depressing any numeric key causes transmission of that key code.

The **ENTER** key functions identically to the **RETURN** key except in alternate modes.

4.4.1 Alternate Key Pad Mode

The numeric key pad keys can be altered to transmit Escape sequences instead of the numeric values. This mode is called Alternate Key Pad mode. Different Escape sequences are transmitted depending on whether VT-52 mode or ANSI mode is selected.

Refer to Table 4-4 for the escape sequences transmitted in each mode. Refer to Section 5 for an explanation of the various Escape sequences.

**TABLE 4-4
CODES TRANSMITTED IN ALTERNATE KEYPAD MODE**

Codes Transmitted		
Key Depressed	VT-52 Mode	ANSI Mode
0	ESC ? p	ESC 0 p
1	ESC ? q	ESC 0 q
2	ESC ? r	ESC 0 r
3	ESC ? s	ESC 0 s
4	ESC ? t	ESC 0 t
5	ESC ? u	ESC 0 u
6	ESC ? v	ESC 0 v
7	ESC ? w	ESC 0 w
8	ESC ? x	ESC 0 x
9	ESC ? y	ESC 0 y
—	ESC ? m	ESC 0 m
,	ESC ? ℓ	ESC 0 ℓ
.	ESC ? n	ESC 0 n
ENTER	ESC ? M	ESC 0 M

5. TERMINAL PROGRAMMING

5.1 GENERAL

As previously stated, the VISUAL 102 operates according to two different programming standards — DEC's VT102 ANSI and DEC's VT-52. This section details the control codes and control sequence functions used to control the VISUAL 102 in both ANSI and VT-52 modes.

5.2 CONTROL CODES

This section describes how the VISUAL 102 responds to received control codes. Control codes are defined as codes from columns one and two of the ASCII code chart. Not all control codes have an effect on the VISUAL 102. The control codes that do have an effect on the VISUAL 102 are the same in ANSI and VT-52 modes and are listed in Table 5-1.

**TABLE 5-1
ALPHANUMERIC CONTROL CODES**

Control Code	Oct. Equiv.	Action
NUL	000	Ignored by terminal.
ETX	003	Can be chosen as half-duplex turnaround character.
EOT	004	Can be chosen as a disconnect character or half-duplex turnaround character. When used as a turnaround character, the disconnect character is DLE-EOT.
ENQ	005	Initiate Answerback message.
BEL	007	Rings Bell.
BS	010	Backspace.
HT	011	Tab.
LF	012	Move down one line (Line Feed) or to the left hand margin. Also causes printing if Auto Print is chosen.
VT	013	Same as LF.
FF	014	Same as LF. Also can be chosen as half-duplex turnaround character.
CR	015	Move to first column, current line.
SO	016	Enable G1 character set.
SI	017	Enable G0 character set.
DC1	021	XON code — signals terminal to start transmission.
DC3	023	XOFF code — signals terminal to stop transmission.

Control Code	Octal Equiv.	Action
CAN	030	Abort Escape or Control sequence and displays substitution character.
SUB	032	Same as CAN.
ESC	033	Initiates Control sequence.
DEL	177	Ignored by terminal.

5.3 CONTROL SEQUENCES RECOGNIZED IN ANSI MODE

5.3.1 General

This section describes the format and function of each control sequence recognized by the VISUAL 102 in ANSI mode. Many of the control sequences described in this section conform to the basic format as specified by the ANSI X3.64 standard.

Some of the control sequences described in this section are not specified in the X3.64 standard, but have been added to enhance the operational capabilities of the VISUAL 102. The control sequences not actually specified in the X3.64 standard are noted as private sequences. Those sequences that have [VISUAL] next to them are not present in the DEC VT102.

5.3.2 Control Sequence Format — ANSI Mode

Figure 5-1 describes the basic format of control sequences as specified by the ANSI X3.64 standard.

NOTE

Spaces are used for clarity only, and are not part of the sequence.

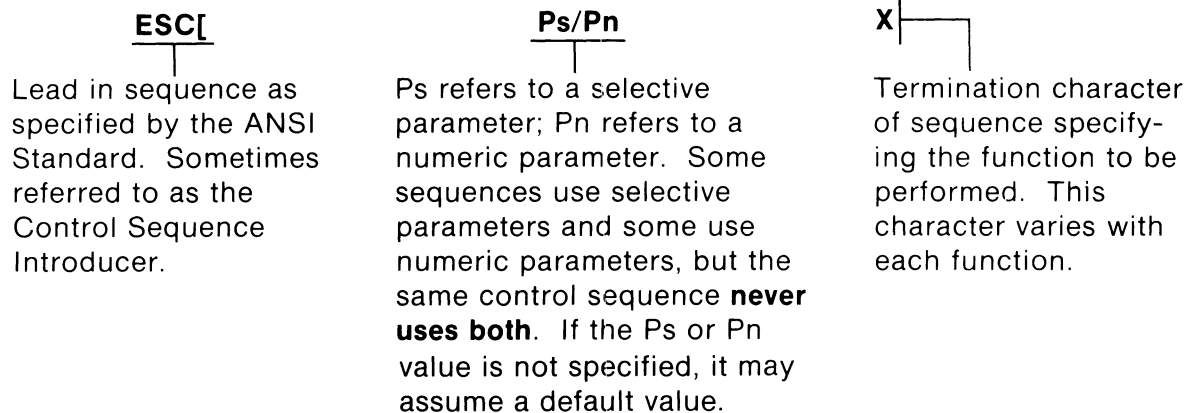

Figure 5-1. Control Sequence Format

If multiple numeric or selective parameters are used in a control sequence, they must be separated with a semi-colon character. A semicolon is not used between the last Ps/Pn and the termination character.

EXAMPLE:

ESC[1;3;4;7h

The following examples demonstrate the use of all three elements of the control sequence as specified by the ANSI X3.64 standard. Once again, spaces are for clarity only, and are not part of the sequence.

EXAMPLE 1:

Control Sequence Using Numeric Parameter, Move Cursor up 6 lines

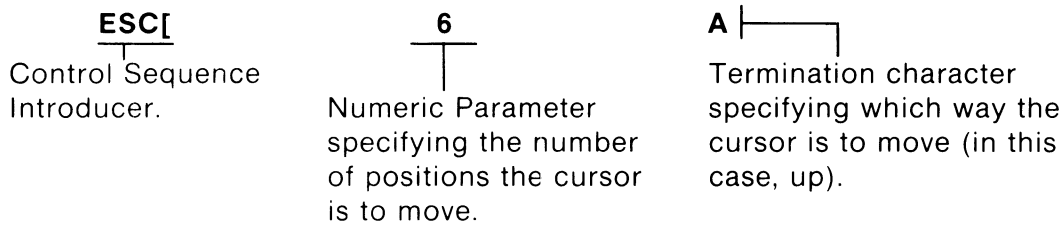

EXAMPLE 2:

Control Sequence Using Selective Parameter, Turn on Blink Attribute

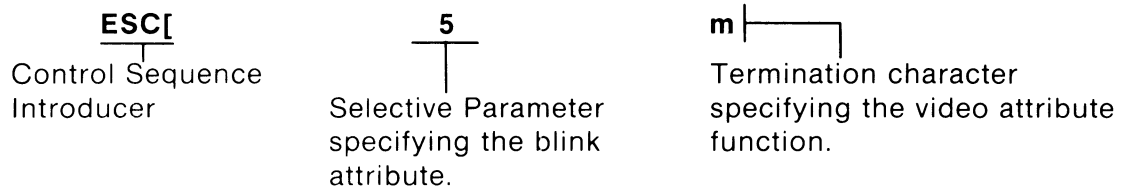

Figure 5-2. Control Sequence Examples

5.3.3 Control Sequence Functions — ANSI Mode

5.3.3.1 Scrolling Region Command ESC [x;y r (private)

This command is used to set the top and bottom lines of the screen scrolling region. The first numeric parameter, x, sets the top boundary and the second numeric parameter, y, sets the bottom boundary of the scrolling region. Both numeric parameters are in decimal notation. The default values are the entire screen, i.e., x=1 and y=24. The minimum size of the scrolling region is two lines.

Once the scrolling region is defined, the cursor positioning commands may move the cursor into but not out of the scrolling region. The only exception to this rule is when Origin Mode is reset and the Absolute Cursor Positioning commands are used. After this command is executed, the cursor moves to the home position, as defined by Origin Mode. Refer to Section 5.4.3.8 or to the last paragraph of the following section.

5.3.3.2 Cursor Movement

The VISUAL 102 provides a wide variety of cursor positioning commands including incremental and absolute positioning and forward tabbing. This wide variety insures that the user can position the cursor in the most efficient manner for his particular application.

The cursor positioning commands described in this section may cause a varying action depending on two factors: The defined scrolling region and the current state of Origin mode.

The user may define the scrolling region of the screen as already described in Section 5.3.3.1. Once the scrolling region is defined, incremental cursor positioning commands (Up, Down, Right, Left) can position the cursor anywhere within the scrolling region, but cannot position the cursor outside the scrolling region. The Absolute Cursor Positioning Command remains unaffected by the screen scrolling region.

After the screen scrolling region is defined, a choice is provided for having line and column numbers on the screen dependent or independent of the defined scrolling region. For example, if line and column numbers are independent of the defined scrolling region, a received Absolute Cursor Positioning command with line and column parameters of 1 would position the cursor to the upper left-hand corner of the **screen**. If line and column numbers are dependent on the defined scrolling region, the aforementioned command would position the cursor to the upper left-hand corner of the **scrolling region**. Simply stated, the current state of Origin mode affects only the numbering of lines and columns on the screen and thus only the Absolute Cursor Positioning command.

5.3.3.3 Cursor Positioning Commands

Cursor Up ESC [Pn A (Pn times)

The cursor moves up Pn times. Pn can be 1 to 255 times (Default value is 1).
The cursor cannot move past the top margin.

Cursor Down ESC [Pn B (Pn times)

The cursor moves down Pn times. Pn can be 1 to 255 times (Default value is 1).
The cursor cannot move past the bottom margin.

Cursor Right ESC [Pn C (Pn times)

The cursor moves right Pn times. Pn can be 1 to 255 times (Default value is 1).
The cursor cannot move past the right margin.

Cursor Left ESC [Pn D (Pn times)

The cursor moves left Pn times. Pn can be 1 to 255 times (Default value is 1).
The cursor cannot move past the left margin.

Absolute Cursor Addressing ESC [y ; x H or ESC] y ; x f

Either of the above control sequences may be used to position the cursor on an absolute basis. These sequences position the cursor to the line specified by y and the column specified by x. Both the line and the column parameters are in decimal notation. The lines are numbered from 1 to 24, and the columns are from 1 to 80 (or 132). The default value for both is 1. If an attempt is made to position the cursor past screen boundaries, the cursor moves to the screen boundary.

Cursor Index ESC D

This sequence causes the cursor to move down one line in the defined scrolling region. If the cursor is positioned on the bottom line of the screen or the bottom line of the screen scrolling region, the contents of the screen or scrolling region scrolls up one line.

Reverse Cursor Index ESC M

This sequence causes the cursor to move up one line in the defined scrolling region. If the cursor is positioned on the top line of the screen or the top line of the screen scrolling region, the contents of the screen or scrolling region scrolls down one line.

Next Line ESC E

This sequence causes the cursor to move up to the beginning of the next line. If the cursor is positioned on the bottom line of the screen or the bottom of the screen scrolling region, the contents of the screen or scrolling region scrolls up down one line.

NOTE

No action occurs if either the Index/Reverse Index or Next Line command is received while the cursor is positioned on the top/bottom line of a screen that contains a scrolling region, if that line is not part of the scrolling region.

Save Cursor ESC 7 (private)

This sequence causes the cursor position, character set, origin mode selection, and graphic rendition to be saved.

Restore Cursor ESC 8 (private)

This selection causes restoration of the previously saved cursor position, character set, origin mode, and graphic rendition.

5.3.3.4 Erasure Modes

The same general control sequence format (ESC[Ps X) is used for all erasure commands. The termination character "X" determines whether erasure will occur on a line or screen basis, and the selective parameter "Ps" determines the portion of the line/screen to be erased. In all cases, erase functions cause no cursor movement.

Erase in Page ESC[Ps J

This sequence erases some or all of the data on a page depending on the value of Ps. See Table 5-2 on the following page.

**TABLE 5-2
PAGE ERASE VALUES**

Ps Value	Action
0 (default)	Erase from cursor to end of page, including cursor position.
1	Erase from beginning of screen to cursor, including cursor position.
2	Erase page, all lines changed to single width. Cursor does not move.

Erase in Line ESC[Ps K

This sequence erases some or all of the data on a line, depending on the value of Ps. See Table 5-3 below.

**TABLE 5-3
LINE ERASE VALUES**

Ps Value	Action
0 (default)	Erase from cursor to end of line, including cursor position.
1	Erase from beginning of line to cursor, including cursor position.
2	Erase line. Line changed to single width.

5.3.3.5 Tabbing Commands

The VISUAL 102 supports forward horizontal tabbing. Tabbing is columnar, much as it is on a standard typewriter.

Once TAB STOPS have been defined, tabbing is initiated using the cursor Tab.

Clear Tabs ESC[Ps g

This command clears one or more tab stops depending on the value of Ps. See Table 5-4 below.

**TABLE 5-4
CLEAR TAB VALUES**

Ps Value	Action
0 (default)	Clear Tab at Current Column
3	Clear All Tabs

Set Tab ESC H

This command sets a columnar TAB STOP in the current column.

5.3.3.6 Screen Alignment Command ESC # 8

This command causes the screen to be filled with upper-case E's and is used to focus and align the terminal display.

5.3.3.7 Program Function Key Command ESC[Pk ; D₁ ; ... D₂₄p [VISUAL]

This sequence is used to program a function key with data. Pk defines which of the sixteen function keys (F1-F8, Shifted F1-F8) is to be programmed. A Pk value of 1 programs key F1; a Pk value of 5 programs key F5, etc.

D₁ through D₂₄ are the decimal values of the ASCII characters desired in the message. Refer to Appendix IV for decimal values. Up to twenty-four (24) characters may be programmed into any function key.

Each function key may be independently linked to another function key. The link terminates the data string. A link is defined as decimal value 128 followed by the function key number.

Selective data within the character string may be routed directly to the screen by adding the decimal value 128 to the decimal value of that ASCII character. For example, to route ASCII character A to the screen, simply add the decimal value of A (65) to 128: 65 + 128 = 193. Once a function key has been programmed, it may be stored via the save operation. Decimal values of the ASCII code are listed in Appendix IV. For the values of the screen routed characters, refer to Appendix 12.

NOTE

To program function keys from the keyboard, refer to Section 3.11.

If a link is desired, the command sequence is as follows:

ESC[Pk; D₁; ... D₂₄; 128; P_ℓ [VISUAL]

You may link a function key to itself (resulting in a loop) by making P_ℓ=Pk. However, the function will repeat only 16 times.

5.3.3.8 Character Set Commands (private)

The character set commands allow for remote selection of either the US ASCII, UK, or Graphics character sets. Of the three character sets available (US, UK, Line Graphics), the user may define any particular set as the G0 set and any particular set as the G1 by using the proper escape sequences listed below. Once the G0 and G1 sets have been defined, they may be easily enabled via the S1 and S0 control codes respectively. Resetting the terminal will enable the G0 set. Once defined, the G0 and G1 sets may be saved in non-volatile memory by performing the save operation (SHIFT S in SET-UP mode). The default value of the G0 and G1 character sets is U.S.

**TABLE 5-5
CHARACTER SET COMMANDS**

Character Set Selection	Command
G0 set UK	ESC (A
G1 set UK	ESC) A
G0 set US	ESC (B
G1 set US	ESC) B
G0 set Line Graphics	ESC (0
G1 set Line Graphics	ESC) 0
G0 set alternate ROM character set	ESC (1
G1 set alternate ROM character set	ESC) 1
G0 set alternate ROM special characters character set	ESC (2
G1 set alternate ROM special characters character set	ESC) 2
Single Shift 2 Selects G2 (default) character set for one character.	ESC N
Single Shift 3 Selects G3 (default) character set for one character.	ESC O

NOTE

1. The Select Character Set commands define G0/G1 character fonts only, and do not alter the keyboard configuration. The keyboard layout must be defined in SET-UP mode (Section 3.7.2.7) when optional character sets are available. Line drawing is considered a subset of US character font.
2. Once the G0 set and the G1 set are selected, the terminal alternates between the two sets by Control-O (Shift Out) for the G1 Set and Control-N (Shift In) for the G0 Set.

5.3.3.9 Report Commands and Sequences

The following sequences allow the host to ask the terminal what configuration it is in. To set the terminal ID response, refer to Section 3.8.4.8. The terminal responses are shown in Table 5-6 through 5-8 below.

Terminal ID ESC[c or ESC Z or ESC[0 c

**TABLE 5-6
TERMINAL ID RESPONSE**

Terminal Sequence	Meaning
ESC[? 6 c	VT102
ESC[1; 11 c	VT100 w/printer

Terminal Condition ESC[5 n

This sequence allows the host to ask the terminal's condition. The terminal responses are shown in Table 5-6.

**TABLE 5-7
TERMINAL STATUS RESPONSE**

Terminal Sequence	Meaning
ESC[0 n	Terminal is OK.
ESC[3 n	Terminal is NOT OK.

Read Cursor Location ESC [6 n

This sequence allows the host to find out where the terminal's cursor is located. Both x and y are in decimal notation. The line number is dependent on Origin mode. No parameters or parameters of zero indicate the cursor is in the home position. The terminal responses are shown in in Table 5-8 below.

**TABLE 5-8
CURSOR LOCATION RESPONSE**

Terminal Sequence	Meaning
ESC[y ; x R	Cursor is at y line and in x column.

Terminal Parameters ESC[1 x [VISUAL] or ESC[0 x

This sequence causes the terminal to report terminal parameters shown in Table 5-9 as follows.

The response to both these commands is in the format

ESC[s;p;n;t;r;c;f;m;pp;pn;px;prx

**TABLE 5-9
TERMINAL PARAMETER VALUES**

Parameter	Possible Parameter Value	Meaning
s	2	This message is a report. (2 is in response to ESC[0x.)
	3	This message is a report. (3 is in response to ESC[1x.)
p (parity)	1	No parity
	2	Mark parity
	3	Space parity
	4	Odd parity
	5	Even parity
n (no. of bits)	1	8 bits per character
	2	7 bits per character
t (transmit speed) and r (receive speed)	0	50 baud
	8	75 baud
	16	110 baud
	24	134.5 baud
	32	150 baud
	40	200 baud
	48	300 baud
	56	600 baud
	64	1200 baud
	72	1800 baud
	80	2000 baud
	88	2400 baud
c (baud rate multiplier)	96	3600 baud
	104	4800 baud
	112	9600 baud
	120	19200 baud
f	0	Reserved for future use

Parameter	Possible Parameter Value	Meaning
m (mode)	0	VT52 mode
	1	ANSI mode
pp (printer parity)	1	None
	4	Odd
	5	Even
pn (printer no. bits)	1	8 data bits
	2	7 data bits
px (printer xmit speed)	See modem transmit and receive speed	
pr (printer receive speed)		

5.3.3.10 Invoke Self Test ESC[2 ; Ps y

This sequence allows the host to initiate one or more of the various self tests on the VISUAL 102. The selective parameter (Ps) indicates which test or tests are to be performed. A parameter value is derived by taking the value of each test and adding the values together. A parameter value of 0 causes a reset. For values of Ps, refer to Table 5-10.

**TABLE 5-10
TERMINAL SELF TEST PARAMETER VALUES**

Ps Value	Test Invoked
1	ROM/RAM Checksum
2	Interface Loopback (Turnaround cable required)
4	EIA Loopback (Turnaround cable required)
9	Repeat ROM/RAM test continuously
10	Repeat Interface Loopback test continuously
12	Repeat EIA Loopback test continuously
16	Printer Loopback
24	Repeat Printer Loopback test continuously

NOTE

Loop Back Cable pin-outs are detailed in Appendix V.

5.3.3.11 Video Attribute Command ESC[Ps ; ...Ps m

Data on the screen may be displayed in any combination of the following video attributes: Bold, Underline, Blank, Blink, and Reverse Video.

The attributes are cumulative. i.e., received data is displayed according to all attributes then enabled. The attributes are enabled by using the above Video Attribute Command with the selective parameters specifying the attributes to be enabled. If multiple video attributes are to be enabled with one control sequence, a semicolon is used to separate each selective parameter in the sequence. Table 5-11 summarizes all video attributes and their associated selective parameters.

**TABLE 5-11
SUMMARY OF VIDEO ATTRIBUTES AND SELECTIVE PARAMETERS**

Attribute	Selective Parameter	Control Sequence
Attributes OFF	0 (default)	ESC [m
Bold	1	ESC [1 m
Blank	2	ESC [2 m [VISUAL]
Underline	4	ESC [4 m
Blink	5	ESC [5 m
Reverse Video	7	ESC [7 m

EXAMPLE:

Display on the screen the Blinking, Underlined word "NAME" and then display on the screen the name "JONES" with no video attributes.

Command	Action
1. ESC[4;5m	Turn on the Blink and Underline attributes.
2. NAME	Send the word "NAME" to the screen.
3. ESC[m (Default value is 0.)	Turn off all attributes.
4. JONES	Send the name "JONES" to the screen.

5.3.3.12 Programmable L.E.D. Commands ESC [Ps q (Private)

The programmable L.E.D. on the DEC VT102 is represented by an indicator on the 25th status line in the VISUAL 102. The programmable L.E.D. may be turned ON or OFF by using the above control sequence, with the selective parameters listed below in Table 5-12.

**TABLE 5-12
L.E.D. COMMANDS**

Meaning	Selective Parameter	Control Sequence
Load LED (L1 off)		ESC [q
Load LED (L1 off)	0 (default)	ESC [0 q
Load LED (L1 on)	1	ESC [1 q

5.3.3.13 Character Size Commands (private)

Characters may be formed on the screen (on a line by line basis) in three different sizes: single height-single width, single height-double width, and double height-double width. When using double sized characters, the number of characters per line is halved.

All of the Character Size Commands are "Private," i.e., they are not specified in the ANSI X3.64 Standard.

Single Height-Single Width Line ESC #5 (Default)

This command causes the line marked by the cursor to be single height-single width.

Single Height-Double Width Line ESC #6

This command causes the line marked by the cursor to be single height-double width. If the line was previously single height-single width, all characters from the middle of the line to the end of the line are lost. The cursor remains in the same character position unless the cursor position is lost, in which case the cursor is moved to the right margin.

Double Height-Double Width Line ESC #3 (Top Half) ESC #4 (Bottom Half)

These two commands are used as a pair, on adjacent lines, to form double height-double width characters. The same character must be sent to the same column of both lines to form each character. If the line was previously single height-single width, all the characters from the middle of the line to the end of the line are lost. The cursor remains in the same character position unless the cursor position is lost, in which case the cursor is moved to the right margin.

EXAMPLE:

ESC#3 VISUAL CR LF ESC #4 VISUAL produces a double height,
double width VISUAL.

5.3.3.14 Reset Command ESC c

This command causes the terminal to reset, and has the same effect as powering-down and then powering-up the terminal.

5.3.3.15 Alternate Keypad Mode

Enter Alternate Keypad Mode ESC =

This sequence causes the terminal to enter Alternate Keypad mode. When entered, this mode causes the numeric keypad to transmit special escape sequences as opposed to their regular codes. The code sequence generated by each key is summarized in Table 5-13.

**TABLE 5-13
CODES TRANSMITTED IN ALTERNATE KEYPAD MODE**

Key	Alternate Keypad Code
0	ESC O p
1	ESC O q
2	ESC O r
3	ESC O s
4	ESC O t
5	ESC O u
6	ESC O v
7	ESC O w
8	ESC O x
9	ESC O y
- (minus)	ESC O m
, (comma)	ESC O l
. (period)	ESC O n
ENTER	ESC O M
PF1	ESC O P
PF2	ESC O Q
PF3	ESC O R
PF4	ESC O S

Exit Alternate Keypad Mode ESC >

This command causes the terminal to exit Alternate Keypad mode.

5.3.3.16 Editing Commands

The VISUAL 102 Editing commands provide a single control sequence to insert or delete one or multiple lines or to delete one or multiple characters.

Insert Line ESC[Pn L

This sequence causes Pn lines (Pn can vary from 1 to 255) to be inserted starting at the cursor line. The Insert Line command pushes the current lines displayed down to make room for the newly inserted line(s). All lines pushed off the screen are lost from memory. This sequence is ignored when the cursor is outside the scrolling region.

Delete Line ESC[Pn M

This command causes Pn lines (Pn can vary from 1 to 255) to be deleted starting at the cursor line. Lines below the deletion move up to fill the gap created by the deletion. These lines added to the bottom of the screen have spaces with the same character attributes as the last line moved up. This sequence is ignored when the cursor is outside the scrolling region.

Delete Character ESC[Pn P

This command causes Pn characters to be deleted from a line starting at the cursor location. The Delete Character command deletes the current character and (Pn minus 1) characters after it. Characters after the deletion will shift to the left to fill the gap left by the deletion. This creates a space character at the right margin. This character has the same character attributes as the character moved left. No cursor movement occurs.

5.4 MODES (SET/RESET)

5.4.1 General

This section describes the modes used to control the VISUAL 102. The highly flexible nature of the VISUAL 102 is accomplished through the use of modes that allow for local or remote selection of terminal parameters and condition how the terminal will function in response to control sequences. For example, modes exist that provide flexibility to editing functions, erase functions, and transmissions.

Each mode described in this section has two possible states: set or reset. A single control sequence may set one or a maximum of 16 modes, or reset one or a maximum of 16 modes. Many of the modes are also selectable and changeable in SET-UP mode. Modes that are selectable in SET-UP mode may also be stored in non-volatile memory giving the user the ability to determine their power-up states.

5.4.2 Set/Reset Mode Format

Figure 5-3 describes the basic format of control sequences used for the Set Mode function.

NOTE

Spaces are used for clarity only, and are not part of the sequence.

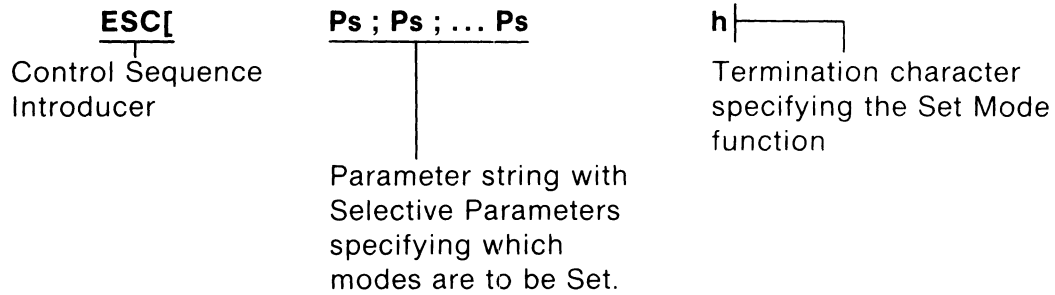

Figure 5-3. Set Mode Control Sequence

Figure 5-4 describes the basic format of control sequences used for the Reset Mode function.

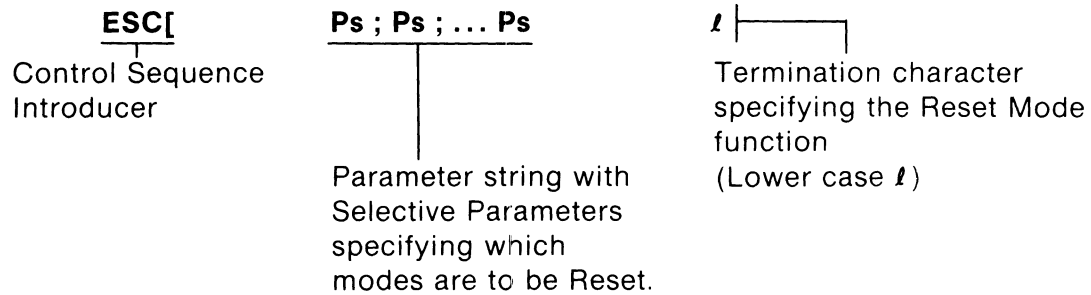

Figure 5-4. Reset Mode Control Sequence

Table 5-14 lists all modes applicable to Set/Reset mode control sequences and their associated selective parameter. The modes that include the question mark character (?) as part of the selective parameter are private modes that have been added to enhance the operational capabilities of the VISUAL 102 and are not actually specified in the ANSI X3.64 standard. Note that when a question mark is included anywhere within the sequence, all parameters in that sequence are treated as private modes.

TABLE 5-14
SELECTIVE PARAMETERS ASSOCIATED
WITH SET/RESET MODE CONTROL SEQUENCES

Mode Name	Selective Parameter (Ps)	Changeable and Saveable In Set-Up Mode
Keyboard Action	2	No
Control Representation	3	Yes
Insert Replace	4	No
Local Echo	12	Yes
Auto New Line	20	Yes
Cursor Key	?1	No
VT 52 Mode	?2	Yes
80/132 Column	?3	Yes
Jump/Smooth Scroll	?4	Yes
Normal/Reverse Video	?5	Yes
Origin	?6	Yes
Auto Line Wrap	?7	Yes
Auto Repeat	?8	Yes

5.4.3 Set/Reset Mode Commands

5.4.3.1 Keyboard Action Mode Ps = 2

When set, this mode causes the keyboard to be locked, thus disallowing local data entry. LOCKED is displayed on the 25th status line. Depressing the

SET-UP key clears the locked condition.

When reset, the keyboard is unlocked.

5.4.3.2 Control Representation Mode Ps = 3 [VISUAL]

When set, this mode causes control codes to be displayed on the screen as opposed to being acted upon, and is primarily used as an aid in program debugging. Control characters are represented by the underlined capital letter corresponding to their position on the ASCII code chart while other characters are displayed with normal attributes.

When reset, control codes are acted upon as usual.

5.4.3.3 Insert Replace Mode Ps = 4

When set, this mode causes the entry of displayable characters to be inserted at the cursor location on a line by line basis. Data at and to the right of the cursor are shifted right one position for each character entered. The cursor also shifts right for each character entered. INSERT is displayed on the 25th status line to indicate the set state of Insert Replace mode.

When reset, Replace mode adds characters by replacing the character at the cursor position. Characters do not wrap past the end of the line.

5.4.3.4 Local Echo Mode Ps = 12

When set, no local echo will occur.

When reset, this mode causes the transmitted data to be echoed back to the screen with the terminal.

5.4.3.5 Auto New Line Ps = 20

When set, this mode causes the RETURN key to generate the CR and LF codes, and a received LF causes a new line function.

When reset, the RETURN key generates CR and a received LF causes only LF.

5.4.3.6 Cursor Key Mode Ps = ?1 (private)

This mode is applicable only when the terminal is in ANSI and Alternate Keypad modes. When set, this mode causes the cursor positioning keys to generate special escape sequences as described in Table 5-15.

When reset, the cursor positioning keys transmit their normal ANSI mode sequences.

**TABLE 5-15
CURSOR KEY MODE ESCAPE SEQUENCES**

Cursor Key Mode	Set	Reset
UP	ESC O A	ESC [A
DOWN	ESC O B	ESC [B
LEFT	ESC O C	ESC [C
RIGHT	ESC O D	ESC [D

5.4.3.7 80/132 Column Mode Ps = ?3 (private)

When set, this mode conditions the terminal for 132 column display.

When reset, the terminal uses 80 column display.

5.4.3.8 Jump/Smooth Scroll Mode Ps = ?4 (private)

When set, the terminal uses the Smooth scrolling method, whereby new lines of data move several scan lines at a time to make room for new lines of data entering the screen.

When reset, the terminal uses the Jump scrolling method, whereby lines of data move one line at a time to make room for new lines of data entering the screen.

5.4.3.9 Normal/Reverse Video Mode Ps = ?5

When set, this Reverse mode causes the screen to form characters using black dots on a white background.

When reset, the Normal mode causes the screen to form white dots on a black background.

5.4.3.10 Origin Mode Ps = ?6

This mode determines whether or not line numbers are dependent on the selected scrolling region.

When set, this mode causes the line and column numbers to be dependent on the selected scrolling region. Line 1, Column 1 is in the upper left hand corner of the **scrolling region**.

When reset, line and column numbers are independent of the selected scrolling region. Line 1, Column 1 is in the upper left hand column of the **screen**.

For an explanation of the Selected Scrolling Region, refer to Section 5.3.3.1.

5.4.3.11 Auto Line Wrap Mode Ps = ?7

When set, this mode causes the cursor to advance automatically to the first position of the next line when characters are entered beyond the last column position of the present line. This function does not affect Tab, however. Tab never moves the cursor to the next line.

When reset, the cursor does not wrap around automatically. Any characters entered will overlay the last character on the line.

5.4.3.12 Auto Repeat Mode Ps = ?8

When set, this mode causes most keys on the keyboard to repeat automatically when held down.

When reset, only single keystroke operation is allowed.

5.4.3.13 Enter VT-52 Mode PS = ?2 (private)

When reset, this mode causes the terminal to respond with DEC VT-52 mode control sequences.

5.5 CONTROL SEQUENCES RECOGNIZED IN DEC VT-52 MODE

This section describes the functions of each control sequence recognized by the VISUAL 102 in DEC VT-52 mode.

5.5.1 Cursor Movement

5.5.1.1 Cursor Up ESC A

This command causes the cursor to move up one line. If the cursor is positioned on the top line, no action occurs.

5.5.1.2 Cursor Down ESC B

This command causes the cursor to move down one line. If the cursor is positioned on the bottom line, no action occurs.

5.5.1.3 Cursor Right ESC C

This command causes the cursor to move right one position. If the cursor is positioned in the last column of a line, no action occurs.

5.5.1.4 Cursor Left ESC D

This command causes the cursor to move left one position. If the cursor is positioned in the first column of a line, no action occurs.

5.5.2 Line Graphics Mode (Line Drawing)

5.5.2.1 Enter Line Graphics Mode ESC F

This command causes the VISUAL 102 to enter Graphics mode. When Graphics mode is entered, all received lower-case ASCII codes (octal 141–172) and the ASCII codes for {, :, }, ~, and _ (octals 173–176 and 137) are displayed as graphic characters. Table 5-16 shows the graphic character associated with each ASCII code.

5.5.2.2 Exit Line Graphic Mode ESC G

This command causes the VISUAL 102 to exit Graphics mode.

5.5.3 Cursor Home ESC H

This command causes the cursor to move to the home position (upper left-hand corner of the screen).

5.5.4 Reverse Line Feed ESC I

This command causes the cursor to move up one line. If the cursor is positioned on the top line, the contents of the screen will scroll down one line.

5.5.5 Erasure Mode

5.5.5.1 Erase to End of Screen ESC J

This command causes the erasure of all data from the cursor position to the end of the screen, including the cursor position.

5.5.5.2 Erase to End of Line ESC K

This command causes the erasure of all data from the cursor position to the end of the line.

5.5.6 Cursor Addressing ESC Y

This command is used for positioning the cursor on an absolute basis. The next two codes following this sequence will be interpreted as the new line and column positions respectively. Table 5-17 shows the codes used for cursor addressing.

5.5.7 Identify ESC Z

This command requests the terminal to verify that it is a VT-52 and is switched and ready for communication. If this is the case, the terminal responds with ESC/M.

**TABLE 5-16
GRAPHIC CHARACTER SET LINE DRAWING**

ASCII Code	Octal	Graphic	Description
—	137		Blank
/	140	◆	Diamond
a	141	⋮	Checkerboard
b	142	HT	Horz. Tab
c	143	FF	Form Feed
d	144	CR	Carriage Ret.
e	145	LF	Line Feed
f	146	°	Degree
g	147	±	Plus/Minus
h	150	NL	New Line
i	151	VT	Verticle Tab
j	152	└	Lower Right Corner
k	153	┐	Upper Right Corner
l	154	┌	Upper Left Corner
m	155	└	Lower Left Corner
n	156	+	Intersect Lines
o	157	—	Bar at Scan 1
p	160	—	Bar at Scan 3
q	161	—	Bar at Scan 5
r	162	—	Bar at Scan 7
s	163	—	Bar at Scan 9
t	164	├	T left
u	165	┤	T right
v	166	┴	T down
w	167	┬	T up
x	170		Vertical Bar
y	171	≤	Less than or equal
z	172	≥	Greater than or equal
{	173	π	P ₁
:	174	≠	Not Equal Sign
}	175	£	Pound Sign
~	176	·	Center Dot

TABLE 5-17
CURSOR ADDRESSING CODE CHART (VT-52 MODE)

ASCII Char.	Oct.	Column No.	Line No.	ASCII Char.	Oct.	Column No.
SP	040	1	1	F	106	39
!	041	2	2	G	107	40
"	042	3	3	H	110	41
#	043	4	4	I	111	42
\$	044	5	5	J	112	43
%	045	6	6	K	113	44
&	046	7	7	L	114	45
'	047	8	8	M	115	46
(050	9	9	N	116	47
)	051	10	10	O	117	48
*	052	11	11	P	120	49
+	053	12	12	Q	121	50
,	054	13	13	R	122	51
-	055	14	14	S	123	52
.	056	15	15	T	124	53
/	057	16	16	U	125	54
0	060	17	17	V	126	55
1	061	18	18	W	127	56
2	062	19	19	X	130	57
3	063	20	20	Y	131	58
4	064	21	21	Z	132	59
5	065	22	22	[133	60
6	066	23	23	\	134	61
7	067	24	24	[135	62
8	070	25		^	136	63
9	071	26		-	137	64
:	072	27		\	140	65
;	073	28		a	141	66
<	074	29		b	142	67
=	075	30		c	143	68
>	076	31		d	144	69
?	077	32		e	145	70
@	100	33		f	146	71
A	101	34		g	147	72
B	102	35		h	150	73
C	103	36		i	151	74
D	104	37		j	152	75
E	105	38		k	153	76
				l	154	77
				m	155	78
				n	156	79
				o	157	80

5.5.8 Alternate Keypad

5.5.8.1 Enter Alternate Keypad Mode ESC =

This command causes the terminal to enter Alternate Keypad mode. When entered, this mode causes keys on the numeric keypad to transmit special escape sequences as opposed to their regular codes. The codes are described in Table 5-18 below.

**TABLE 5-18
CODES TRANSMITTED IN ALTERNATE KEYPAD MODE**

Key	Alternate Keypad Code
0	ESC ? p
1	ESC ? q
2	ESC ? r
3	ESC ? s
4	ESC ? t
5	ESC ? u
6	ESC ? v
7	ESC ? w
8	ESC ? x
9	ESC ? y
- (minus)	ESC ? m
, (comma)	ESC ? l
. (period)	ESC ? n
ENTER	ESC ? M
PF1	ESC P
PF2	ESC Q
PF3	ESC R
PF4	ESC S

5.5.8.2 Exit Alternate Keypad Mode ESC >

This command causes the VISUAL 102 to exit Alternate Keypad Mode.

5.5.9 Enter ANSI Mode ESC <

This command causes the VISUAL 102 to enter ANSI mode.

To use the ANSI configurations available, ANSI mode must be entered from VT52 mode.

6. GRAPHICS OPTION OPERATION

6.1 GENERAL

The optional graphic upgrade board allows the VISUAL 102 to display high resolution (768 × 293), bit-mapped graphics. With the simple plugging in of the new graphic logic board, the VISUAL 102 becomes a PLOT 10-compatible graphics terminal with the following operating modes:

- Alphanumeric
- Point Plot
- Alphagraphics
- Vector
- Incremental Plot
- Crosshair

The V102 uses normal persistence P31 phosphor, resulting in smooth scrolling of text without smearing. Independent memory planes are used for text and graphics, so that text may overwrite or scroll over a graphics image non-destructively. Characters, vectors, and points may be selectively erased without erasing the whole screen.

6.2 PHYSICAL DESCRIPTION

The V102 graphics option board consists of a single, approximately 6½" by 10" printed circuit board which plugs into existing connectors on the main terminal PCB piggy-back style. (The top case must first be removed to install the optional board.)

The board contains additional new firmware on an EPROM. Up to 16K bytes of memory may be included. Note that the standard V102 keyboard already has graphics cursor control keys.

6.3 GRAPHICS SCREEN FORMAT

The VISUAL 102 graphics board option provides a bit map of 293 vertical and 768 horizontal coordinates. Any one of the more than 225,000 grid coordinates are specified by the respective X (horizontal) and Y (vertical) values. Each of these displayable points is a pixel on the screen. Two selectable scaling modes are provided.

6.3.1 Direct Scale Screen Format

The first scaling mode is direct, where received coordinates are plotted as described above in Section 6.3, without scaling onto the bit map.

The screen format for direct scale mode is shown in Figure 6-1 on the following page. The origin (X=0, Y=0) is at the lower left hand corner of the grid, and the coordinates of the four corners and the center of the graphics display are shown.

6.3.2 Proportional Screen Format

The second scaling mode provides for Tektronix 4010 compatibility by scaling coordinates according to the following formula:

$$X \text{ (screen)} = 0.75 * X$$

$$Y \text{ (screen)} = 0.375 * Y$$

The Tektronix 4010 and 4014 display is 1024 × 780.

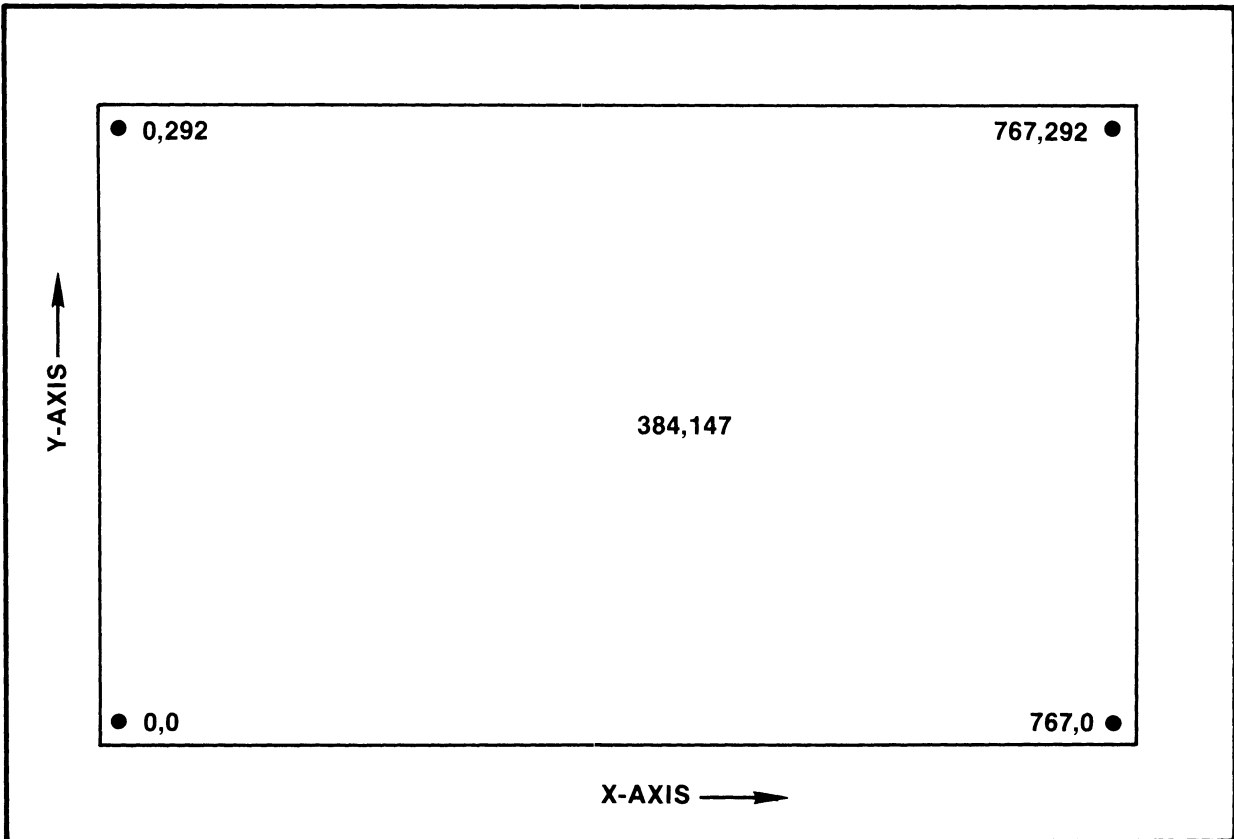

Figure 6-1. Screen Format

6.4 DISPLAY COORDINATE FORMAT

Each of the X and Y coordinates are each converted to a 10 bit binary equivalent. Each is then divided into the high and low 5 bits of each axis. The VISUAL 102 receives this display data in four byte sequences in the following sequence:

BYTE 1	HIGH Y	P01	Y ₉	Y ₈	Y ₇	Y ₆	Y ₅
BYTE 2	LOW Y	P11	Y ₄	Y ₃	Y ₂	Y ₁	Y ₀
BYTE 3	HIGH X	P01	X ₉	X ₈	X ₇	X ₆	X ₅
BYTE 4	LOW X	P10	X ₄	X ₃	X ₂	X ₁	X ₀

Each byte may contain Parity (P) and two tag bits and thus encodes to an ASCII character. THE ASCII equivalents of grid coordinates are described in Appendix X.

6.5 SET-UP — GRAPHICS

Once the graphics option board has been installed, changes are made to the BASIC Set-Up Mode. Also, two additional menus follow the six main V102 menus.

6.5.1 Status Line Set-Up

With the addition of the graphics board, menu choices for key F6 will appear on the Set-Up Mode. This choice is used to select the display mode. There are four choices as follows.

6.5.1.1 Auto Mode

The presentation will be either ALPHANUMERIC or GRAPHICS, depending upon which mode you are presently operating in.

When AUTO display mode is selected, the V102 always prints the ALPHANUMERIC screen presentation.

6.5.1.2 Graphics Mode

The GRAPHICS display presentation is always visible. When the ALPHANUMERIC mode is entered, the ALPHANUMERIC data is overlaid on the GRAPHICS presentation.

When GRAPHICS display mode is selected, the V102 always prints the GRAPHICS screen presentation.

6.5.1.3 Alphanumeric Mode

The ALPHANUMERIC video presentation will always be visible. When the GRAPHICS mode is entered, the Graphics data is overlaid on the ALPHANUMERIC presentation.

6.5.1.4 Both Mode

Both the ALPHANUMERIC and the GRAPHICS presentations will always be visible.

When BOTH display mode is selected, the V102 always prints the GRAPHICS screen presentation.

6.5.2 Revision Menu (Shift V)

With the graphics option board installed, the graphics firmware revision is also displayed. That is, with the graphics option board attached, and in SET-UP Mode, pressing SHIFT and V simultaneously will produce the following display:

**(c) Visual Technology Incorporated V102 Release 01
Graphics Release 01**

6.5.3 Menu #7

Menu # 7 screen presentation is shown in Figure 6-2.

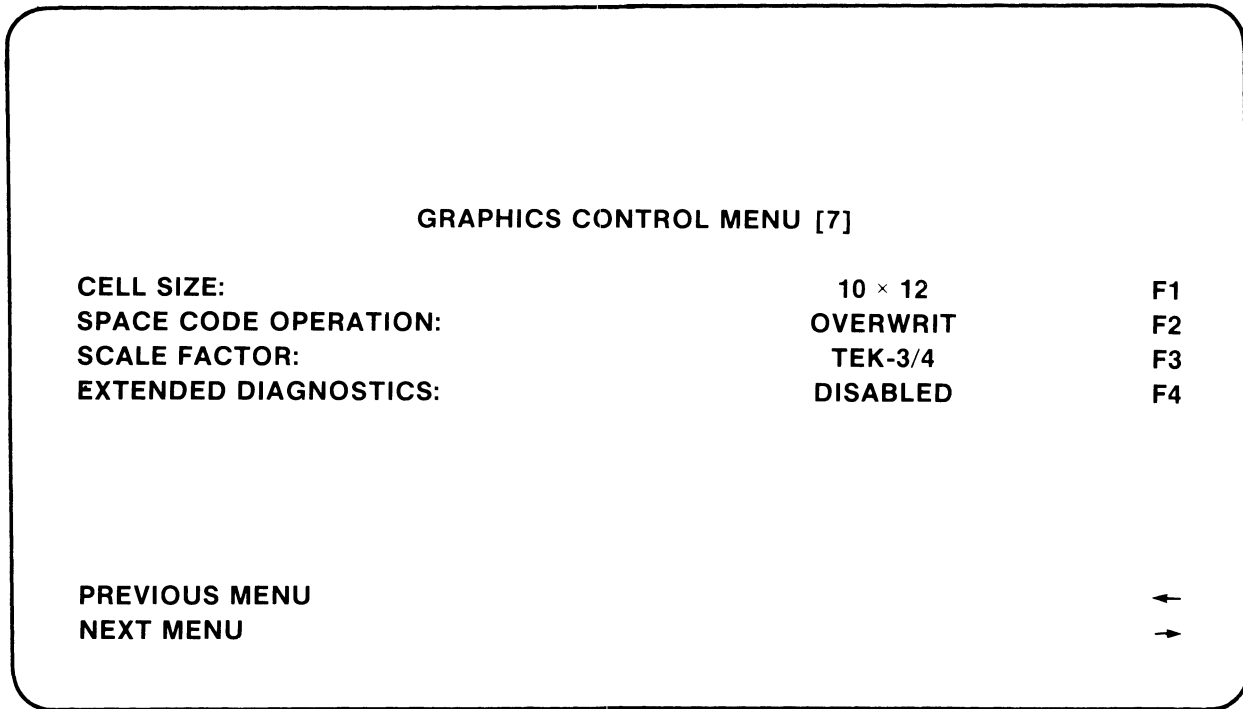

Figure 6-2. Set-Up Menu #7

6.5.3.1 Cell Size (F1)

Depressing key **F1** alternately sets the alphagraphics character cell size to either a 10 × 12 or a 9 × 10 matrix.

6.5.3.2 Space Code Operation (F2)

Depressing key **F2** alternately defines the operation of space code (hex 20) to be either OVERWRITING or NONDESTRUCTIVE.

Overwriting — A received space code moves the alphagraphics cursor one character position to the right and replaces the previous character with a space.

Nondestructive — A received space code moves the alphagraphics cursor one character position to the right. The previous character remains unchanged.

6.5.3.3 Scale Factor (F3)

Depressing key **F3** alternately sets the scale factor (X-Y) to be either 1:1-1:1 or 3:4-3:8. The 3:4-3:8 scaling factor will scale the coordinates to insure compatibility with Tektronix Plot 10 software.

The coordinates are scaled to the following relationship:

$$X' = .75X$$

$$Y' = .375Y$$

6.5.3.4 Extended Diagnostics (F4)

Depressing key **F4** alternately enables and disables the extended power-up diagnostics tests.

WARNING

The extended diagnostics require approximately two minutes to complete.

6.5.4 Menu #8

Menu #8 screen presentation is shown in Figure 6-3.

GRAPHICS COMMUNICATION MENU [8]		
AUX PORT RCV DATA USE	CURSOR MOVE	F1
GRAPHICS PRINTER TYPE	I.D.S.	F2
PRINT IMAGE ROTATION	0 DEG	F3
BIT PAD TYPE	GTCO	F4
BIT PAD TIP SWITCH	DISABLED	F5
TRAILER CODE #1	13	F6
TRAILER CODE #2	04	F7
PREVIOUS MENU		←
NEXT MENU		→

Figure 6-3. Set-Up Menu #8

6.5.4.1 Auxiliary Port Receiver Data Use (F1)

Depressing key **F1** alternately selects one of three auxiliary port modes.

Cursor Move — A local move of the cursor from the bit pad. Coordinates are sent to the host upon depression of a key or pen tip.

Pass B.P. to Host — Allows full bi-directional communication through the terminal to the host with the screen reflecting the cursor moves.

Pass to Host Transparent — Allows full bidirectional communication through the terminal to the host without the cursor movement on the screen.

6.5.4.2 Graphics Printer Type (F2)

Depressing key **F2** causes the VISUAL 102 to step through the available printer types to be connected to the terminal's auxiliary port.

The available selections in Firmware Revision 1.0 are the following:

IDS	MPI
Anadex	WP6000
Texprint	RFU01
Hi-G	RFU02

For a complete listing of the above equipment, refer to Appendix IX.

6.5.4.3 Print Image Rotation (F3)

Depressing key **F3** alternately selects 0 degrees or 90 degrees Print Image Rotation.

A selected Print Image Rotation of 90 degrees causes the graphics display to be rotated 90 degrees from vertical upon transmission to the printer. This is used for 80 column printers.

6.5.4.4 Bit Pad Type (F4)

Depressing key **F4** causes the VISUAL 102 to step through the available bit pad models.

The available bit pad models available in Firmware Revision 1.0 are the following:

GTCO
Summagraphic

For a complete listing of the above equipment, refer to Appendix IX.

6.5.4.5 Bit Pad Tip Switch (F5)

Depressing key **F5** alternately enables or disables the Bit Pad Tip Switch. If Disabled (default), any key may be depressed to send the cross hair coordinates to the host.

If Enabled, the **ENTER** key or the pen tip must be depressed to send the coordinates to the host.

6.5.4.6 Trailer Code #1 (F6)

Depressing key **F6** causes the terminal to step through all the valid ASCII codes from 00 through 31. The Trailer Code #1 is appended to the inquiry message response.

6.5.4.7 Trailer Code (F7)

Depressing key **F7** causes the terminal to step through all the valid ASCII codes from 00 through 31. The Trailer Code #2 is appended to the inquiry message response.

6.6 GRAPHICS COMMANDS — CONTROL CODES

This section describes how the VISUAL 102 graphics option responds to Control Codes. Control codes are defined as codes from Columns 1 and 2 of the ASCII code chart. (Refer to Appendix IV.) Not all control codes have an effect on the VISUAL 102.

Table 6-1 on the following page lists the control codes that the VISUAL 102 responds to.

**TABLE 6-1
GRAPHICS CONTROL CODES**

Control Command	Control Code	Octal Equiv	Action
CTRL G	BEL	007	Rings Bell
CTRL H	BS	010	Move left one character space
CTRL I	HT	011	Move right one character space
CTRL J	LF	012	Move down one character space
CTRL K	VT	013	Move up one character space
CTRL M	CR	015	Enter Alphagraphics Mode
CTRL O	SI	017	Clear Bypass condition
CTRL X	CAN	030	Enter Alphanumeric Mode
CTRL Y	EM	031	Home Alphagraphics cursor, reset margin one flag
CTRL [ESC	033	Begin Escape Sequence
CTRL \	FS	034	Enter Point Plot Mode
CTRL]	GS	035	Enter Vector Mode
CTRL ^	RS	036	Enter Incremental Point Mode
CTRL -	US	037	Enter Alphagraphics Mode

6.6.1 Sound Bell CTRL G (BEL)

This command generates a BEL code (Octal 007), which causes an audible tone to sound.

6.6.2 Cursor Left CTRL H (BS)

This command generates a BS code (Octal 010), which causes the cursor to move left 10 pixels.

6.6.3 Cursor Right CTRL I (HT)

This command generates an HT code (Octal 011), which causes the cursor to move right 10 pixels.

6.6.4 Cursor Down CTRL J (LF)

This command generates an LF code (Octal 012), which causes the cursor to move down. The cursor moves 17 pixel positions (15 pixel positions if 10 × 15 cell size is selected).

6.6.5 Cursor Up CTRL K (VT)

This command generates a VT code (Octal 013), which causes the cursor to move up. The cursor moves 17 pixel positions (15 pixel positions if 10 × 15 cell size is selected).

6.6.6 Alphagraphics Mode

The ALPHAGRAPHICS Mode allows full 96 character alphanumerics to be written at any location on the graphics display. This mode allows four character sizes (1X, 2X, 3X, and 4X) and the Margin 1 feature for full compatibility with Plot 10 software. An ALPHAGRAPHICS cursor is displayed on the screen to indicate the character position.

There are three methods of entering ALPHAGRAPHIC Mode, which follow.

6.6.6.1 Enter Alphagraphics Mode CTRL M (CR)

This command generates a Carriage Return code (Octal 015), resets the VISUAL 102 from GRAPH to ALPHAGRAPHICS Mode and cancels Cross hair cursor if, and only if, the V102 is already in Vector, Point Plot, or Incremental Point Plot Mode.

This command also performs a Carriage Return and sets the data level to dots on.

6.6.6.2 Enter Alphagraphics Mode CTRL - (US)

This command generates a US code (Octal 037), which causes the V102 to enter ALPHAGRAPHICS Mode regardless of its previous mode.

No Carriage Return is performed, and the data level is unchanged.

6.6.6.3 Enter Alphagraphics Mode ESC CTRL L (ESC FF)

This command generates ESC FF codes (Octal 033 014), which cause the V102 to enter ALPHAGRAPHICS Mode regardless of its previous mode.

This command also homes the ALPHAGRAPHICS cursor, clears the graphics memory, sets the data level to dots on, and resets the character size and line styles.

ESC FF can also be generated from the terminal by pressing the **SHIFT** and **SET-UP** keys simultaneously.

6.6.6.4 Set Alphagraphics Cursor

The ALPHAGRAPHICS Cursor is a blinking underline. It may be positioned in one of three ways:

1. Generation of the BS, HT, LF, VT, EM, and CR Control Codes.
2. The ALPHAGRAPHICS cursor is always positioned at the last grid coordinates accessed in vector or point plot modes. Thus the Alphagraphics cursor may be positioned by entering Point Plot or Vector Mode, sending the desired 4 byte X and Y coordinate and then entering Alphagraphic Mode by use of the CTRL-(US) command.
3. The use of the cursor positioning keys on the keyboard may be used. The home position for the Alphagraphics cursor is the upper left hand corner.

6.6.6.5 Set Alphagraphics Character Size

The ALPHAGRAPHICS Mode offers four character sizes listed below in Table 6-2. Each is selected by the appropriate escape sequence for the character size desired. Character size is not line dependent, and characters of different sizes may be mixed. However, the line format will change per Table 6-3.

**TABLE 6-2
ALPHAGRAPHICS CHARACTER SIZE**

Character Size	Escape Sequence	Screen Format
Normal	ESC 0	76 × 24
2X	ESC 1	38 × 12
3X	ESC 2	25 × 8
4X	ESC 3	19 × 6

6.6.6.6 Set Alphagraphics Font Size

To select the various character fonts available in ALPHAGRAPHICS Mode, the following commands are used:

- ESC 8 Select 10 × 12 character cell size.
- ESC 9 Select 9 × 10 character cell size.
- ESC : Select 7 × 9 character cell size.
- ESC ; Select 7 × 9 character cell size.

6.6.6.7 Set Alphagraphics Margins

Two margins are available in the ALPHAGRAPHICS Mode.

Margin 0 is at the left hand side of the screen (Column 0). Attempts to enter Alphagraphics beyond the screen limits will generate a local Carriage Return and a Line Feed.

Margin 1 is at the center of the screen. Margin 1 is automatically enabled when the Alphagraphics cursor is positioned on the last available line and a Line Feed is received.

Margin 1 is useful in creating two columns of text and is compatible with Point 10 software.

NOTE

Any characters that extend beyond the center of the screen may be written over when Margin 1 is enabled.

The numeric column location of Margin 1 and the numeric last available line varies with character size, as described in Table 6-3.

**TABLE 6-3
MARGIN LOCATION**

Character Size	Margin 1 Col #	# of Lines Available
1X	38	24
2X	19	12
3X	12	8
4X	9	6

6.6.7 Alphanumeric Mode

The ALPHANUMERIC Mode is entered automatically upon power-up of the VISUAL 102 with graphics. This mode allows the terminal to function as a full-featured alphanumeric device using a display memory separate from the graphics display memory. ALPHANUMERIC Mode operation is independent of and transparent to GRAPHICS Mode operation. Refer to Section 5 for ALPHANUMERIC Mode programming details.

6.6.7.1 Enter Alphanumeric Mode CTRL X (CAN)

This command generates a CAN code (Octal 030), which causes the V102 to enter ALPHANUMERIC mode. If a CAN code is received when the VISUAL 102 is already in ALPHANUMERIC Mode, then the command will abort an ESC sequence.

6.6.7.2 Alphanumeric Cursor

The ALPHANUMERIC Mode cursor is user selectable to either solid or blinking cursor. Please refer to Section 3.8.2.2 Set Up Mode for details.

6.6.8 Point Plot Mode

The POINT PLOT Mode allows individual points to be plotted on the graphics display screen of the VISUAL 102. The point to be plotted is specified by using the same addressing scheme as that used for specifying the end points of vectors, the only exception being that only the end point dots are plotted and not the whole vector.

6.6.8.1 Enter Point Plot Mode CTRL \ (FS)

This command generates an FS code (Octal 034), which causes the V102 to enter POINT PLOT mode. The data level and status of the alpha and graphics memory are unchanged. There is no POINT PLOT cursor.

<u>NMN</u>	<u>ASCII CODE</u>	<u>ACTION</u>
FS	P 0 0 1 1 1 0 0	ENTER POINT PLOT MODE
HIGH Y	P 0 1 Y ₉ Y ₈ Y ₇ Y ₆ Y ₅ }	Y COORDINATE
LOW Y	P 1 1 Y ₄ Y ₃ Y ₂ Y ₁ Y ₀ }	
HIGH X	P 0 1 X ₉ X ₈ X ₇ X ₆ X ₅ }	X COORDINATE
LOW X	P 1 0 X ₄ X ₃ X ₂ X ₁ X ₀ }	
HIGH Y	P 0 1 }	2ND POINT TO BE PLOTTED
LOW Y	P 1 1 }	
HIGH X	P 0 1 }	
LOW X	P 1 0 }	
LOW X	P 1 0 }	3RD POINT, Y-AXIS DID NOT CHANGE
HIGH Y	P 0 1 }	4TH POINT, X-AXIS DID NOT CHANGE
HIGH Y	P 0 1 }	5TH POINT, NEW X AND Y-AXIS
LOW Y	P 1 1 }	
HIGH X	P 0 1 }	
LOW X	P 1 0 }	
	•	
	•	
	•	
	•	
GS	P 0 0 1 1 1 0 1	TRANSITION TO VECTOR MODE

Figure 6-4. Data Sequence Point Plot Mode

6.6.9 Incremental Point Plot Mode

INCREMENTAL POINT PLOT Mode allows points to be plotted in one of eight directions relative to the current position. The absence of dots (DATA OFF) may be plotted by use of the PEN UP and PEN DOWN characters.

6.6.9.1 Enter Incremental Point Plot Mode CTRL (RS)

This command generates an RS code (Octal 036), which causes the V102 to enter INCREMENTAL POINT PLOT mode. Points are incrementally plotted in the direction defined by the received character. Figure 6-5 shows the direction of each character. The action of the “drawing pen” is defined by the ASCII characters as shown in Table 6-4.

**TABLE 6-4
INCREMENTAL POINT PLOT OPERATIONS**

ASCII Code	Action
SP	Pen Up
P	Pen Down

6.6.10 Clear Bypass Condition CTRL O (SI)

This command generates an SI code (Octal 017) which causes the V102 to clear the Bypass and Carriage Return Inhibit conditions and cancels any escape sequences in progress.

Bypass condition is when data from the bit pad is sent to the host but not displayed on the screen. When this condition is cleared, data from the bit pad is displayed on the screen as well as sent to the host. This feature is also user selectable from Menu #8 in SET UP Mode. Refer to Section 6.5.4.1.

**TABLE 6-5
INCREMENTAL POINT PLOT DIRECTIONAL CHARACTERISTICS**

Character	Octal Code	Direction	Angle (Deg)
D	104	N	90
E	105	NE	45
A	101	E	0
I	111	SE	315
H	110	S	270
J	112	SW	225
B	102	W	180
F	106	NW	135

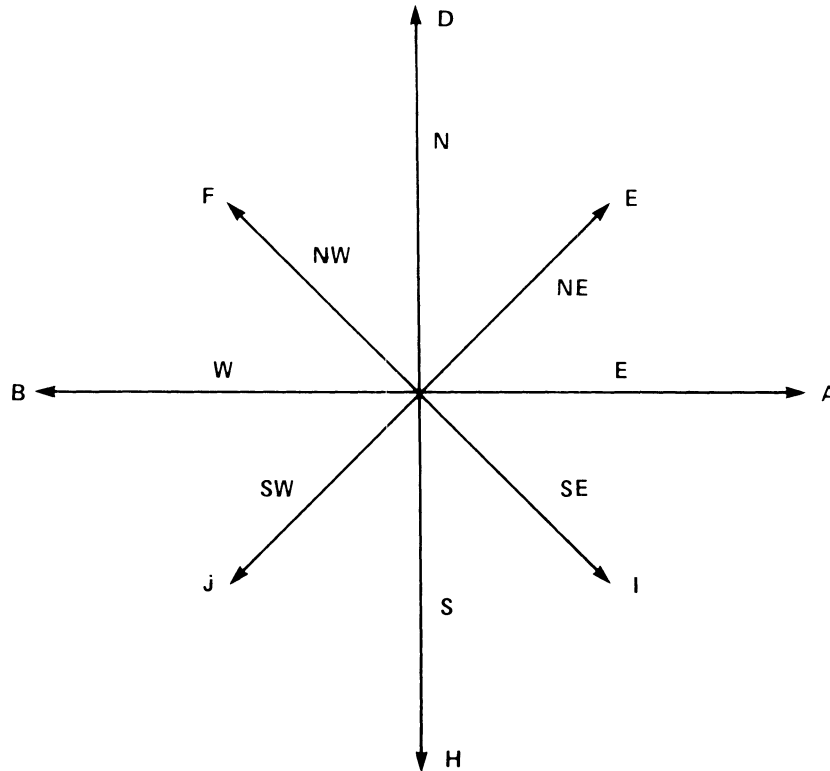

Figure 6-5. Incremental Point Plot Directional Characteristics

6.6.11 Vector Mode

VECTOR Mode allows the VISUAL 102 to automatically draw vectors connecting two specified points. The first coordinate received specifies the begin point, and the second coordinate specifies the end point. A third coordinate received would connect a vector from coordinate two to coordinate three. Each subsequent coordinate received defines the end point of the vector. There is no cursor in VECTOR Mode.

Up to eight line styles are available in VECTOR Mode. Three of these line styles may be user defined. Please refer to Section 6.6.11.4.

The data sequence for VECTOR Mode is defined in Figure 6-6.

6.6.11.1 Enter Vector Mode CTRL] (GS)

This command generates a GS code (Octal 035) which causes the V102 to enter VECTOR Mode. The V102 is set to "normal" line at power up. The received GS for VECTOR Mode does not reset the selected line style. If the V102 is already in VECTOR Mode, the code GS will draw a dark vector from the current point to the next point received.

<u>NMN</u>	<u>ASCII CODE</u>	<u>ACTION</u>
<u>GS</u>	<u>P 0 0 1 1 1 0 1</u>	<u>ENTER VECTOR MODE</u>
HIGH Y	P 0 1 Y ₉ Y ₈ Y ₇ Y ₆ Y ₅ }	Y COORDINATE } VECTOR
LOW Y	P 1 1 Y ₄ Y ₃ Y ₂ Y ₁ Y ₀ }	BEGIN
HIGH X	P 0 1 X ₉ X ₈ X ₇ X ₆ X ₅ }	X COORDINATE } POINT
LOW X	P 1 0 X ₄ X ₃ X ₂ X ₁ X ₀ }	
HIGH Y	P 0 1 }	Y COORDINATE } VECTOR
LOW Y	P 1 1 }	END
HIGH X	P 0 1 }	X COORDINATE } POINT
LOW X	P 1 0 }	
HIGH Y	P 0 1 }	Y COORDINATE } VECTOR
LOW Y	P 1 1 }	END
HIGH X	P 0 1 }	X COORDINATE } POINT
LOW X	P 1 0 }	
<u>GS</u>	<u>P 0 0 1 1 1 0 1</u>	<u>REINITIALIZE VECTOR MODE</u>
HIGH Y	P 0 1 }	Y COORDINATE } VECTOR
LOW Y	P 1 1 }	BEGIN
HIGH X	P 0 1 }	X COORDINATE } POINT
LOW X	P 1 0 }	
HIGH Y	P 0 1 }	Y COORDINATE } VECTOR
LOW Y	P 1 1 }	END
HIGH X	P 0 1 }	X COORDINATE } POINT
LOW X	P 1 0 }	
ESC	P 0 0 1 1 0 1 1	ESCAPE CODE
a	P 1 1 0 0 0 0 1	SELECT DOTTED LINE STYLE
	•	
	•	
	•	
	•	
	•	
FS	P 0 0 1 1 1 0 0	TRANSITION TO POINT PLOT MODE

Figure 6-6. Data Sequence Vector Mode

Graphic plotting information is sent from the host computer in a 4 byte sequence containing High and Low order Y and High and Low order X. Each byte contains the two tag bits plus 5 binary bits. Each byte thus encodes to an ASCII character.

For information on how to obtain the 4 ASCII characters for each addressable part on the display, use the instructions in Appendix X and the conversion chart in Table AP10.

6.6.11.2 Vector Mode Example

To draw the triangle ABC displayed below in Figure 6-7,

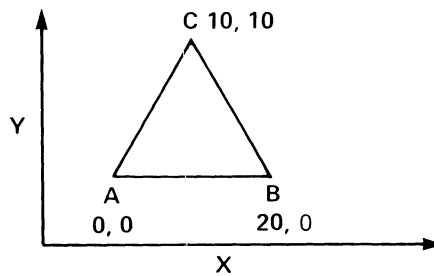

Figure 6-7. Sample Triangle

the following ASCII character sequence would be sent to the V102.

Command	ASCII Character	Action
CTRL]	GS	Enter Vector Mode
	SP	High Y Coordinate A
	(Decimal 39)	Low Y Coordinate A
	SP	High X Coordinate A
	@	Low X Coordinate A
	T	Low X Coordinate B
	j	Low Y Coordinate C
	J	Low X Coordinate C
	(Decimal 39)	Low Y Coordinate A
	@	Low X Coordinate A

NOTE

After the first four bytes are sent, only those bytes that change must be sent. However, although not evident in this sample, if the High X byte changes, then the Low X byte must be resent.

6.7 GRAPHICS ESCAPE SEQUENCES

6.7.1 Select Line Style CTRL [Ps (ESC Ps)

This command generates an ESC code (Octal 033) followed by the value of Ps, which causes the V102 to select the desired line style. Up to eight line styles are available in VECTOR Mode.

The VISUAL 102 is set to NORMAL line at power up. The received GS code does not reset the selected line style. The VISUAL 102 is also set to NORMAL lines upon entering ALPHAGRAPHICS Mode by use of the ESC, CTRL L (ESC FF) command sequence.

Table 6-6 describes the available Line Styles, and the commands to select them.

**TABLE 6-6
LINE STYLES**

Command	Line Style Selected
ESC \	Normal _____
ESC a	Dotted
ESC b	Dot Dash .-.-.-.-.-.
ESC c	Short Dash - - - - -
ESC d	Long Dash - - - - -
ESC x	User Defined #1
ESC y	User Defined #2
ESC z	User Defined #3

NOTE

The line style select must precede a CTRL] (GS code) command.

6.7.2 Define User Line Styles

User defined line Styles are selected by the appropriate character, but must have been previously defined by the following commands

ESC/Pn a	Style #1
ESC/Pn b	Style #2
ESC/Pn c	Style #3

where Pn is a decimal number derived by considering the line definition to be a sixteen bit binary number with each bit defining a dot or pixel of the line. The Low Order bit is the first dot in the line style.

A binary "1" is a dot on. A binary "0" is a dot off.

The value of Pn is the range of 0 to 65535 inclusive.

6.7.3 Figure Draw and Fill

The VISUAL 102 is capable of drawing either a RECTANGLE or a CIRCLE. The RECTANGLE is drawn by specifying a starting point and the distance along the X and Y axis. The CIRCLE is drawn by specifying the starting point and the radius of the circle. Either figure may be filled with any one of fourteen filling styles, two of which are user definable. Additionally, the rectangle may be rotated in 45 degree increments.

6.7.3.1 Filling Type Commands

The Filling Style must be selected before a Rectangle or Circle/Arc Draw and Fill command is received.

The Filling Style ID is defined by the following commands:

**TABLE 6-7
FILL TYPE COMMANDS**

Command	Fill Type
ESC @	Solid Fill (all dots on)
ESC A	Grey Fill (50% dots on)
ESC B	Slope Up (left to right lines)
ESC C	Slope Up (right to left lines)
ESC D	Horizontal Lines
ESC E	Vertical Lines
ESC F	Slant Cross Hatch Lines
ESC G	Vertical Cross Hatch Lines
ESC H	Checkerboard
ESC I	Dotted Fill
ESC J	Vertical Herringbone
ESC K	Horizontal Herringbone
ESC L	User Defined Fill Pattern #1
ESC M	User Defined Fill Pattern #2

6.7.3.2 Define User Fill Pattern ESC/ Pn1; ... Pn8 Ps

where Pn is a decimal number derived by considering that the pattern type definition is to be an eight dot binary numeral with each bit defining a dot or pixel of that row. The low order bit is the first dot of the line style. Each of the eight parameters represents a scan line. Thus, each pattern is an 8 x 8.

A binary "1" is dot on. A binary "0" is dot off. The value of Pn is the range of 0 to 255 inclusive.

6.7.3.3 Rectangle Draw ESC/ x ; y ; X ; Y ; x

This sequence will cause a rectangle to be drawn, starting at coordinate x,y that is X dots wide and Y dots high. The values are specified in decimal format.

Figure 6-8 shows a rectangle that begins at location coordinate 20,50 that is 50 dots square. The figure is drawn by the following sequence being received by the V102:

```
ESC/ 2 0 ; 5 0 ; 5 0 ; 5 0 ; x
```

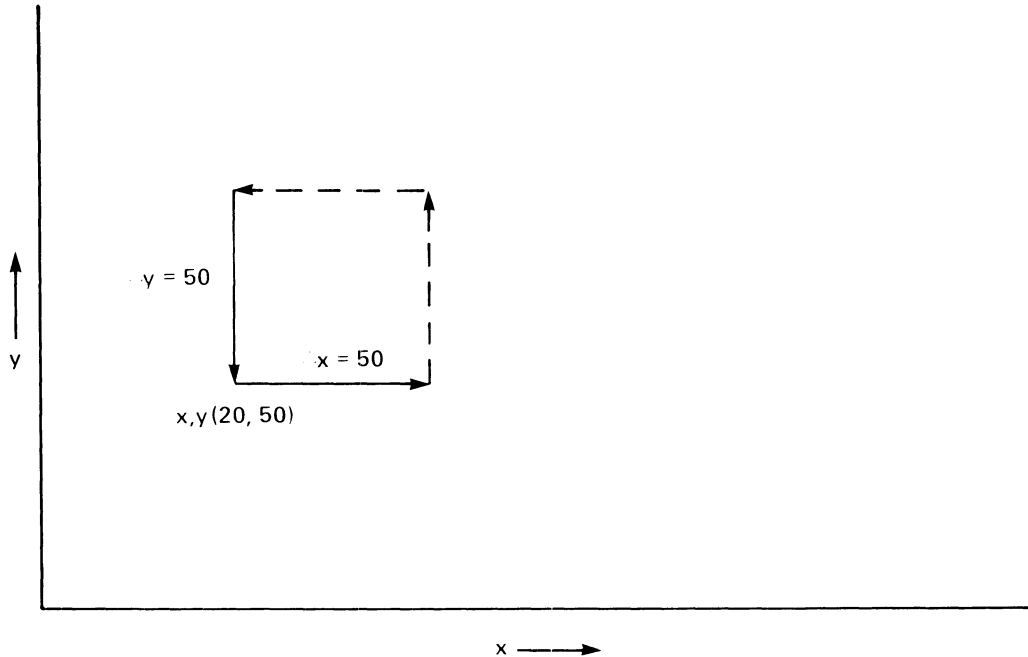

Figure 6-8. Rectangle Draw

6.7.3.4 Rectangle Draw and Fill ESC/ x ; y ; X ; Y ; y

This sequence will cause a rectangle to be drawn and filled with one of the selected filling styles. (Refer to Section 6.7.3.2 for Fill Styles.) The rectangle begins at location coordinate x,y , and is X dots wide and Y dots high. The values are specified in decimal format.

The data sequence is identical to a rectangular draw, with the exception that the last character is an ASCII y (signifying DRAW AND FILL) rather than an ASCII x (signifying DRAW).

6.7.3.5 Circle/Arc Draw ESC/ X ; Y ; R ; T ; P A

The VISUAL 102 equipped with graphics option is capable of drawing a circle or an arc by specifying the starting point and radius of the circle. The above sequence draws a circle or arc of R radius at coordinates X,Y where:

- X— X coordinate (decimal value) of the center of the circle.
- Y— Y coordinate (decimal value) of the center of the circle.
- R— Radius expressed in number of pixels.
- T— Starting point of arc expressed in degrees.
- P— Length of arc expressed in degrees.

If P is omitted, P=0, or P>360, then a circle is drawn.

6.7.3.6 Circle/Arc Draw and Fill ESC/ X ; Y ; R ; T ; P B

The above sequence draws a circle or arc of R radius at coordinates X,Y and fills it with the Fill Style last selected (refer to Section 6.7.3.2 for Fill Styles) where:

- X— X coordinate (decimal value) of the center of the circle.
- Y— Y coordinate (decimal value) of the center of the circle.
- R— Radius expressed in number of pixels.
- T— Starting point of arc expressed in degrees.
- P— Length of arc expressed in degrees.

If P is omitted, P=0, or P>360, then a circle is drawn.

The data sequence is identical to a circular/arc draw, with the exception that the last character is an ASCII B (signifying DRAW AND FILL) rather than an ASCII A (signifying DRAW).

6.7.4 Direction Commands ESC/ Ps e

A defined rectangle may be rotated on its X-axis in 45 degree increments by use of the above direction command. Ps is a selective parameter defining the direction of the X-axis. The Y-axis will always be defined as 90 degrees from the X-axis.

**TABLE 6-8
DIRECTION COMMANDS**

Ps	Degrees
2	0
4	90
6	180
0	270

The direction of the X-axis remains as selected until either a new direction command is received or a power on resets the X-axis to the default value X=0.

EXAMPLE: If the rectangle defined in Figure 6-8 had been prefaced by the command ESC/4e , then it would appear rotated 90 degrees.

6.7.4.1 Characters Direction Commands

The direction command may also be used to position characters in alphagraphics mode. The selective parameters define the axis and direction of cursor movement in alphagraphics mode as defined in Table 6-9 below.

**TABLE 6-9
CHARACTERS DIRECTION COMMANDS**

Ps	X-Axis	Cursor Movement
0	0	Left to Right
2	90	Top to Bottom
4	180	Right to Left
6	270	Bottom to Top

6.7.5 Data Level

Data is plotted into Alphagraphics, Point Plot, Vector, or Incremental Point Plot Mode according to one of four Data Level settings: Dots On, Dots Off, Complement, and Replace.

Dots On — The normal data level whereby plotted data, vectors, or alphagraphics characters are visible.

Dots Off — The data level used to draw invisible vectors or to erase dots or vectors selectively by turning the data level off and replotting or redrawing the data.

Complement — The data level that causes data stored in graphics memory to be complemented when replotting or redrawn with the data level set to complement. Complement is used selectively to erase graphics data.

Replace — The data level that causes the data being plotted to replace unconditionally the data already in the display bit map.

6.7.5.1 Set Data Level ESC/ Ps d

This sequence sets the Data Level according to the value of the selective parameter as defined in Table 6-10 on the following page.

**TABLE 6-10
DATA LEVEL SETTINGS**

Ps	Data Level
0	Dots On
1	Dots Off
2	Complement
3	Replace

The data level is set to Dots On at power up and by entering Alphagraphics Mode by use of the ESC CTRL L (ESC FF) command.

6.7.6 Crosshair Mode

CROSSHAIR Mode is used primarily to allow interaction between the host and the operator in GRAPHICS mode.

When CROSSHAIR Mode is entered, a full screen cursor (crosshair) is displayed at the last point or vector coordinate. The crosshair may be positioned in one of eight directions by depressing the desired key on the numeric keypad. Refer to Section 4 for details.

Each depression of the key selected will move the intersection of the crosshair one dot (pixel) in the direction indicated on the key. If the key is simultaneously depressed with the FUNCTION key, then the crosshair will move eight dots (pixels) in the indicated direction.

6.7.6.1 Enter Crosshair Mode ESC SUB or ESC CTRL Z

These commands cause the VISUAL 102 to enter CROSSHAIR Mode.

The cursor is displayed at the last loaded dot or vector location. The crosshair may then be positioned by use of the cursor movement keys.

The location coordinates are transmitted to the host by depressing any Alpha-numeric key. The VISUAL 102 will transmit the code (ASCII) of the alphanumeric key and the location coordinates of the crosshair. The byte coordinates are in the format specified in the Graphics Inquiry Section 6.8.

NOTE

Transmission of crosshair coordinates causes the V102 to enter alphagraphics mode.

The transmission sequence in CROSSHAIR mode is as follows:

High X
Low X
High Y
Low Y
Trailer 1
Trailer 2

6.7.6.2 Load Crosshair ESC/ f

This command loads the last vector coordinates into the crosshair location.

EXAMPLE:

To position the crosshair to location 60,40, the following code sequence would be used:

NMN	7 Bit ASCII	Code
High Y	0100001	!
Low Y	1100100	h
High X	0100001	!
Low X	1001110	\
ESC	0011011	ESC
\	0101111	/
f	1100110	f
ESC	0011011	ESC
SUB	0011010	SUB

Figure 6-9. Load Crosshair Example

6.8 INQUIRY

The graphics option of the VISUAL 102 will respond to an inquiry command in Point Plot, Incremental Point Plot, Vector, Crosshair, and Alphagraphics Modes. The VISUAL 102 with graphics option will respond to an inquiry with the following data format:

Status Word
High X
Low X
High Y
Low Y
Trailer Code #1
Trailer Code #2

NOTE

If the V102 is in Crosshair Mode, then the cursor location is the crosshair location.

6.8.1 Response Byte Format

Each of the X and Y coordinates are converted to a 10 bit binary equivalent. Each is then divided into the high and low 5 bits of each axis. The VISUAL 102 receives this display data in four byte sequences in the following sequence:

BYTE 1	HIGH Y	P01	Y ₉	Y ₈	Y ₇	Y ₆	Y ₅
BYTE 2	LOW Y	P11	Y ₄	Y ₃	Y ₂	Y ₁	Y ₀
BYTE 1	HIGH X	P01	X ₉	X ₈	X ₇	X ₆	X ₅
BYTE 2	LOW X	P10	X ₄	X ₃	X ₂	X ₁	X ₀

Each byte may contain Parity (P) and two tag bits and thus encodes to an ASCII character. The ASCII equivalents of grid coordinates are described in Appendix X.

6.8.2 Graphics Inquiry Command ESC ENQ

This command returns status information and cursor location to the host.

6.8.2.1 Status Response Word

The V102 responds to an inquiry command with a status word in the following format:

Parity	0	1	HCU	0	Margin	Margin 1
--------	---	---	-----	---	--------	----------

- HCU — 0 Hard Copy Unit Ready
- Mode — 0 Graphics Mode Enabled
1 Alphagraphics Mode Enabled
- Margin — 1 at Margin 1
2 at Margin 2

6.9 SCALING

Two scales are available in the VISUAL 102 Graphics mode:

- 1: 1 (V550 Compatible)
- 3: 4 (Tektronix 4010/4014 Compatible)

Refer to Section 6.3.1 and 6.3.2 for a description of each scale. Refer to Section 6.5.3.3 for setting scale factor.

6.10 BLOCK TRANSFER

All functions of the VISUAL 102 Graphics Modes are interactive (Character by character action). However, the V102 can accept blocks of graphics memory data. These block transfers allow the host to update the graphics memory rapidly.

A block transfer from the host is accomplished by use of the ADDRESS LOAD and DATA LOAD commands.

A block read from the V102 to the host is accomplished by use of the MEMORY READ command.

6.10.1 Address Load ESC" X ; Y a

This sequence specifies the starting address of a block transfer, where X and Y are decimal numbers indicating the starting location in graphics memory.

X is in the range of 0 to 768 and Y is in the range of 0 to 293. 0,0 would represent the home position of the graphics memory.

6.10.2 Data Load ESC+ <CHAR> <CHAR>...#

This sequence loads the graphics memory with data beginning at the previously specified address where:

<CHAR> is an ASCII character in the range of @ (Octal 100) to — (Octal 137).

<CHAR> represents 5 bits of data encoded into an ASCII character.

Data is loaded at the beginning address from the low order 5 bits of <CHAR> starting with D1 and ending with D5.

EXAMPLE:

To lead an alternating pattern of data starting at location 10,20 of graphics memory, the following sequence would be sent to the VISUAL 102.

NMN	7 Bit ASCII Code	ASCII Character
ESC	0011011	ESC
"	0100010	"
Decimal X(10)	0110001	1
;	0110000	0
	0111011	;
Decimal Y(20)	0010100	2
	0111011	0
a	1100001	a
ESC	0011011	ESC
+	0101011	+
Char 1	1001010	J
Char 2	1010101	U
o	o	o
o	o	o
o	o	o
#	0100011	#

6.10.3 Memory Read ESC" X ; Y ; <COUNT> b

This command allows the VISUAL 102 to transmit the contents of graphics memory where:

X and Y are decimal numbers specifying the starting address.

<COUNT> is a decimal number specifying the number of bits to be transmitted. Each five bits of data are encoded into an ASCII character in the range of @ (Octal 100) to — (Octal 137). Sequences of nulls or groups of nulls are transmitted as a decimal Count (indicating the number of zero bytes in the sequence) preceded by a # sign as follows:

#(Count)

This data compression can sharply reduce the amount of time required to perform a memory "dump."

EXAMPLE:

ESC"0;0;44928b

This transmits the entire memory.

6.11 GRAPHICS COMMUNICATIONS

When the VISUAL 102 sends blocks of data to the host computer, the message is ended with up to two trailer codes:

Trailer Code #1

Trailer Code #2

These codes are user definable (refer to Section 6.5.3.6) and are used to indicate the end of transmission.

A full description of communication protocols is contained in Section 7.

6.11.1 Handshaking

A method of handshaking is normally required at transmission speeds above 2400 baud to insure that data is not lost. This is especially true when certain graphics functions such as long vectors are being plotted. Two handshaking methods are available on the VISUAL 102: XON/XOFF and Status Readback Control. Of the two, XON/XOFF is the more desirable.

6.11.1.1 XON/XOFF

A full discussion of the XON/XOFF protocol is contained in Section 7.5.

6.11.1.2 Status Readback Control

This method uses the inquiry function to determine if the VISUAL 102 is ready to receive data and involves sending the VISUAL 102 the inquiry sequence ESC ENQ and waiting for the status byte to be returned before resuming data transmission. Refer to Section 6.8.2.1 for a description of the status response byte.

Since the VISUAL 102 uses a transmission input buffer, it is not necessary to send an inquiry after each function. A general rule of thumb would be to send an inquiry after every 20 coordinate pairs and after every long vector coordinate pair. A rectangular draw and fill is considered a long vector.

As previously stated, if the host supports XON/XOFF, then this automatic protocol is more desirable.

Other "trick" methods such as sending nulls, dummy characters, or breaks that are used to delay communications are time consuming and should be avoided.

6.12 REMOTE PARAMETER SELECTION

The following V102 graphics option set-up parameters may be remotely set or reset by the host:

- Auto Scaling
- Space Code Operation
- Cell Size

6.12.1 Set Parameters Remote Command ESC/ Ps h

This command allows the host to set graphics parameters defined by the value of Ps described in Table 6-9 below.

6.12.2 Reset Parameters Remote Command ESC/ Ps l

This command allows the host to reset graphics parameters defined by the value of Ps described in Table 6-11 below.

**TABLE 6-11
REMOTE GRAPHICS PARAMETER SELECTION**

Ps	Parameter	Set/Reset	Action
1	Auto Scaling	Set	1:1, 1:1
1	Auto Scaling	Reset	3:4, 3:8
2	SP Code Operation	Set	Non Destructive
2	SP Code Operation	Reset	Destructive
3	Cell Size	Set	9 × 10
3	Cell Size	Reset	10 × 12

6.12.3 Set Auxiliary Port Mode ESC/ Pn p

This sequence allows the auxiliary port mode to be set remotely by the host. Pn corresponds to one of three modes as defined in Table 6-12 below. These modes are used for bidirectional communication using the auxiliary port.

The parameter can also be changed in Set-Up Mode (Menu #8). Refer to Section 6.5.4.1.

To select one of the three auxiliary port modes, the remote commands are shown on the next page.

**TABLE 6-12
AUXILIARY PORT MODE COMMANDS**

Ps	Mode	Action
1	Cursor Move	Data from the bit pad is used to move the cross hair cursor.
2	Pass BP to Host	Data is passed to the host and also to the screen.
3	Pass to Host Transp.	Data from the bit pad is passed to the host but not displayed on the screen.

WARNING

There is no flow control protocol when the Aux Port is enabled to these modes. There is, however, a 256 byte receiver buffer written. It is up to the host system to insure that the buffer is not overrun.

6.13 ADDITIONAL ESCAPE SEQUENCES

6.13.1 Pre-Plot 10 Compatibility

Before Plot 10 was developed, all transition control codes were sent as ESC control code. To provide compatibility with this practice, the following sequences are available and perform the same function as if the control code were struck.

ESC LF	Move Down one character
ESC CR	Enter Alphagraphics mode
ESC CAN	Enter Alphanumeric mode
ESC FS	Enter Point Plot mode
ESC GS	Enter Vector mode
ESC RS	Enter Incremental Point Plot mode
ESC US	Enter Alphagraphics mode

6.13.2 Remote Graphics Print Command ESC ETB

This command causes the V102 to print the graphics screen.

6.13.3 Alternate Character Sequence for Rubout ESC ?

This sequence can be used as an alternate for the rubout character.

6.13.4 Clear Screen ESC CTRL L (ESC FF)

This command generates ESC FF codes (Octal 033 014), which cause the V102 to clear the screen and enter ALPHAGRAPHICS Mode regardless of its previous mode.

This command also homes the ALPHAGRAPHICS cursor, clears the graphics memory, sets the data level to dots on, and resets the character size and line styles. If the ALPHANUMERIC video is enabled, the numeric display will also be cleared and the ALPHANUMERIC cursor will be homed.

ESC FF can also be generated from the terminal by pressing the **SHIFT** and

SET-UP keys simultaneously.

7. COMMUNICATION AND INTERFACING

GENERAL

The VISUAL 102 communicates using the standard 7 or 8 bit ASCII code format. Communication is in the start stop (character by character) asynchronous serial mode. This section deals with communication protocols and interfacing, including the Modem Control features discussed in Section 3.8.3.

7.1 WORD LENGTH AND PARITY

The VISUAL 102 may be configured to 7 or 8 bit ASCII code and mark, space, odd, even, or no parity.

Transmitted and received data is formatted into a 10 or 11 bit word containing a start bit, 7 ASCII data bits, a parity bit, and one or two stop bits. The start bit is always a spacing (zero) bit, followed by the 7 data bits with the least significant bit first. The single parity bit is next and can be odd, even, mark (always a one) or space (always a zero). Each character ends with one or two stop bits.

The byte description for each configuration is shown in Figure 7-1.

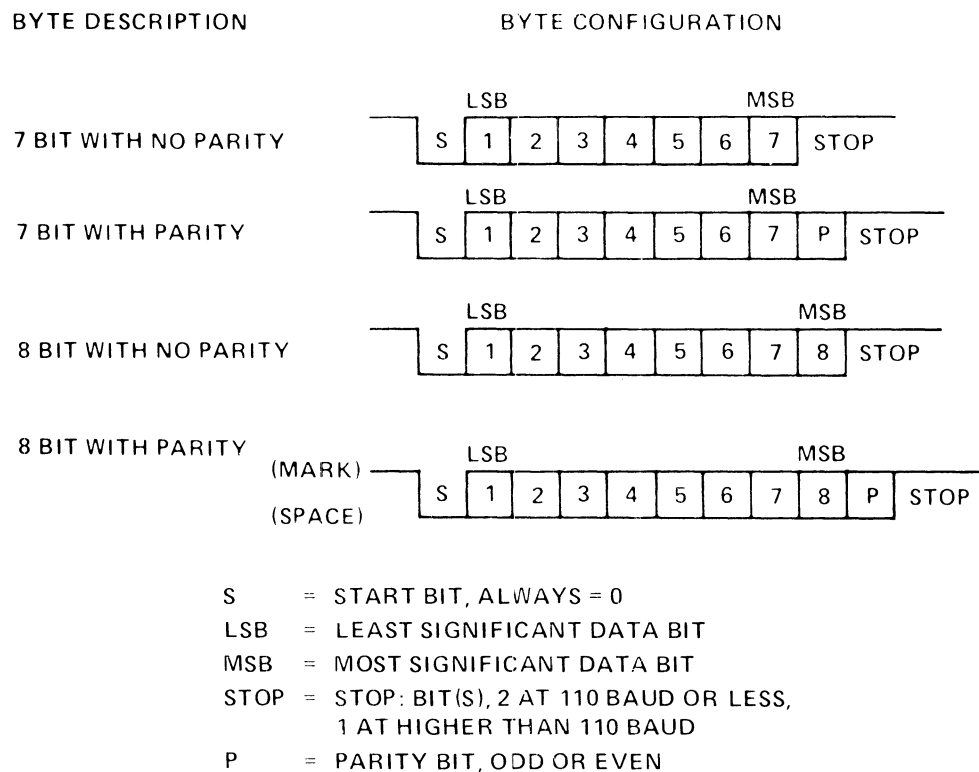

Figure 7-1. Character Word Configuration

Received data is monitored to detect parity errors and framing errors. If the V102 has EVEN parity selected and the received character parity is odd, or when ODD parity is selected and the received character is even, a parity error symbol (PE) is displayed in place of the received character. Framing errors are detected by determining the number of stop bits received as compared to the number selected by the baud rate. Framing errors display the parity error symbol.

7.2 DATA INTERFACE CONNECTIONS

Data interface connections for the VISUAL 102 are provided through two EIA interface connections and through an optional Current Loop interface.

7.2.1 EIA Interface

The VISUAL 102 communications standard is an EIA RS232-C interface, and there are two male connectors located on the rear of the terminal. The pin definitions of these connectors are summarized in Table 7-1.

The connector labeled MODEM is for connection to the host or data set.

The connector labeled AUX PORT is for connection to an external device under

**TABLE 7-1
EIA RS232-C SIGNAL DEFINITIONS AND CONNECTOR PINS,
AND 20 MA CURRENT LOOP PIN POLARITY**

PIN	RS232-C Mnemonic	CCITT V24 Mnemonic	Definition
1	AA	101	Protective Ground
2	BA	103	Transmit Data to Modem
3	BB	104	Receive Data from Modem
4	CA	105	Request-to-Send
5	CB	106	Clear-to-Send
6	CC	107	Data Set Ready
7	AB	102	Signal Ground
8	CF	109	Carrier Detect
11	SCA	–	Secondary Channel Request-to-Send (202 modem)
12	SCF	122	Secondary Channel Carrier Detect
17	–	–	Current Loop Receive –
18	–	–	Current Loop Receive +
19	SCA	120	Secondary Channel Request-to-Send (RS232, V24 modem)
20	CD	108.2	Data Terminal Ready
21	–	–	Current Loop Transmit +
23	CH	111	Speed Select
25	–	–	Current Loop Transmit –

the V102 control, such as a printer. The AUX PORT control is detailed in Section 8, and the AUX port pin definitions are detailed in Table 8-1.

7.2.2 Optional Current Loop Interface

The VISUAL 102 Current Loop Interface is designed to operate at 20 ma. in either Full or Half Duplex. (See Section 7.3, which follows.) With the modem or computer supplying the current source. A marking condition (logical 1) is 20 ma. flowing in the circuit, while a spacing condition (logical 0) is no current flowing. Full and Half Duplex configurations are determined by the wiring of the interface. The VISUAL 102 should always remain in Full Duplex when using the Current Loop Interface. Figure 7-2 illustrates the Current Loop connections.

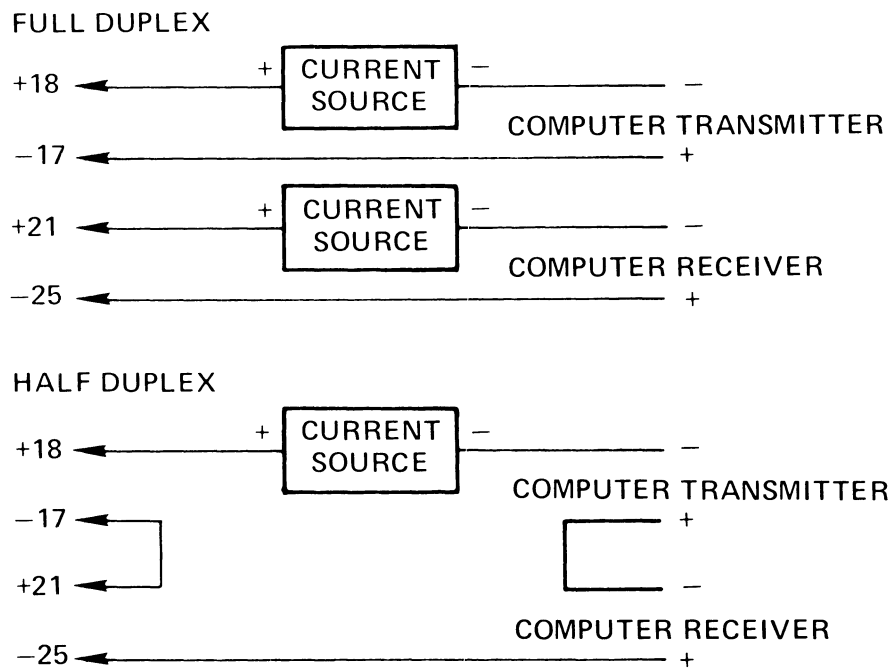

Figure 7-2. Current Loop Connections

NOTE

For Installation instructions on the optional Current Loop Interface, refer to Appendix V.

7.3 COMMUNICATION MODES

The VISUAL 102 supports both Full and Half Duplex communication. Five communication modes are available on the VISUAL 102, three Full Duplex (A,B, and C) and two Half Duplex (A and B).

The communication mode may be selected using the Modem Control commands in MENU Set-Up mode. For a complete description of the procedure to select these options, refer to Section 3.8.3 of this Manual.

7.3.1 Full Duplex

Full Duplex communications mode implies that data can be sent in both directions simultaneously. The VISUAL 102 provides split data rates on both transmit and receive operations when running full duplex.

In Full Duplex mode, data is normally echoed by the host device. The terminal sends a code to the host, the host sends the code back to the terminal, and the terminal then acts on that code. For use in an environment without host echo, the VISUAL 102 provides a means for locally echoing the code.

There are three Full Duplex modes on the VISUAL 102: FDX A, FDX B, and FDX C.

7.3.1.1 FDX A

Full Duplex A (FDX A) lets the terminal communicate with the host regardless of the received modem control signals. The terminal assumes it is connected to the host.

7.3.1.2 FDX B

Full Duplex B (FDX B) allows communication when the terminal receives the correct modem control signals. These signals verify the connection between the terminal and computer before and during communication. The terminal cannot communicate without this connection.

7.3.1.3 FDX C

Full Duplex C (FDX C) is Full-Duplex communication using a Half Duplex modem with a secondary channel. The terminal receives characters on the primary channel at 600 or 1200 baud. It transmits characters on the secondary channel at 75 baud. The terminal internal communication switches are used to configure the terminal to use a secondary channel.

7.3.2 Half Duplex

Half Duplex communication mode implies that data can be sent in both directions, one direction at a time. A problem unique to Half Duplex operation involves who is to be the transmitter and who is to be the receiver, i.e., when should the communication line be turned around. Every time the transmitting device wants to receive, the line direction must be turned around.

The VISUAL 102 uses two types of Half Duplex communication to control line direction, supervisory control or coded control. These are known respectively as HDX A and HDX B.

When operating in Half Duplex, the XON/XOFF protocol is disabled, thus placing the burden of not overflowing the terminal's receive buffer on the host.

7.3.2.1 HDX A

Half Duplex A (HDX A) lets the host control line turnarounds by using the secondary channel control signals. The secondary channel does not transfer data.

7.3.2.2 HDX B

Half Duplex B (HDX B) lets the transmitting device control line turnarounds with a Turnaround Character specified by the Turnaround/Disconnect Character feature selected in Set-Up Mode described in Section 3.8.3 of this Manual.

The Turnaround Character indicates that a line should turn around. The terminal uses ETX and EOT for Turnaround characters. The transmitting device uses modem control lines to perform the line turnarounds. Also available as Turnaround Character options are DC3, FF, or CR, but these characters do not comply with ANSI X3.64-1977.

If the Auto Turnaround SET-UP feature is enabled as described in Section 3.7.3.6, the line automatically turns around when the terminal transmits:

- The Answerback or a Function key message.
 - A cursor position report.
 - A device status report.
- or
- Transmission of a RETURN. If the turnaround character is CR, only one CR character is transmitted.

If the Auto Turnaround SET-UP feature is disabled, then the turnaround character must be selected manually using a CTRL key combination.

7.4 COMMUNICATION DIP SWITCH SETTINGS

To select the communication mode in which the VISUAL 102 will transmit data, a set of ten dip switches is provided at Location U20 on the PC board inside the terminal.

The VISUAL 102 is shipped with default settings to FDX A, the communication mode most commonly used in applications. Those factory-installed default settings are Switches 2, 3, 4, and 9 **ON** and Switches 1, 5, 6, 7, 8, and 10 **OFF**.

To select communication modes other than FDX A, reset the dip switches according to the values in Table 7-2.

7.5 FLOW CONTROL PROTOCOLS

7.5.1 XON/OFF Protocol

The VISUAL 102 can operate at transmission speeds up to 19,200 baud. However, the terminal may not be able to keep up with incoming data. The terminal stores incoming characters in a buffer called the FIFO, and processes them on a first-in/first-out basis. When the FIFO begins to fill up, the terminal transmits an XOFF (DC3) code. On this signal, the host is supposed to suspend its transmission to the VISUAL 102. Eventually, if the host stops transmitting, the V102 processes all of the characters out of the FIFO. When the FIFO is nearly empty, the V102 transmits an XON (DC1) code to signal the host to resume transmission.

**TABLE 7-2
COMMUNICATION DIP SWITCH SETTINGS**

Sw.	EIA Signal	FDX-A V102 DEC*	FDX B V102 DEC	FDX C V102 DEC	HDX A V102 DEC	HDX B V102 DEC
1	14 STxD	off	off	ON 7	off	off
2	2 TxD	ON 6	ON 6	off	ON 6	ON 6
3	4 RTS	ON 1	ON 1	off	ON 1	ON 1
4	5 CTS	ON 2	ON 2	off	ON 2	ON 2
5	13	off	off	ON 3	off	off
6	19 SRTS	off	off	ON 8	ON 8	off
7	11	off	off	off	off	off
8	22 RI	off	off	off	off	off
9	23 SPDS	ON 9	ON 9	ON 9	ON 9	ON 9
10	12 SCD	off	ON 4	off	ON 4	off

*These numbers refer to the corresponding switches on the DEC VT102. only the ON positions are shown.

If the host fails to respond to the XOFF from the V102, the FIFO will continue to fill up. When the capacity of the FIFO is exceeded, a condition called "FIFO overflow" occurs. If the FIFO overflows, the V102 will begin to discard incoming characters, which are lost. The error character (checkerboard pattern) is displayed on a FIFO overflow.

The XON/XOFF synchronization scheme has an advantage over requiring the host to insert delays or filler characters in its data stream. Requiring a minimum of software support, XON/XOFF insures that every character or command sent to the V102 is processed in correct order. It frees interface programs of all timing considerations, and results in more reliable operation.

Besides the FIFO filling condition, there are two other means of transmitting XOFF and XON, namely the NO SCROLL key, and Control S and Control Q. If the Transmitter XON/XOFF feature is enabled, the V102 will coordinate these three sources of XOFF and XON so that the desired effect occurs. For example, if the FIFO filling condition has caused an XOFF to be sent and then the operator types the NO SCROLL key, a second XOFF is not sent. The V102 waits until the operator types the NO SCROLL key again before sending XON.

Entering SET-UP Mode also causes the V102 to temporarily stop processing characters from the FIFO. An XOFF is sent if the FIFO becomes nearly full. Upon exiting SET-UP mode, the FIFO buffer starts processing data once again.

Use of the Control S and Control Q will also be synchronized with the NO SCROLL key.

If the Transmitter XON/XOFF feature is disabled, the FIFO filling condition does not send an XOFF, the NO SCROLL key is disabled, and Control S and Control Q is transmitted as typed.

The V102 also recognizes XOFF and XON. Receipt of XOFF will inhibit the V102 from transmitting any codes if the Receiver XON/XOFF feature is enabled. Up to

24 characters are stored in a keyboard buffer. (Note that some keys generate a multiple code sequence.) If the keyboard buffer overflows, keyclicks stop sounding. Transmissions will resume upon receipt of an XON code.

If the V102 is operating on a full-duplex network with the host echoing back the data and the user transmits an XOFF to the host (by Control S), he should be aware that the host can no longer echo any further type-in until the user types an XON. This places the burden of not overloading the host's output buffer on the user.

Entering and exiting SET-UP mode clears the transmit and keyboard locked modes.

The following is a summary of the various interactions of these occurrences, when the Transmitter XON/OFF feature is enabled.

Sending XOFF — the first occurrence of:

1. FIFO filling condition
2. Pressing the NO SCROLL key.
3. Pressing Control S

Sending XON — if XOFF hasn't been sent, then Control Q will send XON.

— if XOFF has been sent, then the last occurrence of:

1. FIFO empty condition
2. Either depressing NO SCROLL or Control Q

Inhibiting transmit (when Receiver XON/XOFF enabled) — Receiving XOFF.

Locking Keyboard — attempting to send too many keys after inhibiting transmit.

Allowing transmit and/or unlocking keyboard:

1. Exiting SET-UP Mode.
2. Receiving XON.

7.5.2 Data Terminal Ready (DTR)

To enable DTR Busy, please refer to Section 3.8.4.6.

Data Terminal Ready (DTR) works with the FIFO buffer much like XON/XOFF protocol does. At 75% capacity (196 characters) of the FIFO buffer, the terminal drops pin 20 of the RS232C interface from a true +5 volt state to 0 volts. This signifies to the host computer to stop data transmission.

Once the FIFO buffer reaches 25% capacity (64 characters), pin 20 is then raised back up from 0 volts to +5 volts, indicating to the host computer to start data transmission.

With DTR Busy enabled, the NO SCROLL key on the keyboard alternately toggles the DTR strap for operator data flow control.

DTR Busy will only work in FDX A.

8. BUFFERED PRINTER INTERFACE OPTION

8.1 GENERAL

The buffered printer interface allows the VISUAL 102 to be interfaced with a variety of serial printers via a 25-pin male EIA connector. Each pin connector definition is detailed in Table 8-1 below.

The printer port incorporates the following key features:

- 136 Character FIFO buffer.
- Independent Print/Communication Baud Rates.
- Independent Print/Communication Parity.
- 16 Print Baud Rate Selections.
- Printer Busy control using XON/XOFF Protocol or Control Line.
- Printer Controller Mode.
- Auto Print Mode.
- Copy Mode.
- Print Line/Page from Keyboard or Remote

**TABLE 8-1
PRINTER PORT PIN DESIGNATIONS**

Pin Number	Signal Name	Definition
1	AA	Protective Ground
2	BA	Receive Data (From Printer).
3	BB	Transmit Data (To Printer).
4	DTR	Printer Busy
5	CB	Clear to Send (always on).
6	CC	Data Set Ready (always on).
7	AB	Signal Ground
8	CF	Carrier Detect (always on).

Menus 5 and 6 of SET-UP Mode are used to determine Buffered Printer Interface features. Refer to Sections 3.8.5 and 3.8.6 of this manual for a complete description for specific features.

8.2 PRINTER COMMANDS AND MODES

This section describes the commands and modes used to control an attached printer. The commands and modes provided operate in identical fashion in both ANSI and VT-52 modes. However, the control sequences used for printer commands and modes vary depending on whether VT-52 or ANSI mode is selected. In all cases, space suppression is performed on a line basis. That is, all trailing spaces on each printed line are not transmitted to the printer. Embedded spaces on a line are always transmitted.

NOTE

Space suppression is not applicable in Printer Controller or Copy Mode.

8.2.1 Printer Command Sequences — ANSI Mode

8.2.1.1 Print Page ESC[i or ESC[0i

When this command is initiated, the terminal uses the XON/XOFF synchronization codes. XOFF is sent to the host to suspend transmission upon initiation of the command. The contents of the screen are transmitted to the printer at the selected print rate, and each line is ended with the CR/LF codes. If LF suppression is enabled, only CR is sent to the printer. XON is sent to the host to resume transmission once the Print Page function is complete.

8.2.1.2 Print Cursor Line ESC[? 1 i

XOFF is sent to the host to suspend transmission upon initiation of the command. The contents of the cursor line are transmitted to the printer at the selected print rate, and the line is ended with the CR/LF codes. If LF suppression is enabled, only CR is sent to the printer. XON is sent to the host to resume transmission once the Print Line function is complete.

8.2.1.3 Print Line "P" ESC[? 1 ; Pi [VISUAL]

XOFF is sent to the host to suspend transmission upon initiation of the command. The contents of line "P" are transmitted to the printer at the selected print rate, and the line is ended with the CR/LF codes. Line "P" is in decimal notation between the limits of 1 and 24. If LF suppression is enabled, only CR is sent to the printer. XON is sent to the host to resume transmission once the Print Line function is complete.

8.2.1.4 Print Lines "P" through "Q" ESC[? 1 ; P ; Qi [VISUAL]

XOFF is sent to the host to suspend transmission upon initiation of the command. The contents of lines "P" through "Q" are transmitted to the printer at the selected print rate, and the line is ended with the CR/LF codes. Lines "P" and "Q" are in decimal notation between the limits of 1 and 24. If not selected, "P" will default to the cursor line and "Q" will default to the selected print extent (see 8.2.2.2). If LF suppression is enabled, only CR is sent to the printer. XON is sent to the host to resume transmission once the Print Line function is complete.

8.2.1.5 Enter Copy Mode ESC[? 7 i [VISUAL]

Received data is sent to the screen and sent to the printer simultaneously. XOFF is sent to the host in response to Printer Busy. XON is sent to the host in response to Printer Not Busy.

8.2.1.6 Exit Copy Mode ESC[? 6 i [VISUAL]

The terminal exits Copy Mode and automatically appends the CAN or DEL code as the CANCEL SELECT feature dictates. If the BUFFERED PRINT feature is on, no code is appended.

8.2.1.7 Enter Printer Controller Mode ESC[5 i

Data sent from the host is passed through the terminal to the printer without affecting the terminal screen. In effect, the terminal acts as a controller for the printer by using the XON/XOFF synchronization codes to limit the transmitted data to a rate that the printer can accept. XOFF is sent to the host in response to Printer Busy. XON is sent to the host in response to Printer Not Busy.

8.2.1.8 Exit Printer Controller Mode ESC[? 4 i

The terminal exits Printer Controller Mode and automatically appends the CAN or DEL code as the CANCEL SELECT feature dictates. If the BUFFERED PRINT feature is on, no code is appended.

NOTE

Exiting Printer Controller Mode also exits Copy Mode.

8.2.1.9 Enter Auto Print Mode ESC[? 5 i

The contents of the line containing the cursor are transmitted to the printer when the cursor is moved off that line. This can be accomplished in the following ways:

- a. Auto Line Wrap. The line is transmitted, followed by a CR and LF.
- b. Line Feed. The line is transmitted, followed by a CR and LF.
- c. Vertical Tab. The line is transmitted, followed by a CR and VT.
- d. Form Feed. The line is transmitted, followed by a CR and FF.

8.2.1.10 Exit Auto Print Mode ESC[? 4 i

The terminal exits the Auto Print Mode.

8.2.1.11 Printer Status Reports ESC[? 15 n

This command allows the host to initiate a test of the printer status. When the VISUAL 102 receives this command, it checks the status of the printer's DTR line and responds as detailed in Table 8-2 on the following page.

8.2.2 Set and Reset Printer Modes

The flexible nature of the VISUAL 102 allows the remote or local selection of the terminal's parameters. The parameters that are selectable are saved through non-volatile memory.

**TABLE 8-2
PRINTER STATUS RESPONSES**

Response	Meaning
ESC [? 13 n	Printer is not connected. This is detected by verifying that the DTR of the printer has not been on since the terminal was turned on.
ESC [? 11 n	Printer is connected but not ready to print. This is detected by verifying that the printer DTR has been on at some time since the terminal was turned on but is not on at present.
ESC [? 10 n	Printer is connected and ready to print.

The Control Sequence for SET Mode is:

ESC[Ps ; Ps ; ... Ps h

where Ps can be up to 16 different modes, as detailed in Section 5.4.3.

The Control Sequence for RESET mode is:

ESC[Ps ; Ps ; ... Ps l

The VISUAL 102 also allows the remote or local selection of the terminal's printer parameters, which are briefly described in the following sections. These modes include the question mark character (?) as part of the selective parameter because they are private modes that have been added to enhance the operational capabilities of the VISUAL 102 and are not actually specified in the ANSI X3.64 standard.

8.2.2.1 Printer Termination Character Ps = ? 18 (private)

When Set, this mode selects Form Feed (FF) as the print termination character. The VISUAL 102 transmits this character to the printer after each print screen.

When Reset, no print termination character is selected.

8.2.2.2 Print Extent Ps = ? 19 (private)

When Set, the terminal prints the full screen after receiving a Print Screen command.

When Reset, the terminal only prints the scrolling region after receiving a Print Screen command. If no scrolling region is selected, the VISUAL 102 prints the full screen.

8.3 PRINTER COMMAND SEQUENCES — DEC VT-52 MODE

8.3.1 Print Page ESC]

When this command is initiated, the terminal uses the XON/XOFF synchronization codes. XOFF is sent to the host to suspend transmission upon initiation of the command. The contents of the screen are transmitted to the printer at the selected print rate, and each line is ended with the CR/LF codes. If LF suppress is enabled, only CR is sent to the printer. XON is sent to the host to resume transmission once the Print Page function is complete.

8.3.2 Print Line ESC V

XOFF is sent to the host to suspend transmission upon initiation of the command. The contents of the cursor line are transmitted to the printer at the selected print rate, and the line is ended with the CR/LF codes. If LF suppress is enabled, only CR is sent to the printer. XON is sent to the host to resume transmission once the Print Line function is complete.

8.3.3 Enter Printer Controller Mode ESC W

Data sent from the host is passed through the terminal to the printer without affecting the terminal screen. In effect, the terminal acts as a controller for the printer by using the XON/XOFF synchronization codes to limit the transmitted data to a rate that the printer can accept. XOFF is sent to the host in response to Printer Busy. XON is sent to the host in response to Printer Not Busy.

8.3.4 Exit Printer Controller Mode ESC X

The terminal exits Printer Controller Mode and automatically appends the CAN or DEL code as the CANCEL SELECT feature dictates. If the PRINTER TYPE feature is on, no code is appended.

8.3.5 Enter Auto Print Mode ESC ^

On receipt of LF code, XOFF is sent to the host. The contents of the line containing the cursor are transmitted to the printer. Each line transmitted to the printer is ended with CR/LF or just CR as the LF suppress feature dictates. XON is sent to the host after the line is transmitted.

8.3.6 Exit Auto Print Mode ESC _

The terminal exits the Auto Print Mode.

For a condensed list of the Printer Commands, refer to Appendix 2.

9. FIRST LEVEL MAINTENANCE

9.1 GENERAL

The Visual 102 terminal has been designed with subassembly exchange as the prime mode of service. Fault isolation is provided in this section to identify the failing subassembly. Unless otherwise noted, the power cord should be disconnected before disassembly of the terminal. Hazardous voltages may be present.

9.2 TOP COVER

Removal of the top cover will allow the removal of the logic printed circuit board, power supply, graphics option board, and TV monitor printed circuit board, and access to the AC terminal block, allowing rewiring from 110 volts AC to 220 volts AC.

9.2.1 Top Cover Removal

Consult Figure 9-1 to locate the three screws which attach the top cover to the base at the rear of the cabinet. Loosen these screws and simply rotate top cover off by lifting at the rear of the unit.

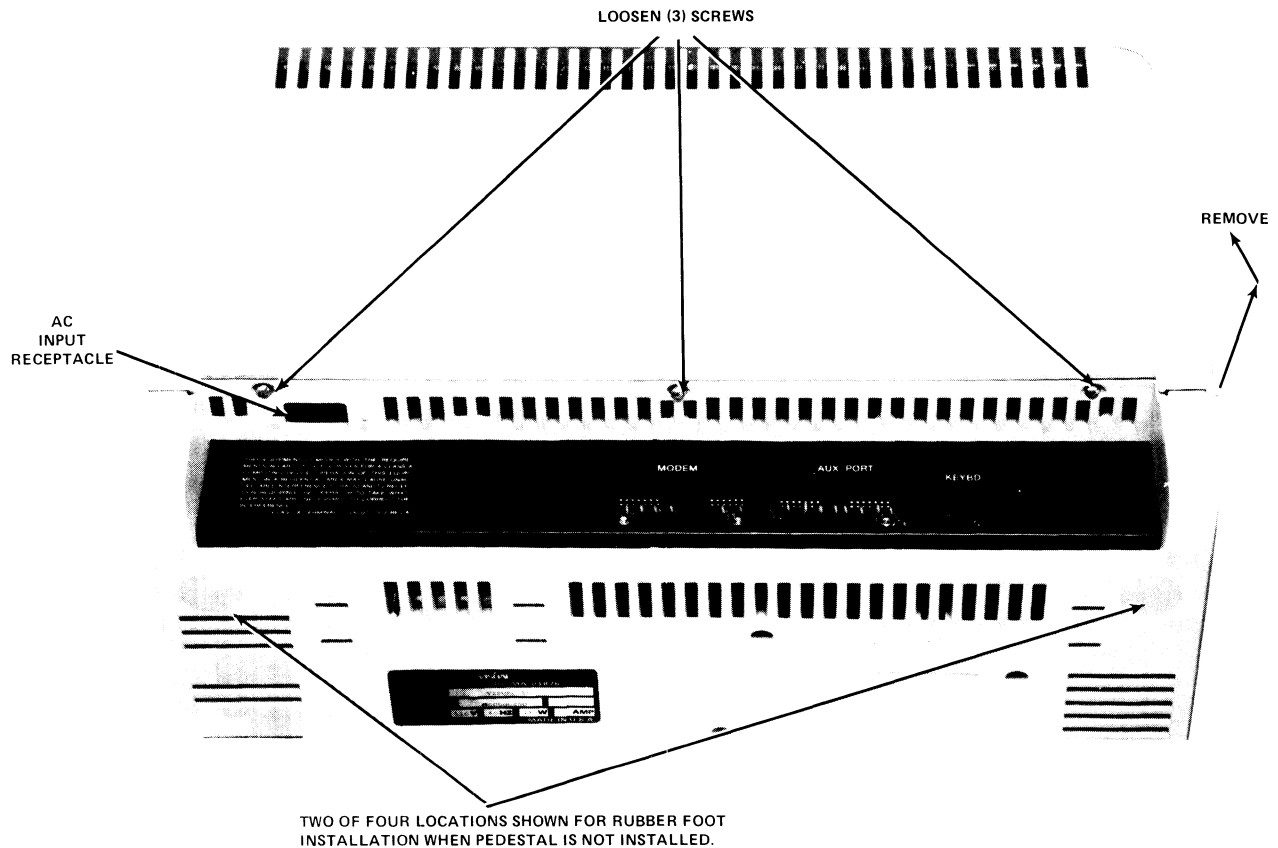

Figure 9-1. Top Cover Removal

9.3 PRINTED CIRCUIT BOARD REMOVAL AND INSTALLATION

9.3.1 Main PCB

Once the top cover has been removed, the main PCB may be removed by removing two screws shown in Figure 9-2, unplugging any modem cables, keyboard cable, power supply cable and monitor cable, and by rotating the top of the PCB toward the rear while lifting it out the housing.

9.3.2 Power Supply PCB

Once the top cover has been removed, the power supply PCB may be removed by removing the two screws shown in Figure 9-3 unplugging the cables from the main PCB, the on off switch, the frame ground strap and lifting the power supply straight up.

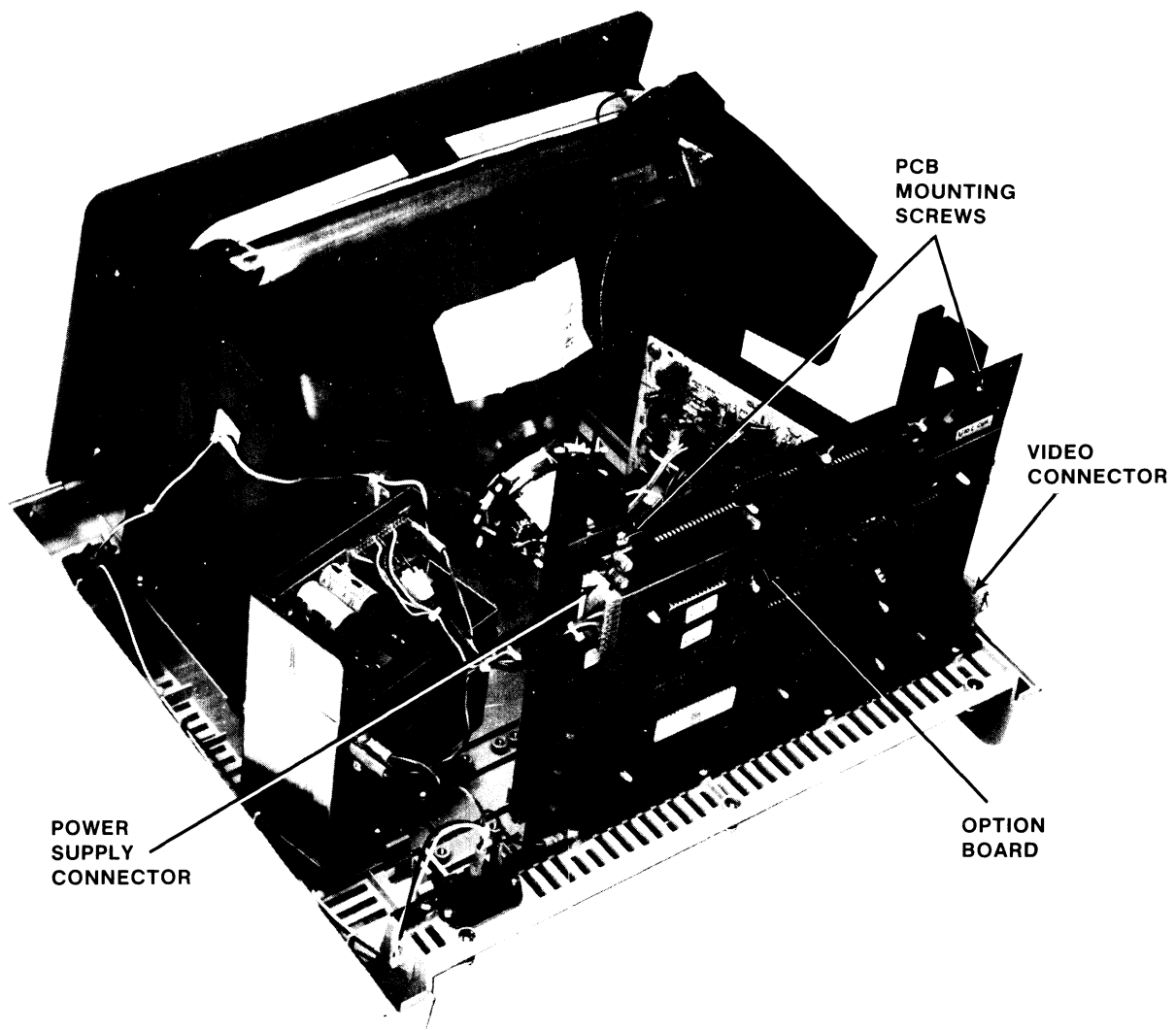

Figure 9-2. PCB Mounting

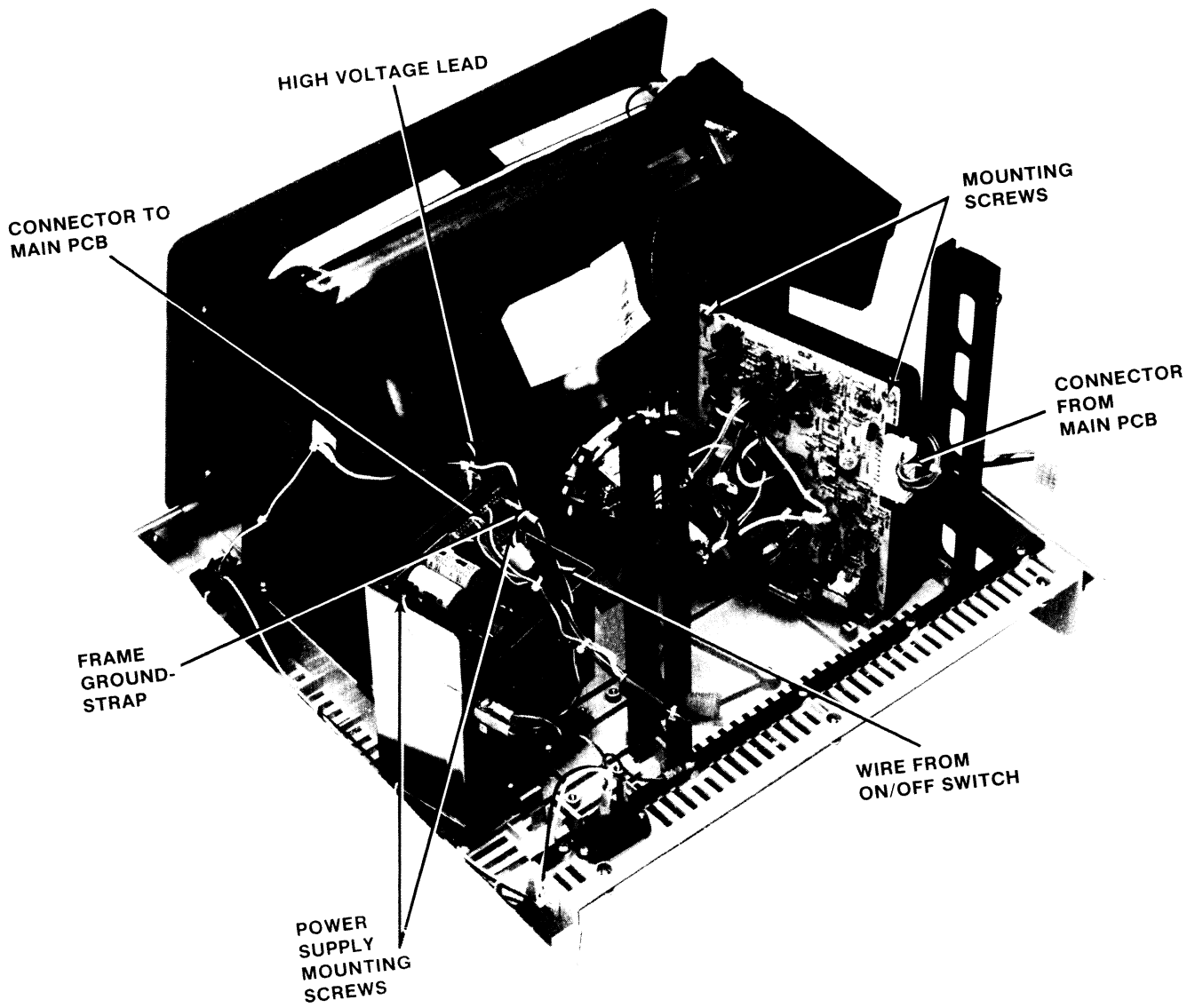

Figure 9-3. PS/TV PCB Mounting

9.4 TV MONITOR PCB REMOVAL

In order to remove the TV monitor PCB, first remove the top cover. Next, disconnect the cable connecting the logic PCB and the TV PCB at the TV end. Disconnect the yellow and black and the blue and red connectors connecting the TV PCB to the yoke at the TV PCB. Unplug the connector assembly from the end of the picture tube. Also, disconnect the black ground wire from the ground clip at the top of the picture tube.

CAUTION

Before removing the high voltage lead from the tube, the voltage present must be discharged carefully. Utilize extreme caution in the following procedure.

Carefully lift the top edge of the high voltage connector and insert the end of an insulated handled screwdriver. Cause the screwdriver shaft to touch the metal bracket and the contact of the high voltage connector simultaneously. The high voltage connector has now been shorted out, and can be removed by rocking it while pulling it up.

Now the TV PCB may be removed by removing the two mounting screws (Figure 9-3) and lifting the TV PCB up.

9.5 CRT REMOVAL AND INSTALLATION

Disconnect the yoke, ground wire, and the tube socket assembly as described in Section 9.4. While holding the lower edge of the picture tube in one hand, remove the four mounting screws, and then remove the picture tube. The picture tube neck should not be subject to any pressure or shock. Store the picture tube on its face.

When installing the picture tube, install the two lower screws first. Insert the ground finger between the mounting bracket and the top of the picture tube mounting tab. Install the two top screws and connect the cables. Be sure that the black ground wire is installed!

9.6 TV MONITOR ADJUSTMENTS

Refer to Figure 9-4 for the location of the adjustments.

Adjust intensity to highest level.

Set terminal to reverse video.

Brightness Control: Adjust it so that the raster lines are visible.

Horizontal Phasing Control: Adjust the phasing control so that the video area is centered horizontally within the raster area.

Brightness Control: Reduce the brightness until raster lines just disappears.

Reduce the screen intensity to a comfortable level.

Focus: adjust the focus control for the best focus over the entire screen.

Set terminal to local mode.

Fill the screen with E's.

Vertical Size: Adjust so that the total height is $6.00 + 0.25$ inches ($152.4 + 6.4$ mm).

Horizontal Size: Adjust so that total width of the screen of data is $8.25 + 0.25$ inches ($209.5 + 6.4$ mm).

9.7 110/220 VOLT SELECTION

Remove the top cover. Make sure that the power cord is disconnected. Refer to Section 9.3.2 for power supply removal. On the the power supply is a white jumper for 110V or 220V selection.

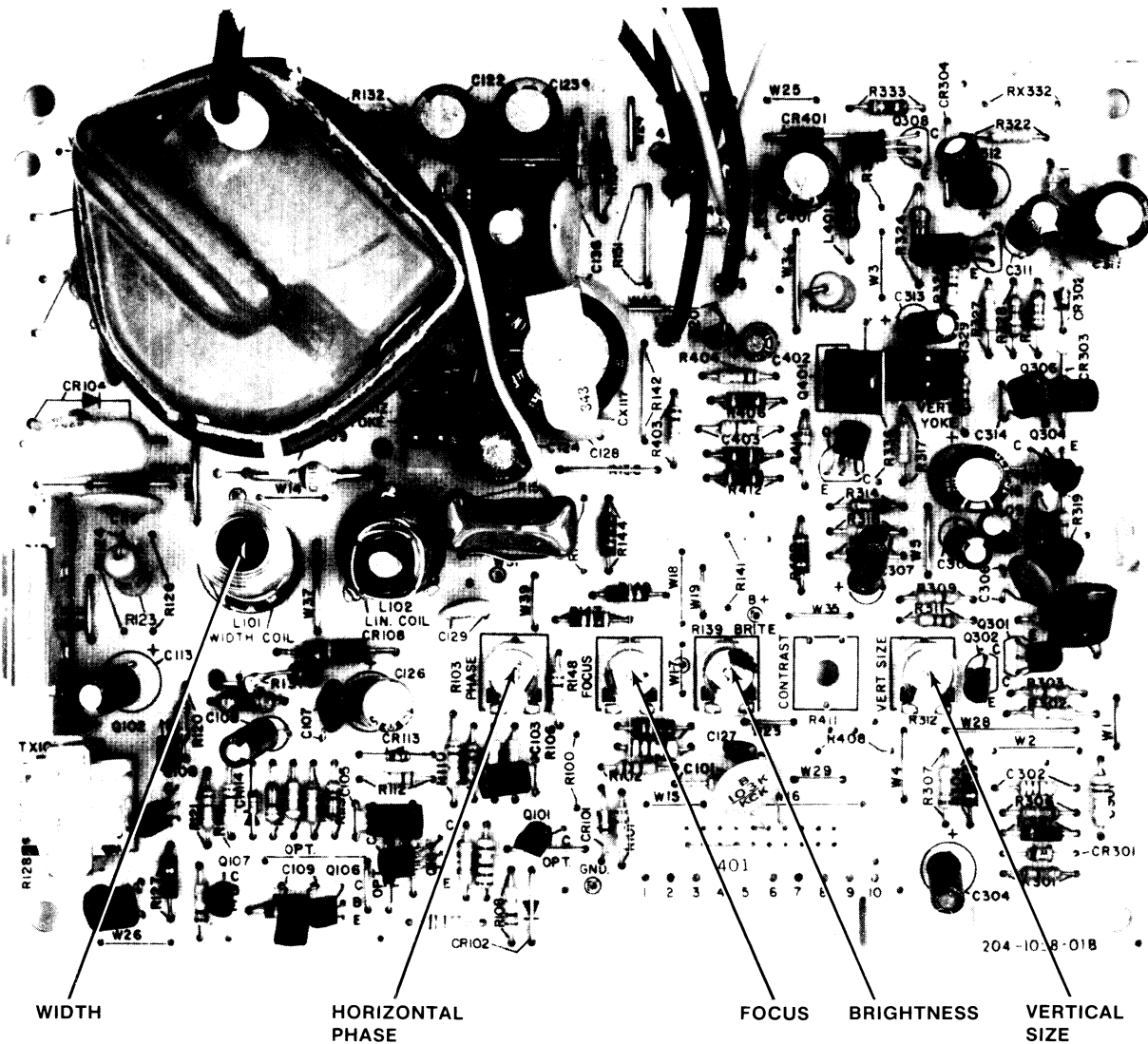

9.8 TROUBLESHOOTING THE V102

Operation	Fault	Probable Cause	Remedy
Turn ON	No bell, but there is a cursor and status line	Keyboard not plugged in	Plug keyboard in
Turn ON	No cursor and bell	Unit not plugged into AC outlet or Circuit breaker tripped or Power supply defective	Plug in Reset circuit breaker Replace power supply
Turn ON	Unit does not pass self test	Main logic PCB	Replace main PCB
Self test	Bell sounds several times	New firmware installed. Non-volatile RAM failure set up.	Default RAM by depressing shift D. Replace the main PCB
No height	Horizontal line on TV	Yoke disconnected	Plug in yellow-black connector
No width	Vertical line	Yoke disconnected	Plug in blue-red connector
Video jittering	Wrong frequency	50/60 Hz parameter	Set up mode. Select the correct parameter
Keyboard	No entry	Terminal on line Defective keyboard Defective main PCB	Switch to local Replace keyboard Replace main PCB
No data	Line or local	Keyboard disconnected Defective keyboard Defective main PCB	Plug in Replace Replace
On line	Parity errors	Wrong data rate Wrong parity Wrong bits/character Defective PCB	Select communication menu Replace
On line or local	Wrong character	Defective keyboard or main PCB	Replace
On line	EIA or Current loop	Internal switches	See table
On line or local	Snapping sound	CRT ground wire not connected	Connect

9.9 SELF TEST

The Visual 102 executes a self test each time it is powered on. A checksum is calculated and checked against the checksum stored in the last two locations of the firmware PROMs. A RAM test is executed and the non-volatile RAM is checked. If all is correct, the screen is initialized and a cursor is displayed. If either the firmware checksum or the RAM test fails, the screen is not initialized. If the non-volatile RAM fails, the bell is sounded twice, the screen is initialized, and the default parameters are selected. In this situation, operation is allowed; however, it will be necessary to set any parameters which differ from the default parameters.

9.10 V102 RAM FAILURE MESSAGE CODE

If extended diagnostics are enabled, the graphic video memory RAMs are checked and a test pattern is displayed on the screen. This test takes 45 seconds to complete. If there is a RAM failure, then the RAM failure is displayed in the following message:

AAAA B P

where

AAAA — is the address of the failed RAM expressed in HEX in the range of 0000 thru 3FFF.

B — is the HEX value of the bit that failed (0 thru F).

P — is the number of the pass on which the test failed.

1 — Pass1 data is the address.

2 — Pass2 data is the compliment of the address.

The addressing scheme of the bit map memory is linear. Therefore, the address failure corresponds to faulty chip location per the following table:

RAM TEST CHIP LOCATION

Chip Location	
Bit Failure	Address 0000-3FFF
0 thru 3	U11
4 thru 7	U12
8 thru B	U13
C thru F	U14

APPENDIX I

VISUAL 102 ANSI MODE ESCAPE SEQUENCES

	Sequence	Reference Section
Cursor Movement Commands		
Cursor Up	ESC[Pn A	5.3.3.3
Cursor Down	ESC[Pn B	5.3.3.3
Cursor Right	ESC[Pn C	5.3.3.3
Cursor Left	ESC[Pn D	5.3.3.3
Absolute Cursor Addressing	ESC [y;x f or ESC [y;x H	5.3.3.3
Index	ESC D	5.3.3.3
Reverse Index	ESC M	5.3.3.3
Next Line	ESC E	5.3.3.3
Save Cursor	ESC 7	5.3.3.3
Restore Cursor	ESC 8	5.3.3.3
Scrolling Region Command	ESC[x;y r	5.3.3.1
Erase Commands		
From Cursor to End of Line	ESC[K	5.3.3.4
From Beginning of Line to Cursor	ESC[1K	5.3.3.4
Entire Line	ESC[2K	5.3.3.4
From Cursor to End of Screen	ESC[J	5.3.3.4
From Beginning of Screen to Cursor	ESC[1J	5.3.3.4
Entire Screen	ESC[2J	5.3.3.4
Character Size Commands		
Single Height-Single Width Line	ESC #5	5.3.3.13
Single Height-Double Width Line	ESC #6	5.3.3.13
Double Height-Double Width Line (Top Half)	ESC #3	5.3.3.13
Double Height-Double Width Line (Bottom Half)	ESC #4	5.3.3.13

NOTE: Spaces are for clarity only, and are not included in Escape Sequences.

	Sequence	Reference Section
Video Attribute Commands		
Video Attributes OFF	ESC[m	5.3.3.11
Bold ON	ESC[1m	5.3.3.11
Blank ON	ESC[2m	5.3.3.11
Underline ON	ESC[4m	5.3.3.11
Blink ON	ESC[5m	5.3.3.11
Reverse Video ON	ESC[7m	5.3.3.11
Programmable LED Commands		
Set LED (L1 on)	ESC[1q	5.3.3.12
Reset LED (L1 off)	ESC[q or ESC[0q	5.3.3.12
Tab Commands		
Set Tab	ESC H	5.3.3.5
Clear Tab	ESC[g	5.3.3.5
Clear All Tabs	ESC[3	5.3.3.5
Character Set Commands		
G0 Set is U.K.	ESC (A	5.3.3.8
G1 Set is U.K.	ESC)A	5.3.3.8
G0 Set is U.S.	ESC (B	5.3.3.8
G1 Set is U.S.	ESC)B	5.3.3.8
G0 Set is Graphics	ESC (0	5.3.3.8
G1 Set is Graphics	ESC)0	5.3.3.8
G0 Set is Alternate ROM character set	ESC (1	5.3.3.8
G1 Set is Alternate ROM character set	ESC)1	5.3.3.8
G0 Set is Alternate ROM special characters set	ESC (2	5.3.3.8
G1 Set is Alternate ROM special characters set	ESC)2	5.3.3.8
Single Shift 2	ESC N	
Single Shift 3	ESC O	
Editing Commands		
Insert Line(s)	ESC[Pn L	5.3.3.16
Delete Line(s)	ESC[Pn M	5.3.3.15
Delete Character(s)	ESC[Pn P	5.3.3.16

Test Commands

Align Display	ESC #8	5.3.3.6
Invoke Self Test	ESC [2; Ps y	5.3.3.10
Use Combined Total of Ps Values to Determine Test(s)	Ps = 1 = ROM/RAM Checksum Ps = 2 = Interface* Ps = 4 = EIA* Ps = 8 = Repeat Tests Ps = 16 = Printer Loopback	
	*Turnaround Connector Required.	

Program Function Key Command

ESC[Pk; D ₁ ; ... D ₂₄ P	5.3.3.7
or ESC[Pk; D ₁ ; ... D ₂₄ ;	
128; P _ℓ	

Status Commands and Responses

What are you?	ESC[c	5.3.3.9
	or ESC Z	5.3.3.9
Response is:		
VT102	ESC[?6c	5.3.3.9
VT100 w/Printer	ESC[1; 11c	5.3.3.9
Is Terminal O.K.?	ESC[5n	5.3.3.9
Response is:		
Terminal is O.K.	ESC[0n	5.3.3.9
or Terminal is not O.K.	ESC[3n	5.3.3.9
What is Cursor Position?	ESC[6n	5.3.3.9
Response is:	ESC[y;x R	5.3.3.9
What are Terminal Parameters?	ESC[1x	5.3.3.9
	or ESC[0x	5.3.3.9
Response is:	ESC[s;p;n;x;r;	5.3.3.9
	c;f;m;pp;pn;px;prx	

Modes

Set Keyboard Action Mode	ESC[2h	5.4.3.1
Reset Keyboard Action Mode	ESC[2ℓ	5.4.3.1
Set Control Representation Mode	ESC[3h	5.4.3.2
Reset Control Representation Mode	ESC[3ℓ	5.4.3.2
Set Insert Replace Mode	ESC[4h	5.4.3.3
Reset Insert Replace Mode	ESC[4ℓ	5.4.3.3
Set Local Echo Mode	ESC[12h	5.4.3.4
Reset Local Echo Mode	ESC[12ℓ	5.4.3.4

NOTE: Spaces are for clarity only, and are not included in Escape Sequences.

	Sequence	Reference Section
Modes (Cont.)		
Set Auto New Line Mode	ESC[20h	5.4.3.5
Reset Auto New Line Mode	ESC[20℄	5.4.3.5
Set Cursor Key Mode	ESC[?1h	5.4.3.6
Reset Cursor Key Mode	ESC[?1℄	5.4.3.6
Set 132 Column Mode	ESC[?3h	5.4.3.7
Set 80 Column Mode	ESC[?3℄	5.4.3.7
Set Smooth Scroll Mode	ESC[?4h	5.4.3.8
Reset Jump Scroll Mode	ESC[?4℄	5.4.3.8
Set Reverse Video	ESC[?5h	5.4.3.8
Reset Normal Video	ESC[?5℄	5.4.3.9
Set Origin Mode	ESC[?6h	5.4.3.10
Reset Origin Mode	ESC[?6℄	5.4.3.10
Set Auto Line Wrap Mode	ESC[?7h	5.4.3.11
Reset Auto Line Wrap Mode	ESC[?7℄	5.4.3.11
Set Auto Repeat Mode	ESC[?8h	5.4.3.12
Reset Auto Repeat Mode	ESC[?8℄	5.4.3.12
Enter VT-52	ESC[?2℄	5.4.3.13
Reset Terminal	ESC c	5.3.3.14
Enter Alternate Keypad Mode	ESC =	5.3.3.15
Exit Alternate Keypad Mode	ESC >	5.3.3.15
Printer Commands and Modes		
Print Page	ESC[i	8.2.1.1
Print Cursor Line	ESC[?1i	8.2.1.2
Print Line "P"*	ESC[?1; Pi	8.2.1.3
Print Lines "P" through "Q"*	ESC[?1; P; Qi	8.2.1.4
Enter Copy Mode	ESC[?7i	8.2.1.5
Exit Copy Mode	ESC[?6i	8.2.1.6
Enter Printer Controller Mode	ESC[5i	8.2.1.7
Exit Printer Controller Mode	ESC[4i	8.2.1.8
Enter Auto Print Mode	ESC[?5i	8.2.1.9
Exit Auto Print Mode	ESC[?4i	8.2.1.10
Printer Status Reports	ESC[?15n	8.2.1.11
Set Printer Form Feed	ESC[?18h	8.2.2.1
Reset Printer Form Feed	ESC[?18℄	8.2.2.1
Set Printer Extent	ESC[?19h	8.2.2.2
Reset Printer Extent	ESC[?19℄	8.2.2.2

*P and Q are in decimal notation within the limits on 1 to 24.

APPENDIX II

VISUAL 102 VT-52 MODE ESCAPE SEQUENCES

	Sequence	Reference Section
Modes		
Cursor Movement Commands		
Cursor Up	ESC A	5.5.1.1
Cursor Down	ESC B	5.5.1.2
Cursor Right	ESC C	5.5.1.3
Cursor Left	ESC D	5.5.1.4
Graphics Mode		
Enter Line Drawing Graphics	ESC F	5.5.2.1
Exit Line Drawing Graphics	ESC G	5.5.2.2
Cursor Home Command	ESC H	5.5.3
Reverse Line Feed Command	ESC I	5.5.4
Erase Commands		
From Cursor to End of Screen	ESC J	5.5.5.1
From Cursor to End of Line	ESC K	5.5.5.2
Absolute Cursor Addressing	ESC Y xy	5.5.6
Identify	ESC Z	5.5.7
Response is:		
VT52 with Printer Option	ESC/M	5.5.7
Alternate Keypad Mode		
Enter Alternate Keypad Mode	ESC =	5.5.8.1
Exit Alternate Keypad Mode	ESC >	5.5.8.2

NOTE: Spaces are for clarity only, and are not included in Escape Sequences.

	Sequence	Reference Section
Printer Commands and Modes		
Print Page	ESC]	8.3.1
Print Cursor Line	ESC V	8.3.2
Enter Printer Controller Mode	ESC W	8.3.3
Exit Printer Controller Mode	ESC X	8.3.4
Enter Auto Print Mode	ESC `	8.3.5
Exit Auto Print Mode	ESC _	8.3.6
Enter ANSI Mode	ESC <	5.5.9

NOTE: Spaces are for clarity only, and are not included in Escape Sequences.

APPENDIX III GRAPHIC RENDITION OF CONTROL CODES

Control Code	Graphic Rendition
NUL	<u>@</u>
SOH	<u>A</u>
STX	<u>B</u>
ETX	<u>C</u>
EOT	<u>D</u>
ENQ	<u>E</u>
ACK	<u>F</u>
BEL	<u>G</u>
BS	<u>H</u>
HT	<u>I</u>
LF	<u>J</u>
VT	<u>K</u>
FF	<u>L</u>
CR	<u>M</u>
SO	<u>N</u>
SI	<u>O</u>
DLE	<u>P</u>
*DC1 (XON)	<u>Q</u>
DC2	<u>R</u>
*DC3 (XOFF)	<u>S</u>
DC4	<u>T</u>
NAK	<u>U</u>
SYN	<u>V</u>
ETB	<u>W</u>
CAN	<u>X</u>
EM	<u>Y</u>
SUB	<u>Z</u>
ESC	<u>[</u>
FS	<u>\</u>
GS	<u>]</u>
RF	<u>^</u>
US	<u>-</u>

*The XON (DC1) and XOFF (DC3) characters will not be displayed unless the Receiver XON/XOFF SET-UP feature has been disabled.

APPENDIX IV NUMERIC EQUIVALENT OF ASCII CHART

ASCII	Decimal	Octal	Hexa-Decimal	ASCII	Decimal	Octal	Hexa-Decimal
NUL	0	0	0	SP	32	40	20
SOH	1	1	1	!	33	41	21
STX	2	2	2	"	34	42	22
ETX	3	3	3	#	35	43	23
EOT	4	4	4	\$	36	44	24
ENQ	5	5	5	%	37	45	25
ACK	6	6	6	&	38	46	26
BEL	7	7	7	'	39	47	27
BS	8	10	8	(40	50	28
HT	9	11	9)	41	51	29
LF	10	12	A	*	42	52	2A
VT	11	13	B	+	43	53	2B
FF	12	14	C	,	44	54	2C
CR	13	15	D	-	45	55	2D
SO	14	16	E	.	46	56	2E
SI	15	17	F	/	47	57	2F
DLE	16	20	10	0	48	60	30
DC1	17	21	11	1	49	61	31
DC2	18	22	12	2	50	62	32
DC3	19	23	13	3	51	63	33
DC4	20	24	14	4	52	64	34
NAK	21	25	15	5	53	65	35
SYN	22	26	16	6	54	66	36
ETB	23	27	17	7	55	67	37
CAN	24	30	18	8	56	70	38
EM	25	31	19	9	57	71	39
SUB	26	32	1A	:	58	72	3A
ESC	27	33	1B	;	59	73	3B
FS	28	34	1C	<	60	74	3C
GS	29	35	1D	=	61	75	3D
RS	30	36	1E	>	62	76	3E
US	31	37	1F	?	63	77	3F

NUMERIC EQUIVALENT OF ASCII CHART (Cont.)

ASCII	Decimal	Octal	Hexa-Decimal	ASCII	Decimal	Octal	Hexa-Decimal
@	64	100	40	\	96	140	60
A	65	101	41	a	97	141	61
B	66	102	42	b	98	142	62
C	67	103	43	c	99	143	63
D	68	104	44	d	100	144	64
E	69	105	45	e	101	145	65
F	70	106	46	f	102	146	66
G	71	107	47	g	103	147	67
H	72	110	48	h	104	150	68
I	73	111	49	i	105	151	69
J	74	112	4A	j	106	152	6A
K	75	113	4B	k	107	153	6B
L	76	114	4C	l	108	154	6C
M	77	115	4D	m	109	155	6D
N	78	116	4E	n	110	156	6E
O	79	117	4F	o	111	157	6F
P	80	120	50	p	112	160	70
Q	81	121	51	q	113	161	71
R	82	122	52	r	114	162	72
S	83	123	53	s	115	163	73
T	84	124	54	t	116	164	74
U	85	125	55	u	117	165	75
V	86	126	56	v	118	166	76
W	87	127	57	w	119	167	77
X	88	130	58	x	120	170	78
Y	89	131	59	y	121	171	79
Z	90	132	5A	z	122	172	7A
[91	133	5B	{	123	173	7B
\	92	134	5C	/	124	174	7C
[93	135	5D	}	125	175	7D
^	94	136	5E	~	126	176	7E
-	95	137	5F	DEL	127	177	7F

APPENDIX V LOOP BACK CONNECTOR FOR INTERFACE TESTS

Turn-around Connector for Current Loop tests.

Switches 2,3,6 ON 4,5 OFF

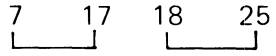

Turn-around Connector for EIA tests.

Switches 1,2,3,4,5,6,7 OFF 8 ON

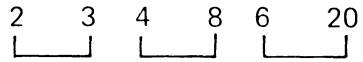

APPENDIX VI U.S./U.K. CODE CHART

				BIT 7	0	0	0	0	1	1	1	1
				BIT 6	0	0	1	1	0	0	1	1
				BIT 5	0	1	0	1	0	1	0	1
BIT	BIT	BIT	BIT	COL	0	1	2	3	4	5	6	7
4	3	2	1	ROW								
0	0	0	0	0	NUL	DLE	SP	0	@	P	`	p
0	0	0	1	1	SOH	DC1	!	1	A	Q	a	q
0	0	1	0	2	STX	DC2	"	2	B	R	b	r
0	0	1	1	3	ETX	DC3	#	3	C	S	c	s
0	1	0	0	4	EOT	DC4	\$	4	D	T	d	t
0	1	0	1	5	ENQ	NAK	%	5	E	U	e	u
0	1	1	0	6	ACK	SYN	&	6	F	V	f	v
0	1	1	1	7	BEL	ETB	'	7	G	W	g	w
1	0	0	0	8	BS	CAN	(8	H	X	h	x
1	0	0	1	9	HT	EM)	9	I	Y	i	y
1	0	1	0	A	LF	SUB	*	:	J	Z	j	z
1	0	1	1	B	VT	ESC	+	;	K	[k	{
1	1	0	0	C	FF	FS	,	<	L	\	l	
1	1	0	1	D	CR	GS	-	=	M]	m	}
1	1	1	0	E	SO	RS	.	>	N	^	n	~
1	1	1	1	F	SI	US	/	?	O	_	o	DEL

U.K. version uses £ in Column 2 Row 3 in place of #

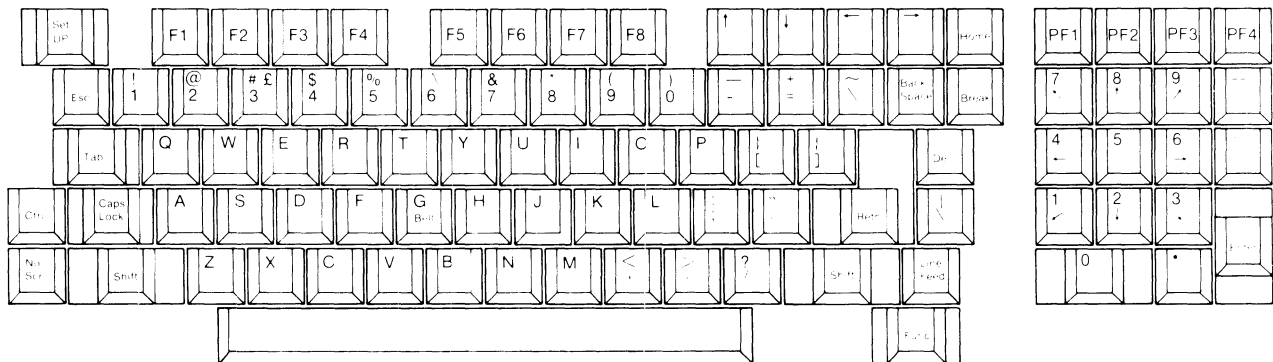

APPENDIX VI SPANISH CODE CHART

					BIT 7	0	0	0	0	1	1	1	1
					BIT 6	0	0	1	1	0	0	1	1
					BIT 5	0	1	0	1	0	1	0	1
BIT	BIT	BIT	BIT	COL	ROW	0	1	2	3	4	5	6	7
4	3	2	1										
0	0	0	0	0	NUL	DLE	SP	0	@	P	`	p	
0	0	0	1	1	SOH	DC1	!	1	A	Q	a	q	
0	0	1	0	2	STX	DC2	"	2	B	R	b	r	
0	0	1	1	3	ETX	DC3	#	3	C	S	c	s	
0	1	0	0	4	EOT	DC4	\$	4	D	T	d	t	
0	1	0	1	5	ENQ	NAK	%	5	E	U	e	u	
0	1	1	0	6	ACK	SYN	&	6	F	V	f	v	
0	1	1	1	7	BEL	ETB	'	7	G	W	g	w	
1	0	0	0	8	BS	CAN	(8	H	X	h	x	
1	0	0	1	9	HT	EM)	9	I	Y	i	y	
1	0	1	0	A	LF	SUB	*	:	J	Z	j	z	
1	0	1	1	B	VT	ESC	+	:	K	ı	k	o	
1	1	0	0	C	FF	FS	,	<	L	Ñ	l	ñ	
1	1	0	1	D	CR	GS	-	=	M	ı	m	f	
1	1	1	0	E	SO	RS	.	>	N	^	n	/	
1	1	1	1	F	SI	US	/	?	O	—	o	DEL	

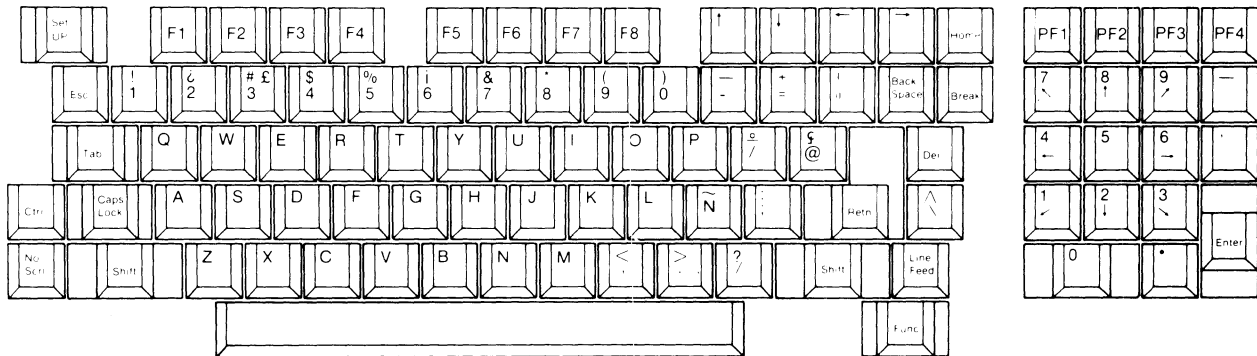

APPENDIX VI NORWEGIAN CODE CHART

					BIT 7	0	0	0	0	1	1	1	1
					BIT 6	0	0	1	1	0	0	1	1
					BIT 5	0	1	0	1	0	1	0	1
BIT	BIT	BIT	BIT	COL									
4	3	2	1	ROW	0	1	2	3	4	5	6	7	
0	0	0	0	0	NUL	DLE	SP	0	@	P	/	p	
0	0	0	1	1	SOH	DC1	!	1	A	Q	a	q	
0	0	1	0	2	STX	DC2	"	2	B	R	b	r	
0	0	1	1	3	ETX	DC3	#	3	C	S	c	s	
0	1	0	0	4	EOT	DC4	\$	4	D	T	d	t	
0	1	0	1	5	ENQ	NAK	%	5	E	U	e	u	
0	1	1	0	6	ACK	SYN	&	6	F	V	f	v	
0	1	1	1	7	BEL	ETB	'	7	G	W	g	w	
1	0	0	0	8	BS	CAN	(8	H	X	h	x	
1	0	0	1	9	HT	EM)	9	I	Y	i	y	
1	0	1	0	A	LF	SUB	*	:	J	Z	j	z	
1	0	1	1	B	VT	ESC	+	;	K	AE	k	ae	
1	1	0	0	C	FF	FS	,	<	L	Ø	l	ø	
1	1	0	1	D	CR	GS	-	=	M	Å	m	å	
1	1	1	0	E	SO	RS	.	>	N	Ü	n	~	
1	1	1	1	F	SI	US	/	?	O	—	o	DEL	

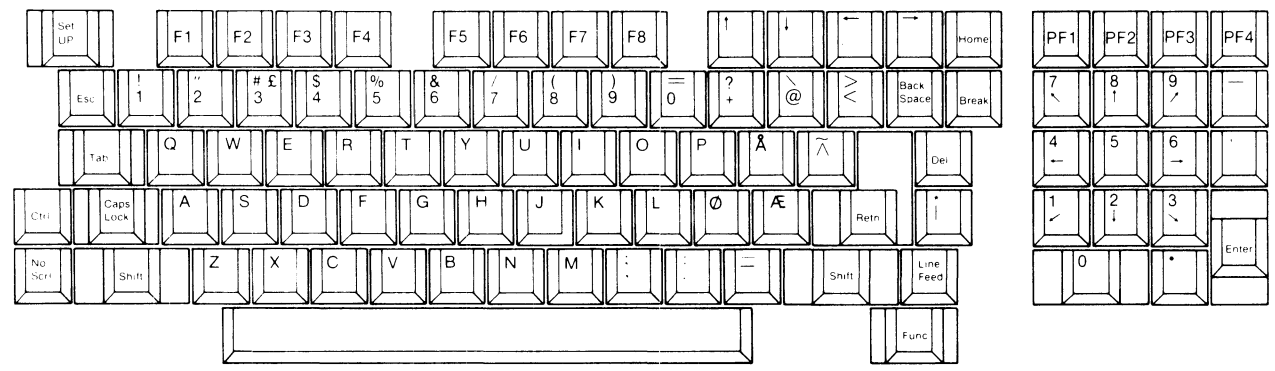

APPENDIX VI DANISH CODE CHART

				BIT 7	0	0	0	0	1	1	1	1
				BIT 6	0	0	1	1	0	0	1	1
				BIT 5	0	1	0	1	0	1	0	1
BIT	BIT	BIT	BIT	COL	0	1	2	3	4	5	6	7
4	3	2	1	ROW								
0	0	0	0	0	NUL	DLE	SP	0	@	P	/	p
0	0	0	1	1	SOH	DC1	!	1	A	Q	a	q
0	0	1	0	2	STX	DC2	"	2	B	R	b	r
0	0	1	1	3	ETX	DC3	#	3	C	S	c	s
0	1	0	0	4	EOT	DC4	\$	4	D	T	d	t
0	1	0	1	5	ENQ	NAK	%	5	E	U	e	u
0	1	1	0	6	ACK	SYN	&	6	F	V	f	v
0	1	1	1	7	BEL	ETB	'	7	G	W	g	w
1	0	0	0	8	BS	CAN	(8	H	X	h	x
1	0	0	1	9	HT	EM)	9	I	Y	i	y
1	0	1	0	A	LF	SUB	*	:	J	Z	j	z
1	0	1	1	B	VT	ESC	+	;	K	AE	k	ae
1	1	0	0	C	FF	FS	.	<	L	Ø	l	ø
1	1	0	1	D	CR	GS	-	=	M	Å	m	å
1	1	1	0	E	SO	RS	,	>	N	Ü	n	~
1	1	1	1	F	SI	US	/	?	O	—	o	DEL

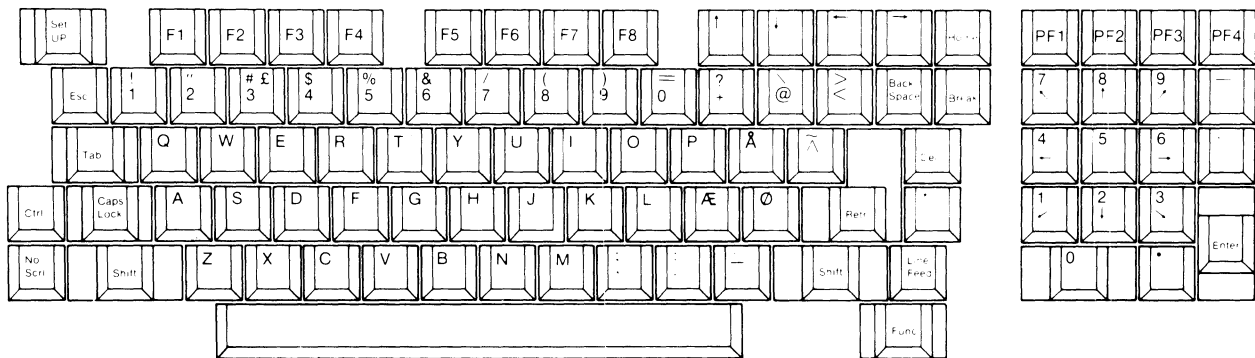

APPENDIX VI SWEDISH/FINNISH CODE CHART

					BIT 7	0	0	0	0	1	1	1	1
					BIT 6	0	0	1	1	0	0	1	1
					BIT 5	0	1	0	1	0	1	0	1
BIT 4	BIT 3	BIT 2	BIT 1	COL ROW	0	1	2	3	4	5	6	7	
0	0	0	0	0	NUL	DLE	SP	0	É	P	e'	p	
0	0	0	1	1	SOH	DC1	!	1	A	Q	a	q	
0	0	1	0	2	STX	DC2	"	2	B	R	b	r	
0	0	1	1	3	ETX	DC3	#	3	C	S	c	s	
0	1	0	0	4	EOT	DC4	\$	4	D	T	d	t	
0	1	0	1	5	ENQ	NAK	%	5	E	U	e	u	
0	1	1	0	6	ACK	SYN	&	6	F	V	f	v	
0	1	1	1	7	BEL	ETB	'	7	G	W	g	w	
1	0	0	0	8	BS	CAN	(8	H	X	h	x	
1	0	0	1	9	HT	EM)	9	I	Y	i	y	
1	0	1	0	A	LF	SUB	*	:	J	Z	j	z	
1	0	1	1	B	VT	ESC	+	:	K	Ä	k	ä	
1	1	0	0	C	FF	FS	,	<	L	Ø	l	ø	
1	1	0	1	D	CR	GS	-	=	M	Å	m	å	
1	1	1	0	E	SO	RS	.	>	N	Ü	n	ü	
1	1	1	1	F	SI	US	/	?	O	—	o	DEL	

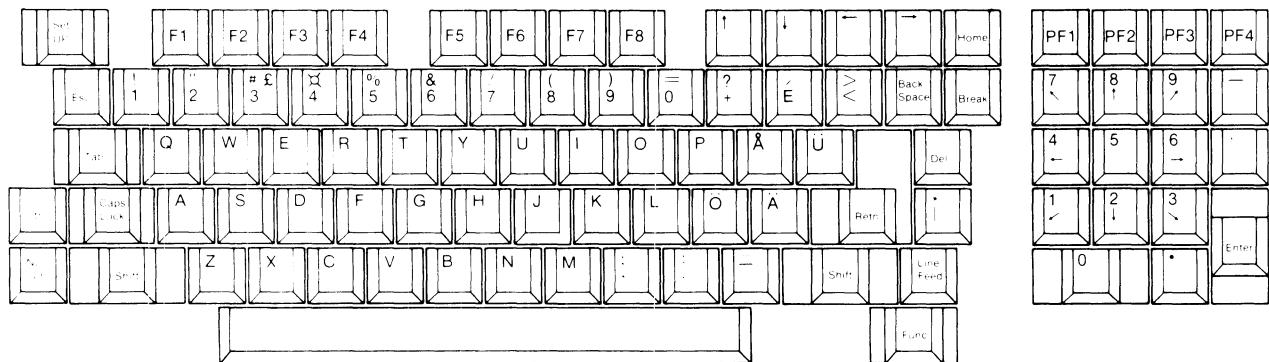

APPENDIX VI GERMAN CODE CHART

				BIT 7	0	0	0	0	1	1	1	1
				BIT 6	0	0	1	1	0	0	1	1
				BIT 5	0	1	0	1	0	1	0	1
BIT 4	BIT 3	BIT 2	BIT 1	COL ROW	0	1	2	3	4	5	6	7
0	0	0	0	0	NUL	DLE	SP	0	§	P	`	p
0	0	0	1	1	SOH	DC1	!	1	A	Q	a	q
0	0	1	0	2	STX	DC2	"	2	B	R	b	r
0	0	1	1	3	ETX	DC3	#	3	C	S	c	s
0	1	0	0	4	EOT	DC4	\$	4	D	T	d	t
0	1	0	1	5	ENQ	NAK	%	5	E	U	e	u
0	1	1	0	6	ACK	SYN	&	6	F	V	f	v
0	1	1	1	7	BEL	ETB	'	7	G	W	g	w
1	0	0	0	8	BS	CAN	(8	H	X	h	x
1	0	0	1	9	HT	EM)	9	I	Y	i	y
1	0	1	0	A	LF	SUB	*	:	J	Z	j	z
1	0	1	1	B	VT	ESC	+	:	K	Ä	k	ä
1	1	0	0	C	FF	FS	,	<	L	Ö	l	ö
1	1	0	1	D	CR	GS	-	=	M	Ü	m	ü
1	1	1	0	E	SO	RS	.	>	N	^	n	β
1	1	1	1	F	SI	US	/	?	O	—	o	DEL

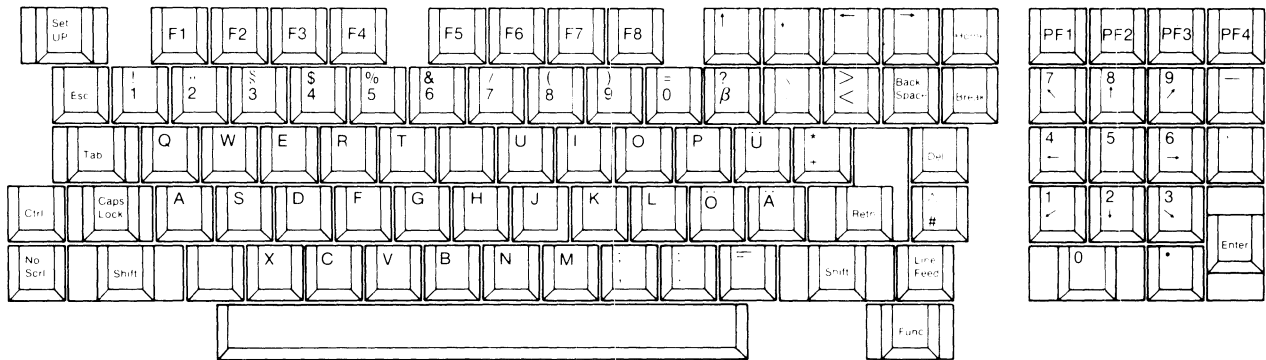

APPENDIX VI FRENCH CODE CHART

				BIT 7	0	0	0	0	1	1	1	1
				BIT 6	0	0	1	1	0	0	1	1
				BIT 5	0	1	0	1	0	1	0	1
BIT 4	BIT 3	BIT 2	BIT 1	COL	0	1	2	3	4	5	6	7
				ROW								
0	0	0	0	0	NUL	DLE	SP	0	à	P	`	p
0	0	0	1	1	SOH	DC1	!	1	A	Q	a	q
0	0	1	0	2	STX	DC2	"	2	B	R	b	r
0	0	1	1	3	ETX	DC3	£	3	C	S	c	s
0	1	0	0	4	EOT	DC4	\$	4	D	T	d	t
0	1	0	1	5	ENQ	NAK	%	5	E	U	e	u
0	1	1	0	6	ACK	SYN	&	6	F	V	f	v
0	1	1	1	7	BEL	ETB	'	7	G	W	g	w
1	0	0	0	8	BS	CAN	(8	H	X	h	x
1	0	0	1	9	HT	EM)	9	I	Y	i	y
1	0	1	0	A	LF	SUB	*	:	J	Z	j	z
1	0	1	1	B	VT	ESC	+	:	K	:	k	é
1	1	0	0	C	FF	FS	,	<	L	Ç	l	ù
1	1	0	1	D	CR	GS	-	=	M	§	m	è
1	1	1	0	E	SO	RS	.	>	N	'	n	..
1	1	1	1	F	SI	US	/	?	O	—	o	DEL

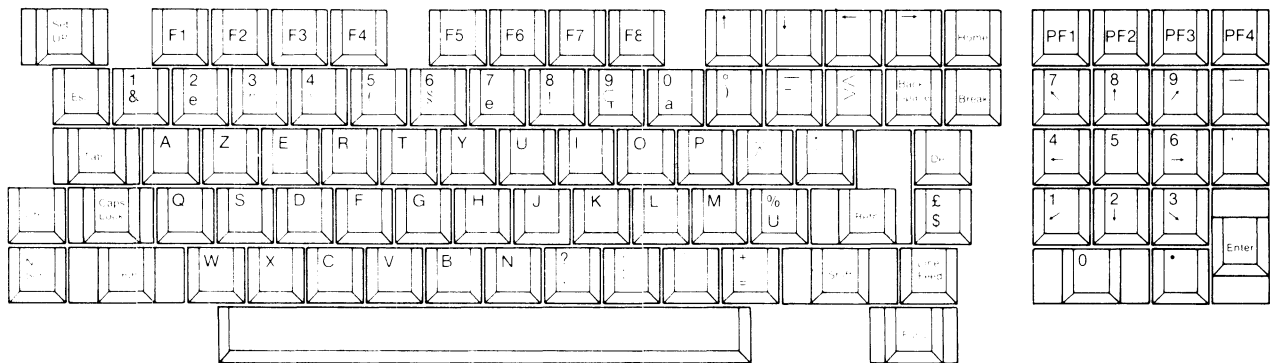

APPENDIX VII VT52 GRAPHICS FONT

ASCII Code	Octal	Graphic	Description
—	137		Blank
/	140	◆	Diamond
a	141	⋮	Checkerboard
b	142	HT	Horz. Tab
c	143	FF	Form Feed
d	144	CR	Carriage Ret.
e	145	LF	Line Feed
f	146	°	Degree
g	147	±	Plus/Minus
h	150	NL	New Line
i	151	VT	Verticle Tab
j	152	└	Lower Right Corner
k	153	┐	Upper Right Corner
l	154	┌	Upper Left Corner
m	155	└	Lower Left Corner
n	156	+	Intersect Lines
o	157	—	Bar at Scan 1
p	160	—	Bar at Scan 3
q	161	—	Bar at Scan 5
r	162	—	Bar at Scan 7
s	163	—	Bar at Scan 9
t	164	├	T left
u	165	┤	T right
v	166	┴	T down
w	167	┬	T up
x	170		Vertical Bar
y	171	≤	Less than or equal
z	172	≥	Greater than or equal
{	173	π	P ₁
	174	≠	Not Equal Sign
}	175	£	Pound Sign
~	176	·	Center Dot

APPENDIX VIII GRAPHICS UPGRADE INSTALLATION

This is the procedure for installing the graphic upgrade board in the VISUAL 102 terminal. The procedure will transform your VISUAL 102 into a multi-featured graphics terminal.

WARNING

SEVERE DAMAGE WILL RESULT IF THIS GRAPHIC UPGRADE BOARD IS INSTALLED INCORRECTLY. Read all the installation instructions carefully before proceeding with the installation.

To install:

1. Remove power from the VISUAL 102. Pull the plug for safety.
2. Remove the keyboard cable, EIA cable, and the auxiliary cable, if any.
3. Remove the top cover of the unit by loosening the three screws in the back of the cover.
4. Remove the power connector (J1) from the upper left corner and the video connector (J2) from the lower right corner of the main logic board (board in back of unit, standing vertically). Both are slip connectors and pull off.
5. Remove the two phillips head screws at the top left and top right of the main logic board.
6. Remove the main logic board from the unit and place it on a clean working area, component side up. It is now ready for graphic board upgrade installation.
7. Inspect the two forty-pin headers for any damaged or bent pins. Straighten any pins that are out of line.
8. Insert the short, blunt end of one of the brown plastic stand-offs (winged flanges pointing down) into the hole above either empty forty-pin socket on the main logic board. Push it in until it locks into place. Repeat the procedure, placing the other three plastic standoffs into each of the holes above and below the forty-pin sockets.

- Place the graphic upgrade board, component side up, on top of the main logic board. When properly placed, the two boards should appear as follows:

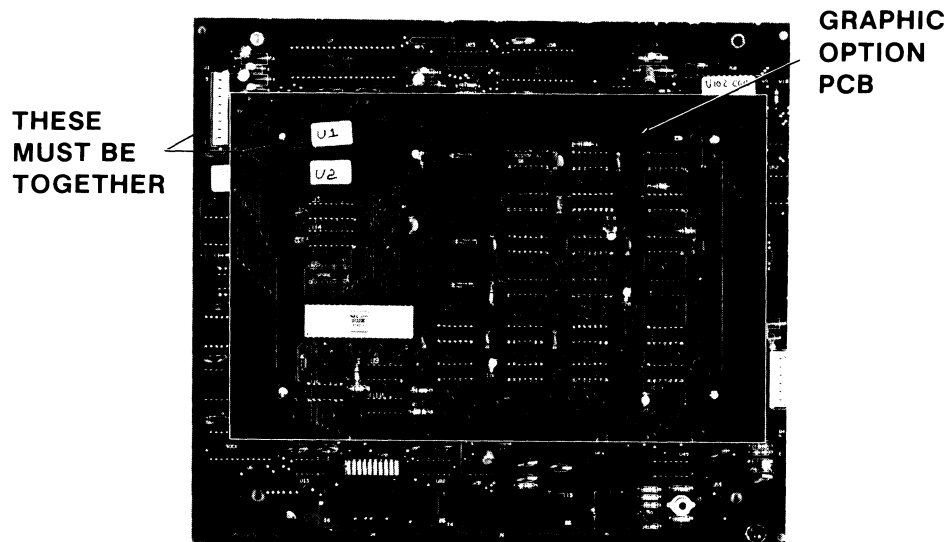

Figure A8-1. Main PCB Board

As can be seen in the preceding diagram, locations U1 and U2 (28 pin sockets) of the graphic upgrade board should be in the upper left corner of that board. That upper left corner must be located beside J1, the power connector on the main logic board.

- Be certain all 80 pins align properly in their respective pin holes, and that the four plastic stand-offs are aligned as well.
- Press the board into place. **DO NOT APPLY EXCESS PRESSURE IN ATTEMPT TO SEAT PINS.** The pins will seat automatically once the four plastic standoffs snap into place.

To insure proper installation:

- The component sides of both boards should be up.
- U1 and U2 (28 pin sockets) of the graphic upgrade board must be in the upper left corner, near the power connector (J1) of the main board.
- The writing on the I.C. chips of the graphic upgrade board should be in the same direction as the main logic board's I.C. chips.
- Just above the graphic upgrade board locations, U7 and U30 should be visible on the top of the main logic board.

To install logic boards:

Repeat steps 5 to 1 in reverse order.

For operation of the graphic upgrade for the VISUAL 102, see Section 7 of your Reference Manual.

APPENDIX IX GRAPHICS PERIPHERALS

DATA TABLETS

The VISUAL 102 supports two tablet types in firmware Revision 1.0. Listed below are the two tablets and their recommended switch settings.

NOTE

The following recommended switch settings for the tablet require that the VISUAL 102 operate at 9600 baud, 8 bit, no parity, 1 stop bit. Please refer to Section 6.5.4.4 for proper printer/tablet set-up parameters.

G.T.C.O. Digi-Pad 5

Manufacturer	Model	Size
GTCO 1055 First St. Rockville, MD 20850 (301) 279-9550	Demi-Pad 5	11" × 11"
	Digi-Pad 5	11" × 11", 11" × 17", 20" × 20"
		36" × 48", 41" × 60"

	1	2	3	4	5	6	7	8
Switch = 1	OFF	OFF	ON	ON	OFF	OFF	OFF	ON
Switch = 2	ON	ON	ON	ON	ON	OFF	OFF	OFF
Switch = 3	OFF	OFF	ON	ON	OFF	OFF	OFF	OFF

- Definitions:
- Switch #1;
 - 1-4 — 9600 baud
 - 5 — no parity
 - 6 — no parity
 - 7 — 1 stop bit
 - 8 — 8 bit character
 - Switch #2;
 - 1 — include push button code
 - 2 — include space
 - 3 — include carriage return
 - 4 — include line feed
 - 5 — 5 digit ASCII
 - 6-7 — serial port A & B
 - 8 — audible alarm disabled
 - Switch #3;
 - 1 — not used
 - 2-3 — 200 coordinate pairs per second
 - 4 — continuous mode
 - 5 — 5 button pen/cursor
 - 6 — inch data
 - 7 — ASCII data
 - 8 — RS232 Interface control line activity not monitored

Summagraphics — Bit Pad I

Summagraphics
 35 Brentwood Ave.
 Box 781
 Fairfield, CT 06430
 (203) 384-1344

Bit Pad
 MM Series

11" × 11"
 9" × 6", 12" × 12"

	1	2	3	4	5	6	7	8	9	10
#6 Switch Bank	ON	OFF	ON	ON	ON	ON	—	—	—	—
#9 Switch Bank	OFF	OFF	OFF	ON	ON	OFF	OFF	ON	ON	—
#10 Switch Bank	OFF	ON	OFF	OFF	OFF	OFF	OFF	OFF	OFF	OFF

Definitions: #6 Switch 1-5 — 200 samples continuous stream
 6 — not used

#9 Switch 1-5 — 100 not adjust — factory calibration setting
 6 — not used

ASCII bld output 8 — crl f
 9 — english (inch) (.005")

#10 Switch 1-10 — 9600 baud

NOTE

Parity and stop bits are preset at factory, refer to the Summagraphic operator manual for options.

GRAPHIC PRINTERS

The VISUAL 102 supports the following printers in Firmware Revision 1.0. The parameters to operate the printers are selected in Section 6.5.4.2.

NOTE

The mode commands are *automatically* sent to the printer by the V102. If an unsupported printer is required, select pass through mode described in Section 6.5.4.1.

Manufacturer	Model	Printer Width
Anadex Inc.	DP9001A	80 col.
9725 DeSoto Ave.	DP9501A	132 col.
Chatsworth, CA 91311	DP9620A	132 col.
(213) 988-8010	WP6000	

(Cont.)

Manufacturer	Model	Printer Width
Mode Command: (ANADEx) Enter Graphics: CTRL \ (FS) Graphics LF: 6 Exit Graphics: CTRL] (GS)		
IDS Milford, NH 03055 (603) 673-9100 Mode Command: Enter Graphics: CTRL c (ETX) Graphics LF: CTRL c CTRL o (EXT) (SO) Exit Graphics: CTRL]	Prism 80 (2080) Prism 132 (2132) Microprism	80 col. 132 col. 80 col.
Data South P.O. Box 240947 Charlotte, NC 28224 (704) 523-8500 Mode Command: Same as Anadex	DS180	132 col.
Texprint 8 Blanchard Road Burlington, MA 01803 (617) 273-3384 Mode Command: Enter Graphics: CR ESC [2; 4; 6; 9; 10y Graphics LF: — Exit Graphics: ESC ESC	DECPlot (LA120)	132 col.
M.P.I. 4426 South Century Dr. Salt Lake City, UT 84107 (801) 263-3081 Mode Command: Enter Graphics: CR ESC CTRL w (ETB) Graphics LF: 6 ESC CTRL w (ETB) Exit Graphics: Ø	MP150G MP99G	136 col. 132 col.

(Cont.)

Manufacturer	Model	Printer Width
HI-G 580 Spring Street Windsor Lock, CT 06096 (203) 623-3363	980	80 col.
Mode Command: Enter Graphics: CR ESC G Graphics LF: / Exit Graphics: +		

APPENDIX X GRAPHICS PROGRAMMING BYTE FORMAT

Each of the X and Y coordinates are converted to a 10 bit binary equivalent. Each is then divided into the high and low 5 bits of each axis. The VISUAL 102 receives this display data in four byte sequences in the following sequence:

BYTE 1	HIGH Y	P01	Y ₉	Y ₈	Y ₇	Y ₆	Y ₅
BYTE 2	LOW Y	P11	Y ₄	Y ₃	Y ₂	Y ₁	Y ₀
BYTE 3	HIGH X	P01	X ₉	X ₈	X ₇	X ₆	X ₅
BYTE 4	LOW X	P10	X ₄	X ₃	X ₂	X ₁	X ₀

Each byte may contain parity (P) and two tag bits and thus encodes to an ASCII character. The ASCII equivalents of grid coordinates are listed in Table 6-1.

Example: To convert X,Y display coordinates to a 4 byte format

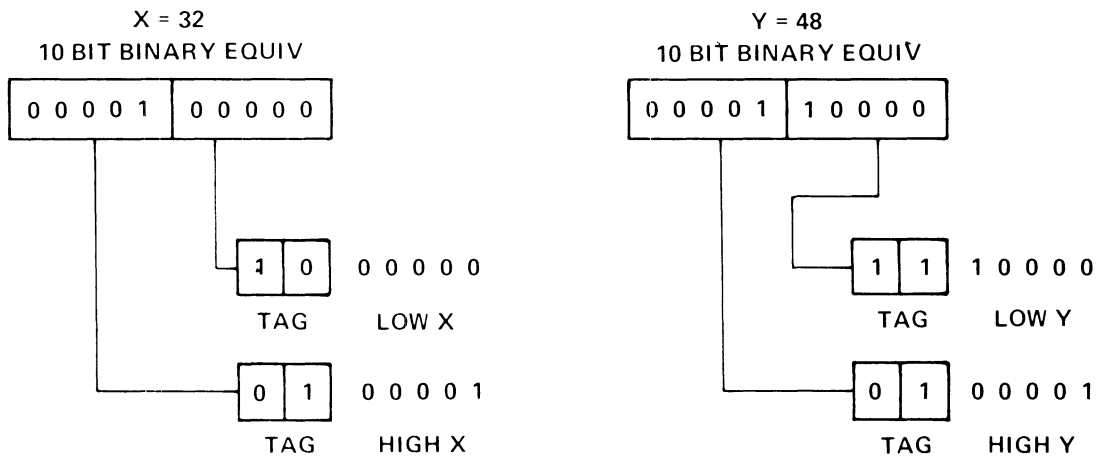

		<u>7 BIT ASCII</u>	<u>OCT</u>	<u>ASCII CHAR</u>
BYTE 1	HIGH Y	0 1 0 0 0 0 1	21	!
BYTE 2	LOW Y	1 1 1 0 0 0 0	70	P
BYTE 3	HIGH X	0 1 0 0 0 0 1	21	!
BYTE 4	LOW X	1 0 0 0 0 0 0	40	@

To plot a point at coordinate 32, 48 the code sequence is !P!

FS	CTRL\	ENTER POINT PLOT MODE
HIGH Y	!	BYTE 1
LOW Y	P	BYTE 2
HIGH X	!	BYTE 3
LOW X	@	BYTE 4

How to Use Table A10-1

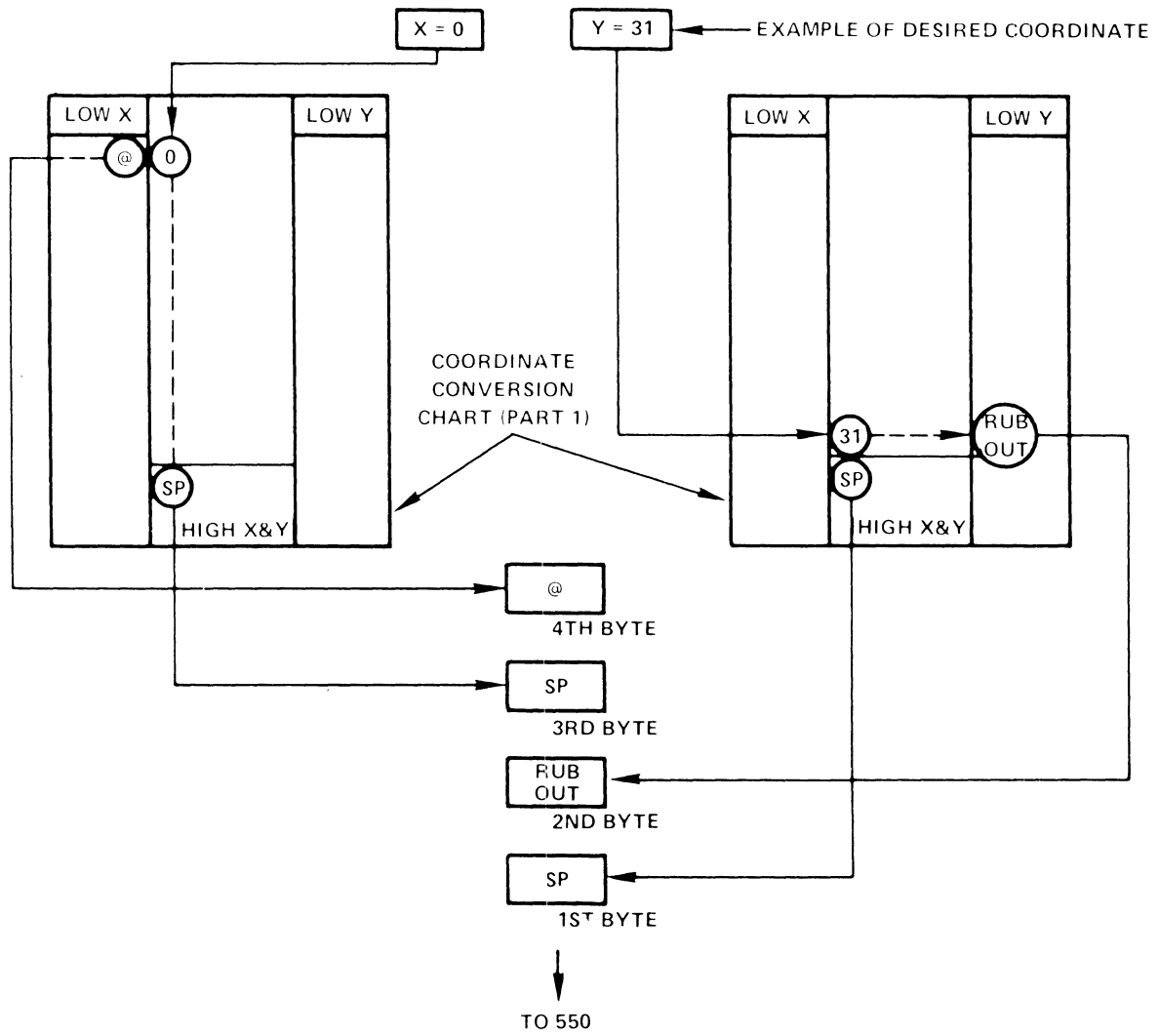

TABLE A10-1

Low Order X		X or Y Coordinate										Low Order Y		
ASCII	DEC.											ASCII	DEC.	
@	64	0	32	64	96	128	160	192	224	256	288	320	`	96
A	65	1	33	65	97	129	161	193	225	257	289	321	a	97
B	66	2	34	66	98	130	162	194	226	258	290	322	b	98
C	67	3	35	67	99	131	163	195	227	259	291	323	c	99
D	68	4	36	68	100	132	164	196	228	260	292	324	d	100
E	69	5	37	69	101	133	165	197	229	261	293	325	e	101
F	70	6	38	70	102	134	166	198	230	262	294	326	f	102
G	71	7	39	71	103	135	167	199	231	263	295	327	g	103
H	72	8	40	72	104	136	168	200	232	264	296	328	h	104
I	73	9	41	73	105	137	169	201	233	265	297	329	i	105
J	74	10	42	74	106	138	170	202	234	266	298	330	j	106
K	75	11	43	75	107	139	171	203	235	267	299	331	k	107
L	76	12	44	76	108	140	172	204	236	268	300	332	l	108
M	77	13	45	77	109	141	173	205	237	269	301	333	m	109
N	78	14	46	78	110	142	174	206	238	270	302	334	n	110
O	79	15	47	79	111	143	175	207	239	271	303	335	o	111
P	80	16	48	80	112	144	176	208	240	272	304	336	p	112
Q	81	17	49	81	113	145	177	209	241	273	305	337	q	113
R	82	18	50	82	114	146	178	210	242	274	306	338	r	114
S	83	19	51	83	115	147	179	211	243	275	307	339	s	115
T	84	20	52	84	116	148	180	212	244	276	308	340	t	116
U	85	21	53	85	117	149	181	213	245	277	309	341	u	117
V	86	22	54	86	118	150	182	214	246	278	310	342	v	118
W	87	23	55	87	119	151	183	215	247	279	311	343	w	119
X	88	24	56	88	120	152	184	216	248	280	312	344	x	120
Y	89	25	57	89	121	153	185	217	249	281	313	345	y	121
Z	90	26	58	90	122	154	186	218	250	282	314	346	z	122
[91	27	59	91	123	155	187	219	251	283	315	347	}	123
\	92	28	60	92	124	156	188	220	252	284	316	348		124
]	93	29	61	93	125	157	189	221	253	285	317	349	}	125
^	94	30	62	94	126	158	190	222	254	286	318	350	~	126
—	95	31	63	95	127	159	191	223	255	287	319	351	RUBOUT (DEL)	127
		32	33	34	35	36	37	38	39					
		SP	!	"	#	\$	%	&	'					

High Order X & Y

TABLE A10-1 (Cont.)

Low Order X		X or Y Coordinate								Low Order Y	
ASCII	DEC.									ASCII	DEC.
@	64	256	288	320	352	384	416	448	480	`	96
A	65	257	289	321	353	385	417	449	481	a	97
B	66	258	290	322	354	386	418	450	482	b	98
C	67	259	291	323	355	387	419	451	483	c	99
D	68	260	292	324	356	388	420	452	484	d	100
E	69	261	293	325	357	389	421	453	485	e	101
F	70	262	294	326	358	390	422	454	486	f	102
G	71	263	295	327	359	391	423	455	487	g	103
H	72	264	296	328	360	392	424	456	488	h	104
I	73	265	297	329	361	393	425	457	489	i	105
J	74	266	298	330	362	394	426	458	490	j	106
K	75	267	299	331	363	395	427	459	491	k	107
L	76	268	300	332	364	396	428	460	492	l	108
M	77	269	301	333	365	397	429	461	493	m	109
N	78	270	302	334	366	398	430	462	494	n	110
O	79	271	303	335	367	399	431	463	495	o	111
P	80	272	304	336	368	400	432	464	496	p	112
Q	81	273	305	337	369	401	433	465	497	q	113
R	82	274	306	338	370	402	434	466	498	r	114
S	83	275	307	339	371	403	435	467	499	s	115
T	84	276	308	340	372	404	436	468	500	t	116
U	85	277	309	341	373	405	437	469	501	u	117
V	86	278	310	342	374	406	438	470	502	v	118
W	87	279	311	343	375	407	439	471	503	w	119
X	88	280	312	344	376	408	440	472	504	x	120
Y	89	281	313	345	377	409	441	473	505	y	121
Z	90	282	314	346	378	410	442	474	506	z	122
[91	283	315	347	379	411	443	475	507	}	123
\	92	284	316	348	380	412	444	476	508	:	124
]	93	285	317	349	381	413	445	477	509	}	125
^	94	286	318	350	382	414	446	478	510	~	126
—	95	287	319	351	383	415	447	479	511	RUBOUT (DEL)	127
		40	41	42	43	44	45	46	47		
		()	*	+	,	.	/			

High Order X & Y

TABLE A10-1 (Cont.)

Low Order X		X or Y Coordinate								Low Order Y	
ASCII	DEC.									ASCII	DEC.
@	64	512	544	576	608	640	672	704	736	`	96
A	65	513	545	577	609	641	673	705	737	a	97
B	66	514	546	578	610	642	674	706	738	b	98
C	67	515	547	579	611	643	675	707	739	c	99
D	68	516	548	580	612	644	676	708	740	d	100
E	69	517	549	581	613	645	677	709	741	e	101
F	70	518	550	582	614	646	678	710	742	f	102
G	71	519	551	583	615	647	679	711	743	g	103
H	72	520	552	584	616	648	680	712	744	h	104
I	73	521	553	585	617	649	681	713	745	i	105
J	74	522	554	586	618	650	682	714	746	j	106
K	75	523	555	587	619	651	683	715	747	k	107
L	76	524	556	588	620	652	684	716	748	l	108
M	77	525	557	589	621	653	685	717	749	m	109
N	78	526	558	590	622	654	686	718	750	n	110
O	79	527	559	591	623	655	687	719	751	o	111
P	80	528	560	592	624	656	688	720	752	p	112
Q	81	529	561	593	625	657	689	721	753	q	113
R	82	530	562	594	626	658	690	722	754	r	114
S	83	531	563	595	627	659	691	723	755	s	115
T	84	532	564	596	628	660	692	724	756	t	116
U	85	533	565	597	629	661	693	725	757	u	117
V	86	534	566	598	630	662	694	726	758	v	118
W	87	535	567	599	631	663	695	727	759	w	119
X	88	536	568	600	632	664	696	728	760	x	120
Y	89	537	569	601	633	665	697	729	761	y	121
Z	90	538	570	602	634	666	698	730	762	z	122
[91	539	571	603	635	667	699	731	763	}	123
\	92	540	572	604	636	668	700	732	764	!	124
]	93	541	573	605	637	669	701	733	765	}	125
^	94	542	574	606	638	670	702	734	766	~	126
—	95	543	575	607	639	671	703	735	767	RUBOUT (DEL)	127
		48	49	50	51	52	53	54	55		
		0	1	2	3	4	5	6	7		

High Order X & Y

TABLE A10-1 (Cont.)

Low Order X		X or Y Coordinate								Low Order Y	
ASCII	DEC.									ASCII	DEC.
@	64	768	800	832	864	896	928	960	992	`	96
A	65	769	801	833	865	897	929	961	993	a	97
B	66	770	802	834	866	898	930	962	994	b	98
C	67	771	803	835	867	899	931	963	995	c	99
D	68	772	804	836	868	900	932	964	996	d	100
E	69	773	805	837	869	901	933	965	997	e	101
F	70	774	806	838	870	902	934	966	998	f	102
G	71	775	807	839	871	903	935	967	999	g	103
H	72	776	808	840	872	904	936	968	1000	h	104
I	73	777	809	841	873	905	937	969	1001	i	105
J	74	778	810	842	874	906	938	970	1002	j	106
K	75	779	811	843	875	907	939	971	1003	k	107
L	76	780	812	844	876	908	940	972	1004	l	108
M	77	781	813	845	877	909	941	973	1005	m	109
N	78	782	814	846	878	910	942	974	1006	n	110
O	79	783	815	847	879	911	943	975	1007	o	111
P	80	784	816	848	880	912	944	976	1008	p	112
Q	81	785	817	849	881	913	945	977	1009	q	113
R	82	786	818	850	882	914	946	978	1010	r	114
S	83	787	819	851	883	915	947	979	1011	s	115
T	84	788	820	852	884	916	948	980	1012	t	116
U	85	789	821	853	885	917	949	981	1013	u	117
V	86	790	822	854	886	918	950	982	1014	v	118
W	87	791	823	855	887	919	951	983	1015	w	119
X	88	792	824	856	888	920	952	984	1016	x	120
Y	89	793	825	857	889	921	953	985	1017	y	121
Z	90	794	826	858	890	922	954	986	1018	z	122
[91	795	827	859	891	923	955	987	1019	}	123
\	92	796	828	860	892	924	956	988	1020		124
]	93	797	829	861	893	925	957	989	1021	}	125
^	94	798	830	862	894	926	958	990	1022	~	126
—	95	799	831	863	895	927	959	991	1023	RUBOUT (DEL)	127
		56	57	58	59	60	61	62	63		
		8	9	:	;	<	=	>	?		

High Order X & Y

APPENDIX XI GRAPHICS OPTION COMMANDS

	Sequence	Reference Section
Graphics Control Codes		
Rings Bell	CTRL G	6.6.1
Move left one character space	CTRL H	6.6.2
Move right one character space	CTRL I	6.6.3
Move down one character space	CTRL J	6.6.4
Move up one character space	CTRL K	6.6.5
Enter Alphagraphics Mode	CTRL M	6.6.6.1
Clear Bypass condition	CTRL O	6.6.10
Enter Alphanumeric Mode	CTRL X	6.6.7.1
Home Alphagraphics cursor, reset margin one flag	CTRL Y	
Begin Escape Sequence	CTRL [6.7
Enter Point Plot Mode	CTRL \	6.6.8.1
Enter Vector Mode	CTRL]	6.6.11.1
Enter Incremental Point Mode	CTRL ^	6.6.9.1
Enter Alphagraphics Mode	CTRL —	6.6.6.2
Graphics Escape Sequences		
Clear Screen (Enter Alphagraphics Mode)	ESC CTRL L	6.6.6.3
Set Alphagraphics Character Size		
Normal Character Size	ESC 0	6.6.6.5
2X Character Size	ESC 1	6.6.6.5
3X Character Size	ESC 2	6.6.6.5
4X Character Size	ESC 3	6.6.6.5
Set Alphagraphics Font Size		
Select 10 X 12 character cell	ESC 8	6.6.6.6
Select 9 X 10 character cell	ESC 9	6.6.6.6
Select 7 X 9 character cell	ESC :	6.6.6.6
Select 7 X 9 character cell	ESC ;	6.6.6.6

	Sequence	Reference Section
Select Line Style		
Select Normal Line	ESC /	6.7.1
Select Dotted Line	ESC @	6.7.1
Select Dot Dash Line	ESC b	6.7.1
Select Short Dash Line	ESC c	6.7.1
Select Long Dash Line	ESC d	6.7.1
Select User Defined #1 Line	ESC x	6.7.1
Select User Defined #2 Line	ESC y	6.7.1
Select User Defined #3 Line	ESC z	6.7.1
Graphics Draw and Fill Commands		
Filling Type Commands		
Solid Fill (all dots on)	ESC @	6.7.3.1
Grey Fill (50% dots on)	ESC A	6.7.3.1
Slope Up (left to right lines)	ESC B	6.7.3.1
Slope Up (right ot left lines)	ESC C	6.7.3.1
Horizontal Lines	ESC D	6.7.3.1
Vertical Lines	ESC E	6.7.3.1
Slant Cross Hatch Lines	ESC F	6.7.3.1
Vertical Cross Hatch Lines	ESC G	6.7.3.1
Checkerboard	ESC H	6.7.3.1
Dotted Fill	ESC I	6.7.3.1
Vertical Herringbone	ESC J	6.7.3.1
Horizontal Herringbone	ESC K	6.7.3.1
User Defined Fill Pattern #1	ESC L	6.7.3.1
User Defined Fill Pattern #2	ESC M	6.7.3.1
Define User Fill Pattern	ESC / Pn1; ... Pn8 Ps	6.7.3.2
Rectangle Draw	ESC / x ; y ; X ; Y ; x	6.7.3.3
Rectangle Draw and Fill	ESC / x ; y ; X ; Y ; y	6.7.3.4
Circle/Arc Draw	ESC / X ; Y ; R ; T ; P A	6.7.3.5
Circle/Arc Draw and Fill	ESC / X ; Y ; R ; T ; P B	6.7.3.6
Direction Commands		
Rotate Rectangle 0 Degrees	ESC /2e	6.7.4
Rotate Rectangle 90 Degrees	ESC /4e	6.7.4
Rotate Rectangle 180 Degrees	ESC /6e	6.7.4
Rotate Rectangle 270 Degrees	ESC /0e	6.7.4

	Sequence	Reference Section
Rotate Characters 0 Degrees	ESC /0e*	6.7.4.1
Rotate Characters 90 Degrees	ESC /2e*	6.7.4.1
Rotate Characters 180 Degrees	ESC /4e*	6.7.4.1
Rotate Characters 270 Degrees	ESC /6e*	6.7.4.1
Data Level Commands		
Set Dots on Data Level	ESC /0d	6.7.5.1
Set Dots Off Data Level	ESC /1d	6.7.5.1
Set Complement Data Level	ESC /3d	6.7.5.1
Set Replace Data Level	ESC /4d	6.7.5.1
Crosshair Mode		
Enter Crosshair Mode	ESC SUB or ESC CTRL Z	6.7.6.1
Load Crosshair	ESC /f	6.7.6.2
Graphics Inquiry Command	ESC ENQ	6.8.2
Block Transfer		
Address Load	ESC " X ; Y a	6.10.1
Data Load	ESC + <CHAR><CHAR> ... #	6.10.2
Remote Parameters Commands		
Set Auto Scaling	ESC /1h	6.12.1
Reset Auto Scaling	ESC /1ℓ	6.12.2
Set SP Code Operation	ESC /2h	6.12.1
Reset SP Code Operation	ESC /2ℓ	6.12.2
Set Cell Size	ESC /3h	6.12.1
Reset Cell Size	ESC 3 ℓ	6.12.2
Auxilliary Port Mode		
Set Cursor Move Mode	ESC /1p	6.12.3
Set Pass BP to Host Mode	ESC /2p	6.12.3
Set Transparent Pass to Host Mode	ESC /3p	6.12.3
Remote Graphics Print Command	ESC ETB	6.13.2
Alternate Character Sequence for Rubout	ESC ?	6.13.3
Clear Screen (Enter Alphagraphics Mode)	ESC CTRL L	6.13.4

*Alphagraphics Mode

APPENDIX XII FUNCTION KEY REMOTE LOAD

Code	Host	Terminal	Code	Host	Terminal
SOH	1	129	/	39	167
STX	2	130	(40	168
ETX	3	131)	41	169
EOT	4	132	*	42	170
ENQ	5	133	+	43	171
ACK	6	134	'	44	172
BEL	7	135	—	45	173
BS	8	136	.	46	174
HT	9	137	∫	47	175
LF	10	138	0	48	176
VT	11	139	1	49	177
FF	12	140	2	50	178
CR	13	141	3	51	179
SO	14	142	4	52	180
SI	15	143	5	53	181
DLE	16	144	6	54	182
DC1	17	145	7	55	183
DC2	18	146	8	56	184
DC3	19	147	9	57	185
DC4	20	148	:	58	186
NAK	21	149	;	59	187
SYN	22	150	<	60	188
ETB	23	151	=	61	189
CAN	24	152	>	62	190
EM	25	153	?	63	191
SUB	26	154	@	64	192
ESC	27	155	A	65	193
FS	28	156	B	66	194
GS	29	157	C	67	195
RS	30	158	D	68	196
US	31	159	E	69	197
SPACE	32	160	F	70	198
!	33	161	G	71	199
"	34	162	H	72	200
#	35	163	I	73	201
\$	36	164	J	74	202
%	37	165	K	75	203
&	38	166	L	76	204

Code	Host	Terminal	Code	Host	Terminal
M	77	205	f	102	230
N	78	206	g	103	231
O	79	207	h	104	232
P	80	208	i	105	233
Q	81	209	j	106	234
R	82	210	k	107	235
S	83	211	l	108	236
T	84	212	m	109	237
U	85	213	n	110	238
V	86	214	o	111	239
W	87	215	p	112	240
X	88	216	q	113	241
Y	89	217	r	114	242
Z	90	218	s	115	243
[91	219	t	116	244
\	92	220	u	117	245
]	93	221	v	118	246
^	94	222	w	119	247
←	95	223	x	120	248
'	96	224	y	121	249
a	97	225	z	122	250
b	98	226	{	123	251
c	99	227		124	252
d	100	228	}	125	253
e	101	229	~	126	254
			DELETE	127	255

VISUAL TECHNOLOGY INCORPORATED

REFERENCE MANUAL/VISUAL 102

**UM-102-001
Rev. 0A
November, 1983**