

home.cd3wd.ar.cn.de.en.es.fr.id.it.ph.po.ru.sw



Technical Information W17e



Reuse and Refining of Waste Engine Oil

Dr.-Ing. Heino Vest (1997, revised in 2000)

From the environmental point of view used engine oil has a high hazardous potential. Not only that already a small amount of pure oil can pollute major amounts of water, e.g. groundwater, but also because used engine oil itself contains a number of additives and is contaminated by impurities and residues resulting from the combustion process. Some of them are

Technical Field:

Energy / Environment (E)
Water / Sanitation (W)
Agriculture (A)
Foodprocessing (F)
Manufacturing (M)

This Technical Information is available in:

English (e)
French (f)
German (g)
Spanish (s)
Other:.....

quantities at a great number of places, e.g. garages, small workshops and private premises. There are, of course, few major generator of waste oil like railways, large truck fleet operators and large industries.

2. Outlets for used oil

11-111

poisonous or carcinogenic (polyaromatic hydrocarbons). Transformer oils contain sometimes PCBs (polychlorinated biphenyls), which are highly carcinogenic as well. Additionally, used engine oil is generated in small quantities at a great number of places, e.g. garages, small workshops and private premises. This makes the collection of the oil difficult and expensive. Many of the professional and in particular the majority of the private consumers of oil are not aware about the potential danger resulting from the improper disposal of waste oil.

1. Sources of oil wastes

By far the largest source for used oil in developing countries are lubrication oils from motor vehicles, combustion engines and gear boxes. Apart from that, minor amounts origin from hydraulic systems, transformers and other diverse industrial applications. Due to the increase of the automotive traffic in developing countries the amount of used oil from motor vehicles increased steadily in the past. The majority of used engine oil is generated in small

Until the applications. Some of them can be used for other are environmentally acceptable.

Oil is utilised as the first and best option for the disposal of used oil is to return the oil **back to the producer. Particular in** industrialised countries there are collection schemes for waste oil in place. The oil producer themselves know best what to do with the waste oil and can secure an environmentally friendly method for disposal or recycling. A big portion of the collected waste oil is re-refined on a large scale in refineries similar to those for crude oil.

Also environmentally acceptable is the use of oil waste as fuel in cement and **lime kilns, in brick works or metallurgical furnaces. Due to the** high combustion temperature and the absorption properties of cement, lime and clay, hazardous hydrocarbons are destroyed while heavy metals, sulphur and chlorides are absorbed. Additionally, modern plants are

gate Information Service / gtz, PO Box 5180, 65726 Eschborn, Germany
Phone: +49 (0)6196 / 79-3093, Fax: +49 (0)6196 / 79-7352, Email: gate-id@gtz.de, Internet: <http://www.gtz.de/gate/gateid.afp>

home.cd3wd.ar.cn.de.en.es.fr.id.it.ph.po.ru.sw



Technical Information W11e



normally equipped with sophisticated gas cleaning systems, which minimise possible air pollution effects.

Mainly in developing countries, used engine oil is often utilised as fuel for **diverse small scale applications**. Apart from its use in foundries, traditional brick and lime kilns, in asphalt-producing vehicles, the oil is also used in traditional bakeries as well. In these cases, the waste oil is often blended with black oil (tar oil, bunker oil) (e.g. bakeries), charcoal/mineral coal powder (lime kilns) or rubber pieces from used tyres (asphalt-producing vehicles).

There are some reports as well, which state that unrefined waste oil can be **mixed in small quantities to the diesel fuel of diesel**

insects, old engine oil is used as a **timber protecting agent**. **Fence posts**, for example, are soaked in used oil to make them resistant against termite attack.

From Botswana it is reported that the oil is used on cows as protective **medicine against ticks or in other cases is sprayed on the ground to keep the dust down**.

Particularly the last two applications are not acceptable under environmental aspects.

As follows, some of the possibilities to utilise waste oil are now described in details.

~~diesel fuel or diesel engines~~ (see also

Another simple method to make use of waste engine oil is the production of **grease. In many developing countries** there are local small scale soap making units. To produce grease, waste oil is added to the ready soap (as long as the soap is still warm and soft) in a composition of 20% soap to 80% waste oil. The mixture is stirred for some while until it forms the typical greasy consistency. The amount of oil determines the viscosity of the final grease. It is obvious that due to a minor quality of oil, the final grease is also of minor quality, but, nevertheless, sufficient for many low scale applications.

Apart from the use of waste oil as fuel or for the production of grease some other traditional applications are known:

In many African countries, where all wooden structures are endangered by termites and other wood eating

3. Use of unrefined waste engine oil

3.1 Use of waste oil as fuel for heating and energy generation

Waste oil can as well be used for heating or energy production. As it is practised in many developing countries waste oil is a cheap fuel for many heating purposes. Depending on the composition and the impurities of the waste oil the off-gas produced by this operations may be very dirty and hazardous. Therefore, the current practice in these countries is not environmentally sound and can be hazardous for people living near by.

In case the off-gas is properly cleaned waste oil can be used for heating and energy production. In industrialised countries, there are a number of companies offering special designed waste oil burners. Incinerator for waste oil which are attached with off-gas heat exchanger supply steam to small steam turbines or steam motors for electrical energy generation.

gate Information Service / gtz, PO Box 5180, 65726 Eschborn, Germany
Phone: +49 (0)6196 / 79-3093, Fax: +49 (0)6196 / 79-7352, Email: gate-id@gtz.de, Internet: <http://www.gtz.de/gate/gateid.afp>

home.cd3wd.ar.cn.de.en.es.fr.id.it.ph.po.ru.sw



Technical Information W11e



3.2 Utilisation of waste oil as fuel for diesel engines

One striking idea for the utilisation of waste engine oil is its use as fuel in diesel engines.

In principle, waste oil can be used in diesel engines, although there are a number of limitations. Suitable engines for the use of waste oil are the big, slow moving stationary diesel aggregates used for power generation or those used as ship engine. Particularly engines which take residual fuel for combustion will run on waste oil too. When using waste oil as fuel, the major limitation is the content of additives in the oil. These additives often reach the amount of 10% of the oil and mainly consist of Ca-based organic compounds. During the combustion of the oil in a diesel

may be added to the ordinary fuel. Some engine manufacturing companies suggests to limit the Ca-content to 100 mg/kg and to make sure that the limits of the ISO 8217 (quality standard of residual fuel) are not exceeded. A preliminary mechanical cleaning step using a centrifuge is recommended as well to remove the suspended matters. When using waste oil as fuel, the engine has to be supervised carefully. By increasing the amount of waste oil slowly, it will be possible to investigate the right percentage of waste oil in the fuel, in order to make sure that no damage is done to the engine. In general, there is no modification of the engine necessary and due to minor percentages of waste oil in the fuel, there is no significant change in the off-gas composition.

oil in a diesel

generate a considerable amount of ash. Additives will partly melt under the working temperature of the engine (400 to 550 C) and will be deposited at the discharge valves or in the turbo-supercharger. This may lead to the destruction of the valves and to a clogged turbo-supercharger.

Used lubrication oil also contains paraffin. If it is mixed with residual fuel, the paraffin may support a segregation of the residual fuel, leading to the formation of a sludge of long-chained hydrocarbons, which will settle at the fuel tank bottom.

In principle, there are two possibilities to overcome these problems. First, all additives are removed by an appropriate refining step. After the removal the refined waste oil can be used without any limitations (in concentration of up to 100%). In this case it is advisable not to mix the refined waste oil with diesel or residual fuel in order to avoid the segregation of the fuel.

In the case that the additives are not removed, only some 3% to 5% of waste oil

4. Refining of waste oil

4.1 The need to refine used oil

Used oil has always been refined in the past on large-scale basis by the big oil producing companies. By applying highly complex processes and plants (e.g. solvent treatment-distillation-finishing rerefining process, distillation-hydrofinishing refining process, high temperature distilling process) they are able to produce a high-quality lubrication oil from former oil waste.

During times when the price for crude oil was high or in isolated economies (e.g. in the South African Republic during the time of Apartheid) the refining of used oil made economic sense. In times when the price for crude oil is low the economic advantage of used oil refining diminished. For example, after the end of Apartheid in the Republic of South Africa and the suspension of economic sanctions by the international community also the political reasons for waste oil refining got lost. As a result, four of the five waste oil refineries in

gate Information Service / gtz, PO Box 5180, 65726 Eschborn, Germany
Phone: +49 (0)6196 / 79-3093, Fax: +49 (0)6196 / 79-7352, Email: gate-id@gtz.de, Internet: <http://www.gtz.de/gate/gateid.afp>

[home.cd3wd.ar.cn.de.en.es.fr.id.it.ph.po.ru.sw](#)



Technical Information W11e



South Africa shut down because of economic constrains.
Nevertheless a reasonable amount of oil waste is constantly generated, last but not least by the numerous motor vehicles populating the streets world-wide.
Industrialised countries with a great number of cement factories, metallurgical plants or incinerators may be able to use oil waste as fuel for the different combustion processes.

Small or less dense populated countries, particularly in developing countries, often have not this opportunity. Additionally the infrastructure for used oil collection and disposal is not sufficiently established. This results in an indiscriminate and improper disposal of oil waste wherever the waste oil is generated.

To fill the gap between the

Obviously small scale recycling processes might not be able to achieve an oil product of high quality, but particularly in developing countries, there are numerous applications for minor quality lubrication oils in the small scale industry sector as well. At least small scale oil recycling offers an opportunity to create jobs and income, makes use of waste oil as raw material, decreases the amount of waste to dispose of and improves the environmental situation in preventing an indiscriminate disposal of used oil.

4.1 Principles of the Acid-Clay refining process

During the use of the oil in the engine of motor vehicles, but also during collection, storage or mixing with oil waste from other sources

To fill the gap between the refining and waste in big industrial plants on one side and an indiscriminate disposal of waste oil somewhere in the bush or backyard on the other, there is a need for small-scale processing plants which produce new products and minimise the amount of waste.

sources contaminated with a number of impurities. On one side the additives of the oil itself. On the other side degraded and

Fig. 1: Acid-Clay used oil refining process

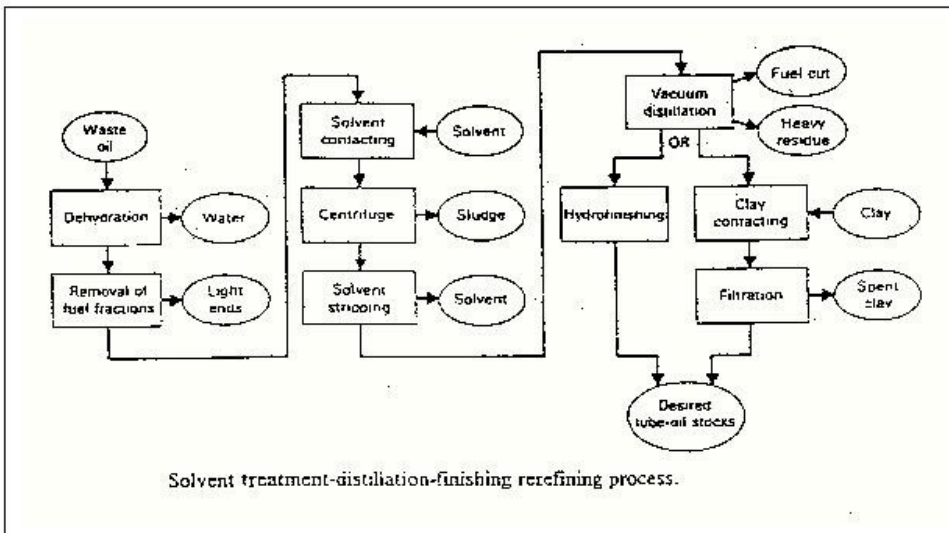

gate Information Service / gtz, PO Box 5180, 65726 Eschborn, Germany
Phone: +49 (0)6196 / 79-3093, Fax: +49 (0)6196 / 79-7352, Email: gate-id@gtz.de, Internet: <http://www.gtz.de/gate/gateid.afp>

[home.cd3wd.ar.cn.de.en.es.fr.id.it.ph.po.ru.sw](#)



Technical Information W11e



they result from the degradation process of the oil during its use, from the mechanical wear of the engine parts and from the combustion of the fuel. During storage and mixing, water, dirt and other objects might enter the used oil as well.

The most commonly used process for many years and in particular for small to medium scale applications is the Acid-Clay process. During this process, the used oil feedstock is mixed with concentrated sulphuric acid to remove most of the impurities and products of the degradation process. During this step insoluble sulphur containing compounds (sludge asphalt) are formed which will settle in the reactor. Thereafter the product is subject to a neutralisation (with lime/caustic soda) and a clay contact/filtration step for colour/ odour enhancement using bleaching earth (e.g. Fuller's earth).

Having reached the temperature of 170 C the oil is pumped into the first steel agitator. This open vessel is double walled to allow water to be pumped through as cooling agent. The oil is cooled down to approximately 30 to 40 C. At that temperature concentrated sulphuric acid is added at a quantity of 10% of the amount of oil. The mixture is stirred steadily for 3 to 4 hours to let the acid react with the impurities forming sulphates.

The oil-acid mixture is afterwards pumped into cylindrical steel vessels with a conical shape at the lower end. It is kept there for one day to allow the insoluble sediments to settle in the bottom cone. Afterwards the acid sludge is removed and filled into old oil drums waiting for disposal.

The remaining clear oil-acid mixture is subsequently

(e.g. Fuller's earth).

As filtration may complete the refining of the waste oil (see fig. 1).

4.2 Refining process of used engine oil in Cairo

A practical example of a small scale Acid-Clay-process can be visited in Cairo. The installed equipment allows to refine 3.000 litre of used oil in one batch. Only used engine oil is accepted for refining. The oil is collected from garages in the town or is delivered by individuals or intermediate waste oil collectors. It is stored at the recycling plant in old 200 litre oil drums.

To start the process the drums are emptied into a supply tank from where the oil is pumped into a heating vessel made of steel. The closed vessel is directly heated by a waste oil burner at the bottom. The oil is heated up to 170 C with an intermediate holding at 100 C to let the water content evaporate. Above 100 C other volatile matter are removed such as petrol or organic solvents which might have been mixed into the oil waste.

subsequently

prepared agitator. This agitator is double-walled as well, here for heating purposes.

The heating takes place indirectly using steam from a separate boiler. After filling the agitator with the oil-acid mixture (content 3000 litre) approximately 100 kg CaO or soda ash is added. Everything is heated up to 170 C while stirring. The whole process last for 2 to 4 hours. The lime will react with the acid neutralising the oil to pH 7 and forming gypsum.

At the end of the lime treatment the content of the agitator is passed through a filter press separating the solids (gypsum) from the oil. The clear oil is now pumped into storage vessels ready for distribution in small or big containers. The oil can be used for minor quality lubrication or cooling purposes, e.g. for slowly moving parts, gearboxes or machines, during the machining of metals. One part of the refined oil is processed further on to grease. For that purpose the oil is mixed with Na- or Ca-stearate in a heated agitator and subsequently filled hot into containers for selling and distribution.

gate Information Service / gtz, PO Box 5180, 65726 Eschborn, Germany
Phone: +49 (0)6196 / 79-3093, Fax: +49 (0)6196 / 79-7352, Email: gate-id@gtz.de, Internet: <http://www.gtz.de/gate/gateid.afp>

home.cd3wd.ar.cn.de.en.es.fr.id.it.ph.po.ru.sw

gate

Technical Information W11e

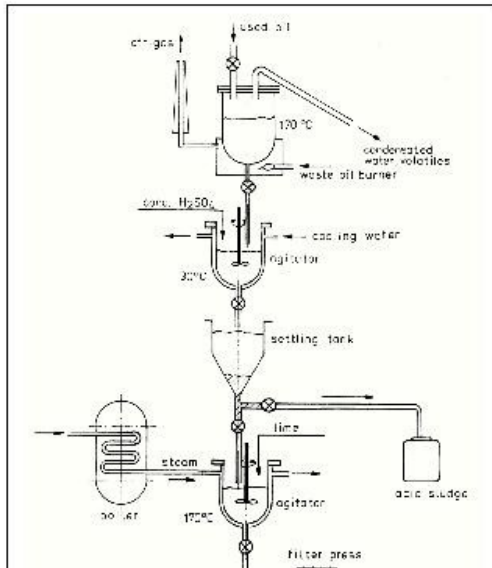

4.3 Improved concept for a small scale Acid-Clay waste engine oil refining process

To avoid the weaknesses of the recycling plant in Cairo the improved process concept puts more emphasis on the environmental protection aspect. Basically two main areas needed further improvement:

- the protection of ground and groundwater against oil penetration
- the collection and treatment of off-gas, volatiles and acid fumes.

Additionally the equipment has been slightly modified to lower the investment cost. Opposite to the plant in Cairo, the removal of water and volatiles by distillation, the neutralisation with lime as

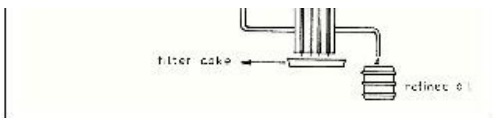

Fig. 2: Small scale Acid-Clay-process in Cairo

The major disadvantage of this process is the generation of residues (acid sludge and oil-soaked gypsum filter cake) which have to be disposed of under certain precautions. During the handling of the oil there is always a danger of spillage. Respective precaution has to be taken to avoid a penetration of oil into the ground. Emissions into the atmosphere, which are generated during the process (off-gas from the combustion of the waste oil in the boiler or heating vessels, volatile organic from the heating of the waste oil, acid fumes from the acid treatment) must be avoided as well.

In this respect the Cairo plant had its weaknesses. The whole area was soaked with oil. No off-gas collection or treatment system existed. The workers had no protective cloths.

well leaching earth takes place in the same vessel. The capacity of the different vessels has been decreased to 1.5 m³, to allow the processing of smaller quantities (approximately 1000 l per batch).

Main features of the improved plant concept (see also fig. 3) therefore are:

All oil storage and handling areas have concrete floors and are surrounded by small protection walls to avoid oily run-offs. The rain water which will be collected on the floor passes an oil separator before it enters the sewer.

Both agitator are equipped with a hood on which a stirrer and an off-gas suction pipe are attached. During the different treatment steps the agitation vessel is covered by the hood. The off-gas is sucked off using a water jet injection pump. The water for the pump is circulated in a closed circle. During the heating of the oil in the first process step the evaporated water and organic are condensed again while passing through the water jet injection

gate Information Service / gtz, PO Box 5180, 65726 Eschborn, Germany
Phone: +49 (0)6196 / 79-3093, Fax: +49 (0)6196 / 79-7352, Email: gate-id@gtz.de, Internet: <http://www.gtz.de/gate/gateid.afp>

home.cd3wd.ar.cn.de.en.es.fr.id.it.ph.po.ru.sw



Technical Information W11e



pump. Condensates of water and volatile organic accumulate in the circulating water. While the water condensate may stay there the organic are separated from the water from time to time. Some lime is added to the water as well in order to neutralise sulphuric acid fumes sucked off during some steps of the process.

The first (heated) agitator has an indirect heating system fueled from outside the treatment plant. The hot combustion gases are used to indirectly heat the agitator and its oil charge. Afterwards the off-gas is cleaned in a wet scrubber or bag filter before it leaves the plant via the chimney. This system was chosen to avoid open fire next to the oil charge.

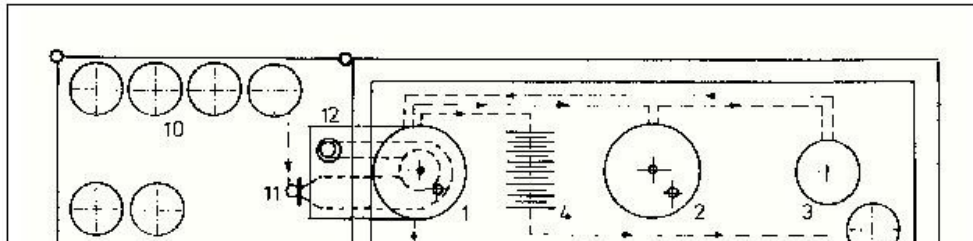

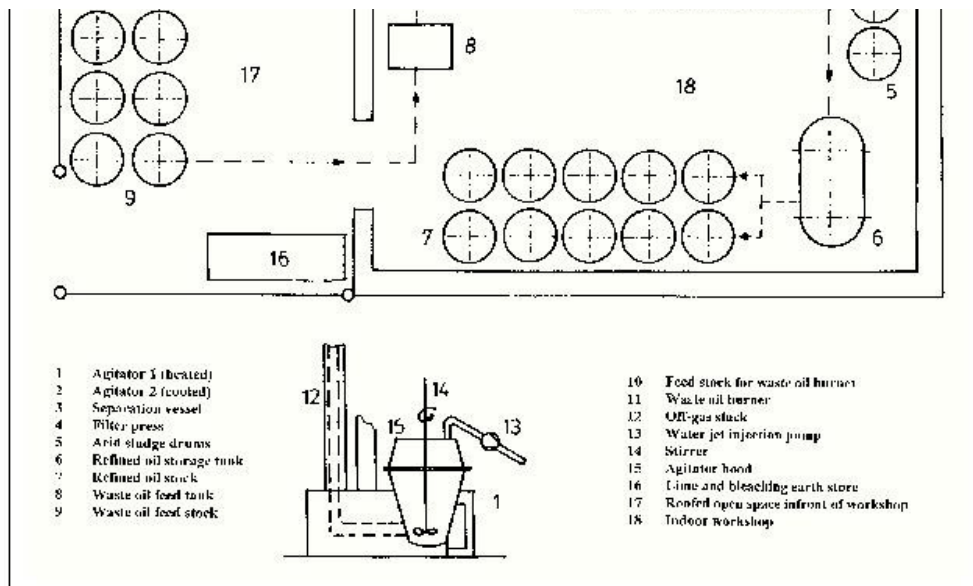

Fig. 3: Possible layout for an improved small scale Acid-Clay waste oil refining plant

gate Information Service / gtz, PO Box 5180, 65726 Eschborn, Germany
Phone: +49 (0)6196 / 79-3093, Fax: +49 (0)6196 / 79-7352, Email: gate-id@gtz.de, Internet: <http://www.gtz.de/gate/gateid.afp>

home.cd3wd.ar.cn.de.en.es.fr.id.it.ph.po.ru.sw



Technical Information W11e



4.4 Modern small scale refining processes for waste oil

There are a number of small scale refining processes for waste oil on the market. As an example, two processes are described which represent two different technical approaches.

4.4.1 Small scale micro-filtration of waste oil

A very interesting opportunity for small scale waste oil refining (investment approximately 25.000 US\$) offers the Dutch Company AXXON B.V. in Arnheim. Their Waste-Oil-To-Energy-Converter filters waste oil with such an efficiency that the refined oil can be used in mix (1-10%) with diesel fuel to be used for diesel motor vehicles (see fig. 4 and 5).



Fig. 4: Equipment for
**micro-filtration of
used engine oil**

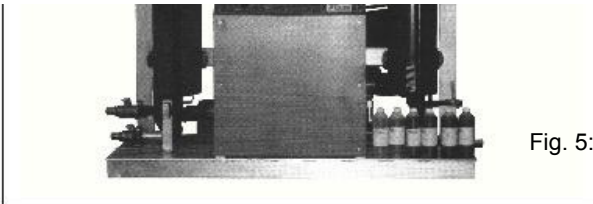

Fig. 5: Specification of the
**Waste-Oil-To-Energy
Converter**

Specifications

Model Number	: 15S
Global Part No.	: 2345
Maximum Flow Rate	: 15 gpm
Waste-Oil Filters	: Depth-med a. ram-packed elements: six (6)-micron primary filter and four (4)-micron final filter.
Two-Stage, Blended-Fuel Final Filter	: Removes particulate matter four (4)-microns and larger, and a coalescing-type element: removes 99-% of emulsified or free standing water.
Static Mixer	: Stainless-steel, multi element, viscosity-sensitive, non-maintenance type.
Dimensions	: Height: 51-1/2"; Width: 38"; Length: 58-1/2"
Inlets & Outlets	: 1" Female NPT
Weight -- Dry	: 374 lbs.
Wet	: 570 lbs.
Operating Pressures	: Factory-set at: 15 psi
Filter Housings	: Pressure-tested to 75 psi
Electrical	: 5 amps @ 220 VAC, 50 Hz 1 ϕ . All wiring is routed through liquid-tight conduit into NEMA 12-rated enclosures.
Crated Shipping Size	: Height: 57-1/2"; Width: 38"; Length: 64"
Crated Shipping Weight	: 560 lbs.

Specifications may change without notice due to improvements.

gate Information Service / gtz, PO Box 5180, 65726 Eschborn, Germany
Phone: +49 (0)6196 / 79-3093, Fax: +49 (0)6196 / 79-7352, Email: gate-id@gtz.de, Internet: <http://www.gtz.de/gate/gateid.afp>

home.cd3wd.ar.cn.de.en.es.fr.id.it.ph.po.ru.sw



Technical Information W11e



4.4.2 Small scale plant for full scale waste oil refining

Still a small scale plant (for up to 9 Mio. litre waste oil), but with a full refining operation for all types of waste oil is offered by the Canadian company EnviroSystems Inc. in Dartmouth. The combined process of distillation, centrifugal separation and conditioning is able to produce recycling oil of a virgin quality (see fig. 6).

Fig. 6: Refining process of Enviro-systems



References and further information:

Companies supplying small scale waste oil refining equipment:

AXXON B.V.

Postbus 256
6800 Arnheim
The Netherlands
Phone: ++31/26/4455723
Fax: ++31/26/4427163

EnviroSystems Inc.

11 Brown Avenue, Dartmouth
Nova Scotia,
Canada B3B 1XB
phone: ++902/481/8008
fax: ++902/481/8019
Mike@enviro.systems.com

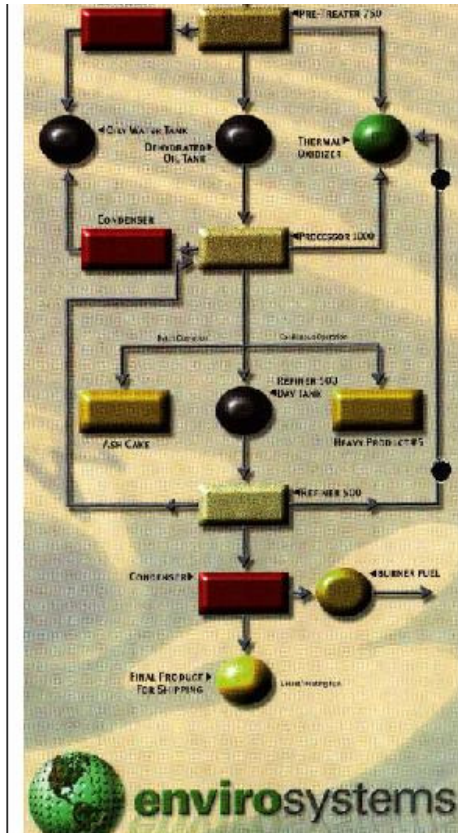

Companies supplying waste oil burners:

Ruhr Brenner Apparatebau GmbH

P.O. Box 3244
58219 Schwerte
Germany
phone: ++49/2304/68051
fax: ++49/2304/63251

SAACKE GmbH & Co KG

P.O. Box 210261
28222 Bremen
Germany
phone: ++49/421/64950
fax: ++49/421/6495224

Companies supplying small scale energy generation plants:

Spillingwerk GmbH

Werftstrasse 5
20457 Hamburg
Germany
phone: ++49/40/7891750
fax: ++49/40/7892836



gate Information Service / gtz, PO Box 5180, 65726 Eschborn, Germany
Phone: +49 (0)6196 / 79-3093, Fax: +49 (0)6196 / 79-7352, Email: gate-id@gtz.de, Internet: <http://www.gtz.de/gate/gateid.afp>

home.cd3wd.ar.cn.de.en.es.fr.id.it.ph.po.ru.sw



Technical Information W11e



Tuthill Nadrowski Turbinen GmbH

Auf dem Esch 28
33619 Bielefeld
Germany
phone: ++49/521/10850
fax: ++49/521/1085199

*Companies which can give information on
the use of waste oil in diesel engines:*

MaK Motoren GmbH & Co. KG

Falckensteiner Str. 2-4
24159 Kiel
Germany
phone: ++49/431/3995490
fax: ++49/431/3995864

MWM Motorenwerke Mannheim AG

Carl-Benz-Str. 5
68167 Mannheim
Germany

Literature:

Vogler, J.;
Work from Waste;
IT-Publications, 1983
ISBN 0-903031-79-5

du Toit, J.;
**Study on the Management of Oil
Containing Wastes;**
Report N: NCS/GTZ 5/96
National Conservation Strategy Agency,
Gaborone, Botswana, 1996

Reiter, B.; R. Stroh;
**Behandlung von Abfaellen in der
Zementindustrie;**
Bd. 72, Umweltbundesamt
Bundesministerium fr Umwelt,
Wien, sterreich, 1995

Berger

Germany
phone.: ++49/621/3848517
fax: ++49/621/3848513

B.U.S. Berzelius Umwelt-Service AG

Vinckeufer 3
47119 Duisburg
Germany
phone: ++49/203/8093115
fax: ++49/203/8093192

BEFESA Medio Ambiente S.A.

Serrano, 41-2
28001 Madrid
Spain
phone: ++34/1/5757110

Collector of waste oil in Southern Africa:

Rose Foundation

P.O.Box 6244
Roggebaai 8012
Suite 13, The Strand Tower
66 Strand Street
Cape town, RSA
phone.: ++27/21/211855
fax: ++27/21/253167

FOISt,
**Handreichung: Umweltorientierter
Umgang mit Alti;**
Umwelthandbuch
BMZ/GTZ, 2000

Internet addresses:

www.wrf.org.uk (World Resource
Foundation)
www.recyclers-info.com (Recyclers
Info Germany)
www.waste.nl (Waste Consultants,
Netherlands)
www.epa.gov (US Environmental
Protection Agency)

gate Information Service / gtz, PO Box 5180, 65726 Eschborn, Germany
Phone: +49 (0)6196 / 79-3093, Fax: +49 (0)6196 / 79-7352, Email: gate-id@gtz.de, Internet: <http://www.gtz.de/gate/gateid.afp>