

[home.cd3wd.ar.cn.de.en.es.fr.id.it.ph.po.ru.sw](#)

Case study 10

Cement mortar jar, 1.0 cubic metre capacity

Introduction

This Case Study is taken from Rainwater Harvesting The collection of rainfall and runoff in rural areas, Pacey and Cullis by IT Publications, 1986. The book can be purchased from the IT Bookshop which can be found at <http://www.oneworld.org/itdg/publications.html>. Information has also been used from a recent EU funded Water and Sanitation Programme in Tanzania.

This type of water vessel was originally developed in Thailand but has also been used widely, often with modifications, in East Africa. There are many variations of this type of tank and we try to give some alternative approaches later in this Case Study

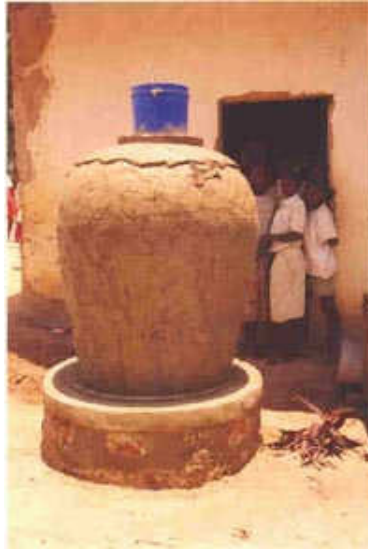

Photo 1 Thai Jar being built as part of a Water and Sanitation Programme in Tanzania (in this example chicken wire is being used for reinforcing and the bucket is being used as a template for the opening at the top of the jar; the jar has also been set on a plinth to facilitate extraction of water by gravity)

Construction details

The mould or formwork for a 1m³ cement mortar jar is made from 2 pieces of gunny cloth or hessian sacking, cut and stitched together with twine as shown in Figure 1. After

sewing, the resulting bottomless bag is turned inside out.

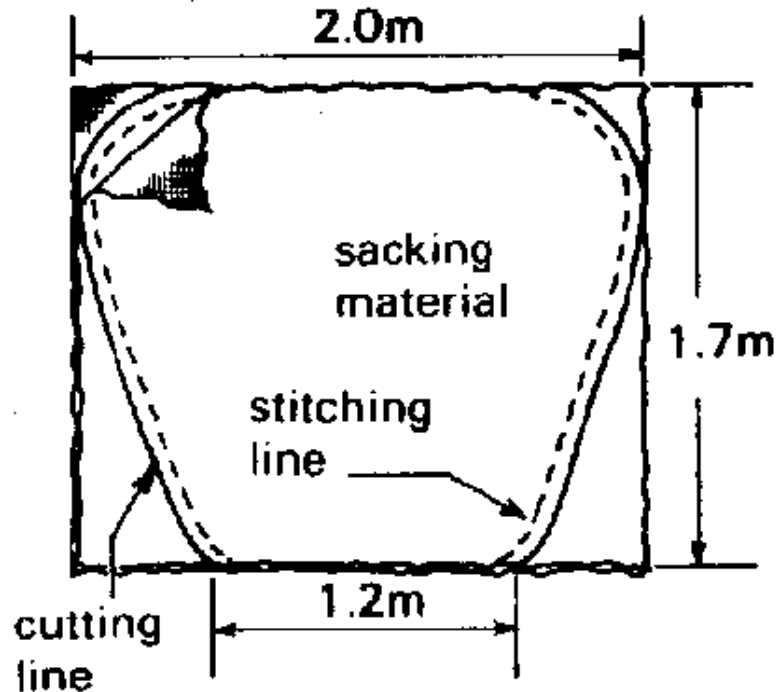

Figure 1 Dimensions for cutting sacking (Pacey and Cullis 1986)

To make the bottom of the tank, mark out a circle on the ground of 1m diameter and place bricks or other suitable material around its circumference to act as a formwork. Spread paper or plastic sheeting on the ground within the circle to stop the mortar sticking. Mix a 1:2 cement:sand mortar and spread within the circle to a depth of 15mm.

When the bottom plate has set, place the sacking bag narrow end down on the plate and begin filling it sand, sawdust or rice husks. Make sure that the mortar base sticks out from under the sack as shown in Figure 2, and tuck the edges of the sacking under the filling material, so that the weight of the filling holds the sacking on the plate.

Fill the sack, fold the top and tie it closed. Then fold and smooth the sack into a regular shape. Make a circular ring from wood or cement mortar and place this on top as the formwork for the opening in the top of the jar (Figure 3).

sand, sawdust
or rice husk

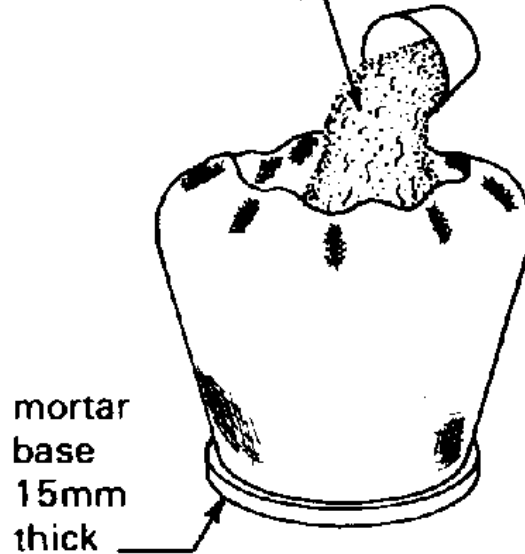

Figure 2 - Filling the sack

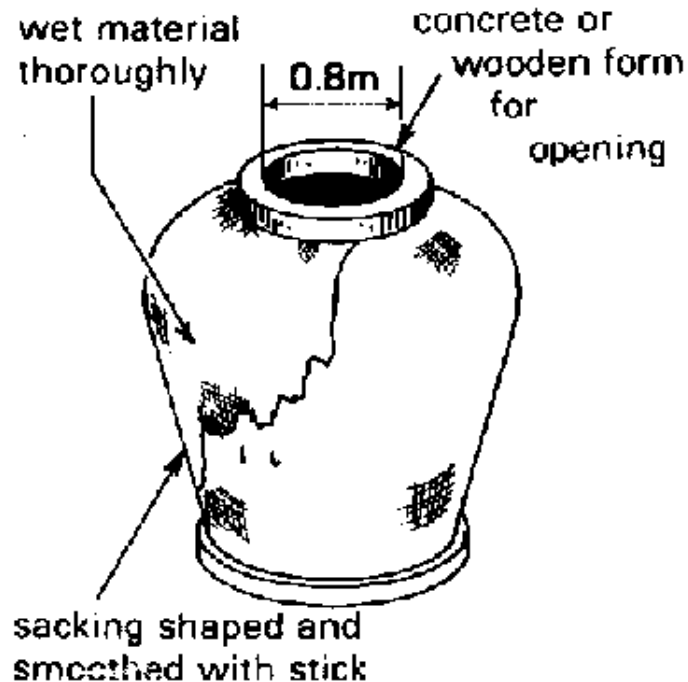

Figure 3 Smoothed sack with circular former in place)

Spray the sacking with water until it is thoroughly wet, then plaster on the first layer of cement mortar o a thickness of 5 7mm.

Plaster on the second 5mm layer in the same manner as the first, checking the thickness by pushing a nail in. Build up any thin spots.

Remove the sack and its contents 24hrs after the plastering is completed. Repair any defects with mortar and paint the inside of the jar with cement slurry. Then cure the jar for 2 weeks protecting it from sun and wind under damp sacking.

General information

This type of jar can be manufactured in any size. However, as the tank size gets bigger the mould becomes unwieldy, and different methods have been devised for making the former. One such example saw the construction of 1.8m^3 jars using specially made curved bricks to construct the formwork. The blocks are built into shape using mud as a temporary mortar and are then removed once the tank is complete. The formwork can then be reused again and again.

In East Africa, the use of chicken mesh between the first and second coats of plaster is a common addition which gives extra strength to the structure. This type of ferrocement tank can be loaded onto a truck for delivery, and therefore has the advantage that it can be made centrally for later distribution.

Watt, 1978 gives detailed instructions for the construction of a 0.25m^3 jar in Ferrocement

Water Tanks. He suggests that similar tanks can be built up to 4m^3 in size. The smaller mortar jars replace the traditional ceramic Thai jars and can be manufactured at about a tenth of the price.

Material requirements

The quantities below are taken from a similar 1m^3 jar used during a recent water and sanitation programme in Tanzania. This tank had reinforcing and a tap and a washout fitted.

Materials	Unit Price (TSh) 1997 Prices	Qty	COST (TSh)	COST (US\$)
Cement (bag)	6,200	2	12,400	27.50
Chicken wire (roll)	25,000	0.25	6,250	13.80
Binding wire (kg)	900	0.50	450	1.00
G.I Pipe 1"	2,000	1	2,000	4.40

(m)				
G.I F-F connectors 1"	300	2	600	1.30
G.I. Elbows	185	2	370	0.80
Locking Tap 1"	2,500	1	2,500	5.50
G.I. Male plug 1"	800	1	800	1.80
		Total	35,220	56.10

Table 1 - Materials and costs for a 1 cubic metre cement jar

*sand and stone are not accounted for here as they were provided by the community as part of a self-help initiative.

** approximately 1 skilled and 1 unskilled person days are required per tank.

[Return to top of page](#)

[Return to index page](#)

[home.cd3wd.ar.cn.de.en.es.fr.id.it.ph.po.ru.sw](#)

[home.cd3wd.ar.cn.de.en.es.fr.id.it.ph.po.ru.sw](#)

Case study 7

10 cubic metre ferrocement water tank using former

Introduction

This example has been taken from Ferrocement water tanks and their construction by S. B. Watt and published by Intermediate Technology Publications which can be found at <http://www.oneworld.org/itdg/publications.html>

Watt states that these tanks have been used for many years in parts of Africa and have been designed to be as simple as possible to build in self-help programmes. The users, who are at first unskilled in this sort of construction, can contribute their time and efforts in collecting sand and water, digging the foundations and preparing the mortar under the general guidance of a trained builder. With experience they quickly learn how to make the tanks without further guidance.

A trained builder with 5 helpers takes approximately 3 days to complete the tank. The users often contribute some money towards the cost of the tank, which helps to cover the builders wages, the cement, reinforcement and the hire of the formwork.

Design

The tanks have been designed for construction by relatively unskilled workers. They have a diameter of 2.5m, a height of 2m, giving a capacity of 10cubic metres. The final wall thickness will be about 4cms. The tanks are built on site and should not be moved.

Formwork

The 2m high formwork is made from 16 sheets of standard galvanised roofing iron, 0.6mm thick with 7.5cm corrugations rolled into a cylinder with a radius of 1.25m. Steel angle iron (40 x 40 x 5mm) is bolted vertically on the inside face at the ends of each set of 4 sheets this allows the sheets to be bolted together to form a circle. Between the edge of each section is placed a wedge which is pulled out to allow the formwork to be dismantled (see Figure 1).

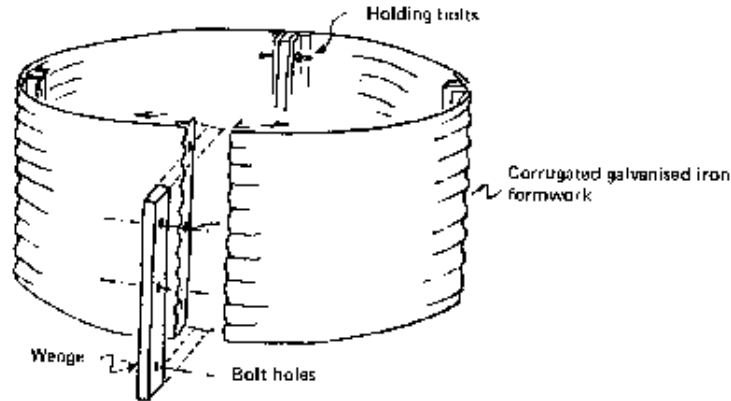

Figure 1 Assembling the formwork (Watt 1972)

Construction

A circular area 2.8m in diameter is cleared at the required site for the tank and excavated down through the loose topsoil. A 10cm layer of sand is laid evenly over the excavation and a 7.5cm layer of concrete mix of 1:2:4 (cement:sand:gravel by volume) will form the foundation slab under the tank. Into this concrete foundation is cast a 1m length of 20mm bore steel water pipe with a tap on the outside end. The pipe is curved so that it projects 10cm above the floor of the tank; a piece of wire is threaded through the pipe to act as a pull through after the tank has been built (see Figure 2).

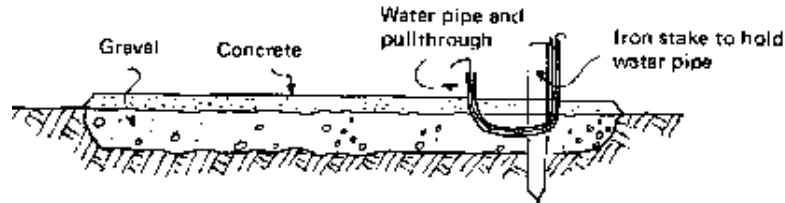

Figure 2 Foundation of tank (Watt 1972)

When this concrete slab has hardened the formwork of the tank is erected. The bolts passing through the angle iron and wedges are tightened to provide a rigid cylindrical form. This is cleaned free of cement and dirt, oiled and the wire netting wrapped around it to a single thickness and tucked under the forms. The netting has a 50mm mesh, and is made from 1.0mm wire.

To form the hoop reinforcements, the straight galvanised iron wire, 2.5mm diameter, is wound tightly around the tank from the base at the following spaces:

- 2 wires in each corrugation for the first eight corrugations
- 1 wire in each corrugation for the remaining corrugations
- 2 wires in the top corrugation

About 200m of 2.5mm diameter wire will be needed, weight 8 kg. The netting provides

vertical reinforcement to the tank and also holds the hoop wire out of the corrugations. The outside is then plastered with a layer of mortar made from a mix of 1:3 (cement : sand by volume) and as soon as this has begun to stiffen a second layer of mortar is trowelled on to cover the reinforcing wire to a depth of 15mm. The surface is finished smooth with a wooden float.

After a day or so the formwork is dismantled by removing the holding bolts and by pulling out the wedges which will leave the shuttering free to be stripped away from the inside mortar wall. The sections are lifted clear of the tank to be thoroughly cleaned of any mortar or cement. A 20cm length of 8cm diameter downpipe is built into the wall at the top of the tank to act as an overflow and the inside of the tank is plastered with mortar to fill up the corrugations. When this has hardened sufficiently, a second final coat is trowelled onto the inside and finished with a wooden float.

A 5cm thick layer of mortar is next laid onto the floor of the tank and the junction of the floor with the walls built into a coving. The floors are not reinforced and so the tank would fracture if it were moved. Take care that the mortar does not fill up the outlet pipe. Before the mortar on the floor has stiffened, form a shallow depression in the middle; this will allow the tank to be cleaned at a later date the sediment can be brushed to the hole and cupped out (see Figure 3).

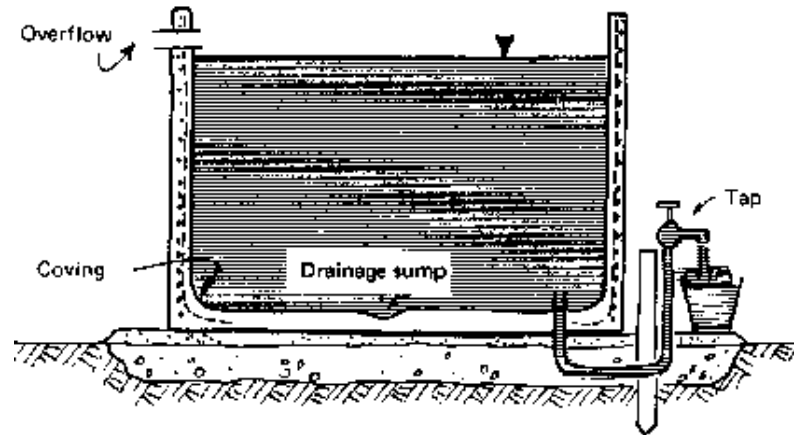

Figure 3 The completed tank (Watt 1972)

The inside of the tank is painted with a thick cement slurry to seal the inside of the tank the a small of water is allowed to stand in the bottom of the tank and the tank is covered and cured for seven days.

Roof

The tank is covered with sheets of 0.5mm galvanised sheeting supported on two lengths of angle iron. Alternatively, a reinforced mortar roof may be built in the way described in Case Study 8 (Factory Made Tanks New Zealand). Building a mortar roof is not difficult but does require more formwork.

Materials

Materials required for a 10m³ tank with galvanised iron roof.

Cement	600 kg
Plain wire 2.5mm diameter	200m
Chicken mesh 1m wide	16m
Water pipe 20mm bore	1m
Water tap	1 No
Overflow pipe 8cm bore iron or concrete	0.2m
Sand	1.0m ³
Gravel	0.5m ³
Galvanised iron sheet and	

angle iron

[return to index page](#)

[home.cd3wd.ar.cn.de.en.es.fr.id.it.ph.po.ru.sw](#)

[home.cd3wd.ar.cn.de.en.es.fr.id.it.ph.po.ru.sw](#)

Case study 8

Factory made tanks, 1 to 25m cubic metre capacity, New Zealand

This example has been taken from Ferrocement water tanks and their construction by S. B. Watt and published by Intermediate Technology Publications - found at <http://www.oneworld.org/itdg/publications.html>

Introduction

Ferrocement tanks have been made commercially in New Zealand for many years and have now largely replaced the traditional corrugated galvanised iron tanks. They are used mainly to store water for domestic and dairy purposes on the farm but they are also winning acceptance for industrial liquid storage. The cost of the smaller tanks is comparable with that of tanks made from other materials such as galvanised iron; the cost per unit volume decreases rapidly with increase in size.

Tank sizes

The tanks are constructed in various sizes, with capacities from 1m^3 to 25m^3 , diameters from 1m to 3.6m, and heights from 1.3m to 2.9m. With specially built formwork and machine mortar mixers each tank takes 2 5 person days to build. There are several manufacturers producing such tanks in New Zealand. The high wage costs in New Zealand are reflected in the prices of the tanks.

Design

The water pressure in a tank full of water generates stresses in a tank that are difficult to calculate structurally. The tanks have been designed to resist only hoop stresses and a layer of woven netting is included as nominal reinforcement; this netting in fact provides the only reinforcement at the base of the wall where it joins with the floor the point of greatest stress. This section is thickened during construction and from information given by the manufacturers there is no evidence that cracks appear under normal loads. The

only causes of failure have resulted from damage during delivery.

All the tanks are built with an integral roof and a covered access hatch.

Capacity (m3)	Diameter (m)	Height (m)	Weight (tonne)
0.9	1.2	1.3	0.25
1.8	1.55	1.3	0.3
2.7	1.85	1.3	0.45
3.6	2.0	1.45	0.8
4.5	2.0	1.95	1.25
9.0	2.9	1.95	2.1
13.5	2.9	2.6	3.0

18.0	3.65	2.6	4.0
22.5	3.65	2.9	5.0

Table 1 Size and weight of New Zealand tanks

Cement	740 kg
Sand	1.0m ³
Plain wire 4mm diameter	330m
Wire mesh 1m wide	28m
Weld mesh for slab	7m ²

Table 2 Materials needed to make a 9m³ tank

The quantities shown in Table 2 are higher than a comparable tank, which would be built in situ. The tanks described here have to be stronger than the self-help tanks to be able to withstand the extra stresses during transportation

Construction

The tanks are constructed on special fabricated steel formwork which is quickly erected (see Figure 1), or on a temporary timber formwork. Usually, the floor of the tank is cast first; this is reinforced with welded steel mesh made from 8mm diameter rods at 20cm centres with a floor thickness between 6cm and 10cm, depending on the size of the tank. Loops of 8mm steel are allowed to project from the base to allow for easy handling; this also reduces the stresses that will be set up in the tanks as they are being lifted or winched. A strip of chicken wire is also cast into the sides of the floor and is bent up into the walls.

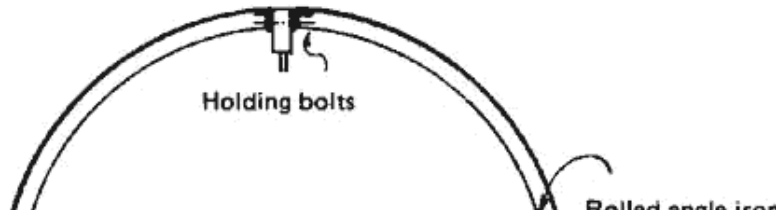

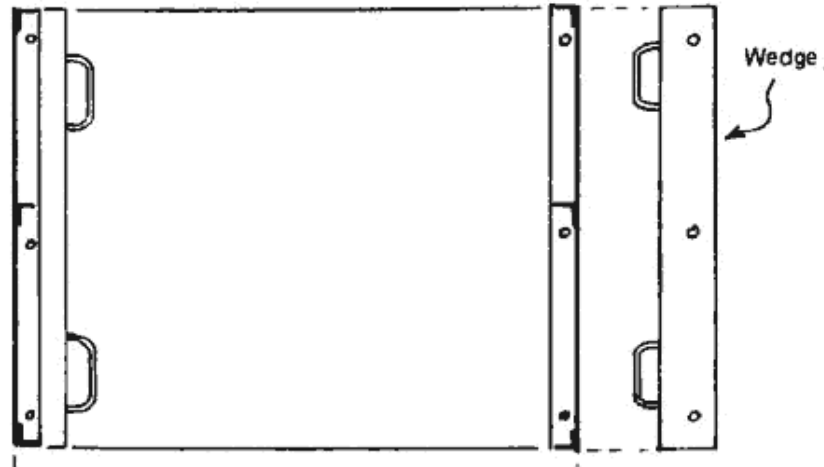
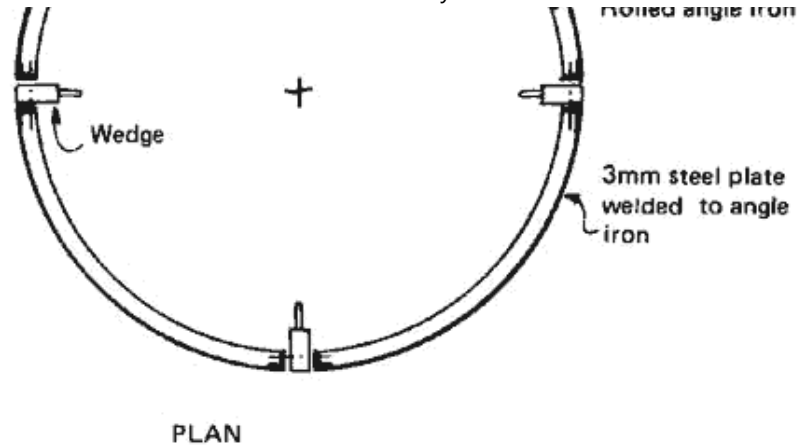

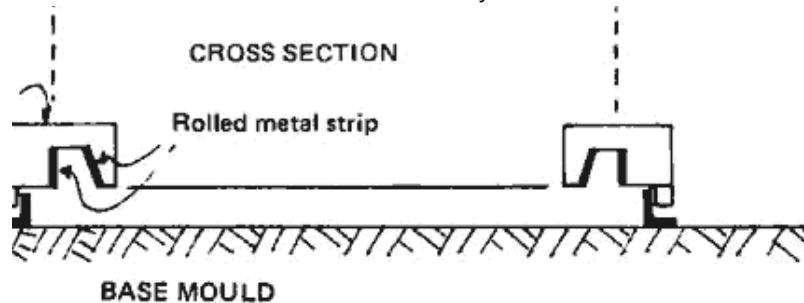

Figure 1 - Commercial tank formwork

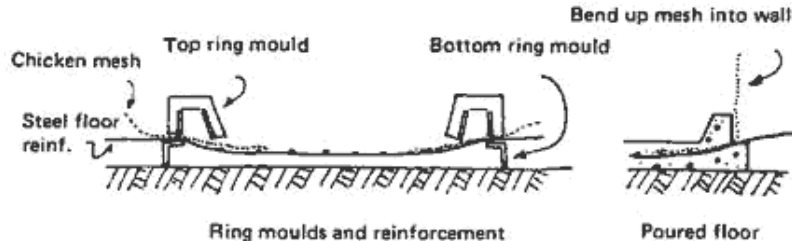

Figure 2 Casting the base slab

When the floor slab has been cast, the formwork is erected and the chicken wire folded up against the shuttering. A layer of chicken wire or weld mesh made from 2mm wire at 5cm centres is wrapped around the tank to cover the shuttering from top to bottom (see

Figure 3).

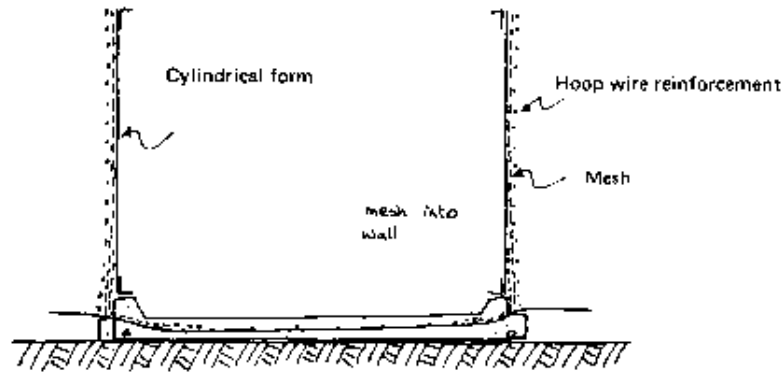

Figure 3 Assembling the formwork and reinforcement

The main reinforcement, 4mm diameter straight wire, is wrapped tightly around the tank in a spiral with a 5cm gap between the wires. Theoretically this gap should be much smaller at the bottom of the tank than at the top to take the extra stresses, but in practice the spacing is left constant. This prevents mistakes during construction and does not add appreciably to the overall cost. The same spacing is often used on all of the tanks, both small and large.

The first mortar layer (1:3 cement:sand by volume) is trowelled onto the tank 1cm thick and given 24hrs to harden. A second layer of mortar is then trowelled on and finished

smooth with a plasterers float; this is also given 24hrs to harden.

The formwork is now carefully stripped and removed from inside the tank and a third layer of mortar is trowelled onto the inside of the tank to completely cover up the reinforcement. A thick un-reinforced coving is added to strengthen the joint between the floor and the tank.

Finally, the roof is built onto the tank y laying mortar onto shaped formwork which is propped from underneath. the roof is reinforced with two layers of wire mesh, which is tied onto the mesh protruding up from the walls (see Figure 4).

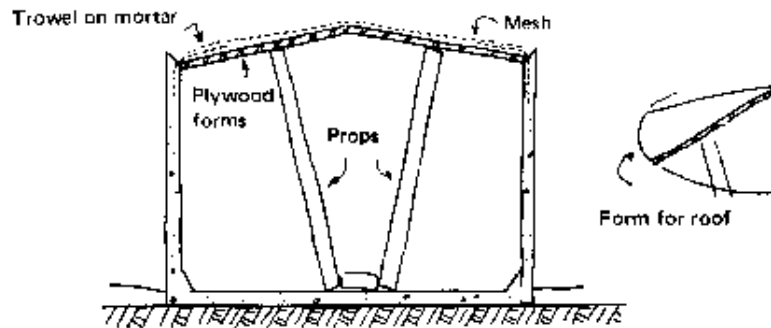

Figure 4 Constructing the roof

A prefabricated angle iron frame is set into the wire mesh to provide formwork for an access hatch into the finished tank. This is removed after the mortar has set. Mortar is trowelled on in a 3cm layer and allowed to cure for 3 days. When it is strong enough the roof and access hatch formwork is stripped and a layer of mortar trowelled onto the inside of tank roof.

The tank is finally painted on the inside with a coat of cement and water slurry, a small volume of water is allowed to sit in the bottom of the tank and the tank is covered and cured for at least 7 days.

Transporting the tanks

The factory tanks of less than 25m³ capacity are light enough to be carried by lorry. They are taken to the prepared site and joined directly to the necessary pipe connections; tanks of larger capacity are usually built on site.

The smaller, lighter tanks are lifted onto and off of the lorry with a truck-mounted hoist. The larger tanks are winched onto the truck with a sling. The first step is to jack one edge of the tank clear of the ground. The truck is then so positioned so that a pair of steel runners resting on its carrying platform can be placed under the tank to form a ramp. A

wire rope sling is fitted around the tank, which is then drawn up the ramp by a winch mounted on the truck. Steel pipes are used as rollers when moving the tank.

For unloading the platform of the truck is raised slightly and the tank slides down the ramp. The steel pipes are again used as rollers and the downward movement is controlled by the winch.

[Return to top of page](#)

[Return to index page](#)

[home.cd3wd.ar.cn.de.en.es.fr.id.it.ph.po.ru.sw](#)

Case study 5

10m³ ferrocement tank, Nagercoil, India

Introduction and background

This RWH system is an example of a suburban solution to inadequate water supply from the municipal authorities. Although the family have a piped supply connected to the

main town supply, the reliability of this supply is very poor the piped supply provides water only every 8 to 10 days and the quality of the water is questionable. The family also has a groundwater supply but this, too, is unreliable. Their solution was to construct a RWH tank and harvest water from their roof. The traditional Nalluketta building style of this area, as shown in Figure 1, lends itself well to RWH. The central rooftop courtyard above a single storey dwelling makes an ideal collection area.

The system was installed as part of a programme run by the Centre for Appropriate Technology, an NGO based in the town of Nagercoil. They have installed more that 100 such systems in the area.

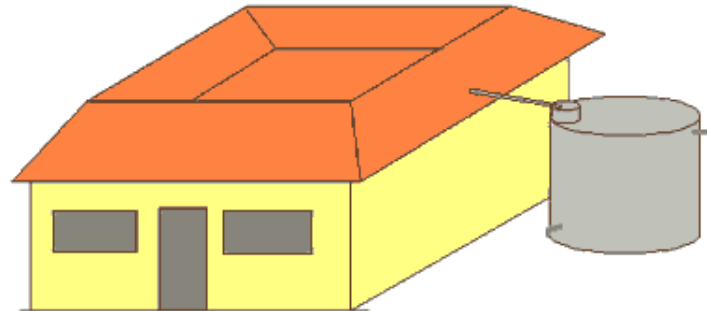

Figure 1 - Showing the traditional Nalluketa roofing style

Technical detail

Tank details

The tank is a cylindrical ferrocement structure, with a diameter of 2.5m and a height of 2m. There was little detail available regarding construction details but it appears from the corrugations on the exterior that a zinc sheet mould had been used to cast the tank. The tank is set on an 18" concrete plinth which means that a bucket can be placed comfortably under the extraction tap while still keeping the extraction pipe near the bottom of the storage area, therefore not wasting any storage capacity. The tank cover is formed using corrugated asbestos sheets. The tank is fitted with an overflow pipe near cover level.

[**Figure 2 Photograph of the tank and roof \(click text to see\)**](#)

[**Figure 3 - Photograph of tank \(click to see\)**](#)

First flush is achieved by simply moving the down pipe away from the inlet basin. There is a pre-filter basin which sits on top of the cover. It contains a plastic bowl which has been punctured repeatedly to allow water to pass through, as with a sieve. The bowl is filled with small stones and sand which acts as a filter. The bowl and basin have been cemented in place to prevent water entering the tank through the joints. A water level sight tube has been fitted but is too discoloured by sun and silt to be of any use.

Catchment area

The catchment area, as mentioned earlier, is the rooftop of the house. Because the rooftop is rather unusual in design (see Figure 1) and the collection area is the internal rooftop courtyard, it is required that the downpipe pass through the roof structure (see Figure 4). This can present problems if sealing is not effectual. The catchment could take place on the outer faces of the pitched roof but this would entail fitting guttering and fascia board, all extra expense. The catchment area is approximately 100m².

The pitched section of the roof slopes at approximately 35^o and is of pantiles. The central rooftop courtyard area is mostly flat with a mix of tiles and cement rendered surface. There are many trees overhanging the roof and it quickly becomes covered in leaves, which could block the downpipe.

[Figure 4 photo catchment area \(click text to see\)](#)

Annual rainfall in the region is about 1200mm. Normally there is a single wet season with a dry season which lasts about 4 months.

User regime

The catchment is about twice the size required to fill the tank, so the tank can be filled early in the rainy season. The families procedure during the rains is:

- to sweep the roof clean and divert the first rain runoff
- to fill the tank early in the wet season
- to then seal the tank (e.g. tape up the entry against mosquito entry) and divert flow away from it
- to use the water for premium quality purposes only during the following dry season: the stored water usually lasts until the next rains



Figure 5 - Pipe has to pass through roof, from central roof courtyard, to tank

[Return to index page](#)

[home.cd3wd.ar.cn.de.en.es.fr.id.it.ph.po.ru.sw](#)

Case study 13 The Green Shop RWH systems, UK

Background and introduction

The Green Shop is a Gloucestershire based retail outlet for consumers concerned with the environment and with ethical issues. They have, for some years, been selling rainwater harvesting equipment, some imported from Germany and other equipment which has been developed by the shops owner. They run courses for people who are interested in RWH, especially those interested in systems installation or systems management. They also offer a design and consultancy service for those interested in installing domestic or commercial RWH systems. They can be found at <http://www.greenshop.co.uk>.

There are several demonstration systems at the Green Shop which can be viewed by the public. They are designed to meet the needs of the shop and adjoining garage and workshop and all the systems are fully functional and meet the requirements of the UK water by-laws. There are a variety of systems available to meet individual requirements and budget, using more sophisticated (and expensive) German equipment or more pocket-friendly solutions developed at the Shop.

Technical detail

There are three standard systems offered. All, at present, require a 240 volt, 13 amp electricity supply, although a system is being developed which will use a 12 volt supply. Each system incorporates an automatic switch over to mains water for periods of extended low rainfall. Each of the systems is adaptable for use in most domestic or commercial applications.

System 1 The WISY system

WISY is a German company who have become the field leaders in the flourishing German RWH market (address given in Resources Section of this document). They have developed a number of innovative components for RWH systems which combine to form reliable and sophisticated systems for domestic or commercial use. One of WISYs leading innovations has been its range of rainwater filter/ collectors which can either be installed directly in the downpipe or below ground, depending on the application (see Figure 1 and Figure 2). They sell a full range of products for RWH systems.

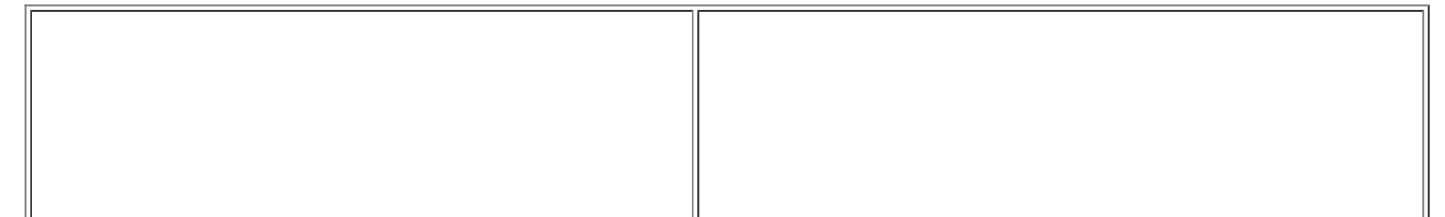

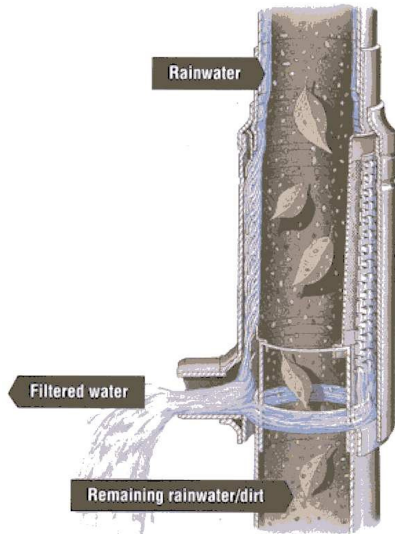

Figure 1 WISY downpipe filter / collector

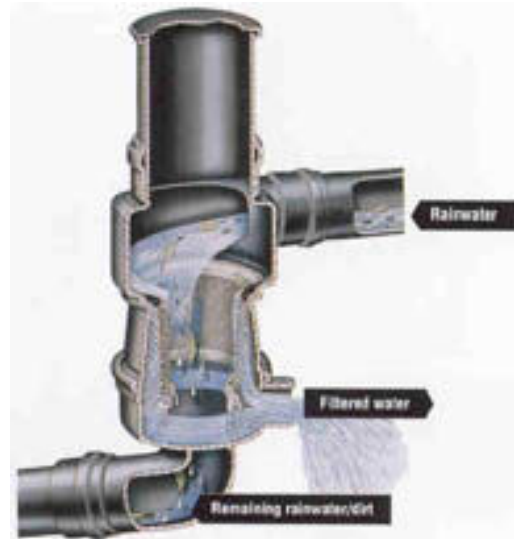

Figure 2 WISY below ground filter / collector

(Source: WISY Catalogue)

The WISY system has sophisticated controls which regulate water pressure, provide dry running protection for the pump and automatically controls mains top-up. They claim long life span and low maintenance for the system. A range of pumps are available for a variety of applications.

The full system includes the following components (see Figure4):

pump with auto switch	floating fine suction filter
electronic control unit	solenoid operated top-up valve
3m suction or pressure hose	smoothing inlet
connectors	overflow trap
filter collector	

WISY AG

D-63699 Kefenrod,
Frankfurt Area,
Germany

Tel: +49 60 54 91 21 0

Fax: +49 60 54 91 21 66

System 2 The KSB Hya-Rain system

Another German company, KSB also offer a full range of RWH equipment. The standard system on offer at the Green Shop includes the following components:

pump	electrical control
------	--------------------

box

motorised valve 7m suction hose

mains water bypass flexible
cistern connectors

floating fine suction filter collector
filter

pressure switch

The main distinguishing feature of this system is a separate mains override cistern for use when the main tank is dry. This allows the topping up to take place in a smaller cistern, decreasing the amount of water needed from the mains at each top-up.

System 3 The Rain Harvester Budget System

This is the Green Shops budget system which has been developed using standard plumbing fittings. The system comprises an 800 watt water pump with integral pressure vessel to smooth the system. An automatic mains top-up is incorporated with suction pipe, foot valve and strainer. The system is shown in Figure 3 below.

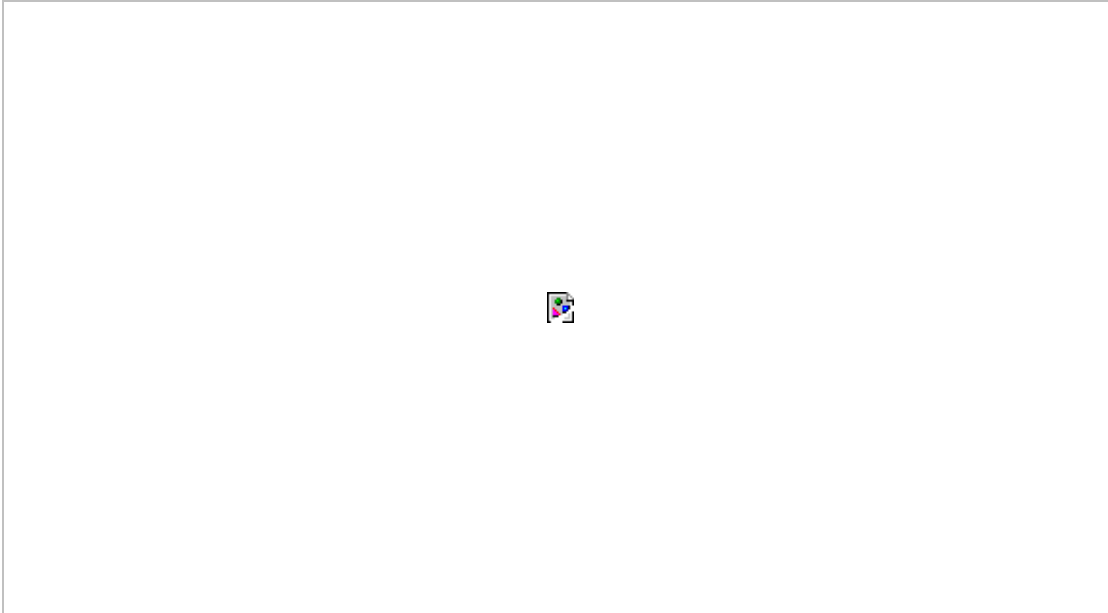

Figure 3 The budget system at the Green Shop (source: Green Shop Catalogue)

Tanks

A number of different types of tank is available for use with the above systems. Obviously, the size of tank will be determined by the application. In Europe, where services tend to be as inconspicuous as possible, the below ground and cellar tanks are both popular. Common tank materials include plastics, fibre glass, concrete and steel.

Many are purpose built and can be expensive. The budget system at the Green Shop uses an old 1520 litre Orange Juice transportation tank. This type of tank is cheap and ideal for the do-it-yourself enthusiast. These tanks can be easily linked to provide incremental increases in storage capacity. A typical below ground system is shown in Figure 4 below.

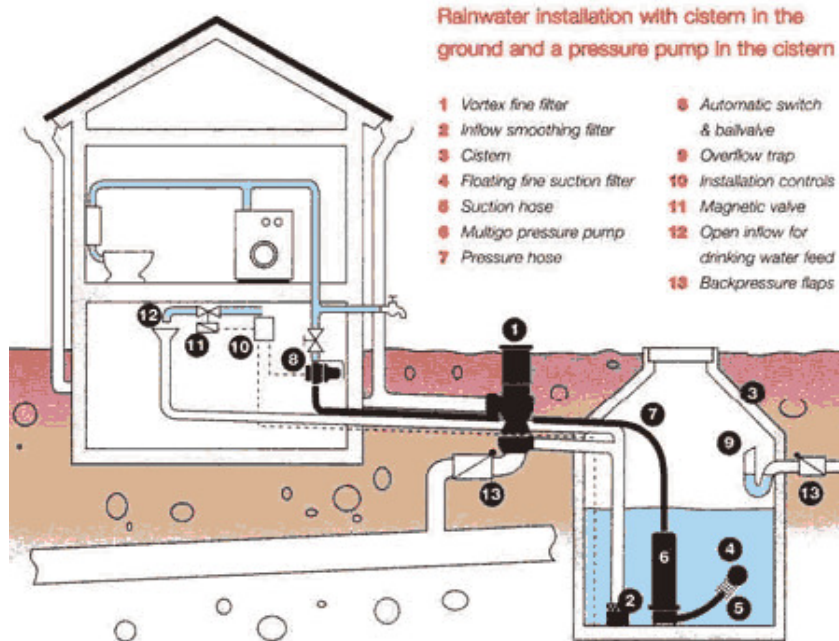

Figure 4 Rainwater Installation with below ground cistern and pressure pump. Source: Construction Resources News, Winter 1997

All plumbing fittings are from plastic to avoid corrosion, which is a real problem when using rainwater.

[Return to top of page](#)

[Return to index page](#)

[home.cd3wd.ar.cn.de.en.es.fr.id.it.ph.po.ru.sw](#)



**Humanitarian Demining
Research Programme**

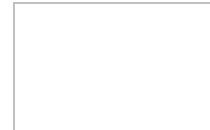

Working Paper No. 48

EQUIPMENT FOR POST-CONFLICT

DEMINING

A Study or Requirements in Mozambique

A.V. Smith

January 1996

[Other DTU
Publications on
This Subject](#)

CONTENTS

[Acknowledgements](#)

[Summary](#)

Mine clearance

Industrial capacity

[Abbreviations](#)

1 Background

2 Objectives of the survey

2.1 Variations to those objectives

3 Mine clearance in Mozambique

3.1 Mozambique

3.2 National mine clearance plan

3.3 Current situation

4 Organisations interviewed

5 Prior to mine clearance

6 Mine clearance methods

6.1 Clearing mines by hand

6.2 Using dogs

6.3 Mine-clearance vehicles

7 Equipment used for hand-demining

7.1 Electronic mine detectors

7.2 Ancillary equipment

8 Cooperation Nationally

8.1 UNADP future plans

9 Reported wants

9.1 Needs table

9.2 Consequences of the equipment
needs survey

10 Industrial capacity

10.1 Industry in Maputo city

10.2 Urban industrial prospects in Mozambique

10.3 Urban industrial prospects in Zimbabwe

10.4 Rural industry in Mozambique

10.5 Conclusions of the industrial capacity study

[Appendix A: Accidents](#)

[Appendix B: The Schiebel and Ebinger Detectors](#)

The Schiebel AN-19/2

The Ebinger detectors

[Appendix C: Mines and ordnance reported](#)

[Appendix D: Comment for discussion](#)

Accident reporting

The value of life?

[▲ Top](#)

[Acknowledgements ▶](#)

[DTU](#)
[Home](#)

[Building](#)
[Materials](#)

[Mine](#)
[Clearance](#)

[Rainwater](#)
[Harvesting](#)

[Water](#)
[Lifting](#)

[Publications](#)

[home.cd3wd.ar.cn.de.en.es.fr.id.it.ph.po.ru.sw](#)

Case Study 14

Rainwater Jars in Cambodia

Below are some pictures taken in Cambodia of RWH practices (Many thanks to Vince Whitehead and Liam Brown for the pictures and information in this Case Study)

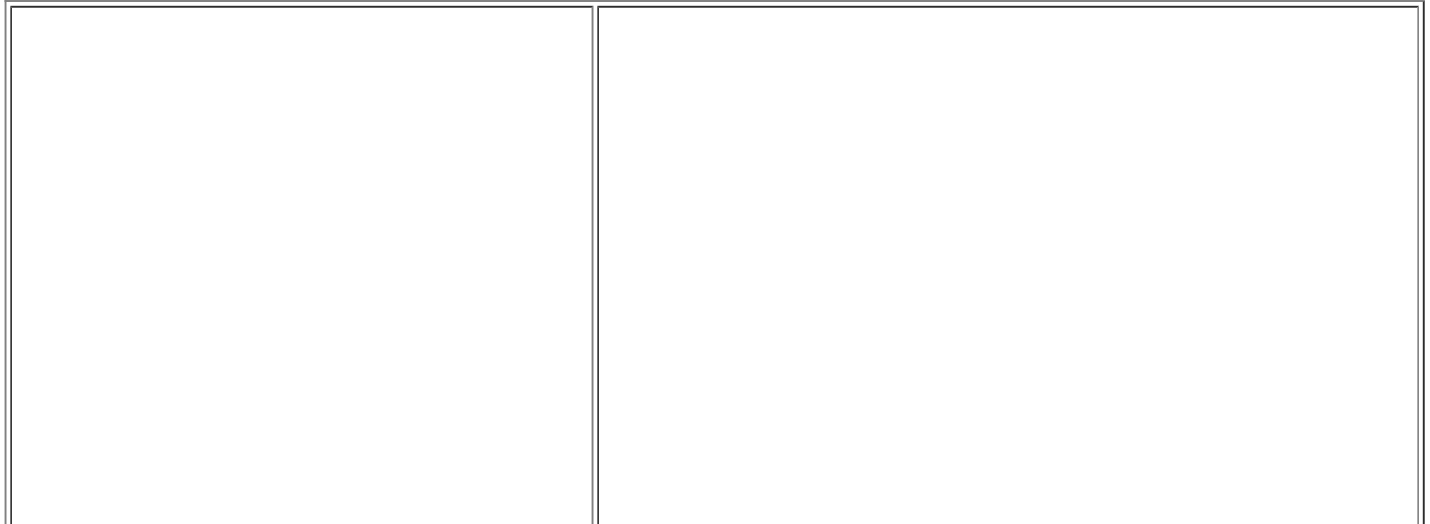



A rainwater jar of approximately 400litre capacity used widely throughout the country. The jars are of ferrocement, using single strand wire rather than chicken mesh.

The construction technique

The jars are manufactured using [wooden blocks](#) that fit together to form a mould. [Clay is then placed inside the the wooden mould](#) to give added strength. The mould is rendered to a thickness of between 1cm and 3 cms with the [wire to give added strength](#). Lids are made from ferrocement also, using a [circular mould](#). The woman who makes these jars sells them for about \$US 5 per piece. Transport is by motorcycle and trailer - see below.

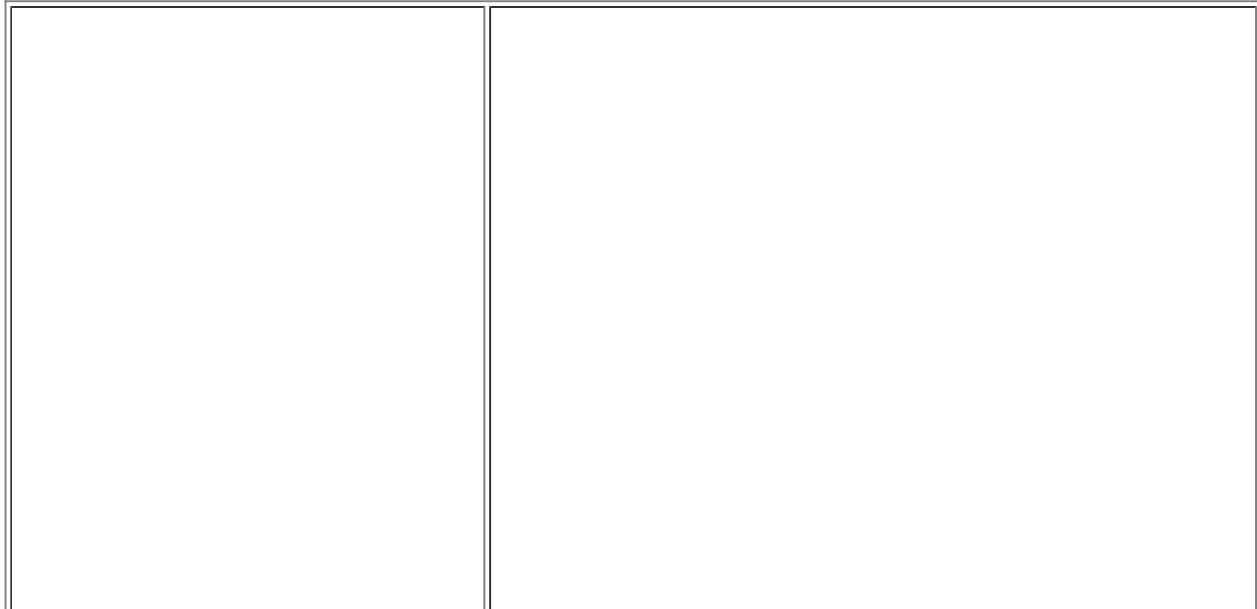



Below we see a series of these jars that have been elevated to provide overhead storage at a roadside restaurant.

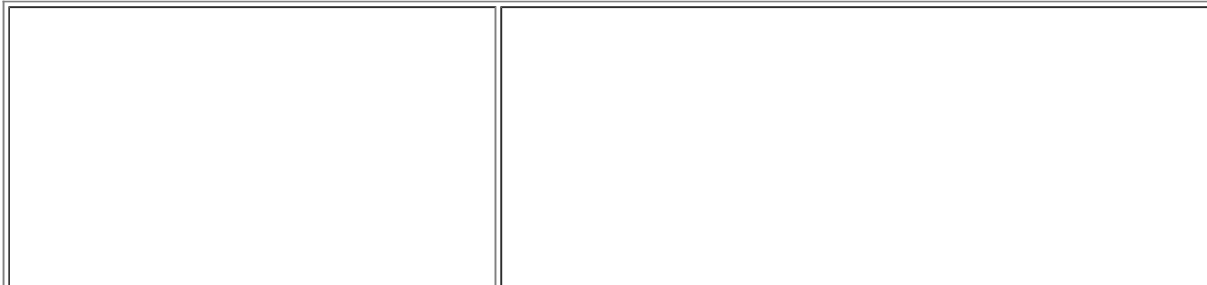



Concrete jars cast in moulds are also commonplace in Cambodia



This rectangular tank is made from rendered brick

[return to index page](#)

[home.cd3wd.ar.cn.de.en.es.fr.id.it.ph.po.ru.sw](#)



RWH Research Note 3

RAIN WATER JAR PROGRAMME IN NORTH EAST THAILAND

**Rajindra De S Ariyabandu,
Lanka Rain Water Harvesting
Forum**

June 2001

[Other DTU publications on this subject](#)

In 1979, the Royal Thai government declared the policy of water resources development for rural areas. The focus was more decentralised with co-ordination and planning responsibilities given to the district and managed by local authorities with user community participation. There were three small scale technologies that were introduced. Jar and tank construction for drinking water, shallow wells for domestic water and small weirs for agriculture.

The visit, which was undertaken from 20th to 26th June 2001 was to study the Thai Jar and tank project which was particularly targeted for household drinking water .

Present status of the programme

The Thai jar programme is very much in practice at present. There are two types of Thai rainwater

harvesting systems. The individual household jars and more community oriented tanks. Both are surface structures with jars varying in its capacity from 1.2 to 2,0 m³ and tanks from 7.5m³ to 10m³ Both these structures are widely seen in most rural areas in N-E Thailand, though jars are more commonly used. Jars and small capacity ferrocement tanks are in use in few urban households, According to what is visible from number of field visits, the distribution of Thai jars can be well over few millions. It is hard to find a house in rural areas that does not have a jar. Most houses that have tanks also have at least one jar. These households who have both tanks and jars prefer to use the tank water for drinking and cooking and jar water for other domestic uses.

At present construction of jars are wholly done by small scale private manufactures. As no statistics are maintained, it is difficult to say the number of small scale manufactures in jar business However,

an indication given by one jar manufacturer, was that there are four such manufactures along the 50km stretch towards north of Khon Kaen. Well made jars are a common sight in front of most jar manufactures. One manufacturer in Nongbuadeedneem, said that he makes 4-6 jars (2m^3 capacity) per day with three workers in his factory .The selling cost of these jars is Bhat 650 (about \$15).Cost of production is about 250-300 Bhat. He uses two bags of cement and two wheel barrow~ loads of "rock dust" and one wheel barrow load of sand per jar.

Construction appears to be very simple. There are 8 segments of 10cm high curved cement blocks placed in 9 circular rows per jar, These cement blocks are placed on the concrete base and worked upwards towards the top flat area. The cement blocks are bound together with clay and once the "block skeleton" is made it is plastered with clay from out side. The cement mortar is applied on the

clay plaster, The top flat part of the jar is shaped with "half moon" shaped wooden planks stuck together with clay. A jar can be cured in one day without any addition of water or laying plastic for curing purposes. Once the jar is fully dried, the cement blocks are removed first and the wooden planks are removed later. The jars I observed in this factory did not have any wire reinforcement. The manufacturer gives a five-year guarantee against leaks for each jar .One important observation with this manufacturer is that cost of a jar is same irrespective to the capacity of the jar. In rural Thailand it is difficult to find the reason for such costing. By the way this jar manufacturer is a full time paddy farmer who does jar making as a part time business. His working hours on jar making is from 5.00am to about 9.00am. Rest of the time he works in the field.

Cost of water in Khon Kaen

There are two water authorities who are supplying water to households in Khon Kaen. The Provincial water authority (PWA) which supplies household water through piped supplies and private water suppliers who supply bottle water for drinking purposes. The piped water supplies cover all major cities in Khon Kaen and rural households to a considerable extent. PWA water cost Bhat 9/m³ of water and private water bottle companies charge Bhat 15/10 liters of drinking water. An average rural household pays between Bhat 20- 50 per month for pipe water delivered by PWA.

Construction problems

During my visit to rainwater users there were no significant construction problems reported. However, in one household, where they moved two rain water jars about 100 meters, burst after filling with water. The occupants of the house believe that one jar would have cracked while

moving and it burst as a result of water pressure. The other jar too burst as a result of the impact. Besides this isolated incidence, the other problems as observed were, lack of taps in some jars to take water and lack of jar covers. Incidentally, covers for jars are not made at the same place as the jar. As a result some take the trouble in buying galvanised covers which costs about Bhat 70-100, but there are others who use jars without covers. This was mostly evident in jars found in schools.

However, if one considers the "jar" as a rainwater harvesting unit, then there are other problems such as absence of effective first flush systems and total absence of any kind of filters. Water usually flows directly from over hanging down pipes into the jars and in some instances through improvised gutters, which are not suitable for rain water collection.

Management problems

As stated before, most schools have totally neglected managing their rainwater jars. As a result one could observe large number of jars idling without being used. Some of these jars have become ideal breeding grounds for mosquitoes. Even the ferro cement tank in number of schools appear to have been neglected. Water flows directly from the roofs to the tanks. It appears that there is hardly any maintenance of roof surfaces before rain storms. Some of the tanks did not have any taps and in most instances the end cap of the first flush systems were closed. In one instance, in the tanks constructed at the "king cobra club" the first flush and the end cap was placed higher so that occupants can't reach it in the event of sudden rain storms. Mosquito breeding appears to be a common problem with rainwater jars. However, people do not think that rain water jars are the primary cause of mosquitoes. During my visit I observed number of "traditional earthen clay jars" full of mosquito larvae. In Bantoom village

the Provincial health authorities have advised rainwater users to cover the mouth of the jars with netting to prevent entry of mosquitoes. However, one could observe large mosquito populations in the vicinity of these jars, suggesting that mosquitoes could be breeding in collected rain water .

Quality of rain water

Almost all people who collect rainwater use it exclusively for drinking and cooking. People prefer rainwater to other water due to its taste. As stated earlier Thai people in this part of the country have been using rainwater traditionally for domestic use including drinking. As such quality of collected water is not a concern for these people. However, judging by the status of collection systems, nothing good can be said about the quality of water. Water quality tests conducted during the early part of the programme under IDRC assistance, indicate

bacteriological contamination of rain jars. However, the research also shows that contamination of other sources are far greater than rain water jars. For instance, traditional earthen jars and shallow ground water have indicated higher concentration of contamination than roof run off. Incidence of mosquito breeding has been highlighted as an issue in research work conducted by Khon Kaen university during the early stages of the programme. It is very much evident even now, specially among community rainwater harvesting centres (i.e. schools and temples). There were slogans seen against the dangers and eradication of dengue fever written in local languages. But people do not appear to relate rainwater collection to spread of dengue. Though most jars used by households had galvanised covers, they were not mosquito proof and the practices of fetching water can facilitate entrance of mosquitoes. The most concerned situation with regards to vector breeding can be seen

seen in schools, where most of the rainwater jars were neglected.

Research on quality of rainwater was conducted exclusively by KKU during the early days of the programme. Professor Wanpen Wirojanagud had pioneered number of studies. However, it is unfortunate that non of these studies have continued and no work is being done on quality of water at present. I have collected two papers written by Professor Wanpen on water quality. These papers give an idea as to the status of collected rainwater, sources of contamination and certain measures adopted to minimise contamination.

Water use

The paper entitled "*Bacteriological quality of rain jar water in rural Northeast Thailand*" by Prof.: Wanpen clearly identify the use of rain water for

drinking and ground water from tube wells and shallow wells for other domestic purposes. According to a large scale survey conducted in two rural villages, 72% and 94% of users in the two villages use rain jar water for drinking. In the village of Ban Daengnoi, 66% of the domestic water is also from rain jars (Wanpen et al 1993). Observations from my short visit to Northeast Thailand, on water use at household level does not differ from this pattern. Water use for drinking at household level is always through a secondary container. However, I personally observed children drinking straight from rainwater tanks, which could be contaminated due to the condition of the collection system.

Acceptance of rainwater in Northeast Thailand

John Gould and Erik Nissen-Petersen in their book on "*Rainwater Catchment Systems for domestic*

water supply", highlights reasons for the popularity of rainwater in Northeast Thailand. However, I would like to complement some of their finding from my visit. According to my observations, following are some of the reasons for acceptance of rainwater in Northeast Thailand.

1. Traditional use of rainwater for drinking.
2. Availability and use of traditional earthen vessels for rainwater collection for domestic use.
3. Unpalatability of ground water due to very high salinity. Hardness of water is 5-6 times more than the prescribed WHO standard. (estimated at 1200 -2000ppm as against <300ppm is the optimum level)
4. Cheap cost of rain water jars and its portability.

This situation is mostly applicable to rural areas in Northeast Thailand. In the urban areas drinking

water is mainly supplied by private water companies. It is believed that some 20 years ago there were only two water companies, one of which is the popular "Corolis water company". Today, there are approximately 80 water companies selling water to urbanities. With the Thai economy picking up after the recent Asian economic crisis and with the new policies of the present Thai Premiere, more rural people will be in a position to afford bottle water. If this trend continues, private water bottle companies may venture into the rural areas as well. Hence, it would be interesting to review the rainwater jar programme again, in say, five years time to understand the water use pattern of rural Northeast Thai people.

Multiple sources of water

Most rural Thai people use at least two water sources. Rain water from jars and tanks and

shallow ground water from tube wells. However, during my visit I also observed some villages having PWA water connections. Which could mean that these households can have up to three water sources. However, what is generally observed is only two sources, of which the ground water is always used for non drinking purposes.

Involvement of NGOs

Development NGOs have taken a keen interest in water resources development in rural Thailand. The Population and Community Development Association (PDA) is one such NGO which has been very active in promoting rain water harvesting in rural Northeast Thailand. PDA has 16 centres distributed all over Thailand. According to its Director, it has so far constructed some 16000, 11m³ water tanks. A set of three 11m³ tanks cost Bhat 40,000 for PDA but the government is supposed to be charging Bhat 70,000 for the same.

The PDA system is that the recipient has to pay back in 3 years, in equal instalments with no interest charged. According to PDA estimates, a 11m³ rainwater tank can be used by a family of five for drinking and cooking, with bathing and washing during the wet months, for a period of one full year. However, this can only be achieved with good water management practices. PDA has staff strength of 600 and it closely works with KKU and other government agencies.

Research on Rainwater harvesting and institutional involvement

Unfortunately there is no research taking place on rainwater harvesting in Northeast Thailand. According to KKU, the reason for inactivity in this area is due to lack of any supportive project that takes a critical view on rainwater harvesting. Also the university itself has shifted their focus to other areas which obviously take priority over rainwater

harvesting. For the same reason, there is hardly anybody, except for Mr Paiboon and Professor Wanpen who has the experience and knowledge on the Thai jar and tank programme. Professor Wanpen is the present Associate Dean for research at KKU, hence she is a very busy person to meet. This leaves only Mr Paiboon, who is a water specialist, a practical engineer and a technician, capable of contributing to work on water at rural and urban level.

Mr Paiboon can be contacted through Professor Wanpen's e-mail



This document is an output from a project funded by the UK Department for International Development (DFID) for the benefit of developing countries. The views expressed are not



[home.cd3wd.ar.cn.de.en.es.fr.id.it.ph.po.ru.sw](#)

Chapter 1

Strength of cementitious mortars: a literature review with special reference to weak mortars in tension

1.1 Abstract

Cementitious materials are commonly used for the construction of low-cost water storage tanks in developing countries. For this purpose an understanding of their properties, particularly tensile, is important.

A literature review is undertaken, starting with factors determining mortar strength. Expressions are quoted for optimum water content varying with determined for each sand:cement ratio; this content will depend on the compaction method being used.

The review is followed by some analytical work based on available data, suggesting that sand:cement ratios of around 6:1 are optimal with respect to materials cost, provided certain strength relationships suggested from existing data hold.

[Strength of cementitious mortars: a literature review with special reference to weak mortars in tension](#)

[1.1 Abstract](#)

[1.2 Introduction](#)

[1.3 Literature Review](#)

[1.3.1 Mortar components and failure](#)

- [1.3.2 Sand-cement ratio](#)
 - [1.3.3 Voids and strength](#)
 - [1.3.4 Water-cement ratio](#)
 - [1.3.5 Pores and air content](#)
 - [1.3.6 Compaction & cement rheology](#)
 - [1.3.7 Determination of optimum water-cement ratio](#)
 - [1.3.8 Curing & Shrinkage](#)
 - [1.3.9 Drying and Strength](#)
 - [1.3.10 Data from literature](#)
 - [1.4 Strength Modelling and Mix Proportioning](#)
 - [1.4.1 Simple Model and optimisation](#)
 - [1.4.2 Model application](#)
 - [1.4.3 Modifications to thickness term](#)
 - [1.4.4 Labour Content](#)
 - [1.5 Conclusions](#)
 - [1.6 Reference List](#)
-

1.2 Introduction

The Development Technology Unit has an interest in work on low cost rainwater storage tanks for developing country applications. In developing countries applications, labour is

relatively cheap compared to materials. In this case, techniques that allow the substitution of mechanical work for materials are likely to be attractive.

Many designs for tanks using cementitious materials exist at present, and the majority of these employ rich mortars (low sand-cement[GS1] ratios). In some cases the wall thickness also seems excessive. However, fieldworkers have observed the successful use of low-cement mortars by local workers. This offers one avenue for exploration, as cement is significantly more expensive than sand (or other fine aggregates), hence using larger quantities of a weaker mix may provide a lower cost product.

A mortar will have a series of properties, including its ultimate compressive and tensile strengths (measured as stresses), Youngs Modulus, Poissons ratio etc. Of these, there is often a relationship between compressive and tensile strength (and compressive is easier to measure). Depending on the tank design, we are largely interested in the tensile strength, though certain designs will make compressive strength important.

To simplify consideration of the mortar, it will initially be considered as consisting of water, fine aggregate (sand), and cement only, without admixtures.

1.3 Literature Review

The range of factors influencing the strength of cementitious products is legion. Included within these are the physical and chemical characteristics of the cement, aggregate, and water, the mixing environment and subsequent curing conditions. To

address all of these experimentally and exhaustively is not feasible some selection of significant variables is required. To this end a review of current literature was undertaken, with the additional aim of avoiding unnecessary duplication of existing results.

1.3.1 Mortar components and failure

A set mortar will consist of four components:

- [1] Cement [\[1\]](#).
- [2] Sand.
- [3] Water.
- [4] Air.

Mortar and concrete fail by crack propagation through the cement paste, rather than failure of the aggregate (Whittmann, 1983). There are some exceptions to this, but given the use of normal-weight aggregates in lean mortars it is highly unlikely that aggregate failure will occur.

There is at least one significant difference between compressive and tensile loading: a crack area in tension cannot contribute any strength to the mortar, whilst two faces in compression can still transfer some load.

A compressive load can cause tensile forces to occur in regions of the material (Orowan,

1948). For biaxial loading it has been shown that, to give the same tensile force around a crack, a compressive force eight times that of the tensile loading would be required. The cracks of highest stress in uniaxial loading would lie at 45° to the axis. These findings accord with the typical ratios for concretes (tensile strength of around 10% of the compressive), and failure geometries, though the ratio of compressive: tensile strength varies with a number of factors. However, the assumptions in this model do provide an oversimplification of the actual situation: the model assumes a homogenous material with a large number of identically sized cracks in all orientations.

Another interesting point is that surface finish will have a more significant effect for failure in flexure: a rough surface will contribute stress concentration effects in the area of greatest stress.

1.3.2 Sand-cement ratio

The received wisdom is that increasing the cement content of a concrete will increase its strength. Whilst in many practical cases this is true, it arises from secondary effects. Certainly, for concretes of strengths above 35MPa, increasing the aggregate content whilst holding the water-cement ratio constant will lead to an *increase* in strength (Neville, 1995). There are several possible explanations for this, but the most plausible is as follows:

Concrete fails through crack propagation. Cracks are initiated in either the matrix or the

matrix-aggregate bonds. Failure is statistical, so increasing the amount of matrix will raise the probability of flaws being present that will cause crack propagation at a given stress. If all other factors are held constant, increasing the quantity of aggregate per unit volume of concrete will reduce the probability of crack-initiating features, hence giving a stronger concrete.

However, it is extremely difficult to hold these other factors constant. In addition, at extremely high sand: cement ratios (around 10:1) there will be insufficient paste to fill the voids between the aggregate particles. For mortars in tension the load must be transferred through the cement matrix. Reducing the amount of matrix taking the load will reduce the strength.

Cement is considerably more expensive per unit mass than sand (ratios of between 20:1 and 70:1 have been recorded in developing countries), so reduction of the cement content is desirable if possible.

1.3.3 Voids and strength

If we take a cementitious material of given sand-cement ratio, the strength is fundamentally determined by the volume of voids in it (Neville, 1995). There are two potential effects:

Increase in stress from reduction in material withstanding load.

Stress concentration effects.

The source of these voids may be:

Free water.

Air voids arising from incomplete compaction.

For normal concretes, the design is for a high degree of compaction (and corresponding low air voids content of around 1% by volume), and hence the water: cement ratio will dominate the strength. However, for mixes that are more difficult to work, such as lean mortars, the presence of air voids will rise, and their effect on strength will become non-negligible.

1.3.4 Water-cement ratio

As mentioned above, in much concrete work the critical factor influencing strength is the water-cement ratio, as famously encapsulated in Abrams rule. This states that the strength of concrete falls monotonically as water-cement ratio rises. A more accurate formulation would be:

The strengths of comparable concretes depend solely on their water-cement ratios regardless of their compositions.

(Popovics, 1998)

The conditions for comparable concretes are given in Table 1.

Table 1: Conditions for comparable concretes

1. The strength-developing capabilities of the cements used are identical.
2. The quantities and strength-influencing effects of the admixtures used are identical.
3. The concrete specimens are prepared, cured and tested under the same conditions.
4. The concrete ingredients (cement, water, aggregate particles, admixtures) are distributed uniformly in the concrete.
5. The air contents are the same in the concretes, the air voids are distributed uniformly in the concrete, and none of the voids is too large for the size of the specimens.
6. The aggregate particles are stronger than the matrix; that is, the fracture propagates more in the matrix than in the particles.
7. The bond between the aggregate surfaces and matrix is equally strong in the concretes compared and is strong enough to transfer the major portion of stresses in the matrix to the aggregate before the concrete is crushed by

the load.

8. The strength-affecting physical and/or chemical processes in the concretes (drying, aggregate reactivity, etc), beyond the cement hydration, are not overwhelming (cracking, etc.) and are the same.
9. The nonhomogeneity or composite nature of concrete, the origin of which is in the differing characteristics of matrix and aggregate particles, affects the strength of the compared concretes to the same extent.
10. The contribution of the aggregate skeleton, resulting from interlocking of the aggregate particles during loading, to the concrete strength, is the same in the various concretes.

(Popovics, 1998)

On closer examination this reduces to a truism along the lines of: if all other factors influencing strength are held constant, the only factor determining concrete strength is water content. In particular for our case, point 5 cannot be guaranteed. At this point the question arises as to what extent Abrams law will be useful.

Abrams law has been found by experiment to fit this algebraic form:

Equation 1.1



Where s is the strength, A_0 and B_0 are constants ($B_0 > 1$), and w/c is the water-cement ratio. A_0 has units of stress, and B_0 is dimensionless. Values of B_0 have been found both for compressive and tensile strengths (both flexural and splitting for tension^[2]) as shown in Table 2.

Table 2: Typical values of B_0 for concretes (Popovics, 1998)

Strength type	B_0	
	Natural aggregates	Lightweight aggregates
Compressive	20	7
Flexural	7	3
Splitting	8	3

It is of particular interest to notice that tensile strength (by either measure) is less sensitive to water-cement ratio than compressive strength.

In general, cementitious materials require water for two functions:

1. To hydrate the cement particles, leading to setting and hardening of the material.
2. To provide some lubrication such that the material is sufficiently fluid to be

moved into the required shape, and for the expulsion of air.

This means that for mortars there should always be some water in excess of that for hydration of the cement.

With insufficient or no lubricating water, the material will have a certain quantity of air voids from incomplete compaction. The presence of these voids leads to a reduction in strength of the mortar, as is covered in 1.3.5.

Perhaps a more sensible approach is not to try to use Abrams rule as a mathematical expression, but to understand the general principle that, for given concretes with other strength-determining factors not varying excessively, the water-cement content is the most significant factor in determining strength.

1.3.5 Pores and air content

The presence of air pores acts to reduce the strength of concrete. There are several possible formulae to represent this effect:



Equation 1.2
(Popovics, 1998)

In this case f_{rel} is a relative mechanical property, defined as f divided by f_0 , the property

for the material with zero voids, a is the volume fraction occupied by air voids, and γ is an experimentally determined constant. The above relationship is that developed for the strength variation with porosity for polycrystalline bodies with air-filled voids.

Typical values for γ are also available:

Concrete Type	γ
Compressive strength of normal-weight concretes up to  air voids between 7 and 90 days age.	0.0384
Flexural strength	0.0232

Table 3: Typical values of γ (Popovics, 1998).

This was modified for cementitious materials by Popovics to:

Equation 1.3



Where $a_{CR} < 100\%$ is the critical air voids at which the physical property goes to zero (%), $a < a_{CR}$ as the actual air voids content (%). The first part of the right-hand side of Equation 1.3 is intended to account for the material removal effect, and the second part for stress concentrations. Note that γ will take different values for this expression than in Equation

1.2.

Assuming the air void content can be varied independent of the water-cement ratio, it should be possible to combine this with some form of Abrams rule or similar, to give:



Equation 1.4

There may be later complications arising from the variation in stress concentration factor with stress level. If Equation 1.4 holds, correlations might be possible between strength, initial air content and compaction method.

1.3.6 Compaction & cement rheology

Compaction normally involves the application of mechanical work to a mix in order to reduce the air content. As covered above, this then improves the strength of the finished material. Techniques used for compaction include:

- Static or slowly varying loading.

- Rapidly varying (e.g. impulsive) loading.

- Application of external vibration (e.g. via mould walls).

- Insertion of a vibrating element.

Rheology is the branch of physics that studies the deformation and flow of matter. In the case of cement this has led to some basic models, such as the approximation of cementitious materials as Bingham fluids (Tattersall & Banfill, 1983). This means that the fluid will have a linear stress-strain rate diagram, with an offset:



Figure 1: Shear stress τ vs. shear strain rate $\dot{\gamma}$ diagram for a Bingham fluid



Equation 1.5

Thus, the application of stresses lower than τ_0 will not lead to any permanent deformation of the mortar.

There is also the phenomena observed with cement that a stiffening effect occurs at high strain rates. Some account is taken of this in recent modelling (Chandler & Macphee, 2003). If validated, the model would be of interest, though it would require the characterisation of a series of material properties.

Similarly, a considerable amount of work has been conducted on the consolidation of soils. The wide variability of soil types has led to much of this work being experimental in nature. While useful for providing descriptions of existing mechanical devices, such as vibrating compactors (Parsons, 1992), there are clear difficulties when considering a material not listed. A common feature in soil mechanics, stabilised soil research and cement production is that there exists an optimum moisture content. With dry soils, high friction exists between particles. As the moisture content increases, there is an initial absorption into soil particles (if they are porous), and then an adsorption of a thin layer around the soil particle surface. This layer can act as a lubricant, leading to the increase in workability mentioned in 1.3.4 above. Above an optimum point, there is a swelling effect as the moisture separates the particles, which reduces both density and strength.

The determination of this optimum water content for different soils has also been linked to other quantities, such as the plastic limit of the soil (Hausmann, 1990). This is an interesting point to note, as it may prove to be of use when generating practical recommendations. It should be easier to determine the water content for a particular type of commonly-tested mortar behaviour (e.g. slump), than to accurately measure

other properties more commonly used in design calculations (such as specific surface).

Mechanical vibration compaction has been used successfully with ferrocement products (Sharma, 1983), with strength gains of around 20% over hand compaction quoted. In this case, the only technical details given were that the machine could run on single-phase 300W power. The images in the article indicate the type of machine used:



Figure 2: Vibrating compactor diagram (a) and in use (b).

Similar vibro-pressing techniques have been used in Poland (Walkus, 1981). In this case the suggestion is made that vibration frequencies above 100Hz be used. For optimum strength a linear relationship between vibration intensity and travelling speed of the machine (a surrogate for inverse of duration of vibration), with intensity defined as:

Equation 1.6

Where A is the amplitude of vibration, and f the frequency of vibration. This also includes the finding that wetter mixes require less compaction, as would be expected.

For a constant intensity then, Equation 1.6 implies that the sensitivity of A to f will be 1.5 i.e. a 1% increase in frequency will allow a 1.5% reduction in amplitude.

However, other researchers (Hausmann, 1990) have suggested using a frequency only just above the natural frequency of the material, and large amplitude is more effective than using high frequency and low amplitude.

Research on roller compacted concrete (extremely dry concrete that is difficult to compact by normal means, used in pavements, water control structures etc) (Kokobu et al., 1996), varied both frequency of vibration (75-150Hz), and the acceleration used. Several results were obtained:

For a given compaction effort (J/l) and peak acceleration, frequency had little effect on compaction achieved.

For a given compaction effort and frequency, increasing the acceleration increased the compaction.

Increasing the acceleration increased the final compaction achieved, though there was negligible increase above 3g acceleration.

Increased compactive effort increased final compaction asymptotically. Full compaction was achieved at around 100 J/l, which is of the same order as that for stabilised soil compaction (200 J/l).

There seems to be some variation in frequencies being recommended: lower limits of 100 Hz from one source (Walkus, 1981), whilst another quotes common practise as using around 35-50 Hz (Hausmann, 1990), and other findings indicate little effect from varying frequency (Kokobu et al., 1996).

1.3.7 Determination of optimum water-cement ratio

Knowing that excessive water content will lead to a reduction in strength, but that insufficient gives poor workability, a method for determining the optimum water content would obviously be desirable.

A method that takes account of the quantity of sand present is particularly important when considering lean mixes (Lydon, 1982). One approach previously employed is based on apportioning water for the two purposes given above: an amount to hydrate the cement, and a second quantity to lubricate the aggregate, based on its specific surface (Thanh, 1991). This can be represented algebraically:



Equation 1.7

Where w_o is the optimum mass of water, M_a and M_c the masses of aggregate and cement, and f_a and f_c are fractions.

Two methods are quoted for estimating w_o , one with water optimum water content varying with the fineness modulus, and the other varying with the square root of the specific surface:

The first method for determining w_o is:

$$w_o = \frac{a}{m} + b$$

Equation 1.8

a and b are constants depending on the desired workability, and m is the fineness modulus [3]. (Values of $a=0.215$ and $b=0.19$ are given for one consistency, and $a=0.236$ and $b=0.18$ for another.)

Another method uses:

$$w_o = \frac{c}{s} + d$$

Equation 1.9

Where s is the specific surface, and w_o a constant fraction fixed by the grading of the aggregate; in the Thanh article, the two figures quoted for w_o are .02 for continuous grading and .015 by mass for gradual grading. The specific surface (s) of sands used by Thanh ranges from 4.8 to 8.2 m²/kg, leading to w_o values of around 0.09-0.11.

The consistent feature in both these expressions is that finer aggregate requires more water.

1.3.8 Curing & Shrinkage

Cement sets hydraulically it requires water. Curing normally consists of controlling the humidity of the product environment, and possible wetting. Work on cement-stabilised soil blocks has indicated the importance of curing on strength, with up to six times greater strength for good quality curing compared to dry conditions (Kerali & Thomas, 2002). Loss of water from cementitious materials is associated with shrinkage. This water loss can come from continued hydration of the cement (leading to autogenous shrinkage, also known as self-desiccation), or from surface losses.

The water present in concrete may be categorised as follows:

Free water held in capillaries beyond the range of the surface forces in the solid phase.

Gel water, which may be either:

- Held by the surface forces of gel particles: adsorbed water.
- Held between the surfaces of certain planes in a crystal: interlayer water.

Chemically bonded water forming a definite part of the hydrated compounds.

With concrete samples there is no shrinkage associated with the loss of at least some

free water. There are some interactions with water quantity though a higher w/c ratio implies more pores, and thus greater shrinkage potential.

Curing temperature has an effect on the strength development of cement products. In general, higher temperatures for curing give more rapid initial strengths, but lower long-term strength. This then raises the question as to whether laboratory testing at Warwick will give significantly different results to those that will be experienced in the tropics. However, experimental data suggests this will not be the case: 28-day strengths of concrete samples varied by only 5% between curing temperatures of 10°C and 50°C (Kim et al., 2002).

1.3.9 Drying and Strength

A series of tests conducted on rich mortars with drying indicate that drying significantly reduces the flexural strength, but that this strength is then recovered by a relatively short period of rewetting (Hotta & Takiguchi, 1995). This effect was maintained over a range of wetting and drying regimes, and a range of water contents.

Surface cracking was observed, with observations of crack healing on rewetting. The presence of the cracks was interpreted as indicating that prestrains were being fully relaxed, though this is not necessarily true.

It is possible that the effects would be greater for stress in flexure. Because in flexure the higher tensile stresses occur at the specimen surface, the material will thus be

weakened at the areas of greatest stress, and have stress concentration elements introduced in those areas.

The implications for mortar tanks could be significant. Current practice generally involves the use of a cement slurry to line the inside of a tank, to prevent leakage. If this drying-weakening effect persists, then it might be preferable to use the slurry on the outside of the tank, to try and maintain a wet environment for the mortar. There is a potential problem with this approach a slurry coating on the inside of the tank will helpfully be driven into cracks by the water pressure, whilst one on the outside would be pushed away from the mortar.

1.3.10 Data from literature

1.3.10.1 Mortar Strength and Abrams Law

Work on Abrams law has been conducted with mortars as well as with concrete (Appa Rao, 2001). In the Rao article there is an attempt to validate Abrams law as applied to mortars. Whilst appearing fairly conclusive in general, there are several areas left uncovered. The sand-cement ratios are not changed significantly (only ratios of 2:1, 2.5:1 and 3:1 are used). This is a less impressive demonstration than that for concrete, where aggregate: cement ratios commonly change from 4:1 to 10:1.

The only results presented graphically in the article are those for compressive strength, such as that shown below:

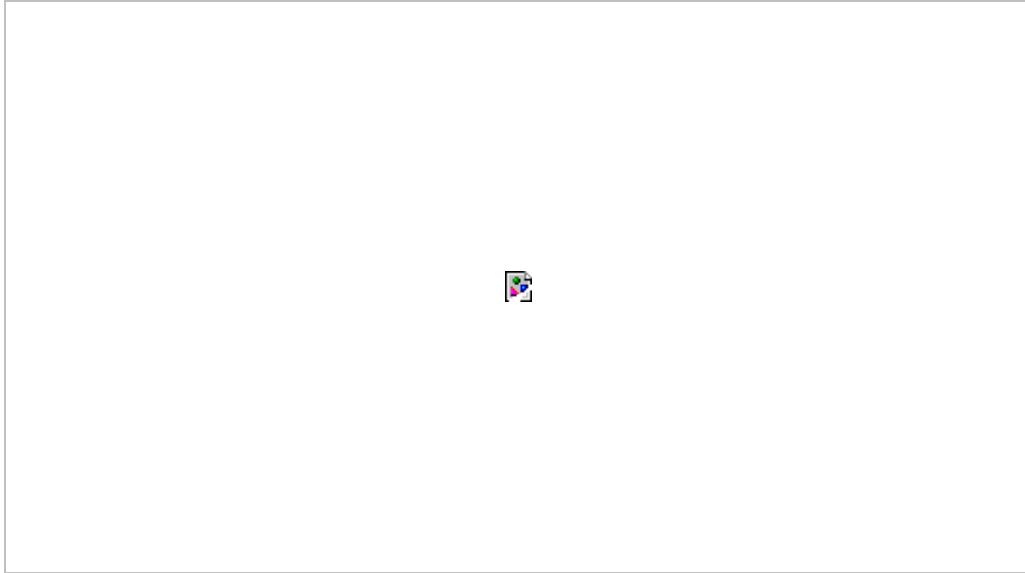



Figure 3: Data from Rao: 28-day compressive strength with water-cement ratio

Whilst this seems fairly convincing when quoted in the article, one obvious departure from Abrams law is the drop in strength at low water: cement ratios (). The data for tensile strength demonstrates a similar feature:

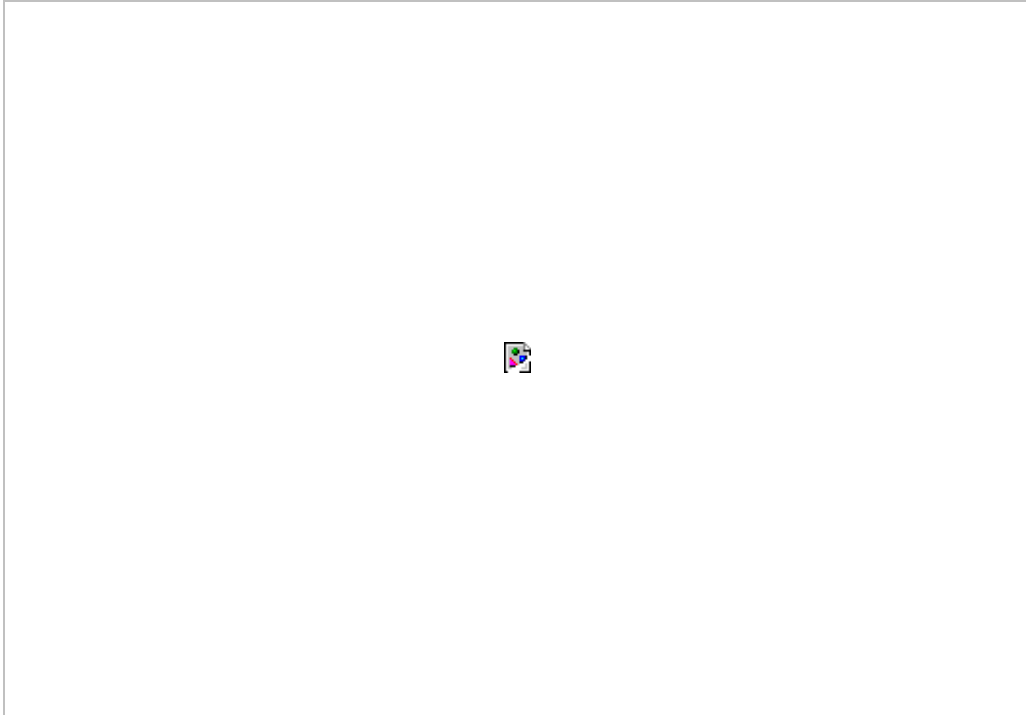

Figure 4: Data from Rao on 28-day tensile strength with water-cement ratio

For each of the series, some data was missing at low water:cement ratios, as the samples failed without being measured. This implies a significant drop in strength at water-cement ratios below the lowest indicated (0.35 for the 1:2 and 1:2.5 mixes, and 0.45 for the 1:3 mix).

As can be seen, this data does show some form of inverse relationship between strength and water content. However, the goodness of curve fit obtained using other relationship types is as good, if not better than that of Abrams law as given in Equation 1.1.

The influence of the change in sand: cement ratio is also interesting: the difference in

compressive strength between ratios of 2 and 2.5 is small compared to that between 2.5 and 3. There is a less significant variation in tensile strength.

There is a considerable difference between the compressive and tensile strengths: the Rao data give tensile strength as only around 5-6% of the compressive. This is clearly shown in Figure 5 where it may be noted that the ratio of tensile to compressive strength is fairly constant over a wide range of water-cement ratios.



Figure 5: Ratio of compressive-flexural strength (Rao data)

However, this relative constancy does not hold for other data sets:

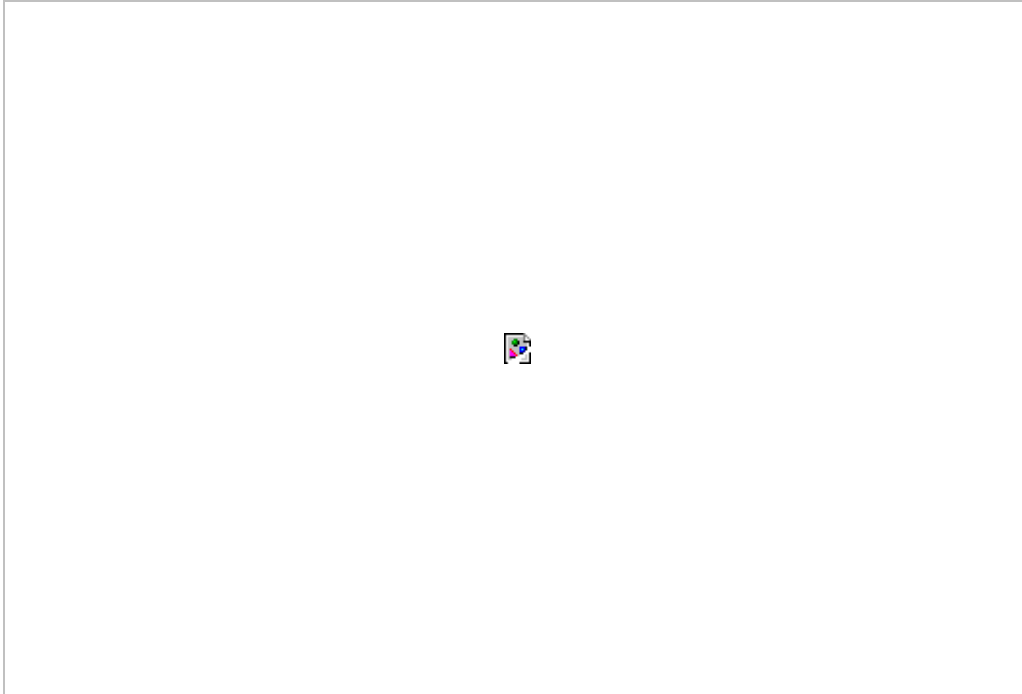

Figure 6: Ratio of tensile:compressive strength (Rao and Thanh data sets)

As can clearly be seen in Figure 6, with the exception of high (>1.5) water:cement ratios, the Thanh data shows a monotonic increase of strength ratio with water:cement ratio. A possible explanation for this trend is the simultaneous variation of sand:cement and water:cement ratios. We are also comparing tensile strengths measured by two different methods: flexural in the Thanh data, and tensile splitting in the Rao data. It is generally found that tensile strength is considerably lower than compressive.

1.3.10.2 Mortar Strength and Sand-cement ratio

A series of mortars were made and tested, with water content determined by the method outlined in 1.3.7 (Thanh, 1991). The data from this is shown below:



Figure 7: Flexural strength with sand:cement ratio

The letters or indicate continuous (*C*) or discontinuous (*D*) grading of sand used^[4], whilst the number 1,2 or 4 indicates the maximum particle size in mm. As can be seen on the plot, the inter-series differences are sufficiently small that we may treat all the series as one data set.

There appears to be a distinct break point at strengths of around 5~6MPa, beyond

which the strength decreases less rapidly with sand: cement ratio. If these high sand: cement ratios are excluded from the data set, there appears to be a linear relationship between strength and sand:cement ratio:

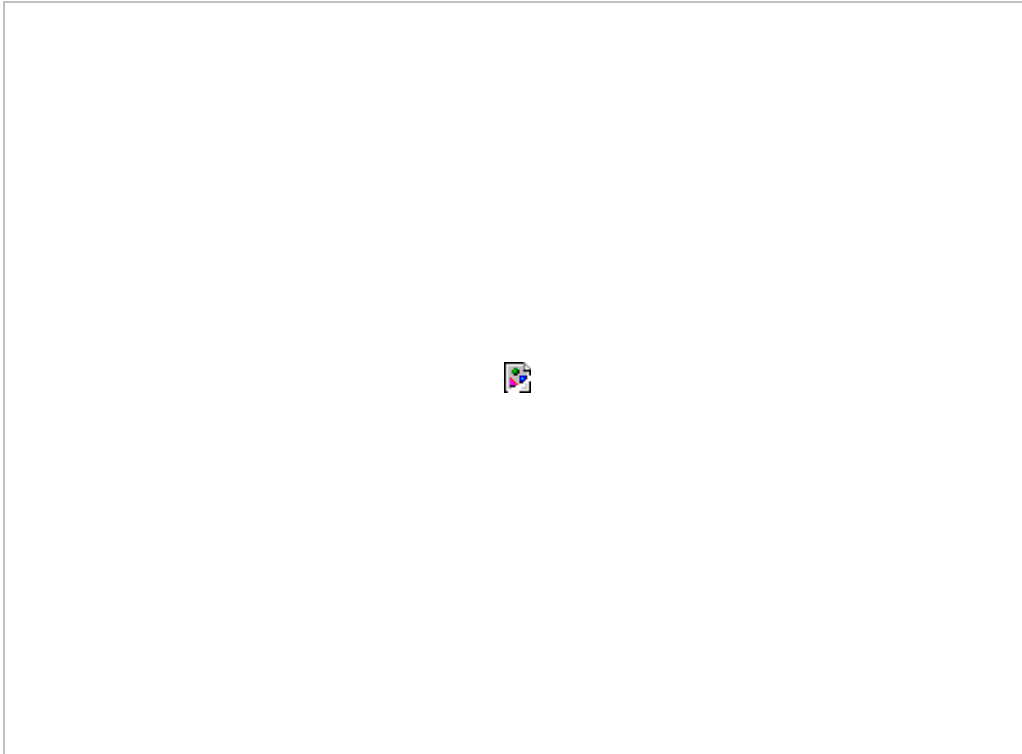

Figure 8: Linear fit of flexural strength with sand: cement ratio up to $s/c=8$

There is then some doubt as to whether the break point is a genuine feature of the data. If it is, it could suggest that using extremely lean mortars is attractive.

1.4 Strength Modelling and Mix Proportioning

1.4.1 Simple Model and optimisation

Following the approach in the literature review, each sand:cement ratio will have a water content for which the strength is maximised. Assuming that this optimisation process is undertaken, a mix may be characterised by its sand:cement ratio only:

Equation 1.10



Where m indicates a quantity (by mass), and the subscripts s and c represent sand and cement respectively.

The optimal strength of this mix is given by the function :



Equation 1.11

Where  is the failure stress of the mortar (in tension).

For a plate of unit area in bending the stress is inversely proportional to the square of plate thickness (t) () , so the minimal thickness will correspond to:



Equation 1.12

As a first approximation, we take the thickness to be proportional only to the combined volumes of sand and of cement present in the mix:

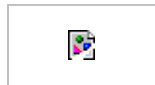

Equation 1.13

So:

Equation 1.14

Using Equation 1.12 and Equation 1.5 gives:

Equation 1.15

Solving for amount of cement:

Equation 1.16

Where k is a constant based on tank geometry.

Taking the cost of mortar as being equal to the cost of cement and sand:

Equation 1.17

And setting , the sand:cement cost ratio ()





Equation 1 .18

So



Equation 1 .19

If we consider a particular manufacturing environment, with a given tank design, all the parameters forming the right hand side of Equation 1 .19 will be dictated by circumstances beyond the control of those manufacturing tanks, with the exception of sand:cement ratio. A value of  that minimises the tank cost by simultaneously altering the strength and quantity of material being used will be obtained by solving Equation 1.20 (and, if multiple solutions arise, ensuring that the selected value of  gives the lowest possible  value).



Equation 1 .20

1.4.2 Model application

DTU field data for typical sand:cement cost ratios ranges from 1:20 to 1:70. Typical densities for the mortar component materials are given in Table 4.

Table 4: Mortar component zero-void densities

Component	Density (kg/m ³)
Sand	2500
Cement	3200
Water	1000

In addition to these, only the expression for mortar strength variation with sand:cement ratio is required. From the Thanh data (Thanh, 1991), the following relationship holds:

$\sigma = A \left(\frac{w}{s} \right)^B$, with $A=15$, and $B=-1.5$, σ all in MPa. This relationship can be substituted in Equation 1.19, and solved for a range of $\frac{w}{s}$ values to give the optimum sand-cement ratio ($\frac{w}{s}$) that minimises C .

However, this solution does not allow for the possibility of the break in strength at sand:cement ratios of around 7. A logarithmic function for σ gives a better overall fit to the data set, and can be used to derive optimum sand:cement ratios for minimising materials cost. However, the fit significantly overestimates the strength in the region of interest. An alternative fit uses two linear functions to include the break feature. At sand:cement ratios above the break point, the data shows considerably greater inter-series scatter than below:

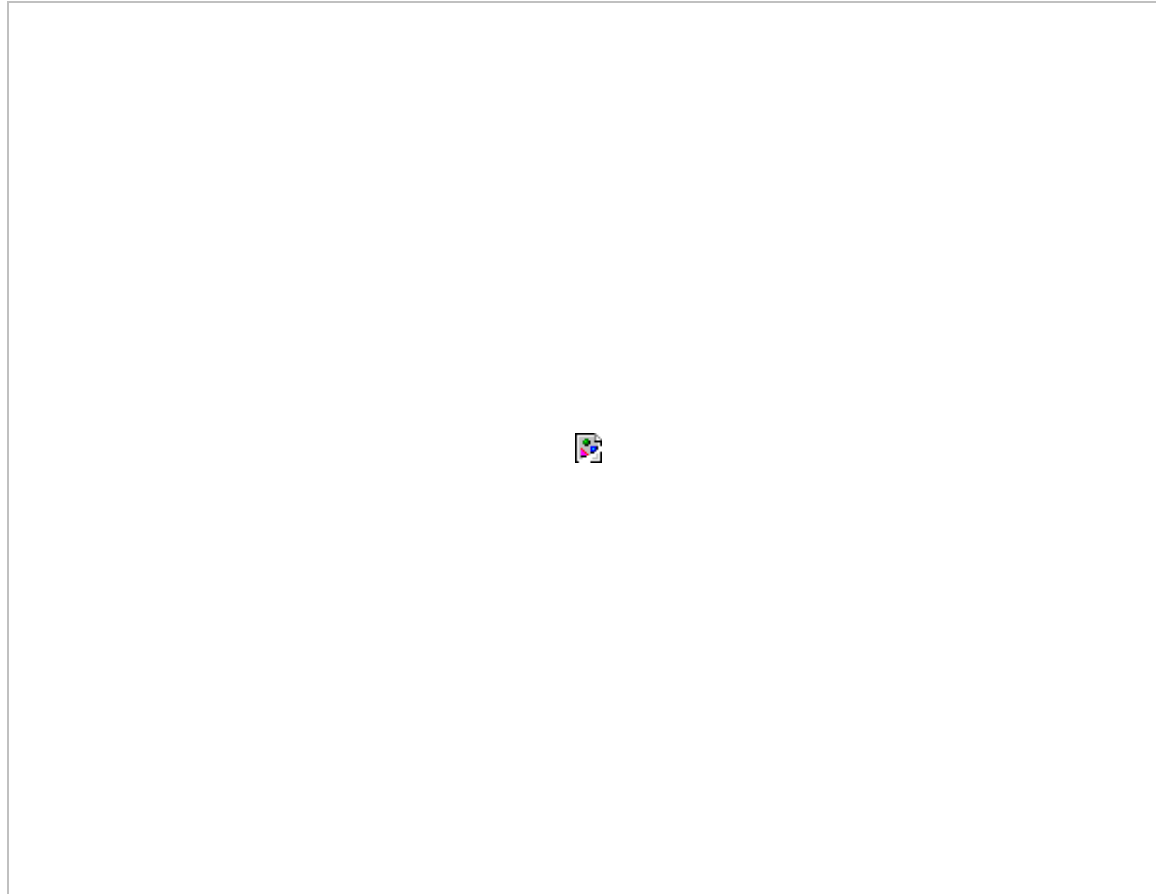

Figure 9: Linear fits applied to high sand:cement ratios (Thanh data)

Three fits were applied to a dual slope model, using the following values of A and B :

Table 5: Values of three linear fits for high sand:cement strength behaviour

Fit title	A	B
Averaged	-0.29	7.0
Largest gradient	-0.74	9.6
Smallest gradient	-0.25	7.6



Using these four fits for  (one linear and three bi-linear), the following data was obtained:

Table 6: Sand:cement ratios that minimise materials cost, for four different sand:cement-strength relationships

Cost ratio (sand:cement by mass)	Form of 	Optimum Sand:cement ratio			
	Linear	Bi-linear averaged	Bi-linear largest gradient	Bi-linear smallest gradient	
10	5.2	10.9	5.2	13.1	
20	5.7	12.7	5.7	15.5	
30	5.9	13.6	5.9	16.6	
40	6.1	14.0	6.1	17.3	
50	6.1	14.3	6.1	17.7	
60	6.2	14.6	6.2	18.1	

80	6.2	14.9	6.2	18.3
90	6.3	15.0	6.3	18.7
100	6.3	15.0	6.3	18.8

These results contain interesting features if we are confident that the linear fit accurately reflects the strength behaviour, and that the strengths at higher sand:cement ratios arise from some error in measurement. If this were the case, we could note that:

The optimum mix from this modelling is around 6:1

This optimum sand:cement ratio is not very sensitive to cost ratio.

However, if we consider the high sand:cement ratio behaviour as being plausible, then there are significant implications:

The scatter present within this data leads to considerable inter-fit variations in optimum sand-cement ratios: the bi-linear, largest gradient fit is identical to the linear fit, whereas the remaining two bilinear fits both give optimums in excess of 10:1 (around 14:1 for the averaged fit, and around 18 for the smallest gradient fit).

The optimum sand:cement ratios for any fit remain fairly insensitive to variations in cost ratio.

1.5 Conclusions

For a given sand-cement ratio, controlling the void content is crucial in the potential for strength development. The ease of compaction for a mix will depend on its water content. Proportioning solely on the basis of water-cement ratio is not feasible, particularly in the case of lean mixes. Data exists for optimum water content in the form:



This may prove useful over the range of mixes in question. It is likely that this approach will not be exact, as it takes no account of the lubricating effect of cement paste [\[GS2\]](#). An expression of the following form might be expected:



Equation 1 .22

Where the 3 terms on the right hand side represent coating the aggregate, hydrating the cement, and a cement lubrication effect for good compaction respectively.

Compaction of the mortar can be achieved using hand application or, more effectively, by mechanised techniques. Some data is available on parameter ranges to use, though this is not conclusive or comprehensive.

As failure of mortar occurs by crack propagation, controlling pre-stress cracking is

important.

It can be seen that there is a considerable amount of data available. However, between the information available and simple rules of thumb and recommendations, there is still quite a distance.

From the simple modelling conducted optimum values for sand:cement ratio have been calculated using experimental data. However, the variability of some of this data leads to different fits giving greatly differing ratios (ranging from around 6:1 to around 18:1). This suggests further experimental work to:

- Validate the methods proposed for calculating optimum water content.

- Resolve the break-point issue and hence allow more accurate calculation of an optimum sand:cement ratio.

1.6 Reference List

Appa Rao, G. (2001) "Generalization of Abram's law for cement mortars", *Cement and Concrete Research*, 31 495-502.

Chandler, H. W., & Macphee, D. E. (2003) "A model for the flow of cement pastes", *Cement and Concrete Research*, 33 265-270.

Hausmann, M. R. (1990) *Engineering Principles of Ground Modification*, McGraw-Hill New York.

Hotta, H., & Takiguchi, K. (1995) "Influence of drying and water supplying after drying on tensile strength of cement mortar", *Nuclear Engineering and Design*, 156 219-228.

Kerali, A. G., & Thomas, T. H. (2002) "Effect of mix retention and curing on low-cement walling blocks", *Building Research & Information*, 30(5), 1-5.

Kim, J.-K., Han, S. H., & Song, Y. C. (2002) "Effect of temperature and aging on the mechanical properties of concrete Part 1: Experimental results", *Cement and Concrete Research*, 32 1087-1094.

Kokobu, K., Cabrera, J. G., & Ueno, A. (1996) "Compaction properties of roller compacted concrete", *Cement and Concrete Composites*, 18 109-117.

. (1982). F. D. Lydon, *Concrete Mix Design*. London: Applied Science Publishers.

Neville, A. M. (1995) *Properties of Concrete*, Longman.

Orowan, E. (1948) "Fracture and strength of solids", *Reports on Progress in Physics*, 12 185-232.

Parsons, A. W. (1992) *Compaction of soils and granular materials: A review of research*

performed at the Transport Research Laboratory, HMSO.

Popovics, Sandor (1998) *Strength and related properties of concrete: A quantitative approach*, John Wiley & Sons.

Sharma, P. C. (1983) "A mechanized process for producing ferrocement roof and wall elements", *Journal of Ferrocement*, 13(1), 13-260.

. (1983). G. H. Tattersall, & P. F. G. Banfill, *The rheology of fresh concrete*. London: Pitman.

Thanh, N. H. (1991) "Optimal concrete composition based on paste content for ferrocement", *Journal of Ferrocement*, 21(4), 331-350.

Walkus, B. R. (1981). An efficient and economical system for producing ferrocement elements. Vol. 11(2), 155-162.

Whittmann, F. E. (1983). Fracture Mechanics of Concrete. *Phenomenological aspects of the fracture of concrete* Elsevier.

Appendix 1 : Modifications to strength modelling

1.6.1 Modifications to thickness term

Actually, the sand will have a voids ratio:



Equation 1.23

For a given quantity of sand, there will be a voids volume of:



Equation 1.24

This volume will be filled, or partially filled, by the mix of cement and water present in the initial mix. If this water-cement mix is not large enough, then the volume of the mortar will be determined by the sand volume (case (i)). If the water cement mix is sufficiently voluminous, the mix volume will be determined by the mass quantities (case(ii)).

For case (i), the determining criteria will be:



Equation 1.25



This simplifies to:



Equation 1 .26



Equation 1 .27

If we are not interested in the case where paste content is less than voids volume, for strength reasons, then it is reasonable to take case (ii) as the working situation:

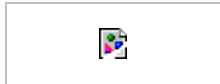

Equation 1 .28

However, the quantity of water present is determined by the sand and cement components, from:



Equation 1 .29

In this case we may say that , and then simplify to give:

Equation 1 .30

Giving an alternative value of mortar cost as:



Equation 1.31

1.6.2 Labour Content

There should be some form of labour component in the production costs for the mortar. A basic approximation would have labour cost as proportional to the volume of material being used:



Equation 1.32

Where C_l is the cost of labour, c_l is the unit cost of labour (per unit volume), and the other quantities are as before.

In this case we now have:

Equation 1.33

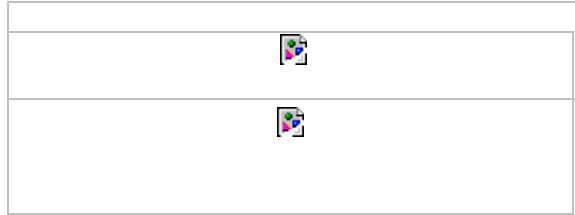

Equation 1.34 Again, it should be possible to optimise for mortar cost with respect to sand-

cement ratio (\square), providing other values are known.

The labour costs may prove significant, and would be expected to reduce the optimum sand-cement ratio, as previously there was no labour cost to increasing the total volume of mortar being used.

[1] Simplifying the situation by neglecting the presence of any unhydrated cement in the mortar.

[2] Splitting strength is determined by the Brazilian cylinder test, whilst flexural is determined by several-point loading of a beam in bending.

[3] Fineness modulus is an empirical factor obtained by adding the total percentages of a sample of the aggregate retained on each of a specified series of sieves, and dividing the sum by 100. A *lower* number indicates a finer aggregate, whilst a high value indicates a

coarse aggregate.

[4] In continuous grading particles of a spectrum of sizes are included, whilst in gradual particles are of discrete sizes.

[GS1] Waffle again?

[GS2] Is this true perhaps it comes in the form of a constant amount of water-cement, plus extra for hydration. Why choose a square root or exponential function?

[home.cd3wd.ar.cn.de.en.es.fr.id.it.ph.po.ru.sw](#)