



➔  **Public Health Technician (MSF, 1994, 192 p.)**

 **(introduction...)**

1. Water in camps of Displaced people

 **(introduction...)**

 **A. Needs**

 **B. Water related health risks**

 **C. Water supply**

 **D. Assessment of water quality**

 **E. Simple water treatment technique**

 **F. Technical briefs**

II - Sanitation

 **(introduction...)**

 **A. Excreta disposal**

 **B. Removal and treatment of wastewater**

 **C. Collection and disposal of refuse**

 **D. Technical briefs**

III - Vector control

 **(introduction...)**





 **A. Introduction**

 **B. The principal vectors: biology and control methods**

-  **C. Precautions for use and storage of insecticides**
-  **D. Spraying equipment**
-  **E. Technical briefs**
-  **IV - Glossary, conversion tables and estimations**
-  **V - Bibliography**

[Home](#) > [ar.cn.de.en.es.fr.id.it.ph.po.ru.sw](#)



-  **Public Health Technician (MSF, 1994, 192 p.)**
-   **(introduction...)**
- 1. Water in camps of Displaced people**
- II - Sanitation**
- III - Vector control**
-  **IV - Glossary, conversion tables and estimations**
-  **V - Bibliography**









Manual intended for the setting up of public health programmes in disadvantaged areas, particularly in refugee and displaced people camps

MEDECINS SANS FRONTIERES 1994 - 1st edition

[Home](#) > [ar.cn.de.en.es.fr.id.it.ph.po.ru.sw](#)



Public Health Technician (MSF, 1994, 192 p.)

- ➔  **1. Water in camps of Displaced people**
 -  **(introduction...)**
 -  **A. Needs**
 -  **B. Water related health risks**
 -  **C. Water supply**
 -  **D. Assessment of water quality**
 -  **E. Simple water treatment technique**
 -  **F. Technical briefs**

Public Health Technician (MSF, 1994, 192 p.)

1. Water in camps of Displaced people

The objective of this section is to suggest some concrete responses to water supply problems faced in camps of displaced people. However, most of the points considered, concern water problems in general, and apply to any deprived situation.

A. Needs

Like any population, displaced people need access to good quality water in sufficient quantity.

This need is that much greater in camps where the population concentration increases the risks of pollution and of epidemics of water-borne diseases.

Quantity

The notion of sufficient quantity is very subjective and depends strongly on the climate and on the habits of the population.

Nevertheless, it may be assumed that ten litres per person per day is a minimum need, while aiming to reach the following targets as soon as possible (UNHCR 1982):

- For domestic consumption: 15 - 20 litres per person per day (drinking, cooking, hygiene).**
- For collective feeding centres: 20 - 30 litres per person per day.**
- For hospitals: 40 - 60 litres per person per day.**

In case of severe shortage, a daily ration of 4 to 5 litres may suffice very provisionally. Unless there is a shortage, it is better not to put any limit on consumption as the health status of the population is influenced by the quantity of water used.

It is not enough to supply 10 - 15 litres of water per person per day to a camp; people should actually be able to use this quantity. Therefore water should be reasonably accessible (in terms of distance and of waiting time at the water point), and the means to transport and store it should be available (if the supply is via taps, allow at least one tap per 200 - 250 people and arrange these taps in groups of 6 or 8 maximum). It is important to ensure that the population has enough containers (jerrycans, buckets, etc.) for the collection and storage of water; otherwise a distribution will be necessary.

If a sufficient quantity of water is not available near the site, moving the camp should be considered.

Quality

The water should be harmless to health and have an appearance and taste acceptable to the population.

Ideally the water supplied should meet the water quality standards of the WHO.

However, in practice it is often necessary to supply water which does not conform to these standards, simply because there is no alternative.

COMMENTS

- The quantity of water available has relatively more importance than its quality.

It is preferable to have a lot of water of average quality than little water of very good quality.

The lack of water to ensure a minimum of hygiene entails even more problems than does the consumption of relatively poor quality water.

- Water quality is important for drinking water but is of less importance for other uses (except where there is a risk of schistosomiasis). It is sometimes possible to supply water of two different qualities, but this generally entails more disadvantages than advantages.

B. Water related health risks

Problems due to a lack of water

In extreme cases of lack of water, life is simply not possible (dehydration and death).

Less extreme shortages also have an impact on the health status of a population.

They provoke an increase in the incidence of numerous diseases due to a lack of hygiene. Good personal hygiene requires a sufficient quantity of water.

The diseases linked to a lack of water for personal hygiene, called "water-washed diseases", are:

DERMATOLOGICAL AND OPHTHALMIC DISEASES

Dermatological and ophthalmic diseases directly due to a lack of hygiene such as scabies, trachoma, conjunctivitis, etc.

DISEASES TRANSMITTED BY LICE

Lack of personal hygiene and washing of clothes encourages the proliferation of lice which, in addition to the problems caused by their presence (itching and scratching, skin sores), are disease vectors. They transmit louse-borne typhus and recurrent fever.

FAECO-ORALLY TRANSMITTED DISEASES

A lack of hygiene, particularly of hands and food, allows the transmission of these diseases from infected individuals (sick people or carriers) to uninfected individuals.

These so-called "dirty hands diseases" are: diarrhoeas and dysenteries (bacterial, protozoan, or viral), cholera, typhoid and paratyphoid fevers, hepatitis A, poliomyelitis and various helminth diseases.

Most of these diseases can spread epidemically in concentrated populations.

Problems due to poor chemical water quality

Water may contain numerous dissolved chemical substances which come either from pollution fertilizers insecticides, industrial waste, etc.), or from the composition of the rocks themselves (fluorine, arsenic, iron, etc.).

These substances may give the water such a bad taste that it is undrinkable (for example, if it contains too many salts or too much iron), but it may also, in the long term, cause severe health problems, for example:

- methaemoglobinaemia in babies, due to high nitrate levels,**
- arsenic poisoning, etc.**

The possible presence of toxic substances in water is something which must be borne in mind, but in the situations considered here, the microbiological quality of the water is a much more important and preoccupying problem.

Problems due to poor biological water quality

Water may contain numerous pathogenic organisms and thereby become a means of transmission for many diseases:

- Typhoid and paratyphoid fevers (bacteria)
- Hepatitis A (virus)
- Cholera (bacteria)
- Poliomyelitis (virus)
- Diarrhoeas (caused by Escherischia Coli, salmonellas and Yersinia Enterocolitica) (bacteria)
- Viral gastroenteritis (virus)
- Bacillary dysentery (caused by various species of shigellas) (bacteria)
- Campylobacter dysentery (bacteria)
- Amoebic dysentery (protozoa)
- Giardia (lambliasis) (protozoa)
- Balantidiasis (protozoa)
- Helminthiasis caused by Ascaris and Trichuris (helminths)

It should be noted that these so-called "water-borne" diseases form part of the group of "water-washed" diseases as well. They may also be transmitted by any of the faeco-oral routes: dirty hands, dirty food, dirty water, etc.

Besides these diseases, water is also involved in the transmission of "water-based" diseases (in other words, those diseases of which the causative agent

passes part of its life-cycle in an aquatic plant or animal):

- **The different schistosomiasis or bilharzias: diseases caused by helminths (worms) which are usually contracted by contact with infested water (washing clothes, bathing, etc.), but sometimes also via the oral route.**
- **Dracunculiasis (Guinea worm), transmitted only by drinking infested water.**

Lastly, water may also transmit:

- **Leptospirosis: a bacterial disease which is contracted primarily by contact with water contaminated with the infected urine of various animals (principally the rat), but also by drinking such water.**

All the infectious diseases transmitted by water -with the exception of Guinea worm- are linked to the pollution of water by the excreta of humans or other animals (from the sick or from healthy carriers).

Problems due to water-based insect vectors

One last category of water-related diseases is those with an insect vector which develops in or lives near to water, for example malaria, dengue and yellow fevers and onchocerciasis.

The solution to these problems lies among other things with the choice of site for a settlement and with environmental hygiene measures (drainage, elimination of stagnant water, covering reservoirs, etc.). They will not be considered in more detail here.

In terms of health

It is of primary importance that the population should be able to use a sufficient quantity of water to allow a minimum of hygiene, in addition to use for cooking. This means that the water should be available in sufficient quantity and easily accessible, and that people should have enough water containers.

In terms of water quality

The major danger is pollution of water by faecal matter. Everything possible should be done to prevent such pollution. Nevertheless, it is preferable to have a lot of water of average quality than a little water of very good quality.

Water related health problems

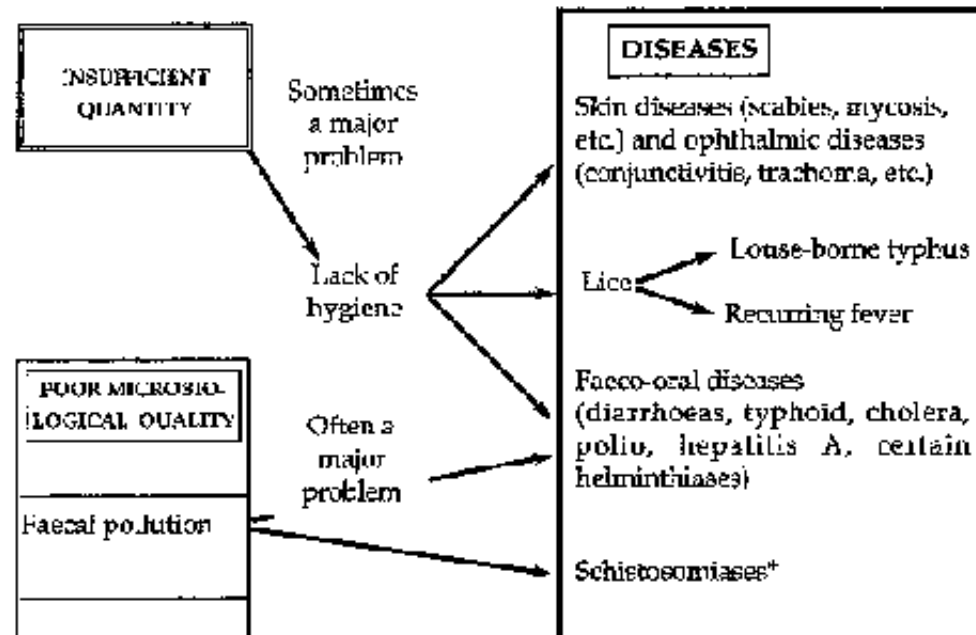

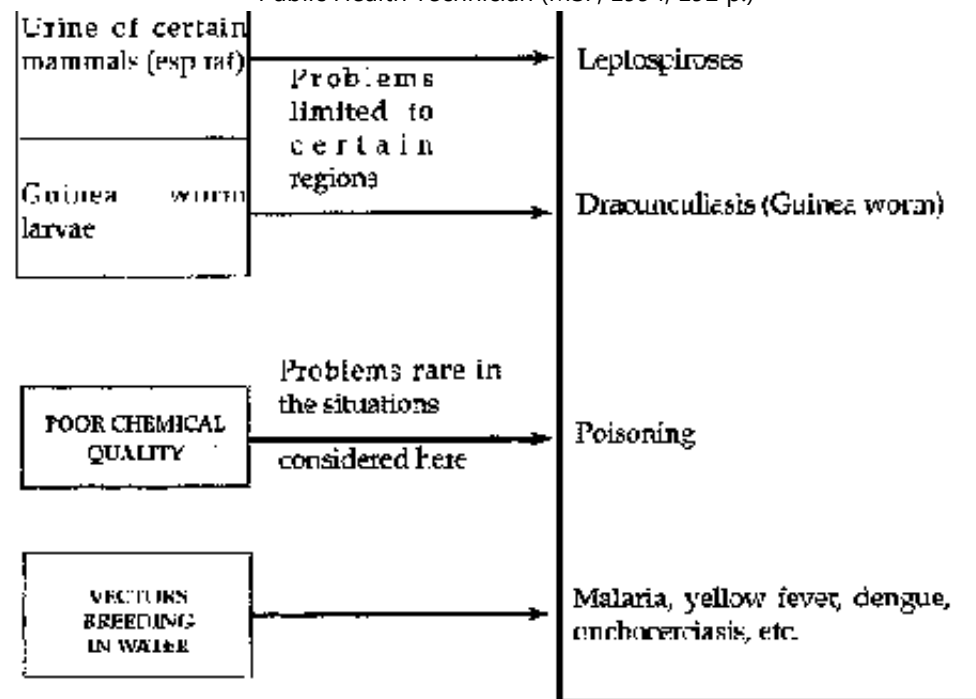

* In schistosomiasis caused by *Schistosoma haematobium*, transmission occurs via urine and not via faeces.

Figure

C. Water supply

Different types of water

Potentially, three types of water may be available:

SURFACE WATERS: STREAMS, RIVERS, LAKES, PONDS, RESERVOIRS (DAMS)

- It is generally heavily polluted particularly during the rainy season.
- Its quantity varies with the season.

- It generally needs complex treatment before use. Nevertheless, certain catchment methods allow a significant improvement of water quality: shallow wells dug close to river banks, river bed filters, infiltration galleries.

GROUNDWATERS: WELLS, BOREHOLES, SPRINGS

- Deep groundwater (boreholes, deep wells, certain springs):

- Generally clear and of good bacteriological quality (filtered by percolation through rocks).**

- Sometimes containing substances rendering it undrinkable because of its taste or because of toxicity.**

- Not generally subject to much seasonal variation in quality or quantity.**

- Shallow groundwater (wells a few metres deep, certain springs, groundwater near water courses):

- The higher the water table, the lower the bacteriological quality tends to be (water from less than 3 metres deep should be treated like surface water).**

- Subject to seasonal variation in quantity.**

RAINWATER

- In non-industrialised regions, rainwater is relatively pure and may be consumed without treatment as long as it is collected with certain precautions, ie on a clean surface (tin roof, tent, plastic sheeting) and the first flow of water is rejected.

- Although rainwater rarely provides a regular supply, it may sometimes be a

useful temporary or complementary supply (it may be a good alternative to heavily polluted surface water during the rainy season).

Warning !!!

- The exclusive consumption of rainwater without a complementary intake of essential minerals (such as iodine) causes problems in the long term.**
- Rainwater dissolves the metal in which it is stored. Do not use containers or pipes made of copper, zinc or lead: clay, cement or plastic containers are suitable.**

In practice there is rarely a choice between these different sources of water, particularly in emergency situations.

When settlement begins, surface water (the most polluted or the most easily polluted) is often the only supply available. It is therefore imperative to concentrate on the problem of water as top priority.

Sometimes, at first, supply by water tanker is the only solution. Other solutions should quickly be planned: drilling, digging wells, moving the camp, etc. (specialist advice will usually be needed).

Sometimes a piped supply from an urban area may be possible.

Priorities

What are the priorities in terms of water supply, when dealing with a concentrated population?

Before anything else:

- **Find out where and how the people go to collect water and where they defecate.**

Then:

- **Designate defecation areas far away from water points.**
- **Distribute water containers if necessary (very important).**
- **Take specific steps to protect water points.**
- **Determine the amount of water available.**
- **If necessary, set up a water rationing system.**

Finally:

- **If necessary, increase the output of the water points or look for additional sources of supply.**
- **Create a reserve water stock.**
- **Improve measures to protect water points.**
- **If possible, set up a system whereby water is pumped into reservoirs before being distributed.**
- **Check water quality if necessary.**
- **Possibly, install a treatment system.**

WATER POINT PROTECTION MEASURES

All the protection measures aim at preventing the introduction of fcal genes into the water (either directly, or indirectly by run-off or dirty soil falling into the water, etc.).

- Protection of water courses

Organize the use of the water course according to environmental health considerations. The point used for collecting water should be upstream of all other uses.

Note: surface water is always difficult to protect (there may be a village upstream). As soon as possible, use other sources (wells, springs, boreholes), or at least, pump the water so that people and animals do not have direct access to the water course.

- Well protection

Immediately (and this does not require any particular materials or skills):

- Employ a watchman to monitor access to the well.**
- Surround the well with a fence against animals. If it is used to water animals, make a channel to take water to a trough situated outside the protective fence.**
- Forbid the use of personal water containers: one rope with a single container should be provided for this use.**
- Install a winch or similar system so that the bucket and rope are not laid on the ground and so that people do not lean over the well.**
- Keep sources of pollution such as latrines at least 30 metres away from the well and downhill from it if there is a slope (caution: in certain hard and fissured rocks, 30 metres is not enough).**

As soon as possible:

- **Make the improvements needed to prevent infiltration of run-off (make the upper part watertight to at least 3 metres depth, install an apron, a concrete slab on the head wall, and drainage of the surroundings, etc.).**
- **Cover the well and install a handpump or a self-priming motorpump (plan for maintenance and the supply of spare parts).**

- Spring protection

Immediately:

- **Install a system which prevents water from standing at the spring (collect the running water with a split bamboo, for instance).**
- **Erect a protective barrier around the spring (10 metres above it).**
- **Dig a drainage channel 10 metres above the spring to avoid it being polluted by run-off.**

As soon as possible:

- **Build a spring box.**

Certain measures for the protection of water points can, and should, be taken during the very first days. Others require particular materials, equipment and skills, and should only be envisaged at a later stage, though as quickly as possible.

Do not wait to be able to solve the whole problem before starting work; every step taken is an improvement.

Note:

Fcal pollution of water may occur at any stage between its origin and its consumption. For example, for water from a well there may be:

- pollution of the water table,**
- pollution of the water inside the well (from soil, run-off, etc.)**
- pollution during transport (from dirty containers, dirty fingers, etc.),**
- pollution during storage in the home (from insects, dust, people taking water with dirty recipients, etc.).**

Consumption of clean water can only be achieved by action at all levels, with a global programme of water point protection, excrete control and health education which is a long term programme).

Pollution at the source or during collective transport is nevertheless more dangerous than pollution in the home, because it affects the whole population at once and consequently encourages large scale epidemics.

CONTAINERS FOR TRANSPORT AND STORAGE

If the displaced people have not been able to bring enough containers with them they cannot use the water which is provided for them.

Each family should have containers with a total capacity of 40 litres as a minimum.

If the people do not have enough containers, it is vital to distribute them as a top priority.

Containers with small openings (like jerrycans) with a cap are the most suitable

because they are used by pouring the water and not by dipping into it (which risks contaminating it each time).

Cooking oil is often distributed in such cans, and they can be re-used.

Traditional clay containers may be suitable as long as they are covered to prevent contamination by dust and insects.

D. Assessment of water quality

Is the water potable or not?

The only criteria really of importance to health are the presence or the absence of pathogenic organisms and of toxic concentrations of certain chemicals.

Unfortunately these two criteria cannot be assessed by simple tests.

For example, there is no direct relation between the appearance of a sample of water and its potability. (A cloudy sample may be safe, whereas a clear sample may be both chemically and biologically dangerous.)

In non-industrialised areas the presence of pathogenic organisms is an infinitely more frequent problem than the presence of chemical substances at toxic concentrations.

In practice, which analysis should be done and when?

TURBIDITY (CLOUDY APPEARANCE)

The presence of suspended solids is always a problem (the water is unpleasant to drink, there is a sediment, etc.), even if it does not necessarily mean that the water is polluted. But it is particularly important to take the turbidity into account if the water needs treatment.

The measurement of turbidity may be done with special equipment (graduated plastic tubes), but generally simply looking through the water in a transparent container gives enough information.

CHEMICAL ANALYSIS

In emergency situations a blind eye is usually turned to the acceptability of the taste and smell of water.

However, a laboratory chemical analysis may be requested:

- if a long term water supply is being planned,**
- if there are particular reasons to suspect chemical pollution.**

BIOLOGICAL ANALYSIS

In other words, how to tell if water contains pathogens.

- Principle

The pathogenic organisms which may be present in water are too numerous and too various to be identified individually in practice (bacteria, protozoa, helminths, etc.).

As their presence is always linked to faecal pollution (except for Guinea worm), it is preferable to look for organisms which are "indicators" of this pollution.

The indicator organisms generally looked for are the faecal coliforms, principally Escherichia coli (E. Coli).

These germs are always present in large numbers in the faeces of man and other warm blooded animals.

The presence of faecal coliforms in water indicates the possible presence of pathogenic organisms.

The absence of faecal coliforms in water indicates the probable absence of pathogens, but is no proof of this (certain pathogens are more resistant than faecal coliforms).

The count of faecal coliforms (or E. Coli) per 100 ml gives an indication of the degree of faecal pollution.

Note:

Other bacteria very similar to faecal coliforms live more or less everywhere in the environment. They also belong to the coliform group.

Coliform group = - Faecal coliforms (principally E. Coli)
(total coliforms) - Other coliforms

In raw water (untreated), only the presence of faecal coliforms is significant for

health, because they are the only coliforms which prove fecal contamination.

Although in certain cases total coliforms are identified, only fecal coliforms are used as indicators in the field.

- Method of bacteriological analysis

The membrane filtration method is generally used. This consists of filtering the water through a membrane which retains bacteria.

The membrane is then incubated at 44°C for 14 - 18 hours on a specific culture medium.

The count of those colonies which develop with a characteristic appearance gives the number of fecal coliforms in the sample of water which was filtered.

Note

When incubating at 37 C all the coliforms develop, so the count is of total coliforms.

There are kits available for field analysis (for example the Del Agua/Oxfam kit or the Milliflex kit from Millipore), composed of portable filtration and incubation systems.

However, these kits are expensive and require good training in their operation and in the reading and interpretation of results.

- How to express the results of analyses?

- **Number of coliforms/100 ml if it concerns total coliforms.**
- **Number of fcal coliforms/100 ml or sometimes number of E. Coli/100 ml (the two may be interchanged, as in human faeces E. Coli represents more than 90% of fcal coliforms).**

When to do a bacteriological analysis?

A bacteriological analysis is rarely necessary. It is generally much more important and useful to do a sanitary inspection (the origin of the water, protection of the water point, its siting in relation to defecation areas, protection of the water during storage and transport, etc.). Such an inspection will often make it possible to see that the water is polluted or has strong chances of being polluted at some time or other.

Analysis only gives an indication of pollution at the precise moment of sampling, and not of the potential risk of pollution.

Moreover, a sanitary inspection may be done by anyone, whereas bacteriological analysis needs equipment and proper training in its use and in the interpretation of results.

A bacteriological analysis should only be considered when:

- **Deciding whether or not to treat surface water (see the next section).**
- **Using properly protected groundwater which, despite everything, is suspected of being the cause of a high incidence of diarrhoeal disease, or of being the origin of**

an epidemic of diarrhoea, cholera or typhoid.

Caution: in no case is the detection of faecal coliforms in water proof that the water is the origin of an epidemic. Detection of heavy pollution indicates that it may be the source of the epidemic, but is no proof of this. However, in this case, action must be taken anyway.

The analysis is done:

- Either by a competent local laboratory within 6 hours of sampling (after this time the samples are no longer representative of the water to be analysed).**
- Or in the field by someone trained in the use of field testing kits.**

As long as the water is chlorinated and the free residual chlorine level is satisfactory (see brief Chlorination), bacteriological analysis is not necessary nor appropriate.

E. Simple water treatment technique

Storage and sedimentation

Storage is the simplest procedure to improve water quality (certain pathogens do not survive beyond several days), but it needs large reservoirs. Storage alone is not always a very effective procedure.

During storage there also occurs purification by sedimentation. Suspended material settles to the bottom of the reservoir with a proportion of the pathogens (mainly the largest: helminth eggs and protozoan cysts).

Sedimentation of turbid water is essential before filtration and disinfection.

If natural sedimentation is too slow, flocculation may be necessary (specialist help is needed for this). In practice, if water in a bottle is still muddy after an hour, then the natural sedimentation will not be enough.

Filtration

Passing water through a permeable bed eliminates a proportion of the pathogens by retaining them mechanically on the surface or within the filter.

Ceramic candle filters and certain sand filters (known as rapid sand filters) work on this principle.

SLOW SAND FILTRATION

Under certain conditions, in passing water through a bed of sand, particularly effective filtration is achieved by biological purification in addition to the mechanical action of the filter. For this to occur, the filtration must be relatively slow.

A deposit is formed at the surface and in the top few centimetres of sand, in which breeds a whole range of bacteria and microscopic plants, forming a skin (called the Schmutzdecke, biological membrane or bacterial film), which works both biologically and mechanically. It acts as a very fine filter which retains or kills most pathogenic organisms: it eliminates eggs, cysts, nearly all pathogenic bacteria and a proportion of viruses.

Slow sand filtration is the only procedure which achieves such an improvement of water quality in a single operation.

A slow sand filter can operate for weeks or even months without maintenance (which consists of the removing of a thin layer of sand when the filtration rate becomes too low).

In practice

At the collective scale, the construction of this type of filter needs the input of a specialist, and then the maintenance is relatively simple.

At a smaller scale, for example in a feeding centre, a small filter may be made with local materials.

Whatever the size of the filter, the operating principle remains the same.

Important

The bacterial layer is fragile and certain precautions should be taken to preserve it: never let it dry out, and never pass chlorinated water through it.

Disinfection with chlorine

Chlorine is a suitable disinfectant for water because it is very powerful without being toxic. It allows the destruction of all viral and bacterial pathogens in water.

Chlorine can also be used to disinfect surfaces in contact with water: the insides of

wells, pumps, pipes, spring boxes, reservoirs, etc., (when putting into service, after repairs or after accidental pollution).

For this purpose it is used at much higher concentrations than for the disinfection of drinking water because the pollution may be much greater (see technical briefs Chlorine-generating products and Chlorination).

In the situations considered here, gas chlorination is not recommended because it can be dangerous and is not practical on a small scale. Chlorine-generating products are preferred: calcium hypochlorite, chloride of lime, sodium hypochlorite solution (see technical brief Chlorine-generating products).

All these chemicals release chlorine when they are dissolved in water.

Chlorine reacts immediately with all the oxidizable substances which may be present in the water (organic matter and certain mineral substances as well as pathogens and other organisms).

These substances consume chlorine. For the chlorination to be effective, sufficient chlorine must be added to meet this initial chlorine demand. This is confirmed by checking that an excess of unconsumed chlorine remains in the water (residual free chlorine: see technical brief Monitoring chlorination).

EFFECTIVENESS

At the doses normally used, chlorine destroys all pathogenic viruses and bacteria in water, but it is ineffective against:

- **protozoan cysts and helminth eggs or larvae,**
- **pathogens within suspended particles (as they are thus not in contact with the chlorine), so it is advisable to filter water prior to chlorination, to remove eggs, cysts, larvae and suspended particles.**

PRACTICAL USE

Chlorination is a very suitable treatment method for emergency situations (e.g. typhoid or cholera epidemics), because it is very effective, but it is relatively tricky to set up and needs constant attention.

If water has to be treated, which method should be used?

The choice of treatment method will depend on the appearance of the water, the supposed degree of pollution, or that measured by bacteriological analysis, and the technical options. See the following table.

In an emergency, chlorination is often the best technique, but in the long term, slow sand filtration is generally the most appropriate solution. However, it is always better to use water which does not need treatment.

Treatment	Effectiveness			Resources needed	Operation and Maintenance	Applications	Remarks
	Cysts Eggs	Bacteria	Viruses				
Storage Sedimentation	+	+	0 to +	<ul style="list-style-type: none"> - Reservoirs with outlet to drain sediment - Pump 	+	<ol style="list-style-type: none"> 1. Treatment of very slightly polluted water 2. Pre-treatment of turbid water before chlorination 	
Simple sand filtration (rapid) (mechanical purification)	++	0 to -	0	For small filters : <ul style="list-style-type: none"> - sand - gravel - empty oil drums 	+	Pre-treatment of turbid water before chlorination	
Slow sand filtration (microbio purification)	+++	++	+	<ul style="list-style-type: none"> - Sand - Gravel - Reservoirs : <ul style="list-style-type: none"> • pre-fabricated or masonry for large filters ▪ empty oil drums for small filters 	++	<ol style="list-style-type: none"> 1. Treatment of slightly polluted water 2. Pre-treatment of very polluted water before chlorination 	Not suitable for : <ul style="list-style-type: none"> - very turbid water - chlorinated water
Chlorination at the doses generally used	0	+++	+	<ul style="list-style-type: none"> - Chlorine (generating product) - Reservoirs If chlorination is continuous : a chlorine doser	+++	<ol style="list-style-type: none"> 1. Treatment of clear water 2. Complementary to sedimentation and filtration for slightly turbid or very polluted water 	Should be preceded by sedimentation and/or filtration if water is turbid

Table

F. Technical briefs

Digging a well

Protecting a well

Protecting a spring

- Washing area**
- Ferrocement tank**
- Fabricating concrete rings**
- Choosing a motorpump**
- Ceramic candle filters**
- Slow sand filter**
- Chlorine-generating products**
- Monitoring chlorination**
- Water sampling**
- Water storage kit: 2,000 l**
- Water storage kit: 15,000 l**
- Distribution tapstand kit**
- Motorpump kit**

DIGGING A WELL

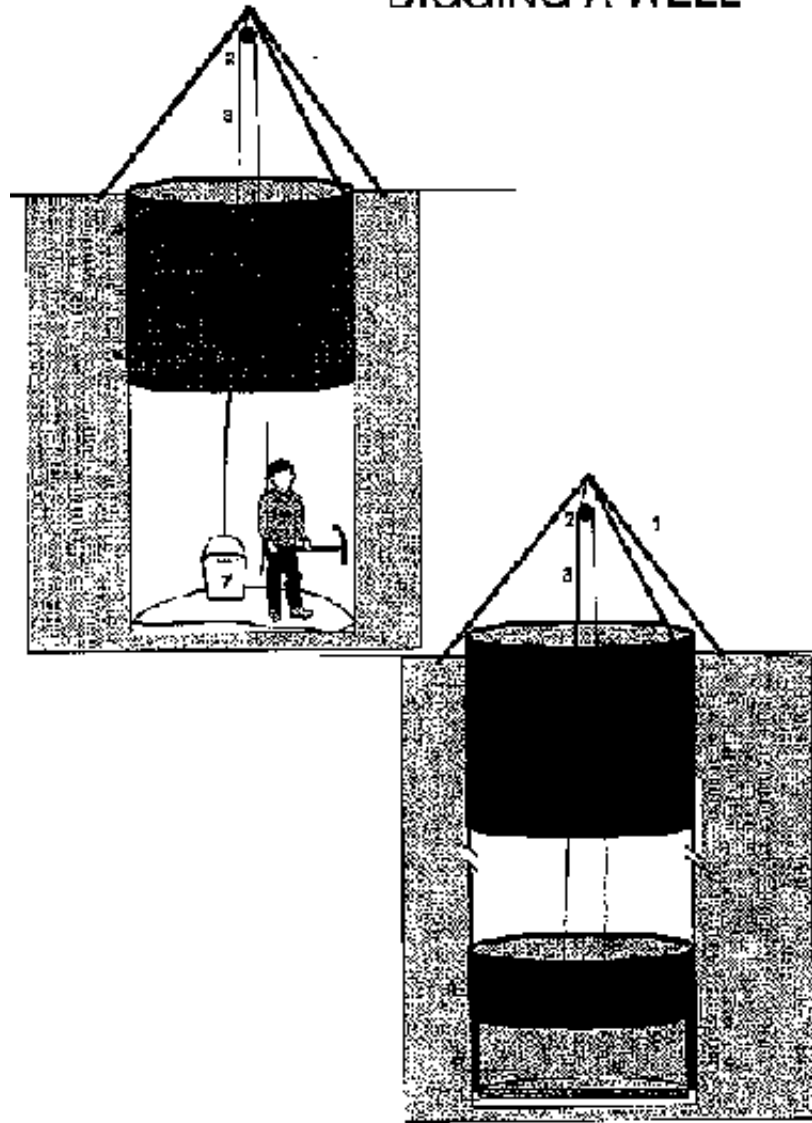

DIGGING A WELL

Method

The aim of this brief is not to look at all the types of wells there are, but to explain

a technique which should be useful in the absence of other technical skills.

Numerous techniques exist for finding water. Good field observation, particularly of the vegetation at the end of the dry season, and above all, the advice of local well diggers will help to decide where and how to dig.

Construction

- Identify a suitable site (vegetation, etc).**
- Mark out a circle about 1.2m diameter.**
- Dig to about 1m deep.**
- Erect a tripod with a pulley over the hole (the legs of the tripod must be firmly anchored).**
- Continue digging, taking out all the soil as the work proceeds, using a bucket and the tripod.**
- At regular intervals as the hole deepens, line the sides with wire mesh and plaster it with cement mortar.**
- When the water table is reached, lower porous or perforated concrete rings, using the tripod, and continue to dig inside the rings: these will descend into the water as digging proceeds. The water which accumulates in the rings should be taken out as the work continues.**
- Place a layer of gravel between the sides of the well and the rings.**
- The capacity of the well should be considered sufficient when there is always water remaining at the bottom of the well after drawing water by bucket over a period of 4 to 5 hours continuously.**
- Place a layer of gravel at the bottom of the well (see technical brief Protecting a well).**

- **Cement the joint between the top edge of the highest ring and the cement-plastered section of the well.**
- **Install a system to draw water from the well, and the protection (see technical brief Protecting a well).**
- **Before use, the well should be disinfected using chlorine solution (see technical brief Protecting a well).**

Key

- 1. Tripod**
- 2. Pulley**
- 3. Rope**
- 4.**
- 5. Sections of wire mesh with cement coating**
- 6.**
- 7. Bucket**
- 8. Bottom section of reinforced cement lining (just above the water level)**
- 9. First concrete ring**
- 10. Joint between reinforced cement lining and concrete rings**
- 11. Gravel**

Inputs

- **1 shovel, 1 pick, 1 miner's bar**
- **3 beams (about 2 m long) and 1 pulley**
- **3 builder's buckets**
- **Mason's tools**

- **Rope (diem. over 10 mm), about 60 m**
- **Cement (about 1 bag per 3 m of well depth)**
- **Wire mesh ("chicken mesh" type)**
- **Sand (0.15 m³ per 3 m of well depth)**
- **Perforated or porous concrete rings: 3 or 4**
- **Material and tools for well protection (see technical brief)**
- **Mechanical pumping system (if the flow of water is too great to keep the well empty by bucket during the work).**

Important

- **Well digging should only be done at the end of the dry season (except in an emergency), when the water table is at its lowest, to avoid the nasty experience of finding the well dry after just a few months of use.**
- **Hand-digging a well without supporting the sides should only be considered in soils which are stable enough to be safe for the diggers.**
- **If other wells in the area show the water table to be more than 30m deep, or if there are good reasons to suspect the presence of a rocky formation between the surface and the water level, then another technique (e.g. drilling) should be considered.**
- **It is important to use local skills and knowledge when deciding where to site a well and which technique to use. Skilled well diggers may often be found locally.**
- **The technique described here (based broadly on the GRET technical briefs) is one of the simplest. However, it is not suitable for all soil types (e.g. sands).**
- **Take care when siting a well to avoid possible sources of pollution (see technical brief Protecting a well).**

PROTECTING A WELL

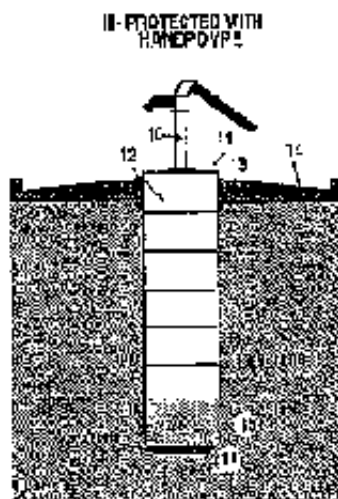
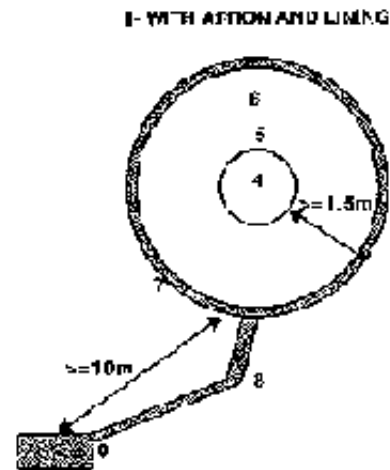
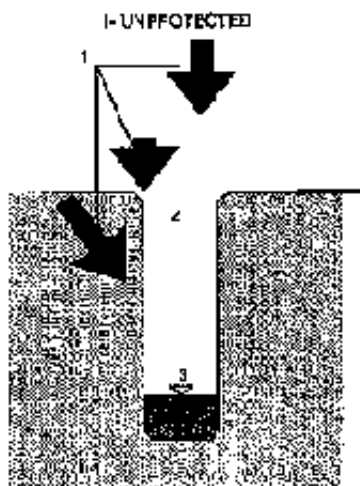

PROTECTING A WELL

Method

A well should be protected as soon as it is dug. This protection consists of preventing anything from getting into the well, and preventing the infiltration of run-off and wastewater which could carry contaminating material. Lastly, protection strengthens the structure of the well.

What to do

- 1. Line the whole well with concrete rings (bought locally or fabricated - see technical brief Fabricating concrete rings); the lowest ring should be porous or perforated. The uppermost ring should extend above ground level. Pack gravel between the rings and the sides of the well.**
- 2. Place a layer of gravel about 10 cm deep at the bottom of the well (in order to avoid the resuspension of settled particles).**
- 3. Excavate the earth around the well head to a depth of about 30 cm, to a radius of about 2 m. Dispose of all the material removed and cast a concrete apron, surrounded by a drainage channel confined by a low wall about 5 cm high, at a radius of at least 1.5 m around the well head.**
- 4. The slope of the apron (1%) should fall to a drainage channel leading to a soakaway pit, an irrigated garden or a cattle drinking trough (see corresponding briefs).**
- 5. Install a pumping system (follow pump manufacturer's instructions).**
- 6. Fix a cover (either removable or fitted with an inspection hole), on which to mount the pump body. (The pump makes work easier for users, but is also useful**

because it prevents potentially contaminated objects like buckets from falling into the well).

Key

I/ 1. Possible entry of pollution

2. The well

3. Water surface

II/ 4. The well

5. Concrete rings

6. Concrete apron

7. Drainage channel

8. Channel to soakaway pit

9. Soakaway pit

III/ 10. Pump

11. Cover

12. Impermeable concrete rings

13. Anchoring collar on concrete ring

14. Apron

15. Permeable concrete ring

16. Gravel layer (about 10 cm)

Inputs

- Cement: about 4 bags of 50 kg**
- Sand: about 400 kg**
- Gravel: about 800kg**

- **Reinforcing steel: about 20 m, or steel mesh, to reinforce the apron (optional).**
- **Bricks or large stones for the base of the apron: enough to fill underneath the apron.**
- **Concrete rings, inside diameter about 1 m, height about 80 cm: allow 10 rings for 7 m of well depth.**
- **Porous or perforated concrete rings: 1 or 2**
- **Cover which fits on the top ring**
- **Handpump with fixtures and fittings**
- **Construction materials for the drainage system (see technical brief Soakaway pit).**

Important

- **Respect safe minimum distances: no latrines closer than 30 m from a well.**
- **Latrines should absolutely be downhill from the well.**
- **Maintenance should be done carefully: the pump, the apron (repair possible**
- **Before the first use, or after accidental pollution, disinfect the well with a chlorine solution as described below. (For the preparation of 1% chlorine solution, see technical brief Chlorine-generating products.)**
- **If it is possible to empty the well: Empty the well, brush the sides above the water level with a solution of 200 mg of chlorine per litre (20 ml of 1% solution/1), leave for half an hour and let the well refill.**
- **If it is not possible to empty the well:**

1. Brush the walls above the water level with a solution of 200mg of chlorine per litre.

2. Determine the volume of water in the well ($\text{vol} = \text{PI} \times r^2 \times h$; $\text{PI} = 3.14$, $r =$

radius of well, h = depth of water or height of water column).

3. Add 10 litres of 1% chlorine solution (see technical brief Chlorine-generating products) per m³ of water, mix and leave the well dosed for 12 hours.

4. After this time, pump out the water until there remains just a faint smell of chlorine.

PROTECTING A SPRING

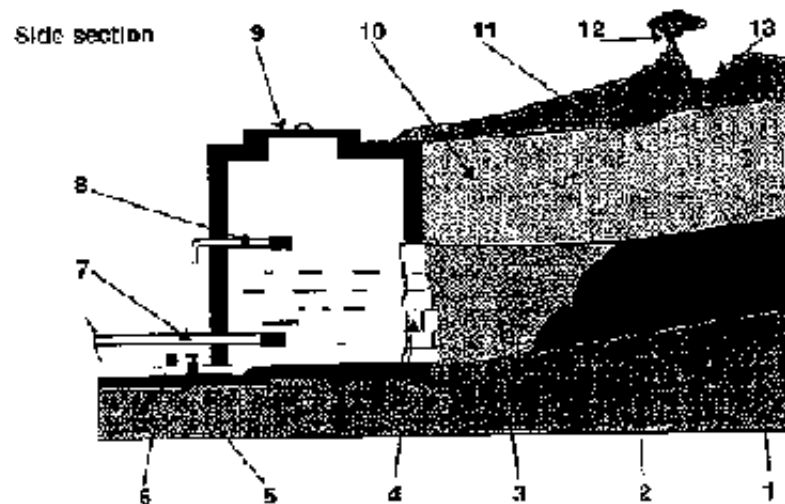

view from above

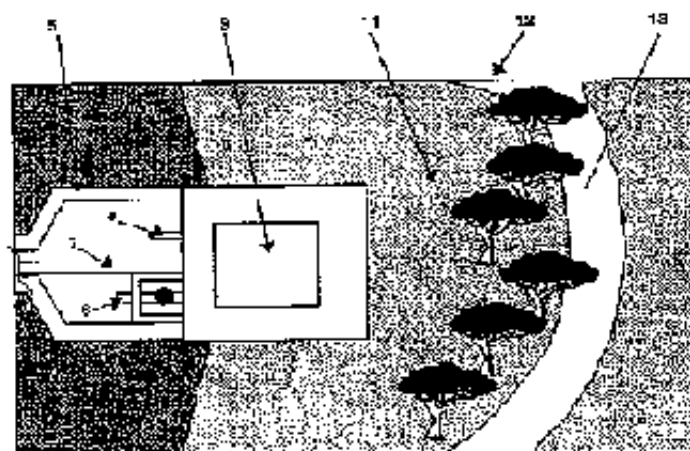

PROTECTING A SPRING

Method

A spring should be captured and protected in such a way as to maximise the

quantify and qualify of water supplied.

- If the spring serves few people, the spring box acts as a storage reservoir before distribution.**
- If the spring serves many people, the spring box is connected to a larger reservoir**
- If the spring box is used for storage, its capacity should be at least equivalent to a 12 hours period demand.**

Construction

- Dig out and clean the area around the spring to uncover all resurgences and so obtain the maximum yield.**
- Calculate the quantities of materials needed (concrete, stone, bricks etc), according to the size of the spring box and the local means of construction.**
- Construct the spring box according to the plan. Its base should be on the impermeable layer (1).**
- Build the back wall (4) of stone without mortar, and fill the space between the wall and the earth with gravel (3). Cover with a layer of compacted clay (10), to prevent infiltration from the surface.**
- Backfill the upper part with soil and dig a drainage ditch about 10m above the spring box to divert run-off.**
- Erect a fence or hedge around the site at a radius of 10 m to keep out animals which could damage or pollute the spring, and to limit erosion of the drainage ditch.**
- Fix an overflow pipe at the height of the top of the spring's flow.**
- Lay a surface of stone or concrete under the overflow and a drainage channel to**

avoid erosion and mud around the spring box.

- Install the delivery pipe connected to the distribution system about 10 cm above the bottom of the spring box.

Key

- 1. Impermeable layer**
- 2. Emergence of spring**
- 3. Gravel backfill**
- 4. Stone wall with open joints**
- 5. Drainage channel**
- 6. Desludging pipe**
- 7. Delivery pipe to distribution system**
- 8. Overflow**
- 9. Cover with lock**
- 10. Layer of clay**
- 11. Soil**
- 12. Protective fence or hedge**
- 13. Run-off drainage ditch**

Inputs

- Detailed plan of spring box**
- 2 masons, 2 labourers**
- Mason's tools**
- Construction materials, according to local availability, quantities calculated from the size of the spring box**

- **Concrete (1: 2: 3 cement: sand: gravel)**
- **Calculate the volume of concrete needed and multiply by 15 to obtain the volume of dry mix (The volume of a 50kg bag of cement is 0.033 m³)**

Important

- **The aim of protecting a spring is to increase its useful yield and reliability, and to protect it from surface pollution**
- **It is important at the outset to carry out a sanitary inspection so as to identify the risks of pollution and to do yield tests to be sure that the supply can meet users' needs.**
- **Never try to make the water rise above the highest point of resurgence as this could produce a backpressure which would make the flow emerge elsewhere. The water should be captured on the impermeable layer.**
- **Be careful not to divert the spring in another direction or into another fissure when digging around it. Terracing should start at the point where the water comes out of the earth. Continue to dig working back up the water-bearing layer, while ensuring that the water flows away.**
- **A good spring should have a constant temperature. If this is not the case, check above the spring to see if the water comes from a surface water source which runs underground. The yield of a spring with such a surface source will rise immediately if it rains.**
- **It may be considered that for a reliable spring:**

the yield in the rainy season

————— = 3 to 5 maximum

the yield in the dry season

- The distribution and overflow pipes should be fitted with a screen (e.g. metal mosquito netting) in order to avoid the passage of insects and/or large particles.

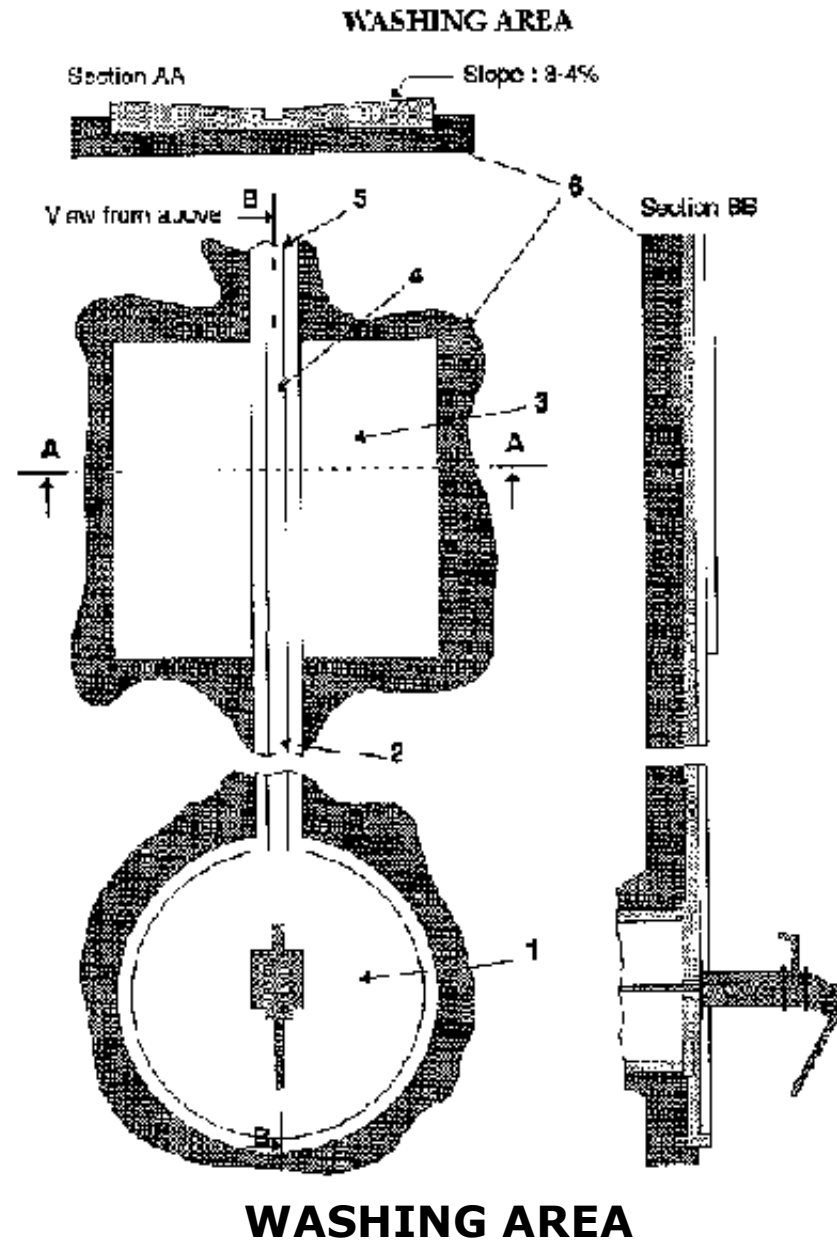

Method

As its name suggests, a washing area should provide a hygiene facility for a population in an emergency situation, without creating environmental health risks (stagnant water etc).

It is built close to a water point and its design should be adapted to the habits of the population (particularly concerning the position generally used by women to wash clothes).

The washing area described here is about the simplest it is possible to be build. It can be made of local bricks and mortar or of stone masonry.

Construction

- Choose a space down the slope from the apron of the water point. Lay out the area using a string line. Its size will depend on the number of people likely to use it at one time.**
- Excavate about 30 cm of soil from this area to create a slope of at least 1% along its length, with a "V" profile across its width (see section AA); spread a 5 cm layer of sand and gravel on the bottom and compact it well.**
- Dig a channel to take water from the water point to the washing area. This channel should have a slope of at least 1% and should join the highest end of the washing area.**
- Lay bricks on the washing area, using a string line and a spirit level, cementing**

the joints (be careful to keep to the same slope and the same cross-section).

- When the cement has set, plaster the surface with a strong cement mortar (1 part cement to 2 parts sand), and smooth it well.**
- Powder the surface of the plaster with cement when it is still wet and smooth it again to waterproof the surface.**
- Cover the slab with plastic sheeting or thick sacking which is regularly wetted, and let it cure for 5 to 6 days before using.**
- Dispose of wastewater in a soakaway pit, an evapotranspiration area or an irrigated garden (see relevant technical briefs).**
- Fence off the area to protect it from animals.**

Key

- 1. Well head**
- 2. Drainage channel**
- 3. Washing slab (sloping towards drainage channel to disposal)**
- 4. Drainage channel**
- 5. Drainage towards disposal**
- 6. Stones**

Inputs

- Shovel and pick**

- **String line and tape measure**
- **Spirit level**
- **Sand and gravel**
- **Cement (about 50 kg)**
- **Bricks or stones**
- **Trowel, float, cement-mixing trough**
- **Plastic sheeting, jute sacking, leaves, etc.**

Important

In all cases the dimensions of the washing area should be adapted to the habits and the average height of its users. The model illustrated here is suitable for people used to washing clothes in a crouching position. If people prefer to wash clothes standing up, a raised washing slab (table height), or an emptyable, raised concrete washtub is better.

During the early days of a camp, it is possible to make washing areas using only plastic sheeting (of the sort used for temporary shelters). The ground surface must be carefully prepared, removing all sharp objects (stones, roots, etc).

Drainage channels may be dug and lined with a double thickness of plastic sheeting, following the above guidelines for the slope. The edges of the plastic should be anchored to the ground with stones covered with well compacted earth.

This technique only lasts a few days because:

- 1) the plastic sheeting gets damaged very quickly,**
- 2) and it will probably be stolen.**

FERROCEMENT TANK

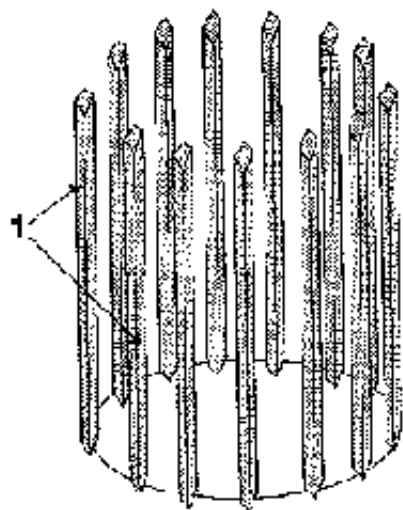

Step 1

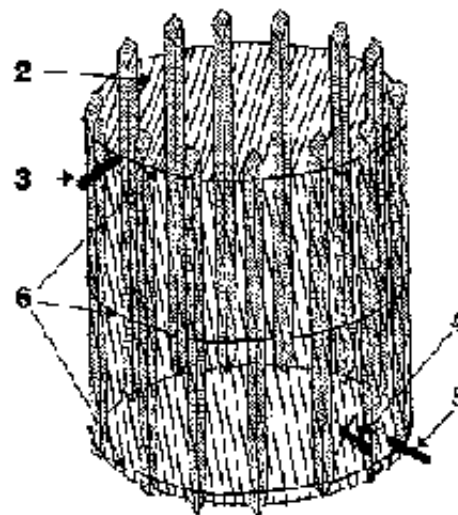

Steps 2, 3, 4

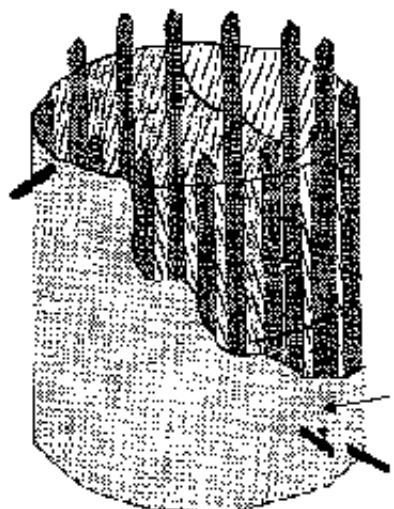

Step 5

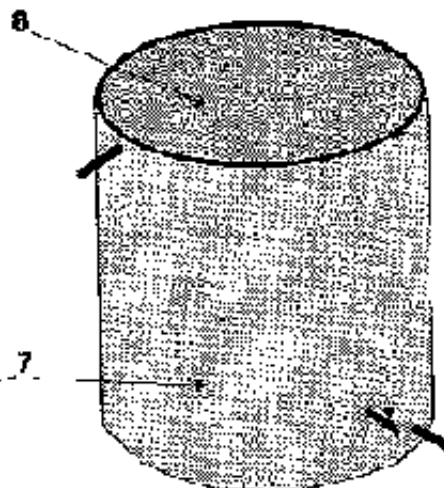

Steps 5, 7, 8

FERROCEMENT TANK

Method

The construction of a ferrocement water tank may be considered when planning to collect rainwater etc. Its watertightness and strength are directly related to the quality of materials used and the care taken in its construction.

A shape in ferrocement is created using a removable mould to which wire mesh is attached and to which a cement coating is applied.

It is equally possible to build a framework of reinforcing steel which avoids having to use a mould. The steel is thus embedded in the cement coating and reinforces the structure.

Technique using wooden stakes (for a tank of 1,500 l)

- 1. Drive stakes into the ground, leaving at least 1.5 m above ground level with centres spaced at 20 cm, to form a circle 1.2 m in diameter.**
- 2. Wind three thicknesses of wire mesh around the circle of stakes. Stretch and flatten the layers of mesh well against each other and fix them to the stakes and to each other with fine wire.**
- 3. Reinforce the structure by winding round it three turns of thick wire at the top, in the middle and at the bottom.**
- 4. Push a length of pipe with a valve attached through the mesh near the bottom**

(for emptying), and another one several centimetres higher with a tap for the outlet. A third pipe for the overflow is fixed near the top of the tank.

5. Apply a 15 mm first coat of cement plaster to the outside. One person should be on the inside to retain the mortar with a float as it is applied. Leave it to harden for 12 to 24 hours, keeping it damp.

6. Pull out the stakes and cut off the wires which stick out.

7. Apply a coat of cement plaster to the inside so as to cover the mesh completely. Leave it to harden for 12 to 24 hours.

8. Apply finishing coat to the inside and the outside and smooth well.

9. Cover the bottom of the tank with wire mesh and curve it up at the corners where the walls meet the bottom. Plaster the base, forming a slope towards the emptying pipe.

Key

- 1. Wooden stakes**
- 2. Wire mesh**
- 3. Overflow pipe**
- 4. Tap**
- 5. Emptying pipe**
- 6. Galvanised steel wire, 2 - 2.5 mm dia.**
- 7. Exterior coat of cement mortar**
- 8. Interior coat of cement mortar**

Inputs

- **20 sharpened wooden stakes (50 x 50 x 1,750 mm)**
- **25 m of fine wire mesh (12 mm mesh, 1.5 mm wire)**
- **2 - 3 bags of cement**
- **500 kg of building sand**
- **3 x 30cm lengths of metal pipe, one fitted with a tap and one with a valve**
- **1 roll of fine wire (0.5 mm)**
- **1 roll of thick wire (2 mm)**
- **Mason's tools**
- **2 people for 3 days**
- **1 sledgehammer**

Important

- **Preparation of cement mortar: 1 part cement to 2 or 3 parts dean, sieved sand.**
- **Final thickness of tank walls: 30 to 40 mm.**
- **A metal cross piece is welded on the pipes to anchor them in the mesh before plastering.**
- **To make a cover on the tank it is possible to extend the mesh with its shuttering or reinforcing steel framework. An inspection hole with a cover should then be made at the top of the tank**
- **Otherwise, the tank should be fitted with a cover to protect the stored water.**
- **Once the coats have been applied it is important to cover the tank with damp jute sacking or plastic sheeting for at least one week for good curing of the cement. This allows the cement to develop its full strength and avoids the risk of cracks appearing.**

FABRICATING CONCRETE RINGS

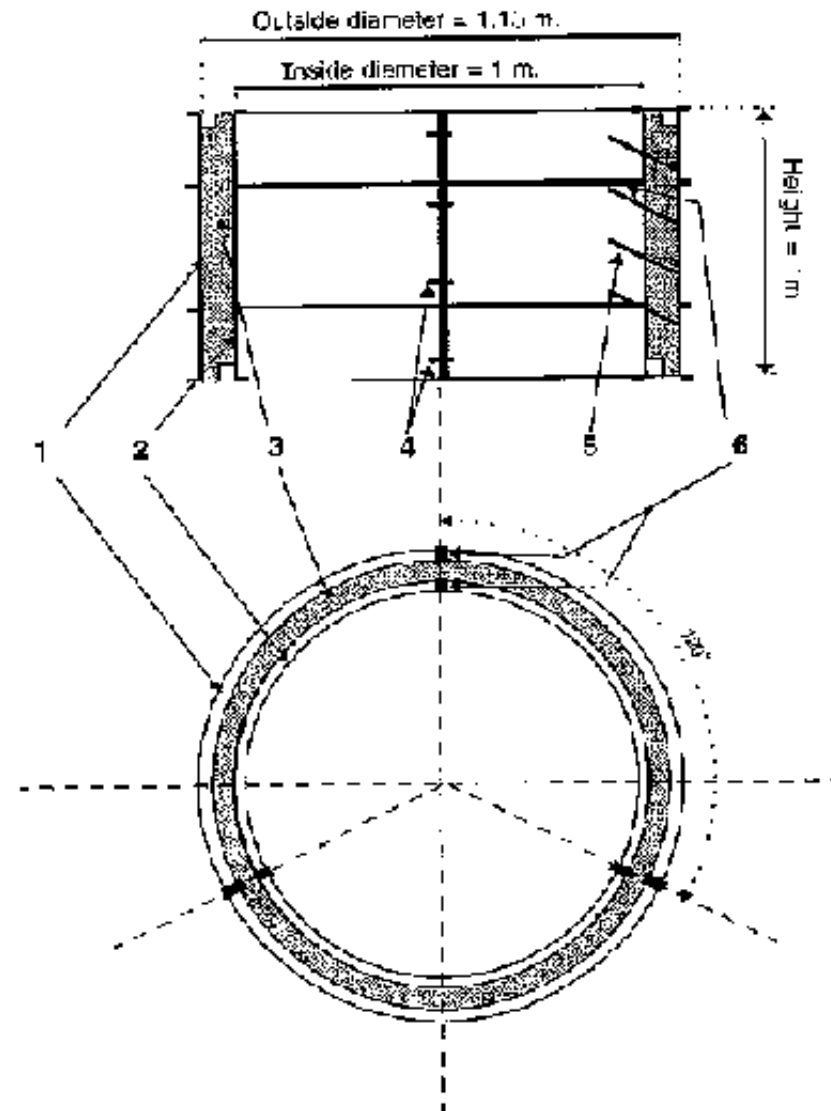

FABRICATING CONCRETE RINGS

Method

Concrete rings are needed to line and protect hand-dug wells. They may have

other uses, such as making a spring box, a rainwater collection tank etc.

Concrete rings for infiltration at the bottom of a well may be perforated during fabrication, or made of porous concrete. Porous concrete rings are preferred for use in decomposed rock, sand or gravel.

Concrete rings used for the main part of a well or for water storage should obviously not be porous or perforated.

- The internal diameter of the rings should be at least 0.8 m so that a person can work inside the ring if necessary.**
- The mould is of steel plate, at least 3 mm thick, reinforced with angle steel. It is composed of two parts: the internal and external rings. Each of these parts is made of three sections which bolt together.**
- The mould is generally 1m high (less if necessary).**
- The bottoms and tops of the rings are stepped so that they fit together well. The groove may be formed using a template or a plastic tubing against the internal face at the bottom of the mould, and against the external face at the top when the mould is almost full of concrete.**
- The mould sections are removed about 24 hours after casting. The rings should be cured in the shade for at least 1 week, during which they should be kept damp (wetted jute sacking or plastic sheeting).**
- For perforated rings, the moulds are made with holes every 15 cm. Greased pegs are inserted when the concrete is cast; they are withdrawn before the concrete sets completely.**
- After each use the mould sections should be scraped and brushed and the contact surfaces coated with used engine oil or diesel to prevent concrete sticking**

to them.

Key

- 1. External mould, diameter 1.15 m**
- 2. Internal mould, diameter 1 m**
- 3. Concrete ring**
- 4. Bolts**
- 5. Wooden or metal pegs (for perforated rings)**
- 6. Reinforcing angle steel**

Inputs

- 2 workers**
- Cement, sand and gravel (about 0.25 m³ of concrete per ring)**
- 1 ring mould**
- 2 shovels, 2 buckets, 2 trowels**
- 1 wire brush**
- Used engine oil**
- 1 spanner, 1 lump hammer**
- Plastic sheeting or jute sacking**

Important

- Concrete mix for ordinary or perforated ring is 1: 2: 4 cement: sand: gravel. Compact the concrete well during casting to drive out air bubbles.**
- Concrete mix for porous rings is 1:1: 4 cement: sand: gravel. The concrete should not be too wet. Instead of compacting, vibrate it by hitting the mould with a**

wooden stick. Porous rings should cure for longer than ordinary ones. They are more fragile and should be handled with care.

- When the rings are produced in series for a programme of well protection, it is recommended to use a sheltered area for curing and storing the rings.**
- A tripod and pulley should be used to lower the rings safely into the well.**

CHOOSING A MOTORPUMP

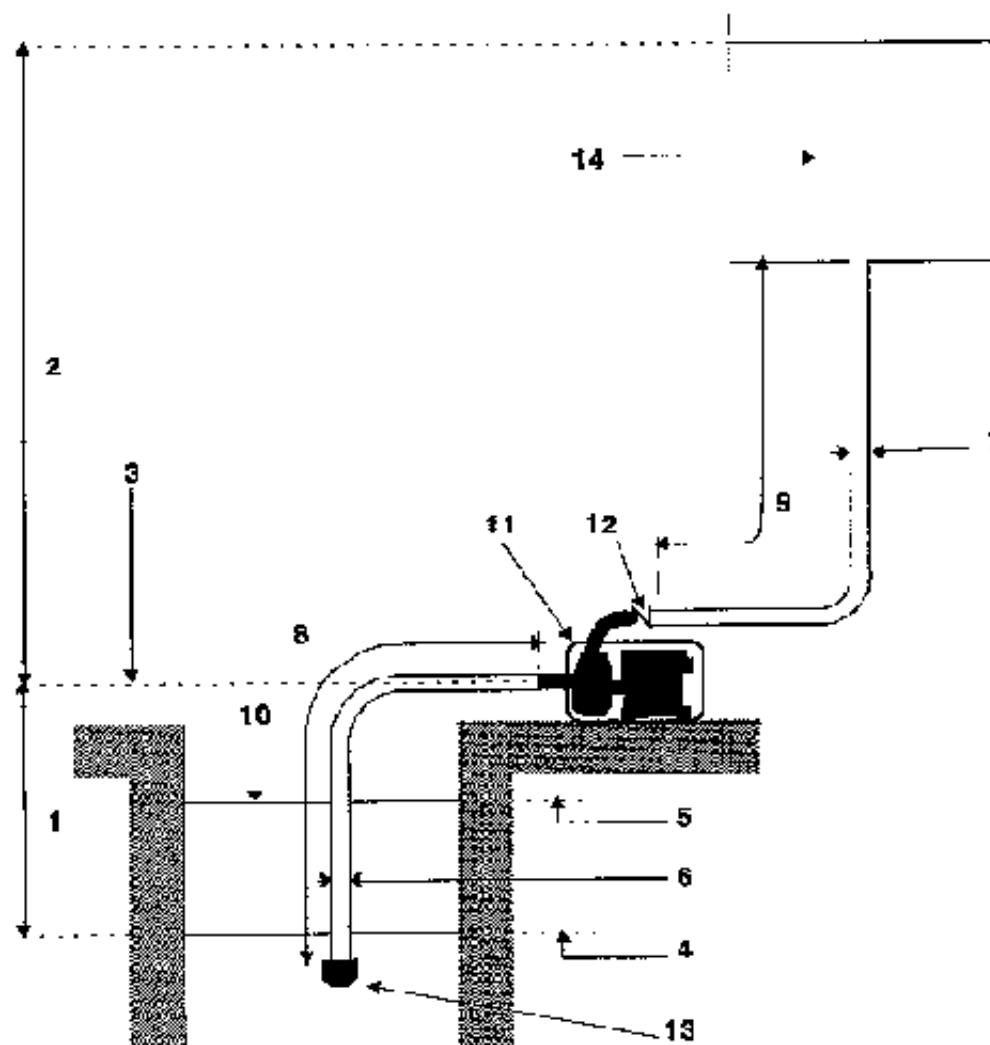



Altitude in metres	Loss of suction head in metres
0	0
500	0,60
1000	1,20
1500	1,70
2000	2,20
2500	2,70
3000	3,20
3500	3,60

CHOOSING A MOTORPUMP

Method

A motorpump is composed of a pumping mechanism and a driving mechanism (electric motor or combustion engine).

The choice of a motorpump depends on the type of water source and the work to be done.

The water source:

A study of the type of water source (river, lake, well, deep or shallow borehole) and its situation allows the choice of a surface pump or a submersible pump.

For a suction height of up to 7 metres, any type of surface pump may be used.(The pump body is at the surface: it sucks and delivers.)

For greater lifting heights (deep wells and boreholes), a submersible pump is suitable (an electric pump, completely immersed: delivery only).

The work to be done:

The following information is needed when specifying a pump for a specific use:

- The discharge, Q , expressed in litres per second or cubic metres per hour, or the demand in cubic metres per day.**
- The vertical distance in metres between the lowest water level and the highest level to which water must be pumped (suction height and delivery height), or the total geometric head.**
- The variation of the water level in metres.**
- Physical information on the site: depth of water, diameter and depth of well or borehole, sketch with dimensions of river bank, lake or channel.**
- The height of the site above sea level.**
- The energy source for pumping: human, animal, wind, electric motor, combustion engine, solar, etc.**
- The average weight which can be easily transported and handled on site.**

Key

1. Suction head

- 2. Delivery head**
- 3. Level of pump axis**
- 4. Lowest water level**
- 5. Highest water level**
- 6. Internal diameter of suction pipe**
- 7. Internal diameter of delivery pipe**
- 8. Length of suction pipe**
- 9. Length of delivery pipe**
- 10. Atmospheric pressure**
- 11. Motorpump unit**
- 12. Non-return valve**
- 13. Suction strainer with foot valve**
- 14. Storage reservoir**

Inputs

- Measuring equipment (rope, tape measure, level, etc)**
- Sketch and description of site**

Important

The following factors must also be considered:

- The possible presence of large quantities of sand in the water which may damage the moving parts of the pump.**
- The presence of salty or brackish water which could produce rapid pump corrosion.**

- **The ease of maintenance and robustness of the pump, the availability of fuel (what type of fuel) or electricity, the availability of tools, spare parts and maintenance skills.**
- **The pumping schedule: a few hours per day, or 24 hours per day?**
- **Calculation and comparison of the costs of different options.**

Note:

The suction ability of a surface pump is limited to 7m head at sea level, whatever its power. It diminishes as the altitude increases (see table opposite).

On the other hand, its discharge capacity is directly related to its power.

The discharge of a pump can be regulated by means of a valve at the discharge outlet.

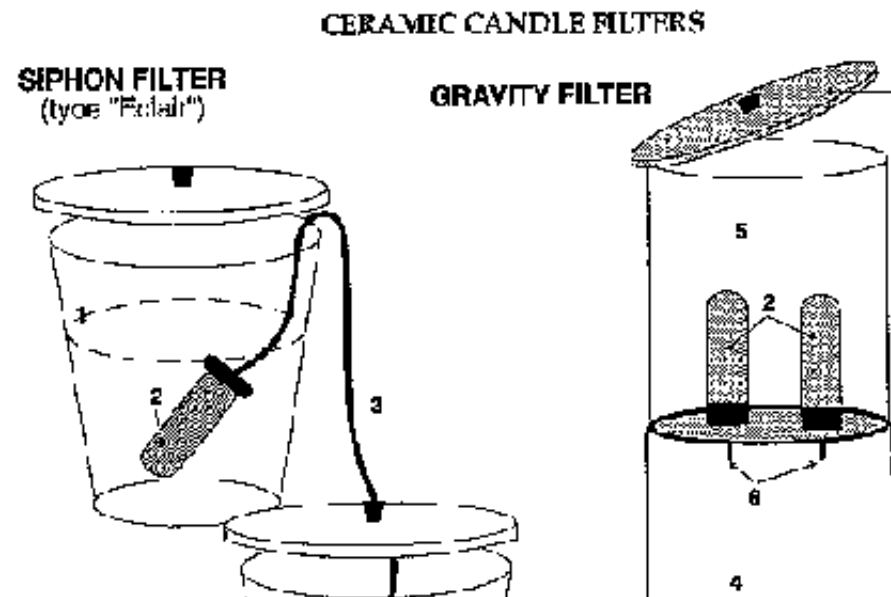

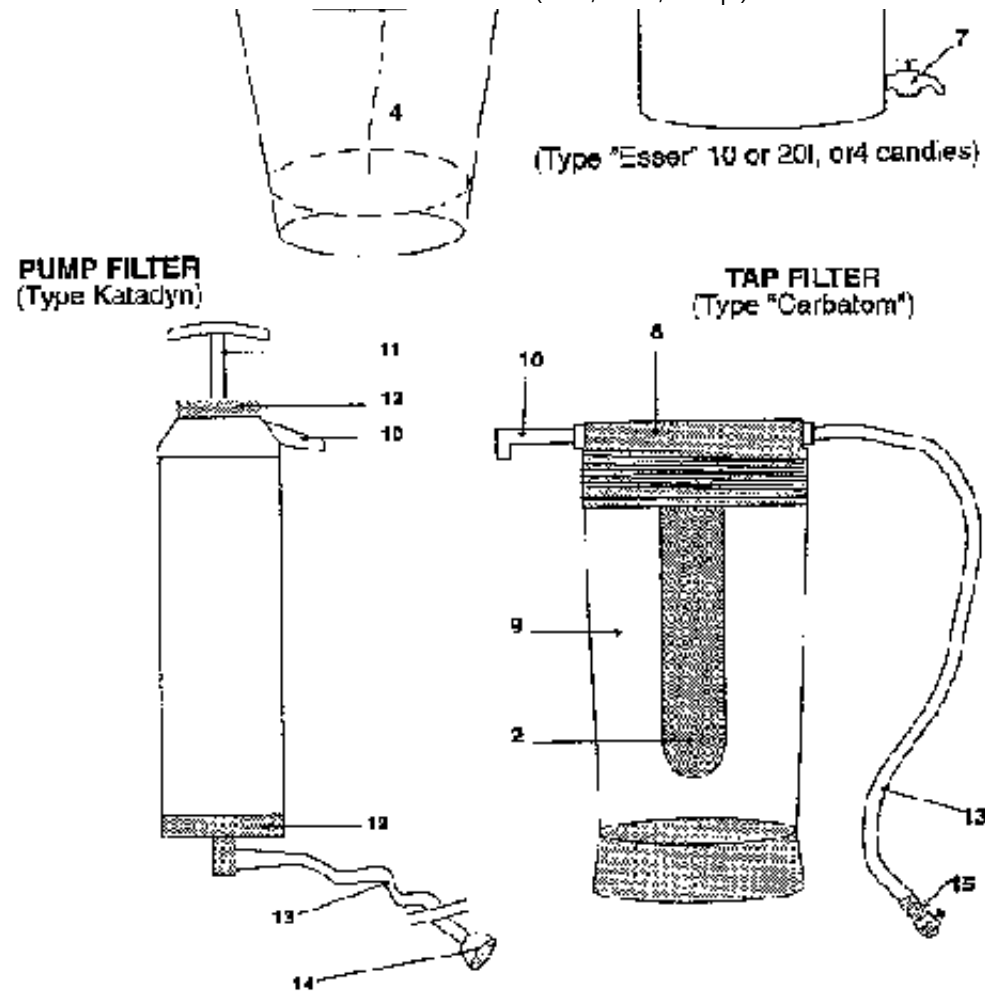

CERAMIC CANDLE FILTERS

Method

Ceramic candle filters can remove practically all bacteria, some viruses and all suspended material from water.

Important: this technique is not effective for dissolved substances (salts, chemical

pollutants, etc.).

Water is passed through microporous ceramic walls with a pore diameter of about 0.45.

Siphon filter

- Place the water to be filtered in a container, immerse the candle, place another container underneath and let the filtered water siphon through, drop by drop (the siphon is primed automatically).

Gravity filter

- The same principle as above, but one container stacks on top of the other.

This method produces a greater flow than the siphon as it uses several candles (provided they are not clogged).

Pump filter (also called "Katadyn")

Here, the water is forced through the filter under pressure using a small integral handpump, thus improving the flow.

- Put the end of the plastic pipe into the water to be filtered, and pump.**
- Inside the candle there is activated carbon which adsorbs dissolved substances and takes away any possible taste from the water.**

Tap filter

- **In this unit the candle is mounted inside a cylinder. (It is like the siphon filter candle, but filled with activated carbon.) A plastic hose is connected to the tap.**
- **When the tap is turned on, water fills the transparent filter body, passes through the candle and comes out of the spout.**
- **Important: this filter can only be used where there is enough pressure in the piped water supply.**

Key

- 1. Water to be filtered**
- 2. Ceramic candles**
- 3. Siphon tube**
- 4. Collecting filtered water**
- 5. Container of water to be filtered**
- 6. Ceramic candle fastening and rubber washer**
- 7. Tap**
- 8. Cover**
- 9. Transparent filter body**
- 10. Outlet for filtered water**
- 11. Handpump**
- 12. Fastening collars**
- 13. Flexible tube (raw water)**
- 14. Strainer (to prefilter raw water)**
- 15. Universal tap fitting**

Inputs

Siphon filter

- **Ceramic candle with flexible siphon tube**

Gravity filter

- **2 containers (metal or plastic)**
- **Ceramic candles (2 or 4) with rubber washers and wing nuts**
- **Tap**

Katadyn

- **Kit containing:**
 - **1 pump filter with flexible tube attached**
 - **1 brush to clean ceramic candle**
 - **1 gauge to measure thickness of candle**

Tap filter

- **Filter body with flexible hose and universal rubber tap adaptor**
- **Ceramic candle (delivered together)**

Important

- **Siphon filter: ensure that the flexible tube is firmly attached to the ceramic candle so that no water is siphoned directly without filtration.**
- **Gravity filter: assemble the candles correctly with their rubber washers to**

ensure that no water passes without filtration.

- **Katadyn filter: change the candle as soon as the measuring gauge passes freely around it (see maker's instructions).**
- **Teams in the field should always drink filtered water because they can never be sure of the quality of local water supplies.**
- **Never let the candles come into contact with boiling water as there is a risk of cracks forming.**
- **Maintenance of ceramic candles: when the flow becomes too weak, brush the candles (e.g. with a toothbrush) under clean running water, rinse and reassemble. The candles are fragile, handle them with care.**
- **The tap filter is ideal for washing hands etc. in an operating theatre, if the hospital has running water. Be careful not to loose the little rubber rings on the tap adaptor.**

**SLOW SAND FILTER
I-FILTER AND PREFILTER**

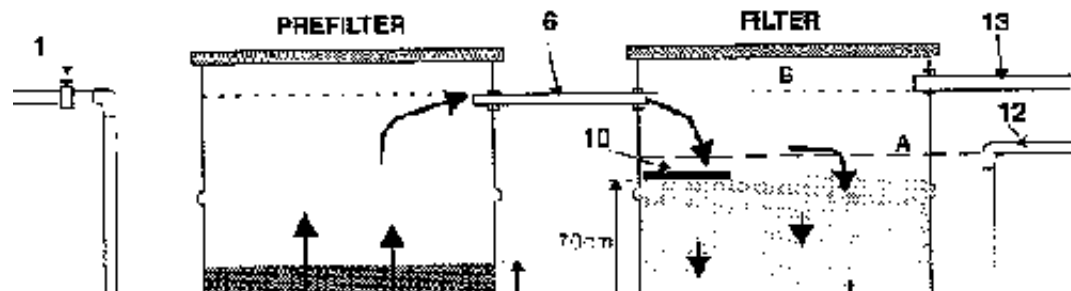

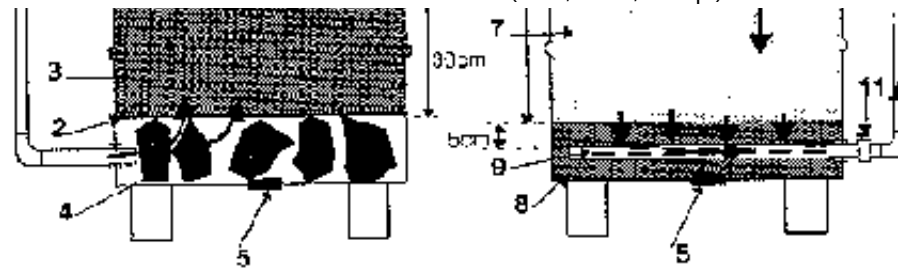

II-SYSTEM OF STORAGE/FILTRATION/DISTRIBUTION POSSIBLE

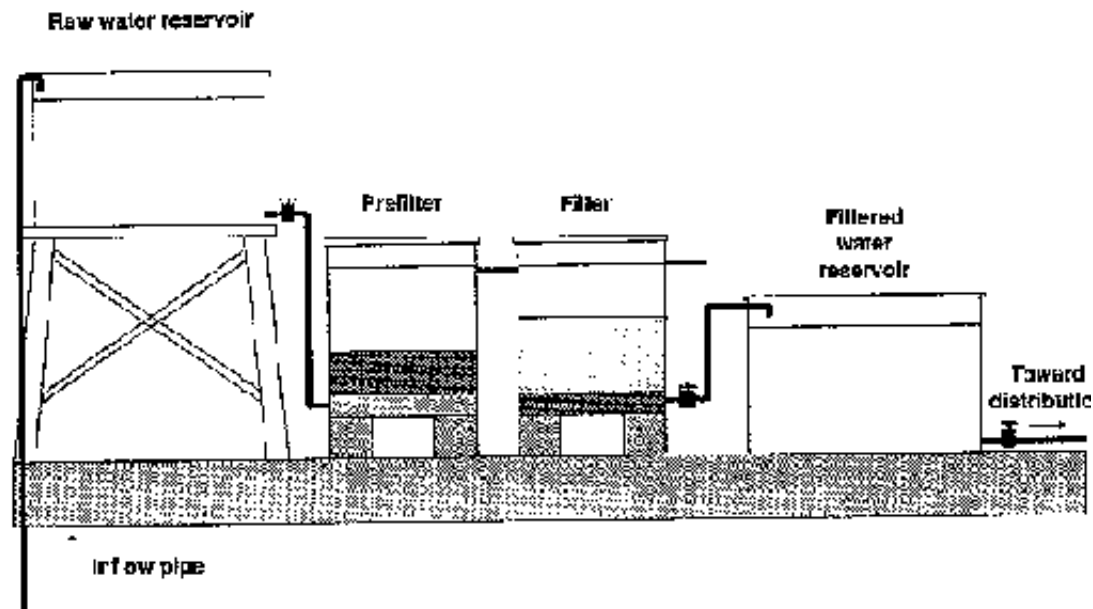

SLOW SAND FILTER

Method

Slow sand filtration a highly effective microbiological purification of water in addition to mechanical purification by the sand.

This microbiological treatment is due to the action of a biological layer (called the Schmutzdecke), which develops at the surface of the filter. This layer actively retains and destroys helminth eggs, bacteria and some viruses.

Construction

- 1. Paint the insides of two 200 l drums. Fix an inlet pipe about 5 cm from the bottom of one drum which which be used for the prefilter (as shown in the sketch).**
- 2. Place a layer of large stones on the bottom of this drum (4), making sure there is a plug-hole at the bottom. If there is not, then make one.**
- 3. Place a perforated plate (e.g. the top cut off the drum) on top of the stones (2), to act as a support for a layer of coarse sand.**
- 4. Place a 30 cm layer of coarse washed sand (1 - 2 mm dia) on top of the metal plate.**
- 5. Fix a pipe connecting the two drums near the top, to take water from the prefilter to the filter.**
- 6. Make sure the second drum has a plug-hole in the bottom. Make a hole about 5 cm from the bottom and insert a perforated pipe (9). A length of PVC pipe with many slots cut with a saw is suitable.**
- 7. Bury the perforated pipe in a bed of gravel (8), which covers it by at least 5 cm.**

- 8. Then add a layer of at least 70 cm of washed, sieved, fine sand (7). The ideal diameter is 0.2 to 0.5 mm, or in any case, less than 1.5 mm. The Schmutzdecke will develop at the surface of this sand.**
- 9. Place a flat stone (10) where the water flows onto the filter so it will not to disturb the Schmutzdecke by its turbulence.**
- 10. Insert and fix the pipework (outlet and overflow). Important: the outlet pipe must rise above the level of the top of the sand, so that the filter surface is always under water, even if the water supply is cut.**

Key

- 1. Raw water inlet valve**
- 2. Perforated plate (holes about 2 mm dia every 5cm)**
- 3. Coarse sand (1-2 mm dia)**
- 4. Large stone (e.g. cobbles)**
- 5. Plug-holes with plugs**
- 6. Prefilter overflow (towards filter)**
- 7. Fine sand (0.2-0.5 mm dia)**
- 8. Gravel**
- 9. Perforated pipe (for collecting filtered water)**
- 10. Flat stone**
- 11. Outlet valve**
- 12. Outlet pipe to distribution**
- 13. Overflow**

A. Minimum water level in filter**B. Maximum water level in filter****Inputs**

- **Two 200 l drums**
- **Metal saw, hammer, cold chisel, tape measure**
- **Drill and bits**
- **Round and half-round files**
- **Pipe (PVC or galvanised), 1/2" or 3/4"**
- **Pipe threader (for galvanised pipe) or solvent and PVC glue**
- **Teflon tape or mastic and tow (for making joints)**
- **Elbows and nipples (for fixing pipes)**
- **Anticorrosion and household paints**
- **Paintbrush and thinners**
- **Cobbles (stones)**
- **Coarse sand (about 1 mm dia): about 0.12 m³**
- **Fine sand (0.2 - 0.5mm dia): about 0.3 m³**
- **Gravel: about 0.03 m³ important**

- **The filter sand should be of uniform size. Sieve it, using mosquito netting for instance.**

- **Before the first use, fill the prefilter and the filter with a solution of 100 mg/l chlorine (10 ml of 1% solution per litre); leave it for 12 hours and empty it through the plug-holes. Never chlorinate after this: it would destroy the biological layer. Cover the drums to prevent the growth of algae.**

- **It is vital that the Schmutzdecke at the surface of the sand is always covered with water; again, make sure that the outlet pipe rises above the level of the Schmutzdecke.**
- **Flow setting: close the outlet valve. Open the inlet valve (not too much, to avoid putting the prefilter sand into suspension); when the filter is full, open the outlet valve so as to have an outflow of about 1 l/min.**
- **The Schmutzdecke is only effective after about 2 weeks, so for the first 2 weeks of service the water is not safe.**
- **Such a filter can treat 1,000 to 1,400 l/24 h. If the needs are greater, several filters may be built in parallel (this also avoids having to cut the supply during maintenance).**
- **Maintenance: when the yield drops significantly, cut the inflow and undo the plugs of the two drums. Let the water empty completely from the prefilter. Let the water level in the filter fall to 15 - 20cm below the filter surface; rake the top 1 - 2 cm of sand from the Schmutzdecke. Replace the plugs and put back into service. After this has been done several times, remove about 10 cm of sand and put it to one side. Place a layer of clean sand and then replace the 10 cm, to bring the total thickness of fine sand back to 70 cm.**
- **If the water is not very turbid (<30 NTU), the prefilter will not be necessary.**

Chlorine-generating products

CHLORINE

Chlorine is a chemical whose strong oxidizing properties are used for disinfection and decontamination. Other than its gaseous form (which is mentioned here just for information, because it is complicated to use), chlorine is found in the form of "chlorine-generating products". Each product is described by its chlorine content.

The chlorine content should be labelled on the product's packaging and is expressed:

- either in % of chlorine
 - or in chlorometric degrees (°chl)
 - or in parts per million (ppm) or mg of active chlorine / litre.
- (1°chl = about 0.3% active chlorine. 1ppm = 1mg/l = 0.0001% active chlorine)

DIFFERENT PRODUCTS

Product	Chlorine content
Sodium hypochlorite solution, 12°chl.....	about 4% active chlorine
Sodium hypochlorite solution, 16°chl.....	about 5% active chlorine
Sodium hypochlorite concentrate, 48°chl.....	about 15% active chlorine
Calcium hypochlorite (HTP).....	about 70% active chlorine
Chlorinated lime (bleaching powder).....	about 30% active chlorine
Sodium Dichloro-isocyanurate or NaDCC (1):	
- powder.....	60-65% active chlorine
- tablets.....	1.5g active chlorine/tab.

or The UK Department of the Environment authorises the use of NaDCC for disinfecting drinking water in emergency or temporary situations as long as doses do not exceed 10mg of product per litre, and it is not used for more than 90 days per year.

Storage:

- store chlorine products in airtight, non-metallic containers sheltered from heat, light and humidity.
- chlorinated lime and all forms of sodium hypochlorite are unstable and do not store well.
- calcium hypochlorite stores better (loss of active chlorine is about 2% per year), but NaDCC is by far the most stable chlorine-generating product.

PREPARATION OF A 1% SOLUTION

For chlorinating drinking water a stock solution of 1% chlorine is used, whichever chlorine-generating product is used.

Product at x% chlorine → 1% solution → use

Starting with a product at x% active chlorine:

- a 1% solution of chlorine contains 10g of chlorine per litre, so it needs $10 \times (100/x)$ grammes of product per litre of solution. Example: calcium hypochlorite at 70% active chlorine: $10 \times (100/70) = 15g/l$ of solution.

Starting with:	Dilution	Remarks
Calcium hypochlorite at 70% active chlorine	15g/l = 1 level souple spoon/litre	Let the deposit and settle and use only the supernatant
Chlorinated lime at 30% active chlorine	33g/l = 2 leve. souple spoons/litre	
Sodium hypochlorite at suitable 3% active chlorine	200ml/litre	Only if manufactured very recently (<3 months) and only if stored away from heat.
Sodium hypochlorite concentrate at 15% active chlorine	75ml/litre	
Sodium dichloro-isocyanurate (NaDCC) at 1.5g active chlorine per tablet	7 tablets/litre	Ensure that the excipients in the tablets are non-toxic.

The 1% stock solution should be kept in an airtight, opaque, non-metallic container, away from light and heat and should be replaced every 1 to 2 weeks.

Calcium hypochlorites and NaDCC are recommended for general disinfection (greater stability and high

chlorine content). NaDCC is completely soluble, is less corrosive and is not affected by IATA rules on the air transport of corrosive substances

Chlorine-generating products

CHLORINATION

Method

Chlorination is one of the best methods of treating drinking water (relatively simple, effective and easy to measure). In spite of this relative simplicity, it should not be forgotten that in an emergency situation it is always preferable to use a groundwater source which can be protected and monitored in terms of environmental hygiene (see technical brief Protecting a well).

Chlorination demands staff trained in the technique and in its monitoring as well as good logistics (supply of chlorine product storage, etc.).

In practice

Only the chlorination of a known volume of water in a reservoir is discussed here.

- The principle is to add enough chlorine[^]generating product to destroy all the organic matter contained in the water and to leave a small fraction of chlorine available for dealing with any possible reintroduction of organic matter. To determine how much chlorine product to add, the chlorine demand is measured.

1. Prepare a 1% chlorine solution (see technical brief Chlorine-generating products).

- 2. Take 3 or 4 non-metallic containers of known volume (e.g. 20 l buckets).**
- 3. Fill the containers with some of the water to be treated.**
- 4. Add to each bucket a progressively greater dose of 1% solution with a syringe:**
 - 1st container: 1 ml**
 - 2nd container: 1.5 ml**
 - 3rd container: 2 ml**
 - 4th container: 2.5 ml**
- 5. Wait 30 minutes (essential: this is the minimum contact time for the chlorine to react).**
- 6. Measure the free chlorine residual in each bucket (see technical brief Monitoring chlorination).**
- 7. Choose the sample which shows a free residual chlorine level between 0.2 and 0.5mg/l.**
- 8. Extrapolate the 1% dose to the volume of water to be treated.**
- 9. Pour the solution into the reservoir, mix well (during filling) and wait 30 minutes before distributing.**

Example

Chlorination of water in a 2,000 l reservoir

- **Follow steps 1 - 5 above.**
- **The free residual chlorine levels of the water in the buckets, measured half an hour after adding 1, 1.5, 2 and 2.5 ml of 1% chlorine solution respectively are as follows:**
 - 1:0 mg/l**
 - 2:0.1 mg/l**
 - 3:0.4 mg/l**
 - 4:1 mg/l**
- **The dosing rate chosen therefore will be that for bucket number 3 (result between 0.2 and 0.5 mg/l)**
- **If it needs 2 ml of 1% solution to chlorinate 20 l of water at the correct dosage, then it needs 100 times as much to chlorinate 2,000l, e.g.: $100 \times 2 \text{ ml} = 200 \text{ ml}$ of 1% chlorine solution**

Inputs

- **1% solution**
- **Several containers of the same known volume (buckets, jerrycans, etc.).**
- **5 ml syringe**
- **Measuring equipment (comparator and DPD1 tablets)**
- **Watch to measure the 30 minutes**

The MSF "chlorination" kit, available through MSF logistics, contains all the material needed for chlorination and dosing.

Important

- **Never chlorinate turbid water because the suspended particles can protect micro-organisms. The measurement of free residual chlorine may indicate a satisfactory result (between 0,2 and 0,5 mg/l), but there is no way of knowing if the chlorine actually comes into contact with all the pathogens. Water to be chlorinated must contain as little visible suspended material as possible. If it is turbid, a pretreatment such as sedimentation and/or filtration should be done before chlorination.**
- **Chlorination is effective against practically all pathogenic micro-organisms in water. The only way to be sure of this effectiveness is to dose the free residual chlorine. Important: even if the dosage rate is correctly determined, the chlorine demand may vary over time with unexpected changes in the amount of organic material in the water. It is thus important to measure the free residual chlorine frequency in order to be able to adjust the dosage rate to the situation.**
- **Metal consumes chlorine, so never prepare strong solutions in metal containers (unless they are enamelled or painted).**
- **Concentrated chlorine products should be kept in a dry, shaded place, and guarded. (Chlorine is dangerous, particularly for children). When in contact with air, chlorine produces a corrosive and toxic gas heavier than air. The ventilation of chlorine stores should therefore be by means of vents at the bottom of the walls.**
- **The doses of 1% chlorine solution given here for the example of calculating chlorine demand are only an indication. It may be that the chlorine demand of**

water to be treated in the field is very different from this example.

- The taste of chlorine in water is no proof of the presence of free residual chlorine (it could be combined residual chlorine).

MONITORING CHLORINATION

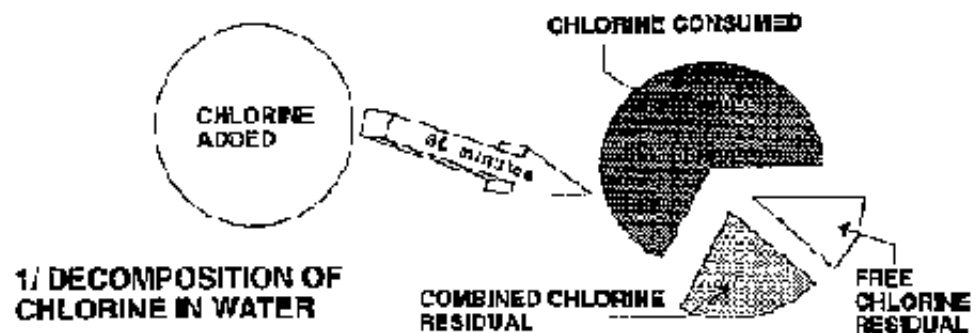

2/ TESTER ("POOLTESTER")

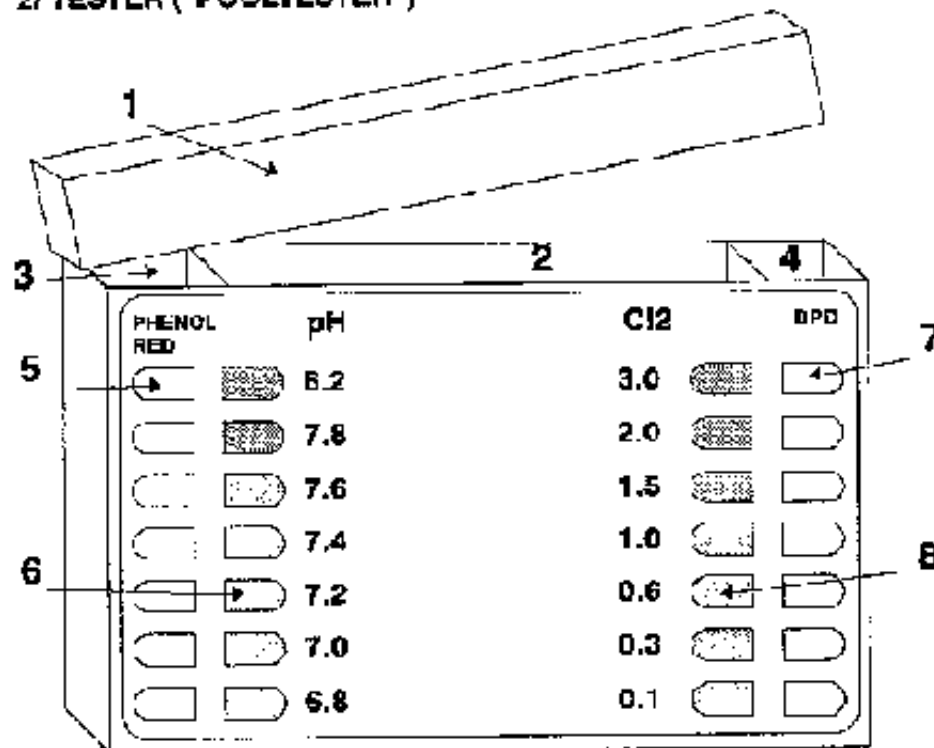

Monitoring chlorination

Method

The simplest and surest way of monitoring effectiveness of chlorination of drinking water is to measure Free Residual Chlorine (FRC).

The presence of FRC in water (after a contact time of 30 mins) proves that enough chlorine has been added to oxidise all organic matter in the water, plus leaving an excess of chlorine available to deal with possible recontamination (in the distribution system, during handling etc.).

The objective of chlorination (see technical brief Chlorination) is thus to add enough chlorine to leave between 0.2 and 0.5 mg/l of FRC after the contact time.

The measurement is most easily done using a "Pooltester"

- 1. Rinse the Pooltester 3 times with the water to be tested.**
- 2. Fill the 3 compartments completely with water.**
- 3. Put 1 phenol red tablet in the left hand compartment (measurement of pH).**
- 4. Put 1 DPD1 tablet in the right hand compartment (measurement of Free Residual Chlorine).**
- 5. Replace the cover.**
- 6. Shake until the tablets are completely dissolved (about 20 secs).**
- 7. Read the results in the light, comparing the colours in the outside compartments (samples) with those in the central compartment (reference).**

Key

- 1. Cover**
- 2. Central compartment**
- 3. pH compartment (phenol red tablet)**
- 4. FRC compartment (DPD1 tablet)**
- 5. pH reading scale**
- 6. pH reference scale**
- 7. FRC reading scale**
- 8. FRC reference scale**

Inputs

(for 1 measurement)

- 1 pooltester with cover**
- 1 phenol red tablet**
- 1 DPD1 tablet ("DPD1" is marked in green on the packet)**
- Water to be tested**

Important

- Never touch the tablets with the fingers: this could affect the results.**
- The printing "DPD1" must be in GREEN on the packaging. There are other DPD1 tablets with the printing in black. They should not be used in this pooltester.**
- Read the results within 60 seconds of the tablets dissolving to be sure of a reliable measurement.**
- Read the results in good light (daylight is best).**
- The pH need not be measured every time. It is used for determining the amount of chlorine product to add to the water.**

- Comments on the pH of water:

pH = 7: neutral

pH < 7: acidic

pH > 7: alkaline (or = basic)

- **Important: chlorination is less effective if the pH is above 8. In this case, the FRC level after the contact time should be double the normal (between 0.4 and 1.0 mg/l instead of 0.2 - 0.5 mg/l) for chlorination to be considered effective.**
- **Important: if chlorine is overdosed, the measurement of FRC may give a false negative result.**

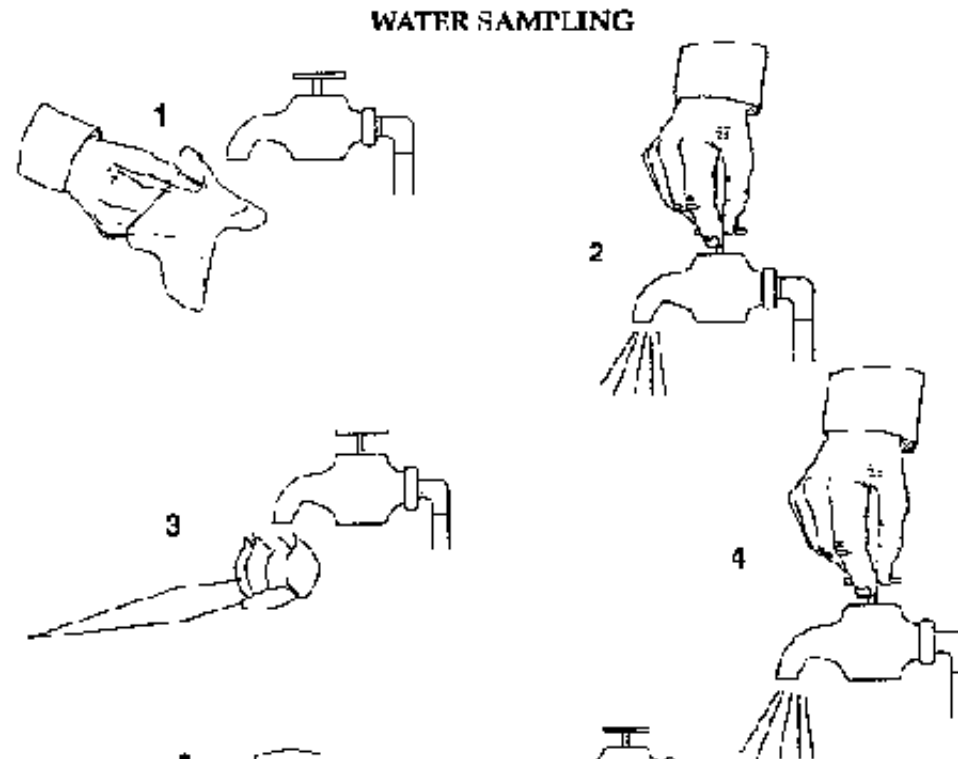

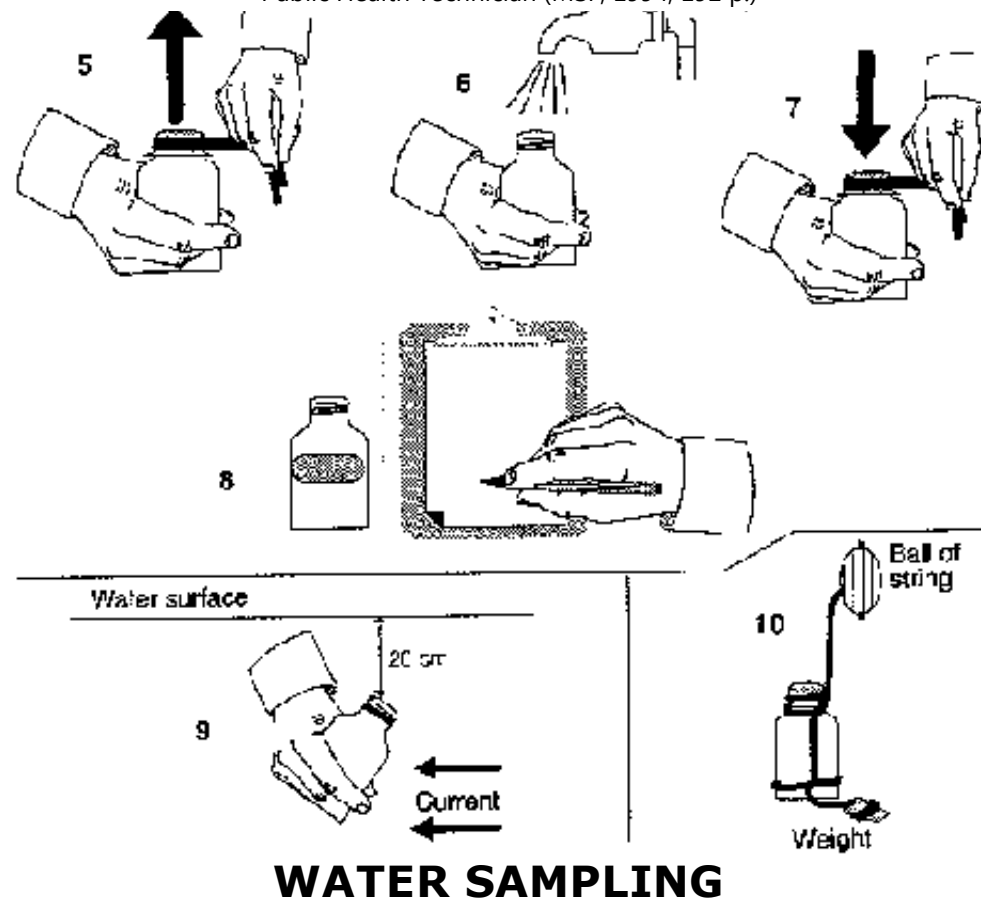

Method

Important: the sampling technique differs according to whether it is for bacteriological or chemical analysis.

The results are in the section "Assessment of water quality".

Chemical analysis

- Collect at least 2 x 11 in plastic bottles (e.g. mineral water bottles), which must

be clean and airtight.

- Rinse the bottles 3 times with the water to be analysed, fill them right to the top, label them and send them to the analytical laboratory.

Bacteriological analysis

- Collect at least 100ml in a sterile bottle.

- To sterilize bottles, place the cap loosely on each one so that steam can circulate inside.

- Wrap each bottle in tissue paper, newspaper or wrapping paper.

- Sterilize in an autoclave for 15 minutes at 121°C (a small autoclave like the "Prestoclav" is quite suitable).

- If there is no autoclave, the bottles may be sterilized by boiling: place each bottle and cap in the water and let it boil for 20 minutes.

- After 20 mins boiling, take out of the water, and let it cool protecting the opening with flamed aluminium foil or a sterilized compress.

- Use as soon as possible.

- For the bacteriological analysis of water that has been chlorinated, add 0.15ml of 1% sodium thiosulphate solution per 100ml of sample to each bottle before sterilizing, in order to neutralize the chlorine which would otherwise affect the results.

Key

(1 - 8: water sampling from a tap for bacteriological analysis)

1. Clean the tap (alcohol or soap)

- 2. Let the tap run fully for about 30 seconds**
- 3. Flame it with a pad soaked in alcohol**
- 4. Let it run fully again for 30 seconds**
- 5. Take off the cap and its protection from the bottle**
- 6. Take the sample**
- 7. Replace the cap**
- 8. Label the sample and record it in a notebook**
- 9. Sampling from a water course**
- 10. Sampling from a well**

Inputs

Chemical

- Glass or plastic bottles, 1 or 1.5l: 2 per sample**
- Marker pen for labelling**
- Thermometer**

Bacteriological

- 2 sterile 100 ml bottles**
- String and weighting stone (for sampling from a well or other inaccessible place.**
- Cloth**
- Alcohol and tights**
- Cotton wool and forceps (e.g. hair tweezers)**
- Thermometer**
- Cool box**

Important

- **The 8 steps described here for sampling from a tap are not necessary for chemical analysis, but are absolutely necessary for bacteriological analysis. They are the only way to be sure that the results of the analysis reflect the quality of the water and are not affected by possible contamination on the tap, during handling.**
- **Always work with clean hands (washed with soap). Any contamination by dirty hands will distort the results.**
- **Never touch the inside of the sterilized bottle or its cap. When sampling, hold the cap by the outside; never put it down unless it is upside down. It is better, for security and reliability, to double each sample.**
- **Mark the following on each sample (and keep a copy):**
 - **an identification number, the place and the type of water sampled, as accurately as possible;**
 - **the date and time of sampling and dispatch;**
 - **the substance(s) or organism(s) to be identified; techniques**
 - **treatment, if any, of the water (product and dose);**
 - **water temperature at the time of sampling (if possible).**
- **Certain chemical tests require special sampling. Enquire about these.**
- **For bacteriological analysis, it is often simpler to use field testing kits (e.g. De l'Agua or Millipore); in fact, samples should reach the analytical laboratory within an hour of sampling if they are kept at ambient temperature, or within 6 hours if**

they are kept at between 4 and 6°C (but not frozen).

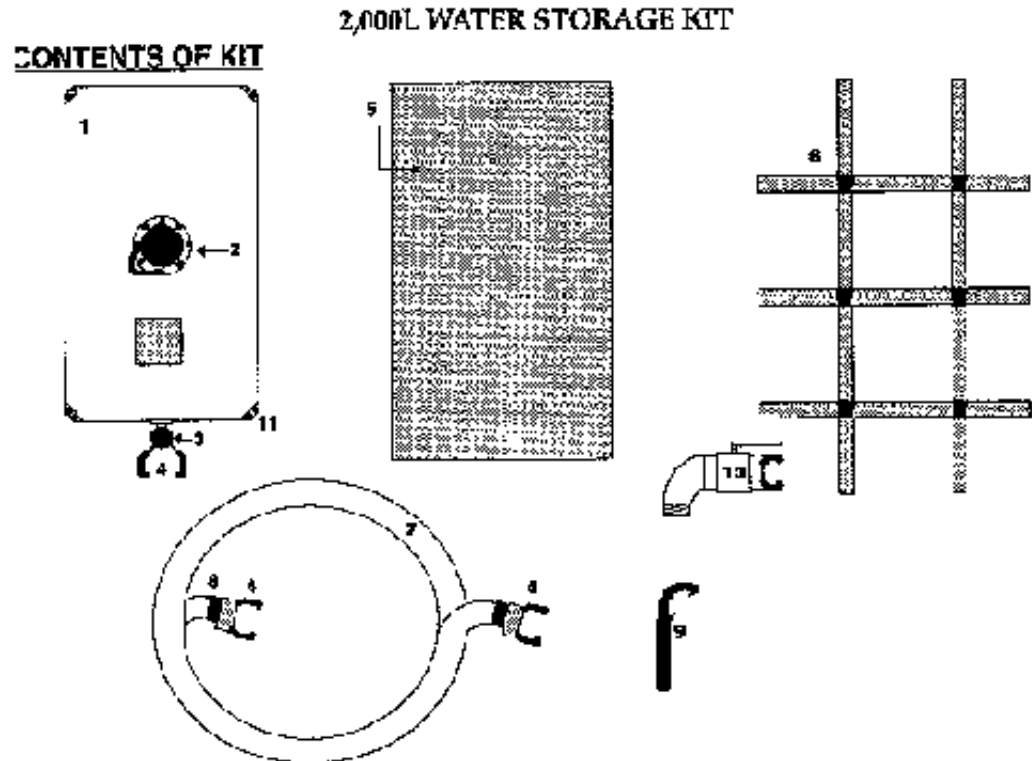

INSTALLATION STEPS

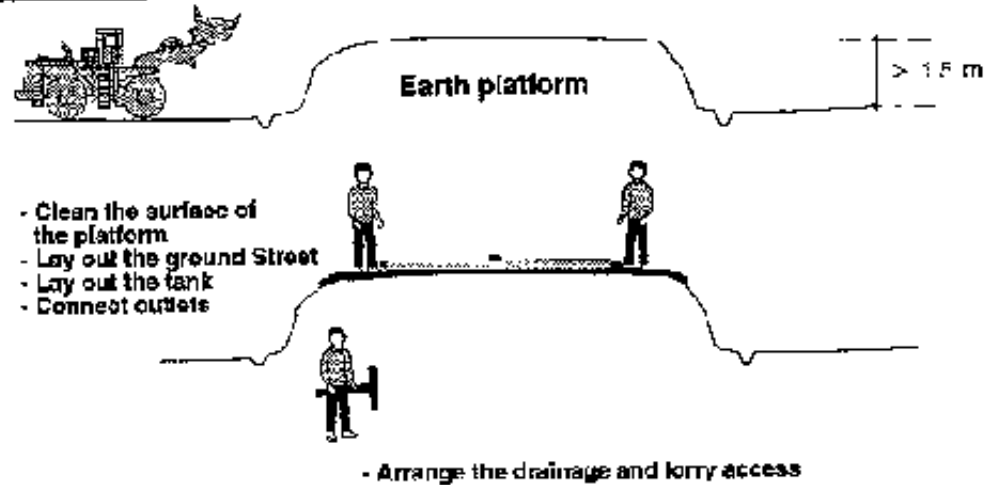

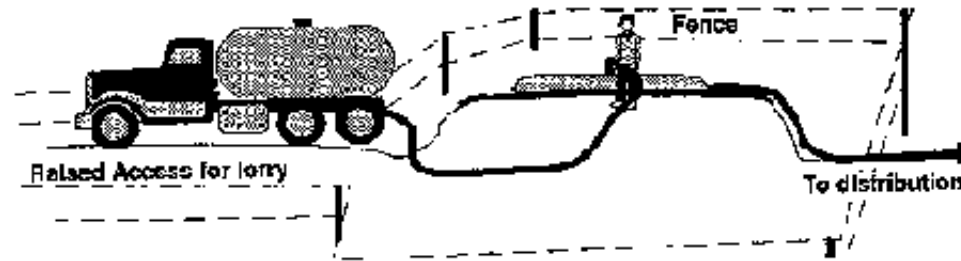

2,000 litres water storage kit

Method

This kit is for the supply of water to a health structure (dispensary, small hospital, feeding centre, etc.).

Once the base has been prepared (a raised earth platform), the bladder tank can be in operation in a few minutes.

Installation

- Choose the site for installing the tank, close to the centre to be served.

Important: make sure that the site is accessible at all times for filling the tank (e.g. by lorry tanker).

- Prepare a flat platform, about 15 m high so that the water may be distributed by gravity. The higher the platform the better the distribution.

- The surface of the platform should be cleared of all objects (stones, sticks, etc.) which could puncture the tank. If possible, cover the surface with a layer of sand.

Important: the area of the platform should be larger than that of the tank (3 m x 1.7 m). Note also that this platform should be strong enough to support 390 kg/m³.

The platform may be made of compacted earth, or oil drums filled with stones or earth with earth packed between them, or a flat roof may be used, etc.

- Spread the groundsheet on the platform.**
- Lay the tank out on the groundsheet.**
- Tighten the outlet valve; it is not completely screwed on by the manufacturer.**
- Attach the pipe to the outlet.**
- Organise the distribution system in the health centre (or right next to it), using either the 1/4 turn valve supplied with the Wt. or a distribution tapstand (there are 2 stands, each with 6 taps in the MSF "Distribution tapstand" kit).**
- Install a drainage system around the platform and around the distribution point to avoid rapid deterioration of the site.**

Key

- 1. Reservoir (bladder tank)**
- 2. Filling opening with cap**
- 3. Outlet valve**
- 4. One half of a DN50 connection, Guillemin system**
- 5. Groundsheet**
- 6. 6m of 2" reinforced hose, DN50, suitable for carrying drinking water**
- 7. Harness for transport by car or lorry**
- 8. Serflex collars for grip and watertightness**

9. Spanner for loosening and tightening the hose connections**10. 1/4 turn distribution valve****11. Corner protection plate****Inputs**

- **2 people per kit for installation**
- **Means of firing: motorpump, lorry tanker, etc.**
- **Distribution points, e.g. MSF tapstand kits with 6 taps**

Important

- **Site the distribution point as far away as possible from the tank.**
- **Do not lose the connection spanner: if it does get lost, there are some in the MSF water supply tool kit (white bucket).**
- **After use, it is essential to dean and dry the inside of the tank before repacking, to extend its life:**
 - **open the valve and the firing cap,**
 - **unscrew the plastic corner reinforcing plates on one side of the tank, push a piece of string or wire,**
 - **between the plates and retighten them,**
 - **hang up the tank by the string or wire,**
 - **slip a piece of wood (for example) between the filling opening and the tank bottom to keep the inner surfaces apart and let air circulate inside.**
- **Do not fold up the tank until the inside is completely dry (2 - 3 days at least).**
- **To repair the tank, use the repair kit supplied and follow the instructions**

carefully.

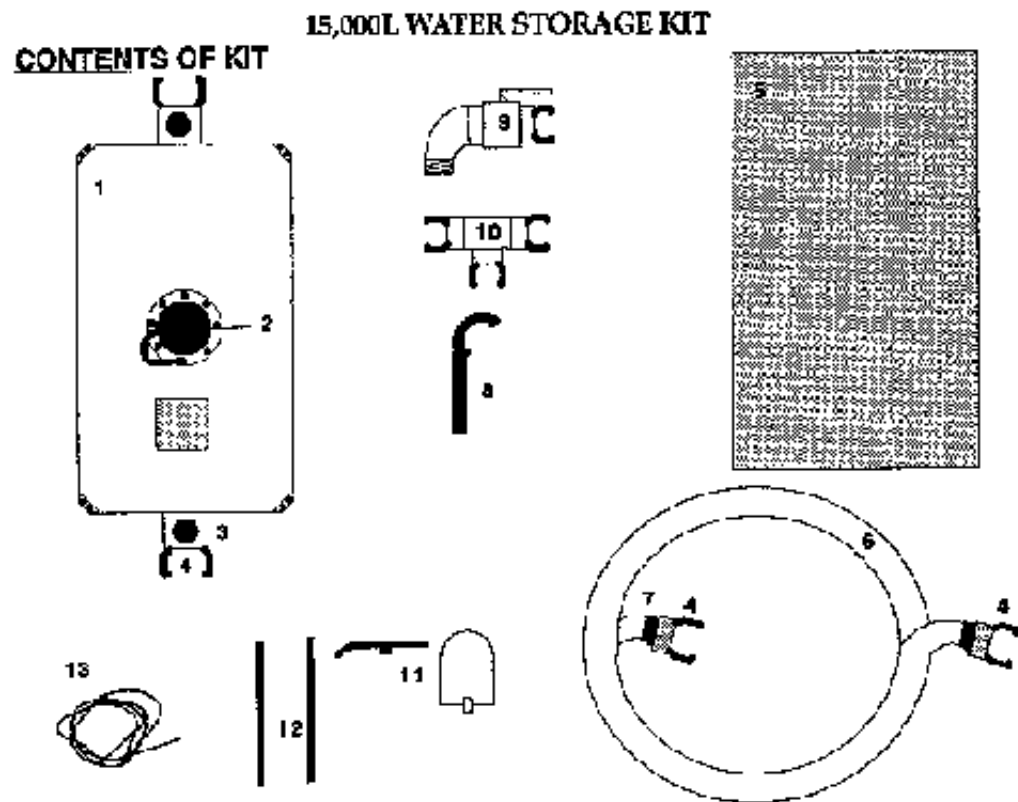

INSTALLATION STEPS

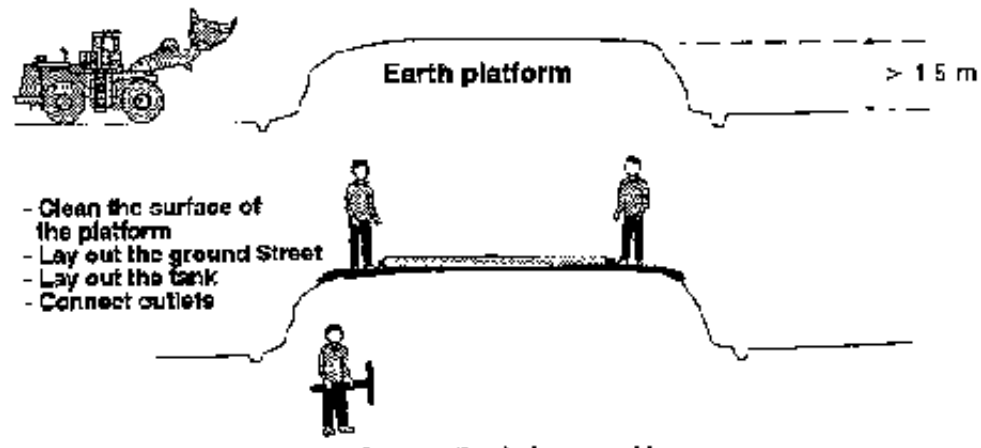

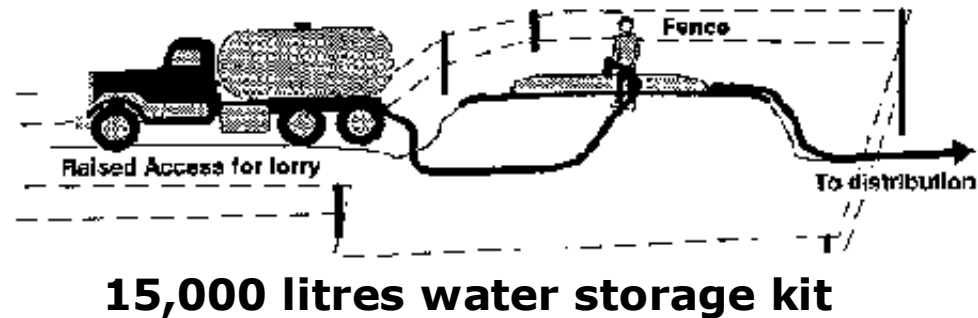

Method

This kit is designed to supply water in a camp. Once the base has been prepared (a raised earth platform), the bladder tank can be operational in a few minutes.

Installation

- **Choose the site for installing the tank, ensuring that it is accessible at all times for filling the tank (e.g. by lorry tanker).**
- **Prepare a flat platform, about 1.5 m high so that the water may be distributed by gravity. The higher the platform the better the distribution.**
- **The surface of the platform should be cleared of all objects (stones, sticks, etc.) which could puncture the tank. If possible, cover the surface with a layer of sand.**

Important: the area of the platform should be larger than that of the tank (6.4 m x 3.2 m). Note also that this platform should be strong enough to support 730 kg/m³.

The platform may be made of compacted earth, or oil drums filled with stones or earth with earth packed between them, or a flat roof may be used, etc.

- Spread the groundsheet on the platform.**
- Lay the tank out on the groundsheet.**
- Tighten the outlet valves; they are not completely screwed on by the manufacturer.**
- Attach one of the three lengths of pipe to one of the outlets; fit the tee and the two other lengths of pipe to the other outlet.**
- Organise the distribution points, using either the 1/4 turn valves supplied with the kit, or distribution tapstands (there are 2 stands, each with 6 taps in the MSF "Distribution tapstand" kit).**
- Install a drainage system around the platform and around the distribution point(s) to avoid rapid deterioration of site.**

Key

- 1. Reservoir (bladder tank)**
- 2. Filling opening with cap**
- 3. Outlet valves (2)**
- 4. Half of a DN50 connection, Guillemin system**
- 5. Groundsheet**
- 6. 6 m of 2" reinforced hoses, DN50 (3), suitable for use with drinking water**
- 7. Serflex collars for grip and watertightness**
- 8. Spanner for loosening and tightening the hose connections**
- 9. 1/4 turn distribution valves (3)**
- 10. 2" tee connection, DN50**

- 11. 2 shovels, 2 picks**
- 12. Handles for shovels and picks**
- 13. Roll of rope**

Inputs

- 2 persons per kit for installation**
- Unpack the shovels and picks first of all to prepare the platform. If mechanical equipment (e.g. a bulldozer) can be used it is much quicker and easier.**
- Means of filling: motorpump, lorry tanker, etc.**
- Distribution points, e.g. MSF tapstand kits with 6 taps.**

Important

- Site the distribution point as far away as possible from the tank Use the rope in the kit for fencing.**
- Do not lose the connection spanner: if it does get lost, there are some in the MSF water supply tool kit (white bucket). When rationing water, the gate valves on the outlets may be closed and the knobs taken off. Be careful not to lose the knobs.**
- After use, it is essential to clean and dry the inside of the tank before repacking, to extend its life:**
 - open the valve and the filling cap,**
 - unscrew the plastic corner reinforcing plates on one side of the tank, push a piece of string or wire between the plates and retighten them,**
 - hang up the tank by the string or wire,**

- **slip a piece of wood (for example) between the filling opening and the tank bottom to keep the inner surfaces apart, and let air circulate inside.**
- **Do not fold up the tank until the inside is completely dry (2-3 days at least).**
- **To repair the tank, use the repair kit supplied and follow the instructions carefully.**

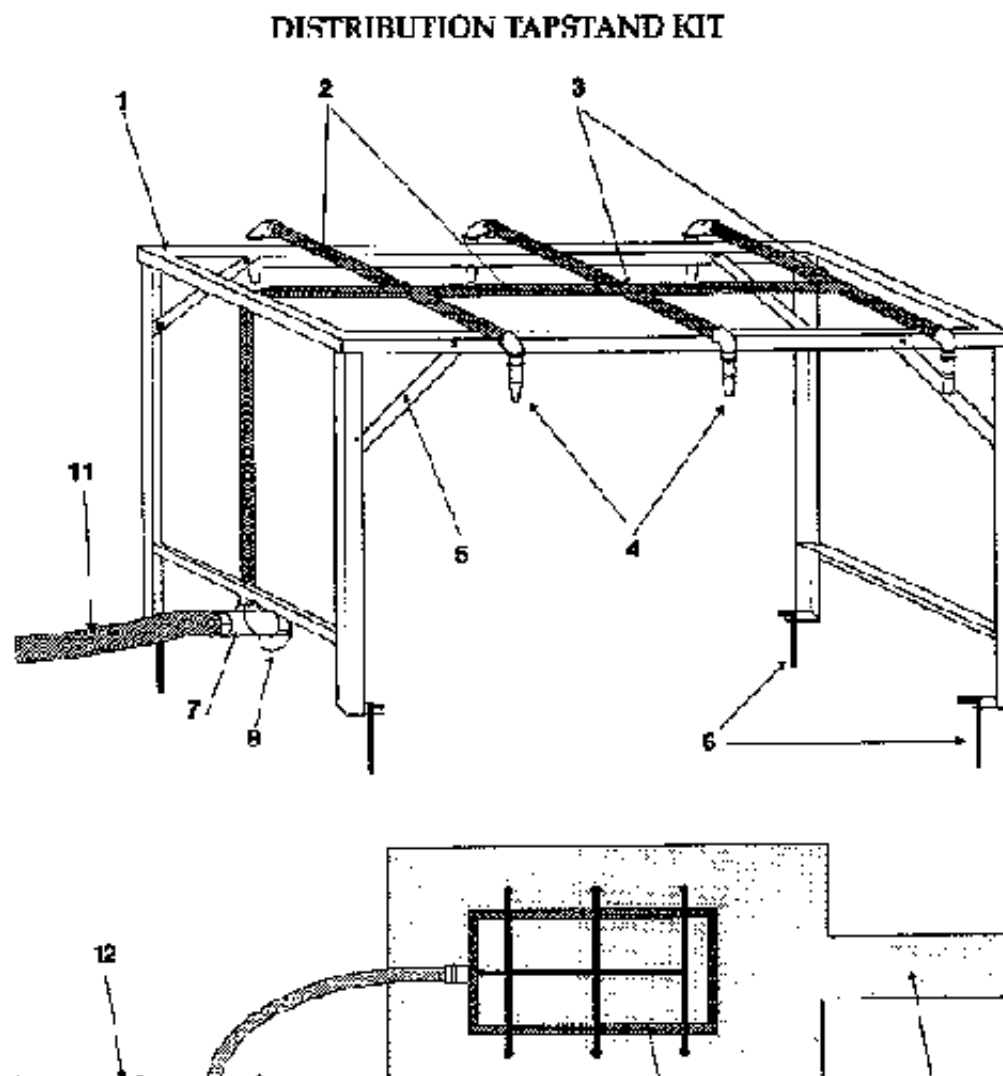

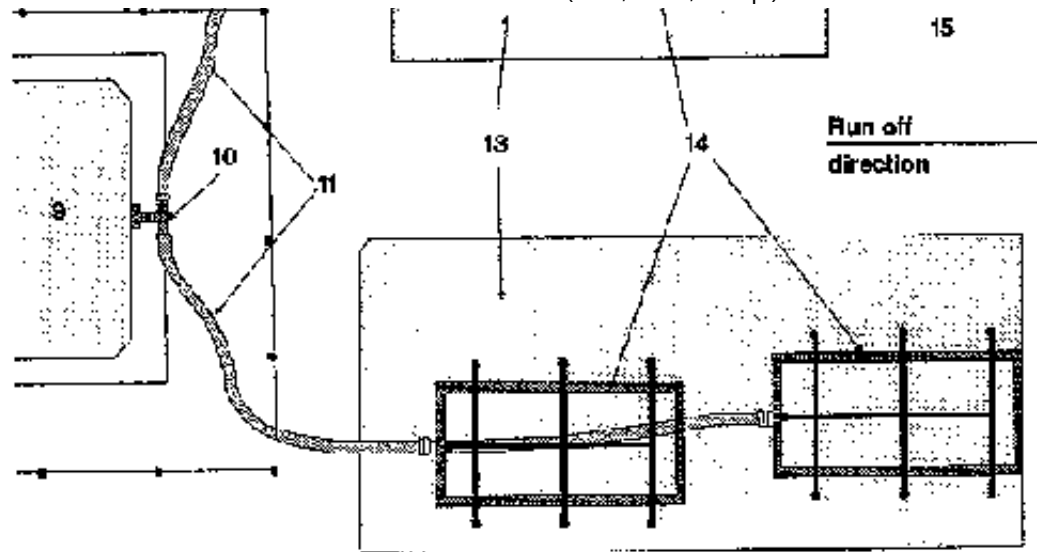

Distribution tapstand kit

Method

The distribution tapstands are pre-assembled and quick to install, allowing rapid provision of water distribution points in emergency situations. The kit is composed of 2 tapstands, each with 6 self-closing taps. The tapstands are designed to be used with the water storage kits (or any other system fitted with DN50 connections).

Installation

- Unpack the two tapstands from the box and identify the various parts (frame, taps, nuts and bolts, etc.).**
- Unfold the legs and assemble the frame with the 4 steel braces. Use the bolts and the Nylostop M10 nuts with the 10mm spanner in the kit.**

- **Secure the reducing tee with its vertical pipe for incoming water. Use Teflon tape (PTFE) on the thread before screwing on the elbow to ensure a watertight joint. Tighten the nuts fixing the pipe to the frame with the 13mm spanner supplied.**
- **Wind teflon tape onto the threaded ends of the pipes on the tapstand.**
- **Attach the 6 Taflo taps, tighten them well (use a wrench supplied in the water supply tool kit). Make sure all 6 taps are vertically aligned.**
- **Choose the site to install the tapstand(s): the site should be well drained (for rainwater and wastewater) and accessible for users.**
- **Position the tapstand(s). Fix them to the ground using the short stakes in hard earth and the long stakes in soft earth.**
- **Connect & tapstand(s) to the tank using 2" Heliflex pipe. Tighten the DN50 connections well using the spanner. Bury the pipe if possible.**
- **To connect 2 tapstands in series, undo the stopper from the reducing tee on the first tapstand and attach one end of a 2" Heliflex pipe. Connect the other end to the reducing tee of the second tapstand.**
- **Pave the area with stones and dig a drain for wastewater.**

Key

- 1. Frame and bolted legs (angle steel)**
- 2. Galvanised steel pipe, 3/4"**
- 3. 1 tee, 2 crosses, 1 elbow for connections**
- 4. 6 Taflo (Talbot) taps**
- 5. Steel braces**
- 6. 4 short stakes or 4 long stakes for anchorage**
- 7. 2" to 3/4" reducing tee for connecting the tapstand**

- 8. Stopper and chain, DN50 connection fitting**
- 9. 15 m³ or 2 m³ bladder tank**
- 10. 2" outlet valve and tee**
- 11. 2" Heliflex pipe**
- 12. Fence (posts and ropes)**
- 13. Paved and drained area**
- 14. Distribution tapstands**
- 15. Drain for wastewater**

Inputs

- 2 people for assembly and installation**
- Bladder tank for supply**
- 2" Heliflex pipe**
- 1 pipe wrench**
- 1 connection spanner**
- 1 large hammer or mallet for driving in the stakes**
- Enough stones to complete the drainage works**

Important

- It is important to arrange the area around the tapstands well (access, drainage), to avoid mud and stagnant water.**
- If several tapstands are to be installed at the same place, separate them enough to avoid pushing and shoving at busy times.**
- The 15 m³ tank has 2 outlet valves, so it is possible to install a tapstand at each**

end to have two distinct distribution points.

- The Taflo self-closing taps are designed to work at very low pressures. A flow of about 10 l per min at each tap may be obtained with a fall of between 1 and 1.5 m between the tank and the taps. In any case this difference in height is recommended as a minimum.
- To have a good flow to all taps, do not place more than 2 tapstands in series.
- Check from time to time that the taps close properly. Solid particles in the water or objects inserted by users may obstruct or prevent closure.

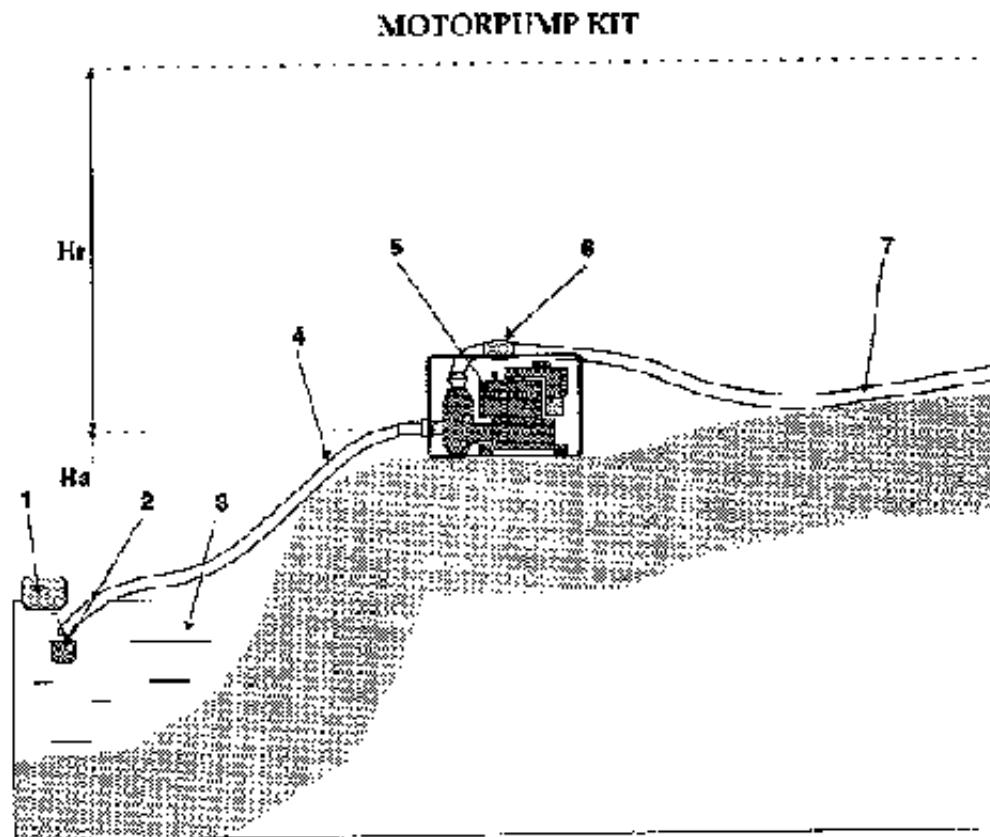

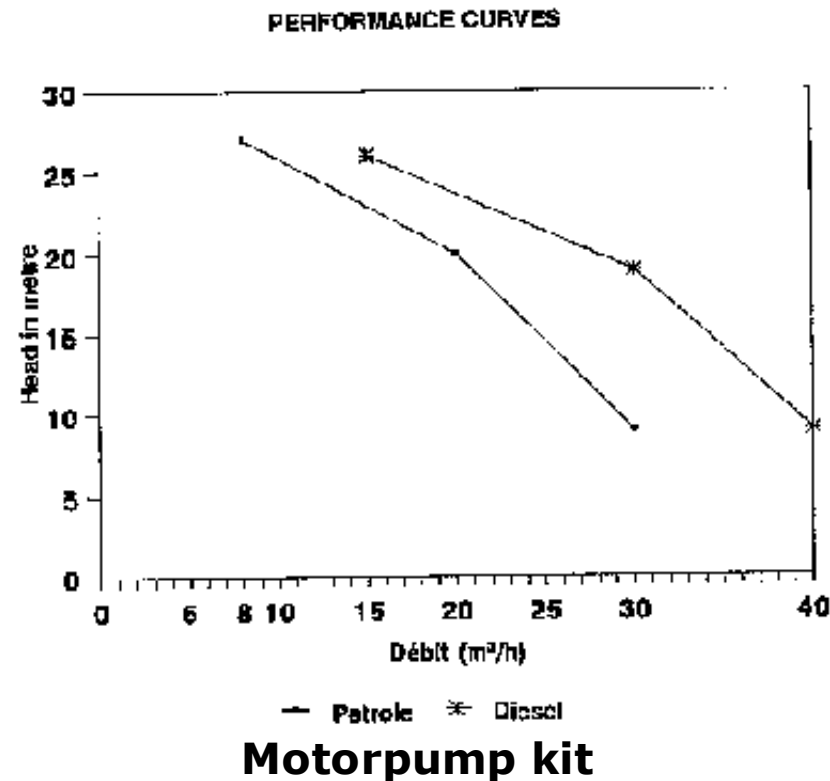

Method

The diesel and petrol motorpump kits are packages designed for providing water in emergency situations. They permit water to be pumped from a water source (well, river, etc.), to a water tanker or a reservoir.

Installation

- **Choose the pumping site:** it should be easily accessible in all seasons and not liable to flooding, particularly where the pump is to be used for filling water tankers.

- **Prepare the site so as to install the pump as close to the source as possible, to reduce the suction head.**
- **Lay the suction pipe on a rising slope (avoid dips), making sure the connections are well tightened. An air leak through the connections could mean losing the priming of the pump. The total suction head should be limited to 7 m.**
- **Fit the strainer and footvalve at the lower end of the suction pipe. Attach a float so as to hold the strainer 30 cm below the water surface (to avoid creating eddies and sucking air) and at least 50 cm above the bottom (to avoid sucking in mud).**
- **Lay the delivery pipe(s) up the slope towards the reservoir or tanker filling point.**
- **Fill the pump engine with oil. New motor pumps are delivered without engine oil in the engine.**
- **Check the general condition of the motorpump. Fill up with fuel. The air filter of the diesel motorpump is an oil bath type; fill it according to the instructions provided**
- **Fill the pump body with water. The motorpumps in the kits are self-priming so there is no need to fill the suction pipe to encourage priming.**
- **Start up the pump, following the user's manual**
- **Record pumping times in the maintenance book to keep a count of pumping hours and plan the engine maintenance schedule.**

Key

- 1. Float**
- 2. Strainer with non-return foot valve (to exclude large impurities and keep the suction pipe full of water when pumping stops)**
- 3. Water source (river, well, etc.)**
- 4. Heliflex suction pipe, 2" (do not use ordinary flexible hose for the suction pipe)**
- 5. Petrol or diesel motorpump**
- 6. Non-return valve (protects against water hammer from backflow)**
- 7. Heliflex delivery pipe, 2"**

· **Hs: suction head / Hd: delivery head**

Inputs

- 2 people to install the kit**
- 1 operator for operation and maintenance**
- Shovels and picks for preparing the site**
- Fuel (petrol or diesel) and motor oil**
- Reservoirs or water tankers for filling**

Important

- The petrol motorpump kit is light, and suitable for mobile use for limited pumping times (e.g. on a pickup or a water tanker). Maximum delivery: 30m³/hour.**

Total pumping head (suction + delivery): 28 m. Fuel capacity: 2.5 l giving 3 hours

running. The motorpump is mounted on a frame and weighs 28 kg. The 4-stroke engine is fitted with a low-oil security system.

- The diesel motorpump kit is suitable for fixed installations and for long pumping hours. The maximum delivery is 40 m³/hour. The total pumping head is 28 m.

The fuel capacity is 4.3 l which gives 4 hours running. The motorpump is mounted on a trolley and weighs 58 kg.

Warning: the diesel engine does not have an oil level security system; check the oil level every day before starting up.

- Every motorpump kit is supplied with 4 lengths of 2" Heliflex pipe, 1 strainer, 1 non-return valve, 1 float for the strainer, 1 20 l jerrycan for fuel, 1 can of engine oil, 1 funnel, 1 tool kit with spare parts for normal survives, a user's manual and a maintenance logbook.

- The recommended conditions of use and the maintenance practices should be followed (pumping hours, frequency of oil changes, etc.), so as to avoid breakdowns which might interrupt an emergency water supply.

- Where the motorpump is to be used for long periods in a fixed position, shelter it from the weather.

- The kit is a complete unit. Its component parts should not be separated. The whole kit should be repacked in its original case if it is to be stored again or sent elsewhere.

[Home](#) > [ar](#).[cn](#).[de](#).[en](#).[es](#).[fr](#).[id](#).[it](#).[ph](#).[po](#).[ru](#).[sw](#)



Public Health Technician (MSF, 1994, 192 p.)

II - Sanitation

 *(introduction...)*

 A. Excreta disposal

 B. Removal and treatment of wastewater

 C. Collection and disposal of refuse

 D. Technical briefs

Public Health Technician (MSF, 1994, 192 p.)

II - Sanitation

This chapter describes the health risks created by inadequate sanitation. It suggests some simple techniques for disposal of excreta, wastewater and refuse, which improve environmental sanitation and thus create "sanitary barriers".

A. Excreta disposal

Introduction

The term "excrete" includes urine and faeces.

The main objective of excrete disposal is to reduce the transmission of diseases due to environmental contamination by faecal matter or the proliferation of vectors.

In an emergency situation, steps must be taken immediately, particularly where there is a large concentration of displaced people.

The methods of excrete disposal which apply to refugee camps as well as rural situations are generally simple and cheap. The choice of method will be decided more by local practices and socio-cultural factors than by technical considerations.

Excreta-related health risks

Many infectious diseases are transmitted by human excrete. The pathogens leave the body of the infected person in the excrete and contaminate one or more healthy individuals.

Urine is less dangerous than faeces, except in the case of one type of schistosomiasis (*Schistosoma haematobium*), typhoid, paratyphoid and leptospirosis (e.g. where water is contaminated by rat urine).

Five types of excrete-related diseases or transmission routes may be identified:

1. Faeco-oral transmission

Pathogens are transmitted by direct and domestic contamination (hands, water, food and objects contaminated by excrete).

The pathogens may be viruses, bacteria, protozoa and certain helminths. The list of faeco-orally transmitted diseases is long and includes diarrhoeas, typhoid fever, cholera, amoebic dysentery, giardia, hepatitis A, etc.

Control measures:

- providing toilets,**
- improvement of water supply,**
- improvement of shelter conditions,**
- improvement of hygiene practices.**

2. Helminths (worms) transmitted by soil

Helminth eggs have a latent period, or period between the moment they are excreted and the moment they become potentially infecting. The transmission of these "geohelminths" takes place through the contamination of soil or crops.

It mainly concerns ascaris, trichuris, ankylostoma and strongyloides. Infection by these helminths is very frequent and prevalences may be greater than 90% in certain populations.

Control measures:

- general excrete control,**
- and/or treatment of excrete before use for fertilizing crops.**

3. Beef and pork tapeworms (taenia)

Cattle and pigs are intermediate hosts of taenia The transmission cycle involves the contamination of soil and forage by human excrete, then the ingestion of undercooked meat by humans.

Control measures:

- **excreta disposal,**
- **and/or treatment before use as a fertilizer,**
- **inspection and thorough cooking of meat.**

4. Water-based helminths

The excreted eggs of this category of helminths pass part of their life-cycle in one or several intermediate aquatic hosts (snails, crustacea, fish), before becoming infectious to man. Examples are schistosomiasis and flukes.

Control measures:

- **excreta disposal,**
- **treatment before disposal in the aquatic environment,**
- **control of intermediate hosts (e.g. snails in irrigation canals),**
- **reduction of contact with potentially contaminated water,**
- **correct cooking of fish and aquatic plants.**

5. Excreta-related diseases transmitted by insect vectors

This includes all the diseases in the previous category which can be transmitted by insects (flies, cockroaches, etc.), and diseases transmitted by mosquitoes

breeding in polluted water (Culex quinquefasciatus which transmits bancroftian filariasis).

Control measures:

- excreta disposal coupled with control of certain vectors.

The impact of an excrete disposal programme on health is difficult to evaluate.

It is generally agreed that a health impact will only be achieved if such a programme is linked to improving water supplies and individual and collective hygiene.

Choice of disposal technique

There are many excrete disposal techniques. In each situation the technique chosen should be adapted to the site conditions and the population concerned.

If this rule is ignored, the system may quickly become unused and damaged and may even create a health risk in itself.

In general the choice of an excrete disposal technique depends on:

- cultural factors, particularly local altitudes and practices concerning defecation;**
- the physical nature of the site (soil type, natural drainage, rainfall patterns, water resources);**
- the space available and locally available materials and skills.**

A distinction may be made between emergency situations, where immediate action should be taken, and chronic or long term situations, where other factors dictating the choice of technique should be given more consideration.

EMERGENCY SITUATIONS

When there is a large collection of people (e.g. a refugee camp), or where the normal sanitation structures are destroyed in a disaster, it is essential to provide defecation facilities immediately. These facilities are usually provisional and are progressively improved or replaced by more suitable structures as the situation develops.

A defecation field or area may provide an emergency solution, particularly in hot dry climates and where there is enough space available. Defecation fields should be clearly marked, fenced if possible, and protected against flooding.

They should be located downwind and away from living areas, avoiding water courses and at a reasonable distance from water points (minimum 50 m).

If a bulldozer is available locally it is recommended that the ground is cleaned regularly and the fecal material is buried in a trench so that the area may be reused.

The use of collective trench latrines may also be an adequate solution for emergency situations (see brief Trench latrines).

If a high water table, rock or sandy soil prevent the digging and use of trenches, elevated platforms may be built. It is also possible to use 200 litres drums, partially buried in the ground with an opening at the top, or to use concrete slabs

which can be set on the top of opened drums.

If augers or drilling equipment are available, drilled latrines covered with simple slabs may be installed rapidly.

Whatever the emergency solution chosen, it is important to take steps to ensure that the facilities work well, are maintained properly and are used.

CHRONIC SITUATIONS

Different disposal techniques may be used in refugee camps and in emergency situations (simple pit latrines, VIP latrines, pour-flush latrines). There is no formula to suit all circumstances. For each situation some basic questions must be asked; the answers should help in the choice of technique:

- What are the traditional methods and habits concerning defecation?**
- What method of anal cleansing is used?**
- What position is used (sitting or squatting)?**
- What are the cultural, social or religious habits which affect the technique of excrete disposal (separation of the sexes, of groups or of individuals, particular orientation of latrines, taboo places, the need to be alone, the acceptability of emptying a latrine pit, etc.)?**
- What is the level of the water table? What seasonal variations are there?**
- What is the rainfall pattern? What is the soil type?**
- What other physical characteristics of the site may influence the choice of system (density of settlement, proximity of water sources, availability and type of building materials)?**

The system should be chosen with the answers to these questions in mind, whilst remaining simple, cheap and above all easy to install and maintain.

As a general rule, individual family latrines are preferred. In most cases, individual family latrines are socially more acceptable and pose fewer problems maintenance than collective systems. If individual latrines are not possible because of population density, centralised units may be built at the edge of a living quarter or camp section where each family has access to its own latrine.

The area allowed for latrines should be big enough to dig new pits when the first ones are full.

Collective latrines usually pose maintenance problems. When this system is adopted for a population or for a central service (e.g. a hospital), it is indispensable to appoint someone to be responsible and possibly to pay them to ensure good maintenance.

An exeretia disposal programme

Eight successive phases may be considered:

- 1. Identify the problem: site survey, questions, medical data, etc.**
- 2. Initiate and organise participation of the population: consult local leaders, etc.**
- 3. Collect information: geographic, climatic, demographic, socio-cultural technical and material.**
- 4. Propose alternatives: analysis of data and technical options.**
- 5. Choose a method: needs, social suitability, resources (financial, material and human), geography (soils, water, climate), space (family or collective systems).**

- 6. Implement the system chosen: involve the population, control the costs, plan the construction.**
- 7. Use and maintain the system: inform, educate. Take special care with collective systems.**
- 8. Evaluate the system: sanitary inspection and monitoring system.**

Calculation of the effective volume of a latrine pit

The pit latrine is the most common system of excrete control in the world.

To calculate the effective volume of a pit, proceed as follows:

$$\mathbf{V = N \times S \times Y}$$

where V = effective volume in m^3 ,

N = number of users,

S = solids accumulation rate in m^3 /person/year,

Y = lifetime of latrine in years.

For dry pits, use a solids accumulation rate of $0.04m^3$ per person per year. For wet pits, use $0.02m^3$ per person per year.

When calculating the total pit volume a free space of $0.5m$ at the top of the pit is added to the effective pit volume.

The volume may also be increased by 30 to 50% if bulky anal cleansing material is used (e.g. stones, maize cobs, etc.).

The suggested design life of a non-emptyable simple pit latrine is 5 to 10 years.

That of an emptyable latrine (simple or alternating twin pit) is at least two years.

Conclusion

The designs shown in the technical briefs which follow represent the most simple and common techniques of excrete disposal:

- trench latrines, suitable for emergency situations;**
- simple pit latrines, ventilated or not, the most frequently used;**
- twin pit emptyable latrines, suitable for public facilities;**
- pour-flush latrines, more sophisticated, suitable where there is plenty of water and where the population is familiar with this technology;**
- flushing toilets with septic tanks, sometimes seen in hospitals, but which need constant running water.**

This is just a quick review of disposal techniques. There are variations which allow adaptation to local conditions.

In general terms, an excrete disposal technique may be considered acceptable when:

- it contains the excrete in one place;**
- it does not create an attraction for insects;**
- it is not a source of pollution of water points;**
- it is accessible to users;**
- it gives a minimum of privacy;**

- it is adapted to local habits.

B. Removal and treatment of wastewater

Introduction

"Nothing is lost, nothing is created, everything is transformed.." This principal applies equally to water: it is the source of life, much effort is spent to get it; but it also is a source of death, and it is essential for health that the same effort is made to remove it after use.

Health risks and nuisance

These risks are due to organic and biological pollution carried by wastewater as well as the presence of stagnant water:

- breeding of insect vectors (anopheles, culex);**
- spread and multiplication of pathogenic agents such as cholera vibrios and schistosomonas, etc.;**
- chemical contamination of water (nitrates, detergents) and ecological disturbance of aquatic environments;**
- production of noxious and corrosive gases.**

Definition of wastewater

The risks associated with wastewater depends on its origin, and it is useful to classify the important sources:

- Domestic wastewater

- **Sewage: water carrying excrete in suspension, thus containing bacteria, viruses and fecal parasites and also nitrogen.**
- **Sullage: water from the bathroom, the kitchen, laundry, etc., containing detergents and fats as well as micro-organisms of fecal origin.**

- Agricultural wastewater

- **Stockraising effluent: slurry and manure.**
- **Crop growing activities: fertilizers and pesticides.**

It is usual to measure the degree of pollution by the following parameters:

- **Daily volume of effluent.**
- **Chemical Oxygen Demand (COD): a measure of the total organic content.**
- **Five day Biological Oxygen Demand (BOD5): the organic content biodegradable within 5 days.**
- **Total Suspended Solids (TSS).**
- **Nitrogen content (ammonia and organic nitrogen).**
- **Phosphorous content**

General principles

For every place supplied with water there should be a removal system which prevents stagnant water and local pollution.

Treatment methods aim to fix the chemical and biological pollution (by

sedimentation, filtration, etc.), and/or to destroy it by biological, chemical or physical processes and then to dispose of the treated water by infiltration into the ground, or into surface water (river, lake sea, etc.).

This field may become very technical and involves special expertise which is beyond our capabilities.

In practice, the problems faced in the field are few and generally simple to solve; for instance:

- stagnant water around a water point: well, tap, etc.,**
- washing areas: bathing, cooking, laundry, etc.,**
- laboratory and health centre wastes, etc.**

More rarely:

- flushing toilets,**
- house or hospital sewers.**

Removal

A removal system should be able to remove wastewater, so as to avoid stagnant water, and to channel it to the disposal or treatment site without contaminating the local environment.

The collection surface should be gently sloped (1%) and cemented. Before removal, it may be necessary to pretreat the water to remove solid or dissolved matter which could hamper the removal and final treatment (see technical briefs):

- **Grease-trap to eliminate fatty material which might block channels.**
- **Screen to remove floating objects.**
- **Sedimenter or sand trap to separate sand, soil, etc.**

These structures become ideal vector breeding sites if they are not well maintained.

The removal system design may be based on different techniques:

- **Open channel**

This is the most simple and least costly technique but it entails maintenance problems: blockages, stagnant water, damage to the sides, etc.

This technique should be used only for drainage of rainwater or of wastewater over short distances; the channel should be cement-lined if possible and with enough slope to be self-cleansing

- **Gravel drain**

The open channel may be improved by lining it with plastic sheeting, filling it with coarse gravel, covering it with more plastic sheeting and then with earth.

The wastewater should never contain suspended material capable of blocking this type of drain which is impossible to unblock. This technique may be used in an emergency, for example at a dispensary or a laboratory.

- **Pipe drain**

This is the most effective way of removing wastewater but also the most costly.

Various types of pipe may be used (PVC, polythene, cement, fibrocement, etc.), with a minimum diameter of 100 mm.

The slope and the pipe diameter should be adequate for the flow, and the pipes should be buried correctly so as not to be destroyed by the passage of heavy vehicles (20cm of compacted earth minimum).

Check regularly in order to spot and deal with blockages.

Treatment

Wastewater treatment techniques mostly need specialised skills and technologies.

For this reason, these sophisticated techniques will not be studied in this guide. Information will be limited to infiltration systems and the basic principles of waste stabilization ponds.

INFILTRATION

Infiltration uses the natural capacity of the soil to fix particles present in water by filtration, and to purify the water by a process of biological decomposition capable of destroying micro-organisms and chemical pollution.

This natural capacity is always extremely variable, depending on the soil type:

- A mature organic-rich soil is host to intense biological activity favouring

- purification, but it blocks rapidly and so has a reduced infiltration potential;**
- Conversely, a sandy soil may have an infiltration rate which is too rapid and which does not allow sufficient time for purification if the water table is too close to the surface;**
 - For the same reasons, a fissured rock would have only a small purifying capacity.**

In practice, the two following parameters should be studied:

- The slope of the ground: a slope too steep may encourage water to reappear and so contaminate the ground.**
- The infiltration rate: determined by percolation tests with clean water (see technical brief Soil permeability).**

The principle of infiltration is used in the following techniques:

- soakaway pit,**
- infiltration trench,**
- evapotranspiration area,**
- irrigated garden.**

WASTE STABILIZATION PONDS

Waste stabilization is a biological process which takes place in ponds arranged in series.

It is an effective technique for the elimination of pathogens and is relatively easy to maintain, but the design and implementation should be left to specialists, or the result may be an almost insoluble problem.

It may be assumed that with a series of three ponds and a retention time in the ponds of 11 days, a reduction of 99.9% in the number of fecal germs may be achieved.

The reuse of wastewater for irrigation after treatment in ponds may be useful, provided that the following rules are followed:

- ensure that irrigation is not likely to create areas of stagnant water;**
- irrigate crops which are not in contact with the soil (e.g. fruit tree), or which are cooked before eating.**

C. Collection and disposal of refuse

Introduction

The accumulation of household waste creates a public health refuse as well as a pollution problem.

The health risks are essentially to do with the encouragement of insect vectors and rodents:

- the breeding of flies which play a major part in the transmission of feco-oral diseases;**
- mosquitoes of the Aedes genus which lay eggs in water lying in empty tins, drums, tyres, etc., and which are responsible for the transmission of dengue, yellow fevers and other arboviruses;**
- mosquitoes of the Culex genus which breed in stagnant water heavily loaded with organic matter, and which are liable to transmit microfilariaes;**

- rodents which are directly or indirectly responsible for the transmission of various diseases such as plague, leptospirosis and salmonella, and whose presence attracts snakes.

In addition to these health risks, poor management of the collection and disposal of refuse may involve the pollution of surface water or groundwater and increase the risk of fire. Lastly, the aesthetic aspects (sight and smell) are far from negligible.

These risks and nuisances are all the more serious at high population densities.

Certain types of refuse (from medical activities) represent a particular risk and so need special attention.

Type and quantity of refuse

The type and quantity of refuse produced by a community are extremely variable.

The main factors affecting the composition of refuse are:

- geographic region;**
- sociocultural, cultural and material levels, which may produce great variations even within the same community;**
- seasonal variations;**
- the importance and diversity of refuse-generating activities (workshops, dispensaries, etc.);**
- packaging of food ration.**

The density of refuse is in the order of 100 to 200 kg/person/day and the volume varies between 0.5 and 101/person/day; an average value of 0.5 litre/person/day may be taken.

The percentage of putrescible matter may range from 20 to 70%.

These few figures simply present orders of magnitude, and in practice the quantity and density (or volume) of refuse should be determined for each situation. Its composition is only really important when disposal is by means of incineration or composting.

In general terms it may be assumed that the volume of refuse will be small when dealing with a population of rural origin and where the basic ration is in the form of dry foodstuffs (as is often the case during the initial phases of an emergency operation).

Refuse containers

The objectives are:

- to gather the refuse to facilitate the collection;**
- to avoid dispersion by wind and animals.**

Metal drums are generally used. The bottoms should be pierced so that they do not retain liquids from decomposition (and to avoid the drums being used for other purposes), and they should be provided with covers and with handles for easy lifting. In the first instance one drum per ten families may be provided, placed at a reasonable distance from the dwellings.

Certain structures need particular storage systems, either because of the specific nature of the refuse produced (hospitals), or because of the large volumes produced (market, slaughterhouse, various workshops). In these cases, solid, covered and easily cleaned bins may be built. In health centres, refuse is collected in separate containers: some dustbins are available for ordinary refuse and others, clearly marked, are used only for medical waste.

Collection

Collection should be done at least once per week to avoid the hatching of flies and odour problems. In practise the use of a whole chain of different resources need to be optimised, but a daily collection is the ideal.

The collection of the contents of dustbins (without forgetting the surroundings) may be done with vehicles. But it may be more reliable logistically to use hand carts or animal carts. Moreover, it is difficult in emergency situations to commit a vehicle exclusively to this task.

The collection should be organised:

- establishment of circuits,**
- constitution of teams,**
- allocation of a circuit to each team.**

After its introduction the collection system should be supervised and evaluated periodically. (Is the circuit appropriate? Are the resources enough?)

These two steps of storage and collection require the co-operation of the

population, which should be involved regularly (once or twice per month) in a general clean-up of the camp.

Disposal

Three techniques are used

- burying,**
- incineration,**
- composting.**

BURIAL

Burial is done in trenches. Controlled tipping (see brief Controlled tip) is only used where there is sufficient space and access to mechanical equipment.

Access to the site should be restricted (a fence). If good drainage is not ensured, there is a great risk of the trenches turning into sickening quagmires.

The siting of the trenches should follow the same rules as for siting latrines, as the risk of polluting the water table is the same.

INCINERATION

Medical waste should be incinerated as it is potentially contaminated.

This method is not generally suitable for household wastes as it is costly and may be dangerous when it is done on a large scale (atmospheric pollution).

COMPOSTING

Composting is biological decomposition in the presence of air, as opposed to anaerobic decomposition which takes place in septic tanks for instance.

It is a technique which needs special care and which may cause major health risks if not mastered correctly. For this reason it should not be used in emergency situations.

D. Technical briefs

Trench latrine

Simple pit latrine

Ventilated improved pit latrine

Twin pit latrine

Latrine slab

Pour-flush latrine

Septic tank

Refuse pit

Controlled tip

Dustbin

Temporary incinerator

Permanent incinerator

Soakaway pit

Infiltration trench

Soil permeability

Grease trap

Irrigated garden
Evapotranspiration area
Sterilization by autoclave
Sterilization by hot air
Sanitary surveillance

TRENCH LATRINE

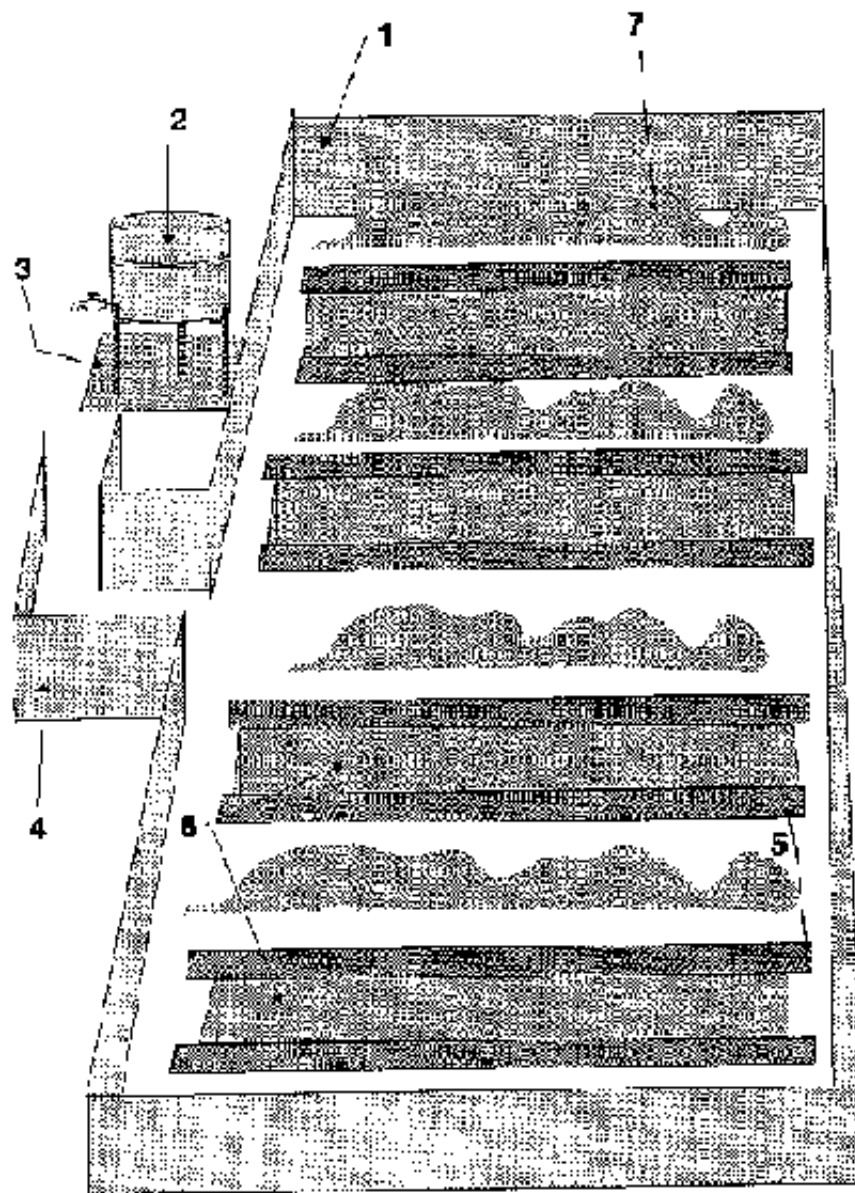

Trench latrine

Method

Trench latrines represent a method of excreta disposal which is simple and rapid to implement, but temporary. They are only justified in emergency situations, until more permanent solutions are implemented.

Installation

- Choose a site away from water points (≥ 30 m), and downhill from them.**
- Dig trenches about 30 cm wide and 90 to 150 cm deep. Allow about 35 m per 100 users. Place the excavated soil near the side of each trench so that the users can cover their excrete with soil after each use, to reduce the attraction of flies.**
- Lay planks down the two sides in order to ensure a good foothold and to limit erosion of the trench edges.**

(When the excrete reaches about 30 cm from the surface, fill in the trench with compacted earth. Mark the spot and dig another trench.)

- Fence the area (for example with plastic sheeting), and put up a zigzag entrance in order to limit the risk of straying of animals and to keep as much privacy as possible for users.**
- Put a water container with a tap and soap in an obvious place (near the exit) to allow the washing of hands after defecation.**

Key

1. Fence (plastic sheeting)

- 2. Water container with tap and soap**
- 3. Stones for drainage**
- 4. Zigzag entrance**
- 5. Planks**
- 6. Trenches (width: 30 cm; depth: 90 to 150 cm)**
- 7. Soil for burying excrete**

Inputs

- Shovels, picks**
- Planks (or wooden poles)**
- Stakes (for the fence)**
- Plastic sheeting (or local material)**
- Empty cans (to handle soil for burying excrete)**
- Water container (e.g. 200 l drum) with tap**
- Soap**

Important

- The planks may be replaced by wooden poles (which should be buried several centimetres).**
- Ensure that living areas are not downwind of the trench latrines.**
- It is usually necessary to build separate trench latrine areas for men and women. Simply separating the male and female sections with plastic sheeting and providing two separate entrances may not be enough from the point of view of acceptability to the population.**

- The objective should be to replace the trench latrines as quickly as possible with a more hygienic system (e.g. ventilated pit latrines; see the other Latrines technical briefs).

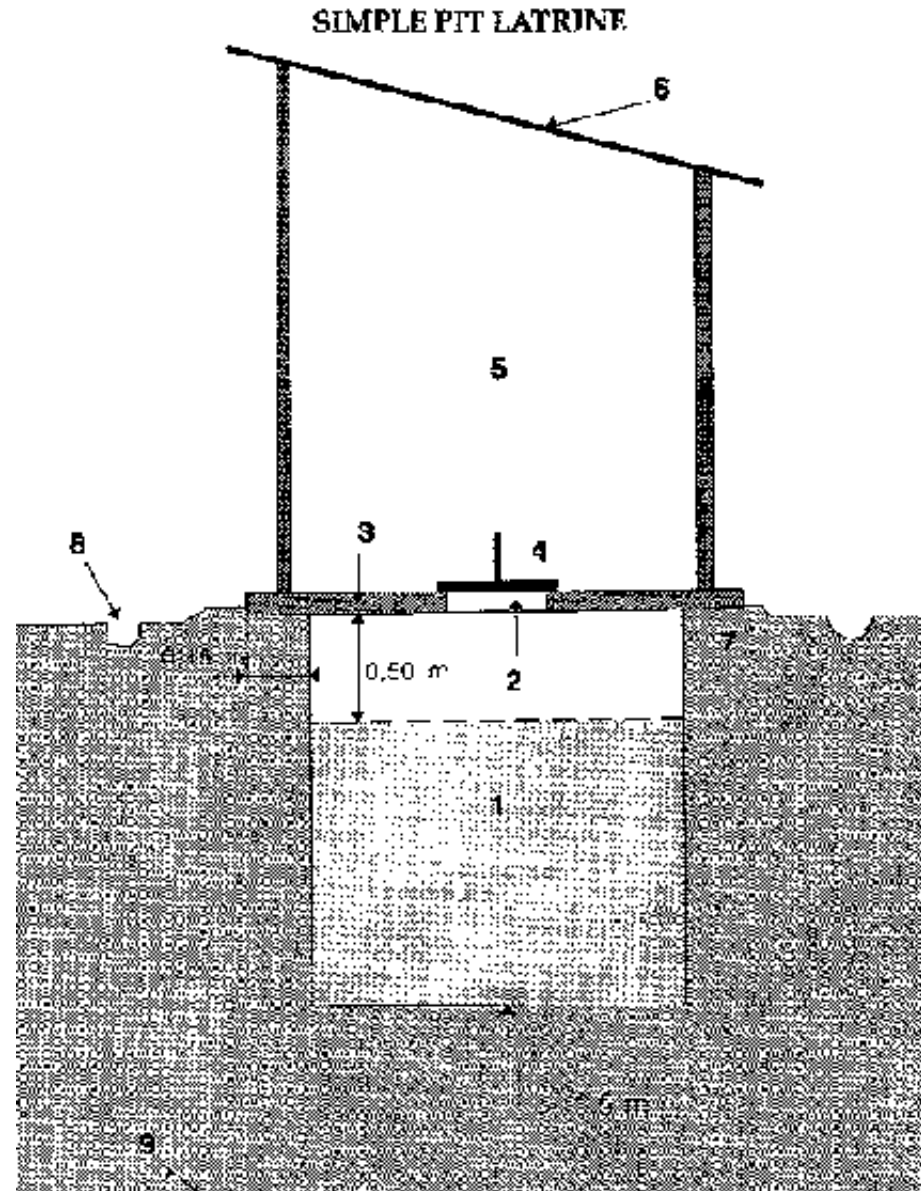

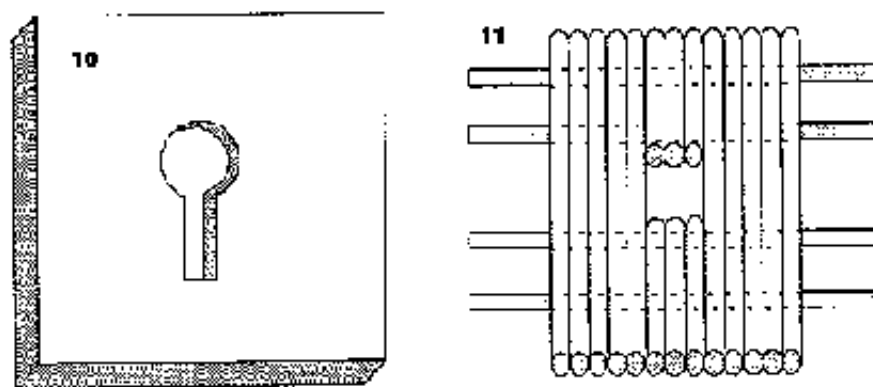

Simple pit latrine

The simple pit latrine is one of the simplest and cheapest means of disposing of human wastes. If well designed and built, correctly sited and well maintained, it contributes significantly to the prevention of fecorally transmitted diseases.

Construction

- 1. Choose a site downhill from groundwater abstraction points and at least 30 m away; the latrine (or group of latrines) should be not less than 5 m and not more than 50 m from the dwellings.**
- 2. Dig a pit, assuming that the solids accumulation rate will be about 0.04 m³ per person per year. Thus, for a group of 25 people (the maximum number per latrine recommended by WHO), it needs a pit of at least $0.04 \times 25 = 1$ m³ per year of use.**
- 3. If a cement slab is to be used, it should extend at least 15 cm beyond each side**

of the pit to ensure a secure seating.

4. Make a slab (see technical brief Latrine slab), and place it over the pit.

If the soil is unstable it may be necessary to build a foundation to strengthen the pit walls before placing the slab.

5. Construct the superstructure. It may be built with bricks, earth, wood, plastic sheeting, etc., but preferably local materials. The superstructure should have a door if local habits dictate. Otherwise a spiral form may be used.

6. Fix a roof with the slope towards the back of the structure.

7. Dig a drainage channel around the latrine to prevent run-off entering and to protect the walls of the pit.

Key

1. Effective volume of pit

2. Defecation hole

3. Slab

4. Cover

5. Superstructure

6. Roof

7. Slab seating

8. Drainage channel

9. Water table

10. Example of a concrete slab (see brief)

11. Possible alternative: slab of logs (covered with soil to make maintenance easier; quality of wood is important: aging + termites = danger)

Inputs

- **Shovel, pick, miner's bar**
- **Slab (see technical brief)**
- **Cover (wood, metal or concrete)**
- **Material for superstructure and door**

Important

- **Try to ensure that the cover is always replaced to avoid breeding of flies and bad smells around and inside the latrine.**
- **The slab and surroundings should be cleaned every day.**
- **If possible, provide lighting for use at night.**
- **Never put disinfectants (chlorine products, Iysol, etc.) in the pit: this only serves to inhibit the natural decomposition of fecal material. The only situation in which it is recommended to pour disinfectants into a latrine pit is during a cholera epidemic.**
- **On the other hand it is recommended that fire ashes are put into the pit after each use. This gives a perceptible reduction of odours and accelerates decomposition.**
- **When the pit is nearly full (50cm from the surface), demolish it, or move the superstructure and slab to a neighbouring place and fill the pit with soil. Do not dig this place again for at least two years.**
- **Important: allow for the spare 50 cm of depth in the calculation of pit size. It is**

not part of the effective pit volume.

- Alternative method: if the subsoil is very rocky or the water table is very high and it is not possible to leave 1.5 m between the bottom of the pit and the groundwater level, the pit may be partially dug in a very very compacted earth mound. In this case the above-ground part should be lined with bricks or stones.

- Improvements: ventilated improved pit (VIP) latrine, twin pit latrine (see corresponding technical briefs).

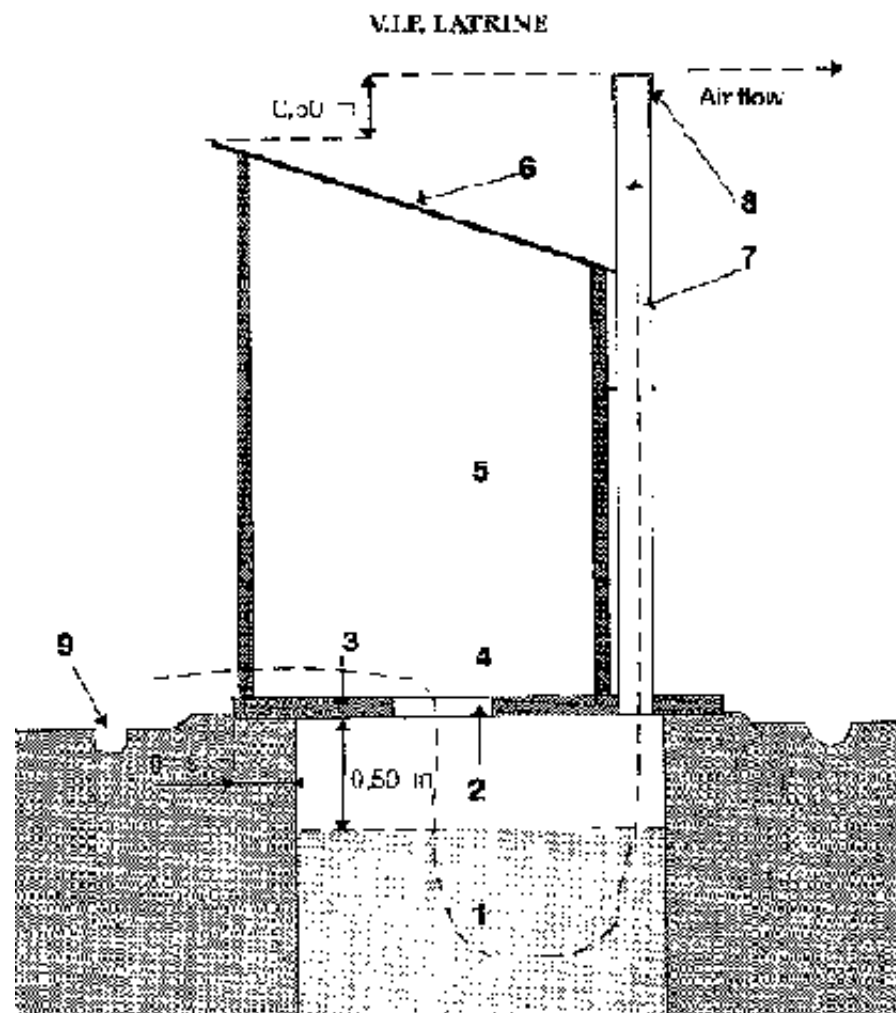



Ventilated improved pit latrine (VIP)

Method

The VIP uses the movement of air across the top of a ventilation pipe to draw odours up the pipe and out of the latrine. Flies entering the pit are attracted to the light at the top of the pipe and die trying to escape through the mosquito netting.

Construction

- 1. Choose a site downhill and at least 30 m distant from groundwater points; the latrine (or group of latrines) should be not less than 5 m and not more than 50 m from the dwellings.**
- 2. Dig a pit, assuming that the solids accumulation rate will be about 0.04 m³ per person per year. Thus, for a group of 25 people (maximum number per latrine recommended by WHO), it needs a pit of at least $0.04 \times 25 = 1$ m³ per year. If possible make the pit big enough to last 5 years.**
- 3. If it is planned to use a concrete slab, it may be necessary to build a foundation**

on the upper part of the pit to support it.

4. Cast a slab (see technical brief Concrete slab) and place it over the pit. The slab should have a second hole behind the defecation hole with a diameter of about 150 mm to fix the ventilation pipe.

5. Construct a superstructure of brick, stone, wood, plastic sheeting etc, but preferably using local materials. A spiral form may be suitable, if it is acceptable to the population; this saves having to fit a door. The superstructure should provide a minimum of darkness so that when flies leave the pit they are attracted to the light coming from the ventilation pipe and not that coming from inside the superstructure.

6. Fix the ventilation pipe at the back of the latrine. It may be round or square, made of PVC, metal, bricks, reeds with earth plaster, etc. It should be vertical, with an internal diameter of about 150 mm. A screen of mosquito netting is fixed at the top of the pipe to prevent the entry and exit of flies. Fit a roof to the superstructure with the slope carrying rainwater towards the back.

Important: the ventilation pipe should extend 50cm above the highest part of the roof.

7. Dig a drainage channel around the latrine to prevent erosion of the pit walls.

Key

1. Effective pit volume

2. Defecation or squatting hole

- 3. Slab**
- 4. Absence of cover**
- 5. Superstructure**
- 6. Roof**
- 7. Ventilation pipe (internal diameter: 150 mm)**
- 8. Mosquito netting**
- 9. Drainage channel**
- 10. Water table**

Inputs

- Shovel, pick, miner's bar**
- Special VIP slab**
- Mosquito netting (preferably nylon)**
- Pipe of PVC or building material**
- Material for superstructure and door**

Important

The slab and surroundings should be cleaned every day.

If possible, provide lighting for night use.

Never put disinfectants (chlorine products, Iysol, etc.) in the pit: this only serves to inhibit the natural decomposition of fecal material. The only situation in which it is recommended to pour disinfectants in a latrine is during a cholera epidemic.

On the other hand, it is recommended that fire ashes are put into the pit after each

use. This gives a perceptible reduction of odours and accelerates decomposition.

When the pit is nearly full (50 cm from the top), demolish it or move the superstructure and the slab to a neighbouring place and fill the pit with soil. Do not dig this place again for at least two years.

Alternative method: if the subsoil is very rocky or if the water table is very high and it is not possible to leave 1.5 m between the bottom of the pit and the groundwater level, it is possible to dig the pit partially in a very well compacted earth mound. In this case the above-ground part should be lined with bricks or stones.

Do not use a cover on the defecation hole: this prevents the circulation of air.

Do not forget the mosquito netting which traps flies at the top of the pipe where they die. Use a synthetic or painted metal mesh because the gases which escape via the pipe are corrosive to metal.

The VIP latrine should be built in a clear space, away from trees which impede air movement. Pay attention to the wind direction so as not to cause an odour nuisance.

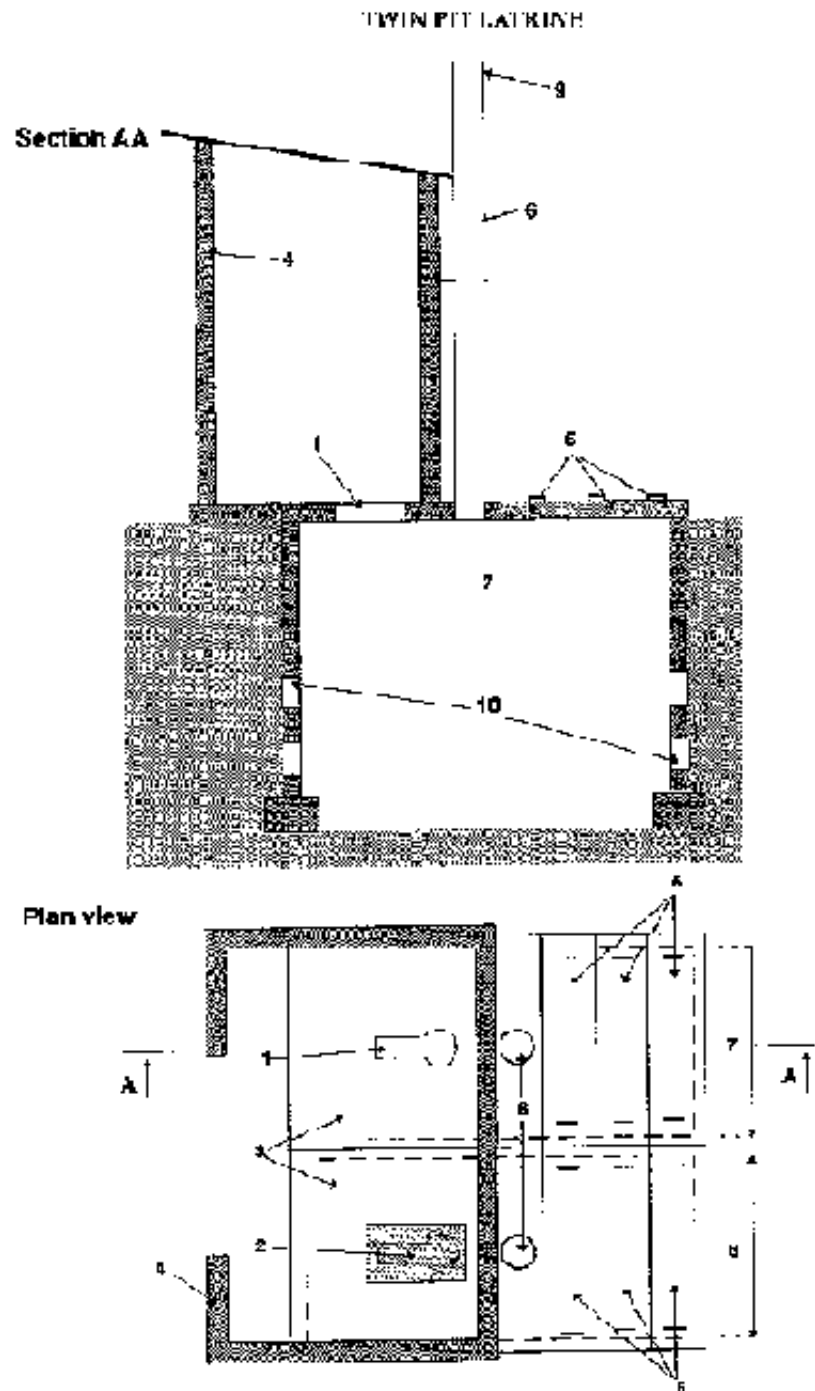

Twin pit latrin

Method

Twin pit latrines may be used in places where toilets have to last for a long time, so as to economise space (public places, health structures, etc.) and, as a bonus, to produce good quality organic manure.

The latrine is built on a lined pit divided in two by a watertight partition wall. Both pits are used alternately and are emptyable. As they are reusable the system is thus permanent. For collective facilities, several pits may be constructed in series.

Construction

- 1. Choose the site (see technical brief Simple pit latrine).**
- 2. Dig the double pit large enough so that each half-pit has a 2 year accumulation capacity (see the chapter Calculation of the effective volume of a latrine pit).**
- 3. Line the pit (brick, stone, etc.), leaving regular gaps in the construction to allow liquids to infiltrate, and build up the watertight partition wall between the two equal parts.**
- 4. Place slabs with a defecation hole over each twin-pit.**

These slabs should not cover the pits completely: one or more removable slabs should cover the back of each pit so that it can be emptied.

5. Construct the superstructure which should include both defecation holes in the same cubicle. Only one hole is used at a time, while the other is blocked.

6. After a period of 1 to 3 years the first pit is full:

- block the first hole and unblock the second.

After a further 1 to 3 years the second pit is full in turn:

- take out the contents of the first pit, which has formed compost, and reuse the pit;

- in this way the alternation between pits may be repeated indefinitely.

The material taken out is inoffensive and does not resemble excrete at all

It is an excellent fertiliser.

Key

- 1. Defecation hole in service**
- 2. Defecation hole on standby (blocked)**
- 3. Slabs**
- 4. Superstructure (spiral, or with a door)**
- 5. Removable slabs (for emptying pits)**
- 6. Ventilation pipe**
- 7-8. Twin-pits**
- 9. Mosquito netting**
- 10. Gaps for the passage of liquids**

Inputs

- **Shovel, pick, miner's bar**
- **Mason's tools**
- **Bricks**
- **Cement**
- **Sand, gravel**
- **Material for superstructure and door**
- **Ventilation pipe and mosquito netting if latrine is to be VIP type**
- **1 experienced builders and 1 or 2 labourers.**

Important

The correct size of each pit is essential: each one should permit the storage of fcal material for about 2 years, during which period possible pathogens contained in it are destroyed (biodegradation). Certain authors recommend one year only, although it is known that Ascaris worm eggs need more than one year to be destroyed.

As this technique demands the handling of fcal material during pit emptying (even if the material is so decomposed that it is neither offensive nor dangerous), it is important to know before choosing such a system if it can be acceptable to the population to do this work. Social, religious and/or cultural factors may forbid it and demand the use of another method.

The compost taken out may be used to fertilize crops or if not, should be buried.

It is perfectly possible to build ventilated latrines on twin pits. Important: each pit

must have its own ventilation pipe.

Remember to provide workers emptying the pits with protective clothing: at least boots and gloves (household glove type).

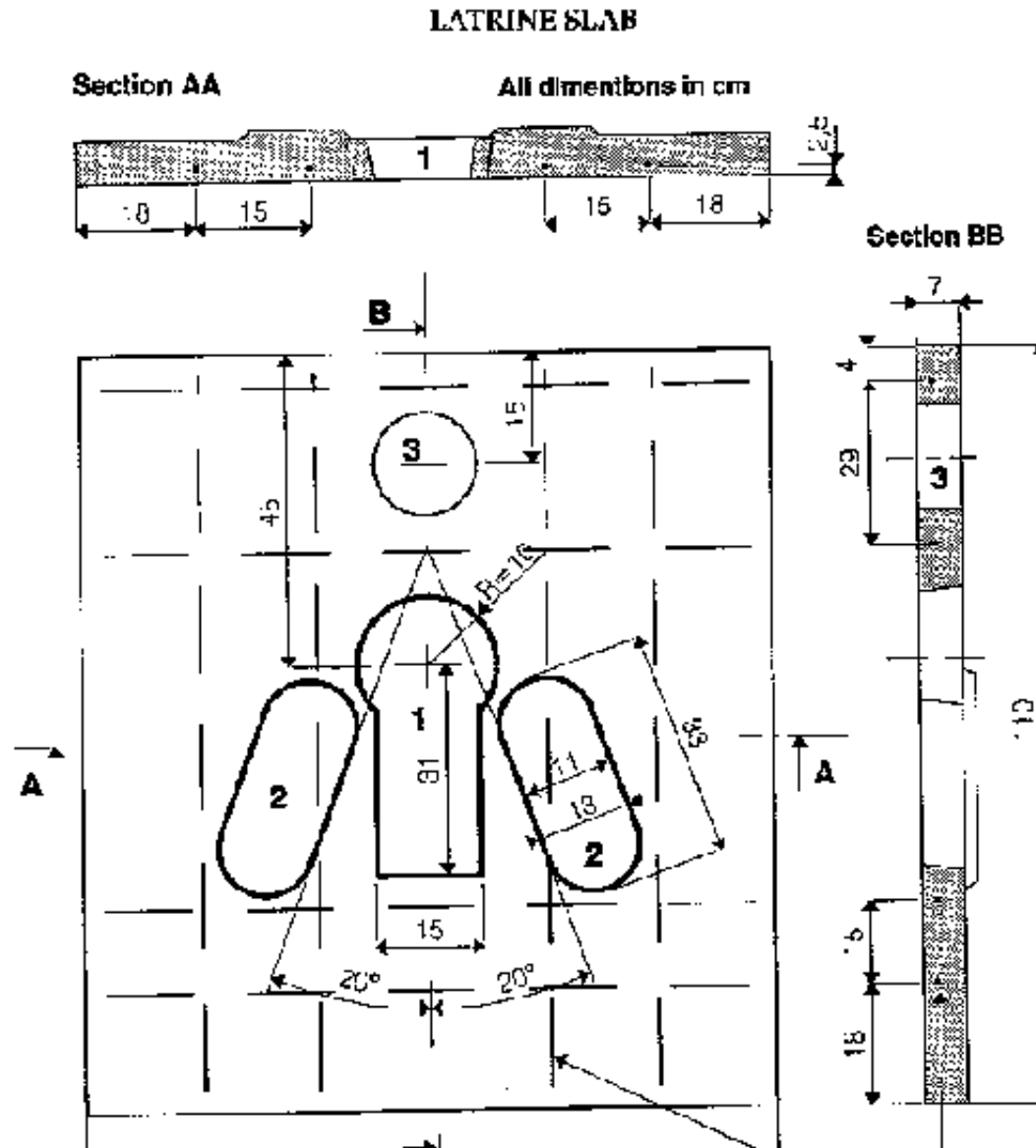

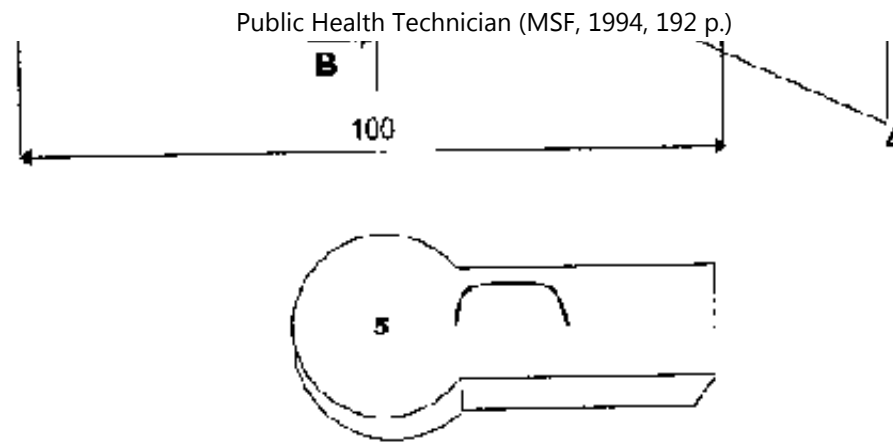

Latrine slab

Method

A latrine slab may be made of local material (e.g. logs covered with earth), but for more durable latrines a reinforced concrete slab is easy and relatively cheap.

Construction

- **Make a mould of metal or wood with internal dimensions the same as the slab. Coat the inside with an oily product such as used engine oil, to avoid the concrete sticking to it.**
- **Place the mould on a flat surface which is covered by a layer of sand, plastic sheeting, paper, etc.**
- **Cut the steel bars to length and join them together with wire.**
- **Make a wooden or metal template for the defecation hole, oil its surface and place it in the mould.**
- **Mix the concrete: 1 volume of cement to 2 volumes of sand and 4 volumes of gravel.**

- **Cast a thickness of about 25 mm of concrete in the mould and level the surface without smoothing.**
- **Place the reinforcing steel on the surface.**
- **Cast the rest of the concrete and smooth the surface, making a curve round the defecation hole (useful when cleaning the slab).**
- **Position the footrests (e.g. bricks. Optional).**
- **If possible, attach handles of bent steel bar to several parts of the slab to aid carrying.**
- **Cover the slab with jute sacking or plastic sheeting and sprinkle regularly with water to keep it damp during curing.**
- **After 24 hours, remove the template from the defecation hole and recover.**
- **Take out of the mould and install after 4 to 6 days curing in the shade.**

Key

- 1. Defecation hole**
- 2. Footrests (optional)**
- 3. Ventilation pipe hole (only for VIPs)**
- 4. 8 mm reinforcing steel bars**
- 5. Template for forming defecation hole**

Inputs

- **Cement: 1/3 of a bag**
- **Sand**
- **Gravel**
- **Shuttering timber, 70 mm: about 5 m**

- **Nails**
- **Reinforcing steel, 8 mm: 8 m**
- **Measure**
- **Shovel**
- **Bucket**
- **Trough or board for mixing concrete**
- **Trowel, float**
- **Saw**
- **Hammer, pincers**
- **Steel bar cutters**
- **Wire for joining reinforcing bars**

Important

- **If possible, make a gentle slope towards the defecation hole; this will ease cleaning.**
- **Don't forget the handles. It is very difficult to move the slab without them.**
- **If the slab is for a VIP latrine, don't forget the hole for the ventilation pipe (150 mm dia).**
- **Take care over the curing (4 to 6 days in the shade): it greatly affects the strength of the slab.**
- **The template for the defecation hole should be tapered to ease its withdrawal from the concrete.**
- **If embarking on a programme of latrine construction, it is well worth the trouble to build a workshop for continuous production. This workshop should have a water point, storage for tools and a covered area for casting and curing slabs.**

POUR FLUSH LATRINE

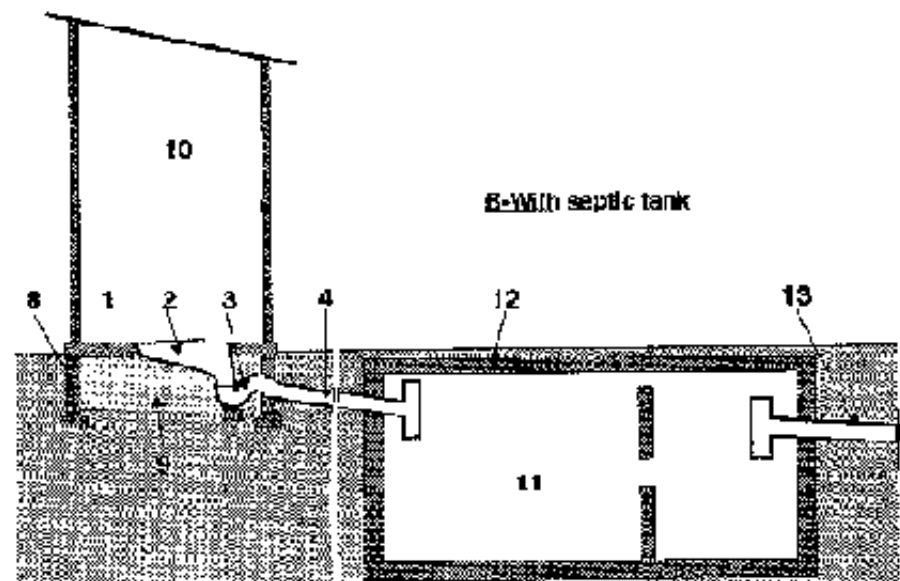
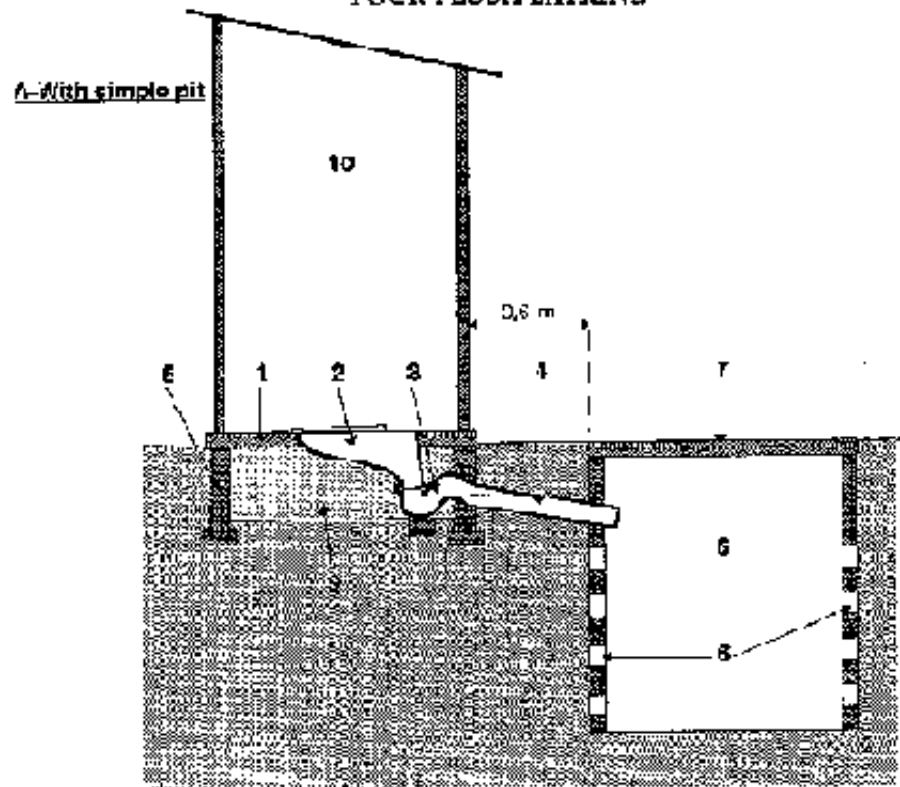



Pour-flush latrine

Method

Pour-flush latrines are relatively simple in design, but should only be considered where there is abundant water for flushing.

The latrine is fitted with a pan and a water trap which stops odours from coming out and prevents flies from reaching the excreta.

Construction

- The siting and construction steps are the same as for the simple pit latrine (see the corresponding technical brief).**
- The simple pit latrine slab is replaced by one fitted with a pan and water trap. In many places such slabs can be found ready made. Otherwise it is possible to make a trap out of 75 mm PVC pipe, and fit it to an ordinary slab.**

Connection

- If the pour-flush latrine is not connected to a sewer or on-site treatment system (e.g. septic tank), the pit should be masonry lined as the heavy water flow would erode the walls of an unlined pit. The lower half of the pit should be lined with open brickwork to let the water infiltrate into the soil.**
- It is possible to construct this type of latrine with an emptyable twin pit if the infiltration rate is too low or if there is a risk of polluting groundwater points. (In**

this case the pit should be airtight: see technical brief Twin pit latrine.)

- To calculate the effective pit volume, use a solids accumulation rate of 0.02 m³/ person/ year.**
- Preferably, connect the pour-flush latrine to a septic tank (see technical brief Septic tank).**

Key

- 1. Slab**
- 2. Pan**
- 3. Water trap**
- 4. 75 mm drainage pipe**
- 5. Simple pit or alternating twin pit**
- 6. Open joints in lower pit lining, to allow passage of liquids**
- 7. Removable slab**
- 8. Foundation**
- 9. Backfill and sand**
- 10. Superstructure**
- 11. Septic tank**
- 12. Inspection/emptying hole with cover**
- 13. Outlet pipe towards an underground soakaway system**

Inputs

- Materials for superstructure**
- Excavation tools (shovels, picks, etc.)**

- **Slab with pan and water trap, or simple slab fitted with a 75 mm PVC water trap**
- **Building materials and tools (for pit or septic tank)**
- **75 mm pipe for connections**

Important

- **As a general rule, the pour-flush latrine is suitable for regions where water is habitually used for anal cleansing. In other cases it is preferable to use dry pit latrines.**
- **It is essential to have a water point close by so that the toilet may be flushed after each defecation. If the water supply fails, closure of these latrines and temporary replacement by a system not using water should be considered.**
- **Maintenance should be frequent: if these toilets block they should be unblocked quickly, or material will solidify and plug the water trap.**

SEPTIC TANK

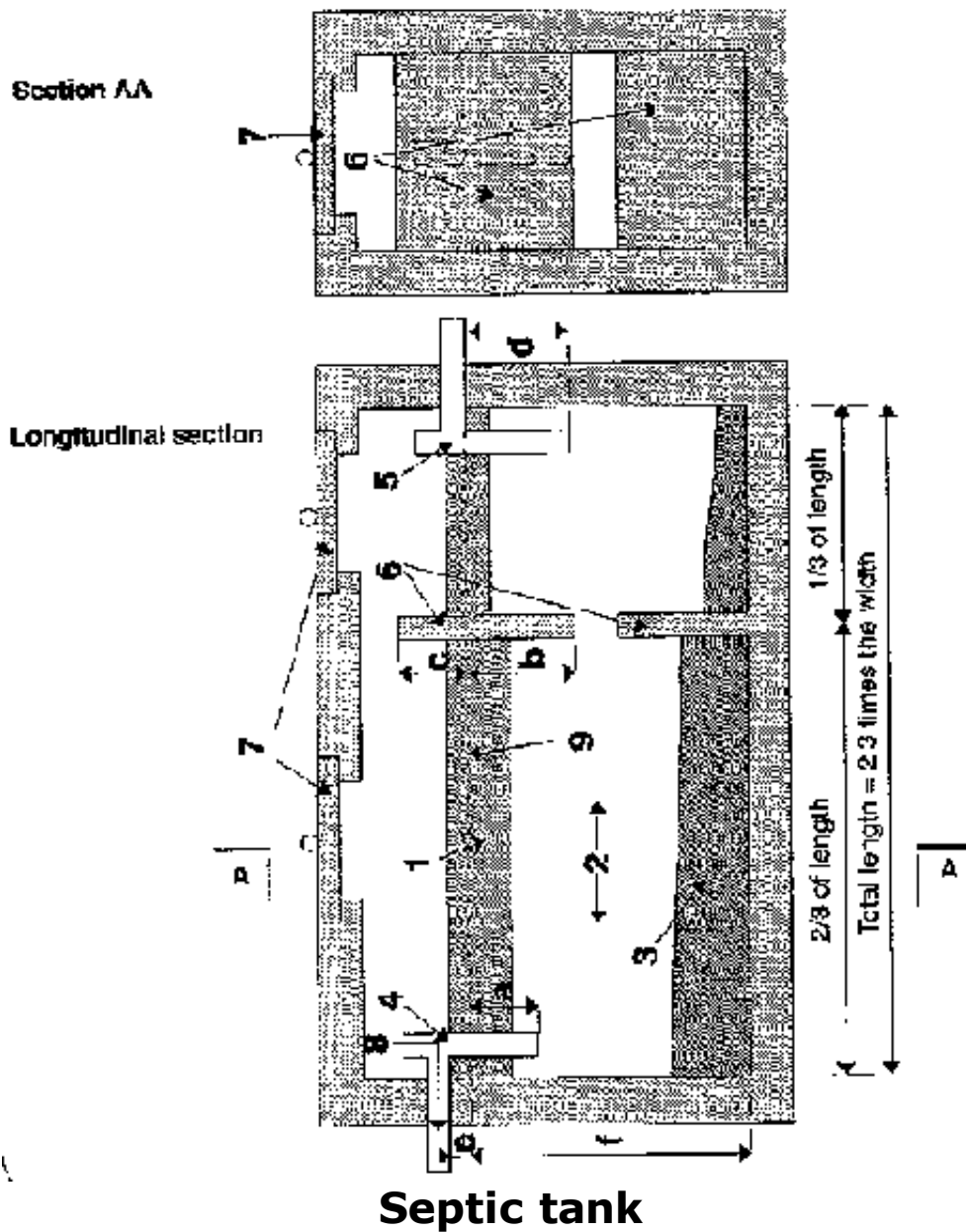

Method

A septic tank receives and treats wastewater before disposal (underground dispersal by infiltration trenches). The septic tank receives all domestic wastewater (sewage and sullage), and is suitable for wastewater from schools, hospitals, etc.

Operating Principles

A septic tank is a container, usually rectangular in shape, built just underground, in which wastewater is retained for 1 to 3 days.

During this period, solid material settles and is decomposed by bacteriological action. Although this biodegradation is reasonably active, the accumulation of solids means that the tank needs emptying at regular intervals, generally every 1 to 5 years.

The effluent from a septic tank needs secondary treatment before final disposal in the environment. It is purified and disposed of by underground dispersal via infiltration trenches positioned after the septic tank (see technical brief Infiltration trench).

Design principles

- In order to reduce the concentration of suspended material in the effluent, the tank has a partition separating it into 2 compartments, the first having double the volume of the second. The depth of the liquid zone is 1 to 2 m. The length of the tank is usually 2 to 3 times its width.

- The volume of the tank is calculated on the basis of a 3 day retention time of the

quantity of water entering in the tank each day. The effective depth of water should not be less than 1m.

Frequency of emptying

- The tank should be emptied when it is 1/3 full of solids. The frequency of emptying is given by:

$$\left[\frac{1}{3}(\text{volume of tank in m}^3) \right] / \left[(\text{solids accumulation, m}^3 / \text{pers.} / \text{year}) \times (\text{number of pers.}) \right] = n \text{ years}$$

The solids accumulation rate depends on temperature. A figure of 0.03 m³/pers./year is considered a reasonable average. After emptying, it is advisable to fill the tank with clean water.

Key

- 1. Floating material (oils, fats)**
- 2. Clarified liquid**
- 3. Settled solids**
- 4. Inlet tee**
- 5. Outlet tee**
- 6. Partition to retain solids and floating material**
- 7. Access holes with covers**
- 8. Ventilation**

a: 20% of effective depth

b: 40% of effective depth

c: 20% of effective depth

d: 40% of effective depth

e: at least 75 cm

f: effective depth of water (minimum 1 m)

Inputs

- **Plans**
- **Shovels, picks, etc.**
- **Builder's tools**
- **Sand for sub-base**
- **Shuttering timber**
- **Concrete (quantity calculated according to tank volume), concrete blocks or prefabricated elements**
- **Pipes and inlet and outlet tees (minimum die 100 mm)**
- **Ventilation pipe**

Important

- **A septic tank may be built in situ, in concrete or concrete blocks, or alternatively, with prefabricated panels in concrete, fibre or plastic.**
- **Whatever the construction method, the tank must be water-tight and strong enough to resist soil and possible groundwater pressures. It should rest on a sub-base of sand several centimetres thick.**
- **The minimum diameter of the inlet and outlet pipes should be 100 mm and their minimum slope 2%.**
- **The siting of a septic tank is dictated partly by the placing of the dispersal area (infiltration trench). The tank should be away from vehicular passage, accessible**

for maintenance, and as near as possible to the building served.

- Make sure that there is enough land available for the underground dispersal system and that the soil allows a sufficient rate of infiltration.**
- The gases resulting from anaerobic digestion in the septic tank should be evacuated without nuisance. This is done by means of a ventilation pipe which extends above roof height, taking into account the wind direction.**
- The quantities of chlorine and detergent products used in normal household and hospital activities should not affect the tank's functioning**
- It is not necessary to use special additives in the tank to activate it. The materials collected in the tank are rich enough in micro-organisms to start biodegradation.**
- Take care if the water table is not deep.**

Example of design calculation for a septic tank

- Design calculation for a septic tank for a health centre of 20 beds and a water consumption of 50 litres/bed/day. The effluent from the septic tank is to be disposed of in an infiltration trench.**
- It is estimated that 80% of the water consumed enters the septic tank**

Assuming a 3 days retention time, the volume of the tank will be:

$(0.04 \text{ m}^3/\text{bed}/\text{day}) \times (20 \text{ beds}) \times (3 \text{ days retention time}) = 2.4 \text{ m}^3$ or 2.4 m long, 1 m wide and 1 m deep.

- The frequency of emptying accumulated solids if one assumes that the accumulation rate is:**

$$\left[\frac{1}{3} (2.4 \text{ m}^3) \right] / \left[(0.03 \text{ m}^3/\text{bed}/\text{year} \times (20 \text{ beds})) \right] = 1.4 \text{ year}$$

- For designing an underground infiltration system, see technical brief Infiltration trench.

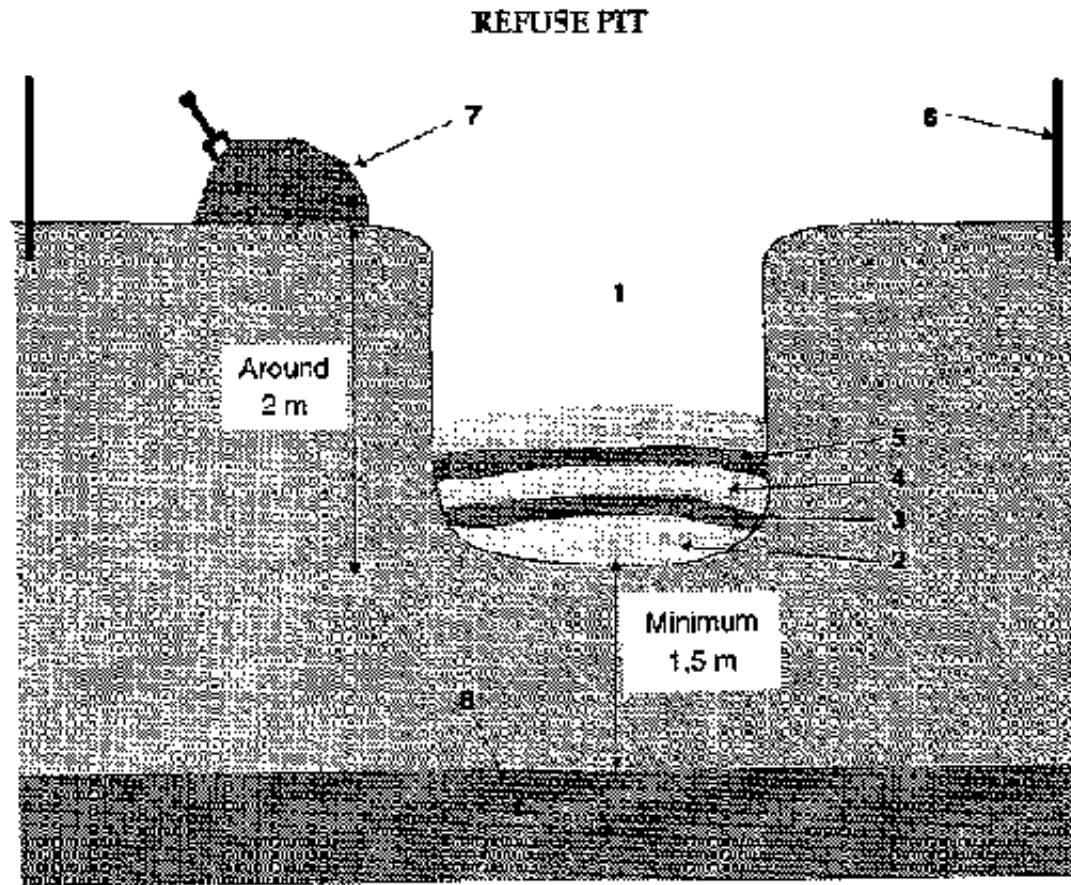

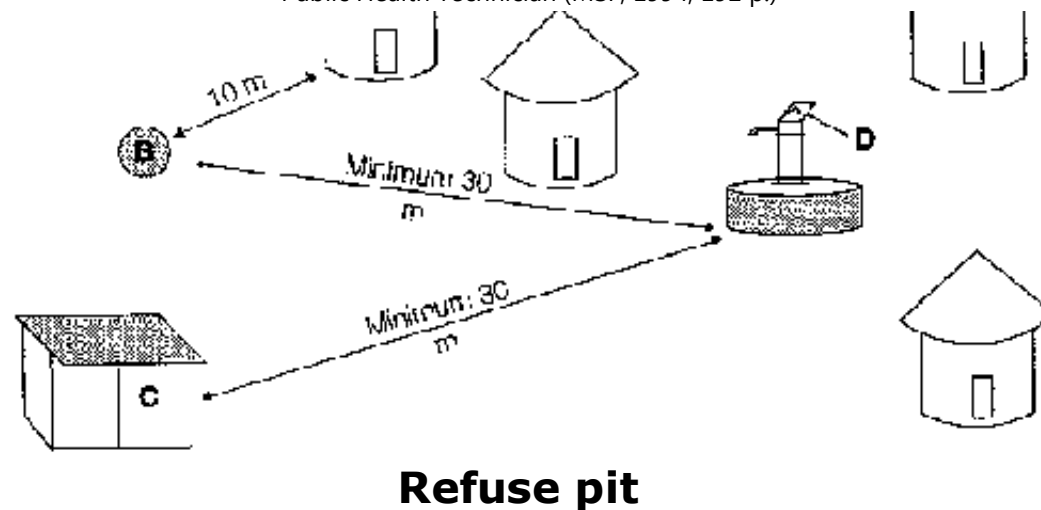

Method

In an emergency situation, the best way to dispose of household refuse (not medical waste) is burial in a controlled tip if possible (see technical brief **Controlled tip), or in collective or family refuse pits if there is not enough land or the transport for controlled tipping.**

The high water content of this type of refuse does not allow it to be burned in the pits; apart from using a lot of fuel, the incomplete combustion obtained by this gives a false sense of security.

- It is important to respect minimum distances to avoid the danger of contaminating water points.

· Distance from water points:

>15m if the pit serves fewer than 10 families,

> 30m if it is a collective pit.

· Distance from dwellings:

>10m if the pit serves fewer than 10 families,

> 30m if it is a collective pit.

- Dig a hole, leaving the earth to one side (to be used for daily covering of refuse).**
- Check that the bottom is more than 1.5m from the water table. (It is possible to drive in a metal bar such as a reinforcing rod to a depth of 1.5m and see if it is wet when pulled out.)**
- Surround the hole with a fence to avoid accidents and prevent the entry of animals etc.**
- Dispose of refuse in the pit each day, covering it with a layer of earth to avoid attracting flies and rodents.
(Ashes or a mixture of ashes and earth may be used for this covering.)**
- Refill the hole completely and compact the earth when the level of refuse reaches from the surface.**

Key

- 1. Pit**
- 2. Refuse, day 1**
- 3. Earth, day 1**
- 4. Refuse, day 2**
- 5. Earth, day 2**
- 6. Fence**

7. Excavated earth

8. Water table

A. Dwellings

B. Refuse pit

C. Latrine

D. Well

Inputs

- **1 pick, 1 shovel**
- **2 buckets (to lift out the earth)**
- **1 miner's bar**
- **2m length of reinforcing rod**
- **Stakes and fencing material**
- **2 people for 1 day (depending on size of pit)**

Important

- **Only throw household refuse in the pit. Do not throw in medical (waste potentially contaminated) before incineration.**
- **If the soil is too unstable it may be useful to support the walls with uncemented bricks.**
- **It is not efficient (it is expensive) to burn household refuse. This technique (described in technical briefs Temporary incinerator and Permanent incinerator) should be reserved for medical wastes.**
- **It is essential that refuse is covered with earth or ashes immediately after**

disposal to avoid attracting flies and rodents and to accelerate decomposition.
- In certain cases (hospital, feeding centre), when the quantities of non-medical waste to be disposed of need a very deep pit, it may be covered by a slab (for safety) with a covered opening. The cover should be heavy and fitted tightly to the opening to prevent the entry of flies. Make sure that the cover is replaced after each use.

CONTROLLED TIP

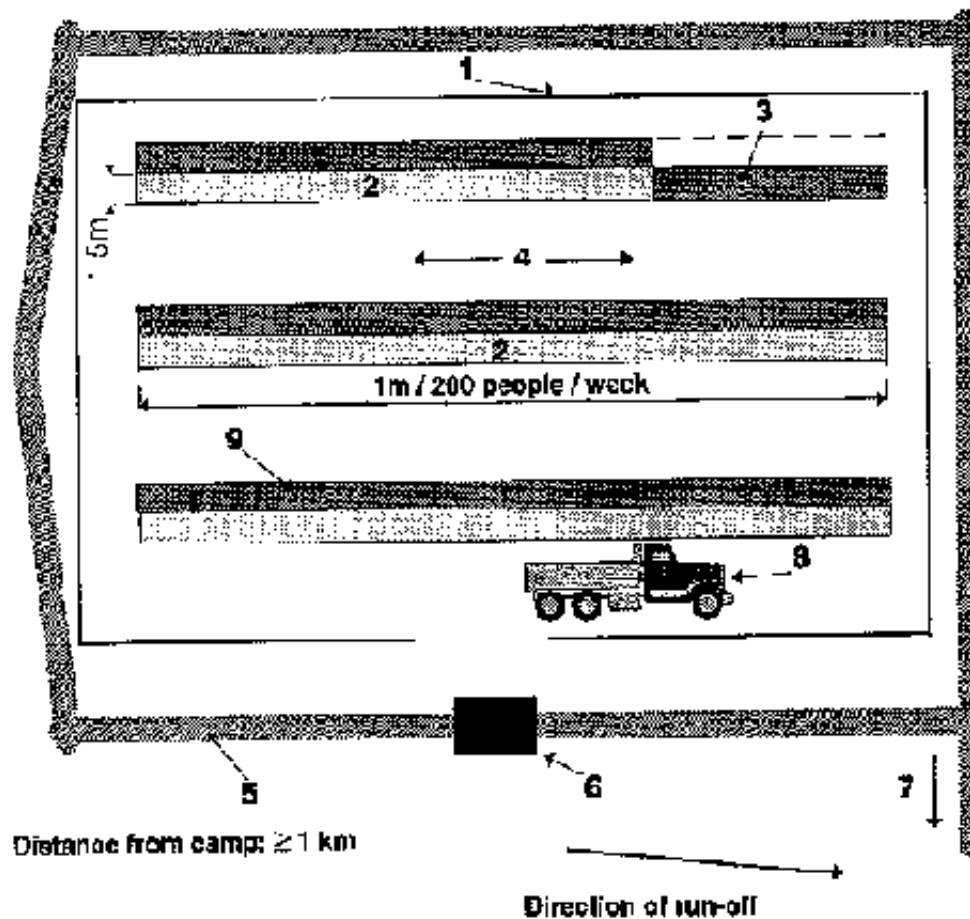

Trench in longitudinal section

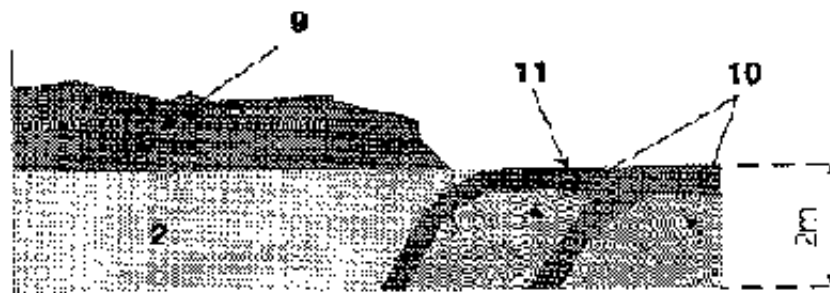

Controlled tip

Method

This technique is used to eliminate a community's waste. Its feasibility is essentially dependent on the land surface available and the availability of collection and transport equipment (animal carts, lorries, etc.).

- Calculate the length of trenches needed using the following formula: for a width of 1.5m and a depth of 2m, dig 1 linear metre of trench per 200 people per week**
- Choose an area at least 800m from dwellings; living areas should not be downwind from the tip.**
- Take care about the distance from water points, which should never be less than 50m away and which should be uphill from the tip.**
- Fence the area well.**
- Dig a surface water drainage ditch around the whole area. The lowest corner of this ditch should lead to a soakaway pit.**
- Dig the trenches with a mechanical shovel if possible, placing the earth beside the trenches; this earth is used as tipping proceeds.**

Operation

- The refuse is collected and taken to the tip, then dumped at one end of the trench and covered immediately with earth. The following load is dumped next to the first, and so on until the trench is full.**
- After 6 months the trenches may safely be redug to make a new tip, or to use the contents as a fertilizer.**

Key

- 1. Fence**
- 2. Trench waiting for use**
- 3. Part of trench already full**
- 4. Alley (wide enough for the passage of the refuse collection vehicle)**
- 5. Drainage ditch**
- 6. Crossing point of ditch**
- 7. Lowest corner: towards soakaway pit**
- 8. Lorry bringing refuse**
- 9. Excavated earth used progressively for covering**
- 10. Refuse**
- 11. Layer of backfilled earth**

Inputs

(construction)

- Land**
- Mechanical shovel or numerous workers**
- Stakes and fencing material**
- Poles or tree trunks to build the bridge crossing the drainage ditch**

(operation)

- Lorry or cart for transporting refuse**
- Trained personnel, permanently at the tip**
- Shovels for covering refuse**
- Boots and gloves for personnel**

- **Broom and 0.05% chlorine solution (or Iysol) for daily cleaning of the cart or lorry.**

Important

- **This technique needs a lot of land and sophisticated equipment for its implementation, which can entail heavy costs.**
- **Important: the bottom of the trenches must be more than 1.5m from the water table to avoid pollution by leachates.**
- **The compulsory distance from dwellings demands the use of a lorry or cart.**
- **The staff should be trained for their task and should wear protective clothes; washing facilities (water and soap at least) should be available at the site.**
- **If the tip is designed to have a lifespan of more than 6 months, it is possible, when the end is reached, to redig the start of the first trench fired, to reopen the tip. Otherwise it is necessary to open a second tip during the time it takes for the first one to stabilize.**
- **The fence is essential to avoid scavenging and accidents at the tip.**

DUSTBIN

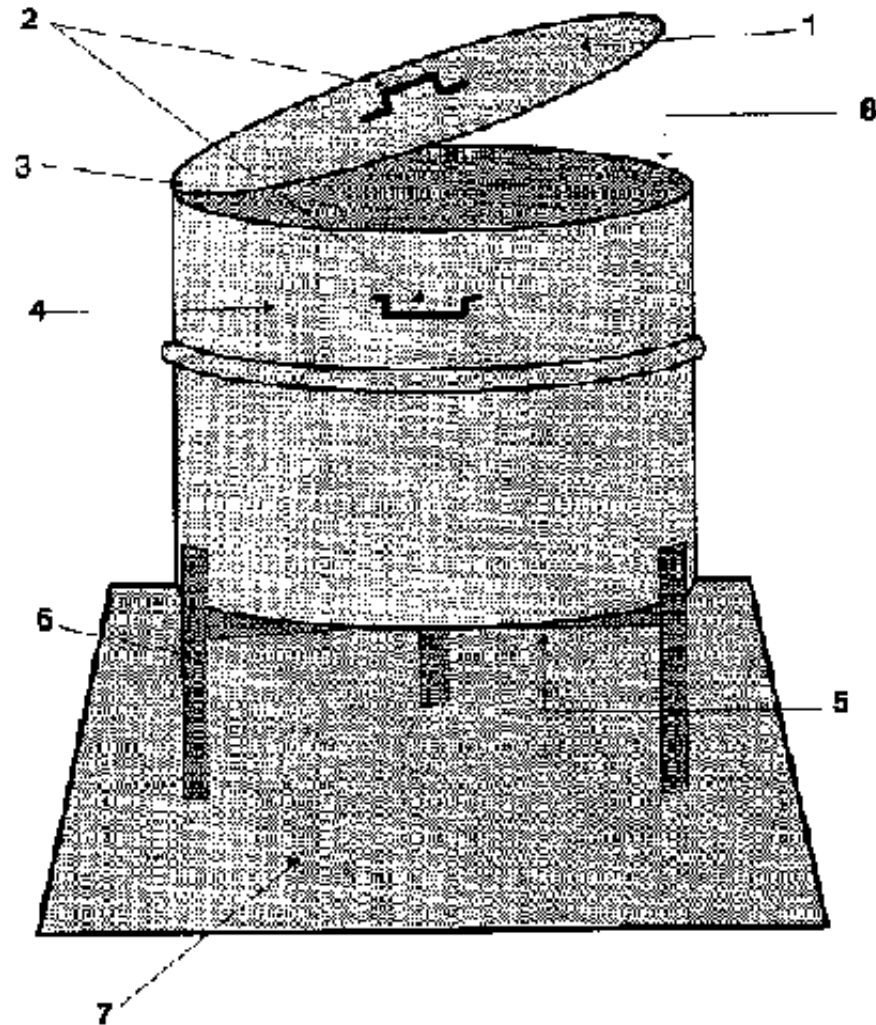

Dustbin

Method

The dustbins may be used along paths and roads in a refugee camp or in the

courtyard of a hospital.

- Cut a 200 litres oil drum in two.**
- Hammer the cut edges to avoid injuries.**
- Fix a cover on the open end with hinges.**
- Pierce about 20 holes in the bottom with a large nail to let decomposition liquids drain out.**
- Fix a handle on the cover for opening, and two on the sides for carrying.**
- Paint the inside of the dustbin with anti-corrosion paint.**
- Paint the outside in a bright and attractive colour to make it clearly visible.**
- Make a support, in metal or wood, for example, to raise the bottom of the dustbin from the floor.**
- Dig a hole where the dustbin will be placed, 50cm deep, the same diameter as the dustbin, and fill it with stones to drain leachates.**
- Place the support on the stones and the dustbin on the support.**

Key

- 1. Cover**
- 2. Handles**
- 3. Hinge**
- 4. 1/2 metal drum**
- 5. Pierced bottom**
- 6. Support**
- 7. Stones (drainage)**
- 8. Hammered edges**

Inputs

- **1 drum, 200l**
- **1 cold chisel or metal saw**
- **Wire, nuts and bolts, or pop rivets for fixing handles**
- **1 hinge (or piece of rubber or leather) for attaching cover**
- **Wood or metal and stones for support**
- **Anti-corrosion and coloured paints**

Important

- **Attach the cover in such a way that it falls shut every time it is let go. This is the only way to be sure that the dustbin is always covered.**
- **Allow one dustbin for every 10-15 houses, and others along roads and in public places (schools, markets, etc.).**
- **Organise refuse collection and disposal.**
- **Organise regular cleaning and disinfection of the dustbins.**
- **Hammer the cut edges to avoid injuries.**

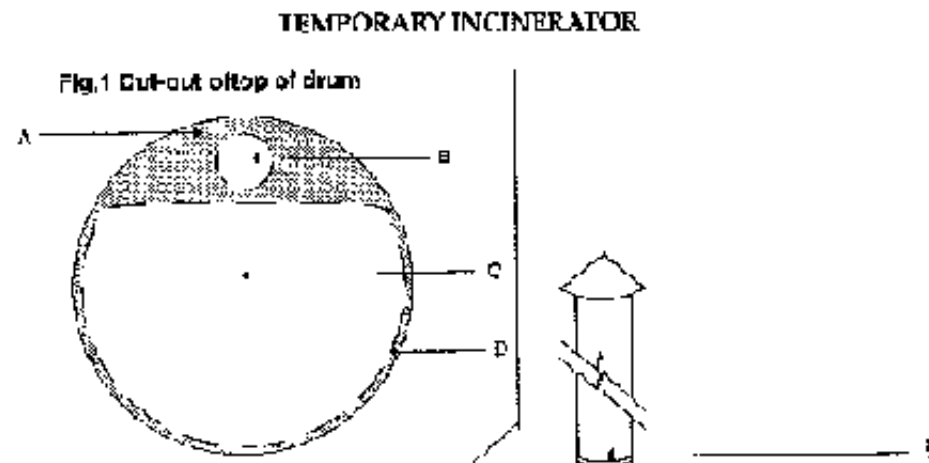

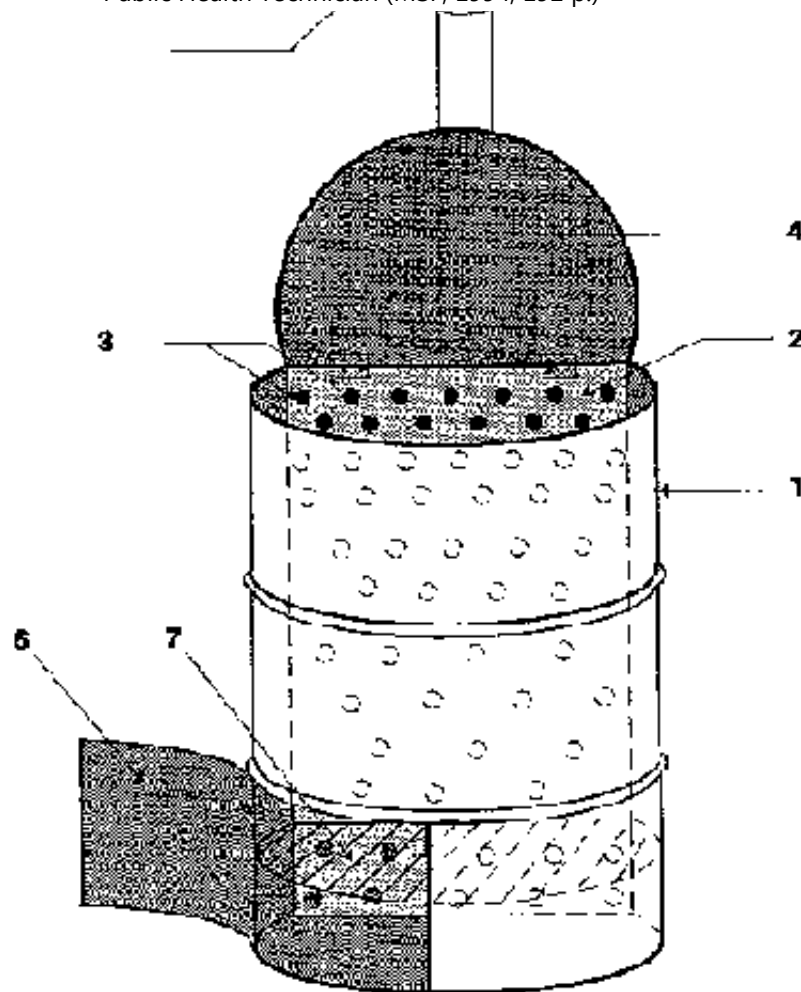

Temporary incinerator

Method

This incinerator serves a temporary purpose in a dispensary or health centre.

If the health structure becomes permanent, it should be replaced by a permanent incinerator.

- **Cut the top cleanly off a 200 l metal drum, around 2/3 of its perimeter (see fig. 1). Cut a hole the diameter of the chimney in the remaining part of the cover.**
- **Perforate a metal plate (length = internal height of drum, width = diameter of drum at the place the cover was cut), all over its surface with holes about 1 - 2 cm diameter. Slide it into the drum and fix it so as to divide the inside into two chambers of unequal volume.**
- **Fix the cut part of the cover to the top edge of the plate with hinges. Attach a handle so that this cover may be opened and closed.**
- **Cut some rigid metal grating, or make some with the same cross section as the large chamber of the drum (in front of the metal plate), and fix it horizontally about 20 cm from the bottom of the drum.**
- **Cut out a panel 40 x 40 cm at the bottom of the drum and remount it as a door using hinges.**
- **Fit a chimney (about 2 m high) on the hole made in the fixed part of the cover.**

Operation

- **Fill with refuse from the top.**
- **Fill the bottom with firewood through the door (6).**
- **Light the fire and give it time to take well.**
- **Monitor the combustion, turning over the refuse frequently.**
- **Once incineration is complete, empty the ashes and dispose of them like domestic refuse (refuse pit or controlled tip).**

Key

A. Top of drum (part not cut)

B. Hole cut for chimney

C. Large chamber (for refuse)

D. Cut-out of cover

1. Metal drum, 200l

2. Perforated metal plate

3. Perforations in the metal plate for draught

4. Movable cover

5. Chimney

6. Fire chamber door (used to regulate the draught)

7. Metal grating (or heavy mesh) to separate the refuse from the fire chamber

Inputs

- 1 drum, 200l (e.g. fuel drum)

- 1 cold chisel and 1 hammer

- 1 metal saw

- 1 pair of pincers and wire

- 1 metal plate (same thickness as drum, same height; width: about 2/3 of drum diameter)

- Large nail or punch (for making perforations)

- System to fix the plate in the drum (e.g. angle steel and nuts and bolts)

- Tin chimney pipe

- Heavy mesh or grating

- Metal hinges (4)

Important

- **Never over-fill with refuse: as the draught comes from the fire, the pile of refuse should not be too compact.**
- **Do not empty the incinerator from the top; only take out the ashes which fall.**
- **Clean out the fire chamber frequently.**
- **Do not try to economise on firewood: always keep a good fire going to guarantee complete combustion.**
- **Turn over the refuse frequently during combustion to make the ashes fall and to expose all the refuse to the flames.**
- **Never put explosive objects (e.g. aerosol cans) in the incinerator, or materials which give off toxic fumes on combustion (certain medicines for example). Always seek advice before in case of doubt.**
- **Situate the incinerator where the smoke will not bother people, and place it under a shelter if possible to avoid corrosion being worsened by rain.**
- **The door (6) may be adjusted to regulate the draught. However, if the draught is enough, incineration with the door closed is the most economical on firewood.**
- **If it is used frequently, such an incinerator will not last more than a few months (less than a year because of corrosion due to the great heat generated).**

PERMANENT INCINERATOR

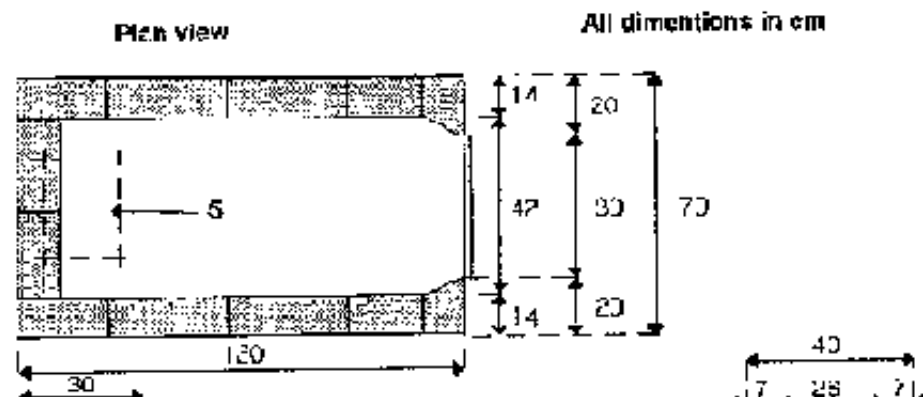

- 1. Draw a detailed plan of the structure.**
- 2. Build brick foundations 100 x 70 x 20 cm (overall dimensions).**
- 3. Shutter and cast the base slab, fire chamber slab, upper slab and chimney-top slab.**
- 4. Lay the base slab on the foundations.**
- 5. Build the refractory brick walls up to the height of the fire bars. Lay the fire chamber slab and cement the fire bars in place.**
- 6. Continue the walls up to the chimney. If possible, plaster the inside of the fire chamber with a heat-resistant mixture.**
- 7. Lay the upper slab which acts as a base for the chimney.**
- 8. Build the chimney at least 1.5 m high (be sure to use a plumb line; the chimney should be perfectly vertical).**
- 9. Fit the fire chamber and refuse-loading doors.**
- 10. Let the structure cure for 2 to 3 weeks, covered in wet jute sacking or plastic sheeting before using it.**

Key

- 1. Brick walls (7 x 14 x 28 cm)**
- 2. Fire bars (3 cm spacings)**
- 3. Door of fire chamber**
- 4. Door for loading refuse**
- 5. Chimney**
- 6. Base (reinforced concrete: 130 x 70 x 8 cm)**
- 7. Fire chamber slab (reinforced concrete: 70 x 60 x 3 cm)**
- 8. Top slab (reinforced concrete: 100 x 70 x 7 cm)**

Pay attention to the opening left for the chimney (25 x 45 cm)

Inputs

- **Detailed plans**
- **About 300 refractory bricks (7 x 14 x 28 cm)**
- **4 bags of cement**
- **Sand (270 litres)**
- **Gravel (125 litres)**
- **Refractory plaster mix (earth, lime or cement)**
- **2 metal doors**
- **15 metal bars (8 mm dia, 650 mm long)**
- **Reinforcing steel, 6 mm: 18 m**
- **Shuttering timber for the slabs**
- **Builder's tools**
- **About 3 days work for one experienced builder and one labourer.**

Important

- **The combustion capacity of such an incinerator is about 100 kg of refuse per hour.**
- **The incinerator should function with the loading door shut to encourage the draught.**
- **The same remarks on operation apply as those for the temporary incinerator (see corresponding technical brief).**
- **It is important that one or two people are responsible for the operation and maintenance of this type of equipment.**

SOAKAWAY PIT

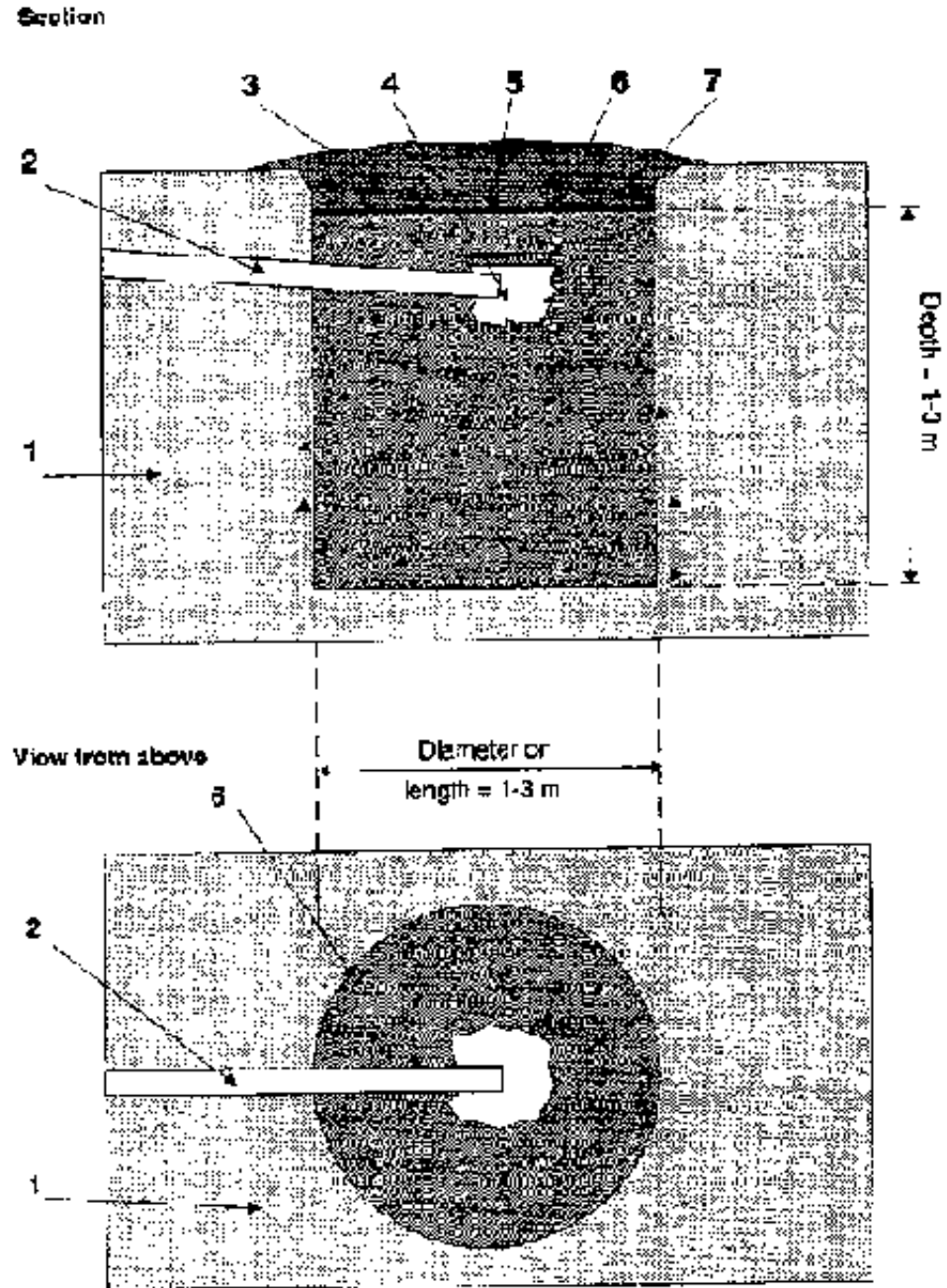

Soakaway pit

Method

A soakaway pit allows the disposal of wastewater from a water point, kitchen, shower etc by infiltration into permeable soil.

Construction

- 1. Choose the site: at least 6 m from dwellings, 3 m from trees or hedges, 30 m from groundwater points if it is a domestic soakaway pit.**
- 2. Determine the dimensions of the soakaway pit according to the quantity of wastewater to be infiltrated and the permeability of the soil.**
- 3. Dig the trench for the inlet pipe (diameter 50 to 100 mm), with a slope of 1%, 300 mm wide and 300 mm deep.**
- 4. Dig the pit to the required dimensions. Measure the depth from the bottom of the incoming trench. If the pit is deep and/or the soil is unstable, support the sides during digging.**
- 5. Fill the soakaway pit with stones up to the level of the trench bottom. The stones should be clean, with a diameter of 5 to 15 cm.**
- 6. Lay the incoming pipe (1% slope). Clear the stones around its end to create an empty space to aid dispersal of the flow.**
- 7. Place a large flat stone over the pipe and add a 10 cm layer of stones.**

8. Cover the stones with straw or a plastic sheet and fill in the hole with earth.

Key

- 1. Permeable soil**
- 2. Pipe (diameter 50-100 mm)**
- 3. Compacted earth**
- 4. Cleared space at the end of the pipe**
- 5. Straw or plastic sheet**
- 6. Stones**
- 7. Flat stone**

Inputs

- 1 tape measure**
- Shovels, picks**
- 1 wheelbarrow**
- 1 pipe, 50-100 mm diameter, in PVC or cement**
- Stones: enough to fill the soakaway pit**
- Straw or plastic sheet**

Important

- To determine the dimensions of the pit, it is important to evaluate the infiltration capacity of the soil and to allow for a possible increase in the amount of wastewater to be disposed of.**
- Install a grease trap before the soakaway pit if it is meant to take wastewater**

from kitchens, in order to avoid clogging by fats (see technical brief Grease trap).

- The straw or plastic sheet over the stones prevents soil from getting between the stones and blocking the system.**
- The bottom of the soakaway pit should be at least 1m above the water table during the wettest period, and 1m above any impermeable layers. If this is not possible, opt for a system of infiltration trenches (see technical brief Infiltration trench).**
- Plant the area of the soakaway pit with grass if water or wind erosion are severe.**

INFILTRATION TRENCH

Longitudinal section

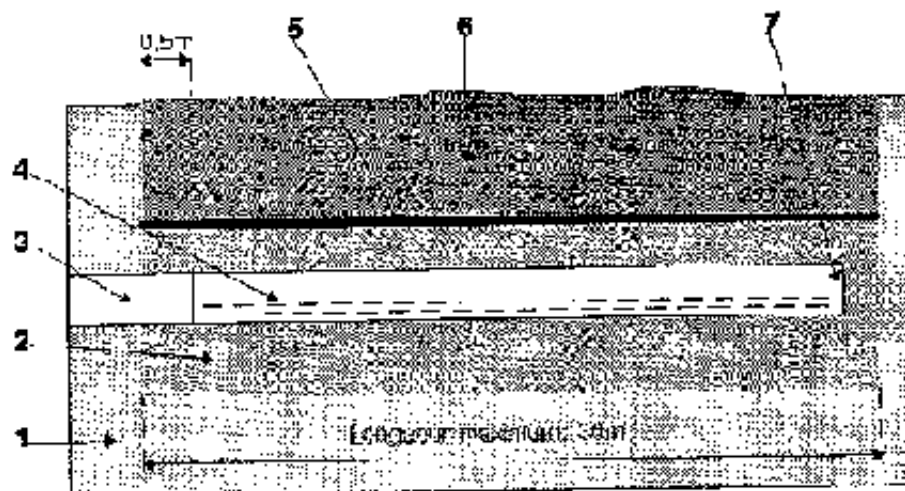

Multiple trench system

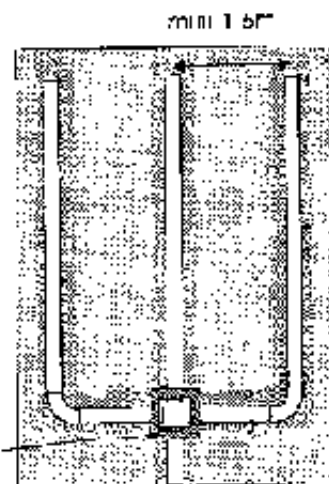

Cross section

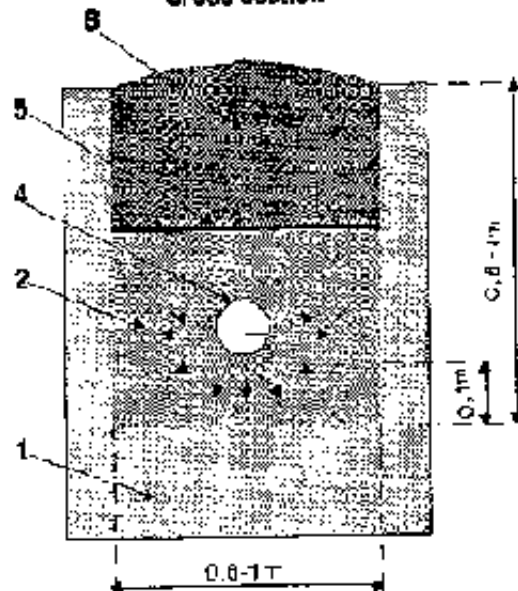

Infiltration trench

Method

Infiltration trenches may be used for the underground dispersal of wastewater from kitchens, health centres, etc. They may equally well be used for disposing of water from septic tanks.

Construction

- 1. Choose a site at least 30 m from groundwater points, 6 m from dwellings and 3 m from trees or hedges and 3 m from possible property boundaries.**
- 2. Determine the dimensions of the trench or trenches according to the permeability of the soil and the quantity of wastewater to be infiltrated (see technical brief Soil permeability).**
- 3. Dig the trench for the incoming pipe (300 mm wide, 1% slope).**
- 4. Lay the pipe (100 mm), and cover with earth.**
- 5. Dig the infiltration trench to the required dimensions (with a slope of 0.5 to 1%).**
- 6. Rake the sides and bottom of the trench. Do not walk in the trench after this step.**
- 7. Fill the trench with gravel up to the level of the inlet pipe (minimum thickness 100 - 150 mm).**
- 8. Extend the inlet pipe about 0.5 m into the infiltration trench.**
- 9. Lay the drain (perforated pipe, or pipe sections with loose joints). Plug the far end.**
- 10. Fill the infiltration trench with gravel to a thickness of 50 mm over the drain.**
- 11. Cover the gravel with straw or a plastic sheet.**
- 12. Fill the trench to the top with earth and compact it lightly.**

13. After one or two weeks, plant grass on the top to limit erosion.

Key

- 1. Permeable soil**
- 2. Gravel**
- 3. Incoming channel**
- 4. Drain (perforated pipe)**
- 5. Straw or plastic sheet**
- 6. Earth**
- 7. Plug at the end of drain**
- 8. Distribution box**

Inputs

- 1 tape measure**
- Shovels, picks**
- 1 wheelbarrow**
- 1 pipe, 100mm die in PVC, cement or clay**
- 1 drain (perforated pipe or pipe sections with loose joints)**
- Gravel**
- Straw or plastic sheeting**

Important

- Dispersal systems using simple or multiple trenches are an alternative to soakaway pits for less permeable soils, where there are large quantities of effluent, in the case of a high water table or where there are rocky layers near the**

surface.

- **To estimate the dimensions of the trench, evaluate the infiltration capacity of the soil and allow for a possible increase in the amount of wastewater to be disposed of.**
- **For a system with several trenches, a distribution box is installed at the beginning of the drains to ensure that the effluent flow is well divided. The box should have an inspection cover and may be designed like a grease trap (see technical brief Grease trap).**
- **The straw or plastic sheet over the gravel bed prevents the entry of soil which would block the system.**
- **The bottom of the infiltration trench should be at least 1 m above the level of the water table during its highest period and 1m above any impermeable layer.**

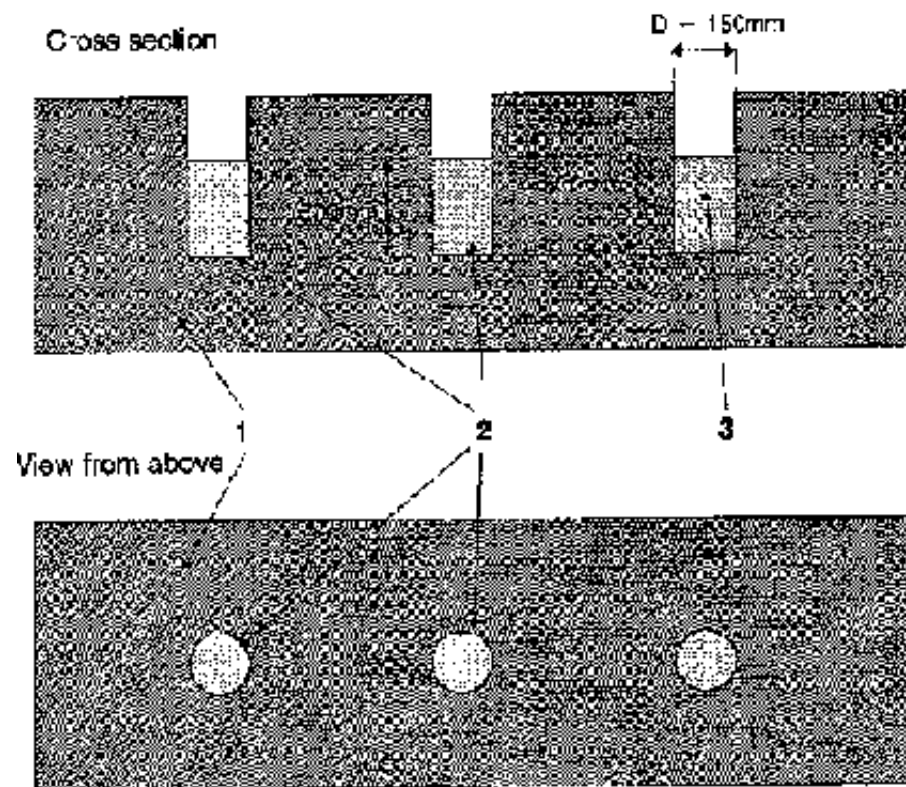
SOIL PERMEABILITY**Percolation test****Soil permeability****Technique**

The measurement of soil permeability by means of percolation tests allows:

- 1. Judgement of the infiltration capacity of a soil to be used for the dispersal of effluents;**
- 2. Determination, using the results, of the dimensions of a dispersal system.**

Method

- **Dig at least 3 test holes, each one 150 mm wide and 500 mm deep on the proposed site.**
 - **Fill the holes with clean water and leave overnight or at least for several hours to bring the soil to a saturated state.**
 - **The next day, fill the test holes with 300 mm of water.**
 - **After 30 minutes and then 90 minutes, measure the water levels in the holes.**
 - **Calculate the difference in level corresponding to this period of 60 minutes.**
- The soil may be considered as having an infiltration rate sufficient for a dispersal system if the level in each hole falls by at least 150 mm during this 60 minute period.**

Key

Percolation test

- 1. Permeable soil, proposed for a dispersal system**
- 2. Test holes: diameter = 150 mm, depth = 300 mm**
- 3. Test hole filled with 300 mm of water to measure the infiltration rate**

Inputs

- **1 operator**
- **1 hand auger or 1 pick and shovel**
- **1 watch or stopwatch**
- **1 tape measure**

Important

- **The percolation test is done with clean water, so does not allow for the clogging effect of the discharge of effluents carrying solids.**
- **It has been found that the infiltration rate for different soil types is more or less the same once the soil surface is partially clogged. The infiltration rate is thus usually found to be between 10 and 30 l/m³/day.**
- **For safety, it is better to work on the basis of 10 l/m³/day for the infiltration of effluents and 20 l/m³/day for clean water (e.g. from a water point).**
- **The following formula is used to calculate the length of trench needed (see also the example opposite):**

Effective infiltration surface (square metres) = Volume of effluent to be infiltrated (litre per day)/(Infiltration rate of soil (litre per square metre per day))

Length of trench in metres = Effective infiltration surface (square metres)/(2 x depth of trench (metres))

APPROXIMATIVE ESTIMATION OF INFILTRATION RATE ACCORDING TO SOIL NATURE

Soil nature Infiltrationrate (litre/m²/day)

Sand 50

Sandy soil, earth soil 30

Porous limestone soil 20

Porous clayey limestone soil

Compact limestone soil 10

Compact clayey limestone soil

Example of dimensions determination of a dispersal system

The effluent of the septic tank of a health centre must be eliminated with infiltration trenches.

- **The effluent volume to infiltrate is 500 litres per day.**
- **The infiltration rate of the soil is estimated at 10 litres/m²/day.**
- **The trenches will be 0.7 m depth.**
- **The effective infiltration surface is calculated the following way:**

Volume of the effluent(l/day)/Infiltration rate(l/m²/day)= 500/10 = 50 m²

- **A trench is made of two vertical walls; the total length of the trench is obtained by:**

Infiltration surface(m²)/(2 x trench's depth (metre))=50 m²/(2x0.7)= 36 metres

- **Notice that only the vertical surfaces of the trench are taken into account when calculating the infiltration surface.**

GREASE TRAP

A: Grease trap with 90° elbow and tee

B: Grease trap in 3 compartments

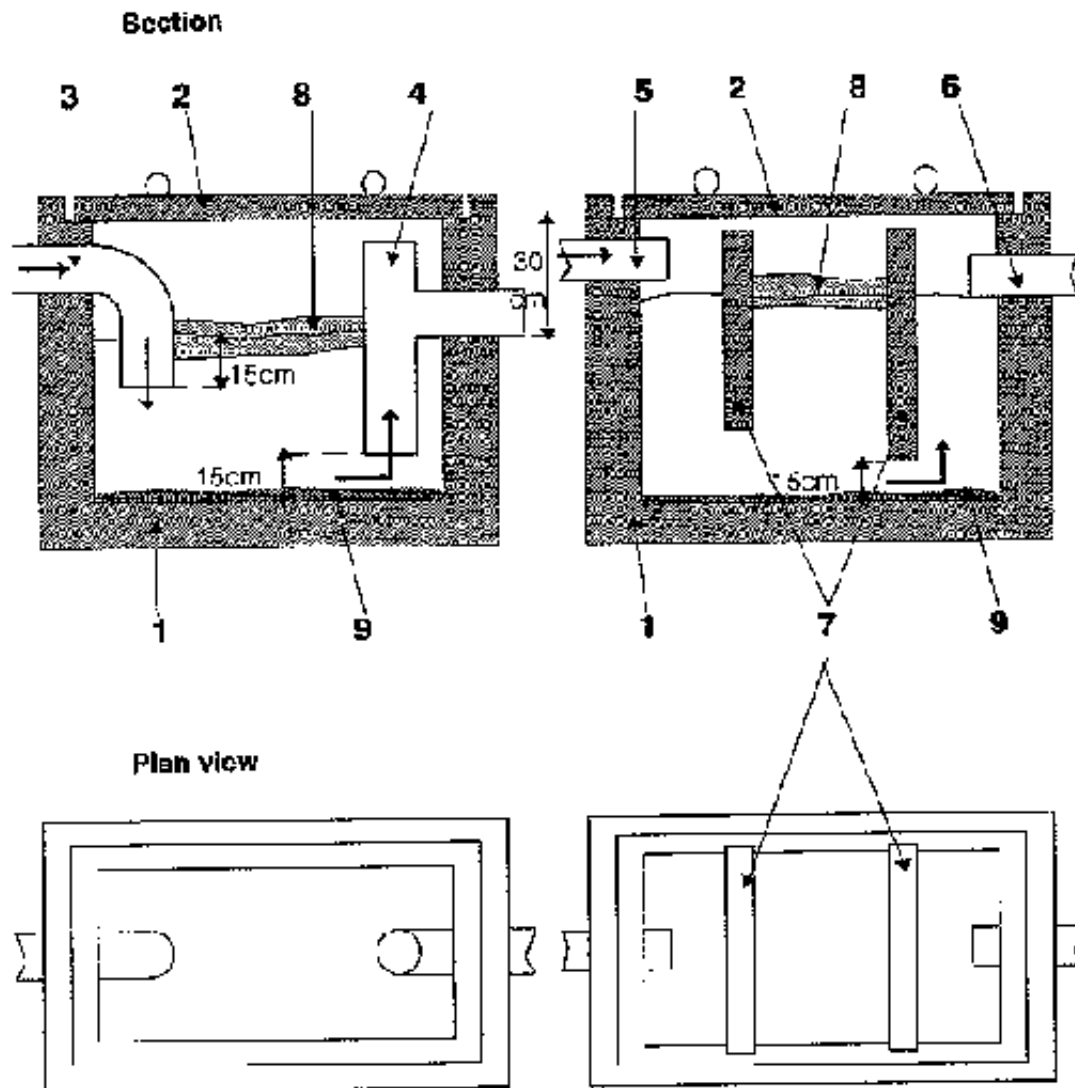

Grease trap

Method

A grease trap is used for separating solid materials, oils and fats contained in wastewater before its disposal in the ground. If oils and fats are left in the effluent they very quickly clog an infiltration system. Two simple types of grease trap may be distinguished (the choice of one or another type will be decided by the resources and skills available): a) With an elbow at the inlet and a "T" at the outlet. b) with separating partitions.

Principle

In both cases the trap operates with three zones:

- 1. Inlet zone which slows down and distributes the effluent in the trap;**
- 2. Middle zone where fatty material floats and accumulates at the surface and where heavier solids settle to the bottom;**
- 3. Outlet zone where grease-free water flows out towards the underground dispersal system.**

Construction

- Choose a place with easy access, above the dispersal system (soakaway pit, infiltration trench).**
- Design the grease trap and draw a detailed plan (see effective volume).**
- Excavate at the chosen place, to dimensions greater than the trap to be built.**
- Build the grease trap using locally available means and materials, e.g. cast concrete, bricks or concrete blocks, with an internal cement plaster.**
- Position the inlet and outlet pipes carefully to facilitate the flow and the**

operation of the trap. The removable cover should fit well on the trap and be sufficiently heavy to avoid unauthorised opening (children).

Key

- 1. Watertight casing**
- 2. Removable cover**
- 3. Inlet elbow, 90**
- 4. Outlet tee**
- 5. Inlet**
- 6. Outlet**
- 7. Separating partitions**
- 8. Middle zone (separation of fats)**
- 9. Settled solids**

Resources

- Detailed construction plans**
- Casing in bricks or cement**
- Cement, sand, gravel**
- Shuttering timber**
- 6 mm reinforcing steel**
- Shovel and pick**
- Bricklayer's tools**
- 10 mm PVC pipe, elbow and tee**

Important

Effective volume

- The effective volume of the grease trap should be enough to allow a retention time of the wastewater sufficient for the separation of oils and fats and the settlement of solids.**
- As a general rule, it may be considered that the effective volume should be double the hourly flow entering the trap.**

Maintenance

- Good maintenance is the key to the efficiency of the grease trap. Weekly cleaning is recommended to limit odours. Material removed by the trap should be buried.**

Section

IRRIGATED GARDEN

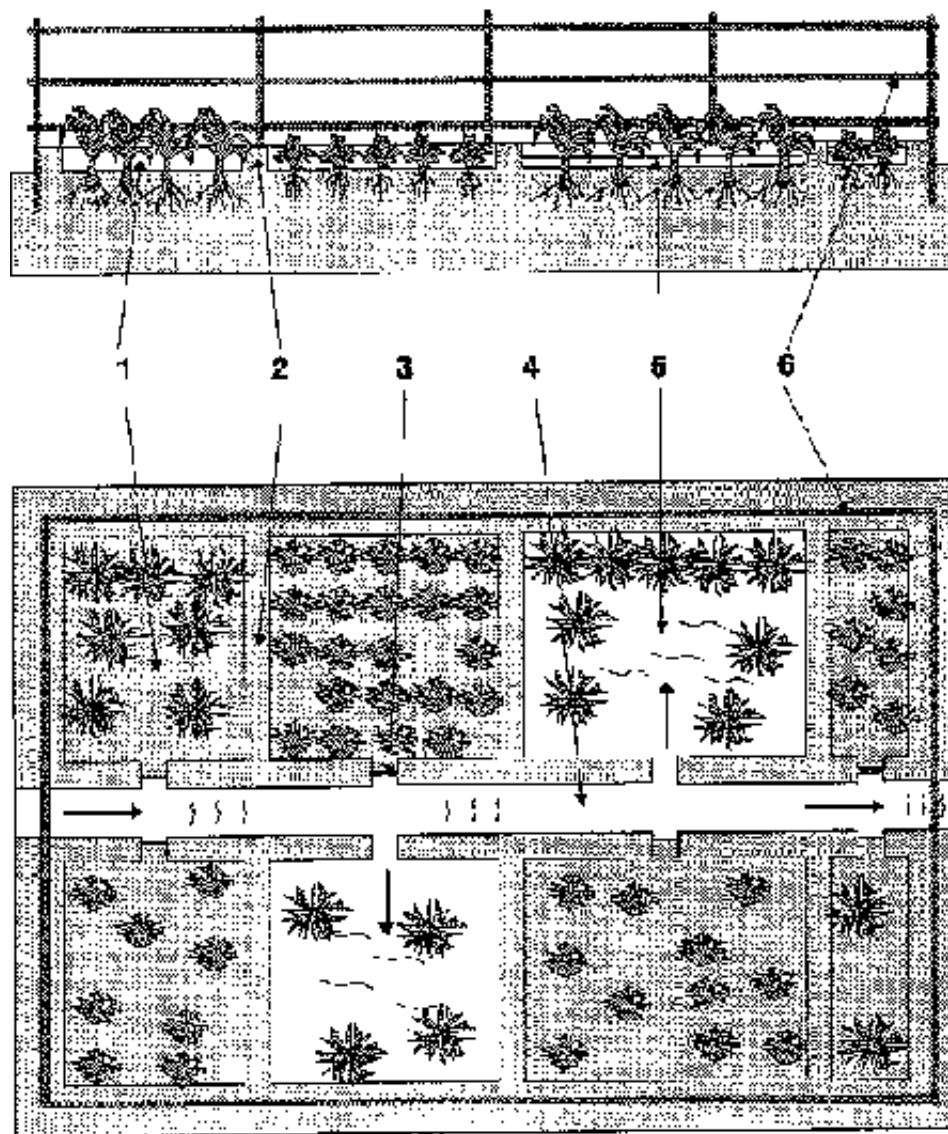

View from above

Irrigated garden

Method

Wastewater from water points may be used to irrigate vegetable gardens. The most common method is flood or basin irrigation.

The basins are periodically flooded and the water stays until it infiltrates into the soil.

Furrow or channel irrigation is also practiced. The water is distributed in a system of channels between rows of plants and infiltrates vertically and horizontally (e.g. for potatoes, beans, bananas, paw paws, etc.).

Construction

- Choose a site for the garden about 15m from the water point.**
- Dig a channel or drain to collect the wastewater.**
- Prepare the garden in basins or furrows, depending on the crops grown and the space available.**
- The passage of water from the channels into the basins may be regulated using sluices or earth.**
- Continue the main channel to the end of the garden to dispose of excess water in a soakaway pit or infiltration trench.**
- Erect a fence to keep animals out.**

Key

- 1. Basins**
- 2. Ridges**
- 3. Sluices**
- 4. Channel**
- 5. Flooding**
- 6. Fence**

Inputs

- Gardening tools**
- Tools and materials for construction of final disposal system (see technical briefs Soakaway pit and Infiltration trench)**
- Fence (local materials)**
- Sluices (e.g. short planks)**
- Seeds**

Important

- In refugee camps, where space is limited, an irrigated garden is preferable to infiltration disposal systems. It provides a nutritional supplement for the refugees and a source of activity and possible revenue.**
- Water containing detergents may be toxic to some plants.**
- Install a grease trap (see corresponding brief) if the water comes from the washing area.**
- Take local advice on the choice of irrigation method and the watering frequency.**
- Wash vegetables (even root vegetables) before cooking and eating.**

EVAPOTRANSPIRATION AREA

Section

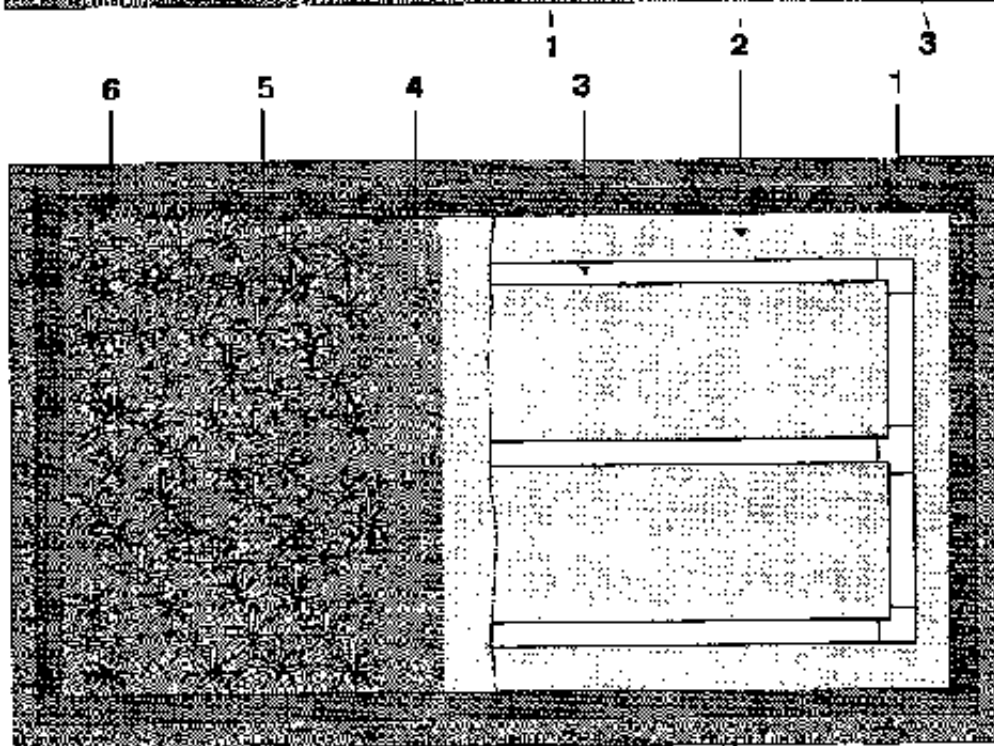
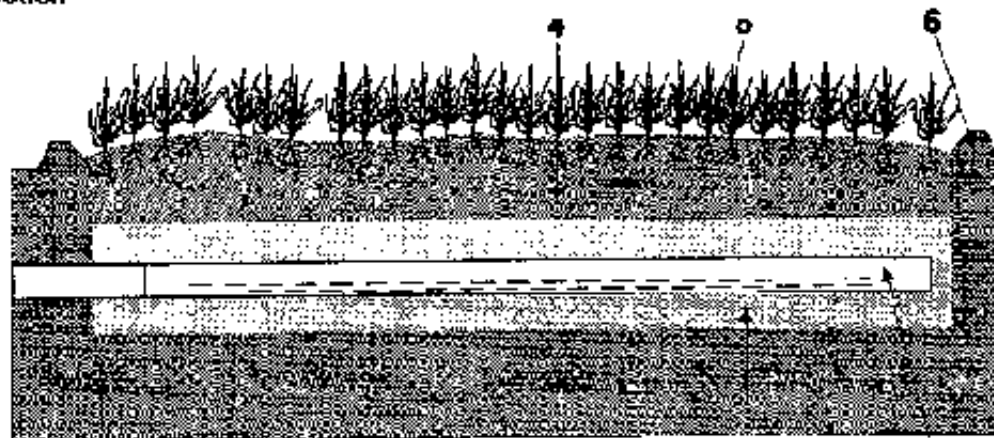

View from above, partially in section

Evapotranspiration area

Method

This is useful where a soakaway pit or infiltration trench cannot be used because of impermeable soils (e.g. clay or rock).

Evapotranspiration combines evaporation of water from the soil and transpiration by vegetation.

Siting: at least 30 m from groundwater points, 5 m from dwellings, property boundaries, trees and bushes.

Evapotranspiration is a complex phenomenon which varies with latitude, season and time of day. An acceptable approximation is given by:

Evapotranspiration rate (mm of water per day) = 0.8 x Evaporation rate

- The dimensions of an evapotranspiration area may be calculated on this basis, in the absence of other data. If the evaporation rate is not known, it may be roughly measured using a square basin of water placed on the ground. Take measurements over several days and take an average.

Construction

- Prepare and mark out the area on the ground.**
- Dig the trench for the wastewater inlet pipe and the trenches of the evapotranspiration area.**
- Spread 5 cm of sand on the bottom of the trenches.**
- Install the dispersal drains (100 mm perforated pipe) on a bed of gravel.**

- **Fill the trenches with a 50cm layer of sand and gravel mixture.**
- **Cover everything with 10 cm of soil.**
- **Plant a quick-growing local grass (for high water consumption).**
- **Build an embankment around the area to protect it from run-off.**

Key

- 1. Impermeable soil**
- 2. Sand and gravel**
- 3. Drains (10 mm perforated pipe)**
- 4. Soil**
- 5. Quick-growing vegetation**
- 6. Run-off protection embankment**

Inputs

- **2 wheelbarrows**
- **4 shovels, 2 picks**
- **Inlet pipe (100 mm PVC)**
- **Dispersal drains (perforated 100 mm PVC)**
- **Tee for inlet pipe to drains**
- **Sand and gravel**
- **Soil**
- **Quick-growing grass: sown or planted out**

Important

- **The evapotranspiration area is most suitable for hot, arid or semi-arid climates.**

- Choose a short-rooted grass which needs a lot of water for growth.
- Cut the grass regularly.
- Use a grease trap (see corresponding brief) when the wastewater originates from a kitchen or washing area.

Design calculation example

- A dispensary in a hot, dry tropical zone generates 300 l of wastewater per day.

The rocky soil will not allow underground dispersal. The evapotranspiration rate is 10mm/day.

Evapotranspiration rate = $10 \times 0.8 = 8 \text{ mm}$ or 0.008 m of water/day

Effective area = volume of wastewater (m³/day)/evapotranspiration rate (mm/day)

Effective area = $(0.3 \text{ m}^3/\text{d}) / (0.008 \text{ m}/\text{d}) = 37.5 \text{ m}^2$

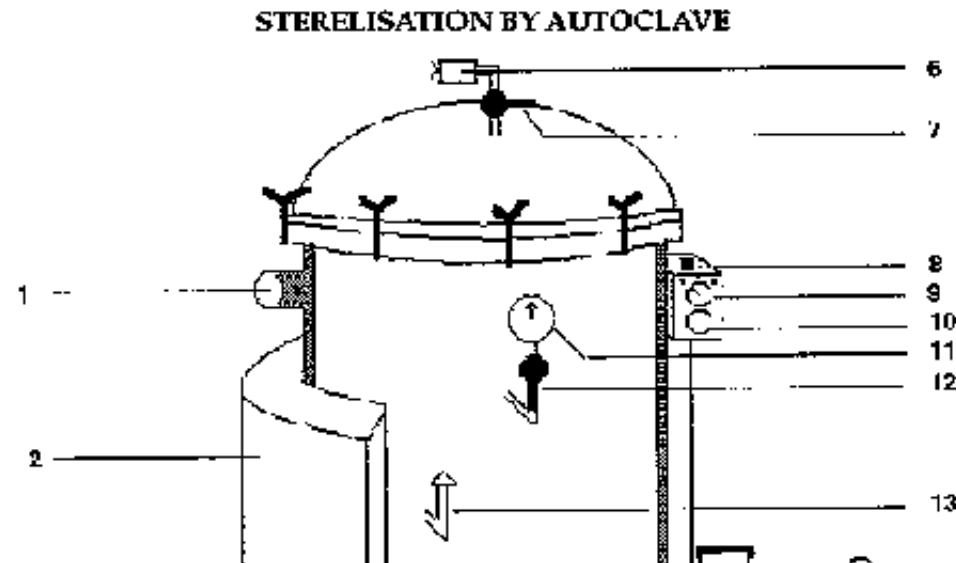

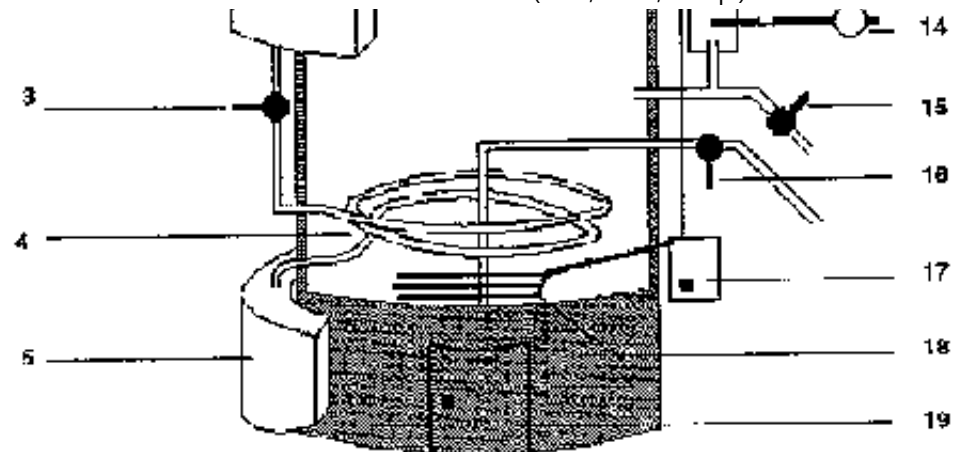

Material to be sterilized	Temperature in		Pressure* in		Duration**
	°C	°F	Atm., Bar or Kg/cm ²	PSI	
Instruments, plastic or glass syringes, rubber	121	250	1	15	30'
Bandages (compresses), operative linen and clothes	134	275	2	30	20'
	121	250	1	15	45'

* Overpressure in comparison with the atmospheric pressure
 ** Add 5 minutes for every 1,000 metres of altitude

Sterilisation by autoclave

Method

There are many types of autoclave on the market. They work on the same principle (water vapour under pressure, like a pressure cookery, but are operated in

different ways.

The mixed energy autoclave described here (Daguerre type) is particularly suitable for emergency situations, as it can be heated by electricity, kerosene stove, gas or charcoal.

Procedure for use

- 1. Put water in the autoclave (8 litres if heating by kerosene, gas or charcoal, 16 litres if heating by electricity).**
- 2. Load the boxes (with covers open) into the autoclave.**
- 3. Close the autoclave, tightening diametrically opposite clamps.**
- 4. Choose the pressure required by moving the weights: 1st notch = 1 bar (121°C), 2nd notch = 2 bars (134°C)**
- 5. Close the Yellow, Red and Blue valves, leaving the Green bleed valve open.**
- 6. Put on full heat. As soon as a continuous jet of steam comes out of the Green valve, close it until the pressure reaches 1 bar; then open it and let the pressure fall to 0.2 bar. Repeat this operation at least once in order to eliminate all air pockets.**
- 7. Let the pressure rise until the desired pressure/temperature is reached (121°C or 134°C).**
- 8. As soon as that pressure is reached the regulating valve releases steam. Count the sterilization time from this moment and start the timer.**
- 9. Reduce the heat (position 1 or 2 on the electric heater, or reduce the kerosene or gas flame) to keep just a light jet of steam coming out.**
- 10. When the sterilization time is finished, cut the heat and open the Yellow valve. (Be careful of the jet of boiling steam: use a flexible tube to vent the steam into**

cold water.) Close the valve again when the pressure drops to 0.1 bar.

11. Fill the outer tank with cold water (16l).

12. Open the Blue valve, (the pressure reading falls because a vacuum is created inside).

13. Wait for 10 mins and dose the Blue valve. Open the Red valve.

14. Open the autoclave. Wait for 15 to 30 mins with the cover half open to allow the material to dry completely.

15. Take out the boxes and close the covers immediately.

Key

1. Chimney

2. Graduated water tank (8l and 16l)

3. Blue valve

4. Condensation coil

5. Removable collection tank

6. Air filter (filled with cotton wool)

7. Red valve

8. Electric heater indicator (optional)

9. Electric control (1,500/3,000/4,500W)

10. Timer

11. Pressure gauge

12. Isolation valve, not used

13. Safety valve

14. Weights (left:1 bar, right: 2 bars)

15. Green valve (bleeding)

16. Yellow valve (for emptying at the end of sterilization)

17. Electric overheating safety cut-out (optional)**18. Electric elements****19. Door for kerosene/gas/charcoal stove****Inputs**

- **1 autoclave and detailed instructions**
- **Boxes with covers**
- **Water: 8 or 161 for sterilization plus 161 for drying**
- **Flexible pipe and container of cold water (for venting steam at the end of the cycle)**
- **Indicator tape (if available)**

Important

- **For more complete instructions, refer to the user's guide for each model**
- **The timer acts only as a reminder. It does not control the electricity supply.**
- **Air bleeding (step 6) must absolutely be done at least twice, or sterilization is not complete.**
- **The heating time is longer when not using electricity. The sterilization time is the same, whatever heating method is used.**
- **Only start counting the sterilization time from the moment the temperature (pressure) is reached, after air bleeding.**
- **If adhesive indicator tape is available (do not confuse this with the tape used for hot air sterilization), stick small pieces to the outside of the boxes; the indicator tape turns brown if the sterilization time and temperature have been achieved.**
- **NEVER operate the autoclave without water (the heating elements will be**

destroyed).

- NEVER try to open the autoclave before the end of the cycle.

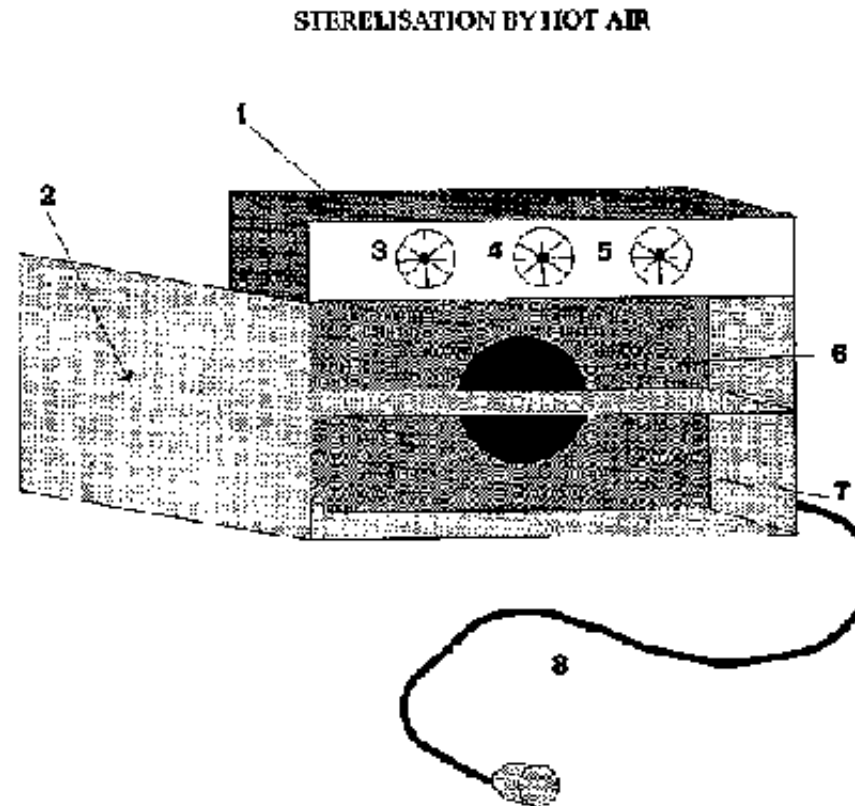

Sterilization by hot air

Method

The "Poupinel" oven is used for sterilizing medical and surgical equipment with hot air.

- Place the hermetically sealed boxes of instruments in the Poupinel loosely

packed and not stacked, so that air can circulate between them.

- Set the thermostat (3) at the desired temperature (see below).

- Set the timer (5) at the desired time (see below).

- Close the door.

- Monitor the temperature (4). Timing starts only when the thermometer shows the sterilization temperature is reached. Adjust the setting of the timer at that moment.

Times/temperatures

- There is a choice of 2 sterilization protocols, depending on the type of equipment and the degree of urgency: - Either 160°C for 120 minutes; - Or 170°C for 60 minutes.

- Avoid exceeding 170°C because you risk to damage the instruments.

Key

1. Oven

2. Door

3. Temperature control

4. Thermometer

5. Heating time control

6. Circulating fan

7. Shelf

8. Electricity supply

Inputs

- **Electricity**
- **Poupinel**
- **Metal instrument boxes**
- **Indicator tape (if available)**

Important

- **Ensure that timing starts only once the sterilization temperature (160°C or 170°C) has been reached.**
- **If "Poupinel" adhesive sterilization indicator tape is available (do not confuse it with the tape used for autoclave sterilization which is very similar), stick small pieces on the outside of the boxes; the indicator tape turns brown if the correct temperature and time have been achieved.**
- **Only sterilize metal instruments (without any plastic or rubber parts), heat-proof glass ("Pyrex" type) or vaseline in the poupinel. Any other type of material will burn.**
- **Anything which can not be sterilized in the Poupinel may be sterilized in an autoclave (see Sterelisation by autoclave).**
- **This method of sterilization consumes a lot of electricity. Although there are charcoal or kerosene-heated Poupinels available, only the electric models are considered reliable.**

Sanitary surveillance

STANDARDIZED FORM
SANITARY SURVEILLANCE FORM

Camp :	Section :	Date :
a) Population :	c) Number of shelters :	
b) Number of families :	d) Number of persons/shelter :	
WATER SUPPLY :		
e) Type :	b) Litres/ person/ day :	

Sanitary surveillance

Method

The aim of sanitary surveillance is to perform a regular and continuous evaluation of the performance of a water supply and sanitation programme. The analysis of its results should reveal both technical and operational problems in such a way as to highlight trends and promote immediate action and, if necessary, a reorientation of the programme by a revision of the objectives and resources deployed.

Sanitary surveillance is done above all through field observation (or sanitary inspection), and by establishing indicators which allow specific objectives set for the programme to be quantified (e.g. quantity of water per person per day).

- The frequency of surveillance activities depends firstly on the situation and the results obtained. Monthly inspections should be considered a minimum. When there are particular problems (e.g. a sudden influx of people, the rainy season, epidemics, evaluation of a programme's impact), this frequency is increased.**
- To carry out the sanitary surveillance correctly, a standardized form is used to collect essential information (see opposite page). This form should be adapted to each situation and should always be designed for use and interpretation by local staff, who should eventually be able to carry out this surveillance themselves.**
- Sanitary inspections develop field knowledge, an understanding of how well the water and sanitation installations function and are maintained, and of the habits and practices of the population and general hygiene conditions. It is preferable to carry out inspections accompanied by local staff responsible for the area, and by**

one or more representatives of the population and anyone else who is influential and who has a good knowledge of the place and the people.

- The indicators to be monitored are most commonly chosen according to specific objectives and standards set by the programme. These indicators may be:

- water quantity: the number of people /water point, litres/person/day, number of containers/family;**
- water quality: free chlorine residual, bacteriological quality, turbidity, taste and odour;**
- disposal of excrete and refuse: number of people/latrine, refuse pits/family or section, etc.**

Key

- Example of a sanitary surveillance form**

Inputs

- 1 sanitary surveillance form, adapted to the particular situation.**
- 1 bucket, 10 or 20l and a watch for measuring water flow.**
- 1 Pooltester (if chlorination is done, to measure free chlorine residual; see brief Monitoring chlorination).**
- 1 portable bacteriological analysis kit (if the programme demands, see brief Water sampling).**

Important

- The analysis of epidemiological data collected in curative health structures**

(morbidity due to diarrhoeal, dermatological and ophthalmic diseases, and diseases transmitted by insect vectors) is complementary to the sanitary surveillance carried out on the ground. It allows a relationship to be established between the health status of the population and its general living conditions and hygiene. It also allows better targeting of action to take and of the health messages to spread.

- The information gathered during a sanitary survey should be interpreted and communicated to everybody involved in the programme, without forgetting the local staff who work directly with the population concerned.

- It is important to maintain the frequency of surveillance in order to sustain interest and to follow the evolution and impact of sanitation and water supply activities over time.

[Home](#) > [ar](#).[cn](#).[de](#).[en](#).[es](#).[fr](#).[id](#).[it](#).[ph](#).[po](#).[ru](#).[sw](#)



Public Health Technician (MSF, 1994, 192 p.)

III - Vector control

 *(introduction...)*

 **A. Introduction**

 **B. The principal vectors: biology and control methods**

 **C. Precautions for use and storage of insecticides**

 **D. Spraying equipment**

 **E. Technical briefs**

Public Health Technician (MSF, 1994, 192 p.)

III - Vector control

This chapter is an introduction to vector control. It presents some methods of chemical control of the principle disease vectors. It should always be born in mind that a large-scale control programme necessarily demands specialist skills.

A. Introduction

Since the introduction of DDT forty years ago, numerous chemical products have been invented for the destruction of disease vectors and agricultural insect pests.

Two major problems have appeared:

- Many insects vectors have developed a resistance to these products.**
- Their human toxicity has, at times, caused serious public health problems.**

In the context of the work of Medecins Sans Frontieres we are confronted by these problems in several ways:

- in the course of medical treatment after poisoning,**
- as users during a specific vector control programme,**
- as trainers in public health.**

This chapter should, within the limited context of our actions, allow us to choose and to use suitably some selected insecticides, to know the precautions for their use and finally to be able to take emergency medical action in the case of

poisoning. But it is also intended as a warning against the apparent ease of use and effectiveness of these products.

The use of pesticides is costly, is never without risk and is not always effective. In the context of a medical programme it may be conceived:

- either in an emergency phase (an epidemic due to a vector),**
- or when the control of vector breeding sites is a problem (difficult to locate, far away, etc.).**

Chemical control should always be planned alongside a programme of improvement of the site and/or of general living conditions and hygiene (the removal of stagnant water and refuse, scrub clearance, reduction of living density, water and sanitation services, etc.).

If no action is taken in this direction even the most active and powerful insecticide would have little impact in the long term.

The pesticides are frequently used in agriculture often, however, the users are not informed of the precautions to take during the transport and use of these products. The health problems which result may go unnoticed because the poisoning is chronic.

Here again, the remedy is prevention: information and education.

B. The principal vectors: biology and control methods

Mosquitoes

Lice
Flies
Fleas
Rodents

General introduction

Knowledge, however small, of the biology of each vector is a sine quae non of effective control measures.

It is useless to try to combat body lice by treating the hair, or to try to control Culex larvae by treating clean standing water. It is vital to know how, where and when to act.

Nevertheless, it is possible to identify some principles common to all vector control programmes:

- The aim should be to make the local environment unfavourable for the development and survival of the vector (environmental hygiene).**
- Combat is generally more effective if * is focused on immature forms of the vector.**
- Complete eradication is frequently unattainable; the objective should be to keep the vector population below a level at which it poses a too great risk of an epidemic.**

Mosquitoes

Mosquitoes form the largest group of vectors of medical importance, with more

than 3,000 species. Their life cycle is closely linked with water.

Life cycle

There are four stages of development. The first three are aquatic (egg, larva, nymph), and generally last for two weeks.

The adult (or imago) feeds on plant sap. Its lifespan varies from one to several months. The maturation of eggs in the female needs a blood meal (except for the first laying in Culex species).

Larvae may thrive in any water body except for deep water such as large river, lake or sea.

Certain genera (Aedes) use sites where the water level is variable (dependent on rainfall), such as tree trunks or leaves. Others are more specific to stagnant and heavily polluted water (Culex).

The activity of the adult varies with species: the sphere of action, hours and places of activity, type and specificity of food, etc.

Thus, in order to carry out effective control it is important to find out what species is concerned and what are its specific features.

Control methods

ENVIRONMENTAL HYGIENE

The main aim is to alter the environment so as to make it unfavourable for the reproduction of the species concerned.

-Aedes aegypti

This species is often associated with human dwellings where it breeds in any open container of water. Control measures aim at getting rid of these types of sites, or at protecting them (with a cover, or mosquito netting with mesh <0.7 mm).

Large water containers should be frequently emptied (at least once per week).

- Culex

Control measures aim to eliminate bodies of stagnant water loaded with organic matter (e.g. in latrines), or if not, then to eliminate surface vegetation in stagnant water and ensure that these water bodies are at least 1.2 m deep.

- Anopheles

Control measures are identical to those for Culex, although Anopheles have a wider distribution. Land drainage and filling also has an impact but this is rarely possible.

However, it may be necessary to couple these environmental hygiene and improvement measures with chemical control of larvae and adults.

In this case the relevant government department should be called in, as the misuse of insecticides, particularly in the aquatic environment may cause

irreparable ecological disturbance and favour the development of resistance, etc.

In the case of a viral epidemic (encephalitis, yellow fever, etc.), individual protection should be done by using:

- **mosquito nets (mesh diameter less than 0 - 7 mm) on openings of houses and over beds;**
- **repellent creams and lotions**

CHEMICAL CONTROL

- **Larvicides**
 - **fuel oil: spread over the whole water surface (little used).**
 - **paraffin: 30 l/ha, 1 glass/latrine/week.**
 - **malathion: 224 to 692 g active product/ha.**
 - **temephos: 56 to 112 g active product/ha.**
 - **deltamethrin: 2.5 to 10 g active product/ha.**

Chemicals formulated in granules or in emulsifiable concentrate.

- **Adulticides**
 - **Persistent treatment**
 - **deltamethrin: 0.05 g active product/m²**
 - **malathion: 1 to 2 g active product/m²**
 - **permethrin: 0.5 g active product/m²**

- **propoxur: 1 to 2 g active product/m,**
- **pirimiphos-methyl: 1 to 2 g active product/m²**

· **Aerial application**

Confined to specialists.

Lice

Only the body louse is a potential vector. It is found almost exclusively between the skin and clothes. Transmission of possible pathogens through the louse's excretions (e.g. typhus) or by the louse being crushed (e.g. recurrent fever).

The louse population may grow when personal hygiene is poor (lack of water, soap or clothes), where there is overcrowding and when it is cold. A situation of a risk of epidemic may be reached, demanding emergency measures, including the use of an insecticide.

Before any action is taken, a study of the resistance of the lice to insecticides should be done by a competent laboratory or by an experienced person in the field. In the absence of resistance (which is rare), DDT or malathion may be used. If in doubt, propoxur (or permethrin) is almost always a good choice.

Powder is used, as treatment of the body. The concentration depends on the product, but 30 g of powder per person is the standard dose. Powder is applied to the fully clothed subject at the neck, half at the front and half at the back, then spread by rubbing. Pay special attention to belts and socks if these are worn. Bedding, blankets and clothes may also be treated, in a plastic bag for example.

Every bout of fever or large drop in temperature (e.g. on death) promotes the movement of lice to a new host. Patients should therefore be disinfected before being admitted to a hospital structure.

Control measures include:

- **Improvement of hygiene and reduction of overcrowding.**
- **Preventive treatment of clothes, blankets etc distributed (by immersion, spraying or powdering).**
- **Active treatment of every body by powdering (treatments, 1 week apart).**
- **Treatment of clothes by damp heat (1 hour at 70) and by dry heat (ironing).**

Only this method ensures the elimination of lice, ticks, and bacteria (but it uses a lot of energy).

It must not be forgotten when treating that dust from clothing etc. is contaminating (excrete of lice).

- **If possible, inform people of the danger of crushing lice between finger nails or teeth (risk of spread of borrelia).**

Equipment

- **Powder blower (hand or knapsack)**
- **Soupspoon: still the cheapest and most practical (1 soup spoon = 15 g: use one at the front and one at the back).**
- **Powdering tin or pierced bag.**
- **Bath, tub or simple knapsack sprayer for liquid application.**

Informing the population and training operators are two essential parts of a control programme.

Precautions:

- **Powders:** dust masks and gloves for teams of operators doing treatment.
- **Liquids:** see Precautions for use.

When treating head lice, malathion is, the usual choice of insecticide (except if there is resistance). Prepare an aqueous solution of 4% active product, add a gentle detergent if possible (e.g. fabric detergent or shampoo, to aid the penetration into ticks) and apply about 15 ml to the head of each person. Leave to act for 24 hours before rinsing. Do not use on children of less than three years.

Deltamethrin may also be used, as a solution of 0.03% active product (2.5 ml of concentrated solution/litre or one sachet of 33 g/litre of water), or a 0.05% solution of permethrin. This treatment should be avoided if at all possible.

Flies

General points

This order is composed of a wide range of species which differ in their ecology, their behaviour and their medical importance.

The domestic fly has a life cycle of 10 to 30 days, depending on temperature.

The larvae develop in mammal and bird excrete, in waste waters, and in

decomposing organic matter (medical and domestic refuse). The adult which lives for 2 to 8 weeks has a radius of activity of about three kilometres. It feeds on moist or liquid substances rich in sugars and proteins.

This species is closely linked to the human environment and frequently moves between contaminated areas (excrete, medical wastes, etc.), food and drink, thus playing a disease-carrying role.

Other species are of particular medical importance due to their specific biology: those attracted by lacrymal or nasal secretions, open wounds, domestic refuse, dead bodies, etc. They are important in the spread of conjunctivitis, plan (yaws), trachoma, dysentery, etc.

Glossinia (Tsetse fly, vector of trypanosomiasis) and glossinnia (black fly, vector of onchocerciasis) demand the implementation of a specific programme because of their medical importance and their biology; the complexity of such a programme is beyond the scope of this guide.

Control methods

Larval sites, i.e. the places where eggs are laid and where the larvae develop, are very often a product of human activity.

The basic principle of all control measures should be to reduce or remove these sites, or to prevent access by flies. Without these environmental hygiene measures, all control efforts are in vain.

In practical terms, these measures focus on:

- **Animal excreta: cleaning of stockraising areas.**
- **Refuse: organize collection and ensure disposal by burning or burial under at least 30 cm of soil. Make covered refuse containers available (in particular in kitchens, laboratories and health centres).**
- **Spilled food: make smooth floors in feeding centres (smoothed cement or plastic sheeting) to aid cleaning.**
- **Wastewater: ensure good removal and disposal, particularly at washing areas for clothes and cooking utensils.**

Recourse to chemical products should be avoided as much as possible, because of the rapidity of appearance of resistant strains which render this option costly and ineffective.

In practice:

- **In the case of massive infestation by larvae of a defecation trench or latrines, used engine oil, diesel or kerosene is used to spread an impermeable layer which asphyxiates the larvae (but take care of the risks of polluting the water table). Ashes or earth may be added to latrines pits (after each defecation, or at least every morning and night), to reduce the contact between flies and excreta.**
- **In the case of an epidemic, when the presence of flies creates a risk of increased spread of the pathogen, and when an operating theatre or treatment room must be protected, the use of larvicides and adulticides may be considered, but always in tandem with environmental hygiene measures.**
- **Destruction of larvae**

Spraying of larval sites with an emulsion or a suspension until the surface is completely wetted.

· Destruction of adults

Treatment with a residual effect should be done on the surfaces where flies land at night, as it is here that there is the longest contact time. These places may differ according to the species and the climate. In general they are external surfaces of building (in hot countries), trees, fences, dustbins, animal shelters, etc.

The insecticide is applied in an emulsion or a suspension.

Malathion (5% solution, 1 to of active or deltamethrin (see technical brief) are the most suitable.

To give a permanent protection to certain places (e.g. operating theatre, dispensary, kitchen), strips of gauze or cotton impregnated with insecticide may be used (1 m length/m² of ground surface area). Renew the impregnation every two months. Where there is a concentration of flies in a limited area (e.g. in a feeding centre), poisoned baits may be used (though there is a risk of poisoning of children and poultry). These baits should always be placed outside (on the windowsill, door, etc). They may be:

- Dried food mixed with a toxic product (1 to 2%). The bait is then spread at a rate of 6g/ 10 m². or**
- A 10% aqueous sugar solution mixed with the toxic product (0.1 to 0.2%), which is spread with a watering can or sprayer.**
- Fly traps.**

Fleas

Fleas are blood-feeding (haematophagic) insects with a close relationship with their host. Their developmental stages all occur on land.

The flea is usually a specific parasite but it is capable of changing its host (wild or domestic rodent, man, etc.) in certain circumstances.

Biology

The development cycle lasts about one month. The eggs are laid in dusty places in houses or in rodents nests.

The larvae are found in dark places (negative photo-trophism).

In the adult stages both sexes are blood feeders.

Contamination of the host may take place through a bite (plague) or excrete (typhus), so dust may be highly contaminating.

Control methods

Control is essentially by chemical methods, even if cleaning dwellings and burning dust gets rid of eggs and larvae.

It is essential to determine the sensitivity to any given insecticide because of the many problems of resistance.

Bedding and clothes are treated with an insecticide powder.

Disinfectant products (chlorine solution, 4% cresyl, etc.) are effective against eggs and larvae.

In the case of a risk of epidemic (plague) it is essential to destroy the population of fleas without harming the host species (e.g. rat) because of the risk of human infestation would be increased.

Control is done by putting insecticide powder on the rodent's trails or in their nests. Permethrin (0.5%), propoxur (1%) or any other effective insecticide is used. (Organochlorines are generally ineffective.). The powder is laid down in lines 50 cm long and 3 mm wide near to a non-poisonous bait, to attract the maximum number of rodents.

Rodents

General points

Rodents make up about half the mammal population and thus play an important role as reservoirs of pathogens in the transmission of diseases to other mammals.

Domestic rodents (and those of medical importance) are composed essentially of three species of the muride family: the black rat, the brown rat and the mouse.

Methods of transmission

Pathogenic agents are transmitted by:

- an ectoparasite of the rodent which thus plays only a secondary role (e.g.

plague);

- rodent excrete (e.g. salmonella, leptospirosis);**
- a bite.**

Biology

- The black rat**

The adult measures about 40 cm from head to tail and weighs 250 g.

The muzzle is pointed, the ears round and protruding from the fur, and the eyes protuberant. The animal may be dark grey or brown.

The nest is built generally on the ground, in vegetation or in trees (and exceptionally in a burrow or sewer).

In houses the nests are generally built under the roof and the territory is more "aerial" than terrestrial with a radius of about sixty meters.

Its diet is very varied (vegetable and animals). Sexual maturity is reached at two months (5 litters of 7 to 8 rats per month).

- The brown rat (or sewer rat)**

The colour is generally brown. It is bigger than the black rat and may exceed 400 g. Its muzzle is rounded and the eyes and ears are smaller than those of the black rat.

This species is not well adapted to hot countries. Nests are built in burrows (entrance diameter: about 8 cm).

The diet is less varied than that of the black rat. The brown rat prefers refuse and human wastes. Its biology is identical to that of the black rat.

- The domestic mouse

This is a well known universal species. Its biology is similar to that of the rats. It can survive with the water enclosed in food (flour, etc.) whereas the rat needs "free" water (e.g. infusion liquids).

Its maximum weight is 20 g, and its length 20 cm. For two animals of the same size, the head and feet are larger in the young rat.

Nests are built in any place where there is an accumulation of material for making the small shelter which the mouse needs, making control difficult, specially as the adult's sphere of activity is never more than a few meters.

Control methods

ENVIRONMENTAL HYGIENE

As for any other vectors, this means making the environment unsuitable for rodents, working on two fronts:

- Food

- **packaging of stored food**
- **disposal of refuse**

- **Reproduction: elimination of likely sites (refuse tips, waste packaging scrub).**

PROTECTION AGAINST RODENTS

The aim is to prevent access by rodents to important or vulnerable areas (food stores, infusion liquids, etc.).

- **Block or protect all openings greater than 6mm with cement or metal netting (1 mm wire, mesh less than 6 mm dia).**
- **Fit discs on cables joining roofs.**
- **Paint a smooth band on walls at 1m from the ground to prevent passage on rough vertical surfaces.**
- **Fix galvanized sheet (1mm) at the bottom of doors and on the skirtings.**

Stores are always places where people come in and out and where doors are often left open. It is therefore useful, in addition to the above mentioned measures, to organise stores according to the following points:

- **Repair all broken packages;**
- **Leave a passage (1m) between walls or pillars and stacks, to allow inspection;**
- **Stack bags with care, leaving a sufficient space between the top of the stack and the roof;**
- **Clean the store daily and never let a stack remain intact for more than a month.**
- **Inspect the store at least once per week, looking for:**

- **insects,**
- **signs of damage on the bags (water, mould, fermentation, etc.),**
- **the presence of rodents,**
- **empty bags and refuse not thrown away.**

TRAPPING

This method never achieves complete eradication by itself. It may be used to get rid of the last few survivors of a chemical control campaign or individuals of an isolated and small infestation.

Spring traps are the only efficient models. The key points to follow are:

- **Many traps should be used.**
- **The traps should be placed perpendicular to the rodents' trails.**
- **Rat traps should be left unset for several days so that the rats become used to them (except for mouse traps). A well placed trap does not need bait.**

POISONING (POISONED BAIT)

Two classes of product are used:

- **Single dose poisons**

These are only effective if the animal ingests a lethal dose at the first feed, otherwise it will not go back to the bait.

These substances are extremely toxic and in addition they need special skills and

experience in rodent control if their use is to be at all effective. For information, they are:

- **Zinc phosphate (1 to 5%),**
- **fluorocetamide (2%),**
- **sodium fluoroacetate (0.25%),**
- **certain anticoagulants.**

- Multiple-dose poisons

These are anticoagulants with a cumulative effect used at low doses, which have two advantages:

- **The slowness of their effect allows the animal to absorb a lethal dose before the first effects are felt.**
- **Their mode of action makes them less dangerous to man and other domestic animals, and there is an effective antidote.**

Products in use

See the table on the following page.

The bait is bought ready to use, or made with broken cereal grains which are soaked over night to moisten them to make a thick paste. Sugar may be added (5%) to make it more attractive, as it is important to persuade the animal away from its usual food and get it to stick to this new diet.

The poison is then mixed in, and the bait is laid on the rodents' trails in piles of

25g (mice) or 200g or more (rats).

These baits should be out of reach of other animals. They can be laid in particular ways (e.g. a slightly open plastic bag, a short piece of pipe, a small wooden box, etc.).

Effects should be seen in 3 weeks for the brown rat, 4 to 5 weeks for the black rat and the mouse.

The baits are always renewed, and left in excess. The dead bodies should be disposed of quickly and well: pick them up twice per day and put them in a plastic bag (with their fleas).

Chemical control will only be effective if it is complemented by environmental hygiene and if both efforts cover the whole area concerned.

Periodic inspection should allow renewed control measures before being faced with a new massive infestation.

MULTIPLE-DOSE PRINCIPAL RODENTICIDES USED IN BAITS

Active product	Poisoning level	Against	Dose in baits
Chlorophacinone	"Poison" or "Dangerous" depending on concentration : $\geq 1\%$	Brown rat, domestic mouse, field mouse	0,005% 60cc of commercial product 0,25% 0,0075%
Coumachlore	"Poison" or "Dangerous" depending on concentration : $\geq 1\%$	Brown rat, black rat, domestic mouse	0,025%
Coumafène (Warfarine)	Depending on concentration : $\geq 1\%$	Brown rat, black rat, domestic mouse	0,025%
Calcitrol		Domestic rodents resisting to classical anticoagulants	0,025%

N.B. : all these products may be used in poison trails (1% powder in a line 50 cm long and 2mm wide).

Figure**C. Precautions for use and storage of insecticides**

Precautions to be taken by the operator

Before use, the operator must be sure of the nature of the product and familiar with the manufacturer's specifications. In case of any doubt about the origin of this product, its storage conditions, or if the label is missing, a concentrated insecticide should never be used.

Check the spraying equipment. Pressured equipment should always be operated first with water to trace any leaks (often a cause of poisoning).

For engine-driven sprayers, protect the insecticide feed pipe from the exhaust pipe.

The preparation stage (dilution, filling the tank) is the most dangerous, as concentrated products are handled.

During preparation and treatment the following rules should be respected and enforced:

- Do not smoke, drink or eat.**
- Do not keep cigarettes on you.**
- Do not put anything to your mouth (to unscrew, blow, unblock, etc.).**
- Wear protective equipment corresponding to the toxicity of the product being used:**
 - Powder: dust-mask and gloves.**
 - Liquid: canvas overalls, wide-brimmed hat, boots and gloves resistant to hydrocarbons, side protection glasses and mask. For the mask, the cartridge**

should correspond to the product being used and should be changed regularly (every 60 hours, in the open air). Check that it is airtight before starting work (take care of beards, hair, etc.).

- **Make sure that these safety precautions are feasible (heat, etc.).**
- **Do not spray if it is windy.**
- **Establish a rotation of the team to avoid too long exposure for each individual.**
- **Empty and clean the equipment at the place of treatment. Do not throw remaining products in ditches, ponds, water courses or any place which may involve pollution of the aquatic environment.**
- **Ensure that the staff are well trained in taking the above measures.**
- **Ensure that the medical services have been warned and that they have the means to take the necessary action in case of poisoning.**
- **Always have a shower system available (bucket of water and soap).**

Criteria for selecting staff

Avoid people with the following risk conditions when selecting staff to make up a treatment team:

- **Pregnancy,**
- **Alcoholism, chronic or otherwise,**
- **History of liver or nerve disorders,**
- **Heavy smoking,**
- **Allergies or skin diseases.**

More subjective criteria are also important:

- **professional integrity,**
- **meticulous work,**
- **neatness and tidiness.**

Before starting to make up and train a team, find out if suitable people are already available in the region (although a mosquito control team is not trained to manage a programme to control lice, or do aerial spraying).

Precautions to take during transport and storage

TRANSPORT

One of the most frequent risks of poisoning by insecticides is from leakages of concentrated toxic products during transport. International legislation forbids the transport of concentrated products with foodstuffs. Serious accidents have already occurred through not respecting this basic rule.

For land transport, always repack drums with leaks or with worn corners at the base. Put straw (or other absorbent material) in the bottom of the vehicle.

This should be burned on arrival. Load with care, pack the drums closely together and tie them down to avoid them jumping up and down.

The packaging of certain powdered products needs special protection against rain (craft paper bags).

Direct contact between the driver and the load should be avoided (separate cab), specially for powdered and granulated products.

STORAGE

Insecticides should be stored under lock and key. They should be out of reach of children, animals and thieves. The store should be separate and at a distance from food stores. The building should be cool, well ventilated and dry. Ideally, the store should not be deep, so that drums of concentrated products may be handled without having to go right into the store. Raise the containers off the ground if there is any risk of flooding.

Long-term storage should be in metal drums coated on the inside with a flexible varnish. Use anti-rust paint if there is any trace of oxidisation. The drums should be stored on their sides with the plugs (of the drain holes) towards the bottom, and recovered with liquid, in order to avoid the entry of air and humidity which would oxidise and denature the product.

Never store more insecticides than necessary, as disposal of the excess requires very special techniques.

Empty containers

There are several important precautions which must be taken when reusing metal containers:

- Empty the container well.**
- Rinse several times with a detergent solution.**
- Rinse a final time with a mixture of water, detergent + 10% sodium bicarbonate. Leave in the container for several hours, stirring from time to time, then rinse with clear water.**

All the water used in this process should be disposed in a hole in the ground.

It is preferable to avoid reusing? the drums for food or water. If, for a good reason, this rule cannot be respected, make sure that the above measures have been taken.

D. Spraying equipment

The type of equipment depends on the product being used and on the type of treatment (surface, spatial, etc.).

Powders

- Soup spoon: treatment of individuals.**
- Powder blower (hand or knapsack): treatment of the ground, bedding, people.**
- Pierced tin, or jute sack: treatment of floors, of vegetation.**

Liquids

-Aerial application

Just for information.

-Atomisers

This equipment gives an immediate and temporary treatment by creating a fog (condensation of the solvent in the air into very fine droplets).It is an engine-driven machine portable or mounted on a vehicle.

- Sprayers

This equipment gives a persistent treatment by spreading the insecticide in visible drops on walls, floors, stretches of water, etc.

Four techniques are used:

- **The liquid is pumped in a tank.**
- **The liquid is expelled in a watertight receptacle by the compression of its surface air.**
- **The liquid is carried away by a gaseous current.**
- **The liquid is expelled by centrifugation.**

E. Technical briefs

Classification of insecticides

Chemical methods for insect control

Formulations

Propoxur

Permethrin

Deltamethrin

Malathion

Pyrimiphos-methyl

Temephos

Repellents

Impregnation of mosquito nets

Classification of insecticides

A classification enables the grouping of chemically related compounds, to deduce their toxicity and precautions for use.

MINERAL COMPOUNDS

- Mineral oils: spreading on the water surface asphyxiates and poisons larvae which are there. (mosquitoes, etc.).

ORGANOCHLORINE COMPOUNDS (NEUROTROPIC POISON)

- DDT (Dichloro-diphenyl-trichloroethane): a compound of low toxicity to vertebrates. Effective against mosquitoes, ectoparasites (lice, fleas, etc.).

Contact insecticide. Large problems of resistance and big-accumulation, not very biodegradable.

- Methoxychlorine: same as for DDT. Partially biodegradable.

- HCH (Hexachlorocyclohexane) ("Lindane", "Gamurexane"): more toxic, less persistent than DDT, but less resistance and more biodegradable.

- Chlordane: used only for controlling cockroaches and grasshoppers.

- Dieldrin: very toxic, problems of resistance. To be avoided.

ORGANOPHOSPHOROUS COMPOUNDS (ACETYLCHOLINESTERASE INHIBITOR)

- Malathion: low toxicity, used against ectoparasites and mosquitoes.

- Fenitrothion: low toxicity, used against mosquitoes (eggs and larvae).

- Fenthion: used against mosquito larvae in urban areas and in stock raising areas.

- Temephos: almost no toxicity, used against larvae in drinking water. Problems of

resistance.

- **Chlopyripos: urban larvicide.**
- **Dichlorvos: against domestic arthropods (high toxicity and vapour pressure).**
- **Chlophoxim: mosquito larvicide.**
- **Pyrimiphos-methyl: skin contact dangerous, used by spraying (aqueous dilution), widely used in public health work**

CARBAMATES (ANTICHOLINESTERASICS)

- **Propoxur: domestic insecticide, low toxicity.**
- **Carbaryl: problems of resistance.**

PYRETHRIN-PYRETHRINOIDS

- **Decamethrin (Deltamethrin) ("K-Othrine"): low toxicity, irritant to mucosa. Effective aluticide, almost universally used but expensive.**
- **Permethrin: ditto.**

Chemical means of insect control

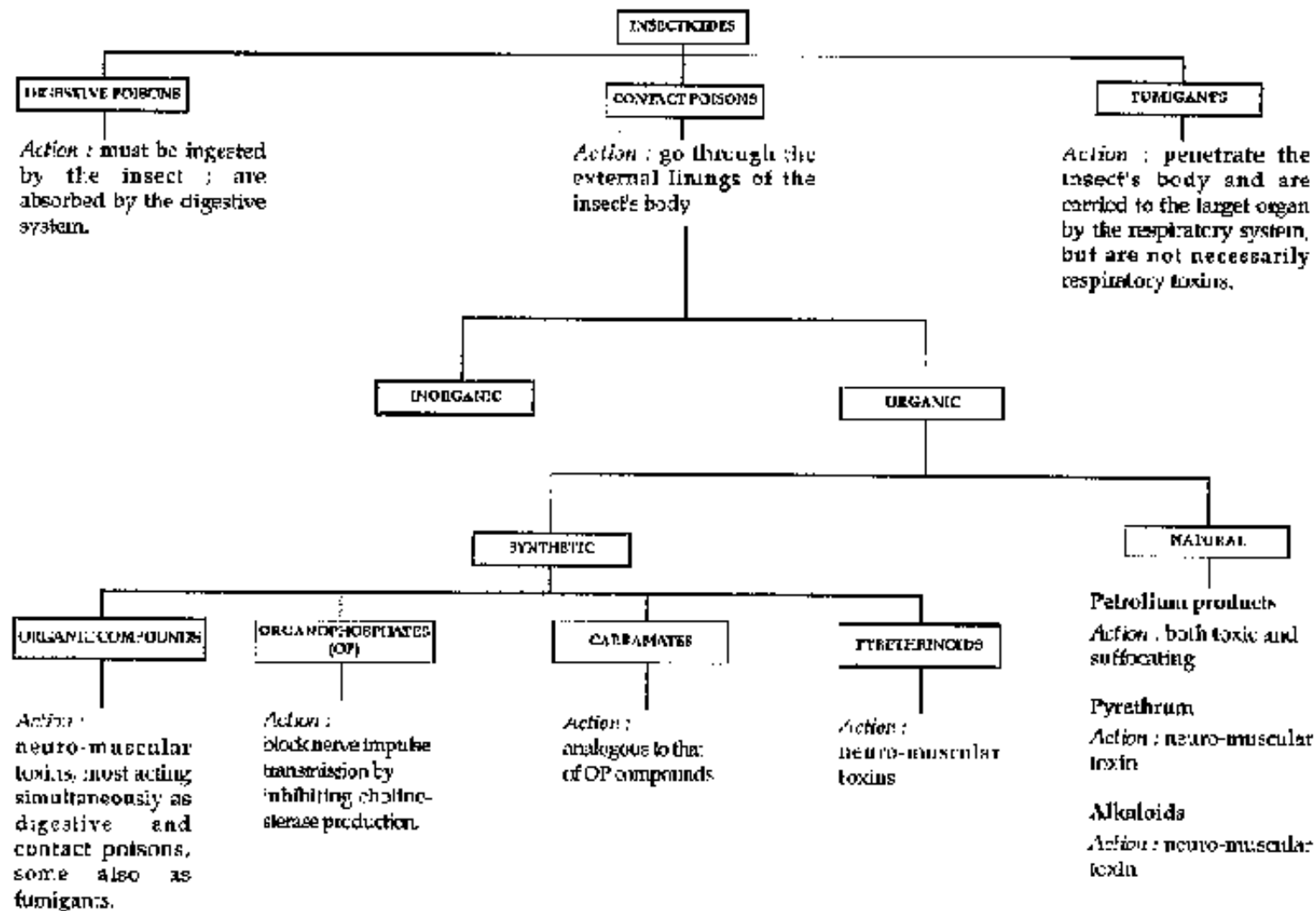

Figure

Formulations

- Technical product

Active ingredient in its purest commercial form. Used almost exclusively for ultra low volume (ULV) application.

- Powder and granules

Active ingredient (0.5 to 10%) with inert carrier (talc, gypsum, etc.). Powder is used for the control of lice and fleas. Granules allow better penetration of dense vegetation.

- Wettable powder

Active ingredient (20 to 80%) + wetting agent + inert carrier. Used for preparation of aqueous solutions.

- Concentrated suspension

Active ingredient in a fine powder (10 to 50%) + wetting agent + water. Used for preparing aqueous suspensions.

- Solution

Active ingredient dissolved in a solvent. As most insecticides are insoluble in water, the solvent is most commonly gas oil, kerosene or even acetone or xylene.

- Emulsifiable concentrate

Active ingredient (25% or more) + solvent + emulsifying agent (oil). This formulation allows dilution in water later.

- Emulsion

Emulsifiable concentrate + water.

- Slow-release formulations

Slow-dissolving capsules, granules, briquettes, etc., which allow continuous release of larvicide in water.

The concentration may be expressed as weight per volume (for liquid formulations) as weight per weight (dry formulations).

INTERNATIONAL CODE OF DIFFERENT FORMULATIONS (EXTRACT)

AB: bait as a grain

AE: aerosol generator

AL: other liquids to be used without dilution

BB: bait as a block

BR: briquette

CB: concentrate for preparation of bait

CG: granulated in capsules

CS: capsules suspended in a liquid, to be diluted in water before use

DP: dusting powder

EC: liquid concentrate, to be diluted in water before use

EO: emulsion with oil, ready to use

EW: emulsion with water, ready to use

FG: fine granules (0.3 to 2.5 mm)

GB: granulated bait

GG: large granules (2 to 6 mm)

GR: granules ready for use

LA: Lacquer

MG: micro-granules (0.1 to 0.6 mm)

OF: concentrated suspension to be diluted in oil

OL: liquid to be diluted in oil

PB: bait in bars

RB: bait, ready for use

SL: liquid formulation to dilute in water

SP: powder to dilute in water

SU: suspension, ready to use for ULV treatment

TC: product in its most concentrated commercial form

UL: liquid, ready to use for ULV treatment

WP: wettable powder, for dispersion in water

Propoxur (Carbamate)

Commercial names

- Baygon
- Blattanex
- Uden

Toxicity (per os for rats)

- LD50 = 95 mg/kg

Mode of action

- Contact or ingestion

Formulation

- Powder to dilute: 1%, 2%**
- Wettable powder: 50 %, 70%**

Method of use

- Dusting powder**

Ready to use at the rate of 1 to 2g of active ingredient (100 or 200g of powder per m²)

- Wettable powder**

Dilute in water for a final concentration of 0.5 to 1% of active ingredient (powder at 50% > 20 g/litre, - powder at 70% > 1kg/litre), spray at a rate of 100 ml/m²

For use against

- Body lice**
- (mosquitoes, cockroaches, bugs, fleas).**

Cost

- Powder: about \$3 US/kg (25kg metal drum).**

Quantity to allow

- **For treating 1,000 people for body lice: 40kg + losses.**

Precautions

- **Avoid inhaling (dust masks for treatment team).**

Permethrin (Pyrethrinoid)

Commercial names

- **Ambush**
- **Coopex**
- **Stomoxin**

Toxicity (rats)

- **LD50 = 430mg/kg**

Mode of action

- **Contact, ingestion**

Formulation

- **Dusting powder: 0.5 and 1%**
- **Concentrated solution: 25% and 10%**

Method of use

- Dusting powder

Ready to use

- Concentrated solution

Depending on vector

For use against

- Lice**
- Impregnation of mosquito nets**

Cost

- Powder: about \$2 US/kg (25kg bag)**
- Concentrated solution: about 16 US \$/litre**

Quantity to allow

- For treating 1,000 people for body lice: 40kg + losses.**

Precautions

- Avoid contact with mucosa (dust mask, goggles).**
- Possible skin allergies.**
- Do not rinse with hot water.**

Deltamethrin (Pyrethrinoid)

Commercial names

- **K-Othrine**
- **Decamethrin**
- **NRDC 161**
- **Cistin**
- **Decis**

Toxicity (rats)

- **LD50 = 135 mg/kg**

Mode of action

- **Contact and ingestion**

Formulation

- **Wettable powder: 2.5%**
- **Concentrated liquid: 25g/litre**

Method of use

- **Wettable powder**

One sachet of 33g/6litres of water

- **Concentrated liquid**

1 litre/ 200 litres of water

- **Spray at the rate of 1 litre/ 10 m²**

For use against

- **Flies, cockroaches (bait)**
- **(fleas, ants, mosquitoes, etc.).**

Cost

- **Wettable powder: about \$3 US per 33g sachet**

Quantity to allow

- **1 sachet per 60 m²**

Precautions

- **No specific precautions**

Malathion (organophosphate)

Commercial name

- **Malathion**

Toxicity (rats)

- LD50 = 2.100 mg/kg

Mode of action

- Contact

Formulation

- Concentrated liquid; concentration varies with manufacturer.

Method of use

- Prepare a 1% Malathion shampoo with a detergent solution. Apply 15 to 20 ml per person. Do not rinse for 24 hours.

For use against

- Headlice

Cost

- About \$6 US/litre

Quantity to allow

- Depends on concentration of initial solution

Precautions

- **Use a deodorised product.**

Pyrimiphos-methyl (organophosphate)

Commercial name

- **Actellic**

Toxicity (rats)

- **LD50 = 2.018 mg/kg**

Mode of action

- **Contact**

Formulation

- **Emulsifiable concentrate**
- **Wettable powder**
- **Dusting powder**

Method of use

- **Flies**
 - **Actellic 50 EC: 1 litre in 40 litres of water**
 - **Actellic 25 PM: 1kg in 20 litres of water**
 - **Powder at 2%: ready for use**

- Bait

1 g/m² of powder at 2%, mixed with sugar half and half)

For use against

- Adulticide with immediate or residual effect on flies, mosquitoes, lice, fleas, etc.

Cost

- Concentrate at 50%: about \$14 US/litre

- Powder, 1%: about \$4 US/kg; powder, 2%: about \$5 US/kg

Quantity to allow

- Depends on formulation used

Precautions

Temephos (organophosphate)

Commercial name

- Abate

Toxicity (rats)

- LD50 = 8.600mg/kg

Mode of action

- **Contact**

Formulation

- **2% solution**
- **Emulsifiable concentrate**
- **Granules**
- **Briquettes**

Method of use

- **Reservoir of drinking water: 56 to 112g of active ingredient/hectare for 2 to 4 weeks**
- **River: 1g/m³ of flowing water for 10 minutes**

For use against

- **Mosquito larvae in drinking water**
- **Simulium (blackfly) larvae**

Cost

- **2 % solution: about \$7 US/kg**

Quantity to allow

- **Depends on the formulation and the area to be treated.**

Example: 2% solution: 3 ml/3 m3 of drinking water.

Precautions

- **No specific precautions**

Repellents

Repellents are chemical products used on cloth or on the skin for protection against insects.

Products used

- **DEET or diethyltoluamide**
- **Dibutyl phtalate**
- **Dimethyl phtalate**

Formulations

- **Lotion**

The active ingredient is dissolved in an organic solvent. This formulation may be used on the skin or on cloth. Only natural fibres or nylon have no risk of reaction with the solvent.

- **Cream**

The active ingredient is incorporated in a cream.

An attractive effect has sometimes been noted during the first minutes. For this reason, creams are not effective until after 30 minutes.

Dose

The normal dose is:

- 20g of active ingredient per m² (cloth, mosquito net, etc.).**
- 7g of active ingredient per person.**

Effectiveness

This varies according to the species concerned. It may be assumed that 100% protection lasts not more than two hours, whatever the product, and that it is about 80% after 5 hours.

Precautions

- These products conform to the standards of the cosmetics industry and do not pose any particular risks for the skin.**
- Only benzyl benzoate and dibutyl phtalate have a repellent action in a very humid atmosphere.**

Other repellents should be applied on a dry surface; this application should be renewed if the surface has got wet (rain, excessive sweating, etc.).

Impregnation of mosquito nets

The use of mosquito nets impregnated with insecticide gives individual protection

against nocturnal insects in houses (carriers of malaria), which is much more effective than using an untreated net.

Choice of insecticide

Deltamethrin 2.5% EC or WP

Or, if not, permethrin, 20 or 10% EC

Dose

-Deltamethrin: 25 mg of active ingredient per m² of cloth (minimum 15 mg/m²)

- Permethrin: 200 to 500 mg/m²

Impregnation method

1. Determine the total area of the cloth

2. Determine the volume of water absorbable by the cloth: dip several identical mosquito nets in a known volume of water, then wring lightly; measure the reduction in the volume of water and divide this volume by the number of mosquito nets (the average is about 15 ml per m²).

3. Dilution

Determine the quantity of active ingredient per mosquito net: multiply the dosage of active ingredient per m² by the area of the net; then determine the corresponding volume of concentrated solution and thus the factor of dilution (volume of water + volume of concentrated solution).

Example:

- **area: 18.7 m²**
- **dose of active ingredient: 25 mg/m²**
- **product: deltamethrin 2.5 mg/m²**
- **volume of concentrated solution: $467.5 \times 100 / 2500 = 18.7$ ml**
- **volume for impregnation of mosquito net: 280 ml**
- **dilution = $280 / 18.7$, or $1/15$**

4. Impregnation

- **One net:**

Put the mosquito net in a water-tight plastic bag. Add the predetermined volumes of water and insecticide for that mosquito net.

Close the bag and knead well to ensure good impregnation, then take out the mosquito net and leave it to dry, preferably flat, to avoid dripping and the movement of the insecticide to the bottom of the cloth.

Replace the mosquito net in the bag for storage and distribution.

- **Several nets:**

After having determined the dilution factor, prepare a volume of insecticide solution sufficient for the number of mosquito nets to be treated. Dip the nets, then wring lightly and proceed as above.

These operations should be performed by staff trained in the use of insecticides.

Take care when disposing of excess solution to avoid damaging aquatic life and affecting water quality.

Choose a coloured cloth which dirties less easily and which is therefore washed less often.

Persistence depends on the product and the climate but mostly on washing; a persistence of six months is realistic in most cases if the net is not washed.

[Home](#) > [ar](#).[cn](#).[de](#).[en](#).[es](#).[fr](#).[id](#).[it](#).[ph](#).[po](#).[ru](#).[sw](#)



 **Public Health Technician (MSF, 1994, 192 p.)**

 **(*introduction...*)**

 **1. Water in camps of Displaced people**

 **II - Sanitation**

 **III - Vector control**

 **IV - GIossary, conversion tables and estimations**

 **V - Bibliography**

IV - GIossary, conversion tables and estimations

Glossary

English French Spanish Definition

A

Absorption	Absorption	Absorpcin	Incorporation of one substance by another (e.g.: of a gas by a liquid, of a liquid by the soil).
Accumulation rate	Taux d'accumulation	Tasa de acumulatin	Rate at which decomposed fecal matter builds up in a latrine pit, expressed in m ³ per person per year, and used for the calculation of effective pit volume.
Activated carbon	Charbon actif	Carbon activo	Specially prepared powdered or granulated carbon, used in final treatment of drinking water by absorption, particularly for the removal

			of dissolved organic pollutants which
			impart taste and odours to water.
Adsorbent	Adsorbent	Adsorbente	Solid particle (e.g.: activated carbon) of
			very large surface with the property of
			fixing dissolved solids and colloids in
			water.
Alternating twin	Latrine a fosse	Letrina sobre	Latrine with two pits used alternately
pit latrine	double	dos fosas	
Apron	Tablier	Banqueta	Concrete surface surrounding the
			head
			of a well for protection and drainage.
Available	Chlore actif	Chloro activo	Pure chlorine content of a chlorine-
chlorine			generating product, expressed as a
			percentage, or in chlorometric
			degrees
			(e.g.: 70% for calcium hypochlorite).

Aquifer	Nappe phratique	Capa freatica	Saturated, permeable, underground rock
(water table)			formation.
Autoclave	Autoclave	Autoclave	Equipment for sterilization by saturated
			water vapour (humid heat) during 20
			mins at 135°C (2 bars) or 30 mins at
			121°C (1 bar).

B

Bacteria	Bactries	Bacterias	Microscopic unicellular organisms,
			certain of which are disease-causing
			agents.
Bacteriological	Analyse	Analisis	Identification of bacteria of the coliform
analysis	bactriologique	bacteriolgico	group and/or other micro-organisms
			indicating contamination of water by
			fecal material.

Biodegradation (decomposition)	Biodegradación	Biodegradación	Natural process of destruction of organic material by microbiological activity.
Burying	Enterramiento	Enterramiento	Action of covering with earth (e.g. refuse: see controlled tipping).

C

Calcium	Hypochlorite	Hipoclorito	Chlorine-generating product in a form hypochlorite
	de calcium	de calcio	containing 65 to 70% available chlorine, made by reacting chlorine with calcium hydroxide.
Candle filter	Bougie	Filtro de porcelana	Ceramic filter element (pore size: 0.45 μ).
Catchment	Captage	Captatin	Part of a well below the static level of the water table which allows water to flow into the well, or the emergence zone of a spring where water may be

			collected.
Catchment ring	Buse de captage	Tubo de captacin	Perforated or porous concrete cylinder
			sunk into the water table, through
			which water passes.
Chemical analysis	Analyse chimique	An lisis quimico	Identification of undesirable or toxic
			chemical substances whose maximum
			permissible concentrations determine
			the potability of water.
Chlorinated lime	Clorure de chaux	Cloruro de calcio	Chlorine generating product (CaO
			2CaOCl ₂) in powder form, containing
			30% chlorine. Less stable than calcium
			hypochlorite.
Chlorine	Chlore	Cloro	Reactive element (Cl) with strong
			oxidising powers, used for the
			disinfection of water (destruction of
			organic material and biocidal action)

			organic material and bacterial action).
Chlorine compound	Produit gnrateur	Derivado Product	used for disinfecting water,
	de chlore	del cloro	containing a proportion of available
			chlorine which is released or dissolving
			in water.
Chlorine demand	Demande	Demanda	Difference between amount of chlorine
	en chlore	de cloro	added to water and total residual
			chlorine level after 30 mins (= chlorine
			consumed).
Combined residual chlorine	Chlore rsiduel combine	Cloro residual combinado	Fraction of chlorine added to water
			which is not consumed, but combined
			with certain substances (with some
			disinfectant power, but less than free
			residual chlorine).
Concrete ring	Buse	Tubo de concreto	Short concrete cylinder for supporting

			and lining the sides of a well to make
			them impermeable.
Contact time	Temps de contact	Tiempo de contacto	Period necessary for the reaction of
			chlorine with organic matter contained
			in water (more or less 30 minutes).
Contamination	Contamination	Contaminatin	Introduction of potentially pathogenic
(pollution)			micro-organisms or chemical
			substances presenting health risks into
			the environment.
Controlled tipping	Dcharge controle	Relleno sanitario	Method of disposal of solid wastes by
(sanitary landfill)			burial in successive layers in ground
			exclusively reserved for this purpose.

D

DPD1	DPD1	DPD1	Diethyl-p-phenylene diamine. Used in
			tablet form with a colorimetric

			comparator to measure free residual chlorine.
Defecation	Dfcation	Defecacin	Passage of waste matter from the bowels.
Detergent	Dtergent	Detergente	Compound used in cleaning (e.g. washing clothes), often found in polluting wastewater.
Disinfect	Dsinfecter	Desinfectar	To kill a large proportion of micro organisms present in water or on a surface.
Distribution box	Bote de distribution	Caja distribuidora	Construction for collecting effluent from a septic tank and distributing it equally among drains in a multiple trench infiltration system.

Domestic refuse	Domestic managers	Basuras	Putrescible or non-putrescible solid
/waste			waste material from household activities.
Drain	Drain	Tubo de desague	Underground pipe with pierced holes or slots to allow the passage and infiltration of water.
Drainage	Drainage	Drenaje	Removal of water by ditches or pipes.

E

Effective grain size	Granulometrie	Granulomtrica	Range and average of size of grains of sand or other material used as a filter material.
Effluent	Effluent	Effluente	Partially or totally treated wastewater coming from a treatment unit

			and going to secondary treatment or disposal in.
Emergence/eye	Rsurgence	Resurgimiento	Place where spring water appears at the
			surface.
Evapotranspiration	Evapotranspiration	Evapotranspiracin	Removal of water into the air by a
			combination of direct evaporation and
			transpiration by plants.

F

Faeco-oral transmission	Transmission fco-orale	Transmicin oro-fecal	Transmission of pathogens from fecal matter to the digestive system via the mouth (fecal contamination of water, food, hands, etc).
Ferrocement	Ferrociment	Ferrocemento	Technique of constructing walls by applying layers of cement mortar to a

FRAMEWORK OF WIRE/MESH.

Filtration	Filtration	Filtracin	Passage of water through a porous layer (filter) which traps suspended solid.
Free residual chlorine	Chlore rsiduel libre	Cloro residual libre	Fraction of available chlorine added to water which remains in excess and which still has disinfectant power after 30 minutes contact time (0.3 to 0.5mg/l).

G

Grease trap	Bac dgraisseur	Trampa para grasa	Construction for separating fatty material from wastewater before disposal in a soakaway pit or infiltration field.
Groundwater	Eau souterraine	Agua subterr nea	Infiltrated water contained in underground layers, forming a body of water.

H

Helminths	Helminthes	Helmintos	Parasitic worms of man and other
-----------	------------	-----------	----------------------------------

			animals (e.g. ascaris).
Hot air sterilizer	Poupinel	Pupinel	Equipment for sterilization by hot air
			(dry heat) during 120 minutes at 160°C
			or 90 minutes at 170°C.
Human wastes	Dchets humains	Desechos humanos	Faeces and urine (excreta).
Hygiene	Hygine	Higiene	Practice related to keeping clean and healthy.

I

Incineration	Incinration	Incineracin	Action of reducing refuse to ashes (e.g. incineration of medical refuse).
Infiltration trench	Tranche d'infiltration	Zanja de absorcin	Structure for disposing of wastewater by underground drainage, using
			trenches and drains.

Irrigated garden	Jardin irrigu	Jardin irrigado	Vegetable garden watered with
			wastewater recovered from water
			points (an alternative technique to
			infiltration systems).

L

Leachate	Liquide de	Liquido residual	Liquid resulting from the
	fermentation	de fermentacin	decomposition of organic matter in a
			refuse tip.
Lysol	Lysol	Lysol	Solution of cresol and soap (powerful
			disinfectant used for floors and other
			surfaces).

M

Medical waste	Dchets mdicaux	Desechos mdicos	Refuse from the activities of a health
			centre. Medical waste is potentially
			contaminated (see Contamination).
Micro-	Micro-	Micro-	Microscopic animal or vegetable

organisms	organismes	organismos	organisms.
Motorpump	Motopompe	Motobomba	Pump powered by an electric motor or combustion engine.

N

Non-return valve	Clapet anti-retour	Valvula de	Valve allowing water to flow in one
	retencin	direction	only, installed at the start of a
			delivery pipe from a motorpump to
			stop backflow when pumping stops.

O

Oxidize	Oxyder	Oxidar	To transform into the oxidised state by
			combination with oxygen.
Organic matter	Matieres organiques	Materias organicas	Residues and extracts of living
			organisms.

P

Permeability	Permabilit	Permeabilidad	Ability of soil to allow water to infiltrate.
Pit latrine	Latrine a fosse simple	Letrina simple	Latrine with a single pit dug in the ground.
pH	pH	pH	Expression of the degree of acidity or alkalinity of a substance. The value of 7.35 is neutral; values above this are alkaline, values below are acidic.
Phenol Red	Rouge de phnol	Rojo de fenol	Chemical compound used to measure pH by colorimetric comparison. May be in tablet form.
Pour-flush latrine	Latrine a siphon d'eaude	Letrina con sifon de ague	Latrine in which the slab has a pan and water trap which is flushed manually.
Protozoa	Protozoaires	Protozoares	Group of unicellular microscopic animals, certain of which cause disease (e.g amoeba).

R

Rainwater	Eaux pluviales	Aguas pluviales	Water from atmospheric precipitation
			which may form a water source.
Resurgence	Rsurgence	Resurgimiento	See Emergence.
Retention time	Rtention	Retencin	Time during which wastewater is held
			in a tank to undergo treatment (e.g. 1 to
			3 days for a septic tank).
Run-off	Eaux de	Aguas de	Water flowing naturally on the ground
	ruissellement	escurrimiento	surface.

S

Sanitary	Inspection	Inspeccin sanitaria	Field observation, using criteria
inspection	sanitaire		to
			evaluate the environmental
			hygiene
			status of a settlement (e.g.
			refugee
			camp).

Schmutzdecke	Schmutzdecke	Schmutzdecke	Biological layer playing a purifying role,
			at the surface of a slow sand filter.
Sedimentation/ settling	Sdimentation	Sedimentacin	Process of deposition of suspended solids in water by gravity.
Septic tank	Fosse septique	Fosa sptica	Tank for collection and partial treatment of household wastewater before disposal by sub-surface drainage.
Sewage	Eaux vannes	Aguas negras	Wastewater from sanitation installations (containing excrete).
Slow sand filtration	Filtration lente	Filtracin lenta en arena	Water treatment technique which combines mechanical filtration

			(sand)
			with biological purification (see Schmutzdecke).
Soakaway pit	Puits perdu	Pozo de	Hole filled with stones, used for
		absorcin	infiltration of wastewater.
Sodium	Hypochlorite	Hipoclorito	Chlorine-generating product (NaOCl)
hypochlorite	de calcium	de calcio	with 5 to 15 % available chlorine, much
			less stable than solid products.
Sodium	Thiosulfate	Tiosulfato	Crystalline chemical substance used for
thiosulphat	de calcium	de sodio	dechlorinating drinking water.
Spring	Source	Manantial	Ground water which flows naturally to
			the surface.
Standing	Eaux	Aguas	Water from rain or human

stagnant water	estancadas	which stays on the ground surface.	activities
Sterile	Strile	Estril	That which contains no germs or any other form of life.
Sterilization	Strilisation	Esterilizacin	Elimination of all microorganisms from water or from a surface: virus, bacteria and microscopic fungi.
Stormwater	Eaux pluviales	Aguas pluviales	Rainwater running on the ground surface (collected and disposed of separately from wastewater).
(rein run-off)			
Stock solution	Solution mre	Solucin madre	Concentrated chlorine solution, generally 1%, used for chlorinating a known volume of water

			KNOWN VOLUME OF WATER.
Strainer	Crpine	Pichancha	Filter at the bottom of a motorpump
			suction pipe to keep back large
			impurities. Often used with a non
			return foot valve.
Submersible pump	Pompe immerge	Bomba submergida	Pump with the pumping part under the
			water (delivery only).
Subsurface	Ependage	Esparcimiento	Treatment and elimination of drainage
	souterrain	subterraneo	wastewater by infiltration into the
			subsoil.
Sullage/grey water	Eaux mnagres	Aguas usadas	Wastewater from kitchens and
			bathrooms.

Surface pump	Pompe de surface	Bomba de superficie	Handpump or motorpump with the
			pumping part at the surface (suction
			head limited to 7m).
Surface water	Eau de surface	Agua superficial	Water from precipitation, making
			streams, rivers, lakes, ponds, etc.
Suspended	Matières en	Materias en	Organic and mineral particles
suspension	suspension	suspended	solids in water.

T

Trench latrines	Feuilles	Letrinas	Shallow trenches used for defecation in
		atrincheradas	certain emergency situation.
Turbid water	Eau turbide	Aqua turbida	Water containing fine particles in
			suspension which gives it a cloudy
			appearance (turbidity is expressed in

			NTU units).
--	--	--	-------------

V

Ventilated improved	Latrine ventilee	Letrina ventilada	Pit latrine equipped with a ventilation pipe to reduce flies and odour, with a fly screen at the top.
(VIP) latrine	ameliore	mejorada	
Virus	Virus	Virus	Extremely small living organisms, which can only multiply inside living cells which they parasitise.

W

Washing area	Aire de lavage	Lavadero	Area or structure designed for washing clothes and personal hygiene (washing slab, wash tub etc).
Wastewater	Eaux uses	Aguas servidas	Sewage and sullage.
Well	Puits	Pozo	Hole in the ground which enters an...

			and	underground body of water (water table)
				to allow its abstraction.

Conversion tables

Distances

Surface

1 km = 0.6214 miles 1 km² = 0.386 miles² = 100 ha

1 m = 1.0936 yards 1 ha = 2.471 acres = 10000 m²

1 cm = 0.394 inches 1 m² = 1.196 yd² = 10000 cm² = 10.76 in²

1 mile = 1.609 km 1 mile² = 2.59 km² = 240 acres = 259 ha

1 yard = 0.914 m

1 foot = 0.305 m 1 acre = 0.405 ha = 4.840 yd²

1 foot = 30.48 cm 1 yd² = 0.836 m² = 9 ft²

1 inch = 2.54 cm 1 ft² = 0.09 m² = 144 inch² = 930 cm²

1 inch² = 6.54 cm²

Volume

Capacity

1 m³ = 1.307 yd³ = 1000 litres 1 litre = 0.22UK Gal.

1 m³ = 35.32 ft³ = 1.76 UK Pints

1 cm³ = 0.061 in³ = 0.26US Gal

1 yd³ = 0.765 m³ = 27 ft³ = 2.11US Pints

1ft³ = 28.32 litres = 1728 in³ 1ml = 0.0675 fluid ounces (fl.oz.)

1in³ = 16.39 ml

1 UK Gal. = 4.55 litres = 8UK Pints = 1.20 US Gal.

Weight

1 tonne = 0.984 long (UK) tons 1 UK Pint = 0.568 litre = 20 fl. oz.

= 1.102 short (US) tons

1 US Pint = 0.473 litre = 16 fl. oz.

= 2204 pounds (lb)

1 fl. oz. = 28.41 ml

1 kg = 2.205 lb

= 35.27 oz

Water weight (at 16.7°, so 62°F)

1 g = 0.03oz 1litre = 1kg

1 UK ton = 1016 kg = 2240 lb 1 UK Gal.= 10lb

1 US ton = 907.1 kg = 2000 lb 1 US Gal.= 8.33lb

1 UK ton = 1.1 US ton

1 lb = 0.4 kg = 16 oz = 453.6g

1oz = 28.35g

Temperatures

From Centigrade to Farenheit: multiply by 1.8 (9/5) and subtract 32.

From Farenheit to Centigrade: add 32 and multiply by 0.555 (5/9).

0°F = -17.8°C

32°F = 0°C

50°F = 10°C

68°F = 20°C

98.4°F = 36.9°C

104°F = 40°C

Materials and work estimate

(From A Handbook of Gravity-Flow Water Systems [18])

EXCAVATIONS Per m³

Ordinary soil 0.55 man - days (m - d)

Gravelly soil 0.77 m - d

Boulder mix 1.10 m - d

Medium rock cutting 1.60 m - d

Hard rock cutting 2.50 m - d

WOOD WORKING Per m³ of finished wood

Skilled labour 18 men - day

Unskilled labour 18 men - day

STONB AGGREGATE PRODUCTION Per m³ of crushed rock

Unskilled labour 14 men - day

CONCRETE Per m³: 1: 2 4 mix 1:1: 3 mix

Cement 0.25 m³ 0.33 m³

Sand 0.50 m³ 0.50 m³

Aggregate 1.00 m³ 1.00 m³

Mason labour 1.1 man - days 1.1 man - days

Unskilled labour 4.0 man - days 4.0 man - days

PLASTER* Per m³:1:4 mix 1: 3 mix 1: 2 mix
Cement 0.0025 m³ 0.0030 m³ 0.0050 m³
Sand 0.01 m³ 0.01 m³ 0.01 m³
Mason labour 0.14 m - d 0.14 m - d 0.14 m - d
Unskilled labour 0.22 m - d 0.22 m - d 0.22 m - d
*** Each coat of plaster = 1 cm thick**

BRICK MASONRY (1: 4 mortar) Per m³
Bricks 75%
Cement 0.063 m³
Sand 0.25 m³
Mason labour 1.4 m - d
Unskilled labour 2.8 m - d

RUBBLE-STONE MASONRY (1: 4 mortar) Per m³
Cement 0.089 m³
Sand 0.35 m³
Mason labour 1.4 m - d
Unskilled labour 3.2 m - d





DRESSBOUND-STONE MASONRY (1: 4 mortar) Per m³
Cement 0.075 m³
Sand 0.30 m³
Mason labour 2.8 m - d
Unskilled labour 5.0 m - d

SPECIFIC WEIGHTS kg/m³

Portland cement: 1,440
Brick masonry: 2,120
Stone masonry: 2,450
Concrete: 2,409
Seasoned wood: 650
Water: 1,000
Dry-stone masonry 2,000

[Home](#) > [ar](#).[cn](#).[de](#).[en](#).[es](#).[fr](#).[id](#).[it](#).[ph](#).[po](#).[ru](#).[sw](#)



-  **Public Health Technician (MSF, 1994, 192 p.)**
-  **(introduction...)**
 - 1. Water in camps of Displaced people**
 - II - Sanitation**
 - III - Vector control**
 -  **IV - Glossary, conversion tables and estimations**
 -   **V - Bibliography**

V - Bibliography

1. ASSAR M.

Guide d'assainissement en cas de catastrophe naturelle
OMS - Genève - 1971

2. BURGEAP**La construction des puits en Afrique tropicale****Ministre de la Coopération et du Développement - Paris -1981****3.* CAIRNCROSS S., FEACHEM R****Small water supplies****Ross Bulletin 10 - 1978****4.* CAIRNCROSS 57 FEACHEM R.****Environmental health engineering in the tropics: an introduction text****John Willey - 1983****5.* CHLEQ J.L., DUPRIEZ H.****Eau et terres en fuite****L'Harmattan - Enda - 1984****6. COMITE FRANCAIS D'EDUCATION POUR LA SANTE****Promotion de la santé, document technique n°: Les eaux usées faciles ...
traiter****Ministre de la Santé - Paris - 1987****7. DIRECCION DE ENGENIERIA SANITARIA, SECRETARIA DE SALUBRIDAD Y
ASISTENCIA****Manual de saneamiento, agua, vivienda y desechos****Limusa - Mexico - 1984****8. FEACHEM R., BRADLEY D., GARELICK H., MARA D.****Sanitation and disease: health aspects of excreta and wastewater management**

John Willey - 1983

**9. FEACHEM R., MC GARRY M., MARA D.
Water, wastes and health in hot climates
John Willey - 1977**

**10. GARANCHERJ.
L'assainissement automome individuel et collectif
Editions du moniteur - Paris - 1986**

**11. GAULENE M.C. PERRAULT A.M.
Lutte antivectorielle contre la trypanosomiase humaine en Haute-Volta
Thse de doctoral en mdecine - Toulouse - 1982**

**12. GENTILINI M., DUFLO B.
Mdecine tropicale
Flammarion - 1986**

**13. GRET
Le point sur la construction de citernes, Recueil et stockages des eaux de pluies
GRET - Paris - 1984**

**14. GRUNDFOS
La pompe en agriculture
Agri - Nathan - 1984**

**15.*HCR
Manuel des situations d'urgence. Premire partie: Oprations sur le terrain**

HCR - Genve - 1982**16. HELVETAS COOPERATION SUISSE AU DEVELOPPEMENT**

**Manuel technique pour l'approvisionnement en eau des zones rurales
SKAT, ATOL - 1981**

17.*HOWARD J.

**Safe drinking water. An Oxfam Technical guide
Oxfam - Oxford - 1978**

18.*JORDAN T.D. Jr.

**A handbook of gravity-flow water systems
Intermediate Technology Publication - 1984**

19. LANOI J.N., ROY M.L.

**Manuel du technicien sanitaire
OMS - Genve - 1976**

20. MARA D.

**Sewage treatment in hot climates
John Willey - 1976**

21.*MARA D.

**The design of pour-flush latrines TAG - Technical note n13
UNDP - World Bank - 1984**

22. MARA D.

The design of pour-flush latrines TAG - Technical note n15

UNDP - World Bank - 1985

23. MINISTERE DE LA COOPERATION

**Memento de l'adjoint technique des travaux ruraux
Ministre de la Cooperation - Paris - 1977**

24. OMS

**Normes internationales pour l'eau de boisson - 3me dition
OMS - Genve - 1972**

25. OMS

**Directives de qualite pour l'eau de boisson, Volumes 1 et 3
OMS - Genve - 1985**

26. OMS

**Techniques de base pour le laboratoire mdical
OMS - Genve - 1980**

27. OMS

**Guide pratique pour l'eau potable et l'assainissement rural et suburbain
OMS - Copenhague - 1984**

28. OMS

**Les leishmanioses
OMS - Genve - 1984**

29.*OMS

Lutte antivectorielle en sant internationale

OMS- Genve - 1973

30. OMS

La trypanosomiase africaine: pidmiologie et lutte

OMS - Genve - 1986

31.*RAJAGOPALAN S7 SHIFFMAN M.

Mesures simples contre les maladies intestinales

OMS - Genve - 1975

32. RODHAIN F., PEREZ C.

Prcis d'entomologie mdicale et vtrinaire

Maloine Sa. Editeur - Paris - 1985

33. ROSS INSTITUTE

Control of domestic flies

Ross Institute Bulletin - n5 - 1982

34. ROSS INSTITUTE

Insecticides

Ross Institute Bulletin - n1 - 1981

35.*SIMMONDS S., VAUGHAN P., GUNN S.W.

Refugee community health care

Oxford University Press - 1983

36. SOGREA H

Les pompes et les petites stations de pompage

Ministre de la Cooperation - Paris - 1978**37.*STERN P. et al.**

Field engineering: an introduction to development work and construction in rural areas

Intermediate Technologies - London - 1983

38. TDRI

Food storage manual

TDRI, 2nd edition - England - 1983

39. THEUNYNCK S., HALTER A.

Filtre ... sable et ... charbon de bois

Fiche n683 - GRET - Paris

40. TROPICAL HEALTH TECHNOLOGY

Medical laboratory manual for tropical countries, Volume II

Monica Cheesbrough - 1984

41.*U.S.A.I.D.

Water for the world - Technical notes

Agency for international development - Washington

42.*UNICEF

Aide aux situations d'urgence

UNICEF - Genève, New York - 1986

43. WHO

Chemical methods for the control of arthropod vectors and pests of public health importance

WHO - Geneva - 1984

44. WHO

Equipment for vector control

WHO - Second Edition - Geneva - 1974

45.*WINBLAD U., KILAMA W.

Sanitation without water

MACMILLAN - London - 1985

