









































- ➔  **A Guide to the Development of On-site Sanitation (WHO, 1992, 246 p.)**
-  **(introduction...)**
-  **Preface**
-  **Part I. Foundations of sanitary practice**
 -  **Chapter 1. The need for on-site sanitation**
 -  **Introduction**
 -  **Historical evidence**
 -  **The present situation**
 -  **Constraints**
 -  **Priorities**
 -  **Chapter 2. Sanitation and disease transmission**
 -  **Diseases associated with excreta and wastewater**
 -  **How disease is carried from excreta**
 -  **Chapter 3. Social and cultural considerations**
 -  **(introduction...)**
 -  **Social structure**
 -  **Cultural beliefs and practices**
 -  **Concepts of hygiene**
 -  **Beliefs about sanitation and disease**
 -  **Forces for change**

-  **Responses to change**
-  **Conclusion**
-  **Chapter 4. Technical options**
 -  **(*introduction...*)**
 -  **Open defecation**
 -  **Shallow pit**
 -  **Simple pit latrine**
 -  **Borehole latrine**
 -  **Ventilated pit latrine**
 -  **Pour-flush latrine**
 -  **Single or double pit**
 -  **Composting latrine**
 -  **Septic tank**
 -  **Aqua-privy**
 -  **Removal systems for excreta**
-  **Part II. Detailed design, construction, operation and maintenance**
 -  **Chapter 5. Technical factors affecting excreta disposal**
 -  **Human wastes**
 -  **Ground conditions**
 -  **Insect and vermin problems**
 -  **Chapter 6. Operation and maintenance of on-site sanitation**

 ***(introduction...)***

Pit latrines

 **Simple pit latrines**

 **Ventilated pit latrines**

 **Ventilated double-pit latrines**

 **Pour-flush latrines**

 **Offset pour-flush latrines**

 **Double-pit offset pour-flush latrines**

 **Raised pit latrines**

 **Borehole latrines**

 **Septic tanks**

 **Aqua-privies**

 **Disposal of effluent from septic tanks and aqua-privies**

 **Composting latrines**

 **Multiple latrines**

 **Other latrines**

Chapter 7. Components and construction of latrines

















 ***(introduction...)***

















 **Pits**

 **Latrine floors**

 **Slabs**

 **Footrests and squat holes**

-  **Seats for latrines**
 -  **Water seals and pans**
 -  **Vent pipes**
 -  **Superstructure**
- Chapter. 8 Design examples**
 -  **Introduction**
 -  **Pit latrine design**
 -  **Septic tank design**
 -  **Aqua-privy design**
 -  **Disposal of effluent from septic tanks and aqua-privies**
 -  **Composting toilets**
- Part III. Planning and development of on-site sanitation projects**
 - Chapter 9. Planning**
 -  **(*introduction...*)**
 -  **The demand for sanitation**
 -  **Project definition**
 -  **Background information**
 -  **Comparison and selection of systems**
 - Chapter 10. Institutional, economic and financial factors**
 -  **Institutional responsibilities**
 -  **Human resources development**

-  **Economic factors**
-  **Financial factors**
-  **Examples**
-  **Chapter 11. Development**
 -  **(*introduction...*)**
 -  **Implementation**
 -  **Operation and maintenance**
 -  **Evaluation**
-  **References**
-  **Selected further reading**
-  **Glossary of terms used in this book**
-  **Annex 1. Reuse of excreta**
-  **Annex 2. Sullage**
-  **Annex 3. Reviewers**
-  **Selected WHO publications of related interest**
-  **Back Cover**

[Home](#) [""](#) ["'"'"'">](#) [ar.cn.de.en.es.fr.id.it.ph.po.ru.sw](#)

-
-  **A Guide to the Development of On-site Sanitation (WHO, 1992, 246 p.)**
 -   **(*introduction...*)**
 -  **Preface**
 -  **Part I. Foundations of sanitary practice**

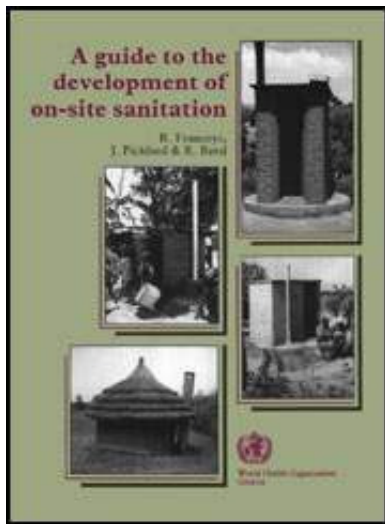

- **Part II. Detailed design, construction, operation and maintenance**
- **Part III. Planning and development of on-site sanitation projects**
- 📄 **References**
- 📄 **Selected further reading**
- 📄 **Glossary of terms used in this book**
- 📄 **Annex 1. Reuse of excreta**
- 📄 **Annex 2. Sullage**
- 📄 **Annex 3. Reviewers**
- 📄 **Selected WHO publications of related interest**
- 📄 **Back Cover**

R. Franceys, J. Pickford & R. Reed

***Water, Engineering and Development Centre
Loughborough University of Technology
Loughborough, England***

**World Health Organization
Geneva
1992**

The World Health Organization is a specialized agency of the United Nations with primary responsibility for international health matters and public health. Through this

organization, which was created in 1948, the health professions of some 170 countries exchange their knowledge and experience with the aim of making possible the attainment by all citizens of the world by the year 2000 of a level of health that will permit them to lead a socially and economically productive life.

By means of direct technical cooperation with its Member States, and by stimulating such cooperation among them, WHO promotes the development of comprehensive health services, the prevention and control of diseases, the improvement of environmental conditions, the development of human resources for health, the coordination and development of biomedical and health services research, and the planning and implementation of health programmes.

These broad fields of endeavour encompass a wide variety of activities, such as developing systems of primary health care that reach the whole population of Member countries; promoting the health of mothers and children; combating malnutrition; controlling malaria and other communicable diseases including tuberculosis and leprosy; coordinating the global strategy for the prevention and control of AIDS; having achieved the eradication of smallpox, promoting mass immunization against a number of other preventable diseases; improving mental health; providing safe water supplies; and training health personnel of all categories.

Progress towards better health throughout the world also demands international cooperation in such matters as establishing international standards for biological substances, pesticides and pharmaceuticals; formulating environmental health criteria; recommending international non-proprietary names for drugs; administering the International Health Regulations; revising the International Statistical Classification of Diseases and Related Health Problems; and collecting and disseminating health statistical

information.

Reflecting the concerns and priorities of the Organization and its Member States, WHO publications provide authoritative information and guidance aimed at promoting and protecting health and preventing and controlling disease.

WHO Library Cataloguing in Publication Data

Franceys, R.

A guide to the development of on-site sanitation/R. Franceys, J. Pickford & R. Reed

1. Sanitation 2. Toilet facilities 3. Waste disposal, Fluid methods I. Pickford, J. II. Reed, R. III. Title

ISBN 92 4 154443 0 (NLM Classification: WA 778)

The World Health Organization welcomes requests for permission to reproduce or translate its publications, in part or in full. Applications and enquiries should be addressed to the Office of Publications, World Health Organization, Geneva, Switzerland, which will be glad to provide the latest information on any changes made to the text, plans for new editions, and reprints and translations already available.

© WORLD HEALTH ORGANIZATION 1992

Publications of the World Health Organization enjoy copyright protection in accordance with the provisions of Protocol 2 of the Universal Copyright

Convention. All rights reserved.

The designations employed and the presentation of the material in this publication do not imply the expression of any opinion whatsoever on the part of the Secretariat of the World Health Organization concerning the legal status of any country, territory, city or area or of its authorities, or concerning the delimitation of its frontiers or boundaries.

The mention of specific companies or of certain manufacturers' products does not imply that they are endorsed or recommended by the World Health Organization in preference to others of a similar nature that are not mentioned. Errors and omissions excepted, the names of proprietary products are distinguished by initial capital letters.

The authors alone are responsible for the views expressed in this publication.

**TYPESET IN INDIA
PRINTED IN ENGLAND
91/8829 - Macmillan/Clays - 7000**



[Home](#) > [ar](#).[cn](#).[de](#).[en](#).[es](#).[fr](#).[id](#).[it](#).[ph](#).[po](#).[ru](#).[sw](#)









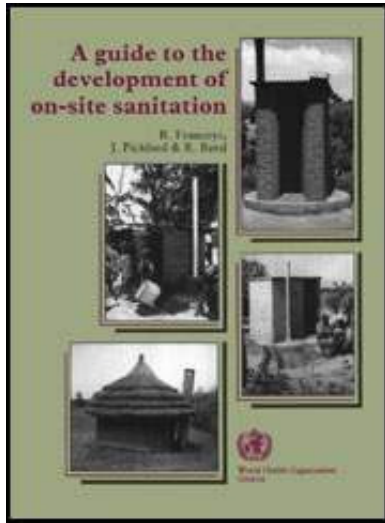





A Guide to the Development of On-site Sanitation (WHO, 1992, 246 p.)



(introduction...)



-  **Preface**
-  **Part I. Foundations of sanitary practice**
-  **Part II. Detailed design, construction, operation and maintenance**
-  **Part III. Planning and development of on-site sanitation projects**
-  **References**
-  **Selected further reading**
-  **Glossary of terms used in this book**
-  **Annex 1. Reuse of excreta**
-   **Annex 2. Sullage**
-  **Annex 3. Reviewers**
-  **Selected WHO publications of related interest**
-  **Back Cover**

Annex 2. Sullage

Sullage is domestic wastewater other than that which comes from the toilet. It results from food preparation, personal washing, and washing of cooking and eating utensils and clothes. It is also called greywater (to distinguish it from blackwater which describes wastes containing human excreta).

There are few published studies of the characteristics of sullage in developing countries. Research in the United States of America has shown that sullage has a lower nitrate content than toilet wastes, and a more soluble and more

biodegradable organic content (Laak, 1974). The suspended solids load in sullage is lower than in wastes from toilets, but it contains more grease and is generally at a higher temperature. Kitchen wastes have a higher suspended solids content, a higher biochemical oxygen demand, and a higher nitrate concentration than other sullage.

The volume and characteristics of the sullage produced by one community may be very different from those of another. A family served only by a remote standpipe or handpump may discard less than 10 litres of sullage per person each day, whereas members of a household with numerous plumbing fixtures may discard 200 litres each or more per day. In some countries, rivers or lakes are used for personal hygiene and for washing clothes and utensils, so that the volumes of wastewater leaving the house are low. Table A2.1 shows the water consumption measured in rural households, demonstrating a wide range of consumption rates.

The nature of the sullage is markedly influenced by factors such as diet, methods of washing clothes and utensils, habits of personal hygiene, and the existence of bathrooms and other facilities.

There are several reasons for keeping sullage separate from excreta. First, there may be a system for on-site disposal of excreta that cannot accept large volumes of water. Alternatively, the sullage may be transported away from the site by a small-diameter pipe that could not handle faeces. A third reason might be to reduce the hydraulic loading on a septic tank by diverting the sullage away from it (Bradley, 1983).

Sullage is discharged or disposed of in a number of ways. Often it is simply tipped

on to the ground in the yard or outside the property where it evaporates or percolates into the soil. It may be used to irrigate a vegetable or flower garden. It may find its way by natural or designed routes into open or subsurface storm drains. Soakpits or drainage fields may be built to disperse the sullage. In some cases the greywater from a number of properties is collected, screened and treated in ponds before it is discharged or reused.

Table A2.1. Water consumption (litres per person per day) in some rural areas in four developing countries

Water use	Lesotho ^a	Uganda ^b		Pakistan Punjab ^c	Mozambique ^d
		Lango	Kigezi		
Drinking and cooking	8.0	5.8	6.4	5.7	2.3
Other domestic use	10.0	11.9	1.6	24.0	10.0
Total	18	18	8	30	12

^a Feachem et al, 1978

^b White et al., 1972

^c Ahmed et al., 1975

^d Cairncross. S., personal communication.

Health implications of sullage management

In general, the health hazards posed by sullage are not as serious as those associated with either wastewater containing excreta or septic tank effluent.

Counts of faecal indicator bacteria have been reported to be significantly lower in sullage than in septic tank effluent (Bradley, 1983), but the washing of babies' clothes and nappies (diapers) is likely to increase the count substantially. Some data suggest that bacteria grow well in sullage (Hypes, 1974).

A substantial danger from pathogens is posed by careless tipping of greywater on the ground. If one particular area is always used, its continual moistness will favour the survival of helminths, such as hookworm, and the breeding of flies and mosquitos. In addition, such an area is more likely to be regarded as a waste dump and so be used for defecation, and this practice will increase the number of parasites. Faeces are not easily seen when the ground is muddy.

The main hazard to public health is posed by mosquitos, especially *Culex quinquefasciatus*, which breed in polluted pond water and may spread bancroftian filariasis. Ponding of sullage is caused by excessive discharge on to the ground, by blockage of surface drains, or by unsatisfactory construction or maintenance of open channels to carry the sullage.

Pollution of groundwater by sullage may be of less concern than the pollution threat from other wastewater, because the bacterial and nitrate contents are relatively low.

It is often thought that the provision of a more abundant supply of water to a community will necessarily bring about an improvement in health. However, if the greater availability of water causes the creation of pools of stagnant sullage (because sullage disposal has not been carefully considered), then the improved water supply could have a negative effect on the health of the community, largely

as a result of the increase in the mosquito population. The disposal of sullage is a particular problem at communal water points. Often, large volumes of wastewater are generated and, if provision is not made for its proper disposal, a significant health hazard may develop.

Disposal of sullage

Pouring sullage on to the ground can be an acceptable means of disposal provided that the soil is not continually moist. This means that the soil must have sufficient permeability and be of adequate area to allow the sullage to percolate away. This method of disposal can be put to good effect by using the sullage to irrigate vegetable gardens, but vegetables that will be eaten raw should not be watered with sullage because of the danger of disease transmission.

Infiltration through field drains or soakpits, as used for the disposal of septic tank effluent, is suitable for sullage. The size of soakpits and trenches may be designed using the long-term infiltration rates shown in Table 5.4. Examples 8.6 and 8.7 in Chapter 8 explain the design of infiltration systems.

Sullage often finds its way, by accident or design, into open drains. Such drains can be a satisfactory method of conducting the sullage to a body of receiving water provided that there is no ponding of sullage in the drains. Pools encourage mosquito breeding, and children often play in them. Ponding is likely to occur where the terrain is flat and the drain slope small, where the drains are rough and unlined so that water collects in depressions, where refuse is deposited in the drains, and where drains are filled in to allow vehicles or pedestrians to cross.

Storm drains that are also used for transporting sullage should have a compound cross-section as shown in Fig. A2.1. This is because the flow of stormwater in the rainy season can be hundreds of times larger than the flow of sullage alone. A simple cross-section designed only for stormwater would conduct the sullage away at a very low velocity, leaving the solids suspended in the sullage in the bottom of the drain. The circular channel in the invert of a compound cross-section allows small flows to move at a higher velocity. Drain-cleaning tools should be adapted to fit the small central channel.

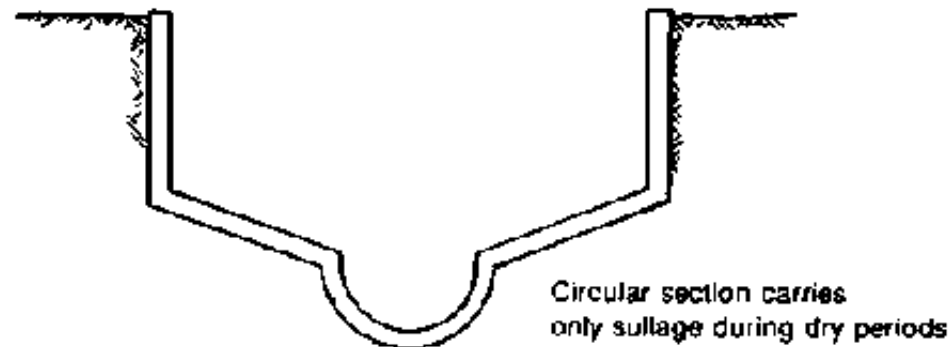

Fig. A2.1. Cross-section of a compound storm drain

WHO 91507

Keeping drains free of refuse is not easy. Unfortunately it is commonly believed that a drain is an appropriate place for depositing solid waste, especially where there is no adequate refuse collection service. Refuse in drains quickly becomes malodorous as it decomposes and is attractive to flies as a site for egg-laying. Removal of such material from the drains is not a popular task. The problem of solid waste in open drains calls for a three-pronged attack:

- the provision of a satisfactory refuse collection service to provide an

alternative outlet;

- **public education, especially on the need to keep the drains clear; and**
- **vigilance on the part of municipal labourers to remove blockages wherever they occur.**

In one city in Brazil, each householder was made responsible for keeping the length of drain outside his or her property clean; grilles were fitted at points in the drains in line with the dividing walls between the properties so that no refuse could be carried on to a downstream neighbour's section, and any flooding occurred in the area where the refuse was deposited (Cairncross, personal communication). Grilles of this type have also been used in other countries, installed by the municipal authorities or by residents to prevent refuse entering the sections of drain for which they are responsible.

Covering the drains may appear to be a solution, but if refuse is deposited in the drains through gaps or by lifting cover slabs, the resulting blockages and ponding are much harder to detect and clear.

Small-bore sewers can be used to convey sullage. Diameters and slopes can be less than those recommended for sewage containing excreta because the solids load is less. Where sand is used for scouring cooking pots it may be necessary to install traps to collect this grit before it goes into the sewer. However, attention must be given to ensuring that these traps are emptied periodically - the mere provision of them without adequate maintenance is not enough. There may also be a risk of grease deposits building up in the pipes. Grease traps can be used to separate grease from the rest of the wastewater, but they are only effective if the accumulated grease is removed at regular intervals. Generally, grease traps are

fitted at garages, restaurants and other commercial premises where large quantities of oil or grease are discharged in the wastewater (Fig. A2.2).

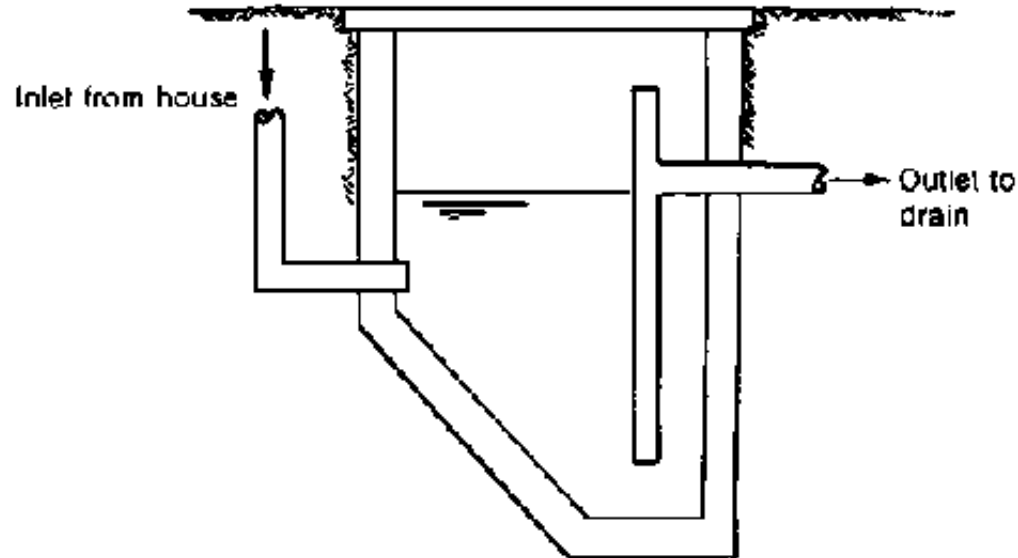

Fig. A2.2. Cross-section of a grease trap

WHO 91508

Sullage can be treated on site to make it more acceptable for final disposal or reuse. Septic tanks can be used; they are effective in removing grease and solids, and do not require frequent desludging (Brandes, 1978). Intermittent sand filters are effective in reducing biochemical oxygen demand and nitrate levels, but Boyle et al. (1982) found they had little effect on the numbers of faecal indicator bacteria.

The selection of the most appropriate sullage disposal system depends on many factors, such as rainfall, soil structure, topography, housing density, water consumption, latrine type, and a variety of social and economic factors. For

example, where there is sufficient yard area, the soil is permeable, the rainfall is such that ponding never occurs, and sullage is produced in small quantities, it may be quite satisfactory to pour the sullage directly on to the soil. Where the subsoil permeability, housing density and income permit, a soakpit is recommended. Alternatively the sullage could be disposed of in a pit latrine, where one exists. Where there is sufficient slope for surface drains, and the ability to keep them free of debris has been demonstrated, disposal to these drains might be acceptable as an interim measure, provided the drainage system has an appropriate discharge point. Small-scale pilot studies are often valuable for assessing the suitability of the various alternatives before implementation on a large scale.

The main problems posed by sullage are socioeconomic rather than technical in origin. Most disposal systems only function correctly if operated and maintained in a proper fashion. This is particularly evident in surface drainage systems where the agencies responsible for maintenance are often under-funded and thus unable to carry out their duties adequately. In such circumstances, the maintenance must be taken over by the community - but the community must first be convinced that clean drains are necessary for good health.

References

AHMED, K. ET AL. (1975) *Rural water consumption survey*. Lahore, Institute of Public Health Engineering and Research (Report No. 026-12-74).

BOYLE, W. C. ET AL. (1982) Treatment of residential greywater with intermittent sand filtration. In: Eikum, A.S. & Seabloom, R.W., ed., *Alternative wastewater treatment*. Dordrecht, Reidel, pp. 277-300.

BRADLEY, R. M. (1983) The choice between septic tanks and sewers in tropical developing countries. *The public health engineer*, 11 (1): 20-28

BRANDES, M. (1978) Characteristics of effluents from grey and black water septic tanks. *Journal of the Water Pollution Control Federation*, 50 (11): 2547-2559.

FEACHEM, R. G. ET AL. (1978) *Water, health and development: an interdisciplinary evaluation*. London, Tri-Med Books.

HYPES, W. D. (1974) Characteristics of typical household greywater. In: Winneberger, J. H. T., ed., *Manual of greywater treatment practices*, Michigan, Ann Arbor Science, pp. 79-88.

LAAK, R. (1974) Relative pollution strength of undiluted waste materials discharged in households and the dilution waters used for each. In: Winneberger, J. H. T., ed., *Manual of greywater treatment practices*, Michigan, Ann Arbor Science, pp. 68-78.

WHITE, G. F. ET AL. (1972) *Drawers of water*. Chicago, Chicago University Press.



[Home](#) > [ar](#).[cn](#).[de](#).[en](#).[es](#).[fr](#).[id](#).[it](#).[ph](#).[po](#).[ru](#).[sw](#)

 **A Guide to the Development of On-site Sanitation (WHO, 1992, 246 p.)**

 **(introduction...)**



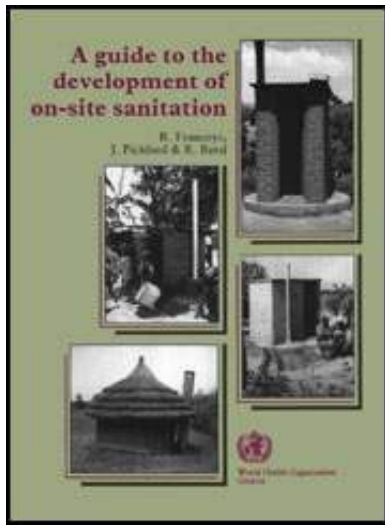

- Preface**
- Part I. Foundations of sanitary practice**
- Part II. Detailed design, construction, operation and maintenance**
- Part III. Planning and development of on-site sanitation projects**
- References**
- Selected further reading**
- Glossary of terms used in this book**
- Annex 1. Reuse of excreta**
- Annex 2. Sullage**
- Annex 3. Reviewers**
- Selected WHO publications of related interest**
- Back Cover**

Annex 3. Reviewers

Dr N. O. Akmanoglu, WHO Centre for Environmental Health Activities (CEHA), Amman, Jordan

Professor S. J. Arceivala, Associated Industrial Consultants, Bombay, India

Dr S. Cairncross, London School of Hygiene and Tropical Medicine, London, England

Mr J. O. Espinoza, WHO Regional Office for Europe, Copenhagen, Denmark

Mr K. Gibbs, United Nations Children's Fund, Quetta, Pakistan

Dr I. Hespanhol, World Health Organization, Geneva, Switzerland

Professor K. O. Iwugo, University of Lagos, Lagos, Nigeria

Mr K. Khosh-Chashm, WHO Regional Office for the Eastern Mediterranean, Alexandria, Egypt

Dr H. Kitawaki, World Health Organization, Geneva, Switzerland

Mr J. N. Lanoix, Consultant Sanitary Engineer, Sarasota, FL, USA

Dr G. B. Liu, WHO Regional Office for the Western Pacific, Manila, Philippines

Dr P. Morgan, Blair Research Laboratory, Harare, Zimbabwe

Mr A. F. Munoz, Pan American Center for Sanitary Engineering and Environmental Science (CEPIS), Lima, Peru

Mr C. Rietveld, World Bank, Washington, DC, USA

Mr A. K. Roy, Consultant Sanitary Engineer, New Delhi, India

Mr L. Roy, Consultant Sanitary Engineer, Neuilly-sur-Seine, France

Mr R. Schertenleib, International Reference Centre for Waste Disposal, Dbendorf,

Switzerland

Dr G. S. Sinnatamby, Senior Sanitary Engineer, United Nations Centre for Human Settlements, Nairobi, Kenya

Mr M. Strauss, International Reference Centre for Waste Disposal, Dbendorf, Switzerland

Mr M. S. Suleiman, World Health Organization, Geneva, Switzerland

Mr H. Suphi, WHO Regional Office for South-East Asia, New Delhi, India

Dr S. Unakul, WHO Western Pacific Regional Centre for the Promotion of Environmental Planning and Applied Studies, (PEPAS), Kuala Lumpur, Malaysia

Mr J. M. G. Van Damme, International Reference Centre for Community Water Supply and Sanitation, The Hague, Netherlands

Dr D. B. Warner, World Health Organization, Geneva, Switzerland



[Home](#) > [ar](#).[cn](#).[de](#).[en](#).[es](#).[fr](#).[id](#).[it](#).[ph](#).[po](#).[ru](#).[sw](#)

 **A Guide to the Development of On-site Sanitation (WHO, 1992, 246 p.)**

 **(*introduction...*)**

 **Preface**

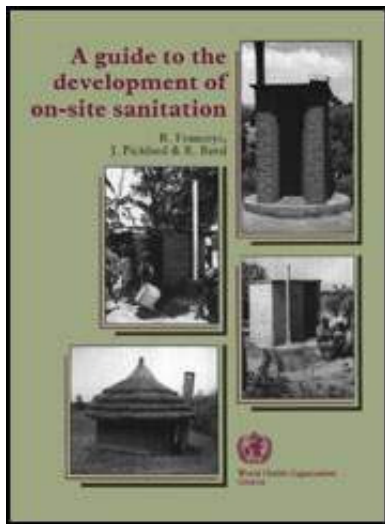

- ☐ **Part I. Foundations of sanitary practice**
- ☐ **Part II. Detailed design, construction, operation and maintenance**
- ☐ **Part III. Planning and development of on-site sanitation projects**
- 📄 **References**
- 📄 **Selected further reading**
- 📄 **Glossary of terms used in this book**
- 📄 **Annex 1. Reuse of excreta**
- 📄 **Annex 2. Sullage**
- 📄 **Annex 3. Reviewers**
- ➔📄 **Selected WHO publications of related interest**
- 📄 **Back Cover**

Selected WHO publications of related interest

Technology for water supply and sanitation in developing countries.

Report of a WHO Study Group.

WHO Technical Report Series, No. 742, 1987 (38 pages)

Price*
(Sw.
fr.)

7.-

Guidelines for the safe use of wastewater and excreta in agriculture and

- aquaculture.** D. Mara & S. Cairncross.
1989 (194 pages) 35.-
- Health guidelines for the use of wastewater in agriculture and aquaculture.**
Report of WHO Scientific Group. 9.-
WHO Technical Report Series, No. 778, 1989 (74 pages)
- Guidelines for planning community participation activities in water supply and sanitation projects.** A. Whyte.
WHO Offset Publication, No. 96, 1986 (53 pages) 10.-
- Improving environmental health conditions in low-income settlements. A community-based approach to identifying needs and priorities.**
WHO Offset Publication, No. 100, 1987 (68 pages) 16.-
- Appropriate technology for the treatment of wastewaters for small rural communities.**
Report on a WHO Meeting. 8.-
EURO Reports and Studies, No. 90, 1985 (62 pages)
- Low-cost water supply and sanitation technology: pollution and health problems.**
SEARO Regional Health Papers, No. 4, 1984 (40 pages) 5.-

Surface water drainage for low-income communities.

1991 (93 pages)

12.-

Health education in the control of schistosomiasis.

1990 (61 pages)

11.-

The impact of development policies on health. A review of the literature. D.

E. Cooper Weil et al.

1990 (174 pages)

31.-

Further information on these and other WHO publications can be obtained from Distribution and Sales, World Health Organization, 1211 Geneva 27, Switzerland.

*** Prices in developing countries are 70% of those listed here.**



[Home](#) > [ar](#).[cn](#).[de](#).[en](#).[es](#).[fr](#).[id](#).[it](#).[ph](#).[po](#).[ru](#).[sw](#)

 **A Guide to the Development of On-site Sanitation (WHO, 1992, 246 p.)**

 **(introduction...)**

 **Preface**

 **Part I. Foundations of sanitary practice**

 **Part II. Detailed design, construction, operation and**

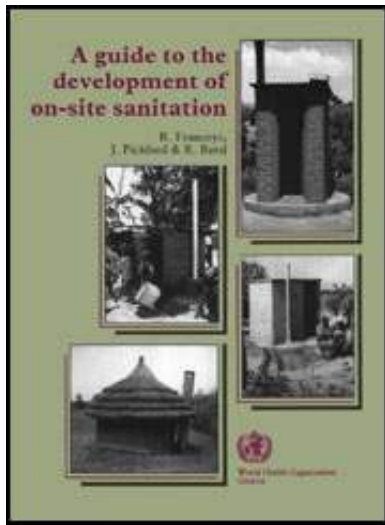

- maintenance**
- ☐ **Part III. Planning and development of on-site sanitation projects**
- 📄 **References**
- 📄 **Selected further reading**
- 📄 **Glossary of terms used in this book**
- 📄 **Annex 1. Reuse of excreta**
- 📄 **Annex 2. Sullage**
- 📄 **Annex 3. Reviewers**
- 📄 **Selected WHO publications of related interest**
- ➔ 📄 **Back Cover**

Back Cover

Safe disposal of excreta is of fundamental importance, not only for the health of the community, but also because of the social and environmental benefits it brings. However, for many low-income communities, particularly in developing countries, installation of a sewerage system, with its high cost and need for a piped water supply, is not a feasible option. For such communities, on-site disposal - dealing with excreta where they are deposited - offers a hygienic and affordable solution.

This book provides in-depth technical information about the design, construction, operation and maintenance of the major types of on-site sanitation facility, from simple pit latrines to aqua privies and septic tanks, with numerous practical

design examples. Recognizing that the introduction of on-site sanitation systems involves considerably more than the application of simple engineering techniques, the authors describe in detail the planning and development processes, and the financial and institutional factors that will need to be taken into account. Particular emphasis is given to the need to involve the community at all stages from planning to evaluation, to adapt projects and programmes to the local situation, and to provide continuing support to the community after the system is installed.

Based on the authors' experiences in a number of developing countries, this book will be of interest to a wide range of readers, from engineers and sanitarians to health personnel, administrators, planners and others concerned with improving sanitation in poor communities.

ISBN 92 4 154443 0



[Home](#) > [ar](#).[cn](#).[de](#).[en](#).[es](#).[fr](#).[id](#).[it](#).[ph](#).[po](#).[ru](#).[sw](#)

 **A Guide to the Development of On-site Sanitation (WHO, 1992, 246 p.)**

 **(*introduction...*)**

  **Preface**

 **Part I. Foundations of sanitary practice**

 **Part II. Detailed design, construction, operation and maintenance**

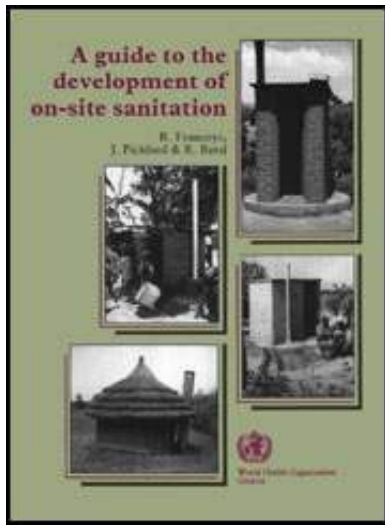

- **Part III. Planning and development of on-site sanitation projects**
- 📄 **References**
- 📄 **Selected further reading**
- 📄 **Glossary of terms used in this book**
- 📄 **Annex 1. Reuse of excreta**
- 📄 **Annex 2. Sullage**
- 📄 **Annex 3. Reviewers**
- 📄 **Selected WHO publications of related interest**
- 📄 **Back Cover**

Preface

For nearly thirty years, the names Wagner and Lanoix have recurred time and time again in connection with water supply and excreta disposal for rural areas and small communities. Their two volumes published by the World Health Organization in the late 1950s (Wagner & Lanoix, 1958, 1959) have stood the test of time.

Since their publication, there has been a massive increase in interest in water supply and sanitation, partly associated with the International Drinking Water Supply and Sanitation Decade (1981-1990). Many countries prepared programmes for the Decade that included optimistic forecasts for the provision of sanitation, but achieving the objectives has proved to be difficult. The majority of people living in rural areas and on the urban fringes in developing countries still lack satisfactory sanitation.

Some excellent publications, dealing with various aspects of appropriate technology for sanitation, have been produced by the World Bank and others. Much of the technology is a refinement of already known and practised methods, based on experience in a number of developing countries in Africa, Asia and Latin America. However, emphasis has been given to socioeconomic aspects of planning and implementing sanitation improvements.

This publication has therefore been prepared in response to these developments, as an update of Wagner & Lanoix's work, on which it draws heavily. The change of title is intended to focus attention on sanitation facilities on the householder's property, which are appropriate for some urban areas, as well as rural areas and small communities.

The book has three parts. Part I deals with the background to sanitation - health, sociological, financial and institutional issues, and the technologies available for excreta disposal. Part II provides in-depth technical information about the design, construction, operation and maintenance of the major types of on-site sanitation facility, while Part III describes the planning and development processes involved in projects and programmes. Annexes on reuse of excreta and sullage disposal are also included; although connected with on-site sanitation, these are primarily off-site activities.

The book has been compiled with the needs of many different readers in mind. The authors hope that it will prove useful for engineers, medical officers and sanitarians in the field, and also for administrators, health personnel, planners, architects, and many others who are concerned with improving sanitation in rural areas and underprivileged urban communities in developing countries.

The views expressed in this publication reflect the authors' field experience in many developing countries, supplemented by discussion with other workers and study of recent publications. The book in its final form has greatly benefited from the comments of the reviewers listed in Annex 3, whose experience and knowledge are internationally recognized. Special thanks are due to Mr J. N. Lanoix for his thorough review and comments, and to M. Bell, A. Coad, A. Cotton, M. Ince and M. Smith of WEDC for their invaluable input.

Although every effort has been made to represent a world view, the authors have been constantly aware of great variations in practices in different continents, countries and districts. Sometimes what is quite satisfactory for one community is rejected by other people living nearby. When applying the information given in this book it is wise to follow the advice of Dr E. F. Schumacher: "Find out what the people are doing, and help them to do it better."

[Home](#) > [ar](#).[cn](#).[de](#).[en](#).[es](#).[fr](#).[id](#).[it](#).[ph](#).[po](#).[ru](#).[sw](#)

 **A Guide to the Development of On-site Sanitation (WHO, 1992, 246 p.)**

➔  **Part I. Foundations of sanitary practice**

 **Chapter 1. The need for on-site sanitation**

 **Introduction**

 **Historical evidence**

 **The present situation**

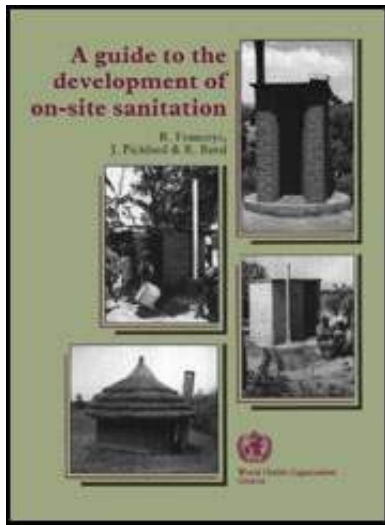

- 📄 **Constraints**
- 📄 **Priorities**
- ☐ **Chapter 2. Sanitation and disease transmission**
 - 📄 **Diseases associated with excreta and wastewater**
 - 📄 **How disease is carried from excreta**
- ☐ **Chapter 3. Social and cultural considerations**
 - 📄 *(introduction...)*
 - 📄 **Social structure**
 - 📄 **Cultural beliefs and practices**
 - 📄 **Concepts of hygiene**
 - 📄 **Beliefs about sanitation and disease**
 - 📄 **Forces for change**
 - 📄 **Responses to change**
 - 📄 **Conclusion**
- ☐ **Chapter 4. Technical options**
 - 📄 *(introduction...)*
 - 📄 **Open defecation**
 - 📄 **Shallow pit**
 - 📄 **Simple pit latrine**

 - 📄 **Borehole latrine**
 - 📄 **Ventilated pit latrine**
 - 📄 **Pour-flush latrine**

 **Single or double pit
Composting latrine**

 **Septic tank**

 **Aqua-privy**

 **Removal systems for excreta**

A Guide to the Development of On-site Sanitation (WHO, 1992, 246 p.)

Part I. Foundations of sanitary practice

Chapter 1. The need for on-site sanitation

Introduction

"Sanitation" refers to all conditions that affect health, especially with regard to dirt and infection and specifically to the drainage and disposal of sewage and refuse from houses (*The Concise Oxford Dictionary*). At its first meeting in 1950, the WHO Expert Committee on Environmental Sanitation defined environmental sanitation as including the control of community water supplies, excreta and wastewater disposal, refuse disposal, vectors of disease, housing conditions, food supplies and handling, atmospheric conditions, and the safety of the working environment. Environmental problems have since grown in complexity, especially with the advent of radiation and chemical hazards. Meanwhile, the world's needs for basic sanitation services (i.e., drinking-water supply, excreta and wastewater disposal) have greatly increased as a result of rapid population growth and higher expectations. This led to the designation by the United Nations of the International Drinking Water Supply and Sanitation Decade (1981-1990).

There has been considerable awareness of community water supply needs, but the problems of excreta and wastewater disposal have received less attention. In order to focus attention on these problems, "sanitation" became used and understood by people worldwide to refer only to excreta and wastewater disposal. A WHO Study Group in 1986 formally adopted this meaning by defining sanitation as "the means of collecting and disposing of excreta and community liquid wastes in a hygienic way so as not to endanger the health of individuals and the community as a whole" (WHO, 1987a). Hygienic disposal that does not endanger health should be the underlying objective of all sanitation programmes.

The cost of a sewerage system (which is usually more than four times that of on-site alternatives) and its requirement of a piped water supply preclude its adoption in the many communities in developing countries that lack adequate sanitation. On-site disposal, dealing with excreta where it is deposited, can provide a hygienic and satisfactory solution for such communities.

Safe disposal of excreta is of paramount importance for health and welfare and also for the social and environmental effects it may have in the communities involved. Its provision was listed by the WHO Expert Committee on Environmental Sanitation in 1954 among the first basic steps that should be taken towards ensuring a safe environment (WHO, 1954). More recently a WHO Expert Committee on the Prevention and Control of Parasitic Infections (WHO, 1987b) stressed that "the provision of sanitary facilities for excreta disposal and their proper use are necessary components of any programme aimed at controlling intestinal parasites. In many areas, sanitation is the most urgent health need and those concerned with the control of intestinal parasitic infections are urged to promote intersectoral collaboration between health care authorities and those

responsible for the provision of sanitation facilities and water supply at the community level."

Historical evidence

There is historical evidence from the industrialized world of the need for sanitation as a high priority for health protection. For example, in England in the nineteenth century, exposure to water-related infections was reduced when government-sponsored environmental measures were taken following enactment of public health legislation.

The present situation

Improved sanitation and domestic water supply warrant high priority for investment in developing countries where they are at the forefront of health improvements in both rural and urban communities. The importance attached to sanitation is part of a movement towards satisfaction of basic human needs - health care, housing, clean water, appropriate sanitation and adequate food. This movement has been instrumental in promoting a shift from curative to preventive medicine and in the designation of the 1980s as the International Drinking Water Supply and Sanitation Decade.

Decade approaches

The decision to designate the Decade was taken at the United Nations Water Conference held in Mar del Plata in 1977. The Conference also agreed a plan of action, recommending that national programmes should give priority to:

- the rural and urban underserved populations;
- application of self-reliant and self-sustaining programmes;
- use of socially relevant systems;
- association of the community in all stages of development;
- complementarity of sanitation with water supply; and
- the association of water supply and sanitation with health and other sector programmes.

The shortfall in sanitation

The percentage of the total population in the developing countries of the WHO Regions who do not have adequate sanitation is shown in Table 1.1, which is derived from statistics available to the Organization (WHO, 1990).

Table 1.1. Percentage of the population without adequate sanitation^a

WHO region	1970		1975		1980		1988	
	Urban	Rural	Urban	Rural	Urban	Rural	Urban	Rural
Africa	53	77	25	72	46	80	46	79
Americas	24	76	20	75	44	80	10	69
Eastern Mediterranean	38	88	37	86	43	93	6	80
South-East Asia	67	96	69	96	70	94	59	89
Western Pacific	19	81	19	57	7	37	11	31
Global total	46	91	50	89	50	87	33	81

***a* From WHO, 1990.**

Notwithstanding some inaccuracies in reporting, there is abundant evidence that the scale of the problem is greatest in countries with a low gross national product (GNP) and especially in rural communities. There are also marked disparities in environmental conditions and in standards of health within the developing countries and particularly in the major cities.

Problems of urban growth

Rates of urban growth of greater than 5% per year have produced concentrations of poor people in city-centre slums and in squatter areas on the periphery of towns and cities. Health risks are high in these areas. High-density living promotes the spread of airborne respiratory infections and hygiene-related diseases such as diarrhoea. Malnutrition is common and hence people are more susceptible to water-related infections. Such infections can spread rapidly since water sources are liable to faecal pollution. A major challenge for those concerned with environmental health is the design and introduction of excreta disposal systems appropriate to these high-density, low-income communities.

Rural problems

There is an equal need for the hygienic disposal of excreta and the promotion of health in rural areas. Rural communities may have evolved what they perceive to be satisfactory disposal systems, but the introduction of improved sanitation facilities can form a useful part of broader rural development programmes. The level of sanitation provision should be linked to that of other facilities in the

community, and to the community's ability to support (financially and culturally) and maintain such provisions.

Constraints

The many constraints on improving health through better sanitation centre on the political, economic, social and cultural contexts of health and disease. Worldwide surveys conducted by WHO identified the following as the most serious constraints:

- funding limitations;**
- insufficiency of trained personnel;**
- operation and maintenance;**
- logistics;**
- inadequate cost-recovery framework;**
- insufficient health education efforts;**
- inappropriate institutional framework;**
- intermittent water service;**
- non-involvement of communities.**

Priorities

There are four main targets for sanitation programmes: rural development, urban upgrading, periurban shanty and squatter upgrading, and new urban development. Programmes for these areas may be similar in content or approach. For example, both rural and shanty town development may have a high level of community contribution in labour, yet they may be very different in the input of health

education, introduction or enhancing awareness of new technologies, development of managerial structure, and provision of finance.

Questions have arisen concerning the kinds of technology that are most appropriate to the communities to be served and how this technology can best be introduced. The need for technical specialists to be aware of the social and cultural context of engineering interventions has been emphasized together with the need for popular participation in project design and implementation. Concepts such as grass-roots development, based on an approach that builds from below, have offered a challenge to the top-down approach based on decisions made at high managerial levels. The former is critical in sanitation programmes, since the effectiveness of these programmes depends not merely on community support but, more particularly, on the consent and commitment of households and individual users. Further, in sanitation programmes, technical and social decisions are closely interrelated.

Chapter 2. Sanitation and disease transmission

Diseases associated with excreta and wastewater

Sources of disease

The inadequate and insanitary disposal of infected human faeces leads to the contamination of the ground and of sources of water. Often it provides the sites and the opportunity for certain species of flies and mosquitos to lay their eggs, to breed, or to feed on the exposed material and to carry infection. It also attracts domestic animals, rodents and other vermin which spread the faeces and with

them the potential for disease. In addition it sometimes creates intolerable nuisances of both odour and sight.

There are a number of diseases related to excreta and wastewater which commonly affect people in the developing countries and which can be subdivided into communicable and noncommunicable diseases.

Communicable diseases

The major communicable diseases whose incidence can be reduced by the introduction of safe excreta disposal are intestinal infections and helminth infestations, including cholera, typhoid and paratyphoid fevers, dysentery and diarrhoea, hookworm, schistosomiasis and filariasis.

Table 2.1 lists some of the pathogenic organisms frequently found in faeces, urine and sullage (greywater).

High-risk groups

Those most at risk of these diseases are children under five years of age, as their immune systems are not fully developed and may be further impaired by malnutrition. The diarrhoeal diseases are by far the major underlying cause of mortality in this age group, accounting for some 4 million deaths each year.

In 1973, children in Brazil under one year of age totalled less than one-fifth of the population but suffered almost four-fifths of all deaths, while in the United States of America this age group represented 8.8% of the population and suffered only 4.3% of deaths (Berg, 1973).

There is no doubt that improving the sanitation within a community should lead to an improvement in health, but it is difficult to ascertain whether the impact would be direct or indirect. Often, provision of better sanitation is part of broader development activities within the community and, even if dissociated from improvement of the water supply, there are usually other factors that influence health which are introduced with sanitation changes, e.g., health and hygiene education (Blum & Feachem, 1983). The effect of these factors, such as increased handwashing or changes in attitudes to children's excreta, may be difficult to monitor and/or evaluate.

Table 2.1. Occurrence of some pathogens in urine,^a faeces and sullage^b

Pathogen	Common name for infection caused	Present in:		
		urine	faeces	sullage
Bacteria				
<i>Escherichia coli</i>	diarrhoea	*	*	*
<i>Leptospira interrogans</i>	leptospirosis	*		
<i>Salmonella typhi</i>	typhoid	*	*	*
<i>Shigella</i> spp	shigellosis		*	
<i>Vibrio cholerae</i>	cholera		*	
Viruses				
Poliovirus	poliomyelitis		*	*
Rotaviruses	enteritis		*	

Protozoa - amoeba or cysts				
<i>Entamoeba histolytica</i>	amoebiasis		*	*
<i>Giardia intestinalis</i>	giardiasis		*	*
Helminths - parasite eggs				
<i>Ascaris lumbricoides</i>	roundworm		*	*
<i>Fasciola hepatica</i>	liver fluke		*	
<i>Ancylostoma duodenale</i>	hookworm		*	*
<i>Necator americanus</i>	hookworm		*	*
<i>Schistosoma</i> spp	schistosomiasis	*	*	*
<i>Taenia</i> spp	tapeworm		*	*
<i>Trichuris trichiura</i>	whipworm		*	*

***a* Urine is usually sterile; the presence of pathogens indicates either faecal pollution or host infection, principally with *Salmonella typhi*, *Schistosoma haematobium* or *Leptospira*.**

***b* From Cheesebrough (1984), Sridhar et al. (1981) and Feachem et al. (1983).**

Table 2.2 gives details for different countries of infant and child deaths (including deaths from diarrhoea), life expectancy at birth, and the levels of poverty in both urban and rural areas. In general, these data reflect an interactive relationship between poverty/malnutrition and children's health. In turn, this relationship may be related to the level of sanitation in the children's environment. For instance, the

incidence of diarrhoeal disease in children is affected by poor personal hygiene and environmental sanitation, and also by reduced resistance to disease in malnutrition. Diarrhoea leads to loss of weight, which is normally transitory in the well nourished but more persistent in the malnourished. Repeated infections can lead to increased malnutrition which in turn increases susceptibility to further infection; this may be referred to as the diarrhoea-malnutrition cycle.

Table 2.2. Health indicators^a

Country	Infant mortality rate per 1000 live births		Child mortality per 1000 (1-5 years)	Life expectancy at birth (years)		Population below poverty line (%)	
	1983	1985		1983	1985	Urban	Rural
Bangladesh	130	121	205	48	54	86	86
Ecuador	70	45	95	63	64	30	65
Finland	6	6	8	73	75	-	-
Haiti	130	125	190	53	54	55	78
India	110	114	165	53	54	40	51
Malaysia	30	17	41	67	70	13	38
Nepal	140	140	215	46	52	55	61
Papua New Guinea	75	72	105	53	50	10	75
Paraguay	45	30	65	65	65	19	50

Philippines	50	57	85	65	63	32	41
Sierra Leone	180	225	310	34	47	-	65
Thailand	48	12	60	63	63	15	34
Trinidad and Tobago	24	19	28	70	67	-	39
United Kingdom	10	12	12	74	73	-	-

^a From UNICEF (1986); WHO (1987c).

Noncommunicable diseases

In addition to pathogen content, the chemical composition of waste-water has to be considered because of its effects on crop growth and/or consumers. The number of components to be monitored (e.g., heavy metals, organic compounds, detergents, etc.) is greater in industrialized urban areas than in rural areas. Nitrate content is important, however, in all areas because of the possible effects of its accumulation, in both surface and groundwater, on human health (methaemoglobinaemia in infants), and on the ecological balance in waters receiving run-off or effluent high in nitrates. Although the major human activity resulting in the increase of nitrate levels is the use of chemical fertilizers, poor sanitation or misuse of wastewater can contribute to or, in exceptional cases, be the major determinant of nitrate levels, particularly in groundwater.

How disease is carried from excreta

Transmission of diseases

Humans themselves are the main reservoir of most diseases that affect them. Transmission of excreta-related diseases from one host to another (or the same host) normally follows one of the routes shown in Fig. 2.1. Poor domestic and personal hygiene, indicated by routes involving food and hands, often diminishes or even negates any positive impact of improved excreta disposal on community health. As shown in the figure, most routes for transmission of excreta-related diseases are the same as those for water-related diseases, being dependent on faecal-oral transmission (waterborne and water-washed) and skin penetration (water-based with an aquatic host; soil-based but not faecal-oral; and insect vector with vector breeding on excreta or in dirty water). Table 2.3 gives examples of excreta-related diseases and data on the number of infections and deaths per year.

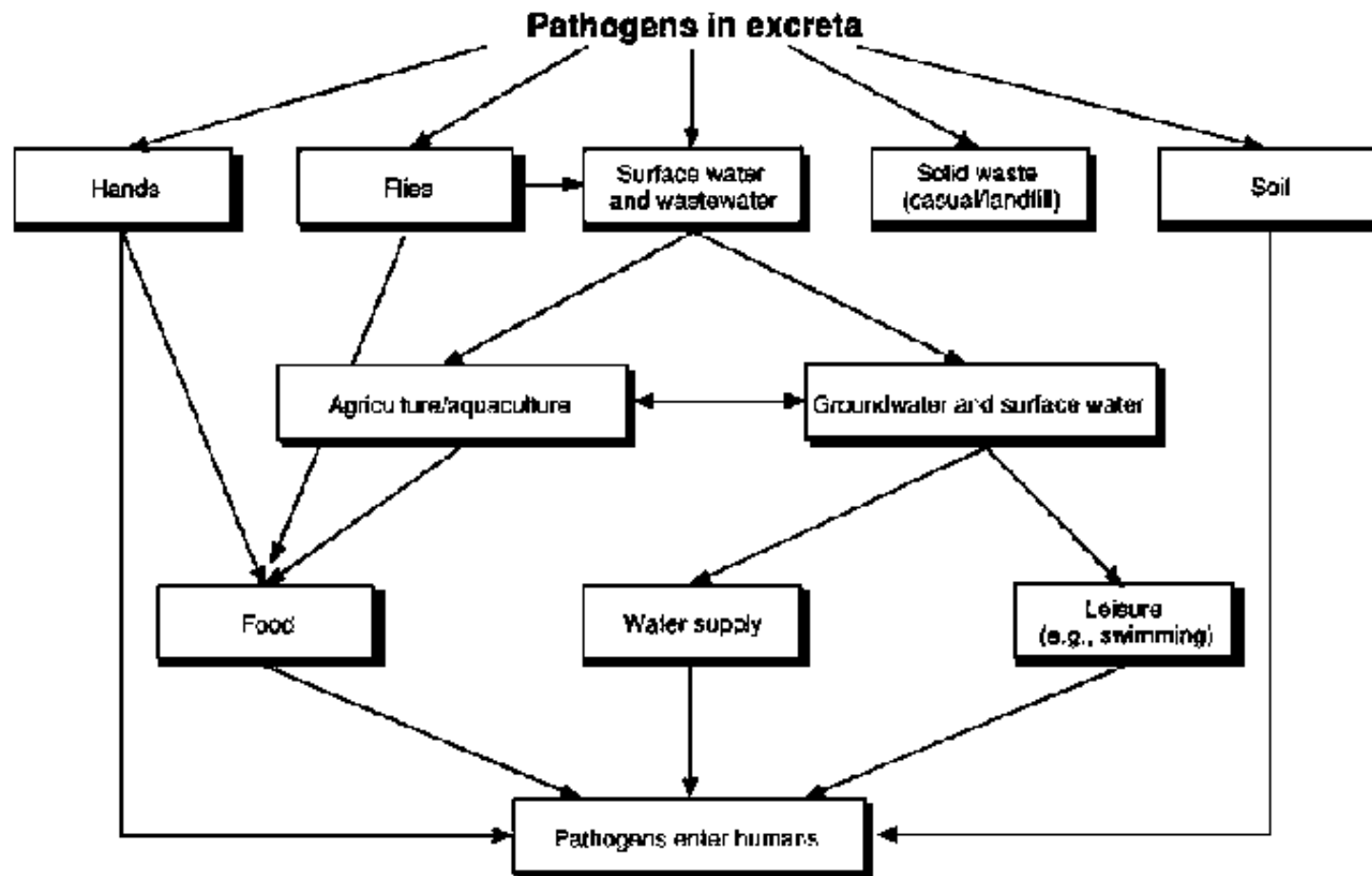

Fig. 2.1. Transmission routes for pathogens found in excreta

WHO 91364

Table 2.3. Morbidity and mortality associated with various excreta-related diseases

Disease	Morbidity	Mortality (no. of deaths per year)	Population at risk
---------	-----------	---------------------------------------	--------------------

Waterborne and water-washed			
diarrhoea	1500 million or more episodes in children under 5 years	4 million in children under 5 years	More than 2000 million
poliomyelitis	204 000	25 000	
enteric fevers (typhoid, paratyphoid)	500 000-1 million	25 000	
roundworm	800-1000 million infections	20 000	
Water-based			
schistosomiasis	200 million	More than 200 000	500-600 million
Soil-based			
hookworm	900 million infections	50 000	

As Table 2.3 illustrates, diarrhoeal diseases and helminth infections account for the greatest number of cases per year although there is a considerable difference in the levels of debility they produce. Schistosomiasis has relatively high rates of infection and death. The socio-economic impact of these diseases should not be ignored or underestimated. To illustrate this further, schistosomiasis will be considered in greater detail.

Schistosomiasis

Schistosomiasis is acquired through repeated contact with surface water contaminated with human excreta (both urine and faeces) containing

schistosomes (WHO, 1985). Contact can be via agriculture, aquaculture, leisure activities (particularly swimming), collection of water, washing and bathing. Of the parasitic diseases, schistosomiasis ranks second in terms of socioeconomic and public health importance in tropical and subtropical areas, immediately behind malaria.

In 1990, schistosomiasis was reported to be endemic in 76 developing countries. Over 200 million people in rural and agricultural areas were estimated to be infected, while 500-600 million more were at risk of becoming infected, because of poverty, ignorance, substandard hygiene, and poor housing with few, if any, sanitary facilities.

People with light infections as well as those with obvious symptoms suffer weakness and lethargy, which decrease their capacity for work and productivity.

As shown in Fig. 2.2, the parasite develops in snails, the intermediate hosts. The free-swimming stage of the parasite penetrates the skin of humans and, if infection is heavy, the disease develops. The incidence of diseases such as schistosomiasis should be much reduced by the provision of sanitation. However, for this disease, as for many others, additional measures including the provision of safe drinking-water can also interrupt transmission by reducing contact with infested water. People living in endemic areas can benefit greatly from health education aimed at increasing their understanding of their role in transmission, and the importance of the use of latrines. Since young children are often most heavily infected, early use of latrines, especially in schools, will promote healthy habits.

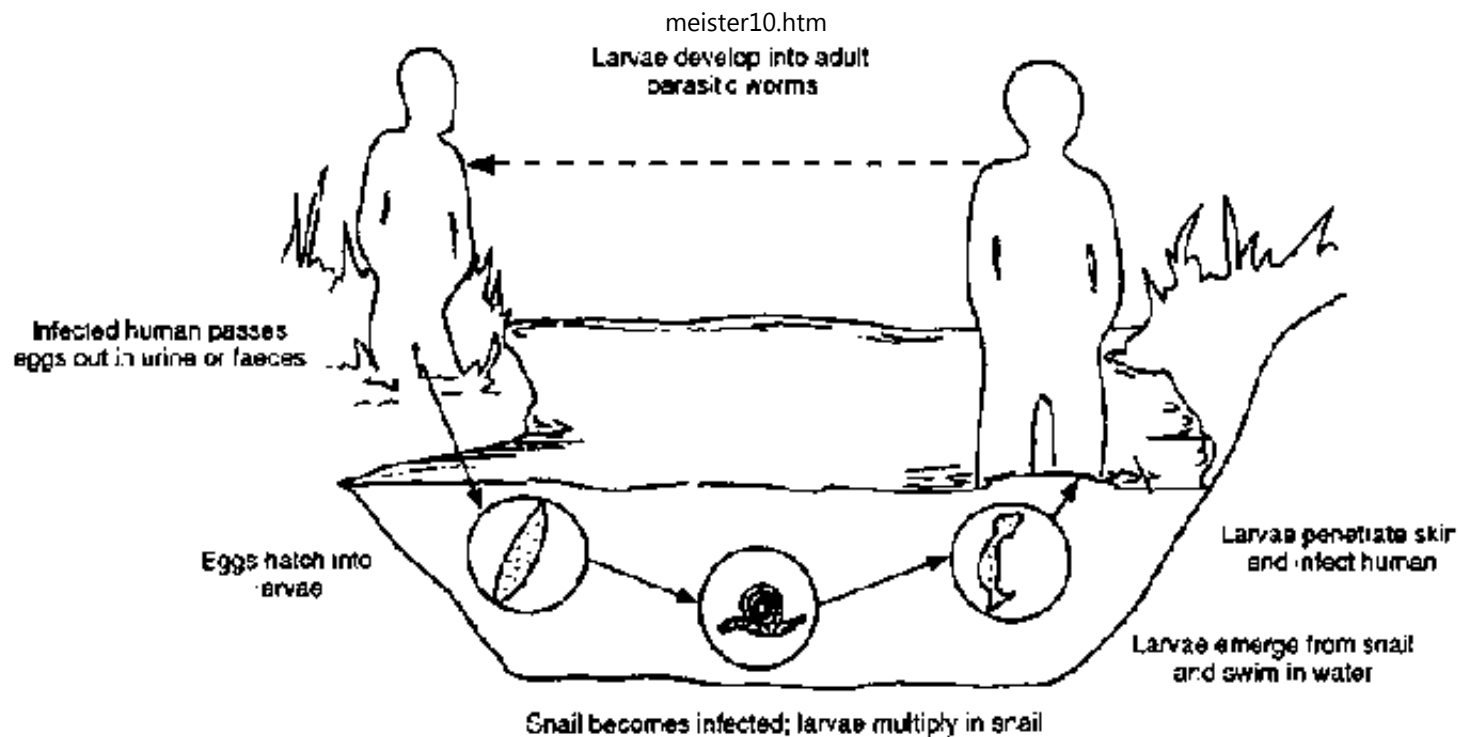

Fig. 2.2. The cycle of transmission of schistosomiasis

WHO 91365

Reuse of excreta and wastewater in agriculture

Sanitation is not always the only factor to be considered when relating excreta disposal to disease transmission within and between communities. The reuse of excreta (untreated or treated to differing extents) as a fertilizer, and reuse of wastewater (including sullage water) for many purposes, but especially for irrigation, may also contribute to the incidence of excreta-related diseases. In many countries where the demand for water is greater than the supply, use of wastewater for irrigation of crops for consumption by animals or humans can have a major impact on community health. This is especially important in areas with

poor soils and insufficient income for purchase of commercial fertilizers and conditioners, where the use of human as well as animal excreta to condition and fertilize soil is actively encouraged. With such practices the degree of the hazard is dependent on several parameters including:

- the level (or lack) of treatment prior to reuse;**
- the nature of the crop;**
- the method of irrigation;**
- the extent of reuse;**
- the incidence and type of disease in the area;**
- air, soil and water conditions.**

The groups most at risk of infection will also depend on these factors and on other agricultural practices. The diseases that may show the greatest increase in incidence where reuse is practised are helminth infestations, particularly hookworm, roundworm and whip-worm; schistosomiasis may also increase markedly in some circumstances. Bacterial infections, such as cholera and diarrhoea, are affected to a much smaller degree, with the incidence of viral infections being least affected by these practices (Mara & Cairncross, 1989; WHO, 1989).

Epidemiological characteristics of pathogens

Pathogen survival

The survival times and other epidemiological characteristics of organisms in different media are given in Table 2.4; it should be noted that these periods are

approximate, being dependent on local factors such as the climate and the number (concentration) and species of organisms.

Pathogen infectivity and latency

In addition to knowing how long the infectious agent may survive, i.e., its persistence, knowledge of the infectivity and latency of the organism is of value. Some pathogens remain infective for only short periods after being excreted, yet the incidence of associated disease is high. This may be attributable to the low infectious dose of the organism, e.g., protozoal cysts. The latency of an organism (i.e., the period between leaving a host and becoming infective) can vary from zero for some bacterial infections to weeks for some helminth eggs. For example, schistosome eggs have a latency of a few weeks during which time they develop in an intermediate host into the infective, free-swimming cercariae (Fig. 2.2); however, both the eggs and the cercariae have a persistence of only a few hours if they do not enter a new host (intermediate or human). In contrast, *Ascaris* eggs can become infective within ten days of being excreted (latency) but may remain in the soil for at least a year and still be infective (persistence).

Table 2.4. The epidemiological characteristics of excreted pathogens^a

Pathogen	Latency period	ID ₅₀ ^b	Survival times for pathogens in:		
			wastewater	soil	crops
Bacteria	0	>10 ⁴	few days to 3 months		
<i>Vibrio cholerae</i>	0	10 ⁸	~1 month	<3 weeks	<5 days

Faecal coliform	0	$\sim 10^9$	~ 3 months	<2 months	<1 month
Viruses	0	unknown	months	months	1-2 months
Enteroviruses ^c	0	100	~ 3 months	<3 months	<2 months
Protozoa (cysts)	0	10-100	few days to few weeks		
<i>Entamoeba</i> spp	0	10-100	25 days	<3 weeks	<10 days
Helminths ^d	variable	1-100	months	months	months
<i>Ancylostoma</i> spp	1 week	1	3 months	<3 months	<1 month
<i>Ascaris</i> spp	10 days	several	~ 1 year	many months	<3 months
Flukes ^e	6-8 weeks	several	life of host ^f	hours ^f	hours ^f

^a Sources: Feachem et al. (1983); WHO (1987a).

^b The ID₅₀ is the number of organisms required to cause the development of clinical symptoms in 50% of individuals.

^c Including coxsackieviruses, echoviruses and polioviruses.

^d Eggs or larvae/cercariae.

^e Excluding *Fasciola hepatica* but including *Schistosoma* spp.

^f Outside the aquatic host, the pathogen survives for only a few hours. In

the host, survival is for the life of the host.

Control of excreta-related diseases

If transmission is blocked at one or more points, excreta-related diseases can be controlled or possibly eradicated. Sanitation provides one such block. For example, water-seal slabs in latrines reduce the breeding sites for culicine mosquitos, vectors of filariasis; treatment of excreta prior to its disposal can kill the eggs and cysts of many human parasites (*Ascaris*, *Entamoeba*, and *Schistosoma* spp), thus preventing contamination of both ground and water.

Relationship of health to disposal method

The technical objective of sanitary excreta disposal is to isolate faeces so that the infectious agents in them cannot reach a new host. The method chosen for any particular area or region will depend on many factors including the local geology and hydrogeology, the culture and preferences of the communities, the locally available raw materials and the cost (both short-term and long-term).

The types of disease that are endemic in an area should also be considered. The survival of endemic pathogens (eggs, cysts, infectious agents) and the destination or possible reuse of different products of disposal/treatment can have a great effect on incidence of disease in that area and, possibly, adjacent areas.

The possible sites for both negative and positive impacts on health, taking all the above parameters into consideration, should be considered during the planning stages of development projects to improve sanitation. This should ensure that the projects achieve the greatest possible effect on the incidence of diseases related

to excreta and wastewater in the community.

Chapter 3. Social and cultural considerations

The introduction of on-site sanitation systems is much more than the application of simple engineering techniques - it is an intervention that entails considerable social change. If sanitation improvements in rural and urban areas are to be widely accepted, the relevant social and cultural factors have to be taken into consideration during planning and implementation. It is therefore necessary to understand how a society functions, including the communities and households within it, and what factors promote change.

Social structure

Consideration should be given to the institutions of a political, economic and social nature that are operating at the national and/or local level, such as government, the civil service, religious institutions, schools and colleges, and the family, and to the forms of leadership and authority that are generally accepted by the majority of the people. It is also important to consider the various roles and patterns of behaviour of individuals and social groups, and to determine who is traditionally responsible for such areas as water supplies, environmental hygiene, family health and children's defecation habits, etc.

Cultural beliefs and practices

Group and community identity, gender roles, the relative importance attached to different forms of authority and the ways in which it is exercised are all influenced by culture, i.e., all that is passed down by human society including language, laws,

customs, beliefs and moral standards. Culture shapes human behaviour in many different ways including the status attached to different roles and what is deemed to be acceptable personal and social behaviour. In many cultures, for example, the elderly command traditional authority and influence within the family and community.

As regards sanitation behaviour, defecation is often a private matter which people are unwilling to discuss openly, while the burying of faeces is widely practised to ward off evil spirits. Contact with faecal matter is unacceptable to certain individuals in societies where it is the responsibility of low-income or low-caste groups, while taboos may dictate that separate facilities should be provided for particular social groups.

A particular cultural practice to be considered, which has direct technical consequences, is the method of anal cleansing used by the community. Whether water, stones, corncobs or thick pieces of paper are used will affect the design of the sanitation system.

Culture also influences how people interpret and evaluate the environment in which they live. Investments in sanitation seek to improve health by providing a clean physical environment for households. There is a logical series of technical questions that need to be asked in order that acceptable technical solutions can be found. It may be confusing, therefore, when sanitation behaviour is found to vary widely between communities within the same physical environment.

Predetermined rules cannot be applied. However, the sanitation behaviour of individuals usually has a rational basis, and people are often aware of the environmental causes of ill-health. Many societies have a detailed knowledge of

the physical environment as a provider of resources for curative and preventive medicine and as a cause of illness. More than this, they have an understanding of the environment, not only in its physical sense, but also in relation to social and spiritual factors. This holistic view of the environment permeates many of the cultural beliefs and customs that impinge on both water use patterns and sanitation behaviour. Some illustrations of these beliefs are given below.

Concepts of hygiene

Although communities may lack knowledge of modern medical explanations of disease, they often have concepts of what is pure and polluting. Of the water resources available to particular households for domestic purposes, running water may be most acceptable for drinking because it is exposed to the sunlight; it is considered to be "alive" and therefore "pure", while water in shallow wells, which does not have these attributes, is deemed suitable only for washing and cooking. Communities have been observed to use the environmental resources available to them, such as bamboo, to bring fast-flowing river water to their villages in preference to more convenient well water that is unacceptable in taste, colour and smell.

Concepts of clean and dirty, pure and polluting, are well developed in the major world religions, and have a ritual and spiritual significance as well as referring to a physical state. When people are told that new sanitation facilities will make their environment "cleaner", it is their own interpretation of this concept that will be used. "Clean" may have quite different meanings to project promoters and recipients. Thus "it is essential to look into traditional categories of cleanliness and dirtiness, purity and pollution before embarking on a campaign to motivate

people to accept a project in improved ... sanitation or to change their behaviour to comply with new standards of 'cleanliness'" (Simpson-Hebert, 1984).

Beliefs about sanitation and disease

Evidence of the value attached by communities to cleanliness and, by implication, environmental sanitation is found in studies of diarrhoea. People's perceptions of its causes may be divided into three categories, physical, social and spiritual. In many cases, physical causes are identified and, although the germ theory is not explicitly stated, the faecal-oral transmission routes of diarrhoea appear to be understood. Households may associate diarrhoea with a polluted environment including uncovered food, dirty water and flies. Graphic descriptions of pollution have been quoted (de Zoysa et al., 1984):

- "We have to drink the dam water where animals and children bathe and the dirty water makes us ill."

- "Flies sit on dirt which they eat then they come on to uncovered foods and spit on to foods which we eat."

As on-site sanitation involves improving the physical environment, it may therefore be readily accepted as one means by which to reduce the incidence of disease.

Equally, social and spiritual causes are perceived to be important, and include, for example, female social indiscretions and witchcraft. But these three apparently unrelated causes of diarrhoea should not be interpreted as mutually exclusive or divergent approaches to disease. They are often closely interrelated in practice,

within a holistic interpretation of the environment.

Efforts should be made to determine how a community's beliefs, knowledge, and control over the environment can be harnessed in a positive way. Careful judgement is required to distinguish between those beliefs and ritual behaviour that are conducive to good sanitation practice and those that need to be changed.

Forces for change

All societies undergo adjustments in their social structure and culture over time. This may result from contact between societies or from alterations in the physical environment such as prolonged drought. Further, changes in development practice and in international aid influence national goals and priorities with respect to different sectors and regions. How change is brought about and what it is that changes are important issues that need to be addressed.

The profound impact of forces for change on diverse societies finds expression in patterns of apparently increasing uniformity between countries and cultures. In demographic terms, these include rapid rates of national population growth, and internal migration of people from rural to urban areas coupled with urban expansion.

Responses to change

The responses of individuals and groups to urban life, to factory employment or to new technology are a product of the values, experiences and behaviour patterns that they have assimilated over time as members of particular communities and societies. Some groups and individuals are more open to change and more able to

adapt to it than others. Decisions are taken to accept or resist an innovation on the basis of characteristics peculiar to the individual, household or group within the context of the local physical, social, economic, cultural and demographic environment.

Access to education may increase awareness of the health benefits of improved sanitation technology, while income will influence the ability of a household to acquire particular facilities. Personal experience and demonstration of alternative technologies may help to convince people that the benefits of the investment will outweigh any costs incurred. Community organizations and influential leaders can assist in marketing the concept by emphasizing factors valued locally. These may include the status attached to possessing a facility, or its functional value in terms of comfort. Equally, factors such as rapid increase in population which limits privacy may heighten the perceived need for innovations in sanitation.

People resist change for many reasons. There may be resentment towards outside "experts" who know little of local customs and who are perceived to benefit more from the innovation than local people. Leadership may not be united within a community. For example, those with traditional authority who fear a loss of power and status may oppose innovation strongly supported by political or educated elites. New technologies may be aesthetically unacceptable or conflict with established patterns of personal and social behaviour. Furthermore, households vary widely in the resources of money, labour and time available to them and have their own priorities. For those with limited resources, the costs in the short term of an apparently "low-cost" system may be too great when set against their need for food, shelter and clothing. In addition, in terms of capital investment latrines may be very costly for households if they take a long time to clean, are difficult to

use or involve radical changes in social habits (Pacey, 1980). There may also be seasonal variations in the availability of money and labour. Thus the timing of the promotional aspects of a project in relation to, for example, agricultural seasons may be important in determining the local response.

The demographic composition, economic characteristics and attitudes to sanitation of individual households change over time. Experience shows that once people start to improve their houses their interest in latrines is likely to be aroused. Thus some households may be encouraged to install a latrine as one aspect of the modernization process. Projects should be flexible enough to allow households to invest in on-site sanitation not only when they feel motivated but also when they have the resources to do so. Indeed it may be most appropriate to introduce a range of on-site technologies within a particular community from which households can make a choice according to their own changing needs and priorities.

Conclusion

To identify a demand for improved sanitation is more positive than to initiate a supply of technology that is deemed to be good for communities. The former depends upon cooperation between providers and beneficiaries which comes through dialogue and the exchange of information. Individual users are the ultimate decision-makers in the acceptance or rejection of new technology. It is they who determine the success of a project, since the value of the investment depends not only upon community support but, more particularly, on the consent of households and individual users. They need to be convinced that the benefits of improved sanitation, and the new technology with which it is associated, outweigh

the costs. Equally, it is for providers to appreciate the social context and the constraints within which individual decisions are made. They must learn from communities about why improved sanitation may elicit negative responses and also the positive features of community values, beliefs and practices which can be harnessed to promote change.

Chapter 4. Technical options

In this chapter various sanitation systems are introduced with a brief indication of their suitability for particular situations, the constraints on their use, and their disadvantages. The whole range of options is covered, including off-site systems and some that are not recommended because of the associated health risk and other disadvantages. Each community must choose the most feasible and convenient option to provide necessary health protection. Selecting the most appropriate option requires a thorough analysis of all factors including cost, cultural acceptability, simplicity of design and construction, operation and maintenance, and local availability of materials and skills. Further details of the design, construction, operation and maintenance of these systems are given in Part II.

Open defecation



Figure

Where there are no latrines people resort to defecation in the open. This may be indiscriminate or in special places for defecation generally accepted by the community, such as defecation fields, rubbish and manure heaps, or under trees. Open defecation encourages flies, which spread faeces-related diseases. In moist ground the larvae of intestinal worms develop, and faeces and larvae may be carried by people and animals. Surface water run-off from places where people have defecated results in water pollution. In view of the health hazards created and the degradation of the environment, open defecation should not be tolerated in villages and other built-up areas. There are better options available that confine excreta in such a way that the cycle of reinfection from excreta-related diseases is broken.

Shallow pit



Figure

People working on farms may dig a small hole each time they defecate and then cover the faeces with soil. This is sometimes known as the "cat" method. Pits about 300 mm deep may be used for several weeks. Excavated soil is heaped beside the pit and some is put over the faeces after each use. Decomposition in shallow pits is rapid because of the large bacterial population in the topsoil, but flies breed in large numbers and hookworm larvae spread around the holes.

Hookworm larvae can migrate upwards from excreta buried less than 1 m deep, to penetrate the soles of the feet of subsequent users.

Advantages	Disadvantages
No cost	Considerable fly nuisance
Benefit to farmers as fertilizer	Spread of hookworm larvae

Simple pit latrine

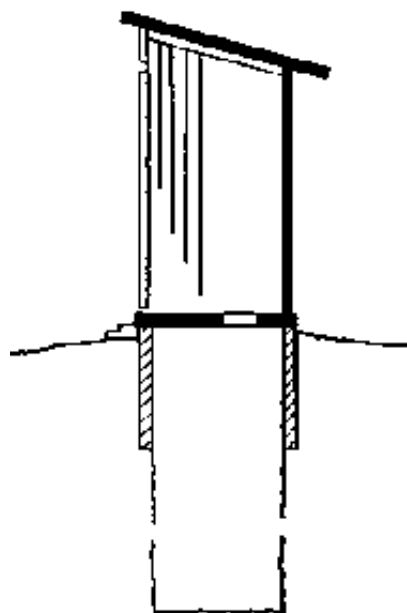

Figure

This consists of a slab over a pit which may be 2 m or more in depth. The slab should be firmly supported on all sides and raised above the surrounding ground so that surface water cannot enter the pit. If the sides of the pit are liable to collapse they should be lined. A squat hole in the slab or a seat is provided so that

the excreta fall directly into the pit.

Advantages	Disadvantages
Low cost	Considerable fly nuisance (and mosquito nuisance if the pit is wet)
Can be built by householder	unless there is a tight-fitting cover
Needs no water for operation	over the squat hole when the latrine is not in use
Easily understood	Smell

Borehole latrine

A borehole excavated by hand with an auger or by machine can be used as a latrine. The diameter is often about 400 mm and the depth 6-8 m.

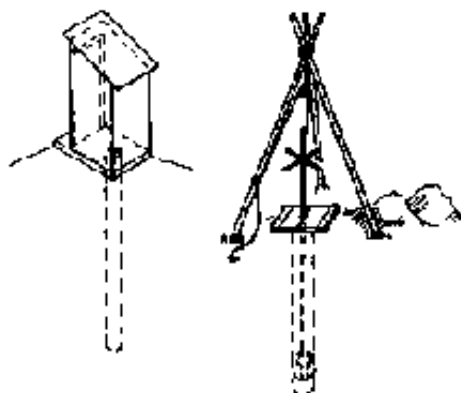

Figure

Advantages

Disadvantages

Can be excavated quickly if boring equipment is available	Sides liable to be fouled, with consequent fly nuisance
Suitable for short-term use, as in disaster situations	Short life owing to small cross-sectional area
	Greater risk of groundwater pollution owing to depth of hole

Ventilated pit latrine

Fly and odour nuisance may be substantially reduced if the pit is ventilated by a pipe extending above the latrine roof, with fly-proof netting across the top. The inside of the superstructure is kept dark. Such latrines are known as ventilated improved pit (VIP) latrines.

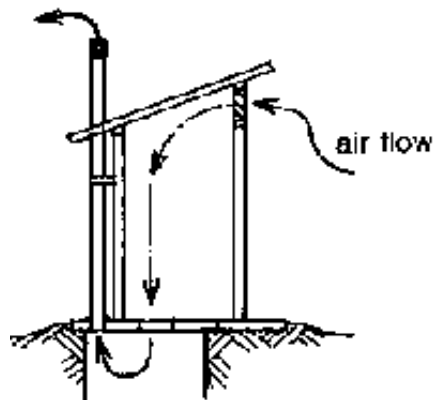

Figure

Advantages	Disadvantages
Low cost	Does not control mosquitos

Can be built by householder	Extra cost of providing vent pipe
Needs no water for operation	Need to keep interior dark
Easily understood	
Control of flies	
Absence of smell in latrines	

Pour-flush latrine

A latrine may be fitted with a trap providing a water seal, which is cleared of faeces by pouring in sufficient quantities of water to wash the solids into the pit and replenish the water seal. A water seal prevents flies, mosquitos and odours reaching the latrine from the pit. The pit may be offset from the latrine by providing a short length of pipe or covered channel from the pan to the pit. The pan of an offset pour-flush latrine is supported by the ground and the latrine may be within or attached to a house.

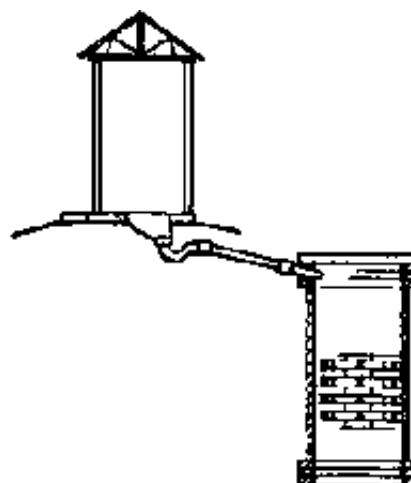

Figure

Advantages	Disadvantages
Low cost	A reliable (even if limited) water supply must be available
Control of flies and mosquitos	Unsuitable where solid anal cleaning material is used
Absence of smell in latrine	
Contents of pit not visible	
Gives users the convenience of a WC	
Can be upgraded by connection to sewer when sewerage becomes available	
<i>Offset type</i>	
Pan supported by ground	
Latrine can be in house	

Single or double pit

In rural and low-density urban areas, the usual practice is to dig a second pit when the one in use is full to within half a metre of the slab. If the superstructure and slab are light and prefabricated they can be moved to a new pit. Otherwise a new superstructure and slab have to be constructed. The first pit is then filled up with soil. After two years, faeces in the first pit will have completely decomposed and even the most persistent pathogens will have been destroyed. When another

pit is required the contents of the first pit can be dug out (it is easier to dig than undisturbed soil) and the pit can be used again. The contents of the pit may be used as a soil conditioner.

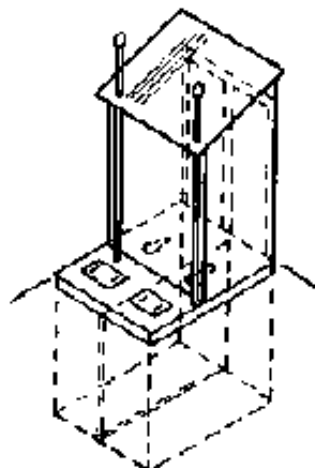

Figure

Alternatively, two lined pits may be constructed, each large enough to take an accumulation of faecal solids over a period of two years or more. One pit is used until it is full, and then the second pit is used until that too is full, by which time the contents of the first pit can be removed and used as a fertilizer with no danger to health. The first pit can then be used again.

Advantages of single pits	Advantages of double pits
Will last for several years if large enough	Once constructed the pits are more or less permanent
	Easy removal of solids from the pits as they are shallow
	Pit contents can be safely used as a soil conditioner after 2

years, without treatment

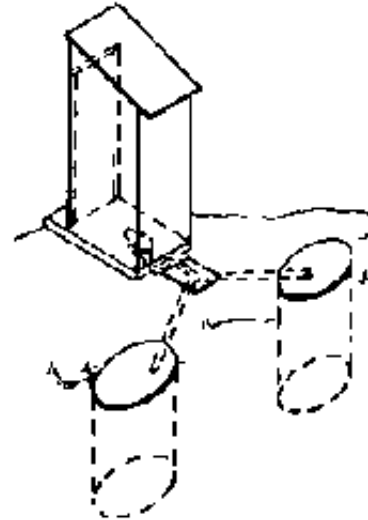

Figure

Composting latrine

In this latrine, excreta fall into a watertight tank to which ash or vegetable matter is added. If the moisture content and chemical balance are controlled, the mixture will decompose to form a good soil conditioner in about four months. Pathogens are killed in the dry alkaline compost, which can be removed for application to the land as a fertilizer. There are two types of composting latrine: in one, compost is produced continuously, and in the other, two containers are used to produce it in batches.

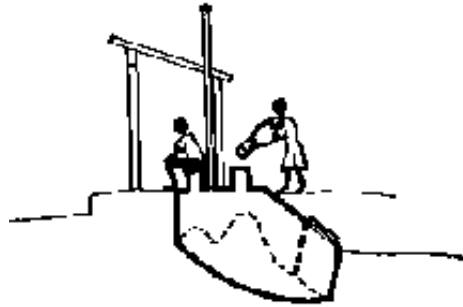

Figure

Advantages	Disadvantages
A valuable humus is produced	Careful operation is essential
	Urine has to be collected separately in the batch system
	Ash or vegetable matter must be added regularly

Septic tank

A septic tank is an underground watertight settling chamber into which raw sewage is delivered through a pipe from plumbing fixtures inside a house or other building. The sewage is partially treated in the tank by separation of solids to form sludge and scum. Effluent from the tank infiltrates into the ground through drains or a soakpit. The system works well where the soil is permeable and not liable to flooding or waterlogging, provided the sludge is removed at appropriate intervals to ensure that it does not occupy too great a proportion of the tank capacity.



Figure

Advantages	Disadvantages
Gives the users the convenience of a WC	High cost
	Reliable and ample piped water required
	Only suitable for low-density housing
	Regular desludging required, and sludge needs careful handling
	Permeable soil required

Aqua-privy

An aqua-privy has a watertight tank immediately under the latrine floor. Excreta drop directly into the tank through a pipe. The bottom of the pipe is submerged in the liquid in the tank, forming a water seal to prevent escape of flies, mosquitos and smell. The tank functions like a septic tank. Effluent usually infiltrates into the ground through a soakpit. Accumulated solids (sludge) must be removed regularly. Enough water must be added to compensate for evaporation and leakage losses.

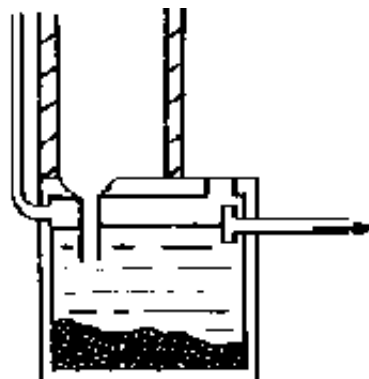

Figure

Advantages	Disadvantages
Does not need piped water on site	Water must be available nearby
Less expensive than a septic tank	More expensive than VIP or pour-flush latrine
	Fly, mosquito and smell nuisance if seal is lost because insufficient water is added
	Regular desludging required, and sludge needs careful handling
	Permeable soil required to dispose of effluent

Removal systems for excreta

Overhung latrine

A latrine built over the sea, a river, or other body of water into which excreta drop directly, is known as an overhung latrine. If there is a strong current in the water

the excreta are carried away. Local communities should be warned of the danger to health resulting from contact with or use of water into which excreta have been discharged.

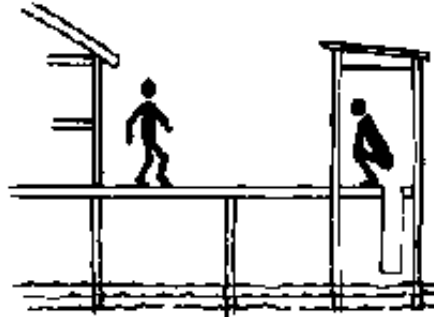

Figure

Advantages	Disadvantages
May be the only feasible system for communities living over water	Serious health risks
Cheap	

Bucket latrine

This latrine has a bucket or other container for the retention of faeces (and sometimes urine and anal cleaning material), which is periodically removed for treatment or disposal. Excreta removed in this way are sometimes termed nightsoil.

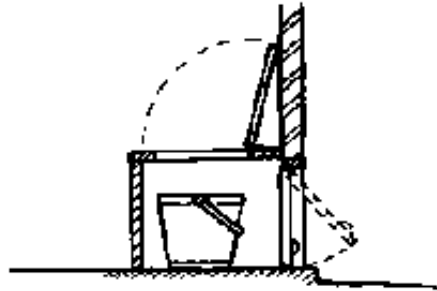

Figure

Advantages	Disadvantages
Low initial cost	Malodorous
	Creates fly nuisance
	Danger to health of those who collect or use the nightsoil
	Collection is environmentally and physically undesirable

Vaults and cesspits

In some areas, watertight tanks called vaults are built under or close to latrines to store excreta until they are removed by hand (using buckets or similar receptacles) or by vacuum tanker. Similarly, household sewage may be stored in larger tanks called cesspits, which are usually emptied by vacuum tankers. Vaults or cesspits may be emptied when they are nearly full or on a regular basis.

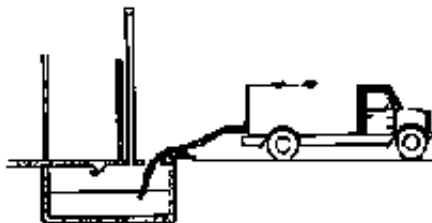

Figure

Advantages	Disadvantages
Satisfactory for users where there is a reliable and safe collection service	High construction and collection costs
	Removal by hand has even greater health risks than bucket latrines
	Irregular collection can lead to tanks overflowing
	Efficient infrastructure required

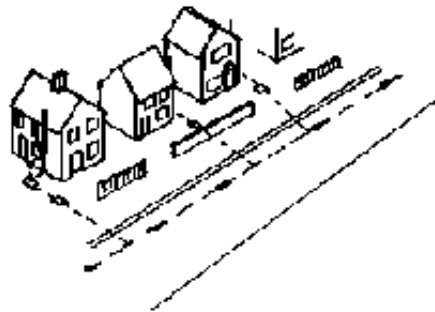

Figure

Sewerage

Discharge from WCs and other liquid wastes flow along a system of sewers to treatment works or directly into the sea or a river.



Advantages	Disadvantages
User has no concern with what	High construction costs

happens after the WC is flushed	
No nuisance near the household	Efficient infrastructure required for construction, operation and maintenance
Treated effluent can be used for irrigation	Ample and reliable piped water supply required (a minimum of 70 litres per person per day is recommended)
	If discharge is to a water-course, adequate treatment required to avoid pollution

Sewers of smaller diameter than usual (small-bore sewerage), sewers built nearer to the surface than usual, and sewers with flatter gradient than usual have been tried. Many of these systems require a chamber at each house to retain solids, which have to be removed and disposed of from time to time. Some of these systems have been found to be suitable for providing sanitation simultaneously for a large number of high-density dwellings.



[Home](#) > [ar.cn.de.en.es.fr.id.it.ph.po.ru.sw](#)

-  **A Guide to the Development of On-site Sanitation (WHO, 1992, 246 p.)**
-  **Part II. Detailed design, construction, operation and maintenance**
- Chapter 5. Technical factors affecting excreta disposal**



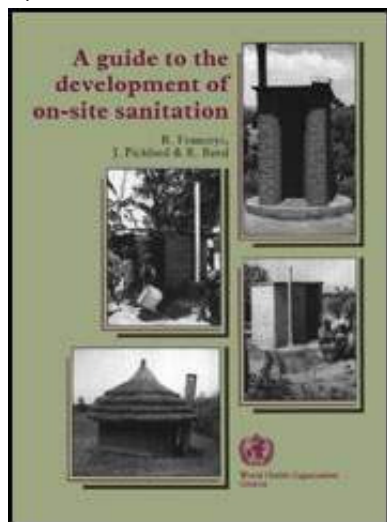

Human wastes

Ground conditions

Insect and vermin problems

Chapter 6. Operation and maintenance of on-site sanitation

(*introduction...*)

Pit latrines

Simple pit latrines

Ventilated pit latrines

Ventilated double-pit latrines

Pour-flush latrines

Offset pour-flush latrines

Double-pit offset pour-flush latrines

Raised pit latrines

Borehole latrines

Septic tanks

Aqua-privies

Disposal of effluent from septic tanks and aqua-privies

Composting latrines

Multiple latrines

Other latrines

Chapter 7. Components and construction of latrines



-  **(Introduction...)**
-  **Pits**
-  **Latrine floors**
-  **Slabs**
-  **Footrests and squat holes**
-  **Seats for latrines**
-  **Water seals and pans**
-  **Vent pipes**
-  **Superstructure**
-  **Chapter. 8 Design examples**
 -  **Introduction**
 -  **Pit latrine design**
 -  **Septic tank design**
 -  **Aqua-privy design**
 -  **Disposal of effluent from septic tanks and aqua-privies**
 -  **Composting toilets**

A Guide to the Development of On-site Sanitation (WHO, 1992, 246 p.)

Part II. Detailed design, construction, operation and maintenance

Chapter 5. Technical factors affecting excreta disposal

Human wastes

Volume of fresh human wastes

The amount of faeces and urine excreted daily by individuals varies considerably depending on water consumption, climate, diet and occupation. The only way to obtain an accurate determination of the amount at a particular location is direct measurement. Table 5.1 shows some reported average quantities of faeces excreted by adults (grams per person per day).

Even in comparatively homogeneous groups there may be a wide variation in the amounts of excreta produced. For example, Egbunwe (1980) reported a range of 500-900 g of faeces per person per day in eastern Nigeria. Generally, active adults eating a high-fibre diet and living in a rural area produce more faeces than children or elderly people living in urban areas eating a low-fibre diet. Both Shaw (1962) and Pradt (1971) suggested that the total amount of excreta is about one litre per person per day.

The amount of urine is greatly dependent on temperature and humidity, commonly ranging from 0.6 to 1.1 litres per person per day.

In the absence of local information the following figures are suggested as reasonable averages:

- high-protein diet in a temperate climate: faeces 120 g, urine 1.2 l, per person per day.**
- vegetarian diet in a tropical climate: faeces 400 g, urine 1.0 l, per person per day.**

Table 5.1. Quantity of wet faeces excreted by adults (in grams per person per day)

Place	Quantity	Reference
China (men)	209	Scott (1952)
India	255	Macdonald (1952)
India	311	Tandon & Tandon (1975)
Peru (rural Indians)	325	Crofts (1975)
Uganda (villagers)	470	Burkitt et al. (1974)
Malaysia (rural)	477	Balasegaram & Burkitt (1976)
Kenya	520	Cranston & Burkitt (1975)

Decomposition of faeces and urine

As soon as excreta are deposited they start to decompose, eventually becoming a stable material with no unpleasant smell and containing valuable plant nutrients. During decomposition the following processes take place.

- Complex organic compounds, such as proteins and urea, are broken down into simpler and more stable forms.**
- Gases such as ammonia, methane, carbon dioxide and nitrogen are produced and released into the atmosphere.**
- Soluble material is produced which may leach into the underlying or surrounding soil or be washed away by flushing water or ground-water.**
- Pathogens are destroyed because they are unable to survive in the environment of the decomposing material.**

The decomposition is mainly carried out by bacteria although fungi and other organisms may assist. The bacterial activity may be either aerobic, i.e., taking place in the presence of air or free oxygen (for example, following defecation and urination on to the ground), or anaerobic, i.e., in an environment containing no air or free oxygen (for example, in a septic tank or at the bottom of a pit). In some situations both aerobic and anaerobic conditions may apply in turn. When all available oxygen has been used by aerobic bacteria, facultative bacteria capable of either aerobic or anaerobic activity take over, and finally anaerobic organisms commence activity.

Pathogens may be destroyed because the temperature and moisture content of the decomposing material create hostile conditions. For example, during composting of a mixture of faeces and vegetable waste under fully aerobic conditions, the temperature may rise to 70°C, which is too hot for the survival of intestinal organisms. Pathogens may also be attacked by predatory bacteria and protozoa, or may lose a contest for limited nutrients.

Volumes of decomposed human wastes

As excreta become decomposed they are reduced in volume and mass owing to:

- evaporation of moisture;**
- production of gases which usually escape to the atmosphere;**
- leaching of soluble substances;**
- transport of insoluble material by the surrounding liquids;**

- consolidation at the bottom of pits and tanks under the weight of superimposed solids and liquids.

Little information is available regarding the rate at which the reduction takes place although there are indications that temperature is an important factor (Mara & Sinnatamby, 1986). Weibel et al. (1949) measured the sludge accumulation rate in 205 septic tanks in the United States of America, and obtained the results shown in Fig. 5.1; other authors have reported the accumulation rates listed in Table 5.2.

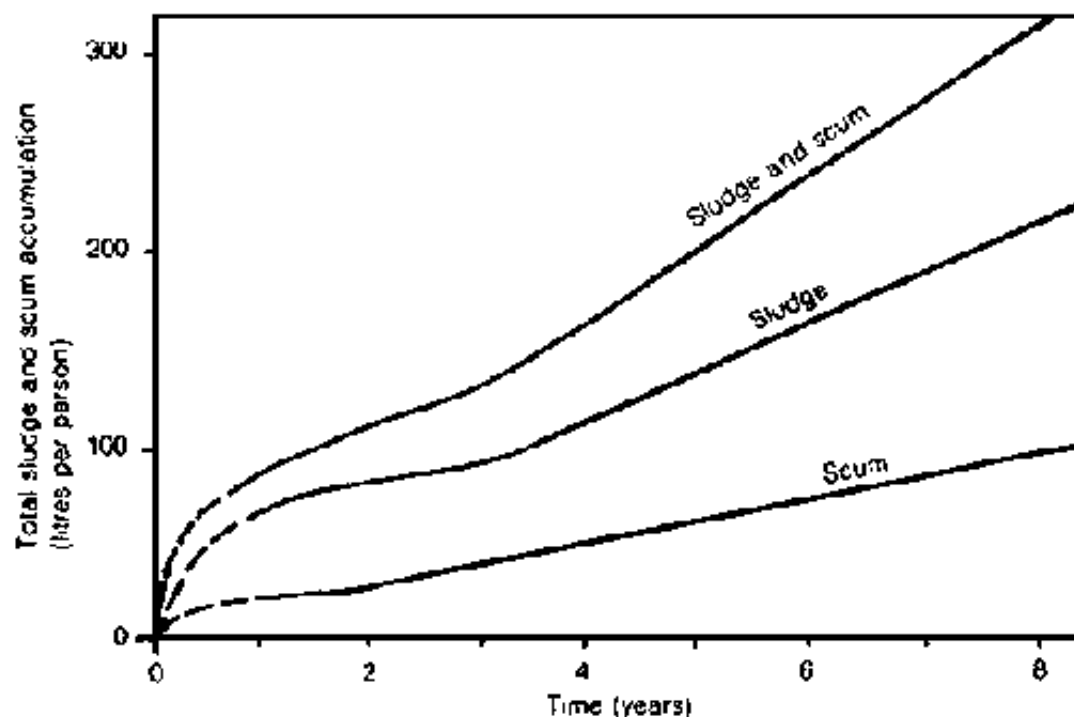

Fig. 5.1. Rate of accumulation of sludge and scum in 205 septic tanks in the United States of America (from Weibel et al., 1949)

WHO 91416

Table 5.2. Excreta accumulation rates (litres per person per year)

Location	Accumulated excreta	Remarks	Reference
Zimbabwe	20	Latrine regularly washed down; degradable cleaning material	Morgan & Mara (1982)
West Bengal	25	Wet pit - ablution water used	Wagner & Lanoix (1958)
West Bengal	34	Wet pit	Baskaran (1962)
Philippines	40	Wet pit; degradable cleaning material	Wagner & Lanoix (1958)
USA	42	Faeces (adult); half amount for children	Geyer et al. (1968)
Brazil	47	Dry pit	Sanches & Wagner (1954)
Philippines	60	Dry pit; degradable cleaning material	Wagner & Lanoix (1958)

The factors with the biggest effect on the sludge accumulation rate are whether decomposition takes place above or below the water table and the type of anal cleaning material used. Decomposition under water produces a much greater reduction in volume than decomposition in air. This is due to better consolidation, more rapid decomposition and removal of the finer material in the water flow. Anal cleaning materials vary widely around the world, from those requiring little

or no storage space; such as water, to those having a greater volume than the excreta, such as corn cobs, cement bags or stones.

Table 5.3. Suggested maximum sludge accumulation rates (litres per person per year)

	Sludge accumulation rate
Wastes retained in water where degradable anal cleaning materials are used	40
Wastes retained in water where non-degradable anal cleaning materials are used	60
Waste retained in dry conditions where degradable anal cleaning materials are used	60
Wastes retained in dry conditions where non-degradable anal cleaning materials are used	90

When designing a latrine it is strongly recommended that local sludge accumulation rates should be measured. In the absence of local data, the volumes given in Table 5.3 are suggested as a maximum. There is some evidence to indicate that these figures are on the high side. However, if refuse is added to excreta, the accumulation rate may be much greater.

Where excreta are stored for short periods only, such as in double pit latrines or composting toilets, the reduction process may not be complete before the sludge is removed. In such cases it will be necessary to use higher sludge accumulation

rates than indicated above. A 50% increase is tentatively suggested.

Ground conditions

Ground conditions affect the selection and design of sanitation systems, and the following five factors should be taken into consideration:

- bearing capacity of the soil;**
- self-supporting properties of the pits against collapse;**
- depth of excavation possible;**
- infiltration rate;**
- groundwater pollution risk.**

Bearing capacity of the soil

All structures require foundations, and some soils are suitable only for lightweight materials because of their poor load-carrying capacity - marshy and peaty soils are obvious examples. In general, it is safe to assume that if the ground is suitable for building a house it will be strong enough to support the weight of a latrine superstructure made of similar materials, providing the pit is appropriately lined.

Self-supporting properties of the pits

Many types of latrine require the excavation of a pit. Unless there is specific evidence to the contrary (i.e., an existing unlined shallow well that has not collapsed), it is recommended that all pits should be lined to their full depth. Many soils may appear to be self-supporting when first excavated, particularly cohesive soils, such as clays and silts, and naturally bonded soils, such as laterites and soft

rock. These self-supporting properties may well be lost over time owing to changes in the moisture content or decomposition of the bonding agent through contact with air and/or moisture. It is almost impossible to predict when these changes are likely to occur or even if they will occur at all. It is therefore safer to line the pit. The lining should permit liquid to percolate into the surrounding soil.

Depth of excavation

Loose ground, hard rock or groundwater near to the surface limit the depth of excavation possible using simple hand tools. Large rocks may be broken if a fire is lit around them and then cold water poured on the hot rock. Excavation below the water table and in loose ground is possible by "caissoning" (see Chapter 7), but it is expensive and not usually suitable for use by householders building their own latrines.

Infiltration rate

The soil type affects the rate at which liquid infiltrates from pits and drainage trenches. Clays that expand when wet may become impermeable. Other soils such as silts and fine sands may be permeable to clean water but become blocked when transmitting effluent containing suspended and dissolved solids.

Opinions vary regarding the areas through which infiltration takes place. For example, Lewis et al. (1980) recommended that only the base of pits or drainage trenches should be considered and that lateral movement (the sidewall influence) be ignored. Mara (1985b) and others have assumed that infiltration takes place only through the side walls as the base rapidly becomes blocked with sludge. Until

more evidence is available, it is recommended that the design of pits and trenches should be based on infiltration through the side walls up to the maximum liquid level. For trenches, the area of both walls should be used.

The rate of infiltration also depends on the level of the groundwater table relative to the liquid in the pit or trench. In the unsaturated zone, the flow of liquid is induced by gravity and cohesive and adhesive forces set up in the soil. Seasonal variation may produce a change in the amount of air and water in the soil pores and this will affect the flow rate. Conditions at the end of the wet season should normally be used for design purposes as this is usually the time when the groundwater level is at its highest. In the saturated zone all pores are filled with water and drainage depends on the size of the pores and the difference in level between the liquid in the pit or trench and the surrounding groundwater.

Soil porosity also affects infiltration. Soils with large pores, such as sand and gravel, and rocks such as some sandstones and those containing fissures, drain easily. Silt and clay soils, however, have very small pores and tend to retain water. Soils containing organic materials also tend to retain water but the roots of plants and trees break up the soil, producing holes through which liquids can drain quickly.

The rate of groundwater flow in unsaturated soils is a complex function of the size, shape and distribution of the pores and fissures, the soil chemistry and the presence of air. The speed of flow is normally less than 0.3 m per day except in fissured rocks and coarse gravels, where the speed may be more than 5.0 m per day, with increased likelihood of groundwater pollution.

Pore clogging

Soil pores eventually become clogged by effluent from pits or drainage trenches. This may reduce or even stop infiltration through the soil. Clogging may be caused by:

- blockage of pores by solids filtered from the liquid;**
- growth of microorganisms and their wastes;**
- swelling of clay minerals; and**
- precipitation of insoluble salts.**

When liquid first infiltrates into unsaturated soil, aerobic bacteria decompose much of the organic matter filtered from the liquid, keeping the pores clear for the passage of air as well as effluent. However, once organic matter builds up so that air cannot pass through the pores, the rate of decomposition (now by anaerobic bacteria) is slower, and heavy black deposits of insoluble sulfides are built up.

Clogging of the pores can be minimized by ensuring that infiltration occurs uniformly over the whole system. Poorly designed infiltration systems (particularly trenches) often cause the liquid to converge on a small section of the system. This produces localized high infiltration rates and clogging in that area. Clogging can sometimes be reduced by a regime of alternate "resting" and "dosing" of the soil. The infiltration area is allowed to rest, i.e., to become fully drained of liquid for a period before infiltration recommences. During the resting period, air reaches the soil surface and the anaerobic bacteria causing the clogging die off, allowing the surface to become unclogged.

Determining infiltration rates

It is rarely possible to measure accurately the rate of flow of effluent from pits and drainage trenches, especially as the flow often decreases as soil pores become clogged. Consequently various empirical rules are used. Some recommendations are based on the rate of percolation of clean water from trial holes dug on the site of a proposed pit or drainage field using various design criteria to allow for differences in infiltration rates (US Department of Health, Education, and Welfare, 1969; British Standards Institution, 1972). Laak et al. (1974) found that, for a wide range of soils, the infiltration rates of effluent were 10-30 litres per m² per day. A conservative rate of 10 litres per m² per day was recommended for general application. On the other hand, rates of up to 200 litres per m² per day are considered applicable in practice in the United States of America (US Department of Health, Education, and Welfare, 1969), and Aluko (1977) found that, in Nigeria, designs with a maximum of 294 litres per m² per day have proved satisfactory. The infiltration capacities given in Table 5.4 (US Environmental Protection Agency, 1980) are recommended as a basis for the sizing of pits and drainage trenches where information about actual infiltration rates is not available. The capacities given for coarse soils are restricted to prevent possible groundwater pollution and therefore may be unnecessarily conservative in areas where this is not a problem. Gravel is capable of much higher infiltration rates, which may be a problem in areas where shallow groundwater is used for human consumption.

Table 5.4. Recommended infiltration capacities^a

Type of soil	Infiltration capacity, settled
---------------------	---------------------------------------

	sewage (l per m² per day)
Coarse or medium sand	50
Fine sand, loamy sand	33
Sandy loam, loam	25
Porous silty clay and porous silty clay loam	20
Compact silty loam, compact silty clay loam and non-expansive clay	10
Expansive clay	<10

^a Source: US Environmental Protection Agency, 1980.

Groundwater pollution risk

This section summarizes the likely effects of on-site sanitation systems on groundwater and the ways in which pollution can be minimized. Lewis et al. (1980) have carried out detailed reviews of these aspects.

The effluent from pits and drainage trenches may contain pathogens and chemical substances that could contaminate drinking-water supplies. Because of their comparatively large size, protozoa and helminths are rapidly removed by the straining action of the soil, but bacteria and viruses are more persistent. The bacterial and viral pathogens that may be carried in water are discussed in Chapter 2.

Of the chemical substances generally present in domestic wastes, only nitrates present serious health dangers. Young babies bottle-fed with milk made from water with a high nitrate concentration may develop "blue baby disease", methaemoglobinaemia, which can be fatal if untreated. There is conflicting evidence suggesting that low nitrate concentrations may contribute to gastric cancer (Nitrate Coordination Group, 1986).

The usual means by which effluents affect drinking-water supplies is through pollution of groundwater that feeds wells and boreholes. A further danger is when effluent infiltrates the ground at shallow depth near to water pipes in which there is intermittent flow or in which the pressure is at times very low. Just as poor joints, cracks and holes in the pipe walls allow water to leak out when the pipes are full, so effluent leaks into the pipes when they are empty or under reduced pressure. Recommendations for allowable levels of pollutants in drinking-water are given in *Guidelines for drinking-water quality* (WHO, 1984).

Purification in unsaturated soil

Effluent passing through unsaturated soil (that is, soil above the groundwater table) is purified by filtration and by biological and adsorption processes. Filtration is most effective in the organic mat where the soil pores are clogged. In sandy soils, Butler et al. (1954) found a dramatic reduction in coliforms in the first 50 mm. The passage of pollutants from a new pit or drainage trench reduces as the pores become clogged.

Viruses, because of their small size, are little affected by filtration and their removal is almost entirely by adsorption on to the surface of soil particles; this is

greatest where the pH is low (Stumm & Morgan, 1981). Adsorption of both viruses and bacteria is greatest in soils with a high clay content, and is favoured by a long residence time - that is, when flow rates are slow. Because the flow is much slower in the unsaturated zone than below the groundwater table, there is longer contact between soil and effluent there, increasing opportunities for adsorption. Adsorbed microorganisms can be dislodged, for example by flushes of effluent or following heavy rainfall, and may then pass into lower strata of the soil.

Viruses, whether they have been removed or remain in effluent, live longer at lower temperatures (Yeager & O'Brien, 1979). Both viruses and bacteria live longer in moist conditions than in dry conditions, and therefore in soils with a good water-holding capacity than in sandy soils. Bacteria live longer in alkaline than in acid soils. They also survive well in soils containing organic material, where there may be some regrowth.

Generally there is little risk of groundwater pollution where there is at least 2 m of relatively fine soil between a pit or drainage trench and the water table, providing the rate of application is not greater than 50 mm/day (equivalent to 50 litres per m² per day). This distance may have to be increased in areas subject to intense rainfall, as the increased infiltration rate produced by the percolating rainwater may carry pollution further.

Fissures in consolidated rock may allow rapid flow of effluent to underlying groundwater with little removal of microorganisms. Holes in soil caused by tree roots or burrowing animals can act in the same way as fissures.

Purification in groundwater

There is little information about survival of either viruses or bacteria in groundwater, although it appears that low temperature favours long survival times. Enteric bacteria may survive in cool groundwater for more than three months (Kibbey et al., 1978). Field experiments indicate that the maximum distance that viruses and bacteria travel in groundwater before being destroyed is equal to the distance travelled by the groundwater in about ten days (Lewis et al., 1980).

In fine-grained soils and pollution sources surrounded by a mature organic mat, the distance travelled may be as little as 3 m, whereas a new source in fast-flowing groundwater may cause pollution up to 25 m downstream (Caldwell, 1937). The pollution extends from the source in the direction of groundwater flow, with only limited vertical and horizontal dispersion. However, this does not apply to pollution in fissured ground, where the pollution may flow through the fissures for several hundred metres, often in an unpredictable direction.

In most cases the commonly used figure of a minimum of 15 m between a pollution source and a downstream water abstraction point will be satisfactory. Where the abstraction point is not downstream of the pollution, i.e., to the side or upstream, the distance can be reduced provided that the groundwater is not abstracted at such a rate that its direction of flow is turned towards the abstraction point (Fig. 5.2). This is particularly useful in densely populated communities, where shallow groundwater is used as a water supply.

If it is not possible to provide sufficient space between the latrine and the water point, consideration should be given to extracting water from a lower level in the aquifer (Fig. 5.3). The predominant flow of groundwater (except fissured flow) is

along the strata, with very little vertical movement. Provided the extraction rate is not too great (handpump or bucket extraction is acceptable), and the well is properly sealed where it passes through the pollution zone, there should be little or no risk of pollution.

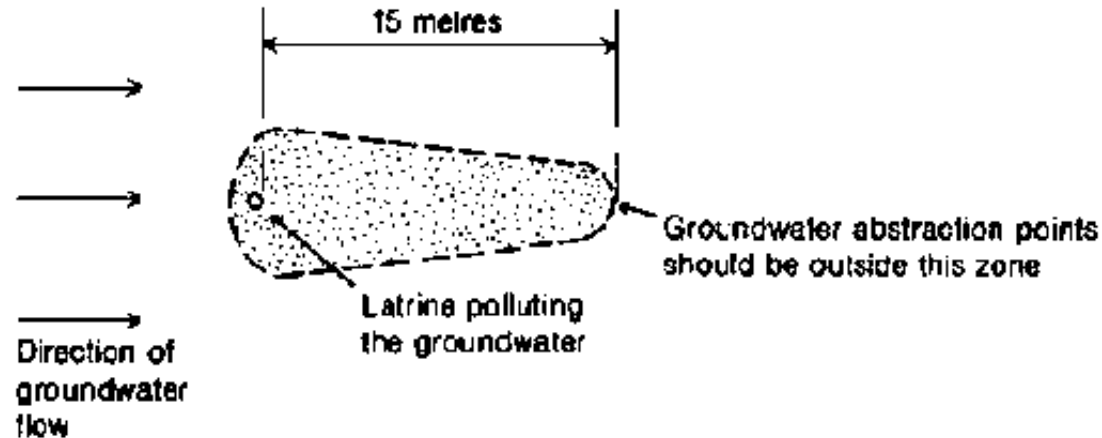

Fig. 5.2. Zone of pollution from pit latrine

WHO 91417

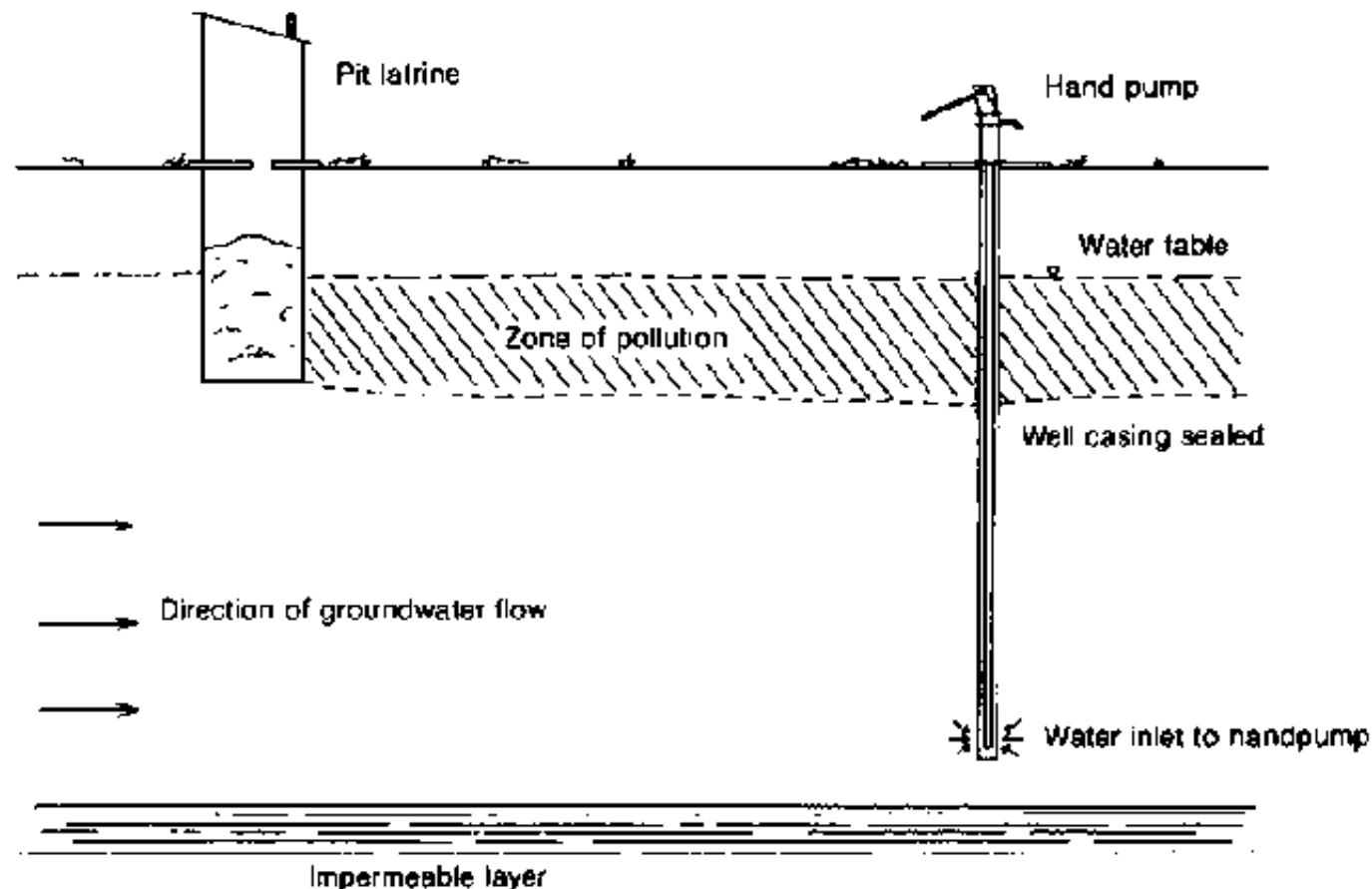

Fig. 5.3. Protecting a hand pump from the pollution from a pit latrine

WHO 91418

Significance of pollution

While faecal pollution of drinking-water should be avoided, the dangers of groundwater pollution from on-site sanitation should not be exaggerated. A depth of two metres of unsaturated sandy or loamy soil below a pit or drainage trench is likely to provide an effective barrier to groundwater pollution and there may be

little lateral spread of pollution. Where the groundwater is shallow, artificial barriers of sand around pits can control pollution (Fig. 5.4).

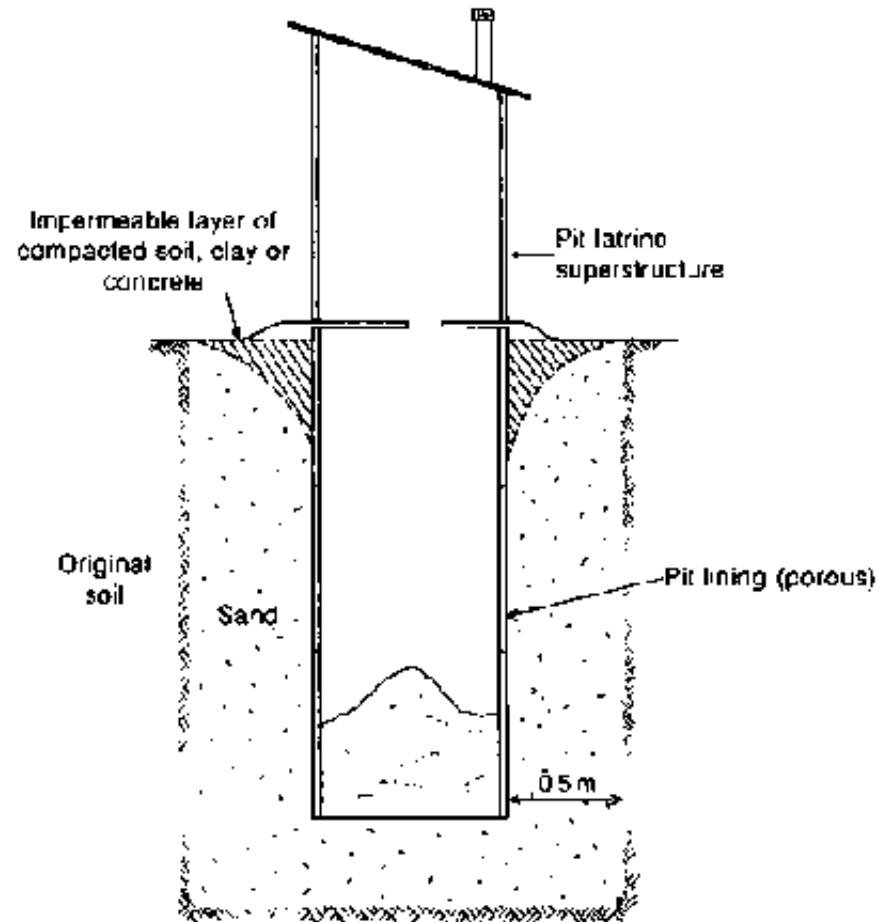

Fig. 5.4. Reducing the pollution from a pit latrine with a barrier of sand

WHO 91419

Unless water is extracted locally for domestic purposes, pollution of groundwater from on-site sanitation does no harm and is to be preferred to the considerable risks associated with defecation in the open. Where on-site sanitation would

result in pollution of wells used for drinking-water, it is generally cheaper and easier to provide water from outside than to build sewers or use vacuum tankers to remove excreta.

Insect and vermin problems

Insects

Many insects are attracted to excreta because they provide rich organic material and water, both of which are essential for the insects' development. The most important groups from a health point of view are mosquitos, houseflies, blowflies and cockroaches.

Mosquitos

Some mosquitos, particularly *Culex pipiens* and some species of *Anopheles*, breed in polluted water, including that found in some pit latrines. Unlike flies, mosquitos are not deterred by low light levels, so keeping excreta in a dark place does not prevent them from breeding. Possible solutions are to keep the pit fully sealed or to cover the surface of the liquid with a film that prevents mosquito larvae from breathing. Oil and proprietary chemicals have been used effectively but may contaminate the groundwater. An alternative is to use small plastic balls that float on the surface producing a mechanical cover to the liquid. Fortunately many latrines only have a free water surface for a short period immediately after starting up or emptying. After that a layer of scum forms on the water surface preventing further mosquito breeding.

Horseflies and blowflies

These are medium- to large-sized flies that are attracted to human food as well as faeces and refuse. The three larval stages are found in excreta or mixtures of excreta and decaying vegetable matter. Solid, moist and fermenting material is most suitable for the breeding of houseflies, but the larvae of the blowfly prefer more liquid faeces and may liquefy masses of faecal material (Feachem et al., 1983). Open pit latrines are ideal breeding places.

Flies use both sight and smell to find food. This is an important consideration when designing latrines since not only must excreta be stored in a dark place but any ventilation holes must be screened.

Cockroaches

Cockroaches are attracted to latrines by the moisture and organic matter; they are then likely to transmit disease by carrying pathogenic organisms on their bodies. Provided that a site has a continuous food supply the cockroaches tend to remain where they are. Accordingly latrines should be sited as far as possible from where food is stored and prepared, to prevent migration of cockroaches from one to the other.

Rats

Rats look upon excreta as a food source. If they come in contact with excreta and then with food intended for human consumption there is a possibility of their transmitting disease. In Nepal, there has been a problem with rats burrowing into double-pit latrines through the holes left in the pit walls. Not only does this create a possible transmission route for disease but the rats deposit large volumes of soil

in the pit which rapidly fill it. A full lining of the top 0.5 - 1.0 m of any pit should prevent rats from entering.

Chapter 6. Operation and maintenance of on-site sanitation

Any review of on-site sanitation shows that there are a large number of options to choose from. This is to be expected, since every project has different characteristics, requiring a different solution. Many of the alternatives are variations on, or combinations of, other designs and it is not possible to describe them all. Those planning on-site sanitation should adopt and combine the major options described in any way that will produce the most appropriate solution.

This chapter describes how the different types of latrine introduced in Chapter 4 work and discusses their relative merits. Details of construction of individual parts is given in Chapter 7 and design examples in Chapter 8.

Pit latrines

The principle of all types of pit latrine is that wastes such as excreta, anal cleaning materials, sullage and refuse are deposited in a hole in the ground. The liquids percolate into the surrounding soil and the organic material decomposes producing:

- gases such as carbon dioxide and methane, which are liberated to the atmosphere or disperse into the surrounding soil;**
- liquids, which percolate into the surrounding soil;**

- a decomposed and consolidated residue.

In one form or another, pit latrines are widely used in most developing countries. The health benefits and convenience depend upon the quality of the design, construction and maintenance. At worst, pit latrines that are badly designed, constructed and maintained provide foci for the transmission of disease and may be no better than indiscriminate defecation. At best, they provide a standard of sanitation that is at least as good as other more sophisticated methods.

Simplicity of operation and construction, low construction costs, the fact that they can be built by householders with a minimum of external assistance, and effectiveness in breaking the routes by which diseases are spread, are among the advantages that make pit latrines the most practical form of sanitation available to many people. This is especially true where there is no reliable, continuous and ample piped water supply.

Unfortunately, past failures, especially of public facilities, discourage some sanitation field workers from advocating their widespread use. Objections to the use of pit latrines are that poorly designed and poorly constructed latrines produce unpleasant smells, that they are associated with the breeding of undesirable insects (particularly flies, mosquitos and cockroaches), that they are liable to collapse, and that they may produce chemical and biological contamination of groundwater. Pit latrines that are well designed, sited and constructed, and are properly used need not have any of these faults.

Design life

As a general rule, pits should be designed to last as long as possible. Pits designed to last 25-30 years are not uncommon and a design life of 15-20 years is perfectly reasonable. The longer a pit lasts, the lower will be the average annual economic cost and the greater the social benefits from the original input.

In some areas, ground conditions make it impractical to achieve such a design life. If the maximum possible design life is less than ten years, serious consideration should be given to using an alternating double-pit system. In such systems the pits must have a minimum life of two years. In the past, a minimum life of one year was considered sufficient for ensuring the death of most pathogenic organisms, but it is now known that an appreciable number of organisms can live longer (see Chapter 2). In any event the increased cost of designing a pit to last two years as compared to one designed to last one year is minimal because of decomposition and consolidation of the first year's sludge (see Chapter 5).

Pit shape

The depth of the pit to some extent affects the plan shape. Deep pits (deeper than about 1.5 m) are usually circular, whereas shallow pits are commonly square or rectangular. As the pit gets deeper the load applied to the pit lining by the ground increases. At shallow depths, normal pit linings (concrete, brick masonry, etc.) are usually strong enough to support the soil without a detailed design. Also square or rectangular linings are easier to construct. At greater depths, the circular shape is structurally more stable and able to carry additional loading.

Commonly, pits are 1.0-1.5 m wide or in diameter, since this is a convenient size for a person to work inside during excavation. The cover slab required is simple to

design and construct, and cheap to build.

Emptying pits

The emptying of single pits containing fresh excreta presents problems because of the active pathogens in the sludge. In rural areas, where land availability is not a constraint, it is often advisable to dig another pit for a new latrine. The original pit may then be left for several years and when the second is filled it may be simplest to re-dig the first pit rather than to excavate a new hole in hard ground. The sludge will not cause any health problems and is beneficial as a fertilizer. However, in urban areas, where it is not possible to excavate further holes and where the investment in pit-lining and superstructure has been substantial, the pit must be emptied.

From the public health point of view, manual removal should be avoided. Where the groundwater level is so high that the pit is flooded or where the pit is sealed and fitted with an effluent overflow, the wet sludge can be removed by ordinary vacuum tankers. These tankers are the same as those used for emptying septic tanks or road gullies (Fig. 6.1). Hand-powered diaphragm pumps have so far proved to be very slow and laborious in emptying pits and have not been widely adopted.

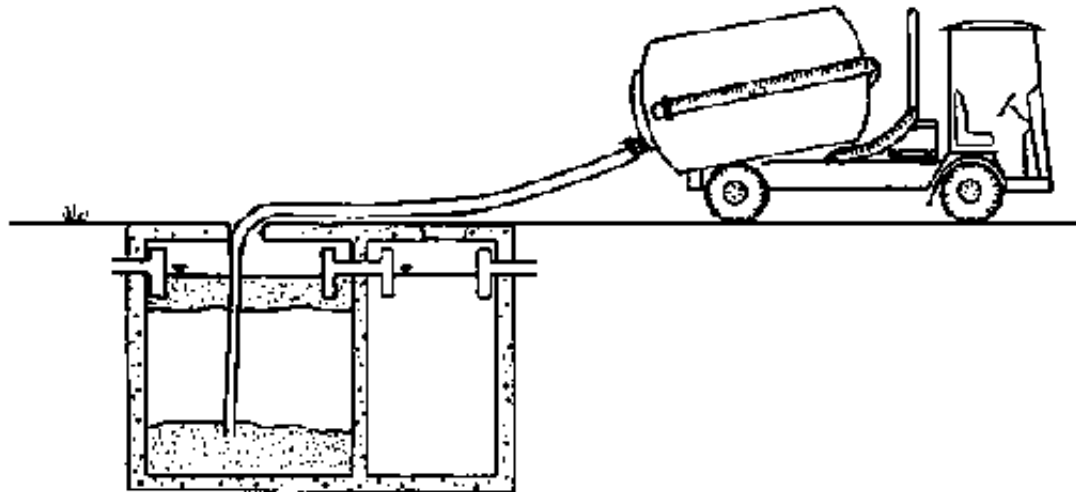

Fig. 6.1. Vacuum tanker desludging a septic tank

WHO 91420

Where pits are mainly dry, the greater part of the contents will have consolidated into solid material which conventional vacuum tankers cannot lift. In addition to this difficulty Boesch & Schertenleib (1985) summarized pit emptying problems as follows.

- The machinery may be too large to get to the latrines. Conventional vacuum trucks are too big to be driven into the centre of many ancient cities or urban/periurban unplanned or squatter settlements where pedestrian routes predominate.**
- Maintenance of vacuum tankers is often poor. Their engines must be kept running all day, either to move the truck or to operate the pump when stationary. This causes rapid wear and makes them particularly susceptible to breakdown if preventive maintenance is neglected.**

- **Management and supervision of emptying services is often ineffective.**

High-performance vacuum tankers able to deal with consolidated pit latrine sludge have been developed (Caroll, 1985; Boesch & Schertenleib, 1985) and are able to exhaust sludge over a horizontal distance of 60 m, thereby getting round problems of accessibility. However, considerable time is needed to set up and then dismantle and wash out the suction pipes.

As an alternative, the pump and tank may be mounted on a small, highly manoeuvrable site vehicle or on separate small vehicles in order to reach a latrine with limited accessibility. The disadvantage of using a smaller tank is that more journeys to the disposal point are required. Consequently, the suction pump is unused during this waiting period unless several small tankers are used with each pump. This can lead to a considerable increase in costs, particularly where disposal points are distant from the latrines. Larger-capacity transfer tankers may be employed to ensure best use of the costly vacuum pump.

Another approach involves the use of a container which can be manhandled close to an otherwise inaccessible latrine, even through the house where necessary. Small-diameter, clean vacuum lines connect the container to the distant tanker, providing the suction necessary to fill the container (Fig. 6.2). A fail-safe method of shutting off the sludge intake when the container is full is required to prevent sludge being carried through the air-line into the vacuum filter and engine. The containers have to be of such a size that they can be manhandled safely when full but also that the least possible number of container movements is required for each pit (Wilson, 1987).

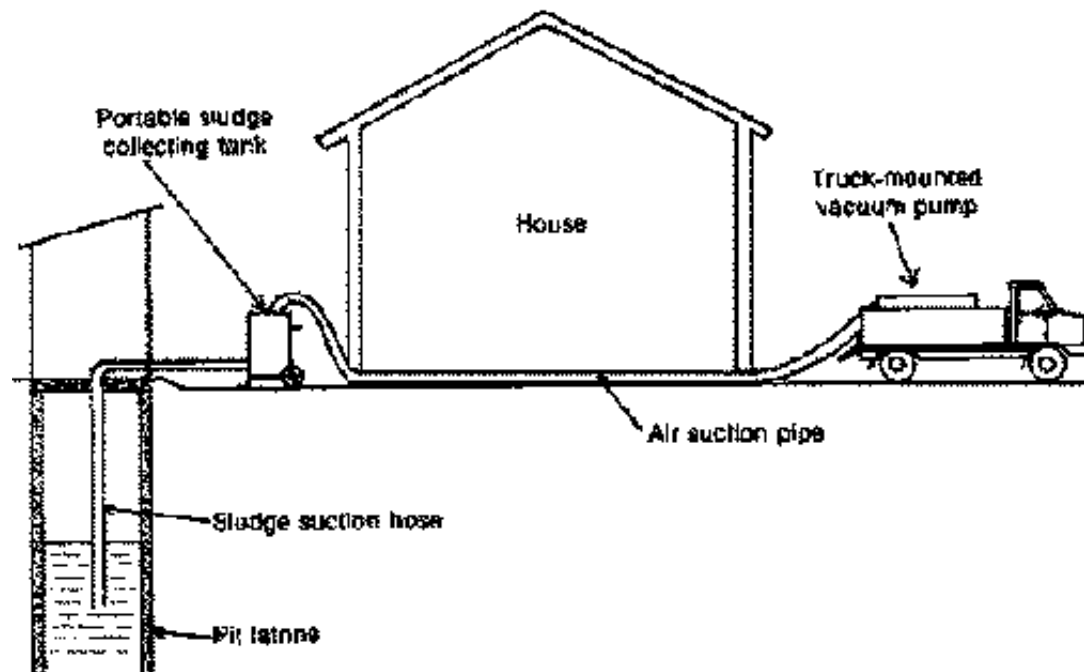

Fig. 6.2. Remote vacuum pump emptying system

WHO 91421

All these systems are relatively expensive and require efficient mechanical maintenance to ensure reliability. The least sophisticated system should be used wherever possible for the majority of pit emptyings.

Simple pit latrines

The simple pit latrine (Fig. 6.3) consists of a hole in the ground (which may be wholly or partially lined) covered by a squatting slab or seat where the user defecates. The defecation hole may be provided with a cover or plug to prevent the entrance of flies or egress of odour while the pit is not being used.

The cover slab is commonly surrounded by some form of superstructure that provides shelter and privacy for the user. The superstructure design is irrelevant to the operation of the latrine but crucial to the acceptability of the latrine to the user. Superstructures range from a simple shelter of sacks or sticks to a building of bricks or blocks costing more than the rest of the latrine. The choice of superstructure will reflect the income and customs of the user.

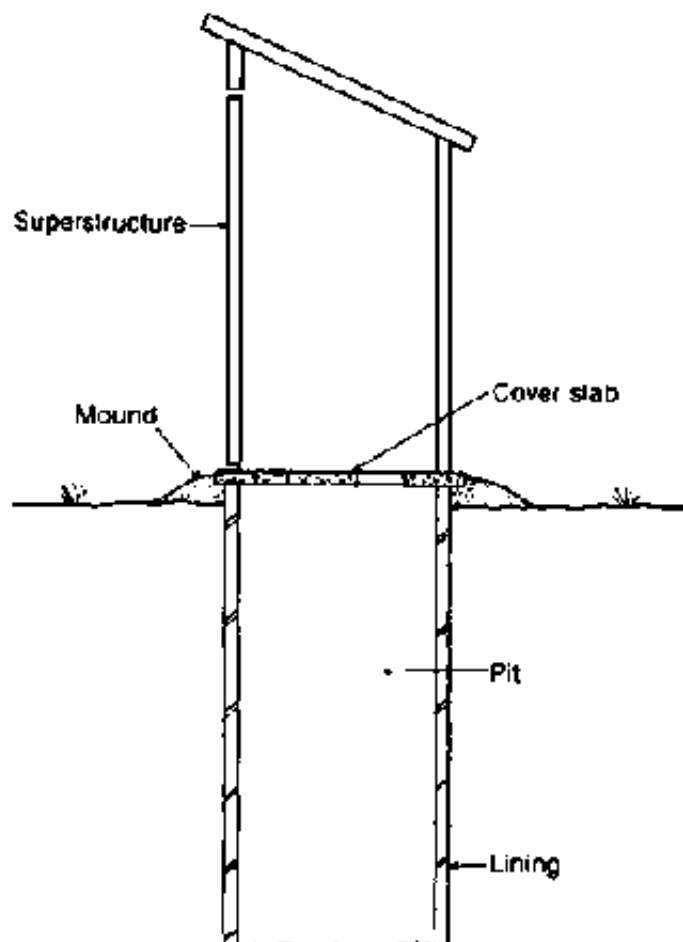

Fig. 6.3. Simple pit latrine

WHO 91422

The cover slab should be raised at least 150 mm above the surrounding ground to divert surface water away from the pit. Commonly, the cover slab sits directly on the lining, but if the lining is made of very thin material, such as an old oil drum, a concrete foundation beam may be necessary to distribute the load of the slab to the lining and surrounding ground (Fig. 6.4).

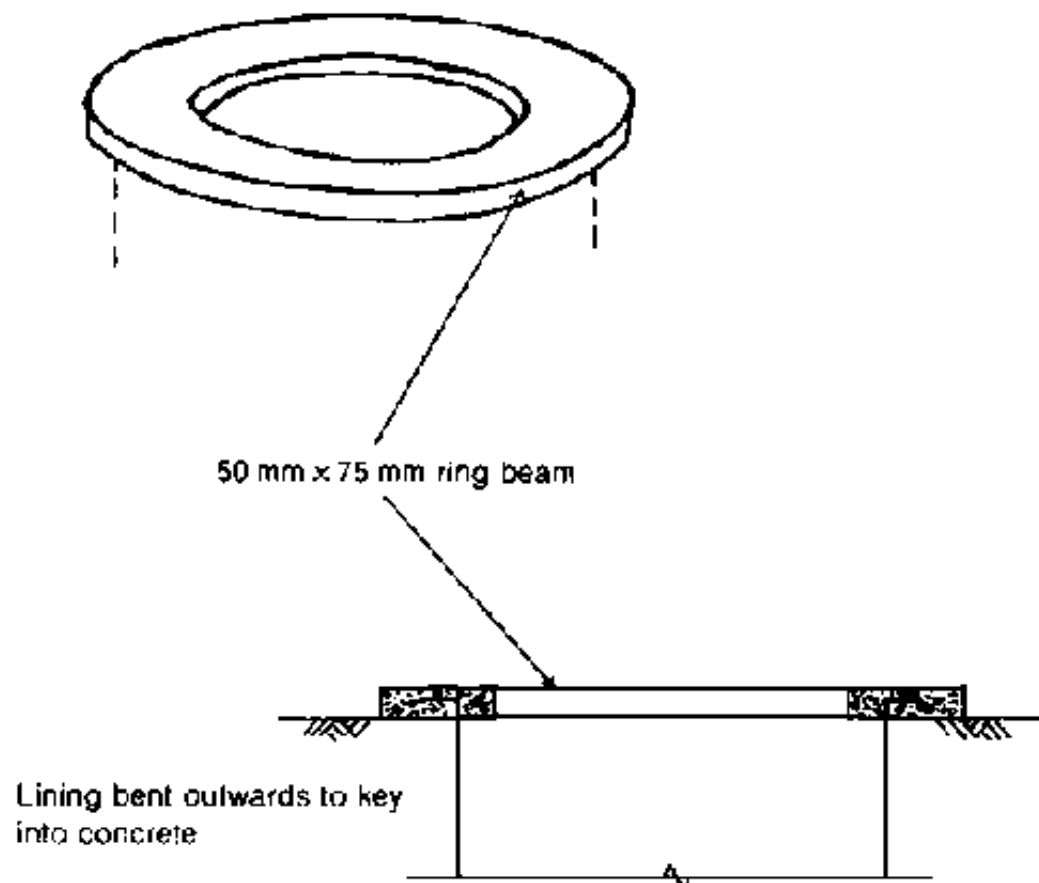

Fig. 6.4. Ring beam on top of a thin pit lining to support the cover slab

WHO 91423

The simple pit latrine is the cheapest form of sanitation possible. Once constructed it requires very little attention other than keeping the latrine area clean and ensuring that the hole cover is in place when the latrine is not in use. Unfortunately the superstructure frequently becomes infested with flies and mosquitos and full of pungent odours because users do not replace the squat hole cover after use. Self-closing hole covers have been tried but are often disliked because the cover rests against the user's back. There may also be resistance to constructing new simple pit latrines because of their resemblance to existing, badly constructed, pit latrines.

Ventilated pit latrines

These are also known as ventilated improved pit (VIP) latrines (Fig. 6.5). The major nuisances that discourage the use of simple pit latrines - smell and flies - are reduced or eliminated through the incorporation of a vertical vent pipe with a flyscreen at the top (Morgan, 1977). Wind passing over the top of the vent pipe causes a flow of air from the pit through the vent pipe to the atmosphere and a downdraught from the superstructure through the squat hole or seat into the pit. This continuous flow of air removes smells resulting from the decomposing excreta in the pit and vents the gases to the atmosphere at the top of the vent pipe rather than through the superstructure. The flow of air is increased if the doorway of the superstructure faces the prevailing wind (Mara, 1984). If a door is fitted it should be kept shut at all times (except when entering or leaving) to keep the inside of the latrine reasonably dark, but there should be a gap, normally above the door, for air to enter. The area of this gap should be at least three times the

cross-sectional area of the vent pipe.

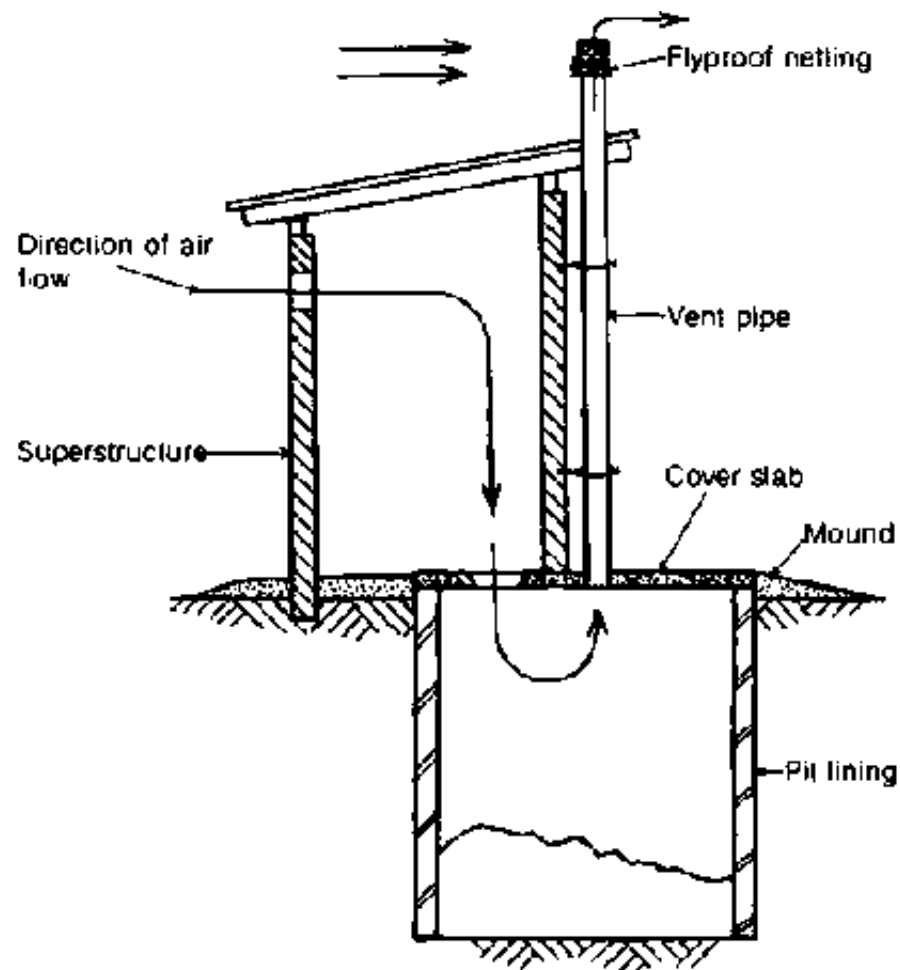

Fig. 6.5. Ventilated improved pit (VIP) latrine

WHO 91424

The superstructure can be constructed in the form of a spiral (Fig. 6.6). This excludes most of the light whether a door is fitted or not. The defecation hole must be left open to allow the free passage of air. The vent pipe should extend at

least 50 cm above the latrine superstructure except where the latter has a conical roof, in which case the pipe should extend as high as the apex. Air turbulence caused by surrounding buildings or other obstructions may cause reverse air flow, leading to foul odours and flies in the superstructure. If mean wind speeds are about 2 m/s, as is fairly common in rural areas, air speeds in the vent pipe are about 1 m/s (Ryan & Mara, 1983). Air flow may also occur at lower wind speeds because of solar radiation heating the air in the vent pipe, causing the air to rise. The vent pipe should then be placed on the equator side of the superstructure. It may be painted black to increase solar absorption, if the material of the pipe is not itself black.

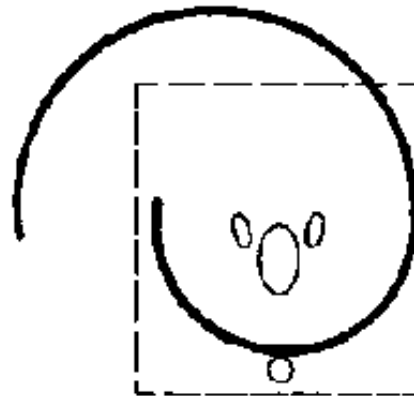

Fig. 6.6. Spiral construction for the superstructure

WHO 91425

In latrines relying on solar radiation for ventilation, foul odours are sometimes experienced in the superstructure at certain times of the day (usually early morning). This occurs where the outside air temperature is colder than the air in the pit, which may prevent the air circulating. Very little can be done to prevent this, other than sealing the defecation hole at night.

In addition to removing odours from the pit, the screened vent pipe significantly controls flies. In Zimbabwe, Morgan (1977) compared the number of flies leaving the squat hole of a VIP latrine with the number leaving a simple pit latrine. The results are shown in Table 6.1.

Flies are attracted to the pit by the odour coming from the vent pipe but are unable to enter because of the screen. A few flies enter the pit through the squat hole or seat, and lay eggs in the pit. New young flies attempt to leave the pit by flying towards the light. If the latrine superstructure is kept sufficiently dark, the major source of light is at the top of the vent pipe, but the screen prevents the flies from escaping there and they eventually fall back into the pit to die.

Well-constructed and maintained VIP latrines combat all the problems associated with simple pit latrines, except mosquitos. However, they are considerably more expensive than simple pits, since a ventilation pipe and full superstructure are required. Because the defecating hole is directly over the pit they accept any form of anal cleaning material without blocking. Routine operation is limited to keeping the superstructure clean, ensuring that the door (where fitted) is kept closed, occasionally checking that the fly-proof netting on top of the vent pipe is not blocked or broken, and pouring water down the vent pipe once a year to remove spiders' webs.

Table 6.1. Comparison of the numbers of flies leaving the squat holes of a simple pit latrine and a VIP latrine^a

Period of trapping	No. trapped in unvented privy	No. trapped in vented privy
8 October-5 November	1723	5

5 November-3 December	5742	20
3-24 December	6488	121

^a Source: Morgan, 1977.

Ventilated double-pit latrines

Although it is usually best to provide large deep pits, this may not be possible where rock or groundwater lie within one or two metres of the ground surface. A variation of the VIP latrine suitable for such situations has two shallow pits side by side under a single superstructure (Fig. 6.7). The pits are usually lined with bricks or blocks. Each pit may have its own squat hole or seat. Alternatively, slabs may be movable, one with a hole for the pit in use and a plain slab for the other pit. Whichever design is used, only one hole must be available for defecation at any time. The latrine may be provided with two ventilation pipes (one for each pit) but more usually only one is fitted, to the pit in use. The hole for the ventilation pipe for the pit not in use is sealed. As with single VIP latrines, the superstructure must be kept partially dark at all times to discourage flies.

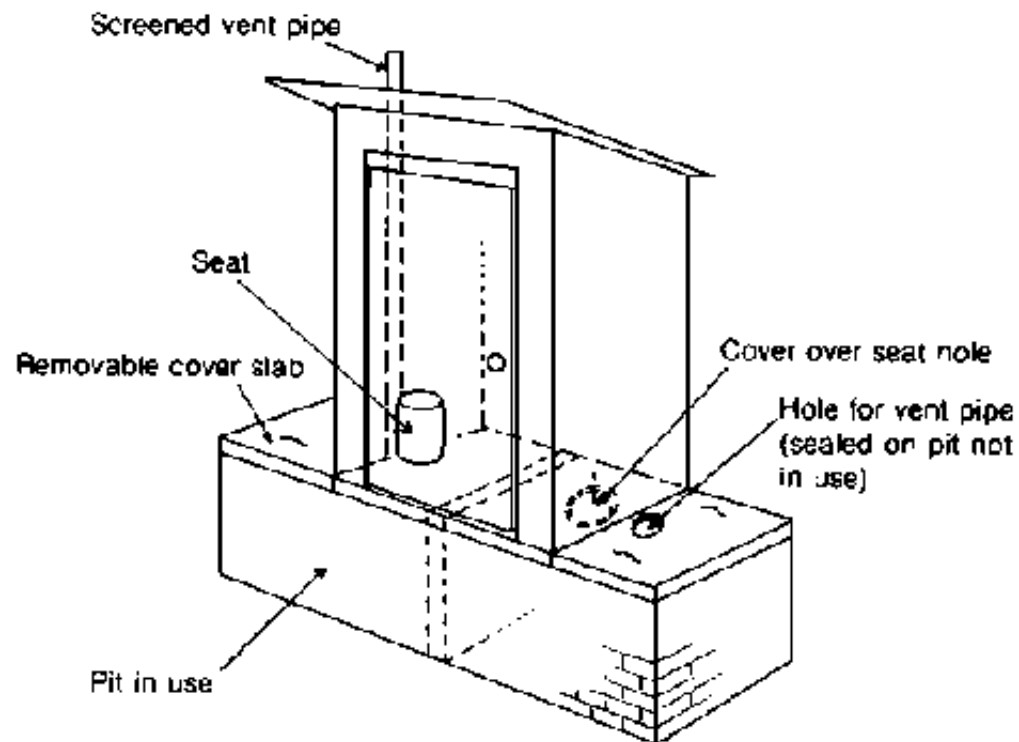

Fig. 6.7. Double-pit VIP latrine

WHO 91426

Operation

One pit is used until it is filled to within about half a metre of the top. The defecation hole over the full pit is then sealed and the one over the empty pit opened. Where necessary, the ventilation pipe is moved from the full to the empty pit, and the vent hole in the slab of the full pit sealed. The second pit is then used until filled to within half a metre of the top. The contents of the first pit can now be removed and the pit reused. The pits must be large enough to allow each pit to be used for at least two years. This ensures that when the pit contents are dug out

most of the pathogenic organisms have died.

Double-pit latrines can be considered as permanent installations. The small effective capacity (0.72 m³ for a family of six, using a sludge build-up rate of 60 litres per person per year, as suggested in Chapter 5) enables pits to be relatively shallow, and therefore easier to empty than deep pits. The pits should extend beyond the superstructure, either to the sides or at the back, with removable slabs for emptying. These slabs should be easy to lift, but should be sealed to prevent flies getting in or out. The central wall between the two pits should be made with full mortar joints and may be rendered with cement mortar on both sides.

As with the single-pit VIP latrine, the double-pit VIP latrine has the advantages of reduced smell and fly nuisance. Also the contents of the latrine dug out every two years or so are a valuable soil conditioner (see Annex 1). Double-pit VIP latrines are usually (but not always) more expensive than single-pit VIP latrines, and require a greater operational input from the user, particularly in changing over pits. Some societies have shown resistance to handling the decomposed contents of the pit but this can often be overcome with education and time. Allowing people to see (and handle) the contents of a pit as it is emptied is the strongest persuader for those concerned.

All projects involving the construction of double-pit latrines must allow for a prolonged support programme. Householders need to be reminded to change pits at the right time and should be assisted in doing so. This assistance will probably have to be available for at least the first two pit changes to ensure that the complete cycle is covered.

Pour-flush latrines

The problems of flies, mosquitos and smell in simple pit latrines may be overcome simply and cheaply by the installation of a pan with a water seal in the defecating hole (Fig. 6.8). Chapter 7 gives details of the design and fabrication of water seals. The pan is cleared by pouring (or, better, throwing) a few litres of water into the pan after defecation. The amount of water used varies between one and four litres depending mainly on the pan and trap geometry. Pans requiring a small amount of water for flushing have the added advantage of reducing the risk of groundwater pollution. The flushing water does not have to be clean. If access to clean water is limited, laundry, bathing or any other similar water may be used.

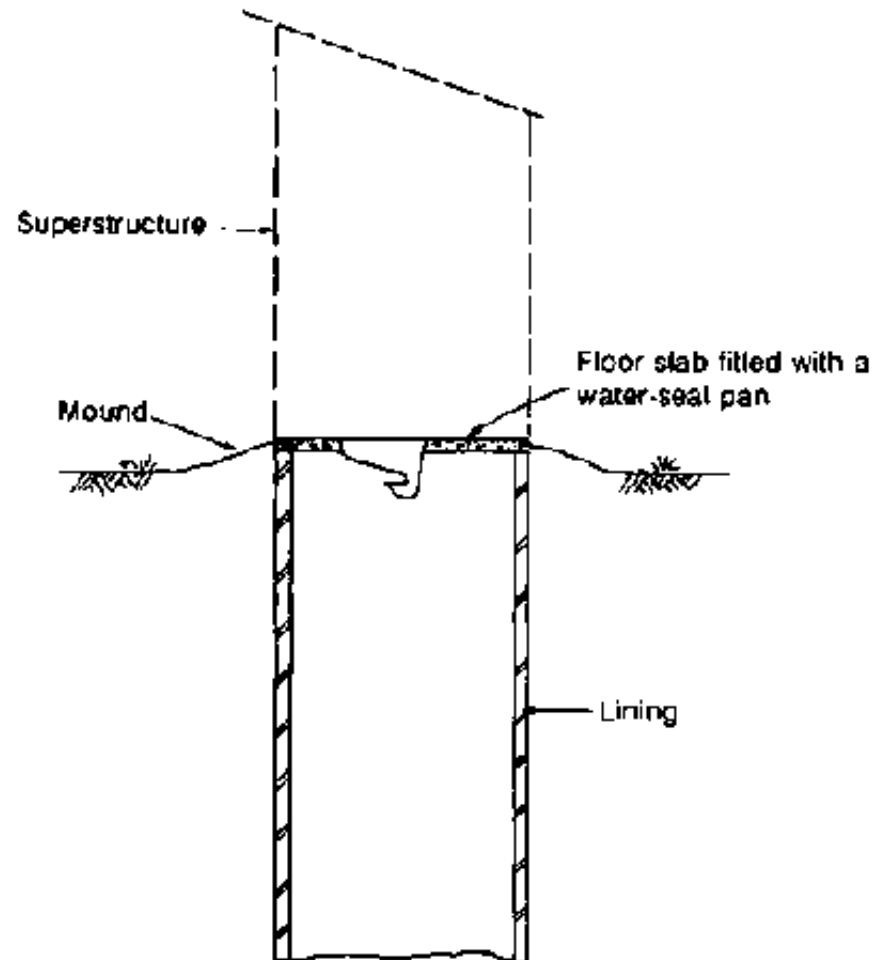

Fig. 6.8. Pour-flush latrine

WHO 91427

Pour-flush latrines are most appropriate for people who use water for anal cleaning, and squat to defecate, but they have also proved popular in countries where other cleaning materials are common. However, there is a likelihood of blockage where solid materials such as hard paper or corncobs are put in the pan. The placing of solid cleaning materials in a container for separate disposal is not

generally recommended unless careful attention can be given to the handling of the waste and sterilizing of the container. Blockage may also be caused by material used by menstruating women. This should be disposed of separately, e.g., by burying or burning. Efforts to clear blockages often result in damage to the water seal.

In most cases, because of the small quantity of water required for flushing, pour-flush latrines are suitable where water has to be carried to the latrine from a standpipe, well, or other water source. There is no justification for the belief that the pit should be ventilated to prevent the build up of gases. A vent pipe adds to the cost of the latrine and any gases produced easily percolate into the surrounding soil.

Offset pour-flush latrines

An extension of the idea of the pour-flush pan with a water seal is for the pit to be outside the latrine building (Fig. 6.9). The contents of the pan are discharged through a short length of small-diameter pipe or covered channel with a minimum gradient of 1 in 30. PVC, concrete or clay pipes, 100 mm in diameter, are often used, but the diameter may be the same as the water seal (usually 65-85 mm). Masonry or brickwork channels with smooth circular concrete inverts have been adopted in some Asian countries. The channel is covered by precast concrete slabs or by bricks laid transversely across the top (Fig. 6.10). Pipes or channels should project at least 100 mm into the pit.

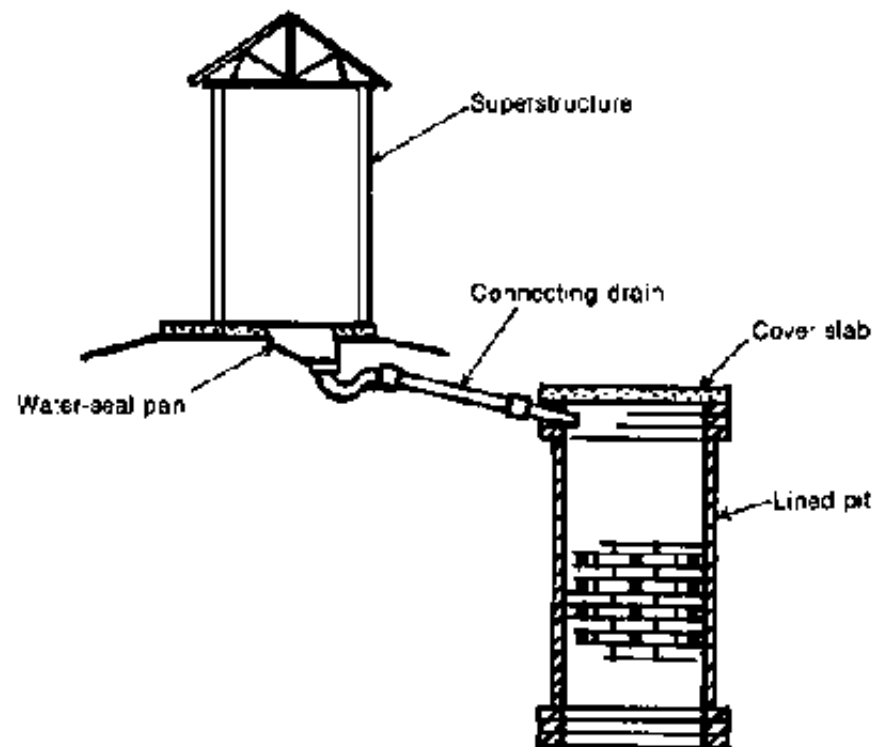

Fig. 6.9. Offset pour-flush latrine

WHO 91428

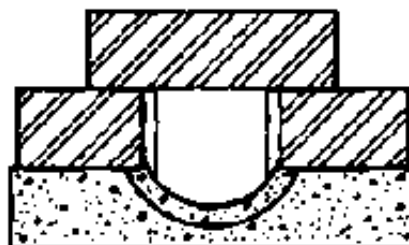

Fig. 6.10. Brick-covered drain

WHO 91429

Generally speaking, an offset pour-flush latrine requires a larger volume of

flushing water than a simple pour-flush latrine. The amount of water required depends on the pan design, pipe slope and roughness. As little as 1.5 litres has been recorded as necessary for each flush, but usually considerably more than this is required.

Offset pour-flush latrines are favoured by many because the superstructure can be permanent. When the pit is full, another pit can be dug alongside and the connecting pipe excavated and relaid to the new pit without damaging the superstructure (Fig. 6.11).

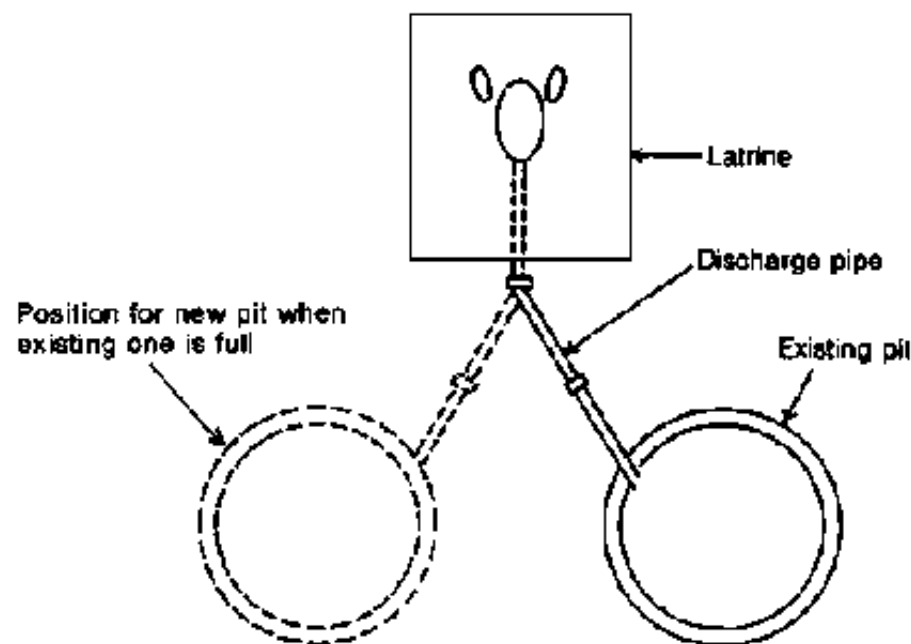

Fig. 6.11. Moving the discharge pipe of an offset pour-flush latrine to a new pit

WHO 91430

Another benefit is that the toilet can be located inside the house and the pit

outside. If this layout is used, care must be taken to allow for movement of the pipe where it passes through the house wall. This can be achieved either by cutting a slot in the wall (Fig. 6.12) so that it does not bear directly on the pipe, or by installing two short lengths of pipe (Fig. 6.13) joining in the centre of the wall. Both systems allow movement of the wall without breaking the pipe. The distance of the pit from the house wall should be not less than its depth, to prevent the load from the wall causing the pit to collapse. If this is not possible, the pit may be located not less than one metre from the wall, provided that the pit is fully lined and the unsupported plan length parallel to the wall does not exceed one metre (Fig. 6.14).

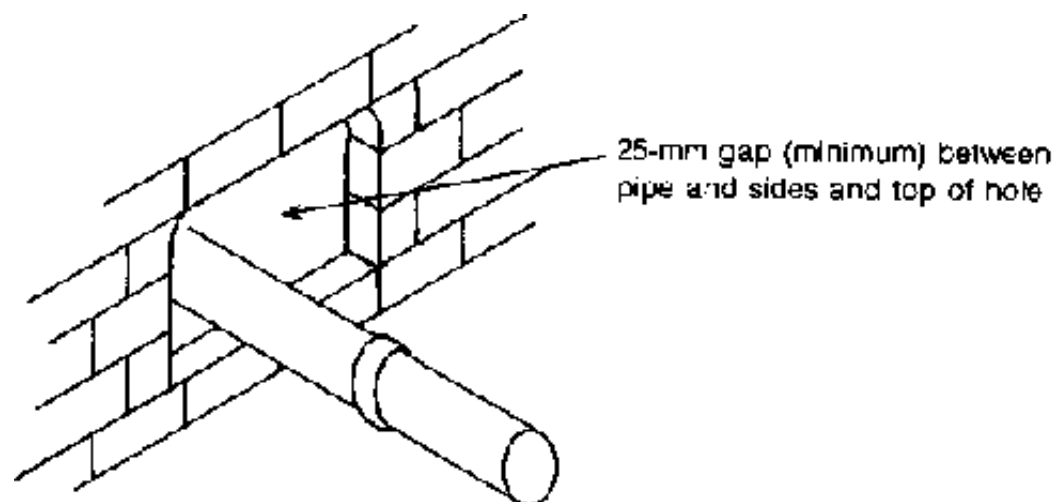

Fig. 6.12. Pipe laid through a hole in an external wall

WHO 91431

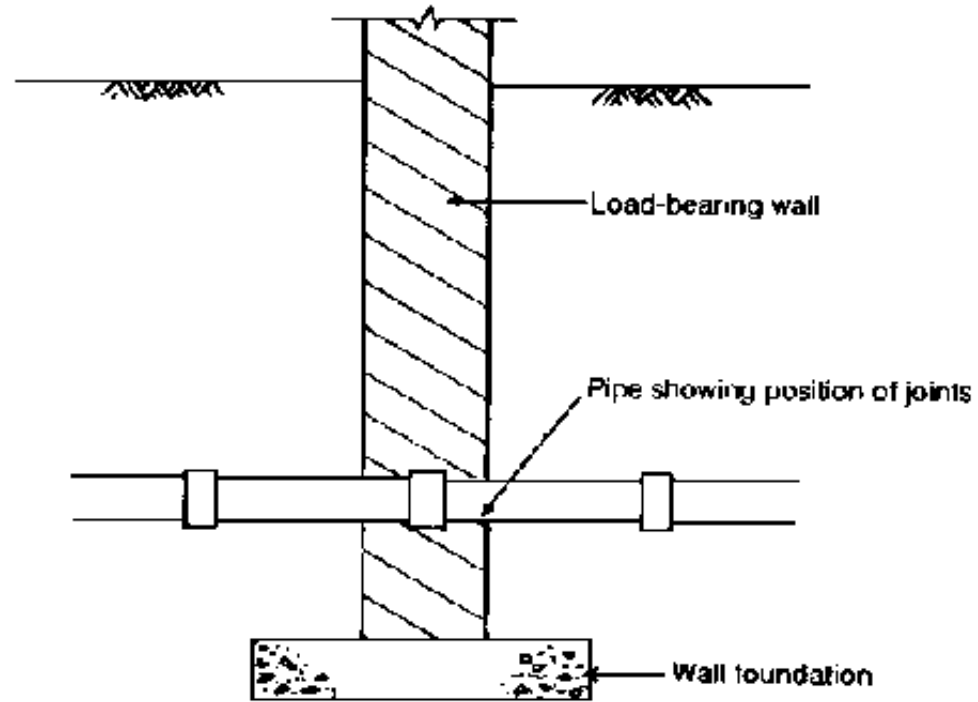

Fig. 6.13. Pipe fixed in place through a wall

WHO 91432

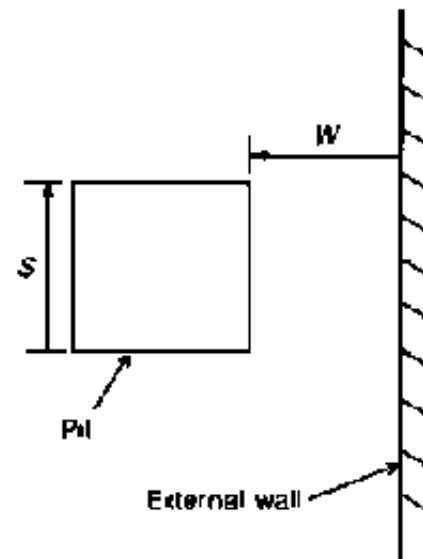

Fig. 6.14. Minimum distance between a pit and the external wall of a house

WHO 91433

Double-pit offset pour-flush latrines

As with VIP latrines there are occasions when two shallow pits are more appropriate than a single deep pit. Double pits with pour-flush pans and water seals have been successfully used in India (Roy et al., 1984) and elsewhere. The pit design is the same as in the double-pit VIP latrine but the two toilets are replaced by a single waterseal pan connected to both pits by pipes. An inspection chamber containing a Y junction is normally built between the pits and the pan so that the excreta can be channelled into either pit (Fig. 6.15).

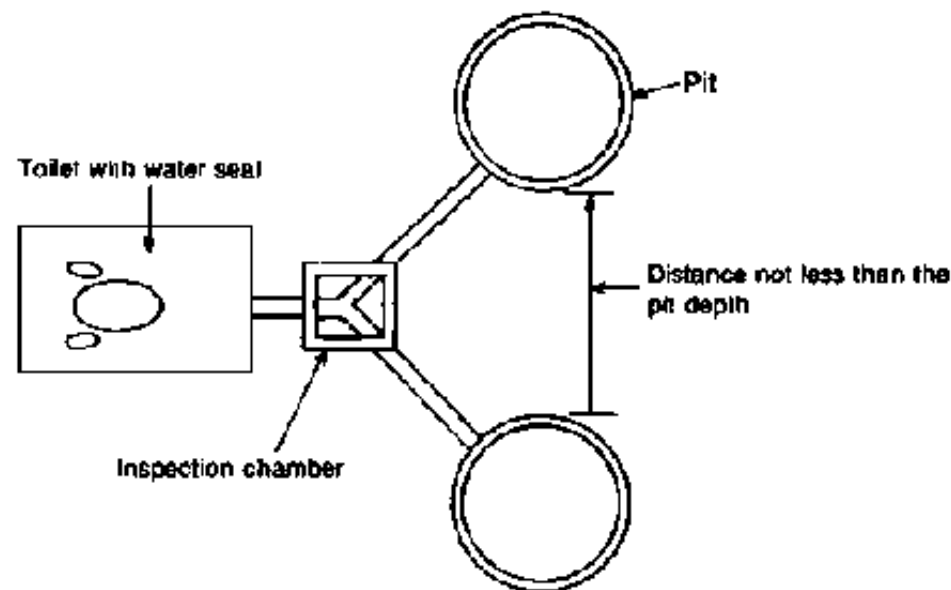

Fig. 6.15. Double-pit offset pour-flush latrine

WHO 91434

Before a new latrine is brought into service, the inspection chamber is opened and one of the pipes leading to the pits is stopped off (a brick, stone, mound of clay or block of wood is quite satisfactory). The cover is then replaced and sealed to prevent gases escaping to the atmosphere. The latrine can now be used like an offset pour-flush toilet except that slightly more water may be required for flushing to prevent solids blocking the Y junction. Since one of the outlets from the chamber is blocked, all the contents of the toilet pan are directed into a single pit. When the first pit is full, usually after a couple of years, the inspection chamber is opened and the stopper blocking the outlet pipe removed and placed in the other outlet pipe. The cover is again replaced and sealed. The pan contents now enter the second pit.

In a further two years the contents of the first pit will have decomposed and nearly all of the pathogenic organisms will have died. The lid of the first pit is taken off and the contents of the pit removed and disposed of or reused (see Annex 1). After replacing and sealing the lid, the first pit can be used again if the stopper in the Y junction is returned to its original position. In this way, the twin pits can be used indefinitely, each pit in turn being used for two years, rested for two years, emptied and then used again.

The positioning and shape of the pits is determined to a large extent by the space available. Some options are shown in Fig. 6.16. If possible, the distance between the pits should be not less than the depth of a pit. This is to reduce the possibility of liquid from the pit in use entering the pit not in use. If the pits have to be built adjacent to each other, the dividing wall should be non-porous. It can also be extended beyond the side-walls of the pit, to prevent cross-contamination. Alternatively, the pit lining can be constructed without holes for a distance of 300 mm either side of the dividing walls.

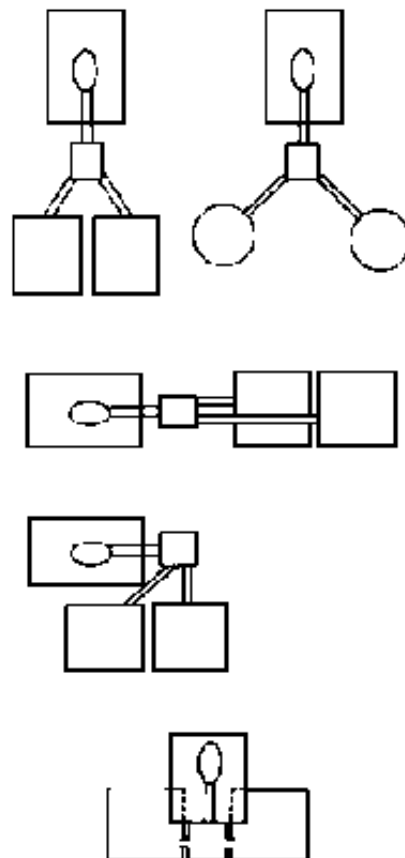

Fig. 6.16. Some layout options for double-pit offset pour-flush latrines

WHO 91435

As with double-pit VIP latrines, double-pit pour-flush latrines are most useful in areas where it is not possible to dig a deep pit or where excreta are to be reused.

For proper operation it is most important that the construction, particularly of the Y junction, is carried out properly, and the user is made fully aware of how the latrine should be operated. Long-term support facilities to remind and assist the user in changing and emptying pits will greatly improve operational success.

Raised pit latrines

Another way of dealing with the problem of difficult ground conditions close to the surface is to construct raised pit latrines. The pit is excavated as deep as possible, working at the end of the dry season in areas of high groundwater. The lining is extended above ground level until the desired pit volume is achieved.

If the pit extends more than 1.5 m below the ground there will probably be sufficient leaching area below ground for a pit latrine having a full depth of 3.5 m. In such cases, the lining above ground should be sealed by plastering both sides (Fig. 6.17). The minimum below-ground depth depends on the amount of water used in the pit and the permeability of the soil. Where insufficient infiltration area can be obtained below ground level, the raised portion of the pit can be surrounded by a mound of soil. The section of the lining above ground (excluding the top 0.5 m) can be used for infiltration provided the mound is made of permeable soil, well compacted with a stable side slope, and is thick enough to prevent filtrate seeping out of the sides (Fig. 6.18). Earth mounds are not recommended on clay soils as the filtrate is likely to seep out at the base of the mound rather than infiltrate the ground.

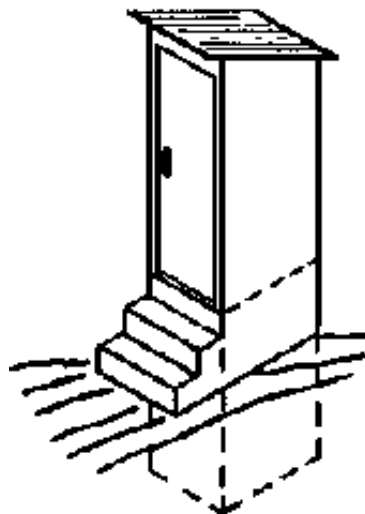

Fig. 6.17 Raised pit latrine

WHO 91436

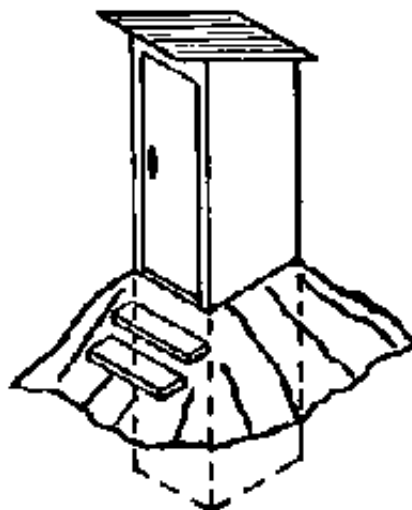

Fig. 6.18. Mound latrine

WHO 91437

Raised pits can be used in combination with any other type of pit latrine (VIP, pour-flush, double-pit). A common application is where the groundwater level is close to the surface. A slight raising of the pit may prevent splashing of the user or blockage of the pit inlet pipe by floating scum.

Borehole latrines

Borehole latrines have an augered hole instead of a dug pit and may be sunk to a depth of 10 m or more, although a depth of 4-6 m is usual. Augered holes, 300-500 mm in diameter, may be dug quickly by hand or machine in areas where the soil is firm, stable and free from rocks or large stones. While a small diameter is easier to bore, the life of the pit is very short. For example a 300-mm hole 5 m deep will serve a family of five people for about two years.

The small diameter of the hole increases the likelihood of blockage, and the depth of the augered hole increases the danger of groundwater contamination. Even if the hole does not become blocked, the sides of the hole become soiled near the top, making fly infestation probable. However, borehole latrines are convenient for emergency or short-term use, because they can be prepared rapidly in great numbers, and light portable slabs may be used.

The holes should be lined for at least the top half-metre or so with an impervious material such as concrete or baked clay. Because of the small diameter and short life, the full depth is not usually lined.

Septic tanks

Septic tanks are commonly used for wastewater treatment for individual

households in low-density residential areas, for institutions such as schools and hospitals, and for small housing estates. The wastewater may be waste from toilets only, or may also include sullage.

The septic tank, in conjunction with its effluent disposal system, offers many of the advantages of conventional sewerage. However, septic tank systems are more expensive than most other on-site sanitation systems and are unlikely to be affordable by the poorer people in society. They also require sufficient piped water to flush all the wastes through the drains to the tanks.

Treatment processes

Wastes from the toilet, and possibly kitchens and bathrooms, pass through drains into a sealed, watertight tank, where they are partially treated. After a period - usually 1-3 days - the partially treated liquid passes out of the tank and is disposed of, often to the ground through soakpits or tile drains in trenches (Fig. 6.19). Many of the problems with septic tank systems arise because inadequate consideration is given to the disposal of the tank effluent.

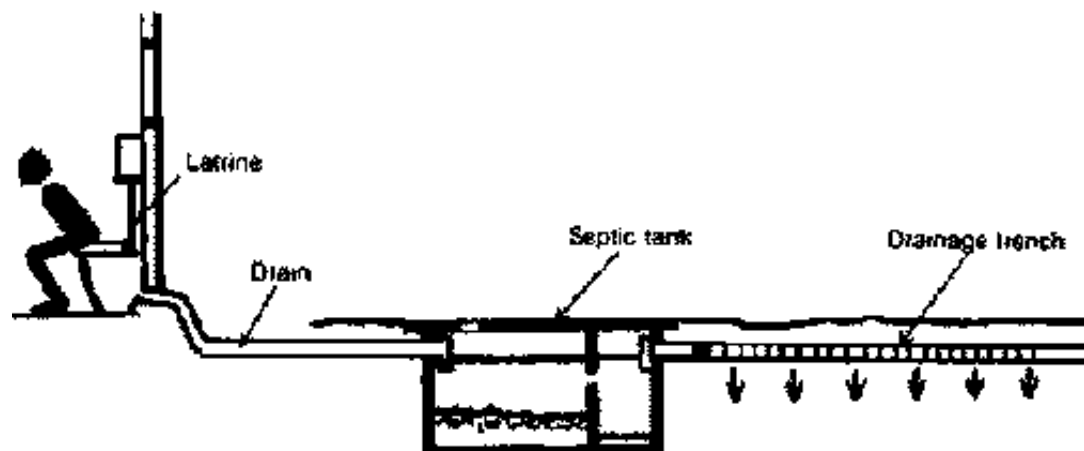

Fig. 6.19. Septic tank disposal system

WHO 91438

Settlement

A principal aim of septic tank design is to achieve hydraulically quiescent conditions within the tank to assist the settlement by gravity of heavy solid particles. The settled material forms a layer of sludge on the bottom of the tank which must be removed periodically. The efficiency of removal of solids by settlement can be high. Majumder et al. (1960) reported removal of 80% of suspended solids in three tanks in West Bengal; similar removal rates were reported in a single tank near Bombay (Phadke et al., undated). However, much depends upon the retention time, the inlet and outlet arrangements, and the frequency of desludging. Large surges of flow entering the tank may cause a temporarily high concentration of suspended solids in the effluent owing to disturbance of the solids which have already settled out.

Flotation

Grease, oil, and other materials that are less dense than water float up to the liquid surface, forming a layer of scum which can become quite hard. The liquid moves through the tank sandwiched between the scum and sludge.

Sludge digestion and consolidation

Organic matter in the sludge and scum layers is broken down by anaerobic bacteria with a considerable amount of organic matter being converted into water

and gases. Sludge at the bottom of the tank is consolidated owing to the weight of liquid and solids above. Hence the volume of sludge is considerably less than that of raw sewage solids entering the tank. Rising bubbles of gas cause a certain amount of disturbance to the liquid flow. The rate at which the digestion process proceeds increases with temperature, a maximum rate being achieved at about 35°C. The use of ordinary household soap in normal amounts is unlikely to affect the digestion process (Truesdale & Mann, 1968). The use of abnormally large amounts of disinfectant causes bacteria to be killed off and thereby inhibits the digestion process.

Stabilization of liquids

The liquid in the septic tank undergoes biochemical changes, but there are few data on the removal of pathogens. Both Majumder et al. (1960) and Phadke et al. (undated) found that although 80-90% of hookworm and *Ascaris* eggs were removed by the septic tanks studied, in absolute terms very large numbers of viable eggs were contained in the effluent, with 90% of effluent samples containing viable eggs.

Since the effluent from septic tanks is anaerobic and likely to contain large numbers of pathogens which can be a potential source of infection, it should not be used for crop irrigation nor should it be discharged to canals or surface-water drains without the permission of the local health authority.

Design principles

The guiding principles in designing a septic tank are:

- to provide sufficient retention time for the sewage in the tank to allow separation of solids and stabilization of liquid;**
- to provide stable quiescent hydraulic conditions for efficient settlement and flotation of solids;**
- to ensure that the tank is large enough to store accumulated sludge and scum;**
- to ensure that no blockages are likely to occur and that there is adequate ventilation of gases.**

Factors affecting design

The design method outlined below provides sufficient volume for both retention of liquid and storage of sludge and scum. The volume required for liquid retention depends upon the number of users, the amount of wastewater passed to the tank and whether sullage is accepted as well as waste from WCs. The volume for sludge and scum storage depends on the frequency with which the tank is desludged, the method of anal cleaning of the users and the temperature.

Estimating the volume of a septic tank

Retention time

A sewage retention time of 24 hours is assumed to be sufficient. This should correspond to the situation immediately before the tank is desludged. After desludging the effective liquid retention time is greater because liquid then

occupies the regions previously full of sludge and scum.

Codes of practice vary in their recommendations from a retention time of just less than 24 hours to about 72 hours. In theory, improved settlement results from a longer retention time, although the maximum rate of settlement is usually achieved within the first few hours. Settlement is impeded by flow disturbances caused by the inlet and outlet arrangements. The problem is likely to be greater in small tanks than large ones (whose hydraulic capacity is better able to damp out disturbances) and it is reasonable to assume that in large tanks correspondingly lower retention times can be used (Mara & Sinnatamby, 1986). The Brazilian code of practice (Associao Brasileira de Normas Tcnicas, 1982) allows for reduced retention time in large tanks, such as those serving institutions or small communities. In summary, if the wastewater flowrate is $Q \text{ m}^3$ per day, it recommends that the retention time should be T hours, as follows:

If Q is less than 6 $T = 24$

If Q is between 6 and 14 $T = 33 - 1.5 Q$

If Q is greater than 14 $T = 12$

Liquid retention volume

If the septic tank accepts sullage as well as toilet waste, the sewage flow from a house or institution usually represents a high proportion of the water supplied. If the water supply per person is known, the sewage flow may be taken as 90% of the water supply. If the water supply exceeds about 250 litres per person per day, the excess is likely to be used for watering gardens. In most developing countries,

the maximum sewage flow may be assumed to be between 100 and 200 litres per person per day.

If only WCs are connected to the septic tank, the sewage flow is estimated from an assumption about the number of times each user is likely to flush the WC. For example, each person may flush a 10-litre cistern four times a day.

The minimum capacity required for 24 hours' liquid retention is:

$$A = P \times q \text{ litres}$$

where A = required volume for 24 hours' liquid retention;

P = number of people served by the tank;

q = sewage flow per person (litres per person per day).

Volume for sludge and scum storage

The volume required for the accumulation of sludge and scum depends upon the factors discussed in Chapter 5. Pickford (1980) suggested the formula:

$$B = P \times N \times F \times S$$

where B = the required sludge and scum storage capacity in litres;

N = the number of years between desludging (often 2-5 years; more frequent desludging may be assumed where there is a cheap and reliable emptying service);

F = a factor which relates the sludge digestion rate to temperature and the

desludging interval, as shown in Table 6.2:
 S = the rate of sludge and scum accumulation which may be taken as 25 litres per person per year for tanks receiving WC waste only, and 40 litres per person per year for tanks receiving WC waste and sullage.

Table 6.2. Value of the sizing factor F in determining volume for sludge and scum storage

Number of years between desludging	Value of F		
	Ambient temperature		
	>20°C throughout year	>10°C throughout year	<10°C during winter
1	1.3	1.5	2.5
2	1.0	1.15	1.5
3	1.0	1.0	1.27
4	1.0	1.0	1.15
5	1.0	1.0	1.06
6 or more	1.0	1.0	1.0

Total tank volume

The total capacity of the tank (C) is:

$$C = A + B \text{ litres}$$

In practice, there are limitations on the minimum size of tank that can be built; the guidelines described below are illustrated in the design examples given in Chapter 8.

Shape and dimensions of septic tanks

Having determined the overall capacity of the septic tank it is necessary to determine the depth, width and length. The aim is to achieve even distribution of flow so that there are no dead areas and no "short-circuiting" (that is, incoming flow shooting through the tank in less than the design retention time).

A tank may be divided into two or more compartments by baffle walls. Most settlement and digestion may occur in the first compartment with some suspended materials carried forward to the second. Surges of sewage entering the tank reduce the efficiency of settlement but have less effect in the second compartment. Laak (1980) reported a number of studies in which septic tanks with more than one compartment performed more effectively than single-compartment tanks. His survey also indicated that the first compartment should be twice as long as the second. Any advantage of more than two compartments has not been quantified.

The following guidelines can be used to determine the internal dimensions of a rectangular tank.

- 1. The depth of liquid from the tank floor to the outlet pipe invert should be not less than 1.2 m; a depth of at least 1.5 m is preferable. In addition a clear space of at least 300 mm should be left between the water level and**

the under-surface of the cover slab.

2. The width should be at least 600 mm as this is the minimum space in which a person can work when building or cleaning the tank. Some codes of practice recommend that the length should be 2 or 3 times the width.

3. For a tank of width W , the length of the first compartment should be $2W$ and the length of the second compartment should be W (Fig. 6.20). In general, the depth should be not greater than the total length.

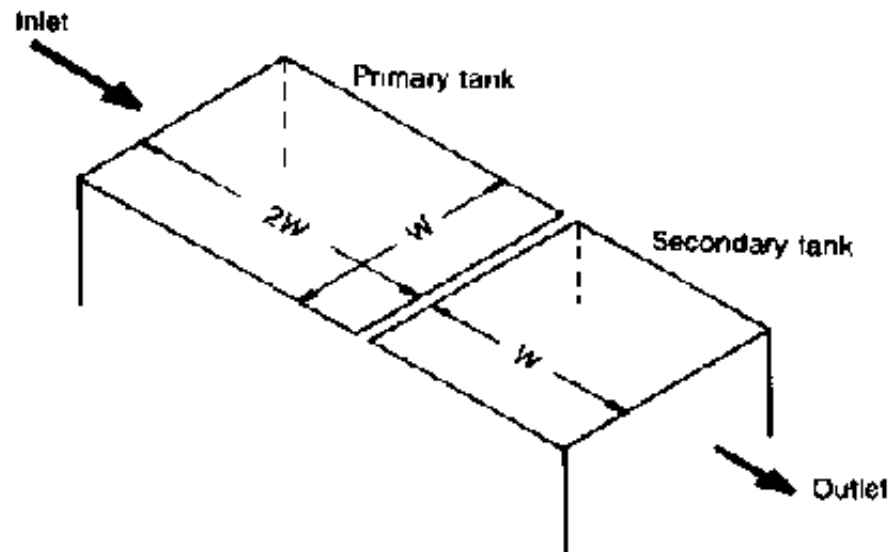

Fig. 6.20. Tank dimensions

WHO 91439

These guidelines give the minimum size of tank. There is no disadvantage in making a tank bigger than the minimum capacity. It may be cheaper to build larger tanks using whole blocks, rather than cutting blocks. Examples of septic

tank design are given in Chapter 8.

Construction

The construction of a septic tank usually requires the assistance and supervision of an engineer or at least an experienced construction foreman. The design of the inlet and outlet is critical to the performance of the tank. Careful checking of levels is particularly important for large tanks that include complicated inlet, outlet and baffle-board arrangements.

For small household tanks, the floor is usually made of unreinforced concrete thick enough to withstand uplift pressure when the tank is empty. If the ground conditions are poor or the tank is large, the floor may have to be reinforced. The walls are commonly built of bricks, blocks or stone and should be rendered on the inside with cement mortar to make them watertight. Large reinforced concrete tanks serving groups of houses or institutions must be designed by a qualified engineer to ensure that they are structurally sound.

The tank cover or roof, which usually consists of one or more concrete slabs, must be strong enough to withstand any load that will be imposed.

Removable cover slabs should be provided over the inlet and outlet. Circular covers, rather than rectangular ones, have the advantage that they cannot fall into the tank when removed.

Septic tanks have been constructed from a variety of prefabricated sections, including large-diameter pipes. Experience has shown that the problems involved in fixing the inlet and outlet outweigh the advantages of using pipes. A number of

proprietary designs of tank are manufactured from asbestos cement, glass-reinforced plastic and other materials and are sold commercially.

Inlet

The sewage must enter the tank with the minimum possible disturbance to the liquid and solids already in the tank. Surges and turbulence reduce the efficiency of settlement and can cause large amounts of solid matter to be carried out in the tank effluent. Suitable inlet arrangements are shown in Fig. 6.21 and 6.24.

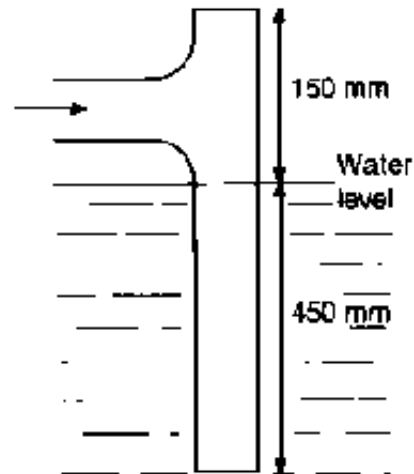

Fig. 6.21. Septic tank inlet pipe

WHO 91440

Surges are caused by flushing of the WC and emptying of sinks and baths. Their effect can be minimized by using drainpipes of not less than 100 mm in diameter and ensuring that the gradient of the pipe approaching the septic tank is flatter than about 1 in 66. Sizes and gradients of pipes between the building and the

septic tank may be specified in local building regulations.

Outlet

For septic tanks less than 1.2 m wide, a simple T-pipe arrangement can be used for the outlet. A removable cover above the T-pipe should be provided to permit clearance of any blockage. An alternative to the T-pipe is a baffle plate made of galvanized sheet, ferrocement or asbestos cement fitted round the outlet pipe (Fig. 6.22). A deflector may be provided below the outlet to reduce the possibility of settled sludge being resuspended and carried out of the tank. For tanks wider than 1.2 m, a full-width weir can be used to draw off the flow evenly across the tank. A scumboard should be fitted to prevent the scum washing over the weir (Fig. 6.23).

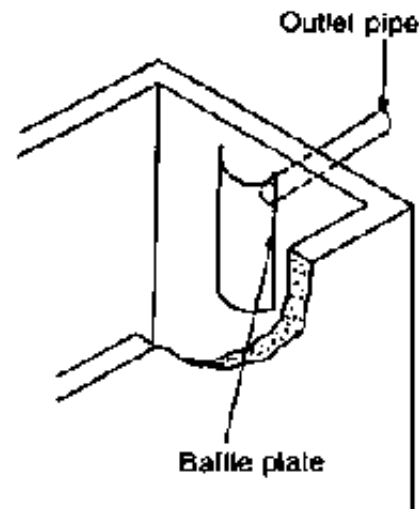

Fig. 6.22. Septic tank out-let baffle plate

WHO 91441

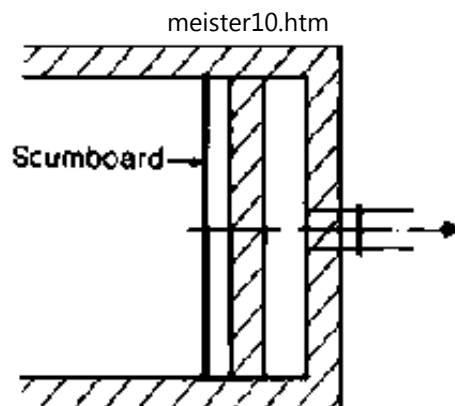

Fig. 6.23. Septic tank outlet using full width weir (Plan)

WHO 91442

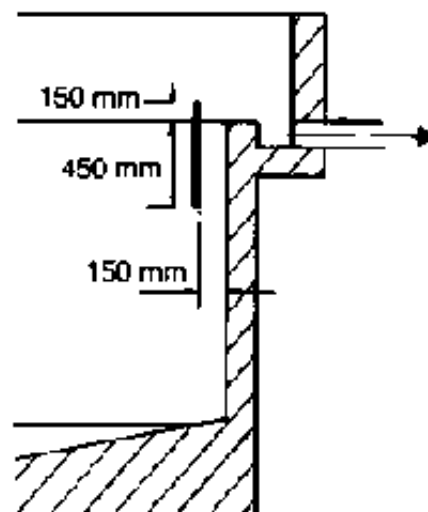

Fig. 6.23. Septic tank outlet using full width weir (Section)

WHO 91442

Dividing wall

If a tank is divided into two or more compartments, slots or a short length of pipe

should be provided above the sludge level and below the scum level, as shown in Fig. 6.24. At least two should be installed to maintain uniform flow distribution across the tank.

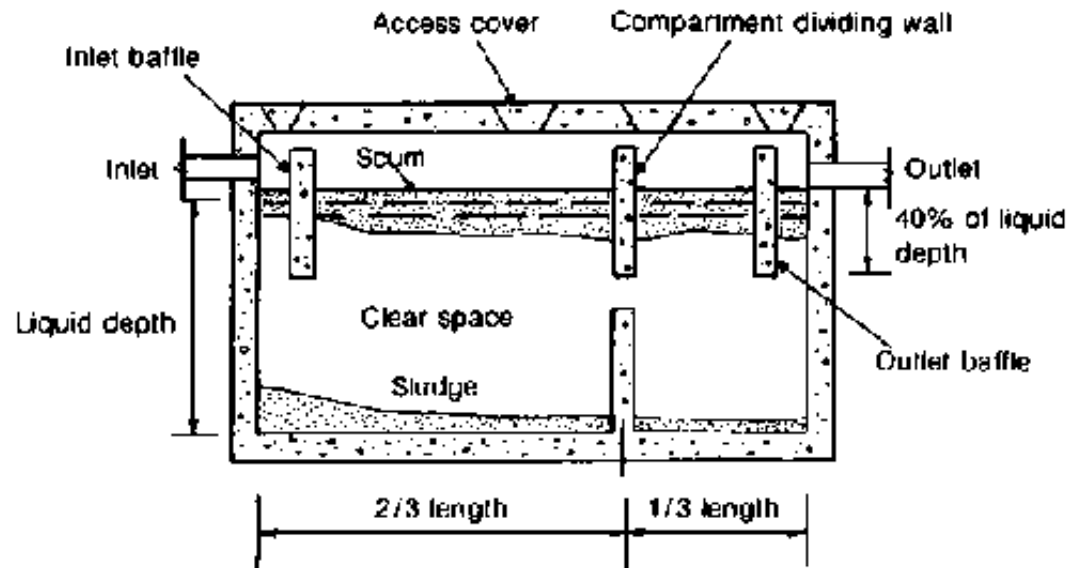

**Fig. 6.24. Septic tanks showing options for connections between compartments
(A)**

WHO 91443

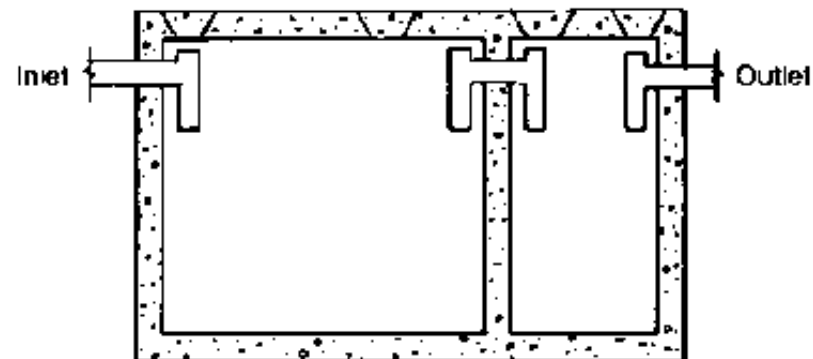

Fig. 6.24. Septic tanks showing options for connections between compartments

(B)

WHO 91443

Ventilation of the tank

The anaerobic processes that occur in the tank produce gases which must be allowed a means of escape. If the drainage system of the house or other building has a ventilation pipe at the upper end, gases can escape from the septic tank along the drains. If the drainage system is not ventilated, a screened vent pipe should be provided from the septic tank itself.

The tank floor

Some codes of practice recommend that the floor of a septic tank should slope downwards towards the inlet. There are two reasons: firstly, more sludge accumulates near the inlet, so a greater depth is desirable; secondly, the slope assists movement of sludge towards the inlet during desludging. For a two-compartment tank, the second compartment should have a horizontal floor and the first compartment may slope at a gradient of 1 in 4 towards the inlet. When calculating the tank volume, it should be assumed that the floor is horizontal at the higher level. The effect of sloping the floor provides extra volume. The disadvantages of providing a sloping floor are that additional depth of excavation is required, the construction is made more complicated, and the cost of construction is increased.

Operation and maintenance

Starting up the tank

The process of anaerobic digestion of the sewage solids entering the tank can be slow in starting and it is a good idea to "seed" a new tank with sludge from a tank that has been operating for some time. This ensures that the necessary microorganisms are present in the tank to allow the digestion process to take place in a short time (McCarty, 1964).

Maintenance

Routine inspection is necessary to check whether desludging is needed, and to ensure that there are no blockages at the inlet or outlet. A tank needs to be desludged when the sludge and scum occupy the volume specified in the design. A simple rule is to desludge when solids occupy between one-half and two-thirds of the total depth between the water level and the bottom of the tank. One of the difficulties with septic tanks is that they continue to operate even when the tank is almost full of solids. In this situation the inflow scours a channel through the sludge and may pass through the tank in a matter of minutes rather than remaining in the tank for the required retention time.

The most satisfactory method of sludge removal is by vacuum tanker. The sludge is pumped out of the tank through a flexible hose connected to a vacuum pump, which lifts the sludge into the tanker. If the bottom layers of sludge have cemented together they can be jetted with a water hose (which may be fitted to the tanker lorry) or broken up with a long-handled spade before being pumped out.

If a vacuum tanker is not available, the sludge must be bailed out manually using buckets. This is unpleasant work which exposes the operatives to health hazards.

Care must be taken to ensure that sludge is not spilled around the tank during emptying. Sludge removed from a septic tank includes fresh excreta and presents a risk of transmission of diseases of faecal origin. Careful disposal is therefore necessary.

When a septic tank is desludged it should not be fully washed out or disinfected. A small amount of sludge should be left in the tank to ensure continuing rapid digestion.

Aqua-privies

An aqua-privy is a latrine set above or adjacent to a septic tank and is useful in situations in which there is a limited water supply (Fig. 6.25). Where the latrine is above the tank, a chute drop-pipe, 100-150 mm in diameter, hangs below the squat hole or latrine seat so that excreta drops directly into the tank below water level. The bottom of the pipe should be 75 mm below the liquid level in the tank, providing a seal which prevents gases escaping into the latrine superstructure and limits the access of flies and mosquitos to the tank. Alternatively the toilet may be fitted with a pan with a water seal. Where the latrine is adjacent to the tank, the pan with water seal is connected by a short pipe. Effluent from the tank goes to a soakpit, drainage trench or sewer. There is usually only a small flow of effluent and it is therefore very concentrated.

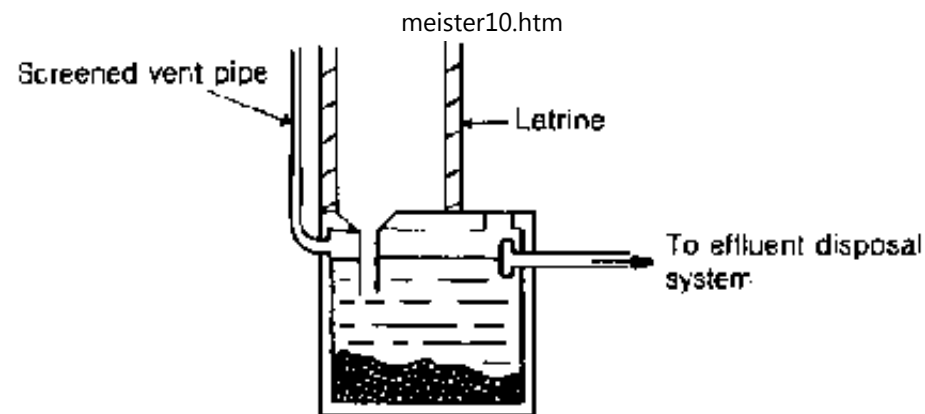

Fig. 6.25. Aqua-privy

WHO 91444

In order to keep a seal at the bottom of the drop-pipe it is essential that the water level in the tank is maintained. If the tank is completely watertight, a bucketful of water every day, used to clean the latrine, is sufficient to compensate for any losses due to evaporation. However, it has been found in practice that many tanks leak. In some places sullage is discharged into the tank (Fig. 6.26), but even this has not proved sufficient to ensure that the water level is above the bottom of the drop-pipe at all times. In Calcutta, aqua-privies used by people who use water for anal cleaning have a water seal incorporated in the drop-pipe below the pan (Pacey, 1978).

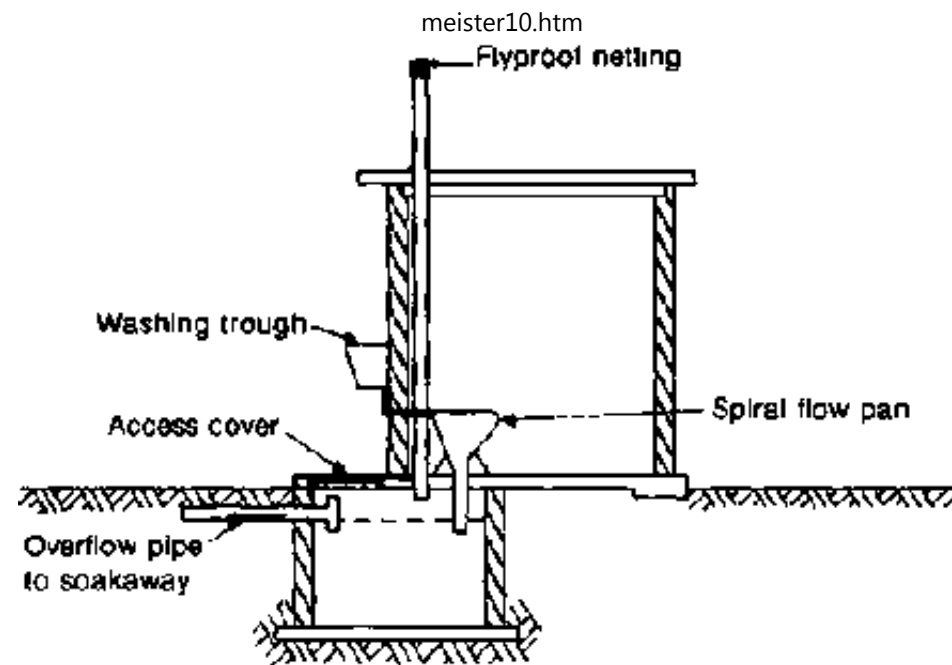

Fig. 6.26. Aqua-privy with pan flushed by waste from a washing trough

WHO 91445

The design capacity of aqua-privy tanks may be calculated by the same procedure as for septic tanks. Regular removal of sludge and scum is essential, so a removable cover for desludging is required. A vent pipe is usually provided.

Disposal of effluent from septic tanks and aqua-privies

A septic tank or aqua-privy is simply a combined retention tank and digester; apart from losses through seepage and evaporation, the outflow from the tank equals the inflow. The effluent is anaerobic and may contain a large number of pathogenic organisms. Although the removal of suspended solids can be high in percentage terms, the effluent is still concentrated in absolute terms, and the need

for safe disposal of septic tank effluents cannot be too strongly stressed.

The effluent from large tanks dealing with sewage from groups of houses or from institutions may be treated by conventional sewage treatment processes such as percolating filters. Effluent from septic tanks and aqua-privies serving individual houses is normally discharged to soakpits or drainage trenches for infiltration into the ground. The infiltration capacities of the soil given in Table 5.4 may be used to determine the required wall area of both soakpits and trenches.

Unfortunately it is not possible to predict the useful life of such disposal systems, which depend on the efficiency of the septic tank and the soil conditions. Pools of stagnant liquid often form when both toilet wastes and sullage are discharged to a septic tank and then to a drainage field which is too small or is clogged. This creates a potential health risk. Overloading of the drainage field may be avoided by allowing only toilet wastes to go to the septic tank. Sullage can be dealt with separately with fewer health risks than a mixture of partly treated toilet waste and sullage. Kalbermatten et al. (1980) proposed the use of a three-compartment septic tank, where sullage is introduced into the final compartment. It is suggested that the effluent infiltration rates may be double those for two-compartment tanks.

Soakpits

Pits used to dispose of effluent from septic tanks are commonly 2-5 m deep with a diameter of 1.0-2.5 m. The capacity should be not less than that of the septic tank.

Depending on the nature of the soil and the local cost of stone and other building

material, soakpits may either be lined or filled with stones or broken bricks. Linings are generally made of bricks, blocks or masonry with honeycomb construction or open joints (Fig. 6.27), as for the linings of pit latrines which are described in Chapter 7. The infiltration capacity of the soil may be increased by filling any space behind the lining with sand or gravel (Cairncross & Feachem, 1983). Hard material such as broken rock or broken kiln-dried bricks not less than 50 mm in diameter may be used to fill an unlined pit (Fig. 6.28).

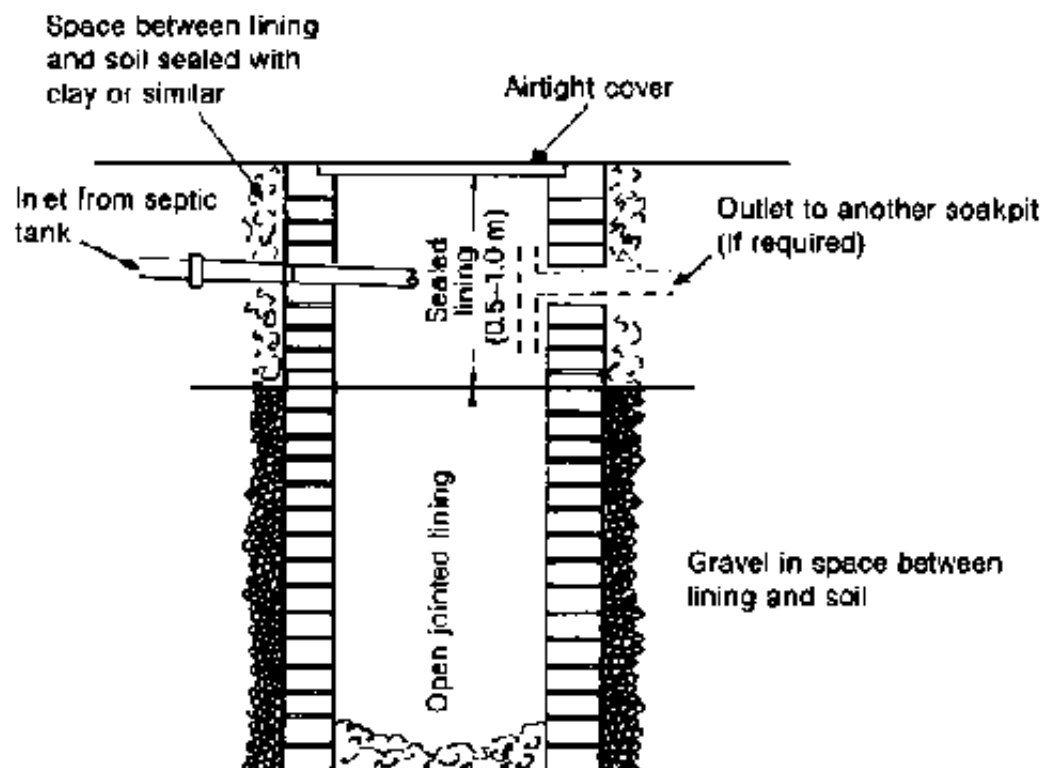

Fig. 6.27. Lined soakpit

WHO 91446

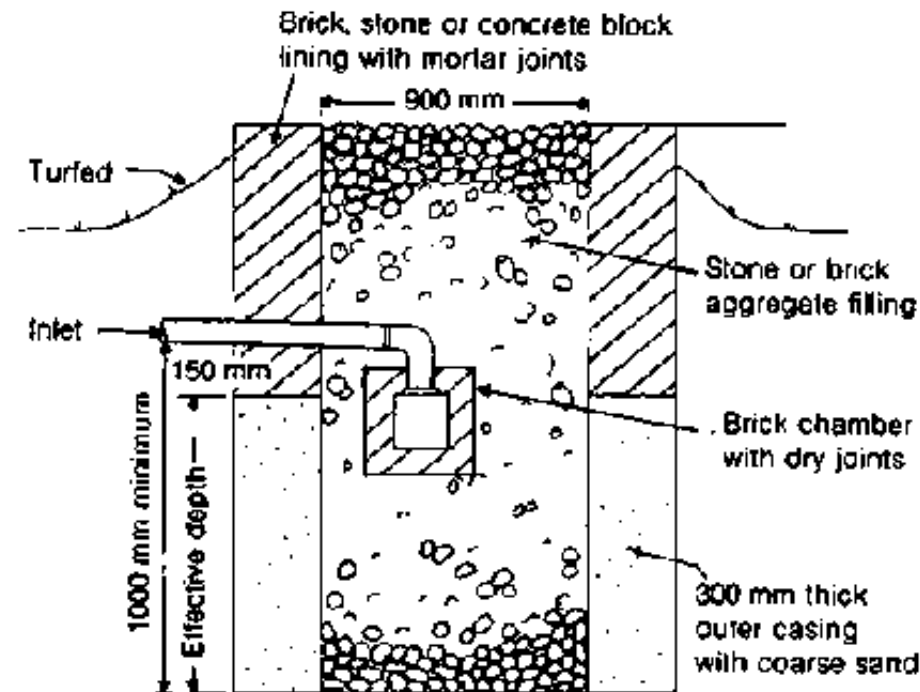

Fig. 6.28. Unlined soakpit

WHO 91447

Whether the main part of the pit is lined or filled, the top 500 mm should have a ring of blocks, bricks or masonry with full mortar joints to provide a firm support for the cover. The ring may be corbelled to reduce the size of the cover. Covers are usually made of reinforced concrete and may be buried by 200-300 mm of soil to keep out insects.

The area required for infiltration should be calculated from the data given in Chapter 5, as illustrated in Example 8.6 in Chapter 8. Increasing the diameter of the pit results in a disproportionate increase in the volume of excavation and in the cost of the cover slab compared with the increase of wall area. Therefore, if

the required infiltration area is large, it may be more economical to provide drainage trenches.

Drainage trenches

The disposal of the large quantity of effluent from septic tanks is often effected in trenches which disperse the flow over a large area, reducing the risk of overloading at one place. The trenches make up a drainage field. The effluent is carried in pipes which are normally 100 mm in diameter with a gap of about 10 mm between each pipe. Unglazed stoneware pipes (tile drains) are often used, either with plain ends or with spigot and socket joints. The upper part of the gap between plain-end pipes may be covered with strips of tarred paper or plastic sheet to prevent entry of sand or silt. With spigot and socket pipes, a small stone or cement fillet can be placed on each socket to centre the adjoining spigot (Fig. 6.29).

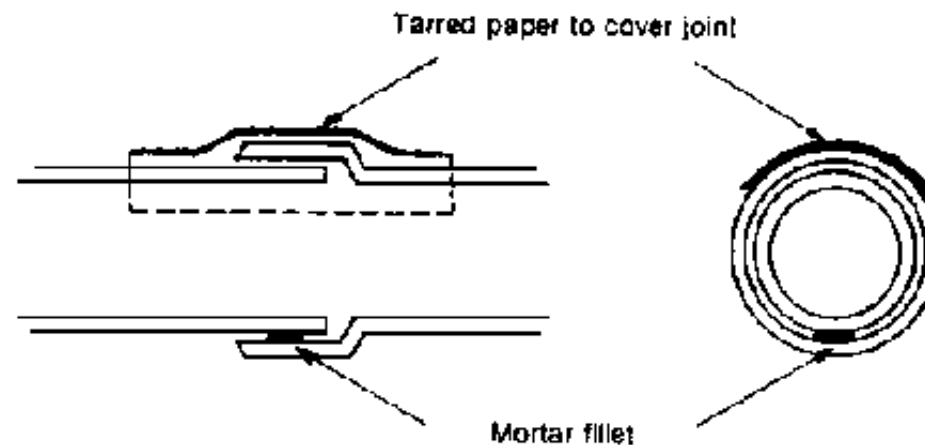

Fig. 6.29. Open pipe joint in a drainage trench

WHO 91448

Drainage trenches are usually dug with a width of 300-500 mm and a depth of 600-1000 mm below the top of the pipes. A common practice is to lay the pipes at a gradient of 0.2-0.3% on a bed of gravel, the stones with a diameter of 20-50 mm. Soil is returned to a depth of 300 500 mm above the stones, with a barrier of straw or building paper to prevent soil washing down (Fig. 6.30).

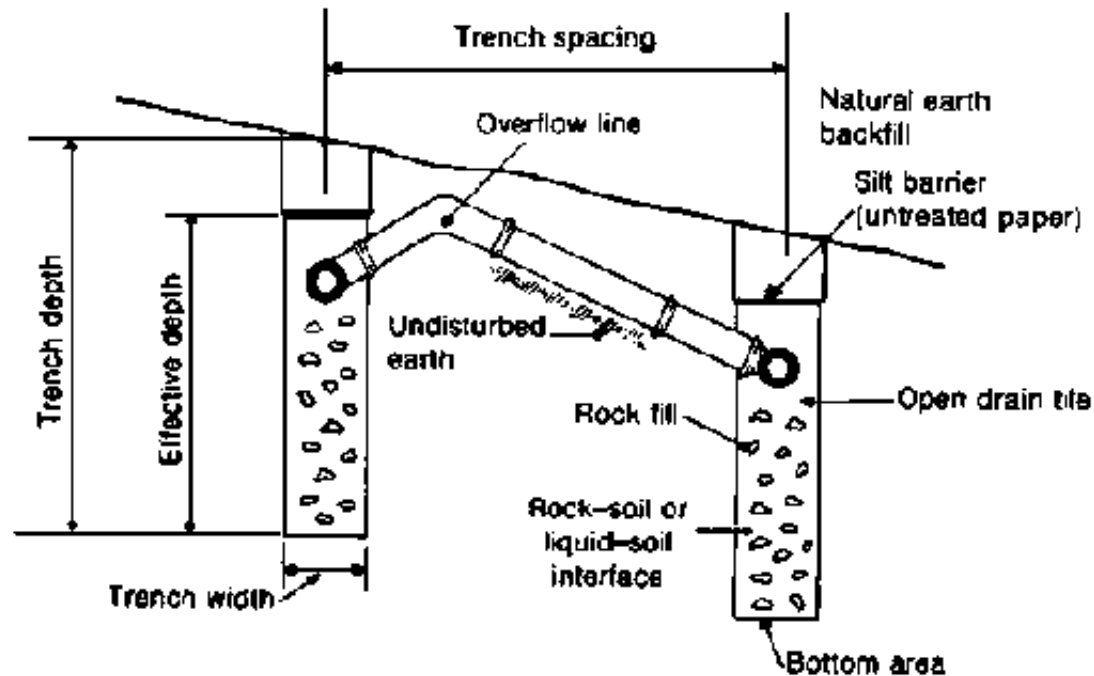

Fig. 6.30. Drainage trench

WHO 91449

If more than one trench is needed it is recommended that the drains be laid in series (Cotteral & Norris, 1969). Drains in series are either full or empty, allowing the soil alongside empty drains to recover under aerobic conditions (Fig. 6.31). If drains are laid in parallel, there is a tendency for all trenches to contain some

effluent. Trenches should be 2 m apart, or twice the trench depth if this is greater than 1 m.

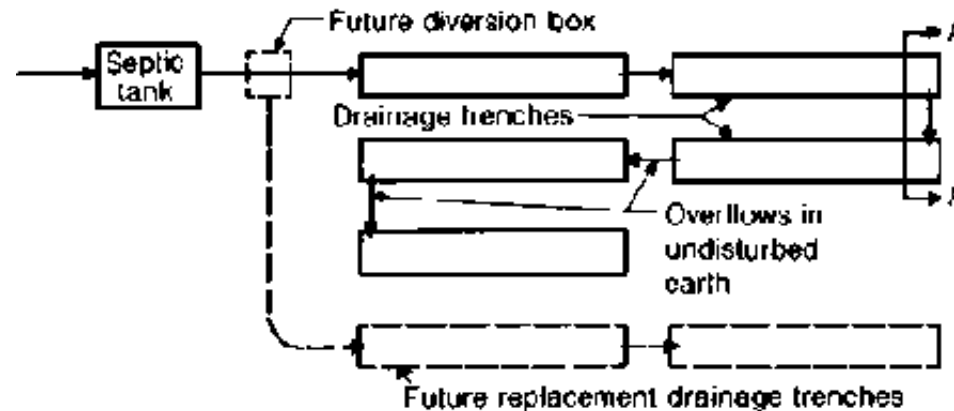

Fig. 6.31. Drainage trenches laid in series in a drainage field. A-A indicates section shown in Fig. 6.30

WHO 91450

The length of trench should be calculated by dividing the flow of effluent by the infiltration rate, allowing for the area of both sides of the trench, as illustrated by the examples given in Chapter 8.

Composting latrines

The value of composting excreta with dry organic matter is discussed in Annex 1. Composting toilets are of two types: those such as double-vault latrines, which use anaerobic bacteria, and continuous composting latrines, which make use of aerobic bacteria.

Double-vault latrines

Each latrine consists of two chambers or vaults used alternately (Fig. 6.32). Initially a layer of about 100 mm of absorbent organic material such as dry earth is put in the bottom of one vault, which is then used for defecation. After each use, the faeces are covered with wood ash or similar material to deodorize the decomposing faeces and soak up excess moisture.

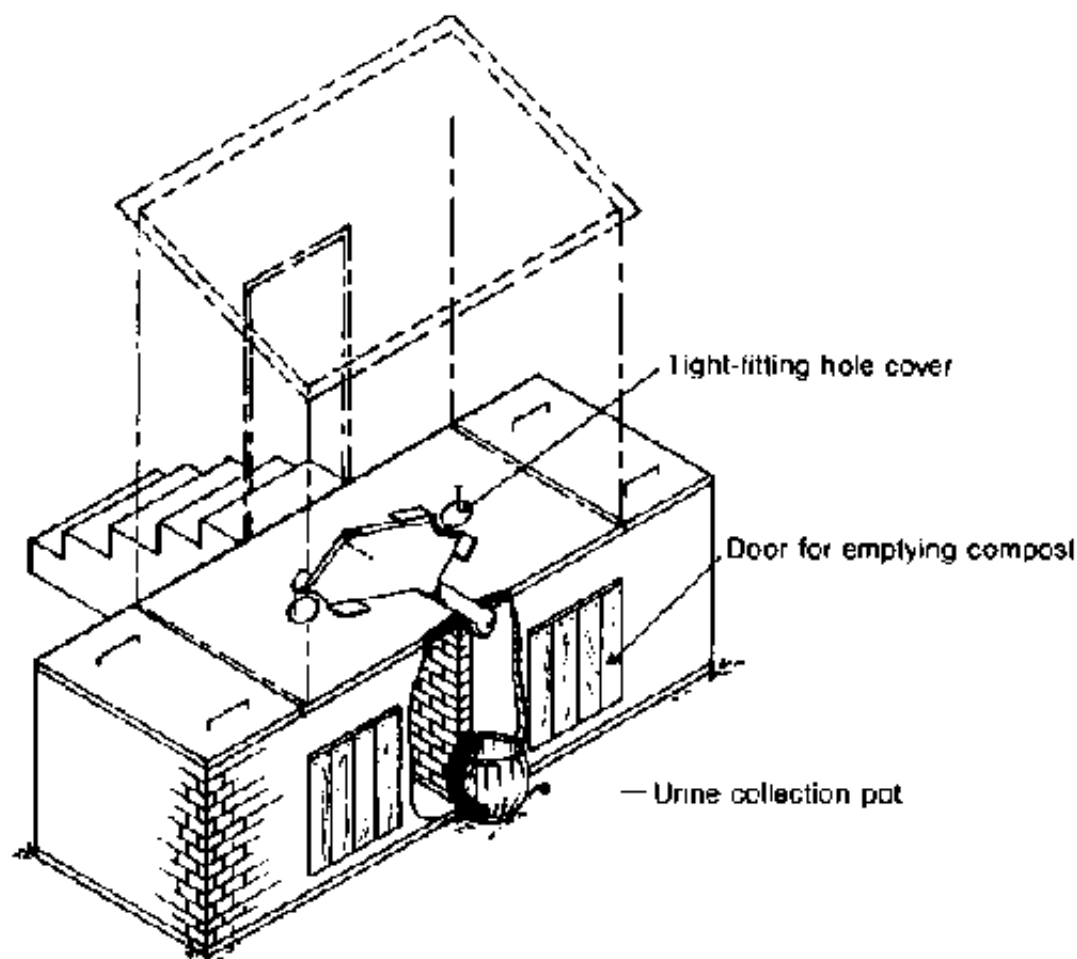

Fig. 6.32. Double-vault latrine

When the vault is three-quarters full, the contents are levelled with a stick and the vault is completely filled with dry powdered earth. The squat hole is then sealed. While the contents of the first vault are decomposing anaerobically, the second vault is used. When the second tank is full, the first one is emptied through a door near the bottom and the chamber is reused. The contents may be used as a soil conditioner.

Each vault should be large enough to hold at least two years' accumulation of wastes so that most pathogenic organisms die off before the compost is removed. Recommended vault sizes range from 1.1 m³ (Winblad & Kalama, 1985) to 2.23m³ (Wagner & Lanoix, 1958).

Normally the superstructure is built over both vaults, with a squat hole over each vault. A cover sealed with lime mortar or clay should be fitted in the squat hole above the chamber not in use. A flyproof lid should be placed on the other hole when it is not being used for defecation. Flyproof vent pipes may be provided to avoid odour nuisance in the latrine, although covering the faeces with ash is reported to be sufficient to eliminate bad smells.

Control of the moisture content is vital for proper operation of the latrine. Consequently composting latrines are not appropriate where water is used for anal cleaning. It is usual to collect urine separately, dilute it with 3-6 parts of water and use it as a fertilizer (although this may cause a health hazard). Some latrines are constructed with soakpits below the vaults so that excess moisture can drain into the ground (Fig. 6.33). This allows for the disposal of urine into the vaults but with consequent loss of a valuable fertilizer and possible pollution of the groundwater. Wood ash, straw, sawdust, grass cuttings, vegetable wastes and

other organic material must be put into vaults to control moisture content and improve the quality of the final compost.

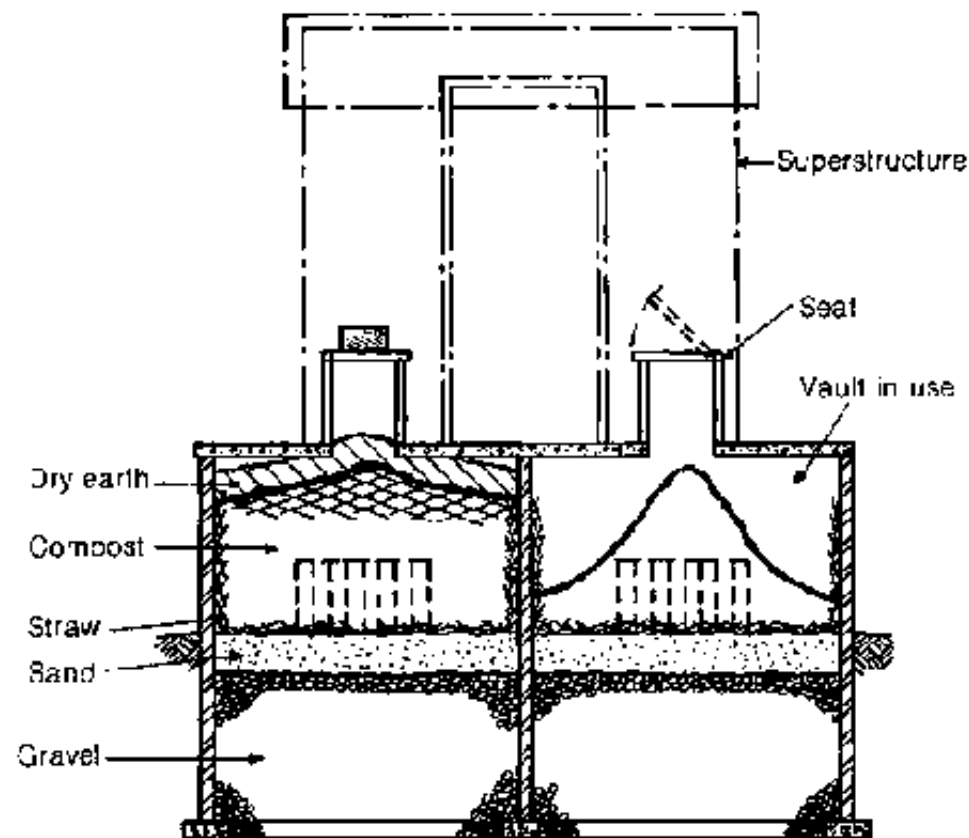

Fig. 6.33. Double-vault latrine with soakpits

WHO 91452

Besides providing a reusable resource, the double-vault latrine has the added advantage that it can be built anywhere. Since the vault contents are kept dry, there is no pollution of the surrounding ground, even if the vault is buried. In rocky areas or where the water table is high the vaults may be built above ground.

Walls and base should be watertight.

Double-vault composting latrines have been successfully used in Viet Nam (McMichael, 1976) and Guatemala (Buren et al., 1984). When tried elsewhere they have usually been unsatisfactory. Most of the disadvantages revolve round the problem of controlling the moisture content. Proper operation of the latrine is difficult to understand and considerable effort may be required to educate local people in its use. The contents are often allowed to become too wet, making the vault difficult to empty and malodorous.

Continuous composting toilets

These consist of watertight sloping chambers about 3 m in length. Excreta fall into the chamber from a toilet. Dry organic kitchen and garden waste is tipped in through a separate opening (Fig. 6.34).

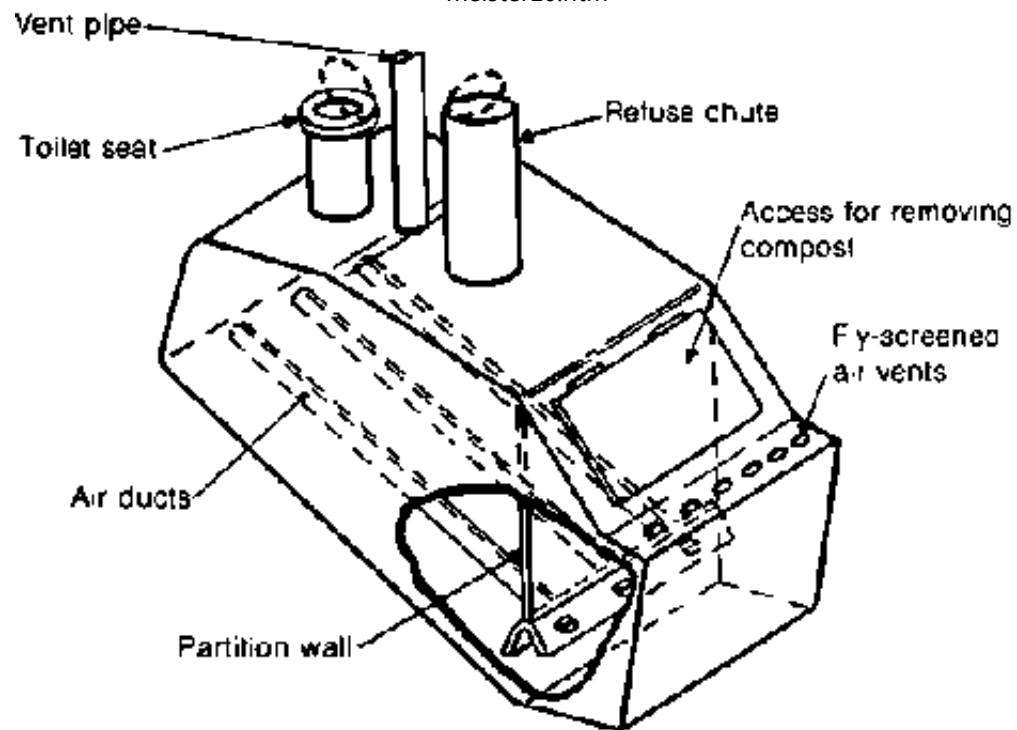

Fig. 6.34. Continuous composting toilet (A)

WHO 91453

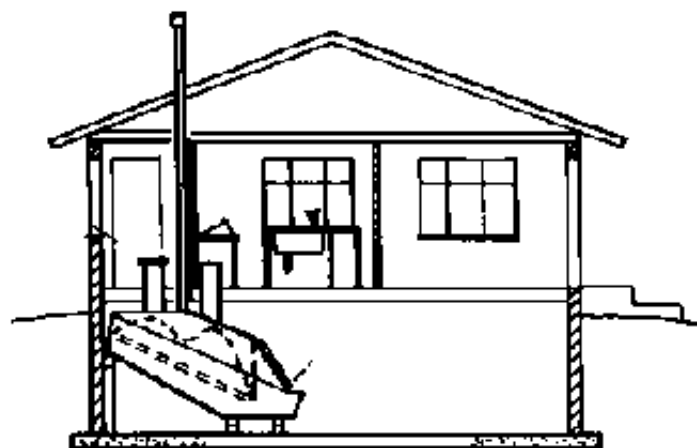

Fig. 6.34. Continuous composting toilet (B)

WHO 91453

Inverted U-shaped ducts and a ventilation pipe encourage the passage of air through the mass, preventing it from becoming anaerobic and allowing excess moisture to evaporate. As new material enters at the top of the chamber, older material gradually moves to the bottom and then slides into a smaller compartment from which it is removed periodically.

Such toilets have proved satisfactory in holiday homes and other isolated buildings in industrialized countries, where they are sometimes installed in a cellar beneath the latrine and kitchen.

Attempts have been made in Botswana and the United Republic of Tanzania to adapt the design to suit African materials and customs (Winblad & Kalama, 1985) using tanks made with concrete or sand and cement blocks. They were found to be inappropriate because of their high cost and sensitivity to user operation. Retaining the proper carbon-nitrogen balance and moisture content is crucial to proper operation. In practice, it has been found that moisture content is the most difficult to control. Fly and odour problems are also common, particularly soon after commissioning.

Multiple latrines

In some cultures there is a preference for separate latrines for men and women or adults and children. There is also a need for multiple latrines at places where large numbers of people meet, such as schools, restaurants, offices, etc.

Latrines fitted with a water seal may be connected to a common pit by drains (Fig. 6.35). VIP latrines may also be constructed over a common pit but the number of toilet holes using a single vent pipe should be limited to two. A multiple double-pit VIP latrine has been developed where each cubicle has two holes or seats (Fig. 6.36). These holes are used alternately in the same way as double-pit VIPs. The holes are used in such a way that the two holes which serve a pit are in use (or not in use) at the same time. The holes not being used are sealed. The dividing walls in the pit must extend to the full height of the pit.

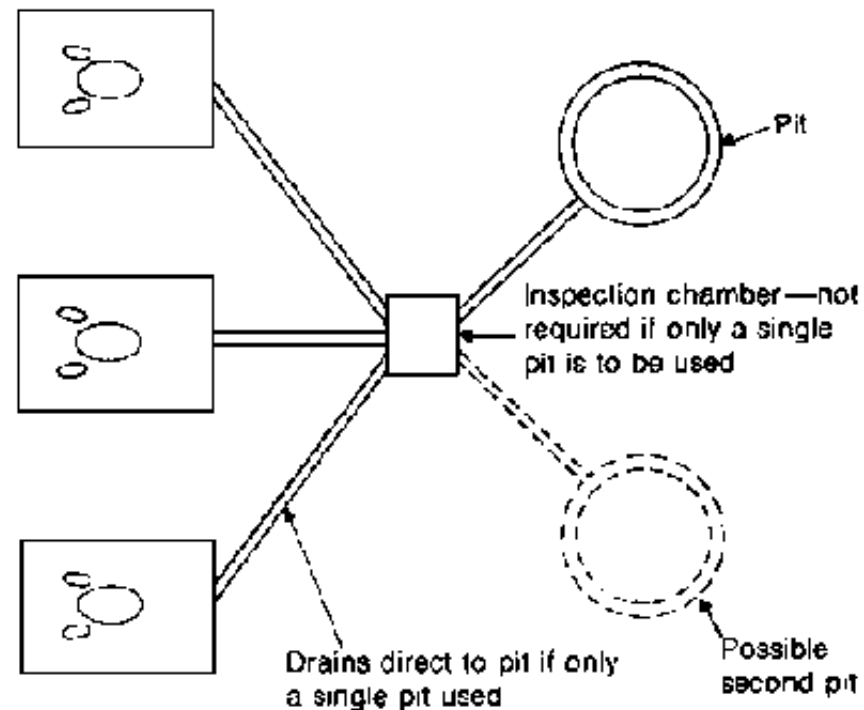

Fig. 6.35. Connecting a number of pour-flush latrines to a common pit

WHO 91454

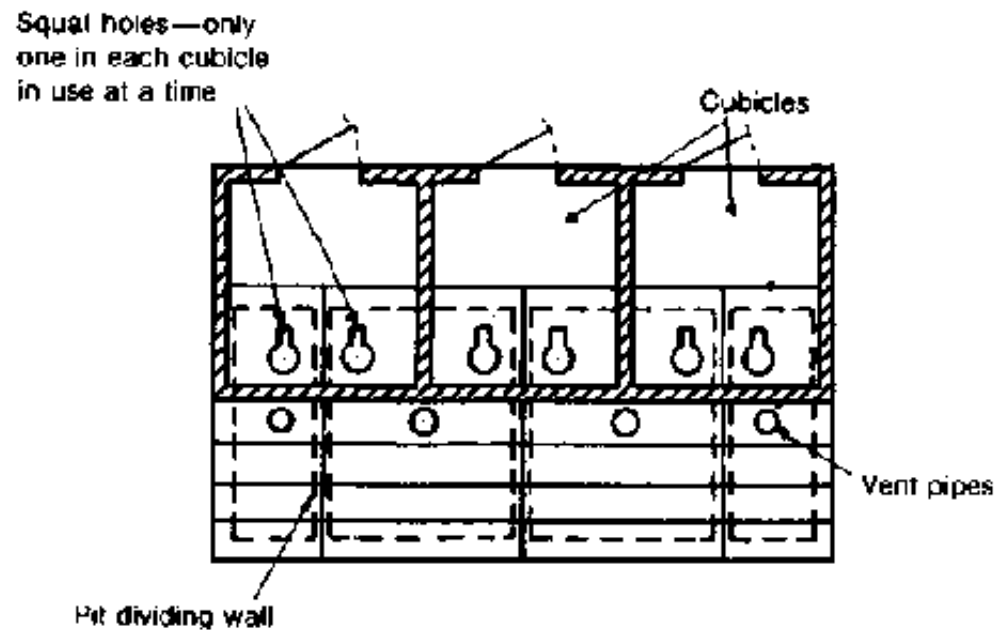

Fig. 6.36. Multiple double-pit VIP latrine (A)

WHO 91455

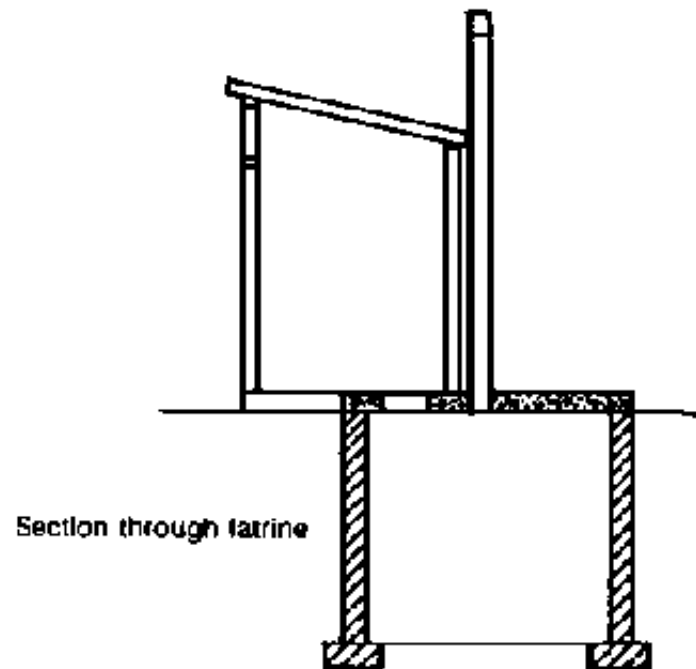

Fig. 6.36. Multiple double-pit VIP latrine (B)

WHO 91455

Other latrines

Bucket latrines

The system in which excreta are removed from bucket latrines (also called nightsoil latrines or earth closets) is one of the oldest forms of organized sanitation. Bucket latrines are still found in many towns and cities in Africa, Latin America and Asia, because their low capital cost makes them attractive to underfunded local authorities.

In some rural and periurban areas, members of households take nightsoil to

manure heaps or apply it directly to fields as fertilizer. In towns and cities, nightsoil is often collected by sweepers engaged by householders on contract, or by the local authorities. Buckets are usually emptied into larger containers near the latrine. In some places labourers carry these containers by hand or on their heads; hand-carts, animal-drawn carts, bicycles and tricycles are also used.

For the reasons given in Chapter 4, nightsoil collection should never be considered as an option for sanitation improvement programmes, and all existing bucket latrines should be replaced as soon as possible.

The number of bucket latrines is declining rapidly. However, for many years to come, some people will have to rely on bucket latrines as their only form of sanitation. The following paragraphs give suggestions for improvements to existing systems until they can be replaced by more acceptable forms of sanitation.

Good operation

A container made of non-corrosive material is placed beneath a squatting slab or seat in the bucket chamber, with rear doors which should be kept shut except during removal and replacement of the bucket. The bucket chamber should be cleaned whenever the bucket is removed. The squat hole should be covered by a flyproof cover when not in use. The cover of the seat should be hinged (Fig. 6.37) and the cover of the squatting slab should have a long handle.

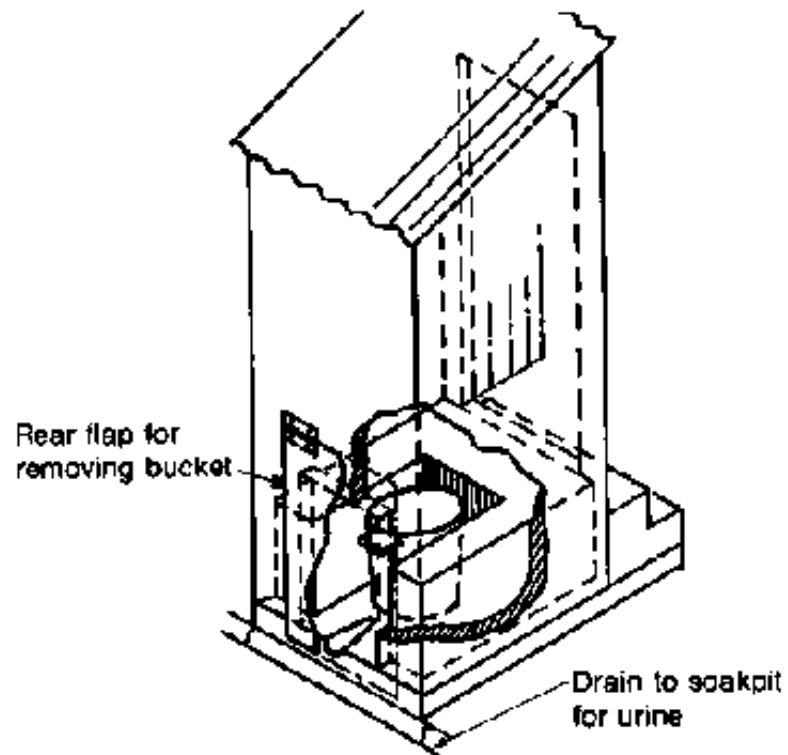

Fig. 6.37. Bucket latrine (A)

WHO 91456

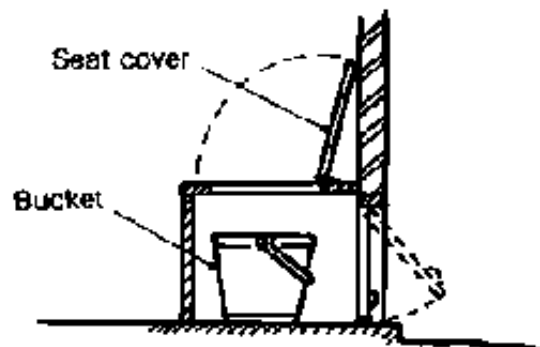

Fig. 6.37. Bucket latrine (B)

WHO 91456

At regular intervals (preferably each night) the container should be removed and replaced by a clean one. Full containers should be taken to depots or transfer stations where they are emptied, washed and disinfected with a phenol or cresol type of disinfectant. In some towns it is the practice to provide two buckets painted in different colours for each latrine. Containers should be kept covered with tight-fitting lids while in transit and the operators should be provided with full protective clothing. Proper supervision and management are essential. Defective buckets should be repaired or replaced and transport vehicles should be kept in good order.

In some systems, urine is diverted away from the buckets to reduce the volume to be dealt with. It is usually channelled to soakpits, but may be collected separately and used directly as fertilizer. Water used for washing latrines and bucket-chambers should pass to soakpits, and should not be allowed to pollute the ground around the latrines.

Disposal methods

The practice of dumping nightsoil indiscriminately into streams or on open land is objectionable and causes health hazards.

Sewers

Bucket latrines are sometimes found in towns that are partially provided with sewers, in which case it may be convenient to discharge the nightsoil into a main sewer. Tipping points on sewers require careful design to prevent contamination

of surrounding areas and should be as near to the sewage works as possible. Extra water may have to be added to prevent blockage of the sewers.

Sewage treatment works

Nightsoil may be discharged into the sewage flow at the works inlet, at sedimentation or aeration tanks, or directly to waste stabilization ponds or sludge digestion tanks.

Trenching

Trenches about 1 m deep and 1 m wide may be filled with nightsoil to within not less than 300 mm of the top. The trench is then backfilled with excavated soil, which should be well compacted to prevent the emergence of flies or the excreta being dug up by animals (Fig. 6.38). At the end of each day any exposed excreta must be covered with at least 200 mm of soil, well compacted. After backfilling, the trench should remain untouched for at least two years, after which it can be re-excavated for reuse and the contents used as fertilizer. The trenching site should be close to the collection area but away from residential areas. It should have deep and porous soil, be well above the water table, and not be subject to flooding.

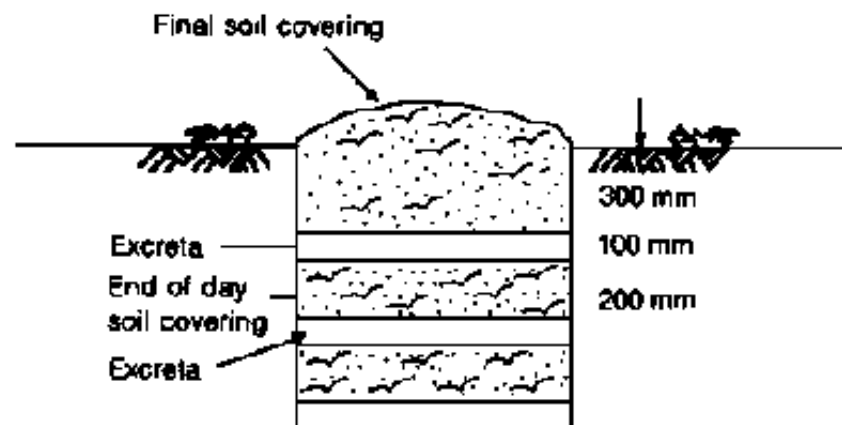

Fig. 6.38. Disposing of excreta from bucket latrines by trenching (A)

WHO 91457

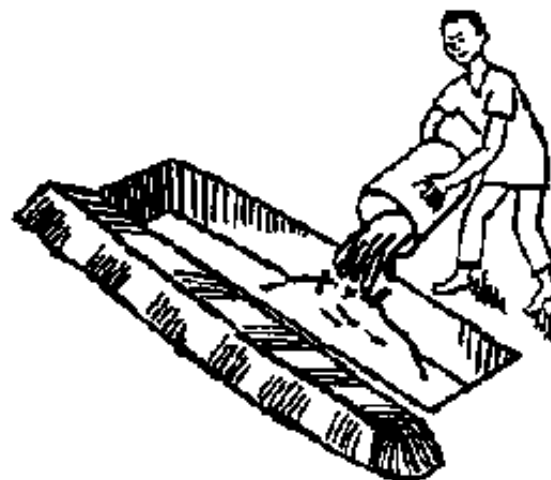

Fig. 6.38. Disposing of excreta from bucket latrines by trenching (B)

WHO 91457

Reuse

Nightsoil can be used as a fertilizer after all pathogens have been destroyed. It may also be added to ponds for fish cultivation (see Annex 1).

Vault latrines

Vault latrines are a way of overcoming the problem of frequent emptying needed with bucket latrine systems. A watertight tank or vault below or close to a latrine is used to collect faeces, urine and sometimes sullage. The capacity of the vault is often sufficient for 2-3 weeks' accumulation of excreta, after which time the vault is emptied. The system is satisfactory if collection is reliable and hygienic, and the vaults are properly flyproofed, vented and fitted with water-seal toilets.

In some places, the contents of vaults are bailed out by hand and taken away in tanks mounted on carts. This is highly undesirable. Trials with manually operated pumps to empty vault contents have not been very successful because with a low pumping rate (about 400 litres per hour) complete evacuation of the vault is a long and tedious operation. This method is obviously also undesirable.

Motorized vacuum tankers can provide safe removal but must be backed up by good institutional support for operation and maintenance. Most vacuum tankers cannot lift vault contents if the proportion of solids exceeds about 12%, but some have facilities for adding water to vaults before lifting the contents.

Sufficient extra space to allow for irregularities in collection time should be planned for in designing vault capacity. In communities where finance, spare parts and good maintenance are available, the additional space needed may be only 15-20%. However, where vehicle maintenance is poor, an allowance of 50% may be

advisable.

The performance of vaults has been mixed, mainly dependent on the levels of finance and vehicle maintenance. Poorly constructed vaults are common, leading to problems with odour and flies, ground pollution and thickening of the vault contents. It is not recommended that new vault latrines be constructed.

Cesspits

Cesspits, like vaults, are watertight tanks with sealed covers (to keep out mosquitos). They differ from vaults in that they are usually located outside the premises and collect sullage as well as the wastes from water closets. The capacity may be sufficient for up to several months' use (Fig. 6.39). The cost of providing a regular removal service for all the wastewater from a house with a good supply of piped water can be very high, making cesspits an expensive form of sanitation.

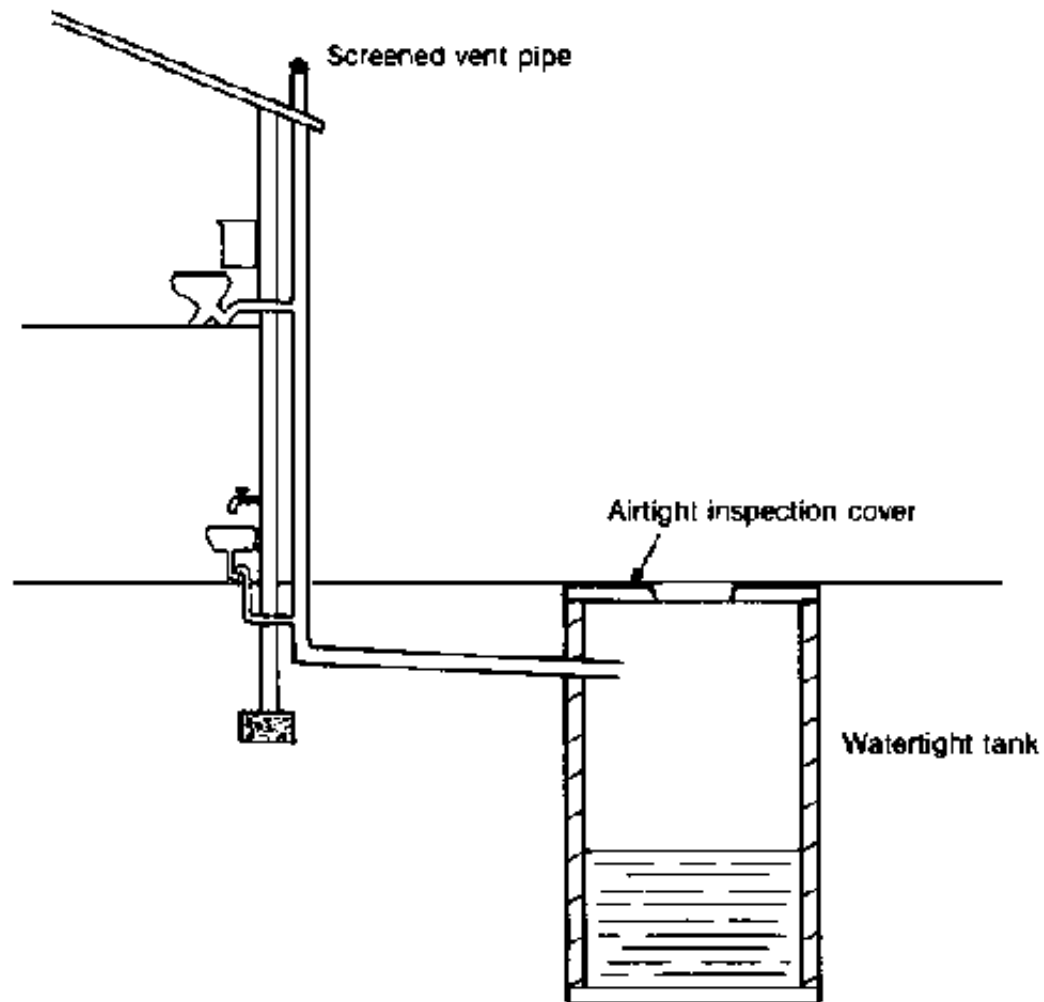

Fig. 6.39. Cesspit

WHO 91458

Chemical toilets

Modern chemical toilets are normally of the following types:

- a cylindrical bucket fitted with a plastic seat and lid; the capacity is usually 20-30 litres; after the bucket has been emptied and cleaned, about 50 mm depth of fluid is put in;
- two tanks: the flushing-liquid reservoir contains a mixture of fresh water and a deodorizing chemical which is pumped manually to the rim of the pan; discharge is to the waste-storage tank (Fig. 6.40);
- a single tank in which a flushing pan is fitted; a manual or electrically operated pump recirculates oil, drawing it from the base of the tank through a filter and discharging it around the rim of the pan; the pan has a counter-balanced flap so that the contents cannot be seen (Fig. 6.41).

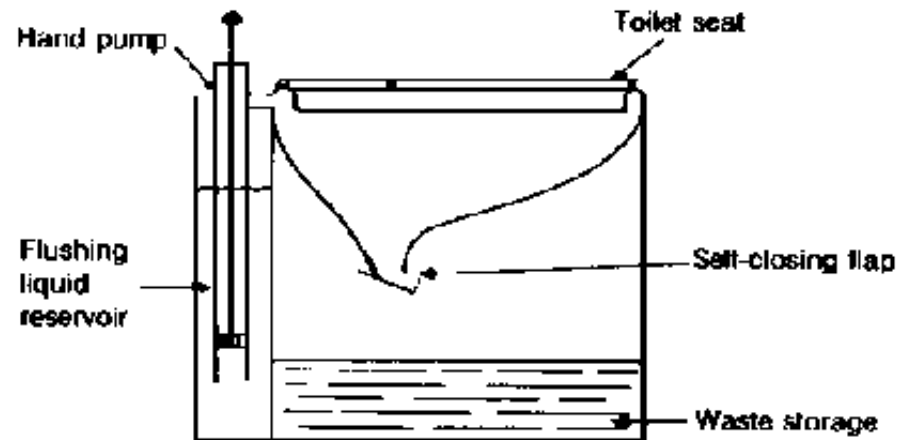

Fig. 6.40. Manually flushed chemical toilet

WHO 91459

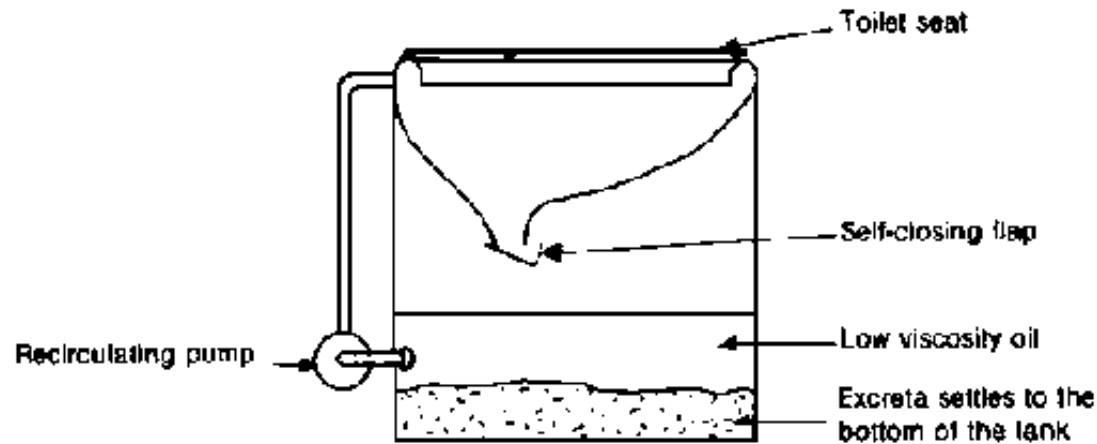

Fig. 6.41. Recirculating oil toilet

WHO 91460

The fluid is normally a chemical diluted with water which renders excreta harmless and odourless. When containers are full, the contents are tipped into pits or sewers, or pumped into storage tanks.

Chemical toilets are used in aircraft, long-distance coaches, caravans, vacation homes and construction sites. The chemical is expensive.

Overhung latrines

An overhung latrine consists of a superstructure and floor built over water (Fig. 6.42). A squat hole in the floor allows excreta to fall into the water. A chute is sometimes provided from the floor to the water. Overhung latrines should never be built in places where pit latrines can be provided. However, they may be the only possible form of sanitation for people living on land that is continuously or seasonally covered with water.

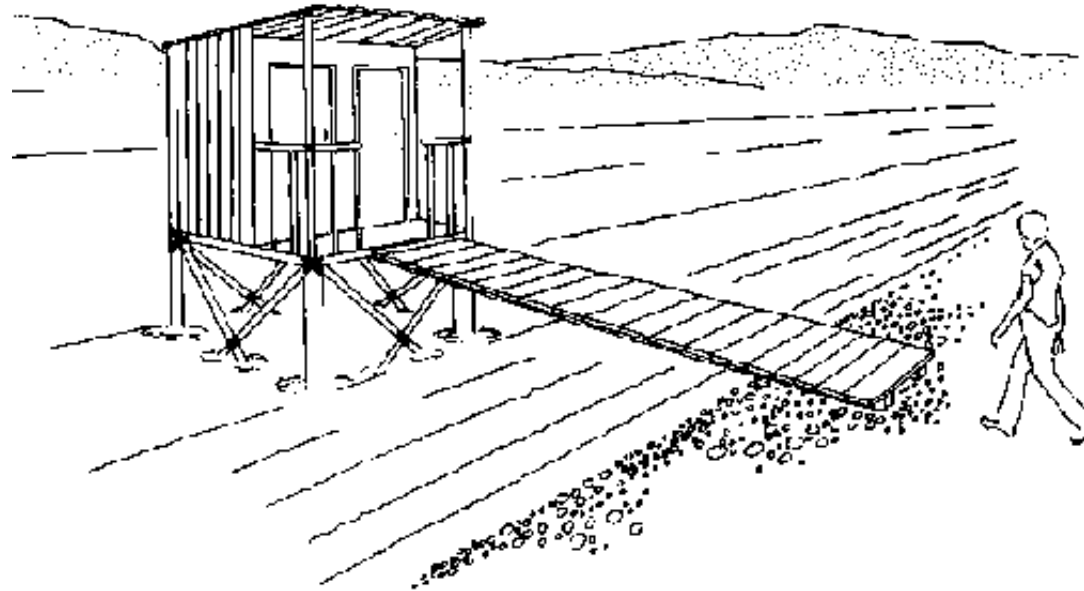

Fig. 6.42. Overhung latrine

WHO 91461

Wagner & Lanoix (1958) suggested that such latrines might be acceptable provided the following conditions are met.

- **The receiving water is of sufficient salinity all year round to prevent human consumption.**
- **The latrine is installed over water that is sufficiently deep to ensure that the bed is never exposed during low tide or the dry season.**
- **Every effort is made to select a site from where floating solids will be carried away from the village.**
- **The walkways, piers, squatting openings, and superstructures are made**

structurally safe for adults and children.

- **The excreta are not deposited in still water or into water that will be used for recreation.**

Chapter 7. Components and construction of latrines

Many components of sanitation systems are common to different types of latrines. In this chapter, the technical details of the following components are considered:

- **pits and pit linings;**
- **latrine floors, which may be cast directly on the ground where the pit or vault is offset;**
- **slabs, supported over direct or offset pits;**
- **footrests and squat holes;**
- **seats;**
- **water seals, pans, pipes and junction chambers;**
- **vent pipes;**
- **superstructures.**

Pits

Excavation

Most pit latrines provide sanitation for a single household, usually necessitating a pit about 1 m across and 3 m or more in depth (although much larger pits are common in some areas), or two shallow pits of up to 1.5 m in depth. The pit may be circular, square or rectangular in plan. Circular pits are more stable because of

the natural arching effect of the ground around the hole, with no sharp corners to concentrate the stresses (Fig. 7.1). However, people often find that square or rectangular pits are easier to dig. The depth of the pits often follows local traditions. It is usually advantageous to dig the pit as deep as possible, but this depends on soil conditions, cost of lining and the level of the groundwater.

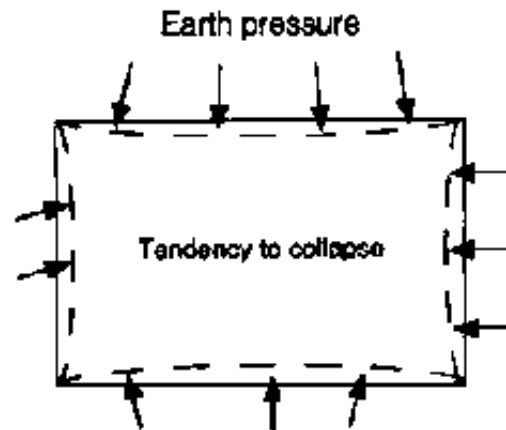

Fig. 7.1. Strength of different pit shapes (A)

WHO 91368

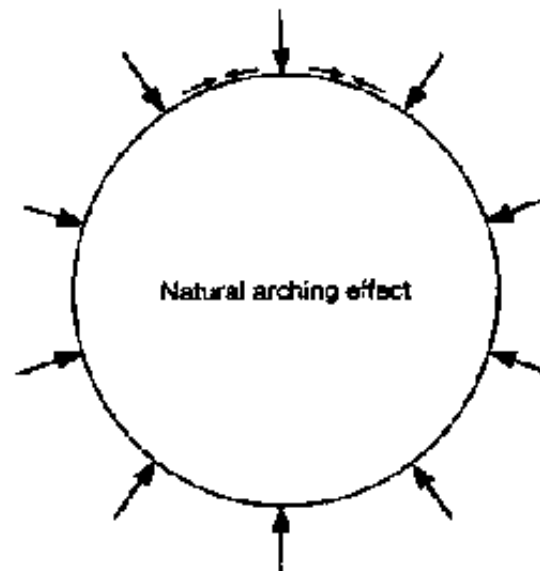

Fig. 7.1. Strength of different pit shapes (B)

WHO 91368

Pit linings

The need for a pit lining depends upon the type of latrine under construction and the condition of the soil. In septic tanks and aqua-privies, for example, which require watertight compartments, the pit is always lined. However, in pit latrines it is only necessary to have a lining if the soil is likely to collapse during the life span of the latrine.

It is not easy to decide in advance whether a soil will be self-supporting. If other excavations in the locality (such as shallow wells) have proved to be self-supporting over a number of years, then it is probably safe to assume that a pit for a latrine can be dug without support. Granular soils such as sands and gravels

normally require support. Cohesive soils, such as silts and clays, and soils with a high proportion of iron oxides, such as laterites, are often self-supporting. However, silts and clays may lose their self-supporting properties when wet, particularly where there is a varying water table.

If there is any doubt about the conditions it is better to assume that the soil is not self-supporting. Increasingly it is recommended that all pits should be lined, especially where the design life is over five years. Failure of an unlined deep pit can be extremely hazardous for the person excavating it. If the failure occurs some years later it can be expensive for the owner and disturbing for the users. In all cases the top 300-500 mm should be lined and sealed to support the slab (and where necessary the superstructure) and to prevent contamination of the surface and entry of vermin.

The lining may be of any material that supports the soil and that will last as long as the design life of the pit. Commonly, materials such as fired bricks, concrete blocks, concrete, ferrocement and local stone are used, but stabilized soil blocks, old oil drums (though with a limited life in corrosive groundwater) and unglazed fired clay pipes have also been successful.

Quarried stone, where available cheaply, makes a satisfactory lining. The more regular blocks should be used for the top 500 mm with mortar joints. Less-regular stone can be used for the remainder of the lining without mortar in the vertical joints. The builders or masons must be skilled and experienced if the lining is to last a reasonable length of time. Where local stone is used, its durability must be confirmed. Some stone will deteriorate when exposed to air or water or to frequent changes between wet and dry conditions.

The use of timber or bamboo is not generally recommended, since they are subject to insect and fungal attack and often have a limited life. Some hard woods can be satisfactory provided they are treated with tar, creosote or other preservative to lengthen their life. Care must be taken to ensure that none of the preservatives leach into the ground-water as even low levels of some preservatives can be toxic (WHO, 1984). Woven cane and bamboo have been used for the lower part of a lining with stronger materials used for the top 500 mm. However, unless the pits are designed to have an extremely short life, cane and bamboo should be avoided.

Construction

Shallow pits

In almost all cases, pits of up to 1.5 m in depth can be excavated to their full depth and then lined from the bottom up. If the soil is very loose, the sides of the excavation may have to be sloped to prevent collapse. The space between the lining and the soil can then be backfilled, preferably with a granular material such as sand or gravel. Granular materials are used because they fill the space between the soil and the lining without leaving large voids. They also act as a filter to prevent soil particles being washed into the pit. Voids behind the lining produce locally increased loads on the lining which may cause collapse.

It is usual to provide a foundation for the lining similar to that provided for a domestic house. In most soils, a foundation width equal to twice the wall thickness is usually sufficient (Fig. 7.2). In very soft ground it may be necessary to construct wider foundations to prevent the weight of the lining itself forcing it into the soil (Fig. 7.3). Where the superstructure load is not directly applied to the

lining, a widened foundation may not be required since the load applied to the ground at the base of the lining is small and considerable skin friction builds up between the sides of the lining and the ground.

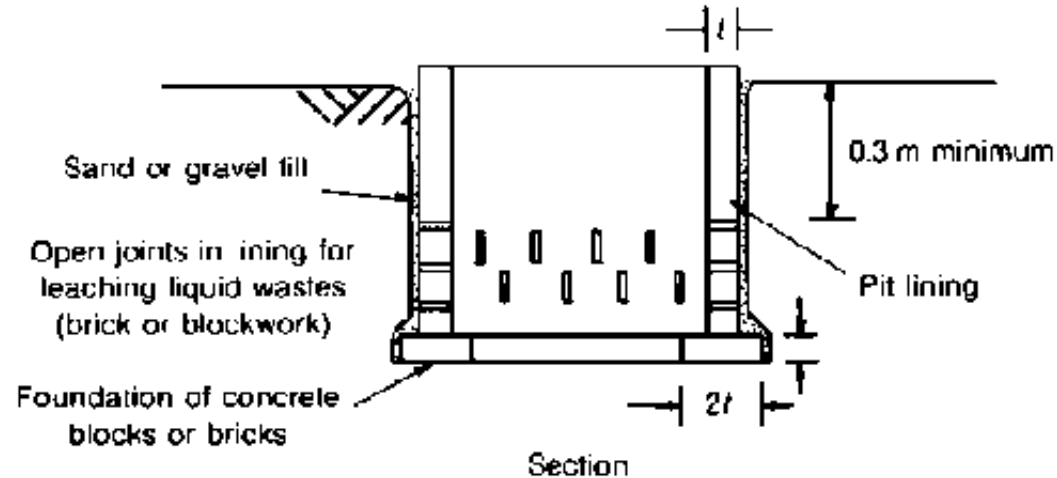

Fig. 7.2. Lining for a shallow pit in firm ground

WHO 91462

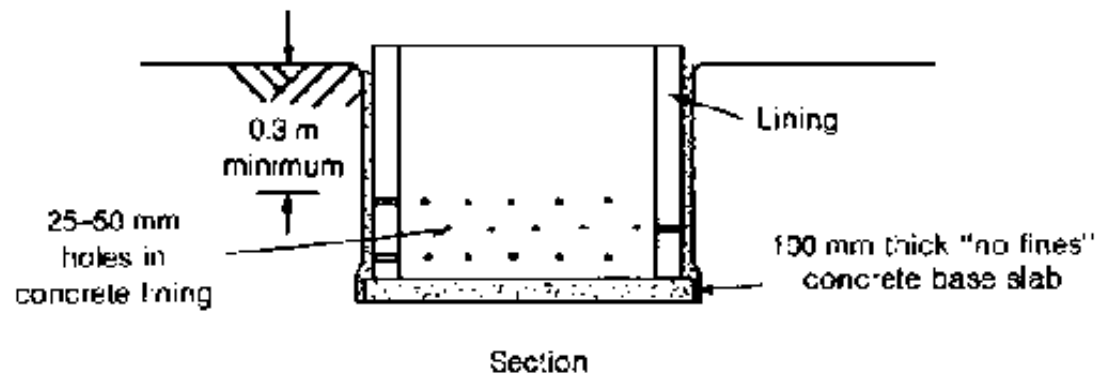

Fig. 7.3. Lining for a shallow pit in soft ground

WHO 91463

Soakpits or leaching pits require a porous lining to allow the wastewater to escape into the ground. The method of achieving this depends upon the lining material used. With bricks, blocks or local stone, a proportion of the vertical joints are left unmortared. These unmortared joints may be confined to specific courses (e.g., every third or fourth course) rather than being spread throughout the lining. This enables the fully mortared courses to carry the load exerted by the soil on the lining. Where the ground is relatively strong, a more open, honeycomb technique is used, with only small dabs of mortar joining the masonry. Alternatively, specially manufactured bricks with angled ends to suit round pits and a central opening to allow for infiltration may be used (D. J. T. Webb, personal communication).

Concrete, ferrocement and fired clay ring linings are made porous by creating holes of 25-50 mm in diameter through the lining. Alternatively, the ring joints are held open by small stones or bricks. Additionally, concrete linings may be made of "no fines" concrete, that is, concrete without any fine aggregate (sand). A mix of one part of cement to four parts of clean gravel (with stones of 6-18 mm in diameter) is suitable. Where precast rings are used, the upper and lower 100 mm of the ring should be made of conventional concrete for extra strength.

Deep pits

The method of excavating deep pits depends upon the stability of the soil during the construction period. In soils that are self-supporting, the pit may be dug to its full depth and the lining installed afterwards. If the ground is not self-supporting, the lining must be constructed as the pit is dug.

Where a lining is not required for support during excavation, the pit is dug to the full depth, making allowance for the thickness of the lining to be installed subsequently. Accurate dimensions are maintained by using a plumb bob to ensure verticality and a template, either circular or rectangular to retain the horizontal dimensions. Ensuring correct dimensions minimizes the costs of lining and backfilling. Sometimes the soil near the surface is weathered and likely to collapse. In that case, the top metre of soil may be supported with a temporary lining (Fig. 7.4). If the finished lining is to be of precast concrete rings, then the top metre of soil will have to be excavated to a larger diameter so that the rings can pass inside the temporary lining.

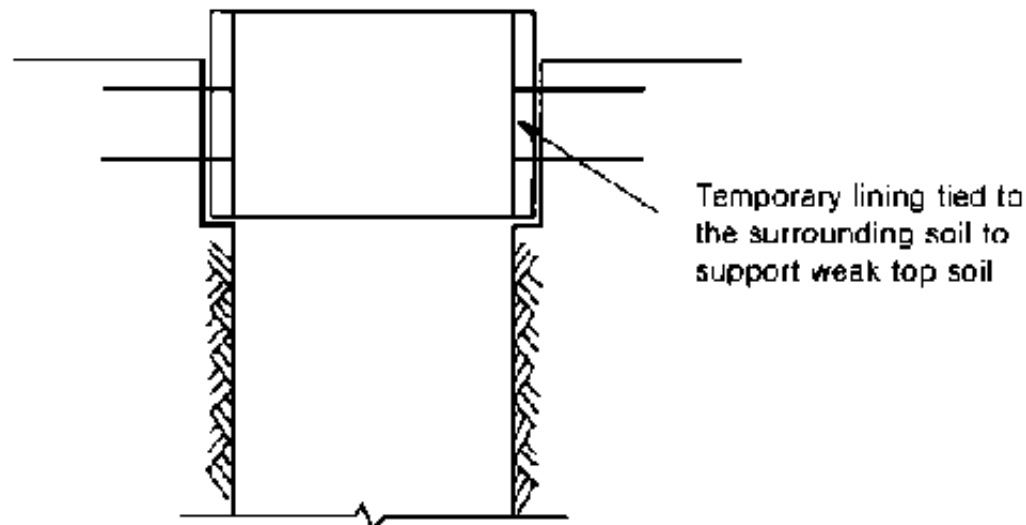

Fig. 7.4. Excavation for a pit to be lined with precast concrete rings

WHO 91464

When the hole has been excavated to the design depth, the bottom is levelled and cleaned. In firm ground, a foundation can be constructed by cutting a groove into

the walls of the pit and building a ring beam. In exceptionally soft ground, where the lining is likely to sink into the floor of the pit, the ring beam foundation can be replaced by a floor slab of "no fines" concrete, 75-100 mm in thickness, covering the whole base of the pit. This will distribute the weight of the lining over a larger area of the pit base, thus reducing the load per unit area and preventing upwards heave of the soil (see Fig. 7.3).

Construction of linings

Precast rings

The use of precast concrete (Fig. 7.5) or fired clay rings for the lining of pits has the advantage that the lining can be prepared before excavation begins. This is particularly useful in weaker soils because it reduces the time the soil remains unsupported. The rings to be placed at the bottom of the hole may be porous, designed to allow the liquid wastes to seep into the surrounding soils or they may be sealed to create a wet tank, designed to increase the rate of sludge digestion. The ring nearest to the surface should be fully sealed to prevent entry of surface water and rodents and also contamination of the soil. As with shallow pits, any space between the back of the rings and the soil should be filled with sand or gravel.

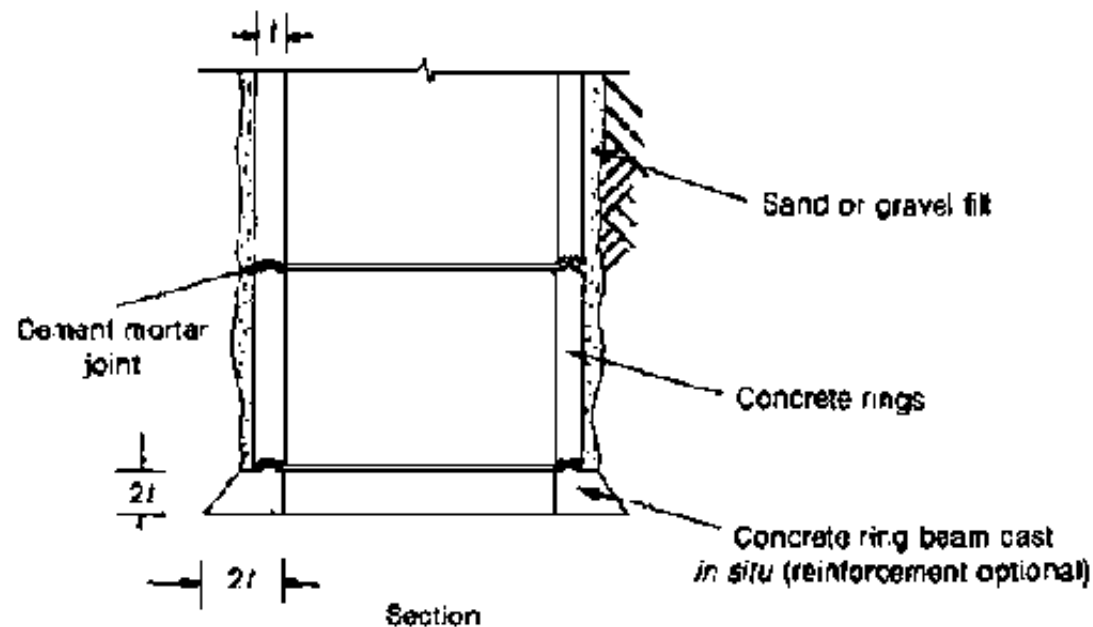

Fig. 7.5. Pit bottom lined with precast concrete rings

WHO 91465

Brick, blockwork and stone lining

These are built in a similar way to precast concrete linings, i.e., by building up from the foundations. With very deep pits it may be wise to allow time for the cement mortar to gain strength before filling any space behind the lining, to prevent the weight of the fill from deforming the lining. Except for the top 300-500 mm, the joints are left open as described above to ensure infiltration of liquid to the soil.

In situ concrete lining

In this method the hole is lined with concrete cast in the hole (Fig. 7.6). After

excavation, shuttering is positioned to a convenient height allowing for compaction, and the space between is filled with concrete. Normally the concrete does not require steel reinforcement for structural strength. However, a small amount of steel may reduce shrinkage cracking. The lining can be made porous by leaving small holes in the concrete (short lengths of 25-50 mm of pipe fitted between the shuttering and the soil will be satisfactory). Alternatively "no fines" concrete can be used.

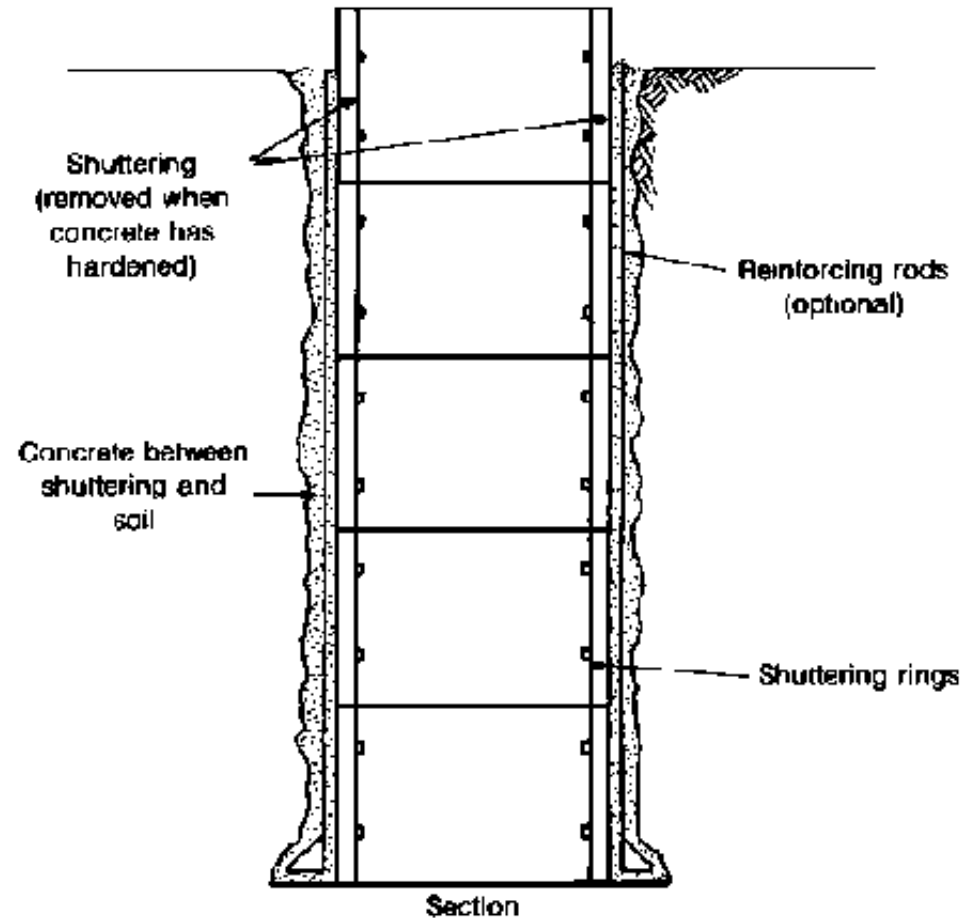

Fig. 7.6. Pit with concrete lining *in situ*

WHO 91466

Ferrocement lining

When mortar is plastered over layers of fine wire mesh (such as chicken wire) the resulting material is called ferrocement. It is strong, light, requires no shuttering and is easy to construct. It is now widely used for such structures as water tanks and latrine slabs and can be adapted for use as a pit lining.

In some countries the term ferrocement refers to any cement-based material reinforced with steel. Specifically it now describes a material consisting of several layers of small-diameter steel mesh (usually hexagonal chicken wire, with wire of 0.7-1.3 mm in diameter and openings of 12 mm). The layers are tied together with fine wire at 150-mm intervals and then plastered with a rich cement mortar (one volume of cement to two volumes of sand) to give a finished thickness of about 25 mm.

After excavating the hole, as much loose material as possible is removed from the pit walls. Cement mortar is applied directly to the walls of the pit to give a layer approximately 12 mm thick. This layer is then covered with two or three thicknesses of steel mesh, held in place with long staples driven through the mortar into the soil. A second coat of mortar is then applied and pushed firmly into the holes in the wire mesh. On completion, the mortar covering the mesh should be at least 10 mm thick. Where a porous lining is required, holes can be punched through the mortar while it is still weak.

Ferrocement rings may also be precast on the surface and used in the same way

as concrete rings.

Excavation in loose ground

Where the ground is very loose and liable to collapse if left unsupported, or where the excavation enters the water table, the most common method of construction is to prefabricate the lining on the surface, place it in a starter excavation, dig out the soil below and allow the lining to sink as the hole is dug. This method is called "caissoning" (Fig. 7.7).

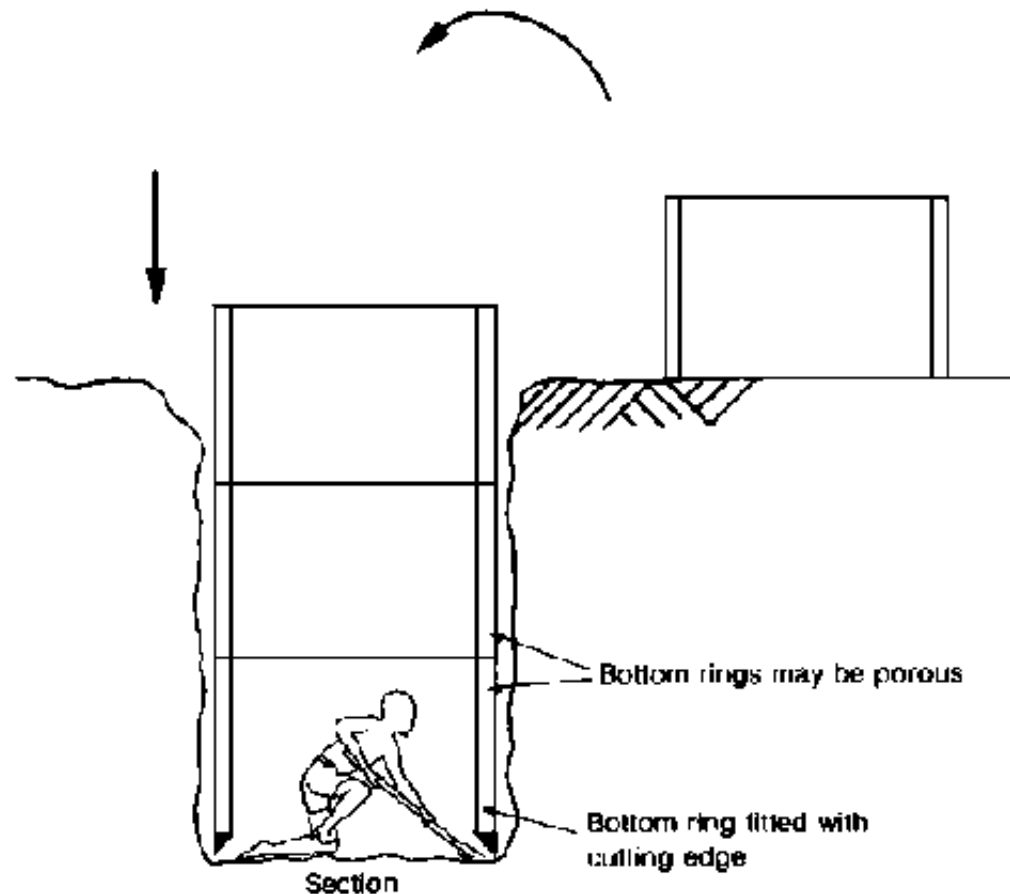

Fig. 7.7. "Caissoning" a pit

WHO 91467

A hole is excavated as deep as possible (experience of the local ground conditions will determine the depth). A precast concrete ring fitted with a cutting edge is then placed in the hole. Additional rings are placed on top until ground level is reached. Excavation now begins inside the rings. As the ground is dug away from under the cutting edge, the rings start to sink under their own weight. Additional rings are then placed on top until the required depth is reached.

This method may also be used for linings of bricks or blocks. However, the lining must be constructed sufficiently far above the ground to ensure that the mortar has fully set before the lining enters the ground. The honeycomb method of construction cannot normally be expected to have sufficient strength to be sunk as a caisson.

Where caissoning is employed because of a high groundwater table, excavation should take place towards the end of the dry season when the water table is at its lowest. As the lower ring enters the water it is possible to continue excavation for up to one metre by scooping material in a bucket or with a specially shaped shovel.

Backfilling

Any space around the outside of the lining should be backfilled with compacted earth taken from the pit or, where available, with sand and gravel. If the ground is particularly weak, the top of the pit may be backfilled with weak concrete or a

soil-cement mixture to give additional strength. Strengthening may be important if the top of the pit has become overly enlarged during excavation.

Latrine floors

Floors of latrines, whether laid on the ground or supported over a pit, should be smooth and impervious so that they may be cleaned easily and have a satisfactory appearance to users. The upper surface should be at least 150 mm above the surrounding ground level (Fig. 7.8) to prevent rain and surface water entering the latrine.

The floor surface should slope gently to facilitate cleaning and to prevent surplus wash water from collecting in puddles. The slope is normally from the outer edge of the floor towards the squat hole or pan at the centre, so that the water used for cleaning flows into the pit and does not foul the area surrounding the slab. A fall of about 20 mm between the edge and the centre of a slab up to 1.5 m across is sufficient to prevent pools of liquid forming (Fig. 7.8). Where seats are used, the floor should slope away from the seat support so that any wash water flows towards the latrine entrance.

A latrine slab serves two main purposes, as a support and as a seal. It has to support the weight of the person using the latrine and, possibly, the weight of the superstructure. It also seals the pit, with the exception of the squat hole and, where required, the vent-pipe hole. This facilitates control of flies and smells and reduces the likelihood of rodents and surface water entering the pit. Where the slab has been made in sections (for ease of placing and emptying) or has a removable cover, the joints should be sealed with a weak mortar such as a lime or mud mortar.

To support the weight of a person over a latrine pit the suspended slab has to act structurally in the manner of a bridge. Where seats are provided, the extra weight has to be allowed for when designing the slab. Depending on the design of the slab, the materials may have to be able to resist forces in tension as well as in compression (Fig. 7.9). The materials needed to carry the tensile forces are often more expensive than those commonly used in low-cost buildings. The slab is often the most expensive individual component that has to be paid for by the user. It is therefore important to ensure that it is carefully designed to serve its purpose with a minimum of costly material.

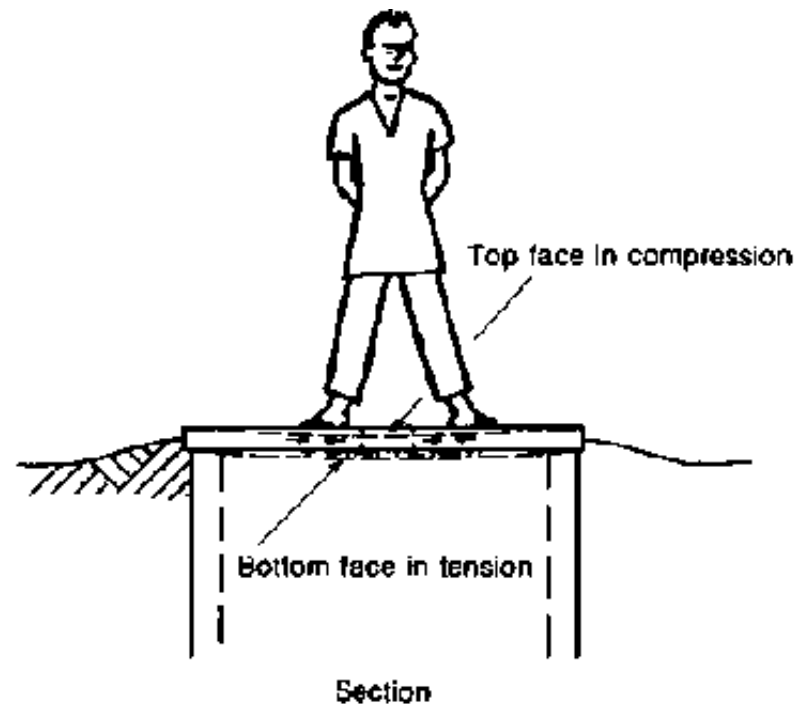

Fig. 7.9. Tension and compression forces in a slab

WHO 91469

The slab normally rests on a foundation or on the top of the pit lining (see Fig. 7.8). This ensures that the weight of the slab and the weight of the person using it are spread evenly on the soil. Particular care must be taken where the slab also has to carry part of the weight of the superstructure. If the ground is weak, the foundation prevents subsidence or collapse of the ground underneath the load. Any gaps between the slab and the pit lining should be sealed with earth or a weak mortar to prevent ingress of water. This seal also prevents small animals and insects getting into and out of the pit.

Where a pit is excavated to a larger diameter than planned, precast slabs are

occasionally supported on timber poles. This practice is not advisable as the heavy load on the poles is likely to lead to early failure. However, small slabs (approximately 500 mm square), designed to provide a hygienic squat hole for existing latrines at minimum cost, will not overload a timber support (Fig. 7.10).

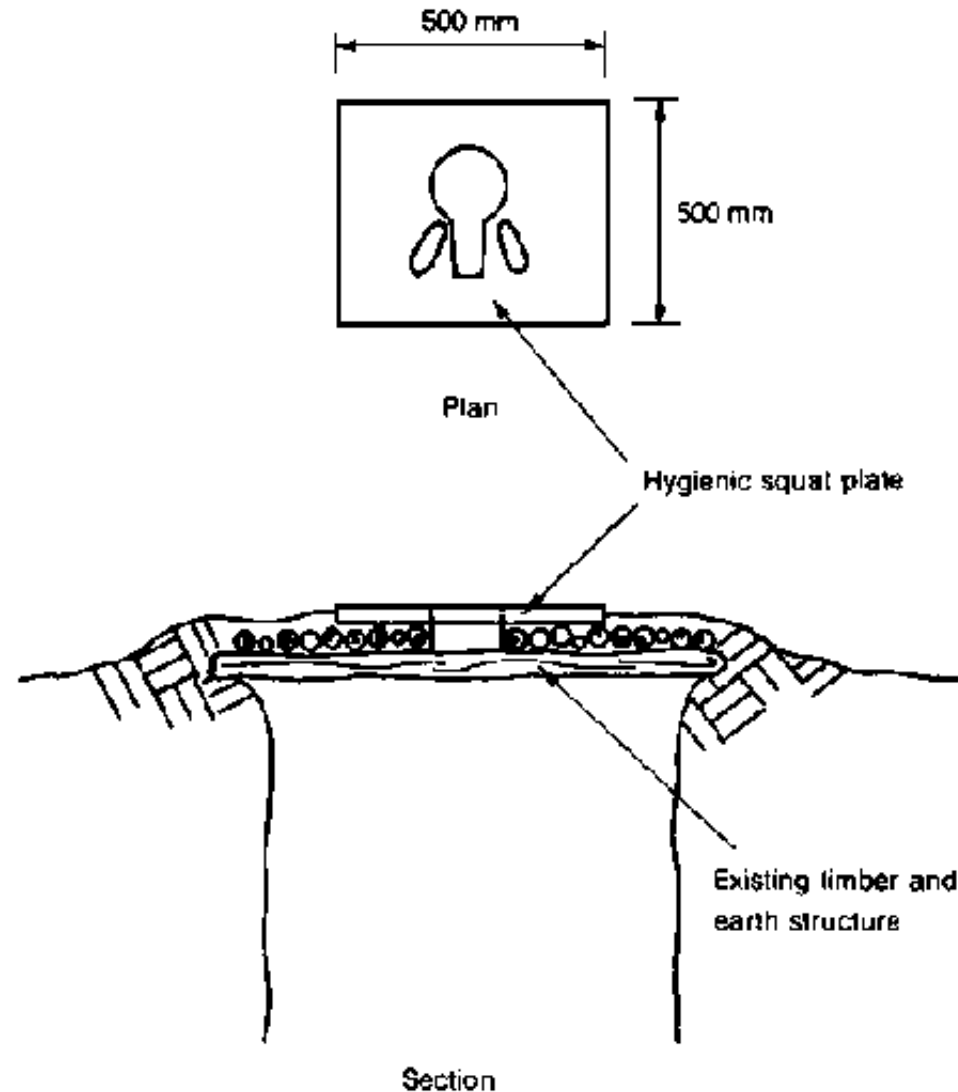

Fig. 7.10. Small slabs for upgrading timber and earth structures

WHO 91470

The latrine slab should feel secure and should not deflect noticeably under the weight of a person using the latrine. It needs to be as clean and attractive as possible so that people feel comfortable using the latrine. There is then much less chance of the latrine being misused or fouled.

Offset pits used with pour-flush latrines require a cover slab to prevent entry of flies and rodents and to ensure safety, particularly of children. With the omission of a squat hole, the structural requirements are the same as for a latrine slab.

Shapes of direct pit slabs

The shape and size of the pit are the first factors to be considered when designing a supported slab. Latrine pits can be round, square or rectangular and it is usual to find that a particular shape becomes the accepted design for a particular area.

Borehole latrines have a small span and therefore require very simple slabs. The shape will depend on the users' needs for a clean hygienic area with correctly spaced footrests, rather than being controlled by the size of the hole to be covered. Larger, hand-dug pits 1-1.5 m in width require a shape designed to span and seal the pit. An exception to this is where the span of the slab is reduced by corbelling the top of the lining (Fig. 7.11). This decreases the amount of material required in the slab and thus reduces the cost.

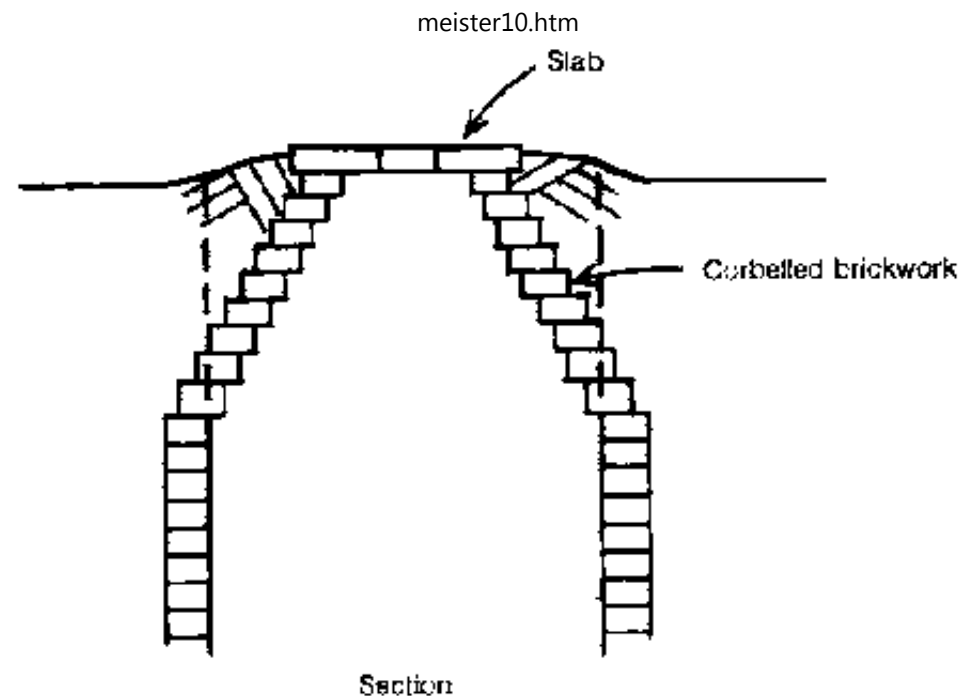

Fig. 7.11. Minimizing the span of the slab

WHO 91471

Slabs may be precast or constructed *in situ*, which means that the slabs are built over the pit, exactly where they are to be used. In a large agency-assisted programme, slabs are often manufactured at a convenient construction site away from the latrines and then brought to the site and laid across the pits. Where slabs are to be moved, weight and shape are both significant factors.

The shape of the slab is also determined by the type of latrine. Water-seal latrines, aqua-privies, ventilated pits and pits sealed with hole covers all have different requirements. For example, the need for an extra hole close to the edge of the slab for a vent pipe makes the unreinforced dome slab unsuitable for ventilated latrines.

The slab normally overlaps the supporting pit lining or foundation by at least 100 mm on all sides to ensure that the load is adequately transferred. This overlap may have to be extended to 200 mm where the pit is unlined and the slab is resting directly on the soil (see Fig. 7.8).

Cement-based slabs and components

In most countries, concrete or cement-based slabs provide the most durable and economic method of covering latrine pits. There are many different ways of using cement. Its ability to bind with other materials and provide a clean watertight surface make it the obvious choice for the majority of programmes.

Concrete is a mixture of cement, sand, gravel and water. When set, it forms a hard dense material which is extremely strong in compression but weak in tension. Cast as a simple flat slab across a pit, its own weight and the weight of any person on it forces the concrete to deflect downwards in the centre. As the load increases, small tension cracks form on the underside of the beam. With heavy loads, these cracks may extend upwards through the concrete until the slab breaks. To prevent this happening, steel bars or other reinforcement may be placed in the concrete on the lower side of the slab to carry the tension load and prevent the cracks spreading.

Unreinforced concrete

Small slabs, such as those required for borehole latrines or to provide a hygienic platform for the squatting area of timber-supported slabs (see Fig. 7.10), do not need any reinforcement. Where an unreinforced span of greater than 0.5 m is

required, the slab should be cast in the form of a "flat" arch. The weight of the load is then directed through the arch to the supporting area on the ground. The underside of the concrete remains in compression and no reinforcement is required. Using this principle, a shallow circular dome or arch can be constructed to cover a latrine pit. The dome is strong enough to support itself and the people using it without any expensive steel reinforcement. A slab using this principle has been developed by a team in Mozambique (Fig. 7.12) and has proved to be economical and popular. The slabs are about 40 mm thick and rise 100 mm in the centre to give the arch effect (International Development Research Centre, 1983).

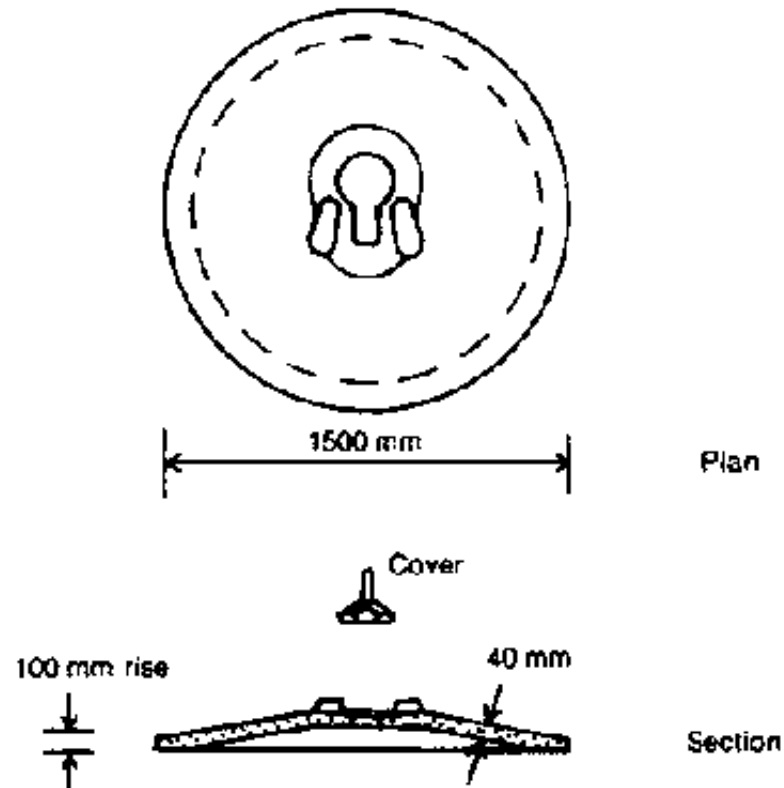

Fig. 7.12. Dimensions of domed slab without reinforcement

WHO 91472

Although such domed slabs fall away from the centre, a small inward slope about 100 mm wide immediately around the squat hole is incorporated to direct any waste into the pit. These slabs have been used most effectively in areas with sandy soil which quickly absorbs any surplus wash water.

The concrete slab is given the shape of a dome by mounding up earth to the required profile of the underside of the slab. The earth is compacted and smoothed. It may then be covered with plastic sheeting or old cement bags, or coated in old engine oil to break any bond between the earth and the fresh concrete. A circular iron strip made from an oil drum is used as the edge former or mould. The concrete around the centre hole is made slightly thinner so that a slope towards the hole can be made. Each slab has to be allowed to harden undisturbed for several days after casting.

To save space in the casting yard, up to five slabs may be cast on top of each other, using a lower, previously cast slab as a former for the next slab. Particular attention has to be given to the concrete mix of a thin unreinforced slab. A maximum aggregate size of 10 mm and slightly more cement than usual is required. The recommended mix is one part by volume of cement to two parts of sand and one and a half parts of 6-10 mm aggregate.

An unreinforced slab may also be produced in a rectangular mould with a flat upper surface and a dome on the underside (Fig. 7.13). As an unreinforced dome slab cannot accept a second hole close to one edge for a vent pipe, flies, smells and cockroaches are prevented from leaving the pit by providing a tight-fitting

cover over the squat hole. This is cast directly in the squat hole so that it fits exactly. A layer of cement bag paper may be used to prevent the fresh concrete sticking to the old.

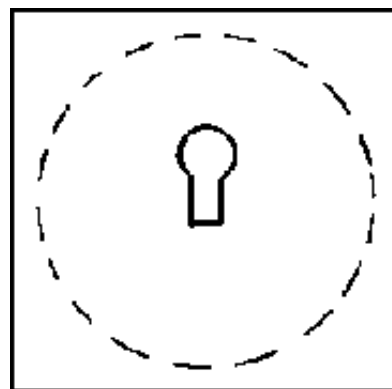

Fig. 7.13. Semi-domed slab (Plan)

WHO 91473

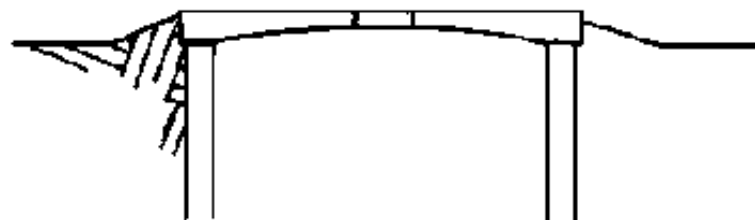

Fig. 7.13. Semi-domed slab (Section)

WHO 91473

Bricks can be used to form an unreinforced arch across a rectangular pit (Fig. 7.14) using a rough framework of bamboo, reeds or forest poles which is left in the pit. The space above the arch is levelled with river sand and topped with a 20-mm cement-sand screed sloping towards the centre. This technique requires very

little cement and no steel. However, these structures have to be built by skilled masons and there is no opportunity for precasting. Emptying of the pit can only be carried out through the squat hole.

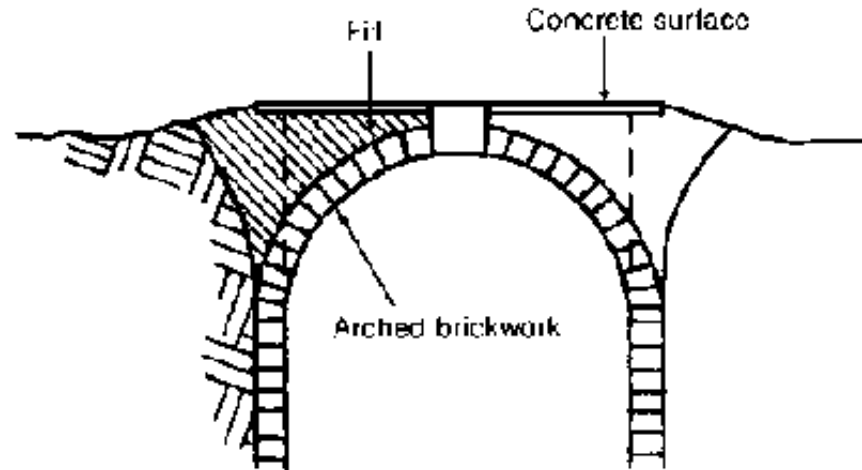

Fig. 7.14. Arched brickwork lining and support (Section)

WHO 91474

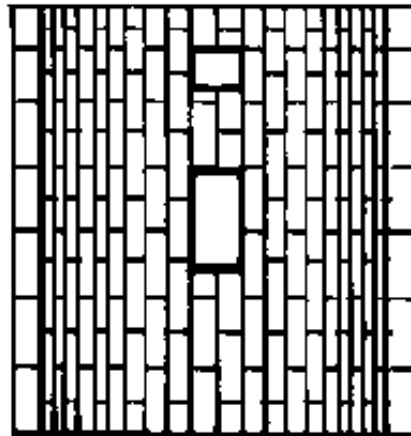

Fig. 7.14. Arched brickwork lining and support (View from below)

WHO 91474**Reinforced concrete**

Because of the weakness of concrete in tension it is often reinforced with other materials. Most commonly it is strengthened by the inclusion of steel bars. Details of the reinforcing steel required for common sizes of slab are shown in Table 7.1. Mild steel bars, 6 mm in diameter spaced at intervals of 150 mm, or 8 mm in diameter spaced at intervals of 250 mm in each direction, are normally sufficient for 80-mm thick slabs of up to 1.5 m in span. This span distance is measured at the point of minimum span, that is, the shortest distance between two points which fully support the slab. Where used correctly, reinforcement in a concrete slab will support at least six adults on a 1.5-m span slab. For the small spans illustrated, extra steel is not required for trimming around the pit opening.

Table 7.1. Spacing of steel reinforcement bars for concrete slabs^a

Slab thickness (mm)	Steel bar diameter (mm)	Spacing of steel bars (mm) for minimum slab span of:				
		1 m	1.25 m	1.5 m	1.75 m	2 m
65	6	150	150	125	75	50
	8	250	250	200	150	125
80	6	150	150	150	125	75
	8	250	250	250	200	150

a The steel bars should be fixed on the lower side of the slab, with 12-mm cover or thickness of concrete beneath each bar. Steel to be laid at above spacings in both directions. Size and spacing of steel calculated for grade 20 concrete and mild steel reinforcement, with characteristic yield stress of 210 N/mm², or high-yield mesh, yield stress 485 N/mm².

The reinforcing steel is laid in both directions, that is, with one layer of bars perpendicular to the second layer (Fig. 7.15). Where the slab is rectangular, the bars parallel to the direction of the minimum span should be beneath the bars in the direction of the longer span. For the bars specified, a characteristic yield strength for the steel of 210 N/mm² is assumed. Care is required to ensure that the steel is of the required quality.

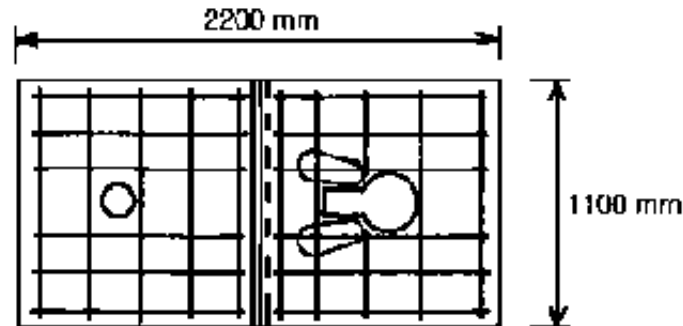

Fig. 7.15. Reinforced concrete rectangular slab (for details of reinforcement see Table 7.1) (Plan)

WHO 91475

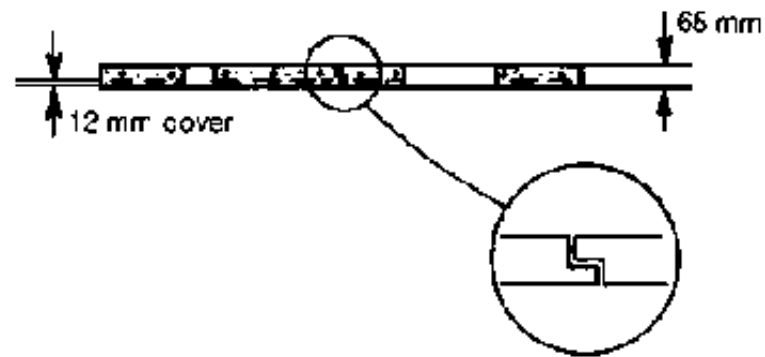

Fig. 7.15. Reinforced concrete rectangular slab (for details of reinforcement see Table 7.1) (Section)

WHO 91475

When individual bars are used, some may be omitted by mistake. One way of avoiding this is to use steel mesh, which consists of smaller-diameter bars welded together. This can be cut to the required shape but there is likely to be wastage of the off-cuts that have to be discarded. A mesh with 7-mm bars at 200-mm centres, with a cross-sectional steel area of $193 \text{ mm}^2/\text{m}$ (yield stress 485 N/mm^2) is normally sufficient.

Care must be taken when reinforcing concrete with steel to ensure that the steel is completely surrounded by the concrete. There should be at least 12 mm of concrete under the steel bars and at the ends of all bars. This protects the steel from the corrosive effect of gases and moisture in the pit. When concrete is placed in a mould or former it has to be compacted by manual or mechanical vibration to remove any air bubbles and to ensure the durability of the completed slab. Simple wooden or steel moulds can be reused many times to give the required shape to the wet concrete if they are coated with a suitable release agent. There are many

proprietary agents, but used engine oil painted on to the mould effectively prevents the concrete from sticking. Alternatively, plastic sheeting or empty cement bags may be used to prevent bonding. These materials may also be used between the ground and the underside of the slab. The squat hole is formed using a shaped wooden mould with a bevelled edge. A vent pipe opening may be created with an offcut of plastic pipe which is removed a few hours after casting so that it can be reused many times.

An alternative way of using steel for reinforcement is to precast a ferrocement slab. The method of construction is described under construction of linings. A flat ferrocement slab is strong enough to carry the imposed load but is too flexible for the users' comfort. In order to ensure adequate stiffness, the ferrocement may be shaped as a dome or may be cast with ribs on the soffit (Fig. 7.16). Four layers of mesh are normally required for a slab with a 1-m span. It is necessary to ensure that the cement mortar has been adequately pressed through all the layers of wire mesh and compacted to a dense material if it is to have adequate strength.



Fig. 7.16. Ferrocement slab (Section)

WHO 91476

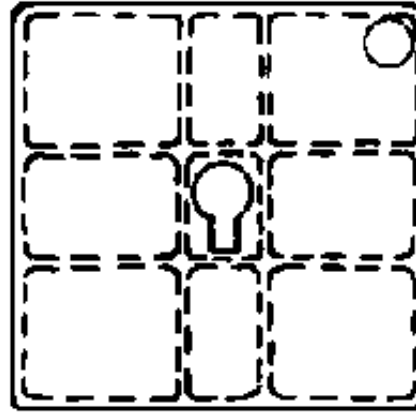

Fig. 7.16. Ferrocement slab (Plan)

WHO 91476

Steel reinforcement is used in various ways in different countries reflecting differences in price and availability. Because of the relatively high cost of steel, many techniques have been investigated in the search for cheaper alternatives. One approach is to reinforce concrete with small unconnected fibres with a low modulus of elasticity. These are either natural fibres, such as sisal, jute, coir, Manila hemp or kenaf, or man-made fibres such as fibrillated polypropylene. The fibres are chopped and added to the cement mix. Use of these low-modulus fibres does not reinforce the concrete in the conventional sense of carrying the tensile load, but is particularly beneficial in ensuring adequate curing of the concrete without the formation of minute shrinkage cracks (Parry, 1985). The resultant "unreinforced" concrete attains a much higher tensile strength than would otherwise be possible. Slabs made from fibre-reinforced cement should normally be given the shape of an arch or dome to minimize tensile forces in the soffit.

Slabs have also been reinforced with barbed wire, fencing wire, scrap steel from

cars and broken machinery, redundant universal beams and almost anything that is available. Although a saving is made on reinforcement, these methods usually lead to a much greater use of concrete in order to cover the larger sections of steel and therefore are rarely economical.

Bamboo has a high strength-to-weight ratio and in certain parts of the world is widely available. Because of the low cost, bamboo strips have been used as an alternative to steel bars but it is important to ensure that the bamboo strips in a slab are completely covered by the concrete so that water and vapours cannot rot the bamboo. The strips should initially be treated with preservative. One recommended method (UNCHS, undated) is for the bamboo to be dipped in white lead and 10% varnish to inhibit water absorption from the freshly placed concrete. Even where treated, there is some doubt as to the long-term durability of bamboo as reinforcement.

Where cement is relatively expensive, a technique known as reinforced brickwork can be utilized, in which part of the concrete is replaced by whole or half bricks, leaving steel reinforced concrete ribs to support the bricks (Fig. 7.17). The whole slab requires a cement skimming over the surface to make it impervious to fouling by the users.

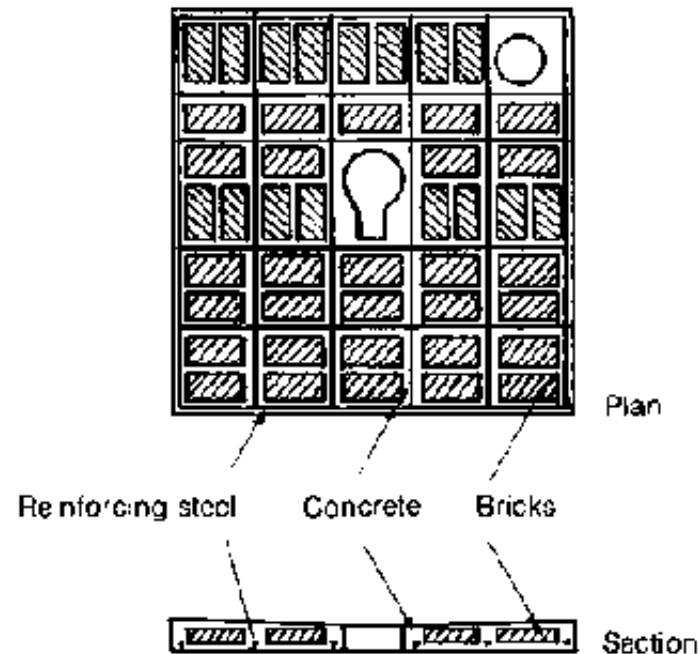

Fig. 7.17. Reinforced brickwork slab

WHO 91477

Concrete mixes

Different concrete design mixes (that is, combinations of cement, sand, aggregate and water) are suitable for use in various circumstances. The concrete mix that is most often used is 1:2:4 (one unit by volume of cement with two units by volume of sand and four units by volume of aggregate). The sand should be clean and hard and may be sized by sieving through ordinary mosquito netting. Coarse aggregate comprises graded stones 6-18 mm in size and should be free of fine dust. This mix results in a finished volume of concrete which is approximately 70% of the total volume of the individual dry materials.

The cement, sand and coarse aggregate have to be mixed with a specific amount of water to give the optimum strength for the amount of cement used. For concrete mixed and placed by hand, there should normally be a water: cement ratio of 0.55 by weight, i.e., the weight of water is approximately half the weight of cement. Cement weighs 1400 kg/m^3 and water 1000 kg/m^3 ; a 50-kg bag of cement thus has a volume of 0.035 m^3 . A 1:2:4 concrete mix using one 50-kg bag of cement therefore requires 0.070 m^3 of clean sand, 0.140 m^3 of aggregate and 0.027 m^3 of water, which results in 0.17 m^3 of finished concrete.

The volume of water is applicable where the aggregate and sand are "saturated, surface dry". In hot dry climates, the small pores in the aggregate, as well as the surface, are likely to be "oven dry" rather than saturated. To use the specified amount of water would then lead to an extremely stiff, unworkable concrete. The aggregate should therefore be thoroughly wetted with water before mixing begins. The correct water: cement ratio results in a relatively stiff but workable material which produces a skim of water on the surface of the concrete as it is worked flat with a trowel. When the mix has too much water, the strength is reduced considerably. An increase of only 50% in the water content decreases the finished concrete strength by half, which is the equivalent of wasting half the cement in the bag.

To check that the calculated amount of water is correct, a trial mix may be prepared and a slump test carried out. In this test, the concrete mix is compacted into a slump cone (Fig. 7.18), which is similar to an upturned bucket 300 mm high with the base removed. When the cone is removed, the concrete will slump, i.e., reduce in height; the maximum slump, for concrete that is to be reinforced, should

be about 100 mm, and less for unreinforced concrete.



Fig. 7.18. Checking the water content of concrete with a slump cone (A)

WHO 91478

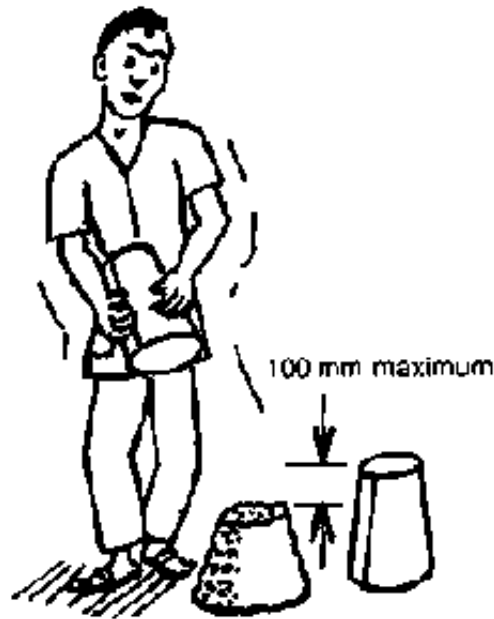

Fig. 7.18. Checking the water content of concrete with a slump cone (B)

WHO 91478

Caring for concrete

After it has been cast, concrete must be cured. It should be covered with either wet sand, straw, cement bags, jute sacks, plastic or palm leaves to keep the concrete moist and as cool as possible. The chemical reaction which causes the cement particles to bind is dependent upon the amount of water present. If the moisture has been sucked out from the surface of the concrete by the heat of the sun, the chemical reaction cannot take place and the surface of the slab will not be durable. In hot dry climates the concrete and its covering need to be watered twice a day for seven days after casting. If the concrete is not cured, it will have only 60% of its ultimate design strength; if cured for three days, it will attain only

80%, but if kept damp for seven days will reach almost 100% (Reynolds & Steedman, 1974).

A good guide for field workers is: "Make the concrete mixture as dry as you can; and then keep the cast concrete as wet as you can."

The most effective way of checking the strength of a slab is to test load it seven days after casting. As, normally, only one person at a time will use the latrine, to test load the slab with five or six people gives an adequate and convincing factor of safety. The slab should be supported at its edges by four or five bricks placed on flat ground, and the people should stand on the slab, avoiding areas directly over the bricks. Testing the strength of precast slabs by throwing them off the back of the delivery truck at the site, on the understanding that those that do not break are adequate, is not recommended.

The final concrete surface should be clean, dense and free of blemishes. The surface will absorb urine unless it is sealed effectively with, for example, proprietary sealant, alkali-resistant gloss paint, bitumastic paint, or two coats of a 25% solution of silicate of soda (Khanna, 1985).

A screed (a thin layer of cement mortar) is sometimes applied to a flat slab after casting to create the desired slope towards the squat hole. However, unless the screed is applied before the concrete has completely set there is a danger of its flaking off in use. Wherever possible the required slope should be cast in the original concrete, a dense surface being obtained by trowelling with a steel float as the concrete begins to set. Alternatively the slab may be cast upside down on plastic sheeting to ensure a good finish.

Footrests are normally cast separately, after the concrete of the slab has hardened. The area where the rests will be cast is roughened when the slab surface is being given its final trowelling. Formers for the footrests can be made out of any available material such as tin or wood, but the individual formers should be connected together and to fixed points on the edge of the slab to ensure that the rests are always cast in the same position (Fig. 7.19).

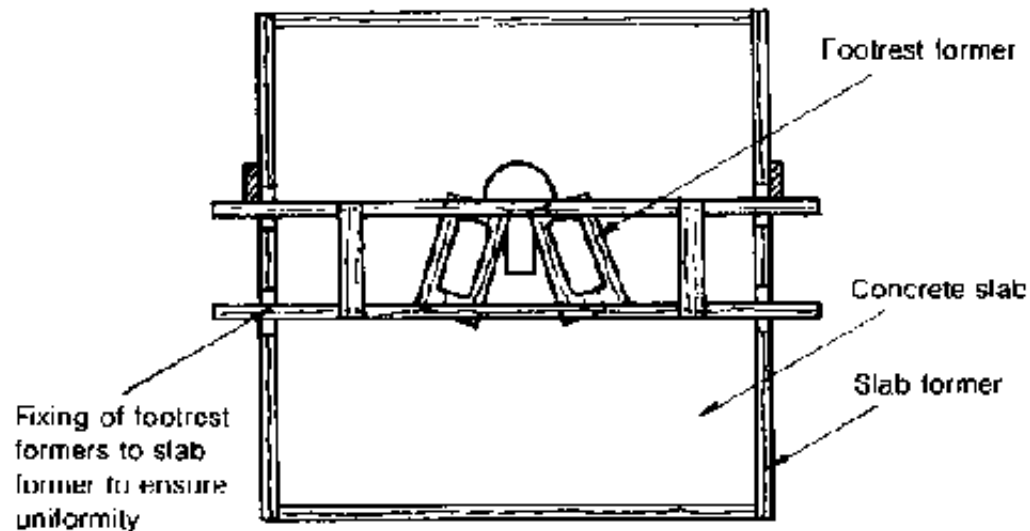

Fig. 7.19. Formwork for the casting of footrests (Plan)

WHO 91479

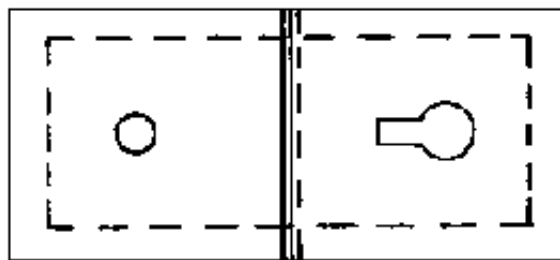

Fig. 7.19. Formwork for the casting of footrests (Section)

WHO 91479

Weights of concrete slabs

If cement-based slabs are to be moved, weight is an important consideration. For example, a 65-mm-thick circular concrete slab, 1.5m in diameter, weighs approximately 275 kg, while an 80-mm thick slab weighs 340 kg. A rectangular slab, 65 mm thick, designed to cover a pit of size 2.2 m × 1.1 m would weigh 360 kg, unless made in sections (Fig. 7.20). Circular slabs are not normally made in sections. When whole, a round slab can be moved by two or three people, rolling it on its edge (Fig. 7.21). This is particularly useful in the management of the construction yard and can sometimes even be used to transfer the slab to the household site without a vehicle.



Precast slab in two sections
for ease of transport

Fig. 7.20. Rectangular slab in two sections (Plan)

WHO 91480

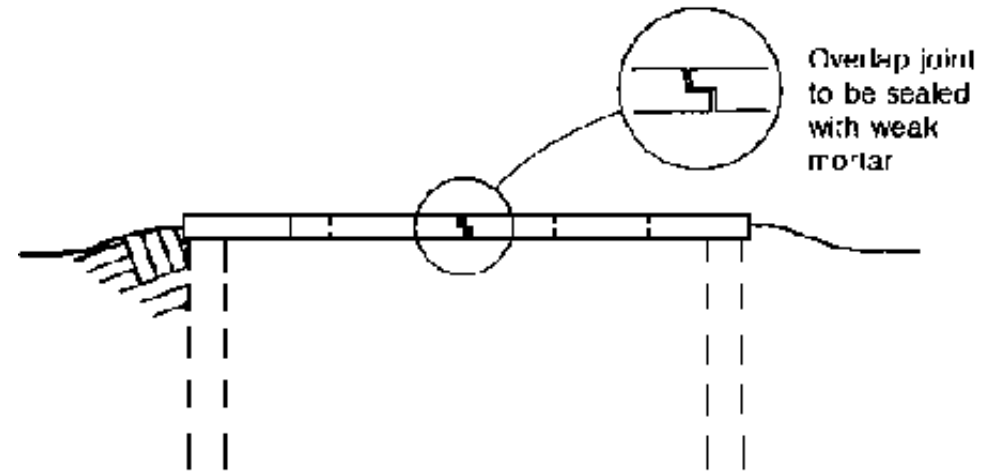

Fig. 7.20. Rectangular slab in two sections (Section)

WHO 91480

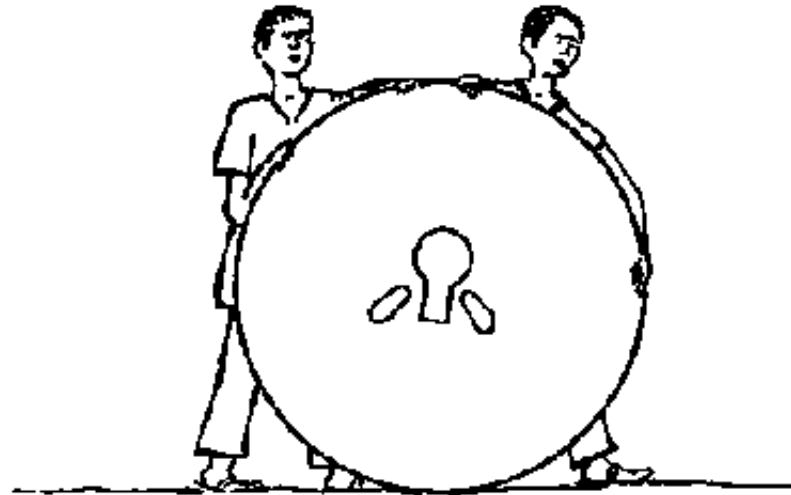

Fig. 7.21. Circular slab for ease of transport

WHO 91481

Concrete for other components

Concrete for floors of latrines that are not directly above the pits is cast *in situ*. A slightly weaker concrete mix of 1:3:6 may be used but the curing requirements remain as described above. The outlet pipe and pan should be carefully laid to the desired level before the concrete is cast.

Cover slabs for offset pits and floors and cover slabs of septic tanks are normally also made of concrete. Walls of septic tanks are usually constructed from concrete blocks or cement-plastered fired bricks. The requirements for good quality concrete are identical to those for components discussed previously.

Other materials for slabs

Wood

The simplest slabs in rural areas are made from rough poles and tree branches laid closely together over the pit. A timber slab is always liable to deterioration because of fungal decay owing to the moist gases rising from the pit and also because of the threat from termites and boring insects in tropical climates. Durable timbers such as the heartwood of some tropical hardwoods are normally too expensive for use in latrines but, where available, may be expected to last satisfactorily for several years.

A thick layer of earth or mud is often spread over the poles or branches to bind them together and create a smooth surface (Fig. 7.22). In many places, people are skilled at making mud floors which are almost as hard as cement and quite smooth. They need not be rough or unsanitary. There are various methods of improving the mud with local materials, such as mixing the soil with a liquor

obtained by soaking animal dung overnight. In some areas the mud is mixed with charcoal or other small aggregate, or with cow dung and then smeared with ashes. Alternatively, the mud from ant-hills has been found to make a hard, practically waterproof surface (Denyer, 1978). If the surface is not kept in good condition, however, there is a danger of hookworm larvae penetrating the feet of users.

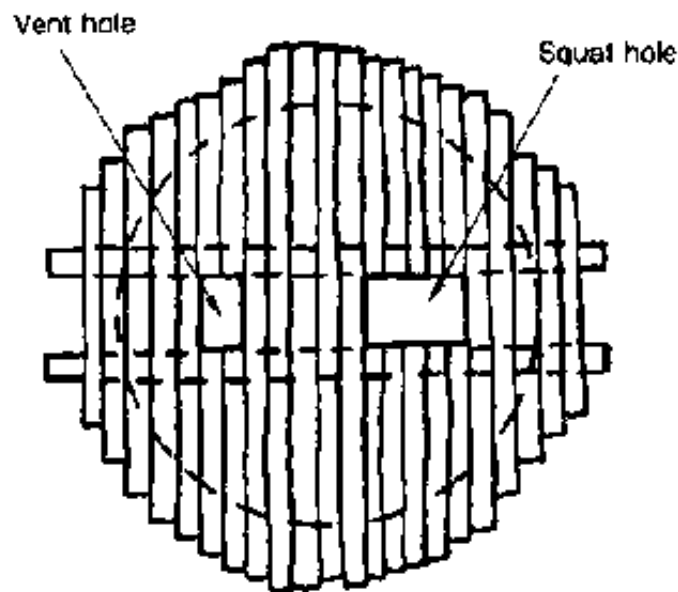

Fig. 7.22. Timber and earth slab (Plan)

WHO 91482

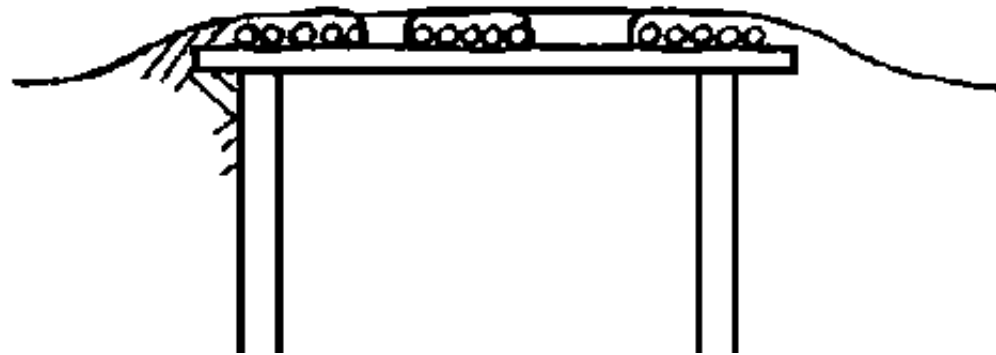

Fig. 7.22. Timber and earth slab (Section)

WHO 91482

The life of a rough timber slab can be extended by using a mixture of soil and cement to plaster and protect the wood. Alternatively, a thin cement mortar screed can be laid over the surface of the earth to protect against hookworm and to improve hygiene. However, it is usually more cost-effective to use the cement to provide a permanent concrete slab which can be transferred to a new pit when the first is filled. Where more than half a bag of cement is needed to stabilize the earth, a concrete slab is likely to be a cheaper alternative.

In an area where timber is abundant, hewn or sawn logs supporting a platform of wooden planks make a floor that is preferable to the mud and pole version (Fig. 7.23). The surface can be kept clean, and signs of imminent collapse are normally apparent to the adult user. The durability of timbers may be improved by some form of treatment. The effectiveness of these treatments depends upon the amount of preservative that the timber can be made to absorb, which is a function of the permeability of the timber and the process used. Suitable preservatives include ordinary tar, tar-oils such as creosote, water-based preservatives such as

copper/chrome/arsenic, and specialized organic solvents (Tack, 1979). Each type of preservative has its own characteristics and particular uses. Where treated timber is not available and the cost of using preservatives on a small scale is high, other more durable alternatives may be cheaper in the long run.

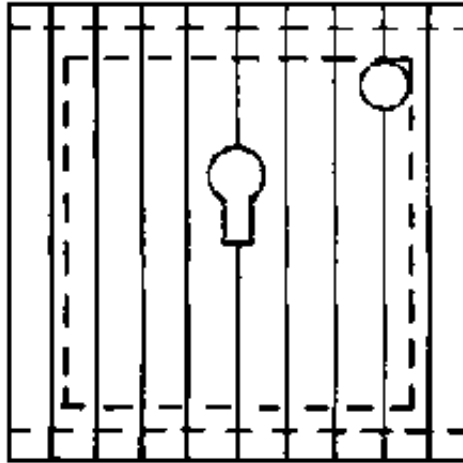

Fig. 7.23. Sawn timber slab (Plan)

WHO 91483



Fig. 7.23. Sawn timber slab (Section)

WHO 91483

Simple timber slabs are often considered to be unsuitable for sanitation projects,

since people are less likely to use the latrine if they are afraid that the slab may collapse under them. However, the danger of collapse is usually less than the dangers associated with not having any appropriate system of sanitation. If no other materials are available at reasonable cost, a rough pole slab that has to be renewed every few years is to be preferred to no latrine at all.

Scrap iron and steel

In urban areas where sanitation is most urgently required, supplies of even the cheapest materials, such as rough poles, are usually limited and relatively expensive. The simplest alternative used by householders on an informal basis is to lay parts of discarded vehicles or any other scrap materials across the pit opening to provide support, with flattened containers, oil drums or galvanized iron roofing sheet to make a surface. Such materials do not seal the pit but they enable the user to excrete into a relatively safe hole rather than at the side of the street. However, where there are significant dangers, especially for children, these methods cannot be recommended.

Miscellaneous materials

Slabs have been made in a variety of other materials. Glass-reinforced plastics, polyvinyl chloride (PVC), ceramics and glass fibre have all been used to meet particular needs and situations. Plastic floors tend to flex under the weight of the user unless they are deeply ribbed. Some of these materials can also be used to give a special surface finish to concrete slabs.

Footrests and squat holes

Footrests are required to lift the users' feet off the slab in case it is already fouled and also to position the users so that they are less likely to dirty the slab or the edge of the squat hole. The positions and sizes of footrests must be determined to suit the needs of the people in each area. Fig. 7.24 indicates a typical layout. Different people in different societies with different-sized bodies and varying flexibility of tendons may excrete between their feet or behind their ankles. Their feet may be parallel or angled. It is therefore advisable to check with young and old, and with male and female in a community before assuming a particular layout. McClelland & Ward (1976) reported that in one sample of 140 people, the distance from heel to anus in a squatting adult varied from 0 to 0.25 m with a mean of 0.13 m for men and 0.10 m for women.

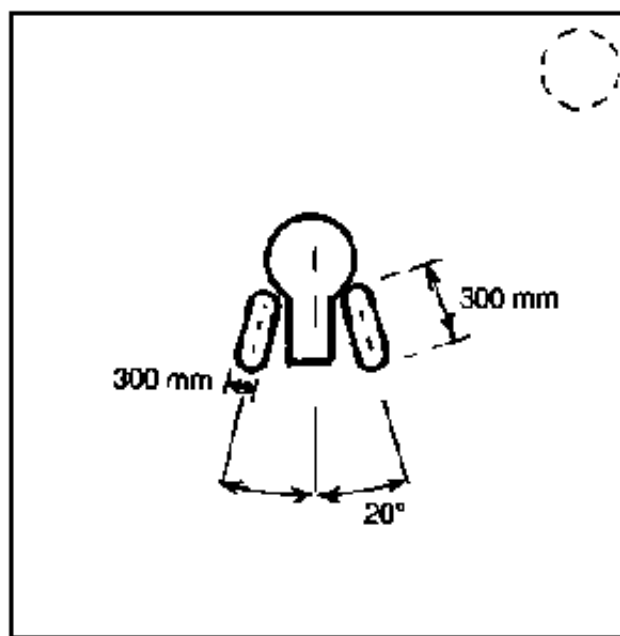

Fig. 7.24. Possible footrest positions

WHO 91484

Excreta enter a pit either by falling through a squat hole or by passing through a water seal. Details of seals are given later. Squat holes have to be large enough to limit fouling of the edges but not so large that children are frightened of using the latrine. The hole can either be rectangular, elliptical, pear-shaped or circular with a straight extension as in a keyhole (Fig. 7.25). The maximum width should be 180 mm and the length at least 350 mm. In a concrete slab, the edge of the former used to make the hole should be angled to ease its withdrawal after casting.



Fig. 7.25. Squat hole shapes and former (Different shapes for squat holes)

WHO 91485

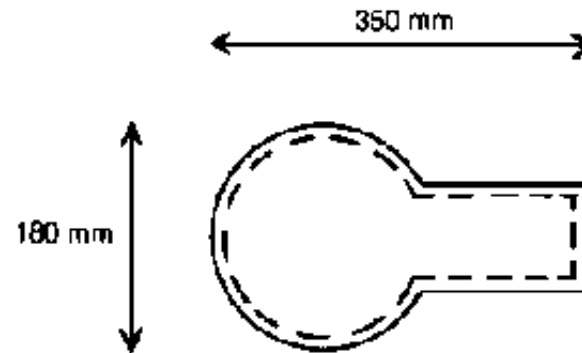

Fig. 7.25. Squat hole shapes and former (Plan)

WHO 91485

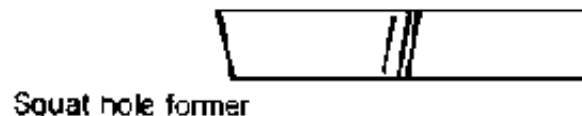

Fig. 7.25. Squat hole shapes and former (Elevation)

WHO 91485

Seats for latrines

In many parts of the world, people prefer to sit to defecate. To make a latrine seat, a support or pedestal is built or mounted on top of the slab. The seat level should be at a position that is comfortable for the majority of the users (Fig. 7.26); this is normally about 350 mm above the top of the slab.

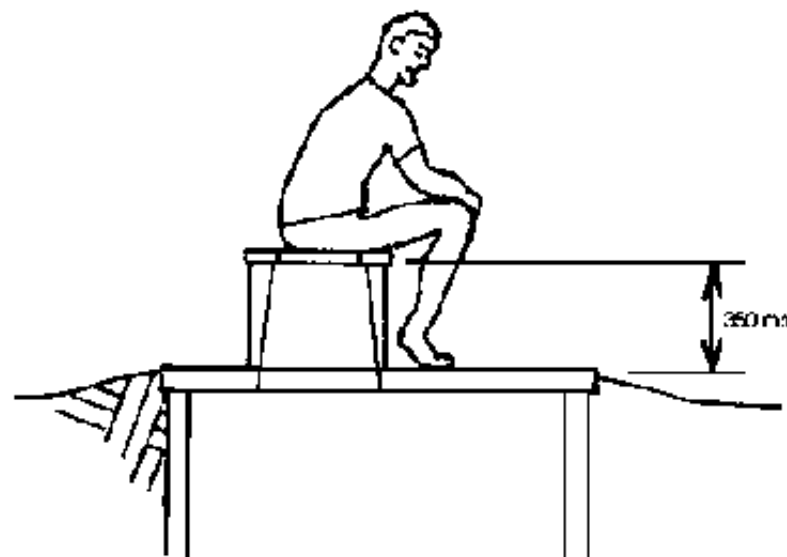

Fig. 7.26. Latrine seat

WHO 91486

The seat support can be made on site from brick, concrete, mud block or timber and should be designed to minimize the load on the slab. A heavy type of

construction adds weight to the slab which then requires more expensive reinforcement to carry the load. Commercially available or project-manufactured pedestals made of ceramic, glass-reinforced plastic (GRP), PVC or ferrocement can also be used where people can afford them.

The inside of the pedestal should be designed to prevent constant fouling by excreta, which leads to increased odour and fly breeding. One approach is to use a large-diameter opening of 250 mm or more, but this might discourage use by children who are frightened by the large opening. An alternative is to have a 180-mm diameter hole through the pedestal which is lined with a smooth material such as cement mortar or an insert of glass fibre (Fig. 7.27) or ceramic. A third alternative is a tapered hole, increasing from an opening size of about 180 mm at seat level to 300 mm at the slab. If possible the pedestal should overhang slightly so that the seat can be used with the feet tucked under to mimic the squatting position.

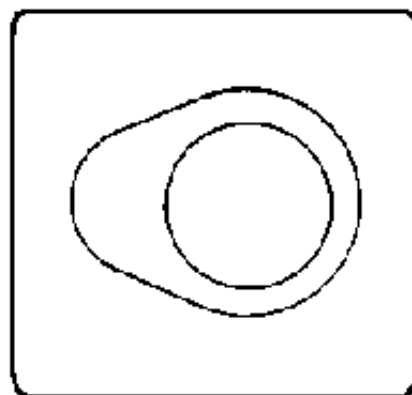

Fig. 7.27. Pedestal seat liner (A)

WHO 91487

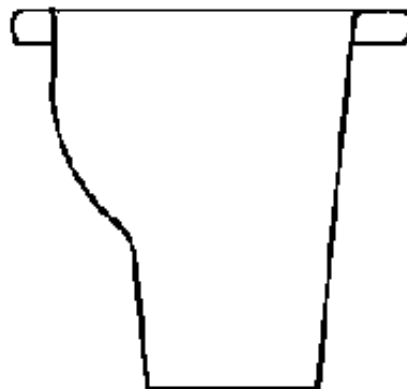

Fig. 7.27. Pedestal seat liner (B)

WHO 91487

Shapes of locally made pedestals vary from a rectangular box, where the user sits on one side but can also sit across a corner with one foot on either side, to a circular or oval design. It is important to obtain a good seal between the pedestal and the slab.

A seat cover may be fitted to seal off an unventilated pit. Where a vent pipe is fitted, an adequate flow of air to the pit can be obtained by raising the seat cover slightly above the seat, as is the case with conventional flush pedestals.

A special fitment with a small opening can be made to encourage children to use the latrine. Alternatively the pedestal top can be enlarged to accommodate a second seat with a smaller opening, possibly at a lower level, for the use of children.

Water seals and pans

A pour-flush latrine utilizes a water seal to prevent odour and insects entering the latrine from the pit. This water seal may be part of the pan unit (Fig. 7.28) or may be connected immediately below the pan (Fig. 7.29). For on-site sanitation, flushing is normally carried out by the wash-down method where the force of the flush water thrown into the pan is enough to drive the excreta through the water seal.

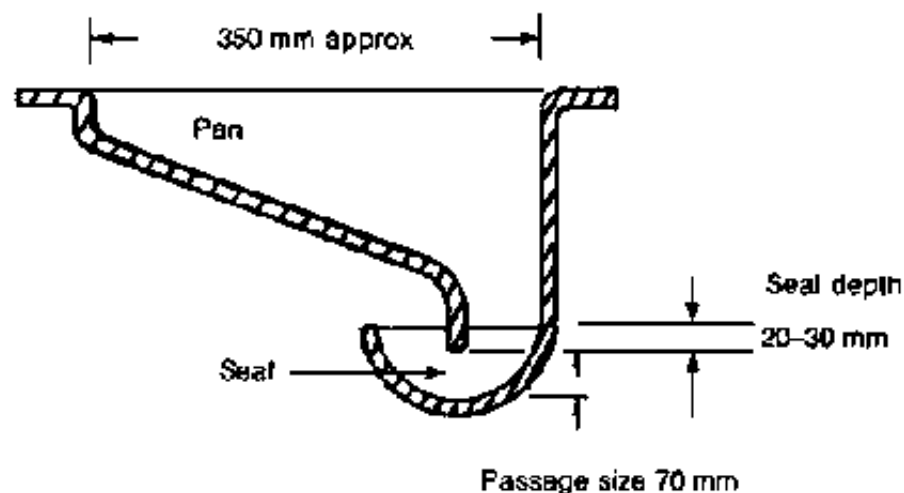

Fig. 7.28. Combined pan and water seal for direct pour-flush latrine

WHO 91488

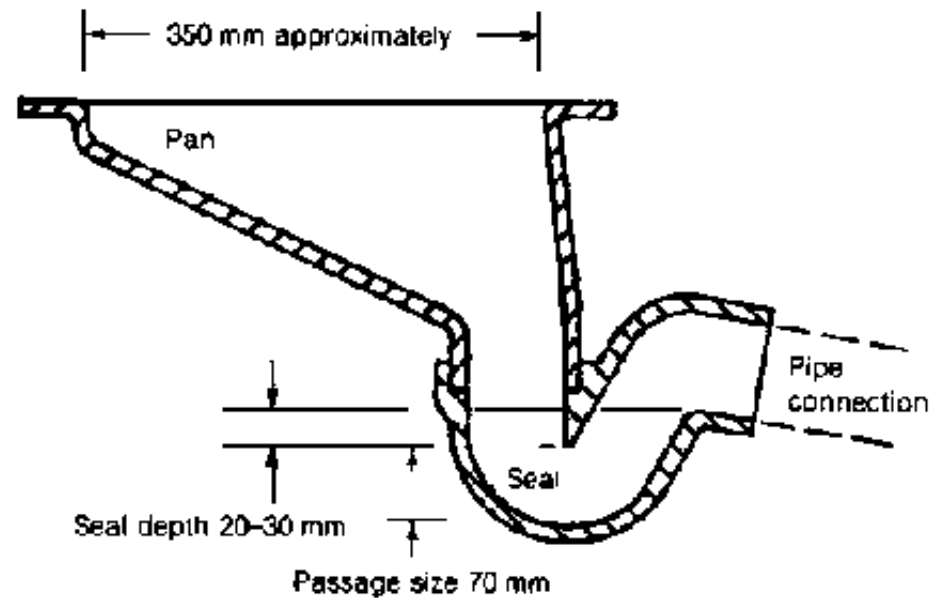

Fig. 7.29. Pan and seal for offset pour-flush latrine

WHO 91489

The pan may be of the squatting type or of the pedestal variety where the user can sit. The amount of water needed for flushing depends on the design of the pan or pedestal, the depth and volume of the water seal, and the minimum passage size through the seal. For a water seal directly above the pit about 1 litre of water is normally sufficient for flushing. Two litres may be required for an offset pit and a minimum of 3 litres for an improved pedestal pan and offset pit.

The depth of the water seal is measured as the depth of water that would have to be removed from a fully filled trap to allow the passage of air (Fig. 7.28). The seal volume is the amount of water held within the trap when the unit is not being used, and the minimum passage size is the opening through which the water must flow and which may be of a smaller diameter than the connecting pipe. The depth

of the seal in a conventional WC is approximately 50 mm. However, the deeper the seal the more water is required for flushing. In pour-flush latrines, the depth of the seal is normally reduced to the minimum compatible with maintaining the seal in hot weather. The seal volume will be reduced by evaporation, the water loss being proportional to the time between consecutive flushings and the degree of exposure to direct sunlight and air movement. A minimum seal depth of 20 mm is considered reasonable with an optimum passage size of 70 mm (Mara, 1985b).

Water seals that can be removed during the dry season to minimize water usage are not recommended. It is likely that the seal would not be replaced at the beginning of the wet season and therefore the latrine would not work effectively.

Types of water seal

Where the water seal services a direct pit, the pan and the seal should be made as a single piece with a hemispherical bowl known as a "gooseneck" trap. This is designed to discharge into the centre of the pit and not against the pit lining where it might cause damage. These types of seal can easily be damaged by users trying to clear blockages with a rod where the thin cement of the seal is unsupported. As direct pits have become less popular because of emptying difficulties, the use of the gooseneck trap has also declined.

In many countries, the pan is made separately from the seal to facilitate manufacture and to give the installer greater freedom as to where the offset pit is located in relation to the pan. The normal system, which has an inclined outlet, is known as a P-trap, while the system with a vertical outlet is called an S-trap.

Water-seal materials

Pans and water seals may be produced by manufacturers or by project staff to standard specifications in a variety of materials. Ceramics, such as white vitreous china or other glazed earthenware, have traditionally been used for pans and pedestals. However, such items may be expensive to purchase and require careful attention to packing if they are to be transported safely. They may also be heavy and require a strengthened slab for a direct pit. Particularly because of the problems of transport and handling, the use of plastics for pans and water seals is becoming more common. Glass-fibre pans and high-density polyethylene (HDPE) water seals are light and easily transportable, even by bicycle, and are often preferred by users, even when more expensive than the cement-based systems described below.

The cheapest pans and seals are made from cement mortar (10-30 mm thick) close to the point of sale or delivery. They can be produced on a large scale without factory facilities, and can be repaired easily when damaged. Such units are likely to be rougher than manufactured pans and seals, and a reaction between urine and the cement normally leads to some staining of the surface and some odour from the trap. This can be minimized by the addition of marble dust and chippings to the cement mortar. When dry, the surface can then be rubbed down with carborundum stones to provide an attractive mosaic finish. Colourings may also be added to the mortar to give a more attractive appearance.

An alternative method of production uses casting boards to cast the pan and seal in two halves with a 1:2:2 concrete mix pressed around the form. After 24 hours the two sections can be removed from the moulds and joined together with neat

cement, the inner surface also being smoothed off with neat cement. One disadvantage of having the pan and water seal in one piece is that the trap cannot be rotated in the direction of the offset pit.

The Thai model, which is now in use in about 3 million rural homes, employs a two-part mould and is cast in a single step, including the platform, without the need for grouting pieces together. The depth and angle of the seal are uniform. Large numbers of moulds can be cast quickly, thus facilitating production of pans and seals so that large numbers of households can have pour-flush latrines in a very short period of time (J. T. Visscher, personal communication).

Making the pan and trap separately enables very simple forms to be used. These may be built up from clay and husk or plastered brick or concrete which can be reused many times. A release agent is needed to break the bond between the mould and the new concrete. Proprietary agents are available, though used engine oil or even cow-dung wash have proved to be cheap and effective.

Pedestals designed for pour-flushing with small quantities of water (about 3 litres) are normally made of ceramic to ensure a smooth finish. Less efficient units may be made using cement-based methods with ferrocement, fibre-reinforced cement and concrete with marble chippings.

Pipes and junction chambers

The water seal may be connected to the offset pit by conventional pipework (see Fig. 6.9) or by a covered drain (see Fig. 6.10). Where double pits are in use, a junction chamber or inspection chamber (see Fig. 6.15) is required whereby the

flow can be directed into one pit or the other.

The pipe or channel should be not less than 75 mm wide and should be as smooth and direct as possible. Any roughness or sharp bends will tend to slow the passage of excreta, eventually leading to a build-up of deposits and a blockage. The cheapest available non-pressure pipes will be adequate, whether in fired clay, plastic or asbestos cement. The minimum slope should be 1 in 30 for smooth pipes and 1 in 15 for rougher pipes or hand-shaped channels. If the slope is too steep there is a danger of solids being deposited in the pipe.

Special care must be taken where the pipe passes through the superstructure wall (see Fig. 6.12 and 6.13). If possible, some degree of flexibility is required at the pipe joints or in the channel so that differential settlement of the latrine superstructure or the pit lining will not cause damage. There is unlikely to be significant loading on the ground above the connecting pipe, but where there is any possibility of vehicles crossing the area between latrine and pit, conventional pipe-bedding and protection should be used.

The pipe or drain should extend some distance into the pit so that the wastewater discharges directly towards the centre and does not dribble down the pit walls, with a consequent build up of deposits.

Where a covered drain is used to connect a double-pit system, a simple Y-junction can be constructed to divert the flow. The junction in a pipework connection between pits and latrine requires a chamber which should be of sufficient size to allow for ease of construction of the concrete benching. It must also allow for the flow to be diverted from one pit to another with a temporary blockage in one or

other arm of the Y-junction. A minimum internal dimension of 250 mm is recommended (Roy et al., 1984). The chamber cover slab needs to be removable to allow for access to divert the flow, but also has to be heavy enough and fixed in such a way that it is difficult for children to remove.

Vent pipes

The vent pipe, i.e., the tube connecting the latrine pit to the open air above the pit, serves two purposes: (1) to create a draught of air from the superstructure, through the squat hole and out of the pit, passing up the vent; (2) to act as a light source which will attract flies to the screen trap which is attached to the top of the vent. Normally the vent pipe is straight and rises vertically above the pit so that the daylight at the top can be seen directly by any flies in the pit (Fig. 7.30). A straight pipe also maximizes the air flow; bends in the vent absorb part of the energy in the air movement.

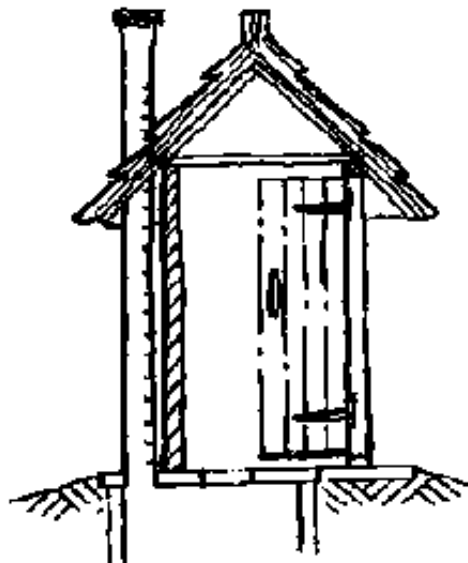

Fig. 7.30. Straight vent pipe

WHO 91490

With certain types of slab, or where existing slabs require upgrading with a vent, there may be a need to bring the pipe out horizontally underneath the slab before turning to the vertical. In this situation an ancillary light source is required in the form of a glass or perspex window at the bend (Fig. 7.31). Flies in the pit are first attracted to the light source at the window. They cannot escape from the vent at that point so, following the air flow upwards, they then go towards the light at the top of the vent.

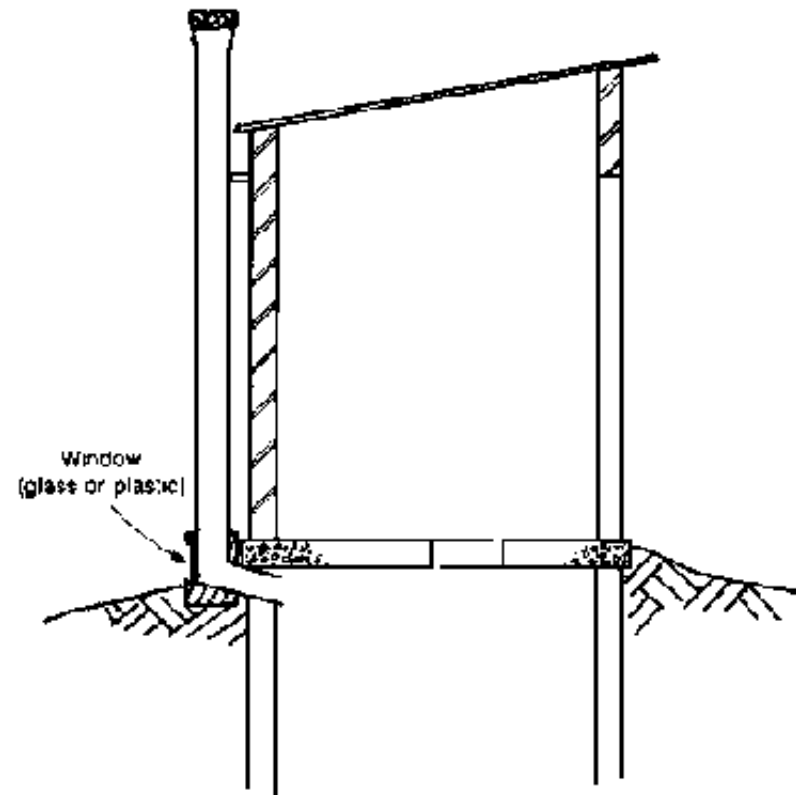

Fig. 7.31. Angled vent pipe with window

WHO 91491

The draught through the vent is created primarily by the movement of wind across the top of the pipe. This air movement creates a suction effect, sucking air out of the pit and up the vent. To achieve satisfactory air movement, the top of the vent should be at least 500 mm above the highest part of the roof, except where the roof is conical, in which case the pipe should reach at least the height of the roof apex. However, if the pipe can be extended even higher, a stronger updraught will be created in the vent. Wind speed increases even at slightly higher elevations above the ground, which creates a stronger suction effect. Also, the higher the vent, the less likely it is to be shielded by buildings or other obstructions which may cause air turbulence and reduce or even reverse the updraught in the vent. Any large trees or overhanging branches close to the vent may significantly affect air movement and thus reduce the effectiveness of the ventilated latrine. Similarly, a rain cowl should not be placed on top of the vent, as it will reduce the air flow; the amount of rain entering the pit is not likely to be significant.

The vent should therefore be located in the best position to catch any air movements across the upper end of the pipe. Vent pipes are normally placed outside the superstructure, particularly where the building materials available make it difficult to construct a watertight joint where the pipe would pass through the roof. Free-standing pipes may be secured to the wall of the superstructure using standard pipe fittings, strips of galvanized steel, galvanized wire or other non-corrosive material. Where possible, the vent should be located on the side of the building which faces the equator, that is the side which receives most sunlight.

The warming of the surface of the vent pipe, raises the temperature of the air in the pipe, increasing the upward draught. Painting the vent black aids this thermal effect. However, the air movement over the top of the vent is the most significant factor in causing updraught and a vent placed inside the building will still work effectively.

The updraught may also be increased by using a spiral design for the superstructure, which funnels the air into the structure. If there are no other ventilation holes, this produces a positive pressure inside the structure, thus forcing air through the squat hole and the pit and up the vent. However, where the winds are particularly variable and often blow from a direction away from the superstructure opening, a negative pressure may be created which will suck foul air out of the pit and into the building (Fig. 7.32).

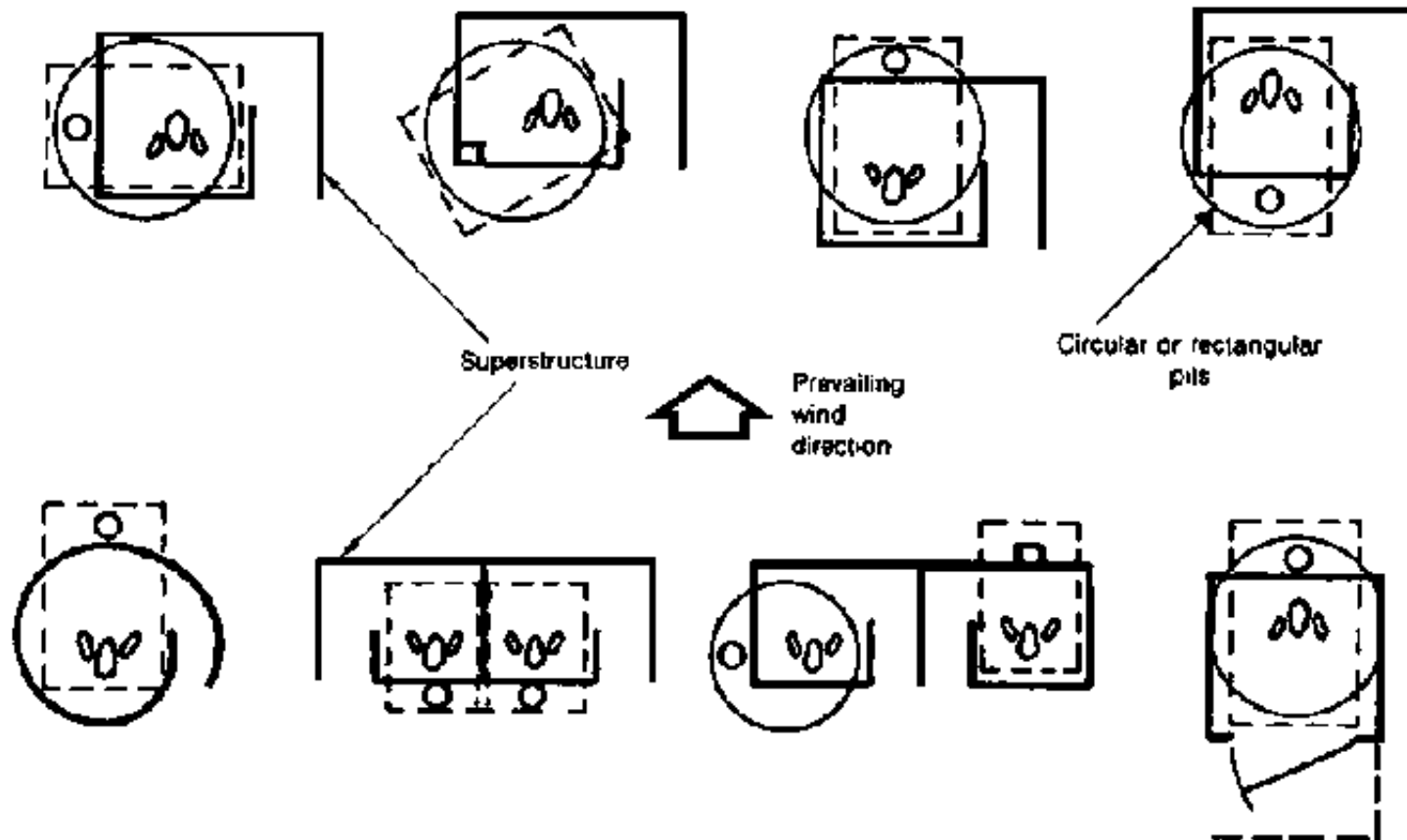

Fig. 7.32. Layouts for superstructures, vent pipes and pits

WHO 91492

Dimensions of the vent pipe

Vents may be square or round and can be constructed from a wide variety of materials. Circular vent pipes should normally have an internal diameter of at least 150 mm for smooth materials (PVC or asbestos cement) or 230 mm for rough surfaces (such as locally produced cement-rendered pipes), although in exposed places with high wind speeds a smaller diameter may be sufficient. It is normally

advantageous to enlarge the top of the vent pipe by about 50 mm to account for the head losses, that is, the reduction in energy and therefore in updraught caused by the air passing through the fine mesh of the flyscreen (Fig. 7.33). There is a danger that cobwebs, dirt or insect matter may build up on the screen, restricting air flow. Belling the top of the pipe can serve to balance these restrictions.

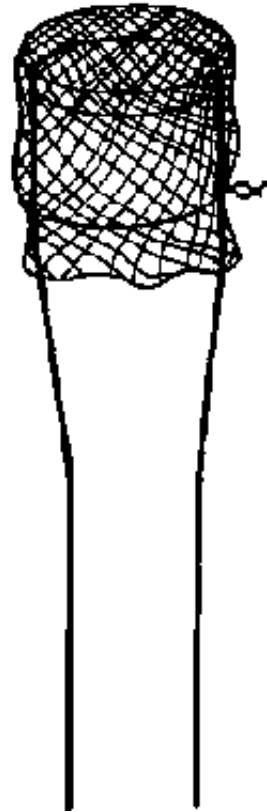

Fig. 7.33. Belled vent with fly screen

WHO 91493

Materials

Materials suitable for vent pipes include asbestos cement, unplasticized PVC, bricks, blocks, hollowed-out bamboo, ant-hill soil, cement-rendered reeds or bamboo, and cement-rendered hessian (Ryan & Mara, 1983). The choice of material will need to take into account durability, availability of materials and skills, cost, and availability of funds. Ordinary PVC becomes brittle when exposed to strong sunlight, so material with a special stabilizer should be used if possible. Because galvanized steel corrodes in a humid atmosphere, the use of thin sheets is not recommended for vent pipes except in very dry climates.

Brick and block chimneys

Vent pipes may be made from bricks or blocks with cement mortar joints in the form of a chimney that is at least 230 mm² internally. The flyproof screen should be stretched over the top surface of the highest bricks. If it is built into the course joint one brick down, a receptacle is created which catches leaves and other debris. The chimney may be free-standing or built into the corner of the superstructure. Morgan & Mara (1982) suggested that thermal updraught in such chimneys continues well into the night because the brickwork retains heat which is released slowly to the air over a period of several hours.

Locally made vent pipes

Reeds, poles, thin bamboo or strips of 10-20 mm of large bamboo can be tied together with wire or string to make a mat which forms a base for cement mortar. The mat, about 2.5 × 1.0 m, is rolled round rings made of green sticks to form a tube about 300 mm in diameter. Flyproof netting is fixed over one end of the tube, which is then laid on the ground. The upper part of the pipe is covered with a layer

of cement mortar made with one part of cement to three parts of sand. When the mortar has dried the tube is put in position with the mortared part against the wall of the latrine. Then the outer part of the pipe is plastered with cement mortar. Alternatively the pipe may be rotated on the ground and completely plastered before erection.

A vent pipe can also be made with hessian. First, a 250-mm-diameter tube is formed of spot-welded steel mesh made of 4-mm bars at 100-mm centres (100 mm apart, centre to centre). Hessian or jute cloth is stitched tightly round the outside of the tube and flyproof netting is stitched over one end. Cement mortar, made of one part of cement to two parts of sand, is then brushed over the tube in several layers until a total thickness of about 10 mm is formed. The vent pipe is then fixed in place. Alternatively, a pipe may be made from ferrocement with three or four layers of mesh plastered with cement mortar and without any hessian.

Fly screens

Fly screens should be made of material that will not be affected by temperature, sunlight, or the corrosive gases that are vented from the pit. Stainless steel or aluminium are considered to be best. Their comparatively high cost may be justified by their long life, especially as the screen accounts for a very small proportion of the total cost of the latrine. PVC-coated glass-fibre netting is relatively cheap and has lasted for more than seven years in Zimbabwe (Morgan & Mara, 1982). However, it tends to become brittle after about five years and is likely to tear at the point where it passes over the edge of the pipe. Ordinary plastic screens deteriorate quickly in sunlight. Painted mild steel mesh, commonly sold as window screening against mosquitos, and galvanized mild steel mesh last

only a few months before corrosion by the pit gases renders them ineffective. Gases and sunlight weaken the screens but the actual tearing of the material is assumed to be caused by birds alighting or possibly by lizards which frequent the top of rough-walled vent pipes or simply by the tension within the flexing screen (P. R. Morgan, personal communication).

A mesh size of 1.2-1.5 mm is recommended. If the apertures are larger small flies can pass through. If the apertures are smaller there is too much resistance to the updraught of air. The screen should be firmly fixed to the top of the pipe. Netting may be fitted over the top of brick and block chimneys during building and on locally made vent pipes during fabrication. Screens may be glued to PVC pipes with epoxy resin or tied on with a piece of wire. Where there is a particular problem with mosquitos breeding in wet pits, it may be necessary to install removable traps over the squat hole or pedestal (Curtis & Hawkins, 1982).

Netting should be inspected regularly (at least once a year) to ensure that it is still in place and that it remains in good condition. Part of routine maintenance is to pour a bucketful of water through the screen and down the pipe to wash away cobwebs and other material.

Superstructure

The building or superstructure of any latrine is required to give privacy and protection to the user. From the health point of view the superstructure is less important than the pit and slab. However, as most people initially desire sanitation because of the convenience and privacy of having their own facilities, it is important that the superstructure meets the users' needs. Many sanitation

projects leave the design and construction of the superstructure to the user. Although there may be some benefit in having a uniform design, it is advantageous to involve the owner or user in the construction. A properly built superstructure should conform to certain guidelines, the most important of which are outlined below.

Size

The size of the building should be such that people are encouraged to use the facility properly, without its becoming an oversized status symbol. If the floor area is much larger than the pit slab, people may be tempted to defecate on the floor, particularly if the squat hole has been fouled by previous users. The height should accommodate a person standing upright without his or her feeling oppressed by the roof. However, if people are used to stooping when going into buildings, a lower entrance may be acceptable or even preferred. Where latrines are also being used as wash rooms or bath houses, a larger area should be allowed for.

Shape

Where the superstructure is not attached to the dwelling, there are two possible basic shapes (see Fig. 7.32): (1) a simple round or rectangular box, with or without a privacy wall; (2) a spiral, which may be round or rectangular. Although the spiral design uses more wall materials (while saving on the possibly more expensive door and hinges), it has the advantage of keeping the inside of the building partially dark and is therefore more suitable for ventilated pit latrines.

If there is a door in a spiral design the functioning of the latrine is not affected by its being left open. The design automatically incorporates a privacy screen. However, if the pit has only a short life and the superstructure will need to be moved to a new location when the pit is full, then a simpler structure may be more suitable.

In some cultures there may be a prohibition on facing in a particular direction when defecating. This must obviously be taken into account when the latrine is being positioned.

Location

The latrine may be built as a free-standing unit within the compound or may be attached to the house. If it is reached from inside the house there is a greater likelihood that it will be properly maintained. It also has the advantage that access can be controlled more easily by the householder. However, greater care has to be taken of the pit lining because of its proximity to the house foundations and the pit must be accessible from outside the house for emptying. Offset pour-flush latrines have the advantage that the pit or pits may be sited in any convenient space, even in the most cramped urban conditions. The pits may even be under the footpath access to the latrine.

Ventilation

It is desirable to provide openings in the superstructure or around the door to ensure adequate ventilation of the latrine. The inlet vents are most effective when they face the prevailing wind and should preferably be at a different height from

the outlet vents to improve the efficiency of air change (Fig. 7.34). A minimum requirement of about six complete air changes per hour (10 m³/hour) has been recommended by Ryan & Mara (1983). An opening of at least 0.15 m² should be adequate in most climates.

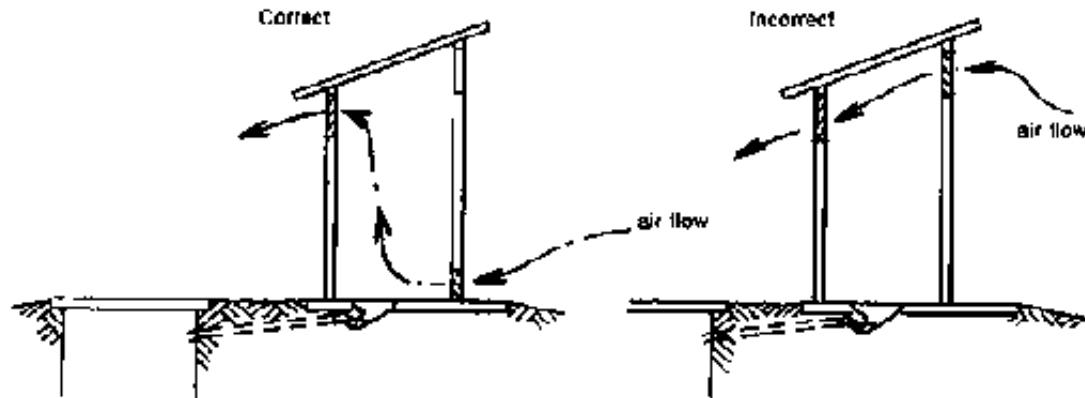

Fig. 7.34. Ventilation in a pour-flush latrine

WHO 91494

With a ventilated pit, the air movement is required to clear the superstructure of stale air by passing into the pit for exhaust through the vent pipe. Where there is a fairly constant prevailing wind, any openings should be on one side of the structure only, facing the wind, so that there is no through draught and to ensure maximum air movement through the pit (Fig. 7.35). However, where the prevailing wind is variable, it may be necessary to have other openings in the superstructure to prevent a suction effect when the wind blows from a different direction. This can lead to foul air being sucked out of the pit through the superstructure, to the discomfort of the users.

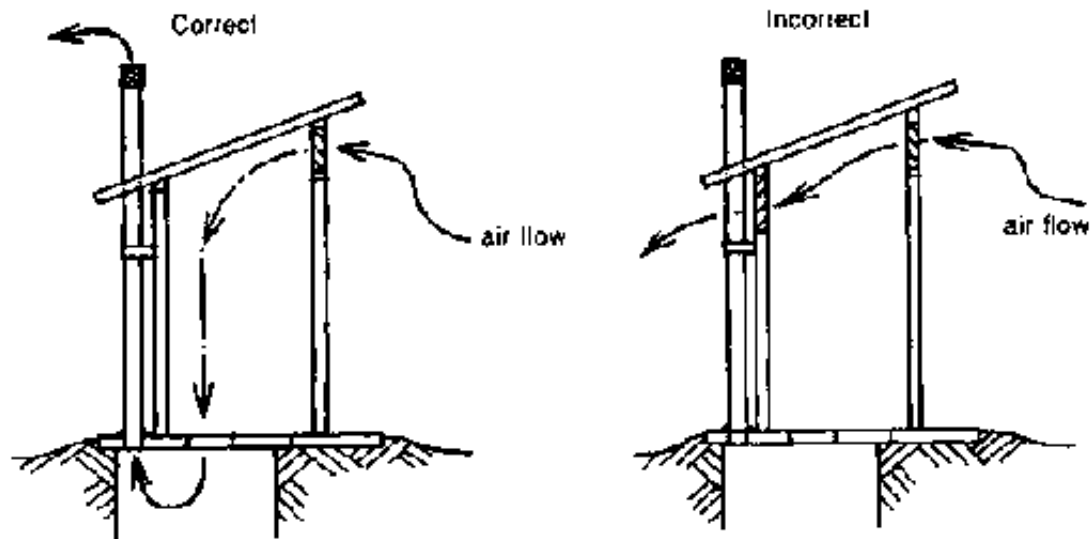

Fig. 7.35. Ventilation in a VIP latrine

WHO 91495

The superstructure must be strong enough to support a vent pipe extending 500 mm above the roof line. Alternatively it may be found that a block or brick vent adds rigidity to the superstructure.

Lighting

In general a latrine that is bright and light is more attractive to its users. A ventilated pit requires a partially darkened superstructure so that any flies in the pit are attracted by the daylight at the top of the vent pipe rather than light from the inside of the latrine. However, the internal walls of the superstructure may be whitewashed and some light allowed through ventilation openings.

Where possible, the opening spiral or door of a ventilated pit latrine should not

face east or west as the low sun in the morning or evening would light up the inside of the structure and encourage the movement of flies out of the pit.

Access

Contrary to normal building practice, the door is usually designed to open outwards to increase the usable space inside the building and to avoid hitting any footrests. This may not be practicable in grass-roofed structures with low eaves. In some cultures a privacy wall is required to screen the door. If a spiral design is used, no door is required (though one may be fitted if desired), which is an advantage where wood and other material for making doors are expensive or in short supply.

Cleanliness

A superstructure that is left dirty and in a constant state of disrepair will soon be unused as a latrine and abandoned. It is therefore important that the building can be cleaned and maintained easily.

Materials

The design of the superstructure and the materials employed normally depend upon the style and construction methods of other buildings in the area. It is to be expected that people will build their latrine out of the same materials as their dwelling - although perhaps to a slightly lower standard. The temptation for projects to produce structures in a grand style should be avoided. If the latrine buildings promoted by a project are of more expensive construction than local housing (even if they are temporarily subsidized) they cost more than people can

ordinarily afford. This acts as a disincentive for new households to construct sanitation systems when the initial promotion is finished. Similarly, the introduction of new materials and methods should normally be avoided in a latrine programme as this diverts attention from the real purpose of the sanitation system. It is better to use local skills and materials which local tradesmen understand how to use and, most importantly, how to maintain.

Many different types of materials can be used and the most common of these are described below.

Screens and fences

The superstructure does not necessarily have to be a roofed building, although there are obvious advantages in providing protection from the rain and sun. However, in some cultures people have become used to defecating in the open and find it objectionable to have to go into a small building. Also, where funds are limited the overall cost of the latrine is considerably reduced by erecting a simple fence made out of the cheapest locally available "waste" materials (such as grass, grain stalk, woven palm) to meet the need for privacy (Fig. 7.36).

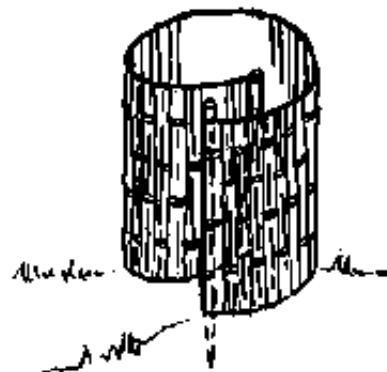
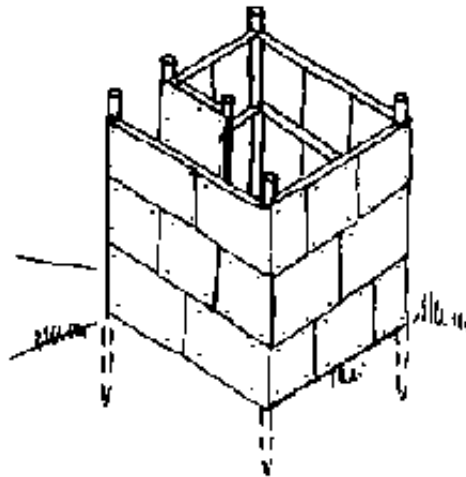

Fig. 7.36. Privacy screens made from cheap locally available materials (A)**WHO 91496****Fig. 7.36. Privacy screens made from cheap locally available materials (B)****WHO 91496**

In periurban areas, agricultural byproducts may not be available. Other waste products such as cardboard or beaten tin cans or sacking suspended on poles can provide the required privacy at very little cost.

It should be noted that a ventilated pit design needs a roofed and darkened superstructure.

Mud and wattle

In many parts of the world the housing consists of mud and wattle, that is upright poles, with the bark removed, interwoven with small branches, the whole being

plastered with mud. Such a system can be readily adapted to the needs of a small latrine, whether round or spiral, with a thatched roof made from palm leaves or grass thatch. Mud and wattle may be improved by nailing bamboo strips to straight upright poles and filling the gaps with small stones before plastering with mud. A more regular, longer-lasting structure is obtained. This can be roofed with thatch or with beaten tin or even galvanized corrugated iron to provide a strong weatherproof structure (Fig. 7.37).

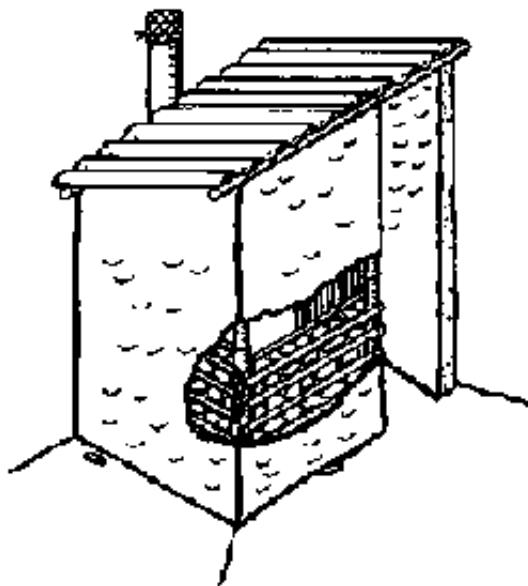

Fig. 7.37. Reinforced mud and wattle superstructure

WHO 91497

Bamboo

Shelters can be made from larger-diameter bamboo poles forming the main frame with smaller bamboos nailed or strapped to them to form the walls. Alternatively

palm leaves or bamboo matting can be used to fill in the walls of the bamboo frame.

Sawn timber

Increasingly, sawn timber is becoming an expensive and rare commodity in low-income areas, but if off-cuts are available from a saw mill, these can be used to clad a simple timber-framed structure.

Sun-dried bricks

Known as adobe, modagadol, kacha or by other local names, these bricks are simply made from a mixture of well-puddled and tempered clay. Moulded in simple wooden formers, they are allowed to dry slowly, out of direct sunlight. They can be strengthened with the addition of natural fibres such as fine grasses or coconut fibres. The superstructure is erected slowly using mud mortar, and where necessary the walls can be strengthened with the addition of fencing wire on alternate horizontal joints. Care must be taken to ensure that the walls are not made too thick if the superstructure is built above a pit. A great weight of walling can exert undue pressure on the foundations and sides of the pit and may lead to collapse.

Machine-pressed blocks

This technique employs a portable steel press to compact prepared soils in order to produce regular blocks. The blocks may be stabilized with up to 8% of cement or lime depending upon the character of the soils used and the degree of exposure of the finished wall. The blocks are laid in mud mortar and can be plastered

externally with mud mortar which requires attention every couple of wet seasons. However, as is the case with the sun-dried bricks, care has to be taken to ensure that walls are not made too thick and heavy.

Fired bricks

Where also used for housing, these make an excellent material for latrine construction. To exert minimum pressure on the ground, a half-brick wall (112 mm thick) built in cement mortar is used with pillars at the corners. If mud is used as the mortar to reduce costs then a one-brick wall (225 mm thick) should be constructed.

Concrete blocks

Where a more expensive standard is acceptable, or if firewood for brick firing is restricted, concrete blocks can be made by hand on site or purchased from a local manufacturer. The blocks are usually 150 mm thick but to reduce materials 65-mm blocks can be made. However, greater skill is required in the laying of these blocks and it is unlikely that a householder would be able to build without skilled assistance.

Stone

Traditional building techniques with stones are sometimes used for latrine construction. This is normally to be avoided over direct pits as the thickness of the walls (often 450 mm or more) exerts a high load, requiring a strong pit lining for support. Stone buildings are quite acceptable, however, for offset pits.

Ferrocement

A strong cement mortar pressed into three or four layers of wire mesh forms a strong, reasonably stiff membrane known as ferrocement. This material has been used successfully for spiral superstructures but can only be used where cement costs are low and the people are willing to accept a new technology along with their new latrines.

Other materials

Plasticized materials, corrugated asbestos cement, galvanized iron and aluminium sheets are also used.

Roofing

Materials such as thatch, palm leaves, clay tiles, fibre-cement tiles, wood shingles, corrugated iron, corrugated aluminium, asbestos cement, ferrocement and precast concrete can all be used for roofing the latrine superstructure. An important point to note is that the roof must be adequately tied into the wall structure and the walls must be strong enough to resist the uplift of high winds. Some materials, for example, galvanized corrugated iron, lead to greatly increased temperatures inside the latrine which may increase odour and make the building less pleasant to use.

Doors

A door is not required for efficient functioning of most latrines. However, for various reasons, users often wish to have a sawn timber door. Where possible it is

advisable to mount the door on self-closing hinges. Doors can also be made from beaten tins or corrugated iron on a wooden frame, bamboo strips or anything else that is available. Simple curtains may suffice where timber is scarce. A door is not necessarily required for privacy of the user. Where spiral designs have become common it is normal for people to knock on the outside of the structure before entering to warn anybody using the latrine of their approach.

Hinges do not have to be manufactured in steel; strips of old car tyres or leather from old shoes can equally well be used.

Conclusion

In conclusion it may be emphasized that a superstructure is usually required first for privacy and secondly as a shelter for the user from the wind and rain.

Brandberg (1985) asked the question, "Why should a latrine look like a house?" to demonstrate that the poorest people need not be excluded from the benefits of sanitation because they cannot afford the superstructure. A simple screen for privacy can adequately serve as a first phase while funds are found for a building. At a later stage materials in common use for house construction in the area will be suitable for building the latrine superstructure.

Chapter. 8 Design examples

Introduction

The design of a latrine is governed by both consumer expectations and public health requirements. Although basic design factors remain the same (pit volume, septic tank retention time, etc.), the factors that govern the final cost of the latrine

are controlled by local circumstances and requirements.

It is not feasible to illustrate all the possible design options. However, this chapter gives details of how to determine the basic dimensions for the most common designs and gives examples to illustrate the design procedure.

Pit latrine design

Pit size

When calculating the dimensions of a hole for a pit latrine, three conditions must be satisfied.

- 1. The pit should have sufficient storage capacity for all the sludge that will accumulate during its operational life or before its planned emptying.**
- 2. At the end of the pit's operational life there should still be sufficient space left for the contents to be covered with a sufficient depth of soil to prevent surface contamination with pathogenic organisms (soil seal depth).**
- 3. There should be sufficient wall area available at all times to enable any liquid in the pit to infiltrate the surrounding soil.**

Storage volume

The storage volume required to accommodate the sludge that accumulates in the pit during its operational life can be calculated from:

$$V = N \times P \times R$$

where V = the effective volume of the pit (m^3)

N = the effective life of the pit (years)

P = the average number of people who use the pit each day

R = the estimated sludge accumulation rate for a single person (m^3 per year).

Once the effective volume of the pit has been calculated, the plan area is decided. This should be based on local preference, ground conditions and construction materials, and is generally circular or rectangular in shape. Note that only the area inside the lining is utilized for sludge accumulation, not the excavated area.

Having determined the plan shape and area, the depth of pit required for sludge accumulation is calculated as follows:

$$\text{Sludge depth} = \frac{\text{total sludge volume (V)}}{\text{plan area}}$$

Soil seal depth

This is usually taken as 0.5 m. In the case of double pit latrines it is the depth to the bottom of the inlet drain.

Infiltration area

In communities where people use water for anal cleaning or bathe in the toilet, a considerable amount of water may enter the pit. If it is assumed that the soil

pores below the sludge surface are blocked, then additional wall area must be allowed for infiltration of the liquids above the sludge.

The infiltration area cannot include the soil seal depth since the top 0.5 m of a pit has a fully sealed lining.

Assuming that all the liquid entering the pit lies on top of the sludge, then the liquid depth will rise until the area of contact between liquid and soil is large enough to permit infiltration of the daily intake of liquid.

Pit depth

The total depth of the pit is calculated as follows:

Pit depth = sludge depth + infiltration depth + soil seal depth

■ *Example 8.1*

A family of six intends to dig a pit latrine with an operational life of 20 years. The family uses newspaper and corncobs for anal cleaning, and sullage is disposed of separately.

■ *Sludge volume*

$$V = N \times P \times R$$

The values of N and P are given (20 years and 6 people) but the sludge accumulation rate (R) is not. In the absence of local information the rate given in

Chapter 5 can be used. The accumulation rate cannot be determined without some knowledge of the depth to the water table. Assuming this is greater than the likely pit depth, an accumulation rate of 90 l/year is used (see Table 5.3).

$$\text{Sludge volume} = 6 \times 20 \times \frac{90}{1000} \left(1 \text{ m}^3 = 1000 \text{ litres} \right) = 10.8 \text{ m}^3$$

If it is found that the pit does enter the groundwater, then the calculation should be done again using the appropriate sludge accumulation rate (60 l/year, from Table 5.3).

■ *Plan area*

The pit will be rectangular, with internal dimensions of 1.2 m by 2.0 m. Thus the depth required for sludge is:

$$\frac{10.8}{1.2 \times 2.0} = 4.5 \text{ m}$$

■ *Infiltration area*

Since solid objects are used for anal cleaning and sullage is disposed of elsewhere, there will be very little liquid to infiltrate. Accordingly the infiltration area can be ignored.

■ *Soil seal depth*

Assumed to be 0.5 m. Therefore the designed pit depth is:

$$4.5 + 0.5 \text{ m} = 5 \text{ m.}$$

This is very deep and consideration could be given to increasing the plan area or reducing the life of the pit.

■ **Example 8.2**

A family of six intends to construct a pit latrine to last 20 years. The family uses water for anal cleaning and intends to use the toilet as a bathing area. The ground is mainly a fine sand with a water table 3 m below the surface.

■ **Sludge volume**

Using the figures given in Table 5.3, the sludge accumulation rate will be 60 l/year above the water table and 40 l/year below. First assume that the pit will be mainly above the water table. If it is found that it enters into the groundwater by more than 1.0 m then the volume can be recalculated.

$$\text{Volume (V)} = N \times P \times R = 6 \times 20 \times \frac{60}{1000} = 7.2 \text{ m}^3$$

■ **Sludge depth**

If the pit is to be circular, with an inside diameter of 1.3 m, the sludge depth will be:

$$\frac{\text{Sludge volume}}{\text{Plan area}} = \frac{7.2 \times 4}{\pi \times 1.3^2} = 5.42 \text{ m}$$

A pit of these dimensions would mean that most of the sludge would collect below the water table. Therefore the volume should be recalculated using a sludge

accumulation rate of 40 l/year.

$$V = 6 \times 20 \times 0.04 = 4.8 \text{ m}^3$$

Therefore the new sludge depth will be:

$$\frac{4.8 \times 4}{\pi \times 1.3^2} = 3.62 \text{ m}$$

■ ***Infiltration rate***

The infiltration capacity of a fine sandy soil is about 33 l/m² per day (see Table 5.4). Assuming the volume of water entering the pit each day is 200 l then the infiltration area required will be:

$$\frac{200}{33} = 6.1 \text{ m}^2$$

Therefore liquid will build up in the pit until a contact area of 6.1 m² is achieved.

$$\text{Water depth} = \frac{\text{infiltration area}}{\text{pit circumference}} = \frac{6.1}{\pi \times 1.3} = 1.49 \text{ m}$$

Assuming a soil seal depth of 0.5 m, the total depth required for the pit is:

$$3.62 + 1.49 + 0.5 = 5.61 \text{ m}$$

This is a slight underestimate of the required depth because some of the sludge will accumulate above the groundwater level. Bearing in mind the inaccuracy of the basic design data, however, it is not necessary to carry out a more accurate

calculation.

■ *Example 8.3*

An offset pour-flush double-pit latrine is to be constructed for a family of six who use water for anal cleaning. The groundwater table is within 0.5 m of the surface during the rainy season and the soil is a sandy silt.

■ *Sludge volume*

As for the previous examples:

$$V = N \times P \times R$$

In a large pit the value of R would be taken as 40 l/year (see Table 5.3) but as this is a double pit, full consolidation of the sludge is unlikely to have taken place within the time taken to fill the pit (generally 2 years). Therefore a higher sludge accumulation rate (such as 60 l/year) should be used.

$$\text{Sludge volume} = 6 \times 2 \times \frac{60}{1000} = 0.72 \text{ m}^3$$

■ *Sludge depth*

If each pit is 1.2 m wide and 1.2 m long, the sludge depth will be:

$$\frac{0.72}{1.2 \times 1.2} = 0.5 \text{ m}$$

■ *Infiltration depth*

An offset pour-flush toilet uses about 3 l of water per flush. Assuming 20 flushes per day the total liquid inflow will be:

$$3 \times 20 = 60 \text{ litres}$$

If 6 l of urine enter the pit each day, the total daily inflow of liquid will be 66 l. The infiltration rate for sandy silt is about 25 l/m² per day (see Table 5.4); therefore the infiltration area required is:

$$\frac{66}{25} = 2.6 \text{ m}^2$$

The perimeter length of each pit is $1.2 \times 4 = 4.8$ m, therefore the liquid depth will be:

$$\frac{2.6}{4.8} = 0.5 \text{ m}$$

■ *Pit depth*

The pit depth is the sum of the component depths, i.e.:

depth to bottom of inlet pipe	0.2 m
liquid depth	0.5 m
sludge thickness	0.5 m
Total depth of each pit below ground level	1.2 m

Septic tank design

■ **Example 8.4**

Design a septic tank suitable for a household with up to eight occupants in a low-density housing area in which the houses have full plumbing, all household wastes go to the septic tank and the nominal water supply is 200 l per person per day. Water is used for anal cleaning and the ambient temperature is not less than 25°C for most of the year.

■ **Stage 1**

Volume of liquid entering the tank each day

$$A = P \times q$$

where A = volume of liquid to be stored in the septic tank

P = number of people using the tank

q = sewage flow = 90% of the daily water consumption per person (Q).

$$q = 0.9 \times Q = 0.9 \times 200$$

$$= 180 \text{ litres per person per day.}$$

Therefore $A = 8 \times 180 = 1440$ litres

■ **Stage 2**

The volume of sludge and scum is given by

$$B = P \times N \times F \times S$$

where B = volume of sludge and scum

P = number of people using the tank

N = period between desludgings

F = sizing factor (see Table 6.2)

S = sludge and scum accumulation rate (see Chapter 6)

Assume N is 3 years; from Table 6.2, $F = 1.0$; as all wastes go to septic tank $S = 40$ l per person per year.

Therefore:

$$\begin{aligned} B &= 8 \times 3 \times 1.0 \times 40 \\ &= 960 \text{ litres} \end{aligned}$$

■ **Stage 3**

$$\begin{aligned} \text{Total tank volume} &= A + B \\ &= 1440 + 960 \\ &= 2400 \text{ litres (2.4 m}^3\text{)} \end{aligned}$$

■ **Stage 4**

Assume liquid depth = 1.5 m

Assume tank width is W m

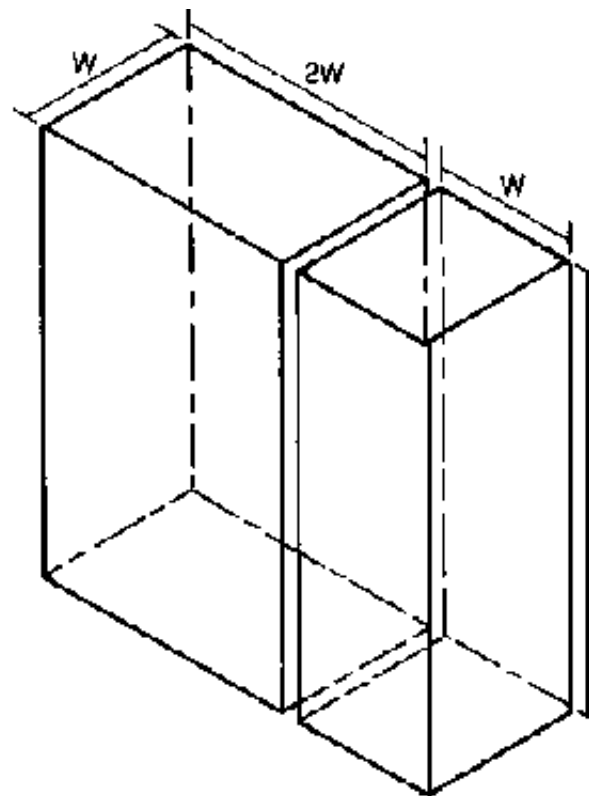

Fig. 8.1. Internal dimensions of the septic tank designed in example 8.4

WHO 91496

Assume two compartments,

length of first = $2W$

length of second = W

This tank is illustrated in Fig. 8.1.

Volume of tank (V) = $1.5 \times (2W + W) \times W$

$= 1.5 \times 3W \times W$

$$= 4.5 \text{ m}^3$$

$$\text{Thus } 4.5 W^2 = 2.4 \text{ m}^3$$
$$W = 0.73$$

Therefore:

width of tank = 0.73 m
length of first compartment = 1.46 m
length of second compartment = 0.73 m

Depth of tank from floor to soffit of cover slab

$$\begin{aligned} &= \text{liquid depth} + \text{freeboard} \\ &= 1.5 + 0.3 \\ &= 1.8 \text{ m} \end{aligned}$$

Flotation

Since septic tanks have sealed walls and floor, the design must be checked to make sure that the tank does not float out of the ground. Flotation will occur if the total mass of the empty septic tank is less than the mass of the water it displaces. This will only happen if the groundwater level is higher than the bottom of the tank.

Calculate the mass of the walls, floor, roof and any baffle walls (concrete: 2400 kg/m³; brickwork: 1500 kg/m³). Measure the volume of the tank (outside

dimensions) between the highest groundwater level and the bottom of the tank.

Multiply the volume by the density of water (1000 kg/m^3). This gives the mass of water displaced.

If the mass of water displaced is greater than the total mass of the empty septic tank then the tank may float. This can be prevented by increasing the mass of the structure (e.g., by increasing the thickness of the floor or walls) or reducing the amount of the tank that is below the water table.

Soil pressure

For large tanks, such as for a school or a number of houses, it is necessary to check that the side walls of the tank are not likely to collapse owing to the outside soil and water pressure. This is most likely when the tank is empty. Such a calculation is beyond the scope of this book, and reference should be made to a manual on reinforced concrete or masonry design.

■ Example 8.5

Design a septic tank for a household having five occupants in a medium-density housing area in which the houses have full plumbing. Only WC wastes go to the septic tank, and paper is used for anal cleaning. The ambient temperature is more than 10°C throughout the year.

■ Stage 1

Daily volume of liquid

$$A = P \times q$$

If the WC has a 10-litre cistern and each person flushes it four times a day, the sewage flow $q = 4 \times 10 = 40$ litres per person per day and $A = 5 \times 40 = 200$ litres.

■ Stage 2

Volume for sludge and scum

$$B = P \times N \times F \times S$$

Assume N is 3 years; from Table 6.2, $F = 1.0$; as only WC wastes go to septic tank $S = 25$ litres per person per year.

So

$$\begin{aligned} B &= 5 \times 3 \times 1.0 \times 25 \\ &= 375 \text{ litres} \end{aligned}$$

■ Stage 3

$$\begin{aligned} \text{Total tank volume } V &= A + B \\ &= 200 + 375 \\ &= 575 \text{ l (0.575 m}^3\text{)} \end{aligned}$$

As this is less than the minimum recommended volume of 1.0 m³, the dimensions for the minimum volume should be calculated.

■ Stage 4

Assume liquid depth = 1.5 m.

Assume tank width is W m.

Assume two compartments:

$$\text{length of first} = 2W$$

$$\text{length of second} = W$$

$$\begin{aligned}\text{Volume of tank} &= 1.5 \times (2W + W) \times W \\ &= 4.5 W^2\end{aligned}$$

$$\begin{aligned}\text{If } 4.5 W^2 &= 1.0 \text{ m}^3, \\ \text{then } W &= 0.47 \text{ m}\end{aligned}$$

As this is less than the recommended minimum width of 0.6 m, assume $W = 0.6$ m.

Length of first compartment ($2W$) = 1.2 m

Length of second compartment (W) = 0.6 m

Depth of tank from floor to soffit of cover slab

$$\begin{aligned}&= 1.5 \text{ m (liquid depth)} + 0.3 \text{ m (freeboard)} \\ &= 1.8 \text{ m}\end{aligned}$$

The tank volume (excluding freeboard) is:

$$(1.2 + 0.6) \times 0.6 \times 1.5 = 1.62 \text{ m}^3$$

which is larger than the required volume calculated in stage 3. This is no disadvantage; in practice the minimum retention time will be greater than 24 hours or the tank will provide longer service than three years before requiring desludging.

Aqua-privy design

Aqua-privies are basically small septic tanks. They have the same purpose as septic tanks and work in the same way. It is recommended therefore that they are designed in the same way as septic tanks. It is also recommended that the minimum size of tank should be 1.0 m^3 . This is because smaller tanks are more difficult to build and the turbulence produced by the inflow will prevent proper settlement.

Disposal of effluent from septic tanks and aqua-privies

■ Example 8.6

Determine the size of soakpit required in porous silty clay to dispose of the effluent from the septic tank considered in Example 8.5.

From Example 8.5, the sewage flow is 200 litres per day.

From Table 5.4, the infiltration rate for sewage is 20 l per m^2 per day.

Therefore, the wall area required is $\frac{200}{20} = 10 \text{ m}^2$

If the pit is 1.5 m in diameter, then the depth required from the bottom of the pipe from the septic tank to the bottom of the pit is:

$$\frac{10}{\pi \times 1.5} = 2.12 \text{ m}$$

■ Example 8.7

Determine the size of drainage field required in porous silty clay to dispose of the effluent from the septic tank considered in Example 8.4.

From Example 8.4 the sewage flow is 1440 l per day.

From Table 5.4, the infiltration rate for sewage is 20 l per m² per day.

So the wall area required is $\frac{1440}{20} = 72 \text{ m}^2$

If the effective depth of the trench (the depth from the bottom of the pipe to the bottom of the trench) is 0.6 m, the length of trench required is:

$$\frac{72}{0.6 \times 2} = 60 \text{ m}$$

This allows for infiltration on both sides of the trench.

If the plot is large enough, the drainage field should consist of two trenches, each 30 m long, connected in series.

Composting toilets

Double-vault latrines

The design of a double-vault latrine is similar to that of a pit latrine, i.e., the volume of each vault is calculated using the formula:

$$V = N \times P \times R$$

where V = the effective volume of the vault (m^3)

N = the number of years the vault must last before becoming full

P = the average number of users

R = the estimated sludge accumulation rate for a single person (m^3 per year).

The difficulty with vault design is that very little information exists on the sludge accumulation rate in vaults where excreta are mixed with ash and other organic material, and there has been little research into the pathogen survival rate in such an environment.

Desludging period

Pit latrines are usually designed such that excreta are not handled for two years. Since the inside of a composting toilet is similar to that of a pit latrine, it is reasonable to assume that it should be designed using similar parameters. However, some researchers disagree with this, saying that the low moisture content of the compost produces very alkaline conditions that destroy the pathogens in a much shorter time. Times as low as four months have been

suggested. In the absence of more accurate information, however, a two-year retention time is recommended.

Sludge accumulation rates

The accumulation rate for the excreta component of the compost can be determined in the same way as for a double-pit latrine. In the absence of more accurate local information, figures 50% greater than those given in Table 5.3 are suggested.

Estimating the volume of ash and other organic material is more difficult. Experience in Viet Nam indicates that approximately twice the volume of faeces has to be added (Jayaseelan et al., 1987). Rybczynski (1981) suggested five times the volume of faeces, and Kalbermattan et al. (1980) recommended allowing 0.3 m³ per person per year for all wastes.

In the absence of information to the contrary, it is suggested that the total sludge build-up rate is calculated as three times the estimated faecal build-up rate.

■ *Example 8.8*

Design a double-vault composting toilet for a family of six who use paper for anal cleaning.

The effective volume of each vault (*V*) must be:

$$2 \times 6 \times (0.06 \times 1.5 \times 3) = 3.24 \text{ m}^3$$

Vaults are usually sealed when they are three-quarters full, therefore the actual volume of the vault must be:

$$\frac{4}{3} \times 3.24 = 4.32 \text{ m}^3$$

If the vault has a plan area of 1.3 × 1.3 m, the depth will be:

$$\frac{4.32}{1.3 \times 1.3} = 2.56 \text{ m}$$

Continuous composting toilets

Even fewer design data are available for continuous composting toilets than for double-vault latrines. Past designs have been empirical and little published information exists indicating the level of their success. It is suggested that, until more data are available, the size of the primary tank in the toilet should be based on the formulae and factors used for double-vault latrines. The second tank should be 10-20% of the size of the first tank. The floors of both tanks should slope at an angle of 30° to the horizontal. No design data exist for calculating the size and number of aeration channels or the diameter and height of the ventilation pipe.

■ Example 8.9

Using the information given in Example 8.8, design an appropriate continuous composting toilet.

From Example 8.8 the volume of the primary tank should be 4.32 m³.

The volume of the second tank will be:

$$4.3 \times 0.15 = 0.65 \text{ m}^3$$

Assuming the first tank is 1.2 m wide and 2.2 m long then its depth will be 1.65 m.

The length of the second tank will be:

$$\frac{0.65}{1.2 \times 1.65} = 0.33 \text{ m}$$

This is short and would make emptying very difficult; increase the length to 0.5 m.

Since the vault floor must slope at an angle of 30°, the depth of excavation at the outlet end will be greater than the depth at the inlet.

Assuming the floor of the second tank is horizontal the internal floor level will be at a depth of:

$$1.65 + 2.2 \tan 30^\circ = 2.9 \text{ m}$$

Fig. 8.2 shows the final internal dimensions of the tank.

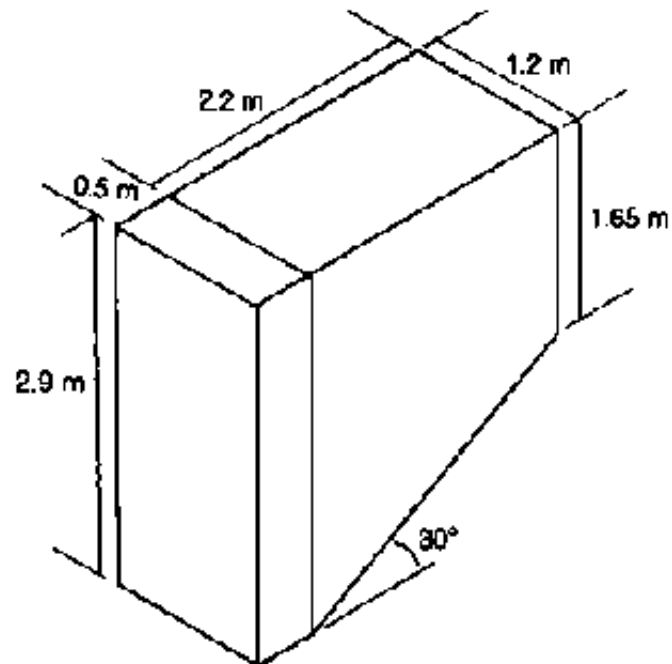

Fig. 8.2. Internal dimensions of the continuous composting toilet designed in example 8.9

WHO 91499

