

Drilling Boreholes for Handpumps

Peter Wurzel



Author: Dr Peter Wurzel

Desktop Publishing: Erich Baumann, SKAT

Illustrations: Source of Illustrations is credited in the respective chapters

Copyright: © SKAT, 2001

Copyright waver: Permission is granted to use the material found in this volume for educational and development purposes. Acknowledgement is requested.

First edition: 2001, 200 copies

Published by: SKAT
Swiss Centre for Development Cooperation
in Technology and Management
Vadianstrasse 42
CH-9000 St.Gallen
Switzerland
Tel: +41 71 228 54 54
Fax: +41 71 228 54 55
email: info@skat.ch

Distributed by: ITDG Publishing
103-105 Southampton Row
London WC1B 4HL, UK
Tel: +44 20 7436 9761
Fax: +44 20 7436 2013
email: orders@itpubs.org.uk

ISBN: 3-908156-02-5

Foreword

HTN, the global Network for Cost-effective Technologies in Water Supply, aims to facilitate the provision of safe water to the poor and unserved through the promotion of affordable technologies. HTN's scope includes the sustainable exploitation of groundwater resources, with a specific focus on the following topics:

- Handpumps,
- Supply chains of goods and services that support system sustainability, and
- Development of efficient drilling operations.

Especially in African countries, the provision of underground water supplies has suffered for many years from a mismatch between the water source (the borehole) and the pumping device (the handpump). This uneven correlation has often led to the construction of costly and unsustainable systems based on imported technology. In Africa, drilling costs are 5-10 times higher than they are in Asia.

Optimisation of the processes for producing boreholes can reduce well drilling costs and thus help to accelerate production. Well costs can be diminished by optimising methods employed during the following stages of construction:

- Finding groundwater,
- Borehole design,
- Drilling techniques, and
- Well development and construction

Drilling equipment that is light and easy-to-maintain can be used for drilling boreholes. Its successful application requires rather sound procedures and skilful operations than high investments. This allows making use of the resources that lay in the local private sector.

This booklet seeks to suggest ways in which funds can be better used for making safe water available to the poor by illustrating how drilling costs can be reduced without compromising water quality, water quantity, or the productive life of the borehole. These arguments are directed towards the rural water supply sector as a whole. Those directly addressed are primarily decision makers, government civil servants, planners and implementers of water projects who are not experts in drilling, as well as technical people, project leaders, technical aid personnel etc. This publication is neither a detailed drilling manual nor a methodology of drilling methods.

The author draws on his extensive experience as a member of the UNICEF Water and Environmental Sanitation community. He hopes that his views and proposals will be a catalyst for change, and that this contribution will stimulate interest in experimenting with ideas on low cost drilling of boreholes for handpumps.

This publication was made possible thanks to support and contributions made by UNICEF NYHQ and the Water and Infrastructure Section of SDC. Although both organisations are committed to the provision of safe water, the interesting and valid views expressed in this booklet are primarily intended to stimulate discussion and do not necessarily reflect the official policies of either UNICEF or SDC.

Acknowledgements:

I would like to record my gratitude to my former colleagues and good friends in UNICEF Mozambique (1991-95) whose input has been invaluable in arriving at the conclusions reached in this booklet. The ideas mooted were jointly developed over several years of discussion, analysis and field trips, I thank Edward Karczewski, a skilful, hands-on driller with a M.Sc. in hydrogeology (an unusual combination), who played a pivotal role phasing in the low cost drilling fleet in Mozambique. To the Water and Environmental Sanitation section in UNICEF New York who funded this work, and particularly Gourisankar Ghosh who recognised that a 'drilling revolution' is overdue, my grateful thanks. I also acknowledge The Swiss Centre for Development Cooperation in Technology and Management (SKAT), and especially Erich Baumann who provided the hospitality of his home, wise counsel and, additionally, took the risk of allowing me to carry several SKAT library books around the world. A word of thanks to two friends and UNICEF stalwarts, Rupert Talbot and Ken Gray who (mostly) cheerfully put up with an endless stream of requests, questions and argument. In Zimbabwe, Zambia, Lesotho and Mozambique I spoke to many of the local experts, all of whom gave generously of their time and to whom I am most grateful. Finally I thank my wife, Pauline for her enthusiastic interest in this somewhat dry topic, her critical review and her special talent for transforming my words and thoughts into language that is grammatically correct.

TABLE OF CONTENTS:

Low Cost Drilling Methods	3
Matching depth of borehole to required yield	4
Borehole Diameter	4
Casing and Screens	4
Borehole development	4
Artificial gravelpacks	4
Borehole Pump Testing	5
Borehole Siting - Can the 'experienced eye' and science see eye to eye?.....	5
Data Collection, Record Keeping and the Low Yield Water Source	5
Environmental aspects.....	5
Lessons from India	5
Rural Water Supply and Drilling Case Histories from Africa.....	5
1 INTRODUCTION.....	6
2 A brief history of drilling	8
3 The occurrence and disposition of underground water	9
3.1 Water level fluctuations.....	14
3.2 Groundwater and the environment.....	15
3.3 Geology/hydrogeology of the African continent.....	16
3.3.1 Groundwater in Africa - the Resource of the Future.....	17
4 Drilling methods-a brief description.	18
4.1 Overview.....	18
Manually constructed Wells	18
4.2.1 Dug wells.	18
4.2.2 Hand drilled boreholes.....	19
4.2.3 The hand dug-well versus the hand-drilled borehole.....	19
4.3 Machine drilled boreholes	20
4.3.1 Cable Tool/Percussion Method	20
4.3.2 Rotary Rigs.....	22
4.3.3 Rotary-percussion or Down-the-Hole Hammer method.....	23
4.4 Dug well versus hand bored (drilled) borehole versus machine drilled borehole	23
4.5 Pollution and Shallow Groundwater	25
5 The low cost borehole-design and costing	26
5.1 Overview.....	26
5.2 Borehole Diameter.....	26
5.3 Matching depth of the borehole to required yield	26
5.4 Borehole development.....	27
5.5 The use of PVC casing and screening.....	29
5.6 Artificial gravelpack - when and where needed?	31

5.7	Borehole Pump Testing.....	32
5.8	Locating Groundwater - Can the 'experienced eye' and science see eye to eye?	33
5.8.1	Costs of Finding Groundwater.....	34
5.9	Drill type - which is best?.....	37
5.9.1	Rotary versus percussion?.....	37
5.10	Data Collection, Record Keeping and the Low Yield Water Source.....	39
5.11	Quality versus costs - low yield, hence low cost, is NOT low quality.	40
6	Case studies from African Countries.....	41
6.1	Case Studies from Mozambique	41
6.1.1	CASE STUDY 1 –	41
	Government of Mozambique/UNICEF drilling programme	41
6.1.2	CASE STUDY 2	44
	State Drilling Company, Mozambique	44
6.1.3	CASE STUDY 3	44
	Commercial Drilling in Mozambique.....	44
6.1.4	Lessons Learned from the 3 case histories in Mozambique	45
6.2	Case histories from Zimbabwe	45
6.2.1	Manual drilling in Zimbabwe	45
6.2.2	The Government of Zimbabwe-Rural Water Development.....	46
6.3	Case histories from Zambia	48
6.3.1	Machine drilled holes before 1992 and 1992 to 95	48
6.3.2	The UNICEF Water and Sanitation and Health Education (WASHE) programme.....	49
6.4	Lesotho Case History	51
7	Drilling for Rural Water Supplies in India	54

Terminology. The terms 'borehole' and 'well' are used interchangeably, in contradistinction to 'hand dug well' or 'hand/manually-drilled well'. A full glossary of terms is found in Appendix 1.

FAST TRACK

Jump on the fast track for a quick preview of the book and see the framework of the cost saving ideas expanded in the text. We hope that it whets your appetite to investigate in more detail the new drilling philosophy.

“The Handpump Option” was one of the most notable developments of the International Drinking Water Supply and Sanitation Decade, which recognised the ‘triad’ of clean water together with sanitation and health, and hygiene education as fundamental to improved health in rural communities. The Village Level Operation and Maintenance concept (VLOM) applied to the handpump underlined the desirability of design standardisation within countries and regions and saw handpump costs plummet. **The costs of construction of the water source, however, have remained several times more expensive than the handpump, sanitation facilities and health education costs combined. The impetus now must be to reduce the costs of construction and development of the water source.**

Since the absolute maximum yield of a handpump is 1m³/hr, savings can be made by tailoring depth and other parameters to this, in groundwater terms, small yield, through the application of low cost drilling methods and design criteria adapted specifically to handpump mounted boreholes. In many circumstances and hydrogeological settings, borehole-drilling costs can be reduced by a factor of 2 - 3 in Africa.

Cost savings can be made without jeopardising quality in design areas including: depth and diameter of the borehole, both of which can be limited for handpump yields, casing and screens, borehole development, gravel packs, borehole sitting and pumping tests.

The recommendations below are not inviolate and may not be appropriate in all geological settings since nature, and particularly geology and groundwater hydrology, are infinitely variable. Nevertheless, the rural water supply personnel should be cognisant that drilling procedures and techniques for handpump

specific boreholes can be simplified, without compromising quality, by relaxing their design criteria. Even so, there is much scope and need for experimentation and innovation.

Low Cost Drilling Methods

Dug well vs. hand bored (drilled) borehole vs. machine drilled borehole

If the water table is shallow and the rock is soft then manual techniques should be favoured. Both hand dug and hand drilled methods are least cost solutions in shallow water table areas (generally up to 15 or 20 metres). If, however, speed is important then machine drilling in such an area is justified. The hydrogeology and relative cost aspects of dug wells and hand-drilled boreholes are dealt with in the main text on pages 18 through 25.

What is the best drill type? Horses for Courses! For the small yield borehole select the small drill! Drilling methods using machine-mounted rigs are essentially of two types, the cable tool method (percussion) or one of several rotary methods. Both have particular advantages and disadvantages which are discussed in the main text (pages 19 through 23) but the message is: modern, light manoeuvrable rotary/down the hole rigs (DHT) should be used if and only if trained crews and a supportive infrastructure-logistics are available. If not, simple old-fashioned percussion rigs are more appropriate. They are simple, rugged (many in Africa are over 50 years old), easy to maintain and admirably suited to low cost drilling. Simplicity of design means easy servicing and relatively short training periods for crews. The payment of drilling bonuses has been shown to have benefits way beyond their costs.

The cost defining decision for handpump equipped borehole design is to aim for a limited yield of 1 - 2m³/hr, the most that the handpump can deliver. The modified design guidelines are discussed below:

Matching depth of borehole to required yield

See 5.3 p. 26 of main text

Historically boreholes have been drilled on the precept of “the greater the depth, up to a critical level, the greater the yield”. If we take 1.5m³/hr. as being the upper limit of the handpump’s delivery ability (a generous figure) then drilling should stop 10m or so beyond the depth at which the required yield is obtained. This provides a reserve column that will allow for seasonal variations and excessive drawdown.

Once the required yield of 1.5m³/hr. is attained, drill a further 10m to allow for seasonal water level fluctuations and drawdown levels. The yield can be established with a simple bailer test (if percussion drilling is used) as drilling proceeds in intervals of 2 or 3m after water is first struck,

Areas where seasonal water level fluctuations exceed 10m are relatively rare, but if the area is hydrogeologically ‘known’ to have large fluctuations then clearly a reserve column of 15 - 20m will be necessary. In sub-artesian conditions, the borehole can be considerably deeper than the norm for handpumps of the 50-60m, because the water level will rise. It should be noted that the shallower the water table the greater the danger of groundwater pollution, hence properly constructed well aprons are mandatory.

Borehole Diameter

See 5.2 of main text

Six inch diameter was the historical standard in Africa and in many countries still is, but as the cost differential, particularly with rotary drilling, is negligible, there is a case for 8” as standard,

If the hole is to be artificially gravel packed for hydraulic reasons, i.e. a very fine, well sorted aquifer, then an 8” diameter hole is in any event essential.

Casing and Screens

See 5.5 p. 29 of main text

For handpump supplies, low cost (locally manufactured) PVC casing and screening should be utilised. The slot size of the

screens is not critical for low yields in normal conditions, although it can be critical in fine-grained aquifers. Primitive machine sawn slots with a total opening of 5% (slot size 0.5-1mm) are appropriate. PVC casing and screens can be joined by either the bell and socket (male/female) joint with solvent cement, or threaded joints.

Borehole development

See 5.4 p. 27 of main text

The development of the borehole (pumping and surging) results in the finer fractions of material being drawn from the unconsolidated aquifer (and from fissures in consolidated and semi-consolidated aquifers) leaving behind a stable envelope of the coarser, and therefore more permeable, material of the aquifer. This natural gravelpack is not to be confused with an artificial gravelpack.

Development of a borehole is a crucial adjunct to a properly completed hole,

For low yield boreholes pumping, or better still over-pumping, is the best method of development. Rule of thumb pumping periods vary from 2-24 hours or until the pumped water is clear, often within an hour or two,

The bailer (standard equipment on the percussion rig) can be effectively employed for development in the process of surging, and even for pumping if a submersible pump is not available,

Pumping and surging will create a natural gravelpack around a borehole drilled in unconsolidated sediment that is crucial to the long and productive life of the borehole,

Artificial gravelpacks

See 5.6 p. 31 main text

From a hydraulic viewpoint an artificial gravelpack is seldom required in low yielding boreholes, and screen open areas can be low (5%),

Despite the fact that, in hydraulic terms, an artificial gravelpack is not required nearly as frequently as it is used, the widespread practice in many countries of routinely placing an artificial gravelpack should continue given its low cost and possible ‘anchoring’ action of screens and casing.

In hard rock boreholes neither a gravelpack nor a screen and casing are needed but several countries routinely use them, primarily for mechanical purposes such as the protection of the handpump rising main, which in turn anchors the screen. Stabilisers or centralisers would do the same job for less cost. Exceptions to this rule exist (see Zambia case history).

Borehole Pump Testing

See 5.7 p. 32 of main text

Pump tests are a fundamental procedure to assess both borehole and aquifer performance.

In low yielding limited depth boreholes classical extended pump tests are frequently meaningless and certainly unnecessary on a routine basis.

A simple test using either a bailer or small submersible pump to determine the yield over a 2-3 hour pumping period is all that is needed. Timed water level depth measurements should be taken if possible.

Borehole Siting - Can the 'experienced eye' and science see eye to eye?

See 5.8 p. 33 main text

The author considers that the use and cost-effectiveness of geophysics in low cost water supply is debatable since, in most cases, low yield boreholes do not justify relatively expensive geophysical investigation. Most current drilling programmes support this view (India is the most important example). However, there is an important role for geophysics in geologically difficult areas and also in virgin groundwater regions.

Data Collection, Record Keeping and the Low Yield Water Source

It is vital for accurate records to be kept on every borehole drilled and well dug. Some degree of monitoring should subsequently take place so that a rigorous and complete database and groundwater inventory is maintained and/or built up. But there has to be a compromise between the extent of data collection and record keeping of limited depth, low yielding boreholes and the time, money and effort expended in obtaining such information.

Environmental aspects

These are discussed throughout the text - low yield shallow water sources are susceptible to surface pollution. The issue of large-scale irrigation schemes affecting rural water sources is also discussed; as is the fact that groundwater is the water source of the future, particularly in Africa.

Lessons from India

A brief chapter (Chap. 7, page 54) is devoted to a comparison of drilling costs in India and Africa. Clearly, the economies of scale in India can never be achieved in Africa but there are many lessons to be learned.

Rural Water Supply and Drilling Case Histories from Africa.

(Chapter 6, p. 41) is devoted to drilling case histories from several African countries.

The different drilling approaches are highlighted and areas of possible cost reduction are discussed. Examples of low cost drilling programmes (possibly the best method of convincing sceptics!) are cited, as are conditions where the low cost approach is somewhat limited.

The 'handpump option' of the 1980's revolutionised rural water supply and sanitation programmes worldwide. By implementing at least some of the cost saving drilling and development ideas suggested in this document more rural areas would be able to benefit from the provision of potable water together with sanitation programmes and health and hygiene education.

1 INTRODUCTION

One of the most significant developments of the International Drinking Water Supply and Sanitation Decade (IDWSSD) was the recognition within the rural water supply sector of the critical importance of what has become known as '**THE TRIAD**' of (a) Water, (b) Sanitation and (c) Health and Hygiene education. Classical studies by Feacham and others showed that whilst the provision of clean water within rural areas improved the quality of life of the beneficiaries, it did not, on its own, make a real impact on child morbidity and mortality. Only when clean water was combined with sanitation and health and hygiene education - '**THE TRIAD**', did health significantly improve.

The pioneering work of Arlosoroff et al (1987), which focused initially on the mechanical aspects of the 'the handpump option', led to improved handpump designs compatible with the evolving Village Level Operation and Management of maintenance concept (VLOM) and underlined the desirability of design standardisation within countries and regions. A new philosophy of community driven Community Water Supply (CWS) was emerging: a demand based approach, which emphasised the importance of 'the triad' as a unit.

The cost of handpumps has plummeted over the past decade but machine-drilling costs, although decreasing in some countries, remain, in general, inappropriately and unnecessarily high. The ratio can be highlighted on an example from Mozambique; for a village of 210 people the cost of the handpump is USD 870, (including installation, sanitation facilities and health education costs). Yet, the cost of construction of the water source (in particular the machine drilled borehole) is USD 5,000-6,000, several times more expensive than the handpump. Published data indicate that in Africa drilling costs range from USD 3,000 -USD 15,000. It is now time for a concerted focus on the water source; an area where large savings could be generated in a sector notoriously strapped for global funds and where low cost does not imply low quality.

Drilling for water in Africa is still largely tradition bound: drilling deeper than

necessary to obtain the maximum possible yield from the water source, regardless of whether the water-lifting device (in most cases the handpump) can take advantage of that yield.

The **impetus** now must be to correct the **mismatch** between the water lifting device and the water source.

Savings can be made by tailoring depth, diameter and other parameters to yield, through the application of low cost drilling methods and design criteria adapted to handpump mounted boreholes. In many circumstances and hydrogeological settings, borehole drilling-costs can be reduced by a factor of 2 - 3 in Africa.

This publication will attempt to define how drilling costs can be reduced without compromising water quality, water quantity, or the productive life of the borehole. To free funds not only for more boreholes but also for the other two essential elements of the Community Water Supply 'triad'. It is addressed to the Rural Water Supply sector as a whole, primarily decision makers, government civil servants, planners and implementers of water projects who are not experts in drilling, as well as technical people, project leaders, technical aid personnel etc. It is neither a detailed drilling manual nor a methodology of drilling methods (although a brief resume is given). Hopefully, the views and proposals outlined will be a catalyst for change, and will arouse interest in experimenting with some of the ideas about drilling of boreholes for handpumps.

The fundamental premise of this booklet is that groundwater, particularly in Africa, is and will continue to be the primary source of water for the rural areas. Further, that handpumps will be the water lifting technology of choice. In 'Community Water Supply: the Handpump Option' by Arlosoroff et al (1987) the authors foresaw that evaluation of drilling methods and management would be an important component of future research, requiring the

same concentrated attention on this major cost element as had already been focused on handpump development.

In the last years progress has been made towards lowering drilling costs, with several African countries reporting significant reductions; but these results have been insufficiently studied and the progress made so far has not perhaps received the recognition it deserves. Hopefully some of the suggestions to be found in this work may spur the 'drilling revolution' on to the heights and intensity achieved in 'the handpump revolution'.

Hand dug wells and hand drilled boreholes, for which several excellent texts are available, will be dealt with only briefly. Instead we will focus on the details of design optimisation of machine drilled boreholes to avoid over-design and wasteful expenditure when drilling for a small yield.

The absolute maximum yield of a handpump is 1m³/hr!

A handpump can pump 1m³/hr (in classical groundwater hydrology/hydraulics this is an extremely small yield) yet; traditionally boreholes for handpumps have been over-designed.

If the borehole design is optimised to the small yield cost savings can be made without jeopardising quality or productive life. Areas where cost savings can be made include: depth and diameter of the borehole, both of which can be limited for handpump yields, casing and screens, borehole development, gravel packs, borehole siting, the extensiveness of pumping tests, water level monitoring and the need to keep records.

Drilling costs are obviously critically dependent on the topography, geology, rainfall frequency and intensity, soil profile,

etc., and indeed there may be circumstances where local geology may not allow the adoption of all the low cost solutions suggested. More experimentation, field testing, research and, possibly, modification are required in these situations.

The focus in this text is on low cost solutions using machine-drilled boreholes, in marginal groundwater areas other low cost technologies such hand drilled or hand dug wells can be more cost-effective. The maxim 'if you can dig, don't drill' is not inviolate and calls for judgement on the part of the decision-maker. In shallow water table areas, hand drilled boreholes are cheaper and faster to construct and can be more cost effective and efficient than dug wells. However, where low soil permeability results in excessively low yields, the hand dug well is the only appropriate technology. In such cases, the well acts as a reservoir into which water can leak slowly but continuously in order to fulfil a peak demand much greater than the instantaneous yield of the aquifer. In other words, the inherent yield can be as low as 0.25 m³/hr but water accumulated during the night will be sufficient for extraction of 1m³/hr during several daylight hours.

While the benefits of optimising borehole design to a small yield of 1-2m³/hr can be demonstrated, there is a drawback. If the design is optimised on such a limited yield, it will not be possible, in the future, to easily increase the level of service to include motorised pumps in areas that perhaps could have yielded supplies larger than the 1m³/hr initially sought. The response to this valid argument is that ten years after the end of the IWASSD, and despite ongoing intense advocacy for 'the handpump option'; the sector is currently unable to keep pace with population growth in Africa. The number of people worldwide who lack access to potable water is still in the order of 1.2 billion. Thus, in the author's opinion, the primary sector focus at this time should be to minimise costs and at the same time increase the rate of production of completed boreholes, so as to reach the greatest number of people, albeit at a low level of service.

2 A BRIEF HISTORY OF DRILLING

It is axiomatic that man's existence on earth is dependent upon water. Every early civilisations - Mesopotamia, China, Egypt, India, Greece, and Rome - centred around sources of this life-giving liquid. In these hot, populous areas so often parched by drought, water was precious. No wonder, then, that the village well, the oasis in a desert, became a focal point for human activity. History tells us that the Egyptians used drill bits made of gemstones and quartz to grind rock beds, and records indicate that the Chinese and Persians constructed wells as early as 2000 BC by methods other than digging.

The Chinese were drilling boreholes by the percussion method over 2000 years ago, great depths were reached (1800 ft) with bamboo rods as the drill stem.

There is no reference to costs!

The most significant progress in design and manufacture of drilling equipment and in water well construction methods has been made within the last 100 years. Primarily for the oil industry, sophisticated truck mounted hydraulic/pneumatic rigs capable of drilling rapidly through the hardest rocks were developed. Although not as large as the oil drilling industry, the water drilling industry, using these new rigs, has become 'big

business'.

While the development of the modern 'super-rigs' is interesting, the focus here will be more on the simple, less sophisticated and less costly machines because the borehole fitted with a handpump can be relatively shallow, of limited yield, and of small diameter. Unless ultra fast progress is important, the use of large sophisticated rigs has to be carefully weighed in Africa. But this does not mean that modern rigs (especially the small versions) have no place in low yield borehole drilling programmes. They do, in special circumstances; an extended drought, a large emergency resettlement programme as well as in an environment where a high degree of managerial and technical competence exists. Fierce private enterprise competition can reduce drilling costs dramatically also for the use of the modern rotary/DTH drill. India best illustrates this latter situation, as will be seen in Chapter 7. An examination of drilling methods in Zambia illustrates that because mining is the major industry, skilled drillers are available and the water drilling fleet is made up primarily of small DTH rigs. Good logistics are in place and technical expertise is available. In the hard rock setting of Zambia the new modern DTH drills are cost effective and much faster than percussion rigs

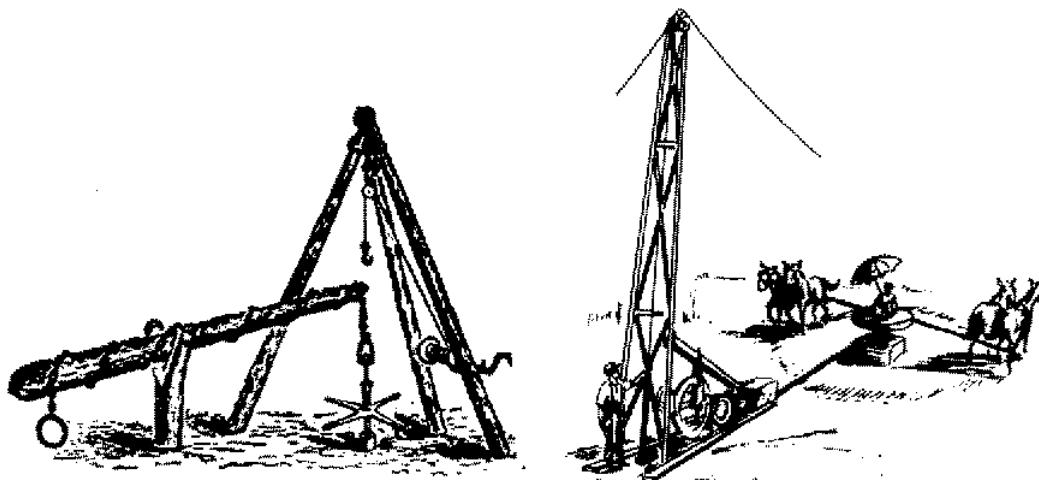

Figure 1. Early drilling rigs.

3 THE OCCURRENCE AND DISPOSITION OF UNDERGROUND WATER

A brief resume for the non-technical reader.

Central to an understanding of groundwater hydrology is the global water circulatory system known as the hydrological cycle; depicted in Figure 2 below.

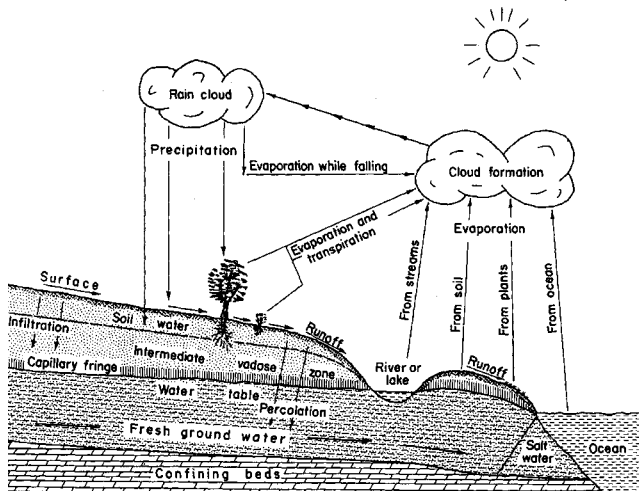

FIGURE 2. The Global water cycle or Hydrological cycle

Precipitation falling on the land surface represents the source of fresh water for all living things. A part of the precipitation runs off the surface into streams that discharge into larger streams that finally discharge back into the oceans. Part of the precipitation enters or soaks into the soil. Much of the water that enters the soil is detained in the plant root zone and eventually is drawn back into the atmosphere by plants (evapotranspiration) or direct evaporation from the soil abetted by soil capillarity. However, part of the water that soaks into the soil passes through the soil root zone and, under the influence of gravity, continues moving downward until it enters the groundwater reservoir.

The quantity of water entering the groundwater reservoir, known as recharge, depends on the soil type, rainfall amount and rainfall intensity. Water-bearing formations of the earth crust act as conduits for transmission and as reservoirs for the storage of water. Water enters these formations as recharge and travels slowly

underground (from a fraction of a metre to hundreds of metres per year) until it returns to the surface, sometimes several tens of thousands of years later, by way of natural flow (springs) and human enterprise (wells and boreholes).

At this point a few terms need to be defined (a full glossary of terms will be found in Appendix 1:

Permeability: the ability of a rock or formation to transmit water. Gravel, an unconsolidated rock, has a high permeability, whereas granite, a consolidated rock, has a low permeability and generally, unless fractured, equally low porosity.

Porosity: those portions of a rock or soil not occupied by mineral matter that can be occupied by groundwater. These spaces are known as voids, interstices, pores and pore space. Sand and gravel have a high porosity and a high permeability, decomposed rock has a high porosity and a reasonable permeability. Surprisingly clay has a very high porosity (the reason being that clay is made up of minuscule grains where the pore space is 40-50%) but a very low permeability.

Aquifer: a formation that contains sufficient saturated permeable material to yield significant quantities of water for wells, boreholes and springs. The term 'aquifer' implies an ability to store and transmit water. Unconsolidated rocks, sands and gravel making the best aquifers.

Aquiclude: an impermeable formation, of which clay is the best example.

Some aquifers, called confined or artesian aquifers, are overlain by a confining layer of rock. Water in the aquifer under the confining layer is under pressure; the potentiometric surface for a confined aquifer is the surface representative (height) of the level to which water will rise in a borehole drilled into the aquifer.

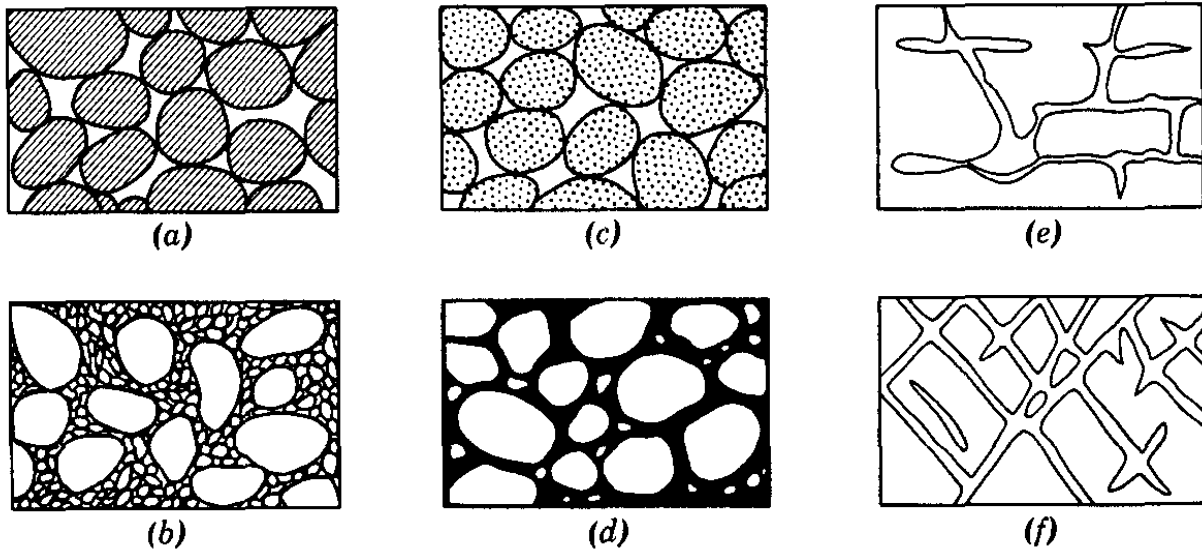

Figure 3. Examples of rock interstices and the relation of rock texture to porosity.

- a) Well-sorted sedimentary rock having high porosity,
- b) Poorly-sorted sedimentary rock having low porosity,
- c) Well-sorted sedimentary deposits consisting of pebbles that are themselves porous so that the deposit as a whole has a very high porosity,
- d) Well-sorted sedimentary deposit where porosity has been diminished by the deposition of mineral in the interstices,
- e) Rock rendered porous by solution,
- f) Rock rendered porous by fracturing.

(after Meinzer)

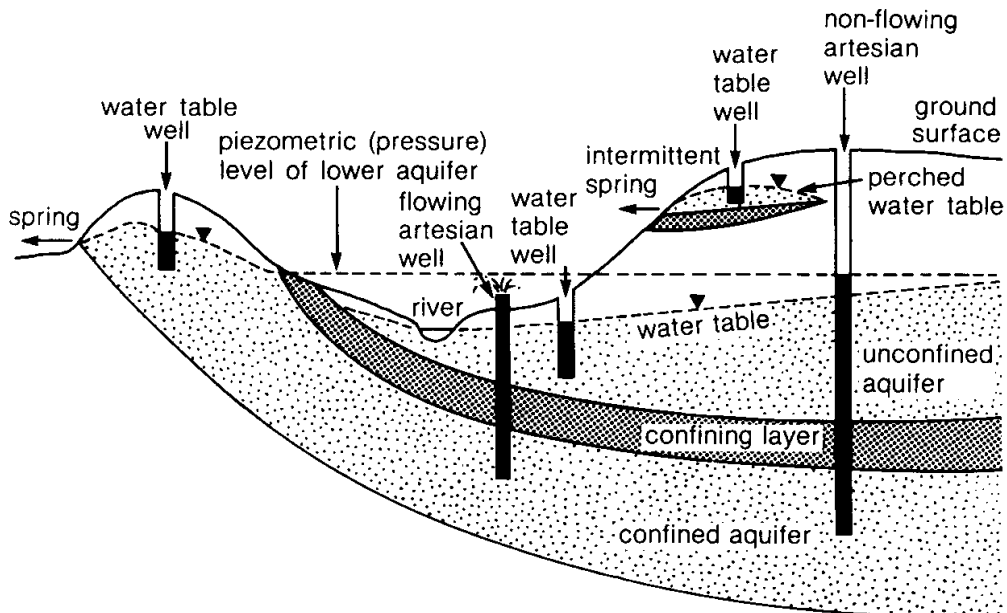

Figure 4. Disposition of groundwater and the borehole.

On the centre is a flowing or artesian borehole while on the right is the sub-artesian borehole referred to in the nomenclature of this book. A simple borehole is seen on the left.

There are 3 types of rock in which groundwater can be stored:

1. Crystalline Rock - this is a solid, dense rock where groundwater is stored in joints, crevices, cracks and mini-faults. See Figures 3 and 6.

In crystalline rock groundwater yields are generally small (except for limestone and possibly basalt in special structures). Such rocks would include igneous rocks (granite), metamorphic rocks and consolidated sedimentary rocks.

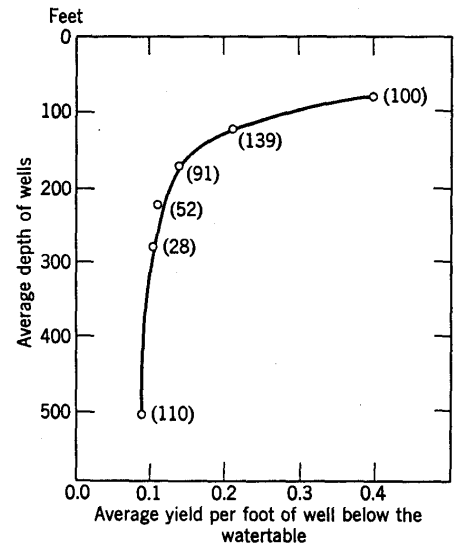

Figure 5. An example of the decrease in yield of boreholes with depth in crystalline rocks in North Carolina, United States. Numbers near points on curve indicate the number of boreholes used for each average shown. (after Davies & DeWiest)

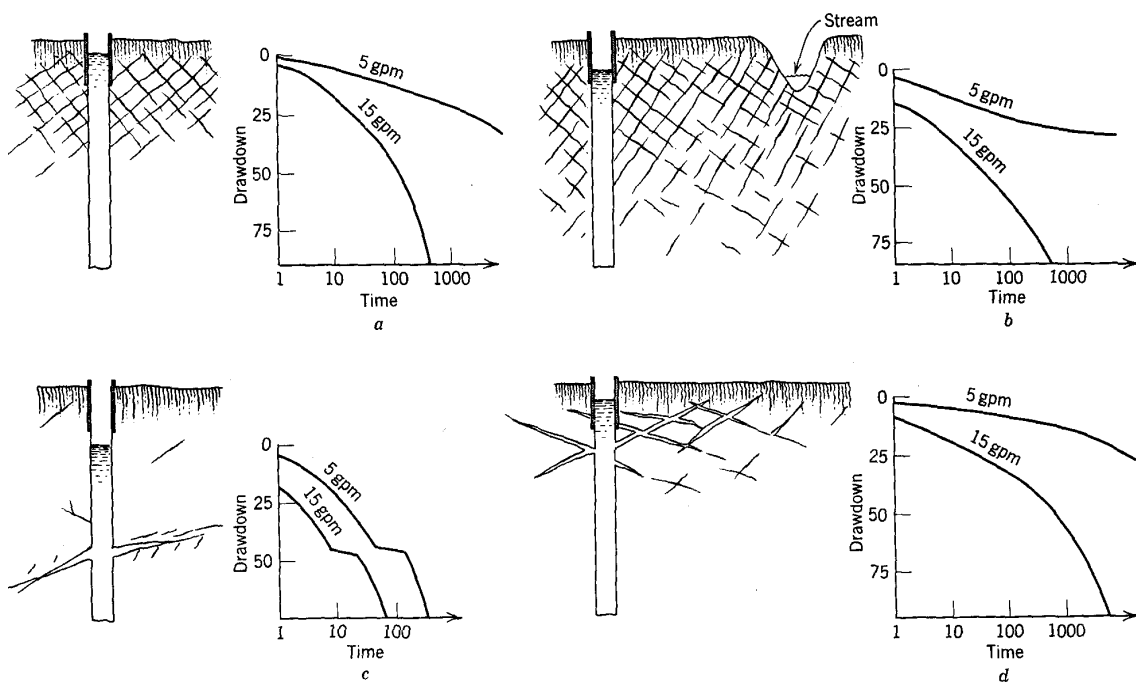

Figure 6 shows how water occurs in non-weathered crystalline rock. It reveals different groundwater dispositions in non-weathered crystalline rock. The intensity of fracturing, fracture size and the degree of fracture interconnection govern the yield of the borehole (after Davies & DeWiest). (For an understanding of the term 'drawdown' see Figure 8).

- Borehole drawing water from small fractures near the surface. A safe pumping rate for this hole is less than $1.4\text{m}^3/\text{hr}$, but still enough for a handpump.
- Extensive small fractures connect this borehole with a nearby source of recharge. A safe pumping rate is more than $1\text{m}^3/\text{hr}$.
- This borehole is a failure except as a source for very small amounts of water. The drawdown curve reflects dewatering of the hole and a large isolated fracture intercepted by the hole.
- Large fractures that drain the porous weathered rock maintain a moderate yield of about $1\text{m}^3/\text{hr}$ in this hole. (after DeWiest)

2. Decomposed Weathered Rock - When crystalline rock weathers over thousands of years water occurs in interstices of the thoroughly weathered mantle as well as in the lower semi-decomposed layer. Water may also occur in jointing in the underlying fresh rock. The term, 'basins of decomposition', in vogue in Southern Africa during the fifties related to areas of deeper decomposition. Low yield supplies were frequently found in such 'basins' that could vary in aerial extent from a few hundred square yards to several square kilometres, occurring typically in the granitic areas of the region (see 3.3 below). The model looked upon the upper thicker weathered layer of low permeability but high porosity as 'the sponge', while the lower, thinner semi-decomposed and highly permeable layer was the 'conduit'. Below this lies the fresh country rock or bedrock, which may or may not be fissured and thus may or may not contain water.

The concept of 'basins of decomposition' is no longer fashionable. Instead, considerable

data has accumulated on the African regolith, which is summarised by Wright and Burgess (1992). Generally, water is obtained from all 3 elements, the regolith, the zone of semi decomposition and the bedrock. Clearly ratios vary considerably. It is now evident that boreholes in Zimbabwe draw primarily from the bedrock and, interestingly, there does not appear to be a correlation between yield and regolith thickness, contrary to previous thinking. In other parts of the African crystalline basement, according to Wright & Burgess, 'yield correlations are mainly apparent in relation to mean values and are negative with relief and positive with regolith thickness'. The complexity of the new emerging data on the African regolith is such that the interested reader should refer to 'The Hydrogeology of Crystalline Basement Aquifers in Africa', Wright & Burgess (1992).

A rather detailed vertical profile through regolith overlying crystalline rock is shown in Figure 7.

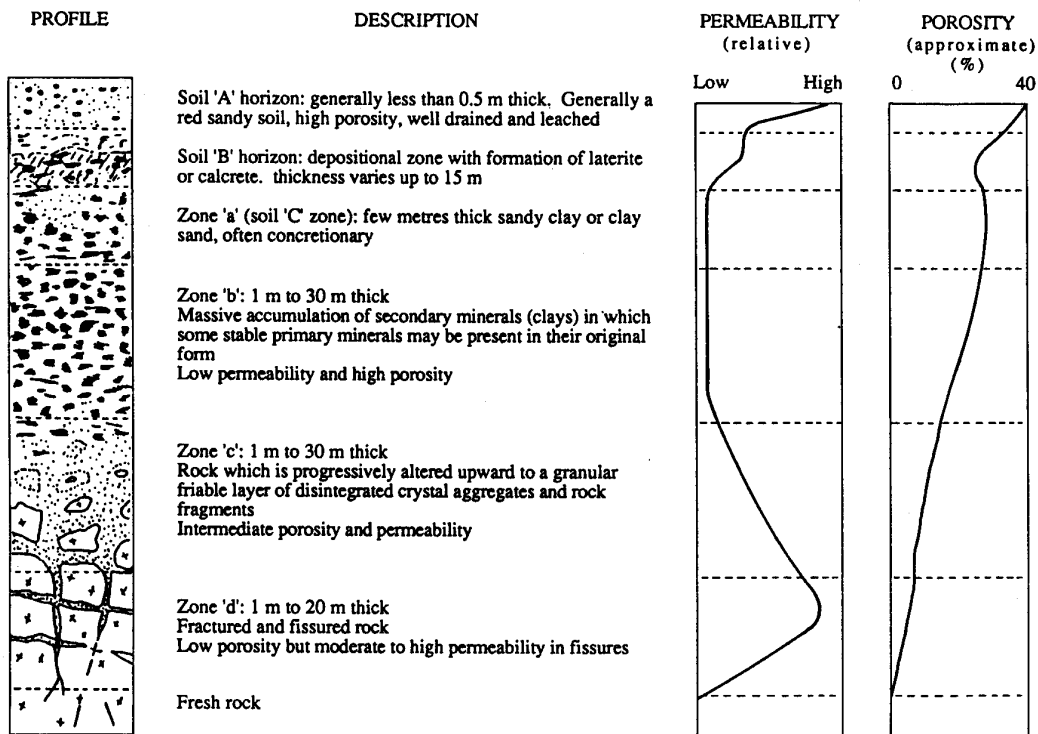

Figure 7. Vertical profile through regolith showing variation of weathering, storage capacity and permeability (after Acworth 1987 quoted by Barker et al in Wright and Burgess 1992)

Unconsolidated Rock - Examples are gravel and alluvial sands and these form the best aquifers. (See figure 8, well type 7)

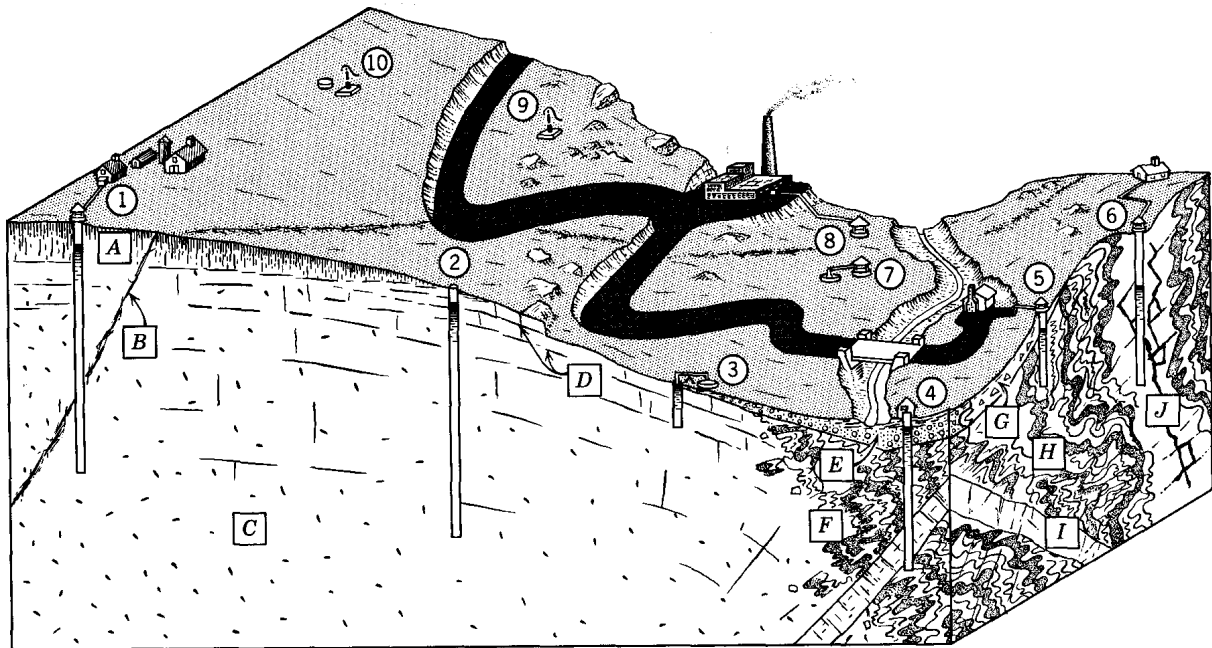

Figure 8.

In an attempt to summarise geology and expected borehole yield this figure shows the relationship between geological features and expected yield in a hypothetical region. (after Davies & De Wiest)

	Type of well	Use	Depth (m)	Source of water
1.	Drilled	Farm	70	Lower part of weathered granite and fault zone. Small amount from joints.
2.	Drilled	None	70	Very small amount from joints
3.	Drilled	Stock	10	Small amount from joints. Water is artesian.
4.	Drilled	Observation	40	Lower part of alluvium and fractures and joints near dyke
5.	Drilled	Domestic	35	Lower part of colluvium and schist
6.	Drilled	Domestic	45	Cavernous zone in small body of marble
7.	Dug	Stock	7	Alluvium
8.	Drilled	Industry	55	Lower part of alluvium and same fault as in borehole no. 1.
9.	Dug	None	5	Small amount from joints. Well dry during droughts
10.	Dug	Stock	8	Weathered granite

GEOLOGIC UNITS

A	Residual soil on granite.	C	Granite	E	Alluvium	G	Colluvium.	I	Dyke
B	Fault.	D	Joints in granite	F	Contact between granite and schist	H	Schist.	J	Marble

3.1 Water level fluctuations

Seasonal water level fluctuations (fluctuations of the general water table) are a function of local variables such as water table depth, the permeability of the overlying local soils, recharge, climate, rainfall intensity and frequency. It is difficult to predict generalised water table fluctuations as the shallower the water table the greater the fluctuation. Only systematic water level recording over several years in a particular locality allows knowledge of the possible range of fluctuation. Such records are very important, the data obtained leading to a better understanding of the local hydrogeology. Yet in many areas, particularly in Africa, limited funds and manpower often restrict data collection and record keeping. The practical aspects of generalised seasonal water level fluctuations relative to borehole depth must be considered by the project manager (or more realistically by the drilling supervisor and drilling crew). These important topics are discussed in 3.6.4.

Apart from seasonal fluctuations there are also water level fluctuations in the borehole itself because of pumping the borehole or as a result of pumping nearby boreholes. As soon as water is pumped out of a borehole there is an immediate drop in water level in the borehole and the area surrounding the borehole. The drop in water level in the borehole is known as the drawdown.

Clearly in any given situation the less drawdown the better. Drawdown is essentially dependent on 3 parameters: the discharge, the permeability of the aquifer and borehole design.

If large amounts of water (in excess of $10\text{m}^3/\text{hr}$) are being pumped then (and only then) borehole design particularly in relation to screen length, type of screen, screen slots, gravelpack, diameter etc. is very important and must adhere stringently to certain criteria. The screen must have large percentage openings yet screen slot sizes must be small. An artificial gravelpack (hence a large diameter hole more than 250-300mm) is mandatory and the hole must be thoroughly developed using specialised tools. These design features will ensure minimal drawdown and no sand/silt ingress for significant pumping rates. But borehole

design can be relaxed where a small amount of water (maximum $1\text{m}^3/\text{hr}$) is being pumped.

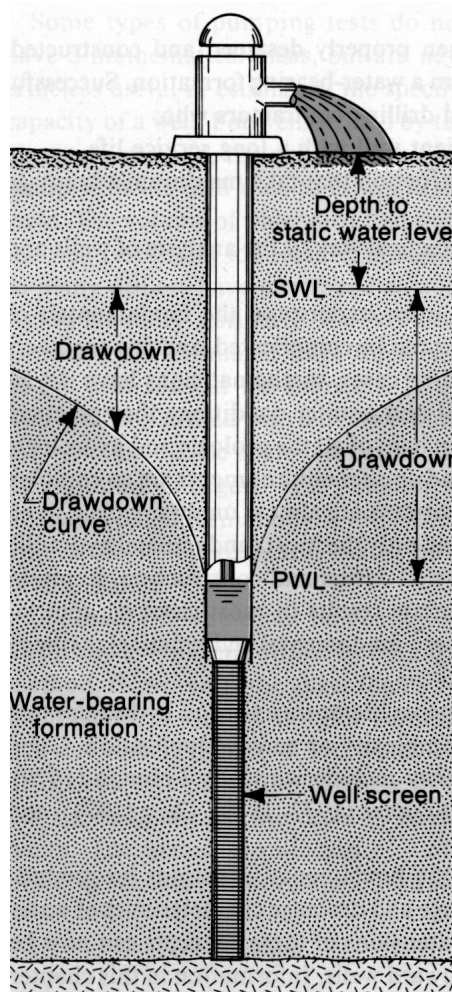

Figure 9. A high yielding borehole (motorised pump) shown here to emphasise significant drawdown, large screens and terminology (after Johnson)

The drawdown in a borehole can also be affected by the pumping of nearby boreholes, a phenomenon known as borehole interference. In a typical rural water supply setting where all the boreholes are handpump mounted and a reasonable distance apart from each other (50-100m), borehole interference is very unlikely. However, as soon as motorised pumps appear (a nearby irrigation project pumping large amounts) interference and, in the worst-case scenario, the drying up of handpump mounted boreholes is a possibility. Therefore known proximity to an irrigation scheme or a proposed irrigation scheme means that depth of drilling becomes critically important. See Chapter 5.

3.2 Groundwater and the environment

Water stored in aquifers is almost always of excellent microbiological and chemical quality, requiring minimal treatment (in the author's experience of Africa newly drilled boreholes never require treatment). Groundwater is naturally protected from evaporation (particularly important in Africa where evaporation rates are high, mean 2m/annum) and the volume stored underground in certain areas and regions can be immense. Groundwater can offer water supply security in areas prone to frequent and extended droughts.

Groundwater is mostly of excellent microbiological and chemical quality.

Pollution of groundwater is a serious environmental concern. The turnover time of a groundwater reservoir is measured in years if the reservoir is small, and in hundreds of years if it is large, because the ratio of recharge to the volume stored is small. Conversely, a surface water dam has a turnover time of only months (small dam) to tens of years (large dam) because the mean annual run-off into the dam is in the order of the total volume stored. Therefore, if a dam becomes polluted (and action to stop the pollution is taken) it will clear within a comparatively short time. A case in point is Chivero Dam, which supplies Harare, the capital of Zimbabwe, with drinking water. A decade ago the dam, which has a turnover time of 12 months, became polluted. The Harare Municipality took legal steps to prevent pollutants going into the dam and the pollution cleared within 2-3 years, the time it took to turn over the total volume. Not so with a groundwater reservoir. If a groundwater reservoir becomes heavily polluted, in practical terms it remains polluted forever! This danger cannot be over-emphasised. Several of the large groundwater reservoirs of the United States now showing nitrate pollution are forever ruined. Immediate pumping can probably rectify localised pollution within the circle of influence of the borehole (in the order possibly of hundreds of metres).

If a groundwater reservoir becomes heavily polluted, in practical terms it remains polluted forever.

The handpump, with its maximum yield of 1m³/hr, is environmentally friendly, taking enough but seldom too much from the aquifer. The World Health Organisation defines the minimum water requirement for drinking and personal hygiene purposes combined as 20 litres per person per day. Observations show that the time it takes a woman to fill a 7litre bucket from a handpump is approximately 1 minute. If women were lined up at the pump to create maximum demand the well could supply 60 x 7 = 420 litres per hour. Assuming 10 hours per day continuous pumping a total of 4,200 litres of water would be supplied by one handpump. This is sufficient for a village of 210 people. The reality is that frequently one handpump has to serve 500 people and more meaning that the WHO defined minimum requirement is not met.

In terms of water wastage, the handpump is singularly environmentally friendly. Seldom, if ever, is there water wastage or over-pumping in areas where handpumps are used.

3.3 Geology/hydrogeology of the African continent

Wright (1992) reproduced a simplified geohydrological map of the African continent (after Dijon - Les Eaux Souterraines de l'Afrique), which reflects the groundwater regions of Africa, shown below.

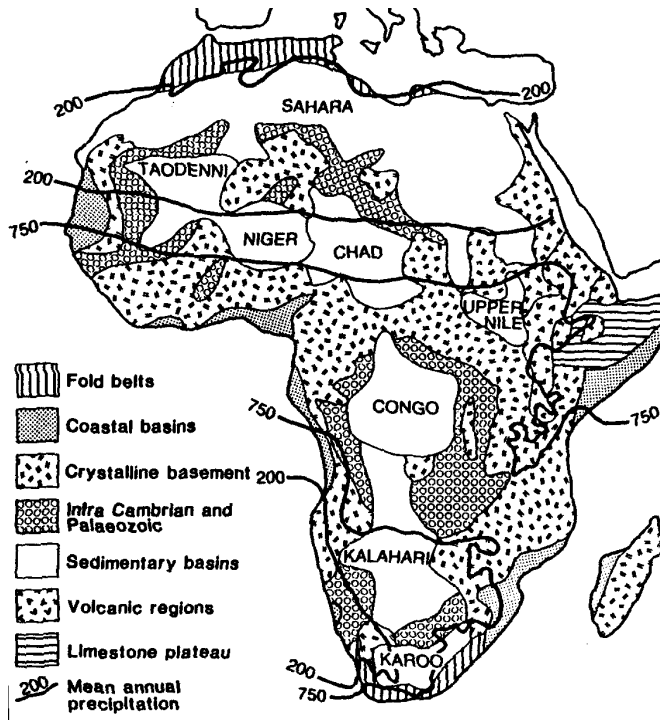

Figure 10. A simplified hydrogeological map of Africa. Note that Africa is made up primarily of crystalline igneous rocks (synonymous generally with smaller yields); only in a few areas where there are unconsolidated sedimentary rocks/alluvial plains can large yields can be obtained. There are also a few limestone areas where large yields are possible.

Geohydrological provinces are delineated. As can be seen from the map, the crystalline basement rocks of the so-called 'continental shield' underlie extensive areas of Africa. Here relatively small low yielding aquifers are developed in weathered mantle and in fractures and fissures below the mantle in the bedrock. Below the mantle of decomposed rock is semi-decomposed rock which is usually of high permeability but limited depth, say 1-2 meters, leading to fresh bedrock where there may be limited water bearing fissures and cracks (See Figure 7). The crux here is that large yielding aquifers are unlikely to occur in the vast areas of crystalline rock in Africa.

One of the prime challenges in present day hydrogeology is, according to Foster (1984),

the need to reach '... a fuller understanding of the evolution of the weathered mantle aquifer, leading to a unified conceptual model of its hydrogeology and hydrochemistry which in turn will allow improved criteria for borehole siting and construction.'

It is aquifers in the major sedimentary basins and valley areas containing a variable thickness of unconsolidated material that yield the substantive groundwater supplies needed for major irrigation schemes or urban supplies. Groundwater yields in such aquifers can be very large, for example in the Sabi Valley in South Eastern Zimbabwe the Sabi Alluvial Aquifer has boreholes that yield 6-8m³/minute but such yields are outside the domain of this work. It is the decomposed /weathered mantle in the crystalline rocks and the consolidated sedimentary rocks that are of interest here. In consolidated sedimentary rocks the weathered mantle is generally not so well developed but small supplies can be found in the interstices, if any.

Yields sufficient to justify motorised pumps in boreholes drilled in crystalline rock are not common, but when they do occur then the level of service can be improved and supplies sufficient for supplementary irrigation can be considered. Generally the likelihood of such increased supplies is a function not only of geology (as is the case with all boreholes) but also of rainfall and depth of borehole. Here we will consider only boreholes to be fitted with handpumps. They can therefore have a limited yield, which usually means a limited depth. Groundwater hydrology, while theoretically highly mathematical, is actually a remarkably imprecise science and there have been cases where, when drilling has reached a depth of say 40m the yield is only 0.5m³/hr and yet, by drilling just half a metre more, the yield is suddenly 10m³/hr. Predictions are difficult. It is therefore advocated that drilling should only be deep enough to obtain a flow into the borehole sufficient to support the discharge of a handpump, plus enough extra depth to account for seasonal water level fluctuations and drawdown into the borehole.

Groundwater hydrology, while theoretically highly mathematical, is in practical terms remarkably imprecise.

Where only small yields are required groundwater can generally be found close to the surface and close to the area of demand.

In the early eighties Chilton and Grey made reference to the construction of low cost boreholes for handpump yields. They noted that, in Malawi, drillers invariably 'cased off' the weathered mantle and sought water below the mantle in the semi-decomposed layer or even deeper in the fresh bedrock in the hope of intersecting joints or fissures and cracks containing water. Chilton and Grey argued that the mantle contained sufficient water for handpump supplies and should be utilised, thus eliminating the need for deeper drilling. They concluded that boreholes in the mantle should be screened and that with artificial gravel packing and thorough development, productive, low yielding (but sufficient for handpumps) low cost boreholes could be drilled. Unfortunately this pioneering work did not reach a wide audience. In any event the focus of the sector at that time was on the development of the most appropriate water raising device, the handpump, and the evolving concept of Village Level Operation and Maintenance (VLOM). Our purpose here is to develop the ideas of Chilton and Grey and give to drilling the concentrated focus that Arlosoroff et al foresaw would be the natural follow-on from the extremely successful 'handpump option revolution'.

The capital costs of groundwater development are relatively modest (and if some of the 'philosophy' of this book is accepted, can be further cut where only small yields are needed), and compared to large dams the land requirements are minimal. Additionally, in rapidly developing areas where larger yields are sought and are available, the resource lends itself to phased development to meet rising demand.

Groundwater is always of excellent quality, close to the area of demand, protected from evaporation and, in many regions, volumes stored underground are immense, providing security of water supplies during drought years. The capital costs of groundwater development are relatively low.

Africa's rural population is dispersed over immense areas in discrete and isolated pockets as small as 100-200 people. It is not, therefore, surprising that groundwater, uniquely suited to this setting, is the prime water supply source for the near future, as is the case in most of the rural developing world.

3.3.1 Groundwater in Africa - the Resource of the Future

In rural Africa groundwater is the resource of the future given its many advantages over surface water supplies. Yet, until fairly recently, engineers tended to prefer to develop surface water supplies where the hydrology was better understood and their visibility made them more susceptible to precise calculation. Groundwater was considered 'out of sight out of mind'.

In Africa groundwater is virtually ubiquitous, where only small yields are required groundwater can generally be found close to the surface and close to the area of demand.

4 DRILLING METHODS-A BRIEF DESCRIPTION.

4.1 Overview

For the Government or Aid Agency water supply manager planning a national or regional water supply strategy, the following discussion on manual and machine drilling or excavation with hand tools is intended to be a generalised orientation to what is essentially a complex topic. Familiarity with the various technology options, their relative advantages and disadvantages, is an essential aspect of planning.

Water can be extracted from the ground either from a hand dug well or a hand drilled or machine drilled borehole and there are a variety of techniques in each case. Selection of a particular method depends on the quantity of water required, depth to groundwater, geological conditions, and economic factors.

Shallow wells, generally less than 15 metres, are constructed by digging, boring, driving or jetting. Deeper boreholes are usually drilled by a machine rig. Driving and jetting techniques are not relevant to the African continent and will therefore not be discussed. Digging and hand boring are very important low cost options in high (or shallow) water table environments and deserve some amplification. Machine drilling will be discussed in 4.3



4.2 Manually constructed Wells

4.2.1 Dug wells.

Dug wells are ubiquitous throughout the world and, since biblical times, have provided countless water supply points. They range from a simple unprotected hole in the ground to a properly constructed facility equipped with a handpump as depicted in Figure 11.

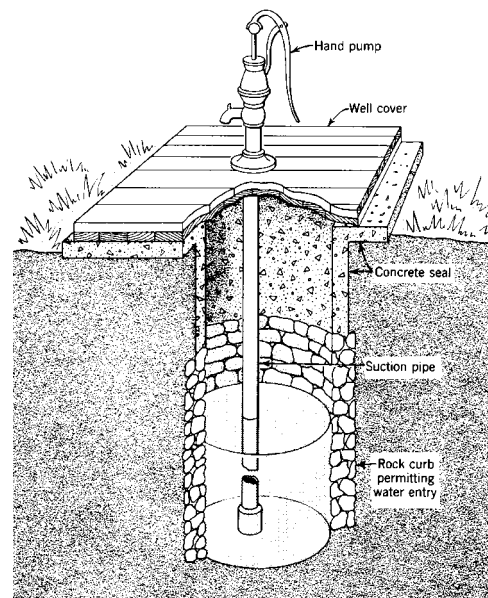

Figure 11 - A modern domestic dug well with a rock lining, concrete seal and handpump (after Todd).

The advantages:

- The level of community involvement is very high,
- Skilled labour (unless blasting takes place) is not required,
- Until recently, it was considered the most inexpensive technology available, although data from some African countries reveal this is not universally the case,
- Most of the construction materials are available locally,
- The rejuvenation of an old hand dug well is frequently the first step towards a safe water supply for the community,
- Water can continue to be drawn from a

well equipped with a handpump, even if the pump fails,

- Storage capacity allows wells to produce sufficient water even when aquifer permeability is extremely low,
- Horizontal drilling can improve yield,
- Reliable maintenance of a well requires little technical skill.

The disadvantages:

- Hand dug wells are usually shallow and thus can tap only the upper levels of the aquifer, where water level fluctuations are relatively large,
- The technology is only suitable for soft geological formations and shallow water tables thus restricting it to specific areas and regions,
- Wells are susceptible to bacteriological contamination,
- A shallow water table generally means large water level fluctuations and the possibility of the well drying up, especially during drought periods.

Digging is relatively easy in unconsolidated rock (alluvial deposits). During the early eighties in the hard rock terrain of South West Zimbabwe, shallow wells were the chosen technology because no drilling equipment was available. The expensive technique of rock blasting was used to deepen the wells when they dried up at the end of the dry season.

After digging or blasting, loose material is hauled to the surface in a container by means of pulleys and lines. As digging proceeds casing is inserted forming a permanent lining to prevent caving in. Casing can be of wood, brick, metal, or concrete (pre-cast rings) and should contain openings for the entry of water. Dug wells must extend several metres below the water table (although it cannot be too far because, even in a moderately permeable rock, dewatering needs to take place to enable digging to continue, thus limiting the depth attained). In extended drought years, shallow dug wells frequently dry up and the possibility of being able to 'chase the water down' is attractive. Thereafter only particularly severe droughts will cause the well to fail.

4.2.2 Hand drilled boreholes

Asia has had a long and successful history with hand drilling techniques but it is only in the last twenty years or so that small, hand operated drilling machines have been used in Africa. Due largely to the efforts and achievements of the International Drinking Water Supply and Sanitation Decade small, hand operated drilling rigs have been used with varying success in such African countries as Zimbabwe, Mozambique, Malawi, and particularly Tanzania. There are 3 types of hand operated drills: the auger, the percussion and the rather specialised 'palm and sludger' method. In Africa, the auger is most commonly used while the other 2 have for many years proved successful in several Asian countries.

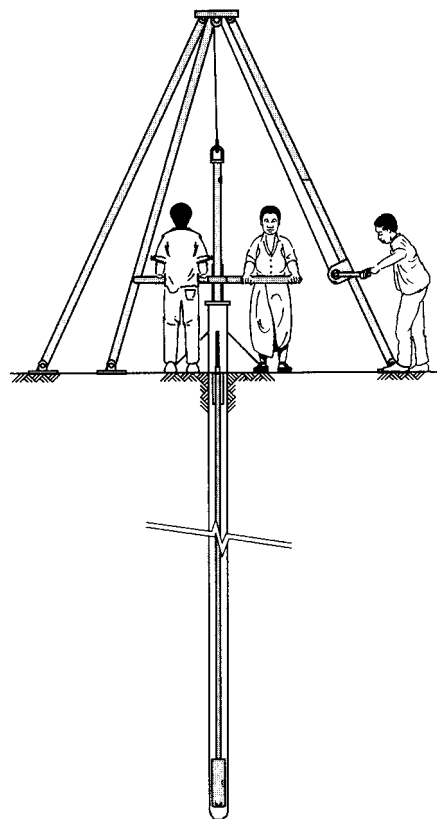

Figure 12. The auger method

4.2.3 The hand dug-well versus the hand-drilled borehole

Drilling a borehole with the manual drill rigs is considered easier than digging a 1m diameter hole. Whilst digging has the great advantage of involving virtually the whole

community, hand-drilled holes now also involve them. Only in a particular region or area where well digging is an accepted, competently practised and well-understood technique, is it perhaps better not to encourage change. In a new area, however, where the rock permeability is not excessively low and a shallow water table exists, there is merit in encouraging the hand-drilled borehole technique.

Where the reservoir capacity of the hand-dug well is not needed, i.e., areas with a shallow water table and a reasonably high permeability, the relatively low cost of the manually drilled borehole (see below), the potential for substantial community involvement, low maintenance, faster penetration and better inherent protection against surface pollution makes the hand-drilled borehole a more attractive proposition than the hand-dug well.

In Tanzania, for example, it takes 2-7 weeks to dig a well depending on depth and soil conditions, whereas a hand-drilled borehole is normally constructed in 3-5 days (Blankwaardt, 1984). The portability of hand drills has improved markedly and for small distances they can be carried by hand, whereas pre-cast concrete lining rings for wells need a truck.

Data from Tanzania clearly shows that investment costs for hand-drilled boreholes are less than dug wells and the differential increases with depth.

Advantages of the manually drilled well:

- More cost effective than the hand-dug well,
- Far speedier completion,
- High potential for community involvement,
- Lower capital costs,
- Can usually go somewhat deeper than hand-dug wells

Disadvantages

- Unlike the hand-dug well, pump failure renders the manually drilled well unserviceable,
- In extremely low permeability terrain handpump yields may not be sufficient,

- In very fine grained, well-sorted sands or silt, even a gravelpack and small slot screen may not be able to stop abrasive sand ingress harming the pump, although this is unusual.
- Decision-makers should be well versed in the advantages and benefits of each technology in specific environments and able to discuss them thoroughly with the community at the planning stage.

Key Points of hand-dug and hand-drilled boreholes

- Hand-dug wells have been known since biblical times and are ubiquitous in Africa,
- The old rule in rural water supply "dig before you drill", is still true where digging is a well-established method. In low permeability areas the storage capacity of a dug well is critical,
- Compelling evidence of the advantage of the hand-drilled borehole in Africa is well documented,
- Hand drilling a borehole is easier than digging a 1 metre diameter well as the equipment is more portable, the cost is significantly less and it provides an inherently better seal against the danger of polluted surface water entering the groundwater reservoir.

4.3 Machine drilled boreholes

Drilling methods using machine-mounted rigs are essentially of two types, the cable tool method (percussion) or one of several rotary methods. Both methods have particular advantages, but here the drill type and drilling approach suitable for low yielding holes will be emphasised.

4.3.1 Cable Tool/Percussion Method

The cable tool or percussion method is one of the oldest and still one of the most popular drilling techniques. In Africa, there are hundreds of percussion rigs, some still operating effectively after 50 years.

The essential parts of a cable tool rig are shown in figure 13.

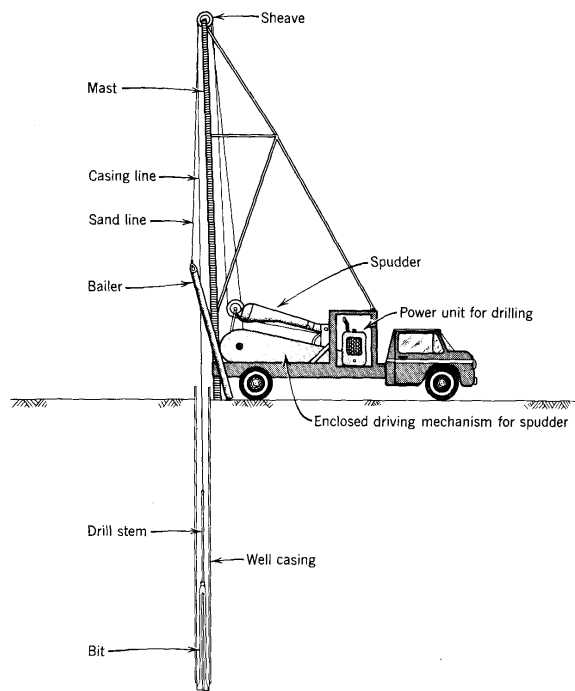

Figure 13 - Typical truck mounted percussion drill. It can also be mounted on a two-wheel bogey (after Todd).

Drilling is accomplished by the regular lifting and dropping of a string of tools made up of a swivel socket, a set of jars, a drill stem and drilling bit, the total weight being up to several tons. The drilling bit, which does the actual drilling, is essentially a chisel. It can weigh a ton or two and is variously shaped for drilling in different rock formations. The drill bit is worked up and down in the hole pulverising the rock until 1-2 metres of loose material fills the hole. The cuttings are removed from the borehole by a bailer or sand bucket.

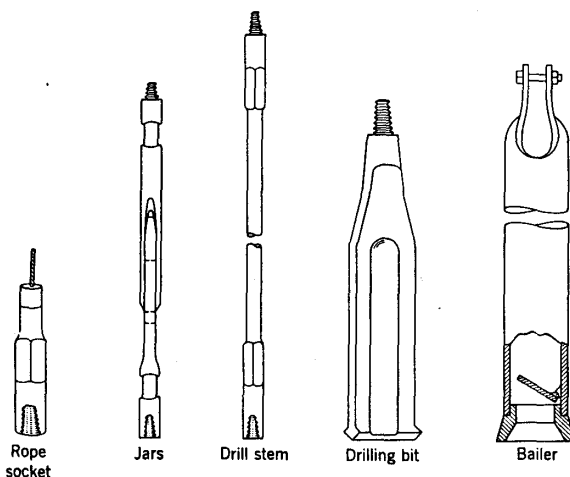

Figure 14. Basic drilling tools for the percussion drilling method (after Todd).

To monitor drilling progress the experienced driller holds the drilling cable to 'feel' progress. The 'feel of the cable' as 'old timers' generally refer to it, can give information as to the hardness of the rock, whether water has been struck, whether the bit is blunt, etc.

Percussion rigs are mechanically simple machines able to drill holes of 100mm diameter (150mm is most common in southern Africa) to as much as 400mm diameter through consolidated rock materials to depths in excess of 600 metres. Whilst percussion rigs are less effective in unconsolidated sand and gravel, especially quicksand because the loose material slumps around the bit, drilling rates in loose flowing sand, while slow, can reach 3-6 m/day. These rigs also provide the only method of drilling through material containing boulders, usually associated with unconsolidated alluvial material.

The cable tool is highly versatile in its ability to drill effectively over a wide variety of geological conditions. There is no consensus on the limitations of the percussion rig. Several authoritative drilling texts insist that in hard rock it is not effective, while others maintain that in dense, very hard rock the method offers no unusual difficulties although clearly penetration is usually slow.

Casing is not required when drilling in hard rock (except for the top few metres where the soil is loose). If the material being drilled is loose, it is necessary to advance casing during drilling to prevent caving. In the author's experience it is surprising how infrequently this occurs. In Zambia (1992-94), however, the borehole collapse rate in hard rock was approximately 20%, due to soft, loose intervening layers in the hard rock. Casing is now invariably used in all boreholes in Zambia.

Key Points of percussion drilling:

Advantages:

- The cable tool is simple to operate and maintain,
- It has relatively low capital costs,
- There is a great deal of experience with this method in Africa,

- It is suitable for a wide spectrum of geological conditions,
- The majority run on a Lister engine and spare parts are generally available,
- For water chemistry studies this method proves superior.

Disadvantages:

- When compared to other methods it is slow,
- Problems can occur with exceedingly loose formations

4.3.2 Rotary Rigs

In the recent past, rotary rigs have become increasingly popular in the sector due to the speed of drilling and the fact that casing is rarely needed during drilling.

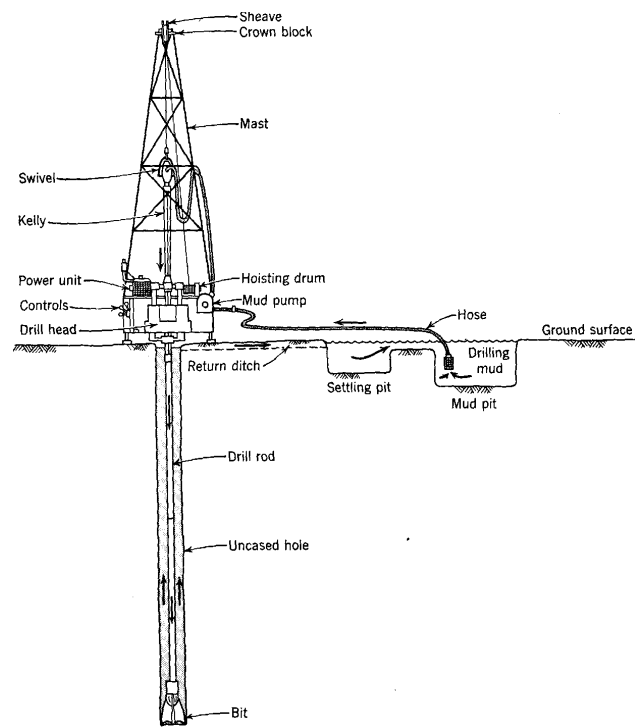

Figure 15. The principle of rotary drilling: arrows indicate direction of mud circulation. (after Davies & DeWiest)

Cutting of rock is achieved by rotating bits of various types. The power is delivered to the rotating bit by a rotating hollow steel tube or drill pipe. Pre-mixed mud is forced down the drill pipe and out of the bit. The role of the mud is to carry the rock fragments upwards and then deposit them in a settling tank. It also supports the hole wall and minimises fluid loss into the aquifer, which, perversely, means it seals off the aquifer! Drilling mud

consists of a suspension of water, bentonite, clay, and various organic additives. The maintenance of the correct mud in terms of weight, viscosity, jelling strength is important to ensure trouble free drilling and requires considerable skill. Generally no casing is required because the hole is filled with the mud slurry and, once drilling stops and the water level goes down, the mud cake keeps the walls intact.

Rotary drilling is difficult in cavernous highly permeable rocks (basalt and limestone) because there can be a total loss of drilling fluid into the rock. Furthermore the mud cake left on the wall in unconsolidated aquifers significantly reduces the inherent permeability of the aquifer. For large yields considerable development must take place to remove the cake and mud that has entered the aquifer itself. It is not easy to determine when water is struck and what the yield is, but an experienced driller will be able to make a reasonable 'guesstimate'.

Below in Figure 16 is a schematic diagram of a large direct rotary rig illustrating the major operational components of a truck-mounted machine. It operates either with air-based or water-based drilling fluid.

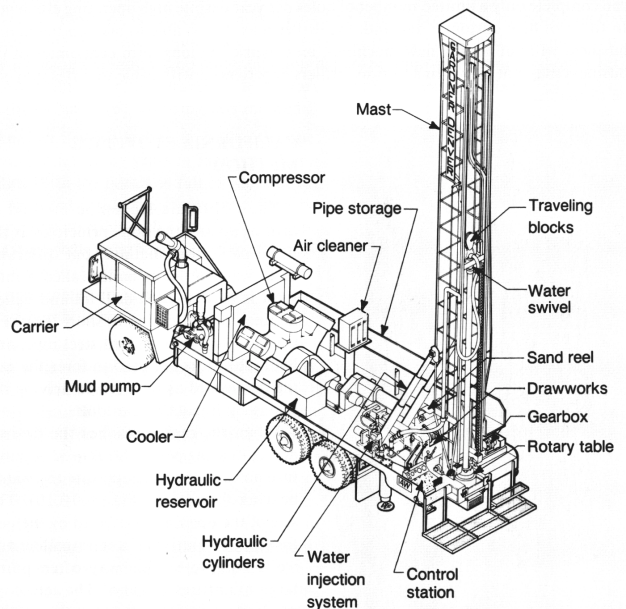

Figure 16. The 'monster' 'super rig'. In the seventies there were many such 'monsters' drilling for water in Africa, but not for long. A lack of spare parts and maintenance soon decimated these rigs - a rather inappropriate tool for a low yield borehole often far from an accessible road. Today, much smaller versions of this drill are available.

Key Points:**Advantages:**

- Most rock formations can be drilled,
- Relatively fast for semi-decomposed rock,
- Water and mud supports unstable formations,
- Small manoeuvrable rigs now available

Disadvantages:

- High capital costs,
- Complex and sophisticated, operational logistics can be difficult in Africa,
- Drillers need lengthy training and experience for best results due to the complexity of the technique,
- Water is required for drilling, posing a problem in arid areas,
- Mud reduces aquifer permeability, necessitating the efficient removal of the mud cake,
- It is not easy to determine yield while drilling.

4.3.3 Rotary-percussion or Down-the-Hole Hammer method

This is a recently developed technique on the rotary principle where air is used as the drilling fluid and the rotary bit has the action of a pneumatic hammer delivering 10-15 impacts/second, known as down-the-hole-hammer (DTH). It is particularly suited to dense, hard rock where penetration rates of 0.3 m/min have been achieved (equivalent to say 30-100m/day, which is very fast in hard rock). If large yields are required (which are seldom to be expected in hard rock but the rule proves the exception in limestone and some volcanic rocks) another method must be chosen because DTH is suitable only for small to moderate yields.

Key Points of the Rotary-percussion method**Advantages:**

- Very fast in hard rock with moderate water yields,
- Small manoeuvrable rigs are now available.

Disadvantages:

- High equipment costs,
- Requires experience to operate and maintain,
- Air compressor mandatory, complex equipment.

4.4 Dug well versus hand bored (drilled) borehole versus machine drilled borehole

A frequently reproduced table from 'the handpump option', Arlosoroff et al (1987) showing cost comparisons for different technologies plus other parameter comparisons is shown in the table below. The capital cost figures are now outdated, and while the cost comparison between the various technologies is still valid; absolute values will have increased.

Interestingly 200mm holes are considered as standard by the authors, clearly so that an artificial gravelpack can be placed.

Table 1.

WELL CONSTRUCTION TECHNOLOGIES					
	Hand digging	Hand drilling	Cable-tool rig	Small air flush rotary	Multipurpose rotary
Approx. capital cost range	USD 1000	USD1000-5000	USD20,000-100,000	USD100,000-250,000	USD200,000-500,000
Running cost	very low	low	low	medium	very high
Training needs for operation	very low	low	low-medium	medium	very high
Repair skills	very low	low	low-medium	medium	very high
Back-up support	very low	low	low-medium	medium	very high
Approx. range of penetration rates in metres/ 8-hr day	0.1-2.0	1-15	1-15	20-100	20-100
200mm holes to 15m in unconsolidated formations	-	fast	fast	impossible	very fast
200mm holes to 50m in unconsolidated formations	-	slow and difficult	fairly fast	impossible	very fast
200mm holes to 15/50m in semi consolidated formation	-	Impossible	fairly fast	impossible	very fast
100mm holes to 15/50m in consolidated (hard) formation (not gravel packed)	-	Impossible	very slow	very fast	very fast

Another valuable and more recent cost study by The Swiss Centre for Development Cooperation in Technology and Management (SKAT) attempts costing the various technologies in Table 2.

Table 2.

Type of Technology	Targeted persons per source	Investment costs (USD)	Cost/capita (USD)	Running cost (USD)	Cost/m ³ (USD)	Running costs/m ³ (USD)
Dug well	150	1,650	11	50	0.35	0.06
Dug well with direct action pump	200	2,700	14	125	0.49	0.11
Borehole with handpump	300	13,500	45	224	1.29	0.14
Borehole with electric pump	2,400	84,000	35	1,960	0.63	0.11
Borehole with diesel pump	2,400	68,000	28	3,900	0.79	0.22
Borehole with solar pump	2,400	72,000	30	1,435	0.76	0.10

Quite unexpected is the cost/capita ranking, the handpump mounted borehole having the highest cost/capita. Clearly the water source here is costed at a high figure, which is typical for West Africa.

If the water table is shallow and the rock is soft then manual techniques should be favoured. Deciding which method is the most appropriate can be difficult. Both hand-dug and hand-drilled methods are least cost

solutions in shallow water table areas. If, however, speed is the main factor then machine drilling in such an area is justified. All variables must be considered but the general statement can be made; in shallow water table areas manual digging or drilling is the most appropriate technique. The definition of shallow water table will vary, but a reasonable figure is up to 15 or 20 metres.

Matabeleland, the dry South-Western province of Zimbabwe, where hand dug wells are often employed, provides an interesting case study of how past tradition frequently dictates a certain approach. The water table is relatively shallow but the weathered mantle is extremely thin and, in order to produce sufficient water, expensive rock blasting is used in the wells. If, as at first sight, machine drilling would appear more appropriate, why is blasting chosen? The reason is that machine drills were not available at the time immediately after Independence when an accelerated water supply programme began in the early eighties. Consequently, there is now a large cadre of trained well diggers and explosives experts therefore well construction continues to be the major water technology. It should, however, be noted that while a machine-drilled borehole might seem to be more appropriate in such hard rock, there is no guarantee that it would be. The permeability of the rock (i.e. the amount of water which the rock will yield) may be so low that a borehole may not have sufficient reservoir capacity. A hand-dug well will be recharged during the night by water slowly seeping into the well. By morning, it will have perhaps 3-4 m³ of water in it, which can be pumped out.

Costs are calculated based on an average of figures obtained from several countries in Africa. Cost considerations will usually dominate in rural water supplies where funding is limited and demand is great but there are other factors, which will influence the choice of drilling method. If, for example, cost and community participation are paramount (and there is a shallow water table in soft terrain with low permeability) then the hand-dug well is the technique of choice. If the same criteria apply but the rock has a relatively high permeability then the hand-drilled borehole may be more appropriate. If, alternatively, speed is the overriding factor then the machine-drilled borehole is clearly the answer.

4.5 Pollution and Shallow Groundwater

In shallow water table conditions the danger of bacteriological pollution is ever present and mandates the need for proper construction of the well/borehole, particularly of the surface apron that seals the aquifer from surface water pollution. The well is usually completed with a sealing slab and the surrounding apron with a drain. It is the area immediately adjacent to the well that primarily determines whether pollution can take place. If apron construction, and thus sealing is poor, then pollutant can easily make its way into the groundwater reservoir along the wall of the well. Cleanliness near the well must be encouraged at all times, notwithstanding proper apron construction, and excess water should drain some distance away from the well.

The shallower the water table the greater the danger of groundwater pollution.

Properly constructed well aprons are mandatory.

5 THE LOW COST BOREHOLE-DESIGN AND COSTING

5.1 Overview

We now come to the central theme of this work - how to ensure economic optimisation of a handpump mounted borehole design thus reducing the current cost incompatibility between the water source and the other elements of 'the triad'. Design and construction should be guided on common-sense guidelines to avoid over-design where only small yields are needed. Yield being the only variable; design is critically dependent on yield.

In large yielding boreholes, especially in unconsolidated material, stringent design and construction parameters are required. Large yields lead to high velocity water flow (entrance velocity) into the borehole, which in turn requires screens with high percentage openings and a thick artificial gravelpack. The thickness required depends on the maximum velocity and aquifer material. Where large yields are sought, detailed hydrological and geophysical field investigations are justified because the borehole will most likely be deep, of large diameter, cased, gravel packed, expensively screened and thoroughly developed; resulting in a high cost but high production hole.

Boreholes drilled specifically for handpumps should be viewed differently. The required yield is extremely small, the entrance velocity is low, and flow hydraulics simplified so that several of the expensive requirements of large yielding boreholes fall away. It must be emphasised that the 'downscaling of boreholes' does not and should not suggest a lowering of borehole construction quality. Even for very small water yields, borehole quality must be maintained or improved so that productive life is long and trouble free.

The new departure point for the design of a handpump equipped borehole is therefore a limited yield of 1-2m³/hr. Design guidelines are discussed below:

5.2 Borehole Diameter

The most commonly used handpump in Africa has a rising main of 50mm and the borehole is normally drilled at 150mm with a 100mm casing if required. Should a substantial artificial gravelpack be required in a particular area then the 150mm hole can be reamed out to 200mm. When rotary drilling is used there is virtually no cost differential between 150 and 200mm. Many experts believe that 200mm give more leeway and are thus preferable to 150mm. A thin gravelpack is routinely used in Mozambique, the annulus between the 100mm screen and the 150mm bore being packed with gravel to just above the screen. While its hydraulic efficacy is negligible, the gravelpack has the advantage of anchoring the screen in the hole, although centralisers would do equally well.

Key Points:

- 150mm diameter is suggested as standard, but as the cost differential, particularly with rotary drilling, is negligible, some feel there is a case for 200mm as standard,
- If the hole is to be artificially gravel packed for hydraulic reasons, i.e. a very fine, well sorted aquifer, then an 200mm diameter hole is mandatory,
- In Mozambique 150mm boreholes are routinely gravel packed, even though the annulus is only 25 mm.

5.3 Matching depth of the borehole to required yield

Whilst it cannot always be said that 'the greater the depth the greater the yield' it is a reasonable rule of thumb up to a critical depth. If we consider 1 -1.5m³/hr to be the upper limit of the handpump's requirement (a generous figure) then drilling should stop 10m or so beyond the depth at which this yield is obtained. This reserve column will allow for seasonal variations and excessive drawdown in aquifers with low permeability or, more correctly, transmissibility. Areas

where seasonal water level fluctuations exceed 10m are rare, but if the area is hydrogeologically 'known' to have large fluctuations then clearly a reserve column of 15 - 20m will be necessary.

In practical terms the drill crew (only if a percussion rig is used), once they have struck water, should carry out a rapid bailer test (an eminently appropriate methodology in this type of work) to establish the yield. The bailer test saves time and money and gives a good indication of what can be expected from the borehole.

If the test shows a yield less than 1m³/hr, drilling should continue with testing in depth intervals of, for example, 2 metres. When the required yield is attained drilling must continue for a further 10m and then stop, although in Zambia the drilling is stopped 5m after a yield of 0.8m³/hr is obtained. A drawdown of more than 10m with handpump yields is uncommon but, if the aquifer has low permeability, then the borehole must be deeper. Experienced drillers can at times 'gauge' or 'feel' the permeability of the aquifer.

In 90% of cases, groundwater yields suitable for handpumps exist within 50m of the surface. In any event handpumps have a maximum practical lifting capability of 60m (new developments currently being researched may increase this figure to 80m) so generally drilling should stop at 70m. In some regions, however, first water may be penetrated only at a relatively deep level, i.e. 80-100m. Because there is a possibility that it may be sub-artesian (and therefore under pressure and able to rise to a level which can be pumped by the handpump), it is worth drilling to such depths in areas where sub-artesian conditions are known to occur, e.g. in the so-called 'basins of decomposition' in granite areas.

In some areas in Zimbabwe there are instances where local politics overtake technological acumen. In the mid-eighties a cycle of droughts hit Zimbabwe and many boreholes dried up. There is now the perception in these areas that only exceptionally deep boreholes will not be subject to drought.

Key Points:

- Once the required yield of 1.5 m³/hr is

attained, drill a further 10m to allow for seasonal water level fluctuations and drawdown levels,

- The yield should be established with a simple bailer test as drilling proceeds in intervals of 2 or 3 m after water is first struck,
- In sub-artesian conditions the borehole water first struck can be considerably deeper than the norm for handpumps of 50-60m, but it may rise to these levels.

5.4 Borehole development.

In percussion drilling in unconsolidated rock the inherent permeability is reduced; permeability is lost through vibration and compaction, but the loss is minimal. This is in contradistinction to boreholes drilled by the rotary method, where mud or bentonite is used, resulting in a dramatic fall in permeability. In a fissured aquifer the mud may be forced into the fissures cutting them off from the borehole. To produce high yields in a potentially high yield aquifer, borehole development is required to eliminate the 'skin' effect or 'cake' from the wall or extract the 'mud' from blocked fissures. In essence, therefore, the action of drilling will lead to some damage to the aquifer immediately adjacent to the hole and a reduction of borehole performance. By developing the borehole, damage is reduced and long-term performance improved. Thorough development also ensures the accelerated egress of sand and fine material from the aquifer. If a borehole is not developed, and the handpump is mounted, then the pumped water may contain sand and/or silt which can damage handpump seals and valves.

Development procedures are varied and include pumping, surging, use of compressed air, hydraulic jetting, the addition of chemicals (an important advance in rotary drilling is the use of a biodegradable mud instead of bentonite or clay), hydraulic fracturing and the use of explosives. These are specialised techniques and details can be found in specialised drilling texts.

For small yields the 'cake' effect is not so critical and, in any event, development by the various methods available (excluding pumping and surging) all have a minimal effect with screens that have a small

percentage opening appropriate for small yields. In large yielding boreholes, screen openings of 30-50% are common and with such a large percentage of open area the various development methods are relatively efficient. Low yielding boreholes with screen openings of 1-5% (sufficient for handpump yields) render the more sophisticated development techniques grossly ineffective. The most economical method of developing the low yield borehole is to use a bailer to pump or over-pump the hole until ingress of fine material stops. In the low yield borehole, an effective method of development, apart from pumping and over-pumping, is the use of the same simple bailer to surge the borehole. Surging is a process that attempts to set up a washing action by forcing the water backwards and forwards through the material to be cleaned, i.e. the screen, the gravelpack (if there is one) and the aquifer matrix. The simplest way of surging a borehole is to use a bailer, taking it up and down rapidly. The bailer acts as a piston in the screen to pull loose material into the borehole for subsequent pumping out.

The development of a borehole (pumping and surging) results in the finer fractions of material being drawn from the unconsolidated aquifer (and from fissures in semi-consolidated aquifers) leaving behind a stable envelope of the coarser, and therefore more permeable, material of the aquifer. This natural gravelpack is not to be confused with an artificial gravelpack.

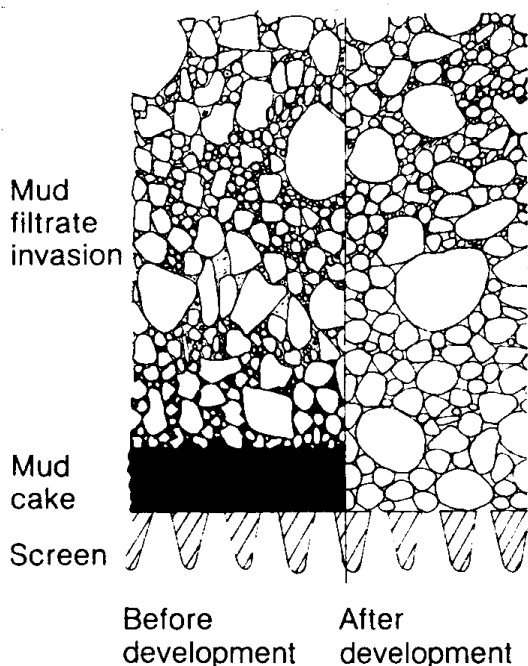

Figure 17. Natural gravelpack development, (after Clarke 1988)

The grain size distribution of an unconsolidated aquifer dictates how efficiently development creates a natural gravelpack. The D number, or more importantly the sorting or uniformity coefficient expresses the grain size distribution. The D number is related to the grain size; for example D40 relates to the sieve mesh diameter through which 40% of the aquifer material will pass (how sediment sieving is carried out is explained in several texts marked in the list of references). An ill-sorted aquifer has a sorting or uniformity coefficient (D_{60}/D_{40}) of more than 2.5. The grain size and sorting of sediments are illustrated by grain size distribution curves, which are used for the design of screen slot size and artificial gravelpacks. This discussion will not be taken further in technical terms, suffice to note that if large yields are required in unconsolidated aquifers the design of screen slot size and gravelpack are critical to the long life of the borehole.

There are instances where, even following pumping and surging, pumped water may take weeks to clear up completely. If sand and silt continue to ingress after such a period, a possibility in very fine-grained aquifer material, an artificial gravelpack is mandatory. Even in fine-grained material, however, an artificial pack is often unnecessary. For example, in the Tharpakar Desert in Pakistan with a drilling programme that did not include gravel packing despite fine-grained material, sand ingress several weeks after drilling was reported in only 1 borehole out of 75. This one-off case did not warrant a change in design strategy, i.e., to gravelpack all boreholes; the particular hole was simply abandoned.

Key Points:

- Development of a borehole is a crucial adjunct to a properly completed installation,
- For low yield boreholes pumping, or better still over-pumping, is the best method of development. Rule of thumb pumping periods vary from 2-24 hours or until the water pumped is clear, which is frequently within an hour or two,

- The bailer (standard equipment on the percussion rig) can be effectively employed for development in the process of surging, and even for pumping if a submersible pump is not available,
- Pumping and surging will create a natural gravelpack around a borehole drilled in unconsolidated sediment which is critical to the long productive life of the borehole,
- The brief technical discussion above relating to distribution curves and sorting coefficient is not essential reading but illustrates the complexity of borehole design for large yields,
- Despite the fact that, in hydraulic terms, a gravelpack is not required nearly as frequently as it is used, the widespread practice in some countries of routinely placing an artificial gravelpack should be allowed to continue given its low cost and 'anchoring' action.

5.5 The use of PVC casing and screening

In boreholes designed for large flows screens have the effect of:

- Stabilising the sides of the hole,
- Preventing sand movement into the well,
- Allowing a maximum amount of water to enter the hole with minimum hydraulic resistance.

The choice of a particular screen type will depend on a combination of factors including strength and corrosion resistance as well as slot size and design and open area (which is the proportion of a screen face made up of open slots).

An important design criterion relating to the open area of a screen is the entrance velocity, which is the discharge of the borehole divided by the effective open area of the screen. It is widely accepted that the entrance velocity should be kept below the critical value of 0.3m/min. If the entrance velocity is higher than the critical value (assuming for the purposes of this discussion an unconsolidated aquifer, typical porous media), sand and silt or even finer material will enter the borehole and turbulent flow will cause a loss of head. The loss of head with the onset of turbulent flow into the borehole

will not be considered here; it is only important when large yields are pumped.

Inflowing sand or silt after development can occur and the only way to stop it is to slow down the water flowing into the borehole. This can be achieved by means of a high screen open area and a natural or artificial gravelpack, which creates a high permeability zone around the borehole. The small handpump yield of 1 m³/hr translates to a very low entrance velocity, well below the critical velocity concept in borehole design, above which sand/silt may be carried into the borehole. High percentage opening, small slot size screens (which are expensive) are not required; they are only needed when yields are high and inflow velocities are consequently large.

Screens are manufactured from a variety of materials, PVC, mild steel, stainless steel and various alloys. Slot designs are many and varied, stainless steel screens and spiral wound wire being extremely expensive, although allowing an open area of 40-50%.

For handpump supplies, low cost (locally manufactured) PVC casing and screening can be utilised. The slot size of the screens is not critical for low yields in normal conditions, although it can be critical in fine-grained aquifers. In aquifers requiring screens, primitive machine sawn slots with a total opening of 5% (slot size 0.5-1 mm) are appropriate. Casing and screens can be of low cost PVC. PVC casing and screens can be joined by two methods, either bell and socket (male/female) joint with solvent cement, or threaded joints. In most areas, and certainly in the developed world, threaded joints are significantly more expensive than the bell/socket. Recent developments in Southern Africa, however, show that local manufacturers are charging little more for threaded flush joints than the bell/socket joints. For a price differential of USD 1-3 per joint, threaded flush joints are probably a better choice than the bell and socket joint. In those regions, however, where the use of threaded joints would significantly increase costs in low capacity boreholes, bell and socket joints should be used. It could be argued that while the casing is being inserted the solvent cement joint could come apart. As a safeguard against this unlikely event, two small self-tapping

screws inserted at every joint guarantee that there will be no problems. Interestingly, the drilling industry in much of Africa has long been suspicious of solvent cement joints, however in Asia there is considerable experience of effective use of this type of casing. In South Africa, irrespective of the small cost differential between the two types of joints, most commercial drillers now use the bell and socket joints routinely and successfully. In addition, recent research

work carried out in the United Kingdom on solvent cements has resulted in the availability of improved products on the market.

It has taken time for drillers to 'adapt' to the use of PVC casing and screening. In the past, steel casing and screens were the norm and, while much more expensive, the toughness of steel meant that less care was required in its handling.

Table 3. Cost of different casing and screens and effect on total cost of borehole. (Based on 5m of screen and 45 m of casing in a 50m hole).

	Cost/m (USD)	Cost of Screen /Casing in a 50m borehole (USD)
Steel screen with flame cut slots used in Zambia, pre 1995	50	
Steel casing used in Zambia, pre-1995	40	2050
PVC screens (bell socket joint) manufactured and used in Zimbabwe	7.3	
PVC casing (bell and socket joint) manufactured and used in Zimbabwe	5.3	280
Steel screen used in Zimbabwe, low percentage opening, large slots	20	
Steel casing used in Zimbabwe	15	775
PVC screen used in Mozambique, imported from Holland	28	
PVC casing used in Mozambique, imported from Holland	18	1040
PVC screen manufactured and used in Pakistan	6,50	
PVC casing manufactured and used in Pakistan	5.50	280
PVC screen manufactured in South Africa used in Zambia	10	
PVC casing manufactured in South Africa used in Zambia	8	390

The table reveals how dramatically costs can be reduced with locally manufactured PVC screens and casing; imported PVC is expensive.

The collapse resistant rating is an important figure for screens and casing as it determines the permissible installation depth and likelihood of failure. Usually the highest external pressure load occurs during development and gravel packing. For boreholes with handpumps development is normally carried out by pumping and/or by the bailer acting as a surging tool. Light, low cost screens are safe but care must be taken in raising and lowering the bailer. The heavy development tools used in large yielding

holes such as a surge block, which exerts considerable pressure on the screens, are inappropriate for low yield holes.

Generally casing and screens are not required in hard rock and seldom in semi-decomposed rock, (except the top few metres of overburden) yet many countries (e.g. Mozambique) use them despite the fact that there is no reason to do so. The explanation is sometimes proffered that casing protects the rising main in a hard rock

borehole from rubbing on the wall of the borehole. It is an unsatisfactory explanation since the problem can be overcome easily and cheaply by using PVC piping cut in half lengthways as stabilisers or centralisers.

There are, however, exceptions. In hard rock terrain in Zambia the drills sometimes cut through a soft, loose decomposed layer at depth, only to go through hard rock again after a few metres. Previously such holes were left uncased but it was discovered that, in time, 10-30% of such holes collapsed. Consequently, hard rock holes in Zambia are now routinely cased. Research work is planned on the thin decomposed layers lying within fresh rock so that clear guidelines may be established as to when and when not to case.

In the decomposed mantle in Malawi where Chilton and Grey did their early work, screens, some casing and gravel packing were routinely used. Conversely, in Zimbabwe, under very much the same conditions, the policy was to case off the overburden, usually the top 10-15m, drill into the decomposed zone and the fresh rock and leave it open. Screens and gravel packing were seldom used. No harmful effects such as silting or decreasing yield were experienced. The few screens used were made of mild steel with torch cut slots (at least 3mm wide) resulting in an open area of only 1-2%. Although it must be said that Chilton and Grey suggested tapping the overburden.

Key Points:

- Two important design criteria are discussed in relation to screens. Entrance velocity and critical velocity. It becomes apparent that the low handpump yield means a low entrance velocity well below the critical velocity; again emphasising the significant difference that yield makes in borehole design requirements,
- PVC screens and casing are appropriate for low yields,
- In some countries and regions there is a significant cost differential between the jointing mechanism for PVC screens and casing. Threaded joints are preferable but, if the cost differential is significant, bell and socket joints should be used.
- PVC casing and screens are low cost and can be easily transported and handled,
- The smallest slot size of about 0.5mm is generally acceptable. For low yields, an open screen area of 5% is sufficient,
- Boreholes drilled in either hard or decomposed rock generally do not require screens and casing; the use of stabilisers or centralisers is effective and low cost but further experimentation is desirable. Note the Zambian experience (see 6.3.1).

5.6 Artificial gravelpack - when and where needed?

At a typical discharge rate of a handpump of 750 l/h, a 3-metre screen with only a 5 percent opening, and no gravelpack, is theoretically "safe" in terms of sand ingress. The average velocity of the water passing through the screen is at least a factor 3 below the critical velocity where turbulent flow may be generated and 0.5mm sand grains begin to move. In large capacity boreholes sited in aquifer material that is fine-grained and well sorted, an artificial gravelpack is mandatory. The advantage of a gravelpack is that, because the pack material is coarser than the formation, screens with larger slot sizes can be used and, by surrounding the screen with highly permeable material, inflow velocities are reduced.

In terms of hydraulic theory, it is clear that for small yields an artificial gravelpack is not essential. Yet, in practice, even when boreholes have gravelpacks, movement of sand into boreholes can still occur. Although infrequent, the fact that it happens at all illustrates how the theoretical aspects of groundwater hydraulics can and do diverge from field reality. Such sand may actually find its way into handpump plungers and accelerate the wear of seals and washers.

This rare, but inconvenient ingress of sand into low capacity boreholes dictates that some of the possible causes should be examined before adopting a blanket policy of 'no gravelpack use'. Possible explanations for the presence of sand in handpump plungers include physical and hydraulic factors. The physical factors relate to the

grain size of the sand and, more importantly, the grain size distribution; the finer the sand/silt and the greater the uniformity coefficient the more sand migration is likely. The hydraulic aspects are that theory assumes a completely porous media with water flowing through all pores at the same velocity. In practice, however, porosity varies and so do flow velocities. Additionally, flow caused by 'handpumping' is not constant but pulsing, which will also increase flow velocities over short spans of time. In fact, a faulty footvalve may even cause a small scale jetting action within the screen if the handpump plunger is inserted.

The author believes that the above discussion demonstrates that in most situations low yield boreholes (meaning entrance velocity well below the critical velocity) do not require an artificial gravelpack on hydraulic grounds. In Zimbabwe, there are well over 25,000 documented boreholes in a variety of terrain and rock types with no gravelpack and no screens. Some boreholes have primitive screens with 'wide' flame cut slots and an open area of 1-2%. From a purist's design viewpoint nothing could be worse, yet many of these bores are 40-50 years old and show no sign of deterioration.

Nevertheless, in several countries a gravelpack is frequently installed in the belief that it is needed, even in hard rock boreholes where it definitely is not. In such circumstances the gravelpack has a mechanical effect; it helps to anchor the screen and casing in the borehole, but, perversely, this too is unnecessary in a hard rock borehole!

Geotextile is a new material now being experimentally used instead of an artificial gravelpack, and sometimes in addition to such a pack. Unlike the gravelpack, which reduces water velocity, geotextile acts as a filter, letting water in but excluding sand/silt and other fines. Data on its long-term efficacy is still lacking.

Key Points:

- From a hydraulic viewpoint, it is concluded that an artificial gravelpack is seldom required in low yielding boreholes, and screen open areas can be low (5%),

- In hard rock boreholes neither a gravelpack nor a screen and casing are needed but several countries routinely use them, primarily for mechanical purposes such as the protection of the handpump rising main. Stabilisers or centralisers would do the same job for less cost.
- There is compelling evidence that the gravelpack can be eliminated but its low cost, mechanical, and at times even hydraulic advantage, coupled with widespread practice, probably means that its use should not be discontinued in countries that routinely place a gravelpack.

5.7 Borehole Pump Testing

There are two main reasons usually cited for pump testing a borehole:

- a) To measure the well performance and efficiency with a varying discharge,
- b) To measure the aquifer characteristics of storativity and permeability (for the aquifer as a whole it is called transmissibility).

Pump tests are fundamental in groundwater hydrology. Boreholes are pumped for extended periods and the drawdown is measured over time, thus enabling assessment of well performance and aquifer characteristics. Pump tests normally vary from 6-72 hours and at times are even longer. The tests are conducted with a varying discharge and/or constant discharge. The flow equations describing water flow into a borehole are complex and analysis of the depth/time data to obtain the required functions used to be intricate. Now, with the advent of the computer, analysis is much simpler. Notwithstanding, for low yielding holes of limited depth it is needless to carry out a 'sophisticated' test. In these holes neither theoretical well performance nor aquifer characteristics can easily be obtained. All that needs to be established is whether the borehole has a yield of 1-2 m³/hr. Pumping for 2-3 hours at 1-2m³/hr can do this. If, at the same time water depth measurements are taken, all the better; a first order approximation of the transmissibility is now available for future

reference. No more is required! To attempt extensive pump tests on low yield boreholes is woefully extravagant! Nonetheless the obligation for a particular region or country to build up a comprehensive groundwater database can sometimes colour the perception of the hydrogeologist tasked with collecting such data.

Pump test results are most valid in unconsolidated aquifers; in hard rock they are an approximation at best. A private contractor in Mozambique gets around the difficulty by combining a simple pump test with development of the borehole (see case study). In Zambia formal pump tests are no longer carried out on handpump mounted boreholes. But what if, when drilling for a normal low yield, a large yield is struck? In this situation a comprehensive pump test is justified.

In India simple two-hour pump tests are carried out on handpump mounted boreholes. Water is air-pumped (using compressed air) to the surface and led through a 'v' notch that measures the yield. It may not satisfy the purists but it is simple, low cost and appropriate.

Key Points:

- Pump tests are a fundamental procedure to assess both borehole and aquifer performance. In low yielding, limited depth boreholes classical extended pump tests are frequently meaningless and unnecessary on a routine basis.
- A simple test using either a bailer or small submersible pump to determine the yield over a 2-3 hour pumping period is all that is needed. Timed water level depth measurements should be taken if possible.
- Often the yield of the test pump is greater than the yield of the hole (5m^3 - 10m^3 /hr vs. 1m^3 /hr, so that the water is rapidly drawn down to the pump. If that happens, the yield of the test pump should be reduced so that the rate of drawdown can be measured for an hour or so.

5.8 Locating Groundwater - Can the 'experienced eye' and science see eye to eye?

A 1994 UNDP-World Bank funded report entitled 'Finding Groundwater, A Project Manager's Guide to Techniques and How to Use Them' provides valuable insights into this controversial topic.

Boreholes sites should be chosen principally on hydrogeological grounds, yet an important cornerstone of the new philosophy of community water supplies is the complete involvement of the community in all aspects of water supply, including the decision on siting of boreholes. Quite naturally the community will usually prefer that the water source be sited as near as possible to the village, a location which may be at variance with the 'scientifically' chosen site.

The Bank study suggests that a logical and low cost approach to borehole siting should have the following sequential levels of investigation:

Level 1: Inventory of Existing Data

Geological Data
Hydrological and Climatic Data
Existing Well Data

Level 2: Remote Sensing Interpretation

Satellite Imagery
Aerial Photography

Level 3: Hydrogeological Fieldwork

Geomorphological Analysis
Water Point Inventory and Monitoring
Hydro-Climatic Monitoring

Level 4: Geophysical Surveying

Electrical Resistivity
Seismic Refraction
Electromagnetic Profiling (EM)

Level 5: Exploratory Drilling

Hand Drilling
Machine Drilling
Geological Logging
Geophysical Logging
Test Pumping
Water Pumping

The approach above is sensibly systematic but perhaps it should also include a zero level that allows ‘the experienced eye’ to site the borehole since groundwater in small quantities is ubiquitous.

The ‘experienced eye’ refers to the hydrogeologist who draws upon his scientific training and experience to assess the natural clues for siting a borehole: the type of vegetation, rock outcrops, soil colour, topography, valleys and drainage areas, existing nearby wells or boreholes and springs. Negative indicators such as high ground, areas of mudstone or basalt overburden etc., etc. are also considered. For low yields and shallow depth, this is a powerful location method.

The author (a geophysicist) has felt for many years that the use and cost-effectiveness of

geophysics in low cost water supply is debatable since in most cases low yield boreholes do not justify relatively expensive geophysical investigation. In his view casting the ‘experienced eye’ and ‘throwing of the hat’, or bones (more appropriate in Africa) on to the spot to be drilled is the method of choice in many (but clearly not all) hydrogeological situations.

5.8.1 Costs of Finding Groundwater

The 1994 UNDP World Bank study has attempted to evaluate costs of groundwater assessment studies and borehole location in Africa. These costs show tremendous variation as can be seen below:

Table 4.

Category/region	Average well construction cost (USD)	Average cost of investigation per site (USD)
Low cost rural water supplies		
West Africa	12,000	1,053
East Africa	10,095	359
Southern Africa	2,766	182
Compare these figures with Construction and siting high yield boreholes	81,091	2,254

The variation in construction costs per borehole between the regions of West, East and Southern Africa is extraordinary. In several East African projects the inclusion of sanitation and health and hygiene education, etc., obviously raises costs. In West Africa costs are very high because of deeper drilling and the use of more expatriate staff. Note too the far higher siting costs in West Africa. In Southern Africa a highly competitive commercial drilling industry keeps costs lean. Nonetheless there are many unanswered questions and such regional differences deserve closer scrutiny. Interestingly, the percentage cost of siting in relation to construction for low yield boreholes in West Africa is significantly greater (8%), than in East Africa (3.5%). In

absolute terms though these figures are very low in East and Southern Africa. With such low figures, geophysics is certainly worthwhile but once construction costs go down the issue is more debatable.

The Case Study I, (Mozambique, see 6.1.1) shows geophysical siting cost of USD 250-500 (in 1994) is 17%-30% of total drilling costs. The critical question is; would the money saved by omitting scientific borehole siting have made up for the loss involved in drilling 11 dry boreholes? The Mozambique Case Study shows that it did, even assuming an unlikely 100% success rate had geophysics been used. The summing up of Farr et al. is applicable here; ‘Groundwater search techniques are only justified if they increase the chances of subsequent

boreholes being successful, such that the overall saving in drilling cost, in the long run, is greater than the cost of the search'.

The evaluation of actual costs to determine the extent of the investigation depends on local circumstances. Information on the existing success rate without siting and the likely increase in success rates with investigation must, if available, be acquired from earlier projects in the area with

comparable conditions.

The UNDP/WB study shows significant savings in several large-scale projects, in particular in high yielding borehole siting, but also in low cost projects. An excellent example is shown in the table below, although so dramatic is the improvement that perhaps it is too good to be entirely true; perhaps another look at the results is warranted?

Table 5.

Rock type	Number of boreholes	Success rate %	Mean depth (m)	Mean yield (m ³ /d)	Drilling cost per productive well (USD)
Existing boreholes.					
Tertiary volcanic	38	44	126	140	17,700
Nyanzian volcanic	19	68	116	95	10,600
Granites	7	43	70	48	10,200
Programme boreholes					
Tertiary volcanic	60	78	66	340	5,400
Nyanzian volcanic	11	91	54	94	3,700
Granites	10	60	61	140	6,350

In areas of high rainfall and unconsolidated sediments, groundwater is usually shallow and in such cases the UNDP/World Bank study agrees that no investigation is necessary for determining precise well sites and that the community can select the digging/drilling sites. The UNDP/World Bank study also allows that in areas where '... groundwater is known to be present at shallow depth, such as in many alluvial aquifers or areas with significant recharge from rainfall or surface water resources, the limited abstraction needs of handpumps only require a very basic hydrological investigation...'

However, over the vast crystalline rock areas of Africa where groundwater occurs in the weathered mantle, the study suggests that geophysical techniques are useful, '... especially where the subsurface conditions are simple...'. Subsurface conditions, however, are seldom simple, and for some

50 years, until a decade ago when competing methods were introduced, geophysical methods in Africa centred around an electrical resistivity depth profile used after the geophysicist had selected the site based on his experience. For 40 years borehole sites were thus located in Zimbabwe. No cost figures for such surveys are available and an estimate would not be meaningful. The author has long been sceptical of the 'confirmatory sounding', and has found 'the experienced eye' alone to suffice. Witness the following success rate from a recent low yield borehole-drilling programme in Mozambique. Out of a total number of 145 boreholes, 129 were successful, (10 were dry and 6 saline) - a success rate of 89%. The most striking fact is that only 60 (40%) of these were sited by an experienced hydrogeologist (using his experienced eye and throwing his hat), the rest were sited by newly trained medium level technicians with little experience of

hydrogeology. The boreholes were drilled over a large area covering 7 of the 10 provinces in the country and, while most of the hydrogeology was relatively simple, in Manica province, which is known as a very difficult area, the drillers (all newly recruited) themselves sited 6 holes of which 3 were successful.

There is little doubt that in virgin areas the first two levels of investigation (UNDP/WB study): desk study, aerial photographs used for a photogeological study, geological maps, bulletins, reports and records of nearby wells etc, are mandatory and, in areas known to be difficult, systematic and thorough investigation leading up to level 4 can increase drilling success rates significantly. For example, in an accelerated drought relief programme in Zimbabwe, a rapid survey technique that included systematic electromagnetic profiling together with electrical resistivity soundings increased the success rate by 10-20%.

The crux is that if geophysical surveys are to be used (notwithstanding the author's view that the 'experienced eye' can and should be utilised more often) then the surveys must be carried out systematically and sequentially. This should include working up the 5 levels of investigation listed, rather than the ad hoc electrical resistivity depth soundings that are often still practised by both government and private geophysicists. In Zimbabwe and much of Southern Africa over the past 50 years the reality was that the 'experienced eye' was utilised as the primary 'locator'. Once the geophysicist had used his 'experienced eye' and decided on a site he would carry out a 'confirmatory' electrical resistivity depth sounding; a debatably cost effective procedure.

In terms of a cost benefit analysis where large yields are sought with attendant high-cost borehole design, a full geophysical investigation is well justified. Such an investigation is of doubtful value for small yields, although the real expense starts at level 4 and leaps up at level 5.

To complicate matters we have the frequent case, as emphasised by Arlosoroff et al (1987), of a drilled borehole sited purely based on a geophysical survey, irrespective of the community's wishes. Consequently, '...few people make use of the new facility,

regarding it as inconvenient'. The need to share information with the community (and listen to their opinion, including potentially useful information about local water and soil conditions) at all phases of the planning, siting and designing of the proposed water supply system is of paramount importance.

Finally, (Blankwaardt, 1984) presents an interesting finding in the Tanzanian environment; 'The best method for site investigation has proved to be the drilling by hand of small test boreholes followed by a simple pump test whenever a prospective aquifer is found'. There is no mention of how the aquifer is found but clearly it must be in a shallow water table area.

Key Points

- Finding groundwater is a mixture of experience and science,
- For the extremely low yields required by the handpump, 'the experienced eye' can often be enough; it is less expensive and frequently as effective as more sophisticated options,
- A recent publication by the UNDP/WB Water and Sanitation Program addresses itself to the role of hydrogeology and geophysics in locating small yields,
- The UNDP/WB study indicates that in Southern Africa the siting cost (including all 5 levels of investigation) is USD 150-180/borehole. Estimates in other literature are considerably higher.
- For the water supply manager the crux is whether the cost of a geophysical search can be justified by an anticipated increase in drilling success rates to offset the cost of failed boreholes. In each area time and experience will tell, but this is a "catch-22" situation requiring a decision to be made before knowing the answer.
- Completed boreholes, sited purely upon geophysical surveys without reference to the wishes of the community, are frequently ignored by them.

5.9 Drill type - which is best?

The answer is that there is no ideal all-purpose rig! The maxim 'horses for courses' applies to the choice of rig. Therefore, for the small yield borehole select the small drill rig.

Table 1 summarises several aspects of the different drill types. As noted, this table has not been updated and costs are currently greater than the table suggests, although the relative costs remain approximately the same.

Several factors are recognised by Talbot, 1992, as fundamental to the success of a drilling rig design. These include:

- Access to the drilling site and manoeuvrability over rough terrain - generally smaller rigs are more manoeuvrable,
- Reliability,
- Maintainability - with limited or virtually no access to a workshop, design must allow maximum field maintenance,
- Cost effectiveness-'the right drill for the job'.

5.9.1 Rotary versus percussion?

The choice is between differing models of each type; but at least there can be no argument about size, for handpump mounted boreholes drilling equipment must be small, mobile and compact.

Percussion rigs are simple, rugged (many in Africa are over 50 years old), easy to maintain and admirably suited to low cost drilling. Simplicity of design means easy servicing (most have the ubiquitous Lister engine) and relatively short training periods for crews because the equipment is so straightforward to operate. (Nevertheless only long experience makes a proficient driller). Recent design advances, in which UNICEF has played a significant role, have focused upon size. Compact cable rigs are now available with specifications that allow drilling to depths of 90m (150mm diameter) and 55m (400mm diameter). The drill is highly manoeuvrable, vital in countries with few roads and possibly a 5-month rainy season.

The Government of Mozambique purchased

10 of these rigs in 1993 (for the price of 2 large rotary rigs) and an analysis of their field performance will be found in one of the case studies from that country. The rigs proved cost effective and reliable, cost/m was 60% less than the normal drilling costs at the time. Drilling covered a wide spectrum of rock types, from unconsolidated to hard rock, but drilling rates were slow.

The rotary/pneumatic drill is a speedy alternative in all types of terrain with rates of 100m/day not uncommon. In hard, dense rock the DTH can achieve a similar figure. Here too, designers and manufacturers have recognised the need for compact, less complex units and several well known manufacturers produce high quality equipment that is manoeuvrable and mobile and which, while still expensive, costs less than the 'monsters' of a decade ago.

In Africa logistical support is extraordinarily expensive, making sophisticated machines inappropriate. Logistics are crucial with even the less sophisticated models tending to have long down times awaiting spares and/or servicing. The pneumatic rig requires a compressor, useful for development (and pump testing of the hole!) but difficult to maintain, with high capital costs. The attendant disadvantages of this type of technical complexity warrant serious consideration before purchase, although the days of fleets of large, sophisticated drilling rigs lying idle and broken down over much of Africa have largely disappeared.

Several African countries, notably the Sudan, Ethiopia, Zambia and Nigeria, have achieved substantial reductions in drilling costs with rotary rigs. Appropriately managed to ensure maximum utilisation, with technically competent and experienced crews and good logistics, the unit costs of rotary rigs compare favourably with percussion rigs. This is especially so if the operation is commercially run in a competitive environment as in Zambia in the past two years (see case history, 6.3).

At first sight the choice of a drilling rig for a new CWS project manager may appear confusing, although at least size is no longer a variable. If logistical support and technical competence is available there is little doubt that the small rotary/DTH is the most cost-effective rig. But the simplicity and

ruggedness of the cable tool, especially the newer and more compact models, make it still the best and most cost-effective alternative in developing Africa where there is little logistical support. As has been noted above, several countries have reduced

drilling costs with the use of hydraulic rotary and pneumatic rigs, but an objective analysis of the costing reveals that, while relative costs have fallen, absolute values are still high.

Some of the quoted figures for borehole construction in Africa are reported by Skinner and Franceys (1993):

Nigeria	USD	3,700- 28,000	
Sudan	USD	2,800	
Zimbabwe	USD	6,000	
Angola	USD	7,500	
Senegal	USD	18,000	
Namibia	USD	8,250	
South Africa	USD	6,000	
Togo	USD	9,700	
Zambia	USD	2,700	
Burkina Faso	USD	16,150	(including USD 4,400 administration costs!)
Mozambique	USD	4,000	

Unfortunately in most of these examples the cost/m cannot be easily estimated and hence there is no direct comparison and, further, it is not clear what is included in each costing. Nonetheless these statistics can be considered first order approximations and rough comparisons can be made.

The Mozambique figure is that given by the government drilling company (GEOMOC), which operates mostly large rotary rigs, and percussion rigs, as well as private contractors, mostly operating large rotary equipment. The figure does not actually correspond to GEOMOC costing and private enterprise costing researched by the author in January 1998. In addition the author found borehole costs in Zimbabwe (March 1998) unexpectedly low (to be discussed below).

Contrast these costs with the recent case study in Mozambique, where, utilising a newly purchased fleet of small percussion rigs, a figure of USD 1,330/ borehole or USD 37/m is quoted (although this figure does not include the cost of 11 unsuccessful holes).

The decision as to whether a country should standardise on a particular rig or purchase a mix of rigs has obvious long-term

implications, complicated by the multifactor issues involved.

Key Points

- The choice of drilling rig in the African setting is crucial in terms of subsequent project costs.
- There is a wide variety of types and models of rigs available - although there can no longer be any debate as to size - for low capacity boreholes compact rigs are the answer.
- The degree of sophistication is an important criterion; the choice lies between the modern, versatile fast rotary/pneumatic rigs which allow rapid drilling through the whole spectrum of rock types, and the simple but slow cable tool machine.
- If logistics are a problem, technical sophistication has no place in a drilling programme.
- A brief analysis of drilling costs reveals that costs for handpump mounted boreholes are falling in several African countries. Mozambique is one such success story, where the costs of drilling

utilising a fleet of small percussion rigs is seen to be lower than most of those reported from the rest of Africa. In Zambia small DTH rigs demonstrated low cost, rapid and cost effective drilling capability.

- While the type and size of drilling equipment is a vital factor affecting cost, (apart from the invariable of geology and topography), the importance of human resources cannot be overstated. Training and experience are prerequisites, along with commitment, and, as has been shown in the Sudan and Mozambique among other countries, the payment of production related bonuses could reap production benefits way beyond their cost.

5.10 Data Collection, Record Keeping and the Low Yield Water Source.

It is vital to keep accurate records on every borehole and well dug to ensure for some degree of subsequent monitoring. The degree to which this should be done, and at what stage it ceases to be cost effective, are moot points. Most Ministries of Water Development have a section charged with recording the details of the nation's groundwater in order to better understand the occurrence and disposition of the resource. Data collection from each borehole and record keeping of selected parameters allows the creation of a database for groundwater research and study in a particular region or country. From the theoretical hydrogeologist's viewpoint exhaustive data collection is obligatory. This may explain the routine (but flawed) procedure in Mozambique whereby an extended pump test is done in every low yield borehole (from which a meaningful analysis of aquifer parameters is seldom achieved). There has to be a compromise between the extent of data collection and record keeping and the time and effort expended for obtaining such information in limited depth low yield holes.

A comprehensive record of drilling progress and hole details is important. Most countries have a protocol in the form of a borehole completion record, in which drilling data is recorded, preferably by the drilling supervisor

or by the drill crew themselves. Details such as depth at which water is first struck, penetration rate of drilling, depth of borehole, yield at various depths, static water level etc., etc. are noted. This information would normally be entered into a database and thus be available for the Ministry, for the major aid agencies and University research departments. Equally important is the collection by the crew of drilling samples taken at pre-determined depth increments. As a rule, if the geology is new, sample every 1m, if not, every 5m is sufficient. The description of the samples is best done in the field, if possible by the supervisor/hydrogeologist. A geological depth profile is crucial to determine if screens are required, as proper placement of the screens requires analysis of the rock samples taken during drilling. There are also times when it is necessary to do a simple sieve analysis in the field to decide whether a gravelpack is needed. After analysis the samples should be bagged and kept by the Groundwater Section in the Ministry, where more detailed descriptions may be done in the future if required.

Data collection from low yield boreholes need not be exhaustive but it should be accurate, thorough and uniform. The same records **MUST** be collected for every hole drilled. There is seldom justification for logging the borehole with sophisticated geophysical equipment, as the cost does not justify the data captured from a limited depth borehole.

Two parameters should be monitored over time. Firstly the yield, although strictly speaking this does not need monitoring since it is being continuously 'self monitored' by the simple act of pumping. A progressive decrease in yield is soon evident. The second parameter that should be monitored is water level fluctuation, both seasonal and drawdown. Both are important, the former for regional groundwater studies, the latter for the localised setting. For example, if a handpump stops pumping water and the drawdown is known, it is simple to diagnose whether the fault is in the handpump or borehole.

Water level measurements are important for several reasons. Natural water level fluctuations are a response to either recharge or evapotranspiration or pumping.

Serial measurements over a number of years (statistics of natural events) are critical and can be obtained by the establishment of regional monitoring networks. Water level measurements are particularly important in large yielding boreholes but are also of value in low yielding holes. From such data it is possible to compute approximate figures for water in storage and aquifer yield, to establish whether an aquifer is being over-pumped or recharged, etc. In large yielding aquifers, measurements are taken on a weekly or monthly basis in what are known as 'open boreholes' that are used solely for measuring purposes.

5.11 Quality versus costs - low yield, hence low cost, is NOT low quality.

The assumption that low cost equals poor quality tends to colour perceptions with regard to the projected productive life of low cost boreholes. Low cost is in fact a relative term used to compare the cost of boreholes yielding several hundred m³/hr with those required to produce but a fraction of such a yield (in the order of less than 0.5% of that figure). Low cost must not be correlated with low quality but rather low yield. Low cost in this text is related to design features and not inferior materials. High quality, long lived but low cost boreholes are eminently possible. Casing and screens, the major hardware component of a borehole (which are large

cost elements but which are NOT moving parts), can be made of low cost PVC, as there is little wear and tear.

Correct methodology and procedures will ensure the construction of quality low cost boreholes. The borehole must be drilled straight. Screens and gravelpacks, if needed, should be accurately positioned. The apron must be properly designed and constructed to prevent pollution. 'Quality' here is a function of how carefully and diligently a drill crew works, which in turn is related to the thoroughness of training and the commitment and enthusiasm of the crew. A high level of quality can only be maintained with an adequate supervision of work and effective quality control.

Despite all that has been said, there will be those sceptics who will continue with steel casing, expensive screens, deep holes, extensive pump tests, mandatory geophysics, gravelpacks in hard rock holes, etc. etc., in the belief that this is at least tried and tested methodology. The shortage of both TIME (even The Decade did not catch up with population growth in providing rural water supplies) and FUNDS, however, suggests that, at the very least, project managers and decision-makers in water supply programmes should experiment with some of the ideas discussed, so that drilling rates may be increased and costs reduced. A trial sub-programme with close monitoring of the medium term (1 - 5 years?) performance could be considered.

6 CASE STUDIES FROM AFRICAN COUNTRIES

6.1 Case Studies from Mozambique

6.1.1 CASE STUDY 1 –

Government of Mozambique/UNICEF drilling programme

Objective of programme - To drill low yielding handpump mounted boreholes using new small percussion rigs.

Drill type: 10 small light and manoeuvrable percussion rigs were selected, the purchase being based on 4 factors,

i. Suitability and cost effectiveness.

Because the yield sought was only 1-2m³/hr and the depth would therefore be limited, many borehole design parameters could be relaxed and small, simple and relatively low cost drills could be used.

ii. Transport difficulties during the Mozambique civil war.

A small rig could easily be packed into an Antonov cargo aircraft, often the only means of travelling around the country during the war.

iii. Logistics.

The decision to select a Lister engine power plant for the Dando 3000 was based on the availability of spares.

iv. Ease of training.

The simplicity of the drill allowed for relatively easy training of newly recruited crews who readily accepted the concept that only low yielding boreholes were to be drilled. Older, more experienced crews tended to think in terms of larger yields.

Results and Analysis:

Total number of boreholes drilled (1994-5)	145
--	-----

Total metres drilled	5,152
----------------------	-------

Average depth in metres	35.5
-------------------------	------

Mean yield in m ³ /hr	3.7
----------------------------------	-----

Drilling rates:	Drilling rates in hard rock varied from 1-3m/d, while rates of 20-30m/d were achieved in fine to medium sands.
-----------------	--

The accompanying map and table (Figure 18) reveal that the 10 drills operated in 7 provinces over a wide geographical distribution, essentially in the unconsolidated sediments of the coastal belt, extending in some areas as far inland as 150km. In Tete and Manica Province drilling took place in Quaternary alluvial sediments and Cretaceous sandstone and conglomerates.

Two major aspects determined drilling rates:

a) Geology;

90% of all boreholes were drilled in the unconsolidated to semi-consolidated sediments for which the small percussion drill

is suitable. Nevertheless, several boreholes were drilled in hard, siliceous sandstone. The small percussion rig can drill in hard rock but progress is slow, primarily because the small mast height of 5.2 metres means that jars cannot be used to loosen a stuck drill bit, a not unusual occurrence in jointed fresh rock. Additionally, the lack of a spudding arm makes drilling in hard rock difficult and slow.

b) Competent field management;

Only one experienced hydrogeologist supervised the drilling operation of 10 rigs, (compare this with Lesotho where 1 hydrogeologist normally supervises 2 drills albeit that they are both rotary drills). To

optimise the operation of a drilling fleet is a skilful managerial and technical task; leap-frogging and operating in 'packs' of 3-4 rigs minimises costs and increases drilling rates.

Competent drill management and supervision is as critical to success as the correct choice of drill. Leap-frogging and operating in 'packs' of 2-4 rigs will minimize costs and increase drilling rates.

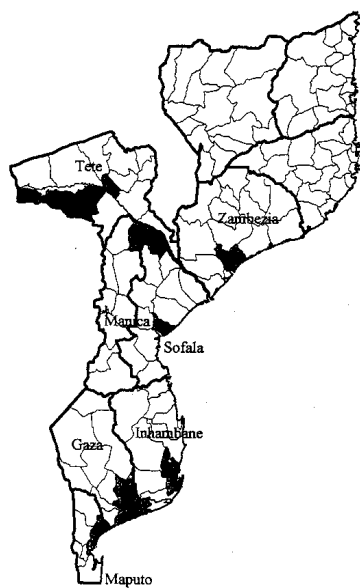

PROVINCE	Number of rigs	Date of commission	Number of drilled boreholes	Percentage of successful boreholes
Zambezia	1	12.10.94	8	100
Tete	1	26.07.94	10	100
Manica	1	01.03.94	6	50
Sofala	2	01.02.94	13	62
Inhambane	2	27.08.93	40	90
Gaza	2	04.05.93	49	94
Maputo	1	23.05.94	19	95
National	10		145	89

Figure 18. Geographical distribution of boreholes drilled by the small percussion rigs.

Costs

Detailed costs are summarised below:

COSTED ITEMS	AMOUNT USD
Crew (5-6 workers/drill)	100
Food for crew	30
Fuel, lubricants (rig compressor and vehicle)	85
Drill cable for 15 boreholes	33
PVC casing and screens	245
Depreciation of rig over 10 years	287
Depreciation of compressor over 10 years	100
Depreciation of vehicle, Toyota Land Cruiser, over 5 years.	154
Depreciation of water tank (10 years)	12
Depreciation on centrifugal pump (10 years)	4
Camping equipment (10 years)	10
Percentage on administration and a 'profit' for Govt. of Mozambique based on 25% of the cost of borehole.	265
TOTAL PER BOREHOLE	1,330

It must be stated that the rigs were purchased before some of the suggestions as to borehole construction discussed in this text were formulated. The rigs were equipped with small compressors, which meant that development pumping was done with air. The PVC screens and casing were imported and drilling cable and bailer valves needed to be imported more than once during a 2-year period. Costs of drilling cable are based on the assumption that cable will need to be renewed every 15 boreholes. With greater crew experience the useful cable life increases to 25 boreholes.

Drilling stopped once a yield of 1-3m³/hr was obtained, and after allowing several metres for a reserve water column. Pump tests were short, 2-4 hours. Development was by over-pumping until the water was clear and an

artificial gravelpack was installed in each borehole.

The cost per borehole of USD 37/m is based on 2 boreholes drilled per month to an average depth of 35m. This was 30% of the usual drilling costs in Mozambique in 1995. If a 50% production bonus were paid to the drilling crew, a production rate of 4 boreholes a month would be realistic which in turn reduces the cost per borehole by 22%. Moving costs for a small percussion drill were low, USD 2/km as opposed to the USD 11/km charged by the government drilling company for a large drill.

The Human Aspect

It takes many years of experience to become a proficient driller and the crews working with the Dando 3000s were all new to the drill. Despite initial enthusiasm, low pay and lack of incentive bonuses tended to sap commitment, as shown by an experimental attempt to increase output by paying a production bonus, which resulted in a rise in productivity of 100%!

Because of the high esteem in which drillers are held in most African village communities they should be widely used to train villagers in handpump maintenance, in promoting the VLOM concept and even in health/hygiene education. By so doing the drillers could augment their salaries (which in any case are unacceptably low) whilst providing valuable benefits to the communities.

Drilling Success Rate

Out of 145 holes, 10 were dry and 6 were saline. The success rate was 89%. The drills were scattered countrywide and the hydrogeology in many areas was simple. Nonetheless the high success rate is compelling evidence of what can be achieved by experience and minimal investigations without the use of geophysics. An experienced hydrogeologist sited 60 of the holes, the rest being sited by medium level technicians with minimal experience. Community siting preferences were considered (where the hydrogeology permitted) and local knowledge of the area drawn upon.

The mean yield of the boreholes was

3.7m³/hr with a range of 0-25. This is a relatively high yield and, with experience, the drilling crews will learn to stop drilling earlier, although with an average depth of only 30m a few metres more will make little cost difference.

Conclusions:

- Small, simple, relatively low cost, manoeuvrable percussion rigs proved successful in Mozambique in a variety of rock types, essentially soft or unconsolidated rock, semi-decomposed and hard,
- Costs were reasonably low, at USD 37/m per borehole, based on drilling 2 boreholes/month. This is 10% of the prevailing drilling rate in Africa (figure based on UNDP-WB Geophysics document) and 35% of prevailing costs in Mozambique,
- With a 50% production bonus the crew increased their production two-fold to an average 4 boreholes per month. This reduces the cost per borehole by 22%.
- Success was critically dependent on competent field management and supervision,
- Costs can be further reduced and drilling rates increased if the drills work in 'packs', leap-frogging each other and as crews gain more experience and as more of the guidelines suggested in this text are adopted by the decision makers in the country,
- The Government of Mozambique new drilling tender document reveals enlightened thinking that recognises the need to drill specifically for low yield boreholes.

6.1.2 CASE STUDY 2

State Drilling Company, Mozambique

GEOMOC is the state drilling company in Mozambique.

A typical costing schedule (1996) is given below:

Borehole drilled for handpump supplies in August 1996 in Tete Province.

COSTED ITEMS	AMOUNT USD
Drill mobilisation	380
Transport and packing equipment	268
Unpacking equipment and preparing drill site	251
Drilling 24m 15" diameter hole in hard rock	836
Drilling 16m, not so hard rock	512
Drilling 28m very hard rock	1,100
6m PVC screen	140
24m PVC casing	432
Gravelpack (13m)	156
Air lift development	280
Air lift pump test 10 hours	423
30% Regional coefficient	1,433
TOTAL	6,221
Cost/m	91

Static water level	22m
Dynamic water level	34m

Observations:

- Note depth of borehole (68m) and static water level. The borehole is too deep.
- Dynamic water level was measured with an airlift pump, the yield of which is not constant but which is well above 1-2m³/hr. The drawdown of 12m caused by airlift pumping is more than would occur with a handpump of lower yield.
- The regional coefficient covers

depreciation and administrative costs.

- The cost of mobilisation quoted is small. Private companies charge an initial mobilisation fee of USD 10,000
- Pump test of 10 hours is grossly wasteful, particularly with an inconstant yield, although development is taking place,
- Note the diameter of 15 inches, which is unnecessarily large.
- The drill was a Schram, DTH.
- Geophysical siting is not included.
- The community was not involved in design and siting.

The cost/m is average for the country at present (excluding the small Dando holes).

Commercial drilling costs surprisingly (see next case study) are only 10-15% lower, with better supervision and management being offset by very high mobilisation fees. Many of the drills have to be brought in from outside the country.

Geophysics in Mozambique is carried out by the Water Ministry. They cost USD 250-400/site. This generally will include some elements of level 1 and 2 investigation (as mentioned in the UNDP/World Bank study) and several electrical resistivity soundings and profiling traverses. Success rates are not convincingly demonstrated.

6.1.3 CASE STUDY 3

Commercial Drilling in Mozambique

Below are brief details of the costs of contracting a commercial company to manage a drilling programme:

The project was in Sofala Province in 1996 and had 2 sub contracts, 1 for the engineering consultants and 1 for the drilling contractors. It was a large, all encompassing project. The consultants worked throughout 1996 conducting geophysical investigations, inspecting the drilling work, installing handpumps, supervising training of community health and hygiene workers and pump maintenance mechanics.

A total of 54 holes were drilled by the commercial drilling company, of which 32

were successful (59% success rate). The contractor costs averaged USD 5,200 per attempt, or USD 7,926 per successful borehole. Average depth was 60m at USD 87/m. Drill type was a Schram DTH. Geophysical costs are not included.

The pump test and development were combined. A submersible pump was used in which the yield of the pump was greater than that of the borehole, so for an hour or so the borehole was over-pumped. The pump was then stopped and the water level recovered. The sequence was repeated several times, an excellent development procedure. Following development the pump yield was reduced so that the rate of drawdown could be measured over 1 hour. After 1 hour the pump was stopped and water recovery readings were taken.

Geophysical work was carried out on all boreholes drilled in 13 villages. This included investigations up to level three including 69 electrical resistivity depth soundings and 28 fixed depth profiles. The total cost for this work was USD 23,000. The cost/site was USD 500. The success rate was low, (59%) but the area is known to be difficult.

Community responsibilities included clearing access roads for the drilling rig, forming a maintenance group to receive training in handpump maintenance and repair and accepting responsibility for the full cost of purchasing spares and hiring a local mechanic to effect repairs.

Drilling was carried out in accordance with the new (1996) Government of Mozambique tender document. This document specifies several of the ideas discussed in this booklet; namely drilling to continue until a yield of 1-1.5m³/hr is obtained and then an extra 10m be drilled, PVC screen and casing to be used, only a rudimentary pump test to be carried out, and strict and thorough supervision of drilling and sample collection to take place.

Observations

Despite a new and sensible Government tender document, costs were relatively high. Drilling and transportation difficulties, the high drill mobilisation costs, the broad range of the project, which included long training times for the community on handpump maintenance, all contributed to outlay.

Overall costs, which included training of health education workers, community handpump maintenance training, geophysics etc., brought the cost per borehole to USD 10,500.

6.1.4 Lessons Learned from the 3 case histories in Mozambique

- a) Case history 1 reveals that a fleet of small percussion rigs performed exceptionally well at a cost of 35% of current drilling rates, although progress was slow.
- b) Case history 2 shows the high costs associated with the State Drilling Company, which has large drills and crews still imbued with the 'large yield syndrome'. Progress rates were little faster than using a small percussion fleet.
- c) A new government tender document that specifies low yield drilling for handpump mounted boreholes is an enlightened attempt to reduce drilling costs.
- d) Above all, the 3 case histories show that, while an improved mechanical approach to drilling can reduce costs dramatically, the non-technical, human aspect is crucial if costs are to be lowered. Competent supervision and management of individual drills as well as the drilling fleet itself together with forward planning of the drilling programme are essential. Training and more training is imperative.

6.2 Case histories from Zimbabwe

6.2.1 Manual drilling in Zimbabwe

One of the new types of hand drill, which has performed successfully in several African countries, the Wonder Rig, costing USD 600, was invented and produced in Zimbabwe. Ironically, it has found more favour and success outside Zimbabwe than within.

It was first manufactured in Zimbabwe in 1982 and the Government, particularly the Ministry of Health, bought several units. Several hundred holes were drilled in the early eighties in soft, decomposed granite with exceptionally shallow water levels, ideal conditions for the drill. Drilling was usually stopped 1m after striking water, average

depth of boreholes being 10-15 m, the maximum depth being 35 m. The holes were 100mm in diameter, 3 m of PVC screen was inserted and gravel packed. The screens and casing had bell and socket joints and the hole was mounted with either the Blair handpump or the Bush pump, both of which were developed and manufactured in Zimbabwe. Not surprisingly drill penetration rates were low although at such small depths this was of no great consequence. The cost of each borehole was USD 150.

As noted above, the manual drill technique became popular in Zimbabwe in the early eighties but it appears to have been introduced to the sector at the wrong time, a time, which saw several years of consecutive drought. Within a few years many of the shallow hand drilled boreholes had dried-up, and with that, the technique of hand drilling fell from favour. The practice at the time was to cease drilling 1m after striking water; which proved problematical in Zimbabwe where seasonal shallow water table fluctuations can be in the order of several metres. Many of the boreholes drilled were too shallow to cope with the extended drought. Deeper boreholes are less susceptible to drought since the deeper the water table/level the less dramatic the seasonal water level fluctuations.

By the mid-eighties hand drilling was replaced by the hand dug 'family well'. Hand dug wells by the thousands were constructed (simply and cheaply in the soft over-burden of the granitic areas on the high plateau of Zimbabwe). The family well was successful because the water level could be 'chased' down during drought years and the concept as practised in Zimbabwe is a fascinating development deserving of study by sector personnel. In his paper "The change of attitude of the Government of Zimbabwe to the 'family well'" (1990) Morgan illustrates clearly how political will is crucial to success.

While the hand drill has had a chequered history in Zimbabwe, in Tanzania and Malawi the low cost and simple, user-friendly technology, along with a normal rainfall sequence of years, was a singular success. It behoves the sector to look closely at manual drilling technologies in suitable situations i.e., shallow water table areas in decomposed to semi-decomposed rock.

6.2.2 The Government of Zimbabwe-Rural Water Development

a) Drilling operations

The Government of Zimbabwe (GOZ) operates approximately 100 drills (50-60 medium sized air drills and the rest percussion machines). The private drilling sector has about 100 drills, mostly percussion rigs.

Drilling operations are directed specifically for handpumps with a cut off yield of only 0.7m³/hr. Yet there is an obsession in Zimbabwe that government drills should not stop at too shallow a depth - the vulnerability to drought and the possible drying-up of the borehole is a source of some friction between the political functionaries and the water-drilling technologists. The perception amongst the water professionals is that political influence is far too wide-ranging and entrenched and that many boreholes are drilled deeper than necessary. In a sense this is understandable in areas that have experienced the 'drought stricken dry borehole', but slowly a compromise is being achieved whereby technical conviction can reverse political demands. In the Rural District Councils where previously political power frequently overruled technological know-how, many examples can be found where the static water level is 5-20m yet the borehole was drilled to 80m.

The GOZ specifies 2 borehole designs.

- Type A-hard rock formations where the regolith (upper 3-4 m) is screened off and the borehole is left open, the norm for hard rock areas (see though the Zambian experience).
- Type B-soft formations, where casing and screening is used, gravel packing is standard.

The cost of a GOZ type A borehole is USD 3,000-4,000, type B is usually drilled to 200mm costs USD 5,000. Steel casing and screening is preferred to PVC, despite a twofold increase in cost. Steel casing costs USD 20/m and screening USD 21/m. To reduce costs drillers make their own screens

from steel casing by flame cutting 2-3mm wide vertical slots. The resulting screens are primitive, with a low percentage opening (1-2%). In terms of hydraulic design they are futile. PVC casing and screens manufactured in Zimbabwe cost USD 7/m and USD 8/m respectively, a relatively low cost. The antipathy of the Zimbabwe drilling industry (surprisingly not only Government drillers but also the private drillers) towards PVC is difficult to rationalise.

The antipathy of the Zimbabwe drilling industry towards PVC is difficult to rationalize

Geophysics is routine, although mostly it comprises only a desk study, some aerial photo interpretation and examination of the records of previously drilled boreholes in the area, all appropriate and sensible minimal cost measures.

b). Countrywide groundwater data base-record keeping.

GOZ has recognised the advantages of meticulous and rigorous efforts to collect and collate data from all boreholes drilled in the country. By law every borehole drilled must have a borehole completion form in which data such as location, rock type, depth, yield, water first struck, static water level etc. are recorded and the form is sent to the Ministry of Water Development, Groundwater Section; giving the government a record of every borehole drilled in the country. The data from the completion form is transferred into the standard groundwater data base programme providing invaluable information about the occurrence and disposition of groundwater in all areas of Zimbabwe. This is a powerful tool for planning future groundwater development in specific areas. It also plays an important role in the ever-present 'battle' in Zimbabwe between political influences and technological wisdom based on rigorous long-term data.

The groundwater data base built up over two decades in Zimbabwe is crucial to a better understanding of the occurrence and disposition of underground water in all areas of Zimbabwe.

c) Private sector drilling operations.

The private drilling industry in Zimbabwe is vigorous, innovative and successful, illustrating perhaps more clearly than anywhere else in Africa, the benefits of competition.

In Zimbabwe, perhaps more than anywhere else in Africa, the benefits of a competitive environment are most clearly illustrated.

Typical costing from a private driller in Zimbabwe is as follows (March 1998):

Drilling (0-100m)	USD 13/m
Casing, steel	USD 20/m
Screen (steel with flame slots)	USD 24/m
Mobilisation	USD 60
Pump test (cable tool)	USD 65

Thus, for a 50m hole, in hard rock (open hole with overburden casing) the cost is approximately USD 800-900. The current practice, as with Government drills, is that all holes are now commenced at 200mm through the regolith reducing to 150mm after a few metres.

Geophysics is not routine, the 'experienced eye' often does the job, although in areas where the rainfall is less than 600mm/annum some drilling contractors consider scientific siting essential. They use electrical-electromagnetic-geomagnetic-techniques. The siting is not systematic; readings are taken on sites that 'look promising' for the contractor. Such soundings are looked upon as 'essentially confirmatory in nature' - an eminently debatable point!

During drought years in Zimbabwe, the competition becomes even more acute with an influx of South African drilling teams - an influx understandably resented by the local industry.

The private drilling companies the author interviewed confirmed the strong political involvement in technical aspects of drilling for water. More experience with optimal depth of

drilling in drought prone areas and careful measurements of regional water levels will, hopefully in the not too distant future, weaken the hold of the political catchphrase - 'drill as deep as possible...!'

In post independence Zimbabwe there is considerable sophistication, knowledge and much data available to the drilling industry; good use has been made of the available resources thus far - but there is still much to learn. Borehole prices are relatively low, but optimal drilling depths, diameters, design, failure rates, optimal rigs, etc., require further study and experimentation.

6.3 Case histories from Zambia

The Zambia case history can be divided into three elements, before 1992, the drought years of 1992-5 and post 1995. Of the 24,020 water points in the rural areas only 3,174 (data as at April 1998) are machine-drilled, 320 are jetted wells, 169 hand augured tube wells and the rest are dug wells.

6.3.1 Machine drilled holes before 1992 and 1992 to 95

Before 1992, drilling was mostly done by the Ministry of Water and Energy, through their Department of Water Affairs (DWA) in 8 provinces using a range of drilling rigs, mostly down the hole combination rigs and a few percussion rigs. The weak private sector was primarily engaged in drilling for commercial farmers.

The cost per borehole was in the order of USD 5-6,000. The annual rate of drilling was 200-300 holes with an average of around 10 per district. The drilling depth was frequently a standard depth; 60m regardless of water level or yield (see figure 19 that shows borehole depths and casing/screens depths). Also, as figure 19 reveals, the lengths of screens were extraordinarily large.

The casing was steel 150mm as was the screen, which was cut with large flame slots or hacksaw. The cost of casing was USD 40/m and the screen USD 50 /m. Borehole diameter was 175 mm but 228 mm was also drilled. A gravelpack was used at times but, clearly, with 150mm casing in 175 mm diameter hole its efficacy was minimal.

Geophysics carried out on an ad-hoc basis, principally electrical resistivity, cost USD 300/site. DWA staff was mostly responsible for surveying. In hard rock areas the policy was to leave the hole uncased except for the upper few metres.

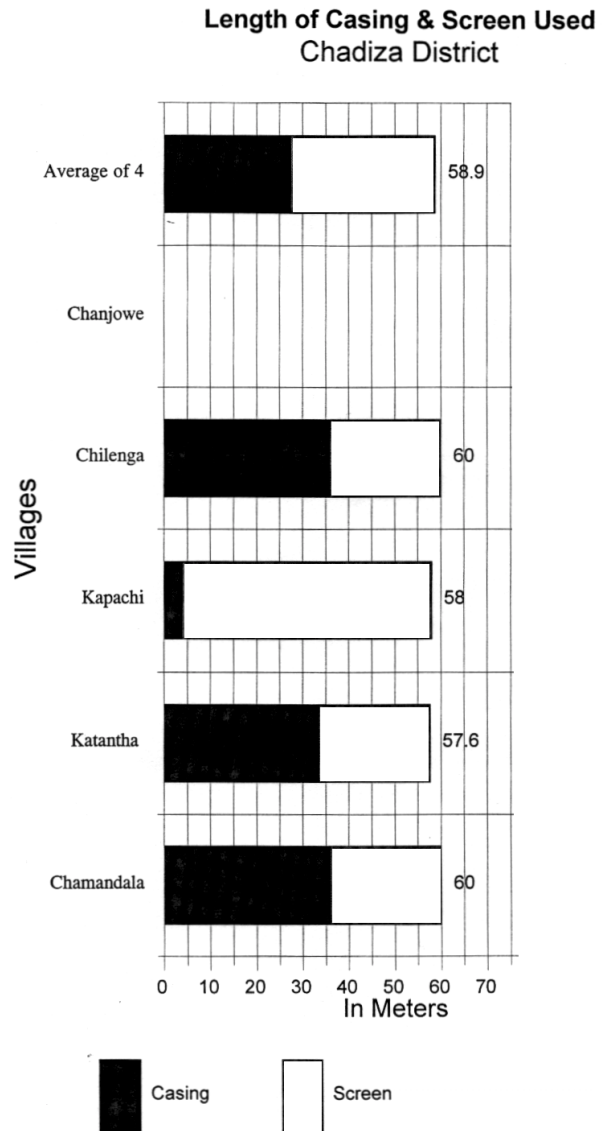

Figure 19. Borehole depths and casing/screens used.

In summary therefore drilling in Zambia was expensive prior to 1992. There was no standard design, the drilling fleet was costly to operate and many rigs were often not operational. Waiting for spare parts and repairs were the norm (an average of 15-20 borehole/year with the large drills was normal, with weak monitoring and supervision). There was no borehole inventory and thus no groundwater data bank, no guidelines, no central policy, nor basic sector principles. The 'standard' depth of drilling was 60m irrespective of water first

struck and the yield.

This situation was compounded by the drought of 1992-1995 when an expanded drilling programme was initiated with minimal guidelines and the same generalised specifications as described above. Borehole statistics during the emergency drought period were poorly recorded. During the drought period the limited Government drilling capacity was recognised and large drilling contracts were awarded to the private drilling industry. Many of these private drilling companies were South African, operating with local partners. During the 3 years of drought, the target was 2,000 boreholes. The DWA lacked the capacity to manage this accelerated borehole drilling programme. Again, supervision was weak and with some of the work reported complete had in fact not been done.

In 1995 a systematic and rational low cost drilling approach in which UNICEF played an important role was introduced. The crucial importance of a rigorous borehole inventory throughout the country was early recognised and there is now (April 1998) a complete data bank of all water points and considerable knowledge of the occurrence and disposition of groundwater in Zambia has been accumulated.

6.3.2 The UNICEF Water and Sanitation and Health Education (WASHE) programme

Using available countrywide data and the lessons from the past, appropriate technology was promoted. With well digging remaining by far the major rural water supply source over much of Zambia.

The drilling programme incorporates the following guidelines:

- Drilling to halt when a yield of only 0.7m³/hr is reached, a further 5 m then being drilled to allow for water level fluctuations,
- Casing and screens to be PVC class 10, with 110mm nominal diameter,
- Screen slot sizes of 0.5 mm and screen lengths installed to be left to the discretion of the drillers.
- All boreholes drilled in hard rock to be screened and cased,

- All drilling for handpumps to be carried out by commercial drillers operating the new small and manoeuvrable DTH rigs. Government drills are being phased out to form private semi-autonomous bodies.
- Each drill to have a compressor for efficient development, by airlift pumping for three hours.
- No formal pump test.

Siting the borehole involves close co-operation between the village and the drilling contractor. The village designates 3 sites based on social factors, which are then assessed for suitability by the drilling contractor. Should he reject all 3 on technical grounds he has then to select an alternative site as close as possible to the village using either geophysics or the 'experienced eye', the choice is left to him.

Electrical resistivity soundings are used in most cases. In Southern Province the failure rate is very high, especially in 2 districts where the failure rate is in excess of 50%. In 1997, assisted by UNICEF, 330 boreholes were drilled country wide, of which 70% were sited using electrical resistivity soundings.

Some interesting data is available on the frequency of the use of geophysics and divining shown in the table below. Regrettably the relative success of each technique is not available. Geophysics means in most cases several ad hoc electrical resistivity depth soundings at a 'likely' location, which this author interprets as: the prime location is sited by 'the experienced eye' and 'confirmed' by geophysics!

Table 6.

Relative use of geophysics and water divining for site location.

Driller	Water points Nos.	Number of sites selected using:	
		Geophysics	Divining
Coratom	80	0	80
Foradex	20	0	20
Zarus	70	70	0
Aquanova	145	145	0
Desons	15	15	0
Total	330	230	100

(70%) (30%)

(Data: From UNICEF assisted programme in 10 districts in Southern and Eastern Provinces).

It is interesting to note that 30% of all the sites were divined by traditional methods, now commonly used by drillers in Zambia. The success rate for either technique is not known. Although, in hard rock areas where the decomposed mantle is thin, geophysics is generally considered important.

Drilling quality is internally controlled by interaction between the client (e.g. aid agency), the community and the contractor. Frequent meetings are necessary and the importance of careful and thorough work is stressed. The community, too, has a 'supervisory' role, whereby they keep an eye on depth of drilling, type of casing inserted and so on in a long-term participatory process that they themselves evaluate.

The Results: The results of the low cost drilling endeavour appear promising; the data from the recently drilled 330 boreholes indicate:

- a) Average depth of drilling has decreased from 60m to 44 m, and average casing used is 33 m and 25 m of screen.
- b) Mean yield is 1m³/hr,
- c) the number of boreholes now being drilled has increased dramatically to 400/year, 330 in 1997 by UNICEF alone.
- d) The drilling tender document which evolved as a result of the UNICEF WASHE program is now the standard document for drilling handpump

mounted boreholes.

- e) the philosophy of drilling specifically for low yielding boreholes rather than a potential future upgraded level of service is accepted in Zambia. The fact that, globally, only about 0.1% of handpump mounted boreholes are eventually converted to motorised higher yield pumping holes underlines the appropriateness of this precept.
- f) Geophysics success rates are poor. Traditional divining (which probably has a high component of the 'experienced eye and throw the hat' has proved successful.
- g) Most important of all; the cost per borehole has decreased by almost a factor 2, from USD 5,000 in 1994 to USD 2,800 in December 1997. (See figure 20). These figures apply to the GOZ/UNICEF assisted programme.

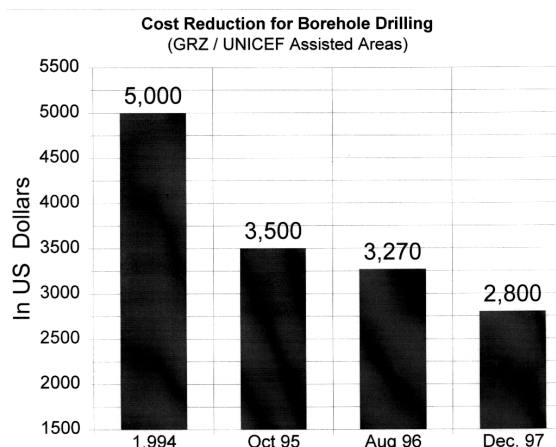

Figure 20. Cost reduction of borehole drilling in

Zambia.

6.4 Lesotho Case History

Lesotho case history-a dramatic ‘turn-about’ strategy

Lesotho holds a special place in the annals of rural water supply and sanitation. It was there that the first interdisciplinary team approach to rural water supply was undertaken with the evaluation ‘Water, Health and Development’ published by Feacham et al (1978). Considerable changes have taken place and lessons clearly learned since the pioneering work of the Feachem team in 1978.

In April 1998 the author found a distinct but understandable antipathy towards handpumps by the Government of Lesotho (GOL). An analysis of a 1996 Handpump Trial Project revealed: at any one time 60 - 70% of the handpumps in Lesotho were not working. The capital costs of the (Mono) handpumps were considerable and their repair costs were very high. Current thinking of the Department of Rural Water Supply leans towards submersible and diesel pumps, both incompatible with VLOM philosophy. The reason for such high handpump failure rates, according to GOL, is that general water levels are too deep in Lesotho for present handpump technology. Figure 21 reveals that 70% of all boreholes had water levels of 60-70 metres; the greatest number of repairs occur at that or greater depth.

The effect on borehole drilling routines of a move towards ‘high yield’ pumping systems is that yields now need to be in the region of 4-5m³/hr, rather than 1m³/hr. Clearly therefore, drilling depths must generally be greater in order to locate the higher yields required for motorised pumping. Sensibly, GOL has built into the pumping scheme costs a drilling success rate of only 40%.

Lesotho has turned its back on the handpump and the VLOM approach-higher yield boreholes and hence higher service level technology is the new strategy.

Current (1998) costs of drilling a typical borehole for handpump supplies (1m³/hr) are contrasted with the cost of a ‘high capacity’ borehole drilled to produce a minimum of 3m³/h, considered the lower limit for a motorised pump. These costs are shown in the table below.

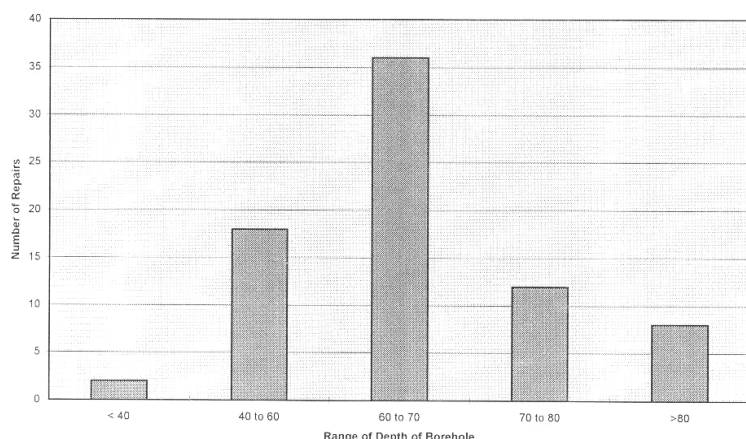

Figure 21. Depth of borehole versus number of repairs in Lesotho.

Table 7.

APPROXIMATE COST ESTIMATES FOR VARIOUS PUMPING SYSTEMS

Handpump	Quantity	Unit	Unit Price USD	Amount USD
Drilling (average depth 60m)	60	metres	23.00	1,380.00
Additional cost of failure (success rate 60%)				552.00
Casing 150mm ID/SABS, supplied & installed	20	metres	23.00	460.00
Cleaning, development	1	per BH	580.00	580.00
Base plates and cover plates	1	each	114.00	114.00
Pump testing (6 hours)	6	Hours	27.00	162.00
contingencies @ 15%				425.50
Total for Drilling only				3,260.00
Handpump (average cost)				
Head	1	each	250.00	250.00
Cylinder	1	each	360.00	360.00
Connecting rods including sockets, stabilisers, bobbin rubbers, coupling etc	15	each	33.00	495.00
Installation costs	1	each	150.00	150.00
Contingencies @ 10%				125.00
Total for handpump only				1,380.00
TOTAL FOR DRILLING AND INSTALLATION OF HANDPUMP				4,640.00

Table 8:

High Capacity Borehole (<3m³/hr)	Quantity	Unit	Unit Price USD	Amount USD
Drilling (average depth 70m)	70	metres	23.00	1,610.00
Additional cost of failure (success rate 40%)				966.00
Casing 150mm ID/SABS 62, supplied installed	70	metres	23.00	1,610.00
Cleaning & development	1	per BH	580.00	580.00
Base plates and cover plates	1	each	114.00	114.00
Pump testing (48 hours)	48	Hours	33.00	1,584.00
contingencies @ 15%				1,020.00
TOTAL COST FOR DRILLING ACTIVITIES				7,484.00

The geology of Lesotho is essentially hard rock and therefore the cost per borehole is not unreasonable in the context of Africa (for the handpump borehole approx. USD 3,000, April 1998). The most significant saving to be sought is in lowering the failure rate of drilling. But significant savings could be considered for the 1m³/hr borehole - if hard rock, reduce diameter; the pump test of 6 hours is too long, and development and cleaning costs appear very high. A possible cost reduction of 50% is not unreasonable. For the high capacity holes the extensive pump test and development costs are justified.

The statistical data on borehole success rates was essentially anecdotal and the author saw no actual data during his visit. The main question is to reduce the drilling failure rate. Thus far it has not been possible to demonstrate in Lesotho the superiority of any one of the location techniques (geophysics, traditional divining or 'the

experienced eye') over another. Methodical data collection of success related to location technique over a period of years could provide a comparison.

Relatively deep water levels and handpump unreliability at such depths are the factors behind the Lesotho Government's change of strategy.

The dramatic new approach taken by the Government of Lesotho in the rural water sector will provide an important observation opportunity for the sector in other countries. Rigorous records should be kept of costs in all aspects of the programme, rates of progress, consistency and reliability of water supply etc. If there are lessons to be learned from the non-handpump, high yield approach the sector will have ample data that can be used in other areas where water levels are too deep for today's handpumps.

7 DRILLING FOR RURAL WATER SUPPLIES IN INDIA

Are there lessons for Africa in the Indian experience?

Drilling costs in India are much lower than in Africa. In this text the UNDP/ World Bank study is taken as the definitive costing for African boreholes. The large regional differences in costs are averaged out and an approximate figure for drilling in Africa is accepted as USD 100/m. An approximate figure for India ranges between USD 4-6/m (although according to UNICEF there are examples in India where drillers are drilling for USD 3/m). These figures apply to hard rock holes, which are left open (no casing or screens except a few metres of casing holding the overburden). So, using the figures above we have a factor 20 differential in costs. There are, however, pitfalls in approximating drilling costs and making comparisons based on such figures. Clearly such an attempt cannot be more than a rough comparison given the differences in geology and hence rock hardness, depth, diameter, use of casing, etc., but nevertheless the significant cost differential between holes drilled in Africa and those in India requires analysis and discussion.

Some of the factors that help to explain the drilling cost differential are as follows:

1. India has a well established, competitiveness private drilling industry and most importantly, economies of scale. There are several million boreholes in India and such large numbers foster lower costs. Productivity is high, for example, a drill rig with an output of 150 boreholes of 60m mean borehole depth per annum drilled over a period of 10 years (many of the rigs in India are still drilling efficiently after 15 years) 90,000 metres. The amortised capital investment costs are very low per metre.

To further emphasise the competitive nature of drilling in India; in the summer it is not unusual for drilling to take place overnight so that in a 24 hour period 2-3 boreholes can be drilled with a DTH rig.

In addition, a rather surprising aspect of the low drilling costs in India is that, in

general terms, the rocks in India, mostly basalt, are harder than those in Africa, which are mostly granite/gneiss.

2. Drilling contractors in a sovereign region as large as India are not constrained by borders and customs regulations. To illustrate the difficulties involved with cross border and customs regulations consider here the attempt by Mozambique (1994) to establish an experimental regional co-operation structure in order to reduce handpump manufacturing costs. Focusing on the strengths of each country (a steel factory in Mozambique, rubber in Malawi, PVC in Zimbabwe) to the mutual advantage of the countries involved should have been economically advantageous for regional handpump manufacturing. Unfortunately such was not the case. Political jealousies and customs bureaucracy torpedoed the attempt and handpump costs continue to be relatively high. This same lack of mutual co-operation affects drilling costs in Africa. In India drillers can traverse the length and breadth of the country 'without let or hindrance'. Conversely, in Africa the large number of borders within the continent means that commercial drillers willing to drill in other African countries have to pay large sums in taxes and customs guarantees, thus limiting competition.
3. The long established road and rail infrastructure in heavily populated India is superior to that in Africa. Where still large areas are sparsely populated.
4. The industrial infrastructure in India is MUCH larger and better developed than that in Africa. India has the capacity to manufacture drilling rigs and this capability has allowed the Government, working together with UNICEF, to evolve over the past several decades the 'ideal' drill design. Because large numbers are produced costs are relatively low. In Africa all drills are imported with concomitant high capital costs, with the exception of South Africa where a

fledging drill manufacturing industry does exist.

The immense scale of the rural water supply programme in India has forged a close relationship between the Indian government and UNICEF during the past 3 decades. They were jointly responsible for the considerable experimentation and innovation with types and sizes of drilling rigs, which has led to the development of the near ideal rig for India. This evolution of the 'ideal' drill in India means that since the mid-eighties there has been a balance reached between drill capital and running cost and performance; the drill rigs are neither too fragile nor of excessively large capacity.

The impact on costs of the important aspect of drill reliability deserves discussion. Because, in general, the drill rigs in India have now the ideal specifications, new rigs enjoy high reliability. But even with very old and less reliable drill rigs, low cost drilling in India is still possible. A contractor in Karnataka is presently drilling with old equipment for USD 3/metre. Whilst reliability is low, such is the infrastructure in India that the contractor can get the required spares in the local market and with frequent rapid repairs can still make a profit, albeit a slim one!

5. Paragraphs 3 and 4 indicate that logistical support in India is much further advanced than in Africa.
6. As a result, sophisticated rigs (rotary/DHT) can operate cost effectively and are routinely used, resulting in rapid drilling rates (especially in hard rock), which in turn translate into lower drilling costs.
7. Casing and screens are imported in Africa (often from Europe) and are therefore expensive. Local manufacture in India plus large volume local production of casing and screens (even though most boreholes are only minimally

lined) enables dramatic cost reductions to be made. Although some countries in Africa have local manufacturing capacity (viz. South Africa and Zimbabwe), even so prices are higher than in India. In future, however, the relatively large industrial and manufacturing capacity of South Africa, if utilised by other African countries, may lower prices.

8. Unlike Africa, India has numerous practical, hands on, training institutions - an invaluable asset.

So, what are the lessons for Africa from the brief Africa/India comparison above? Clearly the economy of scale factor in India is unlikely to be duplicated in Africa. The issue of competition is, however, something already being swiftly assimilated in Africa. Additionally in Africa there is a general move to scale down the size of drilling rigs and, in the case of South Africa, there is even an attempt to manufacture drills in-country.

Customs and cross-border bureaucracy will hopefully improve in an era of greater regional co-operation. Better transport infrastructure is not only dependent upon a greater allocation of resources but also on co-operation between countries. Standardisation of rail gauges would facilitate transport from country to country and take pressure off roads, but peace and stability in the region are paramount if these improvements are to take place. Training is an area where Africa can learn a lot from India and more hands-on training facilities for drillers are an urgent requirement. It is critical, too, that such institutions fully recognise the importance of cost reduction and increased drilling rates and that some of the other elements discussed in this text form part of the training courses. The formal drilling curricula seen by the author in an Australian drilling school focus on large yield holes only and are patently unsuitable for the ubiquitous low yield handpump mounted borehole found in Africa.

Appendix 1 Glossary/terminology

Terminology is not standardised globally, and some confusion exists as a result of differing nomenclature in British and American texts.

The terminology used in this text is defined below:

Borehole - small diameter hole (usually 150mm but can be up to 1.2 metre) machine drilled (machine can be motorised or operated manually) drilled for the principal purpose of obtaining a water supply. Synonyms are, tubewell (US terminology), water well, production well or even just well.

Hand-dug well - A large diameter (usually 1m but there are examples of 6m), shallow water table, well constructed by digging manually. Synonyms are: open well, dug well, shallow well.

An **aquifer** is a water-bearing geological formation capable of yielding groundwater in significant amounts.

Alluvium - Sediments deposited by flowing rivers.

Gravel packing - placing graded gravel on outside of borehole screen to allow water to enter and prevent 'fines' from entering the borehole.

Permeability - the capacity of a porous medium to transmit water.

Geophysics - the location of underground water by the use of indirect surface electrical and seismic techniques and the measurement of magnetic variation over the surface.

Static water level - is the level at which water stands in a borehole or unconfined aquifer when no water is being pumped.

Dynamic water level - is the level at which water stands in a borehole when pumping is in progress.

Hydrogeology - the study of the interrelationship of geologic materials and processes with water, especially groundwater.

Porosity, primary - the porosity that represents the original pore openings when the rock or sediment formed.

Porosity, secondary - the porosity that has been caused by fractures or weathering in a rock or sediment after it has been formed.

Well development - the process whereby a well is pumped or surged to remove any fine material that may be blocking the well screen or the aquifer outside the well screen.

REFERENCES

Arlosoroff S., Tschannerl G., Grey D., Journey W., Karp A., Langenegger O., and Roche R., (1987), Community Water Supply - The Handpump Option, The World Bank, Washington, D.C., USA

Considered the 'bible' of the sector, bristles with original ideas, well illustrated and succinctly written.

Beale, G., Water Management Consultants (1990), Development of the Drilling Industry in Nigeria - An Overview, (unpublished), quoted by de Rooy (1992)

Blankwaardt, Bob (1984), Hand Drilled Wells - A Manual on Siting, Design, Construction and Maintenance, Rwegarulila Water Resources Institute, Dar es Salaam, Tanzania (contact TOOL Foundation, Amsterdam)

A detailed hands-on text on this topic, full of outstanding diagrams and photographs.

Chauvin J., Plopper S. and Malina A., (1992), Final Evaluation of the Benin Rural Water Supply and Sanitation Project, WASH Field Report No. 349, Water and Sanitation for Health Project (WASH), USAID, Washington, D.C., USA.

Chilton P.J. and Smith-Carrington A.K. (1984) Characteristics of the Weathered Basement Aquifer in Malawi in Relation to Rural Water Supply. In Challenges in African Hydrology and Water Resources, Ed. Walling D.E et al. IAHS Publ. 144. U.K. An admirable discussion on low cost boreholes in Malawi.

Clark L. (1988) The Field Guide to Water Wells and Boreholes. Open University Press. UK. A concise, excellent text, some technical knowledge assumed.

DHV (1985), Low Cost Water Supply - For Human consumption, cattle watering, small scale irrigation, Part 1: Survey and Construction of Wells, DHV Consulting Engineers, Amersfoort, The Netherlands.

Feachem, Richard, et al. (1978). Water, Health and Development. Tri-Med Books Ltd. London. The first interdisciplinary evaluation in the sector; historically important.

Foster S.S.D (1984). African Groundwater Development-The Challenges for Hydrogeological Science. In Challenges in African Hydrology and Water Resources, Ed. Walling D.E et al. IAHS Publ. 144. U.K.

Franceys R.W.A. (1987), Handpumps - Technical brief No. 13, Waterlines, Vol. 6, No. 1 Intermediate Technology Publications, London, UK., pages 15 - 18, (also in ITP (1991).

Lefort L, and Marchal J (?), Les Forages a Faibles Coûts.- Research Technology Group, Paris. The non-French speaker will not be disadvantaged because the text is in French because the diagrams are so outstanding, numerous and easily understood that the text is of secondary import.

Laver, Sue, (1987), Well Sinking - a step by step guide to the construction of wells using the blasting method, UNICEF, Harare, Zimbabwe. The illustrations are remarkably easy to understand.

Lewis, Clark, (1988), The Field Guide to Water Wells and Boreholes. Open University Press, UK. A comprehensive but succinct text addressed to practicing geologists and engineers responsible for designing and implementing drilling projects.

Meinzer, Oscar, (1946) Hydrology. U.S. Geological Survey, USA.

An early classic-good on the history of hydrology and water supplies.

Morgan, Peter, (1989), Upgraded Well Manual for Field Workers, Blair Research Laboratory and Ministry of Health, Zimbabwe.

Morgan, Peter, (1990), Rural Water Supplies and Sanitation, Macmillan, London, UK. A classic, by one of the pre-eminent workers in the sector.

Rowles, Raymond (1990), *Drilling for Water*. Cranfield Press. U.K.

A well illustrated and clearly written practical drilling manual.

Skinner, Brian and Franceys, Richard. (second draft 1993). *Cost Effective Technologies for Water Supply in Guinea Worm Endemic Areas*. Loughborough University of Technology. A Report for UNICEF New York.

An interesting, well written and illustrated text covering the whole gamut of water supply technologies.

Todd, David, (1989), *Groundwater Hydrology*. John Wiley and Sons. NY.

Probably the best short text on the topic for the qualified engineer/geologist.

Valentine, H.R. (1967), *Water in the Service of Man*. Penguin Books, London.

Whilst the section on underground water is brief this delightful , illuminating and thoughtful book deserves to be read by all in the Sector.

van Dongen P. and Woodhouse M. (1994) *Finding Groundwater A project Manager's Guide to Techniques and How to Use Them*. (1994) UNDP-World Bank Water and Sanitation Program. Washington D.C. Recommended reading for project supervisors and the non-technical layman. Best brief discussion of methodology this author has seen. Chapter on results disappointing; tables and graphs difficult to understand.

Watt, S.B. and Wood, W.E. (1976), *Hand Dug Wells and their Construction*, Intermediate Technology Publications, London, U.K. One of the definitive texts on the topic.

Wright E.P. and Burgess W.G (1992), *The Hydrogeology of Crystalline Basement Aquifers in Africa*. The Geological Society, London. The most up to date research on the topic-more for the professional geologist/geophysicist.

Wright E.P. and Herbert R., (1985), *Collector Wells in Basement Aquifers, Waterlines*, Vol. 4, No. 2, Intermediate Technology Publications, London, U.K., pages 8 - 11. Interesting research and practical methodology on augmenting the yield of dug wells.

Wurzel P. and de Rooy C., (1994), *The Handpump versus Borehole, Addressing a Mismatch*. Waterfront Issue 4, UNICEF, New York.

Wurzel P. (1994), *Water Level Measurements in Boreholes-a Gap in Our Knowledge*. Waterfront Issue 5, UNICEF New York.