

























































➔  **Water Manual for Refugee Situations (UNHCR, 1992, 160 p.)**



-  **(introduction...)**
-  **Foreword**
-  **Drinking water**
-  **1. Introduction**
- 2. Assessment and organization**
 -  **(introduction...)**
 -  **General**
 -  **Assessment**
 -  **Personnel and materials**
- 3. The need**
 -  **(introduction...)**
 -  **Water demand/quantity**
 -  **Quality**
- 4. Immediate response during emergencies**
 -  **(introduction...)**
 -  **General**
- 5. Refugee water supply systems**
 -  **(introduction...)**
 -  **General**
- 6. Water sources, their protection and development**
 -  **(introduction...)**

























-  **General**
-  **Surface water**
-  **Rainwater**
-  **Groundwater**
-  **Springs**
- Dug wells, boreholes, infiltration galleries**
 -  **General**
 -  **Dug wells**
 -  **Driven wells**
 -  **Jetted wells**
 - Boreholes**
 -  **Drilling techniques**
 -  **Well design and completion - Technical specifications**
 -  **Borehole and aquifer yield assessment - Test pumping**
 -  **Borehole maintenance**
 -  **Technical specifications and contractual documents for borehole drilling contracts**
 -  **Infiltration galleries**
 -  **Municipal or private systems as source of water supply**
- 7. Pumping equipment**
 -  **(introduction...)**
 -  **General**
 -  **Description of pumping equipment**
 - Pumping power sources**
 -  **(introduction...)**























-  **Animal traction**
-  **Other non-conventional sources of power**
-  **Internal combustion engines**
-  **Electric motors**
-  **Handpumps**
-  **Basic pump choice calculations**
 -  **(introduction...)**
 -  **Total manometric head**
 -  **Net positive suction head**
 -  **Characteristic curves**

-  **8. Water treatment**
 -  **(introduction...)**
 -  **General**
 -  **Water quality and treatment requirements**
 -  **Pre-treatment**
 -  **Coagulation, mixing and flocculation**
 -  **Sedimentation**
 -  **Filtration**

 -  **Disinfection**
 -  **Other water treatment processes**
 -  **Disposal of treatment plant waste**

-  **9. Water storage**
 -  **(introduction...)**
 -  **General**

-  **Open air storage**
-  **Centralized water storage**
-  **Storage capacity needs**
-  **Water storage at distribution points**
-  **Water storage at household level**
-  **10. Water distribution systems**
 -  *(introduction...)*
 -  **General**
 -  **Types of pipeline systems**
 -  **Valves and taps**
 -  **Other system components**
 -  **Considerations for pipeline designs**
 -  **Pipeline construction**
-  **11. Operation and maintenance of water supply systems**
 -  *(introduction...)*
 -  **General**
 -  **Training needs**
 -  **Operation and maintenance plan**
 -  **Water inventory data**
 -  **Preventive maintenance**
 -  **Refugee participation**
 -  *(introduction...)*
 -  **"Village level operation and maintenance"**
 -  **Standard designs and equipment**

-  **Logistics support**
-  **Maintenance of sources and catchments**
-  **Maintenance of water treatment facilities**
-  **Maintenance of reservoirs**
-  **Maintenance of standposts and other watering points**
-  **Maintenance of pumping facilities**
-  **12. Management of emergency water supply systems**
 -  ***(introduction...)***
 -  **Needs assessment**
 -  **Conceptual design**
 -  **Immediate response**
 -  **Plan of action**
 -  **Emergency project submission**
 -  **Project preparation**
 -  **Tender documents**
 -  **Project implementation**
 -  **From emergency to general programmes in the water sector**
 -  **Budgets**
-  **Annex A - Refugee water supply inventory forms**
-  **Annex B - Approximate daily water requirements in refugee emergency situations**
-  **Annex C - Guidelines on water quality**
-  **Annex D - Recommended format for technical specifications for water well construction**



[Home](#) > [ar.cn.de.en.es.fr.id.it.ph.po.ru.sw](#)

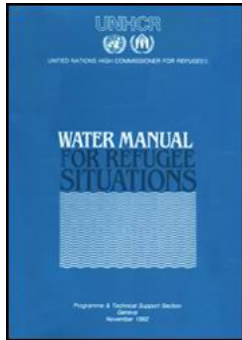

Water Manual for Refugee Situations (UNHCR, 1992, 160 p.)

(introduction...)

Foreword

Drinking water

1. Introduction

2. Assessment and organization

3. The need

4. Immediate response during emergencies

5. Refugee water supply systems

6. Water sources, their protection and development

7. Pumping equipment

8. Water treatment

9. Water storage

10. Water distribution systems

11. Operation and maintenance of water supply systems

12. Management of emergency water supply systems

Annex A - Refugee water supply inventory forms

Annex B - Approximate daily water requirements in refugee emergency situations

Annex C - Guidelines on water quality

Annex D - Recommended format for technical specifications for water well construction

UNHCR**UNITED NATIONS HIGH COMMISSIONER FOR REFUGEES****PROGRAMME & TECHNICAL SUPPORT SECTION****GENEVA****NOVEMBER 1992**

This manual may be freely reproduced and adapted, with acknowledgment to UNHCR. UNHCR would be grateful for copies of any translations into other languages.





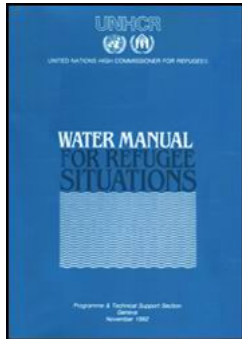

[Home](#) > [ar](#) [cn](#) [de](#) [en](#) [es](#) [fr](#) [id](#) [it](#) [ph](#) [po](#) [ru](#) [sw](#)



Water Manual for Refugee Situations (UNHCR, 1992, 160 p.)

- ➔ **7. Pumping equipment**
 - (introduction...)**
 - General**
 - Description of pumping equipment**
 - Pumping power sources**
 - (introduction...)**
 - Animal traction**
 - Other non-conventional sources of power**
 - Internal combustion engines**
 - Electric motors**
 - Handpumps**

- **Basic pump choice calculations**
 -  **(introduction...)**
 -  **Total manometric head**
 -  **Net positive suction head**
 -  **Characteristic curves**

Water Manual for Refugee Situations (UNHCR, 1992, 160 p.)

7. Pumping equipment

- **Mechanical pumps will often be needed. Seek expert local advice on what is suitable and remember there will be future need of operators, fuel and spares.**
- **Pumping requirements should always be calculated to be minimal. Maximum use of gravity flow for treatment processes, water conveyance and distribution should also be pursued.**
- **As it is always difficult to predict for how long a refugee water supply will be required, emergency water supply solutions involving pumping devices should guarantee a long-term and effective system from the beginning. Ad-hoc approaches to solving emergencies are bound to be problematic and difficult to operate and maintain, unless solutions are chosen in accordance with the realities of the site, the long-term operation and maintenance possibilities available and sound engineering practice.**

General

- 1. Once an adequate source of water has been established, arrangements are necessary to store and distribute the water to meet minimum needs on a continuing and equitable**

basis. The water source may be situated topographically higher than the refugee camp or the points where water distribution should take place; all efforts should then be made to study the possibility of conveying the water by gravity flow; operation and maintenance requirements of gravity fed systems are minimal and negligible if compared to the high cost and technical requirements of pumping systems.

2. In areas subject to seasonal flooding, or where the level of a river source varies markedly, great care must be taken in the siting of any pumps, distribution, storage and treatment systems. It may even be necessary to mount a pump on a raft.

3. Water can be raised in two basic ways: by hand, using some kind of water container or bucket, or by using pumps. A captive rope and bucket carries a low pollution risk and is more reliable and much cheaper than any pump. Where this system can meet the demand, it is to be preferred (not more than 200 people should depend on a well with one rope and bucket!). The importance of teaching refugees to use one single bucket does not need explanation. Nobody should be allowed to put individual containers into the source (See 5.29)

4. The main uses of pumping equipment in refugee water supply systems are:

- i) Pumping water from wells or boreholes;**
- ii) Pumping water from surface water intakes;**
- iii) Pumping water into storage reservoirs.**

Additionally, in some cases where gravity flow may not be used for other requirements, there may be a need to use pumping equipment for other purposes (feeding water treatment plants, boosting the flow through long pipelines, feeding water tankers, etc.); refugee water supply systems should use gravity flow as much as possible for these purposes as a way to minimize long-term requirements.

Description of pumping equipment

5. Based on their mechanical characteristics, pumps may be classified as:

i) **Reciprocating Pumps:** These pumps have a plunger (piston) which moves up and down within a cylinder to produce positive displacement of water. On the upward stroke the plunger forces water out through an outlet valve, and at the same time water is drawn into the cylinder through an inlet valve; the downward stroke brings the plunger back to its starting position, and a new operating cycle can begin. They can be operated by hand, wind or engine power; their efficiency is low (25-60%); their capacity range is between 10 and 50 litres per minute; their valves and pump seals (washers) require regular maintenance attention. Several types of reciprocating pumps may be distinguished:

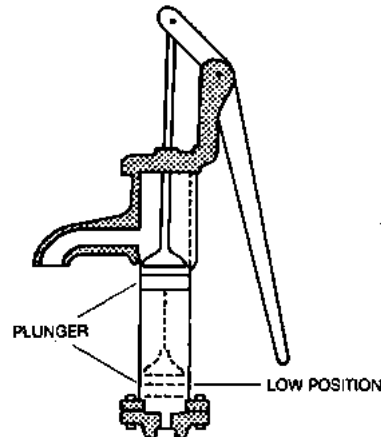

Fig. 13 Suction Pump

a) **Suction pumps:** In this type the plunger and the cylinder are located above the water level, usually within the pump itself. (fig 13). Contrary to popular belief, this pump does not lift the water up from the source, but relies on atmospheric pressure to push the water upwards; this limits the effectiveness of these pumps to pumping from sources that are not more than 7 metres lower than the suction valve and depends on the altitude of the site where pumping is to take place.

b) **Deep well (lift) pumps:** In these pumps, plunger and cylinder sets are located below the water level. Water may be lifted with these pumps up to 180 metres (or even more). Forces created by pumping work increase with depth and maintenance requirements become more frequent and difficult.

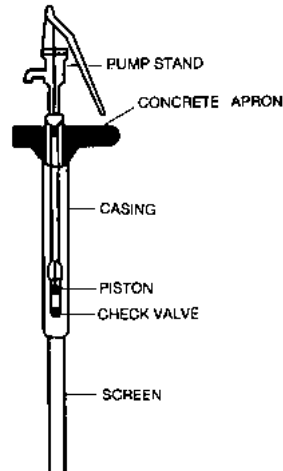

Fig. 14 "Deep Well" (Lift) Pump

c) Free delivery (force) pumps: These pumps are able to pump water from a source and to deliver it to a higher elevation or against pressure. They may be used in deep or in shallow wells. They operate in accordance with the same principle described for reciprocating plunger pumps, with the difference that, for force pumps, plungers are located at the top and, therefore, can be used to force water to elevations higher than the pump site. These pumps are frequently provided with an air chamber to even out flows in such a way that a continuous stream comes out of the pump outlet at all times during pumping. For deep wells the cylinder is put down in the well to allow the lifting of water even from depths greater than 7 metres.

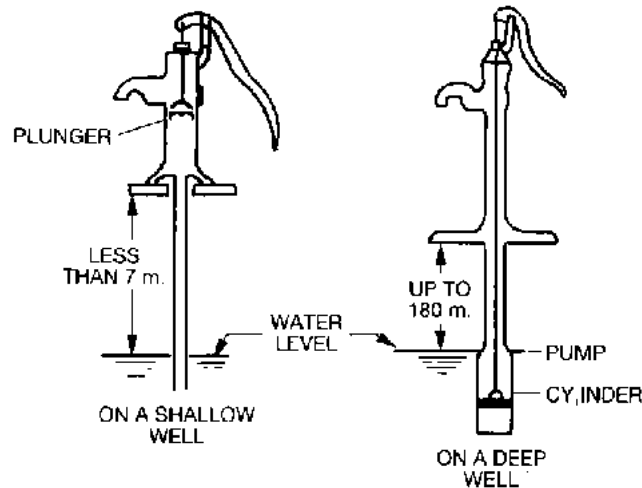

Fig. 15 Free Delivery (Force) Pumps

d) Diaphragm pumps: Their main component is a diaphragm, a flexible disc normally made of rubber or metal. Non-return valves are fitted into the inlet and outlet (Fig 16). The edge of the diaphragm is bolted to the rim of the water chamber but the centre is flexible. A rod, fastened to the centre, moves it up and down. As the diaphragm is lifted, water is drawn in through the inlet valve; when it is pushed down, water is forced out through the outlet valve. Pumping speed usually is about 50-70 strokes per minute. Many new handpump designs are based on this principle.

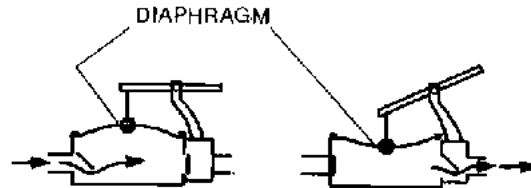

Fig. 16 Diaphragm Pumps

ii) Positive Displacement (Rotary) Pumps: These pumps lift water when their mechanisms rotate; due to that rotation, water is "picked" and forced up. The most widely known positive displacement pumps are the helical rotor pumps, whose pumping mechanism consists of a single thread helical rotor rotating inside a double thread helical sleeve. The two closely adjusted helical surfaces force the water up, in a uniform flow manner and at a rate proportional to the rotating speed. Due to their design, these pumps require no valves; their maintenance requirements are minimal, but maintenance action is, however, relatively complex and requires skills (training) and equipment. They may be used to pump from as deep as 150 metres or more; they are very well suited for low output-high lift pumping and may be efficiently operated with hand, wind or motor power.

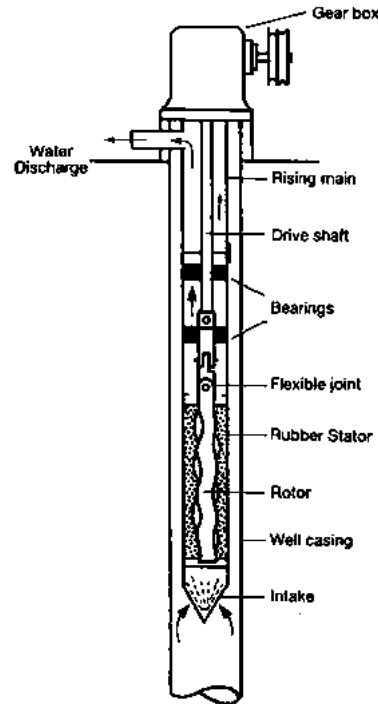

Fig. 17 Helical Rotor Pumps

iii) Axial Flow Pumps: In this type of pump, radial blades are mounted in an *impeller* (propeller type of wheel) which rotates in an enclosure (casing). The pump's action is to mechanically lift water when the impeller is rotating; water moves parallel to its axis. The casing has fixed guide blades that dissipate the whirling movement of water before it leaves the pump. These pumps have a depth

range varying between 5 to 10 metres; their flow capacity is high. Due to their construction characteristics, these pumps can handle waters which have a fair amount of sand or silt in suspension.

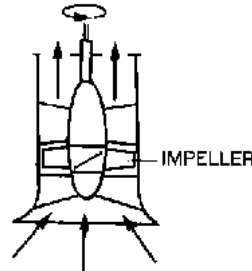

Fig. 18 Axial Pump

iv) *Centrifugal Pumps:* These pumps are also made with an impeller within a casing. In these pumps, the impeller is a wheel with blades radiating from the centre to the periphery which, when rotated at high speed, impart movement to the water and produce an outward flow due to centrifugal forces; the angle between the direction of entry and exit of water flow is 90 degrees. The casing is shaped in such a way that part of the energy created by the water's movement is converted into useful pressure to force water into the delivery pipe; water leaving the impeller creates a suction which will force additional water from the source into the casing under static head. Impellers and casings can be installed in series to increase water pressure; each set of impeller and casing is then called a *stage*; when this is done, all impellers are attached to a common shaft and therefore rotate at the same speed, water passes through each stage and gains additional pressure. Multiple stage centrifugal pumps are normally used for high pumping

heads. The performance of a centrifugal pump depends largely on its rotational speed, its efficiency improves as the speed increases; high speeds, on the other hand, lead to more frequent maintenance requirements. The usual depth range of single stage pumps varies between 20 and 35 metres; multi-stage shaft driven pumps are normally used for depths between 25 and 50 metres. If the centrifugal pump is directly connected to an electric motor in a common housing as a single unit for operating below the water level, the set is called a *submersible pump*. These sets are usually supported by the discharge pipe which conveys the pumped water to the surface. Submersible pumps are extremely sensitive to the presence of sand particles in the water; the abrasive action of sand shortens drastically the life of the pump. Submersible pumps are usually a "tight fit" in a tube well as their outside diameter is usually 1 or 2 cm. less than the internal diameter of the casing; consequently, care should be taken to place these pumps only in wells which have been checked for alignment, as any small bend in the bore or its casing may obstruct the passage of the pump into the well.

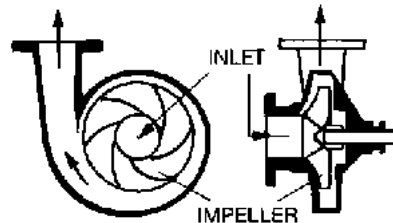

Fig. 19 Centrifugal Pump

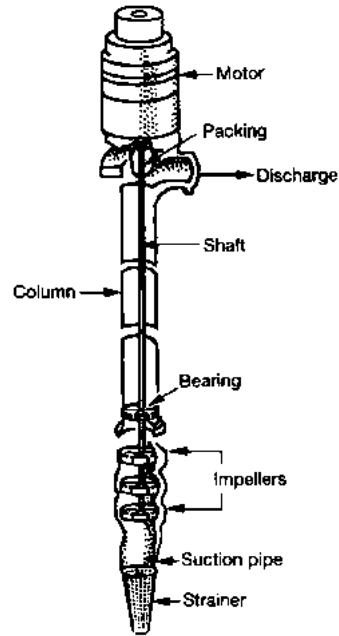

Fig. 20 Three-Stage, Shaft Driven Pump

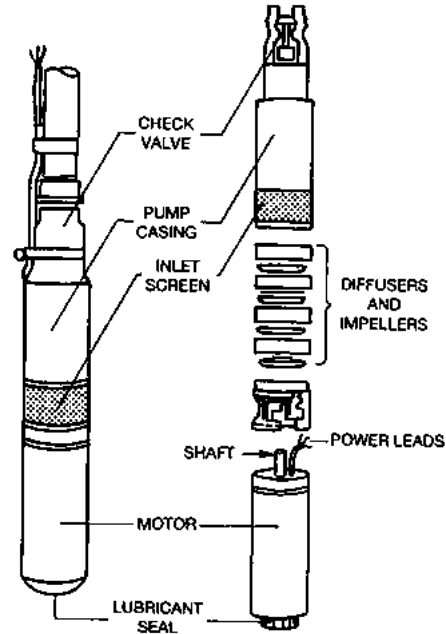

Fig. 21 Submersible Pump

v) Hydraulic Rams: Basically, rams may be defined as hydraulically driven pumps; they require no fuel or electricity to operate. They operate by making use of the gravitational energy contained in a large amount of falling water to pump a small amount up a high distance (Fig 22). Rams require a steady and reliable source of water whose yield should be larger than the total pumping requirements. The amount of water and the height it may reach depend on the height and output of the source. They are very suitable in hilly or mountainous areas but may not be

used to pump water from wells. A large amount of water flowing down from the source through a *drive pipe* into the ram's chamber compresses the air inside which later expands and drives a small amount of water up the delivery pipe. A ram can rarely pump more than 25% of the source's flow to higher elevations; the higher the water must be pumped the smaller the flow will be. The advantages of hydraulic rams are that they have no running costs related to energy supply, they are simple machines that any skilled plumber should be able to construct; simple equipment and materials, usually available even in quite remote areas, may be used to make them; they only have two moving parts which require maintenance attention. Maintenance is simple and infrequent, it includes a periodical replacement of valve washers, tightening bolts and tuning (adjustment of the non-return valve). If a hydraulic ram is to be used to pump water from a stream, it will be necessary to build a storage tank to ensure a regular, constant flow into the drive pipe; if the water is likely to have a lot of suspended particles (sediment) a sedimentation tank will be necessary (See 8.14; 6.16), as rams are extremely sensitive to sand or silt particles. Drive pipes must be made of galvanized iron, they should be as straight as possible and should be well anchored, to avoid movement. Accurate planimetric and altimetric surveying of the ram site and its installations is recommended before final development plans are made. In cases when the required pumping capacity is greater than the one a single ram may provide, a battery of several rams may be used, all of them connected to a single delivery pipe (the water source should, of course, be of adequate capacity); it is also possible to use the "waste water" from a ram to operate a lower ram or to incorporate a ram into a "break pressure tank" (See 10.8). These possibilities are shown in Figure 22.

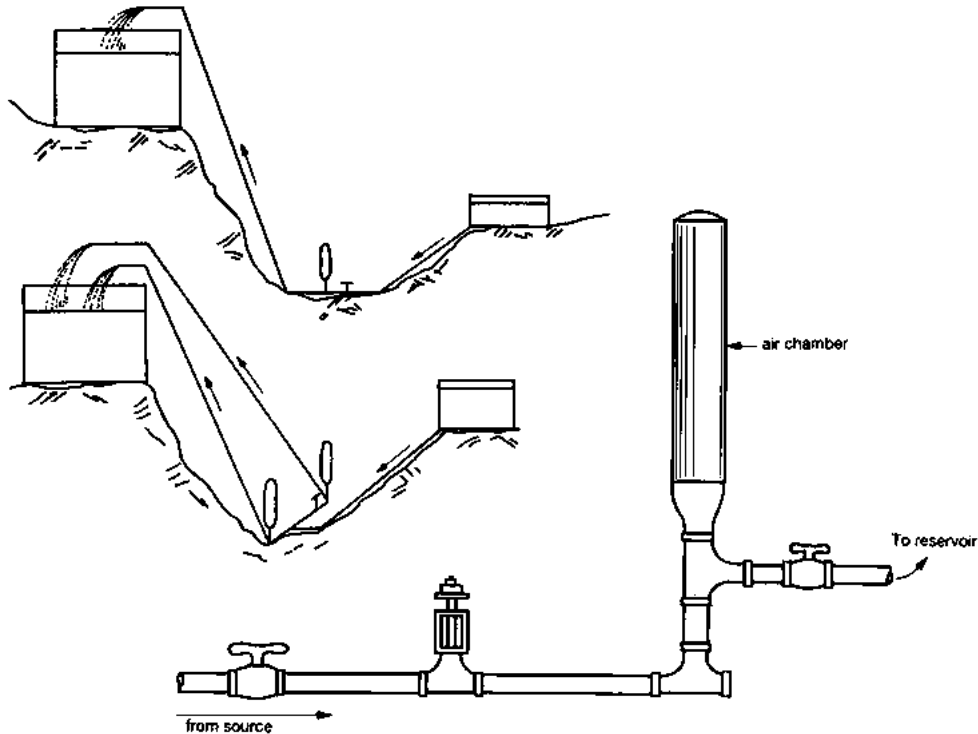

Fig. 22 Hydraulic Ram Installations

Pumping power sources

6. A variety of possibilities are available for choosing the source of power required for pumping. They range from the most traditional ones (hand power, animal traction) to

technologically more complicated ones (wind power, fuel-driven engines, solar energy). Suitability, relevance, availability and effectiveness in the real working conditions are the factors to be taken into account when deciding on the type of power supply required for pumping.

Animal traction

7. In many developing countries draught animals are still widely used; they are a common and vital source of power. Camels, donkeys or oxen are used to lift irrigation water from large diameter wells which do not normally meet potability standards (See 3.5). For human water supply, the best way to use animal power is by covering the well with a properly constructed sanitary apron through which the pump is installed with a water tight connection; the apron should have an impermeable drainage canal to lead drainage away from the well mouth (at least 35 metres). The rotating power generated by the animals pulling a treadmill mechanism is transmitted to the pump through a gear box (Fig. 23). To be effective, this requires slow moving, large displacement pumps.

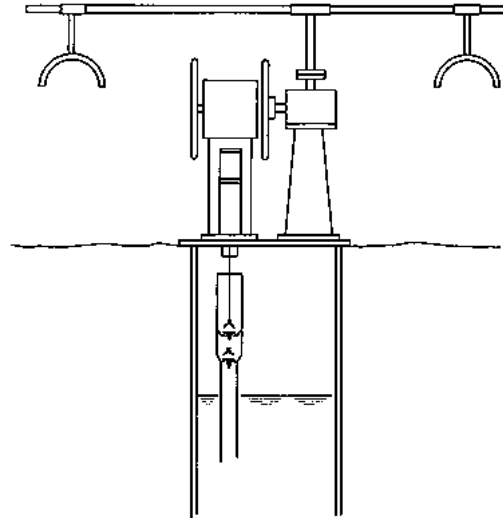

Fig. 23 Mechanism for Animal Traction Pumping

Other non-conventional sources of power

8. The technology involved in the construction of efficient and appropriate windmills has advanced in recent years. The feasibility of using windmills as a source of *wind power* for human water supply depends, however on a large variety of factors; the system may only be reliable if there is a guarantee that all these factors will be fulfilled to maintain a constant supply. Winds are required to have a velocity of at least 2.3 metres per second during 60% of the time. The water source's yield should be at least equal to the pump's output. Enough storage (at least 3 days demand!) should be possible in order to cushion times of low wind or calm weather. Additional information on the design of the windmill, technical specifications and operational requirements should be sought, assessed and

compared to the possibilities of site and source before deciding on its use. Photovoltaic cells are literally capable of converting *solar energy* into electricity. The use of photovoltaic cells has rapidly evolved during the past thirty-five years and is now a proven power source for many applications, including water pumping. Feasibility of solar power pumping should always be explored, especially in remote places where it is difficult, or impossible, to guarantee a timely supply of fuel. There is a cost-effective role for sun-powered pumping in many refugee water supply applications. For moderate size demands (1500 to 2500 persons at 20 litres per capita per day), it could be implemented at costs comparable to hand pump based systems; operation and maintenance activities are minimized by the need to cater for only one pumping set and by the minimal requirements of such sets. For relatively shallow pumping, submersible centrifugal pumps are more commonly used with solar power, whilst for deeper pumping requirements, reciprocating pumps may be more cost-effective. A typical sun-powered pumping system has an array of photovoltaic cells to convert light to electricity, a set of batteries to store the energy, and the electric pump and other components to control, conduct, condition, protect, support and back up the system (the control panel). The design of such a system should be entrusted to specialists and should be based on detailed specifications of output requirements, on the expectation for future growth in demand or system expansion and on other details pertaining to the site and its climatic conditions. All designs should also contain a "users manual" covering basic operation, maintenance and safety requirements, and other instructions on service and repair.

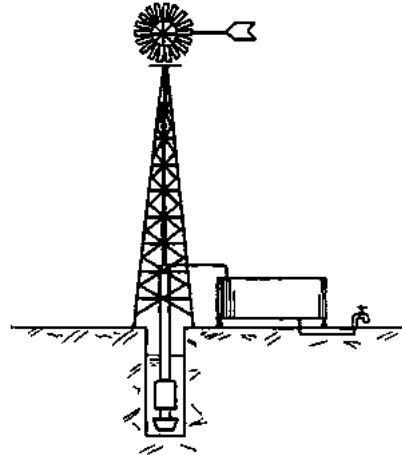

Fig. 24a Windmill Installations (groundwater)

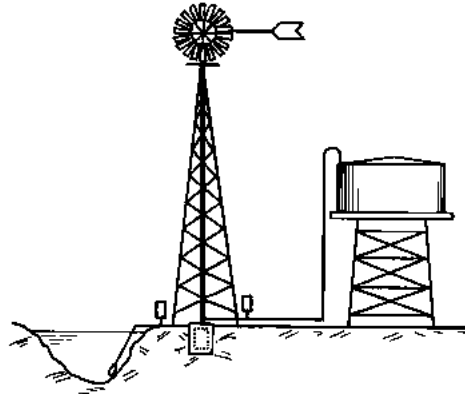
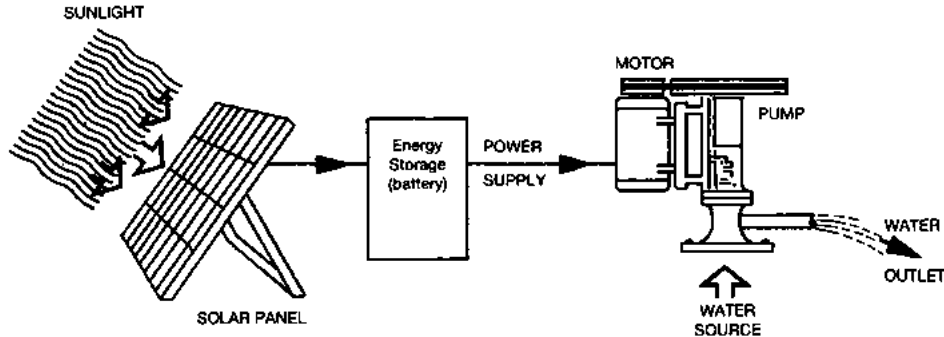

Fig. 24b Windmill Installations (surface water)**Fig. 25 Solar Powered Pumping System**

Internal combustion engines

9. Due to their comparatively lower running costs, Diesel engines are the most widely used fuel driven engines in water supply systems. They are cost-effective power sources for medium and large pumping installations; for these type of installations fuel consumption would vary between 0.15 and 0.25 litres per hour per Horsepower. They can operate independently in remote areas; they only need a continuous supply of fuel and lubricants. A Diesel engine operates through the compression of air to a high pressure in its combustion chamber, this compression raises the air temperature to over 1000 degrees Celsius; when the fuel is injected through nozzles, the compressed mixture of air and fuel ignites spontaneously. Diesel engines may drive any type of pump; gearing or any other type of suitable transmission connects the engine to the pump. It is generally recommended that engines should be selected to provide some 25% surplus power, to allow for future heavier duty.

Electric motors

10. These type of motors should be preferred as a source of power for pumping if a reliable supply of electricity is available, as they have a better performance than Diesel engines and require less maintenance. The motor should be capable of carrying the workload required, taking into consideration the various adverse conditions under which they may have to operate; pump power requirements should be lower than the safe operating load of the motor; the characteristics of the power supply and the motor specifications should always receive attention in this respect. The choice of a suitable electric motor should always be made after consulting relevant technicians.

Handpumps

11. These pumps, (some of which, by design, should be operated by foot) are pumps that utilize human power. They are capable of lifting relatively low quantities of water; their capital cost is generally low; their outputs are usually adequate to meet drinking water requirements of small communities. The availability of human power for pumping depends on the cultural background of the users, on the individual's age, sex and overall health conditions, on the duration of the task and on the environment. Handpumps can be used in wells of almost any depth; reciprocating pumps which have a suction lift of less than 5 metres usually have their cylinder placed above the ground; when the static water lift is more than 5 metres the cylinder is attached to a pumping line and placed within the well; diaphragm and positive displacement pumps may also be easily adapted to handpump drives (See 7.5). Experience has shown that the success of handpumps as the main source of supply for refugee communities largely depends on the choice of pump and on correct operation and maintenance arrangements (See 11.5). Very few handpump system failures may be blamed solely on the pump: provisions for appropriate well design and construction, maintenance, project management, monitoring, supervision, water quality control and periodical project evaluations are all aspects that should be addressed when

planning a handpump based water supply system. Moreover, handpump systems may only reach their highest potential of sustainability, if and only if, the user community is involved in all phases of the project, starting from the planning stage; people should recognize the need for an improved service, be able and willing to contribute in covering maintenance costs and should be willing (and trained) to manage this maintenance. These conditions are very seldom applicable in emergency refugee camps; they may, however, be applicable in rural refugee settlements or other longer term camp-like situations; this aspect requires considerable thought and attention from planners. The future of the camp and its life-span has to be explored to adapt its infrastructure to its realities since the onset of emergency assistance actions (See 5.2; 11.2). It is evident that the choice of handpumps depends not only on the price of the pump itself: pumps should be suitable for the maintenance possibilities available; they should be able to draw the required amount of water, which depends on factors such as the required lift and the planned number of users (200 people should be the largest group depending on one single handpump). When large amounts of handpumps are to be used in a single system, the standardization of the equipment to one or a few pump types should be pursued as this will have a significant impact on maintenance (See 11.15). Resistance to corrosion is a factor to take into consideration when the presence of aggressive water is either suspected or confirmed. UNHCR has considerable experience with handpump based water supply systems, some of these experiences are well documented. The Programme and Technical Support Section will use this information when assisting in planning, implementation, operation and maintenance actions related to handpump based water supply systems.

Basic pump choice calculations

12. The final choice of the type and size of pumps to be used for human water supply purposes should be entrusted to an experienced engineer. It is always a sound practice to involve manufacturers or their representatives in the choice of pumps and pump drives. The following explanations are only intended to introduce concepts and terminology and

as a way of to indicating the type of information required by technicians.

Total manometric head

13. Total manometric head is the difference in pressure (in metres) between the pump's inlet and outlet points. This value is always higher than the actual difference in elevation between these two points; when pumping is going on, the pump needs also to overcome friction losses occurring as the water flows through the intake and outlet pipes. Appropriate tables and graphs are used to calculate "unit" friction losses; for this purpose, precise altimetric and planimetric plans containing pipeline layouts provide the best and most complete information (Fig 35).

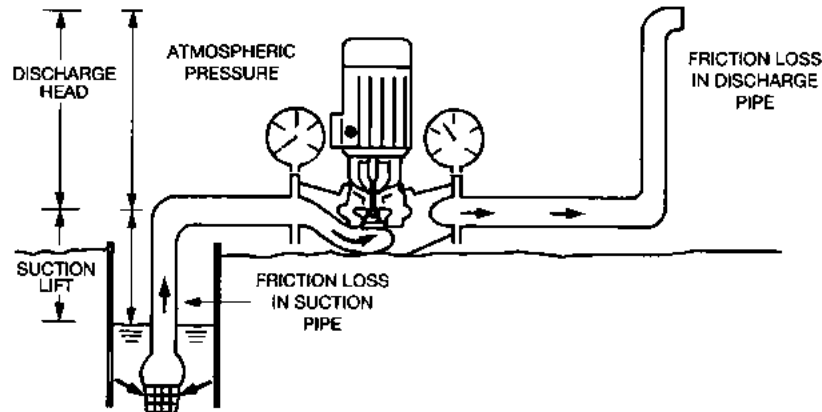

Fig. 26 Definition of Total Manometric Head

Net positive suction head

14. Net positive suction head measures the "inability" of a centrifugal pump to create a complete vacuum (See 7.5.i.a. and 7.5.iv). If a vacuum is made in a pipe it is possible to lift water inside it to a height equivalent to the atmospheric pressure; at sea level this height is equal to 10.33 metres, at higher altitudes atmospheric pressure decreases and therefore this height decreases too; additionally friction losses within the pipes make this height even lower. The net positive suction head is dependent on the flow rate. Its variation is shown in curves normally prepared by pump manufacturers.

Characteristic curves

15. Characteristic curves: these are three type of curves that should be calculated by manufacturers for every centrifugal or axial flow pump; they are verified at test installations. The *yield-head* curve shows how the total manometric head that a pump is able to reach varies in accordance with variations in the pump's output. They are parabolic in shape (Fig. 27). The head at zero discharge is called "shut-off" head. As the discharge is increased, the head produced by the pump may rise or fall slightly depending on the type of pump; eventually, the head developed by the pump will drop for any further increase in discharge. The *efficiency curve* indicates the discharge range at which a pump works at its highest efficiency. For any given speed of operation, there is a particular discharge for which the efficiency is a maximum (the related head values may be inferred from the yield-head curve). This discharge is known as the pump's "*normal discharge*" or its "*rated capacity*" at that particular speed. In case of a need to vary the quantity of water delivered by the pump, this can be accomplished by using a regulating valve in the discharge pipeline; since maximum pump efficiency (at a given speed) occurs at a particular discharge value, this usually results in a reduced pump efficiency. The *power requirements curve* shows its variation for different discharge rates. For centrifugal pumps their shape is concave towards the bottom, a feature that avoids overcharging the motors or engines with varying working conditions. In the case of positive displacement pumps, power requirements at shut-off heads may be considerably higher than those under normal

operating conditions, a factor that should always be taken into account during operation or maintenance activities; in this context it is worth noticing that the presence of regulating valves at the discharge pipe should be completely avoided, especially if the power source is an electric motor.

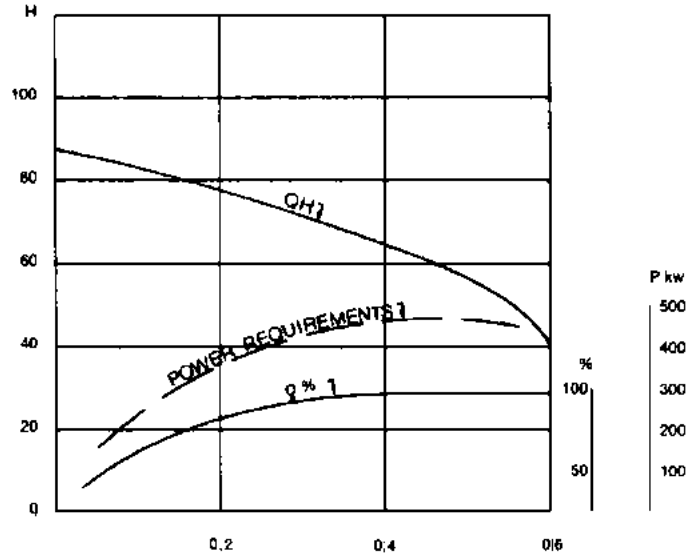

Fig. 27a Characteristic Curves (centrifugal pump)

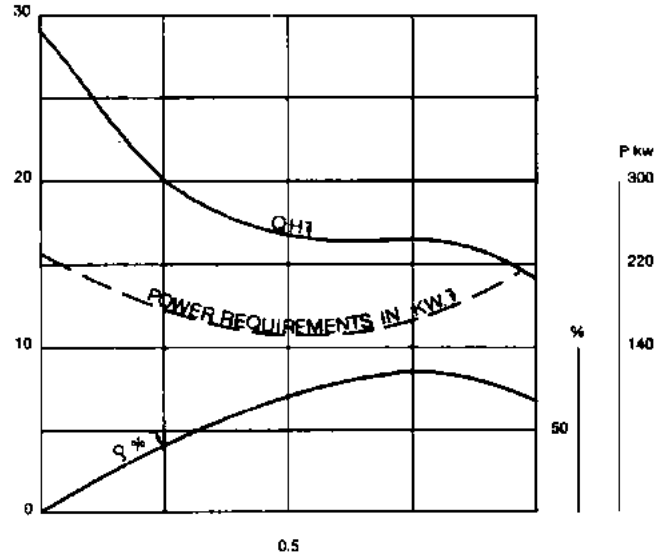

Fig. 27b Characteristic Curves (helicoidal pump)

16. An indication of the pump type to be selected for a particular application may be obtained from Fig. 9.28. The final choice, as previously pointed out, should be left to specialized technicians.

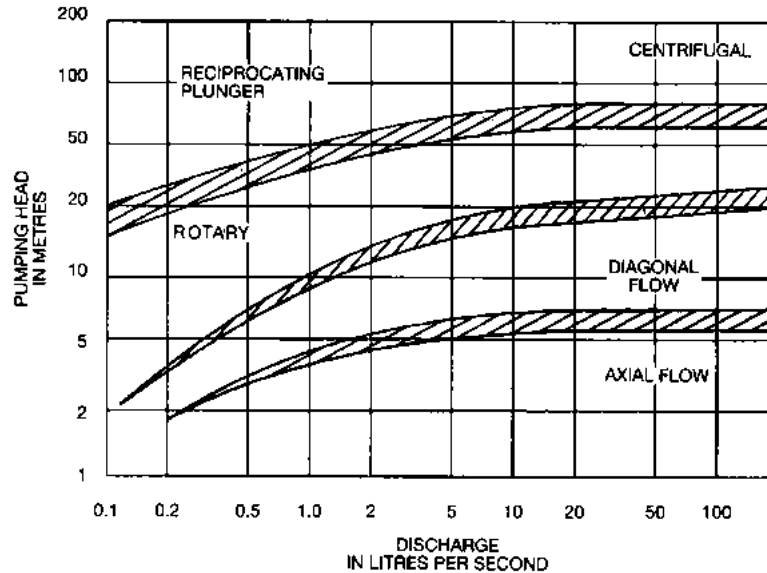

Fig. 28 Pump Type Selection Chart



[Home](#) > [ar.cn.de.en.es.fr.id.it.ph.po.ru.sw](#)

 **Water Manual for Refugee Situations (UNHCR, 1992, 160 p.)**







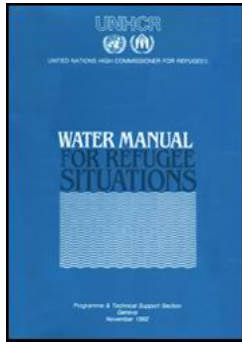

➔  **8. Water treatment**

 **(introduction...)**

 **General**





-  **Water quality and treatment requirements**
-  **Pre-treatment**
-  **Coagulation, mixing and flocculation**
-  **Sedimentation**
-  **Filtration**
-  **Disinfection**
-  **Other water treatment processes**
-  **Disposal of treatment plant waste**

Water Manual for Refugee Situations (UNHCR, 1992, 160 p.)

8. Water treatment

- **All water treatment methods require some expertise, regular attention and maintenance.**
- **In general terms, a large quantity of reasonably safe water is preferable to a smaller amount of very pure water.**
- **The most serious threat to the safety of a water supply is faecal contamination.**
- **In any refugee situation, including emergencies, the use of water treatment should be restricted to those cases where such treatment is absolutely essential and where correct plant operation and maintenance can be secured and verified. This is especially applicable in most situations where refugees live in a dispersed manner, mixed with the local population or in organized rural settlements. If large numbers of refugees are concentrated in refugee camps, disinfection of drinking**

water should be deemed as strictly necessary; other types of treatment should be considered, in accordance with the characteristics of the raw water.

- **Under normal refugee situations, treatment is carried out to improve the physical and the bacteriological characteristics of the drinking water. Only under very special circumstances would the improvement of chemical quality (desalinization, reduction of Fluor contents, etc.) be considered (See 8.25).**
- **It is impractical to chlorinate cloudy or turbid waters; they must be treated before disinfection.**
- **Water purification tablets or boiling are not generally appropriate for large-scale water treatment.**
- **Water quality control and treatment activities, although necessary to ensure adequate health within refugee communities, have to be combined with improved personal hygiene and environmental health practices, sometimes difficult to enforce in certain environmental, cultural or social situations.**

General

- 1. The potability of any water source has to be assessed before a decision to use it for human water supply is taken. Criteria and guidelines used in this assessment have been previously discussed (See 3.10-16).**
- 2. The importance of trying to find water sources which do not require too much treatment is obvious. When necessary, treatment undertaken should be the minimum required to ensure acceptably safe water; it should involve appropriate technological approaches and reliable methods to ensure operation and maintenance requirements within the scope of camp managers and service staff. Determining how to treat water on a large scale is best**

done by experts, and if possible, professional engineering advice should be sought. However, simple and practical measures can be taken before such help is available.

3. During an emergency situation, in addition to the physical measures to protect water at its source (See 4 and 6) and initial disinfection of wells and boreholes (See 6.45), there are four basic methods of treatment that may be easily applied: storage, filtration, chemical disinfection and boiling. They can be applied singly or in combination.

4. Water is sterilized by boiling. At low altitudes, water that is brought to the boiling point may be assumed to be free of pathogenic bacteria. At higher altitudes, water should, as a rule, continue to boil for *at least* one minute for every 500 metres of altitude above sea level, as boiling temperature reduces with altitude. Boiling, however, is a wasteful treatment method that should be avoided, especially if the energy source is fire wood collected from camp surroundings. Boiling increases the concentration of nitrates, which in large quantities are dangerous for very young babies.

5. Although filtration or chemical disinfection may be easily applied in emergency refugee situations, the design, construction, operation and maintenance of the required facilities should be entrusted to qualified technicians. This is also true for any other water treatment method.

Water quality and treatment requirements

6. Pure water is rarely found in nature (See 3). Water impurities are classified in accordance with their state: suspended, colloidal and dissolved. Running water may pick up and transport solid particles of higher density than water; the higher the velocity, the bigger the particles that may be picked up. Surface waters during floods are, therefore, at their most turbid point; they have maximum loads of *suspended matter*. Finer particles (*colloids*) may not be visible to the naked eye but could impart colour and turbidity to the water. Colloids remain in suspension even when the water is at rest. In its passage over or

under the ground, water may pick up substances which are soluble. Among these *dissolved solids*, the most common in natural waters are bicarbonates, carbonates, sulfates, chlorides and nitrates of Calcium, Magnesium, Sodium, Potassium, Iron and Manganese. The products of decomposition of organic wastes such as nitrates and nitrites may be regarded as an indication of *organic pollution*. The presence of bacteriological indicators such as *Escherichia coli* (E. coli) provides positive proof of the faecal origin of such pollution. Algae may grow in water under certain conditions and they may impart objectionable *tastes* and *odours* to drinking water; the removal of algae is essential but often difficult. The presence of Iron or Manganese may also impart tastes or odours to water and may stain articles that are washed with it. *Hardness*, caused by bicarbonates, sulphates and chlorides of Calcium and Magnesium forms insoluble precipitates with soap and causes the deposition of scale. Sulphates of Magnesium and Sodium, if present in excess, act as laxatives; chlorides, in concentrations higher than 500 milligrammes per litre, give water a salty taste, while fluorides, in concentrations above 1.5 milligrammes per litre, are undesirable; in concentrations above 3 milligrammes per litre they may cause mottling of teeth. Detergents and pesticides may find an easy way into raw water and are objectionable if present in excess. Water with a high content of dissolved CO₂, a low pH value and low alkalinity is *corrosive* and is apt to attack metals.

7. There are no set rules as to the acceptable quality for potable water, but certain guidelines have been laid down (See Annex C). If these guidelines are not exceeded, no action is necessary. Short-term deviations above the guideline values do not necessarily mean that the water is unsuitable for human consumption; the amount by which, and the period for which, any guideline value may be exceeded without affecting public health depends on the specific substance involved. In developing drinking water standards for any refugee situation it is necessary to take into account its geographical, socio-economic, dietary and environmental conditions.

8. A common treatment plant consists of many processes: screening, coagulation,

flocculation, sedimentation, filtration and disinfection, each of which performs one main function although it may incidentally assist with some other. Water impurities are removed in order of size, the bigger ones being eliminated first. Not all water contains all the impurities, therefore not all water requires all the treatment processes. Whenever necessary, impurities are removed as follows:

- i) floating objects by screening;**
- ii) algae (if present) by straining;**
- iii) excessive iron, manganese and hardness by chemical precipitation;**
- iv) normal suspended solids by settling (sedimentation);**
- v) excessive bacterial pollution by pre-chlorination;**
- vi) the remaining fine particles and some more bacteria by filtration;**
- vii) final bacteria, surviving filtration, by chlorination.**

All these processes overlap to some extent and many need auxiliary processes to be fully effective.

Pre-treatment

9. It is unusual that raw water is pumped directly from its source to the treatment plant. The use of intermediate processes, which can collectively be called pre-treatment, increases the effectivity and life-span of the treatment plant. Raw water storage, pre-chlorination, aeration, algal control, straining, preliminary settling, coagulation, mixing and flocculation are all pre-treatment processes. Each performs a particular function and unless the quality problem they are intended to resolve is part of the raw water's characteristics, they should be omitted.

10. In general terms, the quality of water that is left undisturbed in containers, tanks or reservoirs improves since some pathogenic micro-organisms die and heavy matter in suspension settles (sedimentation). Efforts to provide maximum *storage* capacity at

refugee sites at the onset of emergency assistance operations is a logical step. This task may not always be accomplished, however, especially when water demand is large (large refugee populations) or when water is limited in quantity. To bring about a substantial improvement in water quality, storage should be possible for at least 12 to 24 hours; the longer the period of storage and the higher the temperature, the greater the improvement. Storage periods of up to two weeks are recommended as necessary to achieve maximum improvement in raw water by storage. The fact that other organisms are encouraged to develop in stagnant water should, however, not be forgotten. Storage of raw water may create a silt problem; reservoirs tend to silt up very quickly in the absence of some sort of a silt trap. The cost of building reservoirs large enough to be effective for water quality improvement is fairly high and, on this basis, they should normally be omitted from the treatment processes.

11. The practice of injecting chlorine into the raw water soon after it is abstracted from its source (normally a surface stream) is called *pre-chlorination*. This step is usually omitted for reasonable quality water and is normally more effective in low turbidity water having a high bacteria content. The amount of chlorine used is fairly high (2-5 mg./l). Chlorine oxidizes organic matter, iron or manganese during the time water spends in settling basins; it will also reduce colour and slime formation. As much greater quantities of chlorine are used than in post-chlorination and complete water disinfection may very seldom be accomplished with it, pre-chlorination should not be regarded as a substitute for post-chlorination (See 8.21) but as a safeguard to be adopted only when extremely polluted (but fairly clear) raw water has to be used in emergency situations.

12. *Aeration* is practiced to add oxygen from the atmosphere to water and to liberate undesirable gases such as carbon dioxide or hydrogen sulphide. It is commonly done by splashing the water over trays or by blowing air bubbles through the water. It is a viable and cheap means of controlling tastes, odours and corrosion but its results may not be considered complete in all cases. Among the equipment normally used for aeration, the

most common are some special nozzles which direct thin jets of water into metallic plates to produce fine sprays exposing water to the atmosphere; cascade-type aerators which create turbulence in thin streams of water flowing down; tray-type aerators consisting of some five perforated trays, increasing in size from top to bottom, where water (falling from tray to tray) is exposed to air; and diffused air aerators, which are tanks where air is bubbled upwards from diffuser pipes laid on their floor. The latter method is the most efficient; the amount of air needed may be regulated; the tanks are normally about 4 metres deep and have a retention time of about 15 minutes. Among all the methods, however, trays are the most commonly used because of their low cost, simple operation and reasonably high efficiency.

13. *Algal control* is necessary to eliminate outbreaks of these organisms which are usually classified as plants and which proliferate in rivers and reservoirs. These outbreaks tend to be sporadic or seasonal but normally severe and can cause trouble to waterworks' operators. Fairly alkaline waters, with an appreciable concentration of nitrates or phosphates, are likely to develop important algal colonies. Although heavy pollution may impede the growth of algae, water treatment, by itself, may encourage it (once pollution has been eliminated). Chlorine doses of up to 1 mg./l may kill the algae (See 9.8.23). Algal growth is inhibited by Copper sulphate in concentrations of 0.3 mg./l; these doses are, however, toxic to some fish species and may therefore not be acceptable in some circumstances. Strainers are widely used to remove algae, some of them functioning as rapid sand filters (See 8.18) which, if their filtration medium is coarse, are known as "roughing filters" (See 8.14). Other devices, called "microstrainers", which are mainly of proprietary make, are excellent, provided that the water is relatively free of silt.

14. Where sediment loads in raw water can reach concentrations of more than 1000 mg./l, it is helpful to put in small, non-chemically assisted, horizontal flow basins immediately upstream of other treatment works, such as normal sedimentation basins, to increase the effectiveness of the treatment process, minimize plant maintenance and save on the use of

chemicals. These facilities are called "*pre-settlement basins*". Alternatively, *horizontal roughing filters* may be used to improve the quality of raw water that will undergo further treatment through slow sand filtration devices; they are rectangular boxes similar to the basins used in plain sedimentation (See 8.16); their raw water inlet is situated on one side of the box, their outlet at the opposite side (Fig 29). In the main direction of flow, water passes through various layers of graded coarse material (in the sequence coarse-fine-coarse). Vertical depths of filtration are in the range of 0.8 to 1.5 m.; suitable filtration rates are in the range of 0.4 to 1.0 m/h); the total length of the filter would vary between 4 and 10 metres. Pre-settlement basins and horizontal roughing filters are sometimes built as a remedy, where changing raw water characteristics have put in jeopardy existing waterworks facilities (a common occurrence in developing countries).

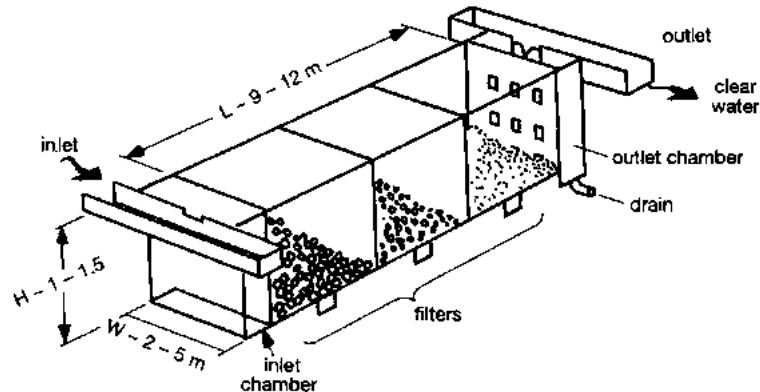

Fig. 29 Features of a Horizontal Flow Roughing Filter

Coagulation, mixing and flocculation

15. The main chemical means of dealing with the improvement of surface waters is *coagulation*. Chemical coagulation removes turbidity-producing colloids such as clay particles, bacteria and other organic matter and colourants resulting from the decaying vegetation, animal or industrial wastes. It is directly followed by *flocculation*, a process whereby the products of coagulation are made to agglomerate and form "flocs" of sufficient size and specific weight to allow removal by sedimentation or filtration. As the use of chemicals should be avoided as much as possible, coagulation should be used only when strictly necessary. The most widely used coagulant is Aluminium sulphate, commonly known as alum; Iron salts (such as ferric chloride) can be used, despite their higher cost, when broader pH ranges for coagulation are required. (N.B. pH values for alum's effectiveness range from 5 to 8, while those for the Iron salts range from 4 to 9). These coagulants react with the alkalinity of the water and hydrolyze in it; if the required alkalinity is not present in the raw water it should be added through dosage of lime or Sodium carbonate. The optimum dosing, pH, concentration of coagulant and the most effective order in which to add the various chemicals will be determined with a *jar-test* which should be carried out by qualified technicians and requires the collection of water samples and the use of specialized laboratory equipment (See 9.12.8). During emergency situations, before jar-tests are done and if there is a need to lower the turbidity of raw water, dosing alum at 50 mg./l is recommended. Dosing is usually done in the form of solutions prepared in special tanks with a holding capacity of 10 or more hours of coagulant feeding requirements; two tanks are required as a minimum (one in operation, the other for the preparation of new solution). To accomplish flocculation, mixing is necessary and may be accomplished hydraulically, in turbulent flow conditions at specially made structures such as weirs or "flocculation chambers", or at the suction side of the pump; it can also be accomplished mechanically (manually or with paddles, rakes, turbines, propellers, etc.). Normally, water should be retained in flocculation tanks for at least 30 minutes to ensure maximum flocculation. Coagulation and flocculation processes should be done (only if required) before sedimentation, filtration and disinfection. The sedimentation basin should be designed in such a way that the last flocs settle before the

filtration units.**Sedimentation**

16. The process to eliminate all impurities present as suspended particles which are carried along by flowing raw waters but which will settle in quiescent or semi-quiescent conditions is called *sedimentation*. It is usually considered the *minimum* treatment for turbid surface waters; if 24 hours can be allotted for sedimentation, clarified waters can be directly chlorinated. The sun's bactericidal effect has also been documented. Below a certain particle size, depending on the material concerned, settling velocity becomes very small and therefore sedimentation becomes unfeasible. This is the case for colloidal matter, which, as it has been discussed, requires coagulation and flocculation before the sedimentation process. Sedimentation facilities normally operate under continuous flow to:

- i) achieve quiescent conditions in the settling zone;**
- ii) ensure uniform flow across the settling zone;**
- iii) obtain uniform concentration of solids as flow enters the settling zone;**
- iv) ensure that solids entering the sludge zone are not re-suspended.**

The efficiency of these structures basically depends on the ratio between the influent flow rate and the surface area of the tank; their design should be based on the settling velocities of the particles to be removed, a factor that should be assessed by qualified technicians and requires the collection of water samples and specialized laboratory equipment (See 12.8). The main tanks found in practice are shown in Fig. 30. Horizontal tanks are compact; sludge is removed from them under hydrostatic head. Circular tanks offer the advantage of simpler scraping mechanisms but are not so compact. The vertical flow tanks, like the one shown in the figure, operate with a sludge blanket which serves to strain out particles smaller than those that could be removed by sedimentation alone at

the flow rates employed.

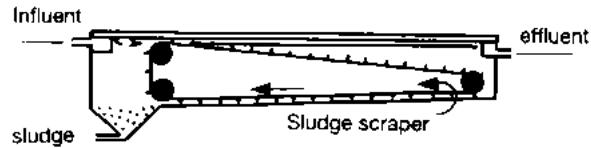

Fig. 30a Type of Sedimentation Tanks (horizontal flow)

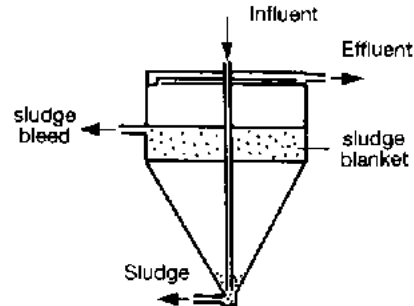

Fig. 30b Type of Sedimentation Tanks (vertical flow)

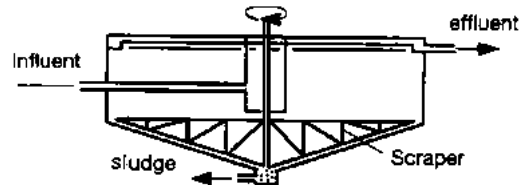

Fig. 30c Type of Sedimentation Tanks (radial flow)

Filtration

17. Filtration of suspensions through porous media, usually sand, is an important stage in the treatment of potable water to achieve final clarification. It follows the settlement process and, to a certain extent, could be considered complementary: the more effective the settlement, the less the filters have to do. It is the final stage in water clarification and unless clear groundwater is used, it should be regarded as essential. The process consists of passing the water through a bed of sand or any other suitable porous medium. The sand retains suspended matter while permitting the water to pass; if the process is effective, the filtrate should be clear and sparkling in appearance. There are limits to the capacity of filters to achieve this final degree of clarity; pre-treatment and sedimentation processes are used to improve the water quality to levels more easily handled by filters.

18. One of the most commonly found filters is the *rapid gravity sand filter*, it can handle low turbidity waters and for this reason is normally operated with coagulants and often follows settling basins. The *Rapid pressure filter* has many characteristics similar to those of the gravity type, but is enclosed in steel pressure vessels and is used where hydraulic conditions in the system make its adoption desirable; it equally depends on coagulants for its action, although it does not always follow settling basins. A refinement of the rapid gravity filters may be called the *mixed media filter* where media of different densities are used; as a result a very coarse upper layer of light weight material (pumice, anthracite) provides void space to store impurities removed from incoming water. The rapid filter requires, in general, a raw water input of fairly good quality and is therefore limited in its application to only very particular situations, which normally do not include emergency response.

19. The *slow sand filter* is a simple filtration device which is increasingly being used in refugee camps and rural areas in view of its simple operation and maintenance requirements. Its construction, also very simple, may be carried out using widely available

materials; a medium coarse sand, similar to the one use for concrete mixtures, is often a good enough filtration medium. Filters may also be obtained in prefabricated versions ("filtration package kits") which have proven their value in many emergency refugee camps during the last decade. During the slow sand filtration process the water quality improves considerably not only in its physical characteristics but also due to the reduction of the number of micro-organisms (bacteria, viruses, cysts), the removal of colloidal matter and changes in its chemical characteristics. Bacteriological changes are due to the development of a thin and active layer of algae, plankton, bacteria and other forms of life on the surface of the sand bed called the *schmutzdecke*, where these micro-organisms break down organic matter. While rapid sand filters require cleaning by rather complicated backwashing operations, slow sand filters are cleaned by the relatively simple periodical removal of the top of the filter bed, including the *schmutzdecke*. The design of a slow sand filter is a complex engineering problem that should be left to specialists. Its capacity should be such that no serious water shortages occur at the camp at any time; the quality of the supplied water should under no circumstances deteriorate below safety limits (See 3.13; 8.7) and provisions should be made therefore to deal with possible future deterioration of the raw water quality (See 8.14), breakdowns of critical elements in the system and malfunctioning due to operational failure or unfavourable conditions (low temperatures do not allow slow sand filters to operate effectively) (See 11.9). The dimensions of the filter should be decided upon after its mode of operation and output have been established to achieve a filtration rate of about 0.1 m/h, bearing in mind that it is desirable that the filters are operated for part of the day at a so-called declining head filtration (which may be achieved by closing the raw water inlet valve at the end of the day's working shifts while keeping the filter outlet valve open). The use of at least two filters in any water supply system is recommended to maintain the supply of treated water even during the time one of the filters requires cleaning or another type of maintenance. Prefabricated filtration package kits are available on the international market which allow a quick and relatively easy installation of slow sand filtration plants even in remote locations. The most typical kit consists of two raw water storage tanks and two slow sand

filtration tanks and may be fitted with adequate pumping sets, if needed. Both filters would function simultaneously except during the process of cleaning, when one unit may be left in operation while the other one is cleaned. Some of these filters are provided with a synthetic filter fabric which is located at the top of the filter bed and allows a quick cleaning process, since the need to scrape off the upper sand layer each time is eliminated. These kits do not normally provide the sand, which has to be obtained, washed and graded locally. Assembling this kit would require only a few hours and may be carried out by unskilled labour with minimal supervision.

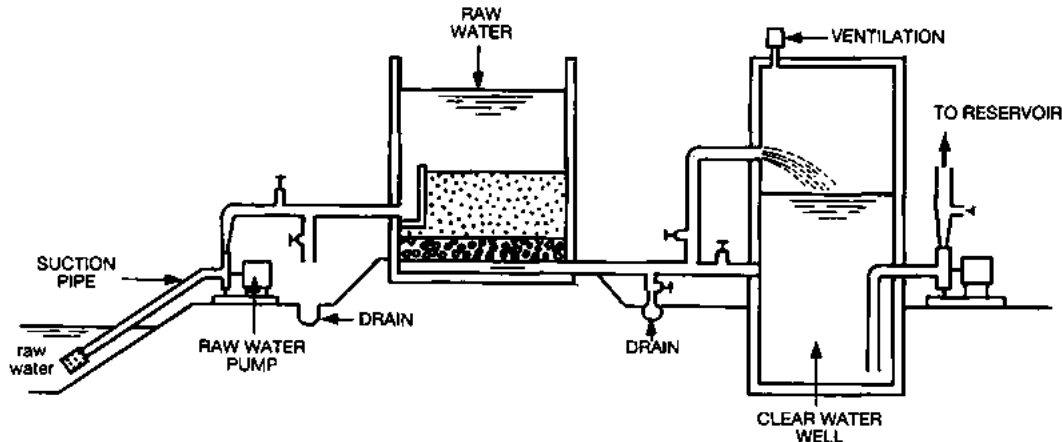

Fig. 31 Slow Sand Filtration Installations

20. Other types of sand filter include the *packed drum filter* that can be improvised if drums and sand are available and may be a very good way of providing limited quantities of safer water quickly to cover small water demands (at household or health post levels, for instance). In these filters, water passes down through sand on a 5 cm. layer of gravel

and is drawn off at a rate that should not exceed 60 litres per hour for a 200 litre drum; infiltrated water equal to the amount drawn off is added to the top. The *river bed filter* consists of a well (See 6.18) or infiltration galleries (See 6.58) that may be constructed in permeable river beds and may be used to treat large amounts of water; they are likely to be difficult to construct.

Disinfection

21. Disinfection serves to destroy pathogenic organisms which may cause various types of water-borne diseases and it can be considered as the final stage in the water treatment process. Although water disinfection can be accomplished by the addition of certain chemicals, by ozone, by ultraviolet light or by boiling (See 8.4.) the vast majority of waterworks, including those for the supply of emergency refugee camps, use chlorine or chlorine compounds. *Bleaching powder*, also known as *chlorinated lime*, is a mixture of Calcium hydroxide, Calcium chloride and Calcium hypochlorite which may contain between 20% and 35% of *available chlorine*, i.e. 20-35 parts by weight of chlorine per 100 parts by weight of bleaching powder. Although bulky and relatively unstable, bleaching powder is easy to handle; it is sold in drums; once the drum is opened it loses its chlorine relatively quickly: if the container is opened once a day for 10 minutes it loses some 5% of its initial available chlorine over a span of 40 days, but if it is left open all the time for the same period almost 20% will be lost; chlorine solutions made from bleaching powder, may be stored in containers kept in the dark for periods not longer than ten days. The lime content of bleaching powder is insoluble and a solution should be well mixed and allowed to settle before dosing, to avoid clogging of valves or feed lines. If 2 kg of bleaching powder, with a 25% available chlorine, is mixed with 20 litres of water, it will result in a 2.5 % solution of chlorine. *HTH* (high test hypochlorite material) is easily available on the international market under different brand names and contains 60-70% available chlorine; it is granular, much more stable than bleaching powder (it deteriorates much less during storage) and due, to the fact that it is quite soluble, relatively clear solutions may be

prepared if the concentration of the solution is kept below 5 % (the strength of the solution should be between 2% and 4%). If 0.84 kg HTH with 60% available chlorine is mixed with 20 litres of water, the result will be a 2.5% solution of chlorine (two drops of this solution may effectively disinfect one litre of relatively clean water and leave approximately 0.5 mg/l residual of chlorine; four or more drops may be needed for cloudy waters). Chlorine compounds should be stored in a dark, cool, dry and well ventilated place in closed containers resistant to corrosion (IATA's air transport regulations for corrosive and toxic substances require special containers; these are the most desirable containers for storage in any given circumstance); chlorine gas is poisonous and may provoke fire or explosions if present in high concentrations, due to exothermic chemical reactions.

22. When added to water, chlorine reacts to form hypochlorous acid and hypochlorite. These two compound together represent the "free available chlorine" and are a powerful bactericide; if ammonia is present in the water chloramines will be formed, the type of which depends on the water's pH and its ammonia concentration. Chloramines are also powerful bactericides. At normal pH values (5-8), the total quantity of chloramines is known as the "combined available chlorine".

23. Because chlorine is an oxidizing agent, part of the chlorine applied will be used by other constituents of the water (Chlorine demand); enough chlorine must therefore be applied for reaction with such constituents and the pathogenic organisms (See 8.13). That is why chlorination should normally be done after the water has undergone other treatment processes such as sedimentation and filtration, to ensure minimum use of chlorine by anything other than bacteria.

24. Care must be taken to ensure strict control of chlorination processes and, particularly, to test the water for chemical residual levels after each disinfection and before distribution. Chlorine residual must be measured only after an appropriate *contact time*.

After chlorination, and once chlorine has reacted, oxydizing the other constituents of the water (30 minutes are considered appropriate), there should still be at least 0.5 parts per million (or mg./l) of "free available chlorine" left in solution. The amount of chlorine required to achieve this concentration is usually a broad indication of the level of pollution of the water. If the amount of free available chlorine is higher than 1.0 mg./l, people may reject the water because of its unpleasant taste. A pocket size chloroscope (chlorine comparator kit, preferably of the "DPD" type) is required to test for residual chlorine levels; it consists of two tubes, each containing a measured quantity of the water under test, which can be compared by eye for colour. One of the two tube samples is coloured by the addition of a chlorine sensitive reagent (o-toludine, a common reagent, should be avoided, as it decomposes in hot climates; it is also a poor indicator if water has been over-chlorinated), the other by a range of standard glass slides; the chlorine concentration can be read off directly after matching the colour of the tube with the added reagent with that of the nearest standard. This test is simple and all treatment plant attendants should be trained to use it frequently to check the water quality; any water leaving the plant with a residual chlorine content of 0.4 mg./l of free residual chlorine can be regarded as safe. The dosage of chlorine should be of constant concern; no water should normally be distributed when chlorination equipment is not working (chlorination equipment should be fully duplicated in any water treatment plant).

Other water treatment processes

25. As it has been previously suggested, the treatment of water in emergency refugee situations should be kept to the minimum required to ensure its safety. When refugees are living in rural environments, where the main water sources are dug wells or spring catchments, efforts should be directed to clean, disinfect and to protect these installations from further pollution since the onset of the emergency and to continue monitoring water quality to ensure the effectiveness of these protective measures; further source disinfection campaigns may be necessary in the long term. In other situations, where

refugees are living in large concentrations, in refugee camps or mixed with the local population in villages or towns, regular water disinfection should be regarded as strictly necessary; other simple treatment measures should be carried out if the quality of the raw water supply would require them as a way of ensuring the effectiveness of disinfection (See 8.11 and 8.23). In these cases, processes to be used would normally include slow sand filtration and even pre-treatment processes, necessary for the due functioning of the sand filters; the aim of these treatment processes is that of improving the physical and bacteriological quality of the drinking water. The improvement of the chemical characteristics of raw water should, however, be decided only after careful consideration of potential health hazards and other risks involved in the provision of drinking water with questionable chemical components, combined with an analysis of alternative solutions, capital costs and long-term operation and maintenance requirements. This exercise would not normally be possible during emergency refugee situations and should wait until the emergency is over, when preparations for longer term care and maintenance activities are under way (See 12.20). From a health point of view this approach should not normally present major problems, as most chemical-related water quality problems do not cause serious health hazards if the water is consumed during short periods (real refugee emergencies are normally short in duration). In the case where a refugee situation evolves, which makes it necessary to prolong care and maintenance assistance programmes for an undefined period, problematic chemical characteristics should have already been recognized and, if important enough, should be addressed in a technically sound and cost-effective manner. In this case, expert advice (which should include expertise in the fields of Public Health, Environmental Health and Engineering) should be sought. Among those processes normally used to improve chemical water quality, water softening, the removal of Iron or Manganese, the control of fluorides or nitrates and the removal of detergents and pesticides should be mentioned. Water desalinization practices are, by their nature and high costs, out of reach of refugee assistance programmes and should be fully discouraged under all circumstances; the search for alternative water sources should be the only solution to high salinity in refugee water supplies.







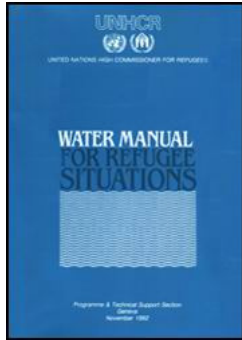

Disposal of treatment plant waste

26. The wastes of water treatment plants normally used during refugee emergencies are mainly heavy sludges consisting of highly concentrated suspensions of solids in a liquid which may or may not have chemicals, depending on the type of treatment plant. Sludges without chemicals come from primary settling tanks, roughing filters (See 8.14) and sand washers attached to slow sand filtration plants (See 8.19). Total daily volumes of sludge in treatment plants may normally be 5 % of the daily plant's throughput. This sludge is inoffensive and may be returned to the river with no treatment, if the river is large enough. If the river is small, it may be necessary to dry in special drying beds before transporting it to the final dump site, which could be a land-fill site or a rubbish dump. If chemicals are present in sludge coming, for example, from sedimentation basins where coagulation takes place. (See 8.15-16), its collection, treatment and disposal become more problematic; dewatering is more difficult, recovery of chemicals is not cost-effective and the disposal of partially treated sludge may create big nuisances. If allowed to accumulate, the sludge putrefies; this process occurs very quickly in warm climates. Although "lagooning" is a traditional method of sludge treatment, sludge lagoons are complicated to build and to operate; they require large plots of land, and the end product is a very sticky stuff that should be picked up and carted away to a dump site. The use of concentration tanks and drying beds is also common. This is normally done at two settling basins (one being filled and the other one being cleaned at any given moment); the thickened sludge is transported (sometimes by pumping) to drying beds similar to lagoons but with permeable sand and gravel bottoms for efficient drainage and, when dry, it is picked up and transported away to dump sites. Choosing the right site for a sludge dump requires the same care and considerations as if it was for rubbish, in view of the need to avoid contamination of surface or groundwater. Contrary to a common belief, these sludges have no manurial value.





Water Manual for Refugee Situations (UNHCR, 1992, 160 p.)

- ➔  **9. Water storage**
 -  **(introduction...)**
 -  **General**
 -  **Open air storage**
 -  **Centralized water storage**
 -  **Storage capacity needs**
 -  **Water storage at distribution points**
 -  **Water storage at household level**

Water Manual for Refugee Situations (UNHCR, 1992, 160 p.)

9. Water storage

- **All refugee sites must be provided as soon as possible with adequate water storage facilities.**
- **Water storage may be the only means of ensuring a constant availability of water to cover the needs of a camp population at a given site and therefore could become the main source of supply.**
- **The use of local technology for the design and construction of storage tanks or reservoirs should always be pursued. In many refugee emergencies, however, the use of prefabricated tanks may be the only way of ensuring the availability of water where needed in the quickest way.**

- **As storage tanks are a main component of water supply systems, their design should satisfy all the system's technical requirements.**

General

1. In nearly all water supply systems it will be necessary to store water between the source and distribution points. Substantial water storage may be needed and will always be an advantage in monitoring, collecting, treating (See 9.8.10) and distributing safe water as well as for the provision of a reserve to meet the various needs during emergency and long-term use.

2. In any given situation, storage tanks may be located in four different locations within the water supply system:

i) At the water collection point (raw water tanks at surface water intakes, run-off water collection and storage facilities such as "birkas" or haffirs, at rainfall water collection points, etc.)

ii) At central storage tanks, before or after treatment, to balance the supply from the sources with the needs and in many cases, to provide the system with enough hydraulic head to allow for gravity-fed distribution (See 6.1; 10.16).

iii) At distribution points, which may include public standposts, other service points (health or feeding centres, camp administration facilities, and sometimes at staff houses).

iv) At refugee household level. At this level, use is normally made of small containers; in this case, an effort should be made to ensure a clear distinction between the containers used to obtain and transport water form distribution points and those used for storage (See 4.5; 10.9).

3. Whatever type of storage is needed, adequate enclosure should be provided to prevent any contamination from humans, animals, dust or from any other source. A tight cover and dark storage also prevent algal growth and the breeding of mosquito larvae.

Open air storage

4. Under certain circumstances, notably in areas with pronounced dry and rainy seasons, and where alternative sources are limited, the construction of reservoirs to collect water to be used during the dry season may be an option, despite the dangers of pollution and of mosquito breeding. To locate the right site for these type of structures requires a good knowledge of regional environmental conditions and local technological approaches; considerable engineering experience is also needed for the design of the most appropriate structures. An erosion-protected overflow spillway should always be provided to allow for the evacuation of excess water. Enough attention should also be given to the need to control excessive weed growth on the banks of water ponds, haffirs or valley dams. Water losses in open ponds due to evaporation are considerable and efforts should be made to minimize this: well-located wind-breaks will prove useful for this purpose. With time, the loss of storage capacity due to siltation is also important; silt-traps in their inlet structures will lower siltation rates and facilitate maintenance. Water quality in these ponds degrades very easily; fencing-off the reservoirs to avoid access by people and animals should be regarded as strictly necessary; pumping and pipeline facilities to transport water to conveniently-located service tanks and distribution points should, therefore, be required.

Centralized water storage

5. *Service tanks* are used to store water which is ready for distribution. Their size and location should be decided by experienced engineers based on the location of highest consumption points and the overall distribution network, the topography of the terrain

and its ability to provide support to the tank's foundations as well as on the technique, materials and design to be used for their construction. Although *brick* and *stone masonry* tanks are most appropriate for larger storage volumes, they may be difficult and time consuming to build under certain emergency conditions. *Reinforced concrete* tanks are common in many areas and have the advantage of being possible to build of virtually any size; while they are very durable, their construction is time consuming and may not be the right solution for water storage needs during refugee emergencies. A number of types of simple, air-portable, plastic or butyl rubber storage tanks (known as pillow tanks, onion tanks or bladder tanks, depending on their design and shape) are available and can be speedily supplied to any given location to meet the most urgent storage requirements during emergencies. *Metal* storage tanks may be made from different materials, the most common being galvanized iron sheets; their size is limited by the tendency of the material to deform unless a reinforcement framework, made out of wood or steel, is incorporated into their design. The use of *corrugated metal* sheets makes it possible to construct self-supporting prefabricated structures which are easy to transport, erect and commission to respond to emergency needs; some of these tanks are supplied in kit form, and may be obtained in different sizes (10, 45,70 and 95 cubic metres) to meet different storage needs. The kit may contain other fittings and material to allow for appropriate pipeline connections and for water chlorination. The use of pre-fabricated fibreglass tanks may be advisable during refugee emergencies, especially when water has been found to be corrosive.

6. The choice of tank type and design should always be entrusted to an experienced engineer. Several features, however, should always be present in storage tanks to allow for their fullest and safer utilization in a water supply system. Their foundations and structure should be sound as water is heavy and even the smallest structural weakness would cause the tank to either leak or completely fail. All tanks should be provided with an outlet hole situated some 20 cm from the bottom; an overflow and vent pipe (with an appropriate screen to avoid the entrance of small animals) and the inlet pipe should

always be at the top and at the opposite end to the outlet, to allow for water mixing and aeration; the tank's bottom should slope towards its lowest point, where a drain should be installed for cleaning and flushing the tank. The drain's outlet should be piped away from the tank to avoid the creation of unsanitary conditions around the tank or the destabilization of the tank's foundations by excess water. A manhole, with an appropriate cover and ladders, should be provided to allow access to the interior for cleaning and inspection purposes; storage tanks should be fenced-off to avoid free access to people, and in many cases, there could be a need to have them guarded to protect the structures and pipe-work from vandalism or to avoid theft of water (See Fig 32). Elevated tanks (water towers) are mainly used to gain the necessary pressure head to allow an efficient gravity flow into the distribution network, to stabilize pressures within the system and to facilitate meeting fluctuations in water demand; if the topography of the camp and its surroundings is adequate (hills of adequate elevation), surface reservoirs should be preferred for this purpose as the economic limit of height and volume of water towers is determined when the supporting structure for an elevated tank becomes more expensive than alternative conduction pipelines.

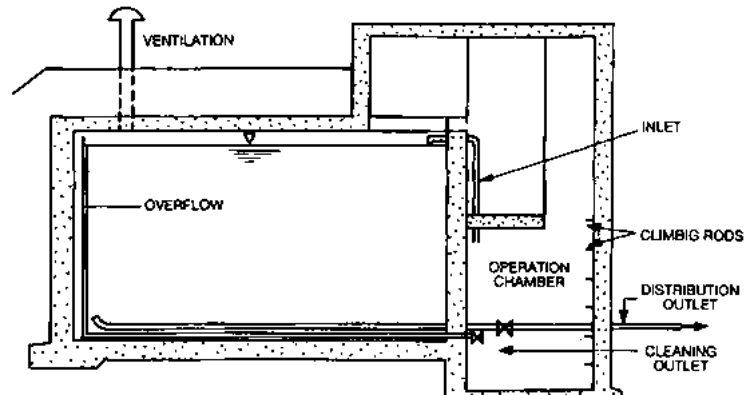

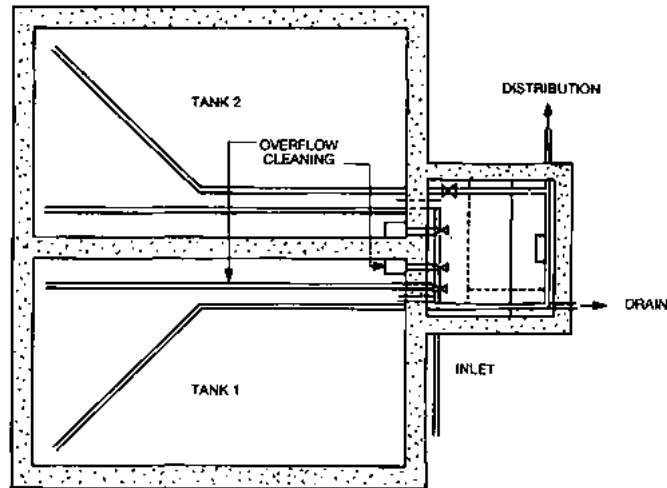

Fig. 32 Details of a Reservoir Tank

Storage capacity needs

7. It has been previously suggested that water supply systems should be provided with maximum storage capacities. Practical limits, some of them technical, but also budgetary ones, should, however, be taken into account when planning this important feature of any water supply system. Among the most important technical aspects to bear in mind are the dependability of the source and the possible fluctuations of its output, which may be seasonal (See 6.20) or related to other causes such as well interference (See 6.27; 6.38; 6.55) or well-efficiency (See 6.41). The possibility of conveying water from the storage

tanks to distribution points should also be considered, as the need to use towers to elevate tanks for the obtention of the necessary hydraulic heads to achieve this would, of course, limit the size of the tanks that may be built with the available funds (water towers should be used only when strictly required as they are expensive and difficult to construct and maintain) (See 9.6). If the population to be supplied is small (say smaller than 2000 people), the aim should be to store a volume equal to at least one day's water demand (See 3.1-9). For economic reasons, larger camp populations will have less storage capacity but, under no circumstances should this capacity be smaller than 1/6 of the camp's daily water demand. In camps with a population of more than 5000 people, the total storage capacity could be obtained through a battery of smaller (and less expensive) reservoirs, strategically located to facilitate the construction of a hydraulically efficient and well balanced water distribution network to provide an even coverage of the total camp population.

Water storage at distribution points

8. It is always advisable to provide individual storage facilities to service centres (such as health or supplementary feeding facilities, administrative buildings and even staff houses). Special circumstances (distribution points located along gravity-fed mains, for instance) could make it advisable to provide individual storage facilities for each public distribution standpost. In these cases the aim should be to have a volume of storage equal to the daily water consumption at each of the individual water points. For this purpose, the use of properly adapted oil drums, metallic, rubber or fibreglass tanks may be considered. When water is being conveyed to the camp by water tanker (bowser), care should be taken to avoid water pollution and waste when filling the tanks. As soon as the piped distribution system is operational, these tanks may be connected to it, after the installation of appropriate float valves to avoid overflows and waste. These individual tanks should be located high enough to ensure an efficient gravity flow and other head requirements (See 10.9) to all taps. In view of complicated operation and maintenance requirements of this

type of systems, their use should be restricted to only very special cases.

Water storage at household level

9. Average size refugee households (5 to 7 people) should be able to store at least 20 litres of water at any given time. However, the ultimate goal of providing a storage capacity of at least 10 litres per person should be clear at the onset of emergency assistance operations (See 4.5). As household storage containers should not be used to transport water from watering points, enough containers to perform this task should also be provided. The best type of storage containers are narrow neck water bottles or jerrycans; they should have a lid. Water pollution is more difficult to avoid with open containers such as buckets or saucepans; their use for household water storage should, therefore, be discouraged. It is advisable to disinfect household storage containers at least once a week, as silt or other materials may collect in them.



[Home](#) > [ar.cn.de.en.es.fr.id.it.ph.po.ru.sw](#)

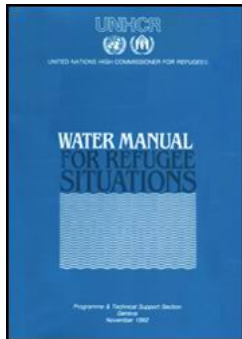

Water Manual for Refugee Situations (UNHCR, 1992, 160 p.)

- 10. Water distribution systems**
 - (introduction...)**
 - General**
 - Types of pipeline systems**
 - Valves and taps**
 - Other system components**
 - Considerations for pipeline designs**
 - Pipeline construction**

Water Manual for Refugee Situations (UNHCR, 1992, 160 p.)

10. Water distribution systems

- **Water distribution systems are needed to convey the water drawn from the source, through treatment and storage facilities, to the points where it is delivered to the users.**
- **Water distribution systems should be kept simple. They should, however be designed and constructed in a proper way as they represent a substantial capital investment that should always be useful and cost-effective.**
- **An appropriate water distribution system should ensure an even coverage of water needs among the camp population.**
- **Under normal circumstances, water distribution in refugee camps should be carried out through public distribution standposts. Service and administrative buildings should be provided with house connections. Staff housing should, whenever possible, be provided with private connections.**
- **The design, construction, operation and maintenance of the water supply system should be carried out bearing in mind the need to minimize eater wastage. This is particularly important in systems based on low yield water sources or on those requiring treatment or pumping.**

General

1. Water distribution systems (or "*reticulation*") should be built to deliver the required quantity of water to individual users and under a satisfactory pressure. In refugee camps, water reticulations are always a major investment and as such require careful design,

construction, operation and maintenance. Under normal refugee situations, distribution systems should cater for the domestic and sanitary requirements of the refugees, camp administration and service centres. Garden or livestock watering may be unavoidable cultural factors which should be covered, as far as possible, in many refugee camps (See 9.11). As the water demand in refugee camps varies considerably during the day, the pipeline network should be designed to supply the "maximum hourly demand", usually estimated to be 30% higher than the estimated average hourly demand (daily water demand divided by 24) (See 3.1-9).

2. The main system components are the pipelines; other basic components are break pressure tanks (See 10.8), valves (See 10.6), service reservoirs (See 9.5-6) and watering points (See 10.9).

Types of pipeline systems

3. From a layout point of view, there are two types of piped distribution systems (See Fig 33):

i) *Branched systems* are those that convey water from a distribution main to different consumption points, following a treelike pattern; all their branches finish in dead-ends. Their design is straightforward but has a main disadvantage in the fact that it causes stagnant water pockets in all dead-ends. If repairs are necessary, large areas must be cut off from service. Head losses, due to heavy local demands - or during a fire - (See 7.13) may be excessive unless the pipes are quite large.

ii) *Looped network systems* usually have a ring mains to which secondary pipes may be connected. Their design is much more complicated; with them the possibility of stagnant water is reduced. If part of the pipeline needs cleaning or repair, it may be isolated from the rest of the system (with appropriate valves); all

watering points outside of it may continue to be supplied.

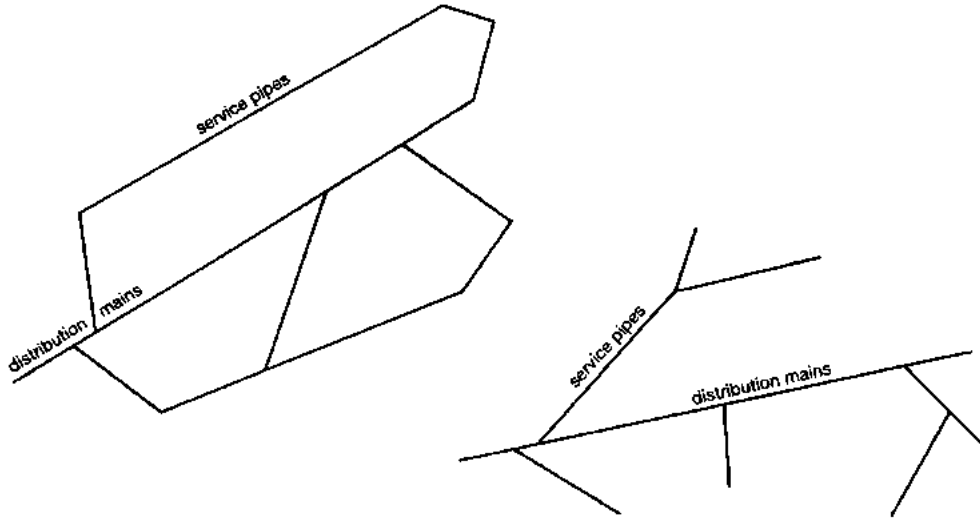

Fig. 33 Pipeline Layouts

4. Pipelines can be classified in accordance with the tasks they should perform:

i) *Trunk mains* convey water from the sources to other points in the distribution system over long or short distances. They may be *pumping mains* if the water is coming under pressure from a pumping system or *gravity mains* if gravity is the only force used to generate flow. *Distribution mains* are those to which standposts and other service connections are connected.

ii) *Service pipes* connect the mains to a camp's section, a standpost or a house

connection.

iii) *Plumbing pipes* form the pipework within standposts, showers, houses, etc.

5. In refugee camps, the most commonly used pipe materials are polyvinyl chloride, known as *PVC* and high density polythene, known as *HDPE*; under special circumstances, especially when the pipeline has to withstand high pressures, galvanized iron (*GI*) pipes are used. The use of *asbestos-cement* pipes for human water supply should be avoided. The choice of pipe materials should be decided bearing in mind availability on local markets, the cost, the diameters available and their pressure ratings. Resistance to corrosion and mechanical damage, as well as transportation requirements to the project site should also be considered. Although both PVC and HDPE pipes are relatively easy to transport in view of their light weight (HDPE has the additional advantage of being provided in rolls for pipe diameters of 160 mm. or less, thus reducing the number of necessary joints), both have the disadvantage of being very easy to tap in unauthorized ways (illegal connections). This can be avoided to a large extent by laying the pipe in appropriate trenches and then covering them. This is, in any case, strictly required by PVC, which is a material that degrades when exposed to sunlight, losing part of its strength and becoming brittle; care should therefore be taken to cover PVC pipes when they are stocked in the open.

Valves and taps

6. All pipeline systems require the use of valves to control flows and pressures as well as for closing or opening a pipeline or a section of it (Fig 34). As the pipeline must always follow the terrain's topography, some valves are used for the release of air that may be trapped at high points (*air valves*) and to facilitate emptying and scouring the pipeline to flush out sediments that may have been deposited at low points (*wash out valves*). *Sluice valves* are fitted to the pump outlets in the case of pumped supplies, but are also installed

to isolate pipeline sections during operation or maintenance activities; these valves are also known as *gate valves*. *Non-return valves* consist of a flat disk set pivoted within the pipe in such a way that it may be forced open by water flowing in one direction but also forced shut, thus impeding the flow, if water tends to flow in the opposite direction. *Float valves* function with the same principle; the driving force is given to the mechanism by the upwards movement of a floater or buoy, thus allowing the automatic closure of inlet pipes before tanks overflow. Other valves, such as the butterfly valves, screw plug valves or ball valves are also used for flow control tasks and are built on the principle of a plug, diaphragm or jumper which is forced into the pipe's opening, thus reducing or shutting off completely the flow; as their sealing device (gasket) wears down rather quickly, they require constant attention and periodical renewal; this may become an important maintenance problem if the valves have a frequent use; an additional disadvantage of these valves is that, due to their design, they cause considerable pressure-head losses, even when completely opened. *Stopcocks*, also known as water *taps* or *faucets*, used at water distribution outlets at public standposts or house connections, are normally designed in accordance with the same principles of screw plug valves. They therefore suffer from the same shortcomings related to the short working life of gaskets, thus creating a major maintenance problem, especially when distribution is carried out through public distribution standposts; these taps may be opened and closed hundreds of times during a single day; as their malfunctioning is one of the main causes of water wastage, this should be given close attention during the planning and implementation of a preventive maintenance programme. Recently, very sturdy, easy to repair and maintain self-closing taps (known as *water saving taps*) have been developed specifically to address these problems; their introduction in public distribution standposts at refugee camps has proven successful in minimizing water wastage and camp maintenance costs.

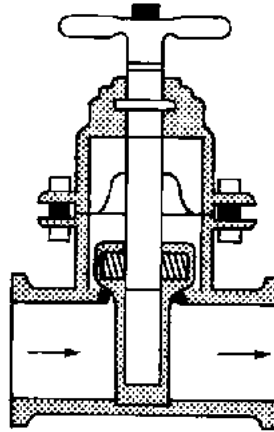

Fig. 34a Type of Valves: gate valve

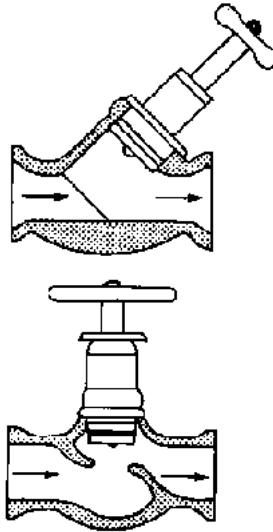

Fig. 34b Type of Valves: plug valves

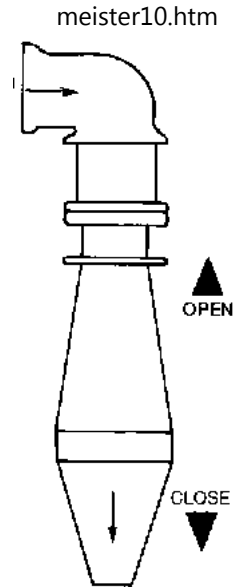

Fig. 34c Type of Valves: water-saving tap

Other system components

7. Valve boxes should always be built to protect control valves from undesirable tampering, which may upset the hydraulic behaviour of an entire water supply system or some of its components; valve boxes are to protect control valves - and the whole supply system - from this type of disturbance; they may be attached to other structures (e.g. storage tanks) or placed independently along the pipeline. They may be made from many materials, depending on local availability, but they should always be provided with a secure cover, adequate drainage, and a size large enough to allow easy operation and maintenance.

8. Whenever it becomes necessary to reduce hydrostatic pressures in gravity pipelines, *break-pressure* tanks are used. These tanks permit the flow to discharge into the atmosphere, thus reducing pressures to zero; a new static level is, therefore, established. Strategic placing of break-pressure tanks minimizes capital costs, as the need to use GI pipes or more expensive, higher grade plastic pipes is reduced (See 10.5). Cement masonry, concrete or any other suitable material may be used for their construction.

9. The most common water distribution facility used in refugee camps is the *public distribution standpost* or *tapstand*. These structures should be designed and built bearing in mind that no other component in the water supply system will suffer more abuse and that they should always be adapted to social and cultural needs of the beneficiary refugee population. This is particularly important in view of the fact that standposts are more than a physical structure; they will normally become a social gathering point where several day-to-day activities (water collection, clothes washing, bathing) will take place (See 6.29). This means that, as part of their design, enough attention should be paid to their location and to the additional facilities necessary to make them sanitary and attractive. The control of water wastage at standposts should also be given importance. Users should never fail to turn off the taps and constant maintenance should be ensured to avoid leaky or broken taps; self-closing, water saving taps have proven effective in this context and their installation in tap-stands should be encouraged (See 10.6). The use of prefabricated distribution standposts may be considered during emergency situations, especially if other system components, such as pumping sets, storage or filtration tanks, etc., are also being brought in as prefabricated packages or kits; these should, however, be of sturdy construction and should allow the use of water saving taps. No single standpost location is likely to meet all ideal requirements; selecting the most appropriate ones will always be a process of compromise. Standposts should be located in places where distances to water users are minimal; as a guideline, 200 metre distances are advisable for most refugee camps, while in less congested situations, such as in rural refugee settlements, a minimum distance of 500 metres may be acceptable. The need to drain away all waste water should

also be given consideration; the costs for this drainage system may be substantially reduced by locating other service components, such as laundry or bath/shower facilities, in the vicinity of the standpost or by using some of this waste water (free of soap or detergents, please!) in fruit or vegetable garden irrigation. Water pressure at standposts should not be too high, never higher than 4 bars (40 metres); very low pressures should also be avoided (absolute minimum: 0.70 bars or 7 metres). While it would be desirable that a single tap would not be used by more than 20 beneficiaries on average, this figure could be as high as 100, depending on the characteristics of each particular refugee situation; to provide an appropriate coverage, multiple tap standposts may be constructed; common designs allow for the installation of 5 to 10 taps in each post.

10. The need to include appropriate *washing/laundry facilities* as a standard infrastructure component of a refugee camp is often overlooked. Washing cooking dishes and clothes is a basic need and, as such, should be appropriately covered by the camp infrastructure. If not, more wasteful, and perhaps less sanitary alternatives, will be developed by the refugees themselves. It is not possible to give general rules or guidelines for the design or construction of appropriate laundry or bathing facilities, as they should respond to the individual needs, as well as to cultural and religious practices of the refugee users. Therefore, their design should be entrusted to qualified engineers who should take into account cultural habits, sanitation requirements as well as the need to minimize water wastage.

11. In some circumstances, there will be a need to provide appropriate watering points for cattle (See 10.1) or for the filling of animal driven carts or water tankers (See 3.5). Adequate designs for these facilities are available in the literature. Their location (normally outside camp boundaries) should, as a rule, be away from refugee water supply standposts. These facilities should always be provided with appropriate access and efficient drainage facilities.

Considerations for pipeline designs

12. Water moving through a piping system is subject to *friction* with the inner surface of the pipes and therefore continuously loses pressure in the direction of flow; this loss is proportional to the length of pipes, to the roughness of their interior and to the square of the velocity. These friction losses may be calculated by using formulas; different graphs may also be used for this purpose (See Fig. 35). This means that in a pipeline system with flow under dynamic equilibrium, pressure drops in the direction of flow in accordance to what is known as the *hydraulic gradient*, which also represents the energy levels at each point along the pipeline.

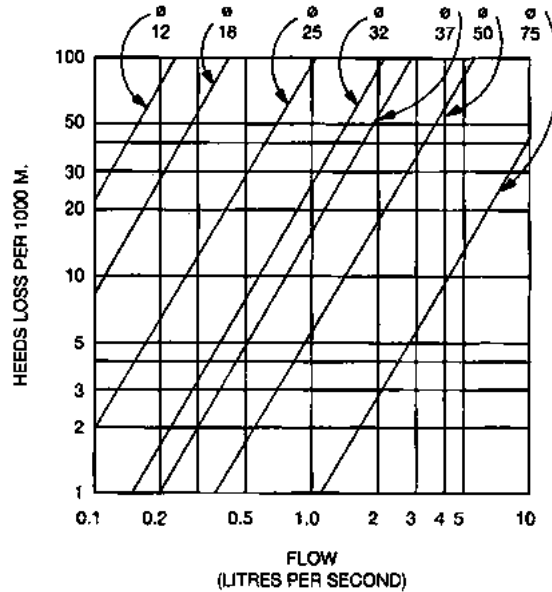

Fig. 35a Graphic Determination of Friction Head Losses in Pipes: HDPE pipes*

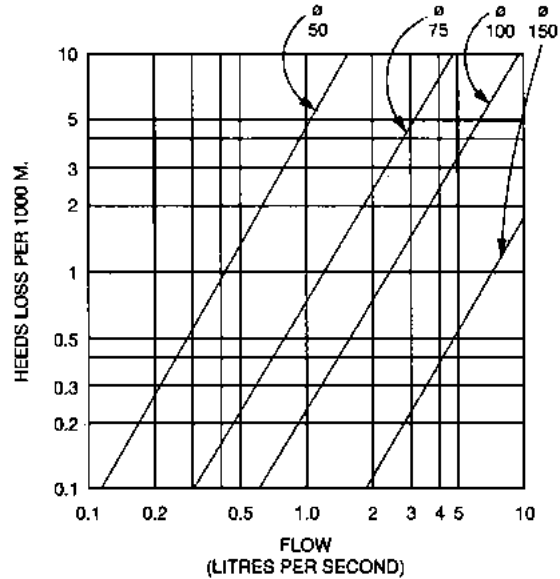

Fig. 35b Graphic Determination of Friction Head Losses in Pipes: PVC pipes*

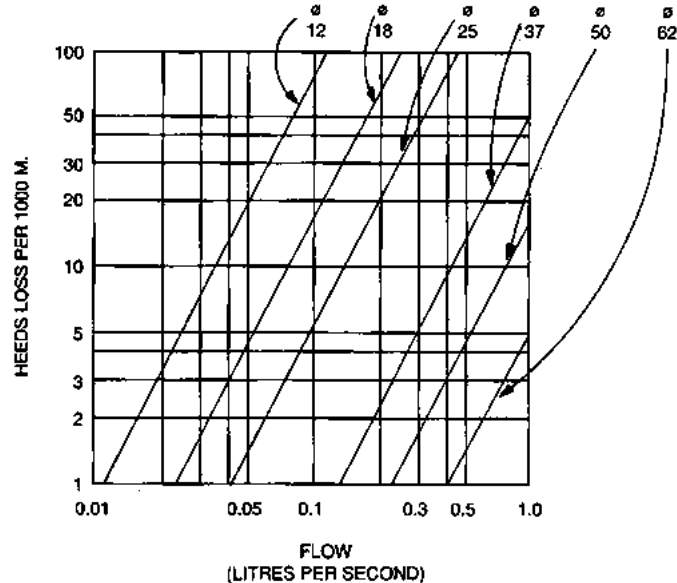

Fig. 35c Graphic Determination of Friction Head Losses in Pipes: galvanized steel pipes*

* All pipe diameter are in millimetres

13. The amount of energy remaining in the pipeline system by the time the desired flow has reached the distribution points is what is called *residual head*, and may be either positive or negative. While positive heads indicate the presence of energy in excess and that there is enough energy to move an even greater flow through the pipeline, negative heads would indicate that, within the pipeline, there is not enough energy to move the desired quantity of water. If a pipeline with a positive residual head is allowed to discharge into the atmosphere, the flow will increase until the residual head is reduced to

zero; this flow, which for the given conditions of each pipeline is always maximum, is called the *natural flow* of the system. In a gravity fed pipeline, the natural flow should always be smaller than the safe yield of the water source (See 6.20 and 6.38), otherwise, the pipe would drain faster than it can be filled and the result will be that the pipe will not flow fully and any standpost located in this section would not function normally.

14. As already mentioned, high *velocity* flows within a pipeline increase friction losses. At the same time, with high velocities, suspended particles can also cause excessive erosion of the pipes; if the velocity is too low, these suspended particles may settle and collect at low points within the pipeline, which may even clog if provisions have not been made for sedimentation (See 8.14-16) of the water or for the provision of appropriate wash-out points for the pipeline (See 9.6).

15. *Air blocks* are bubbles of air that remain trapped, particularly at high points of a pipeline; their size may be such that they could interfere with the normal flow of water through this section. They may become very important (and problematic) in the case of pipelines which are subject to periodical drainage and refilling and provisions should be made to install air valves (See 9.6) at all high points of the pipeline.

16. The bases for the design of any pipeline is the graphic plotting of the topographic survey along the pipeline's route in the form of an "altimetric profile" showing the variation in soil elevations from the source to storage, treatment and distribution points. This survey should have been previously carried out as part of the basic studies to assess the beneficiaries' needs and to produce the conceptual design and budgets required for project approval and funding (See 5.1; 12.8). The hydraulic design comes next; the possibility of using gravity as the only driving force for the water to flow is assessed (See 10.12) and, if insufficient, the calculations for pumping requirements are made; all system components (including treatment facilities, storage, pumping and gravity mains, distribution lines and taps for which it may be possible to use standard models) are also

designed (hydraulic and structural designs) and the final checking for hydraulic soundness and efficiency is done, bearing in mind the ultimate goal of providing a cost effective and reliable supply of safe drinking water to the refugees. The final drawings, showing all technical details of the system, are then finished and will accompany the topographical profile (showing also the pipeline's hydraulic gradients) and the planimetric map showing the exact location of all system components. Once this is done, the documents are ready for "blue-printing". Detailed estimates of materials, labour and money required for the construction are then calculated.

17. As mentioned before, the task of designing any water supply system should be entrusted to a qualified and well-experienced engineer. It will be the responsibility of this engineer to provide a complete record of his investigations, surveys, calculations and designs; this data will prove useful in the project approval and funding exercise, in the negotiations for project implementation (identification of implementing partners, tender procedures, contractual negotiations) and for supervision, operation and maintenance purposes (See 12.8-17). Such data should contain, at least, the following:

i) Pipelines: All relevant data on the different sections of the pipeline (pumping mains, gravity mains, branches, tap connections, etc.) (See 10.4), including pipe material, lengths and diameters. A planimetric map, at an appropriate scale, of the layout of each section of the pipeline, giving clear indication of the length and diameters of each pipeline component, the position of related structures (intakes, valve boxes, reservoirs, etc.)

ii) Surface water catchments, boreholes or wells: Description of the catchment, well or borehole as a water yielding structure (See 6.37; 6.54); results of test pumping and productivity assessments (See 6.38; 6.55); water quality characteristics (See 3.13).

- iii) Intake sections: Sketches (using convenient scales) of the location of sources and the future structures to tap them; design drawings of these structures; calculations of construction needs (volumes of excavation, construction materials, etc.) and labour.**
- iv) Treatment facilities: details and scaled sketches of pre-treatment and treatment structures required (sedimentation, filtration, chlorination, etc.), including specific details of all piping and valves, construction requirements in terms of material, labour, special tools, etc. (See 8.8).**
- v) Break pressure (See 10.8) and reservoir tanks (See 9.2): Careful drawings of the designs are required, depicting all necessary construction details on the structure, pipe and valve arrangements; construction requirements in terms of material, labour, tools, etc.**
- vi) Distribution points: Drawings of each water outlet (individual connections to service, administration or staff accommodation buildings, public distribution standposts, animal troughs, etc.); construction requirements in terms of materials, labour, tools, etc. (See 10.9-11).**
- vii) Other system components: Drawings and other relevant details (location, construction characteristics, piping and valve arrangements, etc.) of special components such as valve boxes, river crossings, etc.**
- viii) Total estimates: Two lists, one for locally procured material and another one requiring purchase and transportation into the country or project area. Unit prices and total costs should accompany these lists. All tool requirements should also be presented, as well as other logistical details on transport of material and related costs (See 12.17).**

Pipeline construction

18. Beneficiaries, not taking into account strangers, heavy animals or vehicles, may cause considerable damage to exposed pumping equipment, pipes or fittings with frustrating results. These problems should be prevented by taking practical and tailor-made steps for each project. In this context, efforts should be undertaken to make beneficiaries understand the difficulties of repairing damaged systems and the negative impact that such repairs have on their own welfare; their cooperation in protecting the system should, therefore, be fostered and encouraged.

19. The design and construction of a water supply system should be guided by the need to avoid these problems and to provide maximum protection to the whole system against adverse weather and other environmental conditions. If pipelines are not constructed properly the first time, remedial actions are difficult, time consuming and discouraging tasks, especially if they have to be undertaken as a result of carelessness or sloppy construction techniques or practices.

20. Pipes should normally be laid within trenches to protect them from damage from traffic or weather conditions. In the tropics, the proper depth of trenches should be at least 0.80 metres; deeper trenches are necessary to avoid freezing and other cold weather effects in higher latitude countries; local experience should therefore be taken into account in choosing the right depth of trenches, always bearing in mind the increased costs deeper trenches represent. Although there are no special requirements for the width of trenches, cost factors determine that this width should be kept to the minimum necessary (mainly determined by the width of the trenching equipment). The trench should be dug in sections equal to the length of the pipe to be buried in it each day and should be free of sharp rocks or bends that may interfere with the pipe; when the entire section is dug, it should be inspected before the pipe is laid.

21. Once the pipe is laid within the trench, and all connections inspected, backfilling may be carried out. The material to be used should be soft and granular; large stones should be avoided. An initial backfilling, to cover the pipes with a minimum of 20 cm. of soil, should be carried out as soon as possible after the pipe has been laid into the trench to provide protection to the pipe. Final backfilling may be carried out after the entire pipeline section has been tested.

22. Although the pipeline should, ideally, follow the route that was originally surveyed and used in the pipeline design and related calculations, it may be necessary during construction activities to introduce some detours or other changes to avoid impassable areas (rocky terrain, landslides, deep gullies) not identified by the original survey. In this case, these detours must be re-surveyed to determine how will they affect the overall hydraulic behaviour of the pipeline system and to calculate additional requirements (pipes, construction materials, other structures, etc.).

23. It is always worthwhile remembering that, within relatively short periods, visible traces of buried pipelines may disappear, making it difficult, and sometimes costly, to find a pipe trace. Permanent markers, at strategically located reference points should be used for future reference. Concrete pegs are the most commonly used markers. They should be located at all branch points, reducers, changes in pipeline direction and at regular intervals in open terrain or bush. A record of each marker, containing at least information on pipeline materials, diameters and direction of pipes should be kept at hand.

24. Leaks or damages to the pipeline should be identified before the final backfilling of the trenches is undertaken. Test pressures should be the maximum pressures possible if the system is gravity fed, or at least 20% higher than the working pressure of pumping mains. The test should be carried out continuously for at least 15 minutes for each 100 metres of pipeline; the air at all high points must be released during the filling of the pipeline, before the testing.



[Home](#) > [ar](#) [cn](#) [de](#) [en](#) [es](#) [fr](#) [id](#) [it](#) [ph](#) [po](#) [ru](#) [sw](#)

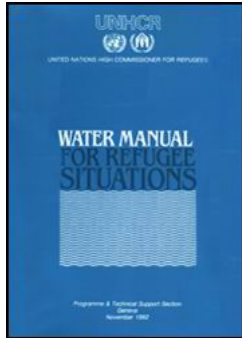

Water Manual for Refugee Situations (UNHCR, 1992, 160 p.)

11. Operation and maintenance of water supply systems

 **(introduction...)**

 **General**

 **Training needs**

 **Operation and maintenance plan**

 **Water inventory data**

 **Preventive maintenance**

 **Refugee participation**

 **(introduction...)**

 **"Village level operation and maintenance"**

 **Standard designs and equipment**

 **Logistics support**

 **Maintenance of sources and catchments**

 **Maintenance of water treatment facilities**

 **Maintenance of reservoirs**

 **Maintenance of standposts and other watering points**

 **Maintenance of pumping facilities**

Water Manual for Refugee Situations (UNHCR, 1992, 160 p.)

11. Operation and maintenance of water supply systems

- **The effectiveness of any water supply system depends, in the long run, on the correct operation of each of its components and on the efficiency of the arrangements to service, repair or replace used or damaged ones.**
- **Although refugee communities cannot assume responsibility for operation and maintenance activities in an emergency camp by themselves, efforts should be made to ensure their maximum involvement in these activities as early as possible, in order to instill a sense of ownership in the community and to facilitate their involvement in longer term care and maintenance assistance activities.**
- **Every camp should have a plan to cover the operation and preventive maintenance needs of all its infrastructure. The engineers in charge of camp design and construction should provide clear and practical guidelines for its elaboration.**

General

1. Once a water supply system is completed it should be operated and maintained to ensure the continuous and reliable supply of safe drinking water to its beneficiaries. Experience shows that refugee water supply systems are more difficult to keep running than to construct. The negative effects of inoperative systems on refugee health, the adverse impact on hygiene practices and sanitary conditions within the camp and the costs of regularly upgrading or repairing wrongly operated or badly maintained systems are reasons enough to make efforts to develop adequate operation and maintenance schemes already during the design and construction stages of project implementation (See 3.8; 5.2; 6.40; 6.56).

2. Whilst the primary responsibility for the continuous functioning of small water supply systems in rural areas and small towns lies with the community, emergency refugee water supply systems, due to their nature, should be kept operational throughout the emergency relief operations by those responsible for camp management (See 5.2), who may or may

not be assisted by specialized government agencies (water authorities, municipalities, etc.) or other organizations working on behalf of UNHCR (voluntary or non-governmental agencies, service contractors, etc.) (See 12.7-iii). Once the emergency needs have been met, and if camp activities are to continue for an undefined period of time, refugee participation in simple operation and maintenance tasks should be gradually introduced, following an education and training campaign which should have started soon after the onset of the emergency (See 11.6; 12.20). At the same time, the possibility of handing over these responsibilities to specialized government agencies with a presence and similar responsibilities in the region where the camp is located will be explored and, if appropriate, pursued, always bearing in mind the intrinsic differences between a refugee camp and normal communities; these differences are created by the legal framework within which refugee assistance is carried out during emergency situations and a lack of sound economic bases for refugees to pursue any type of self-sufficiency at the camps (See 5.2).

3. When the construction of the system is finalized, a water supply operation and maintenance committee should start its work. This committee, as already pointed out, should be under the administrative and financial responsibility of camp managers and should be adequately supported by technical staff from the government or specialized agencies acting as UNHCR's implementing partners in protection or assistance efforts for camp beneficiaries. The committee should appoint a caretaker, preferably a person with technical background and experience in water supply operations, to coordinate and ensure the most effective operation and timely maintenance of the system at any time. The engineer concerned with the design or construction of the system should always be responsible for instruction and training the caretaker before handing over the project to the camp authorities. The camp authorities will make sure that all administrative and financial matters related to these activities are appropriately covered and well understood by the committee and the caretaker in advance.

4. The main task of the water supply operation and maintenance committee should be to ensure that the caretaker (and his staff) operate the system in accordance with a preventive maintenance concept (See 11.9) and by using appropriate and cost-effective "curative" procedures whenever necessary. Preventive actions are those that may be carried out while the system and its components still function, in order to reduce breakdowns and ensure a good continuity and effectiveness of the service. Curative procedures are those actions necessary to upgrade or repair a system or its components to put them in working order again. While preventive actions are cost-saving in the long run, they require an effective use of available resources as well as good planning, organization and management skills from camp authorities and the committee.

5. The arrangements for the operation and maintenance of emergency refugee water supply systems should always be adapted to the needs of the refugees, to camp requirements, to the site's resources and environmental conditions and to the institutional framework of UNHCR's assistance programme (See 2.8; 12.20). The involvement of specialized government or non-government agencies in the operation and maintenance of camp infrastructure should be sought at the onset of the emergency relief efforts. Funds will have to be made available, on a periodical basis, to the responsible entity to pay for the staff and materials needed for the planned inspections and necessary repairs to system components; estimating these funds will require knowledge of the system and its requirements, on the number of personnel required to efficiently carry out all related functions, the level of competence and involvement of the refugee community in these tasks, and the salary scales to be adopted.

Training needs

6. The agency responsible for the operation and maintenance of these water supply systems should develop a training programme on a continuous basis for staff and selected refugees who could eventually get involved in these activities, especially when the

emergency phase is over, and when "care and maintenance" activities take their shape to cater for refugee needs until a durable solution is found for their plight (See 2.9; 3.8; 7.11; 12.20). This programme should include vocational (mechanics, plumbing, etc.), simple record keeping and other administrative training, depending on the technical approach and complexity of the system and on other institutional requirements of the agency and the "care and maintenance" programme being implemented. Technical staff at higher levels should also benefit from the training programme, which should include tailor-made training, covering administrative, accounting, finance and engineering aspects (See 11.20). These programme should also be carried out in such a way as to support and complement other on-going efforts in the fields of preventive health and hygiene education (See 8.24). In this context, a coordinated plan, including estimates of manpower, training staff, equipment, materials and operating costs should be pursued as a way to ensure the necessary funding and assistance from the international community and UNHCR's implementing partners (See 5.1).

Operation and maintenance plan

7. Activities related to the operation of emergency water supply systems depend on the type of system in use. The technical characteristics of the systems have been decided after considering all available resources and constraints. Their operation and maintenance requirements, as well as the approach to meet them, should also have been considered by the design engineer (See 2.10). It is his responsibility, therefore, to provide a clear and practical plan to operate and maintain all system components to camp authorities and relevant service personnel. This plan should be detailed and specific (it should refer to every single system component requiring operation or maintenance actions); it should also be realistic and have a time element in the form of work schedules, giving emphasis to preventive maintenance activities (See 3.16; 4.3; 6.40-45; 6.53; 6.56; 7.5; 7.11; 7.15; 8.19; 8.24; 8.26; 9.4-6; 10.6; 10.9; 11.9). This plan should already include a complete set of technical information required by the operation and maintenance staff to understand

the system and its components as well as to monitor their performance (See 2.6; 10.23); the ways and means of obtaining, storing, retrieving and analyzing additional technical data generated by operation or maintenance activities should also be included in the plan.

Water inventory data

8. It is the responsibility of camp management (and more precisely of their engineering support), (See 11.2) to ensure that technical information is obtained and used to produce and periodically update a *water history file* for each system; experience has shown that this goal may only be attained if the operation and maintenance plans include a routine to ensure that all technical files are kept up-to-date (See 6.40). This water inventory will indicate, on an on-going basis, the operational possibilities, costs and constraints of the systems as well as the type of maintenance required and its possible timing and costs. For this purpose, check-lists may be useful, which should include all physical actions required as well as a complete breakdown of the type and quality of information needed to manage the system's operation and maintenance (See 2.6). The use of water by the beneficiary community should also be monitored and appropriate records maintained on this subject; the impact of a water supply system in an emergency refugee camp is related to social and cultural factors as much as to the technical characteristics of the systems and their components (See 2.8; 3.9; 5.2).

Preventive maintenance

9. A preventive maintenance concept requires that enough technical attention be given to the functioning and performance of each single component of the refugee water supply system to allow the identification of future system faults (loss of efficiency, signs of wear, bacteriological contamination of the supplied water, leaks, etc.) before its breakdown occurs (See 11.4). It also requires a plan for visiting and inspecting every system component on a periodical basis. The results of these visits are to be recorded in the water

history files for monitoring and future reference purposes (See 11.8) as well as all preventive maintenance actions then carried out (servicing engines and other mechanical devices, replacing worn parts, repairing leaks, etc.). The frequency of the visits and the type of actions to be taken at each site will be decided according to the system's technology and characteristics. Appropriate check-lists are also required to assist camp managers and caretakers in their tasks.

10. Camp managers, assisted by the water maintenance committee (See 11.3) will periodically read and analyze field reports to detect troubles before they occur, to take the actions required to solve them (e.g. usage leading to breakdowns, lowering of the water table, low levels of residual chlorine in the supplied water, unsanitary conditions at water points, etc.) and to obtain enough information for budgetary and other management requirements. Information and complaints from beneficiaries should be appropriately recorded and considered by the committee as part of their normal duties. For this purpose, a simple and practical system to receive these complaints or reports from the beneficiaries (refugees, service centres, administration, etc.) should be established, and each of these complaints should trigger the appropriate remedial actions by the committee, the caretaker and his staff.

Refugee participation

11. Refugee communities do not live in "normal conditions" and therefore may not collaborate with camp authorities in maintaining the camp's infrastructure and services as neighbouring host communities would do (See 5.2). The "temporary" nature of emergency refugee camps as well as the socio-economic and political situation of these refugees do not allow for a close and effective involvement of refugees in this type of activities (See 2.8). Efforts should, nevertheless, be made to identify and motivate members of the refugee community with the right technical expertise (or who are willing to be trained) to collaborate with camp authorities during the design and construction of the system and

later in operation and maintenance activities (See 2.9; 3.8; 4.2; 5.1-iv; 6.33; 6.36-iii; 7.11; 11.22). This will facilitate their closer involvement in camp activities should the emergency camp evolve into a longer term "care and maintenance" camp.

12. When designing an approach for refugee participation in an operation and maintenance scheme for camp infrastructure which is likely to be useful, beyond the emergency, in longer term "care and maintenance", it should be borne in mind that the approach required should be adapted to the cultural and social background of the beneficiaries as much as to the technical characteristics of the system itself. The role of women and children as beneficiaries and their possible contribution to operation and maintenance efforts should always be considered; they have been, and are, successfully playing an important role in these type of camp activities in many camps throughout the world (See 3.8). The size of the refugee camp should be considered very carefully when defining modalities and degrees of refugee participation in water supply operation and maintenance activities, as experience shows that whilst it is possible to adapt operation and maintenance schemes which have proven successful in rural non-refugee villages (particularly in developing countries) to *small* refugee camps (say, with populations of less than 3000-5000 beneficiaries), it is practically impossible to apply these approaches to larger refugee camps, whose water supply systems should be managed, operated and maintained in accordance with schemes more similar to those used in larger towns, which require a stronger central system and less participation from the beneficiaries.

"Village level operation and maintenance"

13. An operation and maintenance approach that has proven useful and relatively successful in ensuring continuous and efficient water supply services in refugee camps located in rural environments of some developing countries is the so-called "Village Level Operation and Maintenance" concept (*VLOM*). Although its original conception was to address the operation and maintenance problems of handpump-based water supply

systems, its main principles may be applicable to other types of systems such as those serving small refugee camps (populations ranging between 3000 and 5000 refugees or less). As the bases for this approach should be established during the early stages of camp planning and construction (i.e. during the emergency phase) its applicability to each particular camp should be analyzed by camp authorities and technical staff at the start (See 2.9; 5.1; 12.3).

14. The VLOM approach was made possible by the agreement of handpump manufacturers to develop pumps allowing maintenance efforts to be carried out by village caretakers with minimal skills and working tools, giving preference to the use of spare parts that could be manufactured at local level, and with special emphasis on the cost-effectiveness of these pumping systems and their operation and maintenance requirements. The system also contemplates a great deal of users' involvement in choosing when to service the pumps, the appointment of the caretakers and in meeting (at least partly) the financial requirements of the scheme (this last point is normally not applicable in refugee camps). The advantages (technical, financial and even social) of this concept are reasons enough to analyze its applicability to any refugee situation and to make efforts to adopt it in all camps showing the possibility of success. In this context, advise and support from donor agencies, local authorities, implementing partners and pump manufacturers should be sought.

Standard designs and equipment

15. Very often, several refugee camps may be located in one district, province or region within a "refugee-affected area" and the provision of services to them will very likely be the responsibility of the same government authorities and implementing partner agencies, with the support of the same UNHCR's field or branch office. The delivery of these services, their efficiency and cost-effectiveness and the general impact on refugee welfare will greatly increase if standard designs and plant equipment are used in the construction

of camp infrastructure, including the water system. Efforts and a great deal of planning are required at the early stages of camp development to achieve this goal. Camp authorities, with the technical support of the design engineer and other relevant technicians (See 11.2), will explore the uses and practices of local authorities and government agencies to define the best technological approach to use in the design of the system and its components (See 2.7; 9.16). They will also look at the local and, if necessary, the international market to ascertain the immediate and future availability, and prices, of the equipment considered as most suitable to the project and the local environment. A decision to use the same equipment on a continuous base should then be made, bearing in mind the need to be as flexible as possible to adapt future needs to changing social, technological and financial circumstances. In this context, the use of emergency water supply prefabricated packages should be carefully planned in such a way that, they could either continue to provide a cost-effective service or be easily replaced for more permanent structures and equipment if the need to continue longer term assistance for the refugees arises (See 4.1; 4.7; 7.11; 8.19; 9.5; 12.20).

Logistics support

16. To keep water flowing through a water system requires the importation to the camp of a large number of items. This task should also be "carefully planned in the early stages of camp development. The needs are determined by the size and technological approach used in the system as much as by the camp's geographical situation and by the local social and economic circumstances. Arrangements should, therefore, be made to assess the procurement, transport and warehouse needs of each camp to ensure a timely and effective supply of fuel, spare parts, disinfectants and other materials required for the operation and maintenance of the water supply systems (See 8.21; 10.5).

17. In most cases procurement of assistance items for refugee camps is made outside the camp, by people not necessarily having a thorough knowledge of the technical details

required for the obtention of the right type of equipment or materials for a given water supply system. Although the standardization of designs and equipment may prove useful to ensure a more effective procurement effort, a sound and complete description, with special emphasis on the provision of standard, easy to understand technical specifications, is the only way to ensure the timely availability of the operation and maintenance crews' requirements. It is most important to obtain an exhaustive record of the technical characteristics of each water system component from the design engineer; this record will be kept by the caretaker and adjusted periodically to reflect recent changes. On those occasions when there may be difficulties in obtaining the correct data, an experienced engineer should be consulted (See 11.2)

18. It is the joint responsibility of UNHCR, government counterparts, their implementing partners and camp managers to hold a large enough stock of fuel, spare parts and any other material necessary for the due functioning of the water supply system and its components and to provide workshop facilities for regular operation and maintenance activities. Enough attention should also be given to the conservation of perishable items, such as PVC pipes or disinfection chemicals, to slow down their decay (See 8.21; 10.5). To ensure an effective supply of these basic items, arrangements should be made for the utilization of the procurement, warehouse/storage, and control facilities (and their staff) covering charge of the provision and distribution of other assistance items to the refugees (construction materials, medical supplies, food items, etc.). When more than one refugee camp is under the responsibility of the same agencies, efforts should be made to centralize the system so as to ensure an even supply of the requirements to all camps (See 11.15). At camp level, warehouse facilities should be adapted to the technical characteristics of the water supply system and its components; details of these facilities should be given by the design engineer as part of the information to be submitted by him upon completion of his work (See 6.26-ii; 8.21; 9.17-vi).

Maintenance of sources and catchments

19. The need to protect all water sources from pollution has been previously discussed (See 2.2; 3.11; 4.3; 6.9; 6.19; 6.29). Appropriate actions should be planned, included in the operation and maintenance plan (See 11.7) and undertaken by the caretaker and his staff to periodically check that this protection is effective (prevention of farming in the catchment areas, cutting grass and overgrowth in the vicinities of structures, regular inspections at collection chambers of spring intakes, cleaning and greasing of locks, repairs to cracked slabs or leaks, etc.). As periodical coliform bacteria counts provide the best indicators on the evolution of bacteriological water quality, they should be performed on a regular basis (See 3.16); appropriate actions should be immediately taken to locate and eliminate any source of pollution thus detected. Catchment structures such as surface water intakes, dug wells, boreholes, hafirs, etc., require specific actions for the repair of erosion damages, for the cleaning of siltation or incrustation deposits or for periodical disinfection (See 6.11; 6.21; 6.40-45; 6.53; 6.56); these actions should be included in the preventive maintenance plan (See 11.7).

Maintenance of water treatment facilities

20. Water treatment plants may perform many processes in accordance with the raw water quality and the design of the system; technological approaches to treatment are also many and very varied (See 8.8). It is most important to make sure that these facilities are well understood by the caretaker and his crew to ensure the continuous potability of the supplied water. Cutting grass and overgrowth around the structures; greasing doors and locks, provision of preventive maintenance to valves (greasing, replacement of gaskets, etc.), periodical cleaning and disinfection of tanks, preventive maintenance, service and repairs to mechanical equipment (pumps, chlorine dosers, agitators, etc.) and water quality control (See 3.16; 8.24) are important activities related to the operation and maintenance of most treatment facilities. Slow sand filters, for instance (See 8.19), require water to be drained off first before 1 to 2 cm. of the sand surface is carefully scraped off, a process that could be repeated periodically until the sand filter layer

approaches its minimum effective thickness (not less than 50 cm.); the intervals for cleaning depend on the quality of the raw water and the filter's throughput (generally between 3 to 8 weeks). Previously removed sand is carefully washed to eliminate all its contamination and dirt, additional "new" sand is added to complete the initial volumes and the filter is backfilled for another cycle once this minimum sand level has been reached.

Maintenance of reservoirs

21. Maintenance of reservoirs is often overlooked or neglected; tanks need, however, periodical cleaning and repairs to keep their effectiveness and to avoid any possibility for them to become sources of pollution to the supplied water. Checks for damages in their structures and covers, detection of leaks, and related repairs may be carried out just after cleaning the tanks. Disinfection of the tanks should always be carried out after these operations and before they are put back into service. The surroundings of all tanks and reservoirs should be kept clear of grass and overgrowth.

Maintenance of standposts and other watering points

22. Actions to take care of public distribution standposts and other watering points (e.g. cattle trough facilities) may, to a large extent be carried out by the refugee beneficiaries themselves. The importance of this collaboration should be stressed in hygiene education programmes (See 2.9; 11.2). Among the tasks that should be carried out by refugees are all those necessary to maintain the standposts clean and the drainage facilities (for waste water) operational (See 6.29; 10.9). All leaky taps should be replaced or repaired as soon as possible; the use of automatic closing, water saving taps may prove important in controlling water wastage and leaks (See 10.6). Valve chambers should also be inspected and cleaned on a periodical basis; repairs to them should be made without delay as soon as the faults are discovered

Maintenance of pumping facilities







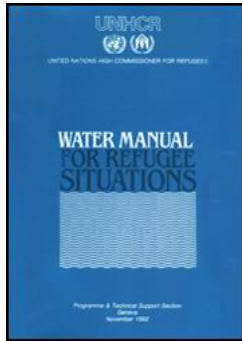



23. Little can be said on this subject apart from insisting that the manufacturer's instructions on operation and maintenance of mechanical equipment should be *closely and strictly* followed. The buildings should also be checked with some periodicity; valves should be maintained and leakages repaired (See 7.5; 7.8).



[Home](#) > [ar.cn.de.en.es.fr.id.it.ph.po.ru.sw](#)



Water Manual for Refugee Situations (UNHCR, 1992, 160 p.)

- ➔ **12. Management of emergency water supply systems**
 -  **(introduction...)**
 -  **Needs assessment**
 -  **Conceptual design**
 -  **Immediate response**
 -  **Plan of action**
 -  **Emergency project submission**
 -  **Project preparation**
 -  **Tender documents**
 -  **Project implementation**
 -  **From emergency to general programmes in the water sector**
 -  **Budgets**

Water Manual for Refugee Situations (UNHCR, 1992, 160 p.)

12. Management of emergency water supply systems

- **The identification of appropriate water sources, the construction of the necessary structures to tap, treat, store, and distribute drinking water to the refugees and the activities related to the operation and maintenance of these facilities are only a small component of the assistance activities to be undertaken for emergency programmes. In view of their particular requirements, however, water sector activities require specific planning and implementing arrangements to attain the ultimate objective of providing enough safe water to the refugees and to their communal facilities in the most cost-effective way.**
- **Water projects, as many other refugee assistance efforts, require specific actions to achieve their objectives. These actions should follow a previously defined order of actions to ensure the timely and effective coverage of refugee needs.**
- **These specific activities should be developed within the overall emergency programme and its cycle. Efforts should be made to identify the correct working paths to follow and their timing, in such a way that full and up-to-date information is always available for programming purposes.**

Needs assessment

1. Emergency programmes should cover total needs of refugee camps from the start of the emergency. These programmes are designed on the basis of the assessment of total emergency assistance needs. As may be the case for other assistance sectors, it is very seldom that the basic data necessary for water supply project design and implementation, is available during the needs assessment exercise. Conceptual designs of the necessary structures and systems will have to be used for the initial planning of emergency response.

Conceptual design

2. Conceptual designs will be useful for programme formulation, a basic step in ensuring a consistent approach towards meeting all refugee needs, including adequate funding, appropriate implementation arrangements and a clear time frame for emergency operations. Conceptual designs should be based on available technical data and should be flexible enough to allow for their adjustment to the physical realities of the project site, to the socio-cultural background of the beneficiary refugee population and to the institutional framework of the programme itself (including arrangements for possible longer term assistance to refugees, beyond the emergency programme's time frame) in accordance with the results of further investigations and surveys (See 12.8).

3. Any refugee water supply system is a combination of structures and other facilities to produce (collect, treat, store) and distribute potable water to a group of people living in camps (See 10.17). Its design should be based on a thorough knowledge of the available water resources and other relevant environmental conditions of the site; its construction and technological approach should ensure the compatibility of each system component with the others; both the type of service delivered and its operation and maintenance requirements should be appropriate to the socio-cultural background of the beneficiaries and to the operational characteristics of assistance activities in the camp. Several basic studies and surveys may be necessary for planning and final design purposes; the selection of adequate equipment should be carefully done after considering its technological characteristics, procurement possibilities, constraints (including those of spare parts) and operation and maintenance requirements.

Immediate response

4. Short-term emergency measures will almost invariably be necessary to meet water needs of a refugee community while efforts are made to obtain the necessary data on the

available water resources and the means to develop them into an efficient and cost-effective water supply system (See 4.1; 5.1; 6.4; 8.1; 8.3; 8.10; 9.17; 11.2). There are flexible funding mechanisms to cover these initial requirements at the onset of emergency operations; they are made available through the *Emergency Letter of Instruction (ELOI)*, which, while not intended to cover the whole emergency operation, should permit a rapid response to immediate needs.

Plan of action

5. Once the most basic water needs of the refugee community have been met, and as a result of the needs assessment exercise, a plan of action will be needed to develop, in the minimum time possible, a water system capable of covering *all* camp needs on a longer term basis. This plan will include the description (*terms of reference*) of all investigations, studies or surveys necessary to obtain basic data for the design of the future system, construction and operation of the future system (See 4.1; 5.1). It will also include a complete description of any other action, already foreseen as necessary, which could be performed before the final design of the system is available (development of sources, borehole drilling, access roads, organization of refugee involvement, etc.). This plan of action should give a clear idea of the correct timing for each activity (and the plan's "critical path") as well as an *estimate*, as accurate as possible, of the required technical and financial inputs. This plan of action will be instrumental in formulating the water sector of the *emergency programme*, the instrument which should ensure the full coverage of sector needs from the start of the emergency.

Emergency project submission

6. The correct formats and procedures to be adopted for project submission are clearly explained in other handbooks. A *technical project description* containing the objectives and actions to be undertaken to achieve them should be part of this documentation. While

some of these actions could be carried out as a part of the same project, others, in view of their complexity or requirements, should be carried out independently. This is the case for some topographical surveys, highly specialized hydrogeological studies, borehole drilling programmes, etc. The implementation of these projects (or sub-projects) should respect, as much as possible, the time schedules proposed in the plan of action (See 12.5).

7. A correct technical project description is an important tool for both, UNHCR and the executing agency (implementing partner) (See 1.7; 5.1-iii). It should provide, in clear and concise terms, enough information to justify the need for the project, to assess its cost-effectiveness, to be the basis for the preparation of budgets, implementation and monitoring plans and to facilitate the fund raising exercise. An *executive summary*, covering all important aspects of the project should be presented first, for the convenience of interested individuals, particularly decision-makers who may not read the entire document. Location maps and other simple information should also be included in this summary, to enable clear presentation and quick understanding of all project characteristics. Project descriptions should also include a list of project objectives, a mention of all preparatory work required, and a detailed list of constraints, recommendations and actions to be taken; their main body should contain:

i) Introduction:

- Reasons for project proposal and its objectives;**
- Background information on the water supply and sanitation sectors, including present water conditions; situation of existing infrastructures; socio-economic and cultural background of the beneficiary refugee population; self-help activities; and, if relevant, long-term development plans for the project site;**
- Location map, showing project site and overall layout of the proposed**

system (water source, water lifting methods, conduction pipelines, treatment facilities, distribution system, waste water disposal, etc.).

ii) Institutional background:

- Description of all governmental and non-governmental institutions or organizations having an impact on water supply, sanitation or public health in the camp or its vicinity, giving special emphasis to the proposed implementing partner. Information should be provided on their purpose and goals, operational responsibilities, managerial capability, staffing, location of headquarters and their regional and local facilities;**
- Sector policies, including targets for service and standards, financial arrangements, institutional development, refugee community participation, administrative and technical support;**
- Beneficiaries. Description of social, cultural and economic background of the beneficiaries (refugees and host communities, if applicable), criteria for selection of target groups, water demand estimates (including livestock, gardening or other purposes);**
- Public Health aspects. Presence of water borne diseases and other existing health conditions, curative and preventive health practices, health education and hygiene training programmes, institutional arrangements, etc.;**
- Water resources. Overview of available surface and groundwater resources; available geological, meteorological and hydrological data; its reliability and results of analyses in terms of water balances and budgets, present and future water demand and patterns (in space and time); water quality and pollution problems;**

- **Existing water supply services (if any), type of service, coverage, standards, reliability, water quality, user charges, operating and maintenance status;**
- **Need for the project. This section should explain why existing water supply arrangements (if any) cannot cope with present or projected water demands, and the consequences the lack of better services will have on present and future refugee population. It should also give an outline of priorities and comments on the urgency of project implementation.**

iii) The project:

- **Technical description. Definition of the project and outline of its components, including maps, photos, drawings, sketches and bills of quantities, as appropriate. Description of additional project preparation work requirements (studies or surveys; further design work; related projects, such as opening of access roads, borehole drilling, etc.); necessary support activities, such as logistics, training of local operators, health education;**
- **Implementation arrangements. Identification of all institutions and voluntary organizations involved in project implementation, including the need for consultants or contractors (if applicable); description of their functions and responsibilities, coordination and monitoring mechanisms, needs for assistance or support (staff, training, financial, etc.); implementation schedule, complete with chronogram depicting the tasks of each group involved, critical paths and necessary administrative steps (provision of budget, preparation of tender documents, obtention of land and water rights, etc.);**

- **Operation and maintenance arrangements. Description of future arrangements for operation and maintenance of the water system facilities, including self-help (refugee participation) activities, technical assistance required, annual costs and any other requirement;**
- **Environmental impact. Description, in brief terms, of the various environmental impacts to be expected as a result of the project, including public health, sanitation and water resources themselves;**
- **Cost estimates: A summary of estimated project costs, taking into account a realistic provision for unexpected costs for each budget item. These costs are to be estimated on the proposed bills of quantities and on unit prices for each element; a breakdown of costs into foreign exchange and local currency components would always be desirable; a full explanation on how costs were estimated and a list of basic assumptions (particularly those for unit prices, contingencies, price increases, etc.) should be included. A breakdown of "in kind" and "in cash" costs should also be desirable;**
- **Financial plan. A final budget summary, in accordance with the FMIS formats (See 12.21) will be presented in this section and, if relevant, all possible sources of funding should be identified, both for project implementation and for the long-term operation and maintenance of the system to be constructed. A discussion on arrangements for future accounting and reporting should also be included.**

iv) Technical annexes:

- **Map of the camp/village/settlement, including all project related buildings and installations (existing or to be constructed);**

- **Assessment of water source productivity (pumping test analysis, flow measurements, hydrographs, etc.);**
- **Chemical and bacteriological assessment of water quality;**
- **Planimetric details and hydraulic profile of conduction and distribution lines;**
- **Technical details, specifications and plans ("blue prints") of all structures, system components and their interconnections;**
- **Terms of reference and technical specifications for additional technical inputs.**

Project preparation

8. In many cases, additional project preparation work will be required to study alternative sources (geophysical prospection or hydrogeological surveys, water quality analyses), to obtain basic data still required for the final design of the system (topographical surveys, assessment of source potential and safe yields) and to make the necessary adjustments to conceptual designs, in accordance with the results thus obtained (See 8.15-16). The nature of most of these actions allows for them to be carried out independently and requires rather specialized technical inputs. They could, therefore, be regarded as "sub-projects" and as such should be planned and implemented in accordance with normal project implementation rules and practices. In some of these cases, the project description may take the form of *"terms of reference"* if the project is to be undertaken on a consultancy basis; in other cases, especially when construction or other types of physical work have to be undertaken in the field under contractual arrangements, the project description should take the form of *"technical specifications"*.

9. Terms of reference for a consultancy work should ideally include as much background and technical information on the project as possible (See 12.7) to provide a clear idea to potential consultants; a detailed description of objectives, project requirements and arrangements for the consultant to carry out his work as well as suggested (or required) methodologies should also be included; details on reporting and other project output requirements (blue prints, bills of quantities, budgets, tender documents, etc.) and a mention of the required technical expertise and experience will complete these terms of reference. Consultancy work may be carried out by individual specialized technicians or by consultancy companies offering a wide variety of technical expertise. The use of local expertise in this type of work should be encouraged (See 2.7).

10. The technical specifications given to a contractor for any work should be detailed enough to describe exactly the works required and the characteristics of resulting structures or other types of facilities (See 6.57). This is especially important because it is the only way to ensure the compatibility of the facilities thus built with the rest of the system. These specifications should refer to design documents (blue prints, sketches, etc.), bills of quantities and overall responsibilities for the contractor to carry out his work. Supervision and control mechanisms (including the description of tests or other verification work) as well as work acceptance or rejection procedures should also be contained in the technical specifications to allow the client (UNHCR or the implementing partner) to ensure the contractor's full compliance with contractual terms and, therefore, the quality of his work. Annex D1 gives an example of this type of document.

11. Once all necessary basic data and other project requirements have been obtained, the final design of the system may be undertaken (See 2.3; 10.16-17). Appropriate sketches and blue prints of every single component of the system should then be prepared in final form; accurate bills of quantities (a list of all materials, labour and other inputs required for the completion of the system or any of its parts) should be drawn up and final budget estimates calculated.

Tender documents

12. The nature of the work required to build and commission a water supply system is such that very often this work may only be undertaken by contractors having specialized knowledge and equipment. Financial rules require that, in this case, potential contractors be invited to offer their services in accordance with a tender and bidding procedure. For this invitation, appropriate documents should be prepared by the executing agency (UNHCR or an implementing partner) to describe the procedures, the type of work to be carried out, the type of contractual arrangements that will regulate the future works and the mutual relations between the client and the contractor during project implementation.

13. Tender documents, in general, should contain an *introduction* section, where the basic "rules" to be applicable to the future contract are explained (these rules, of course, should always be compatible with UNHCR's financial and programming rules); a list of the document's terms, expressions, abbreviations, etc., and their respective meanings will also be included, as well as the definition of the working language(s) and type of units to be used (usually metric units should be used; however, the final choice depends on the country and its normal practice; in this case, conversion factors should be defined). Currency units should also be defined. The next part of the document should be the *instructions to bidders* section, which should clearly explain:

- i) General principles, including general specifications and instructions for bidding and for the handling and flow of documentation, as well as the price (if any) to be paid for these documents by bidders;**
- ii) Procedures for the amendment of published documents; it may be necessary to amend, cancel or make addenda to previously published documents; procedures for this purpose, and their time frame, should be adequately explained;**
- iii) Type of information to be given to potential bidders and UNHCR's (or the**

implementing partner's) responsibilities and limits on the type of information given. This is the place to make it well understood that although legal constraints may not be spelled out, they should be applicable in as much as national or regional laws are applicable to UNHCR, implementing partners or contractors. The procedures to be followed for the obtention/release of specific information, including time frames, should be explained. The value of "non-technical" or "unofficial" information given or received by UNHCR, the implementing partner or government counterparts should also be defined here;

iv) Legal requirements for bidding companies/individuals (i.e. contractors); technical or financial capacity, required expertise and experience, definition of the "rules of the game" for groups of individuals or companies who, as in a "joint venture", decide to participate as a single body;

v) Definition of restrictions and incompatibilities, to exclude persons/companies which, by legal restrictions, or any other reason, may not work as UNHCR's contractor; these restrictions may also be extended to all activities within the future contract (i.e. banks, consultancies, supervision, monitoring, etc.);

vi) Presentation of offers. It is necessary to define the number of copies required for each document, the formats, language, style, currency used, pricing criteria, cost breakdowns (e.g. local versus international procurement, international staff, local labour, etc.), payment arrangements. It will also be necessary to define the treatment to be given to incomplete, partial or late offers, to incorrect (e.g. arithmetically) offers, as well as the legally binding character of the offers. All additional documentation, to be handed jointly with the offers, is to be defined (legal certificates, guarantees, bonds, etc.) as well as the procedures required for the amendment of offers, addenda to them or their withdrawal;

vii) Assessment of offers. The opening of offers should be defined in terms of exercise (private/public), venue and date;

viii) Treatment of bidding documents. The legally binding character of the offers should be repeated here, and a definition of unacceptable documents or offers due to defects or legal constraints should also be given;

ix) Contractual arrangements. Definition of who is to award the contract, when and how; criteria used, always leaving open the possibility to reject all offers if found unacceptable; procedures and criteria for appeals;

x) Documentation and guarantees for the contract. A definition of what documents, when and how they should be provided by the successful contractor; these documents should, at least, contain information on the contractor's legal and financial status and on the required performance guarantees, licenses or permits;

xi) Procedures to formalize contractual agreements. Definition of document formats, procedures for their approval at all levels (local, regional, national, UNHCR Headquarters, etc.), other documents necessary for the due completion of contractual documents (insurances, lists of prices, etc.); work programmes and time schedules, other management tools (bar charts, flow diagrams, etc.); direction, monitoring, inspection and acceptance (or rejection) criteria and procedures should also be defined.

A last section should contain the *general contractual norms*, including:

i) Legal obligations of the different parties involved, the legal character of all documents, the obligations of the contracting party or client (UNHCR or implementing partner) including all mandatory clauses for project implementation and contractual arrangements; information to be provided by the client, other

requirements and responsibilities;

ii) The obligations of the contractor, including the provision of labour and his obligations towards them, services to UNHCR/implementing partner and their staff, provision of adequate materials and equipment, laboratory/sampling/testing facilities, storage facilities, etc;

iii) General principles and rules to be followed during project implementation should be spelled out and discussed in this section, including:

a) The need to follow plans, specifications, instructions and other decisions made in accordance with contractual terms, sound technical practices and "good faith";

b) Contractor's responsibilities during implementation, including those at working sites, obtention of permits and licenses as required;

c) The type of communications between the contractor and UNHCR or the implementing partner, specifying the inclusion of a "log book" which will be part of the official communication channels between parties and which should always remain at the work sites;

d) UNHCR's or the implementing partner's inspection authorities and responsibilities;

e) The importance of technical plans and specifications;

f) The procedures to solve discrepancies within plans, to amend them or to change them;

- g) The need for temporary arrangements at the construction site, especially if these arrangements are likely to interrupt existing services or facilities (opening of existing roads or destruction of crops for pipe laying, etc.). Provisions should always be made here against the destruction of trees, wild life pollution, etc.;**
- h) The property of the material resulting from works and the responsibility for cleaning work sites from debris, pollutants, etc.;**
- i) The need to follow previously agreed time schedules and other work plans, while making provisions for required changes of any of these working plans within the limits of contractual arrangements;**
- iv) Procedures to make changes outside of contractual arrangements (supplementary agreements, procedures, practices, other documentation, communications);**
- v) All aspects related to inspection mechanisms, procedures, rules and practices, including the use of the "log book", reports and acceptance/rejection tests, adjustments and changes of designs or schedules, practices during partial or total suspension of works, procedures for partial or final payments and the use of guarantees and quality or function bonds;**
- vi) If required, arrangements for subcontracted interventions should also be spelled out (applicability, relations between contractors, subcontractors, UNHCR, implementing partners);**
- vii) Conditions for compliance and resolution should also be given (cancellation of contract, claims, arbitration).**

Tender documents are finally completed with a collection of the technical drawings/blue prints, showing the location, characteristics and technical specifications of the water system which are added as an annex to the main body of the documents. In view of the large amount of information that should be contained in these drawings, it is necessary to be careful in the choice of their scale and layout to avoid cluttering and difficulties in reading them. As a minimum, this set of drawings should include:

i) the topographic and hydraulic profiles of the pipeline;

ii) a detail of each system component (main or branch lines, intakes, pumping stations, break pressure tanks, treatment plant structures, storage facilities, distribution standposts) and of any sections of the pipeline requiring special attention or construction methods (river crossings, valves boxes, interconnections, etc.);

iii) a general plan view of the system, showing its layout and its relative position as referred to appropriate landmarks or camp infrastructure;

iv) a "key plan" of the system, showing, schematically, the relative arrangements for the tanks, control valves, branchlines, standposts and other service connections.

Project implementation

14. A project is ready for implementation once its final design has been achieved and approved and adequate funding has been secured for it. To initiate construction works, some initial steps, depending on the implementation arrangements and the institutional set up of the assistance programme, need to be taken. It is necessary to emphasize the need to follow designs and plans as closely and accurately as possible, as well as the inspection, acceptance and rejection mechanisms, specially if UNHCR's implementing

partners are themselves undertaking the construction works (no contractors' involvement). It will be necessary to carry out further discussions with successful contractors, to make sure every single contractual detail (as suggested by the tender documents) is agreeable to all parties involved; the results of these discussions will be recorded and included in the final *contractual document*, which, after approval by a Contracts' Committee if necessary, is to be signed by the contractor and UNHCR or the implementing partner, as appropriate. This document will be based on the general contractual norms forming part of the tender documents, the time frames for construction and on the technical specifications and drawings of the future system (See 6.57; 12.13).

15. During construction works, UNHCR and the implementing partners will collaborate with the contractor in all matters related to the organization of the work site, storage/warehouse and other logistic needs, the organization of refugee labour or other community inputs, etc. and any other aspect considered important for the timely and effective completion of the project. It should always be clear, however, that the ultimate responsibility for these activities belongs to the contractor (See 6.36; 11.15; 11.18).

16. During construction, close supervision is necessary to ensure that each system component is being built in accordance with plans and specifications and on time (according to contractual time frames). At the project site, the contractor will make daily reports on his activities, achievements and use of materials in a *log book* (a sturdily bound notebook having all its pages numbered). The inspector, an engineer with adequate professional background and expertise, working on behalf of UNHCR or the implementing partner, will periodically review this book and annotate there his comments and instructions, or the results of relevant discussions with the contractor or his crews. On the basis of this book and other relevant information, the inspector will prepare periodical reports on the works' progress, the problems encountered, and propositions on how the project should continue. This report should provide enough information to allow the estimation of partial or periodical payments, in accordance with achievements and

contractual rules; for this purpose, it may also be necessary for the inspector to present a financial statement to substantiate his recommendations.

17. Once the project is considered completed, the contractor should hand over to UNHCR or the implementing partner a *financial statement* showing clearly the costs in cash or in kind for each system component. This statement is to be certified by the supervisor.

18. The contractor will also hand over a *final report* to UNHCR or the implementing partner containing at least:

i) A brief history of the project and its implementation phase;

ii) Technical details and plans, with necessary comments, of all system components;

iii) Comments on technical aspects relevant to operation and maintenance requirements, life expectancy of installations, special care required by them, possibilities for extension of the system or its services, etc.;

iv) Hand over note, concerning the system and its installations, with a clear sheet of instructions for operation and maintenance, for the use of caretakers (See 11.7).

v) A complete set of "*as built plans*" for all structures, buildings, pipelines and other system components, where all modifications to the initial designs should be made to reflect the real characteristics of the resulting structures and installations (See 10.22).

19. All these reports, technical information, guidelines and drawings should be collected to be used as the basis of the technical documentation required for future operation, maintenance and control purposes (See 2.11; 11.3; 10.23).

From emergency to general programmes in the water sector

20. In a refugee camp, operation and maintenance activities are long-term responsibilities of camp managers (See 2.8; 5.2; 11.2; 11.5; 11.15; 11.18), the water committee, relevant refugee groups and relevant staff (caretaker and his crew). Adequate funding for all these activities and their requirements should be secured through their inclusion within the general assistance programme in accordance with the standard formats for *project submission* and with the *technical project description* of the activities to be carried out and their expected results (See 12.7). Care should be taken to spell out every single activity requiring funds or other inputs and some allowance should be made for unforeseen or additional requirements. In this context, close attention should be given to the estimation of materials, labour, expertise, logistic and technical support required for their inclusion in working plans, time schedules and budgets (See 8.9; 8.25; 11.7; 11.16).

21. Maximum involvement of local authorities and specialized government departments in the construction operation and maintenance of camp infrastructure should be sought at the early stages of project implementation. Water supply operation and maintenance activities at a refugee camp offer a good opportunity to trigger this involvement; efforts should be made to promote the eventual integration of refugee services into existing national programmes, especially if a durable solution to the refugee problem is not at hand.

Budgets

22. UNHCR's budget structure defines a project in terms of the fund (annual programme, emergency fund, trust funds...) the type of assistance (emergency, care and maintenance, local settlement...) and the caseload (beneficiaries). This definition is the basis of a system of symbols and codes to enter or retrieve budgetary information for programming or project management purposes. This system is called the *FMIS* budget structure (See the

UNHCR Handbook, Chapter 4). Within this structure, water supply activities are grouped under "sector D - Water (Non-agricultural)" which requires the allocation of project activities to six different codes:

- D.01 Plan/survey/research/evaluation**
- D.03 Water system development/construction**
- D.21 Water system operations**
- D.97 Training/orientation/seminar, etc.**
- D.98 Other water activities (specify)**
- D.99 Sector support/management**

The first code includes all project activities and requirements for the obtention of basic data (e.g. hydrogeological or topographical surveys, water quality studies, etc.) and for the design of the system or any of its components (See 5.1); the cost of activities undertaken during the needs assessment and project preparation (See 12.1; 12.8) as well as those to cover the costs involved in sector evaluations (comparison between objectives and achievements; corrective measures) should, therefore, be included under this code. The second code (D.03) comprises the cost of all those activities related to the construction of the water system or any of its components. It should include the costs of repairs to the system's infrastructure and extensions of existing facilities (See 3.9). The third code (D.21) should cover all those activities related to the operation and maintenance of the water supply system and its components and which, at least during the emergency operations, should necessarily be covered by the assistance programme (See 11.2). The nature of operation and maintenance activities depends on the system's technological approach and should be reflected in the camp's operation and maintenance plan (See 11.7), which should also identify its logistic needs to ensure their appropriate coverage under this code (See 11.16). The next code (D.97) should cover those activities related to on-the-job training to those responsible for operation and maintenance activities within the sector, including individual or refugee groups and counterpart staff

(See 2.9; 11.3; 11.6). Code D.98 may cover any water sector activity which should be depicted in budgetary and other programming and financial documents for any particular reason; the type of activities under this code should, of course, be identified. Water tanker operations or the coverage of household water storage needs (See 8.9) may be examples of budgetary lines under this code. Code D.99 should include all staff and technical support costs (expertise, specialized equipment, etc) related to day-to-day operation, maintenance and management of the water system, including in-kind payments to refugee workers.

23. The FMIS budget structure requires two additional budget specifications after the sector and the activity codes to complete the specification of any budgetary line. These codes define the line's item and sub-item. A list of item and sub-item codes is presented in Chapter 4 of the UNHCR Handbook and in other FMIS documentation. This list should be consulted to ensure the appropriatedness of the coding.



[Home](#) > [ar.cn.de.en.es.fr.id.it.ph.po.ru.sw](#)

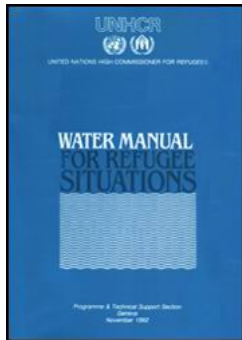

 **Water Manual for Refugee Situations (UNHCR, 1992, 160 p.)**

 **(introduction...)**

 **Foreword**

 **Drinking water**

 **1. Introduction**

 **2. Assessment and organization**

 **3. The need**

 **4. Immediate response during emergencies**

 **5. Refugee water supply systems**

- 6. Water sources, their protection and development**
- 7. Pumping equipment**
- 8. Water treatment**
- 9. Water storage**
- 10. Water distribution systems**
- 11. Operation and maintenance of water supply systems**
- 12. Management of emergency water supply systems**
- ➔ **Annex A - Refugee water supply inventory forms**
- Annex B - Approximate daily water requirements in refugee emergency situations**
- Annex C - Guidelines on water quality**
- Annex D - Recommended format for technical specifications for water well construction**

Annex A - Refugee water supply inventory forms

REFUGEE WATER SUPPLY INVENTORY FORM

Date:...../...../.....

Country:..... **Camp:**.....

Location:.....,,

State/province District Locality

Source Name:.....

Sketch Location Map

Drafted by:..... Scale:

Present Use:

- Unused**
- Unprotected**
- Abandoned**
- Protected**
- Other (specify):.....**

Observations:.....

Location by Coordinates:

Latitude:

Longitude:

Elevation (metres above sea level):

Measurement device:

- Altimeter***
- Theodolite***
- Estimate***
- Other (specify)***

TYPE OF SOURCE:

Surface water

Groundwater

Other (specify):

Lake

Sprina

.....

- Pond
- Swamp
- River
- Creek
- Other (specify):.....
- Sump
- Dug well
- Tube well
- Infiltration Gallery
- Other (specify):.....

DESCRIPTION OF EXISTING WATER SUPPLY AND WATER USE (actual or potential) of this source within the system: (use additional pages, if required).....

REFUGEE WATER SUPPLY

Source:.....

INVENTORY FORM

Date:.... / / Camp:..... Identification (name or number).....

Elevation (metres above sea level).....

Description of source:

Type.....

Type of water catchment structures (if any) (include drawings, sketches, etc. as annexes):.....

Description of existing water supply and water use (actual or potential) of this source within the system:.....

Water quality and quantity:

Description of general conditions and factors affecting water quality and quantity. Include, as annexes, laboratory or field records on quality tests and a summary of volumes/yields measurements with significance for productivity and reserve calculations:.....

REFUGEE WATER SUPPLY SURFACE WATER SOURCES INVENTORY FORM

Date:..../..../.. Source name:.....

Camp:..... Elevation (*metres above sea level*).....

Type:.....

YIELD ASSESSMENT CHART				
Measurement Number	Date	Flow Measurement (Litres per Second)	Measuring Device	Performed by
1				
2				
3				
4				
5				
6				

WATER QUALITY ASSESSMENT CHART*														
Analysis Number	Date	Physical Characteristics (specify units of measure)					Chemical Characteristics (milligram)							
		Colour	Odour	Turbidity	Suspd	pH	Elec.	Alkalinity	Total	-	-2	-	-2	-

					Solids	Conduct		Hardn	HCO3	CO3	Cl	SO4	NO3

Description of potential or present use (include possibilities and constraints for further development):

Include, as annexes, all laboratory or field analysis reports, including bacteriological data.

REFUGEE WATER SUPPLY SPRING WATER SOURCE INVENTORY FORM

Date:..../..../.. Spring name:.....

Camp:..... Elevation (*metres above sea level*):.....

Type:.....

YIELD ASSESSMENT CHART				
Measurement Number	Date	Flow Measurement (Litres per Second)	Measuring Device	Performed by
1				
2				
3				
4				
5				
6				

WATER QUALITY ASSESSMENT CHART*			
Analysis Number	Date	Physical Characteristics (specify units of measure)	Chemical Characteristics (milligram

		Colour	Odour	Turbidity	Susp Solids	pH	Elec. Conduct	Alkalinity	Total Hardn	- HCO3	-2 CO3	- Cl	-2 SO4	- NO3

Hydrogeological setting (include a hydrogeological sketch, if possible, as an annex):

.....

Description of potential or present use (include possibilities and constraints for further development):

Include, as annexes, all laboratory or field analysis reports, including bacteriological data.

REFUGEE WATER SUPPLY LARGE DIAMETER WELL SOURCE INVENTORY FORM

Date:..../..../.... Camp:.....

Well number:.....

Well name:.....

Construction Date:.../.../....

Elevation (*metres above sea level*).....

Constructor:.....

WELL LOG					
Depth (metres)	Geological Log (graphic)	Design Log (graphic)	Geolog. Log Descriptive	Design Log Descriptive	Pumping Tests*
					Type: <input type="checkbox"/> constant yield <input type="checkbox"/> step drawdown <input type="checkbox"/> other (specify)..... Date:..../..../...

Static water level:.....
Rate of extraction:.....
Duration:.....
Flow measurement device:.....
Level measurement device:.....
Reference point for measurement (datum):
Dynamic water level:.....
Specific capacity:.....
Safe yield:.....
Other observations.....

*** Pumping test measurements must be included as annexes.**

Description of casing and filter elements:.....

Description of well head design (including apron, sanitary seals, drains):.....

Observations:.....

Pumping test measurements should be included as annexes.

REFUGEE WATER SUPPLY BOREHOLE SOURCE INVENTORY FORM

Date:.... / / Camp:..... Borehole number:.....

Borehole name:.....

Drilling Date:.... / /

Elevation (metres above sea level).....

Driller:..... Rig/drilling technique:.....

BOREHOLE LOG					
Depth (m) graphic	Geological Log (graphic)	Design Log (graphic)	Geolog. Log Descriptive	Design Log Descriptive	Pumping Tests*
					Step drawdown: Date:..../..../.... Static water level:..... Number of steps:..... Pumping rates:..... Constant yield: Date:.../.../.... Static water level:..... Observation wells: **..... Rate of extraction (l/sec);..... Duration:..... Flow measurement device:..... Level measurement device:..... Dynamic water level:..... Specific capacity (l/sec per metre drawdown):..... Storage coefficient/Specific yield:.....

Transmissibility:.....
Safe yield:.....
Observations:***.....

*** Pumping test measurements must be included as annexes.**

**** If measurements made in observation wells, add location maps, design log, pumping test data and any other relevant information as annex.**

***** Laboratory or field water quality analysis reports should be added as annexes.**

Description of casing: diameters:..... Material:.....

Description of screens: diameters:..... Material:.....

Slot openings:.....

Description of gravel pack:.....

Description of well head design (include description of apron and sanitary seal):.....

Observations:.....

REFUGEE WATER SUPPLY BOREHOLE SOURCE INVENTORY FORM

Borehole Number:.....

Elevation (*metres above sea level*):.....

Camp:.....

STATIC WATER LEVELS RECORD

Date	Measurement Device	Reference Point	S.W.L.	Date	Measurement Device	Reference Point	S.W.L.	Date	Measuri Devi
.../.../...				.../.../...				.../.../...	
.../.../...				.../.../...				.../.../...	
.../.../...				.../.../...				.../.../...	
.../.../...				.../.../...				.../.../...	
.../.../...				.../.../...				.../.../...	
.../.../...				.../.../...				.../.../...	
.../.../...				.../.../...				.../.../...	
.../.../...				.../.../...				.../.../...	
.../.../...				.../.../...				.../.../...	
.../.../...				.../.../...				.../.../...	
.../.../...				.../.../...				.../.../...	
.../.../...				.../.../...				.../.../...	
.../.../...				.../.../...				.../.../...	
.../.../...				.../.../...				.../.../...	
.../.../...				.../.../...				.../.../...	

PHYSICO-CHEMICAL WATER QUALITY ASSESSMENT CHART*														
Analysis Number	Date	Physical Characteristics (specify units of measure)						Chemical Characteristics (millig						
		Colour	Odour	Turbidity	Suspd Solids	pH	Elec. Conduct	Alkalinity	Total Hardn	- HCO3	-2 CO3	- Cl	-2 SO4	N
1	.../.../...													
2	.../.../...													
3	.../.../...													
4	.../.../...													
3	.../.../...													

6	.../.../...												
7	.../.../...												
8	.../.../...												
9	.../.../...												
10	.../.../...												

BACTERIOLOGICAL WATER QUALITY CHART

Analysis Number	Date	Total Coliforms MPN/100 ml	Escherichia Coli MPN/100 ml	Analysis Number	Date	Total Coliforms MPN/100 ml	Escherichia Coli MPN/100 ml	Analysis Number	Date
1	.../.../...				.../.../...				.../.../...
2	.../.../...				.../.../...				.../.../...
3	.../.../...				.../.../...				.../.../...
4	.../.../...				.../.../...				.../.../...
5	.../.../...				.../.../...				.../.../...
6	.../.../...				.../.../...				.../.../...
7	.../.../...				.../.../...				.../.../...
8	.../.../...				.../.../...				.../.../...
9	.../.../...				.../.../...				.../.../...
10	.../.../...				.../.../...				.../.../...



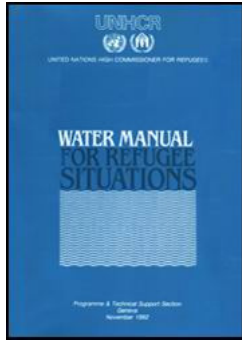

Water Manual for Refugee Situations (UNHCR, 1992, 160 p.)

 **(introduction...)**

 **Foreword**

 **Drinking water**

 **1. Introduction**

 **2. Assessment and organization**

 **3. The need**

 **4. Immediate response during emergencies**

 **5. Refugee water supply systems**

 **6. Water sources, their protection and development**

 **7. Pumping equipment**

 **8. Water treatment**

 **9. Water storage**

 **10. Water distribution systems**

 **11. Operation and maintenance of water supply systems**

 **12. Management of emergency water supply systems**

 **Annex A - Refugee water supply inventory forms**

 **Annex B - Approximate daily water requirements in refugee emergency situations**

 **Annex C - Guidelines on water quality**

 **Annex D - Recommended format for technical specifications for water well construction**

Annex B - Approximate daily water requirements in refugee emergency situations

(Only for indicative purposes, actual values depend on many variables that should be assessed by specialists)

1. Human consumption

a) Minimum, "survival" allocation.	7 litres per capita
b) Minimum refugee camp allocation.	15-20 litres per capita

2. Services, at camp level (Additional to human consumption)

a) Out-Patient Health Centres	5 litres per patient
b) In-Patient Health Centres	40-60 litres per patient
c) Hospital (with laundry facilities)	220-300 litres per bed
d) Schools (Toilet requirements not included)	2 litres per student
e) Schools (water-flushed toilet system)	10-15 litres per student
f) Feeding Centres	20-30 litres per patient
g) Camp Administration. (Staff accommodation not included)	5 litres per capita
h) Staff accommodation	30 litres per capita
i) Mosques	5 litres per visitor

3. Livestock

a) Bovine cattle (4-5 times weight of ingested dry food)	25-30 litres per head
b) Horses, mules (3-4 times weight of ingested dry food)	20-25 litres per head
c) Goats and sheep (2-3 times weight of ingested dry food)	15-20 litres per head
d) Pigs (2-2.5 times weight of ingested dry food)	10-15 litres per head

e) Chicken

10-20 litres per 100

Agricultural Crop Requirements

* "Rule of Thumb" for irrigation	1 litre <i>per second</i> per hectare
a) Vegetable gardens	3-6 litres per square meter
b) Maize	2.5-5 litres per square meter
c) Rice	3-5.5 litres per square meter
d) Tomatoes	2.5-5 litres per square meter
e) Onions	2.5-4 litres per square meter



[Home](#) > [ar.cn.de.en.es.fr.id.it.ph.po.ru.sw](#)

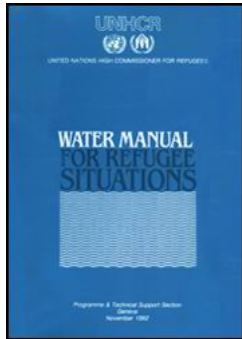

Water Manual for Refugee Situations (UNHCR, 1992, 160 p.)

(introduction...)

Foreword

Drinking water

1. Introduction

2. Assessment and organization











3. The need

4. Immediate response during emergencies

5. Refugee water supply systems

6. Water sources, their protection and development

7. Pumping equipment

-  **8. Water treatment**
-  **9. Water storage**
-  **10. Water distribution systems**
-  **11. Operation and maintenance of water supply systems**
-  **12. Management of emergency water supply systems**
-  **Annex A - Refugee water supply inventory forms**
-  **Annex B - Approximate daily water requirements in refugee emergency situations**
-   **Annex C - Guidelines on water quality**
-  **Annex D - Recommended format for technical specifications for water well construction**

Annex C - Guidelines on water quality

Source: Guidelines for Drinking Water Quality, Vol. I World Health Organization Geneva, 1984

Table 1. Microbiological and biological quality

Organism	Unit	Guideline value	Remarks
I. Microbiological quality			
<i>A. Piped water supplies</i>			
<i>A.1 Treated water entering the distribution system</i>			

faecal coliforms	number/100 ml	0	turbidity < 1 NTU: for disinfection with chlorine, pH preferably < 8.0: free chlorine residual 0.2-0.5mg/litre following 30 minutes (minimum) contact
coliform organisms	number/100 ml	0	
<i>A.2 Untreated water entering the distribution system</i>			
faecal coliforms	number/100 ml	0	
coliform organisms	number/100 ml	0	in 98% of samples examined throughout the year - in the case of large supplies when sufficient samples are examined
coliform organisms	number 100 ml	3	in an occasional sample, but not in consecutive samples
<i>A.3 Water in the distribution system</i>			
faecal coliforms	number/100 ml	0	
coliform organisms	number/100 ml	0	in 95% of samples examined throughout the year - in the case of large supplies when sufficient samples are examined
coliform organisms	number/100 ml	3	in an occasional sample, but not in consecutive samples
<i>B. Unpiped water supplies</i>			
faecal coliforms	number/100 ml	0	

	ml		
coliform organisms	number/100 ml	10	should not occur repeatedly: if occurrence is frequent and if sanitary protection cannot be improved, an alternative source must be found if possible
<i>C. Bottled drinking-water</i>			
faecal coliforms	number/100 ml	0	source should be free from faecal contamination
coliform organisms	number/100 ml	0	
<i>D. Emergency water supplies</i>			
faecal coliforms	number/100 ml	0	advise public to boil water in case
coliform organisms	number/100 ml	0	of failure to meet guideline values
Enteroviruses	-	no guideline value set	
II. Biological quality			
protozoa (pathogenic)	-	no guideline value set	
helminths (pathogenic)	-	no guideline	

		value set	
free-living organisms (algae, others)	-	no guideline value set	

Table 2. Inorganic constituents of health significance

Constituent	Unit	Guideline value	Remarks
arsenic	mg/l	0.05	
asbestos	-	no guideline value set	
barium	-	no guideline value set	
beryllium	-	no guideline value set	
cadmium	mg/l	0.005	
chromium	mg/l	0.05	
cyanide	mg/l	0,1	
fluoride	mg/l	1.5	natural or deliberately added: local or climatic conditions may necessitate adaptation
hardness	-	no health-related guideline value set	
lead	mg/l	0.05	
mercury	mg/l	0.001	
nickel	-	no guideline value set	
nitrate	mg/l (N)	10	
nitrite	-	no guideline value set	

selenium	mg/l	0.01	
silver	-	no guideline value set	
sodium	-	no guideline value set	

Table 3. Organic constituents of health significance

Constituent	Unit	Guideline value	Remarks
aldrin and dieldrin	µg/l	0.03	
benzene	µg/l	10 ^a	
benzo [a]pyrene	µg/l	0.01 ^a	
carbon tetrachloride	µg/l	3 ^a	tentative guideline value ^b
chlordane	µg/l	0.3	
chlorobenzenes	µg/l	no health-related guideline value set	odour threshold concentration between 0.1 and 3 µg/l
chloroform	µg/l	30 ^a	disinfection efficiency must not be compromised when controlling chloroform content
chlorophenols	µg/l	no health-related guideline value set	odour threshold concentration 0.1 µg/l
2,4-D	µg/l	100 ^c	
DDT	µg/l	1	
1,2-dichloroethane	µg/l	10 ^a	
1,1 -dichloroethene ^d	µg/l	0.3 ^a	
heptachlor and	µg/l	0.1	

heptachlor epoxide			
hexachlorobenzene	µg/l	0.01 ^a	
gamma-HCH (lindane)	µg/l	3	
methoxychlor	µg/l	30	
pentachlorophenol	µg/l	10	
tetrachloroethene ^d	µg/l	10 ^a	tentative guideline value ^b
trichloroethene ^d	µg/l	30 ^a	tentative guideline value ^b
2,4,6- trichlorophenol	µg/l	10 ^{a,c}	odour threshold concentration, 0.1 µg/l
trihalomethanes		no guideline value set	see chloroform

a These guideline values were computed from a conservative hypothetical mathematical model which cannot be experimentally verified and values should therefore be interpreted differently. Uncertainties involved may amount to two orders of magnitude (i.e., from 0.1 to 10 times the number).

b When the available carcinogenicity data did not support a guideline value, but the compounds were judged to be of importance in drinking-water and guidance was considered essential, a tentative guideline value was set on the basis of the available health-related data.

c May be detectable by taste and odour at lower concentrations.

d These compounds were previously known as 1,1-dichloroethylene, tetrachloroethylene, and trichloroethylene, respectively.

Table 4. Aesthetic quality

Constituent or characteristic	Unit	Guideline value	Remarks
aluminium	mg/l	0.2	
chloride	mg/l	250	
chlorobenzenes and chlorophenols	-	no guideline value set	these compounds may affect taste and odour
colour	true colour units (TCU)	15	
copper	mg/l	1.0	
detergents	-	no guideline value set	there should not be any foaming or taste and odour problems
hardness	mg/l (as CaCO ₃)	500	
hydrogen sulfide	-	not detectable by consumers	
iron	mg/l	0.3	
manganese	mg/l	0.1	
oxygen - dissolved	-	no guideline value set	
pH	-	6.5-8.5	
sodium	mg/l	200	

solids - total dissolved	mg/l	1000	
sulfate	mg/l	400	
taste and odour	-	inoffensive to most consumers	
temperature	-	no guideline value set	
turbidity	nephelometric turbidity units (NTU)	5	preferably <1 for disinfection efficiency
zinc	mg/l	5.0	

Table 5. Radioactive constituents







Constituent	Unit	Guideline value	Remarks
gross alpha activity	Bq/l	0.1	(a) If the levels are exceeded more detailed radionuclide analysis may be necessary. (b) Higher levels do not necessarily imply that the water is unsuitable for human consumption
gross beta activity	Bq/l	1	

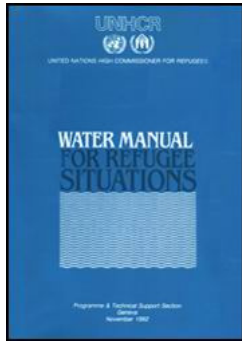

[Home](#) > [ar](#).[cn](#).[de](#).[en](#).[es](#).[fr](#).[id](#).[it](#).[ph](#).[po](#).[ru](#).[sw](#)

Water Manual for Refugee Situations (UNHCR, 1992, 160 p.)
(introduction...)



-  **Foreword**
-  **Drinking water**
-  **1. Introduction**
- 2. Assessment and organization**
- 3. The need**
- 4. Immediate response during emergencies**
- 5. Refugee water supply systems**
- 6. Water sources, their protection and development**
- 7. Pumping equipment**
- 8. Water treatment**
- 9. Water storage**
- 10. Water distribution systems**
- 11. Operation and maintenance of water supply systems**
- 12. Management of emergency water supply systems**
-  **Annex A - Refugee water supply inventory forms**
-  **Annex B - Approximate daily water requirements in refugee emergency situations**
-  **Annex C - Guidelines on water quality**
-  **Annex D - Recommended format for technical specifications for water well construction**

Annex D - Recommended format for technical specifications for water well construction

Key:

A = Number of wells to be drilled

B = Location of drilling sites

C = UNHCR's implementing partner for the project

1. GENERAL CLAUSES

1.1. Subject of the Contract

The subject of the contract comprises the construction of (A) water wells for potable water supplies for refugee settlements in (B).

The contractor will carry out the drilling work and provide the proper tools, machinery, implements, materials and labour for due construction of the wells, their development and pump testing. He will also provide the casing and screen materials according to the quality specifications given hereunder.

1.2. Information supplied by (C)

(C) will supply all available information about the possible hydrogeological conditions at each drilling site. It should be clear that this information does not hold (C) responsible for the locally different conditions at the specific drilling site or for the particular problems the contractor may face while carrying out his work.

1.3. Drilling Sites

(C) will indicate the drilling sites and provide the required permits for the use of the land where the contract is to be carried out.

The contractor will be responsible for all damages occurring outside the allocated land.

The contractor will clear all debris of any kind, and leave the land, as far as it is possible,

in the original condition, once the well has been finished, developed and pump-tested.

1.4. Abandoned Well

If the contractor is not able to finish the drilling or has to abandon the well due to loss of tools or any other accident or contingency, he should remove the casing or drive pipes already placed in the hole and refill it with clay or concrete, at his own expense. All material extracted from such holes, after refilling them will be considered the property of the contractor.

In this case, (C) will not pay for any of the work carried out, and will authorize in advance the drilling of a new hole, at a site near the abandoned one.

2. TECHNICAL SPECIFICATIONS

2.1. Boreholes

2.1.1. *Information concerning each borehole*

The contractor will supply a detailed borehole log, in which all relevant information on drilling velocity, well casing and other well construction operations will be recorded.

The contractor will also annotate all information pertaining to the appearance of water filtrations and aquifer, types of rock found and rock sampling details.

2.1.2. *Casing and diameters*

The drilling of each hole will be carried out according to the characteristics specified in the Appendix of these specifications, using the proper drilling tools, drive pipes, casing pipes, gravel packs and sanitary protection (see 2.5.), based on the real characteristics of the aquifer formations. The casing pipe and sanitary protection (seals) should isolate the

aquifers from other formations, which are considered improper for the exploitation of wholesome water.

The well design is to be authorized by (C) before the casing pipes and screens are introduced into the well.

2.1.3. Pipes and screen filters

The contractor will supply all pipes, screen filters and fittings for the proper casing of the wells at the agreed price.

2.1.4. Drilling equipment and depth of drilling

The contractor will use drilling equipment capable of drilling down 25 per cent deeper than indicated in Appendix I. The use of cable tool, rotary or down the hole hammer (air percussion) rigs is acceptable. The depths indicated in the Appendix are tentative and should only be regarded as a guide.

If the real characteristics of the wells being drilled justify any change in these specifications, the contractor will request the authorization of (C) for such changes to be made.

These communications will be made verbally and shall be properly recorded by (C).

In every case, if the actual characteristics of the well differ from those indicated in the Appendix I, and once these changes have been authorized by (C), a proper price adjustment will be made according to the final depth of the well, and the unit price rendered by the contractor in his original proposal.

2.2. Well Completion and Test Pumping

2.2.1. Pumping tests

The contractor will have a pumping unit capable of discharging 50 per cent more water, at the well's pumping water level, than the maximum yield indicated for each well in the Appendix.

Once the well construction is finished, the well will be developed by hydraulic surging (by means of a packer piston, compressed air or dry ice treatment). Immediately after this operation is completed, the well will be cleaned and the pumping unit introduced into the well. The contractor will communicate (3 days in advance) the date the pumping test is to be carried out.

The test pumping of the well will be performed according to 2.2.1.1.

2.2.1.1. Pumping test

The test will consist of continuously pumping the well at the maximum yield specified in Appendix I for the respective well (or at any other previously defined rate, according to the results of the drilling work, between the contractor and (C). The duration of this test will be 48 hours. The measuring of the dynamic water levels will be performed according to the logarithmic time-scale schedule normally used for test pumping water wells.

2.2.1.2. Other specifications

The contractor will evacuate all the pumped water in such a way that no impoundments are produced at distances less than 200 m from the well. The contractor will provide all the necessary elements for this purpose.

The contractor will provide all necessary implements (weirs, pipes, gauges, etc.) for the proper measurement of discharge rates and water levels.

2.2.2. Well yield

After the pumping tests have been carried out, (C) will decide the recommended yield for each well, according to the test results, appropriate hydrogeological techniques and the actual needs.

2.3. Well Plumbness and Alignment

2.3.1. Tests

The well will be tested for plumbness and alignment by means of a 12 metre long, and perfectly straight, steel pipe that will be introduced along the whole well. The external diameter of this will, at the most, be 13 mm less than the well casing inside the diameter. This pipe will be supplied by the contractor.

2.3.2. Minimum requirements

Such a test pipe, as described in 2.3.1. should easily move through the whole well. The loss of plumbness of the well's axis should never be more than 2/3 the smaller inside diameter of casing. If these minimum requirements are not met by the well, the contractor will, if possible, correct the defects. If not, (C) will reject the well and no payments will be made for its drilling and completion. This test should normally be made before pump testing the well.

2.4. Protection of the Water Quality, Disinfection and Sampling

2.4.1. The contractor will take maximum care to avoid the physical, chemical or bacteriological contamination of the well water, during the construction operations. In any case, where water is polluted due to the contractor's neglect, he will be obliged to carry out all the necessary operations, at his own cost, in order to extract such pollution from

the well.

2.4.2. Well sterilization

Once the well has been completed and tested, the contractor will sterilize the well with a chlorine solution yielding at least 50 mg/l of active chlorine in all parts of the well.

The chlorine solution may be prepared for this purpose, by dissolving calcium hypochlorite, sodium hypochlorite or gaseous chlorine in water. The chlorine solution should stay in the well for at least four hours, at the specified concentration.

2.4.3. Rock samples

The contractor will keep a complete record of the rock samples taken during the drilling operations, in properly packed and identified sample bags, and will make them available to (C) upon his request.

The contractor will take at least one sample every three metres of drilling, unless a change in rock formations is spotted by the driller. In such cases, additional samples should be taken. The minimum weight for each sample should be 500 grammes.

For each rock sample that has not been taken, the contractor will be fined a penalty amounting to 1 per cent of the total value of the well and this will be deducted from the final payment. If the total amount of samples not taken is more than 15 per cent of the specified number, the well should be started again and (C) will not make any payments for the work already done.

2.4.4. Water samples

The contractor will take two water samples for laboratory analysis, after completion of the

long duration pumping test. One sample will be used for physical and chemical analysis. It should be put in a clean and properly sealed plastic or glass container. Its volume should not be less than 5 litres. The other sample will be used in a bacteriological analysis. It should be collected in triplicate, in sterilized, properly sealed and protected containers. The volume of such containers should not be less than 100 millilitres. The samples will be handed to (C) as soon as the samples have been taken.

2.4.5. Sand particle content in pumped water

The water drawn out of the well will be acceptable if it has a sand particle content of less than 5 grammes per cubic metre. In case this maximum limit is not kept, the contractor will make all necessary adjustments to the well structure, at his own expense, in order to meet this specification.

2.5. Finishing Works

2.5.1. Temporary lid

The contractor will pay close attention to the due protection of the well's mouth against the entrance of water or any other pollutants while drilling or after the completion of the well. For this purpose, he will provide a lid to be placed at the well's mouth at any time the drilling rig is not in operation. This lid will also be placed after the well has been completed.

2.5.2. Artificial filter packs

An artificial properly graded gravel pack will be placed in the annular space between the hole wall and the outer face of the casing according to Annex 1. Proper techniques should be used for the accurate placing of this pack on the site. The gravel to be used should be clean, well-rounded and the grains should be hard and of alluvial origin and in size

between 0.5 and 2.5 cm diameter. This gravel has to be approved by (C).

2.5.3. Sanitary protection seal

All the wells that have been completed and tested with success, should have a proper sanitary seal protection built of concrete.

This protection will be placed from 3.5 metres below the ground to 0.25 metres above the ground and will occupy all the annular space between the hole face and the outer face of the casing.

APPENDIX I.

Characteristics of the Water Wells

Tentative Specifications (see 1.2 Technical Specifications)

WELL SITE LOCATION	DRILLING DIAMETER mm	DIAMETER Of CASING mm	MAXIMUM DEPTH OF DRILLING mm	LENGTH OF CASING m	LENGTH OF SCREEN m	MINIMUM EXPECTED YIELD lps	MAXIMUM EXPECTED YIELD lps	REMARKS

lps: litres per second

m: metre

mm: millimetres



[Home](#) > [ar](#).[cn](#).[de](#).[en](#).[es](#).[fr](#).[id](#).[it](#).[ph](#).[po](#).[ru](#).[sw](#)

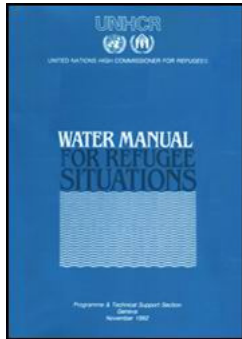

 **Water Manual for Refugee Situations (UNHCR, 1992, 160 p.)**

 **(introduction...)**

  **Foreword**

 **Drinking water**

 **1. Introduction**

2. Assessment and organization

3. The need

4. Immediate response during emergencies

5. Refugee water supply systems

6. Water sources, their protection and development

7. Pumping equipment





8. Water treatment

9. Water storage

10. Water distribution systems

11. Operation and maintenance of water supply systems

12. Management of emergency water supply systems

-  **Annex A - Refugee water supply inventory forms**
-  **Annex B - Approximate daily water requirements in refugee emergency situations**
-  **Annex C - Guidelines on water quality**
-  **Annex D - Recommended format for technical specifications for water well construction**

Foreword

This manual is dedicated to everyone with an interest in providing a better life to refugees.

A reliable supply of an adequate quantity of clean, wholesome water is a vital need for any community; it will stimulate productive work and help to improve personal hygiene, food preparation and health care among the beneficiaries. Planning for the provision of drinking water to refugees should take into account their special social, economic and political characteristics, which will determine the approach in the construction, operation and maintenance of service infrastructure. This should, in essence, be different from approaches followed by local urban or rural communities, the standards and levels of service should, however, be kept similar to those received by the "local neighbours".

The purpose of this manual is to explain to those involved in the provision of refugee assistance the technical characteristics and functioning of components, structures or equipment that may form part of a refugee water supply system. It should make them aware of the need to follow rational approaches, adaptable to the specific circumstances of the refugee sites and communities, which will normally require the involvement of specialized technicians. For these technicians, the manual will provide an indication of UNHCR's technical guidelines and criteria

for the design, operation and maintenance of the water systems, as well as for the technical management of construction or operation projects.

It is important to point out that, although the manual may sometimes seem too idealistic, its main message should be interpreted as a call to planners, decision makers and constructors to always use the highest possible standards, taking into account the political, social and funding circumstances of each project. The aim should be to achieve a reliable and cost-effective service for the beneficiaries for as long a time as possible.

M. Douglas Stafford
Deputy High Commissioner for Refugees



[Home](#) > [ar](#) [cn](#) [de](#) [en](#) [es](#) [fr](#) [id](#) [it](#) [ph](#) [po](#) [ru](#) [sw](#)

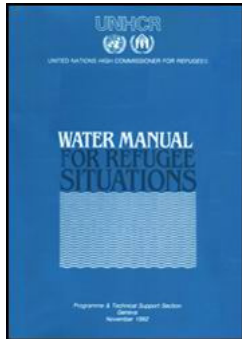

 **Water Manual for Refugee Situations (UNHCR, 1992, 160 p.)**

 **(introduction...)**

 **Foreword**

  **Drinking water**

 **1. Introduction**

2. Assessment and organization

3. The need

4. Immediate response during emergencies

5. Refugee water supply systems

6. Water sources, their protection and development

7. Pumping equipment

- ☐ **8. Water treatment**
- ☐ **9. Water storage**
- ☐ **10. Water distribution systems**
- ☐ **11. Operation and maintenance of water supply systems**
- ☐ **12. Management of emergency water supply systems**
- 📄 **Annex A - Refugee water supply inventory forms**
- 📄 **Annex B - Approximate daily water requirements in refugee emergency situations**
- 📄 **Annex C - Guidelines on water quality**
- 📄 **Annex D - Recommended format for technical specifications for water well construction**

Drinking water

Need

Water is essential to life and health. In emergencies it is often not available in adequate quantity or quality, thus creating a major health hazard.

Aim

To provide enough safe water to refugees and to meet communal needs in the most cost-effective way.

Principles of Response

- **Seek expert advice, coordinate closely with the appropriate national service and involve refugees.**

- **Ensure consideration of water supply needs when a site for a future camp is selected and its development planned. Coordinate response closely with physical planning, public health and environmental sanitation measures.**
- **Provide a reserve supply and spare capacity, to meet temporary difficulties and the needs of new arrivals.**
- **Take account of seasonal variations of quantity and quality of water from any source.**
- **If at all possible, avoid the need to treat water.**

Action

- **Organize an immediate, competent assessment of water supply possibilities in relation to needs.**
- **Carry out an inventory of all known water sources, assess them as accurately as possible in terms of their water quality and quantity and make provisions to protect them from pollution.**
- **Develop sources and a storage and distribution system to supply a sufficient amount of safe water, including a reserve.**
- **Ensure regular testing of water quality.**
- **Set up structure for Organization and Maintenance.**

