

TR-RWH 10 RAIN-JAR HANDBOOK

PRODUCTION AND USE OF MORTAR RAINWATER JARS

This Handbook was written with special reference to Uganda, whose climate is favourable to roofwater harvesting. It is based on 2-years immediate research in Uganda and several years Ugandan experience of jar production (however general Ugandan DRWH practice is based on other, and more expensive, forms of water storage). Unreinforced mortar jars are sometimes called 'Thai Jars' as they have been extensively used in Khon Kaen Province of Thailand since 1985 and are also common in Cambodia and Vietnam. In these countries, concrete rather than wooden moulds (as described below) are preferred: however trials of three type of mould when making 8 jars in Mbarara in 2005 indicated that wooden moulds are easier to use.

Costs are given in Ugandan shillings – USh.2000 = €1.0; USh.3000 = £1.0

Acknowledgment We acknowledge with thanks the financial support (in 2006) and encouragement of WaterAid Uganda that enabled the completion of mortar rain-jar development and testing, and the writing of this Handbook.



Contents

- 1 Why collect roofwater
 - 2 How much roof do you need; how much water can you harvest
 - 3 Where to place rain-jars round a house.
 - 4 Why mortar jars rather than other forms of water storage
 - 5 Making a jar – preparing for the two stages of production
 - 6 Stage A – making the base disc
 - 7 Stage B – making the jar shell
 - 8 Inlet, outlet and overflow arrangements
 - 9 Testing the completed jar
 - 10 Delivering the completed jar
 - 11 Costing the jar production
 - 12 “On-site” versus ‘factory’ production of jars compared
 - 13 What can go wrong in jar manufacture
 - 14 Instructions for using rain-jars
 - 15 General conclusions
-
- Appendix A Classification of Ugandan districts by their rainfall
- Appendix B Instructions for making a wooden mould-set
- Appendix C Instructions for making a jar-delivery car
- Appendix D Guttering
- Appendix E Labelling demonstration and normal jars

1 Why collect roofwater

Rainwater running off a roof is a very convenient source of household water, because you don't have to walk far to fetch it. If roofwater harvesting is done carefully, the quality of the water is similar to that of water fetched from boreholes or protected springs.

Roofwater harvesting needs

- A water store such as a jar, tank or underground cistern.
- A suitable roof (normally of mabati or tile – collection from thatch is rarely worthwhile)
- A guttering system to intercept the run-off and lead it to the water store

Normally roofwater harvesting is only considered for houses that already have a suitable roof, in which case, the water store is the main expense. This Handbook is about how to make a 1600 litre mortar jar (with little or no metal reinforcement). Such rain-jars provide one of the cheapest and most flexible forms of water storage – costs can be as low as US\$0.50 per litre of storage capacity (= €25 per cubic meter). The technology of manufacture is fairly simple, does not require an electricity supply and is suitable for a micro-enterprise in a village.

2 How much roof do you need; how much water can you harvest?

Most of Uganda gets a good rainfall (1000 to 1500 mm a year) spread over two rainy seasons. In all but the far North it is uncommon to have more than 8 weeks with no rain. In the 'Cattle Corridor' rainfall is less – 800 to 1000 mm a year – but adequate for harvesting. Only in NE Uganda is rainfall so low (under 800 mm a year) that roofwater harvesting is not rewarding. Appendix A lists Ugandan Districts and their rainfall status.

Roofing is a bigger problem, since although over 60% of houses have some 'hard' roofing, there are parts of the country where the fraction is much lower (whereas other parts have over 90% hard roofing). However for many reasons, metal roofing is steadily growing in popularity and the fraction of roofs suitably for roofwater harvesting will probably rise to over 80% within ten years. In extreme cases it is worth

Of the rain that falls on even a hard roof, a fraction is lost as splash or evaporation. The rest can be led to a water store, but sometimes that store is already full so the new water is wasted as 'overflow'. A small store overflows more than a big store. Using the water jars described in this handbook, you may assume that 15% of the rainfall on the roof does not reach the jar and another 25% overflows the jar, leaving 60% of the rainfall to be drawn from the store.

Table of expected yields from a roofwater harvesting system

The **bold** figure is thousands of litres per year; the figure in brackets () is yield in litres per day for 8 months a year (during the remaining 4 months the yield is only half this figure)

District Rainfall (see Appendix A)	High	Medium	Low	Suggested number of jars
Large roof (100 m ²)	78 (250)	66 (220)	54 (180)	4 - 6
Medium roof (60 m ²)	47 (150)	40 (130)	32 (100)	3 - 4
Small roof both sides (40 m ²)	31 (100)	26 (85)	22 (70)	2 - 3
Small roof one side (20 m ²)	15 (50)	13 (45)	11 (35)	1 - 2

The table above is based upon a particular way of managing the stored water. It would be possible to draw 40% more water in the wet months if none were saved for the dry months.

3 Where to place rain-jars round a house

Most Ugandan houses are rectangular and longer (along the roof ridge) than they are wide. For this shape of building, the best place to put rain-jars would be near the centre of each long wall – at the front and the back. This arrangement is shown in Figure 1 and will work with small gutters (for example 2" wide ones). However many householders would not want to place a jar in front of their house but prefer it at the end of the house as in Figure 2 -

which will require bigger (say 3”) guttering. With jars it is **not** normally sensible to lead the water from both front roof and back roof to the same jar since the long piping will be ugly and too expensive for the benefit obtainable.

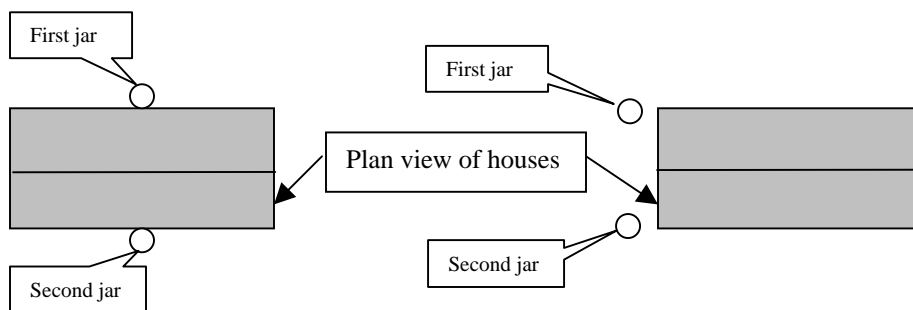

Figure 1

Figure 2

If the roof is single-sided – as is the case with many trading centre shops – the jars can be set side by side. The same arrangement usually applies where more than 2 jars are used, as shown in Figure 3.

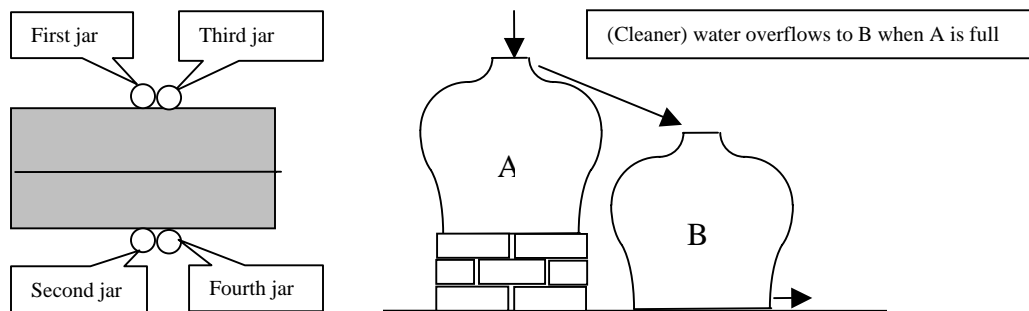

Figure 3

4 Why mortar jars rather than other forms of water storage

For storing very large quantities of water the ground itself is the cheapest store: thus wells draw from a reservoir of groundwater that is replenished during each rainy season. Artificial ponds (‘valley dams’) are another way of storing hundreds of thousands of litres of water. However neither the ground nor a pond is suitable for cleanly storing roofwater, for which we always install a jar, tank or cistern.

The main options for a roofwater store are as follows

Pottery jar	30 litres	v small & difficult to keep water clean	US\$100 per litre
Oil drum	180 L	if open-topped then water gets polluted	US\$170 per litre
Plastic drum	1000-12000 L	clean and light but expensive	US\$250 per litre
GI Tank	2000-10000 L	shortened life due to rusting	US\$70 per litre
Ferrocement tank	6000 L	built on site	US\$80 per litre
Partly below ground	6000-12000 L	needs a handpump and good ground	US\$65 per litre
Mortar Rain-Jar	1500 L	built in workshop	US\$50 per litre

5 Making a jar – preparing for the two stages of production

Each jar has a base and a shell (body). Both of these are made of un-reinforced ‘mortar’ (sand + cement) which once formed into shape needs to be cured for 7 days. So the main stages of production are (A) making the base disc, (B) making the shell and (C) curing.

Before starting work we need to establish a suitable working space (workshop) that has enough shaded space, tools for making mortar, somewhere to keep tools and materials secure at night and the special equipment needed for jar manufacture.

Space requirement Each jar needs about 5 square meters of floor-space. It needs to be both made and cured under shade from the sun. However production includes applying a layer of mud and then letting it dry, which may be difficult on wet days. A completely indoor workshop is perhaps too expensive and cannot use the sun to dry the mud quickly, however it offers the best security against damage to newly plastered jars and against theft of water. An outdoor workshop with shade matting cannot be used during rain. The ideal would be to build each jar on a trolley that could be moved in and out of the workshop door.

The number of jars in the workshop at any one time depends on how quickly they are sold once they are ready for sale. Jars are not safe to be moved until they have been cured for 7 days. So a workshop making 4 jars per week needs to be *at least* 20 square meters of shaded, hard and level space with 2.4 meters headroom, plus 'outside' space for jars awaiting collection. The workshop door must allow entry of the special jar-lifting cart, which is approx 2 meters high and 2.2 meters wide.

Tools A minimum tool-kit is

- Wheelbarrow for fetching and holding mud
- Spade
- Trowel
- 'Floats' (wooden for main plastering, metal for finishing)
- Level
- Container for measuring out sand and cement
- Blankets or grass to completely cover each jar during curing
- Polythene (such as DPC) for putting on the floor under the base disc and for covering jar during curing

Special equipment

- Two sets of wooden moulds (or more if production is to exceed 4 jars per week). For details of the moulds see Appendix B. There are other sorts of moulds such as filled-bag moulds and concrete ones. Each has disadvantages and we recommend wooden moulds.
- Jar-transporting hand-cart (both for delivery and to move jars from workshop to sales area). For details of the cart see Appendix C.
- Frame to allow each jar to be entered by a man/woman (in order to remove the wooden moulds in it 1.5 to 2 days after plastering.) without their touching the still-weak top of the jar.

Materials

The materials involved in constructing jars are cement, sand, mud, water and steel (rod and pipe). The cement is standard 'ordinary portland' cement (experiments substituting pozzolanic cement for Portland cement have not been done, so we recommend you **don't** use pozzolanic cement). To the cement, which should be bought from a reliable source, a waterproofing agent ('leak-seal') should be added and well mixed. The usual mix is 1kg of waterproofing agent to 50 kg cement.

Sand is a subject of much discussion in Uganda. 'Lake sand' is claimed to be the best for concrete and mortar, but it is often expensive to transport to the production site and we try to use local sand wherever possible. A local sand is 'suitable' for making mortar if

- It contains less than 10% 'fines' (as measured by the bottle test described below)
- Not more than 65%, and not less than 15%, of the sand is so small it will pass through a 0.4mm sieve (see the sieve test described below).
- It does not feel sticky when wet
- There is no organic material in it and it does not smell of vegetation

If the available local sand is too fine to satisfy this specification, it may be mixed 50:50 with a coarser sand, or with stone dust, brought from elsewhere.

Mud is required (1 – 2 wheelbarrows-full) for covering the wooden moulds as a release agent. This should be sticky enough to hold onto the wood, but not so sticky (so much clay) that it dries very hard. The producer may need to try out different sandy soils to make the mud from. See section 15 about possible problems relating to mud.

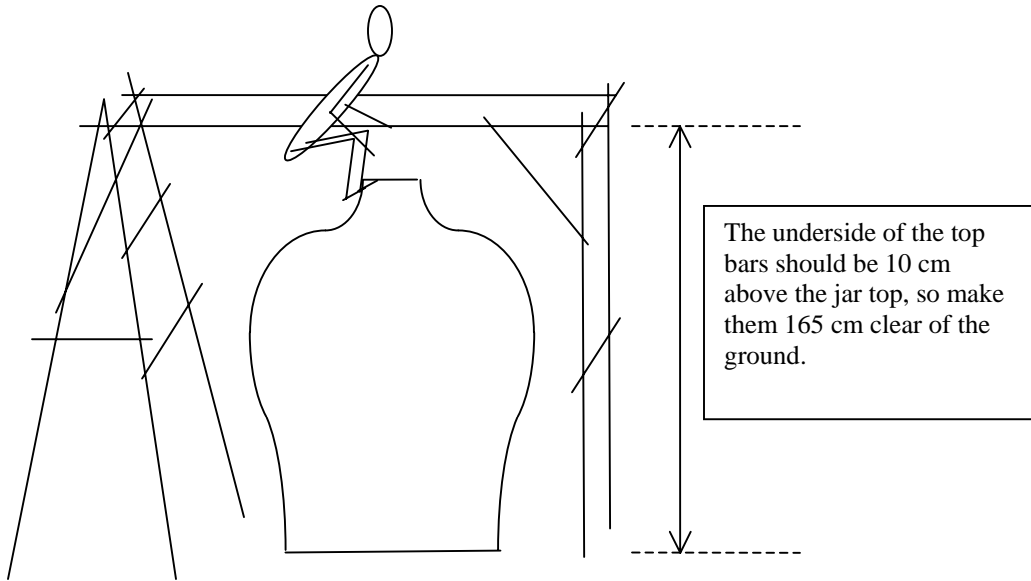

Figure 4 Frame of nailed poles for access into top of jar

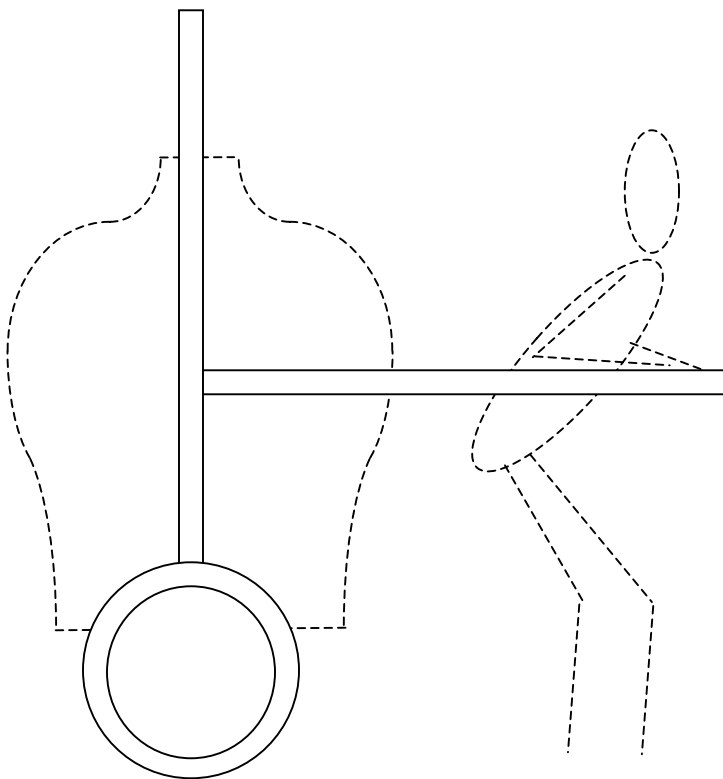

Fig 5 Special handcart (or donkey cart) for lifting, transporting and placing jars

Two Tests For Selecting Mortaring Sand

Bottle Test for seeing what fraction of a soil is 'fines'

Take the 'sand' you would like to use and break up any lumps with a mortar and pestle (or with the back of a spoon in a saucepan). Pass the soil through a very coarse kitchen sieve or through coffee-tray mesh. With what passes through the sieve, 1/3 fill a transparent bottle such as a ribbed plastic spring-water bottle and add clean water to nearly fill the bottle. (If you use chlorinated tap water, let it stand in an open pan for some hours to get rid of the chlorine.) Let the soil soak for 10 minutes, then shake it hard for ½ minute. At the end of shaking, immediately put the bottle on a flat surface in good light and start timing.

After ½ minute all the sand will have fallen to the bottom and will form a layer whose height H you should measure. (Sometimes you can use the corrugations of the bottle itself to measure height).

After 24 hours the 'fines', namely the silt and clay, will have fallen down to form a layer on top of the sand. The height of this extra layer we can call F .

For good mortar work F should not be more than 1/10 of H .

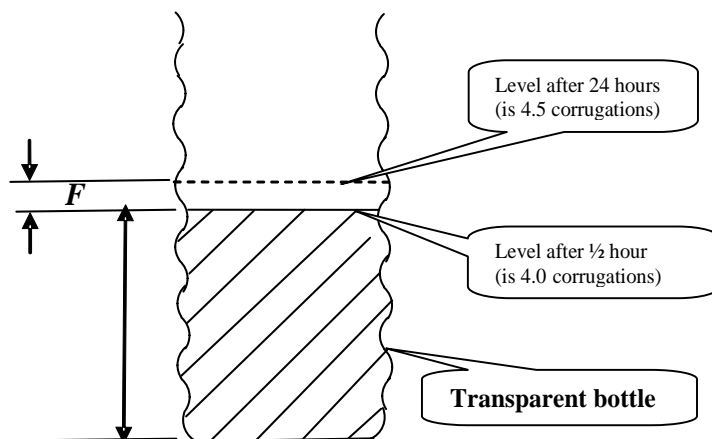

Sieve test to check the grading of the sand

You will need two sieves, a coarse one (with 1.2 to 2 mm holes) and a fine one (such as a household sieve for tea) with 0.4mm holes.

First sieve some soil through the coarse sieve and weigh out 100 grams (on a Post Office scale?).

Now sieve this 100 grams through the 0.4 mm fine sieve and weigh what goes through. Not more than 65% (or at worst 70%) should go through.

6 Stage A – Making the base disc

The base disc is a simple component of mortar (3:1 sand:cement), but it must be made before the tank shell and properly cured (= kept covered and moist). It is essentially a mortar disc (115cm in diameter x 25mm thick) in which other components are embedded. These components are

- a water outlet pipe (essential)
- a washout pipe (usually omitted)
- lifting handles (optional)
- a strip of steel mesh (optional)

The disc is cast onto a flattened surface covered with polythene and inside a metal strip 25mm thick bent into a circle and joined by adhesive tape to maintain its inside diameter as 115 cm. The mortar must be tamped so that it completely fills the space inside the strip – the mix being made **just** moist enough to do this reliably but still rather dry and stiff. After 2 hours, the metal strip can be removed (unwrapped). The top of the disc, for 5cm in from its edge, is made rougher by heavily pitting it with a trowel or spike or by cutting. In addition a 7 cm strip of (3-4mm) mesh may be buried in the part of the disc where the shell will sit on it, leaving about 4 cm protruding. The disc is next covered and kept moist for at least 6 (and preferably 24) hours to cure.

The outlet connection is set into the base disc as soon as the mortar there has set enough to cut a slot for it. The outlet (3/4" metal pipe + elbow or pipe and bent-up length of hose) is placed in the slot and mortared over. The inside end of the outlet (elbow or hose) should stand at least 2 cm above the surface of the base disc. This is so that outflowing dirty water is not drawn from the very bottom of the jar. The entry to this outlet should be plugged with wood or cloth to prevent mortar falling into it during later stages of construction.

The reason why a washout pipe is usually omitted is that an inlet filter should be used that prevents much debris ever entering the jar so that it doesn't need annual cleaning. Moreover the base disc is not thick enough to allow a washout pipe of useful diameter (over 25 mm bore). Cleaning a jar itself introduces further likelihood of contamination so is best avoided, however these jars are small enough that some accumulated mud can be removed without a person actually entering the jar.

Lifting handles can be incorporated in the base as an alternative to lifting the jar with a chain wrapped round its circumference below its widest point. (That is the method employed when the jar is lifted onto the Delivery Handcart described in Appendix C).

The base is now ready for moulds to be placed onto it as the first stage in shell construction.

Figure 5 The base of the jar

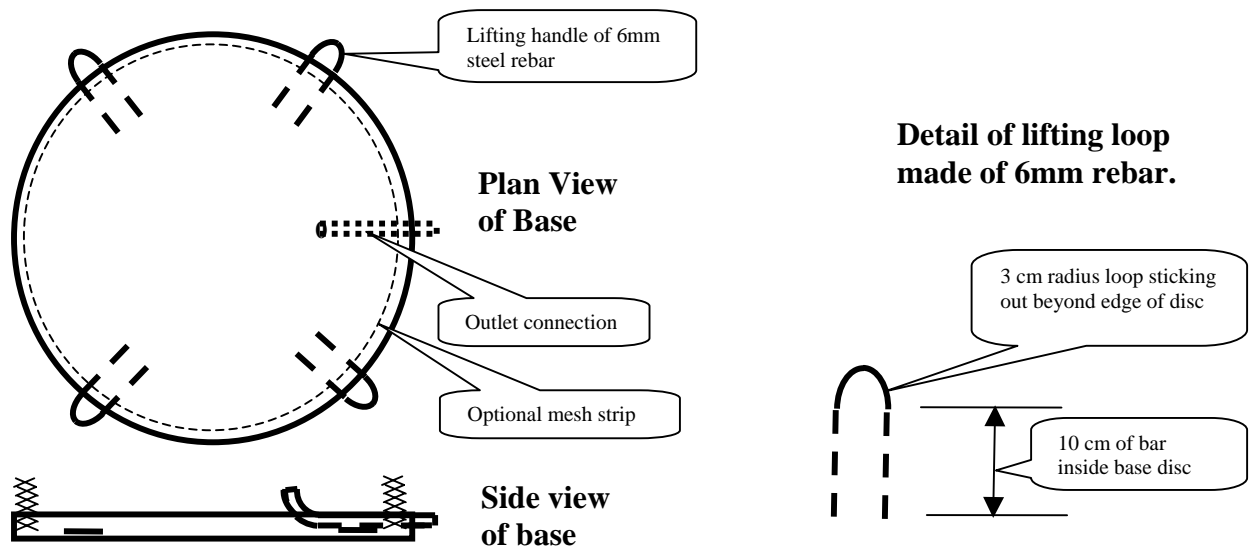

7 Stage B – Making the jar shell

The shell is made in 4 or 5 steps once the base has been cast and allowed to set (for at least 3 hours). These steps are

- a) Assemble wooden moulds on the base and cover them with mud to roughly form shape of jar.
- b) Let the mud dry then plaster over it with mortar.
- c) Cover and cure for at least 48 hours, then remove the wooden moulds and mud and add ‘nil’ layer.
- d) Cover and cure for 2 more days then (optionally test with water.
- e) Cure for 3 more days.

Step	a)	b)	c)	d)	e)
Activity	Mud onto moulds	Plaster with mortar	Remove moulds, add ‘nil’	Test with water (optional)	Completed, ready for delivery
	Cure under moist cover (see box titled ‘Curing’ below)				
Days	1	2	4	6	9

Notice that each jar occupies workshop space for 7-8 days and the wooden moulds are in use for 3-4 days. Thus each set of moulds can be used to produce, at most, 2 jars per week.

The steps above are now described in more detail.

a) Mould assembly and mud application on Day 1

The 5 layers of mould boxes (A to E) and the 4 layers of planks (F to I) are assembled on the base, using mud to fix them in position and to space one above each other. A spirit level can be used to ensure each layer is level. A basin (at least 45 cm diameter), weighted with stones, is placed at the top. A wooden bar may be used to support it, as shown below.

Figure 7 Joint between shell wall and base

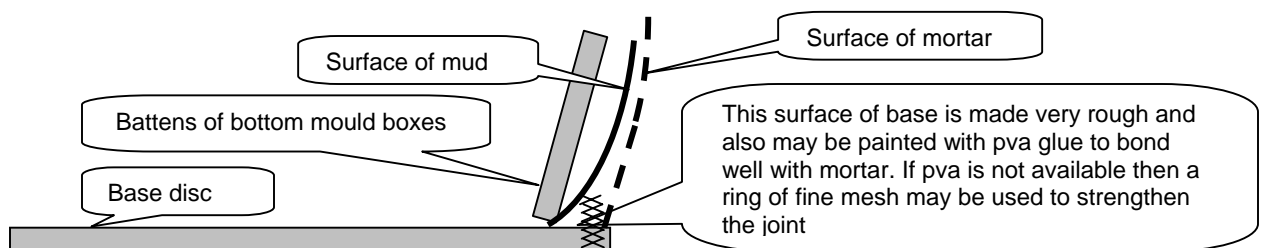
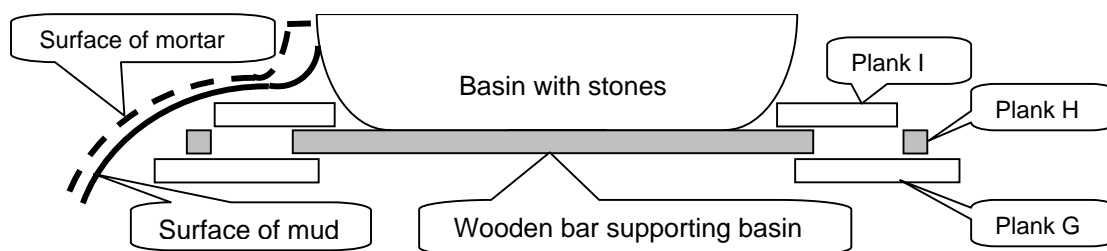

Figure 8 Applying mud to top of moulds



The moulds are then covered with a fairly thin layer of mud shaped to make the desired shape of the jar. The mud should be moist enough to stick to the battens on the outside of the moulds when thrown at them in the manner of a plasterer. The shaping can be with a wooden or metal plasterer's float. The edge 5 cm of the base disc and the protruding mesh (if used) should be kept clear of mud.

Curing

Unlike mud bricks or lime, cement needs to be kept as dry as possible during mixing and as wet as possible during the next week (the 'curing' period). As we are applying mortar by plastering, the water content of the mix has to be suitable for the plaster to stick to a vertical surface. However after a couple of hours, when the mortar has 'gone off' (hardened a little) we want to put it into a moist atmosphere to stop it losing water by evaporation. Experiments have shown that well-cured cement is much stronger than cement left out in the sun.

In practice we do three things:

- shade the jar from the sun
- put some water inside the jar and close its top opening
- cover the jar with wet grass or wet cloth and covering that with polythene sheet to keep the moisture in.

Curing for a long time means the workshop must be large enough to hold many jars. In practice 7 days curing should be enough. When the jar is transported to site it may experience bigger forces than after it has been placed in its final position. For this reason it is unwise to move it after only 3 or 4 days.

Because it must be applied and removed many times, it is worth making a polythene cover which can be slipped over the top of a jar and then tied together round the bottom of the jar. Under the polythene can be wet grass or wet blankets. Grass is probably easier to moisten and then keep moist. Blankets should be sewn together to make a jacket that can easily be put on and taken off a jar. They should be dried out after use on each jar to stop them rotting. Production workers are always reluctant to replace the exterior grass/blankets once they are removed, so it is recommended that only the material covering the top aperture is removed to allow access for demoulding on Day 4.

b) Let mud dry, then plaster over it with mortar on Day 2

When the mud is semi-dry, with a wet float fill over any large cracks that have formed and to give it an even surface. (If the cracks are more than 5 mm wide, the mud has shrunk a lot and therefore contains too much clay: this will cause problems during demoulding [step c]) – a sandier mud should be used for the next jar.)

The whole jar shell should be mortared, over the mud, to a uniform thickness of 10-12 mm with 3:1 well-mixed sand-cement. The cement contains 2% leak-sealing compound. The water content of the mortar should be that which allows good dense plastering – if it is too wet the final mortar will be weaker, if it is too dry the plastering will be rough and contain voids. On completion of applying the mortar, it should be re-trowelled with a well-moistened metal float to give a dense smooth surface. Later, see step c), the inside of the jar below the widest point will be given another 2 mm of 'nil' (cement + water slurry).

The top collar of the jar should be formed using the basin as a mould and (for best appearance) a scraper resting on the basin to ensure the collar is uniform thickness (say 25 mm), circular. The top should be flat or sloping slightly down to the outside.

The joint between shell wall and base is an important one and is shown in the figure above. The base must be very rough (pitted or grooved), clean and wetted where the wall meets it. If available (not in Uganda), pva glue, neat or diluted 1:1 with water, should be applied to the base and allowed to go sticky before applying the mortar. Where pva is not available and there is any uncertainty about the quality of the joint between base and wall, a strip of mesh will have been set in the base with 4 cm protruding. Bend this mesh outwards to allow mortar to be placed behind it, then bent it back upright, press it into the mortar and cover it with further mortar.

Some water should be put in the jar as soon as the mortar has hardened to ensure the atmosphere inside the jar is moist and the mud does not dry out further (thereby getting too hard and also perhaps stealing moisture from the mortar it touches).

c) Cover and cure, then remove both wooden moulds & mud, add ‘nil’ layer on Day 4

Cure for 48 hours (see Section 8 below). Now carefully remove basin and moulds without cracking the shell. This takes some skill and it may be prudent to start with mould removal on day 5 and change to day 4 once skill has been built up. To remove planks or boxes the mud holding them in place must be loosened with a knife or stick. Only the planks can be taken out from above. All the boxes are loosened and passed out by a person *inside* the jar. However to enter and leave the jar no force must be put on the jar’s collar: instead the person enters and leaves using the framework shown in Figure 4.

After removing the moulds they should be inspected for any damage (like loose battens) and repaired if necessary.

All loose mud is scraped or brushed from the inside of the jar and taken out. The jar inside is then washed and the plug blocking the outlet pipe is removed. Do not leave much mud in the shallow pool at the bottom of the jar.

A slurry is made of cement and water using about 10 kg of cement. This is brushed onto the *inside* of the jar from its widest point downwards to the base to form a waterproofing layer 1 to 2 mm thick.

d) Cover and cure for 2 more days then (optionally) test with water on Day 6

Cure for 48 more hours. Now a strength test can be applied by filling the jar with water. As it is 4 days since the mortar was applied, the strength of the jar should have reached 50% of its final value. The different test options are described in Section 10 of this Handbook. The outlet hosepipe should be tied up the side of the jar to a wooden stick marked with heights (10cm, 20cm etc) so that the level of water in the jar can be monitored. If water is available it certainly a good idea to at least half-fill the jar (say up to 65 cm deep). this has two purposes:

- to make sure the jar has no serious defects low down (damp patches may form on the surface but these will disappear after 24 hours as the leak-seal compound reacts with the seeping water). If however there is leakage from a point defect, fine sand can be sprinkled onto the inside water surface immediately above the defect so that the sand is drawn into the leak to block it.
- to help it cure completely.

e) Continue curing until Day 9

Day 9 is 7 days after the mortar was made. Curing well (moistly) for 7 days should have developed most of the jar’s strength so that it is ready for transport to site.

8 Inlet, outlet and overflow arrangements

The purpose of an **inlet filter** is to let in water but to prevent organic debris *or light* from entering the jar. The inlet to a jar is usually a basin that fits snugly into the top collar (e.g. the same basin that was used for forming the collar, whose diameter of 45-50cm was big enough to allow entry of the demoulder to the jar). Basins are slightly tapered and this taper improves the fit. The bottom of the basin should be pierced with many holes (for example using a heated nail) to let the water flow through it. The basin is next 2/3 filled with gravel sufficiently large that it does not slip through the holes. Finally the basin is covered with a cloth that allows water to flow through it. If the cloth is given an elasticated edge, it can easily be removed, washed and replaced. A stick can be used to raise the centre of the cloth so that some of the debris (twigs, leaves) that it catches will slide off it. However if the stick is too long (and the cloth-cone too steep-sided) some water will be lost too.

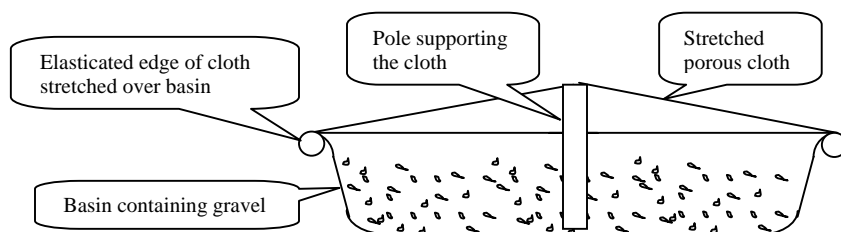

Figure 9 Basin used as inlet filter

If the bowl is directly under the end of a gutter, or (even better) under the ends of two gutters discharging towards each other) then no down-pipe may be needed. If the water overshoots the basin during intense rainfall, a chain can be hung from gutter-end to basin to guide the run-off flow.

Some systems, especially those near dusty roads, have an arrangement called ‘first-flush diversion’ whereby water falling from the gutter can be temporarily diverted so that it misses the basin. This diversion is put into place during a dry season so that when the first rains come, the very dirty ‘first flush’ runoff doesn’t go into the jar. After 10 minutes of good rain, the runoff should become cleaner and it is time to remove the diverter.

The combination of a cloth-and-gravel inlet filter and the diversion of the silt-laden ‘first flush’ will ensure that the jar very rarely needs cleaning – perhaps once in 3 years. Frequent cleaning is not a good practice for rainjars as it introduces contamination and removes any slime layer on the walls that are digesting bacteria.

An **overflow** is needed so that when the jar is completely full any new roof-runoff water has somewhere to go. The simplest arrangement is to allow water to emerge around the rim of the basin and run down the outside of the jar. However it is often better to incorporate a 20-25mm bore pipe in the collar of the jar that leads out as far as the shoulder of the jar, so that overflow water can be directed in a chosen direction or taken to a second jar as shown in Figure 3 (in Section 3 above). Overflow water is generally a little cleaner than the water already in the jar, so the overflow jar should be used mainly as a source of drinking/cooking water.

An **Outlet** is obviously needed. We have shown the outlet pipe embedded in the base. This is because if the outlet pipe were just held by the thin jar wall, it would not be secure and big forces applied to it could break the jar. Where the pipe emerges from the base, at the bottom of the jar wall, it can be a simple metal tube onto which a hosepipe is fitted (and tied by rubber strap). The other end of the hosepipe should be hooked over a spike coming from the collar of the jar. Such a hosepipe outlet is cheap, easy to use to fill containers and can be easily replaced if broken or stolen.

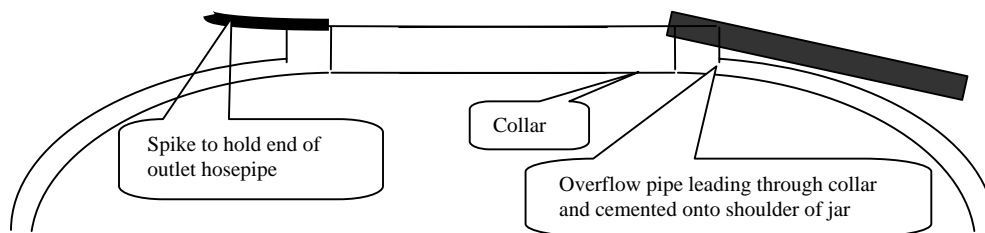

However a hosepipe gives no protection against water being stolen or the tank contents being lost due to careless or malicious dropping of the pipe. So some users will prefer to have a tap which in turn requires a thread to be formed on the end of the tube emerging from the jar base.

Whether using a tap or a hosepipe, when the jar is nearly empty the water is available only at the level of the jar’s base. (The last 2-3 cm of water cannot be withdrawn – it is likely to be dirty with sediment). Thus to fill a jerrycan placed on the ground, the jar base must be on a plinth at least 30-40 cm high. Alternately the plinth can be lower and a pit dug next to it to accommodate the jerrycan. Such a pit may need a gravel base and a drain.

9 Testing the completed jar

A good jar is one of the right thickness (about 13mm at the bottom and 10mm at the top), good to look at, having no leaks and of course not breaking when filled with water.

We can roughly test the average thickness by noting how much cement we use. More than 1.6 bags and the jar is too thick; less than 1.2 bags and it is too thin.

The jar is made of mortar – a material that gets stronger over time. Mortar reaches almost its full strength 28 days after it was mixed, but at 7 days it has only developed 70% strength and at 4 days only 50%. So if we can half fill it at 4 days without it bursting, it is likely we could safely fill it completely at 28 days. Actually we want the jar to be

more than ‘just’ strong enough so filling it completely on the 4th day shows it has a ‘safety factor’ of about 2. – a good value.

It is possible to apply an ‘over-pressure’ to the jar at 7 days or even 28 days after mixing the mortar. This is an interesting test to apply during research but too difficult to do during production, because it needs the inlet filter to be replaced by a special strong and watertight seal. Indeed all testing with water is a bit difficult because it requires a lot of water (75 jerrycans) to be available, to be put into the jar and taken out again. The likely water tests are therefore

- a) half-fill every jar at 4 days (with 750 litres of water) to confirm safety factor >1,
- b) completely fill every jar at 4 days (with 1500 litres of water) to confirm safety factor >2,
- c) completely fill at 4 days every 10th jar that is made to check that the production procedures are sound,
- d) completely fill at 7 days every jar whose purchaser pays to have it so tested (say US\$5000/-)

Although passing test a) does not absolutely guarantee that a jar is sound, it requires less water than the other loading tests and it enables any low-down cracks to be identified. It is very difficult to effectively repair cracks, so a jar found to have vertical cracks over 50mm long should be abandoned.

Test b) is the most severe.

Passing tests d) shows a safety factor of at least 1.5.

The overall requirement for test-water is reduced if water can be transferred from jar to jar. Half the water in a jar can be transferred to another jar by gravity (through a hosepipe connected from outlet to outlet), but the rest of the water will need raised by hand-pump or by lifting jerrycans.

When a jar is first filled with water its outside surface will become moist and remain so for a day or more until the waterproofing additive develops its power to seal off seepage.

10 Delivering and placing the completed jar

The jar, once made and purchased, needs to be delivered. It is heavy (say 270 kg) and not easy to grasp. The easiest way is to suspend it from two hooks by chains sleeved with hosepipe. One chain is fitted round the jar at about 40 cm above the ground: the chain is joined by a bolt with washers and a nut. Two more chains are bolted to this ring-chain to form loops that will connect to carrying poles or to a special transporter cart. The cart, sketched in Figure 5, has hooks about 1.8 meters off the ground which can be lowered to 1.55 meters when the cart is tilted back. So the jar chains are attached to these hooks in their low (tilted back) position and then – with the pull of several people – the cart is pulled upright, so lifting the jar 20-25 cm. The jar is then tied with ropes to the frame of the cart (at all points of contact a car tire is used to buffer the mortar jar from the steel frame) and the cart is pulled or pushed by 3 people or a donkey.

A jar can be carried on a pick-up truck (or even, in flat country, on a motorcycle trailer. However in both cases it is difficult to lift the heavy jar on and off the vehicle. Therefore for distances up to 6 km in a low-wage country, delivery by handcart is likely to be the best option, even though it needs a team of three people or one person and a donkey.

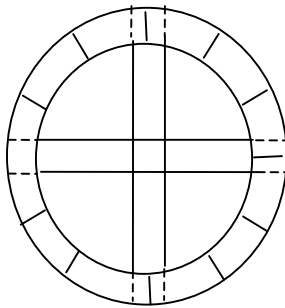

On arrival at site, where a plinth of 40 cm height has already been built, the jar must be lowered onto the plinth. This will require temporary ramps to be placed for the cart wheels to run up – for example planks supported by two bricks at one end. The arrangement is shown in Figure C2 of Appendix C. Once positioned above the plinth, the jar is lowered onto it. The plinth should be solid, given a level mortar top and then be surfaced with 1 cm of wet mortar just before the jar is placed on it. A suitable plinth would be built on a rammed foundation 15 cm below ground level and take the form of a circular wall with one or two interlocked diameter walls – as shown in the plan alongside.

11 Costing the jar production

The costs below are in Ugandan shillings in 2006 at which time the exchange rate to one Euro was about US\$2000/-

There are three main costs associated with jar production (up to the point a jar is ready for delivery) namely:

- Materials and components
- Labour
- Use ('rental') of capital equipment.

Materials and components

Each jar requires

Cement (opc) 65-75kg	US\$24000/-
Sand (assumed local sand 'balanced' by up to ½ 'Lake sand' brought from afar) 200 kg	US\$ 2000/-
'Leak-seal' waterproofing agent, 1 kg	US\$ 1500/-
Basin and outlet pipe/hose	US\$ 6000/-
[optionally 3m x 8cm mesh	US\$ 1000/-]
<i>Total materials</i>	<i>US\$34000/-</i>

Labour

Assuming a production rate of 4 jars per week from a team comprising 1 mason and 1 labourer

Labour cost per jar is US\$.(60000+20000) / 4	<i>US\$20000/-</i>
---	--------------------

Use of capital equipment

Wooden moulds costing US\$150000 and assumed to last for 30 jars	US\$ 5000/-
Premises – 6 m ² -wk per jar @ US\$700/m ² /month	US\$ 1000/-
Hand tools and frame - US\$100000 divided over 6 months production	US\$ 1000/-
Water for testing, assume some recovery so 300 L per jar @ US\$5000 / m ³	US\$ 1500/-
<i>Total rentables per jar</i>	<i>US\$ 8500/-</i>

On site cost

A plinth of height 400mm and diameter 1100mm needs to be built at the site for each jar and the jar mortared to it after delivery	<i>US\$ 6000/-</i>
---	--------------------

Total without delivery **US\$68,500/-**

Delivery by handcart over 3km (cart rental & unskilled labour) *US\$ 8000/-*

So the cost per delivered jar (with no profit to the producer) would be **US\$76,000/-**

The investment required to set up jar production at a rate of 4 per week is

Moulds (2 off) x US\$150000	US\$300000/-
Tooling	US\$100000/-
Handcart	US\$350000/-
Work in progress (4 jars not delivered)	US\$270000/-
Total investment excluding premises	<u>US\$1,020,000/-</u>

12 "On-site' and 'factory' production of jars compared

There are two ways of making mortar jars for use at a household. Under 'on-site' construction the jar is made in its final position alongside the house; under 'factory' construction the jar is made in a workshop and then carried to its final site. With large above-ground tanks and with all underground tanks, there is no choice – they have to be made 'on site'. With the mortar jars described in this Handbook, which weigh about 270 kg, there is the possibility of carrying them to site and hence the option of making them in a small workshop 'factory'.

The advantages of 'factory' production are

- a higher level of production quality control can be maintained, hence allowing thinner jar walls and the use of less cement,
- suitable sand can be found and used,
- A permanent shading structure can be created and used rather than having to be created anew for each jar,
- the bulky moulds (occupying 1.5 m³) do not need to be carried to the customer's house,
- the jar can be made and displayed prior to purchase – the householder does not have the uncertainty about timing or quality that comes with having to commission a mason to visit their home to construct jars,
- if each (or every say 5th) jar is to be water-tested, which requires 1500 litres of water, this water can be held at the workshop and used for testing many jars,
- the jar-builder does not have to visit the site three times (for moulding, for plastering after the mud has dried and for demoulding) or stay on site for 3 days.

The advantages of 'on-site' production are

- the jar does not have to be transported or lifted onto its plinth,
- some materials and perhaps a little labour can be provided by the householder,
- the location of any jar subsidised by some aid programme can be guaranteed.

13 What can go wrong in jar manufacture

Making jars takes some skill. The first jar made by a new producer is likely to have faults and will probably need to be discarded.

A badly made jar may fail either by leaking or by actually bursting when filled with water. It may also look misshapen or ugly. Here is a list of what could go wrong:

- the cement and/or sand is of poor quality
- the jar develops cracks when the moulds are being taken out
- the jar leaks where the shell joins the base
- the jar shell is too thin in places
- the jar was not cured properly
- the jar looks irregular.

(a) Poor cement and/or sand

Cement quality is often a problem in Uganda. The cement is of variable quality before it reaches the market and often deteriorates due to bad storage thereafter. Occasionally cement is adulterated with ash etc. There have been several recent building collapses in Kampala that may be due to poor cement. It is not practical to thoroughly test cement but a test for really poor cement is as follows:

Mix sand:cement in proportions 3:1 and cast three mortar bars (inside a wooden mould) each 5cm x 5cm x 60cm. Make sure the mortar is not too wet and tamp it well into the corners of the mould. Cure it well – 7 days under moist conditions. Now put it on two round poles resting on flat ground and placed 5 cm from each end of a bar as shown. Put a load of 10 kg onto the centre of each bar. If all bars break the cement is quite unsuitable; if only 1 bar breaks it is barely suitable (the jars should be made thicker than normal). If all the bars survive the "10 kg test" the cement-sand combination is acceptable.

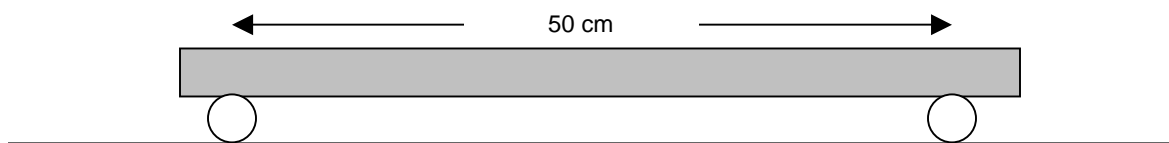

In the **materials** paragraph of section 5 of this Handbook, there is advice on selecting sand.

(b) The jar develops cracks when the moulds are being taken out

When a jar contains water, its walls are subject to tension so that any crack will tend to open up slightly: cracks cannot carry any tension. Vertical cracks more than 5cm long make the jar much weaker, and it may fail by bursting

when filled. If the crack is 10 cm long and is found anywhere except near the top of the jar, the jar will almost certainly fail. The main cause of cracks is too much force being applied when taking out the moulds. This may be due to wrong practice (esp. to not scraping away enough mud before taking out each mould box) or due to the mud being too strong when dry (containing too much clay). So inspect the jar for cracks before and after taking out the moulds to see if demoulding has produced new cracks. If it has, try to be more careful next time, or wait longer (more than the two days listed in Section 7 of this Handbook), or make the mud more sandy.

(c) The jar leaks where the shell joins the base

The shell is made about 2 days after the base, so the joint between the two is a joint between ‘new’ and ‘old’ mortar. This is not ideal but it cannot be avoided. So to make a good joint we want the part of the base under the shell (wall) to be very rough – pitted with a chisel or grooved, completely cleaned/washed of mud and at least 4cm thick. If there is significant leakage under the bottom of the wall, for the next jar pay more attention to roughening and cleaning. If PVA adhesive is available, paint the edge of the base with a 1:1 mix of that before mortaring the shell wall onto it. Alternatively introduce mesh into the joint, as described in Section 6 as an option.

(d) The jar shell is too thin in places

It is almost impossible to measure the wall thickness of a jar (unless it breaks) so the main check on thickness has to be during plastering. Remember the lower part of the jar (below its widest diameter) needs to be about 2 mm thicker than the upper part. Using too little cement (under 1.25 bag) in the 3:1 mortar is an indication the walls are *on average* too thin. However if a jar fails it will probably be where it is thinnest. So if a jar does fail during water testing, examine the pieces to see whether any are thinner than 12mm (lower part) or 10mm (upper part).

(e) The jar was not cured properly

It is hard to persuade masons to take moist curing seriously, as many believe that cement is like mud and has to dry out. There is no test you can apply to test whether curing was good, so you cannot ever be sure poor strength is due to inadequate curing. Thus good practice has to be enforced during production and it is especially important that the jar is not exposed to the sun during its curing period, that ‘wet covers’ are replaced after demoulding and that as soon as possible some water is put inside the jar.

(f) The wall-base joint leaks after the jar is delivered although it did not leak earlier when tested.

The cause of this is inadequate support from the plinth. The plinth must meet the base disc all the way round and also not be made of such soft material that the disc can sink perceptibly under the weight of the water in it (1.5 tonnes). Inadequate foundations for the plinth may also allow the jar to gradually lean over after some months of use.

(g) The jar looks irregular

The good shape of the jar mainly depends on the skill of the plasterer when applying the mud and therefore should improve with experience. Jars produced in Thailand over the last 20 years look very smart and ‘machine-made’ although they use only hand-plastering. It would be possible to make a shaped piece of plywood to place across the whole top of the jar to check its symmetry after mudding, but this is not really necessary. However such a guide could be more useful in making sure the top collar (round the basin) has a level top, is of uniform thickness and looks a clean circle.

The surface of the jar can be made smoother by painting it with a thin layer of weak ‘nil’ (= cement plus water) or with whitewash/lime.

14 Instructions for using rain-jars

[These instructions need to be passed on from the jar-maker to the jar user by word of mouth or by some sort of document.]

How much water should you draw from each jar?

A rainjar accepts water on wet days so that you can use it later on dry days. However you need to ‘manage’ the stored water to get the greatest benefit from having the jar. The method of management is to decide how much water to draw from the jar each day – an amount that may vary from one season to another.

Sometimes a jar overflows because there isn’t room in it to accept more rainfall: overflow water is wasted. If you draw more water from the jar each day, that creates more space for new water to enter and so reduces overflow. Up to a certain point, the more water you draw in the wet season, the more water you get.

However if you draw too much water in the wet months there won’t be much left at the beginning of the next dry season.

We recommend the following way of balancing wet and dry season use, by varying what you try to draw from the jar according to how much water is still left in it.

The jar is marked with three bands:

Band 1 (coloured red) is 0-600 litres. If the water level is in this band, you haven’t much left and we recommend you draw ***not more than 2 jerricans a day*** from each rainjar. If there is no more rainfall, the water will last for 15 days. To make it last a month without rainfall, reduce the demand to ***not more than 1 jerrican a day***.

Band 2 (coloured yellow) is 600-1000 litres. If the water level is in this band, we recommend you draw ***not more than 3 jerricans*** a day from each rainjar.

Band 3 (coloured green) is 1000-1500 litres. If the water level is in this band, we recommend you draw ***not more than 5 jerricans*** a day from each rainjar.

How can you ensure high water quality?

Properly used, roofwater is safe to drink and cook with. For this to be so you should:

Clean out your gutters twice a year – more often if your roof is under trees.

Make sure the filter bowl is always in position, that it is full of gravel or very coarse sand and its cloth cover is in position. Wash that cover whenever it gets clogged with leaves or mud and replace it when it gets torn or decayed. This inlet filter stops vegetation, lizards, rats and insects from entering the jar.

The first rains of a new wet season will wash much dust off the roof, making the run-off water very cloudy. So for two days after such ‘new rains’ boil the water from the jar before drinking it. Some people also divert the roofwater away from entering the jar during the first half hour of such new rains. If you live by a dusty road it is also worth sweeping down your roof at the end of the dry season (but not leaving the sweepings in the gutter!)

It should NOT be necessary to regularly clean out your jar: such cleaning may do more harm than good. In any case do not let anyone enter the jar – if you want to clean out a jar, do so from above using a cup on the end of a stick.

Mosquitoes

Although adult mosquitoes and their eggs can easily get into a rainjar, new mosquitoes will not breed in it provided organic matter like leaves is not allowed to enter and the water in the jar is kept DARK. (Light enables microscopic plants to grow and indirectly to feed the mosquito larvae.)

16 General conclusions

1500 litre mortar jars can be made in a simple workshop at a “workshop-door” cost of around US\$70,000, including testing with water on Day 4. After adding the cost of small gutters, a plinth, transport to site and some producer profit, the price might rise to US\$100,000. This is cheaper per litre than other roofwater storage technologies available in Uganda, and such capacity can be installed in easy steps up to say 6000 litres (US\$350,000/-).

However successful jar production requires skills and an attention to detail unlikely to be obtained from a casual employee or self-help householder. Therefore the technology is only suitable for serial production by an artisan who carries the consequences of poor quality control.

Capital of about US\$1 million is needed to set up each workshop.

APPENDICES

Appendix A Classification of Ugandan districts by rainfall

The table below (for all Ugandan Districts created by end 2004 but not those created since) categorises each District according to its annual rainfall (averaged over the whole District). In some large Districts there is such variation *within* the district that some parts may be wetter and other parts drier than as shown in the table.

The four rainfall categories are

High H (over 1200mm); **Medium M** (1000-1200mm); **Low L** (800-1000mm) and
Very low U (under 800mm and therefore unsuitable for roofwater harvesting).

District	R	District	R	District	R	District	R
<i>NW Region</i>		<i>E Region</i>		<i>Central Region</i>		<i>SW Region</i>	
Adjumani	M	Bugiri	H	Kalangala	H	Bushenyi	H
Arua	H	Busia	H	Kampala	H	Kabale	M
Moyo	H	Iganga	H	Kayunga	M	Kanungu	M
Yumbe	H	Jinja	H	Kiboga	M	Kisoro	H
<i>N Region</i>		Kaberamaido	H	Luweero	M	Mbarara	L
Apac	H	Kamuli	M	Masaka	M	Ntungamo	L
Gulu	H	Kapchorwa	M	Mpigi	H	Rukungiri	M
Lira	M	Kumi	H	Mubende	M	<i>W Region</i>	
Kitgum	M	Maguye	H	Mukono	H	Bundibugyo	H
Pader	H	Mbale	M	Nakasongola	L	Hoima	M
<i>NE Region</i>		Pallisa	M	Rakai	M	Kaberole	M
Amuria	M	Sironko	M	Sembabule	L	Kamwenge	L
Katakwi	L	Soroti	M	Wakiso	H	Kasese	M
Kotido	U	Tororo	H			Kibale	M
Moroto	U					Kyenjojo	M
Nakapiripirit	U					Masindi	M

Appendix B Instructions for making a wooden mould-set (for a 1500 litre Rainjar)

A mould set consists of 5 layers of open wooden boxes (A to E) and 4 layers of plain planks. Each mould box consists of

- A top plate
- A bottom plate
- Spacers to keep the two plates the right distance apart
- Battens connected the curved edges of the two plates together.

A typical full plate has the shape below. Its curved edge makes exactly 1/3 of a circle.

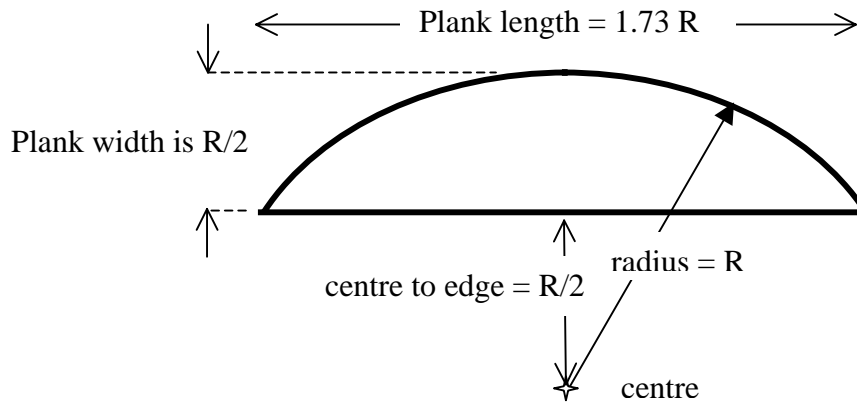

A typical mould piece uses two plates with different radii (R_1 and R_2) but the same centre and from *above* might look like this

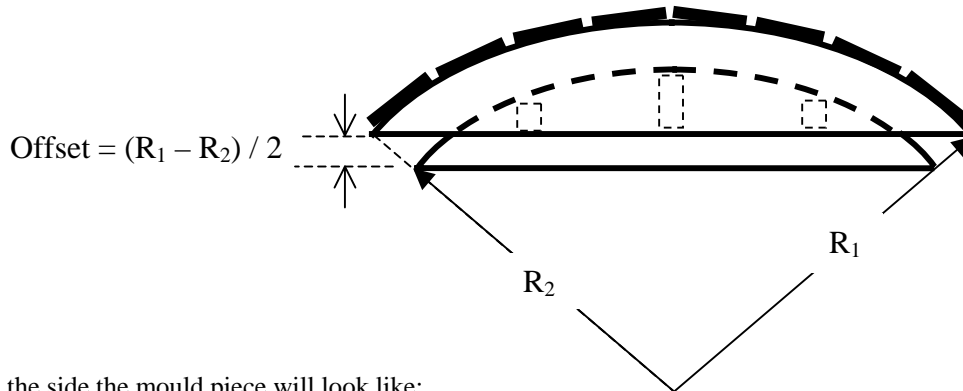

From the side the mould piece will look like:

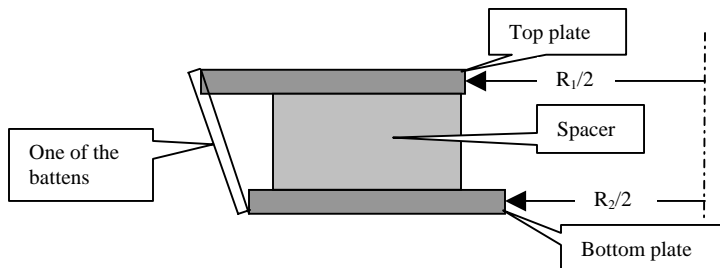

The height H of the mould piece is the measurement from top face to bottom face,
Make $H = 230\text{mm}$.

The plates are made of wood 20-25mm thick, so make the spacers 190mm high.

The battens should also be made 240 mm long.

Table of dimensions for Mould pieces

Layer (200mm)	Plate	Radius, mm	Width, mm	Offset, mm	Length, mm
A (bottom box)	Bottom (a)	480	240	12	830
	Top (b)	505	253		874
B	Bottom (b)	505	253	25	874
	Top (c)	555	278		960
C	Bottom (c)	555	278	28	960
	Top (d)	612	306		1059
D	Bottom (d)	612	306	14	1059
	Top (e)	640	320		1107
E (top box)	Bottom (e)	640	320	-85	1107
	Top (f)	470	235		813
F (first plank)		430	126		608
G		380	111		537
H		320	95		455
I		250	73		354
Extra planks D-E		640	320		1107

Wood required

We need two qualities of wood: fairly good and well-dried (for the top and bottom plates of the boxes and for the top planks) and rough unplanned wood for the outside battens.

Good quality wood (the individual plates can be cut so that they overlap a little along the plank and hence there is a little saving on total length) comprises:

- Planks F, G, H and I need 6” wide wood of total length about 7.5 meters
- Plates (a), (b) and (f) need 10” wide wood of total length about 10 meters
- Plates (c), (d) and (e) need 12” wide wood of total length about 16 meters
- Plates (e) need an extra strip attached to their inside edge to make them wide enough.

Such good wood costs US\$6000 to US\$12000 per plank of length 3 to 3.5 m.

Production

Each box layer is divided into several mould pieces. First three ‘full-size’ pieces are made for each layer (A to E), then one of them is cut into three parts as shown below 1(i), 1(ii) and 1(iii), so that it is easy to extract them first [starting with 1(ii)] when taking the moulds out, after the mortar has cured for 2 days. For the top two layers (D and E) it is a good idea to also cut pieces 2 and 3 into two parts, to make them smaller and easier to extract from the jar after moulding.

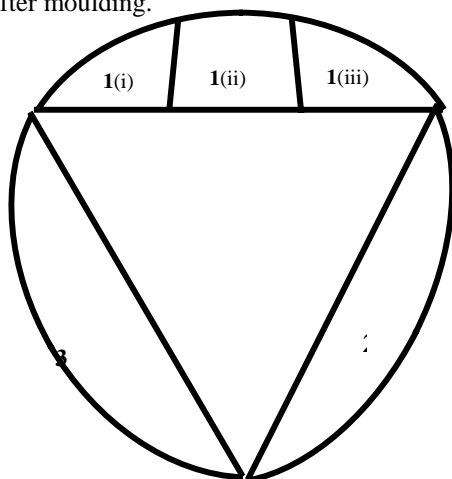

**Lower layers
A, B and C, 5 pieces**

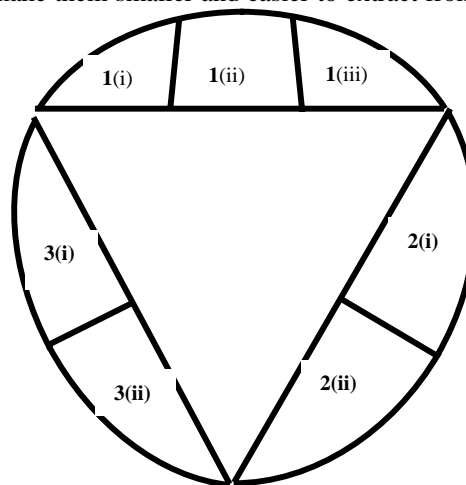

**Upper Layers,
D and E, 7 pieces**

The actual shaping of the planks can be done quickly and cheaply with a panga by a skilled woodworker, can be cut with a saw or can be machined in a mechanised carpentry shop. It is helpful to first mark out the shape of each piece onto thin (1/8") plywood and cut out a set of patterns. Only one pattern is needed for each of the plates (a) to (e) and planks F to I. These easily transportable patterns are used to mark out the 1" planks.

After cutting (and perhaps transporting), the 1" thick plates and spacers need to be nailed together in the right relative positions (with correct offsets) and then the battens are nailed onto the outsides. 2" (=50 mm) nails should be used.

Making the jar without too-sharp corners

Because layers D and E meet at a sharp angle, the finished jar will also have such a sharp angle, which does not look good. This can be avoided by adding an extra plank layer (called *D-E* in the table). Other alternatives are to use a lot of mud between layers D and E, or to shape the edge battens on boxes D and E so that they meet in a more gently rounded way.

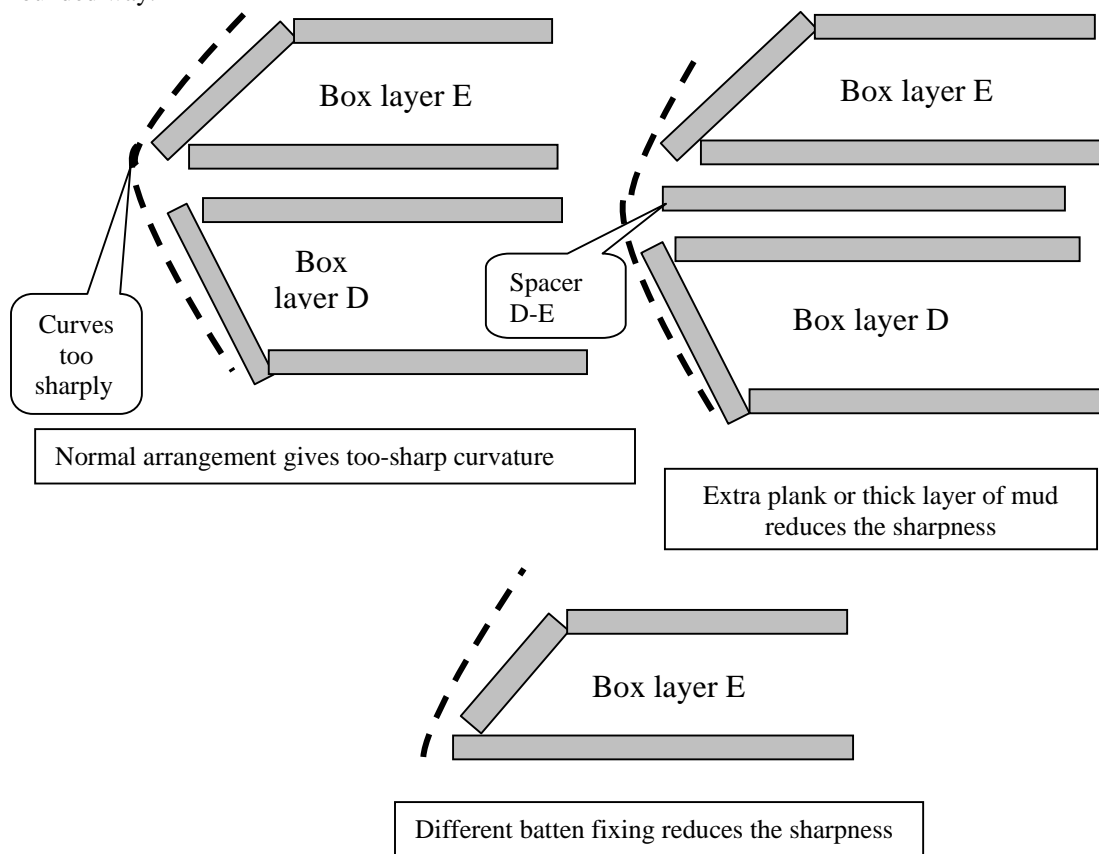

Top pieces

To complete the top of the tank there needs to be several layers of thinner wood. This is because the neck of the tank decreases in size fairly rapidly. The top pieces are not hollow boxes but planks (with no battens attached to their rims) laid directly onto each other.

There should be four layers (F, G, H and I) each of thickness 25mm (separated with a layer of mud), with four pieces per layer. The layers will be placed on top of each other so that they overlap. A plastic bowl is placed on the top layer to act as mould for the neck of the final jar. Removing these planks should be quite easy, as they will slide out and can then be extracted through the top of the partly-cured mortar jar.

The drawing below shows two of four layers on top of each other (as viewed from below). The radii will decrease from each layer to the next. Suggested radii for 4 layers (x 25mm) are given in the table above.

The plastic bowl is not just a part of the mould as it will later be the inflow screen. Its diameter needs to be enough (at least 45mm) for a man to climb through. The bowl edge should be rounded (as shown) and not folded over.

Assembly of top pieces (F to I) and bowl on top of boxes E

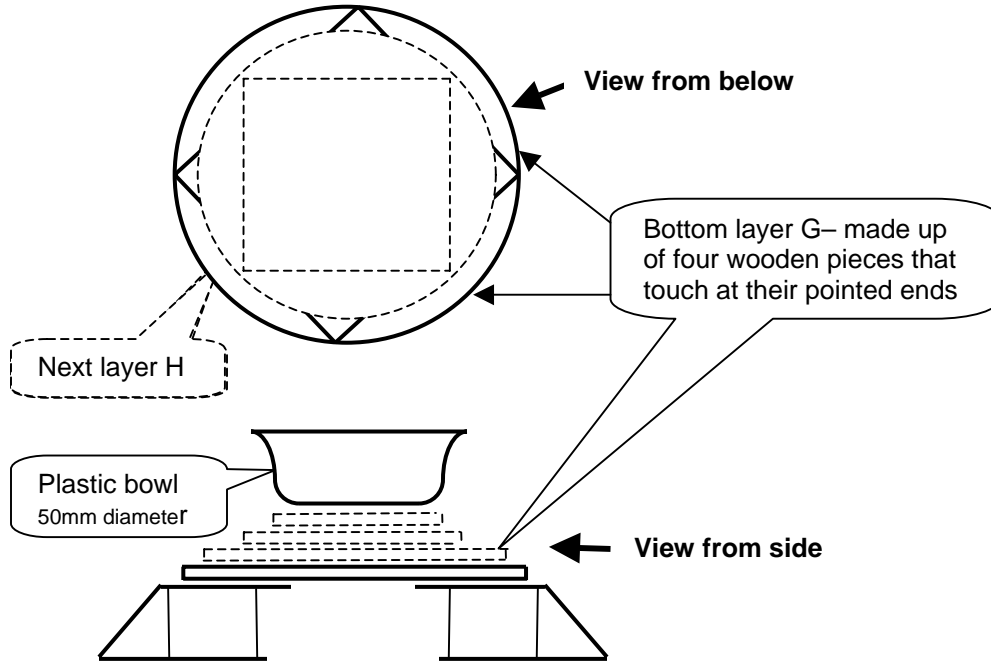

Appendix C Instructions for making a jar-delivery cart

Jars are 140 cm wide and 140 cm high and weigh over 250 kg: they are therefore very difficult to lift onto a motor vehicle for transport from workshop to house. Therefore a handcart (which can also be a donkey-cart) has been developed specifically to lift jars, transport them and lower them into place. Such a cart can also be used to move jars round the workshop.

The main parts of such a cart are

- 2 wheels,
- 2 wheel bearings but *no* axle crossing from side to side,
- A frame with hooks from which a cart may be suspended by chains,
- One or two forward shafts (one shaft for 2 donkeys, two shafts for one donkey)

A suitable cart that uses motor-vehicle inflated wheels is described in Technical Release TR56 “Water tank delivery cart for two donkeys” that can be downloaded from web site www.eng.warwick.ac.uk/dtu/pubs However the drawings in this TR56 are in fact for a one-donkey cart (two shafts). Moreover the TR shows a winch above the cart frame for lifting the jar. Most users will omit this feature and instead use tilting the cart frame as their way of lifting the jar off the ground.

Figure C1 Tilted cart, jar on ground Figure C2 Upright cart on ramp, jar 400mm above ground

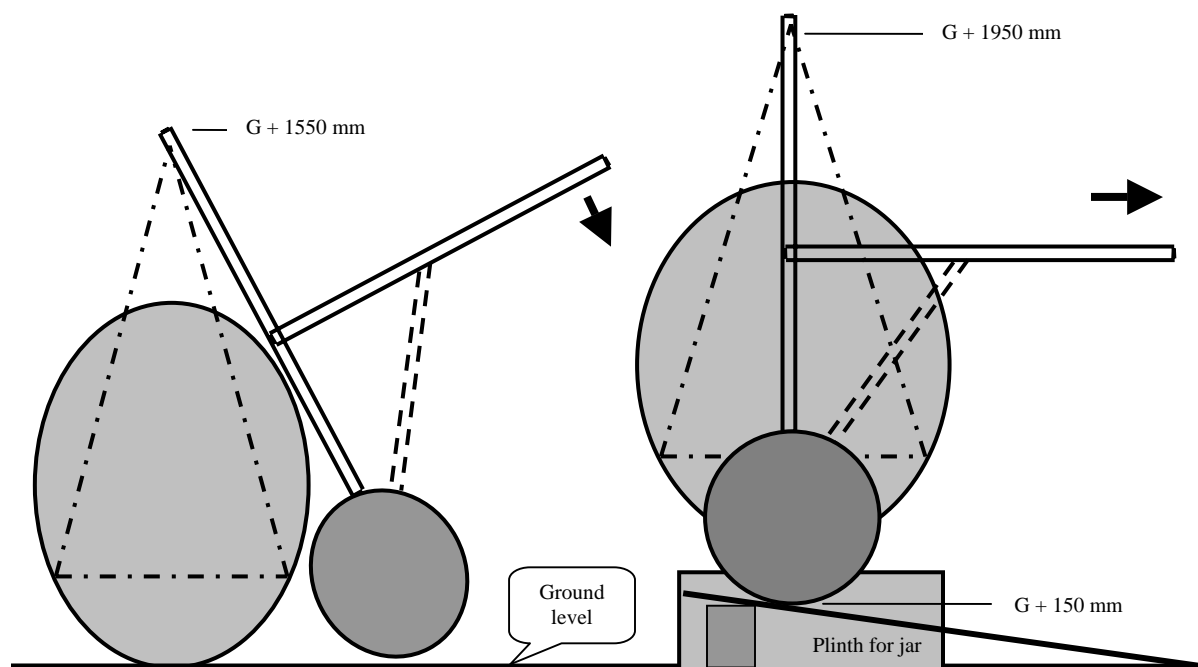

In Figure C1, the tilted cart has just been attached to the jar by chains (15-20mm steel chain, sheathed in plastic piping and joined together by bolts and nuts).

Before transport the cart must be pulled upright, so that the shafts are horizontal and the jar is clear of the ground. The jar is then secured to the frame by ropes. A cushion such as a car tyre is placed between jar and frame to protect the jar from damage.

During transport it is pulled (and pushed from behind) with the shafts horizontal and hence the load balanced.

After transport, on arrival at the site, the cart is run up onto two planks as shown in Figure C2 so that it is high enough to clear the plinth built to receive it. The cart can now be tipped a little to lower the jar onto the plinth.

The cart described in TR56 is built of heavy hollow, square-section, rolled steel (RHS) 50 x 50 x 3 mm. This thick section is only available in Kampala. One alternative is to make such a section by welding together pairs of angle iron (each 50 x 50 x 3 mm), but this is expensive. Another alternative is to use a thin but widely available section (50 x 50 x 1.2 mm) and add extra members to the frame such as that shown dashed in Figure C1. The bottom ends of the two frame uprights (where the wheels bearings are to be welded on) can be stiffened by forcing a short length of 1½" water pipe up inside them.

Having made the steel frame, choose suitable scrap car wheels (rim + tyre); no good tread is required. A 14" rim with 4 bolt holes is suitable. (If a pipe-in-pipe bearing is used – see below – then the hole in the wheel centre should be large enough to pass over a 2" water pipe.

Either find a scrap front-wheel car bearing that fits the wheel (usually available in Kampala) and weld it onto the frame (with or without the brake disc still attached)

Or make a pipe-in-pipe bearing, which is a 2" water pipe rotating round a 1½" water pipe. The space between the pipes is filled with grease and with a spiral of 1mm thick plastic cut from a pvc pipe. The outer pipe attaches to the wheel. The inner pipe is welded to the frame. Further details are given in TR28.

Appendix D Guttering

There are many demonstrations in Uganda of guttering that is ineffective or unnecessarily expensive. Gutter slopes are often wrong, large guttering is commonly used where small gutters would suffice, joints leak etc. The PVC guttering widely used in other countries is not yet available in Uganda. With jars, long gutters are not required and it is not necessary to lead water from one side of a house to the other. Ideally each jar should be fed from its own 8–15 m² of roofing via its own guttering. If the jar is fed from both sides by short (e.g. 3m) length of guttering, then these gutters can be as small as 50mm width – for example a medium-gauge 2” pvc pipe sawn in half. The ‘non-discharge’ end of the gutter needs to be blocked with wood or by using heat to fuse the two sides of the gutter together.

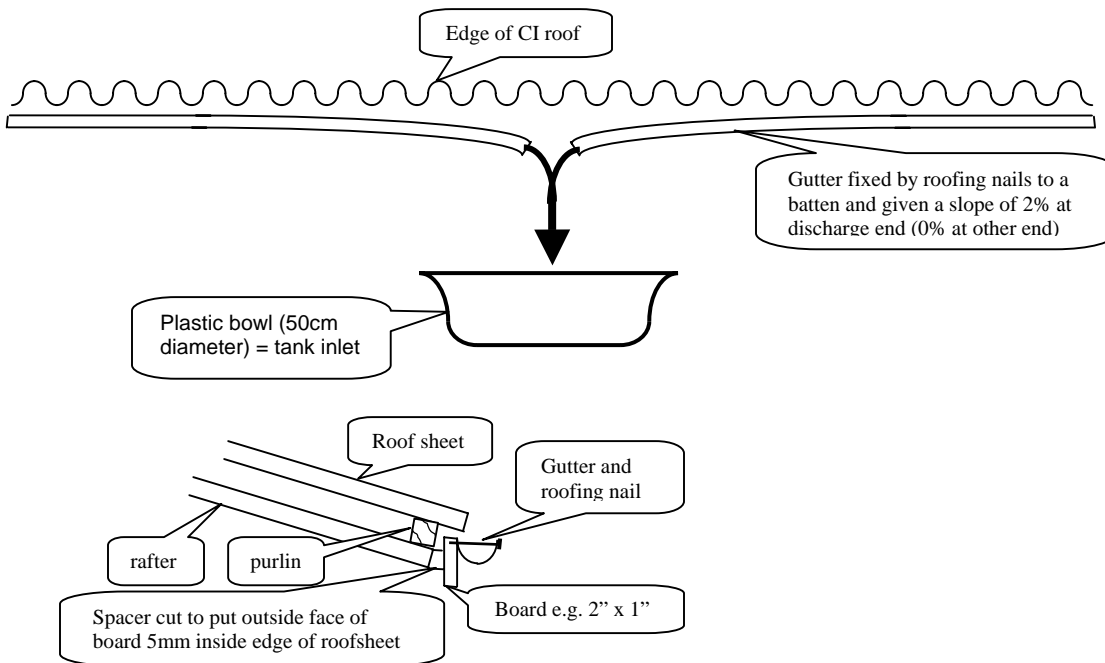

If the jar can be placed right under the gutters, no further connection is needed. However the jar is 140 cm diameter and usually needs to be placed a little further out than the roof edge. In this case a short length of sloping larger gutter (say 4”) needs to be placed perpendicular to the roof edge to bring the runoff out to the tank inlet bowl.

Appendix E Labelling demonstration and normal jars

If information is painted onto jars by a signwriter, then the jar 'explains' itself. The following 4 boxes show possible patterns of information.

Yellow box

This Rain-jar holds 75 jerrycans (1500 litres) of water.

It was made on [Date] using 1.1/4 bag (70kg) cement and no steel reinforcement.

With one rain-jar + 6 m of gutter you can harvest 60 litres of water a day in the wet months. With 4 rain-jars + 16 m of gutter you can harvest 100 L a day in wet months, 60 L per day in dry months.

Green box

1500 litres

When the water level is in this band, draw up to 5 jerrycans per day.

Orange box

1000 litres

When the water level is in this band, draw not more than 3 jerrycans per day.

Red box

600 litres

When the water level is in this band, draw not more than 2 jerrycans per day.

The green band is at the top of the jar, the orange band in the middle and the red band at the bottom.