






















































































- ➔  **Water and Sanitation Technologies: A Trainer's Manual (Peace Corps, 1985)**
-  **(introduction...)**
-  **Acknowledgements**
-  **Training staff contributors**
-  **Introduction**
-  **Training program textbooks**
-  **Training subject areas**
-  **Program goals**
-  **Behavioral objectives skill sheet**
-  **Block schedule**
- Sessions**
  -  **Session 1 - Water and sanitation issues in third world countries**
  -  **Session 2 - Introduction to the training program**
  - Session 3 - Facilitation skills**
    -  **(introduction...)**
    -  **Attachment 3A: Participative & directive training styles**
    -  **Attachment 3B - Skills for development facilitators**
  - Session 4 - Community mobilization**
    - 

-  ~~*(introduction...)*~~ **Attachment 4A: Development and self-reliance**
-  **Attachment 4B: Community mobilization**
- Session 5 - Math review**
  -  *(introduction...)*
  -  **Attachment 5A: Conversion chart**
- Session 6 - Concrete and reinforcement**
  -  *(introduction...)*
  -  **Attachment 6A: Concrete and mortar**
- Session 7 - Project documentation**
  -  *(introduction...)*
  -  **Attachment 7A: Format for trainee documentation**
-  **Session 8 - Field demonstration: Formwork and pouring concrete**
- Session 9 - Introduction to environmental sanitation**
  -  *(introduction...)*
  -  **Attachment 9A: Water-related diseases**
-  **Session 10 - Non-formal health education**
- Session 11 - Community water supply case study**
  -  *(introduction...)*
  -  **Attachment 11A: Ecoli case study**
- Session 12 - Project planning and management**
  -  *(introduction...)*
  -  **Attachment 12A: Steps to proactive planning**

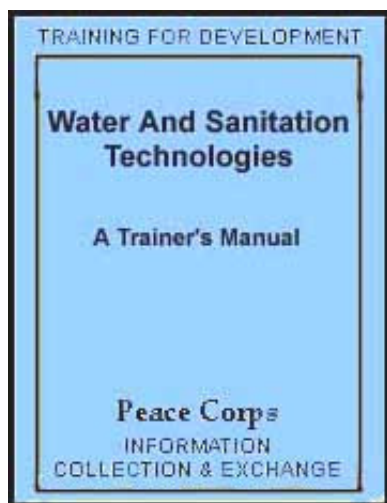
-  **Session 13 - Community needs and resource assessment**
-  **Session 14 - Communicable diseases and control**
  -  ***(introduction...)***
  -  **Attachment 14A: Communicable diseases**
-  **Session 15 - Excreta disposal systems**
  -  ***(introduction...)***
  -  **Attachment 15A: Improved ventilated pit latrine**
-  **Session 16 - Health education presentations**
  
-  **Session 17 - Basic drawing and blueprint reading**
-  **Session 18 - field demonstration: block laying**
-  **Session 19 - Project planning: Latrine construction**
-  **Session 20 - Latrine construction**
-  **Session 21 - Women and water**
  -  ***(introduction...)***
  -  **Attachment 21A: Women, water and the decade**
-  **Session 22 - Hydrology**
  -  ***(introduction...)***
  -  **Attachment 22A: Groundwater hydrology and sources**
-  **Session 23 - Water supply improvements**
-  **Session 24 - Pumps: Installation, operation, maintenance**
















-  **Session 25 - Field demonstration: Pump assembly and disassembly**
-  **Session 26 - Field demonstration: Pipework and plumbing**
  -  *(introduction...)*
  -  **Attachment 26A: Pipes and pipeworking**
-  **Session 27 - Principles of hand-dug shallow wells**
  -  *(introduction...)*
  -  **Attachment 27A: Large diameter tube wells**
-  **Session 28 - Well site inspection and feasibility survey**
-  **Session 29 - Project planning: Well rehabilitation**
-  **Session 30 - Shallow well rehabilitation**
-  **Session 31 - Gravity water systems: Part I**
  -  *(introduction...)*
  -  **Attachment 31A: General explanation of pressure, head, HGL, and friction losses**
-  **Session 32 - Survey and measurement**
  -  *(introduction...)*
  -  **Attachment 32A: Alternative ways of measuring elevations**
  -  **Attachment 32B: Profiling**
-  **Session 33 - Field demonstration: Surveying**
-  **Session 34 - Gravity water systems: Part II**

-  **(introduction...)**
-  **Attachment 34A: Design guidelines and layouts for simple gravity water systems**
- Session 35 - Principles of spring development**
-  **(introduction...)**
-  **Attachment 35A: Design features of spring development**
-  **Session 36 - Spring site feasibility survey and flow measurement**
-  **Session 37 - Project planning: Spring development**
-  **Session 38 - Spring development construction**
-  **Session 39 - Ferrocement technology and construction**
-  **Session 40 - Project planning: Ferrocement water tank**
-  **Session 41 - Ferrocement water tank construction**
-  **Session 42 - Constructing projects in a community**
- Session 43 - Proposal writing**
-  **(introduction...)**
-  **Attachment 43A: Guidelines for a small-scale non-technical proposal**
-  **Session 44 - Training review and assessment**
-  **Session assessment**
-  **Critique sheet for trainers using this manual\***
-  **Bibliography**

 **Peace corps water and sanitation sector background**

[Home](#) > [ar](#).[cn](#).[de](#).[en](#).[es](#).[fr](#).[id](#).[it](#).[ph](#).[po](#).[ru](#).[sw](#)

 **Water and Sanitation Technologies: A Trainer's Manual (Peace Corps, 1985)**

-   **(introduction...)**
-  **Acknowledgements**
-  **Training staff contributors**
-  **Introduction**
-  **Training program textbooks**
-  **Training subject areas**
-  **Program goals**
-  **Behavioral objectives skill sheet**
-  **Block schedule**
-  **Sessions**
-  **Session assessment**
-  **Critique sheet for trainers using this manual\***
-  **Bibliography**
-  **Peace corps water and sanitation sector background**

**Written by BRADLEY D. HANSON**

**Illustrated by Karen Munsterman**

**Peace Corps  
Information Collection and Exchange  
Training Manual T-32  
March, 1985**

**INFORMATION COLLECTION & EXCHANGE**

**Peace Corps' Information Collection & Exchange (ICE) was established so that the strategies and technologies developed by Peace Corps Volunteers, their co-workers, and their counterparts could be made available to the wide range of development organizations and individual workers who might find them useful. Training guides, curricula, lesson plans, project reports, manuals and other Peace Corps-generated materials developed in the field are collected and reviewed. Some are reprinted "as is"; others provide a source of field based information for the production of manuals or for research in particular program areas. Materials that you submit to the Information Collection & Exchange thus become part of the Peace Corps' larger contribution to development.**

**Information about ICE publications and services is available through:**

The Peace Corps Internet Web Site address:

<http://www.peacecorps.gov>

Please note the new Peace Corps Mailing Address from July 1998 on is:

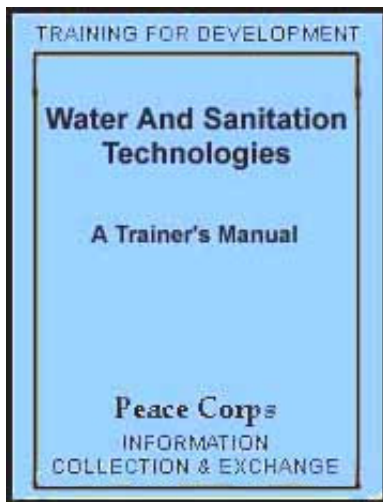
ICE/ Peace Corps  
1111 20th Street N.W.

Washington, DC 20526  
USA

**Add your experience to the ICE Resource Center. Send materials that you've prepared so that we can share them with others working in the development field. Your technical insights serve as the basis for the generation of ICE manuals, reprints and resource packets, and also ensure that ICE is providing the most updated, innovative problem-solving techniques and information available to you and your fellow development workers.**



[Home](#) > [ar](#).[cn](#).[de](#).[en](#).[es](#).[fr](#).[id](#).[it](#).[ph](#).[po](#).[ru](#).[sw](#)



## **Water and Sanitation Technologies: A Trainer's Manual (Peace Corps, 1985)**

### **Sessions**

 **Session 1 - Water and sanitation issues in third world countries**

 **Session 2 - Introduction to the training program**

 **Session 3 - Facilitation skills**

















 **(introduction...)**


















 **Attachment 3A: Participative & directive training styles**




















 **Attachment 3B - Skills for development facilitators**





-  **Session 4 - Community mobilization**
  -  **(introduction...)**
  -  **Attachment 4A: Development and self-reliance**
  -  **Attachment 4B: Community mobilization**
- Session 5 - Math review**
  -  **(introduction...)**
  -  **Attachment 5A: Conversion chart**
- Session 6 - Concrete and reinforcement**
  -  **(introduction...)**
  -  **Attachment 6A: Concrete and mortar**
- Session 7 - Project documentation**
  -  **(introduction...)**
  -  **Attachment 7A: Format for trainee documentation**
-  **Session 8 - Field demonstration: Formwork and pouring concrete**
- Session 9 - Introduction to environmental sanitation**
  -  **(introduction...)**
  -  **Attachment 9A: Water-related diseases**
-  **Session 10 - Non-formal health education**
- Session 11 - Community water supply case study**
  -  **(introduction...)**
  -  **Attachment 11A: Ecoli case study**
- Session 12 - Project planning and management**

-  ***(introduction...)***  
**Attachment 12A: Steps to proactive planning**
-  **Session 13 - Community needs and resource assessment**
- Session 14 - Communicable diseases and control**
  -  ***(introduction...)***
  -  **Attachment 14A: Communicable diseases**
- Session 15 - Excreta disposal systems**
  -  ***(introduction...)***
  -  **Attachment 15A: Improved ventilated pit latrine**
-  **Session 16 - Health education presentations**
-  **Session 17 - Basic drawing and blueprint reading**
-  **Session 18 - field demonstration: block laying**
-  **Session 19 - Project planning: Latrine construction**
-  **Session 20 - Latrine construction**
- Session 21 - Women and water**
  -  ***(introduction...)***
  -  **Attachment 21A: Women, water and the decade**
- Session 22 - Hydrology**
  -  ***(introduction...)***
  -  **Attachment 22A: Groundwater hydrology and sources**
-  **Session 23 - Water supply improvements**
-  **Session 24 - Pumps: Installation, operation,**

-  **maintenance**
-  **Session 25 - Field demonstration: Pump assembly and disassembly**
-  **Session 26 - Field demonstration: Pipework and plumbing**
-  ***(introduction...)***
-  **Attachment 26A: Pipes and pipeworking**
-  **Session 27 - Principles of hand-dug shallow wells**
-  ***(introduction...)***
-  **Attachment 27A: Large diameter tube wells**
-  **Session 28 - Well site inspection and feasibility survey**
-  **Session 29 - Project planning: Well rehabilitation**
-  **Session 30 - Shallow well rehabilitation**
-  **Session 31 - Gravity water systems: Part I**
-  ***(introduction...)***
-  **Attachment 31A: General explanation of pressure, head, HGL, and friction losses**
-  **Session 32 - Survey and measurement**
-  ***(introduction...)***
-  **Attachment 32A: Alternative ways of measuring elevations**
-  **Attachment 32B: Profiling**
-  **Session 33 - Field demonstration: Surveying**

- **Session 34 - Gravity water systems: Part II**
  - 📄 **(introduction...)**
  - 📄 **Attachment 34A: Design guidelines and layouts for simple gravity water systems**
- **Session 35 - Principles of spring development**
  - 📄 **(introduction...)**
  - 📄 **Attachment 35A: Design features of spring development**
- 📄 **Session 36 - Spring site feasibility survey and flow measurement**
- 📄 **Session 37 - Project planning: Spring development**
- 📄 **Session 38 - Spring development construction**
- 📄 **Session 39 - Ferrocement technology and construction**
- 📄 **Session 40 - Project planning: Ferrocement water tank**
- 📄 **Session 41 - Ferrocement water tank construction**
- 📄 **Session 42 - Constructing projects in a community**
- **Session 43 - Proposal writing**
  - 📄 **(introduction...)**
  - 📄 **Attachment 43A: Guidelines for a small-scale non-technical proposal**
- 📄 **Session 44 - Training review and assessment**

## **Water and Sanitation Technologies: A Trainer's Manual (Peace Corps, 1985)**

## Sessions

### Session 1 - Water and sanitation issues in third world countries

TOTAL TIME	2 Hours
OBJECTIVES	<ul style="list-style-type: none"><li>* Articulate important issues concerning water and sanitation in third world countries</li><li>* Discuss various methods of dealing with water and sanitation problems on the Volunteer level</li></ul>
RESOURCES	"Journey for Survival"; UNICEF film <u>Small Community Water Supplies</u> ; IRC, pp. 9-16 <u>Assignment Children</u> ; UNICEF, pp. 9-49
PREPARED MATERIALS	Newsprint and felt-tip pens  Movie projector and screen
FACILITATORS	Two or more trainers

### Trainer Introduction

**This session requires active participation by the facilitators and trainees in the exchange of ideas and opinions. It could be scheduled during the evening to allow more time if the discussion is lively. The session is meant to raise issues, rather than provide solutions to problems. Trainees should complete the reading assignment prior to scheduled meeting time. The film is available through Peace Corps or UNICEF Field Staff. If the film is not available, another suitable visual aid presentation may be used in its place.**

## PROCEDURES

Step 5 minutes

1

Introduce the objectives and describe the session format.

Step 25 minutes

2

Show the film "Journey for Survival,"

Step 15 minutes

3

As a group, make note of the major water/sanitation issues brought out in the film and the reading assignment. List these on a flip chart.

### Trainer Note

**This step should be conducted as a brainstorming activity. List all points briefly on a flip chart.**

Step 20 Minutes

4

Select four or five major issues out of those listed, and break up into as many groups, each assigned to one issue. The trainees discuss possible ways to deal with their issue in terms of Volunteer development work.

### Trainer Note

**Each group should have a facilitator participating in the discussion, but not leading it. If this is not possible, facilitators should rotate from group to group.**

Step 45 Minutes

5

The trainees come back together and each small group reports on ideas they discussed. Possible strategies are listed on a flip chart.

Step 10 Minutes

6

Review the objectives and conclude the session with a reference to the upcoming training program. Emphasize that the goal of the training is to provide trainees the skills needed to approach, and begin to solve the problems discussed during the session. Ask them to keep these issues in mind as the weeks progress and new skills are learned.

## **Session 2 - Introduction to the training program**

TOTAL TIME 2 Hours

OBJECTIVES

- \* Familiarize the trainees with the program goals, behavioral objectives, and the training schedule
- \* Review the trainee's strengths and weaknesses with regard to the co-facilitation of sessions
- \* Explain the organizational framework that will be used for construction projects during training

RESOURCES Program Goals  
Training Program Behavioral Objectives

## Training Schedule

**PREPARED** Newsprint and felt-tip pens, copies of Program Goals, Behavioral Objectives  
**MATERIALS** List, and Training Schedule for all trainees  
**FACILITATORS** One or more trainers

## Trainer Introduction

**Trainees inevitably come to training with many expectations concerning what they will learn and how the program will be conducted. In many cases, these expectations create a certain amount of anxiety in the trainees. This session is meant to relieve that anxiety by giving them general information about the program including content, scheduling, and procedures. It also first introduces the concept of trainee facilitation, and helps the trainer become familiar with the skills, knowledge, and experience of the trainees. For this reason, all trainers should be on hand for the session.**

**The Behavioral Objectives List and Training Schedule should be prepared by the trainers prior to the session. A complete list of the Behavioral Objectives for this manual can be found on page 11, a training schedule can be found on page 17. Both may need to be edited to fit a specific technical training program.**

## PROCEDURES

Step 5 Minutes

1

Present the objectives and format for the session.



## Step 20 Minutes

2

Hand out the Program Goals and Behavioral Objectives List, briefly explain their format, and allow time for the trainees to read through them.

## Step 10 Minutes

3

Invite questions concerning the lists.

## Trainer Note

**It is important to answer questions that the trainees may have without getting into the actual details of any one subject. The intent is to inform them of the general content of the program. Point out that the Behavior Objectives carry a dual responsibility. Trainers must work hard to teach the skills and trainees must work hard to learn them. By working together throughout the program, the objectives can be met.**

## Step 10 Minutes

4

In reference to the Behavioral Objectives, ask the trainees to write down, individually, one or two of their personal strengths and weaknesses.

## Step 10 Minutes

5

Trainees write their responses on two sheets of newsprint, one titled "Strengths," and the other "Weaknesses." Names should be used.

## Step 15 Minutes

6

Lead a group discussion outlining both the strengths and the weaknesses. Point out commonly listed areas, identify trainees with strong skills, and those who wish to work on a particular weakness.

### **Trainer Note**

**Keep the discussion moving, without dwelling on any specific strength or weakness. The object is to identify trainees with good skills in any one area, and to target weaknesses which the group may have as a whole. Both lists should be typed and handed out at a later date.**

## Step 7 10 Minutes

Explain the importance placed on Trainee Facilitation during the program.

### **Trainer Note**

**Mention the fact that everyone involved in the training, both trainees and staff, can serve as information resources. Sharing information can be done informally at any time, or formally through the facilitation of sessions. Emphasize that all trainees will be asked to facilitate a session, or part of one, during the program. Point out that this will help them share their experiences and knowledge with the overall group and also help them practice and improve facilitation skills.**

## Step 8 15 Minutes

Present the Training Schedule

## **Trainer Note**

**A training schedule laid out by half-days, or even weeks, is usually sufficient to give the trainees a good idea of the training format.**

Step 9 20 Minutes

Present the organizational framework that you will use for construction projects.

## **Trainer Note**

**Use this time to discuss, in general, how a construction project must be organized in order to be successful. Explain that each project will have one or two trainee project managers who will be responsible for directing activities from start to finish. Emphasize that developing management skills is an important goal of the program.**

**Next, point out that Volunteers often serve as project managers. Ask trainees to list some responsibilities that they think a manager might have. The following points should be emphasized:**

- \* Planning ahead to determine the tasks necessary to complete the project and the sequencing in which the tasks should be performed.**
- \* Making sure that the resources, both human and material, are on hand.**
- \* Delegating responsibilities among the work group to ensure that all participate**

## **and feel useful.**

- \* Supervising various tasks or asking others to supervise them.**
- \* Coordinating the various tasks in a logical manner.**
- \* Motivating the work group in a positive manner.**
- \* Documenting all procedures during construction.**
- \* Evaluating the progress of the project in terms of both procedure and process.**

Step 10 5 Minutes

Review the objectives and conclude the session.

## **Session 3 - Facilitation skills**

TOTAL TIME	2 Hours
OBJECTIVES	<ul style="list-style-type: none"> <li>* Define participative and directive training styles</li> <li>* Identify criteria necessary for evaluating facilitation skills</li> <li>* Design and carry out an activity using effective facilitation techniques</li> </ul>
RESOURCES	Attachment 3-A: "Participative and Directive Training Styles" Attachment 3-B: "Skills for Development Facilitators"
PREPARED MATERIALS	Newsprint and felt-tip pens

Prons for presentations

props for presentations

Copies of Attachments for all trainees

FACILITATOR

Three or more trainers

## **Trainer Introduction**

**This session is designed to introduce the trainees to the training format that will be used throughout the program. It also gives them an opportunity to practice facilitation skills. The activity part of the session calls for short presentations by the trainees on a topic dealing with water and sanitation. The presentations should be spontaneous, on the nature of role plays rather than formal presentations. For this reason, a relatively short amount of time is set aside for preparation. However, props may be necessary and should be made ready ahead of time by the trainers.**

## **PROCEDURES**

Step 1 5 Minutes

Present the objectives and format for the session.

Step 2 10 Minutes

Write this question on newsprint and ask the trainees for answers.

Record answers on newsprint.

What is facilitation?

## **Trainer Note**

**The dictionary states that facilitation means "to make things easy" or "to solve**

**problems creatively and in cooperation." Mention this to the trainees and emphasize that Peace Corps Volunteers need to be effective facilitators in their communities.**

Step 3 10 Minutes

Handout Attachment 3A. Compare and contrast the two training styles.

### **Trainer Note**

**Point out the differences between the two styles in terms of both content and process. Emphasize that a participative style will be used throughout the training program. Make note that this style calls for active participation, by both trainers and trainees, to create a positive learning environment.**

Step 4 10 Minutes

Lecturette on criteria for evaluating facilitation skills. List criteria on newsprint.

### **Trainer Note**

**Here are some possible criteria:**

- objectives are stated and realistic**
- directions are clear and adequate**
- content is organized and flowing**
- processing is thorough**
- time is adequate and schedule is adhered to**
- staging is appropriate**

- **materials are appropriate**
- **style is conducive to learning atmosphere**

Step 5 10 Minutes

Present the following Training Format

## **TRAINING FORMAT**

- 1. Establish a dialogue with your audience or community**
- 2. Formulate objectives you want to accomplish**
- 3. Identify resources in your audience or community**
- 4. Plan an activity to meet your objectives**
- 5. Carry out that activity**
- 6. Evaluate the activity in relationship to the objectives**
- 7. Evaluate the process as a whole**

### **Trainer Note**

**Copy the format on newsprint. Discuss each step individually and in relation to each other. Make it clear that this format should serve as a general guideline and may be adapted to fit a specific environment or subject matter.**

Step 15 Minutes

6

Divide the trainees into three groups, and have each group plan a short presentation, on a topic relating to water and sanitation, using effective facilitation skills.

## **Trainer Note**

**Allow the groups to come up with their own ideas for the presentation or assign topics such as boiling water before drinking, washing hands after going to the toilet, protecting food from flies, proper nutrition, or maintenance of a latrine. Make sure that the trainees keep their presentations short and simple (no more than five minutes per presentation). Assign a trainer to each group to serve as an advisor.**

Step 30 Minutes

7

The groups give their presentation. While one group presents, one group serves as an audience of villagers, the other as observers.

After each presentation, the villagers report on whether they understood the objectives and information presented. The observers report on the effectiveness of the facilitation techniques used. Rotate so that each group plays each part.

## **Trainer Note**

**List on newsprint the effective facilitation techniques used by the groups. Also, list those which were not as effective.**

Step 8 20 Minutes

Evaluate the activity as a whole.

## **Trainer Note**



## **Here are some questions you may use in the discussion:**

- **Was the objective of practicing facilitation skills met?**
- **Was a skills criteria list developed? (Review the list.)**
- **What was the level of participation among the group?**
- **What went well?**
- **What could be improved?**
- **How will the skills we learned today be useful during the rest of the program?**

Step 10 Minutes

9

Handout Attachment 3-B. Review the objectives for the session and conclude with a discussion on the use of facilitation skills during Peace Corps service.

### **Trainer Note**

**Trainees should study the Attachment on their own, using it as a guideline for future reference.**

### **REFERENCE:**

**Farallones Institute and CHP International. A Training Manual in Appropriate Community Technology: An Integrated Approach for Training Development Facilitators. Peace Corps ICE**

### **Attachment 3A: Participative & directive training styles**

<p>1 Involves the trainee in creation or revision of program objectives; and/or the identification of individual learning needs and objectives; strives to keep objectives related to where trainee is and wants to go.</p>	<p>1 Defines objectives for trainee achievement at the beginning of the program; holds to these throughout to maintain consistency and coherence.</p>
<p>2 Assists trainees in identifying possible learning activities and in effectively structuring such activities.</p>	<p>2 Decides what learning activities are most appropriate and expects trainees to follow this structure.</p>
<p>3 Expects the trainee to learn by exploration and discovery, asking questions, making use of available resources and solving problems.</p>	<p>3 Expects the trainee to learn primarily by absorbing material through lectures, readings, etc., by memorization or practice and by responding to trainer questions.</p>
<p>4 Involves the trainees in decision making; invites ideas, suggestions and criticism from the trainees.</p>	<p>4 Makes the decisions or carries out decisions made by the staff; does not invite suggestions or criticism from the trainees.</p>
<p>5 Structures the training so that unplanned and unexpected problems will be treated as learning opportunities.</p>	<p>5 Follows the schedule closely; avoids problems or dispenses with them quickly so they will not interfere with the planned sequence or schedule.</p>
<p>6 Promotes cooperative work among trainees and climate of openness, trust and concern for others.</p>	<p>6 Promotes individual learning effort, accountability and competition among trainees.</p>
<p>7 Promotes self assessment by trainees and</p>	<p>7 Personally assesses trainees</p>

7 Promotes self-assessment by trainees and provides feedback of information needed by trainees to evaluate their own progress.	7 Personally assesses trainee performance and progress, usually through formal tests.
8 Involves the trainees in mid-course or final evaluation of training program, process, materials and its progress toward objectives and elicits suggestions.	8 Does own mid-course or final evaluation of training program and its effectiveness; draws own conclusions about needed revisions.

**REPRINTED: Farallones Institute and CHP International. A Training Manual in Appropriate Community Technology: An Integrated Approach for Training Development Facilitators. Peace Corps ICE**

**Attachment 3B - Skills for development facilitators**

**I. Taking Preparatory Steps**

**In the preliminary stage of collaboration with a community or other group of people, the facilitator should:**

**A. Understand and be able to articulate his or her:**

- 1. Motivation**
- 2. Expectations of the experience**
- 3. Strengths and weaknesses**
- 4. Role as a facilitator**
- 5. Individual values**

**B. Be sensitive to and able to identify:**

- 1. Expectations of the local community or other group**
- 2. Local culture and resources, including customs, values, knowledge and ways of life**

**C. Communicate in ways that demonstrate:**

- 1. Active listening and observation skills**
- 2. An ability to filter information**
- 3. Skill in working cooperatively and in collaboration with others**
- 4. An understanding of the participatory approach to development**
- 5. An ability to synthesize and articulate information in ways that promote local self-reliance, integrity and well-being**

**D. Utilize appropriate on-going techniques for evaluating the preliminary stages of involvement**

## **II. Establishing a Dialogue**

**In the next stage of involvement, the facilitator should:**

**A. Demonstrate skills in facilitation and organization that include:**

- 1. An ability to work with existing local social structures and groups**
- 2. Stimulating active local participation**
- 3. Motivating others to contribute their skills and knowledge**
- 4. Planning and facilitating meetings, when appropriate**
- 5. Sharing techniques for effective problem solving, team building and negotiating**

**B. Be able to examine, analyze and prioritize issues, concerns and needs within the local context.**

**C. Understand and be able to articulate development issues in relation to local problems and strategies for change**

**D. Continue to develop skills in interpersonal communication, including:**

- 1. Encouragement of local leadership, when appropriate**
- 2. Building trust and confidence**
- 3. Consultation (e.g., active listening, conferring and feedback)**

**E. Use on-going and appropriate techniques to evaluate the use of dialogue in community work**

### **III. Planning with the Community**

**In planning for active community participation, the facilitator should:**

**A. Collaborate with the local community or group to identify:**

- 1. Needs**
- 2. Resources**
- 3. Goals and objectives**
- 4. Potential problems or limiting factors**

**B. Assist in the establishment of:**

- 1. Project criteria**
- 2. Plan of action**
- 3. Methods of project documentation**
- 4. Relationships with appropriate organizations and agencies to form a supportive network**

**C. Articulate the manner and extent of his or her involvement in the development process**

**D. Use on-going evaluation methods to review the planning stage**

#### **IV. Using the Dialogue Approach**

**Throughout the stages of community involvement, the facilitator should:**

**A. Demonstrate an understanding of non-formal education through the use of:**

- 1. A variety of communication techniques**
- 2. Problem-solving activities**
- 3. Methods that motivate others to actively participate in the education process**

**B. Stimulate project implementation through the use of local skills, knowledge and resources during:**

- 1. Development and/or construction**
- 2. Adaptation and modification**
- 3. Utilization**
- 4. Project review**

## **C. Use on-going methods of evaluation to ensure that project implementation is consistent with the participatory approach to development**

### **V. Evaluating the Process**

**In order to learn from, and improve upon the experience of working with a community or other group, the facilitator should:**

**A. Collaborate in the establishment and use of appropriate evaluation criteria and techniques.**

**B. Use a continuing process of evaluation to:**

- 1. Review the level of local participation**
- 2. Review methods and approaches used during development work**
- 3. Assess the level of local self-reliance and well-being**
- 4. Analyze each phase of development work**
- 5. Generalize and apply the knowledge gained to improve the participatory approach to development**

**REPRINTED: Farallones Institute and CHP International. A Training Manual in Appropriate Community Technology: An Integrated Approach for Training Development Facilitators. Peace Corps ICE**

### **Session 4 - Community mobilization**

**TOTAL TIME** Two hours

**OBJECTIVES** \* Describe various strategies that a volunteer could use to mobilize a

community for a development project

\* Practice the group decision making process

RESOURCES Assignment Children: UNICEF, pp. 109-130  
Attachment 4-A: "Development and Self-Reliance"  
Attachment 4-B: "Case Studies"

PREPARED Newsprint and felt-tip pens

MATERIALS Copies of both Attachments for all trainees

FACILITATORS Two or more

## Trainer Introduction

**The theme of community participation in development projects should be emphasized throughout the training program. This session is designed to stress the importance of that theme, and develop possible strategies for community mobilization. Trainers should encourage an exchange of ideas among the trainees, stressing important points that are brought up. The session may be scheduled in the evening to allow additional time if a lively discussion occurs. The readings in Assignment Children and Attachment 4-A should be read prior to the session.**

## PROCEDURES

Step 5 minutes

1

Present the objectives and format for the session.

Step 10 minutes



2

Divide the trainees into four groups. Each group should receive one case study from Attachment 4-B, with enough copies for all group members. Individually, the trainees should read their case study and decide on a strategy.

## Trainer Note

**There should be no discussion within the groups at this time. Trainees should decide on a strategy individually. They may select one of the possible strategies listed or develop their own.**

Step 10 minutes

3

Each group should discuss their case study among themselves and arrive at a consensus decision on a strategy.

Step 60 minutes

4

Each group reports back. They read their case study, present possible strategies, and announce their decision. The trainees, as a whole, discuss each case study and the small group decisions.

## Trainer Note

**Allow each small group to lead the discussion concerning their case study. Provide input to the discussion by emphasizing important points that are raised, or by suggesting ideas that the trainees may have overlooked. Listed below, by case**

**study number, are some important points that should be mentioned.**

### **Case Study I**

**A successful project needs support from both community leaders and followers.**

### **Case Study II**

**When a community need is beyond a Volunteer's ability to fulfill, it is important to work out some acceptable alternative in order to keep the community involved and enthused in the development process.**

### **Case Study III**

**A community's enthusiasm for a project is, in many cases, directly linked to the community members' level of understanding of the technology which the project uses.**

### **Case Study IV**

**It is important that the community understands the Volunteer's capabilities and limitations right from the start. Conversely, the Volunteer should try to understand what the community's concerns and interests are, as well as their capabilities.**

**A Volunteer's perception of community needs may be different than that of the community's own perception of its needs. Also, agreement on community problems does not necessarily lead to agreement on solutions to those problems. In such cases, education, sharing information, and community consensus should**

## **precede attempts at implementation of a project.**

Step 30 minutes

5

As a large group, discuss the decision making process that went on during Steps 2, 3, and 4.

### **Trainer Note**

**Facilitate this discussion, pointing out the dual importance of actual development strategies and the decision-making process used to select those strategies. Emphasize the fact that in many third world countries, a consensus decision-making process is used. Also, mention the fact that the way a Volunteer approaches and works within a community greatly affects the level of community involvement. Here are some questions to consider:**

- \* Was the decision easier to reach individually, or as a group?**
- \* What were the dynamics involved in the consensus decision process?**
- \* Would the chosen strategies solve the problems faced by the community?**
- \* Would they lead to community self-sufficiency or dependency?**

Step 5 minutes

6

Review the objectives of the session and conclude by asking the trainees to think about how their own choices of development strategies, and their own decision making processes can greatly affect the local people they work with, and what they accomplish.

## **Attachment 4A: Development and self-reliance**

**As development workers, Peace Corps Volunteers perform technical and professional services at the request of the governments they serve.**

**The form Peace Corps' development assistance takes varies from Volunteer to Volunteer, from project to project and from country to country depending on an infinite variety of individual and local factors.**

**The goal is nevertheless the same: helping people improve their lives in ways they themselves determine to be important, and in ways they themselves can sustain.**

**It is an approach based on the premise that people must participate in, and determine what is best for themselves, their families and their community, for any development project to have a lasting impact. It recognizes that development projects cannot be imposed from above, and will be truly effective only when they are based on an understanding of local needs, resources and opportunities. It is axiomatic to state that the relevance of any local project can only be judged locally.**

**External development assistance should be viewed as a means of strengthening the ability of individuals to participate in, and take charge of development initiatives which affect their lives. It should foster pride, confidence and the desire to become increasingly self-reliant.**

### **International Assistance**

**International organizations have at times provided their development assistance**

**to Third World countries in ways that cause recipients to become increasingly dependent on the source of that assistance.**

**Providing large amounts of food or material without tying the assistance to a longer term locally-based development effort does not serve to increase the capacity of local individuals or institutions. To the contrary, it may even result in the neglect of skills they have already acquired. In either case, it can easily lead to greater dependency.**

**Some external assistance is more directly related to a donor nation's self interest than to any genuine desire to support a recipient country's development programs. Such assistance can create a crippling dependence of one nation on another.**

**In spite of attempts to provide assistance, if it comes in this fashion, those who could benefit most from becoming increasingly self-reliant instead become more dependent on an external source for their survival.**

**David Werner, in his seminal work The Village Health Worker, states that under these circumstances "the rural poor become the voiceless recipients of both aid and exploitation."**

**One of the most influential theorists of the development process is the late E. F. Schumacher. In his book, Small is Beautiful, he states that, "The new thinking that is required for aid and development will be different from the old because it will take poverty seriously. It will care for people - from a severely practical point of view. Why care for people? Because people are the primary and ultimate source of**

**any wealth whatsoever. If they are left out, if they are pushed around by self-styled experts and high handed planners, then nothing can ever yield real fruit...." Schumacher goes on to say that, "Development does not start with goods; it starts with people and their education, organization and discipline. Without these three, all resources remain latent, untapped, potential."**

**Standards which primarily measure development in material terms have inevitably led to an overemphasis on material assistance to the detriment of strategies which emphasize the direct benefit to, and the involvement of, people.**

**Rusty skeletons of unused farm machinery on the hills surrounding villages throughout the world are a testament to the problems inherent in relying on material assistance. Well meaning foreign donors all too often sent machinery that could not function for long without money for fuel, trained technicians for repairs, and access to foreign factories for spare parts.**

**Development assistance which stresses self-reliance avoids creating such dependencies while helping people acquire the skills to improve their circumstances in ways they themselves can sustain.**

### **Including All Segments of a Community**

**In order to help a community become increasingly self-reliant the impact on, and contribution of, all individuals must be taken into account. Consideration must be given to the equal participation in the development process of all segments of a community including women, men, children, the elderly and any minority group. They must be given the opportunity to become part of the decision-making**

**process which influences the direction of any development project which has an impact on their lives.**

**The potential effect of a project, however, may differ in how it impacts on the lives of women, men, children, the elderly, etc.**

### **Example: The Introduction of Running Water to a Village**

**A classic example of this principle is illustrated by following the potential effects of introducing running water to increase the health and sanitation standards of a village.**

**The most immediate effect will be on the women, since they are the ones who spend up to three hours a day fetching water. Yet it should be evident that such a change will also have an impact on other members of the village as well. These potential changes pose a series of questions. How, and by whom, these questions are answered will ultimately determine what new patterns of daily life emerge.**

- What each woman does with the added time will certainly have an impact on her children.**
- Whether she spends more time in housework, the fields, or devotes time to other activities, such as marketing her handicrafts, will certainly affect her husband who may have a completely different notion of his own and his family's needs.**
- How the monies which may result from her new activities are spent and who will make that decision will again have an impact on all the individuals involved.**

**What patterns are created throughout the community by the collective and cumulative impact of these individual changes will influence whether the faucet, or any new technology, will be eventually integrated into the life of the village or allowed to fall into disuse.**

**Thus even the introduction of something as simple as a water faucet must no longer be seen exclusively from a technical perspective.**

**Once understood, it is a relatively easy lesson to learn. It is, however, far more difficult to apply. More often than not, the very groups which are most affected by development projects are the very ones omitted from the decision-making process. In virtually every country (including the United States) it is the rich, the powerful, and the men who make most of the decisions. Whereas, it is the elderly, the children, the women and the poor who must live with both the positive and the negative effects of those policies.**

**Gradually, more and more individuals working in development have become aware of these patterns of exclusion. In the early seventies, a series of studies and reports were issued which focused on the plight of women. Statistics were quoted that showed that although women contributed 50% of the human resources world-wide they continued to be excluded from having a meaningful voice in the decision-making process that affected their lives, this despite the fact that in many countries they performed a good deal of the manual labor.**

**Women in the Development: Background on Peace Corps' Efforts**

**In 1973, Senator Charles Percy sponsored an amendment to the Foreign**



**Assistance Act requiring that all U. S. bilateral assistance programs give particular attention to incorporating women at all levels in development projects. Peace Corps, along with other development assistance agencies, quickly issued guidelines aimed at assuring the inclusion of women in all aspects of the development process. Women in Development, or WID, as this concern for the involvement of women in the development process became known, was integrated into all Peace Corps Volunteer training.**

**With passage of the Percy Amendment, and the steady increase of field-related literature promoting the concepts behind WID, those that had long promoted self-reliance as an approach to development found their cause greatly enhanced.**

**For years they had tried, unsuccessfully, to get development agencies to take into account the following criticisms:**

- **More often than not, women were being left out of the development process;**
- **Traditional women's roles, such as gathering food, water and fuel for the family were being ignored by professional planners;**
- **Women were not being seen as technical and human resources.**

**Peace Corps' particular approach was to begin by gradually incorporating WID principals into all program and training materials designed for Volunteer use. Since then what has emerged is a body of material under the title of "The Role of the Volunteer in Development Work" which incorporates most of what Peace Corps has learned about development work in the last twenty years, including those concerns such as self-reliance and WID discussed in this paper.**

## **The Role of the Volunteer**

**The following is an outline of some of the concepts/principals which are covered in greater detail in other training materials. They are presented here merely to stimulate an initial discussion on the role of the Volunteer in development.**

### **1. VOLUNTEERS AS FACILITATORS**

**As development workers, Volunteers are part of a process which recognizes that the needs of a community can only be expressed by that community.**

- The role of the Volunteer is to encourage people to identify their changing needs as their circumstances change, and then to work with them to address those needs.**
- Peace Corps Volunteers, or for that matter, any outsider, should never presume to know what is best for someone else, nor should they see their role as doing things for people.**

### **2. SELF-RELIANCE AND THE ROLE OF THE VOLUNTEER**

**Volunteers can help people acquire additional skills, knowledge, and resources thereby better enabling them to make decisions regarding their own futures.**

- Volunteers should share their skills so that the people most affected can maintain the same, or similar, level of effort after the Volunteer has left.**

**Example: When farmers are taught more efficient methods of raising chickens,**

**teachers are trained to teach science, and children are taught to read, they become more self-reliant rather than more dependent on some external source of assistance.**

- **Volunteers should seek to multiply their effectiveness by emphasizing methods which continue to have an impact after they have gone.**

**Example: Working with host country extension agents who will continue to work with farmers for years to come and/or writing a useable "how-to" manual which records in local terms what worked in a particular technology so that others can benefit from these same lessons, are examples of the "multiplier effect" as applied to Peace Corps.**

- **A Volunteer may be assigned to a project to help establish an institution which would then continue to provide service without outside assistance.**

**Example: When a school is built and staffed, a cooperative is started and is directed by its members, or when a well is dug and can be maintained locally, a community is strengthened and does not become more dependent on external sources of assistance.**

- **Projects which emphasize the use of local materials, resources and appropriate (accessible or adaptable) technologies are less likely to become dependent on outside sources for the continuing effectiveness of their project.**

- **Volunteers should strengthen a community's desire to take charge of programs/technologies that affect them most. This "can-do" attitude, when reinforced by successes, tends to be self-perpetuating. In**

**the long run, this will be the single most contribution of any development program.**

### **3. VOLUNTEERS MONITOR THEIR PROJECTS**

**Four basic tenets contribute to Peace Corps' uniqueness as an agency.**

**They are:**

- **Volunteers live among the people with which they work.**
- **Volunteers are trained to function in a different culture.**
- **Volunteers are required to learn the local language.**
- **Volunteers are assigned to project for a period of two years.**

**It is these four tenets that allow Volunteers to be able to view monitoring as an on-going function, rather than as a hit-and-run proposition.**

**It is relatively easier for them to determine whether a project is having a positive or negative impact on a particular segment of the population. It nevertheless requires that the Volunteer pay attention to the concepts discussed in this section, particularly since the diverse effects of a project may affect a different part of the population at different times.**

**Example: When plans to build a road between an up-to-that-point isolated Indian village and a school are being discussed, a development worker should ask him/herself (and obviously others in the community) the following questions:**

- **What impact will the road have on the men?**

- **Will they have access to more/different jobs?**
- **Will they spend less time with their families?**
- **What effect will the road have on the women?**
- **Will they be able to leave the village to sell their goods?**
- **If they do, what will happen to the small children?**
- **Will the elderly be affected?**
- **If both the men and the women start commuting, who will do what needs to be done in the fields?**
- **Will any of these changes have an effect on local traditions?**

**The important point is that if Peace Corps Volunteers are concerned with how their projects affect all the people of a community they will ask these, and similar, questions.**

**Volunteers should try to involve people in decisions that affect the development of their community and their own destiny. Such decisions may well include what to do with a new road, whether to plant a crop, or what to do with newly acquired free time that result from introducing a new well.**

**Volunteers should recognize that each segment of the population may be affected differently by even the slightest change.**

**Volunteers should work so that the community's self-reliance is enhanced and so that every element of the community is viewed as a participant in the development process.**

## **Summary**

**Moving into a new culture, learning a new language, and even trying out one's own skills for the first time can make the work of a Peace Corps Volunteer twice as challenging.**

**Enthusiasm, coupled with a sense of wanting to achieve set goals, all too often makes Volunteers "jump in" to their assigned projects. It is, thus, doubly important that the Volunteer remain aware of what she/he is doing to enhance a community's self-reliance.**

**Volunteers need to constantly ask themselves:**

- **Am I helping people acquire skills and make decisions for themselves?**
- **Am I considering the needs and participation of all segments of the population including men, women, children and the elderly?**
- **Am I, even though inadvertently, contributing to a sense of dependency?**
- **Am I strengthening the feeling of self-reliance?**

**With these questions being asked and answered, Peace Corps Volunteers can actively and effectively participate in a development process which emphasizes self-reliance.**

**REPRINTED: The Role of the Volunteer in Development Manual, Peace Corps, ICE.**

**Attachment 4B: Community mobilization**

## **CASE STUDIES**

**REFERENCE: In-Service Training Manual, Peace Corps ICE.**

### **CASE STUDY I**

**You are a water and sanitation Volunteer who has been in the community for a few months. During this time, you have developed a good relationship with your counterpart. You have confidence in his/her abilities and have gladly given responsibility for community mobilization to him/her. However, lately it has appeared to you that your counterpart does not have the respect of the community and people have little enthusiasm for the project you would like to do. You want to build a strong project team, yet keep the good relationship with your counterpart. What should you do?**

#### **Possible Strategies**

- a. Talk to the counterpart and offer to lead the next community meeting.**
- b. Help the counterpart plan the next meeting and offer specific suggestions concerning mobilization.**
- c. Ask the counterpart questions about how she/he thinks the project is going, especially community participation, and watch for opportunities to provide constructive feedback.**
- d. Leave the situation alone and hope for more community participation.**

## Other Strategies

### **CASE STUDY II**

**You are a water and sanitation Volunteer in the middle of your service. The local project committee is urging you to start a large-scale gravity water system, similar to the system in a large town nearby your village, before you leave. It is unclear whether you will be replaced by another Volunteer and you are not sure if you can complete the project in the time you have left. How would you handle this situation?**

### Possible Strategies

- a. Start the project and try as hard as you can to complete it.**
- b. Lead a planning meeting with the local project committee and try to develop alternative strategies such as scaling down the project to a manageable level.**
- c. Concentrate on developing skills in the committee to enable them to complete the project after your departure.**
- d. Pass the problem on to the committee and encourage them to solve it and tell you what to do.**

## Other Strategies

### **CASE STUDY III**



**You are a water and sanitation technician assigned to a shallow wells project in a community where potable water is in short supply. You know how to dig wells and have demonstrated that to the community by completing one well with the help of three local men whose labor you paid for. However, you soon find that manual labor is frowned upon by most men in the village, and you are unable to involve more community members in the program. You cannot afford to continue paying for labor. You need community support. What will you do?**

### **Possible Strategies**

- a. Continue digging wells to show that manual labor is acceptable and, by example, influence local men to join you.**
- b. Meet with influential leaders and point out the necessity for potable water and its relationship with health problems in the community. Hope that their influence can mobilize the village.**
- c. Stop digging wells and focus your attention on overall community needs and how you might help meet some of those needs by such methods as health education.**
- d. Meet with community leaders and ask them to solve the problem and tell you what steps to take.**

### **Other Strategies**

## **CASE STUDY IV**

**You are a water and sanitation Volunteer newly arrived in your village. You notice that there are many cases of water-borne diseases and also very few latrines. A meeting is called to welcome you to the community and the leaders ask you what you intend to do for the community. You respond by telling them that you are there to help the people help themselves. You ask the villagers to hold a meeting and to decide what they consider their most pressing problems to be. Later, everyone returns to the meeting and a leader informs you that many of their children are sick and die young. Therefore, the village needs a hospital. Will you build one for them? How would you respond to this request?**

### **Possible Strategies**

- a. Explain to the villagers that you are unable to build a hospital and that your skills are in water and sanitation. Present some alternative projects that you would be able to help them implement.**
- b. Ask the villagers if they have the funds for a hospital and if not, offer to help them obtain money through an independent funding source.**
- c. Discuss with the villagers the overall health problems in the community, pointing out that many of their problems can be prevented by proper hygiene and the use of latrines. Organize some health education classes for the near future.**
- d. Agree to help the villagers organize in order to build a hospital for themselves and at the same time emphasize the importance of good sanitary practices in the prevention of disease.**

### **Other Strategies**

## Session 5 - Math review

TOTAL TIME 1 Hour, 30 Minutes

OBJECTIVES \* Review simple mathematical formulas, applicable to water and sanitation projects  
\* Practice solving math problems

RESOURCES Attachment 5-A: "Conversion Chart"

PREPARED Newsprint and felt-tip pens

MATERIALS Copies of Attachment for all trainees

FACILITATORS One or more trainers and trainees

### Trainer Introduction

**This session is a review of basic math, intended to brush up the skills of the trainees. It deals primarily with geometry, finding the area and volume of various geometric shapes. When working on sample problems, small groups should be used. Ask for volunteers among the trainee group, prior to the session, to assist you with the facilitation. The Attachment should be handed out to all trainees to use as reference information.**

### PROCEDURES

Step 1 5 minutes

Introduce the objectives and format for the session.

Step 2 25 minutes

Review simple math formulas and conversions

## Trainer Note

Here are some formulas to review:

- **Pythagorean Theorem =  $a^2 + b^2 = c^2$**
- **Circumference of a Circle =  $\pi$  (diameter)**

Surface Area	Volume
- Rectangle = (length) (width)	- Cube = (length) (width) (height)
- Triangle = $\frac{1}{2}$ (base) (altitude)	- Cylinder = $\pi$ (radius) <sup>2</sup> (height)
- Circle = $\pi$ (radius) <sup>2</sup>	- Cone = $\frac{1}{3}$ (area) (height)
- Cylinder = $2\pi$ (radius) (height)	

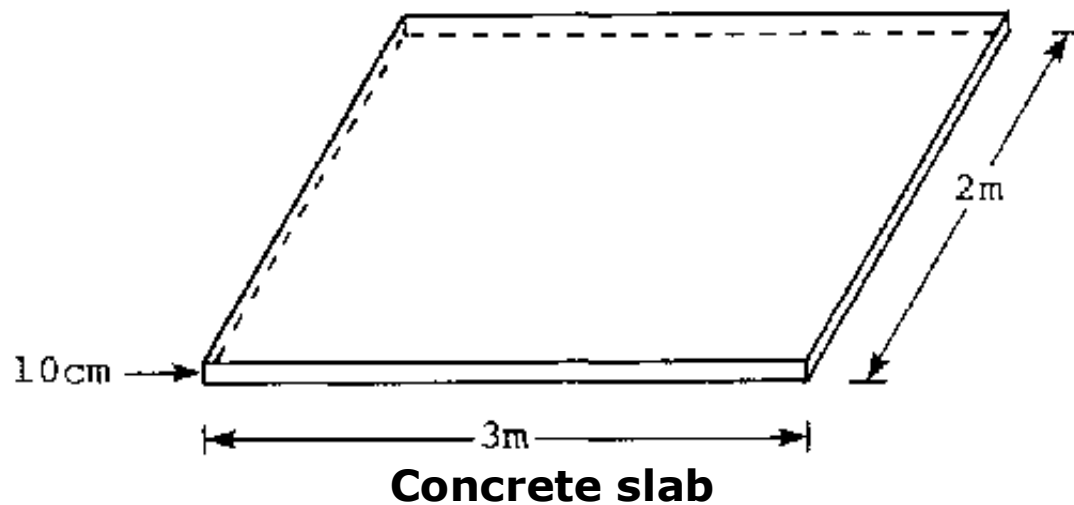
Step 3 60 minutes

Solve sample problems individually or in small groups

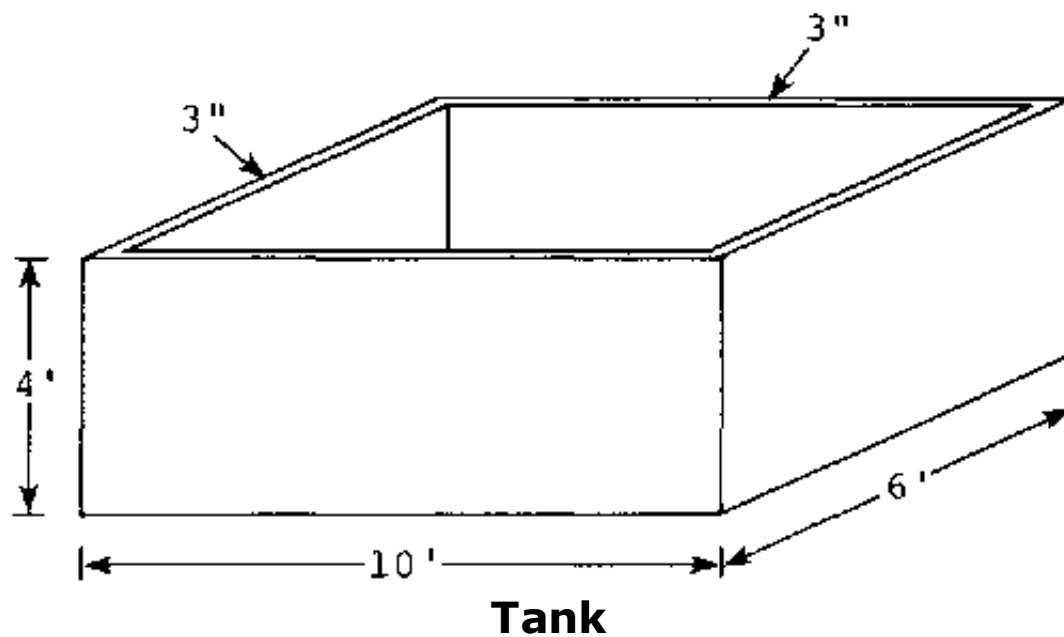
## Trainer Note

**Use sample problems that are applicable to work the trainees will be required to do during the training program. Here are some suggested problems.**

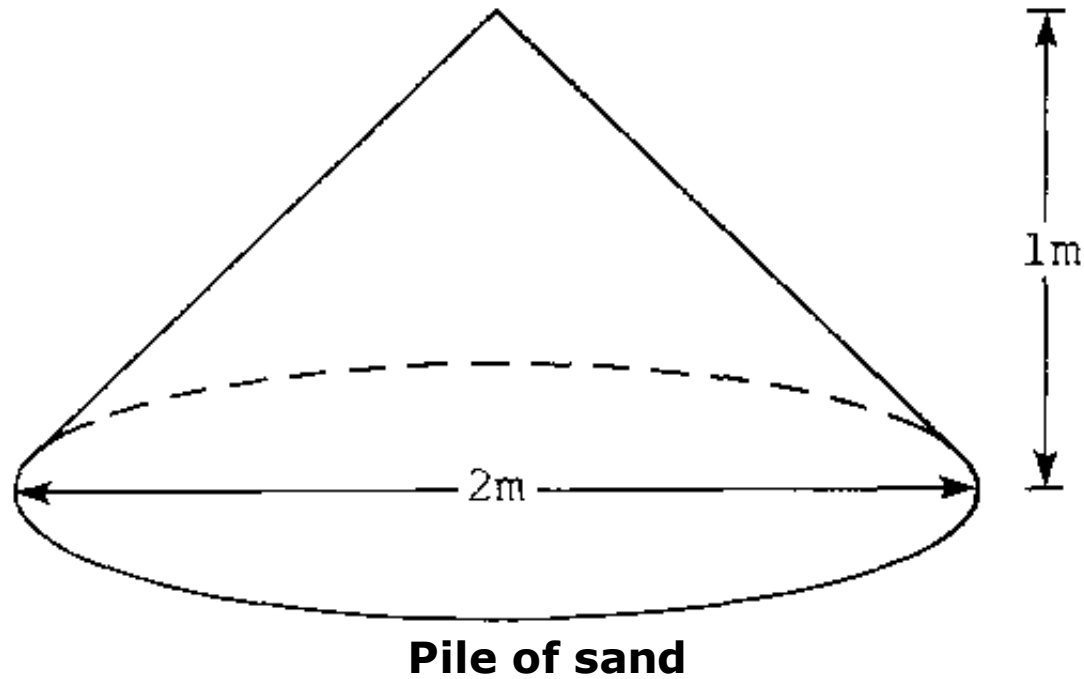
**1. Find the volume of a concrete slab in m<sup>3</sup>. in ft<sup>3</sup>**



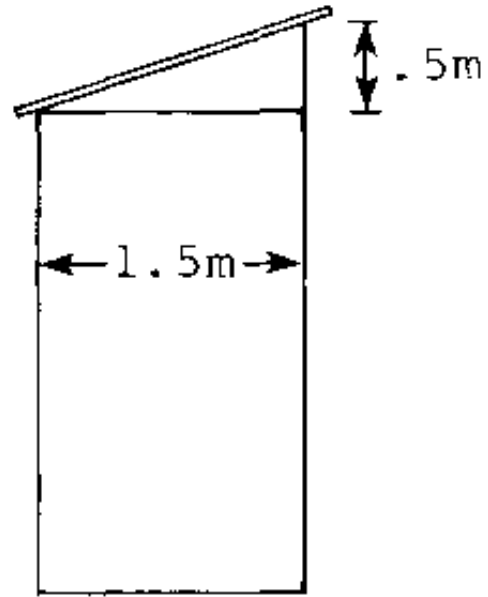
**2. Find the volume in  $\text{ft}^3$  of this tank. How many gallons will it hold? How many liters?**



**3. Find the volume of this pile of sand in  $\text{m}^3$ , in yards $^3$**

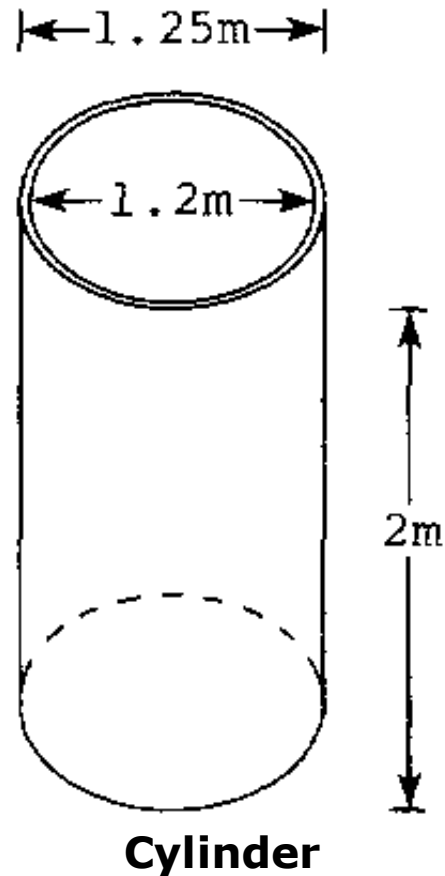


**4. Find the length of this roof rafter (the overhang on the front and back is 15cm)**



**Roof rafter**

**5. Find the volume of this cylinder in  $\text{m}^3$ , in liters.**



**6. Find the outside surface area of the tank (in m<sup>2</sup>) in problem 5.  
Find the volume of the tank walls in m<sup>3</sup>.**

### **Attachment 5A: Conversion chart**

#### **Common Equivalents**

- \* 1 cubic foot equals .0283 cubic meter**
- \* 1 cubic foot equals 7.48 gallons**
- \* 1 cubic foot of water equals 63.43 pounds**



- \* **1 cubic yard equals. 7616 cubic meter**
- \* **1 gallon equals 3.7854 liters**
- \* **1 gallon equals 8.345 pounds of water**
- \* **1 pound equals. 4536 kilogram**
- \* **1 meter equals 39.37 inches**
- \* **1 meter equals 3.2808 feet**
- \* **1 meter equals 1.0936 yards**
- \* **1 kilometer equals 3,281 feet**
- \* **1 square meter equals 10.764 square feet**
- \* **1 square meter equals 1.196 square yards**
- \* **1 cubic centimeter equals 1 gram**
- \* **1 cubic meter equals 35.314 cubic feet**
- \* **1 cubic meter equals 1.308 cubic yards**
- \* **1 liter equals 1.0567 quarts**
- \* **1 liter of water equals 1 kilogram**
- \* **1 kilogram equals 2.2046 pounds**
- \* **1 atmosphere equals 14.7 psi at sea level**
- \* **1 atmosphere equals 33.947 feet of water at 62 degrees F.**
- \* **1 psi equals 2.309 feet of water at 62 degrees F.**
- \* **1 psi equals .0703 kilograms per square centimeter**
- \* **1 foot of water at 62 degrees F. equals .433 psi**

### Common Formulas

- \* **To find the number of gallons in a Cylindrical Tank:**
  - **Diameter in feet squared x. 7854 x 7.48**

- \* To find the number of gallons in a Rectangular Tank:**
  - Length x Width x Height in feet x 7.48**
- \* To find the Pressure in psi of a Column of Water:**
  - Height in feet x.434**
- \* To find the Head in feet, the Pressure being known:**
  - Psi x 2.31**
- \* To find the number of gallons in a foot of Pipe of any size:**
  - Square of the Diameter in inches x.0408**
- \* To reduce Centigrade Temperature to Fahrenheit:**
  - Multiply the Centigrade temperature by 9, divide the result by 5, and add 32**
- \* To reduce Fahrenheit Temperature to Centigrade:**
  - Subtract 32 from the Fahrenheit temperature, multiply by 5, and divide by 9**

<b>Conversion Factors</b>		
<b>Multiply</b>	<b>By</b>	<b>To Obtain</b>
Centigrams	.01	Grams
Centiliters	.01	Liters
Centimeters	.3937	Inches
Centimeters	.01	Meters
Centimeters	10	Millimeters
Centimeters/second	1.969	Feet/min.

Centimeters/second	.03281	Feet/sec.
Centimeters/second	.036	Kilometers/hr.
Centimeters/second	.6	Meters/min.
Centimeters/second	.02237	Miles/hr.
Cubic Feet	1728	Cubic inches
Cubic Feet	.02832	Cubic meters
Cubic Feet	.03704	Cubic yards
Cubic Feet	7.48	Gallons
Cubic Feet	28.32	Liters
Cubic Feet/minute	472.0	Cubic cms./sec.
Cubic Feet/minute	.1247	Gallons/sec.
Cubic Feet/minute	.4720	Liters/sec.
Cubic inches	16.39	Cubic cms.
Cubic Meters	1,000,000	Cubic cms.
Cubic Meters	35.31	Cubic feet
Cubic Meters	1.308	Cubic yards
Cubic Meters	264.2	Gallons
Cubic Meters	1,000	Liters
Cubic Meters	1,057	Quarts
Cubic Yards	27	Feet
Cubic Yards	46.656	Cubic inches

Cubic yards	.7646	Cubic meters
Cubic Yards	202.0	Gallons
Cubic Yards	764.6	Liters
Cubic Yards	807.9	Quarts
Decigrams	.1	Grams
Deciliters	.1	Liters
Decimeters	.1	Meters
Feet	30.48	Centimeters
Feet	12	Inches
Feet	.3048	Meters
Feet of water	304.8	Kgs./sq.meters
Feet of water	62.43	Lbs./sq.ft.
Feet of water	.433	Lbs./sq.inch
Feet/minute	.5080	Cms./second
Feet/minute	.01667	Feet/second
Feet/minute	.3048	Meters/minute
Feet/second	30.48	Cms./second
Feet/second	18.29	Meters/minute
Gallons	3785	Cubic cms.
Gallons	.1337	Cubic feet
Gallons	231	Cubic inches
Gallons	3.785	Liters

Gallons	4	Quarts
Gallons	8.345	Pounds of water
Gallons/minute	2.228 x.001	Cubic feet/sec.
Gallons/minute	.06308	Liters/sec.
Gallons/minute	8.0208	Cubic feet/hr.
Grams	.001	Kilograms
Grams	1,000	Milograms
Grams	.03527	Ounces
Hectares	2.471	Acres
Inches	2.54	Centimeters
Kilometers	100,000	Centimeters
Kilometers	3,281	Feet
Kilometers	1,000	Meters
Kilometers	.6214	Miles
Kilometers	1,094	Yards
Kilometers/hr.	16.67	Meters/minute
Kilometers/hr.	.6214	Miles/hr.
Liters	1,000	Cubic cms.
Liters	.03531	Cubic feet
Liters	61.02	Cubic inches
Liters	.001	Cubic meters

Liters	.2642	Gallons
Liters	1.057	Quarts
Meters	100	Centimeters
Meters	3.281	Feet
Meters	39.37	Inches
Meters	.001	Kilometers
Meters	1.094	Yards
Meters/minute	1.667	Cms./sec.
Meters/minute	3.281	Feet/minute
Meters/minute	.05468	Feet/sec.
Meters/second	196.8	Feet/minute
Meters/second	3.281	Feet/second
Miles	5,280	Feet
Miles	1.609	Kilometers
Miles	1,760	Yards
Millimeters	.1	Centimeters
Millimeters	.03937	Inches
Ounces	.0625	Pounds
Ounces	28.349	Grams
Pounds	16	Ounces
Pounds	453.592	Grams

Pounds/sq. inch	2.307	feet of water
Pounds/sq. Inch	.07031	Kg./sq. cm.
Pounds/sq. Inch	.7031	Meters of water
Square Centimeters	100	Sq. millimeters
Square Centimeters	.0001	Sq. meters
Square Centimeters	.1550	Sq. inches
Square Feet	929.0	Sq. cms.
Square Feet	144	Sq. inches
Square Feet	.09290	Sq. meters
Square Feet	1/9	Sq. yards
Square Inches	6.452	Sq. cms.
Square Inches	645.2	Sq. millimeters
Square Meters	10.76	Sq. feet
Square Meters	1.196	Sq. yards
Square Yards	9	Sq. feet
Square Yards	.8361	Sq. meters
Yards	91.44	Centimeters
Yards	3	Feet
Yards	36 -	Inches
Yards	.9144	Meters

## Session 6 - Concrete and reinforcement

TOTAL TIME	Two hours
OBJECTIVES	<ul style="list-style-type: none"><li>* List the principle steps in making good concrete</li><li>* Define the component parts of concrete and demonstrate how they mix together</li><li>* Discuss water/cement ratios and their effect on concrete strength</li><li>* Explain the importance of reinforcement in concrete and demonstrate tension and compressive forces</li><li>* Describe proper curing procedures for concrete</li><li>* Identify some typical concrete and mortar mixes and ways to estimate proportions</li></ul>
RESOURCES	Attachment 6-A: "Concrete and Mortar" <u>Wells Construction</u> ; Peace Corps, ICE, pp. 221-238
PREPARED MATERIALS	Small quantities of cement, sand, aggregate, and water, measured containers of various sizes, length of string or rope, several examples of concrete reinforcement materials, newsprint and felt tip pens Copies of Attachment for all trainees
FACILITATORS	One or more trainers

## Trainer Introduction

**A considerable amount of technical information is presented in this session; therefore, it is important to keep the session moving. However, trainers should be responsive to questions and comments by the trainees as well. Be sure to have the necessary materials organized before you begin. Handout the Attachment a day or two prior to the session.**



## PROCEDURES

Step 10 minutes

1

Present objectives and format for the session.

Step 15 minutes

2

Discuss the basic principles of making good concrete by comparing it to baking bread.

### Trainer Note

**Most trainees are able to learn from this comparison. Present the following on newsprint:**

Ingredients:	Bread	Concrete
	Flour	Aggregate
	Yeast	Sand
	Shortening	Cement
	Sugar	Water
	Water	
Process:	Sifting	Sifting
	Mixing dry	Mixing dry
	Adding water	Adding water
	Kneading	Mixing wet

	Preparing	Finishing wet
	Rising	Tamping/Screeding
	Baking (function of time/temperature)	Floating
		Curing (function of time/temperature)

**By relating these two activities to each other, explain the principles of making good concrete. Mention that both procedures need care and a watchful eye during each step of the process. Experience is the best teacher along with a desire for quality and craftsmanship in your work. Here are some helpful hints:**

- \* **Good, clean ingredients make a good mix.**
- \* **Thorough dry and wet mixing makes a consistent mix.**
- \* **The right amount of water makes a strong mix.**
- \* **Proper working makes for quality concrete.**
- \* **Proper curing makes for strong concrete.**

Step 3 15 minutes

Present, in greater detail, the ingredients of concrete.

### **Trainer Note**

**Discuss aggregate size and quality, the importance of clean well-graded sand, portland cement and its binding qualities, and other such information. Pass around samples of each material or assemble the trainees around a table where they are laid out for observation. Demonstrate the void space in aggregate by filling a container with a fixed amount, then adding sand, and then cement in a 1:2:4 ratio.**

## **Show that the sand and cement fill the void spaces.**

Step 15 minutes

4

Discuss the hydration process that occurs when water is added to cement. Explain water/cement ratios in relation to concrete strength.

### **Trainer Note**

**Try adding water to a small amount of cement to demonstrate the effect. Refer to the attachment for common water/cement ratios. Explain how this ratio is the most important factor affecting mix workability, strength, and water tightness.**

Step 20 minutes

5

Demonstrate tension (stretching) and compression (squeeze) forces.

Explain that concrete has great compression strength, but little tension strength.

Discuss reinforcement of concrete.

### **Trainer Note**

**Tension and compression can be demonstrated in this manner: Ask a trainee to face you with hands in front of her/his chest, palms forward. Place your palms together and both push. That is compression. Grasp hands and pull. That is tension. A length of rope can be pulled to show that it has tension strength, but little compressive strength.**

**Pass around the room the examples of reinforcing materials. Describe their primary application, strengths, weaknesses, and proper placement techniques.**

Step 6 15 minutes

Explain the proper method of curing concrete.

### **Trainer Note**

**Mention, again, the comparison to baking bread. Baking and curing are functions of time and temperature. With concrete, moisture is necessary to regulate the hydration process. Discuss the importance of slow, even curing. Describe common methods of curing concrete.**

Step 20 minutes

7

List on newsprint some typical concrete and mortar mixes. Explain one or two methods of estimating quantities needed for a concrete slab.

### **Trainer Note**

**Describe how concrete proportions are written: cement:sand:aggregate.**

**Common concrete mixes are:**

**1:2:4 - general use, strong mix**

**1:2½:5 - general use, medium mix**

**1:3:6 - general use, lean mix**

**1:2:3 - waterproof, very strong mix**

## **Common mortar mixes are (cement:fine sand):**

**1:4 - general masonry**

**1:3 - waterproof strong mix; finishing plaster**

**1:6 - general plaster**

**1:2 - ferrocement**

**Two common methods for estimating materials are:**

**1. Calculate the total volume of the slab, and use that figure for the proportion of aggregate. Then, calculate the sand and cement quantities from the aggregate figure according to your selected mix.**

**2. Use the 3:2 rule which is described in Wells Construction.**

Step 8 10 minutes

Review the objectives and conclude the session.

## **Attachment 6A: Concrete and mortar**

### **Introduction**

**Concrete and mortar are two of the principal building materials used throughout the world. When used correctly, they will provide years of strong, durable service. Making good concrete and mortar is a relatively simple task if a few rules are learned and followed. What follows serves as a basic introduction to the subject.**

### **Definitions**

**1. Aggregate:** A graded mixture of clean, hard, and durable granular material used to make concrete. Fine aggregate is normally less than  $\frac{1}{4}$  inch in size. Coarse aggregate may range up to three inches in size although, the average size is  $\frac{3}{4}$ -1 inch. Aggregates may be natural sand and gravel, or artificially produced.

**2. Portland Cement:** A dry powdered material ground from a burned limestone-clay mixture. It is used as a binder in conjunction with aggregates to make concrete.

**3. Concrete:** A hard, durable building material composed of aggregates, bound together with hydrated cement paste.

**4. Mortar:** A mixture of cement and sand, in various proportions as desired, used to cement together bricks or stones in masonry, and to plaster walls.

**5. Hydration:** The chemical bonding of water and cement to form a hard cementitious material.

**6. Paste:** A mixture of cement and water only. The properties of the paste determine many of the properties of the finished concrete.

**7. Water/Cement Ratio:** The amount of water added to the concrete per unit of cement added. The ratio may be expressed the following ways:

- Gallons of water per sack of cement (94 lb. sack)
- Liters of water per sack of cement (50 kg. sack)
- Number of volume units of water per volume units of cement
- Number of weight units of water per weight units of cement

## **Aggregates**

**Aggregates are the filler materials which make up a large portion (roughly 70-75%) of the concrete volume. Considerable care should be taken to provide the best aggregates available. The following properties are important:**

- 1. Strength and Durability: Soluble, weak, or friable material must be avoided. As a rough guide, aggregates which have been tumbled down streams for sufficient distances to be well rounded and unbroken are strong and durable enough for concrete use. Strength can also be tested by cracking with a hammer.**
- 2. Gradation: The gradation of the aggregate influences the amount of paste required, the workability of the concrete, and the strength and watertightness of the finished product. In general, it is desirable that the size increase uniformly from fine sand to the maximum allowed for a given job.**

**As a rule of thumb, the maximum aggregate size allowed should be about one-fourth the minimum thickness of the concrete to be poured. In practice, however, it is desirable to use slightly smaller maximums where reinforcement is used, and slightly greater maximums where no reinforcement is used.**

**Fine aggregate (sand) should be clean (free of clay, silt, salt, or organic materials) and well graded, that is, containing grains of various sizes mixed together. Coarse aggregate (gravel, stones, crushed rocks, or brick) should also be clean. It is normally used in a uniform size but can have some variations within a mix of concrete. The most common size for slabs is 3/4-1 inch (20-25mm).**

**When natural gradation is not adequate, the gradation can be improved by**

**screening and cleaning. A screen for separating coarse from fine aggregates can be made from 1cm mesh on a timber frame, inclined roughly 60 degrees to the horizontal. Aggregate is thrown against the screen with a shovel so that the fines pass through and the coarse material rolls off. Also, a shaking screen can be made so that two people shake the screen while a third person shovels the aggregate. Once separated, the fine and coarse materials may be recombined in the proper proportions.**

**3. Cleanliness: The cleanliness of the aggregate affects the bond between the paste and the aggregate surface, and therefore, affects the strength and watertightness of the concrete. Coarse aggregates may be checked visually. Fine aggregates can be checked by placing two inches of the material in a glass jar, which is then filled three-fourths full with clean water and sealed. Turn the jar on its side and shake vigorously for one minute. Set the jar upright, level the sand by shaking sideways, and let it stand for about three hours. Any silt present will be suspended by the shaking and will settle back on the sand surface when allowed to stand. If more than 1/8 inch (3mm) of silt skim is formed, then the sand is too dirty to form strong concrete. In the field, a simple test may be performed by rubbing a moist sample of sand between the palms. Suitable sand will leave the hands only slightly dirty.**

**Aggregate may be cleaned by filling a barrel with water, than shoveling in the aggregate. Next, tip the barrel to allow water displaced by the aggregate to run off. Repeat as necessary. If available, running water will do a better job. Pipe the water into the bottom of the barrel so that it flows upward through the aggregate. A mixing trough may be used as well with a hoe for moving the aggregate around.**



**4. Shape:** Aggregate shape is generally not critical to concrete strength, but rounded aggregate is easier to work with than angular. More sand may be required with the latter material to make the mix more workable. Very flat or extremely sharp material should be avoided.

**5. Moisture:** The moisture present in the aggregate affects the total water needed for the mix. The ideal moisture is "saturated surface dry" wherein all pores of the material are filled with water but no free moisture exists on the surface. Most problems occur with the use of very wet or very dry fine aggregate. Allowance must be made for the amount of water added under such conditions.

## **Water**

**Water serves two purposes in making concrete. First of all, it triggers the hydration of cement and secondly, it makes the mix fluid and workable. Clean water is important for the same reasons as is clean aggregate; any impurities present will affect bond strength between the paste and aggregate. In general, any water which is potable can be used for concrete. Sea water may also be used, but concrete strength will suffer by some 10-15%.**

**Although water is an essential ingredient, too much water added results in a weak concrete. Very little water is necessary to cause the hydration process. Therefore, as a general rule, no more water should be added than necessary to make the mix workable.**

## **Cement**

**Various types of cement are made for use under a variety of conditions. The most**

**common is Portland cement and comes in a fine free flowing gray powder. Cement will generally be provided in 94 pound sacks, (one cubic foot) although this may vary with the country of origin. A sack size common to many countries is 50 kgs. (34-35 liters of cement).**

**Cement should be stored in a dry place and stacked in closely packed piles, not more than 810 bags high. Also, the piles should sit on a platform off the floor. Storing this way will reduce air circulation around the bags. Too much air circulation results in a loss of cement strength. An even greater problem results from moisture contact. Always protect bags from any moisture during storage.**

**Old or spoiled cement will contain lumps. These lumps should be screened out if they cannot be easily crumbled by the fingers. If cement has been stored for over six months, increase the amount of cement in your concrete by i-1 part, depending upon the condition of the cement.**

## **Mix Design**

**The water/cement ratio is the major determinant of concrete workability, strength, and watertightness. In general, the lower the ratio, the higher the strength and the poorer the workability. Good mix design reaches a reasonable compromise between workability and strength. Table I shows water/cement ratios which are in common use and may be mixed and placed by hand.**

### **TABLE I**

#### **Water/Cement Ratios**

	<b>Gallons per 1 94 lb. sack</b>	<b>Liters per 1 50 kg. sack</b>	<b>Vol. of Water per Vol. of Cement</b>
Non-critical Work	7	30	0.93 (9/10)*
General Work	6	26	0.80 (4/5) *
Watertight Work	5.5	24	0.73 (3/4) *

**\*Use these ratios for practical mixes. For example, 4/5 means 4 parts water to each 5 parts cement.**

**The relative amounts of aggregates necessary varies with size, gradation, and shape of the materials, as well as what the concrete is used for. These amounts will also affect the workability and strength of the concrete. A good starting point is a volume ratio of 1 part cement to 2 parts fine aggregate to 4 parts coarse aggregate, expressed as a ratio of 1:2:4. This ratio is the most common and serves most general uses. Other common ratios are: 1:2:3 very strong, 1:2½:5 medium strength, and 1:3:6 lean strength. In each mix, the proportion of cement to aggregate differs and thus the strength (water/cement ratio being equal) of the concrete will differ. The mix you use should suit the needs and conditions of your construction project.**

## **Reinforcement**

**Concrete forms a mass having very high compressive strength but very poor tensile strength. When concrete is used in a situation where tensile strength is**

**needed, a reinforcing material should be embedded in the concrete so as to resist tensile loads. Situations of this nature include slabs over holes and walls where uneven interior and exterior loads may exist.**

**Steel reinforcement is usually welded wire mesh or iron bars. The wire mesh is usually made from #10 wire laid in 4x4 or 6x6 inch squares. This is considered to be light reinforcement for low-stress applications. Where higher strengths are needed, reinforcing bar should be used. The most common sizes are: 1/4", 3/8" and 1/2". For slabs and walls, reinforcing bars should be laid in a checkerboard pattern and where two layers of bar cross, they should be tied together to prevent shifting during concrete placement. The bars should be spaced uniformly and, generally speaking, on 9-12 inch centers.**

**For small areas, 2-3 feet in dimension, and under light loads, reinforcing may be omitted. Low walls not subject to high stress, such as a spring box, may also not require reinforcement. However, concrete without reinforcement is much more likely to experience failure than is properly reinforced concrete. Therefore, reinforcement should be used whenever it is available.**

**The placement of reinforcement is as important as its use. In general, the reinforcement should be placed within the concrete completely, approximately 1-1½ inches (3-4cm) from the surface receiving the greatest tensil stress. Therefore, for a roof slab the rebar would be placed towards the bottom of the slab. For a floor slab, near the top of the slab. In all cases, the most important factors to consider are that the rebar is securely fastened so it will not shift, and that it is completely encased by concrete (2" all around) at all points.**

## Formwork

**Concrete, because it is fluid at the time of mixing, can be made into almost any shape. Forms are used to make that shape and hold concrete in place until it is strong enough to stand on its own. Forms should be well constructed and substantial enough to retain their correct shape when filled with fresh concrete. Primary considerations for forms are as follows:**

- 1. Strength: Fresh concrete weighs 140 to 160 pounds per cubic foot and behaves much like a viscous fluid. Consequently, force against forms can be very high. Forms must be made out of materials such as wood or steel, that can withstand such forces.**
- 2. Rigidity: Forms must be braced at frequent intervals to resist bulging due to the weight of concrete.**
- 3. Tightness: Forms should be built to minimize wasteful concrete leakage through cracks.**
- 4. Finish: The finished concrete will reflect all imperfections and joints in the forms. If appearance is important, care should be taken to use smooth forms.**
- 5. Durability: It is often possible to use forms more than once. In order to do this, they must be durable. Forms should be built in sections or panels so that they can be easily dismantled. Steel, cast iron, or other metals should be used if possible. If lumber is used, it should be strong and of reasonably good quality. Forms may be lightly oiled (mineral oil is best however, car oil can be used if the surface will not contact potable water) to prevent concrete from sticking and to make removal**

**easy. If dry lumber is used, it should be wetted down before concrete is placed inside. This will prevent the wood from drawing too much water from the fresh concrete.**

**The length of time concrete should be left in the form work will vary according to the type of construction and the climate. In warm weather, forms can usually be removed after two or three days. In cold weather, 4-7 days of curing time is required.**

## **Mixing Concrete**

**The purpose of concrete mixing is to provide a uniformity blended product of cement, water, and aggregates. Concrete can be mixed using hand tools or in power equipment of various sizes. Regardless of the type of process used, however, the principles are the same.**

**There should be an organized system for supplying cement, sand, aggregate, and water to the mixers. The actual mixing and pouring of concrete should be done in a continuous operation, without long delays between steps. Once the ingredients are mixed with water, the concrete should be used within 30 minutes.**

**For power mixing, ingredients should be added as uniformly as possible. For example, some water would be followed by some cement, then sand, then aggregate, then the whole process is repeated until all the ingredients are mixed (everything must be in the right proportions, of course). Mixing should continue only until ingredients are thoroughly mixed, which usually takes about five minutes.**

**For hand mixing, a proper mixing place should be set up with a mixing pad. This pad can be made the day (or two) before out of lean concrete, wood, or metal. It should be large enough to accommodate the largest amount of concrete that will be mixed at any one time and have raised edges around all sides.**

**When mixing, start with sand and cement in correct proportions. Mix them together thoroughly until a uniform color is reached. Next, the correct amount of water is added slowly, a small quantity at a time, and the mix is turned over numerous times until a smooth, consistent paste is formed. Lastly, the coarse aggregate is added and the entire mix turned over until the desired consistency is reached. For general use, the mix should be workable, of even consistency, and mushy rather than soupy.**

**An alternative hand mixing method is as follows: mix sand and cement together thoroughly on the mixing pad. Spread the mix out evenly and add the coarse aggregate. Mix thoroughly again, and form into a pile. Hollow out the top portion of the pile and slowly add small amounts of water while mixing all ingredients together. Continue mixing and adding water until the desired consistency is attained.**

**There is a natural tendency to over-wet hand mixed concrete, but this tendency can be avoided by measuring both the cement and water to maintain the desired water/cement ratio. Then, if the mix is too dry, add both water and cement in the proper ratio. If too wet, add sand and gravel in proper proportions. If too stiff, add a small amount of sand, and if too sandy, add a small amount of cement.**

## **Placing Concrete**

**The techniques used in placing concrete are another important consideration in the strength, water tightness, and appearance of the final product. The principal concern is to maximize the density of the concrete as it is placed, while not allowing one layer to dry before the next layer is placed. To maximize density, concrete should be mixed to the dryest workable mix, using proper proportions of water, cement, and aggregates.**

**Care must be taken to prevent the segregation of the concrete ingredients. Segregation occurs when the majority of the coarse aggregate sinks to the bottom and excess water rises to the surface. This segregation can severely weaken the finished concrete and cause leaks in otherwise water tight structures. To avoid segregation, the concrete should be mixed as close as possible to its final location. It should never be dumped from a height. In deep forms, concrete should be laid vertically into place and not thrown against forms or piled in one location for spreading. Any throwing of concrete is likely to produce segregation, and the higher the throwing force, the greater the segregation.**

**As each layer is placed, it should be compacted with a smooth stick or piece of rerod (shovels should not be used for rodding reinforced concrete because they will displace the reinforcement). Rodding should continue until the aggregate disappears and a uniform, reasonably level surface is obtained. Special care should be taken to rod all corners, around reinforcement, and along forms. Where lifts are placed on top of each other, rodding should penetrate two or three inches into the previous layer. The outside of the forms may be hit with a hammer to help compact the concrete. However, care should be taken so as not to over-compact the concrete, as this will cause segregation.**



**A general rule of pouring concrete is to minimize the unfinished surface area. This is the contact area between successive pours. For slabs, this means starting at one end and working outward, bringing each pour to finished elevation before expanding the work area. The concrete should be laid across the form in approximately 12 inch strips. Fresh layers of concrete should be placed down on the previous layer before that layer has had time to set (usually about 30 minutes).**

**For wall construction, the most desired strength characteristics are obtained from keeping the top of each pour horizontal. Therefore, for small structures each layer should be kept thin and work should progress continuously around the structure. The time for making a complete circuit should be kept to less than 30 minutes to prevent setting of previous layers.**

**When concrete is to be brought to finished elevation, it should be slightly overfilled, then struck off with a straight board screen, moved along the forms with a seesaw-like motion. This should be done as the work progresses so that the struck-off concrete can be incorporated in the structure.**

**In order to submerge all aggregate and provide a smooth finish, the concrete should be smoothed with a wood float 15 to 20 minutes after the concrete is struck off. Only a minimum of such work should be done at this time, because excess working will bring water to the surface and weaken the top layer. The excess water, known as bleeding, is commonly formed by the consolidation of concrete. If bleeding occurs, final work should be stopped until the excess water evaporates. Dry cement or sand should not be added to the surface to control the water. If heavy bleeding occurs, the water may be removed by light scraping or**

## **absorption into burlap.**

**Once the concrete has set so that heavy pressure exerted by a finger is required to make a small depression, the surface should be troweled to the desired smoothness using a steel trowel and heavy pressure to compact the concrete.**

**For sidewalks and other heavily traveled surfaces, a broomed or rough finish may be desired. After the concrete has been struck off and floated, a broom or brush is used to provide a textured finish. However, when sanitary protection is desired, such as on a latrine slab, the surface should be as smooth as possible to facilitate cleaning.**

## **Curing**

**To develop maximum strength, concrete must be cured, rather than being allowed to dry. The principle of curing is quite simple; moisture required for hydration must be kept in the concrete rather than being allowed to evaporate.**

**The most common method for curing small areas is simply to keep the concrete surface wet. This may be done by spraying water on the surface, or by placing a wet burlap, canvas, sand, or straw on the surface. These materials must be wetted at regular intervals. The second most common method is to prevent evaporation by coating with a chemical membrane or by placing plastic over the concrete. All curing methods should be started only after the initial set has occurred. This will prevent marring of the surface. Plastic should be used with care, because solar heat gain through the plastic can cause cracking of fresh concrete. Leaving form work in place can also aid the curing process, especially with walls and other**

**vertical surfaces. Hanging canvas or burlap over the forms will help even more.**

**The curing time should never be less than three days, and seven days is even better. Concrete gains strength by hydration, and hydration can continue only if sufficient moisture is present. Studies show that hydration and consequent strength gain continue as long as moisture is present, even for a period of years. If hydration is stopped, strength gain is stopped.**

**Concrete should not be allowed to freeze for a least seven days following placement. Concrete strength will be destroyed by early freezing of water in the mixture. If the daily mean temperature is less than 35°F, it is desirable to provide an external heat source. If the temperature is greater than 35°F, the heat caused by hydration will keep the concrete warm. If concrete sections are precast, they should be cured for five to seven days before there is any attempt to move them.**

## **Construction Techniques**

**Various construction techniques are available to make concrete work easier and more efficient. Of particular interest for rural applications are casting in place, and precasting. Casting in place is a common construction method. This simply means that the concrete structure is constructed in its final location. This is the easiest method when a site is accessible, needed materials are easily available, or structures are too large for easy movement. The form work is usually put in place, such as over the hole of a latrine, well-supported, and then the concrete is poured. After the concrete has cured, the forms are removed.**

**Precasting means casting of concrete in a location other than the final location.**

**Precasting may be done adjacent to the construction site or many miles away. Precasting is used where it is easier to transport the finished product than it is to transport the components, or where cast-in-place concrete requires excessive form work. For example, casting a small latrine slab over an open hole requires extensive forming to hold the wet concrete; in this case, it would be easier to cast the slab on the ground and slide it over the hold. Another example is repetitive castings, such as concrete well castings which are often more economically constructed at central locations.**

**In some cases, both precasting and cast-in-place may be used. For example, it is possible to precast concrete beams, which can be placed over a latrine hole. A cast-in-place topping can then be used to form the final floor surface.**

## **Structural Considerations**

**When a load is applied to a section of a structural member which is supported only at its ends, the member tends to bow or bend. Forces develop within the member to resist the bending tendency. These forces, known as flexural forces, consist of matching compressive and tensile forces. The former occurs on the side towards the force, and the latter, on the side away from the force. If a material has either insufficient tensile strength or insufficient compressive strength, that material will fail in flexure.**

**In reinforced concrete, the compressive strength exceeds the tensile strength by a factor of ten to one. Consequently, for a nonreinforced member in flexure, up to 90% of the compressive strength goes unused and virtually all failures are tensile failures. The use of steel reinforcement to resist tensile loads allows full use of the**

**compressive strength of concrete and therefore, significantly improves the usefulness of concrete.**

**The ability of a beam, slab, or wall to resist a force is dependent on several factors:**

- 1. The free span. This is the distance between supports. By reducing the free span by the use of cross braces, the load-carrying ability increases greatly.**
- 2. The loads. Loads consist of two factors. Dead loads are produced by the weight of the structure itself. Live loads consist of applied forces such as those produced by people, equipment, or snows. Live loads are obviously more variable and difficult to predict than dead loads, but the dead loads are often greater in magnitude.**
- 3. The section shape, particularly the depth or thickness of a beam, slab, or wall. As a general rule, the greater the thickness, the greater the load-carrying ability. However, this is partially offset by the greater dead load of the thicker sections.**
- 4. The construction materials. It is obvious that wood, concrete, and steel have differing characteristics. Reinforced concrete has much greater strength than unreinforced concrete.**

### **Porous Concrete**

**Most concrete is intended for use in watertight structures. However, for dug wells and springs, it is sometimes desirable to make the concrete porous so that water may seep in. Porous concrete is made in the same way as normal concrete, except**

**that the sand is deleted. For best performance, the coarse aggregate should be uniform in size, and not exceed one inch in maximum dimension. Mixes should be somewhat lean so that the voids are not filled with paste. However, do not make the mix so lean that it is unworkable. The water/cement ratio may be increased to seven gallons per U.S. sack or 30 liters per 50 kg sack to improve workability. Another common mix proportion is 1:4. Reinforcement is generally not necessary.**

## **Mortar**

**Cement mortar is used for masonry construction of brick or block walls, for plastering walls, and for ferrocement. Mortar consists of clean, uniformly graded sand, cement, and water. It is mixed in a similar fashion to that of concrete, without coarse aggregate. Ordinary masonry uses a mix of one part cement to four parts sand, depending upon the type of construction. A masonry water tank, for example, would require a stronger mix (perhaps 1:3) than a plain storage building. The water/cement ratio is also similar to that of concrete. Generally speaking, a mushy, buttery mix consistency is desired.**

**Plastering brick walls helps to make them watertight. Several thin coats, of increasingly higher cement content, are applied to the walls with a steel trowel.**

**The first coat uses a 1:4 mortar mix and is left with a rough surface. The second coat uses a 1:3 mix and is also left rough. The third finish coat uses a 1:2-3 mortar mix and is troweled smooth. Each coat must be given time to set up before another is applied.**

**Ferrocement is a combination of cement mortar and wire reinforcement used to**

**construct such things as water tanks. The mortar mix is rich in cement, 1:2, and uses less water than masonry mortar. All mortar construction must be cured properly using the methods described for concrete. It is especially important to shield fresh mortar from direct sunlight, high winds, or rains.**

## **Masonry Construction**

**To build a masonry wall, start with a firm foundation (usually concrete). Place a layer of mortar on the foundation and set the first blocks. Pack mortar between these blocks. Subsequent layers are formed by mortaring the top edge of the laid blocks, and then placing the next block. For best results, work from the corners towards the center of each wall. The blocks are kept in a straight line by the use of a string stretched from end to end of the wall. Mortared joints between blocks should be three-eighths inch thick. After mortar has started to stiffen, tool the joint to compact the mortar into it.**

**Masonry walls may be reinforced by several methods. First, a ladder of wire with welded cross pieces may be used within the mortar on horizontal runs. Second, small reinforcing steel rods may be used at the corners. Third, vertical steel bars may be placed in the hollow blocks and grouted into place. These methods are usually unnecessary for small block buildings, but are desirable for larger structures.**

**If masonry is to be used for watertight structures, it must be waterproofed. This may be done with a one-inch layer of plaster inside and out. Rock masonry construction may be performed in a similar manner to block construction. However, more skill is required to properly place the rocks and the waterproofing**

**plaster is always necessary.**

## **Grout**

**Grout is a cement, fine aggregate, and water mix used as a topping for slabs made of precast beams, or used to fill the cores of masonry blocks. The normal mix for grout used as a topping is 1:3, with just enough water to make it workable. The normal mix for filling cores is one part cement, three parts sand, and two parts pea gravel, with just enough water to make the mix fluid.**

**Grout toppings are placed and finished in much the same way as is regular concrete, and must be cured in the same manner. The surface upon which the topping is poured must be clean and damp for maximum adhesion. Wire mesh installed in the grout will help prevent cracking.**

**REFERENCE: United States Indian Health Service.**

## **Session 7 - Project documentation**

**TOTAL TIME** 1 hour, 30 minutes

**OBJECTIVES**

- \* Discuss project documentation as a learning tool used in the training program
- \* Relate project documentation to the development process during Peace Corps service
- \* Identify methods of documentation and their applications

**RESOURCES** Attachment 7-A: "Format for Training Documentation"

**PREPARED** Newsprint and felt-tin pens



PREPARED      newspaper and felt tip pens  
MATERIALS      Copies of Attachment for all trainees  
FACILITATORS One or more trainers

## **Trainer Introduction**

**The purpose of this session is to introduce the documentation process that will be used during training, and to emphasize its value during Peace Corps service. It is important that all trainees understand the format for training documentation and that trainers make very clear its purpose and procedure,**

## **PROCEDURES**

Step 1 10 minutes

Present the objectives and format for the session.

## **Trainer Note**

**Emphasize that trainees will be documenting their projects during training. Mention that documentation can be an effective tool used during Peace Corps service and is often neglected by Volunteers.**

Step 2 20 minutes

Write this question on newsprint and ask trainees to answer it.

Record answers on newsprint as well.

- Why use documentation during training?

## **Trainer Note**

**Lead a short discussion among the group; attempt to get as many answers as possible and record them, emphasizing important points. Here are some possible answers:**

- Recordkeeping**
- Reference Source**
- Project Management**
- Problem Solving**
- Evaluation**
- Learning Tool**
- Information Sharing**
- Planning**

Step 3 15 minutes

Write this question on newsprint and ask trainees to answer it.

Record answers on newsprint as well.

- How can documentation be used during Peace Corps service?

## **Trainer Note**

**Many of the answers here will be the same as those in Step a. However, there are some differences. For example, some Volunteers work within organizations that have certain requirements related to project documentation. Volunteers need to find out such information and become familiar with the specific procedures. Documentation can also be very useful in regards to skill transferal with local**

**community members. In this case, it must be formulated in a manner suited to the local environment. Also, it can be used as reference information for new Volunteers coming into a new area or joining a project team. Furthermore, Volunteer documentation can be shared with Peace Corps ICE in which it would then become part of a worldwide information network. Emphasize these points and other relevant points raised during the discussion.**

Step 35 minutes

4

Handout Attachment 7-A: "Format for Training Documentation," and thoroughly explain each component of the documentation process.

### **Trainer Note**

**Make sure that all trainees understand this format and all of its components. Mention the importance of:**

- **Clear and specific objectives**
- **Concise and understandable project description**
- **Clear and readable design drawings and specifications**
- **Objective evaluation of project performance**
- **Objective evaluation of group dynamics**
- **Overall continuity of information**
- **Participation by all group members**
- **Relevant recommendations**

**Use this time to show examples of good documentation from previous programs.**

Step 10 minutes

5

Review objectives and conclude the session with a reference to the documentation necessary for the next session: Field Activity: Form work and Pouring Concrete.

## **Trainer Note**

**This session should closely precede Session 8, in which documentation of the field activity is necessary.**

**REFERENCE: Domestic Technology International, Evergreen, Colorado.**

## **Attachment 7A: Format for trainee documentation**

### **I. Introduction**

- a. Name of project**
- b. Date started, date completed**
- c. List of trainees involved in project**
- d. List of trainees responsible for documentation**

### **II. Project Description**

- a. Objectives of project**
- b. Basic design**

### **III. Project Design**

- a. Design drawing, including basic specifications**
- b. Materials list and tool requirements**
- c. Construction schedule**
- d. Construction methods**

#### **IV. Project Evaluation**

- a. Operational performance of project**
- b. Schedule modifications**
- c. Design alterations or modifications**
- d. Group working dynamics**
- e. Project strengths and weaknesses**
- f. Recommendations**

**REFERENCE: Domestic Technology International; Evergreen, Colorado**

#### **Session 8 - Field demonstration: Formwork and pouring concrete**

TOTAL TIME 2 Hours

OBJECTIVES \* Construct proper formwork for a concrete slab  
\* Practice mixing concrete in correct proportions, and pouring a slab

RESOURCES Attachment 6-A: "Concrete and Mortar"  
Wells Construction: Peace Corps, ICE, pp. 221-238.

PREPARED MATERIALS Lengths of two by four lumber, #16 nails, hammers, builders' levels, crosscut saws, hacksaws, T-squares, tape measures, wheelbarrows, shovels, buckets, trowels, floats, burlap sacks, cement, sand, aggregate, water,

reinforcing material, bailing wire, pliers and gloves

FACILITATORS One or more trainers

## Trainer Note

**This session is designed to give the trainees hands-on experience forming and pouring concrete slabs. It requires substantial preparation. Assemble the trainees at the location of the demonstration. Have all materials and tools laid out for observation. Trainees should work in groups of four. You will need separate stations for each group, and may assign one trainer to each group if possible. However, the trainer should serve as a group adviser, not a group leader. The slabs should be no larger than two feet by two feet, with a thickness of 3-4 inches. Also, because of the fact that this is the first hands-on session of the training program, a discussion on proper tool use and safety should precede the exercise. Trainees who have experience working with concrete should be divided among the group. Each group must document the exercise, using the format from Session #8. The resource book and attachment is meant to serve as reference information for the trainees.**

## PROCEDURES

Step 5 minutes

1

Present the objectives and format for the session.

Step 30 minutes

2

Lecturette on the procedures for the layout of form work and the pouring of concrete

for a small slab.

## **Trainer Note**

**Explain each step thoroughly. You may actually form and pour a slab yourself if you feel it is necessary. Stress the importance of each step in achieving a satisfactory slab.**

Step 3 1 hour, 15 minutes

Trainees break into groups of four, and complete the exercise.

## **Trainer Note**

**Trainees should be allowed to work through the exercise themselves. Make sure that they satisfactorily perform each step: preparing the site, constructing the formwork, leveling and squaring it, placing the reinforcement, mixing the concrete, pouring it into the form, tamping the concrete, screeding it, floating the surface smooth, and setting up a proper curing schedule.**

Step 10 minutes

4

Review the objectives and conclude the session by having each trainer set up a time to review the documentation from his/her group (within a day or two).

## **Session 9 - Introduction to environmental sanitation**

**TOTAL TIME** Two hours

- OBJECTIVES**
- \* Discuss the relationship between the environment and disease through an understanding of the disease cycle
  - \* Identify the causes of water related disease, common means of transmission, preventative measures, and general treatments
  - \* Define several important epidemiological concepts
- RESOURCES** Rural Water and Sanitation Projects; USAID, pp. 11-27  
Sanitation Without Water; Winblad/Kilama, Chapter 1  
Small Excreta Disposal Systems; Ross Institute, Chapter 1  
Attachment 9-A, "Water-Related Diseases"
- PREPARED MATERIALS** Newsprint and felt-tip pens, copies of Attachment 9-A for all trainees
- FACILITATORS** One or more trainers

## **Trainer Introduction**

**This session is designed to deal primarily with water-related and excreta-related disease. Trainers should be quite familiar with the subject matter. The reading assignment should be read by the trainees prior to the session.**

## **PROCEDURES**

Step 1 5 minutes

Present the objectives and format for the session.

## **Trainer Note**



**Acknowledge the fact that this session may produce some anxiety in the trainees when they think about life in third world countries. Point out that exposure to disease is unavoidable as Peace Corps Volunteers. However, in actuality, the environments they will live in are generally wholesome and the diseases that are prevalent there are recognized, understood, and controllable. Mention that in contrast, many of the diseases prevalent in the western world, such as cancer, are not so recognizable, understood, or easily controlled.**

Step 10 minutes

2

Trainees brainstorm a list of environmental factors that facilitate disease transmission.

### **Trainer Note**

**Disease transmission occurs directly, such as in colds, or sexually transmitted disease, and indirectly, such as dysentery transmitted through bad water. Facilitate the discussion and list responses on newsprint. Some possible answers are:**

**pollution**

**lack of education**

**poverty**

**climate and topography**

**insects, animals**

**unsanitary facilities**

**population density**

## **contaminated water, air or soil**

**Emphasize the interrelationship between the environment and disease transmission. The study of infectious disease is, in fact, an ecological one, because of the interrelationship between organisms and their environment. This concept is important because it leads one to study what organisms (or infectious agents) need to live, propagate, and survive in their environment. This knowledge can lead to a change in environment which then leads to disease prevention.**

Step 3 15 minutes

Discuss ways to prevent disease transmission

### **Trainer Note**

**Focus the discussion on these two primary areas:**

#### **1) Interrupting the cycle of infection on one of two levels:**

- Community, i.e., eliminating breeding areas for mosquitos in the case of malaria, or banning swimming in snail infected waters in the case of shisto**
- Personally, i.e., boiling drinking water, wearing shoes, using latrines, washing hands before eating, washing vegetables and fruit.**

#### **2) Resistance measures such as:**

- Vaccinations**
- Prophylaxis**

- **Self care through proper nutrition, adequate sleep, stress management, etc.**
- **Early diagnosis and treatment**
- **Avoidance of situations which may compromise immunity**
- **Natural immunity which all people have. However, when entering a foreign environment the natural immune system will be challenged.**

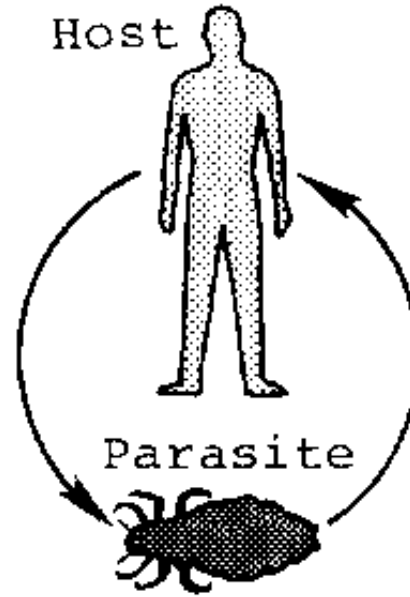
Step 4 30 minutes

Lecturette on the Disease Cycle and Chain of Infection.

### **Trainer Note**

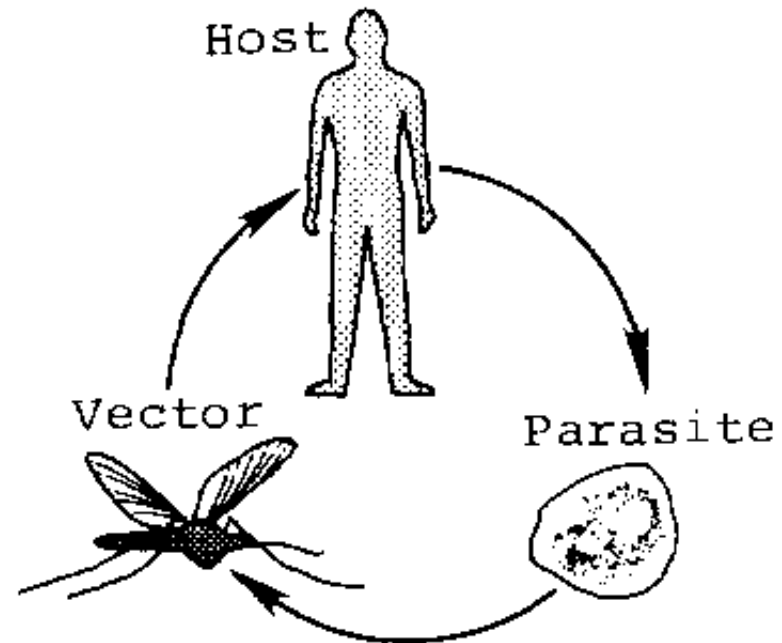
**Begin by listing the three primary living factors in a disease cycle: host, infectious agent, and vector or vehicle. Explain the relationship between the three factors and the following types of disease cycles:**

**Host and Infectious Agent: diseases which are transferred from person to person without intervention: measles, scabies, sexually transmitted disease, colds:**



### Host and Infectious Agent

**Host, Infectious Agent, and Vector or Vehicles: diseases which are transmitted by, and often perpetuated in, animal carriers: malaria, filariasis, yellow fever, epidemic typhus**



### Host, Infectious Agent, and Vector or Vehicles

**Next, explain each of the following terms, giving examples of each:**

**Infectious Agents: small organism or virus living in or on, and at the expense of, a large organism. The number of organisms necessary to initiate disease varies according to its virulence and the resistance of host. Infectious agents vary greatly in the length of time they live within their host, or outside in the environment. They also use various pathways to host.**

**Examples include:**

- **viruses as in hepatitis (cannot be fought with medication)**
- **bacteria as in typhoid or gonorrhoea**
- **parasites such as protozoa as in amoeba, giardia; and helminths as in ascaris,**

## **ankylostoma (hookworm)**

**- fungus, fleas, and lice**

**Vector: the living transporter and transmitter of the causative agent of disease. Examples are flies, mosquitoes, ticks, cockroaches, lice, rats, bats, snails and dogs.**

**Vectors use various methods to transmit disease: mosquitoes inject into bloodstream, flies deposit pathogenic organisms on food, dogs and rats bite, etc.**

**There are two types of vectors:**

**1) Mechanical, i.e., directly transmits the disease by crawling or flying, such as insects like flies, and does not require propagation or development of an organism.**

**2) Biological, i.e., propagation or multiplication must take place before the vector can transmit the infectious form of the agent, such as the female mosquito in the case of malaria.**

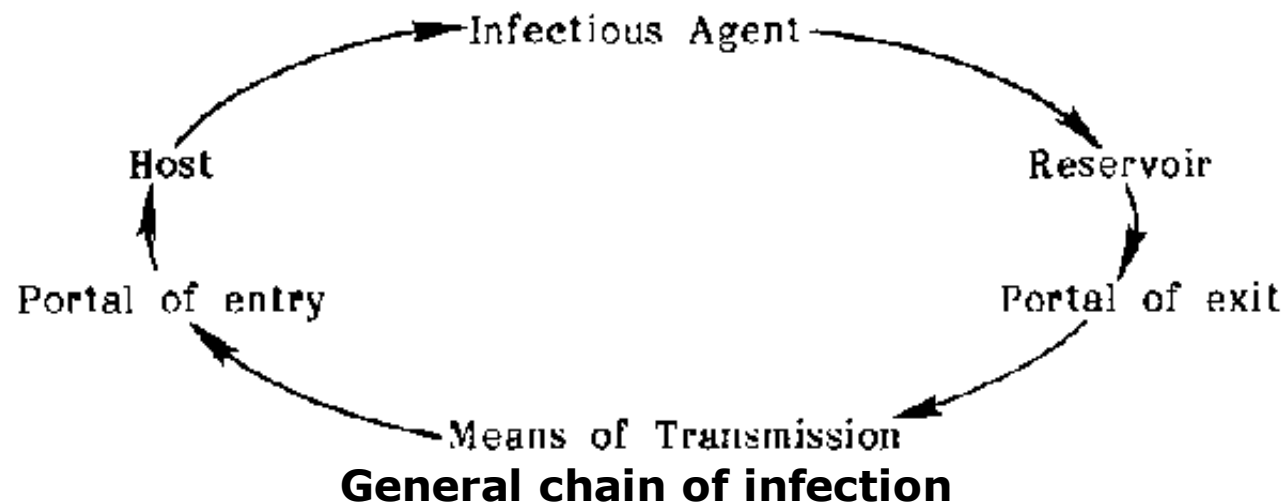
**Vehicle: an inanimate material or object which serves as an intermediate means by which an infectious agent is transported. Examples include: toys, clothes, utensils, water, food, blood products.**

**Host: any living animal or plant affording subsistence and, often, lodging to an infectious agent under natural conditions. Examples include people, animals, and insects.**

**A primary host is a carrier in/on which the organism attains maturity or carries out sexual cycle. The secondary host is a carrier in/on which the organism is in larval stage or carries out asexual development. A transport host is a carrier in which an organism remains alive but does not undergo development. There is often a varied interval of time between when an infectious agent enters a host and when symptoms of disease appear. It can do many things in a host: die quickly, live without causing harm, cause disease, or kill the host. Various factors influence how infected the host will become. The host may have natural immunity to an organism because of previous exposure, or because of generally good health and nutrition. A host may acquire immunity through vaccines or prophylaxis. Lastly, the virulence of the organisms will influence its effect on the host.**

**Reservoir: a place where an infectious agent normally lives and multiplies, on which it depends primarily for its survival, and reproduces itself in such a manner that it can be transmitted to a susceptible host. Examples are people, animals, birds, reptiles, and insects. A reservoir may carry a disease for varied lengths of time, often without showing symptoms.**

**Lastly, briefly explain a general Chain of Infection such as the one shown below.**



Step 10 minutes

5

Briefly define the four water-related disease categories: waterborne, water hygiene, water contact, water-related insect vector.

Step 40 minutes

6

Handout Attachment 9-A. Give presentations on four diseases, one from each water-related disease category.

## Trainer Note

**Discuss each disease, explaining the chain of infection and means of transmission, preventative measures, and general treatments. Use the information provided in the attachment and from the reading assignment in Rural Water and Sanitation Projects.**



**Step / 10 minutes**

Review the objectives and conclude the session.

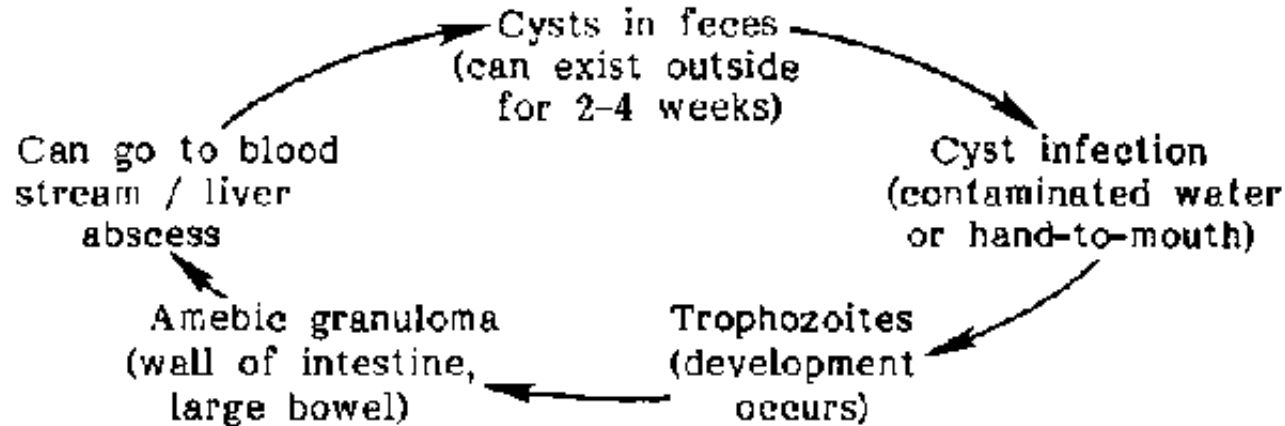
**Trainer Note**

**Conclude by pointing out that communicable diseases, such as those discussed during this session, are a part of life in third world countries. Consequently, such diseases are a part of all Peace Corps Volunteers' lives. However, as pointed out in Step 1, these diseases are for the most part recognized, understood, and controllable. In fact, many Volunteers around the world are working hard to prevent, control, or even eradicate these diseases.**

**Attachment 9A: Water-related diseases****DISEASE: AMEBIASIS (A MEBIC DYSENTERY)**

<b>Infectious Agents:</b>	Entamoeba histolytica; a protozoon
<b>Vector/Vehicle:</b>	Fecal-Oral by water, food, flies, utensels, food handlers
<b>Host:</b>	Humans
<b>Reservoir:</b>	Humans, usually a chronically ill or asymptomatic cyst passer
<b>Symptoms:</b>	Intestinal disorder, chills, fever, blood/mucoid diarrhea often occuring in cycles of attack and remission
<b>Treatment:</b>	Drug treatment; flagyl. Fluid rehydration for 18-24 hours, then rice/bread, etc. Avoid milk products.
<b>Prevention:</b>	Sanitary disposal of feces, clean water supplv, personal hvdiene, flv

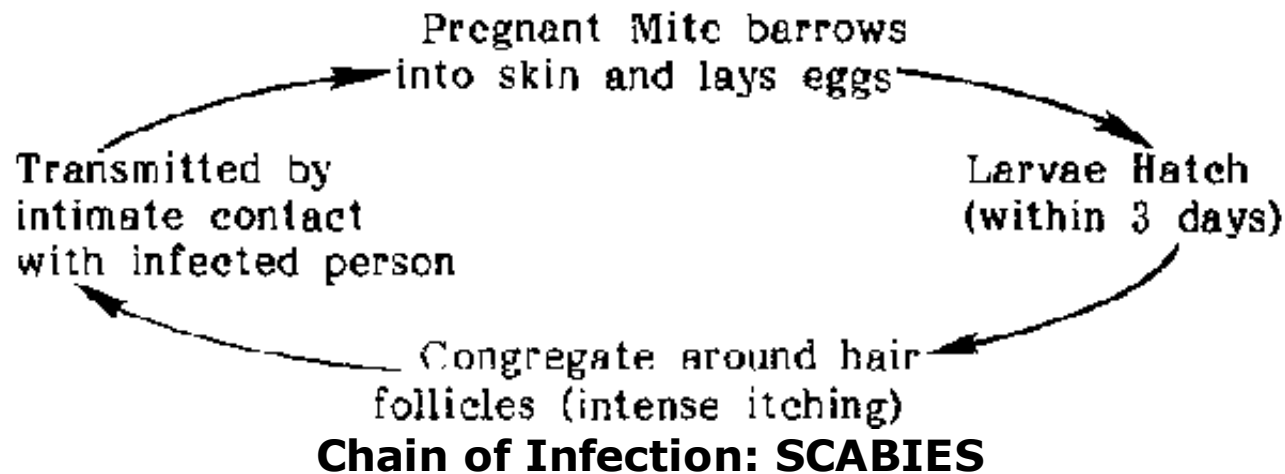
	control
<b>Long Range Effects:</b>	Dissemination via blood stream can produce liver abscess.
	Ulceration of skin from intestinal lesions



### Chain of Infection: AMEBIASIS

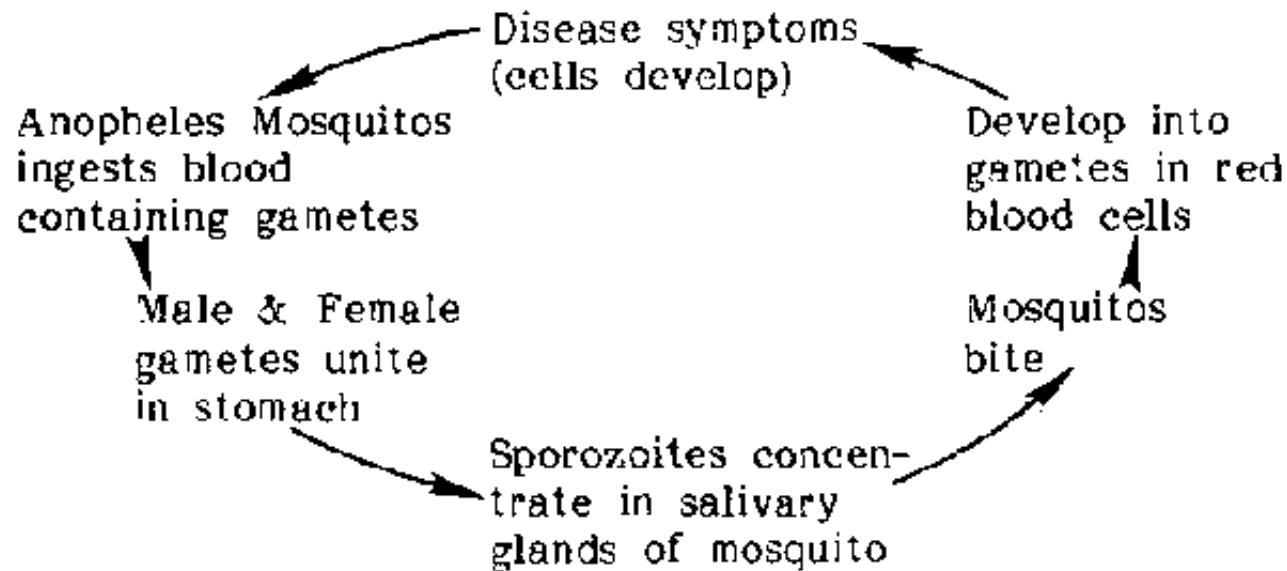
## DISEASE: SCABIES

<b>Infectious Agents:</b>	Sarcoptes scabiei: a microscopic mite
<b>Vector/Vehicle:</b>	Direct contact, garments, bedclothes
<b>Host:</b>	None
<b>Reservoir:</b>	Humans
<b>Symptoms:</b>	Intense itching, lesions
<b>Treatment:</b>	Cleansing bath followed by ointment
<b>Prevention:</b>	Sanitary hygiene, bathing, cleaning of garments/ bedclothes.
<b>Long Range Effects:</b>	Repeated scratching can cause secondary infection



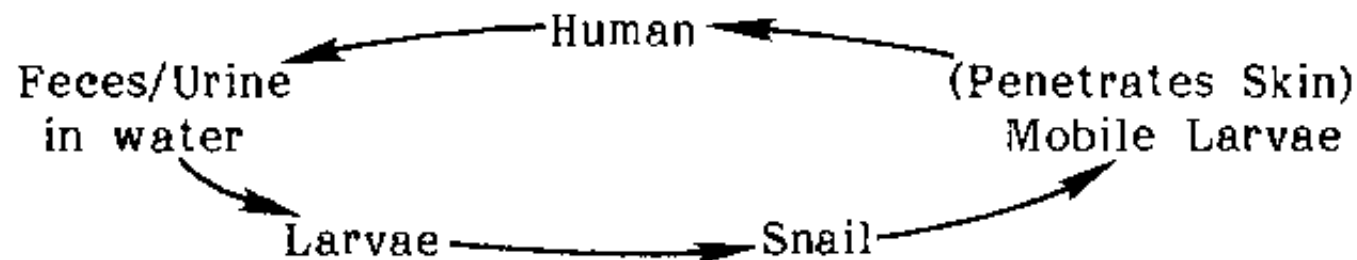
## DISEASE: MALARIA

<b>Infectious Agents:</b>	Plasmodium Vivax, P. Malariae, P. Falciparum, P. Ovale
<b>Vector/Vehicle:</b>	Infective female anopheline mosquito
<b>Host:</b>	Humans
<b>Reservoir:</b>	Humans
<b>Symptoms:</b>	Cycle of chills, profuse sweating, rapid rising temperature, headaches, nausea
<b>Treatment:</b>	High doses of suppressive prophylaxis. Fluid rehydration.
<b>Prevention:</b>	Regular use of suppressive prophylaxis, mosquito control, insect repellents, use of screens and bed nets, control of mosquito breeding habitats.
<b>Long Range</b>	If untreated, can cause irreversible complications and death

**Effects:****Chain of Infection: MALARIA****DISEASE: SCHISTOSOMIASIS (BILHARZIASIS)**

<b>Infectious Agents:</b>	Larval eggs of <i>Schistosoma mansoni</i> , <i>haematobium</i> , and <i>intercalatum</i>
<b>Vector/Vehicle:</b>	Water
<b>Host:</b>	Appropriate Freshwater Snail Intermediate Host
<b>Reservoir:</b>	Human
<b>Symptoms:</b>	Chronic infection, stomach pains, blood in urine
<b>Treatment:</b>	Long-term intramuscular drug injections
<b>Prevention:</b>	Disposal of feces/urine, snail control, protective clothing, brisk toweling

	after contact.
<b>Long Range Effects:</b>	General debilitation, death



### Chain of Infection: **SCHISTOSOMIASIS**

## Session 10 - Non-formal health education

TOTAL TIME Two Hours

OBJECTIVES

- \* Articulate concepts and characteristics of non-formal education
- \* Discuss non-formal health care practices in developing countries
- \* List techniques and tools useful in non-formal health education

RESOURCES Helping Health Workers Learn; Werner/Bower, Chapters 1-7  
"Health Care by the People;" a Hesperian Foundation film

PREPARED MATERIALS Newsprint and felt-tip pens, as many health education tools as possible, such as chalkboard, flannel board, posters, flash cards, slides, flip charts, and games, film projector and screen

FACILITATORS One or more trainers

## Trainer Introduction

**This session is designed to illustrate the importance of non-formal education in rural health care. Facilitate an exchange of ideas among the group during each step of the session. Have the film on hand for the session, or substitute another appropriate visual aid. Also, the reading assignment is long and trainees should be told well in advance.**

## **PROCEDURES**

Step 5 minutes

1

Present the objectives and format for the session.

Step 15 minutes

2

Ask the group for some ideas on the definition and characteristics of "non-formal education."

## **Trainer Note**

**The following is a possible definition:**

**"Education that takes place primarily outside of school's formal hierarchy, uses nonacademic teaching techniques, tries to provide understanding rather than transfer information, promotes expression rather than reception, and focuses on nonacademic subjects, such as farming, nutrition, health, technical skills, and literacy."**

**Listed below are some characteristics:**

- **deals with students in the context of their experience, i.e., their problems and needs**
- **curriculum is designed to solve those problems**
- **curriculum must have value for community in which it is taught**
- **it is usually part-time, short-term, and specific**
- **flexible and varied in content and learning techniques**
- **rewards are tangible and should improve student's well-being**
- **tends to motivate others to actively participate**
- **uses local skills, knowledge and resources**

Step 15 minutes

3

Present four non-formal education criteria, and the six step problem solving technique.

### **Trainer Note**

**The criteria focus on what a person would want to know or do in order to utilize effective non-formal education. The four criteria are:**

- **Self concept of the learner: This would be the learner's self-image and his/her perceptions of education in general.**
- **Utilize learner's experience: This promotes participation and effective sharing of information.**
- **Readiness to learn: This measures the participants' commitment to the education**

## **process.**

- **Time perspective and orientation to learning:** This would be an analysis of the format for the education and its perspective.

**The six step problem-solving technique is as follows:**

- 1. Ask a relevant question**
- 2. Document what people already know**
- 3. Present new information**
- 4. Compare steps 2 and 3**
- 5. Develop a generalization or action plan**
- 6. Demonstrate the generalization or carry out the activity**

**Discuss each step individually and the importance of the sequencing.**

Step 4 45 minutes

Show the film, "Health Care by the People."

### **Trainer Note**

**Give a brief introduction to the film. Mention that it uses a non-formal approach to health care in rural areas of developing countries. Ask the trainees to make note of development strategies used in the film.**

Step 15 minutes

5

Have the trainees give their impressions of the film, and identify some of the non-



formal education strategies illustrated in the film.

## **Trainer Note**

**Some points emphasized in the film are:**

- Medical knowledge should be shared, not hoarded. People have a right to the medical knowledge which leads to self-care.**
- Health care should be promoted through cooperation with local citizens on a self-help basis. They can and should be responsible for their health care.**
- Lasting improvements come from building on strengths of the community,**
- Trust is the best foundation for the relationship between health workers and their community.**
- Seek out local knowledge and resources to aid in health education and care.**
- Lasting change comes through cooperation and education.**
- Total health care is a combination of three factors: prevention through care, treatment and education.**

Step 10 minutes

6

Brainstorm various techniques and tools which could be used in health presentations.

## Trainer Note

**Helping Health Workers Learn has helpful descriptions of techniques and tools. Facilitate a discussion on the effectiveness of: chalkboards, flannel boards, posters, flash cards, slides, flip charts, games, role plays, demonstrations, story telling, photos Show examples of the tools if you have them on hand.**

Step 15 minutes

7

Allow the trainees to divide into groups of four to five, and begin planning their health education presentations for Session 16. Review the objectives and conclude the session.

## Trainer Note

**If possible, give the groups scheduled time to plan their presentations after this session. Be available during the time between this session and Session 16 to advise the trainees on their presentations. Encourage them to be creative in their ideas, and serious in their approach. They should follow the guidelines for non-formal education set out during this session. The presentations should be 10 to 15 minutes in length.**

## Session 11 - Community water supply case study

TOTAL TIME 2 Hours and 30 Minutes

OBJECTIVES \* Identify criteria necessary for development of a community water supply system in terms of quality, quantity, and convenience

RESOURCES Attachment 11-A: "Ecoli Case Study"

PREPARED Newsprint and felt-tip pens

MATERIALS

Ecoli village map drawn on flip chart

Copies of Attachment for all trainees

FACILITATORS One or two trainers

## Trainer Introduction

**This session is a way of introducing the trainees to community development work in the area of water and sanitation. It provides some technical information, but its emphasis is on community involvement in the selection of appropriate projects. Before the session is scheduled, read the case study carefully. Copies of the case study, divided into its three parts, should be prepared in advance for all trainees.**

## PROCEDURES

Step 1 5 minutes

Present the session objective and outline the activities.

Step 2 15 minutes

Hand out Part I of the Case Study and allow trainees time to read through it.

Step 3 15 minutes

Review the flow chart and Part I. Highlight important points.

Step 4 30 minutes

Hand out Part II; each trainee should complete the exercise by him/herself.

## Trainer Note

**Before the trainees begin the exercise, go over the flip chart map of Ecoli with the entire group. Then, each trainee should work through the exercise individually in order to get them all thinking about the various options for the community.**

Step 20 minutes

5

Break the trainees into four groups, assign one group to each water site, and have each group evaluate their site only.

## Trainer Note

**Each group should reach a consensus of opinion regarding the pros and cons of their site. The process of reaching a consensus among the group is as important as the actual conclusions reached.**

Step 30 minutes

6

Each group reports back, and their conclusions are listed on a flip chart. The group as a whole discusses the various sites.

Step 15 minutes

7

Hand out Part III and allow time to read. Then, as a group, highlight the important points.

## **Trainer Note**

**It is not necessary that a specific option be agreed upon and the others discarded. Each site should be discussed as to their strengths and weaknesses, and the best option or options singled out.**

Step 8 20 minutes

Review and discuss the case study exercise as a large group.

## **Trainer Note**

**Write the following questions, or similar ones, on a flip chart and discuss the answers:**

- 1. Was the decision on site selection easier to reach individually or as a group?**
- 2. Does our solution address the criteria necessary for adequate quality, quantity, and convenience of the water source?**
- 3. As a Volunteer, what did Rod need to know?**
  - technical information?**
  - community's felt and real needs?**
  - community resources?**
  - traditions and customs?**
- 4. As a Volunteer, what did Rod need to do?**

- **survey the community?**
- **discuss and plan with community leaders?**
- **interact with people?**
- **implement and maintain the project?**

## **Trainer Note**

**The case study illustrates that community involvement, starting with the decision making process, is vital for the success of any project. It also points out that technical knowledge is only part of what a volunteer needs in order to work successfully in community development. These points should be emphasized.**

## **Attachment 11A: Ecoli case study**

### **DEVELOPMENT OF COMMUNITY WATER SUPPLY SYSTEMS**

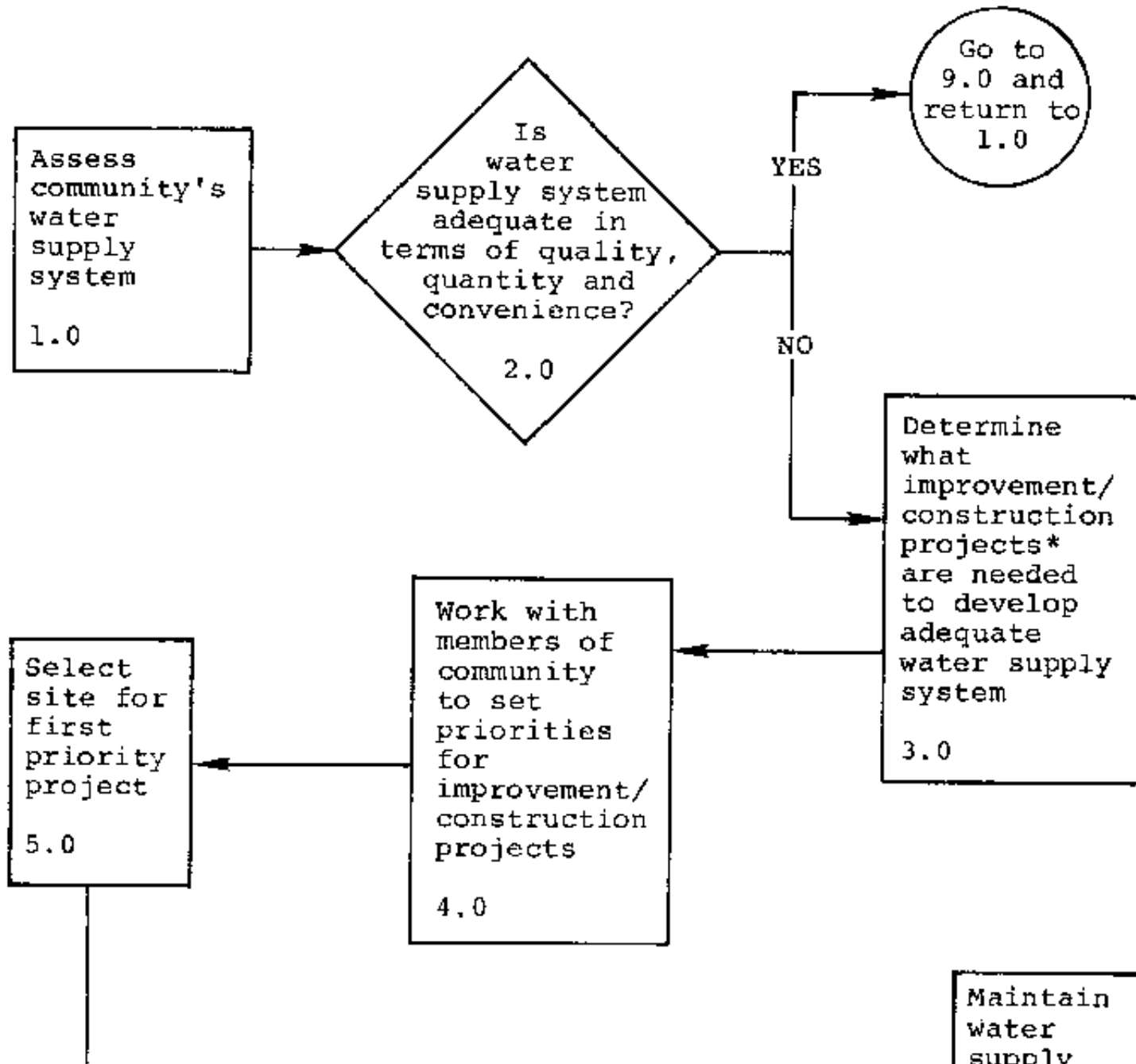
#### **PART I**

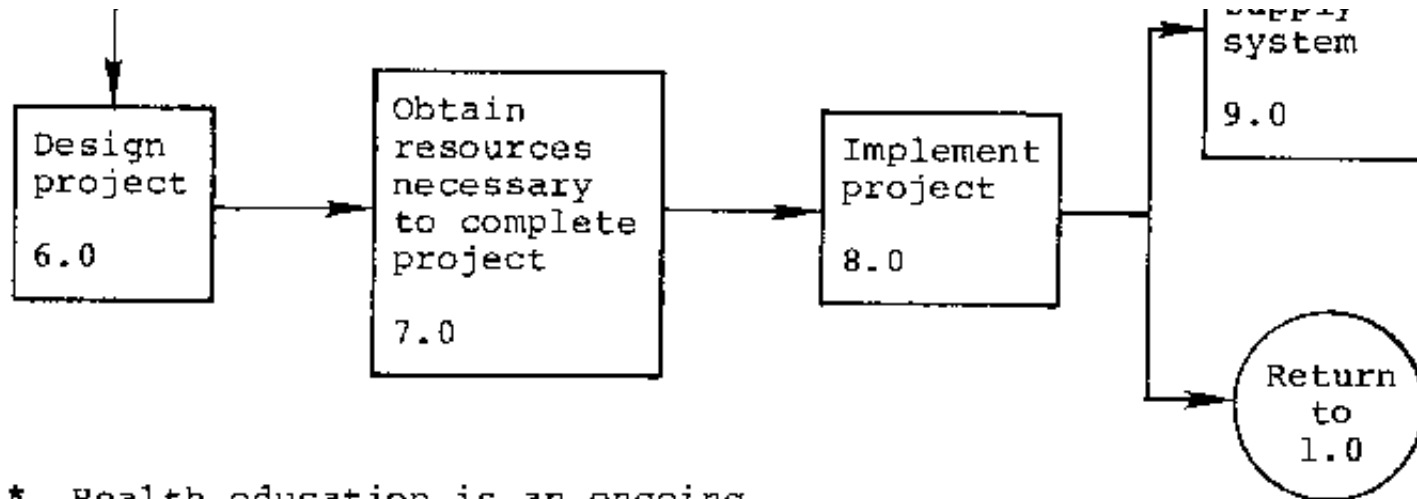
#### **Overview**

**The basic steps in development of a community's water system are pictured in the overview flowchart on the following page. The flowchart begins with assessment of the community's current water supply and ends with maintenance of an improved water supply system and reassessment of needs. In between is a sequence of decisions and activities, many of which this case study will focus on.**

**Turn to the flowchart now and study it carefully. Then begin reading the case study. If, as you read, you encounter any terms with which you are not familiar,**

# feel free to ask a course trainer for an explanation.





- \* Health education is an ongoing activity accompanying construction and physical improvements.

## Develop an adequate water supply system for a community

### INTRODUCTION

#### Objective and Priorities

**As a Peace Corps Volunteer, one of your major objectives will be to develop an adequate water supply system for the community to which you are assigned. Exactly what is meant by adequate? To be adequate, a water supply system must meet the following basic criteria for quality, quantity, and convenience:**

- **Water used for drinking and cooking is properly protected from contamination.**
- **Water supply is sufficient in quantity to meet yearly drinking and cooking needs of community.**
- **Water supply points are located within convenient walking distance of the population. (Note: Different communities will have different estimates of**



**"convenient" walking distances; you will have to define convenience with the help of the specific community to which you are assigned.)**

**It is not expected that all of the above criteria can be achieved in every community through a single development project. Depending upon such factors as local geologic and hydrologic conditions, cost and availability of resources and community interest, achievement of the criteria for an adequate water supply system may have to proceed in stages, according to priorities. For example, suppose that the members of a very dry, flat village wanted to pump water from an old, unprotected well to an elevated tank, from which the water could be distributed by natural gravity flow. Assuming the old well was located at a safe distance from known sources of contamination and adequate to meet demand, the first priority project would be to rehabilitate and protect it. Later, as resources become available, an elevated storage tank might be installed and pipes to several distribution points laid. Each day a different village could take a turn at pumping water to fill the tank by hand, until a power-operated pump could be obtained and installed to complete the system.**

**When working with the community to set priorities (i.e., to determine the sequence in which projects will be undertaken), keep in mind that good quality water is the most important consideration for an adequate supply system. Developing a small source of good water for drinking and cooking, thereby preventing a great deal of water-related diseases and death, is better than increasing a supply of contaminated water or making it more convenient.**

## **SELECTING THE SITE**

**There are three basic sources which can be developed to provide an adequate water supply for a community: wells, springs, and rainwater, which can be collected from roofs or other smooth surfaces into large storage containers. If there were no other possibilities, surface waters such as ponds or streams might be developed, but development of wells, springs, or rainwater is always preferable. Sites for development of these sources should meet certain criteria to ensure an adequate water supply.**

### **Safe Distances from Contamination**

**The most important criteria for wells, springs, and underground rainwater storage containers (e.g., cisterns) is that they be located a safe distance from sources of contamination (e.g., latrines, fecally contaminated streams, animal pens, etc.). Because so many factors affect the definition of "safe's however, it is impractical to set fixed rules for safe distances. It can be said that in all cases the distance should be the maximum that resources, geology, and topography permit and that in no case should the distance be less than 50 meters. Some factors that affect the determination of safe distances are listed below:**

- **Slope**

**The steeper a slope, the more easily contaminants may travel to a water source at a lower location. Though the direction of ground water flow does not always follow the slope of the land, it is preferable to locate a water source on higher ground than any nearby sources of contamination.**

- **Subsurface Formation**

**Contaminants are likely to travel greater distances through earthen formations**

**which are too coarse to provide good filtration (e.g., limestone, fractured rock) than through good filtering materials (e.g., sand, fine gravel).**

- **Depth of Water Table**

**If the water table is only slightly deeper than the source of contamination, or close to ground level, the chances of ground water becoming polluted are greatly increased. Deep cesspools or bored hole latrines may actually penetrate the water table, in which case the minimum "safe" distance for a water source might be a half mile or more, depending on other conditions. There is NO SAFE DISTANCE for spring development if a source of contamination is located uphill or at the same level as the spring, and soil conditions permit easy passage of contaminants.**

- **Concentration of Sources of Contamination**

**The existence of more than one source of contamination in the area increases the total pollution load in the soil and thus, the danger of contamination is greater.**

**When selecting a site for development of a water source, you will need to consider all of the above factors, think about the conditions of the possible sites in your mind and/or on paper, and then determine which of the possible sites is/are likely to be at a safe distance from contamination. Having narrowed down the possible sites, you can evaluate them in terms of additional criteria. Suggested criteria are provided below for well sites, spring sites, and rainwater catchment sites.**

### **Other Criteria for Well Sites**

**Ideally, in addition to being at a safe distance from sources of contamination, a site for a well should meet the criteria listed below.**

- **The water table should be at a depth to which it is possible to dig safely with available equipment and expertise. Earthen formations surrounding the site should be favorable in terms of the quality and quantity of the groundwater. Also, it should consist of materials that allow for safe construction practices.**
- **Well site should be on higher ground than any nearby sources of contamination (e.g., latrines, animal pens).**
- **The site should not be subject to flooding.**
- **The site should allow surface waters to drain away from the well on all sides. A slope of at least a half inch per foot will be sufficient to direct water away from the well.**
- **The site should be within convenient walking distance of the population, or should allow for future piping to convenient supply points by natural gravity flow.**

### **Other Criteria for Spring Sites**

**Ideally, in addition to being at a safe distance from sources of contamination, a site for development of a spring should meet the criteria listed below. Of course, these are criteria for an ideal site, and not all of them need be met in every case:**

- **Soil formations surrounding the site should be favorable; i.e., consist of sand, fine gravel, and/or other materials with good filtering properties.**
- **The site should not be subject to flooding by greater quantities of surface water than diversion ditches can be expected to divert.**

- **The site should be on higher ground than any nearby sources of contamination (e.g., latrines, animal pens).**
- **Spring should produce adequate quantities of water year-round.**  
**Note: If flow is weak, but spring is downhill from a stream or surrounded by several small seeps, infiltration galleries may be installed to increase the flow, provided soil formations surrounding the site have good filtering properties.**
- **If water is ultimately to be piped to convenient supply point(s), a proper survey and design should be carried out.**
- **Spring area should be fenced and protected from all contamination.**

### **Other Criteria for Rainwater Catchment Sites**

**Distance from contamination is not as an important factor in choosing a site for above-ground storage, provided the storage container is to be water-tight and set on a slightly raised wooden, concrete, or packed clay base. A site for either underground or aboveground storage, however, would ideally meet the criteria listed below. If not all of the criteria can be met, at least the most important criteria (as listed below) should be met:**

- **Site should be near a smooth surface which will not absorb water and thus, can be used as a catchment area (e.g., a metal roof).**
- **Site should be convenient to those who will use the water collected.**
- **Site should be on higher ground than any nearby sources of contamination (e.g.,**

**latrines, animal pens).**

- **Area surrounding storage container should be sloped to provide good drainage. (If the natural slope is not appropriate, the container may be set on a slightly sloped concrete or clay base.)**

## **PART II**

### **Exercise**

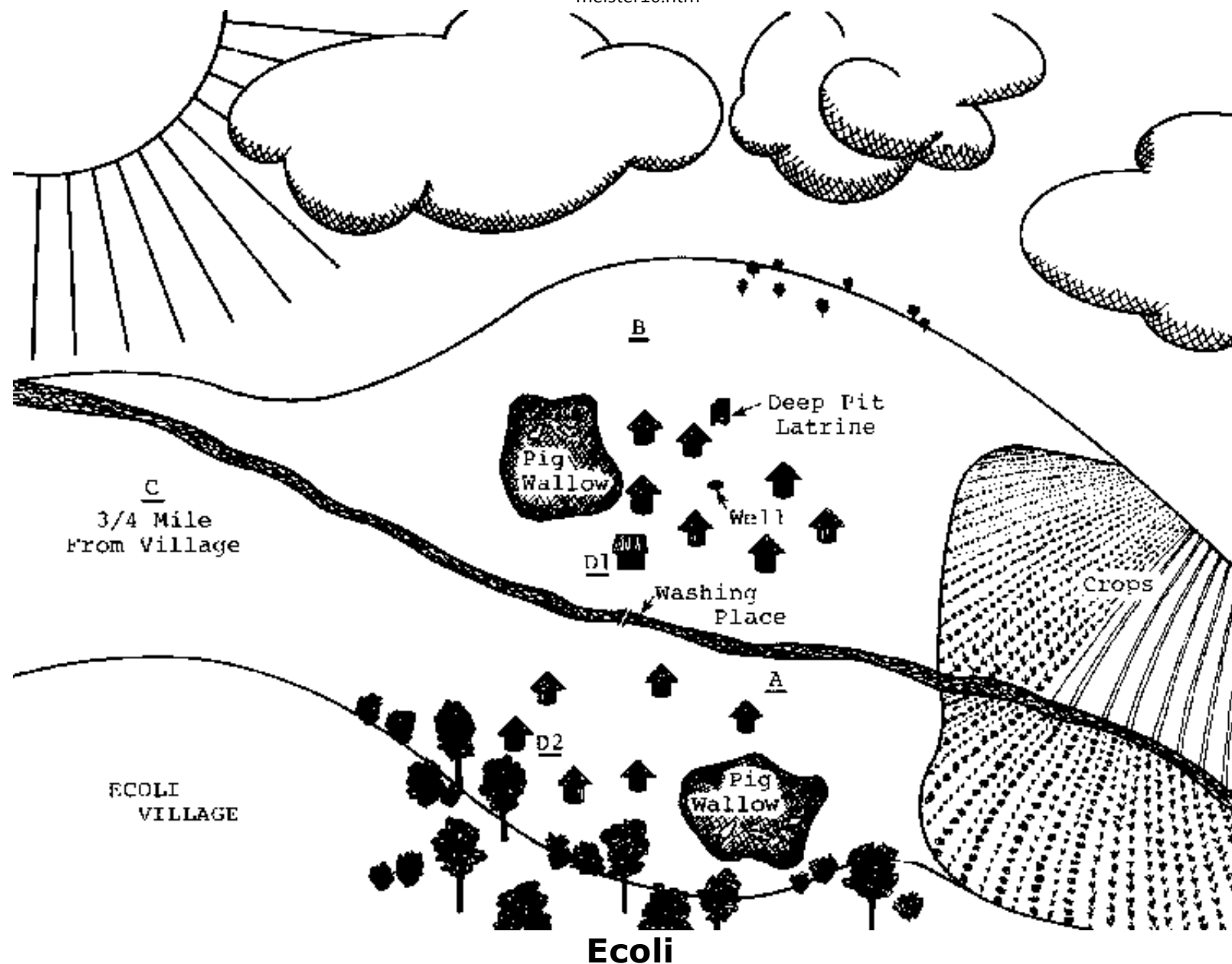
**In this exercise, you will use the criteria provided in the previous section of the case study to select the best site for a water development project in the hypothetical village of Ecoli. First read the background information below, which describes the assessment and decision making which have already taken place in the village.**

### **Background Information**

**Several months ago, Rod DeVine arrived in the village of Ecoli as a Peace Corps Volunteer. As he got to know the people, he began to assess their water supply and excreta disposal systems. He observed that the villagers were relying on two sources for all their water needs: drinking, cooking, bathing, washing clothes, providing water for their animals, and watering their crops. These sources were a small creek and an old well, which was simply an unprotected, 40-foot-deep hole in the ground. Each family had its own bucket for retrieving water from the well, and a long rope for community use was kept coiled on the ground by the well opening. In conversations with the villagers, Rod found that they felt they had enough water for their needs, and that it was conveniently located as well.**

**For the most part, the people of Ecoli had no organized system of Excreta disposal, and were inclined instead to use any convenient bush or ditch for that purpose. On the advice of a visiting health worker, one family had built a deep pit latrine behind their home, but it was rapidly filling up and becoming smelly, and the family had decided it would be impractical to dig another one. After talking with this family and others, Rod concluded that it would take a long time to persuade the villagers of the benefits of an excrete disposal system, and that he would be wiser to concentrate on the water system first.**

**On the following image is a sketch of Ecoli. Refer to it now and familiarize yourself with the village. (Note: The entire village is located on the sides of two hills.)**



As you probably guessed, Rod found that Ecoli's water supply was not adequate in quality, even though the villagers had described it as convenient and adequate in



**quantity. Droppings and soil from the upper pig wallow were washed into the creek every time it rained. The villagers washed themselves and their clothes upstream from the places where some of them dipped their drinking water. The well was potentially contaminated every time a bucket was dropped into it, and it was located only 50 feet downhill from the latrine. Since the well walls had no protective casing, shallow ground water could easily carry contaminants from the latrine into the well. What's more, the high frequency of diarrhea! episodes among young children was clear evidence of poor quality water.**

**At village meetings, Rod began to discuss the relationship between diarrhea and water problems, and the people become interested. Finally, after many meetings, they reached the conclusion that Rod had been hoping for. They decided that the old well and the creek should be used only for the animals, crops, and some washing, and that a new source should be developed for drinking, cooking, and washing young children.**

**Rod then began discussions of the different kinds of sources that might be developed and the factors to be considered in choosing a site. Since the villagers were used to drawing water from a well, most of them thought that development of a new well was the best idea, though there was some argument about whether the well should be located in the upper or lower part of the village. The villagers already had most of the tools necessary for construction of a dug well, and Rod was fairly sure he could get the equipment for a bored or driven well in the nearest town.**

**Several of the villagers thought that rainwater catchment systems were an interesting possibility and eagerly offered their own roofs as catchment surfaces.**

**There was also the possibility of finding a spring further uphill, but most people thought the distance would be inconvenient. Rod explained that they would not have to walk to the spring if the water could be piped down to the village; he knew that they could order adequate pipeline materials in town. Rod then explored the hill with several villagers and did find a spring about three-quarters of a mile from the village.**

## **Instructions**

**1. Here is a list of the possible development projects and sites suggested by Rod and the villagers. Each site is marked on the map provided.**

**With the criteria provided in Part 1, examine the drawing and consider the advantages and disadvantages of each site:**

**A. A new well on the lower side of the creek.**

**B. A new well on the upper side of the creek, further uphill than the old well.**

**C. A spring about 3/4 mile uphill, on the lower side of the creek.**

**D. Rainwater catchment systems using the tin roof of one house on the upper side of the creek and the thatch roof of one house on the lower side of the creek.**

**Storage containers would be above ground.**

**2. Now fill in the Site Evaluation Chart on the following page as an aid in deciding which site or combination of sites you would choose to develop. A description of the old well site has been completed for you as an example. Some of the information on site A-D which could not be obtained from the background description or the drawing of Ecoli has also been entered for you. If there is other information which cannot be deduced from the background description or**

**drawing, simply write "unknown" in the space for that information. You should still be able to reach a conclusion about the site(s) to develop.**

**If you have any questions, please feel free to go to a course trainer for assistance.**

### **SITE EVALUATION CHART**

<b>FACTORS TO CONSIDER:</b>	<b>OLD WELL</b>	<b>SITE A</b>	<b>SITE B</b>	<b>SITE C</b>	<b>SITE D</b>
1. Location with respect to sources of contamination (distance and slope)	About 50' downhill from latrine, 100-150' slightly downhill from pig wallow				
2. Soil formation surrounding site	Loose rock, sand; gravel	Loose rock, sand, gravel	Some boulders, otherwise loose rock, sand, gravel	Sand, fine gravel, with underlying rock	
3. Depth of water table	About 40'	Unknown, probably less than 40'	Unknown, probably greater than 40'		

4. Quantity of water likely to be produced	Produces adequate quantities year-round	Unknown, probably adequate since so close to creek	Unknown	Good flow, probably adequate for drinking and cooking	Rainfall is sufficient to supply about two households per catchment system with drinking and cooking water year-round
5. Drainage, possibility of flooding	Surface water tends to drain into well since it is on a slope. Flooding is very unlikely, however				
6. Convenience of site, potential for piping to supply points	Central location, no need to pipe water				
7. Other considerations	Even reconstruction of well could not guarantee safe quality water				
8. Conclusions	Not to be used for				

	drinking or cooking				
--	------------------------	--	--	--	--

**3. Carefully review the Site Evaluation Chart which you have just completed. Which site(s) would you choose to develop in Ecoli? Enter your answer and the main reasons for your answer in the space below.**

### **PART III**

#### **FEEDBACK FOR QUESTION 3**

**Though there are many unknown variables in the Site Evaluation Chart, as there would be in any real-life situation, we believe that the wisest choice would be to develop spring Site C and also construct a rainwater catchment system using the tin roof of the house on the upper side of the creek. Our reasoning, with which you may legitimately disagree, is described below:**

- **Site A is within 50 feet of contamination from the polluted creek. Since the water table is not likely to be deep, creek water carrying contaminants from the pig wallow and community washing place might easily flow downhill and enter a well at this site. Flooding may also be a problem during the rainy season.**
- **Site B is probably at a safe distance from contamination, about 75 feet uphill from the pig wallow and about 100 feet uphill from the latrine. The site is fairly convenient and has good potential for piping water by natural gravity flow to the center of the village, provided a force pump could be installed and storage tank constructed. Not much pipeline would be needed.**

**There are several important "unknowns" about Site B. however. The water table is of unknown depth, and is probably deeper than 40 feet (depth of water table at old well site). If the water table were actually deeper than 50 feet, it would be very difficult to construct a dug well; other methods of well construction, however, might be impeded by the presence of boulders. The quantity of water likely to be produced is another unknown factor. In addition, it might be conjectured that the village is likely to spread further uphill (especially if a well is located there), thus increasing chances that future sources of contamination would be located in the vicinity of this site. There is also one known disadvantage of Site B; that is, because of the topography, considerable excavation would be required to ensure proper drainage away from the well on all sides. Thus, though Site B is a possibility for development, we believe Site C would be a wiser choice.**

- **Site C, our choice for development, has no nearby sources of contamination; nor is there any likelihood that the village would expand 3/4 of a mile and cause future possibilities for contamination. The spring has good flow already, and possibly more water could be obtained through the use of infiltration galleries.**

**The inconvenience of Site C can easily be overcome by piping water to the lower part of the village. A storage reservoir and lots of pipe would be needed, but no pump would be required. Diversion ditches would be needed to divert surface waters from the site, but digging these would be much less difficult than the excavation required to provide an appropriate slope for Site B. Assuming enough pipeline materials can be obtained, Site C is a good choice. Even if the water can only be piped part of the distance to the village initially, more pipeline can easily be added as it becomes available. Later, if even more convenience were desired, water could be pumped to a storage tank above the upper part of the village and**

**piped from the storage tank by natural gravity flow to additional distribution points.**

- **Sites D1 and D2 both meet most of the relevant criteria. They are both convenient and could provide a significant amount of water for drinking and cooking to supplement the water piped from the spring. Since the proposed catchment systems will incorporate above ground containers, the distance from sources of contamination is not very important. The soil formations are also irrelevant, assuming they are firm enough to support the containers without shifting markedly. The depth of the water table is irrelevant. So is the matter of drainage, since containers can easily be set in a sloped concrete base.**

**The only problem is that the thatch roof planned for use at Site D2 is likely to trap many contaminants, which may enter the water supply in spite of precautions. The thatch would also absorb a significant amount of water instead of allowing most of it to run off the roof into the storage container. Therefore, it seems wisest to first build one catchment system, using the tin roof at Site D1, as an experiment. If the system proves a success, investment in more tin roofs could be made and more systems constructed to supplement the water piped from the spring.**

**Your answers and reasoning may differ from the answers and reasoning presented above. If you feel these differences are legitimate, discuss them with your course trainer. There are many "educated guesses" involved in site decisions, and yours may be quite appropriate.**

**Agreeing on the Site**

**The site that you consider the best choice for development may not be the site that most of the community prefers. You can do your best to avoid this possibility by discussing with the people beforehand about the criteria for a good site, and by involving them in the decision-making process.**

**In Ecoli, Rod reached his conclusions just as you did. Instead of announcing a chosen site, however, Rod made sure that respected members of the village understood the criteria for site selection and then went through a similar decision-making process themselves. When these respected individuals were committed to the appropriate site, it did not take much effort to convince the other villagers that it was the best choice for development. Rod made the decision based on his knowledge and experience. Then, he explained fully the decision-making process to the elders and worked through it with them.**

**REFERENCE: United States Indian Health Service**

**Trainer's Use Only**

### **SITE EVALUATION CHART ANSWER SHEET**

<b>FACTORS TO CONSIDER:</b>	<b>OLD WELL</b>	<b>SITE A</b>	<b>SITE B</b>	<b>SITE C</b>	<b>SITE D</b>
1. Location with respect to sources of contamination (distance and	About 50' downhill from latrine, 100-150' slightly downhill from	About 75' uphill from pigs, about 200' downhill	1. Uphill from all sources of contamination, about 75' from pigs and 100'	No nearby sources of contamination	Far enough; distance won't really matter since system will have from



slope)	pig wallow	from pigs and latrine, less than 50' downhill from polluted creek			latrine above-ground containers
2. Soil formation surrounding site	Loose rock, sand; gravel	Loose rock, sand, gravel	2. Some boulders, otherwise loose rock, sand, gravel	Sand, fine gravel, with underlying rock	Unknown; won't matter assuming soil is firm enough to support containers
3. Depth of water table	About 40'	Unknown, probably less than 40'	3. Unknown, probably greater than 40'	Not relevant, water is visible at surface	Not relevant
4. Quantity of water likely to be produced	Produces adequate quantities year-round	Unknown, probably adequate since so close to creek	4. Unknown	Good flow, probably adequate for drinking and cooking	Rainfall is sufficient to supply about two house holds per catchment system with drinking and

					cooking water year-round
5. Drainage, possibility of flooding	Surface water tends to drain into well since it is on a slope. Flooding is very unlikely, however	Poor drainage since on slope, may flood; Diversion Ditches necessary	5. Uphill side of site would require excavation in order to provide good drainage. Flooding likely	Diversion ditches can be dug to divert surface waters	Containers can be set on sloped cement bases. Flooding unlikely
6. Convenience of site, potential for piping to supply points	Central location, no need to pipe water	Very convenient, no need to pipe	6. Fairly convenient. Good potential for piping downhill if force pump and storage tank can be provided	Inconvenient now, but good potential for piping to lower part of village. Storage tank and lots of pipe would be needed but no pump would be required	Very convenient, no need to pipe
7. Other considerations	Even reconstruction of well could not guarantee		7. Village might spread further uphill, in creasing chances of later	Infiltration galleries would provide even stronger flow	Thatch roof of D2 allows too much chance of

	safe quality water		contamination. Boulders and depth of water table may require special equipment which would increase cost of development		contamination. It would also tend to absorb water rather than allow it to run off
8. Conclusions	Not to be used for drinking or cooking	Too close to a polluted creek, not a good site	8. A possibility, but there are several unknowns	Strong possibility	D1 (with tin roof) is a strong possibility as a supplementary source

## Session 12 - Project planning and management

TOTAL TIME Two hours

OBJECTIVES

- \* Analyze factors which -influence the management of development projects.
- \* Identify practices and procedures which can assist in the management of water and sanitation projects in rural communities
- \* Learn and practice simple methods of managing one's time spent on a development project.

RESOURCES Small Community Water Supplies, IRC, pp. 19-35

## Attachment 12-A: "Steps to Proactive Planning"

PREPARED Newsprint and felt-tip pens, copies of Attachment 12-A for all trainees  
MATERIALS  
FACILITATORS One or more trainers

### Trainer Introduction

**The theme of effective project management should be emphasized throughout the training program. This session focuses on that theme and provides a guideline for successful project management. Trainers are encouraged to discuss their experiences as project managers during the session. Trainees who have had experience managing projects should also be encouraged to discuss management methods they have used successfully, or unsuccessfully.**

### PROCEDURES

Step 1 5 minutes

Present objectives and format for the session

Step 2 20 minutes

Lecturette overview of project management

### Trainer Note

**Begin by defining what a project is. Here is a possible definition:**

**"A project is defined as an activity carried out for a definite purpose or goal, within a limited time frame, with limited resources, and in uncertain conditions."**

**Next define project management. Here is a definition:**

**"Project management is the process of using human and material resources towards accomplishing tasks necessary to achieve the goals of a project."**

**Lastly, ask the trainees for some ideas on what good project management would involve. Here are some points which should be mentioned:**

**\*Good planning: A good plan is essential and based on sound organization. It should clearly identify the project goals and objectives, list the human and material resources that will be needed, contain a schedule and time-line for project tasks, speculate on possible obstacles that may need to be overcome, and have a project evaluation component.**

**\*Resource and Information Gathering: Sound knowledge concerning the resources available in the project area, and information about organizations or officials who may be able to assist in the project, are invaluable to successful management.**

**\*The Right People: Any project is only as good as the people who participate in it. Building solid relationships among participating individuals, based on clearly defined roles, delegation of responsibilities, and an open constructive dialogue, can make the difference between the success or failure of any project.**

Step 10 minutes

3

Lecturette on the importance of good project management during Peace Corps service.

## Trainer Note

**Point out that most Volunteers, at some point during their service, manage a development project. Some Volunteers start new projects, some take over an existing on-going project, and others find themselves called upon to complete work that had been started long ago but never finished. Whatever the case, many Volunteers have difficulty with that management task. There is a tendency to plan on a day-to-day basis only, reacting to events rather than planning ahead to control them. However, through the use of effective management skills, Volunteers can, in many cases, carry development projects through to successful conclusions.**

Step 25 minutes

4

Discuss the advantages and disadvantages of reactive planning and proactive planning.

## Trainer Note

**Start out by writing "Reactive Planning" on the top of a sheet of newsprint. Ask trainees what the term means to them. Here are some possible responses:**

- \* Passive acceptance of events**
- \* Responding to immediate problems**
- \* Short-time crisis management**
- \* Lack of overall coherent plan**

### **Ask for some advantages of this type of planning:**

- \* Takes little or no preparation time**
- \* Allows participation to avoid personal responsibility for circumstances of the project, and decision-making**

### **Ask for some disadvantages of this type of planning:**

- \* Keeps things at a crisis pace**
- \* Never lets you see or plan ahead**
- \* Often leads project away from original goals**
- \* Rarely leads to a successful conclusion**

**Next write "Proactive Planning" on a newsprint sheet and ask trainees what the term means to them.**

- \* Active management of project tasks**
- \* Advance planning and setting goals**
- \* Contingency planning to overcome obstacles**
- \* Evaluation and continual improvement of project**

### **Ask for some advantages of this type of planning:**

- \* Anticipates needs and avoids unexpected events**
- \* Allows organization of resources**
- \* Promotes community participation and enthusiasm**
- \* Helps keep the project on track towards goals**
- \* Helps achieve successful conclusion to project**

## **Ask for some disadvantages of this type of planning:**

- \* Takes time, and skill, and hard work**
- \* Requires organization and participation by all involved individuals**
- \* Requires management responsibility and decision-making**

**Lastly, relate some examples of situations you have been in involving reactive or proactive planning. Or, ask the trainees to give some personal examples.**

Step 5 5 minutes

Break

Step 8 10 minutes

Handout Attachment 12-A and review with trainees

## **Trainer Note**

**Briefly review each step in the proactive planning process.**

Step 20 minutes

7

Discuss three techniques for managing personal time:

- \* "To Do" List - This is a list of activities relating to the project, things that the Volunteer should do in the immediate future. The list should be checked and revised, if necessary, daily. It should also be prioritized.
- \* Time Schedule/Calendar Plan - Such a scheduled plan enables a Volunteer to lay out his/her activities for the coming weeks and months. It singles out tasks that need



to be accomplished, important dates or deadlines, and resources necessary to carry out various tasks.

\* Contingency Plan - Volunteers should always have in mind some alternative plan(s) in case events do not take their expected course. Writing down contingency plans, or simply keeping such plans in mind, should be part of any management program.

## Trainer Note

**Give examples of each technique as you go along. A sample "To Do" list may be written on newsprint, the same for a calendar plan. Relate some personal experiences on the subject of contingency planning. Point out that these organizational techniques are primarily directed at helping Volunteers manage and plan their own activities. Emphasize that being personally organized and prepared is an essential component of effective project management. This is especially true in third world countries because of the fact such countries often lack the framework and infrastructure found in western countries.**

Step 15 minutes

8

Trainees, individually, develop a "To Do" list, calendar plan, and contingency plan for the next week of the training program.

## Trainer Note

**The trainees need not go into specific detail. Advise them to be general with their lists and plans. Remind them to write down resources. They will need to carry out their plans.**

Step 10 minutes

9

Review objectives and conclude by asking if any trainee would like to share what they have written with the group.

**REFERENCE: The Role of the Volunteer in Development Manual. Peace Corps, ICE.**

### **Attachment 12A: Steps to proactive planning**

**1. Identify the goal - A goal is a broad general aim or mission. It is what you want to happen as a result of your efforts, e.g., "to raise the standard of health of the village people by improving village sanitation and cleanliness."**

**2. Outline specific objectives for achieving the goal - From one project goal, several specific objectives may emerge. A well-defined objective will clarify in detail what the tasks will be for reaching the goal.**

#### **Objectives specify:**

- for whom the project is being done;**
- by whom;**
- within what period of time;**
- where; and**
- what we want to accomplish.**

**Objectives are clearly measurable and can be evaluated. Clear objectives are crucial to proactive planning, e.g., "during the first four months, work with my**

**counterpart conducting ten home visits discussing sanitation and health with family members."**

**3. Anticipate possible obstacles - Good proactive planning should try to identify possible problems and how they may be solved, e.g., a possible obstacle to the above objective would be language ability to conduct home visits. A solution would be to study the language before attempting the visits, or have the help of a translator.**

**4. Identify resources - To successfully complete your objectives, you may need some resources, i.e., other people, information, materials, and/or money. Knowing these resources and planning how to obtain them will be a key to successfully completing your project, e.g., you may need a language tutor and may need money to pay for this.**

**5. Evaluation measures - A good plan must include how to measure if you are meeting your objectives and goals. Evaluation is something that should be on-going, which allows you to make minor adjustments or changes before completion. If your objectives are very specific, then evaluation can be based on them - did you accomplish the specific task?**

**6. Documentation - Planning is not something you do and keep in your head; clear work plans help you in your daily, weekly, and monthly tasks. It is important to document what you plan to do but also to document the implementation as you do it. Keep records of what steps you take, what obstacles you encounter, how you overcome them, what creative solutions you use, and what evaluation measures you use. This will be important in looking at the development of the project and its**

**success; likewise, it can be shared with other Volunteers involved in similar projects.**

**REPRINTED: The Role of the Volunteer in Development Manual, Peace Corps, ICE.**

### **Session 13 - Community needs and resource assessment**

TOTAL TIME	Two hours
OBJECTIVES	<ul style="list-style-type: none"><li>* Describe the role of community survey and assessment in the development process</li><li>* List information that would be needed to assess a community and various ways to gather that information</li><li>* Practice developing survey questions and informal interviewing</li></ul>
RESOURCES	<u>Assessing Rural Needs</u> ; Jeffrey Ashe, Prologue and Part I
PREPARED MATERIALS	Newsprint and felt-tip pens Props for role play
FACILITATORS	Four or more trainers

### **Trainer Introduction**

**This session involves a role play and therefore, requires substantial preparation. Those trainers participating in the role play should meet before the session and coordinate, to a necessary degree, the information they will give the trainee interviewers. A role play should be fun as well as a valuable learning experience and the session should be approached with this in mind. The reading assignment**

**in Assessing Rural Needs should be completed prior to the session.**

## **PROCEDURES**

Step 5 minutes

1

Present the objectives and format for the session

Step 10 minutes

2

Have the trainees list individually two to three facts they would want to know upon arriving in a community, and two to three facts they would need to know.

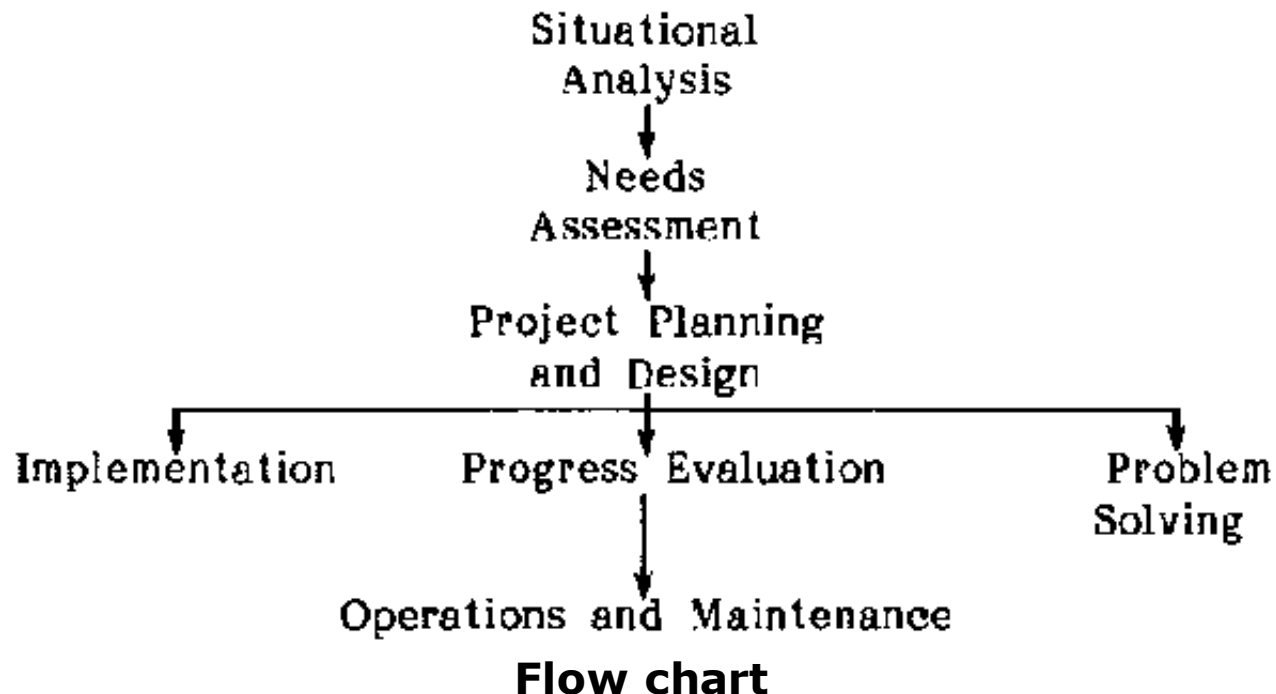
## **Trainer Note**

**An example of a fact that they would want to know is who are the leaders of the village. An example of a fact that they would need to know is the location of a house to live in or the location of the market.**

Step 20 minutes

3

Present the following flow chart on newsprint and discuss where the facts listed by the trainees in Step 2 fit into the first two categories of the chart. Then, briefly review the entire chart step by step.



**Flow chart**

## **Trainer Note**

**Situational analysis includes general information such as boundaries, population, tribal or religious groupings, language, educational system, economic situation, political situation, community infra-structure, any large public or private organizations, and community development history.**

**Needs assessment includes more specific information such as potable water situation, common diseases, health care facilities, hygiene beliefs and practices, nutrition and available foods, and skilled and unskilled labor resources.**

Step 15 minutes

4

Have the trainees list, individually, three information gathering techniques. Ask individual trainees to read what they have written and list the techniques on a flip chart. Lead a general discussion on the strengths and weaknesses of the various techniques listed.

## **Trainer Note**

### **Some techniques are:**

- \* **General observation**
- \* **Informal interviewing**
- \* **Research**
- \* **Formal interviewing**
- \* **Map making**
- \* **Walking the community**

Step 50 minutes

5

Divide the trainees into two groups for the role play. Give them three topics on which to base their interviews: (1) cultural information, (2) water resources and health, and (3) impact of existing programs. The trainers should also divide into two groups, one playing government officials and the second playing village people such as farmers or local women.

One group of trainees should be assigned to interview the government officials, and the other, the village people. Allow ten minutes for the trainees to prepare questions and 15 minutes for actual interviews. Then, the groups switch and follow the same procedure with the other trainer role players.

## **Trainer Note**

**Keep a careful watch on the clock, the role play should move along as scheduled. Trainers playing roles should play the part realistically to the best of their abilities. Props work well to create a more realistic setting.**

Step 6 15 minutes

End the role play and as a large group, discuss how the interviews went.

## **Trainer Note**

**All trainers and trainees should take part in this discussion. Here are some questions to ask:**

**To Trainees:**

**Did they feel comfortable during the interviews?**

**Did they receive useful information?**

**Did they feel that the information was reliable? What about the local people?**

**In what way do they feel that their actions affected the interviews and information received?**

**Did they think that their sex made a difference in the answers they received?**

**What would they do differently next time?**

**To Trainers:**

**Did they feel comfortable being interviewed?**

**Did they feel that the trainees could be trusted?**



**Did the questions seem relevant?**

**Did they feel offended at any time during the interviews?**

Step 5 minutes

7

Review the objectives and conclude the session by asking trainees to think about the activity in relation to Peace Corps Service.

**SOURCE: The Role of the Volunteer in Development Manual, Peace Corps, ICE.**

## **Session 14 - Communicable diseases and control**

TOTAL TIME	Two Hours
OBJECTIVES	* Describe, in detail, various communicable diseases, and effective means to control them
RESOURCES	<u>Control of Communicable Diseases in Man</u> ; Benenson <u>Rural Water and Sanitation Projects</u> ; USAID, pp. 11-27 Attachment 14-A: "Communicable Diseases"
PREPARED MATERIALS	Newsprint and felt-tip pens, copies of Attachment 14-A for all trainees
FACILITATORS	One or more trainers and trainees

### **Trainer Introduction**

**This session is intended to provide specific information on communicable diseases and their control. Try to select diseases that are prevalent in the host countries to**

**which the trainees will be sent. If there is a qualified health practitioner on the staff, that person should lead the session.**

## **PROCEDURES**

Step 1 5 minutes

Present the objective and format for the session.

Step 2 15 minutes

Discuss communicable diseases in general.

### **Trainer Note**

**Review the material from Session 9 on water-related diseases.**

Step 3 1 hour, 30 minutes

Hand out the attachment. Give presentations on various communicable diseases.

Question and answer period follows each presentation.

### **Trainer Note**

**Use the Benenson book as a reference, or other appropriate sources. Focus on the following areas for each disease:**

- methods of identification/symptoms**
- infectious agents**
- reservoirs**
- methods of treatment**

- **host**
- **vector/vehicle**
- **chain of infection**
- **how to break the cycle**
- **long-range effects**

Step 4 10 minutes

Review the objectives and conclude the session.

### **Trainer Note**

**It is quite natural for trainees to feel somewhat personally threatened by the information contained in this session. Mention that in fact, most Volunteers in-country find themselves more concerned about the health of those people around them, than their own. The reason for this is simple. Many of the people they work with are chronically ill, while in contrast, their own health is relatively good.**

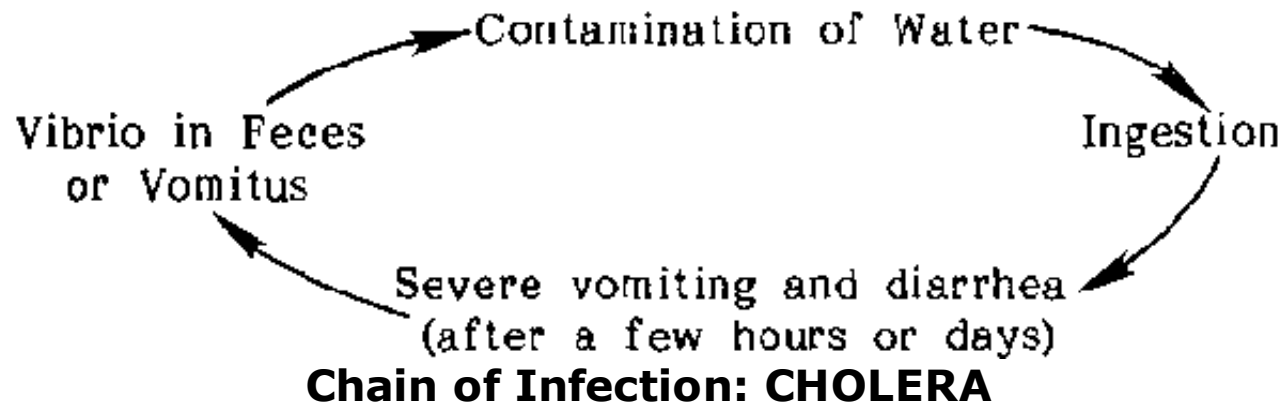
**Point out that gaining knowledge and understanding of communicable diseases is essential for prevention, both for Volunteers themselves and for host country people. Emphasize that improved water supplies and sanitation facilities can help prevent the diseases that have such a debilitating effect on people around the world.**

**Any nation's best resource is its people, and prevention of communicable disease can make people more productive and healthy. This will in-turn lead to lasting improvement in their lives.**

## Attachment 14A: Communicable diseases

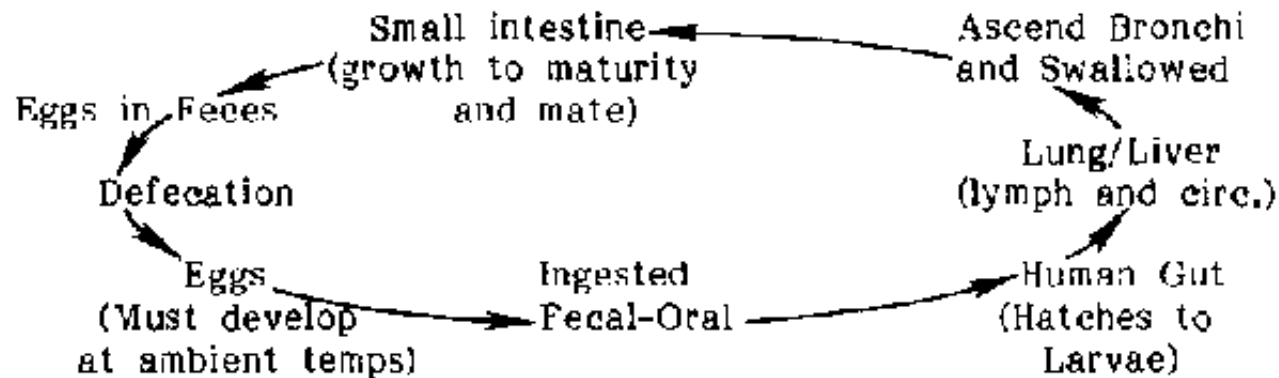
### DISEASE: CHOLERA

<b>Infectious Agents:</b>	Vibrio cholerae: comma vibrio bacteria
<b>Vector/Vehicle:</b>	Fecal-Oral by contaminated water (sometimes food, flies, direct contact)
<b>Host:</b>	None
<b>Reservoir:</b>	Humans
<b>Symptoms:</b>	Severe vomiting/diarrhea, rapid dehydration
<b>Treatment:</b>	Fluid rehydration. Drug treatment: antibiotics
<b>Prevention:</b>	Proper latrines/use, sanitary hygiene, improved water supply, vaccination
<b>Long Range Effects:</b>	If untreated, can cause rapid death



## DISEASE: ASCARIS (ROUNDWORM)

<b>Infectious Agents:</b>	Ascaris lumbricoides: large intestinal roundworm
<b>Vector/Vehicle:</b>	Fecal-Oral by contaminated food or water
<b>Host:</b>	Humans
<b>Reservoir:</b>	Humans
<b>Symptoms:</b>	Hacky cough, stomach pains, vomiting, digestive problems
<b>Treatment:</b>	Drug treatment: dewormer
<b>Prevention:</b>	Proper latrines and use, sanitary hygiene
<b>Long Range Effects:</b>	Bowel obstruction. Migration of worms to liver, gall bladder, or appendix which can cause death

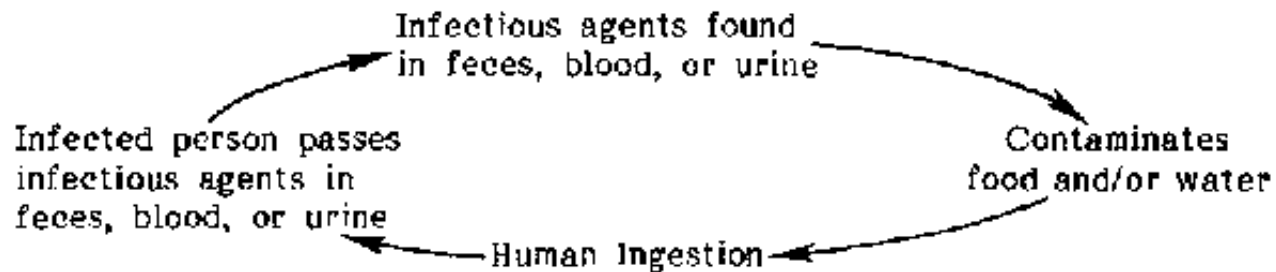


### Chain of Infection: ASCARIS

## DISEASE: HEPATITIS (TYPE A)

<b>Infectious Agents:</b>	Believed to be enterovirus and/or paravovirus
---------------------------	---

<b>Agents:</b>	
<b>Vector/Vehicle:</b>	Fecal-Oral by contaminated water and/or food
<b>Host:</b>	None
<b>Reservoir:</b>	Humans, chimpanzees
<b>Symptoms:</b>	Abrupt fever, malaise, nausea, stomach discomfort, followed by jaundice. Long convalescence with anemia and malaise
<b>Treatment:</b>	No specific treatment, rest and proper diet is helpful during convalescence stage
<b>Prevention:</b>	Sanitary disposal of feces/urine, personal hygiene, sanitary handling of food, clean water supply
<b>Long Range Effects:</b>	Can cause liver damage

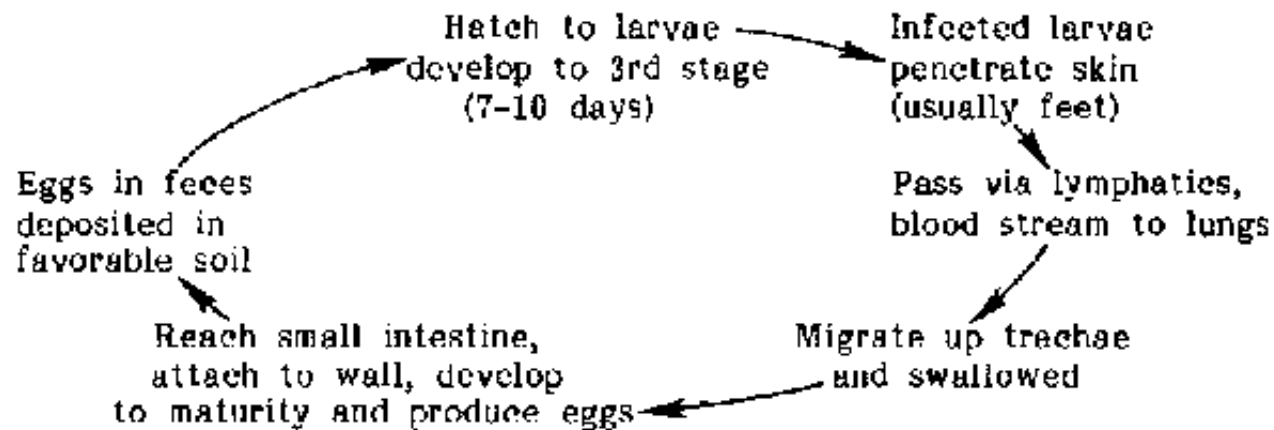


### Chain of Infection: HEPATITIS (TYPE A)

### DISEASE: ANCYLOSTOMIASIS (HOOKWORM)

<b>Infectious Agents:</b>	Necator americanus, Ancylostoma duodenale, and A. ceylanicum; a nematode worm
<b>Vector/Vehicle:</b>	Soil

<b>Host:</b>	None
<b>Reservoir:</b>	Infected persons discharging eggs into feces, also dogs or cats for <i>A. ceylanicum</i>
<b>Symptoms:</b>	Chronic anemia, hacky cough, mucus, dermatitis
<b>Treatment:</b>	Drug treatment; tetrachlorethylene, bephenium, thiabendazole, or pyrantel pamoate. Protein and iron diet supplement
<b>Prevention:</b>	Sanitary disposal of feces, wearing shoes, treatment of infected persons
<b>Long Range Effects:</b>	Retarded mental and physical development in children, general debilitation

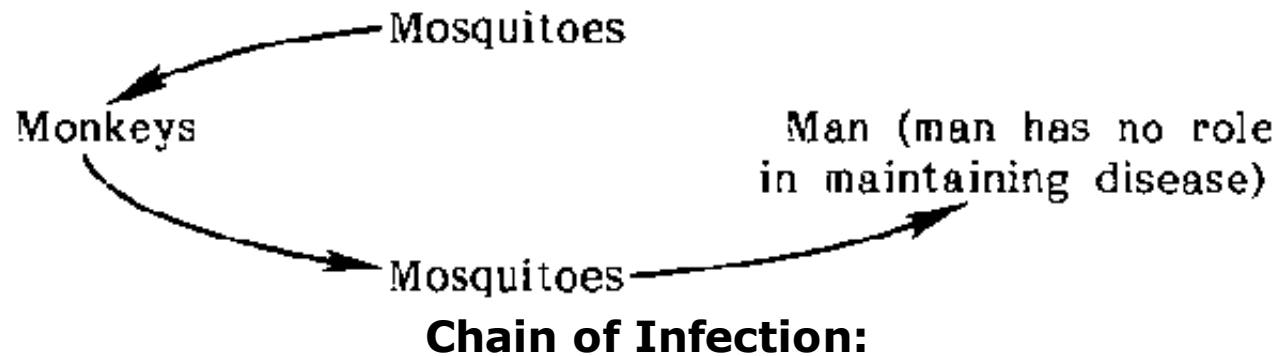


### Chain of Infection: ANCYLOSTOMIASIS

## DISEASE: YELLOW FEVER (JUNGLE)

<b>Infectious Agents:</b>	Togavirus
<b>Vector/Vehicle:</b>	<i>A. africanus</i> , <i>A. simpsoni</i> , <i>Aedes aegypti</i> mosquitoes

<b>Host:</b>	None
<b>Reservoir:</b>	Monkeys, mosquitoes
<b>Symptoms:</b>	Fever, headaches, backaches, vomiting, nose bleeds, blood in feces, prostration, slowing pulse rate with fever, jaundice
<b>Treatment:</b>	None
<b>Prevention:</b>	Immunization by vaccination, vector control, protective clothing, bed nets, insect repellents, recovery leads to immunity
<b>Long Range Effects:</b>	Fatality among indigenous population of endemic regions is 5%. Among non-indigenous groups in epidemics, 50%

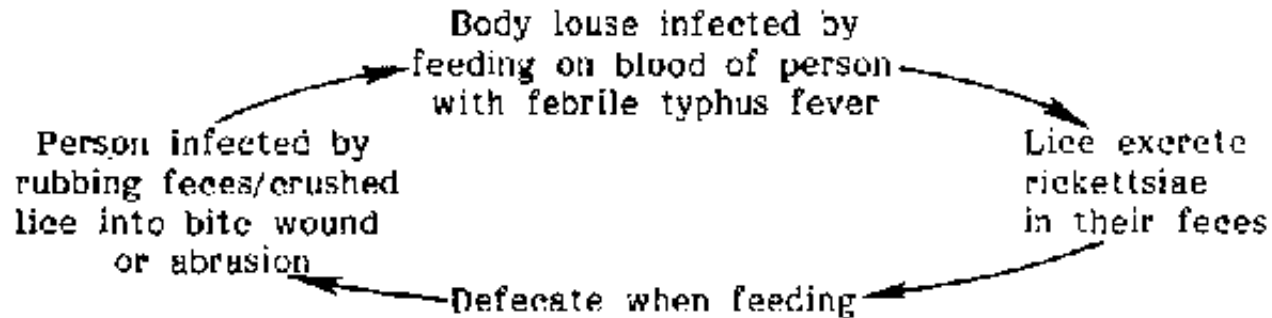


## DISEASE: TYPHUS FEVER (EPIDEMIC LOUSE-BORNE)

<b>Infectious Agents:</b>	Rickettsia, a bacteria
<b>Vector/Vehicle:</b>	Body louse
<b>Host:</b>	Humans
<b>Reservoir:</b>	Infected persons



<b>Symptoms:</b>	Attacks of headaches, chills, prostration, fever, general pain, and toxemia
<b>Treatment:</b>	Drug treatment; antibiotics
<b>Prevention:</b>	Immunization through vaccination, application of residual insecticide to clothes and persons, improved sanitary practices with provisions for frequent bathing and washing clothes.
<b>Prevention:</b>	Without treatment, fatality rate varies from 10-40%, increasing with age and severity of attack.

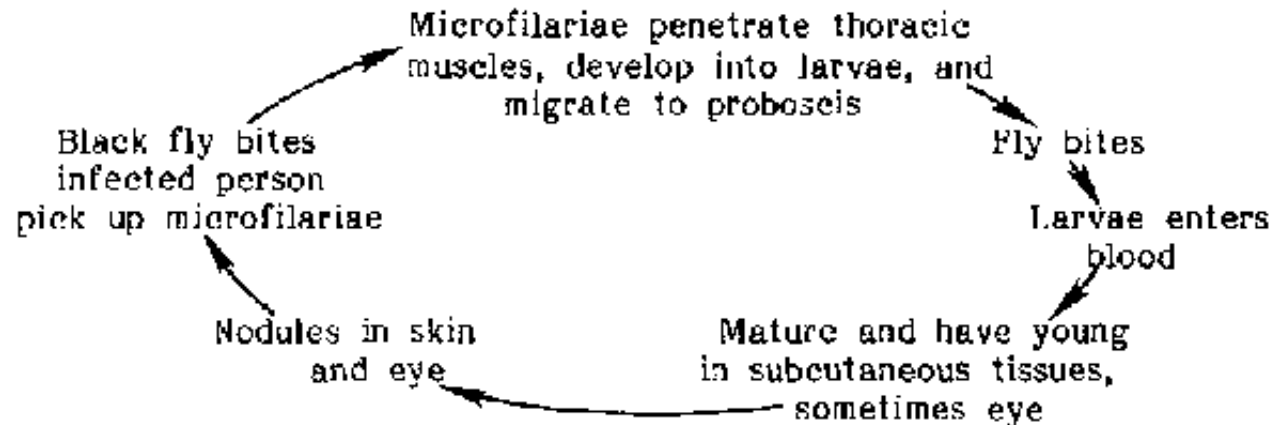


### Chain of Infection: TYPHUS FEVER

## DISEASE: ONCHOCERCIASIS (RIVER BLINDNESS)

<b>Infectious Agents:</b>	Onchocerca volvulus; a nematode worm
<b>Vector/Vehicle:</b>	Infected female black fly; genus Simulium
<b>Host:</b>	Humans
<b>Reservoir:</b>	Infected persons
<b>Symptoms:</b>	Early stages include: intense itching/rash, atrophy of skin, visual

	disturbances. Late stages: blindness
<b>Treatment:</b>	Drug treatment; hetrazan, naphuride, antrypol
<b>Prevention:</b>	Protective headgear/clothing, insect repellent, vector control in fast running water and thick bush river banks
<b>Prevention:</b>	Nonfatal yet chronically debilitating dependent on amount of exposure, blindness
<b>Long Range Effects:</b>	Nonfatal yet chronically debilitating dependent on amount of exposure, blindness

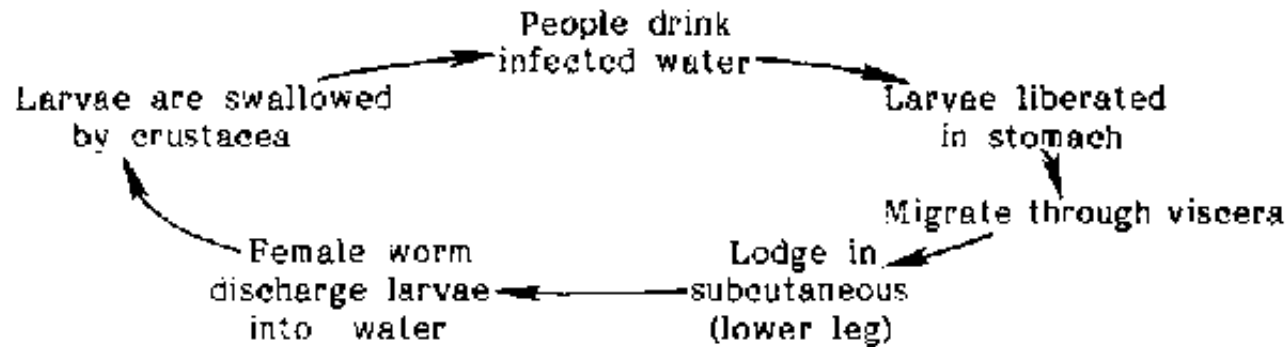


### Chain of Infection: ONCHOCERCIASIS

### DISEASE: DRACONTIASIS (GUINEA WORM)

<b>Infectious Agents:</b>	Dracunculus medinensis; a nematode worm
<b>Vector/Vehicle:</b>	Water
<b>Host:</b>	Crustacea of genus cyclops

<b>Reservoir:</b>	Infected person
<b>Symptoms:</b>	Blister on lower extremity, then lesion with burning and itching of skin. Accompanying fever, nausea, vomiting, diarrhea. Worm ruptures skin
<b>Treatment:</b>	Drug treatment: antibiotics
<b>Prevention:</b>	Boiling of water, filtration of water through fine mesh, chlorination, prevent contamination of drinking water by contact with infected persons
<b>Prevention:</b>	Multiple infections can cause severe crippling, lesions can lead to blood infections



### Chain of Infection: DRACONTIASIS

## Session 15 - Excreta disposal systems

TOTAL TIME

Two Hours

OBJECTIVES

\* Identify factors influencing the selection of a community excreta disposal system

\* Describe various types of latrine design and evaluate their relative

strengths and weaknesses

\* List the construction steps for a ventilated pit latrine

## RESOURCES

Sanitation Without Water; Winblad/Kilamer, Chapters 3, 4 and 5

Small Excreta Disposal; Ross Institute, Chapters 3, 4 and 5

Rural Water and Sanitation Projects; USAID, pp. 185-198, 209-217, 233-243, 261-266

Rural Sanitation Planning and Appraisal; Pacey, Chapters 1-5

Attachment 15-A, Improved Ventilated Pit Latrine Construction Steps

## PREPARED

Newsprint and felt-tip pens

## MATERIALS

FACILITATORS One or more trainers and four trainees

## Trainer Introduction

**This session is designed for trainee facilitation. Those who facilitate should be given ample time to prepare for the session. Make available any requested teaching aids prior to the session. The reading assignment is long, and trainees should be told well in advance.**

## PROCEDURES

Step 5 minutes

1

Present the objectives and format for the session.

Step 20 minutes

2

Facilitate a discussion to identify the factors influencing the selection of a community excreta disposal system. Encourage response from the trainees.

## Trainer Note

**Most trainees immediately think of latrine construction when asked to think about excreta disposal systems. Constructing latrines is an important step in a system, but it is by no means the only step. Below is a list of other factors that should be considered:**

- **traditional methods of Excreta disposal and hygiene practices**
- **social customs, beliefs, and taboos in this area**
- **types and numbers of systems already in place**
- **condition of existing systems**
- **geology of the area; soil types and water levels**
- **prevalent diseases and health care facilities**
- **human and material resources available**
- **level of community commitment towards improving sanitation**

Step 1 hour

3

Trainees give presentations on four latrine types: simple privy with pit or bucket, ventilated pit latrine (VIP), off-set pit privy (Reid's Odourless Earth Closet, ROEC), pour-flush bowl and soakaway.

Question and answer periods follow each presentation.

## Trainer Note

**Each presentation should cover such factors as: design features, construction method, materials involved, cost, applications, hygiene, and maintenance requirements. The presentations should be organized and use appropriate visual aids such as drawings on newsprint. Feel free to substitute other latrine types in the presentations, if they are more appropriate for your training program.**

Step 30 minutes

4

Hand out Attachment 15-A. Describe the following construction steps for a VIP latrine: site selection, foundation collar, pit excavation, slab, superstructure, roof, vent pipe, finishing, and maintenance.

## Trainer Note

**This step focuses on the VIP latrine because it will be the type of latrine constructed during Session 20. If you plan to construct a different type on your program, substitute that type for the VIP during this step.**

**Listed below are some important points to mention:**

<u>Site Selection:</u>	Know the soils in the area and the ground water level.
	Make sure the latrine is placed a safe distance, at least 30m, from any water source.
<u>Foundation</u>	This footing defines the dimensions of the pit. It should be 12-14cm thick.

<u>collar:</u>	and be similar in width. It should rise up higher than ground level when finished and can be made of concrete, soil/cement, brick, or wood.
<u>Pit excavation:</u>	The deeper the pit, the longer the latrine will be in use.
	A formula can be used to calculate the pit size; (number of users) (years of use) x 0.06 = pit size. Three meters is a good average depth. Line the top portion of the pit as necessary to prevent the soil from caving in,
<u>Slab:</u>	It should be made of reinforced concrete and fitted to the foundation collar. Two holes are made in the slab, one for the squat hole, and the other for the vent pipe.
	The slab should be placed to fit the superstructure design.
<u>Superstructure:</u>	This should be made from locally available building materials, and preferably, material that can be reused on another latrine when the pit is full. It should be constructed so that sunlight cannot penetrate inside and hit the squat hole. In this way, the squat hole needs no cover and air is allowed to circulate.
<u>Roof:</u>	The roof is made to fit the superstructure. It should be <u>weather tight</u> and allow no sunlight to penetrate inside and hit the squat hole.
<u>Vent pipe:</u>	Made of ferrocement, PVC pipe, or brick, it should be at least 150mm in diameter. The vent pipe should be placed outside, on the sunny side of the superstructure, painted black to cause a convection updraft which will draw air and gases from the pit, and be screened to prevent flies from escaping.
<u>Finishing:</u>	Interior walls and slab should be clean and smooth. They may be painted to facilitate cleaning.
<u>Maintenance:</u>	Cover slab should be cleaned regularly. Keep area around latrine clear

Maintenance.

Cover slab should be cleaned regularly. Keep area around latrine clear and clean. Inspect the fly screen.

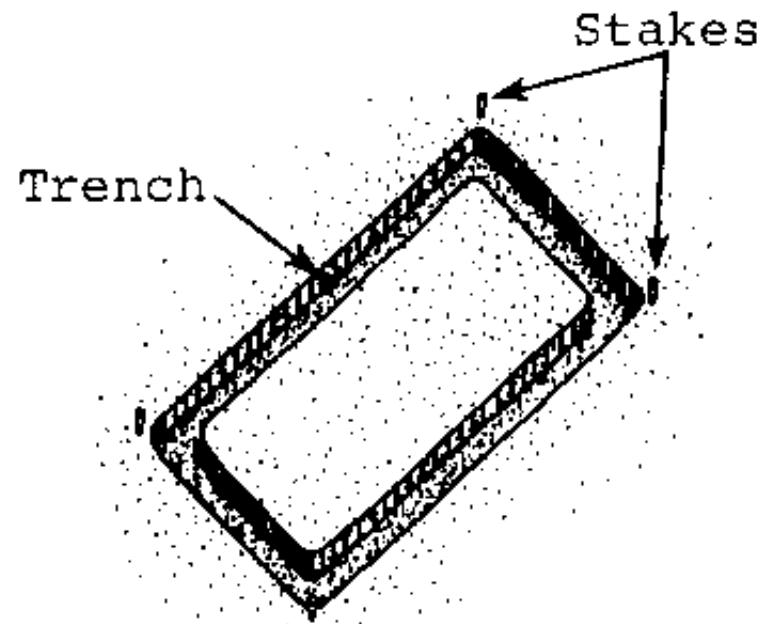
Step 5 5 minutes

Review objectives and conclude session.

**REFERENCE: Rural Ventilated Improved Pit Latrines: A Field Manual for Botswana, The World Bank, Washington, D.C.**

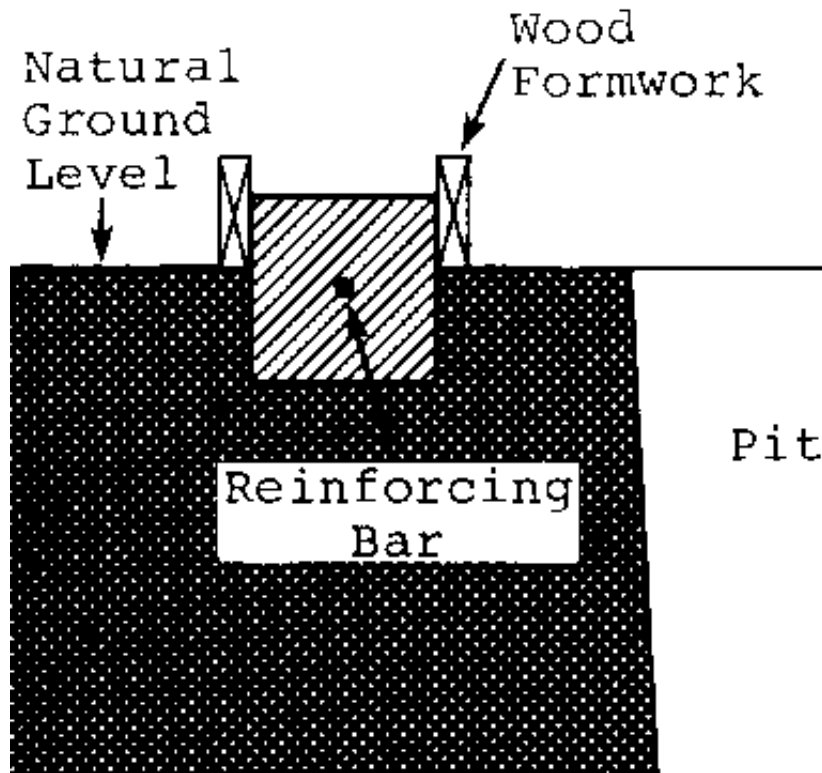
**Attachment 15A: Improved ventilated pit latrine**

**Construction Steps**



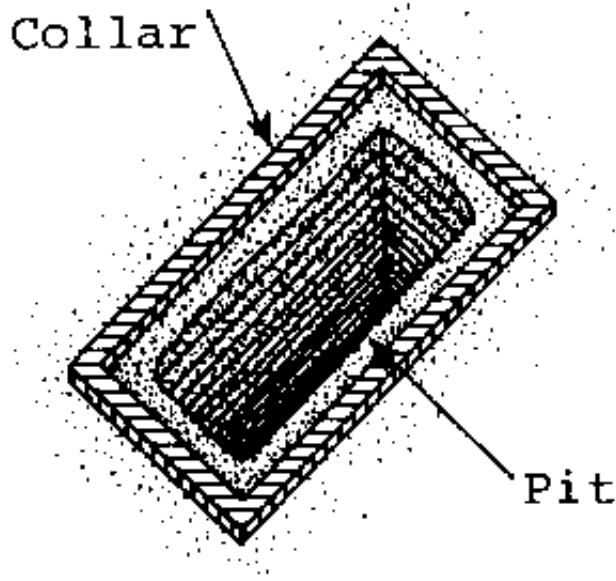
**Trench For Foundation Collar**





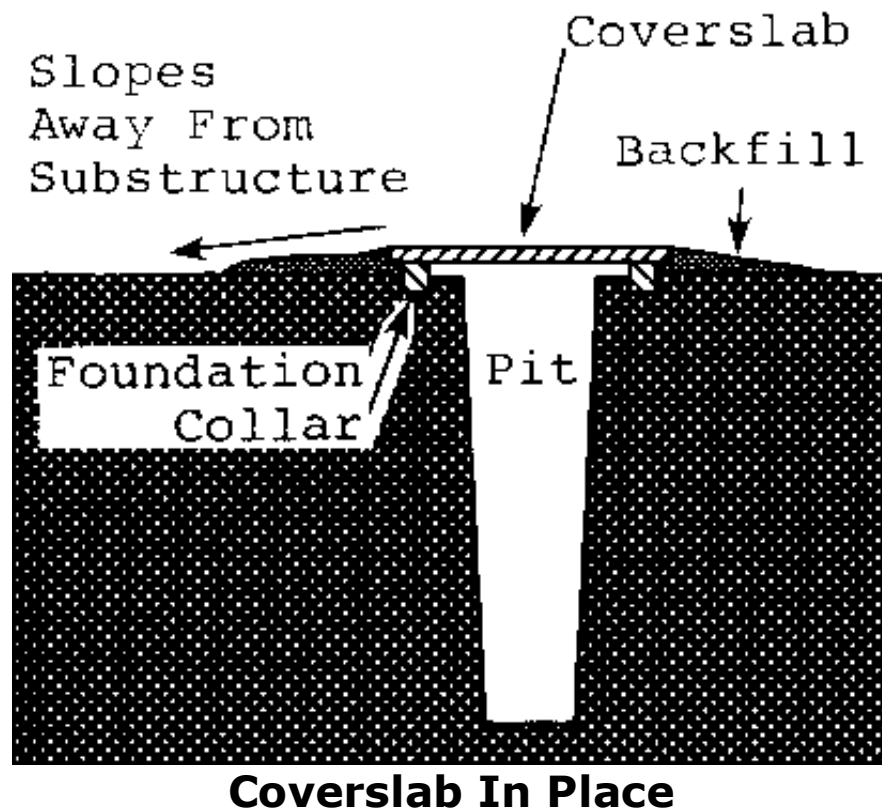
**Rectangular Foundation Collar Showing Formwork**

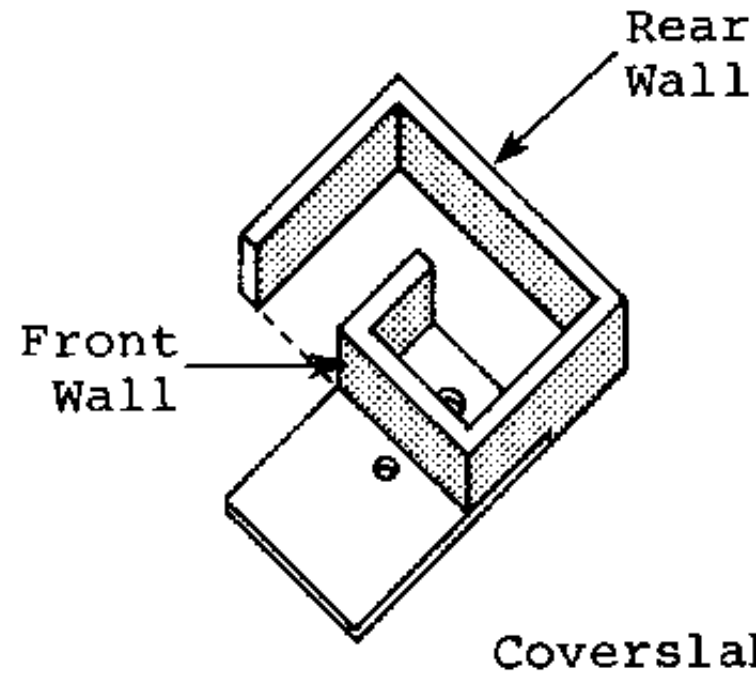
Foundation  
Collar



Pit

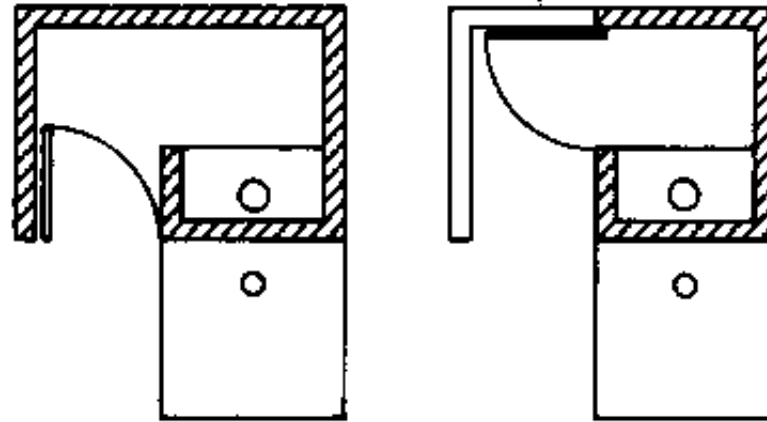
### **Pit Excavation**





### Constructing The Superstructure Walls

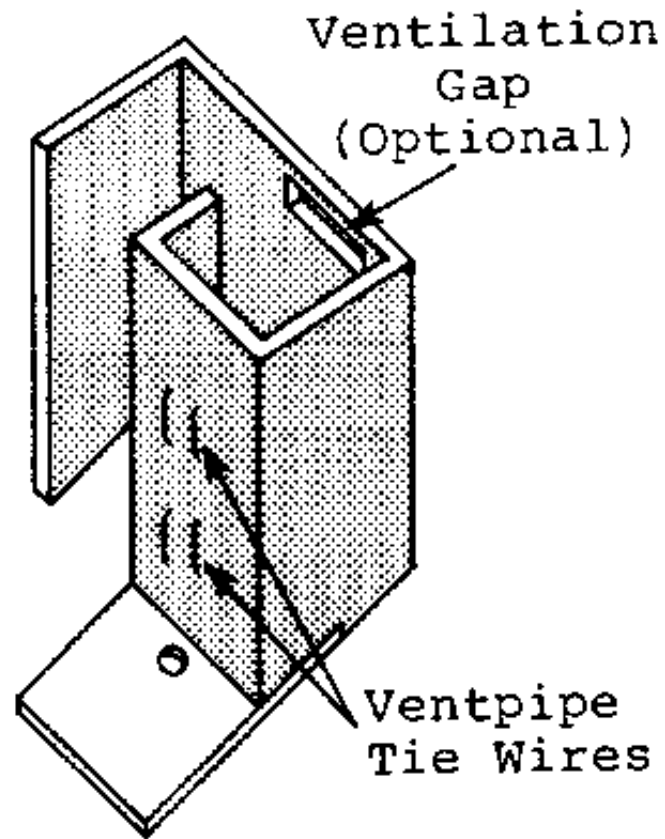
Privacy  
Wall



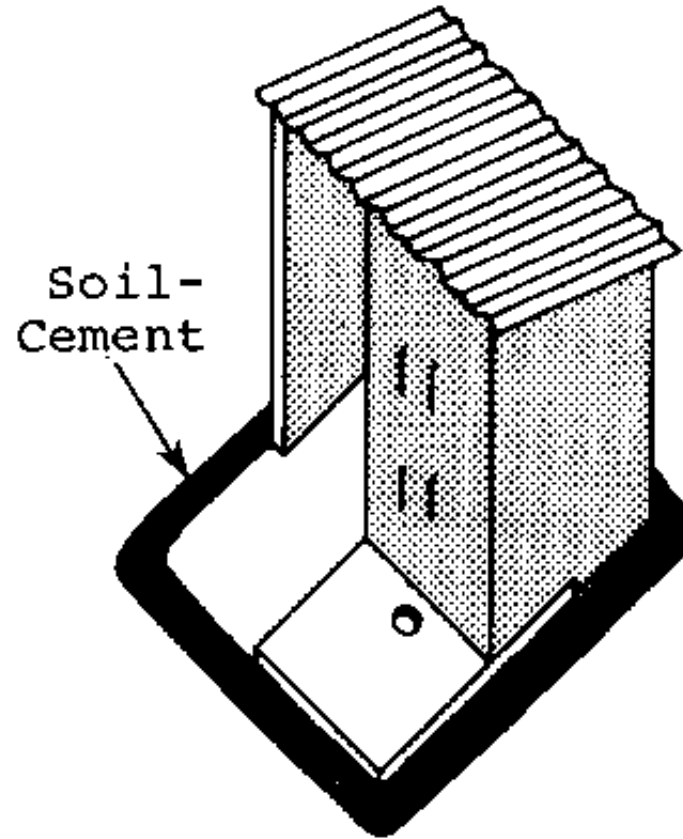
Option 1

Option 2

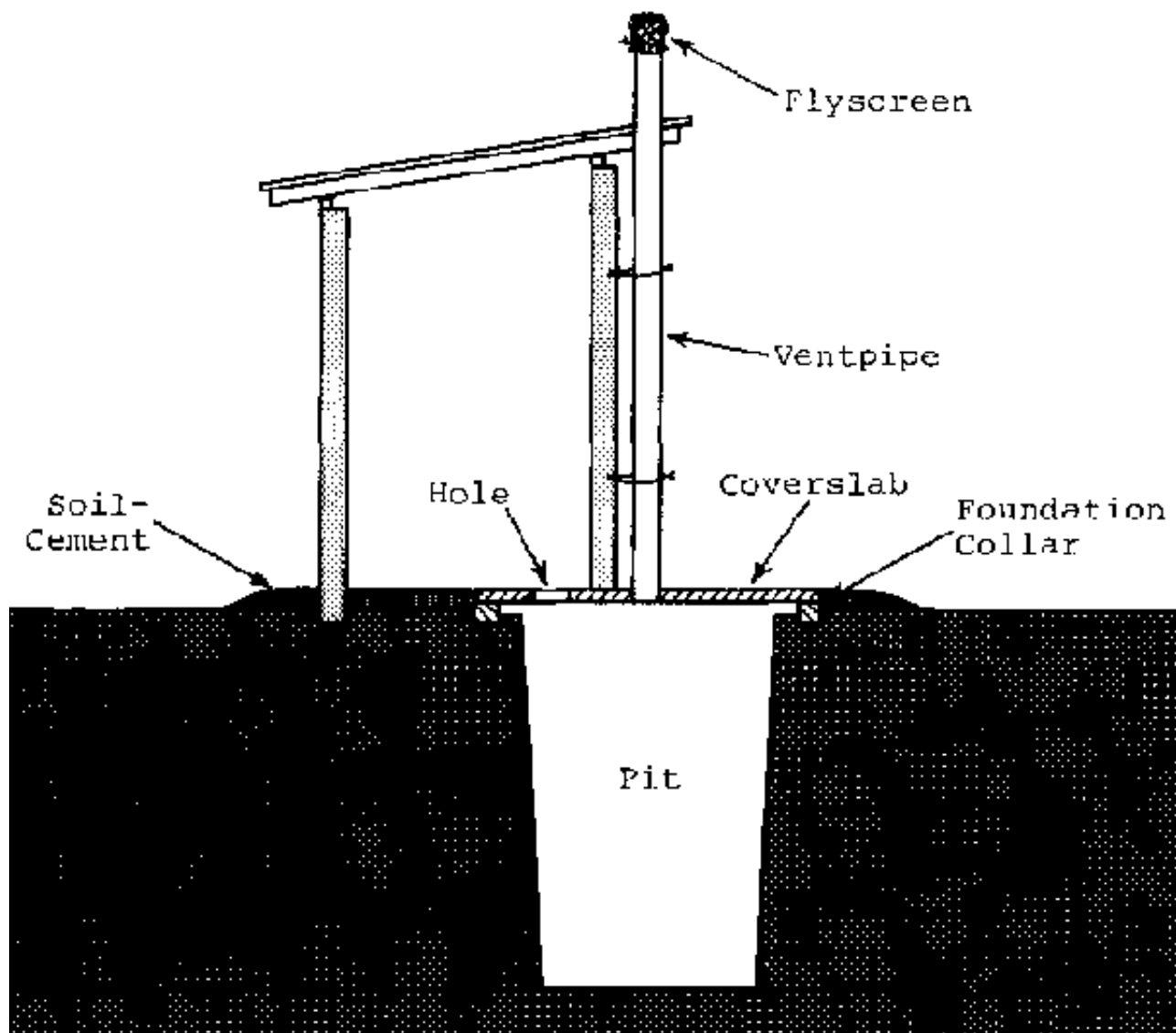
**Superstructure: Optional Door Locations**



### Completing The Superstructure Walls



## Roofing The Superstructure



**VIP Latrine**

**REFERENCE: Rural Ventilated Improved Pit Latrines: A Field Manual for Botswana;  
The World Bank; Washington, D.C.**

## **Session 16 - Health education presentations**



TOTAL TIME	Two Hours
OBJECTIVES	* Prepare and deliver a health education skit or role play, using appropriate visual aids
RESOURCES	<u>Helping Health Workers Learn</u> ; Werner/Bower, Chapters 11-14 and Chapter 22
PREPARED	
MATERIALS	Visual aids needed for presentations
FACILITATORS	As many trainers as possible

## **Trainer Introduction**

**This session should be both fun and educational. The entire training community should be on hand.**

## **PROCEDURES**

Step 5 minutes

1

Present the objective and format for the session.

Step 30 minutes

2

Trainees are allowed to finalize the preparations for their group presentations.

Step 1 hour, 15 minutes

3

The groups give their presentations. After each one, the performing group comes back

in front of the audience to discuss their presentation.

## **Trainer Note**

**The audience should form a semi-circle and allow plenty of room for the presentations. When a group returns to discuss what they have done, have them sit together at the front of the room to answer questions. Here are some possible questions:**

### **To the Group:**

- **How did the group formulate an idea for the presentation?**
- **What degree of preparation was necessary?**
- **Do you feel that your message was effectively presented?**
- **What did you learn through the process?**

### **To the Audience:**

- **What effective techniques did the group use to present information?**
- **What did you learn through the presentation?**
- **Were you required to actively participate?**
- **Was the presentation fun to watch, as well as educational?**

Step 4 10 minutes

Review the presentations as a whole and conclude the session.

## **Trainer Note**

**Mention effective techniques and tools that were used during the presentations. Emphasize the importance of combining health education with water and sanitation field projects.**

## **Session 17 - Basic drawing and blueprint reading**

TOTAL TIME	Two Hours
OBJECTIVES	* Learn to represent objects by freehand sketching and dimensional drawing * Practice reading and interpreting blueprints
RESOURCES	<u>Rural Water and Sanitation Projects</u> ; USAID
PREPARED	Newsprint and felt-tip pens, flipchart reproduction of drawings
MATERIALS	in Step 3, mechanical pencils, rulers, protractors, and compasses for all trainees, several construction blueprints, and examples of dimensional drawing from Water For the World
FACILITATORS	Two or more trainers

### **Trainer Introduction**

**This session requires a good deal of preparation. It begins on an introductory level and all trainees should be equipped with a mechanical pencil, ruler, protractor, and compass. The room should be set up so that trainees have a desk or table in front of them. The drawings shown in Step 3 should be reproduced on newsprint prior to the session. If there are trainees in the group with drafting experience, they should be asked to co-facilitate the session and to assist less experienced trainees during steps five and six.**

## PROCEDURES

Step 5 minutes

1

Present the objectives and format for the session.

Step 10 minutes

2

Ask all trainees to draw, freehand, the following figures in three dimensions: square, rectangle, triangle, cylinder, and cone.

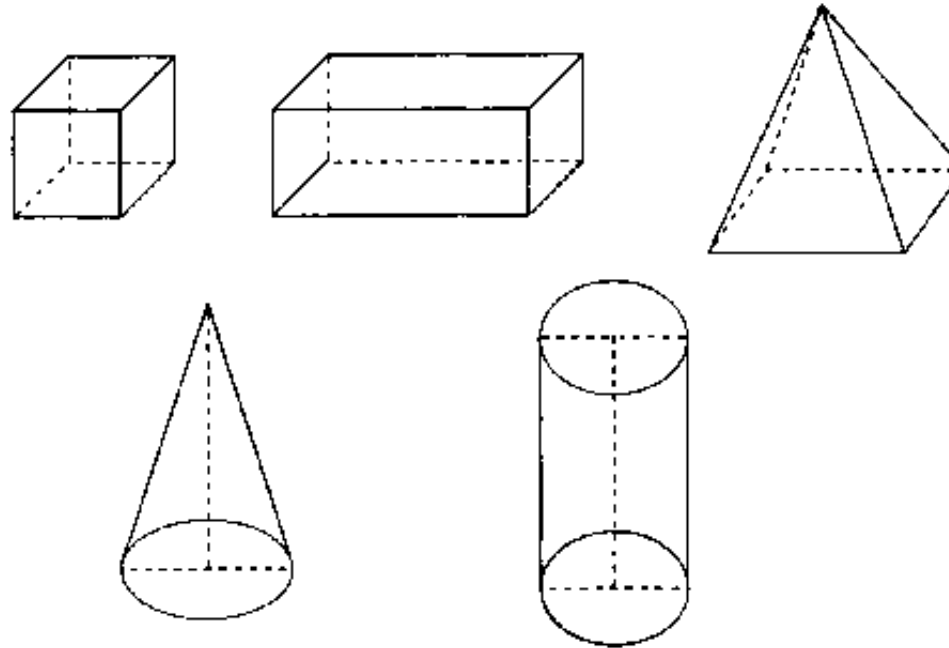
### Trainer Note

**Give the trainees the opportunity to draw the figures several times. They should compare their drawings among themselves.**

Step 15 minutes

3

Using a flipchart reproduction of the figures below, briefly explain how to draw them precisely with the tools provided. Ask the trainees to draw the same set of figures using the drawing tools.



**Figures**

### **Trainer Note**

**By measuring side lengths and angles, the trainees should be able to draw the figures in a more precise manner. Give them the opportunity to draw these figures several times.**

Step 4 15 minutes

Lecturette on dimensional drawing.

### **Trainer Note**

**Discuss the importance of accurate, easy-to-read drawings. Such drawings can be a valuable teaching tool, as well as the most important component of a project**

## **documentation.**

**Describe the differences between a plan view drawing, a profile drawing, a cut-away drawing, and an exploded view. There are helpful examples of each of these in Water For the World. Look through the technical notes dealing with design and construction, and point out examples to the trainees. If you have other examples, show them at this time.**

Step 5 45 minutes

The trainees practice dimensional drawing.

## **Trainer Note**

**Give them an object to draw, such as a latrine slab, superstructure, or a water storage tank and base. They may refer to Water For the World for examples to follow.**

Step 25 minutes

6

Divide the trainees into groups of three to four. Give each group some construction blueprints to read and interpret.

## **Trainer Note**

**Walk among the groups and answer any questions the trainees have.**

Step 7 5 minutes

Review the objectives and conclude the session.

## **Session 18 - field demonstration: block laying**

TOTAL TIME	Two Hours
OBJECTIVES	<ul style="list-style-type: none"><li>* Articulate the basic characteristics of three types of masonry bricks: adobe, soil/cement, and concrete</li><li>* Practice correct block laying, using appropriate mortar</li></ul>
RESOURCES	Attachment 6-A: "Concrete and Mortar"
PREPARED MATERIALS	Samples of brick making materials for the three brick types including soils, cement, and aggregates, an adequate supply of bricks for masonry, trowels, shovels, mortar boards, wheel barrows, builders' levels, line levels, and string
FACILITATORS	One or more trainers

### **Trainer Introduction**

**This session is designed to give the trainees hands-on experience laying blocks. It requires substantial preparation. Assemble the trainees (a group of no more than eight, preferably four to six) at the location of the demonstration.**

**Samples of brick making materials and tools should be laid out for observation. Also have ready-made bricks available to practice block laying. The bricks can be adobe, soil/cement, or concrete, whichever is most appropriate for local building conditions. The trainees will need to lay several courses of bricks, including**

**corners, and an area should be prepared for that exercise. They should work in teams of two, one laying the blocks and the other supplying bricks and mortar. Make sure that the teams rotate the two roles. Trainees with experience in block laying should be divided among the groups. The resource material, Attachment 6-A, is meant to serve as reference information for the trainees.**

## **PROCEDURES**

Step 1 5 minutes

Present the objectives and format for the session.

Step 2 45 minutes

Lecturette on the characteristics of adobe, soil/cement, and concrete bricks.

## **Trainer Note**

### **Discuss each type of brick thoroughly:**

#### Adobe

Mention soil content. A sandy loam, sandy clay loam, or light clay loam soil type is best. The mixture should be 75% sand and 25% clay mixture, with no more than 15% pure clay. Water content is 15-20% mixed to a smooth mud like consistency. Simple soil tests may be performed to judge quality such as the agitating jar, ribbon extrusion, or drop-ball. Mortar can consist of the same materials as the bricks.

#### Soil/cement

Mention soil content; there should be no organic matter. Sandy soil is best. High clay content makes poor bricks. Cement content is normally between 6-12%. Water content is normally between 8-18%. Mortar can consist of the



same materials as the bricks, or use a slightly higher cement content.

### Concrete

Aggregate is normally fine and medium coarse sand, with fine gravel. A cement to aggregate ratio of 1:6 is adequate for most walls. Bricks for a water tank will need a higher-cement content. Mortar should consist of a cement and fine sand mixture, normally a 1:4 ratio.

**For all three types, describe how the bricks are made, and the curing process. Also, mention their strengths, weaknesses, and primary application. A summary of these characteristics is as follows:**

<u>Adobe</u>	Made manually in wooden forms. Sun-dried curing process.	
	<u>Strengths:</u>	Inexpensive, readily available, easy to make, ease of construction, good thermal properties
	<u>Weaknesses:</u>	Low compression strength, low resistance to moisture and erosion, high maintenance requirements, hard to transport, irregular shape
	<u>Applications:</u>	Low-cost housing, low cost latrine superstructure or pit lining
<u>Soil/Cement</u>	Made manually in wooden forms, block press, mechanically-pressed, or hydraulically-pressed. Open air curing process with water.	
	<u>Strengths</u>	Better compression strength if pressed, relatively inexpensive, ease of construction, requires more skill to make when pressed but high production capacity and regular shape
	<u>Weaknesses:</u>	Relatively low resistance to moisture and erosion, medium maintenance requirements, hard to transport

	<u>Applications:</u>	Low-cost housing, low cost latrine superstructure or pit lining
<u>Concrete</u>		Made manually in wooden forms or manufactured. Open-air curing process with frequent water applications
	<u>Strengths:</u>	High compression strength, good resistance to moisture and erosion, easy to transport, regular shape, high production capacity if manufactured
	<u>Weaknesses:</u>	Relatively expensive, may require high transportation cost
	<u>Applications:</u>	Housing, latrine structure, water tanks, schools, clinics, etc.

### Step 3 1 hour

Trainees practice block laying using appropriate mortar.

### Trainer Note

**Demonstrate the correct procedures. Make sure trainees are given ample time to practice mixing mortar and laying blocks on their own.**

### Step 4 10 minutes

Review the objectives and conclude the session.

**REFERENCE: Ronald Stulz, Appropriate Building Materials, Swiss Center for Appropriate Technology and Intermediate Technology Publications. London, England.**

## Session 19 - Project planning: Latrine construction

TOTAL TIME Two Hours

TOTAL TIME	TWO HOURS
OBJECTIVES	* Formulate a plan for a latrine construction project including a satisfactory design for all components of the latrine, a list of materials and tools necessary, and a construction schedule for the project
RESOURCES	<u>Small Excreta Disposal Systems</u> ; Ross Institute, pp. 17-37 <u>Sanitation Without Water</u> ; Winblad/Kilama, Chapters 4 and 5 <u>Rural Water and Sanitation Projects</u> ; USAID, pp. 191-260
PREPARED MATERIALS	Newsprint and felt-tip pens
FACILITATORS	One or more trainers

## Trainer Introduction

**This session is meant to give the trainees scheduled time to plan their project before actual construction begins. Trainers should be available during this time to serve as information resources and to offer guidance if necessary. However, it is important that the trainees be given the opportunity to work through the planning of the construction project themselves. In many cases, two hours will not be adequate time to complete all necessary planning. If additional time is available in the schedule, add that time to the session. If time is not available, give the trainees at least an overnight period before actual construction is scheduled to begin. The resource books are designed to serve as reference information for the trainees.**

## PROCEDURES

Step 10 minutes

1

Present the objectives and format for the session. Divide the trainees into their work groups for the latrine construction, making sure that each group has a project manager.

## Trainer Note

**If necessary, review at this time the basic construction steps for a latrine; i.e., site selection and preparation, foundation collar, excavation of pit, slab, and superstructure. Also, discuss the components of a proper design for any construction project; i.e., detailed drawings, basic specifications, construction schedule and methods, project documentation, and the evaluation process.**

Step 2 1 hour, 40 minutes

In their individual work groups, the trainees plan their upcoming project.

## Trainer Note

**Make sure that all trainers are available at this time. Assign a trainer to each group as an advisor. However, trainers should not direct or lead the planning process.**

Step 10 minutes

3

Review the progress made during the session with regard to project planning. Make arrangements for additional planning time, if necessary, before actual construction

begins.

## Trainer Note

**Check all components of the design before construction begins. One effective way of checking the design is to have the trainee give a design presentation. If such a presentation is scheduled, trainees should be given time to prepare, not only the design, but the presentation as well.**

## Session 20 - Latrine construction

TOTAL TIME 38 Hours

OBJECTIVES \* Construct a ventilated pit latrine using reinforced concrete, adobe block walls, cement stucco finish, and framed roof  
\* Formulate a maintenance plan for the latrine

RESOURCES Small Excreta Disposal; Ross Institute, Chapters 4-5  
Sanitation Without Water; Winblad/Kilama, Chapters 4-6  
Rural Water and Sanitation Projects; USAID, pp. 199-208, 219-231, 245-259  
Rural Sanitation: Planning and Appraisal; Arnold Pacey, Chapters 4-5

PREPARED MATERIALS Shovels, hammers, crosscut saws, keyhole saws, hacksaws, hoes, sledge hammers, trowels, picks, paint brushes, pliers, crow bars, brace and bit, tape measures, T-squares, builders' levels, line levels, string, screwdrivers, woodrasp, buckets, wheelbarrows, wrenches, mattocks, vise grips, wire cutter, water level, bailing wire, reinforcement bar, nails (#8, #12, #16, roofing), lumber (4x2, 1x4, 1x6, 2x6), anchor bolts, roofing

material, cement, sand, aggregate, adobe blocks, door hinges and fittings, chicken wire, PVC pipe and fitting, PVC solvent cement, screening, plastic sheeting, burlap sacks, and gloves

FACILITATORS One or more trainers

## **Trainer Introduction**

**During this session, an improved ventilated pit latrine is built. The basic design consists of a pit (two to three meters deep), a foundation collar for the pit (three meters by two meters), a reinforced concrete slab (three meters by two meters), adobe brick walls (two meters high), a framed roof, and a finished cement stucco. It is designed with one squat hole chamber and entry way with door. Refer to the drawings on pages 165 & 166. This basic design may be altered to fit the circumstances of specific training program. However, it should be kept in mind that this design focuses not only on latrine building, but also on teaching construction skills such as masonry and framing.**

**If the design is changed, time allotments for each step will have to be changed in accordance. Whatever basic design is selected, the exact specifications should be done by the trainees themselves, in conjunction with local community members if the project is done on the community level. The number of trainees in the group should be between eight and 12. Trainers should serve as technical advisors during the design and construction phases of the project. The resource books should serve as reference information for the trainees. The time set aside for each construction step is a close approximation, based on previous training experience. It does not include time spent on logistics, transportation, or digging the pit. It is assumed that the pit is dug before the overall session begins.**

**There are a variety of activities during this session. Make sure all trainees participate in all activities by having the project manager rotate trainees through the various tasks. Finally, proper construction safety practices should be followed at all times. Trainers should take the time to explain such practices and make sure that they are followed throughout the exercise.**

## **PROCEDURES**

Step 4 hours

1

Form and pour a reinforced concrete foundation collar, 12-14cm in width and depth (depending on soil conditions), around the edge of the pit.

### **Trainer Note**

**The foundation collar serves as the footing for the slab and superstructure. Rough lumber can be used for the formwork and should be squared and leveled. However, the surface of the concrete should be left rough to provide a good bond with the slab. Reinforcement should be properly placed. The collar should be cured properly and allowed to set up at least overnight before Step 2 begins.**

Step 6 hours

2

Form and pour in place a reinforced concrete slab with squat hole and vent pipe hole.

### **Trainer Note**

**Pouring the slab in place is done for two reasons. First of all, it will not be necessary to move the slab after it has been poured, which is difficult for a slab of this size. Secondly, the process teaches valuable concrete and formwork skills.**

**To pour the slab in place, a table must be constructed over the pit (rough lumber works well). It should be well supported both across horizontally and vertically down in the pit, and sit flush with the top of the foundation collar. A form of 2x4 lumber should be set around the outside edge of the collar and leveled, which will serve as the finished dimensions of the slab. Reinforcement should be properly placed, as should the holes for the squat and vent pipe. A PVC pipe fitting may be cast in the slab to allow easy installation of the vent pipe. The slab should be cured properly and allowed to sit two to three days before Step 3.**

Step 3 8 Hours

Erect at least three-fourths of the adobe walls. Construct door frame.

### **Trainer Note**

**At least three quarters of the wall should be laid; if time allows finish the wall. Starting with the first course, make sure the bricks are laid properly and plumb. Inspect how the corners are being laid and the overall brick laying patterns. Insert wooden blocks, the exact size of a brick, into the walls every two or three courses (gringo blocks) to serve as nailers for the door frame. The dimensions for the door frame must be exact or it will not fit when put in place. The door frame should be set no later than after two or three courses of bricks have been laid. Step Four may begin the following day.**



## Step 8 Hours

4

Finish the adobe walls. Form and pour a concrete bond beam. Construct door. Apply cement stucco scratch coat.

### **Trainer Note**

**The final courses should also be laid properly and plumb. The bond beam should be 12-14 cm thick. It can be formed by fitting lengths of rough lumber to the top of the walls, inside and outside, held together by lengths of wire at the top and bottom. The forms should be leveled, reinforcement placed, concrete poured, and anchor bolts set for the roof plate. Make sure the bolts are properly placed, and the beam is cured.**

**To apply the stucco, the walls must first be wrapped tightly with chicken wire. Use nails to anchor the wire, nailing into bricks rather than joints. Next, wet the walls down with water and then plaster the cement stucco. The plaster used for stucco is usually a cement to sand ratio of 1:4, with lime added to the mix, if available, in a lime/cement ratio of 1:3. This coat should cover the walls completely, with little or no wire exposed. It should be scratched rough to provide for a good bond with the finish coat. Make sure that the walls are protected from direct sunlight and cured properly.**

**Step Five may begin the following day, or allow the bond beam to set one full day if time allows.**

## Step 5 8 Hours

Place a roof plate on the bond beam, secured with anchor bolts.

Place a roof plate on the bond beam, secured with anchor bolts.  
Build the roof frame. Lay the roofing material. Place the door(s).  
Apply finish coat of cement stucco to the walls.

## Trainer Note

**If the bond beam is level, anchor bolts placed correctly, and the walls built plumb, the roof construction should go smoothly. Begin framing by securing the roof plate on the bond beam. Then, frame out the roof structure with rough lumber. The roof header should be square, securely nailed in place, and provide a 1:3, or 1:4 pitch. The rafters should be notched, placed on centers, and nailed in place. For roofing material, use rough lumber covered by roofing paper, or use corrugated iron or tin sheeting. A hole should be cut in the roof for the vent pipe, if necessary. The plaster used for the stucco is again a 1:4 mix, with lime if available. Wet down the walls before applying the plaster. This will be the finish coat and should be worked smooth with no exposed wire when completed. Make sure the stucco walls are cured properly and protected from direct sunlight. Start Step Six the following day.**

Step 4 hours

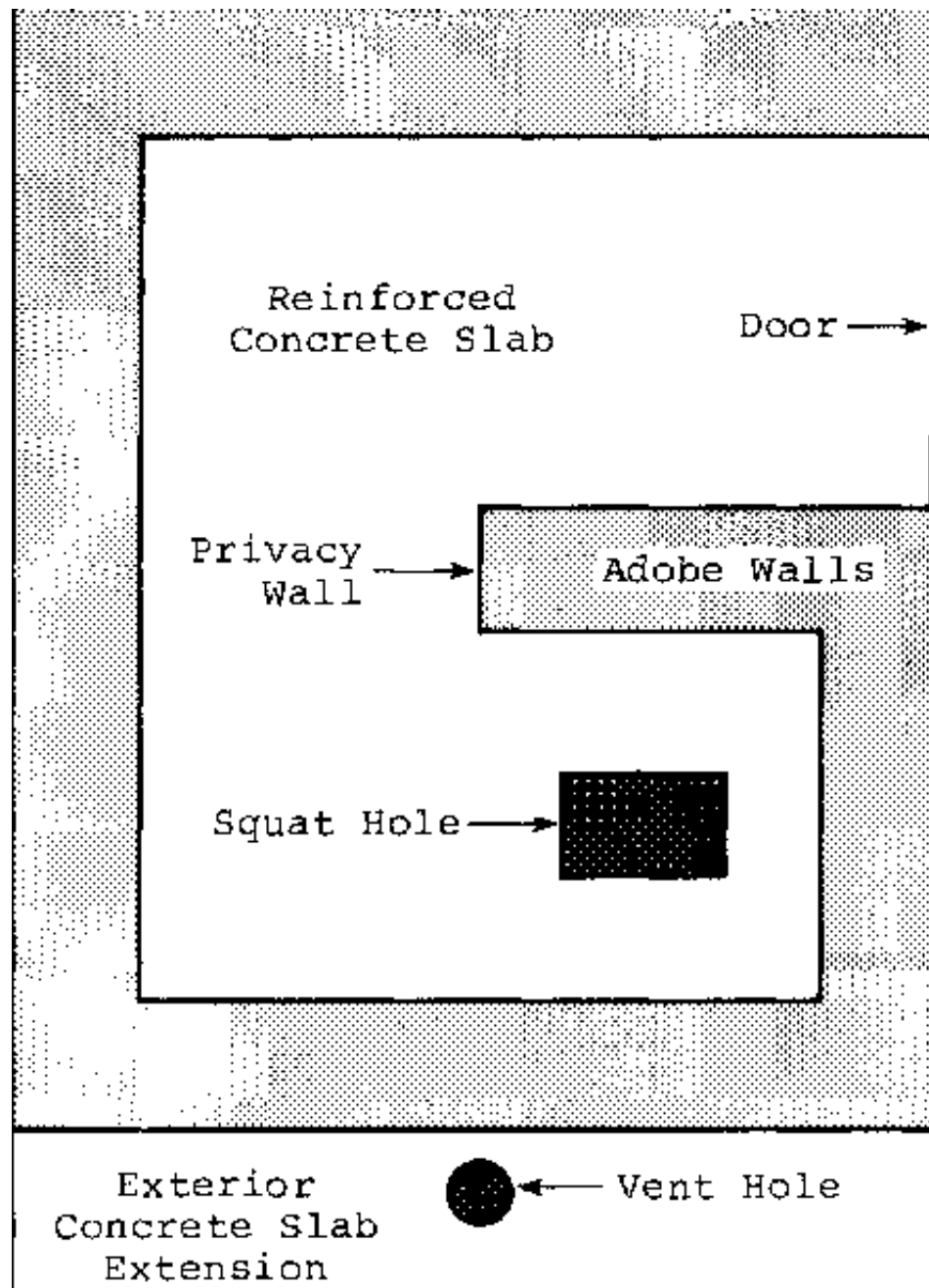
6

Install and secure the vent pipe. Complete any remaining work on the latrine, such as painting, stuccoing, and cleaning. Formulate a maintenance plan, and explain it to local community members.

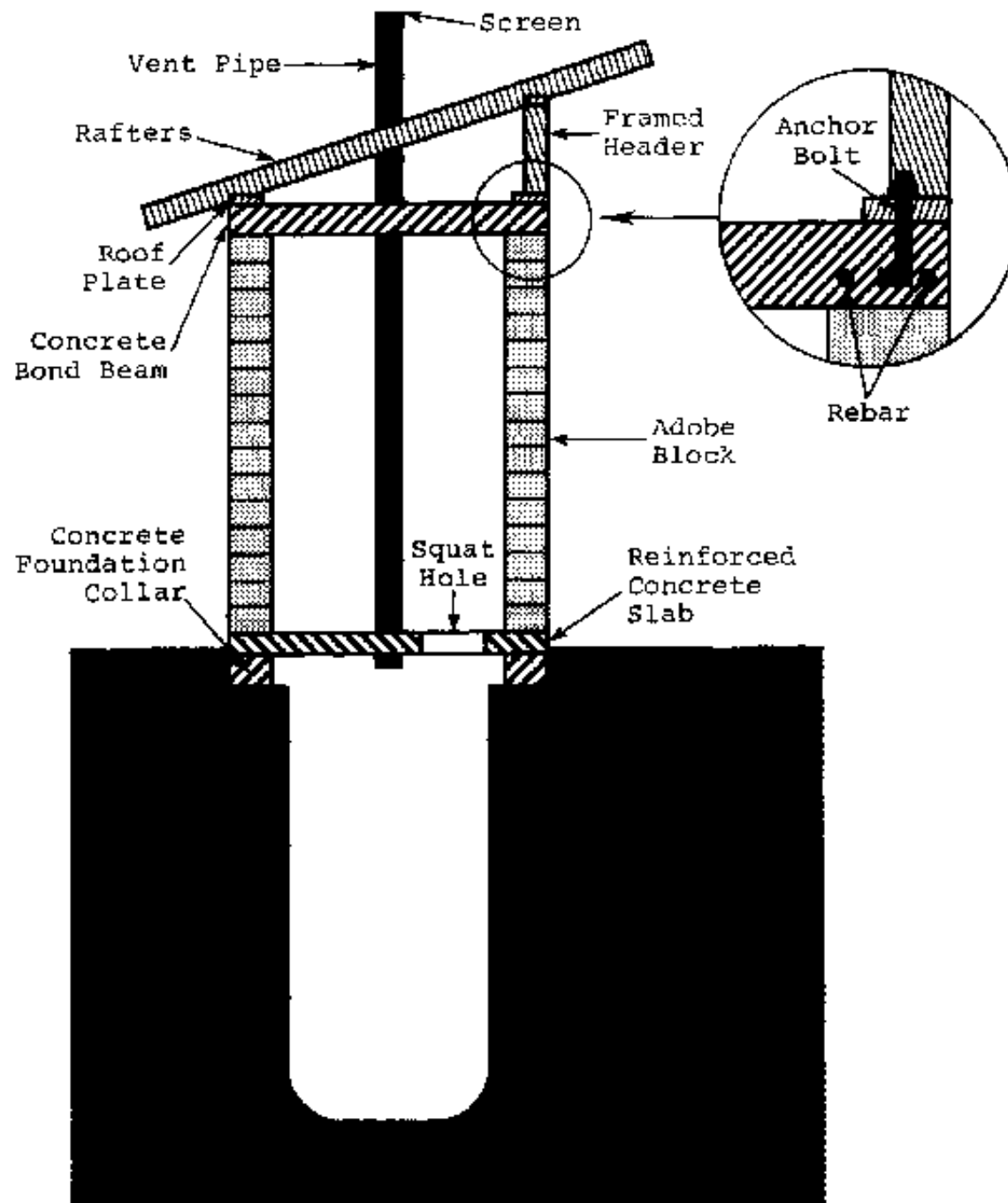
## Trainer Note

**This time is set aside to finish all remaining work and clean up the site. If the latrine will be used by members of the community, make sure they understand the maintenance plan.**

**Lastly, the entire group should review the construction procedures and processes that went into the project. Discuss positive and negative aspects. Ask what could have been done differently to improve the construction. Ask about the group dynamics of the exercise. What improvements could have been made? What worked particularly well? Point out the importance of hard work, flexibility, and cooperation throughout such an activity.**



**Latrine Design Drawing - Plan View**



**Latrine Design Drawing - Side View**

## Session 21 - Women and water

TOTAL TIME	One and a Half Hours
OBJECTIVES	<ul style="list-style-type: none"><li>* Clarify views, expectations, and assumptions concerning the relationship between women and water/sanitation problems in developing countries</li><li>* State various ways Peace Corps Volunteers can include women in the development process</li><li>* Discuss ways in which community development can improve the living conditions of women in third world countries</li></ul>
RESOURCES	Attachment 21-A: "Women, Water and the Decade"; WASH Technical Report No. 6, Mary Elmendorf Assignment Children; UNICEF, pp. 167-174
PREPARED MATERIALS	Newsprint and felt-tip pens  Copies of the attachment for all trainees Five or six large pots (3-5 gallons)
FACILITATORS	One or more trainers. Also participating will be all staff, visitors, and/or trainees who have had experience working with women in third world countries.

### Trainer Introduction

**The trainers should facilitate a free flowing exchange of ideas during this session. The subject matter can lead to very lively discussions, often involving opposing view points. The WASH paper is excellent and should be distributed to all trainees.**

## PROCEDURES

Step 30 minutes

1

As an ice breaker, divide the trainees into groups of four to six people. Each group receives one large pot filled with water. A course is laid out and each trainee must travel the course, in relay race fashion, carrying a pot on his/her head and then passing it to the next person in the group. Afterwards, the pots are compared to see if any water was spilled.

### Trainer Note

**After the race, facilitate a short discussion on how it felt to carry water in such a way. Point out that this is the traditional method used in many parts of the world and women are usually responsible for this task, often carrying water long distances, several times each day. Also, mention other responsibilities of women in these countries, such as family farming, heading the household, caring for the health and preschool education of their children, hauling wood, cooking, leaning, and building traditional houses. Conclude by pointing out that although women play a vital role in the developing world, it is they who are most often excluded from the design process, decision making, and implementation of development work.**

Step 10 minutes

2

Individually, trainee writes down two or three ways that they could include women in their Peace Corps work.

Step 20 minutes

3

Trainees discuss, as a large group, their individual ideas for including women in their projects.

### **Trainer Note**

**Encourage as many trainees as possible to read their suggestions. Facilitate a discussion of give and take between trainees, pointing out positive ideas and areas of conflicting opinions. Some steps which may be suggested to include women in the development process are listed below:**

- Establish a relationship and learn about their roles**
- Ask them their ideas and support those ideas whenever possible**
- Make a special effort to understand their point of view**
- Support them by personal example**
- Hold women's meetings or attend such meetings already organized**
- Consult and involve women in all phases of a project including decision making, design, implementation, and maintenance**
- If possible, give women formal positions, such as working as your counterpart on a project.**



**Step 4 25 minutes**

Group discussion led by "panel of experts."

**Trainer Note**

**At this point, all those who have had experience (especially women) working with women in third world countries should be singled out as the "panel of experts." They should be informed prior to the session of the question they will be asked, so they will have time to think about their answer.**

**The panel members are asked to respond individually, on a personal level, to the question:**

**\* What is the one most valuable thing a volunteer could do to help women in third world countries?**

**After all members have answered, the floor is opened for general questions and discussion.**

**Some probable answers to that question are as follows:**

- Help women organize themselves into cooperatives to save money and time, and/or generate income.**
- Support formal education for females to better the quality of life for themselves and their families, and to increase their opportunities for employment.**
- Teach a vocational skill or craft to give them pride, enrich their lives through**

**creative expression, and generate income.**

**- Through development work such as water supply projects, save them time by reducing their work burden. Given more free time, women will be able to pursue other activities.**

Step 5 minutes

5

Review the objectives and conclude the session by asking the trainees to think about how their Peace Corps service in third world countries can help and improve the position of women.

## **Attachment 21A: Women, water and the decade**

**Mary Elmendorf**

**Consulting Anthropologist**

**Water and Sanitation for Health Project**

**1611 N. Kent Street, Suite 1002**

**Arlington, Virginia 22209, USA**

### **Introduction**

**Over a billion people in remote rural areas and urban slums of the third world lack safe drinking water and even rudimentary sanitation facilities. By 1990 their numbers will reach two billion.**

**"The International Drinking Water Supply and Sanitation Decade 1981-1990" is a**

**massive international effort to tackle what has become a top priority issue on world development agendas. Formally launched at a United Nations General Assembly meeting on November 10, 1980, the Decade involves UN agencies and private organizations, national governments, engineers, health professionals and social scientists, and most importantly, the people in the far-flung areas of the world who will become the beneficiaries of improved water supply and sanitation.**

**The World Bank estimates the cost at between \$100 and \$300 billion over the next ten years depending on the new facilities provided. Obviously, the answer is low-cost technology and systems which the users can help build and maintain themselves.**

**In this paper the key roles played by women in water use and management in traditional societies are discussed as well as the need to involve women in planning and implementing Decade activities. Strategies are suggested, for the active participation of women - at local, regional, national and even international levels which can contribute substantially to the successful achievement of water and sanitation goals and objectives.**

**In this same context it is also useful to consider the significance of improved water and sanitation facilities for the World Health Organization goal of health for all by the year 2000 (Ref. 1). Primary health care, which has emerged as the leading strategy for meeting health needs in developing countries, includes, among other elements community participation, universal coverage, and accessibility of appropriate technologies for improved water and sanitation. Thus, the concept, and methods discussed in this paper are firmly linked to the broad aims of both the Water and Sanitation Decade and the Health for All by 2000**

## **movement.**

**It has become overwhelmingly clear that the main obstacle in the use and maintenance of improved water and sanitation systems is not the quality of technology (Ref. 2, 3 & 4), but the failure "in qualified human resources and in management and organization techniques, including a failure to capture community interest" (Ref. 5). An appalling 35 to 50 percent of such systems in developing countries became inoperable five years after installation (Ref. 2, 6 and 7).**

**In 1976, the World Bank undertook a two-year research program in an attempt to identify technologies used in successful water and waste disposal projects in 26 developing countries.\* Case studies of villages and urban fringe areas in Latin America, Asia and Africa brought to light some of the intricate problems encountered in water and sanitation development programs and the importance of the "software" in successful systems, especially the need for community involvement. Similar research by other international and bilateral development agencies and academic institutions confirm the need for community participation at all stages of program planning and implementation.**

**\*The results of the research are currently appearing in a 12-volume series, "Appropriate Technology for Water Supply and Sanitation," available from The World Bank, Washington, D.C.**

**Engineers know how to build improved water and sanitation systems, health specialists understand the relationship between the multitude of diseases and illnesses related to water and sanitation, planners and economists know how to**

**develop schemes and projects; but for engineers, health specialists, planners and economists to know how to build, how to plan, and how sanitation facilities should be used is not enough. The social and cultural factors influencing peoples responses to changes in water supply and excrete disposal systems must be understood and reflected in program design and implementation, because these factors determine acceptance, effective use, diffusion and ultimately the success or failure of recently introduced technologies. The problems impeding the achievement of Decade goals in water and sanitation improvement are thus not primarily in the engineering aspects but in the way in which new facilities are introduced and in the social and behavioral obstacles to their effective use. The most effective way of gaining understanding of these impediments and how to overcome them, is through the participation of members of the client community in the early planning of projects (Ref. 3 and 8).**

**That women make up more than 50 percent of these communities is often overlooked. Also overlooked are the key roles of women in the drawing, carrying, use and management of water. Many women spend from four to eight hours a day in this burdensome task (Ref. 7, 9, 10, 11, 12 and 13). Women themselves are well aware of the time and energy spent in obtaining this basic need, and of the time and energy lost from more productive tasks.**

**Furthermore, it is the woman as mother and housekeeper who determines the appropriate and hygienic use of water. Women are therefore vital in efforts to halt the cycle of infection, especially for diarrhetic illnesses resulting from the fecal contamination of food and household water.**

**When only "community leaders" are consulted in needs assessment and women**

**are not, household water supply is rarely given priority (Ref. 5, 14 and 15). On the other hand, when needs assessments include the views of women, water for home consumption seldom fails to be among the top three felt needs (Ref. 5).**

**Women may not be aware of the germ theory of disease nor be able to see a direct relationship between health and improved water supply, but once they have had better access to water they quickly perceive the benefits in terms of improved health and reduced fatigue. The women of Chan Kom in Yucatan noted an increase of diarrhea! disease after a pump breakdown and went to the mayor to complain that their children were becoming ill and to request repairs to the water system (Ref. 16).**

**Women also are well aware of the time saved from carrying water, which combined with energy savings, can lead to income-producing activities or better care and nurturing of themselves and their families; thus, contributing to improving the quality of life for the poorest of the poor (Ref. 13, 17 and 18).**

**Just as for water, the perceptions of women are essential in early planning for sanitation. As mothers caring for infants and toilet training toddlers, and as the primary users and caretakers of new latrines, their preferences and opinions should be considered (Ref. 17 and 19). Latrine location and type should be planned after consultation with women to assure their most effective use.**

**Let us look briefly at some of the key roles of women related to improvements in water supply and sanitation and suggest ways to improve project design which hopefully will diminish failures and maximize effective use.**

## **The four key roles I want to discuss today are:**

- 1. Women as acceptors of existing water services and sanitation customs.**
- 2. Women as users of new water and sanitation facilities.**
- 3. Women as managers of household and community water resources and socializers in sanitary practices.**
- 4. Women as change agents in breaking the fecal-oral route of infection through better use of water and sanitation facilities.**

## **Women as Acceptors of Improved Water and Sanitation Technologies**

**Women, just as men, acting within complex structures of traditional use and management patterns, are acceptors of the resources, including water, in their environment. Their role as household managers means that in food preparation, washing and bathing, women are the primary users, and mediate between the water source and the household. Any planned change in water availability or excreta disposal should be based on information about their present knowledge, attitudes, and practices. Careful observation and discussion, not just standard surveys, are needed to get at their perceptions and beliefs and preferences regarding water and defecation. How and what water is used for drinking, cooking, laundry, bathing, and other household functions, is a result of women's careful decisions based on what they have learned from their mothers and grandmothers and from their observations of costs and benefits of any change.**

## **Factors Influencing use of Near Water Supplies**

**Decisions about drinking water are usually based on sensory perceptions color, taste or smell - rather than purity in the scientific sense. Everywhere macroscopic qualities are substituted for microscopic ones in the assessment of water quality. Decisions not to use improved drinking water facilities, such as tube wells or piped water, are often based on the unpleasant taste or smell such as those given off by iron sulfide, or chlorine. There is often a fear of such things as metallic tastes, and women will decide against using them rather than risking the unknown.\***

**\*In addition, in many societies processing of water affects its perceived quality. In many cultures there are beliefs about hot and cold food and drink which influence water use. For example, in some societies, cold boiled water is acceptable for daily use, but warm boiled water is just for invalids. Boiled water, even though cool, is considered "hot" unless redefined as "cold" boiled water after which it is no longer considered medicinal. Understanding these practices makes discussion of change by redefinition possible.**

### **Factors influencing Acceptance of New Sanitary Facilities**

**The importance of understanding attitudes toward Excreta cannot be over emphasized. The widespread perception that children's feces are "harmless" (Ref. 20) can generate a continuous cycle of reinfection whether the feces are thrown on a nearby garbage heap or diapers are washed with dishes in an urban home with a newly installed standpipe. In many cultures, infant feces, even though not considered "harmless," are not perceived as the harmful germ carriers they so often are (Ref. 17, 20 and 21). Such factors should be understood and addressed in the planning and preparation of water and sanitation education projects.**



**In some areas women and children use the same latrines, but in many places the children defecate just outside since they are afraid of falling through the large opening or of entering dark distant latrines. These problems have been solved in a very innovative way in Sri Lanka where specially designed low-cost small water seal latrines are available. These were installed near the house for the children. These children's latrines without any walls can be placed under the eaves of the house just outside the kitchen door, so that mothers can easily toilet train toddlers. Water used for washing children is then used to flush the latrine.**

**A commonly held belief in Honduras is that women should not use the same latrine as men lest they become pregnant (Ref. 22). In other cultures the fear among men of menstrual blood limits the use of even latrines in many instances to women. In Tanzania it is believed that the Excreta of fathers and daughters should not be mixed. In Nicaragua, women did not like to use the new latrines because the metallic sides were ten inches off the ground so that their feet were visible. Other latrines were not used because the sides came to the ground and made an attractive shelter for snakes (Ref. 23).**

**These types of beliefs have great significance for planning. They explain in part why in a study of 120 villages in Bangladesh the latrines were used by only 12.8 percent of the children, while 59.9 percent of the adults (mostly women) use them (Ref. 24). A similar study of 525 latrines in India revealed many more women using the latrines than men, whereas children's feces were thrown on garbage heaps.**

### **"User-choice" Approach to Planning**

**Feachem has noted, that it is essential that planners in designing projects "take account of user preferences and of the socio-economic setting of the project" (Ref. 25). The approach, which focuses on the product from the point of view of the consumer, has been described as "user-choice" (Ref. 26) and has been applied in several instances in development planning. However, not enough emphasis has been given to the choices of women as users of services and facilities.**

**A World Bank case study of water supply and Excreta disposal in Colombia revealed that families preferred brightly colored cement stools and slabs over drab gray facilities (Ref. 9 and 27). When asked about latrine preferences and practices in the Yucatan, women preferred an attractive latrine with a shiny porcelain seat or a brightly painted cement floor or stool even if the cost and labor involved were much more (Ref. 16).**

**One other factor to be discussed with women in early planning is the reuse of gray water for flushing of water-seal latrines. Even though this requires more labor to carry water, women may prefer such facilities.**

### **The Collection of Social and Behavioral Data for Effective Project Planning and Implementation**

**Socio-cultural variations among villages and between the sexes in the same area or country, as well as those of different countries, with respect to fears and constraints surrounding water and excrete, appear in cross-cultural studies. For purposes of effective project design, however, more detailed information concerning these constraints is needed.**

**In the same way, for a better understanding of knowledge, attitudes and practices, each community does not need to be surveyed in detail. Often there are similar data from other social and cultural areas which can be used for other cultures and geographic areas, particularly if they are of similar size and with a similar cultures and geographic areas, particularly if they are of similar size and with a similar physical environment. However, there are bound to be important differences. If communities or households feel that new facilities are theirs, they are much more apt to fully accept, use and maintain them. Simple adaptations to local needs also increase the chances that they will be used. Feachem noted, and various studies verify (Ref. 28), that 'in general, the design issues that will be improved through user participation are minor in their engineering or financial consequences, but major in the potential effect upon acceptance and correct use of the new facilities.' These minor changes, however, have major importance in meeting the perceived needs of the local community and the resulting responsibility for operating and maintaining them.**

**It must also be noted that effective community participation may slow down or stop a project. In one instance a Mexican community would not accept a water installation connected only to some houses nor wells accessible to clusters of huts. The community decided that everybody should have water at once or they would all continue walking to the rather distant poor well (Ref. 29).**

**A Maya community in Yucatan also delayed the construction of latrines until a model appropriate to their perceived needs and the specific environmental and geological characteristics of the limestone soil could be designed and demonstrated (Ref. 16). Even though some may consider these cases failures, both communities were ready to work only for what they felt they needed, and**

**thus unwanted facilities were not installed to fall into disrepair.**

**Thus far, the numbers of successful rural water and sanitation projects are much fewer than those that failed or achieved only limited success. There is evidence that all successful projects had community participation and there is increasing evidence that this, combined with the user choice approach, is a viable strategy (Ref. 14, 26, 30 and 31).**

### **Women as Users of Improved Water and Sanitation Technologies**

**A central question confronting each new water and sanitation project is whether or not the new facilities, once installed, will, in fact, be used by those for whom they are intended. A further question concerns who uses the facilities and how they are used. In the frequent preoccupation with ultimate outcomes of water and sanitation improvements, these questions, like so many, others may be overlooked. Women are the primary users of water supply facilities the world over and are frequently the first to use sanitary installations. However, they may not be included in the intensive user education so critical to the success of a project.**

### **Strategies for the Education of Women as Effective Users of Water Supply and Sanitation Facilities**

**New knowledge which results from education or training must be related to local beliefs and behaviors as noted above. Linkages must be developed between the old and the new. Hygiene education, particularly personal and household hygiene, should focus primarily on women and have four primary objectives:**

**1. Increased knowledge of the water/health and the excreta/water/ food/health**

## **relationship.**

**2. The promotion of positive attitudes toward proper and hygienic use of the water transport vessels, and storage receptacles, and the use and care of latrines by women and their children. (It goes without saying that such vessels, receptacles and cleaning materials or supplies should be locally available at affordable prices.)**

**3. The promotion of practices in water handling, excreta disposal, and food preparation that contribute to better health, including the use of clean, covered transport and storage vessels, hand washing after defecation and before food preparation, the toilet training of toddlers, proper disposal of infants' stools, and covering left-over food.**

**4. The promotion, where possible and acceptable, of appropriate reuse of wastewater and excrete through careful planning of spatial relationship and existing practices.\***

**\*Study of two Egyptian provinces revealed that families preferred to use the same water for washing clothes, then vegetables, and finally dishes. "It is not so much the reuse of this water that is detrimental to health as the sequence of its reuse." Also significant is the fact that multiple uses were directly related to scarcity of water and to the arduous task of transporting it (Ref. 57).**

## **Women as Promoters of Improved Practices Related to Water and Sanitation**

**Women have been found to be the most effective agents in promoting family planning, nutrition, home economics programs and other programs where women are the primary targets (Ref. 32). In Ghana, home extension agents have been**

**effective in delivering combined nutrition, family planning, agricultural extension, and child health education services (Ref. 33). So in the promotion of proper use of water and sanitation facilities, women should be actively recruited as health inspectors, assistant sanitarians, agricultural extension workers, primary health care workers, and sanitation educators.**

## **Educating Women through Support Groups**

**If women are to benefit from user education services, such services should focus not only on individuals as recipients of information and motivation, but on the involvement of existing women's groups, or the creation of new groups, to encourage peer support for desired change. Savings and loan associations, family planning groups, religious organizations, tribal societies, and kinship and friendship networks need to be identified and invited to participate in the promotion of improved practices related to water and sanitation (Ref. 28, 34 and 35). Where feasible, efforts should be made to mobilize the general community to support such education for women, and women should participate in community organization in order to forge those supportive links.**

## **Settings for Communicating with Women**

**Certain sites may also lend themselves to more effective delivery of new information than others, such as markets, clinics, hospitals, and laundry and grain grinding sites, etc. (Ref. 36). Schools may well serve as an ideal place for reaching young girls who are already preparing for motherhood and housekeeping and who have had long experience in hauling water. And, in fact, school children, both boys and girls, can teach both their parents and peers about changing customs and**

**behaviors and give further support to their mothers. The effectiveness of education in groups is based on the notion of group support.**

## **Development of Learning Materials**

**When field workers from the Diarrheal Disease laboratory in Bangladesh were contemplating their hygiene education program as a part of a new water and sanitation effort at Teknaf, they tested specially prepared educational materials among the local population, mostly women, but found that most were unintelligible (Ref. 37). Objects in the designs were not even recognized for what they were. In the Cameroon, (Ref. 38) testing materials found a nearly 25 percent rate of non-comprehension of visual images.**

**At present, it is not known what proportion of rural populations, and particularly women in developing countries, do not perceive the meaning of visual representations, but, it is known that there are cultural differences in visual perceptions of printed materials. The implications for water and sanitation user education are extremely important. Rather than heavy investment in materials prepared without client participation or use of existing educational materials, locally developed and pre-tested materials should be used together with demonstration models of the new facilities and the training of field workers in verbal communication skills (Ref. 39 and 40). Mass media campaigns can be used as reinforcements if they are repeated and locally relevant (Ref. 41).**

## **Women as Managers of Water and Sanitation Districts**

**Although men are often perceived as the "prime movers" in the development**

**context, the central role that women play in raising children and maintaining the fabric of society, as well as in health education and health care, and their permanence within the household and the community gives them great potential as effective managers and trainers for community water and sanitation projects.**

**Women are, of course, managers of household water supplies, but whether recognized or not, women also have a strong potential role as managers of community water supplies as well, especially in the growing number of places in developing countries where there are more women than men. Women are, for one, bound more tightly to the household and to the community than their male counterparts who must often seek work elsewhere. Women are usually responsible for either obtaining water or seeing that it is available for daily use and deciding how and where it is to be used and for what. In many diverse geographic areas, in addition, women select water sources and some play key roles in seeing that funds and/or labor are available to maintain them.**

**It has been suggested that when people participate in planning and/or implementation of a project, they will collectively consider the project theirs and have a sense of responsibility for its care and maintenance. This has been challenged by Feacham, who suggests that some villagers feel they have made their contribution at the construction stage, so that it is more than ever the responsibility of the government to maintain the project (Ref. 21). Alastair White notes that outsiders' expectations about community participation are based on how they themselves would, or think they would, respond. But communities are not individuals. To speak of a community having a commitment to a project can only be a metaphor for a range of attitudes among individuals, none of whom may value the project highly in relation to his or her own private affairs (Ref. 42). If we**



**accept this concept, however, and recognize at the same time that a large proportion of the participants are women, for whom the importance of a water and sanitation project has understood value, the chances for collective approval and continued support is much greater.**

**Several tasks in the maintenance and repair of new water supply and sanitation facilities must be learned by someone in the community. Among these tasks are monitoring for leakage and other defects, keeping stocks of spare parts, overseeing a small budget, doing routine maintenance and minor repairs, maintaining liaison with local authorities and district and regional technical services, and training other community and household members in maintenance and repair techniques. All these tasks require training. Women, as those who already exercise considerable influence over water sources and uses, should be in a good position to benefit from such training.**

**These latter considerations have implications for both the substance and the form of training. In the first place, improved facilities, while they should be appropriate, need not be crude or even simple. The idea that the technology is too complex for "simple rural folk" of developing countries is a myth and a rather unconvincing myth at that. Broken and inoperative water supply schemes and abandoned latrines are to be seen in environments where village skills extend to maintaining and repairing bicycles, transistor sets, irrigation pumps, ceiling fans, air conditioners and a variety of small industrial machines and tools (Ref. 25). We could add sewing machines, ancient pedal models and electric ones, that are kept running by women.**

**Of course, the new skills required for the effective management of improved**

**technologies must be added to these existing skills, but most women are eager learners of any information or skill that promises to make life better for themselves and their families.**

**In Angola where women have been recruited as water source monitors, the breakdown rate has declined decidedly (Ref. 43). As an adjunct to an agricultural development project in Bolivia bilingual indigenous women, 17 to 25 years of age, were trained to administer immunizations, provide information on child nutrition and lecture on the proper maintenance of water and sanitation facilities. A number of these young women are now in complete charge of repair and maintenance of the facilities (Ref. 44). Armed with these skills and with information about alternative water sources, women can improve their ability to plan for more accessible and more reliable sources of water for their households and communities.**

### **Women as Trainers, Trainees, and Trainers of Trainers**

**The implications for women as users of new or improved systems of water and sanitation are multiple. Women can become important as trainers, trainees, promoters, and managers of the systems. In fact, women already are the mediators between the home and the environment.**

**Training in the technical skills mentioned above, but also in those related to training and liaison work, will be more effective if it is "on-the-job" rather than didactic (Ref. 45). Training should be used as an opportunity to acquire needed skills in a working context with the supervision and support of technical staff with a minimum of time spent in the classroom. This approach has proved to be**

**effective in a number of programs for training community development workers (Ref. 19 and 46). Considerations of formal training are several. In many cultures women as trainers and as trainers of trainers are more effective, and sometimes required if female participation is desired. Every effort should be expended to recruit women for these roles.**

**Since 1972, some communities in Paraguay have selected local literate people, many of them women, for special training to carry out basic surveys including assessment of attitudes toward water Excreta and garbage. The communities participate in the selection of the kinds of services and education they want, as well as the actual construction of the water supply systems. After special training, the responsibility for management and maintenance of the system is assumed by an elected Water Board (Ref. 47). In Upper Volta, female community workers will be the major collectors of data for evaluating a rural water supply project (Ref. 35). It would be quite feasible to include in the training of these "trainers"!, the necessary knowledge and skills to improve water and sanitation practices among their clients, especially women. This type of integration in training can lead to reduced costs, more nearly integrated field programs, and can focus on priority areas as defined by communities: health, education, nutrition and water supply...areas which often cut across disciplinary boundaries (Ref. 48).**

### **Women as Agents of Change in Water and Sanitation**

**This section is based on the assumption that the role of women as diffusers of improved water and sanitation technology and associated behavior change must be taken into account in evaluating projects. This assumption holds true whether one is concerned with households or communities and needs to be incorporated**

**into both external and self or participatory evaluation design (Ref. 34, 49 and 50).**

## **Effects on the Household**

**To a large extent the health and social benefits within the household of improved water and sanitation facilities are dependent on the ability of women to diffuse information leading to changed attitudes and practices among other household members. As carriers of water, women influence directly the volume consumed (Ref. 7), and thus, the health status of the household for illnesses which are directly related to the volume of water consumed, such as diarrhea, skin infections, trachoma, etc. As the selectors of water sources, women determine the quality of water delivered to the house based on their perceptions of what is a good and acceptable source. As those who select the transport and storage vessels, wash them, and cover them, women influence both the volume of water consumed (Ref. 7) and the quality. Finally, as those who give their infants and small children liquids, they determine the cleanliness of the cup, spoon and water and thus, in part, health status of the infant or toddler (Ref. 41).**

**All potential health benefits will be influenced by the woman's behavioral change related to excrete, unclean hands, left over food, uncovered water, and flies (Ref. 41). It is she who forms a constant link in the chain of contamination from feces to fingers to food, and she who in turn can break the chain by latrine use, hand washing, and protection of left-over food.**

**From this change in the woman's perceptions and resultant behavior, efforts to alter the behavior of other family members will stem. For instance, women have a major role to play in the adaptation of small children to latrine use (Ref. 9 and 19)**

**through promoting the construction of child-sized latrines, through showing a model of appropriate behavior, and through nurturing the child through the process of training. Experience in the above-mentioned case in Sri Lanka since the 1950's with child latrines needs careful evaluation. Users, such as the staff of Sarvodaya, a private agency, feel this is an effective innovation (Ref. 51). These changes in behavior may become permanent and persist into adulthood. They can also influence the behavior of older siblings, particularly girls, who care for younger children, carry water, and perform other household tasks.**

### **Effects on the Community**

**In the vast majority of communities where a single water source serves from 30-200 or more persons, the health and socio-economic benefits of the water supply will also depend a great deal on women. Women as the drawers of water also control to a great extent the possibility of contamination of the water through the manner in which they use the installation. For example, in the case of open wells, which are by no means advocated in this paper, the use of a clean bucket, and the prevention of spilt water running back into the well depends upon the actions of women. In the prevention of Guinea worm transmission, care must be taken that water does not run back into the well after coming into contact with infected hands and feet. Women also are among the first to notice defects in the structure of wells or pump breakdowns and are therefore, in a good position to call attention to problems, make simple repairs or arrange for more extensive repairs.**

**In these and other ways the roles of women must be accounted for when one attempts to evaluate the community level outcomes of introducing improved water technologies.**

**Regarding sanitation, although most installations for Excreta disposal are at a household rather than a communal level, the crucial role of women as the most frequent users of such facilities (Ref. 28 and 52) must be recalled in those instances where communal sanitation blocks and other forms of public sanitation installations are the prevailing pattern. The installation of handwashing facilities and the provision of soap may depend for their effectiveness on focusing user education on women (Ref. 9).**

### **Implications for Evaluation**

**Warner has suggested that evaluation of water and sanitation improvements should be viewed in three stages: project operation, project performance, and project impact (Ref. 58).**

**At each stage of the evaluation, whether one is describing the function of a pump or its use by villagers, if one is to effectively evaluate results one must account for the role of women as diffusers of knowledge, attitudes, and behavior associated with new water and sanitation technologies. In effect, if one has not included the role of women as a key moderating variable one is likely to miss many of the reasons for the results of a given project.**

**Externally administered evaluations of water and sanitation projects have the obvious advantages of expert design, use of valid measures, and access to facilities for data management. Achieving interpretable results, however, in the case of water and sanitation projects may involve sharing a part of the responsibility for carrying out the design, execution, and interpretation of the evaluation with the participants/beneficiaries of the project themselves (Ref. 53**

**and 54). The inclusion of a focus on the role of women in order to explain results, in particular, demands that women in the communities where water and sanitation facilities are installed be entrusted with the responsibility for identifying criteria for each stage of the evaluation, for the collection and recording of data, and for a share in the interpretation of results. Only thus will reliable collection of evaluation data be achieved. With a stake in the outcome of the evaluation, women will be more likely to see that the necessary care is taken to select feasible data items and to collect them reliably. At the same time they will feel responsible for suggesting modifications or changes in the facilities themselves based on interpretation of the data gathers. In Honduras, the women not only collected the survey data but organized a workshop analyzing it and preparing a final evaluation document (Ref. 47 and 50).**

## **Summary and Conclusions**

**Ineffective or modestly effective water and sanitation programs in the past are primarily the result of non-use and misuse of new facilities, not to the engineering aspects. Until women participate in project design and implementation, including user education and management of such facilities, limited acceptance and impact can be anticipated. It is obvious to neither peasants nor scientists that interventions in water supply and sanitation alone bring about better health. In seeking an explanation for this paradox, one must look beyond technology to the roles and attitudes of the potential beneficiaries of new water and sanitation facilities, particularly the women, who are the primary users of water and the socializers of their children in matters of personal hygiene.**

**Inculcating the benefits of improved hygiene practices is not a simple process,**

**however, particularly in the area of human defecation - a taboo subject in many cultures, with overtones of magic, witchcraft, or just Victorian prudishness. Information about taboo subjects then does not flow easily or rapidly through a community. When new water and sanitation programs are introduced by and to men, who are usually the decision-makers on public policies, women are not likely to be part of the information network. There is a dearth of information on the roles of women in this field. More research is needed to obtain relevant socio-cultural data on their problems and constraints, and more attention needs to be given to ensuring their participation in decision making.**

**Village mothers, whose roles make them the keys to change, will not know how to break the fecal/oral route of infection - without which we cannot expect much improvement in health - until they have some important bits of additional equipment and understanding of how to use them. They need soap and hand basins, and adequate carrying and storage containers, along with conveniently located, non-odorous safe latrines. Is it possible to talk with the women with respect to where they wash clothes, dishes, hands, their children, and themselves? If water is made available for laundry and bathing, can it be reused in an aquaprivy? Do we think of planning bathrooms only for urban areas?**

**The fecal/oral/infection route is well known, but there has been very little designing of facilities to help break this vicious cycle. If there is only one pail and no money to buy another, of course it will be used for everything. If there is no top for the pail, a covering with leaves is a poor substitute. Inexpensive, even subsidized, kitchen, laundry, and bathroom equipment and soap will make it possible for villagers to take advantage of improvements in water supplies and sanitation. In several countries, brightly colored, lightweight plastic water jugs**



**and tubs have had ready acceptance. In Guatemala, as an incentive in promoting personal hygiene, a simple package containing a wash basin, soap dish, pails and shelf to attach to the latrines was given as a reward to each household following inspection of their new privy (Ref. 55). A mirror and soap could be added to such a kit, and a dipper for ease in transferring water. With these improvements, instructions for the women on how to use and manage the new equipment are needed. Audiovisual messages and health education should be related specifically to the effective use of the new equipment - both community and household - so that it can be used efficiently with pride and pleasure. The messages must be directed primarily to women, for they are the key to the realization of the goals of water and health for all.**

**During the 1977 Water Conference in Mar del Plata, thirty non-governmental organizations issued a statement on "The Special Situation of Women in Regard to Water" (Ref. 56) recommended that developing countries:**

- include strategies to develop human resources at the community level to meet local needs;**
- ensure equal access for women to training with regard to the maintenance, management and technology of water sources and supplies;**
- ensure that women be included in any educational programs on the use of water and its protection from contamination;**
- ensure the participation of women in local councils and planning boards responsible for making decisions on community water supply; and**

**- recognize the increasingly effective role that women, non-governmental organizations, and other women's organizations can play in the education of public opinion for needed change.**

**The importance of community participation has come to be recognized, even if the active involvement of women is seldom practiced.**

**As increased recognition is given to women's participation in the home and community, similar attention needs to be paid to women as members of national planning boards, regional councils and advisory committees at all levels, as recommended at the Mar del Plata Conference.**

## **Session 22 - Hydrology**

TOTAL TIME	2 Hours
OBJECTIVES	<ul style="list-style-type: none"> <li>* Describe the hydrologic cycle</li> <li>* Analyze groundwater hydrology, including aquifers, permeable, and impermeable earthen strata</li> <li>* Identify groundwater and surface water characteristics of a watershed</li> </ul>
RESOURCES	Attachment 22-A: "Groundwater Hydrology and Sources" <u>Small Community Water Supplies</u> ; IRC, pp. 51-56, 91-100
PREPARED MATERIALS	<p>Newsprint and felt-tip pens, flip chart reproduction of Figures 1 and 2 of Attachment 22-A</p> <p>Copies of Attachment for all trainees</p>
FACTILITATORS	One or more trainers

## Trainer Introduction

**This session introduces the trainees to the hydrologic principles of Water Resource Development. Its main objective is to identify aquifers and discuss their characteristics. The trainees should read the Resource book and Attachment prior to the session. Trainers should be familiar with Attachment 22-A, as it is used to facilitate the session.**

## PROCEDURES

Step 1 5 minutes

Present the objectives and format for the session.

Step 2 15 minutes

Lecturette on the hydrologic cycle of a watershed.

## Trainer Note

**Refer to your reproduction of Figure 1 found on Page 1 of the attachment. Refer the trainees to their drawing as you discuss it. Describe each step in the cycle and how they interrelate.**

Step 3 45 minutes

Lecturette on groundwater hydrology.

## Trainer Note

**Referring to the glossary section of the Attachment, describe the various water - bearing layers, zone of aeration, zone of saturation, and water aquifers. Define a water table, artesian, and perched aquifer (you may refer to your reproduction of Figure 2 to illustrate each one. However, these aquifers will be defined in greater detail in Step 4.) Continue to follow the glossary. Ask trainees to define porosity and permeability, giving examples of soils with high or low porosity or permeability. Point out how these characteristics affect the water bearing capacity of an aquifer. Lastly, explain Darcy's Law. Understanding of this law will lead to a better understanding of the piezometric level in an artesian aquifer and the hydraulic principles of a piped water system.**

Step 4 45 minutes

Identify groundwater characteristics of a water shed.

### **Trainer Note**

**Describe, in detail, the three types of aquifers illustrated in Figure 2. Discuss their reliability as water sources, in terms of both quality and quantity. Use the Figure 2 drawing to illustrate each point. Take the time to go over it in detail, and encourage the trainees to ask questions concerning the information. Next, discuss the section of the attachment dealing with the interpretation of ground surface features. Explain each point, with a special emphasis on point eight, local community knowledge.**

Step 10 minutes

5

Review the objectives and conclude the session with a general discussion of

aquifers.

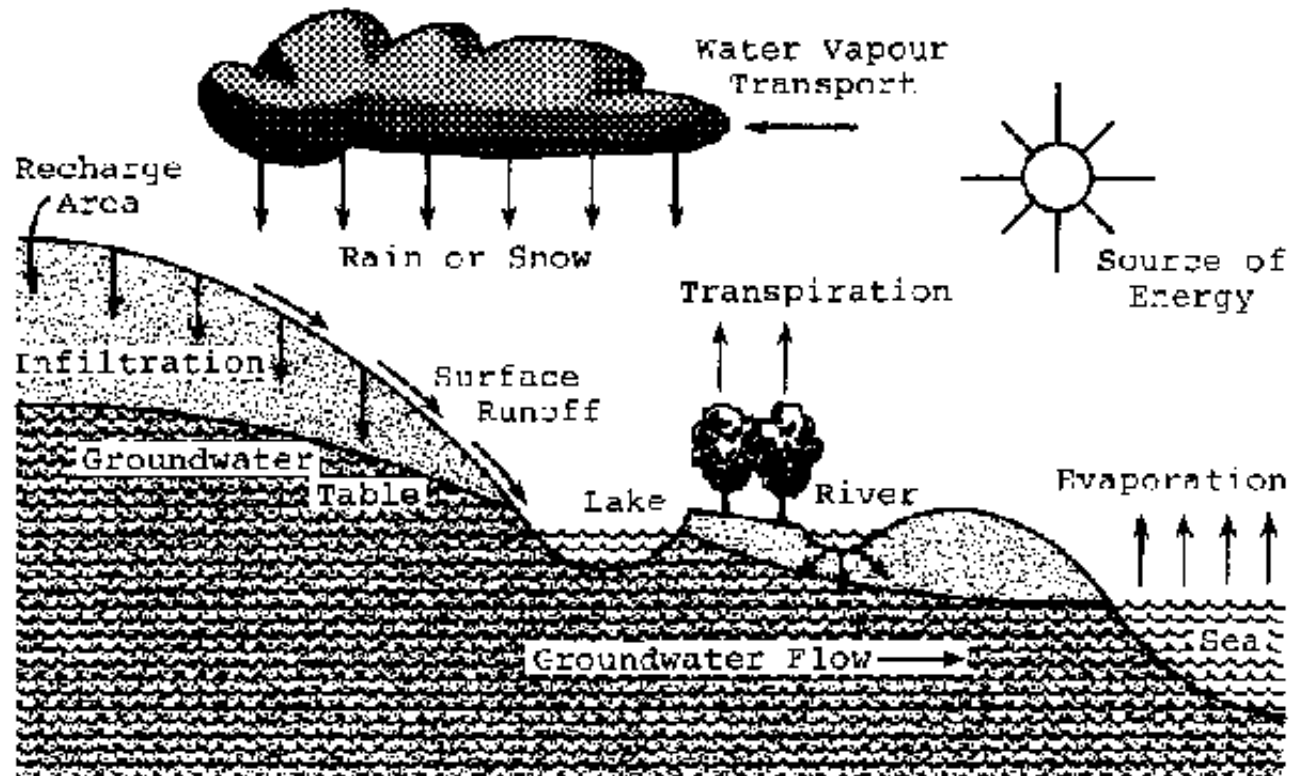
## **Attachment 22A: Groundwater hydrology and sources**

### **Introduction**

**Knowledge of groundwater hydrology is essential to the understanding of why and where springs occur, and where shallow wells might be found.**

### **The Hydrologic Cycle**

**The hydrologic cycle is familiar to us all: water evaporates from the earth's oceans and other water bodies, is carried inland, falls to earth again as precipitation, and flows back to the water bodies to start the cycle again. Within the cycle are various shortcuts, such as evapotranspiration from vegetation and direct evaporation from soil. There are also delays along the way, as moisture percolates into the soil to travel, often for decades and even centuries, through the earth's crust toward the sea. The study of the occurrence and movement of this underground water is known as groundwater hydrology.**



**Figure 1 - The Hydrologic Cycle**

## The Occurrence of Ground Water

Groundwater enters and travels through the earth's crust through pores in permeable materials and/or fissures in impermeable materials. The term "permeable" simply means that water may pass through it. Sand and gravel are highly permeable materials, while clay and hard rock are usually impermeable for all practical purposes. Soft rocks, such as sandstone may or may not be permeable, depending upon specific characteristics.

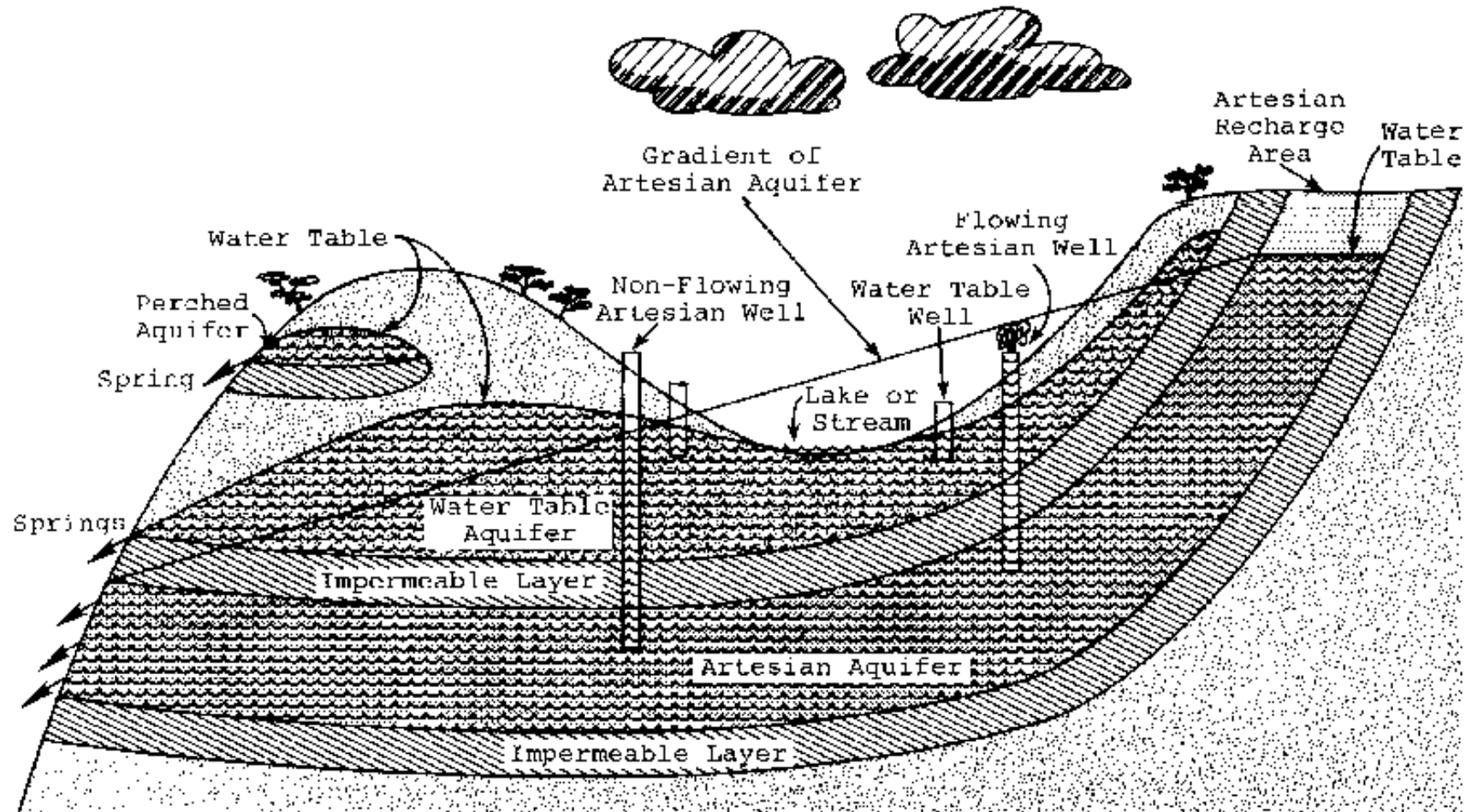
The water percolates nearly vertically until it reaches a depth at which the

**groundwater is continuous. (This is analagous to raindrops falling until they hit a lake surface.) The level at which the groundwater becomes continuous is called the groundwater table, and is represented by the water surface elevation in a well or other excavation.**

**Contrary to the implication in the name, the groundwater table is not flat in most cases, nor is it "just sitting there." In nearly all cases the water is flowing under the force of gravity from a location where the water table is higher to where it is lower. Further, the level of the water table fluctuates up and down from month to month and year to year as the inflow and outflow vary with the seasons and the demands of man. In general, it can be assumed that the water table elevation follows the general shape of the ground surface except that the water table "hills" and "valleys" are less pronounced than the surface features.**

**The layers of the earth's crust which transmit groundwater are called aquifers. In many cases, the aquifer that the groundwater enters tilts downward from some previous geologic activity, and thereby falls below an impermeable layer of clay or rock. The impermeable layer confines the aquifer so that it is not free to seek its own level; these are "confined" or "artesian" aquifers. To differentiate, aquifers which are not confined are called "unconfined" or "water table" aquifers. The difference between an artesian aquifer and a water table aquifer is analogous to the difference between a closed pipeline and open ditch. In each case, there is flow under the force of gravity, but in the pipe and artesian aquifer the water is confined under pressure, while in the ditch and water table aquifer, it is not. If a pipe is punctured or the confining impermeable layer of an artesian aquifer is ruptured (as by a well), the water will rise above its previous surface. This is obviously untrue for a ditch or water table aquifer.**

Finally, a specialized kind of water table aquifer is a "perched" aquifer. This aquifer represents an anomaly, where an impermeable layer of limited size interfere with the percolation of water to a larger aquifer, thereby creating a small aquifer above a much larger water table aquifer.



**Figure 2 - Types of Aquifers and Location of Water Sources**

**Rock fissures and channels provide an additional potential source of water. Water enters and flows through the fissures and channels much as it does through**



**normal aquifers, except that the fissures and channels are usually larger, allowing faster flows, and they are less continuous and therefore harder to predict. Flow in rock may be water table, artesian, or discontinuous. Soft rock, such as limestone, may be eroded and/or dissolved by flowing water, creating underground streams and caverns of large extent (e.g., Carlsbad Caverns in New Mexico, USA).**

### **Reliability of Aquifers**

**The following discussion gives an idea of the reliability of the various kinds of aquifers, as follows:**

**Perched aquifers are often of poor reliability; their small area and ability to drain into larger aquifers make them subject to depletion in dry years or dry seasons.**

**Water table aquifers may be reliable or not, depending upon their size, thickness and other features. Large aquifers tend to be more reliable than small, and thick aquifers tend to be more reliable than thin, because the greater storage capacity dampens the swings caused by changes in recharge. Many rock fissure water table aquifers are often unreliable because the relatively high flow rates make them susceptible to changes in recharge.**

**Artesians are usually the most reliable if only because the presence of pressure implies an aquifer of considerable extent and therefore considerable storage. This is true of rock fissure artesian aquifers as well as alluvial artesian aquifers.**

### **Quality of Water**

**Rainwater in most parts of the world is relatively pure and lacking in minerals. As**

**water travels along the surface of the earth, it picks up biological and other contaminants, and dissolves some materials. Then, as it percolates into the earth, two things happen:**

**1. In most aquifers, the biological contaminants and other particulates are filtered or absorbed from the water. One meter of medium sand will remove most bacteria and all but the finest particulates. Further percolation will produce clear, safe water if no chemical contamination is present. NOTE: This comment is not necessarily true where water is not percolating, but is instead flowing with the groundwater (e.g., if a privy is built into groundwater). In that case, much greater distances are required to remove some biological contaminants because the removal mechanisms are changed.**

**2. The longer the water is in contact with aquifer materials, the more the chance that the water will dissolve soluble mineral constituents, releasing iron, calcium, flouride, sulfates, and other ions.**

**From these two principles, we can make the following conclusions:**

**1. Water table aquifers may normally be considered safe from pathogenic organisms if they are at least three meters below and 50 meters distance from any source of such biological contamination in a fine grained material. Obviously, a coarse gravel will not provide the same protections. Mineral quality of water table aquifers will vary with the size and flow characteristics, but will generally be satisfactory.**

**2. Artesian aquifers (except in rock) will generally have highly mineralized waters**

**which are bacteriologically safe. The minerals present will be dependent, of course, on the nature of the materials through which the water passes.**

**3. Rock aquifers will be highly variable in quality. In some, particularly limestone with large solution channels, the water will be essentially unfiltered and can be easily contaminated. In others, particularly hard rock such as basalt, the bacteriological quality may be good.**

**Chemical quality depends on residence time and type of rock, but is often excellent in the harder types of rock and poorer in the softer types of rock.**

**In summary, most groundwater is bacteriologically and chemically safe, except that special attention must be paid to the safety of very shallow groundwater, and groundwater that issues from rock fissures. The fact that most waters are safe should not make a person entirely sanguine about groundwater. Poor source construction practices can quickly render a Groundwater source unsafe, and chemically harmful groundwaters do exist In many areas. If possible, both the chemical and bacteriological quality of the water should be checked.**

### **Interpreting Surface Features to find Groundwater**

**A few rules of thumb concerning interpretation of surface features will aid in detecting groundwater. These are guides, not gospel, and there are exceptions to each.**

**1. Where plants grow more profusely than at other locations, shallow groundwater is more likely.**

**2. Where phreatophyte plants grow (a deep-rooted plant that obtains water from**

**the water table or the layer of soil just above it), groundwater is more likely. Phreatophytes are water-loving plants, often distinguished by broad flat leaves and bushy growth.**

**3. Groundwater is more prevalent in valleys than on hills (minor hills within valleys have little effect, however).**

**4. Good aquifers often occur where a steep side embankment joins a less steep main valley.**

**5. Groundwater is likely to be present near lakes and streams, although clay layers near lakes frequently cause problems.**

**6. Springs often surface just above or below changes in slope.**

**7. Springs often surface where erosion has laid bare the toe of an aquifer overlying an impermeable layer. Such locations are often in small V-shaped side valleys along streams or drainages, and less often in broad river valleys (exception: where old flood plains drop sharply to a lower river elevation, very strong springs often occur).**

**8. The local population usually has excellent knowledge of where to find groundwater; always consult locally before trying to find water.**

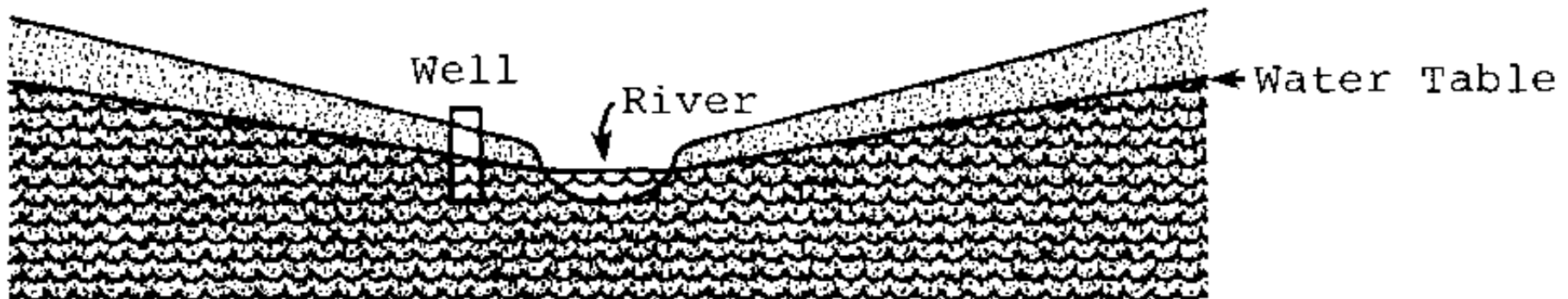
## **Water Table Fluctuations**

**The effect of water table fluctuations on a water source can often be dramatic. For example, shallow wells near rivers often fluctuate with the seasons even more**

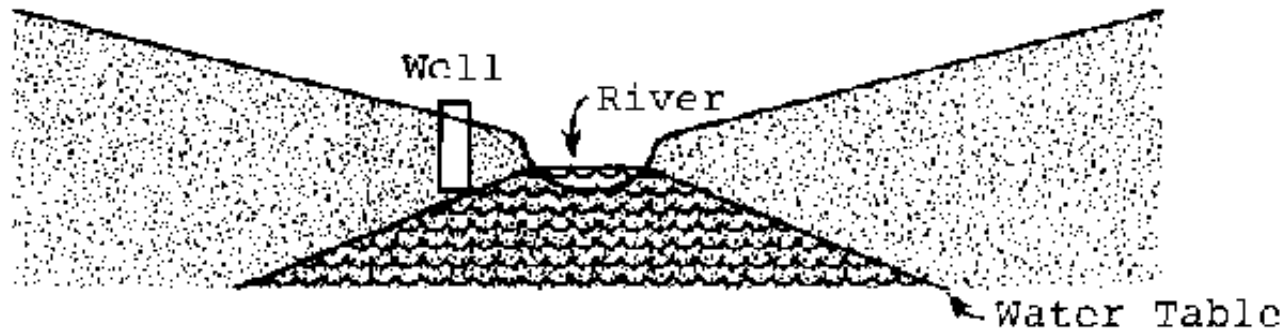
than does the river itself. A simplified look at groundwater flow can illustrate the reason. See Figure 3.

During the wet season, the aquifer may "fill-up" and flow out into the river, thus producing a water level in the well which is higher than the water surface. During the dry season, water is lost from the aquifer and water now flows from the river into the aquifer, thus producing a water level in the well considerably lower than that of the river. This pattern is not necessarily followed in all rivers or even in all parts of a given river (some have constant inflow from aquifers, others have constant outflow to aquifers. Some rivers lose so much water to aquifers that they dry up in the dry season; in this case, there is often considerable subsurface water still available. Fluctuations in the water table may also affect water quality. During the dry season when the river is feeding the well, poorer water quality should be expected.

### Effects of Seasons on Groundwater Flow To/From River



**Figure 3 - During Rainy Season - Water Flows From Aquifer to River**



**Figure 3 - During Dry Season - Water Flows From River to Aquifer**

## **GLOSSARY OF TERMS**

### **Types of Water**

#### **SURFACE WATER**

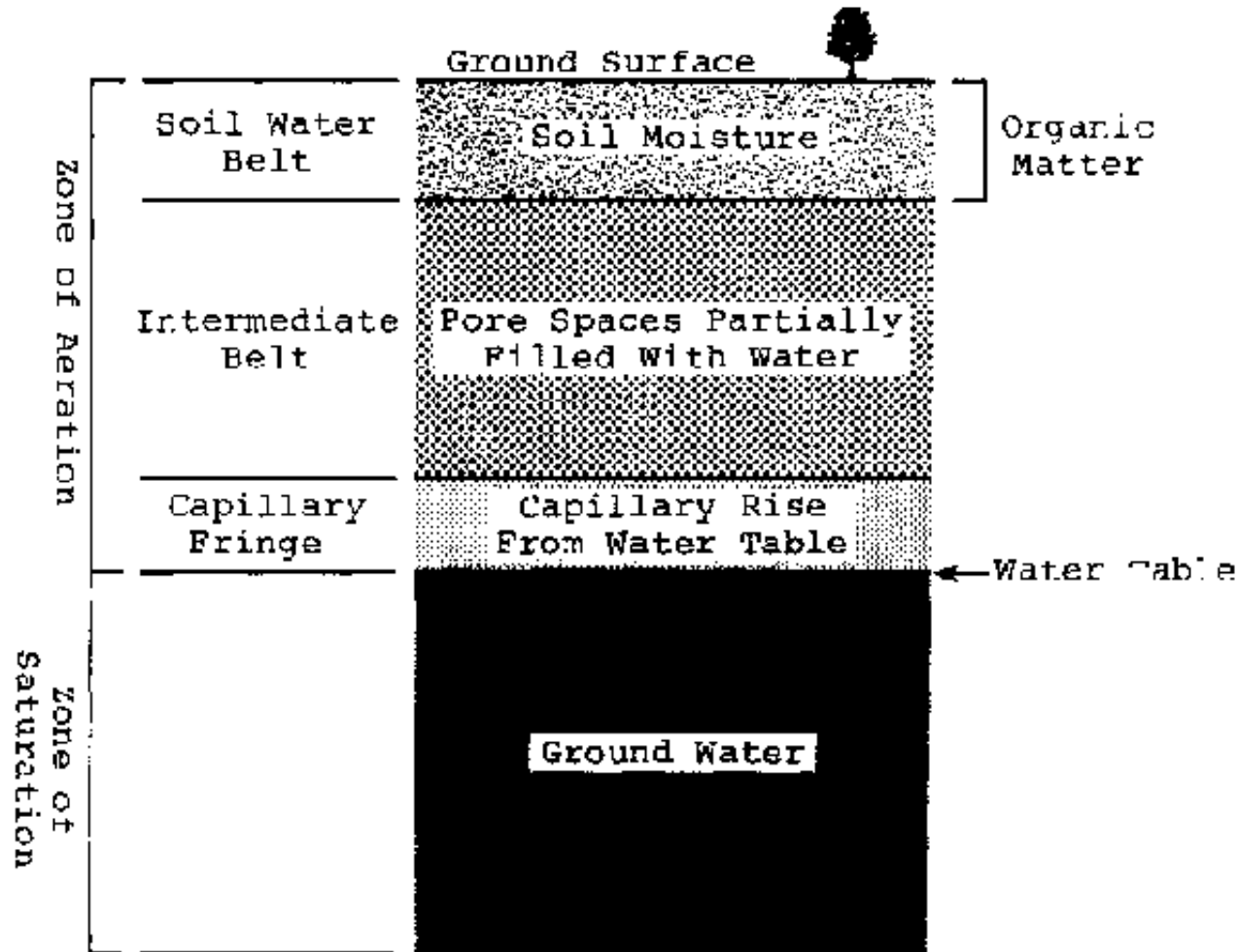
**River, streams, lake, runoff, and sea.**

#### **GROUNDWATER**

**Water that infiltrates the soil is called subsurface water, but not all of it becomes groundwater for the following reasons:**

- 1. It may be pulled back to the surface by the capillary force and evaporated to the atmosphere.**
- 2. It may be absorbed by plant roots growing in the soil and then reenter the atmosphere by transpiration.**
- 3. The water that has infiltrated the soil deep enough may be pulled on downward**

**by gravity until it reaches the level of the zone of saturation - the groundwater reservoir that supplies water to wells.**



**Figure 4 - Soil Belt**

## **ZONE OF AERATION**

**The upper strata, where the openings are partly filled with water.**

**The zone of aeration is divided into three belts:**

**a. Soil water belt - This belt supplies water to roots of the plants, and is two inches to two feet in depth.**

**b. Intermediate belt - Dead storage - it cannot be recovered for use.**

**c. Capillary fringe - It holds water above the zone of saturation by capillary force active against the force of gravity, much like a sponge sucking up water.**

## **ZONE OF SATURATION**

**This is where all the openings are completely filled with water. This is the best source of water for both quality and quantity, though less than 30% of rainwater makes it to this level.**

## **GROUNDWATER**

**The water in the zone of saturation is only part of all subsurface water known as "ground-water".**

**The saturated zone may be viewed as a huge natural reservoir or system of reservoirs whose capacity is the total volume of pores or openings in the rocks that are filled with water.**

**The groundwater may be found in one continuous body or in several separate strata.**

## **AQUIFER**



**It is a water saturated geologic unit that will yield water to wells or springs; e.g., sand, sandstone, limestone, etc.**

## **WATER TABLE**

**The upper surface of the zone of saturation is called the "water table". The shape of the water table is controlled partly by the topography of the land and tends to follow the shape of the land surface.**

## **WATER TABLE-AQUIFER**

**The water in a zone of saturation is at atmospheric pressure as if it were in an open tank. This is also called "unconfined groundwater" or free water.**

## **ARTESIAN AQUIFER OR CONFINED AQUIFER**

**When a water-bearing stratum is enclosed between two impervious layers in a syncline, the water falling on a pervious stratum runs into the synclinal basin and is stored there under pressure. If the upper confined stratum is pierced by a borehole, the water will be forced out under pressure and may even form a jet rising high above the ground level.**

**The elevation to which the water level rises in a well that taps an artesian-aquifer is called the "Piezometric Level".**

**An imaginary surface representing the artesian pressure or hydraulic head throughout or part of an artesian-aquifer is called the "Piezometric Surface".**

## **Occurrence of Groundwater**

**The groundwater occurs in consolidated materials (hard rocks) or unconsolidated materials (soft rock or alluvium).**

### **TYPES OF ROCKS**

#### **1. Igneous rocks**

- Intrusive (plutonic)**
- Extrusive (volcanic)**

**2. Sedimentary rocks - 95% of the groundwater is found here in such rocks as sandstone, limestone, and shales.**

**3. Metamorphic rocks- buried under pressure and heat.**

### **POROSITY**

**The porosity of water-bearing formation is that part of its volume which consists of openings or pores - the portion of its volume not occupied by solid material.**

**Porosity is an index of how much groundwater can be stored in the saturated material. For example, clay and silt have low porosity; sand and gravel, high porosity.**

**Porosity is expressed as a percentage of the bulk volume of the material; e.g., if one cubic foot of sand contains 0.30 cubic foot of open spaces or pores, we say its**

**porosity is 30 percent.**

## **PERMEABILITY**

**It is defined as the capacity of the porous media for transmitting water. Movement of water from one point to another in a porous material takes place whenever a difference in pressure or head occurs between the two points.**

**Porosity and permeability are interrelated when associated with aquifers. A fine grain material usually has higher porosity, but grains must be interconnected to allow movement of water or permeability. To be considered a good aquifer, a strata must have a blend of porosity and permeability.**

**Henri Darcy (1856) investigated the flow of water through beds of filter sand. His experiment showed that the flow of water through a column of saturated sand is proportional to the difference in the hydraulic head at the end of the column and inversely proportional to the length of the column. This is known as Darcy's Law.**

$$V = P \times \frac{h_1 - h_2}{L}$$

**V = velocity of flow**

**$h_1 - h_2$  = difference in head**

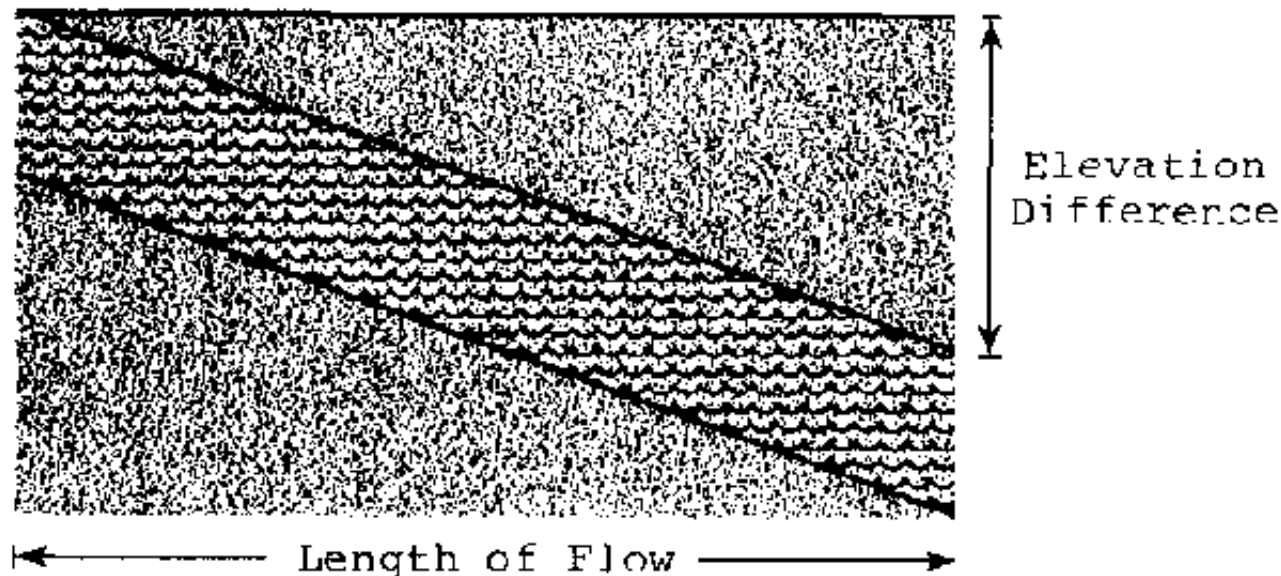
**L = distance along the flow path between point where  $h_1$  and  $h_2$  are measured.**

**P = a constant depending upon the characteristics of the porous material through**

**which the water flows.**

**Simply stated, Darcy's Law looks like this:**

$$\text{velocity of water} = \frac{\text{permeability of soil} \times \text{elevation difference}}{\text{length of flow}}$$



**Figure 5**

**REFERENCE: United States Indian Health Service.**

### **Session 23 - Water supply improvements**

TOTAL TIME Three Hours

OBJECTIVES \* Articulate basic standards for the quality, quantity, and convenience of a water supply system in a rural community.

\* State common techniques used in the field to improve the potability of

water in third world countries.

\* Describe the basic characteristics and methods of implementation of four water supply sources: well water, rainwater, surface water, and spring water

RESOURCES Water Treatment and Sanitation; H.T. Mann and D. Williamson, Chapters 1 and 3

Wells Construction; Peace Corps ICE, Chapter 1 and 2

Small Community Water Supplies; IRC, pp. 39-48, 59-72, 75-88, 100-131, 137-146, 191-313

Rural Water and Sanitation Projects; USAID, pp. 35-48, 59-129, 143-183

PREPARED Newsprint and felt-tip pens

MATERIALS

FACILITATORS One or more trainers and four trainees

## Trainer Introduction

**This session presents a great deal of information. It is designed for trainee facilitation. During Step 4, trainees should give presentations on the four water supply sources. They should be given ample time to prepare before the session. Trainers should consult with them in the days prior to the session to give advice and guidance. Assist the trainees in gathering any teaching aids they may request, such as newsprint and felt-tip pens. The reading assignment is very long. All trainees should be told well in advance. The assignment in Water for the World is meant to serve as reference information for the trainee facilitators. The other readings should be read by all trainees prior to the session, with the exception of**

**pages 191 to 313 in Small Community Water Supplies, which is intended for future use as a reference on water treatment.**

## **PROCEDURES**

Step 1 5 minutes

Present the objectives and format for the session.

Step 2 45 minutes

Lecturette on the quality, quantity, and convenience standards for a water supply.

## **Trainer Note**

### **Quality**

**It is difficult to set exact standards for water quality. Different countries, and in fact, different communities within one country, may have varied standards, and it is best to consult local government officials in an area to find out what the standards are. Small Community Water Supplies, on pages 42 to 48, presents some guidelines to follow. Refer the trainees to these guidelines. Discuss the following physical characteristics affecting water quality:**

TASTE:	minerals, chemicals, organic matter
COLOR:	toxic waste, minerals (iron), organic matter
ODOR:	chemicals (chlorine), organic matter
TURBIDITY:	suspended matter (clay, silt, iron)
TEMPERATURE:	higher temperature means higher bacteria growth

BACTERIA:	fecal coliform count
HARDNESS:	high mineral content
SOFTNESS:	low mineral content

## Quantity

**As in quality standards, consumption figures vary greatly among different communities. However, when designing a system, 20 liters/per person/per day should be the lowest acceptable standard for consumption. Remember, consumption figures always rise when water becomes more accessible. Refer to the table on page 40 of Small Community Water Supplies for specific consumption figures.**

## Convenience

**Even more so than quality or quantity, convenience standards vary greatly among communities. When designing a water system, you should set convenience standards that are acceptable by the local community. Remember that the location of the watering points, along with the quantity of water available, will affect consumption figures. Conversely, you can regulate consumption figures by the placement of water points in a system.**

Step 3 45 minutes

Describe simple techniques used to improve the potability of water.

## Trainer Note

## **Lead a general discussion about each of the following techniques:**

- **proper selection of water source**
- **good construction methods and selection of system components**
- **provisions for sanitary protection at the water source**
- **sand filtration; rapid or slow**
- **aeration**
- **settling chambers**
- **coagulation**
- **disinfection through chlorination**

**Refer to Small Community Water Supplies for more detailed information.**

Step 1 hour

4

Trainees give presentations on four water supply sources: well water, rainwater, surface water, and spring water.

### **Trainer Note**

**Trainees should provide a basic overview of the water supply source they present. Some factors to consider are: quality, quantity, convenience, methods of implementation, cost, labor requirements, and implementation time.**

Step 20 minutes

5

Review the presentations in terms of facilitation skills of the trainees, and technical



content. As a group, fill out the following chart on newsprint.

	<b>Well Water</b>	<b>Rain Water</b>	<b>Surface Water</b>	<b>Spring Water</b>
Quality				
Quantity				
Convenience				
Methods of Implementation				
Labor Requirements				
Implementation Time				

Step 6 5 minutes

Review the objectives and conclude the session.

## **Session 24 - Pumps: Installation, operation, maintenance**

TOTAL TIME Two hours

OBJECTIVES \* Discuss manual and power driven pumping mechanisms and evaluate their applications in rural communities.

\* Describe the basic characteristics and applications of four types of pumps: piston (suction, lift, force), rotary, centrifugal, and hydraulic ram

RESOURCES Hand-pump Maintenance; Arnold Pacey, pp. 6-33

Wells Construction; Peace Corps ICE, pp. 249-260

Rural Water and Sanitation Projects; USAID, pp. 131-142

Small Community Water Supplies; IRC, pp. 163-189  
Manual on the Hydraulic Ram; S. B. Watt  
Assignment Children; UNICEF, pp. 145-149

PREPARED Newsprint and felt-tip pens

MATERIALS

FACILITATORS One or more trainers and five trainees

## Trainer Introduction

**This session is designed to give a basic overview of various pumping mechanisms used throughout the developing world. Trainees are asked to facilitate a major portion of the session by giving presentations on four types of pumps. They should be asked well in advance of the session in order to have ample time for preparation. The resource books should serve as reference information for the trainees. Trainers should offer guidance and provide technical information to the trainee facilitators to aid in their preparations.**

## PROCEDURES

Step 5 minutes

1

Present the objectives and format for the session.

Step 10 minutes

2

Begin with a general explanation of what a pump does and how it can be powered. Then, ask the trainees for a list of criteria necessary in selecting a pump for a

community project.

## **Trainer Note**

**Explain that the purpose of any pump is to move or lift water from one place to another. Pumps can be powered by various means such as animal, human, electricity, wind, gasoline, or diesel. In regard to pump selection criteria, many trainees will reply on a technical level, mentioning such things as pump specifications, hydraulic factors, and depth of well. These criteria are important, but emphasis should also be placed on social, cultural, and organizational factors. The most important criteria for pump selection is the degree in which it is appropriate for the community that will use it. The community must have an organizational framework, a sense of social responsibility, and a technical skill level that fits the pump selected, and an understanding of the maintenance requirements.**

Step 3 10 minutes

Discuss factors influencing pump selection for a specific project.

## **Trainer Note**

**Mention each of the following factors:**

- The community using the wells and pumps: Is there an acceptance of well water? Does the community feel responsible for the pump?**
- The agency or persons administering the wells program: Are they interested in**

**preventative maintenance as well as repair? Are they willing and able to commit necessary resources, both human and material?**

**- The objectives of the wells program**

**- The type of pump used: Are pumps standardized? Are they designed properly and made well?**

**- The environment: Is the pump suited for the climate, hydrology, and geology**

**Refer to the Pacey book, pp. 10-14, for additional information.**

Step 15 minutes

4

Discuss three strategies for pump maintenance:

- Village self-sufficiency in manufacture and maintenance of the pump: This approach usually requires shallow hand-dug wells, with low-lift demands, and a very simple pump design. When successful, this strategy promotes a sense of responsibility and self-reliance in the community.

- Shared responsibility, by purchasing manufactured pumps from outside, and training local citizens in maintenance procedures: This approach requires education on pump maintenance, an emphasis on community participation in the wells program, and an infrastructure which can keep the system working.

- Removal of responsibility, by purchasing manufactured pumps from outside, and giving maintenance responsibility to an outside organization or agency: This approach does nothing but supply water to the village and therefore, is not considered development work. It has substantial organizational and financial requirements.

## **Trainer Note**

**Again, use the Pacey book, pp. 14-26, for additional information. Emphasize the strengths and weaknesses of each approach.**

Step 5 15 minutes

Discuss the three-tier maintenance system.

## **Trainer Note**

**The three-tier system is being used in many parts of the world. It consists of**

**1) Village Caretaker: This person should be a hardworking respected member of the community who is trained to carry out the following functions:**

- Inspect the pump regularly, perform maintenance requirements, and make minor repairs.**
- Educate the community on proper care for their well and pump.**
- Request help from and make reports to the next tier level whenever necessary.**

**2) Pump Fitter: This person lives in a central location and services 100 or so pumps throughout an area. He/she would respond to requests from the caretakers and carry out the following functions:**

- Make larger repairs to all above-ground parts of the pumps.**
- Communicate with village caretakers to ensure that regular pump maintenance is being done.**

- **Request help from and make reports to the next tier level whenever necessary.**

**3) Mobile Team: This is a team of people, stationed at a district level, equipped and qualified to make major repairs on the pumps if necessary. The team has overall responsibility for all components of the maintenance system and is required to respond to the needs of the two lower tiers.**

Step 1 hour

6

Trainee presentations on the basic characteristics of four pump types: piston (suction, lift, force), rotary, centrifugal, and hydraulic ram.

### **Trainer Note**

**One hour is not enough time to thoroughly discuss each pump type. The trainees should concentrate on providing basic information, such as the principles of operation, common examples of the pump, installation procedures, and maintenance requirements.**

Step 7 5 minutes

Review objectives and conclude session.

### **Session 25 - Field demonstration: Pump assembly and disassembly**

TOTAL TIME Two hours

OBJECTIVES \* Review the basic principles of shallow and deep well hand pumps, including installation, operations, and maintenance

\* Disassemble and reassemble a pump head and cylinder for a shallow and deep well hand pump

RESOURCES Rural Water and Sanitation Projects; USAID, pp. 131-142  
Wells Construction; Peace Corps ICE, pp. 249-257  
Small Community Water Supplies; IRC pp. 163-189  
Hand-Pump Maintenance; Arnold Pacey, Oxfam, pp. 6-33

PREPARED MATERIALS Shallow well lift and suction pump, deep well pump head (lift and force), pump cylinder, pump rod, drop-pipe, pipe wrenches, pliers, crescent wrenches, screwdriver, vice - grips, packing, grease, and drum of water

FACILITATORS One or more trainers

## Trainer Introduction

**This session is designed to give the trainees hands-on experience working with simple hand pumps. It requires substantial preparation and the availability of pumps to use in the demonstration. Assemble the trainees (a group of no more than eight, preferably four to six) at the location of the demonstration.**

**The pumps, pump parts, and tools should be laid out for observation. All trainees should practice the disassembly and reassembly procedures for all pumps. The resource material is meant to serve as reference information for the trainees.**

## PROCEDURES

Step 5 minutes

1

Present the objectives and format for the session

Step 15 minutes

2

Lecturette on the principles of shallow and deep well hand pumps, including installation, operations, and maintenance.

### **Trainer Note**

**This material should be a review of a previous session on pumps. Discuss briefly each of the pump types used in the demonstration, pointing out key components.**

Step 1 hour, 30 minutes

3

Trainees disassemble and reassemble the pump heads and cylinders. Test all pumps using the drum of water.

### **Trainer Note**

**The trainees should completely break down the pumps and then reassemble them to working order. It is important that each trainee participate actively during this step. Use this time to discuss each pump in greater detail, mentioning such things as maintenance requirements and operational limitations.**

Step 4 10 minutes

Review the objectives and conclude the session.

## **Session 26 - Field demonstration: Pipework and plumbing**



TOTAL TIME	Two hours
OBJECTIVES	<ul style="list-style-type: none"><li>* Articulate the basic characteristics and correct uses of three types of pipes: GI, PVC, and PE</li><li>* Demonstrate correct methods of cutting and joining different types of pipes, including the assembly of proper fittings and valves for a simple rural standpipe</li></ul>
RESOURCES	Attachment 26-A: "Pipes and Pipeworking"
PREPARED MATERIALS	Select lengths of GI, PVC, and PE pipe, a variety of fittings and valves, including: couplings, 90° bends, 90° elbows, 45° elbows, nipples, tees, unions, bell reducers, bushings, plugs, caps, adapters, globe valves, gate valves, and taps, pipe vise, pipe threader, cutting oil, pipe dope, pipe cutter, hacksaw, steel file, pliers, screwdriver, two pipe wrenches, gloves, sandpaper, dry cloth, PVC solvent cement and cleaner, wormdrive clamps, and bailing wire Copies of the Attachment for all trainees
FACILITATORS	One or more trainers

## Trainer Introduction

**This session is designed to give the trainees hands-on experience working with pipes. It requires substantial preparation. Assemble the trainees (a group of no more than eight, preferably four to six) at the location of the demonstration.**

**Two stations should be set up, one for GI pipe, and the second for plastic pipe. All the materials and tools should be laid out for observation. The fittings and pipes should be of uniform size in order to construct a standpipe at the end of the**

**session. If this is not possible, make sure that you have the necessary bushings or reducers to construct the standpipe. All trainees should practice cutting and joining the pipes. Trainees with experience in this area should be used as co-facilitators. The resource Attachment is meant to serve as reference information for the trainees. The Attachment should be read prior to the session.**

## **PROCEDURES**

Step 5 minutes

1

Present the objectives and format for the session.

Step 15 minutes

2

Lecturette on characteristics and correct uses of all three pipe types and appropriate fittings.

## **Trainer Note**

**Discuss, in general terms, the three pipe types. Mention their primary uses in a water system, their strengths and weaknesses, methods of joining and cutting, and the fittings used for each type. Also, identify the tools appropriate for each pipe type. It is helpful to have all materials and tools laid out on a large table for this step.**

Step 3 1 hour, 15 minutes

Trainees practice cutting and joining all three types using proper tools and fittings.

## Trainer Note

**This should be an active, hands-on exercise. Make sure that all trainees participate throughout. If necessary, demonstrate the procedures at the outset. Also, use this time to discuss such things as trenching procedures, pipe system lifespan, and hydraulic characteristics.**

Step 15 minutes

4

Construct a standpipe with GI pipe and fittings, teeing off from a plastic main water line. See Figures 1 and 2 from Attachment 26-A.

## Trainer Note

**Refer to the attachment for a simple design of a standpipe. Emphasize the importance of proper installation and maintenance.**

Step 5 10 minutes

Review the objectives and conclude the session.

## Attachment 26A: Pipes and pipeworking

### Types of Pipe

**The proper selection and use of pipe is a vital component of all gravity and pumped water systems. Therefore, it is important for all water technicians and**

**engineers to be familiar with the characteristics of various types of pipe and to learn the correct methods of working with pipes in the field. This attachment will deal with three types of pipe which are widely distributed around the world and commonly used for piped water systems.**

**Galvanized iron pipe (GI) is regular iron pipe that is coated with a thin layer of zinc. The zinc greatly increases the life of the pipe by protecting it from rust and corrosion. It usually comes in six meter (21 foot) lengths and is joined together by threaded connections.**

**Plastic polyethylene pipe (PE) is black, lightweight, flexible pipe that comes in large coils, 30 meters or more in length. The pipe varies in density, and is joined by inserted fittings with clamps or heat fusion using a steel plate.**

**Plastic polyvinyl chloride pipe (PVC) is a rigid pipe, usually white or gray in color. It comes in three or six meter lengths, and is joined primarily by solvent cement, but can also be threaded. The pipe varies in density, and when buried, is extremely resistant to corrosion.**

**The following table lists some of the characteristics of the three types of pipe:**

	<b>GI</b>	<b>PE</b>	<b>PVC</b>
<b>Life Expectancy Resistance to Corrosion Underground</b>	Very long life expectancy of 30 years or more. However, joints are subject to rust and may break if not properly supported.	Generally good life expectancy. However, has low stress resistance and poor rigidity	Long life expectancy if properly laid and backfilled

<b>Resistance to Corrosion or Chemicals Inside Pipe</b>	Will corrode in acid, alkaline, and hard water	Very resistant. However, very soft or very hard water can corrode	Very resistant. However very soft or very hard water can corrode
<b>* Safe Working Pressures (PSI)</b>	Adequate for all pressures found in small scale water systems	Ratings from 80-160 PSI	Ratings from 80-600 PSI
<b>Resistance to Puncturing and Rodents</b>	Very high resistance	Low resistance	Good resistance
<b>Effect of Sun and Weather</b>	No effect; however, threaded ends may rust	Weakens with exposure	Weakens with exposure
<b>Ease of Joining, Laying, Bending</b>	Difficult to join, lay and bend. Very heavy	Easy to join and lay because of few joints and light weight. Bends readily, but will collapse on short bends	Easy to join and lay. Rigid, but will bend on long radius. Can be bent by heating
<b>Cost</b>	Very high cost, especially in larger diameters	Low cost	Moderate cost

**\*Always check pressure ratings with local manufacturer.**

## **Working with Pipes**

## **GALVANIZED IRON**

**Before the advent of plastic pipe, GI was the primary type of pipe used in water systems. Much of it is still in use today. GI has several advantages in a water system; it is very durable in the field, able to withstand high pressure heads, and minimally affected by water hammer. Leakage is also rare because the pipe is very hard to puncture and the threaded joints tend to seal themselves over time. GI pipe may be laid above ground, under roads, or across streams, performing well under all these conditions. The threaded joints, however, can be broken much more easily than the solid pipe, and therefore, must always be well supported.**

**GI pipe also has a number of disadvantages: its weight makes it difficult to transport, threaded joints are difficult and time consuming to make, certain kinds of water can corrode and rust the pipe, and it is difficult to repair in the field or tap-in new branch lines.**

**The tools necessary for working with GI pipe are costly. However, if such tools are properly maintained, they can last a lifetime. The basic tools for such work are as follows: pipe vise or clamp, pipe threader, pipe reamer, cutting oil, pipe dope or Teflon tape, pipe cutter or hacksaw, steel file, wire brush, and large pipe wrenches (14", 18").**

**A variety of fittings are used to connect the pipe. Pipe threads are called "male" for outside threads, and "female" for inside threads. The pipes themselves usually come in 21 foot (six meter) lengths, and are factory threaded at both ends; usually one coupling is also provided. A variety of diameter sizes are available, from small (3/8", 1/2" and 1") to large (4" and 6"); these sizes always referring to the inside**

**diameter of the pipe. The outside diameter would measure 1/4" larger because of the wall thickness. The typical procedure for cutting, threading, and joining GI pipe is as follows:**

- 1. Clamp the pipe securely in the vise with 6-8" protruding from the vise jaws.**
- 2. If the pipe needs cutting, cut with a pipe cutter or hacksaw. Make the cut straight and clean all burrs with a pipe reamer or steel file. It is very important to remove all burrs.**
- 3. Carefully place the pipe threader on the end of the pipe. Make sure that you are using the correct size pipe die, and that you have the teeth facing the correct way. The large end of the tapered teeth should go on first. Start the guide onto the pipe by firmly holding the die with one hand, and turning the ratchet handle clockwise several turns with the other hand. Check to make sure that the threader is on straight and the die teeth are cutting properly. Squirt cutting oil generously onto the end of the pipe as you continue to rotate the threader. Every couple of turns, back off the threader a quarter turn to clear off the burr, especially if the teeth bind. Keep going one full turn past the point where the pipe emerges from the die. Stop, reverse the ratchet and back the threader off the pipe. The threads should be clean, sharp, and continuous, with no broken points or burrs. Clean the threads with a wire brush and cloth rag.**
- 4. At this point, you should always test the thread size by putting on a fitting. If you plan to install a fitting, start by applying pipe dope compound to the male thread, not the fitting itself. This will allow the fitting to be easily installed and more importantly, removed at a later date if necessary. Teflon tape can be used**

**instead of pipe dope. The tape is wrapped tightly, one and a half layers around the threads in a clockwise direction.**

**5. Start the fitting with your hand by turning clockwise. Make sure that it is on straight and not cross-threaded. It should turn two or three rotations with your hand before it becomes tight. Now tighten with a pipe wrench, pulling the handle towards the open jaws, not away from the jaws. This will make the teeth bite and hold. Keep turning until the fitting is tight. Usually, the fitting is tight when two or three threads are left exposed. Be careful not to apply too much force. The threads are tapered and too much pressure can split the fitting. If you are using wrenches to install the fitting, place the second wrench facing in the opposite direction on the pipe, close to the fitting. You may turn either the pipe or the fitting, whichever is easier.**

## **Plastic Pipe**

**Plastic pipe has become the preferred type of pipe for small water systems around the world. It has several advantages when used in a water system: it is lightweight and easily transported, simple to join, cut and lay, low in cost relative to GI pipe, very resistant to corrosion inside the pipe, and its smooth inner walls reduce friction loss factors. However, it also has some disadvantages: it is easily punctured, will withstand only moderate pressure heads, weakens when exposed to weather, and must be laid underground in a particular manner in order to perform satisfactorily.**

**The two most common types of plastic pipe are PE, and PVC.**



## **Polyethylene Pipe (PE)**

**The tools necessary for working with PE pipe are few. The basic tools are as follows: handsaw, file or rasp, pliers, and screwdriver. Fittings consist of adapters to inside and outside threads, couplings, elbows, and tees. They are made of either plastic or galvanized steel. The pipe comes in large coil rolls, and size is based on inside diameter. It also comes in various densities which correspond to the amount of pressure head that it will withstand. Its light weight and flexibility make it easy to work with, and because it comes in large rolls, very few joints are needed when laying the pipe. However, of the three pipes discussed here, PE is the weakest; it has poor rigidity, is the most easily punctured and handles the lowest pressure heads.**

**When joining PE, the pipe slips over serrated fittings and is clamped with stainless steel worm drive clamps, or secured tightly with thin steel wire if clamps are not available. The typical procedure for cutting and joining PE pipe is as follows:**

- 1. With a hand saw, make a straight cut on the pipe ends that are to be joined.**
- 2. Remove all burrs with a file, rasp, or knife.**
- 3. Slide the clamps onto the pipe ends.**
- 4. Position the fitting on the pipes and join the ends together.**
- 5. Tighten the clamps with a screwdriver or securely wrap steel wire around the pipe and tighten with pliers.**

## **Polyvinyl Chloride (PVC)**

**PVC is the most versatile pipe used in small rural water systems. The tools**

**necessary for working with PVC are as follows: handsaw or hacksaw, file or rasp, clean dry rags, PVC solvent cement and applicator. Fittings consist of couplings, reducers, elbows, adaptors, tees, and caps. They are joined together by the use of solvent cement. The pipe comes in three or six meter lengths and is usually gray or white. It also comes in various densities which correspond to the amount of pressure head that it will withstand. It is lightweight, but its rigidity makes it quite strong. It is very resistant to corrosion and when properly laid in a trench, will last indefinitely. Cutting, joining, and laying PVC pipe is a simple process. The typical procedure is as follows:**

- 1. With a hand or hacksaw, make a straight cut on the pipe ends which are to be joined.**
- 2. Remove all burrs inside and out with a file, rasp, or knife.**
- 3. Clean all pipe surfaces that will be joined. The pipe and fitting must be clean and dry. You may rough up the pipe surface with a file or rasp for better contact.**
- 4. If available, apply pipe cleaner to the pipe and fitting.**
- 5. Apply a liberal coating (it should not be dripping off, however) of solvent cement to the pipe surface and fitting. Coat all the way around the pipe and fitting. Work quickly because some types of solvent cement set up very quickly. Also, do not expose any cement to direct sunlight, if possible.**
- 6. Join the two surfaces together firmly, making sure that the pipe is pushed all the way into the fitting.**

**7. Gently set the joint down and do not disturb it until it has reached its initial set. (This set time will vary with different types of solvent cement; check the label.)**

## **TRENCHING**

**Both PVC and PE must be buried underground to provide satisfactory service. Therefore, it is necessary to dig a trench the entire length of the pipeline. Trenching is no easy job, even under the best of conditions and consequently, digging the trench is usually the most time consuming and labor intensive task in a water project. If trenching and pipe laying are done properly, however, the life span of the system will be greatly increased, and maintenance problems greatly reduced.**

**The trench itself should be of uniform depth and gradation. The standard acceptable depth is one meter, and the trench should have no sharp corners nor run in a zigzag manner. The bottom should be relatively smooth and free of rocks or sharp objects which could damage the pipe. Join and lay the pipe as described above. When backfilling, the pipe should first be completely covered with dirt alone (no rocks or sticks) up to one third of the trench depth. This earth should be compacted to protect the pipe from surface pressures. The trench is then completely backfilled with the remaining soil. Rocks may be placed towards the top of the trench. Remember to compact the soil while backfilling; this will help stabilize the trench. Also, the top of the trench, when complete, should have a slight crown, to allow water to run off the trench rather than down it.**

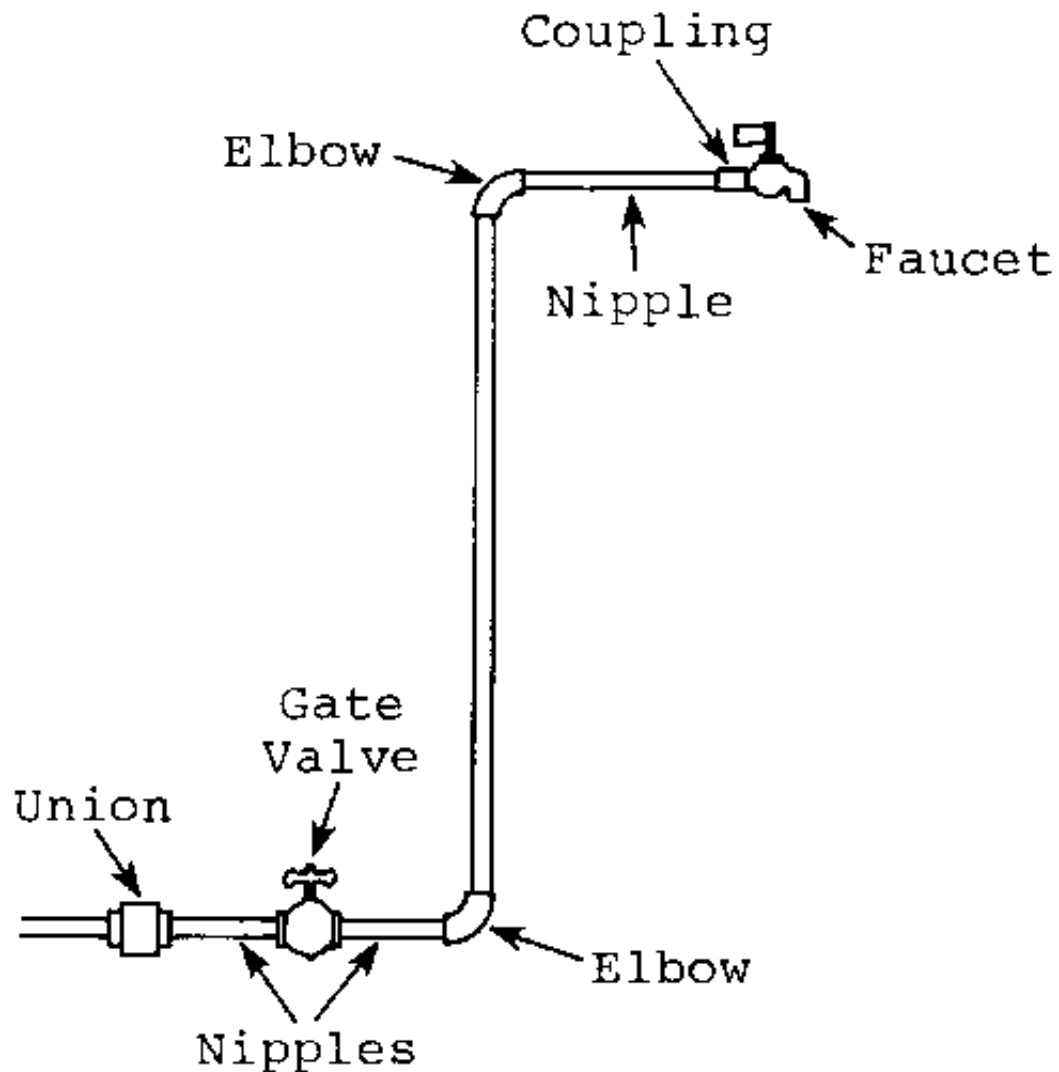
**Once the pipe has been laid in the trench, it should be backfilled as soon as possible. Therefore, one should not lay more pipe in one day than can be backfilled**

**in that same day. The pipe should be completely backfilled except for a two to three meter area at each joint. The joints should be only partially covered until the line has been tested for 24 hours with working pressure.**

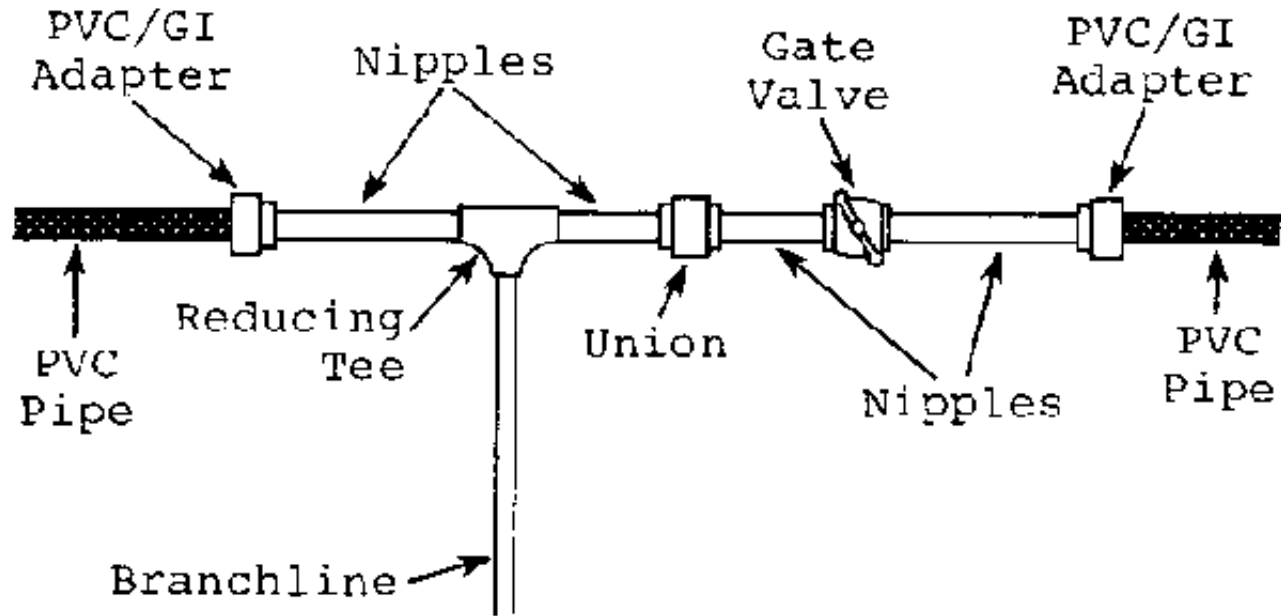
**The course of the trench should follow, whenever possible, the route of the original survey. Some detours may be necessary to avoid such things as heavy erosion areas, extremely rocky places, or steep gullies. However, if detours occur, care should be taken so that the route does not change the hydraulic gradient of the system.**

**At times, GI pipe may be needed to cross streams, roads, or other areas where trenching is impossible. These areas should be marked out when the original survey is done. In determining the rest of the route, the surveyor should select the easiest course for trenching.**

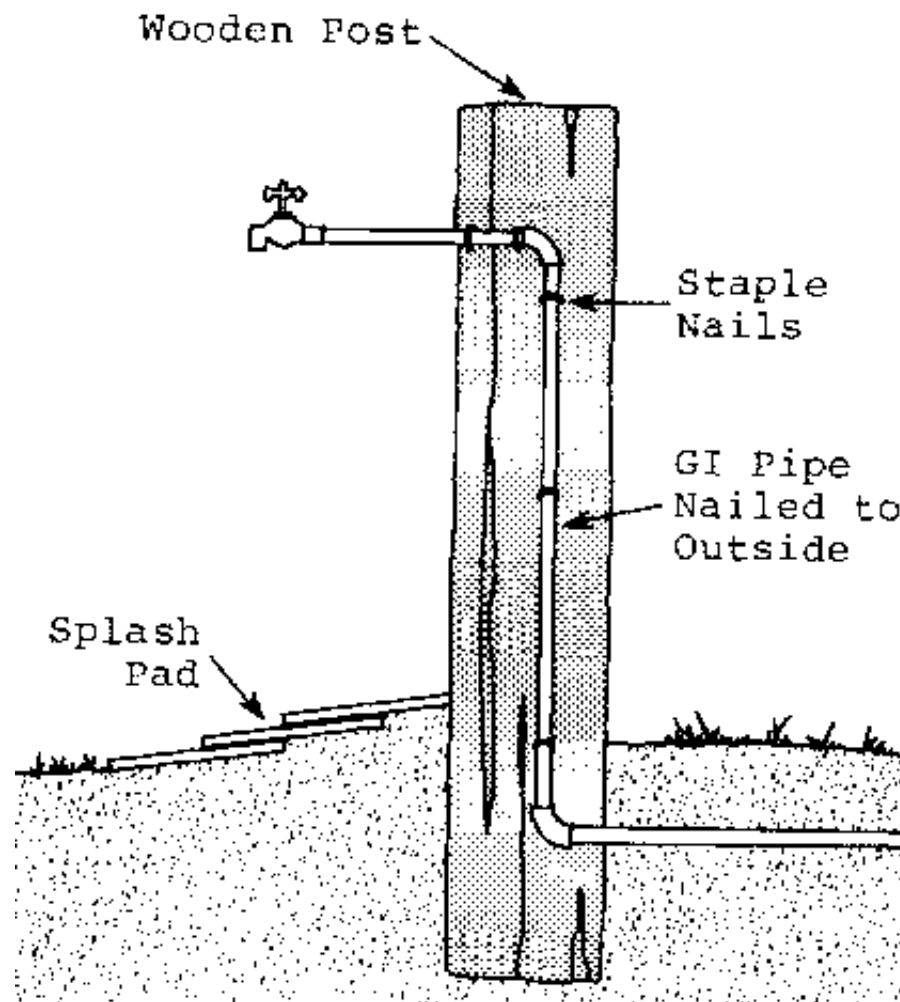
**REFERENCE: Handbook of Gravity-Flow Water Systems for Small Communities. Thomas D. Jordan, UNICEF and Intermediate Technology Publications.**



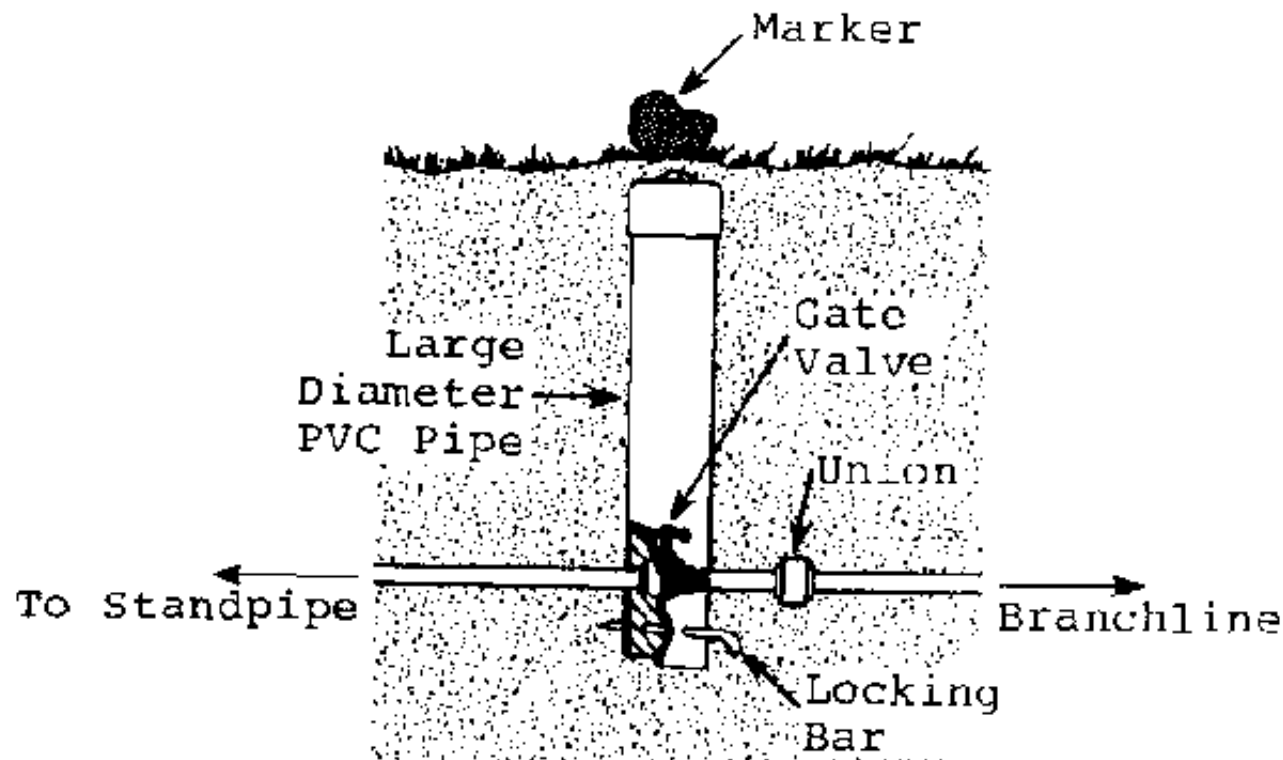
**Figure 1: Simple Standpipe - Profile View**



**Figure 2: Mainline Branch For Standpipe - Plan View**



**Figure 3: Simple Rural Standpipe**



**Figure 4: Simple Rural Valvebox**

## Session 27 - Principles of hand-dug shallow wells

TOTAL TIME Two Hours

- OBJECTIVES
- \* Identify factors that determine a suitable site for a hand dug shallow well
  - \* Explain, in detail, various methods of constructing shallow tube wells
  - \* List proper safety practices that should be followed during well construction
  - \* Describe the construction steps necessary for a shallow well project.

RESOURCES Small Community Water Supplies: IRG, pp. 100-131, 130



Rural Water and Sanitation Projects; USAID, pp. 107-129

Wells Construction; Peace Corps ICE, Chapters 1-9

Attachment 27-A: "Large Diameter Tube Wells"

## PREPARED MATERIALS

Newsprint and felt-tip pens

Slides or sketches of well project construction steps, slide projector and screen, copies of the Attachment for all trainees, reproductions on newsprint of Figures 1, 2 and 3 from the Attachment

FACILITATORS One or more trainers

## Trainer Introduction

**This session is designed to provide detailed information about the construction of hand-dug shallow wells. It concentrates on large diameter tube wells using reinforced concrete for a lining. This is the method of construction that will be used to rehabilitate an existing shallow well during Session #30. If an alternative method of construction is more appropriate for your training program, substitute an explanation of that method(s) during Step 3.**

**The slide or sketch presentation should concentrate on the method of construction you plan to use during the training program. Prepare the presentation prior to the session. The reading assignment is long and therefore, trainees should be told of the assignment well in advance. Hand out the attachment prior to the session.**

## PROCEDURES

Step 1 <sup>5 minutes</sup>

Present the objectives and format for the session

Step 2 15 minutes

Ask trainees to identify criteria that determine a suitable well site.

List the responses on newsprint.

## **Trainer Note**

**Most of the criteria will fall under three general headings: community, hydrology, and topography. Lead a discussion about each heading. Below are factors to consider:**

### **\*HYDROLOGY**

**Geology: Soil type (sand, clay, gravel, boulders), water bearing capacity of soils, suitability for safe digging**

**Aquifer: Depth, size, water quality, recharge (test drilling may be necessary if there are no existing wells nearby)**

### **\*TOPOGRAPHY**

**Contamination: Locating all possible sources of contamination, listing methods to protect well or remove contamination**

### **\*COMMUNITY**

**Community: Well accessibility, project acceptance, project support**

## **Labor: Availability of human and material resources for construction, operations, and maintenance.**

Step 45 minutes

3

Refer to Attachment 27-A. Describe the components, construction sequence, strengths, and weaknesses of large diameter hand-dug shallow tube wells.

### **Trainer Note**

**Review the information presented in the Attachment with the trainees. Use your reproductions on newsprint of Figures 1, 2 and 3 to illustrate important points.**

Step 4 20 minutes

Discuss proper safety practices during well construction.

### **Trainer Note**

**Emphasize that good safety practices are as easy to follow as poor safety practices. If good practices are instigated from the beginning, and followed by all participants, they quickly become part of the normal work routine. Here are some safety points to mention:**

**1. Check all equipment before construction begins. This includes ropes, pulleys, tripods, buckets, digging tools, handles, ladders and all other necessary equipment. Buying quality equipment also helps greatly. It may cost more money initially, but soon pays for itself in terms of safety and efficient use.**

**2. Guard the area around the well hole at all times to prevent material from falling down the hole. This is true when work is in progress and when it is not. Objects falling down the hole can seriously injure people digging. Also, an unattended and uncovered hole is a serious community hazard. Equipment should be kept in a central location and always returned there after being used.**

**3. A well should always be lined during excavation (unless the earthen strata is extremely stable) to prevent collapse. No more than 5 meters should be dug before the lining is put in place and for many types of soil, this figure will be even less. Once put in place (temporarily or permanently) the lining should be checked regularly.**

**4. Asphyxiation can be a serious problem during digging. This is especially true in deep wells or when gasoline powered pumps are lowered into a well to drain the water. Ventilation is poor in wells. Therefore, if gases have built up, no one should go down into the well until the air has cleared.**

**5. A lead person should be designated and always stand near the top of the well to keep in contact with those down below. This person should monitor all safety procedures.**

Step 5 30 minutes

Illustrate the construction steps necessary for a shallow well project.

## **Trainer Note**

**Again, illustrate the method of construction that will be used during the training**

## **program. The following steps should be illustrated:**

- Site Selection	accessibility, water quality and quantity, ease of construction
- Site Preparation	Safety procedures, collection of materials, tools and equipment
- Excavation	Safety procedures, desired depth and width
- Lining	Safety procedures, desired method of lining
- Sanitary Seal	Complete protection from contamination
- Retrieving Water	Appropriate method for community
- Operations/Maintenance	Plan and ongoing program

Step 6 5 minutes

Review the objectives and conclude the session.

## **Attachment 27A: Large diameter tube wells**

### **Introduction**

**Large diameter tube wells are the most common hand-dug shallow well seen around the world. Various forms of this type of shallow well have been in use for hundreds of years.**

**During the last few decades, thousands of large diameter tube wells have been constructed during development projects. The aim has been to provide a safe, adequate, and reliable source of drinking water for millions of people.**

**Throughout the developing world, when properly constructed, this type of well is**

**able to accomplish that aim. It is especially effective in areas where there is a water table of adequate quantity, at a relatively shallow depth below the ground level surface. These wells rarely go deeper than 20-25 meters and are usually 1-1.5 meters in diameter.**

**What follows, is a general discussion of large diameter tube wells.**

## **Components**

### **1. SHAFT**

**This is the section from just below ground level to just above the water level. It consists of reinforced concrete, either cast in-situ or lowered in place with the use of pre-cast concrete rings. It is especially important that the top three meters be impervious to surface contamination.**

### **2. INTAKE**

**This is the section in the water table itself. It should extend from just above the water level to at least three meters below the dry season water level. It consists of porous precast concrete rings or solid rings with a porous cap at the bottom to allow water to enter the well.**

### **3. WELLHEAD**

**This is the sanitary seal for the top of the well. It consists of a headwall rising up from the lining to above ground level and an apron extending out around the perimeter of the well. It may also include a well cover compatible with the method**

**of retrieving water from the well, and a drainage trench.**

## **Construction Sequence**

**Basically, there are two methods used to construct tube wells of this kind. The shaft and intake may be cast in-situ, that is, inside the well itself, or may be precast and set into place. For both methods, the beginning steps are the same.**

- The construction site must be organized and set up properly.**
- All tools and materials should be on hand.**
- Excavation is started and, in most cases, the top section of the well must be temporarily lined to prevent cave-in.**

### **1. CAST IN-SITU:**

**Figure 2. This method requires that form work be placed down the well. In most cases, collapsible round metal forms, are placed down into the hole to serve as the inside form for the concrete shaft. The soil serves as the outside form and concrete is poured between the metal forms and the soil. Pours are usually done in 3-5 meter lengths which obviously requires several sets of metal forms. The average metal form size is .5-1 meter in height, and 1 1.5 meters in diameter and are very similar to the forms used to make drainage culverts.**

**To use the metal forms, the hole must be dug plumb and be of a uniform diameter. The first set of forms is placed down in the bottom of the hole, on firm ground and made level and plumb. Vertical lengths of rerod are placed the full length of the pour. This first set of forms and rerod is secured by partially backfilling with earth.**

**This backfilled section will later tie into the next pour. Then, concrete is poured, anchored at the start with a curb (see Figure 2), and continued to the top of the forms.**

**Next the second set of forms is placed on top of the first and concrete is poured. The process is repeated as you move up the shaft. With this first pour completed, excavation is continued and the same process used to continue lining the shaft (see Figure 3). Concrete curbs must be placed every 3-5 meters and an especially solid curb poured when the bottom of the shaft is reached. A 15 cm space is left open between pours to allow for settling. This space is filled when the shaft is completed.**

**In some cases, the intake section of the well can be constructed in the same manner. However, often this is a very difficult task because of the inflow of water into the well. A most desirable method uses pre-cast culvert rings, slightly smaller in diameter than the shaft, placed on top of one another and lowered into the aquifer. Excavation is then done from inside the rings and they are allowed to sink of their own weight. The rings are stacked, two or three at a time, to help them sink in a more uniform fashion. They need to be connected in some way to prevent them from shifting out of alignment.**

**When the intake has been dug to the desired depth, a portion remains within the shaft. At no time should the top level of the intake be allowed to sink below the bottom level of the shaft (See Figure 2). If, in the future, the intake needs to be lowered, it is a relatively simple task, requiring further digging only.**

**The bottom of the intake is capped with graded aggregate, a porous concrete slab,**



**or both. Lastly, the well head is put in place, backfilling completed, and a method for retrieving water installed.**

## **2. PRE-CAST:**

**Figure 1. This method is similar to that described for placement of the intake section earlier. Two or three meters of excavation are done and then the precast culvert rings are lowered in place. The remaining excavation takes place inside the rings and they slowly sink down the well. It is absolutely necessary that the individual rings be connected in some fashion, either by lap joints, bolts, or chains. If not, they will slip out of alignment, either during construction itself or after the well is complete through pressure from the surrounding soil.**

**In many cases, the intake section of the well may be lowered first and made continuous with the shaft as construction progresses. Porous rings are often used in these cases for the intake section and solid rings for the shaft (See Figure 1).**

**Alternatively, the shaft may be set in place first and the intake lowered inside the shaft as described above.**

**In cases where the soil is exceptionally stable, a complete excavation may be done and the rings then lowered one at a time and stacked on top of one another all the way up to ground level. It is recommended that only experienced well diggers use this method because of the difficulties involved with lowering the rings deep into the well. The rings are very heavy (250 kg. on up) and even lowering them a short distance, using a tripod and wench, is a difficult task.**

**The cap for the intake, well head, and method of retrieving water are constructed**

## **to finish the well.**

### **Retrieving Water**

**A properly constructed well may be rendered useless because of an inappropriate or poorly maintained method of retrieving water. Therefore, the selection of this method is a very important decision. The method that is chosen to collect water from the well can be very simple, such as a rope and bucket, or involve a machine operated pumping mechanism. Whatever method selected, it must be appropriate to the situation and acceptable to the users.**

### **Maintenance**

**A proper plan for operations and maintenance must be put in place from the very beginning. The plan should be a part of the initial design stages and be agreed upon by all participants. User involvement is often a key to successful maintenance. The plan will vary according to each individual situation however, some general maintenance tasks should be carried out in all cases:**

- 1. The area around the well itself, the well head and apron, should be kept clean and free of standing water.**
- 2. Good drainage is required around the well site.**
- 3. The well site should be fenced off to prevent animals from entering the area.**
- 4. Washing clothes and other domestic chores should be done- a safe distance from the site.**

**5. The inside of the well should be cleaned periodically and disinfected if appropriate and acceptable.**

**6. The method of retrieving water must be regularly maintained. If a rope and bucket is used it should be communal and fixed in one safe place. A removable cover should also be placed over the well. If a pumping mechanism is used, a person or persons should be directly responsible for its maintenance. If possible, a self-priming pump should be used because of the fact that constant pump priming can lead to contamination of the well water.**

## **Weaknesses**

**The primary weaknesses of large diameter tube wells are a result of two forces that exert pressure on the well. First of all, there is horizontal sideways pressure on the well which can distort or shift the alignment of the shaft and intake. This pressure can be resisted, for the most part, if the shaft is made of reinforced concrete. If pre-cast rings are used, they must be securely fastened together at the joints. The second pressure is vertical, caused by the weight of the shaft and intake, and can make the well buckle, cave in, or sink. This pressure can be resisted by the use of curbs or footings, poured into the soil, every few meters. Other disadvantages include:**

**\* A fair amount of heavy equipment is necessary, such as metal forms and wench and tripod headframe, to construct the shaft and intake, or to lower precast rings into place. Also, the equipment cost make the overall cost of the wells high, especially if only a few wells are to be constructed.**

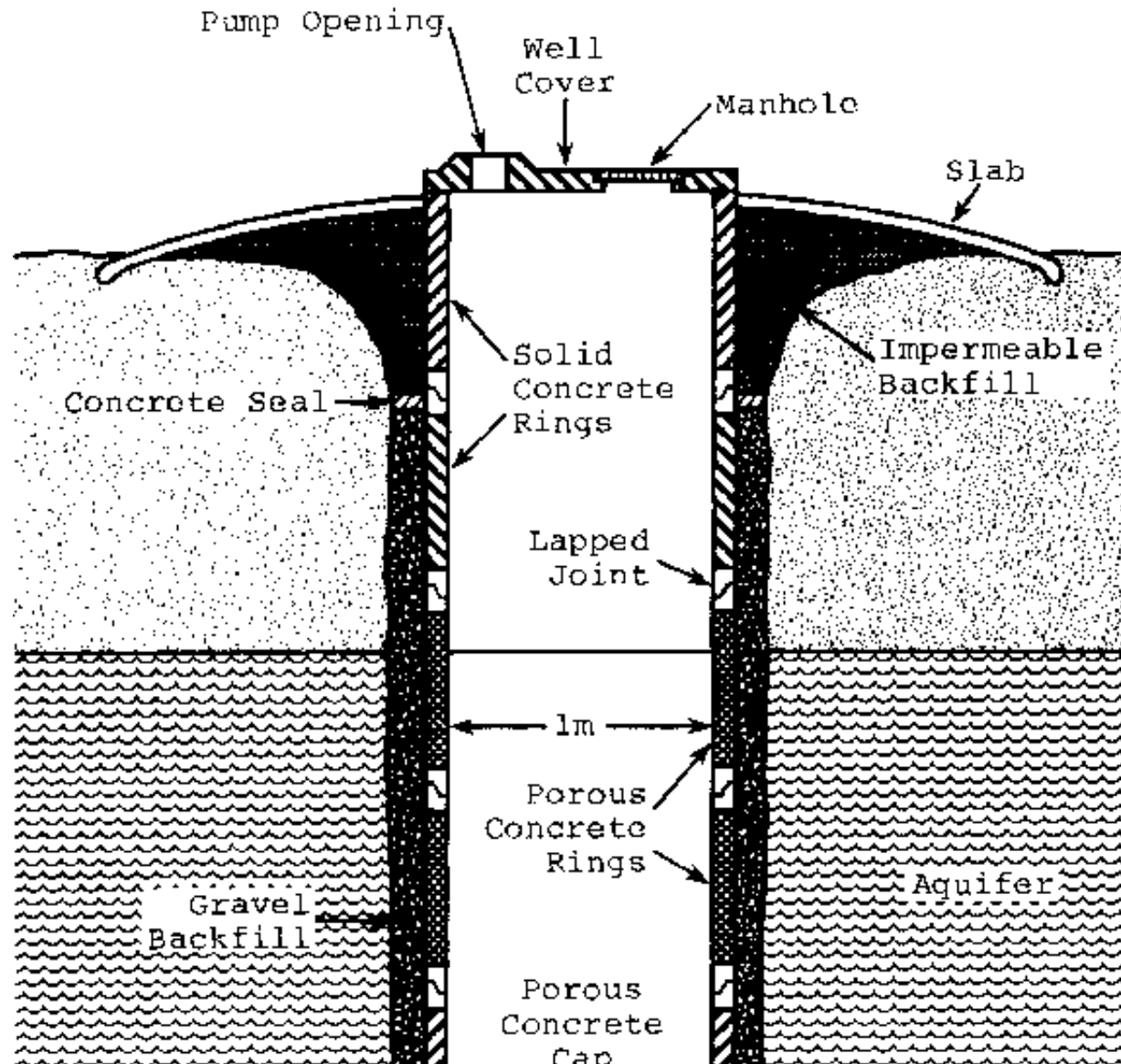
- \* **Pre-cast rings are difficult to handle and are relatively expensive to make or buy.**
- \* **Practically speaking, the maximum well depth possible is 40-50 meters.**
- \* **In the intake section, because of the pressure difference between the inside and outside of the rings, sand and loose soil has a tendency to suck up into the well through the bottom. However, this pressure difference is decreased if porous culvert rings are used in the intake section.**

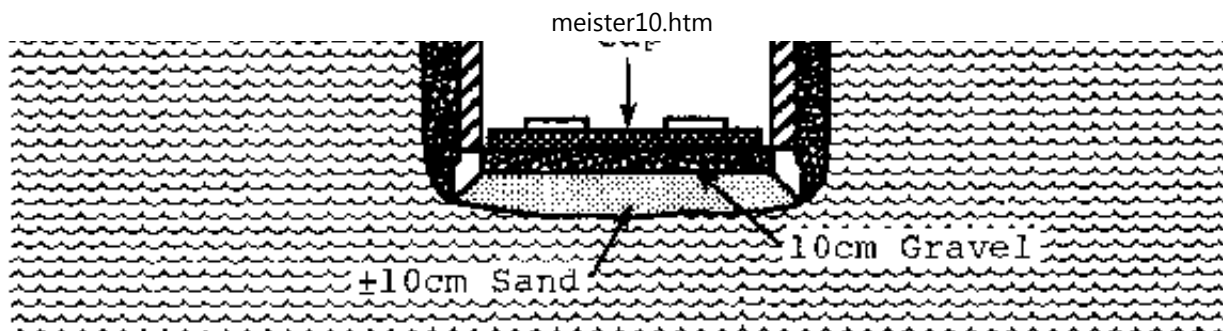
## **Strengths**

**The advantages to this type of well are many.**

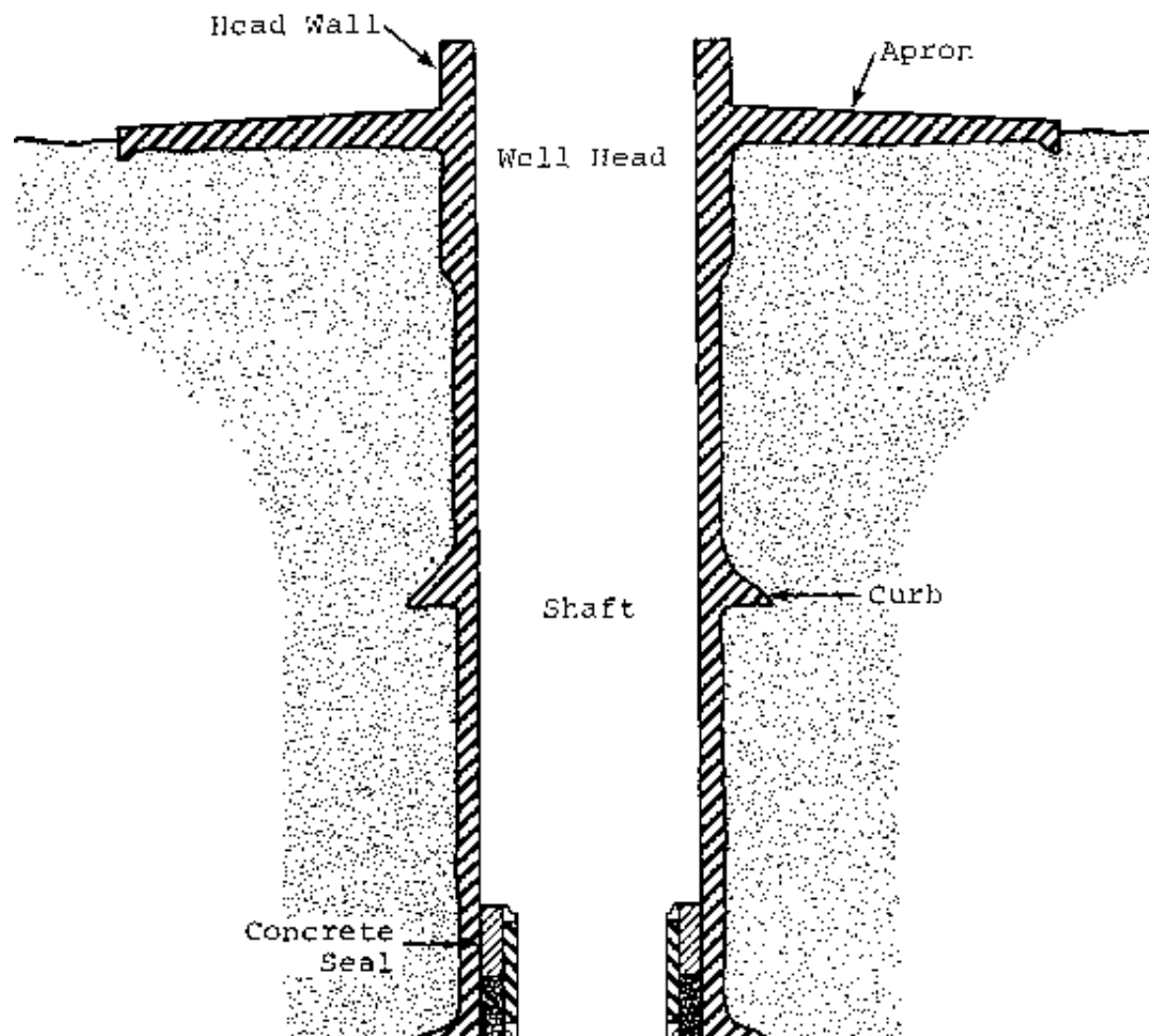
- \* **When dug to the correct depth, the well has a large water storage capacity.**
- \* **The open shaft allows access to the well at all times.**
- \* **A variety of methods are possible to retrieve water.**
- \* **Although some heavy equipment is required, much more is needed for other types of construction such as drilling.**
- \* **The construction equipment can be used over and over again, if properly maintained, which progressively lowers the cost of each well.**
- \* **The technology is relatively simple and easy to learn.**
- \* **When properly constructed and maintained, the tube well protects the water from contamination and has a long life span.**

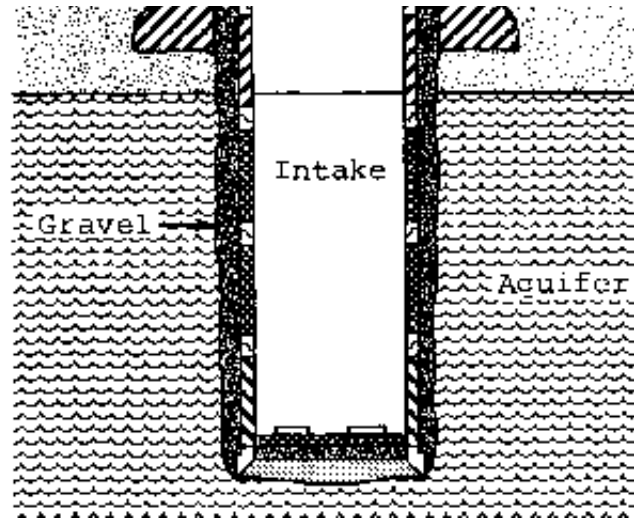
**REFERENCE: Hand Dug Wells and Their Construction; S. B. Watt and W. E. Wood, Intermediate Technology Publications Ltd., London, 1977.**  
**Small Community Water Supplies; E. H. Hofkes, Technical Paper Series Number 18, International Reference Center, The Hague, Netherlands, 1981.**



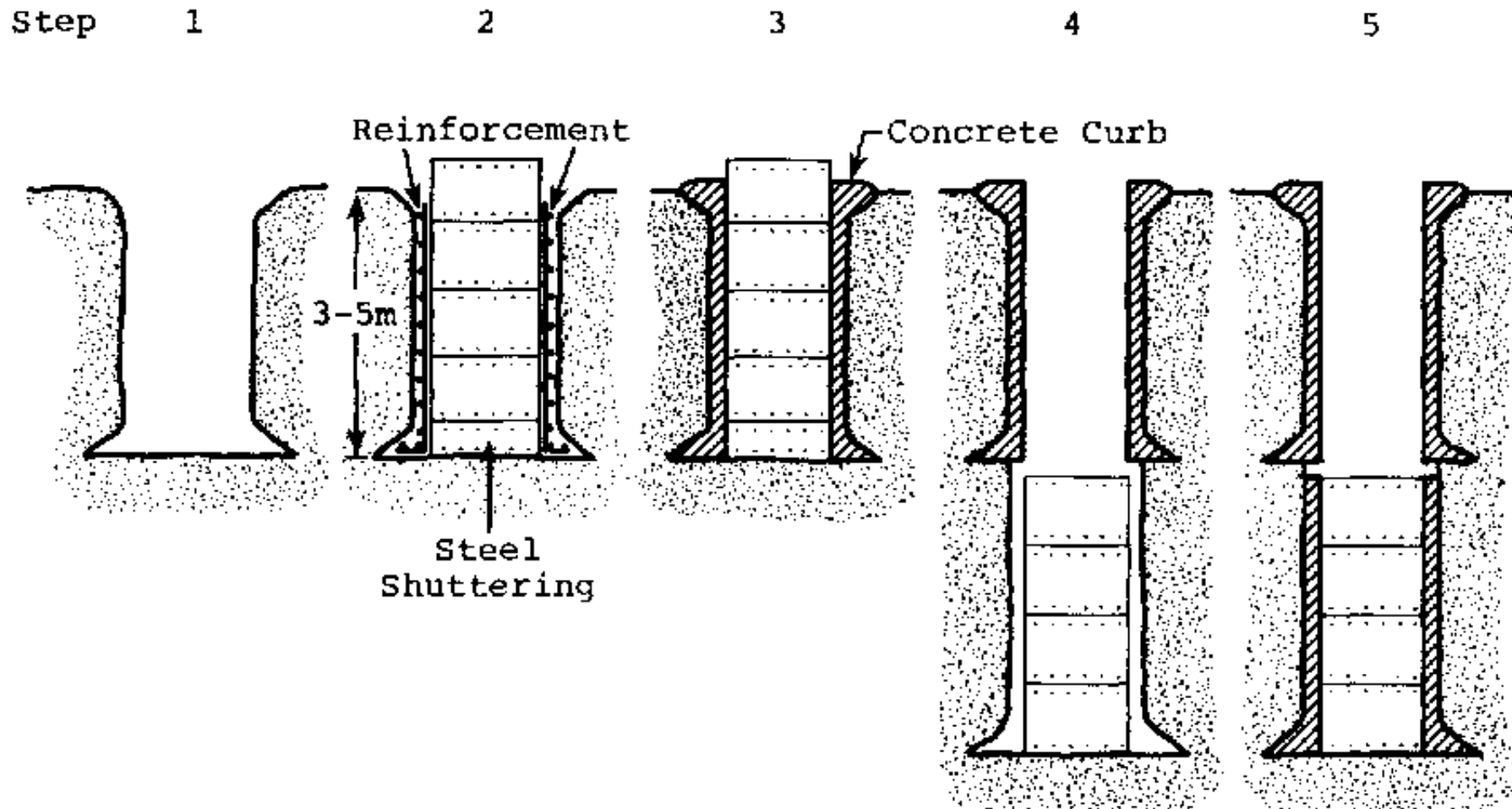


**Figure 1 - Hand-Dug Tube Well**





**Figure 2 - Hand-Dug Tube Well**



**Figure 3 - Steps For Constructing Reinforced Concrete Well Shaft**

## Session 28 - Well site inspection and feasibility survey

- TOTAL TIME** Two to four hours (depending on distance to well sites from training headquarters)
- OBJECTIVES**
- \* Become familiar with shallow hand-dug wells through a tour of existing well sites
  - \* Describe the relative strengths and weaknesses of each site with regard



Describe the relative strengths and weaknesses of each site with regard to method of construction, safety considerations, sanitary protection, method of retrieving water, and steps for possible rehabilitation

RESOURCES Wells Construction, Peace Corps ICE, Chapters 2-9  
Rural Water and Sanitation projects, USAID, pp. 107-124, pp. 135-142

PREPARED Rope, bucket, and tape measure

MATERIALS

FACILITATORS One or more trainers

## Trainer Introduction

**This session requires substantial preparation in order to locate existing shallow wells. If trainers are planning a well rehabilitation project, a visit should be made, during the inspection, to the site at which you plan to work, so that trainees may conduct a feasibility survey. The resource books are from the previous sessions and can be reviewed if necessary.**

## PROCEDURES

Step Time unknown

1

Transport all trainees to the well site area.

Step 60 minutes

2

Visit one to three existing shallow wells in operating condition, and discuss how the wells were constructed, how they are protected from pollution, and how water is retrieved. Check the water quality and measure the depth.

## **Trainer Note**

**These wells should be in working order and fairly well constructed. Point out the components of the well such as the lining, head wall, sanitary seal, and pumping mechanism. Discuss the method of construction in terms of labor, safety, materials, and time requirements. Make note of the operations and maintenance required.**

Step 60 minutes

3

Visit one to three existing shallow wells in need of rehabilitation and discuss possible methods of accomplishing this. Check the water quality and measure the depth.

## **Trainer Note**

**Lead a brainstorming activity on how the wells could be rehabilitated. Mention various methods and their strengths and weaknesses in terms of labor, materials, safety and time requirements. It is important to get the trainees thinking and discussing how the well rehabilitation should be approached.**

Step 4 Time unknown

Return trainees to training headquarters.

## **Session 29 - Project planning: Well rehabilitation**

**TOTAL TIME Two Hours**

OBJECTIVES	* Formulate a plan for a well rehabilitation project including: a satisfactory design for all components of the well, a list of materials and tools necessary, and a construction schedule for the project
RESOURCES	<u>Wells Construction</u> ; Peace Corps ICE, Chapters 3-9 <u>Rural Water and Sanitation Projects</u> ; USAID, pp. 107-124, pp. 135-142 <u>Small Community Water Supply</u> , IRC, pp. 109-121
PREPARED MATERIALS	Newsprint and felt-tip pens
FACILITATORS	One or more trainers

## Trainer Introduction

**This session is intended to give the trainees scheduled time to plan their project before actual construction begins. Trainers should be available during this time to serve as information resources and to offer guidance if necessary. However, it is important that the trainees be given the opportunity to work through the planning of the construction project themselves. In many cases, two hours will not be adequate time to complete all necessary planning. If additional time is available in the schedule, add that time to the session. If time is not available, give the trainees at least an overnight period before actual construction is scheduled to begin. The resource books are designed to serve as reference information for the trainees.**

## PROCEDURES

Step 10 minutes

1

Present the objective and format for the session. Divide the trainees into their work groups for the well rehabilitation project, making sure that each group has a project manager.

### **Trainer Note**

**If necessary, review at this time the basic construction steps for a well-rehabilitation; i.e., site selection and preparation, excavation, lining, sanitary seal, and pumping mechanism. Discuss the components of a proper design for any construction project; i.e., detailed drawings, basic specifications, construction schedule and methods, project documentation, and evaluation process.**

Step 2 1 hour, 40 minutes

In their individual work groups, the trainees plan for their upcoming project.

### **Trainer Note**

**Make sure that all trainers are available at this time. If desired, assign a trainer to each group as an advisor. However, trainers should not direct or lead the planning process.**

Step 10 minutes

3

Review the progress made during the session with regard to project planning. Make arrangements for additional planning time, if necessary, before construction begins.

## Trainer Note

**Check all components of the design before construction begins. One effective way of checking the design is to have the trainees give a design presentation. If such 8 presentation is scheduled, trainees should be given time to prepare not only the design, but the presentation as well.**

### Session 30 - Shallow well rehabilitation

TOTAL TIME 32 Hours

OBJECTIVES \* Rehabilitate a hand-dug shallow well by constructing a solid inner well foundation, reinforced concrete lining, reinforced concrete sanitary seal, and installation of a method for retrieving water.

RESOURCES Small Community Water Supplies; IRC, pp. 107-124

Rural Water and Sanitation Projects; USAID, pp. 113-129, 135-142

Wells Construction; Peace Corps ICE, Chapters 3-9

PREPARED MATERIALS Shovels, hammers, crosscut saws, keyhole saws, hacksaws, pliers, channel locks, hoes, sledge hammers, trowels, picks, crow bars, brace and bit, mattocks, tape measure, T-squares, builders' level, line level, string, screwdrivers, wood rasp, buckets, wheelbarrows, wrenches, vice grips, wire cutter, bailing wire, reinforcement bar, 6"x6" weld mesh, nails (#8, #12, #16), lumber (2x4, 1x6, 1x12), cement, sand, aggregate, plastic sheeting, burlap sacks, pumping mechanism with all parts and tools, rope and pulley, tripod, brake post, sump pump to drain well, ladder, hard hats, and gloves

FACILITATORS One or more trainers

## **Trainer Introduction**

**During this session, a hand-dug shallow well is rehabilitated. Because of the fact that no two shallow wells are the same (especially wells in need of rehabilitation), no two rehabilitation projects will follow the exact same procedures. However, in general, the basic design should follow along these lines. First of all, the unstable top section of the well should be excavated. Next, a solid inner well foundation should be laid where the excavation stopped. Then, a concrete lining or casing should be put in place to rebuild the top section of the well, the well pumped out and cleaned, and a reinforced concrete sanitary seal placed at the well head. Lastly, a method for retrieving water should be installed. Refer to the drawing on page 238. The exact design and specifications should be done by the trainees themselves.**

**The number of trainees per well site should be between six and ten. Trainers should serve as technical advisors during the design and construction phases. The resource books should serve as reference information for the trainees. The time set aside for each construction step is a close approximation, based on previous training experience. It does not include time spent on logistics or transportation. There is a variety of activities involved in this session. Make sure all trainees participate in all activities by having the project manager rotate trainees through the various tasks.**

**The well chosen to rehabilitate should be fairly shallow, no more than 6-7 meters deep. The preliminary survey should be conducted during Session #28. This session starts with the construction phase.**

**Finally, proper construction safety practices should be followed at all times. Trainers should take the time to explain such practices and make sure that they are followed throughout the exercise.**

## **PROCEDURES**

Step 8 hours

1

Prepare the site for construction. Excavate the top section of the well. Form and pour a reinforced concrete well cover.

### **Trainer Note**

**Emphasize the importance of preparing the site properly before beginning to excavate. Safety is a prime consideration and should be emphasized at all times. Tools and materials should be set away from the well itself. A tripod with rope and pulley should be made and put in place. Once excavation begins, dirt should be set in one or two central locations, leaving an access way to the well. The pre-cast well cover should be poured near the well. Check the dimensions of the slab to make sure they are correct. In most cases, the well cover should have a manhole, and in all cases, it should be strongly reinforced. Make sure that it is designed to fit the method you will use to retrieve water from the well. Step 2 may begin the following day.**

Step 8 hours

2

Finish excavation of the top section of the well. Form and pour a reinforced concrete

inner well foundation where excavation stopped. Construct or assemble the formwork for the concrete lining.

## **Trainer Note**

**Excavate down to a solid portion of the well. The foundation should be laid around the edges of the hole and be properly reinforced. Reinforcement may also be placed coming out of this footing to tie into the casing. Various techniques can be used to pour the lining. Wood or metal forms may be lowered into the well and concrete poured behind the forms. If wood is used, the lining will be square which will require additional concrete. Check the dimensions on the forms to make sure that they are correct. Step 3 may begin the following day.**

**(An alternative method uses pre-cast concrete rings, lowered into place in the well. If this is done, the rings must be allowed to cure 5-7 days before being lowered into place in Step 3.)**

Step 8 hours

3

Pump out and clean the well. Cover the well hole. Put in place the formwork for the lining. Pour the lining. Form and pour a continuous well apron at ground level.

## **Trainer Note**

**This is a full day of activity. Strict safety procedures should be followed at all times. The well should be pumped out and cleaned. Place gravel at the bottom of the well if necessary. After cleaning, the hole should be covered securely; several**



**layers of plastic will do the best job. The formwork for the lining should be carefully lowered in place, based on the inner well foundation and continuing up to slightly above ground level. Reinforcement should be put in place and the pour begun. The concrete mix should be fluid, workable, and use small to medium size coarse aggregate.**

**When ground level is reached and the casing is completely in place, pour a continuous well apron around the edges of the casing. Two-by-four lumber can be used to form the outside edge of the apron. The apron should be between 12 and 16 cm in width on all four sides and 8-10 cm deep. The casing and apron should be allowed to set three to four days before Step 4 begins. A curing schedule must be set up and maintained.**

Step 8 hours

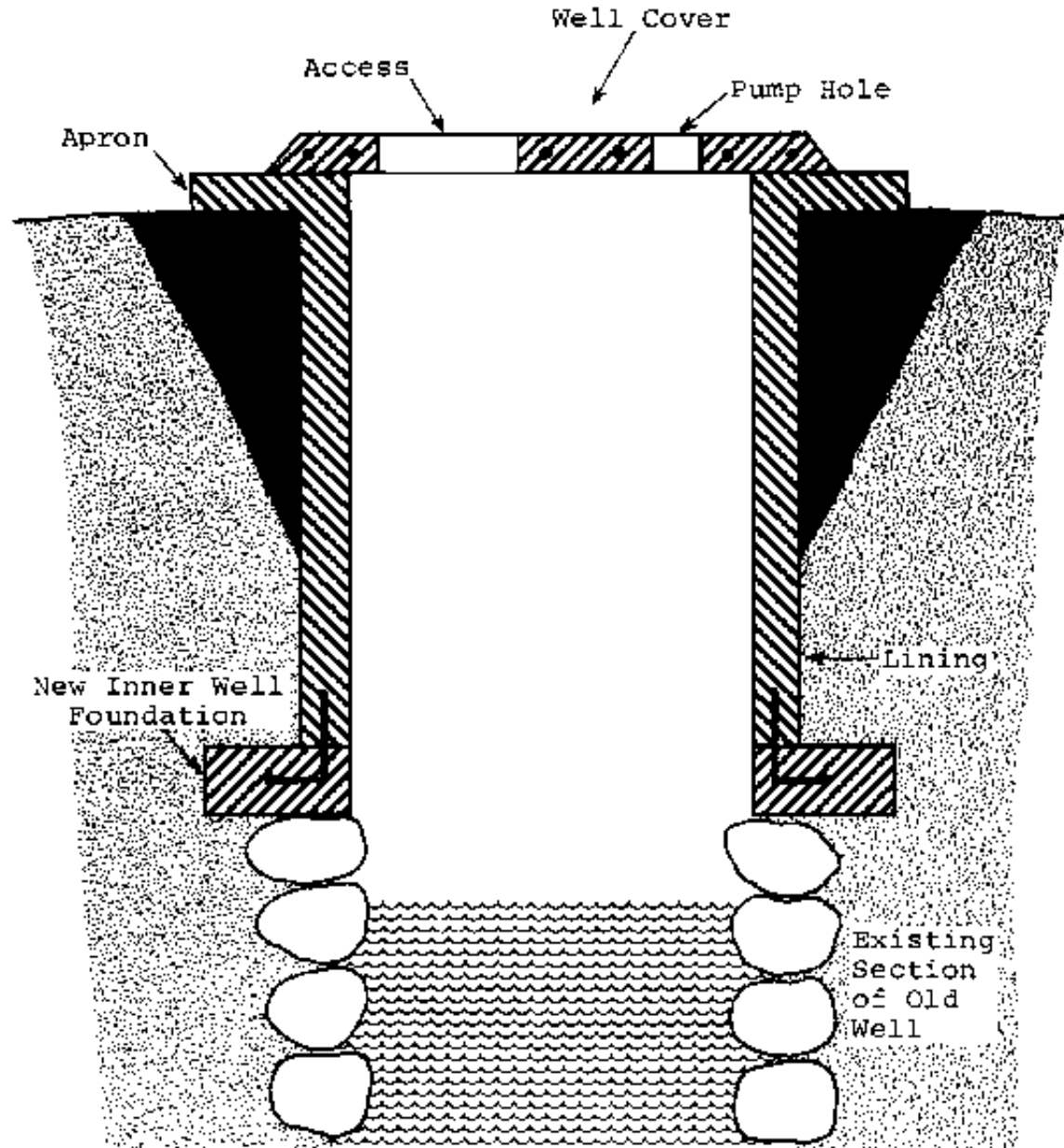
4

Remove the formwork for the lining and apron. Inspect the casing and apron for structural integrity. Place and seal the well cover on the apron. Install pumping mechanism. Complete all necessary tasks. Clean up site.

### **Trainer Note**

**Trainees should remove the formwork carefully, so as not to damage the casing. Also, care should be taken when moving and placing the well cover. It should be centered on the apron and mortared in place to seal the well from surface contamination. Install the method for retrieving water and list all maintenance requirements. Clean the site thoroughly and finish any remaining tasks. Lastly, the entire group should review the construction procedures and processes that went**

**into the project. Discuss positive and negative aspects. Ask what could have been done differently to improve the construction. Ask about the group dynamics of the exercise. What improvements could have been made? What worked particularly well? Point out the importance of hard work, flexibility, and cooperation throughout such an activity.**



**Well Rehabilitation Design Drawing - Side View**

**Session 31 - Gravity water systems: Part I**

TOTAL TIME	Three Hours
OBJECTIVES	<ul style="list-style-type: none"><li>* Define pressure, head and hydraulic gradient in relation to a gravity water system</li><li>* Analyze friction loss factors influencing the selection of pipe type and size, and calculate pipe flows in a water system</li></ul>
RESOURCES	<u>Rural Water and Sanitation Projects</u> ; USAID, pp. 35-42, 49-57 Attachment 31-A: "General Explanation of Pressure, Head, Hydraulic Gradient and Friction Losses"
PREPARED MATERIALS	Newsprint and felt-tip pens  Three to five meters of clear tubing Pitcher of colored water Reproduction of Figures 1, 2 and 3 on newsprint from session steps. Copies of Attachment for all trainees
FACILITATORS	One or more trainers

## Trainer Introduction

**The two sessions on Gravity Water Systems present a great deal of technical information, and require substantial preparation by trainers, as it is very important to present the material in an organized, straight-forward manner. This session, Part I, begins on an introductory level, laying down the general principles of water system hydraulics and discussing the calculation of flow rates in a pipeline. Part II expands on this subject to present the basic design steps for a simple gravity system.**

**In both parts, the technical content is geared towards the water technician, rather than the water engineer. If you have engineers in your trainee group, ask them to assist in the facilitation of the session, reminding them that they are teaching technicians, not other engineers. Most steps in the two sessions call for lecturettes by the trainer. However, trainers should encourage group discussion on the subject matter and take the time to answer all questions the trainees may have as the sessions progress. Handout the attachment prior to the session to allow time for reading by trainees.**

## **PROCEDURES**

Step 1 10 minutes

Present the objectives and format for the session.

### **Trainer Note**

**Explain that the next two sessions contain a considerable amount of technical information. Emphasize that the overall objectives are to give the trainees a basic understanding of how a gravity water system works and the tools necessary to design a simple small-scale system. They will not become qualified engineers overnight, but through careful study and concentration they should be able to achieve the objectives.**

Step 2 25 minutes

Lecturette on the principles of water hydraulics

### **Trainer Note**

**Begin by explaining that the air, or atmosphere, around the earth has a certain weight. That weight varies according to the elevation. For example, on a mountain top air pressure decreases because the blanket of air is not as thick. This weight exerts pressure on the earth's surface. At sea level, the pressure exerted is 14.7 pounds per square inch (psi).**

**Next, explain that water also has weight that exerts pressure. For example, one cubic inch of water weights 0.0362 lb. and one cubic foot weights 62.4 pounds. Illustrate on newsprint:**

**Example:**

**1 cu. inch = 0.0362 lbs.**

**1 cu. ft. = 1,728 cu. inches**

**1,728 x 0.0362 = 62.4 lbs.**

**To express this in terms of pressure use the following example:**

**1 cu. inch = 0.0362 lbs.**

**1 ft. = 12 inches**

**12 x 0.0362 lbs. = 0.43 lbs. pressure exerted against each square inch (psi) for a one foot column of water.**

**Emphasize that this is an important number to remember:**

**\* 1 ft. of water = 0.43 psi**

**From this formula you can calculate the pressure exerted by any column of water.**

## Illustrate on newsprint.

### Example:

2 ft. column	=	0.86 psi
2 x 0.43	=	0.86
10 ft. column	=	4.3 psi
10 x 0.43	=	4.3
46 ft. column	=	20 psi
46 x 0.43	=	20

**Conversely, you can calculate the height of any column of water by knowing the psi at any point. Illustrate on newsprint:**

### Example:

**1 ft. column = 0.43 psi**

$$\frac{1}{0.43} = 2.31$$

**1 psi = 2.31 ft. of water**

### Example:

**10 psi = 23 ft. of water**

$$\frac{10}{0.43} = 23$$

**20 psi = 46 ft. of water**

$$\frac{20}{0.43} = 46$$

**Restate these two formulas:**

**1 ft. column of water = 0.43 psi**

**1 psi = 2.31 ft. of water**

**The same principles can be illustrated using the metric system. Illustrate on newsprint the following steps in the metric system.**

**1. weight of water 1 cm<sup>3</sup> = 1 gram**

**2. In terms of pressure**

**1 cm<sup>3</sup> = 1 gram**

**1 m = 100 cm**

**100 cm x 1 gram = 100 grams (.1 kilogram) pressure exerted against each square cm for a one meter column of water**

**Therefore, 1 meter of water = .1 kg./cm<sup>2</sup>**



**From this formula you can calculate the pressure exerted by any column of water. Illustrate on newsprint:**

**Example:**

**10 m of water = 1 kg./cm<sup>2</sup>**

**20 m of water = 2 kg./cm<sup>2</sup>**

**45 m of water = 4.5 kg./cm<sup>2</sup>**

**It is equally simple to calculate the height of any column of water by knowing the kg/cm<sup>2</sup>. Illustrate on newsprint:**

**Example:**

**1.5 kg./cm<sup>2</sup> = 15 meters of water**

**3.0 kg./cm<sup>2</sup> = 30 meters of water**

**5.5 kg./cm<sup>2</sup> = 55 meters of water**

Step 3 20 minutes

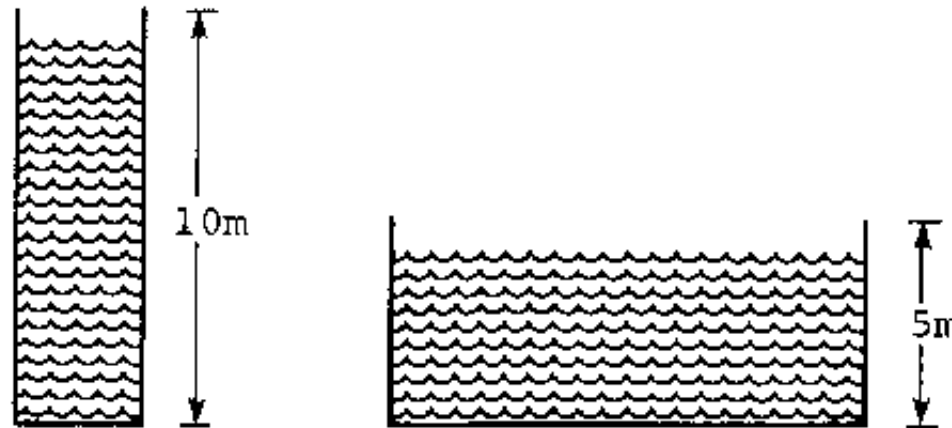
Lecturette on defining gravity head in a water system.

**Trainer Note**

**It is now clear that the weight of water exerts pressure. Emphasize that the pressure is determined by the height of the column of water. In a gravity water system the height is expressed in terms of feet of elevation or head. It is**

**important to emphasize that water pressure is directly related to the vertical elevation of any column of water. Horizontal distances mean nothing. Illustrate on newsprint:**

**\* Ask the trainees which column of water has more pressure at the bottom.**



**Columns of water**

**Use the example of a person swimming in a lake or pool. Diving vertically, the water pressure increases as he/she goes down but to swim horizontally at the same depth causes no change in pressure.**

**Therefore, Head is expressed in terms of feet of water. Because of our formulas in Step 2, we also know that it can be expressed in terms of psi. Ask the trainees to answer the following:**

**1. If a column of water has 20 feet of head, what would the psi be at the bottom?**

**20 ft. x 0.43 = 8.6 psi**

**2. If a column of water has 20 m of head, what would the kg./cm<sup>2</sup> be at the bottom?**

$$20 \text{ m} \times 1 = 2 \text{ kg./cm}^2$$

**3. If a column of water has a pressure reading of 30 psi at its base, what would be its Head in feet?**

$$30 \times 2.31 = 69 \text{ ft.}$$

**4. If a column of water has a pressure reading of 3.0 kg./cm<sup>2</sup> at its base, what would be its Head in meters?**

$$3.0 \times 10 = 30 \text{ meters}$$

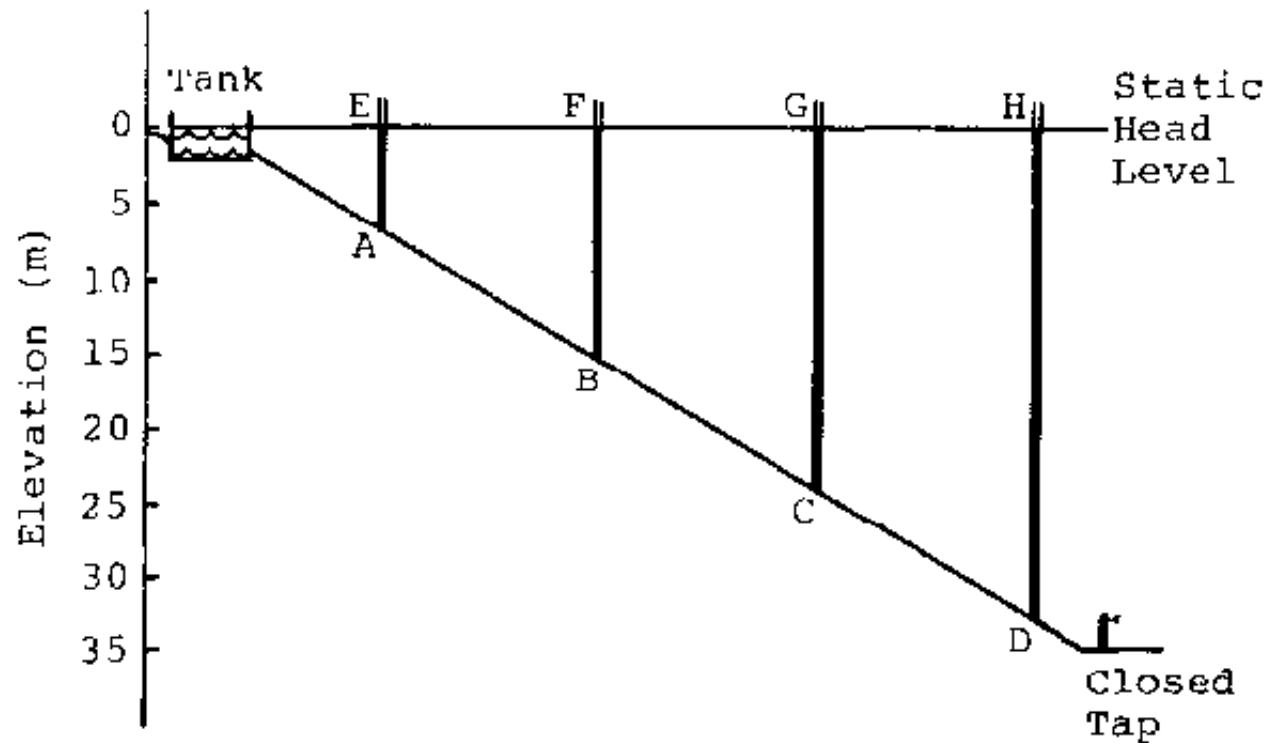
Step 4 20 minutes

Lecturette on Static Water Systems

### **Trainer Note**

**Explain that a pipeline system where no water is flowing is said to be in static equilibrium. Illustrate this concept by the use of the clear tubing and colored water. Show how the water in the tube will seek its own static level when water is not flowing.**

**Next, refer to your reproduction of figure 2 on newsprint.**



**Figure 2 - Static Equilibrium**

**Point out that the system shown is closed, at static equilibrium. Point out the static water level. Mention that the water level in each of the tubes at points A, B, C and D have risen to static level. Emphasize that the gravity pressure head at each point is equal to the elevation difference between the point and the static water level. This is called the static head of each point.**

Step 5 5 minutes

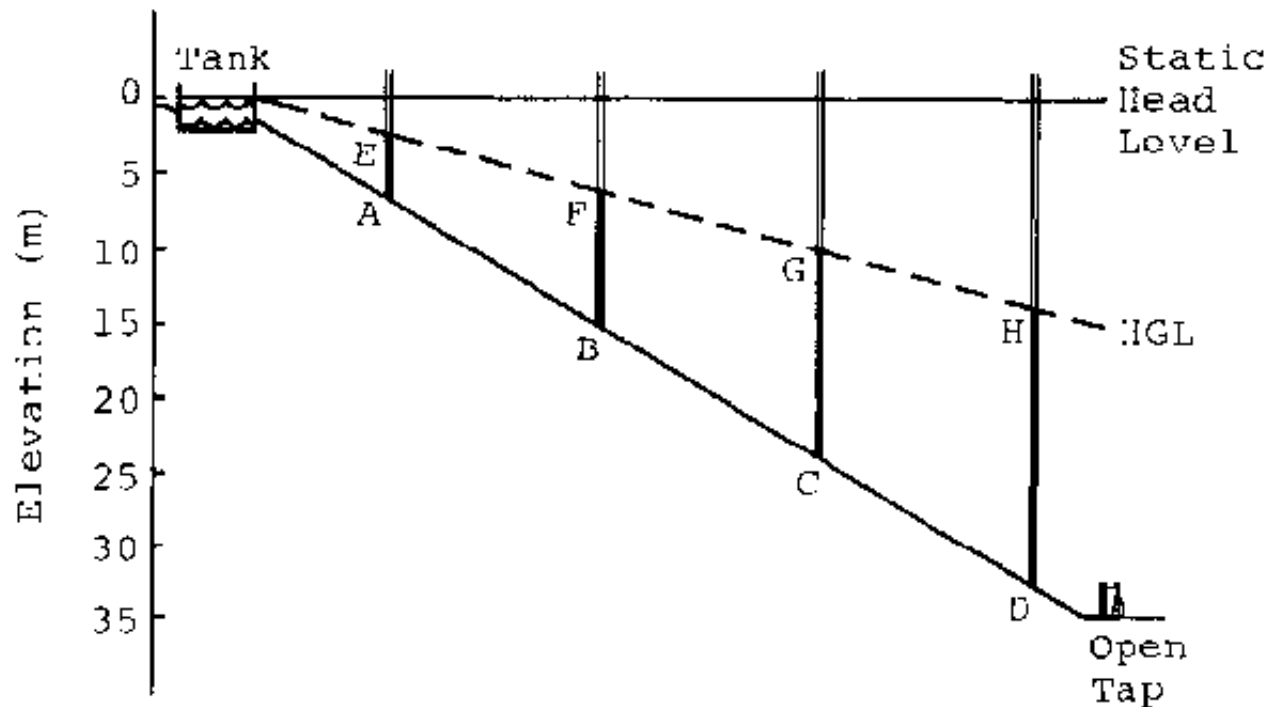
Break

Step 6 30 minutes

Lecturette on Flowing Water Systems

## Trainer Note

**Begin by explaining that the principles of a flowing system are very different from a static system. The reason for this is when water flows through a pipeline, there is pressure lost caused by the friction of the flow against the pipe walls, or fitting in the system. Because of this loss through friction, the water will not be able to reach static level. Therefore, any amount of pressure loss through friction corresponds to a loss in Head. Refer to your reproduction of Figure 3 to illustrate these points.**



Dynamic Equilibrium

**Figure 3 - Dynamic Equilibrium**

**This system is in dynamic equilibrium.**

**Direct attention to the new pressure head levels caused by the friction loss of the flowing water; points E, F, G and H. These levels, called the dynamic head levels are equal to the static head of each point on the pipeline, minus the head loss for each point. The difference between the dynamic head levels and the static level is the head loss, which is caused by friction. Point out the head loss at each point.**

**The difference in elevation between any point on the pipeline (A, B, C, & D) and that point's dynamic head level is called the residual head.**

**Next, point out the hydraulic gradient line (HGL). Explain that it is an imaginary line that plots the head loss of any point in the pipeline and therefore, also plots the dynamic head levels and indicates the residual head. Mention that the HGL is totally determined by the friction loss factors at any one point. Those factors will be discussed in the next step of the session.**

**Emphasize that friction losses are never recovered. Therefore, the HGL always slopes downward along the direction of flow. The steepness of the HGL slope is determined by the relative amount of losses through friction. The HGL is horizontal only when the system is closed and at static level. Otherwise, it varies according to the specific conditions of any one system.**

**Lastly, in review, ask the trainees to define the following terms:**

Static Equilibrium	- closed system.
Static Water	- highest point in the system

Static water Level	highest point in the system.
Static Head	- Difference in elevation between a point on the pipeline and the static water level.
Dynamic Equilibrium	- flowing system.
Head Loss	- loss of water pressure due to friction.
Dynamic Head Level	- Static water level minus the head loss at any point on the pipeline.
Residual Head	- Difference in elevation between any point on the pipeline and the dynamic head level.
HGL	- Imaginary line that plots the head loss of all points in the system.

Step 7 25 minutes

Lecturette on friction loss factors

## Trainer Note

**The amount of head loss due to friction depends on five basic factors:**

- 1. Length of pipe**
- 2. Diameter of pipe**
- 3. Inside smoothness of the pipe**
- 4. Number and types of fittings and valves in the system**
- 5. Rate of flow**

**Discuss each factor. Here are some points to emphasize.**

**1. Length of pipe: The longer the pipe, the greater the loss of head due to friction for any given diameter and rate of flow. This is easy to understand. The longer any given length of pipe, the more friction that occurs and therefore, the more head loss.**

**2. The smaller the diameter of any given length of pipe, the greater the friction losses for any given rate of flow. If the size of the pipe is reduced, there will be an increase in friction and a loss of head.**

**3. The smoother the inside surface of the pipe, the less friction loss for any given rate of flow. Different types of pipe have different inside surfaces. The smoother the surface the less friction and head loss.**

**4. The fewer fittings and valves on a pipeline, the less friction losses for any given rate of flow. Such things obstruct direct water flow in a system. The fewer there are, the less friction and head loss.**

**5. The higher the rate of flow through any given pipe, the greater the friction losses. The rate of flow is calculated mathematically using the following formula:**

$$Q = VA$$

**Q = rate of flow expressed in units of volume per time period such as ft<sup>3</sup>/sec., cm<sup>3</sup>/sec, liters/sec.**



**V = velocity of water expressed in units of distance per time period such as ft./sec., cm./sec.**

**A = cross-section area of pipe expressed in units squared such as ft.<sup>2</sup>, cm<sup>2</sup>**

**Example:**

**A pipe 2 feet in diameter has water flowing through it at a velocity of 1 foot per second. What is the flow in ft.<sup>3</sup>/sec?**

$$Q = VA$$

$$V = 1 \text{ ft./sec.}$$

$$A = \pi r^2 = (3.14) (1 \text{ ft.})^2 = 3.14 \text{ ft.}^2$$

$$Q = (1 \text{ ft./sec.}) (3.14 \text{ ft.}^2) = 3.14 \text{ ft.}^3/\text{sec.}$$

$$Q = 3.14 \text{ ft.}^3/\text{sec.}$$

**Emphasize the point that the higher flow rate, the greater the friction and head losses. The reason for this is simple. Because  $Q = VA$ , the greater the flow, the faster the velocity. Friction increases as the square of the velocity, so a greater flow means more friction. You may point out that friction losses because of increased flow do not rise equally. If flow doubles, friction losses are often quadrupled.**

**Step 8 35 minutes****Lecturette on pipeline design****Trainer Note**

**Begin by explaining that the purpose of pipeline design is to properly adjust friction and head losses so that water flows smoothly through the system. This is accomplished by the careful selection of pipe sizes and the location of such things as fittings, valves, storage tanks, and tapstands.**

**Sizing of pipe is of primary importance and depends, in general, on three factors:**

- Design flows**
- Length of pipeline**
- Available head**

**Discuss each of the three factors. Here are some points to emphasize:**

**1. Design flows are controlled by the designer of the system. The flows are used to calculate head losses and determine pipe diameter. They are related to the number of users in the system, level of service, and type of storage provided. (Design flows will be discussed in detail during Session 34.)**

**2. Length of pipeline is fixed for a given village. The pipeline survey gives the exact distance.**

**3. Available head is also fixed for the given village you are working at. It is the**

**difference in elevation between any two points on the pipeline, such as the source and a tapstand. You get the information from the pipeline survey.**

**Next, point out that in order to actually design the pipeline the designer must sit down with a profile drawing of the system and begin to make calculations. Emphasize that it is very important to get known values listed and start from there. Known values would be:**

- Design flow**
- Length of entire pipeline**
- Length of specific reaches of pipe (lengths of pipe without breaks)**
- Available head for the entire system**
- Available head for specific lengths of pipe**
- Frictional head loss factors: these are values taken directly from tables which state frictional headloss. It is expressed as the head loss per unit length of pipe for a specific flow; "meters of head loss per 100 meters of pipe for a specific flow."**

**Selecting the proper pipe size is a process of trial and error. The calculated values for head loss from different sizes of pipe are compared to the available head on the profile drawing. The smallest diameter pipe, with a calculated head loss less than the available head, is chosen for each section of pipeline.**

**As a large group, work through the three sample problems in the Attachment 31-A.**

Step 10 minutes

Review the objectives and conclude by opening the floor for questions concerning the material covered during the session.

## **Trainer Note**

**Answer all questions about the information presented. It is important that trainees understand the principles and procedures discussed during the session. Do not however, attempt to discuss more detailed design considerations that will be presented during the next session.**

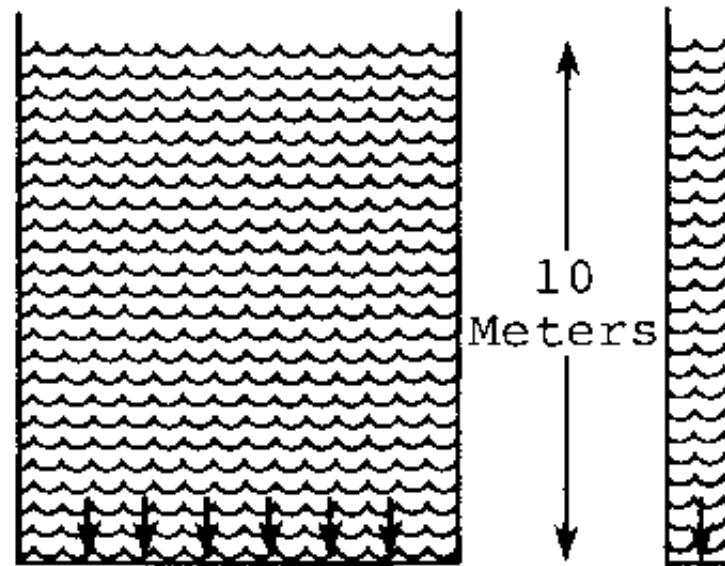
**REFERENCE: Practical Design Notes for Simple Rural Water Systems; a Scott Faiia, CARE, Indonesia, 1982.**

**Handbook of Gravity Flow Water Systems for Small Communities; Thomas Jordan, UNICEF, Nepal, 1980.**

**Attachment 31A: General explanation of pressure, head, HGL, and friction losses**

### **Pressure Exerted by a Column of Water**

**A column of water exerts a force due to the weight of the water. The pressure, or force per unit area, is dependent on the height of the column of water. Therefore, head or water pressure is usually expressed in terms of the equivalent height of water needed to exert that pressure. The pressure under static conditions is not dependent on pipe diameter. See Figure 1.**

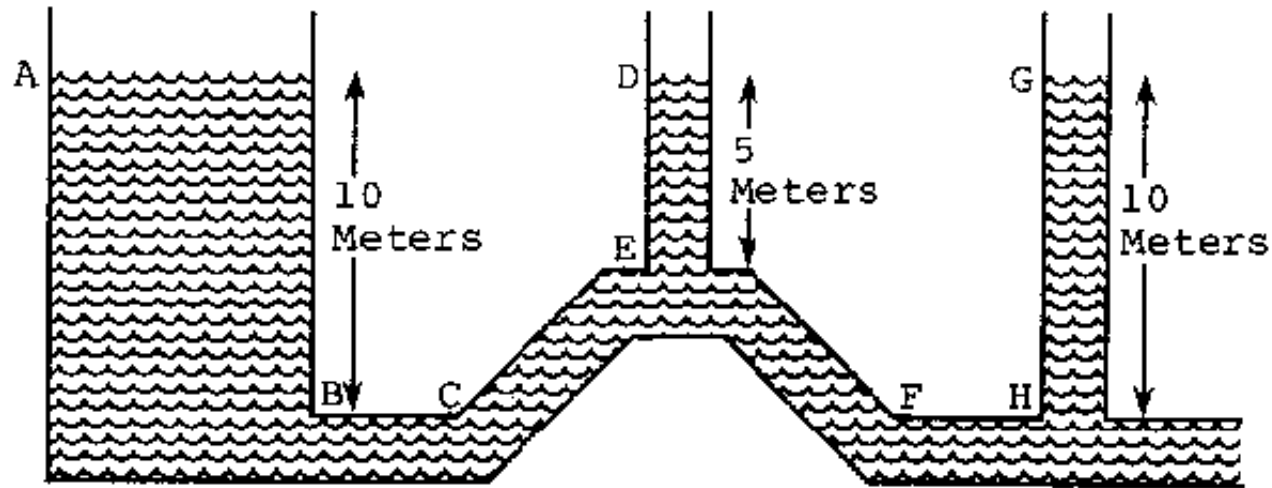


**Figure 1**

**The pressure at the bottom of each column of water is the same. It is 10 meters of head, or  $1.0 \text{ kg/cm}^2$ . The pressure midway in each column would be 5 meters of head or  $0.5 \text{ kg/cm}^2$ .**

### **Pressure in a Static System**

**In a system under static conditions, the pressure at any point is dependent on the difference in height between the point in question and the highest point in the system. If an opening is made in the pipe in any part of the system and a tube connected to it then the water level will rise until it is the same as the highest point. See Figure 2.**



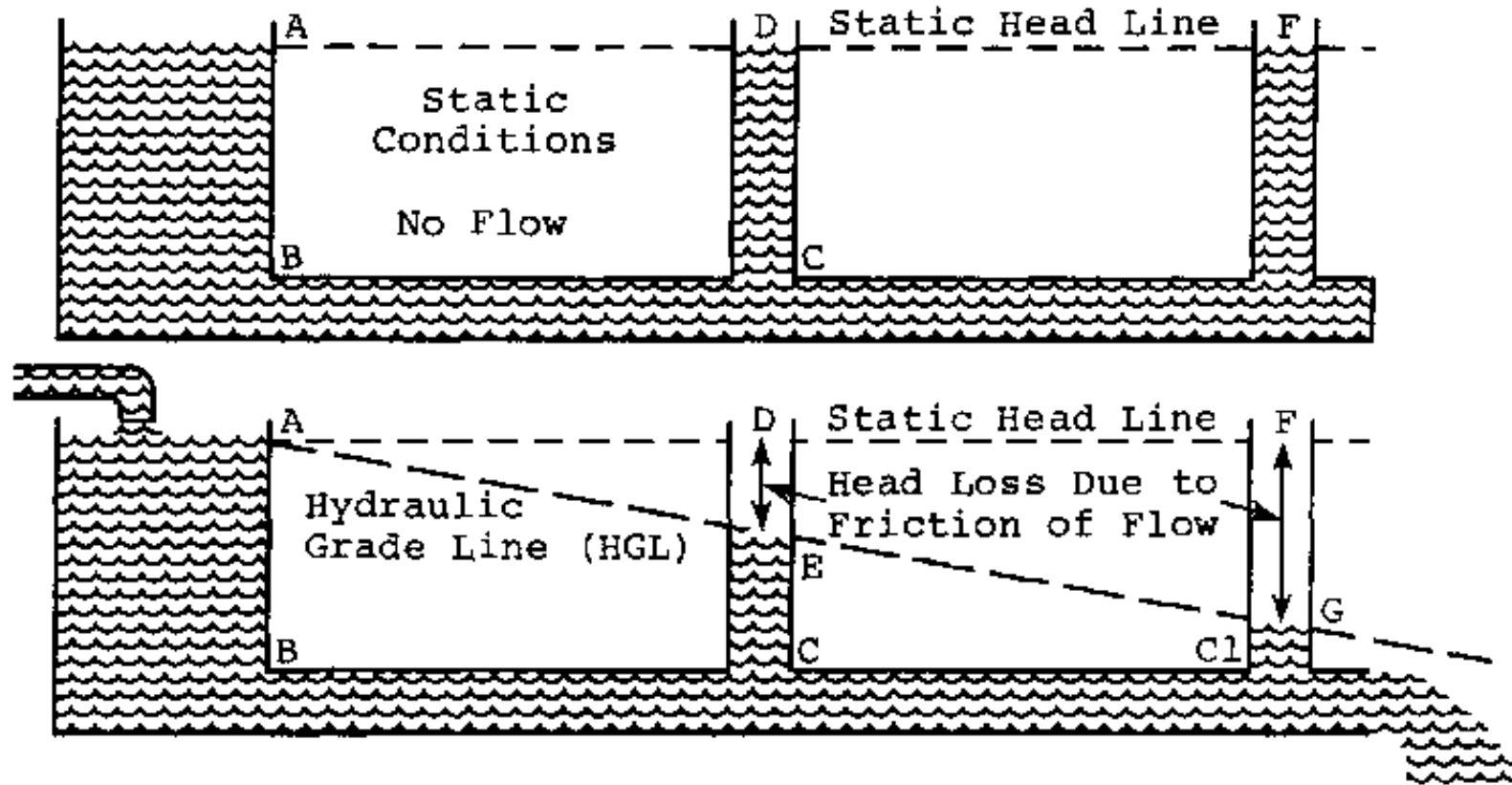
**Figure 2**

**The system in Figure 2 is static and no flow occurs. The pressure or head at points B, C, F and H is the same; i.e., 10 meters. The pressure or head at point E is 5 meters or the difference in height between points A and E. If the pipeline were opened and a tube connected to it at point C or F, then the water would rise 10 meters and be at the same level as points A, D and G.**

### **Pressure in a Flowing System**

**When water in the pipeline is flowing, then the pressure is no longer dependent solely on the height difference with respect to the highest point. There is a loss of pressure or head due to friction between the water and the pipe. The pressure or head at any point is equal to the static head (relative height difference) minus the head loss due to friction. This is then called the dynamic head level. Because of the head loss, the water will not rise to the same level as the highest point but only as high as the pressure or head at that point. Head loss occurs only when water is**

**flowing. See Figure 3.**



**Figure 3**

**Under flowing conditions, the pressure is no longer the same and the pressure at point C or C1 is not sufficient to raise the water level to points D or F. The height difference between points D and E or points F and G is the head loss due to friction in the pipeline. If the flow were stopped, the water level would return to points D and F.**

### **Factors Influencing Head Losses**

**The amount of head loss is influenced by the following factors:**

**a. The length of pipe**

**The longer the pipeline, the greater the head loss. This loss is directly proportional to the length; i.e., the head loss for 200 meters of pipe would be twice that for 100 meters under the same conditions.**

**b. The diameter of the pipe**

**The smaller the diameter of the pipeline, the greater the friction will be for the same flow of water. The differences are not proportional.**

**c. The flow of water in the pipe**

**The higher the flow of water in a given pipe, the greater the head loss due to friction. Friction increases as the square of the velocity.**

**d. The pipe material**

**The smoother the inner surface of the pipe, the lower the head loss. Thus, since PVC pipe is smoother than steel or cast iron, it has a lower head loss for identical conditions.**

**e. The number of fittings or bends in the pipeline**

**A straight pipeline would have a lower head loss than one of the same length with fittings or bends.**



## Pipe Design

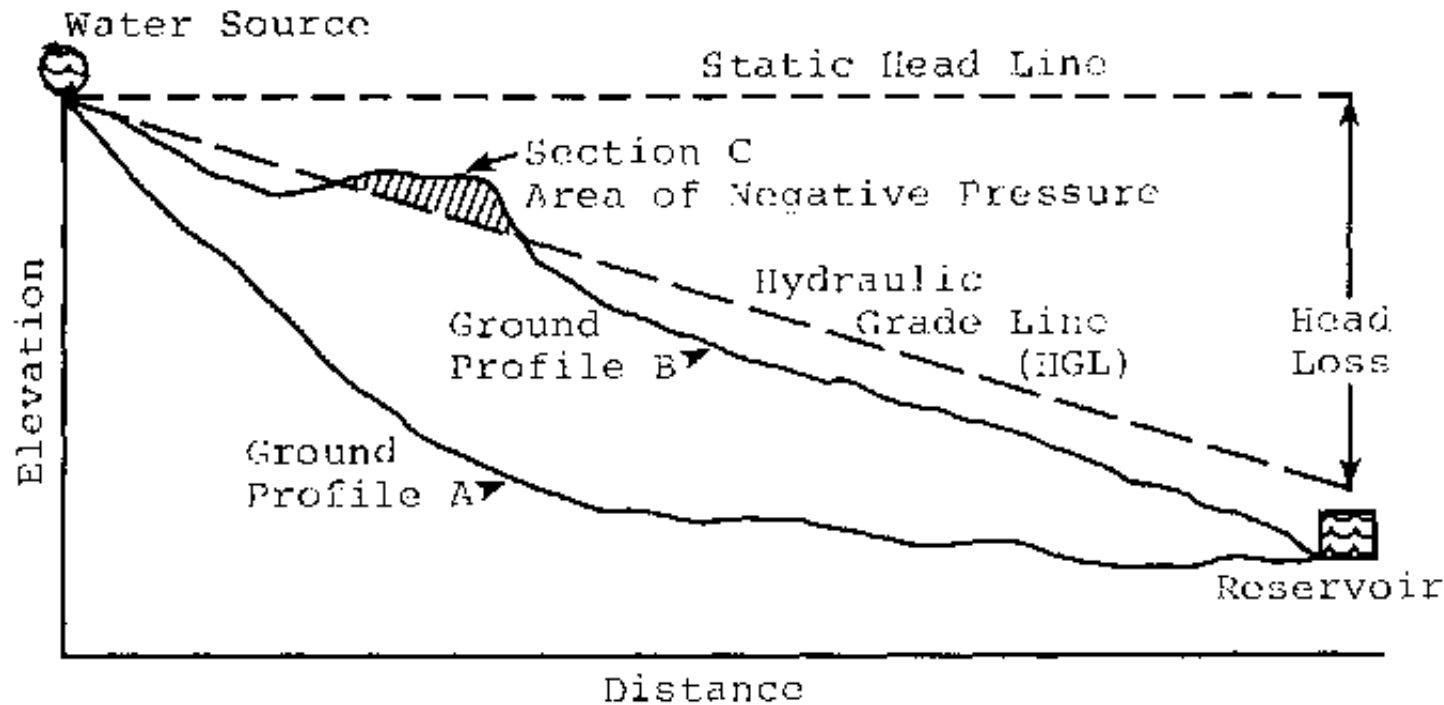
**In designing a gravity flow pipeline, three factors are of primary importance; design flows, pipeline distances, and available head. The latter two are obtained from field measurements. The design flow is calculated by the designer to fit the number of people being served and the projected per capita consumption. A pipe size is then chosen with a head loss less than the available head at that section of the pipeline. When doing the calculations it is important to list the known values of the system and plot the profile from there. Known values would be:**

- Design flows**
- Length of entire pipeline**
- Length of specific reaches of pipe (lengths of pipe without breaks)**
- Available head for the entire system**
- Available head for specific reaches of pipe**
- Frictional head loss factors from tables**

### The Hydraulic Gradient Line (HGL)

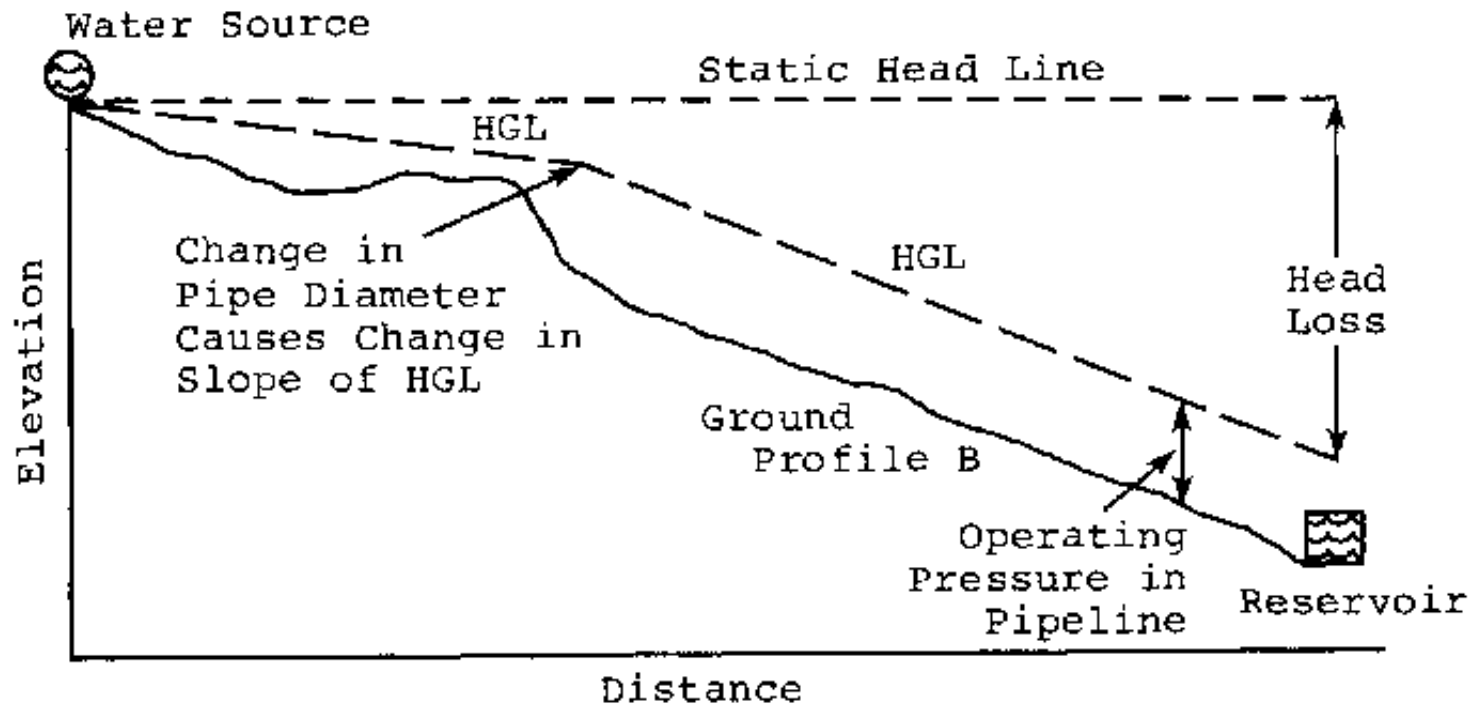
**The hydraulic Gradient Line (HGL) is defined by subtracting the head loss in the pipeline from the static head. The difference between the ground profile and the HGL is the pressure in the pipeline while the water is flowing, or the residual head. If an opening were made in the pipeline and a tube connected to it, then the water would rise to the level of the HGL. The HGL should always lie above the profile, If it does not, then the water may still flow but at sections where the profile lies above the gradient, there is a negative pressure which can cause air or pollution to enter the pipeline. Those sections of the pipeline where negative pressures**

occur should be redesigned to eliminate them. Figures 4 and 5 illustrate this.



**Figure 4**

**If the pipeline followed ground profile A, then the choice of pipe with the given HGL is acceptable. If the pipeline followed ground profile B, then negative pressure would exist in section C, so the pipeline should be redesigned. See Figure S.**



**Figure 5**

The pipe diameters have been changed, thus changing the HGL. Use of a larger diameter pipe near the source ensures that the HGL lies entirely above the ground profile and is acceptable. Note that two pipe diameters are now used between the source and reservoir. For each diameter the HGL has a different slope. The slope is directly dependent on the head loss, so a smaller diameter pipe has a steeper slope.

## Pipeline Design Sample Problems

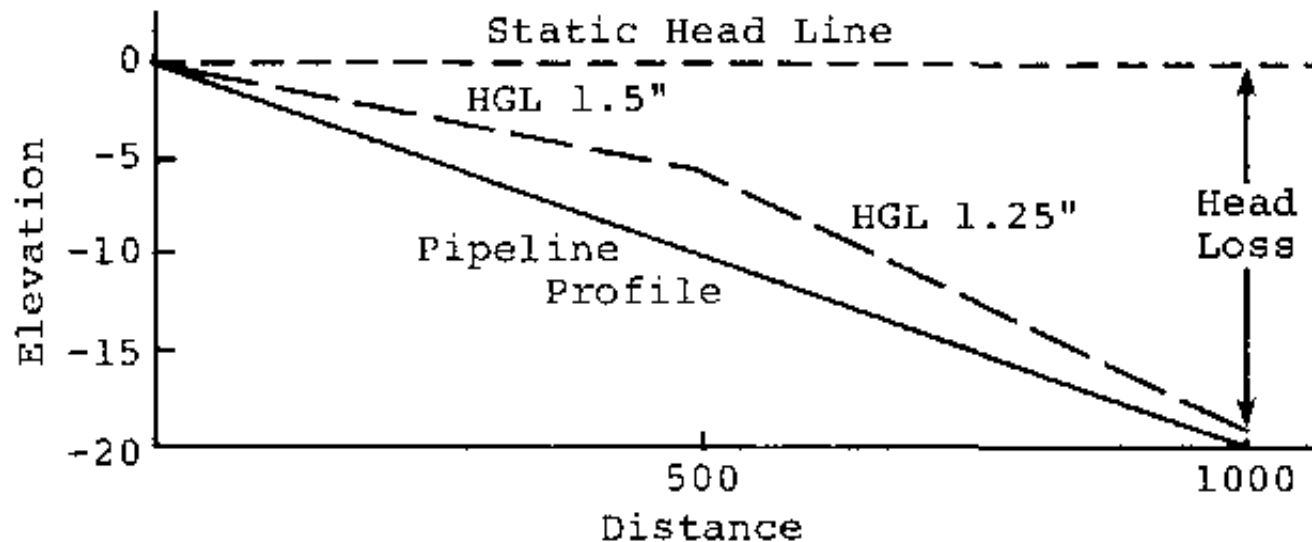
Plotting the pipeline profile is a process of trial and error. The calculated values for head losses from different sizes of pipe are compared to the available head on the profile drawing. The smallest diameter pipe, with a calculated head loss less

than the available head, is chosen for each continuous section of the pipeline.

### Problem 1

A spring with a flow of 0.5 l/s is 1,000 meters from the village and the available head is 20 meters. It is planned to convey the entire flow to a small reservoir in the village. What size pipe is recommended? On the water flow charts, a flow of 0.5 l/s and a length of 1,000 meters using 1.5 inch pipe indicates a head loss of 11 meters. For 1.25 inch pipe the head loss is 26 meters. Thus, the required flow will not be obtained with a 1.25 inch pipe, and a 1.5 inch pipe is too large.

The most economical solution is a combination of two pipe sizes. By trial and error it is found that 500 meters of 1.5 inch GI pipe with a flow of 0.5 l/s has a head loss of 6 meters, and 500 meters of 1.25 inch GI pipe has a head loss of 13 meters. Thus, the total head loss for the 1,000 meter pipeline is 19 meters, which closely matches the available head. The pipeline profile and HGL are plotted in Figure 1.



**Figure 1**

**Calculated head losses for various pipes are as follows: Use for problems 1 and 2**

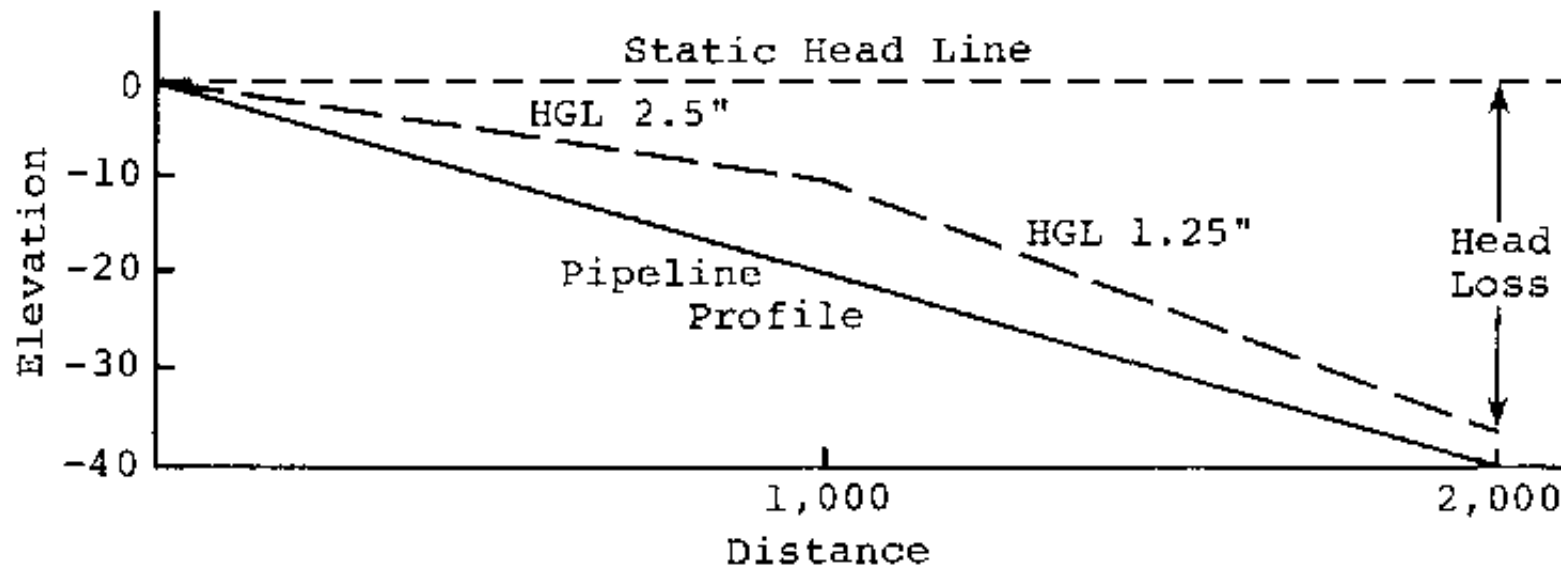
<b>Length (meters)</b>	<b>Flow (1/s)</b>	<b>Pipe Diameter (inches)</b>	<b>Head Loss (incl.10%) (extra meters)</b>	<b>Available Head (meters)</b>
1,000	2	3	5	20
1,000	2	2.5	11	20
1,000	2	2	33	20
1,000	0.5	2	3	20
1,000	0.5	1.5	11	20
1,000	0.5	1.25	26	20

**Problem 2**

**A water source is 1,000 meters from Village One and it is 1,000 meters further to Village Two. The available head between the source and Village One is 20 meters, and between Village One and Village Two, it is also 20 meters. The design flows are 2.0 1/s from the source to Village One and 0.5 1/s from Village One to Village Two. What are suitable pipe diameters?**

**A suitable selection of pipe would be 2.5 inch pipe for the first 1,000 meters, and 1.25 inch pipe for the second 1,000 meters. The total head loss is then 37 meters, which closely matches the total available head of 40 meters. Note that the second 1,000 meters has a head loss of 26 meters and an available head of only 20 meters. This is allowable because there is excess head available from the first**

**1,000 meters of the pipeline and the HGL is always above the pipeline profile. See Figure 2.**



**Figure 2**

### Problem 3

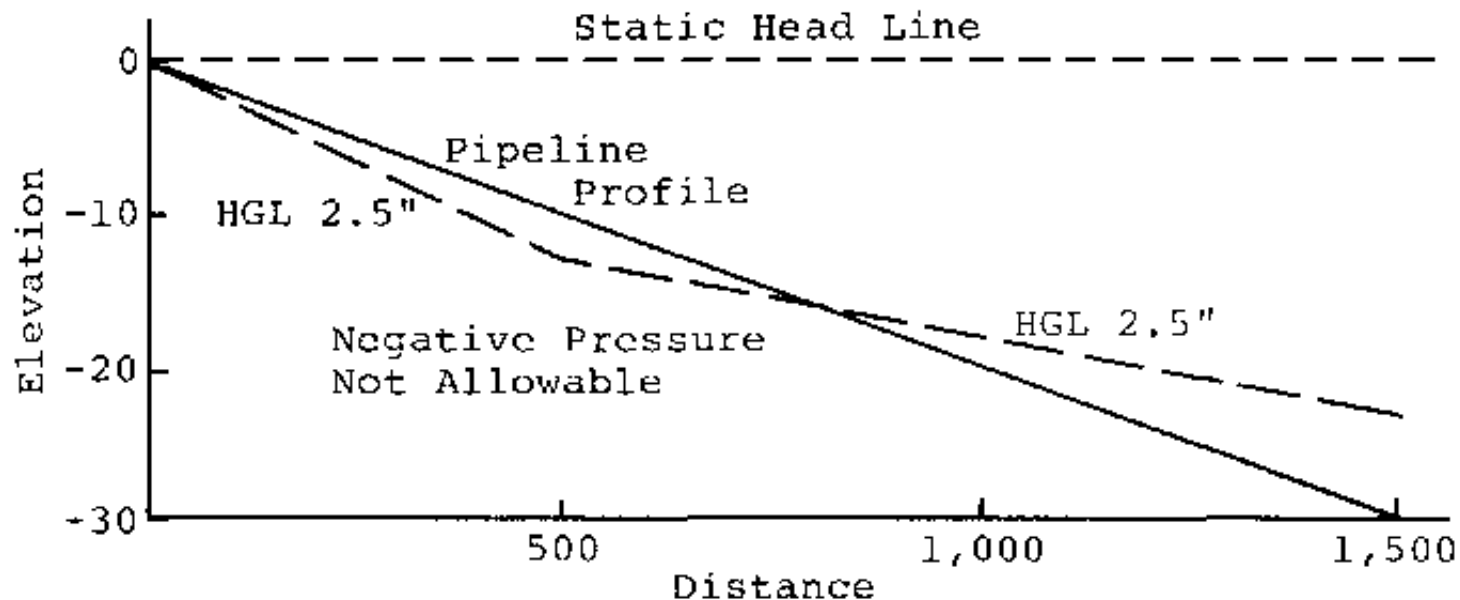
**A spring with a flow of 3 1/s is 500 meters from the Village and the school is 1,000 meters further. A flow of 1 1/s will be used to serve the Village and 2.0 1/s for the school. The available head is 10 meters between the spring and village and 20 meters between the village and the school. What pipe sizes are recommended?**

**Some calculated head losses are as follows (Use for Problem 3):**

<b>Length (meters)</b>	<b>Flow (1/s)</b>	<b>Pipe Diameter (inches)</b>	<b>Head Loss (incl.10%) (extra meters)</b>	<b>Available Head (meters)</b>
500	3	3	5	10

500	3	2.5	12	10
500	3	2	36	10
1,000	2	3	5	20
1,000	2	2.5	11	20
1,000	2	2	33	20
500	2	2.5	6	-
500	2	2	16	-

**If 2.5 inch pipe is used for the entire 1,500 meters, the total head loss is 23 meters, which is less than the total available head of 30 meters. Thus, the desired amount of water may flow. However, the HGL as plotted in Figure 3 falls below the pipeline profile and this is not allowable.**



### Figure 3

An acceptable alternative solution would be to use 500 meters of 3 inch pipe followed by 1,000 meters of 2.5 inch pipe. The total head loss would then be 16 meters and excess available head would be 14 meters. A more economical solution would be 500 meters each of 3, 2.5, and 2 inch pipe, which would convey the full design flows. The HGL for these two solutions are plotted in Figure 4.

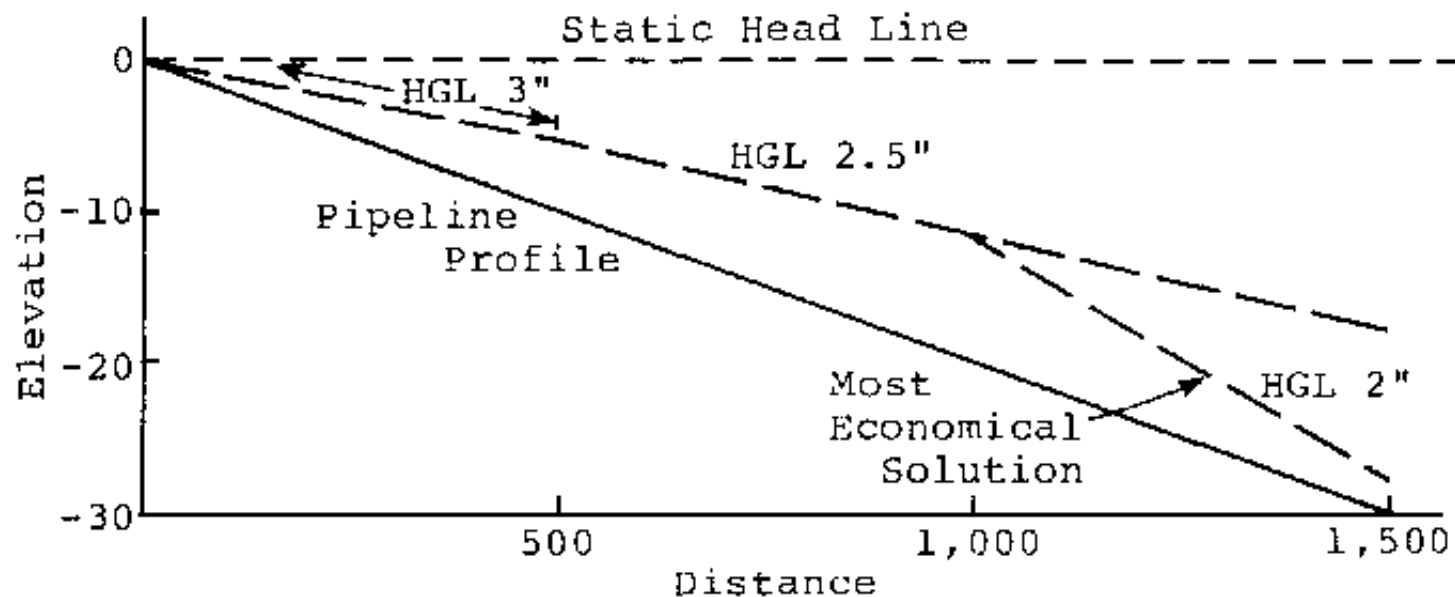


Figure 4

**REFERENCE: Practical Design Notes for Simple Rural Water Systems; A Scott Faiia, CARE, Indonesia, 1982.**

### Session 32 - Survey and measurement

TOTAL TIME Two Hours



OBJECTIVES	<ul style="list-style-type: none"><li>* Demonstrate approximate methods of surveying and taking measurements in the field using simple instruments</li><li>* Define profiling and explain its applications for the design of piped water systems</li></ul>
RESOURCES	Attachment 32-A: "Alternative Ways of Measuring Elevations" Attachment 32-B: "Profiling"
PREPARED MATERIALS	Simple stick level, water level, sight levels, 100' tape measures, steel surveyor's tape, graduated stick Reproductions of Figure 1 and Table 1 from Attachment 32-B on newsprint Copies of both Attachments for all trainees
FACILITATORS	One or more trainers

## Trainer Introduction

**This session deals with simple methods of surveying and taking measurements. It is designed on an introductory level, with the water technician in mind. If you have engineers with survey experience in your trainee group, use them to co-facilitate the session. Prepare the materials before the session begins, and have a flat open area nearby where the trainees can practice pacing. The trainees should read the attachments prior to the session.**

## PROCEDURES

Step 5 minutes

1

Present the objectives and format for the session.

Step 10 minutes  
2

Brainstorm among the group some instances in which surveying skills would be useful.

### **Trainer Note**

#### **Mention these possibilities:**

- **contour land to improve drainage**
- **set foundations for structures**
- **mapping**
- **open channel water system (irrigation, drainage)**
- **wastewater systems**
- **determine pipeline distances and grades for profile drawings**

Step 3 15 minutes

Explain two simple ways to measure horizontal distance:

- 1) pacing
- 2) taping

### **Trainer Note**

**Show how the steel tape is used to measure distance. Demonstrate a proper pacing stride and explain the procedure for finding your stride length:**

## **Known distance divided by number of strides equals length of one stride**

Step 4 25 minutes

Trainees practice pacing in groups of three.

### **Trainer Note**

**Assemble the trainees in the flat open area. Each group should have a 100' tape measure, and mark out a 100' distance. All trainees should pace the distance several times in order to find their true average stride length. After finding their stride length by walking the measured distance, have the trainees pace an unknown distance, compute by stride length the distance, and then check it with the tape measure.**

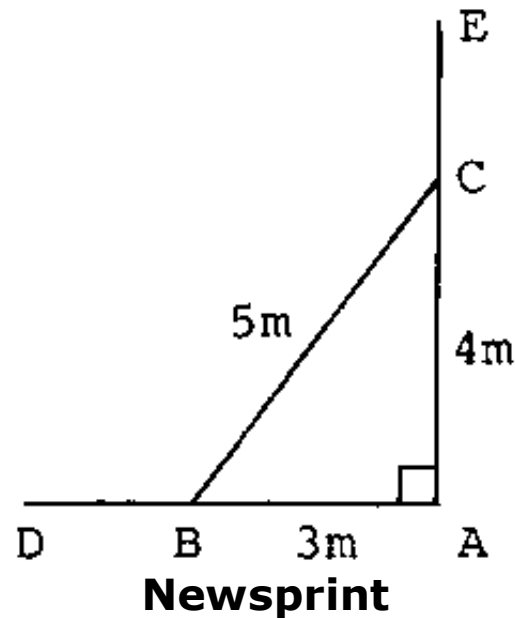
Step 5 10 minutes

Explain two simple ways to lay out a right angle in the field:

- 1) 3:4:5 method
- 2) arms and closed eyes method

### **Trainer Note**

**Both methods are simple and quick to use. Describe the 3:4:5 method on newsprint:**



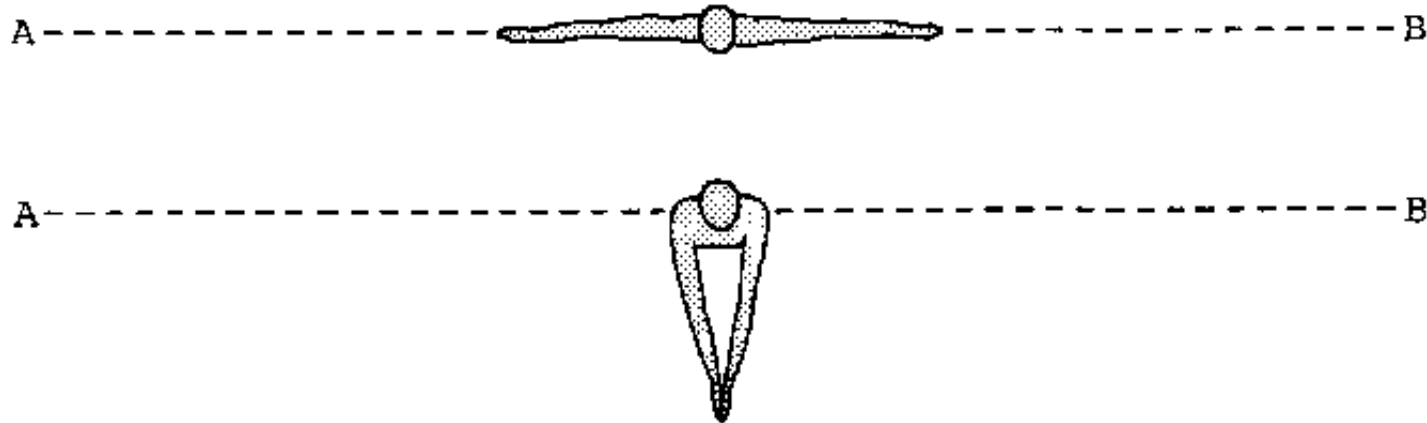
**To find a point perpendicular to line AD at A, use the following method: Place a stake at point A and tie a length of string to it. Measure out 12 meters on the string, marking the 3 meter and 8 meter points. Run the string along line AD, placing a stake at the 3 meter mark (point B). Angle the string towards line AE, placing a stake at the 8 meter mark (point C). Run the string back towards point A, pulling the string taut around the stakes, and adjust the placement of points B and C (angles only, not distance), until the string meets point A at the 12 meter mark. There's now a right angle at point A.**

**Mention that any other distances in 3:4:5 proportion can be used. It is the same principle that is used to construct the simple stick level.**

**The arms and closed eyes method is explained as follows:**

**A person lines up between two points, A and B. He/she points the fingertips of**

**each hand at the two points, at shoulder level. A straight line will be formed along the arms and shoulders. Now the eyes are closed and, keeping the arms at shoulder level, the hands are slowly brought together. The angle formed between line AB and the arms will be approximately 90°.**



### **The arms and closed eyes method**

Step 6 20 minutes

Explain three ways to measure elevation:

- 1) simple stick level
- 2) water level
- 3) sight level

### **Trainer Note**

**Have the trainees refer to the attachment and explain each method. Trainees should use the instruments themselves. By using a tape measure or graduated stick, they can determine small elevation differences for objects around the room**

**or outside in the pacing area.**

Step 7 30 minutes

Describe the profiling procedure. Review, in detail, Attachment 32 B using the reproductions of Figure 1 and Table 1.

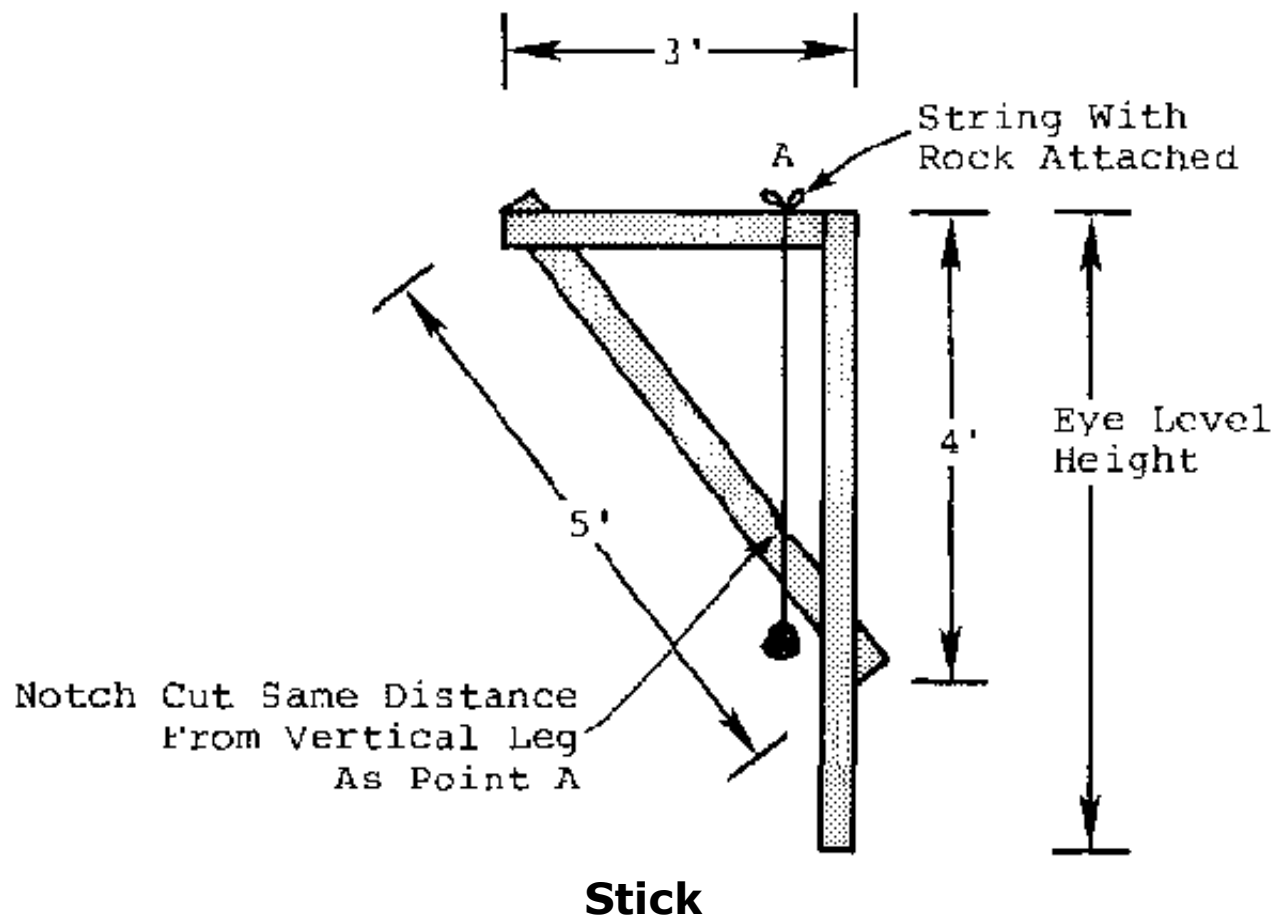
### **Trainer Note**

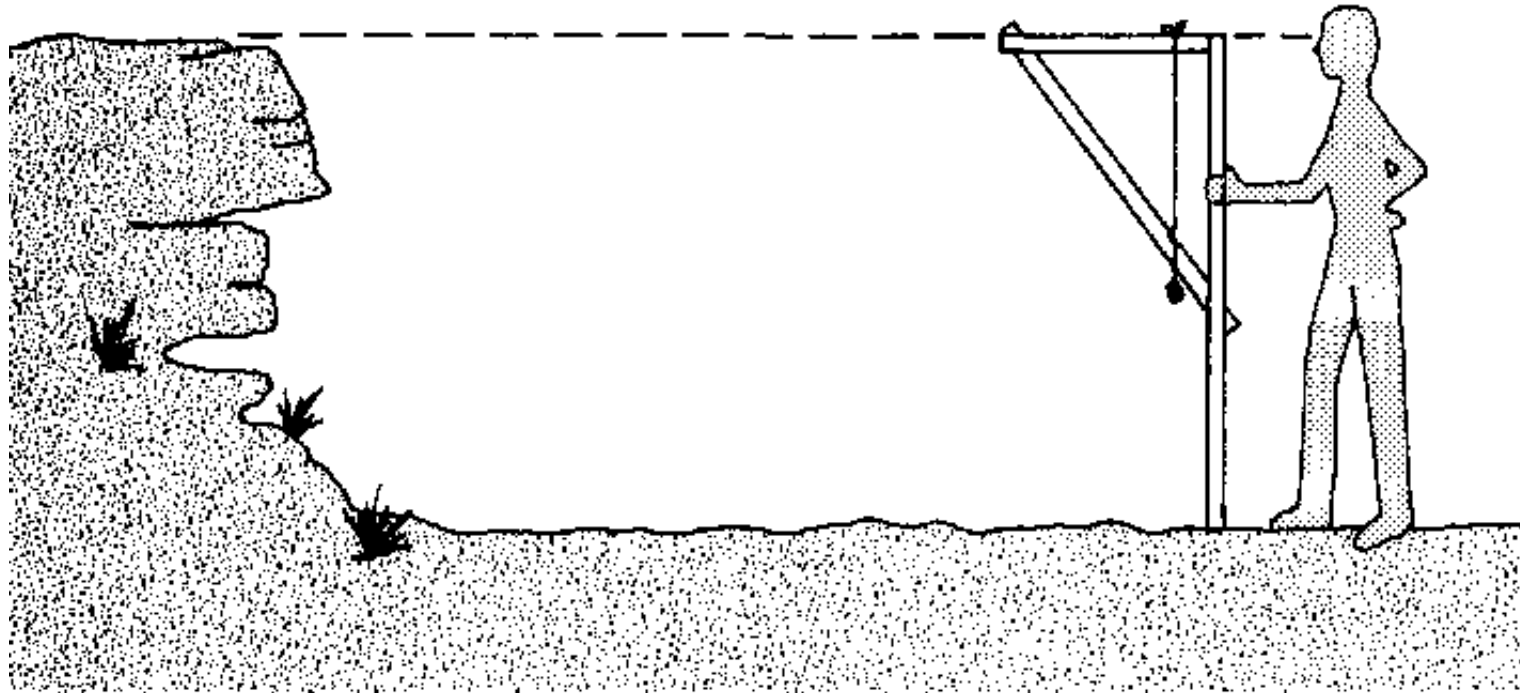
**It is important that the trainees understand the principles and procedures of profiling. Use your reproductions of Figure 1 and Table 1 to walk through the profiling procedure. Discuss the method in relation to designing pipelines. Mention that profiling can provide necessary information on elevation differences for hydraulic calculation, and ground profile information for laying pipe. Demonstrate the profiling procedure using a sight level and graduated stick. If time allows, have the trainees practice profiling around the room or outside.**

Step 8 5 minutes

Review the objectives and conclude the session.

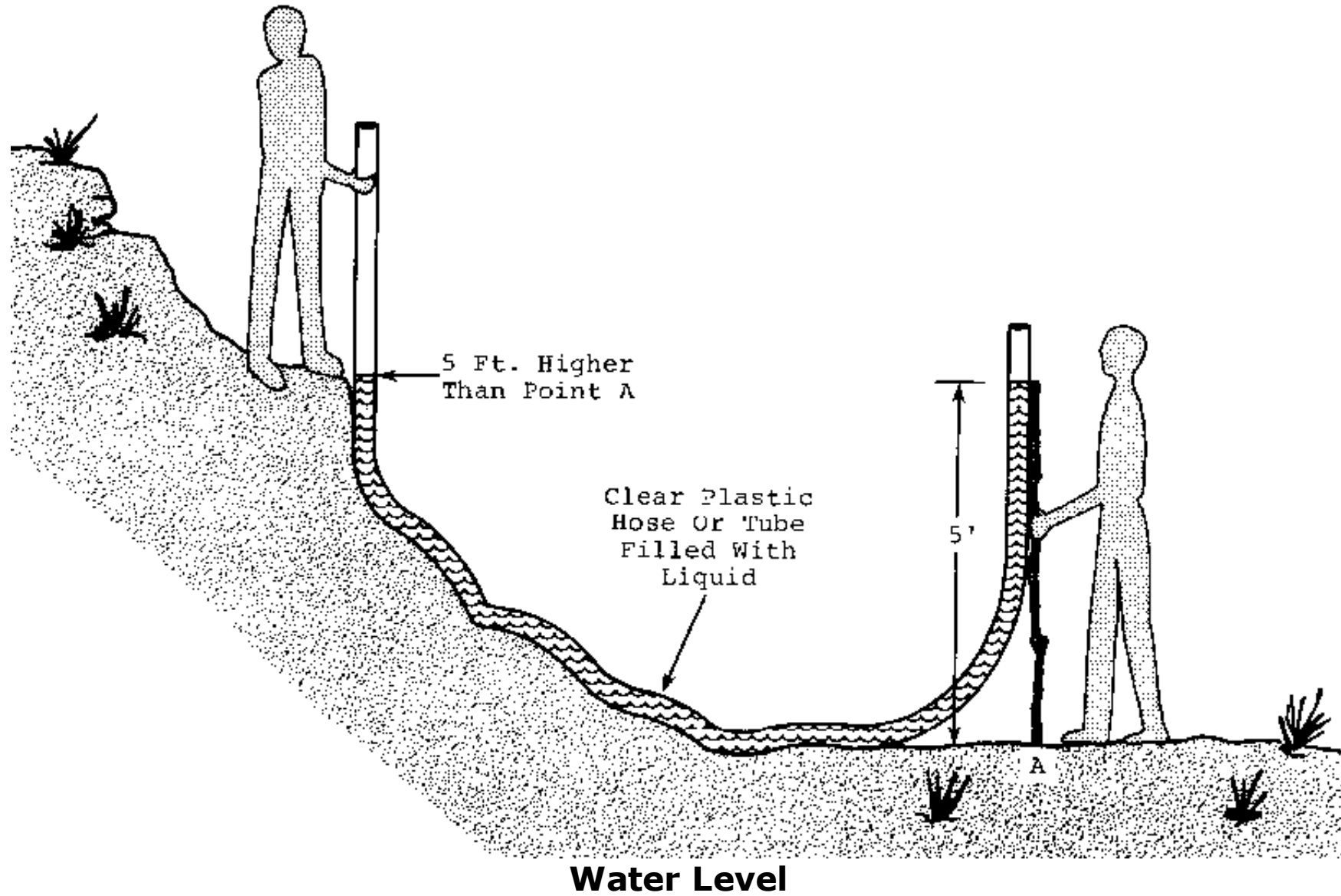
**Attachment 32A: Alternative ways of measuring elevations**

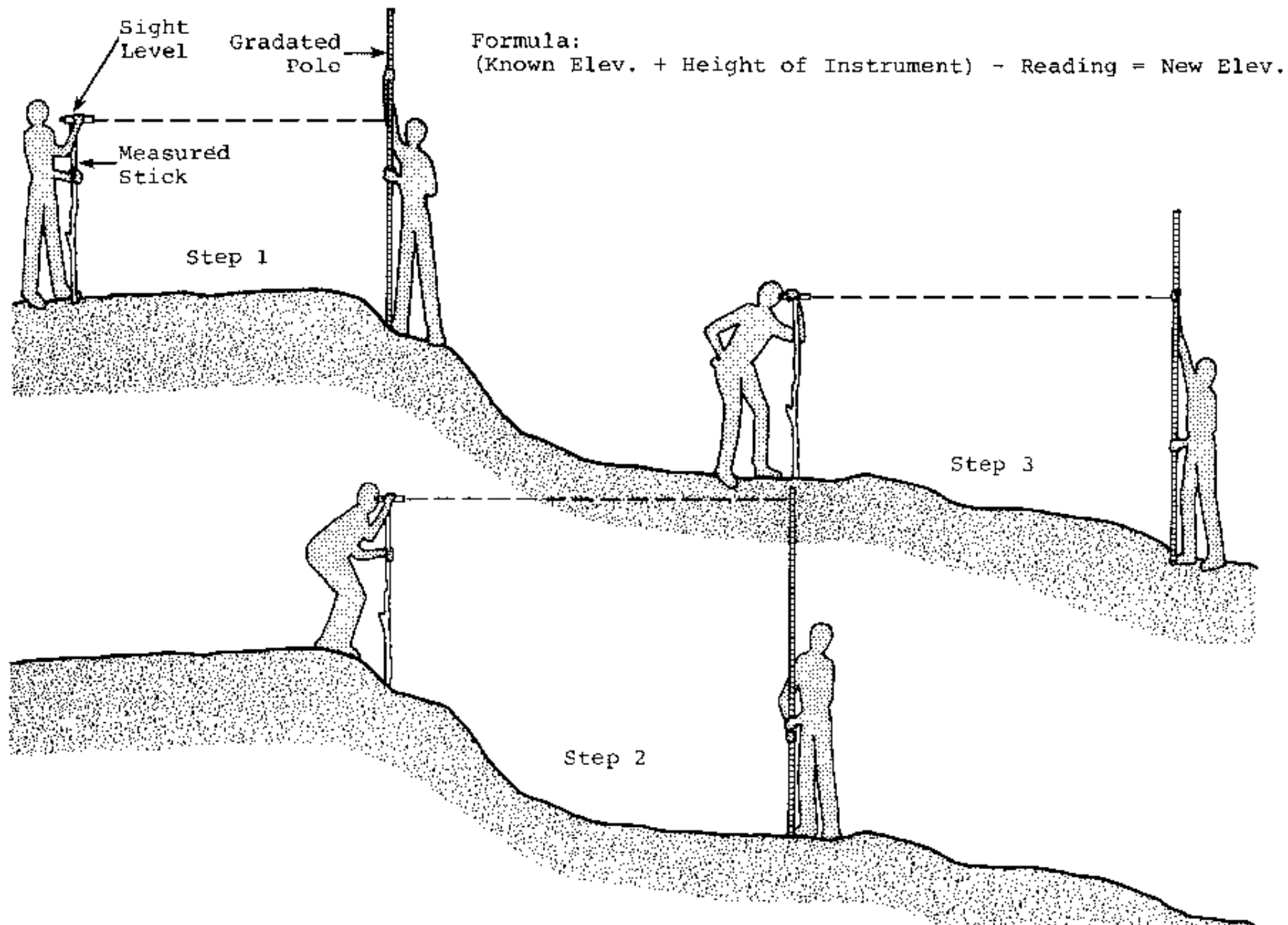




**Simple Stick Level**







## Sight Level

### Attachment 32B: Profiling

**Accurate knowledge of the ground profile along a pipeline route is often critical to proper pipeline design. Correct profiling depends on correct use of simple equipment. "Eyeball" methods of profiling are sufficient only in the simplest of situations. What follows is a general description of profiling methods. Read through the attachment carefully and work through the examples given as you go along.**

### Theory of Leveling

- 1. The line of sight of a properly used level is always at the same elevation, regardless of the direction in which it is pointed.**
- 2. If the elevation at any point on the ground is known, the elevation of the level line of sight may be found by measuring up from the known point. Because of the fact that most work requires the knowledge of relative elevations only, that known point is often assumed to be 100 or 1000.**
- 3. If the elevation of the level line of sight is known, the elevation of any point on the ground may be found by measuring down from the line of sight.**
- 4. By successive use of the above concepts, the elevation of any point may be found.**

## **Equipment**

- 1. Surveying level and tripod or hand level. Levels are surveying instruments that have a telescope and means for orienting the telescope's line of sight in a horizontal plane.**
- 2. A stick marked with distance measurements (feet, meters, etc.). This stick is called a " Rod."**
- 3. Distance measuring equipment, such as a measuring tape, engineer's chain, or optical distance estimating equipment. Pacing is adequate only for flat terrain or short distances.**
- 4. A notebook, properly set up.**

## **Theory of Profiling**

- 1. Profiling involves measurement of elevations (leveling) along a line, together with measurement of horizontal distances.**
- 2. Distances must be measured on a straight line between points for which elevations are taken.**

## **Notekeeping**

- 1. Notekeeping is one of the most critical portions of surveying. Many surveying mistakes can often be traced back to poor notation. A notebook should always be properly set up and the time taken to make notes clear and readable.**

**2. A site sketch should accompany the measurements. This will help the notetaker remember important surface features of the area. The sketch should show salient features such as houses, streams, hills, trees, etc. along the pipeline route. A North arrow should also be included.**

## **Terminology**

**1. Sta = Station. This is the point on the profile line at which an elevation was measured. These are normally numbered by hundreds of feet. For example, a station 10 may be 1000 feet from the beginning of the survey. Intermediate distances are indicated by pluses: Sta 10 + 50 would equal 1050 feet from the beginning.**

**2. Bm = Benchmark. This is a monument or point of known description which includes elevation.**

**3. Tbm = Temporary Benchmark. This is an object that is relatively permanent such as large rocks or trees where the elevation has been determined.**

**4. Bs = Backsight. This is a rod reading at a point of known elevation.**

**5. HI = Height of Instrument. This is the elevation of the line of sight of the instrument.**

**6. Fs = Foresight. This is a rod reading at a point of unknown elevation.**

**7. Elev = Elevation**

## **8. Dist = Distance between points.**

**9. Tp = Turning Point. This is a point used primarily to serve as a reference elevation to move the instrument, Both a foresight and backsight are taken on the point. The point may be on or off the profile line, but should be a solid, easy to relocate, point.**

## **Profiling Procedure**

- 1. Setup and level instrument.**
- 2. Sight Benchmark (point of known elevation) for Backsight reading.**
- 3. Enter rod reading in Backsight (Bs column 2)**
- 4. Add rod reading (column 2) to Benchmark (column 5) to get Height of Instrument (HI column 3)**
- 5. Sight point to be determined (Foresight) and enter reading in Foresight (Fs column 4)**
- 6. Subtract Foresight (column 4) from Height of Instrument (column 3) to get elevation of Foresight (column 5).**

## **Turning Point**

- 1. Rodman maintains position at Foresight**
- 2. Move setup, and level the instrument at new location (Tp 1)**
- 3. Sight rod at Backsight (last foresight station) and enter reading in column 2**
- 4. Add rod reading (column 2) to elevation of backsight (column 5) to get height**

## of instrument (column 3)

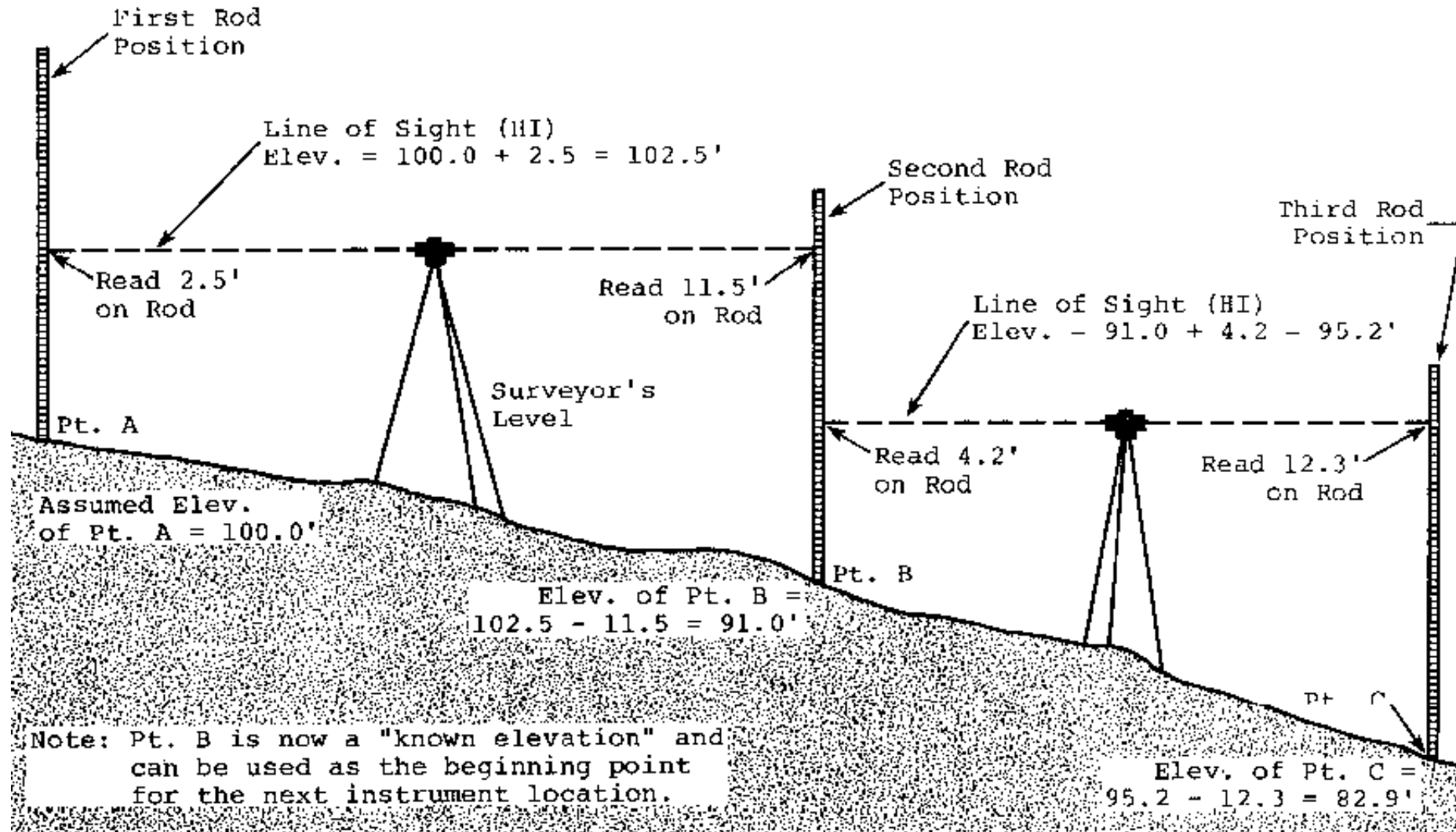
### 5. Proceed with Foresight (steps 5 and 6 above).

#### Example I

1	2	3	4	5	6
	+		-		
Sta	Bs	HI	Fs	Elev	Notes
Pt A	2.5	102.5		1000.0	Assumed Elev.
Pt B			11.5	91.0	
Tp 1	4.2	95.2			Pt B
Pt C			12.3	82.9	

#### Table 1

#### Survey Notation for Figure 1.



**Figure 1 - Profiling**

**The steps used in the example problem are different from those used by professional surveyors. They have been simplified in an attempt to reduce confusion and are more than adequate for the type of surveying that is necessary in small scale piped water systems. When using this method, always remember the following simple calculations:**



- 1. Known elevation + Backsight reading = Height of Instrument.**
- 2. Height of Instrument - Foresight = Next Elevation.**

## **Practical Hints for Surveying**

- 1. Before starting, walk the course to be surveyed and mark the line to be profiled. If the survey is conducted for a piped water system, remember to keep in mind that pipe will have to be laid in trenches along the course. Whenever possible, avoid obstacles that will make laying difficult.**
- 2. Mark with a sturdy stake all turning points, foresights, and backsights as work progresses so they will be visible if a recheck is necessary.**
- 3. After you have finished your calculations, redo the survey if unacceptable errors occur. It is much easier to correct a surveying mistake before pipe has been laid in the ground.**
- 4. It is desirable to recheck horizontal distances as well. Approximate methods, such as pacing, will catch major errors with a minimum of effort.**

## **Plotting the Profile**

**Once the horizontal distances and elevations are surveyed in the field, the data is brought back to the office and plotted on graph paper. This completed profile can be used for sizing of pipelines, locating storage tanks, sir valves, washout points, and so on. Normally, the vertical scale is greater (numerically smaller) than the horizontal scale. For example, the vertical scale may be ten times the horizontal. In the vertical scale, one inch may equal ten feet and in the horizontal, one inch**

**may equal one hundred feet. Other similar ratios may be used.**

**Example II; Figure 2.**

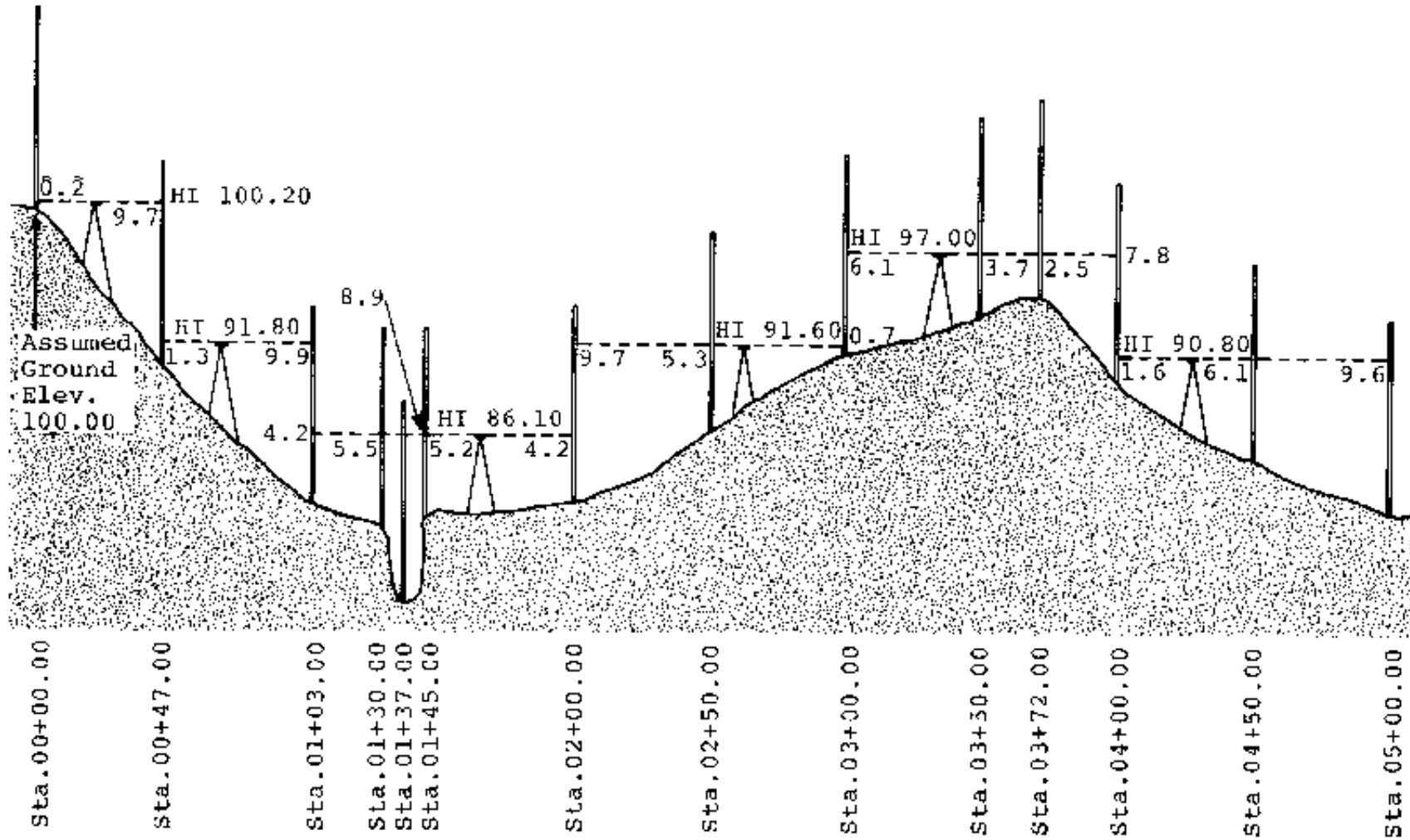
At 0 + 00	$100.0 + 0.2 = 100.2$ (equals HI)
At 0 + 47	$100.2 - 9.7 = 90.5$ (equals next elevation)

**This is repeated for the next instrument set up**

At 0 + 47	$90.5 + 1.3 = 91.8$ (equals HI)
At 1 + 03	$91.8 - 9.9 = 81.9$ (equals next elevation)

**Many different ground elevations may be found from a single Height of Instrument sight, as shown by the following:**

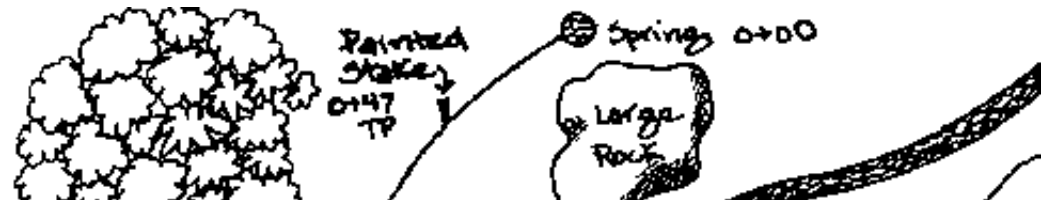
At 1 + 03	$81.9 + 4.2 = 86.1$ (equals HI)
At 1 + 30	$86.1 - 5.5 = 80.6$ (equals ground elevation)
At 1 + 37	$86.1 - 8.9 = 77.2$ (equals ground elevation)
At 1 + 45	$86.1 - 5.2 = 80.9$ (equals ground elevation)
At 2 + 00	$86.1 - 4.2 = 81.9$ (equals ground elevation)



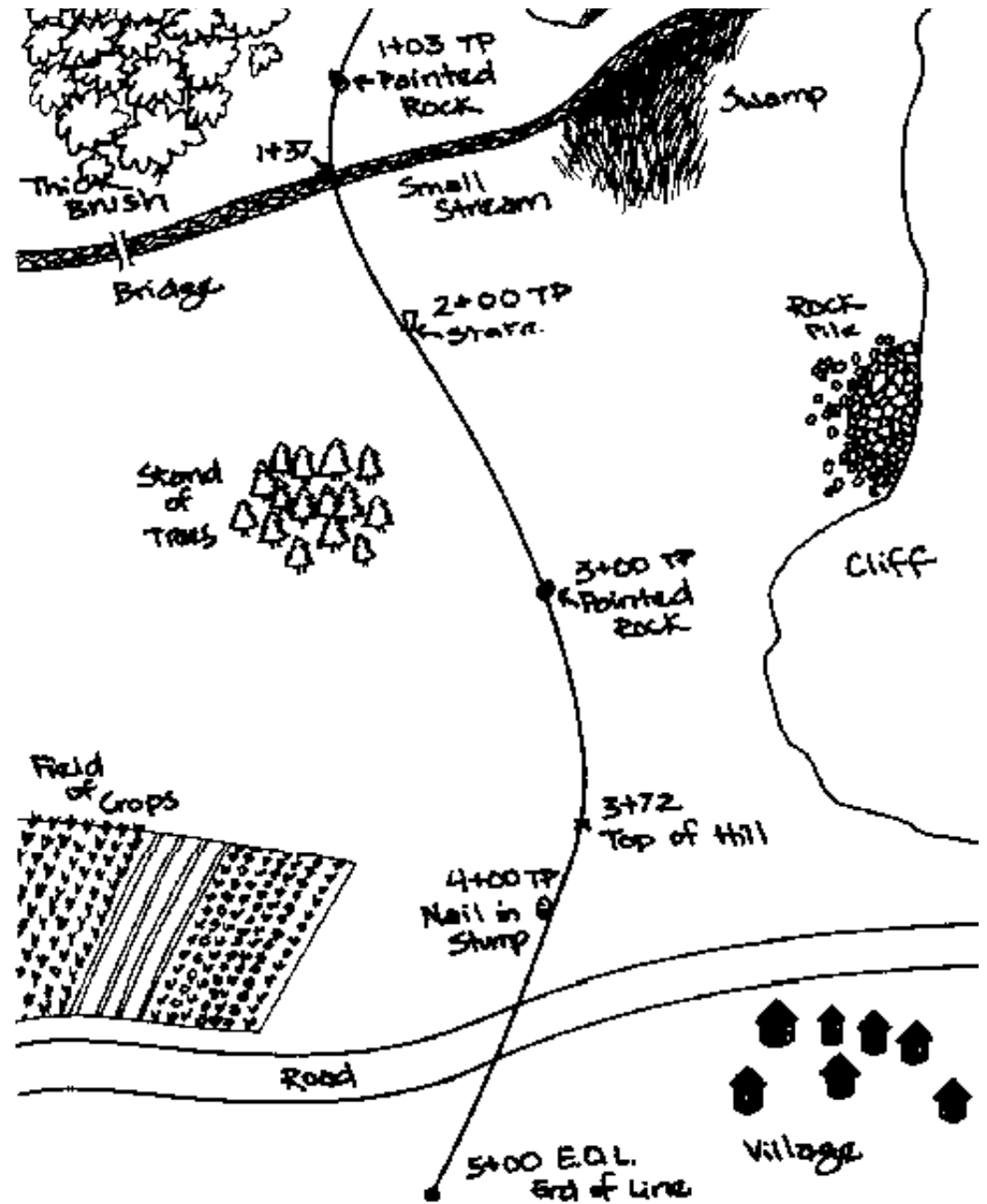
Vertical Scale: 1" = 10'  
 Horizontal Scale: 1" = 60'

**Figure 2 - Typical Profile**

LOCATION:  
 SURVEYOR:  
 DATE:



STA.	+B.S.	H.I.	-F.S.	ELEY.	NOTES
0+00		Assumed		100.0	Spring
	0.2	100.2			
0+47			9.7	90.5	TP #1
	1.3	91.8			
1+03			9.9	81.9	TP #2
	4.2	86.1			
+30			5.5	80.6	Stream West Edge
+37			8.9	77.2	Stream
+45			5.2	80.9	Stream East Edge
2+00			4.2	81.9	TP #3
	9.7	91.6			
2+50			5.3	86.3	
3+00			0.7	90.9	TP #4
	6.1	97.0			
+30			5.1	93.3	
+72			2.5	94.5	Top of Hill
4+00			7.8	89.2	TP #5
	1.6	90.8			
+50			6.1	84.7	
5+00			9.6	81.2	E.O.L.



Survey Sketch And Notation

## Session 33 - Field demonstration: Surveying

TOTAL TIME	Two Hours
OBJECTIVES	<ul style="list-style-type: none"><li>* Practice leveling a survey instrument, reading a rod, and taking notations in the field</li><li>* Complete a ground level traverse using a survey instrument</li></ul>
RESOURCES	Attachments 32-B: "Profiling"
PREPARED MATERIALS	Transits, builders' levels or similar survey instruments with tripods, and surveyors' rods
FACILITATORS	One or more trainers

### Trainer Introduction

**This session is designed to give the trainees hands-on experience with surveying. It requires substantial preparation. Assemble the trainees at the location of the demonstration. Have the survey equipment on hand and establish some sort of traverse for the trainees to follow which simulates true field conditions as closely as possible. The trainees should work in groups of three, one person on the instrument, one on the rod, and one taking notations. They should rotate during the session so that each member of the group performs all three tasks. Place trainees who are familiar with surveying techniques among the groups. The resource Attachment is meant to serve as reference information for the trainees.**

### PROCEDURES

Step 5 minutes

1

Present the objectives and format for the session.

Step 15 minutes

2

Demonstrate the method of surveying in a three person team. Include leveling the instrument under field conditions, holding and reading a rod, and taking notations.

### **Trainer Note**

**Make sure that you explain each surveying task thoroughly. Emphasize how to work together as a team to complete a proper survey.**

Step 1 hour, 30 minutes

3

The trainees complete a ground level traverse with each trainee performing the various tasks.

### **Trainer Note**

**It is important that all trainees practice each task to the point where they feel comfortable performing it. Completing the traverse is not as important as practicing each task.**

Step 4 10 minutes

Review the objectives and conclude the session.

## Trainer Note

**Many trainees will need more time to become proficient at surveying. If possible, provide additional scheduled time for practice. Otherwise, make the instruments available for use during unscheduled training hours.**

### Session 34 - Gravity water systems: Part II

TOTAL TIME	Four Hours
OBJECTIVES	<ul style="list-style-type: none"><li>* Discuss the following design considerations for a gravity water system: project life, growth rate, consumption figures, and source identification</li><li>* Describe some common design layouts for a simple rural system with these basic components: source intake, storage, distribution, and operations/maintenance plan</li><li>* Design a sample gravity water system</li></ul>
RESOURCES	<p><u>Rural Water and Sanitation Projects</u>; USAID, pp. 35-42, 49-57</p> <p>Attachment 34-A: "Design Guidelines and Layouts for Simple Gravity Water Systems"</p> <p><u>Small Community Water Supplies</u>; IRC, pp. 317-360</p>
PREPARED MATERIALS	<p>Newsprint and felt-tip pens</p> <p>Copies of Attachment for all trainees, reproductions of Figures 1-4</p> <p>Pieces of graph paper, straight - edge rulers, and pencils for all trainees</p>
FACILITATORS	One or more trainers

## **Trainer Introduction**

**This is the second part of the two part session on gravity water systems. It builds upon the information presented in Part I to describe the basic design steps for a simple small-scale gravity system. The design standards used are general guidelines, based on field experience, and when used have given acceptable results. The type of systems discussed are simple branch rural systems, serving from 500 to a few thousand people, with usually under ten kilometers of pipeline, and using standpipes for distribution. At all times the emphasis is placed on general standards and practical methods of design. It is believed that these practical methods can be used successfully by the Peace Corps water/sanitation technician and engineer.**

**The reading assignment from Water for the World is a carryover from Part I. The reading in Small Community Water Supplies is additional, more technical, resource information which trainees may choose to study on their own after the session.**

## **PROCEDURES**

Step 1 10 minutes

Present the objectives and format for the session.

## **Trainer Note**

**Point out that this session builds on the information and principles presented in Part I. Mention that the water systems which will be discussed are simple branched rural systems, serving from 500 to a few thousand people, with under**



**ten kilometers of pipeline, and using standpipes for distribution. Emphasize that such systems are relatively easy to design and construct, and can be operated and maintained by trained local community members.**

Step 20 minutes

2

Lecturette on design considerations for a gravity water system; Project life and Growth rate.

### **Trainer Note**

**Begin by discussing project life. Point out that it is important to estimate how long the project will serve the community. Each community, or local government agency, should have set guidelines for project life. General standards are either 10 years, 15 years, or 20 years.**

**Next, explain growth rate. This is also a estimation based on the present population and the percentage of population growth in the area. Many governments have figures on the growth rate of their populations, if so, the designer should use the official percentage. If not, a general figure of 2% per year can be used.**

**When tied together, project life and growth rate play an important role in the design process. Together they determine the future population figure used for the design process. Here is the formula for finding the future population. Write on newsprint**

**\*present population x (1 + growth rate) project life = future population**

**The simplest way to use the formula is to refer to a population growth rate table where the number for (1 + growth rate) project life has been worked out. Here is such a table:**

<b>Growth Rate</b>	<b>Project Life</b>		
<b>% per Year</b>	<b>10 Yrs.</b>	<b>15 Yrs.</b>	<b>20 Yrs.</b>
1%	1.10	1.16	1.23
2%	1.22	1.35	1.49
3%	1.34	1.56	1.81
4%	1.48	1.80	2.19
5%	1.63	2.08	2.65

**Therefore, to use the table the formula would be:**

**\*present x table figure = future**

**Write the following example problem on newsprint:**

**Example:**

**Growth Rate = 2% Project Life = 15%**

**Present Population = 1,000**

**1000 x 1.35 = 1,350**

**This computation can also be worked out mathematically by multiplying the population figure for each year times the growth rate. Such as:**

**Year One = 1000 x.02 = 1020**

**Year Two = 1020 x.02 = 1040.4**

**Year Three = 1040.4 x.02 = 1061.2**

**Year Four = 1061.2 x.02 = 1082.4 and so on**

Step 3 40 minutes

Lecturette on design considerations: Consumption Figures, Source Identification.

### **Trainer Note**

**Begin by discussing consumption figures. These figures result from the relationship between the user population of the system and the per capita demand. You receive the population figure from the project life/growth rate computations. The per capita demand is determined by the designer to fit the type of distribution system. During Session 23, Water Supply Improvements, some guidelines were given. The range fell between 20 and 80 liters/per person/per day depending upon the degree of distribution convenience, such as the difference between using communal standpipes or individual single tap connections.**

**Next, explain Average Daily Use (ADU). Mention that once the per capita consumption has been agreed upon, this figure can be used to compute ADU. The formula is simply (write on newsprint):**

**\*number of users x liters/per person/per day = ADU**

**Example:****Number of Users = 1000****per capita consumption = 30 liters/per person/per day** **$1000 \times 30 = 30,000$  liters/day ( $30\text{m}^3$ ) ADU**

**NOTE: At this point the approximate number of users per distribution point, or water tap, may also be decided upon. This number will too vary depending upon the degree of distribution convenience. The general guideline is between 30 and 100 users per tap. By determining the desired number of users per tap, you can determine the approximate number of water taps needed in the system. Write on newsprint:**

**Example: Population = 1000****Number of users per tap = 50** **$1000 : 50 = 20$  taps**

**Emphasize that the ADU (and number of users per tap) are figures controlled by the designer. These figures must match local acceptable standards and the guidelines presented here may be adjusted to fit individual systems.**

**Mention that the degree of distribution convenience, in other words where the water taps are located in the system, will affect the actual ADU and number of users per tap. The designer must match the distribution system with the design figures she/he uses for ADU and number of users per tap, or actual consumption figures will be different from those used to design the system.**

**Now, mention that identification of the source is a very important step in the design process. In general, the water source must be free of contamination, provide a continuous minimum amount of water to the community, and be able to be supplied to the community in a convenient manner. There are three basic questions to ask:**

- 1. Is the source accessible for development?**
- 2. What is the water quality?**
- 3. What is the flow? (quantity)**

**Here are important points to emphasize for each question:**

**1. The source must be accessible for development, if not, the water quantity and quality mean little. Most intakes require substantial construction work and materials. If there is no available road or path access, the cost of the project will be considerably increased to provide one.**

**2. Water quality standards were also discussed in Session 23, Water Supply Improvements. In general, to establish water quality, measurements must be taken over a period of time during high and low flows. The main considerations in assessing quality of the water source are bacterial quality, chemical quality, and consumer acceptability. The first two are derived from lab testing. The third, consumer acceptability, varies according to local standards.**

**It is difficult to set rigid standards for water quality however, no source should be used if it will not significantly improve the quality of water used by the local community. This is especially true when the source will be used for drinking**

**purposes, good quality is the number one priority.**

**3. Measuring the source flow should be done on numerous occasions, especially during the driest part of the year. There is a simple rule with regard to the quantity of source flow: cumulative inflow must be greater than outflow. Simply stated, this means that the minimum source flow should at least meet, and if at all possible exceed, the ADU.**

**Source flow is stated in units of volume per unit of time, such as liters per second or gallons per minute. You can compare the source flow to the ADU by mathematically reducing the ADU, which would be stated as liters per day for example, to liters per minute, or liters per second. This is called the Average Daily Flow (ADF). It is the continuous flow of water necessary to supply the ADU. You can find the ADF by this formula (write on newsprint):**

**\* ADU in meters<sup>3</sup> - 86.4 = ADF in liters per second (Note: there are 86,400 seconds in one day)**

**Example:**

**ADU = 30,000 liters/day**

**30,000 liters = 30 m<sup>3</sup>**

**30 - 86.4 = .35 liters/second ADF (21 liters/minute)**

**Emphasize that the designer would compare the source flow to the ADF to decide if water quantity was sufficient for development. Mention that the ratio between source flow and ADF will be used later to calculate storage requirements for a**

## **system.**

Step 4 20 minutes

Lecturette on common design layouts for a simple rural system.

Handout Attachment 34-A

### **Trainer Note**

**Refer to the four drawings (Figures 1-4) on the attachment. Review each design layout, discussing their relative strengths and weaknesses. Comments on each system are included in the attachment. Point out, in all four layouts, the basic components of the system: source intake, storage, distribution, and operations/maintenance.**

Step 5 30 minutes

Lecturette on basic components of a gravity system; source intake and storage.

### **Trainer Note**

**Begin by discussing the source intake. Point out that there are a variety of intake designs and methods to construct them. It is not the purpose of this session to discuss them. However, all intakes must perform two basic functions; to collect the source flow for distribution, and to improve the water quality by protecting it from contamination.**

**The construction method and procedures for the intake must satisfy these two criteria to at least a minimum level of sufficiency.**

**NOTE: A more detailed discussion of intake design for springs will take place during Session 35.**

**Next, discuss storage requirements. Emphasize that in most cases, storage of water is necessary. The size and placement of the tank(s) are dependent upon the following:**

**1. The size of the tank, or tanks, is usually determined by comparing the supply curve with the demand curve. This is done by looking at the ratio of the minimum source flow over the ADF. Write on newsprint:**

$$* \text{storagerequirement} = \frac{\text{minimumsourceflow(MSF)}}{\text{ADF}}$$

**To begin with, if the ratio is less than one, the source does not have enough water to supply the system as discussed during Step 3. If the ratio falls between one and two, then storage should be equal to one half the ADU of the system. If it falls between two and three then storage should be one quarter ADU. If it is between three and four then, one-eighth ADU. And, if the ratio is greater than four, then no storage is necessary. Illustrate on newsprint:**

$$\text{Storagerequirements} = \frac{\text{MSF}}{\text{ADF}}$$

**Example:**

**MSF = 2 liters/second**

**ADF = 1.2 liters/second**



$$\frac{2 \text{ liters/second}}{1.2 \text{ liters/second}} = 1.6$$

<b>Ratio</b>	<b>Storage</b>
< 1	= not adequate
1-2	= 1/2 ADU
2-3	= 1/4 ADU
3-4	= 1/8 ADU
> 4	= no storage required
1.6 = 1-2 ratio	= 1/2 ADU for storage

**Mention that in many field cases, the ratio falls between 1 and 2. Therefore, as a rule of thumb, storage capacity can often be fixed at one half the ADU. However, point out that all such figures are approximations based on field experience and may be adjusted to fit specific circumstances.**

**2. In general, the placement of storage tanks depends on two factors: the design layout for the system and the system hydraulics or available head. Refer to the design layouts shown in Figures 1 and 2 of the attachment.**

**In Figure 1, the design layout called for storage at point of use and there are five distribution points. Illustrate the following on newsprint:**

**Example:**

$$\text{ADU} = 105 \text{ m}^3$$

**ADF = 1.2 liters/second**

**MSF = 2.0 liters/second**

$$\frac{\text{MSF}}{\text{ADF}} = 1.6$$

**Storage =  $\frac{1}{2}$  ADU = 50m<sup>3</sup>**

**Storage capacity at each point = 10m<sup>3</sup>**

**Point out that this example assumes that the population is evenly distributed. If it were not, the storage tanks at each point would have to vary in size to match the population distribution. Emphasize that in all cases, however, the total storage capacity would be fixed at  $\frac{1}{2}$  ADU; only their placement would be altered to fit field conditions.**

**In Figure 2, the design layout calls for central storage at some point along the pipeline. Determining total storage capacity is done the same way as in figure one and because only one tank is built, the capacity would be the total storage capacity of the system.**

**In this case, the placement of the tank would be based on the hydraulic conditions of the system. It would be placed to regulate the available head, breaking pressure from the source, and determining the head available at the distribution points. Also, mention that it should be built on an easily accessible site.**

Step 40 minutes

6

Lecturette on basic components of a system; distribution and operations/maintenance.

## Trainer Note

**Begin by discussing the distribution system. Laying out of the distribution system requires two basic procedures: sizing the pipeline and determining the number and placement of the distribution points. Both are dependent upon the data received from the design survey and discussions with the village users.**

**To size the pipeline, the designer must select the design flows she/he will use in the system. Whatever flow is chosen, is then used in the calculation of head losses to determine pipe diameter. As was stated in Part I, the designer will select the smallest diameter pipe with a calculated head loss less than the available head.**

**Explain that the design flow used to size the pipe going from the source to storage is the same as the ADF. Write on newsprint:**

**\*design flow for source to storage = ADF**

**Refer to the design layout shown in Figure 1 of the attachment. In this case, a design flow equal to the ADF would be used to size the entire pipeline.**

**Now refer to Figure 2. Here a design flow equal to the ADF would be used to size only the pipe going from the source to the storage tank.**

**Next, explain peak demand. The demand of water in any system is not a constant, it fluctuates up and down throughout a 24-hour period. Peak demand is the**

**highest demand of water expected to occur over that 24-hour period. This is the time when the most water is used and often times, all taps are fully open. In general, peak demand accounts for 20-25 percent of the operating time (4-6 hours per day) usually in the daylight hours around meal times.**

**Emphasize that the design flow used to size the pipe going from storage to the distribution points must take into account peak demand.**

**From field experience it has been found that the design flow used for this section of pipe can be taken as four times the ADF. Write on newsprint:**

**\*design flow for storage to distribution points = 4 x ADF**

**Refer to the design layout shown in Figure 2. In this case, a design flow equal to four times the ADF would be used to size the pipe from the storage tank to the distribution points.**

**Explain to the trainees that this design flow would be taken as the flow rate for the entire distribution system after the storage tank. Because this pipeline has two branches, the flow would be divided after the branch. Flows used in calculated head losses for subsequent pipeline sections, would be reduced by the amount used at each distribution point. Emphasize that the designer would make his/her decision about what percentage of the flow went into each branch and subsequent distribution point, by looking at the population density at each point and what the water demands are.**

**Now, explain the next step in the design process, calculating the number of water taps necessary for the system. The number of taps needed for the system is**

**determined by the ratio of peak demand over the maximum flow per tap. For a standard 3/4" tap, that maximum flow is .225 liters/sec. Write this formula on newsprint:**

$$* \text{ number of taps} = \frac{\text{Peak Demand}}{\text{Maximum flow per tap}}$$

**Example:**

**Peak Demand = 4.6 liters/sec.**

**Maximum flow per tap = .225 liters/sec.**

$$\frac{4.6}{.225} = 20.4 \text{ taps}$$

**NOTE: There is an alternative way to calculate peak demand and you may explain that method now if desired. During Step 3 a method to calculate the desired number of water taps was discussed. It was done by dividing the population figure by the desired number of users per tap. To find peak demand, multiply that number of taps times .225 liters/sec.**

**Peak Demand = number of taps x .225 liters/sec.**

**You may use this method to calculate the design flows in each branch line, just multiply the number of taps in each pipeline section by .225 liters/sec.**

**Next, mention that the placement of each specific distribution point is important. The village users should be consulted to ensure that the placement is acceptable.**

**In general, no more than 20% of the users should have to walk more than 100 meters to obtain water. However, this figure is a guideline and can be adjusted to fit local standards.**

**Also, emphasize that at each distribution point, a certain amount of head is needed to supply pressure at the taps. This is called residual head. A general guideline for the amount of residual head is 10-15 meters at any standpipe along the pipeline. This guideline may vary according to field conditions. However, the residual head of a standpipe should never fall below seven meters or there may not be sufficient pressure to supply water. If the residual head is more than 25-30 meters, the tap may not be able to withstand the pressure and consequently, blowout. In this case, valves or a short length of small diameter pipe can be used to reduce pressure.**

**Point out that when discharging into a storage tank, a greater amount of residual head is allowable (up to 50 meters) because a straight pipe is used at the discharge point, rather than a water tap.**

**One other general guideline should be mentioned. All points along the pipeline should have a minimum of 7 meters residual head to ensure a smooth continuous flow of water regardless of ground profile.**

**Lastly, discuss the operations/maintenance component of a system. Point out that any system is only as good as its operating and maintenance procedures allow it to be. Countless systems all over the world have been built with skill and the best intentions only to become useless because of failures in operating procedures or lack of proper maintenance.**

**Operation/maintenance plans may vary to fit local standards and practices. In some places, the government may assume responsibility, in others the local users may have communal responsibility. At times, an individual is trained and paid to operate and maintain the system. However, in all cases, the plans should be included in the design phase of the project, specifically delegate responsibility for various tasks, and be agreed upon by all participants.**

Step 7 15 minutes

Lecturette on other design features of a gravity system

### **Trainer Note**

**The guidelines discussed during this session provide the general information and format for the design of a simple rural system. However, there are numerous other design considerations that may or may not be applicable to individual systems.**

**Take this time to discuss such design considerations. Here are some factors to consider:**

**1. Excessive Head. For most systems a maximum static head of 50 meters is desirable at any one point. GI pipe can withstand much greater pressure but most types of plastic pipe can not, especially when valves and fittings are used. It is advised not to push acceptable limits of pressure head. Break pressure tanks or storage reservoirs can be used to bring pressure back to zero in the pipeline.**

**2. Number of Fittings and Valves. Head losses are increased along the pipeline by the use of fittings and valves. A few fittings and valves used to control standpipes**

**or storage tanks do not significantly increase head losses. However, if a large number are used throughout the system, to regulate flow for example, or there are a significant amount of bends and joints in the pipeline, allowances should be made for the increase in head losses. In general, 5% may be added to the calculated losses to account for this. A further 5% may be added to account for errors in measuring head or distances. There are tables which give specific head losses for individual fittings and values but in most cases, these general guidelines may be used.**

**3. Air Blocks. Air bubbles can accumulate at high points in a pipeline and interfere with the flow of water. Normally, air blocks are not a problem if a tank is located at a point lower than the air block and the block is at least 10 m below static level. However, if necessary, air valves can be placed at such points to release the block and allow water to flow.**

**4. Washouts. Over time, suspended particles in the water will tend to settle out at low points in the pipeline, especially when flows are low. Washouts can be placed at these low points to allow for periodic cleaning of the pipeline.**

Step 8 60 minutes

Work through sample problems, Attachment 34-A.

## **Trainer Note**

**Two sample problems have been provided in the attachment. Have the trainees work through each problem individually, or in groups of two to three. Each trainee should draw the pipeline profile and plot the HGL on graph paper. Encourage them**



**to follow the design steps discussed during the session.**

**When plotting the HGL encourage them to use the following steps. Write on newsprint:**

- (1) Starting at the end of the pipeline, indicate points of desired head. At least 10m at each distribution point.**
- (2) Rough in an approximate HGL by plotting these points.**
- (3) Refer to the charts and select specific pipe diameters for each reach of pipe.**
- (4) Plot the true HGL according to exact head losses at each point. Remember, when determining the available head at each new point along the pipeline, be sure and subtract the head losses from preceding points.**
- (5) Recheck head losses (and residual heads) at each point, add them together to determine total head loss for the system.**

**Trainers should walk around the room and check the progress of the trainees as they work, and answer questions they may have.**

**When the trainees have completed the problems, review each one as a large group. Ask trainees to assist in the process. Use newsprint to illustrate the design steps, pipeline profile, and HGL.**

Step 5 minutes

9

Review the objectives and conclude the session by pointing out the Peace Corps water Technicians and engineers around the world have designed and constructed simple gravity water systems. Emphasize that by learning the design process presented during Parts I and II of this session, and through hard work, the trainees themselves will be able to participate in the same kind of work as Volunteers.

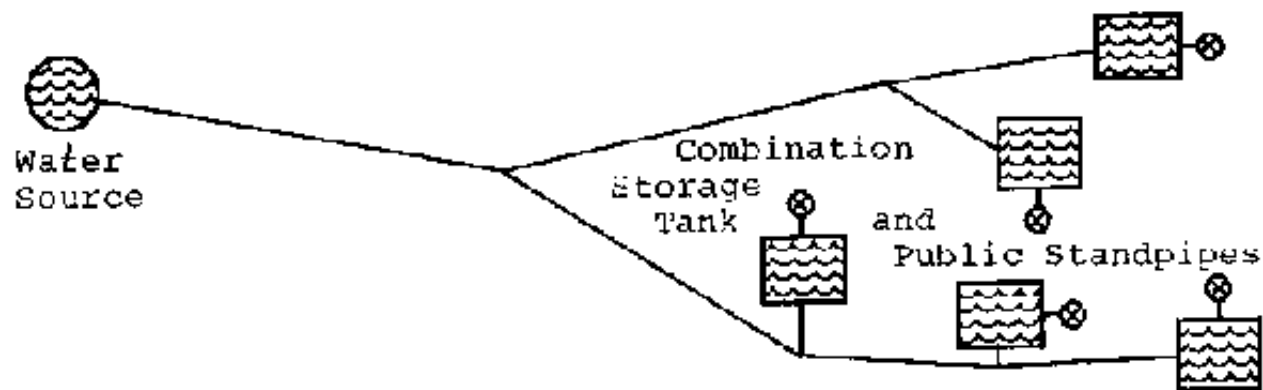
**REFERENCE: Practical Design Notes for Simple Rural Water Systems; A. Scott Faiia, CARE, Indonesia, 1982.**

**Handbook of Gravity Flow Water System for Small Communities; Thomas Jordan, UNICEF, Nepal, 1980.**

**Attachment 34A: Design guidelines and layouts for simple gravity water systems**

**Simple Design System Layouts: The following are four common layouts for a simple rural system**

**Figure 1 depicts the general schematic for placing storage at the point of use.**

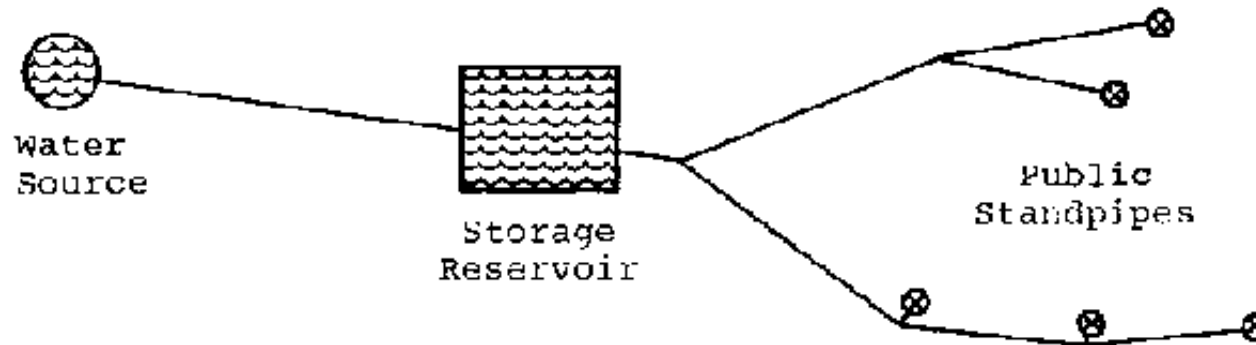


**Figure 1**

## **General Comments for Figure 1:**

- The inflow to each reservoir can be regulated so that each area receives a set allotment of water. If the people at that reservoir tend to waste water then they can only waste their allotment and not that of others. In a standpipe system with storage at the source, wastage would be much greater if taps were left open.**
- The small reservoir acts to break pressure in the system. This means that faucets at the point of use have only the head of the reservoir itself, and will last for a longer period of time because of the reduced pressure. Reduced head at the point of use also reduces wastage.**
- Storage at the point of use means that the main distribution pipe is in use at all times. It can therefore be of smaller diameter and thus reduce costs. (Influence on total cost will depend on the flow of the source compared to average daily usage as this will influence storage costs.)**
- It is sometimes easier to obtain community support and cultivate feelings of ownership and consequently, improve maintenance through the construction of small scattered reservoirs as compared to one large distant reservoir and standpipes. Additionally, the construction of small reservoirs allows each segment of the community to work at its own pace during construction and a lack of community organization will be less likely to impede the project.**

**Figure 2 depicts the general schematic for placing storage between source and distribution. This system also has many beneficial features:**



**Figure 2**

**General Comments for Figure 2:**

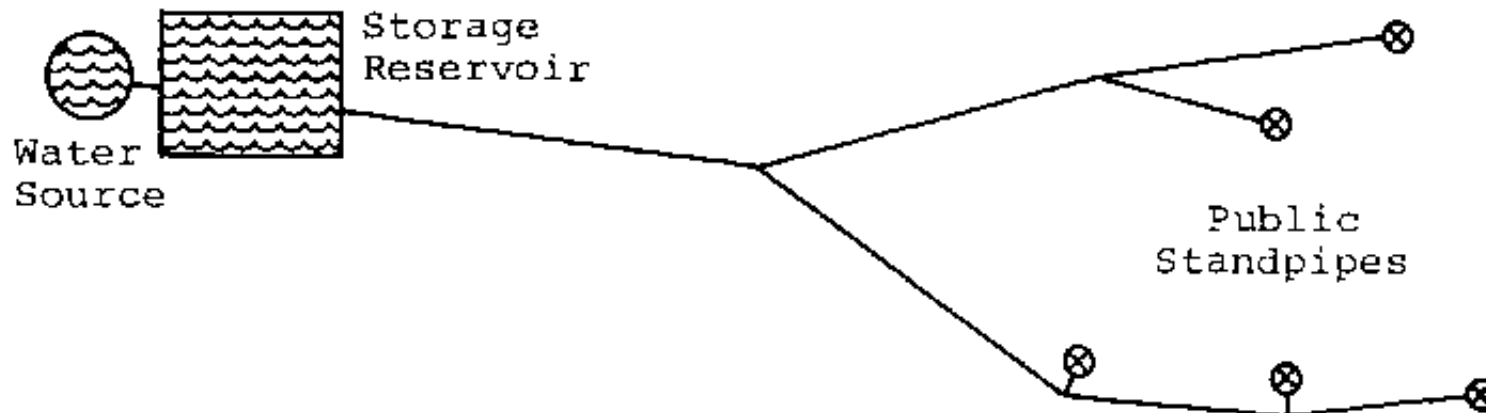
- **The pipeline to the point of storage is small as in Figure 1.**
- **The tank serves as a break pressure point in the system and can be placed to regulate pressure at the distribution points.**
- **Only one storage tank (larger in size) need be constructed and maintained.**
- **Water may be treated to improve quality at one center point.**
- **Standpipes can be easily placed at the desired distribution points.**

**In Figure 3, no storage is provided, and distribution is direct to public standpipes. This type of system requires a larger diameter pipeline, which in many cases, increases the cost of the overall system substantially. This system also requires a strong source flow to provide peak demand without storage.**



**Figure 3**

**In Figure 4, storage is provided at or near the water source, then distribution is direct to public standpipes. The pipeline diameter is the same as in Figure 3 and this is the most expensive option. In certain cases, however, storage may be included with construction of the intake and prove cost-effective for small systems.**



**Figure 4**

## **SUMMARY OF SUGGESTED GUIDELINES**

- 1. Quality:** The quality of the water should always meet local standards and be acceptable to the users. Optimally, there should be no fecal coliforms in any sample from the proposed source. If this is not possible, then there should be an average of less than 50 fecals/100 ml for all samples with no single sample exceeding 100 fecals/100 ml. For levels above this, simple treatment is advisable such as slow sand filtration or chlorination. Other characteristic quality problems such a turbidity or odor may be treated by aeration or settling chambers.
- 2. Quantity:** Optimally, the source should be able easily to supply the ADF. When calculating storage capacity for a system, the rule of thumb is, use 1/2 the ADU. More specifically, storage capacity is dependent upon the ratio of source flow over ADF. For a ratio between one and two, then storage is 1/2 ADU, between two and three, then storage is 1/4 ADU, between three and four, 1/8 ADU, and if greater than four, no storage is required. In regards to per capita consumption, the figure should be between 25-80 liters/per person/per day.
- 3. Convenience:** This criteria is dependent on the standards of each local community; however, it is desired that no more than 20% of intended users have to walk more than 100 meters to obtain water. Also, no more than 100 users per standpipe is desirable.
- 4. Design Flows:** For lengths of pipe from source to storage, use ADF. For lengths from storage to distribution, use ADF multiplied by four.
- 5. Pipe Size:** The smallest diameter of pipe with a calculated head loss less than the measured available head is desirable. Five percent should be added to losses to account for fittings and bends, 5% more to account for errors. Ten to fifteen

**meters of head should be available at any distribution point to ensure adequate pressure at the tap. The HGL should always lie above the ground profile of any system, and if possible 7 meters of residual head should be available at all points.**

**6. Number of Taps: This is determined by dividing peak demand by the maximum flow per tap. For a standard 3/4" tap, the maximum flow is .225 liters/sec.**

## **APPENDIX A**

### **GLOSSARY**

#### **AVAILABLE HEAD**

**The actual difference in elevation between the two points in question.**

#### **AVERAGE DAILY USE**

**The average volume of water which flows through the water system during a 24-hour period. It is based on the total population served and the projected per capita usage and is usually expressed in cubic meters (m<sup>3</sup>). The Average Daily Use is a hypothetical quantity. In reality, on some days water usage is greater and on some days it is less; it is only rarely the same. Moreover, this figure is the basis used for determining other design parameters such as storage volume and design flows. The Average Daily Use for a system supplying 1,000 persons with 100 liters per day is:**

**1,000 x 100 liters or 100 m<sup>3</sup>.**

## **AVERAGE DAILY FLOW**

**The flow of water necessary to supply the Average Daily Use if the water were flowing continuously. It is used as the basis for selecting design flows for pipes. The Average Daily Use in m<sup>3</sup> divided by 86.4 gives the Average Daily Flow in l/s that is necessary to supply that amount.**

## **DESIGN FLOWS**

**The flow used in the calculation of head losses to determine the pipe diameter. It is chosen by the designer based on the number of users, level of service, and type of storage to be provided and is thus related to the Average Daily Flow.**

## **ESTIMATED MINIMUM FLOW**

**The best estimate of the low flow from the water source that can be made with the available data.**

**If long-term estimates are not able to be made, flow measurements should be taken during the dry season in the area. It is best to be conservative in estimating the minimum flow to be used in designing the system.**

## **HEAD**

**The pressure or force per unit area that is available or must be overcome in order to transport water. Head may be supplied by gravity or by mechanical means such as a pump. Although it is a pressure, it is generally referred to in meters or feet of elevation, which is the equivalent pressure that would be exerted by a standing column of water of that height.**



## **HEAD LOSS**

**A loss of pressure (or head) in a closed pipeline due to friction between the pipe and the flowing water. The head loss is affected by flow of water, the distance it is carried, the diameter of the pipe, all fittings and valves in the system, and the inside surface of the pipe. Calculated head losses are compared with the available head to determine if the desired flow of water will be obtained using selected pipe diameters.**

## **PEAK DEMAND**

**The highest flow of water expected to occur on any given day. This flow usually lasts for only a very short time period and does not necessarily occur every day. For designing standpipe systems, it is taken as four times the Average Daily Flow.**

## **STATIC HEAD**

**The various pressures that would be obtained in the water system if it were full of water and the water was not flowing. It is different for each point in the system and depends on the elevation relative to the highest point in the system.**

## **DYNAMIC HEAD LEVEL**

**The pressure head levels of a flowing system caused by the loss of head through friction. These points vary throughout the system and plot the HGL.**

## **HYDRAULIC GRADIENT LINE (HGL)**

**An imaginary line that plots the head loss at any given point in the pipeline. It is determined by friction loss factors and always slopes downward along the direction of flow.**

## **RESIDUAL HEAD**

**The difference in elevation between any point on the pipeline and that point's dynamic head level.**

## **STATIC HEAD LEVEL**

**Highest point in the system.**

## **STEPS IN SURVEY AND DESIGN**

### **I. The Field Survey**

**1. Become familiar with the water source and the village; consult with the community with regard to the acceptability of the water source and proposed system and their commitment to participation.**

**2. From community survey results, decide on the feasibility of constructing the water system.**

**3. For systems considered feasible, a detailed survey is made including: source flow measurement, pipeline distances, and ground level profile.**

**Someone from the village should assist in this survey. At this time, tentative locations for distribution points are decided upon in consultation with the**

**villagers, taking into account their own wishes, population distribution, etc.**

## **II. The Design Process**

**The survey data is used to design the system generally as follows:**

- 1. Decide on general system design, type of distribution facilities, etc.**
- 2. Calculate the project life and growth rate to find the total population to be served. Decide on per capita usage and calculate the average daily use (ADU).**
- 3. From the ADU, calculate the average daily flow (ADF) and by comparison to the minimum source flow, determine the desired storage and its placement. The placement of the distribution points should be set at this time as well.**
- 4. From the average daily flow and the type of system, the design flows for the pipe are selected, taking into account peak demand. The number of taps required is calculated.**
- 5. The pipeline profile is drawn and an approximate hydraulic gradient line (HGL) plotted by making points of desired head.**
- 6. From the design flows and elevations, the exact head losses for various diameter pipes are calculated for each unbroken section of the pipeline.**
- 7. The most appropriate pipe is chosen for all sections of the pipeline based on the calculated head losses. The true hydraulic gradients are then plotted on the profile.**

**8. From the elevation profile and general scheme of the system, the need and placement of break pressure tanks, air valves, wash-outs, etc. are determined and recorded on the general sketch.**

**9. Detailed drawings, specifications, materials lists and budgets can now be prepared.**

**REFERENCE: Practical Design Notes for Simple Rural Water Systems; A. Scott Faiia. CARE, Indonesia, 1982.**

### **RIGID PVC FRICTIONAL HEADLOSS FACTORS**

**These are the approximate headless factors, in m/100m (%), for new rigid PVC pipe. Flows are in liters/second.**

<b>FLOW</b>	<b>1/2"</b>	<b>3/4"</b>	<b>1</b>	<b>1¼"</b>	<b>1½"</b>	<b>2"</b>	<b>2½"</b>	<b>3"</b>	<b>4"</b>
0.1	4.2	1.0	0.25	0.08					
0.15	8.8	2.2	0.53	0.17	0.07				
0.2	15.0	3.7	0.9	0.28	0.12				
0.25	22.0	5.5	1.35	0.44	0.18				
0.3	31.0	7.8	1.9	0.6	0.25				
0.35	41.0	10.0	2.45	0.8	0.34				
0.4	53.0	13.0	3.1	1.0	0.43				
0.45	66.0	16.3	4.0	1.25	0.54	0.13			
0.5		19.0	4.8	1.5	0.65	0.16			

0.55		23.5	5.6	1.8	0.78	0.19			
0.6		27.5	6.6	2.1	0.9	0.22			
0.65		32.0	7.8	2.4	1.04	0.25			
0.7		36.0	8.7	2.7	1.19	0.28			
0.75		41.0	9.9	3.1	1.32	0.33	0.1		
0.8		45.0	11.0	3.5	1.5	0.37	0.12		
0.85		52.0	12.5	4.0	1.7	0.41	0.14		
0.9		57.0	14.0	4.5	1.9	0.45	0.15		
0.95		63.0	15.0	4.9	2.1	0.5	0.17		
1.0			16.5	5.4	2.25	0.55	0.18	0.08	
1.05			18.0	5.8	2.5	0.6	0.20	0.09	
1.1			19.5	6.3	2.7	0.67	0.22	0.1	
1.15			21.5	6.9	2.95	0.71	0.24	0.11	
1.2			23.0	7.3	3.2	0.78	0.26	0.12	
1.3			26.5	8.6	3.75	0.9	0.29	0.13	
1.4			30.0	10.0	4.25	1.0	0.34	0.15	
1.5			35.0	11.2	4.9	1.15	0.39	0.17	
1.6			39.0	12.5	5.5	1.3	0.43	0.19	
1.7			44.0	14.2	6.05	1.45	0.49	0.21	
1.8			49.0	15.9	6.9	1.6	0.54	0.24	
1.9			55.0	17.4	7.5	1.8	0.6	0.26	

2.0			60.0	19.0	8.0	2.0	0.66	0.28	
2.2				22.5	9.7	2.35	0.79	0.34	
2.4				26.8	11.5	2.75	0.9	0.4	
2.6				31.0	13.3	3.2	1.05	0.45	
2.8				35.1	15.2	3.7	1.2	0.52	
3.0				40.0	17.0	4.2	1.36	0.6	
3.2				45.0	19.3	4.7	1.52	0.68	
3.4				50.0	21.9	5.25	1.7	0.75	
3.6				56.0	24.0	5.8	1.9	0.84	0.2
3.8				62.0	26.0	6.3	2.1	0.9	0.22
4.0				69.0	29.0	7.0	2.3	1.0	0.24
4.5					36.0	8.8	2.8	1.2	0.3
5.0					44.0	10.5	3.5	1.5	0.37
5.5					62.0	12.5	4.2	1.75	0.44
6.0						14.7	4.9	2.1	0.52
6.5						17.0	5.6	2.4	0.6
7.0						19.5	6.5	2.8	0.7

## GI FRICTIONAL HEADLOSS FACTORS

**These are approximate headloss factors, in m/100m (%), for new GI pipe. Flows are in liters/second.**

<b>FLOW</b>	<b>1/2"</b>	<b>3/4"</b>	<b>1"</b>	<b>1¼"</b>	<b>1½"</b>	<b>2"</b>	<b>2½"</b>	<b>3"</b>	<b>4"</b>
0.1	5.9	1.58	0.38	0.12					
0.15	12.25	3.4	0.82	0.26					
0.2	21.45	5.65	1.4	0.44	0.19				
0.25	31.65	8.5	2.1	0.68	0.28				
0.3	44.91	11.9	2.9	0.92	0.4				
0.35	58.2	15.8	3.8	1.2	0.52				
0.4	75.5	19.9	4.8	1.55	0.67				
0.45	91.9	25.0	6.0	1.93	0.84				
0.5		30.0	7.3	2.35	1.0	0.25			
0.55		36.0	8.7	2.75	1.2	0.3			
0.6		42.0	10.2	3.25	1.4	0.35			
0.65		48.0	11.9	3.8	1.63	0.4			
0.7		55.0	13.6	4.35	1.82	0.46			
0.75		63.0	15.4	4.9	2.15	0.52	0.17		
0.8			17.4	5.55	2.4	0.59	0.19		
0.85			19.4	6.15	2.65	0.68	0.21		
0.9			21.8	6.9	2.9	0.74	0.23		
0.95			24.0	7.5	3.25	0.82	0.26		
1.0			26.2	8.2	3.6	0.88	0.28	0.12	
1.05			28.5	9.0	3.9	0.97	0.31	0.13	
1.1			31.0	9.8	4.2	1.05	0.34	0.15	

1.15			34.6	10.6	4.6	1.15	0.37	0.16	
1.2			36.0	11.5	5.0	1.25	0.39	0.17	
1.3			42.5	13.3	5.7	1.45	0.45	0.2	
1.4			48.0	15.3	6.6	1.65	0.52	0.23	
1.5			55.0	17.5	7.65	1.9	0.59	0.26	
1.6			62.0	19.5	8.45	2.1	0.67	0.29	
1.7			69.0	22.0	9.5	2.35	0.75	0.33	
1.8				24.2	10.5	2.6	0.82	0.36	
1.9				26.5	11.7	2.85	0.9	0.4	
2.0				29.5	12.8	3.2	1.0	0.44	
2.2				35.0	15.3	3.8	1.2	0.52	
2.4				42.0	17.9	4.45	1.4	0.61	
2.6				48.5	20.5	5.15	1.6	0.71	0.17
2.8				55.0	24.0	5.95	1.85	0.82	0.2
3.0				62.5	26.7	6.7	2.1	0.92	0.22
3.2					30.0	7.6	2.35	1.02	0.25
3.4					34.0	8.4	2.65	1.15	0.28
3.6					38.0	9.4	2.95	1.28	0.32
3.8					41.0	10.3	3.25	1.42	0.35
4.0					45.0	11.2	3.55	1.55	0.38
4.5					56.0	14.0	4.45	1.95	0.46

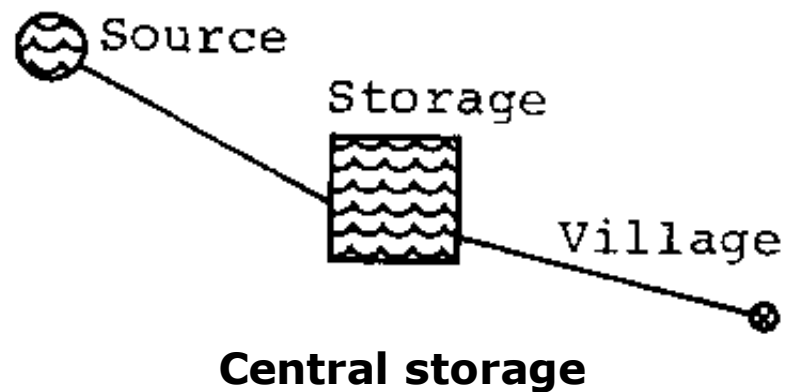


5.0						17.0	5.45	2.25	0.56
5.5						20.0	6.5	2.8	0.68
6.0						24.0	7.5	3.35	0.8
6.5						28.0	8.65	3.9	0.92
7.0						32.0	10.0	4.45	1.05

## SAMPLE PROBLEMS

### Problem I:

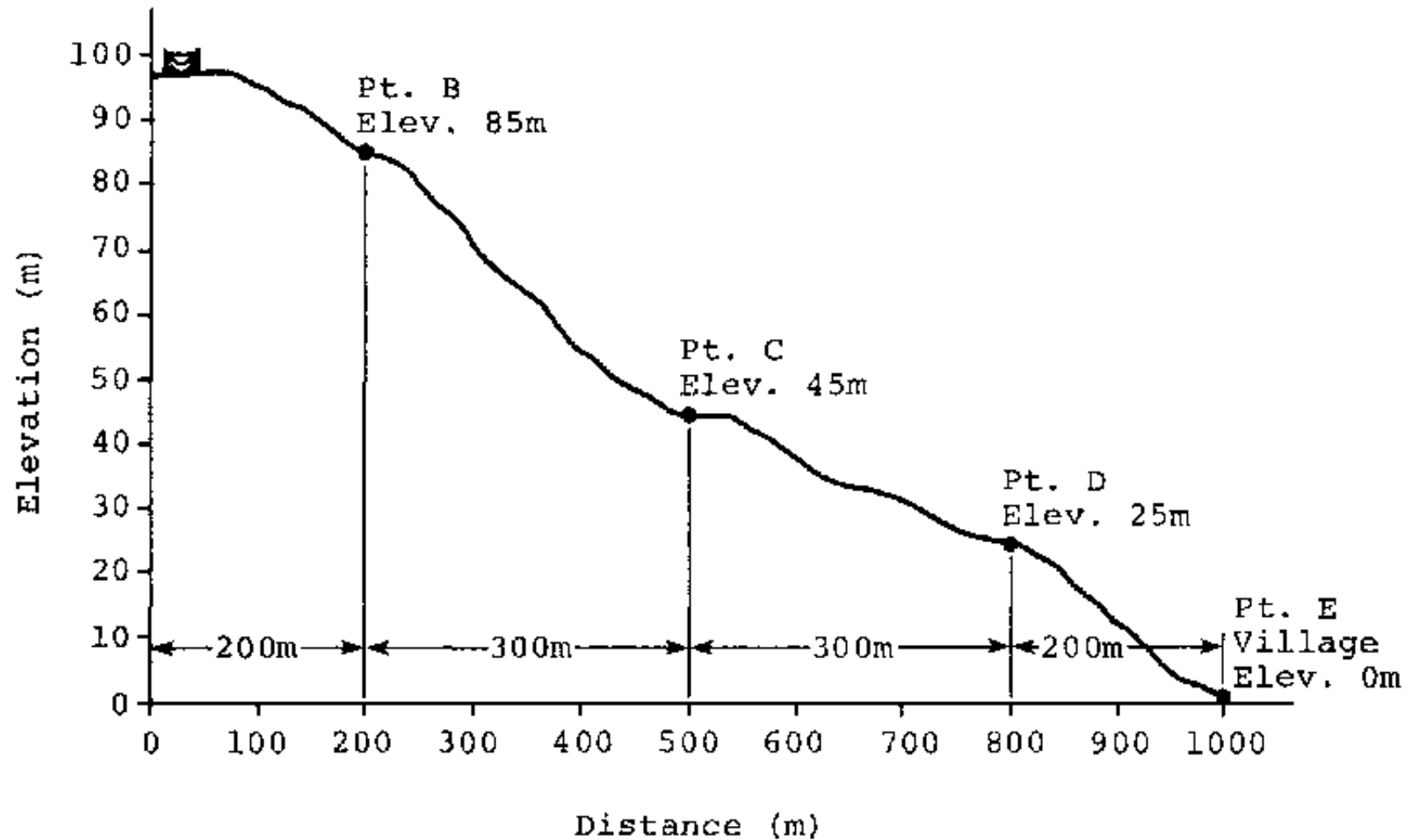
**Design for system with central storage at some point along the pipeline, serving one village**



**Given:**

**Population = 1000**

**Growth Rate = 1.0%**  
**Project Life = 10 yes.**  
**Per capita consumption = 50 liters**  
**Minimum Source Flow = 1.0 l/sec.**  
**Pipe = PVC**  
**Tap size = 3/4"**

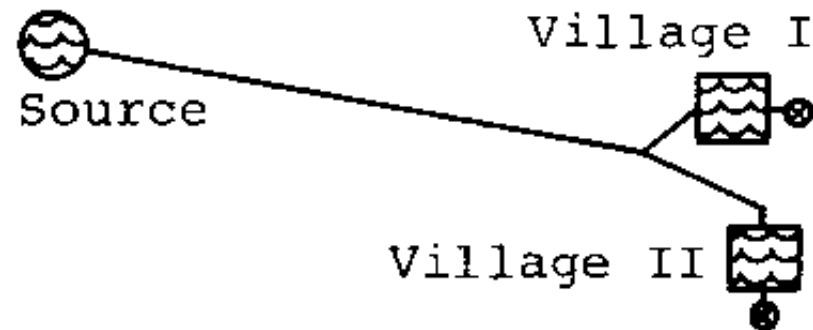


## Pipeline Profile - Problem I

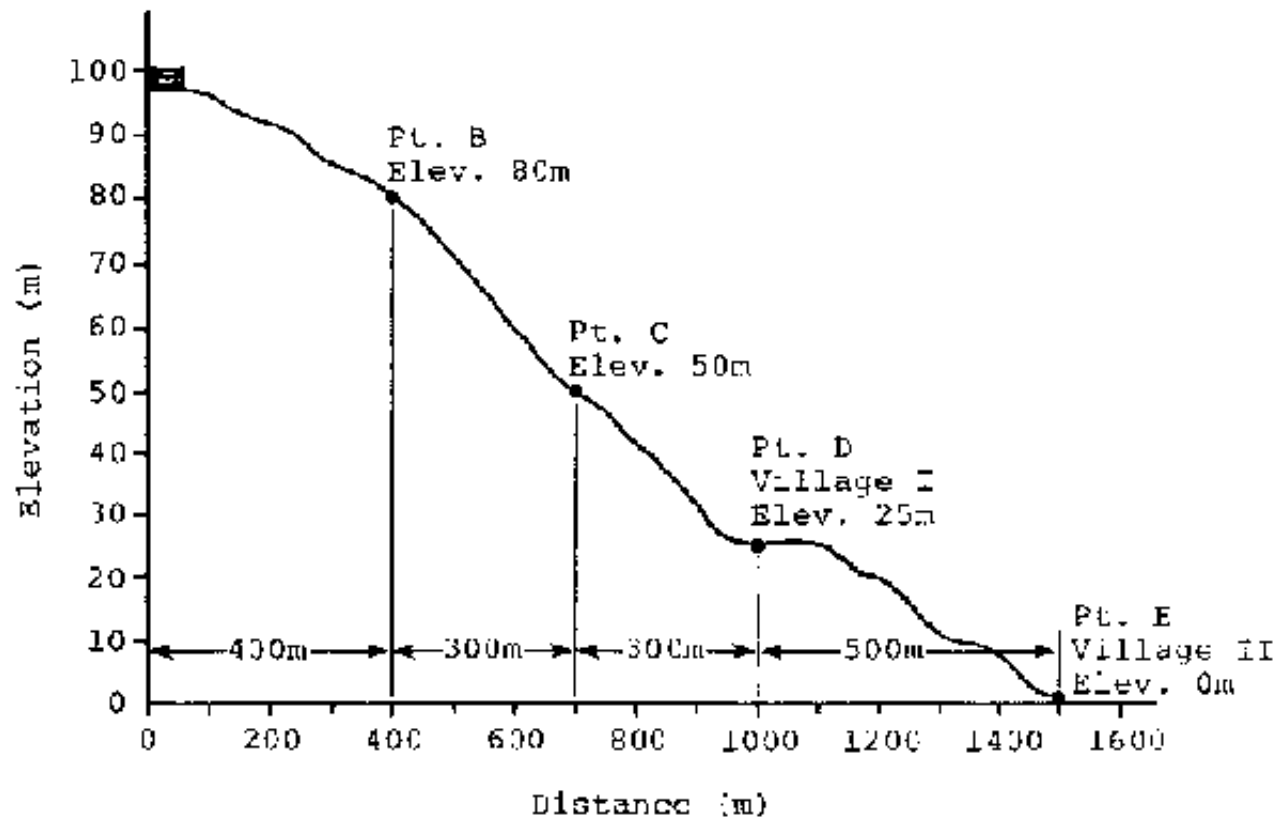
- Step 1. Determine design population figure\_\_\_\_\_
- Step 2. Determine average daily use\_\_\_\_\_
- Step 3. Determine average daily flow\_\_\_\_\_
- Step 4. Determine storage size\_\_\_\_\_
- Step 5. Determine peak demand\_\_\_\_\_
- Step 6. Determine number of required taps\_\_\_\_\_
- Step 7. Determine storage placement\_\_\_\_\_
- Step 8. Determine pipe size for all reaches along the pipeline\_\_\_\_\_
- Step 9. Determine exact head losses and residual head at points B. C, D and E.  
\_\_\_\_\_
- Step 10. Plot HGL.

### Problem II:

Design for system with storage at point of use, serving two villages

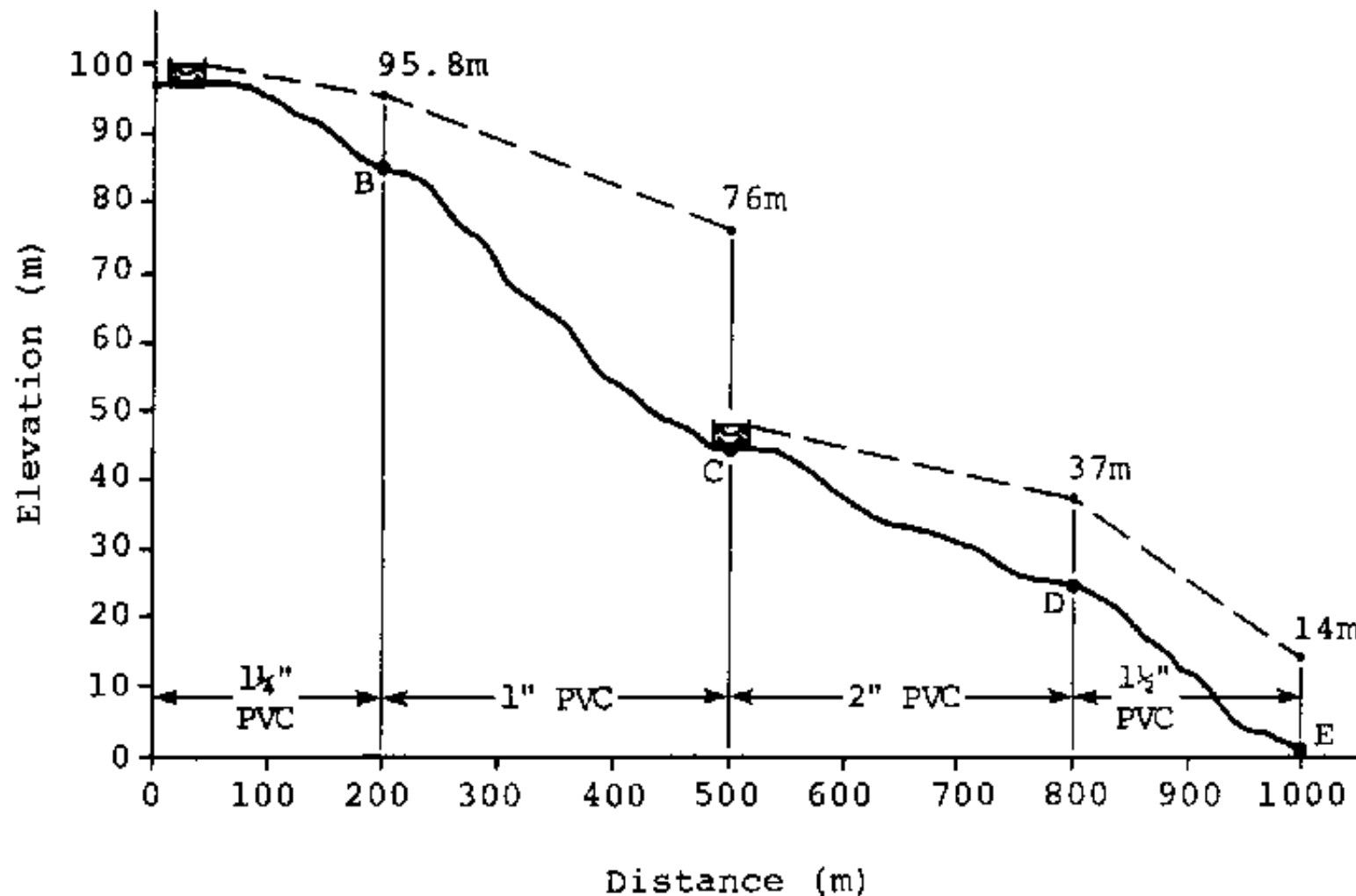


**Storage at point of use**

**Given:****Population = 1500 divided evenly between the two villages****Growth Rate = 2.0%****Project Life = 15 yes.****Per capita consumption = 40 liters****Minimum Source Flow = 1.5 l/sec.****Pipe = PVC****Tap Size = 3/4"****Pipeline Profile - Problem II**

- Step 1. Determine design population figure**\_\_\_\_\_
- Step 2. Determine average daily use**\_\_\_\_\_
- Step 3. Determine average daily flow**\_\_\_\_\_
- Step 4. Determine storage size**\_\_\_\_\_
- Step 5. Determine peak demand**\_\_\_\_\_
- Step 6. Determine number of required taps**\_\_\_\_\_
- Step 7. Determine storage placement**\_\_\_\_\_
- Step 8. Determine pipe size for all reaches along the pipeline**\_\_\_\_\_
- Step 9. Determine exact head losses and residual head at points B, C, D and E.**\_\_\_\_\_
- Step 10. Plot HGL.**

### **Problem I: Answer Sheet**



Distance (m)

**Figure I****Step 1. 1100****Step 2. 55,000 liters = 50m<sup>3</sup>****Step 3. .6 liters/second****Step 4. 25m<sup>3</sup>****Step 5. 2.4 liters/sec.**

**Step 6. 10**

**Step 7. Point C**

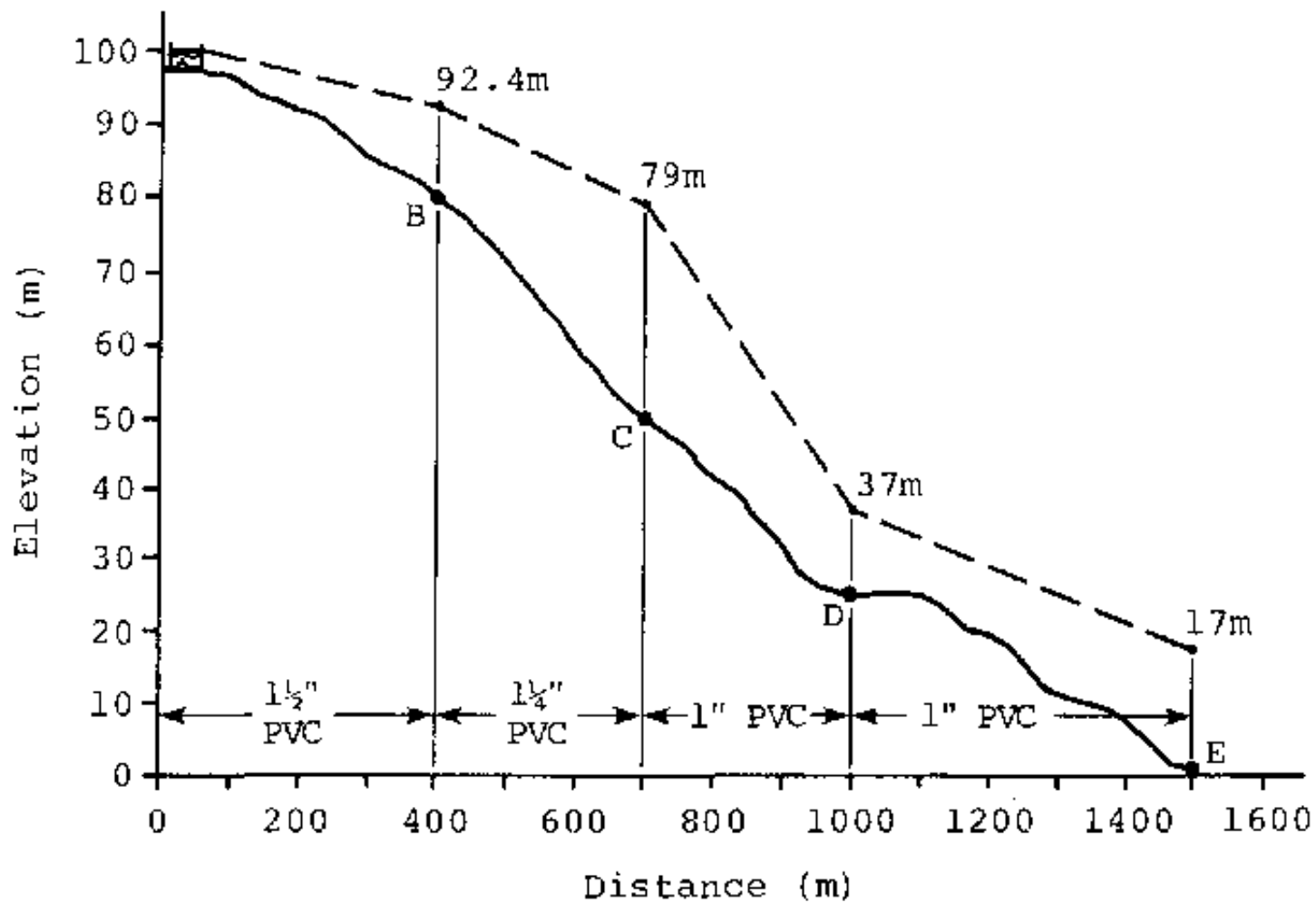
**Step 8. See Figure 1**

**Step 9.**

	<b>pt. B</b>	<b>pt. C</b>	<b>pt. D</b>	<b>pt. E</b>
<b>Head Loss</b>	4.2	20	8	23
<b>Res. Head</b>	10.8	31	12	14

**Step 10. See Figure I**

**Problem II: Answer Sheet**



**Figure II**

**Step 1. 2025**

**Step 2. 81,000 liters = 80m<sup>3</sup>**

**Step 3. .9 liters/second**

**Step 4. 40m<sup>3</sup>**

**Step 5. 3.6 liters/sec.**



**Step 6. 16**

**Step 7. Point D 20m<sup>3</sup>**

**Point E 20m<sup>3</sup>**

**Step 8. See Figure II**

**Step 9.**

	pt. B	pt. C	pt. D	pt. E
<b>Head Loss</b>	7.6	13.5	42	20
<b>Res. Head</b>	12.4	29	12	17

**Step 10. See Figure II**

## **Session 35 - Principles of spring development**

TOTAL TIME Two Hours

OBJECTIVES

- \* Identify potential sources of pollution and methods to protect a spring water source
- \* Describe two methods of developing a spring water system: simple spring box and infiltration gallery
- \* List the construction steps necessary for spring development

RESOURCES

Attachment 35-A: "Design Features of Spring Development",  
Small Community Water Supplies; IRC, pp. 75-88  
Rural Water and Sanitation Projects; USAID, pp. 43-48, pp. 59-78

~~Slide show or sketches of construction steps for spring project~~

**PREPARED  
MATERIALS**

newsprint and felt-tip pens, slide projector and screen

Copies of Attachment for all trainees

Reproductions of Figures 1, 2 and 3 on newsprint from the Attachment

**FACILITATORS** One or more trainers

**Trainer Introduction**

**This session provides detailed information on construction of spring projects, concentrating on the two most common methods: simple spring box and infiltration gallery. Substitute another method if you plan to use it as a training exercise in spring development. The slide or sketch presentation should concentrate on the method that will be used during the program, and should be prepared well in advance of the session. Trainees should study the reading assignments and attachment prior to the session.**

**PROCEDURES**

Step 5 minutes

1

Present the objectives and format for the session.

Step 15 minutes

2

Ask the trainees to name the first steps they might take when starting a spring project. List responses on newsprint.

**Trainer Note**

## **Point out the following steps:**

- Consult with local people: this is an important step, and usually provides valuable information. Find out the history of the spring; its reliability and how it is used.**
- Examination of the area: the area around the spring should be carefully examined, especially above the spring. Make sure you have reached the source. Determine the type of spring. Locate potential sources of pollution.**
- Examination of spring: this is a closer look at the spring itself. Determine the soil type. Determine the most feasible way to develop the spring, and ways to protect it.**

Step 50 minutes

3

Describe two methods of spring development construction: a simple spring box and an infiltration gallery.

## **Trainer Note**

**Refer to the reproductions of Figures 1 and 2. The trainees should refer to their attachments. Lead a thorough discussion on each method. Here are some important points to emphasize:**

### **Simple Spring Box:**

- used primarily with fracture fed or narrow point spring**

- **box should include delivery pipe, scour, overflow, and vent pipes**
- **usually constructed with three sides, poured continuous with the floor, an open back, and removal lid**
- **dimensions are usually no more than one meter by one meter by one meter**
- **reinforced concrete is the most common building material**
- **overflow pipe must be placed properly on level with spring or backup will occur**
- **cut-off wing walls may be necessary to divert water into box**
- **backfill is necessary to prevent surface contamination**

### **Infiltration Gallery:**

- **used primarily on water table or seepage springs**
- **rock-filled trenches or perforated pipe are used to collect water and an impermeable layer is placed on down side of the trench to aid in collecting water. A cutoff wall may also be used.**
- **impermeable soil is placed over gallery to prevent surface contamination**
- **if perforated pipe is used, it must be surrounded by sand or pea gravel to prevent clogging**
- **diversion ditches placed on the up side of the gallery are necessary**

**- a collection chamber placed down slope from the gallery is normally used. The chamber should contain a delivery pipe, scour, overflow, and vent pipes. Reinforced concrete is the most common building material. The dimensions are normally no larger than that of a spring box.**

Step 4 15 minutes

Discuss possible methods of protecting a spring.

### **Trainer Note**

**Here are some common methods to emphasize:**

- diversion ditch**
- concrete sanitary seal**
- earth backfill sanitary seal with impermeable soil**
- sand filtration of spring water**
- fencing the area**

**Discuss each method in detail. Use newsprint to draw examples or refer to the drawings in the attachment.**

Step 5 30 minutes

Illustrate the construction steps of a spring development project.

### **Trainer Note**

**The following steps should be illustrated:**

- **Site Selection: flow measurement, accessibility, water quality**
- **Design of project: basic specifications, materials, tools**
- **Excavation: diversion of spring, finding impermeable layer**
- **Collection: construction of box or gallery**
- **Storage: construction of storage capacity if necessary**
- **Protection: guard against surface contamination**
- **Distribution: how the water will be supplied**
- **Operations/maintenance: plan and on-going program**

**Discuss each step as you present the slides.**

Step 6 5 minutes

Review the objectives and conclude the session.

## **Attachment 35A: Design features of spring development**

### **Introduction**

**A spring is a place on the earth's surface where ground water emerges naturally, usually along hillsides, at the base of slopes, or in low ground areas. All over the world, springs are used as water sources for humans and livestock. When properly developed, they can provide abundant and safe water. To do so, the spring must meet the following criteria:**

- **The local community considers it a viable water source.**
- **The flow rate is adequate to supply water requirements.**
- **The spring can be properly developed and water supplied to a collection point.**

**- Sanitary protection can be provided.**

**Spring development, in general, involves a series of steps and stages that will be discussed in this attachment. The information presented should serve as guidelines for development, not hard fast rules. Work on specific springs will always vary dependent on the physical characteristics of the spring and surrounding area.**

### **Beginning Steps**

**1. Survey of the Area. Observe the local geology. Is the area mostly rock, or mostly alluvial materials (deposited clay, silt, sand, and gravel)? What types of springs are present (i.e., water table, seepage, artesian, fracture fed, narrow point)?**

**Look for sources of contamination, both human and animal, around the area. Check the area in terms of accessibility. Will construction be possible? What type of distribution will be needed?**

**2. Initial Investigation of Spring. Ask the local residents the history of the spring. Is it dependable year around? Do some experimental digging below the spring to check for impermeable material such as rock or clay.**

**Measure the flow by inserting a pipe through a temporary dike, that has collected the spring flow, and record the time needed to fill a container of known volume. It is best to check the flow during the dry season and measure it several times to receive an average rate.**

**If possible, determine the exact water quality. Will it be acceptable to the local community standards?**

**3. Initial Design. If a spring is worth developing, determine the best method of construction. Here are the choices:**

- **Rudimentary Protected Spring**: This is used primarily for fractured or narrow point springs where labor is abundant but materials and money are not. It can be as simple as a mortared rock retaining wall for the spring, and some fencing.
- **Simple Spring Box**: This is also used primarily for fractured or narrow point springs. It consists of a concrete box, which allows water to flow into it, a delivery system, and adequate protection from surface contamination.
- **Deep Spring Box**: This is similar to hand-dug shallow well and used in water table and heavy seepage springs.
- **Infiltration Gallery**: This is used in large seepage springs and consists of water collection trenches and storage chamber.
- **Horizontal Well**: This is used in sloping areas where artesian, or narrow point springs are found. It consists of a concrete casing or pipe driven horizontally into the hillside.

**With all spring projects, you should consider if a separate storage chamber will be necessary. In most cases, separate storage is desirable, especially for springs with a weak flow. However, the decision will be based on the specific spring you have and your consumption requirements.**



**Other initial design steps include; estimates of necessary materials and tools, labor requirements, transportation needs, and an estimate of the time needed to complete the project. The preliminary design should include a distribution system, and a plan for operations and maintenance of the system after implementation.**

## **Developing Specifications for a Spring Box and Infiltration Gallery**

**A spring box is a box intended to protect water flowing from a spring from surface contamination, and collect the water at a central point for use. Water flows into a box through a filter of rocks and gravel and then flows out through a delivery pipe (which often leads to a storage chamber). When designing a spring box, one must specify:**

- 1. Basic construction materials of the box**
- 2. Dimensions of the box**
- 3. Type of spring box cover**
- 4. Types and placement of delivery, overflow, scour, and vent pipes**
- 5. Placement of box and/or Infiltration Gallery**
- 6. Location of Diversion Ditches**
- 7. Location of Protective Fencing**

**The steps are described in more detail below. However, since any individual spring system must be designed appropriately for geologic conditions at the site, the recommended specifications may be adjusted. Refer to the figures at the end of the attachment as you read this section.**

- 1. The first step in designing a spring box is to choose the basic construction**

**material: concrete blocks or cast-in-place concrete. Cast-in-place reinforced concrete, 3 to 4 inches thick, is preferable when it is available and affordable. If concrete blocks are used, they should be coated with one inch of mortar on the inside.**

**2. Next specify the dimensions of the spring box. Specification of these dimensions depends primarily on the flow of water from the spring. For springs ranging in flow from one to ten gallons per minute, dimensions of 2' by 2' by 2' would be adequate. For larger flows, one meter cubed should be adequate. In most cases, spring boxes should not be designed to incorporate storage, as water might back up into the aquifer and seek another outlet. Water must always flow freely through a spring box; a separate reservoir can be built for storage.**

**(NOTE: If small seeps occur over a large area, a spring box would not be designed to cover all of the seeps. Instead, an infiltration gallery might be used to collect water from the seeps and direct it into the spring box. Infiltration galleries will be described in Step 5 below).**

**3. A spring box cover should be made of precast, reinforced concrete about 2 inches thick. It can be formed to overlap and fit tightly around the sides of the box, or it can simply be a flat cover which is sealed to the upper edges of the box with mortar. If a sealed cover must be removed for inspection, it can be pried off and then resealed. A small manhole cover may be incorporated into the lid to aid inspection.**

**4. Suggested specifications for delivery, overflow, scour and vent pipes are as follows:**

**- A delivery pipe (open-ended or leading to storage) should be located 3 to 6 inches above the spring box floor and should discharge at least 12 inches above the ground surface, or into a storage reservoir.**

**The diameter of a delivery pipe should be adequate for the flow of the spring. The stronger the flow, the larger the pipe needs to be.**

**- An overflow pipe should be located above the delivery pipe. It should not be higher than the level of the spring. To prevent back up of water into the aquifer, the overflow pipe should always be wider than the delivery pipe, and normally at least 2 inches in diameter.**

**- Both the inside and outside ends of an overflow pipe should be screened with copper, brass, or other corrosion-resistant screen.**

**- The pipe should discharge downward, and a splash pad put in place to allow proper drainage.**

**- Rock or concrete should be placed at all points where erosion is possible from overflow or delivery pipes.**

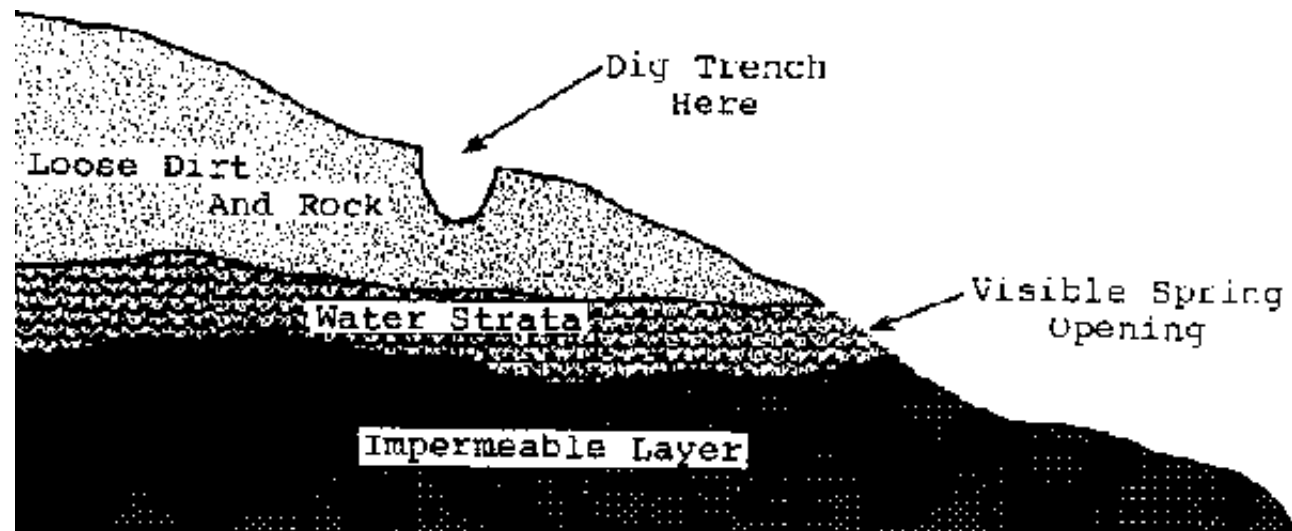
**- A scour pipe, at least 1½" in diameter, should be placed running through the floor of the box. The floor should be sloped towards the scour to provide easy cleaning. The pipe should drain away from the box and be capped at the outside end.**

**- A screened vent pipe should be placed above the overflow pipe, pointing downward, to allow for air circulation in the box.**

**5. To determine appropriate placement of the spring box and infiltration areas, you will need to go to the site and do some experimental digging. Obtain answers to the following questions:**

- **How far below the surface is a layer of impervious material?**
- **Is that impervious material clay or rock?**
- **Is the water flow so strong that water will need to be diverted to allow construction of the spring box?**
- **Are there surrounding seepage points that could feed into an infiltration gallery?**

**Your experimental digging should be done in the area where the spring box will probably be placed, i.e., somewhat uphill from the visible spring opening, as illustrated below:**



**Illustration**

**Dig until you reach impervious clay or rock. If digging becomes so messy that you have to stop, you will need to divert the water through a pipe (or by building a small dam of stones or mud) before further excavation can take place. When digging, remove the surrounding vegetation if necessary. However, care should be exercised so as not to disturb any large vegetation, such as trees, which might alter the spring flow.**

**The bottom of a spring box should be set on the firmest possible ground, preferably clay or rock. Your experimental digging should reveal the best place to set the bottom of the spring box.**

**Depending on the quantity of water, additional infiltration may or may not prove to be necessary. If additional infiltration is needed, infiltration galleries should be installed after the spring box is constructed. If, however, the spring flow is weak, or seeps occur over large areas, and you know before construction begins that additional infiltration will be needed, you should go ahead and develop specifications so that you will know what materials to obtain.**

**There are two basic types of galleries:**

- infiltration galleries which collect water through perforated plastic pipe, open-joint clay pipe, or open-joint concrete pipe**
- infiltration galleries which allow water to trickle through a line of large rocks.**

**If there are plenty of rocks around the spring site, it is cheaper to use the latter type of gallery. If rocks would have to be hauled to the area, it is usually more practical to install some type of perforated or open-joint pipe.**

## **Specifications for installation of infiltration galleries are described below:**

- Locate trenches for infiltration galleries where they will be fed by seepage points (i.e., dig them where you see trickles of water).**
- Trenches may be as long as is likely to be profitable. For example, if there is a large seep 15 feet away, one trench might need to be long enough to collect water from that seep. If enough infiltration can be obtained through 5-foot-long trenches, there is no need to dig them any longer.**
- Dig trenches at least 2 feet wide to the depth of impermeable material (or as deep as possible without causing caving).**
- The bottom of a trench should slope down towards the lower back wall of the spring box or collection chamber, so that water will trickle into the box naturally. If the trench does not slope naturally towards the spring box or collection chamber. The gallery will not supply water.**
- Line trenches with about 4 inches of clean gravel, 3/4 to 1½" maximum size.**
- Lay pipe or large rocks on top of gravel.**
- Cover pipe rocks with four more inches of gravel.**
- Cover embedded pipe or rocks with coarse sand to the top of the aquifer.**
- Cover sand with clay and topsoil.**

**- If infiltration is inadequate, install a "cut-off-wall" of clay downhill from the infiltration gallery. The clay is basically an underground dam intended to hold water in the area of the infiltration gallery. Do not make the underground wall any higher than four to six inches above the depth at which the pipe or rock is buried.**

**6. After the spring box is installed, it is a good idea to dig ditches to divert surface waters from the springs. Suggested specifications for surface water diversion ditches are as follows:**

**- Ditch should be located far enough uphill from spring box (or infiltration galleries if they have been installed) so that surface water at the ditch location must travel at least three feet vertically before contacting ground water. An appropriate distance may be determined by sighting along the top of a three-foot stick or pole positioned vertically at the location of the spring box.**

**- Ditch should be just deep enough to divert normal rains; usually a depth of about six inches is adequate. Rocks may be placed in the trench to prevent erosion.**

**7. If there are animals roaming freely in the area, a protective fence may be needed to keep them away from the spring box. Specifications for such a fence are as follows:**

**- Fence should be strong enough and high enough to keep animals out of vicinity of spring box.**

**- On the uphill side, fence should be outside of the diversion ditch.**

**Placement of an infiltration gallery, diversion ditch, and fence, is illustrated in Figure 3.**

## **Developing Specifications for a Storage Reservoir**

**Since a spring box is intended only to collect water and to protect a spring from contamination, it is usually also necessary to construct a storage reservoir. A storage tank can also be used to remove sedimentation from the water and to break pressure in a piped system. Study the drawing of a typical storage reservoir on page 320 and refer to it as you read this section of the module.**

**When designing a storage reservoir, one must specify:**

- Placement of reservoir**
- Basic construction materials of reservoir**
- Dimensions of reservoir**
- Type of cover for reservoir**
- Type and placement of inlet, delivery, overflow, and scour pipes**

**Recommended specifications are described in steps 1-5 below, but they may need to be adjusted to suit your particular situation.**

**1. First you will need to decide on the exact placement of the reservoir. The reservoir should be located downhill from the spring box; it may be at any distance from the spring box, provided it is at least slightly downhill. It should also be located in an accessible place to allow for ease of construction and collection of water.**

**The reservoir may be situated at ground level or may be completely or partly buried. In any case, it should be situated in or on stable soil or rock to prevent shifting or sliding. If geologic conditions permit, it is usually cheapest and easiest**



**to bury the reservoir, so that during construction, the sides of the hole can be used as a form for the concrete.**

**2. The next step in designing a storage reservoir is to choose the basic construction material: concrete blocks, ferrocement, or cast-inplace concrete. If the storage reservoir is to be buried, cast-inplace reinforced concrete is preferable. If not, construction using concrete blocks, or ferrocement will be cheaper and easier, since extensive forming would be required to pour a concrete reservoir above ground. When concrete blocks are used, they should be coated with an inch of mortar on the inside.**

**3. Next specify the dimensions of the storage reservoir. As a guideline, the storage capacity should equal  $\frac{1}{2}$  of the average daily use of the system. More exact calculations for estimating desired storage capacity will be needed if the system involves an extensive piped delivery system.**

**4. The cover for a storage reservoir should be made of precast, reinforced concrete. It should have a raised "curb" over which a removable manhole cover fits tightly. The manhole cover should be placed near the inlet pipe to allow for inspection.**

**5. Suggested specifications for inlet, delivery, overflow and drainage pipes for storage reservoirs are as follows:**

**- An inlet pipe should be located near the top of the reservoir. It may be fitted with a float valve to regulate flow into the tank, and a gate valve placed outside of the tank to shut down the flow if necessary.**

- **A delivery pipe should be located about three to five inches above the floor of the reservoir. It may be connected to more pipes leading to distribution points at different locations, or it may be a very short pipe, from which people can obtain water right at the reservoir. One reservoir may include both types of delivery pipes. The outlet end of a delivery pipe should point downward, and a self-enclosing valve should be provided to prevent water waste.**
- **An overflow pipe, larger than the delivery pipe, should be located very near the top of the reservoir, on level with the inlet pipe. Both the inside and outside ends of the pipe should be screened with copper, brass, or other corrosion-resistant screen. The outlet should discharge downward.**
- **A drainage pipe should be placed on the bottom of the reservoir so that sludge can be drained out if necessary. It is helpful to leave a sloped indentation for the drainage pipe in the floor of the reservoir, and to slope the floor towards the pipe. The pipe should be closed with a tight cap on the outside end.**
- **Rock or concrete should be placed at all points where erosion is possible from overflow or delivery pipes. The tank should have good drainage on all sides and be fenced for protection.**

**REFERENCE: United States Indian Health Service**

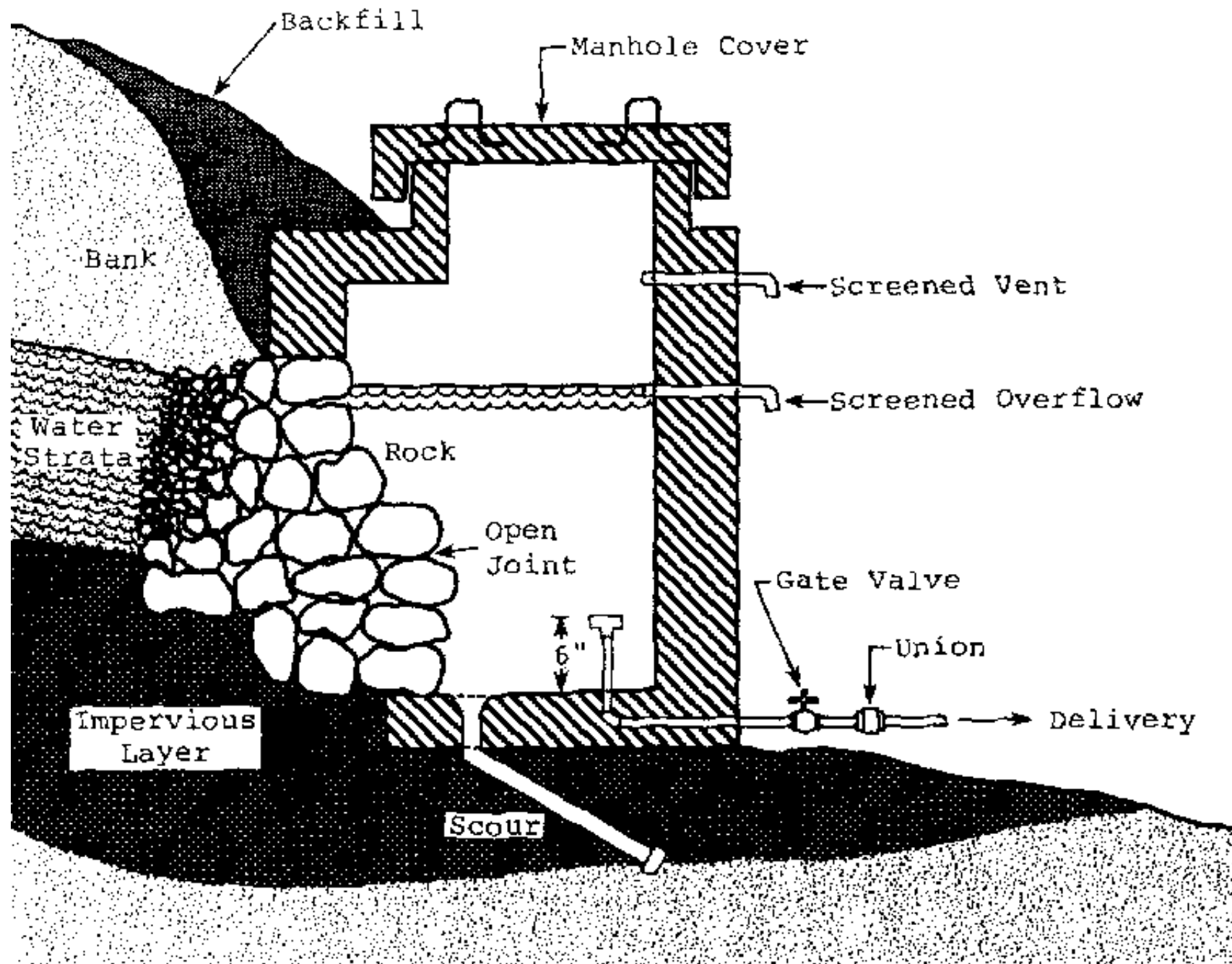
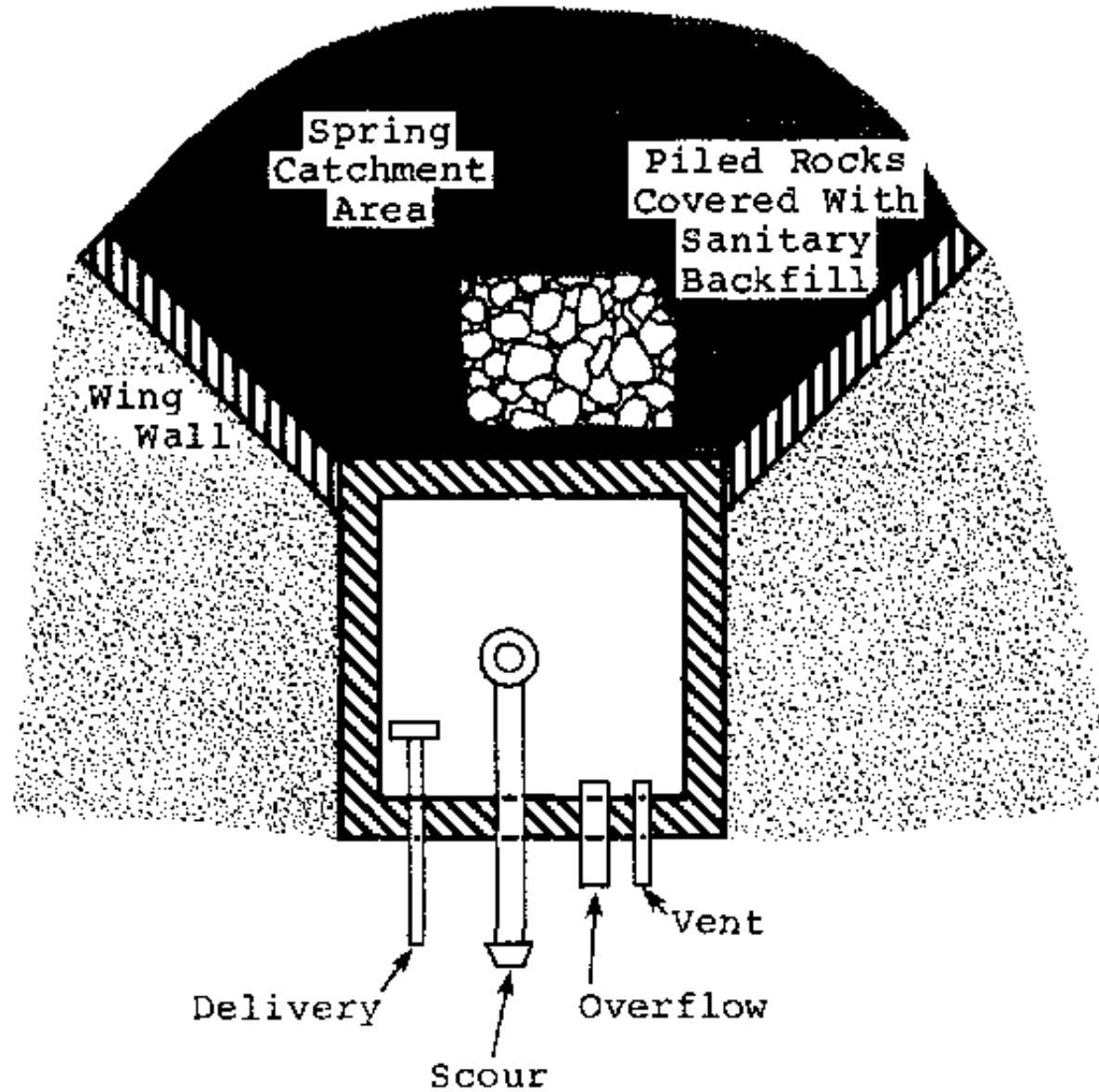
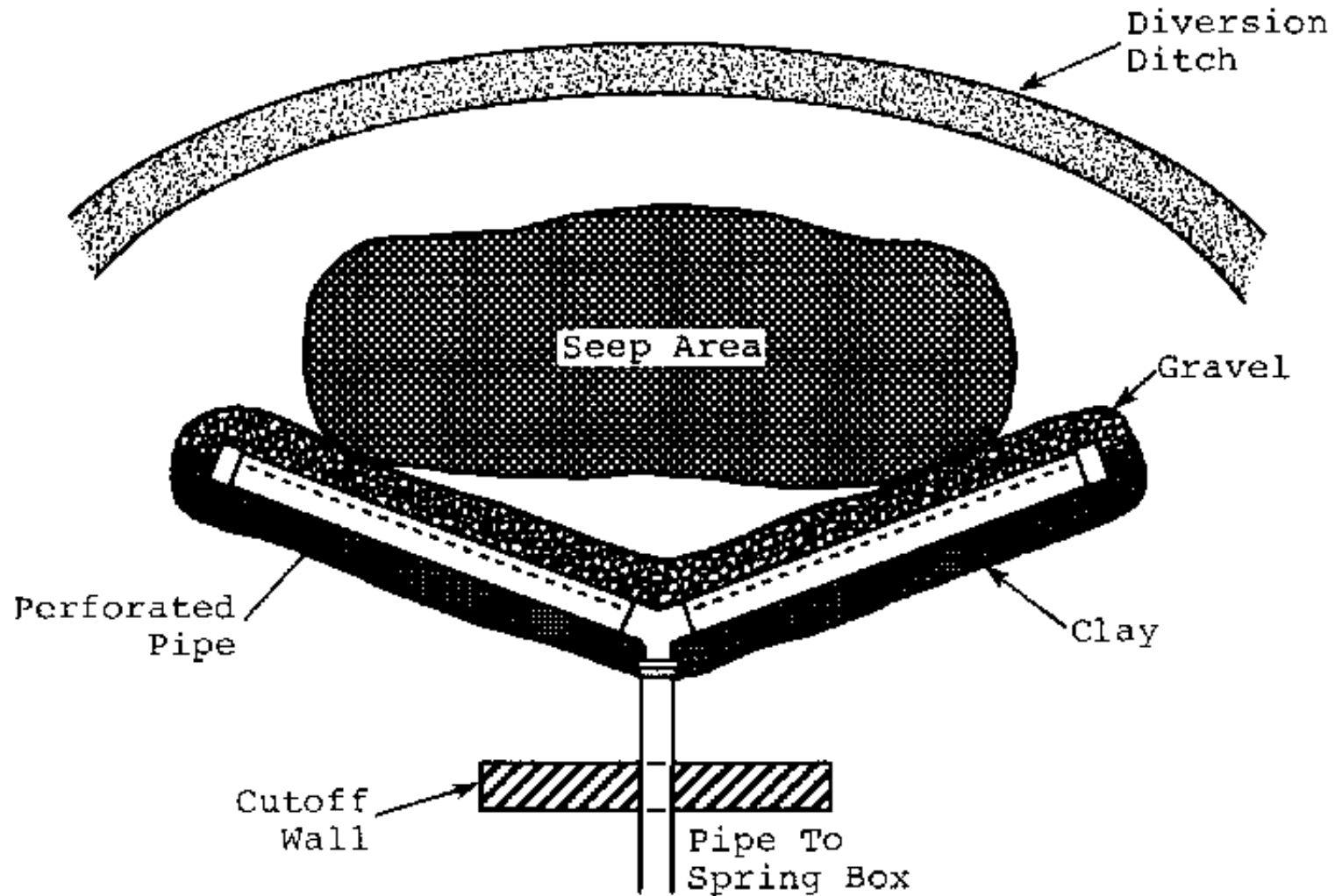


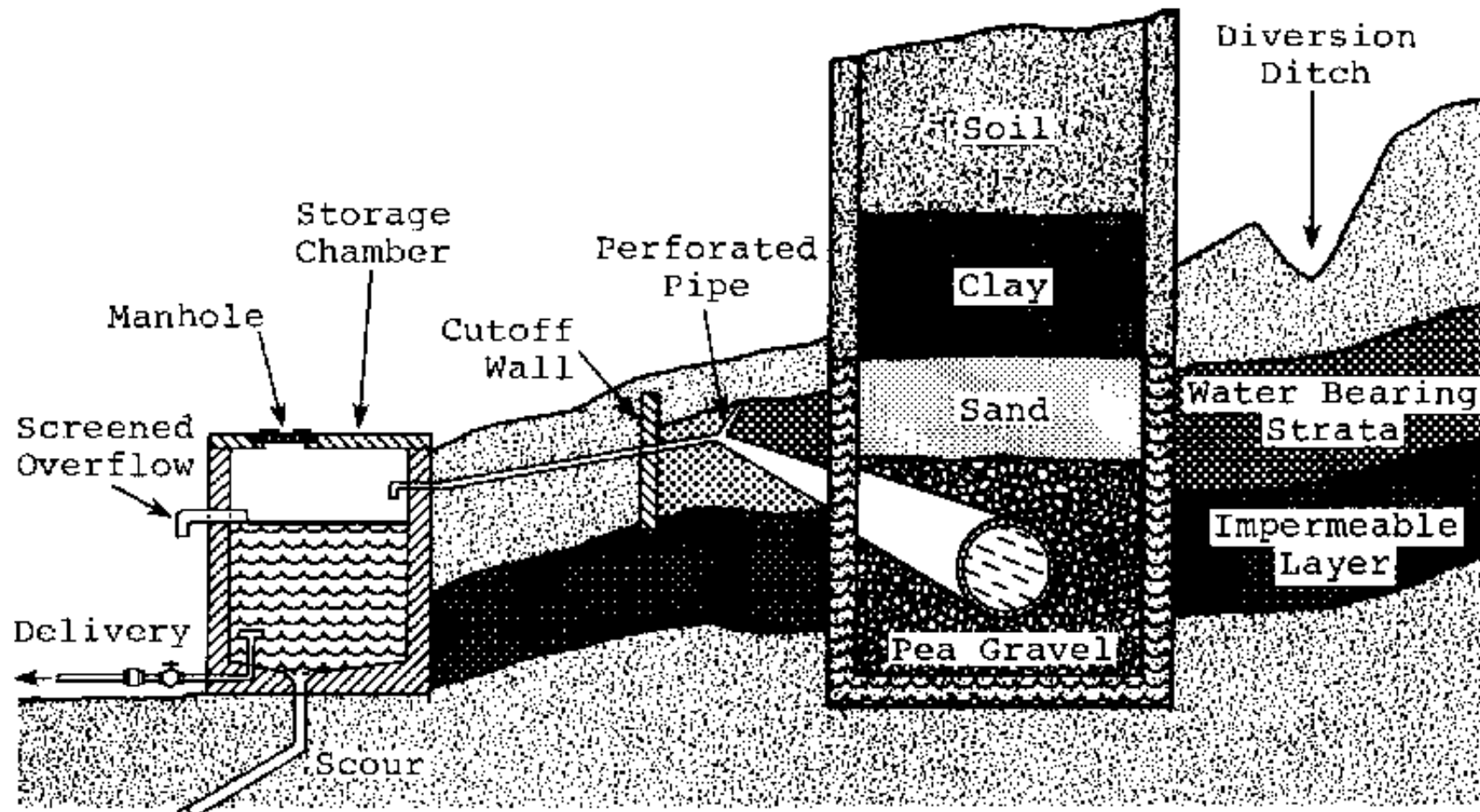
Figure 1 - Simple Spring Box



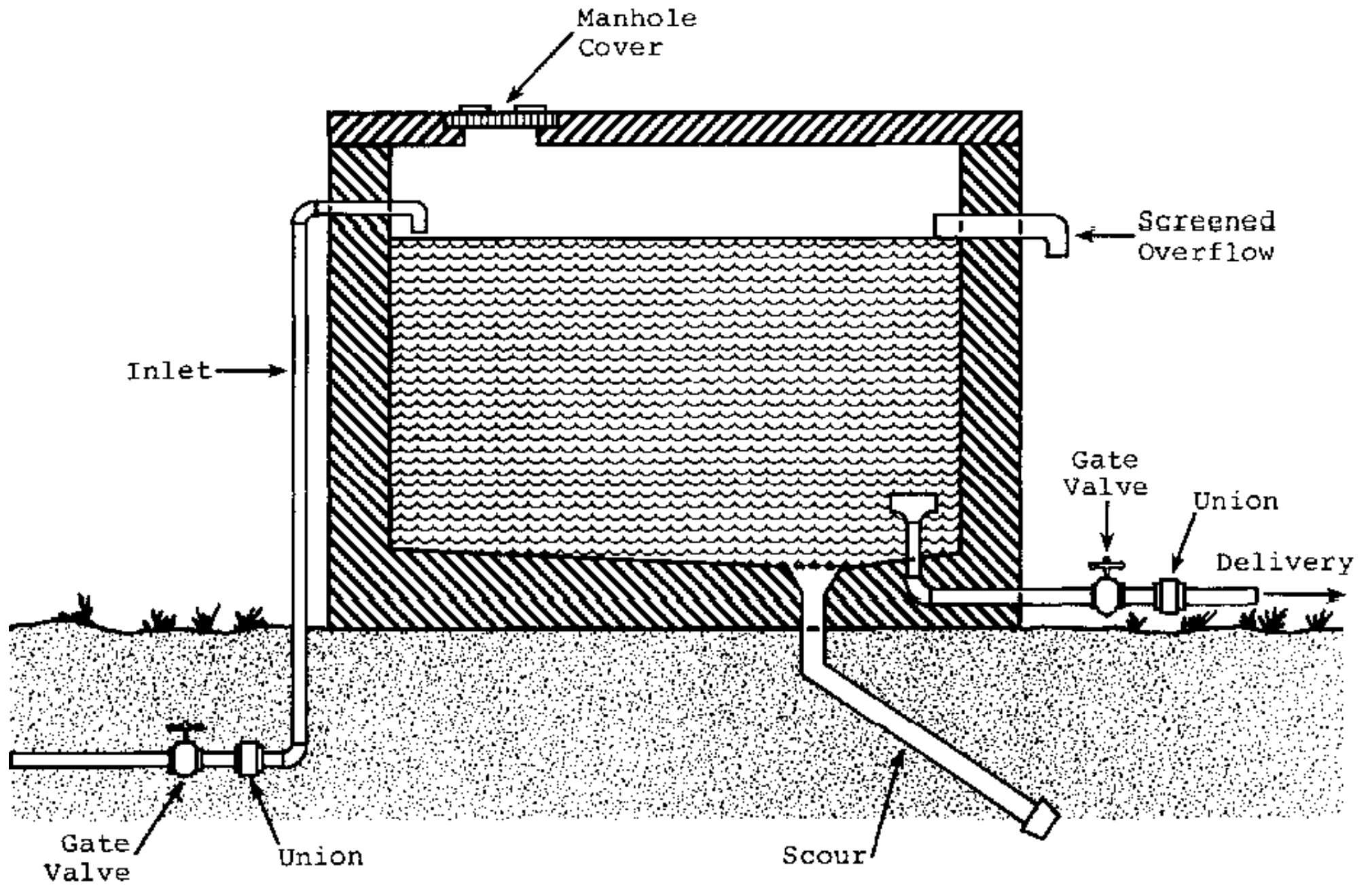
**Figure 2 - Simple Spring Box With Wing Walls - Plan View**



**Figure 3 - Plan View - Simple Infiltration Gallery And Storage Chamber**



**Figure 3 - Profile View - Simple Infiltration Gallery And Storage Chamber**



**Figure 4 - Simple Storage Chamber**

## **Session 36 - Spring site feasibility survey and flow measurement**

TOTAL TIME	Two Hours plus travel time
OBJECTIVES	* Using geographic factors and topographical information, find a suitable spring, trace back to its source, and determine spring type * Measure the flow of the spring and determine if water quantity and quality is sufficient for development
RESOURCES	<u>Rural Water and Sanitation Projects</u> , USAID, pp. 35-42 Attachment 22-A: "Groundwater Hydrology and Sources"
PREPARED MATERIALS	Shovels, buckets, watches, 1-2 foot lengths of pipe
FACILITATORS	One or more trainers

### **Trainer Introduction**

**This session requires substantial preparation in order to locate an area with several suitable spring sites. Ideally, it should be the area in which you plan to conduct spring development construction. If this is the case, trainees will get an important first look at the spring they will later develop. The resource book and Attachment has been used in previous sessions and can be reviewed if necessary.**

### **PROCEDURES**

Step Time dependent on distance from training center

1

Transport all trainees to the spring site location.



Step 5 minutes

2

Present the objectives and format for the session.

Step 60 minutes

3

Divide the trainees into groups of three. Each group should receive the tools necessary for making flow measurements. Discuss the approximate location of various springs in the area. Release the groups to locate suitable springs and measure their flow.

### **Trainer Note**

**Give the trainees some idea of the boundaries of the area in which the springs are located. For example, the springs may be located within a half square mile, or between the two roads and the hilltop. Allow them to go out and search on their own in the small groups. You should not give any more specific clues, unless necessary due to time constraints.**

Step 30 minutes

4

Bring all groups together at one or two of the springs which have been found. Ask the trainees who found the spring how they went about looking for it. Also, ask them how they measured the flow and what their findings were.

Step 30 minutes

5

Lead a general discussion on the exercise; include the relative strengths and

weaknesses of all the springs located with regard to development possibilities.

Step Time unknown

6

Return trainees to training headquarters.

## **Session 37 - Project planning: Spring development**

TOTAL TIME Two Hours

OBJECTIVES \* Formulate a plan for a spring development construction project, including a satisfactory design for all components of spring development, a list of materials and tools necessary, and a construction schedule for the project.

RESOURCES Small Community Water Supply; IRC, pp. 75-89  
Rural Water and Sanitation Projects; USAID, pp. 59-78  
Attachment 35-A: "Design Features of Spring Development"

PREPARED Newsprint and felt-tip pens

MATERIALS

FACILITATORS One or more trainers

### **Trainer Introduction**

**This session is meant to give the trainees scheduled time to plan their project before actual construction begins. Trainers should be available during this time to serve as information resources and to offer guidance if needed. However, it is important that the trainees be given the opportunity to work through the planning of the construction project themselves. In many cases, two hours will not be**

**adequate time to complete all necessary planning. If additional time is available in the schedule, add that time to the session. If time is not available, give the trainees at least an overnight period before actual construction is scheduled to begin. The resource books and Attachment is designed to serve as reference information for the trainees.**

## **PROCEDURES**

Step 10 minutes

1

Present the objectives and format for the session. Divide the trainees into their work groups for the spring development project, making sure that each group has a project manager.

### **Trainer Note**

**If necessary, review at this time the basic construction steps for a spring development; i.e., site selection and preparation, excavation and diversion of spring, collection chamber, distribution, and sanitary seal. Also discuss the components of a proper design for any construction project; i.e., detailed drawings, basic specifications, construction schedule and methods, project documentation, and the evaluation process.**

Step 2 1 hour, 40 minutes

In their individual work groups, the trainees plan their upcoming project.

### **Trainer Note**

**Make sure that all trainers are available at this time. Assign a trainer to each group as an advisor. However, trainers should not lead or direct the planning process.**

Step 10 minutes

3

Review the progress made during the session with regard to project planning. Make arrangements for additional planning time, if necessary, before construction begins.

### **Trainer Note**

**Check all components of the design before construction begins. One effective way of checking the design is to have the trainees give a design presentation. If such a presentation is scheduled, trainees should be given time to prepare, not only the design, but the presentation as well.**

### **Session 38 - Spring development construction**

TOTAL TIME 32 Hours

OBJECTIVES \* Construct a spring development system consisting of a reinforced concrete spring box, water collection point, and adequate protection from potential sources of pollution

RESOURCES Rural Water and Sanitation Projects; USAID, pp. 59-78  
Attachment 35-A: "Design Features of Springs Development"  
Small Community Water Supply; IRC, pp. 75-88

PREPARED Shovels, hammers, crosscut saws, keyhole saws, hacksaws, hoes, sledges

**MATERIALS** hammers, trowels, picks, crow bars, brace and bit, mattocks, tape measures, T-squares, builders' level, line level, string, sight level, screwdrivers, woodrasp, buckets, wheelbarrows, wrenches, vice grips, pliers, wire cutter, bailing wire, reinforcement bar, 6" x 6" weld mesh, nails (#8, #12, #16), lumber, cement, sand, aggregate, GI pipe and fittings, pipe wrenches, pipe vise, pipe cutter, pipe threader, thread compound, screening, plastic sheeting, burlap sacks, and gloves

**FACILITATORS** One or more trainers

## **Trainer Introduction**

**During this session, a simple spring box water system is built. The spring box should be approximately one cubic meter, in size, and constructed with reinforced concrete. The design should generally follow the example shown in Attachment 35-A. The exact design and specifications should be done by the trainees themselves. The number of trainees in the group should be between seven and ten. Trainers should serve as technical advisors during the design and construction phases. The resource books and attachment should serve as reference information for the trainees. The time set aside for each construction step is a close approximation based on past training experience. It does not include time spent on logistics or transportation. There is a variety of activities during this session. Make sure all trainees participate in all activities by having the project manager rotate trainees through the various tasks.**

**This session begins with actual construction. It is assumed that the preliminary survey and flow measurement was completed during Session 36. Finally, proper construction safety practices should be followed at all times. Trainers should take**

**the time to explain such practices and make sure that they are followed throughout the exercise.**

## **PROCEDURES**

Step 8 hours

1

Begin excavation of spring area. Divert spring flow. Form and pour lid for box adjacent to site. Construct spring box forms.

### **Trainer Note**

**Care should be taken during the excavation so as not to disturb the primary flowing point of the spring. The trainees should dig down to a solid impermeable layer of ground on which to pour the box. They should also dig out enough around the site to allow the forms for the box to fit easily. The spring should be diverted to allow the pour to take place. Pouring the box is much easier if careful excavation and diversion are done beforehand. The lid for the box should also be made at this time. Make sure the dimensions are correct. The spring box forms are often difficult to construct, and the trainees may need assistance. The forms should be three (or three and a half) sided, and the inside form should be shorter than the outside, by the thickness of the floor. This will allow the floors and walls to be poured at the same time. Make sure that holes are cut properly for the pipe fitting. Step 2 may follow the next day.**

Step 8 hours

2

Complete all excavation and diversion. Set the spring box forms in place. Lay in reinforcement and pipe fittings. Pour the box.

## Trainer Note

**Getting the forms in place properly is always a difficult task. Provide assistance to the trainees, if necessary. The forms must be braced securely on all sides before the pour. Make sure the pipes (delivery, scour, overflow, and vent) are placed properly. This is especially crucial for the overflow pipe; it must be at the level of the spring, or slightly below it, to prevent backup of the water. To pour the floor and walls at the same time, the outside form must be set in place first and then, the floor poured. Immediately set in the inside form (supported by cross braces on the outside form), and continue pouring up the wall. A strong workable mix, using small to medium size aggregate, should be used to pour the box. The box should be allowed to sit for two to three days before Step 3 begins. A curing schedule should be maintained.**

Step 8 hours

3

Remove forms and inspect for structural integrity. Plaster the walls if necessary, and slope the floor to scour. Place rocks tightly in place on the backside of the box. Pour wing walls on both sides of the box.

## Trainer Note

**Care should be taken when removing the forms so as not to damage the box. Only plaster the walls if it is necessary to ensure a water-tight seal. The floor should be**

**sloped towards the scour to allow easy maintenance. When placing the rocks, select those that fit tightly together. The trainees should take the time to construct the wall properly. Once the large rocks are in place, put in progressively smaller rocks, moving back from the box. If pea gravel is available, use that to fill the final space. Next, divert the spring back into the box and excavate out from each front corner of the box for placement of short wing walls. The walls may be constructed of concrete, using rocks or rough lumber for form work, or alternatively, soil/cement or packed clay may be used for the walls. Step 4 may begin the following day.**

Step 8 hours

4

Place the lid. Backfill around the box. Place sanitary seal over the spring. Dig a diversion ditch. Perform all other needed tasks. Clean up the site.

## **Trainer Note**

**A good job of backfilling should be done around the box. Make sure the backfill is packed tightly. Use an impermeable material to seal the spring, such as concrete, soil/cement, or clay. Dig the diversion ditch and line it with rocks to prevent erosion. If time allows, other tasks may be done as well, such as constructing a drainage trench for the scour or a splash pad for the delivery pipe or overflow. Leave the site clean and in good order. Lastly, the entire group should review the construction procedures and processes that went into the project. Discuss positive and negative aspects. Ask what could have been done differently to improve the construction. Ask about the group dynamics of the exercise. What improvements could have been made? What work particularly well? Point out the importance of**



**hard work, flexibility, and cooperation throughout such an activity.**

## **Session 39 - Ferrocement technology and construction**

TOTAL TIME	Two Hours
OBJECTIVES	<ul style="list-style-type: none"><li>* Discuss the theories and principles of ferrocement technology as applied to the construction of water tanks</li><li>* Describe the building sequence of a ferrocement water tank</li></ul>
RESOURCES	<u>Ferrocement Water Tanks</u> ; S. B. Watt, Chapters 1-12 Slide show or sketches of building sequence for ferrocement water tank
PREPARED MATERIALS	Newsprint and felt-tip pens, one bucket of sand, one bucket cement, plastering gloves, fine sieve, trowel, float, hawk, chicken wire, hoop wire Slide projector and screen
FACILITATORS	One or more trainers

### **Trainer Introduction**

**This session introduces the trainees to ferrocement technology and describes the steps involved in building a small water tank (two to five cubic meters). The slides or sketches must be prepared prior to the session and should illustrate the building sequence for the type of construction which will be used during the program. The reading assignment is long, and trainees should be told well in advance of the session. Emphasize the importance of reading the assignment prior to the session.**

### **PROCEDURES**

## Step 5 minutes

1

Present the objectives and format for the session.

## Step 10 minutes

2

Ask the trainees to name some characteristics of ferrocement. Record the comments on newsprint, and discuss each one.

### **Trainer Note**

#### **Some possible replies are listed below:**

- **Uses cement-rich mortar**
- **Contains reinforced wire meshing**
- **Long-lasting and strong**
- **Corrosion resistant**
- **Relatively inexpensive**
- **Simple equipment requirements**
- **Simple construction method**

## Step 3 35 minutes

Demonstration on ferrocement mortar, and application.

### **Trainer Note**

**Begin by gathering the buckets of sand and cement, the fine sieve, plastering**

**gloves, trowel, float, and hawk on a large table. Sift the sand through the sieve and mix a small portion of ferrocement mortar in a bucket. Next, explain how to apply mortar by hand using plastering gloves, and with tools using a trowel or float and hawk.**

**Stress the importance of the following points during the demonstration:**

- Use fine clean sand and clean water.**
- Mix the dry ingredients well before adding water.**
- The standard mix is one part cement to two parts sand (by volume).**
- If cost factors dictate, a one to two and a half or a one to three mix may be used.**
- Increasing the proportion of cement in the mix makes it more workable, but can lead to shrinkage cracks.**
- The dryer the mix, the stronger it will be, providing it has enough water to be workable. The mix must have enough workability to allow it to hold together when squeezed and bond to the reinforcing wire. However, it should be dry to the pinch. In other words, when the mix is pinched, water does not separate out. During construction, a process of trial and error usually leads to a satisfactory mix.**
- To apply mortar by hand, scoop up a handful and smear it across the wall using the palm and heel of the hand. Smear with strong even pressure over an area taking care not to overwork the mortar by rubbing repeatedly back and forth.**

- **To apply mortar with tools, a hawk is held close to the wall and a trowel or float used to scoop mortar from the hawk and smear it up the wall. Again, strong even pressure should be used to apply the mortar and care should be taken not to overwork the mortar moving the tool repeatedly back and forth over the area. Overworking tends to bring the water to the surface and cause the mortar to slump off.**
- **Generally, two coats of mortar are applied to the outside of the tank and two coats to the inside. A light third coat may be applied to the outside to provide a smooth finish and a cement slurry brushed on to the inside to provide a water tight seal.**
- **A coat of mortar should be allowed to set up before another coat is applied. However, the first layer should still be green, in other words not completely hardened, when the second layer is applied. This will provide a good seal between layers.**

Step 4 10 minutes

Lecturette on proper curing procedures

### **Trainer Note**

**Point out that proper curing procedures are essential. Fresh plaster coats must be covered as soon as they have set. Wet burlap sacks, straw, leaves, or plastic can be used. Emphasize that exposure to direct sunlight, wind, or water will adversely affect the final strength and durability. If the mortar loses moisture too quickly, shrinkage cracks will appear. A curing schedule must be set up and strictly**

**followed. It should consist of regular wettings of the tank wall and floor for a couple of days. Then, two or three feet of water can be put in the tank until a week or so has passed. Lastly, the tank can be slowly filled over a few days period.**

Step 5 20 minutes

Lecturette on the need for reinforcement in ferrocement water tanks.

### **Trainer Note**

**Wire mesh reinforces the mortar by distributing the stress load. It helps prevent the concentration of stress loads in areas of weakness. Tanks are subject to two primary forces: shear stress and hoop stress. Therefore, additional reinforcement is necessary.**

**Shear stress is greatest at the joint where the foundation meets the walls. It is a result of the stress caused by the weight of the water and the walls. In small tanks, shear stress is handled by making foundation reinforcement or mesh continuous with the wall reinforcement. This distributes the pressure evenly.**

**Hoop stress occurs in the walls of the tank. It is a result of that pressure being distributed throughout the tank by the use of reinforcement at the joint between the foundation and walls. It is handled by wrapping heavy hoop wire, in a continuous strand, around the tank. Because the pressure is greater at the bottom, more strands are needed there. As you move up the tank, the pressure decreases and less wire is necessary. It is a good idea to wrap a few strands of wire at the top however, in order to support a tank lid.**

**It is important that the trainees understand these concepts. Use the diagrams on pages 29 through 31 of the Watt book to illustrate the points made.**

Step 6 35 minutes

Present the building sequence of a ferrocement water tank project.

### **Trainer Note**

**Use this time to explain each step in the process. The steps should include: site selection and preparation, foundation, formwork, reinforcement, plastering, finishing, and curing. Answer all questions the trainees may have.**

Step 7 5 minutes

Review the objectives and conclude the session.

### **Session 40 - Project planning: Ferrocement water tank**

TOTAL TIME Two Hours

OBJECTIVES \* Formulate a plan for the construction of a ferrocement water tank, including a satisfactory design for all components of the tank, a list of materials and tools necessary, and a construction schedule for the project.

RESOURCES Ferrocement Water Tanks; S. B. Watt, Chapters 1-7

PREPARED Newsprint and felt-tip pens

MATERIALS

FACILITATORS One or more trainers

## **Trainer Introduction**

**This session is meant to give the trainees scheduled time to plan their project before construction actually begins. Trainers should be available during this time to serve as information resources and to offer guidance if necessary. However, it is important that the trainees be given the opportunity to work through the planning of the construction project themselves. In many cases, two hours will not be adequate time to complete all necessary planning. If additional time is available in the schedule, add that time to the session. If time is not available, give the trainees at least an overnight period before actual construction is scheduled to begin. The resource book is meant to serve as reference information for the trainees.**

## **PROCEDURES**

Step 10 minutes

1

Present the objective and format for the session.

Divide the trainees into their work groups for the water tank construction, making sure that each group has a project manager.

## **Trainer Note**

**If necessary, review at this time the basic construction steps for a ferrocement water tank; i.e., site selection and preparation, foundation, slab, wall superstructure formwork, and plastering. Also, discuss the components of a proper design for any construction project; i.e., detailed drawings, basic**

**specifications, construction schedule and methods, project documentation, and the evaluation process.**

Step 2 1 hour, 40 minutes

In their individual work groups, the trainees plan their upcoming project

### **Trainer Note**

**Make sure that all trainers are available at this time. Assign a trainer to each group as an advisor. However, trainers should not lead or direct the planning process.**

Step 10 minutes

3

Review the progress made during the session with regard to project planning. Make arrangements for additional planning time, if necessary, before construction begins.

### **Trainer Note**

**Check all components of the design before construction begins. One effective way of checking the design is to have the trainees give a design presentation. If such a presentation is scheduled, trainees should be given time to prepare, not only the design, but the presentation as well.**

## **Session 41 - Ferrocement water tank construction**

TOTAL TIME 36 Hours



OBJECTIVES	\$ Construct a water storage tank using reinforced concrete for the foundation, ferrocement for the tank walls, and corrugated galvanized iron for the formwork
RESOURCES	<u>Ferrocement Water Tanks</u> ; S. B. Watt, Chapters 5, 6 and 7
PREPARED MATERIALS	One set corrugated GI formwork cut into sections and fitted with angle iron braces, 2 x 4 wedges to connect form sections, bolts and nuts for the forms, pointed trowels, steel floats, mortar boards, wire brushes, hacksaw, crosscut saw, wrenches, wire cutter, bolt cutter, pliers, hammers, shovels, builders levels, tape measures, string, line level, picks, mattocks, T-squares, hoes, wheelbarrows, plastic sheeting, burlap sacks, 5mm sieve, large paint brushes, plastering rubber gloves, fine sand, cement, chicken wire, reinforcement bar, 12-gauge hoop wire, GI pipe and fittings, 2 x 4 lumber, aggregate, nails (#8, #16), buckets, bailing wire, screwdrivers, pipe wrenches, thread compound
FACILITATORS	One or more trainers

## Trainer Introduction

**During this session, a ferrocement water storage tank is built. The forms used are corrugated iron, cut into sections, similar to those shown in the Watt book, Chapter 7. These forms should be on hand and ready to use when the session begins. The tank size should be two to five cubic meters. It should contain delivery and scour pipes. An overflow pipe may be added if necessary. Refer to drawings on pages 339 and 340. The exact design and specifications should be done by the trainees themselves. The number of trainees in the group should be between eight and twelve. Trainers should serve as technical advisors during the**

**design and construction phases. The resource book should serve as reference information for the trainees. The time set aside for each construction step is a close approximation based on past training experience. It does not include time spent on logistics or transportation. There are many activities during this session. Make sure that all trainees participate in all activities by having the project manager rotate them through the various tasks. Finally, proper construction safety practices should be followed at all times. Trainers should take the time to explain such practices and make sure that they are followed throughout the exercise.**

## **PROCEDURES**

Step 8 hours

1

Excavate site for tank foundation. Form the slab. Place pipe fittings. Place slab reinforcement. Place reinforcement to tie into walls. Pour the slab. Assemble culvert forms. Haul and sift sand. Cure the slab.

### **Trainer Note**

**This step is a full day's activity. The primary task is to form and pour the slab. Make sure that the dimensions are correct. The slab should be larger than the diameter of the tank with at least a 12cm apron. Check the placement of the pipe fittings. The delivery pipe should come out of the foundation at a convenient location. The scour should be flush with the top of the slab, and drain away from the tank. The reinforcement designed to tie into the walls must be placed properly to allow the culvert forms to fit snugly inside. Other activities should also be done today. The culvert forms should be assembled adjacent to the slab. Sand can be**

**hauled and sifted for the ferrocement, and a scaffolding can be constructed to protect the tank from direct sunlight, wind, or rain. The slab should be cured properly and allowed to sit overnight before beginning Step 2. If possible, allow a full day before Step 2 begins.**

Step 2 4 hours

Erect form on slab. Level form. Wrap chicken wire. Wrap hoop wire.

### **Trainer Note**

**The culvert form should be brushed clean before placement. If the slab was made properly, the form should fit snugly. Additional chicken wire may be placed at the bottom edge of the form and tucked underneath to be plastered to the tank floor later. The space caused by the wedges used to connect the forms must be filled in some manner to allow the form to be removed easily. One effective method is to fill the gap with clay before wrapping with chicken wire. The clay should fill the gap completely, take the same shape as the corrugations, and be rubbed smooth. Make sure that the form is level and the chicken wire and hoop wire is wrapped snugly and crimped tight.**

Step 3 3 hours

Apply first mortar coat to outside walls. Properly cure tank.

### **Trainer Note**

**The mortar may be applied with trowels, as described by Watt, or smeared on with plastering rubber gloves. Make sure that the mix is correct, and the trainees**

**apply the first coat properly. Many trainees tend to put the mortar on too thick and overwork it. Stress that this is the first coat and is not intended to completely cover the reinforcement. Also, overworking the mortar will cause it to dry out quickly and peel off the wall. It is very important that the walls be cured properly. Step 4 may begin after the first coat has set up, usually in a few hours.**

Step 4 3 hours

Apply second mortar coat to the outside walls. Properly cure the tank.

### **Trainer Note**

**Brush the tank walls lightly with a steel brush before you begin. Check the walls for structural integrity. If any mortar has slumped off, peel off the bad spot, coat the edges with cement slurry, and replaster the area. Then, begin the second coat. This should be the finish coat on the outside and rubbed fairly smooth. Use trowels or gloves, taking care not to overwork the mortar. The tank should sit for three or four days before Step 5 begins, and a curing schedule must be maintained throughout this period.**

Step 8 hours

5

Remove forms from tank and inspect walls for structural integrity. Clean inside of tank. Apply first inside mortar coat to walls. Properly cure tank.

### **Trainer Note**

**The form should be removed carefully to avoid any stress on the walls. Inspect the**

**walls visually, checking any apparent weak points by applying hand pressure. Brush down the inside of the tank completely. Be sure and clean the tank floor also. The inside coat should be started on the outside edge of the tank floor and move continuously up the wall. This coat is difficult to apply because of the corrugations and also, because the walls have cured for several days and are no longer green. Before starting the coat, try wetting down the walls with water and smearing a very thin coat of mortar over an area. Then, follow up with the normal mortar application. Extra mortar may be placed along the base of the tank to provide support and a good seal. Extra mortar may also be applied at the top of the tank to provide additional strength for a lid. After finishing the coat, make sure that the top of the tank is covered. This will slow the curing process by keeping moisture inside the tank. Two or three buckets of water may be placed on the floor to aid the curing process. Step 6 should begin the following morning.**

Step 6 4 hours

Apply second inside mortar coat to walls. Properly cure tank.

### **Trainer Note**

**Brush down the tank walls and inspect the first coat. If any mortar has slumped off, peel off the bad spot, coat the edges with cement slurry, and re-plaster the area.**

**Then, apply the second coat, again starting on the outside edge of the tank floor and moving continuously up the wall. Properly cure the tank as described in Step 5. Step 7 may begin the next day.**

Step 4 hours

7

Apply finish slurry coat to inside wall. Slope the floor to the scour. Finish any remaining tasks.

### **Trainer Note**

**Again, brush the inside of the tank and clean the floor before applying the slurry. The slurry should consist of cement and water only, mixed to a pancake batter consistency. Use large brushes to apply it, again starting on the floor and moving up the wall. Make sure that the floor is sloped. If time permits, trainees may perform other tasks such as constructing a drainage trench for the scour or a concrete splash pad for the water tap, Step 7 may follow at any time.**

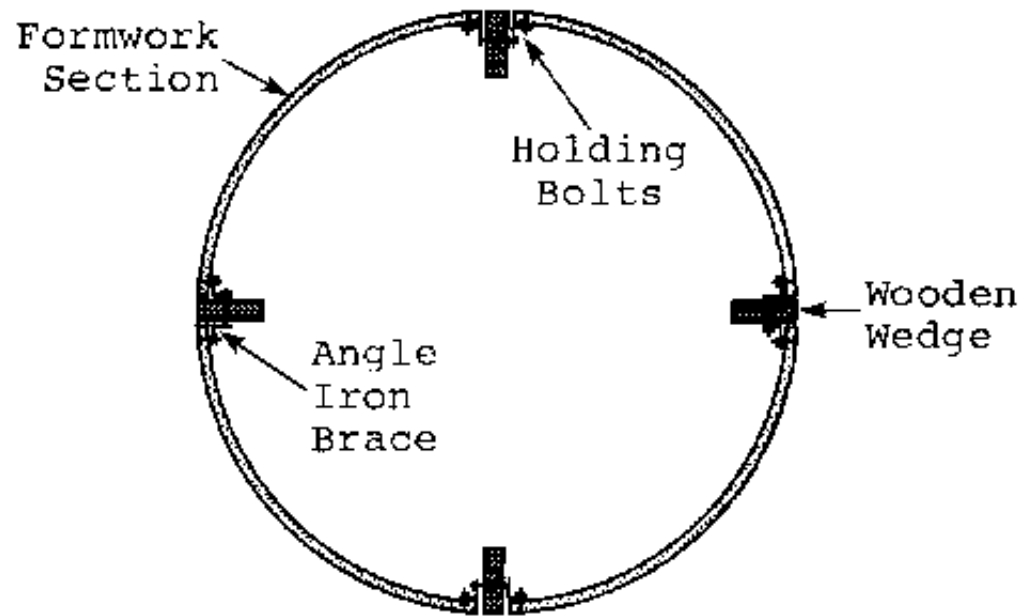
Step 8 2 hours

Review and discuss the construction process. Clean the work site.

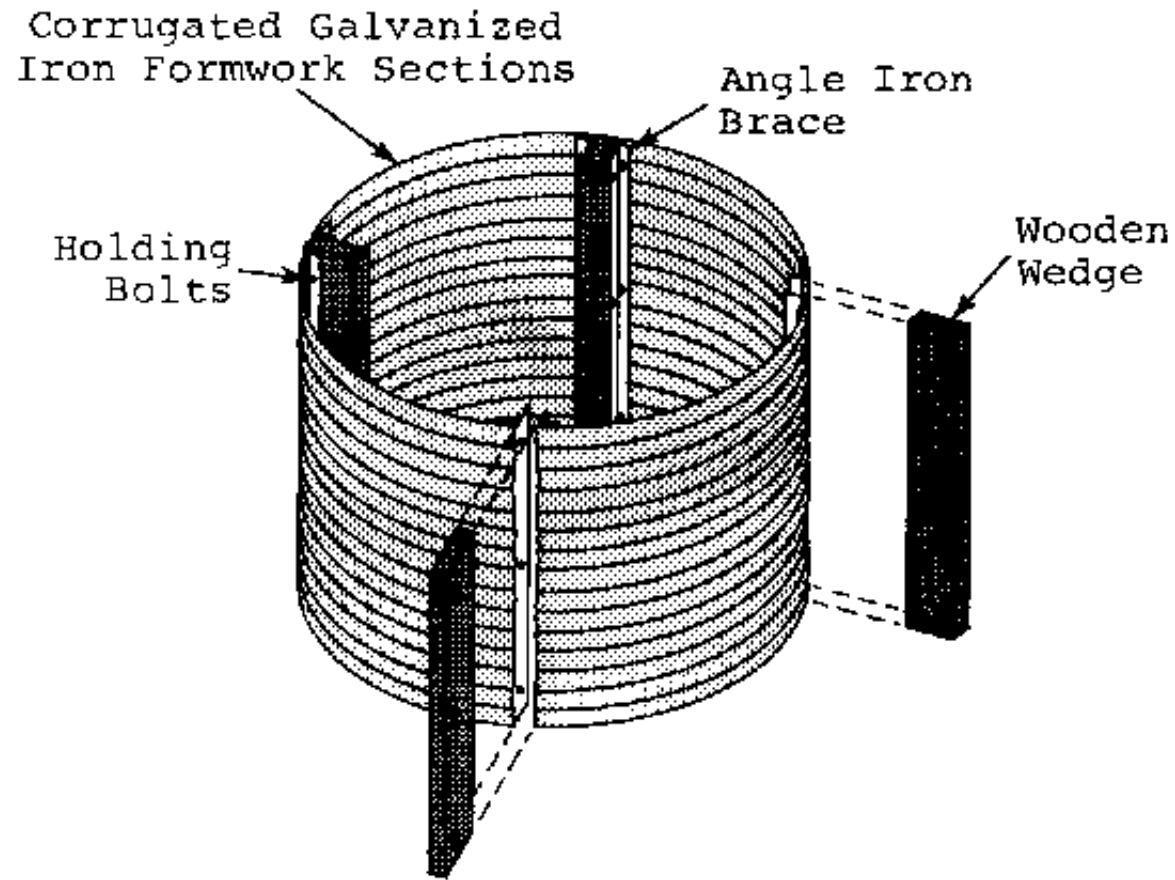
### **Trainer Note**

**Use this time to facilitate a discussion on other applications of ferrocement or discuss different methods of tank construction. A curing schedule for the tank will need to be maintained. The tank may be filled to a depth of one half meter of water after a few days to aid in the curing process. After a week or so, it may be gradually filled completely. Lastly, the entire group should review the construction procedures and processes that went into the project. Discuss positive and negative aspects. Ask what could have been done differently to improve the construction. Ask about the group dynamics of the exercise. What improvements**

**could have been made? What worked particularly well? Point out the importance of hard work, flexibility, and cooperation throughout such an activity.**

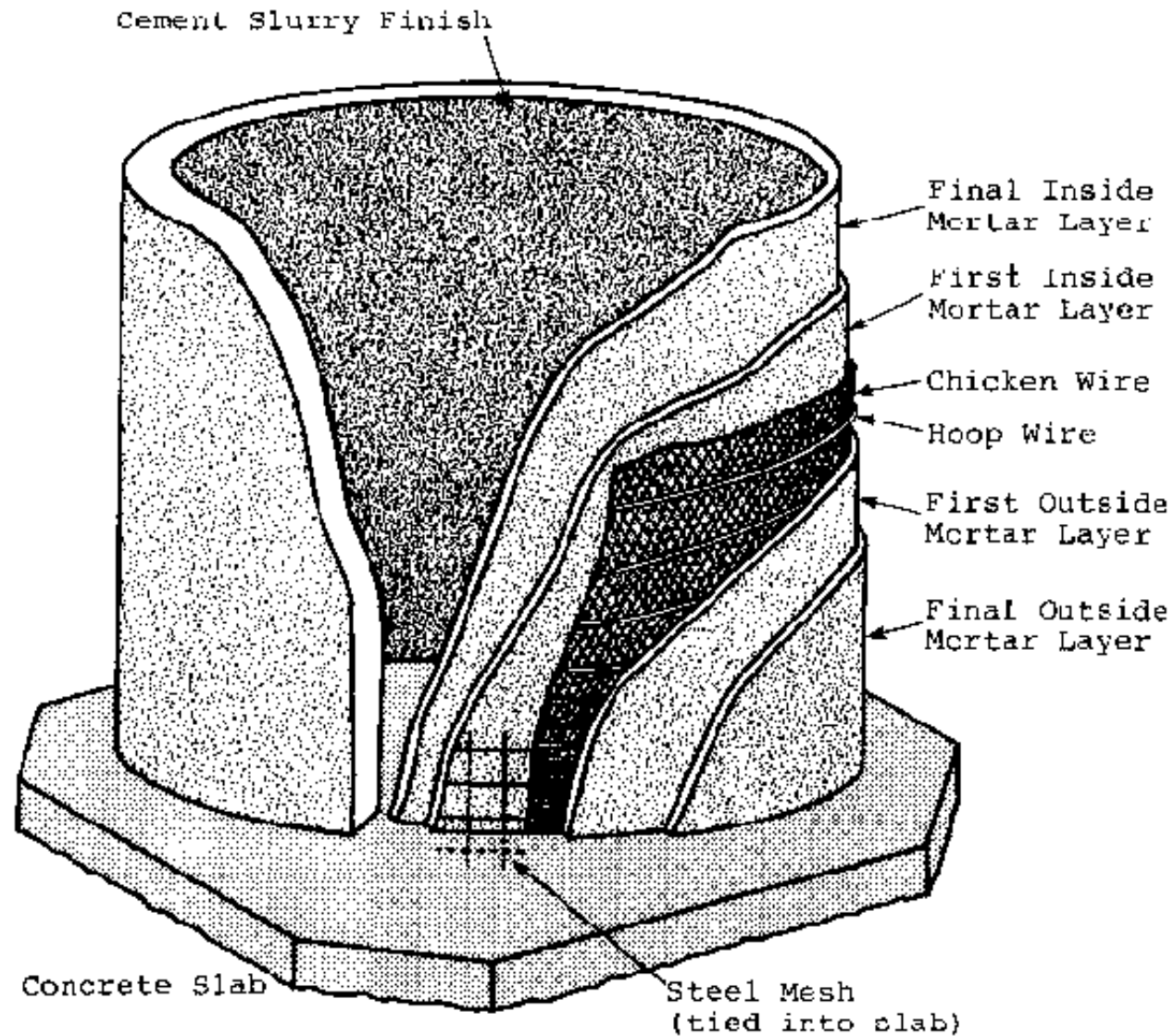


**Ferrocement Tank Design Drawing - Plan View**



**Ferrocement Tank Design Drawing - Formwork**





## Ferrocement Tank Design Drawing

### Session 42 - Constructing projects in a community

TOTAL TIME Two Hours

OBJECTIVES \* Examine and evaluate the construction of community projects as a

**OBJECTIVES**

Examine and evaluate the construction of community projects as a cross-cultural experience

\* Relate the construction of community projects during training to future Peace Corps service

**PREPARED**

Newsprint and felt-tip pens

**MATERIALS****FACILITATORS**

One or more trainers

**Trainer Introduction**

**It is generally assumed that sound knowledge of technical information is the key component to any successful construction project, and this is often the emphasis of a training program. This session is meant to bring out other important components, especially those relating to projects done in a community setting with local participation. The session should be held after the major training construction projects have been completed, and trainers should be familiar with the projects and the community in which they were undertaken. If no projects were done in a community setting, the session may be adjusted to deal with general themes of community involvement in water/sanitation projects.**

**PROCEDURES**

Step 1 10 minutes

Present the objectives and explain the format for the session.

Step 2 15 minutes

Post the following questions on a flip chart paper and briefly explain each one.

## **Trainer Note**

- 1. Can you define the community's view of the Peace Corps trainees, and your view of them?**
- 2. What did you observe to be the strongest social institutions in the community and did you feel that you were a part of them?**
- 3. What impact did the setting have on the technical work sessions?**
- 4. What were your major frustrations during your stay in the community and what personal changes were needed to adjust to the setting?**
- 5. What were the main positive aspects of working in a new community?**

Step 20 minutes

3

Break into five groups, each group taking one question and discussing it at length. Each group lists on a flip chart the answers of each trainee (they need not all agree).

Step 60 minutes

4

Each group reports back to the entire group concerning their question. During each report, time is allowed for general discussion by all trainees.

## **Trainer Note**

**Feel free to add thoughts and observations throughout the discussion without**

**leading it or imposing one point of view. Trainees may have very different comments on any one subject and a consensus need not be reached. Listed below, by question, are some considerations which may be brought out in the discussion:**

### **Question 1**

**The community viewed trainees as: outsiders, agents of change, do-gooders, money for the community, progress for the community, support for the elite, help for the underprivileged.**

**Trainees viewed the community members as: helpful, understanding, polite, proud, easy going, appreciative, or, indifferent, uninformed, resentful, suspicious.**

### **Question 2**

**Did the social institutions such as church, family, school, etc. play a positive or negative role in the community?**

**Were institutions different from what trainees have known in their own communities?**

**Did institutions help or hinder community development? Did the fact that trainees were in the community for only a limited time affect their interaction with social institutions?**

### **Question 3**

**The community setting: made projects more useful and meaningful, increased**

**trainees! desire to learn, increased importance of craftsmanship, encouraged sharing information with local people, increased importance of organization, caused frustration due to community indifference, emphasized the importance of cross-cultural as well as technical skills.**

#### **Question 4**

**Trainees' frustrations in the community included: discomfort with all the attention - the "fish bowl" effect, lack of personal space, lack of transport, the slower pace of projects, the language barrier, guilt feelings resulting from difficulty with adjustment to the community's life style.**

**Trainees adjusted through: open mindedness, reducing expectations, patience, being themselves, studying language and attempting to use it, making the extra effort to get to know someone.**

#### **Question 5**

**Positive aspects of working in a new community were: getting to know new people and places, doing worthwhile projects, learning new skills, practicing language, learning more about themselves, experiencing a cultural exchange, challenging themselves.**

Step 15 minutes

5

As a large group, discuss and answer these questions. Review the objectives and close the session.

## Trainer Note

**Post these questions on flip chart paper:**

- 1. In what ways do you feel this community experience has prepared you for your Peace Corps service?**
- 2. Do you expect the technical projects of your Peace Corps service to be similar to those done in training?**

**Encourage an open exchange of opinions concerning these questions. Mention that as Volunteers, they may not be greeted favorably by all community members. Also, their technical projects may be very different, especially in terms of the process. Emphasize that the way in which a project is initiated, implemented, operated, and maintained will be very different from what they are familiar with. Flexibility and adaptability on their part will be crucial to the success of any project. Finally, point out that all Volunteers encounter difficulties and frustrations during their service. Emphasize that hard work, determination, and perseverance are needed to perform successfully as Volunteers. However, even these qualities do not always ensure success. Ask them if they feel ready to accept a certain amount of failure, as well as success, during their service.**

## Session 43 - Proposal writing

**TOTAL TIME** 2 Hours, 30 Minutes

**OBJECTIVES** \* Evaluate proposal writing as a method of procuring funds for a development project

\* Identify and discuss various components of a small-scale proposal

Identify and discuss various components of a small-scale proposal

- \* Practice writing a sample proposal for a development project

RESOURCES Attachment 43-A: "Guidelines for a Small-Scale Non-Technical Proposal"

PREPARED Newsprint and felt-tip pens

MATERIALS Copies of Attachment for all trainees

Cost estimates and materials list from a training construction project

FACILITATORS One or more trainers

## Trainer Introduction

**This session serves two purposes. First of all, it gets trainees thinking about funding sources for development projects. Secondly, it provides guidelines for writing a small-scale proposal.**

**Many trainees feel unsure about their ability to write proposals and this session should emphasize that the process can be made simple by effective, realistic planning of a project.**

## PROCEDURES

Step 10 minutes

1

Present the objectives and open the floor for discussion on this question:

- How many people here have written a proposal or planned and implemented a community project?

## Trainer Note

**Chances are that most trainees will answer this question in the negative. If some trainees have done such things, ask them to briefly explain the proposal or project, and generally give their impressions of the experience. If no trainees have had experience in this area, briefly relate some personal experience. Emphasize that writing a proposal is not the impossible task that many Volunteers believe it to be. Explain that proposal writing must be preceded by good planning. If a project is well thought out, proposal writing is simply a process of organizing and writing down those thoughts.**

Step 2 25 minutes

Lead a discussion on the procurement of funding for a community project.

## Trainer Note

**Begin with the question many Volunteers face, whether or not to bring in outside sources to fund a community project. In simple terms, there are two schools of thought concerning this issue. One saying that in most cases outside moneys are available and if the project is well thought out and will help the community, there is no valid reason not to bring in outside funding, and the other saying that if the community itself cannot support and pay for the project, it is not a viable project for that community.**

**Emphasize that there is not one correct answer for all situations. Both opinions have validity and carry with them strengths and weaknesses. Volunteers need to study the project and community, consult with their co-workers, weigh the**



**advantages and disadvantages, and then make a decision whether or not to fund a project with money from outside the community.**

**Point out that although this session deals with proposal writing, which usually is connected with outside funding sources, trainers do not mean to imply that outside funding is appropriate for all Peace Corps projects. That decision needs to be made on a case by case process.**

**If a decision is made that a proposal will be used to procure funding for a specific project. Encourage the trainees to think about a project proposal from the point of view of a funding agency. Emphasize that a funding agency must have a clear idea of what the project is all about, and what they are being asked to contribute.**

**Next, mention that Volunteers should check out what funding sources are available before they write the actual proposal. Ask trainees to list some things that they might want to know about a funding source. Here are some possible answers:**

- \* What type of projects do they favor?**
- \* Do they have minimum or maximum amounts of money that can be requested?**
- \* At what times of the year do they release money?**
- \* What kind of turn around time do they have once a proposal is submitted?**
- \* What type of activities in a project will they fund? Materials? Labor? Transportation?**
- \* Do they have a set format for a written proposal to follow?**

**Step 15 minutes**

## 3

Lead a brainstorming activity to answer these two questions. Record answers on newsprint.

- \* When is a good time to write a proposal?
- \* How should a proposal be written?

## **Trainer Note**

**Here are some points which should be emphasized:**

**1. The planning stage of a project should always come first. As for the time table for submitting a proposal, there are no exact rules to follow, but the time for submitting the proposal should be linked to the plan for project implementation. Volunteers should keep in mind the approximate dates the money will be needed, and how long it will take to receive the money after the proposal has been submitted and approved. Much time is often lost waiting for funds.**

**2. Trainees should be encouraged to think realistically with regard to their projects, which usually means to think small and manageable. Most successful Peace Corps projects are small-scale and community oriented; effective proposals follow the same rules. A simple, clearly written, feasible proposal will be more readily accepted by a funding source, and also lead to a realistic and manageable project. Some general rules to follow when writing are:**

**- Write with the audience in mind, being familiar with the organization(s) to whom the proposal will be submitted. Remember, it is often wise to submit the proposal to several sources, instead of counting on a single funding source which**

## **may fall through.**

- **Be concise and specific, straight forward and knowledgeable.**
- **Write in a simple and clear fashion.**
- **Show enthusiasm and commitment to the project by all those involved.**
- **Support your statements with adequate documentation.**
- **Do not lie or say things that cannot be proved.**
- **Take the time to make it look good visually and sound good grammatically.**

Step 4 25 minutes

Handout the Attachment and discuss these guidelines.

## **Trainer Note**

**Lead this discussion, making sure to emphasize each component. Encourage questions without straying too far from the subject matter. Mention that not all proposals need to follow this exact format. However, this format can be used as a general guideline. Make note that many funding agencies have their own guidelines to follow and forms to use.**

Step 50 minutes

5

In groups of six to eight trainees, practice writing a small-scale proposal for a

water/sanitation project. Use a project that has been done during training, such as a ferrocement water tank or latrine.

## **Trainer Note**

**For their proposal, trainees should use the materials list drawn up during the construction of the project they have selected. Make sure that list is on hand. Also, supply prices for necessary materials in the project. Encourage trainees to be brief and to the point. By delegating various responsibilities, they should be able to complete the exercise in the time allowed.**

Step 6 15 minutes

Bring the groups back together. Review one of the sample proposals.

## **Trainer Note**

**Read aloud sections of the proposal and ask the group to critique its content. Lead a discussion on the proposal, looking at it from the point of view of a funding source. Here are some questions to answer:**

- What information does it give? What does it lack?**
- Is the language simple and understandable?**
- Does the project sound realistic and capable of being completed as planned?**
- Would you fund this proposal? Why or Why not?**

Step 10 minutes

7

Review the objectives and conclude the session by reflecting on the importance of community participation in project planning and proposal writing.

## **Trainer Note**

**Ask trainees for ideas concerning how community members might be included in these processes.**

**REFERENCE: In-Service Training Manual, Peace Corps, ICE.**

## **Attachment 43A: Guidelines for a small-scale non-technical proposal**

### **Introduction**

- 1. Summary: Briefly describe the subject of the proposal, the applicant, and the community.**
- 2. Statement of the Problem: This section should grab the reader's attention and make them feel interested in the problem. Make sure that you define the problem in reasonable dimensions, that there is a clear relationship between the problem and the proposed project, in other words the problem can be made better if not resolved by the project, and that you support your statements with evidence, including statistics.**
- 3. Community Background: Describe the community in relation to the type of work you plan to do. Include topographical information, social institutions, socio-economic data, and population information. Describe past development work in the area. This background should give the community and project credibility.**

**4. Personal Background: Describe yourself and your background, including your experience and intentions in the community.**

**5. Goals of the Project: The goals should state what the community wants to accomplish with the project. They should be somewhat general, long term, and attainable by completion of the project.**

**6. Objectives of the Project: Objectives are the individual activities involved in accomplishing the goals of the project. They should be clear, specific, and measurable. They should state what and how much will be done, who will do it, and when it will be done.**

## **Project Outline**

**1. Description of the Project: This section contains the nuts and bolts of your plan. It should clearly state specific activities, construction methods, administrative procedures, and community mobilization strategies. Also, it should include schedules, time lines, a simple design layout, and staffing needs. It is important to be realistic about the scope of your activities, the resources available, and time needed to complete the project.**

**2. Total Cost of the Project: This should be a lump sum figure, including cash needs and in-kind contributions. Keep it feasible.**

**3. Budget Breakdown: This section should be a reasonably detailed listing of expense items. Break it into categories according to:**

**- Materials and Tools**

- **Labor and Personnel Costs (this may be converted into dollar amounts if it is in-kind contributions)**
- **Incidentals such as Transportation or Administrative Costs.**

**Add 10-15 percent to the total for inflation and contingency costs. Also, make sure that your prices are correct, the funding source may check them. Review your list and make sure that it contains all budget information that the funding source requires. If the budget is extremely long, you may want to write a short budget summary after the detailed budget listing.**

**4. Funding Request: This is the amount of money that you want from the funding source. At this point in the proposal, the funding agency know exactly what you plan to do, how much the project will cost, their expected contribution, and donations from other sources.**

## **Project Assessment**

**1. Evaluation and Documentation: This section explains who will evaluate and document the project, and how and when it will be done. You should focus on both the outcome (results) of the project, and the process used for implementation. Define the criteria that will be used in the evaluation, list information gathering techniques, explain how the evaluation will be used to improve the project, and describe the reporting procedures.**

**2. Future of the Project: Describe the project after its implementation, focusing on your program for operations and maintenance. If funds will be required, make sure that you explain how the community plans to meet their operating costs.**

**3. Benefits of the Project:** This section relates directly to the goals of the project. It is an important section which acts as a conclusion to the proposal. The long and short term benefits to the community should be stated, such as health improvements, skills transferal, and community mobilization.

## **Proposal Review**

**Make sure that your proposal is reviewed and edited by a knowledgeable person before you submit it to any funding source. Here are some suggested review guidelines:**

- 1. Is the project activity well planned, and an approach to implementation clearly defined?**
- 2. Are the costs reasonable and related to the work to be done,**
- 3. Is there strong local support and participation by the community?**
- 4. Will community members learn valuable new skills through their involvement with the project?**
- 5. Are the goals and objectives clearly stated, reasonable, and attainable?**
- 6. Is the time allowed for implementation adequate?**
- 7. Is there an evaluation process built into the project and is it ongoing?**
- 8. Is the proposal clearly written and free of grammatical mistakes?**
- 9. Does the proposal give the impression that the project is well organized and will be successful?**

**REFERENCE: In-Service Training Manual, Peace Corps, ICE.**

## **Session 44 - Training review and assessment**



TOTAL TIME	Three Hours
OBJECTIVES	<ul style="list-style-type: none"><li>* Review and answer questions concerning any information presented during the training program.</li><li>* Evaluate the overall effectiveness of the training program.</li><li>* Assess the progress each trainee has made during the training program in relationship to future Peace Corps service.</li></ul>
RESOURCES	Training Program Behavioral Objectives Any relevant resource material from the program
PREPARED MATERIALS	Newsprint and felt-tip pens
FACILITATORS	All trainers in the program and trainee facilitators

## **Trainer Introduction**

**This session is designed to be quite flexible. Use part of the time to review any material the trainees still have questions about. Ask them prior to the session for some topics they would like to review. Use any relevant resource books or attachments from the program to aid in the review. The evaluation of the program should be done by the trainees themselves. Well in advance of the session, ask for volunteers to facilitate the evaluation. The trainees should be allowed to design the procedures and activities. Trainers should offer advice and guidance if necessary. The program's Behavioral Objectives list will be used by the trainees to assess their skill level now that they have completed the program.**

## **PROCEDURES**

**Step 1 5 minutes**

Present the objectives and format for the session.

**Step 2 45 minutes**

Review suggested topics.

**Trainer Note**

**Answer all questions trainees may have concerning the information presented during the program. If time does not allow for a complete review, refer trainees to the appropriate resource books for additional information.**

**Step 3 1 hour, 15 minutes**

Trainee facilitators carry out their evaluation activities.

**Trainer Note**

**Let the trainees know that part of the purpose of the evaluation is to provide feedback which will be used to plan and implement future training programs.**

**Here are some suggested topics for evaluation:**

- **effective teaching techniques used during the program.**
- **ineffective teaching techniques used during the program.**
- **flow and sequencing of the program.**
- **program's relationship to future Peace Corps service**
- **specific sessions which were helpful, others which were not.**
- **skill levels before and after the program.**

- **training program as confidence builder.**
- **training program as motivational force.**

Step 4 10 minutes

Review the evaluation exercise.

### **Trainer Note**

**This review should look at the trainee facilitators" effectiveness in planning and implementing the session, as well as the evaluation itself.**

Step 15 minutes

5

Individually, trainees assess their skill level using the Behavioral Objectives Skill Sheet. Then, begin to think about new strategies they will use to obtain additional skills necessary for Peace Corps Service.

### **Trainer Note**

**Emphasize that this step gives each person the opportunity to look at his/her skill level and to start planning some personal strategies for the coming months.**

Step 15 minutes

6

In groups of three, trainees discuss the strategies they came up with to prepare for the coming months.

## Trainer Note

**Trainers should walk among the groups and participate in the discussions. Encourage the trainees to look ahead, speculating on their upcoming in-country training, how they have been preparing for it, and what things still need to be done.**

Step 7 10 minutes

Review the objectives and conclude the session.

## Trainer Note

**In conclusion, point out that during the past weeks everyone has worked hard to acquire new skills which will make them effective Peace Corps Volunteers. Emphasize that Peace Corps is an on-going learning process, which began here in training and should continue throughout their service.**

**REFERENCE: Farallones Institute and CHP International, A Training Manual in Appropriate Community Technology: An Integrated Approach for Training Development Facilitators. Peace Corps, ICE.**

**Role of the Volunteer in Development Manual; Peace Corps, ICE.**

