

















➔  **Improved Biogas Unit for Developing Countries (GTZ, 1991, 98 p.)**

-  **(introduction...)**
-  **Acknowledgments**
-  **Foreword**
-  **Acknowledgment**
-  **1. Preface**
-  **2. Why biogas ?**
-  **3. Explanation of terms**
-  **4. Biogas extension work**
-  **5. The agricultural biogas unit**
-  **6. Construction of the biogas plant**
-  **7. Construction of cattle stable**
-  **8. Construction of the pigsty**
-  **9. The sanitary biogas unit**
-  **10. Use of slurry**
-  **11. Use of gas**
-  **12. Operation and maintenance**
-  **13. Pending technical issues**
-  **14. Appendix**

 **Improved Biogas Unit for Developing Countries (GTZ, 1991, 98 p.)**

- ➔  **(introduction...)**
-  **Acknowledgments**
-  **Foreword**

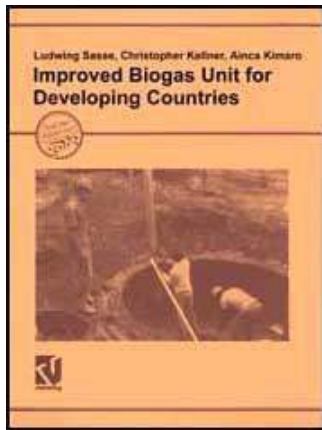

-  **Acknowledgment**
-  **1. Preface**
-  **2. Why biogas ?**
-  **3. Explanation of terms**
-  **4. Biogas extension work**
-  **5. The agricultural biogas unit**
-  **6. Construction of the biogas plant**
-  **7. Construction of cattle stable**
-  **8. Construction of the pigsty**
-  **9. The sanitary biogas unit**
-  **10. Use of slurry**
-  **11. Use of gas**
-  **12. Operation and maintenance**
-  **13. Pending technical issues**
-  **14. Appendix**

The CAMARTEC Biogas Unit

Ludwig Sasse, Christopher Kellner, Ainea Kimaro

A Publication of the Deutsches Zentrum fr Entwicklungstechnologien - GATE , a Division of the Deutsche Gesellschaft fr Technische Zusammenarbeit (GTZ) GmbH - 1988

Die Deutsche Bibliothek - CIP-Einheitsaufnahme

Sasse, Ludwig:

Improved biogas unit for developing countries: the CAMARTEC biogas unit; a publication of Deutsches Zentrum fr Entwicklungstechnologien - GATE in: Deutsche Gesellschaft fr Technische Zusammenarbeit (GTZ) GmbH / Ludwig Sasse Christopher Kellner, Ainea Kimaro. Braunschweig, Wiesbaden: Vieweg, 1991 ISBN 3-528-02063-6 NE: Kellner, Christopher:; Kimaro, Ainea:

The author's opinion-does not necessarily represent the view of the publisher.

All rights reserved.

**© Deutsche Gesellschaft für Technische Zusammenarbeit (GTZ) GmbH,
Eschborn 1991**







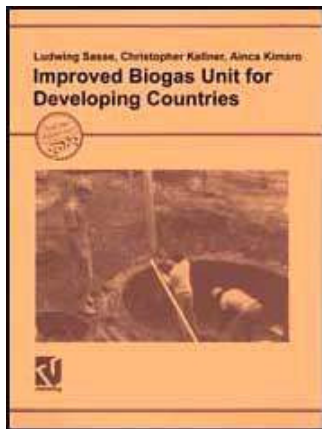







**Published by Friedr. Vieweg & Sohn Verlagsgesellschaft mbH, Braunschweig Printed in the Federal
Republic of Germany by Lengericher Handelsdruckerei, Lengerich**

ISBN 3-528-02063-6

[Home](#) > [ar.cn.de.en.es.fr.id.it.ph.po.ru.sw](#)



Improved Biogas Unit for Developing Countries (GTZ, 1991, 98 p.)

-  **(introduction...)**
-  **Acknowledgments**
-  **Foreword**
-  **Acknowledgment**
-  **1. Preface**
-  **2. Why biogas ?**
-  **3. Explanation of terms**
-  **4. Biogas extension work**
-  **5. The agricultural biogas unit**
-  **6. Construction of the biogas plant**
-  **7. Construction of cattle stable**
-  **8. Construction of the pigsty**
-  **9. The sanitary biogas unit**
-  **10. Use of slurry**

-  **11. Use of gas**
-  **12. Operation and maintenance**
-  **13. Pending technical issues**
-  **14. Appendix**

6. Construction of the biogas plant

General

The overflow of the biogas plant must be higher than the slurry bed or the slurry distribution channel. The inlet must be lower than the stable floor. The biogas plant should be so far from trees that roots will not grow into its brickwork. It should not be in areas where heavy machinery move frequently. Biogas plants are not meant to be a playground, still they should be safe for children and animals.

A gasplant of a rural biogas unit is standardized and preferably a fixed dome plant. Once the decision for standardization is made, modifications are only allowed in order to join existing local structures. The plant itself is not to be changed.

The size of the plant depends on the substrate available. In practice its volume is chosen according to the number of cattle or pigs and their stabling. In case of doubt, the energy demand may also be considered. The biomethanation process is rather hardy and robust and does not require defined loading rates. Therefore, it is possible to consider only a few standard digester volumes. The standard volumes of digester and gasholder have to be estimated in each project area according to gas production rates and general gas consumption patterns.

Larger gasplants have longer retention times and, therefore, higher gas production rates. Nevertheless, the amount of daily fed substrate has more influence on gas production than the volume of the digester. In case of doubt, criteria used are the investment costs and security of gas supply. Larger gas plants have higher gas storage capacity.

The most common size in the Arusha Region is the 16 m³-plant which can provide gas for cooking

and lighting for a normal family. The 12 m³-plant is reserved for places of little gas demand, e.g. small families, or where ground temperature is above 24°C and therefore, retention time could be less. 30 and 50 m³-plants provide gas not only for household use but fuel for big institutional kitchens and special appliances like refrigerators, incubators, hatching heaters or power engines, etc. Structural drawings for the standard plants are to be found in the Appendix.

The Principle Design

The standard fixed dome plant has a half-bowl spherical shape with flat bottom and a top opening. The outer walls rest on a foundation ring beam. The floor has no static function. The upper part of the sphere is separated from the lower part by a joint, called the "weak ring". Gas tightness of the upper part is achieved by a crack-free structure and a gas-tight inner surface plaster.

The Inlet pipe is connected to the spot of dung disposal in the stable. The outlet pipe connects the digester with an expansion chamber of reduced spherical shape. The overflow of the expansion chamber - really the final outlet of the gasplant - leads to the slurry disposal system, i.e. the distribution channel, storage tank or compost pit.

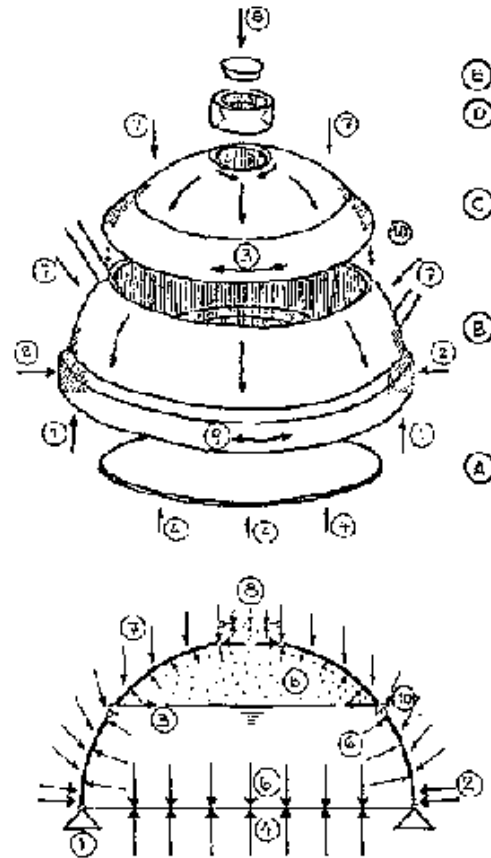

Fig. 14: Principle of statics of fixed dome plant

The plant consists of a non-load bearing bottom (A), the lower slurry~ tight digester (B), the upper gas-tight gas storage part (C), the neck (D) and the gas-tight lid (E). Gas storage part and digester are separated by the weak-ring (10) in order to allow free reaction of the strong-ring (3) and to prevent cracks which have developed in the lower part of the digester to "grow" into the gas storage space.

The plant rests on a foundation ring (1) bearing mainly the vertical loads of' the construction and the soil cover (7). The surrounding soil supports the construction to resist gas pressure (5) and slurry pressure (6). Concrete at the outside of the lower layer of bricks (2) helps to reduce tangential forces at the foot point (9). The ring forces of the upper part are absorbed by the strong-ring (3).

The Reference Line

Because the slurry is a liquid, the biogas plant follows the physical law of communicating tubes. A reference line is used in construction to keep the exact levels, which are of outmost importance for the functioning of the system. Main vertical measurements of the working drawings are given in relation to the reference line. The reference line is 35 cm above the overflow of the expansion chamber and marks the lowest possible point of the stable floor from where the dung is pushed into the mixing chamber. It is also the minimum level for soil covering of the dome.

At the site, the reference line is marked by a string passing over the centre of the digester, preferably in direction from inlet to outlet. The string is fixed in absolute horizontal position with a spirit or hose-pipe level. The pegs for the reference line should be sturdy and well protected during construction time. In order not to lose the level of the reference line it is advisable to also mark it on a tree or a building near to the plant.

In case there is an existing stable, a horizontal string is fixed from the lowest point of the floor to the place of the proposed overflow of the expansion chamber. The overflow might be 35 cm or more below this string. The convenient overflow level might be decided and the string of the reference line is tied 35 cm above that point. In all cases, it will be at, or below, the lowest floor level of the stable. In case of a 16 m³ standard plant, the centre of the digester is 3,30 m away from the inlet point. The point of overflow is 5,00 m away from the centre.

In case a new stable will be constructed, the point of overflow of the expansion chamber might be decided according to the convenience of slurry disposal. A horizontal string 35 cm above this point forms the reference line. The lowest point of the stable floor might be on the same level or preferably above the reference line; but never below this level. In case of a 16 m³ standard plant, the centre of the digester is 5,00 m away from the point of overflow. The inlet chamber attached to the stable is 3,30 m away from the centre.

Digging the Pit and Casting the Foundation

For safety of the labourers, the sides of the pit must be sloped according to the soil properties. Excavated soil should be placed 1 m away from the rim of the pit. Place of inlet and expansion

chamber should be kept free from excavated soil.

The pits of the digester and the expansion chamber are excavated in their proper sizes and positions down to their respective final depths. If soil is soft or of unequal strength, stone or sand packing below the foundation is required. Provide drainage facilities in case of ground or hill water.

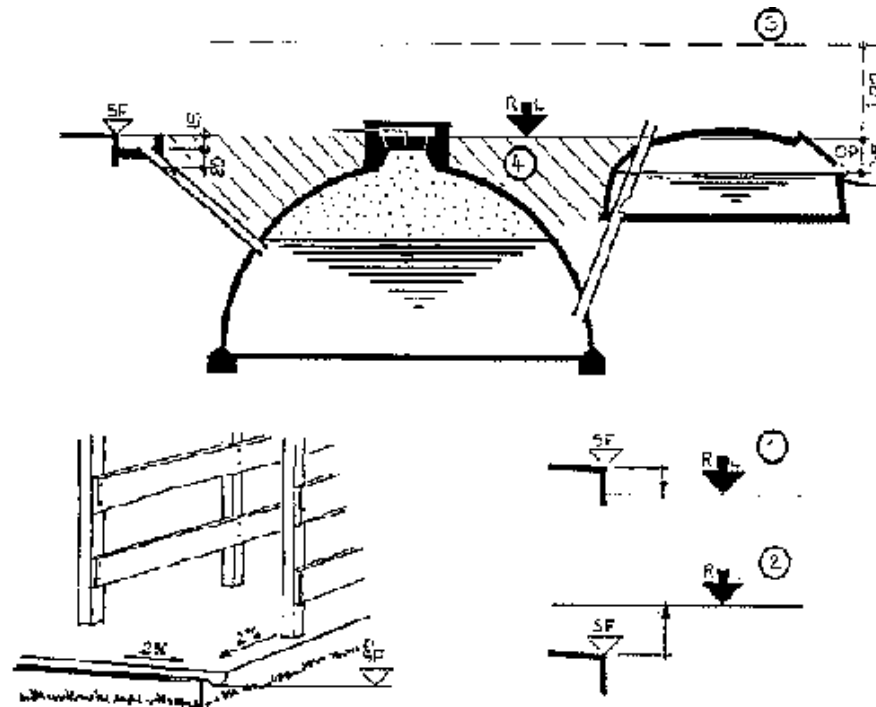

Fig. 15: The reference line

The reference line (RL) is marked by a string during construction to maintain proper levels of essential parts of the gas plant. The lowest point of the stable floor (SF), i.e. the lowest point of the urine drain, must be 35 cm above the overflow point (OP) in order to allow sufficient depth (min. 15 cm) of the inlet chamber. On uneven ground it may be required to fix the string 1 m above the real reference line. Then, 1 m must be added to all measurements. The reference line may be lower than the stable floor (1). It should never be higher as to avoid lifting up the feed material for filling the plant. The reference line also marks the necessary soil cover above the dome (4).

The foundation ring is excavated immediately before filling the concrete of the foundation. A mixture of 1: 2: 4 (cement: sand: aggregate) is used and the concrete is firmly rammed. Casting of the foundation should be done early in the day as to allow sufficient time to place the first two layers of brickwork into the fresh concrete at the same day. These two layers are back-filled with a lean concrete mixture of 1: 3: 9.

Brickwork of Spherical Wall

The centre point at the bottom of the digester is the heart of the construction. The centre peg should be firmly driven in at proper position and level according to the reference line. A nail on the head of the peg marks the exact centre.

To construct the spherical masonry wall, a guide stick is used which keeps the radius constant and helps to create an absolute half bowl shape. Each brick of the wall is laid against the nail of the radius stick. It is easier to do than to describe. Just start putting brick by brick, keeping the top of the brick in the same slope as the direction of the radius stick, which is radial, pointing to the centre. Automatically, brickwork will turn out in spherical shape.

Bricks must be of good quality, preferably of 7·12·23 cm in size. If bricks are less than 5 cm in thickness they should be used in flat layers. The wall becomes then 10-12 cm thick and more bricks will be required. The bricks are soaked in water before laid into 1 cm mortar bed of mixture 1: 1/4 : 4 (cement: lime: sand). Gauge boxes are used to measure the volumes for mixing the mortar. Only sieved and washed river sand is permitted; otherwise the amount of cement must be increased if only quarry sand is available. Vertical Joints should be "squeezed" and must, of course, be offset. The inner edge of the brick forms always a right angle with the radius stick.

Inlet and Outlet Pipe

Inlet and outlet pipe must be placed in connection with brick-laying. It is not possible to break holes later into the spherical shell; this would spoil the whole structure. The pipe rests below on a brick projecting 2 cm to the inside. Above, it is kept in position by being tied to pegs at the rim of the excavation.

The inlet pipe is of 10 cm (4") diameter. Its upper side is in line with the top of the weak ring. The outlet pipe which connects the digester with the expansion chamber is of 15 cm (6") diameter in order to avoid clogging. It starts at the bottom at the 4th layer of bricks and continues above the dome of the expansion chamber to allow poking in case of blocking. A collar of cement mortar 1: 1/4: 4 at the outside of the wall seals the Joint between the outlet pipe and the brickwork. At the level of the expansion chamber it is cut out to allow for slurry flowing in and out.

Outside Plaster of the Lower Part

Only sieved and washed river sand is to be used for plaster. After brickwork has reached the level of the weak ring, smooth plaster of 2 cm thickness and of 1: 1/4 : 4 mixture is applied all over the outside. The plaster should harden over night before back-filling of soil is done.

The outer plaster protects the brickwork against roots growing into the joints. It forms also a smooth surface which reduces friction between soil and structure and thus, reduces static stress of the brickwork.

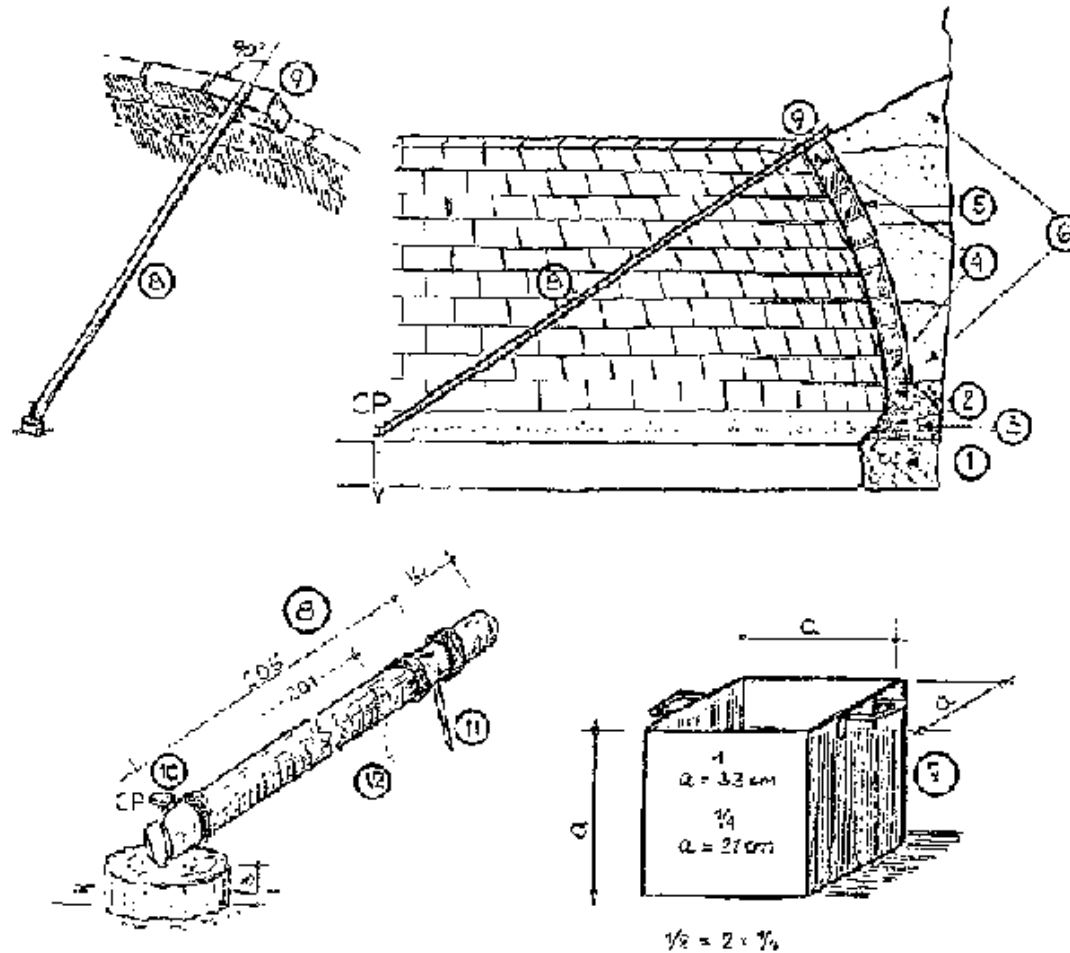

Fig. 16: Construction of the lower part of the sphere

(1) Foundation ring of concrete 1: 2: 4; (2) First two layers of bricks laid in cement-lime mortar 1: 1/4 : 4; (3) Supporting concrete ring 1: 3: 9; (4) Brickwork up to the bottom of the weak ring laid in mortar 1: 1/4 : 4; (5) 2 cm thick outside cement-lime plaster 1: 1/4 : 4; (6) Backfilling soil rammed in layers of max. 30 cm height.

For measuring the correct mixtures a gauge box is used (7). The brickwork is erected with the help of a radius stick (8). The radius stick is set at the centre of each brick. The surface of the brick follows the direction of the radius stick (9). It rests with a groove at the nail of the centre

point (10). Because the floor has not yet been laid, the peg of the centre point is 3 cm above the excavated ground. The upper nail (11) of the radius stick (11) marks the inner edge of the brick. The measure of the stick is reduced by 4 cm for placing the headers of the strong ring (12). When laying the bricks, they are first knocked horizontally, then vertically.

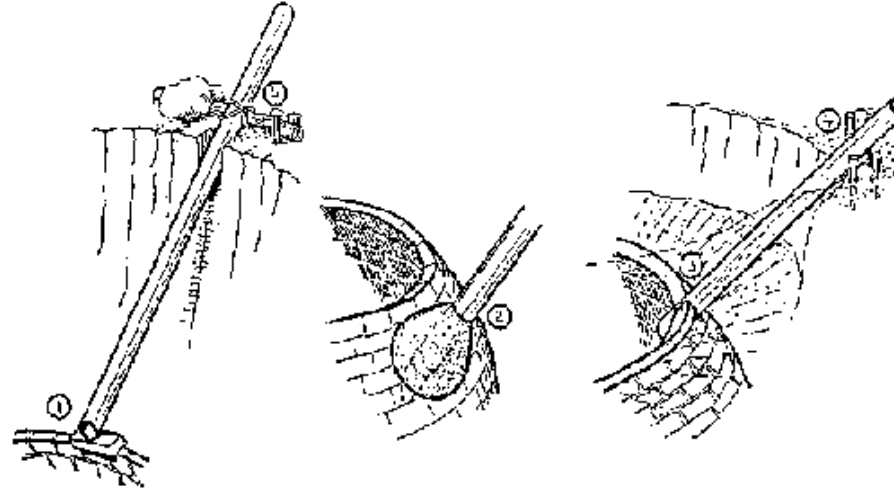

Fig. 17: Inlet and outlet pipe

The outlet pipe (6") rests on a flat brick (1) above the 4th layer of the spherical wall. At the outside of the wall it is surrounded by a mortar collar (2). The inlet pipe (0 4") penetrates the weak-ring (3). The pipe is not allowed to be higher than the top of the weak-ring, because it would then disturb the strong-ring. From the outside it is sealed only by the plaster of the lower brick work. At the top, the pipes are kept in position by pegs (4).

Back-filling

Once the digester is in use, the brickwork is under high pressure from the inside and therefore, must be supported from the outside by firmly back-filling of sand. The first two lines of brickwork are back-filled by lean concrete, mixed In ratio 1: 3: 9 as described before. Back-filling is done one day after the outside plaster is completed; layers not exceeding 30 cm are firmly rammed. Only sand or non-bounding soil is suitable for back-filling. Pure sand may be washed in instead of ramming.

The Weak-Ring

The weak-ring separates the bottom part of the digester from the gas storage part. The weak-ring shall prevent vertical cracks of the bottom part entering the upper part which must be gas-tight as it is the gas storage space. Vertical cracks are diverted into a horizontal crack remaining in the slurry area where it is of no harm to the gas-tightness. The weak ring acts as a swivel-bearing allowing free movement of the above strong ring.

The weak ring is formed by a 5-7 cm thick layer of lean mortar having a mixture of 1: 3: 15 (cement: lime: sand). The top of the weak ring restores the horizontal level. It is interrupted only by the inlet pipe passing through.

Brickwork above the Weak-Ring

The upper part starts above the weak ring with a strong ring to receive tension forces from the dome. It can be seen as a foundation of the upper part of the spherical shelf. It consists of a row of header bricks with a concrete package at the outside. In case of soft or uncertain ground soil one may place a ring reinforcement bar (10 mm or 2· 6 mm) in the concrete of the strong ring. The brick of the strong ring should be about three times wider than the brickwork of the upper wall. In practice this would mean a width of the full brick laid in headers if the spherical wall is of quarter brick. The radius stick must be changed to reduce the radius by 4 cm for Placing the bricks of the strong ring properly.

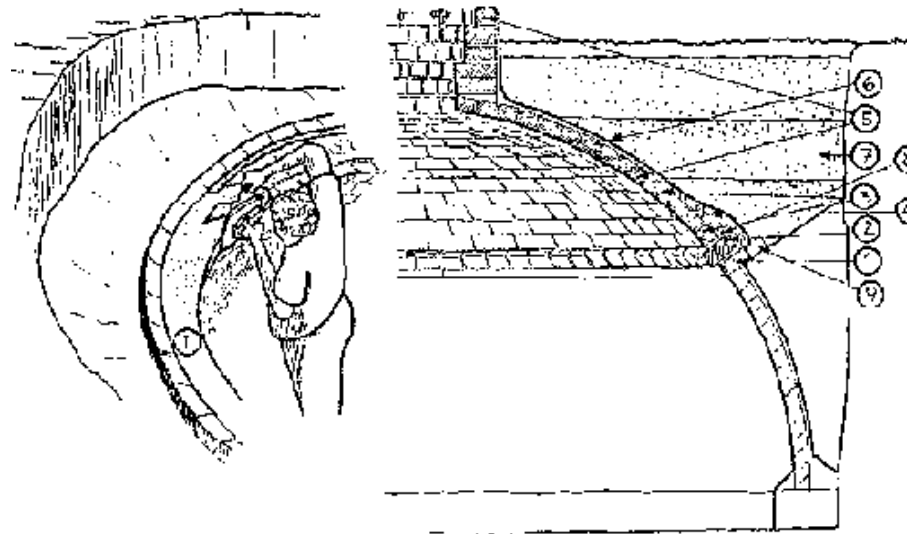

Fig. 18: Wall construction of the upper part of the dome

A row of temporary bricks is laid on the backfilling soil to mark the outer edge of the weak-ring (9). A 20 cm-wide strip of lean cement-lime mortar 1: 3: 15 is levelling the brick wall below and forms the weak ring (1). It should not exceed 7 cm in thickness. A row of full brick header projects 4 cm to the inside, forming the base of the strong-ring (2). For that layer, the nail of the radius stick is put back, shortening the radius by 4 cm. After 4 layers of bricks (3), a wedge of concrete 1: 2: 4 completes the strong-ring (4). Then, brickwork continues up to the neck (5). Outside plaster 1: 1/4 : 4 (6) must be cured for 4 days before backfilling of soil is done (7). The soil is rammed in layers not exceeding 30 cm.

Brickwork continues after the strong ring until an opening of precisely 64 cm in diameter remains. Bricks must be chopped to get the exact round form of this size. The bricks rest now in a slanting position and might fall down before the layer forms a closed ring. Therefore, at least the first and last brick of a layer must be temporarily supported. This can be done by clamps, hooks or leaning poles.

Above the header bricks of the strong ring, 2-3 rows (30 cm) of the following brickwork are covered with concrete of 1: 2: 4 mixture, forming a wedge to the strong-ring which Joins the outside plaster of the upper part. The concrete ring and the plaster is cured by sprinkling water

for 4 days before back-falling is done and masonry work of -the neck continues. In this time construction of the expansion chamber is done.

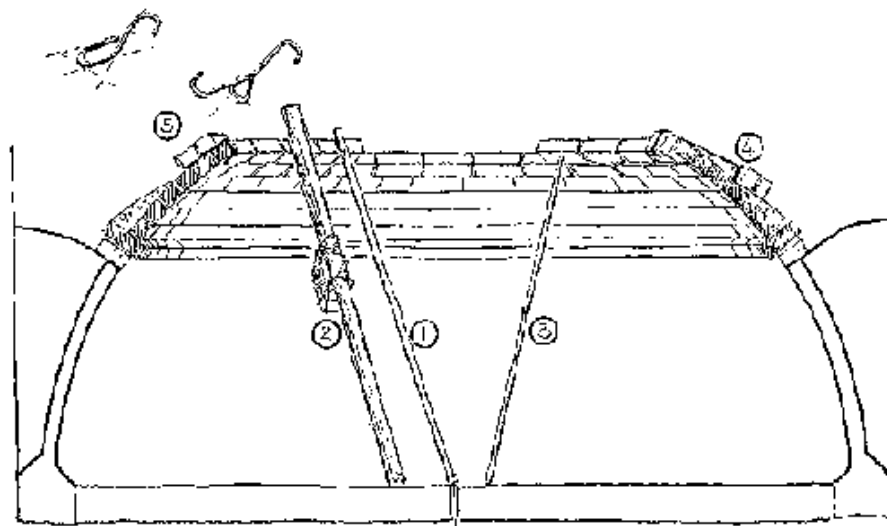

Fig. 19: Temporary support of brickwork

There are several methods to prevent slanting bricks from falling down during construction of the upper part of the sphere. The radius stick (1) supports only the actual laid brick. The last but one and the first brick of a new round must be supported. Near the top, every brick must be held in position until the round is completed. A suitable solution for the lower part above the weak-ring are poles leaning against the brick. There are some bricks tied to it for ballast (2). Sticks placed under the brick (3) are not advisable as they may be too tight and thus loosen the bond of the fresh mortar. A rope with a brick at one end and several at the other end (4) is a rather clumsy solution. Steel hooks with brick ballast (5) are the best solution, especially for the top-most rows as they leave room for the mason to work freely.

The expansion chamber can also have the shape of a covered channel. This is of advantage when slope is not enough to distribute the slurry.

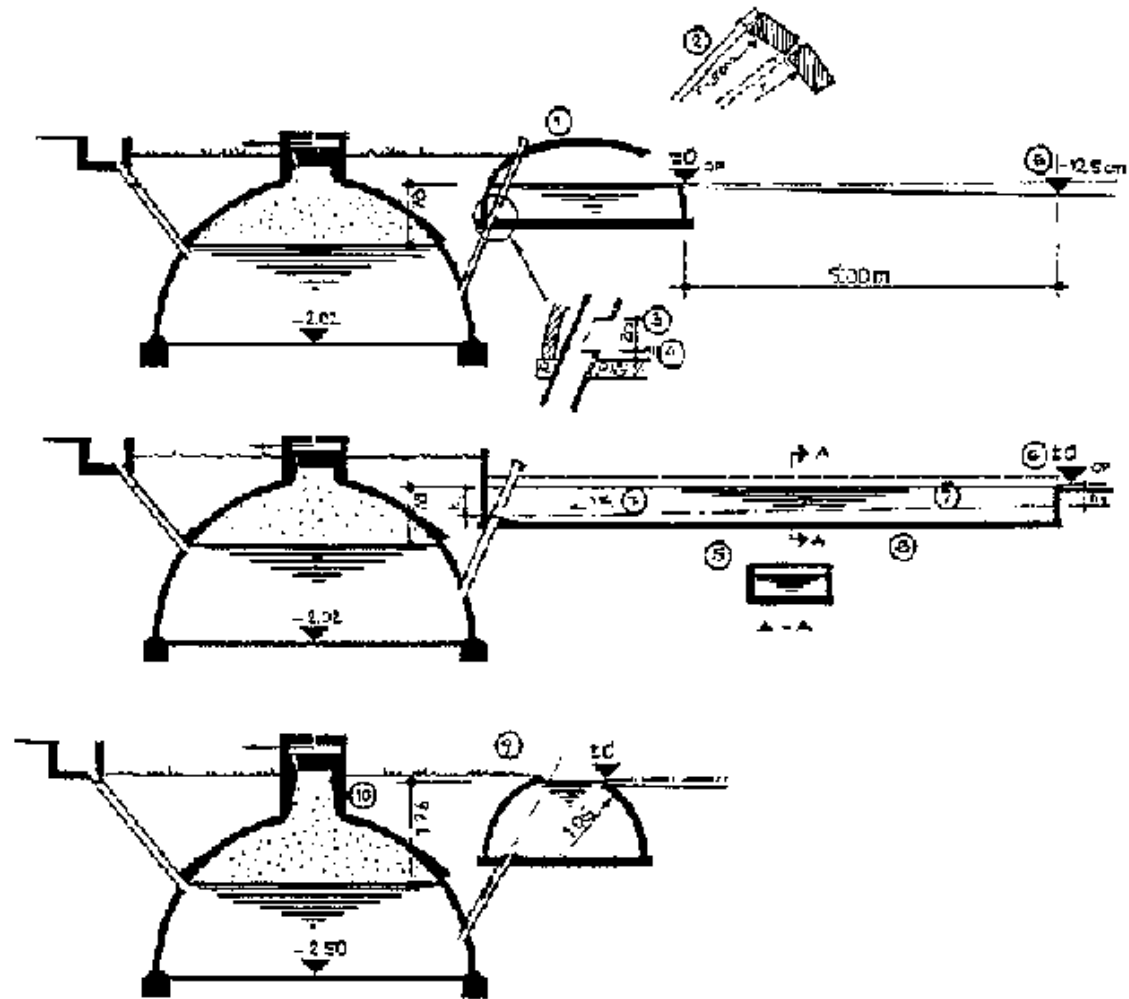

Fig. 21: The expansion chamber

The standard expansion chamber is of spherical shape (1), made from brickwork, plastered from the outside only. For the part above the overflow level the radius stick is reduced by 5 cm for each row as to flatten the dome (2). The outlet pipe passes through the dome in order to allow poking through from the outside. The - slurry opening (3), 2 cm above the bottom of the chamber (4), is

20 cm high and cuts out half the pipe. An expansion channel (5) is used to gain height at the point of overflow (6). It is also very handy in case of compost preparation. The volume of the expansion chamber represents the gas storage capacity. In case of a prolonged expansion channel, only the part above a 3% slope may be calculated (7). The bottom of the canal remains horizontal to allow sedimentation (8). A higher slurry level inside the expansion chamber (9) allows a smaller radius but increases the gas pressure. A higher neck is also required to keep the gas outlet pipe above the point of overflow (10). Therefore, this is not recommended.

Water-proofer

Water-proofer is added to the cement for gas tightness. Water-proofer based on plastic is preferred over crystalline components because of greater elasticity. To obtain gas-tightness, twice the manufacturer's recommendations for water-tightness is added to the cement.

The use of water-proofer has solved the problem of gas tightness of the plaster. Any kind of surface paint is difficult to apply because the structure is still "sweating" for a long time and the surface will not be as dry as recommended for painting. Other methods, like paraffin coating require higher skill and close supervision. Bituminous paints are washed away in little time by the movement of slurry. Further, materials composed of carbohydrate are principally affected by methane bacteria.

The Neck and the Lid

The gasplant is closed on top with a removable concrete cover of conical shape and 20 cm thickness. The mixture is 1 : 3 (cement : sand) with water-proofer added to it. Casting of the lid is done in a mould which is also used to shape the supporting surface at the neck.

The gas outlet (ϕ 3/4") passes through the centre of the lid. It has a steel ring collar welded on to prevent gas leakage between the pipe and the concrete. Two handles made from iron bars are normally provided for lifting the cover. As they may hinder later tinning the wedges and pressing the lid into its clay bedding, a steel ring which folds down is preferable.

At the neck, the frame of the lid is formed by pressing the mould into the mortar bedding. For

preparing the cone in proper shape, the same mould is used in which the lid has been cast.

The gas outlet should be well above the highest slurry level in order to avoid slurry particles entering the gas Pipe. Therefore, the conical support of the cover is raised 2 layers of bricks above the dome structure. For chocking the lid, three pre-manufactured devices are fixed into the brickwork.

A 3/4" gas pipe of 30 cm length with threads on both ends is fixed horizontally in the brickwork of the neck and later connected to the pipe coming out of the lid by a piece of flexible hose pipe. The pipe projects only 6 cm into the inner space of the neck in order not to hinder the placing of the lid. The top of the lid should be above the terrain to prevent grass roots from growing into the clay for sealing the lid.- There is a top-most lid above the water bath. The lid and the neck could also be made from pre-fabricated concrete rings but it is difficult to make them in pieces not exceeding 70 kg of weight.

Inside Plastering

Only sieved and washed river sand is to be used for any plaster. The inner plaster of the lower part of the digester is for water-tightness. It consists of 2 cm cement-lime-plaster of mixture 1: 1/4 : 4, applied in two successive layers. Its surface is wooden trowelled because a rough surface is a better growing place for the bacteria Inlet and outlet pipe should be closed with paper or rags during plastering.

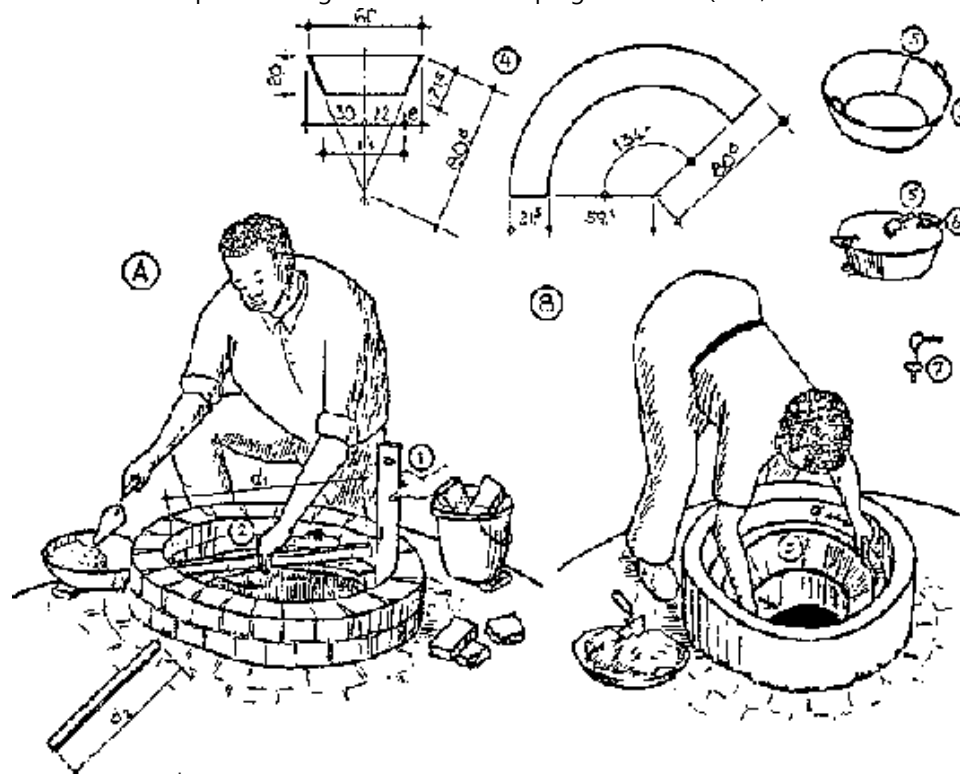

Fig. 22: Construction of neck and lid

(A) The neck is built with the help of sticks having the length of the inner diameter of the cylinder. Separate measuring sticks are used for the different diameters (d_1 , d_2). When keeping the wall vertical (1), a proper round shape is controlled by rotating the stick around the centre (2).

(B) For shaping the cone to receive the lid, the same mould is used as for making the lid (3). The mould is a conical ring made from mild steel (4). Two handles are fixed for easy turning while shaping the cone of the neck. The mould might be not exactly round. Therefore, in case the gas outlet passes through the lid, the mould should be marked in order to form the cone according to the direction of the gas pipe (5). The lid has two handles of steel (min 8mm thick) which can fold down as not to hinder the fixing of the wedges. The gas pipe has a steel plate collar welded to it to prevent gas leakage alongside the pipe (7).

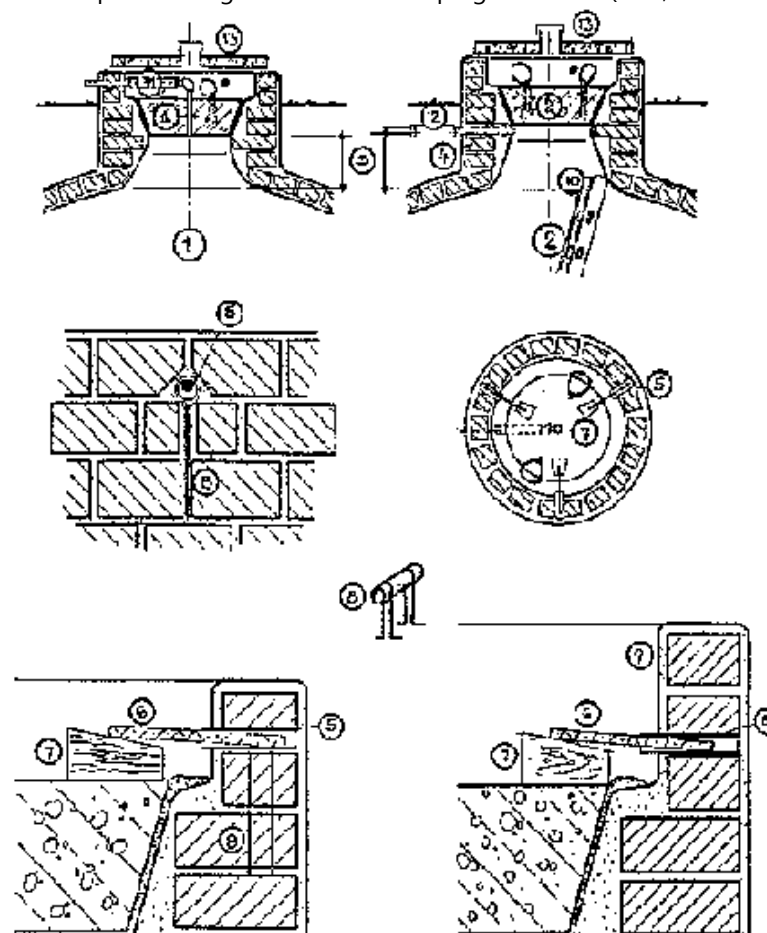

Fig. 23: Details of the neck and the lid

The gas pipe may pass through the lid (1) or the neck (2). When it passes through the lid, it will be connected to the gas pipe at the neck by a rubber hose (11). If the gas pipe passes through the neck below the lid, an additional layer of bricks (4) is needed to preserve sufficient height above the highest slurry level (3). The gas pipe lies lower than when passing through the lid which might result in saving a water trap

In case settling of the structure can be expected, a rubber hose connection is advisable (12).

Above the cone there are 3 pieces of 3/4" pipe (5) to receive the 14 mm steel bars (6) for

wedging in the lid (7). There are two wire anchors fixed to the case-pipe (8). In case no anchors are used, an additional layer of bricks is required above (9). The inside of the lower part of the neck widens downwards to allow using a ladder without narrowing the manhole (10). The part below the lid must be gas-tight, above, it must be water-tight. The neck is covered by a removable top-most lid 01° 5 cm concrete (13). A hole of 4" diameter is kept in the centre to control the water level above the lid. It might be made by a piece of pipe which can be covered with a tin.

The plaster of the upper part has a smooth surface for better gas-tightness. It is applied in seven courses which must be completed within 24 hours. Because the mortar is to be waterproof there is no bond once the mortar has dried. The plaster consists of the following layers:

- 1. Cement-water brushing**
- 2. 1 cm cement plaster 1: 2 1/2**
- 3. Cement water brush in 9**
- 4. 1 cm cement-lime-plaster with water-proofer mixed 1: 1/4 : 2 1/2 + WP**
- 5. Cement water brushing with water-proofer applied consecutively**
- 6. Cement-lime-plaster with water-proofer made of fine sieved sand, mixed 1: 1/4 : 2 1/2 + WP and applied consecutively**
- 7. Cement screed (New) made of cement-water paste with water-proofer, applied consecutively.**

Flooring

The first base for the flooring is formed by dropped mortar from bricklaying and plastering. A 3 cm cement screed (mixture 1: 1/4 : 4) applied to the ground would be sufficient In case of laterite or volcanic mourrum soil. If the structure itself is sound and solid, water losses are a temporary problem until sludge particles have sealed the surface sufficiently. In case of unstable soil, e.g. black cotton soil, high ground water table or hill water flows, a water tight floor should be

achieved right from the beginning. A 30 cm thick layer of rocks covered by 5 to 10 cm of concrete might be necessary to create a proper floor before cement screed can be applied.

In areas where generally unstable soil is found, foundation and flooring is integrated by forming a conical or spherical shell of 12 cm thickness under the digester and if necessary under the expansion chamber as well. To avoid floating up of the whole biogas plant and when lowering the ground water table by pumping is not possible, the construction must be flooded until the top structure is ready and soil covering of 35 cm in height has been packed above the top of the sphere. The mason has then to work while standing in the water.

Supplement Structures

Supplement structures are inlet chambers, slurry channels and gas control chambers. It takes a surprising lot of time to construct these little items. They can be built in brickwork or made from pre-fabricated concrete. When the biogas plant is directly connected to the stable - and this should be the usual case - the inlet chamber consists of the dung and the urine/water collection box. The control chamber houses the main gas valve and the gas control or testing unit. It is a rectangular concrete box with cover to protect the accessories and is placed directly beside the neck of the digester. Pavements for wheelbarrow transport, erosion control or just for beautification are also part of the unit. They may be done from tiles of 1: 2: 4 concrete mixture and 30 30 5 cm in size.

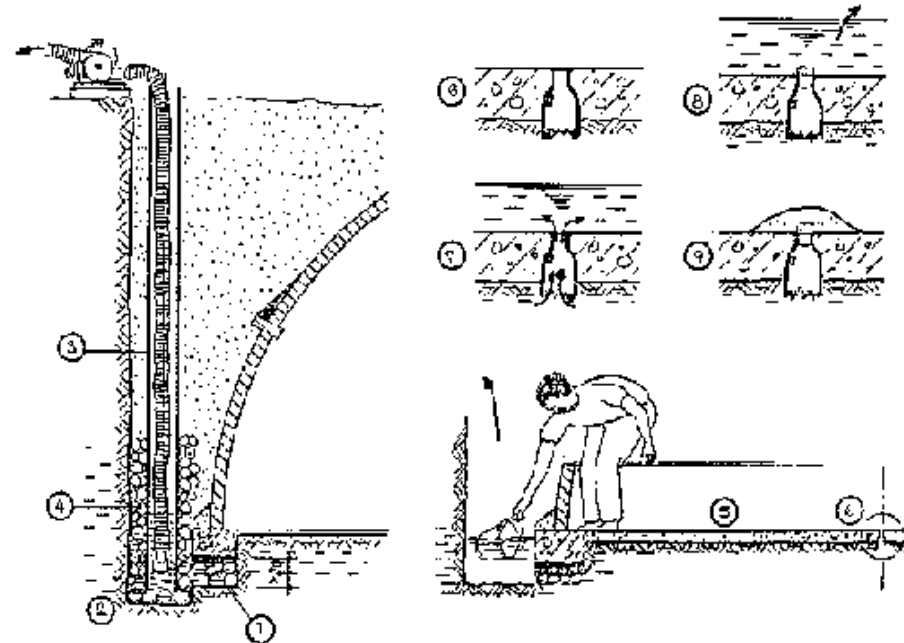

Fig. 24: Construction below the ground water table

During construction, ground water must be kept away. The foundation rests on a stone packing (1) to drain the water into the pump-sink (2). A layer of gravel prevents blockage of the drain. A vertical pipe (3) allows pumping even when backfilling has been done. The lower part of the pipe is surrounded by a stone packing (4).

If the ground water is only slightly higher than the digester bottom or if no pump is available, the construction must be flooded. The floor must be of solid concrete (5). Water must be kept away until the outer wall has reached above the ground water table and has been plastered from the outside. One or several bottles without bottoms are placed into the concrete (6). When scooping of water has stopped, ground water passes through the bottle and floods the floor (7). After completing the masonry work and covering the dome with soil, the bottle is closed and water might be taken off the digester bottom (8). The cap of the bottle is covered with cement mortar (9). In case of high ground water table a conical or bowl-shaped solid concrete slab is required.

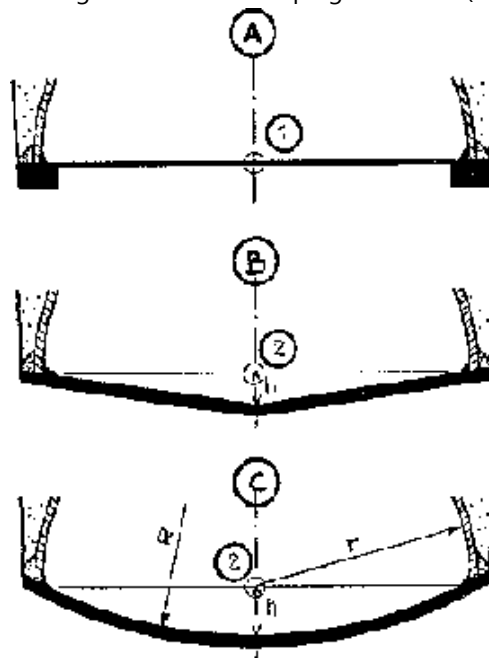

Fig. 25: Shape of the digester bottom slab

A flat bottom (A) is the weakest in view of statics, but it is a great advantage for the mason to work on an even floor. The centre point can be pegged-in easily (1). A conical shape (B) is much stronger and as well easy to construct. The steeper the slope, the stronger the structure. The centre point must be high above ground in line with the foot point of the brick wall (2). The strongest solution is a bowl-shaped bottom (C). The radius of the digester can be reduced because of the additional volume gained below the centre point. It is uncomfortable to work on a curved base and scaffolding becomes necessary because of the increased height to the top of the dome. Therefore, solutions B and C are used only when ground water pressure is high or the sub-soil is too soft for only a ring beam foundation.

The Piping System

Pipes should be short and straight, preferable 30 cm under ground. Biogas contains water vapour. If the gas cools below the dew point of the water vapour then condensation forms. The water always collects at the lowest point in the pipe. Therefore, pipes are laid in slope of min. 1%. At

the lowest level is either the biogas plant itself or an automatic water drainage device, called the water trap. If pipes are not laid in slope and do not have a water trap at the lowest point, the gas supply system will collapse after only a few weeks. Therefore, the bottom of the pipe trenches must as well be even, otherwise water might collect at hollows blocking the gas-flow. The best way of placing a water trap is to avoid it by careful planning of the pipe line.

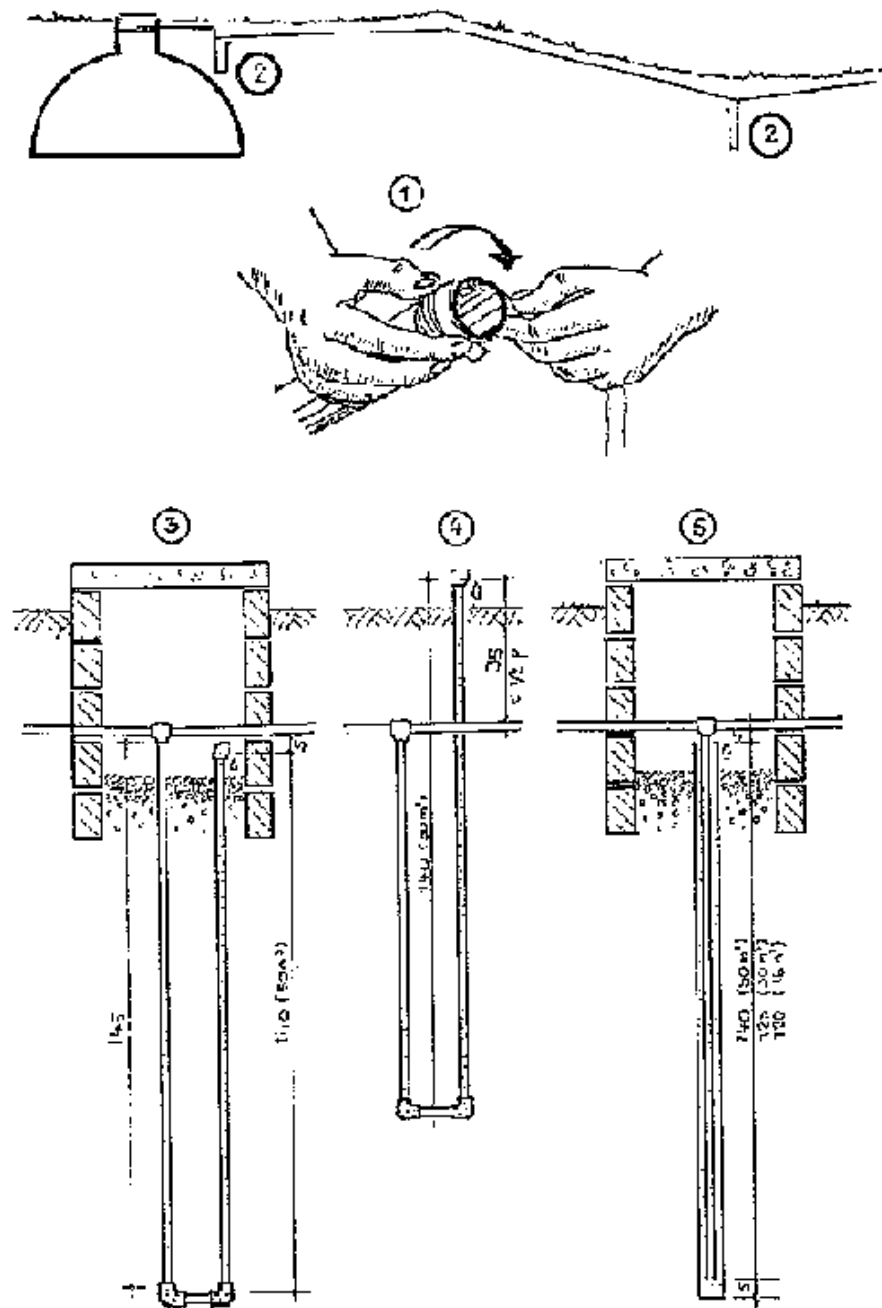

Fig. 26: Installation of gas pipe

All joints have to be sealed by grease and hemp of 5 clock-wise turns of teflon tape (1). The water

trap collects condensed- water and is needed at each of the lowest points in the pipe line (2). The length of the open water pipe should be 40 cm more than the water column of the highest gas pressure. The most common automatic water trap is a U-pipe below the line (3). Cheaper and easier to control is the asymmetric U-trap (4) where the open water pipe ends above ground. The maximum length above the pipe line is half the highest regularly appearing gas pressure. The pipe-in-pipe trap (5) functions like the U-trap (3).

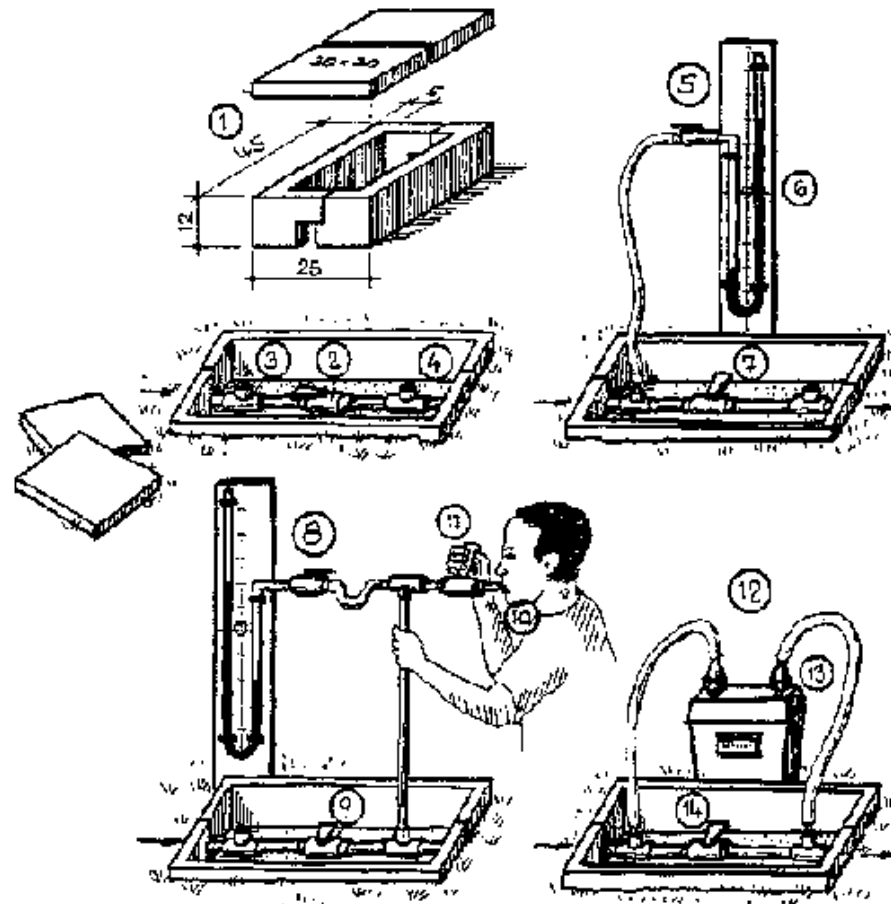

Fig. 27: The test-unit

The test-unit is placed near the plant in a pre-fabricated concrete frame (1). It houses the main valve (2) and two T-joints on each side (3). Normally, the T-joints are closed by plugs (4). For testing the plant (5) a pressure gauge is connected to the T-joint between the valve and the plant.

The manometer is made from transparent plastic tubes fixed to a scaling board (6). The main valve is opened (7) and pressure can be read. To test the piping system (8), the pressure gauge is connected to the T-joint after the valve. The main valve is closed (9). Air is blown into the pipe by mouth or compressor (10). When the valve at the inlet point (11) is closed, pressure remains in the pipe. A pressure drop indicates leakage. For testing gas consumption (12), a gas flow-meter is installed between the T-joints (13). When the main valve is closed (14), all gas has to pass the meter and can be measured.

Gas pipes should not pass roads or trenches with potential danger of soil erosion. If this is unavoidable, pipes must be protected by concrete casing. All gas pipes are of 3/4" diameter and preferably of galvanised iron. Whenever possible they lay 30 cm under ground. Joints must be sealed by grease and hemp (not sisal!) or by 5 layers of teflon tape. Bends and junctions should be kept to the minimum because they reduce gas pressure and are potential points of leakage. Unions are especially harmful and should be avoided unless absolutely necessary. Their outer threads must be sealed with hemp or teflon, their inner threads with silicon latex.

For long distances without junctions or joints, PVC or PU pipes which are suitable for underground installation may be used. They are cheaper, but pipes of smaller diameters might be attacked by rodents. Care must be taken by joining plastic pipes with G.I. pipes. Avoid flexible hose pipes, if not avoidable, use fibre reinforced material.

Before fitting the pipe, dust must be blown out of each piece of pipe or fitting. Pressure tests are to be undertaken for every 30 m of piping installed. If the gas pressure of 1.40 m W.C. does not hold for 10 minutes, all joints must be checked for leakages by help of soap water. Pressure tests can only be carried out under steady temperature conditions. Direct sunlight and alternating cloudy periods have great influence on the temperature and hence, gas pressure inside exposed pipes. The final pressure test is done with all the accessories connected.

For gas production-, pressure- or leakage control a test unit is permanently installed directly behind the gasplant inside the control chamber.

Filling and closing the plant

The initial filling of the gasplant has to be done via the inlet pipe in order to avoid bulky substrate entering the plant which later might block the outlet pipe.

The lid should not be closed until the plant is filled above the Inlet opening, preferably after it is filled up to the level of the bottom of the expansion chamber. Sealing of the lid is done by fine clay applied on the supporting surface at the neck. In order to keep the clay moist the lid will remain constantly under water when the gasplant is in operation. The lid is chocked with wooden wedges in order to resist the gas pressure from below and to press the sealing clay firmly between rest and cover.









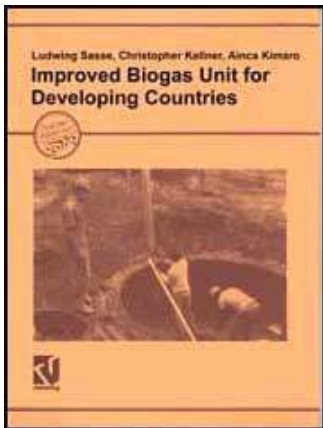









Fig. 28: Closing the lid

The lid is sealed by clay which is kept moist by a water bath above. The clay is dried and groined before being mixed with water into a putty like paste. It is then applied by hand approximately 2 cm thick (1). The lid is placed into the clay bedding and rammed in (2?. Iron bars are put into the case-pipes of the neck and the lid is fixed by wooden wedges (3). In case the gas pipe passes through the lid, the pipe is connected by a rubber hose, The neck is then filled with water (4) and the topmost lid is laid above (5).

[Home](#) > [ar.cn.de.en.es.fr.id.it.ph.po.ru.sw](#)



Improved Biogas Unit for Developing Countries (GTZ, 1991, 98 p.)

-  **(introduction...)**
-  **Acknowledgments**
-  **Foreword**
-  **Acknowledgment**
-  **1. Preface**
-  **2. Why biogas ?**
-  **3. Explanation of terms**
-  **4. Biogas extension work**
-  **5. The agricultural biogas unit**
-  **6. Construction of the biogas plant**
-  **7. Construction of cattle stable**
-  **8. Construction of the pigsty**
-  **9. The sanitary biogas unit**
-  **10. Use of slurry**
-  **11. Use of gas**
-  **12. Operation and maintenance**



13: Pending technical issues

14: Appendix

7. Construction of cattle stable

General

The stable should be near the house in order to keep the pipeline from the gasplant to the kitchen short. The fodder trough must be easily accessible. Water for the animals should be near the trough. The milking place lies at the highest floor level of the stable, opposite to the biogas plant. The roof should not drain its rainwater onto the biogas plant.

The stable should allow easy collection of dung and urine to charge the biogas plant. Whenever possible, the existing stable should be kept and modified if necessary to fulfill the above requirements. In many cases a new concrete or tiled floor will do. A new stable should be constructed in cases the farmer wishes to modernize his live stock or if adaptation would demand intolerable compromises.

The size of the stable depends on the number of animals and whether they are freely moving or tied-up. A stable suitable for a biogas unit might require more space than the existing one. Later extension should also be possible without changing or affecting the biogas plant.

The Principles of Design

The ideal cattle stable is a zero-grazing unit with separation of milk cows, heifers and calves, roofed or non-roofed exercising area, separate milking stand, restricting fodder trough and solid floor with urine channel. The fodder chopper, the squeegee and the dipper are essential tools for operation of the stable.

A stable connected to a biogas plant has to fulfill the following indispensable criteria:

- solid floor with urine drain in order to collect dung and urine without soiling**
- dung and urine collection point lies higher in level than the inlet of the biogas plant in**

order to avoid laborious handling and losses of substrate

-animals are fed from a trough with neck restriction in order to avoid spreading of too much of fibrous material on the floor which will then enter the plant.

Additional favourable criteria are:

-stable is roofed in order to avoid rain water washing away too much of urine and dung

-resting and exercising area are separated in order to limit the area of dung dropping and to keep animals clean

-calves, heifers and milk cows are separated because of their different sizes to allow an optimal design of the stable

-there is a separate milking stand in order to improve hygienic conditions and optimize milk production by undisturbed milking.

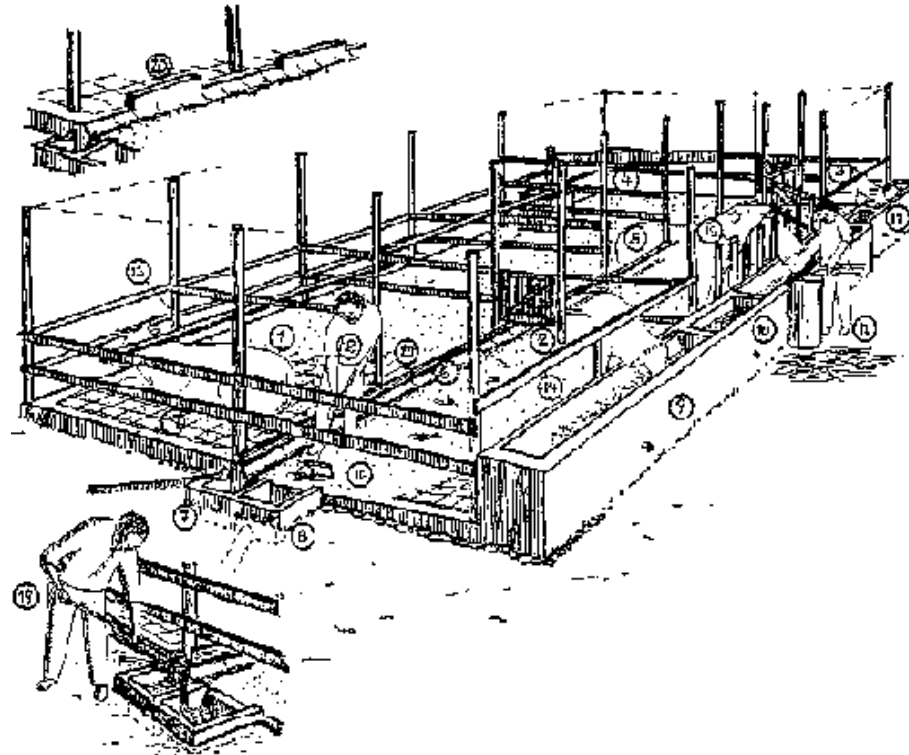

Fig. 29: Principle design of the cattle shed.

The stable is divided into a resting area (1) and an exercising cum feeding area (2). Calves' boxes (3) and the milking stand (4) are at the far end. Milking cows are placed adjacent to it (5). The urine drain (6) ends in the urine chamber (7). The dung and mixing chamber (8), which is the inlet of the biogas plant, are placed beside. The fodder trough passes along the feeding area (9); a water trough (10) is provided between, Calves have smaller troughs (11). The chopping block is at the centre of the trough (12). A bar passes over the necks of the cattle in the sleeping area (13) to force the cows to move back when getting up to drop dung. The necks of the cattle are also restricted at the trough to prevent them from scattering fodder to the floor. This can be done by a bar (14) or by narrow standing poles (15). The floor of the stable is concreted (16) or laid out with concrete tiles (17). The dung is pushed into the mixing chamber daily with the help of the squeegee (18). Urine is taken by a dipper (19) and mixed with the dung before entering the biogas plant. There is a verge of timber (20) or concrete (21) at the end of the sleeping box.

The Floor

The condition of the floor influences most the operation of the gas plant. Smooth stable flooring with appropriate slope encourages and simplifies daily cleaning of the stable. The floor should be even without holes. It should not be slippery but plain and slightly rough. There is a 2% slope of the floor into the urine drain and of the urine drain into the urine chamber. The urine drain is shaped one sided at the lowest end of the slope floor. Its corner is bottle curved.

Normally, floor is of 10 cm concrete (mixture 1: 2: 4) on stone bedding. Anti-termite chemicals should be spread on the stone bedding where applicable. The concrete is firmly rammed or vibrated. A good solution are concrete tiles of 15~15~5 cm in size and 1: 2: 4 by mixture. They are laid into solid sand bedding without joints. The tiles should be cured for at least one week by keeping them moist and cast in steel moulds in order to maintain exact rectangular shape to avoid unwanted wide Joints.

The floor of the calves pen is preferably of wooden boards raised 30 cm above the concrete floor leaving 2,5 cm slats between for faeces to be pushed between in order to keep the place dry and clean.

The Feeding Trough

Well designed fodder troughs prevent too much waste fodder from entering the gasplant. The feeding trough must fit the anatomy of the animal. A trough which is too small increases work for feeding, too big a trough increases waste of fodder. The trough should have rounded bottoms and corners for easy reach of fodder. A drain pipe for cleaning and drainage of rain water should also be provided.

There are different ways to prevent the cows from scattering fodder from the trough to the floor where it could mix with the dung and enter the biogas plant. One alternative is vertical poles of 1,50 m height and 20 cm free space between. These are erected in front of the trough. The poles should be rounded and smooth so as not to cause friction at the cows neck. The distance from the inner side of the trough and the outer side of the poles should not exceed 16 cm in order to allow the cow to reach the full width of the trough. The other, cheaper and easier method, is to place a

bar above the cow's necks to restrict movements of their heads. In both cases, the outer wall of the trough is shaped in such a manner that animals do not push fodder off the trough while eating. Troughs may or may not be placed under the roof of the stable. Wooden troughs wear quickly.

Compartment Walls

All walls should be strong and smooth. Movable wooden bars used for closing of door openings are not recommended because they might be lifted Off by the animals. Normal wooden doors with solid hinges are more appropriate. Built-in wooden poles have to be protected by burning their surface when surrounded by mortar or concrete.

Sleeping Boxes

Sleeping boxes should be clean and dry. Therefore, for defecating, the cow has to get In a position in which she can not soil the floor. A 15 cm raise of the floor above the level of the exercising area prevents the cow from entering the box In reverse. A 15 cm high timber or concrete verge forces the cow to lay fully inside the box.

The neck bar allows the cow to lay inside the box in full length but if she gets up for defecating she has to step back dropping dung and urine outside the sleeping box. The floor should be of concrete or tiles in order to avoid too much of sand or soil being collected with the dung. If bedding is wanted or required, it should neither be of straw nor of sawdust but dried slurry could be used instead. To train cows using the sleeping box, requires tying them up for the first few nights after being placed in the new stable.

Dung and Urine Chamber

When cleaning the stable, dung is pushed into the dung or mixing chamber, which is actually the inlet chamber of the biogas plant. Urine and water collects in the urine chamber from where it is taken out with the help of a dipper and mixed with the dung in the dung chamber. The mixed substrate is then released into the biogas plant.

The urine chamber is in fact a storage and dosing tank designed for the capacity needed to get the

right TS-content for the slurry. If rain or washing water exceeds the required amount, the urine chamber overflows into the slurry distribution channel. If too little urine gets collected, which might be the case in dry places or seasons, the urine chamber has to be filled with water to the required amount.

The Roof

The roof should at least cover the sleeping boxes, the calves pen and the milking stand. In case with no sleeping boxes, part of the exercising cum resting area should be covered. If the roof covers the total area of the stable it should be 3 m high in order to allow ventilation and sunshine. The roof should not drain on the biogas plant.

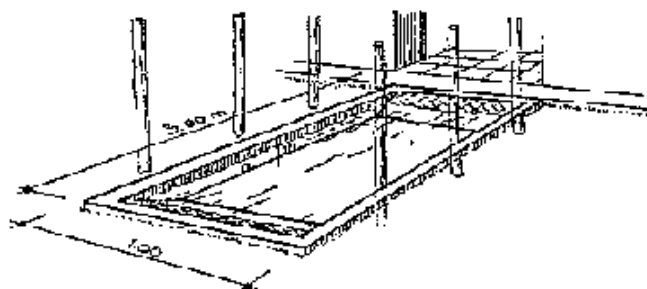



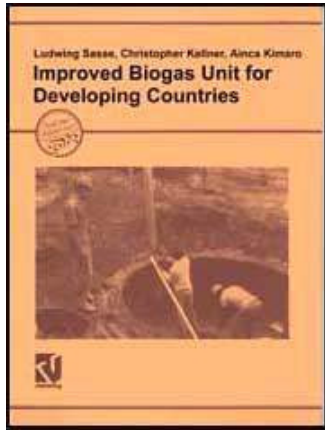

Fig. 30: Cattle foot bath. If cattle are regularly out grazing, they should pass a cleaning foot bath before entering the stable in order to prevent too much soil from entering the gasplant. A drainage pipe would allow easier cleaning.

[Home](#) > [ar](#).[cn](#).[de](#).[en](#).[es](#).[fr](#).[id](#).[it](#).[ph](#).[po](#).[ru](#).[sw](#)

 **Improved Biogas Unit for Developing Countries (GTZ, 1991, 98 p.)**

-  **(introduction...)**
-  **Acknowledgments**
-  **Foreword**
-  **Acknowledgment**



1. Preface
2. Why biogas ?
3. Explanation of terms
4. Biogas extension work
5. The agricultural biogas unit
6. Construction of the biogas plant
7. Construction of cattle stable
- ➔ 8. Construction of the pigsty
9. The sanitary biogas unit
10. Use of slurry
11. Use of gas
12. Operation and maintenance
13. Pending technical issues
14. Appendix

8. Construction of the pigsty

Principles of Design

The ideal pigsty allows easy dung and urine collection and separates the different age groups of the animals. The pigsty should be at the backside of the house in order to avoid disturbance by bad odour. The pigsty is divided into the following compartments:

- The boar box, which is big enough to accommodate both the boar and the sow for mating.
- The farrowing box, with protection rails for piglets to hide when the sow lays down.
- The gestating box for sow and weaning piglets
- The finishing box (boxes) for growing piglets no longer weaning.
- The finishing box (boxes) for pigs to grow to market size.

Each of the compartments consists of a clean resting and feeding area and a dirty area where pigs

defecate. The dirty areas of several boxes are Inter-connected and form a corridor in order to allow easy cleaning and washing of the floor. Pigs need a draft-free and rather uniform environment (min 15°C for adults, 22°C for piglets). Therefore, the wall of the boxes should be built to a height of 1,50 m completely closed and a roof of only 1,80-2,00 m above the floor.

Construction Details

The slope of the floor of the boxes to the corridor and that of the corridor to the dung and urine chamber is 2%. The doors of the boxes close the individual compartments when opening the corridor and vice versa. Walls of the boxes are made from brickwork with rough plastering.

The fodder trough is covered or protected by bars to prevent the pigs from laying in the fodder. There is a pipe for draining and easy cleaning at the bottom of the trough.

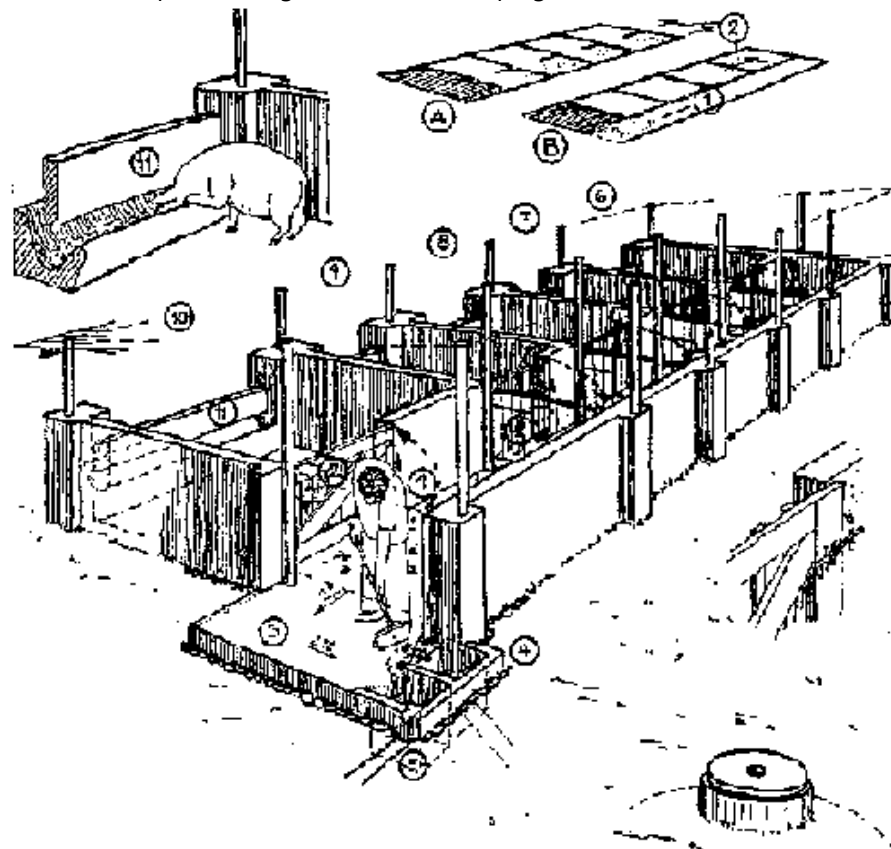
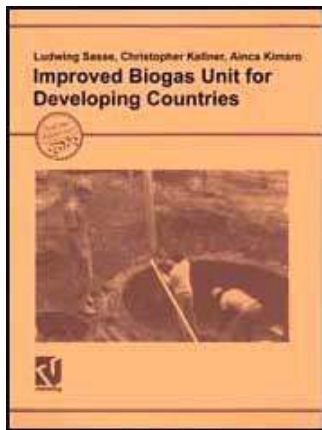

Fig. 31: Principle design of the pigsty



















Pigs have a natural habit of defecating always in the same corner of their stable. Therefore, cleaning becomes easy if the dung areas of several stable boxes are inter-connected to form a corridor (1). The doors of the boxes are of the same width as the corridor (2). Normally the doors are open and divide the corridor into compartments belonging to the boxes (A). During cleaning of the stable, the doors are closed, leaving the corridor free (B). The floor of the stable slopes to the urine drain and the drain into the urine chamber (5). The dung chamber (4) is placed beside. A platform at the open end of the corridor is for easy transport of pigs (3). The stable consists of boxes for boar and sow for mating (6), weaning mother sows (7), older piglets (8), smaller pigs (9), and grown up pigs ready for slaughter (10). The troughs are each of appropriate size to the size of the pigs and are protected by a concrete apron to prevent pigs from laying into the fodder (11).



[Home](#) > [ar](#).[cn](#).[de](#).[en](#).[es](#).[fr](#).[id](#).[it](#).[ph](#).[po](#).[ru](#).[sw](#)



Improved Biogas Unit for Developing Countries (GTZ, 1991, 98 p.)

-  **(introduction...)**
-  **Acknowledgments**
-  **Foreword**
-  **Acknowledgment**
-  **1. Preface**
-  **2. Why biogas ?**
-  **3. Explanation of terms**
-  **4. Biogas extension work**
-  **5. The agricultural biogas unit**
-  **6. Construction of the biogas plant**
-  **7. Construction of cattle stable**
-  **8. Construction of the pigsty**
-  **9. The sanitary biogas unit**
-  **10. Use of slurry**
-  **11. Use of gas**
-  **12. Operation and maintenance**
-  **13. Pending technical issues**
-  **14. Appendix**

9. The sanitary biogas unit

General

Sanitary Biogas Units are installations where the gasplants have been built in order to treat the

waste of latrines. Human faeces are the main digestion material. Additional feeding with animal dung or kitchen waste is possible. Hygienic latrines have to fulfill the following requirements:

- no handling of human excrete by man; even accidental touch should be avoided**
- no access of flies to undigested excrete**
- no worms may escape from the latrine pit**
- no bad odour and no indecent appearance**

Important design criteria concerning hygiene and construction quality must be observed. Main planning criteria are the expected sanitary conditions which depend on frequency of use, frequency of cleaning, and safe slurry disposal. Slurry should be used for fertilizing trees or shrubs but not vegetables. The slurry may also drain into a soak pit. Energy and manure provision are of lesser importance but should be optimized whenever possible.

Construction of Toilets

Toilets connected to a simple fixed dome biogas plant should be latrines where a minimum of water is used for cleaning. Flushing toilets are not suitable for connection to biogas plants of less than 30 m³ digester volume because of the danger of diluting the slurry and thus reducing the retention time.

The toilet chamber is connected to a vent pipe which passes the roof. It is placed outside, if possible not shaded, and is painted black as to heat up for better draft.

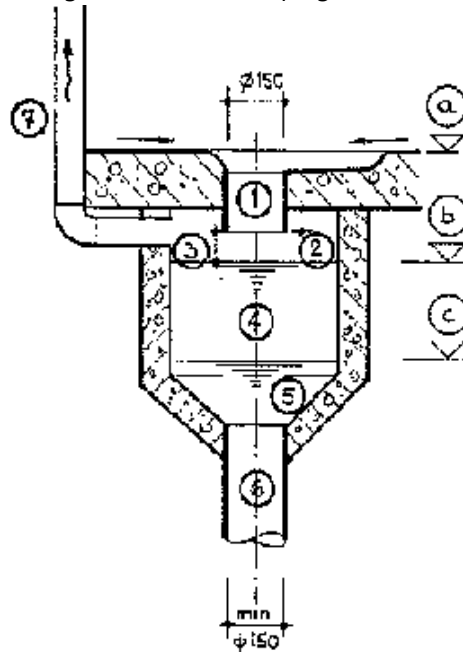
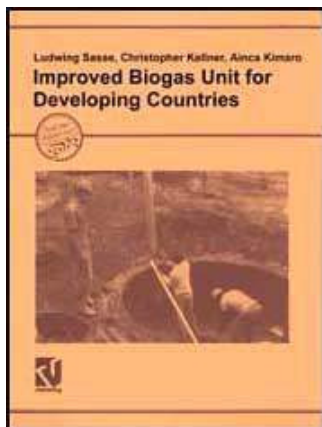



















Fig. 32: Construction details of toilets

The toilet floor (a) has a groove serving as the toilet pan. The highest slurry level (b) and the lowest slurry level (c) depend on the gas storage requirements of the biogas plant. There are a few but very important details to be observed: (1) The inlet consists of a piece of pipe of 6" diameter placed absolutely vertical in order to avoid soiling the sides. (2) The bottom rim of the inlet piece is separated from the lower system in order to prevent worms from crawling out of the toilet. (3) The inlet piece ends always above the highest slurry level. (4) Below the inlet piece is a chamber of larger surface in order to avoid floating feces piling up in the pipe. Feces should drop directly into the slurry but never on parts of the structure which are normally above the slurry level. On the other hand, the dropping chamber should be as small as possible in order to release fresh feces as quickly as possible into the biogas plant. This is important for avoiding bad odour and for producing the biogas there, where it can be collected and utilized, which is the inside of the dome. (5) The down pipe is straight and at least of the same diameter as the inlet piece (6). A vent pipe passes above the roof (7)



Improved Biogas Unit for Developing Countries (GTZ, 1991, 98 p.)

-  **(introduction...)**
-  **Acknowledgments**
-  **Foreword**
-  **Acknowledgment**
-  **1. Preface**
-  **2. Why biogas ?**
-  **3. Explanation of terms**
-  **4. Biogas extension work**
-  **5. The agricultural biogas unit**
-  **6. Construction of the biogas plant**
-  **7. Construction of cattle stable**
-  **8. Construction of the pigsty**
-  **9. The sanitary biogas unit**
-  **→ 10. Use of slurry**
-  **11. Use of gas**
-  **12. Operation and maintenance**
-  **13. Pending technical issues**
-  **14. Appendix**

10. Use of slurry

General Properties of Digested Organic Matter

Digested substrate has almost no smell and is more liquid than undigested dung. These facts are the result of the same process which leads to the production of biogas, the transformation of long carbon chains (cellulose, alcohol and organic acids) into short carbon molecules such as CH₄ and

CO₂. As part of the total carbon content of the substrate is transferred into biogas, the carbon/nitrogen ratio becomes more narrow. Only if the C/N ratio of a manure is narrower than that of the soil, one may talk of nitrogen supply by the manure.

Nitrogen is a major nutrient required for the plant growth. Nitrogen from organic manure has to be extracted by bacteria from large organic molecules and transformed into smaller inorganic water soluble compounds before plants can use it. This transformation is called mineralisation. During the digestion process in a biogas plant, part of the organic nitrogen is mineralized to ammonium (NH₄⁺) and nitrate (NO₃⁻) and thus, may be taken up by the plants immediately. The short term fertilizer value of the dung is doubled while the long term fertilizing effects are cut by half. Under tropical conditions the short term value is of greater importance because rapid biological activities degrade even the slow degrading manure fraction in relatively short time.

If ammonia is not dissolved in water it may escape as gas into the air. Therefore, digested slurry has to be kept moist or covered by soil to preserve its fertilizer value. The best way is to bring it immediately in liquid form to the roots of the plants. An other possibility is to compost the slurry together with other organic material. During composting ammonia is bound again in organic form by bacteria and does not evaporate.

Many chemical processes take place at the same time which need different attention. But in general, two rules must be followed for preserving the plant nutrients of both the undigested dung and the digested slurry:

- avoid long storage times and**
- keep manure moist, cool and covered.**

To avoid long storage times it is better to clean the stable twice a day instead of every second day. It is also better to use the slurry directly on permanent crops like fodder grass, trees or vegetables than on annual crops like maize or millet.

The Slurry Disposal

Clever and realistic planning of the site of slurry utilization is the key to an economical biogas unit. Insufficient slurry disposal leads to blockage of the outlet and rising gas pressure Inside the fixed dome plant. The volume-of digested slurry is about twice as much as that of fresh dung. Slurry manure must reach the crops without losing too much of its fertilizer value. Whenever possible, slurry should be distributed directly to the crop by gravity. The best way is using irrigation channels for slurry distribution. To prevent loss of nitrogen, the manure pits and slurry distribution channels should be covered or placed under shade of plants. A compromise must be found between shading the manure and not disturbing the flow of the slurry by roots growing into the canal. Shading by fodder grass itself might be less troublesome than by trees.

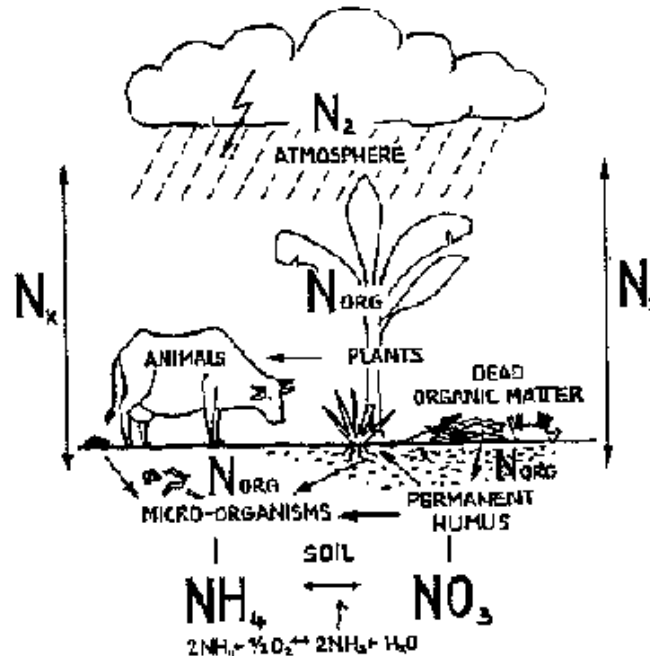

Fig. 33.: The nitrogen-cycle in nature

If fertilizing follows the cropping pattern, space for a liquid storage tank of sufficient size must be provided beside the point of overflow to bridge the time of no fertilizer use. Similar space would be needed if composting of slurry is envisaged.

The point of overflow can be extended nearer to the field to allow sufficient slope when the expansion chamber is shaped like a canal. There is also the possibility of arranging the compost

heap parallel to this expansion canal. Slurry might then be taken out at convenient spots for pouring over the compost.

Use of Liquid Slurry

It is more Important to use the slurry instead of propagating complicated and labour intensive systems of optimum manure utilization. Any use of slurry is a good use. Therefore, whenever possible, slurry should be used in liquid form immediately after leaving the overflow of the biogas plant. A minimum slope of 2,5% is required for short distance distribution. Slope is to be increased for longer distances and in dry areas. Distribution of liquid slurry needs management Uncontrolled distribution may create swamps or thick layers of dried slurry sealing off the roots of crops or trees from necessary oxygen supply.

The most labour saving slurry utilization is for fodder grass. It should be encouraged when controlled fertilizing is unlikely. The fodder is planted near the stable where it is used. The gasplant is near to keep slurry distribution channels short.

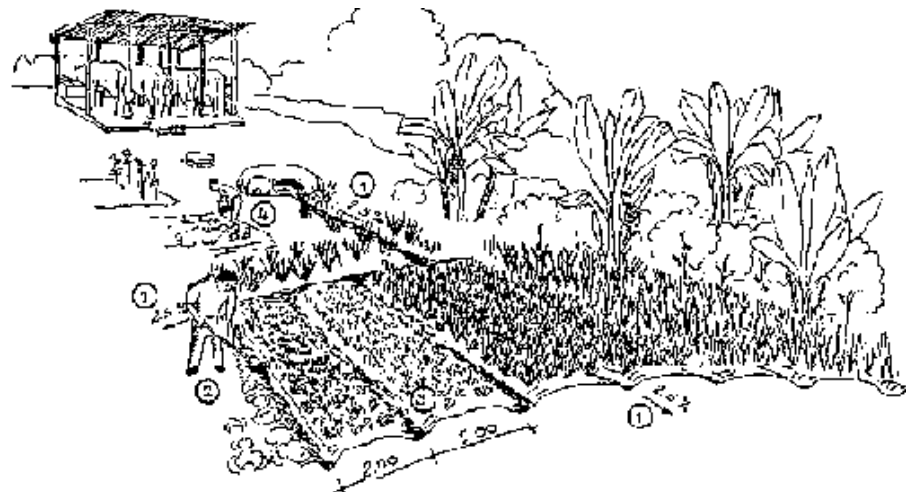

Fig. 34: Slurry distribution by gravity

Distribution channels need a minimum slope of 2,5% (1), in dry areas 5X may be required. The slurry is dumped amongst the fodder grass when cleaning the channels (2). Slurry flows mainly to recently harvested areas (3). Slurry is spread on vegetable fields higher than the outlet and near

the plant by buckets (4), The stable in the background fulfils the minimum requirements.

Fodder grass should be cut when it is only 80 cm high. Slurry is led always to the freshly cut area. Per cow 500 m² of fodder grass are a guiding figure. Fodder grass is a permanent crop which makes the installation of a permanent distribution system advisable. The main distributor could be constructed even in concrete or laid out with concrete slabs. Branch canals every 2 m would allow equal fertilizer supply. Covered channels would be the best.

Where gravity distribution is not possible, liquid slurry must be carried to the plants by buckets or on specially adapted wheelbarrows. Wheelbarrow transport needs passable pathways.

Use of Slurry for Compost

The preparation of compost is best if distribution by gravity is not possible. Investment and labour input are reasonable and the nutrition value of the manure is preserved. Composting is a form of storing the slurry over some time without losing too much nitrogen. Compost is also a method of increasing the amount of organic manure which stabilizes the soil structure. Compost is superior to liquid slurry for long-term improvement of soil fertility. Compost releases its nutrients slowly and therefore, is applied in few but larger doses over the year.

In principal, compost is, prepared in alternate layers of liquid slurry and fibrous agricultural residues. Compost should be made in heaps instead of pits because air is required to promote the rotting process. Compost should be kept in shade and should never dry out. A less optimal but utilized compost is better than propagating the ideal method which will not be applied by the farmer. The compost dam which is regularly poured over with slurry and sometimes turned over, is a reasonable compromise.

When compost is prepared, it is advisable to shape the expansion chamber of the biogas plant like a canal running parallel to the compost heap.

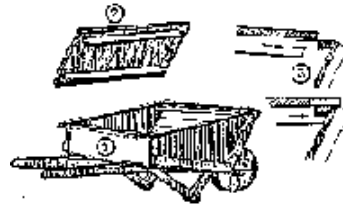

Fig. 35: The slurry-cart

A wooden wheelbarrow (1) developed by CAMARTEC is modified to serve as a slurry transport cart. It is heavy but stout and has almost no metal parts which could corrode. The lid (2) prevents the slurry from spilling over. At the front it is held by a slot (3) at the longitudinal slat. The slurry is either dumped into a distribution system or taken out from the wheelbarrow by buckets.

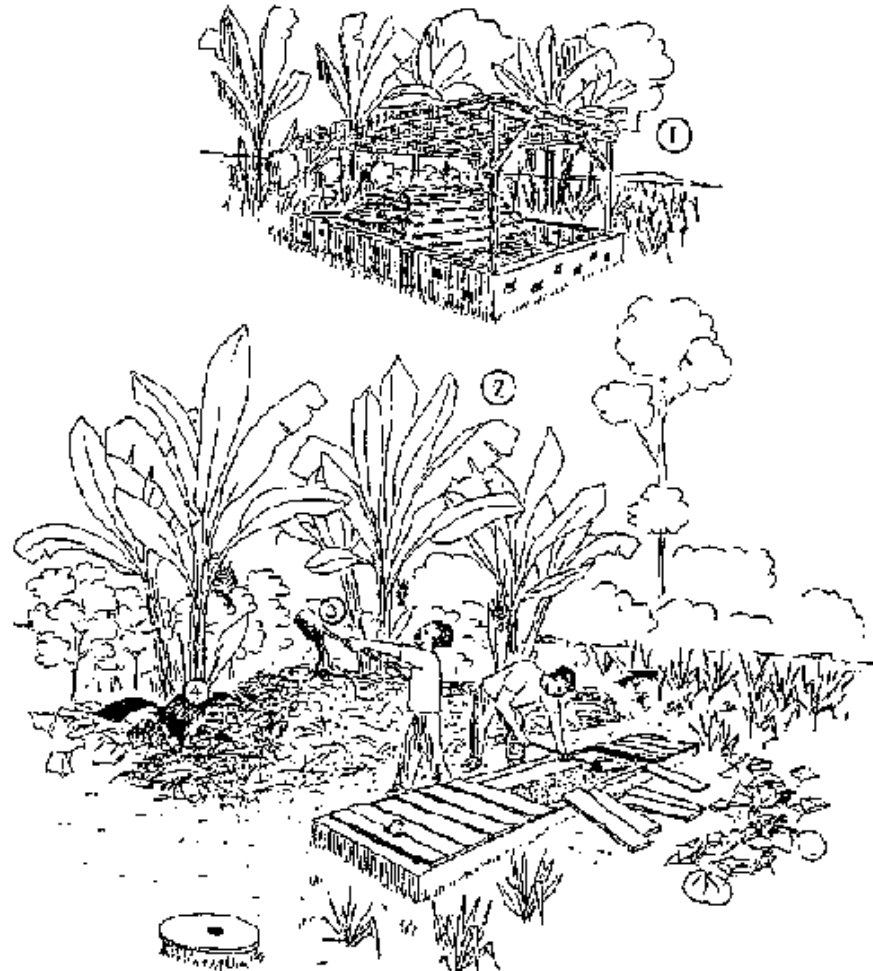
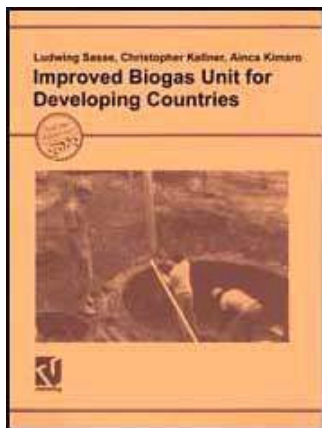

Fig. 36: Compost preparation

Compost consists of slurry and fibrous organic residues, like grass, leaves, and straw. It has a total solids content of 50%. The compost heap must be turned over several times during the 6 months ripening period, The inside temperature of a good compost heap is 60-70°C. The rotting process demands air. Therefore, the compost heap should be narrow and above the ground. The ideal compost heap is roofed and set in alternating layers of residues and slurry ("Indore" method) (1). In connection with an expansion canal of a biogas plant, the compost dam (2) is an appropriate compromise. Dumping 01° residues starts at the far end. The compost dam "grows" to the front and is poured over regularly with slurry (3). After some weeks it is turned over to the

side (4).

[Home](#) > [ar](#).[cn](#).[de](#).[en](#).[es](#).[fr](#).[id](#).[it](#).[ph](#).[po](#).[ru](#).[sw](#)

**Improved Biogas Unit for Developing Countries (GTZ, 1991, 98 p.)**

- (introduction...)**
- Acknowledgments**
- Foreword**
- Acknowledgment**
- 1. Preface**
- 2. Why biogas ?**
- 3. Explanation of terms**
- 4. Biogas extension work**
- 5. The agricultural biogas unit**
- 6. Construction of the biogas plant**
- 7. Construction of cattle stable**
- 8. Construction of the pigsty**
- 9. The sanitary biogas unit**
- 10. Use of slurry**
- 11. Use of gas**
- 12. Operation and maintenance**
- 13. Pending technical issues**
- 14. Appendix**

11. Use of gas**General**

As biogas burns with an open flame, the place of gas consumption should be ventilated but free of draft directly at the flame. The flame will be more stable. For lighting, the lifetime of lamp mantles will also be prolonged. Sensitive equipment like refrigerators or incubators should be situated where they can be controlled.

Biogas can be used like any other combustible gas, e.g. LPG. Each gas has its own properties which must be observed for efficient combustion. The main influencing factors are:

- gas/air mixing rate**
- flame speed**
- ignition temperature**
- gas pressure**

Compared to LPG, biogas needs less air per cubic metre for combustion. This means, with the same amount of air more gas is required. Therefore, gas jets are larger in diameter when using biogas. About 5.7 litre of air are required for total combustion of 1 litre of biogas, while for butan it is 30.9 litres and for propan 23.8 litres.

The flame speed is lower with biogas than with LPG. Therefore, speed of gas at the burner heads must be reduced. This can be achieved by conical orifices, but normally, the bottom of the cooking pot functions as a speed breaker for the flame.

The ignition temperature of biogas is higher than of diesel. Therefore, when biogas is used in engines, ignition spark plugs are required or partly diesel must be added to the gas (dual fuel) to run the engine. Slow turning diesel engines (approx. 2000 RPM) suit biogas better than fast turning Otto-engines (above 5000 RPM).

The efficiency of using biogas is 55% in stoves, 24% in engines but only 3% in lamps. A biogas lamp is only half that efficient than a kerosene lamp. The most efficient way of using biogas is in a heat-power combination where 88% efficiency can be reached. But this is only valid for larger installations and under the condition that the exhaust heat is used profitably. The use of biogas in stoves is the best way of exploiting the energy of farm household units.

Gas Stoves

All gas burners follow the same principle. The gas arrives with a certain speed at the stove. This speed is created by the given pressure from the gasplant in the pipe of a certain diameter. By help of a jet at the inlet of the burner, the speed is increased producing a draft which sucks air into the pipe. This air is called primary air and is needed for combustion. Therefore, it must be completely mixed with the biogas. This happens by widening the pipe to a minimum diameter, which is in constant relation to the diameter of the Jet. By widening the pipe further the speed of the gas again is reduced. This diffuse goes over into the burner head. The cone of the diffuse and the shape of the burner head is formed in such a way as to allow the gas pressure to equal everywhere before the gas/air mixture leaves the burner through the orifices with a speed only slightly above the specific flame speed of biogas. For final combustion the gas needs more oxygen which is supplied by the surrounding air. This air is called the secondary air.

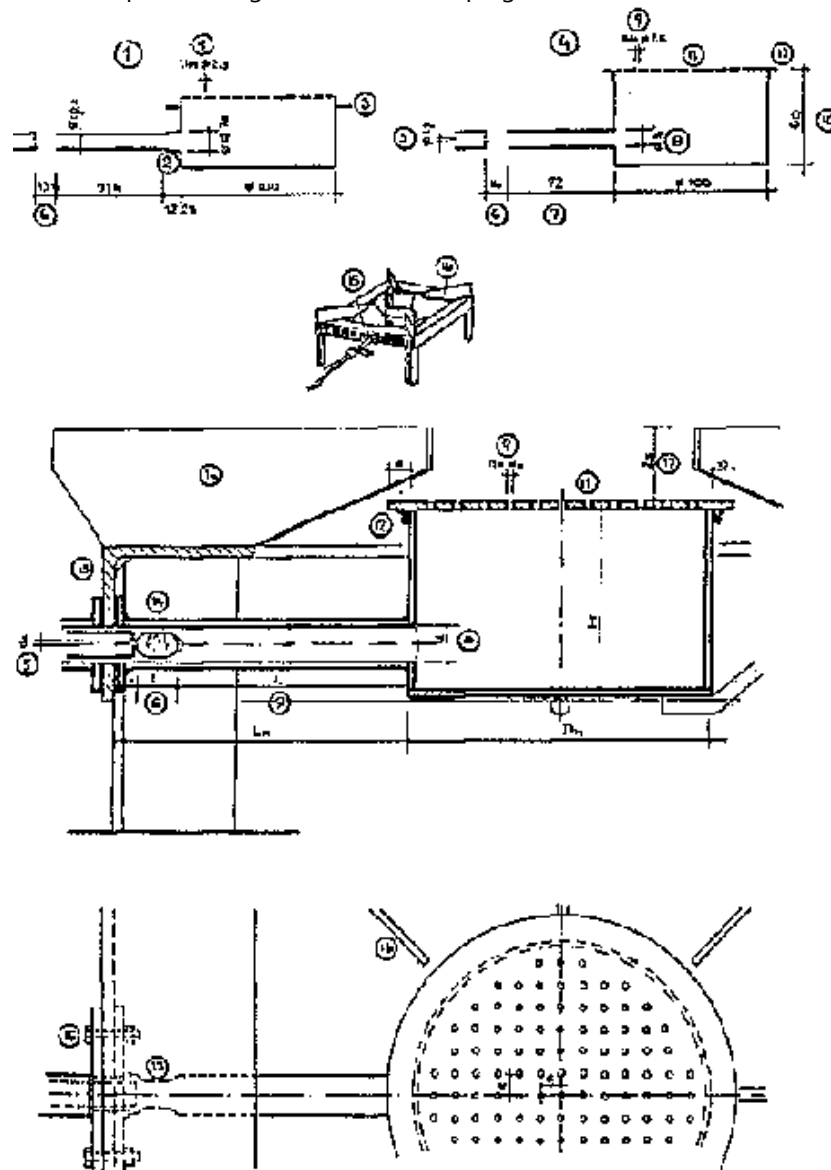

Fig. 37: Gas stoves

Biogas from a fixed dome plant arrives with a pressure of 50-60 cm W.C. on an average. The ideal stove (1) has a diffuse cone (2) and an air breaking ring (3). For manufacturing in a normal ironmonger workshop, the shape of the stove is slightly simplified (4). Important dimensions are the diameter of the Jet (5), the length of the air intake holes measured from the end of the jet (6),

the length of the mixing pipe (7) and its diameter (8),, the number and diameter of the [lame port holes (9). Increasing the height of the burner head (10) makes good for the missing diffuse cone. The top lid (11) is loosely laid on the burner head. It projects 1 cm over the rim (12). The air-intake holes of the mixing pipe (13), made by two drillings of 8 mm (14), should be at the side as to avoid food dropping into them. The burner is screwed to a steel frame out of L 50-3 (15). Brackets welded on the top of it (16) secure the proper distance between the bottom of the pot and the flame port.

If combustion is perfect, the flame is dark blue and almost invisible in daylight. Stoves are normally designed to work with 75% primary air. If too little air is available the gas does not burn fully and part of the gas escapes unused. With too much air supply the flame cools off and thus, prolonging the cooking time and increasing the gas demand.

Manufacturing Stoves

Gas stoves are relatively simple appliances which can be manufactured by most blacksmiths or metal works. Gas stoves of mild steel may corrode if the hydro-sulphur content in the biogas is high. This is often the case when biogas is produced from human excrete or pig dung. Therefore, high quality steel or cast iron is advantageous. Clay burners are widely used in China and have proved to render good service. For experimental use in schools, stoves can be made from used food-tins.

When manufacturing stoves in an ironmongers workshop, the shape of the burner must be simplified. This is justifiable because the methane content and the gas pressure are changing. Full adaptation is not possible for that reason. A standard design used for biogas delivered from fixed dome plants has been developed.

When it happens that all the flames are torn off the flame port and ignition becomes impossible the flow speed must be reduced. This can be done by reducing the volume of the gas/air mixture by partly closing the air intake holes.

The stove itself, i.e. the stand for the pots, needs consideration as local food habits have high influence on the design. The stand must be strong to allow stirring of even thick foods like "ugali",

rice or stew.

Modification of LPG Stoves

LPG stoves can be modified to fit the properties of biogas. The efficiency will often not be as good as with a genuine biogas stove. Hence, the geometry of the burner will not be known exactly, modification remains subject to trial and error. The easiest way is to close the primary air inlet completely and then widen the Jet according to the wanted heat supply. The air intake might then again be opened little by little. When lighting the burner about half of the orifices should bear flames. After a pot is placed on the fire, all orifices are ignited.

The jets of LPG burners can be widened with a drill. It is better to go step by step instead of spoiling the burner by opening the jet too far. For example, an original 1.2 mm jet should be widened in the first step to 1.4 mm only, in the second step to 1.6 mm until it gives the wanted result. If there is no vice at hand, the drill can even be used without a drilling machine when jets are of soft brass metal.

Gas Lamps

Although biogas lamps have proved not to be economical compared to kerosene lamps, they are often the major reason for wanting a biogas plant rather than the clean and smokeless cooking fuel.

The principal of a gas lamp is similar to that of the stove. With a stove, the burning gas heats a pot. In a lamp, the burning gas heats a mantle until it glows brightly. The secret behind a lamp is to adjust the flame in such a way that the hottest part of the flame exactly matches the form of the mantle. Proper air mixture and appropriate size of the mantle play the biggest roles. The methane content of biogas sometimes changes. Therefore, brightness of the light will also change.

Local production of lamps is far more problematic in design and more complicated to manufacture than producing efficient stoves. Trial and error provides the best method in most cases. There are several lamps available that could be imported from India, China, Kenya, Brazil or Italy. The Patel outdoor lamp (Pate Crafters, Bombay/India) has proved to be the most expensive but also the

best serving model. It has an air mixing chamber where outside air gets pre-heated before combustion.

Modification of Kerosene Pressure Lamps

Kerosene pressure lamps (petromax, anchor, butterfly and others) are available in most countries. They can be modified and there is no need to import special biogas lamps. Instead of 0,09 l kerosene 0,186 m³ biogas is consumed per hour. To modify a pressure lamp the workshop must be equipped with a lathe. In principal, the jet is widened and a new mixing pipe is mounted. The gas is connected via the original pump opening.

Other Appliances

Biogas can be used for various activities and requirements common in the project region. Refrigerators and chicken heaters are the most common. There are individual cases of using biogas for coffee roasting, bread baking or sterilization of instruments. If the properties of biogas are observed, there is no limitation to its utilization.

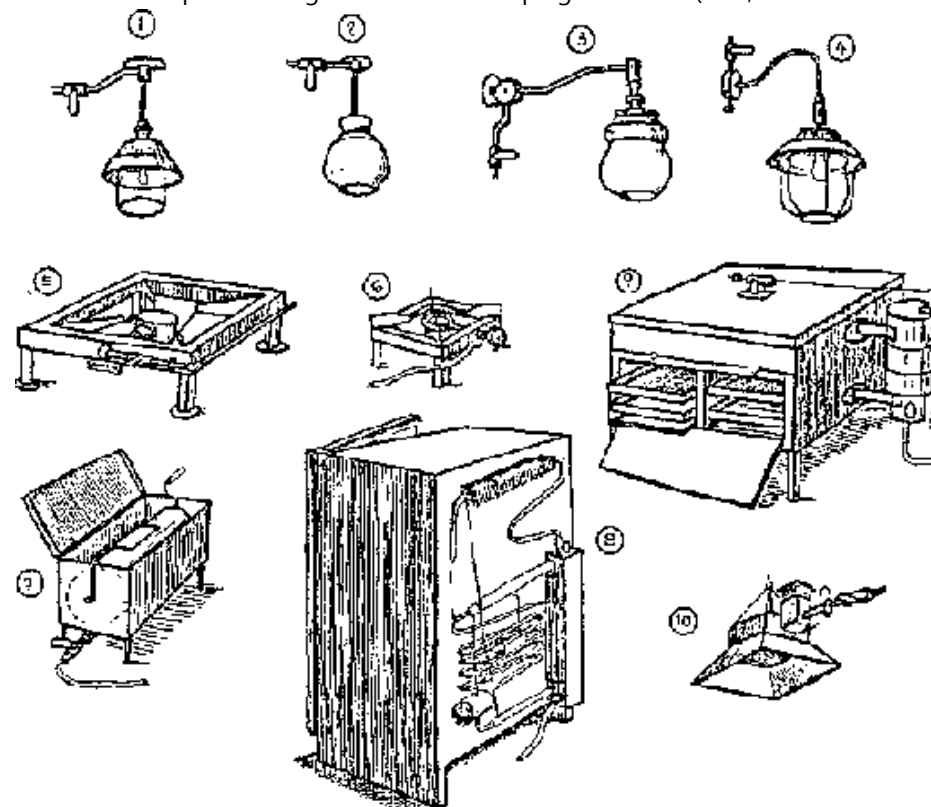

Fig. 38: Biogas appliances

(1) Gaslamp made by CAMARTEC from aluminium vessels and a glass mantle from a kerosene lamp. The lamp worked well but was never mass produced. (2) Gaslamp from Italy, (3) from Germany and (4) from Brazil. (5) Big cookstove for institutions, schools etc., developed, built and exported by CAMARTEC. There should always be a smaller stand-by stove in institutional kitchens (6) Household stove from KIE, Kenya (7) Coffee roaster for 1-3 kg of coffee placed on a tube burner or ordinary kitchen stove. (8) Gas refrigerator modified for biogas by changing the jet and the air-intake holes. (9) The "Detroit" chicken hedger with temperature regulation with a floppy cap (a). (10) A room heating radiator, mainly used in chicken houses or piglet styes. A ceramic plate causes heat radiation.

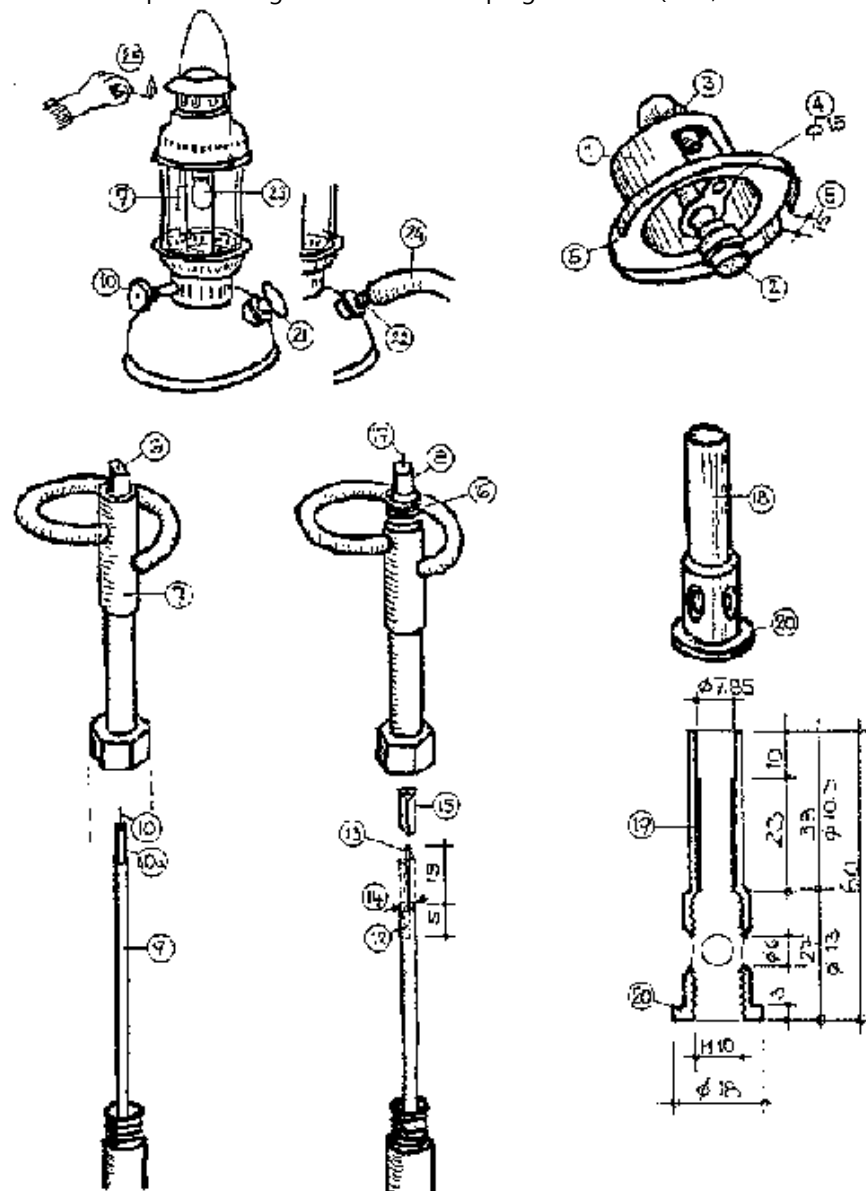

Fig. 39: Modification of pressure lamps

For modification, the head of the lamp (1) is to be taken off after removing the wig. Because the flame port (2) might break, unscrew it and save it. Remove the kerosene adjustment screw (3) from the U-pipe in' the head Either close the hole by hard soldering... or cut the screw so short that

it only closes the hole but does not disturb the gas-flow inside the U-pipe.

Look at the head from below and widen the hole (4) beside the flame port socket to 15 mm in order to receive the new mixing pipe. Then enlarge the two notches at the rim (5) of the head from each side to 15 mm width. This will help to replace and remove the head easily. The head is now modified.

For modification of the gas intake system, unscrew the brass jet (6) which is fixed at the top of the standpipe (7). The jet's opening could be widened to 1 mm but a stainless steel jet (8) is much more durable when using biogas. This will be made from a massive rod of 8 mm and should have a thread of M7 · 1. Now unscrew the standpipe and you will find a long needle (9) with a tiny pin (10) at the top. The pin moves up and down, cleaning the jet when the handle of the main valve is turned (11). Unscrew the pin holder (10a) from the needle and widen the thread at the head of the needle with a drill of 0.9 mm to 5 mm depth (12). Insert a steel pin 0 0.9 mm in there (13) or cut the drill in half and use the drill itself as the new pin for cleaning the new 0 1 mm-jet. Press the head of the needle with pliers to fix the pin (14). Take the old pin holder and cut its thread and the pin off and place the remaining shaft over the new pin (15) in order to give better guidance to the needle when it moves up and down inside the jet.

The top of the standpipe will be provided with a thread M10·1 (16) to receive the new mixing pipe which will extend the existing standpipe by 60 mm. Fix the jet to the standpipe and screw the standpipe in its former position. Make sure that the cleaning pin is turned up when replacing the jet with the standpipe (17).

The new mixing pipe (18) is made from 18 mm brass rod. The lower part is turned to 13 mm with an inner thread of M10·1. Four air holes of 0 6 mm cross the pipe. Their rims are bevelled. The upper part is turned to 10.3 mm outside and 7.85 mm inside, where a stainless steel pipe (19) of 8 mm outside and 6 mm inside is pressed in. At the lower end of the mixing pipe there is a 3 mm flange to prevent uncontrolled air supply to the flame (20). After screwing the mixing pipe to the standpipe the inner parts are modified.

Remove the pump at the kerosene tank (21) and remove the inner valve with a screw driver. Either produce a new cap with hose connection nozzle and thread M20·0,8 mm or fix a hose







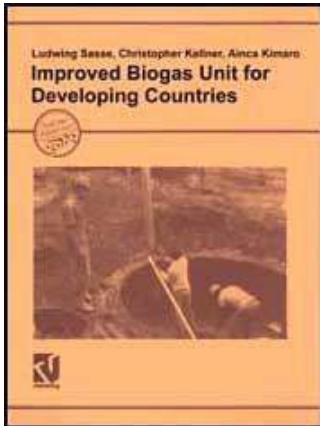









connection to the existing cover cap (22). Make the joint gas-tight by soldering. Use teflon sealing tape for placing the cap on the nipple.

Assemble all parts, fix a new mantle (23), connect the gas (24) and light the lamp (25).

[Home](#) > [ar.cn.de.en.es.fr.id.it.ph.po.ru.sw](#)



Improved Biogas Unit for Developing Countries (GTZ, 1991, 98 p.)

-  **(introduction...)**
-  **Acknowledgments**
-  **Foreword**
-  **Acknowledgment**
-  **1. Preface**
-  **2. Why biogas ?**
-  **3. Explanation of terms**
-  **4. Biogas extension work**
-  **5. The agricultural biogas unit**
-  **6. Construction of the biogas plant**
-  **7. Construction of cattle stable**
-  **8. Construction of the pigsty**
-  **9. The sanitary biogas unit**
-  **10. Use of slurry**
-  **11. Use of gas**
-  **12. Operation and maintenance**
-  **13. Pending technical issues**
-  **14. Appendix**

12. Operation and maintenance

Operation of the Biogas Plant

If operational short-comings are often reported, the set up of the system is not appropriate to the farmer. The main task of a biogas engineer is to design and construct a user-friendly biogas unit. Operation and necessary maintenance must be logical to the user and should not be a burden to the ones attending the plant. A well designed biogas unit is easy to maintain. The ease of maintenance ensures constant attention by the farmer. Nevertheless, even with a perfect design, a minimum of daily care is needed to receive a proper service from the unit.

The clay sealing of the lid must stay moist. Therefore, the lid must be covered with water all the time. In order to reduce evaporation and prevent mosquito breeding, machine oil can be added on the surface of the water. Mineral oil pollutes ground water and should only be used in small quantities and with care. From time to time the water above the lid must be checked and refilled when necessary. A small control opening in the topmost cover makes control much easier and therefore more likely. When water is controlled, possible leakages at the lid are also detected.

Once in a while the expansion chamber should be cleaned In order to avoid solids assembling in the corners and thus, reducing the gas storage capacity.

The plant must be fed regularly in order to achieve regular gas production. The substrate should be free of stalks and other impurities in order to avoid scum formation and blockage of the inlet and outlet pipes. After removing straw and waste fodder from the dung, it should be mixed sufficiently with urine or water to avoid separation of solid and liquid material inside the digester. Every day the liquid from the urine chamber must be transferred into the mixing chamber. How much liquid, i.e. how often the urine chamber needs to be emptied per day, depends on the amount of dung. As a rule of thumb 1 kg of dung requires 1 l of liquid. The user is to be advised by the BES-staff.

Chopping of the fodder into pieces of 3-5 cm length saves fodder grass and reduces the amount of stalk mixing with the dung on the floor.

In dry environments the amount of urine might not be enough to obtain the required mixing rate. Water must then be added. However, It is better to give more water to the cows instead of adding

water to the plant. Beside producing more urine the cows will be in better health and produce more milk.

The overflowing slurry should move away from the outlet. Otherwise It can block the overflow and the gas pressure might increase until it escapes through the inlet pipe or blows off the water trap. Therefore, the outlet and the slurry canal must be cleaned. This must be part of the daily routine of cleaning the stable and feeding the plant. The problem becomes less, if a proper slope is maintained and the slurry canal is shaded off from direct sunshine.

The slurry distribution system must be cleaned and slurry directed towards the plants for fertilization. If this is not done, the biogas plant does not suffer, but the farmer will waste valuable manure.

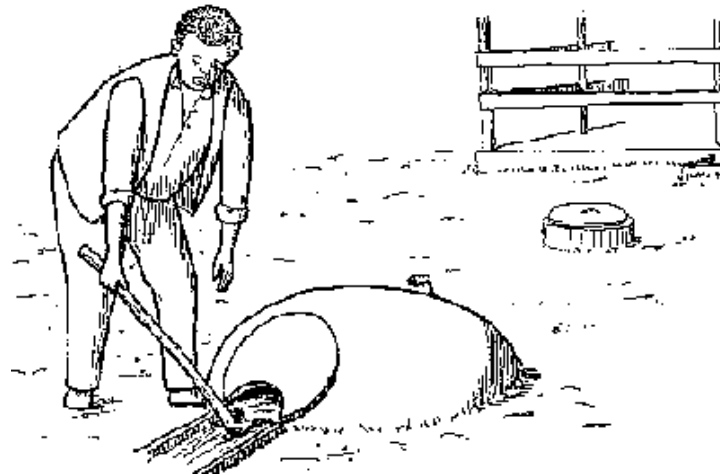

Fig. 40: Cleaning the overflow point at the expansion chamber

Maintenance of Toilets

Well designed toilets do not require any maintenance except for cleaning the inlet and the floor of the cubical. Once a toilet is soiled and starts smelling badly, It is very difficult to again achieve cleanliness. Clean water should be used without disinfectants so as not to kill the methane bacteria in the plant. Soap water, from time to time, can be tolerated.

Regular Maintenance of Appliances

Psychologically, the stove should be regarded as a kitchen ware and not as a fire place. There is no maintenance needed besides keeping it clean like other kitchen vessels and utensils.

The lamp needs cleaning of the glass screen in order to have bright light all the time. Cleaning should be done only if necessary to avoid shocks on the lamp that can destroy the gas mantle. Gas mantles of lamps only have a certain life time and ought to be replaced frequently. They are fixed with a string to the nozzle and the replacement is easy and does not require any skill. Used mantles are radioactive. Therefore, dust or pieces of the broken mantle should not come in contact with foodstuff. Children should be protected from inhaling the dust when they are around. Hands and working place should be cleaned with water after replacement of the mantle.

Disturbance of the System

Trouble shooting becomes necessary if the customer, this is the owner or the user of the gasplant, complains about insufficient service or any nuisance caused by the plant. There are three sources for possible complains:

- Insufficient gasplant performance**
- inadequate amount or kind of feeding material**

- too high expectations on the service of a biogas unit**

The latter is very difficult to deal with, because the fault was done when persuading the farmer with wrong promises. Serious information about possibilities and limitations of a biogas plant are the only way to have content customers. On the other hand, the farmer might have exaggerated the amount of feed material available to him. This can be the case when the animals are taken out for grazing when zero-grazing was expected. The actual amount of dung must be checked in order to distinguish between short-comings in gasplant performance or underfeeding of the gasplant. A well functioning plant produces between 35 to 40 litres of biogas per kg of fresh cattle dung, depending on fodder, temperature and retention time. In rainy or colder seasons the gas production may drop to 60-70% of the normal rate.

Interruption of Gas Production

"There is not enough gas" is by far the most common problem mentioned by the user. When the cause is found, normally the remedy is easy, except for scum problems. The following steps will help to find the reason for the gas shortage quickly:

Ask the user if gas supply is only less or if it stopped completely. Check the information given by the user concerning the appliances complained about. Ask if the problem occurred suddenly or gradual and when it was noticed first. If the problem occurred suddenly, a technical fault is very likely. If gas supply dropped gradually, one may guess that there is something wrong with the performance of the plant. This might be caused either by unsuitable properties of the feeding material or by inadequate feeding practices.

Check If there is gas in the plant. If the slurry level In the outlet chamber is high and slurry at the overflow is fresh, there is gas production. If the gas pressure is high but no gas reaches the point of use, there must be a blockage somewhere.

If there was no discharge of slurry because of not enough pressure inside the plant, there might be a leakage. Ask or observe if there is smell of gas in the kitchen. Check the lid for bubbles. Check the valves and than the Joints for leakages by applying soaped water to it. If no leakage is found, close the main valve and wait one day for gas pressure building up. If gas is produced, which can be seen if bubbles come up at the outlet or inlet pipe, but pressure does not build up, there must be either a leakage which opens up by increased pressure or a crack in the dome below a certain slurry level. A crack in the dome is the worst of all cases. The plant must be emptied and cracks must be repaired.

If there is no gas production at the plant, observe the smell of the slurry. If it smells sour, the fermentation process has been disturbed. Wait some time (maximum 4 weeks) without feeding the plant or feed with material from an other stable. If gas production does not start by itself again, the plant must be emptied and refilled with fresh material. Such a break down of fermentation is very rare and rarely happens with cattle dung, except in case of animal diseases treated with high doses of antibiotics. In most of the cases, gas is produced but can not arrive at the place of consumption.

If gas is produced but not available at only some of the stoves, lamps or other appliances, there is a blockage in the piping system or the Jet. If Jets are clean, there might be a water blockage in the piping system just before the appliances. Ask the customer, if gas was flickering before it finally went off. In this case, check If there is a water trap at the lowest point of the piping system. If not, change the pipe line or place a water trap. If there is once water in the pipe, there will be always water in the pipe. Reconstruction is the only solution.

The Problem of Scum

If there is heavy gas release from the inlet but not enough gas available for use, scum is most likely the reason. Often the gas pressure does not build up because of the continuous release through the inlet. Slurry does not overflow for weeks. There is the danger of blocking the gas pipe by rising scum because of daily feeding without equivalent discharge. The lid must be opened and scum is to be taken out by hand.

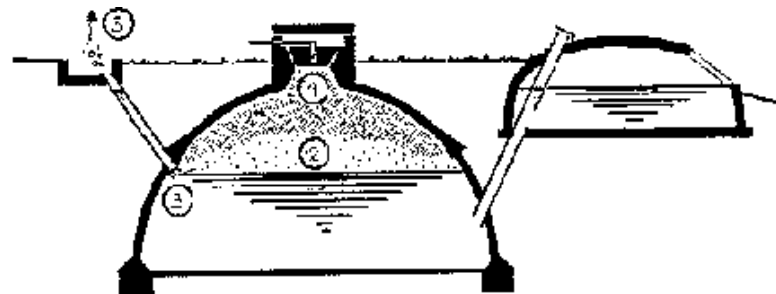

Fig. 41: Scum formation in a fixed dome plant

The scum may prevent the gas from reaching the gas outlet pipe (1). Instead, the gas will form large bubbles below the scum (2) from where the gas escapes through the inlet pipe (3). If the gas cannot escape, it might also burst the brickwork structure. Therefore, unsuitable dung should not enter the plant. Suitable dung should be filled in fresh. Stalks and other fibrous material should be sorted out and be stored directly on the compost heap. Dried dung should be thoroughly mixed with urine or water before entering the plant.

Straw, grass, stalks and even already dried dung tends to float to the surface. Solid and mineral material tends to sink to the bottom and, in the course of time, may block the outlet pipe or

reduce the active digester volume. In proper mixed substrate there is no such separation because of sufficient friction within the paste-like substance.

With pure and fresh cattle dung there is no scum problem. Floating layers will become a problem when husks are part of the fodder. This is often the case in pig breeding. Before installing a gasplant at a piggery, the kind of fodder and consequently the kind of dung, must be checked to ensure it is suitable for a biogas plant. It might be necessary to grind the fodder into fine powder. The user must be aware of this and the occurring costs before deciding on a biogas unit. The problem is even bigger with poultry droppings. The kind of fodder, the sand the chicken pick up, and the feathers falling to the ground make poultry dung the most difficult substrate. In case of doubt, no gasplant should be build.

Scum can be avoided by stirring, but....

Stirring must be done for 5 minutes every hour, throughout day and night to avoid scum formation. This can only be assured by automatic mechanisms and should not be expected from workers attending the stable. For simple gasplants, stirring is not a viable solution against scum formation.

Scum can be broken by stirrers, but....

Scum is not brittle but very filthy and tough. Scum can become so solid after only a short time, that it needs heavy equipment to break it. It remains at the surface after being broken up. To destroy it by fermentation, it must be kept wet. Either the scum must be watered from the top or pushed down into the liquid. Both operations demand costly apparatus. For simple gasplants, stirring is not a viable solution for breaking the scum.

The only solution for simple biogas plants to avoid scum is by selecting suitable feed material and by sufficient mixing of the dung with liquid before entering the plant.

Trouble with Feeding the Plant

When there is a problem of charging dung and urine to the plant, there is a blockage at the inlet

pipe. The problem might be caused by straw or grass and could be solved by thorough poking. If this happens more often, there might as well be scum blocking the inlet pipe from below. By entering a stick or a pipe into the inlet one may find out where and of which nature the blockage will be. Don't be surprised to find stones or other trash in the pipe which had been placed there by playing children. If it feels sandy, there is a heavy accumulation of soil below the inlet pipe. In this case, open the lid and scrap the sand off With a dipper or steel shovel. Only in serious cases the plant needs to be emptied.

Faults at Appliances





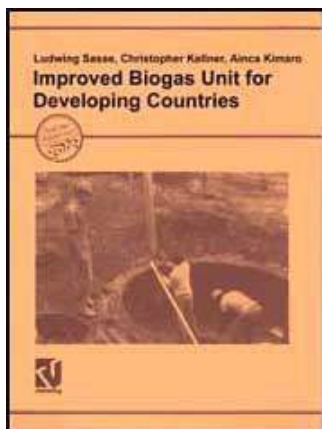

It is surprising to see, how much complaints arise because equipment was not kept clean. Often food has dropped into the- burner head but sometimes dust or cinders block the Jets of burners or lamps. Normally, blockage of the jet is removed with help of a fine wire or needle. Only when blockage occurs in short intervals, the jet must be dismantled and cleaned. The rubber tube is to be disconnected and freed from dust by blowing through.











If a lamp starts to loose its brightness, it is very likely that dust particles have blocked the nozzle. Again, the nozzle must be unscrewed and cleaned.

[Home](#) > [ar](#).[cn](#).[de](#).[en](#).[es](#).[fr](#).[id](#).[it](#).[ph](#).[po](#).[ru](#).[sw](#)



Improved Biogas Unit for Developing Countries (GTZ, 1991, 98 p.)

-  **(introduction...)**
-  **Acknowledgments**
-  **Foreword**
-  **Acknowledgment**
-  **1. Preface**
-  **2. Why biogas ?**
-  **3. Explanation of terms**

-  **4. Biogas extension work**
-  **5. The agricultural biogas unit**
-  **6. Construction of the biogas plant**
-  **7. Construction of cattle stable**
-  **8. Construction of the pigsty**
-  **9. The sanitary biogas unit**
-  **10. Use of slurry**
-  **11. Use of gas**
-  **12. Operation and maintenance**
-  **13. Pending technical issues**
-  **14. Appendix**

13. Pending technical issues

Several tests have been made by CAMARTEC. The results of these tests have not yet been put into practice, but might already be of interest to the reader.

Position of the Outlet

As reported above, the slurry is found in layers of different TS-content. Until now, the outlet pipe has been placed near the bottom, because it is known that digested slurry is heavier than the fresh substrate. At the same time, liquid slurry which hardly produces any gas remains for a long time in the plant. On the other hand, active sludge is driven out from the plant relatively early. Hence, the retention time of the viscous slurry is reduced. When the outlet pipe is placed higher up in the liquid zone, unproductive liquid overflows and active sludge remains longer in the plant. CAMARTEC has not yet decided if the volume of the plant could be reduced when the outlet pipe will be higher or if two alternative outlet pipes would be provided. For the time being, the present models remain valid.

Standpipe for Gas Release in Case of Scum

In one case, where pigs have been fed with husks, a heavy layer of scum had been developed. Most of the gas escaped through the inlet pipe because it could not penetrate the scum. It has now been proposed to place a perforated plastic pipe vertical in the centre of the digester, to allow the gas to pass the scum. It might still be necessary to take out the scum from time to time. For easier opening and closing of the lid, a rubber sealing and wedges of steel would be advisable.

Pre-Heater for Water

In institutions, or when there is a surplus of gas, pre-heating of water might be a reasonable way of utilizing the gas. The gas burns continuously and heats the water to 30-40°C. This water is used for washing or for boiling. A long-lasting and reliable apparatus has not yet been developed.

Slurry Lifting Device (Pressure Booster)

In case of an insufficient natural slope, the slurry could be lifted up with the help of water pressure from a main. Slurry flows in a pressure tank which is connected to a water pipe with sufficient pressure. The slurry inlet valve will be closed when the tank is filled. Then the water cock will be opened. The hydraulic pressure transports the slurry to a higher level from where it flows by gravity to the field. When the slurry becomes watery, the water cock will be closed and water from the pressure tank will be drained off. Then the slurry valve is opened again for re-filling. The system is valid when water is supplied free or at a low price from the main. The volume of the pressure tank depends on the intervals of distributing the slurry.

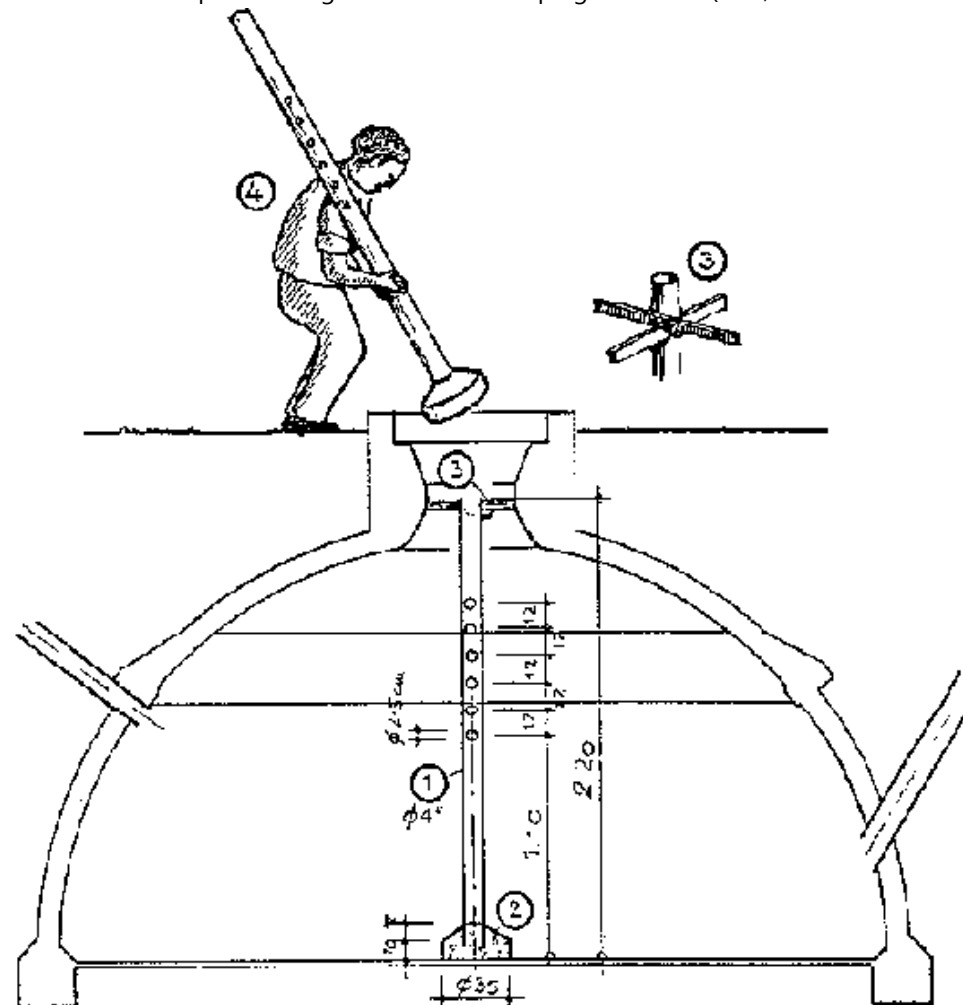

Fig. 42: Stand-pipe for gas release

In case of heavy scum formation, a perforated 4"-plastic pipe (1) is placed in the centre of the digester to allow the gas to pass through the scum. Thus, removing of scum will be only necessary in longer intervals. It is held at the bottom in a concrete foot (2) and fixed at the top with a timber cross (3). The pipe can be inserted, when necessary, even after the plant is in operation (4).





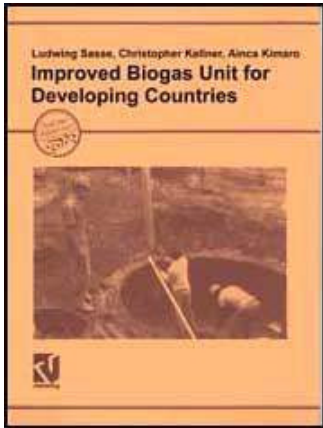

Gas Pressure Equalizer

When there are several biogas plants scattered over the compound of an institution or a bigger farm, the pressure will be different because of the friction losses and different gasplant designs. A standardized instrument is to be developed which can be installed in such places.

[Home](#) > [ar.cn.de.en.es.fr.id.it.ph.po.ru.sw](#)



Improved Biogas Unit for Developing Countries (GTZ, 1991, 98 p.)

-  **(introduction...)**
-  **Acknowledgments**
-  **Foreword**
-  **Acknowledgment**
-  **1. Preface**
-  **2. Why biogas ?**
-  **3. Explanation of terms**
-  **4. Biogas extension work**
-  **5. The agricultural biogas unit**
-  **6. Construction of the biogas plant**
-  **7. Construction of cattle stable**
-  **8. Construction of the pigsty**
-  **9. The sanitary biogas unit**
-  **10. Use of slurry**
-  **11. Use of gas**
-  **12. Operation and maintenance**
-  **13. Pending technical issues**
-  **14. Appendix**

14. Appendix

CHARACTERISTICS OF PROJECT AREA WHERE THE BIOGAS EXTENSION SERVICE IS ACTIVE.

Country: Tanzania: Population 25 Mill. inhabitants, area: 1,25 Mill square Km, GNP 235 US\$ per capita, deriving from Industries 10%, agriculture 59%, services 31%, inflation rate in 1985-1990 25%, local currency 1000 Tsh = 5,30 US\$ (May 1990).

Price relations: 1 adult milking cow 75.000 Tshs, 1 Biogas Plant of 16 m³ VD costs 170.000 Tshs, or 2-3 in-calf cows, 1 daily wage of unskilled labourer is 200-300 Tshs, 1 bag of cement costs 1.150 Tshs, 1 kg of maize (producer price) gains 15 Tshs, 1 l of kerosene costs 51 Tshs.

Project area: Coffee-banana-belt around Mt. Meru with Arusha being the commercial and cultural centre. Population density: 195 inhabitants/km², altitude: 1200-1500 m above NN, rainfall: 2500 mm p.a., semi-dry season: three months, min-max temperature: 10-30°C.

Theoretical Biogas Potential: 10% of households = 4 biogas plants/ km².

LIST OF FORMS

The following list of forms is a proposal for any private or public Biogas Extension Service. It has proven useful in practice for:

**giving the customer a reliable overview over the costs,
not forgetting any details**

coming to clear arrangements with the customer and

having a guideline for quantity and cost calculation.

FORM 1

Letter to potential Customers, asks the customer to send a formal request letter including details about his farm set-up. The data mentioned can be used as a reference for later evaluations, e.g. to compare the number of cows at application and after several years.

The first site-visit and the planning starts only after having received the formal request, in order not to waste any time on unserious applicants.

FORM 2

Calculation Sheet for Unit construction

FORM 3

Quantity survey form are forms to easily calculate the needed building materials for Biogas Plant, cowshed, pigsty, toilet, etc.. They are meant for internal use.

FORM 4

Letter to the customer explains all the details being necessary for a satisfactory functioning BGU on his farm: BGP, stable(s), modifications, gas consumption appliances etc..

It clears communication flow, but is not always necessary, as customer is mainly asking for costs, which can be only discussed after Form 5.

FORM 5

Delivery decision and cost calculation is an agreement between the Biogas Extension Service and the customer on who is delivering what. Often it is cheaper for a farmer to have his own workers digging the pit or he has e.g. a cheaper source of sand or his own is own means of transport. The farmer should have the chance to help make his BGU as cheap as possible, but of course this should be based on a clear arrangement.

The form informs about total value of construction, supervision costs and how much is to be paid to the contractor.

FORM 6

Contract is delivered personally and signed by both customer and constructor, after quantities and costs have been agreed on. While signing the contract, the first installment of 50% of the total

costs has to be paid. As soon as the first installment is received, material delivery and construction work can start.

FORM 7

Material to be delivered by the customer is a form to agree on a certain time, when the building materials supplied by the farmer have to be at the site. If the farmer delays his delivery, B.E.S. or the contractor has the right to supply missing materials in order to avoid delay of construction work.

FORM 8

Slurry Utilisation Agreement is a form with which B.E.S. tries to explain to farmers their duties and B.E.S. inputs in order to establish a sustainable slurry distribution system.

FORM 9

XXXXXXXX

After Sales Service is a contract in which the customer and B.E.S. come to an agreement about sharing the costs for the check-up and necessary modifications of the plant after an operational period of several years.

The above given list of forms should be taken as an example. It depends very much on regional conditions, on the number of BGU's built annually and on the diversity of regularly occurring problems, to which extent a "Form-System" is established.

Forms are created mainly to make a job easier. Things are made clear by writing them down.

EXAMPLE: FORM 2 CALCULATION SWEET FOR UNIT CONSTRUCTION

	(for internal use)		
Name of Customer	:		

Village	:		
Date	: ..		
It is-required for	phase 1	phase 2	phase 3
Size of plant	:m ³	m ³	m ³
additional inlet	:		
toilet complete	:	toilet connection	:
stable Z	:	pigsty R	:
stable modification:			
Item	unit	amount	
cement	bag	..	
sand	ton	..	
murrum	ton	..	
stones	ton	..	
bricks	piece	..	
pillars 15 cm	piece	..	
purlins 2" x 2"	piece	..	
boards 2" x 4"	piece	..	
nails 4"	kg	..	
roofing nails	kg	..	
roof gutter	m	..	
gutter holder	piece	..	
iron sheets	piece	..	
slabs 15 x 15 cm	piece	..	
slabs 15 x 30 cm	piece	..	
slabs 30 x 30 cm	piece	..	

small items		..	
Iabour		..	
		..	
		..	
pipng 3/4"	m	..	
		gas consumption	
household stoves	piece	..	
canteen stoves, type	
canteen stoves ins.pot	.	.	
lamps piece	..	.	
signature of planner		signature of site engineer	

EXAMPLE: FORM 5 COST CALCULATION

Copy to customer)

Name of customer.....Village.....Date.....

Phase.....

Item	amount	will be provided by		additional items provided by BES for the price
		customer	BES	
bricks
cement
Iime
sand
murrum
stones
chippings				

chippings
PVC pipe 4"
PVC pipe 6"
plain wire
chick wire
small items
galv.pipe 3/4"
h. h.stove
cant.stove
stove modif.
Iamp
pillars
boards
gutter
metal piec.
nails
iron sheets
small Items
Iabour
digging
.....
.....

Total Tshs

Total value of construction supervision.....%

Grand Total

Value of customers contribution

Payment to BES

date:.....

signature customer.....

signature BES.....

Floor plan

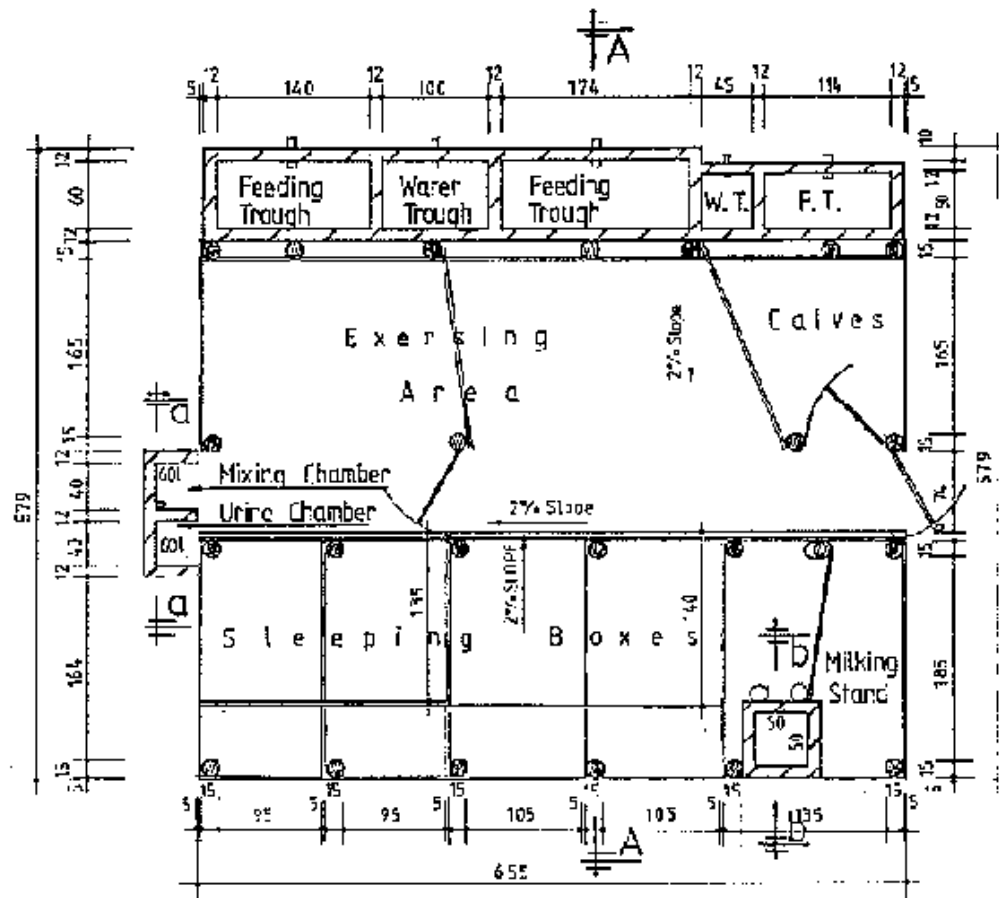

CAMARTEC Z ₄		JOB TITLE: Zero Grazing Unit for Four Cows
DRAWN:	CHECKED:	
SCALE: 1:50	DATE: NOV. 1989	

Figure

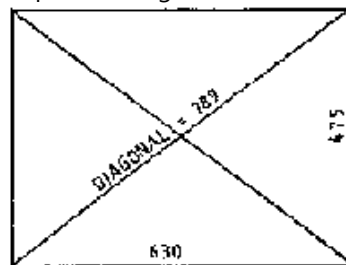

Rectangular check

NOTE:

All dimensions are given for centers of pillars

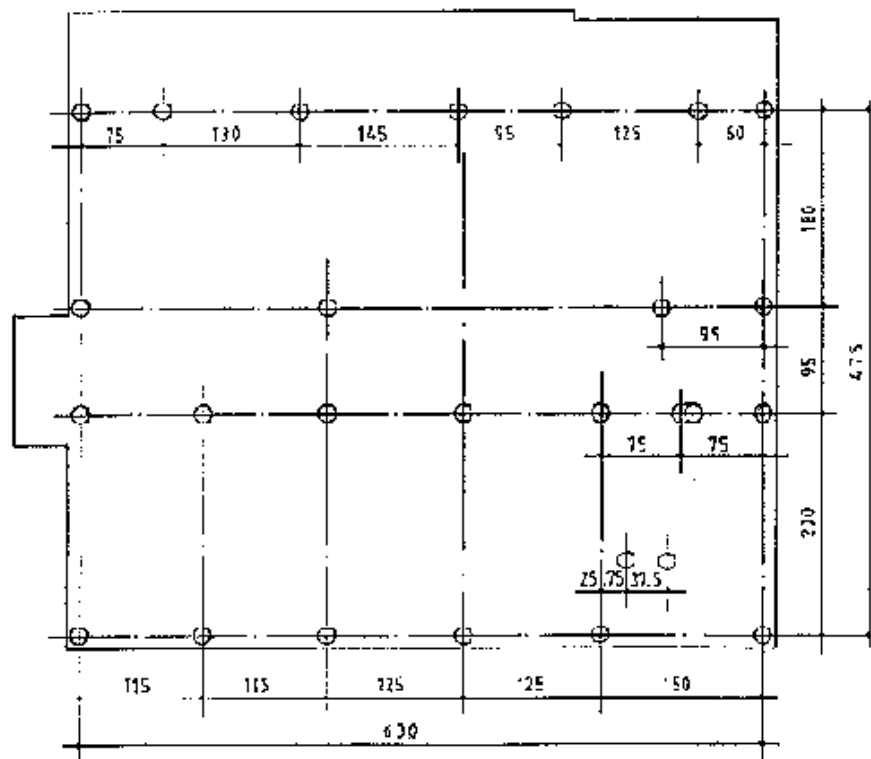

Foundation plan

CAMARTEC Z4		JOB TITLE: Zero Grazing Unit for Four Cows
DRAWN:	CHECKED:	
SCALES: 1:50, 1:100	DATE: NOV. 1989	

Figure

Feeding Trough at Milking Stand
(Section b-b)

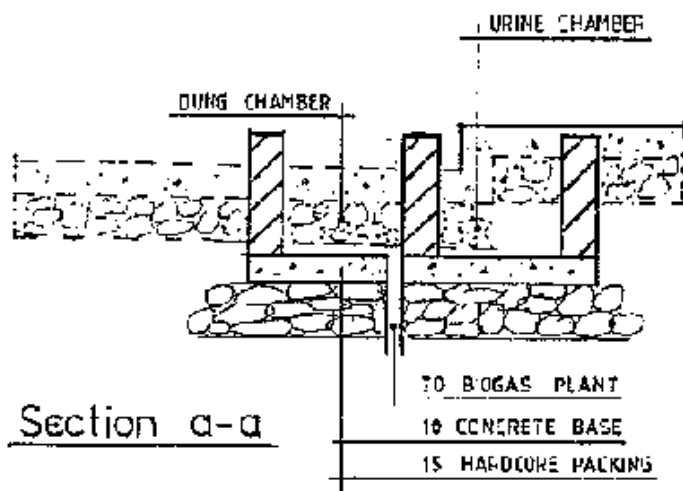
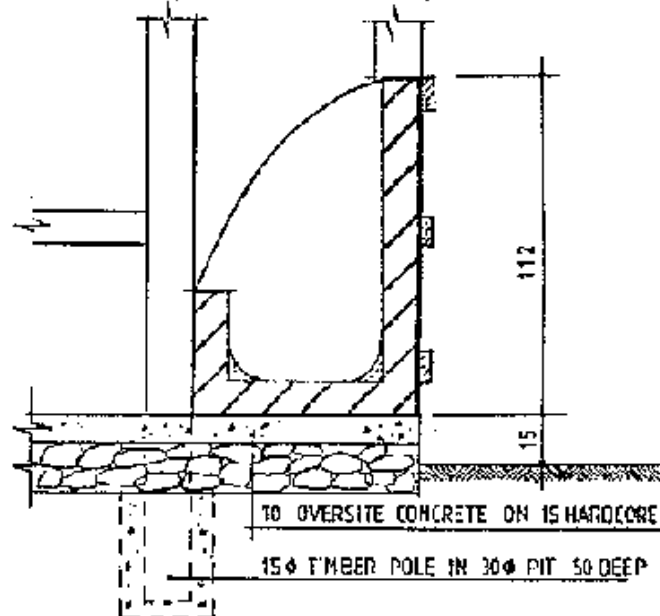

CAMARTEC Z4		JOB TITLE:	
DRAWN: _____		Zero Grazing Unit for	
CHECKED: _____			

SCALE: 1:20	DATE: NOV. 1989	Four Cows
-------------	-----------------	-----------

Figure

Section A-A

- C.I. SHEETS
- 5x5 FURLING
- 10x5 RAFTER
- 10x7.5 WALL PLATE

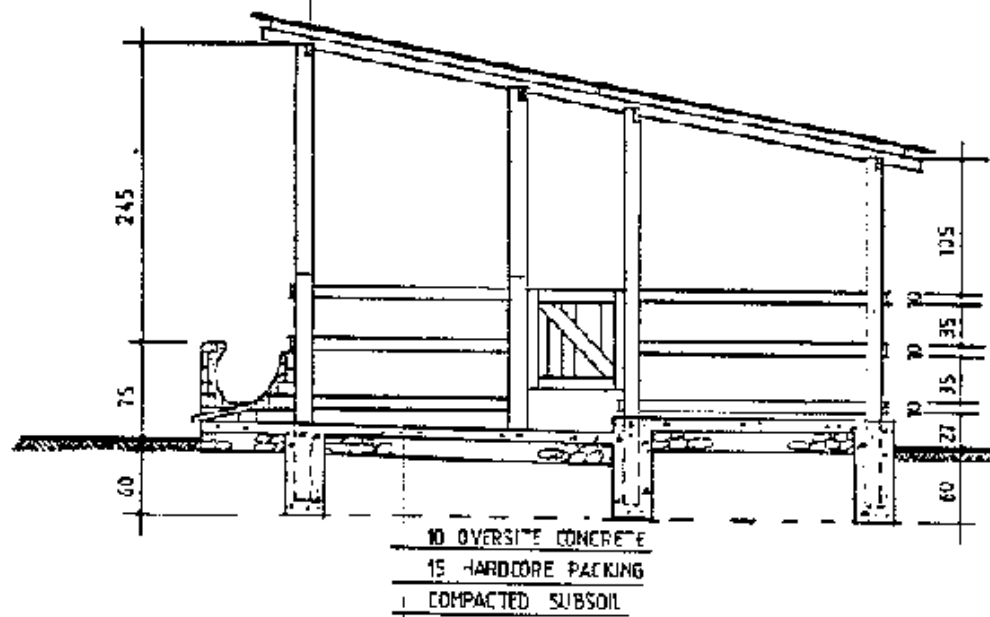

CAMARTEC Z4		JOB TITLE: Zero Grazing Unit for Four Cows
DRAWN:	CHECKED:	
SCALE: 1:50	DATE: NOV. 1989	

Figure



Front elevation

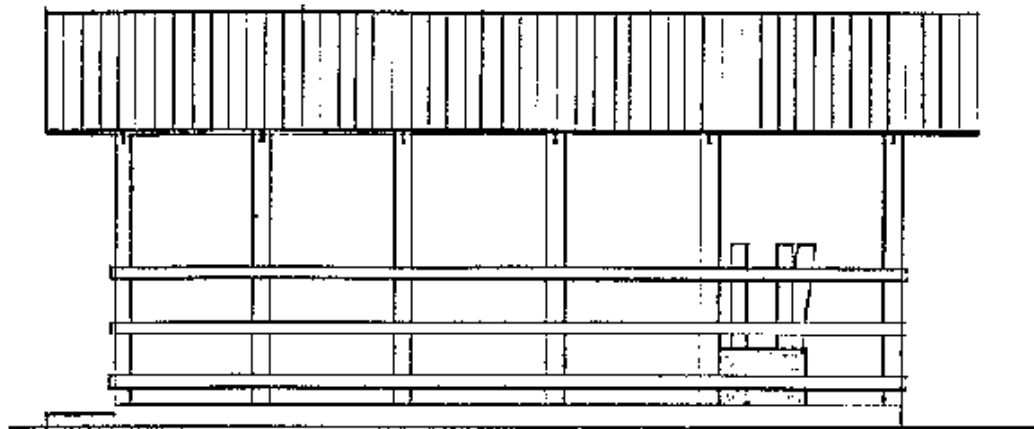

Rear elevation

CAMARTEC Z/4		JOB TITLE: Zero Grazing Unit for Four Cows	
DRAWN:	CHECKED:		
SCALE: 1:50	DATE: NOV. 1989		

Figure

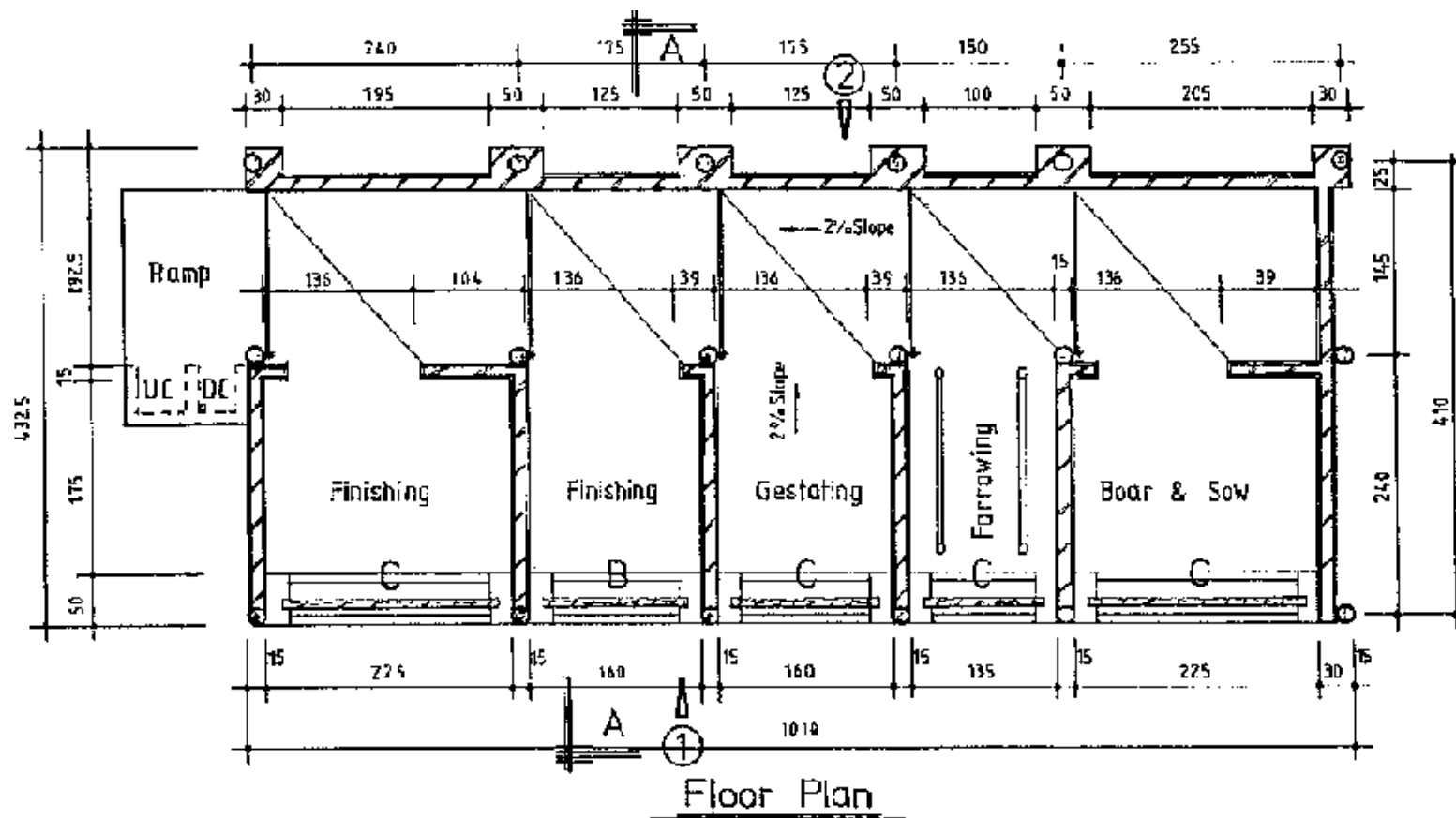

C A M A R T E C		
5 Room Pigsty		
1:50	NOV. 1988	

Figure

Feeding Troughs for Pigsty

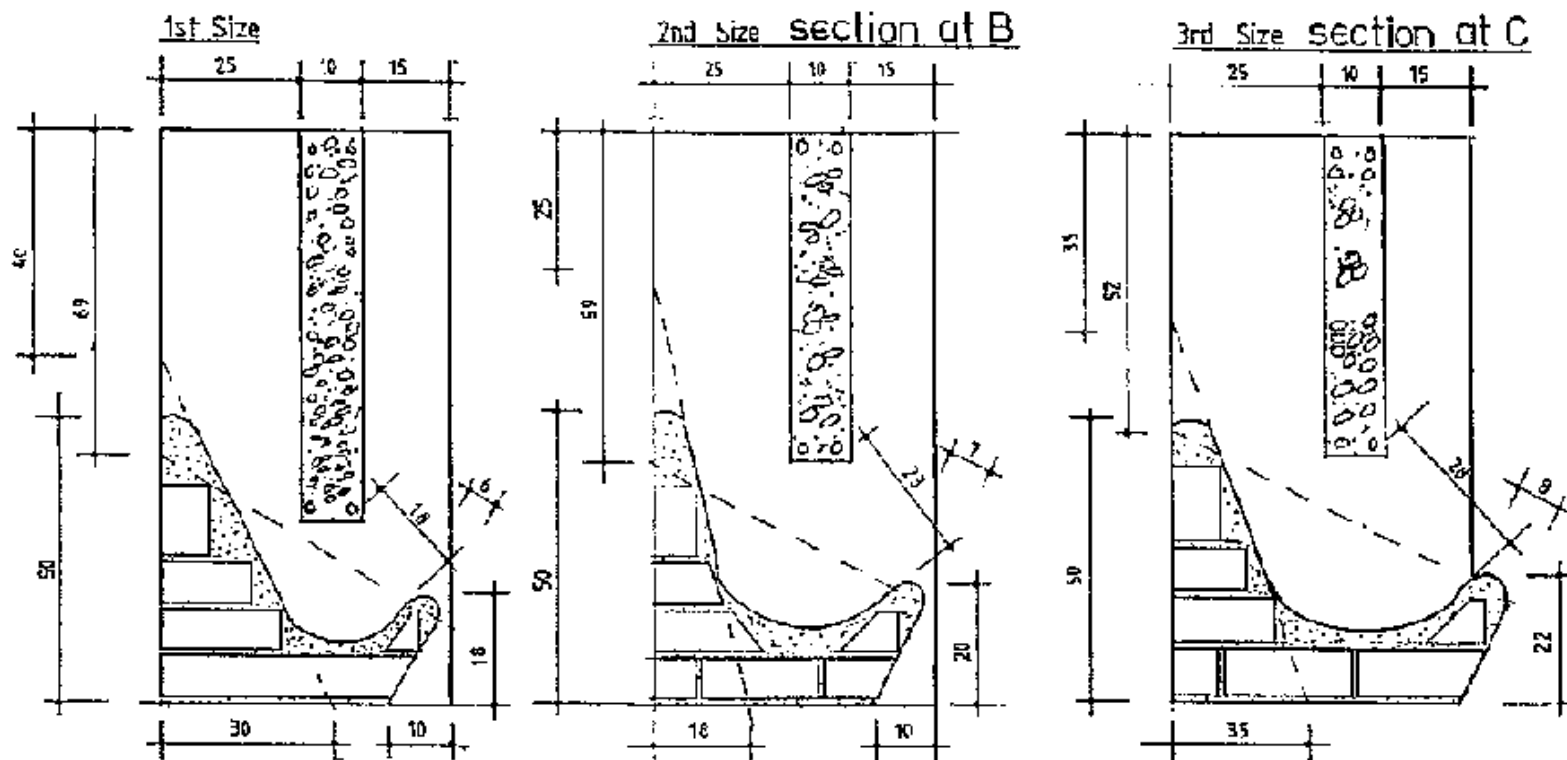

C A M A R T E C		
5 Room Pigsty		
1:10	NOV. 1988	

Figure

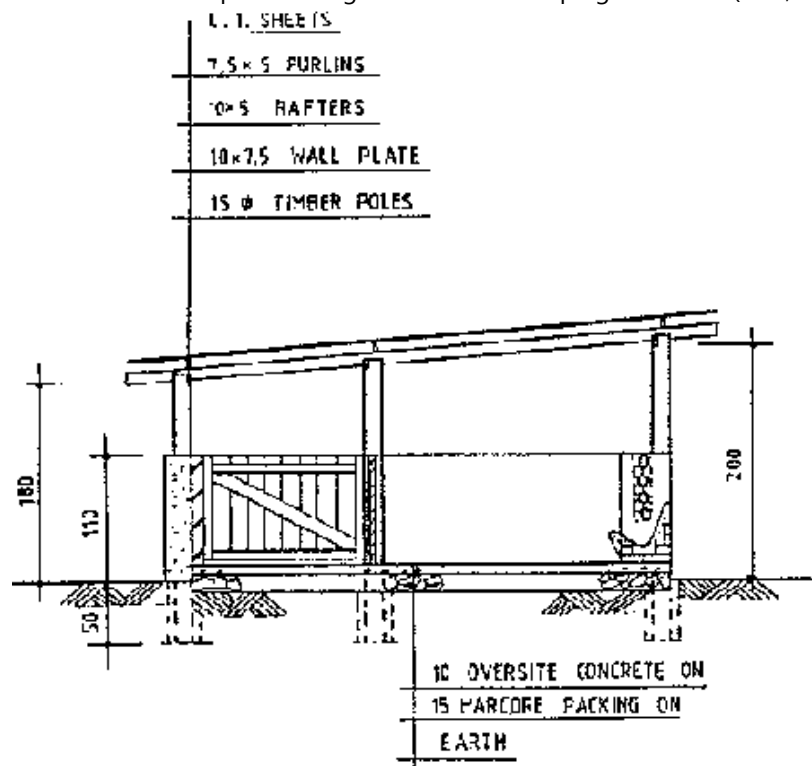

Section A-A

C A M A R T E C		
5 Room Pigsty		
1:50	NOV. 1988	

Figure

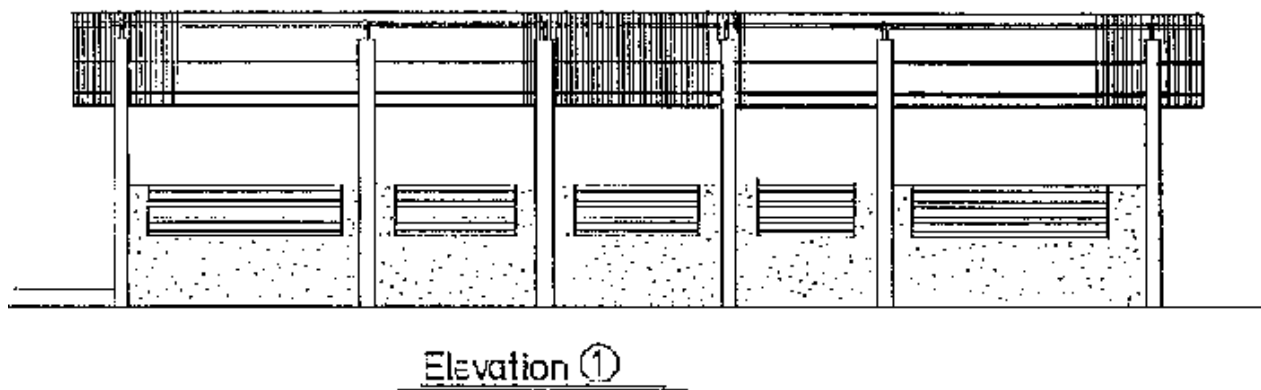
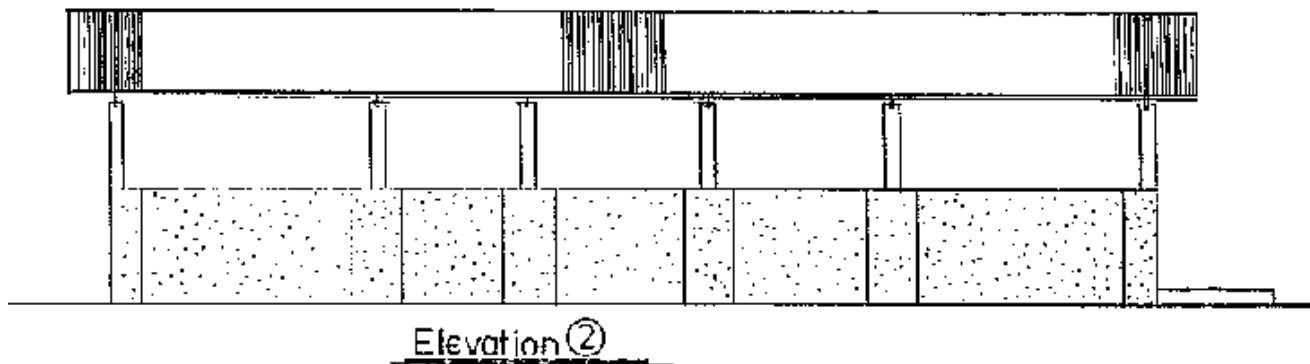

CAMARTEC		
5 Room Pigsty		
1:50	NOV. 1986	

Figure

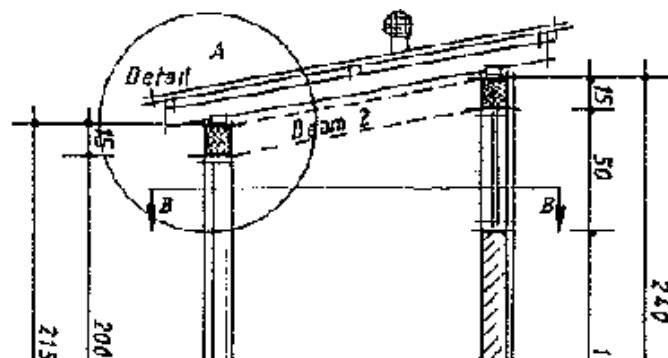

CAMARTEC
Biogas Latrine
2 Seats Drw No 3

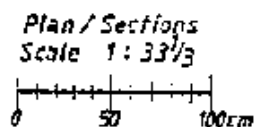

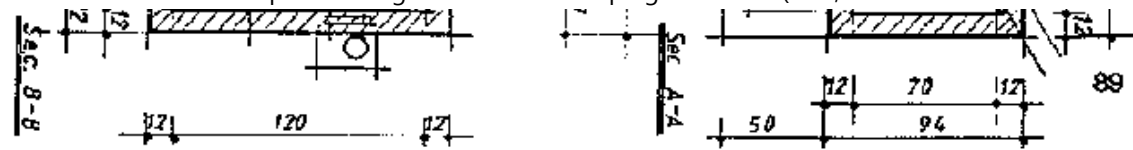

Figure

Foundation plan
Scale 1:50

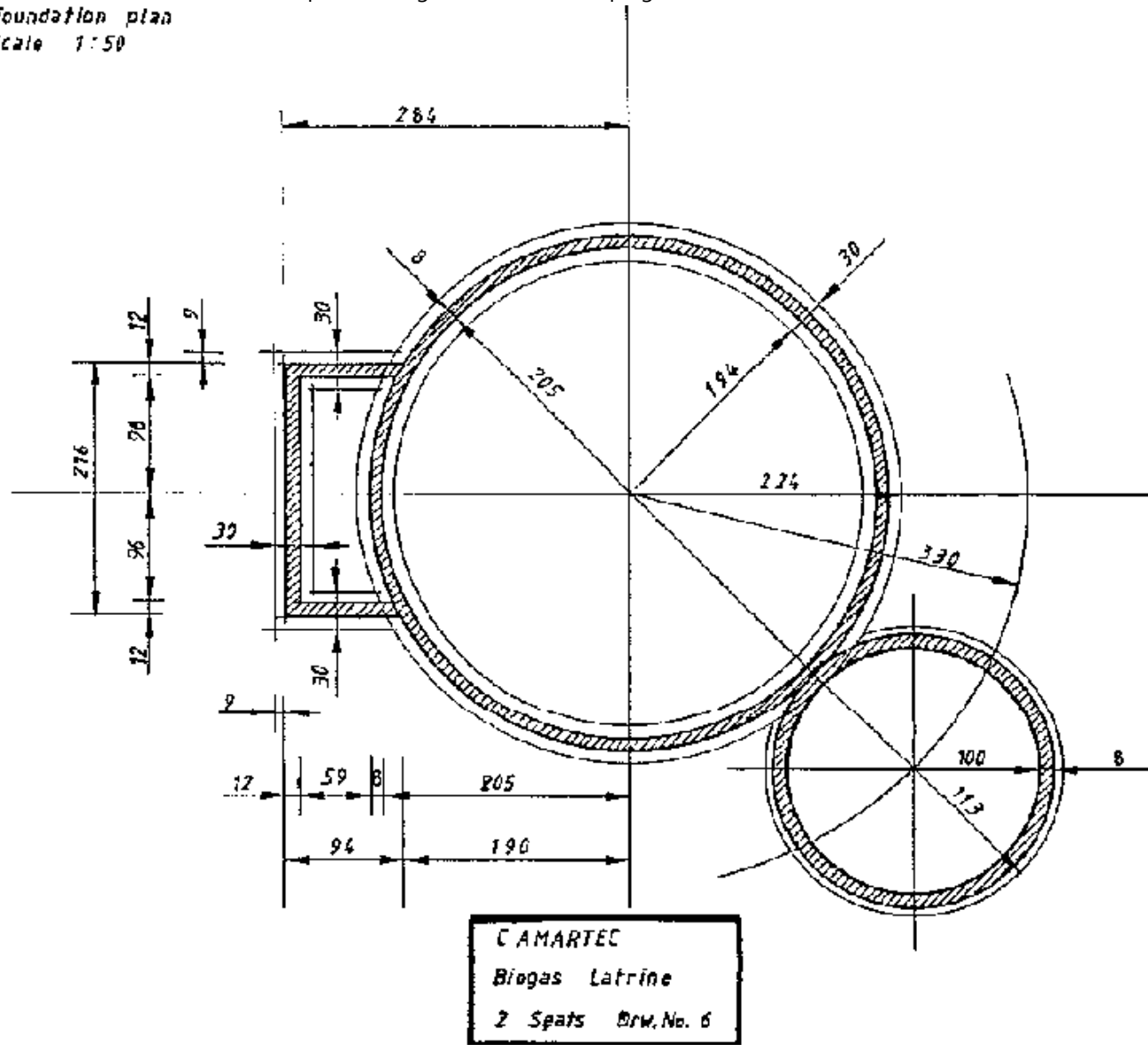

Figure

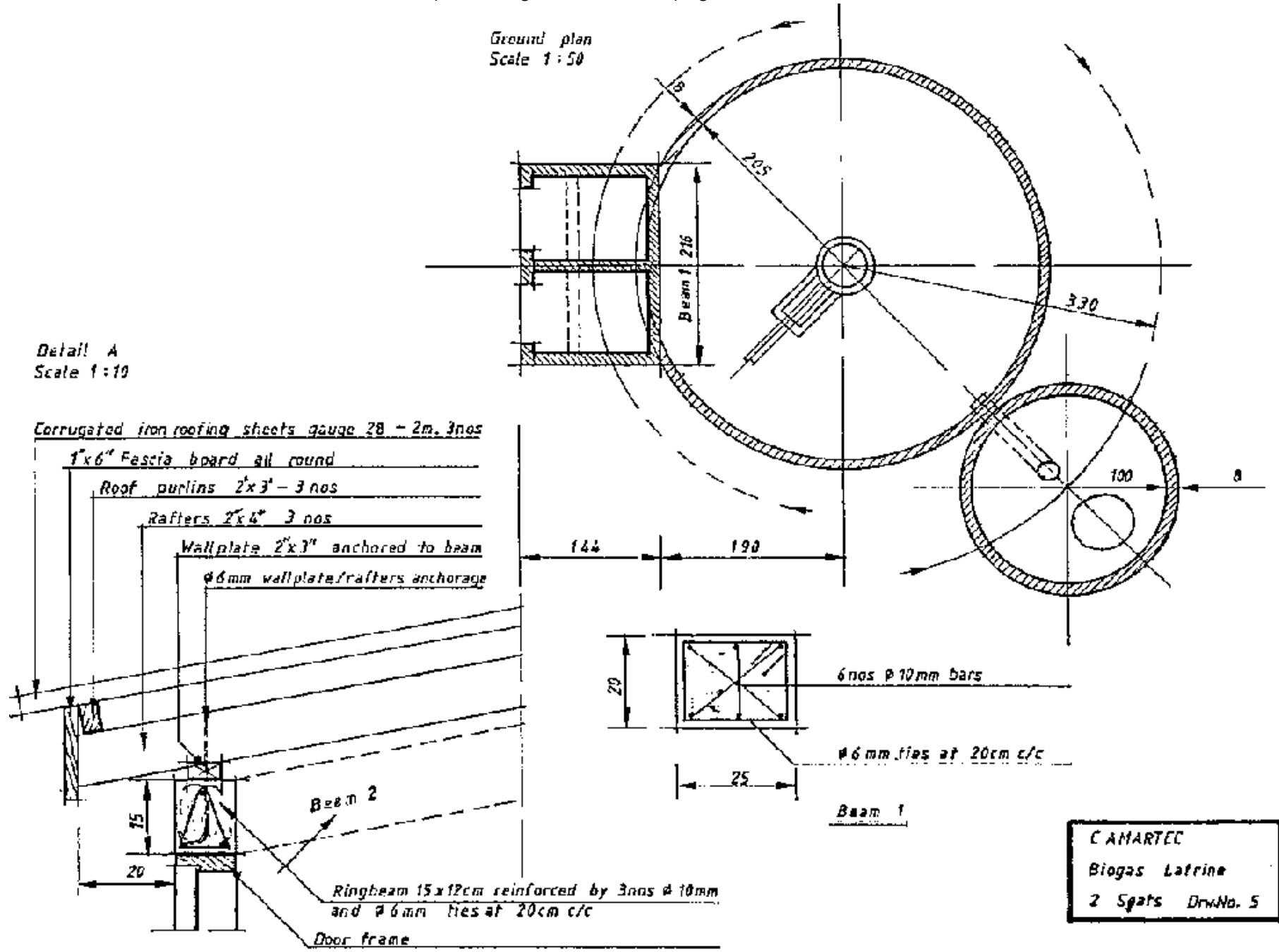

Figure

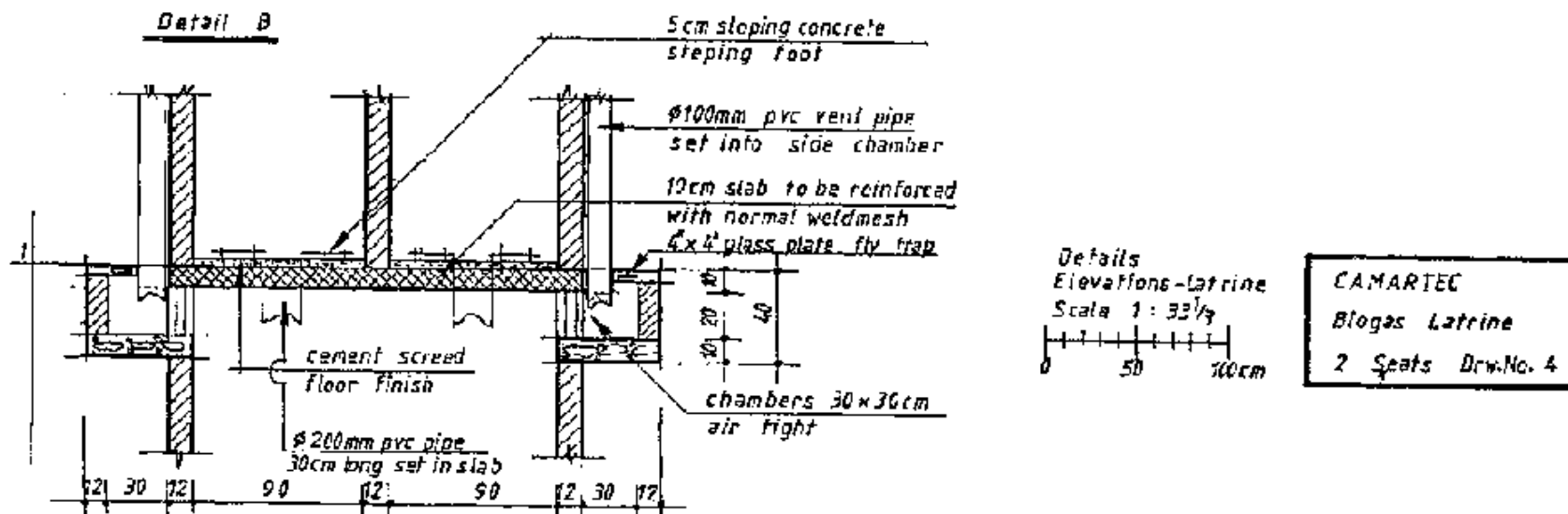
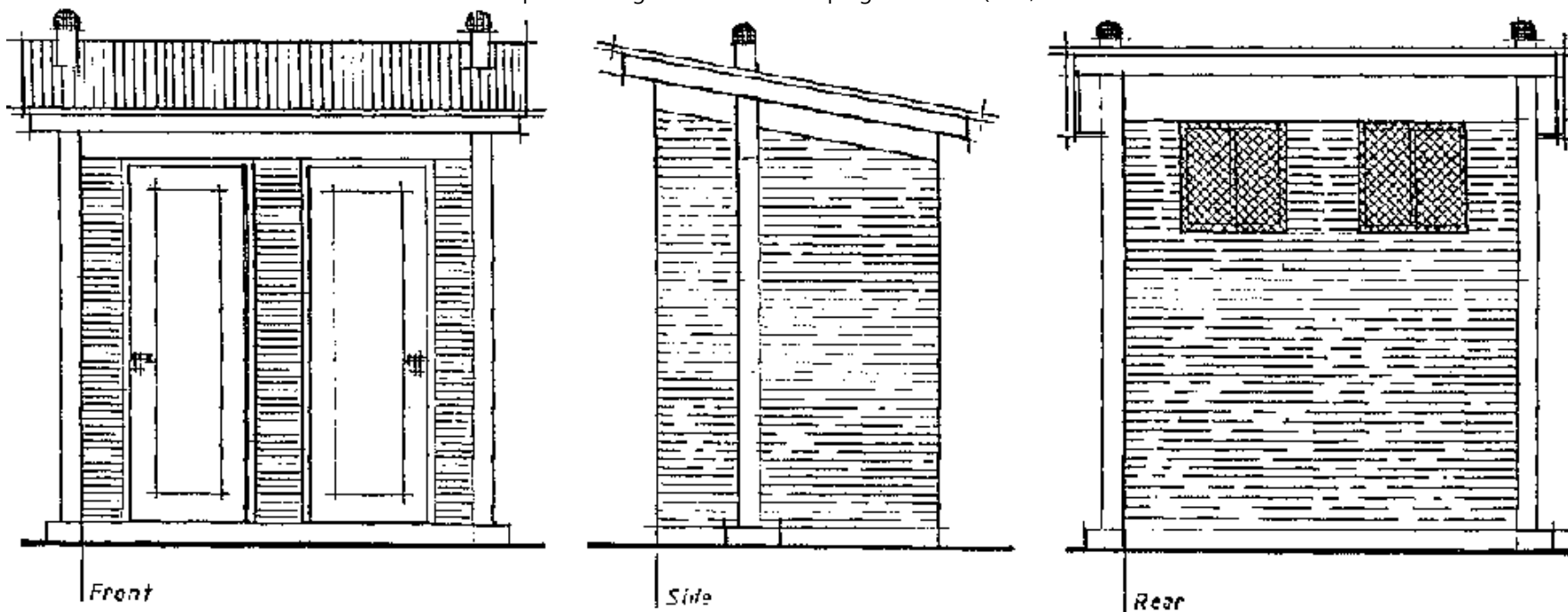

Figure

SQUARE AND CUBIC NUMBERS, GEOMETRICAL FORMULAE

n	n²	n³	n	n²	n³	n	n²	n³
1,00	1,00	1,00	2,00	4,00	8,00	3,00	9,00	27,00
1,05	1,10	1,18	2,05	4,20	8,62	3,05	9,30	28,37
1,10	1,21	1,33	2,10	4,41	9,26	3,10	9,61	29,79
1,15	1,32	1,52	2,15	4,62	9,94	3,15	9,92	31,28
1,20	1,44	1,73	2,20	4,84	10,85	3,20	10,24	32,77
1,25	1,56	1,95	2,25	5,06	11,39	3,25	10,56	34,33
1,30	1,69	2,20	2,30	5,29	12,17	3,30	10,89	35,94
1,35	1,82	2,48	2,35	5,52	12,98	3,35	11,22	37,60
1,40	1,96	2,74	2,40	5,76	13,92	3,40	11,56	39,30
1,45	2,10	3,05	2,45	6,00	14,71	3,45	11,90	41,06
1,50	2,25	3,38	2,50	6,25	15,63	3,50	12,25	42,88
1,55	2,40	3,72	2,55	6,50	16,58	3,55	12,60	44,74
1,60	2,56	4,10	2,80	6,76	17,58	3,60	12,98	46,66
1,85	2,72	4,49	2,65	7,02	18,81	3,65	13,32	48,63
1,70	2,89	4,91	2,70	7,29	19,68	3,70	13,89	50,85
1,75	3,06	5,38	2,75	7,56	20,80	3,75	14,06	52,73
1,80	3,24	5,83	2,80	7,84	21,95	3,80	14,44	54,87
1,85	3,42	6,33	2,85	8,12	23,15	3,85	14,82	57,07
1,90	3,51	6,86	2,90	8,41	24,39	3,90	15,21	59,32
1,95	3,80	7,41	2,95	8,70	25,67	3,95	15,60	61,63

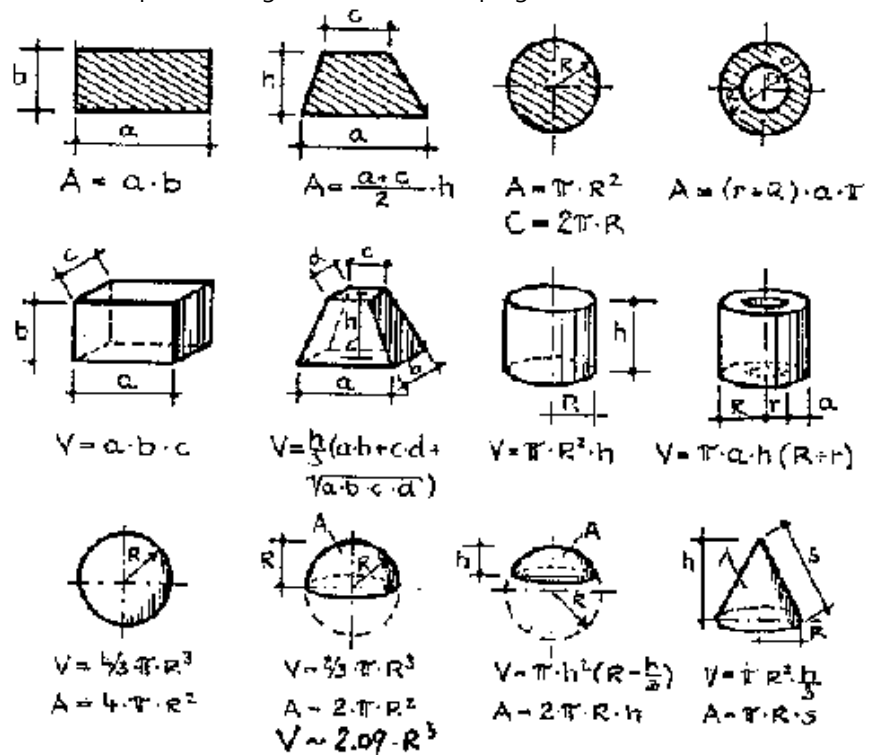

Figure

INFLUENCE OF ALTITUDE AND TEMPERATURE ON BIOGAS

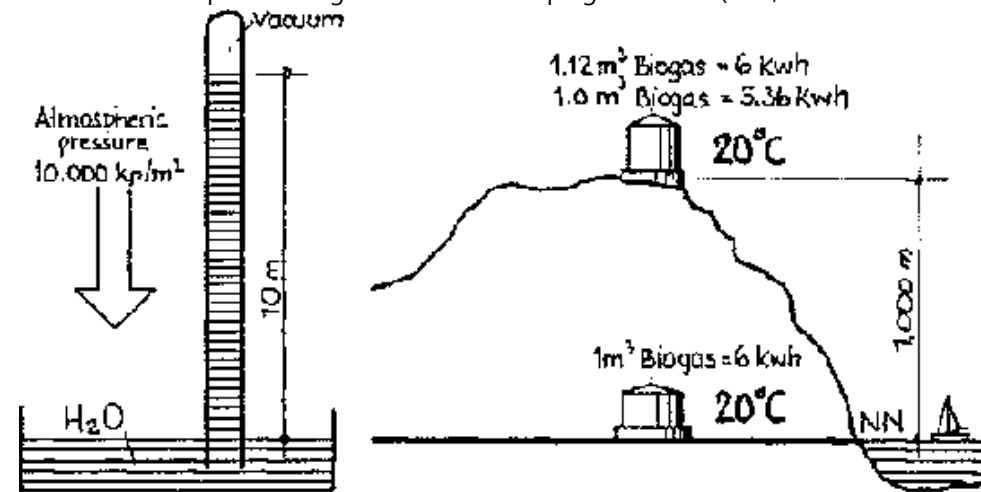

Figure

Examples:

The calorific value of biogas at sea level and 20°C is about 6 kwh/m³

Calorific value of biogas at sea level and 40°C:

$$= (6 \text{ kwh/m}^3 \cdot 273^\circ\text{C}) / (273^\circ\text{C} + (40^\circ\text{C} - 20^\circ\text{C})) = 5.59 \text{ kwh/m}^3$$

where: 273°C = absolute zero point of temperature

Calorific value of biogas 1,000 m above sea level and 20°C:

$$= (6 \text{ kwh/m}^3 \cdot 10,000 \text{ kp/m}^2) / (10,000 \text{ kp/m}^2 + (1,000 \text{ m} \cdot 1,2 \text{ kp/m}^3)) = 5.36 \text{ kwh/m}^3$$

where: 10,000 kp/m² = atmospheric pressure at sea level,

1,2 kp/m³ = density of air

Calorific value of biogas at 1,000 m above sea level and 40°C:

$$= (6 \text{ kwh/m}^3 \cdot 10,000 \text{ kp/m}^2 \cdot 273^\circ\text{C}) / [(273^\circ\text{C} + (40^\circ\text{C} - 20^\circ\text{C})) \cdot 10,000 \text{ kp/m}^2 + (1,000 \text{ m} \cdot 1,2$$

kp/m³)] = 4.99 kwh/m³

GAS PROPERTIES, CALORIFIC VALUES AND GAS CONSUMPTION

Properties of combustible gases						
Gas	Constituent value	Composition to air kwh/m³	Calorific speed= 1	Density requirement cm/sec.	Combustion m³/m³	Air
Methane	CH ₄	100	9.94	0.554	43	9.5
Propane	C ₃ H ₈	100	25.96	1.560	57	23.8
Butane	C ₄ H ₁₀	100	34.02	2.077	45	30.9
Natural Gas	CH ₄ ; H ₂	65;35	7.52	0.384	60	7.0
City Gas	H ₂ ; CH ₄ ; N ₂	50;26;24	4.07	0.411	82	3.7
Biogas	CH ₄ ; CO ₂	80 40	5.98	0.940	40	5.7

Biogas compared with other fuels

Fuel	Unit u	Calorific value kwh/u	Application	Efficiency%	Biogas equivalent m³/u	u/m³ biogae
Cow dung	kg	2.5	cooking	12	0.09	11.11
Wood	kg	5.0	cooking	12	0.18	5.56
Charcoal	kg	8.0	cooking	25	0.81	1.64
Hard coal	kg	9.0	cooking	25	0.59	1.45
Butane	kg	13.6	cooking	60	2.49	0.40
Propane	kg	13.9	cooking	60	2.54	0.39
Diesel	kg	12.0	cooking	50	1.83	0.55
Diesel	kg	12.0	engine	30	2.80	0.36

DIESEL	kg	12.0	ENGINE	50	2.00	0.50
Electricity	kwh	1.0	motor	80	0.56	1.79
Biogas	m ³	6.0	cooking	55	1	1
Biogas	m ³	8.0	engine	24	1	1

Examples of Biogas consumption

Household burner: 200 - 500 l/h

Some figures of gas consumption from India: Boiling 1 l of water: 40 l; boiling 5 l of water 165 l; cooking 500 grice: 140 l; cooking 1000 g rice: 175 l; cooking 350 g pulses: 270 l; cooking 700 g pulses: 315 l

Industrial burner: 1000 - 3000 l/h

Refrigerator (100 l volume): 30 - 80 l/h

Gas lamp: 120 - 180 l/h

Generation of 1 kwh electricity: 700 l

Biogas/Diesel engine per bhp: 420 l/h

FORMULAE FOR THE DIMENSIONS OF FIXED DOME PLANTS

Vs [l/day] volume of feed material

RT [days] wanted retention time

h [m] depth of expansion chamber = 0.45 m the overflow is in level with the peak of the sphere of the digester

VG [m³] wanted gas storage space

$$VG = r^3 \cdot 2.09 - (r - 0.45)^2 \cdot p(r - 0.15)$$

VD [m³] required digester volume

$$VD = (Vs \cdot RT)/1000$$

$$VD = (R^3 \cdot 2.09) - (VG/2) - 0.45^2 \cdot p(R - 0.45)$$

p [m] maximum gas pressure (= lowest slurry level)

$$p = a (0.45^2 \cdot p(R - 0.15) + VG) / (p \cdot (R - 0.30))$$

The real and active volume of the digester in fixed dome plants depends on the gas storage space actually utilized. This is normally not exactly known. Therefore, an approximate calculation of dimensions is sufficient. In the table below, the average digester volume VD is given which occurs with a chosen radius R. The relation between radius r and the volume of the expansion chamber (which is equal to the volume of the gas storage space) is based on a depth of the expansion chamber of 0.45 m. In order to keep the gas pressure below 1 m of W.C., the gas storage capacity should not exceed max VG.

Dimensions of Fixed Dome Plants				
	Digester		Expansion	chamber
R m	avg. VD m ³	max VG m ³	r m	VG m ³
1,50	5,10	2,50	0,90	1,05
1,80	5,30	3,00	1,00	1,31
1,70	8,00	3,00	1,10	1,61
1,80	10,00	3,50	1,20	1,93
1,90	12,00	3,50	1,30	2,29
2,00	14,00	4,00	1,40	2,66
2,10	17,00	4,00	1,50	3,07
2,20	19,00	4,50	(1.60)	(3.51)
2,30	22,00	4,50	(1.70)	(3.97)
2,40	25,00	5,00	(1.80)	(4.46)
2,50	29,00	5,00	(1.90)	(4.98)
2,60	32,00	5,50	(2.00)	(5.53)

2,70	37,00	6,00		
2,80	41,00	6,00	For VD >3.00 m ³ it is advisable to construct several chambers or expansion channels instead of spherical chambers	
2,90	46,00	6,00		
3,00	51,50	6,50		
3,10	57,00	7,00		
3,20	63,00	7,00		
3,30	69,00	7,50		
3,40	76,00	7,50		
3,50	83,00	8,00		

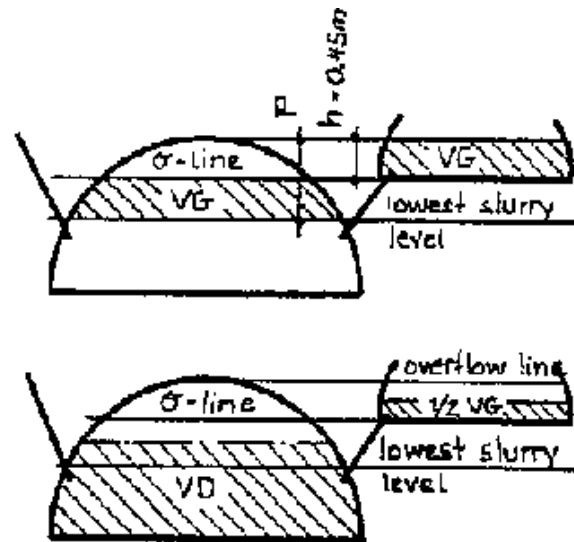

Figure

FORMULAE FOR THE DESIGN OF BIOGAS BURNERS

Starting Values

OR [kcal/h] prescribed heat requirement

VF [m³/h] fuel flow rate

h [m W.C.] prescribed gas pressure

Geometrical data

do [mm] = 2.1 (VF/h)

d [mm] = 6 · do

I max [mm] = 7 · d

I min [mm] = 1.35 · d

Gas pressure 0.60 m W.C. (fixed dome plants)

D [mm] = 1.25 · d

L [mm] = 1.20 · d

n [number] = 50 · do² (dH = 2.5 mm)

Gas pressure 0.10 m W.C. (floating drum plants)

D [mm] = 1.30 · d

L [mm] = 1.50 · d

n [number] = 20 · do² (dH = 2.5 mm)

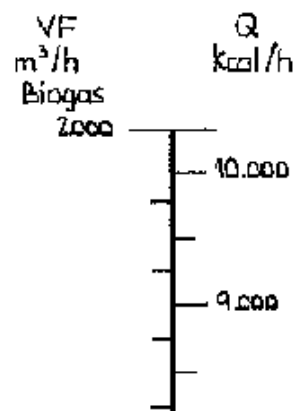

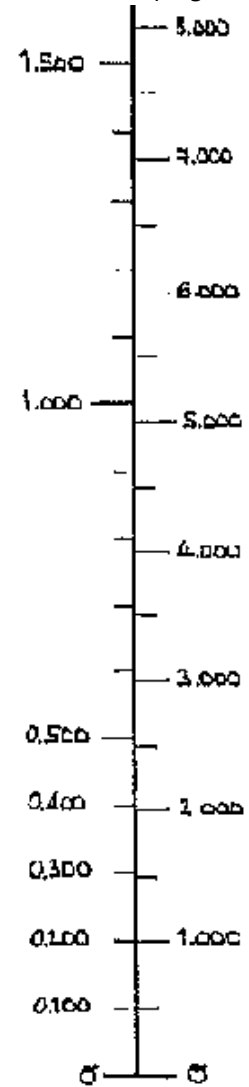

Figure

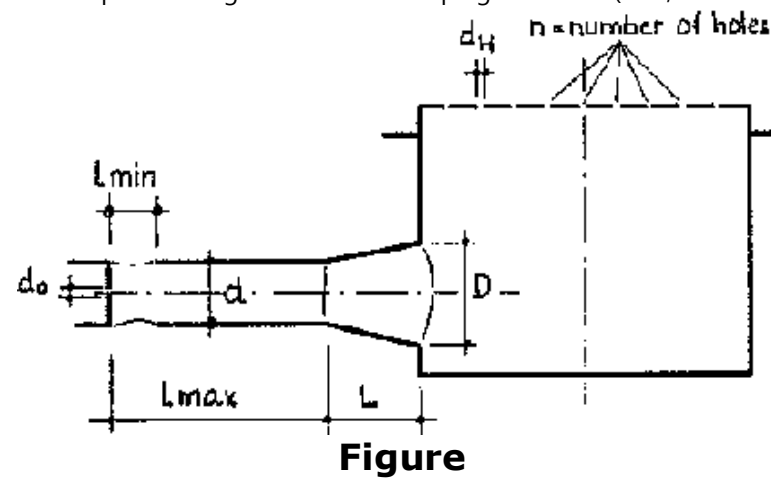



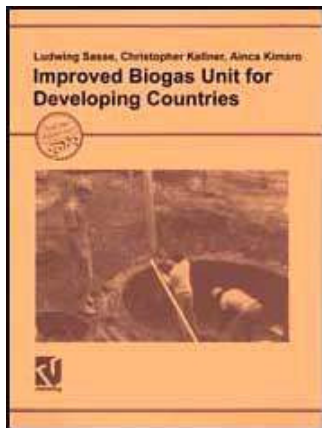

[Home](#) > [ar](#).[cn](#).[de](#).[en](#).[es](#).[fr](#).[id](#).[it](#).[ph](#).[po](#).[ru](#).[sw](#)



📖 Improved Biogas Unit for Developing Countries (GTZ, 1991, 98 p.)

- 📄 *(introduction...)*
- ➔ 📄 **Acknowledgments**
- 📄 **Foreword**
- 📄 **Acknowledgment**
- 📄 **1. Preface**
- 📄 **2. Why biogas ?**
- 📄 **3. Explanation of terms**
- 📄 **4. Biogas extension work**
- 📄 **5. The agricultural biogas unit**
- 📄 **6. Construction of the biogas plant**
- 📄 **7. Construction of cattle stable**
- 📄 **8. Construction of the pigsty**
- 📄 **9. The sanitary biogas unit**

-  **10. Use of slurry**
-  **11. Use of gas**
-  **12. Operation and maintenance**
-  **13. Pending technical issues**
-  **14. Appendix**

Acknowledgments

Deutsches Zentrum fr Entwicklungstechnologien- GATE

Deutsches Zentrum fr Entwicklungstechnologien - GATE - stands for German Appropriate Technology Exchange. It was founded in 1978 as a special division of the Deutsche Gesellschaft fr Technische Zusammenarbeit (GTZ) GmbH. GATE is a centre for the dissemination and promotion of appropriate technologies for developing countries. GATE defines "Appropriate technologies" as those which are suitable and acceptable in the light of economic, social and cultural criteria. They should contribute to socio-economic development whilst ensuring optimal utilization of resources and minimal detriment to the environment. Depending on the case at hand a traditional, intermediate or highly-developed can be the "appropriate" one. GATE focusses its work on the key areas:

- Dissemination of Appropriate Technologies: Collecting, processing and disseminating information on technologies appropriate to the needs of the developing countries: ascertaining the technological requirements of Third World countries: support in the form of personnel, material and equipment to promote the development and adaptation of technologies for developing countries.**
- Environmental Protection. The growing importance of ecology and environmental protection require better coordination and harmonization of projects. In order to tackle these tasks more effectively, a coordination center was set up within GATE in 1985.**

GATE has entered into cooperation agreements with a number of technology centres in Third World countries.

GATE offers a free information service on appropriate technologies for all public and private development institutions in developing countries, dealing with the development, adaptation, introduction and application of technologies.

Deutsche Gesellschaft fr Technische Zusammenarbeit (GTZ) GmbH

The government-owned GTZ operates in the field of Technical Cooperation. 2200 German experts are working together with partners from about 100 countries of Africa, Asia and Latin America in projects covering practically every sector of agriculture, forestry, economic development, social services and institutional and material infrastructure. - The GTZ is commissioned to do this work both by the Government of the Federal Republic of Germany and by other government or semi-government authorities.

The GTZ activities encompass:

- appraisal, technical planning, control and supervision of technical cooperation projects commissioned by the Government of the Federal Republic or by other authorities**
- providing an advisory service to other agencies also working on development projects**
- the recruitment, selection, briefing, assignment, administration of expert personnel and their welfare and technical backstopping during their period of assignment**
- provision of materials and equipment for projects, planning work, selection, purchasing and shipment to the developing countries**
- management of all financial obligations to the partner-country.**

Deutsches Zentrum fr Entwicklungstechnologien - GATE in: Deutsche Gesellschaft fr Technische Zusammenarbeit (GTZ) GmbH

**P. O. Box 5180
D-65726 Eschborn
Federal Republic of Germany**

Tel.: (06196) 79-0
Telex: 41523-0 gtz d
Fax: (06196) 797352

A Publication of Deutsches Zentrum fr Entwicklungstechnologien - GATE in: Deutsche Gesellschaft fr Technische Zusammenarbeit (GTZ) GmbH

The Authors:

Ludwig Sasse, constructional engineer and architect, is the biogas engineer of BORDA (Bremen Overseas Research and Development Agency), Bremen, Federal Republic of Germany. He wrote and illustrated the text in June 1991, in Arusha, Tanzania based on papers and contributions by the senior staff of the Biogas Extension Service of CAMARTEC:

Msafiri Athumani, construction and technology. Albert Butare, plant construction and appliances modification. Thomas Hoerz, rural energy and fertilizer utilization. Reimund Hoffmann, extension services and rural financing procedures. Christopher Kellner, agricultural and technical adviser to the BES. Ainea Kimaro, research and training of engineers and technicians. Sanford Kombe, privet entrepreneur, construction of biogas units. Mubezi Lutaihwa, agricultural structures, technologies and construction. Harold Ngowi, agriculture, research and organisational topics. Petro Omalla, bricks production, construction of biogas units and biolatrines. Alexander Schlusser, had been responsible for technology development and adaptation.

Home > [ar.cn.de.en.es.fr.id.it.ph.po.ru.sw](#)

 **Improved Biogas Unit for Developing Countries (GTZ, 1991, 98 p.)**

 **(introduction...)**

 **Acknowledgments**

 **Foreword**

 **Acknowledgment**

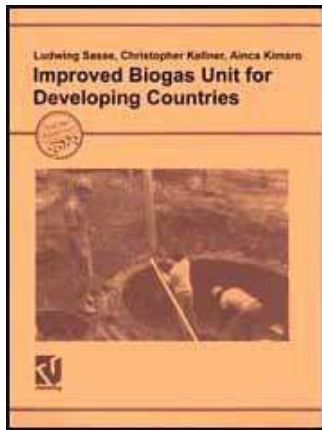

1. Preface
2. Why biogas ?
3. Explanation of terms
4. Biogas extension work
5. The agricultural biogas unit
6. Construction of the biogas plant
7. Construction of cattle stable
8. Construction of the pigsty
9. The sanitary biogas unit
10. Use of slurry
11. Use of gas
12. Operation and maintenance
13. Pending technical issues
14. Appendix

Foreword

Tanzania is facing energy problems in both urban and rural areas. Fuel wood is the major source of supply of energy in rural areas. CAMARTEC was established in order to develop alternative sources of energy among its other objectives

In the process of looking for International support to streng then its activities, the West Germany Government through GATE a branch of GTZ, accepted to establish a technical assistance to CAMARTEC that would deal with development and extension of renewable sources of energy which is BIOGAS. The Biogas Extension Service was then established in 1983.

The results that are seen today, are due to tireless effort by German experts and local counterparts who have designed, field tested and installed over 200 biogas units. The team has worked beyond the gas requirement to include slurry use for agricultural purposes. The technology has been accepted by farmers as indicated by their demand through willingness to pay

for the biogas units. The ownership of a family size biogas unit which is built through CAMARTEC has become a status symbol and has improved the quality of life in the home. Energy obtained from the gas and the light at night have both given utility to the owners of the plants.







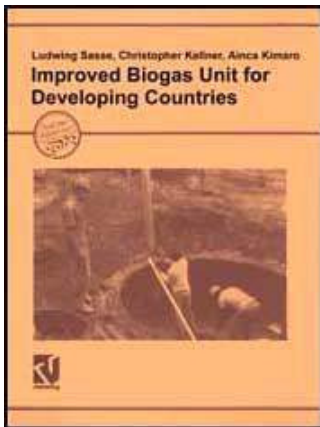



I am very thankful to GTZ for the assistance extended to CAMARTEC. I also appreciate the expatriates contribution towards the success reached so far. Tanzanian counterparts who work in the project also have contributed a lot and deserve my thanks. Lastly, I thank Mr. Ludwig Sasse for compiling this book which will be a useful reference material to many lovers of BIOGAS. I am looking forward to the use of the content embedded in the text and hope that his knowledge will contribute to solving Tanzania's rural energy needs.







**E.M. Ngaiza
DIRECTOR GENERAL
CAMARTEC**

[Home](#) > [ar](#).[cn](#).[de](#).[en](#).[es](#).[fr](#).[id](#).[it](#).[ph](#).[po](#).[ru](#).[sw](#)



Improved Biogas Unit for Developing Countries (GTZ, 1991, 98 p.)

-  **(introduction...)**
-  **Acknowledgments**
-  **Foreword**
-  **Acknowledgment**
-  **1. Preface**
-  **2. Why biogas ?**
-  **3. Explanation of terms**
-  **4. Biogas extension work**
-  **5. The agricultural biogas unit**
-  **6. Construction of the biogas plant**
-  **7. Construction of cattle stable**

-  **8. Construction of the pigsty**
-  **9. The sanitary biogas unit**
-  **10. Use of slurry**
-  **11. Use of gas**
-  **12. Operation and maintenance**
-  **13. Pending technical issues**
-  **14. Appendix**

Acknowledgment

I would like to thank the colleagues of CAMARTEC for their efficient and friendly cooperation while writing the text and preparing the drawings.





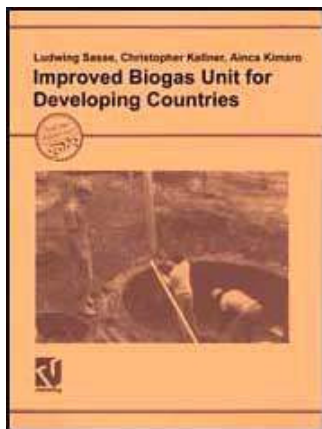

I am greatly indebted to Mwanaidi and Christopher Kellner who did everything possible to provide me a cosy home and a most suitable working place while staying in Arusha.











Ludwig Sasse

[Home](#) > [ar.cn.de.en.es.fr.id.it.ph.po.ru.sw](#)



Improved Biogas Unit for Developing Countries (GTZ, 1991, 98 p.)

-  **(introduction...)**
-  **Acknowledgments**
-  **Foreword**
-  **Acknowledgment**
-  **1. Preface**
-  **2. Why biogas ?**
-  **3. Explanation of terms**

-  **4. Biogas extension work**
-  **5. The agricultural biogas unit**
-  **6. Construction of the biogas plant**
-  **7. Construction of cattle stable**
-  **8. Construction of the pigsty**
-  **9. The sanitary biogas unit**
-  **10. Use of slurry**
-  **11. Use of gas**
-  **12. Operation and maintenance**
-  **13. Pending technical issues**
-  **14. Appendix**

1. Preface

This booklet reflects seven years of experience of the Biogas Extension Service (BES) of CAMARTEC (Centre for Agricultural Mechanization and Rural Technology) in Arusha/ Tanzania which was carried out in cooperation with Deutsche Gesellschaft fuer Technische Zusammenarbeit (GTZ), Eschborn, FRG, 1983 - 1986 as part of the Biogas Extension Programme and as part of the Special Energy Programme during 1983 1990.

We appreciate the patient cooperation of the farmers, especially during the starting phase of the programme when the technology was not yet mature.

This publication is meant as a teaching aid in agricultural colleges and as a reference book for professionals working in the field of rural biogas extension. For that reason, the ideal set-up of a biogas unit is described. The CAMARTEC Biogas Extension Service does not claim to have reached the ideal in practice, but has tried to achieve the maximum for the farmer with the least possible interference in their farm management. Used biogas plants are the best proof of an appropriate biogas unit.

Biogas Units have to be appropriate to the farmers condition. Therefore, the findings and







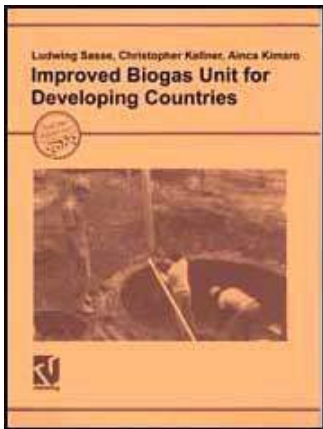



conclusions reported here, must be seen in context with the geographical and socio-economic situation of the project area. For the coffee-banana-beft of Arumeru District of Tanzania the fixed dome plant is the most appropriate. It does not require expensive steel for the gasholder and can be operated with a minimum of daily cars. It took the CAMARTEC team quite some time to come to a reliable structure and a user-friendly layout and design. The basic problems are solved, but minor improvements may still be possible. Beginners in biogas are advised to first follow the given standard design. A non appropriate but functioning solution is still better than an appropriate one which does not work reliable. Nevertheless, we hope that CAMARTEC's experience may encourage the reader to find appropriate solutions for her or his applicable location.







CAMARTEC Biogas Extension Service

Home > [ar.cn.de.en.es.fr.id.it.ph.po.ru.sw](#)



Improved Biogas Unit for Developing Countries (GTZ, 1991, 98 p.)

-  **(introduction...)**
-  **Acknowledgments**
-  **Foreword**
-  **Acknowledgment**
-  **1. Preface**
-  **2. Why biogas ?**
-  **3. Explanation of terms**
-  **4. Biogas extension work**
-  **5. The agricultural biogas unit**
-  **6. Construction of the biogas plant**
-  **7. Construction of cattle stable**

-  **8. Construction of the pigsty**
-  **9. The sanitary biogas unit**
-  **10. Use of slurry**
-  **11. Use of gas**
-  **12. Operation and maintenance**
-  **13. Pending technical issues**
-  **14. Appendix**

2. Why biogas ?

There are several alternatives to solve a farmers energy problem and there are different ways of manure management on a farm. Biogas might not be the best solution for all problems but it is one method to take care of many aspects. The biogas unit is a system in which the three components biogas plant, animal production and fodder grass plantation form a natural cycle.

Each of the three parts has direct benefits to the farmer and his economy:

- The animals generate income by supplying milk and meat.**
- The gasplant provides comfort and saves expenditure by supplying clean cooking and lighting fuel.**
- The fodder grass plantation creates sustainability by protecting the soil against erosion. Fodder plantation gives most profit from a small patch of land and often is less labour intensive than cutting fodder grass outside the farm. Beside the fodder grass, vegetables and fruits benefit the use of digested slurry as fertilizer.**

Biogas is Just a clever way of exploiting nature without -destroying it. Biogas optimizes farm economy. Biogas Plants support self-reliance and fit in concepts of sustainable development.

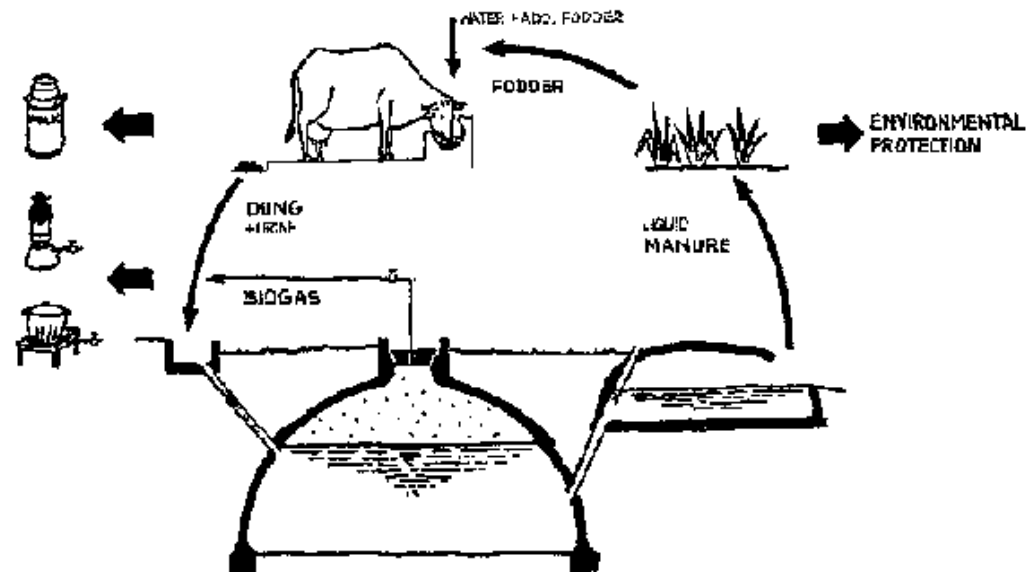
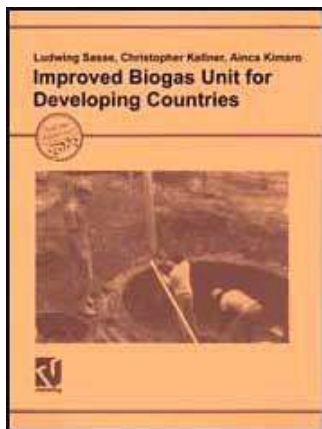













Fig. 1: The cycle of organic matter and the benefits of an agricultural biogas unit The animals provide dung to the biogas plant, the gasplant provides manure to the fodder plantation and the plantation provides feed to the animals. If enough water is given to the animals, no additional water is required for the biogas plant.

[Home](#) > [ar.cn.de.en.es.fr.id.it.ph.po.ru.sw](#)



Improved Biogas Unit for Developing Countries (GTZ, 1991, 98 p.)

- 📄 *(introduction...)*
- 📄 Acknowledgments
- 📄 Foreword
- 📄 Acknowledgment
- 📄 1. Preface
- 📄 2. Why biogas ?
- ➔ 📄 3. Explanation of terms

-  **4. Biogas extension work**
-  **5. The agricultural biogas unit**
-  **6. Construction of the biogas plant**
-  **7. Construction of cattle stable**
-  **8. Construction of the pigsty**
-  **9. The sanitary biogas unit**
-  **10. Use of slurry**
-  **11. Use of gas**
-  **12. Operation and maintenance**
-  **13. Pending technical issues**
-  **14. Appendix**

3. Explanation of terms

Biogas

Biogas is produced by bacteria during digestion or fermentation of organic matter under airless condition (anaerobic process). The gas consists mainly of CH₄ and CO₂. This mixture of gases is combustible if the methane content is more than 50%. Biogas from animal dung contains approx. 60% methane.

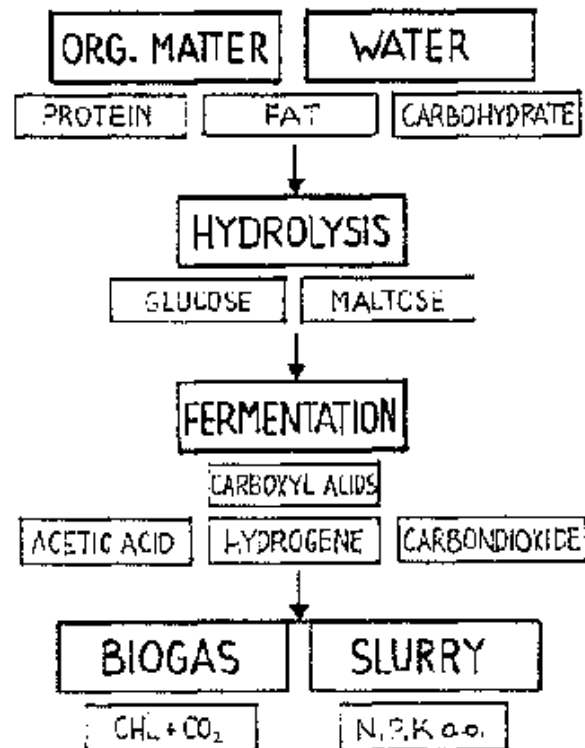

Fig. 2: The big-chemical process of anaerobic digestion The different groups of bacteria responsible for fermentation live in an interacting eco-system. Each type of bacteria depends on others. The fermentation time is shortest when populations of different bacteria are adequately balanced.

Slurry

In practice, the term slurry is used for the digester content or the digested substrate flowing out of the plant. In digesters observed by CAMARTEC, slurry is found in different conditions inside the digester:

- a light and rather solid fraction, mainly straw or fibrous particles, which float to the top forming the scum
- a very liquid, watery fraction remaining in the middle layer of the digester

- a viscous fraction below which is the real slurry or sludge
- heavy solids, mainly sand and soil particles which rest at the bottom.

Slurry separates less if the feed material is homogeneous and the TS-content is high.

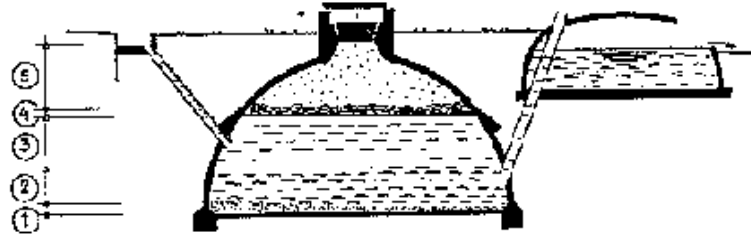

Fig. 3: Slurry condition inside the CAMARTEC digester (1) Settlement of sand and soil. (2) Viscous slurry or sludge, having a TS-content of 6-7%. (3) Liquid slurry fraction, having a TS-content of 12%. (4) Floating scum, having a TS-content between 15 and 50 %. (5) Biogas.

Biogas Technology

Biogas Technology includes everything which is needed to produce and utilize the products of anaerobic digestion which are biogas and manure. Beside energy and fertilizer. other benefits of biogas technology are improved sanitation and environmental protection. The conditions to produce biogas are:

- digestable substrate, i.e. organic matter plus water
- a vessel where the substrate is not in contact with air
- a digestion temperature between 15°C and 35°C
- a retention time longer than 30 days to allow the bacteria to produce the biogas. (The retention time is considerably reduced in industrial high-tech plants).

If methane producing bacteria are already present in the substrate (e.g. in dung from ruminants), biogas production begins within 3 to 5 days. At the farm site. biogas plants are filled slowly and gas production is used only after the plant has been filled completely. If there are problems with certain substrate starting the gas production, 20% of cattle dung should be mixed in the first

filling as a starter.

Gas Production

The gas production potential of a certain substrate is high when organic matter content is high and the C/N ratio ranges from 20: 1 to 40: 1. The speed of the gas production depends further on the physical properties of the substrate and the temperature (optimum at 35°C). Dry and fibrous material takes longer to digest than fine-structured and wet substrate. Favoured total solid (TS) contents of the undigested substrate are between 7% and 11% which is approximately reached if dung is mixed with an equal volume of water or urine. A healthy digestion process shows a pH of 7.0 (neutral stage of substrate).

Biogas Plant

A biogas plant consists of the digester and the gas storage space. A continuous gas plant is charged and discharged regularly, e.g. every day. A batch-plant is filled once and emptied only after the material has been digested. A normal farmers biogas plant is a continuous plant with automatic discharge at the overflow.

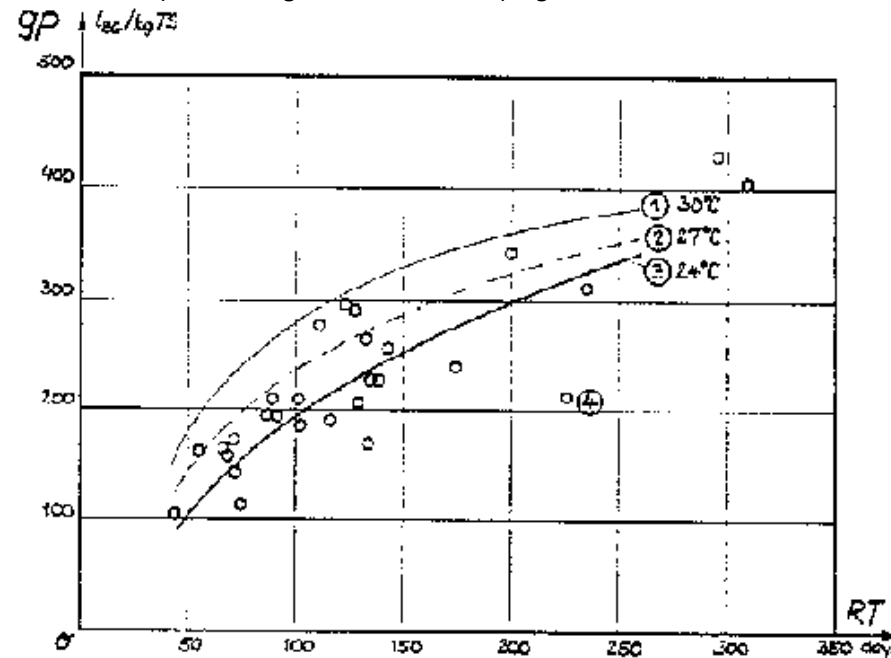

Fig. 4: Relation of gas production and retention time

The daily gas production (gp) is measured in litre of biogas produced by 1 kg of total solids (TS) added per day. The total solids content of fresh cattle dung is 15-25 %. The retention time (RT) is the calculated period of days the substrate remains in the biogas plant before it reaches the overflow. The gas production per day depends on the slurry temperature.

Curve (1) is taken from different sources at 30°C, mainly from India. Curve (2) shows results from field research by UNDARP/BORDA in India on floating drum plants at a temperature of 27°C. Curve (3) is the average gas production with CAMARTEC fixed dome plants at 24°C average digester temperature. The points (4) show some selected samples of CAMARTEC plants of average performance, recorded during the BORDA Biogas Survey 1988. Performance is defined as daily gas production per square root of the total solid content of the daily fed substrate times the active digester volume ($gp \cdot (TS \cdot VD)^{-0,5}$).

Biochemical problems are rare, even in simple gasplants. Technical problems may occur with immature designs and unsuitable, i.e. scum forming, feed material. There are three well

performing and mature designs available which are suitable for farm households:

- **The fixed dome plant**
- **the floating drum plant**

- **the plastic covered ditch.**

In most large scale extension programmes fixed dome plants have been chosen for dissemination because they are long lasting and cheaper than the floating drum plant. Fixed dome plants need the least maintenance of all other types. But building them requires great care in design and workmanship. Once they are constructed well, they are robust and of reliable performance.

The size of the digester depends on the required digester volume (VD) which is found by multiplying the wanted retention time (RT) with the volume of daily fed substrate (VS). In fixed dome plants, the active digester volume is defined by the digester volume below the zero-line, minus half the expansion chamber volume below the overflow line.

The gasholder volume (VG) depends on the daily gas production and the pattern in which the biogas is used. If gas consumption is regular and equally distributed over day and night and from day to day, gas storage space can be small. Irregular and rather concentrated gas consumption demands larger gas holder.

Experimental biogas plants for schools can be made out of 4 kg paint-tins (Ø 17,5 cm) and 2 kg milk powder tins (Ø 15 cm). The gas valve of such a floating drum model is made by a U-pipe filled with water. For gas release, the water is drained off and must be re-filled for closing the valve again.

Fixed Dome Plant

In fixed dome plants the gas is stored in the upper part of the rigid digester structure. Fixed dome plants are sometimes called "Chinese" or "hydraulic" digesters. The accumulating gas needs room and pushes part of the substrate into an expansion chamber, from where the slurry flows back into the digester as soon as gas is released. The volume of the expansion chamber is equal to the

volume of gas storage. Gas pressure is created by the difference of slurry levels between the inside of the digester and the expansion chamber. The main building material is plastered brickwork.

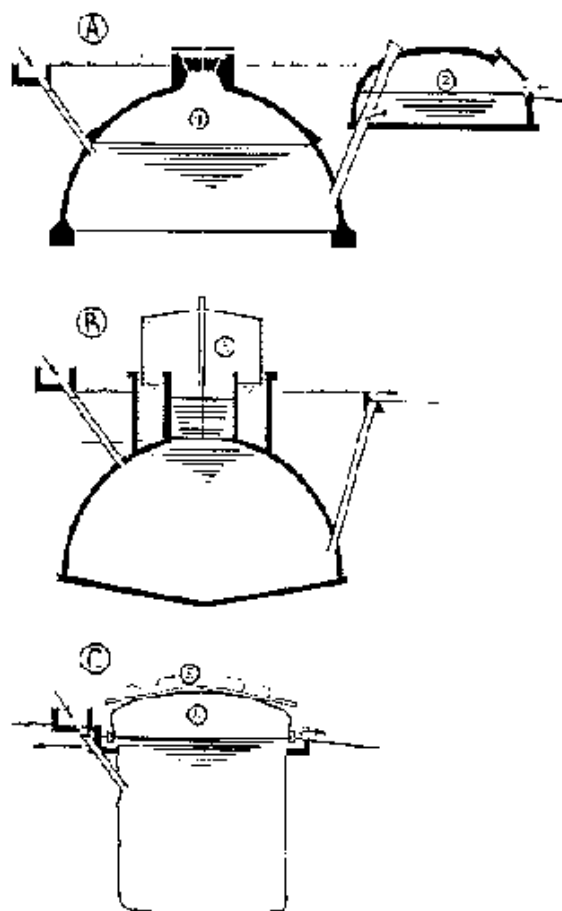

Fig. 5: Small-scale biogas plants for rural areas in tropical countries

(A) Fixed dome plant. The gas collects in the upper part of the digester(1) and displaces the slurry into the expansion chamber(2).

(B) Floating drum plant. The gas collects in a floating steel gas holder (3) which rises according to the volume of gas production.

(C) Plastic covered biogas plant. The gas is collected under an inflating plastic cover (4). A wooden roof (5) protects the plastic against sunlight and increases the gas pressure by its

weight.

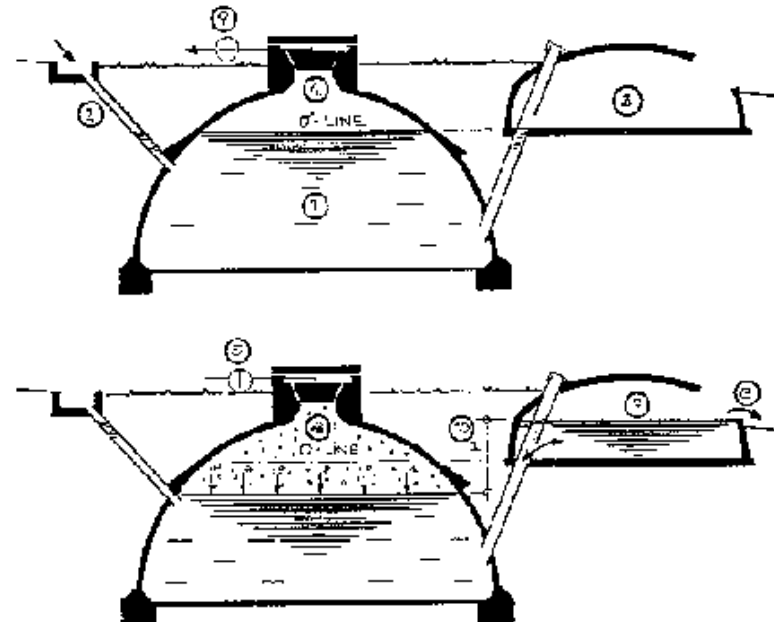

Fig. 6: System of the fixed dome plant

The digester (1) is filled via the inlet pipe (2) up to the bottom level of the expansion chamber (3). The level of original filling is called the zero line. The gasplant is closed by a gas-tight lid (4). Under the airless (anaerobic) condition, biogas is produced. When the gas valve (5) is closed, biogas collects in the upper part of the digester, called the gas storage part (6). The accumulating gas displaces part of the slurry into the expansion chamber. When the expansion chamber is full, slurry overflows into the slurry drain for use as manure. When the main valve (9) is opened, the gas escapes off the gas storage part until the slurry levels inside the digester and inside the expansion chamber balances. The gas pressure "p" depends on the prevailing difference of the slurry levels (10).

The substrate is filled daily so that slurry flows out daily at the time when large amount of gas is stored. Regular gas consumption requires smaller gas storage space. Consequently, the zero-line will rise. While daily feeding of the plant continues, gas is released before the slurry reaches the overflow level. The slurry level rises also when there is gas leakage. The level in the expansion

chamber at zero gas pressure indicates the level of the zero line. The volume of slurry above the zero line inside the expansion chamber is equal to the gas storage space.

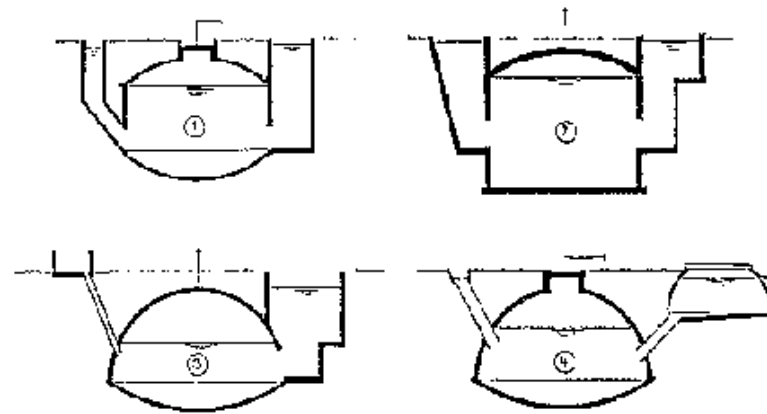

Fig. 7: Different models of fixed dome plants Fixed dome plants originate from China and were built already before 1960. Several variations with or without a removable cover at the top have been developed. (1) Biogas plant from Chengdu/China; (2) Janata Plant from India; (3) Dheenbandhu Plant of AFPRO from India; (4) Modified BORDA plant from Cankuso in Burundi..

Biogas Unit

The terminus "biogas unit" should underline the importance of integrated planning when applying biogas technology. The biogas unit describes the total package offered to the farmer in connection with biogas extension work. The main components are: The biogas plant itself, the stable, the toilet, the slurry storage pit, the slurry distribution canals, the gas piping system, the appliances and the tools to handle the substrate. In individual cases other components could as well be part of the biogas unit, for example, rain water tanks, fish ponds, compost pits, demonstration fields, gas generators or engines with their attachments, etc., etc. one may distinguish between agricultural biogas units and sanitary biogas units.

The big-latrines is the centre part of a sanitary biogas unit. The septic tanks of big-latrines are designed as integrated fixed dome biogas plants. Sanitary aspects, i.e. rather maintenance-free but clean toilets, are more important than a high gas production.

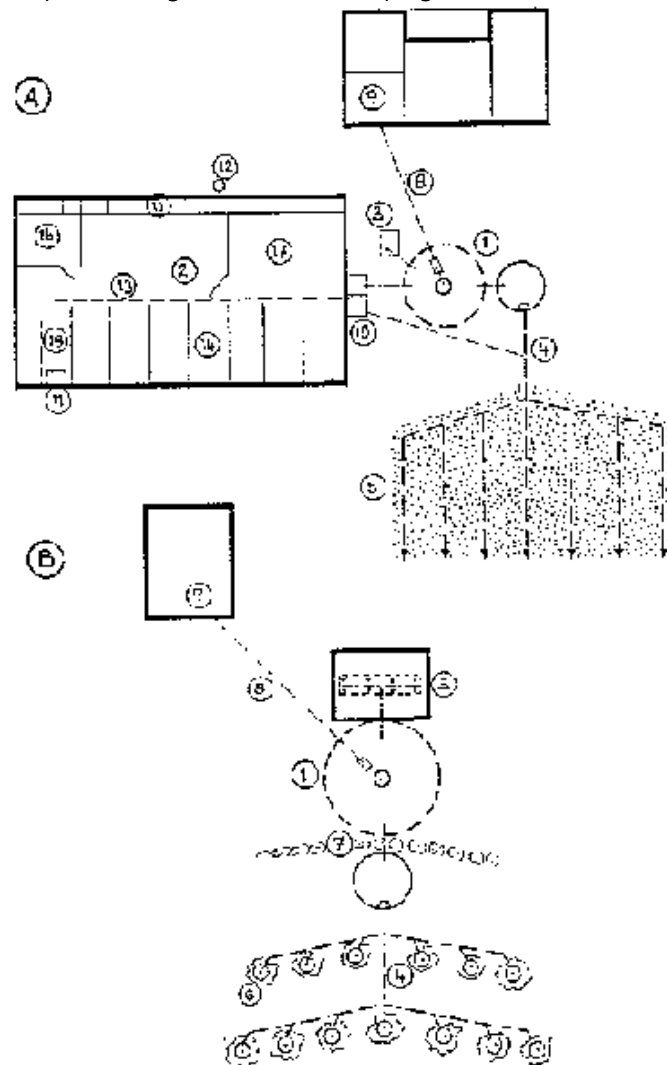

Fig. 8: Principal lay-out.(A) Agricultural Unit; (B) Sanitary unit

(1) Biogas plant; (2) Cattle stable; (3) Toilet; (4) Slurry distribution system; (5) Fodder grass or vegetable plantation; (6) Shrub or tree plantation; (7) Hedge between public area and slurry area; (8) Gas pipe; (9) Place of gas consumption; (10) Dung and urine collection chamber; (11) Fodder trough; (12) Chaffing block; (13) Urine drain (14) Sleeping boxes; (15) Milking stand; (16) Calves' box; (17) Exercising area, separated for cows and heifers.

Biogas Appliances

Biogas Appliances are pieces of equipment for utilizing the energy of the gas. Either special biogas appliances are used or LPG equipment is adapted. Biogas is mainly used in stoves for cooking and in gas lamps for lighting. Frequently, refrigerators and incubators, coffee roasters, baking ovens and water heaters, chicken or piglet heaters, Power engines for milling or generating electricity are fuelled with biogas.







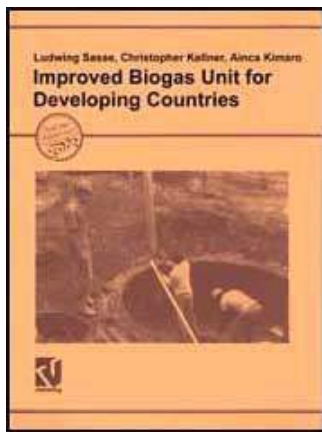

Biogas Extension Service









The biogas extension service (BES) comprises of the organization, the staff and the logistic needed to work for the extension of biogas technology. The BES might be a governmental body, a non-governmental voluntary or commercial organisation or a development project of international cooperation. Normally, the costs for the superstructure of the extension work are not included in the price the gasplant owner has to pay. Because of the benefits for the society as a whole it is justifiable to cover the cost of the superstructure from public funds.

[Home](#) > [ar](#).[cn](#).[de](#).[en](#).[es](#).[fr](#).[id](#).[it](#).[ph](#).[po](#).[ru](#).[sw](#)



Improved Biogas Unit for Developing Countries (GTZ, 1991, 98 p.)

-  **(introduction...)**
-  **Acknowledgments**
-  **Foreword**
-  **Acknowledgment**
-  **1. Preface**
-  **2. Why biogas ?**
-  **3. Explanation of terms**
-  **4. Biogas extension work**
-  **5. The agricultural biogas unit**

-  **6. Construction of the biogas plant**
-  **7. Construction of cattle stable**
-  **8. Construction of the pigsty**
-  **9. The sanitary biogas unit**
-  **10. Use of slurry**
-  **11. Use of gas**
-  **12. Operation and maintenance**
-  **13. Pending technical issues**
-  **14. Appendix**

4. Biogas extension work

General

The following chapter describes extension work within the framework of a project dealing exclusively with biogas units. But most of the points are also relevant when biogas extension is promoted within more general development programmes.

Target Group

The target group of a rural biogas extension programme are farms having at least 50 kg of cattle dung (or 35 kg of pig droppings) available per day' which means they have at least three milk cows or 10 adult pigs fully stable bound, or nine heads of local cattle half stable bound There are several conditions to be fulfilled before a farmer of the target group becomes a customer:

- He has to have enough income to buy a plant or repay a loan.**
- He must be educated enough to understand the system.**
- He must know about biogas and its suitability for his individual case.**
- He must have easy access to sufficient water.**
- He has no real fuel alternatives.**

Standardization

Standardization means to define exactly and restrictives the materials, measurements and methods off the work. Given standards must be clear and universalIy adabtible.

Technical standardization is needed because it can not be expected that an artisan or farmer will fully understand the essentials of a biogas unit. Biogas plants are easy to construct but difficult to comprehend totally. Artisans must be trained to precisely observe all details and methods of construction. This is especially important for extension programmes that aim at handing-over the construction activities to the private sector, where permanent quality control is difficult. It should also be mentioned, that management training of artisans is needed to improve the efficiency of the enterprise and thus the quality of workmanship).

A farm benefits from a biogas plant if the plant works trouble free, gas and slurry are used profitably and operation of the plant is comfortable and easy. In fact feeding the plant must be less labour intensive than not feeding the plant. This user-oriented approach leads to a standardized biogas plant, if possible, connected to a standardized stable which are integrated as much as possible into the existing farm economy.

Strategy

The final goal of the extension project is to have independent artisans who construct standardized biogas units on demand of independent farmers against appropriate payment. connection to zero-grazing units is favoured.

Each biogas extension project starts by building demonstration units at selected farms which might be fully subsidized. The farmers must be willing to cooperate with the biogas extension service by allowing potential customers to visit their installations. It is most important that those farmers maintain and utilize their gasplants well.

After sufficient number of demonstration units have been installed, further biogas units are only constructed on demand and against full payment. Payment is usually done in 2 to 3 instalments. It is helpful to have standardized procedures for application, payment and realization of the

construction (see sample of forms in the appendix).

When a potential customer first comes to the Biogas Extension Office he is given general informations including a price list. He is asked to file a written request which describes his farm and the proposed site of construction. Then the site is visited by BES-staff, assessments are made, technical details are worked out and a fixed price is given to the farmer.

After a contract agreement has been signed and a 50% down payment has been made, the biogas unit will be erected by trained private contractors under supervision of BES-technicians. When the construction is finished, the plant has been filled. appliances are connected and the final payment has been made, the unit is legally handed over to the customer. The customer receives a user manual, detailed explanations about plant operation, gas and slurry utilization and maintenance in his specific case. The customer is also given a set of tools and equipment for cleaning the stable, chopping the fodder and handling the slurry.

The main points of instruction are:

- to keep the overflow free from slurry**
- to check the water trap from time to time, especially when there is no gas available for consumption**
- to clean the burner regular like other cooking vessels**
- to poke from time to time the inlet and outlet pipe, especially if substrate does not enter the plant**
- how to change the mantle of the gas lamp**
- the meaning of the slurry level in the expansion chamber**
- where to turn to in case of problems the farmer cannot solve himself**

The biogas unit is then visited once a month until the persons attending the plant are acquainted

with the daily routine work and the utilization of gas and slurry.

Advertisement

As a principle, the farmer should decide freely whether he wants to have a biogas unit or not. Therefore, advertisement means mainly information and awareness building. Image cultivation is also a part of the publicity work. The biogas unit is presented as a clever way of running a modern farm unit. Well operated biogas units are the best advertisement.

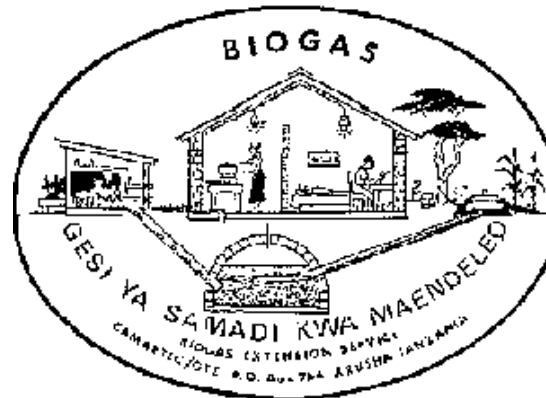

Fig. 10: A Biogas sticker used by CAMARTEC for advertising

Special Requests

Besides the standard applications for biogas plants there will always be special requests for individual solutions reaching the Biogas Extension Service. Special requests often demand individually designed units which differ either in size or proposed utilization of gas or slurry. The BES has to keep planning and supervising capacity for such services' because they often are requested by VIPs (Very Important Persons) who are important for the support of the biogas programme.

Research and Development

In addition to standardization, research and development needs will arise from the project activities. New ideas have to be tried out which will disturb the standardized routine. To minimize







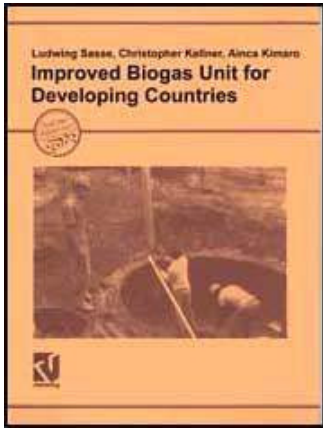







problems and preserve the standard of quality of construction, innovations and modifications should be restricted to a few that really improve the performance of the biogas unit or eliminating severe short-comings.

As for CAMARTEC, the most important research was the development of the weak-ring and the strong-ring. Tests on reducing the requirements for gas-tight plaster are under way. Own appliances have been developed and others from outside have been tested. A bench-scale test has been carried out to define the flow of slurry inside the digester more exactly.

[Home](#) > [ar.cn.de.en.es.fr.id.it.ph.po.ru.sw](#)



Improved Biogas Unit for Developing Countries (GTZ, 1991, 98 p.)

-  **(introduction...)**
-  **Acknowledgments**
-  **Foreword**
-  **Acknowledgment**
-  **1. Preface**
-  **2. Why biogas ?**
-  **3. Explanation of terms**
-  **4. Biogas extension work**
-  **5. The agricultural biogas unit**
-  **6. Construction of the biogas plant**
-  **7. Construction of cattle stable**
-  **8. Construction of the pigsty**
-  **9. The sanitary biogas unit**
-  **10. Use of slurry**
-  **11. Use of gas**

**12. Operation and maintenance****13. Pending technical issues****14. Appendix**

5. The agricultural biogas unit

General

Most faults in biogas units are caused by planning mistakes. Siting of the biogas plant and layout of the biogas unit is as Important as the construction Itself. A good biogas plant at the wrong place Is a useless installation. Similarly, filling a plant with unsuitable material will result In an unproductive unit. Careless planning of the site may require unnecessarily additional structures or cause further labour input. Thorough inspection and assessment of site are preconditions for a profitably functioning biogas unit. This is especially true when using standardized structural elements;

Survey of Site

BES staff first check the proposed feed material for its suitability. After observing the overall environment of the farm, the master plan of the biogas unit is made on the spot In cooperation with the persons having decision making power at the farm. The technician must check if the space Is sufficient and must take the levels of the proposed structures. Planning the utilization of slurry is probably the most Important point to be discussed at the first site meeting with the farmer. The cost of the slurry distribution system should be calculated and made known to the farmer before starting the construction.

To allow swift construction work, access for transport and place for storage of material and excavated soil must be clear before starting. The farmer must be informed about providing approx. 500 l of water per day during the building period for masonry and concrete construction. There must also be agreement as to which building materials are to be provided by the farmer and which quality requirements are to be observed.

The BES staff writes a report about the findings and assessments and gives reasons for decisions

made at site. This is required to keep colleagues at the BES headquarter informed. Such records are also helpful In case of customers trying to save money by constantly complaining about the plant's performance.

Tools and equipment

There are three essential tools which are given to the farmer because they are part of the biogas unit:

-The dipper to scoop urine and water from the urine chamber into the mixing chamber and to take out and pour slurry in case of compost preparation. Several designs have been tested. The most durable solution was found to be a dipper made from a 6" plastic pipe and a 1,30 m long wooden handle. The handle passes through both rims of the pipe and is fixed with a nail to the upper rim. Dippers from metal proved to corrode quickly and handles fixed on a shaft broke within a short time.

-The squeegee is used to clean the stable floor with only a little water, pushing the urine into the urine chamber and the solids into the mixing chamber.

-The chopping block is needed to chaff the fodder with a panga (machete). Chaffed grass Is eaten completely by the animals without leaving the stems or allowing them to be tossed out of the trough where they would mix with the dung and might block the biogas plant. The chopping block can be a standing solid log of wood but it is better to use the wood across the fibre to avoid the knife getting stuck. Truck tires have proofed to be an elegant solution Instead of wooden blocks because the knife Jumps up by itself when chaffing the grass. Mechanical chaff-cutters are, of course, an even better solution.

As farmers are not aquatint with this kind of equipment, It is best to provide these in order to stress the importance for adequate operation of the biogas unit.

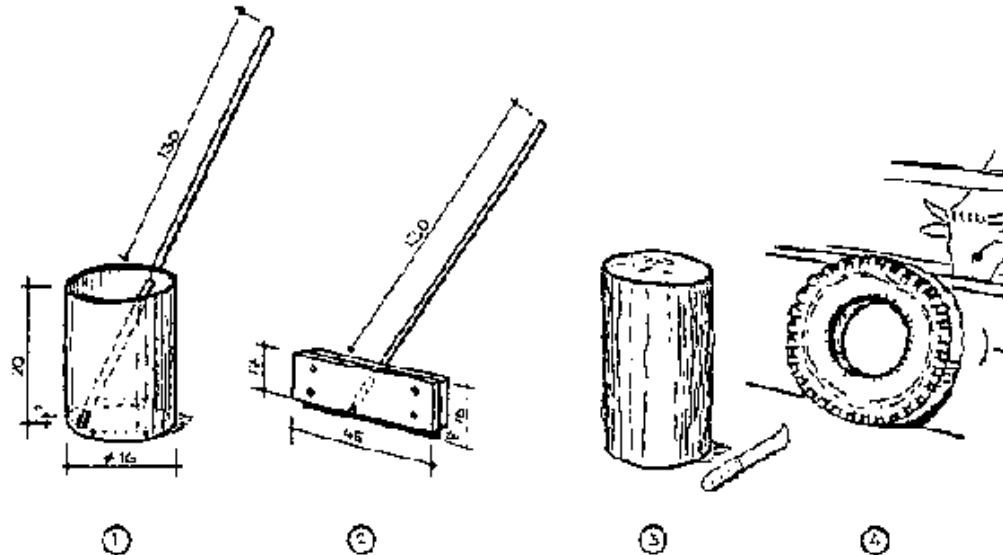

Fig. 12: Necessary equipment to operate a biogas unit

(1) Dipper made of a piece of plastic pipe with a wooden handle coming through. (2) Squeegee made from wooden boards with tyre rubber clamped between and wooden handle coming through both the boards and the rubber lip. (3) Chopping block or (4) used truck tyre for chaffing of fodder grass. The tyre leans against the trough and may be rolled to the place of use.

Principles of Layout

A biogas unit is a considerable investment. It should not be looked at as a temporary structure.

The agricultural biogas plant belongs to the stable. Without any exception. The distance to the kitchen is of secondary importance. With fixed dome plants, there is no practical limitation to the length of gas pipes, except for the cost. As a matter of principle, sustainability has first priority over cost reduction. This means that everything must be arranged in such way that it is less work to feed the plant than not.

On sloping ground, the stable lies higher than the biogas plant. On flat grounds the floor of the stable might be elevated in order to allow dung and urine to enter the plant by gravity. Handling of slurry demands high labour input and can be avoided by proper planning. The outlet of the

biogas plant Is directed towards, or drains into, the fields. Overflowing slurry should never be allowed to accumulate on neighbour's or public ground. The biogas unit must be functional even when attendance and maintenance is poor. The owner has the final decision, but he often can not oversee the consequences of a decision. Beware of false compromises!

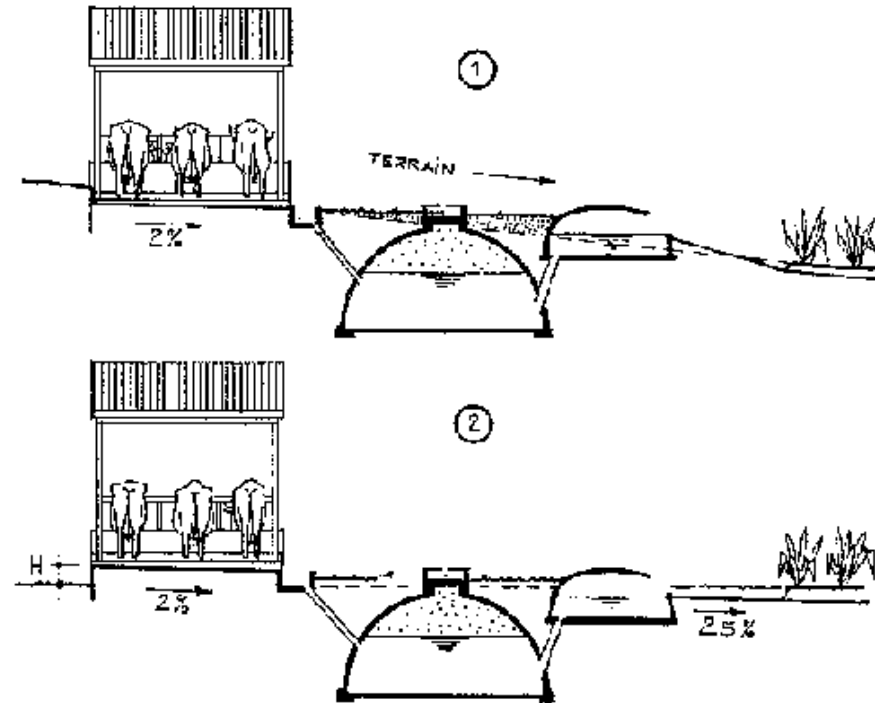

Fig. 13: Position of gasplant to stable floor The ideal situation is a sloping ground, falling from the stable via the gasplant to the crop plantation (1). On horizontal ground (2), it might be necessary to lift the floor of the stable (H).