

AT MICROFICHE
REFERENCE
LIBRARY
A project of Volunteers in Asia

Windpumps for Irrigation

By: H.J. van Dijk and P.D. Goedhart

Published by: Consultancy Services Wind Energy Developing Countries
P.O. Box 85
3800 AB Amersfoort
The Netherlands

Available from: Consultancy Services Wind Energy Developing Countries
P.O. Box 85
3800 AB Amersfoort
The Netherlands

Reproduced with permission.

Reproduction of this microfiche document in any form is subject to the same restrictions as those of the original document.

Handpumps for Irrigation

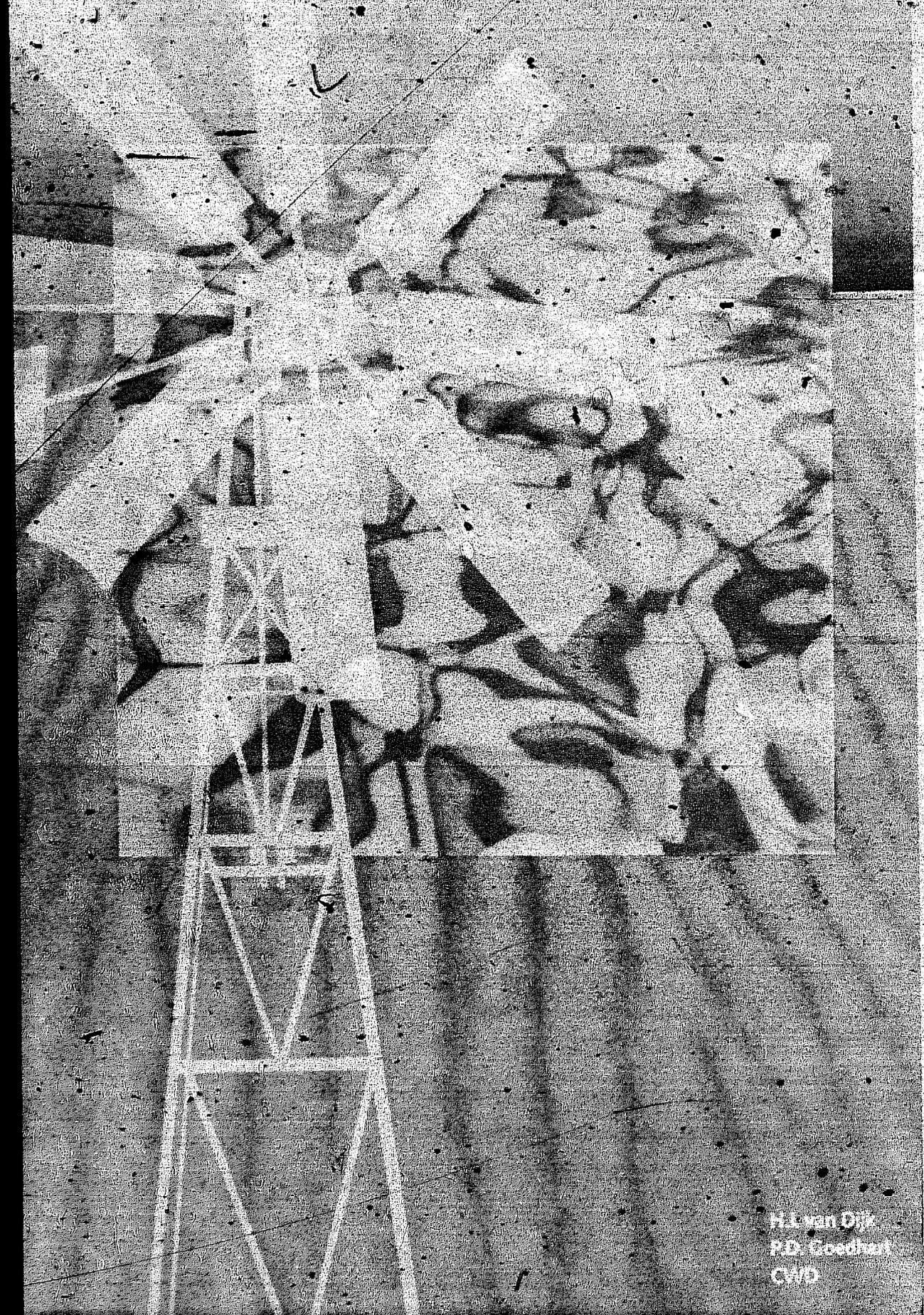

H.A. van Dijk
P.D. Goedhart
CWO

*"High tech is living in the nineteenth century, the pre-management world.
They believe that people pay for technology.
They have a romance with technology.
But people don't pay for technology: they pay for what they get out of technology."*

*PETER F. DRUCKER,
quoted in: "The Frontiers of Management", 1987,*

1 *The introduction of windpumps in different farming systems*

	Page
1.1 The history of windpumps in Crete and Sao Vicente	13
1.1.1 Lassithi, Crete	13
1.1.2 Sao Vicente	15
1.2 Key factors of the viability of windpumps in different farming systems	17
1.2.1 General aspects	17
1.2.2 The introduction of irrigation with wind-pumps into rain-fed farming systems	18
1.2.3 The introduction of windpumps in irrigated farming systems	19

2 *Different types of windpumps and their characteristics*

2.1 Types of windpumps	20
2.1.1 Traditional low-cost windpumps	20
2.1.2 Classic multi-blade windpumps	21
2.1.3 Recently developed windpumps	21
2.1.4 A comparison of three types of windpumps	23
2.1.5 Wind generators in combination with electric pumps	23
2.1.6 Wind systems with long-distance transmission	24
2.2 Windpump characteristics	25
2.2.1 Rotor area and output of a windpump	25
2.2.2 Wind speeds used for design purposes	27
2.2.3 The details of the rotor	28
2.2.4 The tower height	29
2.2.5 The pump	30
2.2.6 Control and safety system	33
2.2.7 Transmission	33
2.3 Maintenance and repair	35

3 *Wind and water availability*

	Page
3.1 The wind regime	36
3.1.1 Data requirements	36
3.1.2 Mean wind speeds	36
3.1.3 Data accuracy	36
3.1.4 Wind data measuring equipment	37
3.2 Analysis of wind data	39
3.3 Site evaluation with respect to wind speed	42
3.4 Availability of water	44
3.4.1 Surface water	44
3.4.2 Ground water	44
3.4.3 Well yield	44
3.4.4 Total pumping head	45
3.4.5 Water quality	45
3.5 Final comments	45

4 *The command area of a windpump*

4.1 Irrigation requirements	46
4.1.1 Crop coefficient	46
4.1.2 Reference evapotranspiration	46
4.1.3 Effective rainfall	47
4.1.4 Irrigation efficiency	47
4.2 Calculating the command area	48
4.3 The influence of inter-annual variations in climate	50
4.4 Factors influencing the command area	50
4.4.1 The design wind speed	51
4.4.2 The storage tank capacity	52
4.4.3 The capacity of the water source	53
4.4.4 The cropping system	53
4.5 Final comments	54



5 Water management and windpump irrigation with special reference to storage tank capacity

5.1 Irrigation without storage tanks	55
5.1.1 A windpump with a large capacity	55
5.1.2 Rice production	56
5.1.3 Preliminary comments	56
5.2 Irrigation with storage tanks	57
5.2.1 Short-term fluctuations in windpump output	57
5.2.2 Nightly output of a windpump	57
5.2.3 Fluctuations in windpump output from day to day	58
5.2.4 Total water management for the day-to-day fluctuations	59
5.2.5 Fluctuations in windpump output from month to month	59
5.3 Calculation of the required storage tank capacity	60
5.3.1 The computer calculation model	60
5.3.2 Water deficit criteria	61
5.3.3 Result	61
5.4 Case studies	61
5.4.1 The cases	61
5.4.2 Evaluation of the graph	62
5.4.3 Comparison of the cases	64
5.4.4 Generalizing the results of the case studies	64
5.5 Design of windpump irrigation systems	65
5.6 Final comments	66

6 The economic and financial feasibility of windpumps

	Page
6.1 Economic analysis	67
6.2 Farm economic analysis	68
6.2.1 Methodology of the analysis	68
6.2.2 Annual costs of windpumps	69
6.2.3 Annual net benefits of windpumps	71
6.3 Financing a windpump	72
6.4 Sensitivity analysis	75

7 Setting up a windpump project

7.1 The different phases of a windpump project	76
7.2 Final comments	79

8 References

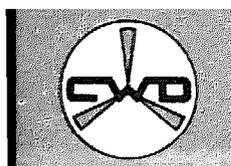

Appendices

	Page
1 Testing the yield of large diameter dug wells	83
2 Kc and Kp coefficients	85
3 Construction of storage tanks for irrigation purposes	87
4 Estimating the investment, maintenance, and repair costs of a windpump irrigation system in Mozambique	89
5 An example of the terms of reference for a pre-feasibility study on the use of windpumps	91
6 Elements to be monitored during the internal testing in the pilot phase	92
7 Timetable of a windpump project in Sudan	93
8 Terms of reference (TOR) for a study on "the potential of windpumps for water lifting near Xai-Xai, Mozambique"	94

List of figures

	Page
1.1 The number of windpumps in use on the Lassithi plateau.	14
1.2 Estimation of the number of windpumps on Sao Vicente.	16
1.3 Factors influencing the activities of a family.	18
2.1 Two examples of traditional "low cost" windpumps.	20
2.2 A classic multiblade windpump.	21
2.3 A recently developed windpump.	22
2.4 A wind generator.	23
2.5 The details of a windpump.	26
2.6 An example of a Q - V - curve.	28
2.7 The operating of a reciprocating piston pump.	31
2.8 Schematic drawing of a reciprocating piston pump connected to a wind rotor.	32
2.9 Ecliptic safety system, with eccentrically placed rotor.	33
2.10 Inclined hinge vane system.	34
2.11 Two different types of transmission.	34
3.1 Some examples of wind measuring equipment.	38
3.2 An example of the yearly pattern of wind-pump output (Q) and gross irrigation requirement (GIR).	39
3.3 Daily pattern of the hourly wind speed (time distribution) at Praia airport in Cape Verde in the month of June 1975.	40
3.4 The frequency distribution data for Praia airport (Cape Verde), June 1975, in both table and histogram form (Pieterse 1982).	40
3.5 The effects of an undisturbed airflow encountering an obstruction.	42
3.6 Air flow over cliffs having differently sloped faces.	43
4.1 The influence of the design wind speed on the output pattern of a windpump (rotor diameter = 3 m) at Hambantota, Sri Lanka (March 1975 data).	52
5.1 General lay-out of a windpump irrigation system where paddy fields are used for water storage.	56



	Page		Page
5.2	57	4.2	49
Hourly windspeed data at Praia airport (Cape Verde) on 08.11.1978 and calculated windpump output for a 5.00 m rotor diameter windpump and 25 m lifting head.		Seasonal command areas of a windpump in Trichy, India	
5.3	63	4.3	49
Relationship between the windpump operation factor (f_{we}) and storage tank capacity (Cape Verde and Sri Lanka).		Command area (ha) of a windpump (rotor diameter 5 m) on the Cape Verdian Islands.	
5.4	64	4.4	51
The relation between the windpump operation factor (f_{we}) and the required storage tank capacity for farmers available to irrigate four hours and 12 hours a day respectively.		The influence of V_d on the supply time of the windpump.	
6.1	73	4.5	51
Comparing the indicative expenditure pattern of a windpump and a fuel pump.		The influence of V_d on the output of the windpump.	
6.2	74	4.6	53
The net cash flow of a windpump and a kerosene pump.		The influence of the maximum well yield on the output of the windpump ($m^3/month$).	
		5.1	58
		Calculated output of a 5.00 m rotor diameter windpump (25 m pumping head) during the month of March 1978 for an inland location on Sri Lanka.	
		5.2	59
		Distribution of the daily output of a 5.00 m rotor diameter windpump in Hambantota, Sri Lanka (1975-1976).	
		5.3	59
		Occurrence of windless periods in two different wind regimes.	
		6.1	70
		Benefits and costs of irrigation on Sao Vicente, Cape Verde.	
		6.2	72
		The net production for different combinations of the windpump exploitation factor f_{we} and storage tank capacity.	
		6.3	75
		Sensitivity analysis (at country level) of the annual costs.	

Figures in appendices

A1.1	84	Determination of optimum yield of a well.	
A3.1	88	Earth diked reservoir with lining of bricks and bitumen.	
A3.2	88	Cemented brick reservoir, type 1.	
A3.3	88	Cemented brick reservoir, type 2.	
A7.1	93	Time table of a windpump project in Sudan.	

List of tables

1.1	16	Number of water lifting devices in use on Sao Vicente (May 1984).	
2.1	23	Characteristics of the three types of windpumps.	
2.2	24	Purchase price and prices per m^2 rotor area for several windpumps in different countries.	
2.3	30	Roughness heights.	
3.1	41	95% probability intervals of monthly mean wind speeds at Praia Airport (Cape Verde).	
4.1	49	Estimated monthly command areas (ha) of a windpump (rotor diameter 3.5 m) in Trichy, India.	

Tables in appendices

A2.1	85	Crop coefficients K_c .	
A2.2	86	Pan coefficient K_p for Class A Pan for different groundcover and levels of mean relative humidity and 24 hour wind.	
A2.3	86	Pan coefficient K_p for Colorado Sunken Pan for different groundcover and levels of mean relative humidity and 24 hour wind.	
A3.1	87	Some different types of reservoirs with a indication of cost.	



List of symbols

A	= rotor area (m^2)	n	= economic lifetime (years)
AC	= annual cost (\$/year)	P	= power output (Watt)
ANB	= net annual benefits (\$)	Q	= windpump water output (m^3/s or l/s)
B_t	= benefits in year t (\$)	Q_{day}	= windpump water output (m^3/day)
C_p	= power coefficient of rotor (-)	Q_m	= windpump water output per month ($m^3/month$)
C_t	= cost in year t (\$)	$Q_{m\text{ eff}}$	= effective water output per month ($m^3/month$)
CA	= command area (ha)	Re	= effective rainfall (mm/month)
CA_m	= command area for month m (ha)	s	= length of pumpstroke (m)
D	= rotor diameter (m)	V	= wind speed (m/s)
e	= irrigation efficiency (-)	\bar{V}	= average wind speed (m/s)
E_{pan}	= pan evaporation (mm/month)	V_d	= design wind speed (m/s)
ET_0	= reference evapotranspiration (mm/month)	V_{in}	= wind speed at which windpump starts working (m/s)
f_{we}	= windpump exploitation factor (-)	V_{out}	= wind speed at which rotor has completely turned out of the wind and thus stops (m/s)
g	= acceleration due to gravity (m/s^2)	$V_{furling}$	
GIR	= gross irrigation requirement ($m^3/ha/day$)	V_{rated}	= wind speed at which rotor starts turning out of the wind (m/s)
GIR_a	= gross irrigation requirement for the area served by the windpump (m^3/day)	z	= height (m)
GIR_m	= gross irrigation requirement for month m ($m^3/ha/month$)	z_0	= roughness height (m)
H	= total pumping head (m)	z_r	= reference height at which a given wind speed is been measured (m)
i	= interest rate (-)	η	= combined efficiency of transmission and pump (-)
I	= investment costs (\$)	ρ_a	= density of air (kg/m^3)
k	= Weibull factor (-)	ρ_w	= density of water (kg/m^3)
Kc	= crop coefficient (-)		
Kp	= pan coefficient (-)		
m	= month number (-) (do not confuse with m for metre)		



This publication examines the use of wind energy in agriculture and more specifically, the application of wind energy to small-scale irrigation. To date, few publications exist with this particular focus. Hence, the authors felt the need to make available some of their experience in windpump irrigation and related research to a larger circle of professional agriculturalists and planners through this publication.

The book purports to offer a tool to assess the technical, economic and institutional feasibility of windpump irrigation systems; general agricultural topics are treated only in so far as they are pertinent to the use of windpumps. The book particularly emphasizes the use of windpumps in irrigation: hybrid configurations of windpumps with other water-lifting devices such as motor pumps, are not considered.

The first draft of the text for this publication was prepared by the authors in 1985 and 1986 while they were attached to the International Institute for Land Reclamation and Improvement (ILRI), at Wageningen, the Netherlands. ILRI, in turn, has executed several projects for CWD, who commissioned the preparations for study. After using the report as an internal CWD reference document, a decision was taken in 1989 to revise the report extensively and to offer it as a publication to a much wider audience. In addition to the numerous staff members at ILRI and CWD who contributed to this report, the authors are particularly indebted to the following persons for their valuable suggestions and comments:

*Mr. J. Van Meel · Ms. E. Bossink · Mr. G. van de Bijl · Mr. A. Meijers
Mr. L. Veldhuizen · Mr. K. Manintveld*

In early 1990 the text of the report was further revised and somewhat shortened. It was particularly kept in mind that the publication should be supplementary to other publications on windpumps (for instance, Van Meel and Smulders, 1989) and on small scale irrigation (for instance, Stern, 1984). Wherever necessary the current publication refers to other publications as suggestions for further reading.

Mr. S. Batchelor, an independent consultant, contributed extensively to the latest revision, for which we thank him. Clearly, the current publication will no doubt contain errors of omission and commission for which neither the authors nor Mr. Batchelor are responsible.

It is hoped, however, that this publication will succeed in making some of the considerations which have a bearing on windpump irrigation available without further delay to a wider group of technicians and development practitioners alike.

May 1990, The editors



Introduction and summary

During the past decade, developing countries have shown an increasing interest in renewable energy sources such as the sun, wind and biomass. These sources may have the potential to meet a sizeable percentage of their energy requirements. In the past, windpumps were applied on a large scale for drainage and the water supply for cattle. Although these fields of application still have good prospects, the renewed interest in windpumps is focused chiefly on small-scale irrigation or rural water supply.

This report deals with the main aspects of windpumps for irrigation. The objective of the report is to give the reader enough information on both windpumps and irrigation, to enable him to judge whether it makes sense to consider using windpumps.

Chapter 1 introduces the key factors to be studied in connection with the viability of windpumps in different farming systems and illustrates two case studies in regions with traditional windpump irrigation: Crete and Cape Verde.

Chapter 2 introduces the technical aspects of windpumps (types, sizes, characteristics and cost prices). Mechanical windpumps can be divided into

- traditional low technology windpumps,
- classic multiblade windpumps, and
- recently developed types.

The level of technology in windpumps is certainly lower than that for motorized pumps. For this reason repair, production of spare parts, and even production of complete windpumps is feasible in well-equipped local workshops in developing countries. This is especially true of the windpumps developed more recently.

Chapter 3 provides information on collecting and analysing climatic data with special reference to the wind regime. The data required at different stages of project development and the equipment required for measuring are both described. Simple methods to determine water availability are also mentioned briefly.

Only after reliable wind speed data has been analysed can it be determined whether or not there is potential for the use of windpumps in the region. The average quantity of water that can be pumped by a certain type of windpump depends mainly on average wind speed, rotor diameter, and pumping head. As an example then, we can say that in an area with an average wind speed of 4 m/s and a pumping head of 10 m, a small windpump with a rotor of 1.5 m diameter can irrigate an area of 0.1-0.2 hectares, while a large 8 m rotor diameter windpump can service 3 - 6 hectares.

In Chapters 4 and 5, the relationships between the output of a windpump and the use of the water output for irrigation is discussed. Estimating the area that can be cultivated (command area) and the factors influencing this command area are the subjects of Chapter 4.



Windpump irrigation has specific problems related to the fact that the windpump output is not constant all the time. The effects of this phenomenon on farm water management are discussed in Chapter 5. Several measures such as storage tanks are suggested to facilitate windpump irrigation and to make more adequate use of the potential windpump output. A method of estimating the required storage tank capacity is included. This method is based on the characteristics of a recently developed windpump, the CWD 5000, but the results can also be applied for other well adapted windpumps.

In Chapter 6, the economics of windpump irrigation are analysed, taking into account the national economics and farm economics. A financial analysis is also included since windpumps have to compete with other water lifting devices.

In general, windpumps can be economically attractive if average wind speeds are at least 4.0 m/s. They are especially adapted to decentralized water pumping, for instance, for an individual farmer or a small group of farmers. Usually, however, they are not very suitable for large scale irrigation with a centralized water pumping and distribution system.

In contrast to the advantageous low running costs of windmills are the high initial investment costs. The investment costs of the windpump and storage tank are generally in the order of two to three times the investment costs of motorized pumps. These initial costs can present a financial barrier to the implementation of windpumps, especially for farmers that were until now involved only in subsistence agriculture. Farming systems with access to the market economy are more open to innovation and "appropriate" credit schemes play an important role in a windpump project. Besides economics, other aspects that are more difficult to quantify such as reliability, performance, social acceptance, etc. should also be considered as is discussed in the first chapter.

Chapter 7 summarises the book with an example set up for a windpump project. Which set up will best fit the local situation depends largely on the present state of agricultural practices in the area.



The introduction of windpumps in different farming systems

Developing countries have shown increasing interest during the past decade in renewable energy sources such as sun, wind, and biomass. These sources may have the potential to meet a sizable percentage of the energy requirements of these countries. Of the three sources, wind energy already has a long history in different fields of application. Windpumps have been applied on a large scale to drainage and supplying water for cattle and, on a more limited scale, to irrigation.

This introductory chapter therefore looks at two existing schemes of windpump

irrigation before discussing in detail the possibilities and problems of windpump irrigation. The focus is on key factors determining the viability of windpumps in different farming systems, particularly where the system is defined as "the whole of activities of a family, which have access to land, undertaken to satisfy their needs" (Kortenhorst 1980).

Section 1.1 focuses on two schemes: the Lassithi scheme on Crete, and another on Sao Vicente (Cape Verde). The last section, 1.2, elaborates on the key factors for different farming systems (rain-fed and irrigated).

THE HISTORY OF WINDPUMPS IN CRETE AND SAN VICENTE

1.1

1.1.1 Lassithi, Crete

The Lassithi plateau is situated at an altitude of 850 metres on the isle of Crete (Greece). The plateau is almost flat and has a total area of 28.8 sq. km. The majority of its inhabitants (total population in 1983: 5,142) have always been engaged in some type of agricultural activities. During the growing season from April to October, the primary crops are potatoes, grains and vegetables. Potatoes are by far the most important.

The cultivation of seed potatoes as a cash crop is particularly popular. Irrigation on the plateau was traditionally carried out by means of various water lifting devices. Since the wind regime at the plateau is favourable (average wind speed during the irrigation season is about 6 m/s), windpumps were used. The history of the use of windpumps at Lassithi indicates that changes in the farming system influence the functioning of the windpumps.

Around 1890, a local carpenter at the Lassithi Plateau built a windpump. It consisted of a wooden tower, a rotor with sail wings (rotor diameter = 6.25 m), and an imported steel piston pump from Italy. At that time, the only water lifting device in use was the "gerani",

a hand-operated construction with a beam and bucket. The gerani was used for supplementary irrigation of traditional crops such as wheat, other grains, and vegetables from very small plots.

Agricultural products were mainly used for own consumption. Animal husbandry (goats and sheep) was more important than agriculture. The wooden windpumps were placed on the existing wells in the home gardens of some rich farmers.

The first reaction of the local population was not very enthusiastic. Compared with the "gerani", windpumps were expensive due to the high labour costs of construction.

The output of the windpumps was also limited and many breakdowns occurred. The total number of these wooden windpumps never exceeded 20.

In the 1890-1920 period, the windpump was considerably improved by local artisans. Almost all of the wooden parts were replaced by iron ones and other technical improvements were incorporated. This resulted in a less expensive, more reliable and more efficient windpump. At the same time the farming system on the plateau changed drastically.



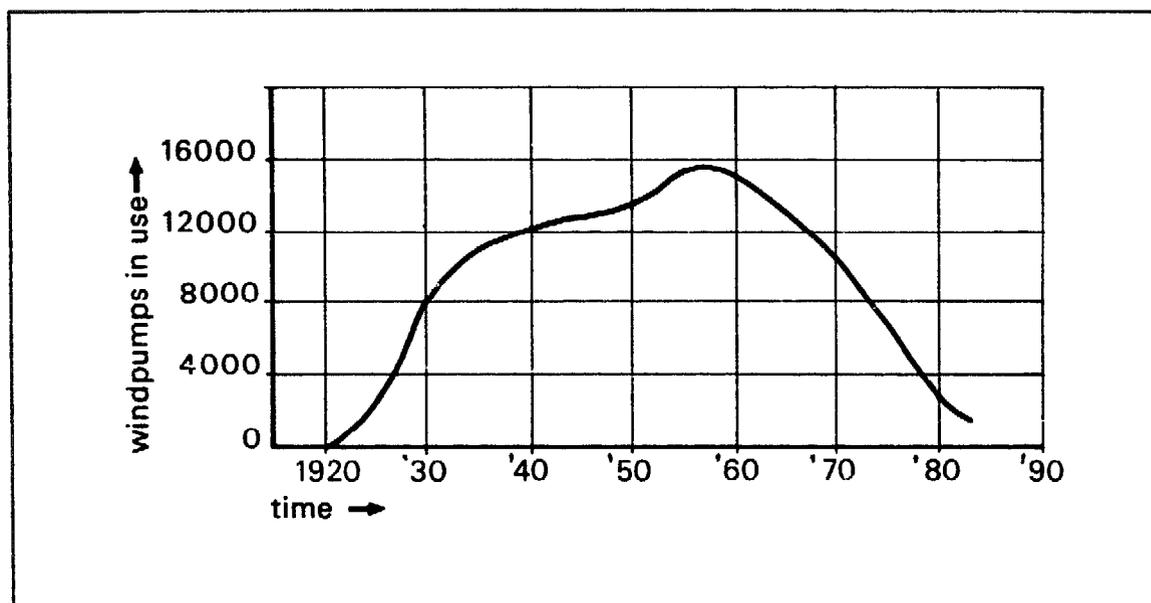

Figure 1.1 The number of windpumps in use on the Lassithi plateau (Hoogervorst and Van 't Land 1983). Note the peak between 1950 and 1960.

The returns on the traditional subsistence farming system were no longer sufficient to meet the food demands of the increased population of the plateau. Farmers were looking for new crops to increase production. The potato crop, which was introduced in 1867 on a limited scale, was promising. Its return was about ten times higher than that of the traditional grains. So farmers started to grow potatoes and found that supplemental irrigation was no longer sufficient. High yields could only be reached with irrigation of the potatoes all season.

The "gerani", which is very labour intensive and has only a limited output, became the bottleneck to further increase in production. With the help of windpumps the irrigated acreage could be expanded. One windpump could irrigate about 0.2 ha of potatoes. So, windpumps became very popular amongst the farmers, who paid for them in kind or in money.

Some time after the introduction of windpumps, the farmers started to use storage tanks made of stones and concrete. They had an average capacity equal to the average daily

output of the windpump (15 m^3). Because most land-holdings consisted of various plots spread over the plateau, most farmers owned more than one windpump (the average number was four). When a plot required water, the farmer unrolled the sails of the rotor. Once the storage tank was full, the farmer started to irrigate. With four or more windpumps running, irrigation was quite labour intensive.

After the introduction of potatoes, the commercial marketing of products increased rapidly. The sale of seed potatoes became especially profitable for farmers. Thus, the area given to potatoes increased rapidly and consequently so did the number of windpumps (see Figure 1.1). With the increased pumping of water, the groundwater level started to drop. That resulted in a smaller output by the windpump and in technical problems (deepening of the well with water levels below 5-7 m meant the piston pump had to be placed inside the well, etc.). As a result, it took a longer time for farmers to irrigate with windpumps. In 1950, the first small motor pumps (5 hp) were installed on the plateau.

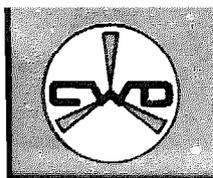

Farmers used these pumps in addition to the windpumps to counteract the disadvantages of the latter: irregular flow and especially higher labour needs. From 1945 onwards, the population on the plateau had declined. Younger people left for further education or to find a non-agricultural job in the larger cities in other parts of Greece.

Decreasing labour requirements became important to the farmers on the plateau, and they could achieved that by mechanizing the different type of activities.

Around 1960, large diesel motor pumps (to 15 hp) were introduced on the plateau. They irrigated more than one plot, which meant that one motor pump could replace several windpumps. The farmers did not use the large motor pumps in addition to windpumps, as they did with the small motor pumps, but rather in place of them.

The main advantages of the larger motor pumps, according to the farmers, were labour saving in irrigation, independence from wind, convenience and "modern outlook". In the process of changing attitudes on the plateau, modernization had become an important part of life. Financial aspects did not play a major role. Farmers, who had bought a large motor pump started to rent or buy land in the surrounding area. This increased the efficiency of farming and enabled further mechanization and ridging of potatoes.

Therefore, the number of traditional low-cost windpumps decreased dramatically following the introduction of large motor pumps. By 1983, only about 1000 windpumps were still in use. They belonged to farmers, who did not cultivate crops on a commercial basis but only irrigated home gardens for their own consumption.

1.1.2 Sao Vicente

The isle of Sao Vicente is one of the more important islands of the Republic of Cape Verde. The island has an area of 227 sq. km and some 31,580 (1980) inhabitants. The Cape Verde Islands are located in the so-called "trade wind zone" and have a favourable wind regime. Rainfall at Sao Vicente is very limited.

The main activities on this island are found in the international harbour of Porto Grande, and small-scale industry and services. Agriculture (mainly animal husbandry and horticulture) plays a minor role. Irrigated horticulture developed because the crews of the ships that used the harbour wanted vegetables. Water lifting from wells at Sao Vincente began when the first windpumps were introduced around 1880. Before that time, irrigation occurred by gravity, using water from a few small springs.

The first windpumps at Sao Vicente were constructed out of wood. Soon after, some steel parts were used, and later on complete "American type" windpumps were imported. From that time onwards, the number of windpumps increased. In 1984, 175 windpumps were in use at Sao Vicente.

Between 1880 and 1950, the number of windpumps in use increased rather slowly because the demand for vegetables did not increase much. From 1930 onwards, local production of windpumps started and resulted in a cheap, reliable windpump (rotor diameter 2.8 m).

Credit facilities were supplied to the users by both the producers of the windpumps and the importers of motor pumps. During the 1950-1960 period, the number of windpumps in use decreased somewhat. That was caused



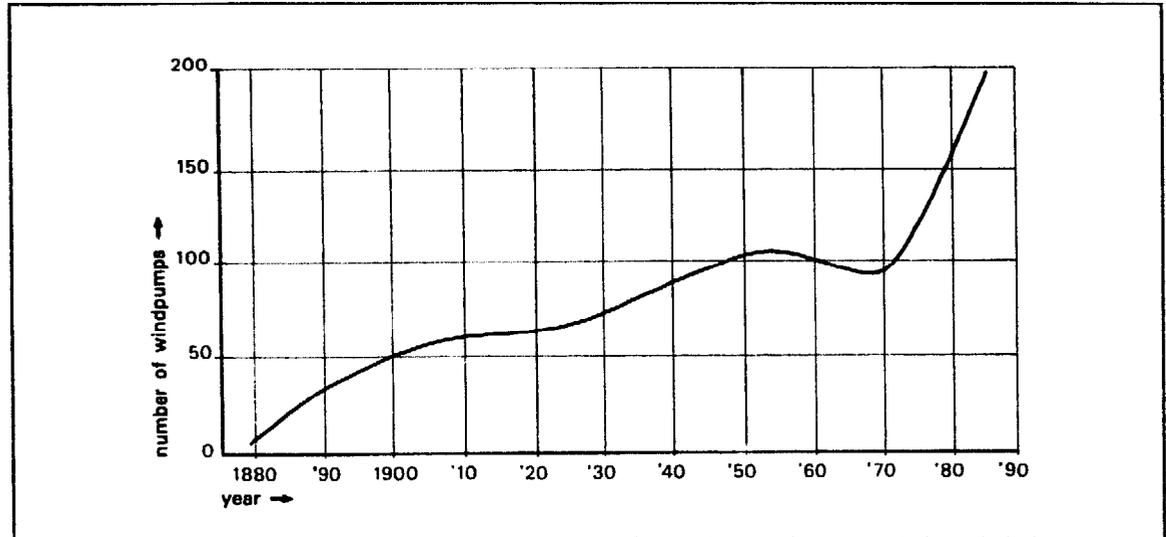

Figure 1.2 Estimation of the number of windpumps on Sao Vicente.

by the decline of the water table and the growing salinity of many of the wells around the city of Mindelo.

After 1960, the windpumps were introduced in areas further away from Mindelo. An increase in the number of people who returned after independence (1975) also played a role. Most of them brought some savings. Prospects for investment were rather limited on Sao Vicente, and one of the more attractive

possibilities was to dig a well and to install a windpump. From 1960 onwards, small motor pumps (2-5 hp) were also introduced.

The more wealthy returning emigrants bought motor pumps and used them in combination with a windpump.

By May 1984, 191 wells were in use for irrigation. The number of water lifting devices used during this period are shown in Table 1.1.

Table 1.1 Number of water lifting devices in use on Sao Vicente (May 1984).

Device	Windpump	Windpump + Motor pump	Motor pump	Others
No. of wells	93	82	8	8
% of total	49	43	4	4

In addition, approximately 75 windpumps were no longer in use because the well had dried up or the water had become too saline.

The command area per windpump used was about 0.12-0.16 ha. The farmers grew a mixture of inter-cropped vegetables and drought resistant crops. In this way, the farmers tried to make optimal use of the fluctuating output of the windpump. The crops were sold at the market by the women. During periods of low

wind speed, irrigation was limited to the area under vegetables.

When high wind speeds occurred, the area with drought resistant crops was also irrigated. To manage the irrigation properly, storage tanks of 1.5 times the average daily output of the windpump were used. Besides selling vegetables, the small farmers tried to generate off-farm income with fishing, brick-laying, constructing new wells, agricultural labour, etc.



Most farmers like to have a small motor pump in addition to a windpump. In this way, they can increase the reliability of irrigation water supply, which enables them to increase the area under vegetables. It was found that the command area of a combined motor pump/windpump is 30% larger than the command area of a windpump alone.

The use of a motor pump alone was not very popular amongst farmers, mainly because of the relatively high running costs and problems with the supply of spare parts.

As one farmer stated: "The supply of wind for the windpump is more secure at Sao Vicente than the supply of spare parts for a motor pump".

The main constraint on farmers purchasing motor pumps is lack of money.

Several factors exist which offset the relatively high investment costs of windpumps. First of all, many of the farmers are re-migrants, with a considerable amount of cash. Others bought their windpump part by part, whenever they could afford it, or purchased a second-hand windpump from a farmer with a dry or saline well. Farmers also started to construct their own storage tanks, in the first instance by using old oil drums and then constructing larger storage tank from bricks or concrete blocks after some years

Contrary to the motor pumps, the windpumps have developed into an "indigenous technology" at Sao Vicente. They are now produced locally, spare parts are available and farmers know very well how to use, maintain, and repair them.

KEY FACTORS FOR THE VIABILITY OF WINDPUMPS IN DIFFERENT FARMING SYSTEMS

1.2

1.2.1 General aspects

The history of windpumps on Crete showed that a change in the local situation of the farmers can directly influence the viability of windpumps in farming systems.

On Crete, the change from subsistence farming to commercial farming and the decreased availability of agricultural labour were the main factors leading to less favourable circumstances for windpumps.

This resulted in a considerable decrease of their use. We can conclude that a thorough analysis of the farming system has to be made when the possibilities for windpumps are being assessed. Figure 1.3 (Kortenhorst 1980) provides an overview of factors to be considered.

As can be seen from this figure, the water supply is only one of many factors that influence the activities of a family. When analyzing the impact of windpump use, attention

should be paid to the specific characteristics of a windpump as well as to the general aspects of irrigation. In short, these factors include the high investment costs, low running costs, variable output with consequences for irrigation practices, and the cropping system.

They will be considered in more detail in Chapters 5 and 6. When analyzing the impact of the use of windpumps in a farming system, special attention should be paid to possible changes in the activities of the different members of the family. Women play an important role in agriculture. The introduction of windpumps can change the workload of women more radically than might be realized at first sight. One also should keep in mind that in many cases windpumps can also be used to supply drinking water for the family.

The key factors that determine the impact of the introduction of windpumps de-



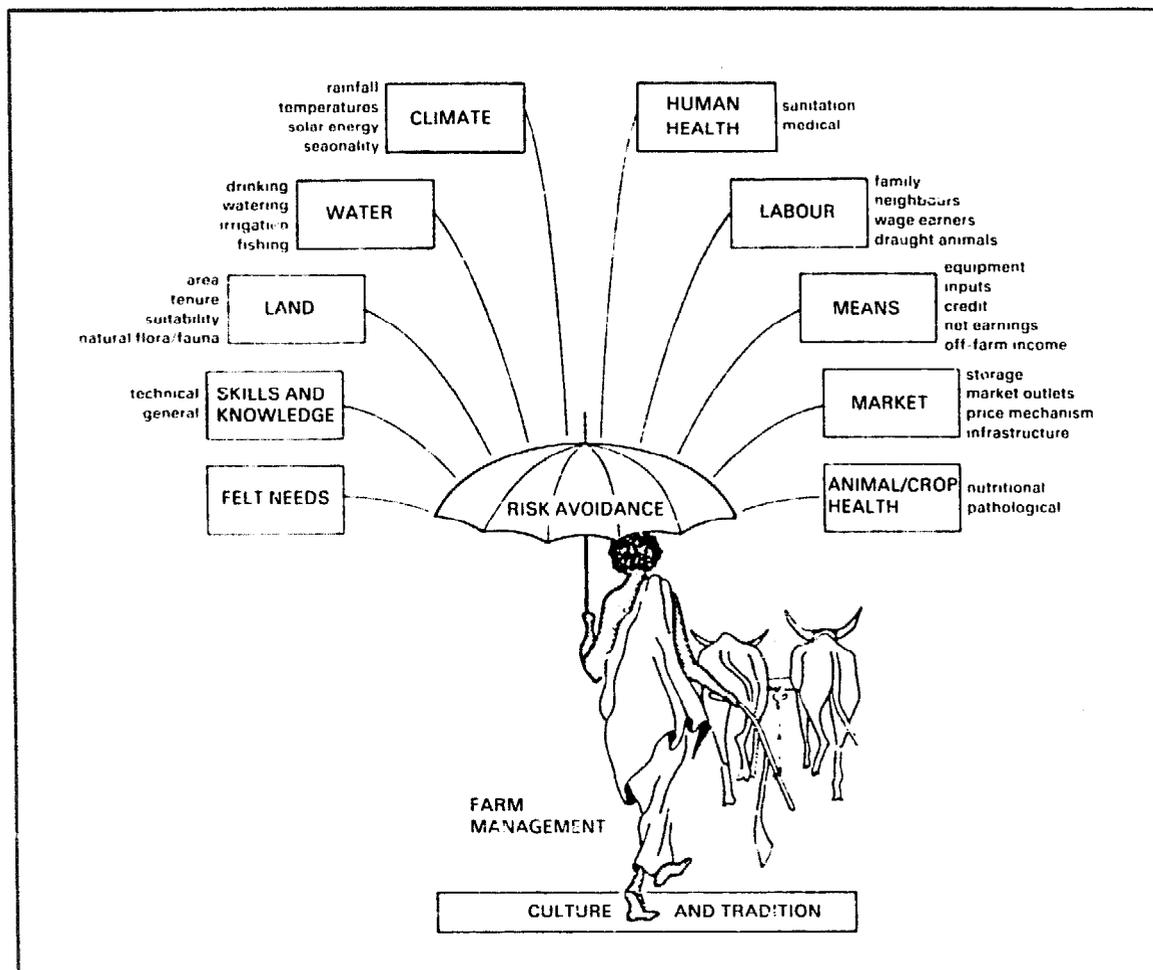

Figure 1.3 Factors influencing the activities of a family (Kortenhorst 1980).

pend on the type of farming system into which windpumps are to be introduced. A clear distinction can be made between rain-fed and irrigated farming systems as is discussed below.

1.2.2 The introduction of irrigation with wind pumps into rain-fed farming systems.

When windpumps are introduced into rain-fed farming, not only are windpumps introduced, but also irrigation. This influences both the economic and financial analyses (see Chapter 6) as well as the windpump analysis. First of all, the role that irrigation can play in the development of the farming system must be carefully studied. It should be recognized that

in many cases rain-fed farming can be improved even without the introduction of irrigation. When a rain-fed farming system has reached its limits, as was for instance the case at Sao Vicente, the introduction of irrigation can be considered.

The social effects of the introduction of irrigation should also be investigated carefully because the social changes are not always positive for the local situation. In some West African countries, for example, the women were responsible for cultivating rain-fed rice in swamps. For cultural reasons, the introduction of a controlled water supply necessitated the involvement of men in the new technology.

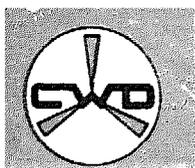

Because of the consequences that this had on the division of labour and the power structures in the family, the introduction of irrigation failed in a number of villages (FAO 1985). Therefore irrigation in general must not be viewed solely as a technological or organizational problem, but also as a social force (Egink and Ubels 1984).

This is also true for the introduction of windpumps. Given the high investment costs and the private ownership, windpumps may benefit the relatively well-to-do farmers first. This will be especially true when windpumps are introduced in rain-fed farming systems. The gap between rich and poor peasants is widened due to this fact, and the crucial question of whether or not it is acceptable has to be answered when the introduction of windpumps is being considered.

Other factors to consider in introducing windpumps in rain-fed farming systems are water management under windpump irrigation and the change to market-oriented farming, including the required infrastructure.

1.2.3 The introduction of windpumps in irrigated farming systems.

If windpumps are introduced in farming systems where irrigation is already present, an initial analysis can be restricted to the specific characteristics of windpumps by comparison with other irrigation devices. If mainly traditional devices are in use, then saving labour, an increase of the command area, and a possible change into commercial farming are key factors.

If the move to commercial farming requires an alternative cropping system, the prospects of this change must be carefully studied. In some cases, like in Crete where traditional farming had reached its limits and farmers already had started to cultivate new crops, such a change will not create many problems.

But, in many cases, the cropping system is determined mainly by cultural and social norms and such a change might not be possible at all. Where no large changes in the cropping system are required, financial aspects may be the key factor. In this situation the price of fuel becomes critical to the relative economics. When modern water lifting devices are in use and families are already market oriented, a windpump should be at least cheaper per litre of pumped water and have a comparable output compared with the other devices.

As with rain-fed farming, the social consequences of the introduction of windpumps also depend on the groups of farmers for whom windpumps are attractive. Small size windpumps might give poorer families with small landholdings the possibility to invest in a modern water lifting device. With such a target orientated approach, the introduction of windpumps can lead to fundamental changes within the local society.

In some cases, such as that at Sao Vicente, the investment in an additional water lifting device can also be an opportunity. Farmers who already own a motor pump can add a windpump to save fuel. If fuel is very expensive and its supply insecure, a combination of a windpump with a fuel pump might be attractive.

If several windpumps are used to irrigate one small-scale project, the direct interest of farmers is probably restricted to the costs of water and the reliability of the water supply only. The farmers will have their own ways of distributing the water within the existing farming system. If windpumps are introduced into this kind of system, they should not make water management too complex. In other words, the windpumps should be the solution to an existing problem, not the source of new ones.



The emphasis in this report is on water-pumping windmills, referred to here as windpumps, with a mechanical transmission. Wind-electrical pumping systems also exist, but they will only be discussed briefly in this report.

Even when it seems promising to use a wind-pump in a particular situation, the best type of windpump to meet the specific needs must still be determined.

Section 2.1 presents an overview of the different types of windpumps, including

their most important features such as construction materials, energy efficiency, investment costs, production methods, maintenance requirements and reach of pumping heads.

After the type of windpump has been selected, the required characteristics have to be determined, such as rotor area, number of blades, tower height, pump type, type of transmission, safety system, and so on. Section 2.2 discusses these details.

Operation and maintenance are covered in Section 2.3.

2.1**TYPES OF WINDPUMPS**

Windpumps with mechanical transmission can be divided into several categories:

1. traditional low-cost windpumps
2. "classic multi-blade" windpumps
3. recently developed windpumps

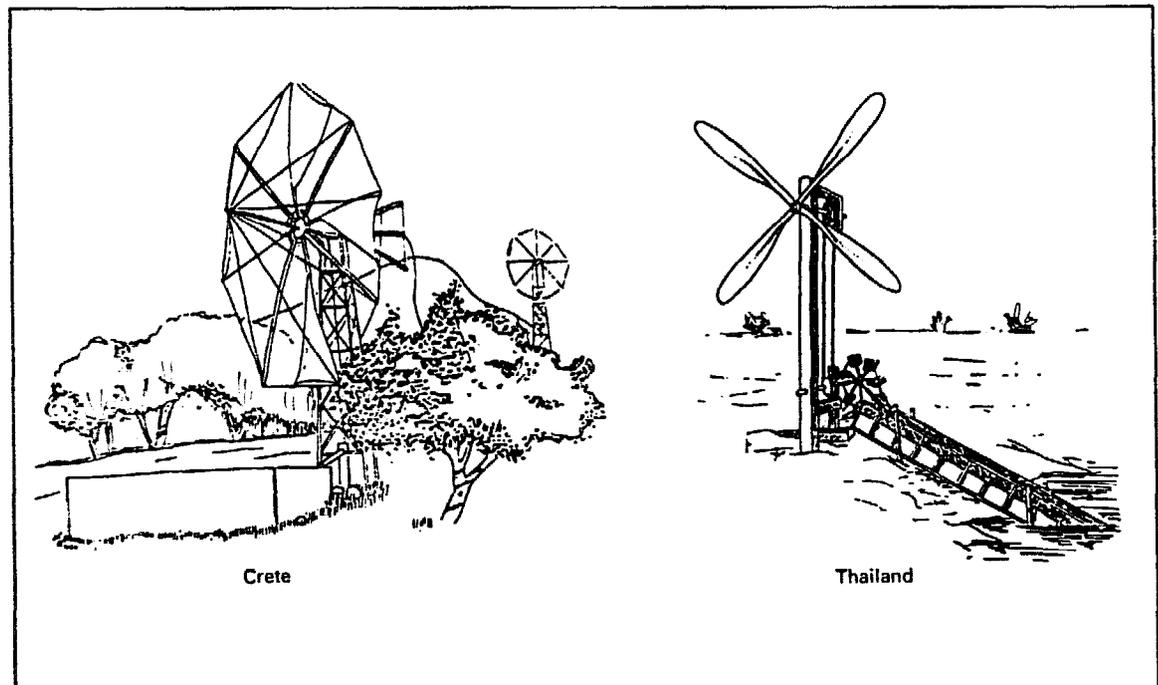

Figure 2.1 Two examples of traditional "low cost" windpumps.

2.1.1 Traditional low-cost windpumps

This category comprises different kinds of windpumps that have traditionally been locally produced, many of which have long development histories such as the windpumps in

China that were already in use 3000 years ago.

Other examples are the windpumps in Crete, Peru, Thailand, and the Netherlands (Figure 2.1). This type of windpump was found in regions with favourable characteristics: high



wind speeds and pumping heads not far below 5 m. These windpumps are not suitable for areas with less favourable conditions because of their relatively low water output.

Traditional windpumps are chiefly:

- constructed of wood, sails and scrap.
- made by local craftsmen.
- have low investment costs (compared to classical windpumps).
- require intensive maintenance and repair.
- are labour intensive to operate.
- have rather low energy efficiency.
- can last a long time with partial replacement, otherwise they are good for five to ten years.
- have pumping heads of less than 5 m.

2.1.2 Classic multi-blade windpumps

The classic multi-blade windpumps are commercially produced windpumps, which were developed over fifty years ago and are still on the market (see Figure 2.2).

They are produced mainly in the United States, Argentina and Australia. Originally they were used for watering cattle in all parts of the world.

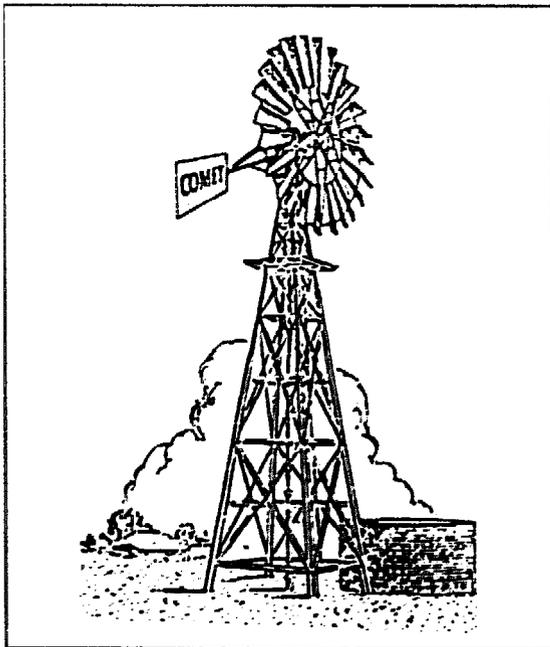

Figure 2.2 A classic multi-blade windpump.

The main characteristics are:

- capital intensive steel fabrication processes.
- construction chiefly of steel, cast iron, bronze, etc.
- construction in a well-equipped metal workshop with a lathe and foundry, among other things.
- high investment costs.
- low maintenance costs.
- more efficient energy conversion than traditional low-cost windpumps.
- long life, typically 25-30 years.
- possibility of high pumping heads (even up to 300 m).
- start-up at low wind speeds, low rotation speed.
- an automatic safety system to prevent damage from high wind speeds.

2.1.3 Recently developed windpump:

The boom in energy prices during the seventies was the primary reason for renewed interest in windpumps as a possible alternative to the use of fossil fuel for water lifting.

Recent developments are twofold:

- Simple low-cost windpumps have been improved.

One example of this development is the improved Cretan windpump. It has a dubious success record. It was introduced into Thailand with some success, but elsewhere, such as in Ethiopia and Kenya, its introduction was not successful.

The Sahores windpumps introduced into West Africa are another example of an unsuccessful introduction. Traditional windpumps are so closely bound to their region of origin that it is difficult to transfer this type of technology.

The Cretan windpumps, for instance, are used for supplemental irrigation in an area with high wind speeds and operation is highly labour



intensive (see Section 1.1.1). The traditional windpump in Peru is inefficient, but with low pumping heads it is not a major problem.

It has become clear that the traditional type of windpump, although satisfactory for the specific region where it was developed, is not easy to adapt to the demands of the small-scale irrigation or drinking water supply projects in regions where they are newly introduced.

On the other hand, classic wind-pumps with high pumping heads are designed to supply drinking water and water cattle, which results in very heavy construction and high investment costs for both the user and the manufacturer. The energy conversion efficiency of this classic windpump at higher wind speeds is only moderate at high heads and quite low at low heads. The high investment cost combined with low efficiency also makes them less attractive for small scale irrigation.

- New windpumps have been designed, which are cheaper than the classic multi-blade windpumps, have wider applications than traditional low-cost windpumps, and can be built in a light engineering workshop.

Another alternative development has been: in the direction of windpumps adaptable for small-scale irrigation, with medium pumping heads and a relatively high output. A characteristic of this new windpump is that it can be easily repaired - and even produced - in a local workshop.

Most of the recently developed windpumps have the following characteristics:

- emphasis on a light but reliable construction, that is less expensive than classic multi-blade windpumps.
- construction of steel, brass, etc.
- tools for construction include lathe, drill-press, welding set and hand tools.

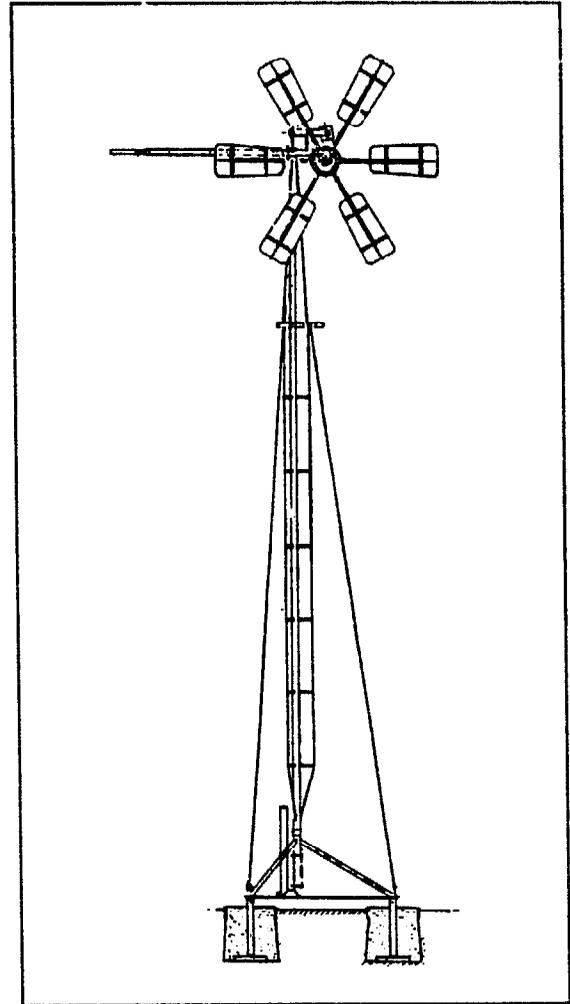

Figure 2.3 A recently developed windpump.

- possibility of local production in a reasonably equipped workshop.
- more labour-intensive maintenance than for classic windpumps, but local repairs are possible.
- non-labour intensive operation.
- life span of 10-15 years.
- pumping heads of 5 to 50 metres.
- high energy efficiency.
- higher rotation speeds with light rotors and few blades.
- automatic safety system, to prevent damage from high wind speeds.



2.1.4 A comparison of three types of wind-pumps

Table 2.1 provides an overview of the chief characteristics of the three types of wind-pumps listed before. As Table 2.1 shows, the recently developed windpumps have rather favourable characteristics for implementation in irrigation schemes especially with respect to costs, labour requirements, water output and

pumping heads. Nevertheless, there are still situations in which a classic windpump is a better option, especially in terms of maintenance requirements and reliability.

Table 2.2 gives the estimated prices of some windpumps that are currently available. The total price and the price per square metre of rotor swept area can be used as a cost indication.

Table 2.1 Characteristics of the three types of windpumps (Mueller 1984).

Type	Traditional low cost windpumps	Commercially produced classic windpumps	Recently developed windpumps
- Materials	wood, sails, scrap	steel (cast) brass	steel, (fabricated), brass
- Investment cost	low	high	moderate
- Maintenance costs	high	low	moderate
- Skills required for repairs	low	moderately high	moderate
- Spare parts availability	easy	difficult	moderate
- Operation/labour intensity	high	low	low
- Optimal rotational speed	low	low	higher
- Energy efficiency*	low	moderate	high
- Life time	5-10 years	25-30 years	10-15 years
- Reliability	low	high	moderate

* The energy efficiency is that fraction of the total wind energy flux passing through the rotor that is effectively used for lifting water

2.1.5 Wind generators in combination with electric pumps

Although electricity generating windmills, the so-called wind generators (see Figure 2.4) have existed since the beginning of this century, combining them with electric pumps is rather new.

Recent research in this field shows good prospects. Although the system has more energy loss (long transmission lines), that could be compensated by the fact that the installation site of the wind generator does not necessarily have to be in close proximity to the well.

More favourable sites with respect to wind exposure or wind speed can therefore be chosen.

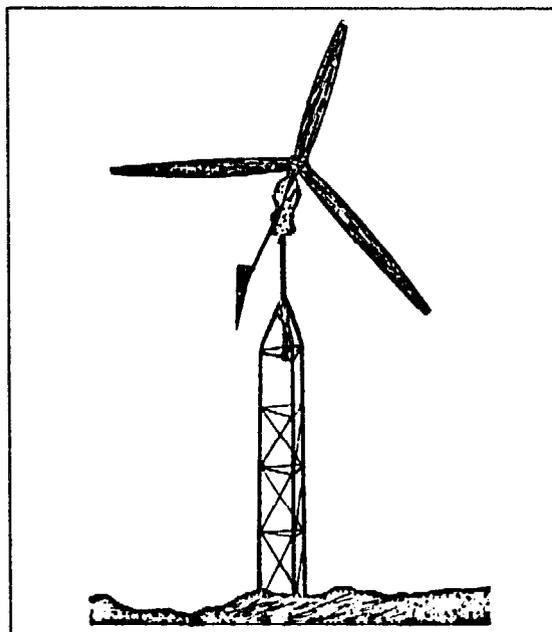

Figure 2.4 A wind generator.



A second advantage occurs in situations when water pumping windmills with mechanical transmission might not have enough capacity to fully exploit tube wells of high productivity and small diameter. In that case, the combination of a wind generator and deep well pump with a larger pumping capacity might be a solution.

This solution might be especially good in cases of high wind speeds on the hills or highlands and lower wind speeds in the valleys where the wells are situated. It should be borne in mind, however, that local production of wind generators is generally not possible, and that maintenance and repairs can cause problems.

Table 2.2 Purchase price and prices per square metre of rotor area for several windpumps in different countries (1983 price level).

Type	Manufactured in	Delivered in	Rotor diameter (m)	Price US\$	Price per m ² rotor area US\$
Presently developed windpumps					
WOT 12 PU 500	Kenya	Kenya	5.0	3.037	155*
ULI 5000	Tanzania	Tanzania	5.0	5.555	282
WEU I-3	Sri Lanka	Sri Lanka	3.0	1.033	148*
CWD 2000	Sri Lanka	Sri Lanka	2.0	355	113*
CWD 5000	Cape Verde	Cape Verde	5.0	5.165	263*
Kijito	Kenya	Kenya	7.3	12.500	299**
Classic multi-blade windpumps					
Southern Cross	Australia	Cape Verde	2.4	2.246	520
Southern Cross	Australia	Cape Verde	5.2	5.881	290
Southern Cross	Australia	Cape Verde	7.6	10.613	245
Dempster	U.S.A.	Cape Verde	3.0	3.105	460
Dempster	U.S.A.	Cape Verde	4.3	5.400	337
Comet	U.S.A.	Cape Verde	3.6	3.402	350
Comet	U.S.A.	Cape Verde	7.3	12.500	299

*estimated prices for commercially produced windpumps

**Kijito is a slow running, locally produced, high reliability system

2.1.6 Wind systems with long-distance transmission

The advantages stated in the former section, better exposure and more than one pump per water source, can also be attained with the introduction of long-distance power transmission. A compromise with the "high" technology of the electrical system is the introduction of pneumatics or hydraulics. There are a number of small wind turbines fitted to compressors now available on the world market.

Water hydraulics have also been used with windpumps, although only Kijito in Kenya offer the system commercially.

In both cases, the power loss over a distance can be a problem unless the increase from improved exposure can be used to offset it. Water hydraulic power transmission has two main advantages: the opportunity for local production in a reasonably well-equipped workshop and the possibility of local maintenance and repairs.

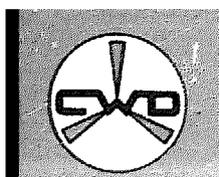

The main criteria for selecting a windpump is the power required (energy per second) to lift the quantity of water needed within a specified period of time over a certain height. This power is supplied by the wind that makes the rotor turn. The main characteristic of a windpump is the diameter of the rotor, which determines the area of the rotor and therefore the mass of wind utilised. There are limitations on how much energy can be extracted by the rotor and, in practice, the maximum for windpumps is about 30%.

However, this is only the efficiency of the rotor at its optimum operating point. The system as a whole can only convert 5% to 15% of the theoretical wind power into actual pumping power.

The next section treats the output/rotor area relationship to the wind. This is followed by a section on design wind speeds. The supplemental windpump characteristics that influence output and windpump selection will then be discussed. They are the:

- number of rotor blades
- tower height
- pump
- control and safety system
- transmission

The last section of this chapter concentrates on the maintenance and repair of windpumps.

To facilitate these discussions, Figure 2.5 presents a drawing of a windpump which illustrates the different parts by name.

2.2.1 Rotor area and output of a windpump

The following losses are incurred by converting the kinetic energy per second gene-

rated by an air mass flowing with a certain velocity V through an area A to the actual lifting of the water:

- conversion of wind energy to rotor axis ($C_p = 0.2$ to 0.4).
- transmission and pump ($\eta = 0.4$ to 0.8).
- improper wind matching (matching factor = 0.5).

The first two losses are obvious to the mechanically minded. The last loss needs some clarification. It originates from the fact that a windpump runs optimally only at the wind speed to which it has been matched.

A wind regime, however, has a continually changing wind speed which results in a sub-optimal operation of the windpump most of the time. Normally up to 50% of the wind energy is lost due to this matching problem. Taking these three factors (C_p, η and matching) into account, the average overall wind-to-water energy conversion can be estimated at 5% to 15%.

If the necessary data for the windpump are not yet known (C_p and η), the following simple formula can be used to estimate the power output of a windpump:

$$P = 0.1 A \bar{V}^3 \text{ (W)} \tag{2.1}$$

where:

- P = power output (W)
- A = area swept by the rotor blades (m^2), where $A = 1/4 \pi D^2$
- D = diameter rotor (m)
- \bar{V} = average wind speed per year or month (m/s)



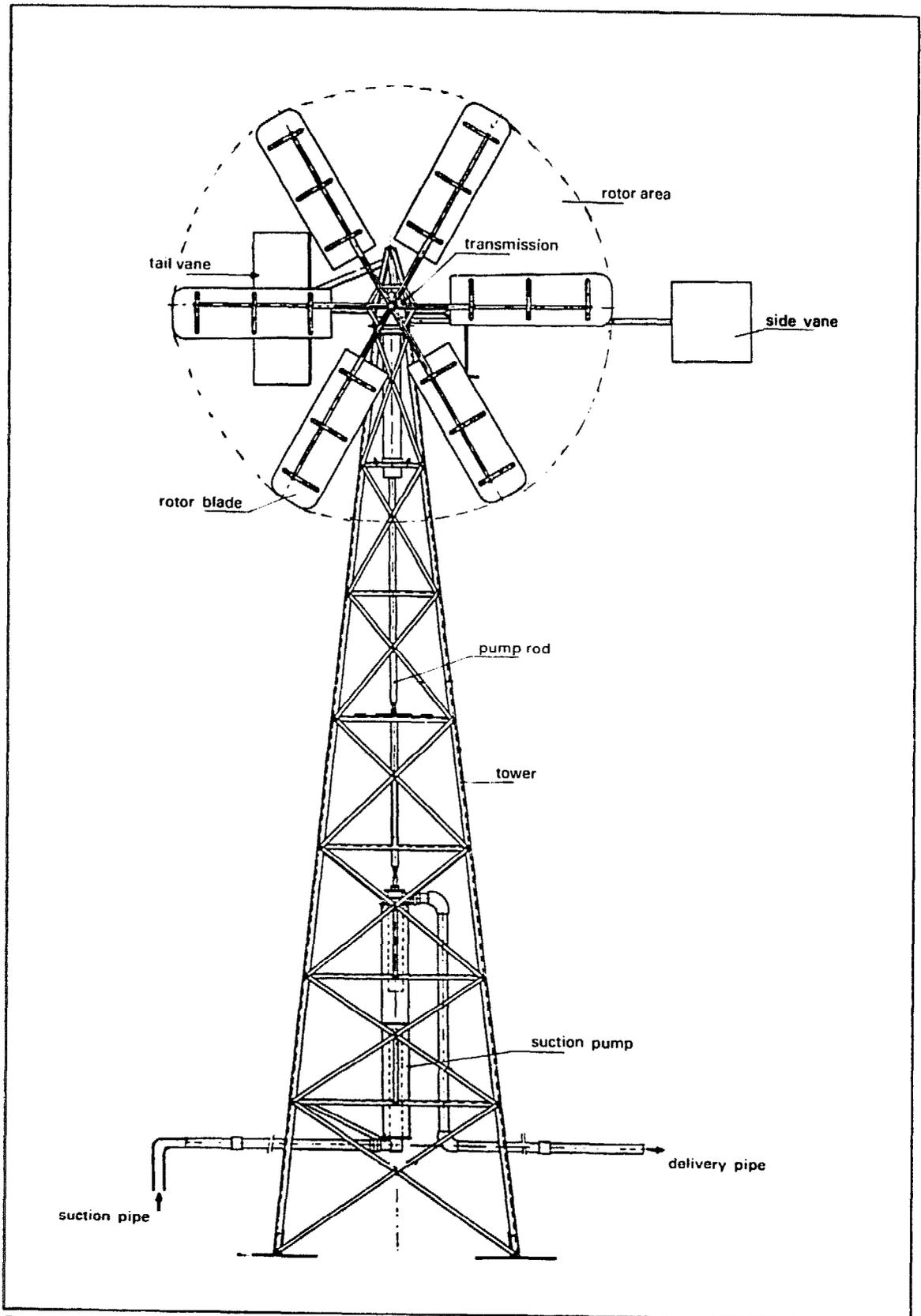

Figure 2.5 The details of a windpump.



For more details see the Wind Pumping Handbook (Van Meel and Smulders 1989)

The power required to lift Q m³/s of water H metres is given by:

$$P = Q \rho_w g H \text{ (W)} \quad (2.2)$$

where:

P = power required (W)

Q = quantity of water per unit of time (m³/s)

ρ_w = density of water (kg/m³)

g = acceleration due to gravity (m/s²)

H = total pumping head (m)

Combining the two formulae 2.1 and 2.2 and substituting for $A = 1/4 \pi D^2$ gives the water output Q of the windpump, for example:

$$Q = \frac{0.1 \frac{1}{4} \pi D^2 \bar{V}^3}{\rho_w g H} \text{ m}^3/\text{s} \quad (2.3)$$

Substituting $\rho_w = 1000 \text{ kg/m}^3$, $g = 9.8 \text{ m/s}^2$ and multiplying by 1000 to convert cubic metres to litres, results in the following formula:

$$Q = 0.008 \frac{\bar{V}^3 D^2}{H} \text{ l/s} \quad (2.4)$$

To convert litre/s to m³/day, multiply formula 2.4 by 3600x24/1000. This results in:

$$Q_{\text{day}} = 0.69 \frac{\bar{V}^3 D^2}{H} \text{ m}^3/\text{day} \quad (2.5)$$

Now the output of a windpump can be calculated for every combination of mean wind speed, rotor diameter, and total pumping head.

Example 2.1

Given a total pumping head H of 10 m and an average wind speed \bar{V} of 5 m/s, the average daily output of a windpump with a rotor diameter D of 2 m and 5 m respectively can be calculated:

rotor diameter 2 m :

$$Q_{\text{day}} = 0.69 \frac{5^3 2^2}{10} = 34.5 \text{ m}^3/\text{day}$$

rotor diameter 5 m :

$$Q_{\text{day}} = 0.69 \frac{5^3 5^2}{10} = 215.6 \text{ m}^3/\text{day}$$

Example 2.2

To determine the required rotor diameter, given water requirement 60 m³/day, water head 5 m, and average wind speed 3 m/s:

$$Q_{\text{day}} H$$

First rewrite formula 2.5 in the following way:

$$D = \sqrt{\frac{Q_{\text{day}} H}{0.69 \bar{V}^3}}$$

and fill in the proper data:

$$D = \sqrt{\frac{60 \times 5}{0.69 \times 3^3}} = 4.0 \text{ m}$$

2.2.2 Wind speeds used for design purposes

Four wind speeds play a role in designing a windpump. They are V_{in} , V_{rated} , V_{design} and V_{out} . They are most important, if exact output predictions are required.

Although designing windpumps is not the object of this report, it is essential to have some idea of these terms. They will be explained using an output curve, (Q-V curve) of a windpump (see Figure 2.6).

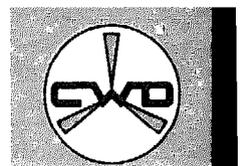

In this figure the output (Q) of a windpump has been plotted against the wind speed. For more extensive information on this subject, refer to Van Meel and Smulders (1989) or Lysen (1983). The windpump starts working at a wind speed equal to V_{in} (called also V_{start}). V_{in} is very dependent on the size of the pump, because a certain amount of initial power is required to drive it. Most piston pumps, however, require about three times more torque to get started than they do to keep going.

This means that a low wind may have enough power to keep the windpump running, that is to drive the pump, but not enough torque to start the pump. V_{in} is actually a range of wind speeds at which the windpump might be running (if it were running the moment before), or it might be stationary (if it were stationary the moment before). For purposes of this publication, V_{in} is given a single wind speed.

All windpumps have a safety system

to protect them against gusts and storms.

The safety system is combined with an orientation system. At low wind speeds the rotor is oriented into the wind; with increasing wind speeds, the rotor is gradually turned out of the wind so as to limit the speed of the pump and the forces acting on the structure. At a wind speed equal to V_{rated} the maximum output is reached and the rotor starts turning out of the wind. This process is called "furling". At a wind speed equal to V_{out} , the rotor is completely out of the wind and stops working.

The design wind speed (V_{design} or V_d), the wind speed at which the rotor pump design combination reaches its highest energy conversion efficiency, is chosen somewhere between the minimum V_{in} and V_{rated} . The design wind speed can be influenced by technical adjustments. One must be careful when using the single figure for V_{in} . In some circumstances, it is advisable to set the V_d lower than V_{in} , which can cause some confusion.

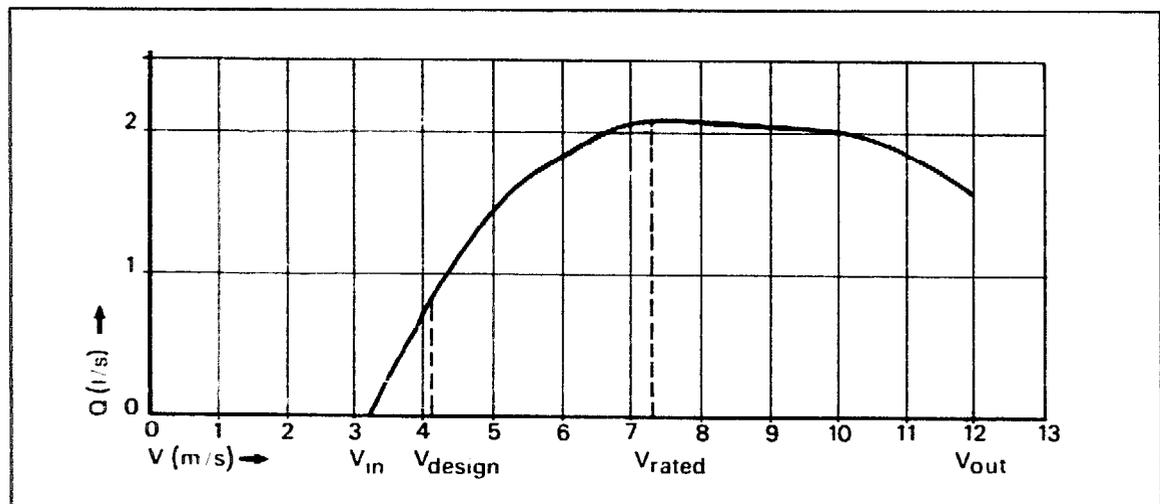

Figure 2.6 An example of a $Q - V$ curve.

2.2.3 The details of the rotor

Although the number of blades plays a less crucial role in the selection of a windpump than say the rotor diameter, the great variety in number of blades for different types of windmills justifies some remarks on this subject.

The traditional "low cost" windpumps generally have only four to eight blades, while the classic multi-blades have 20 or even more. The recently developed windpumps typically have eight to 16 blades whereas wind generators have only two or three blades.



The number of blades determines the rotational speed range at which the rotor operates at optimal energy conversion efficiency. The more blades the rotor has, the lower the angular velocity of the rotor when this optimum is reached. Before and after the optimum, the efficiency decreases (sometimes sharply). One advantage of the multi-blade is that it runs slower at the same wind speed than a windpump with fewer blades.

This is more convenient for piston pumps whereas wind generators with two or three blades run fast, which is more compatible with the generator's requirement. The other advantage of the increased number of blades is the rotor torque. Increased torque at starting allows the peak torque, which is required to start moving the piston, to be reached at a low wind speed.

Multi-blade rotors therefore are used with windmills built for rural water supply and watering cattle in wind regimes with a frequent and prolonged occurrence of wind speeds between 2.5-3.5 metres per second .

Recent windpumps use fewer blades and piston pumps. How can this be? The answer lies in the piston pump or with the counterbalance in the head of the machine. Devices such as starting holes, floating valves, and variable stroke orifice lower the maximum torque requirement of the piston pump. Similarly, devices such as the counterbalance, literally counter the weight of the rods and (sometimes) the water to lower the peak torque requirement.

These devices work best with the lower delivery pressures of low heads and therefore are particularly suited for the newer irrigation windpumps. There is no reason, however, why these devices can not be used with the classic or traditional windpumps, and indeed in some cases they have been used

quite successfully. There is one primary disadvantage of using the pump-based devices with a multi-blade: the lower angular velocity means that the device gives a more intermittent pump output. This is not a serious problem with small windpumps.

Combined wind/electric systems use fast running rotors that have a higher peak (aerodynamic) efficiency than the multi-blade. The higher rotational speed also suits the generator's action. The complete system rarely has a significantly higher overall efficiency when used for pumping water, however.

The main reason for increasing the number of blades is to lower the optimum rotational speed and more importantly to increase the torque available to start the pump. With many blades, the aerodynamics of the rotor are somewhat "spoiled", therefore the lift dynamics of the individual blades are not too important.

A multi-blade rotor can therefore be made with a simple blade shape (a curved plate), while electric generating rotors need aerodynamic profiles.

2.2.4 The tower height

The tower height of mechanical windpumps is normally between 5-12 metres. The most important function of the tower is to raise the rotor above surrounding obstacles such as buildings and trees. In that case a good exposure of the rotor to the wind is guaranteed. The height should be a compromise between economizing on construction costs and the wish for maximum water production.

On the one hand, a lower tower makes a windpump cheaper. The construction, including the foundation, can be made simpler and the transmission between rotor shaft and pump is shorter. On the other hand, the higher the tower, the more advantage can



be taken of the fact that the greater the height above the ground surface the more the wind speed increases. This increase, however, is also

a function of the surface roughness, usually indicated as roughness height z_0 . Values of z_0 are presented in Table 2.3.

Table 2.3 Roughness heights (Lysen 1983)

flat	beach, ice, snow landscape, ocean	$z_0 = 0.005 \text{ m}$
open	low grass, airports, empty crop land	$z_0 = 0.03 \text{ m}$
	low crops, high grass	$z_0 = 0.10 \text{ m}$
rough	tall row crops, shrubs	$z_0 = 0.25 \text{ m}$
very rough	forests, orchards	$z_0 = 0.50 \text{ m}$
closed	villages, suburbs	$z_0 = 1.0 \text{ m}$
towns	town centres, open spaces in forests	$z_0 > 2 \text{ m}$

These values can be used in the standard formula for the logarithmic profile of the wind speed:

$$\frac{V(z)}{V(z_r)} = \frac{\ln(z/z_0)}{\ln(z_r/z_0)} \quad (2.6)$$

where:

- z = height (m)
- z_r = reference height at which a given wind velocity is measured (m)
- z_0 = roughness height (m)
- V = wind speed (m/s)
- \ln = natural logarithm

Example 2.3

What is the average wind speed at a height of 12 m, in an area with orchards, if the wind speed at 8 m height is on average 4 m/s? The roughness height for orchards is 0.50 m, thus:

$$\frac{V(12)}{V(8)} = \frac{\ln(12/0.5)}{\ln(8/0.5)}$$

thus:

$$V(12) = 4 \frac{\ln 24}{\ln 16} = 4.6 \text{ m/s}$$

Example 2.4 (the effect of the tower height)

If we assume that a site has a roughness height of 0.25 m, what is the difference in daily output of a windpump with a tower height of 5 m and 10 m, respectively, if the following data are given: the rotor diameter is 5 m, and the V is 5 m/s (measured at 10 m height). The total pumping head H is 10 m.

With the help of formula 2.6, it can be calculated that the wind speed at a height of 5 m is approximately 4 m/s. Using formula 2.5:

$$10 \text{ m tower: } Q_{\text{day}} = 0.69 \frac{5^3 5^2}{10} = 216 \text{ m}^3/\text{day}$$

$$5 \text{ m tower: } Q_{\text{day}} = 0.69 \frac{4^3 5^2}{10} = 110 \text{ m}^3/\text{day}$$

In this case, it can be noted that a 10 m tower has almost twice the output of a windpump with a 5 m tower.

2.2.5 The pump

Most pumps used in combination with windmills are single acting piston pumps. But axial flow pumps and archimedian screws were and are also in use. Axial flow pumps are coupled to rotors with small diameters (3–4 m) and are used for drainage and irrigation if



pumping heads are very low (1-2 m). Combining archimedian screws with a rotor is rather old and was used in the Netherlands for drainage purposes. There is some renewed interest in this combination in China and India. The results of research in this direction are too preliminary, however, to be worth including in this report.

Next, let's concentrate on piston pumps. A piston pump consists of a piston, two valves, a suction pipe and a delivery pipe.

Sometimes air chambers are incorporated into the delivery or suction pipe of the pump to smooth the flow and reduce shock forces in the pump rod (see Figures 2.7 and 2.8).

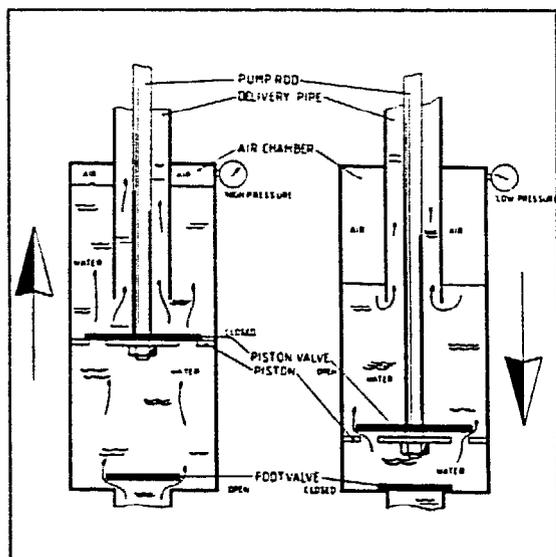

Figure 2.7 The operating of a reciprocating piston pump (Goezinne 1986).

The operating principle of the reciprocating piston pump is simple: if the piston moves downward, the upper valve (piston valve) opens, the lower valve (foot valve) closes. As soon as the piston moves upwards the upper valve (piston valve) closes, the lower valve (foot valve) opens and water above the piston is lifted; water is sucked into the chamber below the piston, if the pump is above water level, or pushed into the chamber

if the pump is below water level.

Windmills can be equipped with pumps of different diameters and stroke lengths. To determine the optimal combination of diameter and stroke, one has to know the total head H over which the pump has to lift the water, the design wind speed V_d , and the average pumping rate Q .

The design wind speed V_d the wind speed at which C_p'' reaches a maximum value in a given wind regime; V_d is normally chosen to be approximately the average wind speed and should lie between V_{in} and V_{rated} as discussed in Section 2.2.2.

Given H , V_d and Q , a windpump manufacturer can give advice about the best pump volume. Usually the volume of the pump increases with a decreasing pumping head and vice versa; thus a great depth requires a small pump.

One of the problems of combining windmill and piston pump is that the required starting torque and power is rather high, thus the wind speed at which pumping starts is high. In other words, choosing a large pump leads to a high output, but a low availability (for instance, the windpump will often stand still). The choice of a small pump improves availability, but reduces output. In matching a pump to a windmill, one needs to establish the best possible compromise between output and availability (see also Van Meel and Smulders 1989).

Recent research has proven that this starting behaviour can be improved in different ways as was discussed in section 2.2.3. The most common methods at present are either drilling a very small hole in the piston or using a floating valve. The effect is that at low speeds, all water that is pumped will leak through the hole or along the valve. This implies that the pressure on the piston is very low and therefore the starting torque is lowered. If the speed is



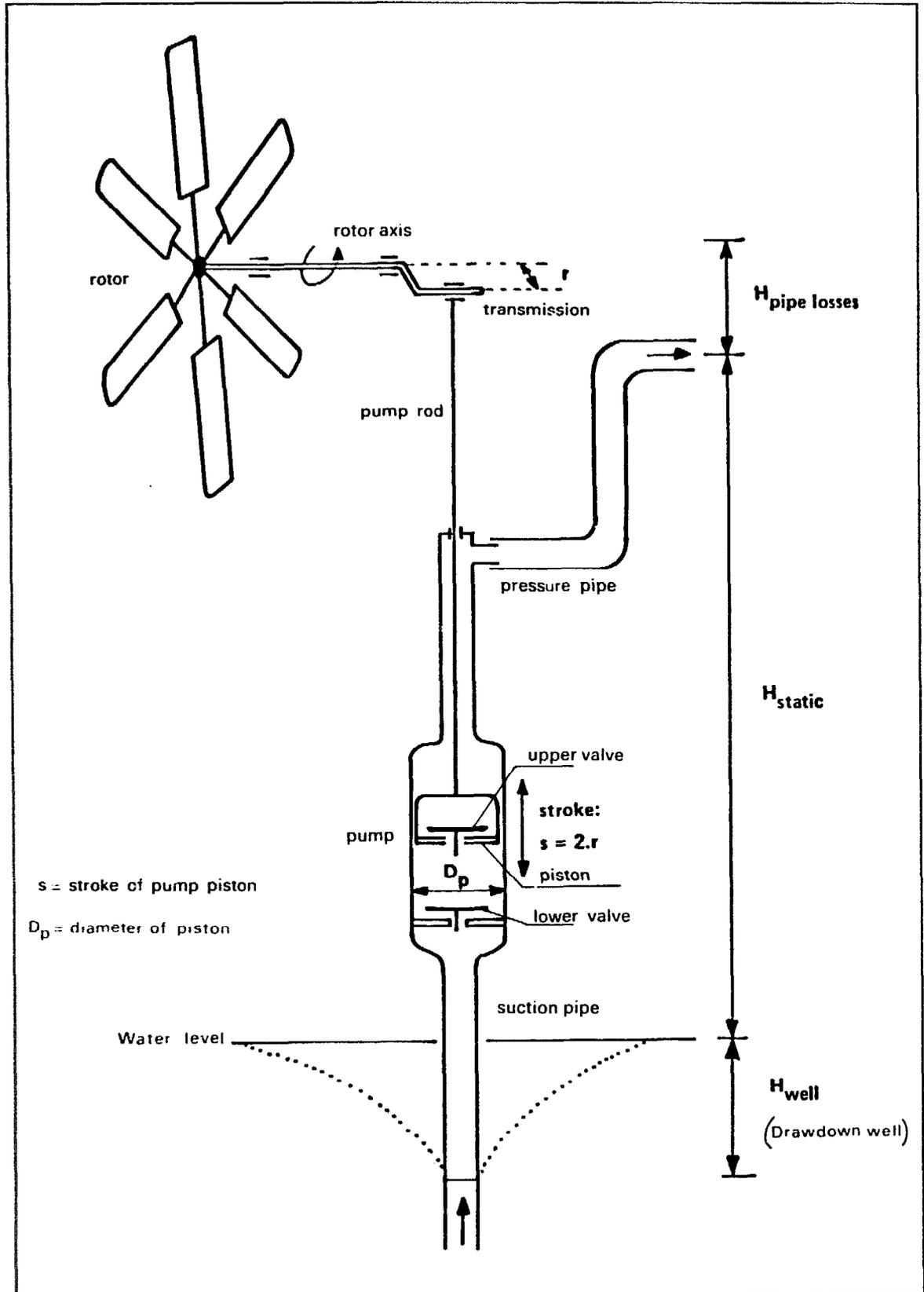

Figure 2.8 Schematic drawing of a reciprocating piston pump connected to the wind rotor (Lysen 1983).



higher than the quantity of water leaking is relatively small compared to the normal output of the pump, and this effect is more than offset by lowering the starting speed.

The pump (or suction pipe) can be placed in a river or lake, in an open well, or in a tube well. In the latter case the diameter of the tube well may be limiting the maximum pump diameter. Another constraint that should be examined is the recharge capacity or yield of the dug or tube well as will be discussed in chapter 4. The pump should not empty the well completely, otherwise it could be severely damaged by running dry.

The pump position can be either submerged or in "suction". In the latter case, the pump can not be placed more than about 6 m above the water level. One should be aware that the water level is drawn down during pumping from its static level to its so-called dynamic level.

2.2.6 Control and safety system

The main functions of a control and safety system are:

- limiting the speed of the rotor (and pump) at high wind speeds.
- limiting the forces on the rotor blades, the rotor head and all its components, and the tower.
- keeping the rotor facing the wind at normal wind speeds; thereby, optimising energy efficiency.

In the ancient windmills that were used in Holland, Portugal, and Greece, among other places, the control system was made up of sails that could be reefed, plus a brake. Modern windpumps generally have a safety system consisting of two vanes, one tail vane that keeps the rotor in the wind, a side vane pushing the rotor out of the wind, and a counter force provided by a spring which is called an

ecliptic safety system. Instead of using a side vane, the rotor can also be placed eccentrically with respect to the vertical rotation axis of the head, as shown in Figure 2.9.

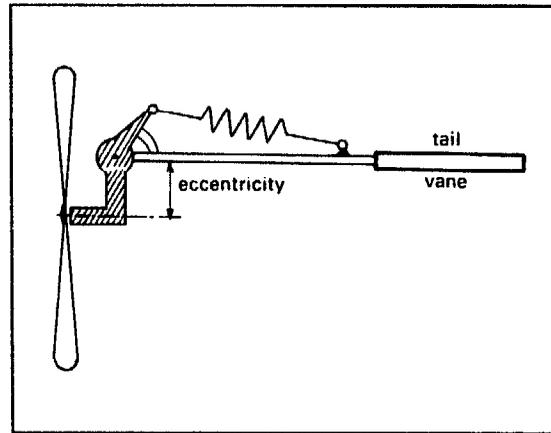

Figure 2.9 Ecliptic safety system, with an eccentrically placed rotor (in this case no side vane is required).

A counter force due to gravity can also be used (inclined hinged vane system, see Figure 2.10) in place of the counter force provided by a spring. This system is well suited to turn the rotor very gradually out of the wind with increasing wind speed.

As the tail vane remains more or less parallel to the wind, this turning of the head means that the tail vane is turned around on its inclined hinge, and is thereby lifted. The vane strives towards its lowest position, however, providing the moment that balances the rotor and side vane (Lysen 1983). Moreover, the windpump should have a lock position (Smulders and Loytenberg 1985).

2.2.7 Transmission

Windpumps are provided with a transmission of either the crankshaft type or the gearbox type in order to transmit the horizontal rotational movement into a vertical up and downward movement (see Figure 2.11).

The crankshaft type is easier to manufacture and cheaper, but in general needs more maintenance and repair than the closed



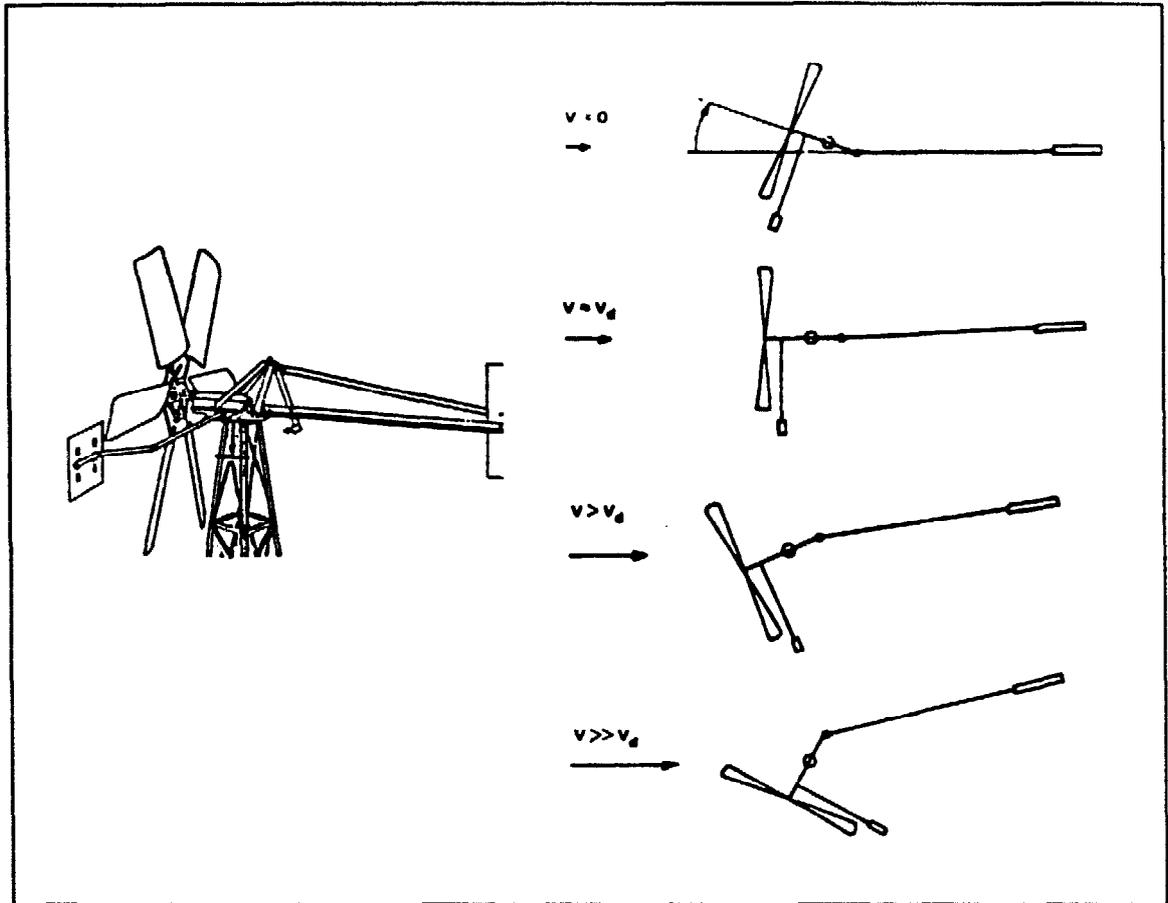

Figure 2.10 Inclined hinge vane system.

gearbox type. Another disadvantage of the former is that no reduction of rotation velocity can be made. The gearbox type is more expensive, however, and needs regular oil changes.

There are now commercial alternatives to the mechanical transmission system. These include the use of compressed air, water hydraulics, and, of course, electricity.

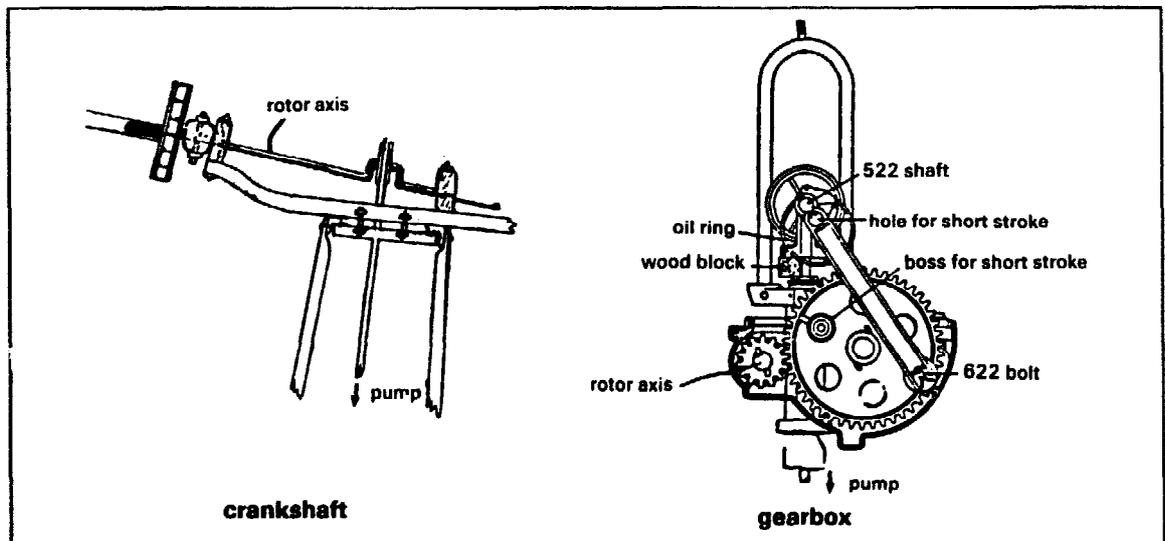

Figure 2.11 Two different types of transmission.



Once a windpump has been installed, it will generally last for at least 10-15 years (locally built windpumps) or up to 30 years (classic multi-blade windpumps), if regular maintenance is carried out. The maintenance involves regular greasing, changing the oil (gearbox type), changing the pump-worn parts, checking the different parts, and depending on the corrosion in a particular area, painting the tower and rotor.

From time to time, some parts will have to be renewed; most frequently, the piston leather (after half a year to one year). It is only seldom that pump rods and bearings, or the pump as a whole, have to be renewed.

The classic multiblade windpumps require very little maintenance (once in 6-12 months). The recently developed windpumps require more regular maintenance (once every 2-3 months).

Annual maintenance and repair costs are in the range of 1%-15% of the total investment cost of the windpump. Table 2.2 shows the investment cost of windpumps exclusive of installation cost. Installation costs are generally some 10%-20% of the price of the windpump.

In a traditional irrigation area on the Cape Verde Islands, where farmers themselves did the maintenance, the yearly costs of maintenance and repair were about 5% of the investment cost of their locally constructed windpump. In the same area, some other farmers used imported commercial windpumps and had annual maintenance and repair costs of only 1%-2% of the investment cost (Van der Bijl 1985). In a windpump project on another Cape Verde Island, however, where imported American windpumps are used for the

domestic water supply, the annual costs for maintenance and repair are between 5%-7% of the investment cost of the windpump, including installation.

The organisational aspects of maintenance and repair are also important. A choice has to be made between a centralized or decentralized organisational set up. Furthermore attention must be paid to the technical knowledge and skills of the users of windpumps. These should be sufficient to allow the users to carry out day-to-day maintenance and minor repairs by themselves.

A farmer cannot easily go with his wind-pump to a local workshop as he could do with a fuel or electric pump.

Therefore training facilities for the users must be included in a project (see section 7.1 pilot project and implementation).

In conclusion it can be stated that the organisational aspects of maintenance and repair influence the scale of a windpump project.



The selection of windpumps for irrigation (or other purposes) requires reliable data on wind and water availability. This data enables estimates to be made of the quantities of water that can be pumped in the course of a year.

This section describes the various aspects of collection, processing, and analyzing wind speed data; data on well yields, pumping heads and site selection will also be treated. Consideration is also given to scheduling data collection in relation to the introduction of the windpump.

3.1

THE WIND REGIME

The decision about whether to use windpumps requires a thorough knowledge of the wind regime in the area concerned. The nature of the wind is such that global or regional surveys are only indicative of the general pattern. The wind at specific sites may deviate considerably from the wider regime. Only in regions with average wind speeds between 6 and 10 m/s (for instance trade wind regions) can activities be started without a detailed knowledge of the regime.

3.1.1 Data requirements

Ideally, the potential for windpumps should be assessed on the basis of long-term records (10 years or more) of wind speed and wind direction patterns. The data should make it possible to determine such things as the:

- hourly, daily, monthly and annual wind pattern.
- duration of low wind speeds and high wind speeds.
- maximum gust speed.
- wind direction.
- amount of wind energy present and the related water quantity that can be pumped per month or year.

Such extensive wind speed data is seldom available however. The minimum amount of data needed for starting a pilot project on wind energy is therefore discussed in the following sections.

3.1.2 Mean wind speeds

The average annual wind speed can be an initial indication of the economic viability of windpumps. This value should normally be at least 3-4 m/s. The annual mean wind speed can be misleading.

All the wind may occur in the dry season giving a high mean for that part of the year, or, as happens in Thailand, the wind may occur during one short period each day. In the Thai case, the wind blows for about 6 hours a day, sufficient to pump for the six hours, but giving a very low (1-2 m/s) 24-hour mean wind speed. One must be cautious, therefore, in the use of annual mean wind speeds.

At the minimum, windpumping pre-feasibility studies tend to require average monthly wind speeds and preferably an indication of the occurrence of windless periods.

If this data does not exist for the windpump site, data from nearby meteorological stations may be used, supplemented by short-term measurements in the specific area. The short-term measurements must be compared with measurements taken concurrently at the meteorological station.

3.1.3 Data accuracy

If one intends to use data from other stations, the methods of measuring and collecting the data and the location of the station should be investigated.



The questions one should ask include:

- Which type of wind measuring system was used?
- How frequently was the wind measured? (once a day, hour)?
- In what units are the results expressed? (m/s, knots, miles/h, etc.)?
- What is the location of the station, in terms of coordinates, height, exposure to the wind, etc.?
- What is the roughness height of the surroundings?
- Were these characteristics the same throughout the years of data gathering?

The last question is particularly significant. The station may have been in a different location, or the wind measuring equipment may have been replaced, overhauled or simply damaged in the past. The accuracy of anemometers (instruments to measure wind speeds) should be checked and they should be weatherproof, and so on. It is likewise advisable to calibrate them regularly.

The reliability of the data measured by an anemometer depends on its position (height above ground level) and its location (proximity to obstacles, etc.). The wind regime that the anemometer (or windpump) experiences depends on several factors:

- exposure
- wind speed profile
- turbulence
- acceleration (topography)

Although they are dealt with in a later section, one should note that for these reasons, measurements at a height of 2 m, which is generally used for agro-climatological purposes, should be considered very carefully. To extrapolate these data to 10 m height might introduce large inaccuracies.

If the results of a pilot project are rather promising and a consecutive project is considered, then the wind regime should be evaluated in more detail. In addition to yearly and monthly mean wind speeds, there should preferably be one year of hourly wind speed data available in order to evaluate fluctuations in wind speed on hourly and daily bases. With these data one can obtain a better insight into the occurrence of windless periods.

Wind direction data are important for the selection of windpump installation sites with respect to obstructions. Likewise, if the wind is predominantly from one direction, as is often the case near a large body of water, the windpump may also be made to face only a single direction.

3.1.4 Wind data measuring equipment

The devices used for collecting wind data are the anemometer (measuring wind speed) and the wind vane (measuring wind direction). Wind speed data tends to be the more important. Figure 3.1 shows some devices. We can divide wind data collecting systems into four categories. The criterium for the classification is the data memory capacity of the system (Wegley et al. 1980).

The classification including price indications in U.S. dollars as of 1989 is given below.

A - No memory

Systems in this class have a display showing only the wind speed at the moment of measuring.

Advantages: low cost, current wind conditions.
Disadvantages: no recorder, based on human observations, biased toward high wind speed.
Cost \$50-\$500.

B - One memory register

This class includes wind run meters (also called wind run counters and odometers).



The wind run ("distance travelled by wind") during a certain time interval divided by the duration of that interval yields the average wind speed of that interval. The more readings are made, the more details on wind speed distribution can be derived.

Advantages: low cost, easy to use, good for remote locations. Disadvantages: minimal information limits data analysis. Cost \$100 to \$500.

C - Extended memory

This class includes data loggers or non-programmable recorders. This type processes the data supplied by an anemometer and stores the results.

These results are usually suitable for direct wind analysis and may include histograms (see for example Figure 3.3).

Advantages: summarises data when collected, ease of analysis, good for remote locations.

Disadvantages: cost, some details of the data is still lost, auxillary equipment needed to retrieve data. Cost \$300-\$1500.

D - Comprehensive memory

This class includes programmable data recorders and computerized equipment. The data supplied by measuring equipment are collected and then stored on cassette tapes, floppy disks or memory chips.

This sequential data is then taken to a processing unit, usually a computer. The data can be analyzed in several ways depending on the needs and the available computer programmes. The results of such processing can include daily, monthly and yearly patterns, lowest and highest wind speeds, wind direction

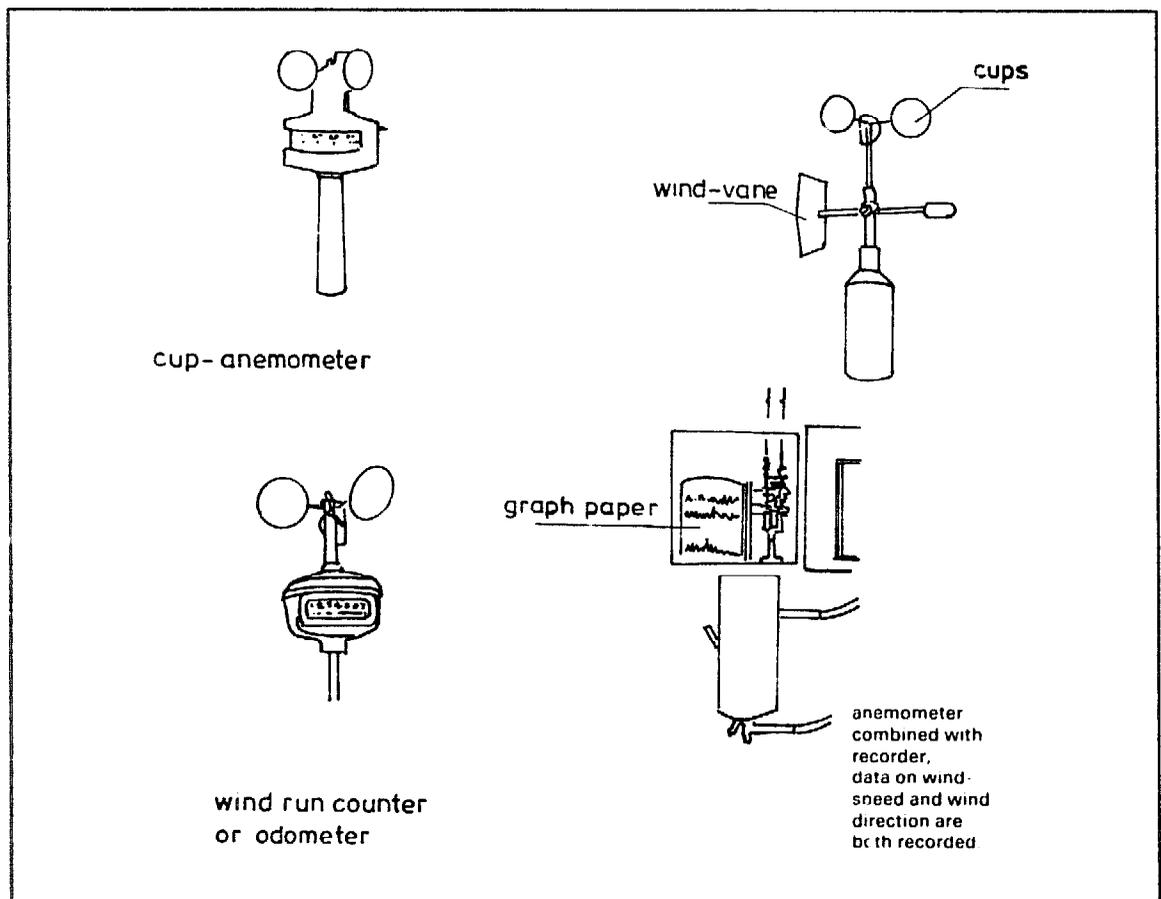

Figure 3.1 Some examples of wind measuring equipment.



patterns, frequency of lulls, and numerical and graphical representations.

Advantages: large amount of detailed data.

Disadvantages: large amount of detailed data! (which then needs analysis). Cost \$1600-\$5000.

ANALYSIS OF WIND DATA

Yearly and monthly average wind speeds are a minimum requirement for initial decisions, that is those made during pre-feasibility studies.

This data can be used with the formula $Q_{\text{day}} = 0.69 \frac{V^3 D^2}{H}$ (see Section 2.2.1) to estimate monthly windpump output. This output pattern can then be compared with the monthly irrigation water requirement pattern shown in Figure 3.2.

This Figure makes it clear that the period with the highest water requirements coincides with the period of low windpump output. In other words, a water deficit occurs in May, June, July, and August.

The example illustrates the importance of analyzing windpump output and water requirement patterns at an early stage in the introduction of the windpump (for further details see Chapter 4).

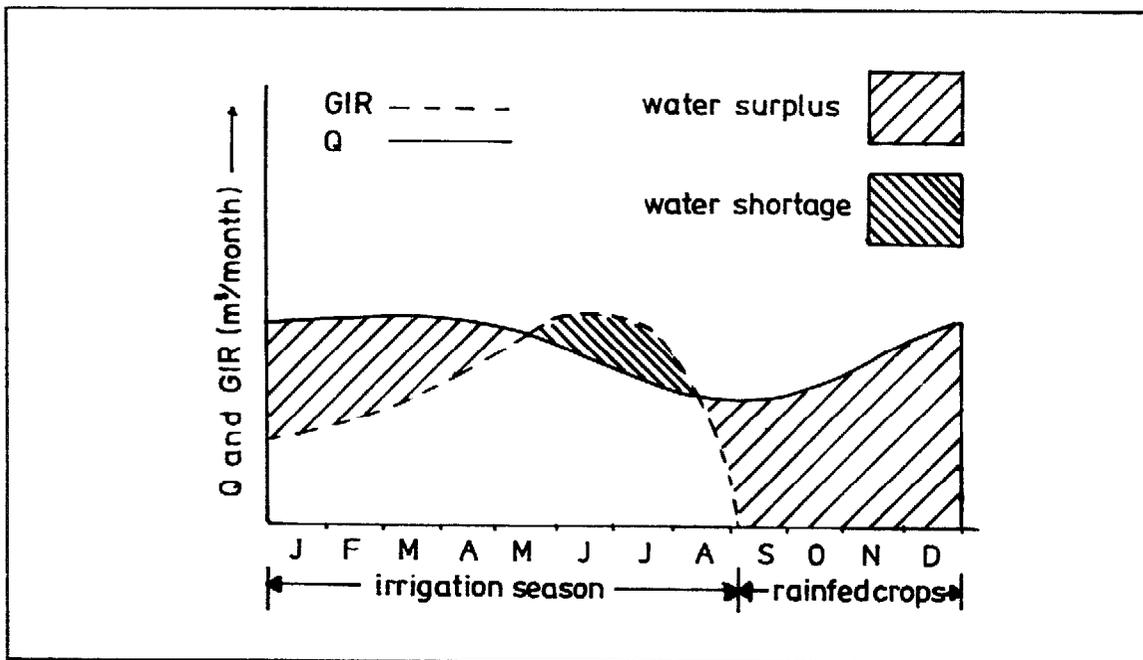

Figure 3.2 An example of the yearly pattern of windpump output (Q) and gross irrigation requirement (GIR).

Additional analysis is required during the pilot phase and prior to starting larger windpump schemes to be able to make a more exact calculation of monthly windpump output. The analysis to be carried out includes:

- analysis of hourly fluctuations.
- analysis of day-to-day fluctuations (periods of windless days).

- analysis of daily wind patterns (difference between day and night output).
- probability of long-term extremes or limits (probability of periods with very high wind or very low winds, lower and upper wind speed limits in certain periods, etc.)

A time distribution and a frequency distribution can be calculated from the hourly



wind speed records, which in turn permits an analysis of the energy available in the wind regime and the output of a windpump as will also be discussed in Chapter 5.

The data is first arranged to give the number of occurrences of the wind speed

within a particular interval. For convenience, that information is then presented as a histogram. The tops of the histogram can be joined to approximate a curve which may be mathematically approximated by a function.

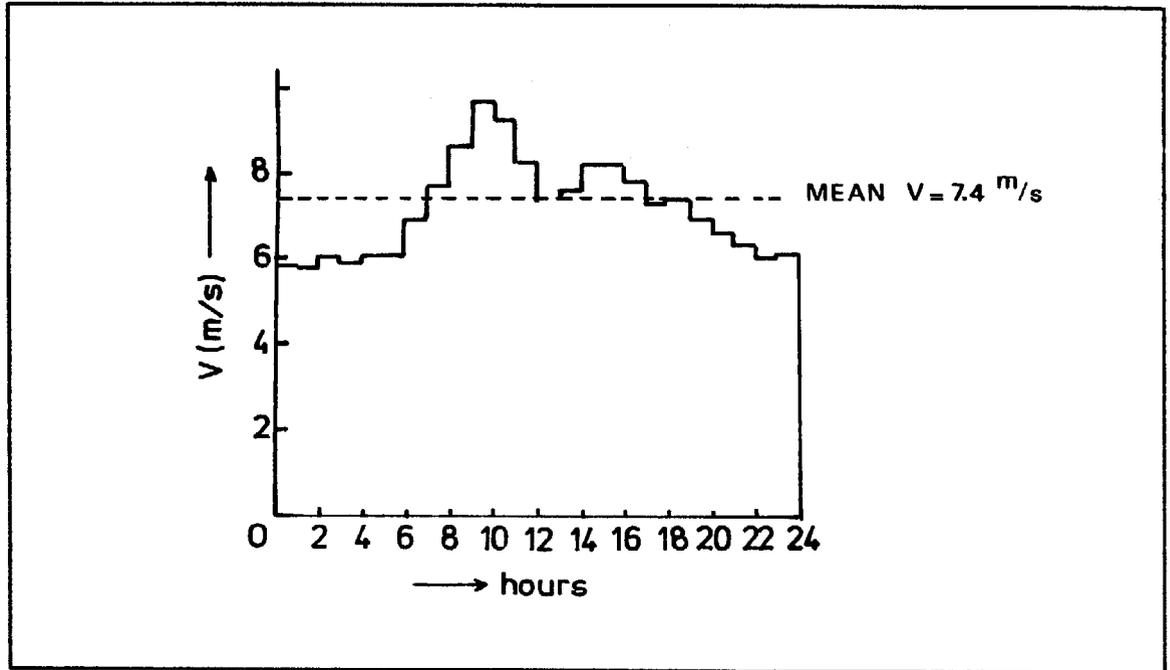

Figure 3.3 Daily pattern of the hourly wind speed (time distribution) at Praia airport in Cape Verde in the month of June 1975 (Pieterse 1982).

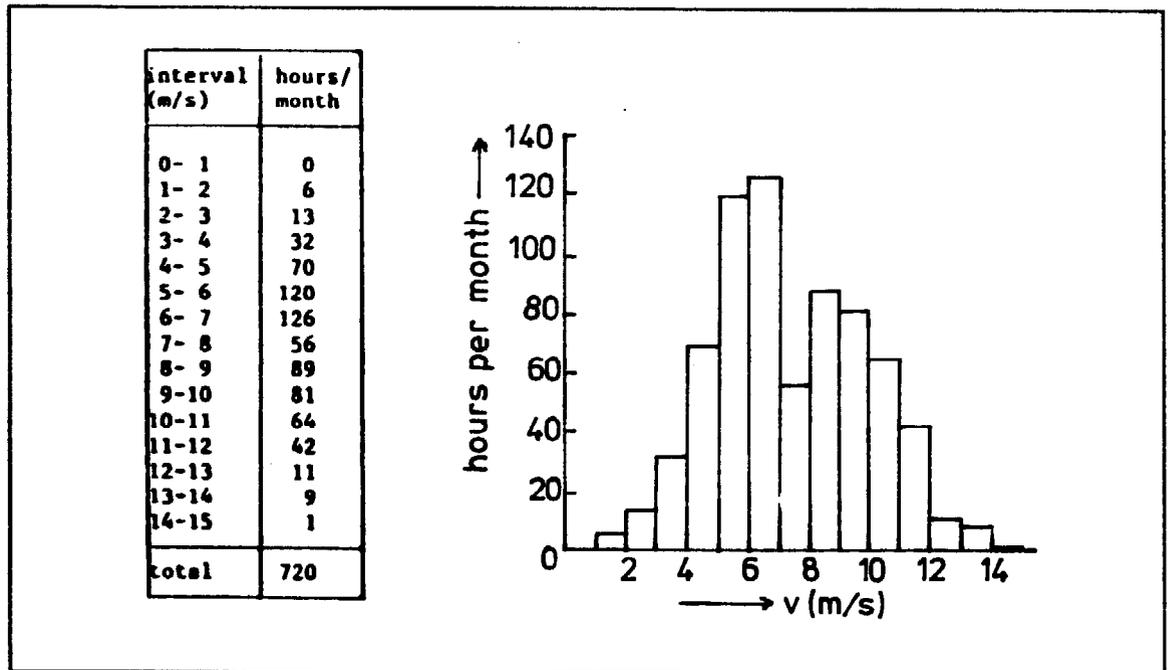

Figure 3.4 The frequency distribution data for Praia airport (Cape Verde), June 1975, in both table and histogram form (Pieterse 1982).



The mathematical function used in wind analysis is called the Weibull distribution function and depends upon two main parameters:

V = average wind speed usually in m/s for the period analysed.

k = Weibull shape factor (dimensionless).

The Weibull factor k has values of 1 to 4. The higher the factor, the more constant the wind speeds.

Examples of time and frequency distributions are given in Figures 3.3 and 3.4 (Pieterse 1982). For a detailed analysis of hourly data using the Weibull distribution, refer to Lysen (1983) or Van Meel and Smulders (1989). Once this distribution is known, it is possible to estimate the windpump output more accurately. It is important, to remember, however, that while the Weibull distribution

gives a more accurate estimate of windpump output, it does not indicate at all when that output occurs. In this respect, frequency distribution analysis, such as the Weibull analysis, should not be seen as a substitute for a time distribution analysis.

For large quantities of hourly data, computer programs permit the numerical calculation of the relationship between windpump output, gross irrigation requirements, storage tank capacity and water deficit (see also Chapter 5).

If wind speed data are available for a longer period, a probability analysis can be done. Among other things, this provides probability intervals of monthly average wind speeds, as shown in Table 3.1. The practical use of such elaborations are shown in the next chapter. In practice, as a general rule of thumb, the monthly means are within 30% of the long-term monthly mean and the annual mean is within 10%.

Table 3.1 95% probability intervals of monthly mean wind speeds at Praia airport, Cape Verde (Pieterse 1982).

Month	2.5% limit (m/s)	97.5% limit (m/s)
January	6.52	7.82
February	7.31	8.51
March	7.34	8.20
April	6.74	8.12
May	7.76	8.32
June	6.35	7.03
July	4.80	5.50
August	4.36	5.16
September	4.52	5.60
October	5.87	6.95
November	6.16	6.70
December	6.29	7.81
Year	6.52	6.80

Note: 95% of the monthly mean wind speed is between the limits mentioned, 2.5% is below the 2.5% limit, and another 2.5% is above the 97.5% limit.

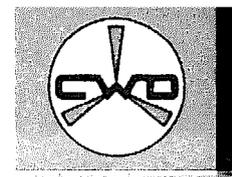

The potential power output of a windpump is related to the cube of the wind speed. This means that the site for a windpump must be chosen carefully to make the best possible use of the wind. More often than not, however, the water resource limits the choice of location for the windpump.

With dug wells and tube wells, the windpump should be placed on top of the hole, with rivers the pump must be within suction height of the water level in the dry season.

The factors that influence the wind speed at a specific location are (Wegley et al. 1980):

■ exposure

With the most important determining factor the exposure of the windpump to the prevailing wind direction.

■ wind speed profile

Vegetation, buildings and the ground surface itself cause the wind to slow down near the ground. In other words, the wind speed increases as the height increases. In the lower air layers, the rate at which height increases wind speed depends a great deal on the roughness of the terrain (see also Section 2.2.4).

■ turbulence

Wind flowing around buildings or over very rough surfaces shows rapid changes in speed and/or direction, called turbulence. This turbulence decreases the power output of the windpump. It can also cause the machine to vibrate (see Figure 3.5).

The same situation occurs near shelter belts of trees: the turbulence is noticeable up to a leeward distance of at least 10-15 times the height of the trees. In a windward direction, the turbulence extends up to five times the height of the obstacle.

■ acceleration (topography)

Apart from the fact that tops of ridges experience higher wind speeds due to the effect of height on wind speed, the ridge also converges the air stream which results in an acceleration of the air near the top. Generally, the effect is stronger when the ridge is rather smooth and neither too steep nor too flat (Figure 3.6).

The last effect, however, is not very significant for windpumps, because the tops of ridges are generally far away from water sources. It can be important for wind generators coupled with an electric pump or one of

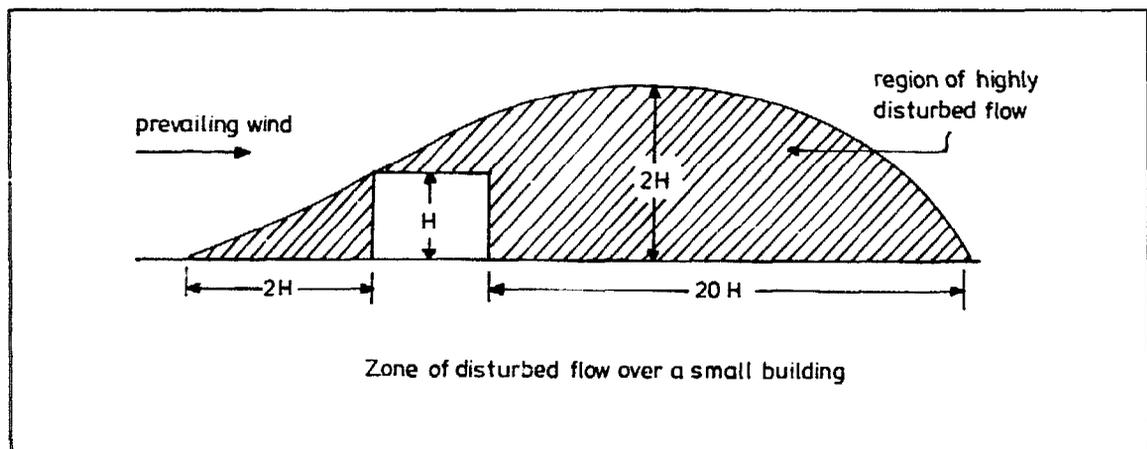
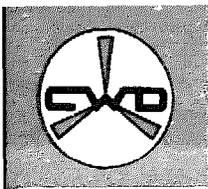

Figure 3.5 The effects of an undisturbed air flow encountering an obstruction (Meroney 1977).



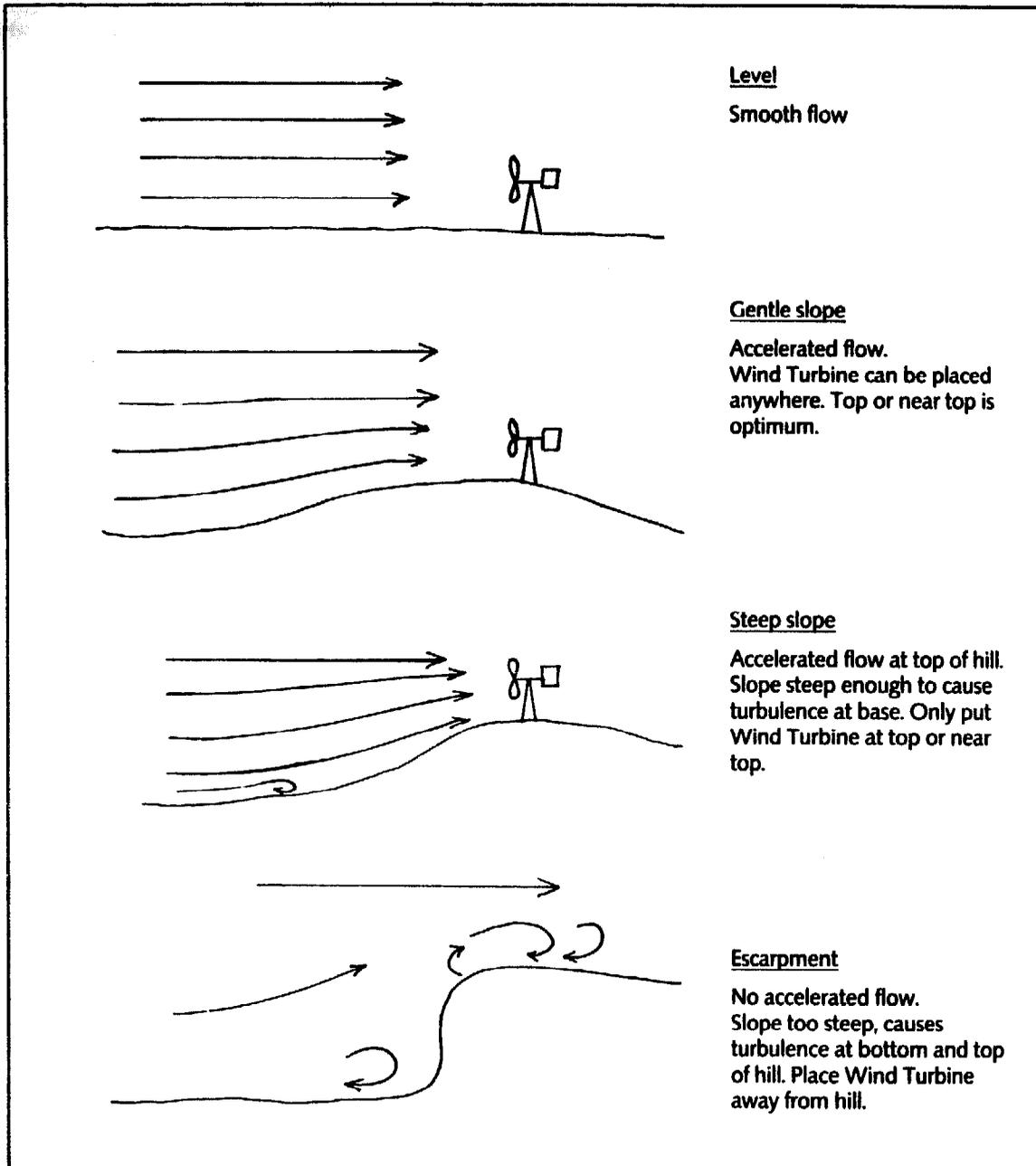

Figure 3.6 Air flow over cliffs having differently sloped faces.

the new generation of windpumps with hydraulic or pneumatic power transmission. These systems have been developed specifically to make use of the tops of the hills.

Site evaluation is less critical in flat terrain than in hilly or mountainous terrains, where it should be done with great care. If the

choice of the site for the windpump is not freed by distance power transmission, then wind speed profiles and turbulence effects have to be accepted and taken into account when choosing the windpump parameters (tower height, rotor area, starting wind speed, for example).



Section 3.1. briefly discussed the matching of the windpump output pattern and the water requirement pattern (Figure 3.2). The water availability pattern should likewise be compared in the same way with the output and requirement patterns.

It is clear that water availability influences the windpump output since the output is directly dependent on the pumping head (Section 2.2.1).

The water resource can be divided into two main categories:

- surface water, (river, lake, pond, tank or canal)
- ground water (tube well or dug well)

3.4.1 Surface water

Even though the supply of surface water is generally not the limiting factor, the fluctuations in the water level should be investigated thoroughly. The pumps can be placed either under or above the surface water level. In the latter case, the suction head should not be more than six metres even though the total pumping head can be up to 100 metres or even more.

Surface water tends to correlate reasonably well with the rainfall in the catchment area. If the catchment region can be found by studying the upstream characteristics, then the water flow in the river can be related to the rainfall data from a nearby meteorological station.

This is similar to relating the wind speed on site with the long-term data from a nearby station. For small streams, the water flow can be found using measuring weirs, that is, an overflow structure built across the stream. The discharge of the stream concerned can then be determined in relation to the depth of the water flowing over the weir crest. (see for

instance Stern 1984). The water flow in large rivers can be measured using a flow meter (see standard texts on hydrology).

3.4.2 Ground water

When the water source is ground water that is extracted from a deep well or a shallow hand dug well, the draw down and specific capacity of the well should be investigated. Fluctuations in the water level due to seasonal influences should be studied, but with deep well aquifers these rarely correlate with the rainfall of the region.

The importance of seasonal and annual changes should not be underestimated. In Gujarat, India, the water level of tube wells throughout the region dropped from 30 m (1986) to 130 m (1989) during three years of drought. Any windpump irrigation programme would have to be abandoned under these circumstances.

3.4.3 Well yield

In deep wells with small diameters, the transmissivity (product of permeability and thickness) of the water-bearing layer (aquifer) should be relatively high compared with a large diameter shallow open well. In case of relatively thick aquifers, the well yield can be increased by deepening the well. Another advantage of large diameter dug wells is their internal storage capacity.

If no data on the well performance are available, pumping tests should be conducted before windpumps are installed on wells. Appendix 1 provides some methods for testing large diameter wells.

Refer to Kruseman and De Ridder (1976) for pumping tests both on small and large diameter wells.

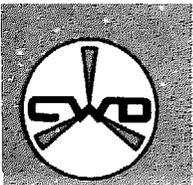

The maximum capacity of a wind-pump should be less than the minimum yield of the well to prevent the well from drying up. Without the lubricating and cooling effect of the water the moving parts of the pump will wear out quickly. Windpumps are well adapted to wells with relatively low re-charge capacities. Diesel driven pumps have higher pumping rates and can, in some cases, pump only for a few hours before the well falls dry. A windpump on the other hand, pumps at a low rate for much longer.

3.4.4 Total pumping head

The total pumping head for irrigation purposes should generally not surpass 10-20 metres. Otherwise, the price of the water would be too high to make crop growing profitable. There are exceptions, however.

Market-oriented vegetable cultivation, for instance, permits higher pumping costs. When the water is used for domestic water supply, the total pumping head can be much higher (even more than 100 m).

3.4.5 Water quality

The quality of the water must also be examined carefully, not only in relation to crop growth but also in regard to the danger of damaging the piston pump and thus shortening the lifetime of the equipment. This danger also exists when water with a lot of sediment, especially sand, is pumped.

A filter fitted to the end of the suction pipe prevents damage. Acidity can corrode pump parts, and serious corrosion can be expected if acidity is high (pH below 6).

FINAL COMMENTS

This chapter has outlined the requirements for wind and water data needed to judge the merits of a proposed windpump project. The wind speed and the water resource have both been assessed. It is now possible to calculate the approximate size of windpump required and to determine whether a more detailed study is necessary.

The next chapter describes ways in which the irrigation requirement can be estimated, and the size of windpump needed to supply this water.



The area which can be irrigated with a windpump is called the command area. Diverse local conditions and various sizes of windpumps result in different command areas. An approximation of the command area of a windpump is based on average monthly data

regarding the output of the windpump and the irrigation requirements of the crops to be grown. This Chapter describes the data and the methodology required in order to calculate the command area, and also looks at other factors that influence the command area.

4.1

IRRIGATION REQUIREMENTS

The first step is to determine the irrigation requirement per unit area of the farmer's land. The critical months during the different agricultural seasons should then be found and used to determine the command area.

The Gross Irrigation Requirement (GIR) is the amount of irrigation water required to irrigate one hectare. It can be calculated with the formula

$$GIR_m = 10 \frac{(Kc ET_0 - Re)}{e} \text{ (m}^3\text{/ha/month)} \quad (4.1)$$

where:

- GIR_m = gross irrigation requirement for month m (m³/ha/month)
- m = month number (-)
- Kc = crop coefficient (-)
- ET₀ = reference evapotranspiration (mm/month)
- Re = effective rainfall (mm/month)
- e = irrigation efficiency (-)

4.1.1 Crop Coefficient

The crop coefficient Kc is specific to the crop grown and the development stage of the crop. Appendix 2 presents the Kc values for some major crops. The appropriate Kc value can be chosen for a specific crop in a specific month. If several crops are grown during one month, the weighted average value of the different Kc factors can be used.

4.1.2 Reference Evapotranspiration

The reference evapotranspiration ET₀ is defined as "the rate of evapotranspiration from an extended surface of green grass cover of uniform height (8-15 cm), actively growing, completely shading the ground and not short of water". Several methods are available to calculate ET₀. Most of these methods can be found in the FAO Irrigation and Drainage Paper No. 24 "Crop water requirements" (Doorenbos and Pruitt 1977).

In addition to mean wind speed for the period concerned, these methods require mean relative humidity, mean net radiation (or mean cloud cover), and mean temperature (or mean maximum and minimum temperature). Often not all these data are available and the calculation method is not that simple.

A simpler approach is to collect evaporation data from the same meteorological station that supplied the wind data. Most meteorological stations measure evaporation data by means of an open pan.

The reference evapotranspiration can then be calculated with the formula:

$$ET_0 = Kp \cdot Epan \quad (4.2)$$

where:

- ET₀ = reference evapotranspiration (mm/month)
- Kp = pan factor (-)
- Epan = pan evaporation (mm/month)



(Note: For feasibility studies, it is usually sufficient to use the monthly values. For studies pertaining to irrigation operation, the period of a decade is often used.)

The value of the pan factor K_p varies for the different type of pan (diameter, distance above ground, etc.); for the same type of pan, it varies with regard to the relative humidity of the air, the wind speed, and the location of the pan in relation to the crops and vegetation. The most commonly-used pan is the so-called American Class A type evaporation pan. The K_p for different pans are given in Appendix 2.

4.1.3 Effective rainfall

The amount of rainfall that can be used effectively by the crops (R_e) depends on local circumstances such as rainfall amount, rain intensity, soil type, soil depth, cropping pattern, agricultural practices, infiltration rate, etc. If there is a distinct season with reliable rains, most of the rainfall can be used effectively; if rainfall is erratic throughout the year, only a small part of it should be taken into account when calculating the command area.

The amount of effective rainfall during the rainy season was estimated at 75% of the total amount for windpump projects in India and Sri Lanka. But on the Cape Verde Islands, where rainfall comes in short heavy showers if at all, no effective rainfall was taken into consideration when calculating the command area.

Data on rainfall can be collected from the same meteorological station where the wind data and evaporation data were collected.

4.1.4 Irrigation efficiency

The irrigation efficiency e is that part of the total amount of water available for irrigation that actually reaches the plant. The overall efficiency in windpump irrigation is rather high, since only small (less than 10 hectares) and nearby acreages are supplied with water.

Assumptions on windpump irrigation efficiency vary from 0.60 to 0.75 (Van Veldhuizen 1981, Goedhart 1982). Losses occur during the conveyance to the field and application there. Conveyance losses during the transport of the water from the windpump to the fields are due mainly to seepage.

They are determined chiefly by soil type, the distance to the fields, and the kind and quality of the channels. If the fields are far away and water has to be transported on percolating soils (for example sandy loam), consideration can be given to lining of the channels but this approach is generally too expensive for the farmers. Proper maintenance of the channels can also reduce these losses. The main losses from irrigation water occur on the fields, for example, run-off from the field and percolation of water below the reach of the plant roots.

The differences in field application efficiency are relatively minor with the methods commonly used in windpump irrigation: furrow, border and basin. (Bos 1980). In some areas, leaching water is required in addition to the amount of water needed for crops. Leaching is used to keep the soil from becoming saline, a condition caused by dissolved salts in the irrigation water applied or salts already present in the soil.



The monthly command areas can be calculated and the critical command areas determined, once the required data has been compiled.

The average command area of a windpump for a specific month can be calculated with the following formula.

$$CA_m = \frac{Q_{m \text{ eff}}}{GIR_m} \text{ (ha)} \quad (4.3)$$

where:

CA_m = command area for month m (ha)

$Q_{m \text{ eff}}$ = effective output of the windpump for month m (m^3 /month)

GIR_m = gross irrigation requirement for month m (m^3 /ha/month)

The effective output of the windpump $Q_{m \text{ eff}}$ can be calculated with a formula similar to Formula 2.5 (Section 2.2), which has been adapted for the month and effectiveness.

$$Q_{m \text{ eff}} = 30 \times 0.8 \times 0.69 \frac{\bar{V}^3 D^2}{H} \text{ (m}^3\text{/month)}$$

where symbols are same as previously defined (see also Chapter 2).

It can be seen that the month is taken as 30 days, and it is assumed that 0.8, or 80%, of the windpump's output can be used effectively for irrigation. This reduction is caused by the variability of the windpump output. This reduction can be decreased by increasing the available water storage. For a detailed description of this reduction, see the next chapter.

Example 4.1 - Trichy, India

The prospects of small and marginal farmers using windpumps for irrigation were investigated in Trichy District, Tamil Nadu, in the South of India (Goedhart 1982).

The monthly output was calculated on the basis of the average monthly wind speed data, and assumed a pumping head of seven metres for a wind pump with a rotor diameter of 3.5 metres. The crop factors of the common cropping pattern were used to calculate the gross irrigation requirements.

They consisted of paddy cultivation during the rainy season, maize and chillies during winter, and chillies and groundnuts during the summer (see Table 4.1).

The pan evaporation data of the meteorological station were multiplied by a pan factor of 0.8. It was assumed that 75% of the rainfall could be used effectively during the rainy season and that the overall irrigation efficiency was 0.75.

The command area of the windpump for each season is determined by the months calculated to have the smallest command area. This resulted in the following seasonal command areas (see Table 4.2).

Since the average landholding of small farmers in the Trichy District is 0.7 ha, it can be concluded from Table 4.2 that the windpump gives sufficient water during the rainy season and almost sufficient water during summer.

During the traditionally main agricultural season in winter, however, only a part of the landholding can be irrigated. Several solutions for this problem are discussed in Chapter 5.

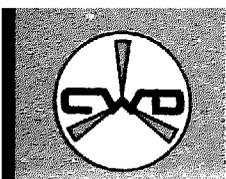

Table 4.1 Estimated monthly command areas (ha) of a windpump (rotor diameter 3.5 m) in Trichy, India (Goedhart 1982).

Season	rainy season				winter				summer			
Crops	paddy				maize and chillies				chillies and groundnuts			
Months	Oct	Nov	Dec	Jan	Feb	Mar	Apr	May	Jun	Jul	Aug	Sep
Q_{eff} (m ³ /month)												
GIR (m ³ /month/ha)												
Ca (ha)												
Critical months				X		X		X		X	X	X

Table 4.2 Seasonal command areas of a windpump in Trichy

Season	Command area (ha)
Rainy season	0.9
Winter	0.3
Summer	0.6

Example 4.2 - Cape Verde

In the Cape Verde islands, by contrast, no distinct irrigation season exists.

Farmers cultivate their lands throughout the year with all kinds of vegetables in a mixed cropping pattern. This involves a different method of calculating the command area.

The average monthly command areas were calculated for a windpump (rotor diameter of 5 m), a pumping head of 25 m, an average crop factor of 0.75, and an irrigation efficiency, including leaching requirements of 60% (Van Dijk 1984). The output of the wind-

pump and the gross irrigation requirement are based on locally measured data of wind speed and evapotranspiration. Table 4.3 shows the results.

To allow for this variable pattern of command areas, the farmers have developed a cropping system that enables them to adapt the average area under vegetables to the varying output of the windpump. They do so by having about 80% of the average command area under cultivation with very productive vegetables. The surplus irrigation water is used from time to time to irrigate the area being cul-

Table 4.3 Command area (ha) of a windpump (rotor diameter 5 m) on the Cape Verdian Islands.

Months	J	F	M	A	M	J	J	A	S	O	N	D
Q_{eff} (m ³ /day)	42	52	50	46	54	35	50	42	49	70	32	40
GIR (m ³ /ha/day)	50	55	70	70	70	55	60	60	65	55	60	60
CA (ha)	0.8	0.9	0.7	0.7	0.8	0.6	0.8	0.7	0.8	1.3	0.5	0.7

Note: average command area equals 0.7 ha.



tivated with drought-resistant crops. Hence, there is not one specific "critical" month that determines the command area; but rather the average annual command area is used.

From these two case studies one can see that the way in which the calculated monthly command areas must be interpreted

depends on the local climate and agricultural practices. When distinct seasonal cropping patterns occur, the critical month of each season determines the command area. When a more continuous cropping pattern exists without any clear distinction between seasons, the average command area can be used.

4.3

THE INFLUENCE OF INTER-ANNUAL VARIATIONS IN CLIMATE

Probability analysis is used in irrigation project planning to deal with inter-annual variations of different design factors. The water available to the farmers can be predicted better on the basis of such an analysis. In calculating the command area of a wind pump three factors with inter-annual variations are used: wind speed, evapotranspiration, and rainfall.

The knowledge about the correlations of the inter-annual variability of these factors is still limited. It is generally believed that these factors do not vary in a systematically related way within the complex of the (tropical) climatological system. On the other hand, some relationship was found between variations in wind speed and rainfall in Mozambique (Hassing and Van Meel 1984).

With respect to annual variations in wind speeds in tropical areas, two regions can be distinguished: the monsoon-type regions and those with trade winds. Regions with a monsoon-type climate include India, Pakistan, Southeast Asia and Australia. In these places,

the annual variations in wind speeds are substantial. In regions with a trade wind climate, the annual variations in wind speed are relatively small. No general statements can be made about the range of inter-annual variations in wind speed in other tropical regions.

For a proper application of a probability analysis, long term records should be available. The observation period must be long enough to be representative for the annual variations. For tropical climates such a period will be in the order of 10 to 15 years or longer. Unfortunately at most locations reliable data of wind speed, rainfall and evaporation over such a period are not available.

When windpumps are used for irrigation the common probability analysis in irrigation engineering can work. Briefly, this means that, when a set of reliable data on wind speed, evaporation and rainfall is available, a probability of occurrence of 75% or 80% is used to calculate the command area (Van Vils-teren 1981).

4.4

FACTORS INFLUENCING THE COMMAND AREA

When the water supply of the wind-pump does not correspond with the water demand of the cropping system, there are possibilities to influence both the supply and demand patterns. The supply pattern of a specific windpump can be influenced by changing the

design wind speed of the windpump, the storage tank capacity (see Chapter 5) and, in some cases, the capacity of the well.

The demand pattern can be influenced by changes in the cropping system or the irrigation efficiency.



4.4.1 The design wind speed

The total amount of water and the output pattern can be influenced by changing the design wind speed V_d of the windpump. A change in the design wind speed is achieved by changing either the pump stroke or the diameter of the pump, that is, the volume pumped by each stroke. Since more power is required, the windpump will start working at a higher wind speed and reach its maximum efficiency at a higher wind speed. The overall effect of the increase in the design wind speed will be a larger output, but a different pattern of availability. With very high design wind speeds, the starting wind speed will be so high that the windpump works only during short periods and, consequently, the total output decreases.

As the design speed increases, so does overall output – to a certain point. The

availability decreases as low wind speeds are no longer utilised. Tables 4.4 and 4.5 illustrate the result of changing the design wind speed.

As shown in Table 4.5, the output increased between $V_d = 3\text{m/s}$ and 4.5m/s , but the availability dropped (not shown). This is because the windpump was making more effective use of high winds but not using the low winds. If the design wind speed is taken too high, the overall output even decreases. For design purposes, an availability of 50% to 60% is usually acceptable.

The change in the supply time and output also influences the output pattern. Figure 4.1 (same example as Table 4.4) shows the increase in daily output variability due to an increase of the V_d .

Table 4.4 The influence of V_d on the supply time of the windpump (Van Meel 1984).

Windpump: Diameter rotor = 2.74 m,
Wind regime: average annual wind speed = 2 m/s, Weibull factor $k = 2$

V_d (m/s)	Supply time (%)
2	78%
3	53%
4	36%
5	18%

Table 4.5 The influence of V_d on the output of the windpump (site: Hambantota, Sri Lanka)

Windpump: Diameter rotor = 3 m
Wind regime: average annual windspeed = 2 m/s; Weibull factor $k = 2$.
Month: March.

V_d (m/s)	Output (m^3/month)
3	600
4.5	786
6	803
7.5	613



In this example, the increased variability in output considerably decreased the possibilities for farmers to use the water effectively (Van Dijk 1984b). Since only small storage tanks were in use, there was no way large amounts of water could be stored during the short periods with high outputs.

In this case, the optimal design wind speed of a windpump was equal to the average annual wind speed. Whether or not a higher design wind speed, that results in a greater but also more variable output, can increase the command area depends largely on the possibilities for storing large quantities of water during short periods.

In practice, this means that large low-cost storage tanks must be available.

In addition, one should keep in mind that a significant increase in the design wind speed also increases the wear and the tear on the windpump. This could shorten the technical life cycle and necessitate more maintenance and repair.

4.4.2 The storage tank capacity

A change in the storage tank capacity can influence the possibilities for using the output of a windpump. If no storage tank is used, then generally only about 40% of the output can be effectively utilised. When very large storage

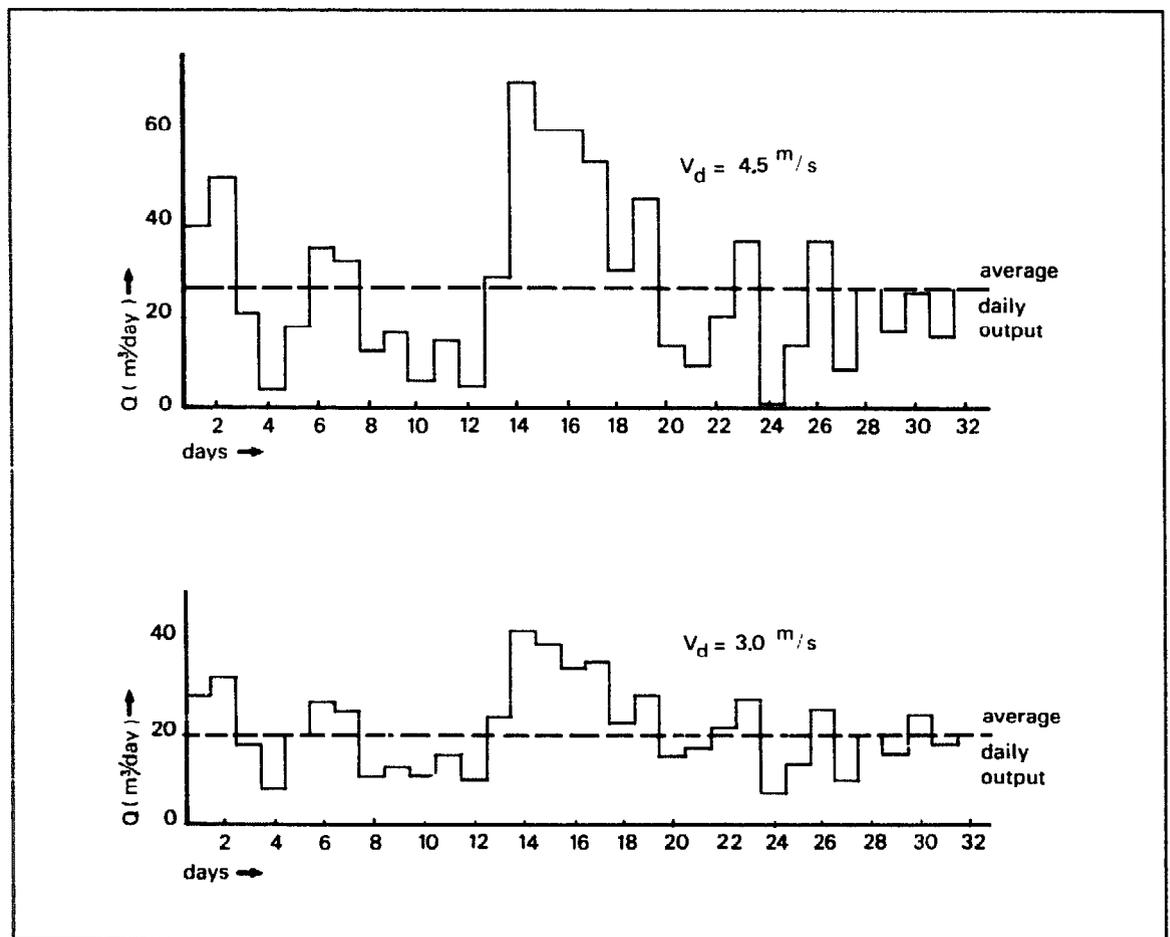

Figure 4.1 The influence of the design wind speed on the output pattern of a windpump (rotor diameter = 3 m) at Hambantota, Sri Lanka (March 1975 data).



tanks are available, the total output of the windpump can be used. The increase in effective use will of course increase the command area. The choice of storage tank capacity is directly related to the water management problems and economic considerations and will be discussed in detail in the subsequent chapters 5 and 6.

4.4.3 The capacity of the water source

Sometimes it is not only the wind regime which determines the output of the windpump but also the water source. Especially during periods with high wind speeds the recharge capacity of the water source can be a limiting factor. In case of an open shallow well the water table can drop below the bottom of the well during the dry season.

An example of how well yield influenced the output of the windpump in Trichy, South India is shown in Table 4.6 (Goedhart 1982).

As can be seen the windpump output was determined by the yield of the well during four months of the year (May-August).

4.4.4 The cropping system

A change in the cropping system alters the demand for irrigation water.

Theoretically, the water demand pattern can be adapted to a large extent to the water supply pattern of the windpump. This increases

the effective use of the windpump's output and, with it, the size of the command area. The cropping system could be changed by altering the type of crops grown, a shift of the period during which crops are grown and/or the acreage under cultivation.

The type of crops grown determines the water requirement. For instance, if only chillies had been grown during the winter season in Trichy (India) instead of two crops, maize and chillies, the command area of the wind pump would increase from 0.3 ha to 0.5 ha (Goedhart 1982).

Since the water requirement for crops depends on the crop development stage, a change in the timing of cultivation also influences the command area. If properly planned, the peak water requirements during the crop's growing season could coincide with periods of high wind speeds, while low water requirements during the early stage, would occur during periods of low wind speeds. Similarly, the windpump could be used to water the seedlings, giving the crop an early start. The finished crop could be entirely rain-fed.

Finally, the water requirement for a cropping system can be adapted by changing the acreage under cultivation; a larger area under cultivation during the months with high wind speeds and a smaller area with crops during the months with low wind speeds.

Table 4.6. The influence of the maximum well yield on the output of the windpump (m^3 /month), Trichy district, India (Goedhart 1982).
Windpump: Rotor diameter = 5 m

Month	Jan	Feb	Mar	Apr	May	Jun	Jul	Aug	Sep	Oct	Nov	Dec
Possible output wind pump	1935	1460	930	920	1940	3160	3410	3305	1740	1095	940	2240
Maximum well yield	4440	4440	3500	2560	1620	1620	1620	1620	1850	2560	3500	4400
Actual output wind pump	1935	1460	930	920	1620	1620	1620	1620	1740	1095	940	2240



In many cases, however, the actual opportunities for realizing these changes are limited. Existing cropping systems are part of the farming system and the result of the farmer's experiences in the past and expectations

for the future. Changes in the cropping system likewise have an impact on other activities in the household. In general, windpumps should fit into existing cropping patterns rather than being based on plans for completely new ones.

FINAL COMMENTS

This chapter has shown how the gross irrigation requirement of a unit area of farmed land can be found using standard climatic and crop data. It then illustrated with examples how the monthly output of a wind-pump could be related to the GIR to provide an estimated command area.

This command area is considered to be that area of land which can be irrigated by a windpump under a specific set of conditions. Inter-annual variations in the data set introduce a probability, which was given as approximating a 75%-80% likelihood of occurrence.

Some factors were then introduced which can be changed to increase or decrease the command area for a particular windpump. Among them were the design wind speed, the storage tank capacity, the water resource capacity, and the cropping system.

This type of general calculation of the command area is suitable for a pre-feasibility study. The next chapter expands this seasonal calculation of command area to include fluctuations in the daily and monthly wind regimes. The possibility of storage tanks is introduced along with their sizing with respect to a more detailed output model of the wind-pump. Enough detail is provided to validate a feasibility study.



Chapter 4 discussed calculating the command area on the basis of average yearly and monthly wind speed data. The discussion included problems related to variations in wind speed throughout the year.

In practice, however, short-term fluctuations in wind speed complicate water management practices for the farmer and strongly influence the size of the actual area that can be irrigated by a windpump. This chapter deals with the problems related to

day-to-day and hour-to-hour fluctuations in wind speed, and thus to windpump output. Information is also supplied to help the farmer make optimal use of the water pumped.

One of the more common ways of integrating - or expanding - storage capacity in the windpump irrigation system is explained in detail, and selected case studies present some simple rules for storage sizing. To complete the chapter, various methods of constructing storage tanks are presented in Appendix 3.

IRRIGATION WITHOUT STORAGE TANKS

Ideally the water pumped by a windpump should be used for irrigating the fields directly as is usually the case with other water lifting devices. In the case of windpumps, this can be done in two situations:

- A farm has a large pump capacity (a large windpump) with respect to the command area.
- A substantial part of the command area is used for rice production.

5.1.1 A windpump with a large capacity

The windpump is used in the same way as a fuel pump: that is, the farmer, who can use the windpump output directly, runs the windpump just long enough to satisfy the water requirements of his crops.

The windpump can only be used in this way in a region with a reasonably reliable wind regime. In addition, the farmer must have certain water management skills and experience with respect to irrigation. Some objections can be raised to this system:

- A farmer can never guarantee that he can irrigate on a particular day, so windpump-irrigation might be rather irregular and possibly inconvenient for the farmer.
- To maximize the use of the potential water

output, a farmer would have to irrigate day and night, if he had no buffer. Generally farmers have more activities and are either unable or unwilling to irrigate at night.

- They prefer to irrigate with a constant flow, usually 5 to 10 l/s or even more. Note, a typical output from say a 5 m diameter rotor windpump with a head of 10 m is in the order of 2 to 3 l/s.

A larger flow can be achieved by creating some kind of buffer.

- If the flow varies, it is difficult to estimate the irrigation application on a certain plot. This leads to either waterlogging or water shortage, which could in turn result in loss of crop yield.
- Varying flow complicates management.
- Irrigation is generally less efficient when a small and varying flow is used for irrigation. Consequently, distribution of water on the fields is unequal, percolation losses are excessive at one location while a water shortage occurs elsewhere. Especially when earthen distribution channels are used, a small and varying flow results also in a low conveyance efficiency. (A low field application efficiency).
- Channel design is more complicated when variations in water flow occur.



5.1.2 Rice production

If a farmer grows rice on a substantial part of his command area, the paddy fields can to a certain extent be used for storage. Small fluctuations in the water level in the paddy fields do not influence total rice production. So the windpump can be used more efficiently by conveying the output (day and night) to the paddy fields.

Such a system can work semi-automatically if the dikes around the paddy fields are provided with overflow structures.

During the daytime the farmer can irrigate his other crops, either directly with the windpump, or by taking water from his paddy fields. In the latter case, simple adjustable overflow weirs can be installed. Figure 5.1 presents a possible lay-out for such a system.

Some problems may arise with such a system, however:

- During periods of preparing the land and transplanting, large quantities of water are needed for puddling. Since the windpump can not deliver so much water at one time, only small fields can be constructed, in combination with a careful recycling of water. These small fields are a disadvantage if ani-

mal-drawn or mechanized land preparation methods are considered.

- rice is not as high a value crop as vegetables. If pumping heads are rather high (10-20 m), rice production is generally not economically feasible, given the high investment costs of a windpump.

5.1.3 Preliminary comments

Although systems without storage are feasible under certain conditions, it is shown that for optimum use of potential water, as well as farm labour, a buffer should be introduced to the irrigation system to contain the windpump output. The buffer need not be a constructed tank, as in the case of irrigated rice, although in most circumstances it is preferable. Reasonable storage would:

- use the potential windpump output more efficiently and thus realize higher agricultural benefits.
- make it more convenient for farmers to handle and operate the system.

Storage tanks are expensive, however, and they must therefore be planned carefully.

The next sections will discuss optimum storage tank capacity.

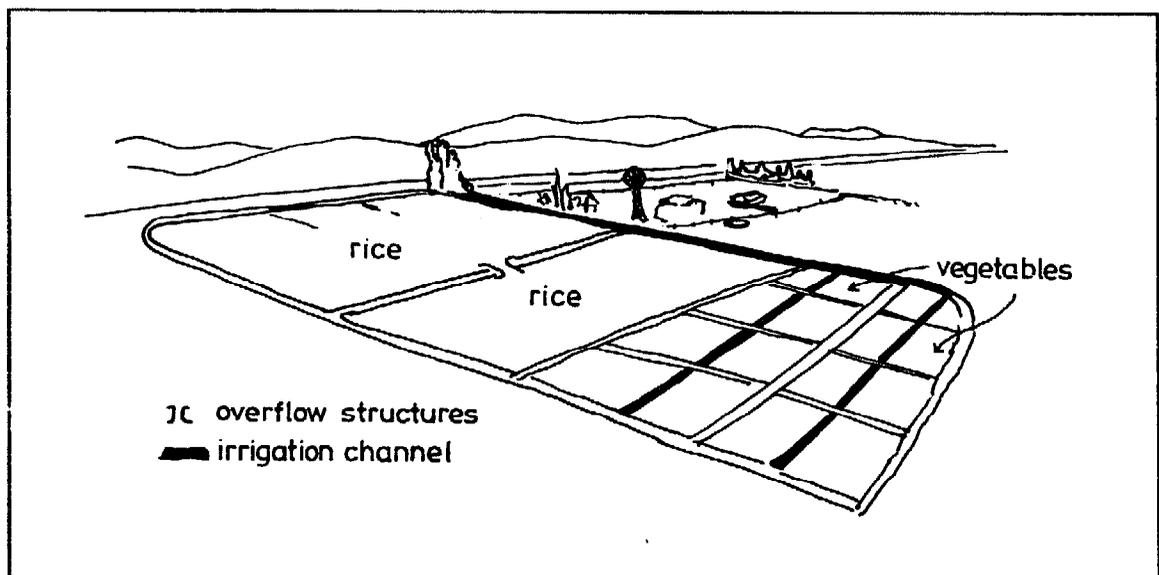

Figure 5.1 General lay-out of a windpump irrigation system where paddy fields are used for water storage.



Five factors are useful in determining storage tank capacity:

- Short-term fluctuations in windpump output.
- Daily fluctuations in windpump output.
- Nightly output of a windpump.
- Monthly fluctuations in windpump output.
- Acceptable water deficit risks.

5.2.1 Short-term fluctuations in windpump output (fluctuations within a day)

Short-term fluctuations refer to the minute-to-minute and hourly fluctuations of the volume of pumped water.

Minute by minute: For the reasons cited above, such as optimum channel flow, use of labour, and control of the amount of water used, a system of direct application is strongly affected by minute by minute fluctuations. Even if there is no need to utilise water pumped at night, a tank with a capacity of 10%-20% of the daily output will assist the application and therefore the efficiency of the system.

Hour by hour: Wind speed fluctuations throughout a day can be rather strong. Generally, a wind regime and the corresponding windpump output show a certain daily pattern (Figure 5.2).

5.2.2 Nightly output of windpump

In order not to lose the potential output at night, it is logical to build a storage tank with a capacity of at least the nightly output of the windpump.

In many wind regimes, night-time wind speeds are somewhat lower than those during daytime, and the corresponding windpump output at night (18.00 pm. to 6.00 am.) is in the order of 1/3 of the total daily output. Even so, it must be remembered that the daily output itself is highly variable.

For example, with the Hambantota (Sri Lanka) wind regime it was found that if the storage tank had a capacity of 50% of the average daily output (about 35 m³), the total nightly output could be stored for nine out of 10 nights.

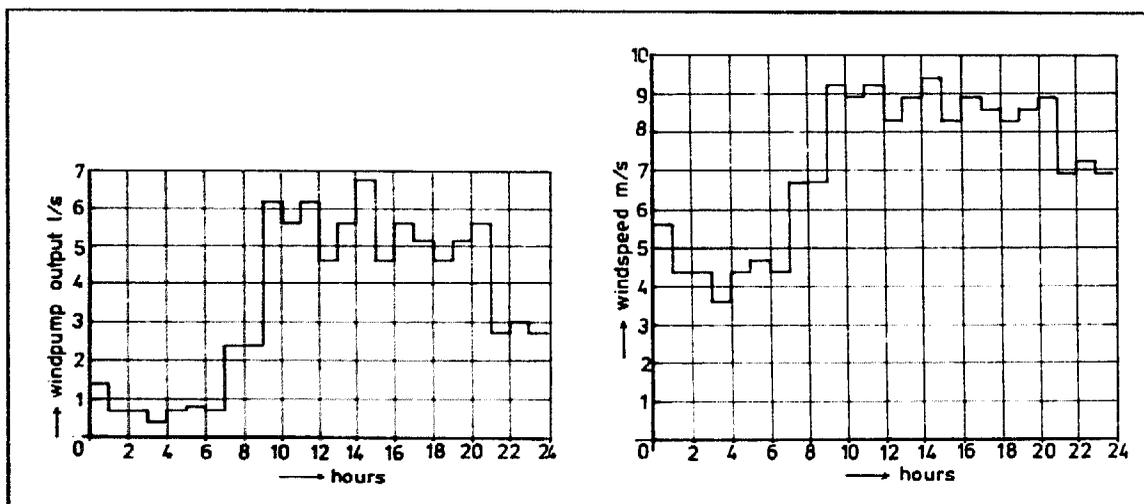

Figure 5.2 Hourly wind speed data at Praia airport (Cape Verde) on 08.11.1978 and calculated windpump output for a 5.00 m rotor diameter windpump and 25 m water lifting head (Pieterse 1982).



5.2.3 Fluctuations in windpump output from day to day

Even with a command area that is well-adjusted to the average windpump output in a certain month, the day-to-day fluctuations may cause farmers some problems.

The fluctuations in output are illustrated in Table 5.1 and Table 5.2. Table 5.1 illustrates that windpump output varies from almost zero to 2.5 times the average daily output. Table 5.2 shows the differences in output distributions that occur from month to month, for example, May and August have a more uniform output pattern than February and November.

An 80% probability of occurrence means that on 80% of the days the output of the windpump will at least match the quantity indicated in the Table.

In order to show how the wind varies, Table 5.3 compares the trade wind regime (Cape Verde Islands) with that of Sri Lanka's wind regime with respect to the occurrence of windless days (a windless day is defined as a day with a wind speed lower than two-thirds the annual mean wind speed) and windless periods (a windless period is one or more consecutive windless days).

Water management will be hampered when:

- days with almost no output alternate with days of one or two times the average daily output.
- windless periods of 3 to 4 days occur.

It can be seen that the Sri Lanka wind regime has more prolonged windless periods than does that of Cape Verde and might therefore be more difficult for a farmer to handle. It is reasonable to expect that, for optimum use of the water, the farmer in Sri Lanka requires a much larger storage tank than his Cape Verde counterpart. (See section 5.4).

Table 5.1 Calculated output of a 5.00 m rotor diameter windpump (25 m pumping head) during the month of March 1978 for an inland location on Sri Lanka (Van Dijk 1984).

Day	V m/s	Output (m ³ /day)
1	3.59	43
2	3.58	51
3	2.81	23
4	2.07	5
5	2.77	20
6	3.43	37
7	4.16	26
8	2.22	13
9	2.19	19
10	2.21	8
11	2.37	16
12	1.94	7
13	3.17	31
14	4.67	73
15	4.16	61
16	3.79	59
17	4.20	56
18	2.95	31
19	3.38	46
20	2.58	16
21	2.74	15
22	3.56	23
23	3.42	39
24	1.90	2
25	2.14	16
26	3.16	37
27	2.26	10
28	2.64	28
29	2.41	19
30	3.14	27
31	3.58	19
Average	3.01	28

Note: Calculations carried out using hourly wind speed data.



Table 5.2 Distribution of the daily output of a 5.00 m diameter rotor windpump in Hambantota, Sri Lanka (1975-1976). Output in m³/day.

Probability of occurrence	90%	80%	70%	60%	50% *)	40%	30%	20%	10%
February	23	38	51	58	63	73	76	85	96
May	65	79	91	96	103	112	123	130	138
August	68	77	84	89	92	95	100	110	118
November	10	18	21	31	39	45	53	57	80

*) median daily outputs.

Table 5.3 Occurrence of windless periods in two different wind regimes

	Number of windless days per year	Number of windless periods per year	Average duration of periods (days)	Weibull factor
Sri Lanka	68	21	3.2	1.79
Cape Verde	47	26	1.8	3.00

Note: Weibull factor 1 indicates strongly variable wind speeds, while a factor 4 indicates very constant wind speeds.

5.2.4 Total water management for the day-to-day fluctuations

Before going on to indicate the size of storage capacity needed for reasonable water management, it is important to note that storage is only one method of tackling the problems of windless periods. There are various measures a farmer can take to facilitate water management with respect to the day-to-day fluctuations in windpump output. These measures fall into four categories:

- Increasing storage tank capacity in preparation for windless periods (in addition to the capacity already installed to overcome short-term fluctuation problems). The total storage tank capacity required will then be in the order of one to four times average daily windpump output.
- Reducing the cultivated area to only a "secure" area. In this way the windpump is under-exploited.

- Growing a variety of different crops with different planting and sowing dates and different growing periods. In case of water shortages, the water can be used for the more sensitive crops, thus diminishing yield reductions (risk spreading).
- Cultivating an area smaller than the command area with high value crops and using the excess of water for more drought resistant crops such as sweet potatoes, sugar cane, or fodder. This is an extension of the latter two categories.
- More experienced farmers vary the amount of irrigation and the intervals in order to use the soil for water storage (advance irrigation).

5.2.5 Fluctuations in windpump output from month to month

As discussed in Chapter 4, experienced farmers can adapt their cropping patterns or cultivated



5.3

area to the variations in output from month to month. The extent in which this can be done, however, depends on the type of crops that can be grown in the region with respect to climate, soil, the flexibility of the farming system, and market possibilities.

CALCULATION OF THE REQUIRED STORAGE TANK CAPACITY

Rather than attempt to deal with all possible cases of windpump size, farm size, irrigation patterns, etc., this section presents the results of two case studies including 4 cases. As will be shown, these cases offer conclusions that apply to most irrigation projects using windpumps.

For convenience of calculation, a computer model has been developed to evaluate the relationship between storage tank capacity and windpump exploitation factor (f_{we}) given a set of water deficit criteria (Van Veldhuizen 1982a, Van Dijk 1984a). (The model can be obtained through ILRI).

The factor f_{we} indicates the potential windpump output which can be used by the farmer; this is equal to the Gross Irrigation Requirement divided by the average windpump output:

$$f_{we} = \frac{GIR_a}{Q_{day}} \quad (5.1)$$

where:

f_{we} = windpump exploitation factor (-)

GIR_a = gross irrigation requirement (average day) for the area served by the wind pump (m^3/day)

Q_{day} = windpump output (m^3/day)

Note that here GIR_a is not the gross irrigation requirement per ha, but the gross irrigation requirement for the area served by the windpump. Both GIR_a and Q_{day} are average values

Other solutions include adjusting the design wind speed to periodical wind speed fluctuations. In practice, however, this solution is too theoretical and there are only a few windpumps that could implement such an idea.

over the irrigation period considered. In the cases discussed below is this one year or multiples of one year. The parameter f_{we} has a direct impact on the required storage tank capacity as will be shown later.

5.3.1 The computer calculation model

Generally speaking, the calculation model transforms hourly wind speed data, collected over a period of one or more years, into hourly windpump output figures. These figures are subsequently compared with the hourly water demands of an irrigated farm. There is no water demand during the night, and the predicted output is either stored in a tank or lost if the tank is already full.

If the daily water requirements for irrigation are met during the day, any water in excess of these requirements is either stored in a tank or lost if the tank happens to be full. But if the farmer does not have enough water from either the windpump or a tank, a water deficit occurs. The extent of this deficit can be calculated. The calculations are repeated for every hour and day and aggregated to find daily, monthly, and yearly values.

The model needs the following input:

- Windpump characteristics (for example V_{in} , V_{rated} , V_{out} etc.).
- Complete data sets of hourly wind speeds for one or more irrigation periods (here periods of a year have been used). Preferably a long span of average monthly wind speed data -



say five years or more - should be available to judge the representativeness of the data used in the model.

- Site parameters such as pumping head, gross irrigation water requirement during the course of the year.
- Water deficit criteria (see next section).

The characteristics of the CWD 5000 Windpump have been used for the calculation of the different cases discussed in section 5.4. The results are valid for other wind-pumps that have characteristics more or less similar to those of the CWD 5000. This is a reasonable assumption given the current performance of most commercially available machines. Some important specifications of the CWD-5000 are:

- Rotor diameter 5.00 m
- Wind speed at which the rotor starts turning out of the wind (V_{rated}) 9.00 m
- Wind speed at which the wind pump has completely turned out of the wind (V_{out} or $V_{furling}$) 12.00 m
- Design wind speed for which the windpump reaches highest efficiency (V_d) $1.0 \times V$ (year)

5.3.2 Water deficit criteria

To obtain a specific storage tank capacity based on the model, certain water shortage criteria have to be formulated so the seriousness of these water shortages can be determined. A statement must be made about the acceptable frequency of deficits.

A study executed by Goedhart (1985) indicates that given a relatively low level of inputs such as fertilizer, insecticides and seed quality, a water deficit of 30% on a monthly basis and 10% on a yearly basis is still acceptable from the standpoint of yield reduction in crops and water management problems. Such water deficits imply a yield reduction of about 5%. Even higher deficits with respect to yield reduction could be permitted, but they should not be planned into the water management.

Within the context of water management, it has been calculated that a 10% water deficit on a monthly basis would imply less than 75% of the daily water requirements for an average four to five days a month. If the monthly water deficit equals 30%, there will be about 20 days with less than 75% of the water requirement available.

5.3.3 Results

The results based on the cases discussed in the next section are presented as a graph with the windpump exploitation factor against the size of the storage tank (see Figure 5.3). The ordinate shows the tank size, expressed in terms of daily windpump capacity, thereby making the results easily applicable to different sizes of windpump. The abscissa shows the exploitation factor f_{we} . The curve indicates the size of tank required for a given exploitation factor, which would ensure that the water deficit does not drop below the water deficit criteria mentioned before (accepting yield reductions up to 5%).

CASE STUDIES

The model discussed has been used in two case studies, consisting of four cases.

5.4.1 The cases

Four different cases were studied:

Case 1 Cape Verde Islands: a farmer has 12 hours per day available for irrigation.

5.4



Cape Verde has a rather favourable wind regime: for instance, in the valleys of Santiago the average annual wind speed is 4.1 m/s while the distribution of the hourly wind speeds has a Weibull factor of 3.0.

The calculation is based on the following assumptions:

- Irrigation is a year-round activity.
- A variety of crops, mainly vegetables, are grown, which gives the farmer the opportunity to adapt his command area to monthly fluctuations in windpump output and thus a constant f_{we} factor can be maintained.
- There is no effective rainfall.

Case 2 Cape Verde Islands: the farmer has four hours per day available for irrigation. The same assumptions were made as in Case 1

Case 3 Sri Lanka: the farmer has twelve hours per day for irrigation. A study similar to that in the Cape Verde Islands has been carried out in Sri Lanka with the same assumptions as in Case 1, except for the wind regime, which is based on the Sri Lanka site. The average annual wind speed is 4.4 m/s and the Weibull factor is 1.79. When compared with the Cape Verde wind regime, the day-to-day and month-to-month fluctuations in the wind speed in Sri Lanka are higher (see also table 5.3).

Case 4 Sri Lanka: the farmer has 12 hours per day for irrigation. The same wind speed data were used as in Case 3. The existing Sri Lankan cropping patterns were used, rather than a cropping pattern more adapted to the windpump output, as was the case with the

Cape Verde cropping pattern. The traditional cropping pattern is less flexible with only a few different crops, that have fixed sowing and harvesting dates (Van Veldhuizen 1981). In general such a traditional cropping pattern is not well adapted to the variability of the windpump output.

The results of the case studies are summarized in Figure 5.3. The curve drawn for each case represents all possible combinations of f_{we} and storage capacity that just meet the criteria (for example, no water deficit greater than a 30% in any one month and none greater than 10% for the whole year). In other words the graph indicates the reasonable minimum required storage capacity for sound water management.

5.4.2 Evaluation of the graph

It should be noted that the storage tank capacity has been expressed in "days" in order to generalize the results. To determine the storage tank capacity in m^3 , the number of days must be multiplied by the average daily windpump output. An example will explain the use of the graph to find the required storage tank capacity.

A Cape Verde farmer in a region with an average wind speed of 4 m/s has a windpump with a rotor diameter of 5 m. The total pumping head is 25 m. His water requirements are $32 m^3/day$. What will be the minimum required storage tank capacity under the assumptions that:

- The farmer has 12 hours available for irrigation.
- He is able to adjust the cropping pattern to the windpump output variations from month to month (Case 1).



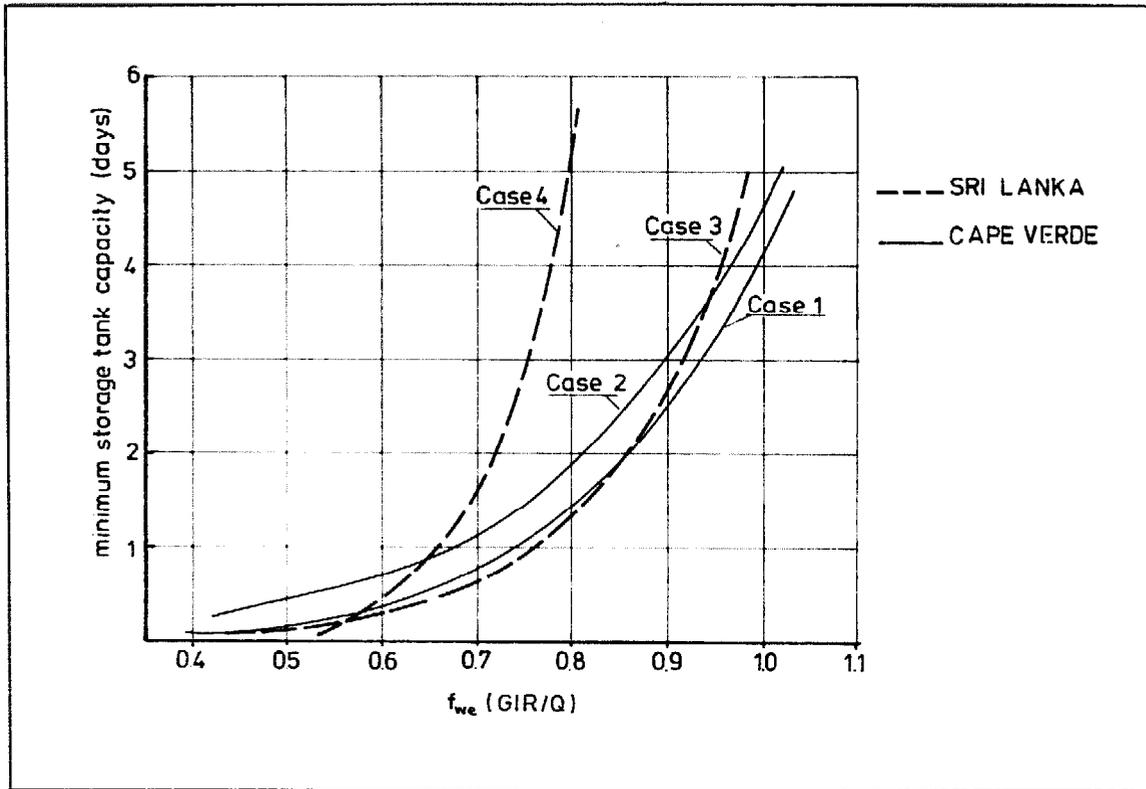

Figure 5.3 The relationship between the windpump operation factor (f_{we}) and storage tank capacity (Cape Verde and Sri Lanka)

First, one must estimate the average daily windpump output by using the formula for average daily output, shown in Chapter 2:

$$Q_{\text{day}} = 0.69 \frac{V^3 D^2}{H} \quad (\text{m}^3/\text{day}) \quad (2.5)$$

where symbols are defined before.
thus:

$$Q_{\text{day}} = 0.69 \frac{4^3 \times 5^2}{25} = 44 \text{ m}^3/\text{day}.$$

Given the average daily water requirement of 32 m^3 over the period considered (one or more years), the windpump exploitation factor f_{we} can be calculated:

$$f_{we} = \frac{\text{GIR}_a}{Q_{\text{day}}} = \frac{3^2}{44} = 0.73$$

With help of the curve belonging to Case 1, the minimum required storage tank capacity can be derived as "0.75 days".

Thus the storage tank capacity should be at least

$$0.75 \times 44 \text{ m}^3 = 33 \text{ m}^3.$$

If the farmer decides to enlarge the cultivated area which increases the water requirements to $40 \text{ m}^3/\text{day}$ with the same windpump, it will result in a f_{we} of $40/44 = 0.91$.

This corresponds with storage of "2.5 days", then the required storage tank capacity will be $2.5 \times 44 = 110 \text{ m}^3$.



5.4.3 Comparison of the cases

The only difference between Case 1 and Case 3 is the type of wind regime (Figure 5.3). The results show that there is no significant difference in required storage tank capacity if f_{we} becomes smaller than 0.90, which is rather remarkable since the wind regimes are quite distinct.

The Cape Verde winds are much less variable (Weibull factor of 3.00) than Sri Lanka's winds with a low Weibull factor of 1.79. At the higher f_{we} values (0.90), the Cape Verde situation is more favourable than that of Sri Lanka with regard to storage tank capacity, as could be expected.

A comparison between Cases 1 and 2, both Cape Verde, shows that the farmer's decision to concentrate his irrigation activities within a shorter period significantly influences the capacities of the storage tank, especially in the range of low f_{we} values. For instance, the farmer from the previous example needed a storage tank capacity of 33 m^3 if he irrigated his field for 12 hours a day ($f_{we} = 0.73$).

Assuming that he might want to limit his irrigation activities to one four-hour period a day, the required storage tank

capacity, corresponding with $f_{we} = 0.73$, would be 1.2 days. Hence, the required storage capacity $1.2 \times 44 = 53 \text{ m}^3$, or 1.6 times larger than before.

Cases 1, 2 and 3 assumed that the farmers were able to adapt either their cropping patterns or the cultivated area to fluctuations in monthly output. Case 4 shows the dramatic increase in required storage tank capacity if no such adaptation is possible.

5.4.4 Generalizing the results of the case studies

The results of the case studies presented above can be used for designing wind-pump storage tank combinations for other regions as well, if one takes into account that:

- The two different wind regimes in the case studies were rather distinct from each other, and most other wind regimes will have a Weibull factor somewhere between the Weibull factors of the Cape Verde islands and Sri Lanka.
- Some of the assumptions incorporated into the calculation model can be described as conservative for several reasons:

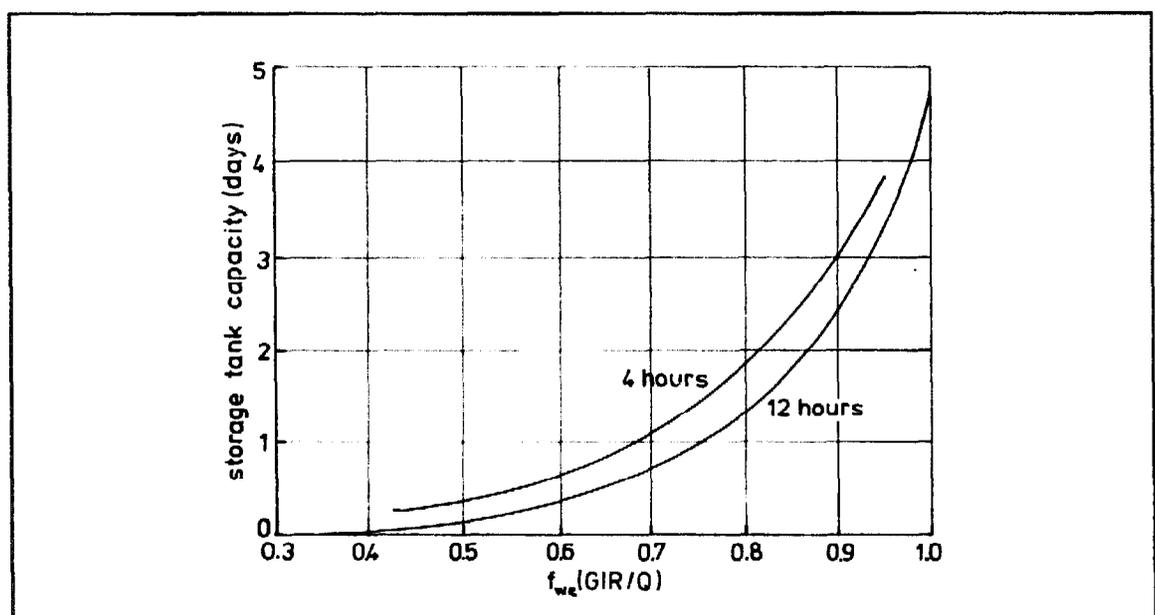

Figure 5.4 The relationship between the windpump operation factor f_{we} and the required storage tank capacity for farmers available to irrigate four and 12 hours a day, respectively.



- Night irrigation was excluded. Although day-time irrigation is the general practice, it would not be logical to assume that a farmer never irrigates at night, not even if his crop has suffered from some days of water shortage.
- Farmers can irrigate in advance, thus using the storage capacity of the soil; but this requires special skills and experience.
- Excess water does not necessarily have to be lost, but can be conveyed to fields with drought resistant crops and an additional crop yield can thus be produced.
- On the other hand, it is very optimistic to assume that farmers are fully able to adjust their cultivated area or cropping patterns to follow the fluctuations in windpump output from month to month, thereby creating a constant f_{we} factor.

Figure 5.4 presents two graphs that can be used to determine the minimum required storage tank capacity.

- A curve which averages Case 1 and Case 3 is considered to be representative for a farmer who has the entire day (12 hours) at his

disposal for irrigation.

- A curve that is deduced from Case 2 and can be seen as an approximation of the situation where a farmers' time for irrigation is limited to four hours per day. It must be emphasized that the basic idea of the graphs is that the farmers are able to adapt their cropping patterns to fluctuations in windpump output. For this reason, Case 4 has not been used for designing Figure 5.4.

The graphs represent all combinations of f_{we} and the minimum required storage tank capacity. The 12-hours curve starts with no storage tank, and a corresponding f_{we} of about 0.35 (hence only 35% of the potential windpump output can be used), and continues up to a storage tank capacity of more than four times the average daily windpump output for a f_{we} of 1.0. If one wants a storage tank capacity of 50% (0.5 day) of the daily windpump output, in order just to collect the nightly output, the windpump exploitation factor will, as the graph shows, be about 0.65 (65%). In other words, 35% of the potential output will be lost.

DESIGN OF WINDPUMP IRRIGATION SYSTEMS

5.5

Feasible solutions for the specific cases can be derived from the graphs in Figure 5.4, in combination with the technical data.

The data required include:

- The amount of land the farmer possesses
- The type of windpump available
- The irrigation method applied
- The number of hours a day the farmer wants to irrigate
- The amount of labour the farmer can make available for irrigation
- The crops that are possible or needed and whether or not the farmer wants to include

drought-resistant crops in his cropping pattern

- The additional economic return on investments in storage tank capacity
- The financial opportunities for the farmer

The last two aspects are discussed in Chapter 6. Larger storage tanks facilitate irrigation water management by reducing the number of irrigation periods and by creating a buffer for windless periods. The cultivated area can also be extended. Large storage tanks are very costly, however, and a farmer has to find a balance between the costs and benefits.



In the case study on Cape Verde (Van Dijk 1984a), optimal storage tank capacity was in the order of 1.0 to 2.0 times the average daily windpump output, when taking account of economical, financial and water management aspects. The result has been confirmed by a field study (Van der Bijl 1985) on Sao Vicente, Cape Verde in an area with a tradition of windpump irrigation since 1900.

To spread their risks, the farmers there grow a variety of crops and include drought resistant crops in their cropping pattern. They have storage tanks equal to 1.0 or 1.5 times average daily windpump output, and the f_{we} factor is 0.80.

If a farmer also has paddy fields, he may consider using these fields for water storage as well. In that case, the required storage tank capacity can be much less than that derived from Figure 5.4.

Another option that has not previously been discussed is the possibility of using a water lifting device such as a small motor pump, or a human or animal-powered pump in addition to the windpump (dual system pumping). Although such a solution might be beyond the financial reach of a small farmer, it could offer rather good opportunities to use

the windpump output more efficiently, and in many cases it could be a more economical solution. Even a relatively cheap hand pump is just enough to deliver a small quantity of water to irrigate the most critical crops when the windpump has stopped owing to a windless period with an empty reservoir. The installation of such additional devices permits larger areas to be cultivated (higher f_{we}) or enables the required storage tank capacity to be drastically reduced.

The storage tank capacity should then be just sufficient to collect the nightly output of the windpump, while the day-to-day fluctuations in the windpump output are covered by the additional device. The extra costs for the additional device (money and labour requirements) should be weighed against the extra benefits such as less storage tank capacity, more crop security and higher agricultural yield.

It should be clear from this discussion that the large number of variables involved demand a complex process to determine the most suitable combination of windpump, command area, storage tank capacity, cropping pattern, and possibly even an additional water lifting device.

5.6

FINAL COMMENTS

This chapter has considered fluctuations in the wind resource. It has considered the circumstances under which a storage tank is required and how to calculate its size. The conclusion has been that, despite the apparent scope of the wind regimes, windpump sizes, command areas, cropping patterns, etc, a single graph can in fact be used to relate the major parameters and derive a tank size.

In general, a tank of one or two times the average daily output is sufficient to buffer the more noticeable fluctuations in windpump output.

The next chapter describes the economics of choosing a windpump and shows when and whether the windpump system is a viable option.

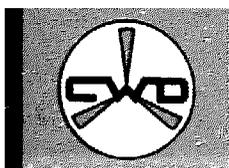

Like other technology which has been introduced into farming systems, the attractiveness of a wind pump is strongly related to economic and financial concerns. Since there is also a clear component of "energy conservation" included in the use of windpumps, economic considerations at the country level are important. They become more important if a significant amount of fossil energy is saved owing to the use of large numbers of windpumps.

The farm economic or financial analysis determines the attractiveness of the

use of windpumps for farmers. Economic models at both the country and farm levels have been developed and published along with decision schemes for the use of windpumps (Mueller 1984).

The economic analysis is described briefly in Section 6.1. The farm economic and financial analysis, including the financing of a windpump by farmers, is discussed in more detail in Sections 6.2 and 6.3. The last section briefly describes sensitivity analysis, that is the influence of a change in parameters on the cost of a windpump.

ECONOMIC ANALYSIS

6.1

The major factors that determine the economic attractiveness of windpumps by comparison with other water lifting devices in a country or one of its regions are the:

- investment costs of water lifting devices.
- economic lifetime of water lifting devices.
- operation costs.
- interest rate and foreign exchange rate.
- availability of other energy sources.
- opportunity costs of rural employment.

Apart from these typical economic factors, the attractiveness is, of course, determined by physical and technical factors such as the wind regime, pumping head, demand for water, and storage tank capacity to bridge windless days, etc.

The accounting costs are calculated on the basis of economic prices which means that taxes and subsidies are excluded. The opportunity costs of rural employment are determined by the scarcity of labour, especially in the case of local manufacturing of windpumps. Opportunity costs mean, the value of resources in their most productive alternative uses. In other words, what else can be done with labour.

The calculation of the economic attractiveness can be based on a comparative cost analysis of different water lifting devices. In a country where windpumps are a new technology, the initial introduction cost (local research, a wind measurement programme, for instance) also has to be taken into account. Based on a number of calculations (Mueller 1984; Van Dijk 1986), windpumps have been found to be economically more attractive than diesel pumps if the average wind speed during the irrigation season is at least 4 m/s. If high investment costs are required for the storage tank, this figure may be somewhat optimistic.

An important factor which determines the economic feasibility of windpumps is the availability of other sources of energy. If the possibility exists to generate electricity in a cheap way, such as by hydropower, and a dense rural electricity grid exists, the use of electric pumps will almost always be the most attractive pumping option.

However, if the alternative to wind energy in a specific country is the use of imported fuel, windpumps would be more feasible than diesel pumps. The use of windpumps de-



creases both the demand for foreign currency and the dependence on foreign energy supplies. Solar energy, which like wind is freely available, is not yet an attractive energy source from an economic point of view. Though solar pumps have long lifetimes, the investment costs are still high compared to other water lifting devices. Solar energy can be important if a high value is attached to clean water such as in the supply for a small rural hospital but, if large quantities are involved as in the case of irrigation, it is not yet considered worthwhile.

If a windpump is introduced or replaces a traditional water lifting device, the so-called opportunity costs of labour must also be included in the analysis. This is because

the running costs of traditional water lifting devices consist mainly of labour costs.

The possibility of producing wind-pumps in workshops in the country concerned can also be an important aspect of the economic attractiveness. Local production instead of imports saves foreign currency. This is especially true if it is not necessary to import the required raw materials. Because wind-pumps are expensive to transport, production should preferably take place not far from the area where the windpumps will be installed.

This implies local production which also creates rural employment which, in many cases, may be very attractive from a national point of view.

6.2

FARM ECONOMIC ANALYSIS

A farm economic analysis determines whether or not the use of windpumps is a feasible investment for a farmer. This analysis is required because a positive or negative outcome of the economic analysis at a regional or country level does not mean the same feasibility for the farmer. Contrary to the economic analysis of a country in regard to windpumps, the farm economic analysis uses the real market prices that the farmer pays for inputs or receives for products. This means that taxes and subsidies are included in the prices and the interest rate for local loans is used.

If windpumps prove to be attractive from an economic point of view, but not from the farm economic point of view, government subsidies might be feasible.

6.2.1 Methodology of the analysis

An individual farmer probably does not see a windpump as a tool to conserve energy but only as a water lifting device. This means that the windpump must be reliable, easy to handle, and cheap vis-à-vis other

water lifting devices. A comparative farm economic analysis of various pumping systems can determine the economic viability of each pumping system.

In cases where windpumps are to be introduced in an area in which water lifting devices are already in use, estimates could indicate that the windpump can meet the water requirements of the existing cropping system. If the benefits of the windpump are equivalent to those of the existing water lifting device, calculation of the annual costs can be sufficient to determine the economic attractiveness.

A comparative analysis of the equivalent benefits of the systems should also include a proper weighing of more immaterial benefits such as the fact that windpump irrigation can be somewhat more labour intensive than motor pump irrigation.

The fact that a farmer using windpumps has to irrigate almost every day should also be taken into account.



The general formula for calculating annual cost reads:

$$AC = \frac{i(1+i)^n}{(1+i)^n - 1} \cdot \left\{ I + \sum_{t=1}^n \frac{C_t}{(1+i)^t} \right\} \quad (6.1)$$

where:

AC = annual cost (\$/year)

i = interest rate (-)

I = investment costs (\$)

n = lifetime (years)

C_t = operating cost in year t (\$)

The cost in year t consists of the operating costs of the water lifting device, the costs of repair and maintenance, and possibly a re-investment component with a shorter life span than the rest of the device.

The annual costs are calculated for each type of water lifting device; the device having the lowest annual costs is the most economically attractive.

Sometimes, windpumps can be used as an additional device. In a small irrigation scheme, where water is supplied by a fuel pump, windpumps can be installed to save fuel during windy periods.

The economic attractiveness is calculated by comparing the annual costs of the windpump with the annual benefits from fuel saving. If the benefits of the windpump differ from the other water lifting devices, a comparison of annual net benefits must be made.

The equation to be used is:

$$ANB = \frac{i(1+i)^n}{(1+i)^n - 1} \cdot \left\{ I + \sum_{t=1}^n \frac{(B_t - C_t)}{(1+i)^t} - I \right\} \quad (6.2)$$

where:

ANB = net annual benefits (\$)

I = investment costs (\$)

B_t = benefits in year t (\$)

C_t = costs in year t (\$)

i = interest rate (-)

n = lifetime windpump/engine pump (years)

The net annual benefits are calculated for each device. If the average net annual benefits of the windpump irrigation system are higher than those of the comparative water lifting devices, than the use of wind pumps is attractive from a farm-economic point of view.

Such a comparative analysis was carried out on Sao Vicente in Cape Verde (Van der Bijl 1985). Table 6.1 shows the results.

This comparison concluded that a windpump is more viable for farmers on small farms than a fuel pump in the favourable wind regime of Sao Vicente (average wind speed 6-7 m/s).

6.2.2 Annual costs of windpumps

In general, the annual costs of pumping water are determined by the investment costs and the lifetime of the device, the interest rates, and the specific costs of maintenance, repair and operation. The investment costs of a windpump irrigation system consist of the cost



Table 6.1 Benefits and costs of irrigation on Sao Vicente, Cape Verde.

Case	1	2
Water lifting device	wind pump	fuel pump
Gross irrigated area	1250 m ²	1250 m ²
Costs per year in Escudos		
- Investments in vegetable garden	22320	15700
- Investments in lifting device	10490	12620
- Running costs	-	26535
- Repair and Maintenance	4000	6000
- Labour	1500	1500
- Others	4000	4000
Total costs	42310	66355
Benefits per year in Escudos:		
- Gross margin	93750	103125
- Extra for animal husbandry	-	-
Total benefits per year	93750	103125
Annual net benefits (benefits - costs)	51440	36770

of the windpump, the storage tank and, if ground water is used, the well.

The investment costs of the windpump are determined by the choice of the type and size of the windpump (see Table 2.2), under the prevailing wind regime. Local production and efficient installation of the windpumps can reduce the investment costs.

The lifetime of the windpump is dependent upon the type of windpump and the level of maintenance and repair.

The investment costs of the storage tank depend on the material used and the required tank capacity. The investment costs vary greatly. If material and construction costs are relatively low (that is, if locally available material such as sand and rocks are used, or if the reservoir can be excavated), the tank capacity can be even larger than the minimum required capacity.

This will provide a simple and more reliable water supply and create the possibility of carrying out fish farming. If storage tanks are constructed out of more expensive materials, such as cement blocks or bricks, the tank capacity is more critical and should be minimized. Appendix 3 gives details on the costs of different storage tanks.

Sometimes a new well has to be dug before the windpump can be installed. Deepening the well may be necessary, for instance, if it was previously operated by means of a water lifting device with a lower pump capacity.

The costs of digging or drilling a new well or deepening an existing one depend on factors such as type of well (dug or drilled), the depth and diameter of the well, the material to be excavated, depth to water level, etc. The life span of a dug well is usually rather long (more

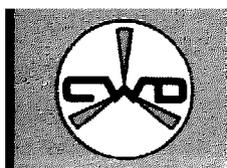

than 30 years), which means that only the initial investment costs have to be considered in the analysis.

The costs of maintenance, repair, and operation are also taken into account in the economic analysis. The main advantage of windpumps is of course that operational costs are rather low. Other water lifting devices have higher operational costs because of fuel or electricity consumption.

In general, it can be assumed that the annual repair and maintenance costs for windpumps are in the range of 2%-10% of the initial investment costs. The maintenance and repair costs of a storage tank depend largely on the material used for construction (see Appendix 3). They can be estimated at 1%-5% of the initial investment costs of the tank.

The maintenance and repair costs of the wells are generally small by comparison with the other costs of the windpump irrigation system.

Appendix 4 shows an example from Mozambique of investment, maintenance and repair costs of a windpump irrigation system.

6.2.3 Annual net benefits of windpumps

The annual net benefits of the windpumps are determined by the yield of the crops grown in the command area. Labour saving can be important when windpumps replace traditional water lifting devices such as the "Persian wheel", which is a very labour intensive technique. In some cases fish farming in the storage tank may be an additional income generating activity.

The annual benefits of a windpump are highly influenced by the possibility of using the pumped water in an optimal way. However, this does not automatically mean that the highest net benefits are derived from the largest command area which also implies the highest exploitation factor f_{we} , where f_{we} is

the gross irrigation water requirement of the area served by the windpump divided by the average windpump output (see Chapter 5).

As Chapter 5 showed, a distinct relationship exists between the storage tank capacity and f_{we} . Larger storage tanks increase f_{we} and less water is lost. Therefore, a larger tank enables a larger command area to be cultivated or a smaller windpump to be installed.

For a specific windpump, a larger storage tank and larger command area initially requires higher investment costs to generate higher benefits.

The combination of f_{we} and storage tank capacity that provides the highest net benefits depends on the agricultural production level. An increase in the f_{we} at a high production level provides relatively more benefits than at a low production level.

For the Cape Verde Islands (Case 1, Chapter 5), the net production has been calculated for three different production levels and eight different combinations of f_{we} and storage tank capacity (see Table 6.2). The costs of the storage tank is estimated at US\$ 40 per cubic metre of storage (1983 prices are used).

At a low production level, the highest net benefit is reached at $f_{we}=0.70$ and a storage tank capacity of 0.6 times the average daily output. Such a storage tank capacity is less attractive from a water management point of view (Section 5.2). However, an increase in the storage tank capacity decreases the net benefit.

For a medium production level, the difference between the net benefit for different tank capacities is not very large. In this instance, the farmer's choice of a specific tank size is not greatly influenced by farm economic considerations.

For a high production level, the largest storage tank with a f_{we} of 1.0 (on the



Table 6.2 The net production for different combinations of the windpump exploitation factor f_{we} and storage tank capacity

f_{we}	m^3	Storage tank capacity tank capacity/ daily output windpump	Net benefit (US\$/year) production level		
			low	medium	high
1.00	240*	4.0	1050	2910	5500
0.90	151	2.5	1285	2960	5280
0.85	100	1.7	1445	3010	5165
0.75	62	1.1	1490	2925	4890
0.70	35	0.6	1545	2880	4715
0.65	18	0.3	1480	2670	4285

* For example, the daily windpump output in this case is $240/4 = 60 m^3$, and the gross irrigation requirement (GIR) = $f_{we} \cdot 60 = 60 m^3$.

average total windpump output can be used) is economically the most attractive. The higher cost of the larger storage tanks is compensated for by the higher benefit of the extra command

area. Whether or not the farmer chooses this solution will depend on the possibilities for financing the higher investment cost of a larger storage tank.

63

FINANCING A WINDPUMP

A positive outcome to the farm economic analysis does not necessarily mean that farmers can finance the windpump or that the net cash benefit is sufficient to make a windpump an attractive choice.

There is a distinct difference between the calculated annual cost of the windpump in the economic analysis and the amount of available cash on an annual basis. A farmer has to repay the loan he takes out to invest in a windpump. The calculated economic value of the crops of the command area can differ from the actual amount of money the farmer receives from the sales of the production on the market.

Therefore, a cash flow analysis is required to determine whether or not it is feasible for the farmer to invest in a windpump. The methodology in this analysis is basically similar to that of the economic analysis, except that the cash flow analysis uses different cash

payments and cash benefits. The debt service (interest plus repayment) of the loan is used rather than the investment costs. The benefits consist only of the money received from the sale of products to the market.

The financial analysis enables the calculation of a cash flow, which gives the net cash benefits over a period of years. This cash flow gives a good indication of the financial viability.

The general characteristics of the expenditure pattern for a windpump investment are high fixed expenditures during the first year, but a large reduction in expenditures after the loan is repaid (see Figure 6.1).

The expenditure pattern for fuel pumps is characterised by equal fixed expenditures and running costs and a more constant expenditure pattern throughout the years.

A comparison of these two expenditure patterns shows that a farmer who invested



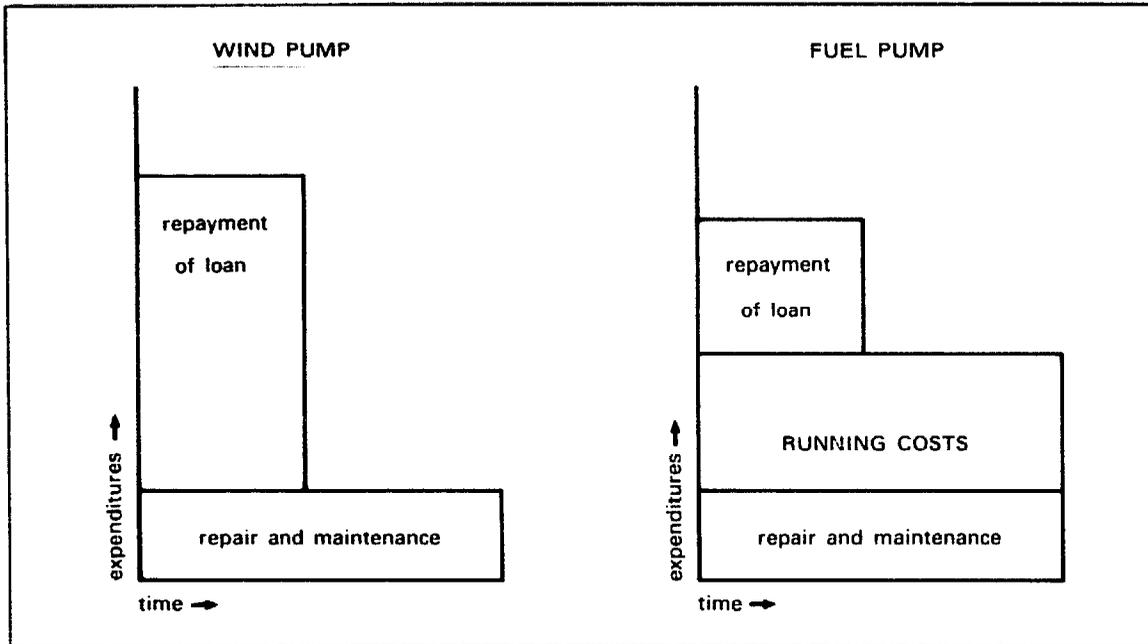

Figure 6.1 Comparing the indicative expenditure patterns of windpump and a fuel pump.

in a wind pump has higher expenditures in the early years than the farmer who has chosen a fuel pump. Taking into account the fact that some time is needed to learn how to use the windpump optimally, the cash benefit of the windpump will probably become higher after several years than those of the fuel pumps, as seen in Figure 6.2.

Mueller and Jansen (1984) calculated the cash flow of a small kerosene pump versus that of a windpump in Sri Lanka and found that the farmer received less money in the first years after the installation of the windpump than with a kerosene pump. This difference in the net cash flow was not caused by differences in benefits but rather due to differences in the expenditure pattern.

The expenditure pattern of a fuel pump is more flexible than that of a windpump. If required, the farmer can reduce the running costs by using the fuel pump less, say, during years with excessive rainfall or when the family cannot put much labour effort into its agricultural activities.

The high fixed expenditures for a windpump during the first years can hamper the successful introduction of windpumps amongst farmers. Given the uncertainties that farmers have to deal with (plant diseases, drought, changes in market prices), it is questionable whether they will take the risk of investing in a device which will not benefit them for a number of years.

The limited time horizon of many farmers in developing countries (who are mainly concerned with the daily struggle for life) is also an influencing factor.

The high investment costs of a windpump and storage tank means that a farmer often needs a bank loan to finance the investment costs. Informal credit systems will probably not be sufficiently available to finance large amounts of money. Adapting bank loan schemes to the specific expenditure pattern of windpumps can be very useful.

Lengthening the loan repayment period or changing the repayment schedule to permit decreasing amounts can be considered.



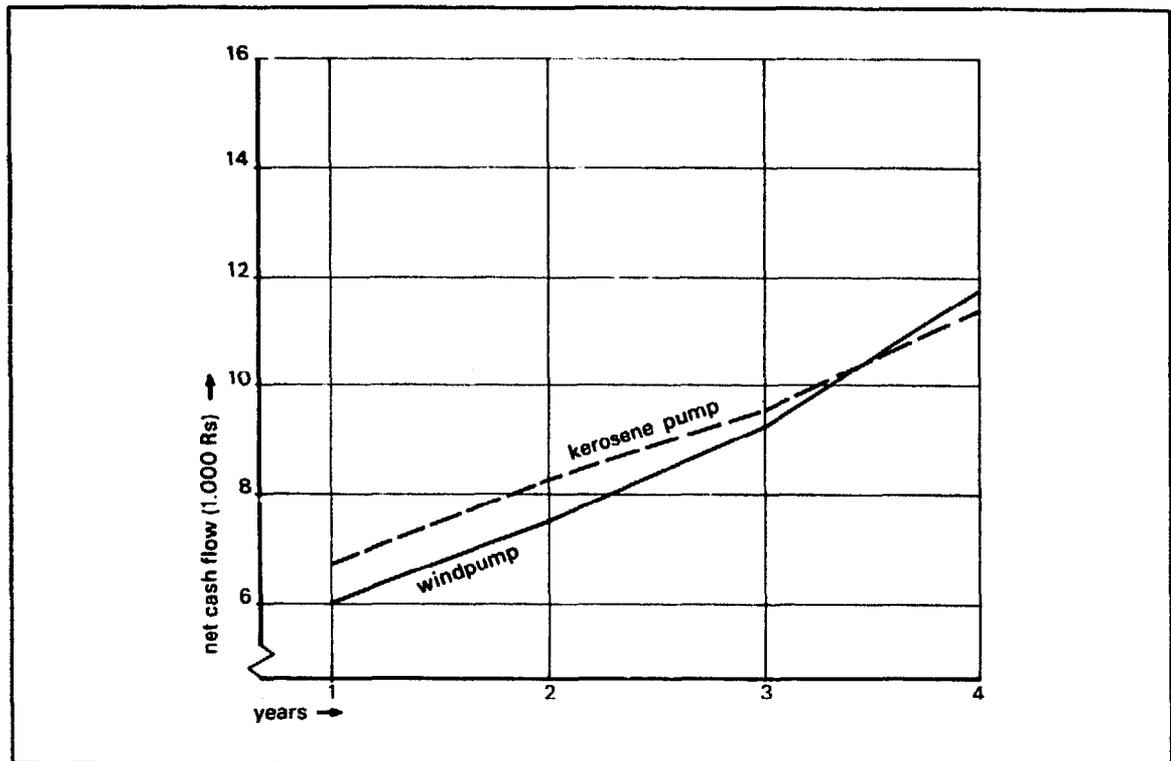

Figure 6.2 The net cash flow of a windpump and a kerosene pump (1 US\$ = 22 Rupees, 1983)

A more flexible repayment schedule is another solution. This schedule could for instance be related to the realized yields and market prices during a specific year.

Finally, if general subsidy schemes exist to encourage farmers to invest, wind-pumps could be included in these schemes. In all cases, the farmer must be willing to risk a rather high investment in a windpump.

The risk-bearing capacity of the household and the involvement of the family in the market structure also indicates the type of households for which windpumps could be attractive. Generally speaking this will not be the subsistence farmers, but those who are at least already partly integrated into a market economy by producing cash crops.

When wind pumps are used to irrigate the fields of a group of farmers, a different

situation exists. In this case, a wind pump is often not a private investment of one farmer, but rather part of the supply system for irrigation water. As in other small scale irrigation projects, the supply system consisting of a water source, a windpump and a canal system is probably not privately owned by the users, but by a (semi- or para-) governmental organization.

Apart from taking care of the operation, maintenance, and repair this organization also finances the investment in the wind-pumps. Farmers who use the water supplied by the scheme pay for these investments either by paying for the amount of water used or by paying a fixed annual water tax. In general, the financial aspects of investment in windpumps will not differ much from the way it is organized in similar irrigation schemes.



SENSITIVITY ANALYSIS

6.4

In all cases of economic and financial analysis, a sensitivity analysis should likewise be made. If reliable data is not available, a sensitivity analysis is imperative. By carrying out such an analysis, the influence of the assumptions made on the outcome of the analysis can be determined.

Future changes in prices of items such as fuel can be analyzed in this way and taken into account. A sensitivity analysis is conducted by increasing or decreasing the key

parameters used in the economic analysis. The annual costs or annual net benefits are calculated once again and the influence of these key parameters can then be determined.

The key parameters of the economic sensitivity analysis of pumping with a windmill are investment costs, interest rates, fuel prices and market prices of the crops.

Table 6.3 presents an example of the outcome of the sensitivity of the annual costs to a change in the level of investment costs (Mueller 1984).

Table 6.3 Sensitivity analysis (at country level) of the annual costs.

Cost component	Percent change	Resulting change in annual costs
Windpump investment costs	+ 10%	+ 4.5%
Diesel pump investment costs	+ 10%	+ 3.0%



A systematic approach to introducing windpumps is one of the prerequisites to success. In the past, several projects have failed because the complexity of this process was underestimated. Mistakes during the initial stages of the project resulted in long-lasting negative attitudes amongst farmers towards windpumps.

Proper monitoring of any windpump project is essential in order to avoid possible mistakes at an early stage and to adjust the project set up. Monitoring is a continuous process of obtaining, analyzing and communicating data.

Experience with proper monitoring, the evaluation of windpump projects and, in fact, general development projects, are limited.

As was discussed in Section 1.2, both the complexity and the key factors that deter-

mine the attractiveness of windpumps in various farming systems can differ substantially.

These differences affect the type of project. For instance, a project for rain-fed farming systems would differ from one which is only a question of replacing diesel pumps by windpumps.

Whatever the situation, some kind of project planning is required. The five different phases of a general project set-up are (refer also to Bodegom 1984):

Phase 1: Assessment of need

Phase 2: Pre-feasibility study

Phase 3: Pilot project

Phase 4: Feasibility study

Phase 5: Implementation

These phases are described in detail below. One or more could be scrapped depending on the local situation.

7.1

THE DIFFERENT PHASES OF A WINDPUMP PROJECT

Phase 1: Assessment of need

During this phase, an investigation is made as to whether there is any need amongst the target group for technological improvements in the farming system. The participation of the target group itself is a prerequisite for the success of this phase. Steps should also be taken to ensure that both men and women have equal opportunities to express their needs. Based on discussions and studies, preferably carried out by local people, an initial list of possible technological solutions is compiled and then compared.

The need assessment phase is especially important when it concerns a region with rain-fed farming. When families that belong to the target group show interest in improved water lifting devices or in the use of windpumps (see Sao Vicente case study), the need assessment phase may not be required.

The chief conclusion of this first phase of the project should be whether or not a real need exists for improving the lifting of irrigation water.

Phase 2: Pre-feasibility study

The pre-feasibility study should determine whether or not the introduction of windpumps would be beneficial. This is done by a comparative study of diverse types of water lifting devices. Only available data is used: no special research is carried out for this study. An example of the terms of reference for a pre-feasibility study is given in Appendix 5.

Unless farmers have already expressed their interest in windpumps, as was the case in Sao Vicente (Cape Verde), the pre-feasibility study is one of the more crucial phases of a windpump project. If the outcome of this study is positive, a pilot project can be



started. A positive pre-feasibility study does not, however, guarantee a successful follow up. A too optimistic study might overlook key factors during this phase, which could create major problems during later phases of the project.

This was the case with the TOOL-ORP Windmill Project in Ghazipur, North India (Goedhart 1980). During the pre-feasibility study, it was assumed that farmers would largely adapt their cropping system to the output pattern of the windpump. This implied cultivating vegetables during the summer season which would give the farmers very high benefits.

Based on this fact, windpumps were considered to be economically very attractive for them. The pilot project phase discovered, however, that cultivation during summer created many problems. Farmers had to stop their traditional on-farm activities during this season; the processing of winter crops could not be accomplished, and there were agro-climatological limitations. Furthermore, many farmers were not eager to cultivate vegetables owing to cultural reasons. As a result, the assumptions of the pre-feasibility study proved to be wrong and during the pilot phase it was concluded that windpumps were not suitable for these farmers.

Phase 3: Pilot project

If a new technology is to be introduced, it is almost impossible to assess the implications without practical experience. The pilot phase is less necessary if windpumps are already successfully in use in other projects in the region. Technical, agronomical, and socio-economical differences will determine whether or not use can be made of experiences in nearby projects. The exact scope of the pilot project phase also depends on the outcome of the pre-feasibility study.

In general, the aim is to provide the data, based on practical experience, required for the feasibility study which in turn investigates the possibility of an implementation phase.

The pilot project phase has two sub-phases: one of internal testing, the other of external testing.

■ **Internal testing** (carried out at the research location). This phase is especially important if one of the aims is the local production of windpumps. The end product of the new technology has to be built, tested and, if necessary, improved and adapted to local circumstances (methods of construction, available materials, etc.).

Adequate wind data to be used for a simulation model on windpump irrigation has to be collected at the test station. Data on the area to be irrigated by one wind pump (command area), storage tanks and cropping pattern can also be investigated. This data collection and processing, and the testing of windpumps can take place at a rural research institute. Appendix 6 gives an example of the elements that must be monitored and equipment required. The duration of the internal testing phase depends largely on the required adaptations of the windpump.

In general, experience shows that a period of six months should be considered the minimum length for internal testing. If the aim is only to import windpumps, this internal testing phase is less important. In some cases, it could even be omitted from the project or restricted to collection of wind data only.

■ **External testing** (testing at field locations)

When the windpump has been adapted to the local conditions and production (or import) becomes possible, the phase of external data collection can be started. In this phase, the windpump is tested under real target group conditions. The set-up must



resemble that of the implementation phase. Provisions must be made to ensure that the testing is as realistic as possible, while at the same time the farmers selected to participate are not exposed to too many risks. It should be clear to everybody involved that the implementation phase has not yet started.

The farmers' wells must be suitable and the farmers themselves have to be given strong support. One of the most essential tasks in this phase is proper data collection. The performance of the windpumps with respect to the technical, agronomical and social aspects should be monitored in detail. This requires trained personnel and cooperating farmers, as well as an adequate planning.

The external testing period must cover at least the main irrigation season. The number and type of farmers involved in this external testing depends on the diversity within the project area and on the project's target group. Logistical aspects can play an important role. Proper collection of data from amongst the farmers is required, which means visits must be made at least once a week.

To minimise difficulties in connection with maintenance and repair, the distances between different test-locations should not be too large. A total of five to ten families is usually sufficient to collect a reliable set of data.

Some pre-implementation activities can also be carried out during this phase, such as making contact with banks and government institutions to arrange for credit and subsidy facilities or for the start-up of production. Attention must also be given to training local people in the production, use and maintenance of windpumps.

Appendix 7 gives an example of an activity-time schedule for a pilot project in Sudan.

Phase 4: Feasibility study

The feasibility study is based on the pre-feasibility study and results of the pilot project (if carried out). This should result in a conclusion about the use of windpumps by the target group. Social, agronomical, economical, financial, technical and organizational aspects of the use of windpumps have to be considered. An example of the terms of reference for a feasibility study is given in Appendix 8. When the study comes to a positive conclusion, the implementation of the windpumps can begin.

Phase 5: Implementation

This is the final phase of a windpump project. The first part of this phase should include the making of definite agreements with banks regarding credit and subsidy facilities. Legal permission must be obtained in order to start production on a large scale.

Farmers, who obtain a windpump free of charge during the external testing phase have to decide whether or not they want to buy the windpump. After that, the sale of windpumps can be started.

A careful implementation requires slow expansion of local production during the first phase here. Contacts with potential windpump farmers should be established on the basis of experience gained during the external testing phase. Special attention must be given to the organization of maintenance and repair facilities and to extension services related to windpump irrigation. In this initial period, it is often expedient to restrict the sale of windpumps to a specific area.

This enables the users of windpumps to collaborate. Maintenance, repair and extension services can also be provided more easily and monitoring, which should still continue, is also easier.

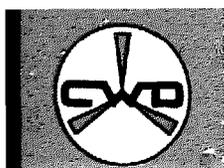

Once the first phase of implementation has succeeded, the next phase of the introduction can be left to market forces. Once the new technology has proved to be reliable and

attractive, the special support given to the production and use of windpumps can be decreased and the introduction of windpumps as a project can come to an end.

FINAL COMMENTS

7.2

Whether or not all the described phases must be part of a project depends on the local circumstances and the results of the various phases of the project.

The duration of the project depends largely on the situation of the target group at the start of the project as well as on the institutional constraints. The introduction of windpumps to replace fuel pumps takes less time than the introduction of windpumps in an area where farmers have very little or no experience with irrigation. Although there is not much data available, a project cycle of five to eight years seems a realistic estimate.

The two case studies of Lassithi and Sao Vicente (Hoogervorst and Van 't Land 1983 and Van der Bijl 1985) show that it takes approximately five to ten years before windpumps are used on such a large scale that they have become one of the many available indigenous technologies.



Bodegom E.V. (1984)

The strategy for the introduction of windmills for irrigation in developing countries.
International Institute for Land Reclamation and Improvement, Wageningen, The Netherlands.

Bos M.G., and Nugteren J. (1974)

On irrigation efficiencies.
Publication 19
ILRI, International Institute for Land Reclamation and Improvement, Wageningen, The Netherlands.

Bremond R. (1965)

Contribution a l'interpretation des mesures de debit et de rabatement dans les nappes souterraines.
Ganthier Villars, France.

Burgeap (1974)

La construction des puits en Afrique tropical et l'investissement humain. Min. de la Cooperation, France.

CWD (1984)

Terms of reference for a feasibility study on "the potential of windmills for water lifting near Xai-Xai, Mozambique".
CWD, Consultancy Services Wind Energy Developing Countries, Amersfoort, The Netherlands.

CWD (1985a)

Proposal for a pre-feasibility study on the prospects of wind energy in Cuba.
CWD, Consulting Services Wind Energy Developing Countries, Amersfoort, The Netherlands.

CWD (1985b)

Windmill Project Sudan. Proposal.
CWD, Consulting Services Wind Energy Developing Countries, Amersfoort, The Netherlands.

Costa J. (1981)

Irrigation water storage tanks made of brickwork.
CWD, Consultancy Services Wind Energy Developing Countries, Amersfoort, The Netherlands.

Costa J. (1982)

Irrigation water storage tanks made of ferro cement and a combination of ferro cement and brickwork.
CWD, Consultancy Services Wind Energy Developing Countries, Amersfoort, The Netherlands.

Costa J. (1983)

Irrigation water storage tanks made of earthen dikes with various linings. CWD, Consultancy Services Wind Energy Developing Countries, Amersfoort, The Netherlands.

Doorenbos J., and Pruitt W.O. (1977)

Crop Water Requirements.
FAO Irrigation and Drainage paper no. 24.
FAO, Food and Agriculture Organization of the United Nations, Rome

Eggink J.W., and Ubels J. (1984)

Irrigation, Peasants and Development.
Dept. of Irr. and Civil Eng. and Dept. of Rural Sociology of the Tropics and Sub-tropics, Agricultural University of Wageningen, The Netherlands.

FAO (1985)

Guidelines: land evaluation for irrigated agriculture.
FAO Soils Bulletin 55.
FAO, Food and Agriculture Organisation of the United Nations, Rome.

Goedhart P.D. (1980)

The target group of the TOOL-ORP Windmill Project, Ghanipur, India (in Dutch).
Technology and Development group, Twente University of Technology, Enschede, The Netherlands.

Goedhart P.D. (1982)

Prospects for small and marginal farmers in Trichy District (Tamil Nadu, India) to use water-pumping windmills for irrigation.
Technology and Development Group, Twente University of Technology, Enschede, The Netherlands.

Goedhart P.D. (1984)

The effects of water deficits in windmill irrigation.
ILRI, International Institute for Land Reclamation and Improvement, Wageningen, The Netherlands.

Goedhart P.D. (1985)

The influence of inter-annual variations in climate on the command area of a windmill.
ILRI, International Institute for Land Reclamation and Improvement, Wageningen, The Netherlands.

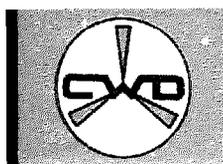

Goezinne F. (1986)

Manual series of the CWD 5000 Wind Pump, Users Manual.

CWD, Consultancy Services Wind Energy Developing Countries, Amersfoort, The Netherlands.

Hassing P., and Van Meel J. (1984)

Windmills in Gaza Province in Mozambique. A feasibility study.

CWD, Consultancy Services Wind Energy Developing Countries, Amersfoort, The Netherlands.

Hoogervorst N., and Van 't Land G. (1983)

Why windmills applied.

ILRI, International Institute for Land Reclamation and Improvement, Wageningen, The Netherlands.

Karanjac J. (1971)

Brief note on testing the possibility of defining "optimum yield" of dug wells of large diameter.

Groundwater 13, No. 4.

Karunaratne A.D.M., and Mueller A.M. (1982)

Research on lining materials of water storage tanks and sparger irrigation, Colombo.

CWD, Consultancy Services Wind Energy Developing Countries, Amersfoort, The Netherlands.

Kortenhorst L. (1980).

Factors affecting the viability of smallholder irrigation.

ILRI, International Institute for Land Reclamation and Improvement, Wageningen, The Netherlands.

Kragten A. (1984)

Draft on water pumping windmill CWD 2740.

Internal Report THE.

Technical University Eindhoven, Eindhoven, The Netherlands.

Kruseman G.P., and De Ridder N.A. (1976)

Analysis of pumping test data.

ILRI, International Institute for Land Reclamation and Improvement, Wageningen, The Netherlands.

Lysen E.H. (1983)

Introduction to wind energy.

CWD, Consultancy Services Wind Energy Developing Countries, Amersfoort, The Netherlands.

Meroney R.N. (1977)

Wind in the perturbed environment; its influence on WECS. Colorado State University, Fort Collins, USA.

Mueller A.M. (1984)

Farm economics of water lifting windmills.

CWD, Consultancy Services Wind Energy Developing Countries, Amersfoort, The Netherlands.

Mueller A.M., and Jansen W.A.M. (1984)

Cost analysis of water lifting windmills and diesel-powered pumps used for small-scale irrigation.

CWD, Consultancy Services Wind Energy Developing Countries, Amersfoort, The Netherlands.

Papadopoulos I.S., and Cooper H.H. Jr. (1967)

Draw down in a well of large diameter.

Water Resources Res., Vol. 3: 241-244.

Pieterse N. (1982)

Caudais estimados das aerobombas baseando-se nos dados de vento da Praia, 1975-1981. DER, Cabo Verde.

CWD, Consultancy Services Wind Energy Developing Countries, Amersfoort, The Netherlands.

Smulders P.T. and Loytenberg A. (1985)

Control and safety systems for wind pumpers, in particular the hinged-side vane mechanism.

CWD, Consultancy Services Wind Energy Developing Countries, Amersfoort, The Netherlands.

Stern P. (1984)

Small Scale Irrigation, a manual for low-cost water technology.

Intermediate Technology Publication Ltd. London, U.K.

Van der Bijl G. (1985)

Rising in the wind's eye.

ILRI, International Institute for Land Reclamation and Improvement, Wageningen, The Netherlands.

Van Dijk H.J. (1984a)

The volume of storage tanks in windmill irrigation systems in Cape Verde.

ILRI, International Institute for Land Reclamation and Improvement, Wageningen, The Netherlands.



Van Dijk H.J. (1984b)

Additional note on storage tanks in windmill irrigation systems.
ILRI, International Institute for Land Reclamation and Improvement, Wageningen, The Netherlands.

Van Dijk H.J. (1986)

The use of windpumps for rural water supply and irrigation on Cape Verde.
ILRI, International Institute for Land Reclamation and Improvement, Wageningen, The Netherlands.

Van Leeuwen R.J. (1985)

Tools and machinery required for production of the CWD 5000.
CWD, Consultancy Services Wind Energy Developing Countries, Amersfoort, The Netherlands.

Van Meel J. (1984)

Water pumping windmill CWD 2740. Range of application and output performance.
Technical University Eindhoven, Eindhoven, The Netherlands.

Van Meel J., and Smulders P. (1989)

Wind Pumping, a handbook.
World Bank Technical Paper Number 101, Industry and Energy Series
The World Bank, Washington DC, U.S.A.

Van Veldhuizen L.R. (1982a)

STOWI computer model for evaluating storage tank capacity.
ILRI, International Institute for Land Reclamation and Improvement, Wageningen, The Netherlands.

Van Veldhuizen L.R. (1982b)

Windless days analysis.
ILRI, International Institute for Land Reclamation and Improvement, Wageningen, The Netherlands.

Van Veldhuizen L.R. (1983)

The choice of design wind speed and storage tank capacity that influences water availability in a windmill irrigation system.
ILRI, International Institute for Land Reclamation and Improvement, Wageningen, The Netherlands.

Van Vilsteren A. (1981)

Aspects of irrigation with windmills.
CWD 81-4, Consultancy Services Wind Energy Developing Countries, Amersfoort, The Netherlands.

Vel J.A.C., and Van Veldhuizen L.R. (1981)

A model for the economics of small-scale irrigation with windmills in Sri Lanka.
CWD, Consultancy Services Wind Energy Developing Countries, Amersfoort, The Netherlands.

Wegley H.L. et al. (1980)

A handbook for selecting sites for small wind energy conversion systems.
Windbooks, Battelle Pacific Northwest Laboratory, Richland, Washington, U.S.A.

WUE (1981)

Recharge test for open wells.
Wind Energy Unit.
Water Resources Board, Colombo, Sri Lanka.



Testing the yield of large diameter dug wells

Three methods are described here to determine the possibilities of using a well for small scale lift irrigation, and to select the appropriate pumping capacity of the water lifting device to be installed. These methods are ranked according to increasing complexity:

1. method based on well geometry.
2. the "optimum yield" approach.
3. the "improved optimum yield" approach.

To evaluate whether or not a well could be equipped with a windpump and to select the best windpump size, the "steady state yield" is a useful criteria. This is the average rate at which a well can be pumped without being emptied. A windpump, however, does not have a constant pumping rate. It could, therefore, still empty a well at high wind velocities.

This can only be prevented by sizing the windpump so that the rated (maximum) output is equal to that of the well capacity. The larger the storage capacity of the well, the smaller the chance of the well being emptied by a windpump.

1. Method based on well geometry

This method is easy to understand. It has been used by the Wind Energy Unit in Sri Lanka (WEU 1981). The idea behind the test is that the recharge capacity of a well can be found by measuring the amount of water needed to refill an emptied well and the time it takes. We need the well diameter (d), the water level after the well has been emptied (h_1), that is after pumping has stopped, the water level after the recharging has nearly been completed (h_2), and the time elapsed (t),

They can be related to each other by the equation:

$$Q = \frac{1/4 \pi d^2 (h_1 - h_2)}{t} \text{ (m}^3\text{/hours)} \quad \text{(A2.1)}$$

where:

- Q = recharge of the well ($\text{m}^3\text{/hours}$)
- d = well diameter (m)
- h_1 = lower level below benchmark (m)
- h_2 = upper level below benchmark (m)
- t = recharge time (hours)

Though this method is very attractive for its simplicity, it has an important shortcoming since it determines the well recharge over the full recovery period.

During pumping, in practice, the well gives a recharge that can be much higher than the values found here since the water level is constantly low in the well, which leads to the maximum possible recharge rate. One also has to be careful in determining the well diameter which might be smaller at the water level than at ground level.

2. The "optimum yield" approach

Karanjac has described this approach and its theoretical background (Karanjac 1971). Here a well is pumped at known output (Q_p). The time required to empty the well from one level to another is recorded (t_p) as is the time needed for the water level to recover to the original level (t_r).

According to Karanjac, the optimum yield of the well can be found from

$$Q_r = Q_p \frac{t_p}{t_p + t_r} \text{ (m}^3\text{/hour)} \quad \text{(A2.2)}$$

where

- Q_r = optimum yield ($\text{m}^3\text{/hour}$)
- Q_p = pumping rate ($\text{m}^3\text{/hour}$)
- t_p = time required to lower the well (hours)
- t_r = time required for the well to recover to the original level (hours)



This optimum yield Q_r is the steady state yield we are looking for. Again this method is very simple. The only problem is that the pumping rate has to be known. In most cases this can be measured, for example, measure the time it takes to fill up a vessel of known volume. Repeat this several times during the test. Calculate an average rate.

3. The "improved optimum yield" approach

This method has been described by Bremond (1965) and has been summarized in a publication of the French Ministry of Development and Cooperation (Burgeap 1974). It is similar to the previous method, but is an improvement. It records not only the time for pumping and recovery, but also the pattern of the well emptying and recovering; that is, the drawdown of the well during pumping as a function of time as well as the rise of the water level.

This has been presented in Figure A2.1.

The "optimum yield" of the well between two chosen levels (S_1 and S_2 where pumping stops) follows from a formula similar to the one of Karanjac

$$Q_r = Q_p \frac{BH}{BC} \quad (\text{m}^3/\text{hour}) \quad (\text{A2.3})$$

where Q_r and Q_p were defined previously.

If the curves BR and RC are straight lines this formula is identical to the one given by Karanjac. The obvious disadvantage of this approach is the details required for the pattern of drawdown, and the presentation of data by means of graphs.

Refer to Kruseman and de Ridder (1976) for more sophisticated methods based on groundwater flow theory. Results are often not significantly better. Method 1, which is based on well geometry, gives rather pessimistic values for the "steady state yield". Methods 2 and 3, the optimum yield approaches, give more accurate results with almost the same effort and are therefore recommended.

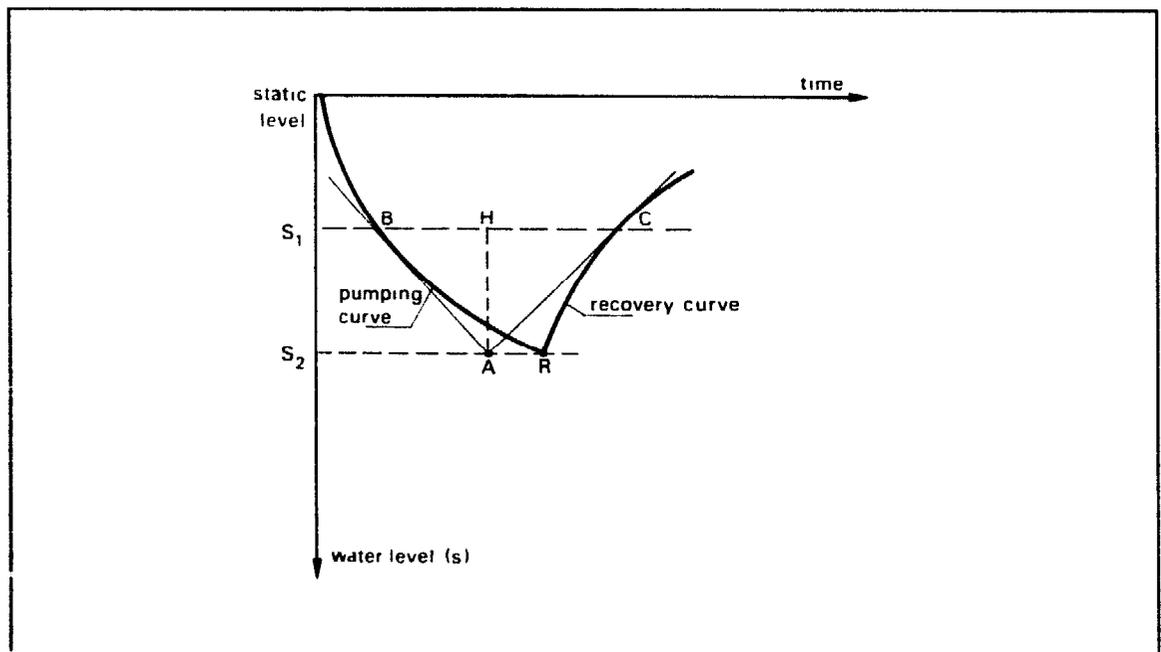

Figure A1.1 Determination of Optimum Yield of a well



Appendix

K_c and K_p coefficients

Table A2.1 Crop coefficients K_c (Doorenbos and Pruitt 1977).

Crop	Crop Development Stages					
	Initial	Crop development	Mid-season	Late season	At harvest	Total growing period
Banana						
tropical	0.4 -0.5	0.7 -0.85	1.0 -1.1	0.9-1.0	0.75-0.85	0.7 -0.8
subtropical	0.5 -0.65	0.8 -0.9	1.0 -1.2	1.0-1.15	1.0 -1.15	0.85-0.95
Bean						
green	0.3 -0.4	0.65-0.75	0.95-1.05	0.9 -0.95	0.85-0.95	0.85-0.9
dry	0.3 -0.4	0.7 -0.8	1.05-1.2	0.65-0.75	0.25-0.3	0.7 -0.8
Cabbage	0.4 -0.5	0.7 -0.8	0.95-1.1	0.9 -1.0	0.8 -0.95	0.7 -0.8
Cotton	0.4 -0.5	0.7 -0.8	1.05-1.25	0.8 -0.9	0.65-0.7	0.8 -0.9
Grape	0.35-0.55	0.6 -0.8	0.7 -0.9	0.6 -0.8	0.55-0.7	0.55-0.75
Groundnut	0.4 -0.5	0.7 -0.8	0.95-1.1	0.75-0.85	0.55-0.6	0.75-0.8
Maize						
sweet	0.3 -0.5	0.7 -0.9	1.05-1.2	1.0 -1.15	0.95-1.1	0.8 -0.95
grain	0.3 -0.5*	0.7 -0.85*	1.05-1.2*	0.8 -0.95	0.55-0.6*	0.75-0.9*
Onion						
dry	0.4 -0.6	0.7 -0.8	0.95-1.1	0.85-0.9	0.75-0.85	0.8 -0.9
green	0.4 -0.6	0.6 -0.75	0.95-1.05	0.95-1.05	0.95-1.05	0.65-0.8
Pea, fresh	0.4 -0.5	0.7 -0.85	1.05-1.2	1.0 -1.15	0.95-1.1	0.8 -0.95
Pepper, fresh	0.3 -0.4	0.6 -0.75	0.95-1.1	0.85-1.0	0.8 -0.9	0.7 -0.8
Potato	0.4 -0.5	0.7 -0.8	1.05-1.2	0.85-0.95	0.7 -0.75	0.75-0.9
Rice	1.1 -1.15	1.1 -1.5	1.1 -1.3	0.95-1.05	0.95-1.05	1.05-1.2
Safflower	0.3 -0.4	0.7 -0.8	1.05-1.2	0.65-0.7	0.2 -0.25	0.65-0.7
Sorghum	0.3 -0.4	0.7 -0.75	1.0-1.15	0.75-0.8	0.5 -0.55	0.75-0.85
Soybean	0.3 -0.4	0.7 -0.8	1.0 -1.15	0.7 -0.8	0.4 -0.5	0.75-0.9
Sugar beet	0.4 -0.5	0.75-0.85	1.05-1.2	0.9 -1.0	0.6 -0.7	0.8 -0.9
Sugar cane	0.4 -0.5	0.7 -1.0	1.0 -1.3	0.75-0.8	0.5 -0.6	0.85-1.05
Sunflower	0.3 -0.4	0.7 -0.8	1.05-1.2	0.7 -0.8	0.35-0.45	0.75-0.85
Tobacco	0.3 -0.4	0.7 -0.8	1.0 -1.2	0.9 -1.0	0.75-0.85	0.85-0.95
Tomato	0.4 -0.5	0.7 -0.8	1.05-1.25	0.8 -0.95	0.6 -0.65	0.75-0.9
Watermelon	0.4 -0.5	0.7 -0.8	0.95-1.05	0.8 -0.9	0.65-0.75	0.75-0.85
Wheat	0.3 -0.4	0.7 -0.8	1.05-1.2	0.65-0.75	0.2 -0.25	0.8 -0.9



Table A2.2 Pan coefficient Kp for class A Pan for different groundcover and levels of mean relative humidity and 24-hour wind

Case A pan	Case A: Pan placed in short green cropped area			Case B: Pan placed in dry fallow area fallow area				
	RH mean %	low < 40	medium 40-70	high > 70	low < 40	medium 40-70	high > 70	
Wind km/day	Windward side distance of green crop m				Windward side distance of dry fallow m			
Light < 175	1	.55	.65	.75	1	.7	.8	.85
	10	.65	.75	.85	10	.6	.7	.8
	100	.7	.8	.85	100	.55	.65	.75
	1000	.75	.85	.85	1000	.5	.6	.7
Moderate 175-425	1	.5	.6	.65	1	.65	.75	.8
	10	.6	.7	.75	10	.55	.65	.7
	100	.65	.75*	.8	100	.5	.6	.65
	1000	.7	.8	.8	1000	.45	.55	.6
Strong 425-700	1	.45	.5	.6	1	.6	.65	.7
	10	.55	.6	.65	10	.5	.55	.65
	100	.6	.65	.7	100	.45	.5	.6
	1000	.65	.7	.75	1000	.4	.45	.55
Very strong > 700	1	.4	.45	.5	1	.5	.6	.65
	10	.45	.55	.6	10	.45	.5	.55
	100	.5	.6	.65	100	.4	.45	.5
	1000	.55	.6	.65	1000	.35	.4	.45

Table A2.3 Pan coefficient Kp for Colorado Sunken Pan for different groundcover and levels of mean relative humidity and 24-hour wind (Doorenbos and Pruitt 1977).

Sunken Colorado	Case A: Pan placed in short green cropped area			Case B: Pan placed in dry fallow area fallow area				
	RH mean %	low < 40	medium 40-70	high > 70	low < 40	medium 40-70	high > 70	
Wind km/day	Windward side distance of green crop m				Windward side distance of dry fallow m			
Light < 175	1	.75	.75	.8	1	1.1	1.1	1.1
	10	1.0	1.0	1.0	10	.85	.85	.85
	100	> 1.1	1.1	1.1	100	.75	.75	.8
					1000	.7	.7	.75
Moderate 175-425	1	.65	.7	.7	1	.95	.95	.95
	10	.85	.85	.7	10	.75	.75	.75
	> 100	.95	.95	.95	100	.65	.65	.7
					1000	.6	.6	.65
Strong 425-700	1	.55	.6	.65	1	.8	.8	.8
	10	.75	.75	.75	10	.65	.65	.65
	> 100	.8	.8	.8	100	.55	.6	.65
					1000	.5	.55	.6
Very strong > 700	1	.5	.55	.6	1	.7	.75	.75
	10	.65	.7	.7	10	.55	.6	.65
	> 100	.7	.75	.75	100	.5	.55	.6
					1000	.45	.5	.55



Construction of storage tanks for irrigation purposes

A lot of different types of reservoirs can be used for windpump irrigation systems. The most suitable type for specific circumstances depends on the following factors:

- Availability of construction materials.
- Quantity and quality of labour available.
- The level at which the reservoir should be constructed.
- The space available.
- The required durability.
- The required capacity of the reservoir.
- Traditions in construction.
- Financial possibilities.
- Cost price of labour and materials.

Although it is difficult to generalize, Table A4.1 indicates the most frequently used types of reservoirs and their corresponding construction costs (Van der Bijl 1985, Karunaratne and Mueller 1982, Van Dijk 1986).

Table A4.1 indicates that earth-lined tanks are generally cheaper in countries with lower labour costs. However, this reservoir requires more space and a suitable soil material.

The construction should be at ground level and preferably lower to diminish the soil movement. Earth-lined tanks require somewhat more maintenance than the other four types.

The most suitable type depends entirely on the available materials and labour. Earth-lined tanks can have large percolation losses. If they are too large, an additional lining can be used.

Cemented tanks are generally more expensive, but require less maintenance and their durability is also better: 30 to 100 years or even longer. If no bricks or stones are available, reservoirs built out of concrete blocks are a suitable alternative. The construction of ferro concrete tanks requires highly skilled labour.

Besides the types mentioned in the table, there are some other locally developed construction methods, for example:

- Tanks made of loam clay with a bamboo reinforcement.
- Ferro soil concrete tanks built with a mixture of soil and cement and reinforced with galvanized iron wire.

Construction costs are generally much lower, in the order of US\$ 500 for a 50 m³ reservoir. Durability is generally less, however.

Figures A4.1, A4.2 and A4.3 present some construction methods (Costa 1981, 1982, 1983).

The construction of the outlet with a simple provision to regulate the water flow as well as the construction of the spillway and drainage channel are also very important.

Table A3.1 Some different types of reservoirs with an indication of cost

Type	Cost indication* for a 50 m reservoir (in US\$)
Unlined earth	700
Earth lined with bricks, bitumen, or PVC	1,500
Cemented brick	1,500
Cemented stone	2,500
Cemented concrete blocks	2,000
Ferro concrete	1,800

* At the 1986 price level in Sri Lanka and Cape Verde Islands.



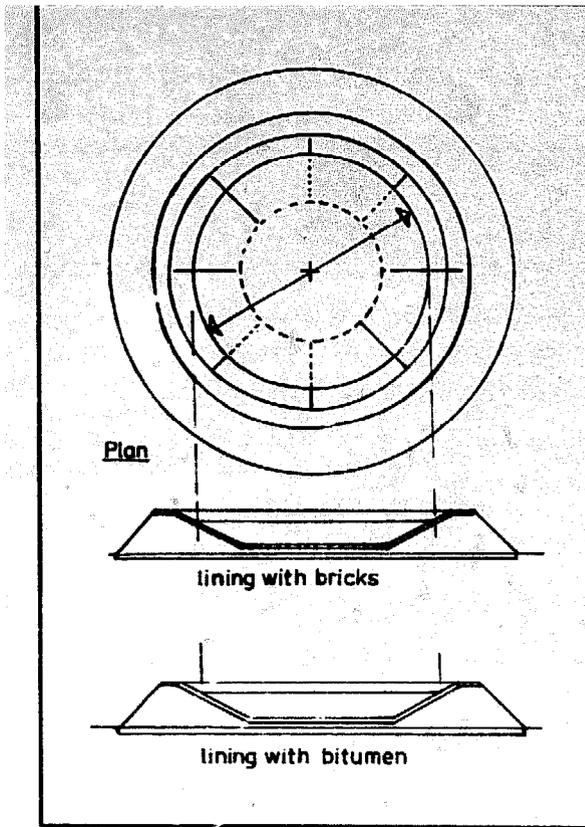

Figure A3.1 Earth diked reservoir with lining of bricks and bitumen.

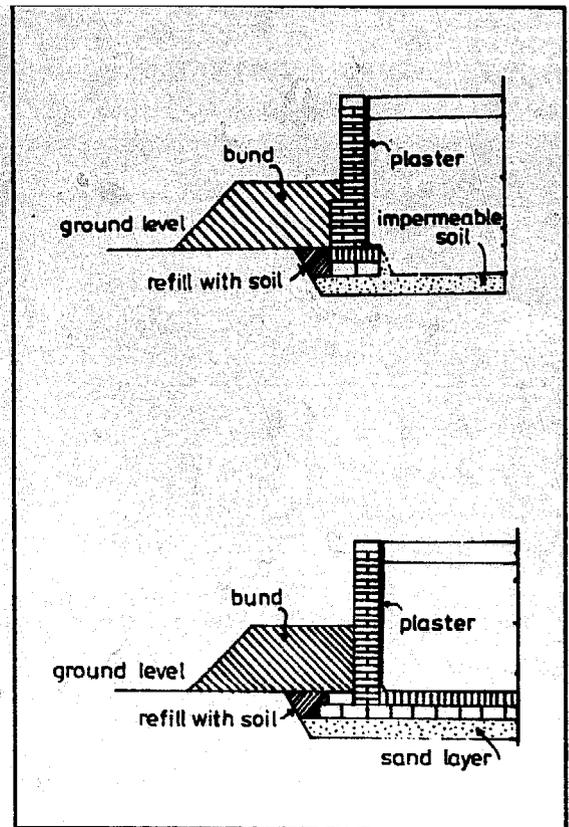

Figure A3.2 Cemented brick reservoir, type 1.

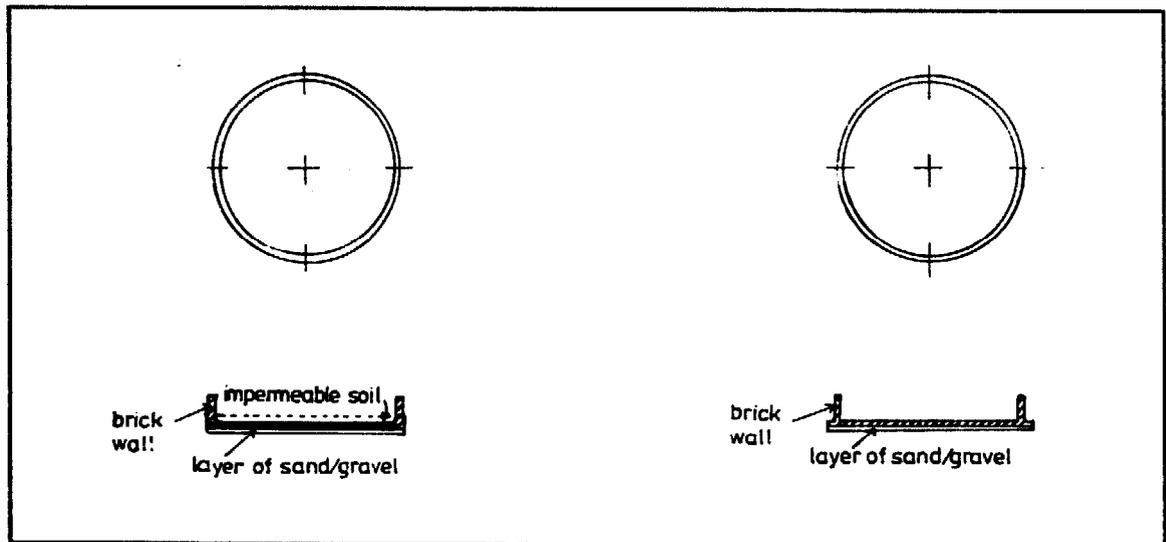

Figure A3.3 Cemented brick reservoir, type 2.



Appendix

Estimating the investment, maintenance, and repair costs of a windpump irrigation system in Mozambique

It is assumed that the materials are purchased in Mozambique in so far as possible. The data are from Van Meel 1984 (US\$ 1 = 50 Meticaïs, 1983)

A. Investment costs		(All amounts in Meticaïs)	
1. Windpump construction: (Rotor diameter = 2.74 metre)	- Materials	26,000	
	- Labour (5 persons, 2 weeks)	15,000	
	- Transport of materials	1,000	
		<u>42,000</u>	-> 42,000
2. Windpump installation:	- Materials (pipes)	5,100	
	- Labour (5 persons, 1 day)	1,500	
	- Transport	1,000	
		<u>7,600</u>	-> 7,600
3. Storage tank (70 m):	- Materials	14,800	
	- Labour	3,300	
	- Transport	2,000	
		<u>20,100</u>	-> 20,100
4. Irrigation channel	- Materials	3,550	
	- Labour	950	
	- Transport	1,000	
		<u>5,500</u>	-> 5,500
	Sub-total:	75,200	
	Overhead workshop (35%):	24,800	
	TOTAL INVESTMENT COST:	100,000	



B. Maintenance and Repair costs for one windpump

(all amounts in Meticals)

1. Windpump

Repairs	- Inspection, minor repairs 6 visits per year, 10 windpumps per day			
	- Transport	1,000		
	- Mechanic	200		
	- Cost per visit	1,200		
	- Cost for 6 visits	7,200		
	- Cost per visit/windpump	720	->	720
	- 1 major repair per year e.g. replacement of cup leather			
	- Transport	1,000		
	- Mechanic	200		
	- Labourer	100		
	Total	1,800	->	1,800
Maintenance:	- Painting, once a year			
	- Transport	1,000		
	- Painter (1 week)	1,000		
	- Paint, material	1,000		
	Total	3,000	->	3,000
	- Minor repairs and maintenance	p.m.		p.m.
	Total Windpump			5,520

Storage tank:

Repairs:	- One repair a year, one day			
	- Transport	1,000		
	- Mason	200		
	- Labourer	100		
	- Bag of cement	98		
		1,398	->	1,398
Maintenance		p.m.	->	p.m.
	Total storage tank			1,398

Sub-Total:	6,918
Workshop overhead (35%):	2,075
TOTAL MAINTENANCE AND REPAIR COSTS	9,000



An example of the terms of reference for a pre-feasibility study on the use of windpumps (CWD 1985a)

- General objective

A Pre-Feasibility Study on wind energy must examine the scope for the use of this form of energy, with particular reference to water pumping. The Study must present recommendations for further action to the Government.

- Meteorology

Evaluation of the wind potential based on available wind-maps, visits to meteorological stations and the impressions of farmers.

Particular points of attention:

- Wind availability (means, diurnal variation, seasonal pattern, extremes)
- Occurrence of whirlwinds
- Rainfall
- Evapotranspiration.
- Site visits to judge data reliability

Recommendations for further action will be made if they are supported by the outcome of other aspects of the Study.

- Water Resources

Groundwater availability, quality, location, types of wells, costs of new wells; drainage water from irrigation projects (either for re-use or for evacuation).

- Present wind energy activities

Inventory of the present activities (research, rehabilitation, production, use, repair, maintenance), plans for the future.

- End-use analysis

Investigation of the most probable wind-pumping applications, for example, irrigation for agriculture and horticulture, rural water supply, animal husbandry, poultry farming and drainage.

- Economics

Indication of the major aspects at the national-economic level (for example, substitutes for fuel imports, self-reliance, regional develop-

ment, employment) and at farm-economic level (cost of imported, refurbished, and locally produced windpumps).

- Local production

Evaluation of the present rehabilitation programme. Prospects for the local production of one or more types of modern windpumps. Expected effects on maintenance and servicing in rural areas.

- Institutional aspects

Which institutions will be involved (for example, the extension services of the Ministry of Irrigation or Agriculture, local water supply companies), and the State institutional aspects worth indicating (imports of spares, etc.).

- Wind generation

If the outcome of the meteorological analysis opens prospects for wind generation, the Study will make recommendations for further action.

- Expected output of the Study

(if wind generation is feasible)

Policy recommendations regarding:

- priority geographic areas
- applications (water supply, irrigation, and electricity, for instance)
- estimates of the expected numbers of wind-pumps needed
- further action on rehabilitation and/or introduction of modern windpump(s), adapted to specific local conditions
- wind data collection, processing and evaluation.
- economic aspects
- possible pilot-projects or specific feasibility studies
- Impact of rural electrification, future electrification plans

- Duration of the study: one (1) month.



Elements to be monitored during the internal testing in the pilot phase

At the start of a monitoring process, it is essential to decide which data are required, at what interval and time they have to be collected, and how and with what accuracy the collecting has to be done.

The following list specifies most of the data elements which have to be collected during the internal testing phase of a pilot project.

ELEMENTS TO BE MONITORED

– Wind

Average hourly (full hours) or average 12 hour (6 am and 6 pm) wind speed in m/s at the same height as the centre of the rotor of the wind-pump(s). For hourly wind data recording, an automatic (mechanical or electronic) anemometer (integrating type) is preferable; for 12-hour recordings a mechanical cup counter type (totalising) anemometer can be used.

– Water Output (discharge)

Measure windpump output in m³ at 12 hour intervals (6 am and 6 pm) using a flow meter (integrating type water meter). The meter should be checked every week; a spare meter and tools should be available at the site.

– Pump Strokes

Record pump strokes at 12 hour intervals (6 am and 6 pm) with a mechanical stroke counter. (This information can be used to check the functioning of the windpump pump and the flow meter). By daily plotting of the values obtained for wind, output and strokes, one can see at a glance if something is wrong with the measuring equipment.

– Water Level

The water level in the dug, or tube wells, has to be checked once every few days using a measuring tape fitted with a sounding device (hand-held water level indicator). Also, initially, the water level should be checked during low winds and during strong winds to obtain some indication of dynamic drawdowns.

– Breakdowns

All windpump and measuring equipment breakdowns should be recorded in a log book, together with time (and cause) of occurrence and time of repair.

– Maintenance

All maintenance activities have to be recorded in detail with the time and material used, in order to check the adequacy of the maintenance budget.



Timetable of a windpump project in Sudan (CWD 1985 b)

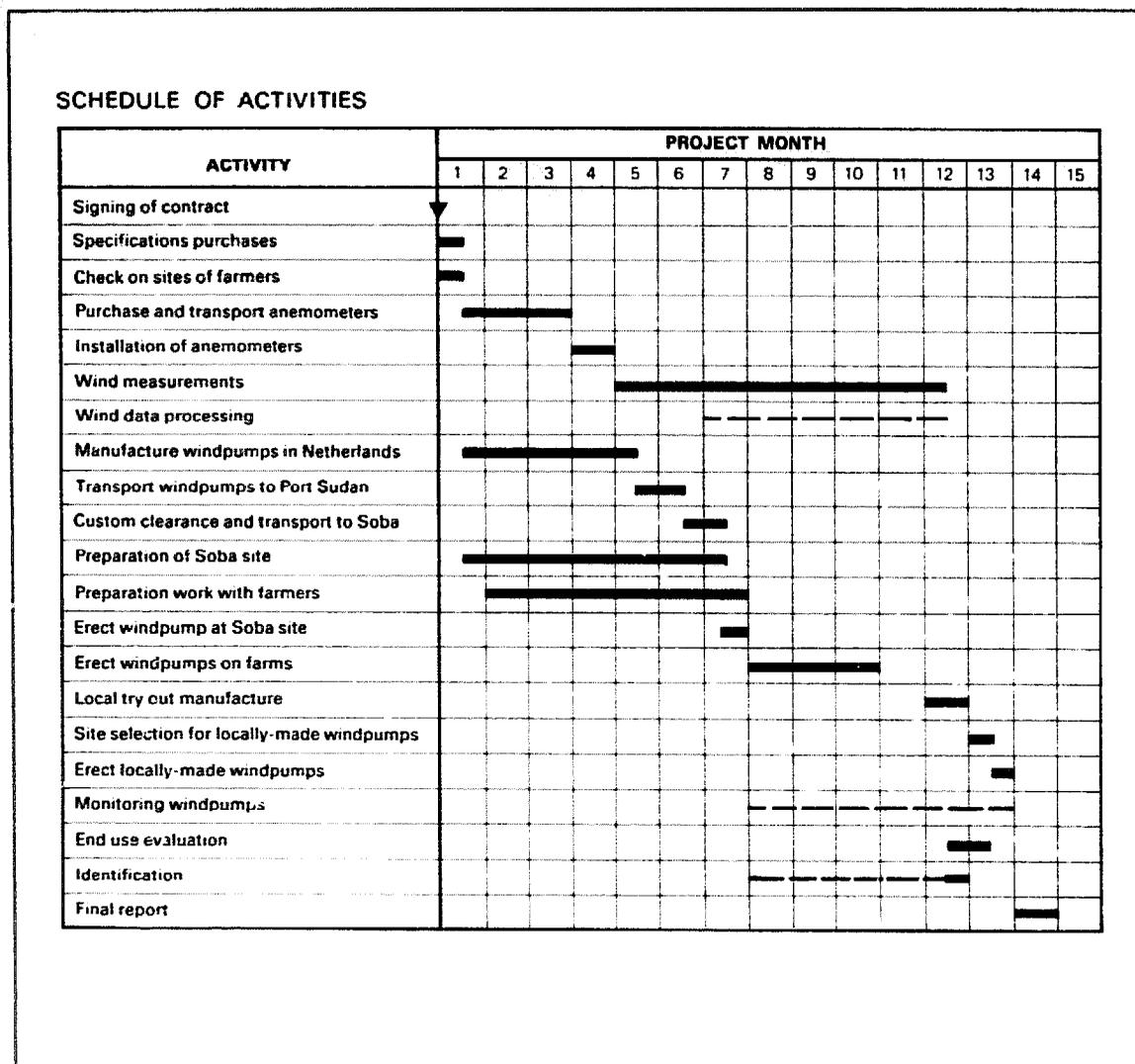

Figure 7.1 Time table of a windpump project in Sudan (CWD 1985 b)



Terms of reference (TOR) for a study on "the potential of windpumps for lifting water near Xai-Xai, Mozambique"

Note. In this case, the feasibility study has not been preceded by a pilot project phase.

OBJECTIVES OF THE STUDY

The study focuses primarily on the use of windpumps for irrigation; consequently, the selection of possible prototype wind-pumps will be based mainly on their potential for irrigation.

Some attention, however, must be given to the suitability of the selected wind-pumps for other water lifting purposes in the areas under consideration, such as watering cattle, drainage, and domestic water supply.

The study has to deal with the possibilities for the local production of windpumps near Xai-Xai. The areas to be considered in the study will be limited to those that can be serviced by a possible windpump unit near Xai-Xai without imposing problems as a result of this service. The Limpopo and Incomati valleys in particular seem to have a certain potential

for windpump utilization. When comparing alternatives to water lifting, other options must also be considered, including the importation of windpumps, motor pumps, and so on.

The objectives of the study can be described as:

- an assessment of the potential for and impact of windpump utilization for irrigation in the areas under consideration.
- recommendations for further windpump irrigation activities.
- inventory of possibilities for and constraints on the use of windpumps for other water lifting purposes in the areas under consideration.
- recommendations for local production or import of windpumps.

CONTENTS OF THE STUDY

The study has to cover the following aspects:

– **Wind energy resources**

Only limited processed data are presently available on the wind regime in the areas considered. Wind data have to be collected from existing meteorological stations.

These (additional) data have to be processed and analysed. Aspects to be included are:

- Daily and seasonal wind patterns.
- Occurrence of calms.
- Occurrence of storms and gusts.
- Reliability of data.

If necessary, short-term measurements will be carried out to obtain cross-check/reference data.

– **Windpump irrigation: agricultural setting**

The present agricultural practices relating to irrigation with windpumps have to be studied, including such aspects as:

- Farm sizes and farm ownership.
- Cropping patterns.
- Water requirements and available water resources (rainfall, groundwater, surface water) and supply (capacities, heads, seasonal fluctuations, etc.).
- Need for drainage of irrigated fields.
- Water quality.
- Soil types.
- Degree of commercialization for instance, marketing of products, credit/subsidy facilities, etc.



- Input supply (seeds, fertilizer).
- Agricultural labour situation.
- Farm management capabilities, degree of mechanization.
- Former experiences with windpump irrigation.

– Windpump irrigation: socio-economic aspects

Based on the above, the study has to inventory possible end-use models for windpump irrigation. The situation with various types of farm ownership to be considered include:

- Cooperatives.
- Private farms.
- Government estates.
- Family farms.

– Agricultural models

At the very least, the following alternative agricultural models must be studied:

- Agriculture without irrigation.
- Irrigation with motorized pumps.
- Irrigation with windpumps.
- Irrigation with other lifting methods, such as *chadouf* or hand pumps.

– Windpump size

Based on the analysis of possible cropping patterns and the water and wind resources, the appropriate windpump size(s) has to be determined, also taking into account the need for water storage. Relevant cropping patterns in the region seem to comprise:

- Vegetables and beans.
- Maize and beans.
- Rice and maize.

– Economics

The above models will be compared on the basis of at least the following aspects:

- Attractiveness from a farm economic point of view.
- Attractiveness from a national economic point of view: employment and foreign currency aspects.
- Social acceptability, for example, servicing aspects, reliability of wind or fuel supply, flexibility/ alternative uses of the lifting device).

Sensitivity analysis must be applied to relevant aspects such as fuel prices, interest rates, etc.

- Windpumps for other water lifting purposes

The above study may result in the selection of a type of windpump with the potential for use for irrigation purposes. The study will also make a rough inventory of other possible water lifting end-uses for windpumps in the region, for example, for the domestic water supply, drainage and watering cattle.

– The windpump selected

The windpump selected has to be studied in the setting in which it will be used. This study will include aspects such as:

- Analysis of present activities that will be affected by the introduction of the windpump.
- Water availability (well discharges, depth below ground level).
- Water quality.
- Required pump capacities.
- Need for storage.
- Cost comparison with alternative lifting options.
- Financial aspects, for instance, the payment for the windpump or the water in case of domestic water supply.
- Social acceptability of domestic water supply with windpumps, such as responsibilities, water management and distribution, reliability and servicing.



– Windpump production

The feasibility of local production of wind-pumps has to be studied. Aspects to be included are:

- Assessment of the potential market for wind-pumps in the region.
- Availability of materials, equipment and workshop facilities.
- Availability of skilled and unskilled labour, and management capabilities.
- Servicing.
- Attractiveness of local production of wind-pumps from a business economic point of view and from a national-economic point of view with regard to foreign currency and employment (including sensitivity analyses).
- Availability of suppliers of credit and foreign currency for the supply materials and spare parts.

– Institutional aspects

Former and present windpump activities in Mozambique should be evaluated, including the institutions concerned. Furthermore, an

inventory of the institutional possibilities for windpump implementation in the areas under consideration should be made. Aspects included could be:

- Windpump production.
- Installation and servicing.
- Storage tank construction.
- Marketing and sale of windpumps.
- Site-selection/feasibility assessment.
- Agricultural extension.
- Credit facilities/formalities/conditions.
- Personnel and logistics.

– Conclusions and recommendations

To be included are, among others:

- The feasibility of windpump irrigation in the area and the extent to which windpump irrigation should be promoted in the area;
- The potential for local production of wind-pumps.
- The feasibility of the set-up of a project in the area;
- Selection of a prototype windpump to be used in possible project activities.

ORGANIZATION OF THE STUDY

The following experts are required for this study:

- an agricultural expert.
- a wind energy expert.

The study will take approximately 3.5 man-months: both experts will stay in Mozambique for about 5-6 weeks.

A progress report must be submitted and discussed before experts leave Mozambique.

The draft final report may be completed outside Mozambique, but must be submitted within 1.5 months after the experts have left.

The final report must be submitted within one month after the annotated draft of the final report has been returned.

