



packaging, storage and distribution of processed milk

CONTENTS

ANIMAL PRODUCTION AND HEALTH PAPER

11

technical requirements and their economic implications

by
wojciech b. tuszynski
meat and milk development service
animal production and health division

**edited by
h.s. hall**

The designations employed and the presentation of material in this publication do not imply the expression of any opinion whatsoever on the part of the Food and Agriculture Organization of the United Nations concerning the legal status of any country, territory, city or area or of its authorities, or concerning the delimitation of its frontiers or boundaries.

M-26

ISBN 92-5-100566-4

The copyright in this book is vested in the Food and Agriculture Organization of the United Nations. The book may not be reproduced, in whole or in part, by any method or process, without written permission from the copyright holder. Applications for such permission, with a statement of the purpose and extent of the reproduction desired, should be addressed to the Director, Publications Division, Food and Agriculture Organization of the United Nations, Via delle Terme di Caracalla, 00100 Rome, Italy.

FOOD AND AGRICULTURE ORGANIZATION OF THE UNITED NATIONS Rome 1978

© FAO

Hyperlinks to non-FAO Internet sites do not imply any official endorsement of or

responsibility for the opinions, ideas, data or products presented at these locations, or guarantee the validity of the information provided. The sole purpose of links to non-FAO sites is to indicate further information available on related topics.

CONTENTS

INTRODUCTION

Chapter1 SYSTEMS

Development

Heat treatment of milk

Selection and evaluation

Chapter2 CHARACTERISTICS OF PACKAGING SYSTEMS

Returnable containers

Single-service containers

Chapter3 EQUIPMENT AND PLANT AREAS

Chapter4 SERVICES

Chapter5 DIRECT LABOUR

Chapter6 TRANSPORT

Chapter7 RETAILING

Retailing packaged milk

Retailing through automatic vending machines

Chapter8 COSTS AND LOSSES OF PACKAGING MATERIAL AND LOSSES OF MILK

Packaging material

Losses of milk

Chapter9 SUMMARY OF COSTS

Chapter10 CONSIDERATIONS AFFECTING THE CHOICE OF SYSTEM

Keeping quality

Returnable versus single-service containers

Retail packaging versus sales from bulk

BIBLIOGRAPHY

INTRODUCTION

FAO has been approached on several occasions by national dairy organizations for advice on systems of processing, packaging and distributing liquid milk likely to be the most suitable for the conditions in the country concerned. In such cases the authorities normally have a primary objective of making a supply of milk available to all sections of the community particularly in urban areas.

A fundamental requirement for a public liquid milk supply is that it will be safe, that is, it will not be a medium for the transmission of organisms responsible for human disease. For this some form of heat treatment is essential. Pasteurization meets this requirement and indeed should be regarded as a basic process whatever the final product. Several well-established systems for packaging and distributing pasteurized milk are in widespread use and are analysed in the following Chapters. Where the marketing requirements are such that an extended shelf life is necessary, for example, because the consumer is located far away or greater flexibility in marketing arrangements is essential, the alternative processes of in-bottle sterilization or ultra-high-temperature treatment (UHT) are in use. These processes involve special methods of packaging and in analysing

the costs of these the cost of the appropriate heat treatment has also been included.

Little information on relative costs of different packaging and distribution systems for liquid milk is available, making the task of selection difficult. This publication attempts to simplify the problem by providing relevant data and methods of evaluation which could be of help in planning appropriate marketing strategies. Wealthy consumers are usually willing to pay more in return for better services - longer shelf life, more hygienic and convenient packaging - even though the basic nutritional value of the product does not change with price. A consumer with low income cannot afford luxuries and must give preference to low-cost products. This may mean that he is denied a supply of safe milk unless provision is made to meet his special needs. It may be that in some markets the milk plant should cater for different types of demand: in others only one system, probably the cheapest, could be justified. A preliminary market survey should provide the necessary indications.

It should be clearly seen that local milk production cannot develop unless prices to producers are remunerative. A policy of attractive producer prices in countries where the majority of the population is rural benefits more people than a policy of low consumer prices in urban areas. Milk is an expensive commodity and consumption of milk sold commercially at prices reflecting the true costs of production, processing and distribution in urban areas is limited in most

developing countries to consumers with higher incomes. Widening the group of consumers is feasible by economizing on packaging and distribution expenses. Should the authorities concerned decide on subsidizing liquid milk consumers, the subsidies should cover only the more economic milk processing and distribution systems aiming at supplying milk to a wider group of consumers. There is no reason for spending subsidies on sophisticated products or packaging and distribution systems. Such systems should be introduced only if the group of consumers with higher incomes is large enough and willing to pay higher unsubsidized prices.

In planning a project to introduce, or extend, a supply of safe liquid milk at an economic cost, consideration must be given at an early stage to decide the optimum system for packaging, storage and distribution in the particular circumstances which are likely to prevail. There are many options, differing in cost by a factor of 5 or even more. The choice of a system may therefore have a critical effect on demand, and therefore on the success of the enterprise, and also may be fundamental in planning the processing plant and the distribution arrangements.

Heat treatment of milk virtually gives it new life and there can be no question that packaging in retail containers at the milk plant has considerable advantages for the consumer. Indeed, retail packaging is an essential part of the in-bottle sterilization and UHT processes. However, packaging costs money and where the

ultimate price which the consumer has to pay is an over-riding consideration the cheaper alternatives, for pasteurized milk, of distribution in cans or, better, automatic vending, must be studied. Both of these alternatives are analysed in the following Chapters.

It is hoped that this publication will provide relevant information on the basic techno-economic implications of the principal systems at present applied successfully in many countries, and that it will help in making wise decisions in the introduction of appropriate systems in developing countries.



Chapter 1 SYSTEMS

Development

Milk is a liquid and therefore requires a container at every stage of movement from the cow to the consumer. At the early stages of dairy development the cow's udder was used as the basic container for all purposes. The cow, kept in the town stall, was brought to the customer's doorstep for milking. In some cases the milk was sold from a shop adjacent to the cowshed. In many European countries town cow-keepers could still be found after the first world war but, for reasons of

hygiene and economy, they quickly disappeared. This trend seems to be unavoidable for the dairy industry worldwide and will certainly be applied to cities in developing countries where town cow-keeping still exists.

The growing demand for milk in towns and the high costs of milk production within their boundaries led to the development - probably around 1860–70 - of containers suitable for various stages of marketing and distribution. These were metal cans, provided with a lid and having capacities up to about 80 litres. The introduction of this type of container (until recent years often called a 'churn') facilitated the transport by railway from rural areas to towns, thus contributing substantially to the rapid growth of milk distribution. Similar containers were also used for retail delivery to the consumer, the milk being dispensed in the street or at the doorstep into the consumer's container.

The first significant development in the packaging of milk for retail sale came at the very end of last century with the introduction of the process for sterilized milk in which the retail container, the glass bottle, formed an integral and essential part. In the third decade of this century bottling of pasteurized milk developed rapidly, first in America and soon after in Europe. The glass bottle as the retail package for milk remained unchallenged until 1933 when the first carton made of waxed paper was introduced. The development and introduction of plastic materials for packaging in the dairy industry (initially polyethylene in 1940), alone and in combination with paper, resulted in a wide range of containers, termed

cartons, suitable for liquid milk.

When we refer to liquid milk we usually mean a product, either processed or, less often, sold raw to the consumer, deriving from a lactating ruminant, mainly the cow. Processing depends on the grade of milk to be manufactured following the regulations and customs of the country. Heat treatment and, in most countries, standardization of butterfat content, are the basic parts of the processing procedures.

Heat treatment of milk

Heat treatment may be classified as:

- **pasteurization**
- **sterilization (in bottle)**
- **UHT (ultra-high-temperature) treatment integrated with aseptic packing.**

Pasteurization HTST (high-temperature short-time - heating at 72°C for 15 seconds) fulfils the following main objectives:

- **to safeguard public health by destroying all pathogenic bacteria**

- **to extend the keeping quality of liquid milk by destroying most of the milk-souring micro-organisms**
- **to ensure a product with a good keeping quality.**

Sterilization (in bottle) is the term applied to a heat treatment process which has a bactericidal effect greater than pasteurization. Although it does not result in sterility, it gives the processed milk a longer shelf life. This is achieved partly by using a more severe heat treatment (about 110°C for 20–30 min) and partly by applying the treatment after the bottle is filled and sealed which eliminates the risk of contamination during packaging. As a result of the long holding time at this elevated temperature, the product has a cooked flavour and a pronounced brown colour.

UHT treatment is a process of high bactericidal effect, developed as a continuous flow process in which the milk is heated at 135°C–150°C for about two seconds only. This treatment must be integrated with aseptic packaging in sterile containers. UHT milk has less pronounced cooked flavour and no brown colour.

As a criterion for packaging requirements for pasteurized milk in general, a shelf life of several days at a temperature below 10°C can be assumed. In-bottle sterilized milk can normally be kept for weeks and UHT milk aseptically packaged can be kept for several months, both without refrigeration, provided the package

is not opened. After opening, the sterility of the product is lost and the shelf life becomes close to that of pasteurized milk.

Sales of unpasteurized milk are rare in countries with a developed dairy industry and often prohibited by law. Nevertheless, there are some where purchased milk is boiled at home as a common habit even though the raw milk is of a high hygienic standard. In such cases heat treatment in the milk plant may be considered as an unnecessary expense and not required by law. This is the case in Switzerland, although even there in recent years the share of heat treated milk in the total sales is increasing. Fig. 1 and 2 show the relevant trends in Switzerland and in Western Europe as a whole.

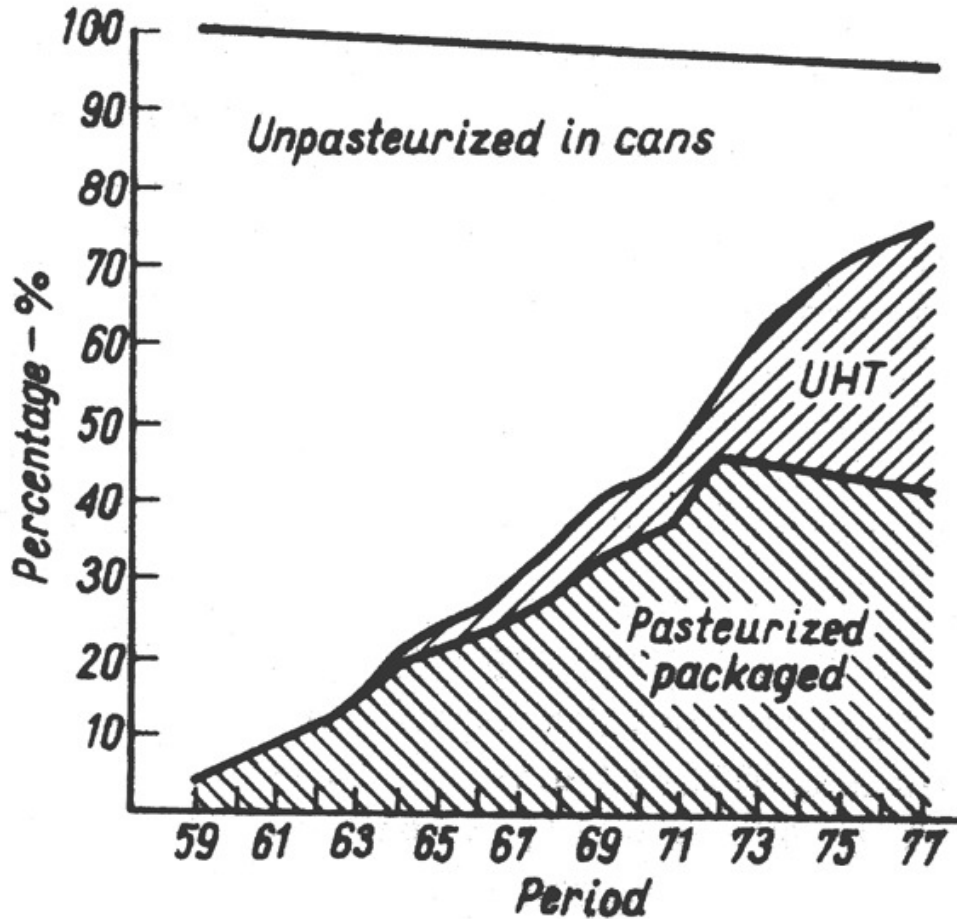

Fig. 1 Distribution of liquid milk in Switzerland

Fig. 2 Packaged milk in Western Europe

From this brief survey of heat treatment methods for liquid milk it becomes evident that the sterilized and UHT milks are commodities which by their very nature must be distributed to the consumer as a packaged product. Pasteurized milk, however, which is normally required to have a shelf life, under refrigeration, of only a few days can be distributed in wholesale quantities provided the necessary care is taken to prevent contamination.

Selection and evaluation

The type of liquid milk produced and the consequent selection of a packaging and distribution system constitutes in many instances an extremely intricate optimizing problem. The selection will have to satisfy the requirements dictated by existing economic limits, production and distribution efficiency, retailing objectives, consumer considerations and ecological aspects.

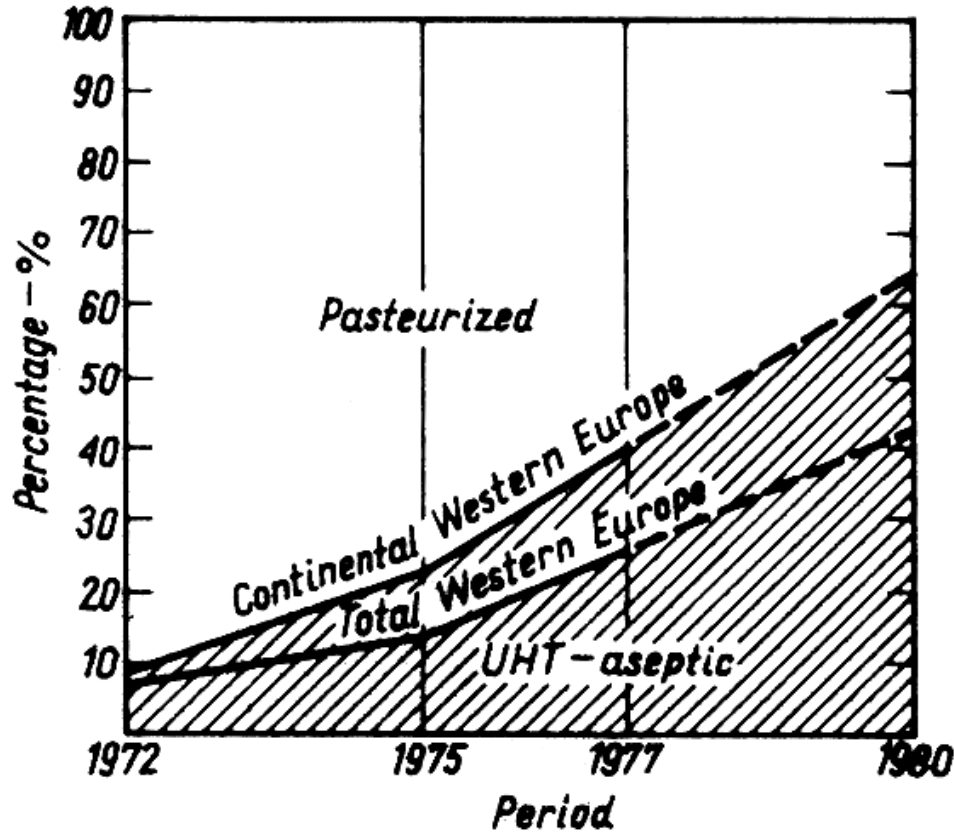
Even when the decision on the packaging system has been well founded and made with due consideration to all relevant demands, the actual application may sometimes prove to be a failure for lack of competent supervision of its application.

For the purpose of this study the classification of processing and distribution

systems of liquid milk - as in use at present - is shown in Table 1.

Table 1. Classification of packaging and distribution systems

Liquid milk	Returnable containers			Single service containers				Despatch by tankers to vending machines
	Glass bottles	Plastic bottles	Cans	Cartons	Sachets	Plastic bottles	Bag in box	
Pasteurized	+	+	+	+	+	+	+	+
Sterilized	+					+		
UHT-aseptic				+	+	+		

The seven systems marked with asterisks have been chosen for a more detailed study in this publication. Returnable and single-service plastic bottles have not been included since they are mainly suitable for larger capacities of milk plants. Plastic bottles are normally used as single-service containers. They are usually blow-moulded from polyethylene which is often a mixture of high and low density grades. Occasionally polystyrene is used. The basic advantage of plastic bottles in comparison with glass is the lower weight of the former (about one-twentieth that of glass).

The bag-in-box system is intended primarily for milk supplies to catering establishments and has not found application to general milk distribution. Aseptic packaging of UHT treated milk in plastic sachets has not been included as this is still in the process of development and must be considered in conjunction with the UHT processing equipment employed. The extra cost of aseptic sachet packaging equipment compared with that for pasteurized milk can be assumed to be in a similar proportion as that for aseptic and normal carton machines. It should be mentioned that a promising UHT system with aseptic filling into plastic sachets is being developed in Finland with electric heating of the milk. Commercial trials are under way.

The sale of milk in bulk through automatic vending machines has been introduced in Mexico and India and seems to be an important innovation in milk packaging and distribution systems. A description of this system is given in Chapter 7.

In presenting data relating to the operations of the liquid milk packaging division of a milk plant, transport from the plant to retail outlets and retail systems it has been assumed that milk reception, raw milk storage, standardization, homogenization, pasteurization and bulk storage of milk after pasteurization are common for all systems. Packaging operations therefore begin at the outlet of pasteurized milk tanks. It is assumed that pasteurized chilled milk is used for UHT treatment and sterilization, homogenization (which is not always necessary) is a part of pasteurized milk processing, while storage tank types and capacities are

considered as uniform though they may differ in practice. In spite of this, data resulting from this analysis can be considered as comparable within a reasonable margin of error.

Fig. 3 illustrates the seven liquid milk packaging systems analysed in this publication. The common divisions of a liquid milk plant also shown in the diagram (two types of reception, recombination, pre-treatment and storage of pre-treated milk) are not included in the subsequent analysis.

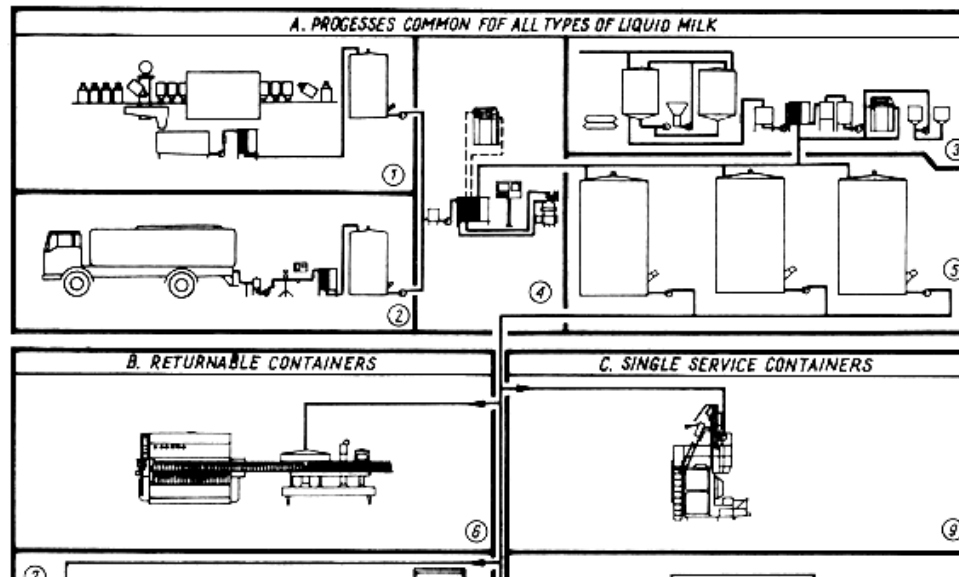

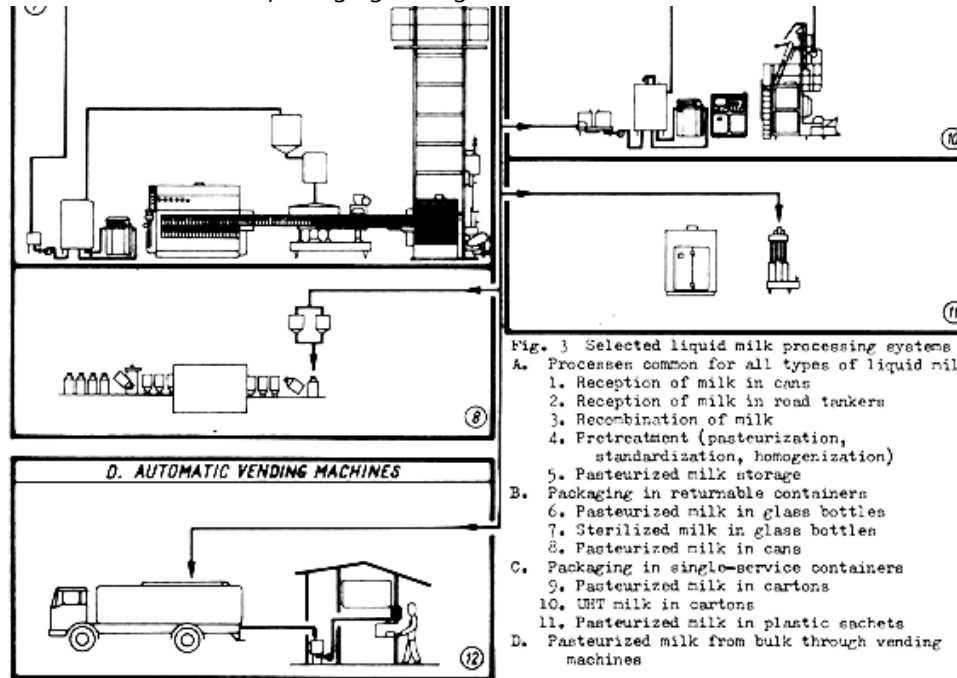

Fig. 3 Selected liquid milk processing systems

Techno-economic evaluation of the systems necessitates consideration of the following essential items:

- **packaging materials and storage systems**

- **machinery, equipment and area requirements in the plant**
- **requirement of services**
- **direct labour**
- **transport to the retailer**
- **retailing**
- **costs and losses of packaging material and losses of milk.**

These components may be considered as basic elements of what may be called divisional costs of liquid milk packaging and distribution within the definitions and limitations described above and are, therefore, a fair indication of the cost differences between the various systems.

In order to arrive at the fullest possible comparability of data, this analysis has been made for one size of package, i.e. half-litre, which is probably the most common size used in developing countries; some data are also provided for units of one litre.

Specific technical requirements for a dairy enterprise often depend on the capacity of the milk plant. For instance, the specific area for milk processing

(m²/1 000 litres) will be smaller in a 100 000 litres/day plant than in a 10 000 litres/day plant. It has been necessary, therefore, to relate the particular specific requirements to the capacity, and for this purpose five capacities have been selected, namely 10 000 litres/day, 25 000 litres/day, 50 000 litres/day, 100 000 litres/day and 250 000 litres/day. Below 10 000 litres/day a milk plant can hardly be considered as a commercial enterprise: on the other hand, in the range of capacities between 100 000 litres/day and 250 000 litres/day the specific requirements of most components become constant and continue beyond the 250 000 litres/day point. Diagrams have been used to illustrate the results, as this appeared to be the most comprehensive method of presentation.

Several assumptions concerning working time, efficiency coefficients, routing of vehicles, etc. have had to be made. As far as feasible, they have been considered as uniform for all systems. Their values have been compared with and adjusted to real figures available from existing plants, particularly in developing countries. All factors taken into consideration in this respect are explained in the paragraphs concerned.

Specifications for basic machinery and equipment depend on the daily throughput of the division, the efficiency with which machines are utilized and on the operations in the storage and distribution rooms. In smaller units the degree of mechanization has been limited to basic functions of the plant. In larger units

operations related to storage and dispatch of the product, as well as those connected with the reception of returnable empties (crates, bottles, cans) have been considered as justifying mechanization. The equipment listed would be usually recommended when establishing a new liquid milk packaging division. It has been assumed that, according to the practice of the majority of milk plants, the division operates two eight-hour shifts daily.

A cost evaluation of the systems, valid for developing countries all over the world, is not a feasible task. Therefore, it seemed appropriate to express first the magnitudes of the various components in physical units (m^2 , kg, hours, etc) as specific values, i.e. related to 1 000 litres of milk distributed. However, a conclusive techno-economical comparison of different systems is not possible when different components cannot be added together, for instance if one component is expressed in $m^2/1\ 000$ litres and the other in kgh/1 000 litres. The only common measure for all components is a currency unit, but this implies application of selected uniform rates for different expenditures (machines, construction, labour, fuel, materials, etc) and there is no uniformity of such costs all over the world. Nevertheless, an attempt has been made to assess and compare the specific divisional costs by applying uniform rates in US currency to the various cost components. They should be considered as figures indicating basically the relations between different components, and not necessarily as reflecting precisely the real costs of any given project. In order to arrive at

estimates of actual costs the methods of calculation given can be applied, but actual rates should be used.

Details of relevant technologies and machines are limited in this analysis to the necessary minimum, since they can be found in specialized publications.

There are numerous different designs of machines and kinds of packaging material for liquid milk packaging on the market. With very few exceptions, the equipment and packaging material for each of the systems are produced by a number of companies. They differ in design, capacities, weight, dimensions, etc., but many of them fulfil equally well the hygienic, technical and economic requirements for use in modern dairying. In this study only one example of each system analysed could be chosen. The companies which have collaborated with FAO by providing information and technical material for this publication are listed on p. 80. The author emphasizes the non-promotional and non-discriminatory nature of this list.



Chapter 2 CHARACTERISTICS OF PACKAGING SYSTEMS

Returnable containers

The basic features of systems using returnable containers are the collection of empties and washing prior to re-filling. Differences in operation times and capacities of the various machines involved make intermediate storage necessary. Storage of unwashed empties is normally essential and may extend overnight so that washing and filling operations can begin next morning before the day's supply of unwashed empties arrives. Storage of washed cans is permissible as they have lids but storage of washed bottles is extremely bad practice because they are unsealed and therefore liable to contamination. Normally storage must be provided for filled cans and bottles to give flexibility in the distribution arrangements. For pasteurized milk this must be refrigerated. The requirements are shown schematically in Fig. 4.

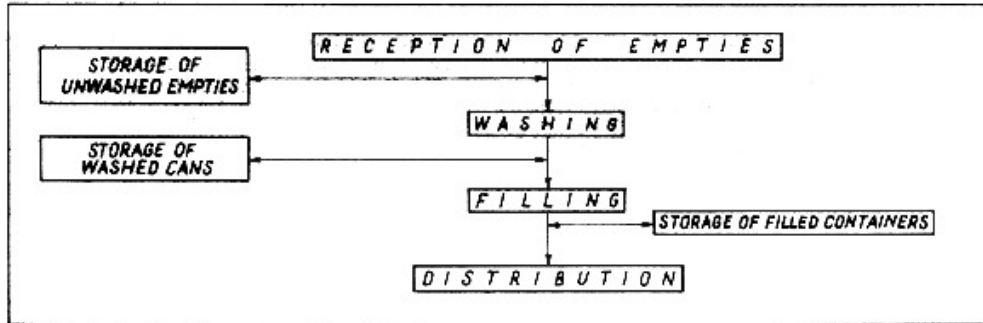

Fig. 4 Sequence of operations with returnable containers

Bottle washing, filling and capping machines should be of matching capacity, otherwise the labour-intensive operations of decrating and crating, as well as unstacking and stacking, would have to be repeated unnecessarily. This problem does not arise with cans, since they are not crated and may be easily stored empty after cleaning.

The required storage area, both for empties and for product, depends on the operation schedule of the plant which in turn is affected by the relation between required dispatch capacity and the capacity of filling machines in operation. The inter-relations between these factors are shown in Figs 5 to 8. As can be seen, the required storage areas may differ considerably depending on the arrangement of working time, type of packaging and capacity of equipment. Although no attempt

is made to present here precise examples of operation schedules, some particulars of the operations are indicated on the diagrams. For instance 'dispatch', which represents on the diagram the loading time in the milk plant, should be completed about three hours before the end of the last transport shift, i.e. it can last either five or thirteen hours, otherwise the vehicles would not return to the plant before the end of the shift. Similarly, the collected empties will not arrive at the plant at the beginning of the shift, since time is required for collection. Thus empties reception can last also either five or thirteen hours.

In this model study no consideration is given to situations where more than one product is manufactured and kept in the same store (such as liquid milk in a variety of packaging and sizes, different grades, etc). Very often quantities wanted by a particular retail centre may not represent an integral number of full crates or cans. The additional area required for marshalling such loads is not included in this analysis. In some markets the daily quantities sold may differ at week-ends and holidays or have peaks which the stores have to balance as far as the availability of milk permits such operations. Such facilities also could not be considered in this study.

Pasteurized milk in bottles. Bottles with wide necks (36 to 40 mm), suitable for sealing with aluminium foil caps made in situ from reeled strip, form the most common system for packaging of pasteurized milk in returnable containers. The bottles are placed into crates, formerly made of galvanized steel wires or strips

and nowadays usually of plastic. The crates have internal divisions so that the bottles are not in contact with one another to minimize risk of breakage. They are designed to interlock, so that a stable stack can be built. For manual handling crates with filled bottles are stacked five and six high for one-litre and half-litre bottles respectively; with empty bottles two to three crates more are put in one stack. Crates usually hold twenty half-litre and twelve to fifteen one-litre bottles.

The stacks can be palletized (Standard Europallets 800 × 1 200 mm are applicable) and moved by fork lift trucks or manually or by hand trolleys without palletizing. There are no international standards for the dimensions of pasteurized milk bottles and crates. However as an example Fig. 9 gives details of those in use in the Netherlands.

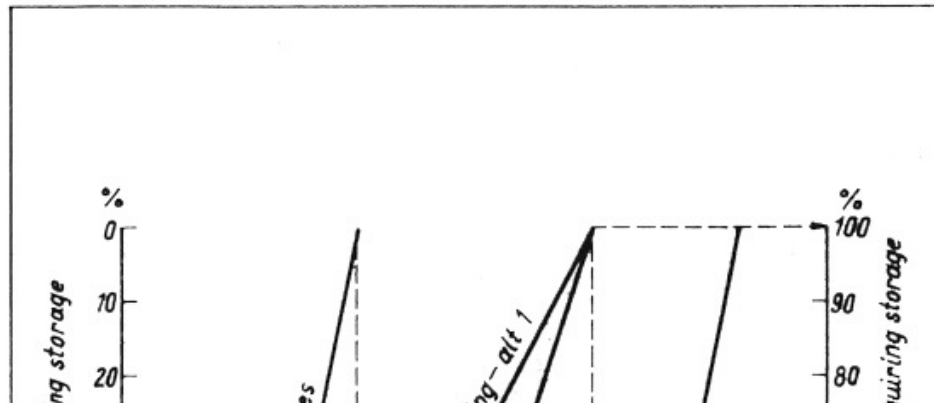

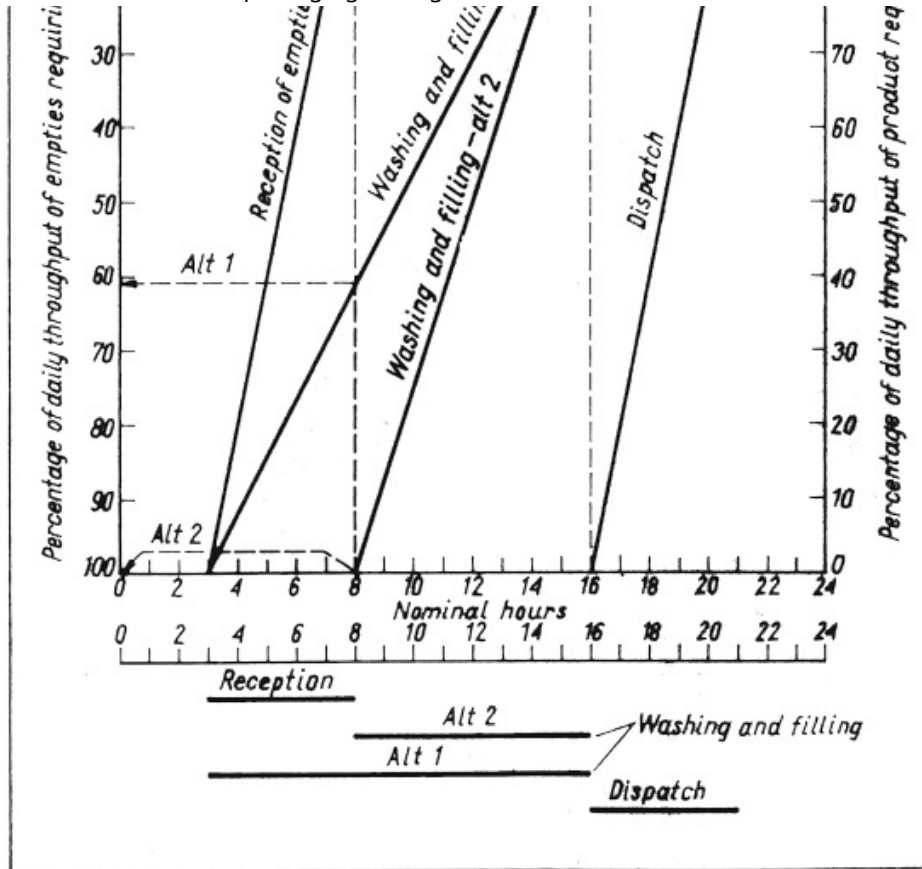
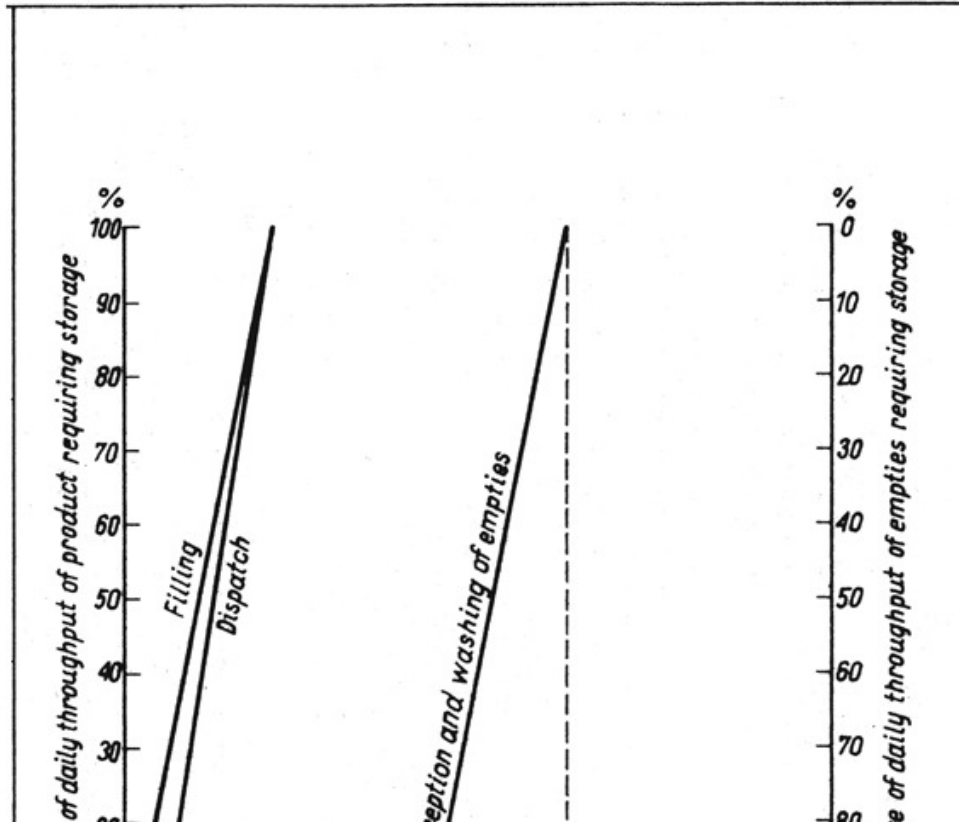

Fig. 5 Estimation of storage area requirements - suitable for low throughput of plants processing liquid milk in returnable containers



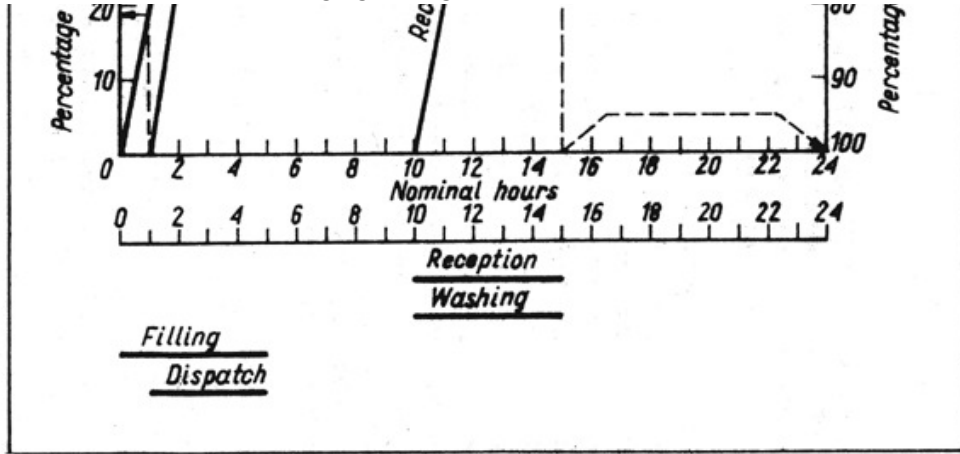

Fig. 6 Estimation of storage area requirements - suitable for higher throughput of plants processing liquid milk in cans



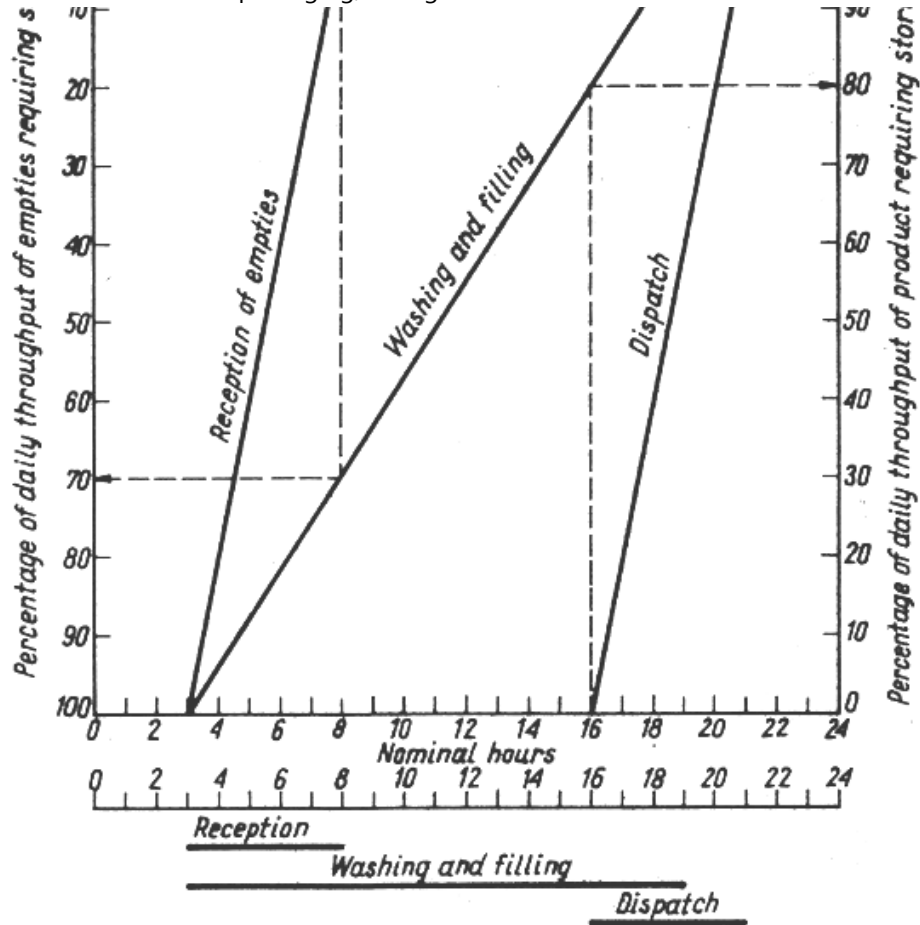
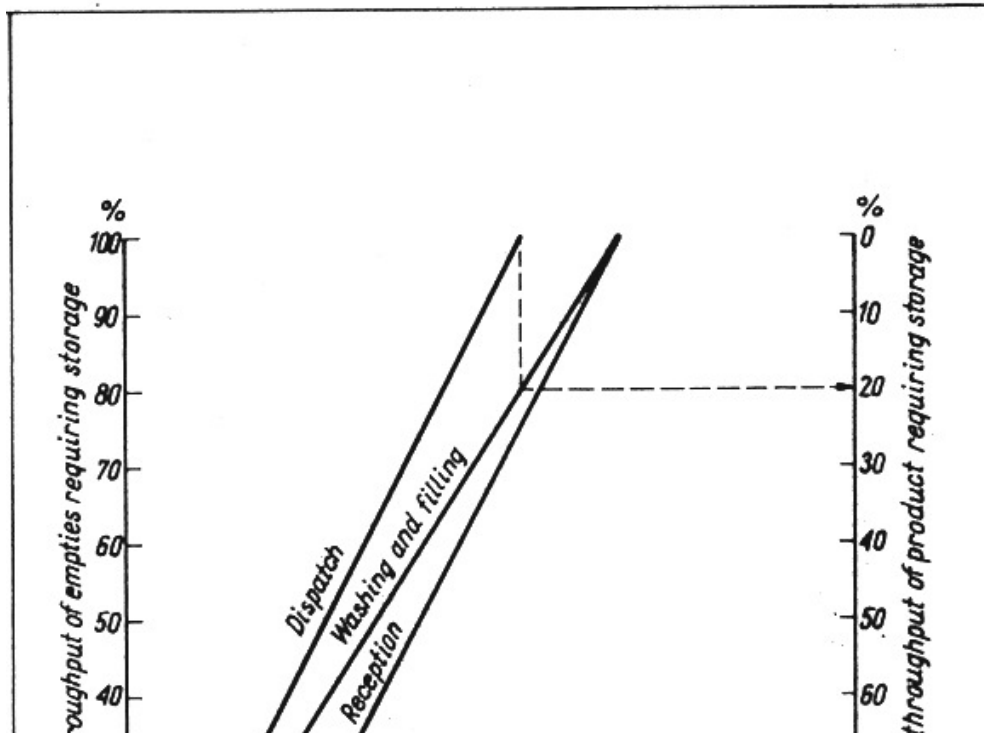

Fig. 7 Estimation of storage area requirements - suitable for higher throughput of plants processing pasteurized milk in glass bottles



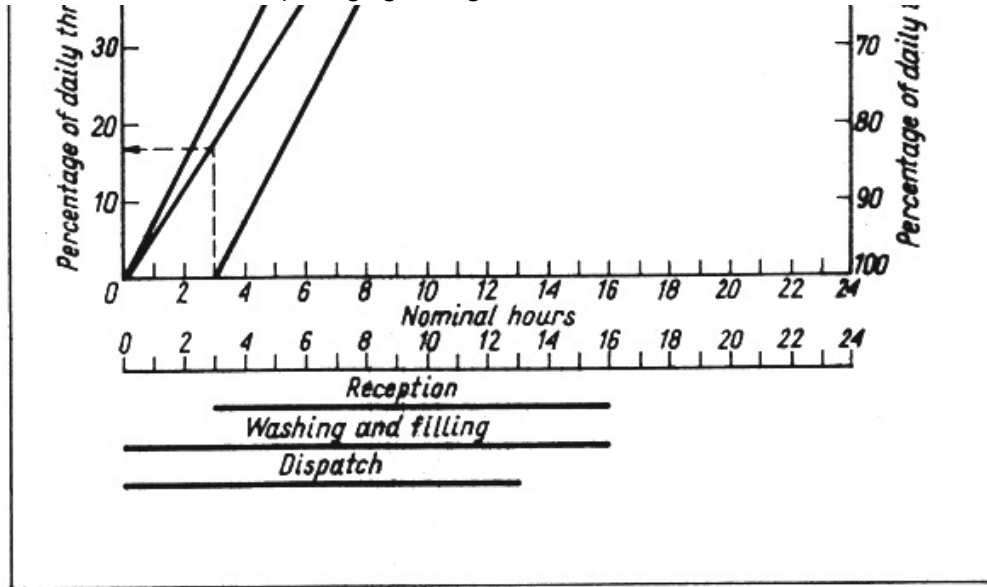

Fig. 8 Estimation of storage area requirements - suitable for higher throughput of plants processing sterilized milk in glass bottles

Volume	Bottle				Crate				Stack	
										
	A	B	C	Weight	A	B	C	No.	H	
	mm	mm	mm	g	mm	mm	mm		mm	
0.5 l	200	36-40	73	418	270	430	350	20	6-high	1545
1.0 l	267	35-40	89	610	330	505	320	15	5-high	1590

Fig. 9 Dimensions of glass bottles, crates and stacks for pasteurized milk

The floor area occupied by one stack of crates is thus about 0.15 m^2 , equivalent to a milk storage capacity of $400\text{--}470 \text{ l/m}^2$ depending on bottle capacity and stack height. For crated empty bottles the equivalent storage capacity is about 30% greater. Additional space must be allowed for access and this is discussed further in Chapter 3.

The initial high cost of a glass bottle prevents single-service use for pasteurized milk. The effective cost depends on the number of times the bottle can be re-used (trippage) which in turn is determined primarily by the effectiveness of the bottle recovery system and the ability of the bottle to withstand breakage. In the UK the

weight of a 1-pint bottle (568 ml) is about 12 oz (340 g) and costs about 4.25 p (1977). In recent years a new design has been introduced weighing about 8 oz (227 g) costing about 15% less but giving the same, or only slightly less, trippage.

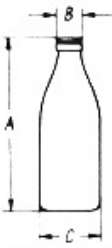
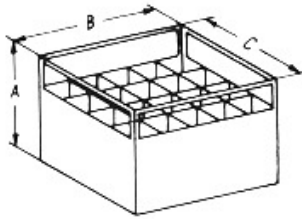
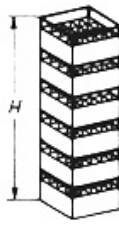
Sterilized milk in bottles. Bottles used for in-bottle milk sterilization have narrow necks (26 mm) so that a more effective seal can be made. Prefabricated crown seals are used to seal the bottles. These bottles must be able to withstand not only mechanical shocks during handling, but also thermal shocks during sterilization and, even more, during cooling. As the milk in the bottle is heated and expands during heating more than the bottle, the air above the milk becomes compressed and the pressure inside the bottle exceeds the external pressure. The contraction of the milk as it cools below the filling temperature results in a vacuum in the space above the milk. This vacuum may encourage contamination through the seal between the bottle and the cap. It is therefore important that the seals be fully airtight.

As can be seen from the above, the demands for a bottle for this process are particularly high, and it must therefore be heavier and more expensive. The bottles are packed in crates as in the method described for pasteurized milk bottles. The stacking system and the resulting storage area required are also similar. As with pasteurized milk, dimensions differ from country to country but a neck diameter of 26 mm is universal. Fig. 10 gives details of the bottles in use in the Netherlands. Crates and stacks in this case have the same dimensions as for

pasteurized milk.

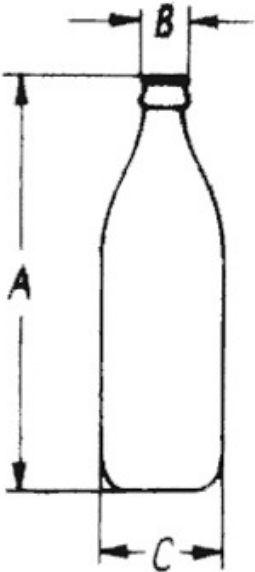
<i>Volume</i>				
				
	<i>A</i>	<i>B</i>	<i>C</i>	<i>Weight</i>
	<i>mm</i>	<i>mm</i>	<i>mm</i>	<i>g</i>
<i>0.5 l</i>	<i>232</i>	<i>26</i>	<i>75</i>	<i>460</i>

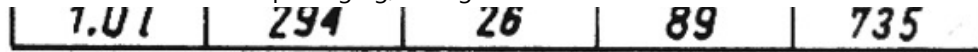

Fig. 10 Dimensions and weight of glass bottles for sterilized milk

Pasteurized milk in cans. The aluminium milk can has proved very satisfactory in service and, since the beginning of the second half of this century, has rapidly replaced the previously-used tinned mild steel can. In recent years high density polyethylene cans began to be introduced in a number of countries, but have not proved popular for various reasons. The most common are cans with lids which do not require rubber gaskets, an adequate seal being achieved with sunken grip or mushroom lids. Because of mechanical washing problems lids attached to the cans by chains are no longer used. Through simple arrangements at the lid ring lead or other seals can be applied to make the contents of the can pilfer-proof. The cans may be palletized, but more often floor conveyors are used. Full cans are stored in one layer, thus allowing about 320 to 360 litres of milk to be stored per square metre excluding access space. Empty cans, after washing, are stacked in layers horizontally, up to the height of 1.5. m. For storing and moving washed empty cans simple trolleys on which the cans can be stored in 4–5 layers are very useful; for instance, about 20 cans each of 40 litres capacity can be stored on trolleys about 1 700 × 700 mm with a supporting frame made of a 1/2" pipe. Some details are given in Fig. 11.

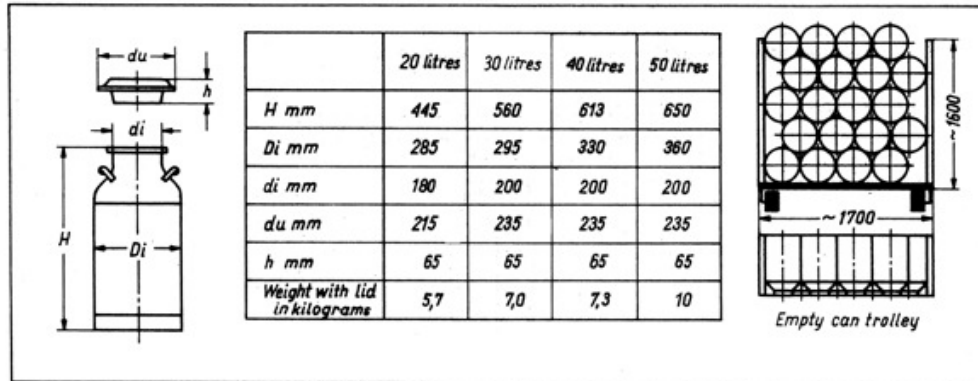

Fig. 11 Dimensions, weights and stacking of empty pasteurized milk cans

Single-service containers

The common feature of single-service containers is that after emptying they are discarded. This fact has a significant impact on the milk plant construction, organization, and on the economics of the whole enterprise. There is no collection and washing of the milk packages - only crates are collected and washed, but even these may be replaced by single-service delivery wraps, trays or boxes. Palletization may be applied as in the case of returnable containers. Intermediate storage of packing material and filled packages is required and this must be provided in the plant.

Two basic types of single-service containers are considered in this analysis, i.e. cartons and plastic sachets. Cartons are usually made in one of the shapes illustrated in Fig. 12.

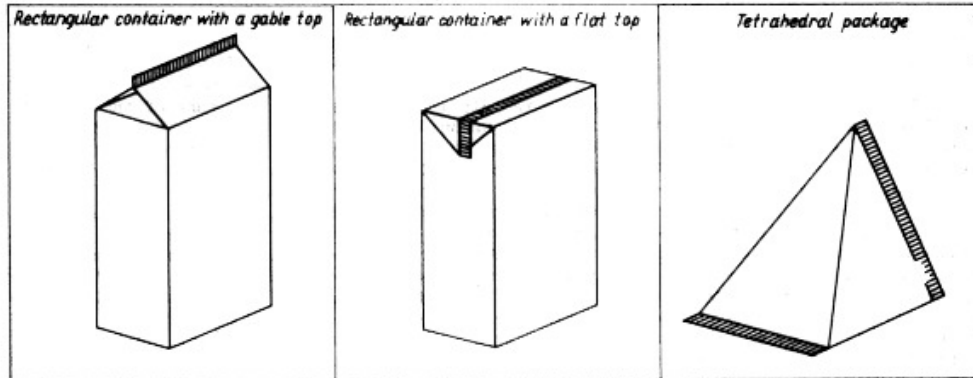

Fig. 12 Basic shapes for milk cartons

The material used in each case is polyethylene-coated paper-board; in aseptic versions an aluminium foil lamina is normally incorporated. Pre-formed cartons or pre-cut, single-piece blanks pre-creased ready for forming into a container must be used for the container with a gable top and these generally are more expensive. The other method of making a carton is to form a tube from a reel of material, seam it longitudinally, fill with milk and then make transverse seals.

Alternatively the tube may be cut into lengths which are formed into cartons before filling and sealing.

Plastic sachets are usually pillow-shaped and made of low density polyethylene film. They may be reeled single or double film or lay-flat tube, the latter avoiding the necessity of making the longitudinal seam in the packaging machine. The material should be coloured to reduce light transmission.

The sequence of operations when packaging into single-service containers comprises forming the container, filling and sealing, storage of the packaged product and dispatch to wholesale and retail outlets. As with packaging in glass bottles the storage space requirements must be related to the process schedule (see Figs 5–8) but there are important differences. Only where returnable crates or pallets are used is space for returned empties required and this can be assessed by the method shown, for example, in Fig. 7. Otherwise there is no constraint on the beginning of the day's packaging operations. However, space must be provided for the paper or plastic stock and this is discussed further below.

For pasteurized milk the percentage of the day's output which will require storage can also be determined by the method shown in Fig. 7. However, this does not apply to UHT milk which must be stored at the milk plant for a minimum of 4 days after packaging while sterility tests on samples from the day's production are

carried out. Thus, to allow for contingencies a product storage area equivalent to about 5 days production is essential. It follows that the times at which packaging begins and ends each day are not affected by storage considerations.

The distribution of food is changing rapidly in the industrialized part of the world. Traffic routes from processor to retailer are becoming increasingly crowded, sales through supermarkets are demanding changes in the systems of packaging and developments aimed at making this distribution feasible and manageable in large concentrations of consumers are taking place constantly. There is no doubt that single-service containers respond better than returnable ones to the demands of this modern trend. Milk distributed in single-service containers in returnable crates relieves the retailer from the necessity of collecting empties from the customer but the need for returning crates to the processor still exists. This may not create too many problems since empty crates may be collected by the processor at the time of milk delivery, provided two sets of crates are put in operation. A completely one-way packaging system requires that the single-service containers are wrapped in non-returnable material, thus forming transportable units. In this study, transporting of single-service containers in returnable crates has been analysed for pasteurized milk and in non-returnable wraps for UHT milk.

Pasteurized milk in cartons. Tetrahedral cartons made from polyethylene laminated paper board and packed in hexagonal plastic crates have been chosen

as the model for analysis of a system of pasteurized milk packaging.

The cartons are produced continuously from a roll of plastic-coated paper which is shaped and sealed into a tube. The tube is filled continuously with pasteurized milk. Transverse seals are made alternately at right angles below milk level so that there is no headspace and the shape of the package is a tetrahedron. The packages are separated by guillotine and placed in hexagonal plastic crates holding 18 cartons each. The crates are stacked on pallets. The crates (and eventually also the pallets) have to be transported from the retail centres back to the milk processing plant. Table 2 gives data on the rolls of laminated paper as used for the system:

Table 2. Paper stock for tetrahedral cartons for pasteurized milk

	width mm	weight of one roll kg	cartons per roll	Rolls for one million cartons		
				No.	weight t	net space requirement m ²
for 1/2 1 packages	287	53	5 000	200	10.6	16
for 1/1 1 packages	362	72	4 000	250	18.0	24

The space requirements shown in Table 2 for the material required to make 1 million cartons must be considered in conjunction with the daily throughput and the material supply arrangements. For a plant packaging 10 000 1/day in 1-litre cartons, 1 million packages represents 100 days production. For a 250 000 1/day plant packaging in 1/2-litre cartons it represents only 2 days production. Depending on the location of the milk plant and the paper supplier and the most economic purchasing quantities it may be necessary to carry two to three months stock. Figs 27 to 33 give storage areas for packaging material equivalent to about 60 days stock for the 250 000 litre plants and 70 to 100 days for the smaller capacities.

Fig. 13 gives details of the dimensions of the cartons, crates and crate stacks chosen for this example. As these particular crates are tapered they will nest when empty so economising in space. (Rectangular crates occupy the same space empty or full).

Volume	Package				Crate for 18 cartons			Stacking	
	A	B	C	Weight g	A	B	Weight g	full (6)	empty (15)
0.5 l	140	165	135	11.8	230	340	850	1230	1485
1.0 l	176	205	170	19.5	280	440	1600	1530	1630

Fig. 13 Dimensions (in mm) of cartons, crates and stacks for pasteurized milk

Thus with a 6-high stack of crates containing ½- litre cartons, store capacity without access is about 500 1/m².

UHT milk in cartons. Rectangular cartons made from polyethylene laminated paper board in shrink-on wraps strengthened by corrugated cardboard trays have been chosen as the model for analysis of a system for aseptic packaging of UHT treated milk. The system represents a completely single-service milk distribution method, with no return transport to the milk processing plant, except for pallets if they are used for transport outside the milk plant.

The cartons are produced continuously from a roll of plastic-coated paper which is chemically and thermally sterilized before being shaped and sealed into a tube. The tube is filled continuously with UHT processed milk, after which the cartons are sealed below fluid level and formed into a rectangular shape. The cartons are filled completely and can be stacked.

Table 3 gives data on the rolls of laminated paper as used for the system:

Table 3. Paper stock for rectangular cartons for UHT milk

				Rolls for one million cartons
--	--	--	--	-------------------------------

	width mm	weight of one roll kg	cartons per roll	No.	weight t	net space requirement m ²
for 1/2 1 packages	322	60	3 500	285	17.1	24
for 1/1 1 packages	322	63	2 500	400	25.2	34

The storage space required for the paper stock is subject to the same considerations discussed above for pasteurized milk cartons.

Fig. 14 gives the dimensions of the cartons, individually and when shrink-wrapped in packs of 12, and of carton stacks suitable for Europallets. The storage space to accept 4 or 5 days production is not subject to critical requirements. It should be within the milk plant, though not necessarily in the same building as packaging, and of such construction that temperature, humidity and cleanliness are maintained within reasonable limits.

Volume	Package				Wrapping			Stacking		
										
	A	B	C	Weight g	A	B	C	A	B	C
0,5 l	88	63	95	17,2	88	190	380	~880	~760	~950
1,0 l	167	63	95	25,2	167	190	380	~835	~760	~950

Fig. 14 Dimensions (in mm) of cartons, packs and stacks for UHT milk

Out of several distribution alternatives for the method by which the single-service containers are collated in transportable units, the most often applied are: (a) crating and (b) wrapping in non-returnable materials. Crating already has been analysed in relation to pasteurized milk in tetrahedral cartons. For one-way (non-returnable) transport packaging shrink-film is most often used. This wrapping can be applied manually or mechanically. When machines are used, the cartons are fed to the marshalling station and then wrapped in shrink-on film. After having passed through the shrinking tunnel the packages are loaded on to pallets and are then ready for distribution. This system is used where short storage times and short distribution distances are involved. However, the film does not give much mechanical support to the packages and cartons wrapped in shrink-on film are often subject to damage, leakage and contamination, particularly when handled manually without the use of pallets and other auxiliary equipment. Special

(perforated) shrink-films may be required in areas with high humidity to prevent condensation. A much safer, although more expensive, system is that by which a group of twelve rectangular cartons filled with milk is placed first on a flat tray blank. The sides of the blank are then folded up tightly around the cartons so utilizing to the full the pressure-absorbing ability of the filled cartons. The packed corrugated tray is then wrapped in shrink-on film which not only affords protection against dust and moisture but also presses the sides of the tray in towards the cartons. This brings about a substantial improvement in the pressure-absorbing ability of the corrugated tray, at the same time giving a compact transport packing capable of resisting the strains and stresses encountered in the course of distribution. The units can easily be handled manually.

This system of packaging the cartons in one-way transport units by wrapping them in shrink-on film after having strengthened the unit of 12 cartons by a tray of corrugated cardboard is used for UHT milk basically meant for longer storage and longer distances of transport (such as once-a-week delivery to a consumption centre from a distant milk plant).

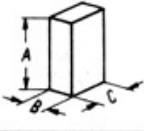
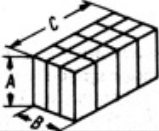
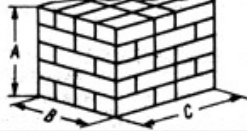
It seemed to be appropriate to take into consideration and present data for this method of wrapping the cartons into one-way strengthened transportable units so as to arrive at indications for the costs - by today's standards - of the most modern liquid milk processing and distribution system. Up to about 600–700 litres

of milk per square metre can be stored when pallets are used (without access).

Pasteurized milk in sachets. Pillow-shaped sachets with a longitudinal seam made from reeled low-density polyethylene film have been chosen as the model for analysis of the system. The film is shaped and welded into a tube. The tube is filled with pasteurized milk from a small balance tank, where the level is kept constant by means of a float. A timer-controlled pneumatically-operated valve is used to dispense constant quantities of milk. The transverse seals are generally made above milk level. The packages are separated by guillotine and placed in rectangular plastic crates holding 20 packages each and the crates are then palletized. The same width and thickness (90 mm) is used for both 1-litre and 1/2-litre packages; capacity is varied by varying the distance between transverse seals. It is important that the film is free from pinholes or micropores.

Table 4 gives data on the rolls of polyethylene film as used for the system.

Table 4. Film stock for pillow sachets for pasteurized milk

					Rolls for one million cartons		
		width mm	weight of one roll kg	cartons per roll	No.	weight t	net space requirement m ²
for	packages	300	appr.25	appr.5 500	180	4.5	7

1/2 for 1/1	packages	300	appr. 25	appr. 4 000	250	6.25	10
-------------------	----------	-----	----------	-------------	-----	------	----

Fig. 15 gives details of the dimensions of sachets, crates and crate stacks. These crates also are usually tapered so that they will nest when empty.



Volume	Package			Crate			Stacking	
							Full (10)	empty (20)
	A	B	Weight g	A	B & C	Weight g	H	h
0,5 l	120÷240	140÷160	4,4	550÷630	160÷320	1200÷2000	~1600	~800
1,0 l		220÷240	5,5					

Fig. 15 Dimensions (in mm) of pillow sachets, crates and stacks for pasteurized milk

Thus with crates stacked 10-high containing 1/2-litre sachets the store capacity without access space is about 500–600 1/m².



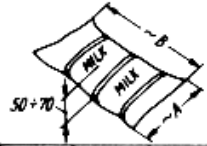

Chapter 3 EQUIPMENT AND PLANT AREAS

The items of processing and packaging equipment, the area required to accommodate them and for storage, together with the costs involved, for the five capacities of milk plant chosen for this study can now be considered. It should be emphasized that this analysis does not include milk reception, raw milk storage and cooling, recombination or other forms of pre-treatment.

The key item of equipment is the packaging machinery, the capacity of which is derived directly from the required daily throughput. The capacity of all other items of equipment (the processing equipment being appropriate to the type of milk to be produced) must be related to this. A more detailed specification of these items is not necessary for the purpose of this analysis.

Different makes of equipment for the same purpose inevitably show differences in capacity, dimensions, cost and other details. It may well be that one make is more suitable than another at one particular plant throughput while a different make has the advantage at some other throughput. It has been necessary, therefore, to make an arbitrary selection to achieve consistency in data comparisons. This may have affected the price or area requirement in some instances but only within the

limits of error and in neither case would this affect the general implications or conclusions of this study. The assessments of machinery costs have been based on information available at mid-1977; applying currency exchange values valid at that time. The costs for auxiliary equipment have been approximated as a varying percentage of the costs of the basic machinery, and are all based on prices ex European ports.

In selecting the basic machines it is necessary to consider whether the required capacity should be covered by one machine or by two of a smaller size. One machine of the full capacity required is cheaper in all respects but two of half capacity each is a much safer solution, particularly where spare parts replacement and general maintenance may create problems. Wherever feasible two half-size machines should be preferred to one full-size. The specifications are shown in Tables 5 and 6.

The indicative value of the cost component related to machinery and equipment has been calculated separately for machines owned by the plant and those obtained on lease because some makes of packaging equipment are available only on the latter basis.

The cost component, Z, has been computed for both owned and rented machines by the following equation

$$Z = \frac{C}{365a} (D + B + G + E) \text{ in US\$ / 1 000 litres}$$

where C = value of owned (C₁) or annual expenses on rental (C₂) for rented machines in US\$

a = throughput in thousand litres of liquid milk per day

D = 'depreciation' (12.5% of C, for owned machines and 100% of C₂ for those on lease)

G = rate of annual maintenance costs (10%)

E = rate of annual expenses on insurance and taxes (2.5%)

The resulting magnitudes are:

- for owned machines $Z_1 = \text{about } 0.001 \frac{C_1}{a}$

- for machines on lease $Z_2 = \frac{C_2}{a}$

It follows that $Z = Z_1 + Z_2$

Having estimated the areas required for machinery rooms and stores the layouts have been designed to conform with the internationally agreed structure modules of 12 m span and 6 m centres for structural beams. The application of these module dimensions gives a better comparability of different sizes and types of buildings but this may leave more space than is required for a particular purpose, particularly in plants with smaller throughputs. Although milk packaging and storage do not represent all the milk plant operations the layouts have been prepared as regular rectangles in order to make the sequence of movements more clear to the reader. In assessing the storage area requirements, use was made of the diagrams in Figs 5 to 8 and the related comments. To arrive at comparable cost assessments of buildings the term 'reduced standard area units' has been introduced. This is intended to compensate for the different costs of construction in different areas of the milk plant. For instance, constructing unit area of a cold store is more expensive than unit area of processing or packaging rooms since thermal insulation is involved. Non-refrigerated stores, docks, and packaging material stores are cheaper than processing areas. Coefficients have therefore been applied to arrive at proper cost comparisons. These coefficients, the actual areas required and the 'reduced' areas are given in Tables 7 and 8. Selected layouts shown in Figs 16–33.

The specific costs given in Tables 5 and 6 are shown graphically in Fig. 34. The

specific actual and reduced areas given in Tables 7 and 8 are plotted in Figs 35 and 36.

Table 5 Number of items of basic equipment for processing and packaging milk in bottles and cans

	GLASS BOTTLES - 1/2 LITRE										MILK CANS - 40 LITRES				
	Pasteurized					Sterilized					Pasteurized				
Plant throughput, thousand 1/day	10*	25*	50	100	250	10	25	50	100	250	10	25	50	100	250
Bottle washer 2000 b/h	1														
6000 "		1	2			1	1								
12000 "				2				1	2						
18000 "					3					3					
Bottle filler** 2000/1200 "	1	1													
7500/ 5000 "		1	2	4		1	1	2							
13000/ 9000 "										6					
18000/12000 "					3				2						

Crate washer	1	2	2	3	1	1	1	2	3					
Bottle conveyor	1	2	4	3	1	1	2	2	6					
Crate conveyor	1	2	2	3	1	1	1	2	3					
Decrater/Recrater <u>***</u>				3					3					
Unstacker/Restacker				3					3					
Pasteurizer and homogenizer					1	1	1	1	1					
Reheater and tank					1	1	1	1	1					
Sterilizer					1	1	1	1	1					
Roller conveyor -m										15	33			
Mechanical churn conveyor -m												120	200	400
Churn washer 200–400 cans/h										1	1			
600 "												1	2	
900 "														3
Automatic churn filler										1	2			

6000 1/h																
24000																
"														1	2	5
Auxiliary equipment (lot)****	1	1	1	1	1	1	1	1	1	1	1	1	1	1	1	1
Estimated cost (FOB European port) of equipment, expressed in thousand US\$ equivalent. Exchange rates and prices valid at mid-1977.	90	200	380	650	1400	220	400	780	1150	2100	25	45	85	170	320	
Cost components related to inputs on machinery US\$/1000	9.0	8.0	7.6	6.5	5.6	22.0	16.0	15.6	11.5	8.4	2.5	1.8	1.7	1.7	1.3	
1																

* Alternatives are shown in layouts Figs 16 and 17

** First figure refers to pasteurized milk, second to sterilized

*** suitable to match output of filling machines

**** not including bottles, crates, cans, etc.

Table 6 Number of items of basic equipment for processing and packaging milk in single-service containers

	CARTONS - 1/2 LITRE										PLASTIC SACHETS - 1/2 LITRE				
	Pasteurized					UHT-aseptic					Pasteurized				
	in returnable crates					in non-returnable wraps					in returnable crates				
Plant throughput, thousand 1/day	10	25	50	100	250	10	25	50	100	250	10	25	50	100	250
Filling machine 2500 packs/h											1	2			
3600 "	1	2	3	6	14	1	2	3	6	14					
5000 "													2	4	10
Crate washer		1	1	2	4						1	1	2	2	
Crate conveyor		1	1	2	4						1	1	1	2	2
Carton/ sachet conveyor						1	2	3	6	14	1	1	2	4	10
Shrink wrapper *						1	2	3	6	14					

Unstacker					2										2
Stacker/Restacker					2										2
Pasteurizer and homogenizer						1	1	1	1	1					
UHT- treatment unit						1	1	1	1	1					
Auxiliary equipment (lot) **	1	1	1	1	1	1	1	1	1	1	1	1	1	1	1
Estimated cost (FOB European port) of equipment, expressed in thousand US\$ equivalent. Exchange rates and prices valid at mid-1977.	12	24	48	96	240	130	200	400	500	700	40	90	140	280	700
Annual expenses on rental of machines on lease	43	86	122	258	652	205	385	590	1150	2700					

Cost components related to inputs on machinery US\$/1000 1	16.2	13.0	10.0	10.0	9.4	85.0	62.0	50.0	45.0	41.0	4.0	3.6	2.8	2.8	2.8
--	------	------	------	------	-----	------	------	------	------	------	-----	-----	-----	-----	-----

* Suitable to accommodate output of filling machines

** not including packaging material and crates.

Table 7 Areas required for processing, packaging, storing and handling milk in returnable containers

NOTE: E = A F = 0.8 B H = 0.5 D G = 1.3 C for cold stores G = 0.8 C for non-refrigerated stores	GLASS BOTTLES - 1/2 LITRE					CANS - 40 LITRES									
	Pasteurized					Sterilized					Pasteurized				
Plant throughput 000 1/day	10	25	50	100	250	10	25	50	100	250	10	25	50	100	250

	ACTUAL REQUIREMENTS - m ²														
A Machinery rooms	48	72	144	216	864	134	216	288	432	1152	36	72	108	144	288
B Empties reception & storage	24	72	96	180	450	10	72	144	288	720	36	72	108	216	512
C Product storage and dispatch	90	180	270	432	864	72	144	216	432	1080	72	72	72	72	216
D Docks	18	36	54	72	144	36	72	108	216	540	72	108	144	216	432
Total required area m ²	190	360	564	900	2322	252	504	756	1418	3492	216	324	432	648	1448
Specific area requirement m ² /1000 1	19.0	14.4	11.3	9.0	9.3	25.2	21.6	15.1	14.2	14.0	21.6	13.0	8.6	6.5	5.7
	REQUIREMENTS REDUCED TO STANDARD AREA UNITS -m ²														
E Machinery rooms	48	72	144	216	864	134	216	288	432	1152	36	72	108	144	288
F Empties reception &	19	58	77	144	360	8	58	116	232	576	29	58	87	174	348

storing																
G Product storage and dispatch	117	234	351	562	1123	58	116	172	344	864	94	94	94	94	282	
H Docks	9	18	27	36	72	18	36	54	108	270	36	54	72	108	216	
Total reduced area requirement m ²	193	382	599	958	2419	218	426	630	1160	2862	195	278	361	520	1134	
Specific reduced area requirement m ² /1000 l	19.3	15.3	12.0	9.6	9.7	21.8	17.0	12.6	11.6	11.3	19.5	11.1	17.2	5.2	4.5	

Table 8 Areas required for processing, packaging, storing and handling milk in single-service containers

NOTE: F = A C = 0.8 B H = 1.3 C for cold stores H =	CARTONS - 1/2 LITRE		PLASTIC SACHETS - 1/2 LITRE

0.8 C for non- refrigerated stores J = 0.5 D K = 0.5 E	Pasteurized in returnable crates					UHT-aseptic in one-way wraps					Pasteurized in returnable crates				
	Plant throughput 000 1/day	10	25	50	100	250	10	25	50	100	250	10	25	50	100
	ACTUAL REQUIREMENTS - m ²														
A Machinery rooms	36	72	144	324	815	180	360	504	720	1800	36	72	72	144	432
B Empties reception & storing	36	72	144	324	648	-	-	-	-	-	36	72	216	216	432
C Product storing and dispatch	72	144	270	540	1250	360	720	1440	2800	7000	72	144	216	540	1008
D Storing of packaging material	108	216	360	648	1296	180	288	504	864	2232	108	216	216	288	864

E Docks Total required area m ²	36	72	90	108	216	36	72	108	252	504	36	72	144	108	144
Specific area requirement m ² /1000.1	28.2	23.0	20.2	19.4	16.9	75.6	57.6	51.1	50.4	42.1	28.2	23.0	17.3	13.0	11.5
REQUIREMENTS REDUCED TO STANDARD AREA UNITS - m ²															
F Machinery rooms	36	72	144	324	815	180	360	504	720	1800	36	72	72	144	432
G Empties reception & storing	29	58	117	258	518	-	-	-	-	-	29	58	172	172	344
H Product storing and dispatch	94	188	351	702	1625	290	580	1160	2250	5600	94	188	282	702	1311
J Storing of packaging material	54	108	180	324	648	90	144	252	432	1116	54	108	108	144	432
K Docks	18	36	45	54	108	18	36	54	126	252	18	36	72	54	72

Total reduced area requirement m ²	231	462	837	1162	3714	578	1120	1970	3528	8768	231	462	696	1216	2591
Specific reduced area requirement m ² /1000 l	23.1	18.5	16.7	16.6	14.9	57.8	44.8	39.4	35.3	35.1	23.1	18.5	14.0	12.2	10.4

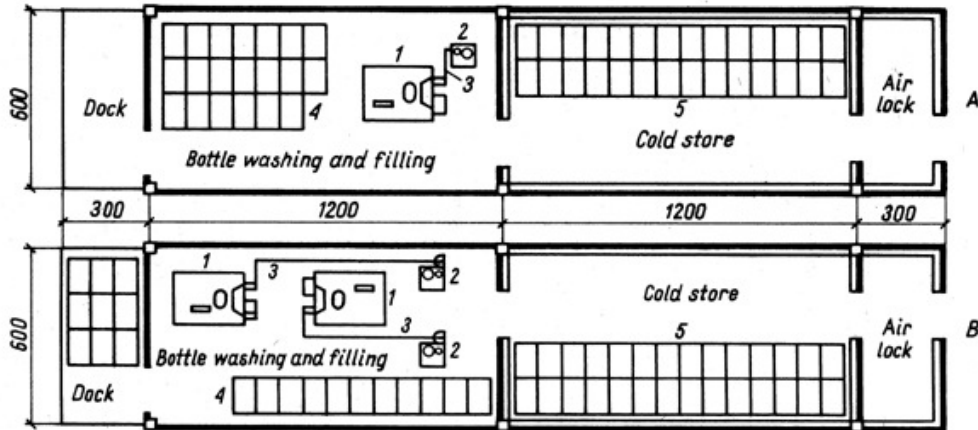

Fig. 16 Layouts for packaging and storage 10 000 litres/day of pasteurized milk in B 1/2 litre glass bottles - alternatives A and B

1. Bottle washer; 2. Bottle filler; 3. Bottle conveyor; 4. Empty bottles in crates; 5. Filled bottles in crates

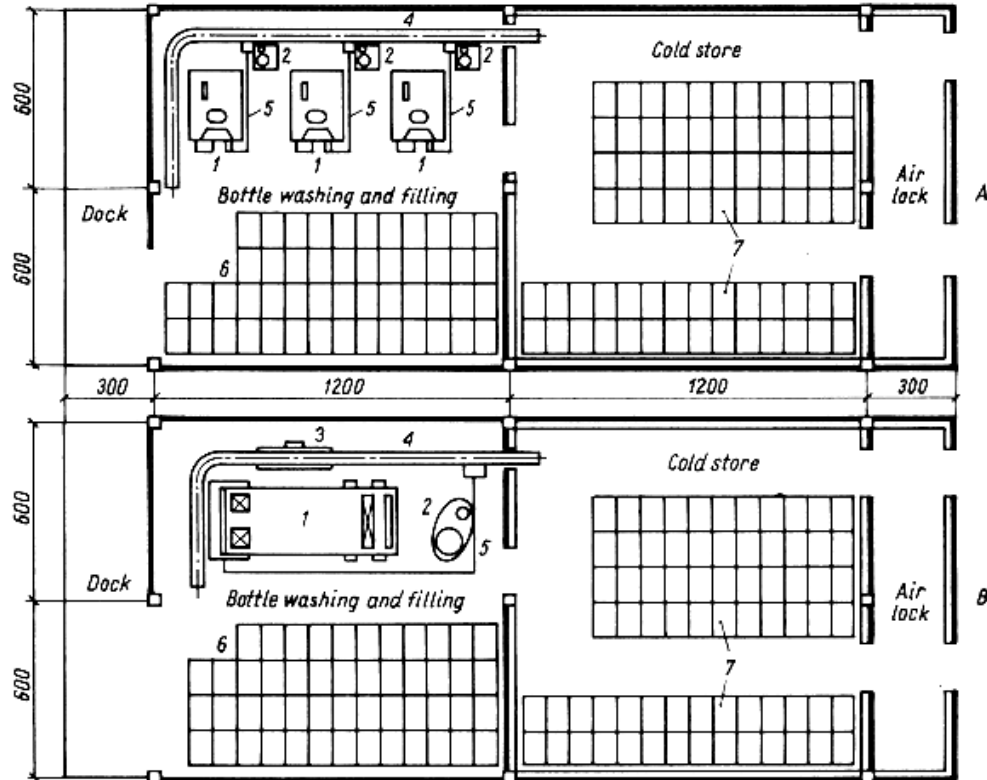

Fig. 17 Layouts for packaging and storage 25 000 litres/day of pasteurized milk in 1/2 litres glass bottles - alternatives A and B

1. Bottle washer; 2. Bottle filler; 3. Crate washer; 4. Crate conveyor; 5. Bottle conveyor
6. Empty bottles in crates; 7. Filled bottles in crates

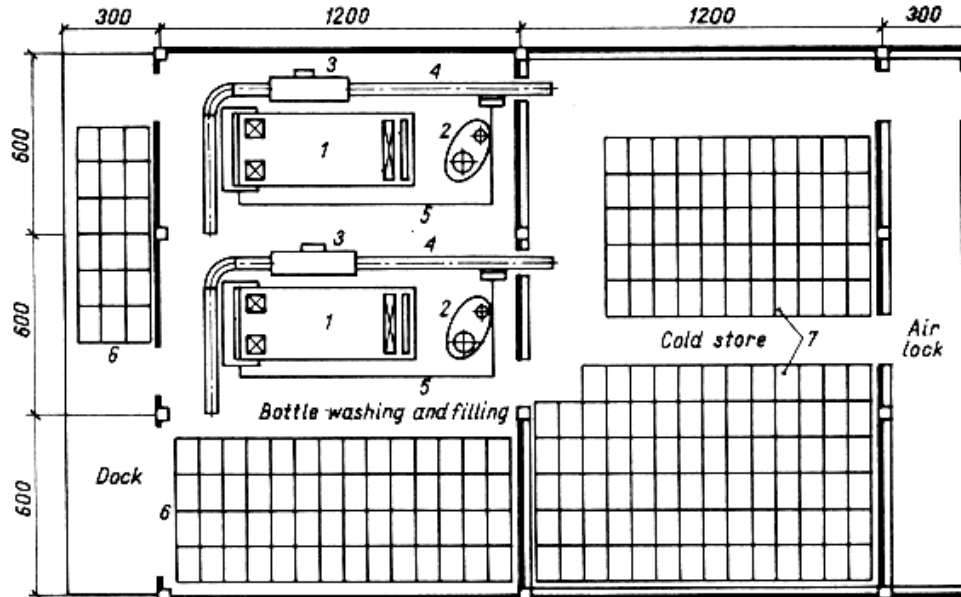

Fig. 18 Layout for packaging and storage 50 000 litres/day of pasteurized milk in 1/2 litre glass bottles

1. Bottle washer; 2. Bottle filler; 3. Crate washer; 4. Crate conveyor; 5. Bottle conveyor; 6. Empty bottles in crates; 7. Filled bottles in crates

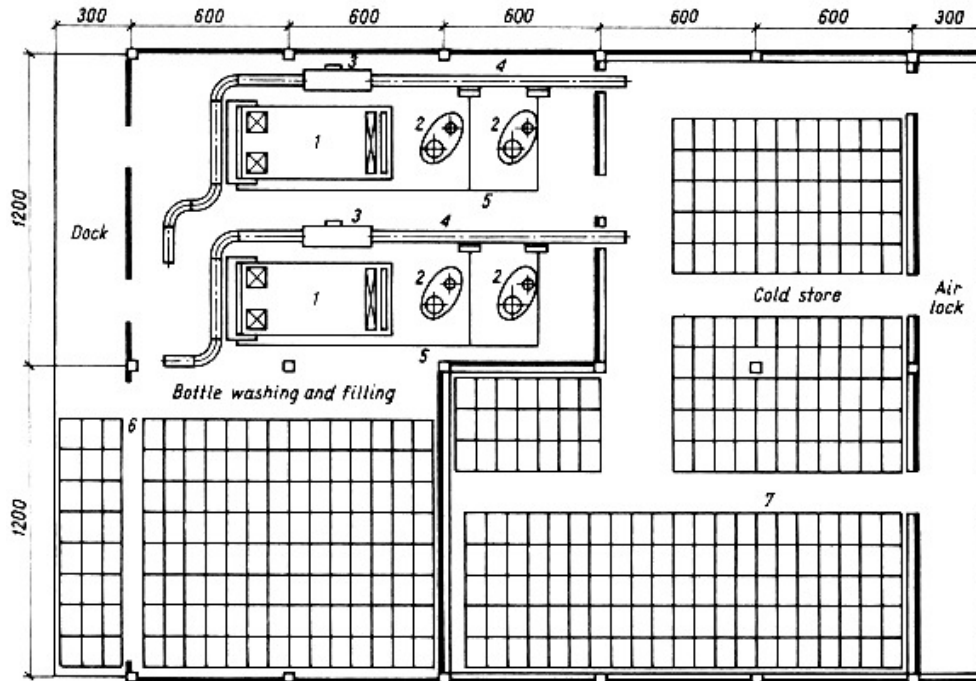

Fig. 19 Layout for packaging and storage 100 000 litres/day of pasteurized milk in 1/2 litres glass bottles

1. Bottle washer; 2. Bottle filler; 3. Crate washer; 4. Crate conveyor; 5. Bottle conveyor; 6. Empty bottles in crates; 7. Filled bottles in crates

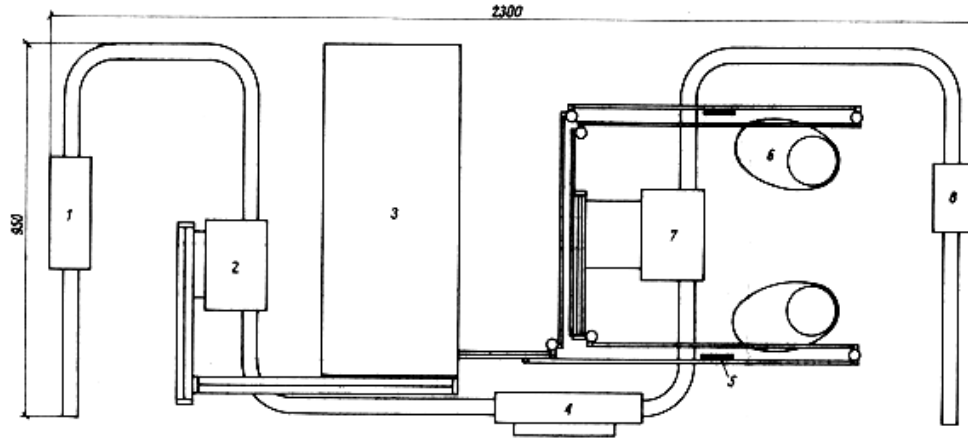

Fig. 20 Typical layout for a bottling line of 20 000 bottles per hour for pasteurized milk

1. Crate unstacker; 2. Decrater; 3. Bottle washer; 4. Crate washer; 5. Sighting light; 6. Filler-capper; 7. Recrater; 8. Crate stacker

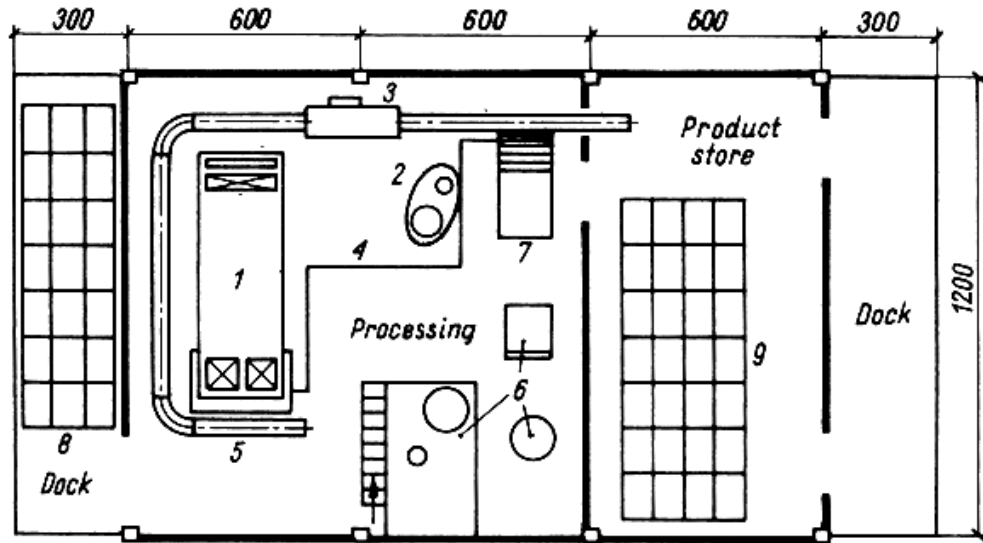
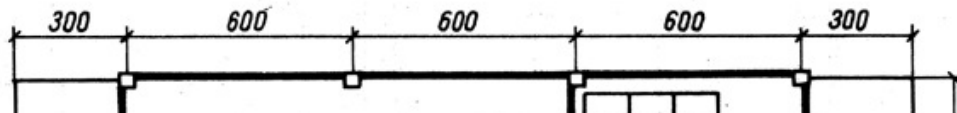

Fig. 21 Layout for packaging, sterilization and storage 10 000 litres/day of sterilized milk in 1/2 litre glass bottles

1. Bottle washer; 2. Bottle filler; 3. Crate washer; 4. Bottle conveyor; 5. Crate conveyor; 6. Pre-sterilization; 7. Sterilizer; 8. Empty bottles in crates; 9. Filled bottles in crates



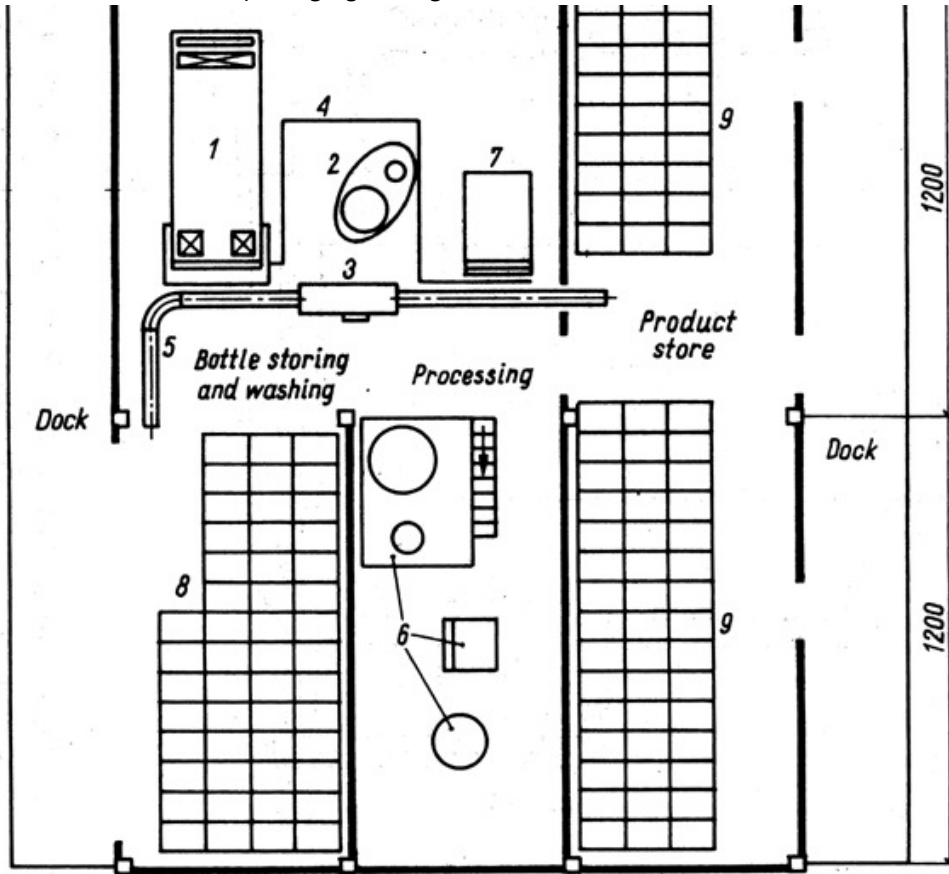

Fig. 22 Layout for packaging, sterilization and storage 25 000 litres/day of sterilized milk in 1/2 litre glass bottles

1. Bottle washer; 2. Bottle filler; 3. Crate washer; 4. Bottle conveyor; 5. Crate conveyor; 6. Pre-sterilization; 7. Sterilizer; 8. Empty bottles in crates; 9. Filled bottles in crates

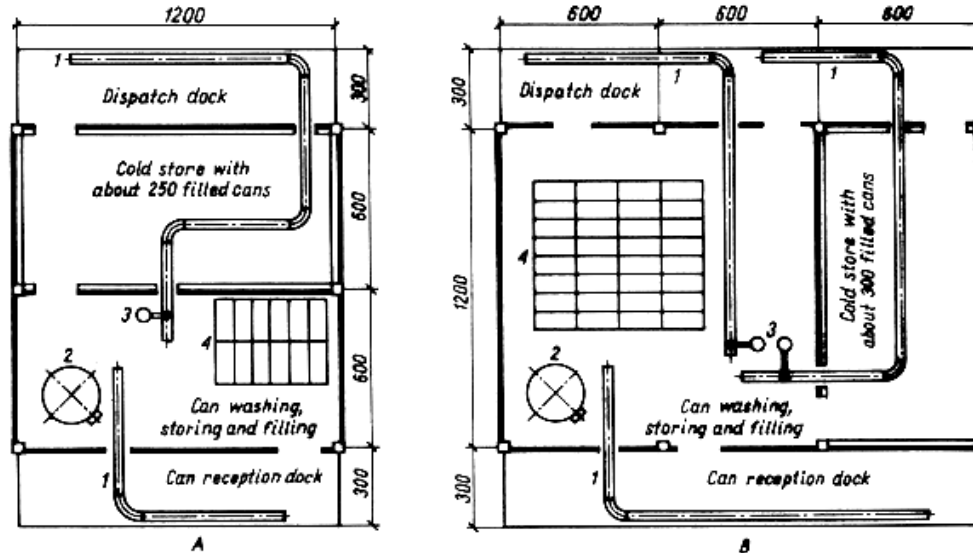

Fig. 23 Layouts for packaging and storage 10 000 litres/day (A) and 25 000 litres/day (B) of pasteurized milk in 40 litre cans

1. Roller conveyor; 2. Can washer; 3. Can filler; 4. Trolleys with washed empty cans

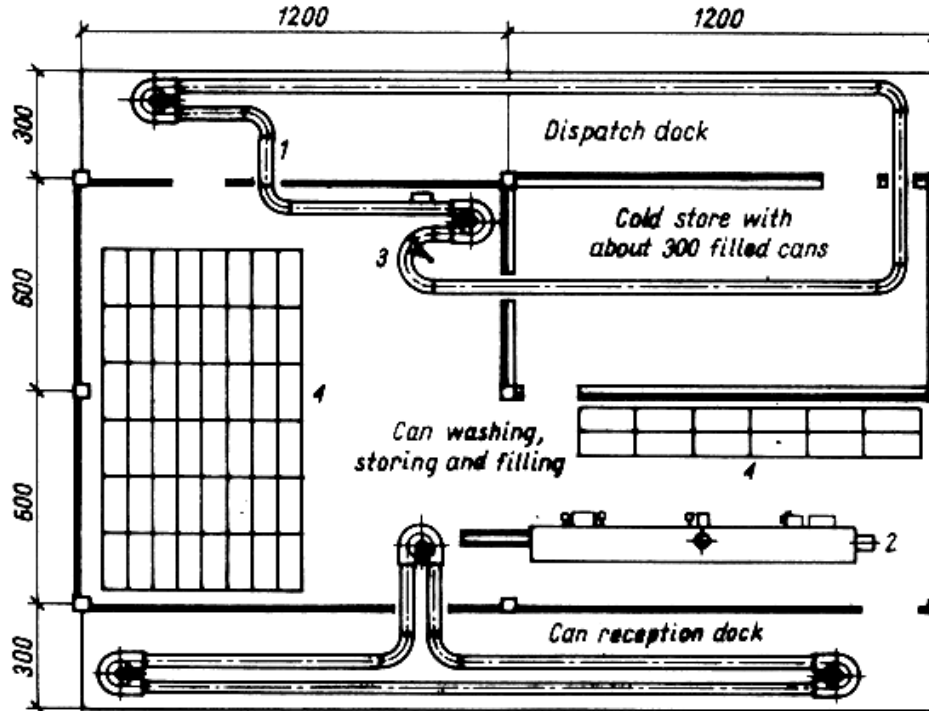

Fig. 24 Layout for packaging and storage 50 000 litres/day of pasteurized milk in

40 litre cans

1. Mechanical can conveyor; 2. Can washer; 3. Can filler; 4. Trolleys with washed empty cans

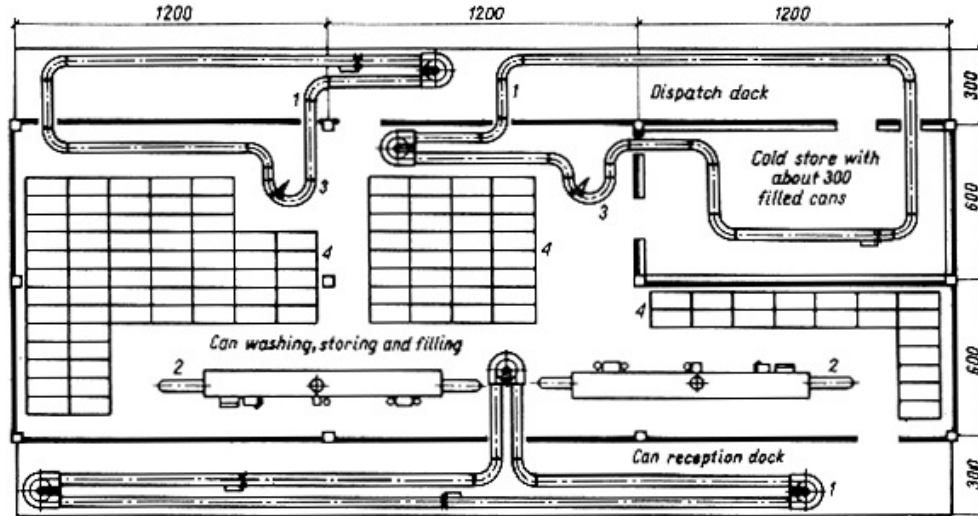

Fig. 25 Layout for packaging and storage 100 000 litres/day of pasteurized milk in 40 litre cans

1. Mechanical can conveyor; 2. Can washer; 3. Can filler; 4. Trolleys with washed empty cans

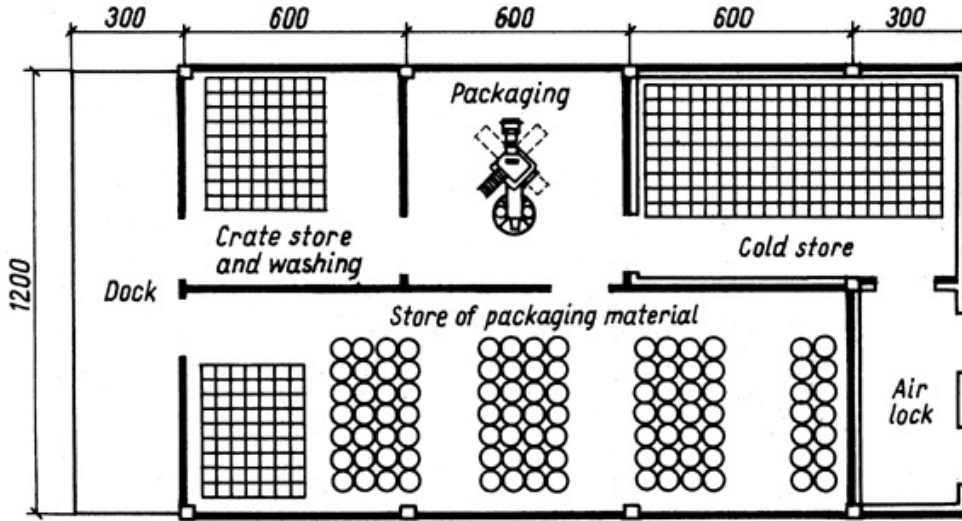
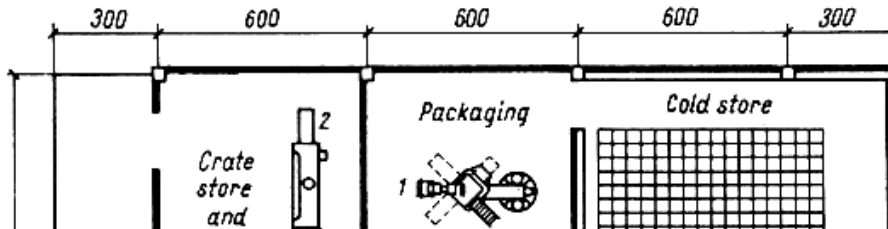

Fig. 26 Layout for packaging and storage 10 000 litres/day of pasteurized milk in 1/2 litre tetrahedral cartons in returnable crates



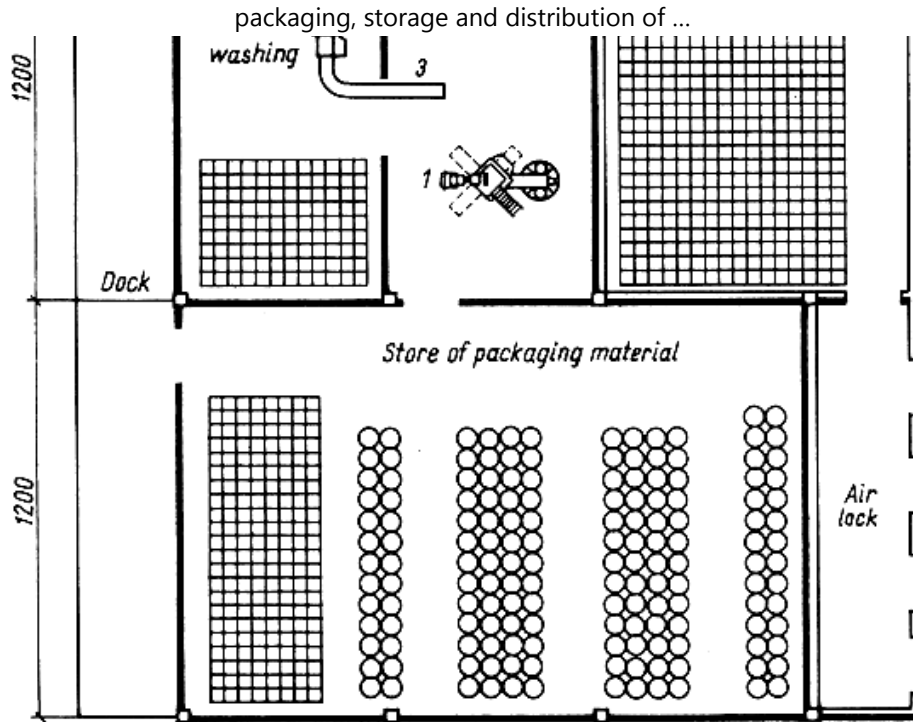
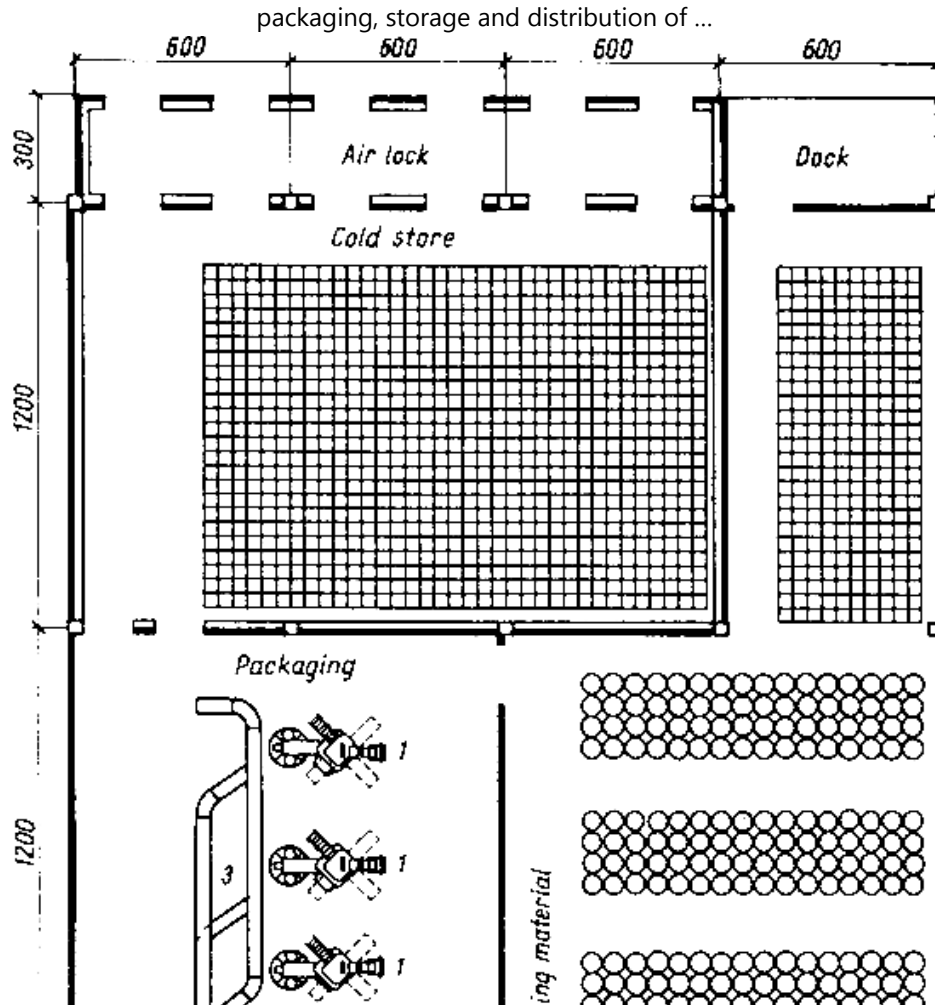

Fig. 27 Layout for packaging and storage 25 000 litres/day of pasteurized milk in 1/2 litre tetrahedral cartons in returnable crates
1. Packaging machines; 2. Crate washer; 3. Crate conveyor



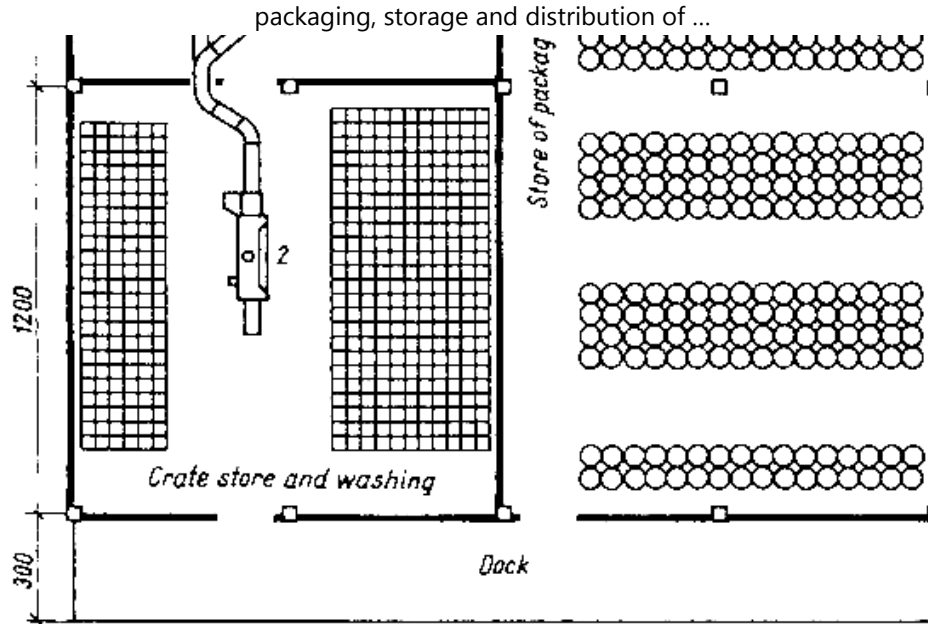
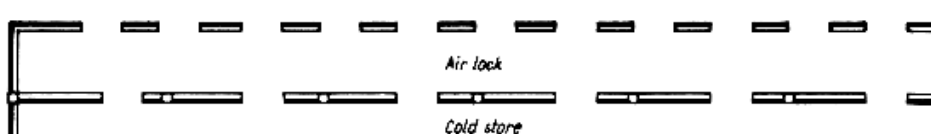
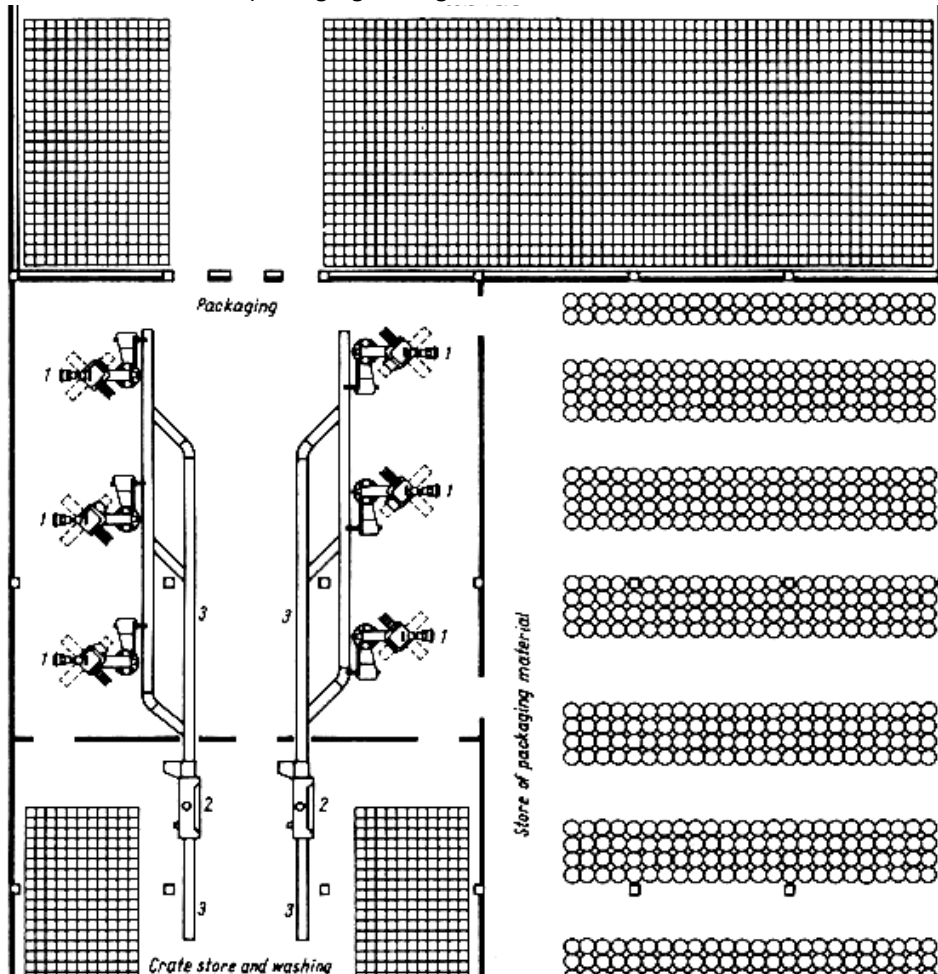

Fig. 28 Layout for packaging and storage 50 000 litres/day of pasteurized milk in 1/2 litre tetrahedral cartons in returnable crates

1. Packaging machines; 2. Crates washer; 3. Crate conveyor





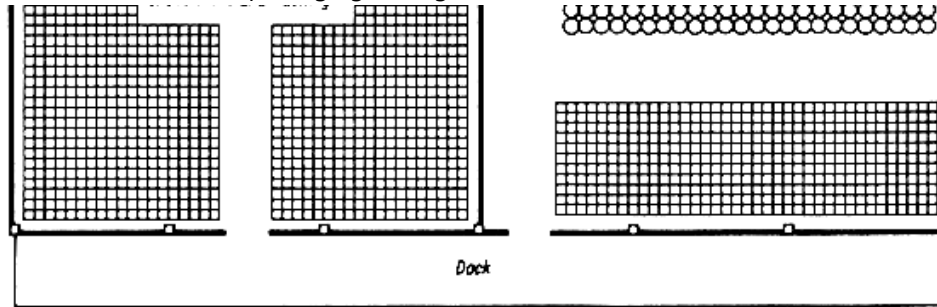

Fig. 29 Layout for packaging and storage 100 000 litre/day of pasteurized milk in 1/2 litre tetrahedral cartons in returnable crates

1. Packaging machines; 2. Crates washer; 3. Crate conveyor

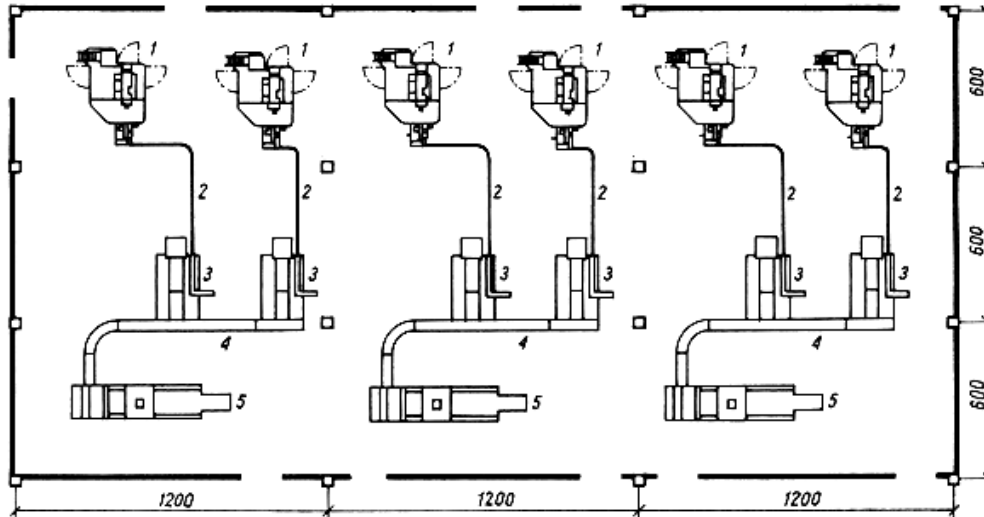

Fig. 30 Example of layout for machinery room for aseptic packaging 100 000 litres/day of UHT milk in 1/2 litre single-service rectangular cartons in non-returnable wraps

- 1. Packaging machines; 2. Package conveyor; 3. Collating and packing on trays; 4. Conveyor; 5. Shrink wrapping**

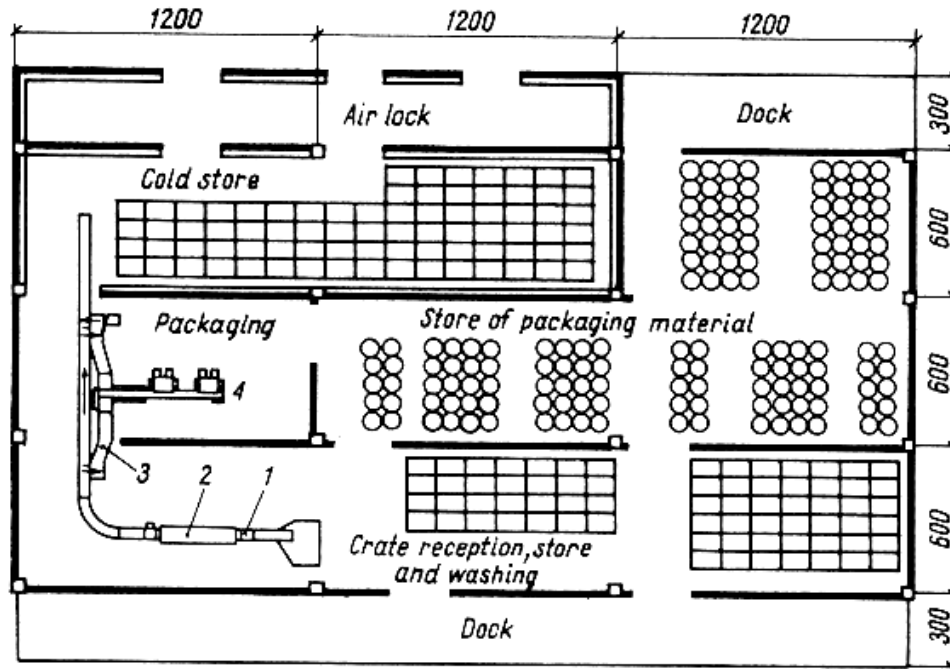

Fig. 31 Layout for packaging and storage 50 000 litres/day of pasteurized milk in 1/2 litre plastic sachets in returnable crates

1. Crate conveyor; 2. Crate washer; 3. Crate filling; 4. Packaging machine

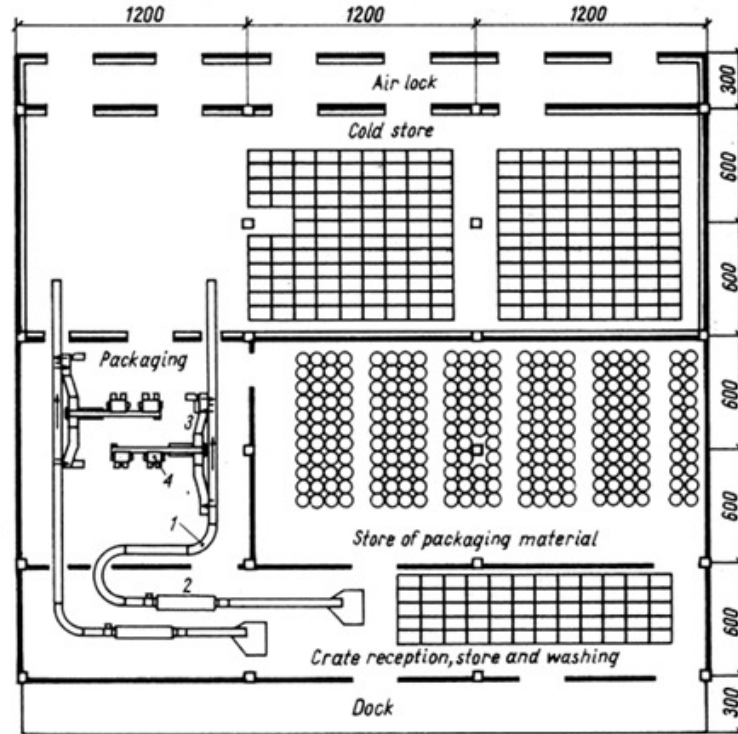
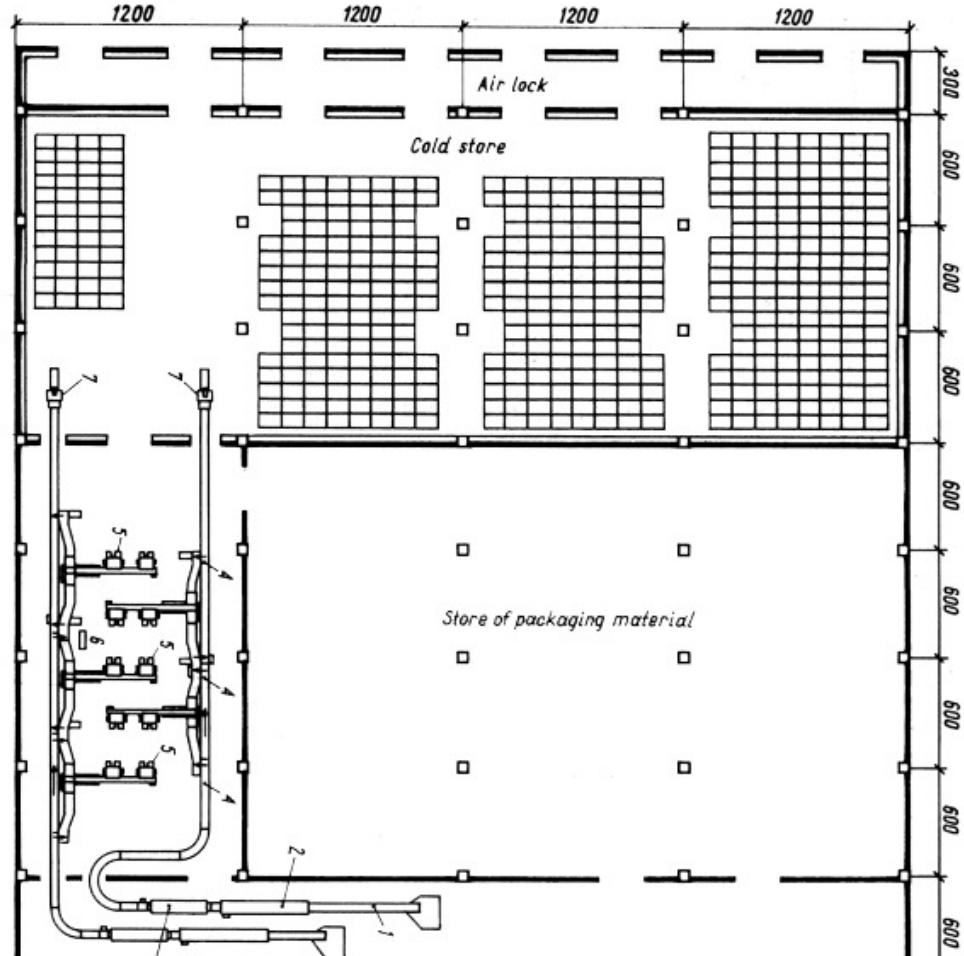

Fig. 32 Layout for packaging and storage 100 000 litres/day of pasteurized milk in 1/2 litre plastic sachets in returnable crates

1. Crate conveyor; 2. Crate washer; 3. Crate filling; 4. Packaging machine



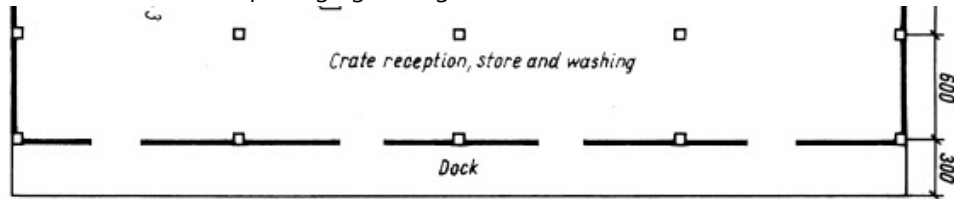
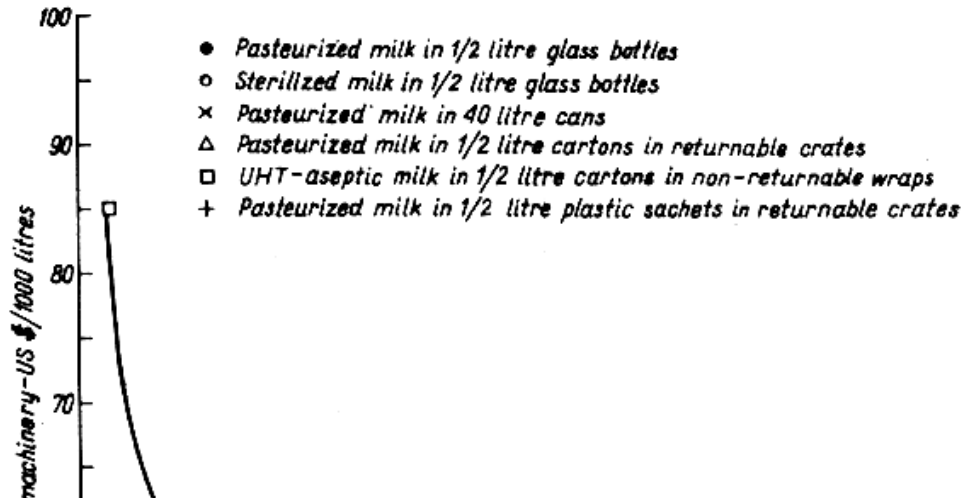

Fig. 33 Layout for packaging and storage 250 000 litres/day of pasteurized milk in 1/2 litre plastic sachets in returnable crates

1. Crate conveyor; 2. Unstacker; 3. Crate washer; 4. Crate filling; 5. Packaging machines; 6. Control panel; 7. Restacker



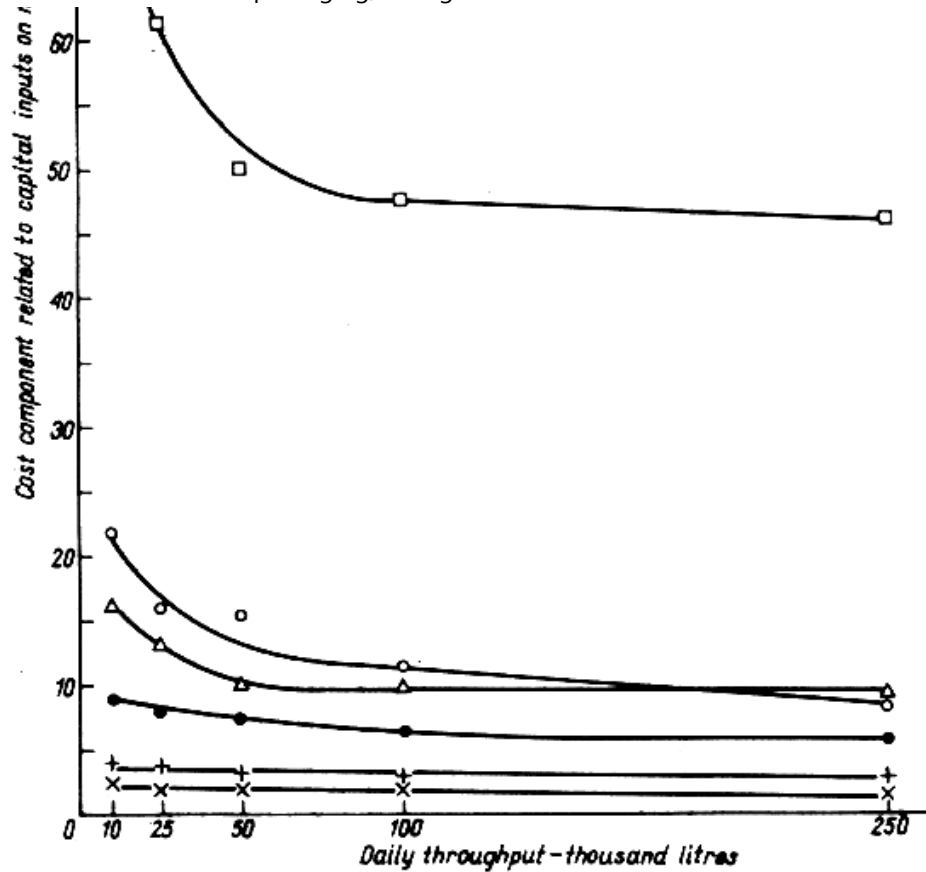
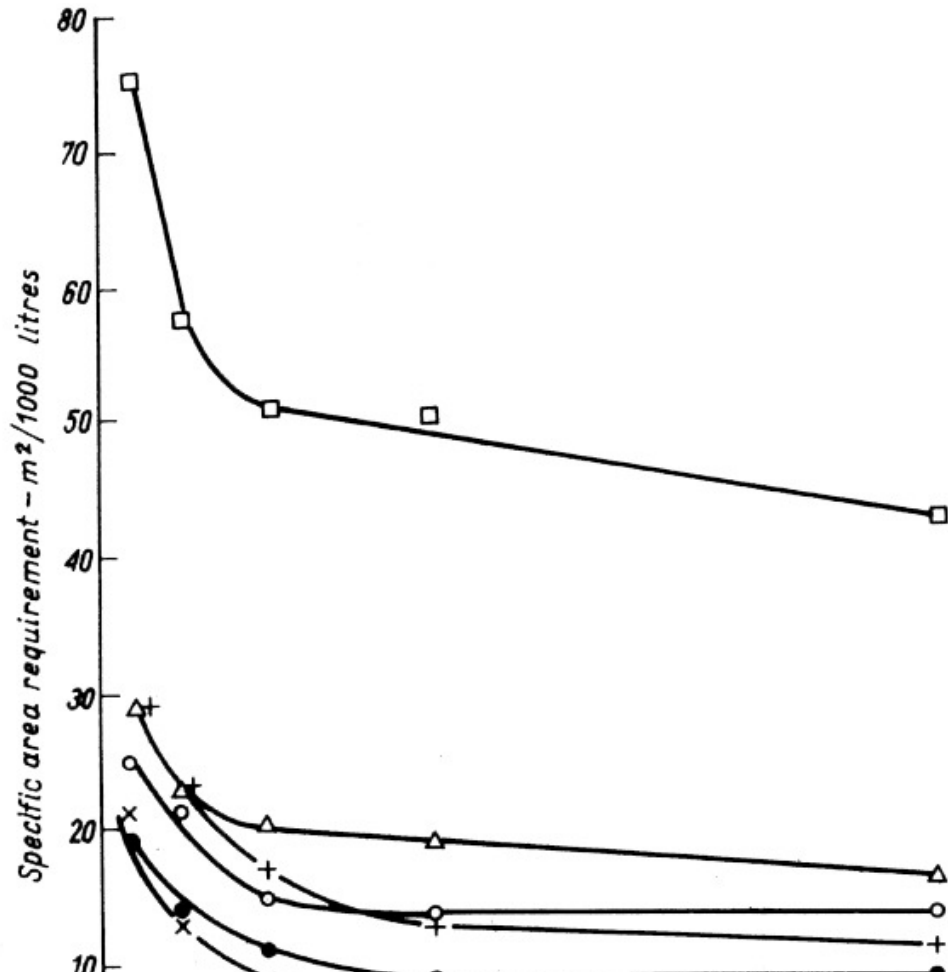

Fig. 34 Estimates of cost components related to inputs on machinery



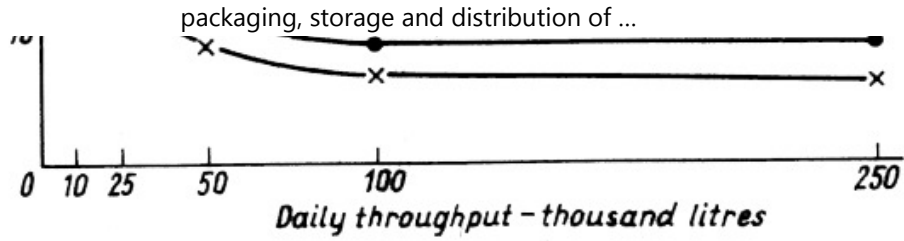

Fig. 35 Specific area requirements

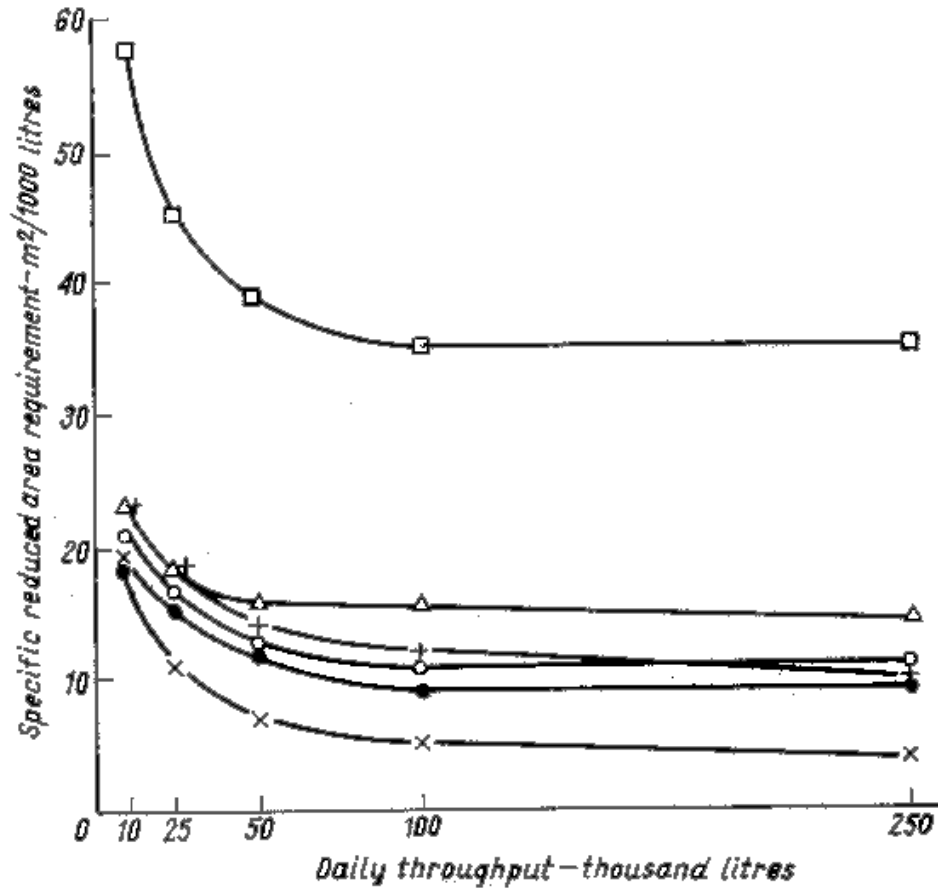

Fig. 36 Specific reduced area requirements

Chapter 4 SERVICES

The consumption of services at full utilization of machine capacities and the effective operating time including pre-running and post-running periods are the major factors affecting the quantities of services required. In addition, the number of cleaning periods per working day and the relation between processing and dispatch times also have an impact on services consumption.

In order to arrive at comparable estimates a simplified model was adopted, according to which the requirements of services except refrigeration (steam, air, water, electricity) are presented by the equations:

$$Q = Q_n (t_f + 2) + Q_n \frac{16 - (t_f + 2)}{2} = Q_n \frac{t_f + 18}{2} \quad \dots (1)$$

$$t_f = \frac{C_d}{C_m} \quad \dots (2)$$

$$Q_{sp} = \frac{Q_n (t_f + 18)}{2 C_d} \quad \dots (3)$$

where **Q** is the total daily quantity of the service concerned

Q_n is the service capacity (consumption per hour) required for full machine throughput (manufacturer's data)

C_d is the daily quantity of liquid milk packaged in thousand litres

C_m is the capacity of installed machinery in thousand litres per hour

t_f is the theoretically required full working time of the machines

Q_{sp} is the specific quantity of a particular service per thousand litres of milk

In equation (1) two hours of full services requirements has been added to the value of t_f for cleaning and sanitation. The second component of this equation covers the assumption that during the period equivalent to the difference between two full shifts (16 hours) and the value of $(t_f + 2)$, the rate of consumption of services is reduced to 50%.*

*** In plants where the value of t_f is short, i.e. about five hours, equation (3) takes**

the form

$$Q_{sp} = \frac{Q_n (t_f + 10)}{2 C_d}$$

Water requirements for steam generation and air supplies have not been included in the estimate since they are negligible. For the refrigeration plant water requirement has been estimated at 250 litres per 1 000 kcal. The term ‘water requirement’ is used in this study as the amount needed to operate the machines, regardless of whether it is recirculated or not. In this respect ‘water requirement’ is different from ‘water consumption’, the latter meaning basically the amount extracted from wells or other sources of supply.

Refrigeration requirements have been estimated as equivalent to 1 200 kcal/m² day of the total cold stores and air-locks area. This calculation is based on the assumption that the temperature of the product should be maintained during storage, but that the product does not require to be chilled during the short time

is normally remains in the store. For refrigeration, the value of Q was obtained by multiplying the cold store and air-lock areas by the coefficient $1\ 200\ \text{kcal/m}^2\ \text{day}$, Q_n being one twenty-fourth of Q .

The electricity consumption has been estimated separately for (a) machines installed for liquid milk packaging, (b) steam raising plant, (c) air supply, (d) refrigeration and (e) water supply. For packaging the installed power was taken as the Q_n value; for the steam raising plant the electricity consumption was estimated at $0.5\ \text{kWh}/100\ \text{kg}$ of steam produced, and for the air supply a constant coefficient of $4\ \text{kWh}/100\ \text{m}^3$ free air has been used. The electric power requirements for refrigeration and water supply change according to the installed capacities on which the respective Q_n values depend. To take this into account the Q_n values of electric power requirements have been calculated using the load/capacity curves given in Fig. 37 and 38. (For the purpose of this study it was also assumed that water is supplied from a well by a pump of suitable capacity and 35 m total head).

The services consumption for the automatic bulk vending system (see Chapter 7) for filling and in-place cleaning (CIP) of tankers is negligible and has not been included in this calculation. Table 9 gives the nominal capacity of services required (Q_n) for the various packaging systems and plant throughputs analysed.

Table 10 gives the corresponding figures for the quantity of each service per 1 000 litres of milk. The data estimated should be considered as approximations, particularly because with the method of calculation used the services requirements for CIP become proportional to the throughput of milk packaged. This would not be the case in practice where the services required per 1 000 litres of milk diminish with increasing plant throughput. The data given in Tables 9 and 10 are plotted graphically in Figs 39–44.

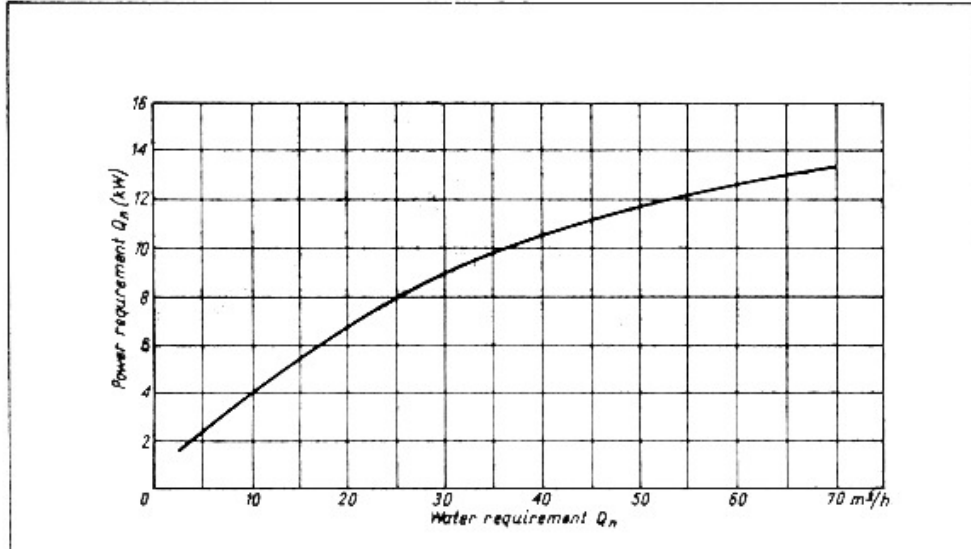
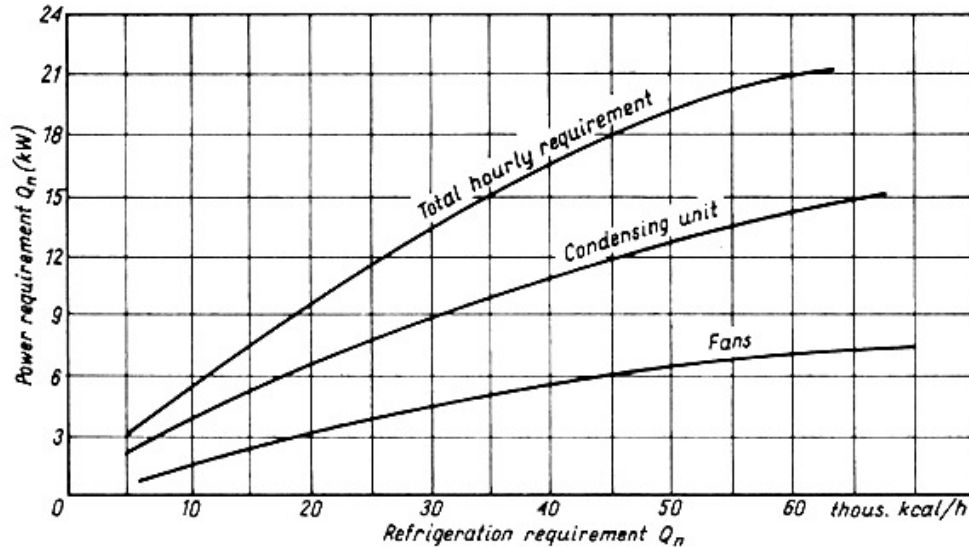

Fig. 37 Nominal power requirement for water supply**Fig. 38 Nominal power requirement for refrigeration****Table 9 Capacity of services required (Q_n)**

	GLASS BOTTLES - 1/2 LITRE	MILK CANS - 40 LITRES
--	----------------------------------	------------------------------

RETURNABLE CONTAINERS	Pasteurized					Sterilized					Pasteurized				
Plant throughput 000 1/day	10	25	50	100	250	10	25	50	100	250	10	25	50	100	250
Steam Kg/h	200	300	550	1700	2500	500	800	1500	3000	5800	180	180	225	450	1020
Refrigeration thou. kcal/h	4.5	9.1	13.3	21.7	43.3	-	-	-	-	-	4.1	5.4	7.1	10.8	21.6
Water (packaging & refrig) m ³ /h	2.2	5.8	10.2	21.0	38.4	4.3	5.8	12.0	25.6	53.0	2.0	3.0	3.2	5.5	11.7
Air free air m ³ h	-	-	-	-	400	-	-	-	-	400	-	-	-	-	-
Power KW	15	24	42	65	126	51	61	113	223	457	16	19	24	39	100

of which for:															
Processing	9	14	28	42	70	46	54	100	200	400	11	13	17	29	80
"															
Steam raising	1	2	3	6	13	3	4	8	15	29	1	1	1	2	5
"															
Refrigeration	4	6	7	10	17	-	-	-	-	-	3	4	5	6	10
"															
Water	1	2	4	7	10	2	3	5	8	12	1	1	1	2	5
"															
Air	-	-	-	-	16	-	-	-	-	16	-	-	-	-	-
"															

<u>SINGLE-SERVICE CONTAINERS</u>	CARTONS -1/2 LITRE								PLASTIC SACHETS - 1/2 LITRE						
	Pasteurized in returnable crates				UHT-aseptic in non-returnable wraps				Pasteurized in returnable crates						
Plant															

throughput 000 1/day	10	25	50	100	250	10	25	50	100	250	10	25	50	100	250
Steam kg/h	-	60	60	120	240	270	600	1100	2000	4200	-	60	60	120	240
Refrigeration thou.kcal/h	5.4	10.8	16.2	22.5	56.6	-	-	-	-	-	5.4	10.8	16.2	27.0	50.4
Water (packaging & refrig.) m ³ /h	1.5	2.8	4.2	5.8	14.4	0.8	1.6	2.4	4.8	11.2	1.6	3.0	4.6	7.8	14.1
Air free air m ³ /h	15	30	45	90	250	70	120	190	370	860	40	80	160	320	800
Power KW	10	20	27	46	112	51	109	164	327	760	11	20	29	55	108
of which for:															
Processing "	4	12	15	29	74	46	100	150	300	700	4	10	14	27	51
Steam raising "	-	-	-	-	1	1	3	6	10	21	-	-	-	-	-
Refrigeration "	4	6	8	10	21	-	-	-	-	-	4	6	8	11	19
Water															

"	1	1	2	3	6	1	1	1	2	5	1	1	2	4	6
Air	1	1	2	4	10	3	5	7	15	34	2	3	5	13	32
"															

Table 10 Specific consumption of services per 1000 litres of milk packages (Q_{sp})

<u>RETURNABLE CONTAINERS</u>	GLASS BOTTLES - 1/2 LITRE										MILK CANS - 40 LITRES				
	Pasteurized					Sterilized					Pasteurized				
Plant throughput 000 1/day	10	25	50	100	250	10	25	50	100	250	10	25	50	100	250
Steam kg	150	162	149	148	135	400	400	390	395	325	60	47	27	27	26
Refrigeration thou. kcal	11	9	6	5	4	-	-	-	-	-	10	5	3	3	2
Water (packaging & refrig.) m ³	3.1	2.9	2.8	2.8	2.1	3.2	3.2	3.4	3.3	3.0	1.6	0.7	0.4	0.3	0.3
Air free air m ³	-	-	-	-	23	-	-	-	-	23	-	-	-	-	-

Electricity kWh	25	15	12	10	8	37	32	29	29	26	15	8	4	3	3
of which for:															
Refrigeration "	10	6	3	2	2	-	-	-	-	-	7	4	2	1	1
All other machines "	15	9	9	8	6	37	32	29	29	26	8	4	2	2	2

<u>SINGLE-SERVICE CONTAINERS</u>	CARTONS -1/2 LITRE										PLASTIC SACHETS - 1/2 LITRE				
	Pasteurized int returnable crates					UHT-aseptic in non- returnable wraps					Pasteurized in returnable crates				
Plant throughput, 000 1/day	10	25	50	100	250	10	25	50	100	250	10	25	50	100	250
Steam kg	40*	30	17	17	14	324	312	297	270	235	30*	18	17	17	5
Refrigeration thou. kcal	13	10	8	5	5	-	-	-	-	-	13	10	8	7	5
Water (packaging & refrig.) m ³	1.9	1.4	1.1	0.8	0.8	1.0	0.8	0.7	0.7	0.6	2.1	1.6	1.3	1.1	0.8

Air free air m ³	19	16	12	12	14	78	65	53	50	48	52	45	45	45	45
Electricity kWh	17	13	9	8	7	61	49	46	46	43	19	14	11	9	7
of which for:															
Refrigeration "	10	6	4	3	2	-	-	-	-	-	10	6	3	3	2
All other machines "	7	7	5	5	5	61	49	46	46	43	9	8	8	6	5
* Estimates not derived from equations															

- ***Pasteurized milk in glass bottles***
- o ***Sterilized milk in glass bottles***
- × ***Pasteurized milk in cans***
- △ ***Pasteurized milk in tetrahedral cartons in returnable crates***
- ***UHT - aseptic milk in rectangular cartons in non-returnable wraps***
- + ***Pasteurized milk in plastic sachets in returnable crates***

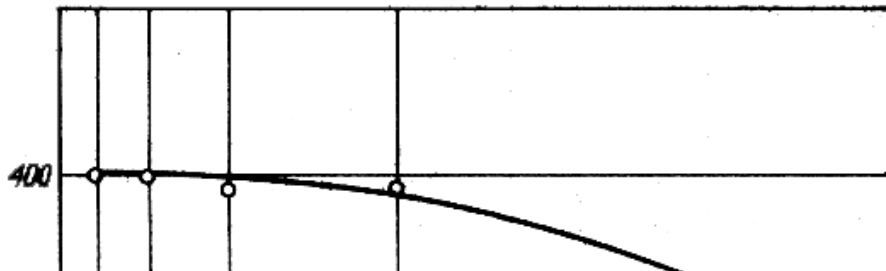

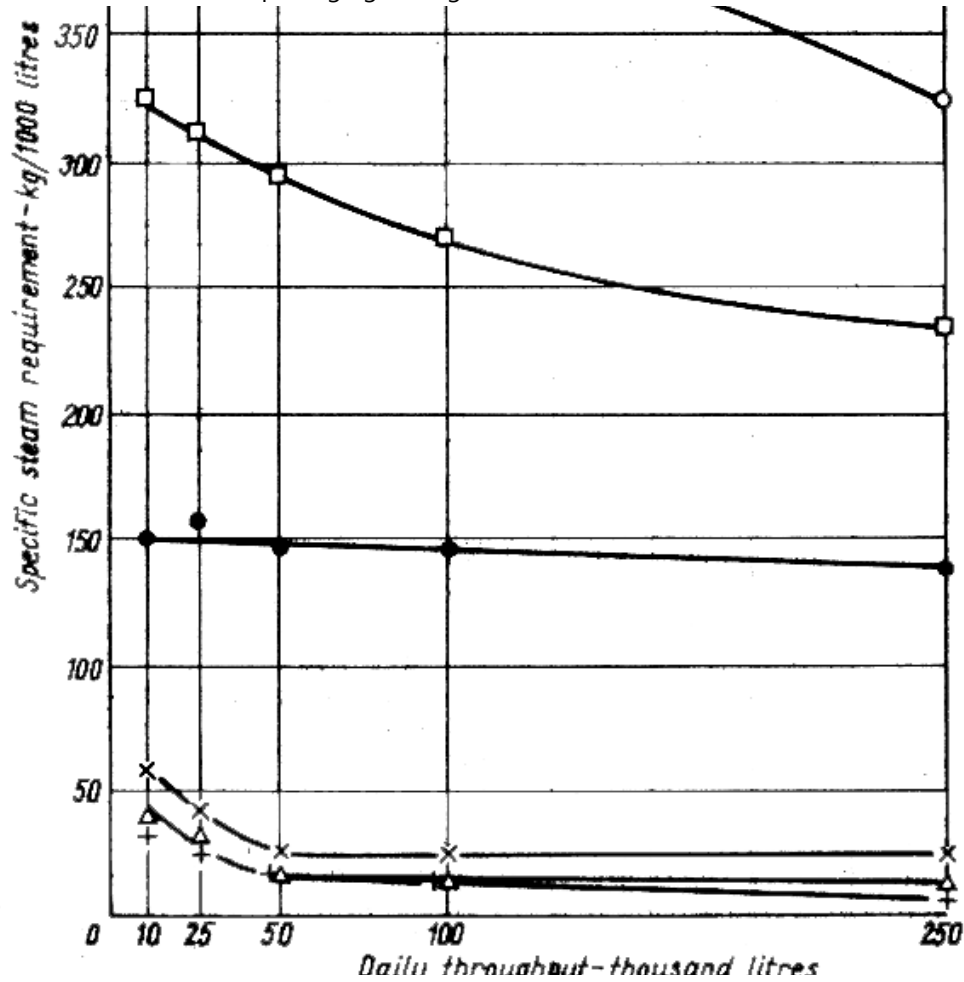
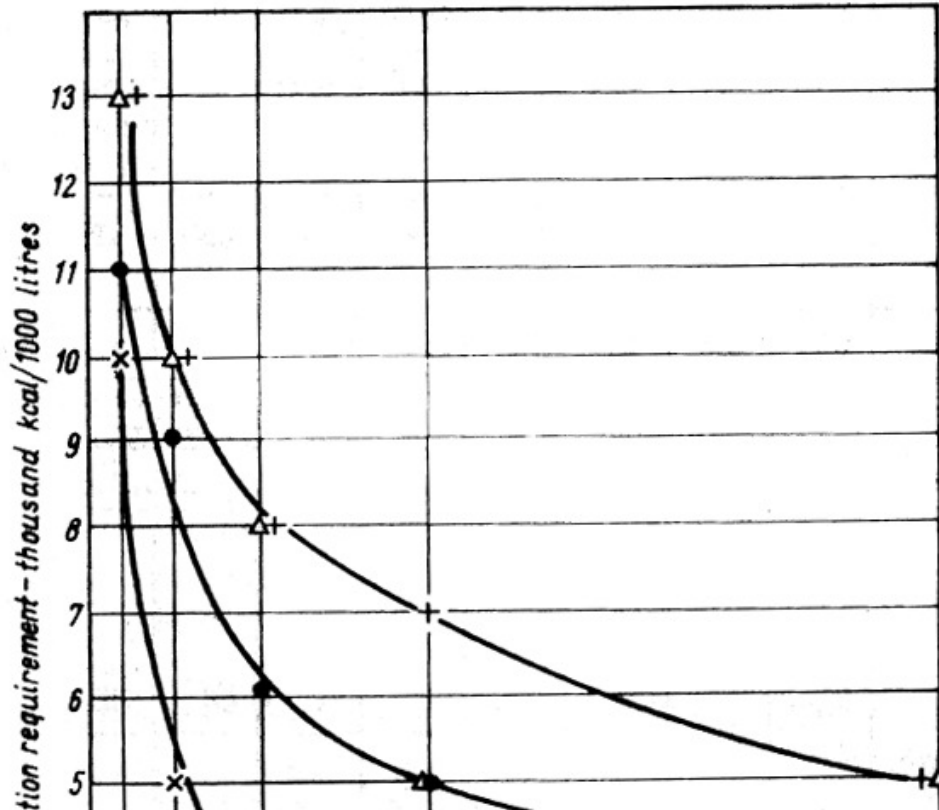

Fig. 39 Specific steam requirements



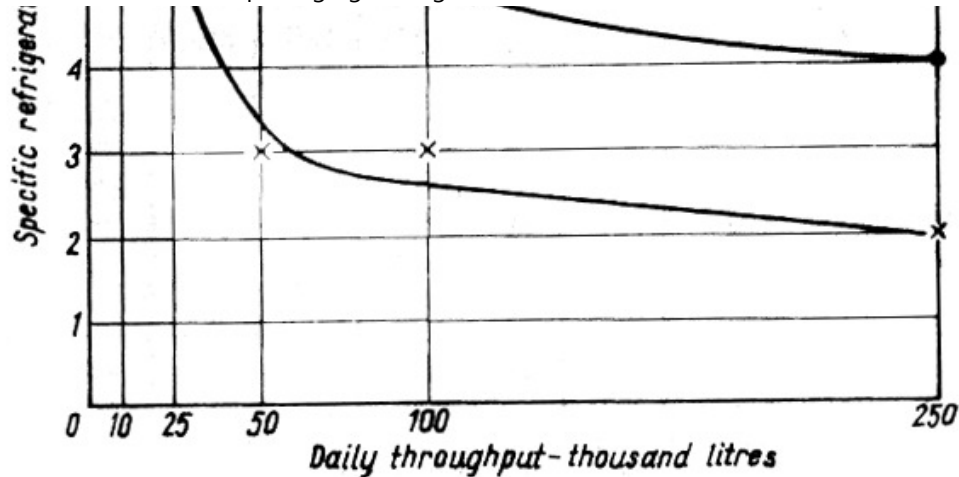
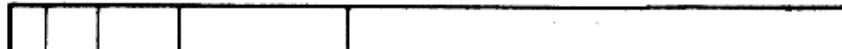
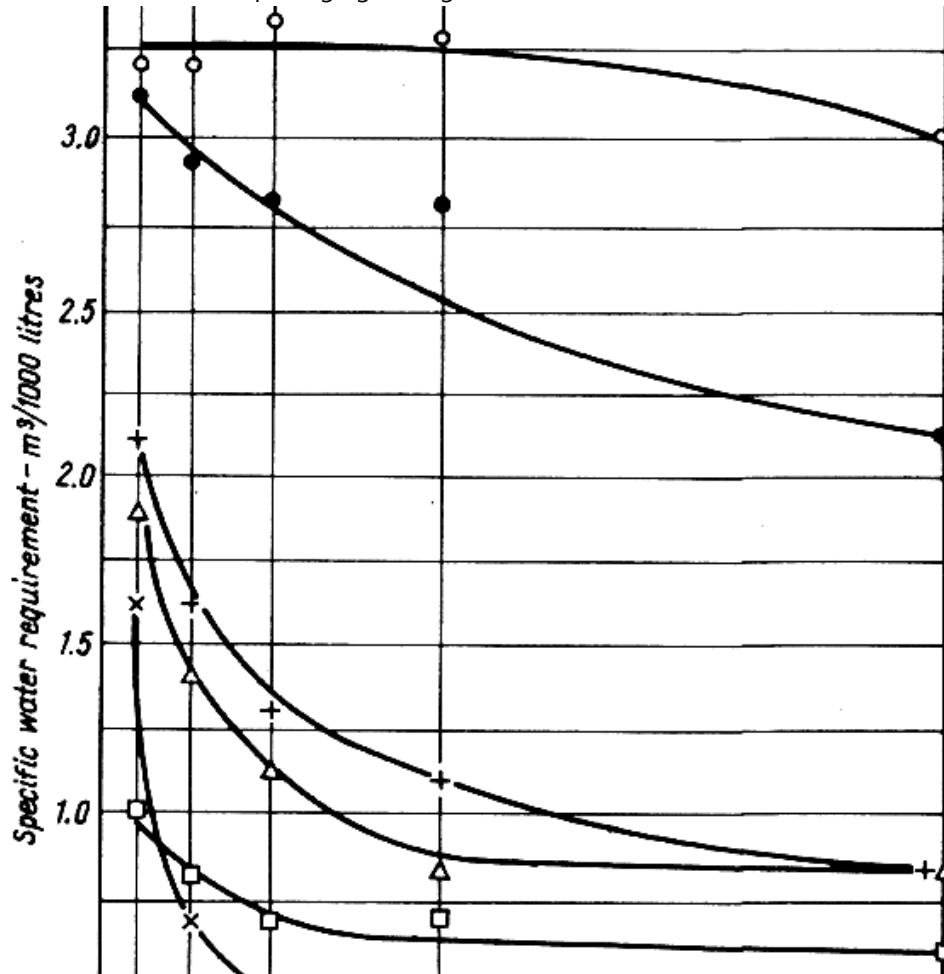

Fig. 40 Specific refrigeration requirements

- *Pasteurized milk in glass bottles*
- o *Sterilized milk in glass bottles*
- × *Pasteurized milk in cans*
- △ *Pasteurized milk in tetrahedral cartons in returnable crates*
- *UHT - aseptic milk in rectangular cartons in non-returnable wraps*
- + *Pasteurized milk in plastic sachets in returnable crates*





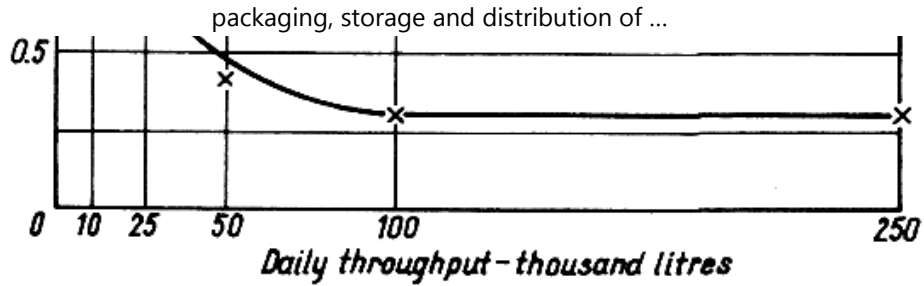
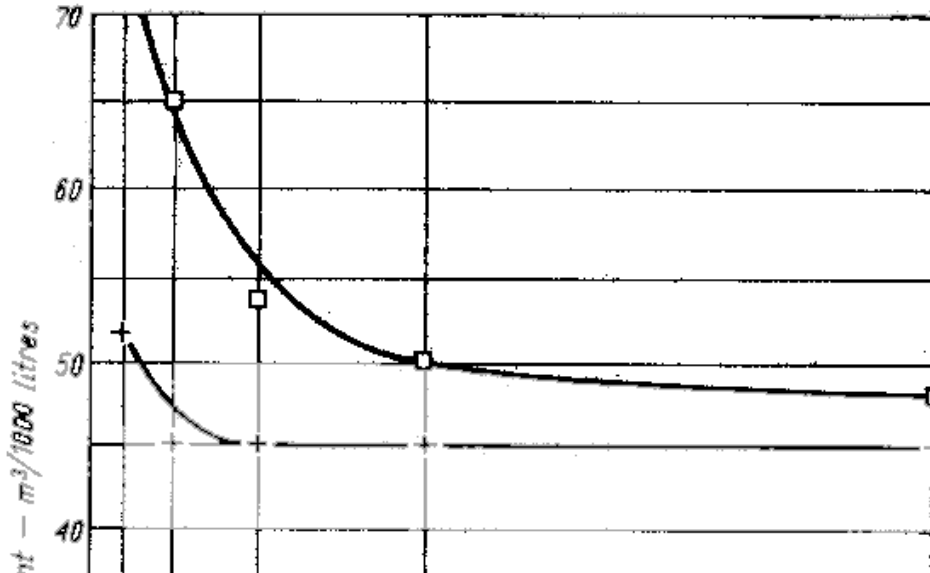

Fig. 41 Specific water requirements



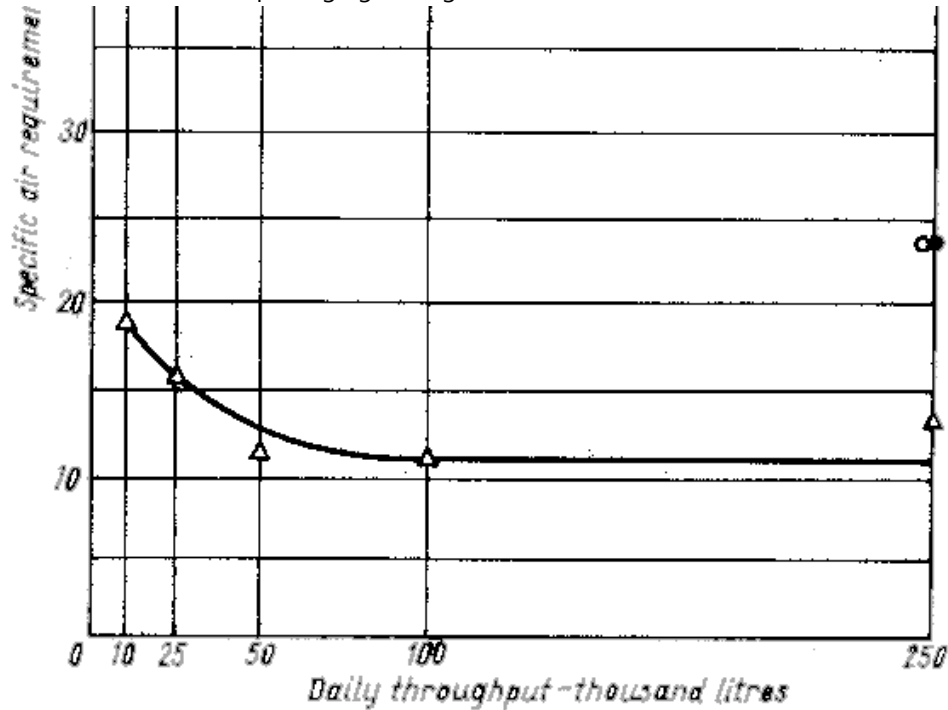
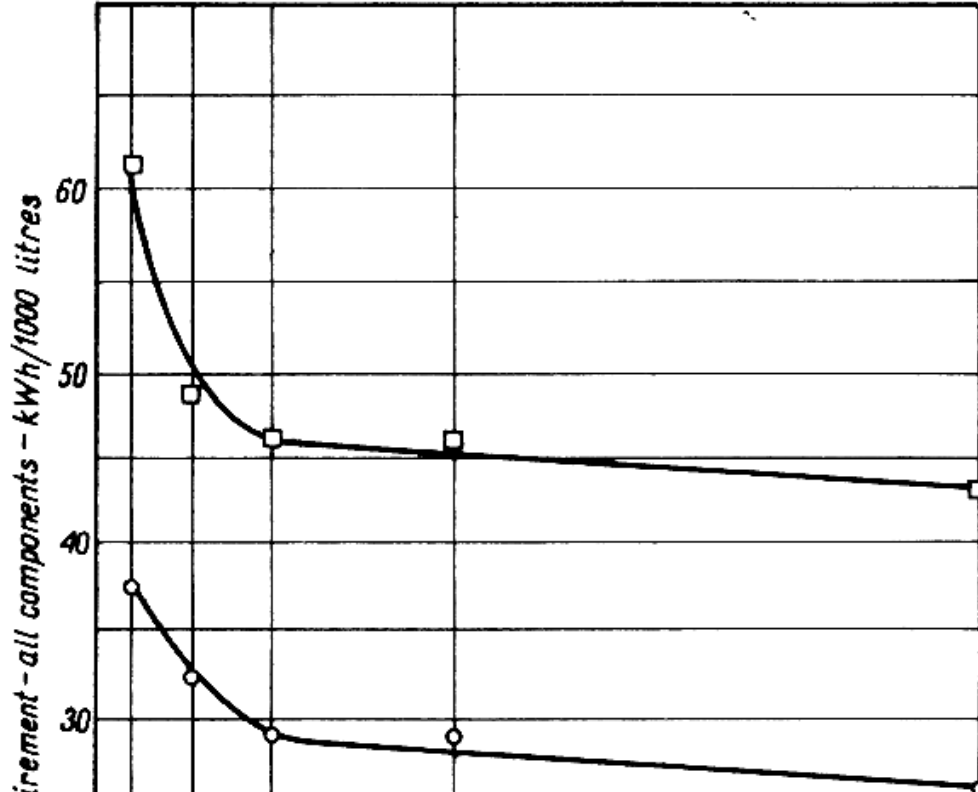

Fig. 42 Specific air requirements

- ***Pasteurized milk in glass bottles***
- o ***Sterilized milk in glass bottles***
- x ***Pasteurized milk in cans***

- △ **Pasteurized milk in tetrahedral cartons in returnable crates**
- **UHT - aseptic milk in rectangular cartons in non-returnable wraps**
- + **Pasteurized milk in plastic sachets in returnable crates**



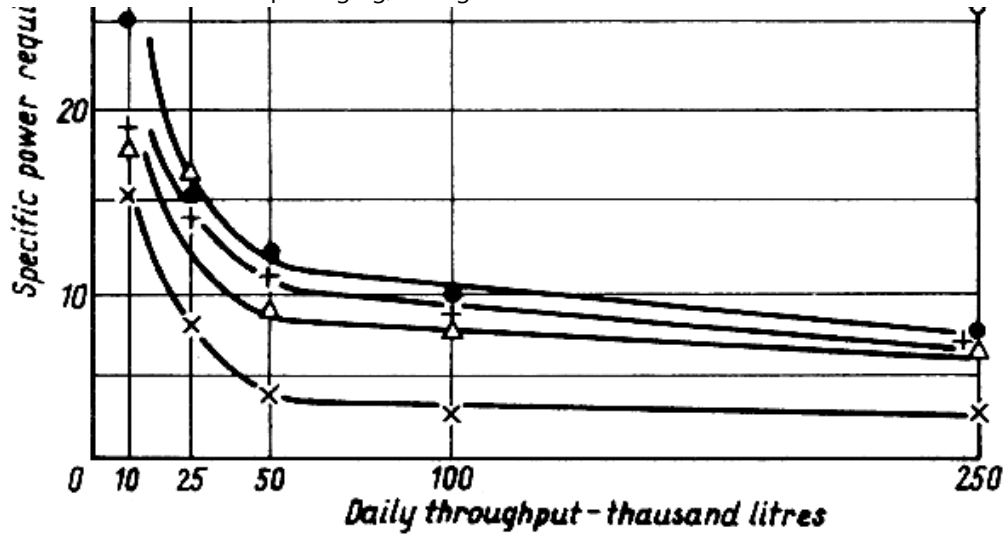
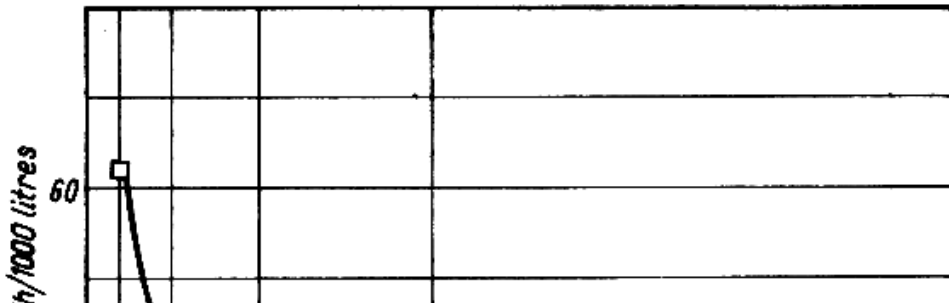

Fig. 43 Specific power requirements - all components



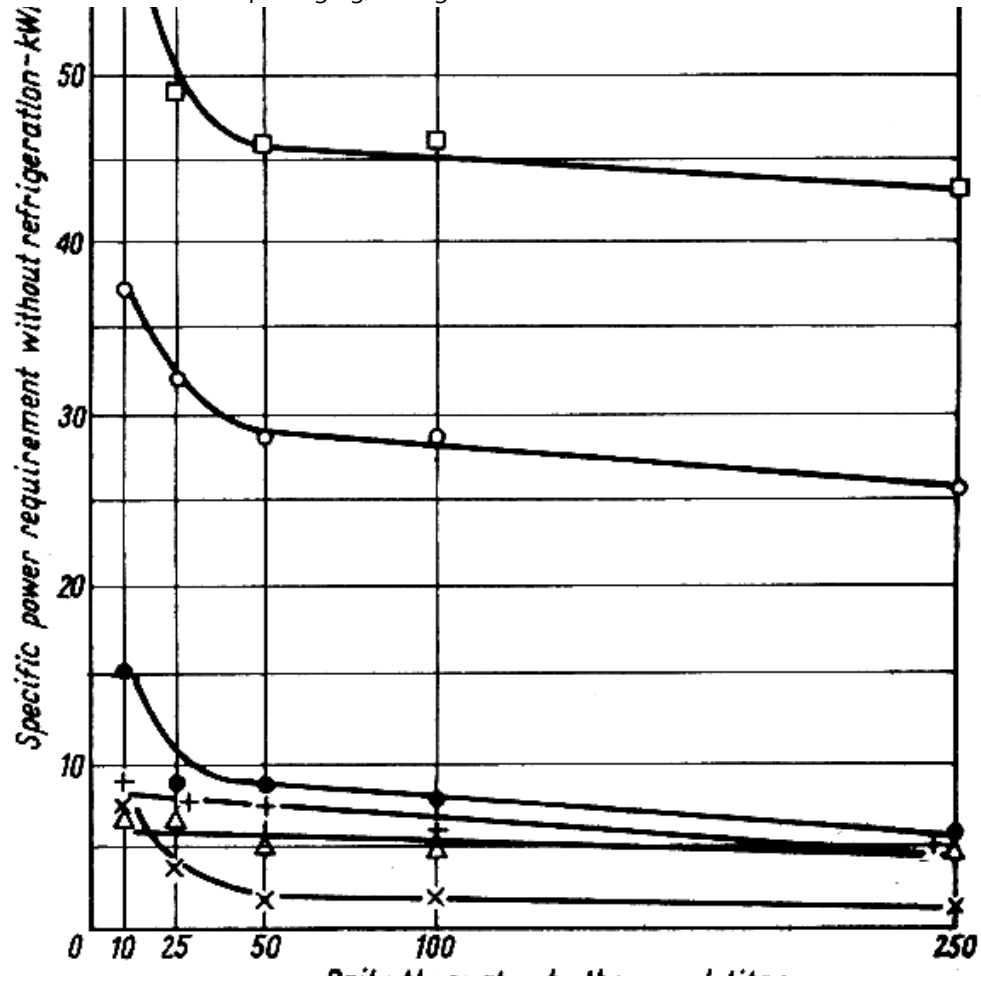

Fig. 44 Specific power requirements - excluding refrigeration

Chapter 5 DIRECT LABOUR

The throughput of the plant, the kind of equipment installed, the organization of work, the efficiency of its execution and, finally, the discipline of the staff are factors affecting the amount of labour required for packaging liquid milk. An attempt has been made to choose uniform levels of organization and efficiency in order to arrive at comparable data. Those chosen are not necessarily the most effective as allowance has been made to take account of the difficulties in obtaining the required skills at both managerial and professional levels in developing countries. On the other hand overmanning caused by general unemployment in an area has been excluded.

Table 11 shows the incidence of labour requirements for liquid milk packaging

which, for this purpose, is divided into seven sections.

Table 11 Incidence of labour requirements for packaging

	Returnable containers		Single-Service Containers				Bulk Vending Machines
	Glass Bottles		Cans	Cartons		Plastic Sachets	
	Pasteur.	Steriliz.	Pasteur.	Pasteur.	UHT	Pasteur.	
1. Special Heat Treatment	0	+	0	0	+	0	0
2. Unloading of empties	+	+	+	+	0	+	0
3. Decrating/washing of empties	+	+	+	+	0	+	0
4. Filling	+	+	+	+	+	+	0
5. Crating/wrapping of filled containers	+	+	0	+	+	+	0
6. Product store operations	+	+	+	+	+	+	0
7. Product dispatch	+	+	+	+	+	+	+

0 - not applicable

+ - applicable

Note Operation 2 and 3 for pasteurized milk in cartons and sachets apply only to crates

Table 12 shows the total labour requirements expressed in man-hours per day and the specific labour requirements in man-hours per 1 000 litres. The figures have been calculated with the following assumptions:

- **The number of shifts in any section depends basically on the operation time of the packaging machines and the timing of transport.**
- **Except for some lower capacities, the majority of plants have a nominal operation time (t_f) for the packaging machines longer than five hours, i.e. a total working time longer than eight hours. Whenever t_f was longer than five, the full two-shift (16 hours) working time of this and of the dependent sections has been calculated.**
- **The number of posts is considered as the decisive factor in calculating the labour. Even in instances where only part-time employment was required for a post, a full shift (shifts) labour requirement has been calculated.**
- **For loading and unloading, the labour requirements shown exclude**

loading/unloading work on the platforms of the transport vehicles (see Chapter 6).

- **In cases where the same staff operates in two sections (as is the case for some systems with crating/wrapping of filled containers and adjacent store operations), the required labour was attributed in total to one section.**

The labour requirements shown in Table 12 appear rather high compared with what is achieved in milk plants in countries having a long tradition in industrialized dairying, but in developing countries many milk plants may find the figures low. However, they have been estimated as a compromise which, it is believed, affects uniformly the various milk packaging and distribution systems considered, thus permitting valid comparisons. The comparisons of specific labour requirements are presented graphically in Fig. 45.

Table 12 Direct labour requirement - man-hours

RETURNABLE CONTAINERS	GLASS BOTTLES - 1/2 LITRE					MILK CANS - 40 LITRES									
	Pasteurized					Sterilized					Pasteurized				
Plant throughput 000 1/day	10	25	50	100	250	10	25	50	100	250	10	25	50	100	250
Special heat															

treatment	-	-	-	-	-	16	32	48	48	96	-	-	-	-	-
Unloading of empties	16	24	80	128	192	32	48	80	128	192	16	16	16	32	64
Decrating, washing of empties	32	48	96	192	96	32	48	96	192	96	32	32	48	64	96
Filling	16	48	32	64	64	16	32	48	64	96	16	32	48	48	96
Crating	16	48	32	64	64	16	32	48	64	96	-	-	-	-	-
Product store operations	32	48	80	128	256	32	48	80	128	256	8	16	16	32	32
Product dispatch	32	48	64	128	320	32	32	64	128	320	16	24	32	64	128
Total man-hours per day	144	264	384	604	992	176	272	416	752	1152	88	120	160	240	416
Specific requirement man-hours/1000 1	14.4	10.6	7.7	6.0	4.0	17.6	10.7	8.3	7.5	4.6	8.8	4.8	3.2	2.4	1.7

<u>SINGLE-SERVICE CONTAINERS</u>	CARTONS -1/2 LITRE										PLASTIC SACHETS - 1/2 LITRE				
	Pasteurized in returnable crates					UHT-aseptic in non-returnable wraps					Pasteurized in returnable crates				
	10	25	50	100	250	10	25	50	100	250	10	25	50	100	250
Special heat treatment	-	-	-	-	-	16	32	32	32	32	-	-	-	-	-

Unloading of empties	16	32	48	64	128	-	-	-	-	-	16	32	48	64	128
Decrating, washing of empties	16	32	32	32	64	-	-	-	-	-	16	32	32	32	64
Filling	8	32	48	96	224	8	32	48	96	224	8	32	48	96	224
Crating, wrapping of filled containers	8	32	48	96	224						8	32	48	96	224
Product store operations	16	32	64	128	240	48	96	160	288	656	16	32	64	128	240
Product dispatch	16	32	48	64	128	16	24	32	48	80	16	32	48	64	128
Total man-hours per day	80	192	288	480	1008	88	184	272	464	992	80	192	288	480	1008
Specific requirement man - hours/1000 1	8.0	7.7	5.7	4.8	4.0	8.8	7.2	5.4	4.6	4.0	8.0	7.7	5.7	4.8	4.0

SALES THROUGH VENDING MACHINES

Product dispatch	16	32	48	64	120
Total man-hours per day	16	32	48	0.6	120
Specific requirement man - hours/1000 1	1.6	1.3	1.0	0.6	0.5

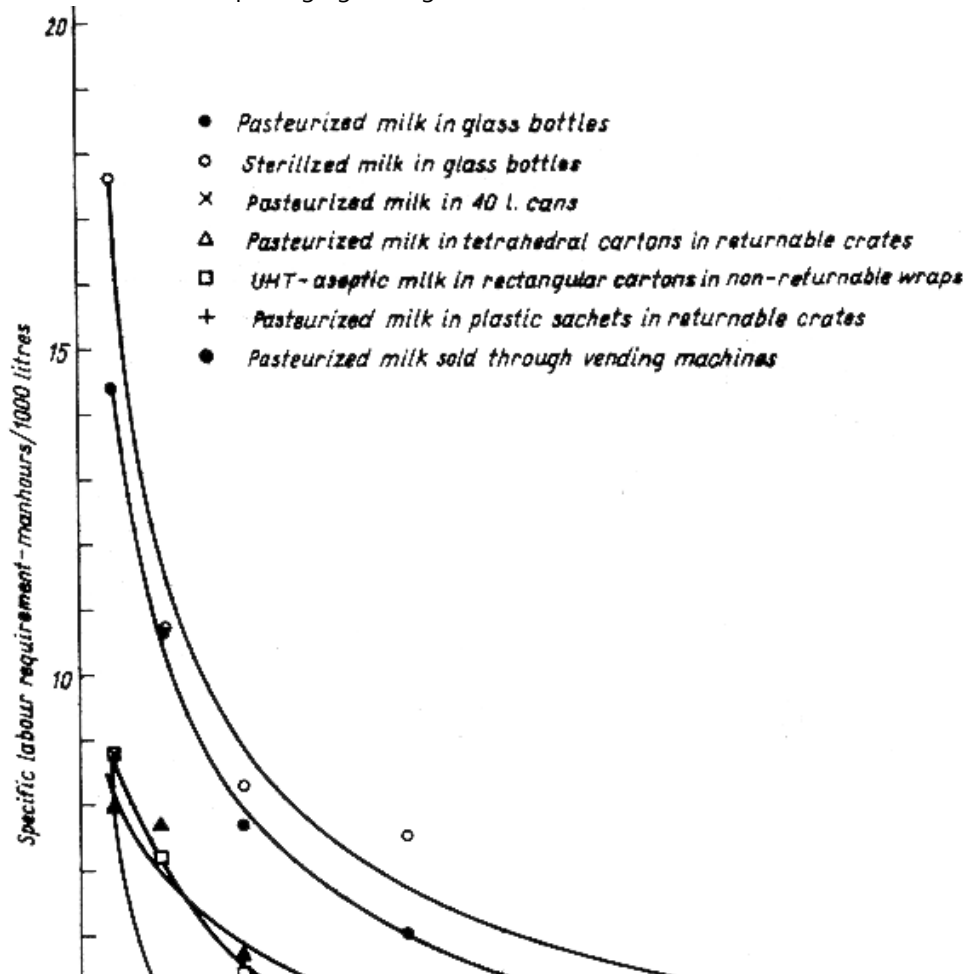

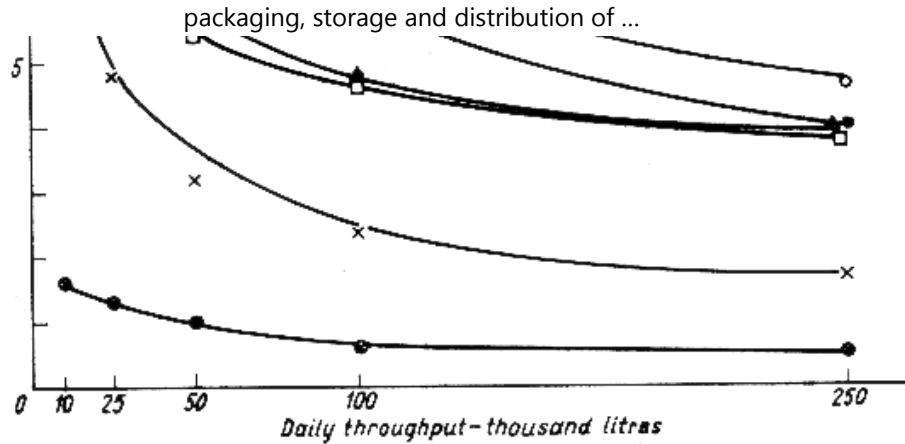

Fig. 45 Specific labour requirements



Chapter 6 TRANSPORT

The type of liquid milk distributed, the packaging system, the number and location

of retail centres, the distance between the retail centres and the plant or depots, and the type of vehicles are major factors affecting the techno-economics of transport. In some areas milk is sold only in the morning, in some twice a day and in some others - particularly where refrigeration is available or UHT or sterilized milk are popular - throughout the day. These purchasing habits of the consumers have also to be considered when assessing transport requirements.

In order to work out a comparative analysis of the techno-economics of transport of different types and quantities of liquid milk, simplified distribution models had to be designed. The analysis is made under these model conditions.

The topographic model of the area of distribution is shown in Fig.46. It is assumed that a daily production of 10 000 to 100 000 litres will be distributed within a square 10 km × 10 km and for 250 000 l/day the area to be served will be a square 20 km × 20 km. Focal points around which 1 000 l/day are sold are marked with a cross. They do not necessarily indicate the locations of retail shops, but rather represent the topographical designation of centres of milk sales areas. This implies the assumption that the additional distance which the milk delivery vans have to cover around the focal point in order to reach the actual retail shops is negligible as compared to the distance between focal points and the plant. The analysis of delivery vehicles routing has been done separately for each capacity and each milk packaging system. An example of this analysis is shown in Fig. 47.

The routing indicated for the transport is not necessarily the shortest. In a real area access to roads, density of traffic, local regulations, etc. will affect the selection of routes and will certainly deviate from the theoretically shortest. In the model presented, routings have been selected following a common pattern thus permitting comparisons between different systems and capacities. It was found that the quantity of milk distributed has little influence on specific distance expressed in km/1 000 litres. For practical calculations the specific distance may be considered as constants for each of the distribution systems.

Transport costs of UHT milk are affected by the fact that the expense of UHT treatment and aseptic packaging can only be justified for markets which require a shelf-life of the product of at least 2 months. Such markets include those where distribution involves very long distances or times, i.e. where the processing plant is at a long distance from the retailer. Transportation costs from the plant to a depot in the consumption centre could not be included in the calculations presented since no relative model conditions could be drafted. In this chapter distribution of UHT milk is to be considered as covering transport operations from a depot, instead of from a milk plant. Additional transport costs from plant to depot should be calculated separately according to local conditions.

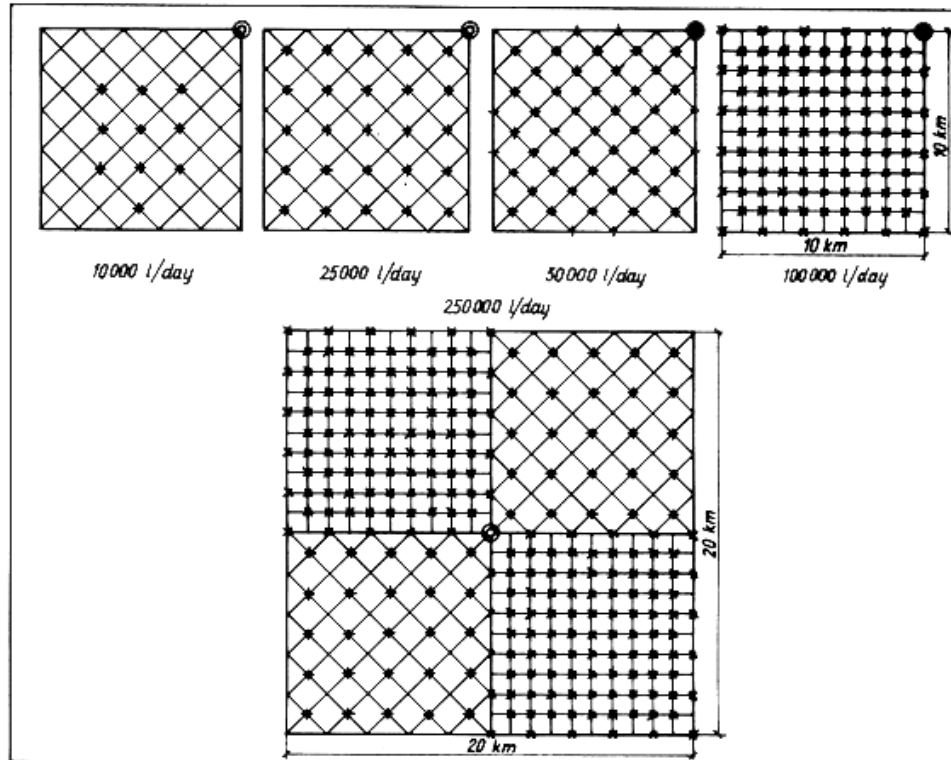

Fig. 46 Models of distribution areas (⊙ milk plant; + focal points of sales areas)

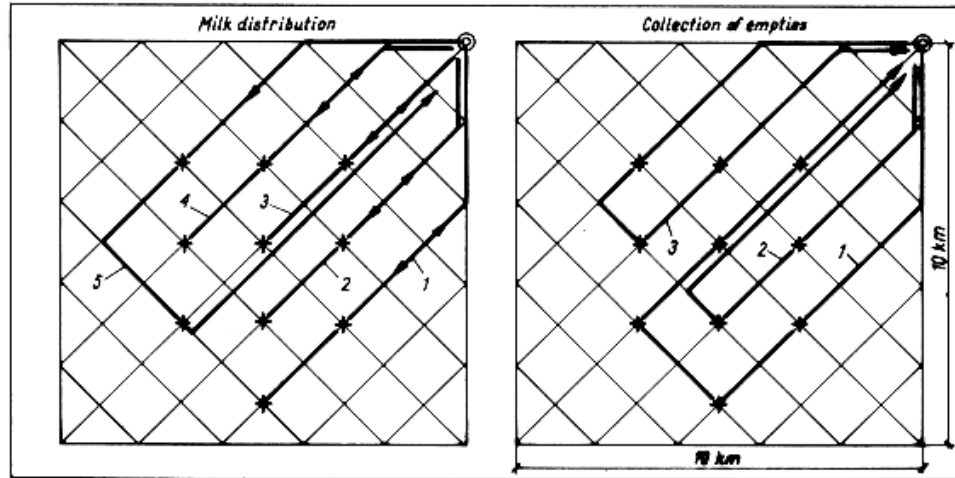

Fig. 47 Model distribution routes for 10 000 litres/day of pasteurized milk in 1/2 litre glass bottles

The type and capacity of milk distribution vehicles cannot be standardized beyond certain limits, since requirements are different for different systems. A prime-mover with a chassis of 5 t carrying capacity was selected as standard. On this standard chassis three types of body may be placed according to requirements:

- i. a closed uninsulated chamber for UHT and sterilized milk;**
- ii. a closed insulated chamber for all pasteurized milks, except for delivery to vending machines;**
- iii. an insulated milk tank for deliveries of pasteurized milk to vending machines.**

The milk-carrying capacity of the chassis was calculated excluding the weight of the appropriate body. It was also assumed that the required platform area may be chosen without affecting the costs of the chassis.

Standard timings of milk delivery to retail centres have been adopted as follows:

- i. Pasteurized milk to vending machines, UHT milk and sterilized milk are delivered during two 8-hour shifts, since the products can be kept safely in the retail centre.**
- ii. Pasteurized milk is delivered to retail centres within one 8-hour shift. Empty bottles and cans are collected during the second 8-hour shift.**
- iii. Empty sterilized milk bottles and crates and the crates for pasteurized milk in single-service containers are collected during delivery trips.**

No door-step delivery system was analysed in this study. Simultaneous

distribution of milk and collection of empties for pasteurized milk in bottles and cans is generally considered as impractical in conditions prevailing in developing countries as the lack of refrigeration necessitates sales during a short time and whole-day storage of uncollected empties at the retail centre is undesirable.

In order to arrive at comparative costs for the various packaging systems studied it is necessary first to identify a number of basic factors and to evaluate these for the model transport systems outlined above. These factors can be considered in groups.

Group 1 - Factors associated with the packaging system and the topography of the area

g1 - weight of containers (kg) per 1-ton load

g2 - weight of crates (kg) per 1-ton load

g3 - quantity of milk (litres) per 1-ton load

g4 - quantity of milk (litres) per 5-ton load

s1 - number of filled crates or trays in one stack on vehicle

s2 - number of empty crates or trays in one stack on vehicle

k1 - specific distance for milk distribution (km/1 000 litres)

k2 - specific distance for collection of empties (km/1 000 litres)

K - total specific distance (km/1 000 litres) ($K = k_1 + k_2$)

The numerical values ascribed to these factors for the purpose of this analysis are given in Table 13.

Table 13 Model values for Group 1 factors

System	g1		g2		g3		g4		s1	s2	k1	k2	k
	0.5 1	1.0 1	0.5 1	1.0 1	0.5 1	1.0 1	0.5 1	1.0 1					
Pasteurized - bottles	385	295	160	225	460	480	2300	2400	4	6	10	6	16
Sterilized in bottles	405	338	154	221	440	460	2200	2300			10	-	10
Pasteurized - cans	154		-		840		4200		1	2	7	3	10
Pasteurized - cartons	20	17	81	78	870	880	4350	4400	5	15	7	-	7
UHT treated - cartons	32	24	-	-	940	950	4700	4750	5	-	6	-	6
Pasteurized - sachets	8	5	92	92	880	880	4400	4400	5	15	7	-	7
Pasteurized - vend.mach.	100		-		900		5000		-	-	5	-	5

Group
2 -

Factors associated with operation timing

n₁ - number of nominal 8-hour shifts per day for distribution

n_2 - number of nominal 8-hour shifts per day for empties collection

t_1 - specific time for loading packaged milk at plant (hours/1 000 1)

t_2 - specific time for unloading at retail centres (hours/1 000 1)

t_3 - specific time for loading empties at retail centre and unloading at plant (hours/1 000 1)

t_4 - time for washing vehicles (hours per shift)

t_5 - workers' rest time (hours per shift)

c - average speed of vehicles on road (km/h)

m - average number of workers in one vehicle crew

The numerical values ascribed to these factors for the purpose of this analysis are given in Table 14. They are based on practical experience.

Table 14 Model values for Group 2 factors

System	n_1	n_2	t_1	t_2	t_3	t_4	t_5	c	m
Pasteurized - bottles - in crates	1	1	0.1	0.5	0.2	0.3	0.5	25	3
Sterilized in bottles - in crates	2	-	0.1	0.5	0.2	0.3	0.5	25	3
Pasteurized - cans -	1	1	0.1	0.5	0.2	0.3	0.5	25	3
Pasteurized - cartons - in crates	1	-	0.1	0.5	0.1	0.3	0.5	25	3

UHT treated - cartons - wrapped	2	-	0.1	0.5	-	0.3	0.5	25	3
Pasteurized - sachets - in crates	1	-	0.1	0.5	0.1	0.3	0.5	25	3
Pasteurized - vending machines	2	-	0.1	0.5	-	1.0	0.5	25	2

Group 3 - Other factors

The following factors may be considered constant for all systems. The numerical values given below are based on practical experience.

F - Coefficient for vehicles under repair and stand-by	F = 1.25
K_L - average mileage of one vehicle during its lifetime	K_L = 250 000km
B - rate of annual interest on capital input	B = 10%
E - rate of annual expenditure on insurance and taxes	E = 3%
G - rate of maintenance costs during lifetime of vehicle	G = 300%
H - fuel consumption	H = 4 km/litre oil

The following equations have been formulated to characterize the techno-economics of transport. In these equations the symbols a and A have been used to represent the quantities of milk in thousands of litres distributed per day and per year respectively.

Total number of vehicles

$$N = a F (t_1 + t_2 + t_3 + \frac{k_1}{c} \frac{1}{n_1(8 - t_4 - t_5)}) \quad \dots (1)$$

Note t_3 should be included only when distribution and empties collection are simultaneous. Specific working time of vehicles - hours/1 000 1

$$T_v = t_1 + t_2 + t_3 + \frac{k}{c} + \frac{N}{aF} (t_4 + t_5) (n_1 + n_2 \frac{s_1}{s_2}) \quad \dots (2)$$

Labour requirement hours/1 000 litres $T_m = T_v m \quad \dots (3)$

Average lifetime of vehicles - years $L = \frac{K_L}{K} \frac{N}{A} \quad \dots (4)$

Depreciation * D $= C_v \frac{1}{L} \frac{N}{A} \quad \dots (5)$

Interest on capital* I $= C_{v,B} \frac{N}{A} \quad \dots (6)$

Maintenance* M $= C_v \frac{G}{L} \frac{N}{A} \quad \dots (7)$

$$\text{Taxes and insurance* } R = C_v \cdot E \cdot \frac{N}{A} \quad \dots (8)$$

$$\text{Fuel costs* } O = c_o \frac{K}{H} \quad \dots (9)$$

$$\text{Labour costs* } W = C_w T_m \quad (10)$$

* In currency units/1 000 litres. Symbols C_v , C_o , C_w represent costs of one vehicle, one litre of fuel and one hour of labour respectively in any currency units applied.

The equations presented above may be considered as having relatively universal application. In this model analysis, the values estimated for N , T_v , T_m and L are given in Table 15.

Table 15 Model values for N , T_v , T_m and L

System	N - depending on litres distributed daily					T_v	T_m	L
	10 000	25 000	50 000	100 000	250 000			
Pasteurized - bottles - in crates	2	5	9	18	44	1.63	4.9	7.5
Sterilized in bottles - in crates	1	3	5	10	24	1.22	3.7	7
Pasteurized - cans	2	4	8	16	39	1.39	4.2	11

Pasteurized - cartons - in crates	2	5	9	18	44	1.09	3.3	14
UHT treated - cartons - wrapped	1	2	4	8	19	0.94	2.8	9
Pasteurized - sachets - in crates	2	5	9	18	44	1.09	3.3	14
Pasteurized - vending machines	1	2	4	8	20	0.99	2.0	11

The costs in US\$ indicated in this model analysis have been calculated with the assumptions that one hour of labour, C_w , costs US\$ 0.70 and one litre of fuel, C_o , costs US\$ 0.15. The value of C_v has been calculated by estimating the cost of a prime-mover with a 5 t chassis at US\$ 15 000. This value was increased by a coefficient 'y' to adapt the chassis to the respective requirements of milk transport. The various transport costs calculated from equations (5) to (10) above in US\$/1 000 l are given in Table 16.

Table 16 Specific transport costs

System	y	C_v US\$	US\$ 1 000 litres						
			D	I	M	R	O	W	Total
Pasteurized - bottles - in crates	1.4	21 000	1.36	1.05	4.08	0.32	0.60	3.43	10.84
Sterilized in bottles - in crates	1.2	18 000	0.70	0.49	2.10	0.15	0.38	2.59	6.41
Pasteurized - cans -	1.4	21 000	0.82	0.92	2.46	0.28	0.38	2.94	7.80

Pasteurized - cartons - in crates	1.2	21 000	0.72	1.01	2.14	0.30	0.27	2.28	6.72
UHT treated - cartons - wrapped	1.4	21 000	0.72	1.01	2.14	0.30	0.27	2.28	6.72
Pasteurized - sachets - in crates	1.4	21 000	0.72	1.01	2.14	0.30	0.27	2.28	6.72
Pasteurized - vending machines	2.2	33 000	0.36	0.40	1.08	0.12	0.19	1.40	3.55

The above analysis indicates that specific values of different transport cost components, that is, cost per 1 000 litres of milk, are almost constant, i.e. not dependent on the quantity of milk distributed but related basically to the system of milk packaging and distribution. This agrees with figures obtained from operating plants. It reflects the fact that the carrying capacity of a single transport vehicle is relatively small compared to the quantity of milk distributed. This results in a high degree of transport equipment utilization and, finally, in constant specific values within each system. The term 'constant' should be considered as expressing the absence of a trend towards increase or decrease of specific values. In the lowest ranges of quantities of milk distributed the various specific values are usually slightly higher, but the difference appeared insignificant for the purpose of this analysis.

Although the specific costs of milk distribution transport as presented above in US\$/1 000 litres are valid only under the model conditions described, several observations resulting from this study have a wider application. They may be listed as follows:

- i. The most expensive is the distribution transport of pasteurized milk in bottles; the cheapest is tanker transport to vending machines followed by UHT-treated milk in single-service containers transported in non-returnable plastic wrapping. The transport costs for the other systems do not differ substantially from one another.**
- ii. In the total transportation costs expenses on fuel play a minor role in all systems.**
- iii. In order to make the transport system reliable, a relatively high capital input is required resulting in a theoretically long life for vehicles.**
- iv. A substantial proportion of the total costs may be represented by labour expenses.**

The equations formulated for calculating different factors affecting milk distribution transport can be applied under conditions different from those presented as model in this study by using the appropriate numerical values.





Chapter 7 RETAILING

Retailing packaged milk

Liquid milk is most commonly sold to the consumer by general grocery stores. In some countries regulations restrict this service to selected dairy shops. In others, particularly those where liquid milk is rationed, special milk sales centres are constructed.

In most countries the dairy industry does not invest in liquid milk retailing, except for promotion and demonstration centres and automatic vending machines. The grocers sell and sometimes distribute the milk delivered by the plant and are entitled for their services to a surcharge on the milk plant price known as the 'retail margin'. In countries where the milk plant also delivers milk directly to consumers, the retail margin is absorbed by the plant.

In many countries milk distributors are licensed but only in some are refrigeration facilities required as a condition for obtaining such a licence. In most cases even pasteurized milk is sold by retailers not equipped with cold storage, and so sales hours have to be limited.

There is no common system for establishing retail margins and they vary considerably between countries and even between localities within the same country. Two similar distribution systems may work at different costs as a result of conditions directly related to the system itself; for instance higher costs (and margins) may be the result of too many links and too many small enterprises each with little trade. Distribution techniques may differ considerably as a consequence of variations between costs of labour and capital costs of equipment. High wages may be the cause of high margins, both in relation to other countries and to the producer price in the country in question. The existence of a strong and well supported organization of producers seems to have the effect of keeping retail margins at low level. It appears that distribution of milk, even with the same amount of services rendered, is cheaper in controlled and well organized markets than in those left to their own devices. Given a sufficient degree of flexibility, State intervention through market regulations often seems to have stimulated sound developments. In uncontrolled markets the retailers tend to increase margins and capture a high proportion of the price demanded from the consumer, particularly where and when milk is in short supply. However, governmental control also has its weaknesses particularly since it may tend to maintain outdated regulations. Any market guidance in countries with a well developed dairy industry should be kept simple and should be lifted as soon as the organization of the controlled aspect of marketing has been perfected.

The difficulty in determining precisely all the functions of a retail system and its

financial implications is increased by the fact that generally not all known types of liquid milk (pasteurized, sterilized, UHT, packaged or in bulk) are required in a country or a locality. Comparisons of prices and margins are not feasible except over a long period of time. During the last twenty years the consumer price of liquid milk has risen in the majority of industrialized European countries three to four-fold. During this period new packaging systems have become popular and, for practical purposes, it is not feasible to distinguish which part of the price increase is due to inflation and which to the change of technologies. In many countries a system of taxes, levies and subsidies have also developed over the last two decades. They must be considered when the relationships between different cost components are analysed in practice.

The general observations resulting from available data on existing retail systems, and which reflect the situation in developing as well as in developed countries, may be listed as follows:

- i. Simple as well as sophisticated forms of liquid milk are being distributed in both developed and developing countries. The applied retail margins vary from country to country, both in absolute monetary values and as a proportion of the retail price.**
- ii. In countries with an advanced dairy industry there is a trend to control margins and to keep them at a relatively stable level. This is achieved either**

by fixing the value of the margin independently of the retail price, or by fixing it as a constant percentage of the retail price.

- iii. In countries with no market control the retail margins often tend to increase in proportion to processing costs. Such practices lead to high retail prices and a low share of the overall revenue for the producer.**

The consumer price can be considered as consisting of three basic components, i.e. milk procurement (producer price plus transport to the plant), processing (costs attributable to liquid milk processing including packaging plus transport to retailer) and the retail margin. The relationship between these components and their impact on the retail price are shown in Fig. 48. As shown, the milk procurement price does not change with processing costs. The latter reach the practical minimum at a value equal to X_1 . Below X_1 only unpasteurized milk can be sold.

When processing and packaging become more sophisticated the value of X (processing costs) increases beyond X_1 and this is reflected in a corresponding increase of the consumer price. The three variants of the retail margin are represented respectively by curves a, b and c. Curve 'a' represents consumer price for pasteurized milk with the retail margin fixed at a constant value; curve 'b' represents consumer price with the retail margin fixed at a constant percentage of the wholesale price; curve 'c' shows the retail margin as a constant

percentage of processing costs.

At the retail price equal to y_1 the proportions selected as an example in the diagram are:

- **procurement costs: $2/3$ of the retail price**
- **processing costs: $1/6$ of the retail price**
- **retail margin: $1/6$ of the retail price.**

These proportions may be considered as reflecting an approximation of the order of magnitude met for pasteurized milk in cans in countries with advanced dairy industries and well organized markets. In such markets the retail margin for liquid milks of a more sophisticated type is fixed either according to the indications of curves a or b, but never of curve c. In some countries milk plants distribute the product by employing part-time concessionnaires whose commission is generally much lower than margins indicated above.

With increase of processing costs the product becomes more expensive to the consumer. This increase in price is accelerated with the application of retail margins according to curve c, and is slower according to curve a. As shown in Fig. 48, the increase of processing costs from X_1 to X_3 (which is three-fold)

causes a corresponding increase of retail prices, viz.:

- 1.34-fold for a fixed value margin (Y_2/Y_1)
- 1.41-fold for a fixed percentage margin (Y_3/Y_1)
- 1.68-fold for margin rate depending on processing costs (Y_4/Y_1)

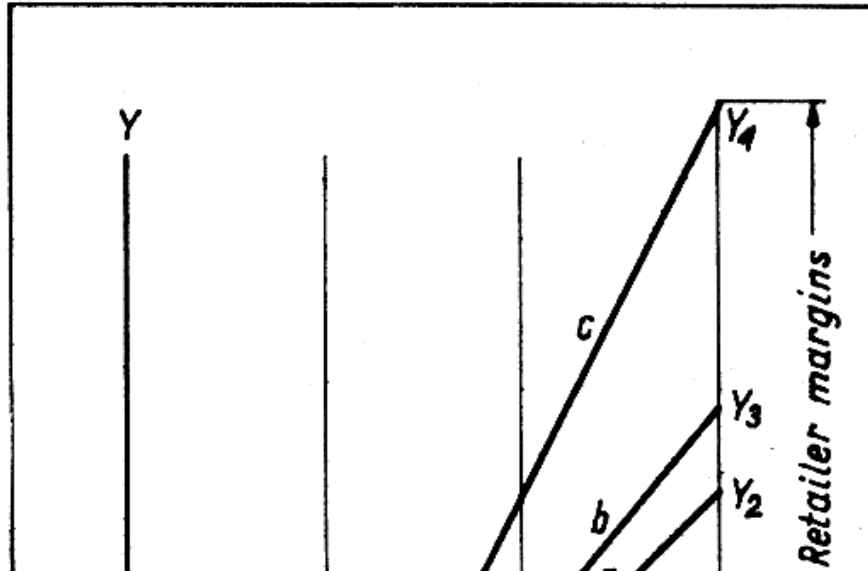

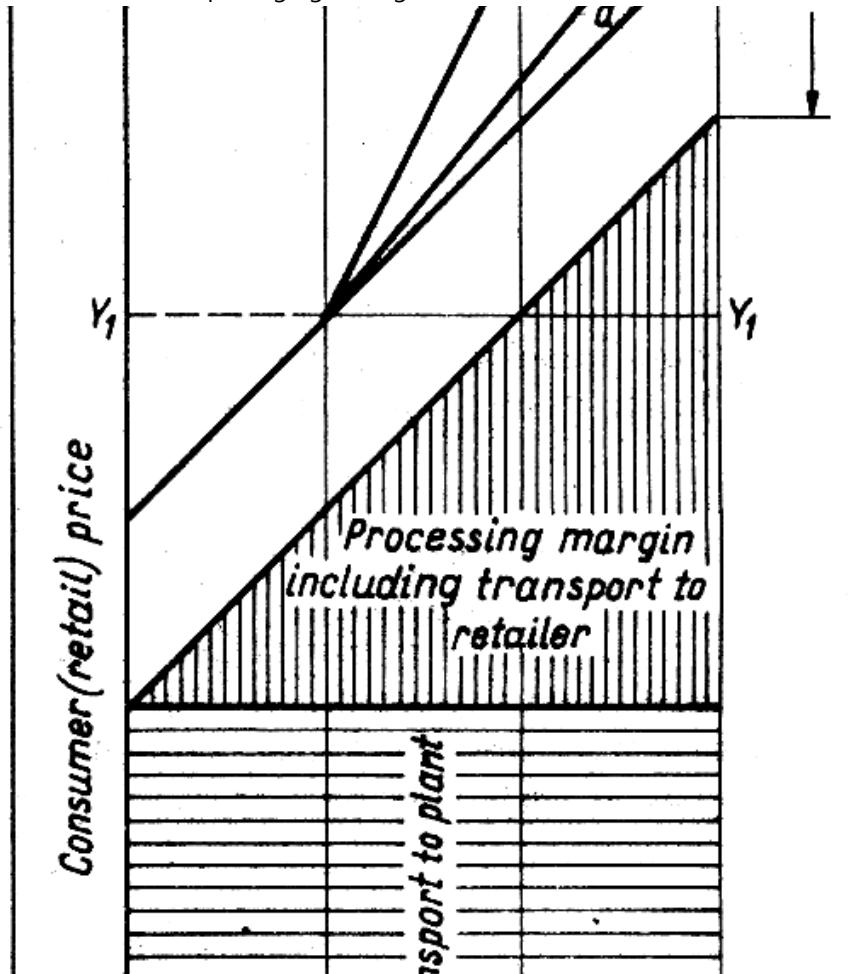

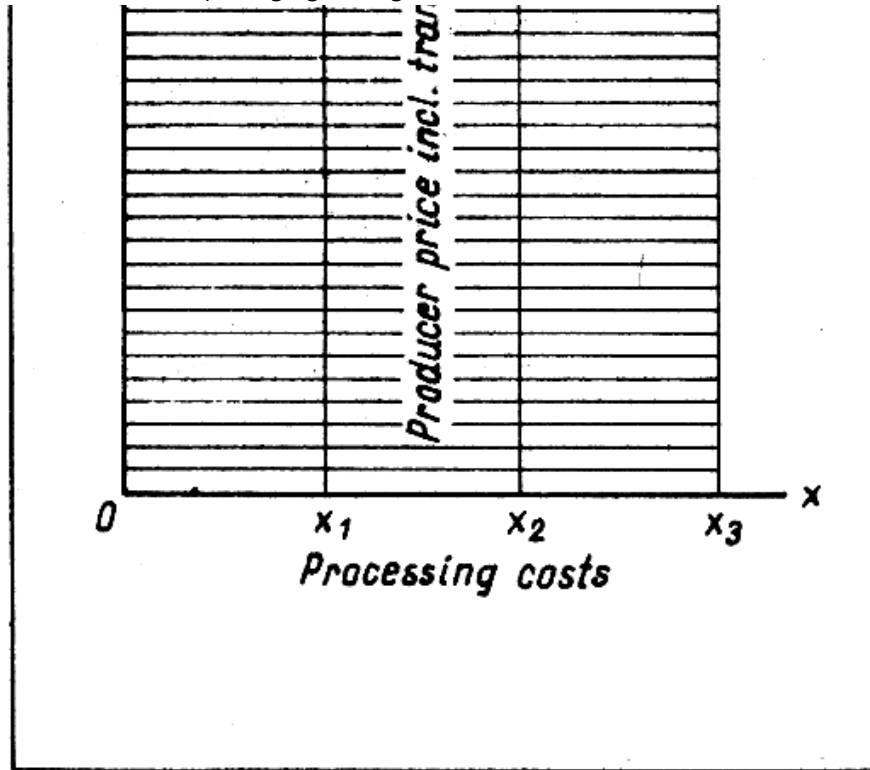

Fig. 48 Consumer prices construction
a - retail margin as constant value added to other costs

- b - retail margin as constant percentage of all costs**
- c - retail margin as constant percentage of processing costs**

With a low level of processing costs the consumer price is kept low and the producer's share of the retail price is high. This is demonstrated in Fig. 48 at the cost/price levels marked X_1 and Y_1 . Raising processing costs and allowing an increase in retail margins causes a very substantial reduction of the producer's share in the consumer's price, in spite of the fact that the consumer pays much more for the product.

Moderate levels of fixed values for retail margins, irrespective of processing costs, i.e. of the type of milk sold, seem to be the most common in organized milk markets. This practice has been assumed for comparisons in the following chapters of this study and the value for the retail margin has been set at US\$32/1 000 litres for all types of milk.

Retailing through automatic vending machines

A system of retailing pasteurized milk through automatic vending machines has been introduced successfully in two countries, Mexico and India. This system does not involve retail packaging by the milk plant as the consumer provides his own container and so eliminates one of the substantial items of cost in providing the consumer with safe milk. Other important characteristics tending to reduce

cost are that the milk plant sells direct to the consumer and that the milk is handled in bulk up to the point of retail sale.

The system has been described previously* and the main features can be summarized as follows. As applied in India, refrigerated pasteurized milk is delivered by tanker to the vending station which is a simple building as shown, for example, in

*** Tuszynski, W. B. (1977) 'Application of automatic vending machines to low-cost distributor of milk' Guidelines to Dairy Development, Working Paper No. 1, FAO, Rome.**

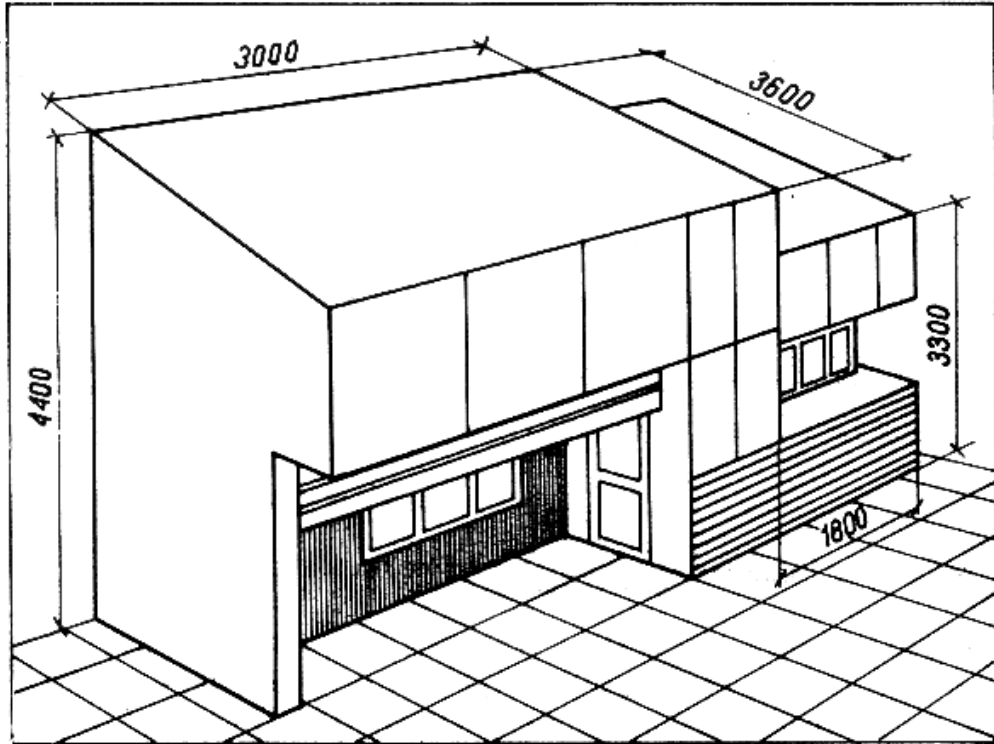

Fig. 49 Typical automatic milk vending station

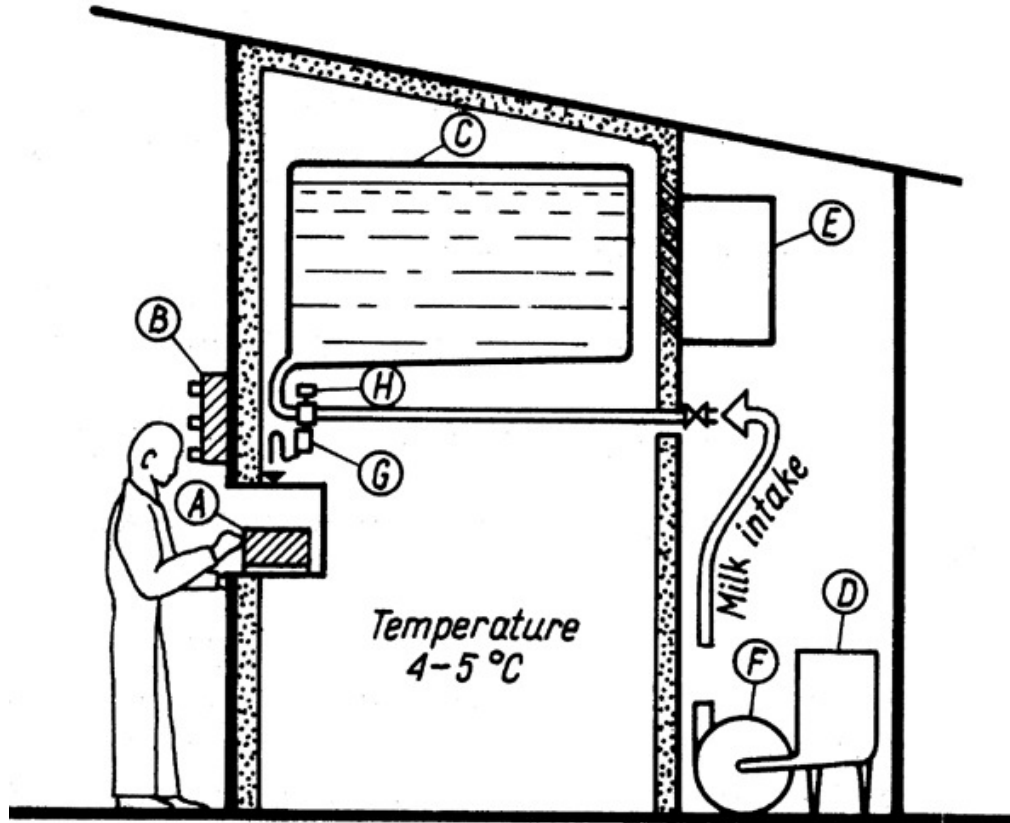

Fig. 50 Automatic milk vending - diagram of equipment

- A - customer's vessel**
- B - push-button panel**
- C - milk tank**
- D - CIP vessel**
- E - room refrigeration unit**
- F - filling and CIP pump**
- G - measuring beaker with flow switch control**
- H - solenoid valve**

Fig. 49. This consists of a refrigerated room housing a milk storage tank of the requisite capacity at high level and a small service room for the CIP equipment and such office or storage facilities as may be required. The milk is pumped from the tanker to the storage tank from which it is discharged as required through the coin- or token-operated dispensers as shown in Fig. 50. The estimated costs given below are based on the system operated in New Delhi by the National Dairy Development Board.

In order to arrive at conservative estimates short depreciation times have been assumed giving an annual depreciation of 8% for the building, and 15% for the equipment. Out of the estimated cost of US\$ 11 000 for one vending station with a 1 000-litre tank and two dispensers, about 1/3 is for civil engineering works and 2/3 is for equipment. The approximate costs related to capital inputs will thus be per annum:

US\$

- depreciation on building	300
- depreciation on machines	1 100
- interest on initial capital	1 100
	2 500

The approximate annual operational costs (excluding commission to the concessionaire) are estimated as follows:

	US \$
- electricity consumption and telephone rental	600
- detergents and materials for sanitation	400
- maintenance and spare parts, excluding own labour	600
- maintenance staff	200
- insurance and sundry charges	100
Total per annum	1900

The two cost components as estimated above thus amount to a total of US\$ 4 400 annually. Assuming that any centre is selling on average 80% of its capacity throughout the year, the specific costs of milk retailing in vending machines

(excluding commission) will be about US\$ 0.015/litre. The commission charge is difficult to estimate: in India it is related to the quantity of milk sold and amounts to 1% of the value of milk. Compared with figures discussed in the first part of this chapter this must be considered as rather low. It seems appropriate for a more realistic comparison that the commission be considered as equivalent to a daily labour cost of 16 hours. With a salary of US\$ 0.70/hour (as before) the approximate daily commission amounts to US\$ 11.20 or US\$ 0.014/litre. The total retail costs by applying automatic milk vending machines thus amount to approximately US\$ 29 per 1 000 litres. This figure is clearly generous and will fall by more than US\$ 5 with full utilization of the capacity.



Chapter 8 COSTS AND LOSSES OF PACKAGING MATERIAL AND LOSSES OF MILK

Packaging material sold together with the product and losses of packaging material and product during packaging, handling in stores and transportation,

represent a substantial part of packaging costs. They may be classified as follows:

A. Packaging material

- 1. Value of returnable bottles lost or broken during distribution.**
- 2. Value of returnable bottles damaged during washing, filling and handling at the milk plant.**
- 3. Loss, depreciation and maintenance of cans.**
- 4. Value of single-service containers purchased by the customer together with milk.**
- 5. Value of single-service containers damaged during packaging and transportation.**
- 6. Loss, depreciation and maintenance of crates.**
- 7. Value of packaging material for single-service wraps.**

B. Milk

Losses due to over-filling or measuring and wastage through spillage and breakage during packaging and transportation.

The incidence of these costs and losses in the various packaging systems is shown in Table 17.

Table 17 Incidence of costs and losses in packaging systems

System	Incidence of costs and losses									
	A1	A2	A3	A4	A5	A6	A7	B1	B2	
Pasteurized milk in glass bottles (1/2 litre)	+	+	-	-	-	+	-	+	+	
Sterilized milk in glass bottles (1/2 litre)	+	+	-	-	-	+	-	+	+	
Pasteurized milk in cans (40 litres)	-	-	+	-	-	-	-	+	+	
Pasteurized milk in cartons (1/2 litre)	-	-	-	+	+	+	-	+	+	
UHT-aseptic milk in cartons (1/2 litre)	-	-	-	+	+	-	+	+	+	
Pasteurized milk in plastic sachets (1/2 litre)	-	-	-	+	+	+	-	+	+	
Pasteurized milk in vending machines	-	-	-	-	-	-	-	+	+	

Except for costs specified under A.5 above, the throughput of the plant has little effect on the listed costs and losses per 1 000 litres. The value of A.5 even at its highest percentage level (low plant capacity, say 10 000 1/day) increases the costs of packaging by a negligible amount and, therefore, is assumed also to be

independent of throughout.

In the following summary of the various costs in US\$/1 000 litres the values of buildings, equipment, vehicles, energy, etc. have been estimated by applying world market prices. However, this criterion cannot be applied to milk for which the farm-gate prices and transportation costs depend entirely on the situation in the area under consideration. The losses listed under B are therefore not included in the summarized cost estimates.

Packaging material

Pasteurized milk in glass bottles. The impact of the cost of the bottle on the retail price depends on the trippage of the bottle. The relation between cost and trippage is demonstrated in Fig. 51. With a reasonable quality of bottles it seems to be fair to assume that a glass bottle for pasteurized milk can be re-used at least 20 times* which means that about 5% of the value of the bottle covers items A1 and A2 as specified above.

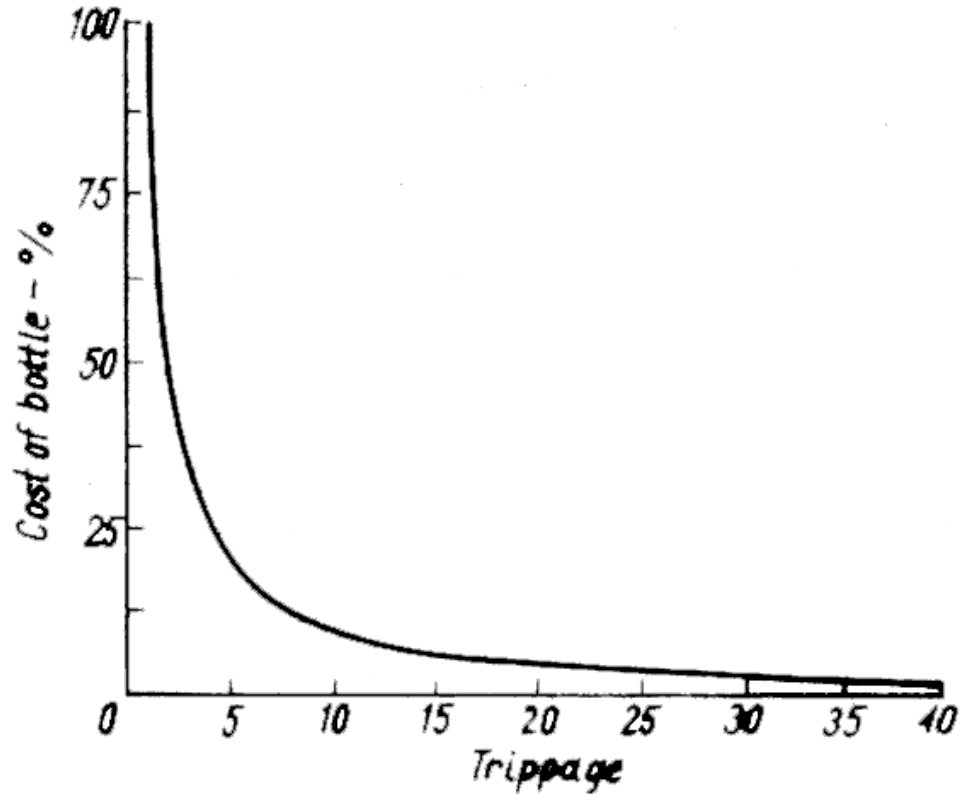

Fig. 51 Relationships between bottle trippage and trip cost

*** In the United Kingdom where about 90% of pasteurized milk is delivered to the home, trippage in well-controlled distribution systems may be as high as 50. In other countries, e.g. the Netherlands, a deposit equal to the full cost of the bottle is charged: thus the consumer pays for all bottles losses occurring after delivery.**

A well-designed crate for twenty half-litre bottles should be suitable for 1 000 trips, i.e. to carry about 20 000 bottles or 10 000 litres of milk.

The cost of a bottle is assumed to be US\$ 0.08 and to be US\$ 5.00 for a crate. The approximate costs and losses of packaging material for 1 000 litres of milk may therefore be estimated as:

	US\$
bottle 1000 × 2 × 0.08	= 8.00
× 0.05	
create $\frac{5.00 \times 1000}{10\ 000}$	= 0.50
	total 8.50

Sterilized milk in glass bottles. For reasons stated in Chapter 2, the trippage of bottles for sterilized milk is lower and re-utilization is assumed to be 15 times. The cost of a bottle is taken as US\$ 0.10. The cost and utilization of crates could be assumed to be the same as for pasteurized milk. The approximate cost for 1 000

litres of milk is therefore:

	US\$
bottle 1000 × 2 × 0.10	= 14.00
× 0.07	
create $\frac{5.0 \times 1000}{10\ 000}$	= 0.50
	total 14.50

Pasteurized milk in 40-litre cans. The cost of a can, including maintenance, can be estimated at US\$ 40.00 and it is assumed that it can be re-used 1 000 times. The approximate cost of the packaging material for 1 000 litres is therefore:

$$1000 \times \frac{40.00}{40 \times 1000} = \text{US\$ } 1.00$$

Pasteurized milk in tetrahedral cartons in returnable crates. The cost of 1 000 cartons (equivalent to 500 litres of milk) is about US\$ 15.00 i.e. US\$ 30.00 per 1 000 litres. Loss during packaging and transportation (about 1%) increases the cost to US\$ 30.30.

The cost of a crate is estimated at US\$ 2.80. The crate is re-usable for about 1 000 trips, i.e. for 9 000 litres. The approximate cost of packaging material per 1

000 litres is therefore:

		US\$
carton	=	30.30
create	$\frac{2.80}{9000} \times 1000$	= 0.30
	total	30.60

UHT milk in rectangular cartons in single-service wraps. The cost of 1 000 cartons (equivalent to 500 litres of milk) is about US\$ 30.00 i.e. US\$ 60.00 per 1 000 litres. Loss during packaging and transportation is about 2% which increases the cost to US\$ 61.20 for 1 000 litres. The material for single-service wrapping is about US\$ 100.00 per 1 000 packs, holding 6 000 litres. The approximate cost of packaging material for 1 000 litres is therefore:

		US\$
carton	=	61.20
single-service wrapping material	=	16.70
	$\frac{100.00}{6000} \times 1000$	
	total	77.90

Pasteurized milk in plastic sachets in returnable crates. The cost of polyethylene

film in three colours can be estimated at US\$ 2.00 per kg which is equivalent to about 250 1/2-litre sachets or 125 litres of milk. Packaging and transportation damage is rather high and should be estimated at 4%. The resulting approximate cost of sachets is therefore about US\$ 16.34 per 1 000 litres. The price of a crate for 10 litres, usable for 1 000 trips, is about US\$ 3.50. The resulting total packaging material cost for 1 000 litres is therefore:

		US\$
sachet	=	16.64
crate	$\frac{3.50}{10\ 000} \times 1000$	= 0.35
		total 16.99

Losses of milk

The seven liquid milk processing and distribution systems considered in this study may be divided in four groups with respect to filling/measuring accuracy:

- **filling of glass bottles**
- **filling of single-service containers**
- **filling of milk cans**

- **dispatch in tankers to automatic vending machines**

The accuracy of filling returnable bottles and single-service containers directly affects the consumer whereas filling of cans or tankers does not. In the latter case the consumer receives the milk measured out of the can or dispensed by the vending machine and it is therefore the accuracy of the means of dispensing at this second stage which affects the consumer.

Glass bottles are filled by the machine to a level which is at a constant distance from the top of the bottle and, therefore, the accuracy of filling depends mainly on the appropriate standards and uniformity of the bottles. The tolerance for bottles may permit differences in the filled quantity as high as $-15 \text{ ml} + 7.5 \text{ ml}$, which in a 1/2-litre bottle may mean $-3.0\% + 1.5\%$. Usually control by check tests on new bottles delivered and well-managed filling operations keep the actual tolerance in filling to within $\pm 1\%$, without significant losses to the milk plant due to overfilling.

Single-service containers are normally filled with a very high accuracy, normally within the range of ± 0.2 to 0.4% , also with practically no losses to the plant due to over-filling. Milk cans and road tankers are most often filled by means of milk flowmeters which operate within $\pm 0.3\%$ if properly maintained. Measuring from the can depends on the dispensing system used. Volumetric dispensing by a metering pot is very inaccurate and the customer may receive, particularly when the can is less than half full, less than 90% of the quantity paid for if measuring is

not done very carefully. A manually-operated mechanized dispenser mounted on top of the can is a better alternative. This operates with an accuracy within $\pm 1.0\%$. Automatic vending machines, if properly maintained, dispense the milk within a tolerance of $\pm 1.0\%$, normally without losses due to over-dispensing.

The wastage of milk during packaging and transportation may differ considerably depending on the quality of the packaging material, maintenance of machines and management of the packaging division, storage and transport. Not all the milk from damaged packages is wasted: a substantial proportion, basically from packages damaged during the packaging process, is usually recovered. Even in well-managed plants with supplies of packaging material of appropriate quality the losses are seldom less than 0.5%. They may become significantly higher particularly with sterilized milk in bottles when the bottles do not withstand the thermal and mechanical shocks during sterilization and after-cooling. They may also become very high with pasteurized milk in plastic sachets because of faulty packaging material and the general fragility of the package.



Chapter 9 SUMMARY OF COSTS

In the preceding chapters the specific costs, in US\$ per 1 000 l/day, arising from machinery, transportation, retailing and costs of packaging materials have been estimated. The costs of the remaining items, plant area, services and labour must now be considered in order to summarize and compare the total costs for the various packaging and distribution systems selected for analysis. It must again be emphasized that for two of these systems, in-bottle sterilized milk and UHT milk, the costs associated with the special heat treatment involved are included as they form an integral part of the packaging operation.

Packaging and storage. The cost of constructing one square metre of a milk plant building according to the required standards (without equipment) is estimated at US\$ 500. This figure is relative to what is called in Chapter 3 'reduced area unit'. Assuming an annual depreciation of 2.5% (about 40 years life), annual maintenance cost about 7%, interest on capital 10% and insurance and taxes at 2.5%, the building overhead cost per day is given by the expression

$$\frac{500}{365} (0.025 + 0.070 + 0.100 + 0.025)$$

$$= 0.30 \text{ US\$}/\text{m}^2$$

This figure when multiplied by the specific reduced area requirements (Tables 7 and 8) gives the building costs in US\$ per 1 000 l/day throughput.

Services. In the specific services requirements listed in Table 10, the electricity requirements included provision for all services. Thus the calculated total electricity requirement includes not only the consumption of electrical energy by processing and packaging machines but also the requirements for steam, refrigeration, water and air. Although this is an approximation, since for instance the consumption of refrigerant is not included, for the purpose of this study the resulting figures may be taken as indicative of requirements in practice. The only other factor remaining to be assessed is the fuel requirement for steam raising and electricity generation.

In order to arrive at approximate total specific costs of services the following assumptions have been made:

- a. One kg of steam can be produced by burning approximately 0.12 litre of fuel equivalent in calorific value to gas oil.
- b. One kWh of electrical energy can be produced by consuming approximately 0.33 litre of fuel (Diesel oil) in a medium size generating set.
- c. The price of fuel for both purposes was assumed at US\$ 0.15 per litre.

Labour. The cost of labour has been estimated at US\$ 0.70 per hour and the data for specific labour requirement in Table 12 have been multiplied by this

coefficient. It may be considered high for developing countries but it includes all costs of employment (seventh day in a week free, annual leave, paid sick and special leave, etc.).

The individual and total costs are summarized in Table 18 and the total costs are presented in graphical form in Fig. 52.

It should be noted that the cost of milk wastage during packaging and distribution is not included in Table 18 and Fig. 52.

Table 18 Estimated costs of liquid milk packaging, transport and retailing in US\$ per thousand litres (component figures rounded to US\$ 0.1, total figures rounded to US\$ 1.0)

	GLASS BOTTLES - 1/2 LITRE										CANS - 40 LITRES				
<u>RETURNABLE CONTAINERS</u>	Pasteurized					Sterilized					Pasteurized				
Plant throughput 000 1/day	10	25	50	100	250	10	25	50	100	250	10	25	50	100	250
Machines and equipment	9.0	8.0	7.6	6.5	5.6	22.0	16.0	15.6	11.5	8.4	2.5	1.8	1.7	1.7	1.3

Milk plant building	5.8	4.6	3.6	2.9	2.9	6.5	5.1	3.8	3.5	3.4	5.8	3.3	2.2	1.6	1.4
Services - electricity total	1.3	0.8	0.6	0.5	0.5	1.9	1.6	1.5	1.5	1.3	0.8	0.4	0.2	0.2	0.2
Services - steam	2.7	2.9	2.7	2.7	2.4	7.2	7.2	7.0	7.1	5.8	1.1	10.9	0.5	0.5	0.5
Direct labour	10.0	7.4	5.4	4.2	2.8	12.3	7.5	5.8	5.3	3.2	6.2	3.4	2.2	1.7	1.2
Transport to retailer	10.8	10.8	10.8	10.8	10.8	6.4	6.4	6.4	6.4	6.4	7.8	7.8	7.8	7.8	7.8
Packaging material	8.5	8.5	8.5	8.5	8.5	14.5	14.5	14.5	14.5	14.5	1.0	1.0	1.0	1.0	1.0
	48	43	39	36	33	71	58	55	50	43	25	19	16	15	13
Assumed retail margin	32	32	32	32	32	32	32	32	32	32	32	32	32	32	32
Total estimated cost															
US\$/1000 litres	80	75	71	68	65	103	90	87	82	75	57	51	48	47	45

SINGLE- SERVICE CONTAINERS	CARTONS - 1/2 LITRE										PLASTIC SACHETS - 1/2 LITRE				
	Pasteurized in returnable crates					UHT-aseptic in non- returnable wraps					Pasteurized in returnable crates				
	10	25	50	100	250	10	25	50	100	250	10	25	50	100	250
Machines and	16.2	13.0	10.0	10.0	9.4	85.0	62.0	50.0	45.0	41.0	4.0	3.6	2.8	2.8	2.8

equipment Milk plant building	7.0	5.6	5.0	5.0	4.5	17.1	13.4	11.8	10.6	10.5	7.0	5.6	4.2	3.7	3.1
Services - electricity total	0.9	0.7	0.5	0.4	0.4	3.1	2.5	2.3	2.3	2.2	1.0	0.7	0.6	0.5	0.4
Services - steam	0.7	0.5	0.3	0.3	0.3	5.8	5.6	5.4	4.9	4.2	0.5	0.3	0.3	0.3	0.1
Direct labour	5.6	5.4	4.0	3.4	2.8	6.2	5.1	3.8	3.2	2.8	5.6	5.4	4.0	3.4	2.8
Transport to retailer	6.7	6.7	6.7	6.7	6.7	4.5	4.5	4.5	4.5	4.5	6.7	6.7	6.7	6.7	6.7
Packaging material	30.6	30.6	30.6	30.6	30.6	77.9	77.9	77.9	77.9	77.9	17.0	17.0	17.0	17.0	17.0
	68	63	57	56	55	200	171	156	149	143	42	39	36	34	33
Assumed retail margin	32	32	32	32	32	32	32	32	32	32	32	32	32	32	32
Total estimated oost															
US\$/1000 litres	100	95	89	88	87	232	203	188	181	175	74	71	68	66	65

AUTOMATIC VENDING MACHINES Out of the components listed above only three (labour, transport and retailing) concern this system. The resulting value is about US\$ 34 per thousand litres for practically all throughputs.

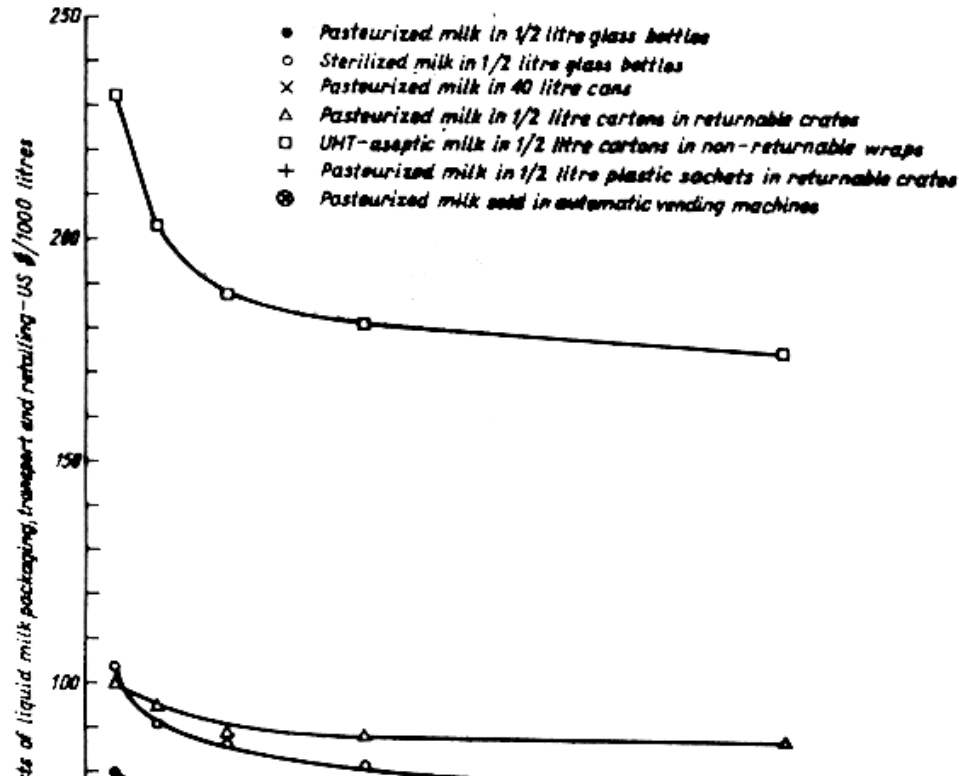

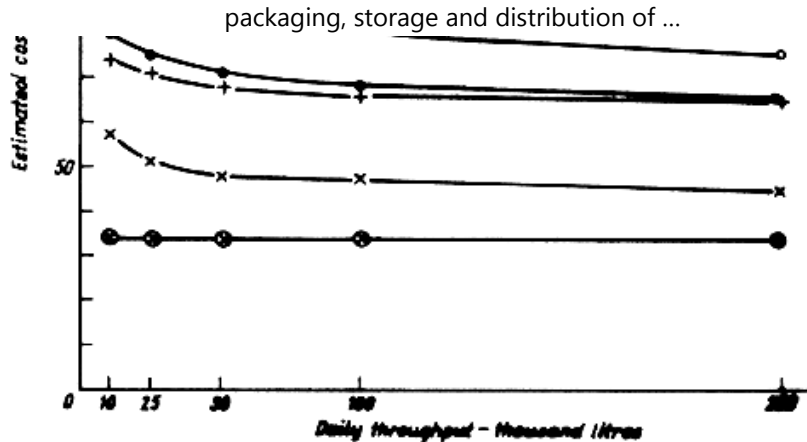

Fig. 52 Estimated costs of liquid milk packaging, transport and retailing



Chapter 10 CONSIDERATIONS AFFECTING THE CHOICE OF SYSTEM

In the preceding chapters basic information on the technical requirements and costs of various liquid milk processing and distribution systems has been

presented. The term basic information is used in order to stress that no attempts have been made in this study to present a complete technical assessment and cost estimate for milk packaging, transport and retailing. The analysis presented in this paper aims at providing data necessary for assessing main requirements and basic differences in requirements among various industrial liquid milk marketing systems. Coefficients have been applied in the cost estimates in order to arrive at indicative financial conclusions but their character inevitably leaves a substantial margin of error. The margin is most likely to be larger than the magnitude of various expenses not considered in this paper such as costs of supervision, indirect labour, administration concerned with liquid milk distribution, costs of sanitation etc. A substantial part of the costs of equipment has not been specified in detail but assessed as a percentage of the main part of the machinery (10 to 30%) since their value will depend mostly on the source of supply (mainly local). Except for single-service packaging systems, stocks of materials have not been included in the calculations, since they will differ very much in size and costs depending on the situation in the country; for instance stocks of new bottles and their accommodation will be larger in countries where bottles have to be imported as compared to those where they are produced locally. A very substantial part of the costs - the losses of milk - could not be estimated financially since the price of milk differs considerably from country to country.

However, apart from all the above reservations, it is believed that the indications given in this analysis will provide those concerned with sufficient information on

the basic characteristics of major liquid milk marketing systems. The analysis of retail margins is discussed because of the inclusion of automatic vending machines as one of the systems analysed. The bulk of the costs of this system lies outside the milk plant, and had to be compared with retailing costs which, in this case, generally mean retail margins. Selecting an arbitrary value for a constant margin for packaged milk is certainly a simplification of a much more complex problem. However, those concerned may rectify the analysis of applying margins more suitable to the commercial systems of a particular area.

The choice of a system cannot be based only on figures related to technical requirements and their economic implications. The demands of markets do not depend entirely on the costs of a product. Therefore, it seems appropriate to add a few more relevant considerations not directly related to economics.

Keeping quality

Pasteurised milk, however packaged, has a very limited keeping quality because spore-forming micro-organisms survive the heat treatment and germinate later to cause the milk to sour. Even if it is stored at the milk plant, transported and stored at the retail centre or shop at a temperature below 4°C it should be sold to the consumer within about 24 hours of processing. Milk dispensed from cans or automatic vending machines is unlikely to be kept cool after sale and its keeping quality will be greatly influenced by the hygienic condition of the consumer's

container. The milk cannot be expected to remain sweet for more than a few hours in warm climates unless it is boiled forthwith, as is a common practice under such conditions.

If the purchaser of pasteurized milk packaged at the milk plant and handled under refrigerated conditions can place the package unopened in a domestic refrigerator within a short time it would be reasonable to expect the milk to keep several days before opening. Once the package is opened the onset of souring of any milk not used immediately will still be delayed for some hours if it is re-placed in the refrigerator, especially if it is retained in the original package. When the consumer has no access to a refrigerator it is usually necessary to use the milk on the day of purchase.

In-bottle sterilized milk at the completion of processing contains very few residual micro-organisms, indeed some bottles may be sterile. Refrigeration is therefore unnecessary and it is generally safe to delay sale of the product for up to 7 days. This may have advantages for the milk plant and the retailer though it must be remembered that the milk represents locked-up working capital until it is sold. However, these two factors make it possible to distribute the milk to far greater distances, though this is limited in practice by the need to recover the bottle. This does not apply if single-service plastic bottles are used. After sale, in-bottle sterilized milk should have a shelf life at ambient temperature of a further 7 days before opening the package. After opening, unused milk remaining in the bottle

may still remain sweet for several days provided the bottle is hygienically re-closed after each use.

The UHT process combined with aseptic packaging is such that the packaged milk is virtually sterile. A practicable hygienic standard is that there should be not more than one organism in 1 000 packages. Thus if no micro-organisms are present there can be no bacterial spoilage and the keeping quality on this account is unlimited. In practice chemical instability determines the shelf life and this can be 4 to 6 months before consumption. After opening the package the same considerations as for in-bottle sterilized milk apply. Typical markets for UHT milk are thus those which need, and can pay for, this long life. They include supply to very distant markets, including export, for ships and aircraft and, in some cases to local consumers who wish (and can afford) to keep an emergency stock in ambient temperature storage.

Returnable versus single-service containers

It will be obvious that the success of a system involving re-use of containers - normally glass bottles - depends entirely on the efficiency of bottle recovery. This is achieved in one of three ways. Firstly, the milk may be delivered to the customer's doorstep and empty bottles recovered at the same time. This system has the advantage that it can work in the customer's absence, payment being collected, say, once per week. Secondly, travelling shops may tour the area with

frequent stops in each street making their presence known by an audible signal. The customers come to the vehicle bringing empty bottles on which they have already paid a deposit equal to the cost of the bottle. If they require more full bottles than the number of empties they return, extra deposits must be paid. If they require less a corresponding credit is allowed. Thirdly, milk may be sold only from shops to which the customer must go to purchase milk. A similar arrangement whereby the consumer pays a deposit on the bottle is usually operated.

Where one of these methods or a combination of them can be operated it is almost certain that for pasteurized and in-bottle sterilized milk the returnable bottle is the cheapest form of retail packaging. At the present time, countries using glass bottles for more than 50% of packaged pasteurized milk include Bulgaria, India, Japan, Malta, New Zealand, Poland, South Africa and the United Kingdom.

Nevertheless, single-service packages have certain advantages as evidenced by the fact that they are widely, if not exclusively used for pasteurized milk in Austria, Brazil, Canada, Switzerland, Sweden, Denmark, Germany, Finland, France, Israel, Norway and USA. For UHT milk, single-service containers must be used as there is no commercially available system for aseptically filling glass bottles. From an organizational point of view, neither the milk plant nor the retailer has to worry about container recovery and the capital cost of equipment and

space for making the container fit for re-use are eliminated. The single-service container is much lighter in weight and generally occupies less space, both of which advantages are attractive to the consumer particularly if he has to purchase from a shop. As has been shown, all the single-service packages are more expensive than the returnable bottle where this is practicable. The most competitive is the sachet because it uses the least weight of material and the packaging operation is simple but this is offset to some extent by the unattractive nature of the filled package and its vulnerability to damage.

From the point of view of availability of materials most countries can produce glass from their own resources whereas in developing countries paper/plastic laminates and the high technology required to produce them must generally be imported with a corresponding need for foreign currency. In some cases disposal of used packages may also present a problem.

These characteristics of the various methods of processing and packaging liquid milk must be borne in mind in relation to the character of the market it is intended to serve and the habits of the milk-consuming population. It should be noted also that the taste and colour of pasteurized milk is different from either in-bottle sterilized or UHT milk and all are different from raw or boiled milk. Where milk is being introduced virtually as a new food these differences do not matter but where the consumer is already accustomed to a particular type time may be needed for a change to be accepted.

Retail packaging versus sales from bulk

Several factors have to be considered when comparing the merits of packaged milk with those of milk sold from bulk. Firstly, as has been shown above, only pasteurized milk can be distributed either packaged or from bulk. Both of the other types (sterilized and UHT) cannot be sold without packaging. Secondly, for reasons also discussed above, the keeping quality of pasteurized milk depends on the temperature at which it is kept after processing. If it leaves the milk plant cold store at a temperature well below 10°C, is transported to the retail shop in insulated vans and is kept by the retailer under refrigerated conditions, the keeping quality of the packaged product after sale is almost always likely to be better than if the milk is dispensed into the customer's container. In addition, packaged milk is generally measured accurately and is safe from adulteration, which is not the case when sales are effected from cans.

If at any stage of operations the temperature of the milk is allowed to rise its keeping quality decreases at a rate depending on this rise and on the time for which it is exposed to ambient temperatures before sale. The system of distributing milk from bulk through automatic vending machines offers a continuity of the 'cold chain'. The temperature of the milk dispensed into the customer's container is low which gives it an advantage over pasteurized milk, packaged or in cans, sold under unrefrigerated conditions.

One of the major drawbacks of sales through vending machines is the necessity to rebuild or construct centres designed to accommodate the machines. This may often be difficult in crowded cities. Besides, both the known designs of the machine (as applied in Mexico and India) are available only in capacities of 2 000 and 1 000 litres. Simplification and further development of these machines is desirable in order to make their application more flexible and suitable for varying conditions and requirements. The experience gained by their application, particularly in India, seems to indicate that the system enjoys full support from the consumers, both in the lower and higher income strata of the society.



BIBLIOGRAPHY

- 1. Morris, C.G. (1940) 'What should be the price of milk' Olsen Publishing Company USA.**
- 2. Bailey, J.C. & Brace, A.W. (1956) 'Experience with aluminium milk cans' Journal of the Society of Dairy Technology 9 (4) 155.**

3. **Milthers, A. (1960) 'Marketing and distribution margins for milk and milk products in OEEC countries' E.P.A.**
4. **Burton, H., Pien, J., Thieulin, G. et al (1965) Milk Sterilization FAO Rome.**
5. **Die Milch auf dem Weg in die Stadt (1972) 17 Feb. Zentralblatt der Land-und Milchwirtschaft Zurich.**
6. **Hall, H.S. (1973) 'Retail packaging of liquid milk' Journal of the Society of Dairy Technology 26 (2) 94.**
7. **De Consumptiemelkprijs (1974) K.N.Z. Officieel Orgaan 45.**
8. **Weber, G. & Reuter, H. (1975) 'Flächenbestimmung für Milchwirtschaftliche Produktionsbetriebe' Kieler Milchwirtschaftliche Forschungsberichte 27 (2).**
9. **Hall, H.S. (1976) Standardized Pilot Milk Plants FAO/ICP Rome.**
10. **Krostitz, W. (1976) Review of national dairy policies 1975/76 ESCB/Misc.76/1 FAO Rome.**
11. **Mejeriaret (1976) Svenska Mejeriernas Riksforening Stockholm.**

- 12. Dairy Facts and Figures (1976) Federation of United Kingdom Milk Marketing Boards England.**
- 13. Tätigkeitsbericht des Milchwirtschaftsfonds über das Jahr 1975 (1976) Milchwirtschaftsfond Wien.**
- 14. Poulsen, P, Ronkilde (1976) 'Selecting packaging systems' International Dairy Federation Annual Bulletin Document No. 92.**
- 15. Restoring balance on the milk market - Action Programme 1977-80 (1976) Bulletin of the European Communities Supplement 10/76.**
- 16. Olson, N.F. (1977) 'Cheese manufacturing in the year 2000' Dairy Industries International 42 (1) 16.**
- 17. The Dairy Situation (1977) March US Department of Agriculture.**
- 18. Burton, H. (1977) 'An introduction to ultra-high-temperature processing and plant' Journal of the Society of Dairy Technology 30 (3) 135.**
- 19. Ball, S. (1977) 'The design of complete aseptic processing systems' Journal of the Society of Dairy Technology 30 (3) 143.**
- 20. Ellis, J.G. (1977) 'Aseptic processing and packaging of milk' Journal of the**

Society of Dairy Technology 30 (3) 148.

- 21. Roberts, A.W. (1977) 'Quality assurance of UHT products' Journal of the Society of Dairy Technology 30 (3) 157.**
- 22. Leonard, M.H. (1977) 'Progress and development of UHT milk and milk products in the UK Dairy Industry' Journal of the Society of Dairy Technology 30 (3) 160.**
- 23. Regez, W. (1977) 'The future of UHT milk and milk products in Europe' Journal of the Society of Dairy Technology 30 (3) 164.**

The following companies have provided information and technical material in connection with this publication:

- Bemberg Folien G.m.b.H., 5600 Wuppertal 2, Federal Republic of Germany**
- Finnpak, Tuomo Halonen Oy, 37800 Toijala, Finland**
- Frederiksons, Verkstads Aktiebolag, P.O. Box 148, S-59200 Vadstena, Sweden**
- Stork Amsterdam N.V., P.O.Box 3007, Amsterdam-N, The Netherlands**
- Tetra Pak International A.B., Fack S-22101 Lund, Sweden**

- **Thimonnier S.A., 79, rue de Bourgogne, 69338, Lyon, France**
- **Vickers-Dawson, Crayford Works, Crayford, Kent DA14AX, United Kingdom**
- **Wedholms A.B., 61101 Nyköping 1, Sweden**

THE FAO TECHNICAL PAPERS

FAO PLANT PRODUCTION AND PROTECTION PAPERS:

1. **1. Horticulture: a select bibliography, 1976 (E*)**
2. **Cotton specialists and research institutions in selected countries, 1976 (E*)**
3. **Food legumes: distribution, adaptability and biology of yield, 1977 (E F*** S***)**
4. **Soybean production in the tropics, 1977 (E*)**
5. **Les systèmes pastoraux sahéliens, 1977 (F*)**
6. **Pest resistance to pesticides and crop loss assessment - 1, 1977 (E* F*)**
7. **Rodent pest biology and control - Bibliography 1970–74, 1977 (E*)**

8. Tropical pasture seed production, 1978 (E* F*** S***)
9. Improvement and production of food legume crops, 1977 (E*)
10. Pesticide residues in food - 1977, 1978 (E* F*** S***)
11. Sup. Pesticide residues in food 1977 - Evaluations, 1978 (E***)

FAO ANIMAL PRODUCTION AND HEALTH PAPERS:

1. Animal breeding: selected from World Animal Review, 1977 (E* F* S*)
2. Eradication of hog cholera and African swine fever, 1976 (E* F* S*)
3. Insecticides and application equipment for tsetse control, 1977 (E* F*)
4. New feed resources, 1977 (Tri*)
5. Bibliography of the criollo cattle of the Americas, 1977 (Biling. E/S*)
6. Mediterranean cattle and sheep in crossbreeding, 1977 (E* F*)
7. Environmental impact of tsetse chemical control, 1977 (E* F*)
8. Declining breeds of Mediterranean sheep, 1978 (E*** F***)

9. **Slaughterhouse and slaughterslab design and construction, 1978 (E* F* S*)**
10. **Treating straw for animal feeding, 1978 (E* F*** S***)**
11. **Packaging, storage and distribution of processed milk, 1978 (E*)**

FAO CONSERVATION GUIDES:

1. **Guidelines for watershed management, 1977 (E* F*** S***)**
2. **Hydrological techniques for upstream conservation, 1976 (E* F*** S***)**
3. **Conservation in arid and semi-arid zones, 1977 (E* F***)**
4. **Special readings in conservation techniques (E*)**

FAO FORESTRY PAPERS:

1. **Forest utilization contracts on public land, 1977 (E* F* S*)**
2. **Planning forest roads and harvesting systems, 1977 (E*)**
3. **World list of forestry schools, 1977 (Tri*)**
4. **World pulp and paper demand, supply and trade, Vol. 1, 1977 (E* F* S*) Vol.**

2, 1978 (E* F*)

5. The marketing of tropical wood, 1978 (E* S*)

6. National parks planning, 1978 (E*)

7. Forestry for local community development, 1978 (E* F* S***)**

FAO FOOD AND NUTRITION PAPERS:

1. Review of food consumption surveys, 1977 Vol. 1 -- Europe, North America, Oceania, 1977 (E*)

2. Report of the joint FAO/WHO/UNEP conference on mycotoxins, 1977 (E* F* S*)

3. Report of the joint FAO/WHO expert consultation on the rôle of dietary fats and oils in human nutrition, 1977 (E* F* S***)**

4. Specifications for the identify and purity of thickening agents, anticaking agents, antimicrobials, antioxidants and emulsifiers, 1978 (E*)

5. Guide to specifications, 1978 (E*)

6. The feeding of workers in developing countries, 1978 (E* S*)

FAO AGRICULTURAL SERVICES BULLETINS:

34 titles published

FAO IRRIGATION AND DRAINAGE PAPERS:

30 titles published

FAO SOILS BULLETINS:

40 titles published

Availability: May 1978

E - English

F - French

S - Spanish

Tri - Trilingual

*** Available**

**** Out of print**

***** In preparation**

The FAO Technical Papers are available through the authorized FAO Sales

Agents or directly from Distribution and Sales Section, FAO, Via delle Terme di Caracalla, 00100 Rome, Italy.

