

➔  **A Complete Handbook on Back-Yard and Commercial Rabbit Production (Peace Corps, 1982, 92 p.)**



(introduction...)



Author's introduction



Author's preface



Selecting a breed



Methods of breeding



How to breed



The rabbitry and its equipment



Housing



Hutches



Feeding equipment



Equipment for watering



Nest boxes



Feeds and feeding



Feeding rabbits



(introduction...)



Concentrates

 **Home-mixed feed**
Important note

 **Forages**

 **Coprophagy**

 **Reproduction**

 **Lactation**

 **Factors that limit conception**

 **Managing the herd**

 ***(introduction...)***

 **Methods of handling rabbits**

 **Determining pregnancy**

 **Kindling**

 **Care of young litter**

 **Causes of losses in newborn litters**

 **Weaning**

 **Determining the sex of young rabbits**

















 **Records**

 **Preventing injuries**

 **Sanitation and disease control**

 **Fur eating habit**

 **Preventing fur block**

- ☐  **Gnawing wooden parts of the hutch**
- ☐ **Various uses of rabbit manure**
 -  **Disposal of rabbit manure**
 -  **First class compost fertilizer**
 -  **Methane generator**
 -  **Construction of methane generator**
 -  **Earthworms in the rabbitry**
- ☐ **Types of production**
 -  **Fryer production**
 -  **Breeder production**
 -  **Roaster production**
 -  **Angora rabbit wool production**
 -  **Grooming**
 -  **Shearing**
 -  **Grading, preparing, and marketing wool**
- ☐ **Marketing rabbits**
 -  **(*introduction...*)**
 -  **Cutting and packaging rabbit meat**
 -  **Crating and shipping live rabbits**
 -  **How to assess sales prospects**

- ☐ **The economics of rabbit production**
- ☐ **Simplified tanning**
 -  **(introduction...)**
 -  **1. Slaughtering**
 -  **2. Curing the skin**
 -  **3. Dehairing**
 -  **4. Actual tanning**
 -  **5. Washing and oiling**
 -  **Oiling formula**
 -  **Making charms from rabbit paws and tails**
 -  **Making artificial rabbit tails**
- ☐ **Cooking recipes**
 -  **(introduction...)**
 -  **Filipino recipes**
 -  **International recipes**
-  **Multiple-project approach to rabbitry**
-  **Glossary**







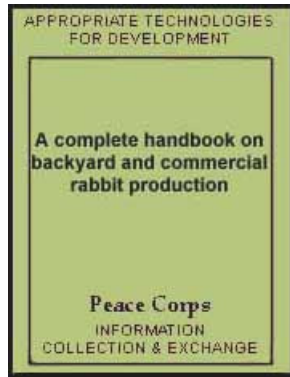





[Home](#) > [ar](#).[cn](#).[de](#).[en](#).[es](#).[fr](#).[id](#).[it](#).[ph](#).[po](#).[ru](#).[sw](#)

 **A Complete Handbook on Back-Yard and Commercial**



Rabbit Production (Peace Corps, 1982, 92 p.)

- ➔  **(introduction...)**
-  **Author's introduction**
-  **Author's preface**
-  **Selecting a breed**
-  **Methods of breeding**
-  **How to breed**
- The rabbitry and its equipment**
-  **Feeds and feeding**
- Feeding rabbits**
-  **Coprophagy**
- Reproduction**
- Managing the herd**
- Various uses of rabbit manure**
- Types of production**
- Marketing rabbits**
- Simplified tanning**
- Cooking recipes**
-  **Multiple-project approach to rabbitry**
-  **Glossary**

APPROPRIATE TECHNOLOGIES FOR DEVELOPMENT

Peace Corps INFORMATION COLLECTION & EXCHANGE REPRINT R-41

INFORMATION COLLECTION & EXCHANGE

Peace Corps' Information Collection & Exchange (ICE) was established so that the strategies and technologies developed by Peace Corps Volunteers, their co-workers, and their counterparts could be made available to the wide range of development organization and individual workers who might find them useful. Training guides, curricula, lesson plans, project reports, manuals and other Peace Corps-generated materials developed in the field are collected and reviewed. Some are reprinted "as is"; others provide a source of field based information for the production of manuals or for research in particular program areas. Materials that you submit to the Information Collection & Exchange thus become part of the Peace Corps' larger contribution to development.

Information about ICE publications and services is available through:

The Peace Corps Internet Web Site address:

<http://www.peacecorps.gov>

Please note the new Peace Corps Mailing Address from July 1998 on is:

ICE/ Peace Corps
1111 20th Street N.W.
Washington, DC 20526
USA

Add your experience to the ICE Resource Center. Send materials that you've prepared so that we can share them with others working in the development field. Your technical insights serve as the basis for the generation of ICE manuals, reprints and resource packets, and also ensure that ICE is providing the most updated, innovative problem-solving techniques and information available to you and your fellow development workers.

Peace Corps

A COMPLETE HANDBOOK ON BACKYARD AND COMMERCIAL RABBIT PRODUCTION

(Sa Kalusugan ng Bayan Rabbit Ang Alagaan)

For the Health of the Nation Go Into Rabbit Production

by

**Rev. Juan B. Sicwaten
and
Ms. Diane Stahl**

**Editor
Ms. Barbara Sims**

**Photography
Ms. Diane Stahl**

**Published by
CARE Philippines**

**Peace Corps
Information Collection and Exchange
Reprint R-41
September 1982**

The majority of information found in this handcook is an adaptation and revision of COMMERCIAL RABBIT RAISING Agriculture Handbook No. 309, U.S. Department of Agriculture. This revision was essential to meet the special environmental conditions found only in tropical climates.

Reprinted with permission for Peace Corps use only. Limited numbers of reprints are available through Peace Corps Information Collection and

**Exchange Office of Program Development 806 Conn. Ave. NW, Washington,
DC 20526 September 1982**



[Home](#) > [ar.cn.de.en.es.fr.id.it.ph.po.ru.sw](#)

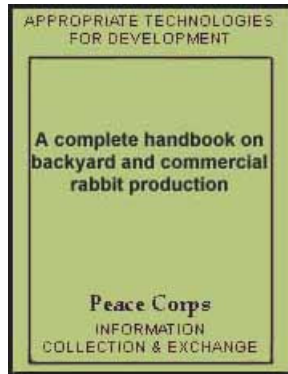

 **A Complete Handbook on Back-Yard and Commercial Rabbit Production (Peace Corps, 1982, 92 p.)**

 **(introduction...)**

 **Author's introduction**

 **Author's preface**

 **Selecting a breed**

 **Methods of breeding**

 **How to breed**

 **The rabbitry and its equipment**

 **Feeds and feeding**







 **Feeding rabbits**

  **Coprophagy**

 **Reproduction**

 **Managing the herd**



-  **Various uses of rabbit manure**
-  **Types of production**
-  **Marketing rabbits**
-  **Simplified tanning**
-  **Cooking recipes**
-  **Multiple-project approach to rabbitry**
-  **Glossary**

Coprophagy



Rabbits re-ingest part of their food, usually in the early morning when they are unobserved. They re-ingest only the soft matter that has passed through the digestive tract. Investigators have called this trait "pseudo-rumination" from the characteristics of ruminants (cows sheep and others) that chew the cud, which is food regurgitated and chewed again. Most rabbit breeders are unaware of this practice. Some who have observed it, believe it indicates a nutritional deficiency and lack of quantity and quality of feed. It is however, normal in rabbits and may actually enhance the nutritive value of the feed by virtue of a second passage through the digestive tract.

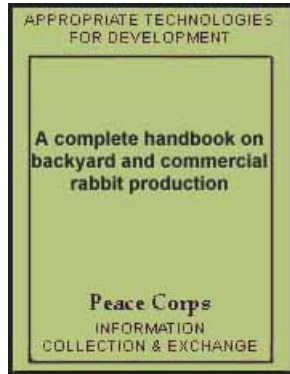

[Home](#)"" """"> [ar.cn.de.en.es.fr.id.it.ph.po.ru.sw](#)



 **A Complete Handbook on Back-Yard and Commercial Rabbit Production (Peace Corps, 1982, 92 p.)**

- ➔  **Reproduction**
-  **Lactation**
-  **Factors that limit conception**

A Complete Handbook on Back-Yard and Commercial Rabbit Production (Peace Corps, 1982, 92 p.)

Reproduction

Lactation

During the last week of pregnancy the mammary glands develop rapidly. Though milk may be produced before kindling, and actually leak from the glands of high-producing does, the actual let-down and production is usually delayed until kindling, and is initiated under hormonal and nervous stimuli induced by the action of suckling. Maximum milk production is usually reached by the third week, after which production gradually declines. The duration of lactation varies depending upon diet, number of

suckling young, and the length of time the young are left with the doe. Ordinarily, milk production is negligible after the sixth or seventh week, though in well-nourished, high-producing does with a litter of eight or nine, milk production may last for 8 weeks or longer. Milk has been observed in the stomachs of young weaned from the doe at 8 weeks of age, and milk can be secreted from the glands for several days thereafter.

The amount of milk produced depends upon several factors such as breed, strain, diet, and genetic constitution. Various studies of milk production in rabbits indicate that during the height of lactation, milk yield may reach 35 grams per kilogram of live weight. On this basis, a 4½ kilo doe would produce approximately 140 grams (5 ounces) of milk a day.

Contrary to popular belief, the doe does not nurse her young throughout the 24-hour period. Especially for the very young in the nest box, nursing is usually performed during the night or early morning. It may consist of a single feeding of only a few minutes. After the young leave the nest box and are consuming solid food they will try to nurse several times during the day. However, the doe will usually push them aside and restrict their nursing to the night-time. Occasionally does will allow the young to nurse during the day, as most rabbit breeders have observed. Students of animal behavior attribute the nursing habits of the doe to the fact that rabbits in their natural habitat are extensively preyed upon and are rather helpless to defend their young. Therefore, it is advantageous for the doe to stay away

from the young as much as possible.

A regular feeding program determines a regular and consistent nursing schedule by the doe. Therefore, if you feed the doe both concentrate and roughage at 5:30 in the morning and 5:30 in the late afternoon, the doe can be expected to nurse her young regularly between 6:00 and 7:00 A.M. and P.M.

Factors that limit conception

Among the causes of failure to conceive, or low conception rates, are false pregnancy (pseudopregnancy), age, poor physical condition, sore hocks, injuries, disease, hot weather, nervousness or restlessness due to mixed colony.

Pseudopregnancy - Does may be stimulated sexually and shed the egg cells, yet fail to become pregnant when the caretaker fails to have her properly mated. In this case, signs of heat are present, forcing her to ride on other does if in colony type hutches. Does which become pseudopregnant are unable to conceive until the false-pregnancy period of 17 days is over. After 18 to 22 days, the doe may give evidence of the termination of false pregnancy by pulling fur and attempting to make a nest. When false pregnancy has terminated, the doe will resume normal reproductive activity and may be bred.

Separate does that are to be mated and put each in an individual hutch 18 days before mating. Then they will have passed through any false pregnancy period by mating time. Sometimes the cycle of pseudopregnancy can be broken by abruptly changing the type of roughage and concentrate or by giving no feed at all for 24 hours. Forced mating can also break the cycle of pseudopregnancy if heat signs are present.

Age - Young does may not be sexually mature at the time of service, and old does may have passed their period of usefulness and fail to conceive. Do not attempt the first mating until the does are sexually mature and properly developed; the proper age is 5½-6 months old and weighing at least 2½ kilos.

Does should reproduce satisfactorily as long as they are maintained in good physical condition and can properly nurse their litters. Retain them if younger and better stock is not available for replacements. In commercial herds, does that are properly cared for should produce litters until they are 2 ½ to 3 years old. An occasional individual rabbit may reproduce satisfactorily 4 to 6 years, or longer.

Physical Condition - Rabbits that go "off feed," go into a prolonged or heavy molt, become abnormally fat or thin, or become out of condition for any reason, may have their reproductive powers impaired. The percentage that will conceive will be low, since they may become temporarily sterile.

In any backyard or commercial rabbitry, quantity and quality of feed should never be sacrificed for economical factors.

Disease - Never mate rabbits when they show any symptom of disease. Remove such animals from the herd and hold them in quarantine until they recover. Certainly, sickly animals produce inferior offspring.





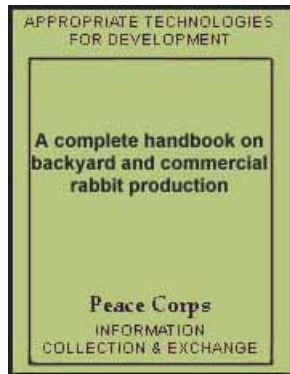

Extreme Heat - Rabbits have a tendency to become temporarily sterile in extreme temperatures such as (30° - 32°C). It is recommended to breed in the early morning or late afternoon.











[Home](#) > [ar](#).[cn](#).[de](#).[en](#).[es](#).[fr](#).[id](#).[it](#).[ph](#).[po](#).[ru](#).[sw](#)



 **A Complete Handbook on Back-Yard and Commercial Rabbit Production (Peace Corps, 1982, 92 p.)**

- ➔  **Managing the herd**
 -  **(introduction...)**
 -  **Methods of handling rabbits**
 -  **Determining pregnancy**
 -  **Kindling**
 -  **Care of young litter**

-  **Causes of losses in newborn litters**
-  **Weaning**
-  **Determining the sex of young rabbits**
-  **Records**
-  **Preventing injuries**
-  **Sanitation and disease control**
-  **Fur eating habit**
-  **Preventing fur block**
-  **Gnawing wooden parts of the hutch**

A Complete Handbook on Back-Yard and Commercial Rabbit Production (Peace Corps, 1982, 92 p.)

Managing the herd

Success in raising rabbits depends on efficient management. Become thoroughly acquainted with your animals - their characteristics and behavior, their likes and dislikes. Consideration for the welfare of animals is always necessary for success in raising them. Proper arrangement of equipment, hutches, and location of buildings is also essential to efficient management. When you enter the rabbitry, do it quietly and make your presence known by speaking in a low tone. Caution others to do the same. Otherwise, the rabbits may become frightened, race around in the hutch and injure themselves, or jump into the nest boxes and injure the litters.

Methods of handling rabbits

Never lift rabbits by the ears or legs. Handling in this manner may injure them and even cause drooping ears.

You can lift and comfortably carry small rabbits by grasping the loin region gently and firmly (Fig. 15). Put the heel of the hand toward the tail of the animal. This method prevents bruising the carcass or damaging the pelt.



FIGURE 15 - Lift small rabbits by grasping the loin region gently.

To lift and carry medium weight rabbits, let the right hand stroke the ears

down and grasp the fold of the skin over the rabbits shoulder. This allows added control of the head portion. Support the rabbit by placing the left hand under its rump.

Lift and carry heavier rabbits in a similar manner. If the rabbit scratches and struggles, tuck his hind legs under the right arm and hold it snugly; or release the animal on the ground and follow the stated steps again(Fig. 16).



FIGURE 16 - Carry heavier rabbits by tucking the hind legs under the right arm and holding snugly.

Determining pregnancy

It is not accurate to determine pregnancy by "test mating" (placing the doe in the buck's hutch periodically). Some does will accept service when pregnant and others will refuse service when they are not pregnant. Diagnosing pregnancy by noting the development of the abdominal region and gain in flesh is not dependable until late in pregnancy.

You can quickly and accurately determine pregnancy by palpating, after 12 to 14 days from mating, but you must handle the doe gently. The method for restraining the doe for palpating is illustrated in figure 17. The doe may be palpated in her own hutch or if it is more convenient she may be placed on a table covered with feed sacks or carpeting to prevent slipping. The ears and a fold of skin over the shoulders are held in the right or left hand; the other hand is placed under the shoulder between the hind legs and slightly in front of the pelvis; the thumb is placed on the right side and the fingers on the left side of the two uteri for palpating the fetuses. At 12 to 14 days following mating, the fetuses have developed into marble-shaped forms that are easy to distinguish as they slip between the thumb and fingers when the hand is gently moved forward and backward and a slight pressure is exerted. Caution must be used in this operation, because if too much pressure is exerted, the tissues may be bruised or torn loose from the walls of the uteri and a toxic condition or abortion may result.

There is less danger of bruising the tissues or causing the fetuses to be torn loose from the walls of the uteri in palpating at 12 to 14 days than at a later period. Also, diagnosing pregnancy after the 16th day of the gestation period is more complicated because the developing fetuses are so large that they may be confused with digestive organs. The inexperienced rabbit owner should make examinations at 12 to 14 days and then as he improves his technique and attains confidence in the operation he may be able to develop the ability for diagnosing pregnancy accurately as early as the 7th or 8th day. The chief advantage to be derived from palpating as early as the 7th or 8th day would be in the case of the breeder selling bred does. When it is desirable to ship bred does a considerable distance, diagnosing pregnancy at this early date makes it possible to have these does arrive at their destination in sufficient time to become settled and acquainted with their new environment, with the minimum risk of complications at kindling.



FIGURE 17 - How to restrain a doe for palpating.

If on palpating no fetuses are found to be present, the doe has failed to conceive, in which case she should be retired. The doe that is pregnant can be placed immediately on a diet that is best suited for pregnant does. Twenty-five-days after breeding, the doe may then be given a nest box with nesting materials, giving her ample time to prepare for kindling.

While palpating is the most reliable method of determining pregnancy, it is also the most dangerous for the inexperienced caretaker. As an alternative to palpating, observe the following signs in a doe:

- 1. Rejecting buck when returned for service.**
- 2. Enlarged abdomen.**
- 3. Total rejecting of new types of feed.**
- 4. Grunting when tapped on head or personality change.**
- 5. Will scratch a corner of her cage thus showing her preferential location for kindling during the second to third week.**

Although the above mentioned signs are not as accurate as palpating, they will assist the caretaker in determining pregnancy with up to 85 per cent accuracy.

Kindling

Place a nest box in the hutch about 25 days after the doe is mated in her preferred corner. This allows the doe to prepare a nest in advance and

assure a proper place for birth of the young.

Sometimes does fail to pull fur to cover their litter, or they kindle the litter on the hutch floor and let them become chilled. If you discover the young in time, you may be able to save them by warming, even if they appear lifeless. To warm the babies prepare a cup of lukewarm water. Hold the baby by the head and dip a few times in the cup. Then, dry with a cloth. Arrange the bedding material to make a comfortable nest, and place the warmed young in it. The doe usually will take over from there. The doe's fur is easily removed at kindling time, and you can pull enough from the doe's body to cover the litter in the nest. It is advisable to keep extra fur on hand for such cases. Remove some fur from nests where does have pulled an excessive amount and keep it handy in a separate bag or box so it will remain clean. It is not necessary to sterilize or to deodorize the fur, but, take special measures to prevent the doe from smelling the strange fur by holding her bunnies with the strange fur and rubbing your hand along the doe's back before placing the fur in the nest box. This aids in transferring her smell to the strange fur. If the doe smells the strange fur, it is likely that she will eat it if these precautionary measures are not followed.

A day or two before kindling, the doe usually consumes less food than normally. Do not disturb her, but make her as comfortable as possible. You may tempt her at that time with small quantities of green feed and commercial feed. This will have a beneficial effect on her digestive system.

After the doe kindles, give her plenty of fresh green feed.

Most litters are kindled at night. After kindling, the doe may be restless. Do not disturb her until she has quieted down.

Leave the young in the hutch with the doe until they are 8 to 12 weeks of age.

Care of young litter

A few hours after kindling, remove the nest box from the cage and inspect the litter to remove any deformed, undersized, or dead young. If you are careful and quiet making the inspection, the doe generally will not object. There is no danger of causing her to disown the young. If she is nervous and irritable, place some tempting feed in the hutch immediately before inspection to distract her attention and quiet her.

Litters vary in size. The more common breeds usually average eight young. Some may number 12 to 18. For commercial purposes 7, 8, or 9 may be left with the doe. Does from strains that have been developed for heavy production may care for 9 or 10.

You can transfer some of the baby rabbits from a large litter to a foster mother that has a small litter. Adjusting the number of young to the capacity of the doe insures more uniform growth and development at

weaning time. Therefore, mate several does so that they will kindle at about the same time. For best results, the young that are transferred should be within 3 or 4 days of the age of the foster mother's young. To facilitate acceptance by the foster mother, rub Vicks Vaporub on her nose as well as the nose of the bunnies to deaden their sense of smell; or better yet, run your hand through the foster mother's fur thus transferring her smell to the bunnies. This will enable a successful acceptance by the doe.

Causes of losses in newborn litters

If the doe is disturbed, she may kindle on the hutch floor and the litter may die from exposure. Even if predators - cats, snakes, strange dogs, ants cannot gain access to the rabbitry, they may be close enough for the doe to detect their presence, and she may be frightened and kindle prematurely. If she is disturbed after the litter is born and jumps into the nest box, she may stamp with her back feet and injure or kill the newborn rabbits. Discourage strangers, even your good friends, from entering the breeding section of the rabbitry during kindling time except for the caretaker, whose voice and presence are familiar to the rabbits.

Occasionally a doe fails to produce milk. In such cases the young will starve within 2 or 3 days unless the condition is noted and the young transferred to foster mothers. Keep a close check on newborn litters for several days after birth to make sure they are being fed and cared for

properly.

Does sometimes eat their young. This may result from a ration inadequate in either quantity or quality, or from the nervousness of a doe disturbed after kindling. It is also possible that the doe is of a strain that exhibits poor maternal instincts and cannibal behavior. Does usually do not kill and eat healthy young, but limit their cannibalism to young born dead, or those that are injured and have died. Proper feeding and handling during pregnancy will do more than anything else to prevent this tendency. Give another chance to a valuable doe that destroys her first litter; if she continues the practice, dispose of her.

Weaning

Young rabbits open their eyes at 10 days old and start coming out of the nest to eat feed when they are 19 or 20 days old. If the young come out of the nest sooner, they may not be getting enough milk or the nest may be too warm or the door blocker is too low at the front section of the nest box.

The doe usually nurses her young at night or in the early evening and morning hours during the first 2 weeks of nursing. After 2 weeks she will nurse them at her will. If the litter becomes divided, the doe will either nurse the young in the nest or those on the floor. She will not nurse both groups, nor will she pick up the young and return them to the nest. This results when the nest box is too large or not tilted backwards or up at the

front.

Leave the young rabbits with the doe until they are 8 to 10 weeks old. By that time, the milk supply will have decreased and the young will be accustomed to eating other feed, thus allowing the doe to prepare for the next kindling. Fryer rabbits should be in marketable size and weight by the time they are 14-16 weeks of age.

Determining the sex of young rabbits

Separate the sexes at weaning if you are saving junior replacements or breeding stock. It is possible to determine accurately the sex of baby rabbits less than one week old, but it is easier to do so when they are weaned at 8 weeks. To keep the rabbit from struggling, restrain it firmly, yet gently. A commonly used method is to hold the rabbit on its back between legs with the head up. With your left hand restrain the rabbit around the chest holding the front legs forward alongside the head. Using the right hand, place the thumb behind the right hind leg and use the index and forefinger to depress the area in front of the sex organs to expose the reddish mucous membrane (Fig. 18). In the buck, the organ will protrude as a rounded tip, while in the doe the membrane will protrude to form a slit with a depression at the end next to the anus.

If your eyes or hands are not keen enough to follow the above method, observe the rabbits during feeding, if they ride or mount on one another at

even 1½ months of age, surely they are males and are bound to be good quality breeders in the future.

Records

As mentioned before, record keeping is essential to good management. The most important features of a simple record system are illustrated in the hutch cards shown in figures 19 and 20.



FIGURE 18 - Sexing a doe: with the thumb depress the mucous membrane so the protrusion shows a slit with a depression at the end below the anus.

Mark each breeding rabbit for your record system. Tattooing is the best marking method because it is permanent and will not disfigure the ears. An adjustable box (Fig. 21) is convenient for restraining rabbits for tattooing. Ear tags and clips are not satisfactory for marking because they tear out and disfigure the ears.

A convenient and simple record system is needed to keep track of breeding, kindling, and weaning operations. Information from the records can be used to cull unproductive animals and to select desirable breeding stock.

Records need not be extremely detailed, unless the personal desires and time of the operator allow for minute record keeping.

Whatever records are kept should permit the operator to calculate costs of production and evaluate the progress made over comparable periods of time (Fig. 22).

Basic information desired includes: (a) the number of does bred, (b) the number of conceptions, (c) the number of does kindling, (d) the number of does raising a litter, (e) total young left with doe, and (f) total number of young weaned or raised per breeding. These facts will provide the necessary permanent production factors. Information can be obtained from the hutch record cards and compiled on a monthly summary form. The monthly figures can then be accumulated on an annual summary form; and an annual summary of the rabbitry can be ascertained by posting the

accumulated investment, income, and expense figures on a summary chart.

Records are essential for success in a rabbitry whether it be on a commercial level or in the backyard and on a small scale. Highly productive does and bucks can be secured from past records for replacement stock and sale.

**FIGURE 19
SAMPLE OF A HUTCH CARD FOR RECORDKEEPING**

A. FRONT

HUTCH CARD

**Animal No. W 301 Born 12/12/61 Breed New Zealand White
Sire W 394 Dam W 604 Litter No. W 714**

DATE BRED	BUCK	DATE KINDLE	NO. YOUNG BORN		NUMBER YOUNG RETAINED	LITTER NO.	DATE WEANED	WEANED NO.
			ALIVE	DEAD				
6/1/62	W 418	7/2	11	0	8	W 19	8/27	8
8/24/62	W418	9/24	9	0	8	W 175	11/19	8
11/16/62	W	Passed	11/30					

	418							
11/30/62	W 421	12/30	9	1	8	W 316	2/24/63	8
2/21/63	W 421	3/24	11	0	8	W 465	5/19	7

B. BACK

PRODUCTION RECORD

LITTER NO.	WEARING			NOTES:
	NUMBER	AGE	WEIGHT	
W 19	8	days 56	gm 30.2	
W 175	8	56	31.0	
Passed	11/30	56		
W 316	8	56	32.0	
W 465	7	56	28.0	

FIGURE 20 - SAMPLE OF A BUCK BREEDING RECORD.

BUCK BREEDING RECORD**Buck No.** _____**Bred** _____ **Sire** _____**Date born** _____ **Dam** _____

Doe	Location	DATE BRED	Result of breeding			Weaned	
			Kindled	Passed			
			Alive	Dead	Date	Number	Weight

FIGURE 21**ANNUAL PRODUCTION OR INVENTORY RECORD**

YEAR	NO OF DOES	NO OF BUCKS	MARKETABLE BUNNIES TOTAL	TOTAL ASSETS *(1)	TOTAL DEBITS *(2)
1973	50	12	1,200		
1974	70	15	1,600		
1975	80	16	1,900		
1976	100	22	2,000		

***(1) Includes equipment, stock, and fur.**

***(2) General overhead: feeds, labor, taxes, electricity, etc.**

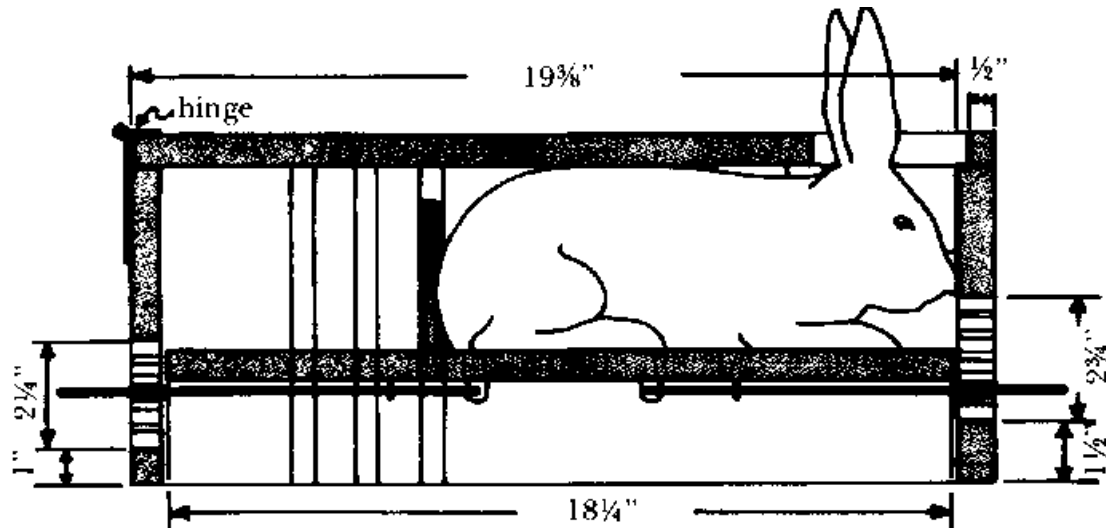

FIGURE 22 - Vertical section of a box for restraining a rabbit for tattooing. The spring-type holders tacked to the lower side of a movable floor compress the rabbit toward the top of the box. A movable cross partition holds the rabbit toward the front. Blocks of wood on each side hold the

rabbit's head in the center of the hole at the top.

Preventing injuries

Another aspect of good management - caring for welfare of the animals - is preventing injuries. Many injuries such as paralyzed hindquarters in rabbits usually result from improper handling or from injuries caused by slipping in the hutch while exercising or attempting to escape predators. Such slipping usually occurs at night around kindling time. Another cause of injuries is faulty cages that possess protruding nails, wire, or improper wire size. Common injuries are dislocated vertebrae, damaged nerve tissue, or strained muscles and/or tendons.

If the injury is mild, the animal may recover in a few days. Make the injured animal comfortable and feed it a balanced diet. If it does not improve within a week, destroy it to prevent unnecessary suffering.

It is important, therefore, that your rabbits be provided with quiet, comfortable surroundings and be protected from predators and unnecessary disturbances. Again, we stress the fact that noise in the rabbitry should be avoided at all times. Also do not allow visitors to poke the rabbits..., instead they should be courteous to them.

Trimming toenails is another preventive measure. The toenails of rabbits confined in hutches do not wear normally. They may even become long

enough to cause foot deformity. The nails may also catch in the wire mesh floor and cause injury and suffering. Periodically cut the nails with side cutting pliers. Cut below the tip of the cone in the toenail. The cone can be observed by holding the foot up to daylight. This will not cause hemorrhaging or injury to the sensitive portion.

Sanitation and disease control

Daily cleaning of hutches, containers and surroundings is the easiest way to insure sanitary condition hence control disease. When rabbits appear sick refer to table 4 on the following pages which presents in a concise form useful information on the more common disorders of the domestic rabbit.

The most common diseases in the Philippines found in rabbits are coccidiosis, pasteurella type pneumonia, and enteritis. These generally are caused by lack of sanitation in the rabbitry. With strict sanitation practices such as cleaning all cages and water containers EVERYDAY and collecting roughage from uncontaminated areas, (ideally, you will have provided space for planting your own forages) you can drastically minimize chances of ANY disease in the rabbitry or even yourself. (Fig. 23)



FIGURE 23 - (Left) healthy Chinchilla and (right) disease stricken New Zealand White.

**TABLE IV
DISEASE, CAUSE, TREATMENT**

DISEASE AND SYMPTOMS	CAUSE	TREATMENT AND CONTROL
SKIN		
<i>Ear Mange or Canker</i> - Shaking of head, scratching of ears. Brown scaly crusts at base of inner ear.	Infestation by mites through feeds or unsanitary cages.	Remove scales and crusts from inner ear and swab with a mixture of 1 tsp. of edible oil to 3 drops iodine. Pour into infected ear. Crush cartilage to break up scabs. Repeat once a week until cured.
<i>Skin Mange</i> - Reddened scaly skin,	Infestation by skin parasites	Sevin sprayable 85 mixed with oil and rubbed on infected areas. In severe cases,

intense itching and scratching, some loss of fur.	due to unsanitary conditions of the cage and feeds.	cull animals.
<i>Favus or Ringworm</i> - Circular patches or scaly skin with red, elevated crusts. Usually starts on head, fur may break off or fall out.	Fungus infection of the skin.	Treat with Fulvicin given orally at the rate of 10 milligrams per pound body weight for 14 days. Combine this treatment with dusting nest boxes with industrial fungicidal sulfur. Apply to infected area, hexetidine, for 7-14 days. Combine with sulfur dusting.
<i>Sore Hocks</i> - Bruised, infected or abscessed areas on hocks. May be found on front feet in severe cases. Animal shifts weight to front feet to help hocks.	Bruised or chafed areas that become infected. Wet floors, irritation from wire, nervous "stompers", are factors in cause.	Small lesions may be helped by placing resting board in cage. Advanced cases are best culled. Apply crude oil mixed with three drops iodine once a week until recovery.
<i>Warbles</i> - Irritated.	Infestations of	Drop chloroform on larvae and remove with

raised area under skin, usually back or flanks. Active larvae can be felt under skin, area usually moist.	skin by fly larvae.	forceps. Apply mild antiseptic to wound
<i>Lymphadenitis</i> - Multiple abscesses or lesions under the skin or in lymph glands. Loss of appetite and weight. May become generalized blood stream infection.	Bacterial infection caused by staphylococcus aureus.	Disinfect nest boxes. Severely infected animals should be destroyed. Combination of 400,000 units of Penicillin and ½ gram Streptomycin to each 2 millimeters should be given orally approx. 1/2 ml. each day for 3-5 days.

MUCOUS MEMBRANES

<i>Urine-Hutch Burn</i> - Inflammation of external sex organs and anus. Area may form crusts and bleed and, if severely infected, pus will be produced.	Bacterial infection of the membranes.	Keep hutch floors clean and dry. Pay particular attention to corners where animals urinate. Daily application of lanolin will hasten recovery.
---	---------------------------------------	--

<i>Spirochetosis or Vent</i>	Infection by	Do not breed until lesions are healed. If
------------------------------	--------------	---

<p><i>Disease</i> - Similar lesions as produced by urine or hutch burn. Raw lesions or scabs appear on sex organs transmitted by mating.</p>	<p><i>spirochete, Treponema cuniculi.</i></p>	<p>only a few animals are infected, it is easier to cull than treat. Do not loan bucks. Inject intramuscularly 100,000 units of Penicillin.</p>
<p><i>Conjunctivitis or Weepy Eye</i> - Inflammation of the eyelids discharge may be thin and watery or thick and purulent. Fur around eyes may become wet and matted.</p>	<p>Bacterial infection of the eyelids; may also be due to irritation from smoke, dust, sprays, or fumes.</p>	<p>Early cases may be cleared up with eye ointments, argyrol, yellow oxide of mercury, or antibiotic. Protect animal from air-borne irritants.</p>
<p><i>Infected Nose</i> - Inflammation or swelling with cracking and chapping of nose and lips. Sometimes brown scabs mat up to considerable thickness on the nose.</p>	<p>Bacterial infection of the nose and lips, similar hutch or urine burn.</p>	<p>Remove scabs from nose and lips and inject intramuscularly 100,000 units of penicillin. For scabby nose continue for 3 days Clean up cases of urine clean and dry.</p>

MTI K GLANDS

NECK STAINS		
<p><i>Caked Breasts</i> - Breasts became firm and congested later hard knots form at sides of nipple. Knots may break open showing dried milk.</p>	<p>Milk not drawn from glands as fast as formed because of too few young, or young not nursing sufficiently. Usually a management problem with high milk producing does.</p>	<p>Do not wean young abruptly; if litter is lost, rebreed doe and protect doe from disturbances so young can nurse properly. Correct faulty nest boxes that injure breasts.</p>
<p><i>Mastitis or Blue Breasts</i> - Breasts become feverish and pink, nipples red and dark. Temperature above normal, appetite poor. Then breasts turn black and</p>	<p>Bacterial infection of the breasts usually by <i>Staphylococcus</i> or <i>Streptococcus</i> species.</p>	<p>For early cases inject intramuscularly 100,000 units penicillin twice each day 3-5 days. Disinfect hutch, reduce feed concentrates. If case advanced, cull. Never transfer young from infected to another doe.</p>

<p>purplish. <i>Snuffles or Cold</i> - Sneezing, rubbing nose, nasal discharge may be thick or thin. Mats fur on inside front feet. May develop into pneumonia, usually chronic type of infection.</p>	<p>Bacterial infection of the nasal sinuses. Sometimes caused by mash feeds given dry.</p>	<p>Individual animals may be treated with combination of 400,000 units of penicillin combined with ½ gram streptomycin to each 2 ml. Give intramuscularly 1 ml. for fryer size, 2 ml. for mature. Repeat on third day. If tends to reoccur add feed grade Sulfaquinoxaline so that level will be 0.025%, feed 3-4 wks. Add water soluble Sulfaquinoxaline so that level will be 0.025%, feed 2-3 wks. This will reduce transmission to young. Save replacement stock from clean animals and cull cases of snuffles from herd.</p>
<p><i>Pneumonia</i> - labored breathing with nose held high, bluish color to eyes and ears, lungs show congestion, red, mottled, moist, may be filled with pus. Often secondary to enteritis.</p>	<p>Bacterial infection of the lungs due to exposure to rains and typhoons.</p>	<p>Treatment the same as for snuffles. Eliminate stress factors, ear mange, sore hocks, abscesses on body all predisposing factors for pneumonia. Provide cover during windy, rainy season for cages.</p>

<p><i>Heat Prostration</i> - Rapid respiration, prostration, blood tinged fluid from nose and mouth. Does that are due to kindle are most susceptible.</p>	<p>Lack of ventilation and improper location of hutch.</p>	<p>Ventilate hutch or building to allow air flow.</p>
<p><i>DIGESTIVE SYSTEM</i></p>		
<p><i>Malocclusion or Buck Teeth</i> - Incisors grow long so mouth cannot close properly Uppers curl back, lowers protrude. Animals cannot eat. Prone to pneumonia.</p>	<p>Some types are inheritable, others are result of injury.</p>	<p>DO NOT SAVE breeding stock from parent showing long teeth. Trim teeth on fryers to get animals to market. CULL RABBITS.</p>
<p><i>Coccidiosis, (Liver)</i> - White circular spots on and through enlarged liver. Bile appears yellow in color and bladder may show</p>	<p>Parasitic infection of the liver and bile ducts caused by Eimeria stiedae</p>	<p>Keep floors clean, dry, remove droppings frequently. Prevent fecal contamination of feed and water. Treat w/ Belmet or Sulmet. Follow instructions on lable.</p>

<p>sediment of cocysts. Usually cannot detect in live animals, not fatal.</p>		
<p><i>Coccidiosis (Intestinal)</i> - Mild cases, no symptoms; moderate cases, diarrhea and no weight gain. Severe cases have pot belly, diarrhea with mucus; and pneumonia is often secondary.</p>	<p>Parasitic infection of the intestinal tract.</p>	<p>Keep floor clean, dry remove droppings frequently. Prevent fecal contamination of food and water. Sulmet or Belmet combined with SANITATION will greatly reduce numbers of parasites and animals infected.</p>
<p><i>Enteritis. Bloat, Scours</i> - Loss of appetite, little activity, eyes dull and squinted, fur rough, and animal may appear bloated. Diarrhea or mucus in drop- pings and animal may grind teeth. Stomach contents</p>	<p>Never has been shown to be infectious or transmitted to other animals. (Beware of fermented, spoiled feeds and forages.)</p>	<p>Terramycin scour tablets with vitamin A, D, and Niacinamide. If this is not available use Sulfasuxidine or Sulfaguanadine. Follow instruction on lable.</p>

fluid, intestinal contents fluid, gaseous, or filled with mucus.		
<p><i>Fur Block</i> - Animals reduce feed intake or stop eating completely, fur becomes rough and weight is lost. Stomach filled with undigested fur, blocking passage to intestinal tract. Pneumonia may become secondary.</p>	<p>Lack of sufficient fiber, bulk or roughage in diet. Junior or developing does most susceptible.</p>	<p>Increase fiber or roughage in the ration. Feed dry Leucerne or timothy hay.</p>
<p><i>Tapeworm Larvae</i> - White streaks in liver or small white cysts attached to membrane on stomach or intestines. Usually cannot detect in live</p>	<p>Intermediate stage of the dog or cat tapeworm.</p>	<p>No treatment, keep dogs and cats away from feed, water and nest box material. Eggs found in droppings of dogs and cats.</p>

<p>animal <i>Pinworms</i> - No symptoms in live animals. White threadlike worms found in cecum and large intestine causes slight local irritation.</p>	<p>Parasitic infection of the intestinal tract.</p>	<p>None; infection not considered one of economic importance.</p>
<p><i>Metritis or White Discharge</i> from female organs, often confused with sediment in urine. Enlarged uterus detected on palpation. One or both uteri filled with white, purulent material.</p>	<p>Infection of the uterus, by a variety of bacteria, nonspecific.</p>	<p>Dispose of infected animal and disinfect hutch. Infected area difficult to medicate. When both uteri are infected animal is sterile.</p>
<p><i>Myxomatosis 3</i> - Inflammation and swelling of the eyes, ears, nose and genitals, high fever, loss of appetite ears may droop from</p>	<p>Infection caused by virus.</p>	<p>None, antibiotics not effective. Reduce mosquito population by spraying, draining stagnant water. and screening, promptly dispose of infected animals.</p>

weight of swelling. Usually fatal, mature animals most affected.		
<i>Papilloma</i> - Wrinkle horny growths, usually on ears, may form "stag horn" type of growth. Not fatal, cannot be transmitted to other domestic rabbits.	Infection caused by virus.	None, not fatal, self-limiting. Usually an infection of the wild rabbit, transmitted to the domestic by the bite of insects.
<i>MILKWEED Poisoning</i> - Paralysis of the neck muscles and lack of coordination. Head droops between front legs, and animal cannot eat or drink. General paralysis in advanced cases.	Paralysis caused by eating leaves or stems of the woolly-pod milk-weed, <i>Asclepias eirocarpa</i> .	Force feed and water into animal.
<i>Pseudotuberculosis</i> - Chronic infection, weight loss weakness,	Bacterial infection.	Destroy hopelessly sick animals, disinfect hutches. Add 50 grams NF-180 per ton of feed to give a final concentration of

and progressive emaciation. Small abscesses found in liver, kidneys spleen, lungs, or intestine.		0.0055%. May be fed intermittently or continuously.
<i>Listeriosis</i> - Loss of appetite and emaciation, generally in young animals. Minute white abscesses in liver, spleen and reproductive organs. May involve central nervous system.	Bacterial infection.	Early treatment with Terramycin at a level of 1 pound to 100-150 gallons of water. Advanced cases should be destroyed. Disinfect hutches.
<i>Hydrocephalus</i> - Found in young only; top of skull raised, resembles large welt, firm to touch. Ventricles of brain enlarged, filled with fluid.	Nutrition deficiency, lack of sufficient Vitamin A in doe's diet.	Insure adequate vitamin A in ration. Damage is done during pregnancy. Symptoms appear in young about 10-20 days old.
<i>Paralvzed Hind</i>	Iniurv.	Protect animals from disturbina factors:

<p><i>Quarters</i> - Found in mature does, hind legs drag, cannot stand or support weight of pelvis. Urinary bladder fills but does not empty.</p>	<p>resulting in broken back displaced disc, damage to spinal cord or nerves.</p>	<p>predators, night prowlers, and visitors or noises that startle animals, especially pregnant does.</p>
<p><i>Wry-Neck</i> - Head twisted to one side, animals roll over, cannot maintain equilibrium.</p>	<p>Infection of the organs of balance in the inner ear, may be bacterial or parasitic. This is severe case of untreated ear canker.</p>	<p>None, eliminate those with ear canker from herd. Some cases result from nest box injuries.</p>

Use Affsilin for general use as a disease resistor. It is used as a food supplement added to the feed. Terramycin premix added to the ration is a general treatment for common rabbit diseases in the Philippines to help prevent serious ailments.

There are certain principles, however, some of which may appear to be self-evident, that are so generally applicable that space would not permit their

repetitious presentation in the table. These together with certain relevant comments are, therefore, enumerated:

1. Disease is in a sense a natural phenomenon which can never be completely eliminated but, can be greatly decreased through an intensive daily sanitation program. (Fig. 24)

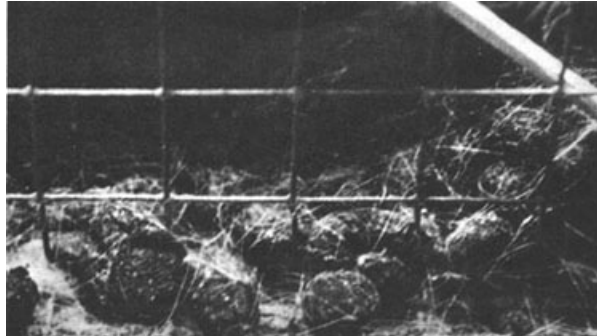

FIGURE 24 - Manure collects daily in corners of the cage. If not cleaned regularly, skin mites multiply and infest the rabbit.

2. Purposeful and intelligent sanitation practices may usually keep disease at a low level.

3. Prevention is vastly to be preferred to treatment and possible cure - proper sanitation practices are PREVENTION.

4. High natural resistance, long life and high productivity are as certainly inheritable as other traits, such as size, color, ear length, etc., but not necessarily in as simple a pattern. Persistent selection of breeding stock on the basis of superior performance will pay well for the trouble expended.

5. Do not overcrowd your animals (see "Hutches").

6. Observe good nutrition practices to permit the greatest expression of superior inheritable traits.

7. Provide plenty of draft-free ventilation. Up-drafts through selfcleaning floor result from over enclosure of the sides; and these drafts are particularly objectionable.

8. Permit your animals plenty of sunlight, if not attended by great heat. Shade must also be provided.

9. Keep all equipment CLEAN and DRY and, to minimize the possibilities of injury, keep it in good repair.

10. Avoid unnecessary handling of animals, their feed, their containers for food and water, or any equipment with which they come in contact. The clothing and hands of the caretaker may spread disease.

11. Isolate all stock being brought into your herd, for 1-2 weeks, whether it

be a new introduction or one of your own animals that has been in possible contact with other rabbits, directly or through equipment and handlers.

12. Isolate animals suspected of having infectious diseases, and care for such animals AFTER the normal ones have had their attention.

13. Protect your animals from disturbing influences, particularly night prowlers. Allow your animals complete rest during the day as routine care will permit.

14. If rabbits are sold on regular schedule to a dealer, have marketable stock segregated and confined outside of the rabbitry or at its entrance. The pickup man visits may rabbitries in rapid succession and will appreciate your cooperation in minimizing the possibility of his becoming a factor in the spread of disease.

Fur eating habit

Rabbits that eat their own fur or bedding material, or gnaw the fur on other rabbits, usually do so because the diet is inadequate in quality or quantity. A common cause is a diet low in fiber or bulk. Sometimes the protein content of the diet is too low. Adding more soybean, sorghum, peanut meal or any other legume may correct the deficiency.

The experienced breeder notes the condition of each animal in the herd and

regulates the quantity of feed to meet its individual requirement. Providing good-quality grass or feeding fresh, sound leguminous feed or rootcrops as a supplement to the home-mix or pelleted diet also helps to correct an abnormal appetite, or else remove all feed for 24 hours.

Preventing fur block

In cleaning themselves by licking their coats, or when eating fur from other animals, rabbits swallow some wool or fur which is not digested. The only noticeable result may be droppings fastened together by fur fibers. However, if the rabbit swallows any appreciable amount, it may collect in the stomach and form a "fur block" that interferes with digestion. If it becomes large enough, it blocks the alimentary tract and the animal starves. The most satisfactory method of preventing this is to shear Angoras regularly, and try to prevent fur eating among your rabbits by providing adequate roughage and protein in their diets. A block of wood soaked in salt for three days and hung in the cage for the rabbits to chew may be used to reduce fur chewing.

Gnawing wooden parts of the hutch

Gnawing wood is natural for the rabbit. However in excess, it may indicate insufficient amounts of salt in the diet. Protect wooden parts of the hutch by placing wire mesh on the inside of the frame when constructing the hutch or by using strips of tin, galvanized iron, or flattened cans (make sure

there are no rough edges protruding) to protect exposed wooden edges. Again, a block of wood soaked in brine solution and hung in the cage is the best solution.





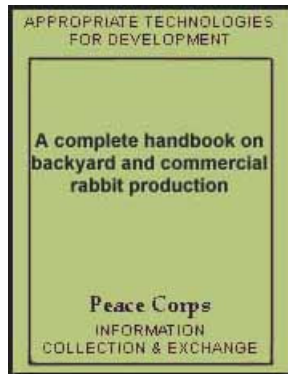

Rabbits that have access to good quality grass and are receiving legumes and rootcrops are less likely to gnaw on their hutches.



Home > [ar.cn.de.en.es.fr.id.it.ph.po.ru.sw](#)



 **A Complete Handbook on Back-Yard and Commercial Rabbit Production (Peace Corps, 1982, 92 p.)**

- ➔  **Various uses of rabbit manure**
 -  **Disposal of rabbit manure**
 -  **First class compost fertilizer**
 -  **Methane generator**
 -  **Construction of methane generator**
 -  **Earthworms in the rabbitry**

A Complete Handbook on Back-Yard and Commercial Rabbit Production (Peace Corps, 1982, 92 p.)

Various uses of rabbit manure

Disposal of rabbit manure

Rabbit manure has a high nitrogen content when the rabbits are fed a well-balanced diet. It will not burn plants and is easy to incorporate in the soil. It is satisfactory as fertilizer on gardens and when placed at the bases of flowering plants, shrubbery, and trees. There is no danger in using it for fertilizing soil on which crops are to be raised for feeding rabbits if mixed well in the soil or covered.

The value of rabbit manure depends on how it is cared for and used. There will be less loss of fertilizing elements if the material is immediately incorporated into the soil. When manure is stored in piles and exposed to the weather, chemicals are lost through leaching and heat. Much of this loss can be prevented by keeping the manure in a compost heap or in a bin or pit(Fig. 25).



FIGURE 25 - Compost heap near rabbitry.

First class compost fertilizer

Materials for Compost:

- **Good quality rice straw - 60 kilos or Kikuya grass (dried or wet)**
- **Rabbit manure (wet) - 110 liters**
- **Ammonium Sulphate - 2 kilos**
- **Rice bran or saw dust - 50-100 liters**
- **Sunflower leaves or any legume (in green form) - 100 kilos**
- **Add a thin layer of soil on top of pile.**

Procedure

Gather all the materials. Dampen straw or grass by placing in water for 1-2

minutes. Pile wet straw and cover to keep moist.

Next, cut straw into pieces 30 cm. long. Place a layer in the bottom of the hole about 15 cm. thick. Sprinkle in 1/5 of rabbit manure, 1/5 of rice bran or grass, and 1/5 of ammonium sulphate. Place another 15 cm. layer of straw, another 1/5 of rabbit manure, 1/5 of rice bran, and 1/5 of ammonium sulphate. Repeat the process until all ingredients have been used up. Cover the pile with grass or pieces of G.I. shed metal.

From time to time, turn the pile. In three to four weeks the compost is ready for use.

**FIGURE 26
DESIGN FOR COMPOST**

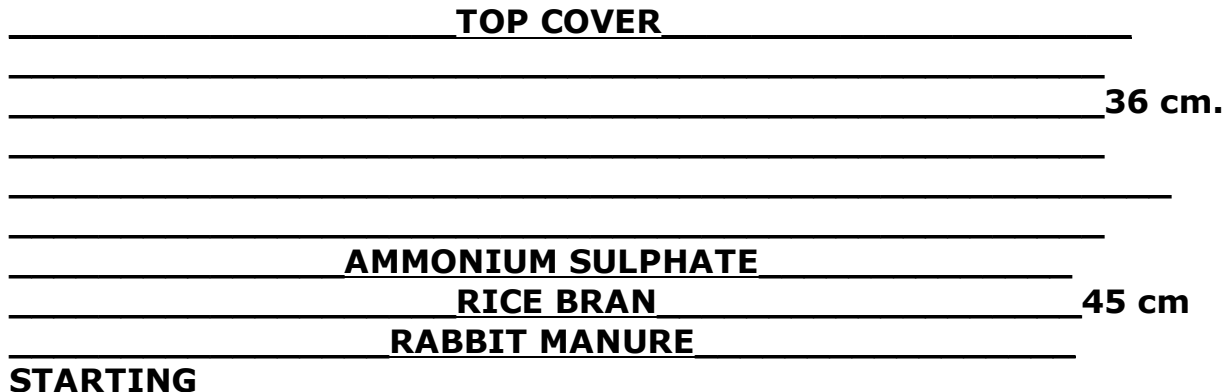

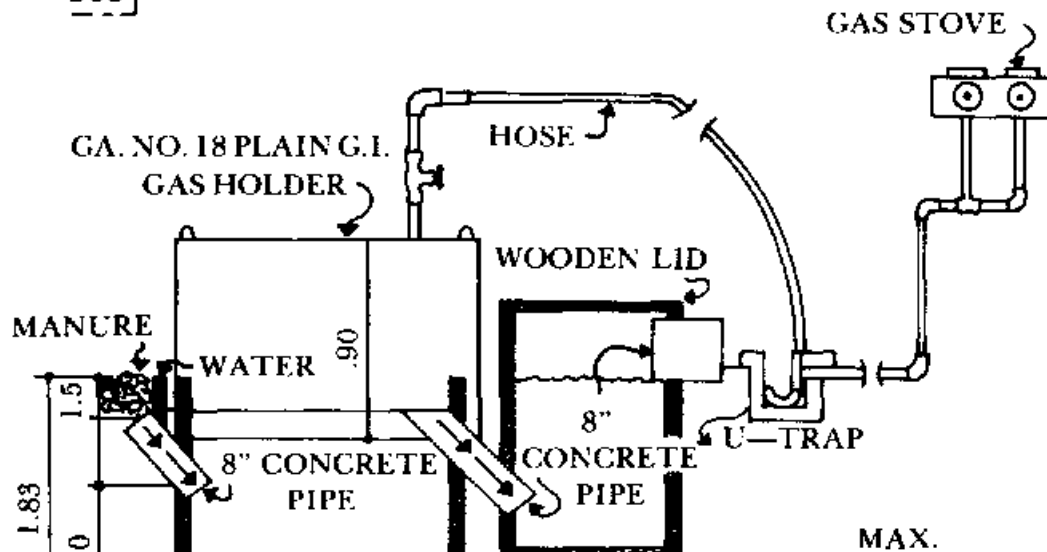
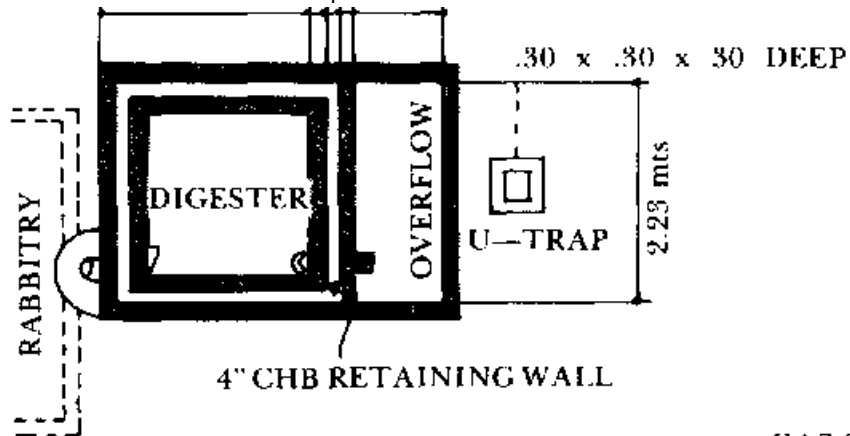



FIGURE 27 - Layout plan of a methane gas generator

The digester is an excavation consisting of inner and outer walls made of 4-inch or 10 cm. concrete hollow blocks with a water seal in between them at least 10 cm. wide. The cement used should be mixed with "Sahara", a water proofing agent, and the mixture added in the usual way to (or with) the aggregate (sand and gravel) for filling up the hollow blocks. The inner side of the outer hollow block wall is also plastered with cement mixed with a water-proofing agent. The inner surface of the inner hollow block wall is plastered in like manner. In addition to these, the cement pipes leading to and from the digester are plastered with cement and water proofing agent at their junction with the water seal to ensure that the water in the water seal does not leak through these pipes. The water seal may be filled up partly with sand since the gas holder does not go all the way down.

The intake cement pipe should enter the digester at as steep an angle as possible. The effluent 8-inch pipe is placed at an almost horizontal but preferably downward direction from the digester towards the effluence compartment. Sufficient depth should be left below the intake pipe for sedimentation of the Manure entering the digester; hence, the intake pipe

should not be lower than 1 meter from the bottom.

The inverted tank forming the gas holder is made of an 18 gauge galvanized iron sheet 1.83 m x 1.83 m and 0.91 m high. The gas holder is first rust-proofed with red lead paint and then given one or two coatings of black paint. A 1/2 inch G.I. pipe with a gate valve is welded on top at one corner of the gas holder. Four 3/8 inch iron rings are also welded at each of the four top corners of the gas holder to facilitate its removal for cleaning.

The effluent compartment can be any shape and dimension. It can also be shallower than the manure (digester) compartment. Care should be taken, however, to have the outlet pipe in the effluence compartment higher than the effluence pipe of the digester (or manure) compartment to prevent the escape of the gas through this outlet.

To start operation, the digester compartment is filled with manure as fast as possible up to and over the level of the effluent pipe. It is recommended that as soon as the digester compartment is filled, sludge from other successful digesters should be added (inoculated) to hasten the process. Even without sludge from successful digesters, the system will eventually generate methane but it might take 3-4 weeks instead of 2 weeks for gas to be produced when sludge is added. As soon as the digester is filled with manure and inoculated with sludge, the gas holder is placed into the double walled digester compartment. The proportion of methane gas increases

with time.

(Used engine oil may be added on top of the water to prevent it from evaporating from the double wall). The valve on top of the gas holder is then turned on, and the gas flows through a 1/4" G.I. pipe to wherever it will be used within a maximum distance of 50 meters. U-traps are provided along the pipe line to collect condensations of water which might otherwise block the pipeline. The free end of the U-trap should be lower than the gas line.

The manure of as few as 3 pigs weighing an average of 115 kilograms can maintain gas production for the larger model for as long as manure is fed continuously into the digester.

It is desirable to have an alternate outlet for liquids coming from the pig house since the passage of large quantities of water through the digester particularly during rainy season somehow allows the gas in the gas holder to escape through the effluent of the digester.

BILL OF MATERIALS FOR METHANE DIGESTER

1.80 x 1.80 m. gas holder for Figure 27

5 pcs. - 4' x 8' plain G.I. sheet gauge 18

465 pcs. - 4" x 8" x 16" CHB

12 pcs - 7 mm bars x 20'

- 12 pcs. - 7 mm bars x 20
- 25 bags - Cement
- 1 cu. m. - Gavel
- 2 cu. m. - Sand
- 3 pcs. - 8" concrete pipe
- 24 bf. - wood lid
- 2 kg. - tie wire
- 10 boxes - Sahara waterproof compound
- 18 cu. m. - Excavation

This methane gas generator plan can be utilized with any type of animal manure including rabbit manure.

Earthworms in the rabbitry

Where earthworms are active throughout the year as in warm climates, they may be used to advantage under rabbit hutches to save labor in removing fertilizer. Make bins the same length and width as the hutch and 30 cm deep for confining the worms. Place the bins on the ground, not on solid floors, and keep the fertilizer moist to insure that the worms can work throughout the bin.

Earthworms convert the rabbit droppings into casts - a convenient form of fertilizer. If you keep a large population of worms, there will be no

objectionable odor. In addition very few flies will breed in the bins. It is necessary to remove the manure only at 3 to 6 months intervals. This is especially conducive to areas which have porous soil.





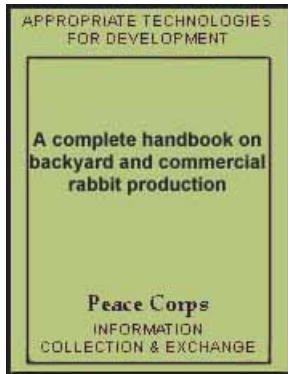



[Home](#) > [ar.cn.de.en.es.fr.id.it.ph.po.ru.sw](#)



A Complete Handbook on Back-Yard and Commercial Rabbit Production (Peace Corps, 1982, 92 p.)

Types of production

-  **Fryer production**
-  **Breeder production**
-  **Roaster production**
-  **Angora rabbit wool production**
-  **Grooming**
-  **Shearing**
-  **Grading, preparing, and marketing wool**

A Complete Handbook on Back-Yard and Commercial Rabbit Production (Peace Corps, 1982, 92 p.)

Types of production

Fryer production

A fryer or young rabbit carcass usually weighs not less than 1.7 kilos and should be from 3½-4 months old so that the pelt is of prime quality to warrant tanning.

A kilo of marketable fryer (dressed weight) will need 5.7 kilos of commercial concentrates from birth to marketing age. It takes about 82. 8 kilos of commercial concentrates to sustain a doe and her litter of 6 - 8, from breeding of the doe to marketing of the young at 3 ½-4 months of age. This is in addition to roughage and root crops given daily (about 1-1½ kilos total per day).

At 45 days to 2½ months, the bunnies are weaned from the doe and separated by sexes to allow for the next breeding. If the young are kept with the doe for over 2½ months, her milk supply will diminish to a level where the next kindling would not have a sufficient quantity.

Learn to castrate the bucks that are not intended for breeding stock to insure less quarreling amongst the bunnies held in colony. Castration demands much time, skill, and patience but, it is the only method to insure top quality meat and fur. It also maximizes space and feed.

Growth from 1 day to 2 months old is extremely fast so, be sure to give enough good quality feed in both roughage and concentrates to insure

proper development.

Breeder production

Breeder production is similar to fryer production. Breeders should be obtained from good producing does and have excellent looks, good performance, docile personalities, good conformation such as stocky body, stub nose, short ears, and alert eyes and be excellent consumers of feed.

Since these will be used as breeding stock, special care must be given to their diet because negligence will result in deterioration, thus, propagating undesirable traits for generations to come. Select the future breeders as early as one month old.

Secure initial breeding stock from RELIABLE farms where records are available for your analysis. In the absence of records, utilize the observation signs listed above to determine breeder quality. In the long run, it will pay to purchase the better quality breeder rather than the less expensive one that does not meet the recommended observation signs of breeder quality.

Roaster production

A roaster or mature rabbit is a mature or old domestic rabbit carcass of any weight and has usually outgrown its productivity. You can fatten a roaster

in 2 or 3 weeks to allow him to gain weight and improve fur quality.

It is doubtful if such production would be more profitable than that of rabbits of fryer weight.

Angora rabbit wool production

Angora rabbits are raised primarily for wool production (Fig. 28). In the Philippines this industry has not yet been developed although it is waiting for exploitation by any venturesome individual. The highlands: i.e. cooler climate, is the most conducive to raising this breed of rabbit.



FIGURE 28 - Angora rabbit.

Angoras grow to a length of.0625 m. to.0875 each 3 months, or approximately.025 per month. You can shear 14 to 15 ounces of wool a

year from a mature Angora that is not nursing young. This wool is valued for its softness, warmth, and strength. It is used in blends with other fibers in the manufacture of children's clothing, sport clothes, garment trimmings, etc. Used alone it is usually too light and fluffy, besides, blends create better tensile strength and durability.

There are two main types of Angora rabbits - the English and the French. Present standards of the American Rabbit Breeders Association, however, make English and French types of wool synonymous. It is difficult to distinguish the English Angora rabbits from the French when they are cross-bred. The choice is largely a matter of personal preference. The typical French Angora usually is larger than the English. The wool fiber of the French is shorter and coarser than that of the English, but the wool yield is greater. Due to competition with other natural and synthetic fibers and competition with imported Angora rabbit wool, the market price is generally low. Therefore, it is advisable to use the Angora as a TRIPLE PURPOSE ANIMAL for meat, for improvement of fur quality of other breeds by cross breeding, which is presently being undertaken, and for wool production. Cross breeding Angoras with other breeds has proven beneficial both for better meat and fur production. The commercial Angora weighs at least 8 pounds and is being bred more and more to improve its meat quality.

Keep herd bucks and does in individual hutches. Keep woolers - does and

castrated bucks maintained primarily for wool production - in groups or colonies to save labor. Castration of bucks that are to be reserved for wool production may reduce fighting in the herd but wool production is not increased by castration.

Feed and care for Angoras is the same as for other breeds. Because of their long wool, however, you must handle Angoras to find out how much flesh they are carrying; determine the amount of flesh by running the hand along the backbone. Reduce or increase the quantity of feed to keep the animal in healthy condition.

Angoras are generally sheared or plucked every 10 to 11 weeks though some producers pluck their animals monthly and some at intervals beyond 3 months.

Wool should be harvested prior to breeding to prevent mauling and soiling the wool.

To prevent internal parasite infestation and to keep wool clean (i.e. unstained by urine, etc.), install wire mesh floors in the pens and CLEAN DAILY.

A properly constructed manger for grass and legumes, or the use of a hopper, protects the wool from foreign matter and prevents contamination of feed. It is to be noted, however, that it is harder to breed Angoras than

other breeds because of the concealment of their genitals due to the length of fur. The caretaker needs to assist in mating by holding the doe's tail upward while the buck mounts.

You will need the following equipment for grooming and shearing:

- A table, waist-high, with a.30 x.60 top covered with carpet or a feed sack to keep the rabbit from slipping and equipped with castors to allow easy turning. A table equipped with straps or cords for restraining the rabbit is advantageous.**
- A hairbrush with single steel bristles set in rubber, for brushing and removing foreign material from wool.**
- A pair of barber's scissors.**
- A ruler for measuring the length of wool.**
- Containers for storing wool.**

Grooming

Commercial woofers require little, if any, grooming between shearing provided they are properly cared for and sheared every 10 to 12 weeks. If you allow the coat to grow for a longer period, the fibers may become webbed, tangled, or matted.

For grooming, place the rabbit on the table. Part the wool down the middle of the back. Brush one side, stroking downward. As you reach the end of

the wool, brush upward and outward to remove all foreign material. Make another part in the wool about half an inch farther down the side. Repeat the operation until the job is completed. Groom the other side the same way.

For grooming the head, front legs, and belly place the rabbit on its back in your lap. Hold its hindquarters gently but firmly between your knees. Separate small areas of wool and groom the way you did the sides.

For grooming the hind legs, place the rabbit on its back in your lap. Hold the head and front feet under the left arm. Use your left hand to hold the rabbit's hind legs.

Shearing

Before shearing, cut off all stained ends of wool. Place the back of the scissors against the rabbit's body to prevent cutting the skin. Begin at the rump and shear a strip about an inch wide to the neck. Repeat this operation until you have removed all the wool from one side. Turn the rabbit around and repeat the shearing operation on the other side, starting at the neck and shearing toward the rump. For shearing the head, front legs, belly, and hind legs, restrain the rabbit as for grooming. Separate small areas of wool and shear the way you did the sides. Do not injure the doe's teats. Do not shear wool from the belly of a pregnant doe. After shearing, lightly brush the rabbit to straighten out the wool fibers and

prevent the formation of mats. Take care not to include the flesh while shearing.

Grading, preparing, and marketing wool

Label a container for each grade of wool and place it near the shearing table. Grade the wool as sheared, following the usual commercial grades.

Plucked wool:

Super -.0825 or longer

No. 1 -.075 or longer

No. 2 -.05 or longer

Sheared wool:

No. 1 -.057 to.075

No. 2 -.038 to.05

No. 3 -.025 to.038

Shorts -.0125 to.019 (may be slightly webbed)

No. 4 - Matted

No. 5 - Stained and unclean

While the above have been the usually acceptable commercial grades for Angora rabbit wool, some grading systems have been simplified to the

extent that only three grades are considered: No. 1 - clean wool; No. 2 - clean mats; and No. 3 - all other wool, including soiled wool.

Put each grade in a separate paper bag not too tightly packed. Tie the bags and place them in sacks or corrugated boxes for shipment.

If the wool is to be stored, store it in a dry place. To protect the wool from moths, put mothballs or moth crystals in a small sack before placing this in the container with the wool.

Some Angora breeders spin the wool on an old-fashioned spinning wheel and knit the yarn into garments for home use or for sale. Others sell the wool to organizations or individuals who collect large quantities for sale to mills.

Rabbit wool production needs to be developed in the Philippines. We included Angora wool production in this handbook, specifically, for future reference of any innovative individuals.



[Home](#) > [ar](#).[cn](#).[de](#).[en](#).[es](#).[fr](#).[id](#).[it](#).[ph](#).[po](#).[ru](#).[sw](#)



A Complete Handbook on Back-Yard and Commercial Rabbit Production (Peace Corps, 1982, 92 p.)

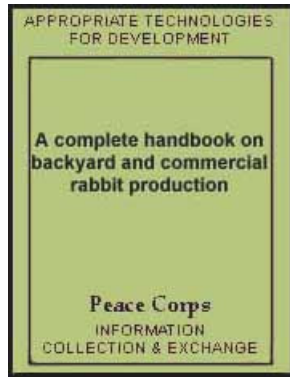

Marketing rabbits

(introduction...)

Cutting and packaging rabbit meat

Crating and shipping live rabbits

How to assess sales prospects

The economics of rabbit production

A Complete Handbook on Back-Yard and Commercial Rabbit Production (Peace Corps, 1982, 92 p.)

Marketing rabbits

Marketing is the number one problem with rabbit raisers in the Philippines today. In theory, the demand is great considering the current population explosion and world wide food shortages. In actuality, the demand for rabbit meat is either too high or too low for the rabbit producers to supply.

Presently, the lack of statistical data concerning the feasibility or the marketability of rabbit meat plagues the backyard and commercial rabbit entrepreneur. Hopefully, in the future, with the involvement of national government agencies and private organizations in rabbit production as an

alternative protein source, there will be studies conducted on the various potentials and/or detriments of this field for the entrepreneur to utilize as guidelines. Until these needed studies are conducted, we truly are pioneers in the field of rabbit production.

Marketing prospects should be located and developed promptly when one engages in rabbit production. The FIRST market for meat is the family, neighbors, towns and cities within the locality. Rabbit meat can then be sold in dressed form to hotels, restaurants, supermarkets, and open markets. Rabbit barbecue can be sold by sidewalk vendors. But if we are to succeed at all we must successfully market the IDEA of eating rabbit meat to ALL strata of the population...not only to the middle and upper class but, to the strata that compose the majority of the populace... the grass roots. WE must in fact convince ourselves before convincing others!

By-products of rabbits such as fur, tails, paws, and manure are certainly added income. In fact, more money will be made in marketing by-products than in the sale of meat alone.

REMEMBER: YOU and your community are the FIRST and BEST market before expanding sales to hotels, restaurants, etc.

Cutting and packaging rabbit meat

After slaughtering the animal (see later chapter on simplified tanning) and

washing the carcass thoroughly, hang it to drain. Wipe excess water with a clean cloth and pack meat attractively in a cellophane bag. Record weight on the bag with a pentel pen (Fig. 29, A and B).



FIGURE 29 - Inexpensive meat packaging method:

A. Fold hind legs into chest cavity leaving liver and kidneys exposed.

Chill the carcass in a refrigerated cooler. Arrange the carcass on a cooling rack so that moderate air movements and suitable temperature within the cooler will reduce the internal temperature of the carcass to no less than 2.22°C and to no more than 4.44°C within 24 hours.

Hanging by the hind legs for chilling may cause a carcass to be drawn out of shape so that the pieces will not fit satisfactorily into a carton. Some processors chill carcasses in wire trays, arranging them so the pieces will

be of a proper shape for packaging.



FIGURE 29 - B. Place in cellophane bag and record weight.



FIGURE 30-Common cuts of rabbit meat.

Hotels, restaurants, hospitals, clubs, and other establishments usually purchase the whole carcass with the liver intact. Their chefs prefer to cut them to meet their own requirements. Housewives usually prefer the cut-up packaged product. Cut up the fryer rabbit with a knife; using a cleaver may splinter the bones. Common cuts from fryer carcasses are illustrated in figure 30; in large commercial processing plants, a bandsaw is used. For sale in supermarkets, a paraffined box with a cellophane window makes a neat, sanitary package for the chilled rabbit carcass. If the package is to be handled considerably or the meat is to be frozen, use a box without the

cellophane window, but wrap the meat or the box in a special wrapping to prevent freezer burns and loss in palatability.

A box 22 1/2 mm long, 10 mm wide, and .164 deep is suitable for a fryer carcass weighing 750 grams to 950 grams. Again arrange the cut attractively. Include the heart, kidneys, and liver.

If you sell to the home trade or furnish butchers with meat that is to be consumed locally, a cellophane bag will suffice or you can make a neat, sanitary, and inexpensive package by arranging the pieces of fryer and a spring of parsley on a paper plate and covering them with a piece of clear cellophane or other wrapping materials.

Crating and shipping live rabbits

You can ship rabbits almost any distance with safety, if they are in good condition, properly crated, and provided with food and water. Do not ship them in extremely hot or cold weather. Always use well-ventilated crates that are long enough to permit the rabbit to lie down. Use straw for bedding. Crates with slanting tops discourage stacking. Consult the quarantine laws in your area (Fig. 31).

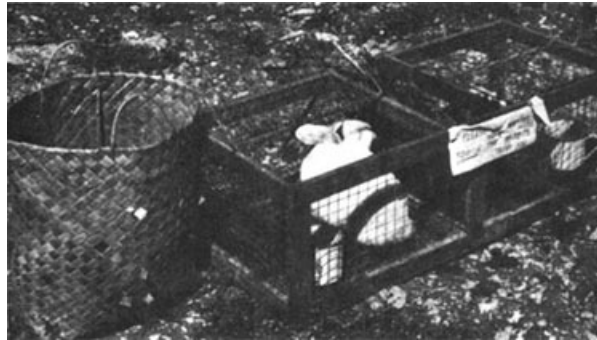

FIGURE 31 - (Left) bag with holes for transporting rabbits short distances - up to 24 hours. (Right) crate with grass manger in the center for long distances.

Put only one animal in each compartment of the shipping crate. Animals to be in transit 24 hours or less need only a small quantity of feed and water. If the trip is longer, more feed and water are needed. It is wise to attach to each crate a bag of feed and a printed request to feed and water the animals once a day. Plenty of fresh water and feed should be accessible to the rabbits at all times. For rabbits in transit, use the type of feed given in the rabbitry. As an alternative, any root crop or vegetable such as sayote placed in the crate will provide enough feed and moisture for several days travel, and eliminates the possibility of spilling feed and water supplied in containers.

Label the crate clearly, advising against exposing the animals to sun or

rain. Notify the purchaser when rabbits are shipped.

You can make shipping crates from packing boxes. It is good business, however, and effective advertising, to ship rabbits in durable crates that are neatly built, light weight and attractive. Furnish ample space in each compartment and be sure that wire netting keeps the rabbits from gnawing the wood.

How to assess sales prospects

To find out how your product will sell, gather and analyze the following information.

Basic

1. Geographical information. Area of country, the terrain, the climate, distance between main population centers. Things that will influence demand for your product. In other words..."who needs it?"

2. Population. What is its size, age range, and concentration?

3. Income. What is the level of income, who has the income (distribution) and who might need your product?

4. Natural resources. Is it limited or not yet developed? (this is especially

important in determining earnings from staple agricultural and other products.)

5. Industrial development. What is the extent and stage of industrial development plans at present and for the future? Amount of foreign investment?

Market Potential

1. Demand: What is the current and future demand for the product?

2. Domestic production: Who is now making the product, where are they located, and what are their plans for future expansion?

3. Imports for product: Increasing, decreasing? Need information on imports by volume, value, and country or origin.

4. Dominant price range for the quality: choose the range with the largest potential sales.

5. What are the prices for the importer? the wholesaler? the retailer?

6. Is there market control by traditional suppliers? Acceptability of new products by buyers?

Market Requirements

- 1. Need to conform to a standard or grade and a procedure for approval of grading system.**
- 2. Special packaging because of climate, ship conditions, government regulations or local tastes and prejudices.**

Distributions

- 1. How much markup and commission is expected for importer / manufacturer / commission / agent / distributor / etc.?**
- 2. Normal distribution patterns.**
- 3. One firm with exclusive distribution rights or several representatives in various locations?**
- 4. One large shipment or several smaller ones to meet quota.**
- 5. Advertising support? Source?**

Sales Promotion

- 1. What media are available for advertising the product? newspaper / magazines / radio / t.v. / cinema / word of mouth?**
- 2. What is the cost of advertising? Which would give the most benefit for**

the cost?

3. Where are there suitable trade fairs / exhibits to display rabbits? Cost of participation.

4. What forms of advertising do customers respond to best?

The economics of rabbit production

Every rabbit raiser is a businessman whether he raises a few or a hundred rabbits. For success, he must put money, time, and talent into the project for some expected return. Economists describe this business operation in this way:

COSTS - INPUTS

- 1. Land and building**
- 2. Hutches, watering and feeder troughs.**
- 3. Feeds**
- 4. Other overhead.**

RETURNS - OUTPUTS

- 1. Livestock**
- 2. Rabbit meat**

3. Rabbit by-products

a. fur

b. paws

c. tails

d. manure

1) Fertilizer

2) Methane gas

Rabbit production is one backyard industry that promises a bright future. Why? Because almost 99 per cent of the rabbit is useful - the meat for food, the fur for clothing, paws and tails for trinkets, and the manure for soil improvement and for new energy source... bio or methane gas.

The returns from rabbit raising vary from place to place and from time to time. So rabbit producers may either expand or close down their projects on the basis of local and national demands.

However, rabbits are perhaps the most economical and profitable of all kinds of livestock. They can utilize inferior feeds and still provide quality meat and fur. Moreover, with a better quality feeding program, they can increase bunny production thus allowing a higher profit margin for the producer.

A good rabbit raiser strives to raise as many bunnies as possible from one doe within a year or during her productive life. Good management includes

the wise selection of initial breeding stock and the determination of how much time and capital is to be invested in the project. It also includes good care of the does, bucks, bunnies and paying alert attention to housing, cages, sanitation, and record keeping.

Here is an example of profit potential for one doe and a kindling of six bunnies.

1. At 4 months of age, 6 fryers slaughtered 6 kilos @ P12.00/K	P
	72.00
2. Fur - tanned skins sold 6 fryers @ P6.00.....	36.00
3. Manure - 1/3 of total feed - $82 \div 3 = 27$ kilos @ P.25 or about .3 cubic. Ft/doe/year.....	6.75
4. Paws and tails 30 pieces @ P1.20 each.....	<u>36.00</u>
GROSS TOTAL	P
	150.75
Minus cost of commercial feed @ P-/K.....	<u>99.00</u>
NET GAIN (for one doe).....	P
	<u>51.75</u>

If bunnies are all sold live at 4 months of age the following computation is applicable:

1. Six bunnies @ P40.00 each P 240.00

2. Manure	<u>6.75</u>
GROSS TOTAL	P 246.75
Minus cost of commercial feed (see above)	<u>99.00</u>
NET PROFIT	<u>P 147.75</u>



[Home](#) > [ar.cn.de.en.es.fr.id.it.ph.po.ru.sw](#)

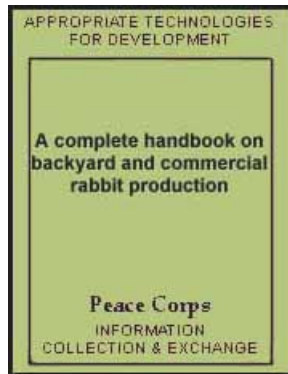

A Complete Handbook on Back-Yard and Commercial Rabbit Production (Peace Corps, 1982, 92 p.)

- ➔  **Simplified tanning**
 -  **(introduction...)**
 -  **1. Slaughtering**
 -  **2. Curing the skin**
 -  **3. Dehairing**
 -  **4. Actual tanning**
 -  **5. Washing and oiling**
 -  **Oiling formula**
 -  **Making charms from rabbit paws and tails**
 -  **Making artificial rabbit tails**

A Complete Handbook on Back-Yard and Commercial Rabbit Production (Peace Corps, 1982, 92 p.)

Simplified tanning

The safest method for tanning rabbit skins is to send the skins to one who specializes in this work, but if home-curing is to be attempted the following procedure if correctly done should produce perfect pelts. Before anyone ever thinks about tanning, he should have enough pelts to tan to warrant his time, talent and money. The skins to be tanned must be of good quality. And good quality skins come from healthy rabbits which are the result of good management. Skins of molting rabbits are not good pelts for tanning. It is a waste of time, talent, and money to try to tan them.

1. Slaughtering

Do not feed the rabbits the day before butchering them, because much of the skins are either wasted or saved during the cutting process. The butcher should know how to butcher the rabbits. In order to skin a rabbit properly one should first suspend the rabbits by its hind legs securely facing the butcher. With his left hand the butcher holds the head firmly and in his right hand, he holds a sharp knife. His left hand then pulls down the rabbit with a jerk to break its neck and then his right hand cuts with the knife just behind the head to drain the blood. When the blood is drained,

continue the cutting across the back of the head clown to the tip of the jaw including all of the thick fur covering the neck and jaw (Fig 32).



FIGURE 32-With a sharp knife cut from the neck to the tip of the jaw.



FIGURE 33 - Make a slit down the back of both hocks.

Next the butcher cuts with the knife, a slit down hock at the back and then

down the other hock (Fig. 33). At this point he should loosen the flesh at the sides of the hocks with his fingers preparatory to skirting the carcass. Cut the tail at its base (Fig. 34) and also the two front legs above the joints at least half an inch high. With two hands pull the skin down the carcass until the skin is pulled off whole like a sock. Immediately afterwards, soak the skin, tail, and feet in the soap solution.

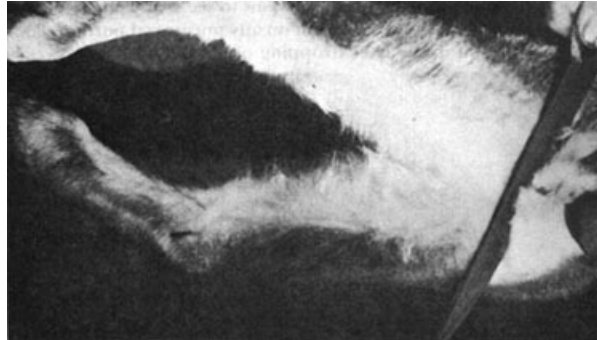

FIGURE 34 - Cut the tail at the base.

Meanwhile, make a slit on the rabbit's flesh from the rectum (Fig. 35), down to the breast, taking care not to puncture the intestines (Fig. 36). Remove the entrails. Wash the meat and hang it to air. The last step is to wash the skin thoroughly with soap and again in clear water to remove all the blood and dirt. Gently squeeze the skin between your hands. Never twist or wring the skin. Drain to remove the water.



FIGURE 35 - With the knife open the anus region to start the removal of the entrails.



FIGURE 36 - Cut the stomach and remove the entrails starting with the urine sac. Make sure urine does not spill on meat.

2. Curing the skin

First, soak the skins in highly concentrated salt solution for one night. The next day, squeeze the water from the skin but again do not twist. Salt thoroughly the flesh side of the skins (1 k salt per pelt, Fig. 37). From time to time examine the skins to see if any portion is not covered with the salt. Rub more salt on any uncovered portion. Poor salting will result in the later dropping off of the fur.



FIGURE 37 - Salting the skin thoroughly. Poor salting results in hair falling off.

3. Dehairing

If you desire rabbit hide without the fur, by-pass the procedure No. 2 "Curing the Skin" (salting) and follow the steps enumerated below for 510 pelts.

- a. Wash the pelts well in soap solution.**
- b. Prepare 500 grams of lime or ash and place or pour the same into a plastic container filled with 2 gallons of lukewarm water.**
- c. Stir the mixture.**
- d. Drop the pelts into the solution and squeeze them.**
- e. Leave the pelts for 24 hours or until the skins are ready for dehairing.**
- f. Dehair the pelts and wash with 100 grams of tide and 50 grams of borax**

several times until the pelts are completely dehaired.

g. Squeeze the water from the pelts and deflesh very carefully the inside part of the skins.

h. Place the skins in the tanning solution - you are ready to proceed to "actual tanning."

4. Actual tanning

Before defleshing your skins, prepare the tanning solutions which are made up of two parts, namely:

a. In a pail dissolve 500 grams of powdered alum in one gallon of warm water.

b. In another pail dissolve 250 grams of salt and 125 grams of soda in a half gallon of warm water.

c. 60 cc formalin.

When these solutions are dissolved, slowly pour the salt-soda solution into the alum solution at the same time stirring with a wooden spoon or paddle. While waiting for the mixed solution to cool off, deflesh your skins to be tanned. Defleshing is one of the hardest parts of tanning. It is done by starting from the back portion of the skin and slowly working the flesh off in a circular pattern (Fig. 38). When all the skins are defleshed, immerse them into the tanning solution for three to thirty days. Stir the skins three times a day since the chemicals separate and settle to the bottom of the

pail.

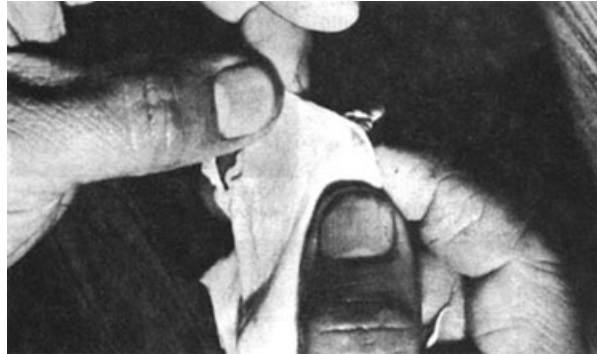

FIGURE 38 - Defleshing is done by starting from the back portion of the skin and working in a circular pattern.

5. Washing and oiling

When the skins are tanned, wash them in soft water. Begin with water that had been mixed with borax to remove the tanning chemicals (one spoonful to a gallon), then wash several more times in plain clear water. Press and squeeze out the water but do not twist or wring the skins.

Stretch the skins on a V-shaped, 1.50 m long piece of No. 9 galvanized iron wire covered with plastic to prevent rusting. The fur should be inside and the flesh facing out. When this is done, apply coconut or olive oil thinly and evenly on the skins (see oiling formula below)(Fig. 39). If either olive or

coconut oil is not available, use 100 cc of any type that is procurable and will not turn rancid. If only one of the recommended is available, use 100 cc for the oiling process, To dry, hang the skins in the shaded place not under the direct sunlight (Fig. 40).



FIGURE 39 - Rub a thin layer of oil solution on the fleshside of the pelt.

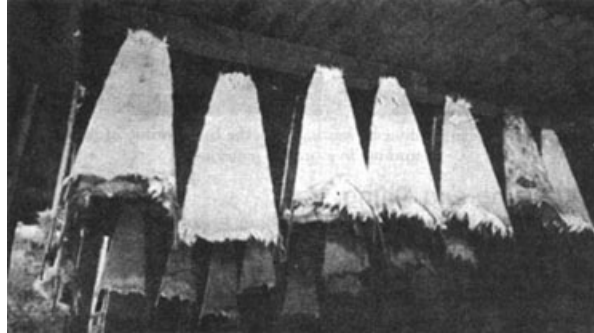

FIGURE 40 - Dry the skin On a U-shaped frame covered with plastic tubing in the shade.

When the skins are about 95 per cent dried, start working or kneading them. Stretching or buffing the skins until they are as soft as linen handkerchiefs may take hours (Fig. 41). This is also one of the most critical parts of the tanning process. Negligence can never be repaired. the more you buff the skins the better. When the skins are well dried and soft and are ready for use, powder them with talcum.

Oiling formula

250 cc water

300 grams borax

50 cc olive oil

50 cc coconut oil

90 grams 1 medium bath soap



FIGURE 41 - Buffing or stretching the pelt.

Dissolve bath soap over fire after slicing or shaving it in small pieces. Mix remaining ingredients and let cool to lukewarm temperature. Rub thin layer on skins.

Tanned pelts can be made into such finished products as bags, hats, coats, bedspreads, and shawls. The most efficient way to market tanned pelts is to sell them in whole form, thus, eliminating overhead costs of making

finished fur products.

Making charms from rabbit paws and tails

- 1. Wash paws and tails thoroughly in any detergent to remove dirt and blood. Remove water by squeezing but do not break the bones.**
- 2. In a plastic container, mix 2 liters formaline and 1 liter water (2:1). Soak paws and tails for 3 days or more. After 3 days, when the bones are hard, the paw and tail are preserved. If the bones are still soft, leave in the formaline solution longer.**
- 3. With a rubber globe, remove the tails and paws from the formaline solution and wash them thoroughly in detergent (borax, tide, baking soda, or sodium bicarbonate). Take care not to inhale toxic fumes from the solution.**
- 4. Dry paws and tails on wire mesh or G.I. in the sunshine until thoroughly dried.**

Materials

- 1. Perstop wood glue.**
- 2. Copper wire.**
- 3. Hand drill made from .05 nail attached to small piece of wood for drilling**

hole into foot.

4. Cup containing water.

5. Key chains.

Procedure

1. Prepare hook by bending copper wire around a.075 nail to form an eye. Use a pair of pliers for easy manipulating (Fig. 42).

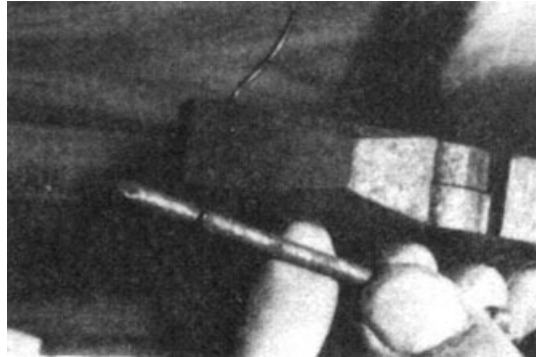

FIGURE 42

2. Mix glue to a consistency like peanut butter, calculating the needed quantity.

3. Having dried the tails and feet thoroughly, chop or cut the exposed bone with a sharp bolo to remove rough edges.

4. With the homemade hand drill, make a hole in the center of the bone about 1 cm to 1 ½ cm deep (Fig. 43).



FIGURE 43

5. Spoon just enough glue with the pointed stick into the drilled hole (Fig. 44).



FIGURE 44

6. Insert hook up to the neck of its eye (Fig. 45)

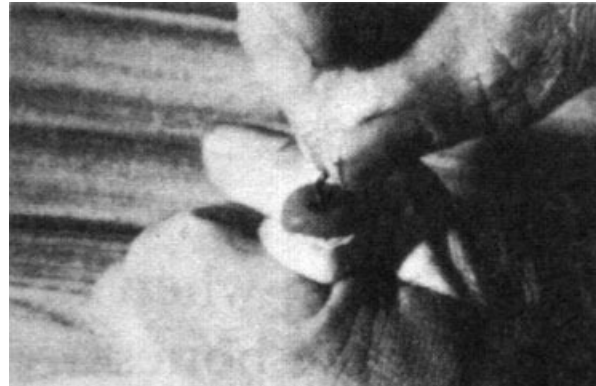

FIGURE 45

7. Dip your index finger into the glass of water and smooth the mound of glue around the hook and edges of the paw or tail (Fig. 46).



FIGURE 46

8. Put foot and tail upright in a welded wire rack or carton. Let stand in sun until glue is hardened (Fig. 47).

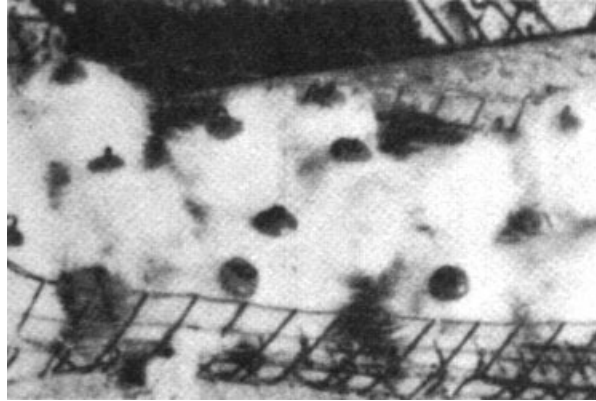

FIGURE 47

9. When glue is dried, place a key chain through the eye of the hook. It is now a completed product (Fig. 48).

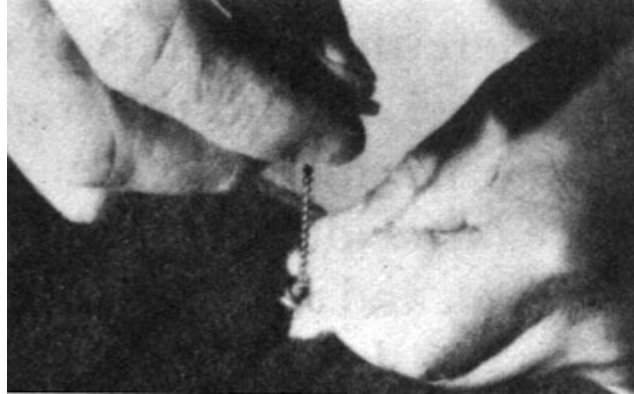

FIGURE 48

10. If you have many completed paws and tails, link them together in strands and place in a cellophane bag to protect them from dirt and crust.

11. Bring them to market.

In places where the demand for artificial rabbit tails is economically feasible for production or to produce them, the following instructions utilizes trimmings and good quality tanned pelts for their construction. Artificial tails are relatively inexpensive to purchase in comparison to the cost of one pelt, thus, the market is open to all strata of the population.

Making artificial rabbit tails

Materials

- Two inch length of stick (this length of stick will serve as the 'bone' so it should be as wide as you want the finished 'tail' to be.)**
- One rabbit hide, slit down the center of the stomach or you can use remnant pieces of hide.**
- One razor blade (single edge is safer and provides more control.)**
- One can of Rugby contact cement.**
- Paint thinner (to clean glue from fingers.)**
- Wood glue (perstop powdered glue).**
- One.075 nail.**
- One inch length of copper wire.**
- One rack which will allow the finished product to dry in an upright position.**
- Paper and pen.**

READ ALL STEPS FIRST BEFORE PROCEEDING

1. Roll a piece of heavy paper (this will serve as your pattern) around the.05 stick frame. Make a 1 cm hole in one end of the frame with it.a.05 nail, where you will later insert the - copper wire hook (Fig. 49).

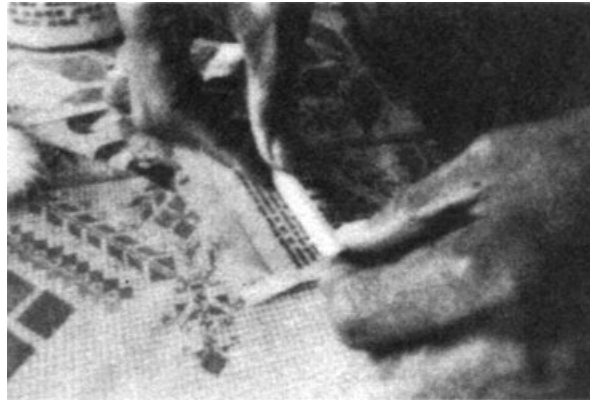

FIGURE 49

2. Make the length of this pattern.064 the extra.0125 will hang off the end of the.05 stick frame to imitate the end of a normal rabbit tail (Fig. 50).

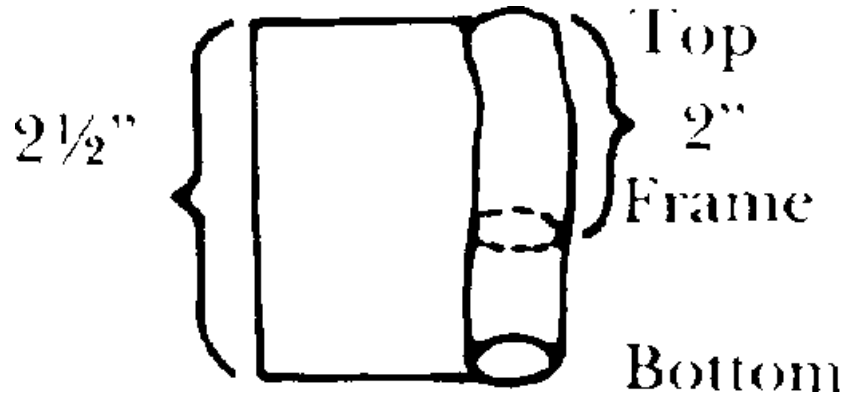

FIGURE 50

- 3. Mark the exact point where the two ends of the pattern meet when wrapped around the frame. (this is the width of the pattern).**
- 4. Cut the pattern at the exact width of the frame.**
- 5. Lay pattern on inside of pelt and trace the pattern onto pelt in such a way so that the direction of the fur will end up running smoothly down toward the end of the "tail" (Fig. 51).**



FIGURE 51

- 6. Then take your pen and ruler and retrace the pattern with a more heavily defined dotted line. Make sure your width is exact to avoid overlap (Fig. 52)!**



FIGURE 52

7. Before you actually cut the hide keep in mind that you do not want to cut the fur...only the hide, except along the edge that will eventual!., be the top of your rabbit's tail (STUDY ILLUSTRATION) (Fig. 53).

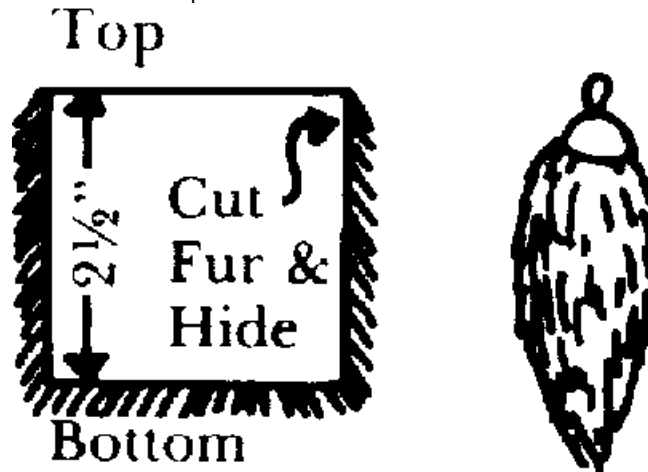

View of hide from
skin side up

FIGURE 53

8. Now take your razor blade (preferably single edge) and slowly cut out the pattern (Caution here because it is very easy to slip and cut yourself and damage the fur) (Fig. 54).

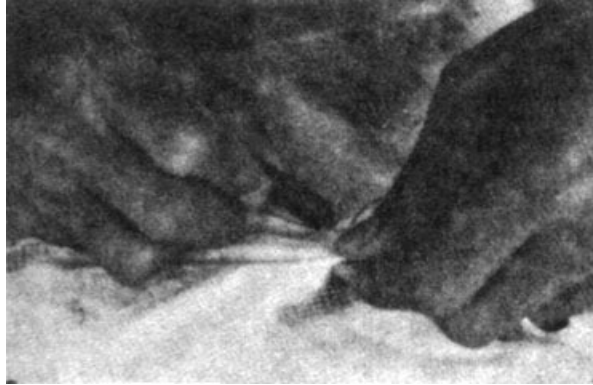

FIGURE 54

9. With your finger, smooth some Rugby contact cement onto the inside of this cut pelt. (Do not get cement on fur!!) (Fig. 55).



FIGURE 55

10. With your finger, smooth a thin layer of Rugby contact cement onto the .05 or-.038 stick frame also (Fig. 56).



FIGURE 56

11. Let these two glued surfaces sit until almost dry-about 20 - 30 minutes. (You can clean your fingers with the paint thinner while you wait.) (Fig. 57).

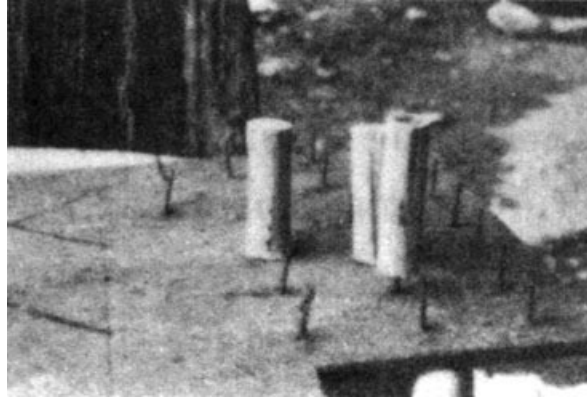
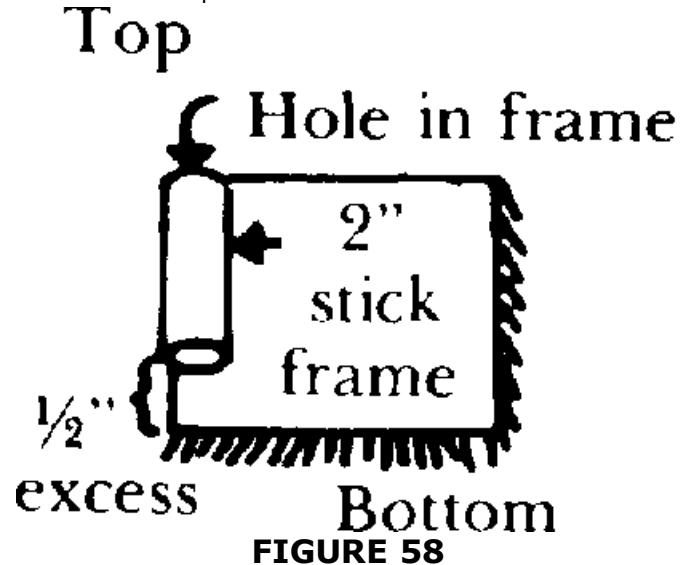

FIGURE 57

12. Slowly and carefully place the stick frame on the pelt as illustrated (Fig. 58).



13. Roll skin onto frame evenly. If you cut the pelt accurately the ends will be flush with each other (not overlapping). If the pelt is too short, try stretching it with your fingers so it will reach (Fig. 59)



FIGURE 59

14. This photo shows a pelt that has not been cut accurately resulting in overlap.. something best to avoid (Fig. 60).

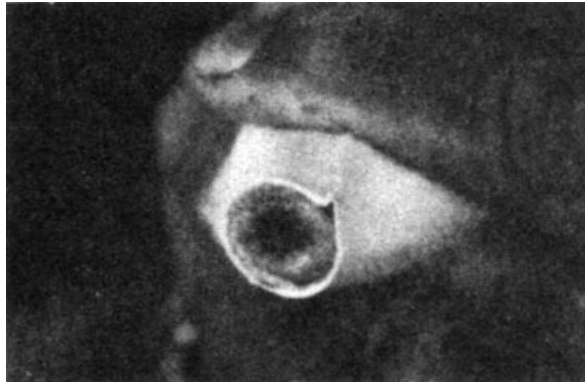
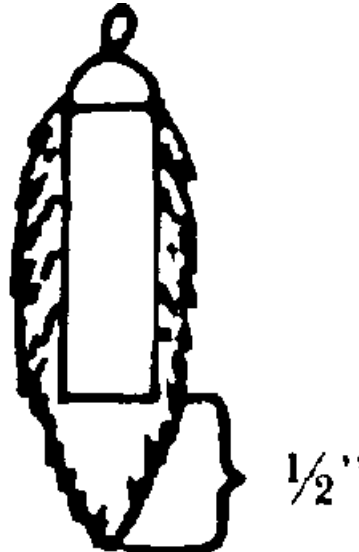

FIGURE 60

15. The .0125 excess in length hangs from the bottom to create the illusion of a tail which you can help by gently molding the "excess" pelt with your fingers (Fig. 61).

**FIGURE 61**

16. Mix a small amount of the Per-stop Powdered glue with a small amount of water so as to make a thick paste about the consistency of very thick peanut butter.

17. Using a small pointed stick, apply this glue to the top of the produced (or fake) rabbit tail-do not get the glue on fur-and form into a small rising mound as illustrated (Fig. 62).

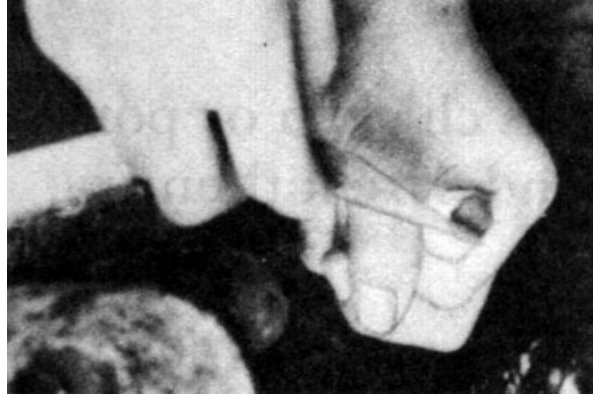

FIGURE 62

18. Then wet your finger and smooth all rough spots on this mound of thick glue. The reason is, this glue dries very hard and any jagged edges will cut you easily (Fig. 63).

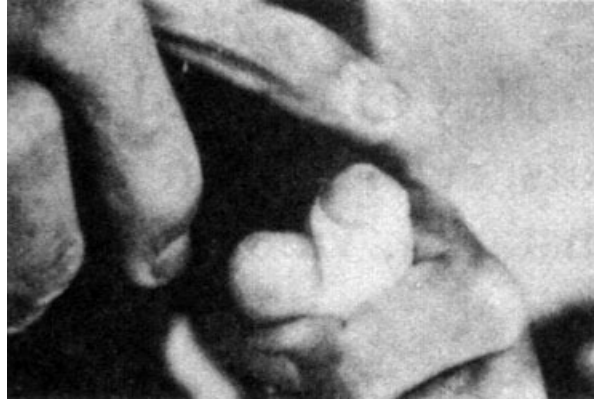

FIGURE 63

19. Bend the .025 length of copper wire around a thick nail to form your hook and insert the bent wire into the hole of the frame, through the mound of glue. (Again smooth rough areas with wet finger.)

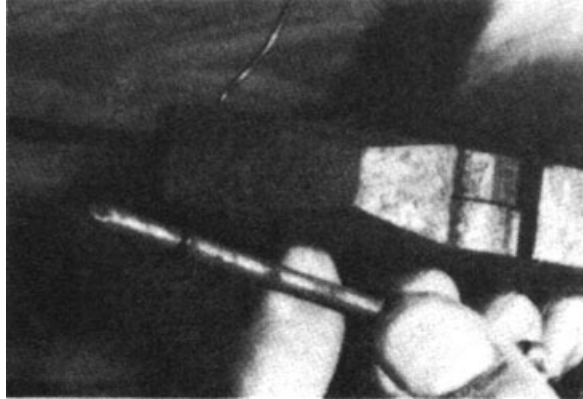

FIGURE 64

20. Put finished rabbit tail into a rack to dry for 24 hours or until the glue hardens (Fig. 65).

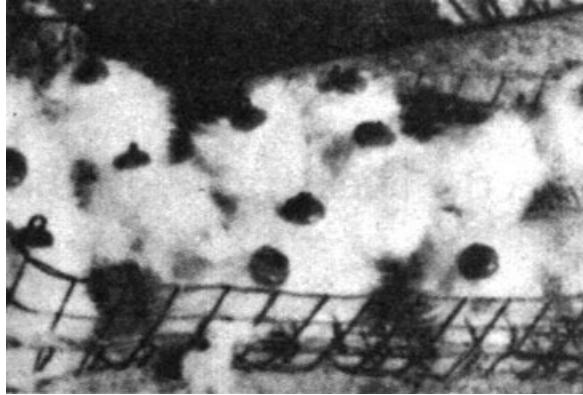

FIGURE 65

21. Strands of colored ribbon or crocheted string looped through the copper hook add a colorful touch. Or attach a metal ball chain fastener (Fig. 66).

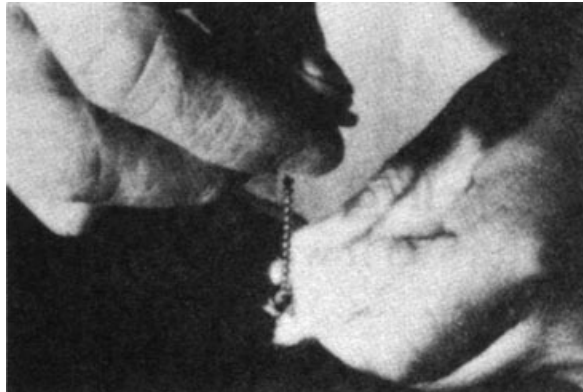

FIGURE 66

22. If you have many rabbit tails, link them together in a long strand and bring them to market.



[Home](#) > [ar.cn.de.en.es.fr.id.it.ph.po.ru.sw](#)

 **A Complete Handbook on Back-Yard and Commercial Rabbit Production (Peace Corps, 1982, 92 p.)**

  **Cooking recipes**

 ***(introduction...)***

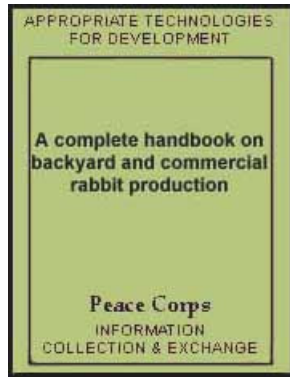

Filipino recipes **International recipes**

A Complete Handbook on Back-Yard and Commercial Rabbit Production (Peace Corps, 1982, 92 p.)

Cooking recipes

Preparing Rabbits for the Table:

- Slaughtering and skinning:

The housewife or anyone (in-charge) should know how to dress the animal.

• Cleaning the rabbit:

- rinse in cold water to remove hairs

- do not leave the carcass in water for more than 30 minutes

- **remove the corn kernel-like scent glands behind the kidneys**
- **disjoint rabbit as preferred**
- **air the meat for a few hours or over night**

Cooking the Rabbit:

- **Rabbits may be cooked in the same manner as chicken or pork.**
- **The usual procedure is to boil in water to tenderize it then fry:**

- a) **to prevent shrinkage**
- b) **to allow for absorption of flour**
- c) **to lessen unfavorable flavor**

1. Sweet-sour rabbit:

(Ingredients depends on the supply or availability of desired ingredients) such as: green pepper, bamboo shoots, celery, bean sprouts, pineapple chunks (canned or fresh), cornstarch, vinegar, oil, salt, toyo, sugar and water.

2. Fried adobo - follow chicken adobo recipe.

Preservation of Rabbits:

- **Rabbits are preserved to IMPROVE THE TASTE**

1. Drying - smoke drying and/or sun drying.

Ingredients - salt and garlic

2. Tucino (for every one kilo of rabbit):

2 tsp. Salt 1/8 tsp. salitre
4 tbsp. brown sugar pepper and garlic as desired

Procedure:

- 1. Mix ingredients together and rub on both sides of meat.**
- 2. Place salted meat in a container and cover.**
- 3. Keep in a cool place (can be cooked after 24 hours).**

In drying or tucino, the bones of the rabbit should be removed to avoid raw centers since the salt cannot reach the center of the meat when rabbits are cured whole. The center does not dry as fast as the outer layer of meat so the meat closest to the bone may decompose and the bad odor may affect the rest of the meat under process. The winning feature of tucino is its "flavorful" taste.

Filipino recipes

Rabbit Estofado

Ingredients:

1 kilo rabbit meat

1/2 cup oil

1/2 cup vinegar

4 segments garlic

1/3 cup wine (white)

1 bulb and 3 tubes green onion and onion bulbs

1 pkg. vetsin salt as desired

1 tbsp. flour sugar (brown) - as desired

Procedure:

1. Rabbit cut in desired sizes.

2. Marinate the rabbit meat in vinegar, wine, sugar, vestsin, toyo, sliced garlic, salt for 1 or 2 hours.

3. Fry the meat.

4. Boil the fried meat in the sauce where it had been soaked until meat is tender enough, drop the sliced onions (green and bulb).

5. Stir in the soaked flour in water.

6. Taste before taking it from the fire.

Rabbit Calderetta

Ingredients:

1/2 cup margarine

/4 cup water

3 tbsp. flour

1 cup (coconut milk or can evaporated milk, 1 small can)

3 quartered onions

1 can tomato sauce (small can)

1 can (small) peas or green olives

4 potatoes (regular size) cut in cubes

1 piece laurel leaf

2 kg. rabbit - cut in serving pieces i/4 tsp. salt little vinegar

1 red sweet pepper 42 m. and two small hot peppers

1 clove garlic crushed

1 tbsp. vetsin, little toyo

Procedure:

Marinate the rabbit meat with the little vinegar, salt and toyo and set aside. Saute the crushed garlic, onions and tomato sauce with margarine. Put in the rabbit meat and simmer until half done with the coconut cream or milk. Add the potatoes, laurel leaf and pepper until cooked. When done add the peas (crushed hot pepper) and vetsin. Add flour to thicken the sauce.

Omba

Ingredients:

1 kilo rabbit
1/2 cup vinegar
1/2 cup sugar salt to taste
1/2 cup soy sauce
1 small package vetsin, spices (garlic, onions)
1 tbsp. lard
1 green pepper
1 cup water

Procedure:

Brown the rabbit meat in a small amount of lard. Add water, vinegar, soy sauce, vestin and spices. Chop onions and green pepper. Simmer until meat is cooked. Serve all your friends!

Puchero Nga Cunejo

Ingredients:

2 potatoes
1/4 cabbage
1 eggplant
6 tomatoes
2 pieces "saba"
1 onion

2 cloves garlic

1 tsp. salt

1/4 cup lard

1/4 kilo rabbit (soaked in vinegar and water for 1 hour)

Procedure:

Saute garlic in lard, remove garlic.

Saute onions and tomatoes. Add rabbit and salt to taste, let cook for about 5 minutes. Add small amount of water and boil for 5 minutes. Add more water and diced potatoes and cook until potatoes and "saba" are soft. Then add chopped cabbage and quartered eggplant. Cook until vegetables are tender. Salt to taste. Serve hot.

Rabbit Snaffu

Ingredients:

1 kg. cubed rabbit meat

1 clove garlic

1 medium sized onion

1/4 kg. potatoes

1 medium sized can tomato sauce

3 spoonful! wine toyo or patis black pepper salt, water

Procedure:

Remove peelings of garlic, crush. Slice the onions to diced size. Cube potatoes. Fix all ingredients and cook until tender.

Barbecue Rabbit

Ingredients:

1/3 clove of onion small head of garlic black pepper

1/4 cup SON sauce

1/4 cup vinegar

1/4 kilo rabbit meat

1 tbsp. wine

Procedure:

Cut the onion into slices and then dice the garlic and pepper. Then prepare a clean basin and place the meat into it. Marinate the slices of onion, garlic, and pepper. Add the soy sauce and vinegar. Place the meat over an open fire.

International recipes

Rabbit Salad

Ingredients:

2 cups diced cooked rabbit meat

1/4 cup chopped sweet pickle

1/2 cup chopped celery

1 tbsp. chopped onion

1/2 cup diced cooked potatoe (optional)

1/2 tsp. Salt

1/2 tsp. lemon juice

1 tbsp. sweet pickle juice

1/4 cup mayonnaise

Procedure:

Mix ingredients and chill one hour to blend flavors.

Chinese Broiled Rabbit - (Hot Mustard Sauce)

Ingredients:

2 tbsp. dry mustard

1/2 tsp. Salt

2 tsp. salad oil

1 tbsp. water tumeric

Procedure:

- 1. Mix mustard, salt and salad oil.**
- 2. Combine cornstarch and water. Bring to boil. Heat and stir until thickened and clear.**
- 3. Gradually add to mustard mixture. Mix well.**
- 4. Add tumeric if a deeper color is desired.**

Broiled Rabbit

Ingredients:

- 1/2 cup finely chopped onion**
- 1/4 cup butter**
- 1 cup (8 oz. can) tomato sauce**
- 3/4 cup pineapple juice**
- 2 tbsp. lemon juice**
- 2 tbsp. brown sugar, firmly packed**
- 1 tsp. salt**
- 1/2 tsp. dry mustard**
- 1/4 tsp. seasoned salt**
- 1/4 tsp. pepper**
- 1 kilo rabbit, cut in serving pieces**

Procedure:

- 1. Cook onion in butter until tender.**
- 2. Mix in tomato sauce, pineapple juice, lemon juice, brown sugar and seasonings.**
- 3. Cook over low heat 15-20 minutes to blend flavors. Pour over rabbit. Let stand 1 I/2 - 2 hours.**
- 4. Place rabbit pieces, meat side up, on rack in broiler pan 7 - 8 inches from heat. Broil 25-30 minutes. Turn. Broil 20-25 minutes longer or until rabbit is tender.**
- 5. Baste every 8-10 minutes with sauce.**
- 6. Salt before serving. Serve with Hot Mustard Sauce. Yield: 3-4 servings.**

Rabbit Paprika

Ingredients:

- 1 cup finely chopped onion**
- 1/2 cup butter**
- 1 tbsp. red paprika**
- 1 kilo rabbit, cut in serving pieces**
- 4 tsp. salt**
- 1 tsp pepper**
- 1 tbsp. lemon juice**
- 1 tsp. caraway seeds**
- 1/4 cup water**

2 cups sour cream

3 tbsp. flour

Procedure:

1. Cook onion in butter until tender. Blend in paprika.

2. Rub rabbit with salt and pepper. Brown.

3. Add lemon juice, caraway seeds and water. Cover.

4. Cook over low heat 40 minutes or until tender. Remove rabbit and keep hot.

5. Blend sour cream, flour and 1 tbsp. paprika together thoroughly. Slowly mix into pan drippings. Heat and stir just to boiling.

6. Serve over Rabbit. Yield: 3-4 servings.

Royal Rabbit Scallop

Ingredients:

1 kilo rabbit

2 stalks celery

1 medium onion, quartered

1 bay leaf

3 peppercorns, slightly crushed

1½ tsp. and 2 ¼ tsp. salt

3 medium potatoes

- 1½ cup coarsely chopped onion**
- ¼ cup finely chopped celery, leaves**
- ¼ cup and 6 tbsp. melted butter**
- 2 cups (15½ oz. can) cut green beans, drained**
- 3 tbsp. chopped parsley**
- ¼ cup diced pimiento**
- 6 tbsp. flour**
- ¼ tsp. rosemary, ground**
- ¾ tsp. pepper**

Procedure:

- 1. Cover rabbit, celery, onion, bay leaf, peppercorns and 1½ tsp. salt with water. Heat to boiling. Cover.**
- 2. Cook over low heat 1½ hours or until rabbit is tender.**
- 3. Add potatoes. Cook 20-25 minutes longer.**
- 4. Strain broth and save 1 ¾ cups. Cut meat into small pieces.**
- 5. Heat oven to moderate (350°). Butter a 2-quart casserole.**
- 6. Cook onion and celery leaves in ¼ cup butter until tender. Peel and thinly slice potatoes.**
- 7. Layer rabbit, green beans and potatoes in casserole. Sprinkle ½ the onion mixture and ⅓ the parsley and pimiento between each layer.**
- 8. Blend flour, rosemary, pepper and 2 ¼ tsp. salt with 6 tbsp. butter. Gradually stir in saved broth. Heat and stir until thickened and boiling. Pour**

over casserole.

9. Sprinkle with remaining parsley and pimiento. Cover.

10. Bake 30 minutes. Uncover. Bake 10 minutes longer of until bubbly.

Yield: 6 servings.

Ragout of Rabbit

Ingredients:

1/2 cup and 3 tbsp. flour

1 tbsp. salt

3/4 tsp. seasoned salt 1/2 tsp. pepper

3/4 tsp. seasoned salt

1 kilo rabbit, cut in serving pieces i/2 cup milk

1/3 cup butter

3/4 cup finely chopped onion

1 tsp. ground caraway

1/2 cup white wine

1 cup chicken bouillon

1 i/2 cups sliced carrots

1 package (10 oz.) frozen green peas

1/2 cup sliced green olives

Procedure:

- 1. Combine 1/2 cup flour, salt, seasoned salt, pepper and paprika. Dip rabbit pieces in milk, then in flour mixture.**
- 2. Brown well in butter. Remove rabbit to a casserole or heavy sauce pan.**
- 3. Cook onions in butter until tender. Add to rabbit with caraway, wine and bouillon. Cover.**
- 4. Cook over low heat 10-15 minutes.**
- 5. Add carrots. Cook 15 minutes.**
- 6. Add peas and olives. Cook 10-15 minutes longer or until vegetables are tender. Remove rabbit and keep warm.**
- 7. Combine 3 tbsp. flour with a little cold water to form a smooth paste. Stir into gravy. Heat and stir until boiling and thickened.**
- 8. Serve over rabbit. Yield: 3-4 servings!**

Hasenpfeffer

Ingredients:

3/4 cup vinegar

3/4 cup red wine

3/4 cup water

3 medium onions, finely sliced

4 juniper berries, crushed (optional)

4 whole cloves

2 teas leaves, crumbled

2 tsp. and 2 tsp salt
1/2 tarragon, ground
3/4 tsp. black pepper
1 kilo rabbit, cut in serving pieces
3/4 cup and 3 tbsp. flour
1/2 cup hot water
1/2 cup hot water
5 tsp. sugar

Procedure:







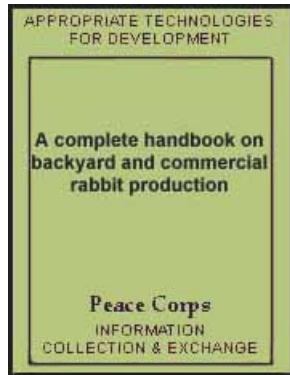

- 1. Combine vinegar, wine, water, onion, juniper berries, cloves, bay leaves, 2 tsp. salt, tarragon and pepper.**
- 2. Pour over rabbit, let stand for 24 hours at room temperature.**
- 3. Combine 3/4 cup flour and 2 tsp. salt. Dry rabbit pieces slightly and roll in flour mixture.**
- 4. Brown well in butter. Drain.**
- 5. Strain marinade. Add water and sugar. Pour over rabbit. cover.**
- 6. Cook over low heat 40-45 minutes or until tender. Remove rabbit and keep hot.**
- 7. Combine 3 tbsp. flour with a little cold water to form a smooth paste. Blend into gravy. Heat and stir until boiling and thickened.**
- 8. Serve over rabbit. Yield: 3-4 servings!**



[Home](#) > [ar](#).[cn](#).[de](#).[en](#).[es](#).[fr](#).[id](#).[it](#).[ph](#).[po](#).[ru](#).[sw](#)



 **A Complete Handbook on Back-Yard and Commercial Rabbit Production (Peace Corps, 1982, 92 p.)**

-  **(introduction...)**
-  **Author's introduction**
-  **Author's preface**
-  **Selecting a breed**
-  **Methods of breeding**
-  **How to breed**
- The rabbitry and its equipment**
-  **Feeds and feeding**
- Feeding rabbits**
-  **Coprophagy**
- Reproduction**
- Managing the herd**
- Various uses of rabbit manure**
- Types of production**
- Marketing rabbits**
-

 **Simplified tanning**
COOKING RECIPES

  **Multiple-project approach to rabbitry**

 **Glossary**

Multiple-project approach to rabbitry

Dorothy M. Hamada
Provincial Rural Youth Officer
Benguet Province

RATIONALE:

Reducing production costs and the waste products that tend to accumulate are two of the most serious and wasteful problems that confront any agriculture enterprise. Moreover, agricultural ventures require that its workers be within constant reach of the project while in most instances underemploying these same workers.

This paper seeks to show how it is feasible for a rabbitry to be maintained at much reduced costs up to a point of self-liquidating status; convert potential waste products into economic by-products; fully employ farm labor; and generate cottage industries which not only promise cash for effort expended but also serve as an outlet for native ingenuity and creative talent.

Rabbits are protein-rich yet cheap sources of human food, a fact documented by Germany's major reliance on this animal as a source of their protein during World War I and II. It is a livestock project which can thrive on grasses and waste and/or excess farm greens which is an asset of vital importance in times of economic depression and food/feed shortage such as we face today. To top it all, schemes presented here will show that the products and by-products from a total rabbitry supply the basic needs of any ordinary family fulltime for food, fuel, cash and clothing.

This is one project meant for the average Filipino family, farmer or suburbanite. It is one way of providing work on the farm, thus, reducing urban-ward migration.

THE SCHEME:

Any rabbitry project, whether small or large, must be fully utilized if it is to be truly economic and beneficial to the average Filipino family. It should not produce a lot of waste or garbage which tends to isolate the farm from neighbors clue to foul odor and/or fly, mosquito, or rat infestation. In other words, we much extract all we can from one single rabbit project.

On the whole, a rabbit project provides a very versatile meat for the table, pelts and/or leather for clothing, upholstery, bag/gloves and decor material. In addition, rabbits can be lapinized for animal vaccines. It supplies manure which can be further utilized to generate odorless gas. The

methane gas tank produces ready-to-use compost; excess tank liquid in which to grow chlorella algae; and water for the garden. Night dung is eaten by the rabbits. Nothing is wasted, unfavorable odor is reduced and under-employment of farm labor is prevented.

While the scheme illustrated in Figure 69 is for a unit farmstead, assuming that the rabbitry project is large enough to supply a methane-gas tank with sufficient manure, the same scheme may be stretched with several small rabbitries pooling their waste into single methane gas tank and alternately using the fuel generated as well as the by-products of chlorella algae and excess liquid and compost for their backyards or communal gardens.

A second alternative is to hook-up the methane-gas tank to the watersealed toilet to supply a single methane gas tank for the farm household.

A. Meat

Dressed rabbits can be prepared in several ways, the most favorite being the same as those prepared out of chicken or goat meat. When rabbits are fed predominantly on grasses or greens, it is recommended that the rabbits be fed concentrate diets for a week prior to slaughter to remove the grassy smell and produce tastier meat.

When slaughtering more than one rabbit for home consumption, cure the remaining meat with your favorite ham recipe. Cured meat commands

higher prices than fresh meat.

The heads which are not sold with the dressed rabbit can be sold to dog keepers for dog food on a piece or kilo basis.

Entrails are either cooked into dinogoan, blood sausages or steamed and dried for animal feeds.

B. Skins

Rabbits are processed into pelts which are trimmed after tanning and sold as single pieces, cut into novelty articles, bags, shoes and accessories or sewn together for coats, stoles, blankets or upholstery.

Pelts can be dehaired and processed into soft leather for bags, or shoes. The shedded wool is cleaned and dried for stuffing pillows or mattresses or spun into wool thread.

Trimmings are further made into trinkets like flowers, car decor, bar pins and the like.

C. Brain

The Bureau of Animal Industry buys rabbits regularly for experiment animals or lapinizes them for animal vaccines. A community or large

rabbitry concern can coordinate with the BAI for this purpose, thus reducing the cost of vaccines and utilizing such parts of the animal that are not used in the preparation of vaccines.

D. Manure

Here are several alternatives to the use of rabbit manure. Consideration has also been made of people's reluctance to handle manure and their rejection of rabbit raising due to its unfavorable odor.

Alternative I - use single hutches and allow the rabbit dung to fall directly into 15 mm deep pits under the hutch. Plant earthworms in the accumulated manure to pulverize the manure and substantially reduce odor.

Alternative II - Prepare the same pits under the hutch and sprinkle them with gypsum once-a-week. Gypsum will neutralize the odor and lock-up the nitrogen in the manure which would otherwise be lost in the air. This will produce richer fertilizers.

Alternative III - Construct methane gas tanks into which the manure and urine are placed. Seven to ten wheel-barrels full of manure will fill a one by one meter tank capable of generating enough fuel for two-hour daily use for two-month periods. The length of service of a tank-full depends on the weather. Warmer climates cause faster fermentation.

Construct one to several shallow ponds adjacent to the methane gas tank in which chlorella, a green algae can grow on excess tank liquid. The chlorella if sieved and air-dried, provides 60 per cent proteinrich feed for the rabbits. With this, you can reduce your cost of concentrates by more than 50 per cent (See Bureau of Fisheries for information on related backyard fish ponds).

A second smaller but creeper pond into which further excess water can flow, will conserve nutrient-rich water for watering and fertilizing pastures and grain/vegetable gardens. The rationale for narrower but deeper ponds is to reduce evaporation. The accumulated water is also helpful during the dry summer months when water is scarce.

The decomposed solid matter inside the methane gas tank, when removed, is ready-to-use compost for the garden. Since it has already been decomposed, the fertilizer will not harm the plants or cause nitrogen-starvation which is usually a problem when utilizing fresh manure.

If grain/vegetable gardens are maintained, the products can be used in the kitchen while the excess greens and bran from the grain provide carbohydrates, mineral and vitamins for the rabbits. All marginal lands within and around the farm should be planted to pasture grasses and legumes for year-round supply of roughage for the rabbits. With this system you assure the rabbits adequate feed while having ready fertilizer

for the pasture and gardens.

Rabbits are known to eat their own night droppings. These are protein rich feed supplements.

E. Paws and Tails

Paws and tails are treated in formaline and dried. Key chains and lucky charms and trinkets can be crafted from treated paws and tails.

The rabbitry, maintenance of the methane gas tank and the vegetable grain gardens can be the concern of the farmer and male members of the farm household while the home industry projects like tanning and leather craft can be done by the female members of the farm household.

Adjustment in Case of Small Rabbitries

Rabbit projects like backyard rabbitries whose main concern is to provide meat for the table have no reason to waste any of their by-products simply because their projects are too small to economically operate any of the by-product enterprises. It is recommended that tanning; sale of excess meat, pelts and crafted articles; even the operation of a methane gas tank and the gardens be a communal effort; that is, some sort of cooperative venture among neighbors.

This will greatly reduce capital investment and overhead expenses per entrepreneur.

Conclusion:

There is nothing in a rabbitry venture which cannot be converted into a useful by-product for home consumption or converted into cash. It requires only a little extra energy to engage in these side-enterprises. Working with rabbits is challenging, creative, and rewarding. So why not go into it? But WASTE NOTHING!

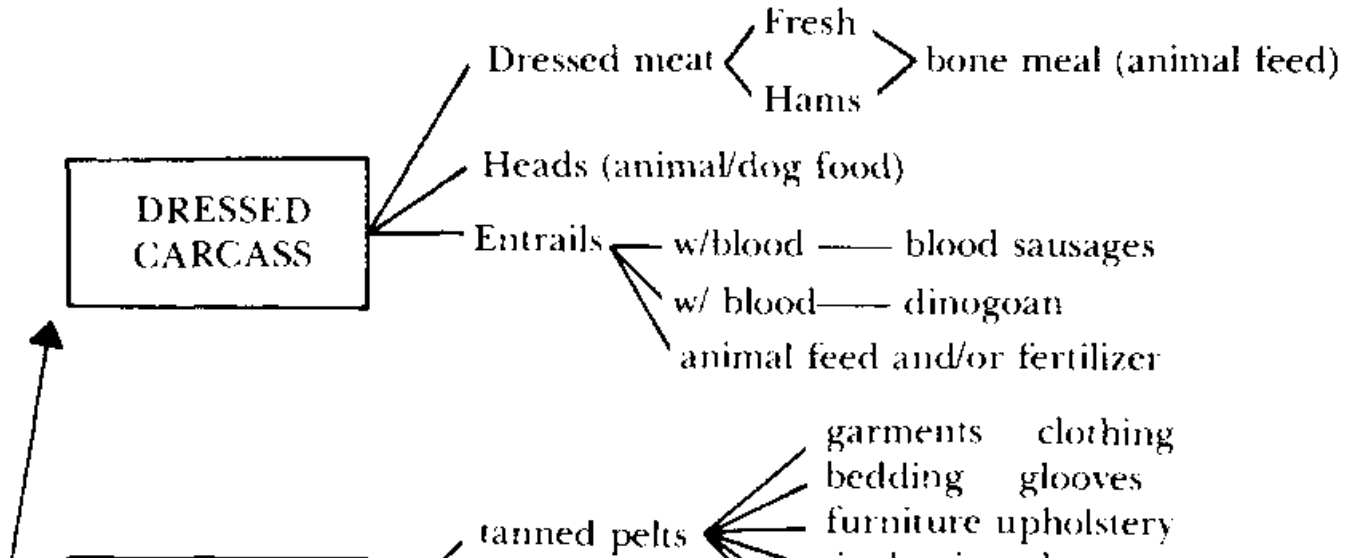

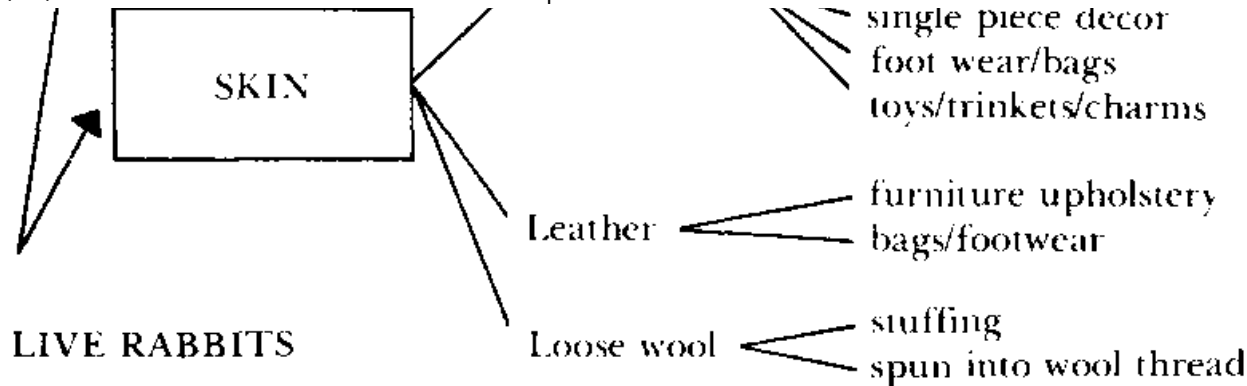

LIVE RABBITS

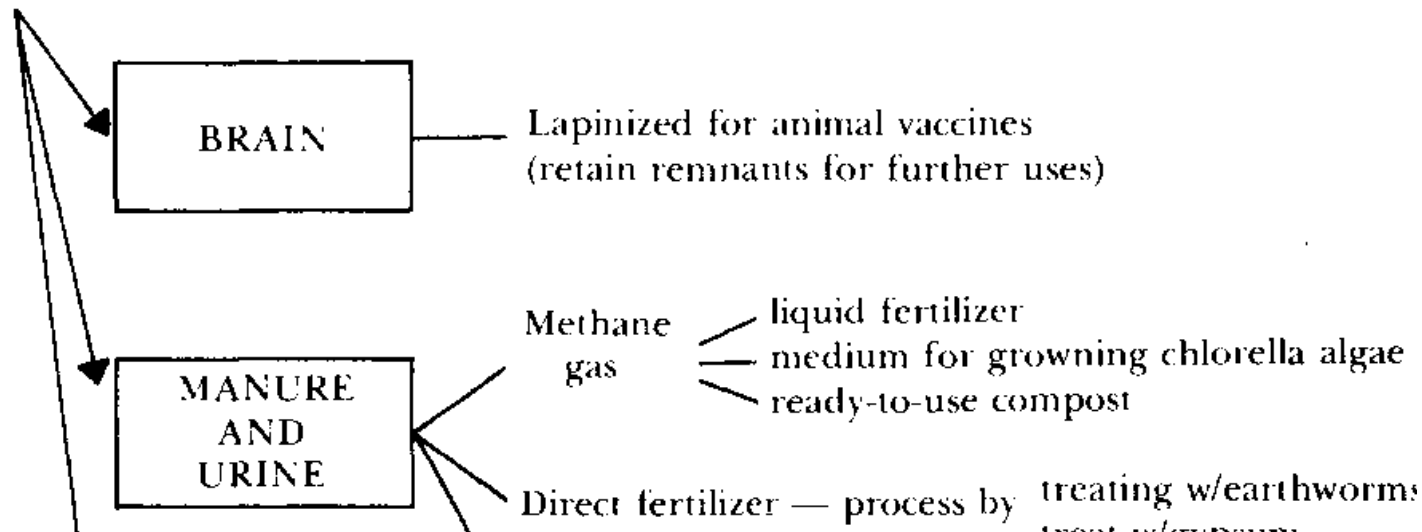

19/10/2011

A Complete Handbook on Back-Yard a...

urea w/gypsum

Night droppings eaten by rabbits for protein

PAWS AND TAILS

Key chains/trinkets/charms

FIGURE 67 - MULTIPLE-USE OF RABBIT AND BY-PRODUCTS*

***Absolutely no waste. Provides jobs for everyone. Home-industry for maximum farm labor utilization.**

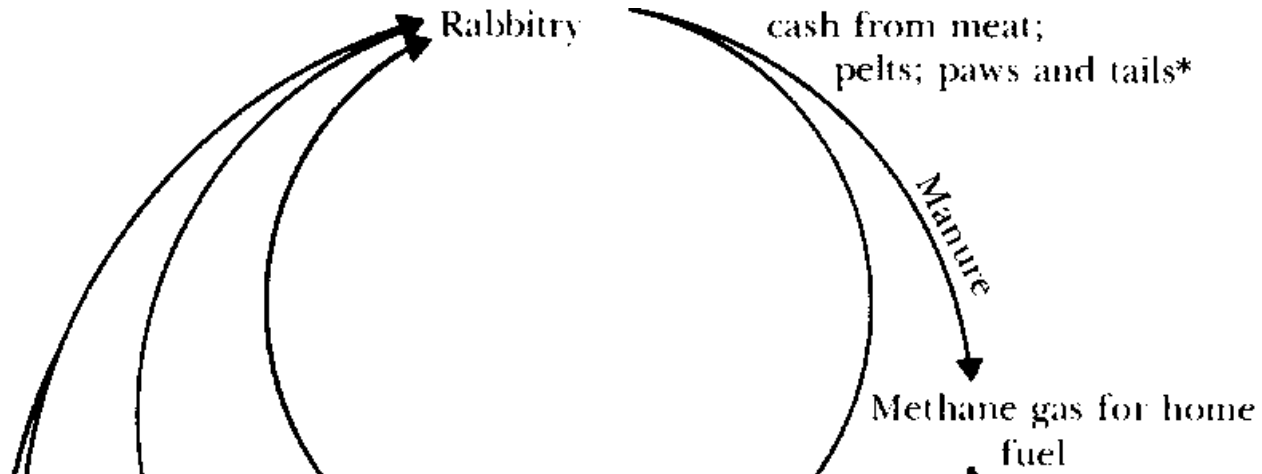

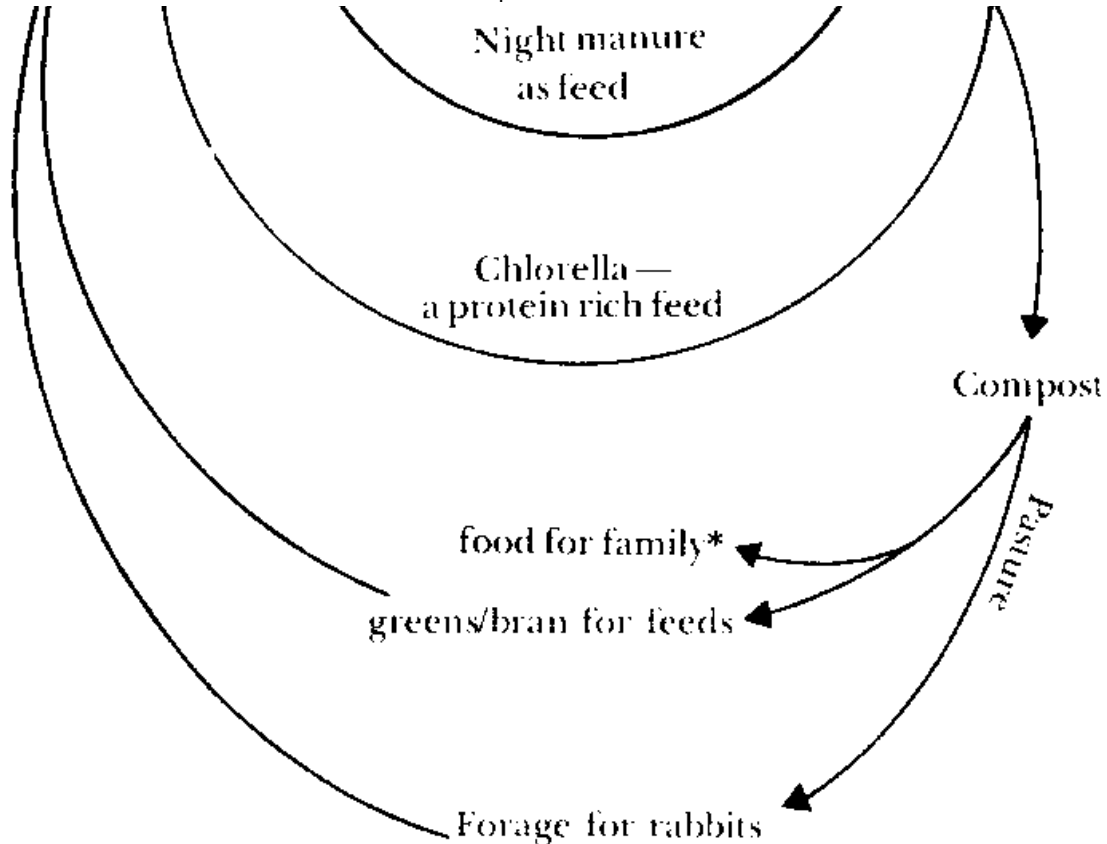
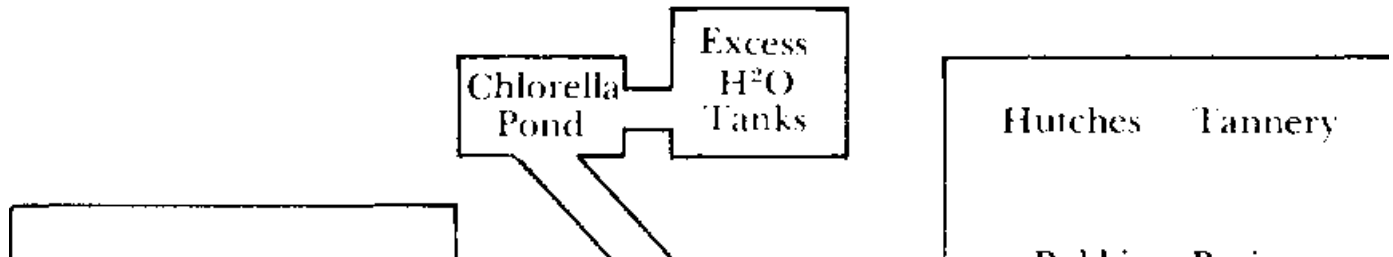
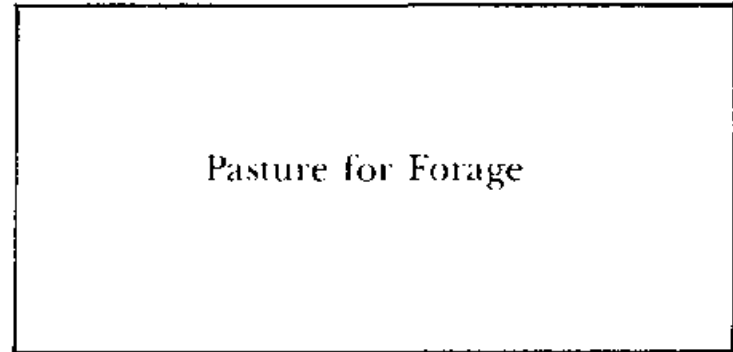
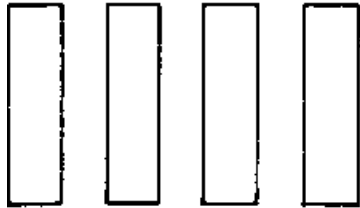

FIGURE 68 - SELF-LIQUIDATING YOUR RABBITRY PROJECT THRU RECYCLING

***Meat; pelts; paws and tails; methane gas and garden products are used for home consumption or may be converted into cash for family use.**

Night manure; chlorella; grain bran; surplus garden greens and forage from pastures are all recycled products from rabbitry making it self-liquidating.

Vegetable/grain garden



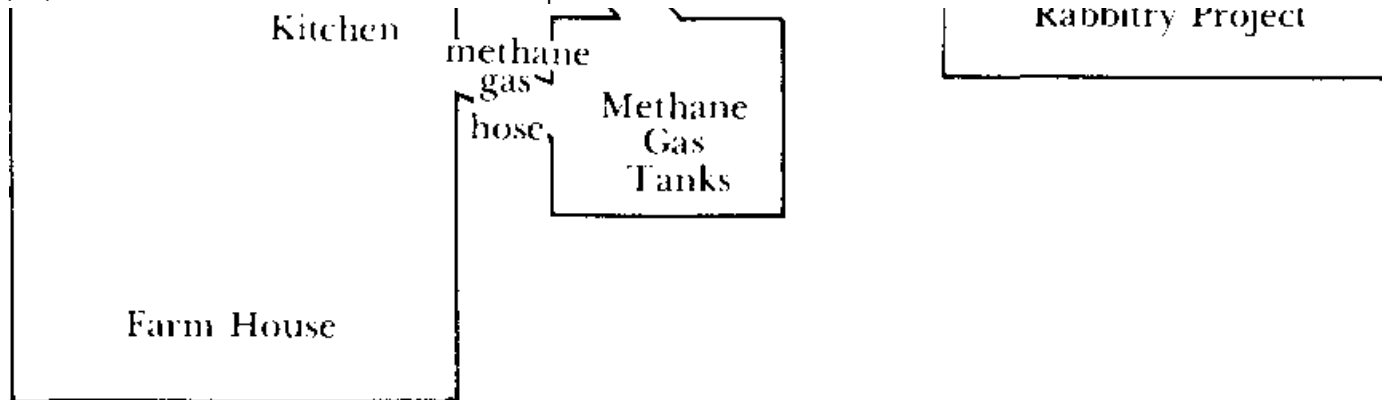

Pooled methane gas tanks/
Commercial garden scheme.

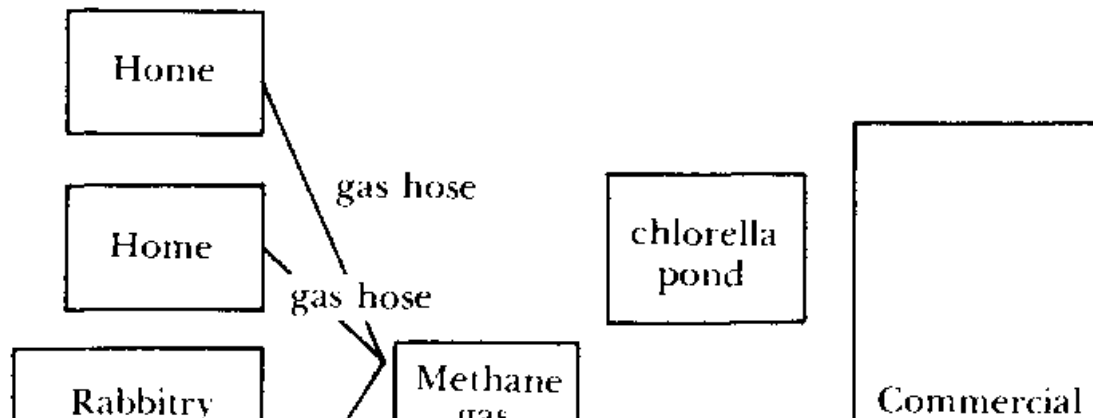

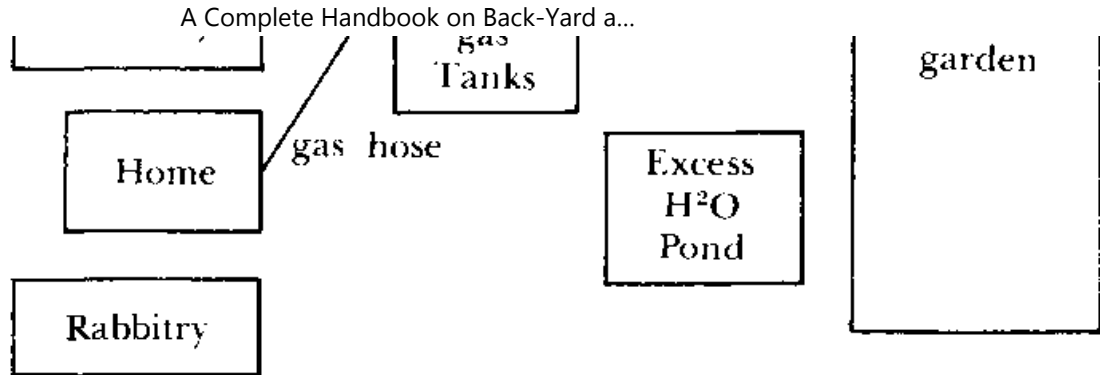







FIGURE 69 - SUGGESTED PLACEMENT OF SUB-UNITS OF AN INTEGRATED RABBITRY PROJECT



[Home](#) > [ar.cn.de.en.es.fr.id.it.ph.po.ru.sw](#)

 **A Complete Handbook on Back-Yard and Commercial Rabbit Production (Peace Corps, 1982, 92 p.)**

-  **(introduction...)**
-  **Author's introduction**
-  **Author's preface**
-  **Selecting a breed**
-  **Methods of breeding**
- 

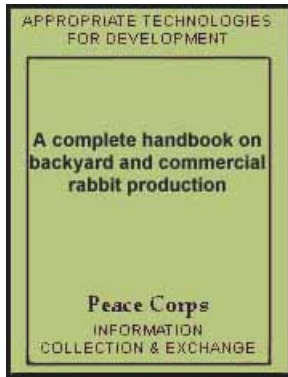

- ☐ **How to breed**
- ☐ **The rabbitry and its equipment**
- 📄 **Feeds and feeding**
- ☐ **Feeding rabbits**
- 📄 **Coprophagy**
- ☐ **Reproduction**
- ☐ **Managing the herd**
- ☐ **Various uses of rabbit manure**
- ☐ **Types of production**
- ☐ **Marketing rabbits**
- ☐ **Simplified tanning**
- ☐ **Cooking recipes**
- 📄 **Multiple-project approach to rabbitry**
- ➔ 📄 **Glossary**

Glossary

BREEDER - One who breeds or rears a special variety of rabbits in conformity with accepted standards of perfection or for the purpose of improving their commercial value.

BREEDING - Mating the doe with the buck.

BUCK - A male rabbit.

BUFFING OR KNEADING - The last stage in tanning when the skins are stretched by hand to soften the pelt.

BUNNY - A baby rabbit.

CAGE - A compartment generally 2' x 4' x 2' used for housing one adult rabbit.

CONCENTRATES - Commercial or home-mixed feeds which provides 16-18% protein necessary in the rabbit 's diet.

CONFORMATION - Structural features such as size, shape, etc.

COPROPHAGY - Reingesting of soft night dropping by the rabbit. It is usually a sign of nutritional deficiency.

CROSS BREEDING - Mating two different breeds of rabbits such as a California and Chinchilla.

CULL - To remove all undesirable rabbits from the herd.

DOE - A female rabbit.

DROPPINGS - Rabbit manure.

DRY DOE - The period of time from weaning the young to the next breeding period tot the doe.

FORAGE - Any green roughage fed to cows, horses, pigs, and rabbits.

FOSTER MOTHER - A doe which nurses the bunnies of another mother in addition to her own bunnies. Fostering is usually done to even up the number of bunnies from other does that have mot-e than they can physically nurse.

FRYER - A bunny aged from 2-4 months old when its meat is prime, weighing about 9 kilos to 1.5 kilos.

FUR BLOCK - The stomach is filled with undigested fur, blocking the passage to the intestinal tract.

GESTATION - Duration of doe's pregnancy from mating to kindling. Can be anywhere from 28 days to 32 days or- an average of 30 days.

HOCK - The middle joint or section of the hind leg, between the foot and the hip.

HUTCH - A string or line of cages. Can be any length.

HUTCH CARD - Recording system where breeding and production are

recorded for managerial evaluation. Usually a card is attached to each cage.

IN-BREEDING - Mating closely related rabbits of any breed.

KINDLING - Giving birth to young rabbits.

LACTATION - Nursing period from kindling to 8 weeks.

LEGUME - Any plant of the pea family with seeds growing in pods for instance peas, beans, and other leafy plants such as centrocema, Ipil-ipil (Peruvian type), Townsville stillo, leucerne (alfalfa), and a green leafy desmodium.

LITTER - A set of bunnies per one birth.

MOLTING - The act or process of shedding or changing the fur, usually three times a year. The baby or nest fur is molted at 2 months old, and the first natural coat of fur- is fully developed at 4 months to six months. For a doe it is nature's way of resting her from motherhood, and she is in no condition to be bred.

NEST BOX - A box measuring 22" long, 11" wide, 9" tall at the rear, 6" tall at the front, 6" x 11" top cover. Used for the doe to kindle her bunnies in.

NURSING - Period when the young draw milk from the teats of the doe.

Lasts from one day to 60 clays.

OILING - The second to the last process of tanning to soften and prolog the life of the pelt.

OUT - BREEDING - Mating unrelated rabbits of any breed to improve the stock.

PALPATING - A met hot of determining the accuracy of the doe's pregnancy on the 12th - 14th day after mating.

PEDIGREE - A correctly written chart recording the male and female ancestors of a rabbit, also showing the date of birth; ownership of clam and the parents, grandparents, and great grand parents of the specimen in question. In short, the history of the animal.

RABBIT - A domesticated rodent of the genus ORYCTOLAGUS CUNICULUS. An animal with four legs, about the size of a large cat, medium or long ears.

REPRODUCTION - The art of reproducing or multiplying of its own kind.

RUMP - The hind portion of the hack and backbone.

SANITATION - The art of maintaining cleanliness in the rabbitry which is the most important part of management.

TANNING - Is a process of curing or preserving the skin or pelt of the rabbit by use of chemicals.

WEANING - Time when bunnies are separated from their mother...usually at 2 months.

GPO 893-631

Since 1961 when the Peace Corps was created, more than 80,000 U.S. citizens have served as Volunteers in developing countries, living and working among the people of the Third World as colleagues and co-workers, Today 6000 PCVs are involved in programs designed to help strengthen local capacity to address such fundamental concerns as food production, water supply, energy development, nutrition and health education and reforestation.

**Loret Miller Ruppe, Director
Edward Curran, Deputy Director Designate
Richard B. Abell, Director, Office of Program Development**

Peace Corps overseas offices:

**BELIZE
P. O. Box 487
Belize City**

BENIN

B. P. 971

Cotonou

BOTSWANA

P. O. Box 93

Gaborone

CAMEROON

B P 817

Yaounde

CENTRAL AFRICAN REPUBLIC

B P 1080

Bangui

COSTA RICA

Apartado Postal 1266

San Jose

DOMINICAN REPUBLIC

Apartado Postal 1412

Santo Domingo

EASTERN CARIBBEAN

**Including: Antigua, Barbados, Grenada, Montserrat, St. Kitts-Nevis, St. Lucia, St. Vincent, Dominica "Erin Court" Bishops Court Hill
P. O. Box 696-C
Bridgetown, Barbados**

ECUADOR

**Casilla 635-A
Quito**

FIJI

**P. O. BOX 1094
Suva**

GABON

**BP 2098
Libreville**

GAMBIA, The

**P. O. Box 582
Banjul**

GHANA

**P.O. Box 5796
Accra (North)**

GUATEMALA

6a Avenida 1-46

Zona 2

Guatemala

HONDURAS

Apartado Postal

C-51

Tegucigalpa

JAMAICA

9 Musgrove Avenue

Kingston 10

KENYA

P. O. Box 30518

Nairobi

LESOTHO

P. O. Box 554

Maseru

LIBERIA

Box 707

Monrovia

MALAWI

Box 208

Lilongwe

MALAYSIA

177 Jalan Raja Muda

Kuala Lumpur

MALI

B P 85

Bamako

MAURITANIA

B P 222

Nouakchott

MICRONESIA

P. O. Box 336

Saipan, Mariana

Islands

MOROCCO

1, Zanquat Benzerte

Rabat

NEPAL

**P. O. Box 613
Kathmandu**

NIGER

**B P 10537
Niamey**

OMAN

**P.O. Box 966
Muscat**

PAPUA NEW GUINEA

**P. O. Box 1790
Boroko**

PARAGUAY

**c/o American Embassy
Asuncion**

PHILIPPINES

**P. O. Box 7013
Manila**

RWANDA

**c/o American Embassy
Kigali**

SENEGAL

**B P 2534
Dakar**

SEYCHELLES

**Box 564
Victoria**

SIERRA LEONE

**Private Mail Bag
Freetown**

SOLOMON ISLAND

**P. O. Box 547
Honiara**

SWAZILAND

**P. O. Box 362
Mbabane**

TANZANIA

Box 9123

Dar es Salaam

THAILAND

**42 Soi Somprasong 2
Petchburi Road
Bangkok 4**

TOGO

**B P 3194
Lome**

TONGA

**B P 147
Nuku' Alofa**

TUNISIA

**B P 96
1002 Tunis-Belvedere
Tunis**

UPPER VOLTA

**BP 537 - Samadin
Ouagadougou**

WESTERN SAMOA

P. O. Box 880
Apia

YEMEN

P. O. Box 1151
Sana'a

ZAIRE

B P 697
Kinshasa.



[Home](#) [ar](#) [cn](#) [de](#) [en](#) [es](#) [fr](#) [id](#) [it](#) [ph](#) [po](#) [ru](#) [sw](#)

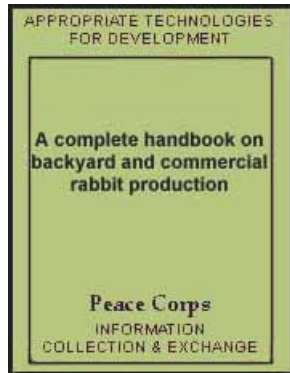

 **A Complete Handbook on Back-Yard and Commercial Rabbit Production (Peace Corps, 1982, 92 p.)**

 **(introduction...)**

  **Author's introduction**













 **Author's preface**

 **Selecting a breed**

 **Methods of breeding**

 **How to breed**



-  **The rabbitry and its equipment**
-  **Feeds and feeding**
-  **Feeding rabbits**
-  **Coprophagy**
-  **Reproduction**
-  **Managing the herd**
-  **Various uses of rabbit manure**
-  **Types of production**
-  **Marketing rabbits**
-  **Simplified tanning**
-  **Cooking recipes**
-  **Multiple-project approach to rabbitry**
-  **Glossary**

Author's introduction

In the Bible, Genesis I: 26-30, we are told how God created man (Adam) in His own image, and told him to multiply his own kind. God also instructed man to have dominion over His other creations. Since then, man multiplied by the millions, causing a population explosion, while his ability to produce food for himself and those millions Lagged far behind.

Thus, today statisticians tell us that nearly half of the world's population

goes hungry daily, and more than half of the world's total are undernourished. On top of this, there are millions being born each year to be added to the world's total. The future looks grim, but not hopeless.

There are solutions to population explosions:

- 1. Control population growth through Family Planning.**
- 2. Increase food production and land areas under cultivation.**

Food production (the concern of this handbook), involves not only the cultivating of rice and corn which are the basic staples, but also the production of food stuffs rich in protein to keep us healthy and resistant to disease. We all need a balanced diet. Meat is one good source of protein, but the meat supply (i.e., cost) today is often beyond the reach of the common man.

As a remedial measure, we should find and raise an animal which is not only rich in protein, but also has the capacity to multiply fast, if not even faster than man. That animal is the RABBIT! Rabbits are easy to raise and can be produced by all strata of our society.

Under good management and using modern farming techniques, one mother rabbit can give birth to 20-35 bunnies or 45 kilos of dressed meat a year. In addition, we can salvage the fur, paws, and tails from which novelty items can be made. The manure is another peso earner. Rabbit manure is

far superior to other manure as proven by those who experimented with the performance of various kinds of manure on plants and trees. Rabbit manure could be utilized to even make methane gas. Labor-wise, it takes only 10 minutes daily or 15 hours a years to care for two does and their young. There definitely is an excellent prospect in rabbit raising.

Importation of new breeds of rabbits from the U.S.A. was undertaken by some rabbit raisers such as Dr. Lasaro P. Ricafort of Baguio City and Mr. Dick Fagan of Rural Life Center, Dasmarias, Cavite, to improve the "native" rabbit. Since this importation, upgrading of rabbits had taken place in many areas, so today there are quality breeding stocks available.

For some time now, urban and rural people have been interested in rabbit raising. However, their main problem was and still is how to obtain the technical know-how of rabbit raising and marketing, since rabbit raising in the Philippines is quite new to many people.

Previous books and pamphlets written on rabbit production were either written stateside or by people who were not rabbit raisers themselves, so their ideas were quite academic and beyond ordinary farmers. This handbook on rabbit raising, on the other hand, tries to adopt stateside information to local situations and attempts to share the many experiences and knowledge gained by rabbit raisers in the Philippines. We have kept no secret success factor to ourselves! Care has also been taken to include the

many suggestions and experiences gathered from participants in several seminars on rabbit raising. Furthermore, conflicting opinions have been reconciled to clear away many doubts and/or questions to those "doubting Thomases."

**Rev. Juan B. Sicwaten
Farmer - Priest
Km. 3, Asin Rd.
Baguio City**



Home > [ar](#).[cn](#).[de](#).[en](#).[es](#).[fr](#).[id](#).[it](#).[ph](#).[po](#).[ru](#).[sw](#)

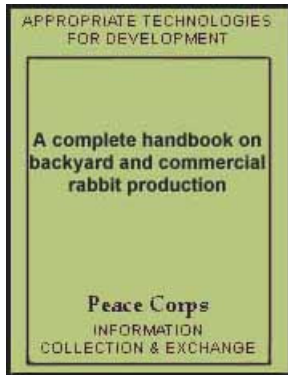

 **A Complete Handbook on Back-Yard and Commercial Rabbit Production (Peace Corps, 1982, 92 p.)**

 **(introduction...)**

 **Author's introduction**











  **Author's preface**

 **Selecting a breed**

 **Methods of breeding**

 **How to breed**

 **The rabbitry and its equipment**

-  **Feeds and feeding**
-  **Feeding rabbits**
-  **Coprophagy**
-  **Reproduction**
-  **Managing the herd**
-  **Various uses of rabbit manure**
-  **Types of production**
-  **Marketing rabbits**
-  **Simplified tanning**
-  **Cooking recipes**
-  **Multiple-project approach to rabbitry**
-  **Glossary**

Author's preface

Sa kalusugan ng bayan, rabbit ang alagaan. For the health of the nation, go into rabbit production.

Utilizing RABBIT, as an alternative protein source and its BYPRODUCTS as an income-generating activity, has been the campaign of dedicated rabbit raisers for many years. We have seen many backyard, commercial, and nutrition education rabbit production projects succeed and fail, although successes have so far surpassed the failures. From observation and

evaluation of these past and on-going ventures, the following criteria are offered as guidelines to insure success in YOUR project.

- 1. A true and sincere dedication to the IDEA of rabbits as food for your family, neighbors, and for the general population.**
- 2. A willing spirit to help and cooperate with your neighbor in his rabbit production project. If you are planning a backyard rabbitry and you cannot supply a market on your own, you MUST coordinate and cooperate with those around you. In this case, the net result of greed (profit for one self only) is eventual failure.**
- 3. A STRICT program of sanitation and disease control. The only excuse for a dirty cage is laziness. If you cannot afford the time to clean your cages, feed and water containers EVERYDAY, DO NOT GO INTO RABBIT PRODUCTION. The majority of failures are due to the lack of proper sanitation.**
- 4. If you cannot afford commercial feed, a balanced diet consisting of a variety of ALL types of forages will serve if the meat is only for local consumption. If you plan to market your rabbits professionally, then it is a MUST for commercial feeds to be given daily. If you do not pay careful attention to diet, your production will decrease and your breeding stock will degenerate. Plant your Green Revolution garden with a variety of legumes and root crops and cultivate an area for those recommended**

grasses BEFORE you begin your project.

5. To make any kind of profit, you must engage in tanning. You cannot make a substantial profit from meat alone unless you have the markets in Manila "cornered".

6. If you are to succeed in rabbit production, you must FIRST DEVELOP A MARKET WITHIN YOUR OWN LOCALITY. If you choose to enter this growing field, you must be willing to propagate the idea of rabbits as food to your neighbors and relatives. You will be a teacher, a change agent, a community developer, and you will truly be a pioneer!

Good Luck to You All!

Diane Stahl

U.S. Peace Corps











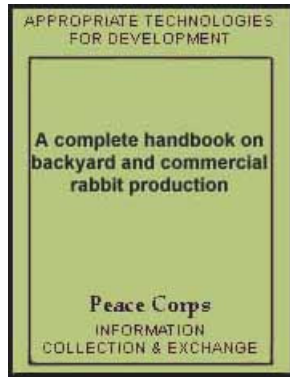









[Home](#) > [ar](#).[cn](#).[de](#).[en](#).[es](#).[fr](#).[id](#).[it](#).[ph](#).[po](#).[ru](#).[sw](#)

 **A Complete Handbook on Back-Yard and Commercial Rabbit Production (Peace Corps, 1982, 92 p.)**

 **(introduction...)**

 **Author's introduction**



- ➔  **Author's preface**
-  **Selecting a breed**
-  **Methods of breeding**
-  **How to breed**
-  **The rabbitry and its equipment**
-  **Feeds and feeding**
-  **Feeding rabbits**
-  **Coprophagy**
-  **Reproduction**
-  **Managing the herd**
-  **Various uses of rabbit manure**
-  **Types of production**
-  **Marketing rabbits**
-  **Simplified tanning**
-  **Cooking recipes**
-  **Multiple-project approach to rabbitry**
-  **Glossary**

Selecting a breed

1. Whether you raise rabbits for meat and fur, wool, or laboratory uses, select the breeds best adapted to the purpose.

2. Table I below lists the common rabbit breeds, their predominant color, weight and uses.

3. The medium and large breeds such as the New Zealand, California, Dutch Grey, English Spot, Chinchilla, and Flemish Giant have the most suitable size and conformation for producing meat and fur. White breeds of rabbits (e.g. New Zealand White and Californian, Fig. 1), are the most prolific and the most desirable for commercial and fur production because white skins usually bring higher prices. Preference among the white breeds is largely a matter of personal choice. Skins are a by-product of the meat production.

**TABLE I
SOME COMMON BREEDS OF RABBITS**

Breed	Color	Approximate Mature Weight	Principal Uses
		KILOS	
American Chinchilla	Resembles the true Chinchilla	5½ - 6	Meat and fur
Californian	White body; colored nose, ears, feet, and tail	3½ - 5	Meat and fur
Dutch	Black, blue, chocolate, tortoise, steel grey,	1½ - 2½	Laboratory

	and grey; white saddle, or band over the shoulder carrying down under the neck and over the front legs and hind feet		
English Spot	Basic body color white; colors of spots: black, blue chocolate, tortoise, steel gray, lilac, and gray; nose, ears and eye circles and cheek spots; spine stripe from base of ears to end of tail; side spots from base of ears to middle of hind quarter.	2½ - 3½	Laboratory and meat
Flemish Giant	Steel gray, light gray, sandy, black, blue, white and fawn. No two colors allowed on solids	6	Meat
New Zealand	White, red, or black	4 - 5½	Meat, fur and Laboratory

If you raise rabbits for laboratory purposes, check with nearby hospitals, laboratories, and city health offices to find out the type, age, and size of animal desired.

With sufficient feeding, mature animals (4½-5 months old) of the smaller breeds should weight 1 1/3 kilos to 1 ¾ kilos each; those of the medium breeds, 4 kilos to 5 ½ kilos; and those of the larger breeds, 6 1/3 kilos to 7

1/3 kilos. There are 28 different breeds, and approximately 77 varieties that vary in type, color, and size.



FIGURE 1 - Representative breeds of meat rabbits. Left, New Zealand White; Center, Chinchilla; Right, Californian.

SELECTING FOUNDATION STOCK

Selection of prime stock is the initial and most basic step toward success or failure of a rabbit operation. Naturally, an animal's appearance will play a major factor in the process of selection. Other essential requirements are health, vigor, longevity, ability to reproduce, and desirable type and conformation. But, overall, the primary criterion remains the rabbit's records. It is vitally important to study! records on family production, hereditary factors, size of animals, growth potential, etc. Therefore, purchase your foundation stock from a reliable and established rabbitry

that keeps such records.



[Home](#) > [ar](#).[cn](#).[de](#).[en](#).[es](#).[fr](#).[id](#).[it](#).[ph](#).[po](#).[ru](#).[sw](#)

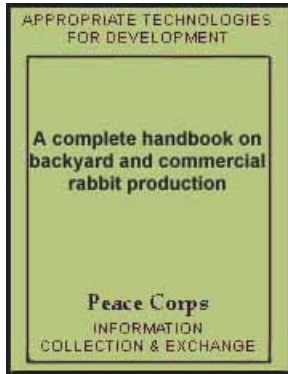

 **A Complete Handbook on Back-Yard and Commercial Rabbit Production (Peace Corps, 1982, 92 p.)**



(introduction...)



Author's introduction



Author's preface



Selecting a breed



Methods of breeding



How to breed



The rabbitry and its equipment



Feeds and feeding



Feeding rabbits



Coprophagy



Reproduction



Managing the herd



Various uses of rabbit manure



Types of production

-  **Marketing rabbits**
-  **Simplified tanning**
-  **Cooking recipes**
-  **Multiple-project approach to rabbitry**
-  **Glossary**

Methods of breeding

Contrary to popular belief, rabbits do have a heat period. The following are signs of heat for a mature doe:

- 1. Reddening and swelling of the vulva.**
- 2. Sudden decrease in feed consumption.**
- 3. Rubbing of chin on side of hutch.**
- 4. Riding on one another if in colony type of cage.**
- 5. Restlessness; trying to gain entrance to neighboring cages and violently spilling water from bowl or cup.**
- 6. Occasionally the doe will ride the buck when service is attempted.**

There are four methods of breeding: natural mating, forced mating, confined mating, and artificial insemination.

NATURAL MATING is the best method. When ready for breeding, females will show reddening of the vulva. Deep red coloration indicates the female

will usually accept the male and conception should occur about 75 per cent of the time. Females may be rebred after their litter is 45 days old allowing a short rest period after weaning. Females in season should be introduced to the males cage. (Fig. 2) If acceptance does not occur within a few minutes, remove the doe and attempt to breed again in the late afternoon or the following morning. This timing method gives the highest conception rate- up to 90 per cent or more.



FIGURE 2 - Natural mating gives the highest conception rate - up to 90% or more if doe shows signs of heat.

FORCED MATING is the most time consuming in man hours and labor. This method requires that eligible females who do not immediately accept the buck be restrained by a caretakers so the buck can mate. Conception rate by this method will calve reach 90 per cent if the doe is in heat but, if there ate few signs of heat, the conception rate may be as low as 20 per cent.

CONFINED MATING for anywhere from several to 24 hours or days is hazardous to the physical well-being of the animals due to their insistent fighting. Lack of knowledge on the part of the caretaker as to when or if conception occurred is also a disadvantage. Thus, it is impossible for the caretaker to prepare the doe for kindling and loss of young is frequent.

ARTIFICIAL INSEMINATION - Semen is collected from males and introduced to females by artificial means. This technique requires experience for good success. At the present time, artificial insemination is not commonly used in rabbit production but may become the preferred method for commercial breeding operations in the future.



[Home](#) > [ar](#).[cn](#).[de](#).[en](#).[es](#).[fr](#).[id](#).[it](#).[ph](#).[po](#).[ru](#).[sw](#)

 **A Complete Handbook on Back-Yard and Commercial Rabbit Production (Peace Corps, 1982, 92 p.)**

 **(introduction...)**



 **Author's introduction**

 **Author's preface**

 **Selecting a breed**

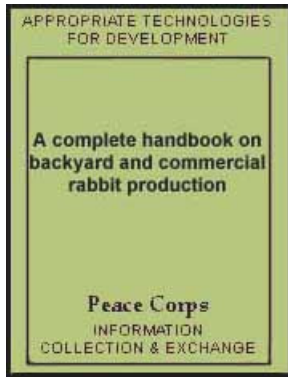
 **Methods of breeding**



- ➔  **How to breed**
- The rabbitry and its equipment**
-  **Feeds and feeding**
- Feeding rabbits**
-  **Coprophagy**
- Reproduction**
- Managing the herd**
- Various uses of rabbit manure**
- Types of production**
- Marketing rabbits**
- Simplified tanning**
- Cooking recipes**
-  **Multiple-project approach to rabbitry**
-  **Glossary**

How to breed

- 1. Breed does first at 5½ months of age for small breeds and 6 months of age for medium size.**
- 2. Use mature bucks at 6 months of age.**

- 3. Breed in the early morning or late afternoon.**
- 4. Take doe to buck's cage for service, leave for repeated service up to 1() minutes; return doe to her cage. If doe fights buck, she may be restrained by caretaker for service.**
- 5. If buck fails to serve doe in minimum time, switch doe to another buck.**
- 6. Doe ovulates about 8 hours after first service. Some producers take doe back for second service at this time. This doubles breeding time but the average conception percentage is not improved greatly.**
- 7. Palpate doe or observe pregnancy signs 10-14 days after breeding to see if doe is pregnant. Rebreed does that have not conceived.**
- 8. Breed all does that show signs of heat at least one or two days a week.**
- 9. When breeding daily, use bucks every other day. When breeding weekly, bucks may service once in the morning and once in the late afternoon on the breeding day. To keep a good buck for a long period of time use him only three times a week. (Do not let rabbit become overweight. She/he will not service as well then.)**
- 10. Keep one buck to every 10 does. Active, high-producing bucks with good replacements coming will solve most breeding problems.**

11. Normal gestation period for rabbits is from 28 to 32 days with an average of 30.

12. Rebreed doe when litter is 45 class old then rebreeding again after 14 days if the doe is in good health.

13. Replace does that produce less than 5 healthy babies, two litters in a row.

14. Replace buck when his record reveals low production, or his offspring show poor feed conversion or poor rate of weight gain.

15. Save replacement stock for expansion as needed to keep cages filled with working does and active bucks. Constantly improve herd by strict culling of low producers.

16. Average production life of good does is about two to three years but, save good producing does as long as production warrants.

17. Average production life of good bucks is from 1 year to 5½ years.

18. Save at least one young replacement doe and buck per month for each 12 working does at the end of the second or third year when replacement is needed. This replacement rate generally will not cover both culling and mortality. Replenish stock as needed.

19. Purchase good bucks occasionally to prevent extreme in breeding from established and reliable farms.

The following figures summarize the information a good manager needs for breeding operations.

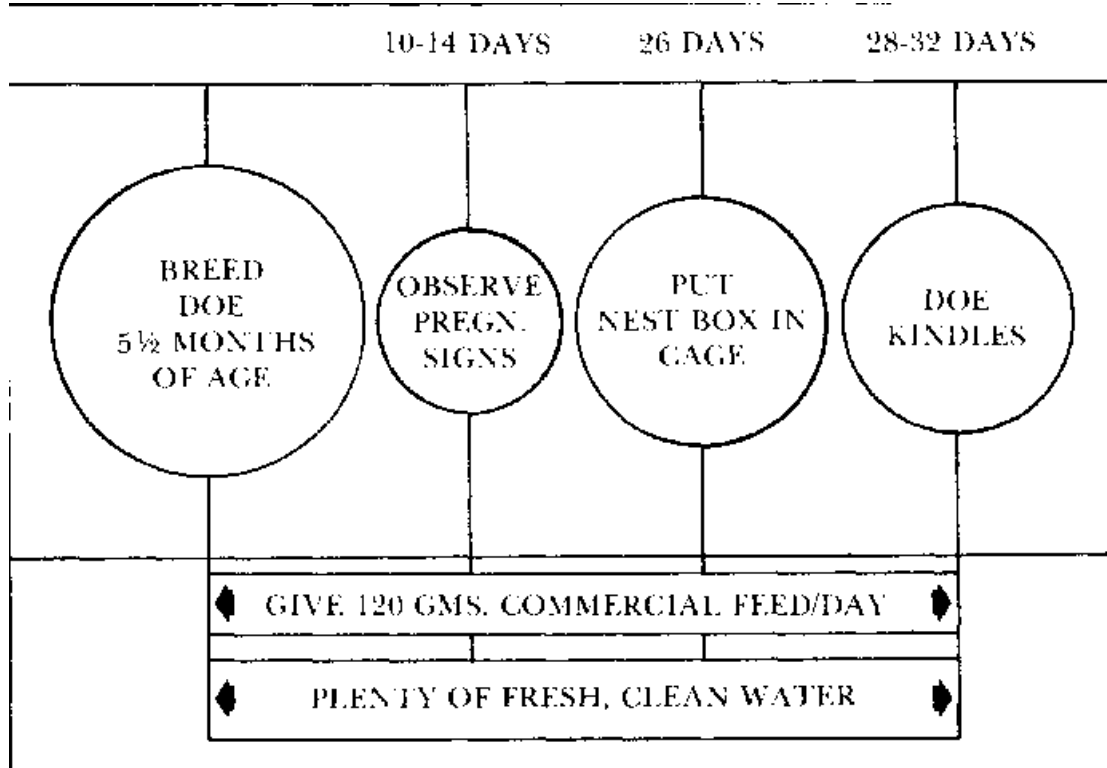

FIGURE 3 - RABBIT GESTATION CALENDAR

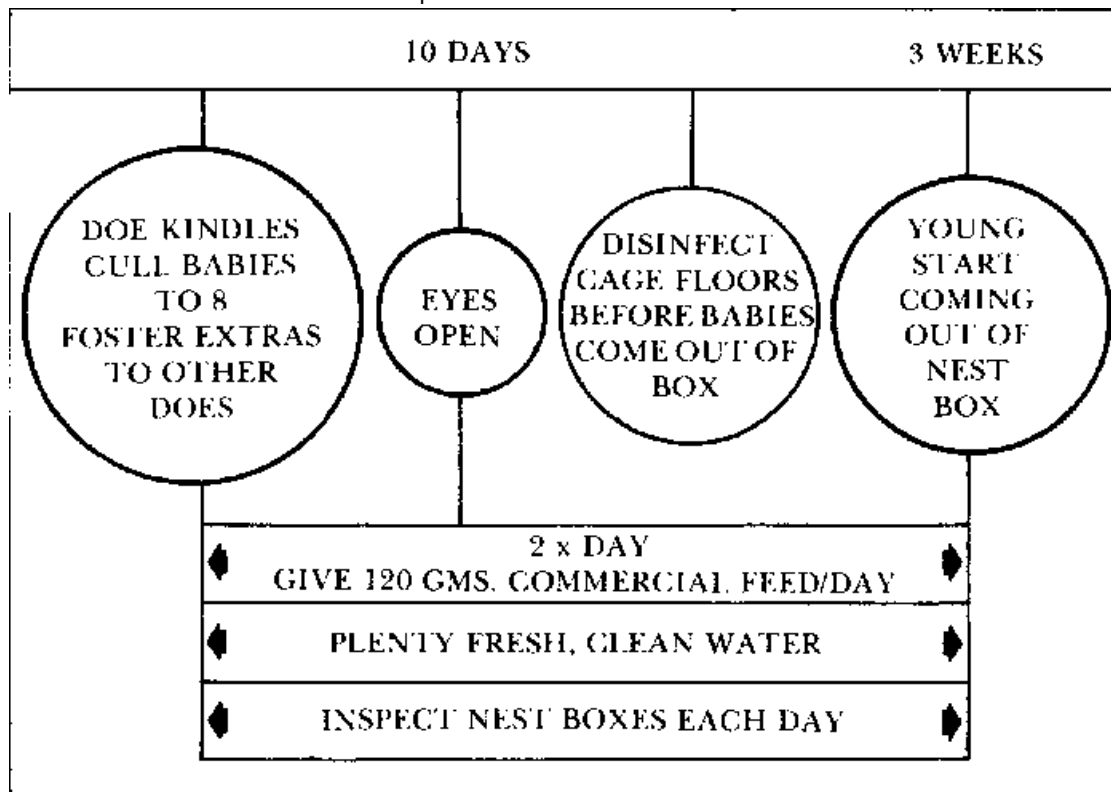

FIGURE 4 - RABBIT LACTATION CALENDAR FOR MEDIUM-SIZED BREEDS

	3 weeks	4 weeks	8 weeks	12 weeks	14-16 weeks	
	YOUNG COME OUT OF NEST BOX		REMOVE NEST BOX	WEAN LITTER	REBREED DOES	EAT OR SELL FRYERS TAN SKINS
DAILY	120 gms	240 gms	480 gms	960 gms	960 gms	Total Consumpt'
MONTHLY	3.6 K	7.2 Kilos	14.4 Kilos	28.8 K	28.8 K	82.8K
 PLENTY OF FRESH, CLEAN WATER EVERY DAY						

FIGURE 5 - RABBIT SUCKLING CALENDAR*

*** NOTE: This includes Doe's ration up to weaning or 8 weeks. After weaning she continues with 120 gms daily feed ration.**

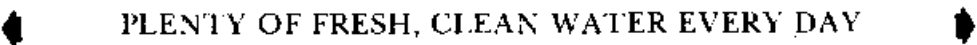
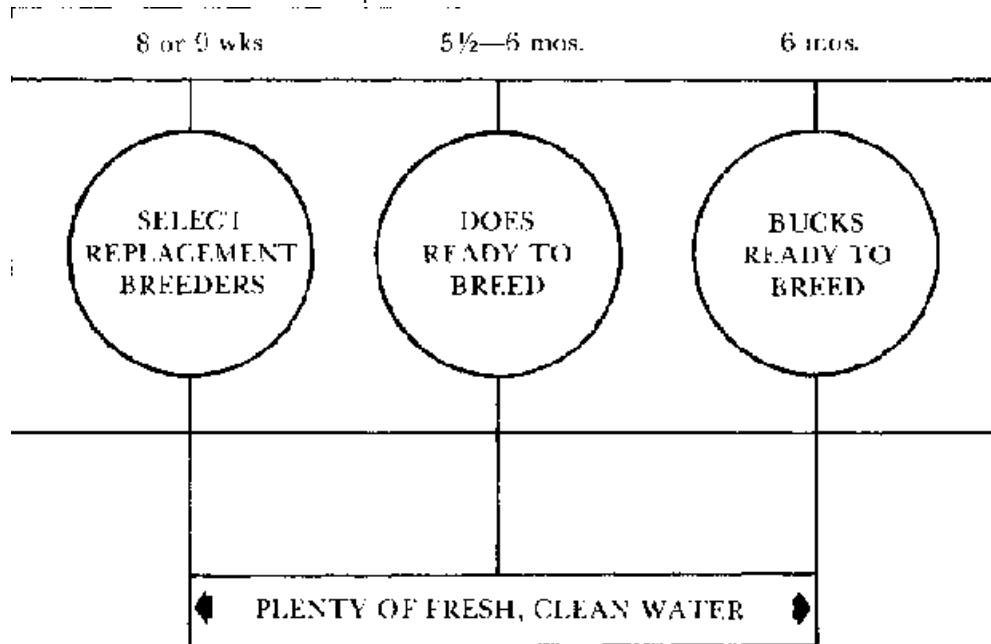
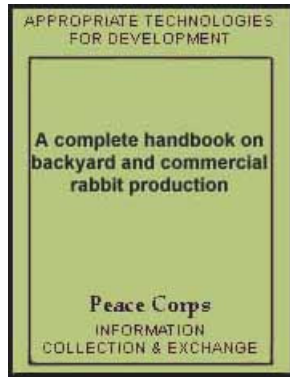

FIGURE 6 - RABBIT BREEDER REPLACEMENT CALENDAR*

*** NOTE: For second or third year of operation.**



[Home](#) > [ar.cn.de.en.es.fr.id.it.ph.po.ru.sw](#)



A Complete Handbook on Back-Yard and Commercial Rabbit Production (Peace Corps, 1982, 92 p.)

The rabbitry and its equipment

 **Housing**

 **Hutches**

 **Feeding equipment**

 **Equipment for watering**

 **Nest boxes**

A Complete Handbook on Back-Yard and Commercial Rabbit Production (Peace Corps, 1982, 92 p.)

The rabbitry and its equipment

Housing

- 1. Any building whether expensive or inexpensive can shelter rabbit hutches as long as it protects the rabbits from predators, wind and rain, and in addition a house should provide plenty of light and ventilation.**
- 2. As much as possible, use locally available materials to cut down on cost. Bamboo is an excellent material for lowland construction.**

3. A good rabbit house, though, should be located in an area where both the caretaker and the rabbits feel comfortable.

Hutches

The type of hutch and equipment for any rabbitry will depend on where the rabbitry is to be located, climate and the amount of money to be invested.

Before starting to build your hutches, the construction and equipment should be designed to minimize labor needed in caring for the herd. Furthermore a neat design and convenient arrangement should be considered to insure the best working environment.

Many types of hutches are in use and no one design is entirely suitable for all purposes or all conditions. Basically, hutches should be well ventilated and should provide maximum comfort for the rabbits by giving adequate protection from all kinds of weather and predators. The animals must be protected from typhoon, winds and hot sun and they must be kept dry.

In order to save on expenses, materials around your own home should be used whenever possible. Scrap lumber and bamboo are good building materials. Chicken wire of different sizes are also used in the construction of many hutches today but, depreciation is extremely high.

Provide individual cages for mature rabbits. The cages should be no more

than.762 mm deep so you can easily reach the rabbits, and.609 mm high. Make the cages.9144 mm long for small breeds, 1.219 m for medium-size breeds, and 1.219 m to 1.828 m for giant breeds (All figures are for inside measurements). Whether you arrange the hutches in single, double, or triple tiers depends upon how much room is available. If you have enough room, waist-high, single-tier hutches are preferable as they are most convenient for observing the rabbits and will also save time and labor in feeding and management. The inconvenience of squatting or stooping to feed and care for rabbits in the bottom tier and of having to use a stool or ladder for the top row of a three-tier arrangement results in additional labor and time as compared to a single-tier arrangement. And worst of all, good sanitation is sacrificed in the long run.

Wire Metal Hutches - A combination two-compartment all-wire hutch is labor-saving and simply designed but more expensive to build. However, an all-wire, quonset-shaped hutch has several advantages. It is easy to clean, neat in appearance, and requires less wire than a standard rectangle hutch (see Figure 7).

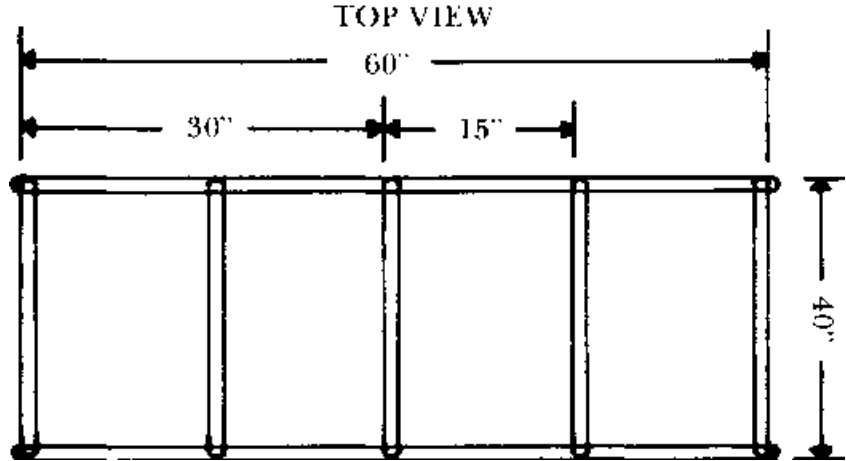
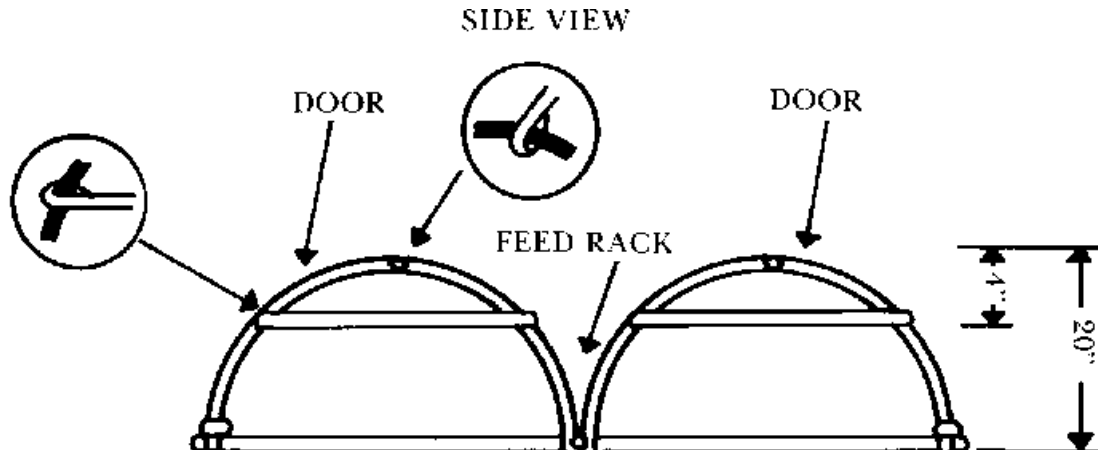
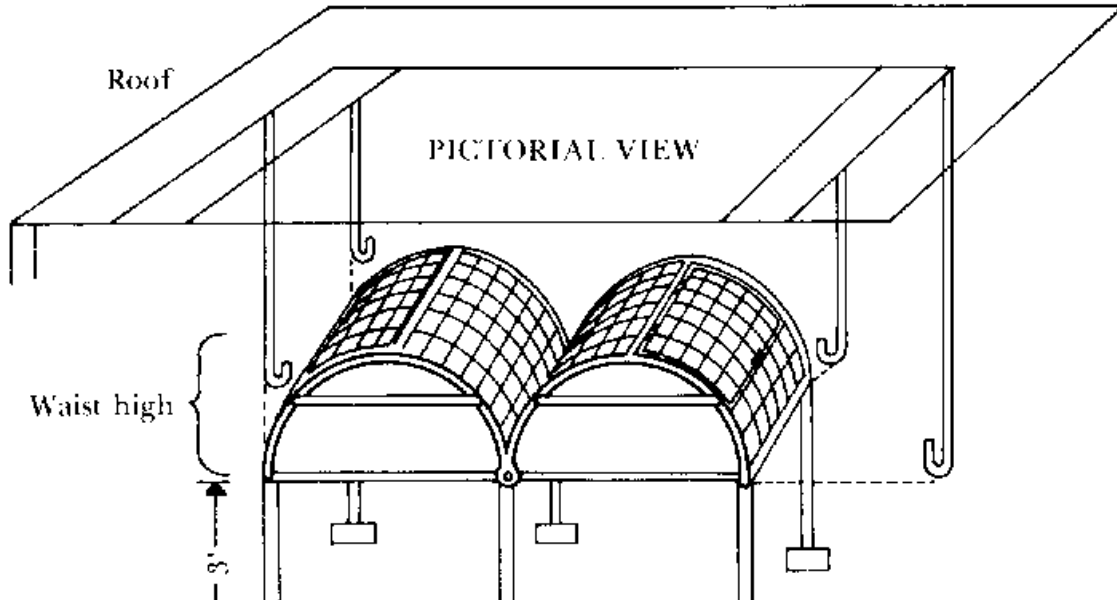
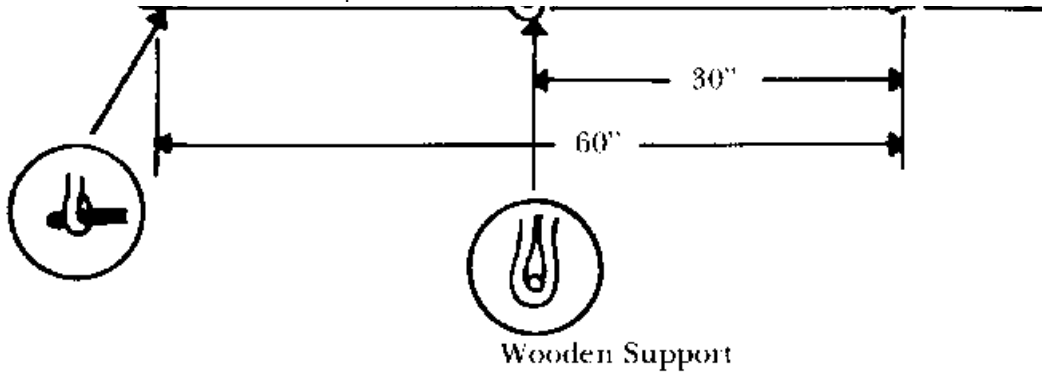
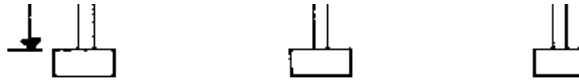

FIGURE 7: 2-CAGE, ALL WIRE QUONSET HUTCH







NEEDED MATERIALS

FIGURE 7

STEEL BAR (Round) 5/16 DIAM x 20 - 4 pcs.

WELDED WIRE #16 1 x 2 - 4' x 10' $\frac{3}{4}$ x $\frac{3}{4}$ or $\frac{1}{2}$ X $\frac{1}{2}$ -2' X 6'

G.I. WIRE #16-1/5 kl.

NOTE:

This style hutch must be hung inside the building where it will be placed. From this sketch, you can make more improvements and add more cages.

The quonset style hutch features a door that opens up over the top. Then, when open, the door does not occupy aisle space or interfere with feeding and cleaning operations. In addition, when this type of hutch is single-tiered at waist height, you can reach all the corners without placing your head and shoulders inside the door opening.

Quonset-shaped hutches can be adapted to fit any type of rabbitry where hutches are housed. They are most easily constructed in 2 hutch units.

Wood-Frame and Wire Hutches - In the Philippines, the most economically

constructed rabbit hutch is a combination of wood and wire. The skeleton is wood and the flooring, sides, and top are all welded wire to insure sanitation. The wood frame is an external skeleton while the welded wire is attached inside (Fig. 8). The positive characteristics of this type of hutch are its durability and excellent ventilation and sanitation. (Fig. 9)

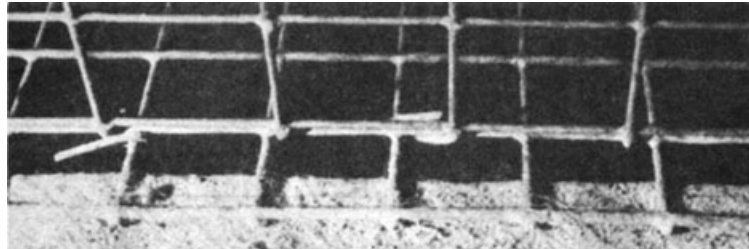
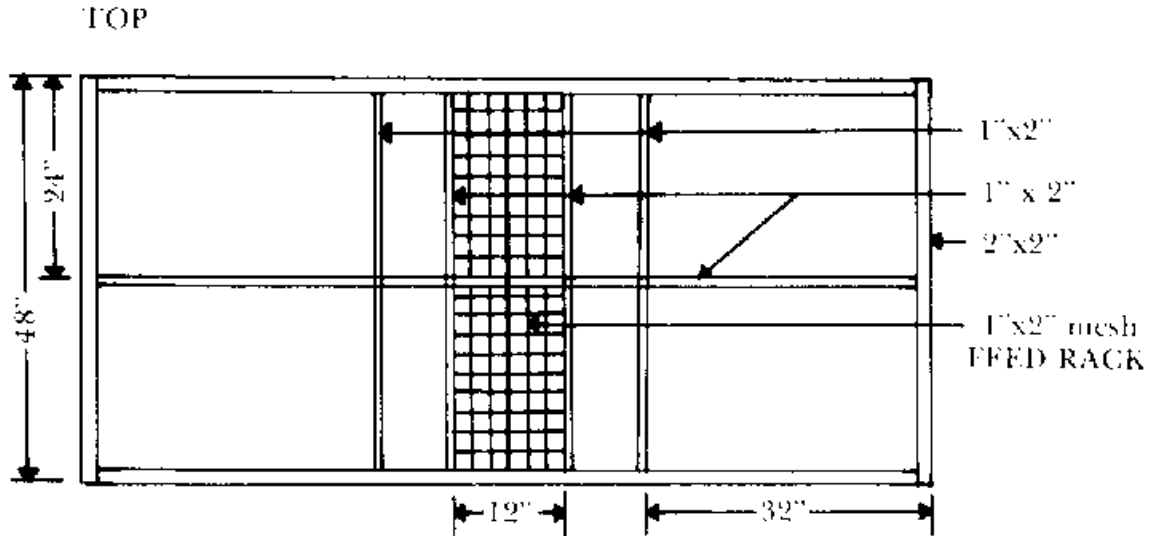
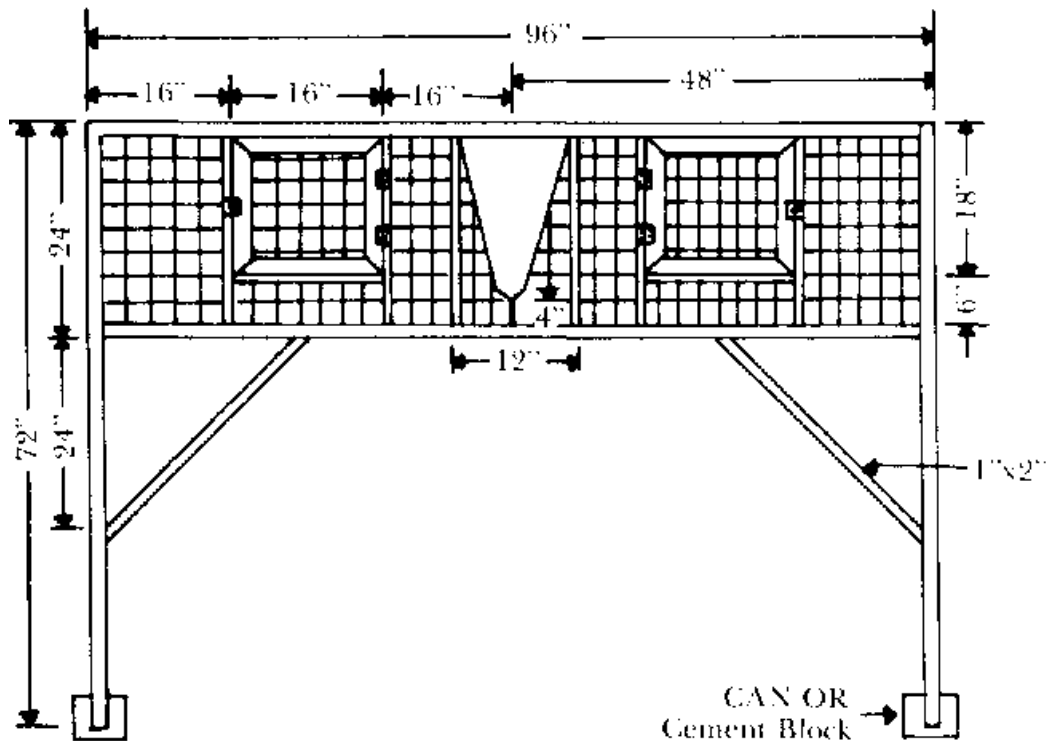

FIGURE 8 - Wood frame hutch with galvanized wire placed inside wood frame.

Hutches may be supported in several ways. If you use corner posts, make them long enough (about 1.067 m high) so that you can clean underneath and do other work around the hutch. Cement blocks beneath the corner posts will increase the longevity of the wood. In areas where ants pose a problem, a depression cut into the blocks can serve as containers for any locally available insect repellent or a gas and oil mixture. You can support a hutch by resting it on a crosspiece nailed between the studs that support the shed, or you can hang it from the rafters or ceiling of the shed with heavy wire or light lumber.

Bamboo Hutch - Bamboo is one of the most economical of all hutch materials when used with a nipa or cogon grass roof. The design is the same as for the wooden frame-wire hutch. For the sides and flooring, use 25 mm wide bamboo slats spaced 16 mm or 19 mm apart. Place the rounded portion of the bamboo slats facing the inside of the cage to eliminate gnawing by the rabbit. To prevent strangulation or breakage of the rabbit's feet, use straight bamboo for the flooring.





FRONT-REAR VIEW

A: WOOD FRAME AND WIRE HUTCH - DOUBLE FACE

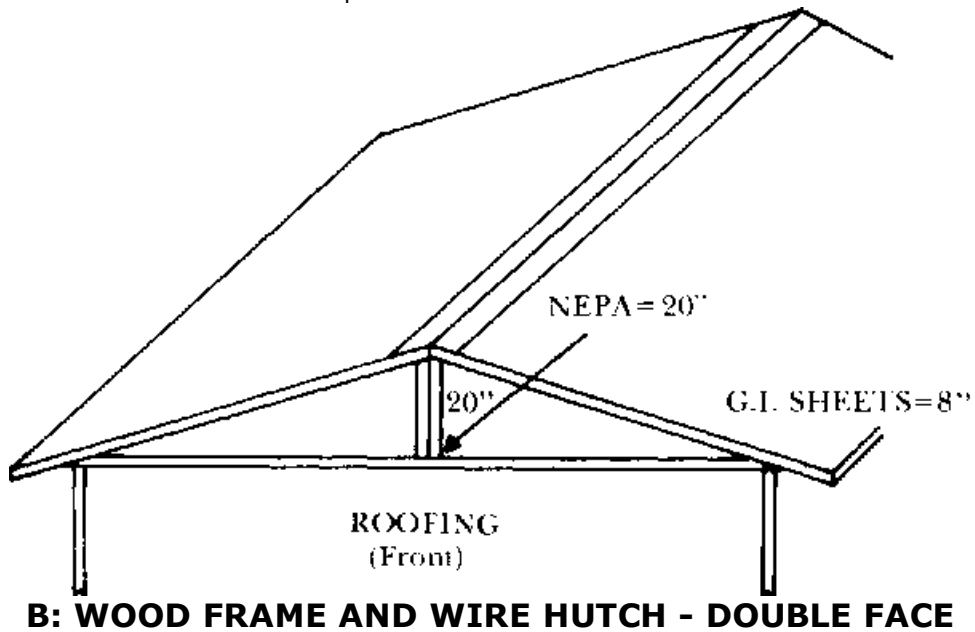

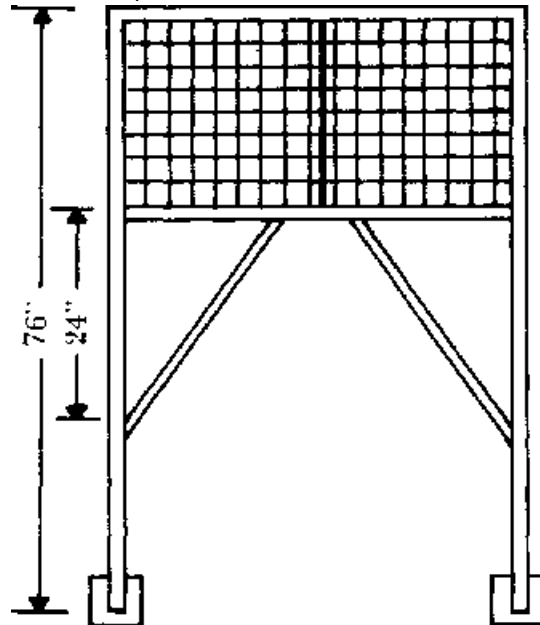

SIDE

C: WOOD FRAME AND WIRE HUTCH - DOUBLE FACE

BILL OF MATERIALS FOR RECTANGULAR WOOD AND WIRE HUTCH

S4S LUMBER - For Framing

2" x 2" x 6' - 2 pcs.

2" x 2" x 8' - 6 pcs.

1" x 2" x 8' - 10 pcs.

WELDED WIRE - 16

4' x 8' - 3/4" x 3/4"

(Double 1" x 1" to make 3/4")

4'x3' - 1"x2"

4' x 24' - 1" x 1"

COMMON NAILS -

1-1/2-kl.

2 - 1-kl.

2 1/2 - 1/4-kl.

HINGES - 3/4" X 2" - 8 pcs.

ROOFING

S4S LUMBER -

2" x 2" x 10' - 2 pcs.

1 " x 2" x 1 2' - 4 pcs.

* FOR NIPA

NIPA - 3'L = 120 pcs.

BAMBOO .. - 5'L (med.) - 2 pcs.

S. RATTAN - 20 pcs.
PLAIN G.I. SHEET - 12" x 6'
*FOR G.I. SHEETS
G.I. SHEET - 32' x 6' - 6 pcs.
ROOFING NAILS - 2" - 1 Kl.

Hutch Floor - Several types of floors are used in hutches, and each has its particular merit.

Wire mesh floors are used extensively where a self-cleaning type is desired. They are a necessity in commercial herds, where it would be impossible to provide enough labor to keep solid floors in a sanitary conditions. In installing this type of floor, examine the wire for sharp points which result sometimes from the galvanizing process. Paint the galvanized wire with iron paint to lessen depreciation. Always put the smooth surface on top. Though solid floors in the long run pose problems with sanitation, this can be minimized if the floors are sloped slightly backwards to provide proper drainage. You can use hardwood or bamboo slats as flooring also. A combination of solid floor at the front part of the hutch and a strip of mesh wire or slats at the back may be used.

When using an all-wire mesh floor, it is advisable to place a resting board made of plywood inside the cage to eliminate sore hocks. The dimensions would be determined by the size of the animal; i.e., large enough for rabbit

to rest comfortably.

Feeding equipment

It is desirable to use feed crocks, troughs, hoppers, and grass mangers that are large enough to hold several feedings to save time in filling. Use a type that will prevent waste and contamination of the feed.

Crocks. Crocks especially designed for rabbit feeding, (about 6 inches wide and 3 inches tall) which are not easily tipped over, have a concave lip that prevents the animals from scratching out and wasting their feed. The chief objection to these is that the young rabbits get into them and contaminate the feed. Earthenware and ceramics are the best suited materials.

Bamboo Troughs - can also be utilized for commercial feeds. To form a concave container, 1/3 of the side should be cut away between the two nodes. To prevent the container from tipping, attach it to the side or floor of the cage with wire.

Grass Mangers - are either U or V-shaped and made of mesh wire 1" x 2" gauge 16. The 2' inch is placed horizontally while the 1' inch is vertical to allow the rabbits easy access to the grass by pulling. Ideally, grass mangers are usually constructed between two cages to save space and labor but they can also be placed at the front or side of the cage although it is more cumbersome for the animal and the caretaker.

Hoppers - (See Fig. 10) Feed hoppers of the proper design and size save considerable time and labor. These can be constructed from metal, wood, ceramics, or other readily available materials. They should hold at least several days supply of feed and be placed within the hutch or suspended on the outside of it. The opening through which the rabbits obtain feed should be not more than .10 m above the hutch floor so that young rabbits can readily eat. This is especially suited for complete rabbit feed pellets. An expensive feed hopper that will hold about 15 pounds of pellets or home mixed feeds can be made from a common square 5-gallon can or can be constructed using plywood, lawanit or ceramics. Using the 5-gallon can first cut off the top. Then cut holes in two opposite sides. If the hopper is to be hung on the side of the hutch, cut a hole on one side only. The holes should be .110 m high, .110 m from the bottom, and .025 m from each side. Bend the rough edges inward to give a smooth edge all around and to acid rigidity. Take a .025 m x .10 m x .34 m board and cut it diagonally into two equal triangular pieces. Use these as supports to the baffle boards which are nailed to them.

The baffle boards, of .0125 m plywood, should extend .()25 m below the bottom of the side openings of the can. The space between the lower ends of the baffle boards permits the pellets to flow clown as the rabbits eat. Cut the baffle boards to fit snugly against the insides of the can so feed cannot slip by!. Mount the top corners of the baffles so that each baffle will rest against the top edge of the can.

Cover the exposed edges of boards with tin to prevent gnawing. Put a finishing nail in the outer edge of the triangular piece supporting; the baffle, and trend the nail to hook over the lower lip of the opening to hold it and the baffle in place.

You can save hutch floor space by using a hopper with a feed opening on one side only and by placing the hopper only part way into the hutch. Cut an opening large enough to accommodate the hopper in the side of the hutch. Then wire the top of the hopper to the hutch for support. One short baffle on the inside opposite the hopper opening will keep feed out of the rear corners.

A one-compartment feed hopper is used when only one kind of feed is given. When nixed feed that the rabbits can separate is offered in the hopper, the feed will be selectively consumed. The rabbits scratch out and waste the part times prefer not to eat. You can prevent this waste by using a hopper with a concave mouth and individual feed compartments.

Caution must be taken to insure that no moisture enters the can during rain showers. If moisture does enter, mold may develop. When this moldy feed is ingested by the rabbit, it causes the build-up of fluids and gas which the rabbit is unable to expel. Bloat and death of the animal will result.

5 Gallon Can

METAL

1/2" BOARD

1 1/2"

Cover

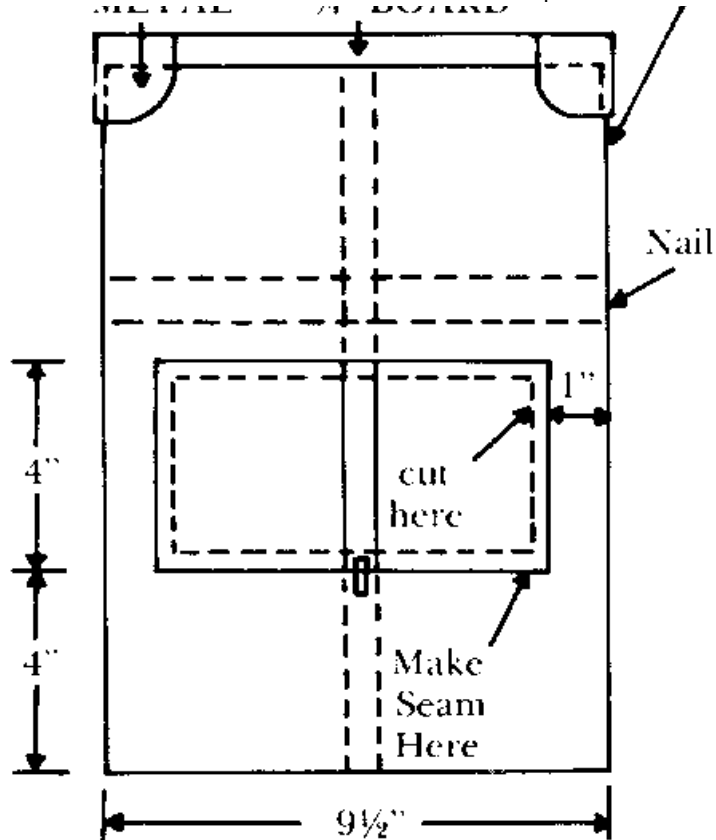

Front & Rear

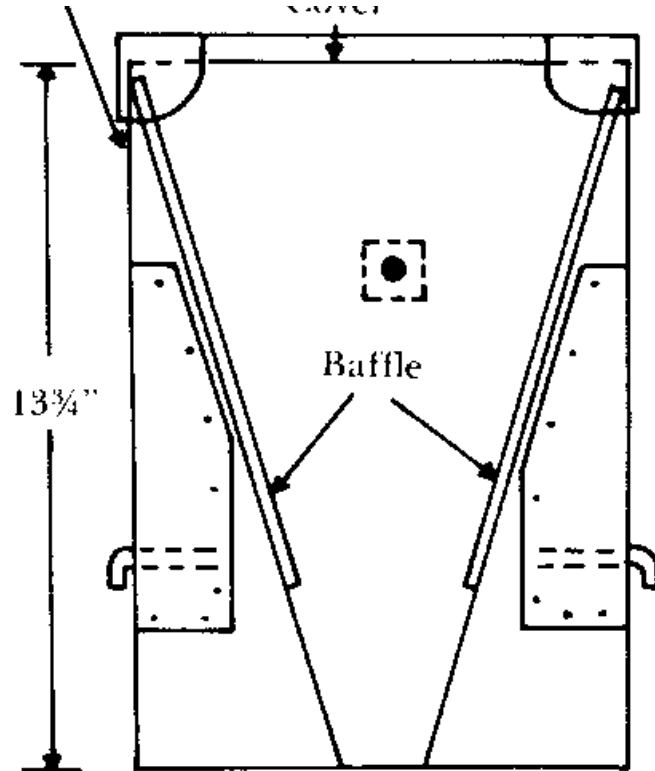

2 Sides

Nail

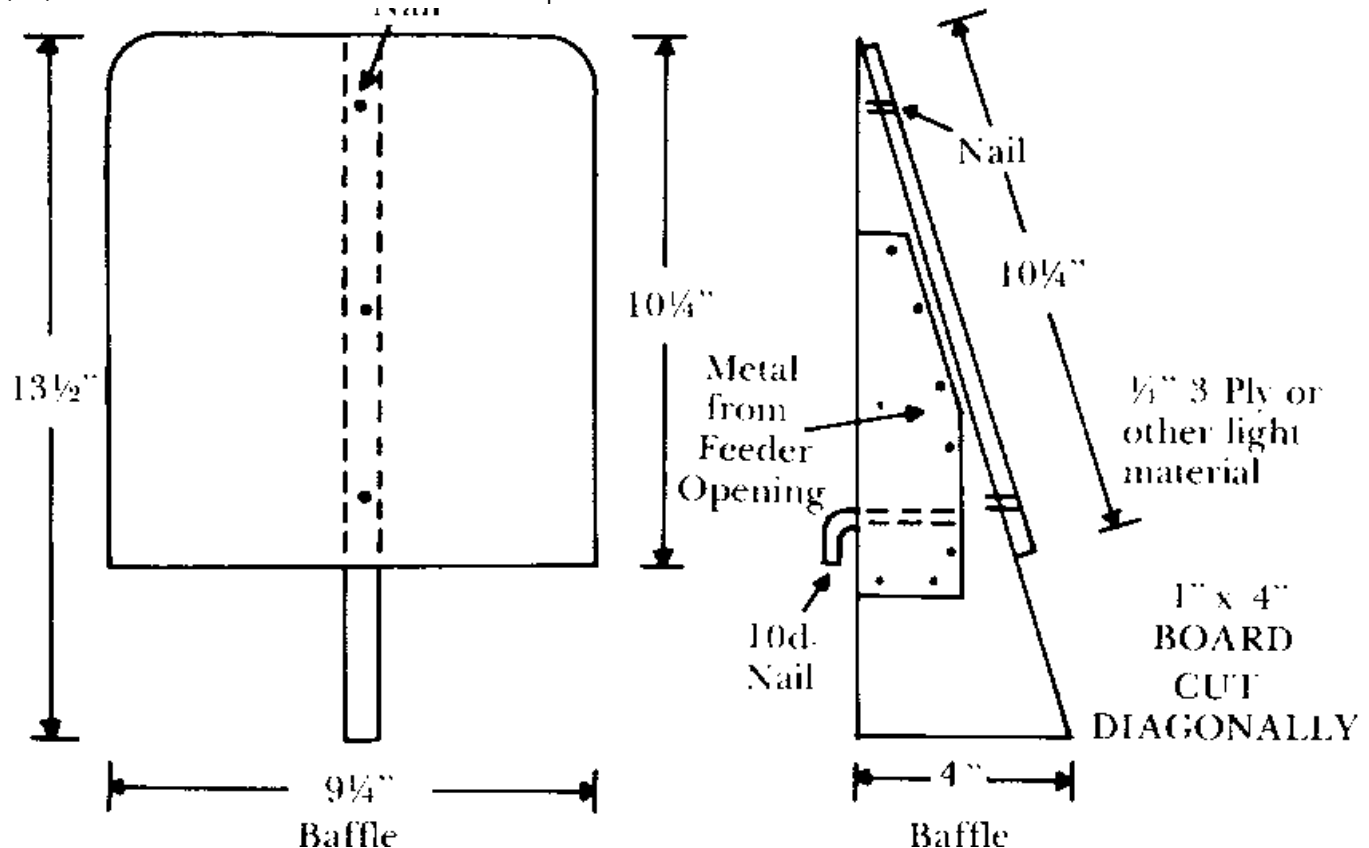

FIGURE 10 - DESIGNS FOR FEED HOPPER MADE FROM 5-GALLON CAN

A common mishap to be aware of with litters is when the uneaten portion

of feed is spoiled by urination of and fecal excretion by the bunnies who climb into feed hoppers.

Pelleted rabbit feed contains salt which will eventually corrode the metal can. If mash is used, a higher rate of corrosion will insue due to the minute particles clinging to the sides of the can. To reduce rusting by coating the can with iron paint is a practical but expensive solution.

Equipment for watering

Contrary to popular belief and practice, rabbits do need clean, fresh water at all times. During hot weather, a doe and her litter of 6 or 8 will consume about 2 liters of water a day. Here are suggested water containers:

Crocks: inexpensive and yet sanitary, earthenware crocks are used quite extensively in the rabbitry.

Enamel Cups: the most sanitary and easier to clean than the crock style. They may he tied to the side of the cage to prevent spillage by the rabbit. (Fig. 11)



FIGURE 11 - Enamel cup for water wired to cage to prevent spillage.

Ceramic Crocks: also recommended if they are within a reasonable price range.

Bamboo Troughs: practical due to their availability but pose a problem due to their susceptibility to algae formation.

Cans: sometimes utilized but, again, problems arise when rabbits eat the rust formed on the can. I Thus their use is not warranted. However, 1 liter-sized plastic oil can, can be cleaned and cut for both water and/or feed

containers. These can be attached to the cage with wire to prevent spilling.

Automatic Watering: automatic watering systems are widely used in commercial rabbitries in the States. Though they are very expensive to install, they could easily be adapted to commercial rabbitries in the Philippines.

Automatic watering systems are better than the conventional type of containers. They eliminate the tedious and time consuming chore of washing, disinfecting, rinsing, and filling. They supply fresh, clean water for the rabbits at all times. When an automatic watering system is properly installed, dirt and fur will not collect in it and plug it up.

While there are many positive aspects to automatic watering systems, the negative must also be considered. It takes time to train rabbits in using this system. In the beginning, water consumption may decrease to a level where production may be drastically affected. If the drinking valves are not properly installed and maintained, water leakage and dripping may eventually corrode the wire mesh.

Nest boxes

When a doe is ready to kindle a nest box is placed in the cage for her to give birth in. This is a carry-over from habit of wild rabbits who kindled inside trees or holes in the ground.

No one type of nest box is best suited for all conditions, but all should provide seclusion for the doe at kindling and also comfort and protection for the young. Nest boxes should be large enough to prevent crowding while small enough to keep the young together. All types should provide good drainage and proper ventilation.

Counterset Nest Box: A type of nest box used in the U.S. is the counteract type, where the box is recessed below the hutch floor. These may be placed at the front of the cage and fitted like drawers for access from the exterior of the hutch. They have the advantages of providing a more natural environment, since rabbits are burrowing animals, and of allowing the young easier access if they should be displaced from the nest at an early age. The young can jump out of the standard type nest box, but they often cannot jump or climb back in. When the litter becomes divided, this means that some of the young may go hungry. The doe usually nurses her young at night or in the early evening and morning hours. If the litter is divided, the doe will either nurse the young in the nest or those on the hutch floor. She will not nurse both groups, nor will she pick up the young and return them to the nest.

The counterset nest box is easy to keep clean because the inner drawer can be slipped out for washing and disinfecting. These drawers also can be interchanged from one hutch to another. When the young no longer need the inner drawer it can be left out to provide more space in the hutch.

BILL OF MATERIALS FOR NEST BOX AND DRAWER

Nest box:

Sides. - Two pieces of lumber,.025 x.30 x.427.

End. - One piece of lumber,.025 x.20 x.31.

Door. - One piece of lumber,.025 x.30 x.31.

Cover. - One piece of.003 x 30 x.31 hardboard

Bottom. - One piece of 16 gauge galvanized wire,.025 x.0125 mesh,.30 x.45.

Nest drawer:

Sides. - Two pieces of 003 inch hardboard (tempered),.184 x.43.

Ends - Two pieces of lumber, 025 x.20 x.25.

Bottom. - One piece of 1/8 inch hardboard (tempered),.216 x.43.

Miscellaneous:

Nails. - Use 025 or 05 nails to fasten the end, top and sides of the nest box,.05 to fasten the nest drawer, and 031 roofing nails (large head) to fasten the wire bottom to the nest box.

Protecting strips. - To prevent chewing and splintering, nail 26-gauge galvanized sheet metal, bent to form a.0125 x.016 angle, to the exposed edges of the nest box and drawer.

Hinges. - Two 025 strap hinges for the door.

In shaping the sides of the nest box for the slanted roof, you can use the piece of number cut from the rear of each side to build up the front. The

completed sides should be. 4125 long, and should slant down from 2064 tall at the rear.

Suspend the completed nest box in the hutch by the cradle of No. 12 wire at the rear and the three remaining strands of hutch flooring in the front. The cradle of No. 12 wire can be made in three sections to fit down each side of the box and under the bottom, or in one long piece. In either case the wire cradle is merely hooked onto the hutch flooring next to the next box on one side, passed down and across beneath the box and up the other side to again hook on the hutch floor. This provides adequate support for the rear of the nest box. Slip the three strands of flooring into notches cut into the front end of the nest box just above the door.

To prevent the nest box from slipping to the rear and losing the support of the floor wire at the front end, the side boards of the nest box can be cut so as to extend a little above the back board of the nest box. Then as the back board comes up under the hutch floor, these side boards project a little above the floor and prevent the nest from being pushed to the rear.

To help keep the nest dry, cut some.006 drain holes spaced.05 apart on the bottom of the nest-box drawer.

Standard Nest Box: It is a characteristic of most does to choose a corner in which to kindle her young, therefore, the standard nest box is the most practical because of its mobility. Some signs exhibited by the doe to display

which corner she prefers for kindling are scratching and gathering grasses or newspaper there to serve as nesting materials.

The nesting materials could be of local sources such as trimmings of clothing or soft grasses but shredded newspaper is the most ideal since it is free from mites and other insects, the usual causes of ear canker and skin mange.

Place the nest box in that area where the signs are observed 25 days after breeding or a week before kindling to allow her to prepare for actual kindling.

The box must be tilted at the front with a .05 x .05 block of wood so the doe kindles her litter at the rear of the nest box where they are protected from possible injure when she enters or exits during nursing (Fig. 12).



FIGURE 12 - Standard nest box.

After each use by the doe and her litter (30 days after kindling) clean, wash, and disinfect the nest box. If commercial disinfectants are not available, use a boiled solution of one kerosene can of water to one small cup of salt... pouring it while it is hot into the nest box and drying it in the hot sun. Burning cogon grass or newspaper inside the nest box will suffice in sanitizing it for use.

For an inexpensive nest box use the ready-made fish box found in the market which is .55 long, .25 high, and .35 wide. It can be easily adapted by following the design of the standard nest box. Again, to help keep the nest box. Again, to help keep the nest dry, cut 1.006 drain holes spaced .05 apart

in the bottom of the nest box.

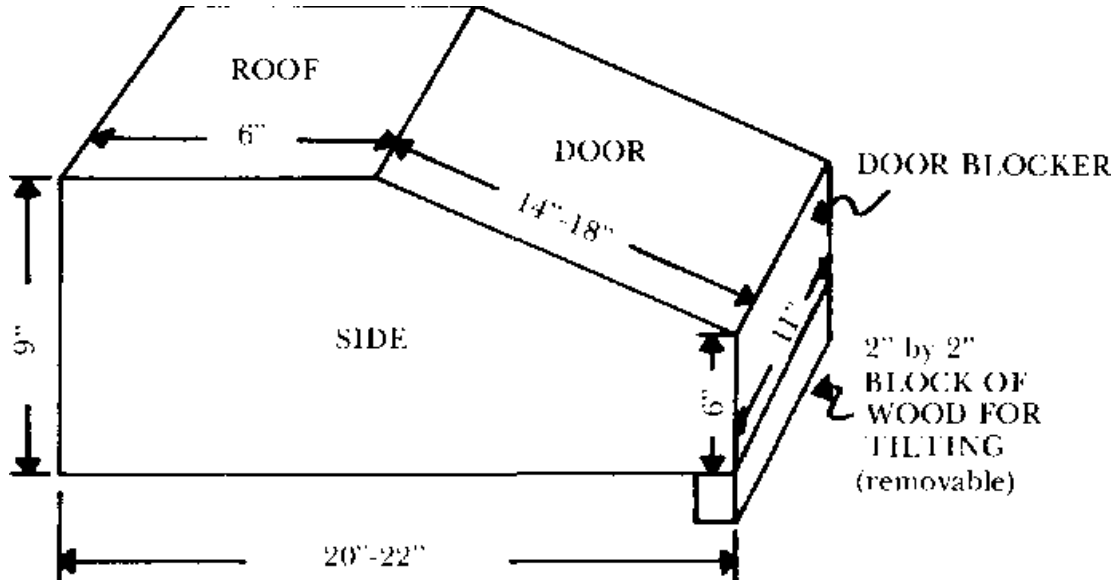

FIGURE 13 - STANDARD NEST BOX



[Home](#) > [ar.cn.de.en.es.fr.id.it.ph.po.ru.sw](#)



A Complete Handbook on Back-Yard and Commercial Rabbit Production (Peace Corps, 1982, 92 p.)

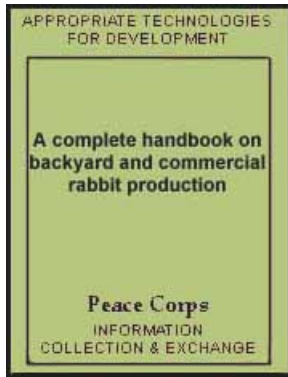

-  **(introduction...)**
-  **Author's introduction**
-  **Author's preface**
-  **Selecting a breed**
-  **Methods of breeding**
-  **How to breed**
-  **The rabbitry and its equipment**
-   **Feeds and feeding**
-  **Feeding rabbits**
-  **Coprophagy**
-  **Reproduction**
-  **Managing the herd**
-  **Various uses of rabbit manure**
-  **Types of production**
-  **Marketing rabbits**
-  **Simplified tanning**
-  **Cooking recipes**
-  **Multiple-project approach to rabbitry**
-  **Glossary**

Feeds and feeding

Success in rabbit production is impossible if you do not give enough attention to diet and provide wholesome feeds in adequate quantity every day.





Feed is one of the major expenses and each herd presents an individual problem. Select diets that are suited to the needs of your rabbits, whether you buy commercially prepared mixtures and/or pellets, or mix feeds yourself.

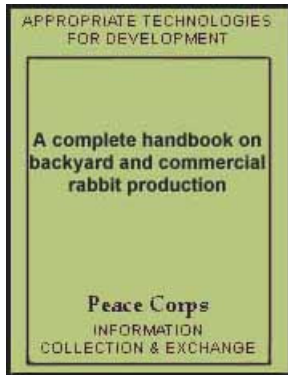

[Home](#) > [ar](#).[cn](#).[de](#).[en](#).[es](#).[fr](#).[id](#).[it](#).[ph](#).[po](#).[ru](#).[sw](#)



A Complete Handbook on Back-Yard and Commercial Rabbit Production (Peace Corps, 1982, 92 p.)

- ➔  **Feeding rabbits**
 -  **(introduction...)**
 -  **Concentrates**
 -  **Home-mixed feed**
 -  **Important note**
 -  **Forages**

A Complete Handbook on Back-Yard and Commercial Rabbit Production

(Peace Corps, 1982, 92 p.)

Feeding rabbits

As with any animal, the way you feed a rabbit depends on what you want to do with it and on what you have available to feed it. For example: the 18-year old farmboy working from dawn to dusk in the ricefield will eat tons of fish, rice, and vegetables while the relatively more sedentary office worker will consume much less meat and rice because he expends less physical energy.

So, as you have rabbits in different stages of development and doing different kinds of things, you feed them differently. Rabbits are generally divided into 4 classes based on their dietary needs. They are: (a) growing and fattening rabbits; (b) resting (non-pregnant and non-lactating) does and bucks; (c) pregnant does and (d) lactating does with litters. Each of these classes should be fed a different ration in varied The "should be" is based on the assumption that you want the rabbits in each of these classes to perform to the best of their abilities (i.e. you wouldn't feed a lactating doe the same moderate amounts of a carbohydrate-rich food that you would feed a mature truck, because you want the lactating doe to produce as much high quality-protein rich milk for her young as possible while you only want the buck to maintain his weight).

The "should be's" of rabbit feeding can be expressed in the form of specific

numerical nutrient levels (i.e. crude protein and TON*), and daily amounts of feed, as shown in Table 2. These "should be's" are requirements if you agree that you want certain things such as at least 8 bunnies per litter; at least 32 grams per day of average daily weight gain for growing, fattening rabbits; a small incidence of reproductive failure; etc. These conditions represent what a good commercial rabbit raiser would like to see on his farm.

**TABLE II
NUTRIENT REQUIREMENTS OF RABBITS
(on air dry weight of ration basis)**

Rabbit Class	Body Weight (kg)	Total Feed Animal/day (gm)	Ton (%)	Crude Protein (%)
Normal Growth Fattening Does/Bucks	1.8	114	65	-
	2.3	136	-	-
	2.7	155	65	16
	3.2	173	-	-
Maintenance Does or Bucks Resting	2.3	91	-	-
	4.5	150	55	12

	6.7	205	-	-
Pregnant Does	2.3	114	-	-
	4.5	186	58	15
	6.7	255	-	-
Lactating Does and litter of 7	2.3	-	-	-
	4.5	-	70	17
	6.7	-	-	-

Expected daily gain 32 gms. Gain (taken from USNRC tables, 1966)

***TON refers to Total Digestible Nutrients, a form measurement of energy.**

Some of you will likely be running a commercial sized rabbitry (say 50 or more does), so we will use the following feeding guidelines (nutrient requirements) for our purpose. In this way we will minimize as much as possible the chances of failure in the rabbitry project due to poor nutrition.

If we simplify these requirements, we come up with a feeding program that looks like this:

1. Feed as much fresh grasses and/or legumes as the rabbits want each

day; up to 85 per cent grass.

2. Feed a commercial feed of at least 16 per cent crude protein at the following levels:

For each rabbit

resting bucks and does

- 120 g. a
day

pregnant does

- 240 g. a
day

lactating does with litters

- 480 g. a
day

growing/fattening rabbits (after weaning to slaughter or 3½-4 months old)

- 960 g. a
day

3. Have fresh water available at all times.

4. Give salt to your rabbits about once a week or mix it into the concentrate at a level of () .5 per cent (½ g. salt/1,000 g. feed).

It is important that you follow a feeding regime using significant amounts of concentrate feeds for two reasons: (a) since this is a pilot-demonstration project, you want to minimize your chances of failure, and (b) since the offspring of these rabbits are intended for use as breeding stock, you want to produce young that are as healthy and vigorous as possible. If you cut down the amount of concentrates or unbalance the diet, the first thing

you'll notice is a lowered reproductive performance followed by a slower growth rate of the young produced. An insufficient or unbalanced diet, therefore, cannot be justified for an animal used or intended for breeding and for meat purposes since the cost of a single reproductive failure or of a greatly reduced litter size is much greater than the savings in reduced feed, whether or not you consider the investment of your labor, your infrastructure (i.e. hutches) and breeding stock of any value at all.

Other general considerations for feeding rabbits should be made as follows:

Concentrates

In the Philippines, a variety of commercial mash and pellet feeds can be found. The ones best suited for rabbits are:

Pig starter pellets

Pig grower mash

Rabbit pellets

These have generally at least 16 per cent crude protein and supply enough energy to meet the needs of a rabbit at the feeding levels suggested in the simplified feeding regime above.

In the States, what is fed as a pelleted ration for rabbits is a feed that contains about 5() per cent alfalfa hay, a leguminous roughage.

In the Philippines, the available commercial pellets or mashes are not formulated for rabbits but for hogs, pigeons, chickens, etc. - animals that cannot utilize roughage the way rabbits can. Thus, commercial feeds in the Philippines are made almost entirely of concentrates (grains or grain byproducts) so you can feed less of them to your rabbits than the USNRC recommended daily levels if you also supply them with plenty of grasses and/or legumes. You can reduce the amount of concentrate feeds since the forages you supply do not have the same nutrient value (due to their lower digestibility, and large amounts of water) as the dehydrated alfalfa used in U.S. pellets.

Pellets are preferable to mashes because the rabbits waste less (they can't snuff and paw them out of the crocks as easily) and they are not dusty and so will not irritate the nose and lungs. If you must use a mash, you can avoid the crustiness and reduce some waste by adding just enough water to slightly moisten the feed. But beware of giving too much moistened feed to the rabbit or leaving it in the pen too long as it will sour and the rabbit will not eat it causing further waste. In the low lands where fermentation is more prevalent, give the rabbits only enough concentrates to be consumed within a 10-15 minute time span. For example, in a large herd, a kilo of feed wasted daily is a substantial economic loss over a year's time.

Home-mixed feed

There are a number of ways of preparing and feeding home mixed rations to rabbits which you may want to try after you've raised rabbits for a while with success, so that you know what your variables are when you begin to experiment with the feeds.

In general, rabbits can be fed almost any food that is not sour, spoiled, or greasy. A few exceptions are meat, potatoes and/or potato peelings and large amounts of cabbage. Thus the rabbit's diet may be supplemented with many things, including vegetable trimmings, fruit peelings, bread crusts and sun-dried leftover rice and leftover milk.

One may mix his Own concentrate feed if suitable ingredients are available. One example of a home-mixed concentrate ration is:

17% "All Purpose" Rabbit Feed

200 g. Corn (sorghum)

200 g. Darak, D.

190 g. Corn Germ (gluten feed)

170 g. Copra Meal

70 g. Ipil-ipil

60 g. Bone Meal

40 g. Soybean Meal

40 g. Fish Meal (Meat and Bone)

20 g. Oyster Shell Flour

10 g. Salt

1,000 g. = 1 kg;

Fish meal in this ration should be reliable, fresh, and of good quality or else use meat and bone meal. For breeders, raise the soybean meal to 60 g. and drop the copra to 150 kg. It would be better to utilize alfalfa (*Leucerne*) instead of ipil-ipil if it is available. If by necessity ipil-ipil is used, the Peruvian variety is less toxic.

The ideal is to feed the rabbit both commercial feed and greens as the rabbit should eat 85 per cent forage of good quality and quantity. In case the commercial concentrates or home-mixed ingredients are not available, green feeding composed of 50 per cent legumes and 50 per cent of other grasses will suffice in providing a minimum dietary requirement especially for dry does and bucks.

As with other sources of feed, a few basic guidelines should be followed with forages:

Do NOT Feed:

a) Green feeds that stand in piles before feeding. They will become heated

and cause digestive disorders due to fermentation.

b) Kangkong leaves or stems (they generally carry the parasites found in swampy areas).

c) Forages collected from places where dogs and cats and other animals commonly defecate as this may cause tapeworm and/or coccidiosis.

d) Forages sprayed or recently in contact with insecticides.

DO feed:

a) Salt. Salt should be provided in the feed at a level of 0.5 per cent or provided in the cage in a block or small container at least 1 tsp. in the grain ration once a week or when needed.

b) Water. Clean, fresh water **MUST** be provided to rabbits at all times. This is important especially in the tropics where a doe and her litter may consume as much as 2 liters of water a day.

Important note

One last point to mention regarding feeds is whatever you use - a type of mash, an ingredient in a feed, a forage - if you wish to make a change in the rabbit's diet, do it slowly. Serious damage or even death may result if large quantities of lush greens are fed to animals accustomed to concentrated feed only. Even sudden changes in a grain diet may cause minor, or possibly serious, digestive disorders. ANY CHANGE IN FEEDING, SHOULD BE MADE GRADUALLY. The best method is mixed feeding (giving greens

and commercial) to avoid any sudden change.

Forages

Forages are essential for their roughage and vitamin value in the Philippines where the commercial pellets and mashes consist of only grain concentrates. In addition, forages greatly economize the amount of concentrate fed (Fig. 14).



FIGURE 14 - Cultivate forages before starting your rabbitry project.

Many kinds of forages as shown on Table III can be fed to rabbits.

TABLE III FEEDS FOR FEEDING RABBITS

LEGUMES	GRASSES
1. Kudzu	1. Alabang X
2. Tapilan	2. Johnson grass
3. Peanut	3. Guinea grass
4. Mani-mamian	4. Para grass
5. Cowpea	5. Bungalon
6. Centrosema	6. Corn leaves and stalks
7. Russian, Japanese Philippine native sunflowers (seeds and trunks)	7. Carabao grass
8. Soybean leaves	8. Napier
9. Sitaw	9. Bermuda grass
10. Batao	10. Kikuyu grass
11. Camote leaves and vines	11. Bamboo leaves
12. Siratro	12. Star grass
13. Goat weed or Ageratum	
14. Viola or violet	OTHERS (Preferably dried)
15. Potato leaves	1. Banana leaves and peelings
16. Bean leaves and vines	2. Pechav

17. Rami leaves and stem	3. Lettuce
18. Mongo leaves	4 Cabbage
19. Desmodium	5. Guava leaves
20. Stylosonthes	6. Alnow tree leaves
21. Japanese weed	7. Ipil-ipil (Peruvian type)
22. Chinese ageratum	8. Timothy hay
23. Thumbergia	9. Rice hay
24. Wild mustard	10. Wheat hay
25. Remex	11. Coffee leaves
26. Mountain Blue weed	12. Gumamela leaves
27. Joseph's coat	13. Aida
	14. Acalypha
GREENS	15. Father weed
	16. Wild cosmos
1. Corn	17. Polygonam
2. Palay	18. Sayote
3. Mongo	
4. Any variety of Bean Family	ROOT CROPS
5. Sovbean	1. Camote

	2. Sinkamas
	3. Carrots
	MILLS
	1. Copra
	2. Rice bran

