

Special Public Works Programmes - SPWP - Soil Conservation - Project Design and Implementation Using Labour Intensive Techniques (ILO - UNDP, 1982, 220 p.)

CHAPTER D. METHODOLOGY FOR SETTING UP A SOIL CONSERVATION PROJECT

D.1. PRELIMINARY STUDIES

1.1. Aims

1.2. Situation analysis

(introduction...)

1.2.1. The physical context

1.2.2. The socio-economic context

1.3. Assessing the extent of possible measures

1.3.1. Damage assessment

1.3.2. Envisaged investment

D.2. DRAFT PROJECT

2.1. Aims

2.2. Analysis of basic data

2.3. Hypothesis of improvements

2.4. Economic analysis

(introduction...)

2.4.1. The expenditures

2.4.2. Income

2.4.3. Balance sheet

2.5. Selection of improvements

- **D.3. THE PROJECT**
 - 📄 **3.1. Objectives**
 - **3.2. Field studies**
 - 📄 **3.2.1. Topographic work**
 - 📄 **3.2.2. Survey borings**
 - **3.3. Project documents**
 - 📄 **(introduction...)**
 - 📄 **3.3.1. Written documents:**
 - 📄 **3.3.2. Drawings:**

Special Public Works Programmes - SPWP - Soil Conservation - Project Design and Implementation Using Labour Intensive Techniques (ILO - UNDP, 1982, 220 p.)

CHAPTER D. METHODOLOGY FOR SETTING UP A SOIL CONSERVATION PROJECT

D.1. PRELIMINARY STUDIES

1.1. Aims

Setting up a soil conservation project comes within the framework of an over-all strategy which involves numerous disciplines and follows a logical process in decision making. The first phase of the process is the analysis of the situation from the physical, human and economic point of view. This should provide the necessary factors for deciding on the value of the project, its limitations and advantages, and the economic fundamentals from which it is possible to evaluate the significance of any measures that might be envisaged.

Preliminary studies are the first stage to help in the decision-making process aimed at defining the aims of coherent and well-founded development, and the means to be employed in achieving these aims.

1.2. Situation analysis

This analysis will cover successively: the physical and hydraulic characteristics of the soil degradation and the impact of this degradation on the socio-economic picture in the region. The analysis should comprise a review of all the available data in order to arrive at a first estimation of the measures that might be envisaged.

1.2.1. The physical context

1.2.1.1. Data collection

The data may be obtained following consultation with the relevant national services. The type of the basic data to be collected and the services that may supply this information are as follows:

(a) Cartography

- topographic maps. The most widely used scale is 1/200,000 or 1/100,000.

Certain regions may be covered by maps using a scale of 1/50,000 or 1/20,000 In the case of numerous countries (North Africa, West Africa, Madagascar, etc.), maps may be obtained in France from the National Geographic Institute (Institut géographique national);

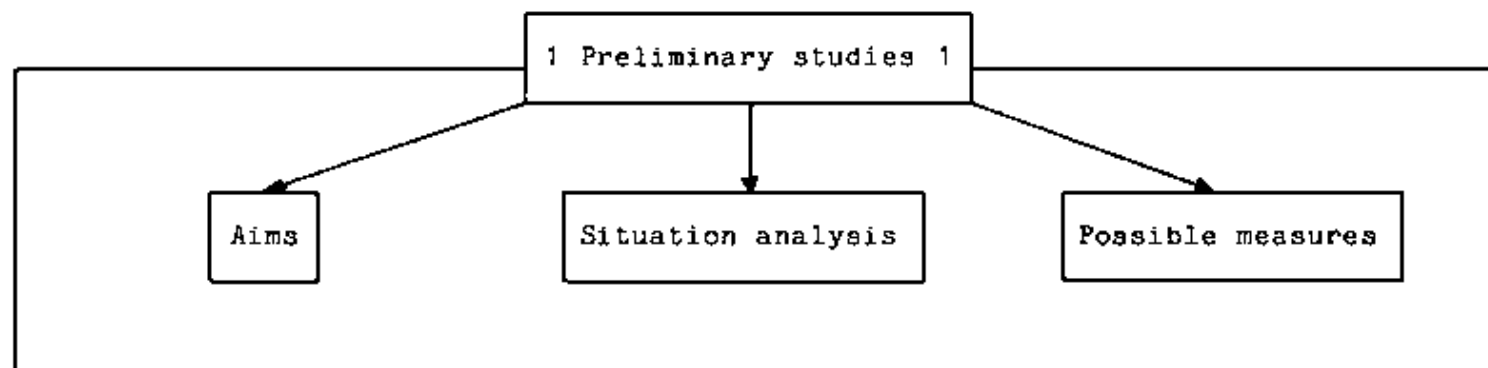

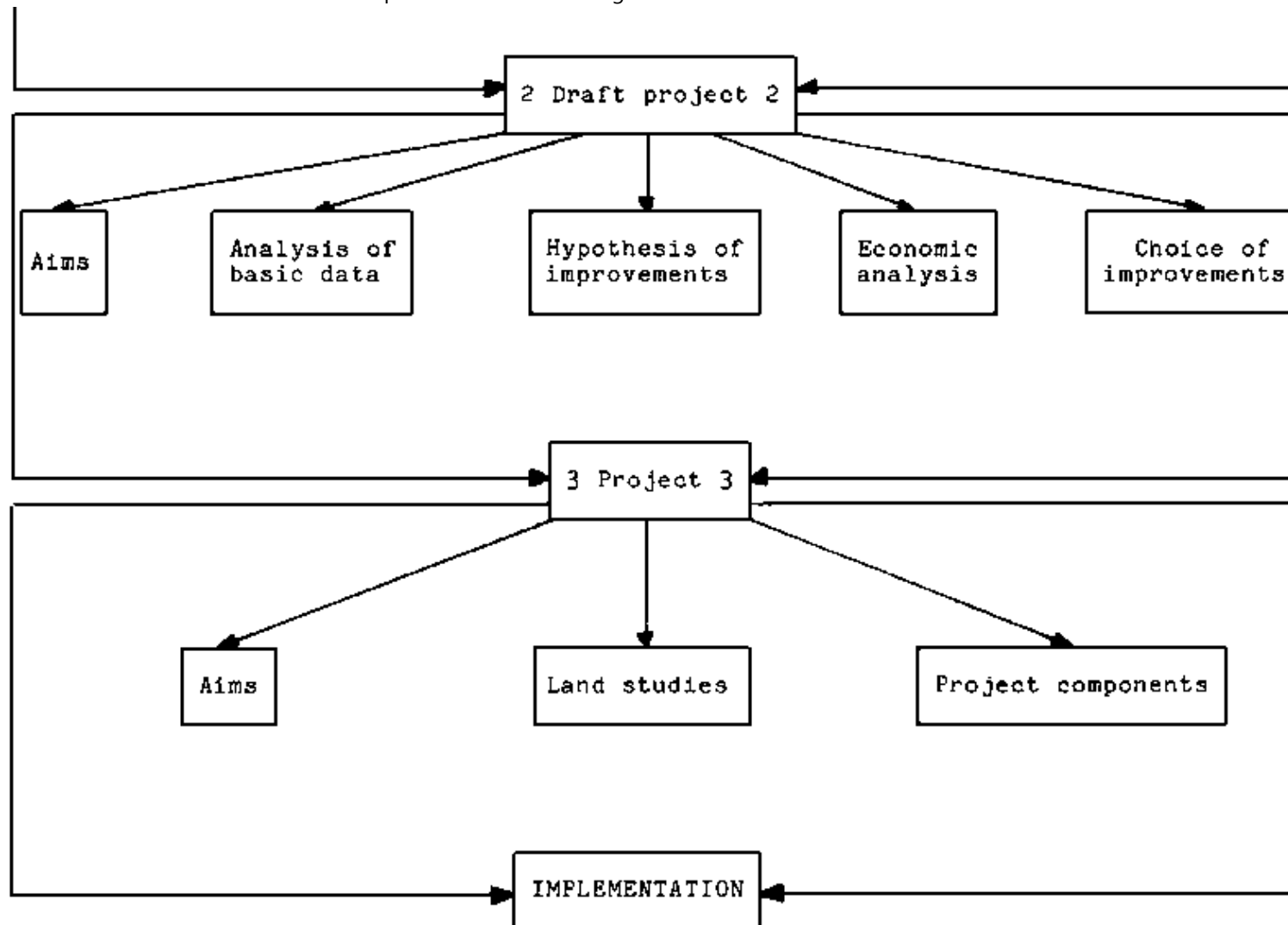

Fig. D.1: Over-all flow chart for drawing up a soil conservation project

- **aerial photographs**. Many countries have been covered by aerial photograph: on black and white panchromatic film at a scale of approximately 1/50,000;
- **satellite photographs** (LANDSAT pictures). These may provide interesting information at the regional level.

(b) Geology

Geological maps at a scale 1/1,000,000, 1/500,000 or 1/200,000. These are usually available from the national geological services (BRGM in France), universities, etc.

(c) Pedology

General pedological maps, where they exist, often have a small scale (1/1,000,000). For certain projects, pedological maps may be available with larger scales, and they can be obtained from geological or agricultural services.

(d) Climatology

Usually, all countries have a precipitation observation network which measures daily precipitation.

Climatological stations make more detailed data collection covering rainfall intensity, temperature, evaporation, hygrometry, wind speed and direction, etc.

These data can be obtained from meteorological services, airports and agricultural departments.

(e) Vegetation

Data about the type and distribution of natural vegetation and the density and main species that can be used for afforestation purposes can be obtained from agricultural, water, forest and animal breeding services.

(f) Hydrology

Characteristics of the hydrographic network and the hydrological regime. Type of hydrometric observations carried out.

1.2.1.2. Data analysis

During the preliminary study, utilisation of the data should make it possible to determine the magnitude of soil degradation phenomena by highlighting the incidence and intensity of the factors behind the degradation.

Soils may be classified according to their erodibility while specifying the type of erosion to which they are subject and the incidence and intensity of the damage caused.

1.2.2. The socio-economic context

1.2.2.1. Data collection

The main data to be collected deal with:

- (a) demography: population in the zone in question, agricultural population, number of working people, trends;**
- (b) farming: type of farming (family, industrial, etc.), areas farmed, production (type, yield, costs), agricultural income;**
- (c) soil utilisation: agriculture, animal breeding, forest, industrial or urban zones;**
- (d) animal breeding;**
- (e) agricultural policy, development plans, current legislative measures.**

1.2.2.2. Data analysis

An over-all review should be made of agricultural activity and soil utilisation in order to specify all sectors which might be affected by soil degradation.

Items which may be damaged or disrupted may be classified under three headings:

- **permanent assets such as land, agricultural infrastructure (buildings, irrigation networks), the infrastructure of economic activity (roads, etc.);**
- **seasonal assets such as crops which may be damaged to different degrees depending on the intensity and period of occurrence of the phenomenon (flooding, crop destruction, etc.);**
- **economic activity which may be perturbed, due for example to the destruction of communication routes, water run-off or by wind-borne materials which may make cultivated land sterile or seriously compromise a region's industry.**

Probable economic growth rates should be estimated in order to determine the growth trend in the value of these assets over coming years.

1.3. Assessing the extent of possible measures**1.3.1. Damage assessment****1.3.1.1. Collecting data about damage**

Damage that may occur in the absence of soil conservation measures may be classified into two categories:

(a) Capital losses, the main one being the loss of land capital under the same heading as other infrastructural assets such as farm buildings, irrigation networks, etc. In estimating capital losses, it is possible to use as a basis estimates of damage that occurred in the past. These should be re-evaluated to bring them in line with current monetary conditions.

(b) Production losses which may result from reduced soil fertility, flooding,

deposition of wind or river-borne sterile soil. Production loss may be a variable phenomenon related to the intensity of the destructed phenomena, the main ones being, precipitation intensity in the case of rain erosion and wind force in the case of wind erosion. In this case, the updated cost of annual damage should be used for calculation.

1.3.1.2. Mean annual damage

The methods that may be used for determining mean annual damage are numerous and related to available statistics:

- where a number of values exist for annual damage, the mean damage should be calculated from the arithmetical mean of damage data;**
- when only a single value for annual damage is available and the incidence of this damage is not known, it may be hypothesised that damage is proportional to the intensity of the phenomena which cause it. With a knowledge of the relationship between the phenomenon behind the damage and the incidence of this phenomenon, it is possible to deduce the cost of damage for various incidences and from this assess the mean annual damage cost;**
- where a number of damage incidence combinations are available, it is possible to draw a "damage incidence distribution curve" (see fig. D.2).**

Mean annual damage is the area bounded by the co-ordinate axes.

1.3.1.3. Future damage

Future damage will vary depending on the forecast economic growth rate for the region. The calculation for mean annual damage should therefore be weighted by the forecast economic growth rate.

1.3.2. Envisaged investment

The amount of future damage at current prices is the sum of envisaged investment. The sum invested may, however, be higher where the planned improvements are expected to result in an increase in the value of agricultural land which, after conservation work, will have higher crop yield. The level of land value increase may be assessed from the amount of increased revenue, at current prices, indexed by the economic growth rate for this type of income.

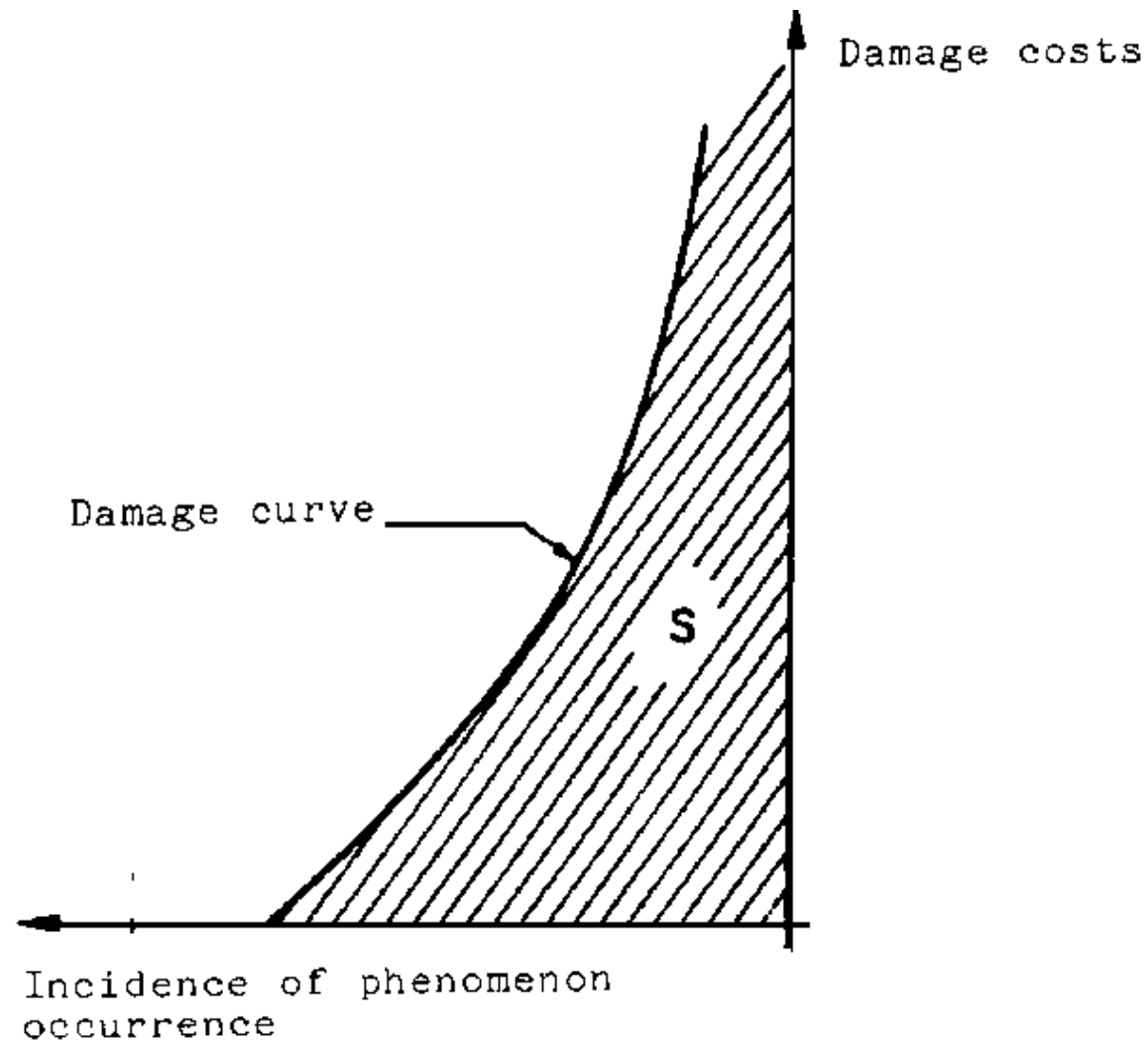

Fig. D.2: Damage incidence curve**D.2. DRAFT PROJECT****2.1. Aims**

Once the draft study has made it possible to assess the value of a soil conservation project and the envisageable investment, the draft project should define the means to be employed to achieve the set aims.

The draft project should define the various possible improvements from both the technical and economic point of view, to permit decision making as to which project will best meet the final objectives. These objectives are often contained in an over-all land improvement policy for the development of a catchment basin. They may be economic, social, political, ecological, etc.

2.2. Analysis of basic data

This analysis should cover all the data relevant to the establishment of the draft project. The basic data collected should usually be supplemented by field studies and surveys and then subjected to detailed analysis so as to form the basis for assessing possible improvements. The analytical methods that can be used are outside the framework of this book. We will, therefore, consider only the main data required in analysing a soil conservation project.

Climatology:

- monthly and annual precipitation: mean values and statistical analysis;**
- exceptional daily precipitation with statistical analysis of maximum annual precipitation;**
- rainfall studies and determination of relationships between rainfall and rainfall**

duration for various probabilities.

Morphology of the catchment basin:

- relief;
- gradient characteristics: classes of slope;
- erosion forms: erodibility classification of various sectors of the basin.

Hydrology:

- surface area of catchment basins - boundaries of sub-basins;
- estimation of run-off coefficients;
- determination of flow rates from man-made structures;
- determination of flow rates from collectors.

Pedology:

- general reconnoitring of terrain;
- auger soil samples with sample density depending on land variations and the scale of the project (usually one sample per 5-10 ha);
- collection of soil samples for analysis of physical and chemical properties and permeability;
- determination and mapping of crop suitability categories;
- evaluation of earthworks.

Topography:

- drawing up of plans suitable for the project (1/10,000 to 1/20,000) by direct

surveying or by photogrammetry;

- survey of land profiles along the main emissaries with preparation of cross-sections for the main features.**

Agriculture - animal husbandry:

- types of crop;**
- crop rotation;**
- yields;**
- animal density, type of grazing, use of passage routes.**

Socio-economics:

- industrial structures;**
- agricultural income;**
- market and rentable value of land.**

2.3. Hypothesis of improvements

When the basic data have been assessed, the project leader may present one or more hypotheses for improvements that are both technically and financially acceptable giving justification for the principle behind the project and the main technical arrangements.

This hypothesis for improvements should be accompanied by the following documents:

- location plan at a scale of 1/20,000 or 1/10,000 from which it is possible to locate the siting of the main structures;**
- the main technical arrangements together with the relevant standard plans, and:**
 - characteristic flow rates,**

- **cross-section and spacing of defence and drainage networks,**
- **layout of main and secondary collectors,**
- **emissary improvements,**
- **standard plans for the main structures,**
- **spacing and type of plants,**
- **layout of forest roads,**
- **requirements for and location of nurseries, etc.;**

- **over-all assessment of improvement costs with an indication of cost per improved hectare.**

2.4. Economic analysis

For each draft project it is necessary to draw up an income and expenditure account, in current prices, for each of the planned conservation measures.

2.4.1. The expenditures

The expenditures include:

- **investment: preliminary studies, cost of improvements, land purchases, eviction compensation, etc.;**
- **maintenance and operating expenses.**

These expenditures should be discounted so that they can be compared on a valid economic footing.

2.4.2. Income

Income covers:

- capital appreciation, the main component in a soil conservation project being the anticipated additional discounted income;

- reduction of damage. As a result of the protection measures, damage will be reduced for a given phenomenon recurrence time, i.e. totally eliminated in the case of small recurrent periods. In the damage incidence distribution curve shown in fig. D.3, this will be seen as a reduction in damage costs for given recurrence time. By comparing this curve with the damage curve as it was prior to the improvements, the reduction in the mean annual damage is the area between the two curves. These curves may have a different shape depending on the type of improvement, and their comparison is essential for selecting between different types of improvement. For example, we have shown in fig. D.3 two types of curve that followed improvements. The curve C_1 shows damage distribution incidence following afforestation work. Curve C_2 applies, for example, to an absorption network in an area where there are heavy, low-incidence rainfalls, embankments may be broken with damage which would be greater than the initial damage.

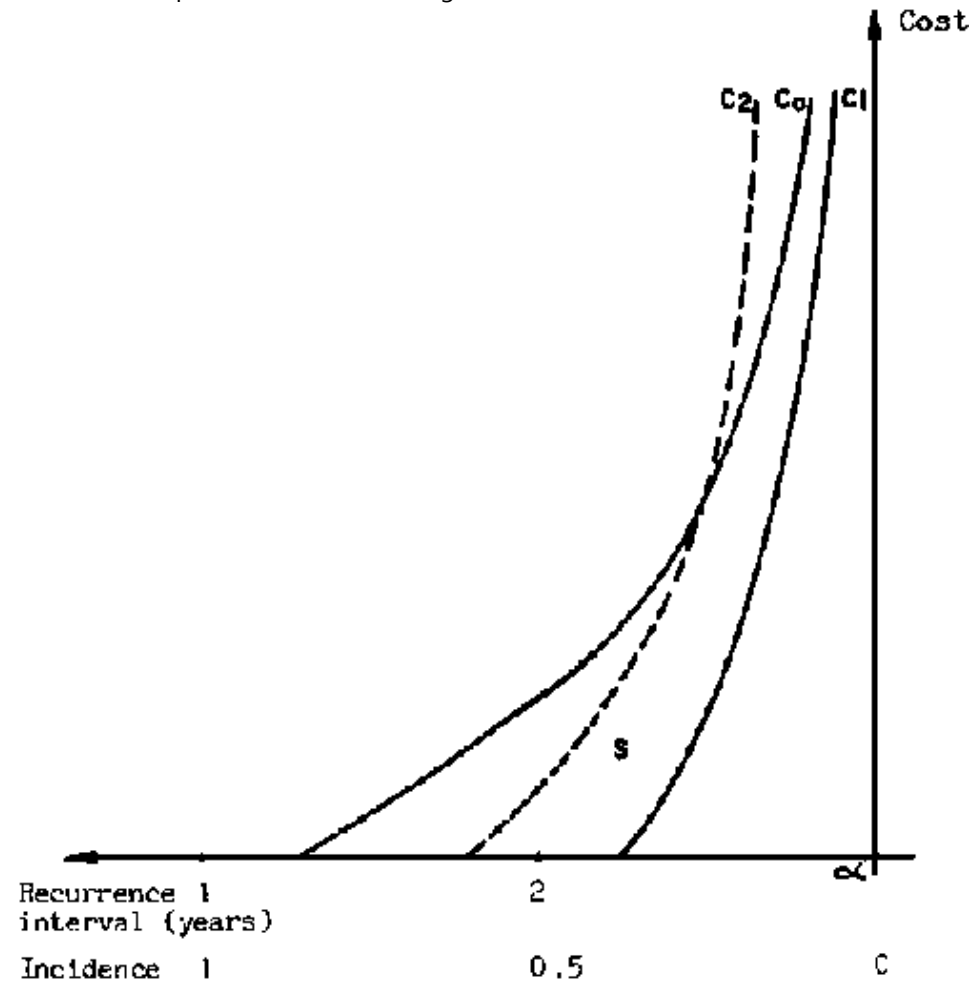

Fig. D.3: Damage incidence distribution

- Damage C_0 before defence measures
- Damage C_1 after defence measures

$$\text{Income } R = C_0 - C_1$$

Mean annual return

$$R_m = \int_{T=T_0}^{\infty} (C_0 - C_1) \frac{dT}{T^2} = S$$

2.4.3. Balance sheet

The balance sheet of income and expenditure makes it possible to define viability and selection criteria.

The main criteria used are:

- **Discounted profit, which is the difference between income and expenditure. The improvements are viable if there is a profit at current prices.**
- **Internal profitability rate, which is the value of the actualisation rate for which the discounted profit is zero. If the improvement is financed by a loan, the internal profitability rate should not be greater than the loan interest rate.**
- **The relative gain at discounted prices, which is equal to the quotient of receipts. This makes it possible to choose between various independent projects.**
- **Cost benefit ratio.**

2.5. Selection of improvements

The draft projects make it possible to define the alternative improvements intended to achieve a stipulated objective and which are technically and economically feasible. They also provide the factors for making a choice; however, this will not always be guided by the economic factor alone but may also take into account other criteria, e.g. social, political, etc.

D.3. THE PROJECT

3.1. Objectives

Once the draft project has permitted the selection of a possible type of improvement, the project itself covers the drawing up of all the necessary items for the implementation.

The project covers additional field studies and the preparation of documents and drawings.

3.2. Field studies

3.2.1. Topographic work

- preparation of plans at a scale of 1/2,000 or 1/5,000 with contour lines at intervals of 0.25 m for slight gradients and up to 0.5-1 m for steeper gradients;**
- longitudinal profiles of natural water outlets and main collectors at a scale of 1/2,000 for the horizontals and 1/100 or 1/50 for the verticals;**
- cross-sections of outlets and all salient points at a scale of 1/100 or 1/50.**

3.2.2. Survey borings

The technique and depth of sample borings and the analyses to be carried out on them will vary depending on the type of work envisaged.

For plantation work, it is necessary to determine soil type, humidity and the difficulty of digging planting holes, by carrying out a sample boring of 1.00 m in depth every 10 ha or so.

For cut-and-fill earthwork, trenching difficulty should be assessed.

For drainage works, it is necessary to determine soil type and in particular permeability. Soil analyses are carried out on samples taken with an auger at a depth greater than the maximum drain depth and at a rate of one sample every 10 ha; it is also necessary to dig a trench every 50 ha to make a descriptive soil survey.

For the construction of small dams, it is necessary to dig one or more trenches along the axis of the structure to a depth equal to the height of the finished structure in order to determine soil types and permeability.

3.3. Project documents

These comprise a description of the project and assessment of expenditure. They comprise:

3.3.1. Written documents:

- (a) an explanatory memorandum describing the project principle and the main technical arrangements;**
- (b) a descriptive estimate which enumerates and describes the work to be carried out and the origin, quality and preparation of materials;**
- (c) specifications for the work to be carried out by a commercial firm;**
- (d) an analysis and breakdown of prices;**
- (e) a quantity estimate which calculates the expenses for each item of work;**

3.3.2. Drawings:

- (f) a location map at a scale of 1/20,000;**
- (g) a map of the defence network at a scale of 1/2,000;**
- (h) a longitudinal profile of the collectors and the emissaries;**
- (i) drawings of the structures at a suitable scale (1/20 or 1/50).**



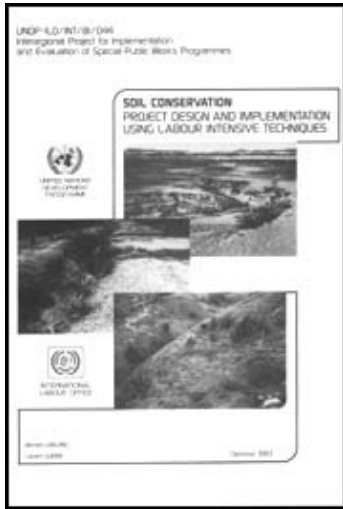

Special Public Works Programmes - SPWP - Soil Conservation - Project Design and Implementation Using Labour Intensive Techniques (ILO - UNDP, 1982, 220 p.)

CHAPTER E. PROJECT IMPLEMENTATION1

(introduction...)

E.1. GENERAL SITE ORGANISATION

1.1. Survey of local conditions and site reconnaissance

(introduction...)

1.1.1. Natural constraints

1.1.2. Technical and economic constraints

1.2. Project planning

1.2.1. Objectives of planning

1.2.2. Forms of planning and their requirements

1.2.3. Planning procedure

1.2.4. Bar chart or GANTT chart

1.2.5. Time and location chart planning

1.2.6. Network or critical path planning

1.3. Setting up the site

1.3.1. Construction of access roads

1.3.2. Construction of site buildings

1.3.3. Plant installation

1.4. Site management

1.4.1. Management technique

1.4.2. Personnel management

1.4.3. Incentive system

1.4.4. Role of project management

- **E.2. TOPOGRAPHICAL STUDIES**
 - 📄 **(introduction...)**
 - **2.1. Topographical survey**
 - 📄 **(introduction...)**
 - 📄 **2.1.1. Planimetric survey**
 - 📄 **2.1.2. Levelling**
 - 📄 **2.1.3. Composition of a topographic survey team and survey standards**
- **E.3. MARKING AND STAKING OUT THE STRUCTURE**
 - 📄 **(introduction...)**
 - 📄 **3.1. Preparation of the ground plan**
 - **3.2. Preparation on the ground**
 - 📄 **(introduction...)**
 - 📄 **3.2.1. Main staking out**
 - 📄 **3.2.2. Additional staking**
 - 📄 **3.2.3. Staking report**
 - 📄 **3.2.4. Displaced stakes**
 - 📄 **3.3. Personnel requirements and work output**
- **E.4. GROUND PREPARATION**
 - 📄 **4.1. Clearing the land over the area covered by the works**
 - 📄 **4.2. Stripping - subsoiling**
- **E.5. EXECUTION OF EARTHWORKS**
 - **5.1. General comments on soil type and handling**
 - 📄 **5.1.1. Land classification**
 - 📄 **5.1.2. Bank gradients**
 - 📄 **5.1.3. Bulking - consolidation**

- **5.2. Tools**
 - 📄 **(introduction...)**
 - 📄 **5.2.1. Trenching tools**
 - 📄 **5.2.2. Tools for loading earth**
 - 📄 **5.2.3. Tools for soil haulage**
 - 📄 **5.2.4. Tools for soil compacting**
- 📄 **5.3. Manpower**
- 📄 **5.4. Labour organisation**
- **5.5. Earth-moving methods and outputs**
 - 📄 **5.5.1. Trench digging and spoil removal**
 - 📄 **5.5.2. Loading and reworking spoil**
 - 📄 **5.5.3. Spoil haulage**
 - 📄 **5.5.4. Unloading, spreading and compacting**
 - 📄 **5.5.5. Bank grading**
- **5.6. Examples of earthworks**
 - 📄 **5.6.1. Construction of a canal or ditch**
 - 📄 **5.6.2. Construction of earth dams**
- **E.6. IMPLEMENTATION OF REAFFORESTATION WORK**
 - 📄 **(introduction...)**
 - 📄 **6.1. Nursery work**
 - 📄 **6.2. Planting**
 - 📄 **6.3. Construction of forest tracks**
 - 📄 **6.4. Plantation maintenance**
 - 📄 **6.5. Examples of a plantation: planting along contour lines**
 - 📄 **6.6. Productivity norms**

- **E.7. IMPLEMENTATION OF DRAINAGE WORKS**
 - **7.1. Installation of a drainage network**
 - **7.2. Tracing out total trench width**
 - **7.3. Calculating trench depth**
 - **7.4. Trench digging**
 - **7.5. Trimming the trench bottom**
 - **7.6. Drain laying and backfilling the trench**
 - **7.7. Manpower and output in manual drainage work**
- **E.8. CONSTRUCTION OF MASONRY WORK**
 - **8.1. Different types of masonry work**
 - **8.2. Dry-stone masonry work**
 - **8.3. Normal masonry work**
 - **8.4. Gabion masonry work**
- **E.9. CARRYING OUT CONCRETE WORK**
 - **9.1. Characteristics of concretes**
 - **9.2. Concrete preparation**
 - **9.3. Shuttering**
 - **9.4. Steel reinforcement**
 - **9.5. Installing the reinforcement bars**

Special Public Works Programmes - SPWP - Soil Conservation - Project Design and Implementation Using Labour Intensive Techniques (ILO - UNDP, 1982, 220 p.)

CHAPTER E. PROJECT IMPLEMENTATION¹

¹ This chapter covers only the general principles of site organisation and project implementation. Soil conservation work does not, in fact, necessitate any special

organisation and the guidelines for other types of work are applicable without any major adaptation. Reference should be made to Training Course No. III "Project design, implementation and evaluation", which has been produced as part of the Inter-regional Project for Planning and Administration of Special Public Works Projects.

This chapter describes the operation of soil conservation work sites in which priority is given to labour-insensitive procedures using untrained manpower, little skilled labour, a large number of simple tools and few machines.

E.1. GENERAL SITE ORGANISATION

1.1. Survey of local conditions and site reconnaissance

Before opening a site, the site manager should make a prior visit to the location to survey the major natural, technical and economic constraints so that he can decide on the work procedures and conditions.

1.1.1. Natural constraints

The main constraint is climate which may make it necessary to halt work at the site for some period during the year, either because of frost which prevents masonry and concreting work being carried out or due to excessive heat which may inconvenience workers and reduce output. The rainy season may also prevent certain types of work being carried out or be an impediment to haulage or materials supplies.

Water flow should be investigated before work is carried out on water courses. Ravine or gully rectification and dam construction should be carried out at the lowest water level or the work may be severely damaged or even totally destroyed during the construction period by the arrival of flood water. Nevertheless, if the work cannot be carried out at any other period or if the flood calendar is not sufficiently regular, additional protection such as the

installation of coffer dams with water diversions, should be planned. However, this type of additional protection is usually expensive. Economic optimisation should be sought between the cost of additional protection and the danger of the structure being destroyed during building. For the small structures described in this document, additional protection is not usually necessary and would be too expensive in relation to the danger of the structure being destroyed during building.

The sanitary conditions in the region are another natural constraint, and are particularly important for the satisfactory progress of labour-intensive works. Information should be obtained about the risk of any epidemic so that the necessary safety and control measures can be taken on site. Since water is a major vector of epidemic disease, the hygiene of the water being used should be the subject of particular attention.

1.1.2. Technical and economic constraints

Site access should be assured. During the site reconnaissance, note should be taken on the condition of existing roads and tracks, their distance from the construction site and any need for the construction of new access routes.

Supplies of materials should be established by examining the potential of existing quarries, the quality of the materials they supply, delivery capabilities and prices. Employment can be increased when use is made of local materials which are available close by and can be exploited without great difficulty using rudimentary techniques.

At the project design stage, it is essential to ensure that these materials are available in adequate quantity, have suitable characteristics and can be processed at a rate which meets site requirements. In addition, the manpower required for materials exploitation, processing and haulage should be assessed carefully before a decision is taken on reliance on local materials.

In this way, a reinforced concrete weir would require large quantities of sand, gravel and

cement and would ideally be constructed using capital-intensive methods. Its replacement by a stonework weir might be envisaged. In such a case, it would be necessary to ensure that the necessary quantity of quarry stones was available, that the stone would be of sufficient hardness and that the haulage distances would not be excessive. If these requirements were not met, the advantage to be drawn from using these materials would be eliminated by the high cost of vehicles for their transport.

For non-quarry materials such as wood, fuel, cement and steel, the supply and price factors should be examined.

Supplies of equipment. It is necessary to assess the number of tools and machines required on the site: conditions for the purchase of new equipment, local resources and the condition of available second-hand material. Supplies of new equipment may take a long time in arriving and it is advisable to make allowance for this when plans are prepared. The possibility of manufacturing certain simple tools and having equipment maintained and repaired by local craftsmen should be considered. If local resources are inadequate, plans may be made to train local craftsmen or equip the site with its own resources (small workshop, etc.).

Local manpower and supervisory workers should be selected taking into account:

- local availability of unskilled workers;**
- local availability of skilled workers such as blacksmiths, masons, etc.;**
- availability of supervisory workers: foremen, topography technicians, etc.;**
- working conditions: working hours, social structure, public holidays;**
- cash wages and payment in kind.**

Consideration should also be given to seasonal variations which may be very marked in certain cases, and be a major constraint for work which requires continuous progression. For example, in river bank protection work, which is normally carried out during the dry season, the time factor may be of particular importance; a marked seasonal shortage of

labour may make it necessary to change the type of protection work or the haulage technique (use of haulage vehicles in operations for which they are particularly viable). Completion of the work in stages or segments might be a possible compromise where there is a temporary labour shortage.

The lack of skilled workers may also be a deciding factor in the design of the structure. A gabion or stonework retaining wall would require less skilled workers than a reinforced concrete structure. On the other hand, it would be necessary to use much larger quantities of materials to achieve the same strength. Consequently the structure will probably take longer to build and its commissioning will be delayed.

1.2. Project planning

1.2.1. Objectives of planning

Operational planning is an essential management tool which will make it possible to pursue a strategy or tactic, to keep control of the numerous factors that may affect final cost, and ensure the best use of available labour. The objectives of planning are those stipulated by task sequencing, work preparation and organisation, and work control and follow-up. These entail the drafting of various documents, the type and precision of which are directly related to the type of work being managed. With these documents it should be possible to have a precise idea of the abstract factors in a site, to highlight interdependence between various activities and pick out those operations which demand the project manager's greatest attention in relation to the numerous constraints that have been foreseen: rainy season, religious holidays, harvesting, etc.

Depending on the size and complexity of the project, it may be necessary to break down the site into activities, operations and basic tasks, the repetition of which over a given cycle calls for specific attention and analysis. Planning is therefore a task for a technician with a thorough experience of building sites, men, working methods, the various presentation techniques and with a good mind for analysis and review. It is a task for a specialist.

1.2.2. Forms of planning and their requirements

It will be necessary to select between various existing planning procedures, all of which have certain advantages and weaknesses. In deciding the suitability of the planning procedure for the project in question, three factors should be taken into consideration:

(a) Project complexity. The criterion affecting the choice of presentation system is that of the complexity of the works. The majority of works involved in a soil conservation programme are relatively simple and the interdependence between the various tasks or operations is direct and relatively uncomplicated. Experience has shown that a choice of one of the following three types of presentation would meet the requirements of nearly all programmes:

- bar chart or GANTT chart planning;**
- time and location chart planning;**
- network or critical path planning.**

(b) Exploitation of the document. The programming technique will depend on the skill of the workers using it. It will therefore differ depending on whether the user is the engineer in charge of the project, the staff responsible for programme accounting, the works supervisor or the foreman.

(c) Type of works. This will also affect the choice of programming technique:

- work covering a large area (reafforestation, dune stabilisation, etc.);**
- linear work (ravine correction, erosion control ditches, etc.);**
- work carried out at a given point (small dam, weir, etc.).**

The factors which are being planned may, of course, also have an effect on the programming technique:

- **labour requirements;**
- **material and tool supplies;**
- **plant rotation and maintenance;**
- **general works organisation;**
- **repetitive cycles of basic tasks;**
- **general progress and supervision of the project;**
- **financing schedule, etc.**

Clarity and ease of interpretation are prime requirements in planning and an effort should be made to present information simply, by giving a self-explanatory and precise picture of the problem being analysed. The highlighting of interdependence between various operations is a fundamental requirement; this makes it possible to pick out critical tasks which should be given major attention.

It should also be noted that planning is merely a hypothesis, although the most realistic possible, for scheduling the various tasks in a project. It must therefore be possible to correct it and, if necessary, modify or adapt it flexibly to any change of work plan.

1.2.3. Planning procedure

All planning commences with collecting various items of information and calculating the basic technical data:

- **assessment of available labour in the project zone;**
- **volumes and quantities for each task;**
- **probable performance for each basic task in view of specific climatic conditions, in particular;**
- **special site requirements: storage, water, access road, etc.;**

- **various constraints (rainy season, harvesting, religious holidays, etc.);**
- **allocation of funds;**
- **labour, equipment, tool requirements;**
- **availability of equipment, tools, etc.**

The various tasks involved in the completion of the project are then placed in a logical sequence. Any form of depiction can be used: arrows, rectangles, bars, etc.; then one adds to the list those tasks which can be carried out in parallel and the ordering tasks (ordering of supplies, rotation of vehicles, requests for topographic studies, for example). In this way, one obtains an initial picture which highlights the task sequencing. The diagram will be supplemented with information on the basic times for each activity, the labour and mechanical resources to be employed and all the constraints which can be seen so far. A number of diagrams are drawn up in this way in order to identify the most economic programming.

The sequencing of operations is the most delicate part of planning and requires maximum attention. Once these studies have been done, the work's programme can be presented in the most suitable form.

In the following paragraphs we will examine in sequence the planning of a single construction site using the three most commonly used methods (bar charting, time and location charting and critical path planning). The example in question is the general organisation of a site of 8 km of protective embankment combined with an irrigation channel (see fig. E.1).

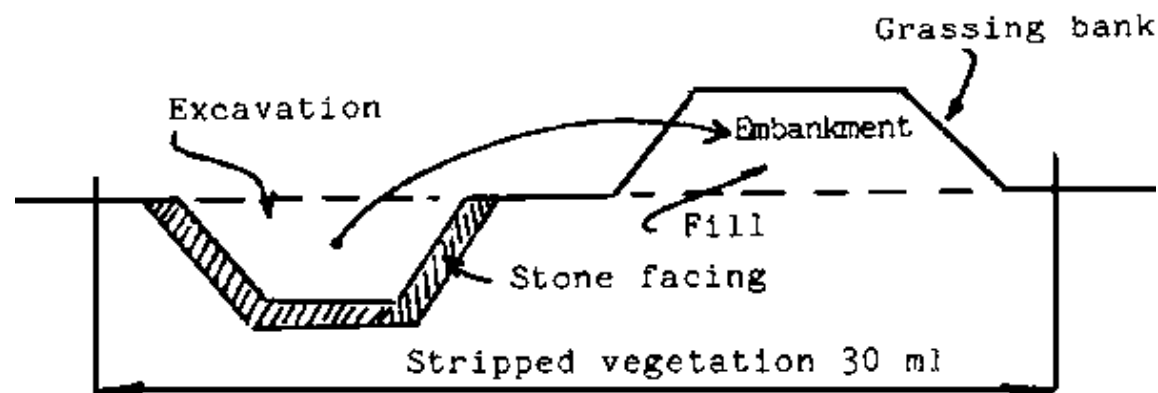

Fig. E.1: Cross-section of channel and embankment

The list of the main operations is as follows:

Task	Operation	Direction of advance	Gang No.	Gang size	Duration (weeks)
A	Install site	0 - 8 km	4	5	3
B	Strip vegetation	0 - 8 km	1	20	13
C	Excavation	0 - 8 km	2	200	12
D	Fill	0 - 8 km	3	100	12
E	Stone facing	8 - 0 km	1 + 2	-	5
F	Grassing	0 - 8 km	3	-	1

This lists the main operational tasks. The ordering operations, which are of zero duration but nevertheless place constraints, have been omitted to facilitate comprehension. These may related to the ordering of stones, cement, etc.

1.2.4. Bar chart or GANTT chart

The type of chart proposed by GANTT is easily read and requires little skill on the part of the person producing it. One lists, on the left-hand side of the chart, usually from top to bottom,

the various operations to be carried out in their logical order of execution and on the horizontal scale the time schedule to a convenient scale. Horizontally, against each operation, are drawn rectangles, or lines, proportional in length to the time the operation will take.

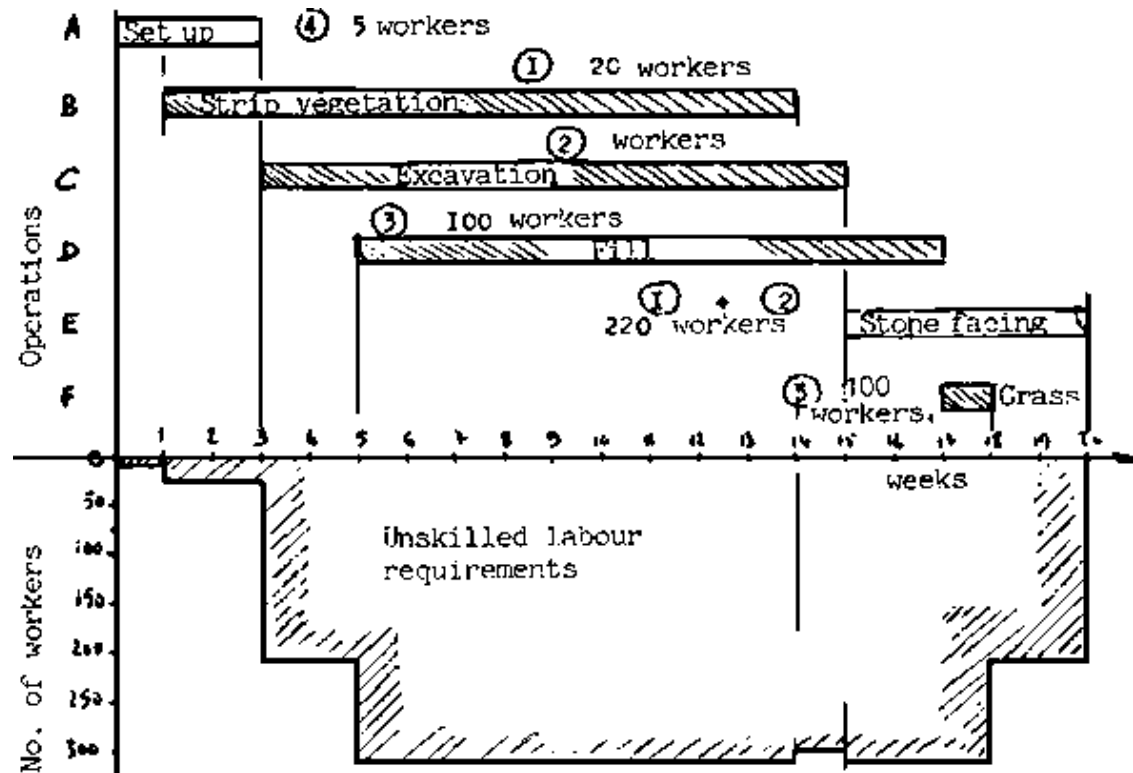

Fig. E.2.

To the lower section of the planning chart it is possible to add a diagram indicating labour, tool, equipment, etc, requirements. Improvements can also be made by joining up the various operations by arrows (linked GANTT chart) to show gang movements during operation of the site.

The major disadvantage of this type of diagram is that it does not show the various relationships that exist between different tasks, especially in the case of complex projects.

It is also difficult to supervise project progress since the spatial relationships of the tasks are not shown.

Nevertheless, this type of diagrammatic presentation is very useful and is usually used for planning simple construction sites, summarising detailed scheduling that has been analysed by other methods, and for displaying to a large number of people, and in particular the workers themselves, the results of these analyses.

1.2.5. Time and location chart planning

This is an extension of the GANTT-type bar chart. However, it can be used only for linear and narrow sites such as: bank protection works, linear soil conservation works, forest tracks, embankments; or for tall and narrow structures: retaining walls, weirs, small dams, which entail successive repetition of the same activities.

The basis for drawing up a time and location chart is very simple and entails merely plotting on a chart points against Y co-ordinates (time in a convenient scale) and an X co-ordinate (the chainage of the project).

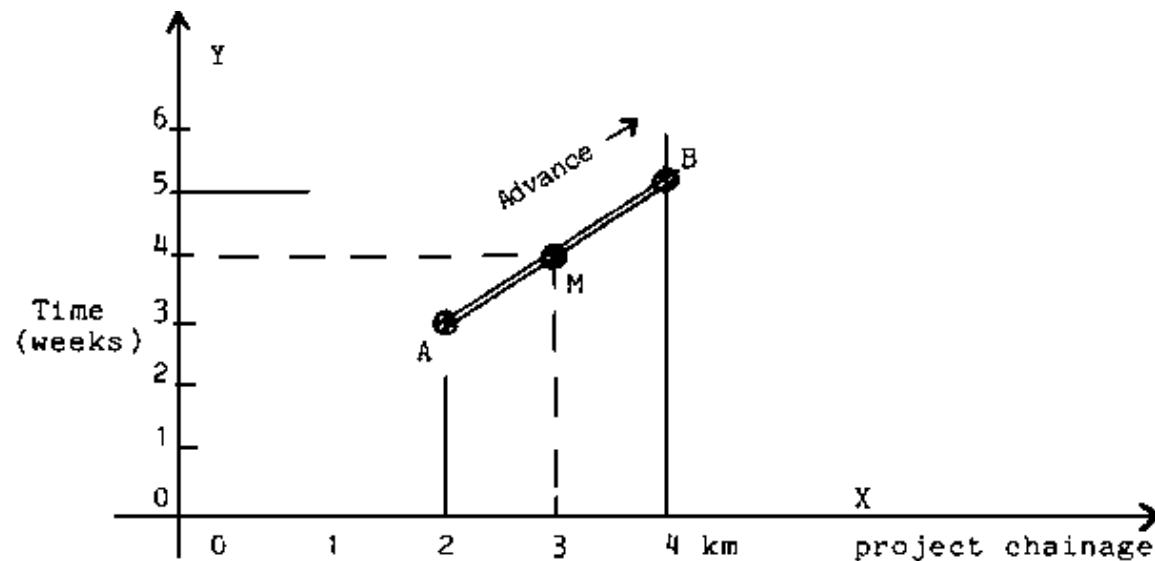

Figure

Using this technique, points A and B are defined in both time and space. Point A is therefore located at the 2 km chainage at the start of the third week; point B is at the 4 km chainage at the start of the fifth week. The line joining A and B therefore represents a two-week task being carried out between the 2 km and 4 km chainages of the project (an erosion control ditch, for example). The direction of advance of this task is of course defined as going from left to right. If a check is made on the advance of the work at the start of the fourth week, it will be necessary to ensure that the 3 km chainage (point M on the chart) has been reached as foreseen in the diagram. One can therefore see the value of this method in site supervision and control, since one can detect at an early date any delay or anomaly and rapidly make the necessary organisational changes.

It is possible to add to the chart a longitudinal section of the work under construction on which are marked the main features which may act as constraints: river to be crossed, cemetery, etc. This diagram should be drawn parallel to the X axis above or below the chart.

Any isolated point on the chart will show a task of 0 duration at the specific point of the site. This will be an order task (for example, ordering the supply of steel, cement, etc. to the site). A vertical line represents a task being carried out at one specific point of the site (construction of a weir, for example): and the duration of the task will be shown by the distance covered by this line on the selected time scale. Two parallel lines indicate operations carried out simultaneously by two teams at different locations:

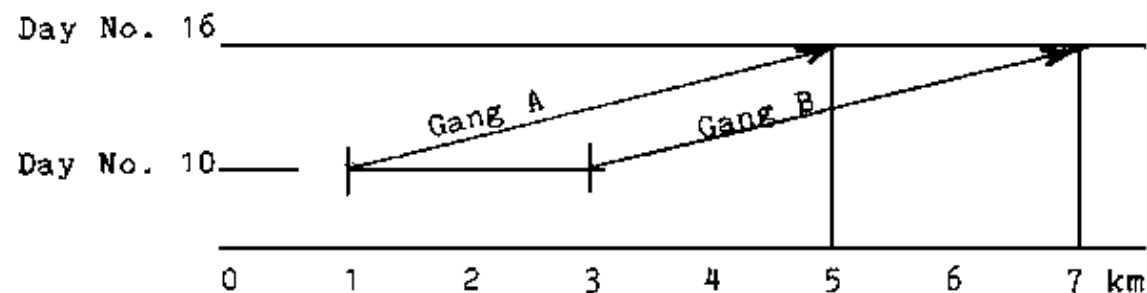

Figure

Tall and slender projects are shown using the same principle; however, for ease in reading the planning chart, the time scale is shown on the X co-ordinate and the height of the structure on the Y co-ordinate as is shown in fig. E.3.

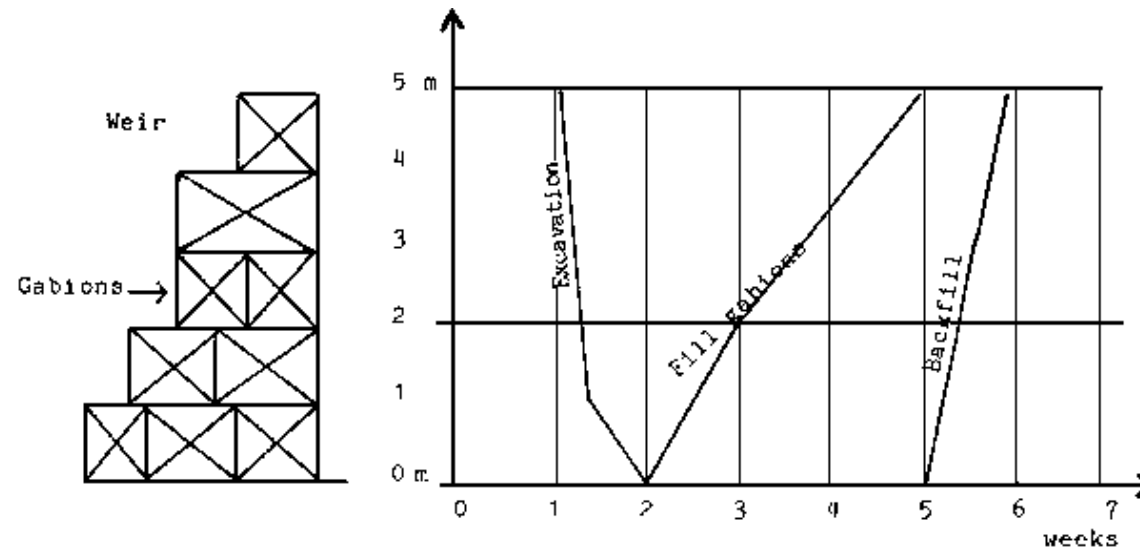

Fig. E.3.

The example of the construction of an embankment and irrigation channel previously plotted on a GANTT-type bar chart looks as follows when plotted on a time and location chart.

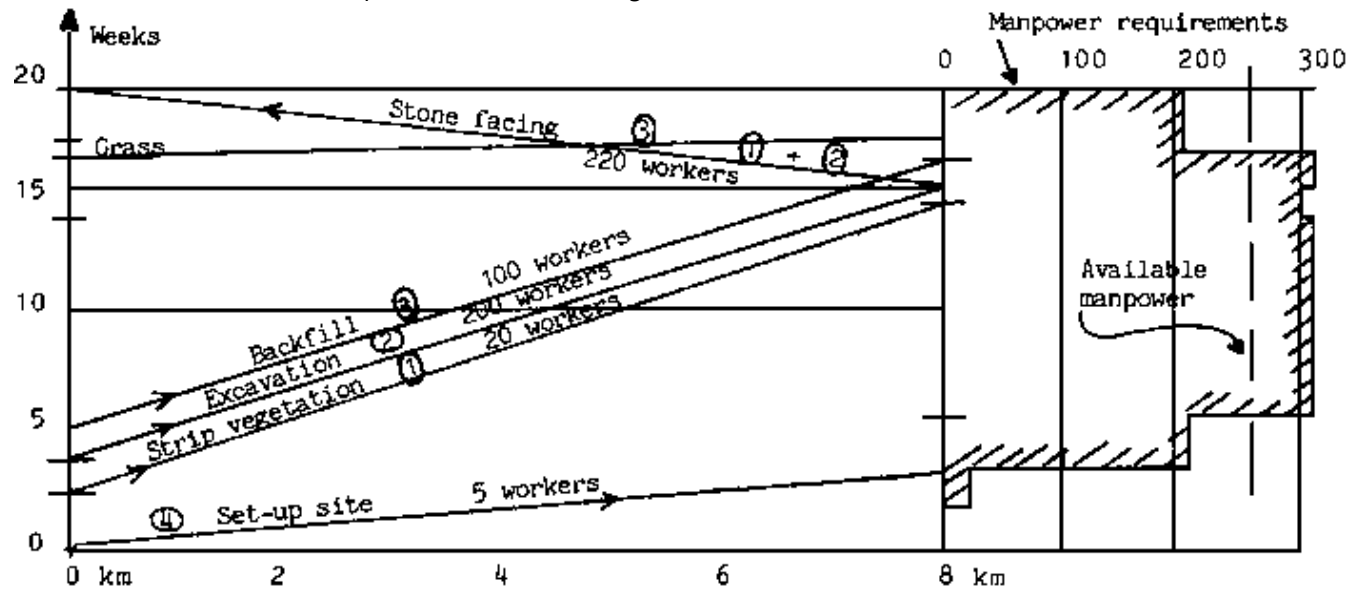

Fig. E.4.

Reading this type of chart poses no major difficulty. The main components of the project are shown, the operations are located in time and space, and the logic behind the programming and scheduling of tasks is indicated. The actual advance of the work can be plotted on the chart in dotted lines and any delays will show up clearly. A diagram showing resource requirements (manpower, materials, equipment) can be added to the right of the chart.

1.2.6. Network or critical path planning

Various systems of network planning exist, all based on the project graph theory. The PERT (Programme Evaluation and Research Task), or critical path system, is the one most commonly used and shows the sequence of operations by a more or less complex closed network of arrows and peaks.

The "critical path" is made up of a number of activities for which the completion times cannot be increased without delaying the final date of completion of the whole project.

Developing an arrow diagram is carried out in two steps. The first step is to identify the operations in their logical order of completion, noting those which are interdependent. This first step will provide the project's logic chart; the required resources are not yet taken into consideration. The second step is to deploy these resources (manpower, time, materials) between the various operations so as to optimise production time and costs.

When the network has been completed, the "critical" activities should be identified so that particular attention can be paid to them during the course of the work. It is usually advisable to present the results in the form of a bar chart which is more easily read and used by the workers themselves.

Developing a network diagram requires the use of special terms, the most important of which are given below:

Network or graph: a chart comprising peaks joined by straight or curved lines, usually orientated.

Event: beginning or end of an activity. Requires no resources. The event is shown by a circle in which are indicated: the event's chronological number, and the earliest and latest finish dates.

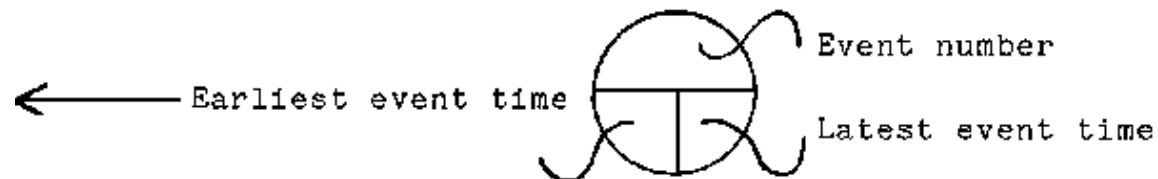

Figure

Task or activity: shown by a line, the length of which is independent of the actual time required to complete it. This line ends in an arrow which shows task sequence.

Logical sequence: this is a sequence of interdependent tasks, the order of which

cannot be changed.

Node: this is an event at which several activities finish or from which several activities commence. A node may initiate a number of operations. It is a strategic stage in the course of the work. In the case of large, complex projects, the network can be broken down into more or less extensive charts starting from these main linkage points.

Earliest event time: starting from the initial event at time zero, the sequence of the arrows is traced and the durations of the successive tasks are added together. When a number of paths coincide on a single event, this event will be given the time of the longest path.

Latest event time: a backward path is made over the network starting from the final event and taking successively the duration of each of the basic tasks. If a number of paths converge on a given event, this event will be given the time of the shortest path.

Free float: is the difference between the latest event time and the earliest event time.

Dummy activity: this is a broken line joining two events showing an interdependence and linking two events in different sequences. A dummy activity is of zero duration.

Network construction method (practical example): i.e. a weir foundation construction site comprising the following activities:

No.	Job	Duration (days)	Immediately preceding job
A	Set-up site	2	Commencement of site
B	Marking out	1	A
C	Construct shuttering	4	Δ

the earliest and latest times for each event.

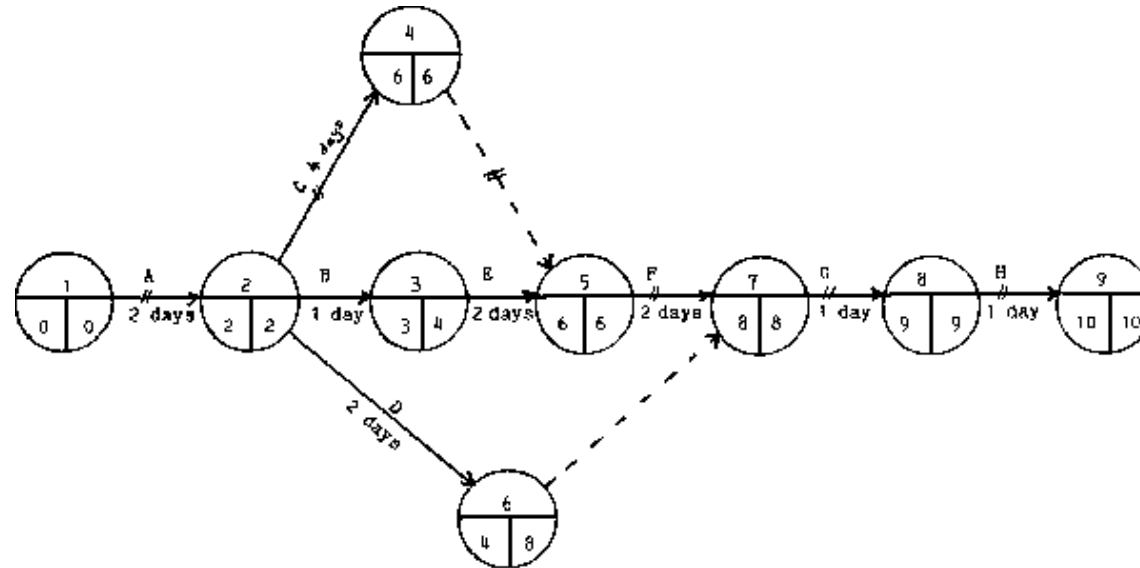

Figure

The “floats” for each event (latest event time minus earliest event time), critical path (--->) will be the one which passes through the events with a zero float.

In this way it will be seen that job D can suffer a four-day delay (8-4) without any repercussion on the final completion of the project. On the other hand, any delay in the completion of job C will have repercussions on the final completion date.

It will be seen that jobs 4/5 and 6/7 are “dummy” activities. They require no resources but indicate respectively that jobs F and G cannot start until jobs C and D have been completed.

The same principle is used below to show the critical path method for the construction of the 8 km embankment and irrigation channel. The stage classification method will be used. It will be noted, however, that for this type of site, certain constraints have to be introduced. They are as follows:

- job B starts one week after the start of job A
- job C starts two weeks after the start of job B
- job D starts two weeks after the start of job C
- job E starts after completion of jobs B and C
- job F starts after completion of job D.

Allowance can be made for these constraints by distinguishing in each job that part which must be carried out independently of the others and that part which has to be carried out simultaneously to others.

Scheduling the tasks by stage:

Stage 1	Stage 2	Stage 3	Stage 4	Stage 5
A (1 day)	A (2 days)	C (2 days)	C (2 days)	F
	B	B	B	E
			D	

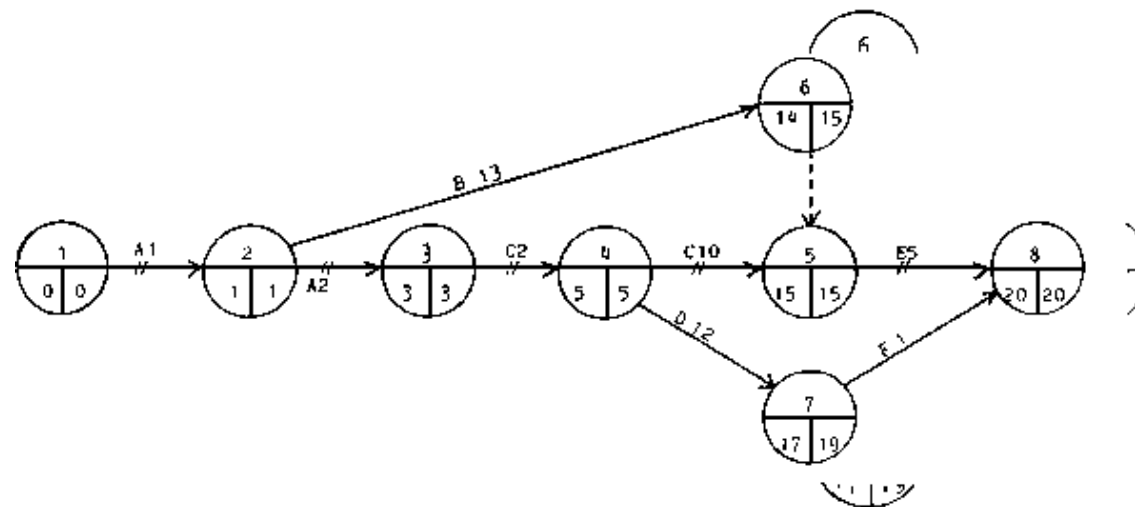

Fig. E.6: Diagram development

1.3. Setting up the site

1.3.1. Construction of access roads

When access to the site is difficult, an access road will be necessary for supplying the site with equipment and materials. The works supervisor should ensure, during the course of the work, that the necessary signs are in position to protect the road construction workers and to avoid accidents.

1.3.2. Construction of site buildings

The buildings (offices, sheds, accommodation for the works supervisor and workers, mess room, etc.) should be located at a relative distance from the site and the access road to avoid noise and dust.

The workshop and store should be built as close as possible to the site to avoid expensive transport.

A shed should be built in a dry place for storing the cement.

1.3.3. Plant installation

Plant should be stored where it is protected from dust and direct sunlight if possible; preference should be given to an area which is not muddy or sandy.

Fuel reserves should be stored in the shade away from accommodation and the plant storage area.

The area around plant and fuel stores should be kept clean to avoid fire hazards.

1.4. Site management

1.4.1. Management technique

(a) Site supplies

Good site planning depends especially on the site being well supplied with the necessary equipment and materials. Delays in supplies may make it necessary to halt the work of a gang and this may affect the whole site; the consequence of this is always an increase in costs.

From the opening of the site, the works supervisor should have a schedule of supply requirements for the various stages of the work. This should be kept up to date as the work advances and steps should be taken in advance to ensure that suppliers are able to meet deadlines and supply the necessary quantities.

At the same time, a stock of the most common spare parts should be established and this should be managed to ensure security of supplies.

(b) Quantity measurements

It is necessary to measure the work actually completed and the quantities of materials used and to compare this with the estimates made prior to the work. In the case of earthworks, these estimates are based mainly on measurements of surface areas and lengths intended to calculate the volumes involved.

Quantity measurement also covers estimation of all the other factors involved in cost calculation: fuel consumed, transport distances, etc.

These estimations may be entrusted to a quantity surveyor.

(c) Productivity improvement

This involves improving gang output and organising the various tasks to avoid individual

gangs being idle.

To achieve this, the foreman should ensure that:

- the workers' capabilities and competence are used to the best effect;
- the gangs are homogeneous;
- the best workers or the best gangs are encouraged (incentives, bonuses, etc.);
- the most suitable tools are used;
- the workers' welfare is looked after (housing, food, etc.).

(d) Works progress reports

Daily progress reports should be drawn up and signed by the foreman.

The planning should be updated each week; if the planned tempo has not been kept, the site supervisor should be informed immediately.

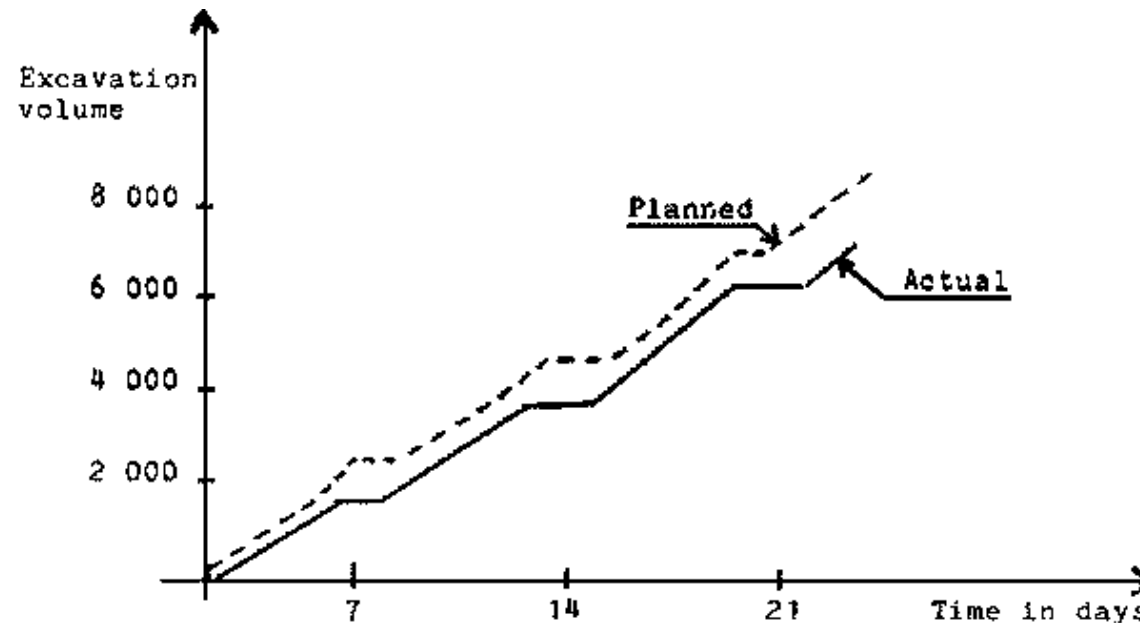

Fig. E.5.

1.4.2. Personnel management

(a) Recruitment of workers

Special labour-intensive public works programmes require special personnel management which are matched to the specific social objectives of these programmes. Voluntary worker participation can be obtained only by suitable prior preparation, which may be of an administrative nature, and make use of public information and awareness campaigns.

When the project exceeds a certain level of workers and time, it is necessary to organise a volunteer recruitment and handling programme; the volunteers themselves should be classified by specific criteria to the jobs they will be expected to carry out taking into account their special abilities. On recruitment, each worker should receive an individual work card which may be based on the model shown below.

Fig. E.8.

Work card

Group (E)

Photo

Name

.....

Sex Age

Place of residence

No. of dependants

Profession

.....

Qualifications

.....

No. Issued on

RECTO

Work periods				
Work details				End
Date	Project	Post No.	Checked	Date checked
25.2	SEGOU reaf- foresta- tion	17	Signa- ture	12.4. Signature

VERSO

A weekly attendance sheet (fig. E.9) should be drawn up for each worker, bearing only his family name, given name and address (with, where necessary, any special capabilities), designed for checking off the number of hours and days worked for calculating pay (or related benefits in kind). Depending on the size of the site, this tally will be kept by a tallyman, foreman or works supervisor himself.

Fig. E.9.

Site	No.
.....	
<u>Work attendance sheet</u>	
Name	
.....	
Category	Hourly wage
.....	
Gang	Month

Weekly payroll

(b) Site regulations

The provisions applied should be in, line with local customs and current legislation.

The regulations should specify:

- working hours;**
- duration of the working week;**
- method of payment;**
- possible sanctions (for absence, late arrival, etc.).**

Regulations may be established in consultation with workers' representatives.

(c) Worker remuneration

The level of remuneration should be set by the competent authorities taking into account the specific nature of the work. Since these are community development programmes carried out by volunteers, remuneration may be lower than the minimum legal wage or paid in the form of benefits in kind.

Payment should be carried out at regular intervals on a daily or weekly basis. The works supervisor should ensure that the necessary funds are available in order to avoid delays in payment. In the case of payment in kind (food rations, for example), care should be taken not to diverge from local tastes which might be a source for discontent.

(d) Transport and quartering

To the extent possible, efforts should be made to recruit manpower locally; however, when the site is at a distance from the workers' homes, it is advisable to organise their transport to the workplace, or if necessary their quartering on the work site by providing lodging, food and adequate sanitary facilities.

(e) Worker training

On small sites and on short-term work, worker training may be rudimentary and aimed primarily at the correct handling of the relevant tools.

In the case of larger and long-term sites, this training should be backed up by training aimed at providing workers with the knowledge necessary for them to take over responsibility for the correct operation and maintenance of the completed project (introduction to modern agricultural techniques, retraining of local craftsmen, reading and writing, etc.).

(f) Human relations, conflicts

The works supervisor should ensure that volunteers receive a warm welcome and are fully informed of the purpose of the work entrusted to them. Volunteers should also be divided up into gangs, where necessary taking into account existing social or community structures.

In special public works programmes, the involvement of the population in question usually leads to collective self-discipline. However, the coexistence of heterogeneous social groups (different ethnic origins) living together for a limited period under artificial conditions may result in conflicts.

The works supervisor should assert his authority and ensure correct progress of the project. To this end, he must ensure that the site regulations are observed and that a good community spirit exists on the site. Any infraction should be sanctioned accordingly.

(g) Health, safety and working conditions

Suitable working conditions will be laid down by practice and legislation; they will have an effect on work productivity and continuity.

Sanitary facilities should be related to the size of the site and the distance from the workers' homes.

Safety and health requirements should be applied. For example:

- for excavations, cuttings, trenches and ditches, it is necessary to ensure the stability of any banks which are higher than 1.20 m;**
- for work carried out in water, it is necessary to ensure that the water is clean and harmless and avoid risks of drowning and cave-ins.**

Every isolated site employing more than ten workers should have an emergency medical kit for first aid which may be carried out by a volunteer who has received prior training or by the works supervisor himself.

In the case of work sites employing more than 50 workers, there should be a nurse or health worker who can provide first aid and treat common diseases (malaria, headaches, dysentery).

In the case of sites employing more than 500 workers or work lasting more than 12 months, it is necessary to provide a small mobile dispensary with a bed and a permanent nurse for every 250 workers.

1.4.3. Incentive system

In all firms employing workers, incentives are desirable to encourage better results. Recompense is therefore given for good results obtained either individually or by the gang

as a whole. Praise or rewards may be made and additional holidays given. However, such procedures may prove unsuccessful especially in the case of short-term work. It will therefore often be necessary to turn to:

- the finish-and-go system,**
- piecework payment.**

(a) The finish-and-go system

This system is particularly attractive to workers, such as small farmers, agricultural workers, etc., who see the special public works programme as a supplement to their main job - agriculture. The interest for them is to finish their work early and return home so that they can possibly spend the rest of the day on this main job. The system also suits agricultural workers who are not usually accustomed to regular working hours.

It is possible to determine a task which lasts for several days, although this is not usually desirable, nor always permitted by legislation. There is a danger that this practice may lead to five daily attendance cards being given for three days' actual work and this is clearly open to abuse. Usually, preference is given to daily tasks; since the result is extra work for skilled workers, the tasks are essentially simple ones, such as for example, digging a certain length of trench of uniform cross-section.

(b) Piecework systems

Where local legislation permits, piecework systems offer numerous advantages, in particular where a standard wage rate is fixed for each task and the worker (or gang) receives a fixed amount for each unit of work carried out. The advantages and disadvantages of these systems are as follows:

Advantages	Disadvantages

the worker is able to earn more than the normal daily wage in return for higher output;

his output will be higher since his wage depends directly on the effort he puts into his work;

these systems promote individual discipline and require less supervision;

the worker himself attempts to improve the efficiency of his working method;

when, instead of an individual, it is a gang which is doing piecework, the gang will organise itself to ensure maximum effectiveness and the most active members will encourage the others to work harder;

in certain cases, where the situation allows, the workers will be able to stipulate their own working hours.

In attempting to achieve higher output, the worker may neglect quality and safety;

if the rates are too low, the incentive to work hard may be lost, or the worker may work too hard to the detriment of his health;

differences in earnings between harder workers and less hard workers may sometimes cause resentment;

these systems are more complex to apply than a daily wage or a finish-and-go system.

1.4.4. Role of project management

The project management is responsible for the correct implementation of planning. The main tasks are:

- work programming;**
- work implementation;**
- supervision and control.**

Work programming requires an over-all long-term view of the project and should be the responsibility of the project manager. Carrying out the work requires daily supervision

which will be the responsibility of the works supervisor.

Responsibilities of project manager	Responsibilities of works supervisor
<ul style="list-style-type: none"> - programming - budgeting and budget control - forecasting - recruitment of assistants - training - research - public relations - selection of main items of equipment - wage negotiations - project control 	<ul style="list-style-type: none"> - implementation of work - quality and productivity control - recruitment and payment of workers - purchasing of materials - discipline - transport and organisation of manpower - supervision of equipment and plant - maintenance of buildings and roads

E.2. TOPOGRAPHICAL STUDIES

Topographical studies may prove necessary in numerous cases, in particular for projects on hilly ground or which cover a large area.

It is difficult, within the framework of this document, to specify precise methodology and the type of topographical studies that should be foreseen since the characteristics of the soil conservation projects within a special public works programme may vary considerably. We will therefore not do more than indicate certain general principles for topographical studies and invite the reader to refer to the numerous specialised documents in this field.

2.1. Topographical survey

A survey comprises:

(a) the planimetric survey which picks out the various natural features of the terrain or a structure;

(b) the levelling survey in which the altitude of these natural features is measured.

2.1.1. Planimetric survey

The planimetric survey is carried out by the measurement of distances and angles. The instruments required are:

Distance measurements

- the surveyor's chain (20 m in length);
- the measuring rod in wood or metal of 4-5 m in length fitted with a spirit level for checking horizontals and a plumb line for measuring horizontal distances on slopes greater than 2 or 3 per cent;
- a folding 2-m rule for measuring the details of the structure.

Angle measurements

- goniometers, the most commonly used being the theodolite; these comprise two plates one of which is graduated to permit the measurement of angles;
- surveyor's squares for locating points and features at an angle of 45 to each other;
- optical square which replaces the surveyor's square;
- plane table, a type of goniograph with which it is possible to measure the relative position of a number of points;
- compasses with which it is possible to measure differences between magnetic azimuths.

2.1.2. Levelling

Two procedures are usually used:

- direct levelling for horizontal sites;
- indirect levelling for inclined sites.

Direct levelling is carried out using a level and a levelling staff.

Since the level can be used only for horizontal sights, it is necessary on steeply sloping ground, to carry out a series of levelling sights. This procedure, called change-point levelling, is illustrated in fig. E.10.

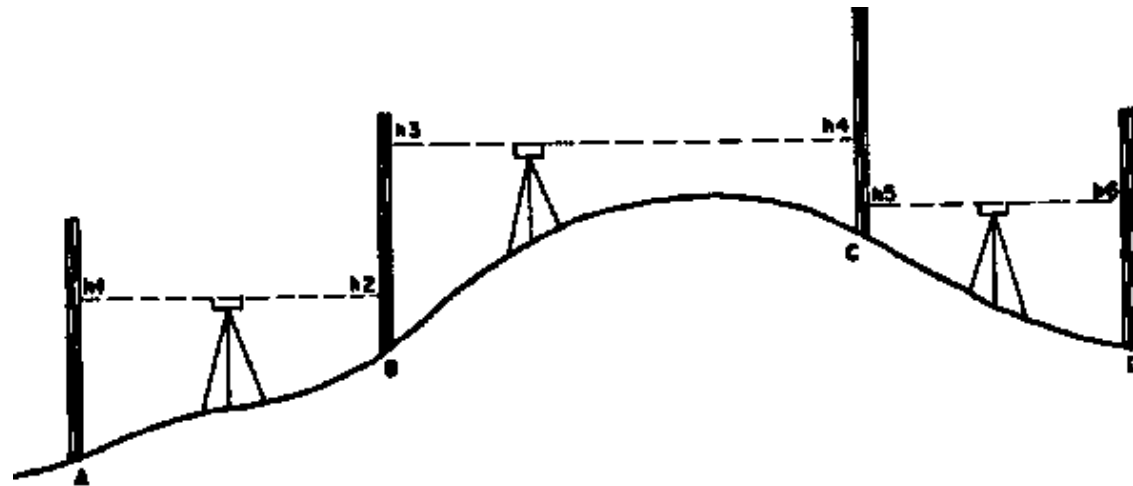

Fig. E.10.

In indirect levelling, the difference in level between two points is calculated by measuring the angle formed between a straight line linking these two points and the horizontal, and the distance between the two points. This method requires the use of theodolites or clinometers. The latter are particularly well suited to rapid reconnaissance surveys and allow gradients to be measured with a precision of around 1/1,000 th.

The indirect leveling method is illustrated in fig. E.11 below.

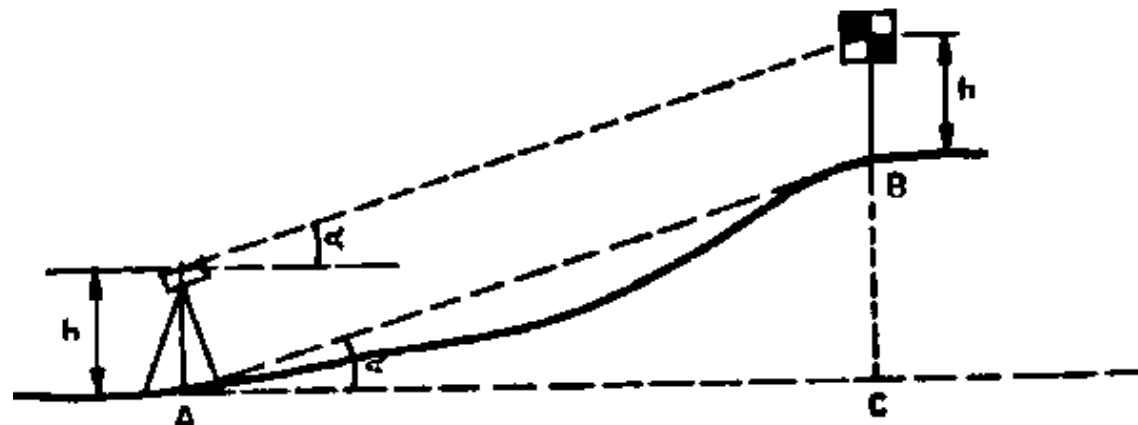

Fig. E.11.

2.1.3. Composition of a topographic survey team and survey standards

The composition of a topographic survey team will vary depending on the slope and difficulties of the terrain. A basic team will usually comprise:

- topographic surveyor;
- one or two staff men;
- two chain men;
- two labourers, to carry the levelling stakes.

The density of levelling points generally accepted for different surveying scales is as follows:

Surveying scale	No. of levelling points per ha
1/10 000 th	1
1/5 000 th	2
1/2 000 th	6-10
1/1 000 th	15-30

E.3. MARKING AND STAKING OUT THE STRUCTURE

Marking out a structure consists in indicating the axes and the external dimensions on the ground. This is done by means of stakes which should be precisely located in relation to fixed reference points. The marking out operations should be carried out in the presence of the project manager and the works supervisor.

3.1. Preparation of the ground plan

The structure should be depicted by a ground plan and by elevations and sections. The ground plan is drawn up by indicating on a tracing paper the main axes and the measurement of angles and altitude.

3.2. Preparation on the ground

The transverse or longitudinal axis of the structure should be indicated by two fixed reference points which would be either boundary stones set in concrete or concrete boundary posts in which a nail is set in the upper part to act as a reference point. The number and altitude of the reference point should be marked on the boundary stone.

The fixed reference points should be located outside the external limits of the work and should be sufficiently visible not to be damaged during the course of the work. They should remain in place throughout the duration of the work and their co-ordinates and altitude are usually incorporated in the general levelling survey of the area.

3.2.1. Main staking out

This is used to define:

- for works of engineering construction: the axes;**

- for earthworks: the axis of the route, the longitudinal profile, the curves, the location of the cross-sections.

Staking out is carried out using hard-wood, square or circular cross-section stakes, 50 cm in length. In loose soil, the stakes should be driven home with a sledgehammer; on rocky land, they should be cemented into holes made with a jumper bar.

The stake heads should be painted to ensure that they are clearly visible, and each stake should be numbered and referred in plan and altitude to the fixed reference points.

The stake head should be set at the exact measurement of the future ground level if this is not more than 30 cm higher or lower, or an exact number of decimals above or below.

3.2.2. Additional staking

This is carried out from the main stakes and indicates the boundaries of the works, such as the edges of trenches or banks. These stakes are not levelled and they should be painted in a different colour to that of the main stakes.

3.2.3. Staking report

This document should be drawn up in the presence of the works supervisor who should indicate the number of the profiles, and the position and altitude of the reference points.

Example:

Part of structure	No. of stakes	Position of stakes		Distance between stakes	Height of earthworks	Comments
		Alignments and curves	Slopes and sections			

3.2.4. Displaced stakes

Before the work is started, the main stakes which are located within the area covered by the works should be displaced at a constant distance outside the boundary of the structure. This displaced staking should also be levelled in relation to the axis stakes as shown in fig. E.12 below:

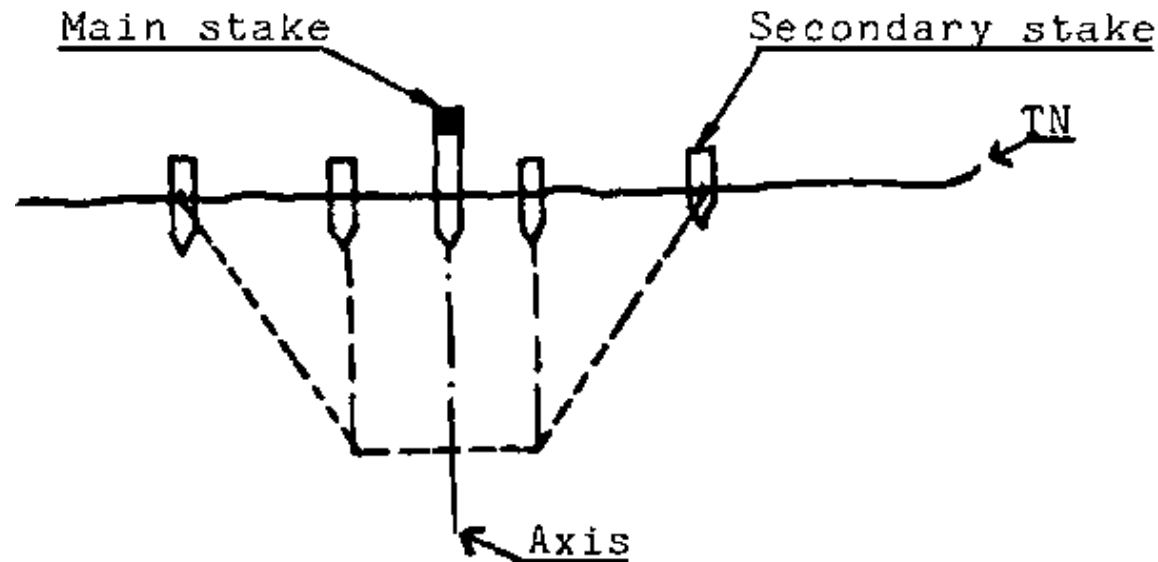

Fig. E.12.

3.3. Personnel requirements and work output

The personnel required for the marking and staking out will be provided by the basic topographical survey team as listed above. On normal ground, such a team should have an output of 4-6 km per day.

Material required for marking out work should comprise, as a minimum:

- a level for determining altitudes;

- a goniometer for the marking out proper;
- two levelling staffs;
- a surveyor's chain (or steel tape);
- stakes;
- cement, sand, water for the installation of the main fixed reference points;
- paint for marking the stakes.

E.4. GROUND PREPARATION

4.1. Clearing the land over the area covered by the works

In soil conservation projects, land clearance will be limited to preparing the areas of work such as channels, embankments and earth dams with a supplementary margin for the movement of workers and plant.

Land clearing consists in eliminating any vegetation which would hinder the progress of the works or might lead to their deterioration.

For manual work, the tools used will vary considerably depending on the country. The main types are the machette, hatchet, axe, hoe, fork, pick, pruning saw, scythe, sickle and hand winch.

Output norms are related primarily to the density of the vegetation. Land types may be classified into various groups. For manual clearing work, five categories can be distinguished as shown in fig. E.13.

Fig. E.13.

Category	Characteristics	Manual output	Observations
Grass savannah	No vegetation higher than 1 m; a few sparse shrubs	Between 200 and 300 m ² per	Output depends on climate and site organisation

		day/man	
Shrub savannah	Scattered bushes; thorny vegetation; land covered with perennial grasses; numerous shrubs	between 100 and 200 m ² per day/man	An alternative is to use a chain pulled between two tractors
Wooded savannah	Semi-arid tropical regions; dense vegetation; thorny brush; numerous shrubs; thickly wooded; some large trees	Between 50 and 100 m ² per day/man	Tree stumps and trunks and brush are left in place; they are burnt on site 3 weeks after having been felled
Forest	Hard and soft wood; large diameter trees forming a vault	Unusual work within the framework of soil conservation projects	Six men and a winch can fell about 10 trees per day; animal haulage might be envisaged
Equatorial forest	Hard and soft woods; very large trees; widespread vaulting		

4.2. Stripping - subsoiling

The stripping operation entails the removal of topsoil over a depth of 20-30 cm in areas which are to be filled. Normal trenching methods are used.

Subsoiling is a deep scarification (up to 60 cm) intended to increase soil permeability or break up a hard pan. It is used in arid zones to prepare the soil prior to reforestation work. It requires powerful mechanical plant (tractors of 35-70 hp for subsoiling to a depth of 60 cm).

Instead of subsoiling the soil may also be loosened with a pick axe under the area to be covered with ridges in which trees are to be planted.

The following productivity data for light stripping and subsoiling were collected in the Philippines. The soil is loosened by a plough before being shovelled clear and the stumps removed by hand.

Soil	Non-cohesive soil; fields of sugar cane which have been cut and burnt, and in which there remains two or three stumps or roots per square metre
Method	Four successive ploughings; followed by removal of the remaining roots by three passes with a bamboo scraper and three times handpicking

Gang composition: 2 ploughs, 1 scraper, 2 labourers handpicking

Productivity	Over-all: 165 m² per hour per gang	
	Per operation:	
	first ploughing:	250 m ² per hour per plough
	subsequent ploughing:	490 m ² per hour per plough
	bamboo scraper:	490 m ² per hour per scraper
	handpicking:	250 m ² per labourer

E.5. EXECUTION OF EARTHWORKS

5.1. General comments on soil type and handling

5.1.1. Land classification

The type of land will determine:

- the working method to be used;

- **the choice of equipment to be used;**
- **output and, consequently, the cost of earthworks.**

Soil type has a considerable effect on trenches and the shape to be given to cuts and fills. A distinction may be made between:

- **loose soil which may be excavated without previous loosening;**
- **rocky soils which may be loosened.**

Loose soils may be classified as follows:

Light soils Dry topsoil, dry sand, fine gravel

Ordinary soil Moist topsoil, firm soil mixed with sand, wet sand, compact clayey sand, compact clayey fine gravel, large gravel, peat

Heavy soil Firm soil mixed with stones, clay soil, compact clay, large gravel, clay, marl, broken rubble

Very heavy soil Wet clay, compact marl, consistent rubble, soft quarry stone; brittle slate, faulted limestone, decomposed rock

Rocky ground may be classified as follows:

Soft rock Soft limestone, chalk, sandstone, compact slate, conglomerates

Hard rock Granite and gneiss, hard limestone

Very hard rock Granite and compact gneiss, quartzite, syenite, basalt

5.1.2. Bank gradients

The slope of a bank should always be less than the angle of repose that would be formed in a bank abandoned to the action of weathering. It is defined by the ratio $H/B = \tan i$ where H is the height of the bank, B its base and i the angle of the bank to the horizontal.

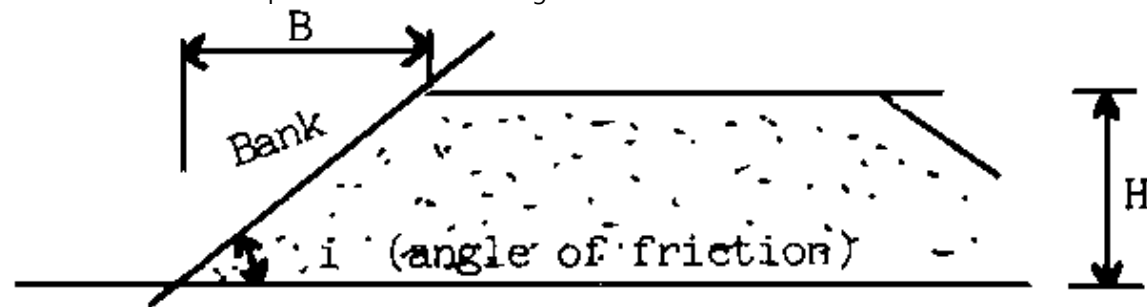
**Fig. E.14.**

Knowledge of the angle of repose is essential in ensuring the stability of earthworks and in estimating the area they will occupy and the volume of earth to be moved.

The angle of repose in a slope will depend basically on the type of soil and its consistency. The angle is higher for dry soils than for wet or submerged soils, and higher on natural banks than on filled banks.

Generally accepted values for angles of repose are given in tabular form in fig. E.15.

Fig. E.15: Angle of repose for banks $\text{tgi} = \frac{H}{L}$

Type of soil	Banks cut in natural ground		Banks cut in dumped soil Filled banks	
	Dry land	Waterlogged land	Dry land	Waterlogged land
Hard rock	5/1	5/1	1/1	1/1
Soft or fractured rock	3/2	3/2	1/1	1/1
Rock debris, scree, pebbles	1/1	4/5	1/1	4/5
Subsoil mixed with stones and topsoil	1/1	1/2	2/3	1/2
Clayey soil, clay, marl	4/5	1/3	2/3	1/3

Gravel, non-clayey coarse sand	2/3	1/2	2/3	1/3
Non-clayey fine sand	1/2	1/3	1/2	1/3

5.1.3. Bulking - consolidation

Soil, when extracted, increases in volume. This is called bulking. There are three types:

- **the coefficient of initial bulking F which is measured when the soil has just been extracted:**

$$F = \frac{V - V_0}{V_0}$$

- **the coefficient of persistent bulking F' which is measured after consolidation:**

$$F' = \frac{V' - V_0}{V_0}$$

- **the coefficient of consolidation which is the decrease in the apparent volume of soil which has consolidated completely in relation to the initial volume of newly extracted soil:**

$$T = \frac{V - V'}{V}$$

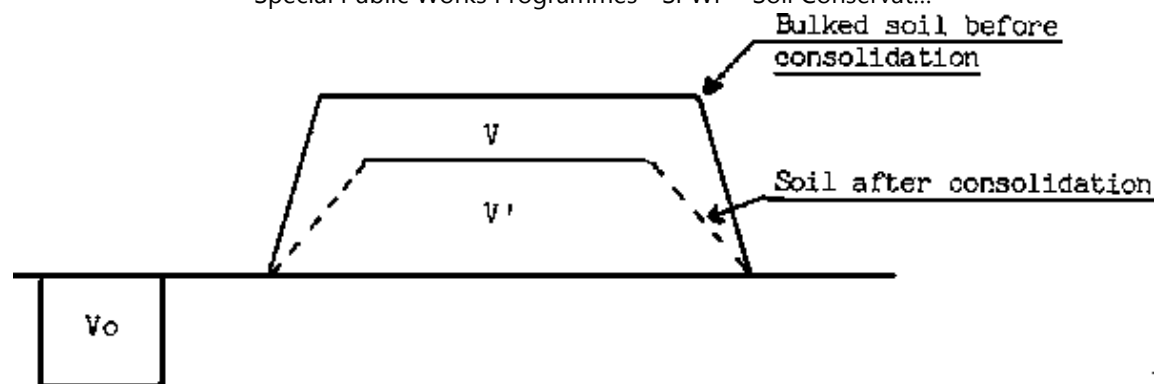
**Fig. E.16.****Fig. E.17: Values of coefficients of bulking and consolidation**

Type of soil	Coefficient of bulking		Coefficient of soil consolidation
	Initial F	Persistent F	T
Topsoil, sand	10-15%	1-1.5%	8-12%
Gravel	15-20%	1.5-2%	12-15%
Heavy soil mixed with sand	20-25%	2-4%	15-17%
Clayey soil	25-30%	4-6%	17-19%
Clay	30-35%	6-7%	19-21%
Marl	35-40%	7-8%	21-23%
Very compact clay and marl	40-65%	8-15%	23-30%
Scree	30-40%	8-15%	17-18%
Hard core (ine)	40-65%	25-40%	10-15%

Knowledge of coefficients of bulking and consolidation is important in carrying out earthworks.

To produce a fill with a final volume V' , it is necessary to place a provisional bulked volume (before consolidation) of $\frac{V = V'}{1+T}$ and excavate an in situ volume of $V_0 = \frac{V}{1+F}$.

5.2. Tools

The tools used for manual earth moving are either hand tools or portable mechanical tools.

5.2.1. Trenching tools

The main manual tools are:

- **The pickaxe. This is made of steel and has a point at one end and a blade at the other; the wooden shaft is about 1 m in length. The point blunts rapidly when used in hard soil; it can be repaired by welding on a new spike. A smith and his mate can repair 30-40 pickaxes per day. It is necessary to expect that about 20 per cent of the stock of pickaxes will be in for repair.**
- **The pick. This is a pickaxe with a point at each end for use in soft rock.**
- **The wedge. This is made of steel and struck with a 2 kg sledgehammer to break fissured rock.**
- **The crowbar. A steel lever 1.20 m in length used to break fissured rock. Portable mechanical tools include:
 - **Pneumatic spades which are used in heavy soil of compact clay or marl. They have an output of 5-10 times higher than the hand pickaxe.**
 - **Pneumatic picks which are used to break soft or fissured rock. They have an output 5-10 times higher than the pick, wedge and crowbar which they replace.****

They can be handled by one man alone and receive their compressed air supply from a small mobile motor compressor.

5.2.2. Tools for loading earth

For loading excavated earth, use is made of:

- the shovel which can be used for excavating very loose earth. It is made of a steel blade weighing 1.0-1.5 kg fixed to a wooden shaft 1.20 m in length. A shovel load usually weighs 2.5-3 kg; lumps weighing more than 5 kg are loaded by hand;**
- the fork which has teeth 3-4 cm apart and is used to grade stoney materials by size.**

5.2.3. Tools for soil haulage

Depending on the country, local resources and haulage distances, the following means are employed:

- wicker baskets;**
- hoppers carried on the back;**
- 2-man bamboo stretchers;**
- 40-60-litre wheelbarrows.**

For larger capacities and haulage distances (greater than 100 m), animal-drawn equipment is used, such as:

- pack saddle with a capacity of: 100-150 kg for an ox,
70-120 kg for a mule,
60-100 kg for a donkey,
120-150 kg for a camel;**

- single-axle cart with a capacity of: 400 kg for an ox, donkey or horse, and 1,000-1,200 kg for a pair of oxen;
- sledge with a capacity of 400 kg for 2 m² and 2,000 kg for 7 m²;
- shaft, piece of wood to each side of which the animals are harnessed.

Where animal haulage is not available, it may be necessary to use light mechanical haulage equipment: motor barrows, dumpers, etc.

Example of productivity

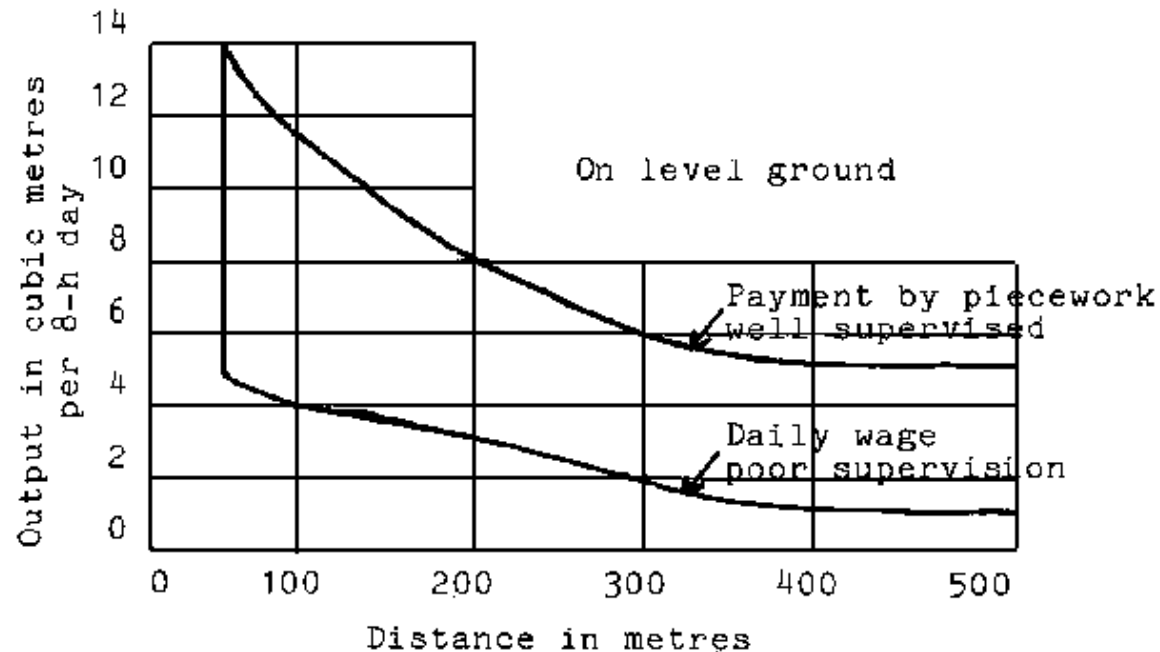

HAULAGE AND UNLOADING OF HOMOGENEOUS LOOSE MATERIALS (by ox cart)

The upper curve shows the outputs attainable with good organisation and supervision, with payment by piecework. The lower curve shows the outputs attained under poor supervision, with daily rated payment.

Mean cart capacity: 0.315 m³.

5.2.4. Tools for soil compacting

The simplest soil compacting tools are hand tampers manipulated by a single worker and pneumatic tampers also operated by a single worker and supplied with compressed air by a small motor compressor.

5.3. Manpower

Earth moving is ideal for the employment of large numbers of unskilled workers and meets perfectly the objectives of labour-intensive work in which manpower utilisation is a solution to the economic problems of a developing country.

However, there are conditions and limits for the use of manpower in this way, and the factors affecting working conditions and output include:

- climate;**
- workers' health;**
- nutritional status;**
- local customs which govern periods of work, job distribution, inacceptability of certain types of work (work with feet in water, etc.);**
- skill in the use of certain tools;**
- the conditions under which the project is being carried out;**
- the way in which workers are paid.**

The example below clearly illustrates the differences in output that can be expected depending on the level of organisation and supervision.

LOADING, HAULAGE AND UNLOADING HOMOGENEOUS LOOSE SOIL
(using buffalo-drawn bamboo scraper)

The soil is previously loosened by ploughing. The scraper can also be used for grading or spreading loose soil. Average output:

soil tipped in large piles (e.g. by a dump truck):	5 m ³ /hour
soil tipped in small piles (e.g. by a buffalo cart):	25 m ³ /hour
scraper maximum haulage capacity:	0.05 m ³

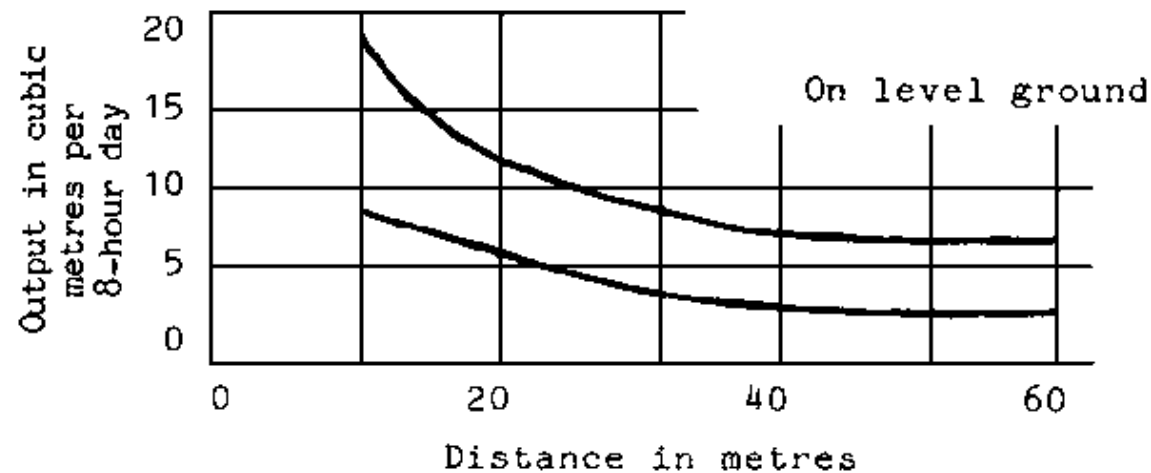

Figure

The upper curve shows the outputs that are obtainable with good organisation and supervision, with payment by piecework. The lower curve shows outputs attainable with poor supervision and daily rated payment.

The special factors affecting productivity include:

- age and condition of buffalo;**
- proximity of water for buffalo;**
- soil type;**
- slope of haulage route.**

5.4. Labour organisation

A manual earth-moving site comprises: a site supervisor, four men or gang leaders, labourers, water carriers where necessary, a topography team, a tallyman and a watchman for the equipment.

There is usually one gang leader for every 20-25 men depending on the difficulty of the work.

The basic gang comprises:

- either one man with a pickaxe and shovel;**
- or two men: one with a pickaxe and the other with a shovel;**
- or three men, with two pickaxes and a shovel for very hard ground, or one pickaxe and two shovels in softer ground.**

The way in which manpower is used may vary depending on the means employed. Either the earth moving can be done entirely by manpower or by manpower in combination with local resources such as animals or mechanical plant. The type of soil and haulage distances will often decide the solution to be employed. Where the haulage distances are large, it may be better to excavate and load by hand and haul mechanically. Certain work cannot be done by hand, such as subsoiling and ripping; manpower is a back-up here.

Finally, certain earth-moving jobs are suitable for piecework payment; this applies to

ditching and banking in particular.

5.5. Earth-moving methods and outputs

5.5.1. Trench digging and spoil removal

In very loose ground, trenches may be dug directly with a shovel; in harder ground, the soil is first loosened and then removed with a shovel; in hard ground, pickaxes, wedges or crowbars may be required.

The work may advance along the axis of the trench using two or three workers: the first loosens the soil with a pickaxe while the second (and third) follow and shovel out the spoil or deepen the trench. This is the procedure usually used for narrow trenches.

For wider trenches, the workers may be arranged in a line and work perpendicular to the trench axis.

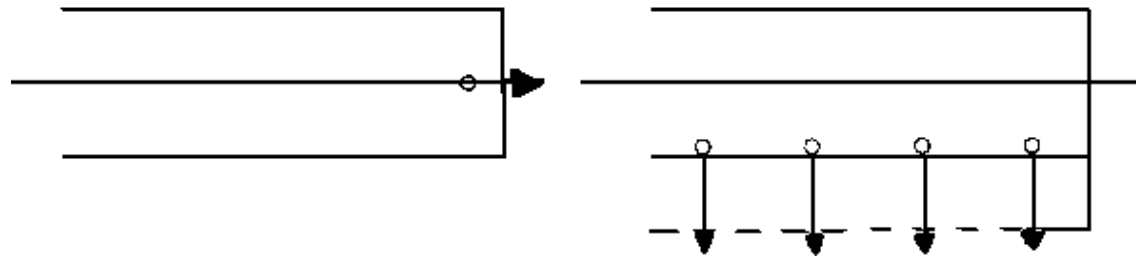

Fig. E.18.

Trench digging methods are shown in the diagrams below:

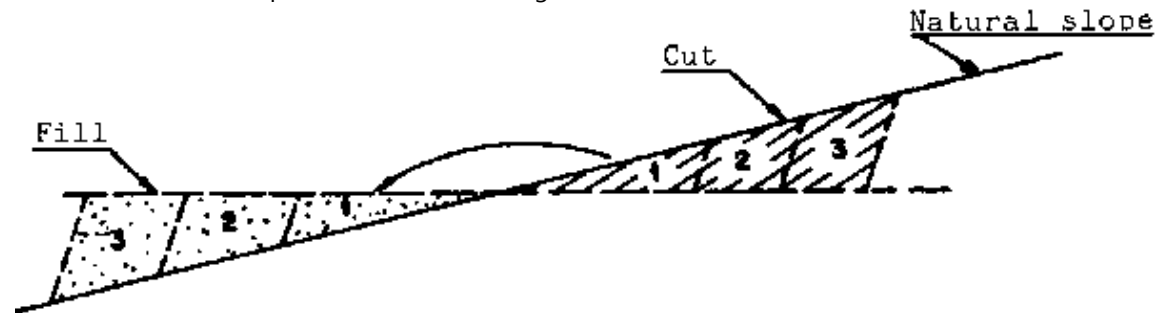
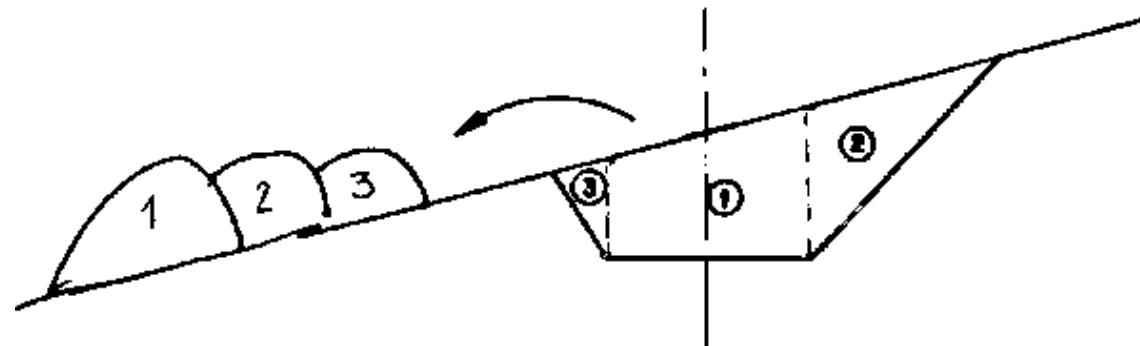

Fig. E.19: Terrace construction

Fig. E.20: Construction of a protection ditch

Deep trenches should be dug as follows:



Construction of a protection ditch with spoil thrown downhill

Output in earthworks varies considerably depending on soil characteristics and trench size.

Soil cohesion, density and adherence are the main factors influencing output; other factors such as soil water content may also play a role.

Cohesion is the measure of soil hardness and directly affects the output of the pickaxe man.

Density affects the shoveller's output.

Soil adherence to the tools affects the output of both pickaxe and shovel men.

Worker deployment also has a great effect on output. Workers should be sufficiently spread out (about 2 m apart) so that they do not get in each other's way.

Under optimal conditions, maximal output of workers using hand tools is as follows:

Fig. E.21: Output in manual earthworks

Type of soil	Daily output (m ³ /md)
Light soil	5.0-7.0
Ordinary soil	3.5-5.0
Heavy soil	2.5-3.5
Very heavy soil	1.0-2.5

In the case of narrow ditches, workers are hindered and output lowered by about 20 per cent if the trench is less than 1.20 m wide or over 2 m deep.

Some common outputs and the breakdown between digging and spoil removal are shown in fig. E.22.

Fig. E.22: Common values for output in trench digging

Soil type	Cubic metres excavated and thrown 1 m in an 8-hour day	Breakdown of 8-hour day	
		Excavation (hours)	Spoil removal pitching or loading (hours)
Topsoil (loam, sand,	3.0	5.0	3.0

etc.)			
Marly or clay soil, moderately compact	2.0	5.3	2.7
Hard, compact soil	1.5	5.7	2.3
Chalky soil	1.5	5.6	2.4
Waterlogged soil	1.0	5.8	2.2
Moderately hard laterite	1.0	6.7	1.3
Very hard laterite	0.8	7.0	1.0
Soft rock worked with pick or wedge	0.6	7.0	1.0

5.5.2. Loading and reworking spoil

A worker can throw a shovelful of earth 3-4 m horizontally or 1.5-1.6 m vertically.

A throw of a distance d and a height h is given by the equation:

$$d + 2h = 4 \text{ metres.}$$

When earth has to be thrown further than that of which a shoveller is capable, a relay may be established. When the earth is to be thrown horizontally, shovellers are placed in a line at intervals of 3-4 m. When the earth is to be thrown upwards, the shovellers are placed on successive steps at distances given by the equation $d + 2h = 4 \text{ m}$.

The output of a shoveller will vary depending on the density of the soil, the method used and the skill of the worker. It also varies depending on the loading height; it falls rapidly when this exceeds shoulder height.

Under optimal working conditions, the following maximum outputs can be expected:

Fig. E.23: Maximum shovelling output in loading or picking up soil

Type of operation	Hourly output in m ³ of bulked soil			
	Light soil	Ordinary soil	Heavy soil	Very heavy soil
Simple shovel throw	1.5-1.0	1.0-0.8	0.8-0.6	0.6-0.4
Loading a wheelbarrow	2.5-2.0	2.0-1.5	1.5-1.0	1.0-0.8
Loading a truck	2.0-1.5	1.5-1.0	1.0-0.8	0.6-0.4
Loading a cart	1.5-1.0	1.0-0.8	0.8-0.6	0.6-0.4
Loading a lorry	1.0-0.8	0.8-0.6	0.6-0.4	0.4-0.3

5.5.3. Spoil haulage

The main means of haulage are shown in section 4.2.

The simplest means are usually used for haulage distances of less than 100 m. The wheelbarrow is the most common and has a capacity of 40-60 litres. A wheelbarrow pusher can complete a return journey of 30 m in each direction whilst a shoveller is filling a 50-litre barrow.

Animals or mechanical equipment are used for haulage of more than 100 m. Animal haulage requires flat ground or the haulage should be downhill with the empty return being uphill.

The theoretical output for transport equipment is given by the formula:

$$R_t = \frac{1}{2} C_u \times V$$

in which: C_u is the payload capacity

in which C_u is the payload capacity

V is the haulage speed in km/h.

Fig. E.24 gives examples of theoretical outputs.

Fig. E.24: Theoretical output of various types of haulage equipment

Equipment	C_u (t)	V (km/h)	$R_1 = \frac{1}{2} C_u \times V$	Remarks
(a) Small haulage equipment				
Wheelbarrow, 50 l	0.075	3	0.12	
Cart - 1 horse, 750 l	1.125	3	1.7	
Cart - 2 horses, 1 500 l	2.250	3	3.4	
Motor barrow, 300 l	0.450	5	1.12	3 wheels, 3 hp
Small dumper, 350 l	0.525	5	1.3	4 wheels, 4 hp
Small dumper, 600 l	0.900	6	2.7	4 wheels, 8 hp

Wheelbarrow haulage: Output and gang composition for natural gradients of 0-5 per cent (good haulage track).

Fig. E.25.

Haulage distance (m)	Volume of material (m ³)		No. of workers			
	In situ	Bulked	Loading	Haulage	Spreading	Compaction
0-20	13.5	17.0	2.0	1.0	1.0	1.0
20-40	10.5	13.5	1.5	1.0	1.0	1.0
40-60	8.5	10.5	1.0	1.0	1.0	1.0

00-00	0.5	0.0	1.0	1.0	0.5	0.5
80-100	5.5	7.0	0.5	1.0	0.5	0.5

A buffalo-drawn steel scraper gives good results for loading, haulage and unloading of homogeneous loose soil for haulage distances of up to 100 m.

The diagram below shows mean outputs for the scraper which has a mean capacity of 0.075 m³ on flat ground.

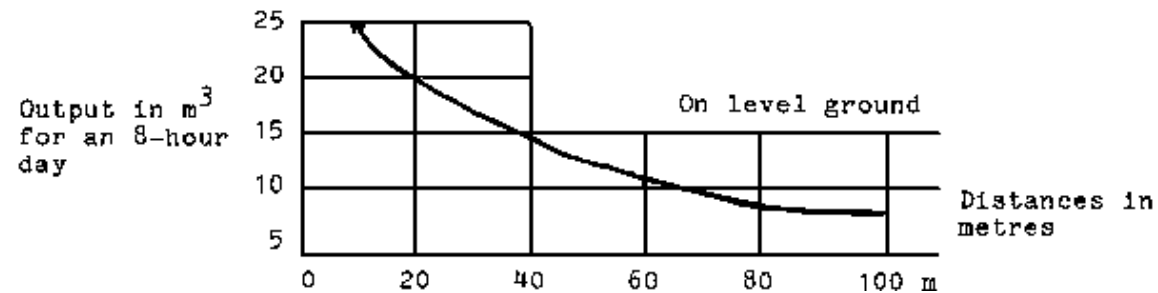

Figure

5.5.4. Unloading, spreading and compacting

After unloading, manual spreading can be carried out at a rate of 2-4 m³/h/man. The work varies however depending on whether the spoil is normal or compacted. Normal spoil is usually encountered in the type of soil conservation work described here, with the exception of fill for dams.

Ordinary spoil should be cleaned of mud, running soil, peat, sods, stumps and vegetable debris. It should be tipped over the total height of the dump, without being compacted.

Compacted soil should be prepared in the same way, then evened out in horizontal layers 15-25 cm thick over the total height of the platform. Since compacting is often inadequate on the edges of banks, the structure may be 20-40 m oversized on each side. Each layer should be dampened and then carefully compacted with hand tampers or drawn rollers to

the specifications laid down. Before each new layer is spread, the base should be scarified, then dampened. The gradient of the bank slope should be checked using a jig fitted with a spirit level.

Output for manual compacting is 1.2-1.5 m³/h using hand tampers and 10-15 times higher using a drawn roller.

5.5.5. Bank grading

The definitive gradient is given to the bank by cuts made with a pickaxe about every 10 m.

The slope is trimmed working from top to bottom.

Workers are placed along a horizontal line at intervals of about 1.5 m. The gradient is checked by stretching a line between two cuts.

5.6. Examples of earthworks

5.6.1. Construction of a canal or ditch

The various operations involved are as follows:

- (a) mark and stake out the canal;**
- (b) on the existing soil, stake the width of the ditch;**
- (c) run a line between the stakes and, using a pickaxe, mark the boundaries of the trench;**
- (d) excavate a trench with vertical sides to the finished depth of the ditch;**
- (e) dig a trench 30 cm wide with the planned shape of the ditch, every 5 m;**

- (f) stretch a line between these and mark out the edges of the ditch with a pickaxe;**
- (g) roughly dig out the banks;**
- (h) give final shape to the banks;**
- (i) check levels with a spirit level;**
- (j) check the cross-section with a jig.**

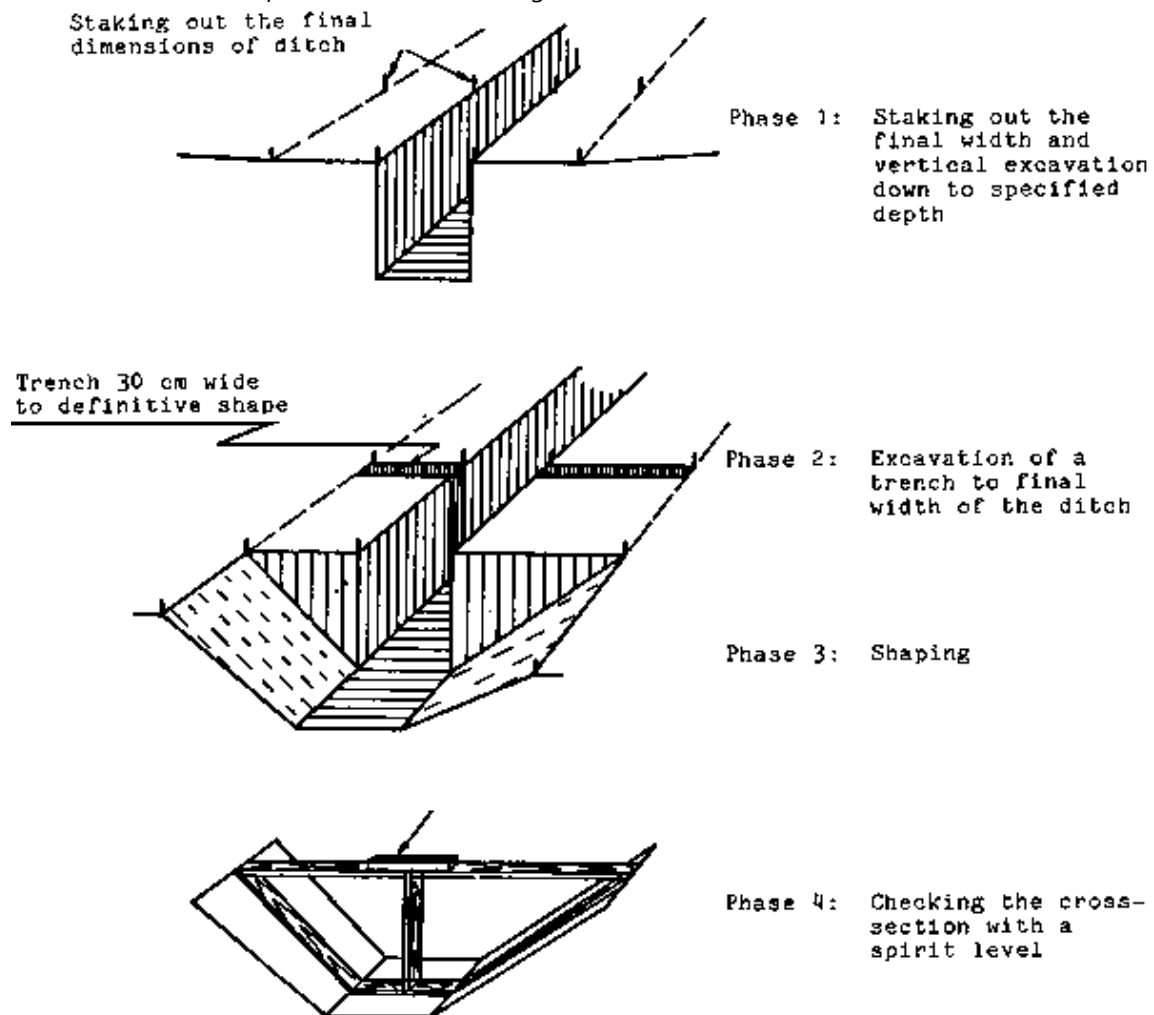

Fig. E.26: Ditch digging technique

5.6.2. Construction of earth dams

The various operations involved are as follows:

- set up site, mark out dam, additional reconnaissance;
- construction of a coffer dam for temporarily diverting the water course;
- strip vegetation and trees from basin;

- **prepare borrow zone;**
- **remove topsoil from foundation area;**
- **fill foundations to natural ground level;**
- **install take-off and emptying pipe;**
- **bring in filtration materials;**
- **install foot drains;**
- **fill;**
- **civil engineering work for take-off and feedback;**
- **civil engineering work for flood escape;**
- **cover banks;**
- **install hydraulic equipment;**
- **finishing work.**

E.6. IMPLEMENTATION OF REAFFORESTATION WORK

Reafforestation techniques have been described in Chapter B. Given below are the principle working methods and outputs.

6.1. Nursery work

This comprises:

- **nursery construction;**
- **seedbed construction;**
- **sowing in seedbeds, plant beds or pots;**
- **pricking out into plant beds or pots;**
- **watering;**
- **plant transport.**

The tools used are: hoes, pickaxes, spades, shovels, rakes, spirit levels, lines, stakes, watering cans, secateurs, polyethylene sachets, etc.

Nursery work requires large amounts of manpower. Work times depend mainly on the type of plants being grown and the type of care being given. A basis can be taken 0.3-0.6 hours per plant which, for various plant spacings, gives the following work times:

Plant spacing (m)	No. of plants/ha	Work times	
		Minimum days/ha	Maximum days/ha
3.0 × 3.0	1 100	47	94
2.5 × 2.5	1 600	68	136
2.0 × 2.5	2 000	86	172
2.0 × 2.0	2 500	107	214
1.5 × 2.0	3 300	141	282
1.5 × 1.5	4 400	188	376

6.2. Planting

Preparatory work includes marking out, staking out, clearing and soil preparation.

The tools used for planting are the same as those used in trenching, i.e. shovels, pickaxes, hoes, lines.

The basic gang comprises two workers: the first digs the planting hole, the second transports the young plants in pots, sacks or baskets, places them in the holes and completes the planting operation. In certain cases, a single worker may do the whole operation himself.

The workers advance in a more or less straight or diagonal line; the gang leader being slightly ahead of the rest. Other workers ensure a constant supply of materials.

Planting holes should be sufficiently wide and deep to take the whole root system without

crushing the roots against each other. Roots should not be bent in towards the centre of the hole, and should be fully covered with earth. To ensure the plant is covered to the right depth, hold it at the earth mark whilst the hole is filled with soil. Soil should be placed around the plant with care and trodden down when the hole is half full and then trodden down once again when the hole is completely full.

A foreman should follow up the line of planters to check a proportion of the plants to ensure that they are vertical and do not come out of the ground when pulled from the tip.

Under the best working conditions, when using hand tools, gangs can plant 100-500 trees in an 8-hour working day. This level of output will vary depending on the difficulties of the site (topography, density of vegetation cover, type of soil, soil preparation, etc.).

6.3. Construction of forest tracks

This comprises basically earth-moving work.

According to the FED productivity norms in Rwanda, forest track construction requires 7.6 hours of work per cubic metre of earth moved.

6.4. Plantation maintenance

Plantation maintenance requirements are considerable during the first two years (replacement of plants that do not take, weeding) and then decrease regularly thereafter.

Maximum output for weeding is 200-300 m² per man-day.

Clearing around young plants requires a man-day for 200 plants.

In Mohanda (Burundi), maintenance requirements for a plantation of 3,000 callitris plants/ha have been estimated at 0.3 h/plant, i.e. 128 7-hour working days per hectare per

year.

6.5. Examples of a plantation: planting along contour lines

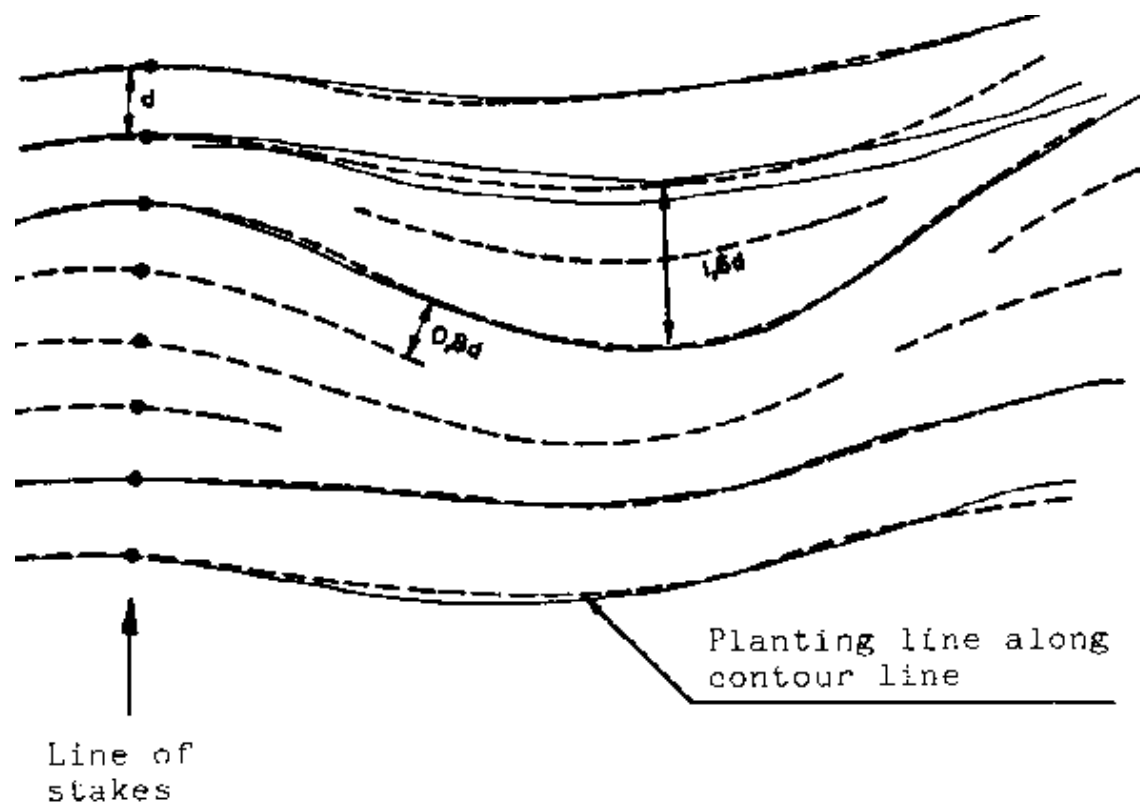

Fig. E.27: Planting along contour lines

With an interval d between plants, a line of stakes is inserted perpendicular to the slope and spaced at d from each other.

A first row of trees is planted along the contour line using a spirit level d in length.

Subsequent rows are planted in a similar manner; however, when the distance between the trees is less than $0.8 d$, a new row is started.

When the distance between rows is 1.6 d or more, an additional row should be inserted until the space between the rows falls to 0.8 d.



Planting in an arid zone. Arrangement designed to concentrate surface run-off

6.6. Productivity norms

Manpower requirements in man-days/ha with a density of 2,500 plants/ha, covering nursery work, planting and maintenance: ranging from 272 to 478 man-days in Burundi.

Some typical outputs (Rwanda):

- filling sachets: 0.03 man-days per plant;
- pricking out sachets: 0.01-0.02 man-days per plant;
- planting: 100 plants per 7-hour day;

- hole digging and planting: 300 plants per man-day;
- holing: number of holes per man-day
 - in rocky soil: 24-30
 - in stony soil: 30-45
 - in deep soil: 40-50

- plant care: 200 per man-day, i.e. 300-400 m²;

- creating a windbreak by direct sowing: 24 man-days for 100 m comprising staking out, tilling, sowing, mulching, separation, three thinning outs, separation or natural regeneration followed by thinning out;

- creating a windbreak by planting: 22 man-days for 100 m for plants in three rows and a spacing of 2 m.

E.7. IMPLEMENTATION OF DRAINAGE WORKS

7.1. Installation of a drainage network

The collectors are marked out in the same way as the ditches.

The drains which are grouped in parallel lines can be marked out as follows:

- mark out the first drain in relation to fixed reference points;**
- mark out a line perpendicular to the first drain, and this is staked out at distances equal to the drain spacing;**
- mark out a second perpendicular line which is staked out in the same way as the first;**

- trace a line between the points staked out on the perpendiculars, marking on this line the specified drain length;
- stake out the whole drain network with stakes every 30 m or so.

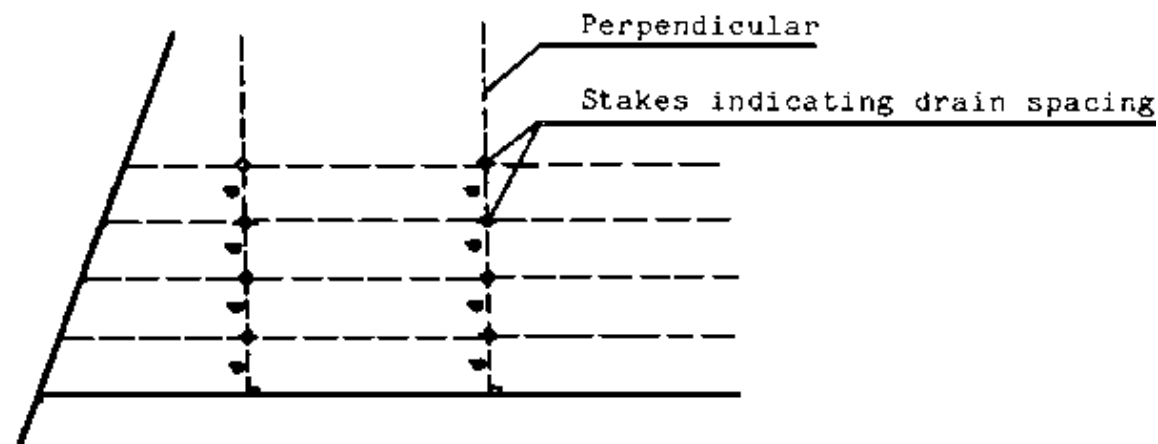

Fig. E.28: Installation of a drain network

7.2. Tracing out total trench width

Drainage trenches intended for laying of underdrains vary in width between 0.30 and 0.70 m at ground level and 0.06 and 0.20 m at the base.

The trench is marked out on the ground by a line of pickets.

A line between the pickets marks the trench axis; along this a groove is marked with a pickaxe.

The line is subsequently moved sideways to the external limit of the trench and a second groove is marked along this line.

The line itself is a 30-m length of string attached at each end to a wooden stake.

7.3. Calculating trench depth

The mean depth and the minimal drain gradient are known.

The level is obtained using a dumpy level.

A 20-cm wooden stake is hammered into soil level approximately every 50 m if there is no rapid change in gradient.

A surveyor's staff is placed alongside each stake.

The elevation of each stake is noted from a single surveying point.

The depth of the trench is then calculated whilst maintaining a relatively uniform slope, and the relevant depth is written on each marker.

7.4. Trench digging

The tools used may vary slightly depending on the country. In general, the following are used for manual trenching:

- an ordinary garden spade for removing the sod and the topsoil layer;**
- a fork and pickaxe for excavating the top layer of stony soil;**
- a draining spade which has a blade 40-50 cm in length and 10-15 cm in width, arranged in direct prolongation of the shaft. The long edges of the blade are curved slightly inwards;**
- a scraper which is used to finish the trench bottom and produce the correct slope. It is made from a piece of curved metal 30-35 cm in length, shaped and sharpened at the end. The shaft is 2-3 m in length and is at 40-50° to the blade. Blade diameter**

should be matched to the diameter of the drainage pipe.

It is necessary to start digging the drain at the lowest point, working uphill so that any excess water will drain away as the work advances.

Fig. E.29: Digging a drainage trench

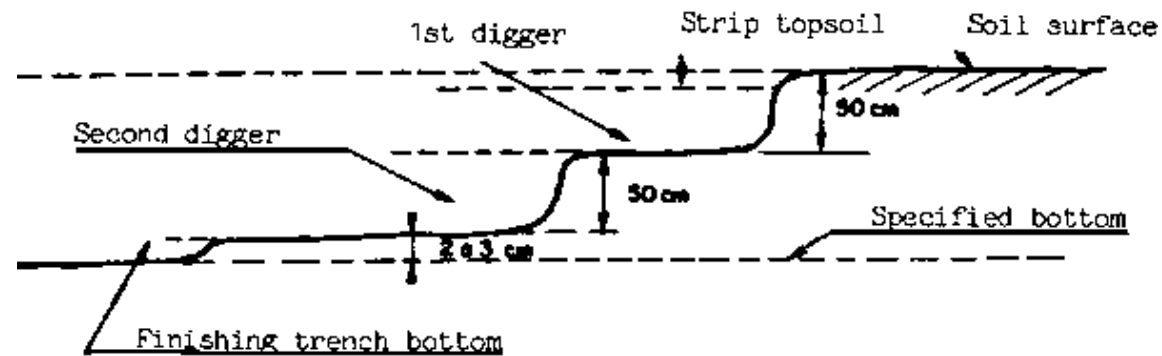

Longitudinal cross-section

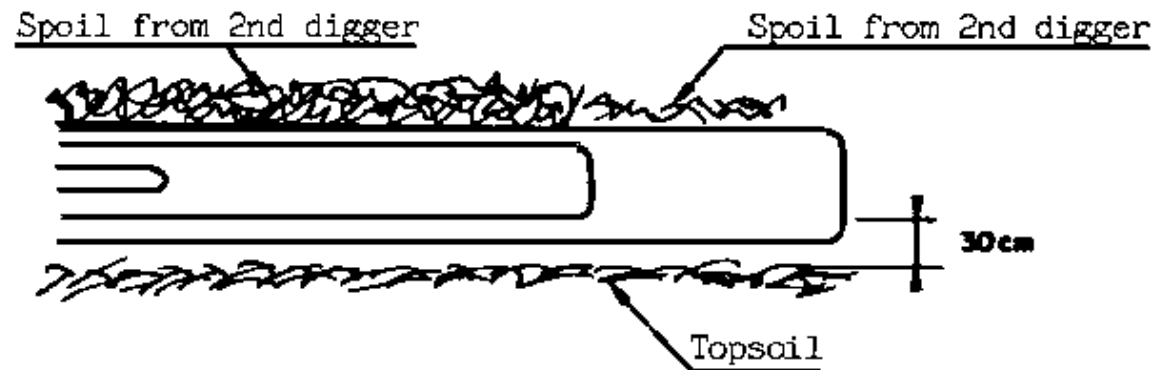

Plan view

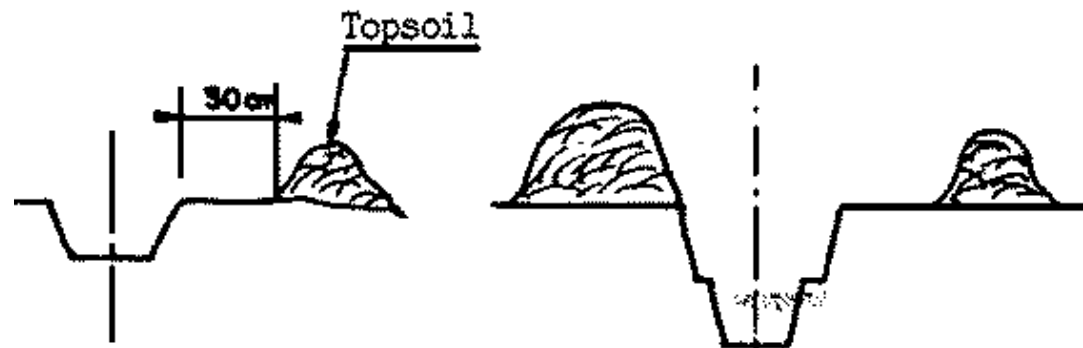

Transverse cross-section

The first digger cuts up the sod and removes the topsoil. This topsoil is placed on the right of the trench about 30 cm from the trench edge leaving a pathway for the pipe layer. This topsoil is the first to be used when the trench is backfilled.

The trench is then dug with a draining spade to a depth of approximately 50 cm. The spoil is thrown onto the left bank of the trench.

The second digger works approximately 3 m behind the first digger. He deepens the trench but to a smaller width and throws his spoil onto the left bank of the trench. He digs the trench an additional 50 cm approximately. If necessary, the trench is further deepened by a third digger who works in the same way as the second.

The trench obtained in this way will be slightly shallower than that specified for the drain.

7.5. Trimming the trench bottom

For this operation one uses the scraper and wooden or steel staffs on which are mounted adjustable rectangular crosspieces ("boning rods").

The object here is to dig the trench to the depth marked on the markers and to connect these points by a uniform gradient.

Using the scraper, the trench bottom is smoothed and compacted to receive the drainage pipe.

The trimming process is shown diagrammatically below:

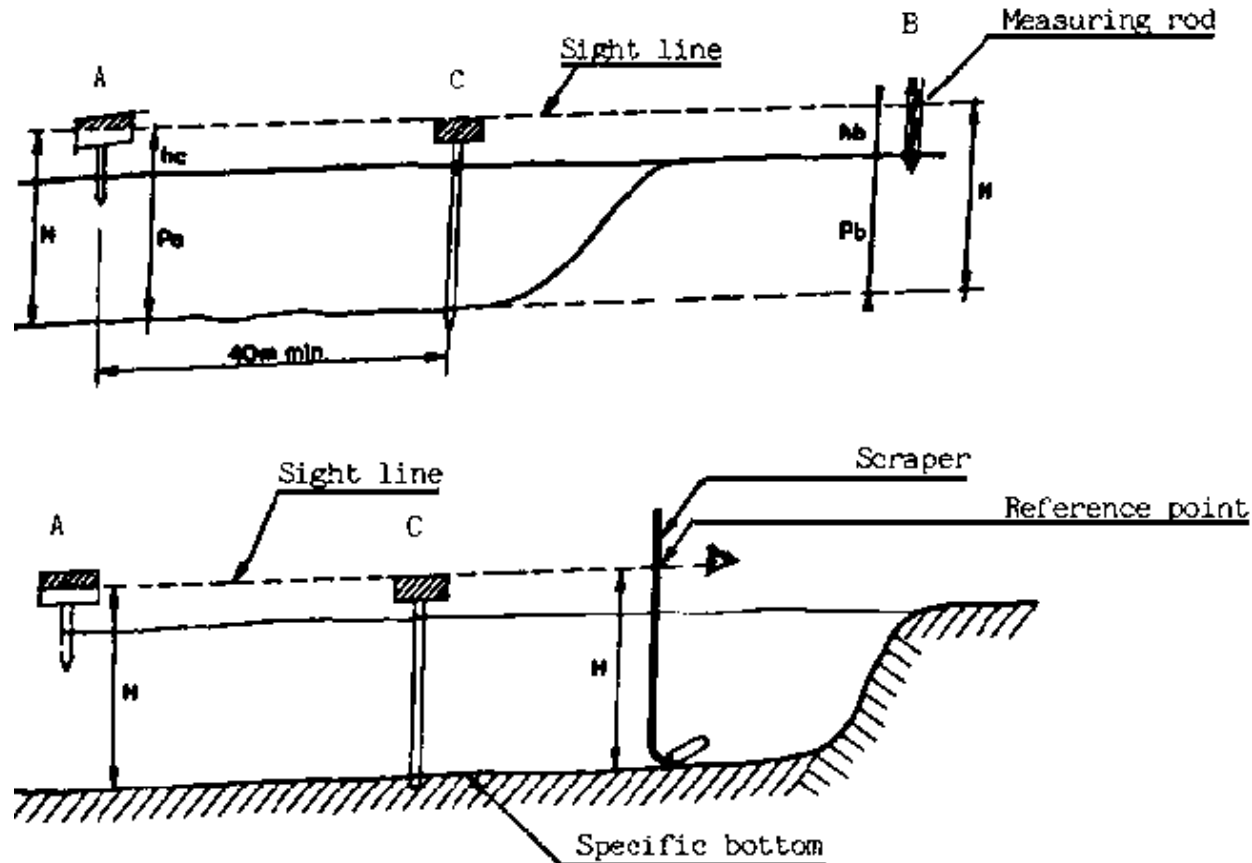

Fig. E.30: Trimming a trench bottom

At point A marked by a stake, where the depth P_a of the trench is known, one places a fixed boning rod adjusted to height h_a above the ground. The height of the boning rod above the bottom of the trench is equal to $P_a + h_a = H$.

At point B where the depth P_b of the trench is also known, one places a marker at a height h_b above the ground so that $h_b + P_b = H$.

At point C, one places a marker of a length such that it will form a sight line between A, C and B.

To trim the trench depth, the worker uses the scraper on which a mark has been drawn at height H.

The correct trench depth is reached when a sight line is established between the mark on the scraper shaft and the crosspieces A and C.

On flat ground, checking the gradient is more difficult and it is preferable to have the work done by a topography survey team comprising an operator and two assistants.

7.6. Drain laying and backfilling the trench

The tools used for laying earthenware or concrete pipes are:

- a long-handled tile hook to pick up the pipe and lay it in the trench bottom;**
- a steel pick hammer for cutting or holing the pipes when being laid.**

The drainpipes are brought to the site on a trailer or on stretchers. They are placed in piles of 30-35 pipes every 10 m or so and at a distance of 3-4 m from the trench.

The pipes are laid starting at the highest point. The pipe layer picks them up with the tile hook and places them on the trench bottom, striking them sharply several times on the edge with the iron hook to seat them together properly.

When it is necessary to turn the pipes round a curve, this is done by cutting the pipes at an angle with the pick hammer.

When placing together drainpipes of different diameters, the joints are covered with earthenware crocks.

Long drains (6 m) are put together outside the ditch and then laid in whole sections on the trench bottom.

Long concertina-type PVC drains are not designed for manual laying and are laid directly on the trench bottom by drainage machines. In certain countries, these machines have almost entirely replaced manual labour. They do not come within the framework of this report on labour-intensive public works. It should merely be noted that there are two types:

- machines which dig the trench;**
- machines which dig the trench and also lay the drainage pipes.**

The trench is backfilled first by covering the drainpipe with topsoil which was laid separately alongside the trench. Subsequently, backfilling is carried out by shovel using the remainder of the spoil and then lightly compacting.

Fig. E.31: Main drainage tools

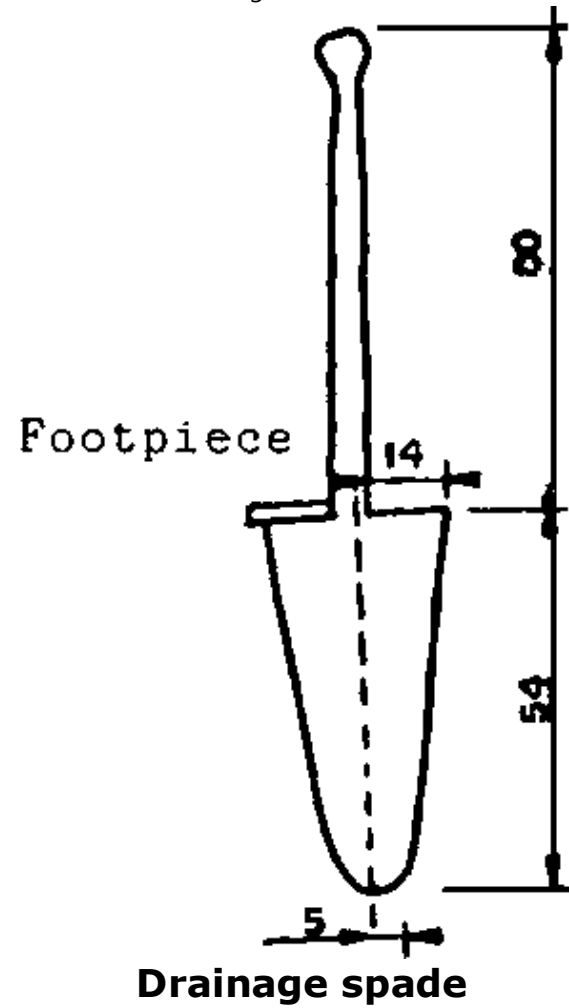

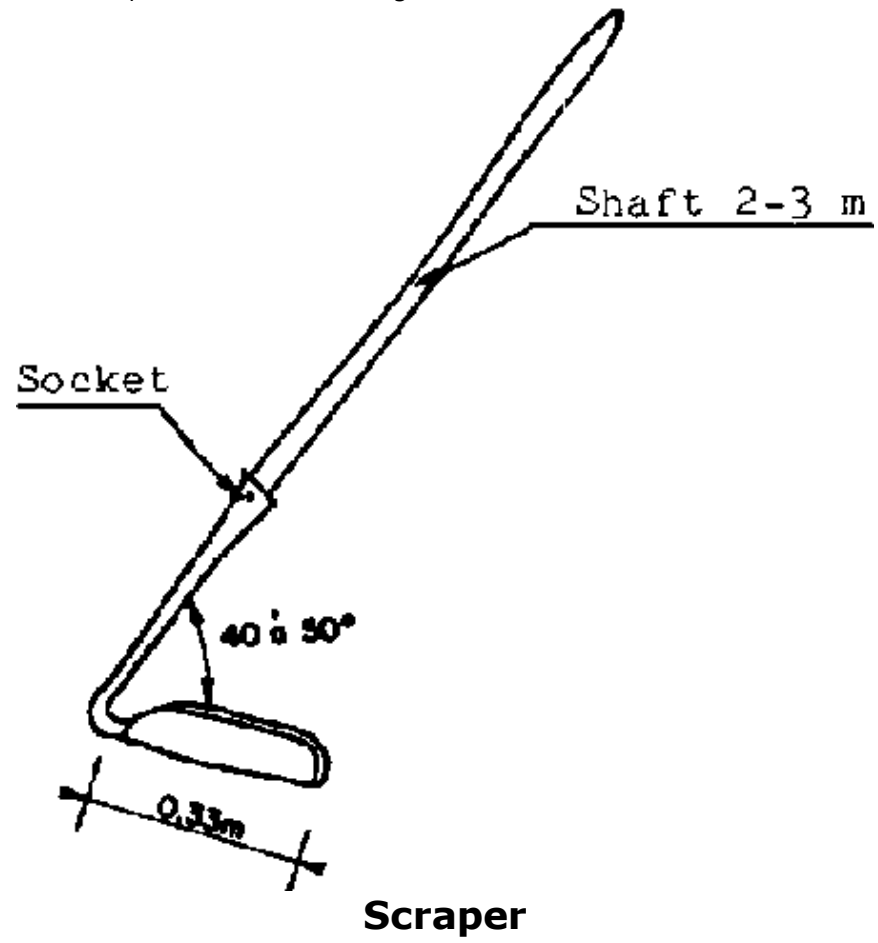



Tile hook

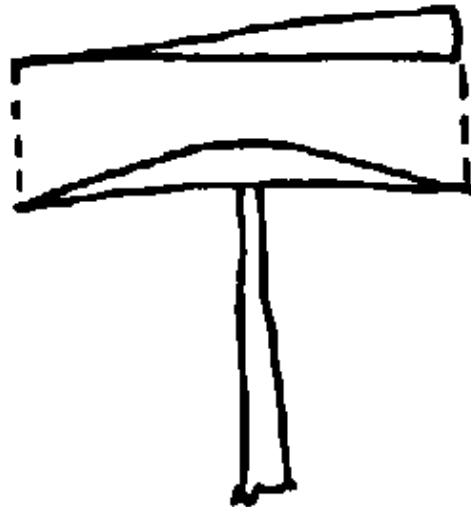

Pick hammer

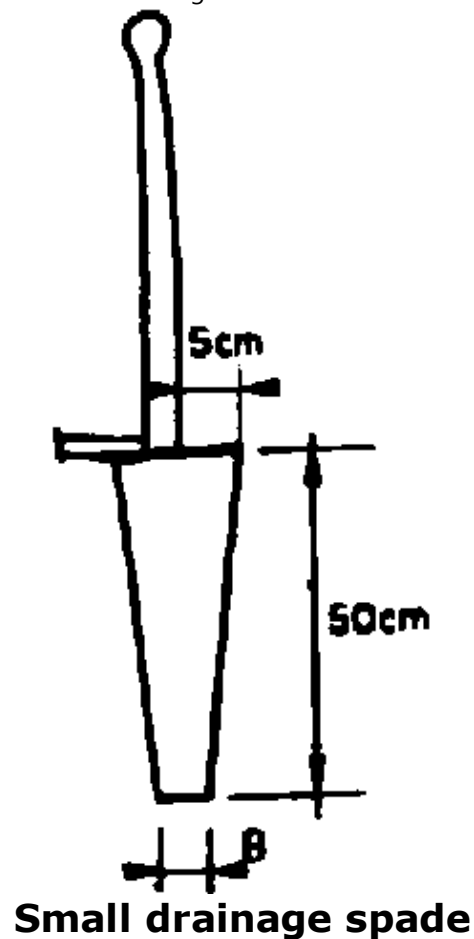

Small drainage spade

7.7. Manpower and output in manual drainage work

A drainage site usually comprises:

- a skilled site supervisor and 4-8 workers whose jobs are divided up as follows:
 - earthworks: 2-4 workers depending on the trench depth;
 - pipe transport: 1 worker;
 - pipe unloading: 1 worker;
 - pipe laying: 1 worker;

- backfilling the trench: 1 or 2 workers.

Under very good conditions (loose earth), a good drainage worker can advance 6-8 m of ordinary 0.8 m depth trench per hour.

Under these conditions, a gang comprising a site supervisor and four diggers can lay 250 m of drain per day. Output of only half this may nevertheless be considered normal.

E.8. CONSTRUCTION OF MASONRY WORK

8.1. Different types of masonry work

The term masonry work covers all types of structures made from stone-Masonry work is used in soil conservation projects for the construction of gully or ravine erosion protection work when the necessary materials are found in adequate quantity close to the site.

One may distinguish between three types of masonry work:

- dry-stone masonry work in which stones are fitted together without binder;**
- normal masonry work in which the gaps between the stones are filled with cement or lime mortar;**
- gabion masonry work in which the stones are held together in a metal mesh cage.**

8.2. Dry-stone masonry work

When they are subject to the action of water, dry-stone facings should be made of blocks of a sufficient weight to resist the action of the current.

Stone size may be calculated on the basis of current speed using, for example, IZBASH's formula:

$$V_{\max} = 0.6 \sqrt{2g \frac{P_s - P}{P} \Delta}$$

in which:

V_{\max} is the maximum current speed at high water

Δ is the rock diameter

g is the acceleration of gravity (9-81 m/s²)

$\frac{P_s - P}{P}$ = density of the material under water. P

In principle, the thickness of the dry-stone facing should be at least 30 cm. When stones are placed on erodable material, it is necessary to place between the stones and the bank a filter made up of a gravel bed of 10-20 cm in thickness.

Mean output for stone breaking by hammer may be estimated as follows:

Mean dimension after breaking	Approx. mean output per man-day of 8 hours
135 mm	1,40 m ³
50 mm	0,80 m ³
45 mm	0,75 m ³
40 mm	0,70 m ³
30 mm	0,55 m ³
11 mm	0,10 m ³

The method of constructing dry-stone facings is as follows:

- **shape and compact the bank;**
- **place the stones by laying them perpendicular to the bank surface so that their greatest length is in the thickness of the facing;**
- **insertion of larger stones, called headers, which are anchored at a depth of approximately 20 cm into the bank, at a distance of one every m^2 .**

Stones should be fitted together with the minimum of voids; if necessary, these voids can be filled with stone fragments.

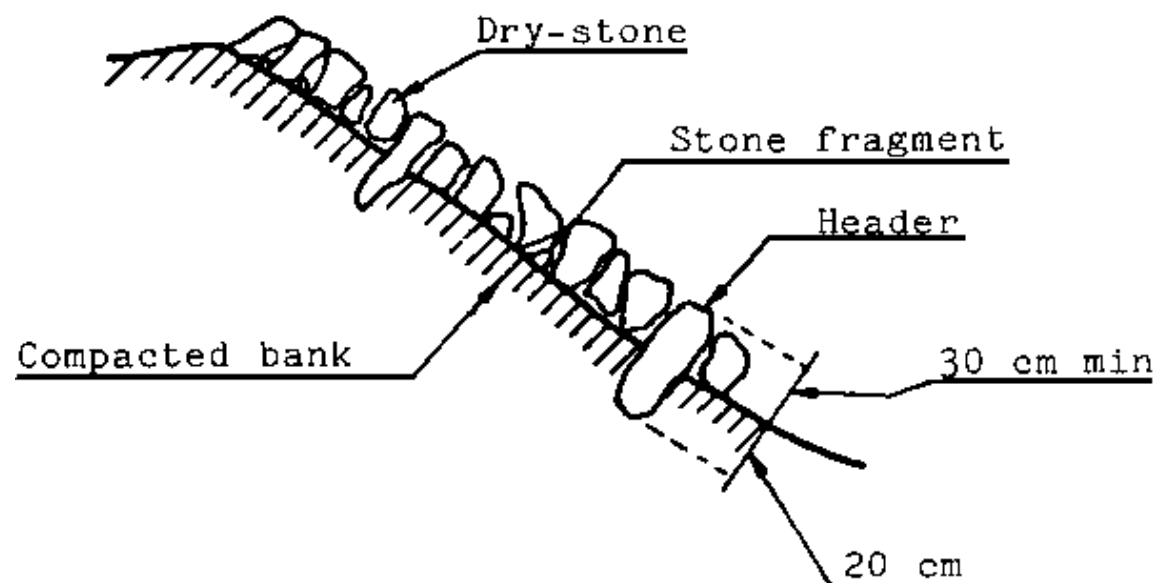

Fig. E.32: Construction of a dry-stone facing

The table below shows the number of man-hours required per m^2 of dry-stone facing constructed manually at thicknesses of 15 and 20 cm.

Material	Man-hours per m^2	
	15 cm thick	20 cm thick

Brick	0.55	0.60
Sandstone/limestone	0.60	0.65
Granite	0.65	0.75

These figures presuppose that the stones, in the required sizes, have been supplied from a quarry in the immediate vicinity of the site.

8.3. Normal masonry work

The stone used for this type of work may be natural stone of 20-40 cm in the largest plane or cut stone of various dimensions. Stone cutting is specialised work and cut stones are used only rarely.

The stones are bound together with cement mortar when the structure is exposed to running water.

The outputs given below presuppose that the materials are brought to the immediate vicinity of the site.

Wall thickness in cm	Mean thickness of stones	
	15 cm	30 cm
30	5 mh/m ²	4.0 mh/m ²
60	7 mh/m ²	5.5 mh/m ²
90	10 mh/m ²	8.0 mh/m ²

It can be taken that the time required per square metre is divided equally between the mason and the labourer.

For a mortar-bonded wall, it is also necessary to take into account:

- manual mixing of cement or lime mortar: 8.5 man-hours per m³;
- mortar jointing as the work advances: 1.0 man-hours per m².

Approximate quantity of mortar required:

Thickness of wall in cm	Mean thickness of stones	
	15 cm	30 cm
30	0.07 m ³	0.05 m ³
60	13.00 m ³	10.00 m ³
90	20.00 m ³	15.00 m ³

The cement content of a mortar is as follows: 350-400 kg of cement per cubic metre of dry sand. If the sand is very fine and made up of grains of less than 0.5 mm, the quantity of cement should increase by 20-25 per cent.

The amount of mixing water (in litres) should be 25 per cent of the weight of the cement plus 6 per cent of the weight of the sand, i.e. 220 litres of water for mortar containing 350 kg of cement/m³ sand and 238 litres of water for a mortar containing 450 kg cement/m³ sand.

Mortar is checked by modelling it by hand. The ball of mortar should be firm and plastic, not stick to the skin and, when dropped from a height of 20 cm, should not fracture.

Constructing a mortar-bonded wall comprises the following operations:

- construction of concrete footings at the base of the structure (ordinary concrete for

small structures, steel reinforced concrete for larger structures);

- **laying stones on a thick layer of mortar (bed of mortar);**
- **settling the bricks against each other by striking them with a hammer and filling the voids with stone fragments without moving the larger stones;**
- **laying headers 40 cm long at intervals of approximately 1 m² to ensure a good bond with the bank;**
- **cleaning the joints by removing mortar runs;**
- **pointing; in which the joints are cleaned to a depth of 3 cm before the mortar sets, and then finishing them with a fine sand mortar with a cement content of 600 kg cement/m³ sand.**

8.4. Gabion masonry work

Characteristics

Gabions are boxes made out of metal mesh filled with carefully aligned stones

A distinction is made between: cage gabions (1 m high) used for the main body work of structures; and footing gabions (0.50 m high) used for the body work of foundations which may be subject to deformation.

Fig. E.33: Common sizes of gabions

Type	Length (m)	Width (m)	Height (m)	Weight (mesh 120-100) in kg
Footing gabions	2	1	0.50	9.8

	3	1	0.50	14.0
	4	1	0.50	18.2
	5	1	0.50	22.4
	6	1	0.50	26.6
Cage gabions	2	1	1	14.0
	3	1	1	19.6
	4	1	1	25.2
	5	1	1	30.8
	6	1	1	36.4



Weir made from gabions and dry-stone work (Cape Verde)

The gabion walls are made of galvanised steel wire, with a double twist hexagonal mesh. The most common mesh sizes are 100 × 120 mm. When using mesh of this size, the size of

the smallest filling stones should be at least 180 mm, and the weight of the stones around 5-10 kg.

To ensure that the gabions do not lose their shape when stacked, adjacent sides are held together by steel wire.

Method of manufacturing a stone-filled gabion (cf. fig. E.34)

- (a) the wire mesh is cut to shape and laid out flat;**
- (b) the walls are folded in to form a box and the edges are tied together;**
- (c) the gabion is located in its final position;**
- (d) the edges are bound to the adjacent gabion;**
- (e) the bottom is anchored to the ground using steel stakes rammed into the soil;**
- (f) the stone filling is commenced;**
- (g) fit in the Internal trusses;**
- (h) continuation of filling whilst adjusting the internal trusses as and when necessary;**
- (i) closing the cover and tying the upper edges together with those of the adjacent gabion.**

The tools required include:

- wire cutters;**
- pliers;**

- jumper bar or steel stake;
- wooden blocks to wedge the stones;
- a sledgehammer to drive home the jumper bar.



Wire mesh cut and laid out flat



Fold walls to form a box open at the top



Tie edges together



Detail of a wire truss



Fill with stones



Fill centre of gabion with small stones if not sufficient large stones



Using a jumper bar align the sides

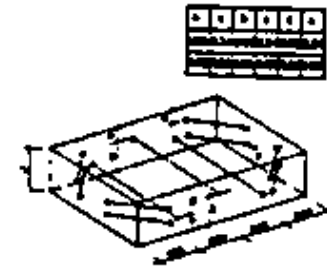

Diagram of trusses

Trusses

Gabion 4x1x0.50

Plan



Elevation



Gabion 0.5 m high used for footings

Trusses

Gabion 4x1x1

Plan

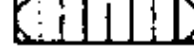

Elevation



Gabions 1 m high used for the main body of the structure on the footing or foundation

Gabion 2x1x1

Plan

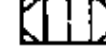

Elevation

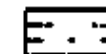



Tying the cover



Tying the edge of the cover with adjacent gabions

Size (cm)	Weight (kg)	Unit weight (kg/m ²)
100 x 100	100	100
150 x 150	225	225
200 x 200	400	400
250 x 250	625	625
300 x 300	900	900
350 x 350	1225	1225
400 x 400	1600	1600
450 x 450	2025	2025
500 x 500	2500	2500
550 x 550	3025	3025
600 x 600	3600	3600
650 x 650	4225	4225
700 x 700	4900	4900
750 x 750	5625	5625
800 x 800	6400	6400
850 x 850	7225	7225
900 x 900	8100	8100
950 x 950	9025	9025
1000 x 1000	10000	10000

Unit weight

Fig. E.34: Assembly and installation of wire mesh gabions

Gabions can be installed using unskilled labour and they meet perfectly the objectives of labour-intensive projects.

Weir in stone masonry



Front view

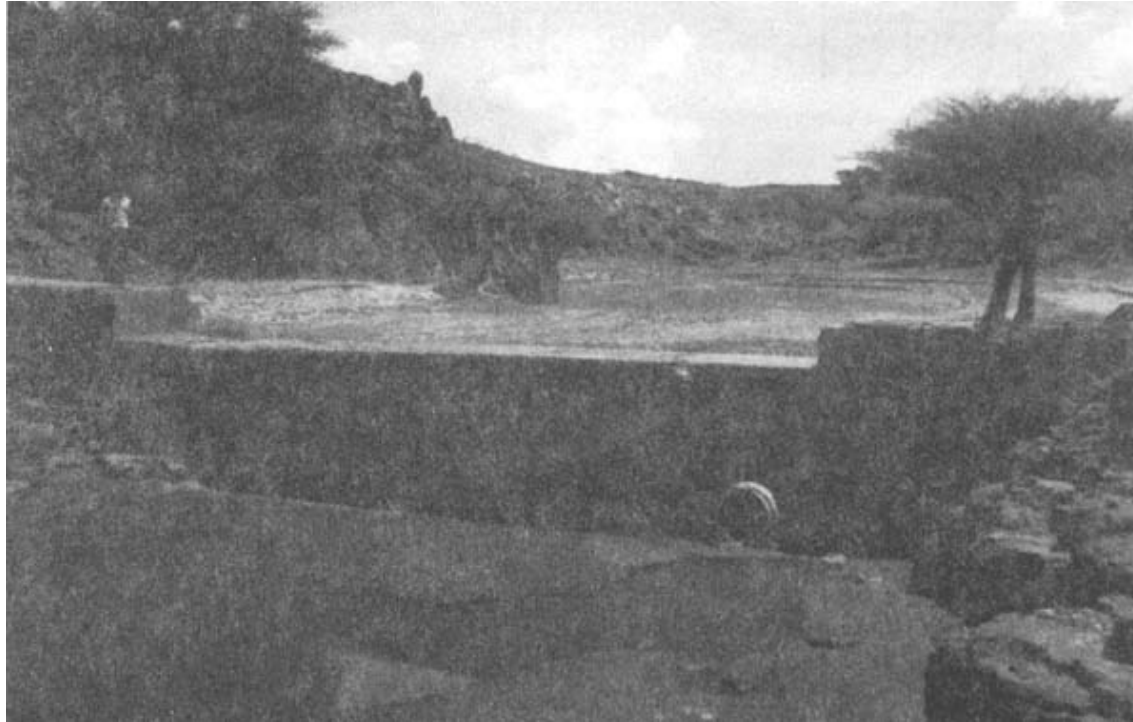

Detail

E.9. CARRYING OUT CONCRETE WORK

9.1. Characteristics of concretes

Concrete is obtained by mixing sand and gravel (called aggregates) with cement and water which act as the binder.

There are numerous categories of concrete:

- lean concrete with a cement content of 250 kg cement per cubic metre of aggregate;**

- **rich concrete with a cement content of 450-600 kg of cement per cubic metre of aggregate;**
- **normal concrete with a cement content of 350 kg cement per cubic metre of aggregate.**

To obtain good quality concrete, it is necessary to use suitable aggregates and to avoid the use of friable materials, reduce voids to the minimum and ensure good adhesion between aggregates.

The choice of materials plays an important role in concrete quality.

The aggregates should be correctly graded with components of various dimensions to minimise the size of voids. It is advisable to use well-known quarries where the aggregates are always produced using the same materials and under the same conditions.

The sand should be sharp.

The water should be clear, odourless and contain less than 2 g/l of dissolved salts. Water containing organic matter or sulphates which attack ordinary cement should be avoided.

9.2. Concrete preparation

A simple mix (by volume) for a batch of concrete is as follows:

- **a 50 kg sack of cement;**
- **two 70-l barrow loads of gravel;**
- **a 70-l barrow load of sand;**
- **20-30 l of water depending on the ambient temperature.**

Another way of proportioning concrete constituents is to use bottomless crates with a

known capacity. A crate 60 cm on each side and 28 cm deep will have a capacity of 0.1 m³.

Concrete should normally be mixed in a concrete mixer. The aggregate is shovelled in first, followed by the cement; the mixture is first turned dry and then water is added. Mixing lasts two minutes and should produce a homogeneous concrete.

Lower category concretes can be mixed by hand in small quantities.

On small sites, the concrete is usually transported to the placement site by wheelbarrow. The time between mixing and placing should not exceed 20 minutes in moderately warm weather.

The concrete should not be dropped from a height during placing since this may cause segregation of aggregates. When it is placed in wooden shuttering, the latter should be clean, watertight and wetted prior to placing. When a large height of concrete is to be placed, it should be poured in successive layers.

The concrete should then be compacted by tamping, rodding or vibration to improve its consolidation. Compacting can be done by hand tampers and this is suitable for shallow layers (20 cm).

Rodding is carried out by thrusting a steel rod into the placed concrete.

Vibration is the most effective procedure; it is carried out using a compressor and a vibrating needle.

Once the concrete has been placed, after-care is required for around two weeks to ensure that the water does not vaporise too rapidly; this is called curing. After-care may be carried out by covering the concrete with a curing agent or with constantly moistened sacking, etc.

Shuttering may be removed after 21 days of drying.

9.3. Shuttering

These are moulds, usually made from wood, in which the steel reinforcement is placed and the concrete is poured. They must be constructed robustly and be suitable for their task.

Usually planks of 2-3 cm thickness are used and the distance of the reinforcement rods between themselves and from the walls of the shuttering should be sufficient to allow the correct placement of the concrete and leave a free space of at least the maximum size of the aggregate.

A distinction is made between the ordinary shuttering which is used for parts of the structure which are underground or not visible, and high-quality shuttering used for exterior walls.

9.4. Steel reinforcement

The main purpose of the steel reinforcement in reinforced steel concrete is to accept the tensile stresses to which the concrete may be subjected. The strength of a reinforced steel concrete structure depends not only on the quality of the concrete but also on the correct layout of the steel reinforcement bars.

Two categories of reinforcement bar are usually used:

- smooth mild steel bars:

limit of elasticity: $2,400 \text{ kg/cm}^2$;

maximum permissible working load: $1,600 \text{ kg/cm}^2$;

relatively poor adherence;

- high-adherence steel bars:

limit of elasticity: 4,200 kg/cm²;

maximum working load: 2,800 kg/cm².

Since high-adherence steel bars are scarcely more expensive than plain round bars whilst they are 75 per cent stronger, it is advisable to use the former in the majority of cases.

A reinforcement plan designed for high-adherence steel bars should under no circumstances be carried out with plain round bars.

Steel bar reinforcement is prepared in the following phases:

- the steel rods are cut to the lengths required by the reinforcement plan;**
- loose rust is removed by means of a wire brush;**
- the rods are bent to shape on a bending bench:**
 - the individual rods are assembled using annealed steel wire and the assembled components are labelled.**

Bending radii (R) of steel rods should not exceed the following values:

mild steel plain round rods $R = 3 \varnothing$

high-adherence steel $R = 5 \varnothing$

boxes, hoops, hairpins in mild steel $R = 2 \varnothing$

9.5. Installing the reinforcement bars

The main concern in installing reinforcement bars is to ensure maintenance of the distances between the steel and the shuttering walls. Steel reinforcement too close to the wall is poorly protected against corrosion. The bars oxidise and this results in blistering which may spall the wall.

To ensure that the distances between the rods and the shuttering walls are maintained during concrete placement, use is made of concrete wedges. Since these wedges are embedded in the concrete, they must be rot resistant.

Steel reinforcement sections awaiting installation

Steel reinforcement which is left on the site awaiting installation is likely to be bent and then unbent, intentionally or otherwise. This is likely to cause fissures in the rods, especially those of high-adherence steel which is relatively brittle. Consequently, it is advisable to have such reinforcements made from mild steel.

Storage of reinforcements

Steel reinforcements should be stored away from moisture.

For prolonged storage, it is necessary to avoid contact with the soil. Ensure that during storage rods of different diameters and different strengths are not mixed up, which may result in subsequent errors on the site.



[Home](#) > [ar](#).[cn](#).[de](#).[en](#).[es](#).[fr](#).[id](#).[it](#).[ph](#).[po](#).[ru](#).[sw](#)

 **Special Public Works Programmes - SPWP - Soil Conservation - Project Design and Implementation Using Labour Intensive Techniques (ILO - UNDP, 1982, 220 p.)**

 **APPENDICES**

 ***(introduction...)***

 **I. STANDARD PLANS**

 **II. BIBLIOGRAPHY**



Special Public Works Programmes - SPWP - Soil Conservation - Project Design and Implementation Using Labour Intensive Techniques (ILO - UNDP, 1982, 220 p.)

APPENDICES

APPENDIX I

I. STANDARD PLANS

Title	Standard Plan No.
Planting techniques	1-2-3
Diversion network	4
Standard terrace cross-sections	5-6-7-8
Protection ditch	9
Ridges	10
Progressively constructed terraces	11
Bench terraces	12

Grassed channels	13
Bank stabilisation	14-15-16-17
Bank protection	18-19
Gully correction	20-21-22-23
Stone dams	24
Weir	25-26-27
Small earth dam	28
Drainage techniques	29-30-31-32

PLANTING TECHNIQUES

SOIL PREPARATION FOR PLANTING IN ARID ZONES

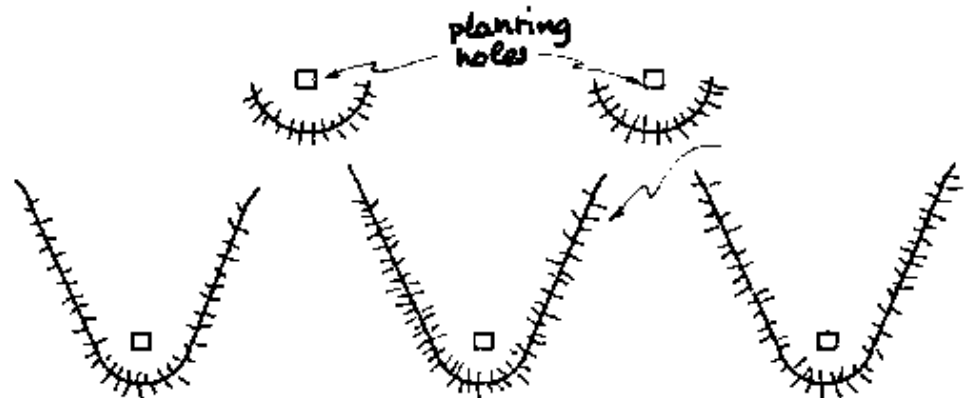
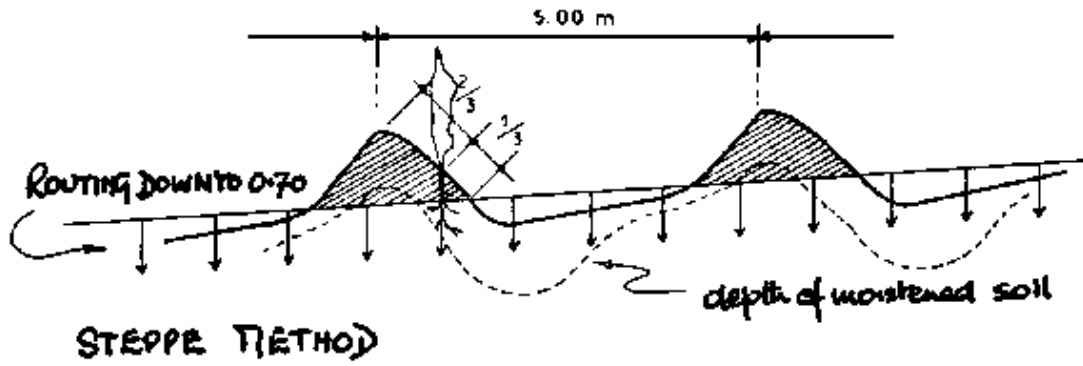
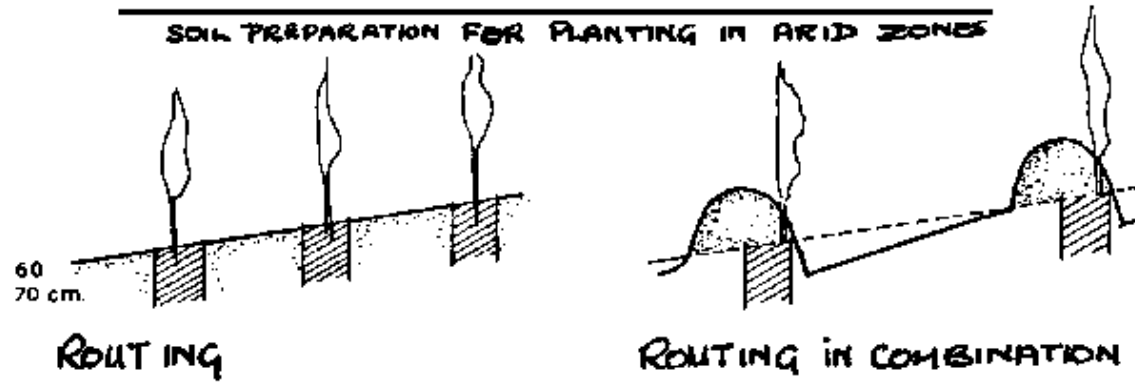

**SPIDER'S LEGS
STANDARD PLAN 1**

PLANTING TECHNIQUES

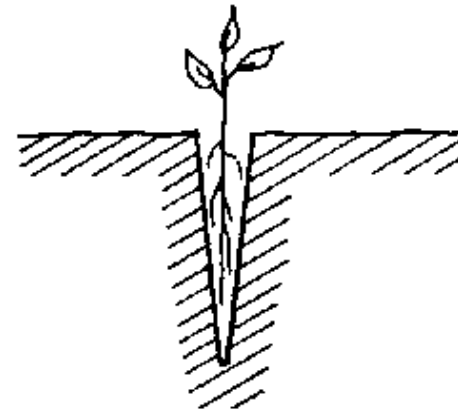
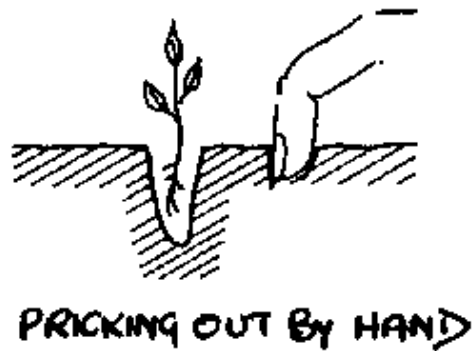
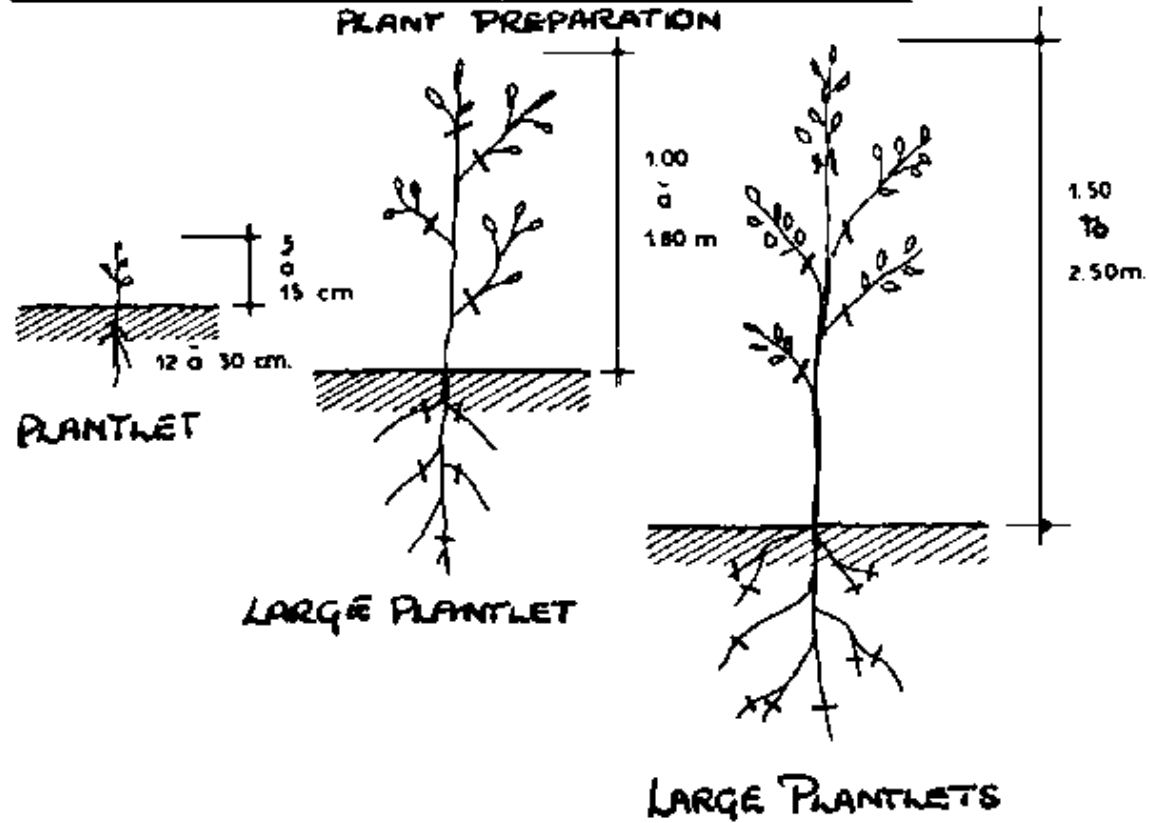

PRICKING OUT WITH A DIBBER STANDARD PLAN 2

PLANTING TECHNIQUES

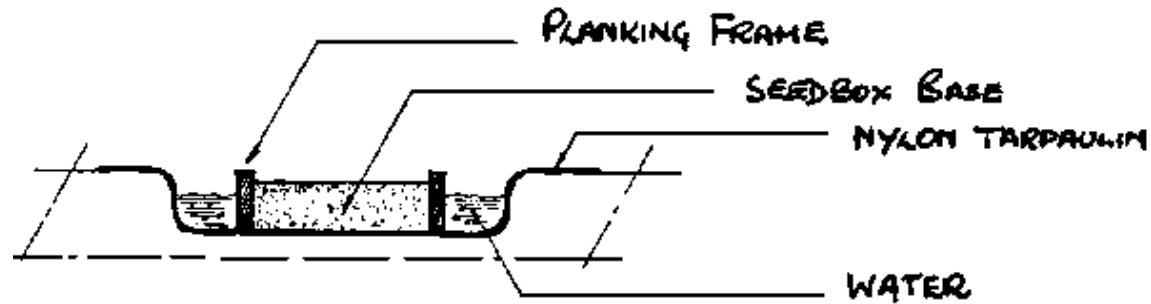

SEEDBED IRRIGATED BY SOAKING

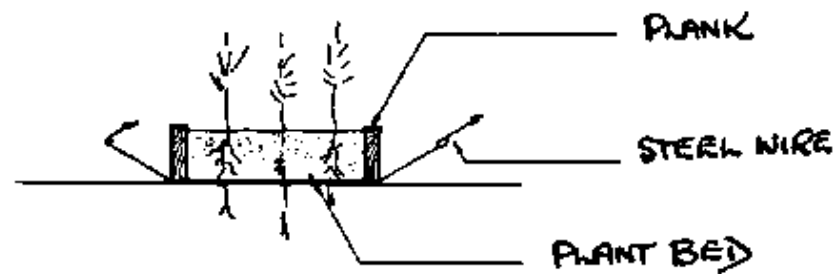

SWANLAND METHOD



DRILL BOARD

STANDARD PLAN 3

DIVERSION NETWORK

DIAGRAM

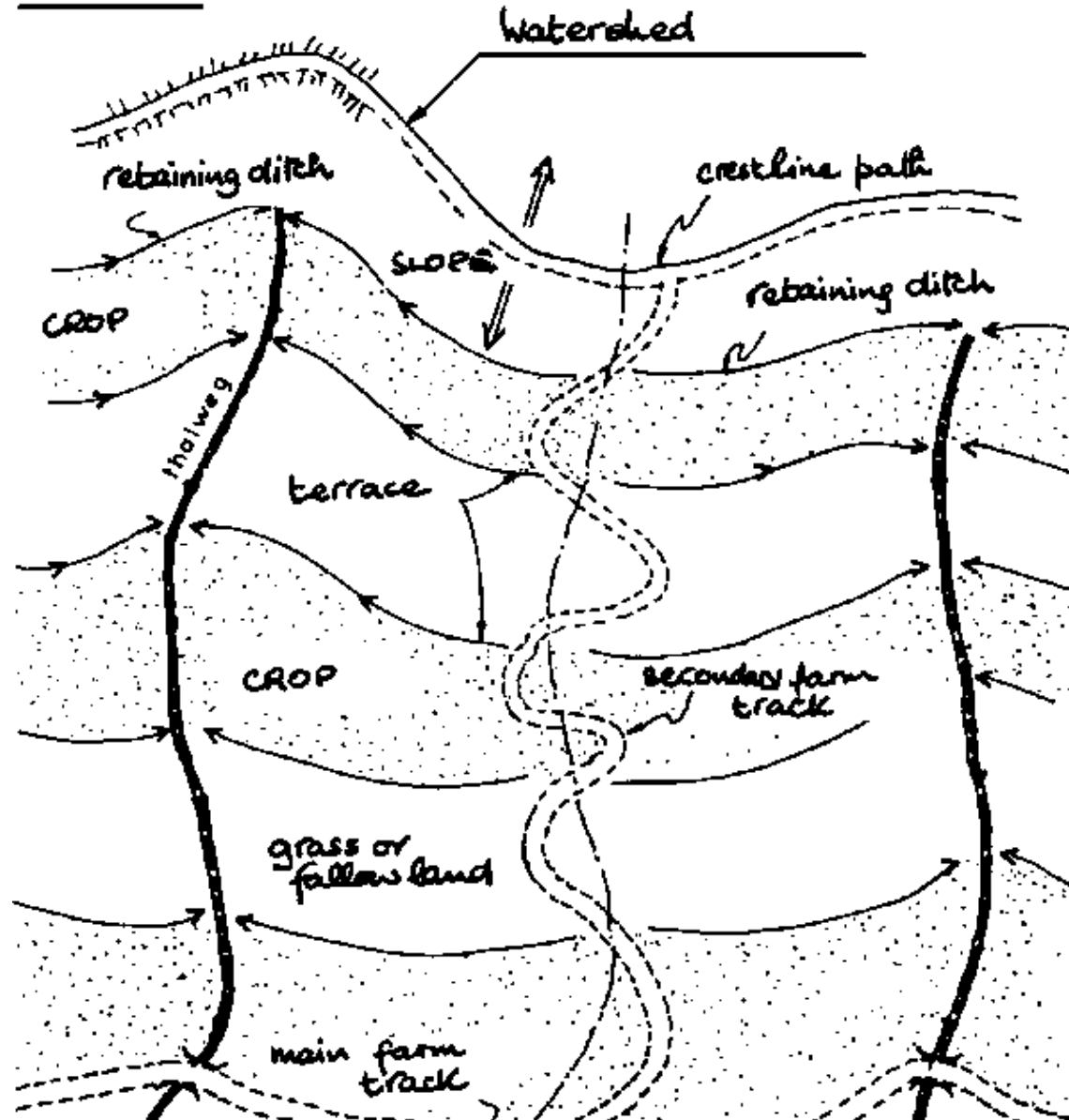

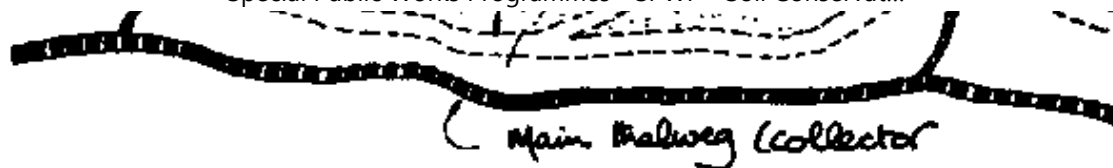

STANDARD PLAN 4

STANDARD TERRACE CROSS-SECTIONS

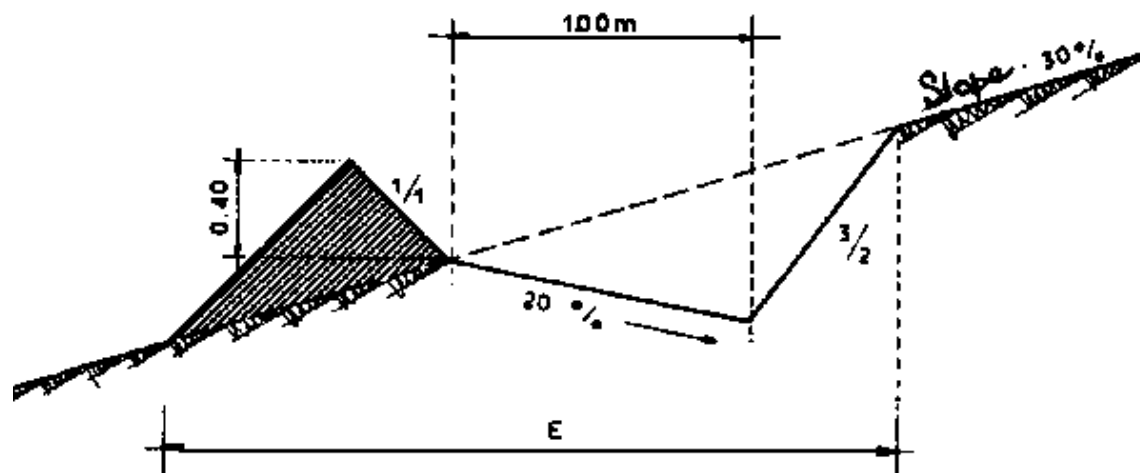

FOREST TERRACE

Slope %	Excavated cross-section m. ²	Effective height m.	Effective cross-section m. ²	Total width m.
20	0.27	0.30	0.54	2.60
30	0.35	0.30	0.51	2.80
50	0.39	0.30	0.51	2.95

STANDARD PLAN 5

STANDARD TERRACE CROSS-SECTIONS

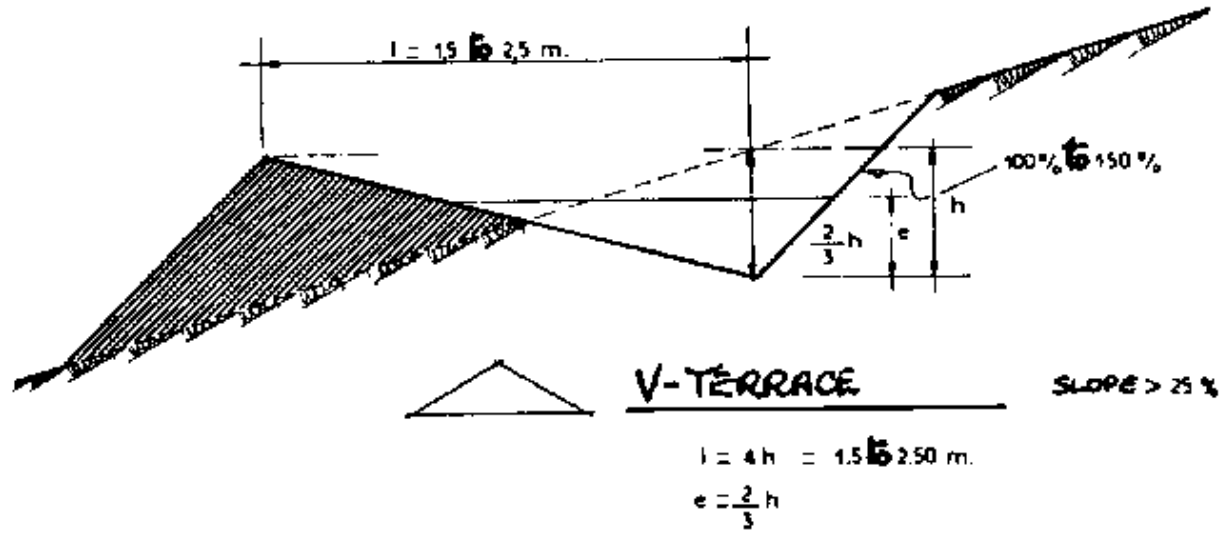

NORMAL-SECTION TERRACE "Algerian" terrace type

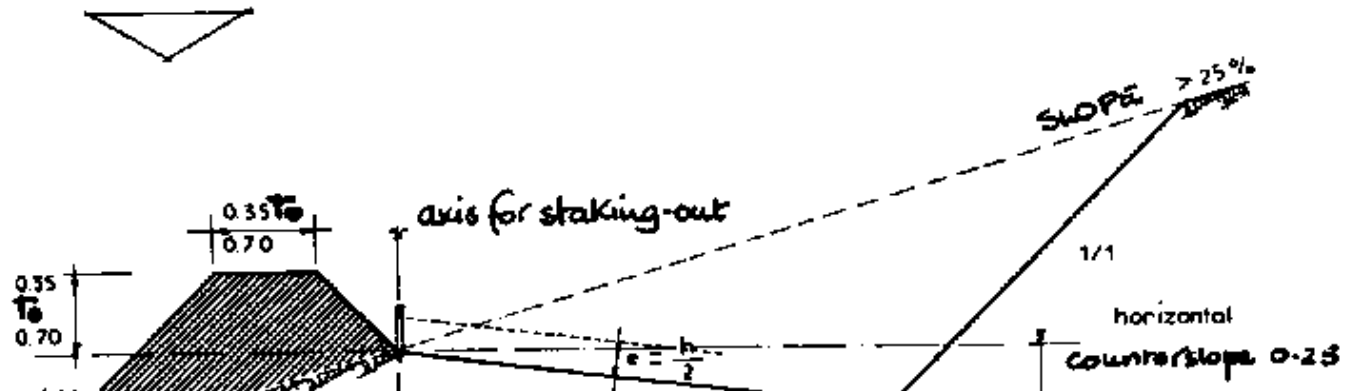

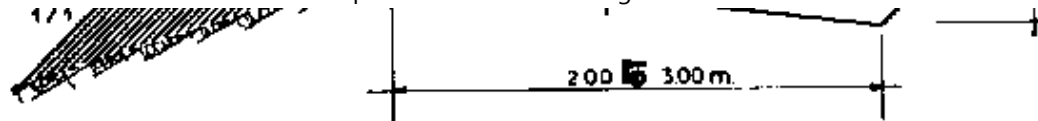

STANDARD PLAN 6

STANDARD TERRACE CROSS-SECTIONS

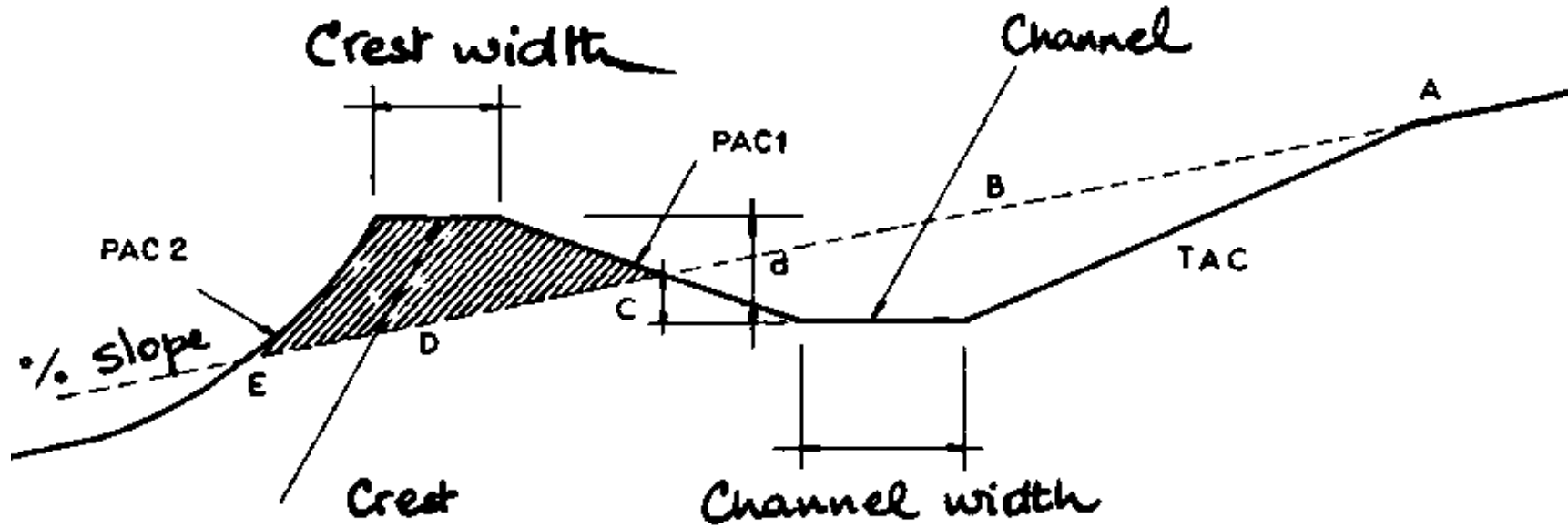

CONVENTIONAL CROPPING TERRACE

(USA)

Example of a table for calculating the dimensions of a

UNDESIGNED CHANNEL

Length in m Field slope%	Channel dimensions					Mean gradients		
	Crest height required (in mm)					TAC b/h	PAC1 b/h	PAC2 b/h
	60	120	180	240	300			
1 to 2	0,24	0,27	0,30	0,36	0,36	10/1	10/1	10/1
3	0,21	0,27	0,30	0,33	0,36	6/1	8/1	8/1
4 to 5	0,21	0,27	0,30	0,33	0,33	6/1	8/1	8/1
6	0,21	0,24	0,27	0,30	0,30	6/1	8/1	8/1
7 to 8	0,21	0,24	0,27	0,30	0,30	4/1	6/1	6/1
10	0,18	0,24	0,27	0,30	0,30	4/1	6/1	6/1
11	0,18	0,24	0,27	0,30	0,30	4/1	4/1	5/1
12 to 13	0,18	0,24	0,27	0,30	0,30	4/1	4/1	4/1
14	0,18	0,24	0,27	0,30	0,30	4/1	4/1	3/1
15	0,18	0,21	0,27	0,30	0,30	4/1	4/1	2,5/1

STANDARD PLAN 7

STANDARD TERRACE CROSS-SECTIONS

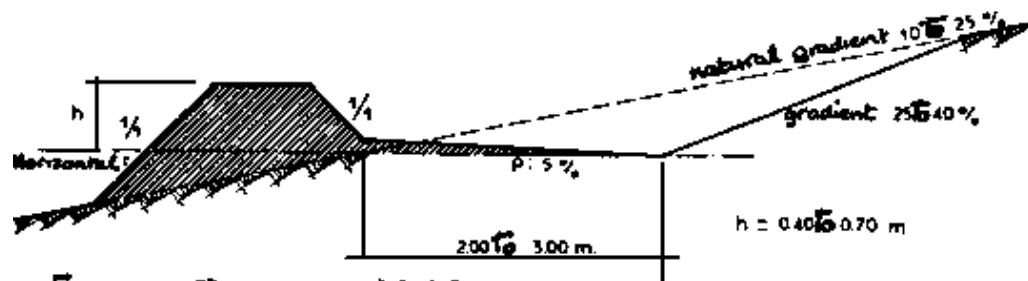

FLATTENED-HUMP TERRACE

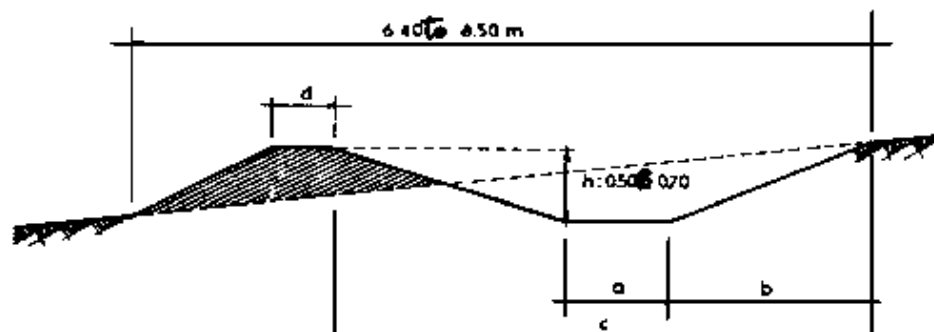

CHANNEL-TYPE FLATTENED CROSS-SECTION TERRACE (COPPING TERRACE)

land gradient	size in metres					Total width m	Cut-off (Elevation) m	Usable height m	Usable section m
	a	b	c	d	h				
4 to 6%	1.50	2.00	6.00	0.50	0.60	8.50	1.03	0.50	1.75
6 to 10%	1.00	2.00	5.30	0.60	0.70	7.50	0.95	0.60	1.80
10 to 14%	0.	2.20	5.00	0.40	0.80	6.40	0.85	0.70	1.60

STANDARD PLAN 8

PROTECTION DITCH

STANDARD CROSS-SECTION OF ALGERIAN TYPE

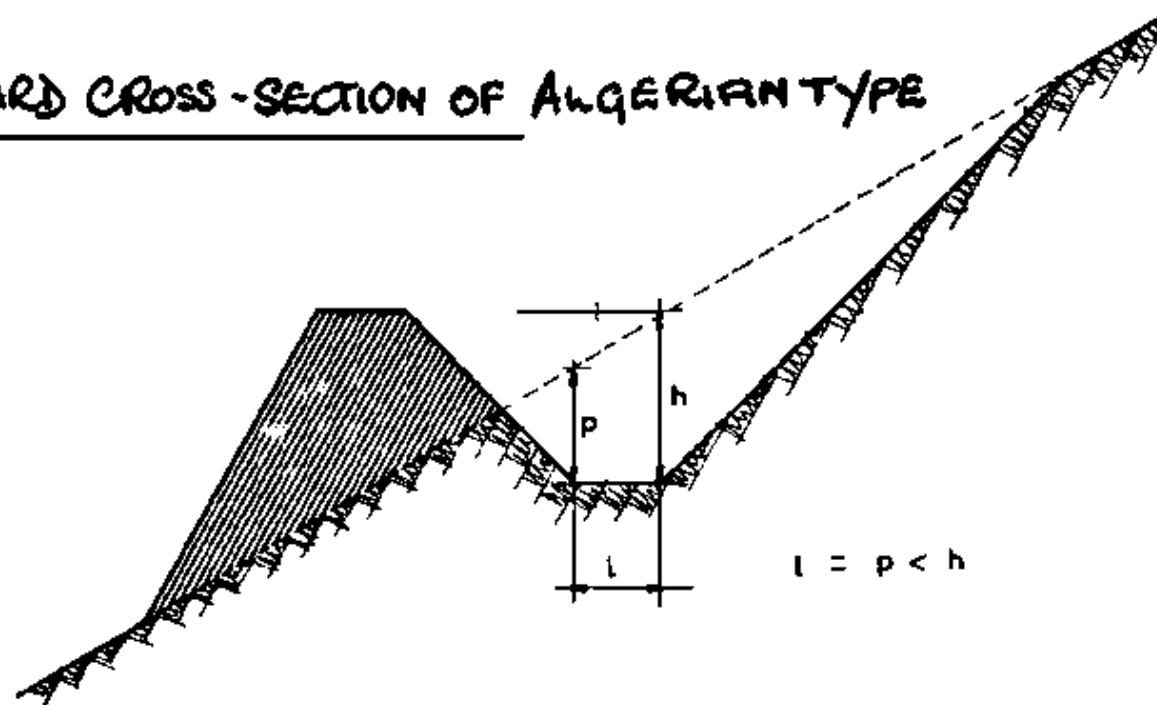

DITCH CHARACTERISTICS

$p = l$ for

Type of soil	run-off coefficient	surface area of catchment basin above ditch (hectares)									
		1	2	3	4	5	6	7	8	9	10
Rocky, clayey	1	0.50	0.76	0.85	1.00	1.10	1.20	1.30	1.40	1.50	1.60
Bare, fallow land	0.9	0.50	0.65	0.80	0.95	1.05	1.15	1.25	1.35	1.40	1.50
Ploughed grassland	0.8	0.45	0.65	0.75	0.90	1.02	1.10	1.20	1.25	1.35	1.45
Bushy grassland	0.7	0.40	0.60	0.70	0.85	0.95	1.00	1.10	1.20	1.30	1.40
Well wooded land or protected by walls	0.6	0.35	0.50	0.65	0.75	0.80	0.90	1.00	1.05	1.15	1.25

of terraces											
longitudinal gradient of ditch	1	0.5	0.4	0.3	0.2	0.2	0.15	0.15	0.15	0.15	

STANDARD PLAN 9

RIDGES

RIDGES (ALGERIA)

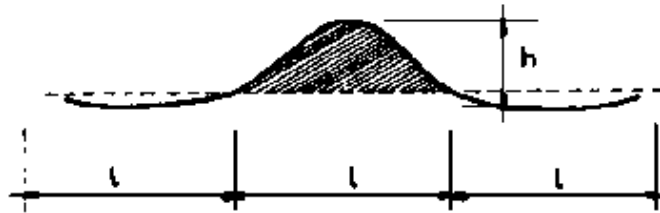

$h = 1.00 \text{ to } 2.00 \text{ m}$
 $L = 3.00 \text{ to } 5.00 \text{ m}$

RIDGES FOR STEPPE-TYPE FOREST PLANTING



$l = \text{base width}$
 $h = 0.70 \text{ m}$

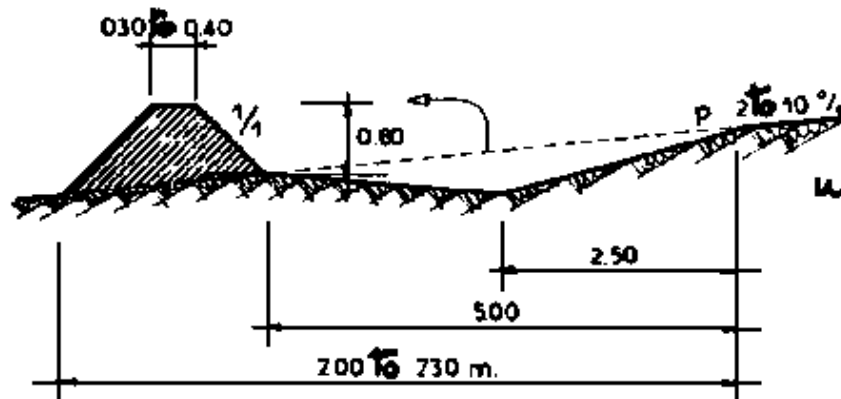

TABIA

usable width 3.6 m to 4.4 m

TABIA TERRACE

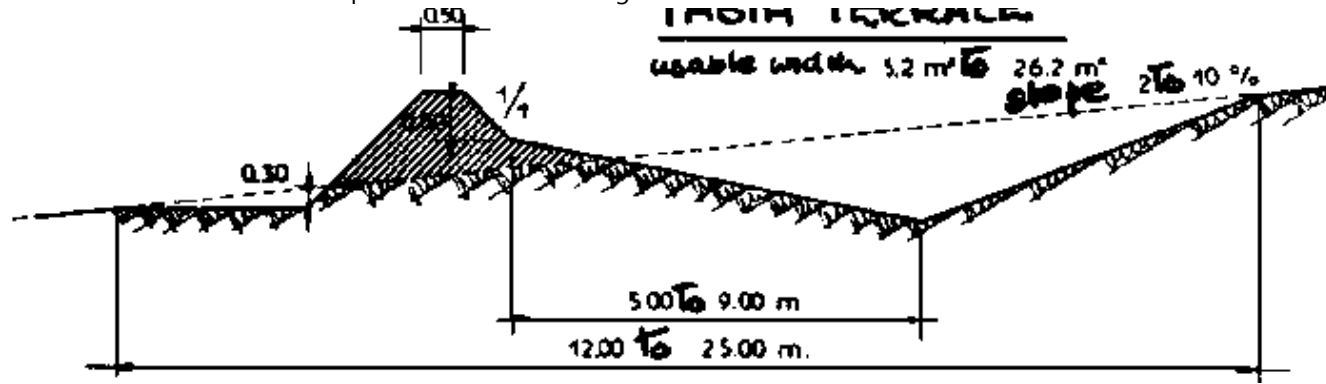

STANDARD PLAN 10

PROGRESSIVELY CONSTRUCTED TERRACES

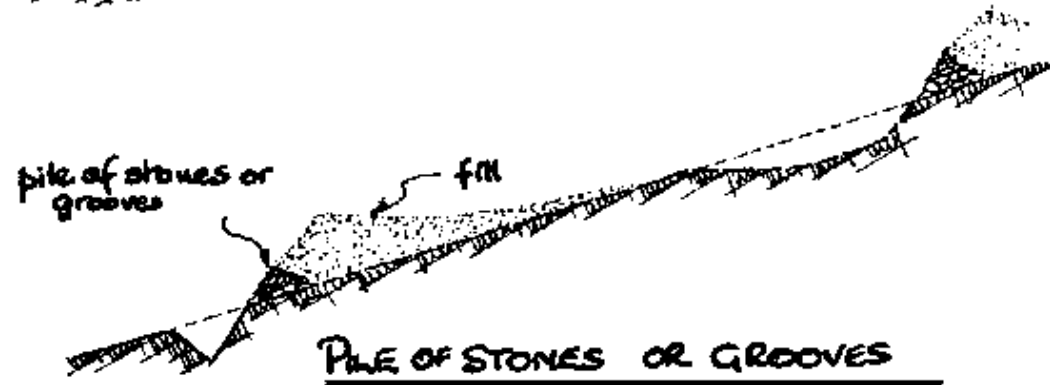
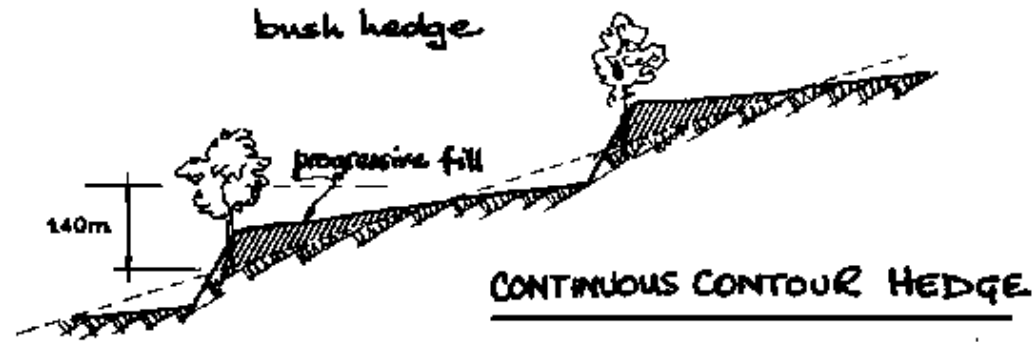

STANDARD PLAN 11

BENCH TERRACES

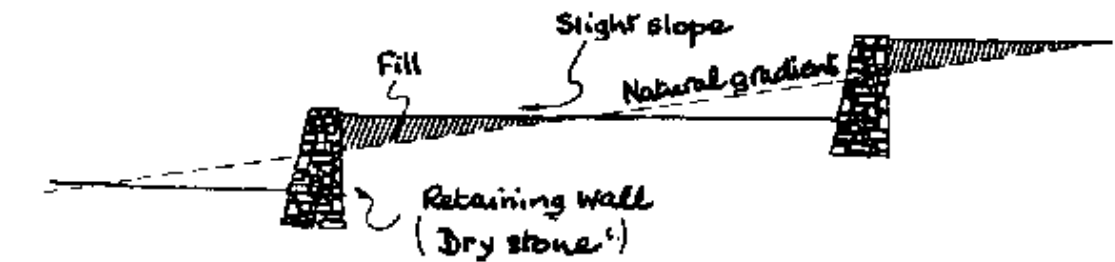
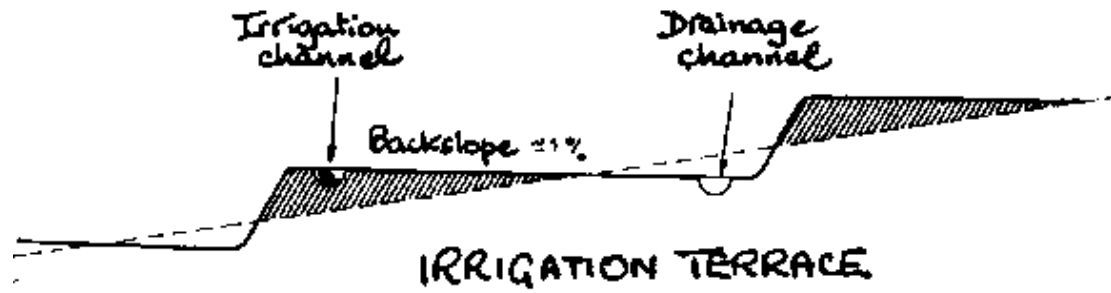
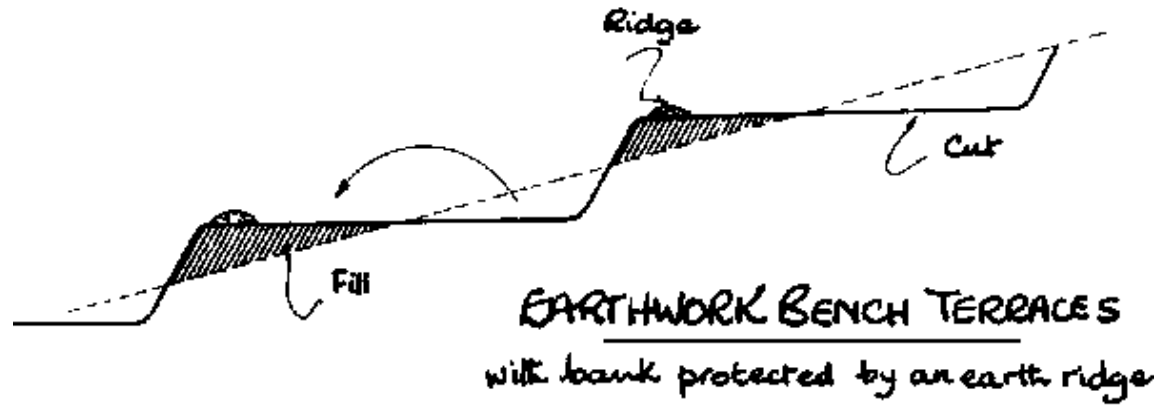

STANDARD PLAN 12

GRASED CHANNELS

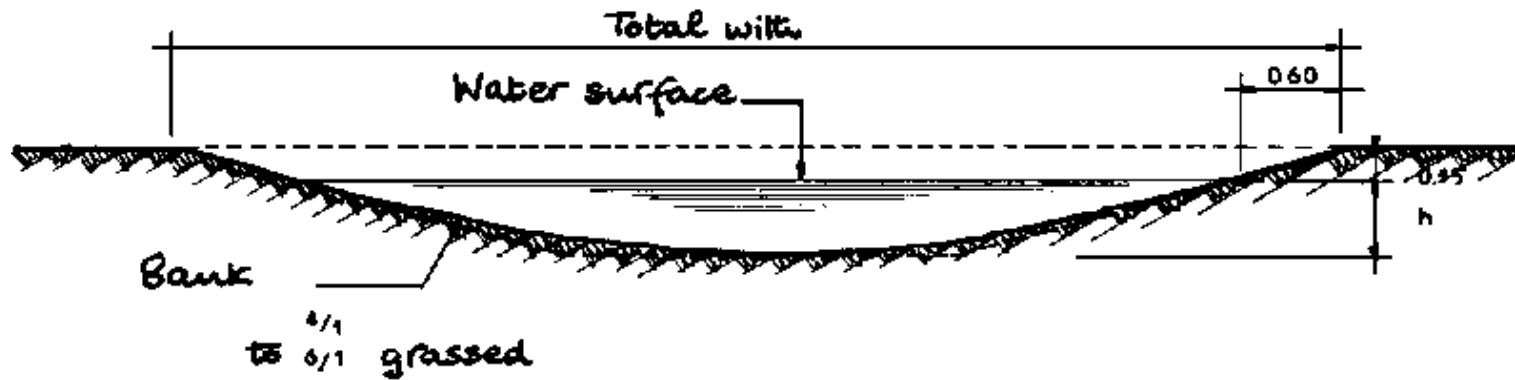

VALUES OF h AS A FUNCTION OF THE SPEED AND THE GRADIENT (in metres)

Slope Speed	0.5 %	1 %	2 %	3 %	4 %	5 %	6 %	8 %	10 %	12 %	14 %
0.9 m/s	0.54	0.33	0.21	0.15	0.12	0.12	0.09	0.09	0.06	0.06	0.03
1.2 m/s	0.61	0.34	0.30	0.24	0.18	0.15	0.15	0.12	0.09	0.09	0.09
1.5 m/s		0.72	0.42	0.30	0.18	0.15	0.16	0.15	0.15	0.12	0.09

Total width can vary depending on the flow as calculated by the
MANNING-STRIKLER formula
STANDARD PLAN 13

BANK STABILISATION





BANK STABILISATION BY VEGETATION

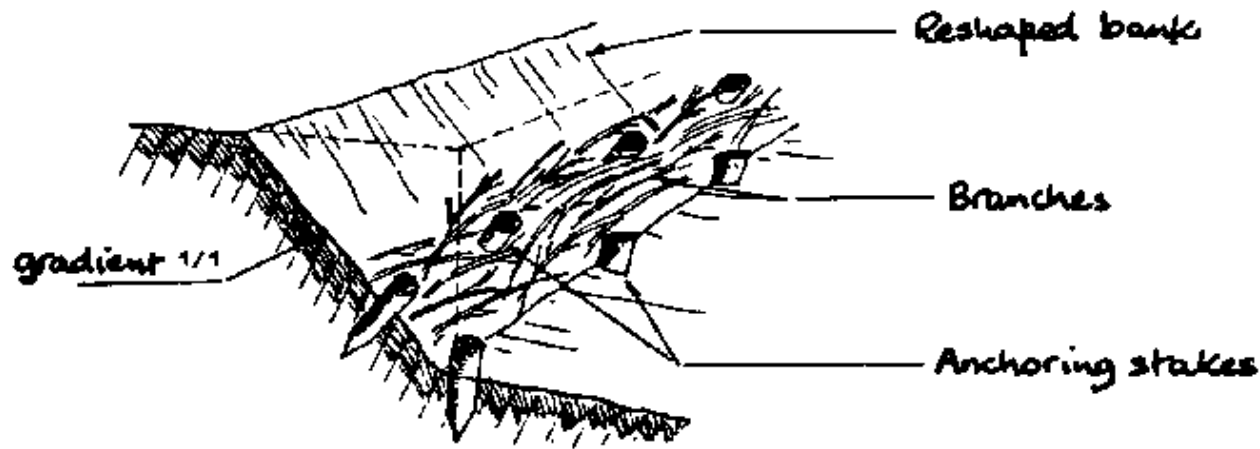

STABILISATION USING BRANCHES

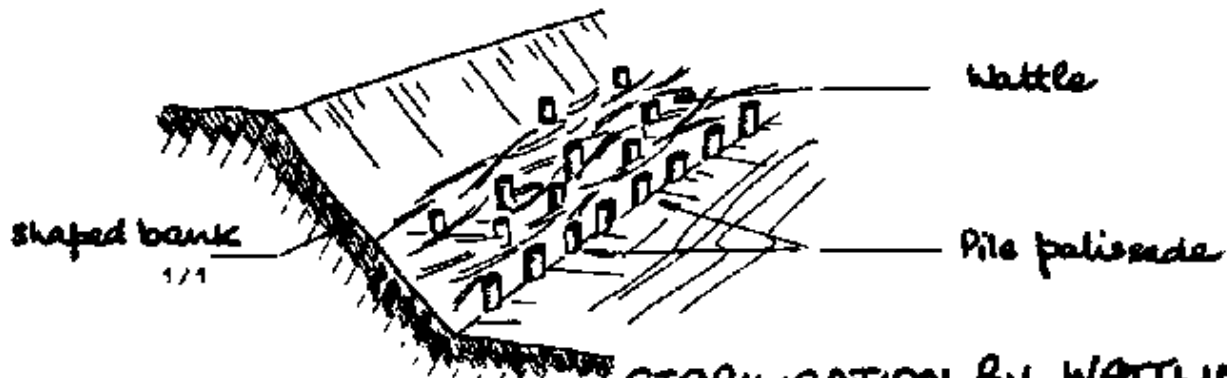

STABILISATION BY WATTLING

STANDARD PLAN 14

BANK STABILISATION

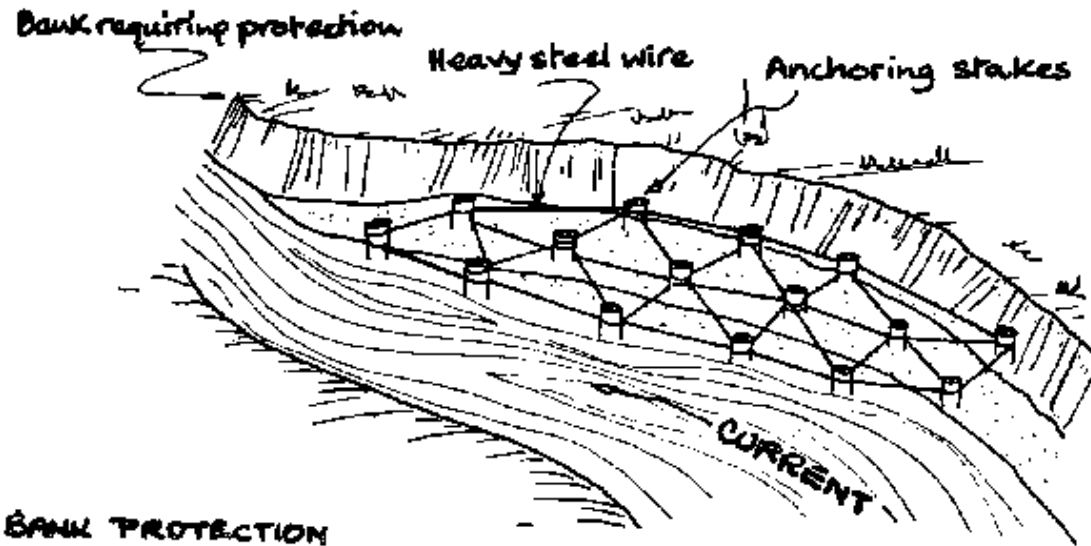

BANK PROTECTION BY ANCHORING STAKES intertwined with steel wire

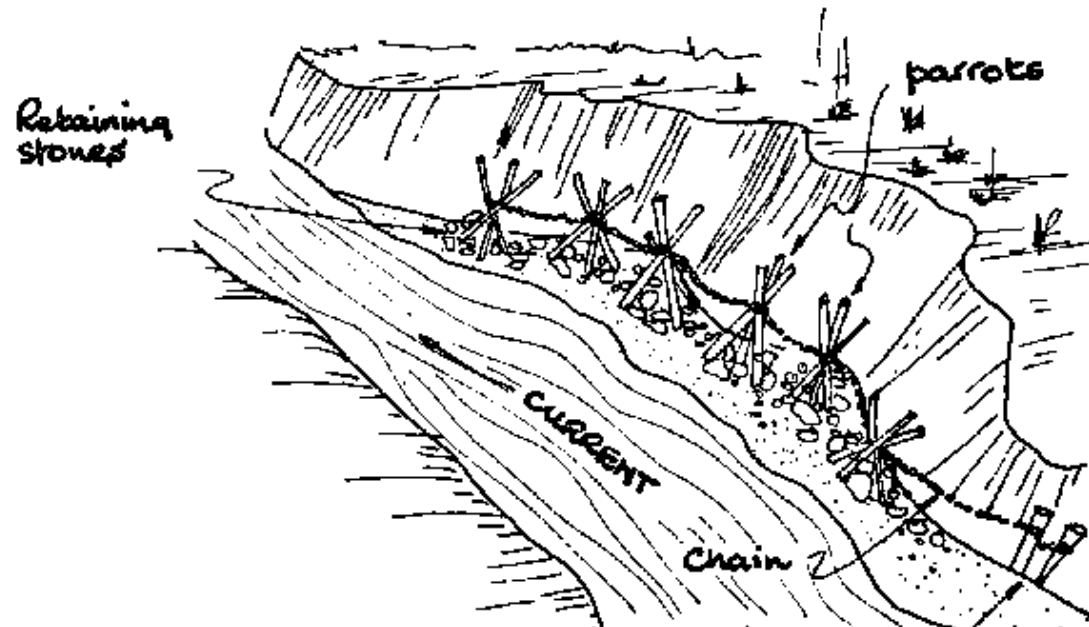

**BANK PROTECTION
BY "JACKS" OR "PARROTS"**

Anchoring
stakes

STANDARD PLAN 15

BANK STABILISATION

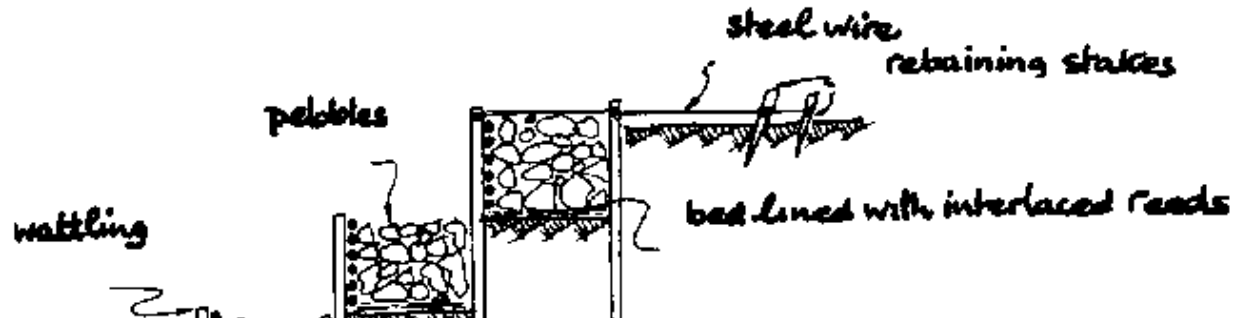
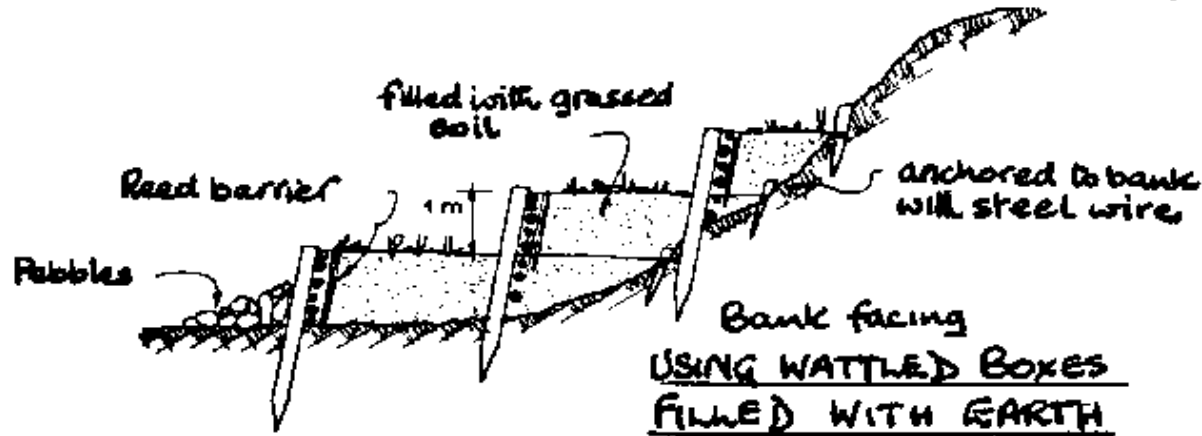
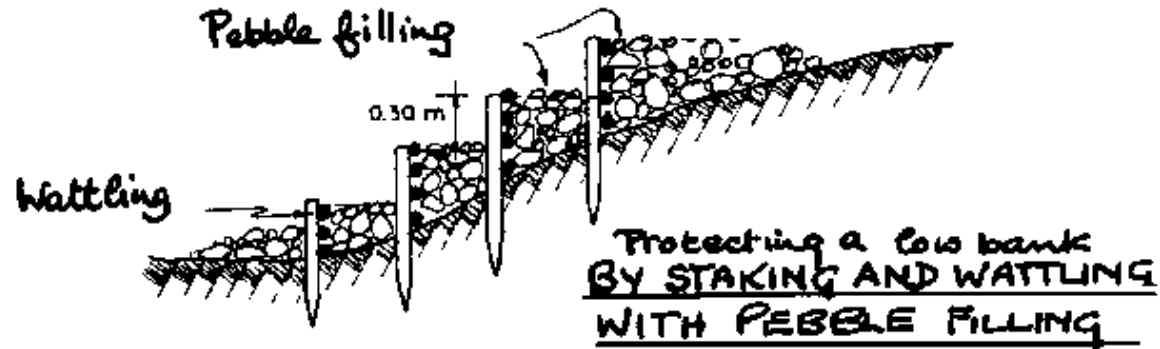

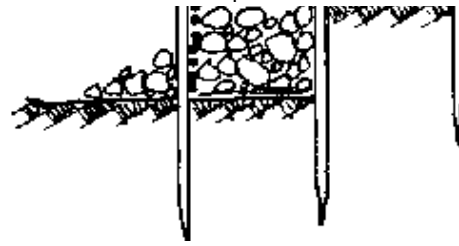

BANK FACING
USING WATTLED BOXES
AND PEBBLES

STANDARD PLAN 16

BANK STABILISATION

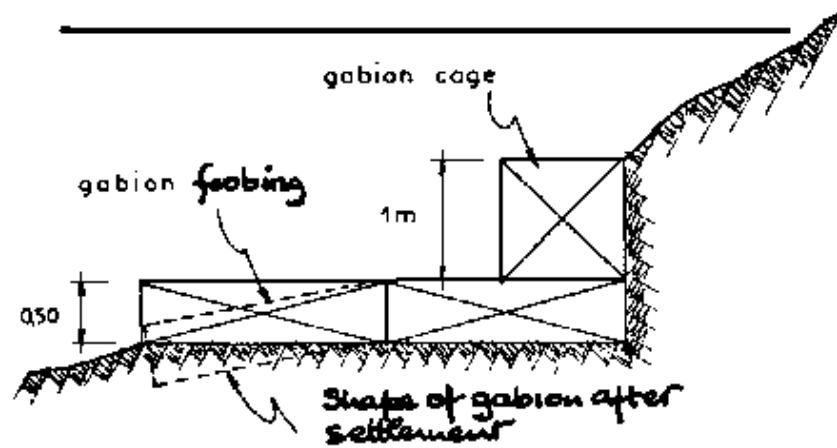

BANK PROTECTION
USING GABIONS

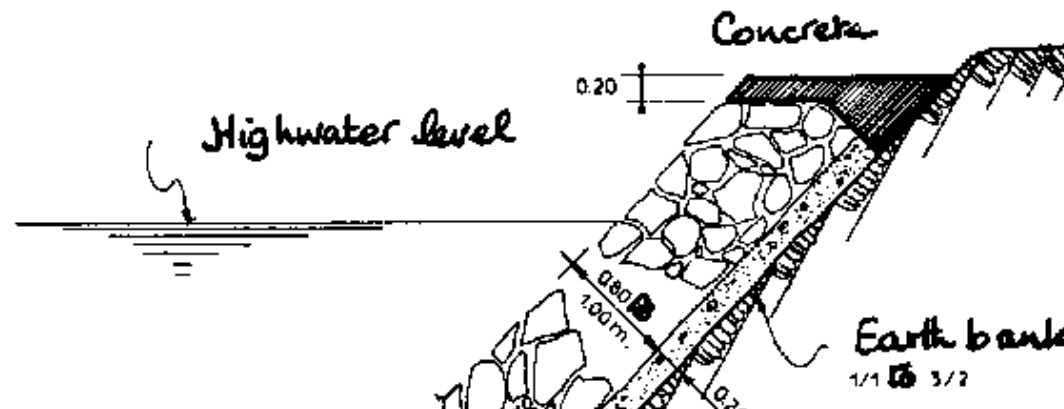

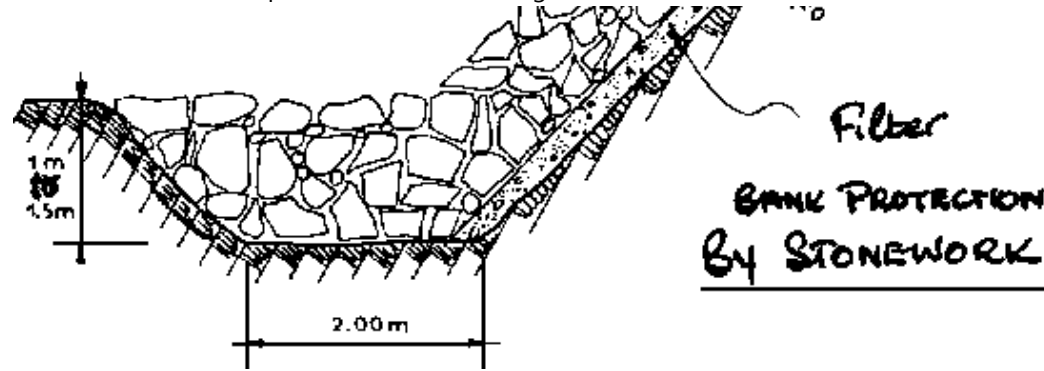

STANDARD PLAN 17

BANK PROTECTION

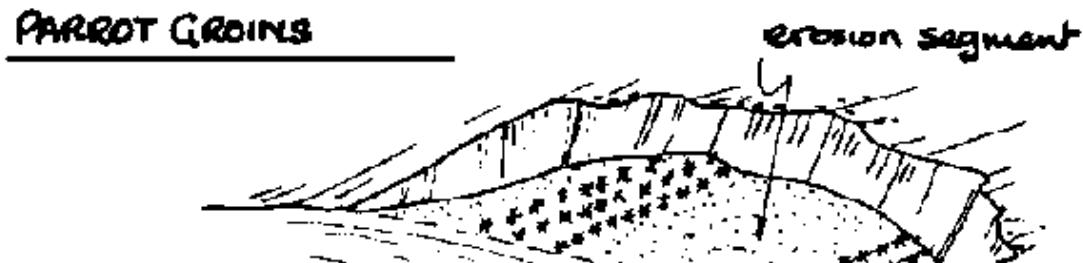
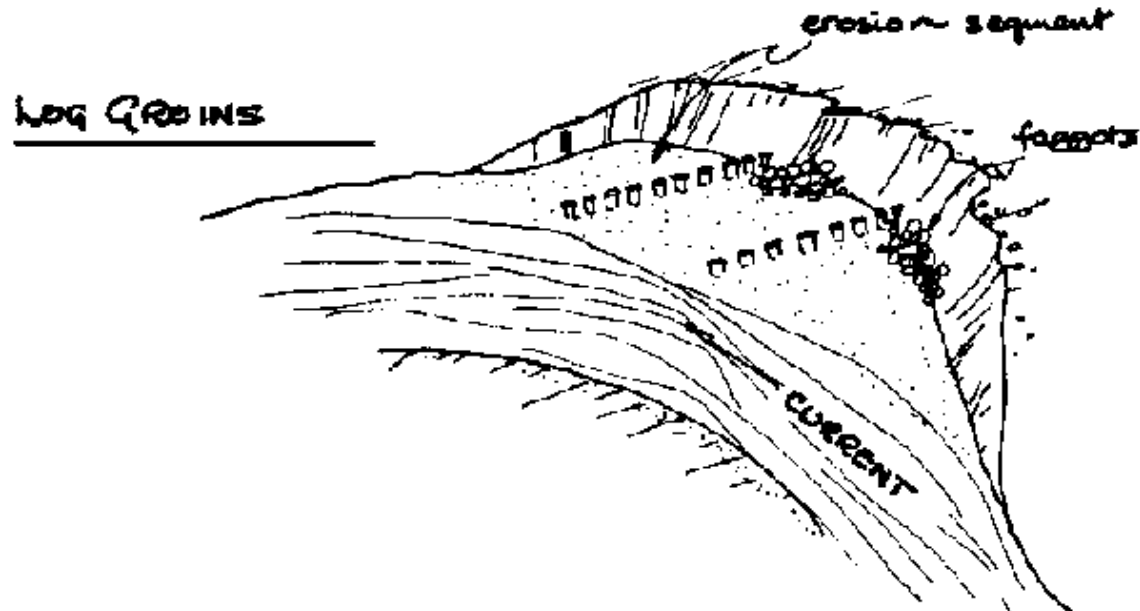

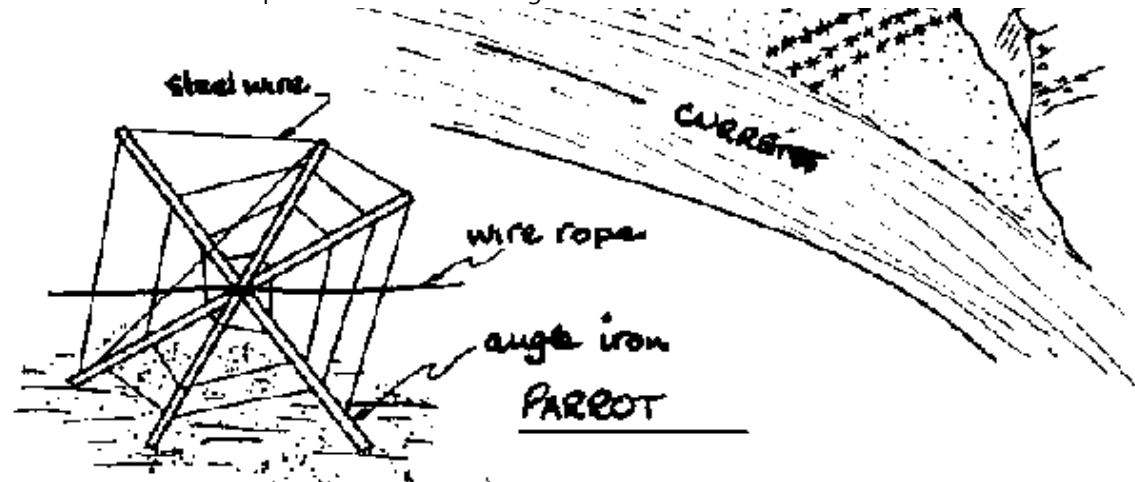

STANDARD PLAN 18

BANK PROTECTION

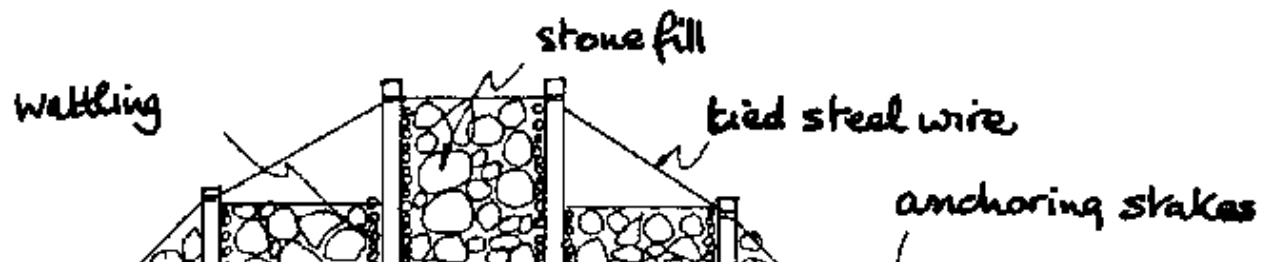
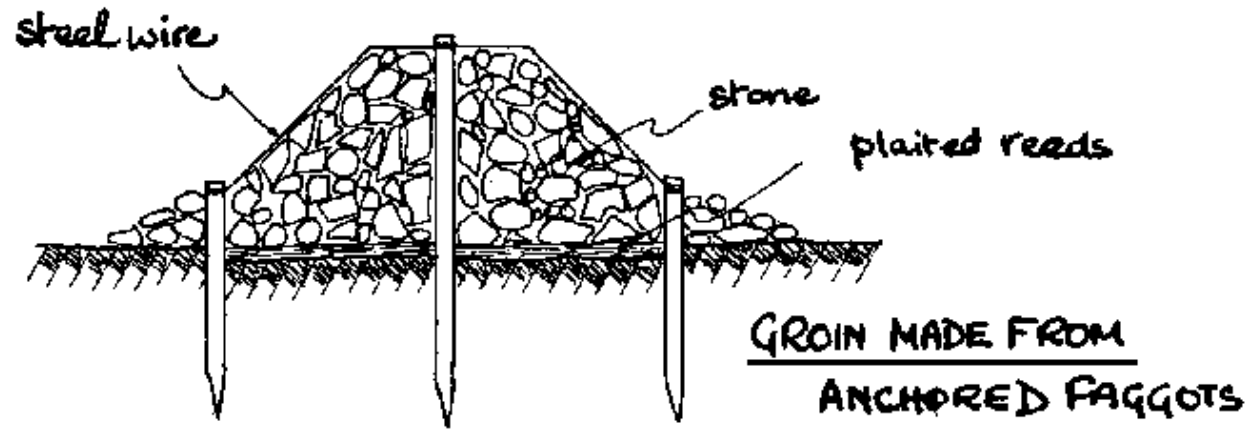

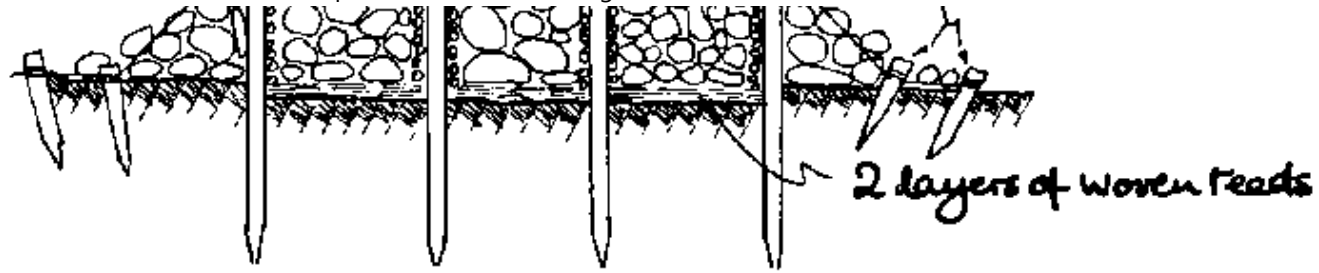

GROIN MADE FROM WATTLED BOXES AND STONES

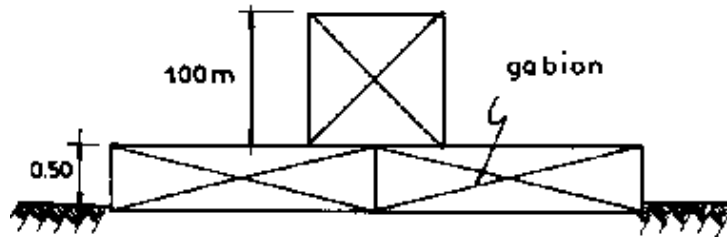

GABION GROIN

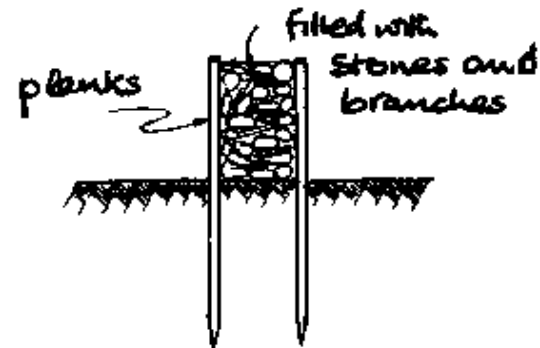

PLANK GROIN

STANDARD PLAN 19

GULLY CORRECTION

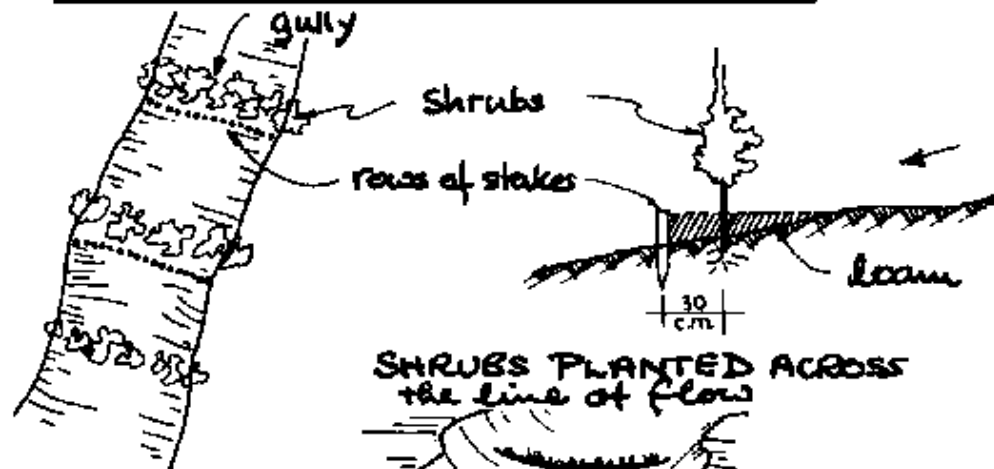

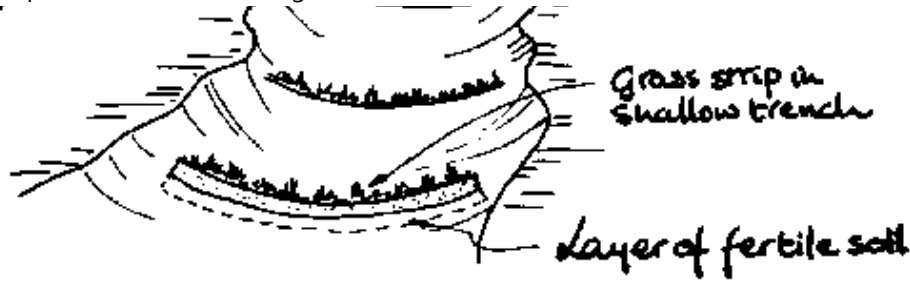

SODS LAID ACROSS A GULLY

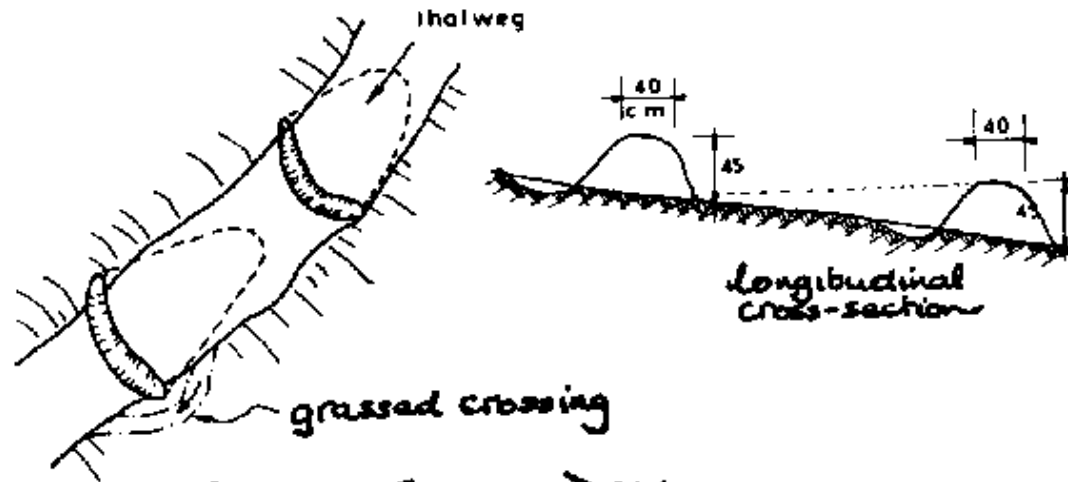

SMALL EARTH DAM

STANDARD PLAN 20

GULLY CORRECTION

Temporary structures

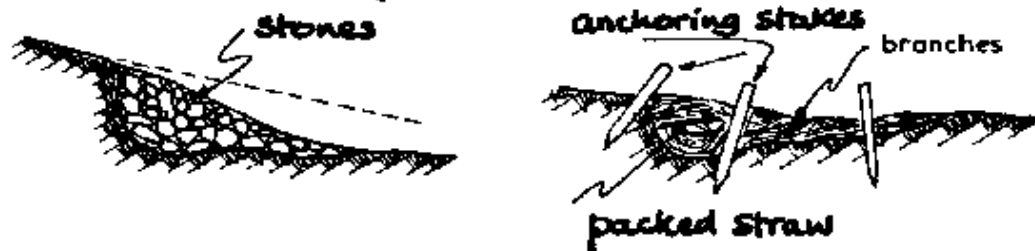

FILLING A GULLY WITH

FILLING A GULLY WITH PICKETS



PICKET AND STRAW DAM

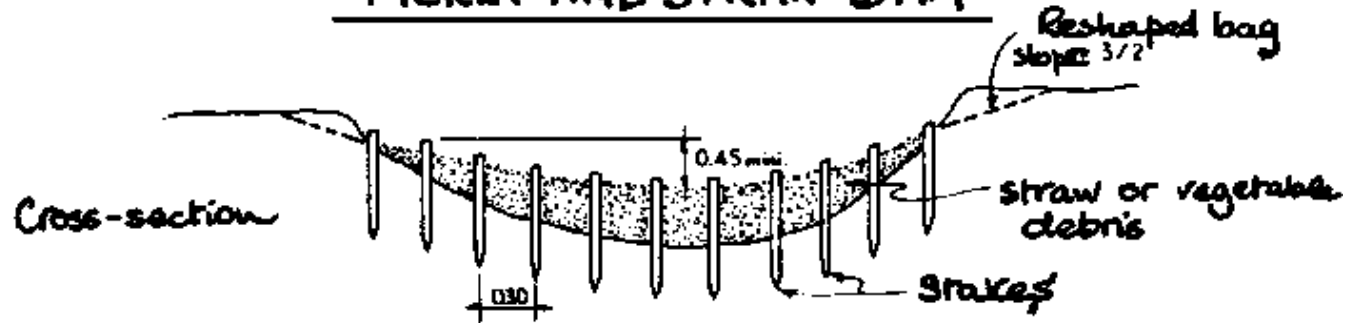

FAGGOT DAM

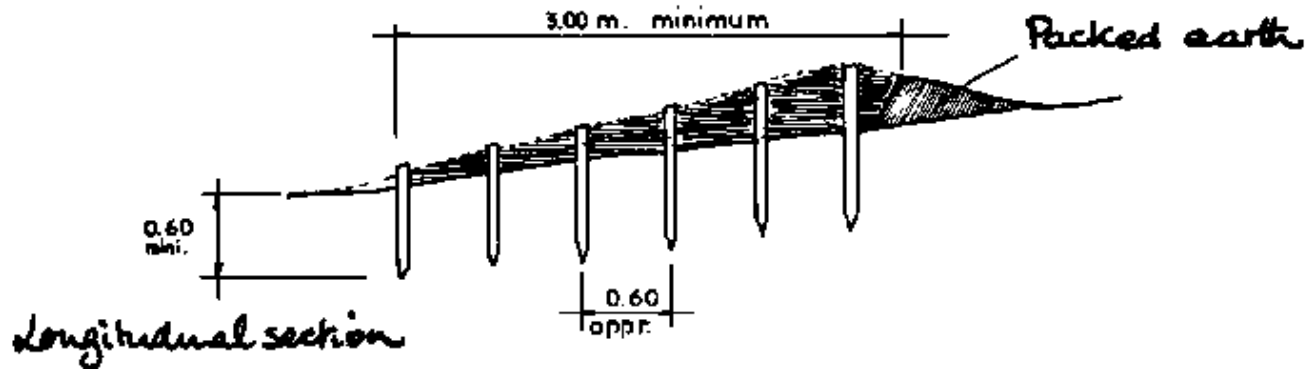

STANDARD PLAN 21

GULLY CORRECTION

SMALL DRystone DAMS

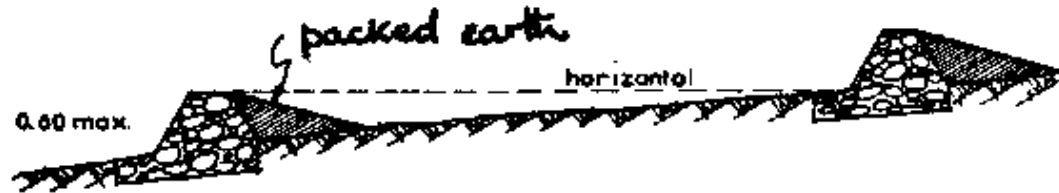

Various profiles used (h = ≤ 0.60 m.)

STANDARD PLAN 22

GULLY CORRECTION

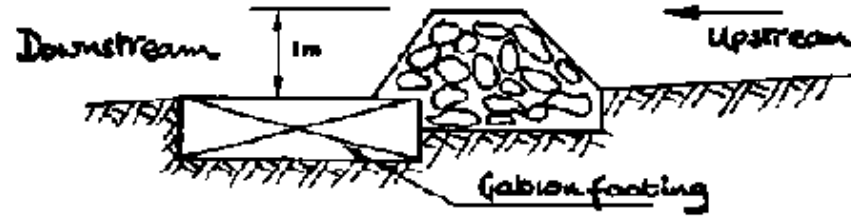

DRYSTONE AND GABION DAM

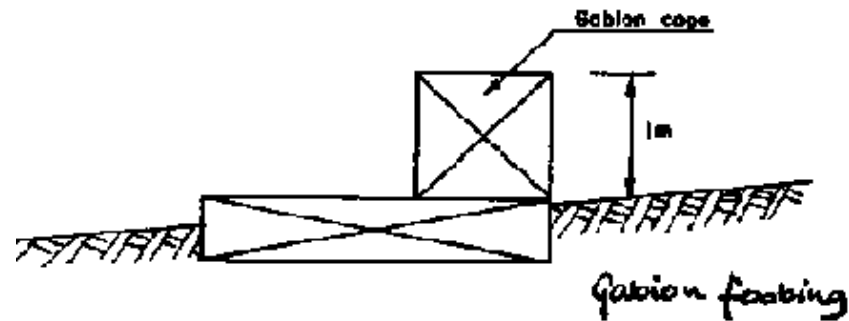

GABION DAM STANDARD PLAN 23

STONE DAMS

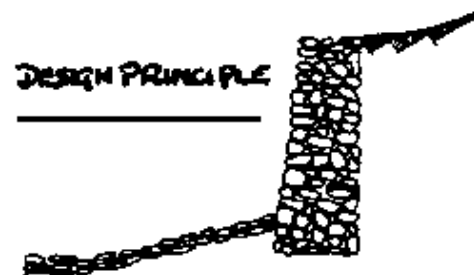
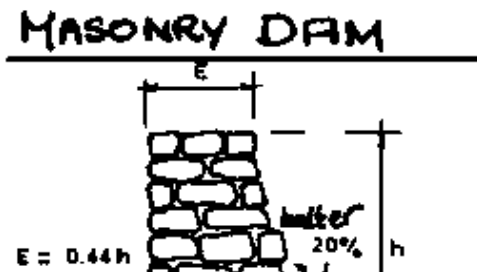

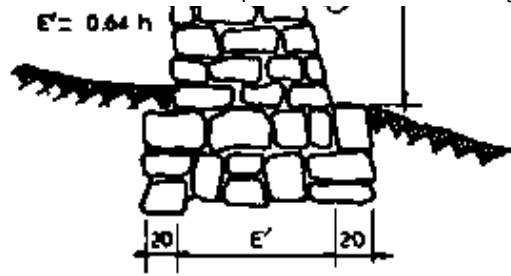

Counter-dam Dam

DRYSTONE DAM

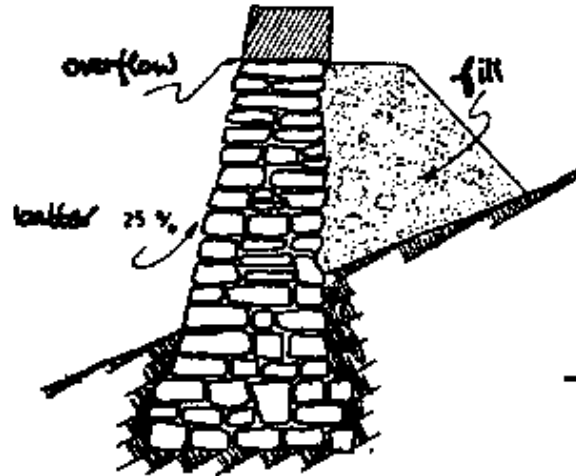

SILL SHAPE

A) Rectangular



B) Trapezoidal

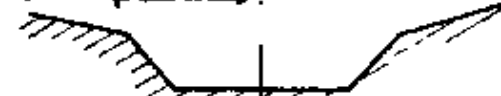

C) Curved

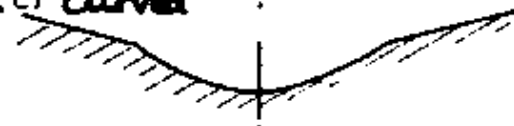

ELEVATION OF FOUNDATIONS

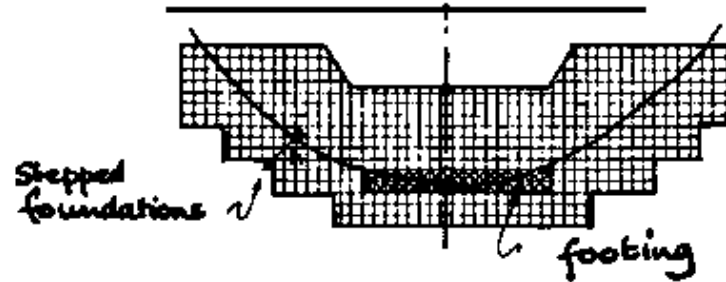

STANDARD PLAN 24

WEIR

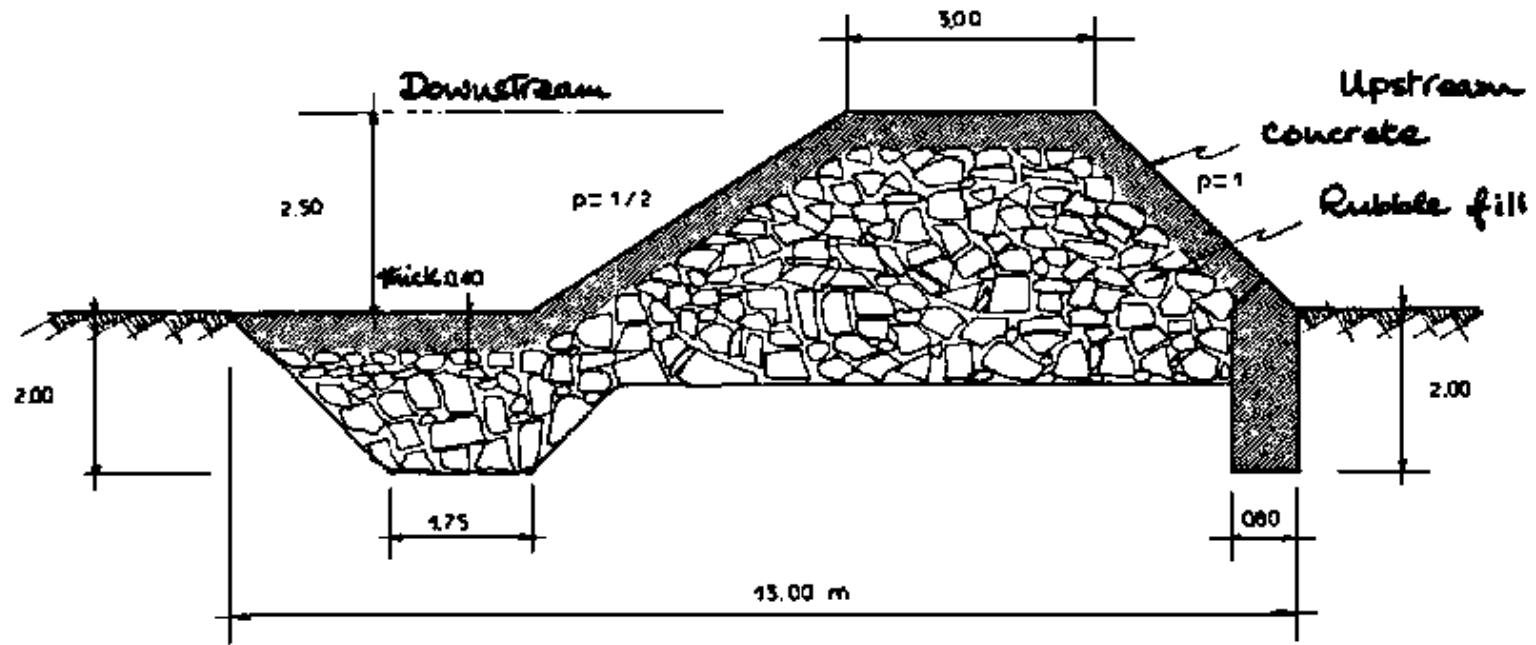

WEIR MADE FROM RUBBLE FILL FACED WITH CONCRETE

fall of 2.50 m.

STANDARD PLAN 25

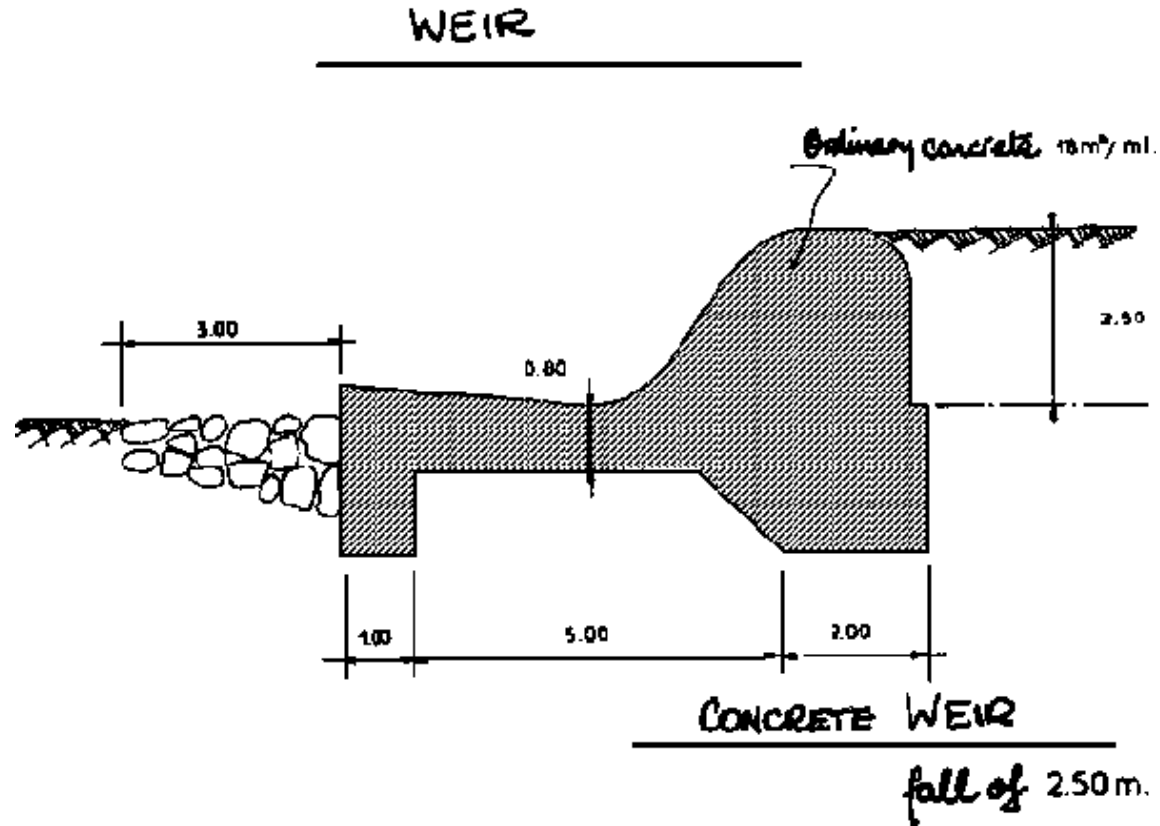

STANDARD PLAN 26

WEIR

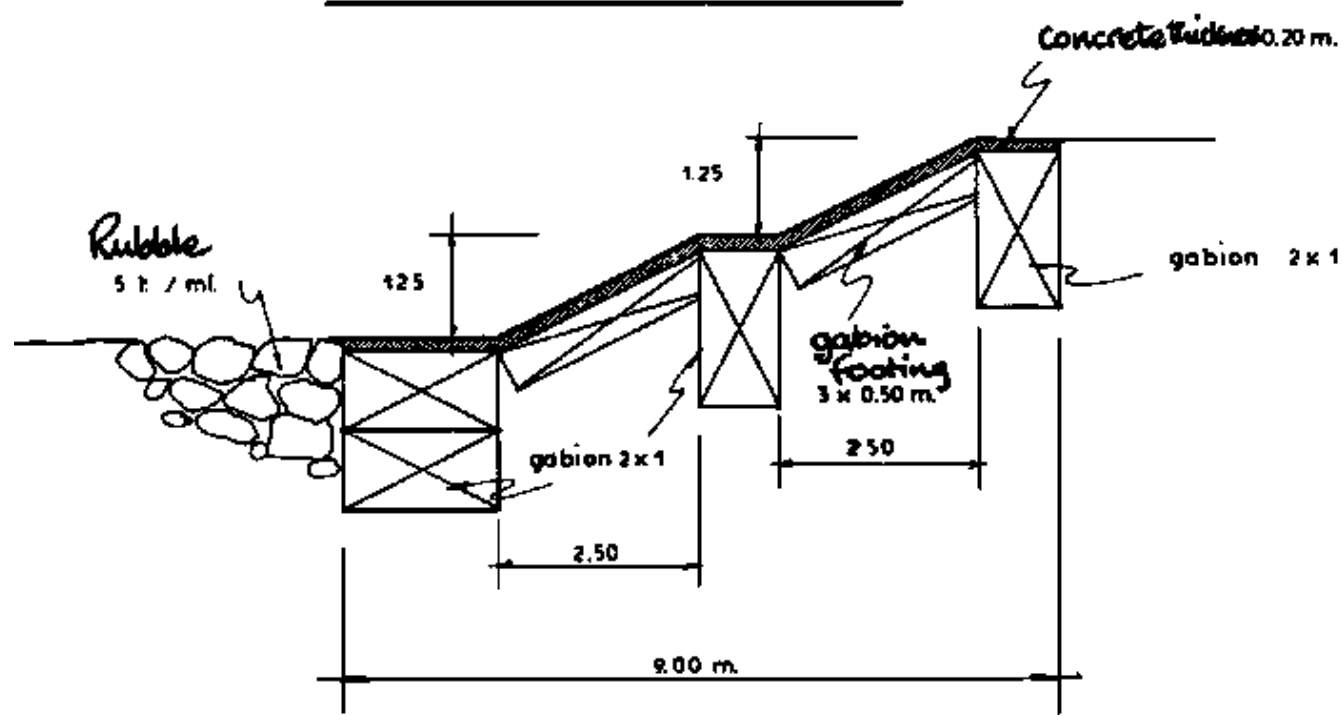

WEIR MADE FROM GABIONS AND CONCRETE

fall of 2.50 m.

STANDARD PLAN 27

SMALL EARTH DAM

Standard cross-section of a small earth dam

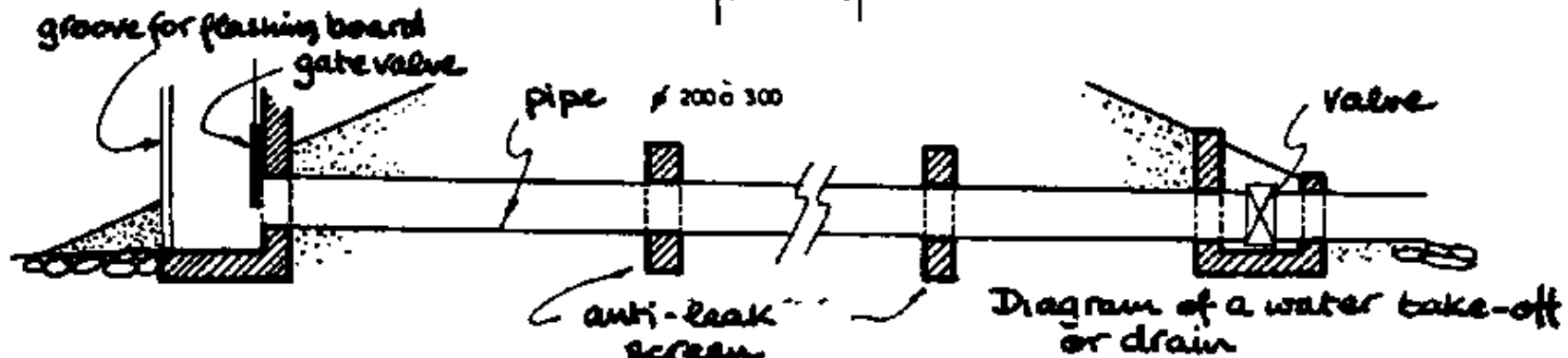
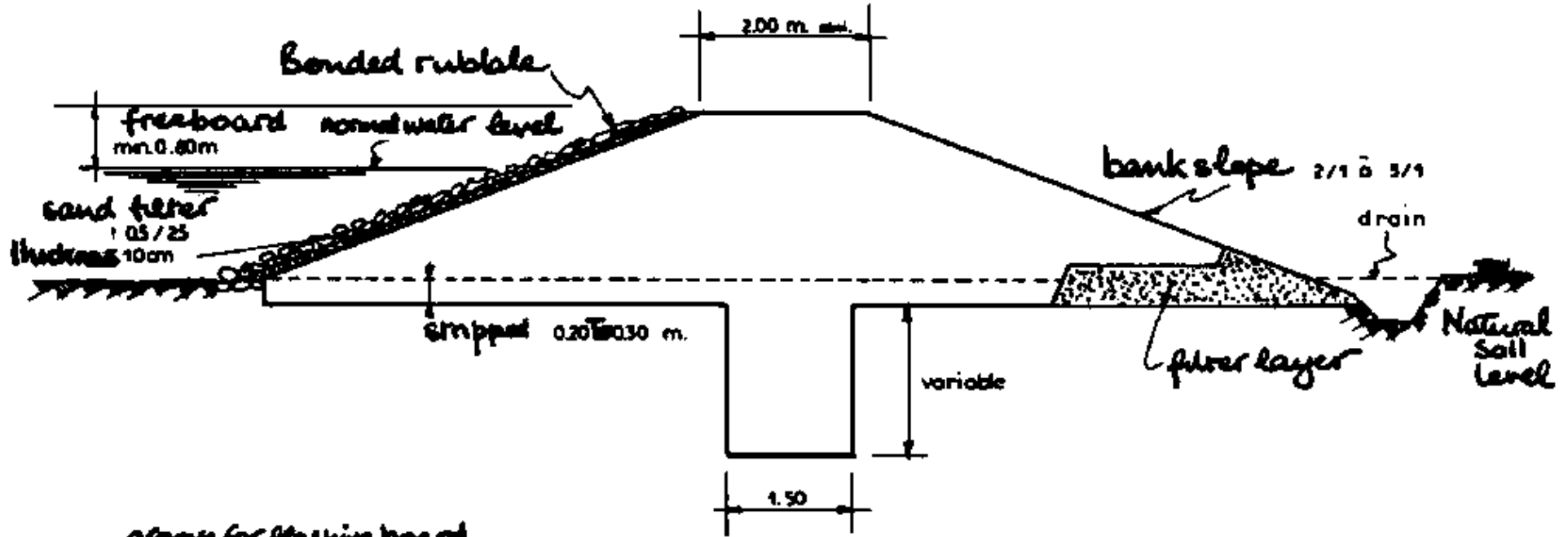

STANDARD PLAN 28

DRAINAGE TECHNIQUES

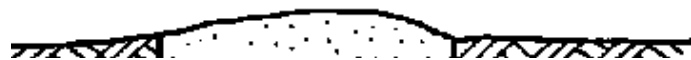

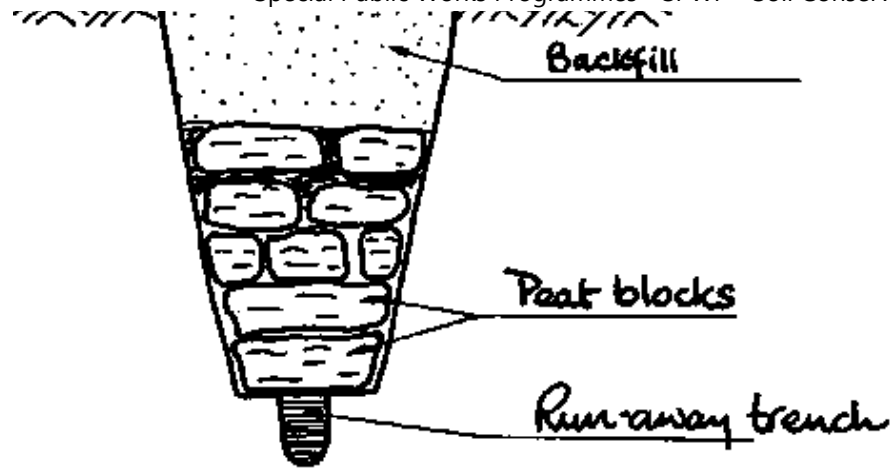

PEAT DRAIN

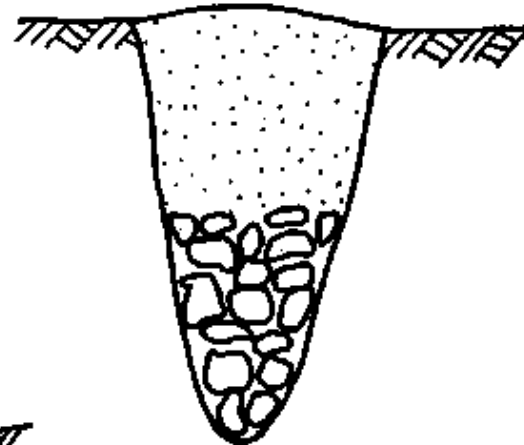

DRAIN TRENCH FILLED WITH RUBBLE

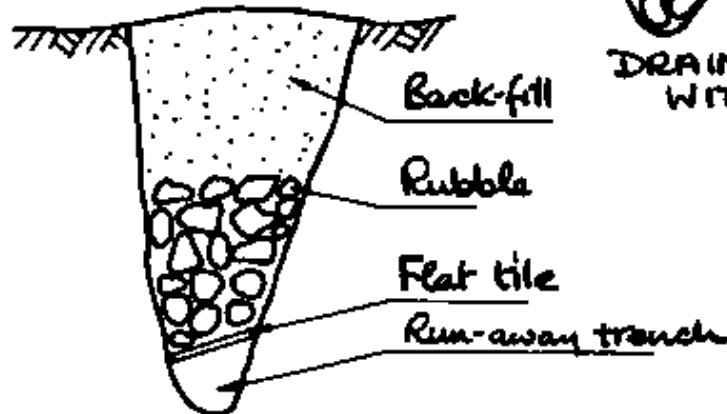

TILE AND RUBBLE DRAIN

STANDARD PLAN 29

DRAINAGE TECHNIQUES

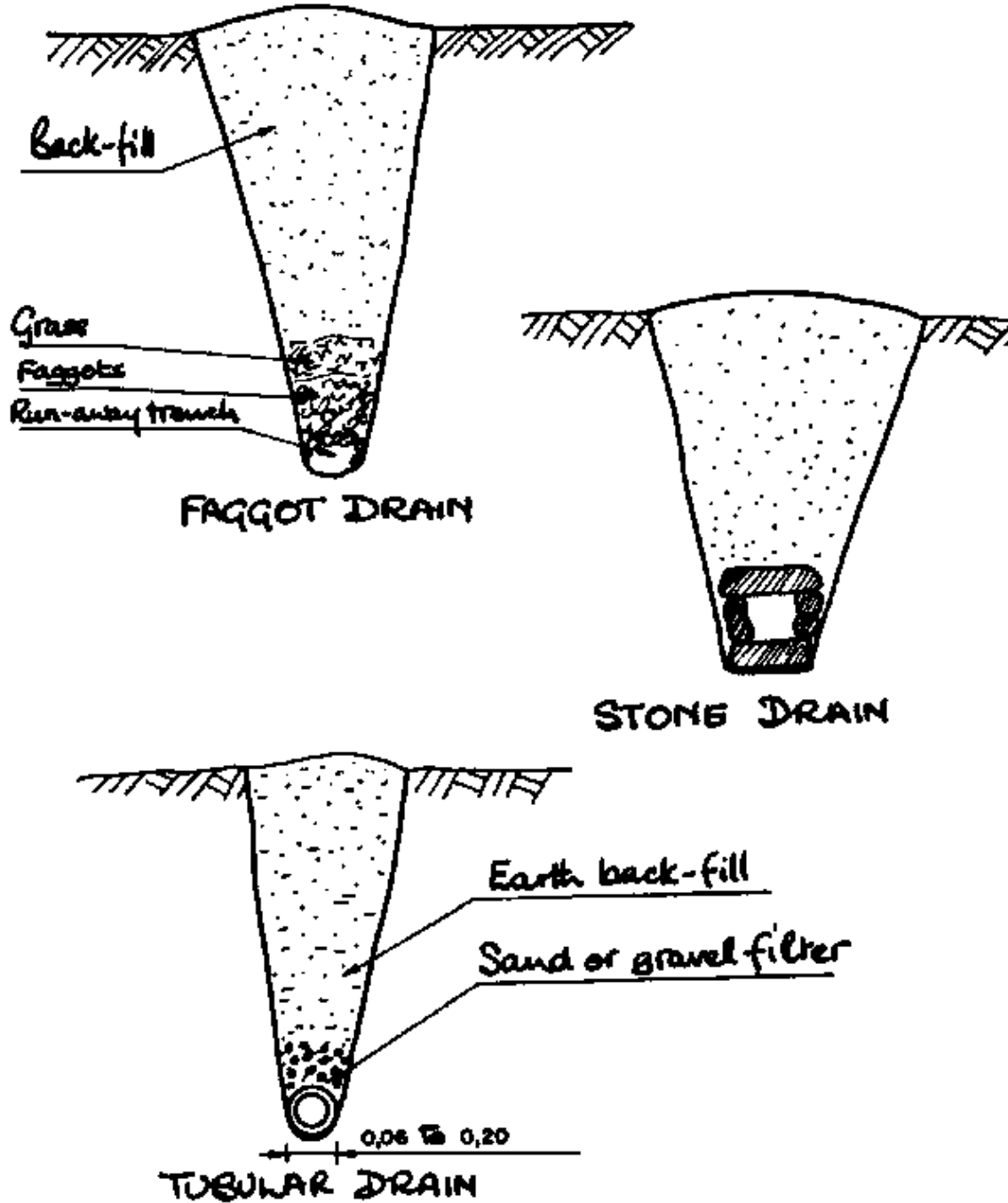

STANDARD PLAN 30

DRAINAGE TECHNIQUES

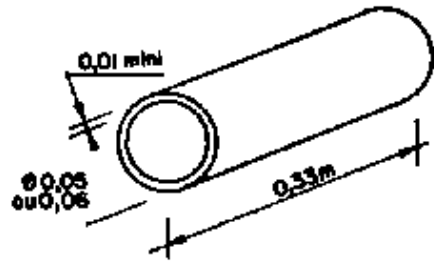

EARTHENWARE DRAINPIPE

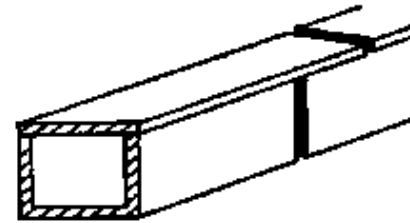

WOODEN DRAIN



Drain sleeve connection

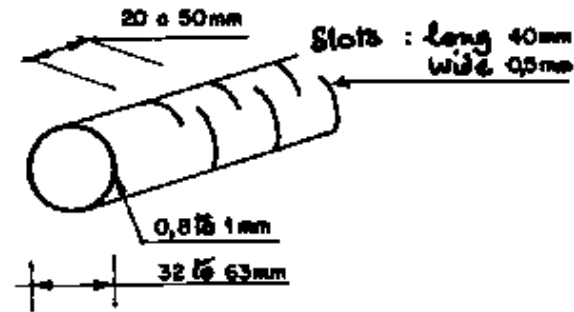

RIGID PVC DRAIN

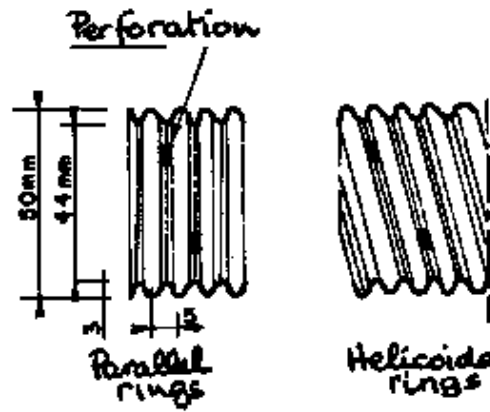

PVC Concertina drainpipe

STANDARD PLAN 31

DRAINAGE TECHNIQUES

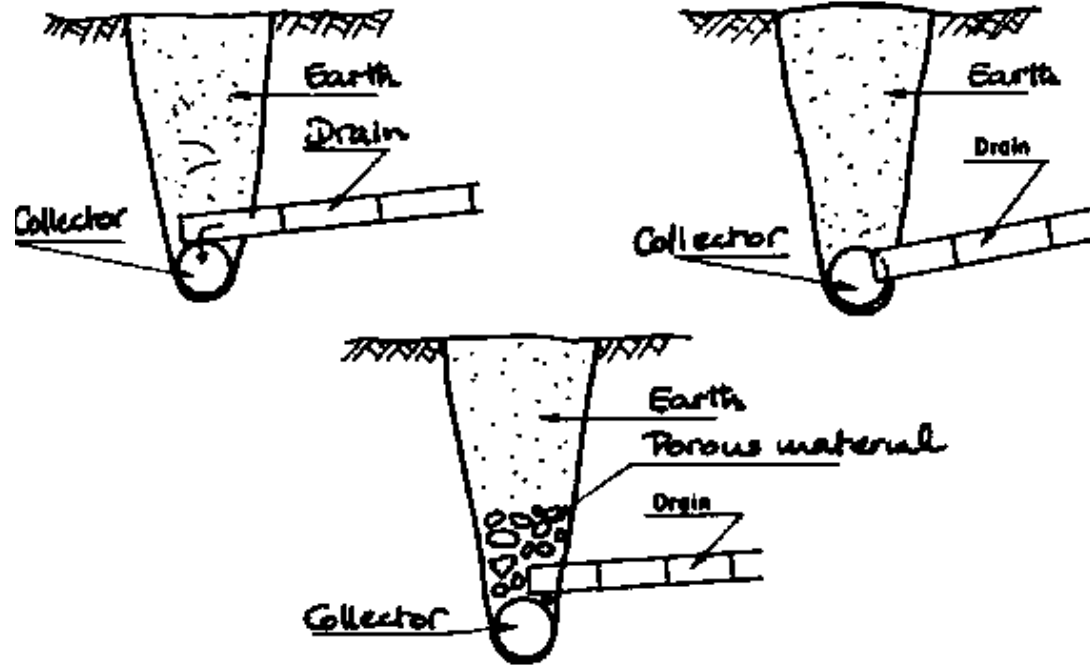

DIFFERENT METHODS OF CONNECTING DRAINS TO COLLECTORS

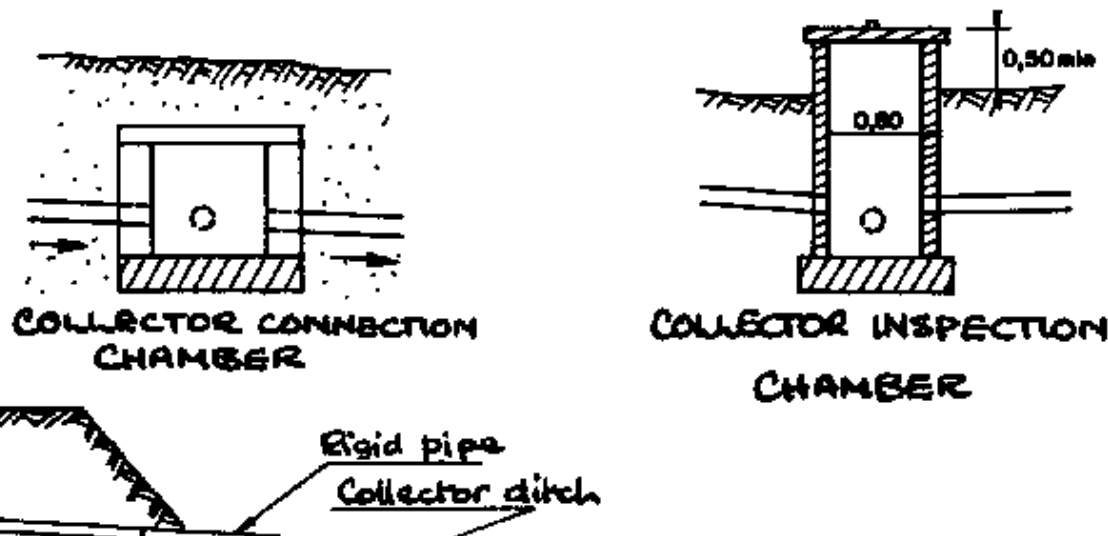

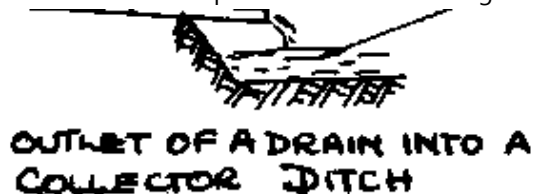

OUTLET OF A DRAIN INTO A
COLLECTOR DITCH

STANDARD PLAN 32

APPENDIX II

II. BIBLIOGRAPHY

Reference

- 1 CTFT. Conservation des sols au Sud du Sahara. Collection Techniques rurales en Afrique, No. 12, 1969.
- 2 Soil Conservation Service of the US Department of Agriculture. Soil conservation manual, Washington, 1950.
- 3 Ministre de la Coopération. Memento de l'agronome. Collection Techniques rurales en Afrique, 1974.
- 4 BRGM. Drainage agricole en rapport avec l'irrigation et la salinité. Bulletin du Bureau de recherches géologiques et minières. Section III, No. 2, 1978.
- 5 FAO. Drainage of salty soils. Irrigation and Drainage Paper, No. 16, Rome, 1973.
- 6 FAO. Drainage of heavy soils. Irrigation and Drainage Paper, No. 6, Rome, 1971.
- 7 United Nations. Earthmoving by manual labour and machines. Flood Control Series, No. 17,

Bangkok, 1961.

- 8 FAO. Methodes et machines pour le drainage par canalisations en poterie et autres materiaux. Energie et machines agricoles, Bulletin No. 6.
- 9 Ministre de l'Agriculture: Agriculture et for. Bulletin technique d'information, No. 347-348, March-April 1980.
- 10 FAO. A manual on establishment techniques in man-made forest, February 1973.
- 11 M. DELOYE and H. REBOUR. La conservation de la fertilit des sols. Collection des techniques agricoles mditerranennes, 1953.
- 12 FAO. Soil conservation for developing countries. Soil Bulletin No. 30.
- 13 Ministre de la Cooprati: Mmento du forestier. Collection Techniques rurales en Afrique.
- 14 GOOR et al. Les mthodes de plantations forestires en zones arides. FAO, Rome, 1964.
- 15 PONCET, A. Reboisement de protection. Aspects techniques et conomiques, 1974.
- 16 L. GUERIN/P. GARNIER. Guide pratique des chefs de chantier. Bit, 1981
- 17 A.I. FRASER. A manual on the planting of man-made forests, FAO, 1973.
- 18 W.F.J. van BEERS. Some monographs for the calculation of drain spacings. International Institute for Land Reclamation and Improvement. Bulletin No. 8.

- 19 M. POIREE and Ch. OLLIER. Assainissement agricole. Editions Eyrolles, Paris, 1973.
- 20 Paul JACOBSON. New methods of bench terracing steep slopes. SCS. USA, December 1962.
- 21 L. SACCARDY. Note sur le calcul des banquettes de restauration des sols. Terres et eaux. Algrie, 1950.
- 22 L. BUGEAT: Cours de conservation des sols, Tunis, 1957.
- 23 Centre de recherche du gnie rural en Tunisie. L'quation universelle des pertes du sol, par M. WISCHMEIER., Calcul des paramtres agricoles, pdologiques, climatiques et utilisation de l'quation. SCET. CSOP, 1963.
- 24 Ministre de l'Agriculture. Retenues collinaires. La Documentation franaise, Paris, 1963.
- 25 SOGETHA. Techniques rurales en Afrique. Les ouvrages en gabions. Ministre de la Coopracion, 1965.
- 26 A. LENCASTRE. Manuel d'hydraulique gnrale. Editions Eyrolles, Paris, 1976.
- 27 R. Benot de COIGNACQ. Travaux de DSR. Ecole des conducteurs de travaux. Polycopi, Algrie, 1958.
- 28 BEEK, K.J. and BENNEMA, J. Land evaluation for agricultural land use planning; an ecological methodology. Landbour Hogeschool, Wageninghen. FAO, doc. 8 B.22.

- 29 H. DIENER. Programme pilote de travaux haute intensit de main-d'oeuvre dans la province de Muramvya (Burundi): les travaux de reboisement. BIT, Genve, 1979.
- 30 Les petits ouvrages en gabions. Collection Techniques rurales en Afrique.
- 31 J. RODIER and C. AUVRAY. Estimation des dbits de crues dcennales pour des bassins versants de superficie infrieure 200 km² en Afrique occidentale. ORSTOM, 1975.
- 32 Guidelines for the Organisation of Special Labour-intensive Works Programmes. ILO, Emile COSTA, Sunhil GUHA, Ibrahim HUSSAIN, Nguyen T.B. THUY and Aim FARDET:
- 33 Introduction aux programmes spciaux de travaux publics. Ph. GARNIER, T.B. THUY, L. GUERIN. BIT, Genve, 1981.
- 34 Normes pratiques de rendement pour les principaux travaux excuts par des techniques haute intensit de main-d'oeuvre (titre provisoire) BIT, paratre.

